

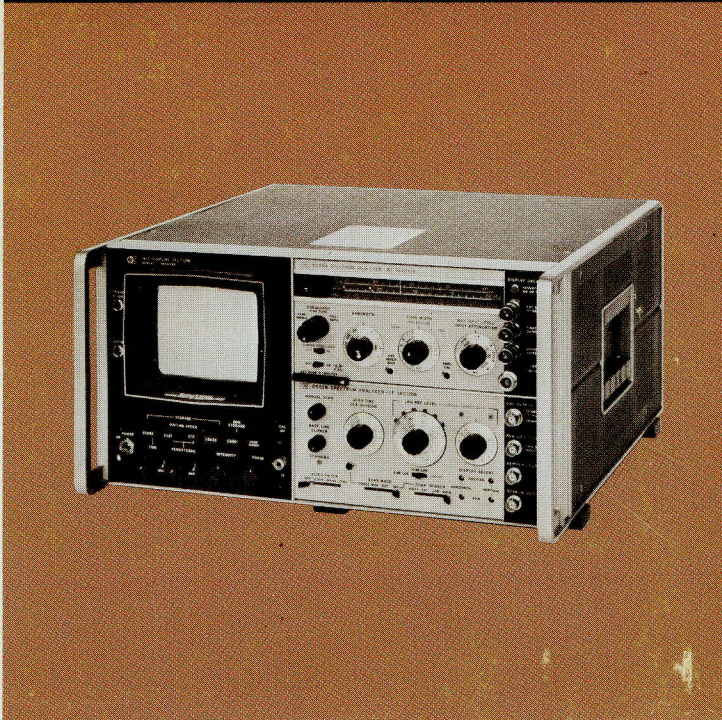

National Semiconductor Corporation

LINEAR INTEGRATED CIRCUITS

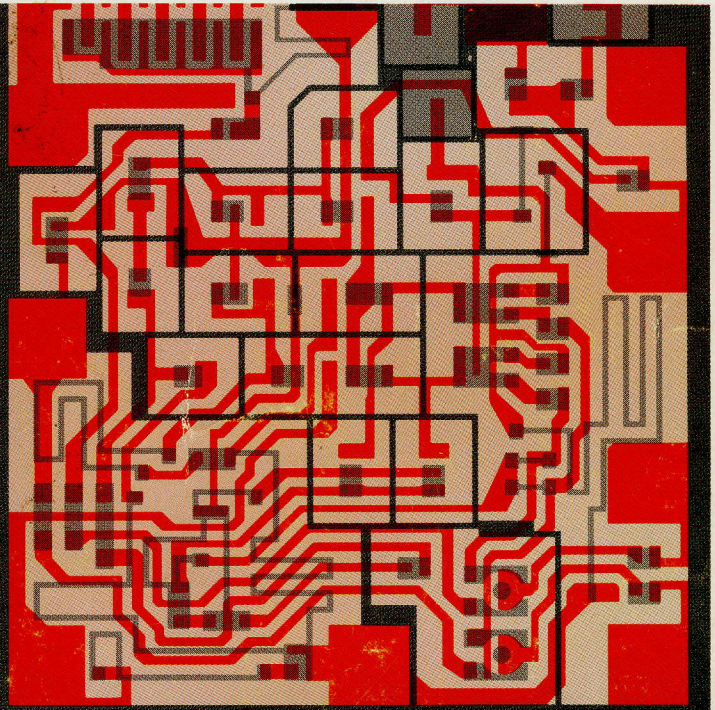
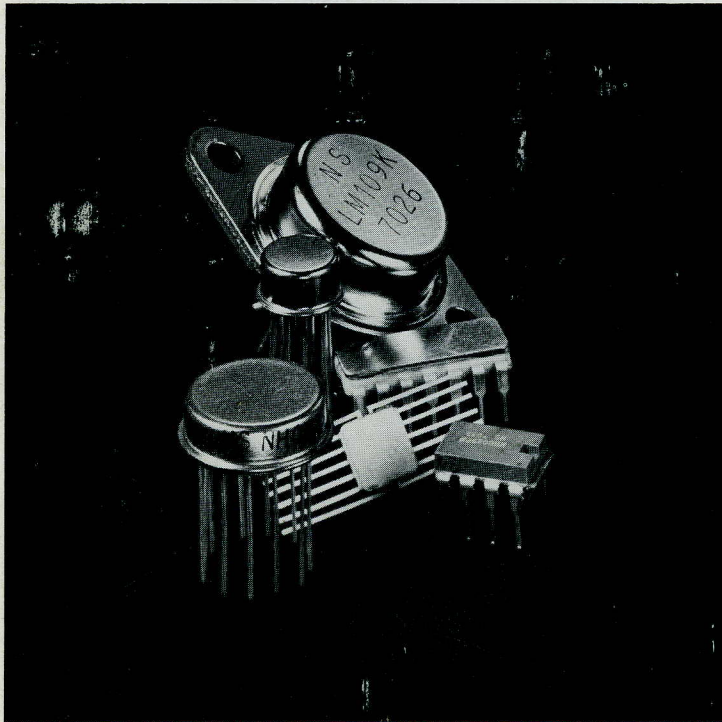

LINEAR INTEGRATED CIRCUITS

NSC 1975-1976

Introduction

Here is National's latest catalog on Linear products. This catalog, and future ones on our major product lines, Digital TTL & DTL ICs, MOS ICs, and Transistors, will be updated periodically by new product supplements. To keep current on our growing product lines, contact a National sales office, representative, or distributor, and ask to be placed on our mailing list.

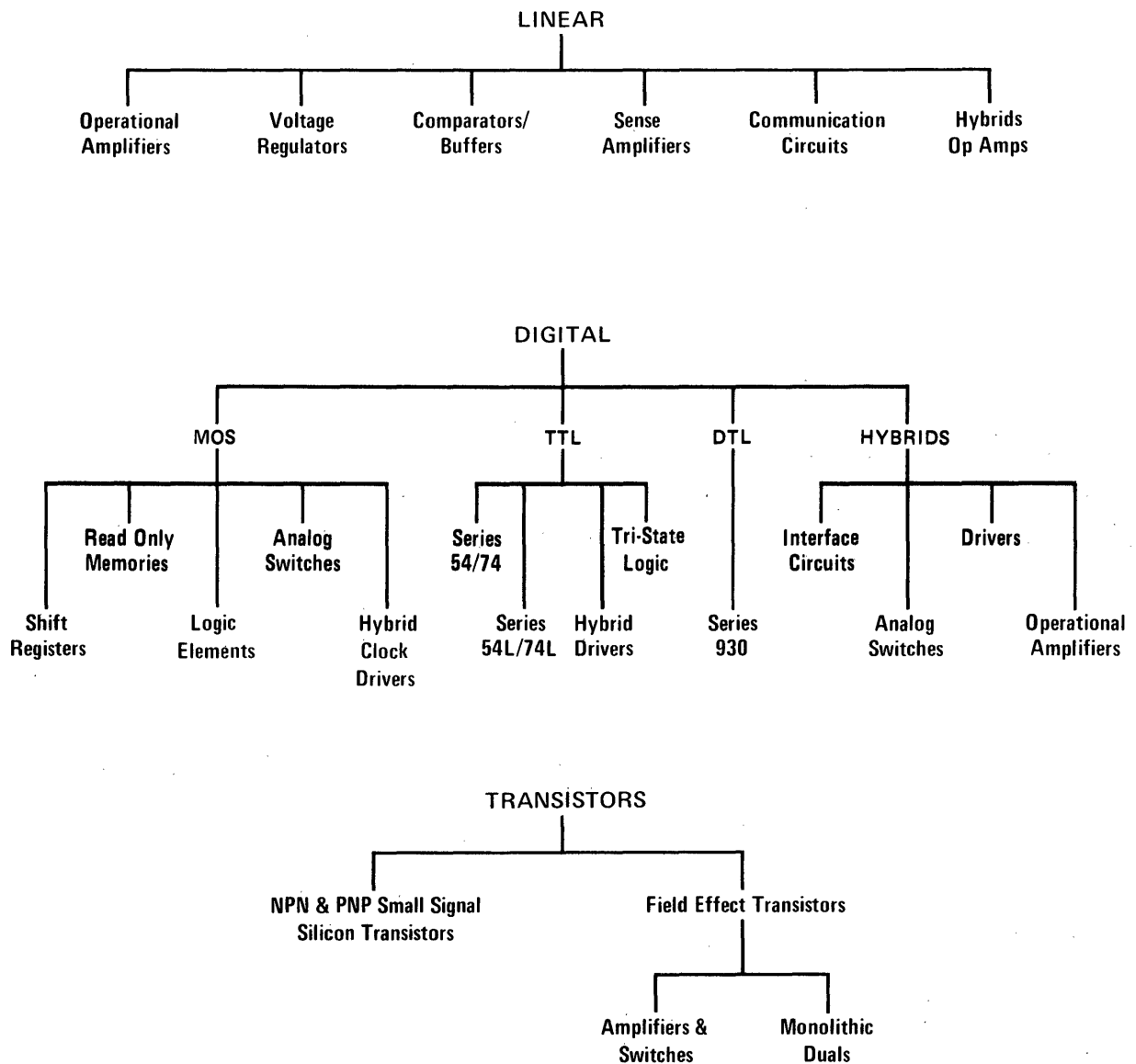

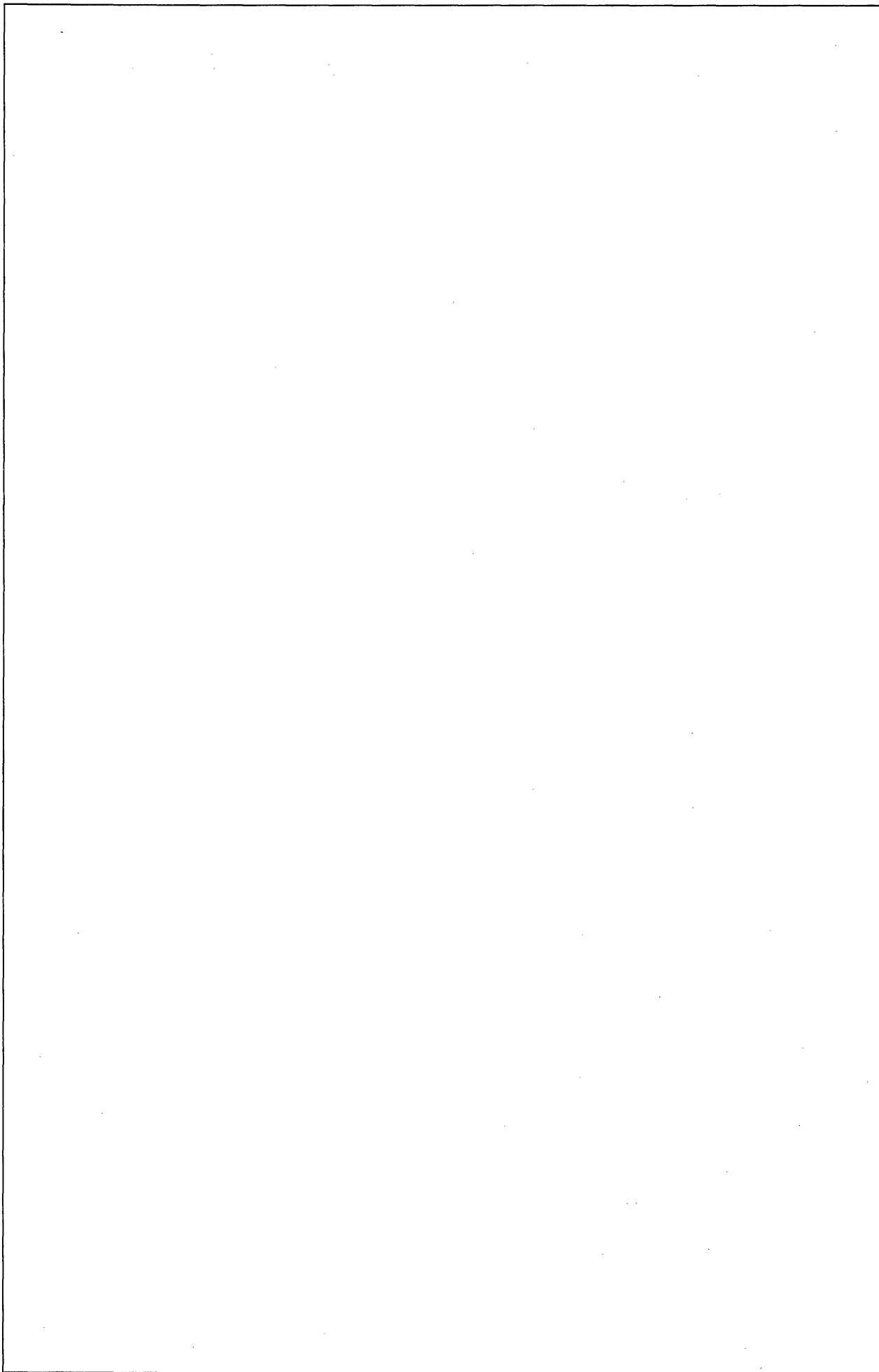



Table of Contents

	Page
Introduction	i
Voltage Regulator Guide	1
Industrial Operational Amplifier Guide	2
Military Operational Amplifier Guide	3
Voltage Comparator Guide	4
Connection Diagrams	5
New Products	
LM112/LM212/LM312 Micropower Operational Amplifier	11
LM113 Reference Diode	12
LM565 Phase Locked Loop	12
LM723/LM723C Voltage Regulator	13
LM1303 Dual Stereo Preamplifier	13
LM1304, LM1305 FM Multiplex Stereo Demodulator	14
LM1558/LM1458 Dual Operational Amplifier	14
LM3028A/LM3028B/LM3053 RF/IF Amplifier	15
LM3064 TV Automatic Fine-Tuning Circuit	15
LM3065 Television Sound System	16
LH740A/LH740AC FET Input Operational Amplifier	16
NH0021 Operational Amplifier	17
NH0022/NH0022C FET Input Operational Amplifier	17
NH0024 Operational Amplifier	18
NH0033 Voltage Follower	18
Voltage Regulators	
LM100/LM200/LM300 Positive Voltage Regulator	19
LM103 Regulator Diode	22
LM104/LM204 Negative Voltage Regulator	25
LM304 Negative Voltage Regulator	28
LM105/LM205/LM305 Positive Voltage Regulator	31
LM305A Positive Voltage Regulator	34
LM109/LM209 Five-Volt Regulator	36
LM309 Five-Volt Regulator	39
LM114/LM114A/LM115/LM115A Transistor Pairs	42
LM376 Positive Voltage Regulator	44
Operational Amplifiers	
LM101 General Purpose Operational Amplifier	47
LM201 General Purpose Operational Amplifier	50
LM101A/LM201A High Performance Operational Amplifier	53
LM301A High Performance Operational Amplifier	58
LH101 Internally Compensated Operational Amplifier	61
LH201 Internally Compensated Operational Amplifier	64
LM102 Voltage Follower Operational Amplifier	67
LM202 Voltage Follower Operational Amplifier	70
LM302 Voltage Follower Operational Amplifier	73
LM107/LM207 General Purpose Operational Amplifier	76
LM307 General Purpose Operational Amplifier	79
LM108/LM208 Low Input Current, High Performance Operational Amplifier	82
LM308 Low Input Current, High Performance Operational Amplifier	85
LM108A/LM208A/LM308A Low Input Current, High Performance Operational Amplifier	88
LM110/LM210 Voltage Follower Operational Amplifier	91
LM310 Voltage Follower Operational Amplifier	96
LM709 General Purpose Operational Amplifier	101
LM709C General Purpose Operational Amplifier	104
LM741/LM741C General Purpose Operational Amplifier	107
LM747/LM747C Dual Operational Amplifier	109
LM748/LM748C General Purpose Operational Amplifier	111
NH0001 Low Power Operational Amplifier	114
NH0002/NH0002C Current Amplifier	117
NH0003/NH0003C Wide Bandwidth Operational Amplifier	120
NH0004/NH0004C High Voltage Operational Amplifier	122
NH0005/NH0005A General Purpose Operational Amplifier	125
NH0005C General Purpose Operational Amplifier	128
NH0020/NH0020C Medium Current Operational Amplifier	130
NH0023/NH0023C Sample and Hold Amplifier	132

Voltage Comparators/Buffers

LM106/LM206 High Speed Voltage Comparator/Buffer	135
LM306 High Speed Voltage Comparator/Buffer	138
LM111/LM211 Voltage Comparator	141
LM311 Voltage Comparator	146
LM710A Differential Voltage Comparator	151
LM710C Differential Voltage Comparator	154
LM711 Dual Differential Voltage Comparator	157
LM711C Dual Differential Voltage Comparator	160

Communication Circuits

LM170/LM270/LM370 AGC/Squelch Amplifier	163
LM171/LM271/LM371 Integrated RF-IF Amplifier	167
LM172/LM272/LM372 AM-IF Strip	169
LM373 AM/FM/SSB-IF Strip	173
LM703L Low Power Drain RF-IF Amplifier	177

Sense Amplifiers

LM5520/LM7520 Series Dual Core Memory Sense Amplifiers	179
--	-----

Definition of Terms	199
-------------------------------	-----

Physical Dimensions	203
-------------------------------	-----

Available Linear Applications Literature	Inside rear cover
--	-------------------

Specifications Are Worst Case Over Operating Temperature Unless Noted.

Product Type No.	Input Voltage Range (V)		Output Voltage Range (V)		Load Regulation (%) (typ.)	I _L (mA)	Line Regulation (%V _{OUT} /ΔV _{IN}) (typ.)	Ripple Rejection (%) (typ.)	Input-Output Differential (V)		Temperature Stability (%)	Operating Temperature Range (°C)		Standby Current Drain (mA) (typ.)	Output Current* (mA)	Package Type	
	Min	Max	Min	Max					Min	Max		Min	Max				
Positive Voltage Regulators	LM100	8.5	40	2.0	30	0.1	12	0.05	0.02	3	30	1.0	-55	125	1.0	20	TO-5, Flat Pack
	LM200	8.5	40	2.0	30	0.1	12	0.05	0.02	3	30	1.0	-25	85	1.0	20	TO-5, Flat Pack
	LM300	8.5	30	2.0	20	0.1	12	0.05	0.02	3	20	2.0	0	70	1.0	20	TO-5, Flat Pack
	LM105	8.5	50	4.5	40	0.02	12	0.015	0.003	3	30	1.0	-55	125	0.8	20	TO-5, Flat Pack
	LM205	8.5	50	4.5	40	0.02	12	0.015	0.003	3	30	1.0	-25	85	0.8	20	TO-5, Flat Pack
	LM305	8.5	40	4.5	30	0.02	12	0.015	0.003	3	30	1.0	0	70	0.8	20	TO-5, Flat Pack
	LM305A	8.5	50	4.5	40	0.02	45	0.025	0.003	3	30	1.0	0	70	0.8	45	TO-5
	LM376	9.0	30	5.0	25	1.0 max	25	0.4 max	0.4 max	-3	15	-	0	70	2.5 max	25	DIP (Molded)
	LM723	9.5	40	2.0	37	0.03	50	0.01	0.02	3	38	2.7	-55	125	1.3	50	TO-5
	LM723C	9.5	40	2.0	37	0.03	50	0.01	0.02	3	38	1.0	0	70	1.3	50	TO-5, DIP (Molded)
Negative Voltage Regulators	LM104	-50	-8	-40	0	0.01	20	0.1	0.01	2	50	1.0	-55	125	3.6	20	TO-5, Flat Pack
	LM204	-50	-8	-40	0	0.01	20	0.1	0.01	2	50	1.0	-25	85	3.6	20	TO-5, Flat Pack
	LM304	-40	-8	-30	0	0.01	20	0.1	0.01	2	40	1.0	0	70	3.6	20	TO-5, Flat Pack
Fixed 5V On-Card Regulators	LM109	7	35	4.7	5.3†	0.6	500	0.005	0.005	2	30	0.4 (typ.)	-55	125	6.0	>1000	TO-5 (3-lead) TO-3
	LM209	7	35	4.7	5.3†	0.6	500	0.005	0.005	2	30	0.4 (typ.)	-25	85	6.0	>1000	TO-5 (3-lead) TO-3
	LM309	7	35	4.8	5.2†	0.6	500	0.005	0.005	2	30	0.4 (typ.)	0	70	6.0	>1000	TO-5 (3-lead) TO-3

Note: The maximum power dissipation for the LM100, LM105 and LM104 regulators is 800 mW. For the LM109, and in most cases for the LM100, LM105 and the LM104, output current will be limited by maximum junction temperature and thermal resistance as indicated.

Package	Thermal Resistance Junction to Air	Thermal Resistance Junction to Case
TO-5	150°C/W	45°C/W
Flat Pack	185°C/W	
Solid Kovar TO-5	150°C/W	15°C/W
TO-3	35°C/W	1.5°C/W

*The output currents given, as well as the load regulation for the LM100, LM105 and LM104 family of regulators can be increased by the addition of external transistors. The increase will be roughly equal to the composite current gain of the added transistors.

†Can be adjusted to higher voltage by external resistors.

Industrial Operational Amplifier Guide

Industrial Temperature Range: -25°C to +85°C

Commercial Temperature Range: 0°C to +70°C

PARAMETER**	Industrial Temperature Range: -25°C to +85°C						Commercial Temperature Range: 0°C to +70°C														UNITS			
	LM201A	LM202	LM207	LM208	LM208A	LM210	LH201	LM201	LM301A	LM302	LM307	LM308	LM308A	LM310	LM709C	LM741C	LM748C	NH0001C	NH0002C	NH0003C		NH0004C	NH0005C	
Input Offset Voltage†	2	10	2	2	0.5	4	7.5	7.5	7.5	15	7.5	7.5	0.5	7.5	7.5	6.0	6.0	1	100	3	1	3	mV	
Drift	*	*	20	15	5	*	*	*	30	*	30	30	5	*	*	*	*	4	*	*	*	*	μV/°C	
Input Offset Current†	20	*	20	0.4	0.4	*	500	500	50	*	50	1	1	*	500	200	200	20	*	200	20	5	nA	
Drift	*	*	100	2.5	2.5	*	*	*	600	*	600	10	10	*	*	*	*	*	*	*	*	*	pA/°C	
Input Bias Current†	75	15	75	2	2	3	1500	1500	250	30	250	7	7	7	1500	500	500	100	10,000	2,000	100	20	nA	
Voltage Gain†	25k	.999	25k	50k	80k	0.999	20k	20K	25k	0.9985	25k	25k	80k	0.999	25k	20k	50k	10k	0.95	20k	10k	2k	V/V	
Bandwidth (typ. at 25°C)	A _V = 1	1	10	1	1	1	1	1	1	10	1	1	1	20	1	1	1	1	50	10	.05	30	MHz	
	A _V = 10	1	*	0.1	1	1	0.1	1	1	*	0.1	1	1	*	1	0.1	1	0.1	*	1	.350	*	MHz	
	A _V = -1	10	*	0.5	1	1	0.5	10	10	*	0.5	1	1	*	1	0.5	10	*	*	*	*	*	MHz	
Slew Rate (typ. at 25°C)	A _V = 1	0.5	10	0.5	0.3	0.3	0.5	0.5	0.5	10	0.5	0.3	0.3	30	0.3	0.5	0.5	0.5	160	70	2	*	V/μs	
	A _V = 10	5	*	0.5	3	3	0.5	5	5	*	0.5	3	3	*	3	0.5	5	*	*	*	30	20	V/μs	
	A _V = -1	15	*	0.5	0.6	0.6	0.5	15	15	*	0.5	0.6	0.6	*	0.6	0.5	15	*	*	*	*	*	V/μs	
Output Current	5	1	5	1	1	1	5	5	5	1	5	1	1	1	5	5	5	4	100	50	6	40	mA	
Min. Supply Voltage	±3	±12	±3	±2	±2	±5	±3	±3	±3	±12	±3	±2	±2	±5	±9	±3	±3	±5	±5	±5	±9	±9	V	
Max. Supply Voltage	±22	±18	±22	±20	±20	±18	±22	±22	±18	±18	±18	±18	±18	±18	±18	±18	±18	±20	±20	±20	±40	±20	V	
Supply Current†	3	5.5	3	.4	.4	5.5	3	3	3	5.5	3	0.8	0.8	5.5	6.6	2.9	2.9	0.09	±6	3	.09	3	mA	
Common Mode Range	±12	±10	±12	±14	±14	±10	±12	±12	±12	±10	±12	±14	±14	±10	±8	±12	±12	±15	±20	±38	±38	±15	V	
Diff. Input Voltage	±30	*	±30	‡	‡	*	±30	±30	±30	*	±30	‡	‡	*	±5	±30	±30	±7	*	±7	±7	±15	V	
Compensation Components	1	0	0	1	1	0	0	1	1	0	0	1	1	0	4	0	1	2	0	2	1	3		
Input Protection	Yes	Yes	Yes	Yes	Yes	Yes	Yes	Yes	Yes	Yes	Yes	Yes	Yes	Yes	No	Yes	Yes	No	No	No	No	No	No	
Output Protection	Yes	Yes	Yes	Yes	Yes	Yes	Yes	Yes	Yes	Yes	Yes	Yes	Yes	Yes	No	Yes	Yes	No	No	No	No	No	No	

*Not applicable or not specified.

**Industrial guaranteed for ±15V supplies and -25°C ≤ T_A ≤ 85°C unless otherwise specified.
Commercial guaranteed for ±15V supplies and 0°C ≤ T_A ≤ 70°C unless otherwise specified.

†Guaranteed at 25°C.

‡Inputs have shunt-diode protection. Current must be limited.

Military Temperature Range: -55°C to +125°C

PARAMETER**	LM101	LH101	LM101A	LM102	LM107	LM108	LM108A	LM110	LM709	LM741	LM748	NH0001	NH0002	NH0003	NH0004	NH0005A	NH0005	UNITS
Input Offset Voltage	6	6	3	7.5	3	3	1.0	6	6	6	6	1	100	3	1	3	10	mV
Drift	*	*	15	*	15	15	5	*	*	*	*	4	*	*	*	10	20	μV/°C
Input Offset Current	500	500	20	*	20	0.4	0.4	*	500	500	500	20	*	200	20	5	20	nA
Drift	*	*	200	*	200	2.5	2.5	*	*	*	*	*	*	*	*	*	*	pA/°C
Input Bias Current	1500	1500	100	100	100	3	3	10	1500	1500	1500	100	10,000	2,000	100	25	50	nA
Voltage Gain†	50k	50k	50k	0.999	50k	50k	80k	0.999	25k	50k	50k	10k	0.95	20k	10k	4k	2k	V/V
Bandwidth (typ. at 25°C)																		
$A_V = 1$	1	1	1	10	1	1	1	20	1	1	1	1	50	10	.05	30	30	MHz
$A_V = 10$	1	0.1	1	*	0.1	1	1	*	1	0.1	1	0.1	*	1	.350	*	*	MHz
$A_V = -1$	10	0.5	10	*	0.5	1	1	*	1	0.5	10	*	*	*	*	*	*	MHz
Slew Rate (typ. at 25°C)																		
$A_V = 1$	0.5	0.5	0.5	10	0.5	0.3	0.3	30	0.3	0.5	0.5	0.5	160	70	2	*	*	V/μs
$A_V = 10$	5	0.5	5	*	0.5	3	3	*	3	0.5	5	*	*	*	30	20	20	V/μs
$A_V = -1$	15	0.5	15	*	0.5	0.6	0.6	*	0.6	0.5	15	*	*	*	*	*	*	V/μs
Output Current	5	5	5	1	5	1	1	1	5	5	5	4.5	100	50	6	50	50	mA
Min. Supply Voltage	±3	±3	±3	±12	±3	±2	±2	±5	±9	±3	±3	±5	±5	±5	±9	±9	±9	V
Max. Supply Voltage	±22	±22	±22	±18	±22	±20	±20	±18	±18	±22	±22	±20	±20	±20	±40	±20	±20	V
Supply Current†	3	3	3	5.5	3	0.6	0.6	5.5	5.5	2.9	2.9	0.09	±6	3	0.09	3	3	mA
Common Mode Range	±12	±12	±12	±10	±12	±14	±14	±10	±8	±12	±12	±15	±20	±10	±38	±15	±15	V
Diff. Input Voltage	±30	±30	±30	*	±30	‡	‡	*	±5	±30	±30	±7	*	±7	±7	±15	±15	V
Compensation Components	1	0	1	1	0	1	1	0	4	0	1	2	0	2	1	3	3	
Input Protection	Yes	Yes	Yes	Yes	Yes	Yes	Yes	Yes	No	Yes	Yes	No	No	No	No	No	No	
Output Protection	Yes	Yes	Yes	Yes	Yes	Yes	Yes	Yes	No	Yes	Yes	No	No	No	No	No	No	

*Not applicable or not specified.

**Guaranteed for ±15V supplies and -55°C ≤ T_A ≤ 125° unless otherwise specified.

†Guaranteed at 25°C.

‡Inputs have shunt-diode protection. Current must be limited.

Voltage Comparator Guide

Temperature Range	Product Type No.	TTL/DTL Fan Out	Input Offset Voltage†	Input Offset Voltage Drift†	Input Bias Current†	Input Offset Current†	Supply Voltage	Response Time*	Input Voltage Range	Output Voltage Swing	Voltage Gain†	Max Power Consumption	Package
-55°C to +125°C	LM106	10	0.5 mV	5 μ V/°C	10 μ A	0.7 μ A	V ⁺ = +12V V ⁻ = -3V to -12V †	40 ns	±5V	0V to +5V (+24V)‡	40,000	145 mW	TO-5, FLAT
	LM111	8	0.7 mV	5 μ V/°C	.06 μ A	0.004 μ A	±18V to +5V and GND	200 ns	±14V	0V to +5V (+50V)‡	200,000	80 mW	TO-5, FLAT, DIP
	LM710A	1	0.6 mV	5 μ V/°C	13 μ A	0.75 μ A	V ⁺ = +12V V ⁻ = -6V	40 ns	±5V	-0.5V to +3.2V	1,700	160 mW	TO-5
	LM711	1	1.0 mV	5 μ V/°C	25 μ A	0.5 μ A	V ⁺ = +12V V ⁻ = -6V	40 ns	±5V	-0.5V to +4.2V	1,500	230 mW	TO-5
-25°C to +85°C	LM206	10	0.5 mV	5 μ V/°C	10 μ A	0.7 μ A	V ⁺ = +12V V ⁻ = -3V to -12V †	40 ns	±5V	0V to +5V (+24V)‡	40,000	145 mW	TO-5, FLAT
	LM211	8	0.7 mV	5 μ V/°C	.06 μ A	0.004 μ A	±18V to +5V and GND	200 ns	±14V	0V to +5V (+50V)‡	200,000	80 mW	TO-5, FLAT, DIP
0°C to 70°C	LM306	10	1.6 mV	5 μ V/°C	16 μ A	1.8 μ A	V ⁺ = +12V V ⁻ = -3V to -12V †	40 ns	±5V	0V to +5V (+24V)‡	40,000	145 mW	TO-5, FLAT
	LM311	8	2.0 mV	5 μ V/°C	0.1 μ A	0.006 μ A	±18V to +5V and GND	200 ns	±14V	0V to +5V (+50V)‡	200,000	80 mW	TO-5, FLAT, DIP
	LM710C	1	1.6 mV	5 μ V/°C	16 μ A	1.8 μ A	V ⁺ = +12V V ⁻ = -6V	40 ns	±5V	-0.5V to +3.2V	1,500	160 mW	TO-5, DIP
	LM711C	1	1.0 mV	5 μ V/°C	25 μ A	0.5 μ A	V ⁺ = +12V V ⁻ = -6V	40 ns	±5V	-0.5V to +4.2V	1,500	230 mW	TO-5, DIP

†Typical values at +25°C

*Response time is specified for 100 mV step input with 5 mV overdrive.

‡Maximum output voltage switching capability.



Connection Diagram

linear IC connection diagrams (Note: All views are top views except for the LM109 series)

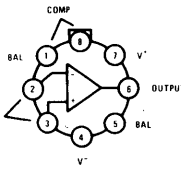
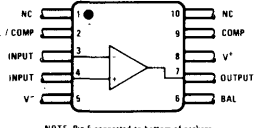
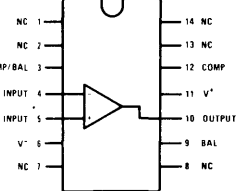
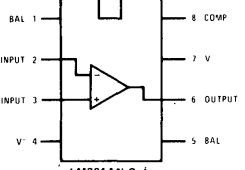
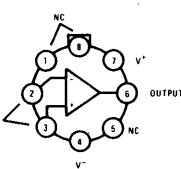
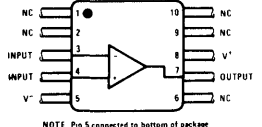
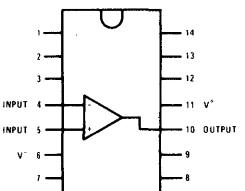
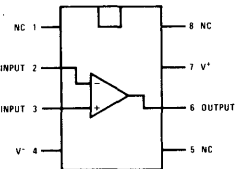
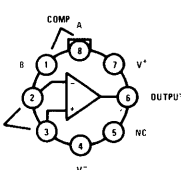
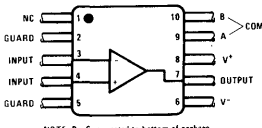
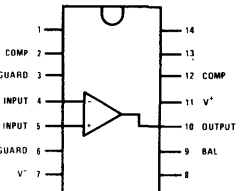
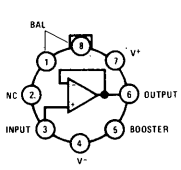
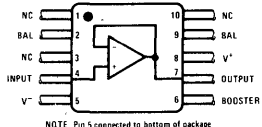
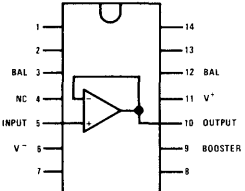
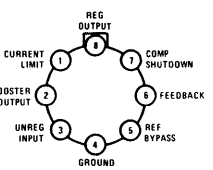
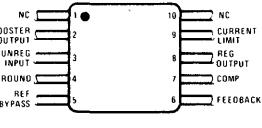
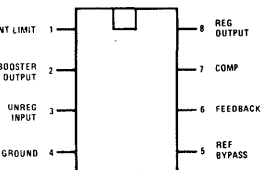
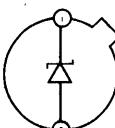
PRODUCT TYPE	METAL CAN PACKAGE (TO-99 or TO-100)	FLAT PACKAGE	CAVITY DUAL-IN-LINE PACKAGE	MOLDED DUAL-IN-LINE PACKAGE
LM101 LM201 LM101A LM201A LM301A	 <p>NOTE: Pin 4 connected to case</p>	 <p>NOTE: Pin 5 connected to bottom of package</p>	 <p>NOTE: Pin 6 connected to bottom of package</p>	 <p>LM301AN Only</p>
LH101 LH201 LM107 LM207 LM307	 <p>NOTE: Pin 4 connected to case</p>	 <p>NOTE: Pin 5 connected to bottom of package</p>	 <p>NOTE: Pin 6 connected to bottom of package</p>	 <p>LM307N Only</p>
LM108 LM208 LM308 LM108A LM208A LM308A	 <p>NOTE: Pin 4 connected to case</p>	 <p>NOTE: Pin 6 connected to bottom of package</p>	 <p>NOTE: Pin 7 connected to bottom of package</p>	
LM102 LM202 LM302 LM110 LM210 LM310	 <p>NOTE: Pin 4 connected to case</p>	 <p>NOTE: Pin 5 connected to bottom of package</p>	 <p>NOTE: Pin 6 connected to bottom of package. LM110/210/310 Only</p>	
LM100 LM200 LM300 LM105 LM205 LM305 LM305A LM376	 <p>NOTE: Pin 4 connected to case</p> <p>LM305A In Metal Can Only</p>	 <p>NOTE: Pin 4 connected to bottom of package</p>		 <p>LM376N Only</p>
LM103	 <p>NOTE: Pin 2 connected to case</p> <p>TO-46</p>			

Connection Diagram

PRODUCT TYPE	METAL CAN PACKAGE (TO-99 or TO-100)	FLAT PACKAGE	CAVITY DUAL-IN-LINE PACKAGE	MOLDED DUAL-IN-LINE PACKAGE
<p>LM104 LM204 LM304</p>	<p>NOTE: Pin 5 connected to case.</p>	<p>NOTE: Pin 4 connected to bottom of package.</p>		
<p>LM109 LM209 LM309</p>	<p>NOTE: Case is ground. BOTTOM VIEW</p>			
<p>LM106 LM206 LM306</p>	<p>NOTE: Pin 4 connected to case.</p>	<p>NOTE: Pin 6 connected to bottom of package.</p>		
<p>LM111 LM211 LM311</p>	<p>NOTE: Pin 4 connected to case.</p>	<p>NOTE: Pin 5 connected to bottom of package.</p>	<p>NOTE: Pin 6 connected to bottom of package.</p>	
<p>LM709 LM709C</p>	<p>NOTE: Pin 4 connected to case.</p>			<p>LM709CN Only</p>
<p>LM710A LM710C</p>	<p>NOTE: Pin 4 connected to case.</p>			<p>LM710CN Only</p>

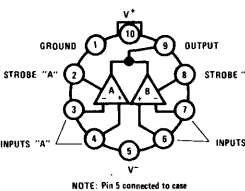
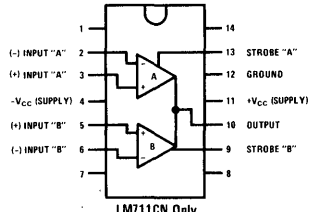
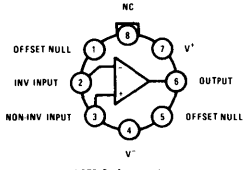
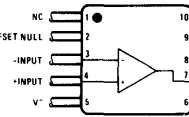
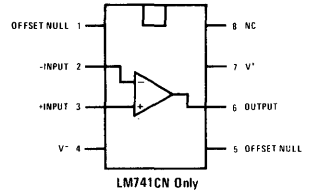
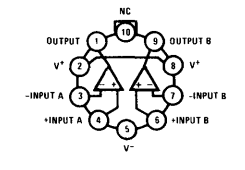
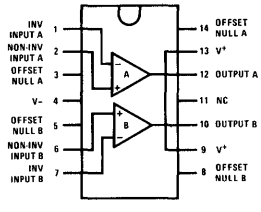
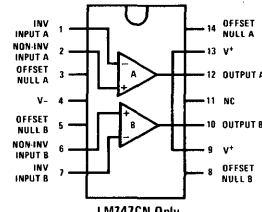
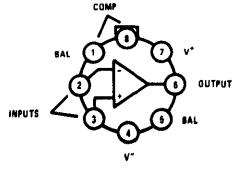
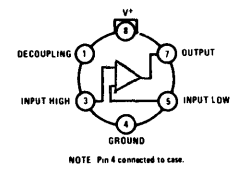
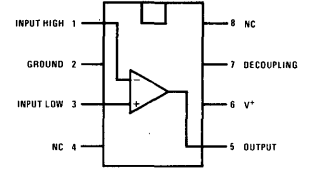
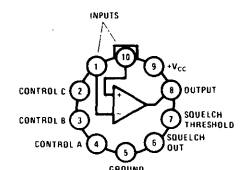
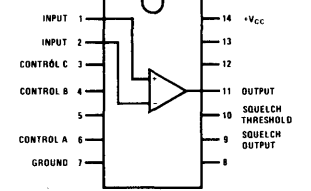
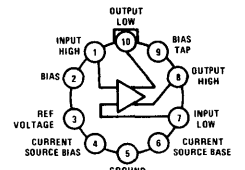
PRODUCT TYPE	METAL CAN PACKAGE (TO-99 or TO-100)	FLAT PACKAGE	CAVITY DUAL-IN-LINE PACKAGE	MOLDED DUAL-IN-LINE PACKAGE
<p>LM711 LM711C</p>	 <p>NOTE: Pin 5 connected to case</p>			 <p>LM711C Only</p>
<p>LM741 LM741C</p>	 <p>NOTE: Pin 4 connected to case</p>			 <p>LM741C Only</p>
<p>LM747 LM747C</p>				 <p>LM747C Only</p>
<p>LM748 LM748C</p>	 <p>NOTE: Pin 4 connected to case</p>			
<p>LM703L</p>	 <p>NOTE: Pin 4 connected to case.</p>			
<p>LM170 LM270 LM370</p>				 <p>LM370N Only</p>
<p>LM171 LM271 LM371</p>				

Connection Diagram

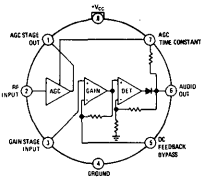
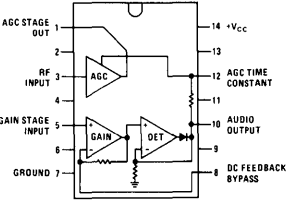
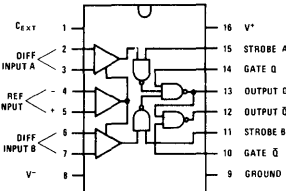
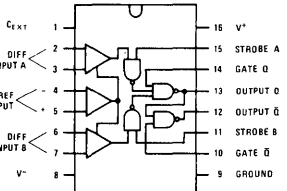
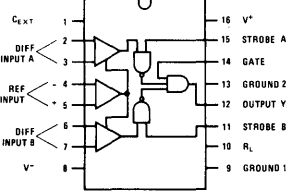
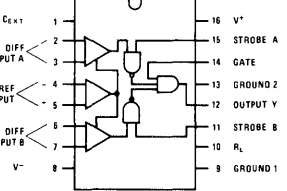
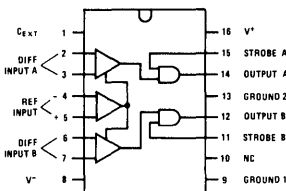
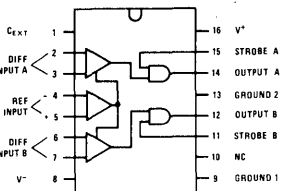
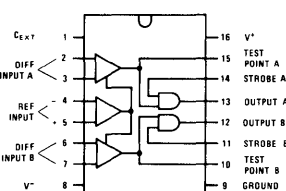
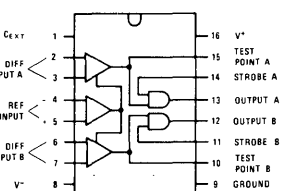
PRODUCT TYPE	METAL CAN PACKAGE (TO-99 or TO-100)	CAVITY DUAL-IN-LINE PACKAGE	MOLDED DUAL-IN-LINE PACKAGE
<p>LM172 LM272 LM372</p>			
<p>LM5520 LM7520 LM5521 LM7521</p>			
<p>LM5522 LM7522 LM5523 LM7523</p>			 <p style="text-align: center;">LM7522N and LM7523N Only</p>
<p>LM5524 LM7524 LM5525 LM7525</p>			 <p style="text-align: center;">LM7524N and LM7525N Only</p>
<p>LM5528 LM7528 LM5529 LM7529</p>			 <p style="text-align: center;">LM7528N and LM7529N Only</p>

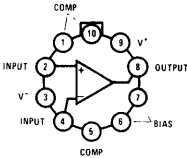
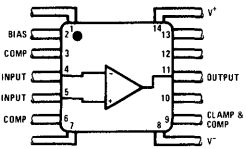
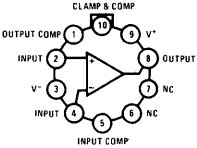
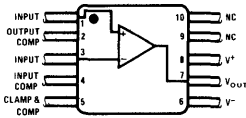
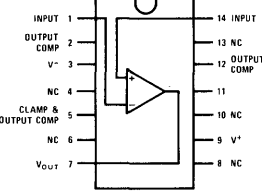
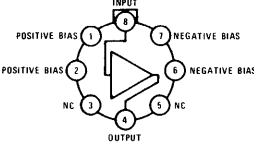
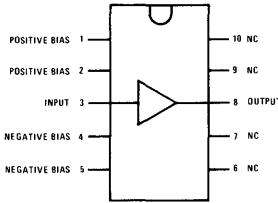
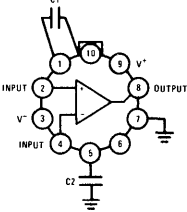
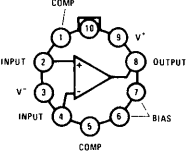
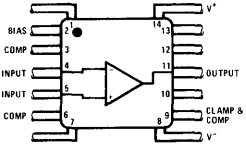
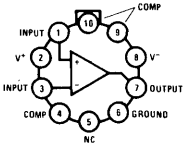
PRODUCT TYPE	METAL CAN PACKAGE	FLAT PACKAGE	MOLDED DUAL-IN-LINE PACKAGE
<p>NH0001 NH0001C</p>			
<p>NH0001A</p>			
<p>NH0002 NH0002C</p>			
<p>NH0003 NH0003C</p>			
<p>NH0004 NH0004C</p>			
<p>NH0005 NH0005A NH0005C</p>			

PRODUCT TYPE	METAL CAN PACKAGE
NH0020	
NH0022	<p>NOTE: Pin 4 connected to case</p>
NH0023	<p>* Tie point for operation with $V_1 = 15V$ only</p>

Note: For those connection diagrams not listed, refer to the specific device data sheet.



New Products

LM112/LM212/LM312 micropower operational amplifiers

general description

The LM112, LM212 and LM312 are micropower operational amplifiers with very low offset-voltage and input-current errors—for the LM112 and LM212, at least a factor of ten better than FET amplifiers over a -55°C to 125°C temperature range. Similar to the LM108 series, that also use supergain transistors,* they differ in that they include internal frequency compensation and have provisions for offset adjustment with a single potentiometer.

These amplifiers will operate on supply voltages of $\pm 2\text{V}$ to $\pm 20\text{V}$, drawing a quiescent current of only $300\ \mu\text{A}$. Performance is not appreciably affected over this range of voltages, so operation from unregulated power sources is easily accomplished. They can also be run from a single supply like the 5V used for digital circuits. Some noteworthy features are:

- Low noise

- Guaranteed drift specifications
- Long term stability typically $3\ \mu\text{V}/\text{year}$

The LM112 series are the first IC amplifiers to improve reliability by including overvoltage protection for the MOS compensation capacitor. Without this feature, IC's have been known to suffer catastrophic failure caused by short-duration overvoltage spikes on the supplies. Unlike other internally-compensated IC amplifiers, it is possible to overcompensate with an external capacitor to increase stability margin.

The LM212 is identical to the LM112, except that the LM212 has its performance guaranteed over a -25°C to 85°C temperature range, instead of -55°C to 125°C . The LM312 has its performance guaranteed over a 0°C to 70°C temperature range.

*Patent pending

connection diagrams

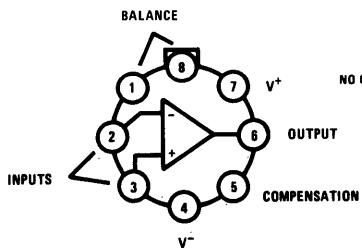

Note: Pin 4 connected to case.
TOP VIEW

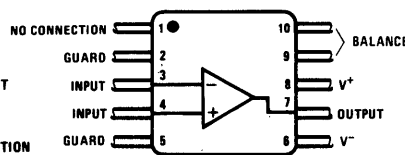

Note: Pin 6 connected to bottom of package
TOP VIEW

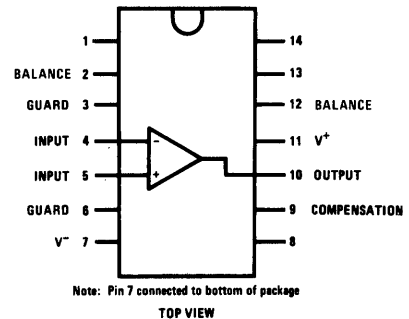

Note: Pin 7 connected to bottom of package
TOP VIEW

LM113 reference diode general description

The LM113 is a temperature-compensated, low-voltage reference diode. It features extremely-tight regulation over a wide range of operating currents in addition to an unusually-low breakdown voltage and good temperature stability.

The diode is synthesized using transistors and resistors in a monolithic integrated circuit. As such, it has the same low noise and long term stability as modern IC op amps. Further, output voltage of the reference depends only on highly-predictable properties of components in the IC; so it can be manufactured and supplied to tight tolerances. Outstanding features include:

connection diagram

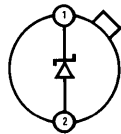

NOTE: Pin 2 connected to case.
TOP VIEW

- Low breakdown voltage: 1.230V
- Dynamic impedance of 0.3Ω from $500\mu\text{A}$ to 20mA
- Temperature stability typically 1% over -55°C to 125°C range
- Tight tolerance: $\pm 5\%$ standard, $\pm 2\%$ and $\pm 1\%$ on special order.

The characteristics of this reference recommend it for use in bias-regulation circuitry, in low-voltage power supplies or in battery powered equipment. The fact that the breakdown voltage is equal to a physical property of silicon—the energy-band-gap voltage—makes it useful for many temperature-compensation and temperature-measurement functions.

LM565 phase locked loop general description

The LM565 phase locked loop (PLL) is a self-contained, adaptable filter and demodulator for the frequency range from 0.001Hz to 500kHz . The circuit comprises a voltage-controlled oscillator of exceptional stability and linearity, a phase comparator, an amplifier and a low-pass filter. The center frequency of the PLL is determined by the free-running frequency of the VCO; this frequency can be adjusted externally with a resistor or a capacitor. The low pass filter, which determines the capture characteristics of the loop, is formed by an internal resistor and an external capacitor. Features include:

- Extreme stability of center frequency— $200\text{ppm}/^\circ\text{C}$ typ
- Wide range of operating voltage— ± 5 to ± 12 volts with very small frequency drift— $100\text{ppm}/^\circ\text{C}$ typ
- Very high linearity of demodulated output— 0.5% typ
- Center frequency programming by means of a resistor, capacitor, voltage or current

connection diagrams

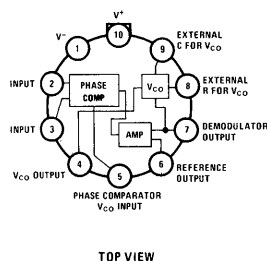

TOP VIEW

- TTL and DTL compatible square-wave output; loop can be opened to insert digital frequency divider
- Highly linear triangle wave output
- Reference output for connection of comparator in frequency discriminator
- Bandpass, adjustable from $<\pm 1\%$ to $>\pm 60\%$
- Frequency adjustable over 10 to 1 range with same capacitor

Applications include:

- Frequency shift keying
- Modems
- Telemetry receivers
- Tone decoders
- SCA receivers
- Wideband FM discriminators
- Data synchronizers
- Tracking filters
- Signal restoration
- Frequency multiplication & division

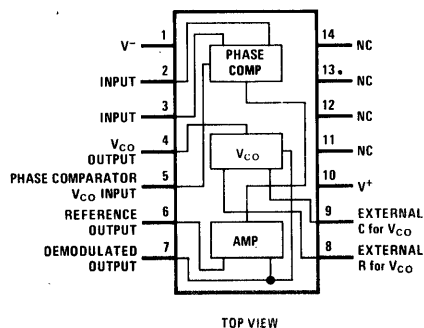

TOP VIEW

LM723/LM723C voltage regulator

general description

The LM723/LM723C are voltage regulators designed primarily for series regulator applications. By itself, they will supply output currents up to 150 mA; but external transistors can be added to provide any desired load current. The circuits feature extremely low standby current drain, and provision is made for either linear or foldback current limiting.

The LM723C is identical to the LM723 except that the LM723C has its performance guaranteed over a 0°C to 70°C temperature range, instead of -55°C to +125°C. Features include:

- 150 mA output current without external pass transistors

- Output currents in excess of 10A possible by adding external transistors
- Maximum input voltage—40V
- Output voltage adjustable from 2V to 37V
- Can be used as either a linear or switching regulator

Applications include:

- Series regulator
- Shunt regulator
- Current regulator
- Temperature controller

connection diagrams

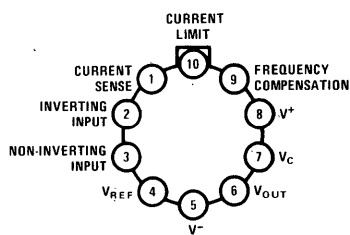

NOTE: Pin 5 is connected to case

TOP VIEW

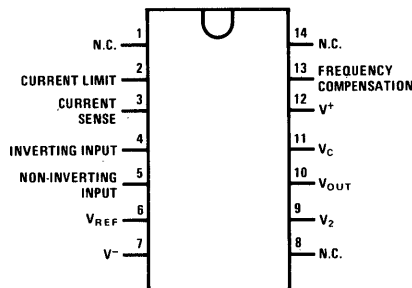

TOP VIEW

LM1303 dual stereo preamplifier

general description

The LM1303 consist of two identical operational amplifiers constructed on a single silicon chip. Intended for amplification of low-level stereo signals, these devices feature:

connection diagram

- Low input noise voltage
- High open-loop voltage gain
- Large output voltage swing
- Short circuit protection.

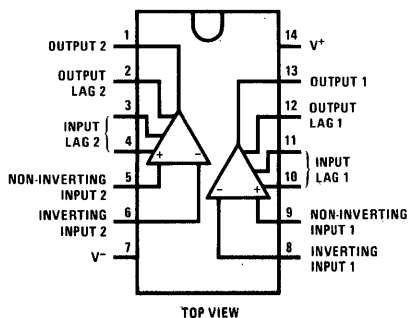

TOP VIEW

LM1304, LM1305 FM multiplex stereo demodulator

general description

The LM1304 and LM1305 FM multiplex stereo demodulators derive the left and right audio information from the detected composite-signal. The device eliminates the need for an external stereo-channel separation control. The LM1305 is similar to the LM1304 but permits the use of an external stereo-channel separation control for maximum separation. Additional features include:

- Operation practicable over wide power-supply range—8-14V dc
- Built-in stereo-indicator lamp driver
- Total audio muting capability
- Automatic switching—stereo-monoaural
- Monoaural squelch capability

connection diagram

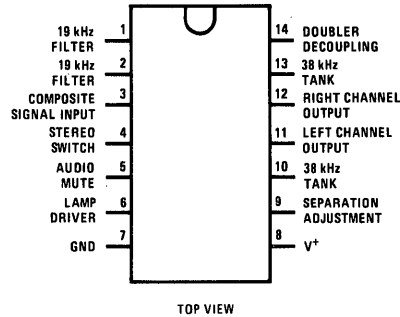

LM1558/LM1458 dual operational amplifiers

general description

The LM1558/LM1458 are general purpose dual operational amplifiers. The two amplifiers share a common bias network and power supply leads. Otherwise their operation is completely independent.

Features of the LM1558/LM1458 include off-set nulling, short circuit protection, internal frequency compensation, wide common mode and differential mode range. Power drain is reduced by sharing bias resistors. Additional features include:

- No frequency compensation required
- Short-circuit protection

- Wide common-mode and differential voltage ranges
- Low-power consumption
- No latch-up
- 8-lead TO-5 and 8-lead mini DIP

The LM1458 is identical to the LM1558 except that the LM1458 has its specifications guaranteed over the temperature range from 0°C to 70°C instead of -55°C to +125°C.

connection diagrams

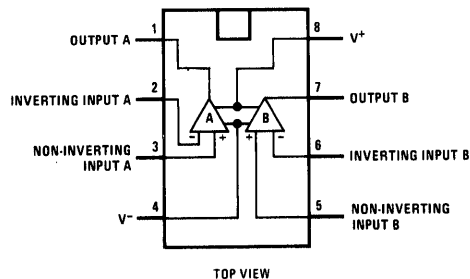
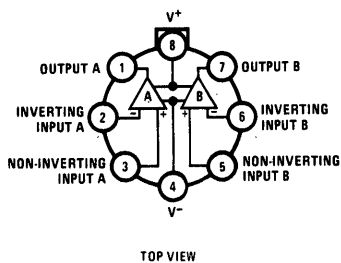

LM3028A/LM3028B/LM3053 rf/if amplifier

general description

The LM3028A/LM3028B/LM3053 are monolithic RF/IF amplifiers intended for emitter-coupled (differential) or cascode amplifier operation from dc to 120 MHz in industrial and communications equipment. The LM3028B is similar to the LM3028A, but has premium performance with tighter limits in offset voltage and current, bias current and voltage gain. The LM3053 is similar to the LM3028A/LM3028B, but is recommended for IF amplifier operation with less critical dc parameters. The devices are direct plug-in replacements for their respective CA equivalents. Features include:

- Controlled for input offset voltage, input offset current, and input bias current*
- Balanced differential amplifier configuration with controlled constant-current source to provide unexcelled versatility
- Single- and dual-ended operation

*Does not apply to the LM3053

- Operation from dc to 120 MHz*
- Balanced-AGC capability*
- Wide operating-current range

Applications include:

- RF and IF linear amplifiers, both differential and cascode
- Mixers
- Oscillators
- Converters in commercial FM
- DC, audio and sense amplifiers
- Limiting IF amplifiers
- Hybrid building block
- Emitter-coupled switches

connection diagram

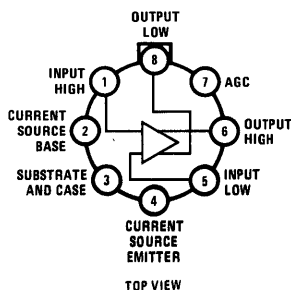

LM3064 TV automatic fine-tuning circuit

general description

The LM3064 TV automatic fine-tuning circuit is designed primarily for AFC (Automatic Frequency Control) applications.

The LM3064 is functionally similar to the CA3044 and CA3044V1 but embodies a higher gain input amplifier which provides a 20 dB improvement in sensitivity. The increased sensitivity extends the application of a proven AFT system to TV

receivers with low level IF amplifiers. Additional features include:

- High gain input amplifier—18 mV input for rated output
- Wide operating temperature range; -40°C to $+85^{\circ}\text{C}$

connection diagram

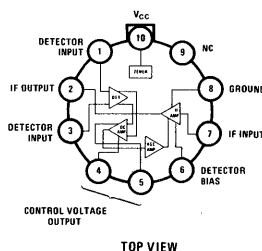

LM3065 television sound system general description

The LM3065 television sound system is a monolithic integrated circuit which combines a multi-stage IF amplifier limiter, an FM detector, an electronic attenuator, a zener diode regulated power supply, and an audio amplifier-driver that is designed to directly drive an NPN power transistor or high-transconductance tube. Because the circuit is so inclusive, a minimum number of external components is required.

The LM3065 provides a high-performance multi-stage subsystem for the sound system of a television receiver. A particular feature is the electronic attenuator which performs the conventional volume control function.

Outstanding features include:

- Electronic attenuator-replaces conventional volume control
- Differential peak detector-requires one single tuned coil
- Internal zener diode regulated supply
- Inherent high stability
- Excellent AM rejection-50 dB typ. at 4.5 MHz
- Low harmonic distortion
- High sensitivity-200 μ V limiting (knee) at 4.5 MHz
- Audio drive capability-6 mA p-p
- Undistorted audio output voltage-7V p-p

connection diagram

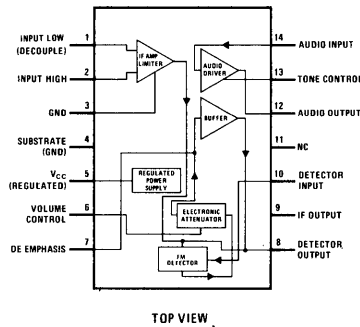

LH740A/LH740AC FET input operational amplifier general description

The LH740A/LH740AC are FET input, general purpose operational amplifiers with high input impedance, closely matched input characteristics, and good slew rates. Input offset voltage is typically 10.0 mV at 25°C, while input bias current is less than 100 pA at 25°C. Offset current is typically less than 40 pA at 25°C.

Features include:

- Internal 6 dB/octave frequency compensation
- Unity gain slew rate in excess of 6 V/ μ s
- Unity gain bandwidth of 1 MHz
- Pin compatible with LM741, LM709, LM101A, and μ A740

- Input offset is adjustable with a single 10k pot
- Excellent offset current match over temperature, typically 100 pA
- Output is continuously short-circuit proof
- Excellent open loop gain, typically in excess of 100 dB
- Guaranteed over the full military temperature range

The LH740A/LH740AC is intended to fulfill a wide variety of applications requiring extremely low bias currents such as integrators, sample and hold amplifiers, and general purpose operational amplifier applications.

connection diagram

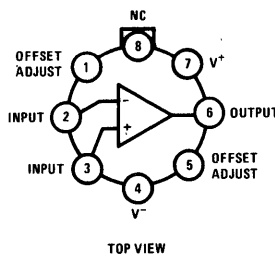

NH0021 operational amplifier

general description

The NH0021 is a high power differential operational amplifier with one amp output current capability. It is available in an 8-pin TO-3 package. Applications include:

- Servo drivers
- Hydraulic controls
- Motor drivers

connection diagram

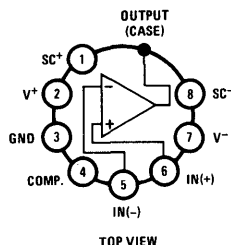

NH0022/NH0022C FET input operational amplifier

general description

The NH0022/NH0022C is a FET input, general purpose operational amplifier with high input impedance, closely matched input characteristics, good slew rates. Input offset voltage is typically 2.0 mV for the NH0022 and 4.0 mV for the NH0022C at 25°C, while input bias current is less than 10 pA at 25°C. Offset current is less than 0.2 pA at 25°C. Other important design features include:

- Internal 6 dB/octave frequency compensation
- Unity gain slew rate in excess of 3 V/ μ s
- Unity gain bandwidth of 1 MHz
- Input offset is adjustable with a single 10k pot

- Pin compatible with LM741, LM709, LM101A, and μ A740,
- Excellent offset current match over temperature, typically 25 pA
- Output is continuously short-circuit proof
- Excellent open loop gain, typically in excess of 100 dB

The NH0022/NH0022C is intended to fulfill a wide variety of applications requiring extremely low bias currents such as integrators, sample and hold amplifiers, and general purpose operational amplifier applications.

connection diagram

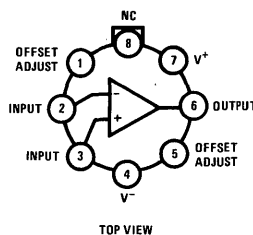

NH0024 operational amplifier

general description

The NH0024 is a high speed operational amplifier which is pin compatible with the LM709, LM101A, and LM741. It is available in an 8-pin TO-5 package. Features include:

- Unity gain slew rate of 500 V/ μ s
- Small signal bandwidth of 20 MHz

connection diagram

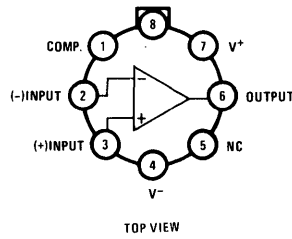

NH0033 voltage follower

general description

The NH0033 is a high speed voltage follower with a FET input and slew rates in excess of 1000 V/ μ s. It is available in a 12-pin TO-8 package. Additional features include:

- Improved input characteristics
- Adjustable offset voltage
- High open loop gain

connection diagram

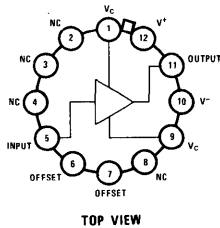



Voltage Regulators

LM100/LM200/LM300

LM100/LM200/LM300 voltage regulators general description

The LM100, LM200 and LM300 are integrated voltage regulators designed for a wide range of applications from digital power supplies to precision regulators for analog circuitry. Built on a single silicon chip, these devices are encapsulated in either an 8-lead, low profile TO-5 header or a 1/4 x 1/4 metal flat package. Outstanding characteristics are:

- Output voltage adjustable from 2V to 30V (LM300 adjustable from 2V to 20V)
- Better than one percent load and line regulation
- One percent temperature stability
- Adjustable short-circuit limiting
- Output currents in excess of 5A possible by adding external transistors

- Can be used as either a linear or high-efficiency switching regulator.

Additional features are fast response to both load and line transients, small standby power dissipation, freedom from oscillations with varying resistive and reactive loads, and the ability to start reliably on any load within rating.

The LM100 is specified for operation over the -55°C to $+125^{\circ}\text{C}$ military temperature range. The LM200 and LM300 are low cost, commercial-industrial versions of the LM100. They are identical to the LM100 except that they are specified for operation from -25°C to 85°C and from 0°C to 70°C respectively.

schematic and connection diagrams

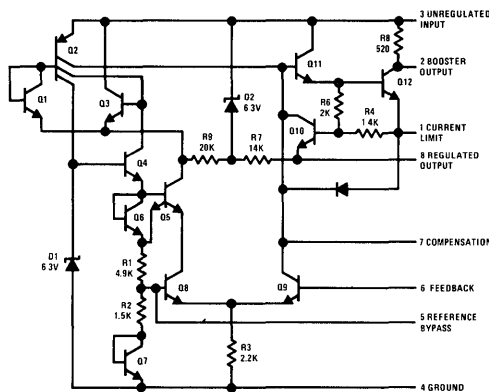

Pin connections shown are for TO-5 package

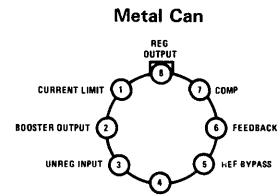

Flat Package

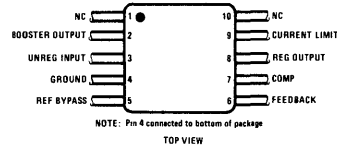

typical applications

Basic Regulator Circuit

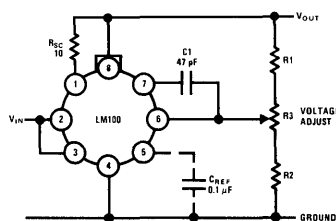

200 mA Regulator

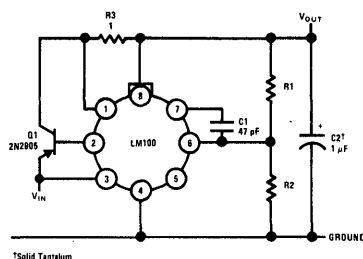

2A Regulator With Foldback Current Limiting

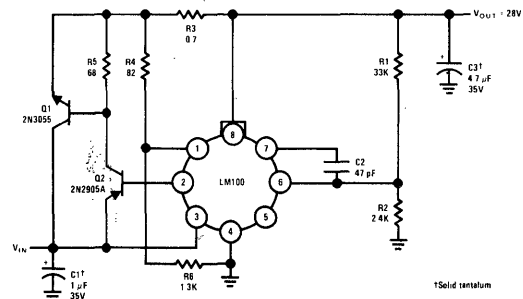

4A Switching Regulator

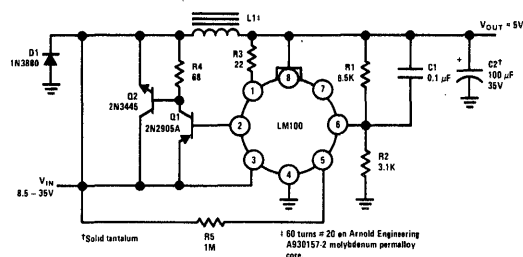

absolute maximum ratings

Input Voltage	
LM100, LM200	40V
LM300	35V
Input-Output Voltage Differential	
LM100, LM200	40V
LM300	30V
Power Dissipation (Note 1)	
LM100, LM200	800 mW
LM300	500 mW
Operating Temperature Range	
LM100, LM200	-55°C to +150°C
LM300	0°C to 70°C
Storage Temperature Range	-65°C to 150°C
Lead Temperature (soldering, 10 sec)	300°C

electrical characteristics (Note 2)

PARAMETER	CONDITIONS	MIN	TYP	MAX	UNITS
Input Voltage Range					
LM100/LM200		8.5		40	V
LM300		8.5		30	V
Output Voltage Range					
LM100/LM200		2.0		30	V
LM300				20	V
Output-Input Voltage Differential					
LM100/LM200		3.0		30	V
LM300				20	V
Load Regulation (Note 3)	$R_{SC} = 0, I_O < 12 \text{ mA}$		0.1	0.5	%
Line Regulation	$V_{IN} - V_{OUT} \leq 5V$ $V_{IN} - V_{OUT} \leq 5V$		0.1 0.05	0.2 0.1	%/V %/V
Temperature Stability					
LM100	$-55^\circ\text{C} \leq T_A \leq +125^\circ\text{C}$		0.3	1.0	%
LM200	$-25^\circ\text{C} \leq T_A \leq 85^\circ\text{C}$		0.3	1.0	%
LM300	$0^\circ\text{C} \leq T_A \leq 70^\circ\text{C}$		0.3	2.0	%
Feedback Sense Voltage		1.63	1.7	1.81	V
Output Noise Voltage	$10 \text{ Hz} \leq f \leq 10 \text{ kHz}$ $C_{REF} = 0$ $C_{REF} = 0.1 \mu\text{F}$				
			0.005		%
			0.002		%
Long Term Stability			0.1	1.0	%
Standby Current Drain					
LM100/LM200	$V_{IN} = 40V$		1.0	3.0	mA
LM300	$V_{IN} = 30V$				
Minimum Load Current					
LM100/LM200	$V_{IN} - V_{OUT} = 30V$		1.5	3.0	mA
LM300	$V_{IN} - V_{OUT} = 20V$				

Note 1: The maximum junction temperature of the LM100 is 150°C, while that of the LM200 is 100°C, and the LM300 is 85°C. For operating at elevated temperatures, devices in the TO-5 package must be derated based on a thermal resistance of 150°C/W junction to ambient or 45°C/W, junction to case. For the flat package, the derating is based on a thermal resistance of 185°C/W when mounted on a 1/16-inch-thick, epoxy-glass board with ten, 0.03-inch-wide, 2-ounce copper conductors. Peak dissipations to 1.0W are allowable providing the dissipation rating is not exceeded with the power averaged over a five second interval for the LM100 and LM200, and a two second interval for the LM300.

Note 2: These specifications apply for an operating temperature between -55°C to +125°C for the LM100, between -25°C to 85°C for the LM200 and between 0°C to 70°C for the LM300 devices for input and output voltages within the ranges given, and for a divider impedance seen by the feedback terminal of 2 k Ω , unless otherwise specified. The load and line regulation specifications are for constant junction temperature. Temperature drift effects must be taken into account separately when the unit is operating under conditions of high dissipation.

Note 3: The output currents given, as well as the load regulation, can be increased by the addition of external transistors. The improvement factor will be roughly equal to the composite current gain of the added transistors.

typical performance characteristics

Optimum Divider Resistance Values vs Output Voltage

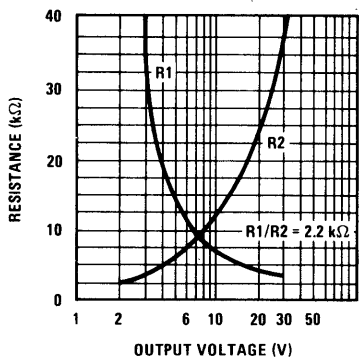

Minimum Input Voltage vs Junction Temperature

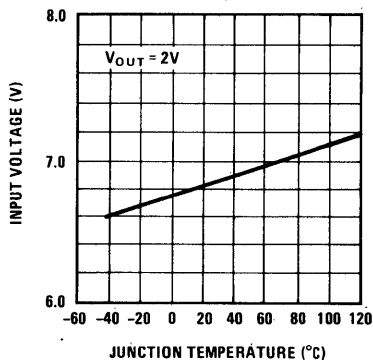

Minimum Load Current vs Input-Output Voltage Differential

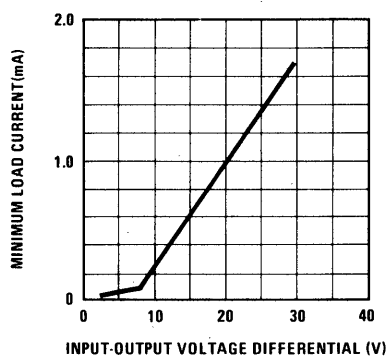

Supply Voltage Rejection vs Input-Output Voltage Differential

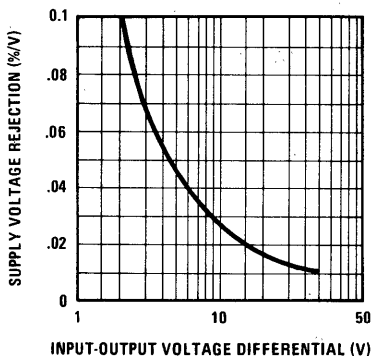

Load Transient Response

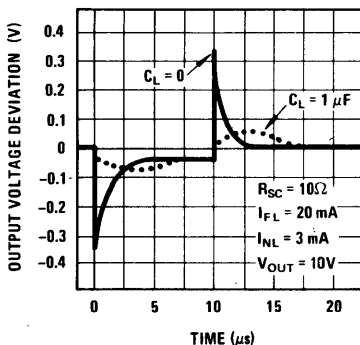

Line Transient Response

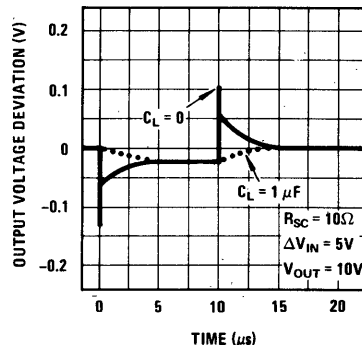

Current Limit Sense Voltage vs Junction Temperature

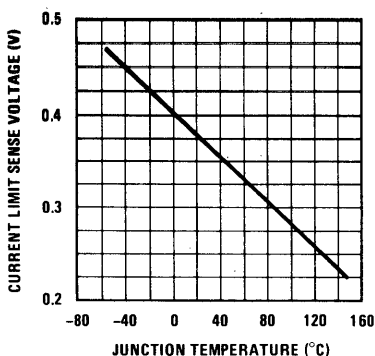

Regulation Characteristics Without Current Limiting

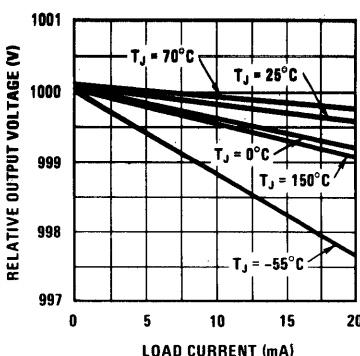

Regulator Dropout Voltage vs Junction Temperature

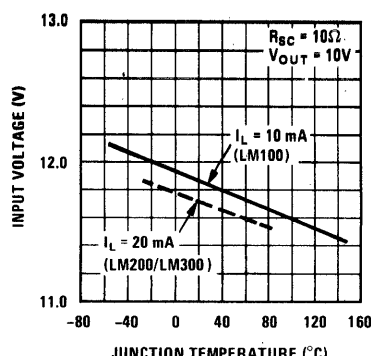

Short Circuit Current vs Junction Temperature

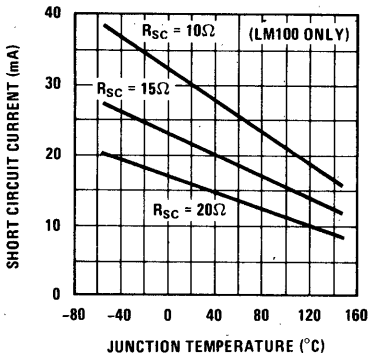

Regulation Characteristics With Current Limiting

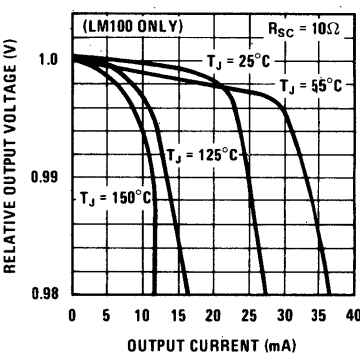

Current Limiting Characteristics

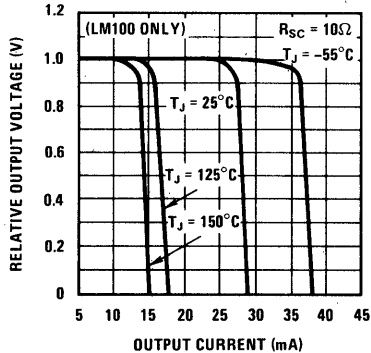



Voltage Regulators

LM103 regulator diode

general description

The LM103 is a two-terminal monolithic regulator diode electrically equivalent to a breakdown diode. The device makes use of the reverse punch-through of double-diffused transistors, combined with active circuitry, to produce a breakdown characteristic which is ten times sharper than single-junction zener diodes at low voltages. Breakdown voltages from 1.8V to 5.6V are available; and, although the design is optimized for operation between $100\ \mu\text{A}$ and $1\ \mu\text{A}$, it is completely specified from $10\ \mu\text{A}$ to 10 mA. Noteworthy features of the device are:

- Exceptionally sharp breakdown
- Low dynamic impedance from $10\ \mu\text{A}$ to 10 mA

- Performance guaranteed over full military temperature range
- Planar, passivated junctions for stable operation
- Low capacitance.

The LM103, packaged in a hermetically sealed, modified TO-46 header is useful in a wide range of circuit applications from level shifting to simple voltage regulation. It can also be employed with operational amplifiers in producing breakpoints to generate nonlinear transfer functions. Finally, its unique characteristics recommend it as a reference element in low voltage power supplies with input voltages down to 4V.

schematic and connection diagrams

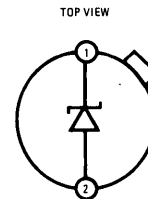
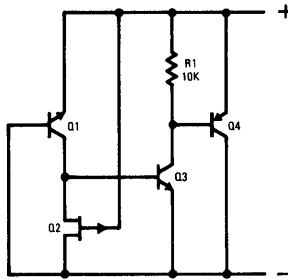

NOTE: Pin 2 connected to case.

typical applications

Saturating Servo Preamp with Rate Feedback

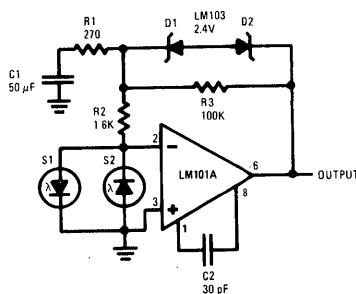

200 mA Positive Regulator

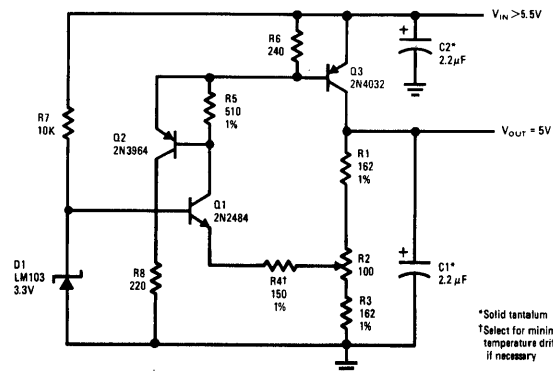

*Solid tantalum
†Select for minimum temperature drift, if necessary

absolute maximum ratings

Power Dissipation (note 1)	250 mW
Reverse Current	20 mA
Forward Current	100 mA
Operating Temperature Range	-55°C to 125°C
Storage Temperature Range	-65°C to 150°C
Lead Temperature (soldering, 60 sec)	300°C

electrical characteristics (Note 2)

PARAMETER	CONDITIONS	MIN	TYP	MAX	UNIT
Reverse Breakdown Voltage Change	$10 \mu\text{A} \leq I_R \leq 100 \mu\text{A}$		60	120	mV
	$100 \mu\text{A} \leq I_R \leq 1 \text{ mA}$		15	50	mV
	$1 \text{ mA} \leq I_R \leq 10 \text{ mA}$		50	150	mV
Reverse Dynamic Impedance (Note 3)	$I_R = 3 \text{ mA}$		5	25	Ω
	$I_R = 0.3 \text{ mA}$		15	60	Ω
Reverse Leakage Current	$V_R = V_Z - 0.2\text{V}$		2	5	μA
Forward Voltage Drop	$I_F = 10 \text{ mA}$	0.7	0.8	1.0	V
Peak-to-Peak Broadband Noise Voltage	$10 \text{ Hz} \leq f \leq 100 \text{ kHz}, I_R = 1 \text{ mA}$		300		μV
Reverse Breakdown Voltage Change (Note 4)	$10 \mu\text{A} \leq I_R \leq 100 \mu\text{A}$			200	mV
	$100 \mu\text{A} \leq I_R \leq 1 \text{ mA}$			60	mV
	$1 \text{ mA} \leq I_R \leq 10 \text{ mA}$			200	mV
Breakdown Voltage Temperature Coefficient (Note 4)	$100 \mu\text{A} \leq I_R \leq 1 \text{ mA}$		-5.0		$\text{mV}/^\circ\text{C}$

NOTE 1: For operating at elevated temperatures, the device must be derated based on a 150°C maximum junction temperature and a thermal resistance of 80°C/W junction to case or 440°C/W junction to ambient (see curve).

NOTE 2: These specifications apply for $T_A = 25^\circ\text{C}$ and $1.8\text{V} < V_Z < 5.6\text{V}$ unless stated otherwise. The diode should not be operated with shunt capacitances between 100 pF and 0.01 μF , unless isolated by at least a 50 Ω resistor, as it may oscillate at some currents.

NOTE 3: Measured with the peak-to-peak change of reverse current equal to 10 percent of the dc reverse current.

NOTE 4: These specifications apply for $-55^\circ\text{C} < T_A < 125^\circ\text{C}$.

guaranteed reverse characteristics

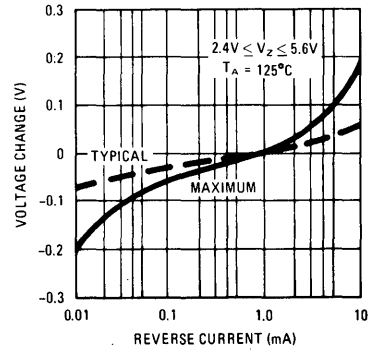
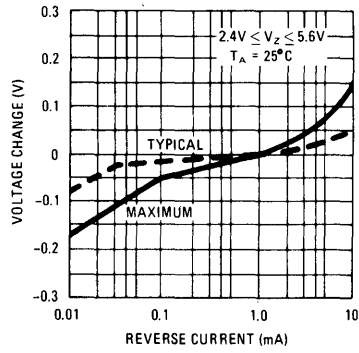
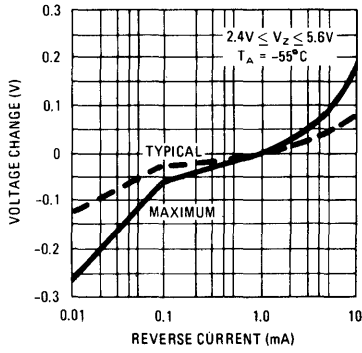

typical performance

Reverse Characteristics

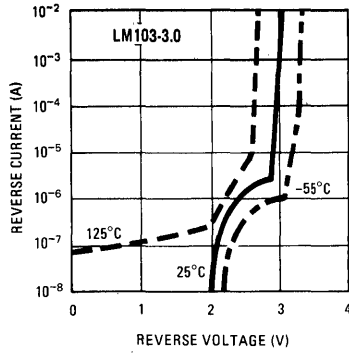

Reverse Dynamic Impedance

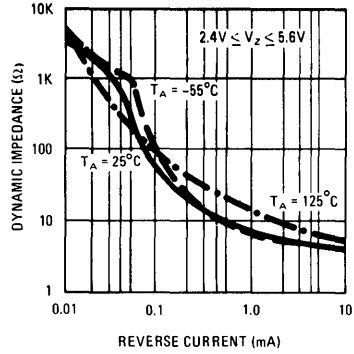

Temperature Drift

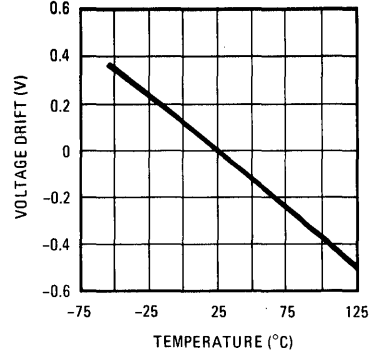

Forward Characteristics

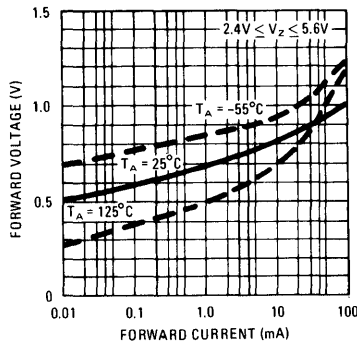

Response Time

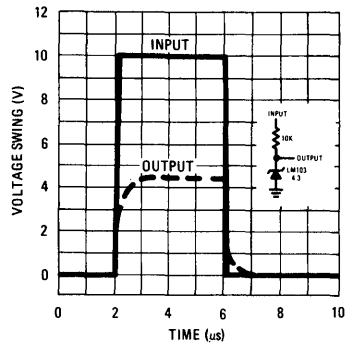

Maximum Power Dissipation

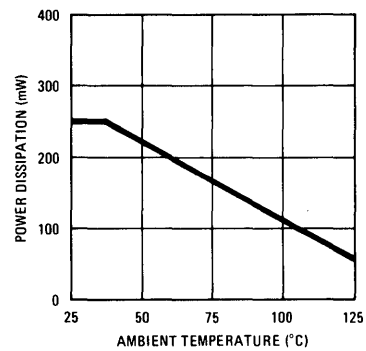

BREAKDOWN VOLTAGE*

- 1.8
- 2.0
- 2.2
- 2.4
- 2.7
- 3.0
- 3.3
- 3.6
- 3.9
- 4.3
- 4.7
- 5.1
- 5.6

PART NUMBER

- LM103-1.8
- LM103-2.0
- LM103-2.2
- LM103-2.4
- LM103-2.7
- LM103-3.0
- LM103-3.3
- LM103-3.6
- LM103-3.9
- LM103-4.3
- LM103-4.7
- LM103-5.1
- LM103-5.6

*Measured at $I_R = 1 \text{ mA}$.
Standard tolerance is $\pm 10\%$.



Voltage Regulators

LM104/LM204 negative regulators general description

The LM104 and LM204 are precision voltage regulators which can be programmed by a single external resistor to supply any voltage from 40V down to zero while operating from a single unregulated supply. They can also provide 0.01-percent regulation in circuits using a separate, floating bias supply, where the output voltage is limited only by the breakdown of external pass transistors. Although designed primarily as linear, series regulators, the circuits can be used as switching regulators, current regulators or in a number of other control applications. Typical performance characteristics are:

- 0.01%/V line regulation
- 0.2 mV/V ripple rejection
- 0.3% temperature stability over military temperature range

The LM104 and LM204 are complements of the LM100 and LM105 positive regulators, intended for systems requiring regulated negative voltages which have a common ground with the unregulated supply. By themselves, they can deliver output currents to 25 mA, but external transistors can be added to get any desired current. The output voltage is set by external resistors, and either constant or foldback current limiting is made available.

- 1 mV regulation no load to full load

schematic and connection diagrams

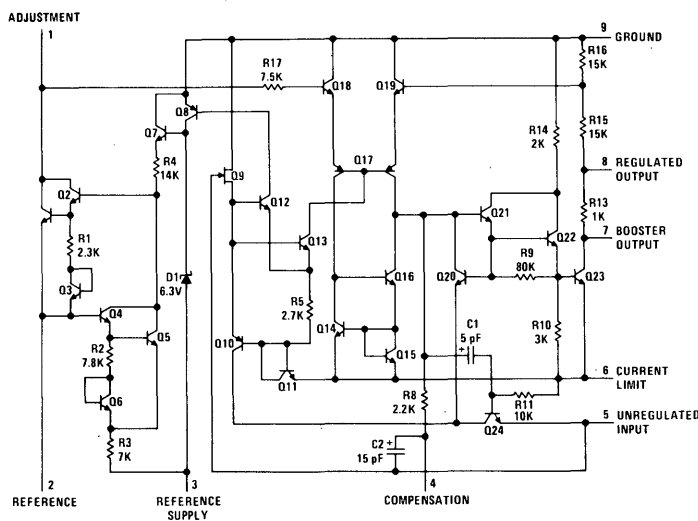

Metal Can

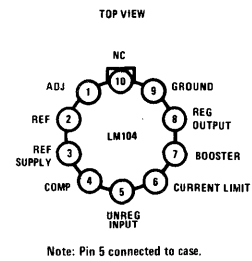

Flat Package

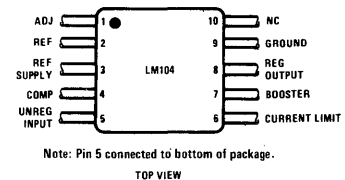

typical applications

Operating with Separate Bias Supply

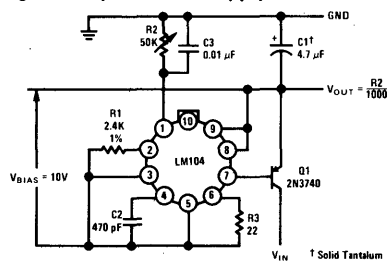

High Current Regulator

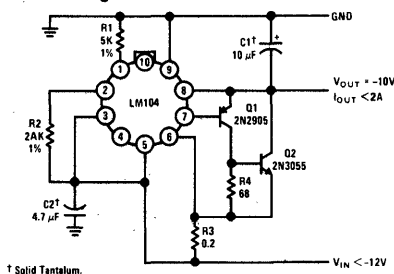

Basic Regulator Circuit

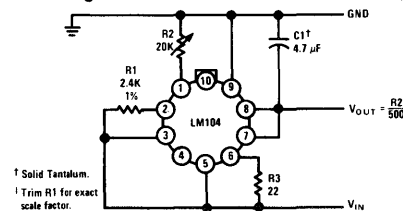

Switching Regulator

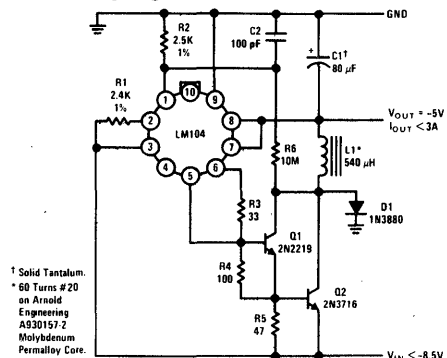

absolute maximum ratings

Input Voltage	50V
Input-Output Voltage Differential	50V
Power Dissipation (Note 1)	500 mW
Operating Temperature Range	
LM104	-55°C to 125°C
LM204	-25°C to 85°C
Storage Temperature Range	-65°C to 150°C
Lead Temperature (Soldering, 10 sec)	300°C

electrical characteristics (Note 2)

PARAMETER	CONDITIONS	MIN	TYP	MAX	UNITS
Input Voltage Range		-50		-8	V
Output Voltage Range		-40		-0.015	V
Output-Input Voltage Differential (Note 3)	$I_O = 20 \text{ mA}$	2.0		50	V
	$I_O = 5 \text{ mA}$	0.5		50	V
Load Regulation (Note 4)	$0 \leq I_O \leq 20 \text{ mA}$ $R_{SC} = 15\Omega$		1	5	mV
Line Regulation (Note 5)	$V_{OUT} \leq -5V$ $\Delta V_{IN} = 0.1 V_{IN}$		0.056	0.1	%
Ripple Rejection	$C_{19} = 10 \mu\text{F}$, $f = 120 \text{ Hz}$ $V_{IN} < -15V$		0.2	0.5	mV/V
	$-7V \geq V_{IN} \geq -15V$		0.5	1.0	mV/V
Output Voltage Scale Factor	$R_{23} = 2.4k$	1.8	2.0	2.2	V/k Ω
Temperature Stability	$V_O \leq -1V$		0.3	1.0	%
Output Noise Voltage	$10 \text{ Hz} \leq f \leq 10 \text{ kHz}$ $V_O \leq -5V$, $C_{19} = 0$		0.007		%
	$C_{19} = 10 \mu\text{F}$		15		μV
Standby Current Drain	$I_L = 5 \text{ mA}$, $V_O = 0$		1.7	2.5	mA
	$V_O = -40V$		3.6	5.0	mA
Long Term Stability	$V_O \leq -1V$		0.1	1.0	%

Note 1: The maximum junction temperature of the LM104 is 150°C, while that of the LM204 is 100°C. For operating at elevated temperatures, devices in the TO-5 package must be derated based on a thermal resistance of 150°C/W, junction to ambient, or 45°C/W, junction to case. For the flat package, the derating is based on a thermal resistance of 185°C/W when mounted on a 1/16-inch-thick epoxy glass board with ten, 0.03-inch-wide, 2-ounce copper conductors.

Note 2: These specifications apply for junction temperatures between -55°C and 150°C (between -25°C and 100°C for the LM204) and for input and output voltages within the ranges given, unless otherwise specified. The load and line regulation specifications are for constant junction temperature. Temperature drift effects must be taken into account separately when the unit is operating under conditions of high dissipation.

Note 3: When external booster transistors are used, the minimum output-input voltage differential is increased, in the worst case, by approximately 1V.

Note 4: The output currents given, as well as the load regulation, can be increased by the addition of external transistors. The improvement factor will be roughly equal to the composite current gain of the added transistors.

Note 5: With zero output, the dc line regulation is determined from the ripple rejection. Hence, with output voltages between 0V and -5V, a dc output variation, determined from the ripple rejection, must be added to find the worst-case line regulation.

typical performance characteristics

Load Regulation

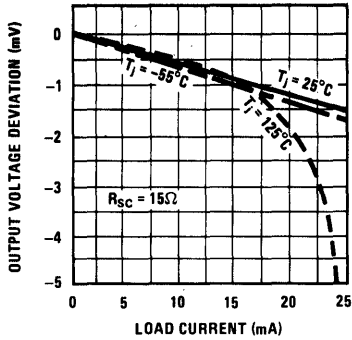

Load Regulation

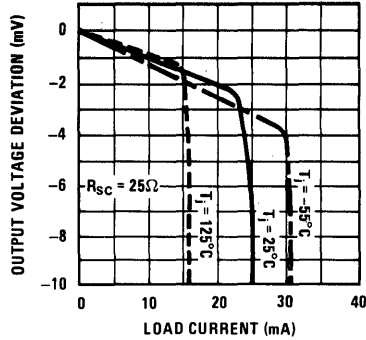

Current Limiting

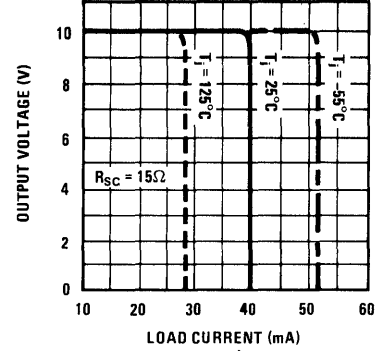

Supply Voltage Rejection

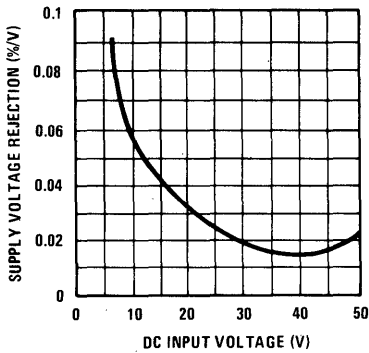

Supply Voltage Rejection With Preregulated Reference Supply

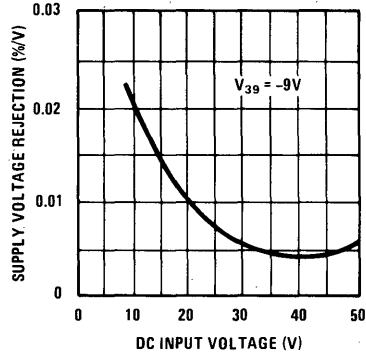

Ripple Rejection

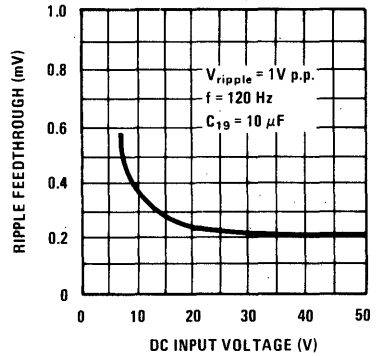

Current Limit Sense Voltage

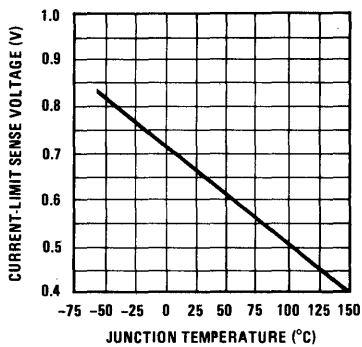

Regulator Dropout Voltage

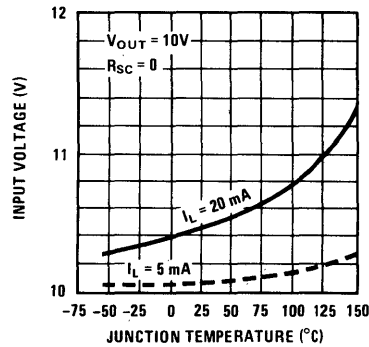

Minimum Input Voltage

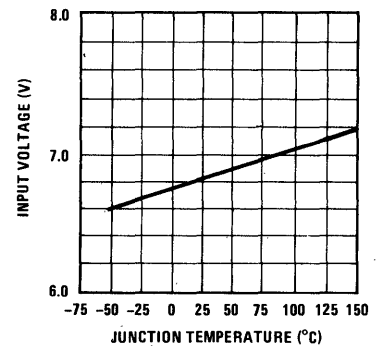

Line Transient Response

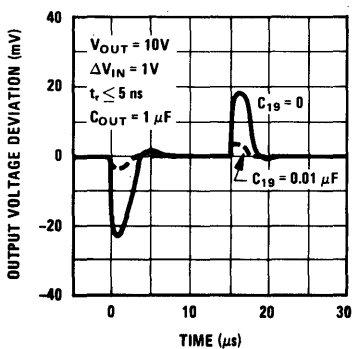

Load Transient Response

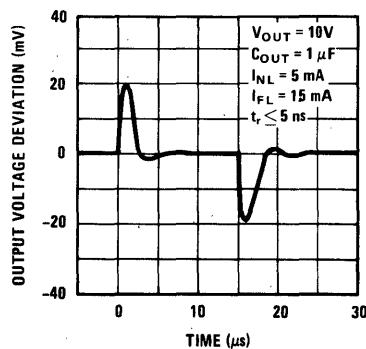

Standby Current Drain

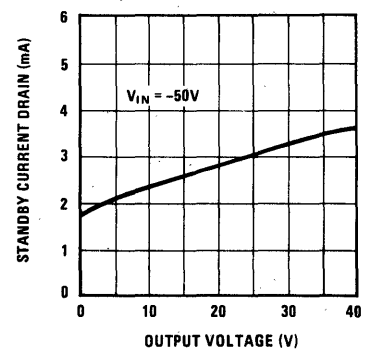



Voltage Regulators

LM304 negative regulator general description

The LM304 is a precision voltage regulator which can be programmed by a single external resistor to supply any voltage from 30V down to zero while operating from a single unregulated supply. It can also provide 0.01-percent regulation in circuits using a separate, floating bias supply, where the output voltage is limited only by the breakdown of external pass transistors. Although designed primarily as a linear, series regulator, the circuit can be used as a switching regulator, a current regulator or in a number of other control applications. Typical performance characteristics are:

- 1 mV regulation no load to full load
- 0.01%/V line regulation

- 0.2 mV/V ripple rejection

The LM304 is a complement of the LM300 and LM305 positive regulators, intended for systems requiring regulated negative voltages which have a common ground with the unregulated supply. By itself, it can deliver output currents to 25 mA, but external transistors can be added to get any desired current. The output voltage is set by external resistors, and either constant or foldback current limiting is made available. The LM304 is a commercial/industrial version of the LM104 and LM204.

schematic and connection diagrams

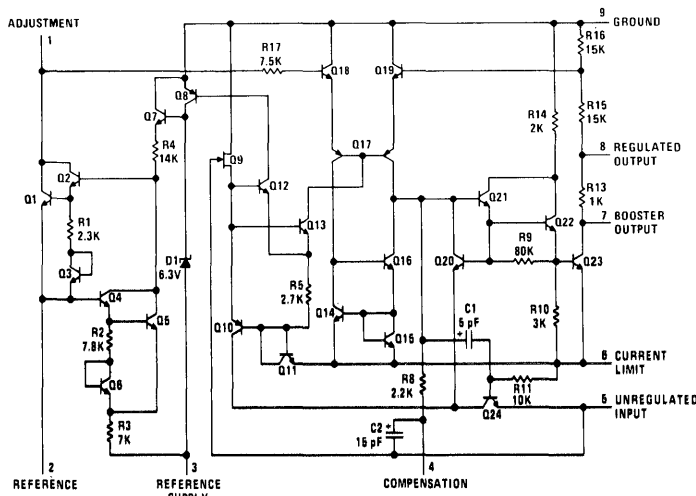

Metal Can

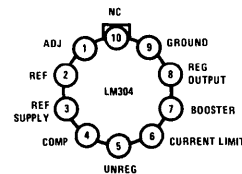

Note: Pin 5 connected to case.

TOP VIEW

Flat Package

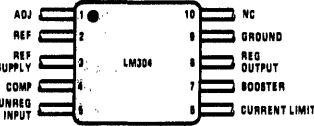

Note: Pin 6 connected to bottom of package.

TOP VIEW

typical applications

Operating with Separate Bias Supply

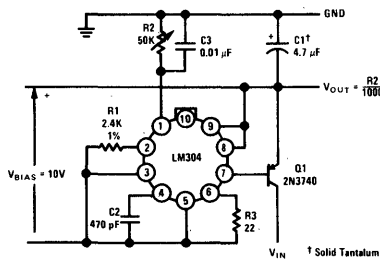

High Current Regulator

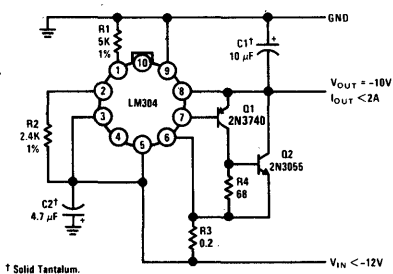

Basic Regulator Circuit

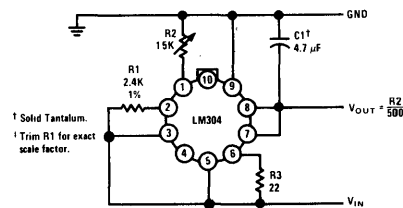

Switching Regulator

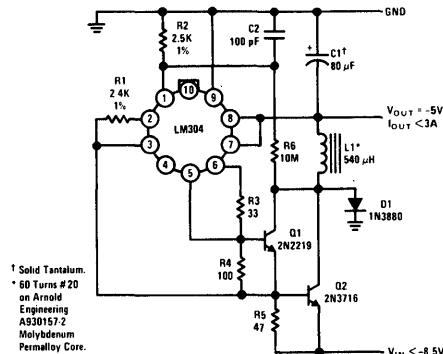

absolute maximum ratings

Input Voltage	40V
Input-Output Voltage Differential	40V
Power Dissipation (Note 1)	500 mW
Operating Temperature Range	0°C to 70°C
Storage Temperature Range	-65°C to 150°C
Lead Temperature (Soldering, 10 sec)	300°C

electrical characteristics (Note 2)

PARAMETER	CONDITIONS	MIN	TYP	MAX	UNITS
Input Voltage Range		-40		-8	V
Output Voltage Range		-30		-0.035	V
Output-Input Voltage Differential (Note 3)	$I_O = 20 \text{ mA}$ $I_O = 5 \text{ mA}$	2.0 0.5		40 40	V V
Load Regulation (Note 4)	$0 \leq I_O \leq 20 \text{ mA}$ $R_{SC} = 15\Omega$		1	5	mV
Line Regulation (Note 5)	$V_{OUT} \leq -5V$ $\Delta V_{IN} = 0.1 V_{IN}$		0.056	0.1	%
Ripple Rejection	$C_{19} = 10 \mu\text{F}$, $f = 120 \text{ Hz}$ $V_{IN} < -15V$ $-7V \geq V_{IN} \geq -15V$		0.2 0.5	0.5 1.0	mV/V mV/V
Output Voltage Scale Factor	$R_{23} = 2.4K$	1.8	2.0	2.2	V/K Ω
Temperature Stability	$V_O \leq -1V$, $0^\circ\text{C} \leq T_A \leq 70^\circ\text{C}$		0.3	1.0	%
Output Noise Voltage	$10 \text{ Hz} \leq f \leq 10 \text{ KHz}$ $V_O \leq -5V$, $C_{19} = 0$ $C_{19} = 10 \mu\text{F}$		0.007 15		% μV
Standby Current Drain	$I_L = 5 \text{ mA}$, $V_O = 0$ $V_O = -30V$		1.7 3.6	2.5 5.0	mA mA
Long Term Stability	$V_O \leq -1V$		0.1	1.0	%

Note 1: For operating at elevated temperatures, the device must be derated based on an 85°C maximum junction temperature and a thermal resistance of 45°C/W junction to case or 150°C/W junction to ambient. Peak dissipations to 1.0W are allowable providing the dissipation rating is not exceeded with the power averaged over a two second interval.

Note 2: These specifications apply for junction temperatures between 0°C and 85°C and for input and output voltages within the ranges given, unless otherwise specified. The load and line regulation specifications are for constant junction temperature. Temperature drift effects must be taken into account separately when the unit is operating under conditions of high dissipation.

Note 3: When external booster transistors are used, the minimum output-input voltage differential is increased, in the worst case, by approximately 1V.

Note 4: The output currents given, as well as the load regulation, can be increased by the addition of external transistors. The improvement factor will be roughly equal to the composite current gain of the added transistors.

Note 5: With zero output, the dc line regulation is determined from the ripple rejection. Hence, with output voltages between 0V and -5V, a dc output variation, determined from the ripple rejection, must be added to find the worst-case line regulation.

typical performance characteristics

Load Regulation

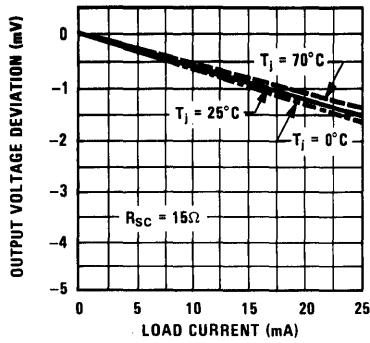

Load Regulation

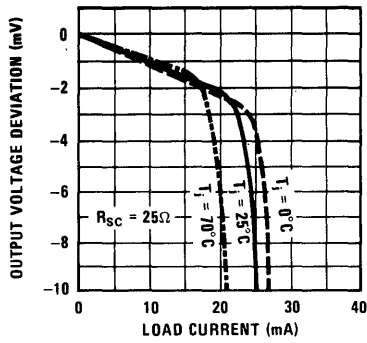

Current Limiting

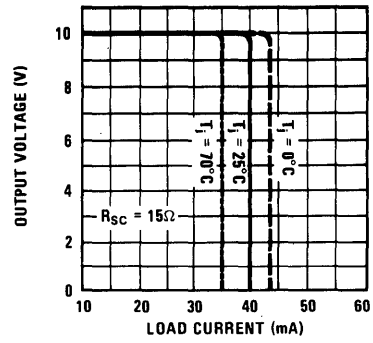

Supply Voltage Rejection

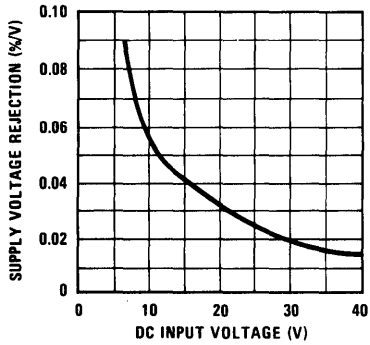

Supply Voltage Rejection With Preregulated Reference Supply

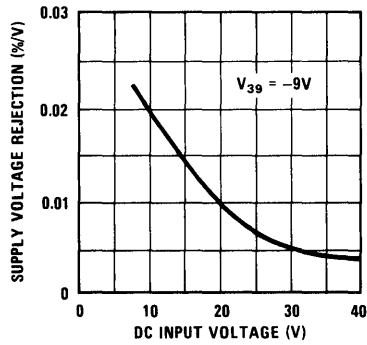

Ripple Rejection

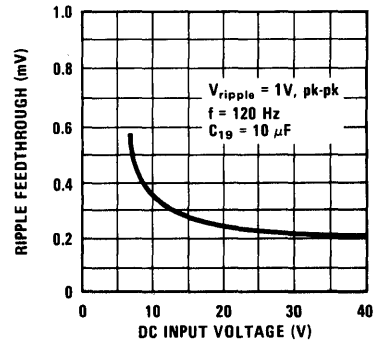

Current Limit Sense Voltage

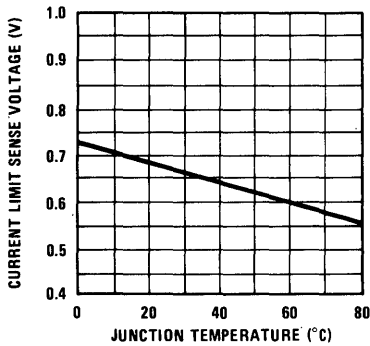

Regulator Dropout Voltage

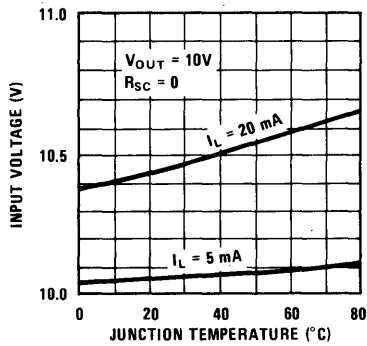

Minimum Input Voltage

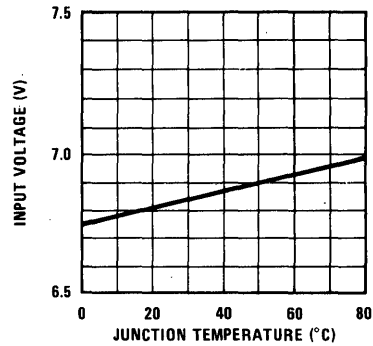

Line Transient Response

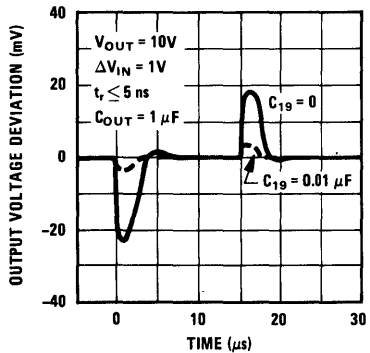

Load Transient Response

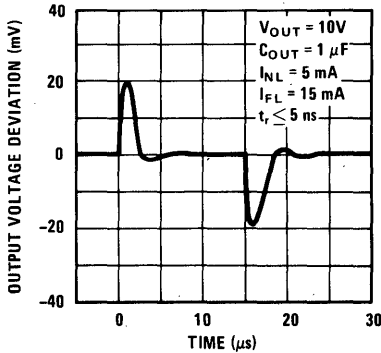

Standby Current Drain

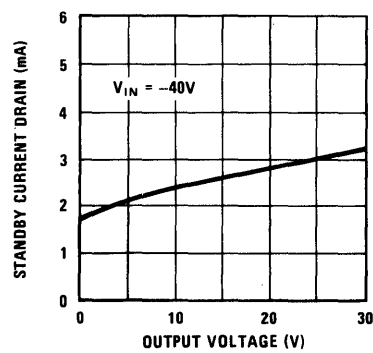



Voltage Regulators

LM105/LM205/LM305 voltage regulator

general description

The LM105, LM205 and LM305 are positive voltage regulators similar to the LM100, except that an extra gain stage has been added for improved regulation. A redesign of the biasing circuitry removes any minimum load current requirement and at the same time reduces standby current drain, permitting higher voltage operation. They are direct, plug-in replacements for the LM100 in both linear and switching regulator circuits with output voltages greater than 4.5V. Important characteristics of the circuits are:

- Output voltage adjustable from 4.5V to 40V
- Output currents in excess of 10A possible by adding external transistors
- Load regulation better than 0.1%, full load with current limiting

- DC line regulation guaranteed at 0.03%/V
- Ripple rejection of 0.01%/V

Like the LM100, they also feature fast response to both load and line transients, freedom from oscillations with varying resistive and reactive loads and the ability to start reliably on any load within rating. The circuits are built on a single silicon chip and are supplied in either an 8-lead, TO-5 header or a 1/4" x 1/4" metal flat package.

The LM205 is identical to the LM105 except that it is specified for operation from -25°C to 85°C.

The LM305 is specified for operation from 0°C to 70°C and for output voltages to 30V.

schematic and connection diagrams

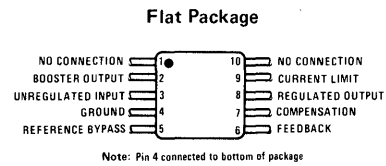
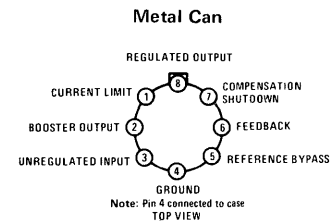
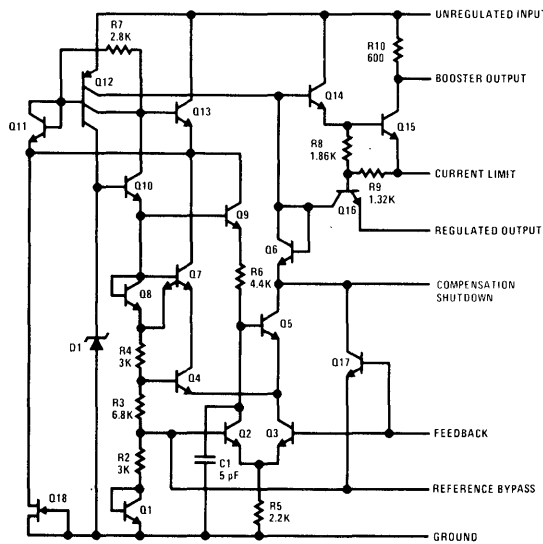

typical applications

10A Regulator with Foldback Current Limiting

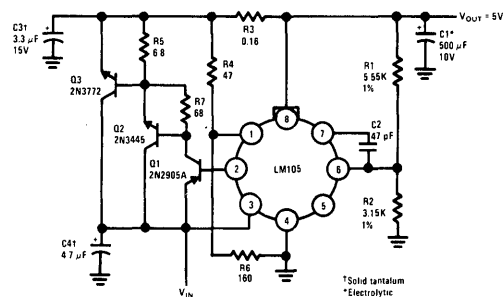

1.0A Regulator with Protective Diodes

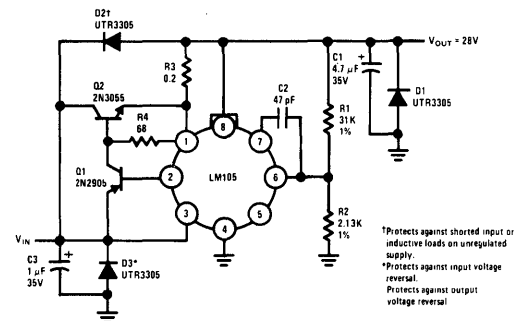

absolute maximum ratings

Input Voltage	
LM105, LM205	50V
LM305	40V
Input-Output Voltage Differential	40V
Power Dissipation (Note 1)	
LM105, LM205	800 mW
LM305	500 mW
Operating Temperature Range	0°C to 70°C
LM105	-55°C to +85°C
LM205	-25°C to +150°C
LM305	0°C to 70°C
Storage Temperature Range	-65°C to 150°C
Lead Temperature (Soldering, 10 sec)	300°C

electrical characteristics (Note 2)

PARAMETER	CONDITIONS	MIN	TYP	MAX	UNITS
Input Voltage Range					
LM105, LM205		8.5		50	V
LM305		8.5		40	V
Output Voltage Range					
LM105, LM205		4.5		40	V
LM305		4.5		30	V
Output-Input Voltage Differential		3.0		30	V
Load Regulation (Note 3)					
LM105	$0 \leq I_o \leq 12 \text{ mA}$ $R_{SC} = 18\Omega, T_A = 25^\circ\text{C}$ $R_{SC} = 10\Omega, T_A = 125^\circ\text{C}$ $R_{SC} = 18\Omega, T_A = -55^\circ\text{C}$		0.02 0.03 0.03	0.05 0.1 0.1	% % %
LM205	$0 \leq I_o \leq 12 \mu\text{A}$ $R_{SC} = 18\Omega, T_A = 25^\circ\text{C}$ $R_{SC} = 10\Omega, T_A = 85^\circ\text{C}$ $R_{SC} = 18\Omega, T_A = -25^\circ\text{C}$		0.02 0.03 0.03	0.05 0.1 0.1	% % %
LM305	$0 \leq I_o \leq 12 \text{ mA}$ $R_{SC} = 18\Omega, T_A = 25^\circ\text{C}$ $R_{SC} = 15\Omega, T_A = 70^\circ\text{C}$ $R_{SC} = 18\Omega, T_A = 0^\circ\text{C}$		0.02 0.03 0.03	0.05 0.1 0.0	% % %
Line Regulation	$V_{IN} - V_{OUT} \leq 5\text{V}$ $V_{IN} - V_{OUT} > 5\text{V}$		0.025 0.015	0.06 0.03	%/V %/V
Ripple Rejection	$C_{REF} = 10 \mu\text{F}, f = 120 \text{ Hz}$		0.003	0.01	%/V
Temperature Stability					
LM105	$-55^\circ\text{C} \leq T_A \leq 125^\circ\text{C}$		0.3	1.0	%
LM205	$-25^\circ\text{C} \leq T_A \leq 85^\circ\text{C}$		0.3	1.0	%
LM305	$0^\circ\text{C} \leq T_A \leq 70^\circ\text{C}$		0.3	1.0	%
Feedback Sense Voltage		1.63	1.7	1.81	V
Output Noise Voltage	$10 \text{ Hz} \leq f \leq 10 \text{ kHz}$ $C_{REF} = 0$ $C_{REF} > 0.1 \mu\text{F}$		0.005 0.002		% %
Standby Current Drain					
LM105, LM205	$V_{IN} = 40\text{V}$		0.8	2.0	mA
LM305	$V_{IN} = 50\text{V}$		0.8	2.0	mA
Long Term Stability			0.1	1.0	%

Note 1: The maximum junction temperature of the LM105 is 150°C, while that for the LM205 is 100°C, and that for the LM305 is 85°C. For operating at elevated temperatures, devices in the TO-5 package must be derated based on a thermal resistance of 150°C/W, junction to ambient, or 45°C/W, junction to case. For the flat package, the derating is based on a thermal resistance of 185°C/W when mounted on a 1/16-inch-thick epoxy glass board with ten, 0.03-inch-wide, 2-ounce copper conductors. Peak dissipations to 1W are allowable providing the dissipation rating is not exceeded with the power averaged over a five second interval for the LM105 and LM205, and averaged over a two second interval for the LM305.

Note 2: These specifications apply for input and output voltages within the ranges given, and for a divider impedance seen by the feedback terminal of 2 kΩ, unless otherwise specified. The load and line regulation specifications are for constant junction temperature. Temperature drift effects must be taken into account separately when the unit is operating under conditions of high dissipation. With the LM205, however, all temperature specifications are limited to -25°C to 85°C.

Note 3: The output currents given, as well as the load regulation, can be increased by the addition of external transistors. The improvement factor will be roughly equal to the composite current gain of the added transistors.

typical performance characteristics

Load Regulation

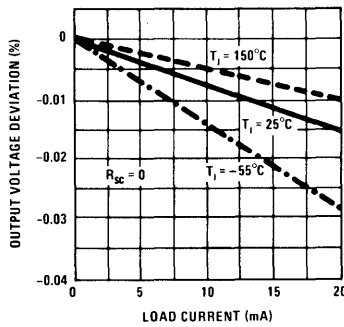

Load Regulation

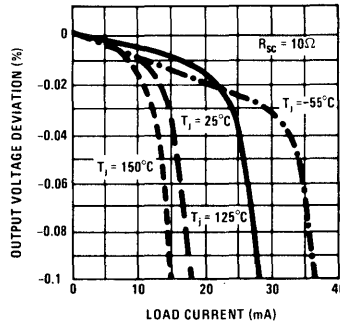

Current Limiting Characteristics

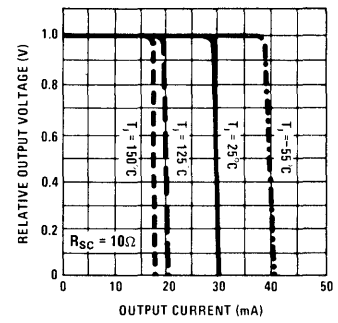

Current Limit Sense Voltage

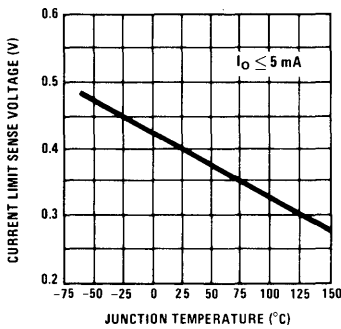

Short Circuit Current

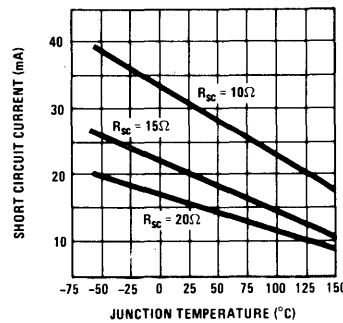

Optimum Divider Resistance Values

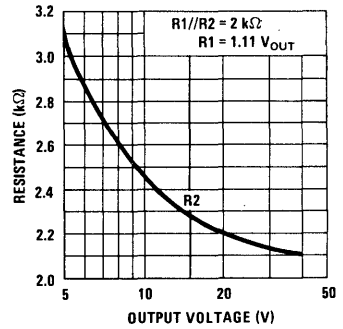

Minimum Input Voltage

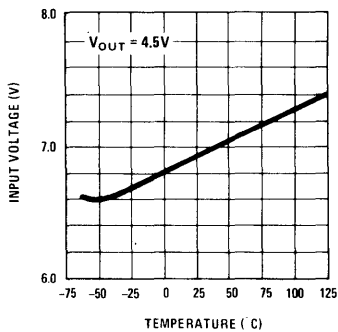

Regulator Dropout Voltage

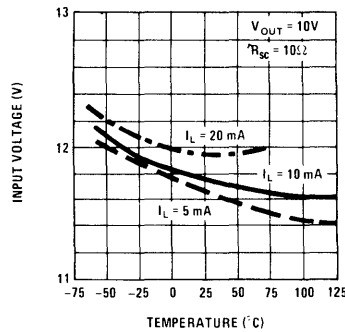

Supply Voltage Rejection

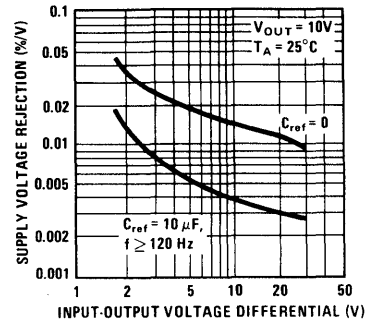

Minimum Output Voltage

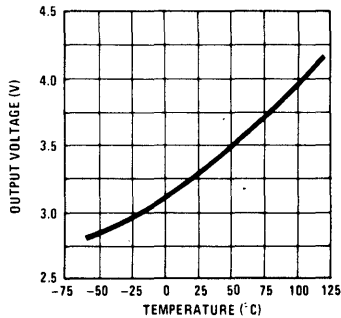

Standby Current Drain

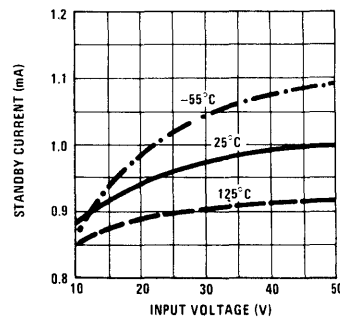

Transient Response

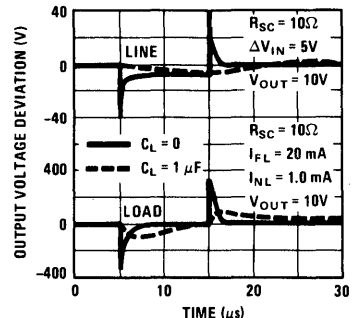



Voltage Regulators

LM305A voltage regulator general description

The LM305A is a positive voltage regulator designed primarily for commercial series regulator applications. By itself, it will supply output currents up to 45 mA; but external transistors can be added to provide any desired load current. The circuit features extremely low standby current drain, and provision is made for either linear or foldback current limiting. Important characteristics are:

- 45 mA output current without external pass transistor

- Output currents in excess of 10A possible by adding external transistors
- Maximum input voltage = 50V
- Output voltage adjustable from 4.5V to 40V
- Can be used as either a linear or a switching regulator

The LM305A is also useful in a wide range of other applications such as a shunt regulator, a current regulator or a temperature controller.

schematic and connection diagrams

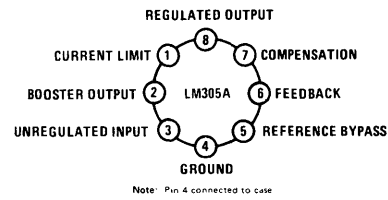
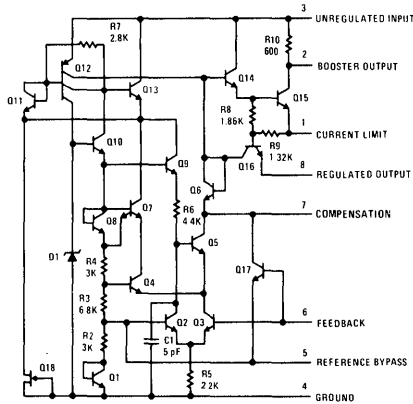

typical applications

Linear Regulator with Foldback Current Limiting

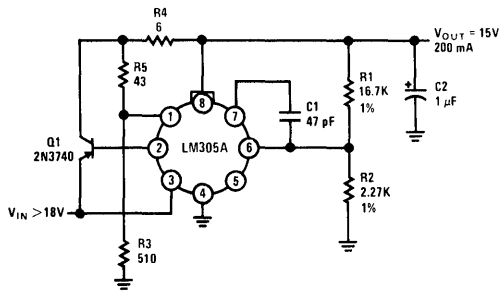

Current Regulator

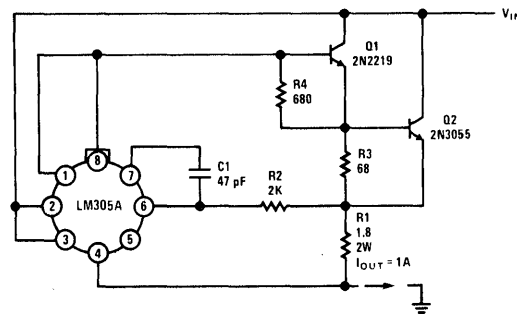

Shunt Regulator

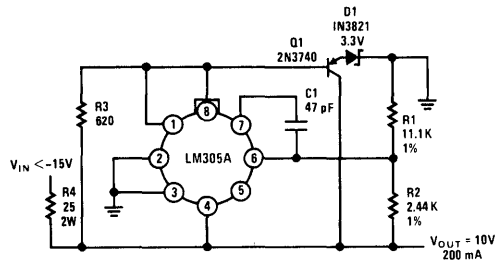

Switching Regulator

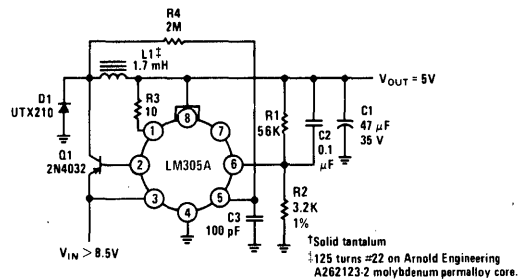

absolute maximum ratings

Input Voltage	50V
Input-Output Voltage Differential	40V
Power Dissipation (Note 1)	800 mW
Operating Temperature Range	0°C to 70°C
Storage Temperature Range	-65°C to 150°C
Lead Temperature (Soldering, 60 sec)	300°C

electrical characteristics (Note 2)

PARAMETER	CONDITIONS	MIN	TYP	MAX	UNITS
Input Voltage Range		8.5		50	V
Output Voltage Range		4.5		40	V
Output-Input Voltage Differential		3.0		30	V
Load Regulation (Note 3)	$0 \leq I_O \leq 45 \text{ mA}$ $R_{SC} = 0\Omega, T_A = 25^\circ\text{C}$ $R_{SC} = 0\Omega, T_A = 70^\circ\text{C}$ $R_{SC} = 0\Omega, T_A = 0^\circ\text{C}$		0.02 0.03 0.03	0.2 0.4 0.4	%
Line Regulation	$V_{IN} - V_{OUT} \leq 5\text{V}$ $V_{IN} - V_{OUT} > 5\text{V}$		0.025 0.015	0.06 0.03	%/V %/V
Ripple Rejection	$C_{REF} = 10 \mu\text{F}, f = 120 \text{ Hz}$		0.003		%/V
Temperature Stability	$0^\circ\text{C} \leq T_A \leq 70^\circ\text{C}$		0.3	1.0	%
Feedback Sense Voltage		1.55	1.7	1.85	V
Output Noise Voltage	$10 \text{ Hz} \leq f \leq 10 \text{ kHz}$ $C_{REF} = 0$ $C_{REF} > 0.1 \mu\text{F}$		0.005 0.002		% %
Current Limit Sense Voltage (Note 4)	$R_{SC} = 10\Omega, T_A = 25^\circ\text{C},$ $V_{OUT} = 0\text{V}$	225	300	375	mV
Standby Current Drain	$V_{IN} = 50\text{V}$		0.8	2.0	mA
Long Term Stability			0.1	1.0	%

Note 1: For operating at elevated temperatures, the device must be derated based on a 150°C maximum junction temperature and a thermal resistance of 45°C/W junction to case or 150°C/W junction to ambient.

Note 2: These specifications apply for an operating temperature between 0°C and 70°C, for input and output voltages within the ranges given, and for a divider impedance seen by the feedback terminal of 2 K Ω , unless otherwise specified. The load and line regulation specifications are for constant junction temperature. Temperature drift effects must be taken into account separately when the unit is operating under conditions of high dissipation.

Note 3: The output currents given, as well as the load regulation, can be increased by the addition of external transistors. The improvement factor will be roughly equal to the composite current gain of the added transistors.

Note 4: With no external pass transistor.



Voltage Regulators

LM109/LM209 five-volt regulators

general description

The LM109 and LM209 are complete 5V regulators fabricated on a single silicon chip. They are designed for local regulation on digital logic cards, eliminating the distribution problems associated with single-point regulation. The devices are available in two common transistor packages. In the solid-kovar TO-5 header, it can deliver output currents in excess of 200 mA, if adequate heat sinking is provided. With the TO-3 power package, the available output current is greater than 1A.

The regulators are essentially blow-out proof. Current limiting is included to limit the peak output current to a safe value. In addition, thermal shutdown is provided to keep the IC from overheating. If internal dissipation becomes too great, the regulator will shut down to prevent excessive heating.

Considerable effort was expended to make these devices easy to use and minimize the number of external components. It is not necessary to bypass the output, although this does improve transient

response somewhat. Input bypassing is needed, however, if the regulator is located very far from the filter capacitor of the power supply. Stability is also achieved by methods that provide very good rejection of load or line transients as are usually seen with TTL logic.

Although designed primarily as a fixed-voltage regulator, the output of the LM109 and LM209 can be set to voltages above 5V, as shown below. It is also possible to use the circuits as the control element in precision regulators, taking advantage of the good current-handling capability and the thermal overload protection.

To summarize, outstanding features of the regulator are:

- Specified to be complete, worst case, with TTL and DTL
- Output current in excess of 1A
- Internal thermal overload protection
- No external components required

schematic diagram

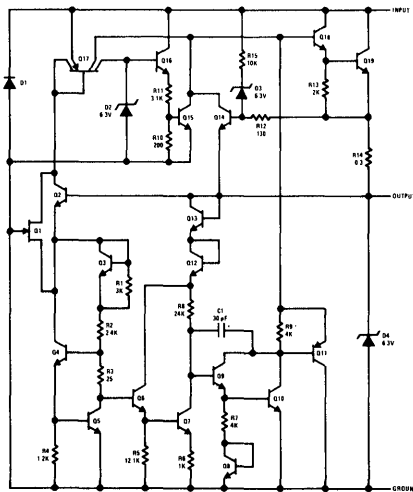

typical applications

High Stability Regulator*

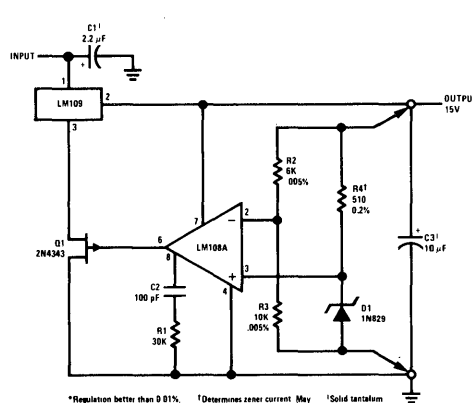

*Regulation better than 0.01%
 †Determines zener current. May be adjusted to minimize thermal drift.
 ‡Solid tantalum

Fixed 5V Regulator

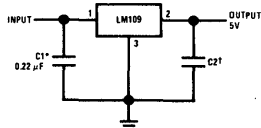

*Required if regulator is located an appreciable distance from power supply filter.
 †Although no output capacitor is needed for stability, it does improve transient response.

Adjustable Output Regulator

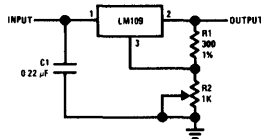

Current Regulator

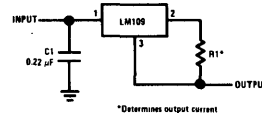

*Determines output current

absolute maximum ratings

Input Voltage	35V
Power Dissipation	Internally Limited
Operating Junction Temperature Range	-55°C to 150°C
Storage Temperature Range	-65°C to 150°C
Lead Temperature (Soldering, 10 sec)	300°C

design characteristics (Note 1)

PARAMETER	CONDITIONS	MIN	TYP	MAX	UNITS
Output Voltage	$T_j = 25^\circ\text{C}$	4.7	5.05	5.3	V
Line Regulation	$T_j = 25^\circ\text{C}$ $7\text{V} \leq V_{\text{IN}} \leq 25\text{V}$		4	50	mV
Load Regulation	$T_j = 25^\circ\text{C}$				
LM109H	$5\text{mA} \leq I_{\text{OUT}} \leq 0.5\text{A}$		20	50	mV
LM109K	$5\text{mA} \leq I_{\text{OUT}} \leq 1.5\text{A}$		50	100	mV
Output Voltage	$7\text{V} \leq V_{\text{IN}} \leq 25\text{V}$ $5\text{mA} \leq I_{\text{OUT}} \leq I_{\text{max}}$ $P < P_{\text{max}}$	4.6		5.4	V
Quiescent Current	$7\text{V} \leq V_{\text{IN}} \leq 25\text{V}$		5.2	10	mA
Quiescent Current Change	$7\text{V} \leq V_{\text{IN}} \leq 25\text{V}$ $5\text{mA} \leq I_{\text{OUT}} \leq I_{\text{max}}$			0.5 0.8	mA mA
Output Noise Voltage	$T_A = 25^\circ\text{C}$ $10\text{Hz} \leq f \leq 100\text{kHz}$		40		μV
Long Term Stability				10	mV
Thermal Resistance					
Junction to Case (Note 2)					
LM109H			15		$^\circ\text{C/W}$
LM109K			3		$^\circ\text{C/W}$

Note 1: Unless otherwise specified, these specifications apply for $-55^\circ\text{C} \leq T_j \leq 150^\circ\text{C}$ ($-25^\circ\text{C} \leq T_j \leq 150^\circ\text{C}$ for the LM209), $V_{\text{IN}} = 10\text{V}$ and $I_{\text{OUT}} = 0.1\text{A}$ for the TO-5 package or $I_{\text{OUT}} = 0.5\text{A}$ for the TO-3 package. For the TO-5 package, $I_{\text{max}} = 0.2\text{A}$ and $P_{\text{max}} = 2.0\text{W}$. For the TO-3 package, $I_{\text{max}} = 1.0\text{A}$ and $P_{\text{max}} = 20\text{W}$.

Note 2: Without a heat sink, the thermal resistance of the TO-5 package is about 150°C/W , while that of the TO-3 package is approximately 35°C/W . With a heat sink, the effective thermal resistance can only approach the values specified, depending on the efficiency of the sink.

typical performance

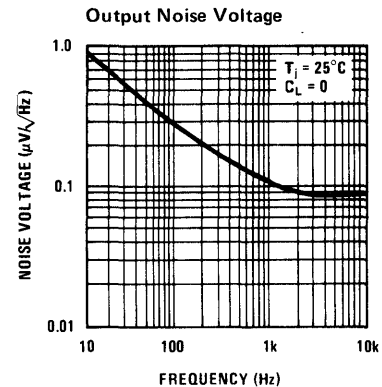
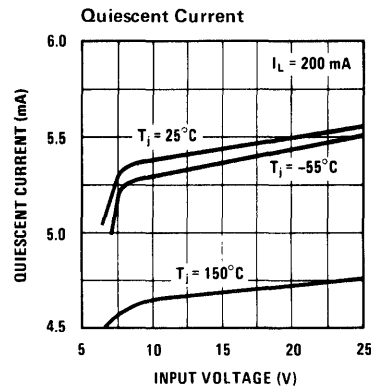
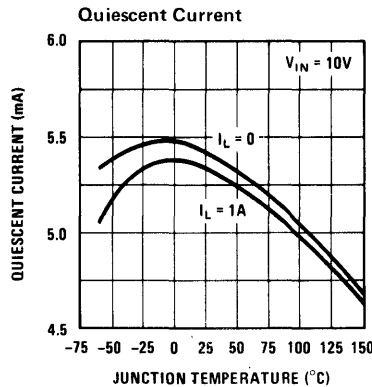
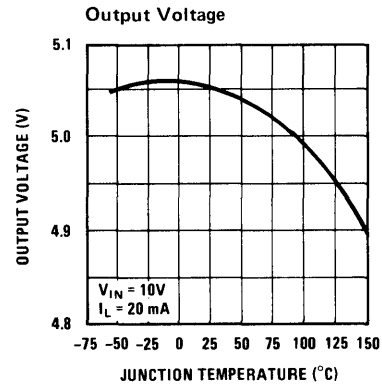
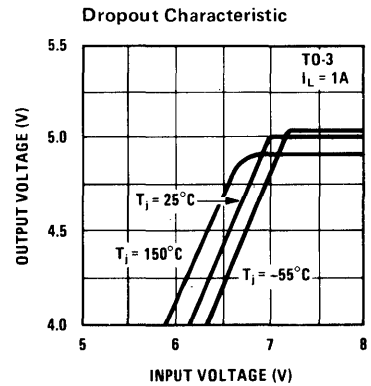
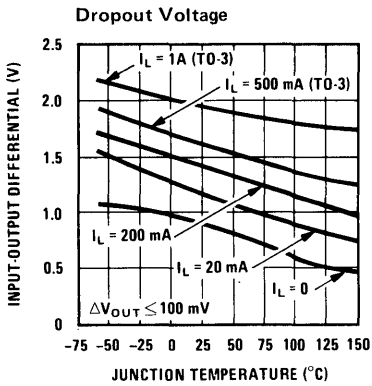
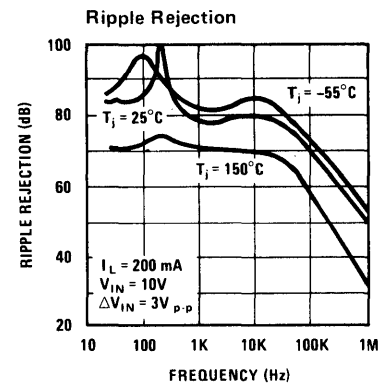
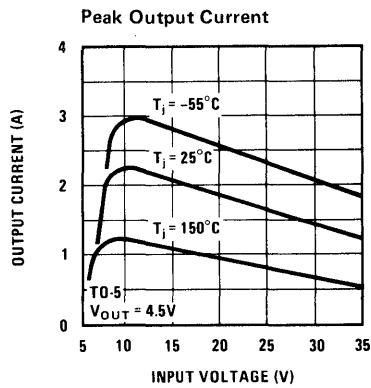
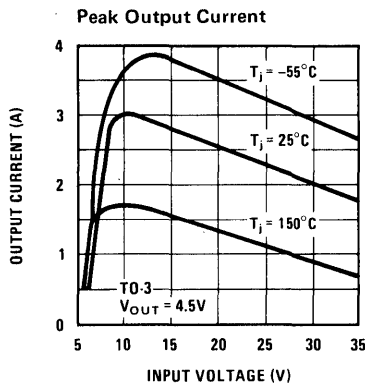
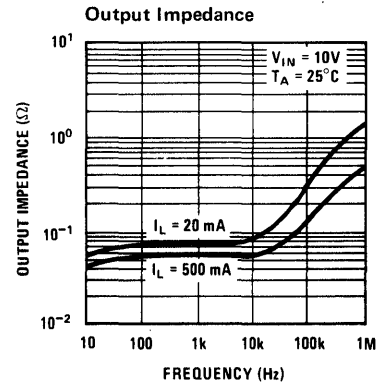
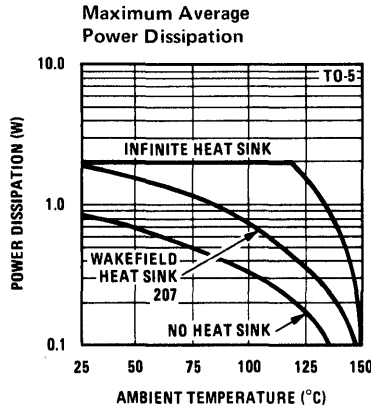
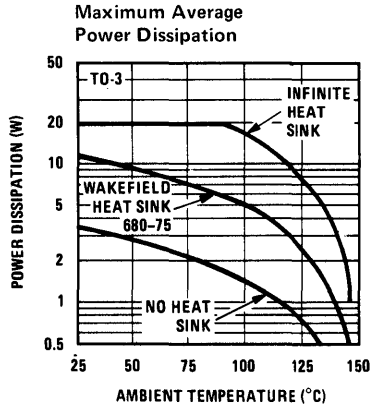



Voltage Regulators

LM309 five-volt regulator

general description

The LM309 is a complete 5V regulator fabricated on a single silicon chip. It is designed for local regulation on digital logic cards, eliminating the distribution problems associated with single-point regulation. The device is available in two common transistor packages. In the solid-kovar TO-5 header, it can deliver output currents in excess of 200 mA, if adequate heat sinking is provided. With the TO-3 power package, the available output current is greater than 1A.

The regulator is essentially blow-out proof. Current limiting is included to limit the peak output current to a safe value. In addition, thermal shutdown is provided to keep the IC from overheating. If internal dissipation becomes too great, the regulator will shut down to prevent excessive heating.

Considerable effort was expended to make the LM309 easy to use and minimize the number of external components. It is not necessary to bypass the output, although this does improve transient

response somewhat. Input bypassing is needed, however, if the regulator is located very far from the filter capacitor of the power supply. Stability is also achieved by methods that provide very good rejection of load or line transients as are usually seen with TTL logic.

Although designed primarily as a fixed-voltage regulator, the output of the LM309 can be set to voltages above 5V, as shown below. It is also possible to use the circuit as the control element in precision regulators, taking advantage of the good current-handling capability and the thermal overload protection.

To summarize, outstanding features of the regulator are:

- Specified to be compatible, worst case, with TTL and DTL
- Output current in excess of 1A
- Internal thermal overload protection
- No external components required

schematic diagram

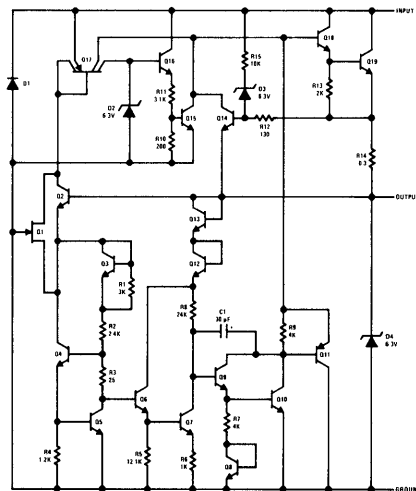

typical applications

High Stability Regulator*

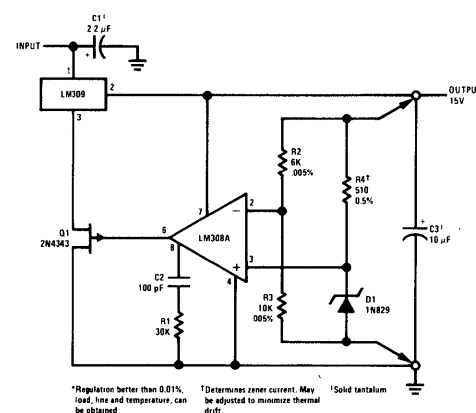

Fixed 5V Regulator

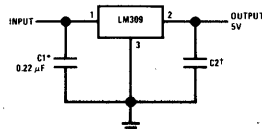

* Required if regulator is located an appreciable distance from power supply filter.
 † Although no output capacitor is needed for stability, it does improve transient response.

Adjustable Output Regulator

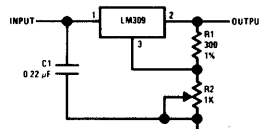

Current Regulator

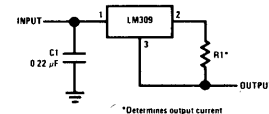

* Determines output current

absolute maximum ratings

Input Voltage	35V
Power Dissipation	Internally Limited
Operating Junction Temperature Range	0°C to 125°C
Storage Temperature Range	-65°C to 150°C
Lead Temperature (Soldering, 10 sec)	300°C

design characteristics (Note 1)

PARAMETER	CONDITIONS	MIN	TYP	MAX	UNITS
Output Voltage	$T_j = 25^\circ\text{C}$	4.8	5.05	5.2	V
Line Regulation	$T_j = 25^\circ\text{C}$ $7\text{V} \leq V_{\text{IN}} \leq 25\text{V}$		4.0	50	mV
Load Regulation	$T_j = 25^\circ\text{C}$				
LM309H	$5\text{mA} \leq I_{\text{OUT}} \leq 0.5\text{A}$		20	50	mV
LM309K	$5\text{mA} \leq I_{\text{OUT}} \leq 1.5\text{A}$		50	100	mV
Output Voltage	$7\text{V} \leq V_{\text{IN}} \leq 25\text{V}$ $5\text{mA} \leq I_{\text{OUT}} \leq I_{\text{max}}$ $P < P_{\text{max}}$	4.75		5.25	V
Quiescent Current	$7\text{V} \leq V_{\text{IN}} \leq 25\text{V}$		5.2	10	mA
Quiescent Current Change	$7\text{V} \leq V_{\text{IN}} \leq 25\text{V}$ $5\text{mA} \leq I_{\text{OUT}} \leq I_{\text{max}}$			0.5 0.8	mA mA
Output Noise Voltage	$T_A = 25^\circ\text{C}$ $10\text{Hz} \leq f \leq 100\text{kHz}$		40		μV
Long Term Stability				20	mV
Thermal Resistance					
Junction to Case (Note 2)					$^\circ\text{C/W}$
LM309H			15		$^\circ\text{C/W}$
LM309K			3.0		$^\circ\text{C/W}$

Note 1: Unless otherwise specified, these specifications apply for $0^\circ\text{C} \leq T_j \leq 125^\circ\text{C}$, $V_{\text{IN}} = 10\text{V}$ and $I_{\text{OUT}} = 0.1\text{A}$ for the LM309H or $I_{\text{OUT}} = 0.5\text{A}$ for the LM309K. For the LM309H, $I_{\text{max}} = 0.2\text{A}$ and $P_{\text{max}} = 2.0\text{W}$. For the LM309K, $I_{\text{max}} = 1.0\text{A}$ and $P_{\text{max}} = 20\text{W}$.

Note 2: Without a heat sink, the thermal resistance of the TO-5 package is about 150°C/W , while that of the TO-3 package is approximately 35°C/W . With a heat sink, the effective thermal resistance can only approach the values specified, depending on the efficiency of the sink.

typical performance

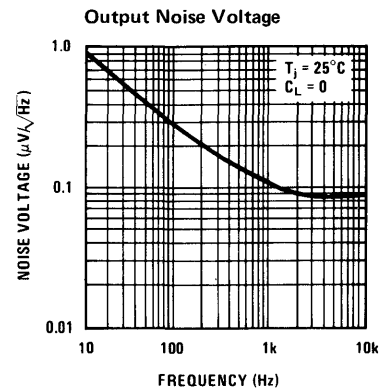
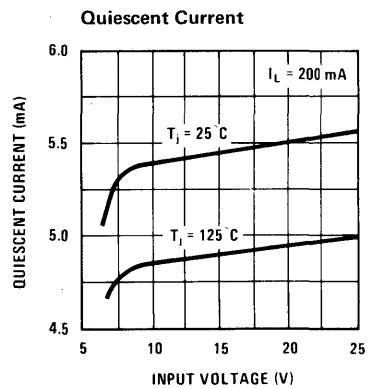
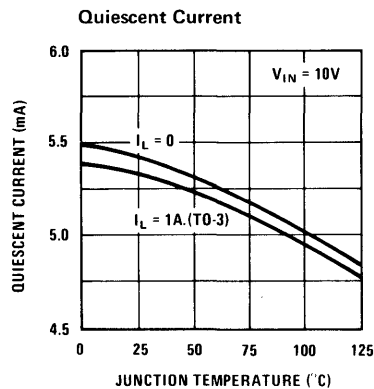
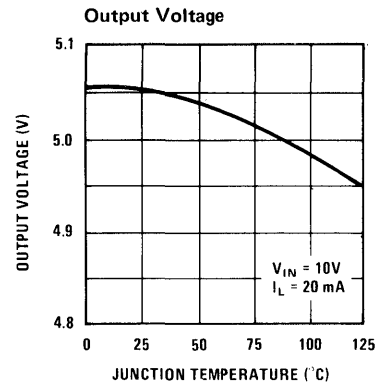
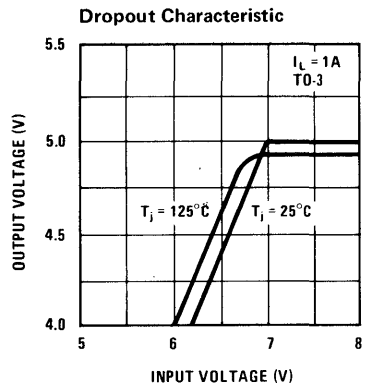
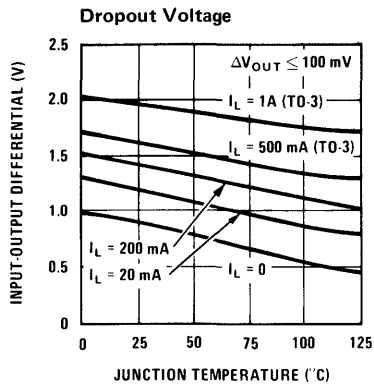
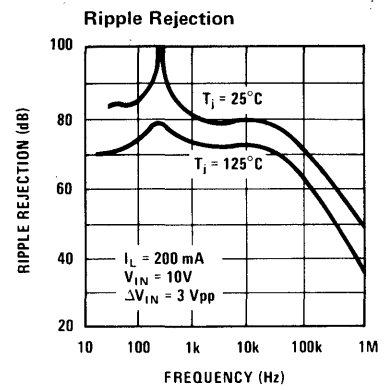
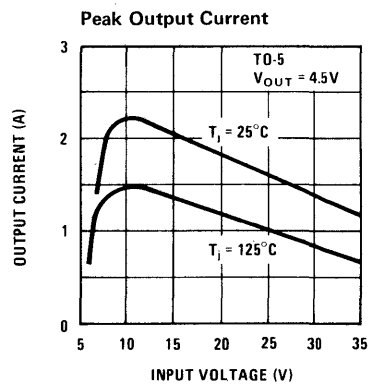
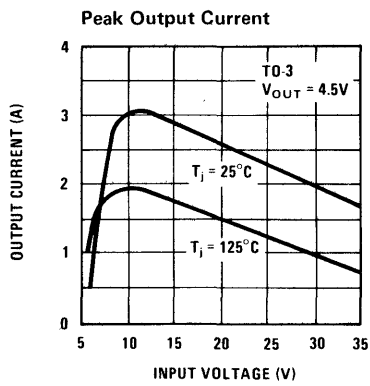
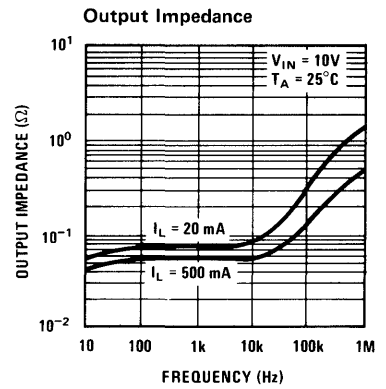
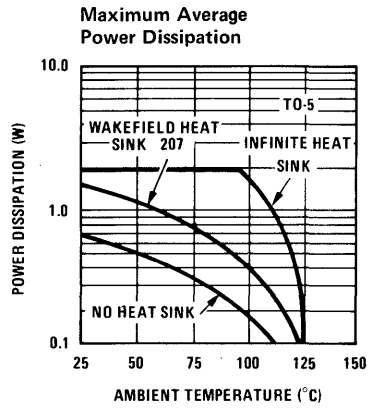
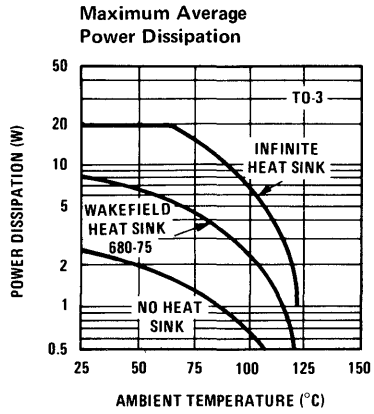



Voltage Regulators

LM114/LM114A/LM115/LM115A transistor pairs

general description

These devices contain a pair of junction-isolated NPN transistors fabricated on a single silicon substrate. This monolithic structure makes possible extremely-tight parameter matching at low cost. Further, advanced processing techniques yield exceptionally high current gains at low collector currents, virtual elimination of "popcorn noise," low leakages and improved long-term stability. Some of the major features of these pairs are indicated by the following specifications:

- Low offset voltage—0.5 mV maximum
- Low drift— $2 \mu\text{V}/^\circ\text{C}$ maximum from -55°C to 125°C

- High current gain—500 minimum at $10 \mu\text{A}$
- Tight beta match—10% maximum
- High breakdown voltage—to 60V
- Matching guaranteed over a 0V to 45V collector-base voltage range.

Although designed primarily for high breakdown voltage and exceptional dc characteristics, these transistors have surprisingly good high-frequency performance. The gain-bandwidth product is 450 MHz with 1 mA collector current and 5V collector-base voltage and 22 MHz with $10 \mu\text{A}$ collector current. Collector-base capacitance is only 1.3 pF at 5V.

connection diagram

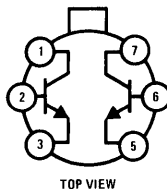

absolute maximum ratings

	LM114 LM114A	LM115 LM115A
Collector-Base Voltage (BV_{CBO})	45V	60V
Collector-Emitter Voltage (BV_{CER})	45V	60V
Collector-Collector Voltage	45V	60V
Emitter-Emitter Voltage	45V	60V
Emitter-Base Voltage (BV_{EBO})	6V	
Collector Current	20 mA	
Total Power Dissipation (Note 1)	1.8W	
Operating Junction Temperature	-55°C to 150°C	
Storage Temperature	-65°C to 150°C	
Lead Temperature (soldering, 10 sec)	300°C	

Note 1: The maximum dissipation given is for a 25°C case temperature. For operation under other conditions, the device must be derated based on a 150°C maximum junction temperature and a thermal resistance of $70^\circ\text{C}/\text{W}$ junction to case or $230^\circ\text{C}/\text{W}$ junction to ambient.

electrical characteristics (Note 2)

PARAMETER	CONDITIONS	MAXIMUM LIMITS				UNITS
		LM114	LM114A	LM115	LM115A	
Offset Voltage	$1 \mu\text{A} \leq I_C \leq 100 \mu\text{A}$	2.0	0.5	2.0	0.5	mV
Offset Current	$I_C = 10 \mu\text{A}$	10	2.0	10	2.0	nA
	$I_C = 1 \mu\text{A}$		0.5		0.5	nA
Bias Current	$I_C = 10 \mu\text{A}$	40	20	40	40	nA
	$I_C = 1 \mu\text{A}$		3.0		6.0	nA
Offset Voltage Change	$0\text{V} \leq V_{CB} \leq V_{\text{max}}$ $I_C = 10 \mu\text{A}$	1.5	0.2	2.0	0.3	mV
Offset Current Change	$0\text{V} \leq V_{CB} \leq V_{\text{max}}$ $I_C = 10 \mu\text{A}$	4.0	1.0	4.0	1.0	nA
Offset Voltage Drift	$-55^\circ\text{C} \leq T_A \leq 125^\circ\text{C}$ $I_C = 10 \mu\text{A}$	10	2.0	10	2.0	$\mu\text{V}/^\circ\text{C}$
Offset Current	$-55^\circ\text{C} \leq T_A \leq 125^\circ\text{C}$ $I_C = 10 \mu\text{A}$	50	12	50	20	nA
Bias Current	$-55^\circ\text{C} \leq T_A \leq 125^\circ\text{C}$ $I_C = 10 \mu\text{A}$	150	60	150	150	nA
Collector-Base Leakage Current	$V_{CB} = V_{\text{max}}$ $T_A = 25^\circ\text{C}$	50	10	50	10	pA
	$T_A = 125^\circ\text{C}$	50	10	50	10	nA
Collector-Emitter Leakage Current	$V_{CE} = V_{\text{max}}, V_{EB} = 0$ $T_A = 25^\circ\text{C}$	200	50	200	50	pA
	$T_A = 125^\circ\text{C}$	200	50	200	50	nA
Collector-Collector Leakage Current	$V_{CC} = V_{\text{max}}$ $T_A = 25^\circ\text{C}$	300	100	300	100	pA
	$T_A = 125^\circ\text{C}$	300	100	300	100	nA

Note 2: These specifications apply for $T_A = 25^\circ\text{C}$ and $0\text{V} \leq V_{CB} \leq V_{\text{max}}$, unless otherwise specified. For the LM114 and LM114A, $V_{\text{max}} = 30\text{V}$. For the LM115 and LM115A, $V_{\text{max}} = 45\text{V}$.

typical performance

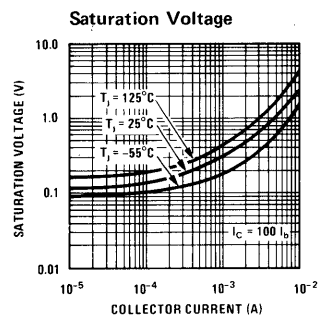
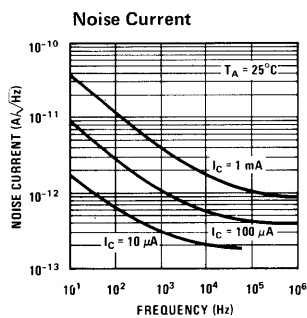
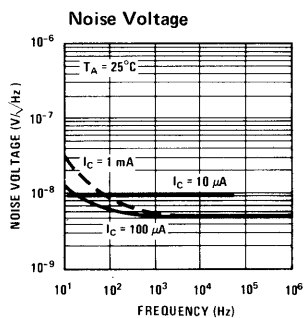



Voltage Regulators

LM376 voltage regulator

general description

The LM376 is a positive voltage regulator for use in consumer products. The characteristics of the LM376 are:

- Output Voltage Range +5 to 27V

- Output Current 25 mA
- Load Regulation 1%
- Line Regulation 0.4%/V

simplified schematic and connection diagrams

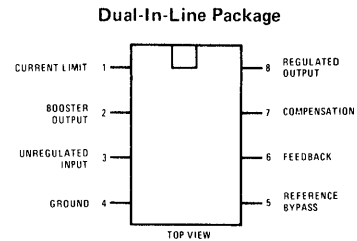
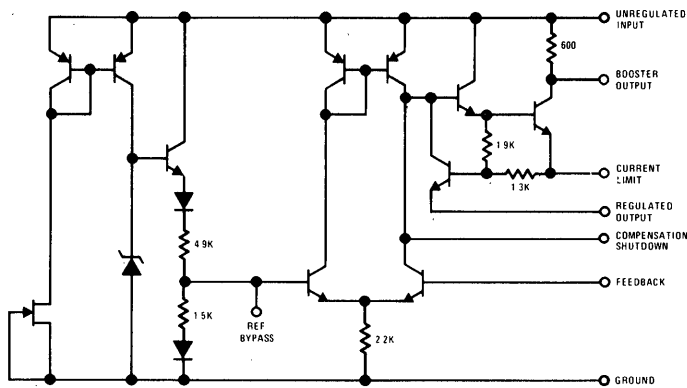

typical applications

Basic Positive Regulator with Current Limiting

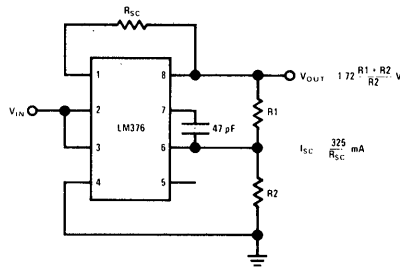

1.0A Regulator with Protective Diodes

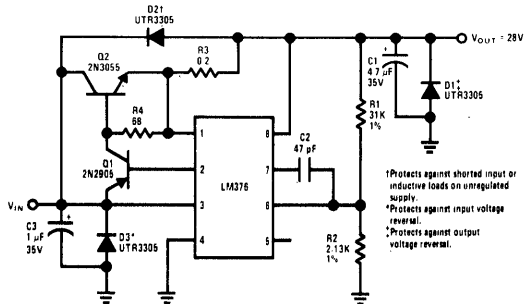

Linear Regulator with Foldback Current Limiting

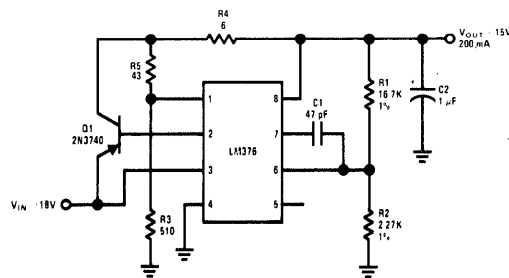

absolute maximum ratings

Input Voltage	30V
Input-Output Voltage Differential	30V
Power Dissipation (Note 1)	400 mW
Operating Temperature Range	0°C to 70°C
Storage Temperature Range	-65°C to +150°C
Lead Temperature (Soldering, 10 sec)	300°C

electrical characteristics (Note 2)

PARAMETER	CONDITIONS	MIN	TYP	MAX	UNITS
Input Voltage Range		9.0		30	V
Output Voltage Range		5.0		27	V
Output-Input Voltage Differential		3.0		25	V
Load Regulation	$0 \leq I_O \leq 25 \text{ mA}$ $R_{SC} = 0\Omega, T_A = 25^\circ\text{C}$ $R_{SC} = 0\Omega, T_A = 70^\circ\text{C}$ $R_{SC} = 0\Omega, T_A = 0^\circ\text{C}$			1.0 1.5 1.5	% % %
Line Regulation				0.4	%/V
Ripple Rejection	$f = 120 \text{ Hz}$			0.4	%/V
Standby Current Drain	$V_{IN} = 30\text{V}$			2.5	mA
Reference Voltage			1.72		V
Current Limit Sense Voltage			.325		V

Note 1: For operating at elevated temperatures, the device must be derated based on a 100°C maximum junction temperature and a thermal resistance of 187°C/W junction to ambient.

Note 2: These specifications apply for an operating temperature between 0°C and 70°C.

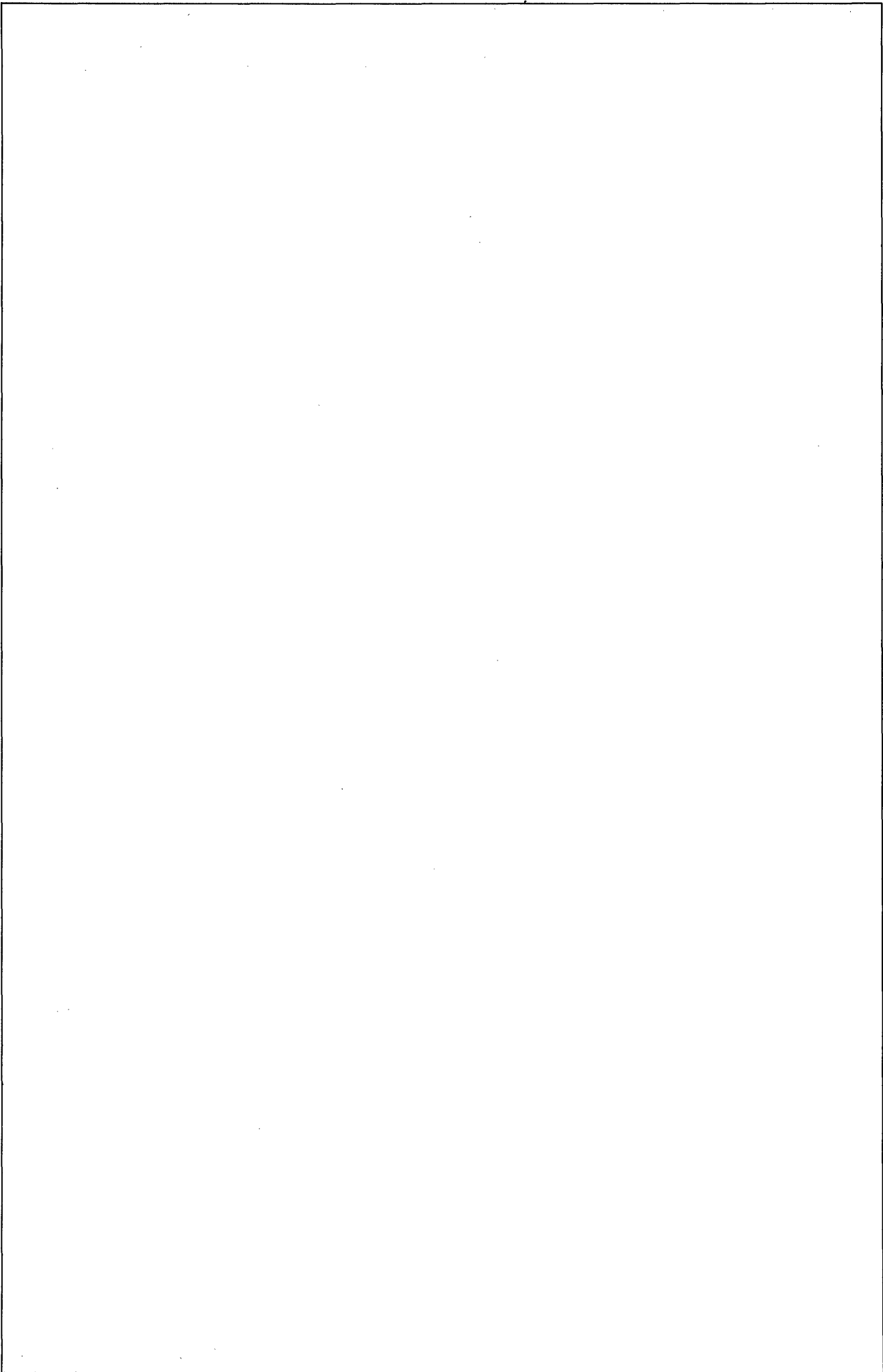



Operational Amplifiers

LM101 operational amplifier general description

The LM101 is a general-purpose operational amplifier built on a single silicon chip. The resulting close match and tight thermal coupling gives low offsets and temperature drift as well as fast recovery from thermal transients. In addition, the device features:

- Frequency compensation with a single 30 pF capacitor
- Operation from $\pm 5V$ to $\pm 20V$
- Low current drain: 1.8 mA at $\pm 20V$
- Continuous short-circuit protection
- Operation as a comparator with differential inputs as high as $\pm 30V$

- No latch-up when common mode range is exceeded
- Same pin configuration as the LM709.

The unity-gain compensation specified makes the circuit stable for all feedback configurations, even with capacitive loads. However, it is possible to optimize compensation for best high frequency performance at any gain. As a comparator, the output can be clamped at any desired level to make it compatible with logic circuits. Further, the low power dissipation permits high-voltage operation and simplifies packaging in full-temperature-range systems.

schematic and connection diagrams

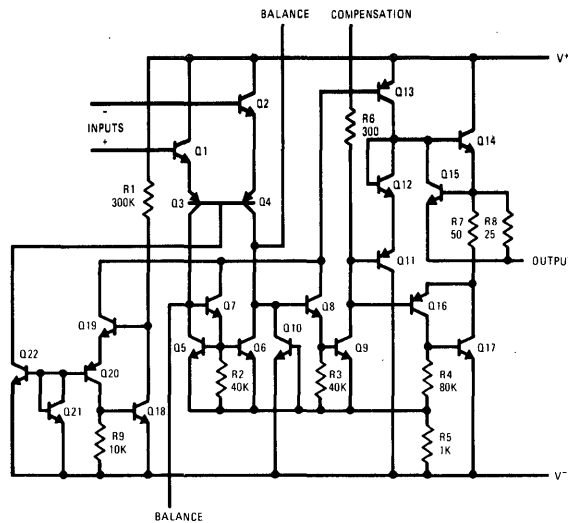

Metal Can

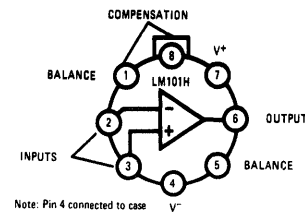

Flat Package

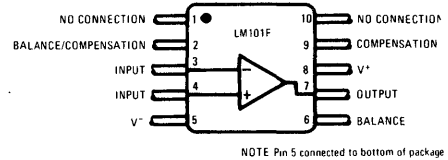

typical applications **

Inverting Amplifier with Balancing Circuit

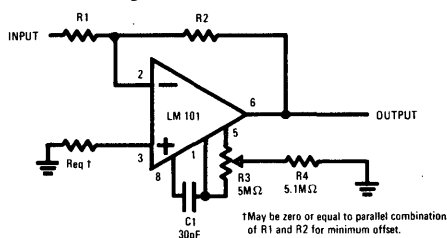

Low Drift Sample and Hold

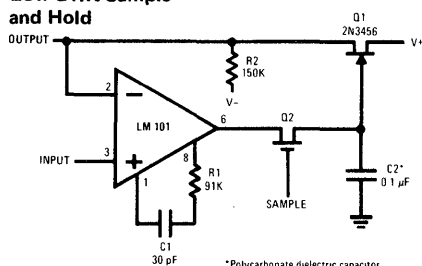

Voltage Comparator for Driving DTL or TTL Integrated Circuits

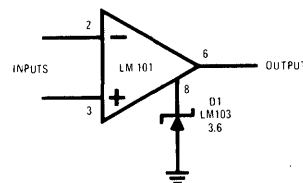

Voltage Comparator for Driving RTL Logic or High Current Driver

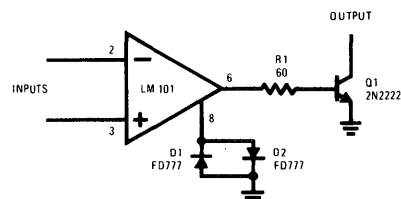

** Pin connections shown are for the metal can package

absolute maximum ratings

Supply Voltage	±22V
Power Dissipation (Note 1)	500 mW
Differential Input Voltage	±30V
Input Voltage (Note 2)	±15V
Output Short-Circuit Duration (Note 3)	Indefinite
Operating Temperature Range	-55°C to +125°C
Storage Temperature Range	-65°C to +150°C
Lead Temperature (Soldering, 60 sec)	300°C

electrical characteristics (note 4)

PARAMETER	CONDITIONS	MIN	TYP	MAX	UNITS
Input Offset Voltage	$T_A = 25^\circ\text{C}$, $R_S \leq 10\text{k}\Omega$		1.0	5.0	mV
Input Offset Current	$T_A = 25^\circ\text{C}$		40	200	nA
Input Bias Current	$T_A = 25^\circ\text{C}$		120	500	nA
Input Resistance	$T_A = 25^\circ\text{C}$	300	800		k Ω
Supply Current	$T_A = 25^\circ\text{C}$, $V_S = \pm 20\text{V}$		1.8	3.0	mA
Large Signal Voltage Gain	$T_A = 25^\circ\text{C}$, $V_S = \pm 15\text{V}$ $V_{\text{OUT}} = \pm 10\text{V}$, $R_L \geq 2\text{k}\Omega$	50	160		V/mV
Input Offset Voltage	$R_S \leq 10\text{k}\Omega$			6.0	mV
Average Temperature Coefficient of Input Offset Voltage	$R_S \leq 50\Omega$		3.0		$\mu\text{V}/^\circ\text{C}$
	$R_S \leq 10\text{k}\Omega$		6.0		$\mu\text{V}/^\circ\text{C}$
Input Offset Current	$T_A = +125^\circ\text{C}$ $T_A = -55^\circ\text{C}$		10 100	200 500	nA nA
Input Bias Current	$T_A = -55^\circ\text{C}$		0.28	1.5	μA
Supply Current	$T_A = +125^\circ\text{C}$, $V_S = \pm 20\text{V}$		1.2	2.5	mA
Large Signal Voltage Gain	$V_S = \pm 15\text{V}$, $V_{\text{OUT}} = \pm 10\text{V}$ $R_L \geq 2\text{k}\Omega$	25			V/mV
Output Voltage Swing	$V_S = \pm 15\text{V}$, $R_L = 10\text{k}\Omega$ $R_L = 2\text{k}\Omega$	±12 ±10	±14 ±13		V V
Input Voltage Range	$V_S = \pm 15\text{V}$	±12			V
Common Mode Rejection Ratio	$R_S \leq 10\text{k}\Omega$	70	90		dB
Supply Voltage Rejection Ratio	$R_S \leq 10\text{k}\Omega$	70	90		dB

Note 1: For operating at elevated temperatures, the device must be derated based on a 150°C maximum junction temperature and a thermal resistance of 150°C/W junction to ambient or 45°C/W junction to case for the metal-can package. For the flat package, the derating is based on a thermal resistance of 185°C/W when mounted on a 1/16-inch-thick, epoxy-glass board with ten, 0.03-inch-wide, 2-ounce copper conductors (see curve).

Note 2: For supply voltages less than ±15V, the absolute maximum input voltage is equal to the supply voltage.

Note 3: Continuous short circuit is allowed for case temperatures to +125°C and ambient temperatures to +70°C.

Note 4: These specifications apply for $-55^\circ\text{C} \leq T_A \leq 125^\circ\text{C}$, $\pm 5\text{V} \leq V_S \leq \pm 20\text{V}$ and $C_1 = 30\text{ pF}$ unless otherwise specified.

guaranteed performance

Input Voltage Range

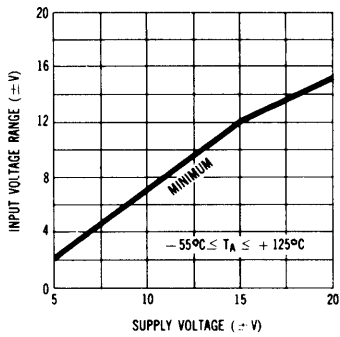

Output Swing

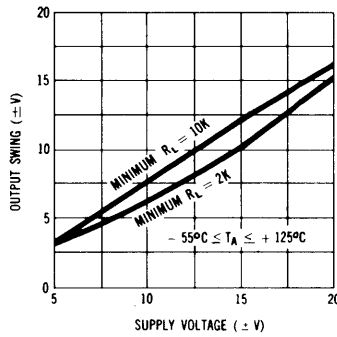

Voltage Gain

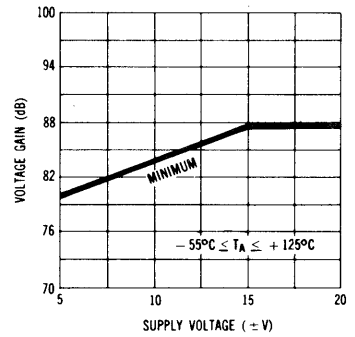

typical performance

Supply Current

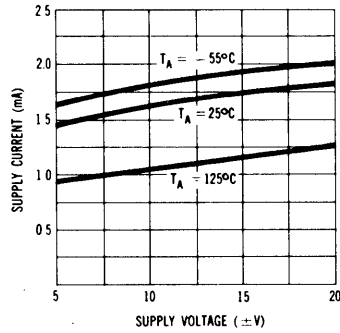

Voltage Gain

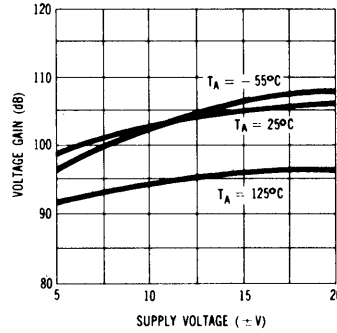

Input Bias Current

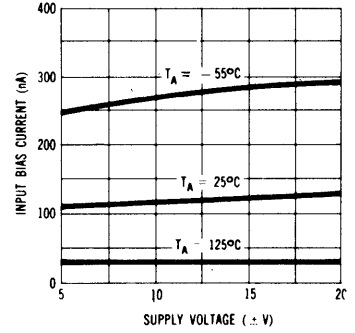

Current Limiting

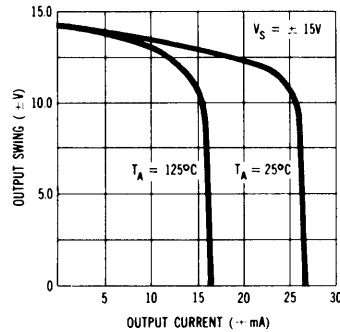

Input Current

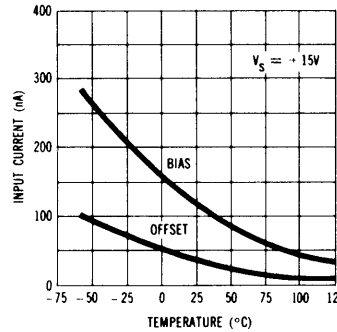

Maximum Power Dissipation

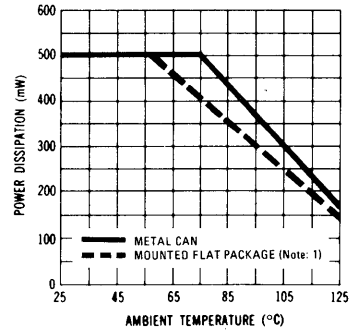

Open Loop Frequency Response

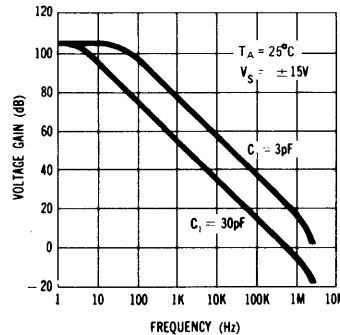

Large Signal Frequency Response

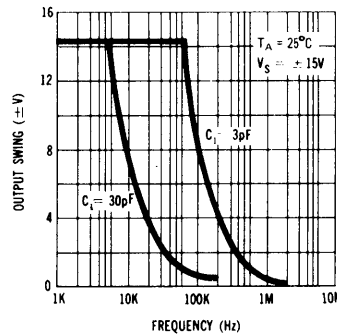

Voltage Follower Pulse Response

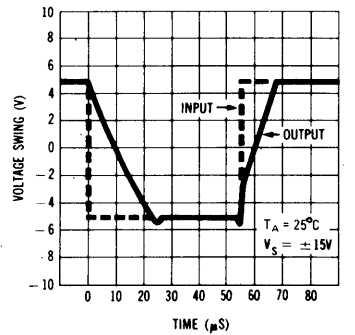



Operational Amplifiers

LM201 operational amplifier general description

The LM201 is a general-purpose operational amplifier built on a single silicon chip. It is identical to the LM101 except that operation is specified over a 0 to 70°C temperature range. The device features:

- Frequency compensation with a single 30 pF capacitor
- Operation from $\pm 5V$ to $\pm 20V$
- Low current drain: 1.8 mA at $\pm 20V$
- Continuous short-circuit protection
- Operation as a comparator with differential inputs as high as $\pm 30V$

- No latch-up when common mode range is exceeded
- LM709 lead configuration in metal cans and flat-packages.

The unity-gain compensation specified makes the circuit stable for all feedback configurations, even with capacitive loads. However, it is possible to optimize compensation for best high frequency performance at any gain. As a comparator, the output can be clamped at any desired level to make it compatible with logic circuits. Further, the low power dissipation permits high-voltage operation and simplifies packaging.

schematic and connection diagrams

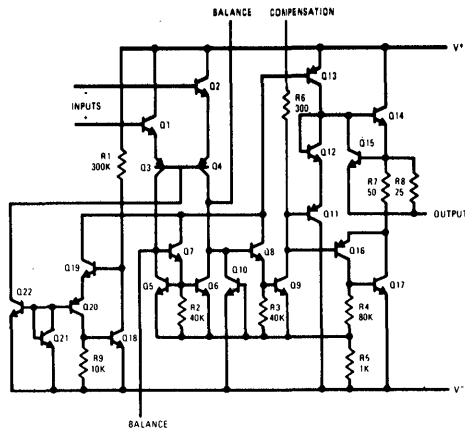

Metal Can

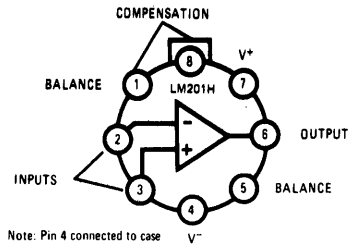

Flat Pack

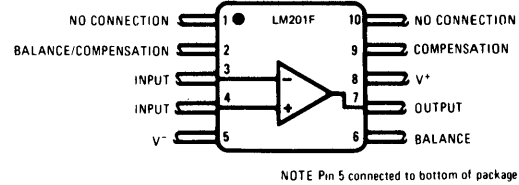

typical applications **

Voltage Comparator for Driving DTL or TTL Integrated Circuits

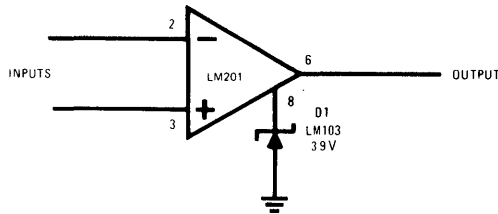

Low Drift Sample and Hold

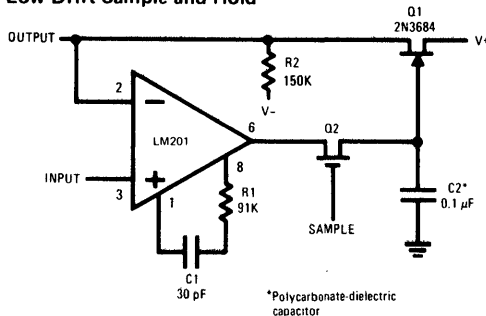

Inverting Amplifier with Balancing Circuit

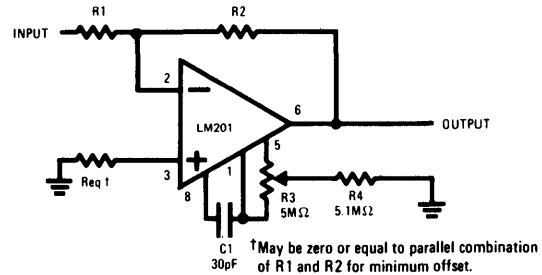

Voltage Comparator for Driving RTL Logic or High Current Driver

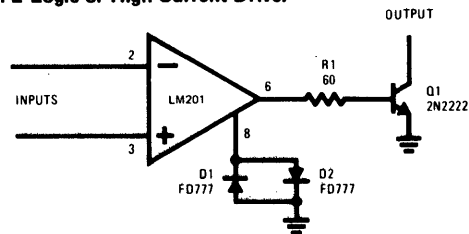

**Pin connections shown are for metal can package.

absolute maximum ratings

Supply Voltage	±22V
Power Dissipation (Note 1)	250 mW
Differential Input Voltage	±30V
Input Voltage (Note 2)	±15V
Output Short-Circuit Duration (Note 3)	Indefinite
Operating Temperature Range	0°C to +70°C
Storage Temperature Range	-65°C to +150°C
Lead Temperature (Soldering, 10 sec)	300°C

electrical characteristics (note 4)

PARAMETER	CONDITIONS	MIN	TYP	MAX	UNITS
Input Offset Voltage	$T_A = 25^\circ\text{C}$, $R_S \leq 10\text{k}\Omega$		2.0	7.5	mV
Input Offset Current	$T_A = 25^\circ\text{C}$		100	500	nA
Input Bias Current	$T_A = 25^\circ\text{C}$		0.25	1.5	μA
Input Resistance	$T_A = 25^\circ\text{C}$	100	400		$\text{k}\Omega$
Supply Current	$T_A = 25^\circ\text{C}$, $V_S = \pm 20\text{V}$		1.8	3.0	mA
Large Signal Voltage Gain	$T_A = 25^\circ\text{C}$, $V_S = \pm 15\text{V}$ $V_{\text{OUT}} = \pm 10\text{V}$, $R_L \geq 2\text{k}\Omega$	20	150		V/mV
Input Offset Voltage	$R_S \leq 10\text{k}\Omega$			10	mV
Average Temperature Coefficient of Input Offset Voltage	$R_S \leq 50\Omega$		6		$\mu\text{V}/^\circ\text{C}$
	$R_S \leq 10\text{k}\Omega$		10		$\mu\text{V}/^\circ\text{C}$
Input Offset Current	$T_A = +70^\circ\text{C}$ $T_A = 0^\circ\text{C}$		50 150	400 750	nA nA
Input Bias Current	$T_A = 0^\circ\text{C}$		0.32	2.0	μA
Large Signal Voltage Gain	$V_S = \pm 15\text{V}$, $V_{\text{OUT}} = \pm 10\text{V}$ $R_L \geq 2\text{k}\Omega$	15			V/mV
Output Voltage Swing	$V_S = \pm 15\text{V}$, $R_L = 10\text{k}\Omega$ $R_L = 2\text{k}\Omega$	±12 ±10	±14 ±13		V V
Input Voltage Range	$V_S = \pm 15\text{V}$	±12			V
Common Mode Rejection Ratio	$R_S \leq 10\text{k}\Omega$	65	90		dB
Supply Voltage Rejection Ratio	$R_S \leq 10\text{k}\Omega$	70	90		dB

Note 1: For operating at elevated temperatures, the device must be derated based on a 100°C maximum junction temperature and a thermal resistance of 150°C/W junction to ambient or 45°C/W junction to case for the metal-can package. For the flat package, the derating is based on a thermal resistance of 185°C/W when mounted on a 1/16-inch-thick, epoxy-glass board with ten, 0.03-inch-wide, 2-ounce copper conductors (see curve).

Note 2: For supply voltages less than ±15V, the absolute maximum input voltage is equal to the supply voltage.

Note 3: Continuous short circuit is allowed for case temperatures to 70°C and ambient temperatures to 55°C.

Note 4: These specifications apply for $0^\circ\text{C} \leq T_A \leq 70^\circ\text{C}$, $\pm 5\text{V} \leq V_S \leq \pm 20\text{V}$ and $C_1 = 30\text{ pF}$ unless otherwise specified.

guaranteed performance

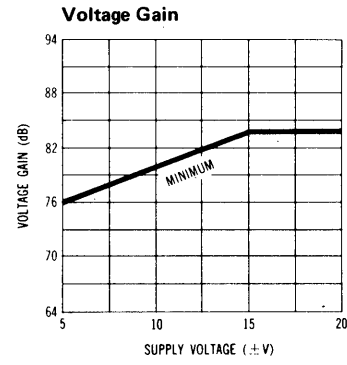
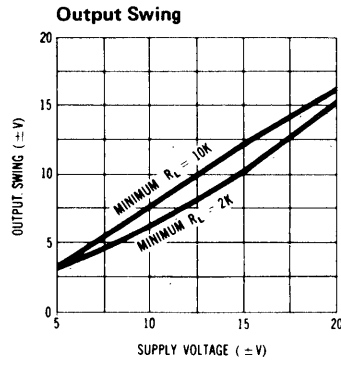
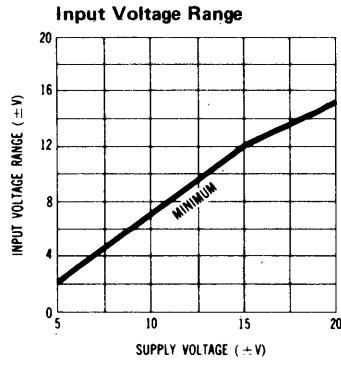

typical performance

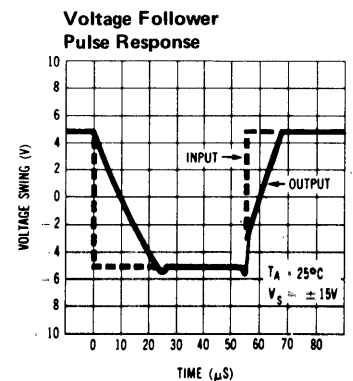
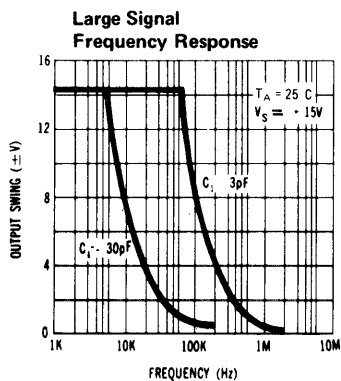
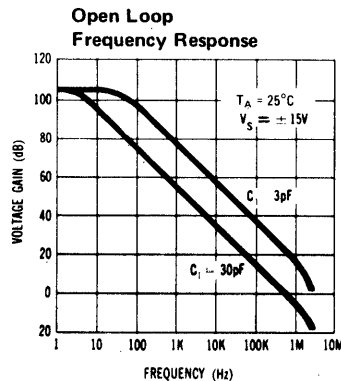
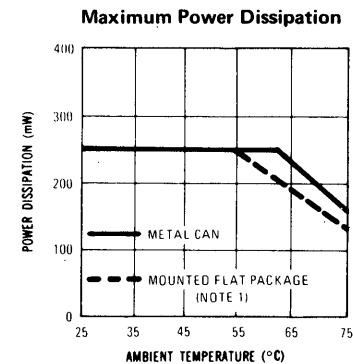
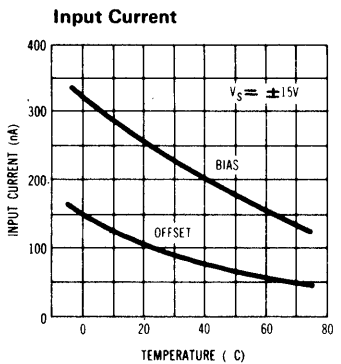
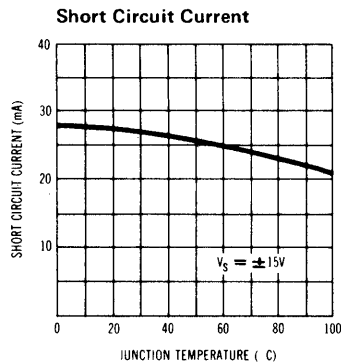
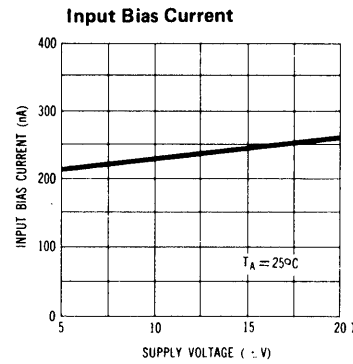
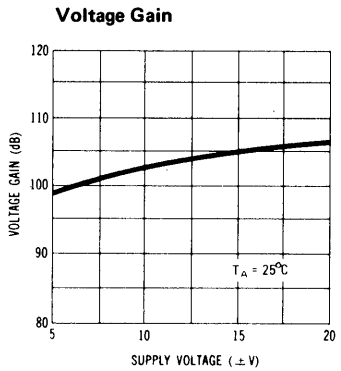
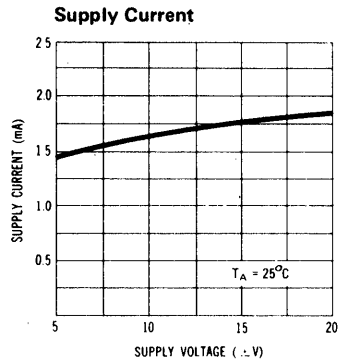



Operational Amplifiers

LM101A/LM201A operational amplifiers general description

The LM101A and LM201A are general purpose operational amplifiers which feature improved performance over industry standards like the LM101 and the 709. Advanced processing techniques make possible an order of magnitude reduction in input currents, and a redesign of the biasing circuitry reduces the temperature drift of input current. Improved specifications include:

- Offset voltage 3 mV maximum over temperature
- Input current 100 nA maximum over temperature
- Offset current 20 nA maximum over temperature
- Guaranteed drift characteristics
- Offsets guaranteed over entire common mode and supply voltage ranges
- Slew rate of 10V/μs as a summing amplifier

This amplifier offers many features which make its application nearly foolproof: overload protection on the input and output, no latch-up when the common mode range is exceeded, freedom from oscillations and compensation with a single 30 pF

capacitor. It has advantages over internally compensated amplifiers in that the frequency compensation can be tailored to the particular application. For example, in low frequency circuits it can be overcompensated for increased stability margin. Or the compensation can be optimized to give more than a factor of ten improvement in high frequency performance for most applications.

The LM101A series offers the features of the LM101, which makes its application nearly foolproof. In addition, the device provides better accuracy and lower noise in high impedance circuitry. The low input currents also make it particularly well suited for long interval integrators or timers, sample and hold circuits and low frequency waveform generators. Further, replacing circuits where matched transistor pairs buffer the inputs of conventional IC op amps, it can give lower offset voltage and drift at a lower cost.

The LM201A is identical to the LM101A, except that the LM201A has its performance guaranteed over a -25°C to 85°C temperature range, instead of -55°C to 125°C.

typical applications

Fast Inverting Amplifier With High Input Impedance

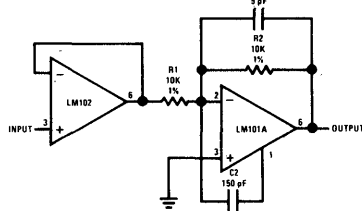

Instrumentation Amplifier

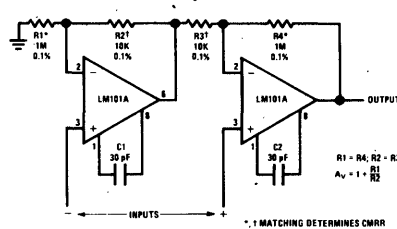

Variable Capacitance Multiplier

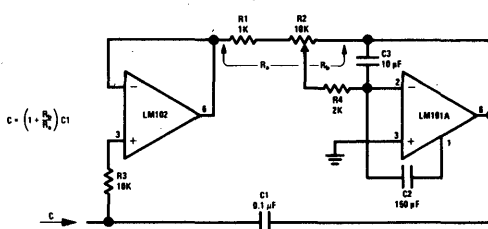

Fast AC/DC Converter*

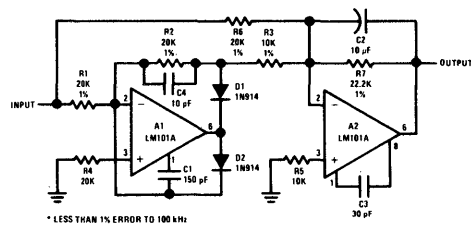

Sine Wave Oscillator

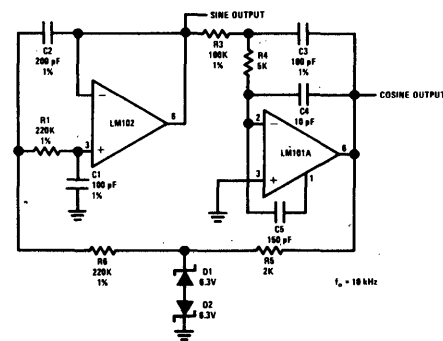

Simulated Inductor

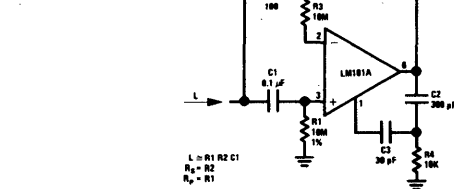

absolute maximum ratings

Supply Voltage	±22V
Power Dissipation (Note 1)	500 mW
Differential Input Voltage	±30V
Input Voltage (Note 2)	±15V
Output Short-Circuit Duration	Indefinite
Operating Temperature Range	LM101A -55°C to 125°C
	LM201A -25°C to 85°C
Storage Temperature Range	-65°C to 150°C
Lead Temperature (Soldering, 60 sec)	300°C

electrical characteristics (Note 3)

PARAMETER	CONDITIONS	MIN	TYP	MAX	UNITS
Input Offset Voltage	$T_A = 25^\circ\text{C}$, $R_S \leq 50\text{ k}\Omega$		0.7	2.0	mV
Input Offset Current	$T_A = 25^\circ\text{C}$		1.5	10	nA
Input Bias Current	$T_A = 25^\circ\text{C}$		30	75	nA
Input Resistance	$T_A = 25^\circ\text{C}$	1.5	4		M Ω
Supply Current	$T_A = 25^\circ\text{C}$, $V_S = \pm 20\text{V}$		1.8	3.0	mA
Large Signal Voltage Gain	$T_A = 25^\circ\text{C}$, $V_S = \pm 15\text{V}$ $V_{\text{OUT}} = \pm 10\text{V}$, $R_L \geq 2\text{ k}\Omega$	50	160		V/mV
Input Offset Voltage	$R_S \leq 50\text{ k}\Omega$			3.0	mV
Average Temperature Coefficient of Input Offset Voltage			3.0	15	$\mu\text{V}/^\circ\text{C}$
Input Offset Current				20	nA
Average Temperature Coefficient of Input Offset Current	$25^\circ\text{C} \leq T_A \leq 125^\circ\text{C}$ $-55^\circ\text{C} \leq T_A \leq 25^\circ\text{C}$		0.01 0.02	0.1 0.2	nA/ $^\circ\text{C}$ nA/ $^\circ\text{C}$
Input Bias Current				100	nA
Supply Current	$T_A = +125^\circ\text{C}$, $V_S = \pm 20\text{V}$		1.2	2.5	mA
Large Signal Voltage Gain	$V_S = \pm 15\text{V}$, $V_{\text{OUT}} = \pm 10\text{V}$ $R_L \geq 2\text{ k}\Omega$	25			V/mV
Output Voltage Swing	$V_S = \pm 15\text{V}$, $R_L = 10\text{ k}\Omega$ $R_L = 2\text{ k}\Omega$	±12 ±10	±14 ±13		V V
Input Voltage Range	$V_S = \pm 20\text{V}$	±15			V
Common Mode Rejection Ratio	$R_S \leq 50\text{ k}\Omega$	80	96		dB
Supply Voltage Rejection Ratio	$R_S \leq 50\text{ k}\Omega$	80	96		dB

Note 1: The maximum junction temperature of the LM101A is 150°C, while that of the LM201A is 100°C. For operating at elevated temperatures, devices in the TO-5 package must be derated based on a thermal resistance of 150°C/W, junction to ambient, or 45°C/W, junction to case. For the flat package, the derating is based on a thermal resistance of 185°C/W when mounted on a 1/16-inch-thick epoxy glass board with ten, 0.03-inch-wide, 2-ounce copper conductors. The thermal resistance of the dual-in-line package is 100°C/W, junction to ambient.

Note 2: For supply voltages less than ±15V, the absolute maximum input voltage is equal to the supply voltage.

Note 3: These specifications apply for $\pm 5\text{V} \leq V_S \leq \pm 20\text{V}$ and $-55^\circ\text{C} \leq T_A \leq 125^\circ\text{C}$, unless otherwise specified. With the LM201A, however, all temperature specifications are limited to $-25^\circ\text{C} \leq T_A \leq 85^\circ\text{C}$.

guaranteed performance

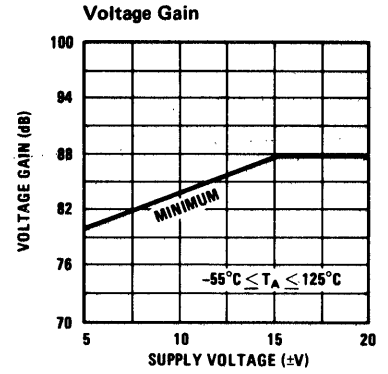
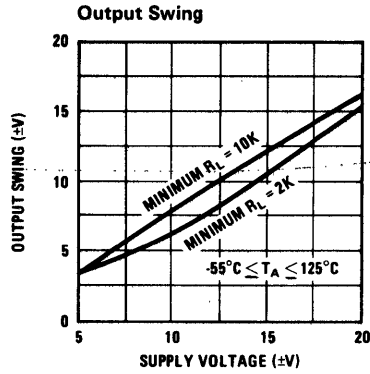
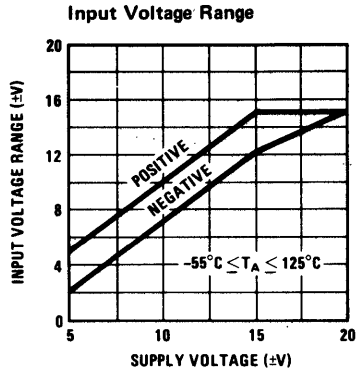

typical performance

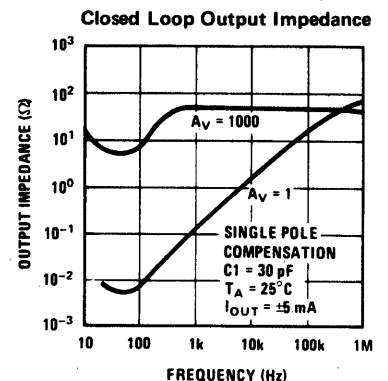
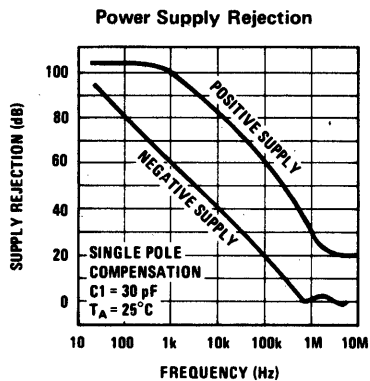
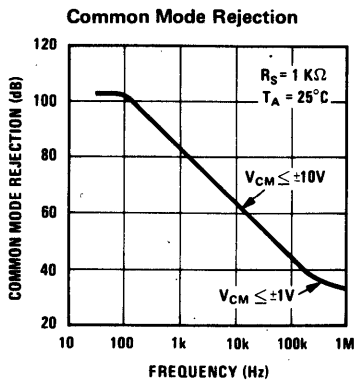
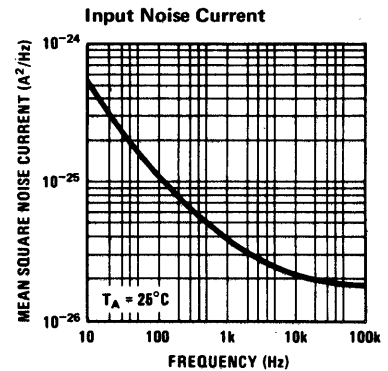
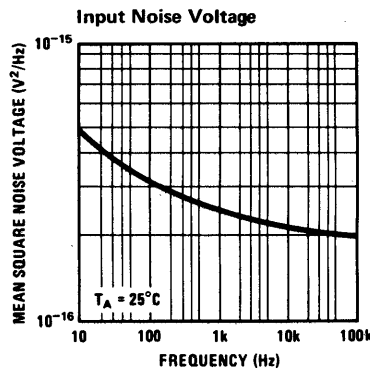
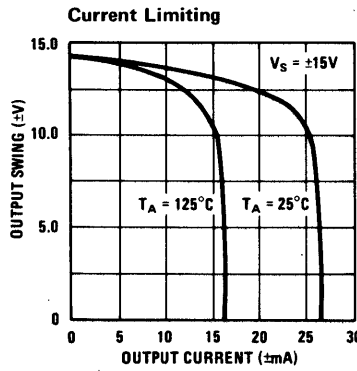
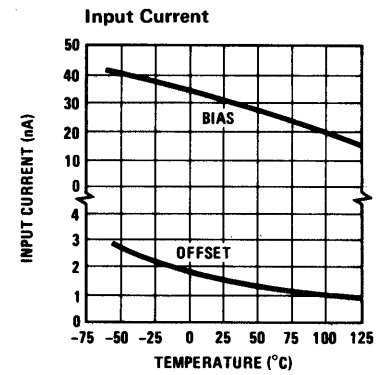
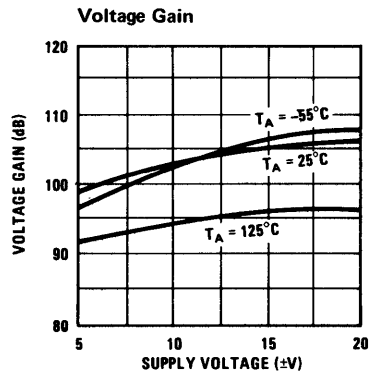
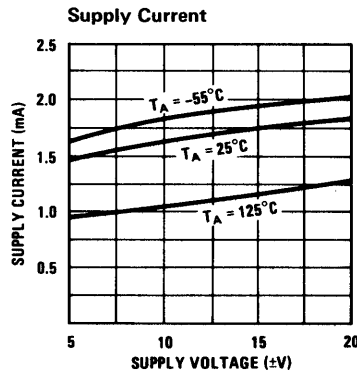

compensation circuits

Single Pole Compensation

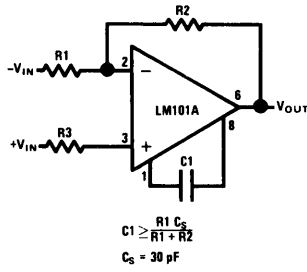

Two Pole Compensation

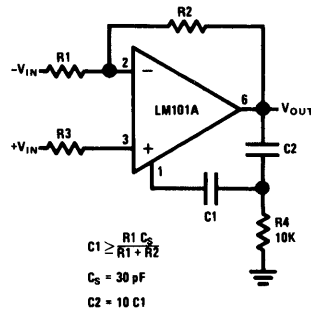

Feedforward Compensation

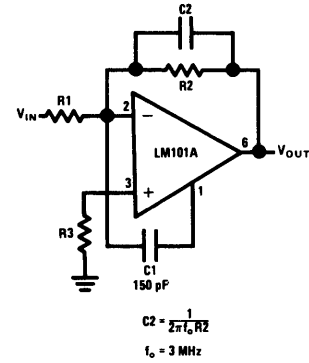

typical performance

Open Loop Frequency Response

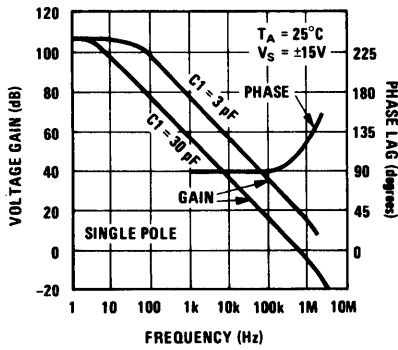

Open Loop Frequency Response

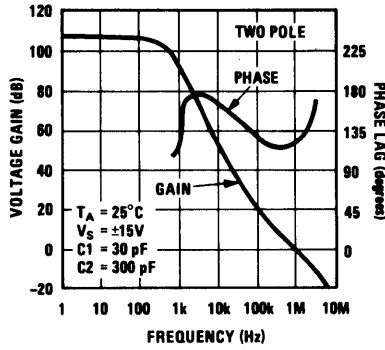

Open Loop Frequency Response

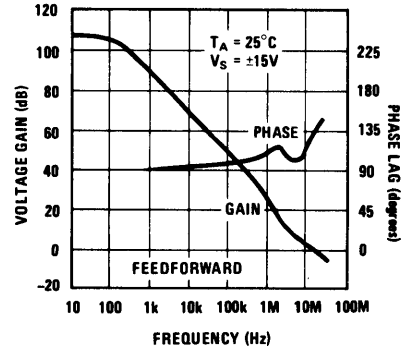

Large Signal Frequency Response

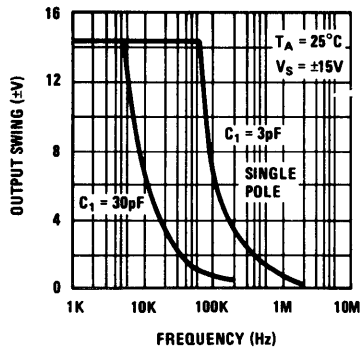

Large Signal Frequency Response

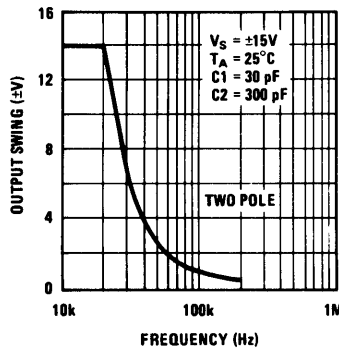

Large Signal Frequency Response

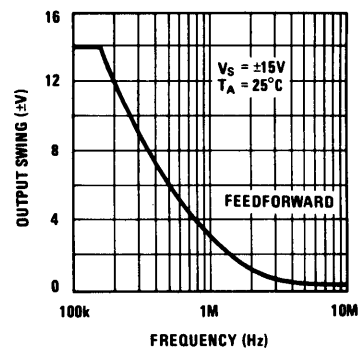

Voltage Follower Pulse Response

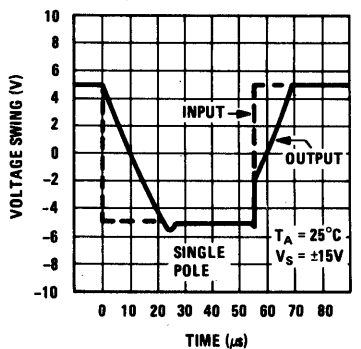

Voltage Follower Pulse Response

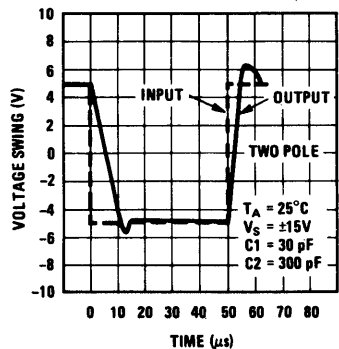

Inverter Pulse Response

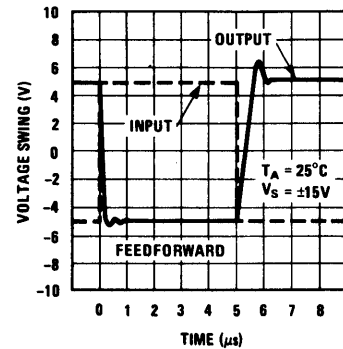

connection diagrams

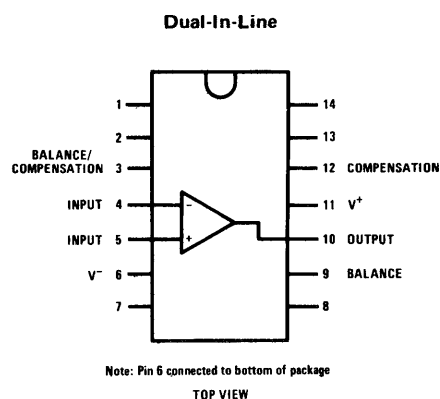
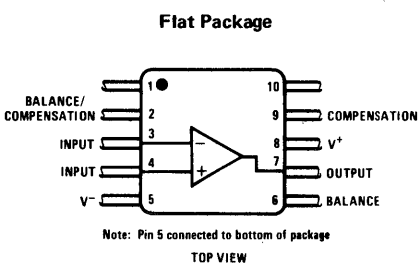
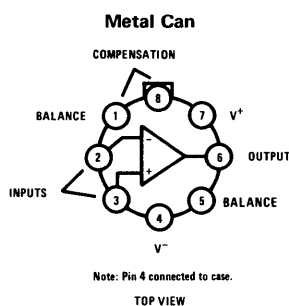

typical applications

Inverting Amplifier with Balancing Circuit

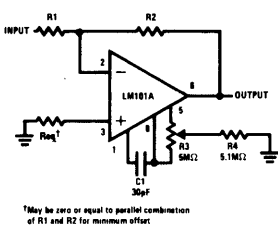

Alternate Balancing Circuit

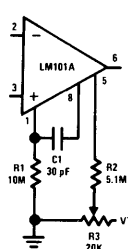

Integrator with Bias Current Compensation

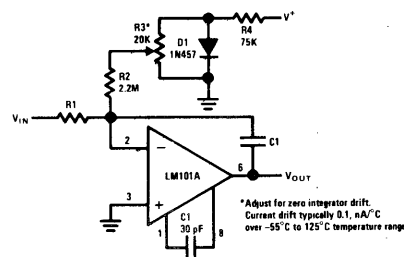

application hints

Protecting Against Gross Fault Conditions

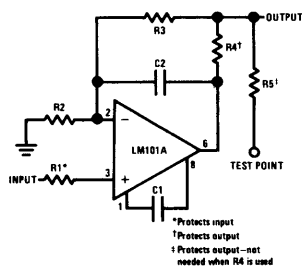

Compensating For Stray Input Capacitances Or Large Feedback Resistor

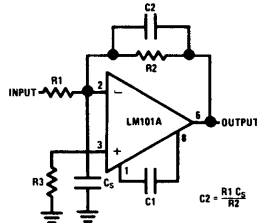

Isolating Large Capacitive Loads

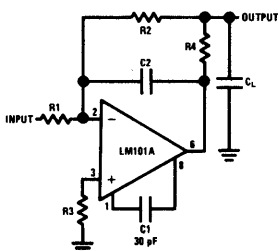

Although the LM101A is designed for trouble free operation, experience has indicated that it is wise to observe certain precautions given below to protect the devices from abnormal operating conditions. It might be pointed out that the advice given here is applicable to practically any IC op amp, although the exact reason why may differ with different devices.

When driving either input from a low-impedance source, a limiting resistor should be placed in series with the input lead to limit the peak instantaneous output current of the source to something less than 100 mA. This is especially important when the inputs go outside a piece of equipment where they could accidentally be connected to high voltage sources. Large capacitors on the input (greater than 0.1 μF) should be treated as a low source impedance and isolated with a resistor. Low impedance sources do not cause a problem unless their output voltage exceeds the supply voltage. However, the supplies go to zero when they are turned off, so the isolation is usually needed.

The output circuitry is protected against damage from shorts to ground or either supply. However, if it is shorted to a voltage which exceeds the positive or negative supplies, the unit can be destroyed. When the amplifier output is connected to a test point, it should be isolated by a limiting resistor, as test points frequently get shorted to bad places. Further, when the amplifier drives a load external to the equipment, it is also advisable to use some sort of limiting resistance to preclude mishaps.

Precautions should be taken to insure that the power supplies for the integrated circuit never become reversed—even under transient conditions. With reverse voltages greater than 1V, the IC will conduct excessive current, fusing internal aluminum interconnects. If there is a possibility of this happening, clamp diodes with a high peak current rating should be installed on the supply lines. Reversal of the voltage between V⁺ and V⁻ will always cause a problem, although reversals with respect to ground may also give difficulties in many circuits.

The minimum values given for the frequency compensation capacitor are stable only for source resistances less than 10 kΩ, stray capacitances on the summing junction less than 5 pF and capacitive loads smaller than 100 pF. If any of these conditions are not met, it becomes necessary to overcompensate the amplifier with a larger compensation capacitor. Alternately, lead capacitors can be used in the feedback network to negate the effect of stray capacitance and large feedback resistors or an RC network can be added to isolate capacitive loads.

Although the LM101A is relatively unaffected by supply bypassing, this cannot be ignored altogether. Generally it is necessary to bypass the supplies to ground at least once on every circuit card, and more bypass points may be required if more than five amplifiers are used. When feed-forward compensation is employed, however, it is advisable to bypass the supply leads of each amplifier with low inductance capacitors because of the higher frequencies involved.



Operational Amplifiers

LM301A operational amplifier general description

The LM301A is a general-purpose operational amplifier which features improved performance over the 709C and other popular amplifiers. Advanced processing techniques make possible an order of magnitude reduction in input currents, and a redesign of the biasing circuitry reduces the temperature drift of input current.

This amplifier offers many features which make its application nearly foolproof: overload protection on the input and output, no latch-up when the common mode range is exceeded, freedom from oscillations and compensation with a single 30 pF capacitor. It has advantages over internally compensated amplifiers in that the compensation can be tailored to the particular application. For

example, as a summing amplifier, slew rates of $10 \text{ V}/\mu\text{s}$ and bandwidths of 10 MHz can be realized. In addition, the circuit can be used as a comparator with differential inputs up to $\pm 30\text{V}$; and the output can be clamped at any desired level to make it compatible with logic circuits.

The LM301A provides better accuracy and lower noise than its predecessors in high impedance circuitry. The low input currents also make it particularly well suited for long interval integrators or timers, sample and hold circuits and low frequency waveform generators. Further, replacing circuits where matched transistor pairs buffer the inputs of conventional IC op amps, it can give lower offset voltage and drift at reduced cost.

connection diagrams

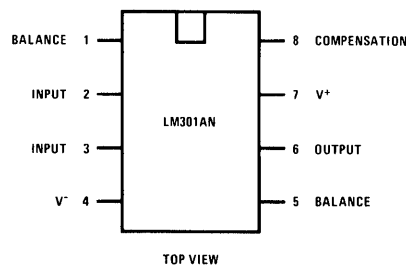
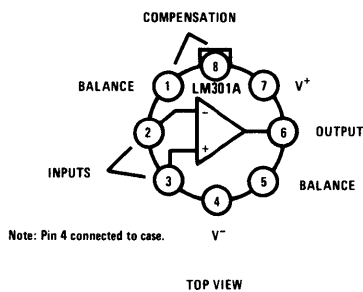

typical applications

Fast Summing Amplifier

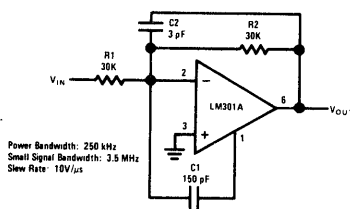

Fast Voltage Follower

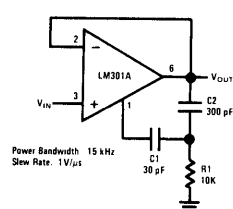

Standard Compensation and Offset Balancing Circuit

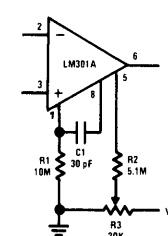

Bilateral Current Source

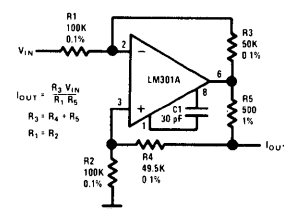

Integrator with Bias Current Compensation

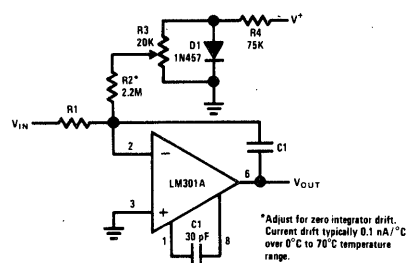

Low Frequency Square Wave Generator

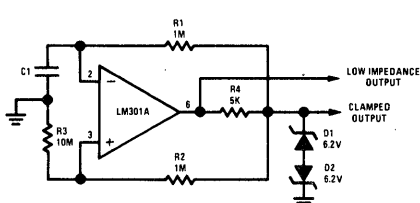

Voltage Comparator for Driving DTL or TTL Integrated Circuits

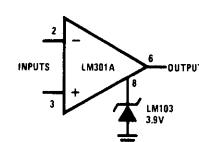

absolute maximum ratings

Supply Voltage	±18V
Power Dissipation (Note 1)	500 mW
Differential Input Voltage	±30V
Input Voltage (Note 2)	±15V
Output Short-Circuit Duration (Note 3)	Indefinite
Operating Temperature Range	0°C to 70°C
Storage Temperature Range	-65°C to 150°C
Lead Temperature (Soldering, 60 sec)	300°C

electrical characteristics (Note 4)

PARAMETER	CONDITIONS	MIN	TYP	MAX	UNITS
Input Offset Voltage	$T_A = 25^\circ\text{C}$, $R_S \leq 50\text{ k}\Omega$		2.0	7.5	mV
Input Offset Current	$T_A = 25^\circ\text{C}$		3	50	nA
Input Bias Current	$T_A = 25^\circ\text{C}$		70	250	nA
Input Resistance	$T_A = 25^\circ\text{C}$	0.5	2		M Ω
Supply Current	$T_A = 25^\circ\text{C}$, $V_S = \pm 15\text{V}$		1.8	3.0	mA
Large Signal Voltage Gain	$T_A = 25^\circ\text{C}$, $V_S = \pm 15\text{V}$ $V_{OUT} = \pm 10\text{V}$; $R_L \geq 2\text{ k}\Omega$	25	160		V/mV
Input Offset Voltage	$R_S \leq 50\text{ k}\Omega$			10	mV
Average Temperature Coefficient of Input Offset Voltage			6.0	30	$\mu\text{V}/^\circ\text{C}$
Input Offset Current				70	nA
Average Temperature Coefficient of Input Offset Current	$25^\circ\text{C} \leq T_A \leq 70^\circ\text{C}$ $0^\circ\text{C} \leq T_A \leq 25^\circ\text{C}$		0.01 0.02	0.3 0.6	nA/ $^\circ\text{C}$ nA/ $^\circ\text{C}$
Input Bias Current				300	nA
Large Signal Voltage Gain	$V_S = \pm 15\text{V}$, $V_{OUT} = \pm 10\text{V}$ $R_L \geq 2\text{ k}\Omega$	15			V/mV
Output Voltage Swing	$V_S = \pm 15\text{V}$, $R_L = 10\text{ k}\Omega$ $R_L = 2\text{ k}\Omega$	±12 ±10	±14 ±13		V V
Input Voltage Range	$V_S = \pm 15\text{V}$	±12			V
Common Mode Rejection Ratio	$R_S \leq 50\text{ k}\Omega$	70	90		dB
Supply Voltage Rejection Ratio	$R_S \leq 50\text{ k}\Omega$	70	96		dB

Note 1: For operating at elevated temperatures, the device must be derated based on a 100°C maximum junction temperature and a thermal resistance of 150°C/W junction to ambient or 45°C/W junction to case.

Note 2: For supply voltages less than ±15V, the absolute maximum input voltage is equal to the supply voltage.

Note 3: Continuous short circuit is allowed for case temperatures to 70°C and ambient temperatures to 55°C.

Note 4: These specifications apply for $0^\circ\text{C} \leq T_A < 70^\circ\text{C}$, $\pm 5\text{V} \leq V_S \leq \pm 15\text{V}$ and $C_1 = 30\text{ pF}$ unless otherwise specified.

guaranteed performance

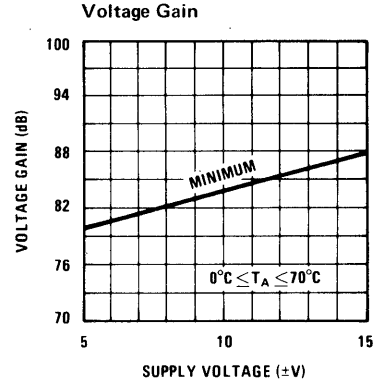
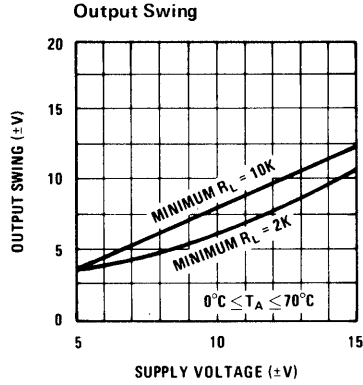
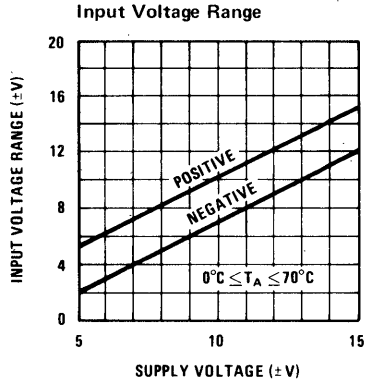

typical performance

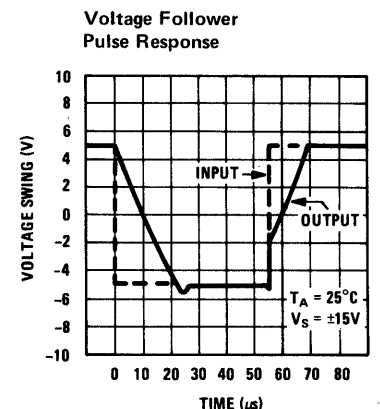
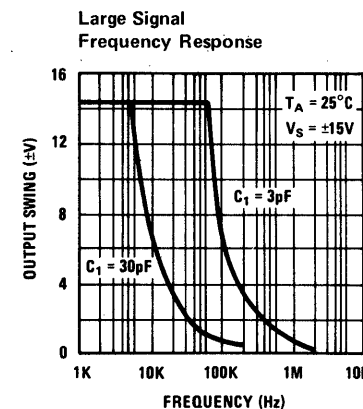
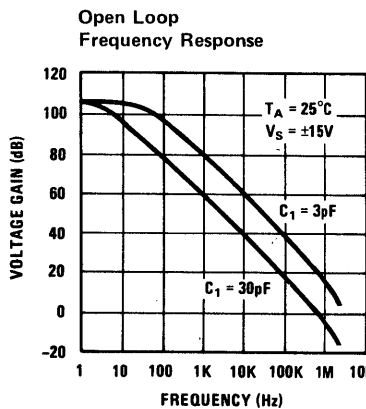
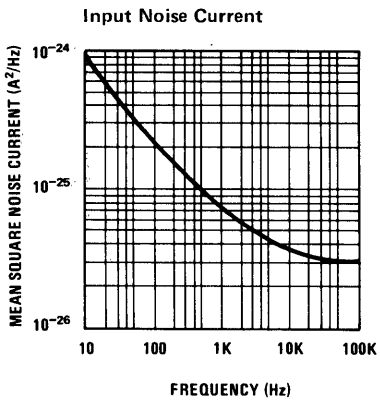
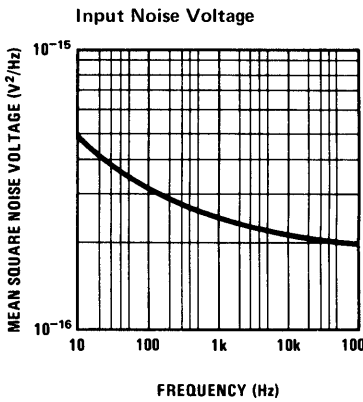
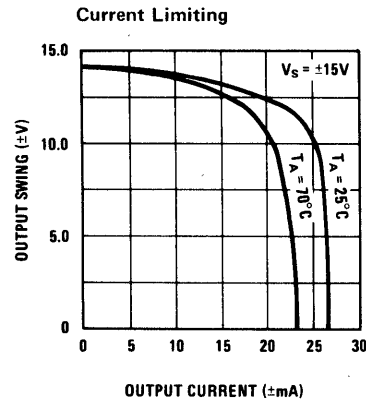
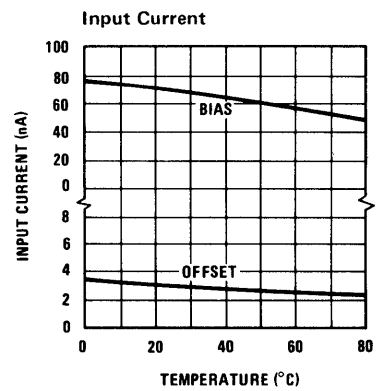
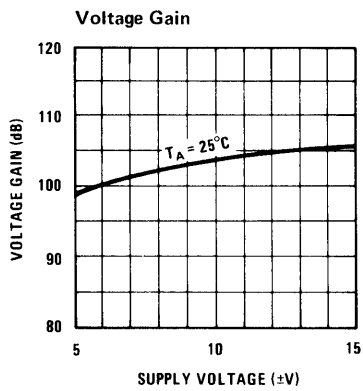
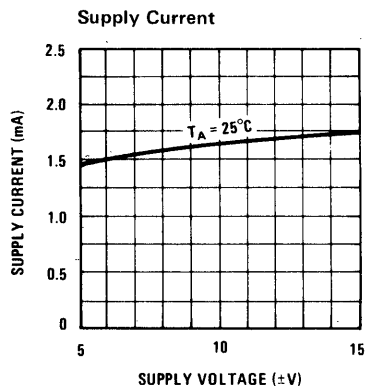



Operational Amplifiers

LH101

LH101 operational amplifier general description

The LH101 is a general-purpose operational amplifier which is internally compensated for unity-gain feedback. The device combines a LM101 operational amplifier and the 30 pF compensation capacitor in a single package. As such, it is a direct, plug-in replacement for both the LM101 and the LM709 in the majority of applications. Features of the amplifier include:

- Operation guaranteed for supply voltages from $\pm 5V$ to $\pm 20V$
- Low current drain – even with the output saturated

- No latch-up when common-mode range is exceeded
- Continuous short-circuit protection
- Input transistors protected from excessive input voltage.

The LH101 is available in either an 8-lead, low-profile TO-5 header or a 1/4" x 1/4" metal flat pack.

schematic and connection diagrams

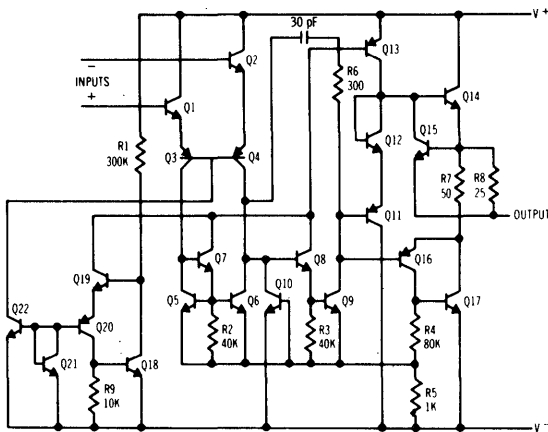

Metal Can

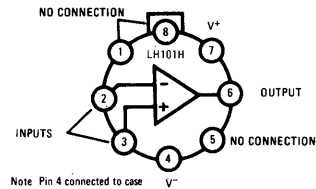

Flat Pack

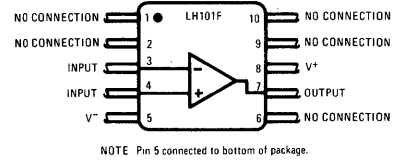

typical applications **

FET Operational Amplifier

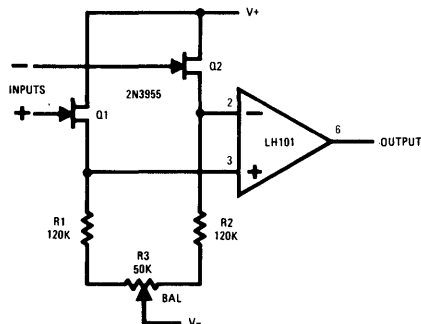

Temperature Probe

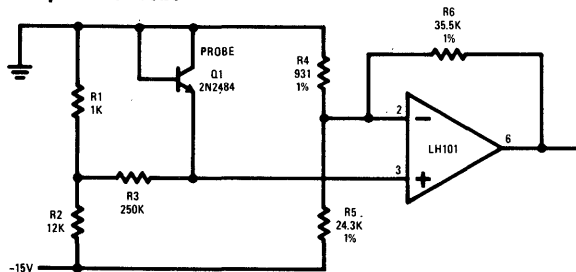

** Pin connections shown are for metal-can package.

Low Drift Thermocouple Amplifier†

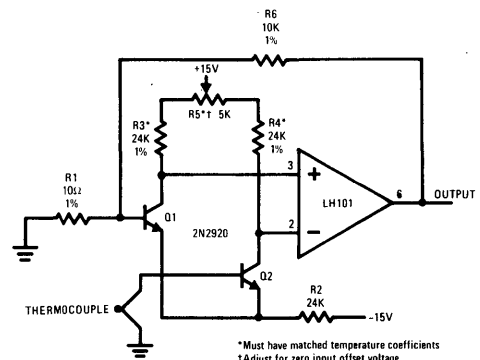

*Must have matched temperature coefficients
†Adjust for zero input offset voltage
‡Drifts less than 0.5 $\mu V/^{\circ}C$ can be obtained consistently

Integrator with Bias Current Compensation

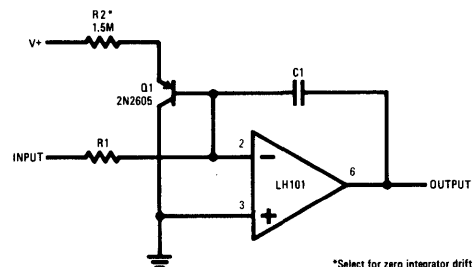

*Select for zero integrator drift

absolute maximum ratings

Supply Voltage	±22V
Power Dissipation (Note 1)	500 mW
Differential Input Voltage	±30V
Input Voltage (Note 2)	±15V
Output Short-Circuit Duration (Note 3)	Indefinite
Operating Temperature Range	-55°C to +125°C
Storage Temperature Range	-65°C to +150°C
Lead Temperature (Soldering, 60 sec)	300°C

electrical characteristics (note 4)

PARAMETER	CONDITIONS	MIN	TYP	MAX	UNITS
Input Offset Voltage	$T_A = 25^\circ\text{C}, R_S \leq 10\text{k}\Omega$		1.0	5.0	mV
Input Offset Current	$T_A = 25^\circ\text{C}$		40	200	nA
Input Bias Current	$T_A = 25^\circ\text{C}$		120	500	nA
Input Resistance	$T_A = 25^\circ\text{C}$	300	800		k Ω
Supply Current	$T_A = 25^\circ\text{C}, V_S = \pm 20\text{V}$		1.8	3.0	mA
Large Signal Voltage Gain	$T_A = 25^\circ\text{C}, V_S = \pm 15\text{V}$ $V_{\text{OUT}} = \pm 10\text{V}, R_L \geq 2\text{k}\Omega$	50	160		V/mV
Input Offset Voltage	$R_S \leq 10\text{k}\Omega$			6.0	mV
Average Temperature Coefficient of Input Offset Voltage	$R_S \leq 50\Omega$		3.0		$\mu\text{V}/^\circ\text{C}$
	$R_S \leq 10\text{k}\Omega$		6.0		$\mu\text{V}/^\circ\text{C}$
Input Offset Current	$T_A = +125^\circ\text{C}$ $T_A = -55^\circ\text{C}$		10 100	200 500	nA nA
Input Bias Current	$T_A = -55^\circ\text{C}$		0.28	1.5	μA
Supply Current	$T_A = +125^\circ\text{C}, V_S = \pm 20\text{V}$		1.2	2.5	mA
Large Signal Voltage Gain	$V_S = \pm 15\text{V}, V_{\text{OUT}} = \pm 10\text{V}$ $R_L \geq 2\text{k}\Omega$	25			V/mV
Output Voltage Swing	$V_S = \pm 15\text{V}, R_L = 10\text{k}\Omega$ $R_L = 2\text{k}\Omega$	±12 ±10	±14 ±13		V V
Input Voltage Range	$V_S = \pm 15\text{V}$	±12			V
Common Mode Rejection Ratio	$R_S \leq 10\text{k}\Omega$	70	90		dB
Supply Voltage Rejection Ratio	$R_S \leq 10\text{k}\Omega$	70	90		dB

Note 1: For operating at elevated temperatures, the device must be derated based on a 150°C maximum junction temperature and a thermal resistance of 150°C/W junction to ambient or 45°C/W junction to case for the metal-can package. For the flat package, the derating is based on a thermal resistance of 185°C/W when mounted on a 1/16-inch-thick, epoxy-glass board with ten, 0.03-inch-wide, 2-ounce copper conductors (see curve).

Note 2: For supply voltages less than ±15V, the absolute maximum input voltage is equal to the supply voltage.

Note 3: Continuous short circuit is allowed for case temperatures to +125°C and ambient temperatures to +70°C.

Note 4: These specifications apply for $-55^\circ\text{C} \leq T_A \leq 125^\circ\text{C}$, $\pm 5\text{V} \leq V_S \leq \pm 20\text{V}$ and $C_1 = 30\text{ pF}$ unless otherwise specified.

guaranteed performance

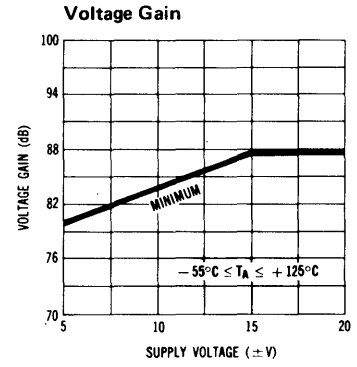
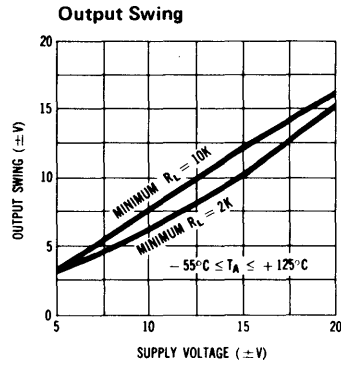
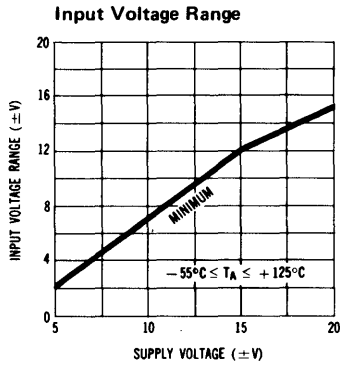

typical performance

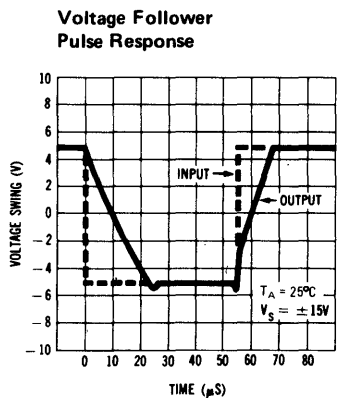
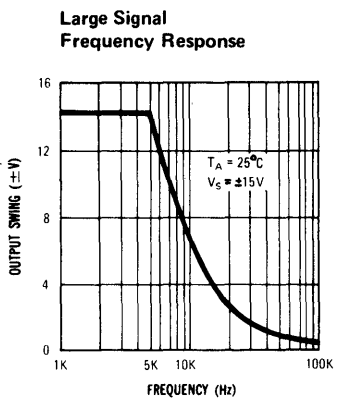
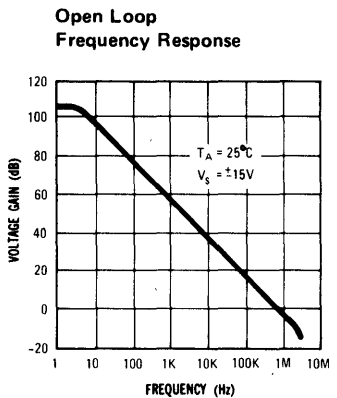
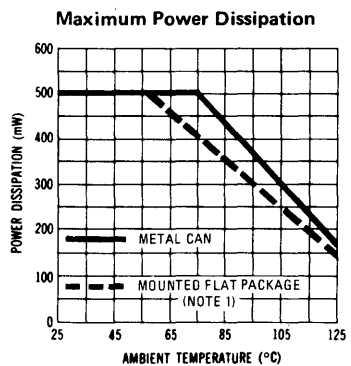
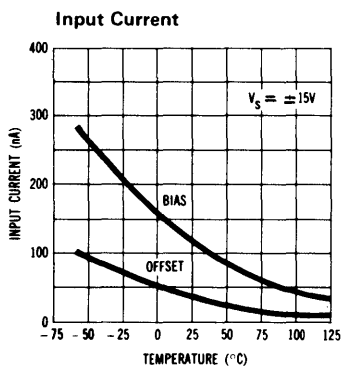
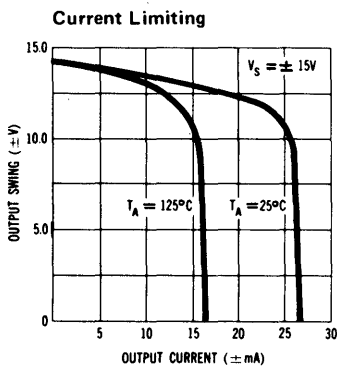
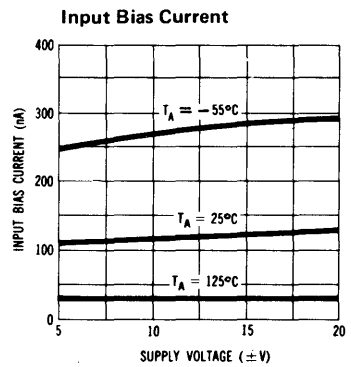
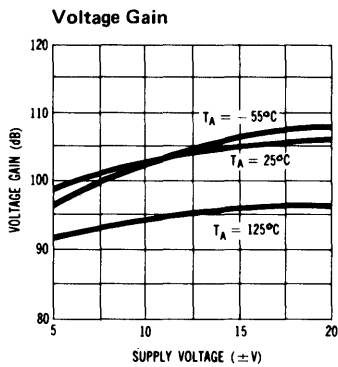
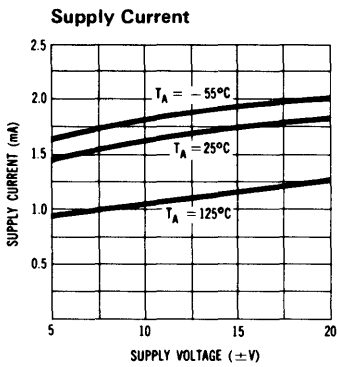



Operational Amplifiers

LH201 operational amplifier general description

The LH201 is a general-purpose operational amplifier which is internally compensated for unity-gain feedback. The device combines a LM201 operational amplifier and the 30 pF compensation capacitor in a single package. As such, it is a direct, plug-in replacement for both the LM201 and the LM709C in the majority of applications. It is identical to the LH101 except that operation is specified over a 0 to 70°C temperature range. Features of the amplifier include:

- Operation guaranteed for supply voltages from $\pm 5V$ to $\pm 20V$

- Low current drain – even with the output saturated
- No latch-up when common-mode range is exceeded
- Continuous short-circuit protection
- Input transistors protected from excessive input voltage.

The LH201 is available in either an 8-lead, low-profile TO-5 header or a 1/4" x 1/4" metal flat package.

schematic and connection diagrams

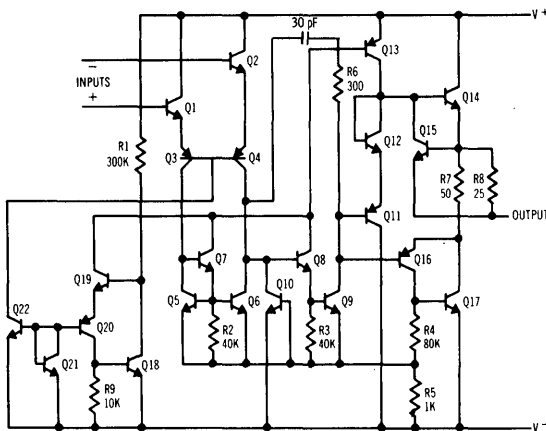

Metal Can

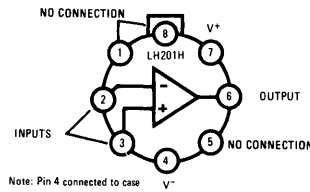

Flat Pack

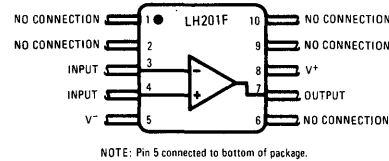

typical applications**

FET Operational Amplifier

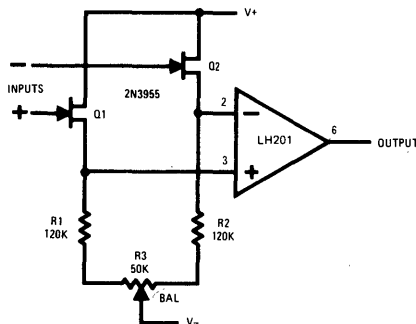

Temperature Probe

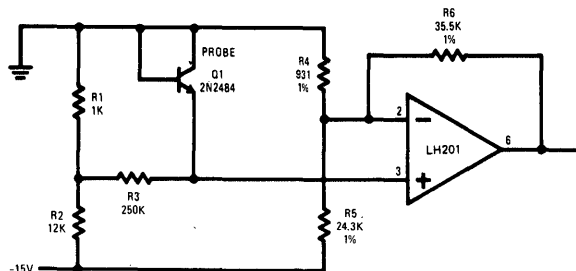

**Pin connections shown are for metal-can package.

Low Drift Thermocouple Amplifier †

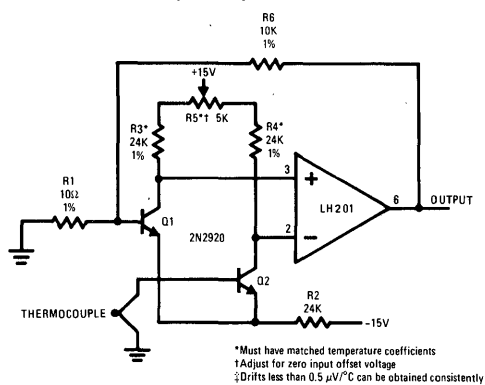

Integrator with Bias Current Compensation

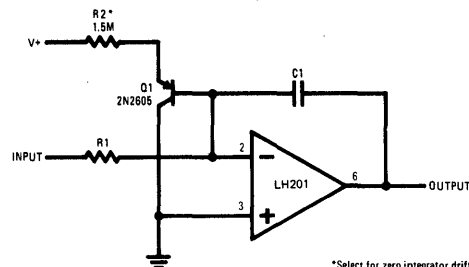

absolute maximum ratings

Supply Voltage	±22V
Power Dissipation (Note 1)	250 mW
Differential Input Voltage	±30V
Input Voltage (Note 2)	±15V
Output Short-Circuit Duration (Note 3)	Indefinite
Operating Temperature Range	0°C to +70°C
Storage Temperature Range	-65°C to +150°C
Lead Temperature (Soldering, 60 sec)	300°C

electrical characteristics (note 4)

PARAMETER	CONDITIONS	MIN	TYP	MAX	UNITS
Input Offset Voltage	$T_A = 25^\circ\text{C}$, $R_S \leq 10\text{k}\Omega$		2.0	7.5	mV
Input Offset Current	$T_A = 25^\circ\text{C}$		100	500	nA
Input Bias Current	$T_A = 25^\circ\text{C}$		0.25	1.5	μA
Input Resistance	$T_A = 25^\circ\text{C}$	150	400		$\text{k}\Omega$
Supply Current	$T_A = 25^\circ\text{C}$, $V_S = \pm 20\text{V}$		1.8	3.0	mA
Large Signal Voltage Gain	$T_A = 25^\circ\text{C}$, $V_S = \pm 15\text{V}$ $V_{\text{OUT}} = \pm 10\text{V}$, $R_L \geq 2\text{k}\Omega$	20	150		V/mV
Input Offset Voltage	$R_S \leq 10\text{k}\Omega$			10	mV
Average Temperature Coefficient of Input Offset Voltage	$R_S \leq 50\Omega$		6		$\mu\text{V}/^\circ\text{C}$
	$R_S \leq 10\text{k}\Omega$		10		$\mu\text{V}/^\circ\text{C}$
Input Offset Current	$T_A = +70^\circ\text{C}$ $T_A = 0^\circ\text{C}$		50 150	400 750	nA nA
Input Bias Current	$T_A = 0^\circ\text{C}$		0.32	2.0	μA
Large Signal Voltage Gain	$V_S = \pm 15\text{V}$, $V_{\text{OUT}} = \pm 10\text{V}$ $R_L \geq 2\text{k}\Omega$	15			V/mV
Output Voltage Swing	$V_S = \pm 15\text{V}$, $R_L = 10\text{k}\Omega$ $R_L = 2\text{k}\Omega$	±12 ±10	±14 ±13		V V
Input Voltage Range	$V_S = \pm 15\text{V}$	±12			V
Common Mode Rejection Ratio	$R_S \leq 10\text{k}\Omega$	65	90		dB
Supply Voltage Rejection Ratio	$R_S \leq 10\text{k}\Omega$	70	90		dB

Note 1: For operating at elevated temperatures, the device must be derated based on a 150°C maximum junction temperature and a thermal resistance of 150°C/W junction to ambient or 45°C/W junction to case for the metal-can package. For the flat package, the derating is based on a thermal resistance of 185°C/W when mounted on a 1/16-inch-thick, epoxy-glass board with ten, 0.03-inch-wide, 2-ounce copper conductors (see curve).

Note 2: For supply voltages less than ±15V, the absolute maximum input voltage is equal to the supply voltage.

Note 3: Continuous short circuit is allowed for case temperatures to +125°C and ambient temperatures to +70°C.

Note 4: These specifications apply for $-55^\circ\text{C} \leq T_A \leq 125^\circ\text{C}$, $\pm 5\text{V} \leq V_S \leq \pm 20\text{V}$ and $C_1 = 30\text{ pF}$ unless otherwise specified.

guaranteed performance

Input Voltage Range

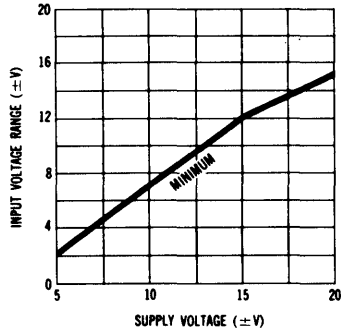

Output Swing

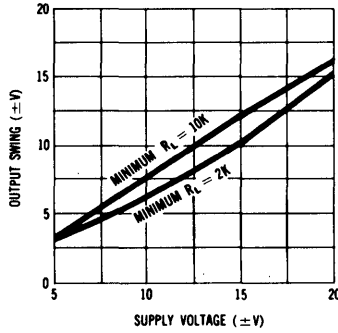

Voltage Gain

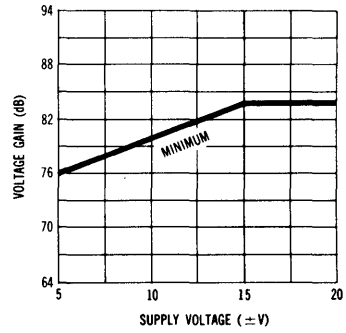

typical performance

Supply Current

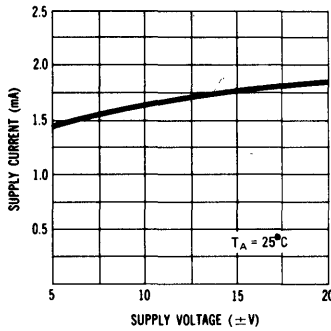

Voltage Gain

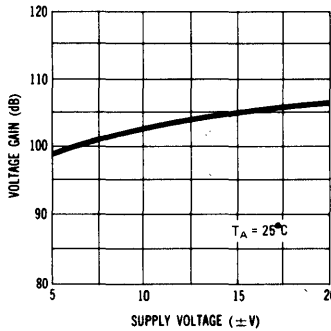

Input Bias Current

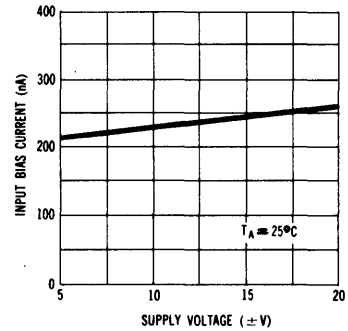

Current Limiting

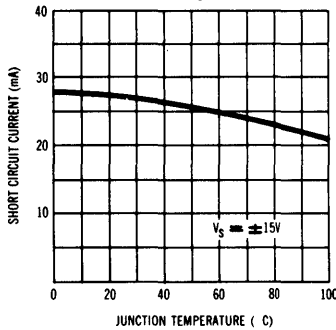

Input Current

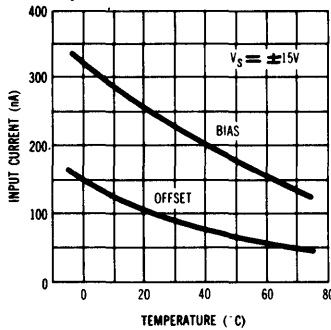

Maximum Power Dissipation

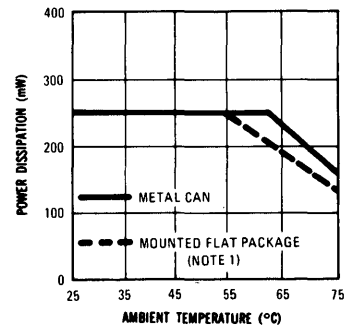

Open Loop Frequency Response

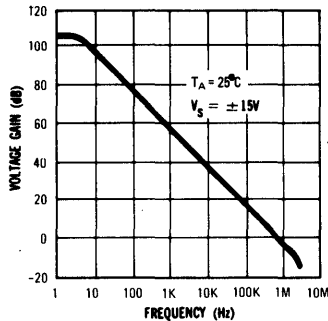

Large Signal Frequency Response

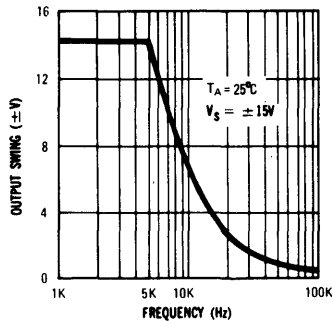

Voltage Follower Pulse Response

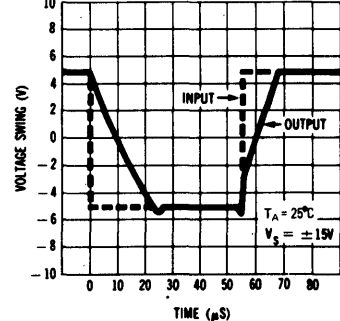



Operational Amplifiers

LM102

LM102 voltage follower general description

The LM102 is a high-gain operational amplifier designed specifically for unity-gain voltage follower applications. Built on a single silicon chip, the device incorporates advanced processing techniques to obtain very low input current and high input impedance. Further, the input transistors are operated at zero collector-base voltage to virtually eliminate high temperature leakage currents. It can therefore be operated in a temperature stabilized component oven to get extremely low input currents and low offset voltage drift. Other outstanding characteristics of the device include:

- Fast slewing – 10V/ μ s
- Low input current – 10 nA (max)

- High input resistance – 10,000 M Ω
- No external frequency compensation required
- Simple offset balancing with optional 1K potentiometer
- Plug-in replacement for both the LM101 and LM709 in voltage follower applications.

The LM102, which is designed to operate with supply voltages between ± 12 V and ± 15 V, also features low input capacitance as well as excellent small signal and large signal frequency response — all of which minimize high frequency gain error. Because of the low wiring capacitances inherent in monolithic construction, this fast operation can be realized without increasing power consumption.

schematic and connection diagrams

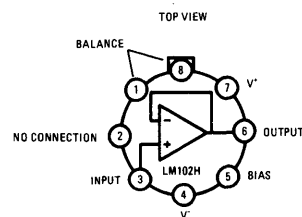
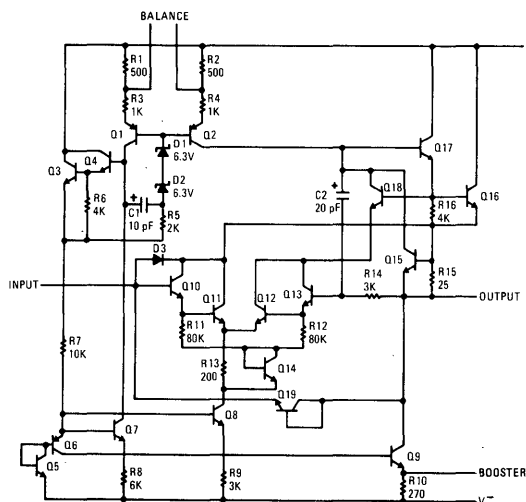

typical applications

Low Pass Active Filter

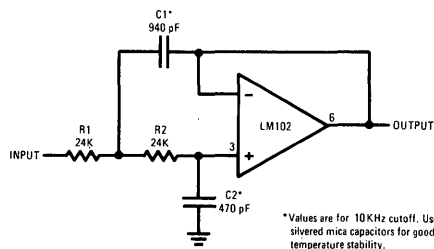

High Pass Active Filter

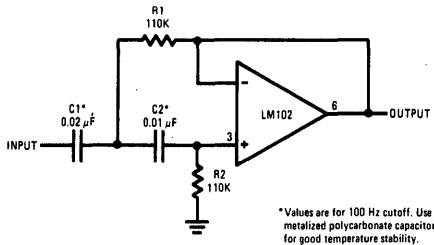

Sample and Hold With Offset Adjustment

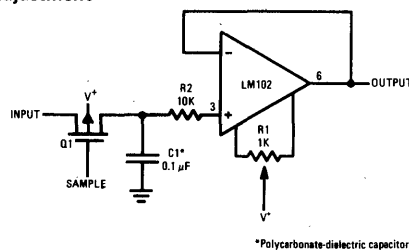

High Input Impedance AC Amplifier

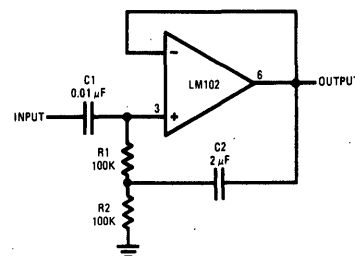

absolute maximum ratings

Supply Voltage	±18V
Power Dissipation (Note 1)	500 mW
Input Voltage (Note 2)	±15V
Output Short-Circuit Duration (Note 3)	Indefinite
Operating Temperature Range	-55°C to 125°C
Storage Temperature Range	-65°C to 150°C
Lead Temperature (soldering, 10 sec)	300°C

electrical characteristics (Note 4)

PARAMETER	CONDITIONS	MIN	TYP	MAX	UNIT
Offset Voltage			2	5	mV
Average Temperature Coefficient of Offset Voltage			6		$\mu\text{V}/^\circ\text{C}$
Input Current			3	10	nA
Input Resistance		10^{10}	10^{12}		Ω
Voltage Gain	$R_L \geq 10 \text{ k}\Omega$	0.999	0.9996		
Output Resistance			0.8	2.5	Ω
Output Voltage Swing (Note 5)	$R_L \geq 8 \text{ k}\Omega$	±10	±13		V
Supply Current			3.5	5.5	mA
Positive Supply Rejection		60			dB
Negative Supply Rejection		70			dB
Input Capacitance				3.0	pF
Offset Voltage	$-55^\circ\text{C} \leq T_A \leq 125^\circ\text{C}$			7.5	mV
Input Current	$T_A = 125^\circ\text{C}$ $T_A = -55^\circ\text{C}$		3 30	10 100	nA nA
Voltage Gain	$-55^\circ\text{C} \leq T_A \leq 125^\circ\text{C}$ $R_L \geq 10 \text{ k}\Omega$	0.999			
Output Voltage Swing (Note 5)	$R_L \geq 10 \text{ k}\Omega$	±10			V
Supply Current	$T_A = 125^\circ\text{C}$		2.6	4.0	mA

Note 1: For operating at elevated temperatures, the device must be derated based on a 150°C maximum junction temperature and a thermal resistance of 45°C/W junction to case or 150°C/W junction to ambient (see curve).

Note 2: For supply voltages less than ±15V, the absolute maximum input voltage is equal to the supply voltage.

Note 3: Continuous short circuit is allowed for case temperatures to 125°C and ambient temperatures to 70°C. It is necessary to insert a resistor greater than 2 k Ω in series with the input when the amplifier is driven from low impedance sources to prevent damage when the output is shorted.

Note 4: These specifications apply for $T_A = 25^\circ\text{C}$, $V_S = \pm 15\text{V}$ and $C_L \leq 100 \text{ pF}$ unless otherwise noted.

Note 5: Increased output swing under load can be obtained by connecting an external resistor between the booster and V^- terminals. See curve.

guaranteed performance

Input Current

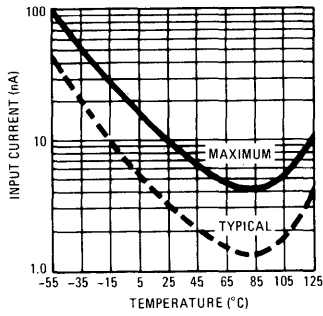

Output Swing

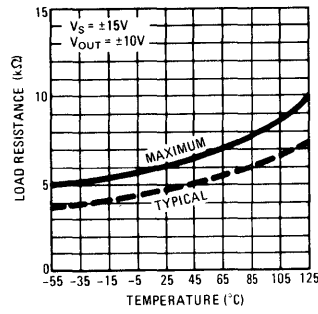

Supply Current

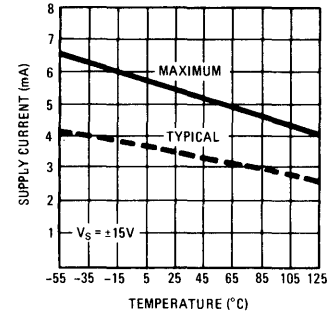

typical performance

Voltage Gain

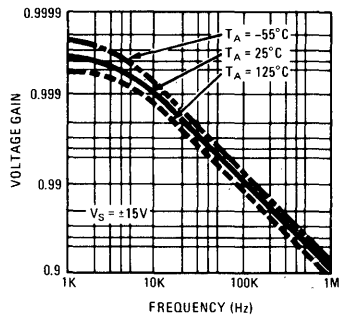

Voltage Gain

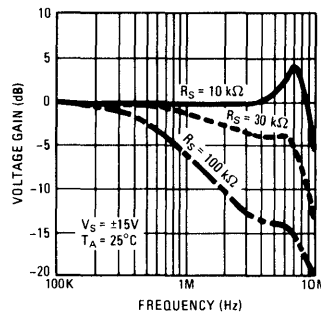

Output Resistance

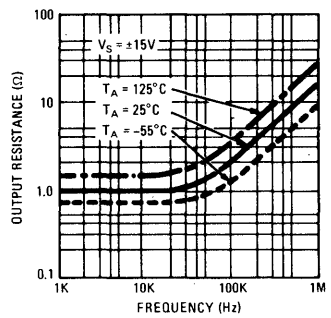

Positive Output Swing

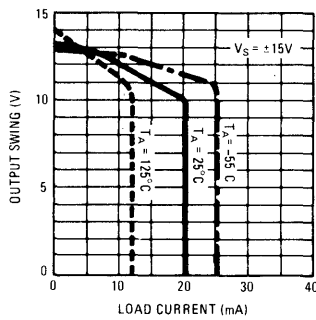

Negative Output Swing

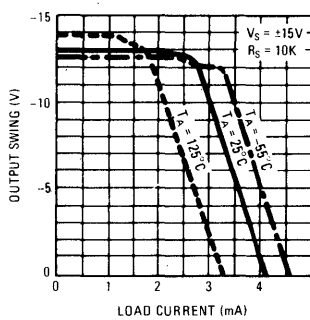

Output Swing

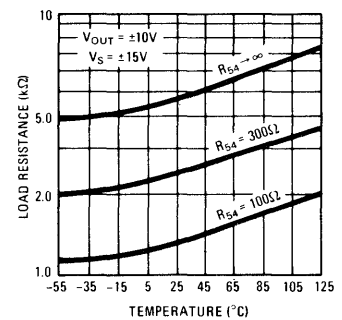

Large Signal Frequency Response

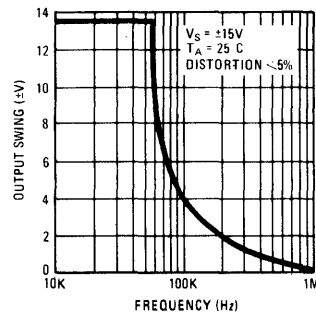

Large Signal Pulse Response

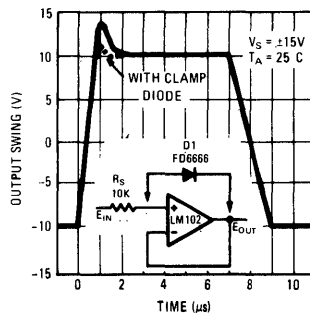

Maximum Power Dissipation

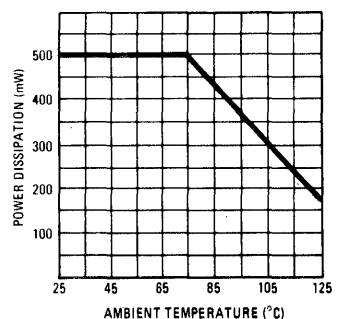



Operational Amplifiers

LM202 voltage follower general description

The LM202, a limited temperature range version of the LM102, is a high-gain operational amplifier designed specifically for unity-gain voltage follower applications. Built on a single silicon chip, the device incorporates advanced processing techniques to obtain very low input current and high input impedance. Further, the input transistors are operated at zero collector-base voltage to virtually eliminate high temperature leakage currents. It can therefore be operated in a temperature stabilized component oven to get extremely low input currents and low offset voltage drift. Other outstanding characteristics of the device include:

- Fast slewing: 10V/ μ s
- Low input current: 15 nA (max)

- High input resistance: 10,000 M Ω
- No external frequency compensation required
- Simple offset balancing with optional 1K potentiometer
- Specified for operation from -25°C to 85°C
- Plug-in replacement for both the LM201 and LM709C voltage follower applications.

The LM202, which is designed to operate with supply voltages between $\pm 12\text{V}$ and $\pm 15\text{V}$, also features low input capacitance as well as excellent small signal and large signal frequency response — all of which minimize high frequency gain error. Because of the low wiring capacitances inherent in monolithic construction, this fast operation can be realized without increasing power consumption.

schematic and connection diagrams

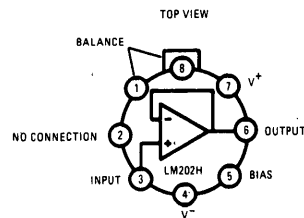
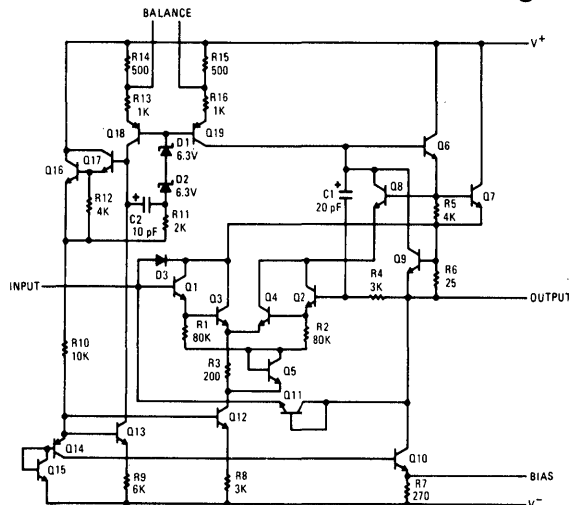

NOTE: Pin 4 connected to case.

typical applications

Low Pass Active Filter

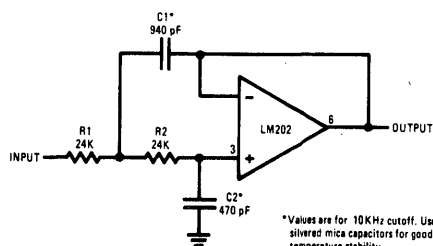

High Pass Active Filter

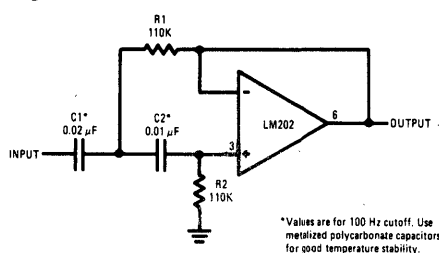

Sample and Hold With Offset Adjustment

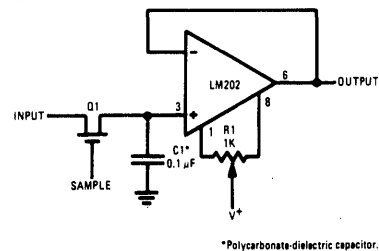

High Input Impedance AC Amplifier

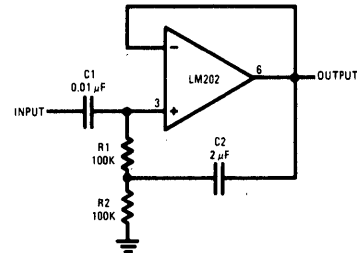

absolute maximum ratings

Supply Voltage	±18V
Power Dissipation (Note 1)	500 mW
Input Voltage (Note 2)	±15V
Output Short Circuit Duration (Note 3)	Indefinite
Operating Temperature Range	-25°C to 85°C
Storage Temperature Range	-65°C to 150°C
Lead Temperature (soldering, 60 sec)	300°C

electrical characteristics (Note 4)

PARAMETER	CONDITIONS	MIN	TYP	MAX	UNITS
Offset Voltage			3	10	mV
Average Temperature Coefficient of Offset Voltage			15		μV/°C
Input Current			7	15	nA
Input Resistance		10 ¹⁰	10 ¹²		Ω
Voltage Gain	R _L ≥ 8 KΩ	.999	0.9995	1.000	
Output Resistance			0.8	2.5	Ω
Output Voltage Swing	R _L ≥ 8 KΩ	±10			V
Supply Current			3.5	5.5	mA
Positive Supply Rejection		60			
Negative Supply Rejection		70			
Input Capacitance			3.0		pF
Offset Voltage	-25°C ≤ T _A ≤ 85°C			15	mV
Input Current	T _A = 85°C		1.5	5.0	nA
	T _A = -25°C		30	50	nA

Note 1: For operating at elevated temperatures, the device must be derated based on a 100°C maximum junction temperature and a thermal resistance of 45°C/W junction to case or 150°C/W junction to ambient (see curve).

Note 2: For supply voltages less than ±15V, the absolute maximum input voltage is equal to the supply voltage.

Note 3: Continuous short circuit is allowed for case temperatures to 85°C and ambient temperatures to 55°C. It is necessary to insert a resistor greater than 2 kΩ in series with the input when the amplifier is driven from low impedance sources to prevent damage when the output is shorted.

Note 4: These specifications apply for T_A = 25°C, V_S = ±15V and C_L ≤ 100 pF unless otherwise noted.

guaranteed performance

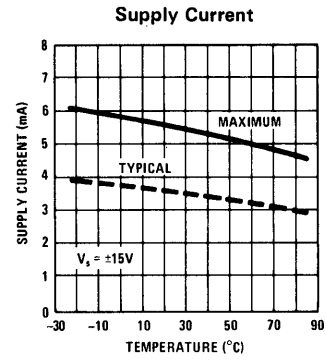
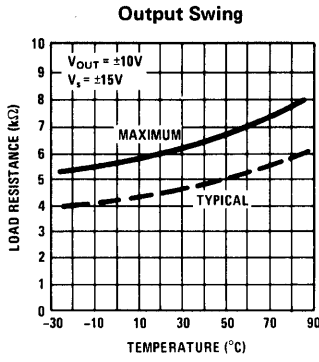
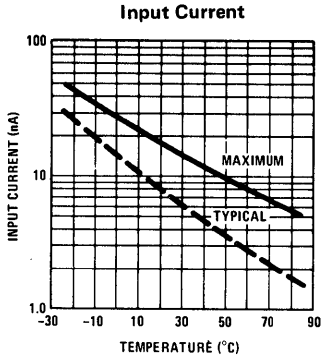

typical performance

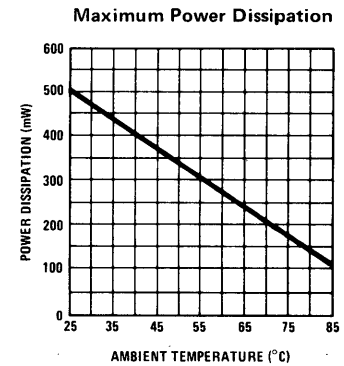
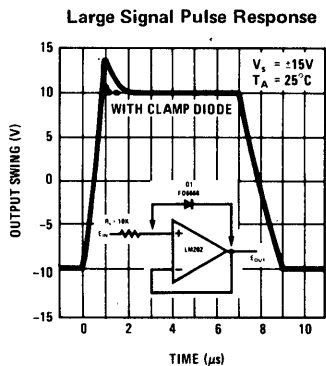
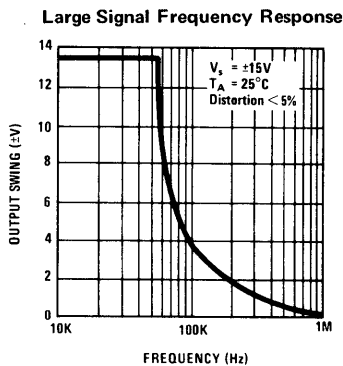
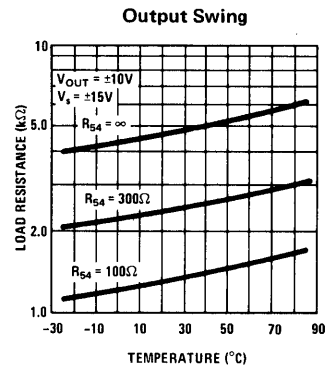
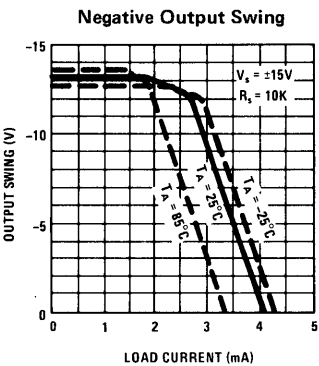
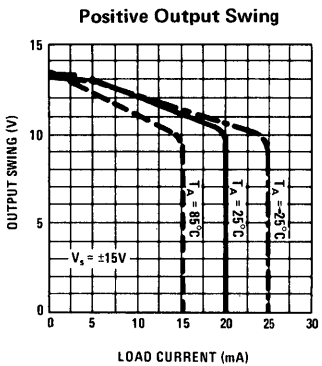
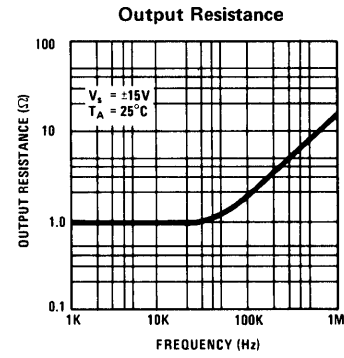
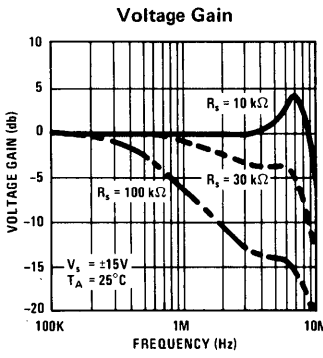
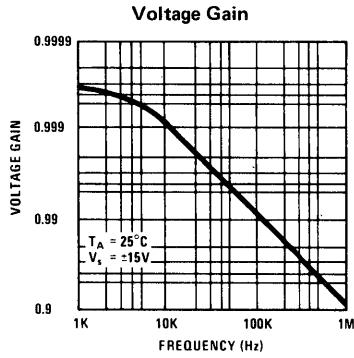



Operational Amplifiers

LM302

LM302 voltage follower general description

The LM302, an epoxy encapsulated version of the LM102, is a high gain operational amplifier designed specifically for unity-gain voltage follower applications. Built on a single silicon chip, the device incorporates advanced processing techniques to obtain very low input current and high input impedance. Further, the input transistors are operated at zero collector-base voltage to virtually eliminate high temperature leakage currents. It can therefore be operated in a temperature stabilized component oven to get extremely low input currents and low offset voltage drift. Other outstanding characteristics of the device include:

- Fast Slewing – 10V/μs
- Low input current – 30 nA (max)

- High input resistance – 1,000 MΩ
- No external frequency compensation required
- Simple offset balancing with optional 1K potentiometer
- Specified for operation from 0°C to 70°C
- Plug-in replacement for both the LM201 and LM709C in voltage follower applications.

The LM302, which is designed to operate with supply voltages between ±12V and ±15V, also features low input capacitance as well as excellent small signal and large signal frequency response – all of which minimize high frequency gain error. Because of the low wiring capacitances inherent in monolithic construction, this fast operation can be realized without increasing power consumption.

schematic and connection diagrams

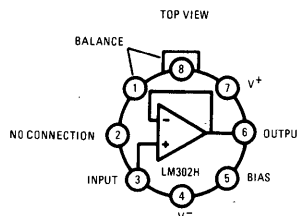
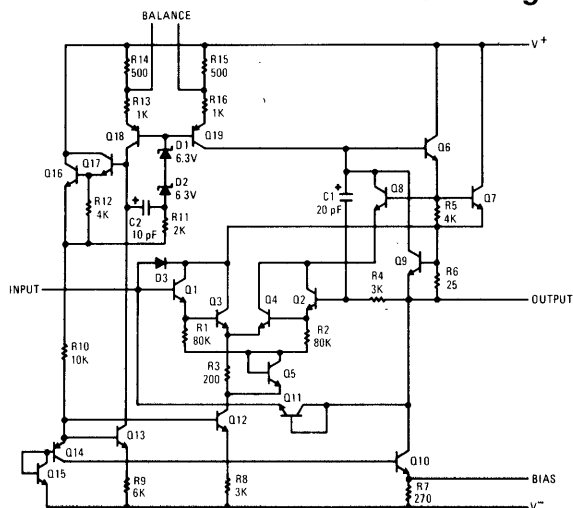

NOTE: Pin 4 connected to case.

typical applications

Low Pass Active Filter

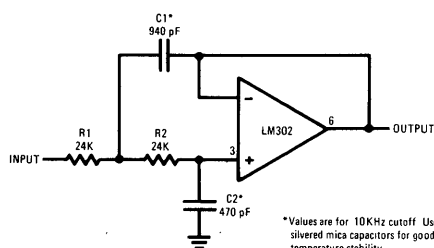

*Values are for 10KHz cutoff. Use silvered mica capacitors for good temperature stability.

High Pass Active Filter

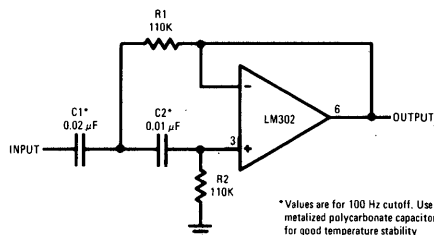

*Values are for 100 Hz cutoff. Use metallized polycarbonate capacitors for good temperature stability

Sample and Hold With Offset Adjustment

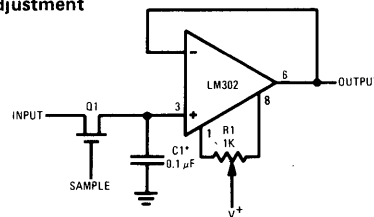

*Polycarbonate-dielectric capacitor.

High Input Impedance AC Amplifier

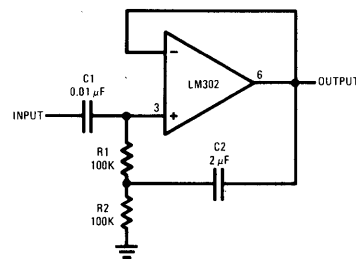

absolute maximum ratings

Supply Voltage	±18V
Power Dissipation (Note 1)	400 mW
Input Voltage (Note 2)	±15V
Output Short Circuit Duration (Note 3)	Indefinite
Operating Temperature Range	0°C to 70°C
Storage Temperature Range	-65°C to 150°C
Lead Temperature (soldering, 60 sec)	300°C

electrical characteristics (Note 4)

PARAMETER	CONDITIONS	MIN	TYP	MAX	UNITS
Offset Voltage			5	15	mV
Average Temperature Coefficient of Offset Voltage			20		μV/°C
Input Current			10	30	nA
Input Resistance		10 ⁹	10 ¹²		Ω
Voltage Gain	R _L > 8 KΩ	0.9985	0.9995	1.000	
Output Resistance			0.8	2.5	Ω
Output Voltage Swing	R _L ≥ 8 KΩ	±10			V
Supply Current			3.5	5.5	mA
Positive Supply Rejection		60			dB
Negative Supply Rejection		70			dB
Input Capacitance			3.0		pF
Offset Voltage	0°C ≤ T _A ≤ 70°C			20	mV
Input Current	T _A = 70°C T _A = 0°C		3.0 20	15 50	nA nA

Note 1: For operating at elevated temperatures, the device must be derated based on a 85°C maximum junction temperature and a thermal resistance of 45°C/W junction to case or 150°C/W junction to ambient (see curve).

Note 2: For supply voltages less than ±15V, the absolute maximum input voltage is equal to the supply voltage.

Note 3: Continuous short circuit is allowed for case temperatures to 70°C and ambient temperatures to 55°C. It is necessary to insert a resistor greater than 2 KΩ in series with the input when the amplifier is driven from low impedance sources to prevent damage when the output is shorted.

Note 4: These specifications apply for T_A = 25°C, V_S = ±15V and C_L ≤ 100 pF unless otherwise noted.

guaranteed performance

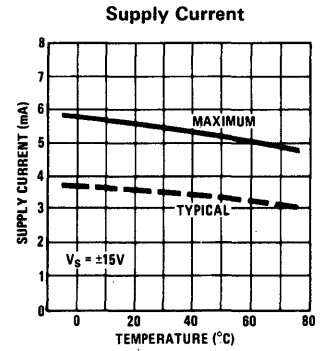
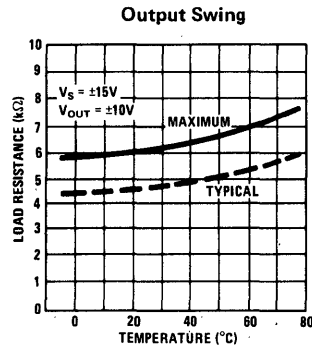
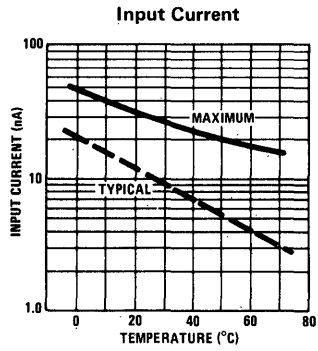

typical performance

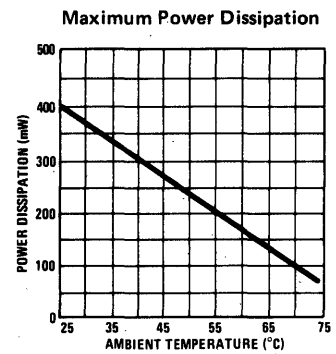
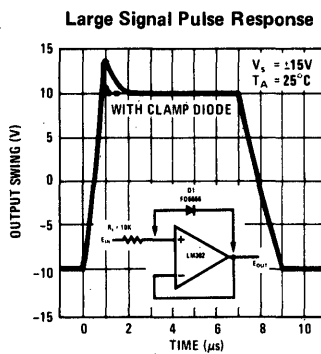
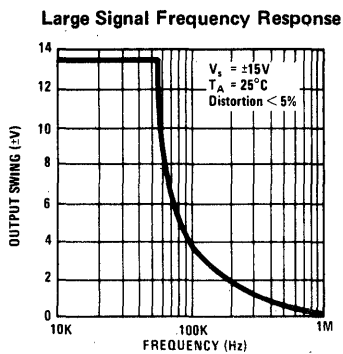
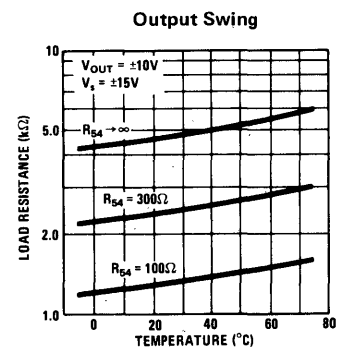
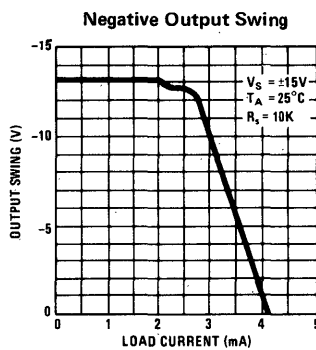
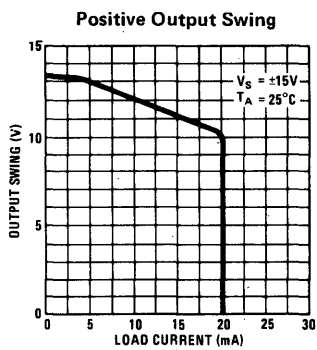
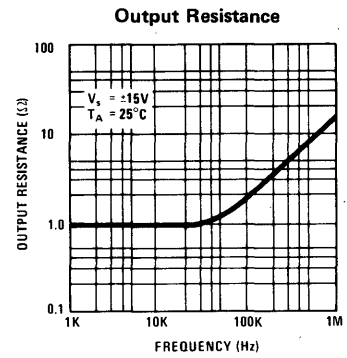
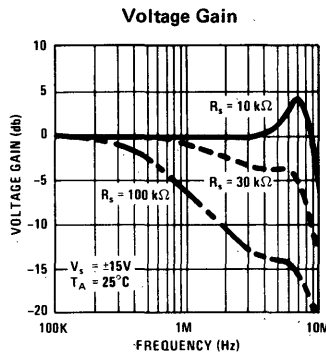
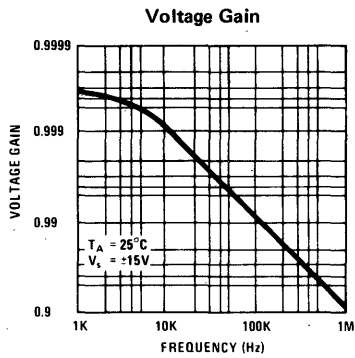



Operational Amplifiers

LM107/LM207 operational amplifiers general description

The LM107 and LM207 are complete, general purpose operational amplifiers, with the necessary frequency compensation built into the chip. Advanced processing techniques make the input currents a factor of ten lower than industry standards like the 709. Yet, they are a direct, plug-in replacement for the 709, LM101, LM101A and 741. Specifications which have been improved include:

- Offset voltage 3 mV maximum over temperature
- Input current 100 nA maximum over temperature
- Offset current 20 nA maximum over temperature
- Guaranteed drift characteristics

- Offsets guaranteed over entire common mode range

The LM107 series offers the features of the LM101, which makes its application nearly fool-proof. In addition, the device provides better accuracy and lower noise in high impedance circuitry. The low input currents also make it particularly well suited for long interval integrators or timers, sample and hold circuits and low frequency waveform generators. Further, replacing circuits where matched transistor pairs buffer the inputs of conventional IC op amps, it can give lower offset voltage and drift at a lower cost.

The LM207 is identical to the LM107, except that the LM207 has its performance guaranteed over a -25°C to 85°C temperature range, instead of -55°C to 125°C .

connection diagrams

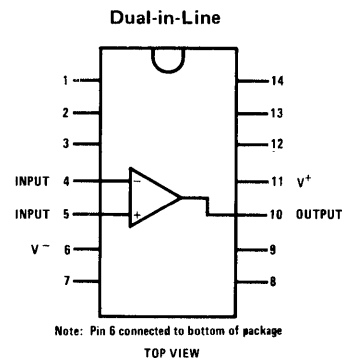
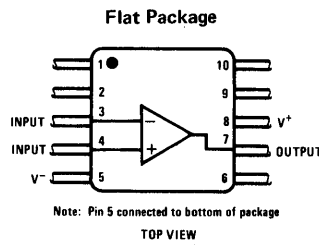
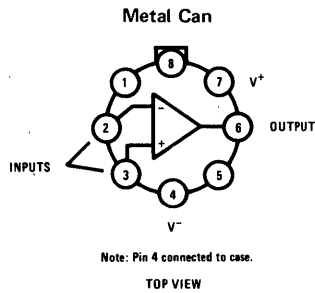

typical applications

Inverting Amplifier

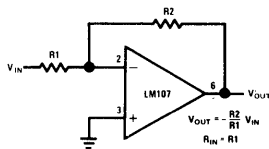

Non-Inverting AC Amplifier

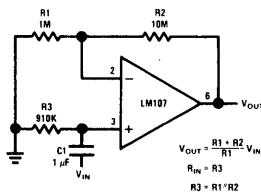

Non-Inverting Amplifier

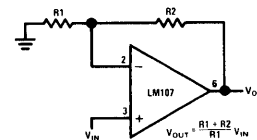

Differential Input Instrumentation Amplifier

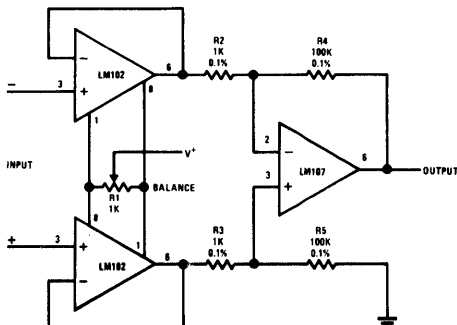

Tunable Notch Filter

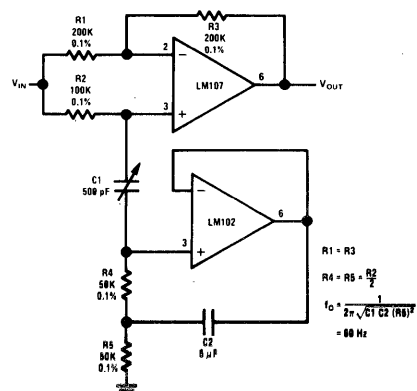

absolute maximum ratings

Supply Voltage		±22V
Power Dissipation (Note 1)		500 mW
Differential Input Voltage		±30V
Input Voltage (Note 2)		±15V
Output Short-Circuit Duration		Indefinite
Operating Temperature Range	LM107	-55°C to 125°C
	LM207	-25°C to 85°C
Storage Temperature Range		-65°C to 150°C
Lead Temperature (Soldering, 60 sec)		300°C

electrical characteristics (Note 3)

PARAMETER	CONDITIONS	MIN	TYP	MAX	UNITS
Input Offset Voltage	$T_A = 25^\circ\text{C}$, $R_S \leq 10\text{ k}\Omega$		0.7	2.0	mV
Input Offset Current	$T_A = 25^\circ\text{C}$		1.5	10	nA
Input Bias Current	$T_A = 25^\circ\text{C}$		30	75	nA
Input Resistance	$T_A = 25^\circ\text{C}$	1.5	4		M Ω
Supply Current	$T_A = 25^\circ\text{C}$, $V_S = \pm 20\text{V}$		1.8	3.0	mA
Large Signal Voltage Gain	$T_A = 25^\circ\text{C}$, $V_S = \pm 15\text{V}$ $V_{\text{OUT}} = \pm 10\text{V}$, $R_L \geq 2\text{ k}\Omega$	50	160		V/mV
Input Offset Voltage	$R_S \leq 10\text{ k}\Omega$			3.0	mV
Average Temperature Coefficient of Input Offset Voltage			3.0	15	$\mu\text{V}/^\circ\text{C}$
Input Offset Current				20	nA
Average Temperature Coefficient of Input Offset Current	$25^\circ\text{C} \leq T_A \leq 125^\circ\text{C}$ $-55^\circ\text{C} \leq T_A \leq 25^\circ\text{C}$		0.01 0.02	0.1 0.2	nA/ $^\circ\text{C}$ nA/ $^\circ\text{C}$
Input Bias Current				100	nA
Supply Current	$T_A = +125^\circ\text{C}$, $V_S = \pm 20\text{V}$		1.2	2.5	mA
Large Signal Voltage Gain	$V_S = \pm 15\text{V}$, $V_{\text{OUT}} = \pm 10\text{V}$ $R_L \geq 2\text{ k}\Omega$	25			V/mV
Output Voltage Swing	$V_S = \pm 15\text{V}$, $R_L = 10\text{ k}\Omega$ $R_L = 2\text{ k}\Omega$	±12 ±10	±14 ±13		V V
Input Voltage Range	$V_S = \pm 20\text{V}$	±15			V
Common Mode Rejection Ratio	$R_S \leq 10\text{ k}\Omega$	80	96		dB
Supply Voltage Rejection Ratio	$R_S \leq 10\text{ k}\Omega$	80	96		dB

Note 1: The maximum junction temperature of the LM107 is 150°C, while that of the LM207 is 100°C. For operating at elevated temperatures, devices in the TO-5 package must be derated based on a thermal resistance of 150°C/W, junction to ambient, or 45°C/W, junction to case. For the flat package, the derating is based on a thermal resistance of 185°C/W when mounted on a 1/16-inch-thick epoxy glass board with ten, 0.03-inch-wide, 2-ounce copper conductors. The thermal resistance of the dual-in-line package is 100°C/W, junction to ambient.

Note 2: For supply voltages less than ±15V, the absolute maximum input voltage is equal to the supply voltage.

Note 3: These specifications apply for $\pm 5\text{V} \leq V_S \leq \pm 20\text{V}$ and $-55^\circ\text{C} \leq T_A \leq 125^\circ\text{C}$ for the LM107 or $-25^\circ\text{C} \leq T_A \leq 85^\circ\text{C}$ for the LM207, unless otherwise specified.

guaranteed performance

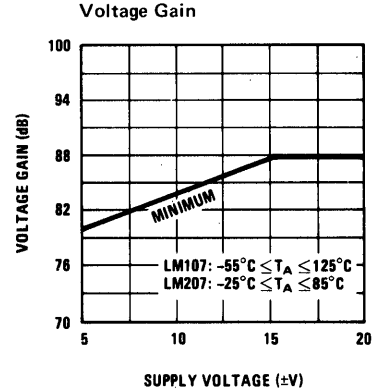
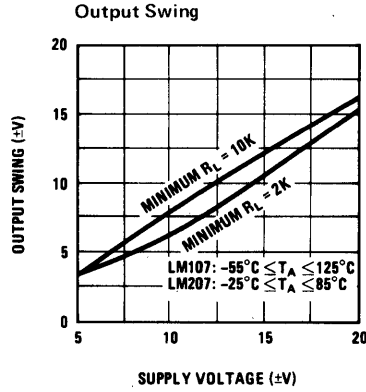
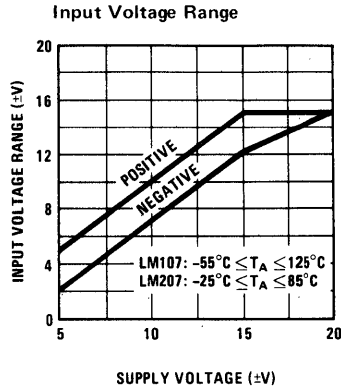

typical performance

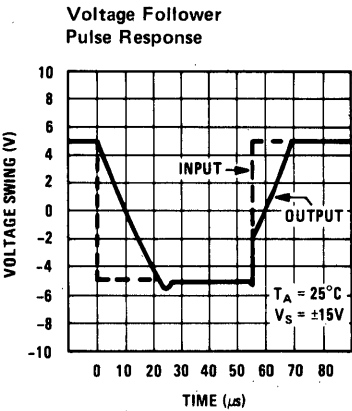
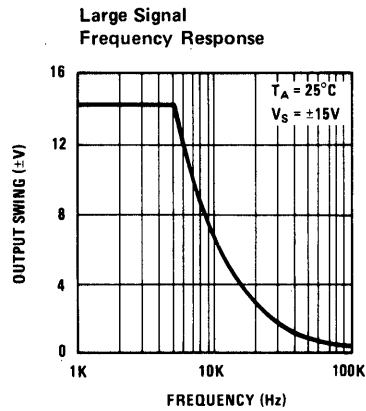
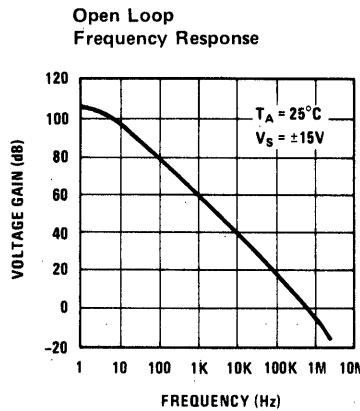
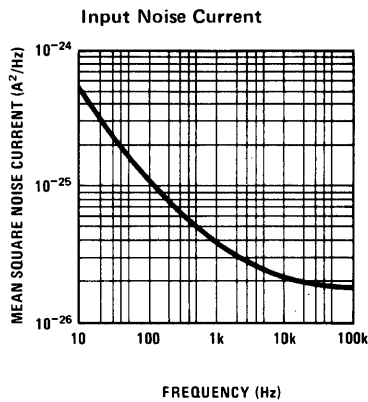
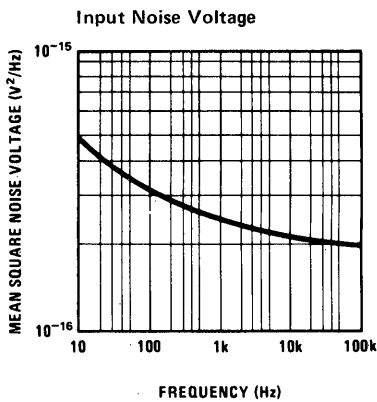
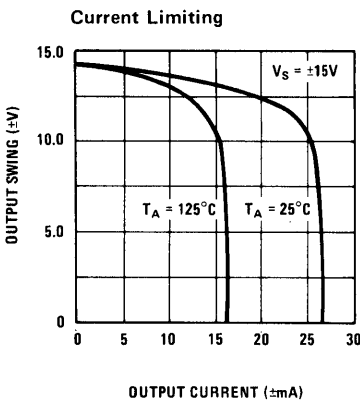
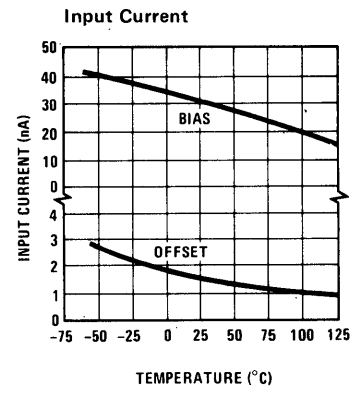
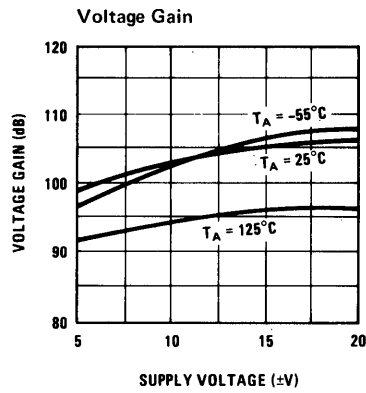
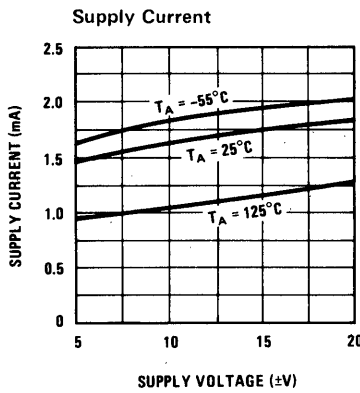



Operational Amplifiers

LM307 operational amplifier general description

The LM307 is a complete, general purpose operational amplifier, with the necessary frequency compensation built into the chip. Advanced processing techniques make the input currents a factor of ten lower than industry standards like the 709C. Yet, it is a direct, plug-in replacement for the 709C, LM201, MC1439 and 741 in most applications.

In addition to reduced input current, the offset voltage and offset current are guaranteed over the entire common mode range and maximum drift specifications are given. The amplifier also offers many features which make its application nearly

foolproof: overload protection on the input and output, no latch-up when the common mode range is exceeded, as well as freedom from oscillations.

The LM307 provides better accuracy and lower noise than its predecessors in high impedance circuitry. The low input currents also make it particularly well suited for long interval integrators or timers, sample and hold circuits and low frequency waveform generators. Further, replacing circuits where matched transistor pairs buffer the inputs of conventional IC op amps, it can give lower offset voltage and drift at reduced cost.

connection diagrams

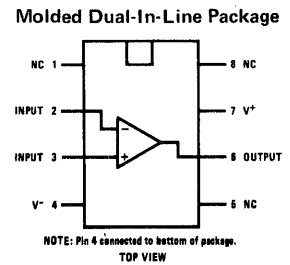
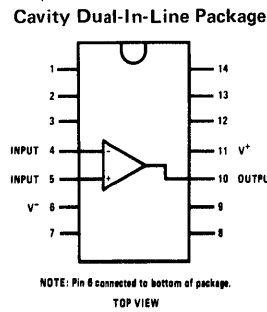
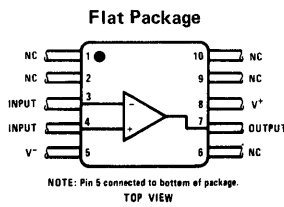
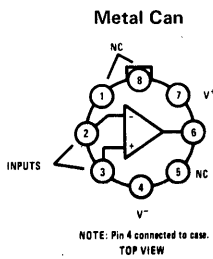

typical applications

Inverting Amplifier

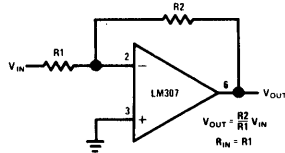

Non-Inverting Amplifier

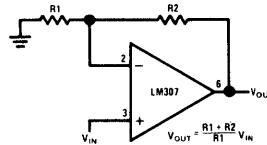

Non-Inverting AC Amplifier

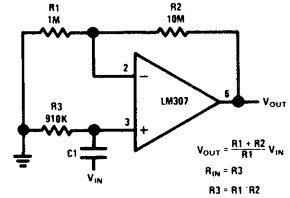

Tunable Notch Filter

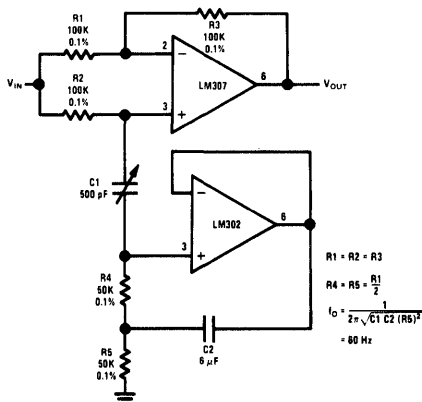

Differential Input Instrumentation Amplifier

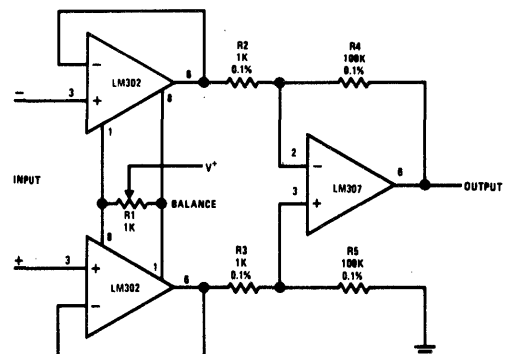

absolute maximum ratings

Supply Voltage	±18V
Power Dissipation (Note 1)	500 mW
Differential Input Voltage	±30V
Input Voltage (Note 2)	±15V
Output Short-Circuit Duration (Note 3)	Indefinite
Operating Temperature Range	0°C to 70°C
Storage Temperature Range	-65°C to 150°C
Lead Temperature (Soldering, 60 sec)	300°C

electrical characteristics (Note 4)

PARAMETER	CONDITIONS	MIN	TYP	MAX	UNITS
Input Offset Voltage	$T_A = 25^\circ\text{C}$, $R_S \leq 50\text{ k}\Omega$		2.0	7.5	mV
Input Offset Current	$T_A = 25^\circ\text{C}$		3	50	nA
Input Bias Current	$T_A = 25^\circ\text{C}$		70	250	nA
Input Resistance	$T_A = 25^\circ\text{C}$	0.5	2		M Ω
Supply Current	$T_A = 25^\circ\text{C}$, $V_S = \pm 15\text{V}$		1.8	3.0	mA
Large Signal Voltage Gain	$T_A = 25^\circ\text{C}$, $V_S = \pm 15\text{V}$ $V_{\text{OUT}} = \pm 10\text{V}$, $R_L \geq 2\text{ k}\Omega$	25	160		V/mV
Input Offset Voltage	$R_S \leq 50\text{ k}\Omega$			10	mV
Average Temperature Coefficient of Input Offset Voltage			6.0	30	$\mu\text{V}/^\circ\text{C}$
Input Offset Current				70	nA
Average Temperature Coefficient of Input Offset Current	$25^\circ\text{C} \leq T_A \leq 70^\circ\text{C}$ $0^\circ\text{C} \leq T_A \leq 25^\circ\text{C}$		0.01 0.02	0.3 0.6	nA/ $^\circ\text{C}$ nA/ $^\circ\text{C}$
Input Bias Current				300	nA
Large Signal Voltage Gain	$V_S = \pm 15\text{V}$, $V_{\text{OUT}} = \pm 10\text{V}$ $R_L \geq 2\text{ k}\Omega$	15			V/mV
Output Voltage Swing	$V_S = \pm 15\text{V}$, $R_L = 10\text{ k}\Omega$ $R_L = 2\text{ k}\Omega$	±12 ±10	±14 ±13		V V
Input Voltage Range	$V_S = \pm 15\text{V}$	±12			V
Common Mode Rejection Ratio	$R_S \leq 50\text{ k}\Omega$	70	90		dB
Supply Voltage Rejection Ratio	$R_S \leq 50\text{ k}\Omega$	70	96		dB

Note 1: For operating at elevated temperatures, the device must be derated based on a 100°C maximum junction temperature and a thermal resistance of 150°C/W junction to ambient or 45°C/W junction to case.

Note 2: For supply voltages less than ±15V, the absolute maximum input voltage is equal to the supply voltage.

Note 3: Continuous short circuit is allowed for case temperatures to 70°C and ambient temperatures to 55°C.

Note 4: The specifications apply for $0^\circ\text{C} \leq T_A \leq 70^\circ\text{C}$ and $\pm 5\text{V} \leq V_S \leq \pm 15\text{V}$, unless otherwise specified.

guaranteed performance

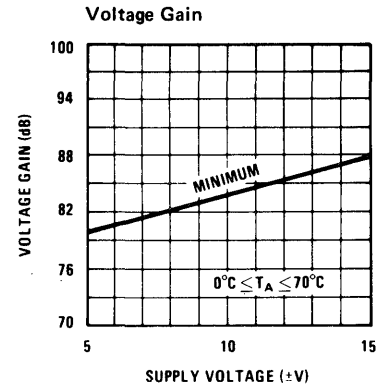
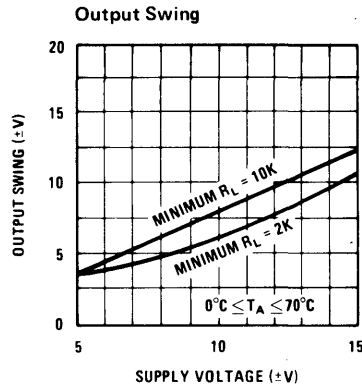
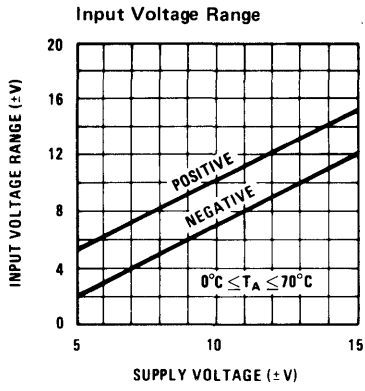

typical performance

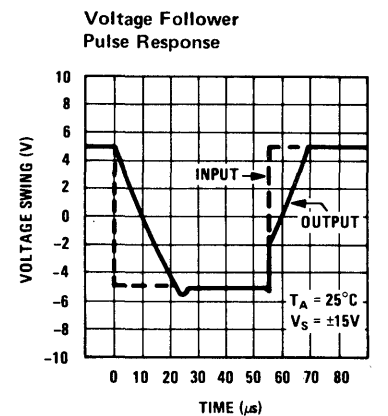
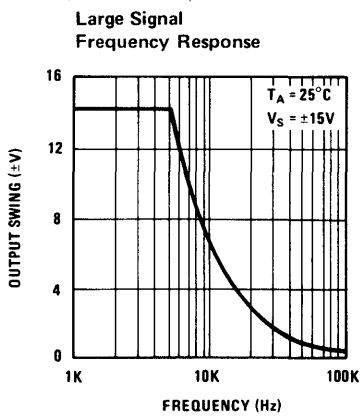
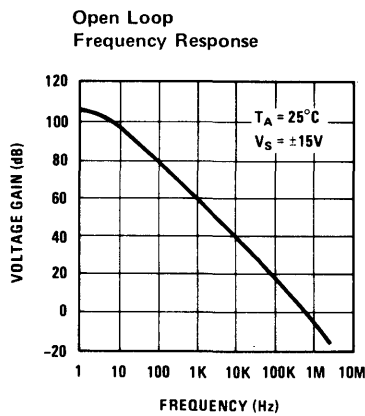
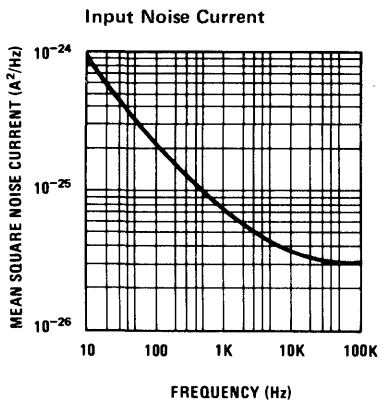
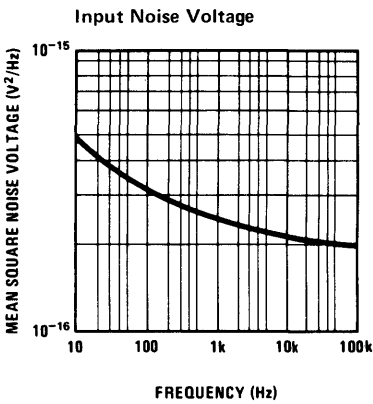
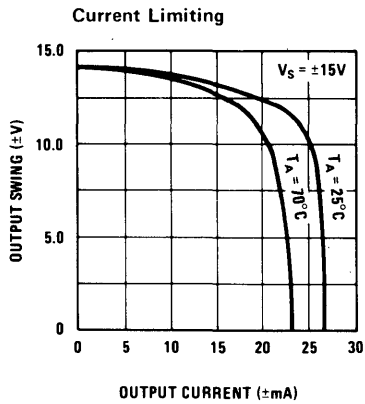
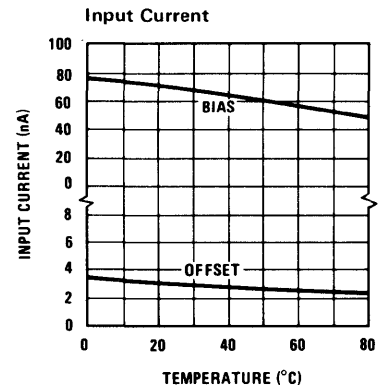
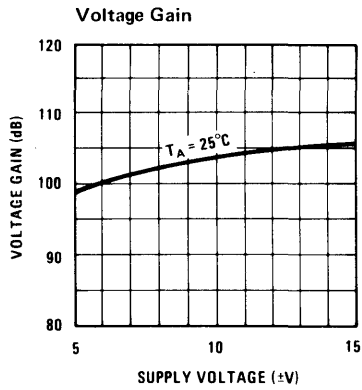
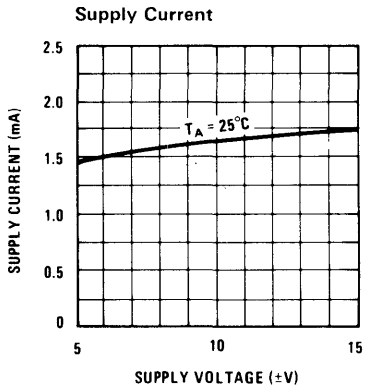



Operational Amplifiers

LM108/LM208 operational amplifiers

general description

The LM108 and LM208 are precision operational amplifiers having specifications a factor of ten better than FET amplifiers over a -55°C to 125°C temperature range. Selected units are available with offset voltages less than 1.0 mV and drifts less than $5\ \mu\text{V}/^{\circ}\text{C}$, again over the military temperature range. This makes it possible to eliminate offset adjustments, in most cases, and obtain performance approaching chopper stabilized amplifiers.

The devices operate with supply voltages from $\pm 2\text{V}$ to $\pm 20\text{V}$ and have sufficient supply rejection to use unregulated supplies. Although the circuit is interchangeable with and uses the same compensation as the LM101A, an alternate compensation scheme can be used to make it particularly insensitive to power supply noise and to make supply bypass capacitors unnecessary. Outstanding characteristics include:

- Maximum input bias current of 3.0 nA over temperature
- Offset current less than 400 pA over temperature
- Supply current of only 300 μA , even in saturation
- Guaranteed drift characteristics

The low current error of the LM108 series makes possible many designs that are not practical with conventional amplifiers. In fact, it operates from $10\ \text{M}\Omega$ source resistances, introducing less error than devices like the 709 with $10\ \text{k}\Omega$ sources. Integrators with drifts less than $500\ \mu\text{V}/\text{sec}$ and analog time delays in excess of one hour can be made using capacitors no larger than $1\ \mu\text{F}$.

The LM208 is identical to the LM108, except that the LM208 has its performance guaranteed over a -25°C to 85°C temperature range, instead of -55°C to 125°C .

connection diagrams *

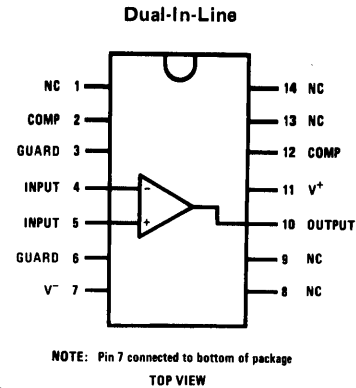
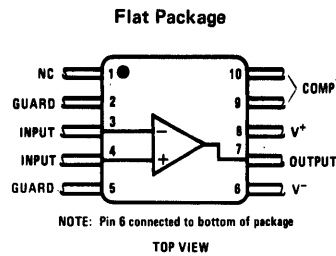
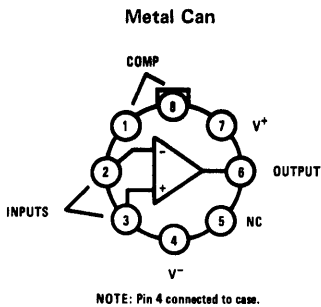

*Pin connections shown on schematic diagram are for TO-5 package.

schematic diagram and compensation circuits

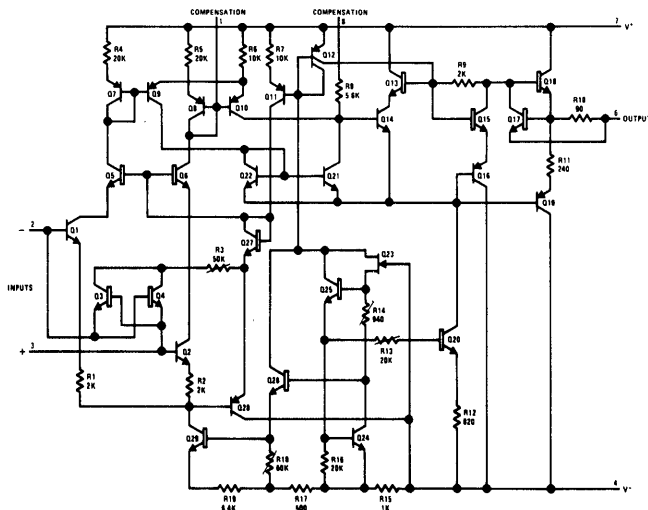

Standard Compensation Circuit

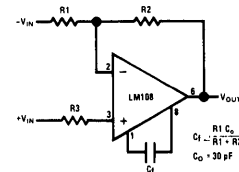

Alternate* Frequency Compensation

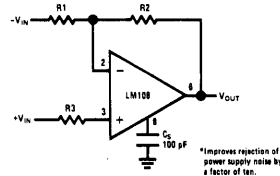

absolute maximum ratings

Supply Voltage	±20V
Power Dissipation (Note 1)	500 mW
Differential Input Current (Note 2)	±10 mA
Input Voltage (Note 3)	±15V
Output Short-Circuit Duration	Indefinite
Operating Temperature Range	LM108 -55°C to 125°C
	LM208 -25°C to 85°C
Storage Temperature Range	-65°C to 150°C
Lead Temperature (Soldering, 60 sec)	300°C

electrical characteristics (Note 4)

PARAMETER	CONDITIONS	MIN	TYP	MAX	UNITS
Input Offset Voltage (Note 5)	$T_A = 25^\circ\text{C}$		0.7	2.0	mV
Input Offset Current	$T_A = 25^\circ\text{C}$		0.05	0.2	nA
Input Bias Current	$T_A = 25^\circ\text{C}$		0.8	2.0	nA
Input Resistance	$T_A = 25^\circ\text{C}$	30	70		M Ω
Supply Current	$T_A = 25^\circ\text{C}$		0.3	0.6	mA
Large Signal Voltage Gain	$T_A = 25^\circ\text{C}$, $V_S = \pm 15\text{V}$ $V_{OUT} = \pm 10\text{V}$, $R_L \geq 10\text{ k}\Omega$	50	300		V/mV
Input Offset Voltage (Note 5)				3.0	mV
Average Temperature Coefficient of Input Offset Voltage (Note 5)			3.0	15	$\mu\text{V}/^\circ\text{C}$
Input Offset Current				0.4	nA
Average Temperature Coefficient of Input Offset Current			0.5	2.5	$\text{pA}/^\circ\text{C}$
Input Bias Current				3.0	nA
Supply Current	$T_A = +125^\circ\text{C}$		0.15	0.4	mA
Large Signal Voltage Gain	$V_S = \pm 15\text{V}$, $V_{OUT} = \pm 10\text{V}$, $R_L \geq 10\text{ k}\Omega$	25			V/mV
Output Voltage Swing	$V_S = \pm 15\text{V}$, $R_L = 10\text{ k}\Omega$	±13	±14		V
Input Voltage Range	$V_S = \pm 15\text{V}$	±13.5			V
Common Mode Rejection Ratio		85	100		dB
Supply Voltage Rejection Ratio		80	96		dB

Note 1: The maximum junction temperature of the LM108 is 150°C, while that of the LM208 is 100°C. For operating at elevated temperatures, devices in the TQ-5 package must be derated based on a thermal resistance of 150°C/W, junction to ambient, or 45°C/W, junction to case. For the flat package, the derating is based on a thermal resistance of 185°C/W when mounted on a 1/16-inch-thick epoxy glass board with ten, 0.03-inch-wide, 2-ounce copper conductors. The thermal resistance of the dual-in-line package is 100°C/W, junction to ambient.

Note 2: The inputs are shunted with back-to-back diodes for overvoltage protection. Therefore, excessive current will flow if a differential input voltage in excess of 1V is applied between the inputs unless some limiting resistance is used.

Note 3: For supply voltages less than ±15V, the absolute maximum input voltage is equal to the supply voltage.

Note 4: These specifications apply for $\pm 5\text{V} \leq V_S \leq \pm 20\text{V}$ and $-55^\circ\text{C} \leq T_A \leq 125^\circ\text{C}$, unless otherwise specified. With the LM208, however, all temperature specifications are limited to $-25^\circ\text{C} \leq T_A \leq 85^\circ\text{C}$.

Note 5: The LM108A has a guaranteed offset voltage less than 0.5 mV at 25°C and 1.0 mV for $-55^\circ\text{C} \leq T_A \leq 125^\circ\text{C}$ and $V_S = \pm 15\text{V}$. The average temperature coefficient of input offset voltage is guaranteed to be less than 5 $\mu\text{V}/^\circ\text{C}$ for these same conditions.

typical performance

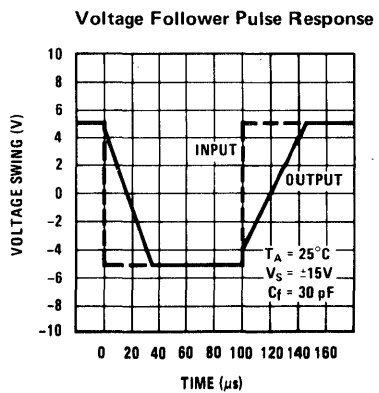
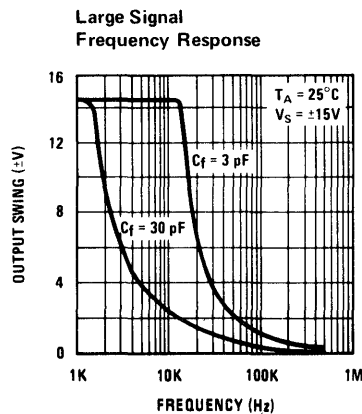
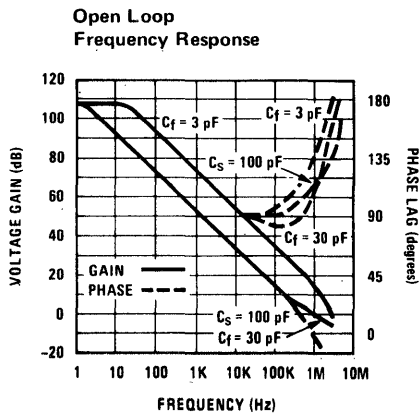
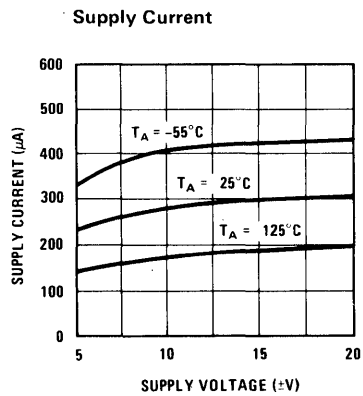
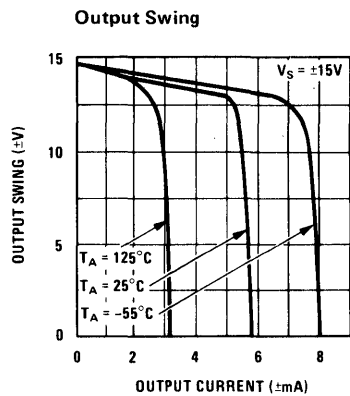
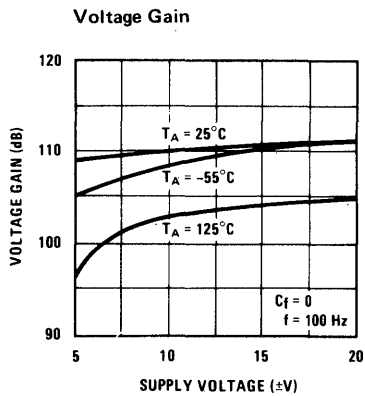
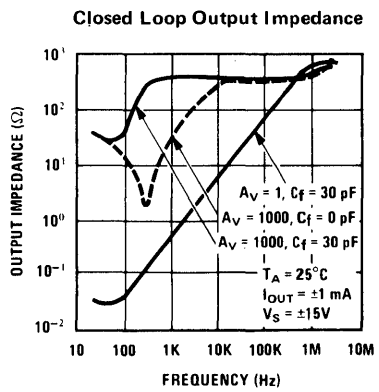
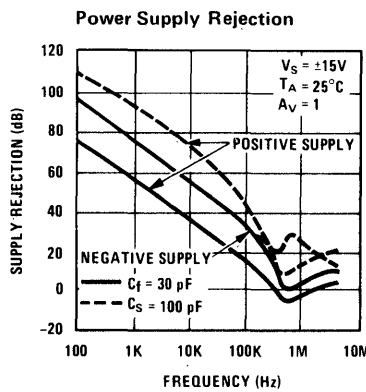
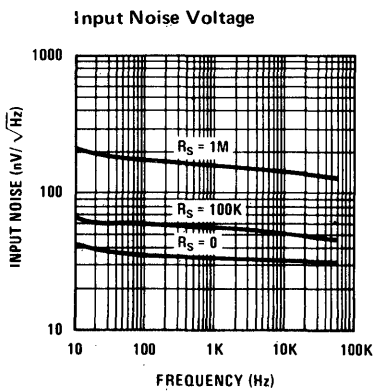
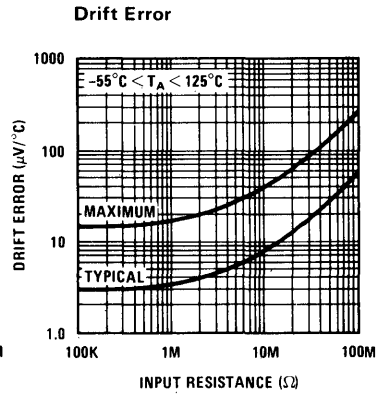
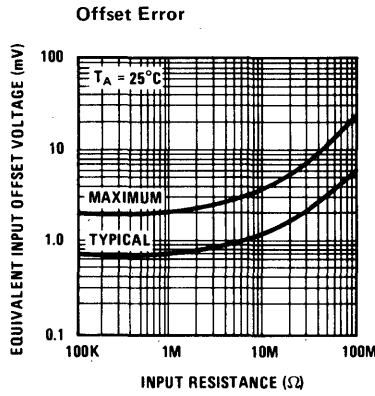
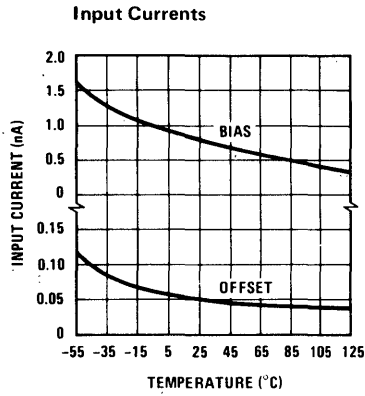



Operational Amplifiers

LM308 operational amplifier

general description

The LM308 is a precision operational amplifier featuring input currents nearly a thousand times lower than industry standards like the LM709C. In fact, its performance approaches that of high quality FET amplifiers. The circuit is directly interchangeable with the LM301A in low frequency circuits and incorporates the same protective features which make its application nearly foolproof.

The device operates with supply voltages from $\pm 2V$ to $\pm 15V$ and has sufficient supply rejection to use unregulated supplies. Although the circuit is designed to work with the standard compensation for the LM301A, an alternate compensation scheme can be used to make it particularly insensitive to power supply noise and to make supply bypass capacitors unnecessary. Power consumption is extremely low, so the amplifiers are ideally suited for battery powered applications. Out-

standing characteristics include:

- Maximum input bias current of 7.0 nA
- Offset current less than 1.0 nA
- Supply current of only 300 μA , even in saturation
- Guaranteed drift characteristics

The low current error of the LM308 makes possible many designs that are not practical with conventional amplifiers. In fact, it operates from 10 M Ω source resistances, introducing less error than devices like the 709C with 10 k Ω sources. Integrators with worst case drifts less than 1 mV/sec and analog time delays in excess of one hour can be made using capacitors no larger than 1 μF . The device is well suited for use with piezoelectric, electrostatic or other capacitive transducers, in addition to low frequency active filters with small capacitor values.

connection diagrams *

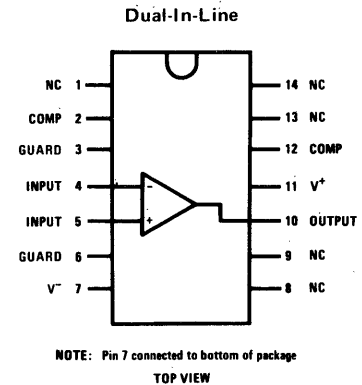
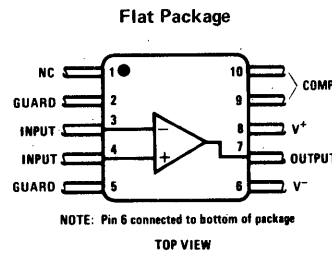
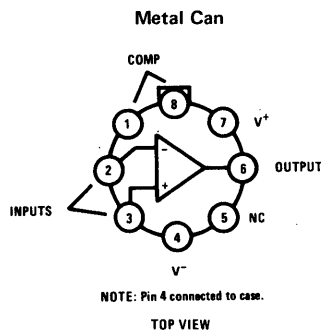

*Pin connections shown on schematic diagram and typical applications are for TO-5 package.

schematic diagram and compensation circuits

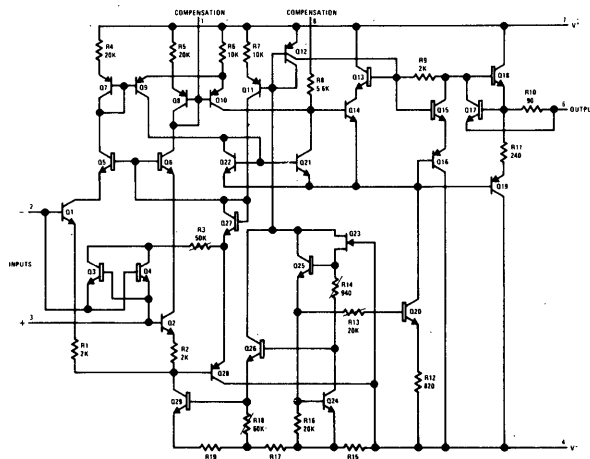

Standard Compensation Circuit

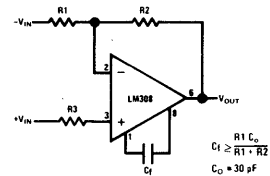

Alternate* Frequency Compensation

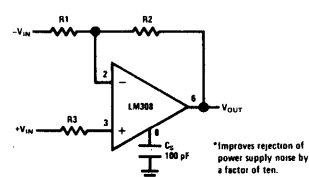

absolute maximum ratings

Supply Voltage	±18V
Power Dissipation (Note 1)	500 mW
Differential Input Current (Note 2)	±10 mA
Input Voltage (Note 3)	±15V
Output Short-Circuit Duration	Indefinite
Operating Temperature Range	0°C to 70°C
Storage Temperature Range	-65°C to 150°C
Lead Temperature (Soldering, 60 sec)	300°C

electrical characteristics (Note 4)

PARAMETER	CONDITIONS	MIN	TYP	MAX	UNITS
Input Offset Voltage	$T_A = 25^\circ\text{C}$		2.0	7.5	mV
Input Offset Current	$T_A = 25^\circ\text{C}$		0.2	1	nA
Input Bias Current	$T_A = 25^\circ\text{C}$		1.5	7	nA
Input Resistance	$T_A = 25^\circ\text{C}$	10	40		M Ω
Supply Current	$T_A = 25^\circ\text{C}, V_S = \pm 15\text{V}$		0.3	0.8	mA
Large Signal Voltage Gain	$T_A = 25^\circ\text{C}, V_S = \pm 15\text{V}$ $V_{OUT} = \pm 10\text{V}, R_L \geq 10\text{ k}\Omega$	25	300		V/mV
Input Offset Voltage				10	mV
Average Temperature Coefficient of Input Offset Voltage			6.0	30	$\mu\text{V}/^\circ\text{C}$
Input Offset Current				1.5	nA
Average Temperature Coefficient of Input Offset Current			2.0	10	pA/ $^\circ\text{C}$
Input Bias Current				10	nA
Large Signal Voltage Gain	$V_S = \pm 15\text{V}, V_{OUT} = \pm 10\text{V}$ $R_L \geq 10\text{ k}\Omega$	15			V/mV
Output Voltage Swing	$V_S = \pm 15\text{V}, R_L = 10\text{ k}\Omega$	±13	±14		V
Input Voltage Range	$V_S = \pm 15\text{V}$	±14			V
Common Mode Rejection Ratio		80	100		dB
Supply Voltage Rejection Ratio		80	96		dB

Note 1: The maximum junction temperature of the LM308 is 85°C. For operating at elevated temperatures, devices in the TQ-5 package must be derated based on a thermal resistance of 150°C/W, junction to ambient, or 45°C/W, junction to case. For the flat package, the derating is based on a thermal resistance of 185°C/W when mounted on a 1/16-inch-thick epoxy glass board with ten, 0.03-inch-wide, 2-ounce copper conductors. The thermal resistance of the dual-in-line package is 100°C/W, junction to ambient.

Note 2: The inputs are shunted with back-to-back diodes for overvoltage protection. Therefore, excessive current will flow if a differential input voltage in excess of 1V is applied between the inputs unless some limiting resistance is used.

Note 3: For supply voltages less than ±15V, the absolute maximum input voltage is equal to the supply voltage.

Note 4: These specifications apply for $\pm 5\text{V} \leq V_S \leq \pm 15\text{V}$ and $0^\circ\text{C} \leq T_A \leq 70^\circ\text{C}$, unless otherwise specified.

typical performance

Input Currents

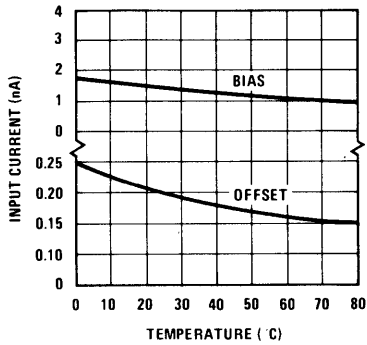

Offset Error

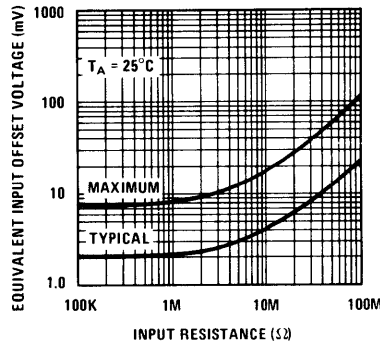

Drift Error

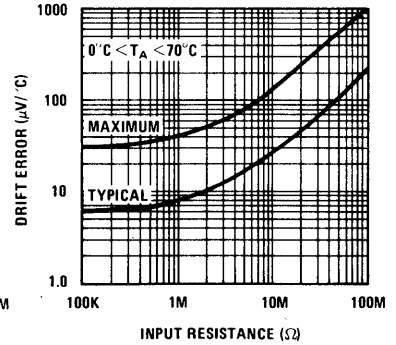

Input Noise Voltage

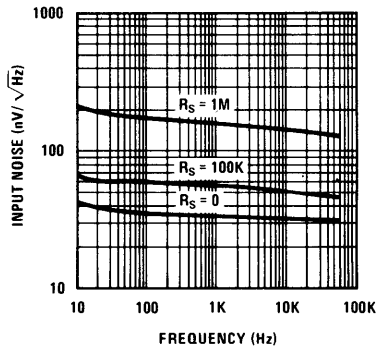

Power Supply Rejection

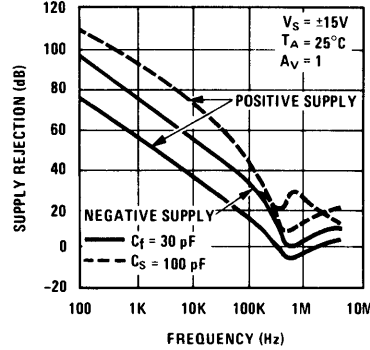

Closed Loop Output Impedance

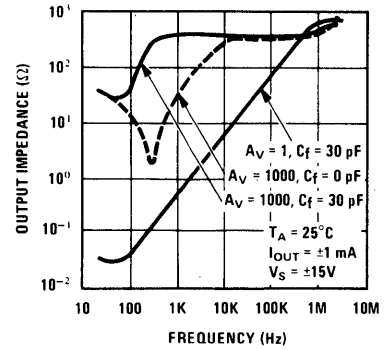

Voltage Gain

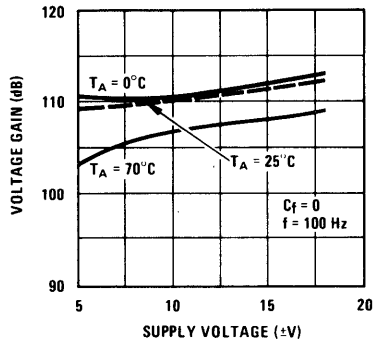

Output Swing

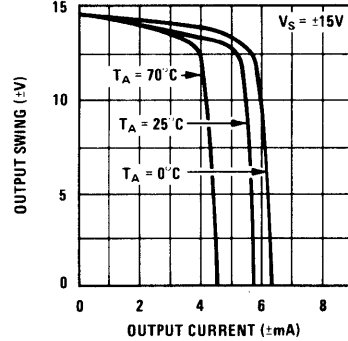

Supply Current

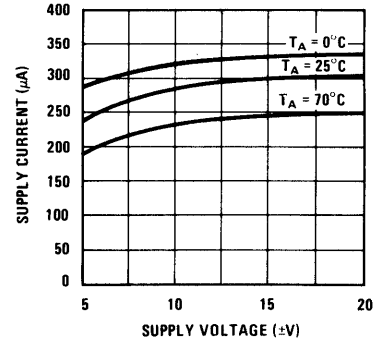

Open Loop Frequency Response

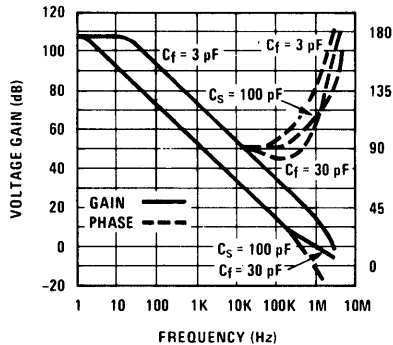

Large Signal Frequency Response

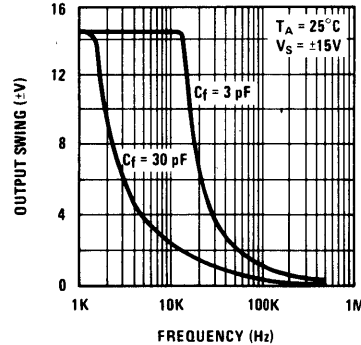

Voltage Follower Pulse Response

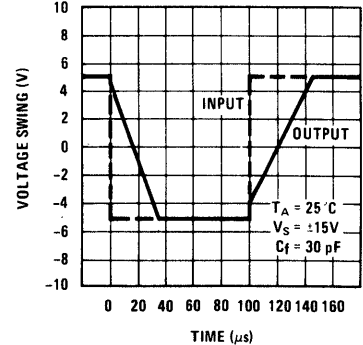



Operational Amplifiers

LM108A/LM208A/LM308A operational amplifiers general description

The LM108A, LM208A and LM308A are precision operational amplifiers having specifications about a factor of ten better than FET amplifiers over their operating temperature range. In addition to low input currents, these devices have extremely low offset voltage, making it possible to eliminate offset adjustments, in most cases, and obtain performance approaching chopper stabilized amplifiers.

The devices operate with supply voltages from $\pm 2V$ to $\pm 20V$ and have sufficient supply rejection to use unregulated supplies. Although the circuit is interchangeable with and uses the same compensation as the LM101A, an alternate compensation scheme can be used to make it particularly insensitive to power supply noise and to make supply bypass capacitors unnecessary. Outstanding characteristics include:

- Offset voltage guaranteed less than 0.5 mV
- Maximum input bias current of 3.0 nA over temperature

- Offset current less than 400 pA over temperature
- Supply current of only 300 μA , even in saturation
- Guaranteed 5 $\mu V/^{\circ}C$ drift.

The low current error of the LM108A series makes possible many designs that are not practical with conventional amplifiers. In fact, it operates from 10 M Ω source resistances, introducing less error than devices like the 709 with 10 k Ω sources. Integrators with drifts less than 500 $\mu V/sec$ and analog time delays in excess of one hour can be made using capacitors no larger than 1 μF .

The LM208A is identical to the LM108A, except that the LM208A has its performance guaranteed over a $-25^{\circ}C$ to $85^{\circ}C$ temperature range, instead of $-55^{\circ}C$ to $125^{\circ}C$. The LM308A has slightly-relaxed specifications and has its performance guaranteed over a $0^{\circ}C$ to $70^{\circ}C$ temperature range.

connection diagrams *

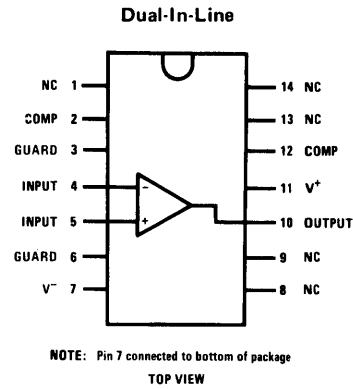
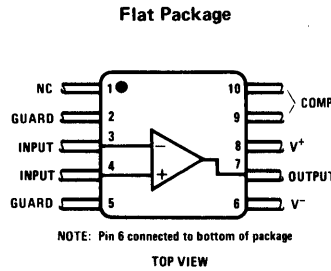
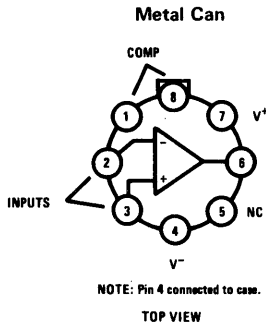

*Pin connections shown on schematic diagram are for TO-5 package.

schematic diagram and compensation circuits

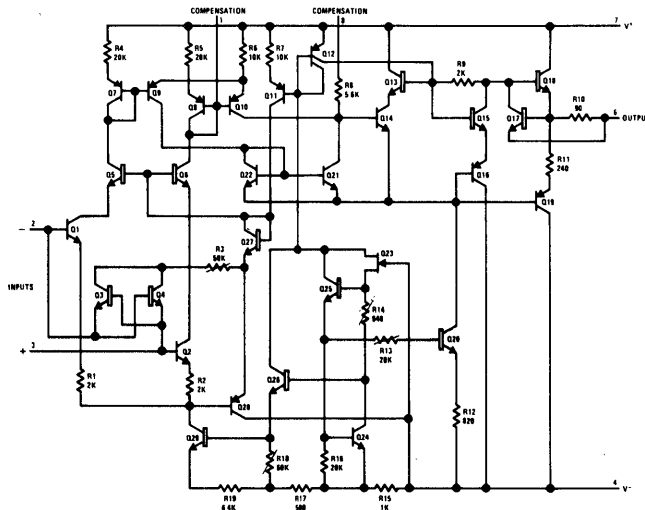

Standard Compensation Circuit

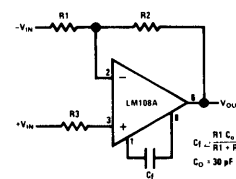

Alternate* Frequency Compensation

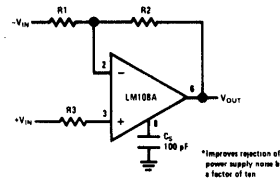

LM108A/LM208A

absolute maximum ratings

Supply Voltage		±20V
Power Dissipation (Note 1)		500 mW
Differential Input Current (Note 2)		±10 mA
Input Voltage (Note 3)		±15V
Output Short-Circuit Duration		Indefinite
Operating Temperature Range	LM108A	-55°C to 125°C
	LM208A	-25°C to 85°C
Storage Temperature Range		-65°C to 150°C
Lead Temperature (Soldering, 10 sec)		300°C

electrical characteristics (Note 4)

PARAMETER	CONDITIONS	MIN	TYP	MAX	UNITS
Input Offset Voltage	$T_A = 25^\circ\text{C}$		0.3	0.5	mV
Input Offset Current	$T_A = 25^\circ\text{C}$		0.05	0.2	nA
Input Bias Current	$T_A = 25^\circ\text{C}$		0.8	2.0	nA
Input Resistance	$T_A = 25^\circ\text{C}$	30	70		MΩ
Supply Current	$T_A = 25^\circ\text{C}$		0.3	0.6	mA
Large Signal Voltage Gain	$T_A = 25^\circ\text{C}$, $V_S = \pm 15\text{V}$ $V_{OUT} = \pm 10\text{V}$, $R_L \geq 10\text{ k}\Omega$	80	300		V/mV
Input Offset Voltage				1.0	mV
Average Temperature Coefficient of Input Offset Voltage			1.0	5.0	$\mu\text{V}/^\circ\text{C}$
Input Offset Current				0.4	nA
Average Temperature Coefficient of Input Offset Current			0.5	2.5	$\text{pA}/^\circ\text{C}$
Input Bias Current				3.0	nA
Supply Current	$T_A = +125^\circ\text{C}$		0.15	0.4	mA
Large Signal Voltage Gain	$V_S = \pm 15\text{V}$, $V_{OUT} = \pm 10\text{V}$ $R_L \geq 10\text{ k}\Omega$	40			V/mV
Output Voltage Swing	$V_S = \pm 15\text{V}$, $R_L = 10\text{ k}\Omega$	±13	±14		V
Input Voltage Range	$V_S = \pm 15\text{V}$	±13.5			V
Common Mode Rejection Ratio		96	110		dB
Supply Voltage Rejection Ratio		96	110		dB

Note 1: The maximum junction temperature of the LM108A is 150°C, while that of the LM208A is 100°C. For operating at elevated temperatures, devices in the TO-5 package must be derated based on a thermal resistance of 150°C/W, junction to ambient, or 45°C/W, junction to case. For the flat package, the derating is based on a thermal resistance of 185°C/W when mounted on a 1/16-inch-thick epoxy glass board with t_{ep} , 0.03-inch-wide, 2-ounce copper conductors. The thermal resistance of the dual-in-line package is 100°C/W, junction to ambient.

Note 2: The inputs are shunted with back-to-back diodes for overvoltage protection. Therefore, excessive current will flow if a differential input voltage in excess of 1V is applied between the inputs unless some limiting resistance is used.

Note 3: For supply voltages less than ±15V, the absolute maximum input voltage is equal to the supply voltage.

Note 4: These specifications apply for $\pm 5\text{V} \leq V_S \leq \pm 20\text{V}$ and $-55^\circ\text{C} \leq T_A \leq 125^\circ\text{C}$, unless otherwise specified. With the LM208A, however, all temperature specifications are limited to $-25^\circ\text{C} \leq T_A \leq 85^\circ\text{C}$.

LM308A**absolute maximum ratings**

Supply Voltage	±18V
Power Dissipation (Note 1)	500 mW
Differential Input Current (Note 2)	±10 mA
Input Voltage (Note 3)	±15V
Output Short-Circuit Duration	Indefinite
Operating Temperature Range	0°C to 70°C
Storage Temperature Range	-65°C to 150°C
Lead Temperature (Soldering, 10 sec)	300°C

electrical characteristics (Note 4)

PARAMETER	CONDITIONS	MIN	TYP	MAX	UNITS
Input Offset Voltage	$T_A = 25^\circ\text{C}$		0.3	0.5	mV
Input Offset Current	$T_A = 25^\circ\text{C}$		0.2	1	nA
Input Bias Current	$T_A = 25^\circ\text{C}$		1.5	7	nA
Input Resistance	$T_A = 25^\circ\text{C}$	10	40		MΩ
Supply Current	$T_A = 25^\circ\text{C}, V_S = \pm 15\text{V}$		0.3	0.8	mA
Large Signal Voltage Gain	$T_A = 25^\circ\text{C}, V_S = \pm 15\text{V}$ $V_{OUT} = \pm 10\text{V}, R_L \geq 10\text{ k}\Omega$	80	300		V/mV
Input Offset Voltage				0.73	mV
Average Temperature Coefficient of Input Offset Voltage			1.0	5.0	$\mu\text{V}/^\circ\text{C}$
Input Offset Current				1.5	nA
Average Temperature Coefficient of Input Offset Current			2.0	10	$\text{pA}/^\circ\text{C}$
Input Bias Current				10	nA
Large Signal Voltage Gain	$V_S = \pm 15\text{V}, V_{OUT} = \pm 10\text{V}$ $R_L \geq 10\text{ k}\Omega$	60			V/mV
Output Voltage Swing	$V_S = \pm 15\text{V}, R_L = 10\text{ k}\Omega$	±13	±14		V
Input Voltage Range	$V_S = \pm 15\text{V}$	±14			V
Common Mode Rejection Ratio		96	110		dB
Supply Voltage Rejection Ratio		96	110		dB

Note 1: The maximum junction temperature of the LM308A is 85°C. For operating at elevated temperatures, devices in the TQ-5 package must be derated based on a thermal resistance of 150°C/W, junction to ambient, or 45°C/W, junction to case. For the flat package, the derating is based on a thermal resistance of 185°C/W when mounted on a 1/16-inch-thick epoxy glass board with ten, 0.03-inch-wide, 2-ounce copper conductors. The thermal resistance of the dual-in-line package is 100°C/W, junction to ambient.

Note 2: The inputs are shunted with back-to-back diodes for overvoltage protection. Therefore, excessive current will flow if a differential input voltage in excess of 1V is applied between the inputs unless some limiting resistance is used.

Note 3: For supply voltages less than ±15V, the absolute maximum input voltage is equal to the supply voltage.

Note 4: These specifications apply for $\pm 5\text{V} \leq V_S \leq \pm 15\text{V}$ and $0^\circ\text{C} \leq T_A \leq 70^\circ\text{C}$, unless otherwise specified.



Operational Amplifiers

LM110/LM210 voltage followers general description

The LM110 and LM210 are monolithic operational amplifiers internally connected as unity-gain non-inverting amplifiers. They use super-gain transistors in the input stage to get low bias current without sacrificing speed. Directly interchangeable with 101, 741 and 709 in voltage follower applications, these devices have internal frequency compensation and provision for offset balancing. Outstanding characteristics include:

- Input current: 10 nA max. over temperature
- Small signal bandwidth: 20 MHz
- Slew rate: 30V/ μ s
- Supply voltage range: \pm 5V to \pm 18V

The LM110 and LM210 are useful in fast sample and hold circuits, active filters or as general-purpose buffers. Further, the frequency response is enough better than standard IC amplifiers that the followers can be included in the feedback loop without introducing instability. They are plug-in replacements for the LM102 or LM202 voltage followers, offering lower offset voltage, drift, bias current and noise in addition to higher speed and wider operating voltage range.

The LM210 is identical to the LM110, except that its performance is specified over a -25°C to 85°C temperature range instead of -55°C to 125°C .

schematic diagram

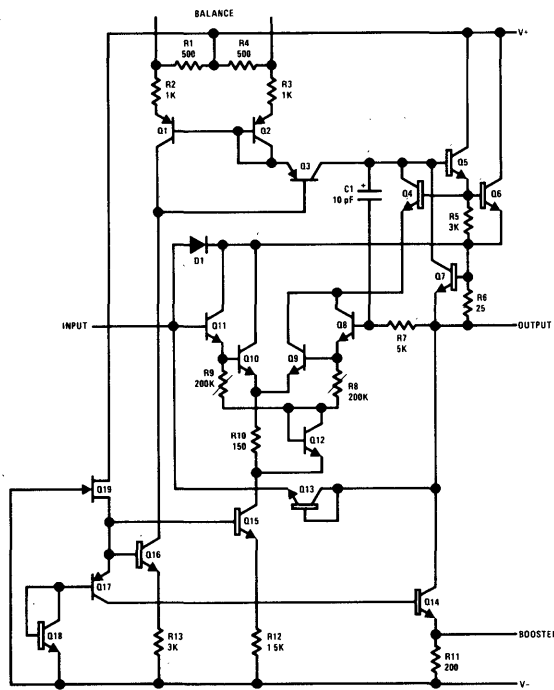

typical applications

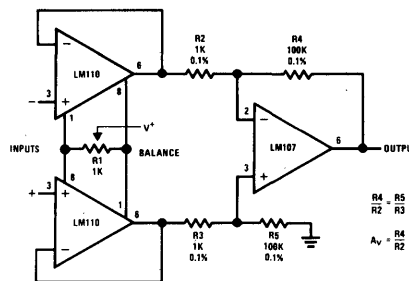

Differential Input Instrumentation Amplifier

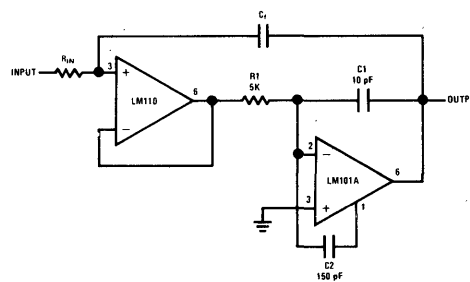

Fast Integrator with Low Input Current

auxiliary circuits

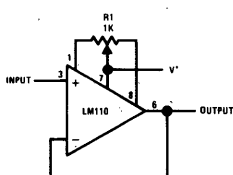

Offset Balancing Circuit

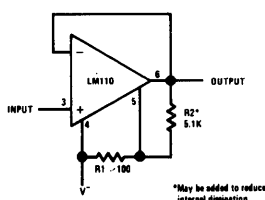

Increasing Negative Swing Under Load

*May be added to reduce internal dissipation.

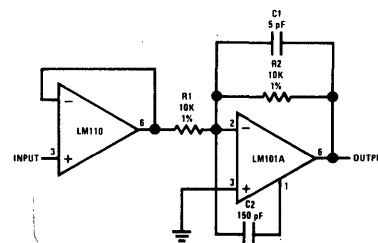

Fast Inverting Amplifier with High Input Impedance

absolute maximum ratings

Supply Voltage	±18V
Power Dissipation (Note 1)	500 mW
Input Voltage (Note 2)	±15V
Output Short Circuit Duration (Note 3)	Indefinite
Operating Temperature Range LM110	-55°C to 125°C
LM210	-25°C to 85°C
Storage Temperature Range	-65°C to 150°C
Lead Temperature (Soldering, 10 sec)	300°C

electrical characteristics (Note 4)

PARAMETER	CONDITIONS	MIN	TYP	MAX	UNITS
Input Offset Voltage	$T_A = 25^\circ\text{C}$		1.5	4.0	mV
Input Bias Current	$T_A = 25^\circ\text{C}$		1.0	3.0	nA
Input Resistance	$T_A = 25^\circ\text{C}$	10^{10}	10^{12}		Ω
Input Capacitance			1.5		pF
Large Signal Voltage Gain	$T_A = 25^\circ\text{C}, V_S = \pm 15\text{V}$ $V_{OUT} = \pm 10\text{V}, R_L = 8\text{K}\Omega$	0.999	0.9999		V/V
Output Resistance	$T_A = 25^\circ\text{C}$		0.75	2.5	Ω
Supply Current	$T_A = 25^\circ\text{C}$		3.9	5.5	mA
Input Offset Voltage				6.0	mV
Offset Voltage Temperature Drift	$-55^\circ\text{C} \leq T_A \leq 85^\circ\text{C}$ $T_A = 125^\circ\text{C}$		6 12		$\mu\text{V}/^\circ\text{C}$ $\mu\text{V}/^\circ\text{C}$
Input Bias Current				10	nA
Large Signal Voltage Gain	$V_S = \pm 15\text{V}, V_{OUT} = \pm 10\text{V}$ $R_L = 10\text{K}\Omega$	0.999			V/V
Output Voltage Swing (Note 5)	$V_S = \pm 15\text{V}, R_L = 10\text{K}\Omega$	±10			V
Supply Current	$T_A = 125^\circ\text{C}$		2.0	4.0	mA
Supply Voltage Rejection Ratio	$\pm 5\text{V} \leq V_S \leq \pm 18\text{V}$	70	80		dB

Note 1: The maximum junction temperature of the LM110 is 150°C, while that of the LM210 is 100°C. For operating at elevated temperatures, devices in the TO-5 package must be derated based on a thermal resistance of 150°C/W, junction to ambient, or 45°C/W, junction to case. For the flat package, the derating is based on a thermal resistance of 185°C/W when mounted on a 1/16-inch-thick epoxy glass board with ten, 0.03-inch-wide, 2-ounce copper conductors. The thermal resistance of the dual-in-line package is 100°C/W, junction to ambient.

Note 2: For supply voltages less than ±15V, the absolute maximum input voltage is equal to the supply voltage.

Note 3: Continuous short circuit is allowed for case temperatures to 125°C and ambient temperatures to 70°C. It is necessary to insert a resistor greater than 2k Ω in series with the input when the amplifier is driven from low impedance sources to prevent damage when the output is shorted.

Note 4: These specifications apply for $\pm 5\text{V} \leq V_S \leq \pm 18\text{V}$ and $-55^\circ\text{C} \leq T_A \leq 125^\circ\text{C}$, unless otherwise specified. With the LM210, however, all temperature specifications are limited to $-25^\circ\text{C} \leq T_A \leq 85^\circ\text{C}$.

Note 5: Increased output swing under load can be obtained by connecting an external resistor between the booster and V⁻ terminals. See curve.

typical performance

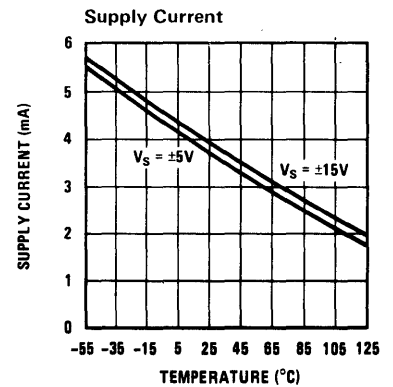
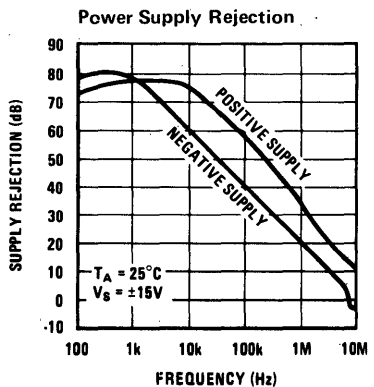
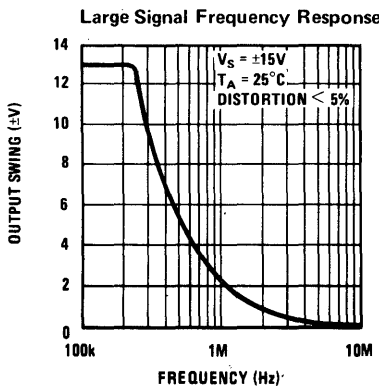
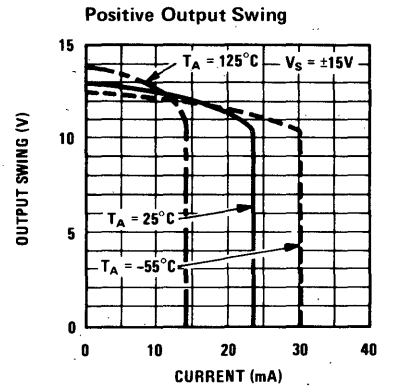
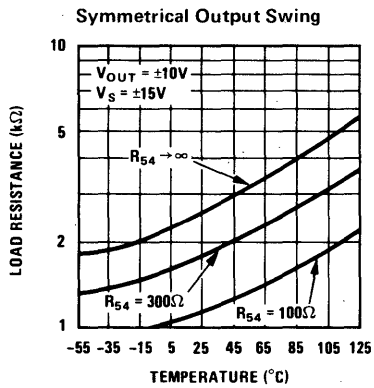
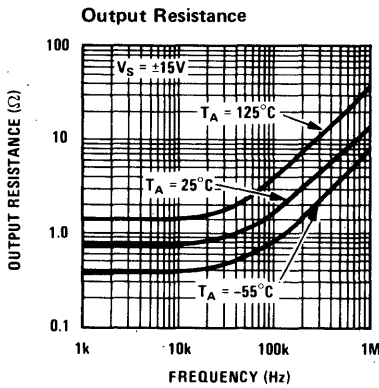
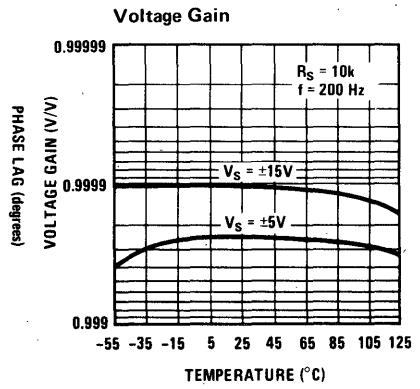
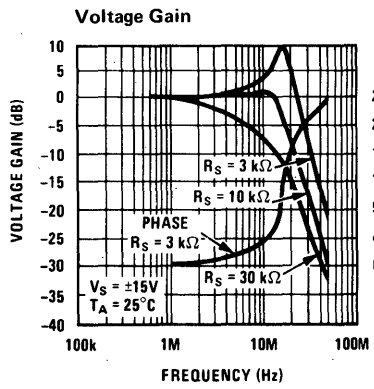
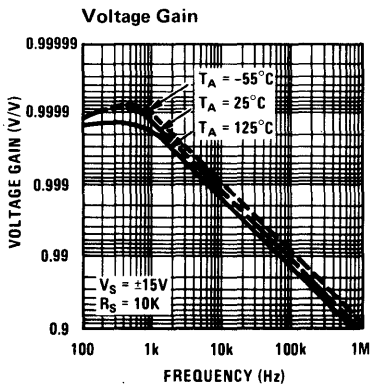
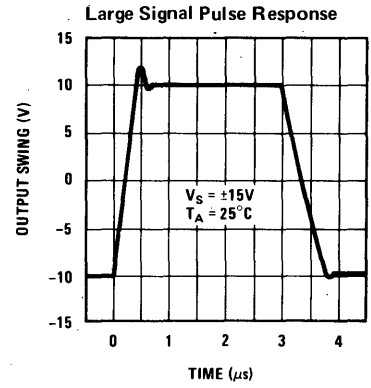
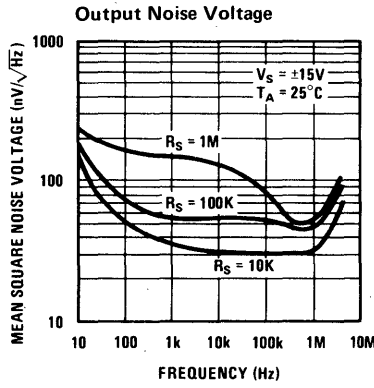
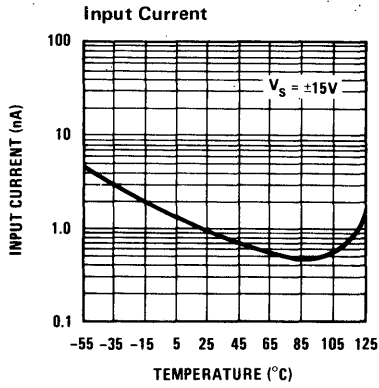

connection diagrams

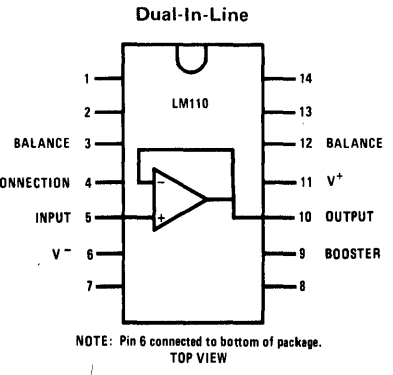
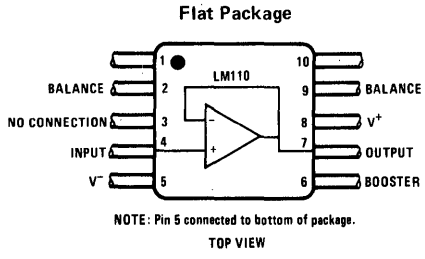
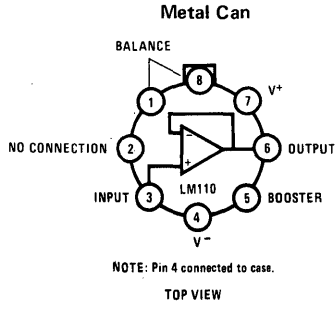

typical applications

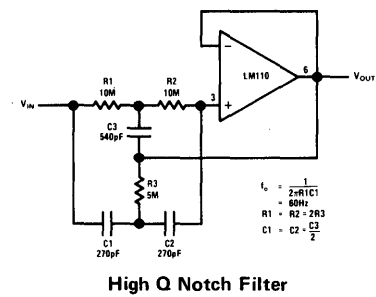

High Q Notch Filter

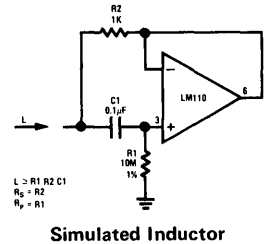

Simulated Inductor

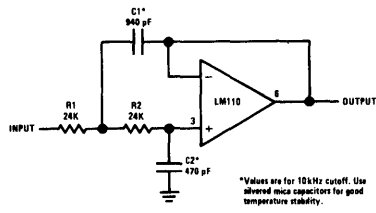

Low Pass Active Filter

*Values are for 10kHz cutoff. Use silver mica capacitors for good temperature stability.

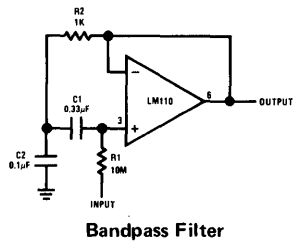

Bandpass Filter

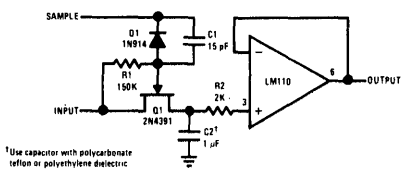

Sample and Hold

*Use capacitor with polycarbonate, teflon or polyethylene dielectric.

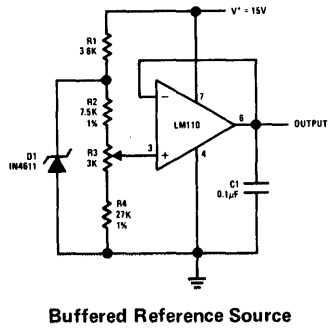

Buffered Reference Source

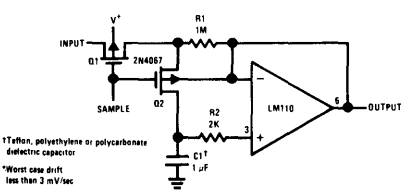

Low Drift Sample and Hold*

*Teflon, polyethylene or polycarbonate dielectric capacitor.
 *Mount case drift less than 2 mV/sec.

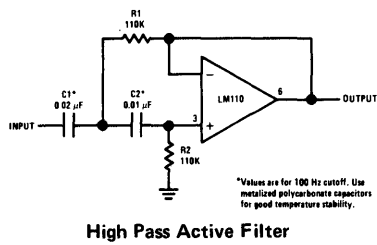

High Pass Active Filter

*Values are for 100 Hz cutoff. Use metallized polycarbonate capacitors for good temperature stability.

typical applications

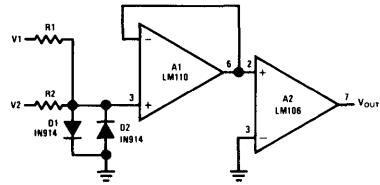

Comparator for Signals of Opposite Polarity

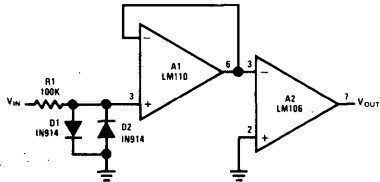

Zero Crossing Detector

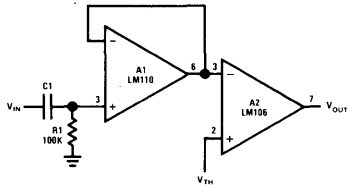

Comparator for AC Coupled Signals

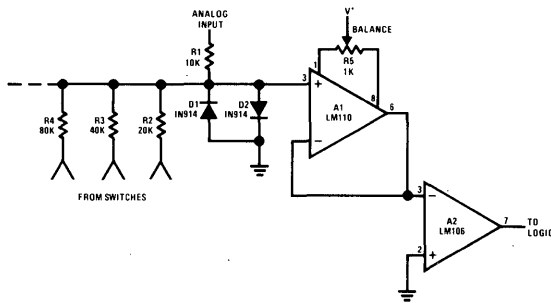

Comparator for A/D Converter Using a Binary-Weighted Network

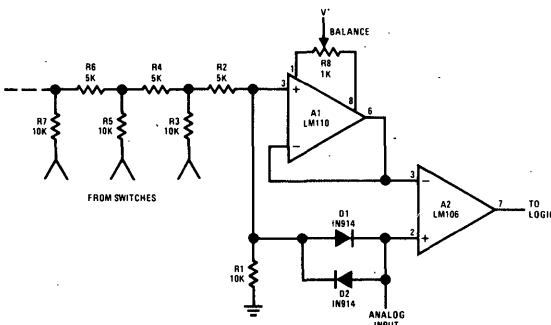

Comparator for A/D Converter Using a Ladder Network

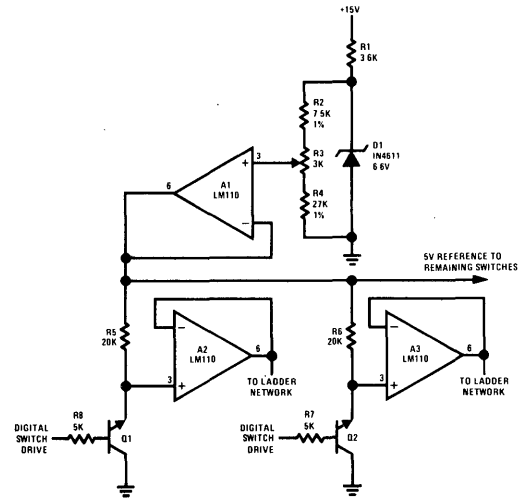

Driver for A/D Ladder Network

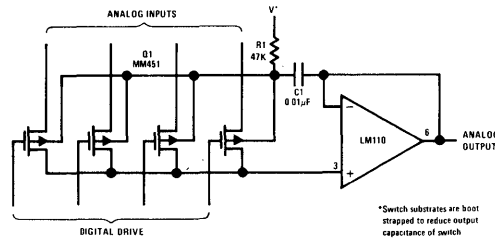

Buffer for Analog Switch*

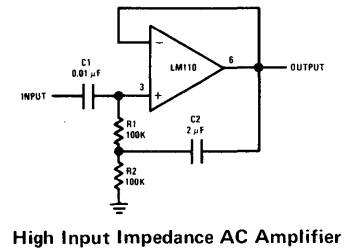

High Input Impedance AC Amplifier

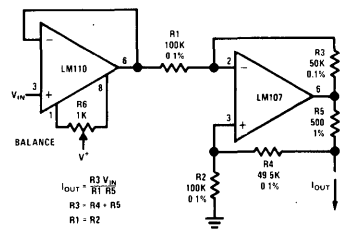

Bilateral Current Source

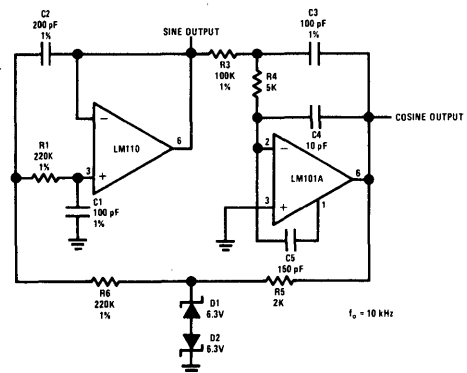

Sine Wave Oscillator



Operational Amplifiers

LM310 voltage follower general description

The LM310 is a monolithic operational amplifier internally connected as a unity-gain non-inverting amplifier. It uses super-gain transistors in the input stage to get low bias current without sacrificing speed. Directly interchangeable with 301, 741C and 709C in voltage follower applications, this device has internal frequency compensation and provision for offset balancing. Outstanding characteristics include:

- Input current: 10 nA max. over temperature
- Small signal bandwidth: 20 MHz

- Slew rate: 30V/μs
- Supply voltage range: ±5V to ±18V

The LM310 is useful in fast sample and hold circuits, active filters or as a general-purpose buffer. Further, the frequency response is enough better than standard IC amplifiers that the follower can be included in the feedback loop without introducing instability. It is a plug-in replacement for the LM302 voltage follower, offering lower offset voltage, drift, bias current and noise in addition to higher speed and wider operating voltage range.

schematic diagram

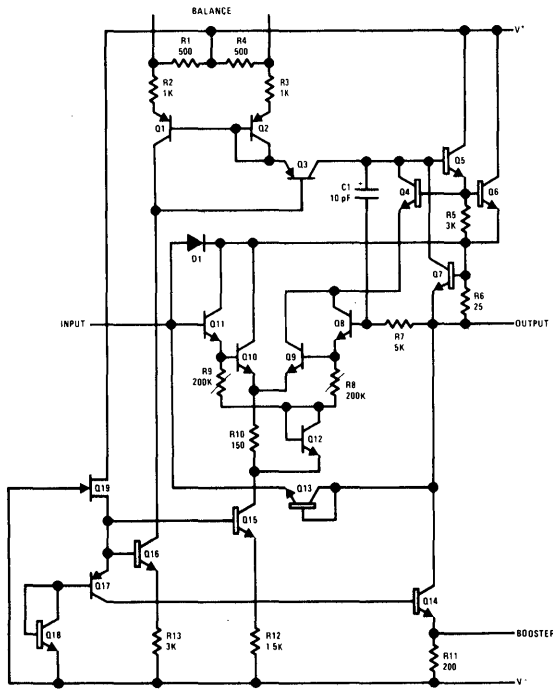

typical applications

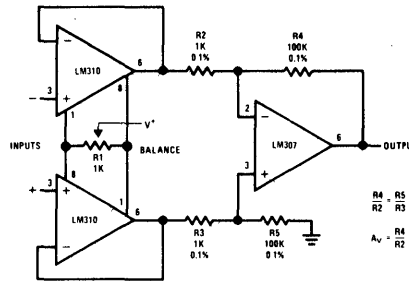

Differential Input Instrumentation Amplifier

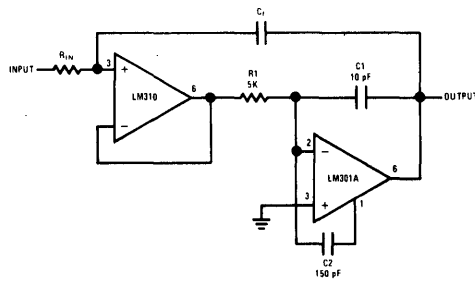

Fast Integrator with Low Input Current

auxiliary circuits

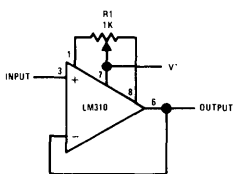

Offset Balancing Circuit

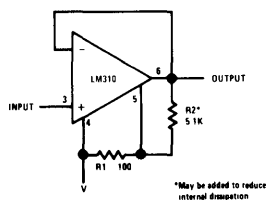

Increasing Negative Swing Under Load

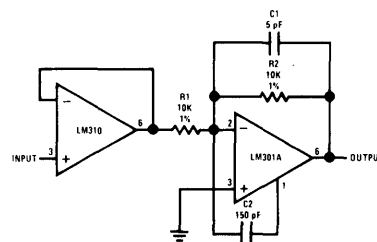

Fast Inverting Amplifier with High Input Impedance

absolute maximum ratings

Supply Voltage	±18V
Power Dissipation (Note 1)	500 mW
Input Voltage (Note 2)	±15V
Output Short Circuit Duration (Note 3)	Indefinite
Operating Temperature Range	0°C to 70°C
Storage Temperature Range	-65°C to 150°C
Lead Temperature (Soldering, 10 sec)	300°C

electrical characteristics (Note 4)

PARAMETER	CONDITIONS	MIN	TYP	MAX	UNITS
Input Offset Voltage	$T_A = 25^\circ\text{C}$		2.5	7.5	mV
Input Bias Current	$T_A = 25^\circ\text{C}$		2.0	7.0	nA
Input Resistance	$T_A = 25^\circ\text{C}$	10^{10}	10^{12}		Ω
Input Capacitance			1.5		pF
Large Signal Voltage Gain	$T_A = 25^\circ\text{C}$, $V_S = \pm 15\text{V}$ $V_{OUT} = \pm 10\text{V}$, $R_L = 8\text{k}\Omega$	0.999	0.9999		V/V
Output Resistance	$T_A = 25^\circ\text{C}$		0.75	2.5	Ω
Supply Current	$T_A = 25^\circ\text{C}$		3.9	5.5	mA
Input Offset Voltage				10	mV
Offset Voltage Temperature Drift			10		$\mu\text{V}/^\circ\text{C}$
Input Bias Current				10	nA
Large Signal Voltage Gain	$V_S = \pm 15\text{V}$, $V_{OUT} = \pm 10\text{V}$ $R_L = 10\text{k}\Omega$	0.999			V/V
Output Voltage Swing (Note 5)	$V_S = \pm 15\text{V}$, $R_L = 10\text{k}\Omega$	±10			V
Supply Voltage Rejection Ratio	$\pm 5\text{V} \leq V_S \leq \pm 18\text{V}$	70	80		dB

Note 1: The maximum junction temperature of the LM310 is 85°C. For operating at elevated temperatures, devices in the TO-5 package must be derated based on a thermal resistance of 150°C/W, junction to ambient, or 45°C/W, junction to case. For the flat package, the derating is based on a thermal resistance of 185°C/W when mounted on a 1/16-inch-thick epoxy glass board with ten, 0.03-inch-wide, 2-ounce copper conductors. The thermal resistance of the dual-in-line package is 100°C/W, junction to ambient.

Note 2: For supply voltages less than ±15V, the absolute maximum input voltage is equal to the supply voltage.

Note 3: Continuous short circuit is allowed for case temperatures to 70°C and ambient temperatures to 55°C. It is necessary to insert a resistor greater than 2 k Ω in series with the input when the amplifier is driven from low impedance sources to prevent damage when the output is shorted.

Note 4: These specifications apply for $\pm 5\text{V} \leq V_S \leq \pm 18\text{V}$ and $0^\circ\text{C} \leq T_A \leq 70^\circ\text{C}$, unless otherwise specified.

Note 5: Increased output swing under load can be obtained by connecting an external resistor between the booster and V^- terminals. See curve.

typical performance

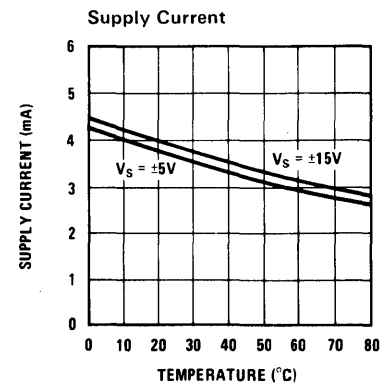
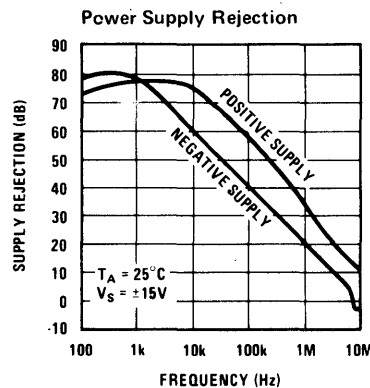
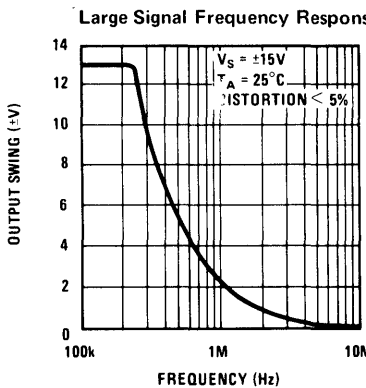
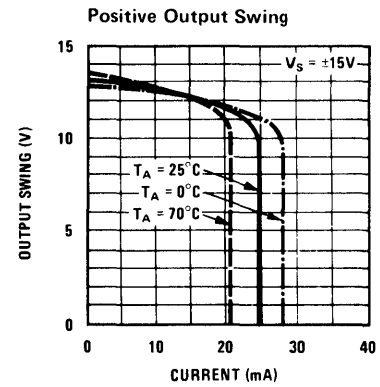
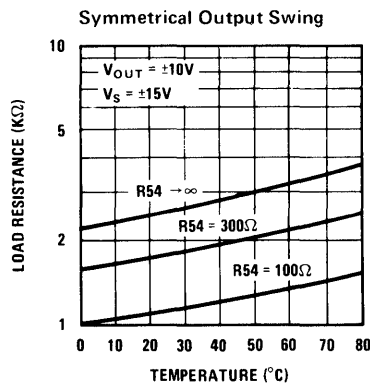
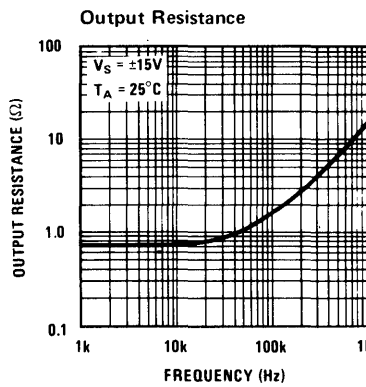
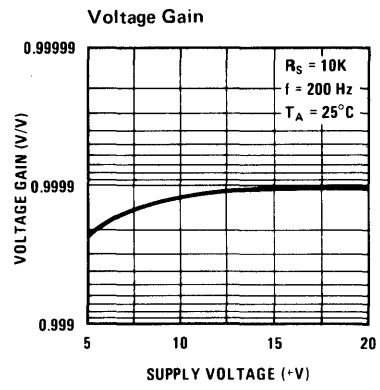
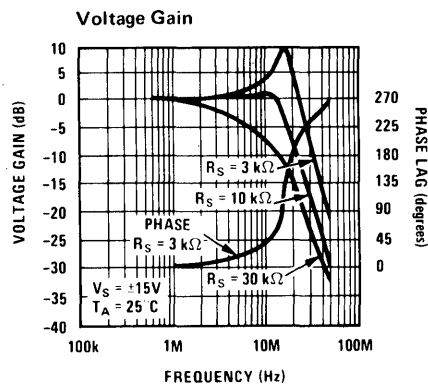
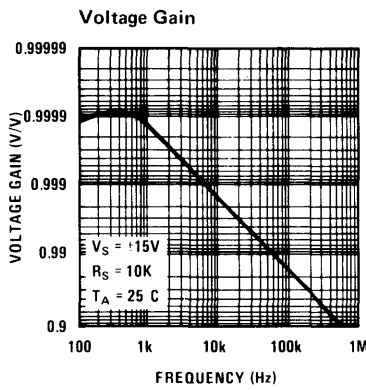
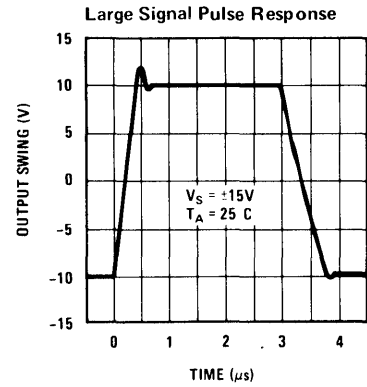
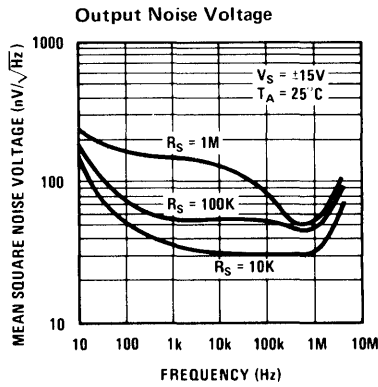
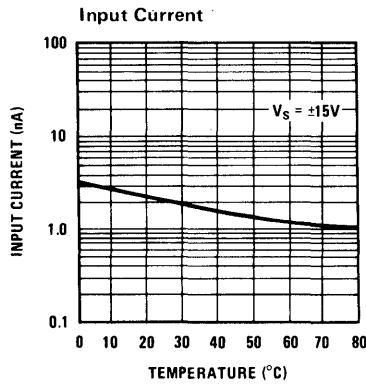

connection diagrams

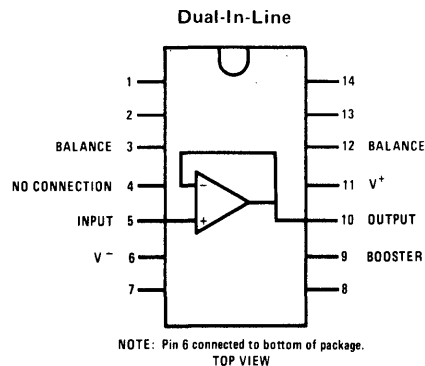
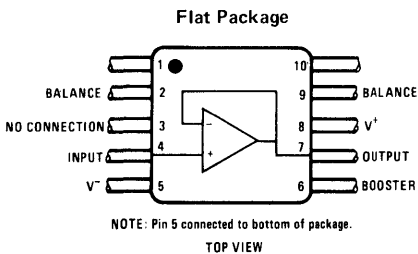
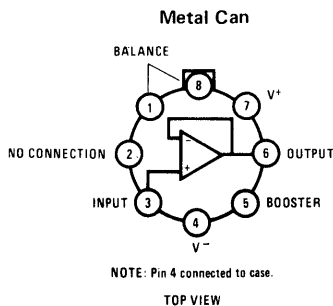

typical applications

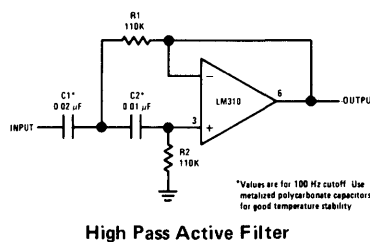
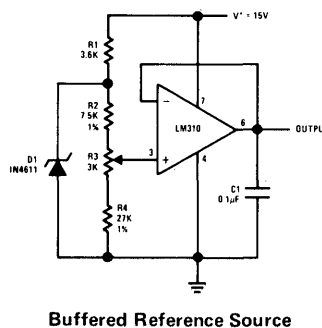
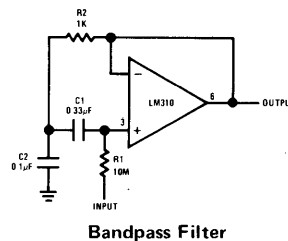
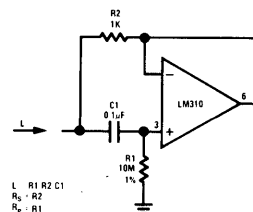
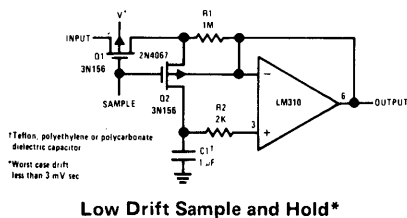
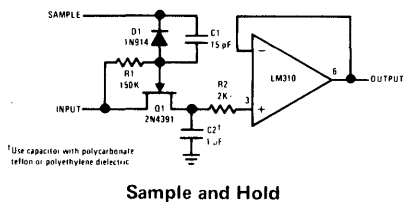
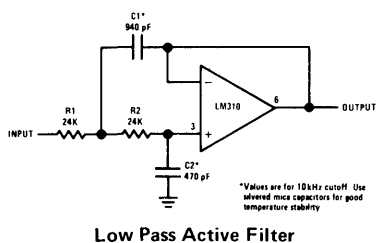
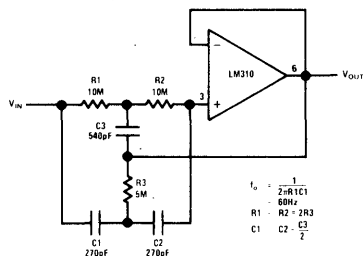

typical applications

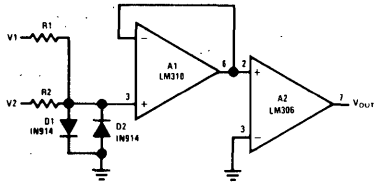

Comparator for Signals of Opposite Polarity

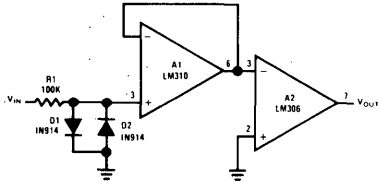

Zero Crossing Detector

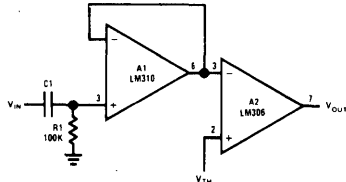

Comparator for AC Coupled Signals

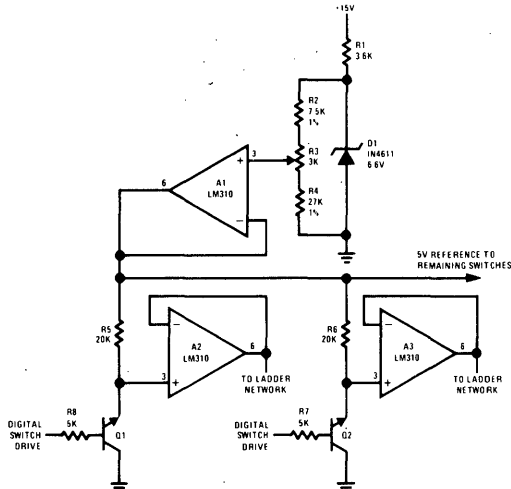

Driver for A/D Ladder Network

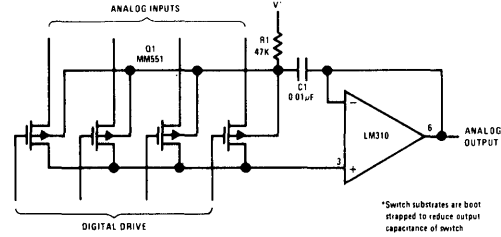

Buffer for Analog Switch*

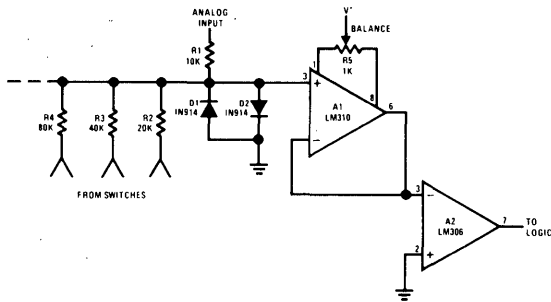

Comparator for A/D Converter Using a Binary-Weighted Network

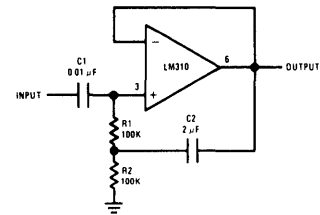

High Input Impedance AC Amplifier

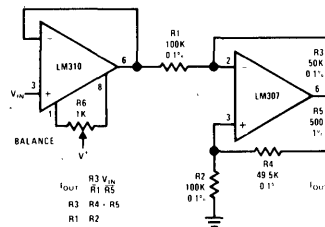

Bilateral Current Source

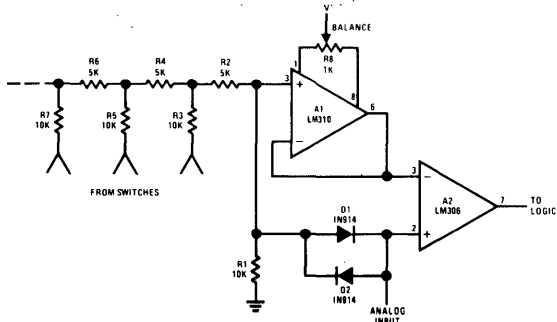

Comparator for A/D Converter Using a Ladder Network

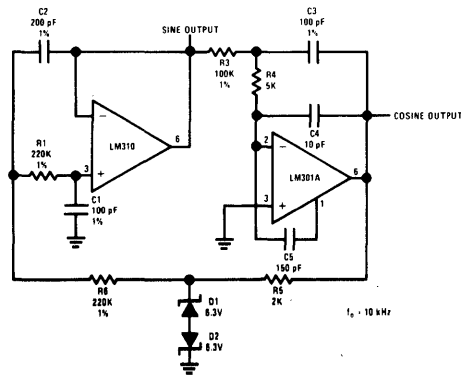

Sine Wave Oscillator



Operational Amplifiers

LM709 operational amplifier

general description

The LM709 is a monolithic operational amplifier intended for general-purpose applications. Operation is completely specified over the range of voltages commonly used for these devices. The design, in addition to providing high gain, minimizes both offset voltage and bias currents. Further, the class-B output stage gives a large output capability with minimum power drain.

External components are used to frequency compensate the amplifier. Although the unity-gain com-

pensation network specified will make the amplifier unconditionally stable in all feedback configurations, compensation can be tailored to optimize high-frequency performance for any gain setting.

The fact that the amplifier is built on a single silicon chip provides low offset and temperature drift at minimum cost. It also ensures negligible drift due to temperature gradients in the vicinity of the amplifier.

schematic and connection diagrams

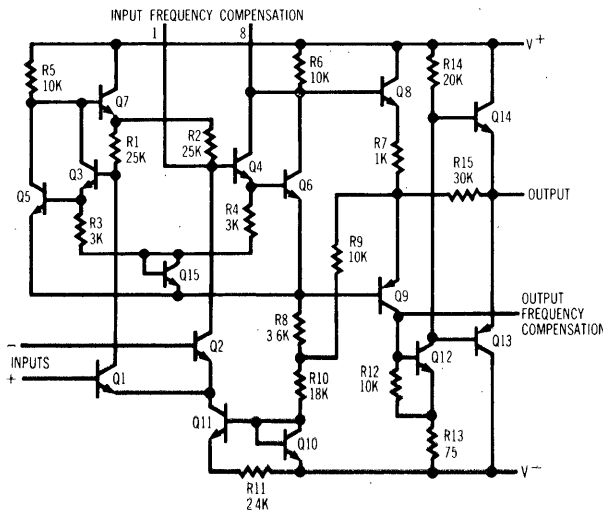

Metal Can

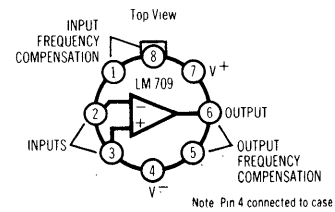

typical applications*

Voltage Follower

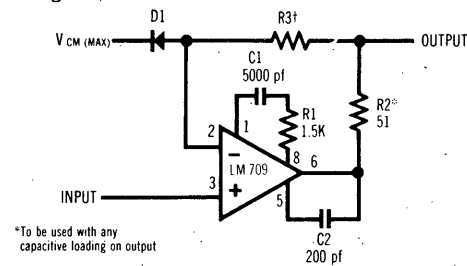

*To be used with any capacitive loading on output
 †Should be equal to dc source resistance on input

Offset Balancing Circuit

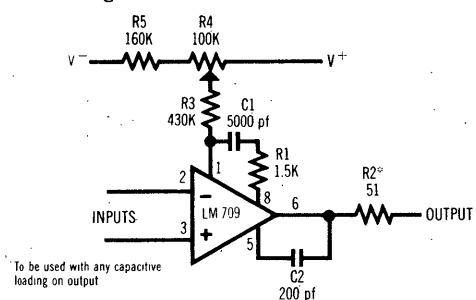

*To be used with any capacitive loading on output

Unity Gain Inverting Amplifier

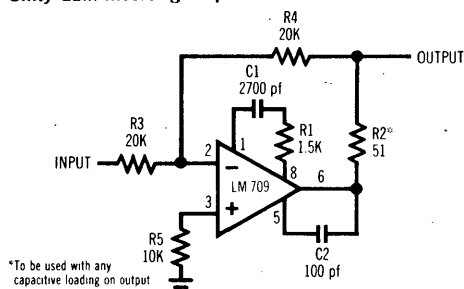

*To be used with any capacitive loading on output

FET Operational Amplifier

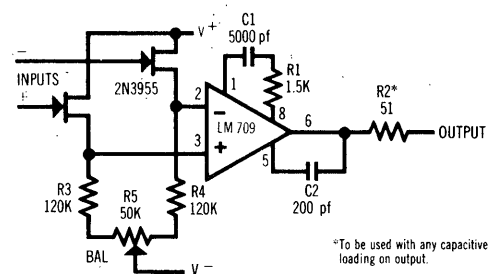

*To be used with any capacitive loading on output.

* Pin connections shown are for Metal Can package.

absolute maximum ratings

Supply Voltage	±18V
Power Dissipation (Note 1)	300 mW
Differential Input Voltage	±5V
Input Voltage	±10V
Output Short-Circuit Duration ($T_A = 25^\circ\text{C}$)	5 sec
Storage Temperature Range	-65°C to +150°C
Operating Temperature Range	-55°C to +125°C
Lead Temperature (Soldering, 60 sec)	300°C

electrical characteristics

PARAMETER	CONDITION	MIN.	TYP.	MAX.	UNITS
Input Offset Voltage	$T_A = 25^\circ\text{C}$, $R_S \leq 10\text{ k}\Omega$		1.0	5.0	mV
Input Bias Current	$T_A = 25^\circ\text{C}$		200	500	nA
Input Offset Current	$T_A = 25^\circ\text{C}$		50	200	nA
Input Resistance	$T_A = 25^\circ\text{C}$	150	400		k Ω
Output Resistance	$T_A = 25^\circ\text{C}$		150		Ω
Supply Current	$T_A = 25^\circ\text{C}$, $V_S = \pm 15\text{V}$		2.6	5.5	mA
Transient Response	$V_{IN} = 20\text{ mV}$, $C_L \leq 100\text{ pF}$				
Risetime	$T_A = 25^\circ\text{C}$		0.3	1.0	μS
Overshoot			10	30	%
Stewing Rate	$T_A = 25^\circ\text{C}$		0.25		V/ μS
Input Offset Voltage	$R_S \leq 10\text{ k}\Omega$			6.0	mV
Average Temperature					
Coefficient of Input	$R_S = 50\text{ }\Omega$		3.0		$\mu\text{V}/^\circ\text{C}$
Offset Voltage	$R_S = 10\text{ k}\Omega$		6.0		$\mu\text{V}/^\circ\text{C}$
Large-Signal	$V_S = \pm 15\text{V}$, $R_L \geq 2\text{ k}\Omega$				
Voltage Gain	$V_{OUT} = \pm 10\text{V}$	25,000	45,000	70,000	
Output Voltage Swing	$V_S = \pm 15\text{V}$, $R_L = 10\text{ k}\Omega$	±12	±14		V
	$V_S = \pm 15\text{V}$, $R_L = 2\text{ k}\Omega$	±10	±13		V
Input Voltage Range	$V_S = \pm 15\text{V}$	±8.0	±10		V
Common Mode					
Rejection Ratio	$R_S \leq 10\text{ k}\Omega$	70	90		db
Supply Voltage					
Rejection Ratio	$R_S \leq 10\text{ k}\Omega$		25	150	$\mu\text{V}/\text{V}$
Input Offset Current	$T_A = +125^\circ\text{C}$		20	200	nA
	$T_A = -55^\circ\text{C}$		100	500	nA
Input Bias Current	$T_A = -55^\circ\text{C}$		0.5	1.5	μA
Input Resistance	$T_A = -55^\circ\text{C}$	40	100		k Ω

Note 1: For operating at elevated temperatures, the device must be derated based on a 150°C maximum junction temperature and a thermal resistance of 150°C/W junction to ambient or 45°C/W junction to case for the metal-can package. For the flat package, the derating is based on a thermal resistance of 185°C/W when mounted on a 1/16-inch-thick, epoxy-glass board with ten, 0.03-inch-wide, 2-ounce copper conductors (see curve).

Note 2: These specifications apply for $-55^\circ\text{C} \leq T_A \leq +125^\circ\text{C}$, $\pm 9\text{V} \leq V_S \leq +15\text{V}$, $C_1 = 5000\text{ pF}$, $R_1 = 1.5\text{K}$, $C_2 = 200\text{ pF}$ and $R_2 = 51\Omega$ unless otherwise specified.

guaranteed performance characteristics

Output Voltage Swing

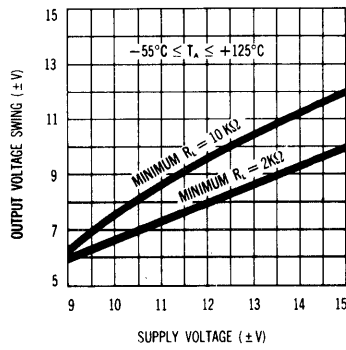

Input Common Mode Voltage Range

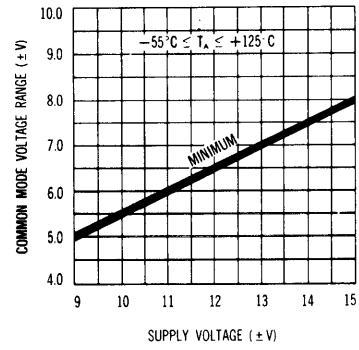

Maximum Power Dissipation

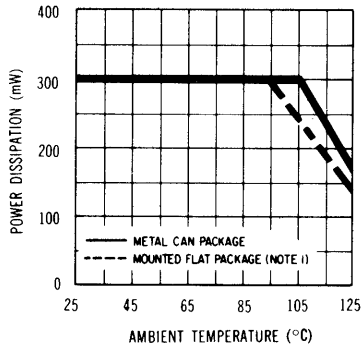

Voltage Gain

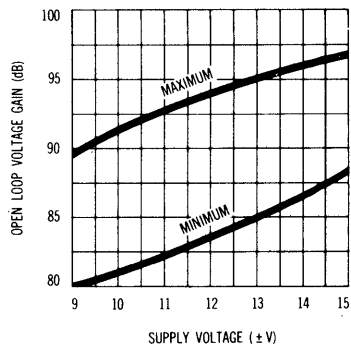

Supply Current

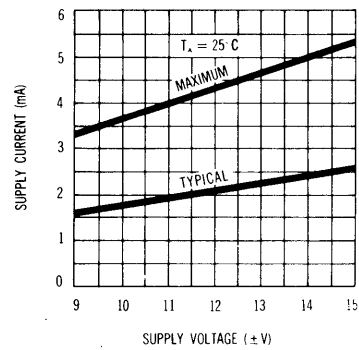

typical performance characteristics

Input Offset Current

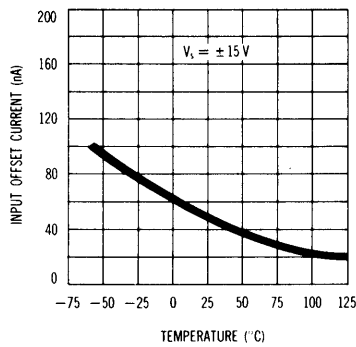

Input Bias Current

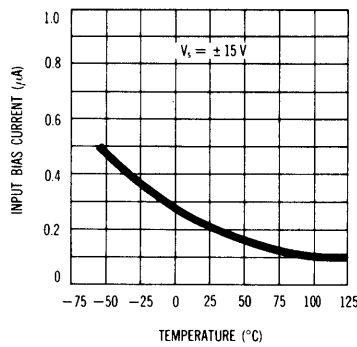

Supply Current

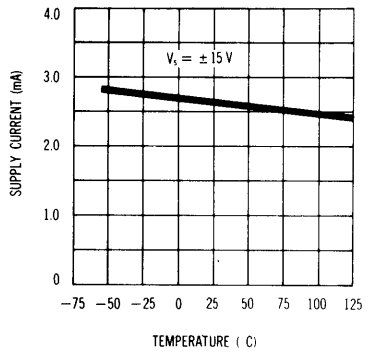

Open-Loop Frequency Response

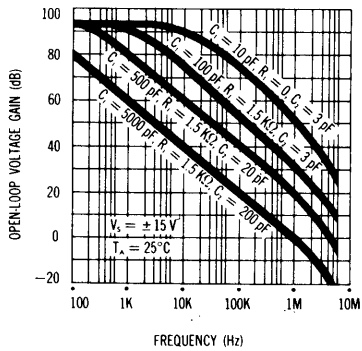

Output Voltage Swing as a Function of Frequency

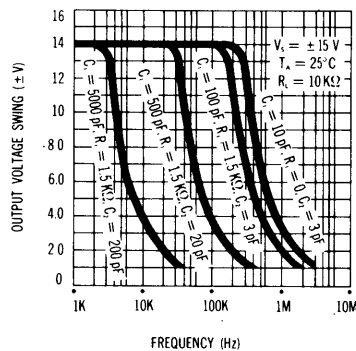

Output Voltage Swing

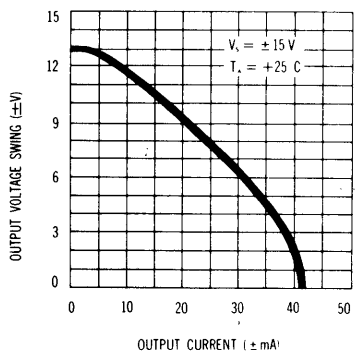



Operational Amplifiers

LM709C operational amplifier

general description

The LM709C is a monolithic operational amplifier intended for general-purpose applications. Operation is completely specified over the range of voltages commonly used for these devices. The design, in addition to providing high gain, minimizes both offset voltage and bias currents. Further, the class-B output stage gives a large output capability with minimum power drain.

External components are used to frequency compensate the amplifier. Although the unity-gain compensation network specified will make the amplifier unconditionally stable in all feedback

configurations, compensation can be tailored to optimize high-frequency performance for any gain setting.

The fact that the amplifier is built on a single silicon ship provides low offset and temperature drift at minimum cost. It also ensures negligible drift due to temperature gradients in the vicinity of the amplifier.

The LM709C is commercial-industrial version of the LM709. It is identical to the LM709 except that it is specified for operation from 0°C to 70°C.

schematic and connection diagrams

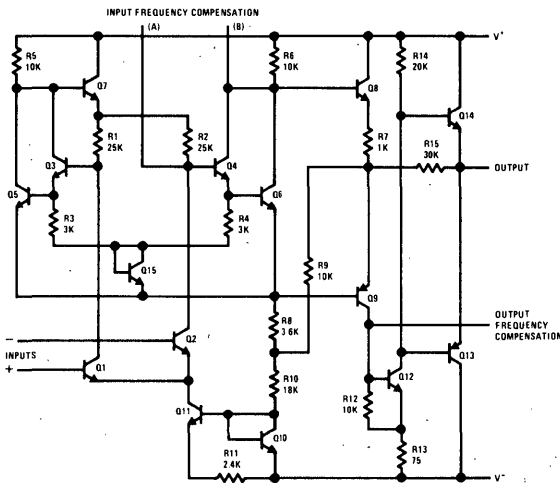

Metal Can

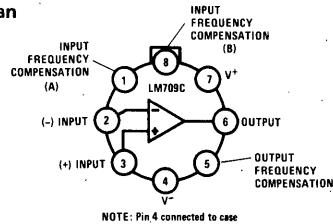

Dip Package

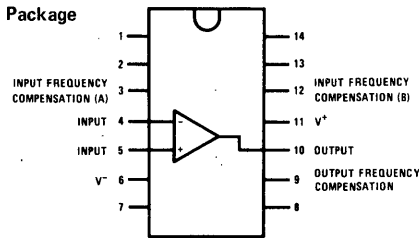

typical applications **

Voltage Follower

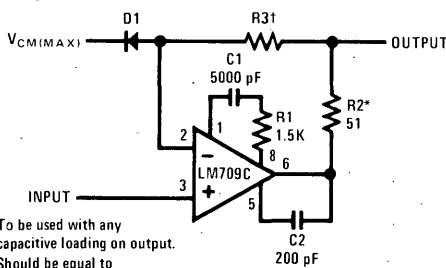

*To be used with any capacitive loading on output.
†Should be equal to dc source resistance on input.

Unity Gain Inverting Amplifier

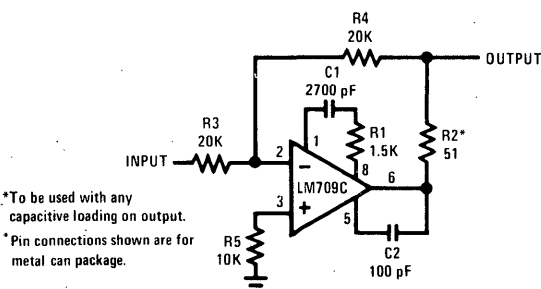

*To be used with any capacitive loading on output.
* Pin connections shown are for metal can package.

Offset Balancing Circuit

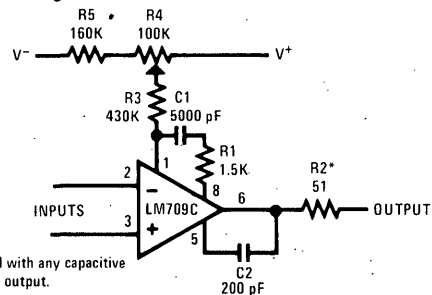

*To be used with any capacitive loading on output.

FET Operational Amplifier

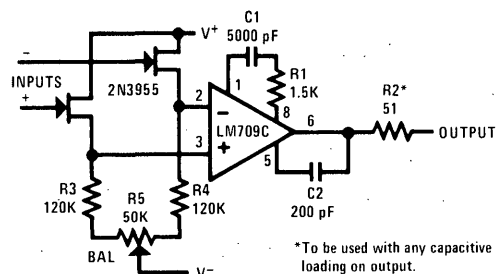

*To be used with any capacitive loading on output.

absolute maximum ratings

Supply Voltage	±18V
Power Dissipation (Note 1)	250 mW
Differential Input Voltage	±5V
Input Voltage	±10V
Output Short-Circuit Duration ($T_A = 25^\circ\text{C}$)	5 sec
Storage Temperature Range	-65°C to +150°C
Operating Temperature Range	0°C to +70°C
Lead Temperature (soldering, 60 sec)	300°C

electrical characteristics (Note 2)

PARAMETER	CONDITION	MIN	TYP	MAX	UNITS
Input Offset Voltage	$T_A = 25^\circ\text{C}$, $R_S \leq 10\text{ k}\Omega$		2.0	7.5	mV
Input Offset Current	$T_A = 25^\circ\text{C}$		100	500	nA
Input Bias Current	$T_A = 25^\circ\text{C}$		0.3	1.5	μA
Input Resistance	$T_A = 25^\circ\text{C}$	50	250		$\text{k}\Omega$
Output Resistance	$T_A = 25^\circ\text{C}$		150		Ω
Supply Current	$T_A = 25^\circ\text{C}$, $V_S = \pm 15\text{V}$		2.6	6.6	mA
Transient Response Risettime	$V_{IN} = 20\text{ mV}$, $C_L \leq 100\text{ pF}$ $T_A = 25^\circ\text{C}$		0.3	1.0	μs
Overshoot			10	30	%
Slewing Rate	$T_A = 25^\circ\text{C}$		0.25		V/ μs
Input Offset Voltage	$R_S \leq 10\text{ k}\Omega$			10	mV
Average Temperature Coefficient of Input Offset Voltage	$R_S = 50\Omega$ $R_S = 10\text{ k}\Omega$		6.0 12		$\mu\text{V}/^\circ\text{C}$ $\mu\text{V}/^\circ\text{C}$
Large-Signal Voltage Gain	$V_S = \pm 15\text{V}$, $R_L \geq 2\text{ k}\Omega$ $V_{OUT} = \pm 10\text{V}$	15,000	45,000		
Output Voltage Swing	$V_S = \pm 15\text{V}$, $R_L = 10\text{ k}\Omega$ $V_S = \pm 15\text{V}$, $R_L = 2\text{ k}\Omega$	±12 ±10	±14 ±13		V V
Input Voltage Range	$V_S = \pm 15\text{V}$	±8.0	±10		V
Common Mode Rejection Ratio	$R_S \leq 10\text{ k}\Omega$	65	90		dB
Supply Voltage Rejection Ratio	$R_S \leq 10\text{ k}\Omega$		25	200	$\mu\text{V}/\text{V}$
Input Offset Current	$T_A = +70^\circ\text{C}$ $T_A = 0^\circ\text{C}$		75 125	400 750	nA nA
Input Bias Current	$T_A = 0^\circ\text{C}$		0.36	2.0	μA

Note 1: For operating at elevated temperatures, the device must be derated based on a 100°C maximum junction temperature and a thermal resistance of 45°C/W junction to case or 150°C/W junction to ambient for the metal can package. For the flat package, the derating is based on a thermal resistance of 185°C/W when mounted on a 1/16-inch-thick, epoxy-glass board with ten, 0.03-inch-wide, 2-ounce copper conductors.

Note 2: These specifications apply for $0^\circ\text{C} \leq T_A \leq +70^\circ\text{C}$, $\pm 9\text{V} \leq V_S \leq \pm 15\text{V}$, $C_1 = 5000\text{ pF}$, $R_1 = 1.5\text{K}$, $C_2 = 200\text{ pF}$ and $R_2 = 51\Omega$ unless otherwise specified.

guaranteed performance characteristics

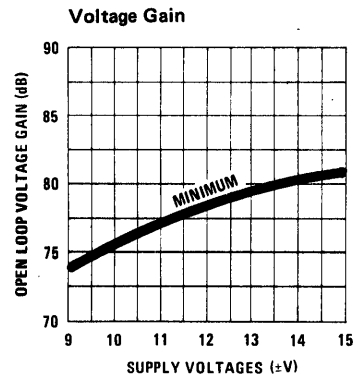
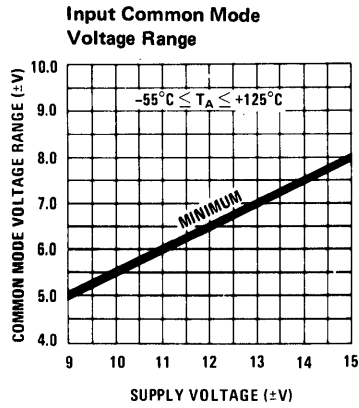
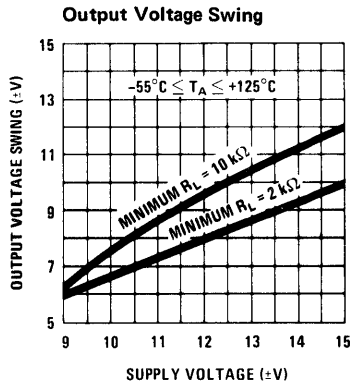

typical performance characteristics

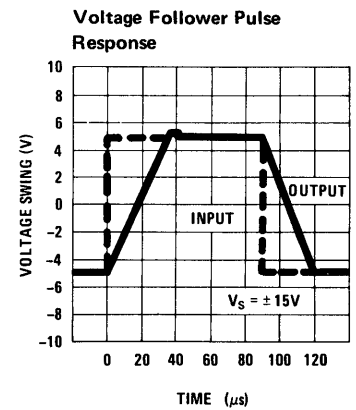
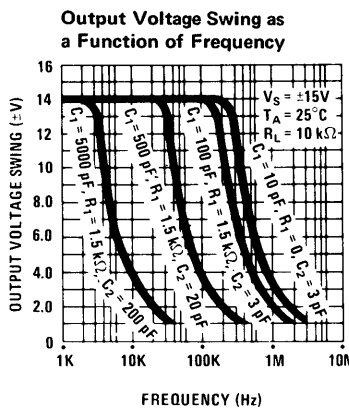
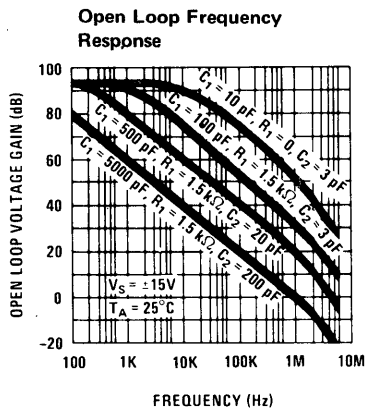
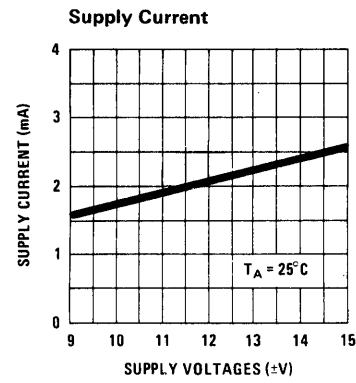
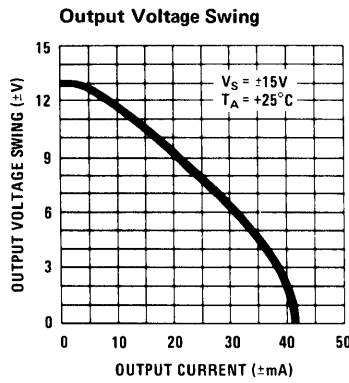
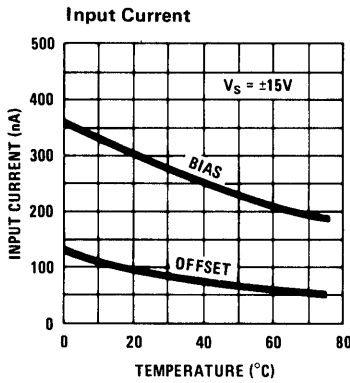



Operational Amplifiers

LM741/LM741C

LM741/LM741C operational amplifiers

general description

The LM741 and LM741C are general purpose operational amplifiers which feature improved performance over industry standards like the LM709. They are direct, plug-in replacements for the 709C, LM201, MC1439 and 748 in most applications.

The offset voltage and offset current are guaranteed over the entire common mode range. The amplifiers also offer many features which make

their application nearly foolproof: overload protection on the input and output, no latch-up when the common mode range is exceeded, as well as freedom from oscillations.

The LM741C is identical to the LM741 except that the LM741C has its performance guaranteed over a 0°C to 70°C temperature range, instead of -55°C to 125°C.

schematic and connection diagrams

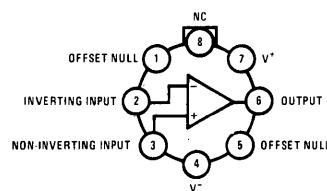
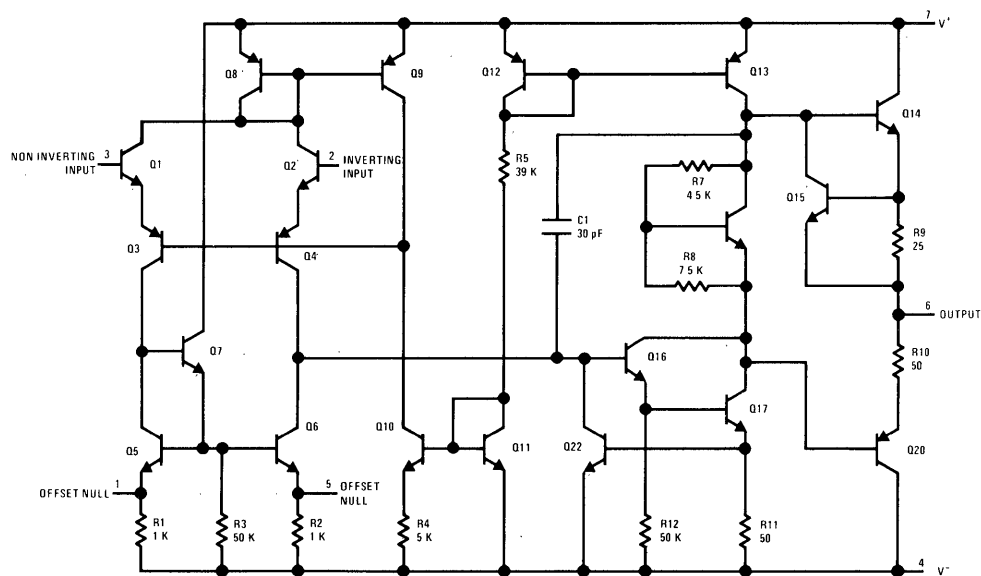

TOP VIEW

NOTE: Pin 4 connected to case.

absolute maximum ratings

Supply Voltage	LM741	±22V
	LM741C	±18V
Power Dissipation (Note 1)		500 mW
Differential Input Voltage		±30V
Input Voltage (Note 2)		±15V
Output Short-Circuit Duration		Indefinite
Operating Temperature Range	LM741	-55°C to 125°C
	LM741C	0°C to 70°C
Storage Temperature Range		-65°C to 150°C
Lead Temperature (Soldering, 10 sec)		300°C

electrical characteristics (Note 3)

PARAMETER	CONDITIONS	LM741			LM741C			UNITS
		MIN	TYP	MAX	MIN	TYP	MAX	
Input Offset Voltage	$T_A = 25^\circ\text{C}$, $R_S \leq 10\text{ k}\Omega$		1.0	5.0		1.0	6.0	mV
Input Offset Current	$T_A = 25^\circ\text{C}$		30	200		30	200	nA
Input Bias Current	$T_A = 25^\circ\text{C}$		200	500		200	500	nA
Input Resistance	$T_A = 25^\circ\text{C}$	0.3	1.0		0.3	1.0		M Ω
Supply Current	$T_A = 25^\circ\text{C}$, $V_S = \pm 15\text{V}$		1.7	2.8		1.7	2.8	mA
Large Signal Voltage Gain	$T_A = 25^\circ\text{C}$, $V_S = \pm 15\text{V}$ $V_{OUT} = \pm 10\text{V}$, $R_L \geq 2\text{ k}\Omega$	50	160		25	160		V/mV
Input Offset Voltage	$R_S < 10\text{ k}\Omega$			6.0			7.5	mV
Input Offset Current				500			300	nA
Input Bias Current				1.5			0.8	μA
Large Signal Voltage Gain	$V_S = \pm 15\text{V}$, $V_{OUT} = \pm 10\text{V}$ $R_L \geq 2\text{ k}\Omega$	25			15			V/mV
Output Voltage Swing	$V_S = \pm 15\text{V}$, $R_L = 10\text{ k}\Omega$ $R_L = 2\text{ k}\Omega$	±12 ±10	±14 ±13		±12 ±10	±14 ±13		V V
Input Voltage Range	$V_S = \pm 15\text{V}$	±12			±12			V
Common Mode Rejection Ratio	$R_S < 10\text{ k}\Omega$	70	90		70	90		dB
Supply Voltage Rejection Ratio	$R_S < 10\text{ k}\Omega$	77	96		77	96		dB

Note 1: The maximum junction temperature of the LM741 is 150°C, while that of the LM741C is 100°C. For operating at elevated temperatures, devices in the TO-5 package must be derated based on a thermal resistance of 150°C/W, junction to case.

Note 2: For supply voltages less than ±15V, the absolute maximum input voltage is equal to the supply voltage.

Note 3: These specifications apply for $\pm 15\text{V} \leq V_S \leq \pm 22\text{V}$ and $-55^\circ\text{C} \leq T_A \leq 125^\circ\text{C}$, unless otherwise specified. With the LM741C, however, all specifications are limited to $0^\circ\text{C} \leq T_A \leq 70^\circ\text{C}$ and $\pm 5\text{V} \leq V_S \leq \pm 18\text{V}$.



Operational Amplifiers

LM747/LM747C dual operational amplifiers

general description

The LM747 and the LM747C are general purpose dual operational amplifiers. The two amplifiers share a common bias network and power supply leads. Otherwise, their operation is completely independent.

Features of the LM747 and LM747C include offset nulling, short circuit protection, internal frequency compensation, wide common mode and differential mode range. Power drain is reduced by sharing bias resistors.

The offset voltage and offset current of the amplifiers are guaranteed over the full common mode range. Additional features of the LM747 and LM747C are: no latch-up when input common mode range is exceeded, freedom from oscillations, and package flexibility.

The LM747C is identical to the LM747 except that the LM747C has its specifications guaranteed over the temperature range from 0°C to 70°C instead of -55°C to +125°C.

schematic diagram (each amplifier)

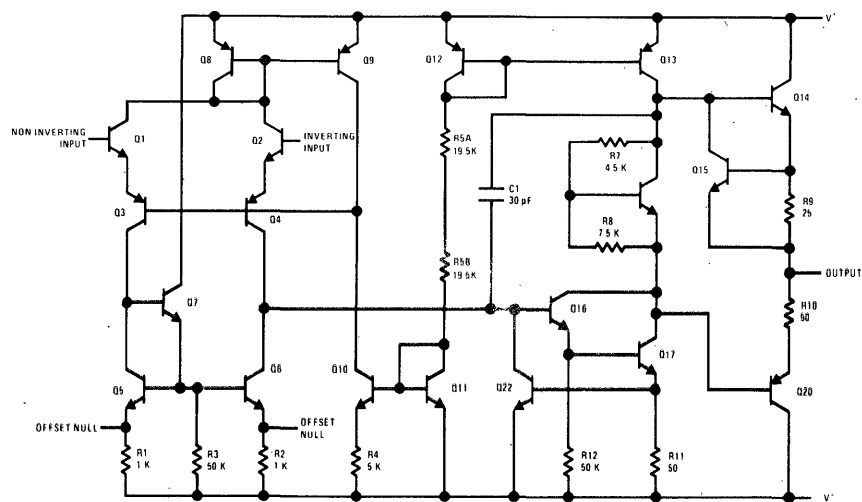

connection diagrams

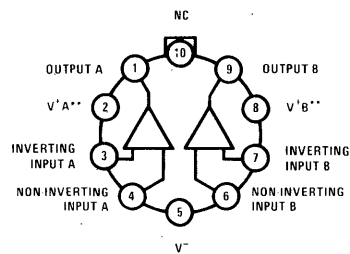

LM747/LM747C

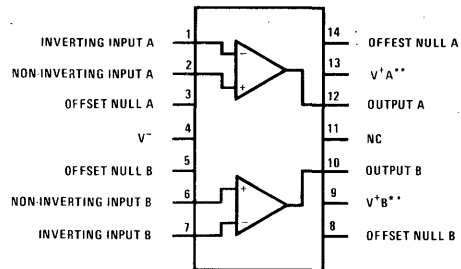

LM747D/LM747CD/LM747CN

**V+A and V+B are internally connected.

absolute maximum ratings

Supply Voltage	LM747	+22V
	LM747C	±18V
Power Dissipation (Note 1)		800 mW
Differential Input Voltage		±30V
Input Voltage (Note 2)		±15V
Output Short-Circuit Duration		Indefinite
Operating Temperature Range	LM747	-55°C to 125°C
	LM747C	0°C to 70°C
Storage Temperature Range		-65°C to 150°C
Lead Temperature (Soldering, 10 sec)		300°C

electrical characteristics (Note 3)

PARAMETER	CONDITIONS	LM747			LM747C			UNITS
		MIN	TYP	MAX	MIN	TYP	MAX	
Input Offset Voltage	$T_A = 25^\circ\text{C}$, $R_S < 10\text{ k}\Omega$		1.0	5.0		1.0	6.0	mV
Input Offset Current	$T_A = 25^\circ\text{C}$		80	200		80	200	nA
Input Bias Current	$T_A = 25^\circ\text{C}$		200	500		200	500	nA
Input Resistance	$T_A = 25^\circ\text{C}$	0.3	1.0		0.3	1.0		M Ω
Supply Current Both Amplifiers	$T_A = 25^\circ\text{C}$, $V_S = \pm 15\text{V}$		3.0	4.0		3.0	4.5	mA
Large Signal Voltage Gain	$T_A = 25^\circ\text{C}$, $V_S = \pm 15\text{V}$ $V_{\text{OUT}} = \pm 10\text{V}$, $R_L > 2\text{ k}\Omega$	50	160		50	160		V/mV
Input Offset Voltage	$R_S < 10\text{ k}\Omega$			6.0			7.5	mV
Input Offset Current				500			300	nA
Input Bias Current				1.5			0.8	μA
Large Signal Voltage Gain	$V_S = \pm 15\text{V}$, $V_{\text{OUT}} = \pm 10\text{V}$ $R_L > 2\text{ k}\Omega$	25			25			V/mV
Output Voltage Swing	$V_S = \pm 15\text{V}$, $R_L = 10\text{ k}\Omega$ $R_L = 2\text{ k}\Omega$	+12 ±10	±14 ±13		±12 ±10	±14 ±13		V V
Input Voltage Range	$V_S = \pm 15\text{V}$	±12			±12			V
Common Mode Rejection Ratio	$R_S < 10\text{ k}\Omega$	70	90		70	90		dB
Supply Voltage Rejection Ratio	$R_S < 10\text{ k}\Omega$	77	96		77	96		dB

Note 1: The maximum junction temperature of the LM747 is 150°C, while that of the LM747C is 100°C. For operating at elevated temperatures, devices in the TO-5 package must be derated based on a thermal resistance of 150°C/W, junction to case.

Note 2: For supply voltages less than ±15V, the absolute maximum input voltage is equal to the supply voltage.

Note 3: These specifications apply for $\pm 5\text{V} \leq V_S \leq \pm 22\text{V}$ and $-55^\circ\text{C} \leq T_A \leq 125^\circ\text{C}$, unless otherwise specified. With the LM747C, however, all specifications are limited to $0^\circ\text{C} \leq T_A \leq 70^\circ\text{C}$ and $\pm 5\text{V} \leq V_S \leq \pm 18\text{V}$.



Operational Amplifiers

LM748/LM748C operational amplifier

general description

The LM748/LM748C is a general-purpose operational amplifier built on a single silicon chip. The resulting close match and tight thermal coupling gives low offsets and temperature drift as well as fast recovery from thermal transients. In addition, the device features:

- Frequency compensation with a single 30 pF capacitor
- Operation from $\pm 5V$ to $\pm 20V$
- Low current drain: 1.8 mA at $\pm 20V$
- Continuous short-circuit protection

- Operation as a comparator with differential inputs as high as $\pm 30V$
- No latch-up when common mode range is exceeded.
- Same pin configuration as the LM101.

The unity-gain compensation specified makes the circuit stable for all feedback configurations, even with capacitive loads. However, it is possible to optimize compensation for best high frequency performance at any gain. As a comparator, the output can be clamped at any desired level to make it compatible with logic circuits.

connection diagram

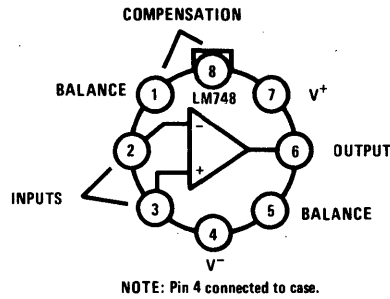

typical applications

Inverting Amplifier with Balancing Circuit

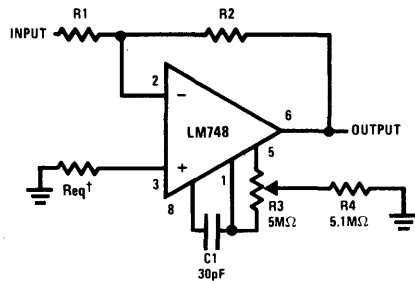

[†]May be zero or equal to parallel combination of R1 and R2 for minimum offset.

Voltage Comparator for Driving DTL or TTL Integrated Circuits

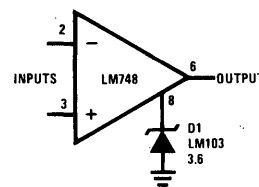

Low Drift Sample and Hold

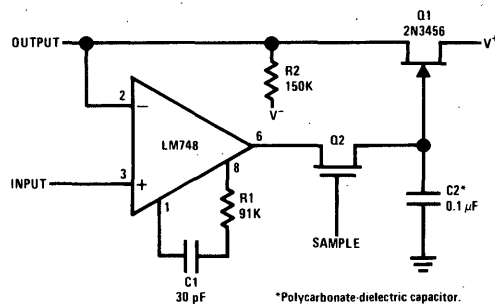

Voltage Comparator for Driving RTL Logic or High Current Driver

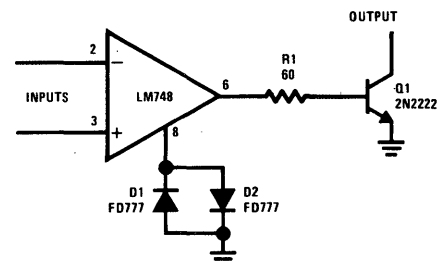

absolute maximum ratings

Supply Voltage	±22V
Power Dissipation (Note 1)	500 mW
Differential Input Voltage	±30V
Input Voltage (Note 2)	±15V
Output Short-Circuit Duration (Note 3)	Indefinite
Operating Temperature Range: LM748	-55°C to +125°C
LM748C	0°C to +70°C
Storage Temperature Range	-65°C to +150°C
Lead Temperature (Soldering, 10 sec)	300°C

electrical characteristics (Note 4)

PARAMETER	CONDITIONS	MIN	TYP	MAX	UNITS
Input Offset Voltage	$T_A = 25^\circ\text{C}$, $R_S \leq 10\text{ k}\Omega$		1.0	5.0	mV
Input Offset Current	$T_A = 25^\circ\text{C}$		40	200	nA
Input Bias Current	$T_A = 25^\circ\text{C}$		120	500	nA
Input Resistance	$T_A = 25^\circ\text{C}$	300	800		k Ω
Supply Current	$T_A = 25^\circ\text{C}$, $V_S = \pm 15\text{V}$		1.8	2.8	mA
Large Signal Voltage Gain	$T_A = 25^\circ\text{C}$, $V_S = \pm 15\text{V}$ $V_{\text{OUT}} = \pm 10\text{V}$, $R_L \geq 2\text{ k}\Omega$	50	160		V/mV
Input Offset Voltage	$R_S \leq 10\text{ k}\Omega$			6.0	mV
Average Temperature Coefficient of Input Offset Voltage	$R_S \leq 50\Omega$		3.0		$\mu\text{V}/^\circ\text{C}$
	$R_S \leq 10\text{ k}\Omega$		6.0		$\mu\text{V}/^\circ\text{C}$
Input Offset Current	$T_A = 0^\circ\text{C}$ to 70°C $T_A = -55^\circ\text{C}$ to 125°C			300 500	nA nA
Input Bias Current	$T_A = 0^\circ\text{C}$ to 70°C $T_A = -55^\circ\text{C}$ to 125°C			0.8 1.5	μA μA
Supply Current	$T_A = +125^\circ\text{C}$, $V_S = \pm 15\text{V}$ $T_A = -55^\circ\text{C}$ to 125°C		1.2 1.9	2.25 3.3	mA mA
Large Signal Voltage Gain	$V_S = \pm 15\text{V}$, $V_{\text{OUT}} = \pm 10\text{V}$ $R_L \geq 2\text{ k}\Omega$	25			V/mV
Output Voltage Swing	$V_S = \pm 15\text{V}$, $R_L = 10\Omega$ $R_L = 2\text{ k}\Omega$	±12 ±10	±14 ±13		V V
Input Voltage Range	$V_S = \pm 15\text{V}$	±12			V
Common Mode Rejection Ratio	$R_S \leq 10\text{ k}\Omega$	70	90		dB
Supply Voltage Rejection Ratio	$R_S \leq 10\text{ k}\Omega$	77	90		dB

Note 1: For operating at elevated temperatures the devices must be derated based on a maximum junction to case thermal resistance of 45°C per watt, or 150°C per watt junction to ambient. (See Curves.)

Note 2: For supply voltages less than ±15V, the absolute maximum input voltage is equal to the supply voltage.

Note 3: Continuous short circuit is allowed for case temperatures to +125°C and ambient temperatures to +70°C.

Note 4: These specifications apply for $\pm 5\text{V} \leq V_S \leq \pm 20\text{V}$ and $-55^\circ\text{C} \leq T_A \leq 125^\circ\text{C}$, unless otherwise specified. With the LM748C, however, all temperature specifications are limited to $0^\circ\text{C} \leq T_A \leq 70^\circ\text{C}$.

guaranteed performance (Note 4)

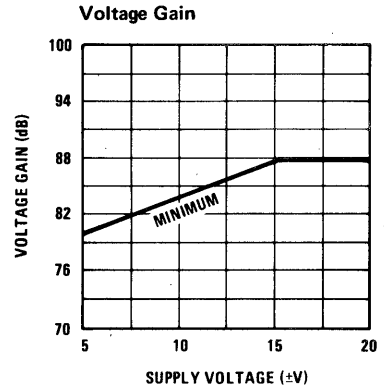
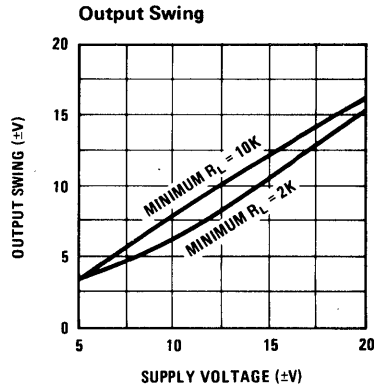
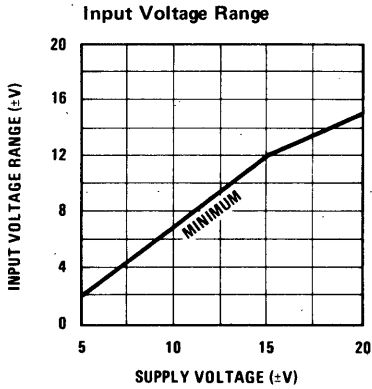

typical performance

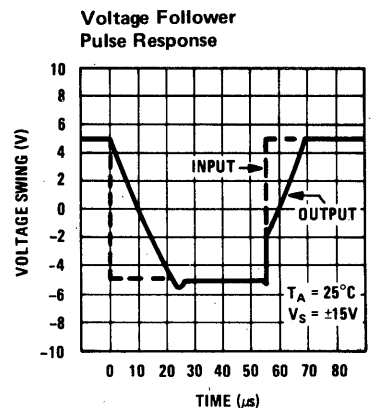
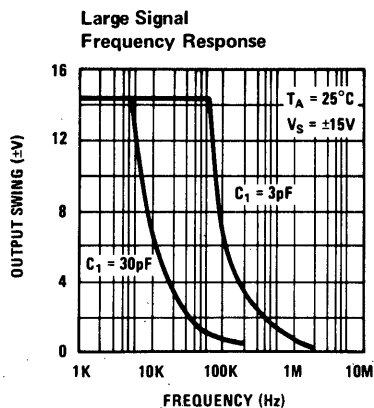
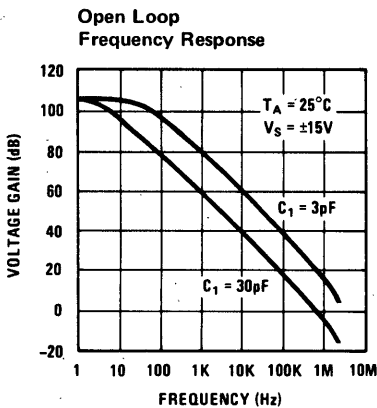
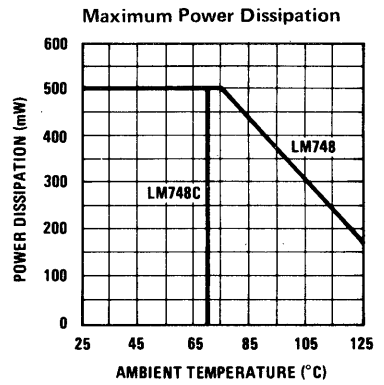
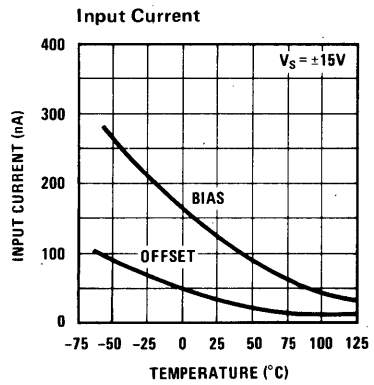
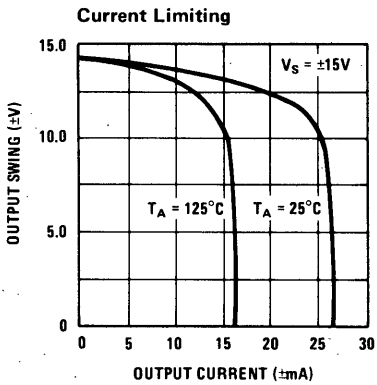
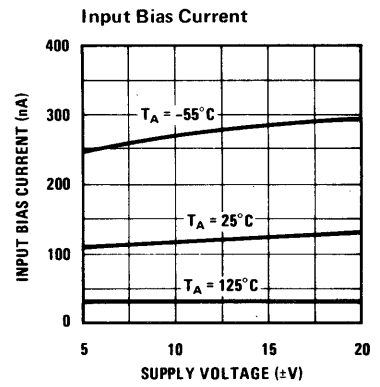
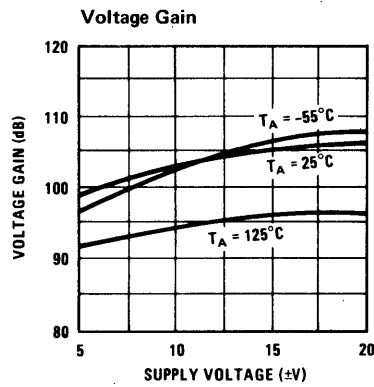
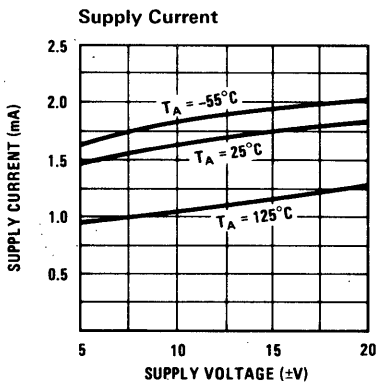



Operational Amplifiers

NH0001 low power operational amplifier

general description

The NH0001 is a general purpose operational amplifier designed for extremely low quiescent power. Typical NO-load dissipation at 25°C is 2 milliwatts at $V_S = \pm 15$ volts, and 0.5 milliwatts at $V_S = \pm 5$ volts. Even with this low power dissipation, the NH0001 will deliver ± 10 volts into a 2K load with ± 15 volt supplies, and typical short circuit currents of 20 to 30 milliamps. Additional features are:

- Operation from $\pm 5V$ to $\pm 20V$
- Very low offset voltage: typically 200 μV at 25°C, 600 μV at -55°C to 125°C

- Very low input offset current: typically 3 nA at 25°C, 6 nA at -55°C
- Low noise: typically 3 μV rms
- Frequency compensation with 2 small capacitors
- Output may be clamped at any desired level
- Output is continuously short circuit proof

The NH0001 is ideally suited for space borne applications or where battery operated equipment requires extremely low power dissipation.

schematic and connection diagrams

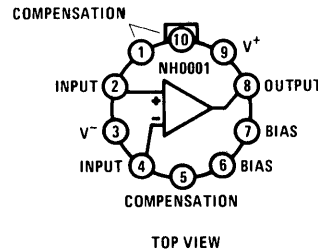
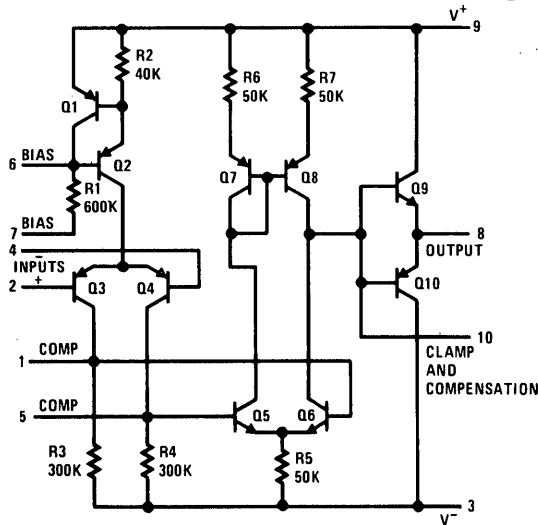

Note: Pin 7 must be grounded or connected to a voltage at least 5 volts more negative than the positive supply (Pin 9). Pin 7 may be connected to the negative supply, however the standby current will be increased. A resistor may be inserted in series with Pin 7 up to a maximum of 100 k Ω per volt between Pin 3 and Pin 9.

typical applications

Voltage Follower

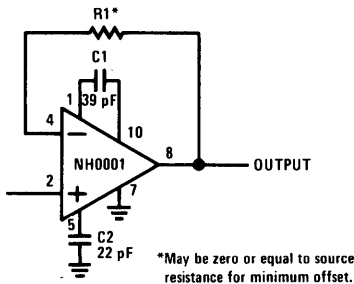

Integrator with Bias Current Compensation

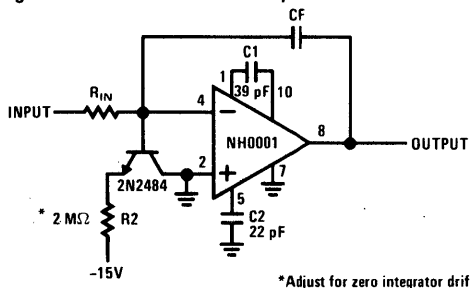

Voltage Comparator for Driving MOS Circuits

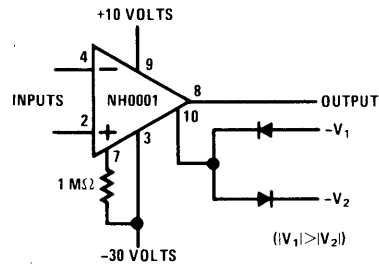

External Current Limiting Method

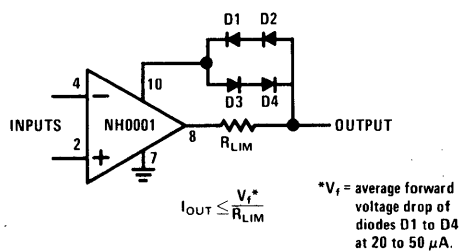

absolute maximum ratings

Supply Voltage	±20V
Power Dissipation (see Curve)	400 mW
Differential Input Voltage	±7V
Input Voltage	Equal to supply
Short Circuit Duration (Note 1)	Continuous
Operating Temperature Range	-55°C to +125°C
Storage Temperature Range	-65°C to +150°C
Lead Temperature Soldering	300°C
(20 sec.; 1/16" from package)	

electrical characteristics (Note 2)

PARAMETER	TEMP (°C)	CONDITIONS	MIN	TYP	MAX	UNITS
Input Offset Voltage	25	$R_S \leq 5K$		0.2	1.0	mV
	-55 to 125	$R_S \leq 5K$		0.6	2.0	mV
Input Offset Current	25 to 125				20	nA
	-55				100	nA
Input Bias Current	25 to 125				100	nA
	-55				300	nA
Supply Current (+)	25	$V_S = \pm 20V$		90	125	μA
	125	$V_S = \pm 20V$		70	100	μA
	-55	$V_S = \pm 20V$		100	150	μA
Supply Current (-)	25	$V_S = \pm 20V$		60	90	μA
	125	$V_S = \pm 20V$		45	75	μA
	-55	$V_S = \pm 20V$		75	125	μA
Voltage Gain	-55 to 25	$R_L = 100 K\Omega, V_S = \pm 15V, V_{OUT} = \pm 10V$	25	60		V/mV
	125	$R_L = 100 K\Omega, V_S = \pm 15V, V_{OUT} = \pm 10V$	10	30		V/mV
V_{OUT}	25	$V_S = \pm 15V, R_L = 2K$	10	11.5		V
	-55	$V_S = \pm 15V, R_L = 2K$	9	10.5		V
	125	$V_S = \pm 15V, R_L = 2K$	11	12.5		V
Common Mode Rejection Ratio	-55 to 125	$V_S = \pm 15V, V_{IN} = \pm 10V, R_S \leq 5K$	70	90		dB
Power Supply Rejection Ratio	-55 to 125	$V_S = \pm 15V, \Delta V = 5V \text{ to } 20V, R_S = \leq 5K$	70	90		dB
Input Resistance	25		0.5	1.5		MΩ
Average Temperature Coefficient of Offset Voltage	-55 to 125	$R_S \leq 5K$		4		μV/°C
Average Temperature Coefficient of Bias Current	-55 to 125			0.4		μA/°C
Equivalent Input Noise Voltage	25	$R_S = 1K, f = 5 \text{ Hz to } 1000 \text{ Hz}, V_S = \pm 15V$		3.0		μV rms

Note 1: Based on maximum short circuit current of 50 mA, device may be operated at any combination of supply voltages, and temperature to be within rated power dissipation (see Curve).

Note 2: These specifications apply for Pin 7 grounded, for $\pm 5V \leq V_S \leq \pm 20V$, with Capacitor C1 = 39 pF from Pin 1 to Pin 10, and C2 = 22 pF from Pin 5 to ground, unless otherwise specified.

guaranteed performance

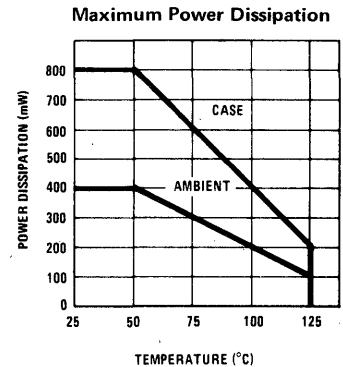
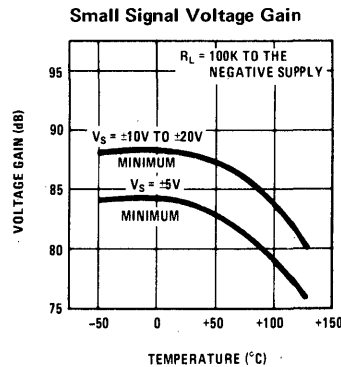
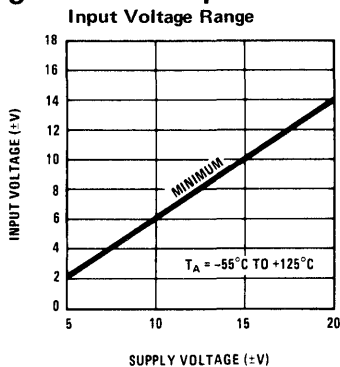

typical performance characteristics

Negative Supply Current

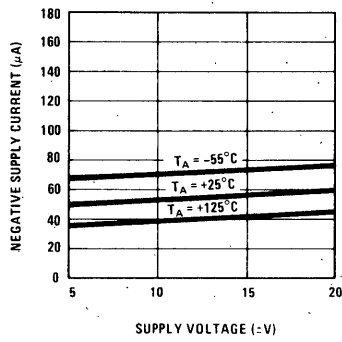

Positive Supply Currents

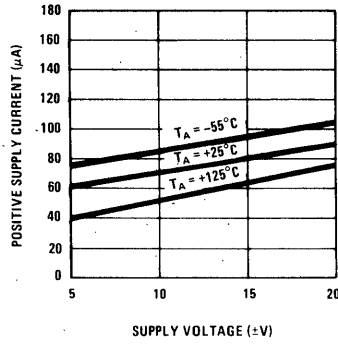

Short Circuit Output Current

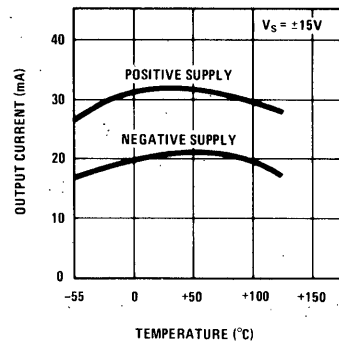

Input Bias Current

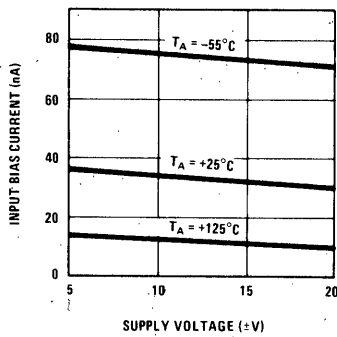

Input Offset Current

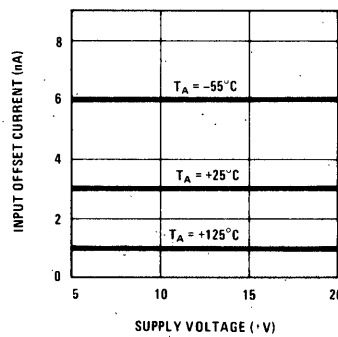

Input Resistance

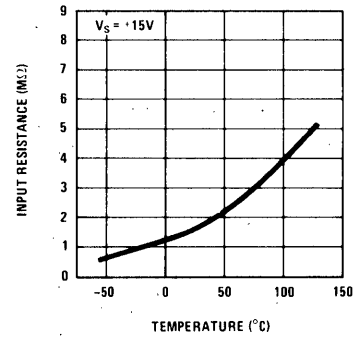

Negative Output Voltage Swing

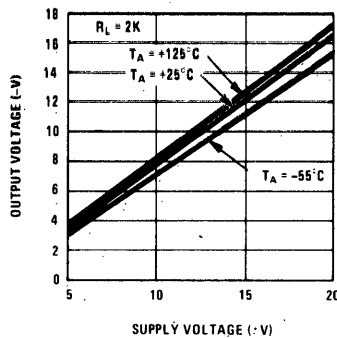

Positive Output Voltage Swing

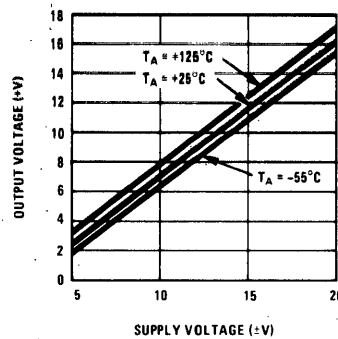

Voltage Gain

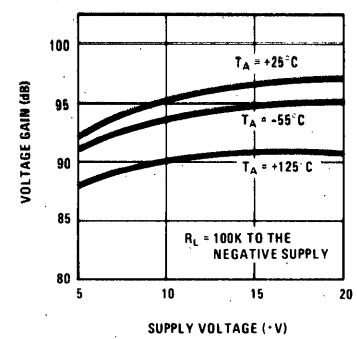

Open Loop Frequency Response

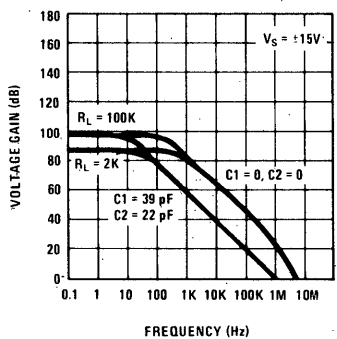

Large Signal Frequency Response

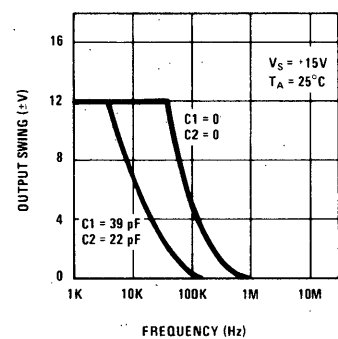

Voltage Follower Pulse Response

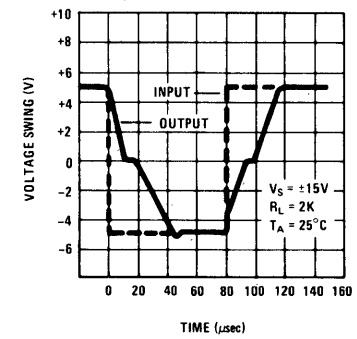

NH0002/NH0002C current amplifier

general description

The NH0002/NH0002C is a general purpose thick film hybrid current amplifier that is built on a single substrate. The circuit features:

- High Input Impedance 400 kΩ
- Low Output Impedance 6Ω
- High Power Efficiency
- Low Harmonic Distortion
- DC to 30 MHz Bandwidth
- Output Voltage Swing that Approaches Supply Voltage
- 400 mA Pulsed Output Current
- Slew rate is typically 200V/μs
- Operation from ±5V to ±20V

These features make it ideal to integrate with an operational amplifier inside a closed loop configuration to increase current output. The symmetrical output portion of the circuit also provides a low output impedance for both the positive and negative slopes of output pulses.

The NH0002 is available in an 8-lead low-profile TO-5 header; the NH0002C is also available in an 8-lead TO-5, and a 10-pin molded dual-in-line package.

applications

- Line driver
- 30 MHz buffer
- High speed D/A conversion
- Instrumentation buffer
- Precision current source

schematic and connection diagrams

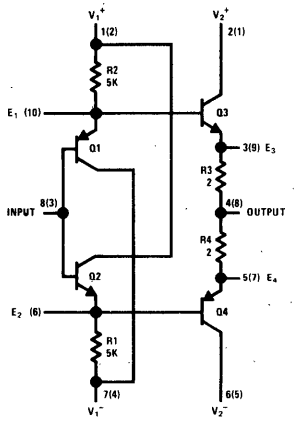

Pin numbers in parentheses denote pin connections for dual-in-line package.

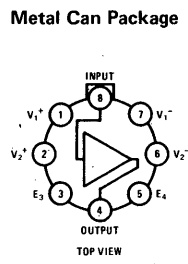
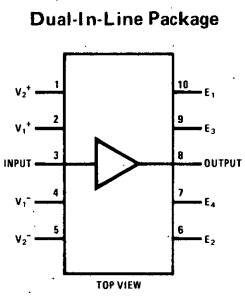

typical applications

High Current Operational Amplifier

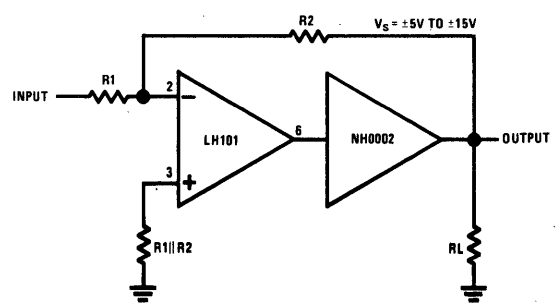

Line Driver

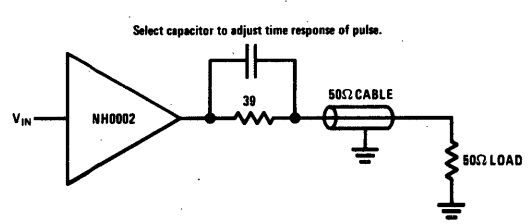

absolute maximum ratings

Supply Voltage		±22V
Power Dissipation Ambient		600 mW
Input Voltage (Equal to Power Supply Voltage)		
Storage Temperature Range		-65°C to +150°C
Operating Temperature Range	NH0002	-55°C to +125°C
	NH0002C	0°C to +85°C
Steady State Output Current		±100 mA
Pulsed Output Current (50 ms On/1 sec Off)		±400 mA

electrical characteristics (Note 1)

PARAMETERS	CONDITIONS	MIN	TYP	MAX	UNITS
Voltage Gain	$R_S = 10\text{ k}\Omega$, $R_L = 1.0\text{ k}\Omega$ $V_{IN} = 3.0\text{ V}_{PP}$, $f = 1.0\text{ kHz}$ $T_A = -55^\circ\text{C}$ to 125°C	.95	.97		
AC Current Gain	$V_{IN} = 1.0\text{ V}_{rms}$ $f = 1.0\text{ kHz}$		40		A/mA
Input Impedance	$R_S = 200\text{ k}\Omega$, $V_{IN} = 1.0\text{ V}_{rms}$, $f = 1.0\text{ kHz}$, $R_L = 1.0\text{ k}\Omega$	180	400	—	k Ω
Output Impedance	$V_{IN} = 1.0\text{ V}_{rms}$, $f = 1.0\text{ kHz}$ $R_L = 50\Omega$, $R_S = 10\text{ k}\Omega$	—	6	10	Ω
Output Voltage Swing	$R_L = 1.0\text{ k}\Omega$, $f = 1.0\text{ kHz}$	±10	±11	—	V
DC Output Offset Voltage	$R_S = 300\Omega$, $R_L = 1.0\text{ k}\Omega$ $T_A = -55^\circ\text{C}$ to 125°C	—	±10	±30	mV
DC Input Offset Current	$R_S = 10\text{ k}\Omega$, $R_L = 1.0\text{ k}\Omega$ $T_A = -55^\circ\text{C}$ to 125°C	—	±6.0	±10	μA
Harmonic Distortion	$V_{IN} = 5.0\text{ V}_{rms}$, $f = 1.0\text{ kHz}$	—	0.1	—	%
Bandwidth	$V_{IN} = 1.0\text{ V}_{rms}$, $R_L = 50\Omega$, $f = 1\text{ MHz}$	30	50	—	MHz
Positive Supply Current	$R_S = 10\text{ k}\Omega$, $R_L = 1\text{ k}\Omega$	—	+6.0	+10.0	mA
Negative Supply Current	$R_S = 10\text{ k}\Omega$, $R_L = 1\text{ k}\Omega$	—	-6.0	-10.0	mA

Note 1: Specification applies for $T_A = 25^\circ\text{C}$ with +12V on Pins 1 and 2; -12V on Pins 6 and 7 for the metal can package and +12V on Pins 1 and 2; -12V on Pins 4 and 5 for the dual-in-line package unless otherwise specified. The parameter guarantees for NH0002C apply over the temperature range of 0°C to +85°C, while parameters for the NH0002 are guaranteed over the temperature range -55°C to 125°C.

typical performance

Maximum Power Dissipation

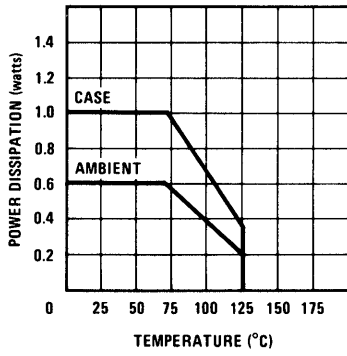

Frequency Response

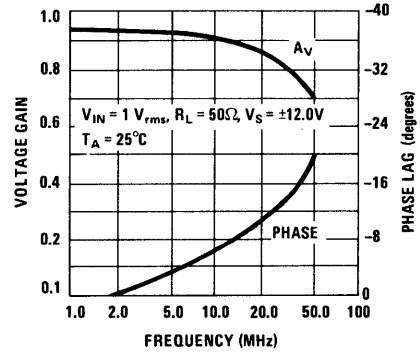

Input Impedance (Magnitude & Phase)

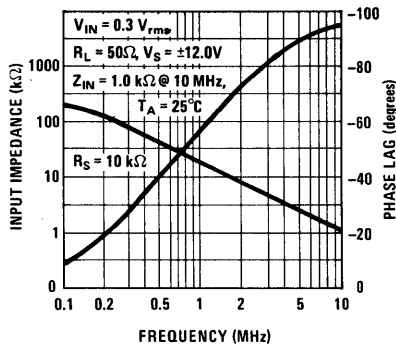

Supply Current

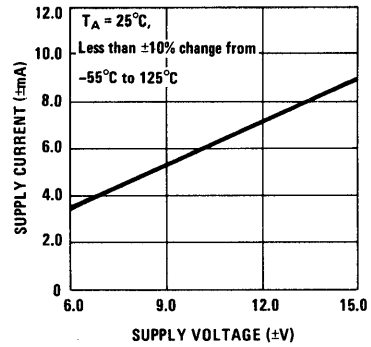

Positive Pulse

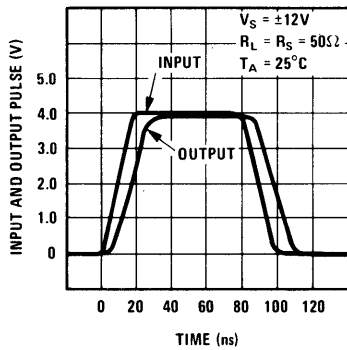

Negative Pulse

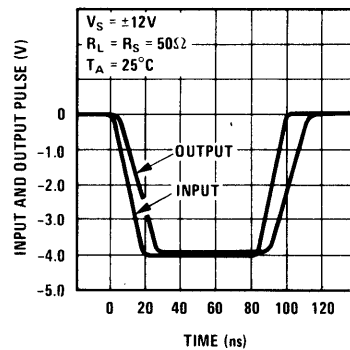

Input Offset Current

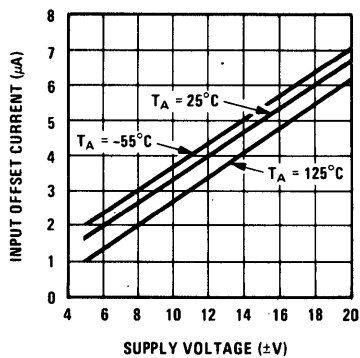



Operational Amplifiers

NH0003/NH0003C wide bandwidth operational amplifier general description

The NH0003/NH0003C is a general purpose operational amplifier which features: slewing rate up to 70 volts/ μ sec, a gain bandwidth of up to 300 MHz, and high output currents. Other features are:

- Very low offset voltage Typically 0.4 mV
- Large output swing $> \pm 10V$ into 100Ω load
- High CMRR Typically > 90 dB
- Good large signal frequency response 50 kHz to 400 kHz depending on compensation

schematic and connection diagrams

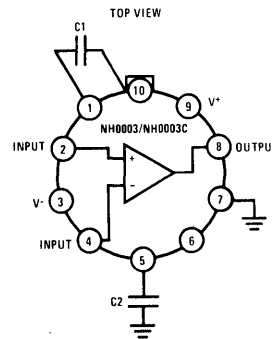
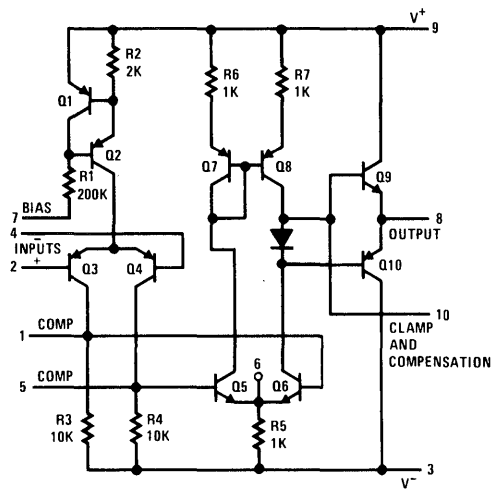

Circuit Gain	C ₁ pF	C ₂ pF	Slew Rate R _L > 200 Ω , V/ μ sec	Full Output Frequency R _L 200 Ω , V _{OUT} = 10 V
≥ 40	0	0	70	400
≥ 10	5	30	30	350
≥ 5	15	30	15	250
≥ 2	50	50	5	100
≥ 1	90	90	2	50

Typical Compensation

typical applications

High Slew Rate Unity Gain Inverting Amplifier

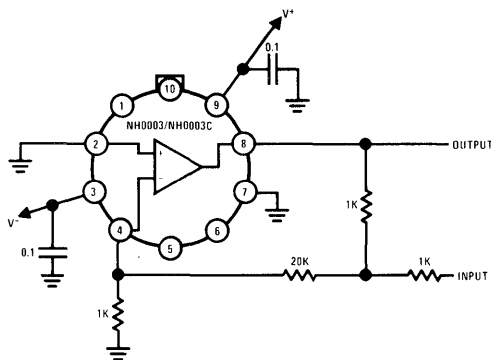

Unity Gain Follower

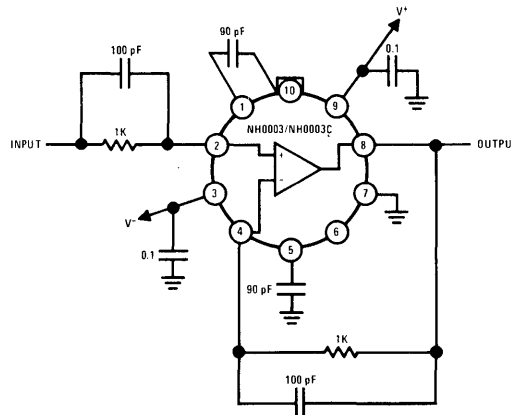

absolute maximum ratings

Supply Voltage	±20V
Power Dissipation	See curve
Differential Input Voltage	±7V
Input Voltage	Equal to supply
Load Current	120 mA
Operating Temperature Range	NH0003 -55°C to +125°C
	NH0003C 0°C to +70°C
Storage Temperature Range	-65°C to +150°C
Lead Temperature (Soldering, 10 sec)	300°C

electrical characteristics (Notes 1 & 2)

PARAMETER	CONDITIONS	MIN	TYP	MAX	UNITS
Input Offset Voltage	$R_S < 1k$		0.4	3.0	mV
Input Offset Current			0.02	0.2	μA
Input Bias Current			0.4	2.0	μA
Supply Current	$V_S = ±20V$		1.2	3	mA
Voltage Gain	$R_L = 100k, V_S = ±15V, V_{OUT} = ±10V$	20	70		V/mV
Voltage Gain	$R_L = 2k, V_S = ±15V, V_{OUT} = ±10V$	15	40		V/mV
Voltage Gain	$R_L = 200Ω, V_S = ±15V, V_{OUT} = ±10V$	5	15		V/mV
Output Voltage Swing	$V_S = ±15, R_L = 100Ω$	±10	±12		V
Input Resistance			100		kΩ
Average Temperature Coefficient of Offset Voltage	$R_S < 5k$		4		μV/°C
Average Temperature Coefficient of Bias Current			8		nA/°C
CMRR	$R_S < 1k, V_S = ±V, V_{IN} = ±10V$	70	90		dB
PSRR	$R_S < 1k, V_S = ±15V, ΔV = 5V$ to 20V	70	90		dB
Equivalent Input Noise Voltage	$R_S = 1K, f = 10$ kHz to 100 kHz $V_S = ±15V$ dc		1.8		μVrms

Note 1. These specifications apply for Pin 7 grounded, for $±5V < V_S < ±20V$, with capacitor $C_1 = 90$ pF from Pin 1 to Pin 10 and $C_2 = 90$ pF from Pin 5 to ground, over the specified operating temperature range, unless otherwise specified.

Note 2. Typical values are for $t_{AMBIENT} = 25°C$ unless otherwise specified

typical performance

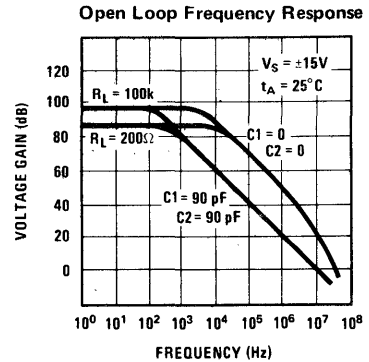
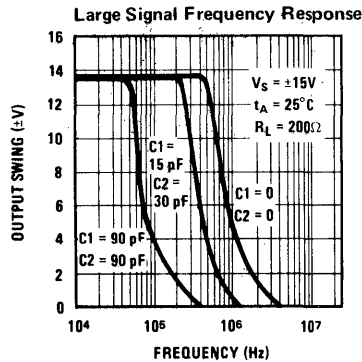
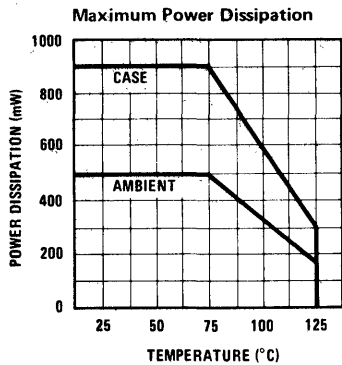



Operational Amplifiers

NH0004/NH0004C high voltage operational amplifier

general description

The NH0004/NH0004C is a general purpose operational amplifier designed to operate from supply voltages up to $\pm 40V$. The device dissipates extremely low quiescent power, typically 8 mW at $25^\circ C$ and $V_S = \pm 40V$. Additional features include:

- Capable of operation over the range of $\pm 5V$ to $\pm 40V$.
- Large output voltage typically $\pm 35V$ for the NH0004 and $\pm 33V$ for the NH0004C into a $2 K\Omega$ load with $\pm 40V$ supplies
- Low input offset current typically 20 nA for the NH0004 and 45 nA for the NH0004C
- Low input offset voltage typically 0.3 mV

- Frequency compensation with two small capacitors.
- Low power consumption 8 mW at $\pm 40V$

The NH0004's high gain and wide range of operating voltages make it ideal for applications requiring large output swing and low power dissipation.

applications

- Precision high voltage power supply.
- Resolver excitation.
- Wideband high voltage amplifier.
- Transducer power supply.

schematic and connection diagrams

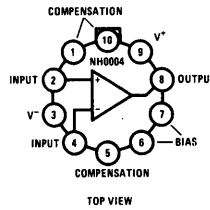
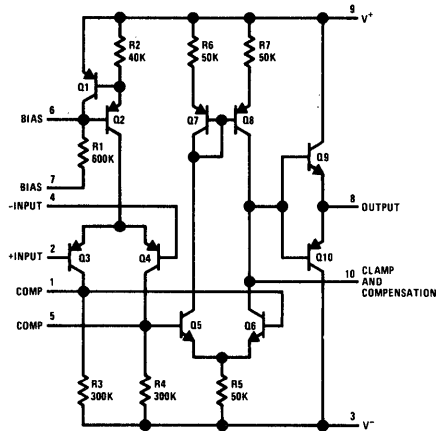

Note: Pin 7 must be grounded or connected to a voltage at least 5 volts more negative than the positive supply (Pin 9). Pin 7 may be connected to the negative supply; however, the standby current will be increased. A resistor may be inserted in series with Pin 7 to Pin 9. The value of the resistor should be a maximum of $100 K\Omega$ per volt of potential between Pin 3 and Pin 9.

typical applications

Voltage Follower

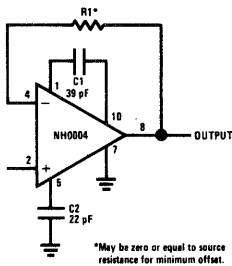

Input Offset Voltage Adjust

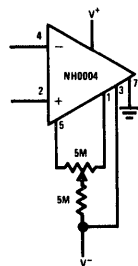

External Current Limiting Method

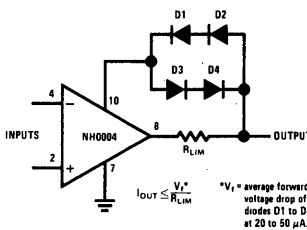

High Compliance Current Source

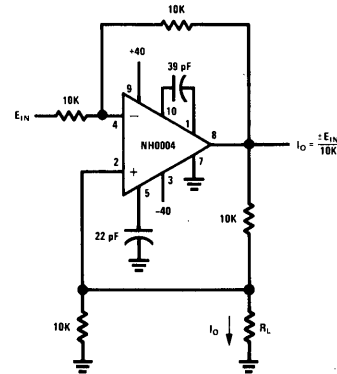

absolute maximum ratings

Supply Voltage, Continuous	±45V
Supply Voltage, Transient (≤ 0.1 sec, no load)	±60V
Power Dissipation (See curve)	400 mW
Differential Input Voltage	±7V
Input Voltage	Equal to supply
Short Circuit Duration	3 sec
Operating Temperature Range NH0004	-55°C to +125°C
NH0004C	0°C to 85°C
Storage Temperature Range	-65°C to +150°C
Lead Temperature (Soldering, 10 sec)	300°C

electrical characteristics (Note 1)

PARAMETER	CONDITIONS	NH0004			NH0004C			UNITS
		MIN	TYP	MAX	MIN	TYP	MAX	
Input Offset Voltage	$R_S \leq 5k, T_A = 25^\circ C$		0.3	1.0		0.3	1.5	mV
	$R_S \leq 5k$			2.0			3.0	mV
Input Bias Current	$T_A = 25^\circ C$		20	100		30	120	nA
	$= -55^\circ C$			300			300	nA
Input Offset Current	$T_A = 25^\circ C$		3	20		10	45	nA
	$= -55^\circ C$			100			150	nA
Positive Supply Current	$V_S = \pm 40V, T_A = 25^\circ C$		110	150		110	150	μA
	$V_S = \pm 40V$			175			175	μA
Negative Supply Current	$V_S = \pm 40V, T_A = 25^\circ C$		80	100		80	100	μA
	$V_S = \pm 40V$			135			135	μA
Voltage Gain	$V_S = \pm 40V, R_L = 100k, T_A = 25^\circ C$ $V_{OUT} = \pm 30V$	30	60		30	60		V/mV
	$V_S = \pm 40V, R_L = 100k$ $V_{OUT} = \pm 30V$	10			10			V/mV
Output Voltage	$V_S = \pm 40V, R_L = 2k$	±30	±35		±30	±33		V
	$V_S = \pm 40V, R_L = 4k$	±34	±36		±33	±35		V
CMRR	$V_S = \pm 40V, R_S \leq 5k$ $V_{IN} = \pm 33V$	70	90		70	90		dB
PSRR	$V_S = \pm 40V, R_S \leq 5k$ $\Delta V = 20V$ to 40V	70	90		70	90		dB
Average Temperature Coefficient Offset Voltage	$R_S \leq 5k$		4.0			4.0		$\mu V/^\circ C$
Average Temperature Coefficient of Offset Current			0.4			0.4		$\mu A/^\circ C$
Equivalent Input Noise Voltage	$R_S = 1k, V_S = \pm 40V$ $f = 500$ Hz to 5 kHz, $T_A = 25^\circ C$		3.0			3.0		μV_{rms}

Note 1: These specifications apply for $\pm 5V \leq V_S \leq \pm 40V$, Pin 7 grounded, with capacitors C1 = 39 pF between Pin 1 and Pin 10, C2 = 22 pF between Pin 5 and ground, -55°C to 125°C for the NH0004, and 0°C to 85°C for the NH0004C unless otherwise specified.

typical performance

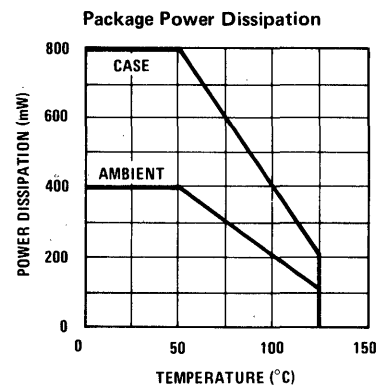
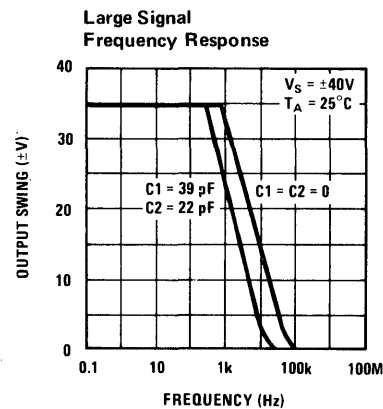
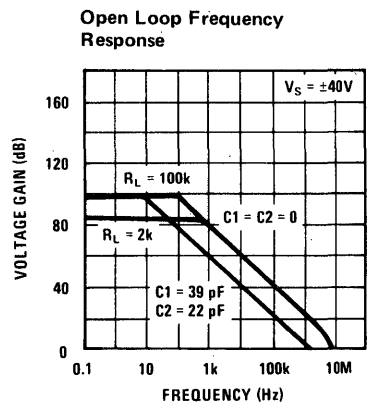
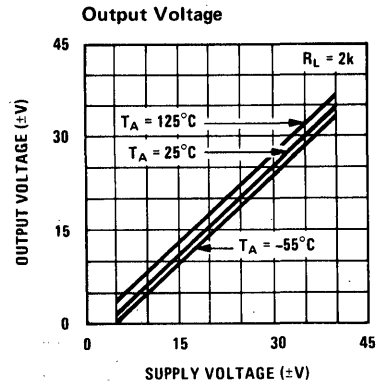
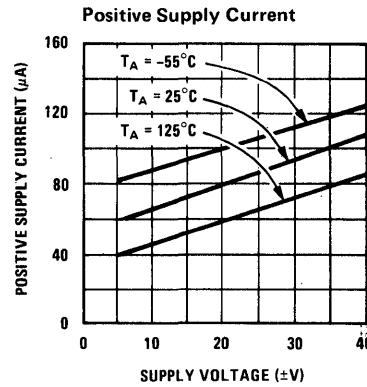
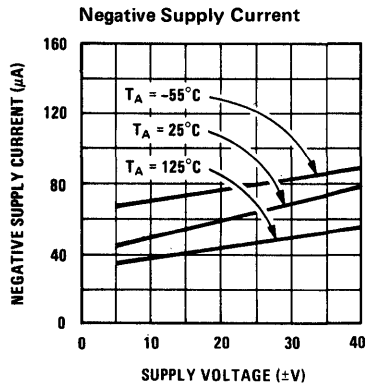
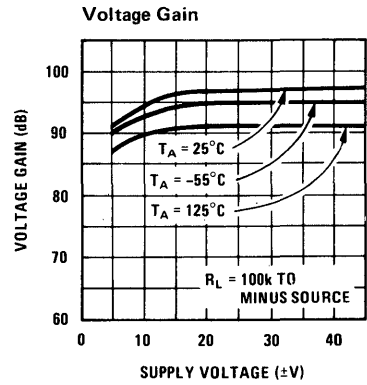
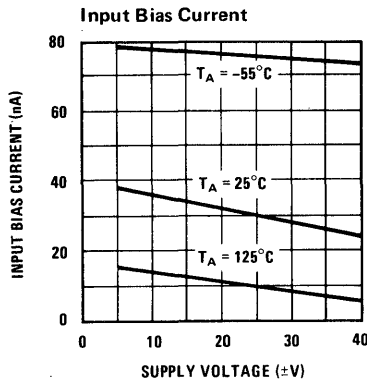
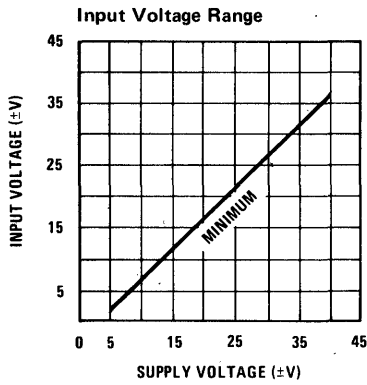



Operational Amplifiers

NH0005/NH0005A

NH0005/NH0005A operational amplifier

general description

The NH0005/NH0005A is a hybrid integrated circuit operational amplifier employing thick film resistors and discrete silicon semiconductors in its design. The select matching of the input pairs of transistors results in low input bias currents and a very low input offset current, both of which exhibit excellent temperature tracking. In addition, the device features:

- Very high output current capability: ± 50 mA into a 100 ohm load
- Low standby power dissipation: typically 60 mW at ± 12 V
- High input resistance: typically 2M at 25°C

- Full operating range: -55°C to $+125^\circ\text{C}$
- Good high frequency response: unity gain at 30 MHz

With no external roll-off network, the amplifier is stable with a feedback ratio of 10 or greater. By adding a 200 pF capacitor between pins 9 and 10, and a 200 ohm resistor in series with a 75 pF capacitor from pin 4 to ground, the amplifier is stable to unity gain. The unity gain loop phase margin with the above compensation is typically 70 degrees. With a gain of 10 and no compensation the loop phase margin is typically 50 degrees.

schematic and connection diagrams

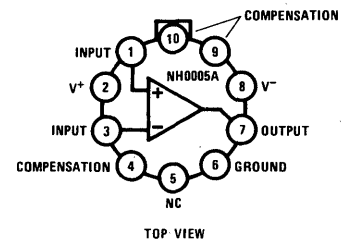
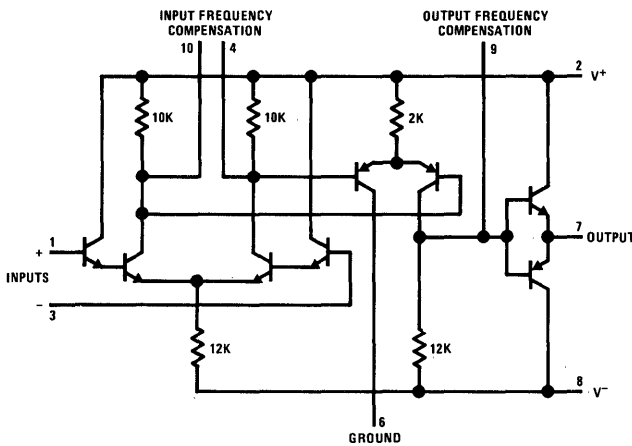

typical applications

Voltage Follower

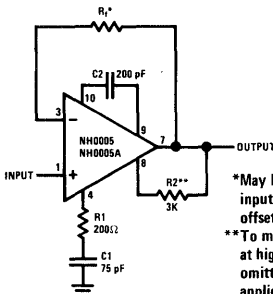

*May be zero or equal to the input resistance for minimum offset.
 **To minimize crossover distortion at higher frequencies. May be omitted for low frequency application or selected to suit design requirements

Offset Balancing Circuit

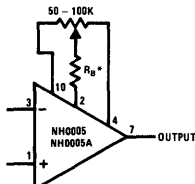

*Typical value, $R_B = 100\text{K}$.
 R_B may be increased for greater sensitivity with reduction in range.

External Current Limiting

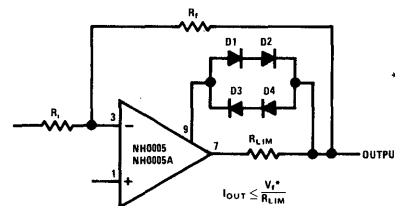

* V_f = Average forward voltage drop of diodes D_1 to D_4 at approx. 1 mA.
 For continuous short circuit protection ($V_S = \pm 12\text{V}$, $-55^\circ\text{C} \leq T_A \leq +100^\circ\text{C}$)
 $R_{LIM} \geq 50\Omega$

Integrator with Bias Current Compensation

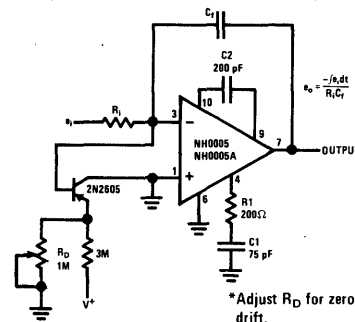

*Adjust R_D for zero integration drift.

absolute maximum ratings

Supply Voltage	±20V
Power Dissipation (see Curve)	400 mW
Differential Input Voltage	±15V
Input Voltage	Equal to supply voltages
Peak Load Current	±100 mA
Storage Temperature Range	-65°C to +150°C
Operating Temperature Range	-55°C to +125°C
Lead Temperature (soldering, 20 sec)	300°C; 1/16" from package

electrical characteristics (Note 1)

PARAMETER	CONDITIONS	NH0005			NH0005A			UNITS
		MIN	TYP	MAX	MIN	TYP	MAX	
Input Offset Voltage 25°C -55°C, 125°C	$R_S \leq 20\text{ k}\Omega$		5	10		1	3	mV
	$R_S \leq 20\text{ k}\Omega$			10			4	mV
Input Offset Current 25°C to 125°C -55°C			10	20		2	5	nA
			25	75		10	25	nA
Input Bias Current 25°C to 125°C -55°C			15	50		8	25	nA
			100	250		60	125	nA
Large Signal Voltage Gain -55°C to 25°C 125°C	$R_L = 10\text{K}, R_2 = 3\text{K}, V_{OUT} = \pm 5\text{V}$	2	4		4	5.5		V/mV
		1.5	3		3	5		V/mV
Output Voltage Swing -55°C to 125°C 25°C to 125°C -55°C	$R_L = 10\text{ k}\Omega$	-10		+6	-10		+6	V
	$R_L = 100\Omega$	-5		+5	-5		+5	V
	$R_L = 100\Omega$	-4		+4	-4		+4	V
Input Resistance 25°C		1	2		1	2		MΩ
Common Mode Rejection Ratio 25°C	$V_{IN} = \pm 4\text{V}, R_S \leq 20\text{ k}\Omega$	55	60		60	66		dB
Power Supply Rejection Ratio 25°C		55	60		60	66		dB
Supply Current (+) -55°C to 125°C			3	5		3	5	mA
Supply Current (-) -55°C to 125°C			2	4		2	4	mA
Average Temperature Coefficient of Input Offset Voltage -55°C to 125°C	$R_S \leq 20\text{ k}\Omega$		20			10		uV/°C
Output Resistance 25°C			70			70		Ω

Note 1: These specifications apply for pin 6 grounded, $V_S = \pm 12\text{V}$, with Resistor $R_1 = 200\Omega$ in series with Capacitor $C_1 = 75\text{ pF}$ from pin 4 to ground, and $C_2 = 200\text{ pF}$ between pins 9 and 10 unless otherwise specified.

guaranteed performance characteristics

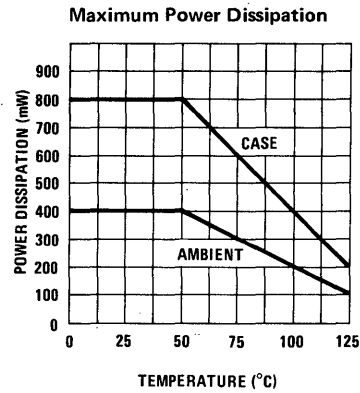
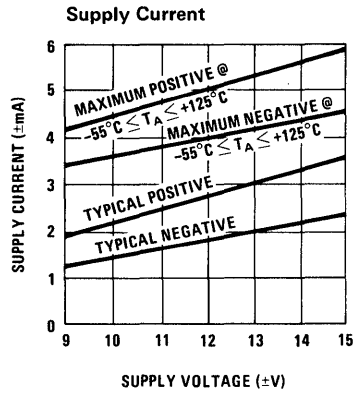

typical performance characteristics

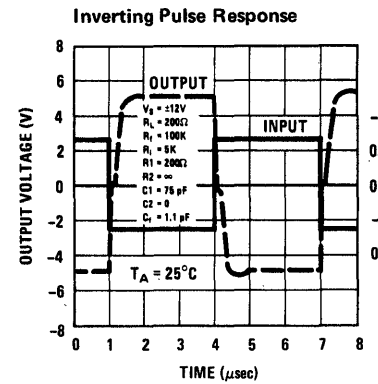
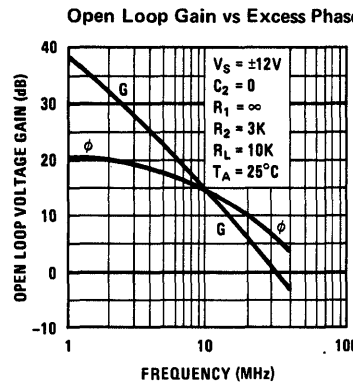
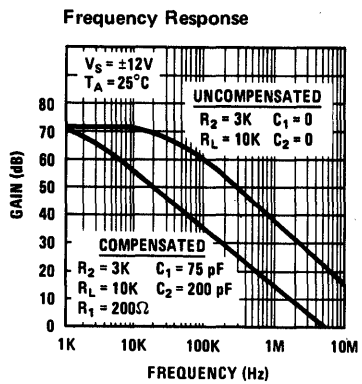
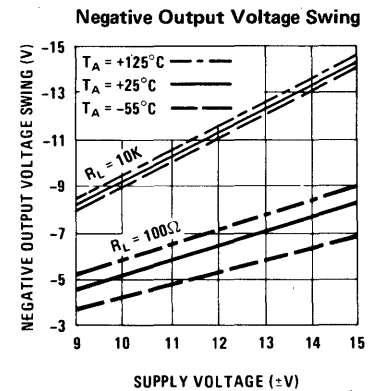
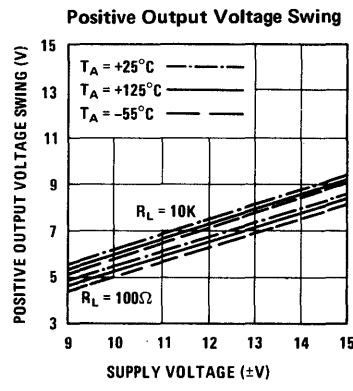
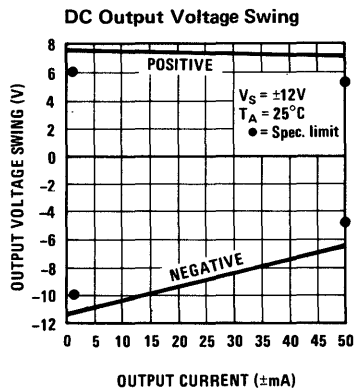
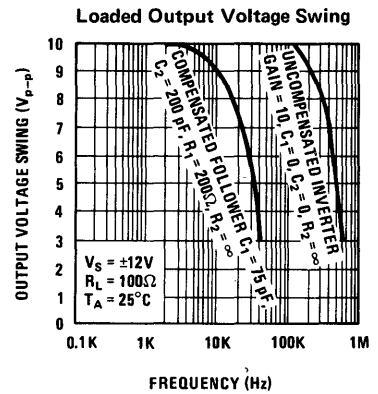
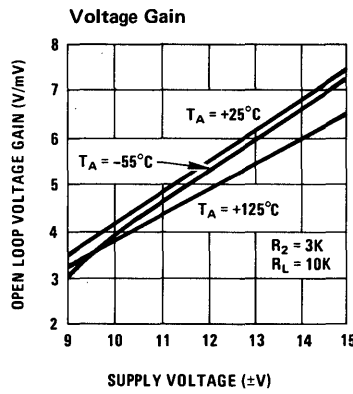
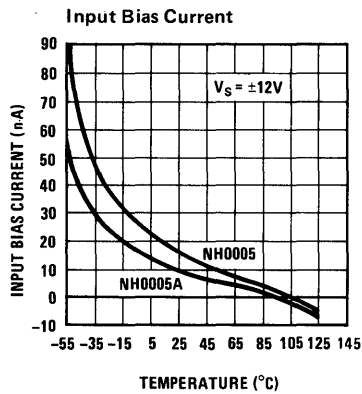



Operational Amplifiers

general description

NH0005C operational amplifier

The NH0005C is a hybrid integrated circuit operational amplifier employing thick film resistors and discrete silicon semiconductors in its design. The select matching of the input pairs of transistors results in low input bias currents and a very low input offset current both of which exhibit excellent temperature tracking. In addition, the device features:

- Very high output current capability: ± 40 mA into a 100 ohm load
- Low standby power dissipation: typically 60 mW at ± 12 V
- High input resistance: typically 2M at 25°C

- Operating range: 0° to 70°C
- Good high frequency response: unity gain at 30 MHz

With no external roll-off network, the amplifier is stable with a feedback ratio of 10 or greater. By adding a 200 pF capacitor between pins 9 and 10, and a 200 ohm resistor in series with a 75 pF capacitor from pin 4 to ground, the amplifier is stable to unity gain. The unity gain loop phase margin with the above compensation is typically 70 degrees. With a gain of 10 and no compensation the loop phase margin is typically 50 degrees.

schematic and connection diagrams

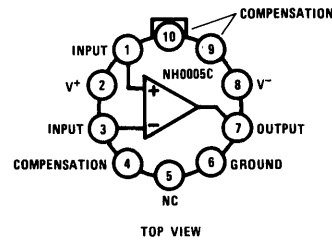
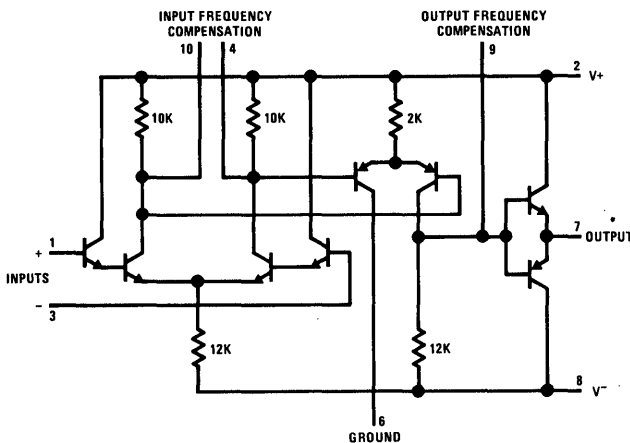

typical applications

Voltage Follower

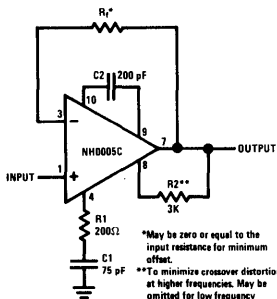

Offset Balancing Circuit

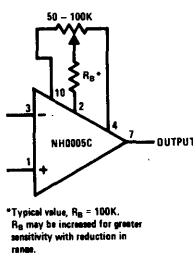

External Current Limiting

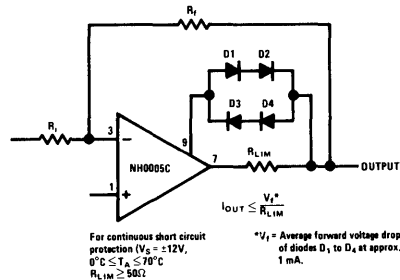

Integrator With Bias Current Compensation

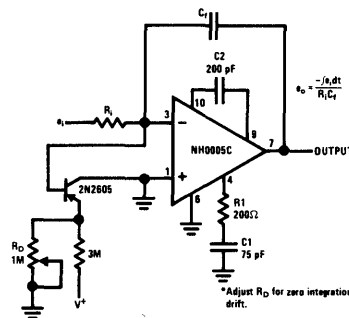

absolute maximum ratings

Supply Voltage	±20V
Power Dissipation (see Curve)	400 mW
Differential Input Voltage	±15V
Input Voltage	Equal to supply voltages
Peak Load Current	±100 mA
Storage Temperature Range	-55°C to +125°C
Operating Temperature Range	0°C to 70°C
Lead Temperature (soldering, 20 sec)	300°C; 1/16" from package

electrical characteristics

PARAMETER	CONDITIONS	NH0005C			UNITS
		MIN	TYP (Note 2)	MAX	
Input Offset Voltage 0°C to 70°C	$R_S \leq 20\text{ k}\Omega$		3	10	mV
Input Offset Current 0°C to 70°C			5	25	nA
Input Bias Current 0°C to 70°C			20	100	nA
Large Signal Voltage Gain 0°C to 70°C	$R_L = 10\text{K}, R_2 = 3\text{K}, V_{OUT} = \pm 5\text{V}$	2	5		V/mV
Output Voltage Swing 0°C to 70°C	$R_L = 10\text{ k}\Omega$	-10		+6	V
	$R_L = 100\Omega$	-4	±6	+4	V
Input Resistance 25°C		0.5	2		MΩ
Common Mode Rejection Ratio 25°C	$V_{IN} = \pm 4\text{V}, R_S \leq 20\text{ k}\Omega$	50	60		dB
Power Supply Rejection Ratio 25°C		50	60		dB
Supply Current (+) 0°C to 70°C			3	5	mA
Supply Current (-) 0°C to 70°C			2	4	mA

Note 1: These specifications apply for pin 6 grounded, $V_S = \pm 12\text{V}$, with Resistor $R_1 = 200\Omega$ in series with Capacitor $C_1 = 75\text{ pF}$ from pin 4 to ground, and $C_2 = 200\text{ pF}$ between pins 9 and 10 unless otherwise specified.

Note 2: Typical values are for 25°C only.

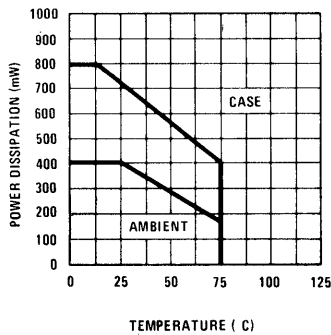

Maximum Power Dissipation



Operational Amplifiers

NH0020/NH0020C medium current operational amplifier

general description

The NH0020/NH0020C is a general purpose operational amplifier designed to source and sink 50 mA output currents. In addition to its high output capability, the NH0020/NH0020C exhibits excellent open loop gain, typically in excess of 100 dB. The parameters of the NH0020 are guaranteed over the temperature range of -55°C to $+125^{\circ}\text{C}$ and $\pm 5\text{V} \leq V_S \leq \pm 22\text{V}$, while those of the NH0020C are guaranteed over the temperature range of 0°C to 85°C and $\pm 5\text{V} \leq V_S \leq \pm 18\text{V}$. Additional features include:

- Low offset voltage typically 1.0 mV at 25°C over the entire common mode voltage range.

- Low offset current typically 10 nA at 25°C for the NH0020 and 30 nA for the NH0020C.
- Offset voltage is adjustable to zero with a single potentiometer.
- $\pm 14\text{V}$, 50 mA output capability.

Output current capability, excellent input characteristics, and large open loop gain make the NH0020/NH0020C suitable for application in a wide variety of applications from precision dc power supplies to precision medium power comparator.

schematic and connection diagrams

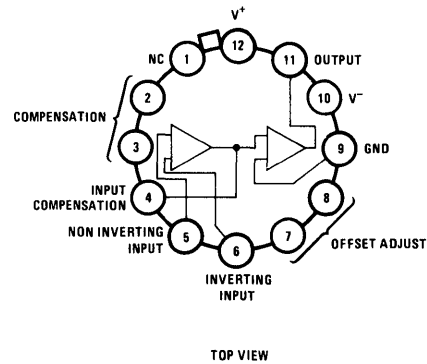
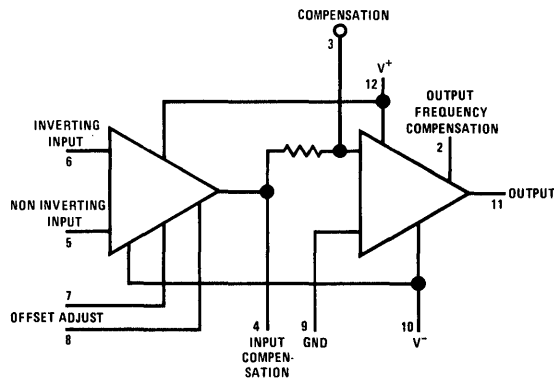

typical applications

Offset Adjustment

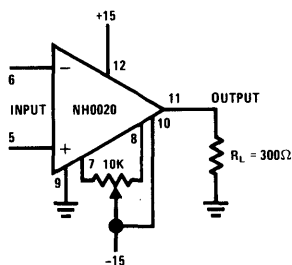

Unity Gain Frequency Compensation

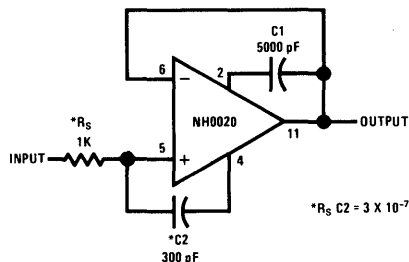

absolute maximum ratings

Supply Voltage	NH0020	±22V
	NH0020C	±18V
Power Dissipation		1.5W
Differential Input Voltage		±30V
Input Voltage (Note 1)		±15V
Output Short Circuit Duration		Continuous
Operating Temperature Range	NH0020	-55°C to +125°C
	NH0020C	0°C to 85°C
Storage Temperature		-65°C to +150°C
Lead Temperature (Soldering, 10 sec)		300°C

electrical characteristics

PARAMETER	CONDITIONS	NH0020			NH0020C			UNITS			
		TEMP °C	MIN	TYP	MAX	TEMP °C	MIN		TYP	MAX	
Input Offset Voltage	$R_S \leq 10k$	25		1.0	2.5	25		1.0	6.0	mV	
		-55 to +125		2.0	4.0	0 to 85		3.0	7.5	mV	
Input Offset Current		25		10	50	25		30	200	nA	
		-55 to +125			100	0 to 85			300	nA	
Input Bias Current		25		60	250	25		200	500	nA	
		-55 to +125			500	0 to 85			800	nA	
Supply Current	$V_S = \pm 15V$	25		3.5	4.5	25		3.6	5.0	mA	
Input Resistance		25		0.6	1.0	25		0.3	1.0	MΩ	
Large Signal Voltage Gain	$V_S = \pm 15V, R_L = 300\Omega, V_O = \pm 10V$	25		100	300	25		50	150	V/mV	
		-55 to +125		50		0 to 85		30		V/mV	
Output Voltage Swing	$V_S = \pm 15V, R_L = 300\Omega$	25		14.2	14.5	25		14.0	14.2	V	
		-55 to +125		14.0		0 to 85		13.5		V	
Output Short Circuit Current	$V_S = \pm 15V$ $R_L = 0\Omega$	25		100	130	25		25	120	140	mA
Input Voltage Range	$V_S = \pm 15V$	-55 to +125		±12		0 to 85		±12		V	
Common Mode Rejection Ratio	$R_S \leq 10k$	-55 to +125		90	96	0 to 85		90	96	dB	
Power Supply Rejection Ratio	$R_S \leq 10k$	-55 to +125		90	96	0 to 85		90	96	dB	

Note 1: For supply voltages less than ±15V, the absolute maximum input voltage is equal to the supply voltage.

Note 2: These specifications apply for $\pm 5V \leq V_S \leq \pm 22V$ for the NH0020, $\pm 5V \leq V_S \leq \pm 18V$ for the NH0020C, pin 9 grounded, and a 5000 pF capacitor between pins 2 and 3, unless otherwise specified.



Operational Amplifiers

NH0023/NH0023C sample and hold amplifier

general description

The NH0023/NH0023C is a complete sample and hold circuit including input buffer amplifier, output buffer amplifier, analog signal sampling gate, and logic circuitry. The device is designed to operate from $\pm 15V$ dc supplies, but provision is made for connection of a separate 5V logic supply in minimum noise applications. Other important design features include:

- 0.5 mV/sec drift at 25°C, $C_S = 0.01 \mu F$ and $V_{OUT} = \pm 5V$
- Sample acquisition time of 100 μs for a full 20V change

- $\pm 10V$ input voltage range
- Logic inputs are TTL/DTL compatible
- Input offset is adjustable with a single 10k trimpot
- Output is short circuit proof

The NH0023/NH0023C is ideally suited for a wide variety of sample and hold applications including analog to digital conversion and synchronous demodulation. The NH0023 is specified over the temperature range of $-55^\circ C$ to $+125^\circ C$; whereas the NH0023C is specified from $0^\circ C$ to $85^\circ C$.

schematic and connection diagrams

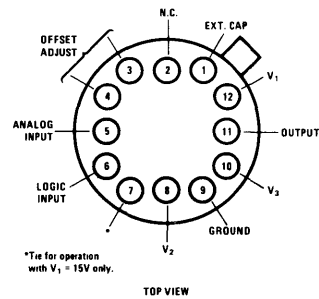
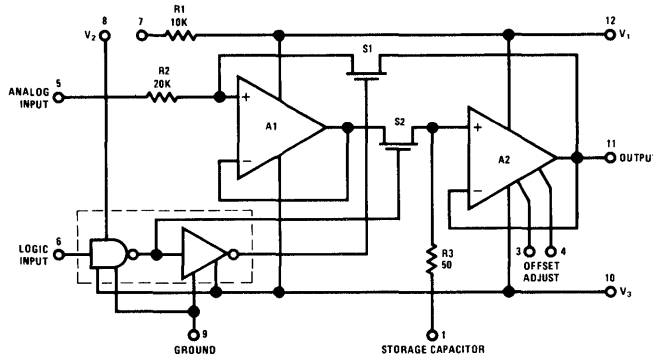

typical application

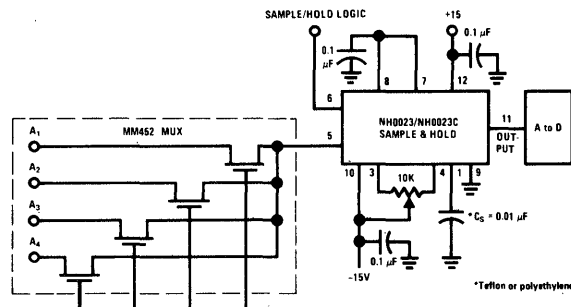

absolute maximum ratings

$V_1 - V_3$ (Differential Voltage)	40V
V_2 Maximum	7V
Logic Input Voltage Maximum	5.5V
Analog Input Voltage	$\pm 15V$
Power Dissipation	1.5W
Storage Temperature Range	-65°C to $+150^\circ\text{C}$
Operating Temperature Range NH0023	-55°C to $+125^\circ\text{C}$
NH0023C	0°C to $+85^\circ\text{C}$

electrical characteristics (Notes 1 & 2)

PARAMETER	CONDITIONS	NH0023			NH0023C			UNITS
		MIN	TYP	MAX	MIN	TYP	MAX	
Sample (Logic "1") Input Voltage	$V_2 = 4.5V$	2.0			2.0			V
Sample (Logic "1") Input Current	$V_2 = 5.5V, V_{IN} = 2.4V$			5.0			5.0	μA
Hold (Logic "0") Input Voltage	$V_2 = 4.5V$			0.8			0.8	V
Hold (Logic "0") Input Current	$V_2 = 5.5V, V_{IN} = 0.4V$			0.5			0.5	mA
Analog Input Voltage Range		± 10	± 11		± 10	± 11		V
Supply Current V_1 & V_3	$V_1 = +15V, V_3 = -15V$ $V_{IN} = 0V, V_{OUT} = 0V$		4.5	6.0		4.5	6.0	mA
Supply Current V_2	$V_2 = 5.0V, V_{IN} = 0V$		1.0	1.6		1.0	1.6	mA
Sample Accuracy	$V_{OUT} = \pm 10V$ (Full Scale)			0.01			0.01	%
Input Impedance Sample	$V_{IN} \geq 2.0$	500			300			$k\Omega$
Input Impedance Hold	$V_{IN} \leq 0.8V$	20			20			$k\Omega$
Drift Rate	$V_{OUT} \leq \pm 5V, C_S = 0.01 \mu F$ $T_A = 25^\circ\text{C}$			0.5		0.5		mV/sec
Drift Rate	$V_{OUT} = \pm 10V, C_S = 0.01 \mu F$ $T_A = 25^\circ\text{C}$		10	20		20	50	mV/sec
Drift Rate	$V_{OUT} = \pm 10V, C_S = 0.01 \mu F$ $-55^\circ\text{C} \leq T_A \leq +125^\circ\text{C}$			100				mV/sec
Drift Rate	$V_{OUT} = \pm 10V, C_S = 0.01 \mu F$ $0^\circ\text{C} \leq T_A \leq 85^\circ\text{C}$						200	mV/sec
Sample Acquisition Time	$\Delta V_{OUT} = 20V$		50	100		50	100	μs
Output Offset Voltage	$R_S \leq 10k$			± 20			± 20	mV
Analog Voltage Output Range	$R_L \geq 2k$	± 10	± 11		± 10	± 11		V

Note 1: Unless otherwise noted, these specifications apply for $V_1 = +15V, V_2 = 5.0V, V_3 = -15V$, pin 9 grounded, a $0.01 \mu F$ capacitor connected between pin 1 and ground over the temperature range -55°C to $+125^\circ\text{C}$ for the NH0023, and 0°C to 85°C for the NH0023C.

Note 2: All typical values are for $T_A = 25^\circ\text{C}$.

typical performance

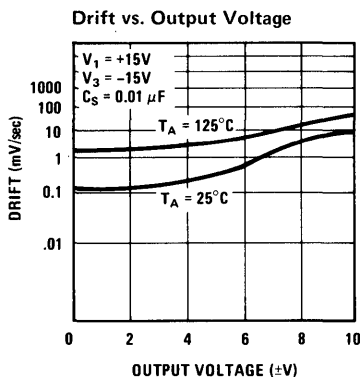
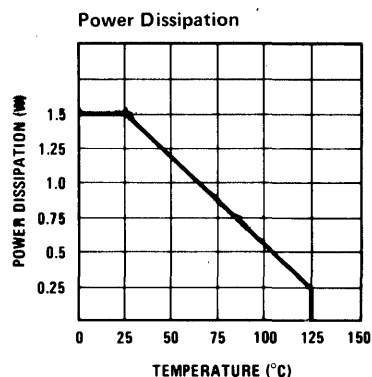
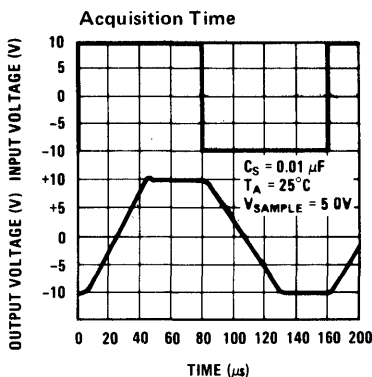
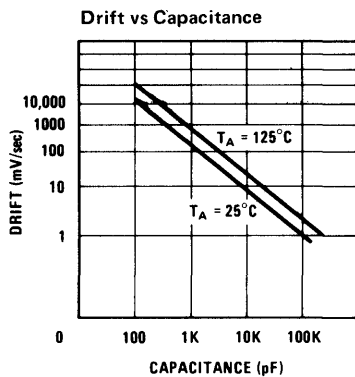

applications information

1. Drift Error Minimization

In order to minimize drift error, care in selection of C_S and layout of the printed circuit board is required. The capacitor should be of high quality teflon, polycarbonate, or polyethylene construction. Board cleanliness and layout are critical particularly at elevated temperatures. See AN-29 for detailed recommendations.

2. Capacitor Selection

The size of the capacitor is dictated by the desired drift rate and acquisition time. The drift is determined by $\frac{dv}{dt} = \frac{I}{C_S}$, where I is the sum of the leakage currents. At room temperature leakage current for the NH0023 is approximately 100 pA. A drift rate of 10 mV/sec would require a 0.01 μF capacitor.

For values of C_S up to 0.01 μF the acquisition time is limited by the slew rate of the input buffer amplifier, A1, typically 0.5 V/ μs . Beyond this point, current availability to charge C_S also enters the picture. The acquisition time is given by:

$$t_A \cong \sqrt{\frac{2\Delta e_o RC_S}{0.5 \times 10^6}} = 2 \times 10^{-3} \sqrt{\Delta e_o RC_S}$$

where: R = the internal resistance in series with C_S
 Δe_o = change in voltage sampled

An average value for R is approximately 600 ohms. The expression for t_A reduces to:

$$t_A \cong \frac{\sqrt{\Delta e_o C_S}}{20}$$

For a -10V to +10V change and $C_S = .05 \mu\text{F}$, acquisition time is typically 50 μs .

3. Offset Null

Provision is made to null the NH0023/NH0023C by use of a 10k pot between pins 3 and 4. Offset null should be accomplished in the sample mode at one half the input voltage range for minimum average error.

4. Elimination of the 5V Logic Supply

The 5V logic supply may be eliminated by shorting pin 7 to pin 8 which connects a 10k dropping resistor between the +15V and V_2 . Decoupling pin 8 to ground through 0.1 μF disc capacitor is recommended in order to minimize transients in the output.



Voltage Comparators/Buffers

LM106/LM206 voltage comparator/buffer general description

The LM106 and LM206 are high-speed voltage comparators designed to accurately detect low-level analog signals and drive a digital load. They are equivalent to an LM710, combined with a two input NAND gate and an output buffer. The circuits can drive RTL, DTL or TTL integrated circuits directly. Furthermore, their outputs can switch voltages up to 24V at currents as high as 100 mA. Other features include:

- Improved accuracy: 2 mV (max) offset, 40,000 gain
- Fan-out of 10 with DTL or TTL
- Added logic or strobe capability

- Useful as a relay or lamp driver
- Plug-in replacement for the LM710.

The devices have short-circuit protection which limits the inrush current when it is used to drive incandescent lamps, in addition to preventing damage from accidental shorts. The speed is equivalent to that of an LM710. However, they are even faster where buffers and additional logic circuitry can be eliminated by the increased flexibility of the LM106 and LM206. They can also be operated from any negative supply voltage between -3V and -12V with little effect on performance.

schematic and connection diagrams *

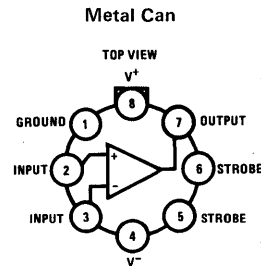
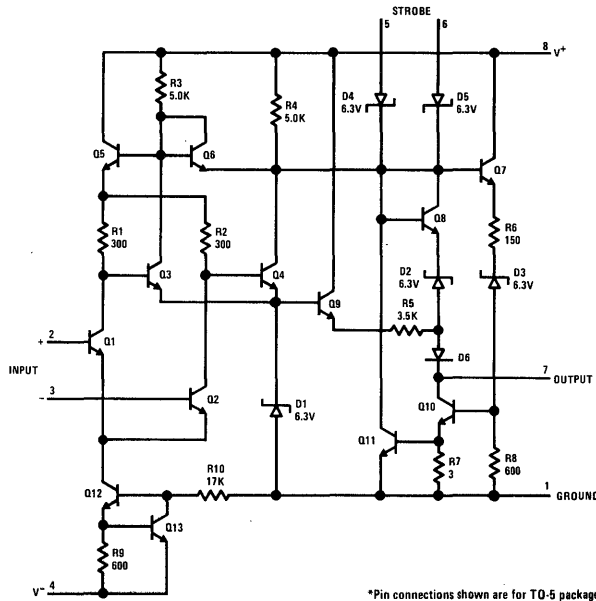

Note: Pin 4 connected to case.

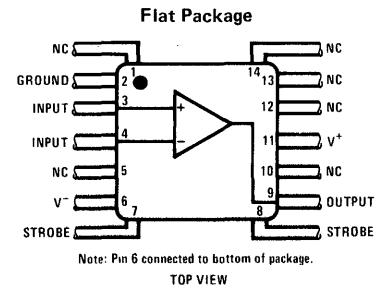

Note: Pin 6 connected to bottom of package.

typical applications *

Level Detector and Lamp Driver

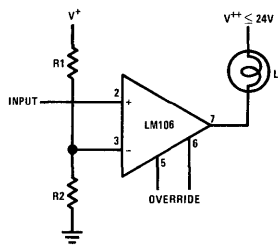

Relay Driver

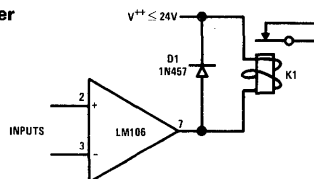

Fast Response Peak Detector

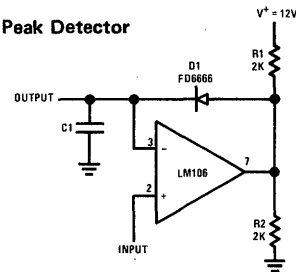

Adjustable Threshold Line Receiver

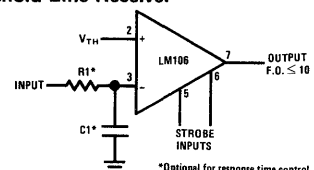

absolute maximum ratings

Positive Supply Voltage	15V	Power Dissipation (Note 1)	600 mW
Negative Supply Voltage	-15V	Output Short Circuit Duration	10 sec
Output Voltage	24V	Operating Temperature Range	LM106 -55°C to 125°C
Output to Negative Supply Voltage	30V		LM206 -25°C to 85°C
Differential Input Voltage	±5V	Storage Temperature Range	-65°C to 150°C
Input Voltage	±7V	Lead Temperature (soldering, 10 sec)	300°C

electrical characteristics (Note 2)

PARAMETER	CONDITIONS	MIN	TYP	MAX	UNITS
Input Offset Voltage	Note 3		0.5	2.0	mV
Input Offset Current	Note 3		0.7	3.0	μA
Input Bias Current			10	20	μA
Voltage Gain			40		V/mV
Response Time	Note 4		40		ns
Saturation Voltage	$V_{IN} \leq -5 \text{ mV}$, $I_{sink} = 100 \text{ mA}$		1.0	1.5	V
Output Leakage Current	$V_{IN} \geq 5 \text{ mV}$, $8V \leq V_{OUT} \leq 24V$		0.02	1.0	μA

electrical characteristics

The following specifications apply for $-55^\circ\text{C} \leq T_A \leq 125^\circ\text{C}$ with the LM106 or $-25^\circ\text{C} \leq T_A \leq 85^\circ\text{C}$ for the LM206

Input Offset Voltage	Note 3			3.0	mV
Average Temperature Coefficient of Input Offset Voltage			3.0	10	μV/°C
Input Offset Current	Note 3, $T_A = -55^\circ\text{C}$ $T_A = 125^\circ\text{C}$		1.8 0.25	7.0 3.0	μA μA
Average Temperature Coefficient of Input Offset Current	$25^\circ\text{C} \leq T_A \leq 125^\circ\text{C}$ $-55^\circ\text{C} \leq T_A \leq 25^\circ\text{C}$		5.0 15	25 75	nA/°C nA/°C
Input Bias Current				45	μA
Input Voltage Range	$-7V \geq V^- \geq -12V$	±5.0			V
Differential Input Voltage Range		±5.0			V
Saturation Voltage	$V_{IN} \leq -5 \text{ mV}$, $I_{sink} = 50 \text{ mA}$			1.0	V
Saturation Voltage	$V_{IN} \leq -5 \text{ mV}$, $I_{sink} \leq 16 \text{ mA}$			0.4	V
Positive Output Level	$V_{IN} \geq 5 \text{ mV}$, $I_{OUT} = 400 \mu\text{A}$	2.5		5.5	V
Output Leakage Current	$V_{IN} \geq 5 \text{ mV}$, $8V \leq V_{OUT} \leq 24V$			100	μA
Strobe Current	$V_{strobe} = 0.4V$		1.7	3.3	mA
Strobe ON Voltage		0.9	1.4		V
Strobe OFF Voltage	$I_{sink} \leq 16 \text{ mA}$		1.4	2.5	V
Positive Supply Current	$V_{IN} = -5 \text{ mV}$		5.5	10	mA
Negative Supply Current			1.5	3.6	mA

Note 1. The maximum junction temperature of the LM106 is 150°C, while that of the LM206 is 110°C. For operating at elevated temperatures, devices in the TO-5 package must be derated based on a thermal resistance of 150°C/W, junction to ambient, or 45°C/W, junction to case. For the flat package, the derating is based on a thermal resistance of 185°C/W when mounted on a 1/16-inch-thick epoxy glass board with ten, 0.03-inch-wide, 2-ounce copper conductors.

Note 2. These specifications apply for $-3V \geq V^- \geq -12V$, $V^+ = 12V$ and $T_A = 25^\circ\text{C}$ unless otherwise specified.

Note 3. The offset voltages and offset currents given are the maximum values required to drive the output down to 0.5V or up to 5.0V. Thus, these parameters actually define an error band and take into account the worst-case effects of voltage gain and input impedance.

Note 4. The response time specified (see definitions) is for a 100 mV input step with 5 mV overdrive.

typical performance characteristics

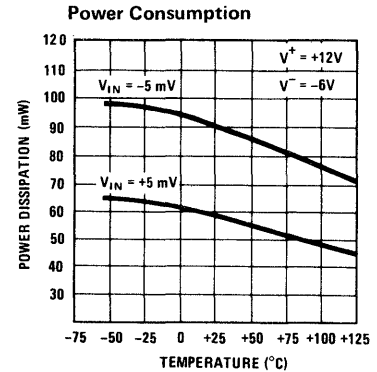
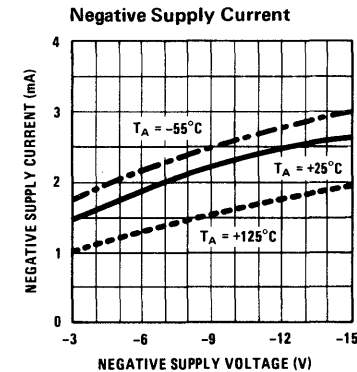
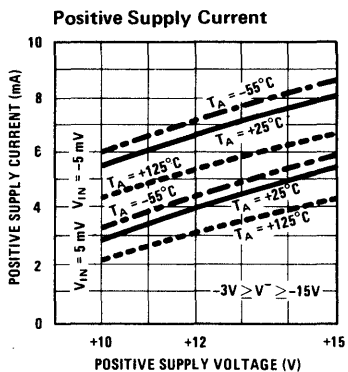
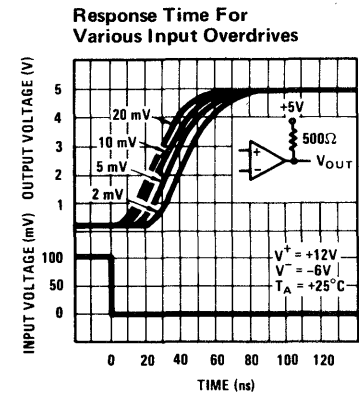
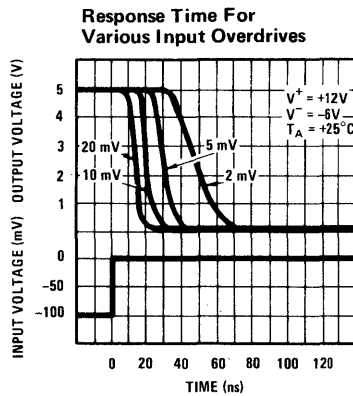
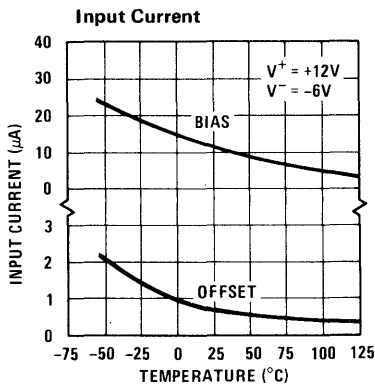
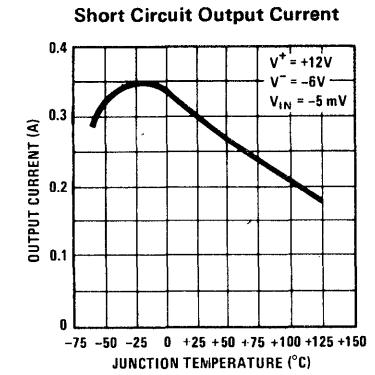
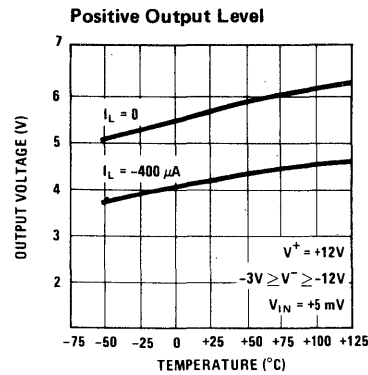
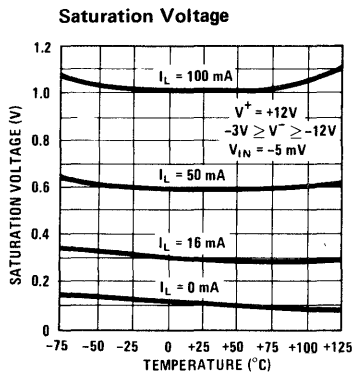
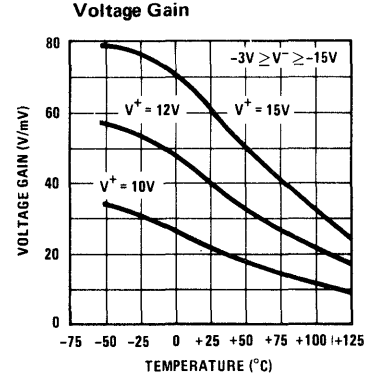
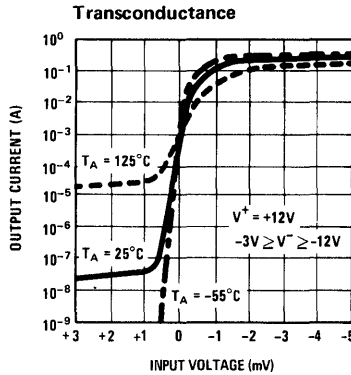
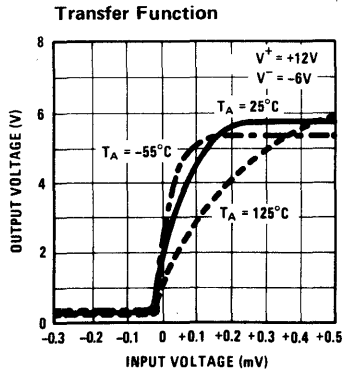



Voltage Comparators/Buffers

LM306 voltage comparator/buffer general description

The LM306 is a high-speed voltage comparator designed to accurately detect low-level analog signals and drive a digital load. It is equivalent to an LM710C, combined with a two input NAND gate and an output buffer. The circuit can drive RTL, DTL or TTL integrated circuits directly. Furthermore, the output can switch voltages up to 24V at currents as high as 100 mA. Other features include:

- Improved accuracy: 5 mV (max) offset, 25,000 gain
- Fan-out of 10 with DTL or TTL
- Added logic or strobe capability

- Useful as a relay or lamp driver
- Plug-in replacement for the LM710C.

The device has short-circuit protection which limits the inrush current when it is used to drive incandescent lamps, in addition to preventing damage from accidental shorts. The speed is equivalent to that of an LM710C. However, it is even faster where buffers and additional logic circuitry can be eliminated by the increased flexibility of the LM306. It can also be operated from any negative supply voltage between -3V and -12V with little effect on performance. The LM306 is identical to the LM106, except that it is specified over a 0°C to 70°C temperature range.

schematic and connection diagrams**

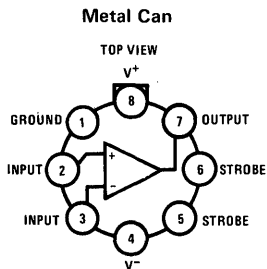
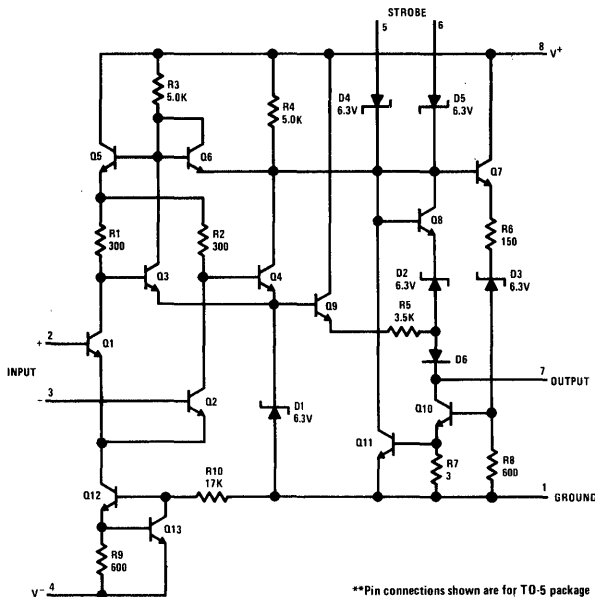

Note: Pin 4 connected to case.

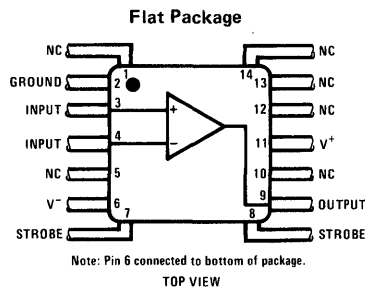

Note: Pin 6 connected to bottom of package.

typical applications**

Level Detector and Lamp Driver

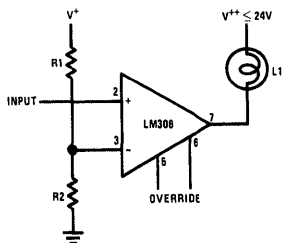

Relay Driver

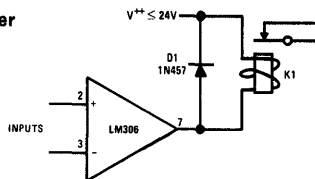

Fast Response Peak Detector

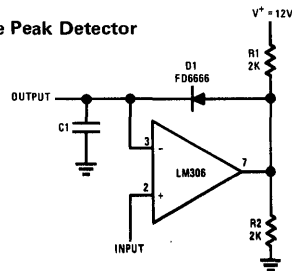

Adjustable Threshold Line Receiver

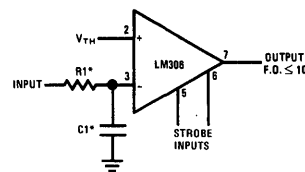

*Optional for response time control.

absolute maximum ratings

Positive Supply Voltage	15V
Negative Supply Voltage	-15V
Output Voltage	24V
Output to Negative Supply Voltage	30V
Differential Input Voltage	±5V
Input Voltage	±7V
Power Dissipation (Note 1)	600 mW
Output Short Circuit Duration	10 sec
Operating Temperature Range	0°C to 70°C
Storage Temperature Range	-65°C to +150°C
Lead Temperature (soldering, 60 sec)	300°C

electrical characteristics (Note 2)

PARAMETER	CONDITIONS	MIN	TYP	MAX	UNITS
Input Offset Voltage	Note 3		1.6	5.0	mV
Input Offset Current	Note 3		1.8	5.0	μA
Input Bias Current			16	25	μA
Voltage Gain			40		V/mV
Response Time	Note 4		40		ns
Saturation Voltage	$V_{IN} \leq -5 \text{ mV}$, $I_{\text{sink}} = 100 \text{ mA}$		0.8	2.0	V
Output Leakage Current	$V_{IN} \geq 5 \text{ mV}$, $8\text{V} \leq V_{OUT} \leq 24\text{V}$		0.02	2.0	μA

electrical characteristics

The following specifications apply for $0^\circ\text{C} \leq T_A \leq 70^\circ\text{C}$

Input Offset Voltage	Note 3			6.5	mV
Average Temperature Coefficient of Input Offset Voltage			5	20	μV/°C
Input Offset Current	Note 3, $T_A = 0^\circ\text{C}$		2.4	7.5	μA
Average Temperature Coefficient of Input Offset Current	$25^\circ\text{C} \leq T_A \leq 70^\circ\text{C}$ $0^\circ\text{C} \leq T_A \leq 25^\circ\text{C}$		15 24	50 100	nA/°C nA/°C
Input Bias Current			25	40	μA
Input Voltage Range	$-7\text{V} \geq V^- \geq -12\text{V}$	±5.0			V
Differential Input Voltage Range		±5.0			V
Saturation Voltage	$V_{IN} \leq -5 \text{ mV}$, $I_{\text{sink}} = 50 \text{ mA}$			1.0	V
Saturation Voltage	$V_{IN} \leq -5 \text{ mV}$, $I_{\text{sink}} \leq 16 \text{ mA}$			0.4	V
Positive Output Level	$V_{IN} \geq 5 \text{ mV}$, $I_{OUT} = 400 \mu\text{A}$	2.5		5.5	V
Output Leakage Current	$V_{IN} \geq 5 \text{ mV}$, $8\text{V} \leq V_{OUT} \leq 24\text{V}$			100	μA
Strobe Current	$V_{\text{strobe}} = 0.4\text{V}$		1.7	3.3	mA
Strobe ON Voltage		0.9	1.4		V
Strobe OFF Voltage	$I_{\text{sink}} \leq 16 \text{ mA}$		1.4	2.5	V
Positive Supply Current	$V_{IN} = -5 \text{ mV}$		5.5	10	mA
Negative Supply Current			1.5	3.6	mA

Note 1: For operating at elevated temperatures, the device must be derated based on a 85°C maximum junction temperature and a thermal resistance of 45°C/W junction to case or 150°C/W junction to ambient.

Note 2: These specifications apply for $-3\text{V} \geq V^- \geq -12\text{V}$, $V^+ = 12\text{V}$ and $T_A = 25^\circ\text{C}$ unless otherwise specified.

Note 3: The offset voltages and offset currents given are the maximum values required to drive the output down to 0.5V or up to 5.0V. Thus, these parameters actually define an error band and take into account the worst-case effects of voltage gain and input impedance.

Note 4: The response time specified (see definitions) is for a 100 mV input step with 5 mV overdrive.

typical performance characteristics

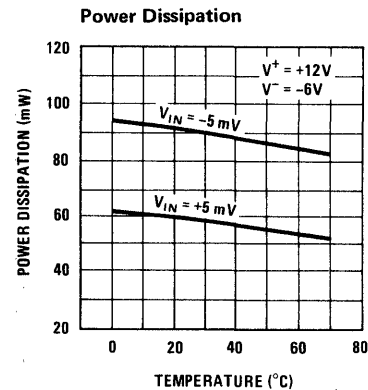
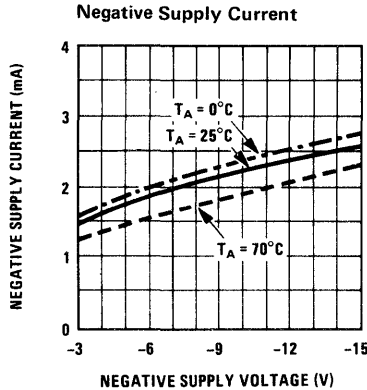
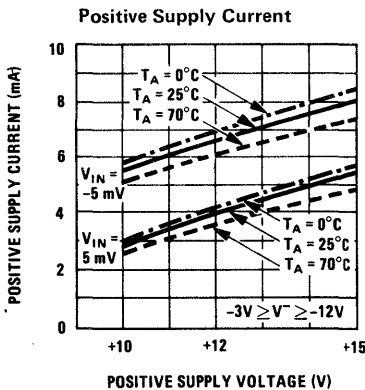
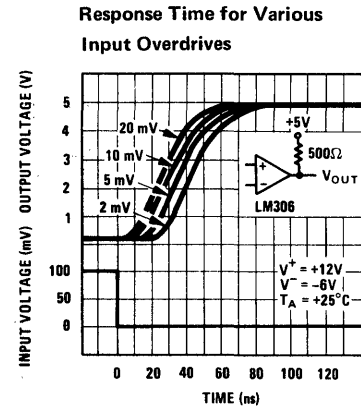
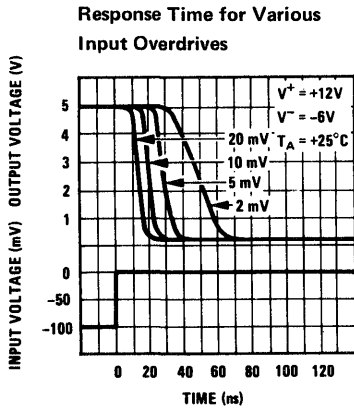
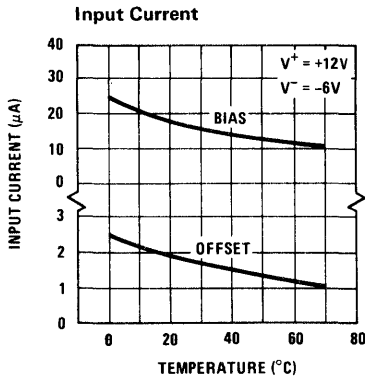
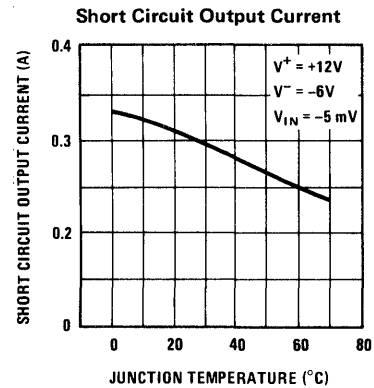
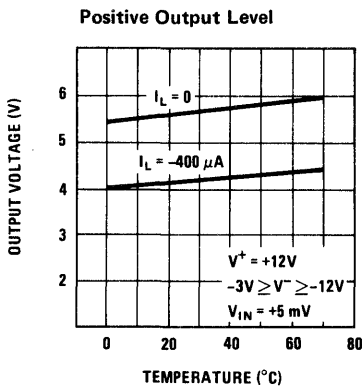
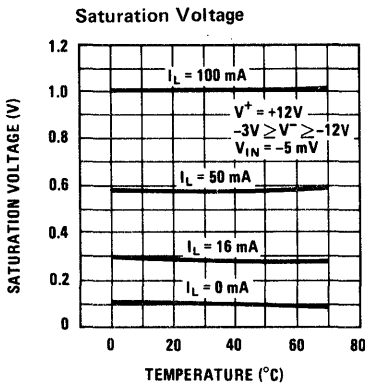
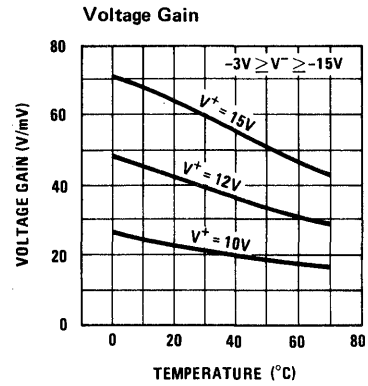
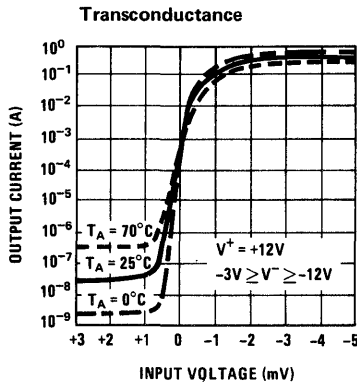
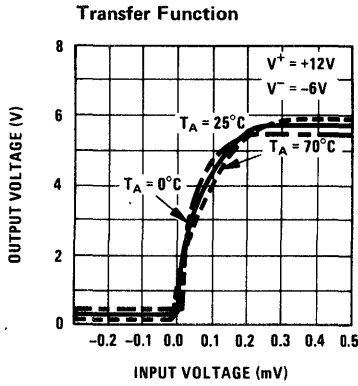



Voltage Comparators/Buffers

LM111/LM211 voltage comparators

general description

The LM111 and LM211 are voltage comparators that have input currents nearly a thousand times lower than devices like the LM106 or LM710. They are also designed to operate over a wider range of supply voltages: from standard $\pm 15V$ op amp supplies down to the single 5V supply used for IC logic. Their output is compatible with RTL, DTL and TTL as well as MOS circuits. Further, they can drive lamps or relays, switching voltages up to 50V at currents as high as 50 mA. Outstanding characteristics include:

- Operates from single 5V supply
- Input current: 150 nA max. over temperature
- Offset current: 20 nA max. over temperature

- Differential input voltage range: $\pm 30V$
- Power consumption: 135 mW at $\pm 15V$

Both the inputs and the outputs of the LM111 or the LM211 can be isolated from system ground, the positive supply or the negative supply. Offset balancing and strobe capability are provided and outputs can be wire OR'ed. Although slower than the LM106 and LM710 (200 ns response time vs 40 ns) the devices are also much less prone to spurious oscillations. The LM111 has the same pin configuration as the LM106 and LM710.

The LM211 is identical to the LM111, except that its performance is specified over a $-25^{\circ}C$ to $85^{\circ}C$ temperature range instead of $-55^{\circ}C$ to $125^{\circ}C$.

schematic diagram and auxiliary circuits

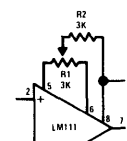
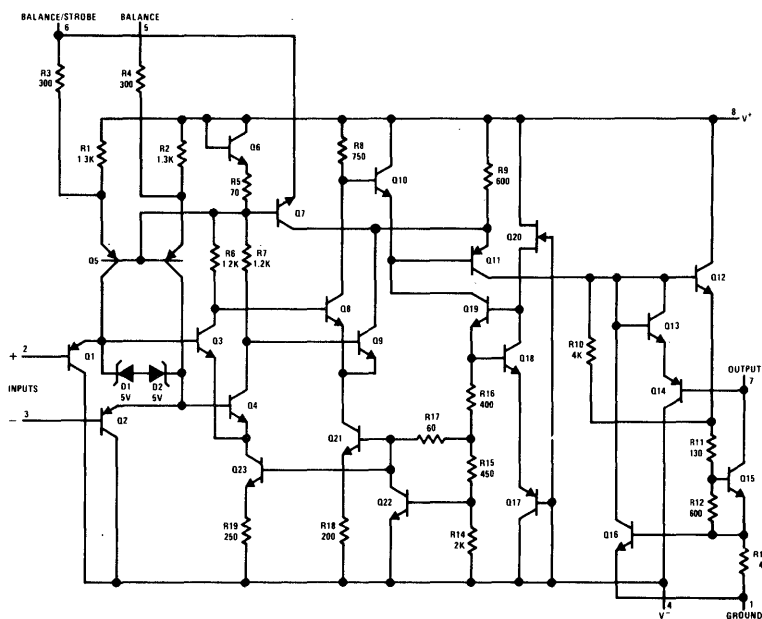

Offset Balancing

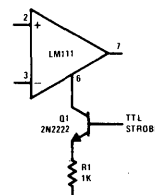

Strobing

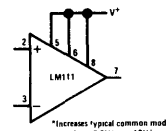

*Increases typical common mode slew from 7.0V/ μs to 18V/ μs

Increasing Input Stage Current*

typical applications

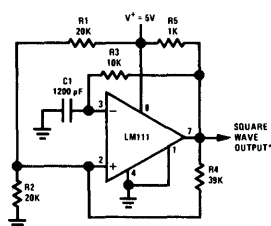

100 kHz Free Running Multivibrator

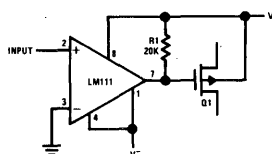

Zero Crossing Detector Driving MOS Switch

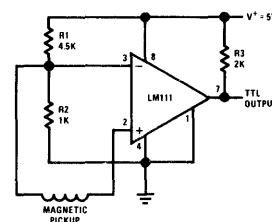

Detector for Magnetic Transducer

absolute maximum ratings

Total Supply Voltage (V_{84})	36V
Output to Negative Supply Voltage (V_{74})	50V
Ground to Negative Supply Voltage (V_{14})	30V
Differential Input Voltage	$\pm 30V$
Input Voltage (Note 1)	$\pm 15V$
Power Dissipation (Note 2)	500 mW
Output Short Circuit Duration	10 sec
Operating Temperature Range LM111	$-55^{\circ}C$ to $125^{\circ}C$
LM211	$-25^{\circ}C$ to $85^{\circ}C$
Storage Temperature Range	$-65^{\circ}C$ to $150^{\circ}C$
Lead Temperature (soldering, 10 sec)	$300^{\circ}C$

electrical characteristics (Note 3)

PARAMETER	CONDITIONS	MIN	TYP	MAX	UNITS
Input Offset Voltage (Note 4)	$T_A = 25^{\circ}C$, $R_S \leq 50k$		0.7	3.0	mV
Input Offset Current (Note 4)	$T_A = 25^{\circ}C$		4.0	10	nA
Input Bias Current	$T_A = 25^{\circ}C$		60	100	nA
Voltage Gain	$T_A = 25^{\circ}C$		200		V/mV
Response Time (Note 5)	$T_A = 25^{\circ}C$		200		ns
Saturation Voltage	$V_{IN} \leq -5$ mV, $I_{OUT} = 50$ mA $T_A = 25^{\circ}C$		0.75	1.5	V
Strobe On Current	$T_A = 25^{\circ}C$		3.0		mA
Output Leakage Current	$V_{IN} \geq 5$ mV, $V_{OUT} = 35V$ $T_A = 25^{\circ}C$		0.2	10	nA
Input Offset Voltage (Note 4)	$R_S \leq 50k$			4.0	mV
Input Offset Current (Note 4)				20	nA
Input Bias Current				150	nA
Input Voltage Range			± 14		V
Saturation Voltage	$V^+ \geq 4.5V$, $V^- = 0$ $V_{IN} \leq -6$ mV, $I_{SINK} \leq 8$ mA		0.23	0.4	V
Output Leakage Current	$V_{IN} \geq 5$ mV, $V_{OUT} = 35V$		0.1	0.5	μA
Positive Supply Current	$T_A = 25^{\circ}C$		5.1	6.0	mA
Negative Supply Current	$T_A = 25^{\circ}C$		4.1	5.0	mA

Note 1: This rating applies for $\pm 15V$ supplies. The positive input voltage limit is 30V above the negative supply. The negative input voltage limit is equal to the negative supply voltage or 30V below the positive supply, whichever is less.

Note 2: The maximum junction temperature of the LM111 is $150^{\circ}C$, while that of the LM211 is $110^{\circ}C$. For operating at elevated temperatures, devices in the TO-5 package must be derated based on a thermal resistance of $150^{\circ}C/W$, junction to ambient, or $45^{\circ}C/W$, junction to case. For the flat package, the derating is based on a thermal resistance of $185^{\circ}C/W$ when mounted on a 1/16-inch-thick epoxy glass board with ten, 0.03-inch-wide, 2-ounce copper conductors. The thermal resistance of the dual-in-line package is $100^{\circ}C/W$, junction to ambient.

Note 3: These specifications apply for $V_S = \pm 15V$ and $-55^{\circ}C \leq T_A \leq 125^{\circ}C$, unless otherwise stated. With the LM211, however, all temperature specifications are limited to $-25^{\circ}C \leq T_A \leq 85^{\circ}C$. The offset voltage, offset current and bias current specifications apply for any supply voltage from a single 5V supply up to $\pm 15V$ supplies.

Note 4: The offset voltages and offset currents given are the maximum values required to drive the output within a volt of either supply with a 1 mA load. Thus, these parameters define an error band and take into account the worst case effects of voltage gain and input impedance.

Note 5: The response time specified (see definitions) is for a 100 mV input step with 5 mV overdrive.

typical performance

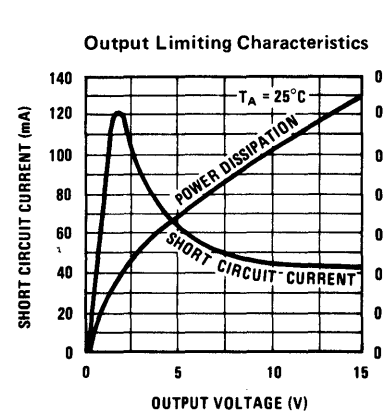
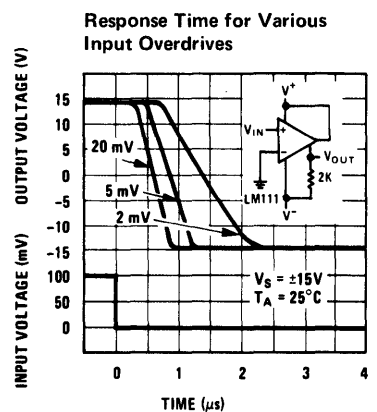
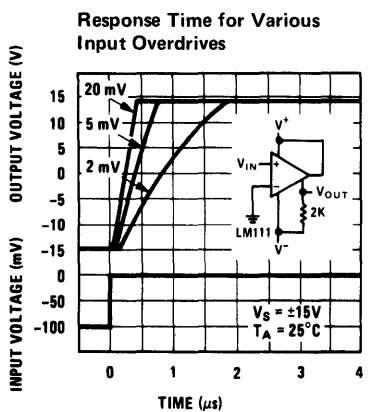
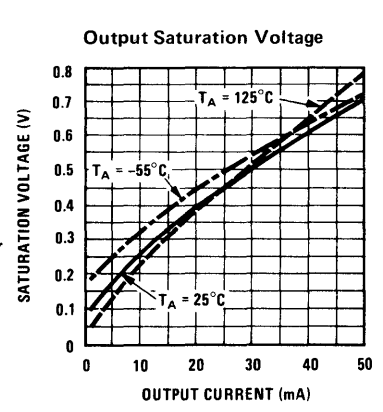
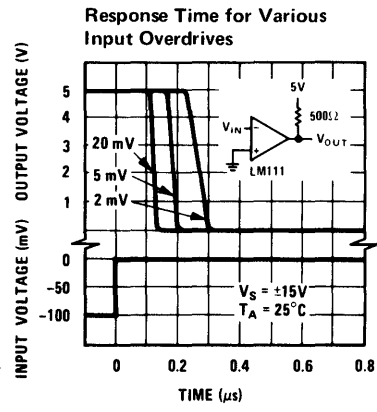
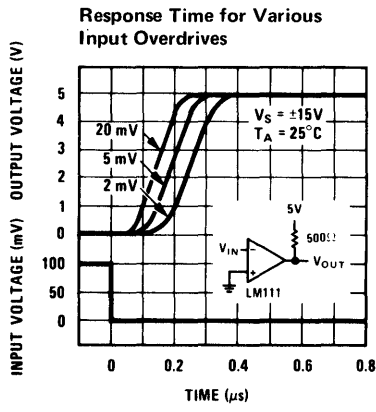
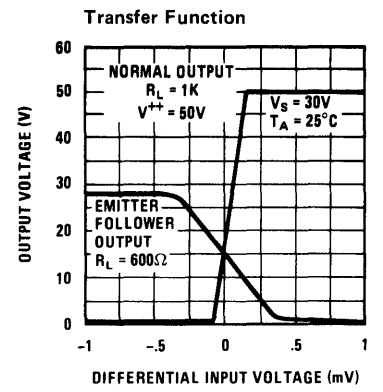
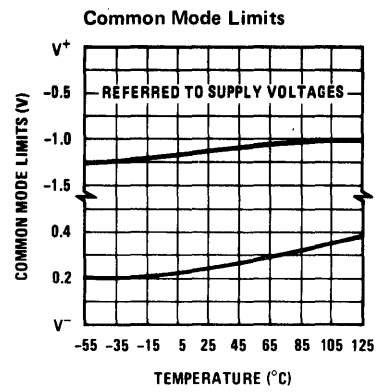
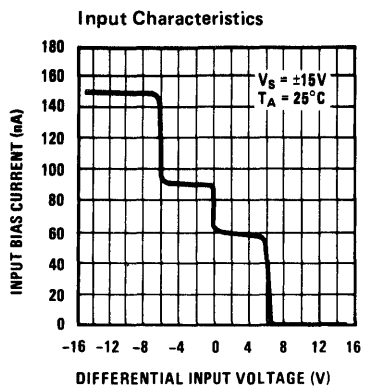
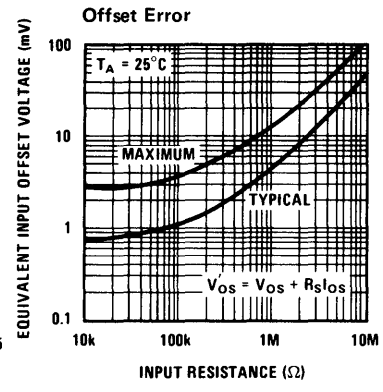
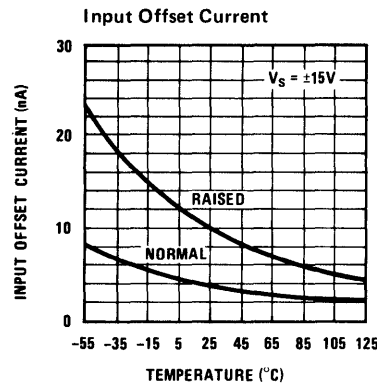
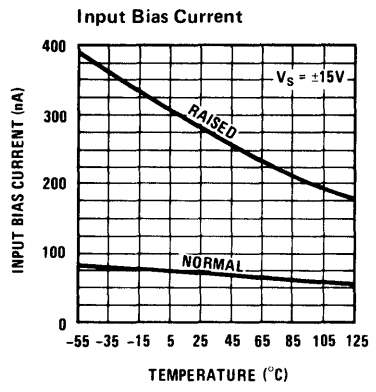

typical performance

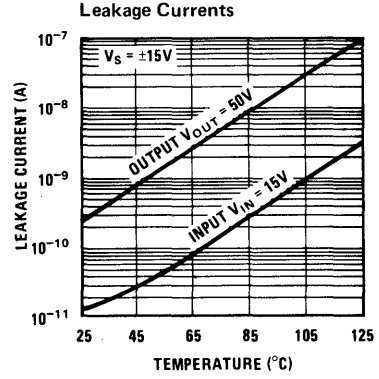
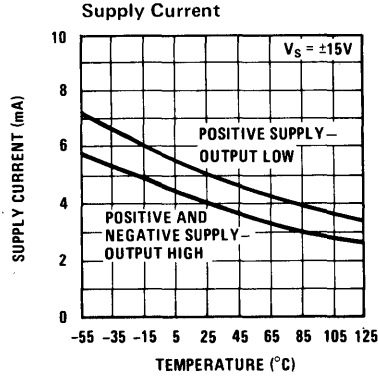
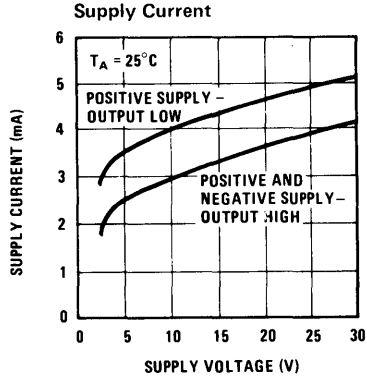

connection diagrams *

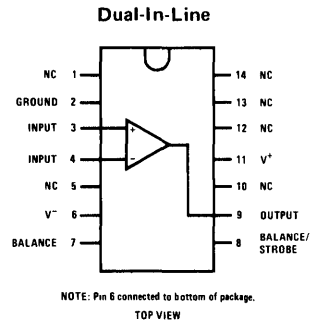
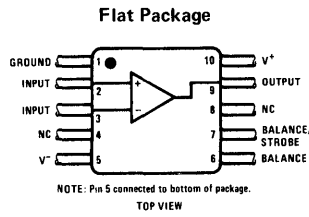
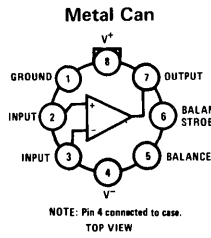

*Pin connections shown on schematic diagram and typical applications are for TO-5 package.

typical applications

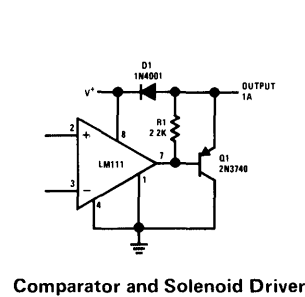
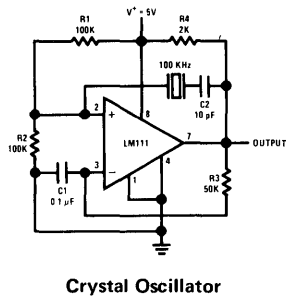
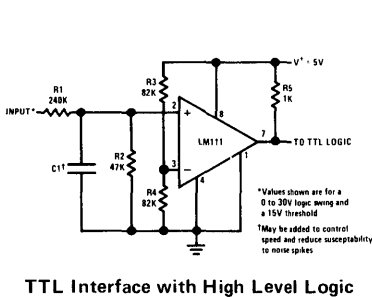
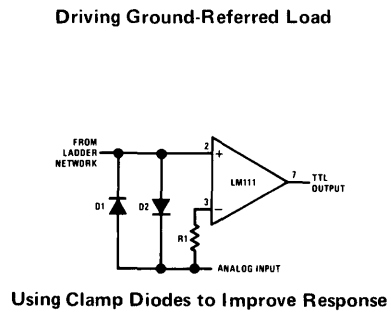
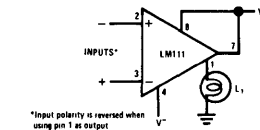
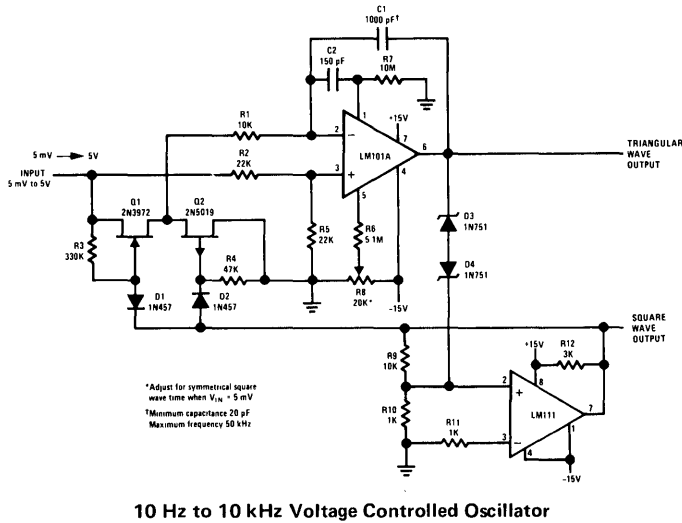

typical applications

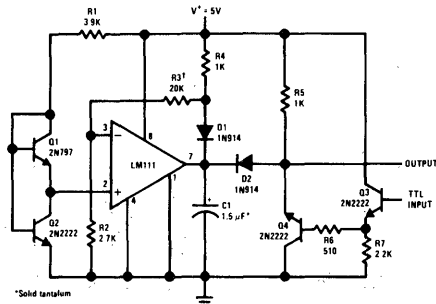

*Solid tantalum
†Adjust to set clamp level

Precision Squarer

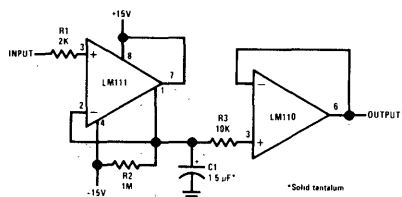

Positive Peak Detector

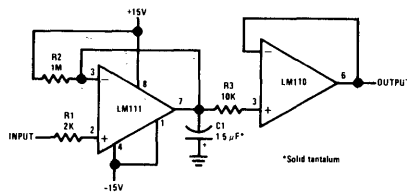

Negative Peak Detector

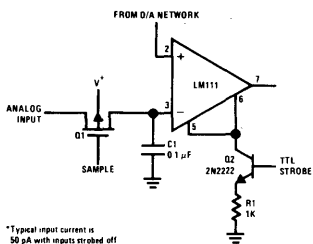

*Typical input current is 50 µA with inputs strobed off

Strobing off Both Input* and Output Stages

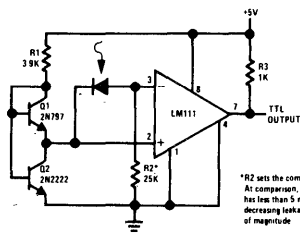

*R2 sets the comparison level. At comparison, the photodiode has less than 5 mV across it, decreasing leakage by an order of magnitude

Precision Photodiode Comparator

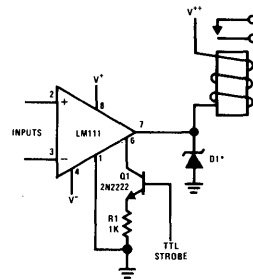

*Absorbs inductive kickback of relay and protects IC from severe voltage transients on V+ line

Relay Driver with Strobe

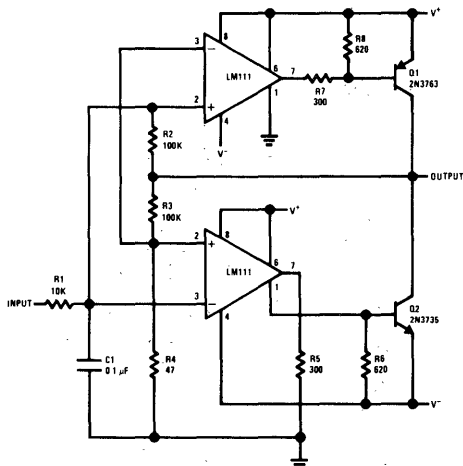

Switching Power Amplifier

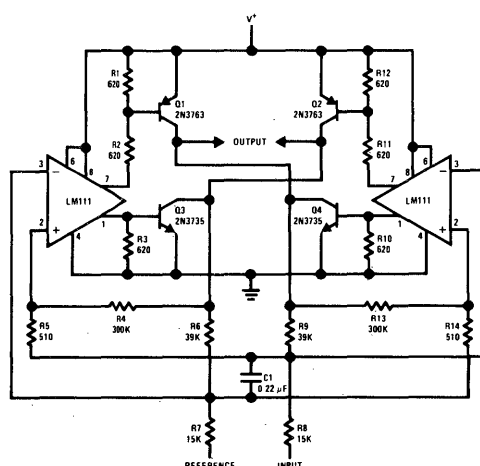

Switching Power Amplifier

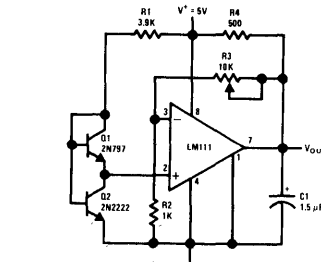

*Solid tantalum

Low Voltage Adjustable Reference Supply

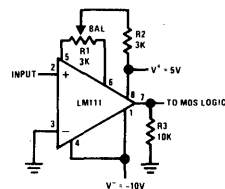

Zero Crossing Detector driving MOS logic

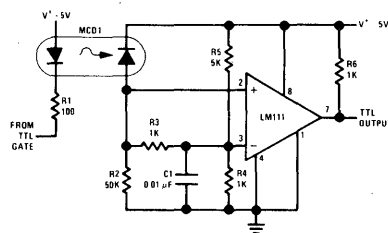

Digital Transmission Isolator



Voltage Comparators/Buffers

LM311 voltage comparator general description

The LM311 is a voltage comparator that has input currents more than a hundred times lower than devices like the LM306 or LM710C. It is also designed to operate over a wider range of supply voltages: from standard $\pm 15V$ op amp supplies down to the single 5V supply used for IC logic. Its output is compatible with RTL, DTL and TTL as well as MOS circuits. Further, it can drive lamps or relays, switching voltages up to 40V at currents as high as 50 mA. Outstanding characteristics include:

- Operates from single 5V supply
- Maximum input current: 250 nA
- Maximum offset current: 50 nA

- Differential input voltage range: $\pm 30V$
- Power consumption: 135 mW at $\pm 15V$

Both the input and the output of the LM311 can be isolated from system ground, and the output can drive loads referred to ground, the positive supply or the negative supply. Offset balancing and strobe capability are provided and outputs can be wire OR'ed. Although slower than the LM306 and LM710C (200 ns response time vs 40 ns) the device is also much less prone to spurious oscillations. The LM311 has the same pin configuration as the LM306 and LM710C.

schematic diagram and auxiliary circuits

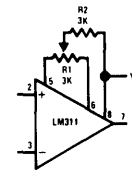
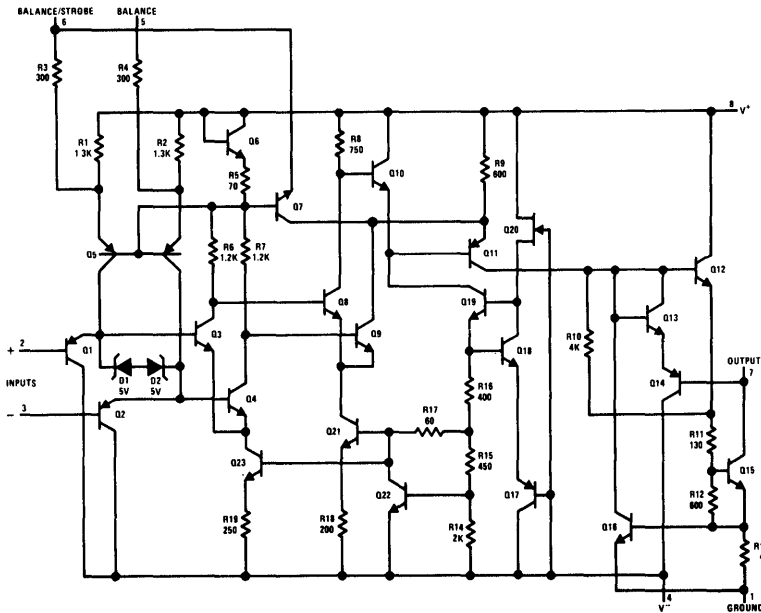

Offset Balancing

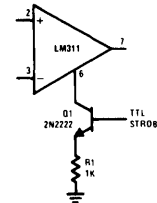

Strobging

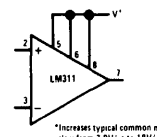

Increasing Input Stage Current*

*Increases typical common mode slew from 7 DV/μs to 18V/μs

typical applications

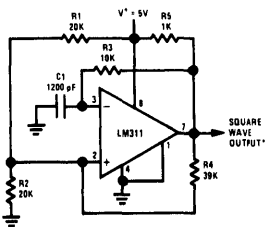

100 kHz Free Running Multivibrator

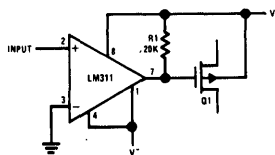

Zero Crossing Detector Driving MOS Switch

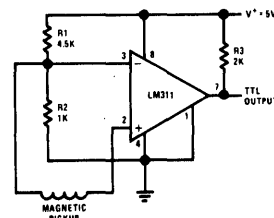

Detector for Magnetic Transducer

absolute maximum ratings

Total Supply Voltage (V_{84})	36V
Output to Negative Supply Voltage (V_{74})	40V
Ground to Negative Supply Voltage (V_{14})	30V
Differential Input Voltage	$\pm 30V$
Input Voltage (Note 1)	$\pm 15V$
Power Dissipation (Note 2)	500 mW
Output Short Circuit Duration	10 sec
Operating Temperature Range	$0^{\circ}C$ to $70^{\circ}C$
Storage Temperature Range	$-65^{\circ}C$ to $150^{\circ}C$
Lead Temperature (soldering, 10 sec)	$300^{\circ}C$

electrical characteristics (Note 3)

PARAMETER	CONDITIONS	MIN	TYP	MAX	UNITS
Input Offset Voltage (Note 4)	$T_A = 25^{\circ}C$, $R_S \leq 50K$		2.0	7.5	mV
Input Offset Current (Note 4)	$T_A = 25^{\circ}C$		6.0	50	nA
Input Bias Current	$T_A = 25^{\circ}C$		100	250	nA
Voltage Gain	$T_A = 25^{\circ}C$		200		V/mV
Response Time (Note 5)	$T_A = 25^{\circ}C$		200		ns
Saturation Voltage	$V_{IN} \leq -10$ mV, $I_{OUT} = 50$ mA $T_A = 25^{\circ}C$		0.75	1.5	V
Strobe On Current	$T_A = 25^{\circ}C$		3.0		mA
Output Leakage Current	$V_{IN} \geq 10$ mV, $V_{OUT} = 35V$ $T_A = 25^{\circ}C$		0.2	50	nA
Input Offset Voltage (Note 4)	$R_S \leq 50K$			10	mV
Input Offset Current (Note 4)				70	nA
Input Bias Current				300	nA
Input Voltage Range			± 14		V
Saturation Voltage	$V^+ \geq 4.5V$, $V^- = 0$ $V_{IN} \leq -10$ mV, $I_{SINK} \leq 8$ mA		0.23	0.4	V
Positive Supply Current	$T_A = 25^{\circ}C$		5.1	7.5	mA
Negative Supply Current	$T_A = 25^{\circ}C$		4.1	5.0	mA

Note 1: This rating applies for $\pm 15V$ supplies. The positive input voltage limit is 30V above the negative supply. The negative input voltage limit is equal to the negative supply voltage or 30V below the positive supply, whichever is less.

Note 2: The maximum junction temperature of the LM311 is $85^{\circ}C$. For operating at elevated temperatures, devices in the TO-5 package must be derated based on a thermal resistance of $150^{\circ}C/W$, junction to ambient, or $45^{\circ}C/W$, junction to case. For the flat package, the derating is based on a thermal resistance of $185^{\circ}C/W$ when mounted on a 1/16-inch-thick epoxy glass board with ten, 0.03-inch-wide, 2-ounce copper conductors. The thermal resistance of the dual-in-line package is $100^{\circ}C/W$, junction to ambient.

Note 3: These specifications apply for $V_S = \pm 15V$ and $0^{\circ}C < T_A < 70^{\circ}C$, unless otherwise specified. The offset voltage, offset current and bias current specifications apply for any supply voltage from a single 5V supply up to $\pm 15V$ supplies.

Note 4: The offset voltages and offset currents given are the maximum values required to drive the output within a volt of either supply with 1 mA load. Thus, these parameters define an error band and take into account the worst case effects of voltage gain and input impedance.

Note 5: The response time specified (see definitions) is for a 100 mV input step with 5 mV overdrive.

typical performance

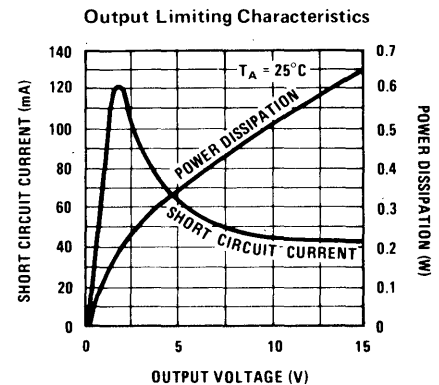
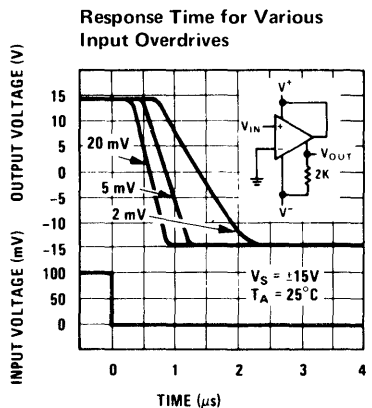
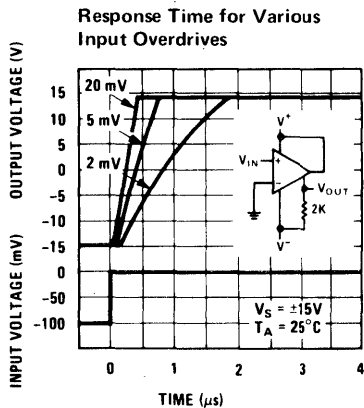
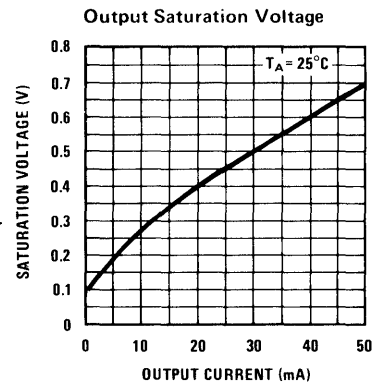
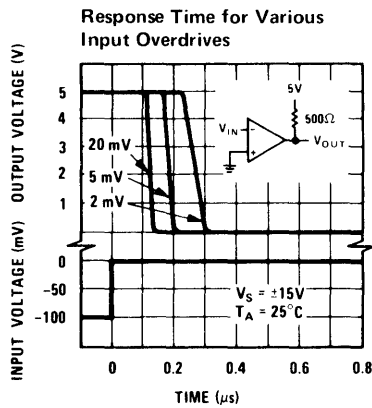
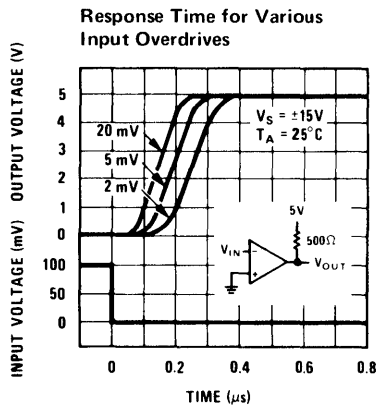
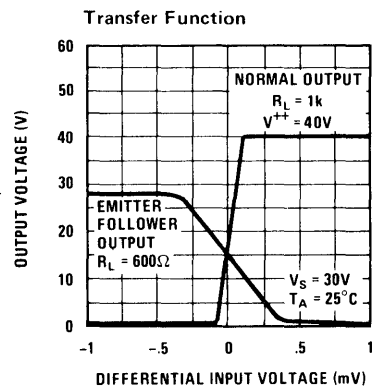
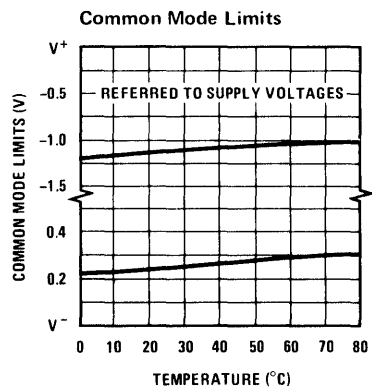
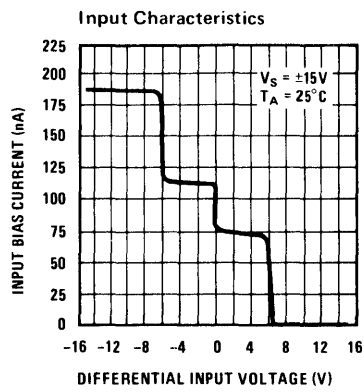
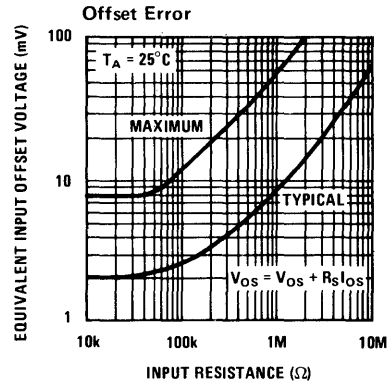
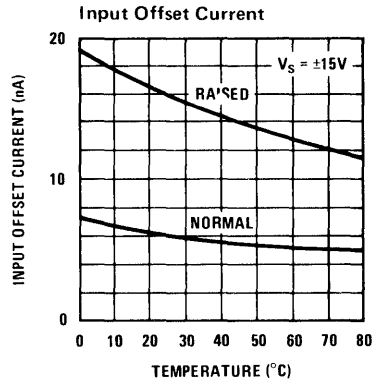
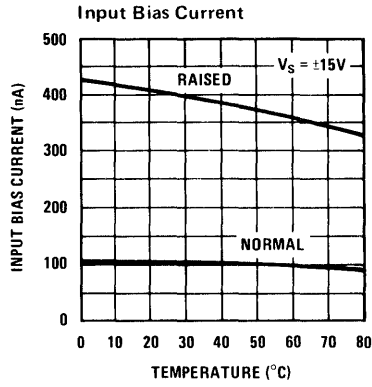

typical performance

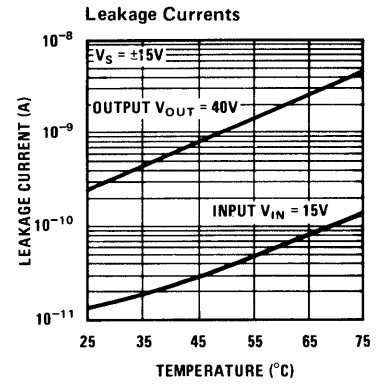
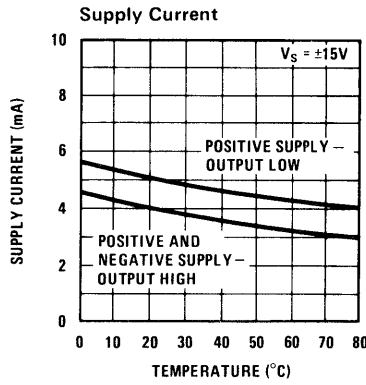
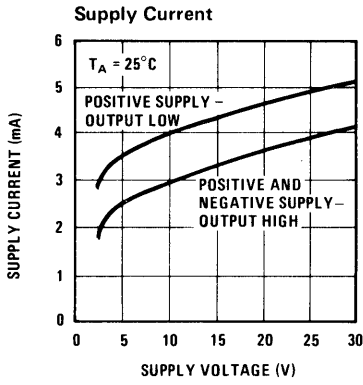

connection diagrams *

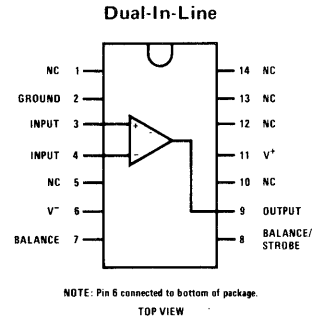
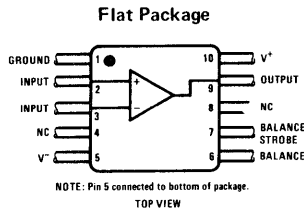
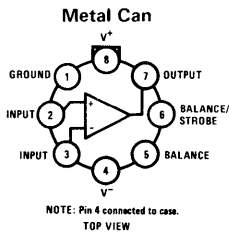

*Pin connections shown on schematic diagram and typical applications are for TO-5 package.

typical applications

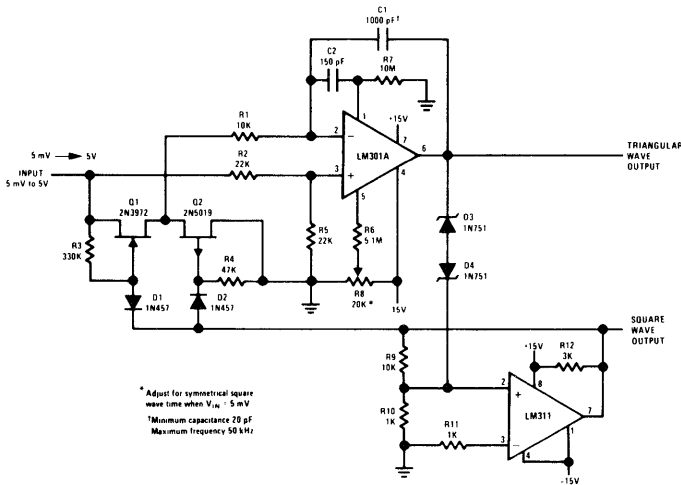

10 Hz to 10 kHz Voltage Controlled Oscillator

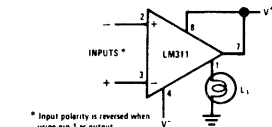

Driving Ground-Referred Load

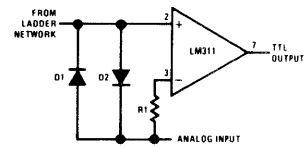

Using Clamp Diodes to Improve Response

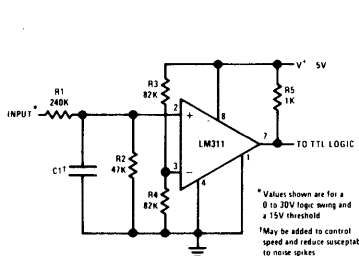

TTL Interface with High Level Logic

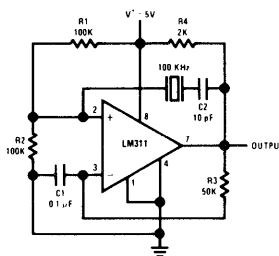

Crystal Oscillator

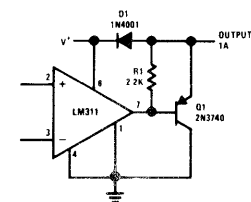

Comparator and Solenoid Driver

typical applications

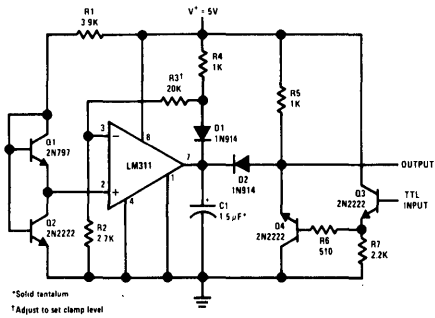

Precision Squarer

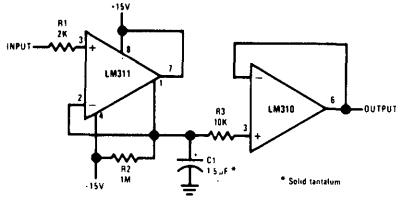

Positive Peak Detector

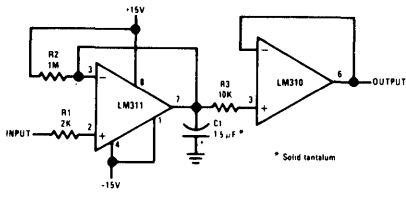

Negative Peak Detector

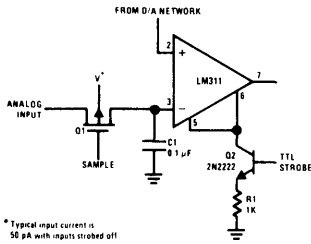

Strobing off Both Input* and Output Stages

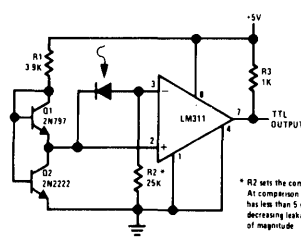

Precision Photodiode Comparator

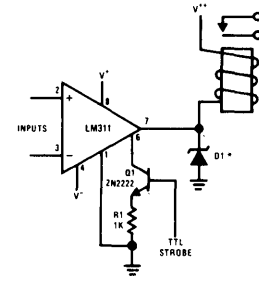

Relay Driver with Strobe

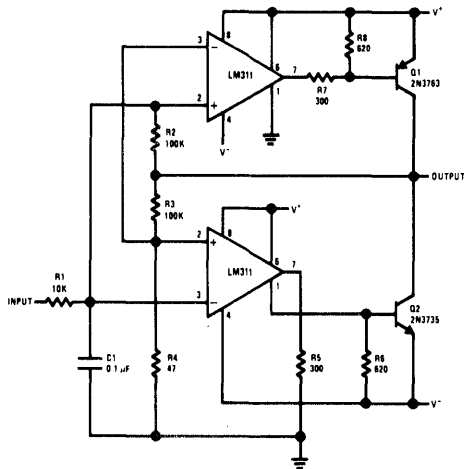

Switching Power Amplifier

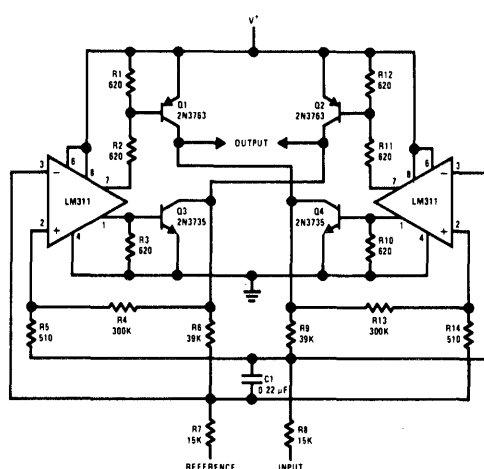

Switching Power Amplifier

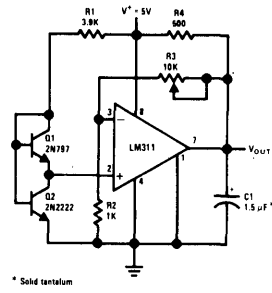

Low Voltage Adjustable Reference Supply

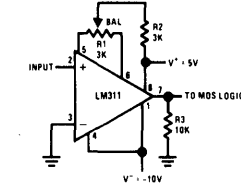

Zero Crossing Detector driving MOS logic

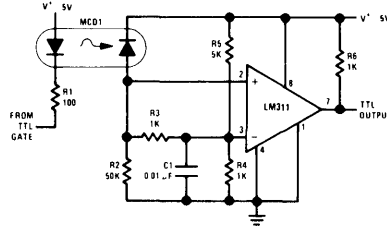

Digital Transmission Isolator



Voltage Comparators/ Buffers

LM710A voltage comparator general description

The LM710A is a high-speed voltage comparator intended for use as an accurate, low-level digital level sensor or as a replacement for operational amplifiers in comparator applications where speed is of prime importance. The circuit has a differential input and a single-ended output, with saturated output levels compatible with practically all types of integrated logic.

The device is built on a single silicon chip which insures low offset and thermal drift. The use of a minimum number of stages along with minority-carrier lifetime control (gold doping) makes the circuit much faster than operational amplifiers in

saturation comparator applications. In fact, the low stray and wiring capacitances that can be realized with monolithic construction make the device difficult to duplicate with discrete components operating at equivalent power levels.

The LM710A is useful as a pulse height discriminator, a voltage comparator in high-speed A/D converters or a go, no-go detector in automatic test equipment. It also has applications in digital systems as an adjustable-threshold line receiver or an interface between logic types. In addition, the low cost of the unit suggests it for applications replacing relatively simple discrete component circuitry.

schematic and connection diagrams

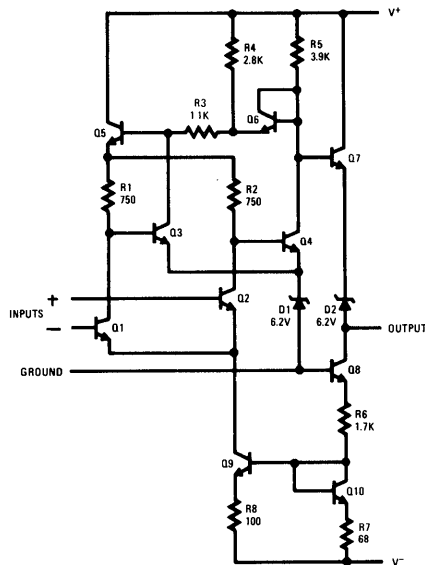

Metal Can

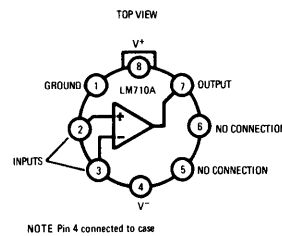

typical applications

Schmidt Trigger

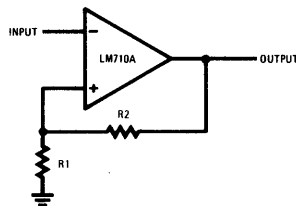

Pulse Width Modulator

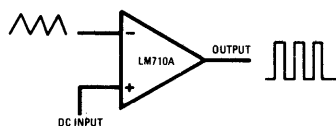

Line Receiver With
Increased Output
Sink Current

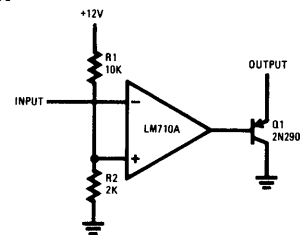

Level Detector With
Lamp Driver

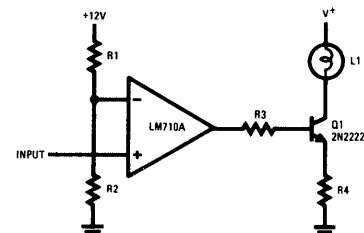

absolute maximum ratings

Positive Supply Voltage	14.0V
Negative Supply Voltage	-7.0V
Differential Input Voltage	±5.0V
Input Voltage	±7.0V
Power Dissipation (Note 1)	300 mW
Output Short Circuit Duration	10 sec
Operating Temperature Range	-55°C to +125°C
Storage Temperature Range	-65°C to +150°C
Lead Temperature (soldering, 60 sec)	300°C

electrical characteristics (Note 2)

PARAMETER	CONDITIONS	MIN.	TYP.	MAX.	UNITS
Input Offset Voltage	$T_A = 25^\circ\text{C}$, $R_S \leq 200\Omega$ $V_{OUT} = 1.4\text{V}$		0.6	2.0	mV
Input Offset Current	$T_A = 25^\circ\text{C}$, $V_{OUT} = 1.4\text{V}$		0.75	3.0	μA
Input Bias Current	$T_A = 25^\circ\text{C}$		13	20	μA
Voltage Gain	$T_A = 25^\circ\text{C}$	1250	1700		
Output Resistance	$T_A = 25^\circ\text{C}$		200		Ω
Output Sink Current	$T_A = 25^\circ\text{C}$, $\Delta V_{IN} \geq 5\text{ mV}$ $V_{OUT} = 0$	2.0	2.5		mA
Response Time (Note 3)			40		ns
Input Offset Voltage	$R_S \leq 200\Omega$			3.0	mV
Average Temperature Coefficient of Input Offset Voltage	$-55^\circ\text{C} \leq T_A \leq 125^\circ\text{C}$ $R_S \leq 50\Omega$		3.0	10	$\mu\text{V}/^\circ\text{C}$
Input Offset Current	$T_A = 125^\circ\text{C}$ $T_A = -55^\circ\text{C}$		0.25 1.8	3.0 7.0	μA μA
Average Temperature Coefficient of Input Offset Current	$25^\circ\text{C} \leq T_A \leq 125^\circ\text{C}$ $-55^\circ\text{C} \leq T_A \leq 25^\circ\text{C}$		5.0 15	25 75	$\text{nA}/^\circ\text{C}$ $\text{nA}/^\circ\text{C}$
Input Bias Current	$T_A = -55^\circ\text{C}$		27	45	μA
Input Voltage Range	$V^- = -7.0\text{V}$	±5.0			V
Differential Input Voltage Range		±5.0V			V
Voltage Gain		1000			
Positive Output Level	$\Delta V_{IN} \geq 5\text{ mV}$, $0 \leq I_{OUT} \leq 5\text{ mA}$	2.5	3.2	4.0	V
Negative Output Level	$\Delta V_{IN} \geq 5\text{ mV}$	-1.0	-0.5	0	V
Output Sink Current	$T_A = 125^\circ\text{C}$, $\Delta V_{IN} \geq 5\text{ mV}$ $V_{OUT} = 0.2\text{V}$ $T_A = -55^\circ\text{C}$, $\Delta V_{IN} \geq 5\text{ mV}$ $V_{OUT} = 0$	-1.6 -1.6	-2.2 -2.3		mA mA
Positive Supply Current	$-5\text{V} \leq \Delta V_{IN} \leq 5\text{V}$, $I_{OUT} \leq 0$			11	mA
Negative Supply Current			4.6	7.0	mA
Power Consumption	$T_A = 125^\circ\text{C}$, $I_{OUT} \leq 0$ $-5\text{V} \leq \Delta V_{IN} \leq 5\text{V}$			160	mW

Note 1: For operating at elevated temperatures, the device must be derated based on a 160°C maximum junction temperature and a thermal resistance of 45°C/W junction to case or 150°C/W junction to ambient for the metal-can package. For the flat package, the derating is based on a thermal resistance of 185°C/W when mounted on a 1/16-inch-thick, epoxy-glass board with ten, 0.03-inch-wide, 2-ounce copper conductors (see curve).

Note 2: These specifications apply for $V^+ = 12.0\text{V}$, $V^- = -6.0\text{V}$, $-55^\circ\text{C} \leq T_A \leq 125^\circ\text{C}$ and for a logic threshold voltage of 1.8V at -55°C , 1.4V at 25°C and 1.0V at 125°C unless otherwise specified.

Note 3: The response time specified (see definitions) is for a 100 mV input step with 5 mV overdrive.

typical performance characteristics

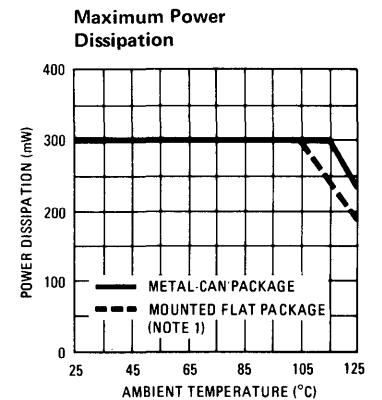
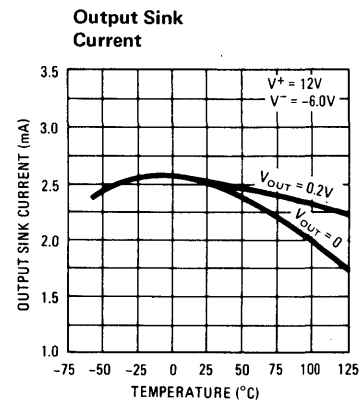
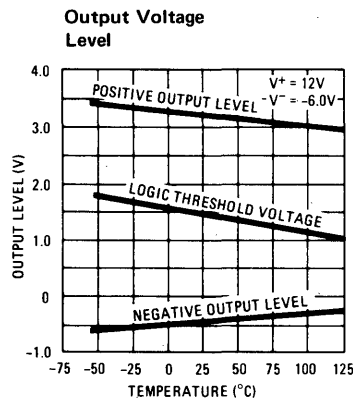
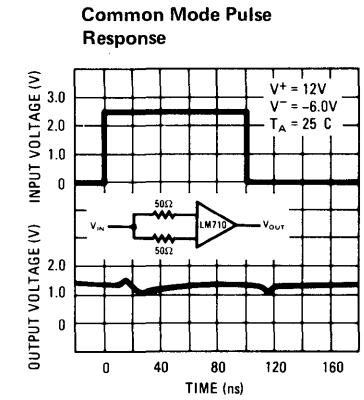
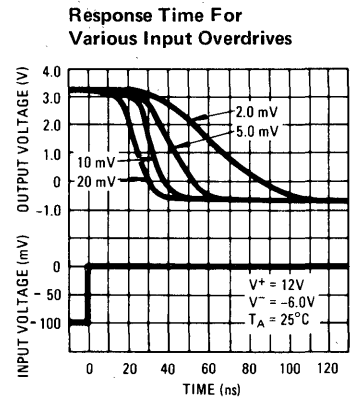
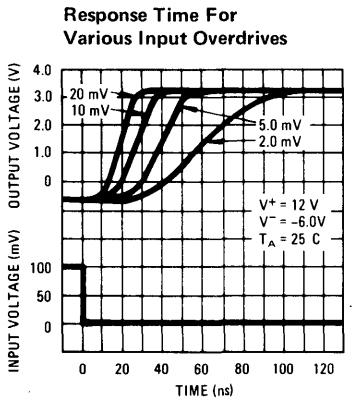
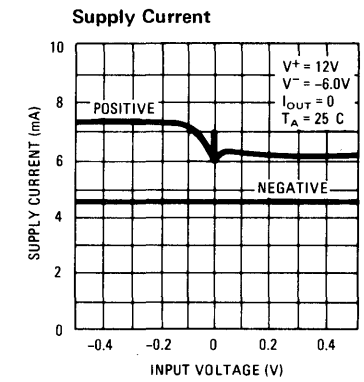
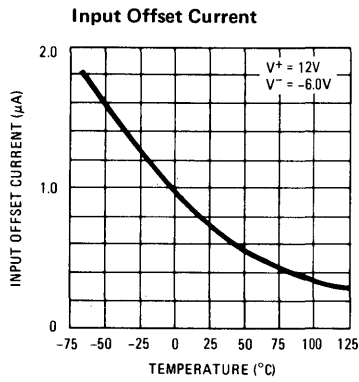
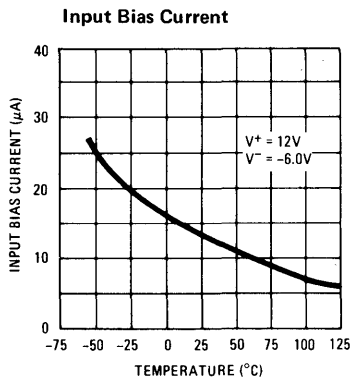
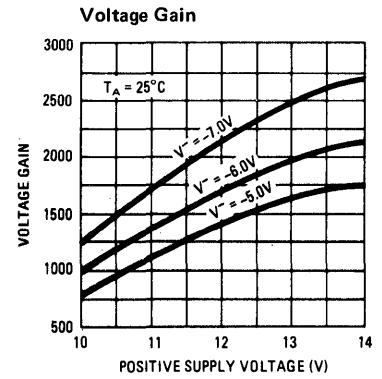
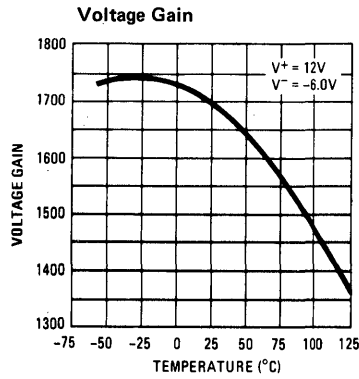
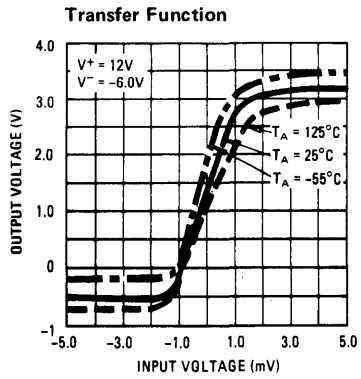



Voltage Comparators/Buffers

LM710C voltage comparator

general description

The LM710C is a high-speed voltage comparator intended for use as an accurate, low-level digital level sensor or as a replacement for operational amplifiers in comparator applications where speed is of prime importance. The circuit has a differential input and a single-ended output, with saturated output levels compatible with practically all types of integrated logic.

The device is built on a single silicon chip which insures low offset and thermal drift. The use of a minimum number of stages along with minority-carrier lifetime control (gold doping) makes the circuit much faster than operational amplifiers in saturating comparator applications. In fact, the low stray and wiring capacitances that can be realized

with monolithic construction make the device difficult to duplicate with discrete components operating at equivalent power levels.

The LM710C is useful as a pulse height discriminator, a voltage comparator in high-speed A/D converters or a go, no-go detector in automatic test equipment. It also has applications in digital systems as an adjustable-threshold line receiver or an interface between logic types. In addition, the low cost of the unit suggests it for applications replacing relatively simple discrete component circuitry.

The LM710C is the commercial/industrial version of the LM710A. It is identical to the LM710A except that operation is specified over a 0°C to 70°C temperature range.

schematic and connection diagrams

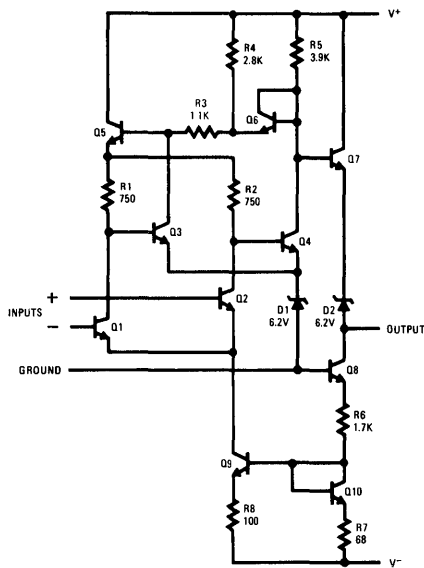

Metal Can

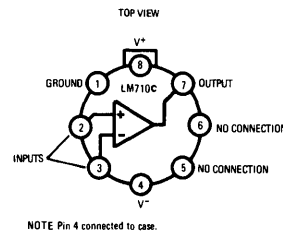

typical applications

Schmidt Trigger

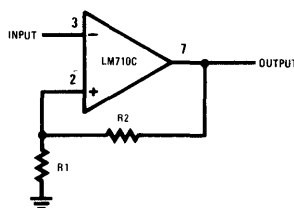

Pulse Width Modulator

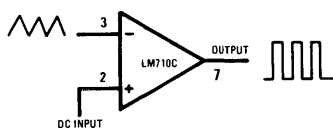

Line Receiver With Increased Output Sink Current

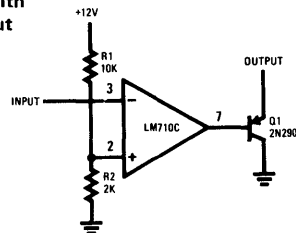

Level Detector With Lamp Driver

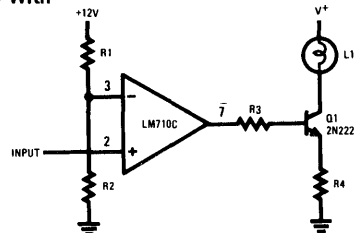

absolute maximum ratings

Positive Supply Voltage	14.0V
Negative Supply Voltage	-7.0V
Differential Input Voltage	±5.0V
Input Voltage	±7.0V
Power Dissipation (Note 1)	300 mW
Output Short Circuit Duration	10 sec
Operating Temperature Range	0°C to 70°C
Storage Temperature Range	-65°C to +150°C
Lead Temperature (soldering, 60 sec)	300°C

electrical characteristics (Note 2)

PARAMETER	CONDITIONS	MIN.	TYP.	MAX.	UNITS
Input Offset Voltage	$T_A = 25^\circ\text{C}$, $R_S < 200\Omega$ $V_{OUT} = 1.4\text{V}$		1.6	5.0	mV
Input Offset Current	$T_A = 25^\circ\text{C}$, $V_{OUT} = 1.4\text{V}$		1.8	5.0	μA
Input Bias Current	$T_A = 25^\circ\text{C}$		16	25	μA
Voltage Gain	$T_A = 25^\circ\text{C}$	1000	1500		
Output Resistance	$T_A = 25^\circ\text{C}$		200		Ω
Output Sink Current	$T_A = 25^\circ\text{C}$, $\Delta V_{IN} \geq 5\text{ mV}$ $V_{OUT} = 0$	1.7	2.5		mA
Response Time (Note 3)			40		ns
Input Offset Voltage	$R_S \leq 200\Omega$			6.5	mV
Average Temperature Coefficient of Input Offset Voltage	$0^\circ\text{C} \leq T_A \leq 70^\circ\text{C}$ $R_S \leq 50\Omega$		5.0	20	$\mu\text{V}/^\circ\text{C}$
Input Offset Current				7.5	μA
Average Temperature Coefficient of Input Offset Current	$25^\circ\text{C} \leq T_A \leq 70^\circ\text{C}$ $0^\circ\text{C} \leq T_A \leq 25^\circ\text{C}$		15 24	50 100	$\text{nA}/^\circ\text{C}$ $\text{nA}/^\circ\text{C}$
Input Bias Current	$T_A = 0^\circ\text{C}$		25	40	μA
Input Voltage Range	$V^- = -7.0\text{V}$	±5.0			V
Differential Input Voltage Range		±5.0			V
Voltage Gain		800			
Positive Output Level	$\Delta V_{IN} \geq 5\text{ mV}$, $0 \leq I_{OUT} \leq 5\text{ mA}$	2.5	3.2	4.0	V
Negative Output Level	$\Delta V_{IN} \geq 5\text{ mV}$	-1.0	-0.5	0	V
Output Sink Current	$\Delta V_{IN} \geq 5\text{ mV}$, $V_{OUT} = 0.2\text{V}$	1.6			mA
Positive Supply Current	$-5\text{V} \leq \Delta V_{IN} \leq 5\text{V}$, $I_{OUT} \leq 0$			11	mA
Negative Supply Current			4.6	7.0	mA
Power Consumption	$T_A = 70^\circ\text{C}$, $I_{OUT} \leq 0$ $-5\text{V} \leq \Delta V_{IN} \leq 5\text{V}$			170	mW

Note 1: Ratings apply for ambient temperatures to 70°C.

Note 2: These specifications apply for $V^+ = 12.0\text{V}$, $V^- = 6.0\text{V}$, $0^\circ\text{C} \leq T_A \leq 70^\circ\text{C}$ and for a logic threshold voltage of 1.5V at 0°C, 1.4V at 25°C and 1.2V at 70°C unless otherwise specified.

Note 3: The response time specified (see definitions) is for a 100 mV input step with 5 mV overdrive.

typical performance characteristics

Transfer Function

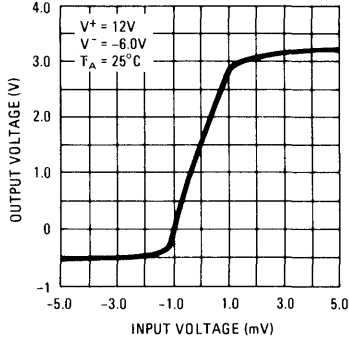

Voltage Gain

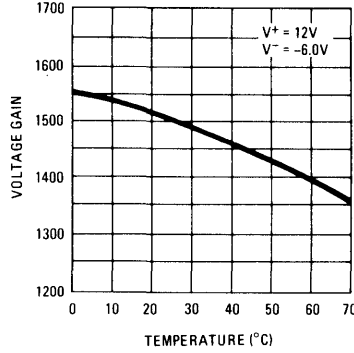

Voltage Gain

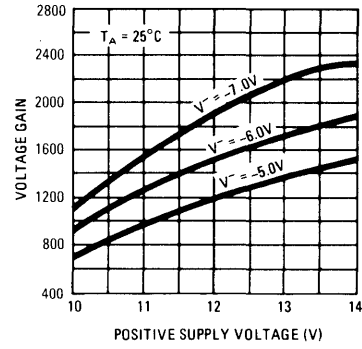

Input Bias Current

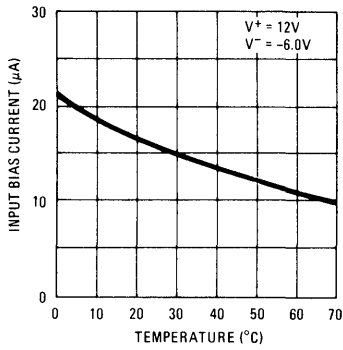

Input Offset Current

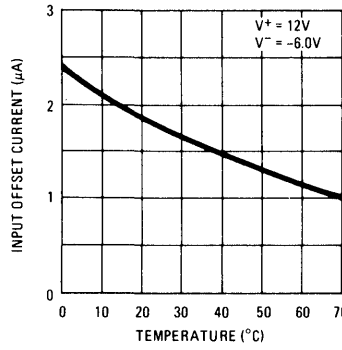

Supply Current

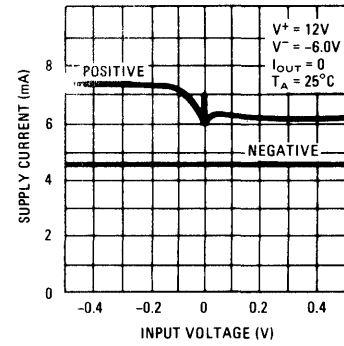

Response Time For Various Input Overdrives

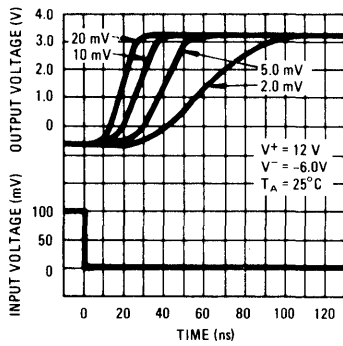

Response Time For Various Input Overdrives

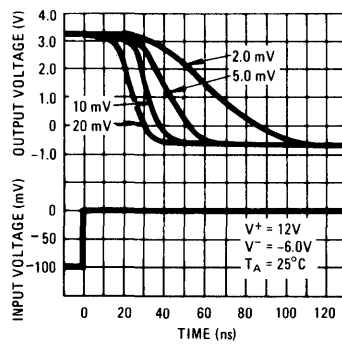

Common Mode Pulse Response

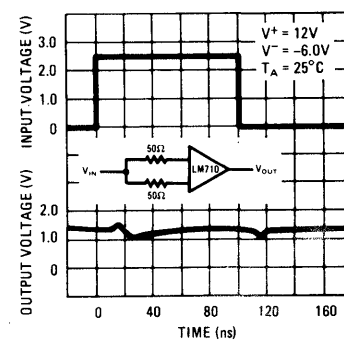



Voltage Comparators/Buffers

LM711

LM711 dual comparator

general description

The LM711 contains two voltage comparators with separate differential inputs, a common output and provision for strobing each side independently. Similar to the LM710, the device features low offset and thermal drift, a large input voltage range, low power consumption, fast recovery from large overloads and compatibility with most integrated logic circuits.

With the addition of an external resistor network, the LM711 can be used as a sense amplifier for core memories. The input thresholding, combined with the high gain of the comparator, eliminates many of the inaccuracies encountered with con-

ventional sense amplifier designs. Further, it has the speed and accuracy needed for reliably detecting the outputs of cores as small as 20 mils.

The LM711 is also useful in other applications where a dual comparator with OR'ed outputs is required, such as a double-ended limit detector. By using common circuitry for both halves, the device can provide high speed with lower power dissipation than two single comparators. The LM711 is available in either an 10-lead low profile TO-5 header or a 1/4" by 1/4" metal flat package.

schematic and connection diagrams

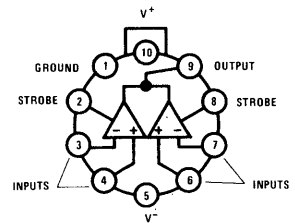
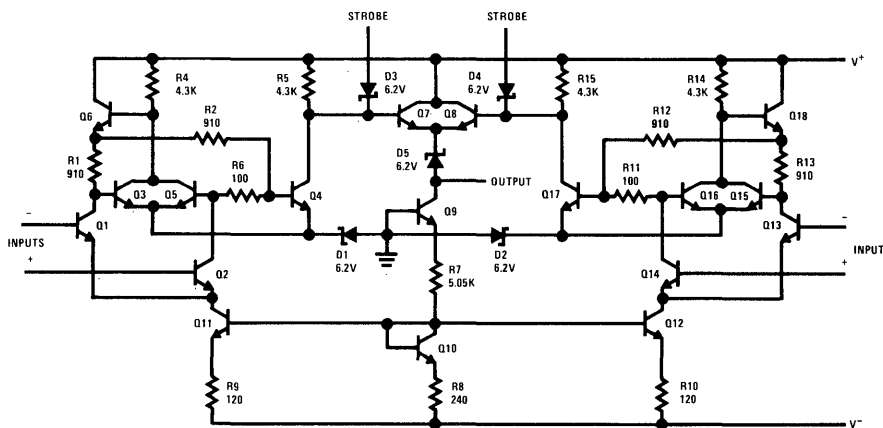

NOTE: Pin 5 connected to case

typical applications

Sense Amplifier With Supply Strobing for Reduced Power Consumption*

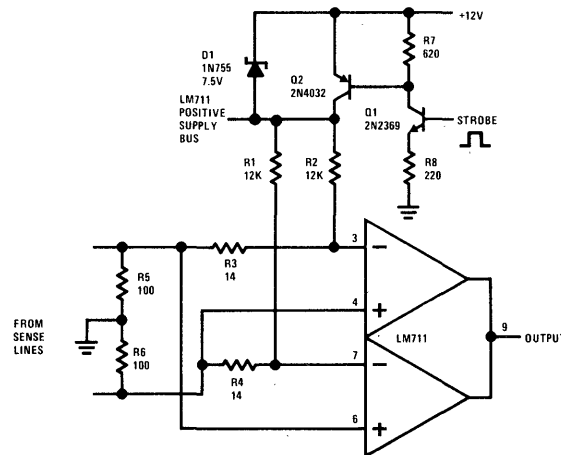

*Standby dissipation is about 40 mW

Double-Ended Limit Detector With Lamp Driver

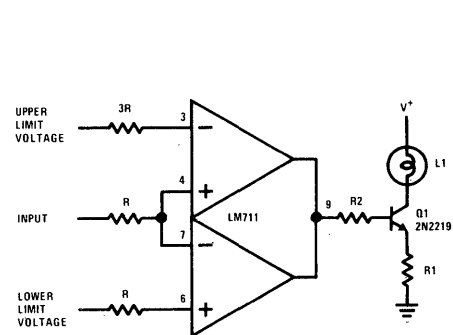

absolute maximum ratings

Positive Supply Voltage	+14.0V
Negative Supply Voltage	-7.0V
Peak Output Current	50 mA
Differential Input Voltage	±5.0V
Input Voltage	±7.0V
Strobe Voltage	0 to +6.0V
Internal Power Dissipation (Note 1)	300 mW
Operating Temperature Range	-55°C to 125°C
Storage Temperature Range	-65°C to 150°C
Lead Temperature (soldering, 60 sec)	300°C

electrical characteristics (Note 2)

PARAMETER	CONDITIONS	MIN.	TYP.	MAX.	UNIT
Input Offset Voltage	$R_S \leq 200\Omega$, $V_{CM} = 0$		1.0	3.5	mV
	$R_S \leq 200\Omega$		1.0	5.0	mV
Input Offset Current			0.5	10.0	μA
Input Bias Current			25	75	μA
Voltage Gain		750	1500		
Response Time (Note 2)			40		ns
Strobe Release Time			12		ns
Input Voltage Range	$V^- = -7.0V$	±5.0			V
Differential Input Voltage Range		±5.0			V
Output Resistance			200		Ω
Positive Output Level	$V_{IN} \geq 10$ mV		4.5	5.0	V
Loaded Positive Output Level	$V_{IN} \geq 10$ mV, $I_O = 5$ mA	2.5	3.5		V
Negative Output Level	$V_{IN} \geq 10$ mV	-1.0	-0.5	0	V
Strobed Output Level	$V_{STROBE} \leq 0.3V$	-1.0		0	V
Output Sink Current	$V_{IN} \geq 10$ mV, $V_{OUT} \geq 0$	0.5	0.8		mA
Strobe Current	$V_{STROBE} = 0$		1.2	2.5	mA
Positive Supply Current	$V_{OUT} \leq 0$		8.6		mA
Negative Supply Current			3.9		mA
Power Consumption			130	200	mW

The following specifications apply for $-55^\circ\text{C} \leq T_A \leq 125^\circ\text{C}$:

Input Offset Voltage (Note 3)	$R_S \leq 200\Omega$, $V_{CM} = 0$			4.5	mV
	$R_S \leq 200\Omega$			6.0	mV
Input Offset Current (Note 3)				20	μA
Input Bias Current				150	μA
Average Temperature Coefficient of Input Offset Voltage			5.0		μV/°C
Voltage Gain		500			

Note 1: For operation at elevated temperatures, the device must be derated based on a 160°C maximum junction temperature and a thermal resistance of 45°C/W junction to case or 150°C/W junction to ambient for the metal-can package. For the flat package, the derating is based on a thermal resistance of 185°C/W when mounted on a 1/16-inch-thick, epoxy-glass board with ten, 0.03-inch-wide, 2-ounce copper conductors (see curve).

Note 2: These specifications apply for $V^+ = 12.0V$, $V^- = -6.0V$, $T_A = 25^\circ\text{C}$ and for a logic threshold voltage of 1.8V at -55°C , 1.4V at 25°C and 1.0V at 125°C unless otherwise stated.

Note 3: The response time specified is for a 100 mV input step with 5 mV overdrive (see definitions).

typical performance characteristics

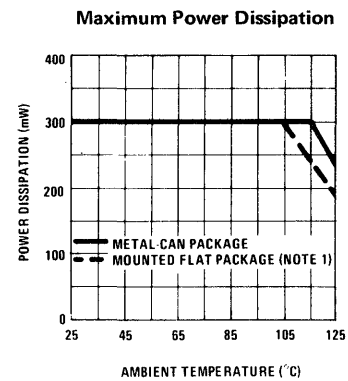
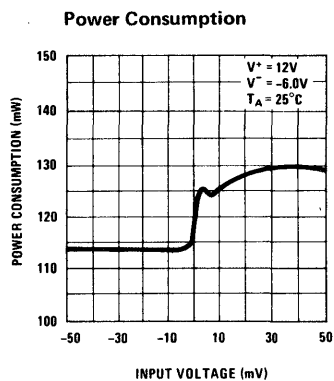
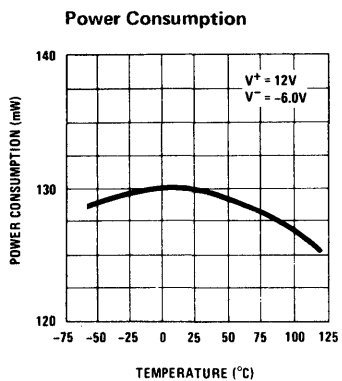
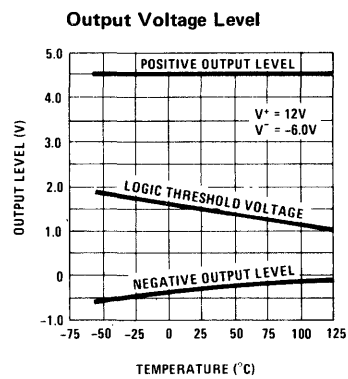
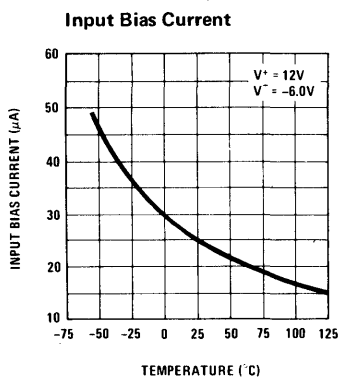
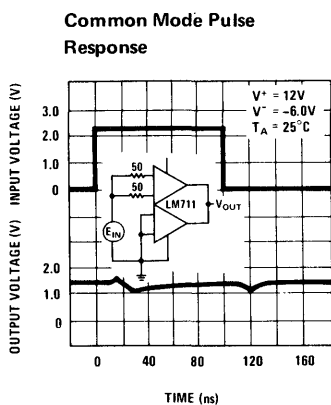
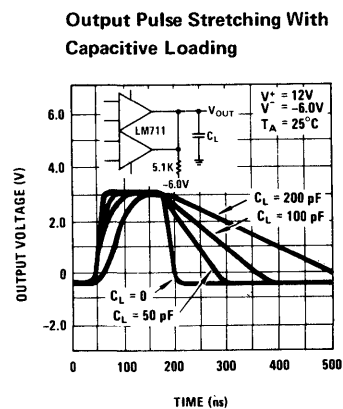
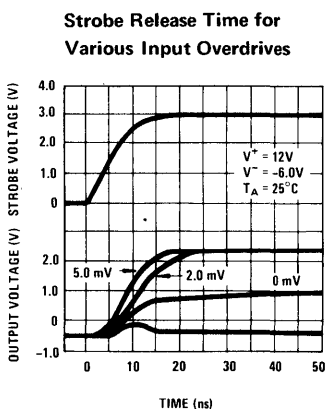
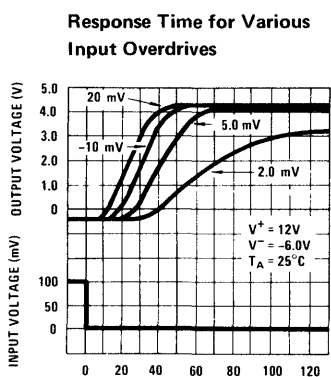
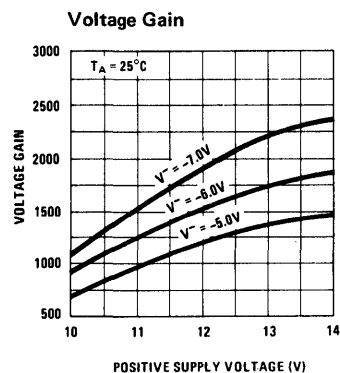
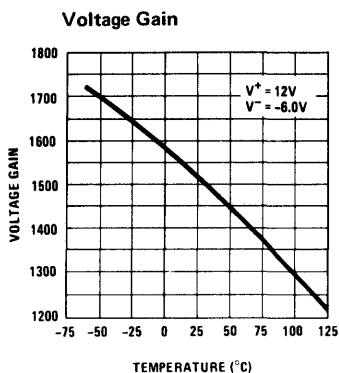
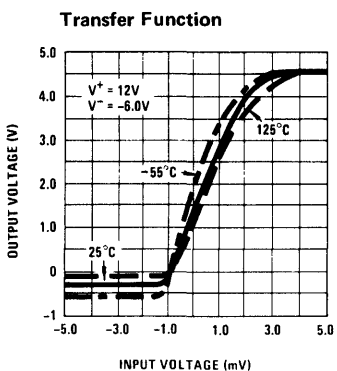



Voltage Comparators/Buffers

LM711C dual comparator

general description

The LM711C contains two voltage comparators with separate differential inputs, a common output and provision for strobing each side independently. Similar to the LM710C, the device features low offset and thermal drift, a large input voltage range, low power consumption, fast recovery from large overloads and compatibility with most integrated logic circuits.

With the addition of an external resistor network, the LM711C can be used as a sense amplifier for core memories. The input thresholding, combined with the high gain of the comparator, eliminates many of the inaccuracies encountered with con-

ventional sense amplifier designs. Further, it has the speed and accuracy needed for reliably detecting the outputs of cores as small as 20 mils.

The LM711C is also useful in other applications where a dual comparator with OR'ed outputs is required, such as a double-ended limit detector. By using common circuitry for both halves, the device can provide high speed with lower power dissipation than two single comparators. The LM711C is the commercial/industrial version of the LM711. It is identical to the LM711, except that operation is specified over a 0°C to 70°C temperature range.

schematic and connection diagrams

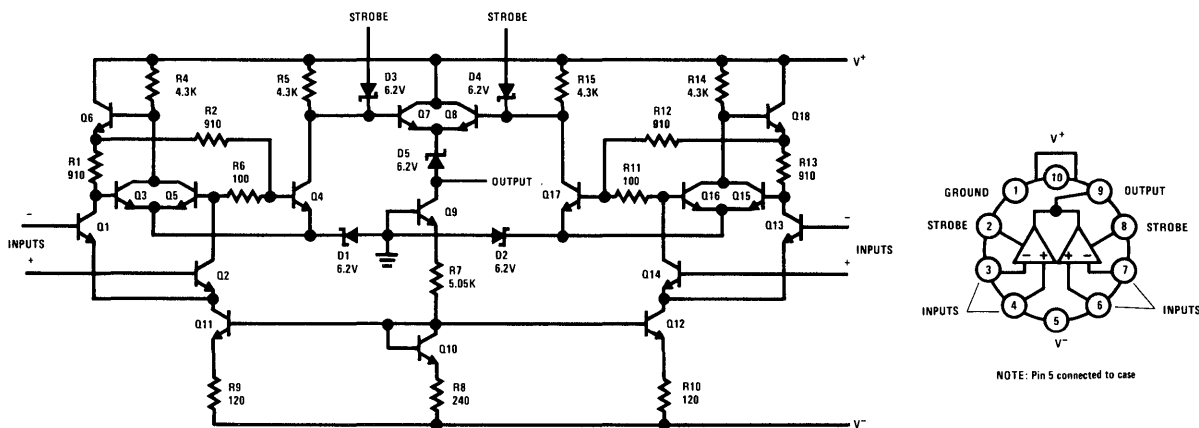

typical applications

Sense Amplifier With Supply Strobing for Reduced Power Consumption*

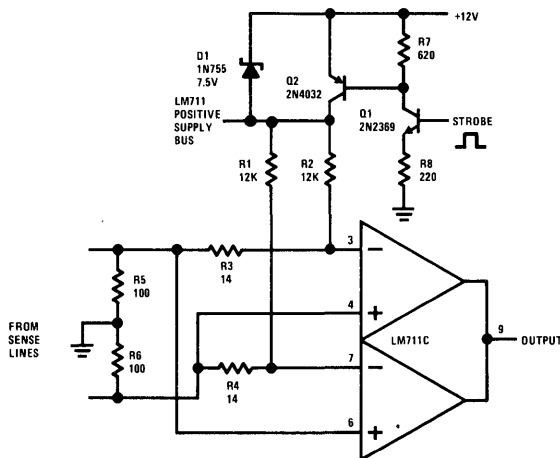

*Standby dissipation is about 40 mW

Double-Ended Limit Detector With Lamp Driver

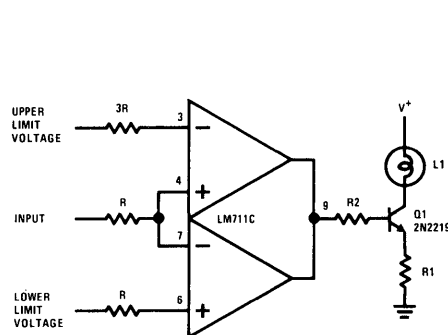

absolute maximum ratings

Positive Supply Voltage	+14.0V
Negative Supply Voltage	-7.0V
Peak Output Current	50 mA
Differential Input Voltage	±5.0V
Input Voltage	±7.0V
Strobe Voltage	0 to +6.0V
Internal Power Dissipation (Note 1)	300 mW
Operating Temperature Range	0°C to 70°C
Storage Temperature Range	-65°C to 150°C
Lead Temperature (soldering, 60 sec)	300°C

electrical characteristics (Note 1)

PARAMETER	CONDITIONS	MIN.	TYP.	MAX.	UNIT
Input Offset Voltage	$R_S \leq 200\Omega, V_{CM} = 0$		1.0	5.0	mV
	$R_S \leq 200\Omega$		1.0	7.5	mV
Input Offset Current			0.5	15	μ A
Input Bias Current			25	100	μ A
Voltage Gain		700	1500		
Response Time (Note 2)			40		ns
Strobe Release Time			12		ns
Input Voltage Range	$V^- = -7.0V$	±5.0			V
Differential Input Voltage Range		±5.0			V
Output Resistance			200		Ω
Positive Output Level	$V_{IN} \geq 10$ mV		4.5	5.0	V
Loaded Positive Output Level	$V_{IN} \geq 10$ mV, $I_O = 5$ mA	2.5	3.5		V
Negative Output Level	$V_{IN} \geq 10$ mV	-1.0	-0.5	0	V
Strobed Output Level	$V_{STROBE} \leq 0.3V$	-1.0		0	V
Output Sink Current	$V_{IN} \geq 10$ mV, $V_{OUT} \geq 0$	0.5	0.8		mA
Strobe Current	$V_{STROBE} = 0$		1.2	2.5	mA
Positive Supply Current	$V_{OUT} \leq 0$		8.6		mA
Negative Supply Current			3.9		mA
Power Consumption			130	230	mW

The following specifications apply for $-55^\circ\text{C} \leq T_A \leq 125^\circ\text{C}$:

Input Offset Voltage (Note 3)	$R_S \leq 200\Omega, V_{CM} = 0$			6.0	mV
	$R_S \leq 200\Omega$			10	mV
Input Offset Current (Note 3)				25	μ A
Input Bias Current				150	μ A
Average Temperature Coefficient of Input Offset Voltage			5.0		$\mu\text{V}/^\circ\text{C}$
Voltage Gain		500			

Note 1: Ratings apply for ambient temperatures to 70°C.

Note 2: These specifications apply for $V^+ = 12.0V$, $V^- = 6.0V$, $0^\circ\text{C} < T_A < 70^\circ\text{C}$ and for a logic threshold voltage of 1.5V at 0°C, 1.4V at 25°C and 1.2V at 70°C unless otherwise specified.

Note 3: The response time specified is for a 100 mV input step with 5 mV overdrive (see definitions).

typical performance characteristics

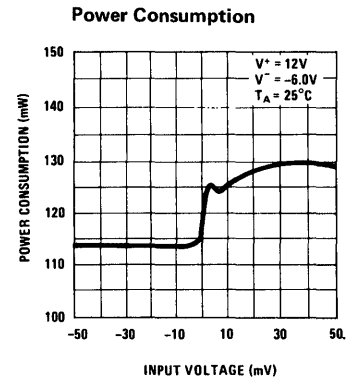
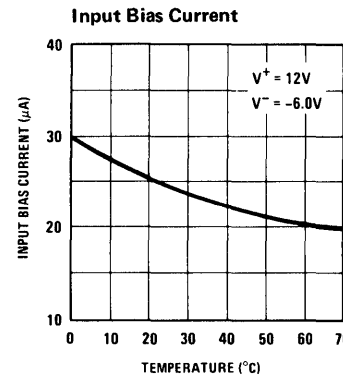
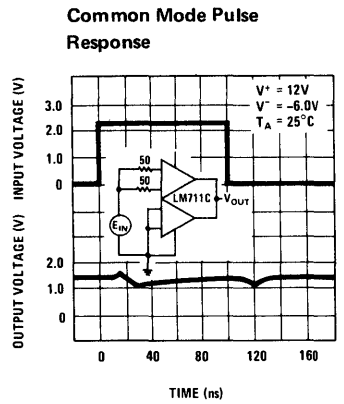
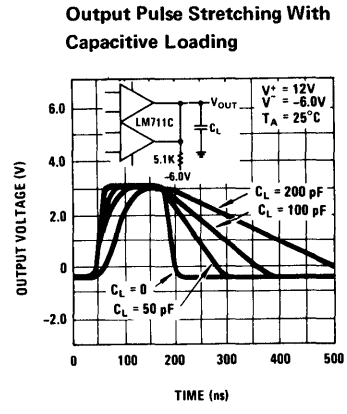
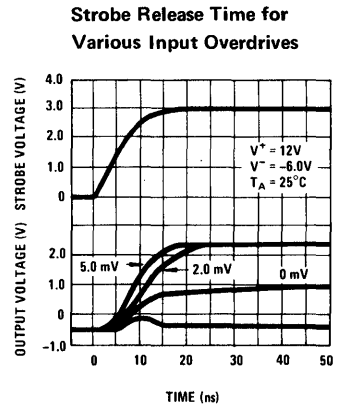
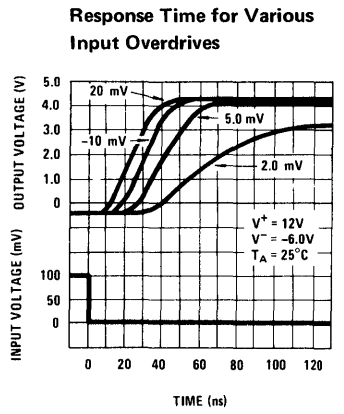
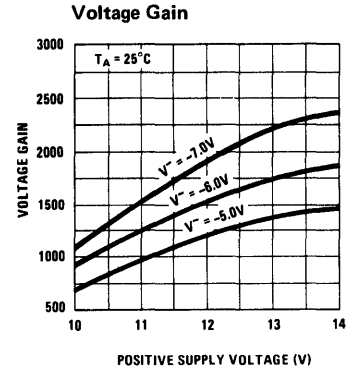
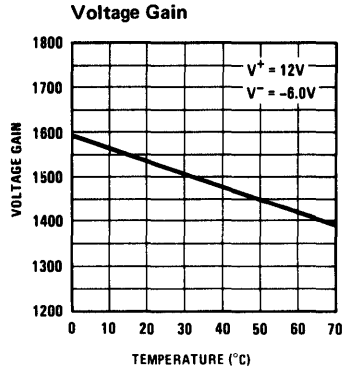
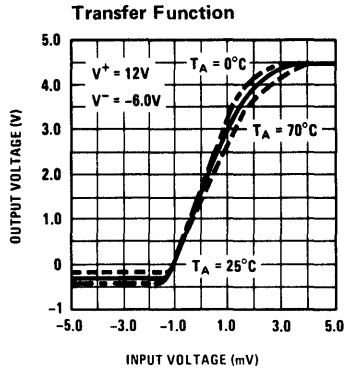



Communication Circuits

LM170/LM270/LM370

LM170/LM270/LM370 agc/squelch amplifier general description

The LM170 is a direct coupled monolithic amplifier whose voltage gain is controlled by an external DC voltage. The device features:

- Large Gain Control Range
- Self-contained AGC/Squelch system, with fast-attack, slow-release.
- Low Distortion
- Minimum DC output shift as gain is varied
- Differential inputs, with large common-mode input range
- Outputs of several amplifiers may be directly summed in multichannel systems.

- Dissipates only 18 mW from +4.5V supply, usable with supply up to +24V.
- Sensitive squelch threshold set by single external resistor.

In addition to communication system squelch and AGC applications, the LM170 is useful as constant-amplitude audio oscillator, linear low frequency modulator, single-sideband automatic load control, and as a variable DC gain element in analog computation.

schematic and connection diagrams

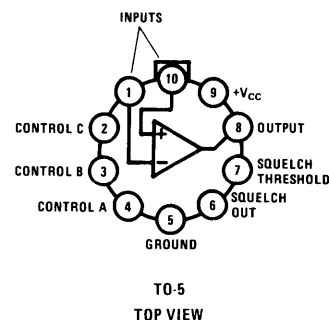
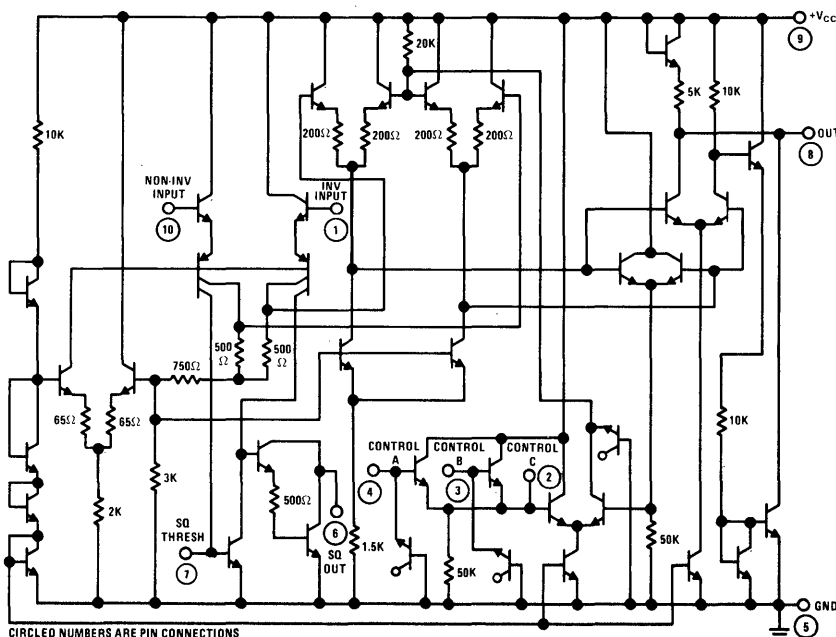

typical applications

AGC Using Built-in Detection, Driven By Additional System Gain

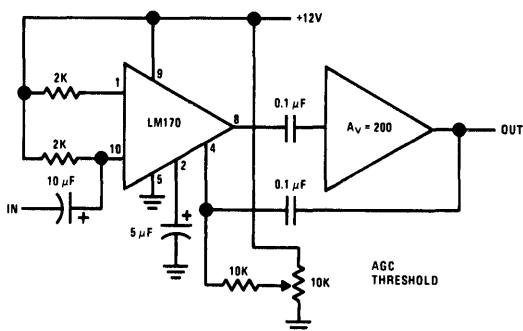

Squelched Preamp with Hysteresis

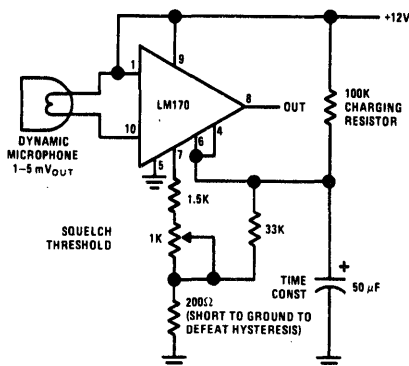

absolute maximum ratings

Supply Voltage	24V
Storage Temperature	-65°C to +150°C
Operating Temperature LM170	-55°C to +125°C
LM270	-25°C to +75°C
LM370	0°C to +70°C
Differential Input Voltage	±19.5V
Common-mode Input Voltage	(V _{CC} + 0.4)V
Output Short Circuit Duration	Indefinite
Voltage applied to Pin 3 or 4	+6.0V
Voltage applied to Pin 2	+12.0V
Surge power into Pin 6 (1 second max.)	1000 mW
Continuous power into Pin 6	100 mW

electrical characteristics (Note 1)

PARAMETER	SYMBOL	CONDITIONS	MIN	TYP	MAX	UNITS
DC CHARACTERISTICS						
DC Output Voltage	V _O (DC)	V _{IN} (dd) = 0, V (gain control) = 0	+5.0	+6.0	+7.0	V
DC Output Voltage	V _O (DC)	V _{IN} (dd) = 0 V (gain control) = +3.0	+5.0	+6.0	+7.0	V
DC Output Shift	ΔV _O (DC)	V _{IN} (dd) = 0 V (gain control) changed from 0 to +3.0V				
		LM170	-200	0	+200	mV
		LM270	-500	0	+500	mV
		LM370	-1000	0	1000	
Power Supply Drain	I _{PS}	V _{CC} = +24V V _{CC} = +4.5V V _{CC} = +12V (LM170, 270) (LM370)		13.5 4.0 8.0 8.0		mA mA mA
Input Bias Current	I _{IB}	LM170, 270 LM370		5.0 5.0	10.0 12.0	μA
AC CHARACTERISTICS						
Voltage Gain	A _V	V (gain control) = 0 LM170, 270 LM370 f = 1 KHz	37.5 35.0	40.0 40.0		dB
Gain Reduction Range	ΔA _V	V (gain control) changed from 0 to +3.0V. Gain reduction occurs for control voltages between +2.1 and +2.5 volts, pin 3 or pin 4. f = 1 KHz		-80.0		dB

Note 1: T_A = 25°C, V_{CC} = +12V, V_{IN(cm)} = +6V

operating notes

Voltage gain is continuously variable from a maximum value, dependent upon supply voltage, to a minimum value, by application of a DC control voltage at Pin 3 or 4. DC output voltage is substantially independent of gain changes, provided that differential DC input voltage is minimized, so that direct-coupled or fast gain-control operation is possible with minimum disturbance of succeeding amplifiers.

Input characteristics are similar to those of an operational amplifier, with common-mode input range extending from +4.5 volts up to and including the positive supply voltage. Lowest distortion occurs at input levels of 20 mV p-p or less. Outputs of several amplifiers, which will have quiescent DC levels approximately half of the positive

supply, may be directly connected together in multi-channel summing systems, without damage.

Emitter-follower control inputs, Pins 3 and 4, may be used as positive peak detectors by connecting a smoothing capacitor at Pin 2, in AGC applications.

A sensitive squelch detector, independent of the amplifier's gain, provides fast-attack, slow release control at Pin 6, with threshold set by an external resistance from Pin 7 to ground. Injecting a portion of the control voltage at Pin 6 into this threshold results in a hysteresis, reducing response to erratic inputs. Since threshold is dependent on DC levels, differential DC input voltage should be held constant for squelch operation.

variable gain characteristics

Voltage Gain vs Control Voltage

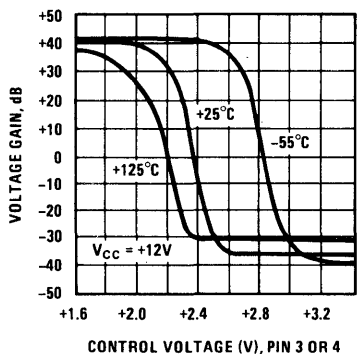

Bandwidth vs Gain Reduction

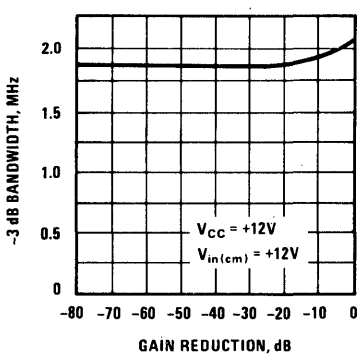

Total Harmonic Distortion vs Gain Reduction

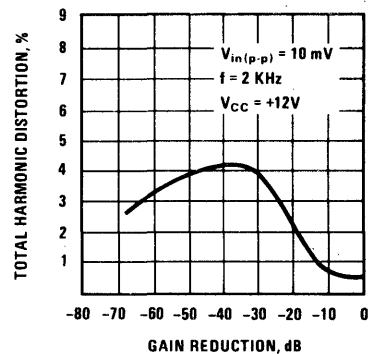

Maximum and Minimum Voltage Gain vs Temperature

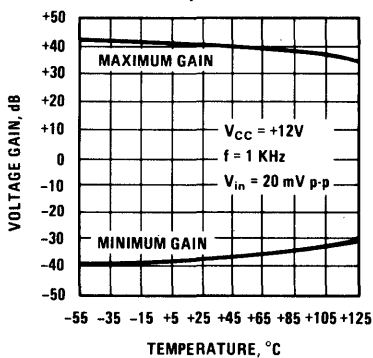

Bandwidth vs Temperature

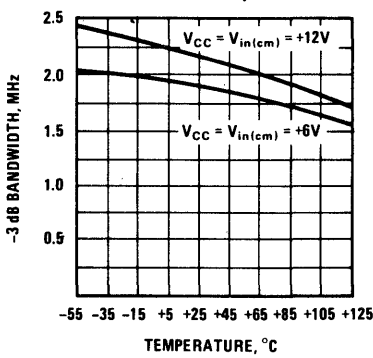

Total Harmonic Distortion vs Input Amplitude

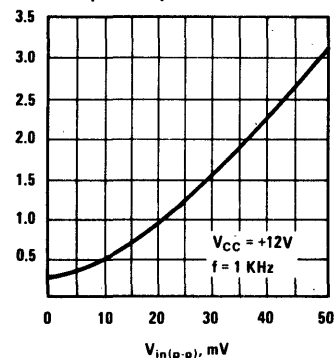

Maximum Voltage Gain vs Supply Voltage

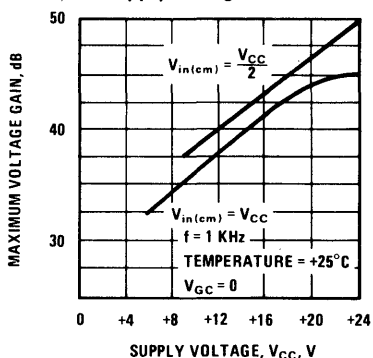

Common-Mode Rejection Ratio vs Temperature

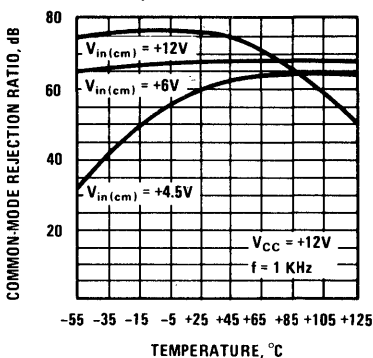

Output Dynamic Range vs Control Voltage

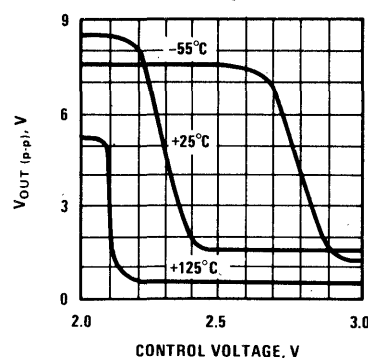

squelch characteristics

Squelch Threshold Voltage vs Threshold Resistance

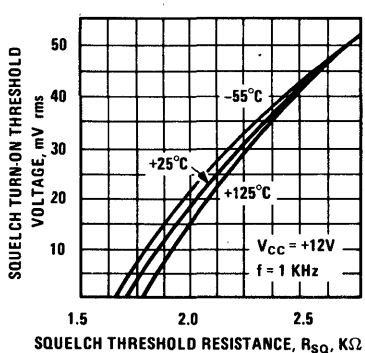

Squelch Hysteresis Voltage vs Squelch Threshold Voltage

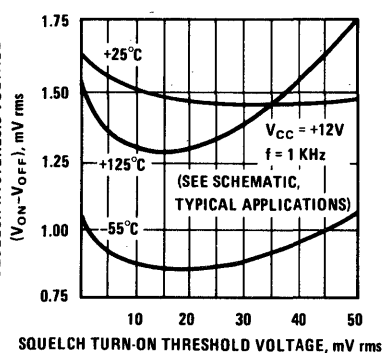

Squelch Release Time vs Time Constant Capacitance

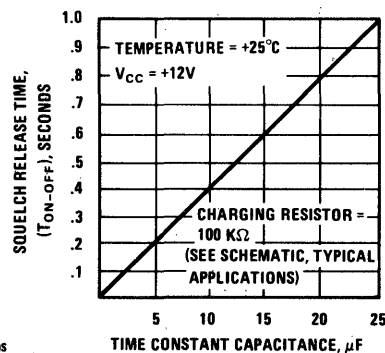

input and output characteristics

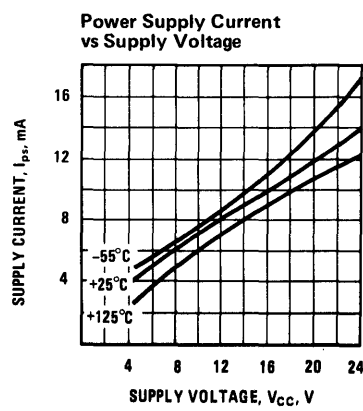
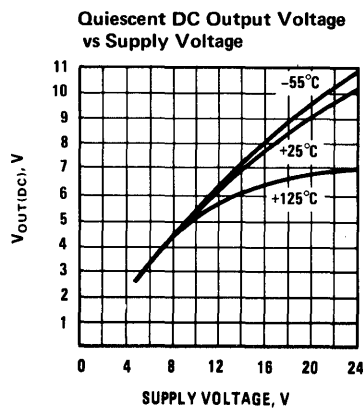
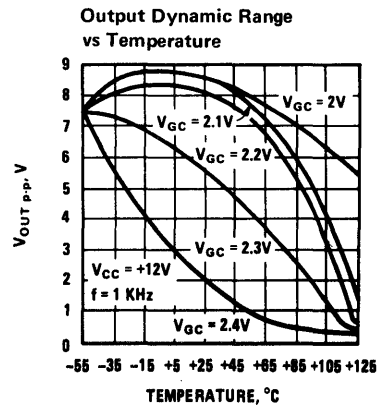
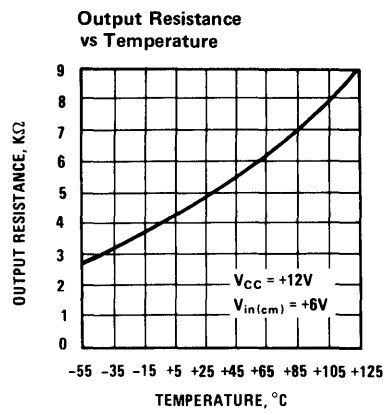
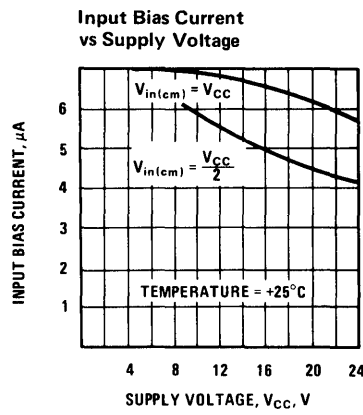
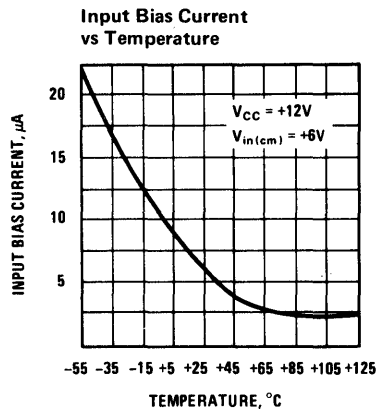
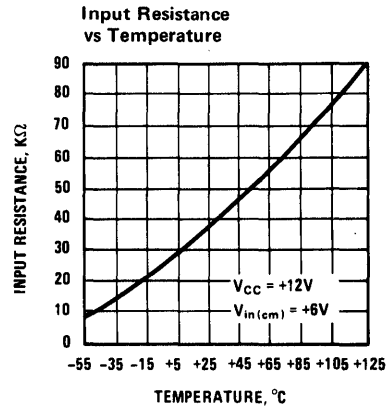
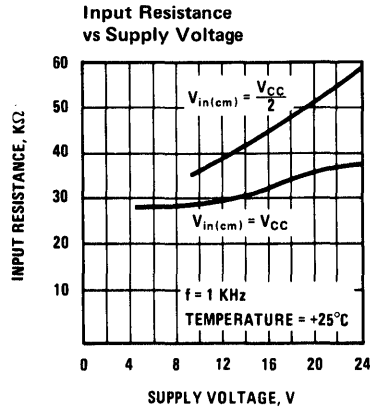
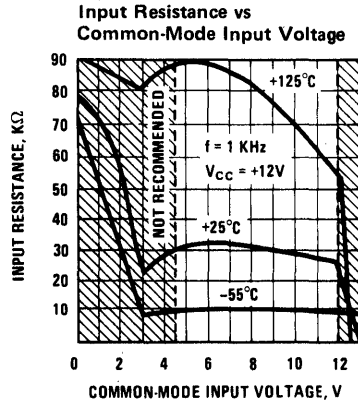



Communication Circuits

LM171/LM271 LM371 integrated rf/if amplifier

general description

The LM171/LM271/LM371 is a monolithic RF-IF amplifier capable of emitter-coupled or cascode operation from dc to 250 MHz. The device features:

- Low internal feedback, allowing high stability-limited gain
- Versatility through user-connected configurations
- As emitter coupled amplifier, symmetrical, non-saturated limiting
- As cascode, wide AGC range with constant input admittance

- As differential DC amplifier, low input offset voltage and wide dynamic range
- As video amplifier, externally selected gain, and high gain-bandwidth product
- 100 MHz tuned power gain

(emitter coupled)	24.6 dB
(cascode)	27.5 dB

In addition to amplifier service, the circuit is useful in mixer, oscillator, detector, modulator, and numerous other applications. The LM271 is a plug-in replacement for the 911C type.

schematic and connection diagrams

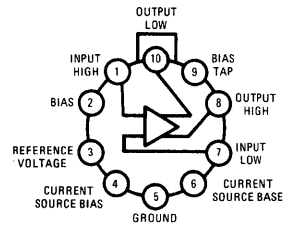
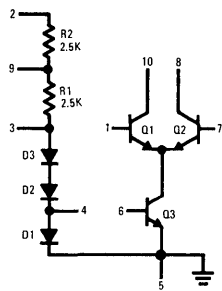

test circuits

100 MHz Cascode Test Circuit

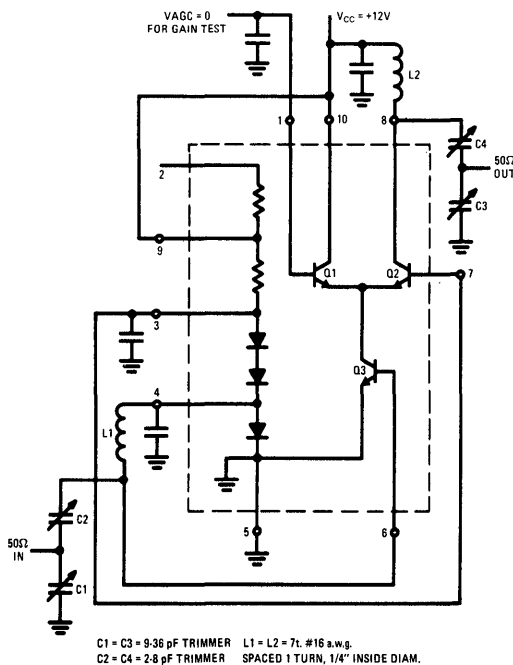

100 MHz Emitter Coupled Test Circuit

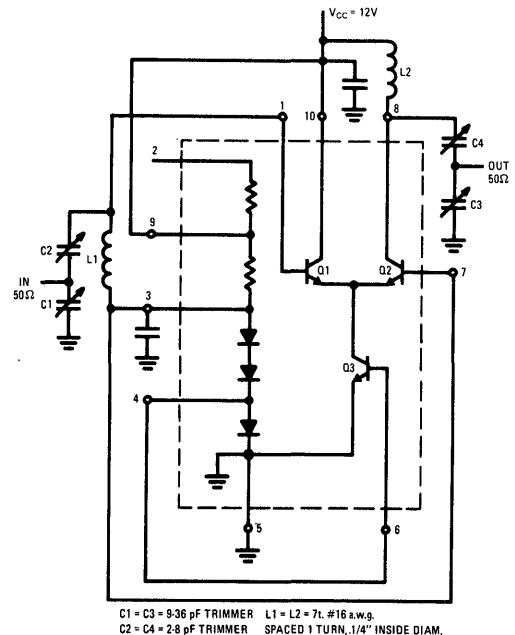

Note: All unmarked bypass capacitors 1000 pF.

absolute maximum ratings

Storage Temperature		-65°C to +150°C
Operating Temperature	LM171	-55°C to +125°C
	LM271	-20°C to +100°C
	LM371	0°C to +70°C
Power Dissipation		230 mW

electrical characteristics (Note 1)

PARAMETER	SYMBOL	CONDITIONS	LM171			LM271			LM371			UNITS
			MIN	TYP	MAX	MIN	TYP	MAX	MIN	TYP	MAX	
DC CHARACTERISTICS												
Input Offset Voltage	V_{OS}	$I_B = I_{10} = 500 \mu A$			3			3			10	mV
Input Bias Current	I_{BIAS}		1.30		2.65	1.3		2.65	1.3		2.65	mA
Ratio of R1/R2			.895		1.12	.895		1.12	.895		.895	
Voltage at Pin 3	V_3	$V_2 = +12V$	2.0			2.0			2.0			V
Current Through Current Source Q3	I_C	$I_C = I_B + I_{10}$	2.45		5.70	2.45		5.70	2.45		5.70	mA
Current Gain	B		40			40			40			
Power Supply Current Drain	I_{PS}	$I_{PS} = I_{BIAS} + I_B + I_{10}$			9.0			9.0			10.5	mA
EMITTER COUPLED CHARACTERISTICS (Input Signal < 10 mV rms)												
Input Conductance	G_{11}				455 kHz			.30		.40		mmhos
Output Conductance	G_{22}				455 kHz			.01		.04		mmhos
Magnitude of Forward Transadmittance	$ Y_{21} $				455 kHz	17.0		27.0				mmhos
Magnitude of Reverse Transadmittance	$ Y_{12} $				200 MHz			0.1				mmhos
Tuned Power Gain	A_P				10.7 MHz BW = 470 kHz			24.6				dB
Tuned Power Gain	A_P				100 MHz BW = 5 MHz			22.7				dB
CASCODE CHARACTERISTICS (Input Signal < 10 mV rms)												
Input Conductance	G_{11}				455 kHz			1.1		2.5		mmhos
Output Conductance	G_{22}				455 kHz Connect pin 1 to 7			.01		.04		mmhos
Magnitude of Forward Transadmittance	$ Y_{21} $				455 kHz Pin 1 ground	25.0		50.0				mmhos
Magnitude of Reverse Transadmittance	$ Y_{12} $				200 MHz			.001				mmhos
Tuned Power Gain	A_P				100 MHz Pin 1 ground BW = 5 MHz			27.5				dB
Tuned Power Gain	A_P				200 MHz Pin 1 ground BW = 6 MHz			25.0				dB

Note 1: These specifications apply for $V^+ = +12V$ and $T_A = 25^\circ C$



Communication Circuits

LM172/LM272/LM372 am if strip

general description

The LM172/LM272/LM372 is a broadband AM receiver subsystem, including a high gain amplifier, an active detector, and self-contained automatic gain control. It is intended for IF or TRF applications from 50 kHz to 2 MHz. Bandpass shaping is performed by a single, external filter, which may be ceramic, crystal, or LC, having single or multiple poles. The IF strip features:

- AGC Range: 60 dB

- Audio Output of 0.8V p-p for 80% modulated inputs, at carrier levels as low as 50 μ V rms.
- Total dissipation only 8.4 mW from +6V supply, usable with supply up to +15V.
- AGC time constant and audio frequency response selected by choice of external capacitors.
- Internal supply regulators eliminate individual stage decoupling.
- AGC voltage available to drive receiver "front end."

schematic and connection diagrams

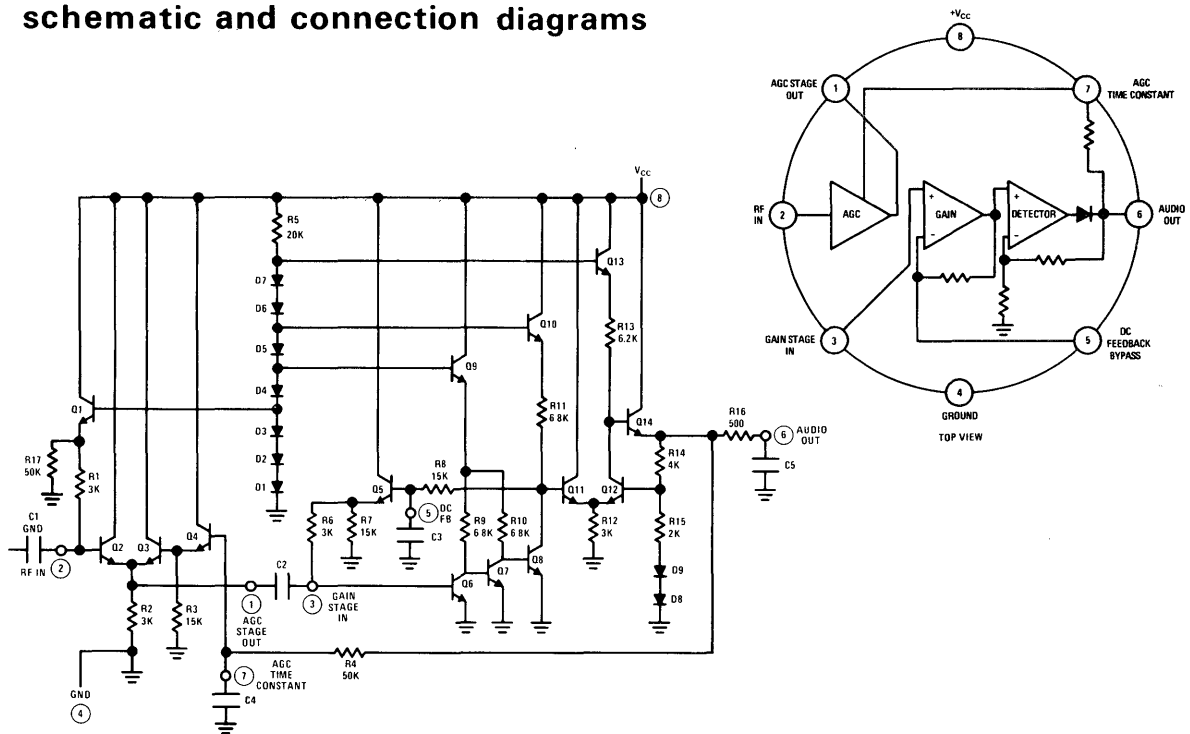

typical application

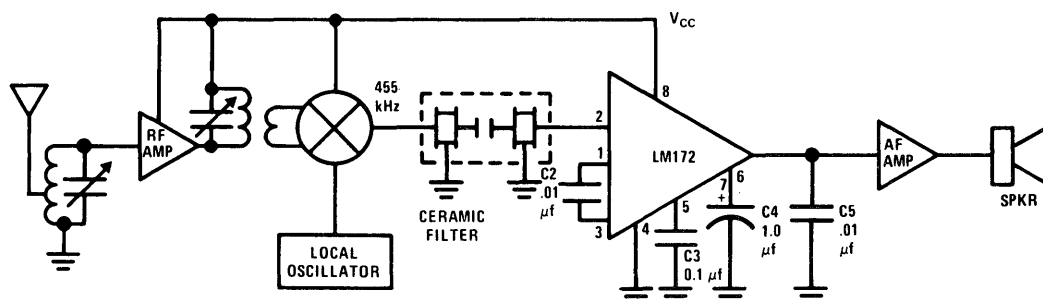

absolute maximum ratings

Supply Voltage Range		+6V to +15V
Storage Temperature		-65°C to +150°C
Operating Temperature	LM172	-55°C to +125°C
	LM272	-25°C to +75°C
	LM372	0°C to +70°C
RF Input Level, Pin 2		500 mV rms

electrical characteristics (T_A = 25°C)

PARAMETER	SYMBOL	CONDITIONS	MIN	TYP	MAX	UNITS	
Power Supply Drain	I _{ps}	V _{CC} = 6V, Input = 50 mV f = 455 kHz		1.4		mA	
		V _{CC} = 6V, Input = 50 μV f = 455 kHz		1.7		mA	
		V _{CC} = 15V, Input = 50 mV f = 455 kHz			2.5	2.65	mA
		LM172/272			2.5	3.2	mA
AGC Range	AGCR	V _{CC} = 6V, f = 455 kHz					
		LM172/272	50	69		dB	
		LM372	47	69		dB	
AGC Threshold	V _{IN(th)}	V _{CC} = 6V, f = 455 kHz		50		μV, rms	
Maximum Usable Frequency	MUF	V _{CC} = 6V		2.0		MHz	
Audio Output Voltage	V _{OUT}	V _{IN} Between 50 μV and 50 mV, 455 kHz, 80% modulated by 100 Hz, V _{CC} = 6V					
			LM172/272	0.4	0.8		V, p-p
			LM372	0.35	0.8		V, p-p
			V _{CC} = 15V				
		LM172/272	0.45	0.9		V, p-p	
		LM372	0.40	0.9		V, p-p	

input-output impedances

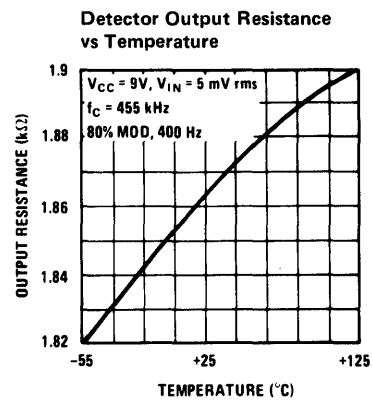
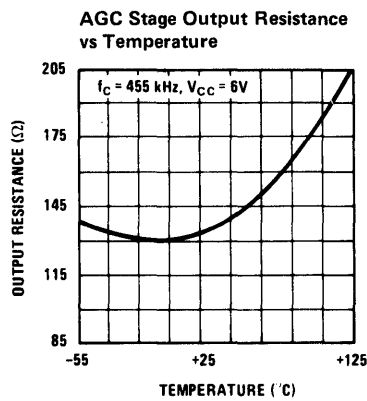
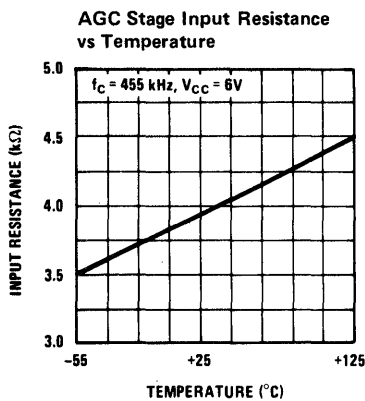

typical characteristics

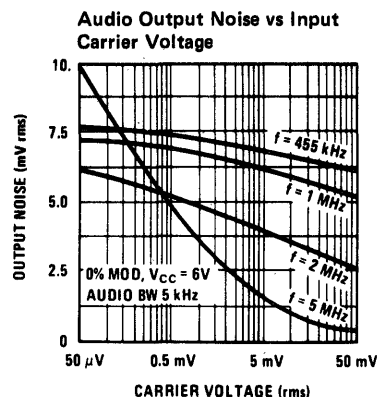
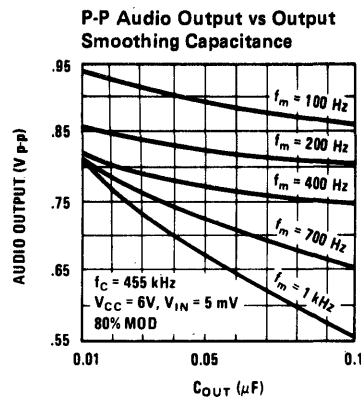
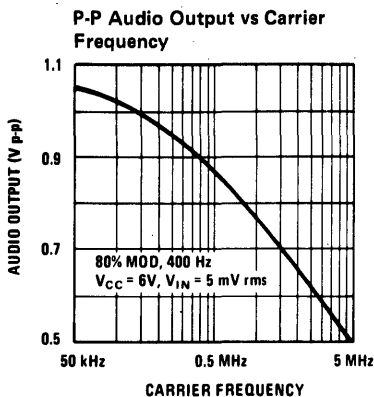
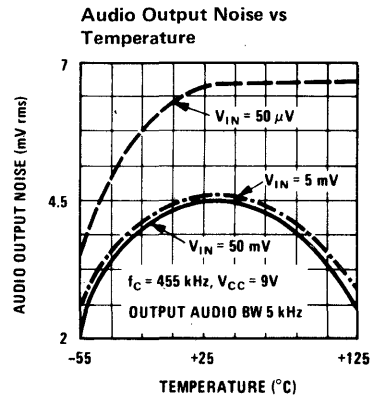
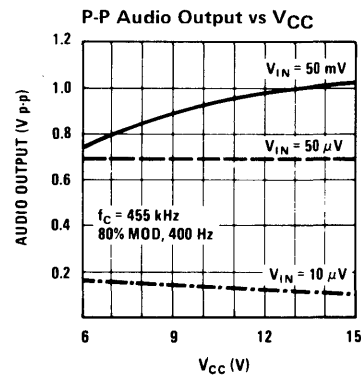
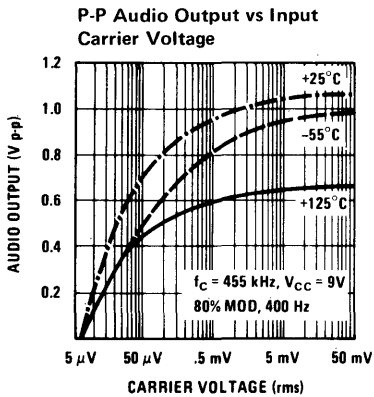
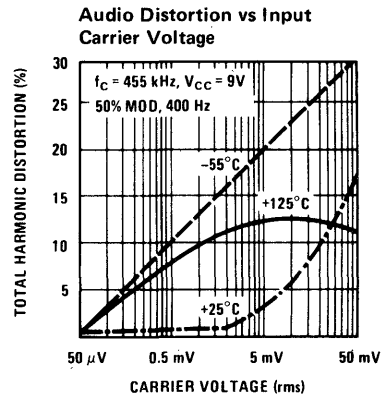
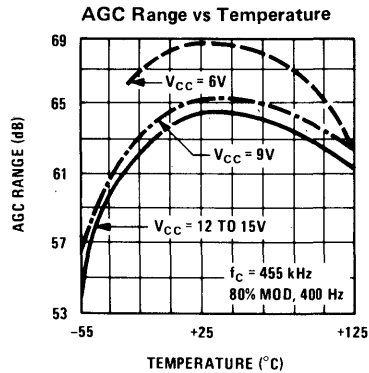
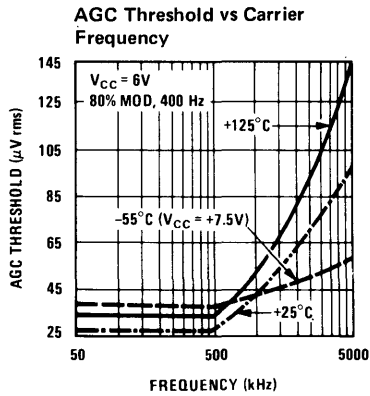
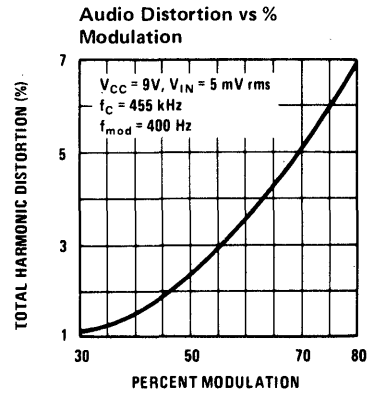
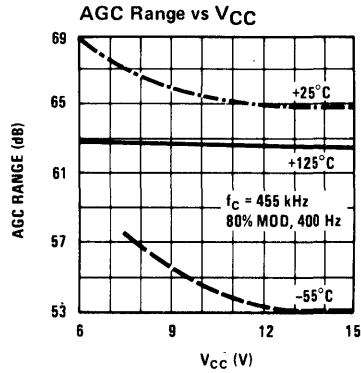
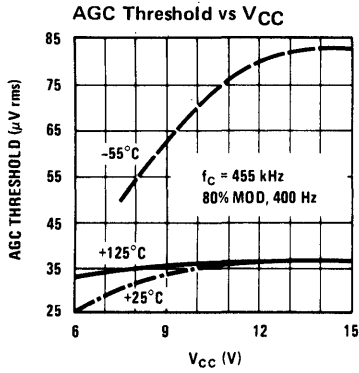

power supply characteristics

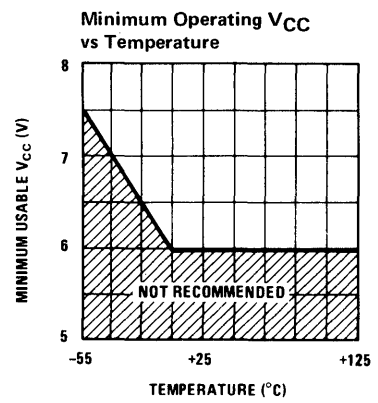
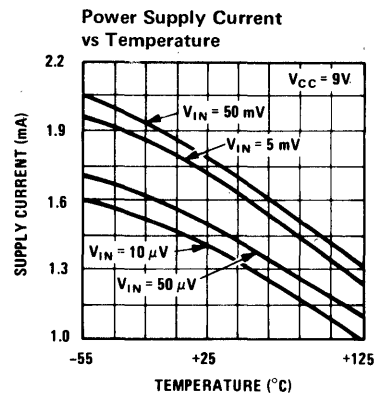
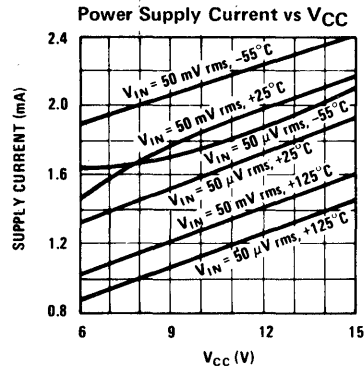
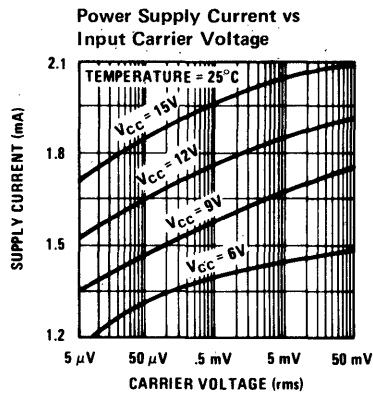



Communication Circuits

LM373

LM373 am/fm/ssb if strip general description

The LM373 is a broadband communications sub-system, capable of performing the diverse functions required in AM, FM or Single Sideband receivers and transmitters. Simple external connections convert the strip from one mode to another. Bandpass shaping may be performed by a single external filter, which may be crystal, ceramic, mechanical or LC, at frequencies from audio up to 15 MHz. The device features:

Connected for FM operation:

- Three emitter coupled limiting stages, quadrature detector.
- For wideband FM, a single LC tuned quadrature circuit gives 80 mV audio out for ± 75 kHz deviation at 10.7 MHz IF.
- Active network for precise dc balance of quadrature detector input

Connected for AM operation:

- Self contained AGC system, gain stages and active detector.
- AGC Range: 70 dB

- High gain; AGC operates down to $50 \mu V$ rms input

Connected for SSB operation:

- Self contained audio operated AGC system, gain stages, and double balanced product detector.
- Fast attack, slow release AGC operated by recovered audio peaks.
- Automatic active mixer balancing loop. Separate external DC control available for nulling of signal and local oscillator ports.

In addition, the versatile microcircuit may be used as a:

- Gated video amplifier with AGC
- Constant amplitude or amplitude modulated RF oscillator
- Balanced modulator
- Suppressed carrier signal generator
- Synchronous demodulating IF strip
- Receiver first IF strip, with balanced mixer output at the second IF.

schematic and connection diagrams

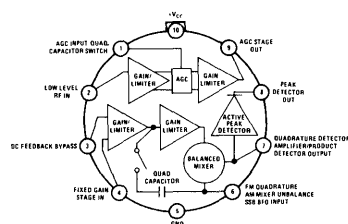
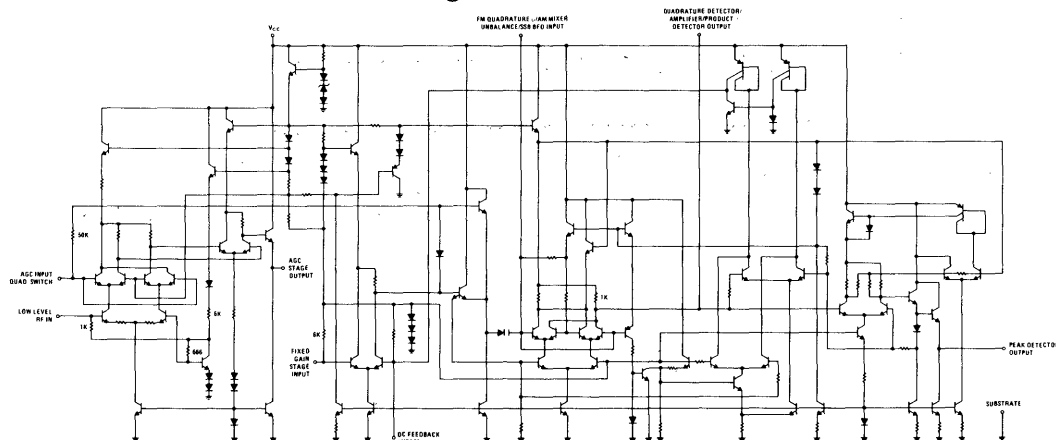

Top View

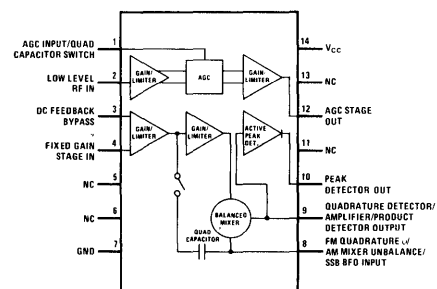

absolute maximum ratings

Supply Surge Voltage	24V
Supply Operating Voltage	18V
Storage Temperature	-65°C to +150°C
Operating Temperature	0°C to +70°C
RF Voltage into Pin 2	1.4V p-p
RF Voltage into Pin 4	1.4V p-p

electrical characteristics ($T_A = 25^\circ\text{C}$, $V_{CC} = +12\text{V}$ unless otherwise noted)

PARAMETER	SYMBOL	CONDITIONS	MIN	TYP	MAX	UNITS
DC Characteristics						
Power Supply Drain Current	I_{ps}	5.1K from pin 6 to gnd.		14	20	mA
Pin 9 DC Output	V_9	Pin 1 gnd.		4.75		V
Pin 9 DC Shift	ΔV_9	Pin 1 from 0 to +5V		0.1	0.2	V
Pin 7 DC Output	V_7	Pin 6 open		3.80		V
Pin 7 DC Output	V_7	10K from pin 6 to gnd.		3.80		V
Peak Detector DC Output	V_8	No RF at Pin 7		3.80		V
AGC Input Current	I_1	$V_1 = 5\text{V}$		50	110	μA
AM Characteristics (See Fig. 1 test circuit)						
AGC Threshold	V_{th}	$f_o = 455\text{ kHz}$ $f_o = 10.7\text{ MHz}$		80 100		$\mu\text{V rms}$ $\mu\text{V rms}$
AGC Figure of Merit		Input change for 10 dB output decrease referred to 100 mV in. $f_o = 455\text{ kHz}$ $f_o = 10.7\text{ MHz}$		60 58		dB dB
Usable Range		$f_o = 455\text{ kHz}$, SNR = 6 dB to overload		80		dB
External Gain		$f_o = 455\text{ kHz}$		80		dB
Control Range		$f_o = 10.7\text{ MHz}$		70		dB
Audio Output	V_o	1 kHz, 70% Mod. $f_o = 455\text{ kHz}$ $f_o = 10.7\text{ MHz}$		120 120		mV rms mV rms
Audio Distortion	THD	1 kHz, 30% Mod. $f_o = 455\text{ kHz}$ $f_o = 10.7\text{ MHz}$		3% 5%		% %

electrical characteristics ($T_A = 25^\circ\text{C}$, $V_{CC} = +12\text{V}$ unless otherwise noted)						
PARAMETER	SYMBOL	CONDITIONS	MIN	TYP	MAX	UNITS
FM Characteristics ($f_o = 10.7\text{ MHz}$) (See Fig. 2 test circuit)						
Limiting Threshold	V_{th}			1500		$\mu\text{V rms}$
AM Rejection	AMRR	$V_{in} = 30\text{ mV rms}$		40		dB
Audio Output	V_o	1 kHz Mod. 75 kHz deviation		80		mV rms
Audio Distortion	THD	1 kHz Mod. 75 kHz deviation		1.5		%
SSB Characteristics (See Fig. 3 test circuit)						
AGC Threshold	V_{th}	$f_o = 455\text{ kHz}$		300		$\mu\text{V rms}$
AGC Figure of Merit		Input change for 10 dB output decrease referred to 100 mV in.		60		dB
Audio Output	$V_{o(p-p)}$	$f_o = 455\text{ kHz}$ $f_o - f_{inj} = 1\text{ kHz}$ $f_o = 455\text{ kHz}$		50		mV rms
Video Characteristics						
Voltage Gain, Pin 2–9	$A_{v_{2-9}}$	Pin 1 gnd	29.0	32.0		dB
–3 dB Bandwidth, Pin 2–9	Bw_{2-9}	Pin 1 gnd		30		MHz
Voltage Gain, Pin 4–7	$A_{v_{4-7}}$	10K from pin 6 to gnd	32	37		dB
–3 dB Bandwidth, Pin 4–7	Bw_{4-7}	10K from pin 6 to gnd		20		MHz
Input-Output Terminal Characteristics ($f_o = 10.7\text{ MHz}$, $V_{meas} < 20\text{ mV}$, $V_{CC} = 12\text{V}$)						
Pin 2 Input Resistance	R_2			1.3		$k\Omega$
Pin 2 Input Capacitance	C_2			3.0		pF
Pin 4 Input Resistance	R_4			5.8		$k\Omega$
Pin 4 Input Capacitance	C_4			4.5		pF
Pin 9 Output Resistance	R_9			85		Ω
Pin 7 Output Resistance	R_7			1.0		$k\Omega$
Pin 7 Output Capacitance	C_7			6.0		pF
Pin 6 Input Resistance	R_6			3.0		$k\Omega$
Pin 6 Input Capacitance	C_6			7.7		pF

test circuits

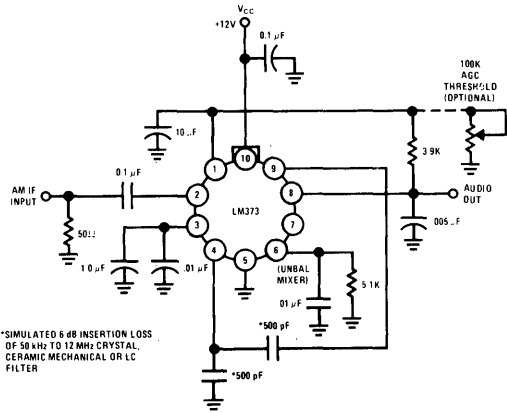

FIGURE 1. AM IF Strip

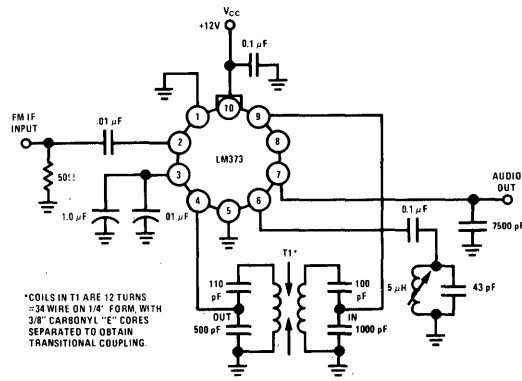

FIGURE 2. FM IF Strip

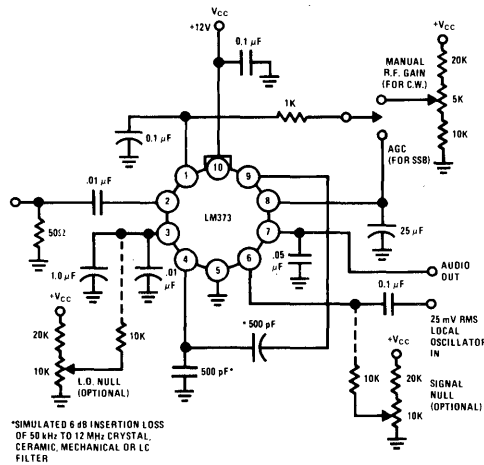

FIGURE 3. SSB/CW IF Strip

application precautions

As with any high gain, wideband subsystem, good RF layout practice is needed to maintain stability. External component leads should be short. High quality grounds, such as to adjacent copperclad board, should be used. Supply bypassing is recommended. It is especially important that bypassing

of the DC bypass point, pin 3, be effective at all frequencies. This is assured by a small, low inductance RF bypass, for high frequencies, in parallel with a larger Tantalum capacitor, for audio frequencies, from pin 3 to ground.



Communication Circuits

LM703L

LM703L low power drain rf/if amplifier

general description

The LM703L is a monolithic RF-IF amplifier, having an efficient DC biasing system, reducing demands upon power supply and decoupling elements. Its low internal feedback guarantees a high stability-limited gain. In addition, the device features:

Power Consumption	84 mw (max.)
Forward Transadmittance	33 mmhos
Input Conductance	0.35 mmhos
Output Conductance	0.03 mmhos
Peak-to-Peak Output Current	5.0 mA

Applications include limiting and nonlimiting amplifiers, mixers, and RF oscillators. The LM703L is specifically characterized for operation in consumer applications such as TV sound IF, FM-IF limiter amplifier, and Chroma reference oscillator for color TV.

schematic and connection diagrams

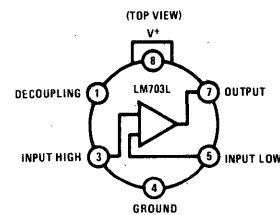
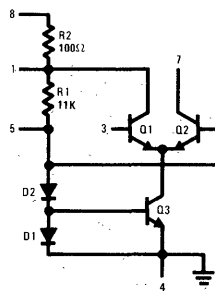

NOTE: Pin 4 connected to c.s.s.

typical applications

100 MHz Narrow Band Amplifier

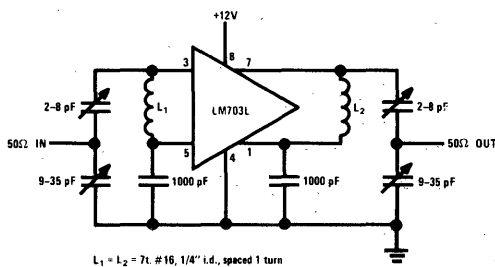

RC Coupled Video Amplifier

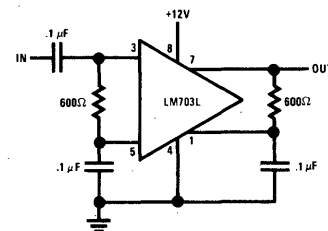

Four Stage 10.7 MHz FM-IF Amplifier

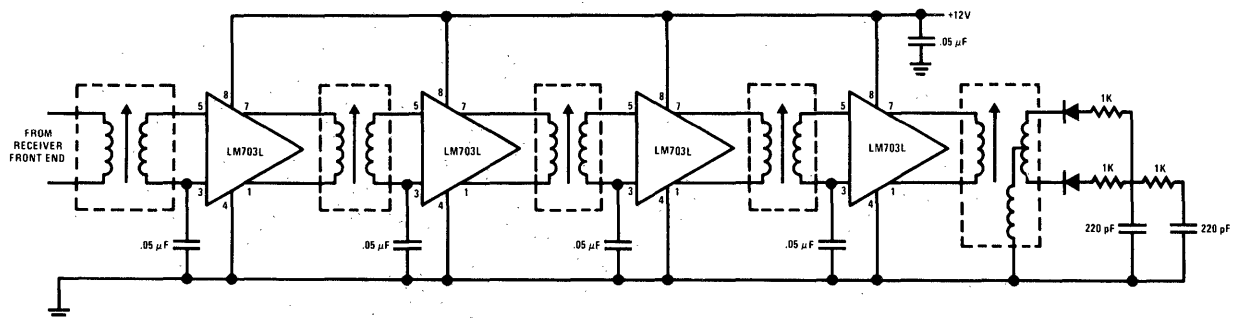

absolute maximum ratings

Supply Voltage	20V
Output Collector Voltage	24V
Voltage Between Input Terminals	±5.0V
Internal Power Dissipation	200 mW

Operating Temperature Range	0°C to 70°C
Storage Temperature Range	-65°C to 150°C
Lead Temperature (soldering – 60 seconds)	300°C

electrical characteristics (Note 1)

PARAMETER	CONDITIONS	MIN	TYP	MAX	UNIT
Power Consumption	$e_{in} = 0$		71	84	mW
Quiescent Output Current	$e_{in} = 0$	1.5	2.5	3.3	mA
Peak-to-Peak Output Current	$e_{in} = 400$ mV rms, $f = 10.7$ MHz	3.0	5.0		mA
Output Saturation Voltage				1.7	V
Forward Transadmittance	$e_{in} = 10$ mV rms, $f \leq 10.7$ MHz	24.0	33.0		mmho
Reverse Transadmittance	$e_{in} = 10$ mV rms, $f \leq 10.7$ MHz		0.002		mmho
Input Conductance	$e_{in} < 10$ mV rms, $f \leq 10.7$ MHz		0.35	1.0	mmho
Input Capacitance	$e_{in} < 10$ mV rms, $f \leq 10.7$ MHz		9.0	12.5	pF
Output Capacitance	$f \leq 10.7$ MHz		2.6	4.0	pF
Output Conductance	$f \leq 10.7$ MHz		0.03	0.05	mmho
Noise Figure	$R_S = 500\Omega$, $f = 10.7$ MHz $R_S = 500\Omega$, $f = 100$ MHz		6.0 8.0		dB dB
Maximum Stable Gain	$f = 100$ MHz		28.0		dB

Note 1: These specifications apply for $T_A = 25^\circ\text{C}$, $V^+ = 12\text{V}$ unless otherwise specified.

typical performance characteristics

Power Consumption as a Function of Supply Voltage

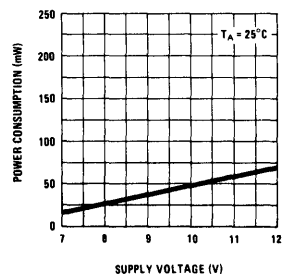

Output Current as a Function of Ambient Temperature

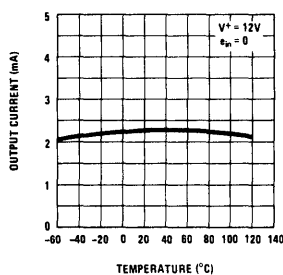

Power Consumption as a Function of Ambient Temperature

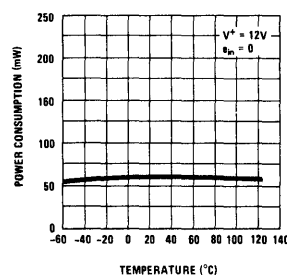

Forward Transadmittance as a Function of Ambient Temperature

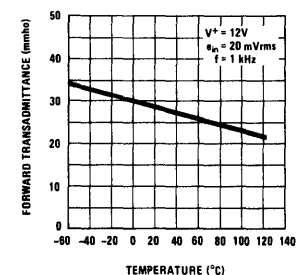

Note: For additional performance curves, and packaging, see LM703/C/E data sheet.



Sense Amplifiers

LM5520/LM7520 series dual core memory sense amplifiers general description

The devices in this series of dual core sense amplifiers convert bipolar millivolt-level memory sense signals to saturated logic levels. The design employs a common reference input which allows the input threshold voltage level of both amplifiers to be adjusted. Separate strobe inputs provide time discrimination for each channel. Logic inputs and outputs are DTL/TTL compatible. All devices of the series have identical preamplifier configurations, while various logic connections are provided to suit the specific application.

The LM5520/LM7520 has output latch capability and provides sense, strobe, and memory function for two sense lines. The LM5522/LM7522 contains a single open collector output which may be used to expand the number of inputs of the LM5520/LM7520, or to drive an external Memory Data Register (MDR). Intended for small memories, the two channels of the LM5524/LM7524 are independent with two separate outputs. The LM5534/LM7534 is similar to the LM5524/LM7524 but has uncommitted, wire-ORable outputs. The LM5528/LM7528 has the same logic configuration of the LM5524/LM7524 and in addition provides separate low impedance Test Points at each preamplifier output. A similar device having uncommitted, wire-ORable outputs is the LM5538/LM7538.

All critical characteristics are guaranteed for operation within normal system parameter variations of temperature, supply voltages, and output loading.

Features of the series include:

- High speed
- Guaranteed narrow threshold uncertainty including temperature and supply voltage variation
- Adjustable input threshold voltage
- Fast overload recovery times
- Two amplifiers per package
- Molded or cavity dual-in-line package
- Six logic configurations

The part number ending with an even number (e.g., LM5520) designates a tighter guaranteed input threshold uncertainty than the subsequent odd number ending (e.g., LM5521). The remaining specifications for the two are identical. All devices meet or exceed the specifications for the corresponding device (where applicable) in the SN5520/SN7520 series and are pin-for-pin replacements.

absolute maximum ratings

Supply Voltage	±7V
Differential or Reference Input Voltage	±5V
Logic Input Voltage	+5.5V
Operating Temperature Range	
LM55XX	-55°C to +125°C
LM75XX	0°C to +70°C
Storage Temperature Range	-65°C to +150°C

typical application

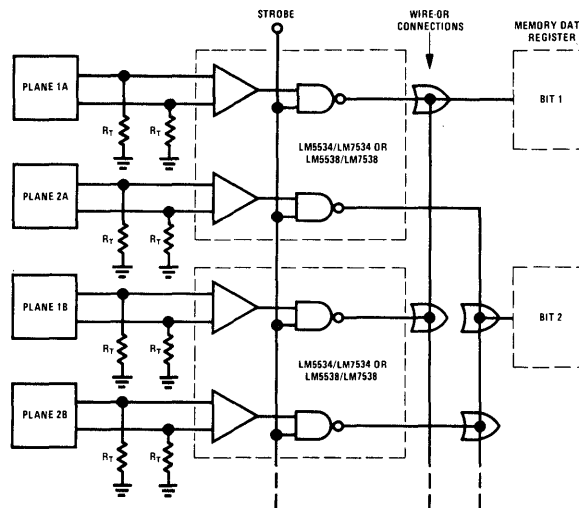

Expanded Small Memory System

LM5520/LM7520 and LM5521/LM7521 electrical characteristics

LM5520/LM5521: The following apply for $-55^{\circ}\text{C} \leq T_A \leq 125^{\circ}\text{C}$, $V^+ = 5\text{V} \pm 5\%$, $V^- = -5\text{V} \pm 5\%$. (Note 1)

PARAMETER	MIN	TYP	MAX	UNIT	TEST CONDITIONS (EACH AMPLIFIER)							LOGIC OUTPUT (NOTE 3)	SUPPLY VOLT.	COMMENTS
					DIFF. INPUT	REF. INPUT	STROBE INPUT	GATE Q INPUT	GATE \bar{Q} INPUT					
Differential Input Threshold Voltage (V_{TH}) (Note 2)	10(8)	15		mV	$\pm V_{TH}$	15 mV	+5V	+5V			+16 mA(Q)	$\pm 5\text{V} \pm 5\%$	Logic Output <0.4V	
		15	20(22)	mV	$\pm V_{TH}$	15 mV	+5V	+5V			-400 μA (Q)	$\pm 5\text{V} \pm 5\%$	Logic Output >2.4V	
	35(33)	40		mV	$\pm V_{TH}$	40 mV	+5V	+5V			+16 mA(Q)	$\pm 5\text{V} \pm 5\%$	Logic Output <0.4V	
		40	45(47)	mV	$\pm V_{TH}$	40 mV	+5V	+5V			-400 μA (Q)	$\pm 5\text{V} \pm 5\%$	Logic Output >2.4V	
Differential & Reference Input Bias Current		30	100	μA	0V	0V	+5.25V	+5.25V	+5.25V			$\pm 5.25\text{V}$		

LM7520/LM7521: The following apply for $0^{\circ}\text{C} \leq T_A \leq 70^{\circ}\text{C}$, $V^+ = 5\text{V} \pm 5\%$, $V^- = -5\text{V} \pm 5\%$

Differential Input Threshold Voltage (V_{TH}) (Note 4)	11(8)	15		mV	$\pm V_{TH}$	15 mV	+5V	+5V			+16 mA(Q)	$\pm 5\text{V} \pm 5\%$	Logic Output <0.4V
		15	19(22)	mV	$\pm V_{TH}$	15 mV	+5V	+5V			-400 μA (Q)	$\pm 5\text{V} \pm 5\%$	Logic Output >2.4V
	36(33)	40		mV	$\pm V_{TH}$	40 mV	+5V	+5V			+16 mA(Q)	$\pm 5\text{V} \pm 5\%$	Logic Output <0.4V
		40	44(47)	mV	$\pm V_{TH}$	40 mV	+5V	+5V			-400 μA (Q)	$\pm 5\text{V} \pm 5\%$	Logic Output >2.4V
Differential & Reference Input Bias Current		30	75	μA	0V	0V	+5.25V	+5.25V	+5.25V			$\pm 5.25\text{V}$	

LM5520/LM5521: The following apply for $-55^{\circ}\text{C} \leq T_A \leq 125^{\circ}\text{C}$, $V^+ = 5\text{V} \pm 5\%$, $V^- = -5\text{V} \pm 5\%$
LM7520/LM7521: The following apply for $0^{\circ}\text{C} \leq T_A \leq 70^{\circ}\text{C}$, $V^+ = 5\text{V} \pm 5\%$, $V^- = -5\text{V} \pm 5\%$

Differential Input Offset Current		0.5		μA	0V	0V	+5.25V	+5.25V	+5.25V			$\pm 5.25\text{V}$	
Logic "1" Input Voltage (Strobes)	2			V	40 mV	20 mV	+2V	+4.75V			-400 μA (Q)	$\pm 4.75\text{V}$	Logic Output >2.4V
	2			V	40 mV	20 mV	0V	+2V			+16 mA(Q)	$\pm 4.75\text{V}$	Logic Output <0.4V
	2			V	40 mV	20 mV	0V	0V	+2V		+16 mA(\bar{Q})	$\pm 4.75\text{V}$	Logic Output <0.4V
Logic "0" Input Voltage (Strobes)			0.8	V	40 mV	20 mV	+0.8V	+4.75V			+16 mA(Q)	$\pm 4.75\text{V}$	Logic Output <0.4V
			0.8	V	40 mV	20 mV	0V	+0.8V			-400 μA (Q)	$\pm 4.75\text{V}$	Logic Output >2.4V
			0.8	V	40 mV	20 mV	0V	0V	+0.8V		-400 μA (\bar{Q})	$\pm 4.75\text{V}$	Logic Output >2.4V
Logic "0" Input Current	-1	-1.6		mA	40 mV	20 mV	+0.4V	+0.4V	+0.4V			$\pm 5.25\text{V}$	Each Input
Logic "1" Input Current (Strobe & Gate Q)	5	40		μA	0V	20 mV	+2.4V	+5.25V	+2.4V			$\pm 5.25\text{V}$	Each Input
	.02	1		mA	0V	20 mV	+5.25V	+5.25V	+5.25V			$\pm 5.25\text{V}$	Each Input
	5	40		μA	40 mV	20 mV	+5.25V	+5.25V	+2.4V			$\pm 5.25\text{V}$	
	.02	1		mA	40 mV	20 mV	+5.25V	+5.25V				$\pm 5.25\text{V}$	
Logic "1" Output Voltage (Strobe)	2.4	3.9		V	40 mV	20 mV	+2.0V	+5.25V			-400 μA (Q)	$\pm 4.75\text{V}$	
	2.4	3.9		V	40 mV	20 mV	0V	+0.8V			-400 μA (Q)	$\pm 4.75\text{V}$	
	2.4	3.9		V	40 mV	20 mV	+4.75V	0V	+0.8V		-400 μA (\bar{Q})	$\pm 4.75\text{V}$	
Logic "0" Output Voltage (Strobe)		0.25	0.40	V	40 mV	20 mV	+0.8V	+4.75V			+16 mA(Q)	$\pm 4.75\text{V}$	
		0.25	0.40	V	0V	20 mV	0V	+2V			+16 mA(Q)	$\pm 4.75\text{V}$	
		0.25	0.40	V	0V	20 mV	0V	0V	+2V		+16 mA(\bar{Q})	$\pm 4.75\text{V}$	
Q Output Short Circuit Current	-3	-4	-5	mA	0V	20 mV	0V	0V			0 V(Q)	$\pm 5.25\text{V}$	
\bar{Q} Output Short Circuit Current	-2.1	-2.8	-3.5	mA	0V	20 mV	0V	0V	0V		0 V(\bar{Q})	$\pm 5.25\text{V}$	
V+ Supply Current		21	35	mA	0V	20 mV	0V	0V	0V			$\pm 5.25\text{V}$	
V- Supply Current		-13	-18	mA	0V	20 mV	0V	0V	0V			$\pm 5.25\text{V}$	

Note 1: For $0^{\circ}\text{C} \leq T_A \leq 70^{\circ}\text{C}$ operation, electrical characteristics for LM5520 and LM5521 are guaranteed the same as LM7520 and LM7521, respectively.

Note 2: Limits in parentheses pertain to LM5521, other limits pertain to LM5520.

Note 3: Q or \bar{Q} in parentheses indicate Q or \bar{Q} logic output, respectively.

Note 4: Limits in parentheses pertain to LM7521, other limits pertain to LM7520.

Note 5: Positive current is defined as current into the referenced pin.

Note 6: Pin 1 to have ≥ 100 pF capacitor connected to ground.

LM5520/LM7520 and LM5521/LM7521 electrical characteristics

LM5520/LM5521 and LM7520/LM7521: The following apply for $T_A = 25^\circ\text{C}$, $V^+ = 5\text{V}$, $V^- = -5\text{V}$

PARAMETER	MIN	TYP	MAX	UNIT	TEST CONDITIONS				
					DIFF. INPUT	REF. INPUT	STROBE AND GATE INPUTS	Q LOGIC OUTPUT	AC TEST CIRCUIT
AC Common-Mode Input Firing Voltage		±2.5		V	PULSE	20 mV	+5V	SCOPE	
Propagation Delays									
Differential Input to Logical "1" Q Output		20	40	ns		20 mV			1
Differential Input to Logical "0" Q Output		28		ns		20 mV			1
Differential Input to Logical "1" \bar{Q} Output		36		ns		20 mV			1
Differential Input to Logical "0" \bar{Q} Output		28	55	ns		20 mV			1
Strobe Input to Logical "1" Q Output		10	30	ns		20 mV			1
Strobe Input to Logical "0" Q Output		20		ns		20 mV			1
Strobe Input to Logical "1" \bar{Q} Output		33		ns		20 mV			1
Strobe Input to Logical "0" \bar{Q} Output		16	55	ns		20 mV			1
Gate Q Input to Logical "1" Q Output		12	20	ns		20 mV			2
Gate Q Input to Logical "0" Q Output		6		ns		20 mV			2
Gate Q Input to Logical "1" \bar{Q} Output		17		ns		20 mV			2
Gate Q Input to Logical "0" \bar{Q} Output		19	30	ns		20 mV			2
Gate \bar{Q} Input to Logical "1" \bar{Q} Output		12		ns		20 mV			2
Gate \bar{Q} Input to Logical "0" \bar{Q} Output		6	20	ns		20 mV			2
Diff. Input Overload Recovery Time		10		ns					
Common-Mode Input Overload Recovery Time		5		ns					
Min. Cycle Time		200		ns					

LM5520/LM7520 and LM5521/LM7521

schematic diagram

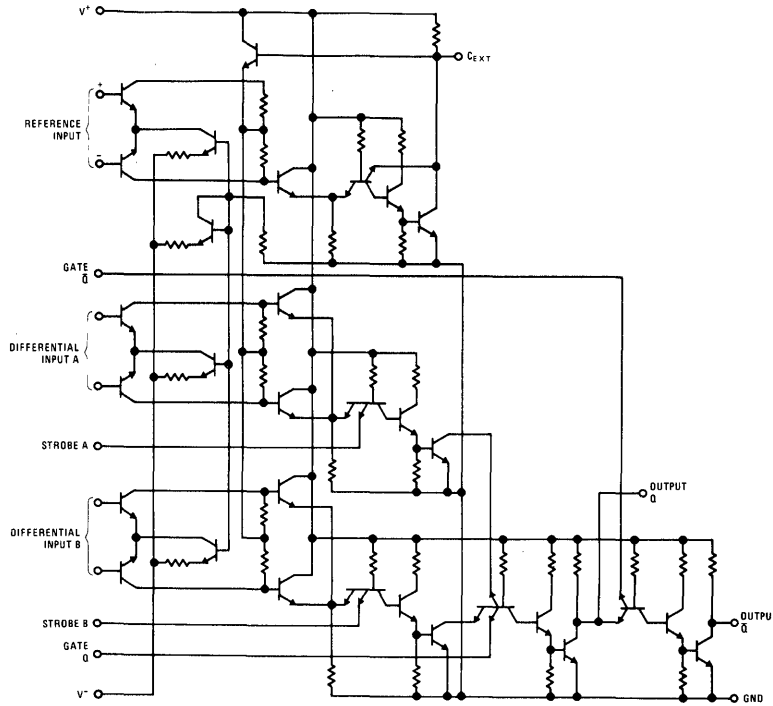

connection diagram

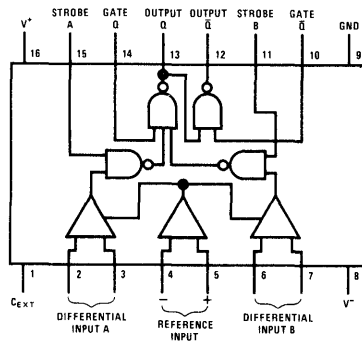

LM5520/LM7520 and LM5521/LM7521 AC test circuit (1)

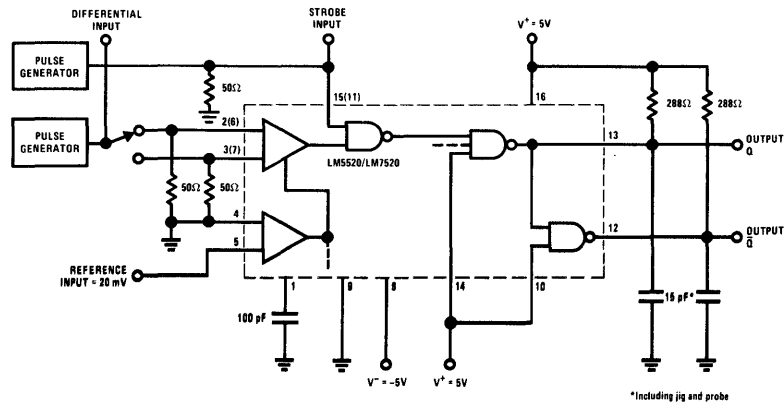

voltage waveforms (1)

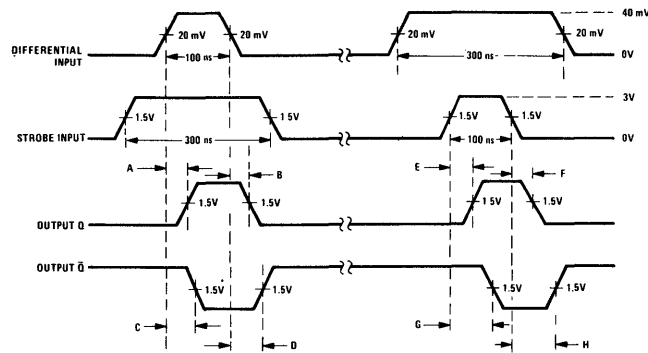

1. Pulse generator characteristics:
 $Z_{OUT} = 50\Omega$, $t_r = t_f = 15 \pm 5$ ns, PRR = 1 MHz
2. Propagation delays:
 A = Differential input to logical "1" output Q
 B = Differential input to logical "0" output Q
 C = Differential input to logical "0" output Q-bar
 D = Differential input to logical "1" output Q-bar
 E = Strobe input to logical "1" output Q
 F = Strobe input to logical "0" output Q
 G = Strobe input to logical "0" output Q-bar
 H = Strobe input to logical "1" output Q-bar

AC test circuit (2)

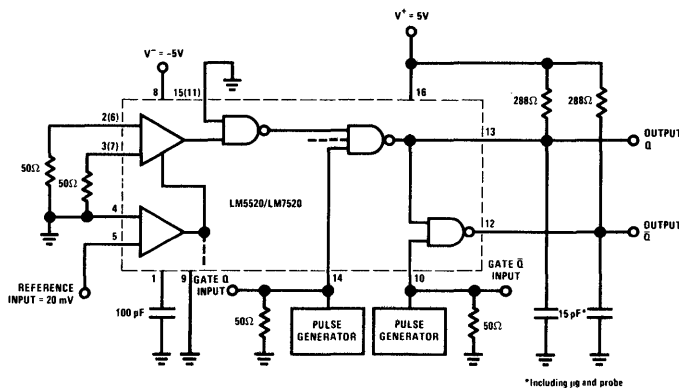

voltage waveforms (2)

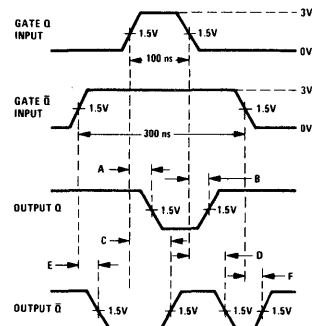

1. Pulse generator characteristics:
 $Z_{OUT} = 50\Omega$, $t_r = t_f = 15 \pm 5$ ns, PRR = 1 MHz
2. Propagation delays:
 A = Gate Q input to logical "0" output Q
 B = Gate Q input to logical "1" output Q
 C = Gate Q input to logical "1" output Q-bar
 D = Gate Q input to logical "0" output Q-bar
 E = Gate Q-bar input to logical "0" output Q
 F = Gate Q-bar input to logical "1" output Q

LM5522/LM7522 and LM5523/LM7523 electrical characteristics

LM5522/LM5523: The following apply for $-55^{\circ}\text{C} \leq T_A \leq 125^{\circ}\text{C}$, $V^+ = 5\text{V} \pm 5\%$, $V^- = -5\text{V} \pm 5\%$ (Note 1)

PARAMETER	MIN	TYP	MAX	UNIT	TEST CONDITIONS (EACH AMPLIFIER)						COMMENTS
					DIFF. INPUT	REF. INPUT	STROBE INPUT	GATE INPUT	LOGIC OUTPUT	SUPPLY VOLT.	
Differential Input Threshold Voltage (V_{TH}) (Note 2)	10(8)	15	20(22)	mV	$\pm V_{TH}$	15 mV	+5V	+5V	-400 μA	$\pm 5\text{V} \pm 5\%$	Logic Output $> 2.4\text{V}$
		15		mV	$\pm V_{TH}$	15 mV	+5V	+5V	+16 mA	$\pm 5\text{V} \pm 5\%$	Logic Output $< 0.4\text{V}$
	35(33)	40		mV	$\pm V_{TH}$	40 mV	+5V	+5V	-400 μA	$\pm 5\text{V} \pm 5\%$	Logic Output $> 2.4\text{V}$
		40	45(47)	mV	$\pm V_{TH}$	40 mV	+5V	+5V	+16 mA	$\pm 5\text{V} \pm 5\%$	Logic Output $< 0.4\text{V}$
Differential & Reference Input Bias Current		30	100	μA	0V	0V	+5.25V	+5.25V		$\pm 5.25\text{V}$	

LM7522/LM7523: The following apply for $0^{\circ}\text{C} \leq T_A \leq 70^{\circ}\text{C}$, $V^+ = 5\text{V} \pm 5\%$, $V^- = -5\text{V} \pm 5\%$

Differential Input Threshold Voltage (V_{TH}) (Note 3)	11(8)	15	19(22)	mV	$\pm V_{TH}$	15 mV	+5V	+5V	-400 μA	$\pm 5\text{V} \pm 5\%$	Logic Output $> 2.4\text{V}$
		15		mV	$\pm V_{TH}$	15 mV	+5V	+5V	+16 mA	$\pm 5\text{V} \pm 5\%$	Logic Output $< 0.4\text{V}$
	36(33)	40		mV	$\pm V_{TH}$	40 mV	+5V	+5V	-400 μA	$\pm 5\text{V} \pm 5\%$	Logic Output $> 2.4\text{V}$
		40	44(47)	mV	$\pm V_{TH}$	40 mV	+5V	+5V	+16 mA	$\pm 5\text{V} \pm 5\%$	Logic Output $< 0.4\text{V}$
Differential & Reference Input Bias Current		30	75	μA	0V	0V	+5.25V	+5.25V		$\pm 5.25\text{V}$	

LM5522/LM5523: The following apply for $-55^{\circ}\text{C} \leq T_A \leq 125^{\circ}\text{C}$, $V^+ = 5\text{V} \pm 5\%$, $V^- = -5\text{V} \pm 5\%$

LM7522/LM7523: The following apply for $0^{\circ}\text{C} \leq T_A \leq 70^{\circ}\text{C}$, $V^+ = 5\text{V} \pm 5\%$, $V^- = -5\text{V} \pm 5\%$

Diff. Input Offset Current		0.5		μA	0V	0V	+5.25V	+5.25V		$\pm 5.25\text{V}$	
Logic "1" Input Voltage (Strobes) (Gate)	2			V	40 mV	20 mV	+2V	+4.75V	+16 mA	$\pm 4.75\text{V}$	Logic Output $< 0.4\text{V}$
	2			V	40 mV	20 mV	0V	+2V	-400 μA	$\pm 4.75\text{V}$	Logic Output $> 2.4\text{V}$
Logic "0" Input Voltage (Strobes) (Gate)			0.8	V	40 mV	20 mV	+0.8V	+4.75V	-400 μA	$\pm 4.75\text{V}$	Logic Output $> 2.4\text{V}$
			0.8	V	40 mV	20 mV	0V	+0.8V	+16 mA	$\pm 4.75\text{V}$	Logic Output $< 0.4\text{V}$
Logic "0" Input Current		-1	-1.6	mA	40 mV	20 mV	+0.4V	+0.4V		$\pm 5.25\text{V}$	Each Input
Logic "1" Input Current (Strobes) (Gate)			40	μA	0V	20 mV	+2.4V	+5.25V		$\pm 5.25\text{V}$	
			1	mA	0V	20 mV	+5.25V	+5.25V		$\pm 5.25\text{V}$	
			40	μA	40 mV	20 mV	+5.25V	+2.4V		$\pm 5.25\text{V}$	
			1	mA	40 mV	20 mV	+5.25V	+5.25V		$\pm 5.25\text{V}$	
Logic "1" Output Voltage	2.4	3.9		V	40 mV	20 mV	+0.8V	+2V	-400 μA	$\pm 4.75\text{V}$	
Logic "0" Output Voltage (Strobes) (Gate)		0.25	0.40	V	40 mV	20 mV	+2V	+4.75V	+16 mA	$\pm 4.75\text{V}$	Tie Pins 10 and 12
		0.25	0.40	V	40 mV	20 mV	0V	+0.8V	+16 mA	$\pm 4.75\text{V}$	Tie Pins 10 and 12
Output Short Circuit Current	-2.1	-2.8	-3.5	mA	40 mV	20 mV	0V	+5.25V	0V	$\pm 5.25\text{V}$	Tie Pins 10 and 12
Output Leakage Current		0.01	250	μA	0V	20 mV	0V	+2V	+5.25V	$\pm 4.75\text{V}$	
V^+ Supply Current		23	36	mA	0V	20 mV	0V	0V		$\pm 5.25\text{V}$	
V^- Supply Current		-13	-18	mA	0V	20 mV	0V	0V		$\pm 5.25\text{V}$	

LM5522/LM5523 and LM7522/LM7523: The following apply for $T_A = 25^{\circ}\text{C}$, $V^+ = 5\text{V}$, $V^- = -5\text{V}$

AC Common Mode Input Firing Voltage		± 2.5		V	PULSE	20 mV	+5V	+5V	SCOPE		
Propagation Delays: Differential Input to Logical "1" Output		26		ns		20 mV					AC Test Circuit
Differential Input to Logical "0" Output		21	45	ns		20 mV					AC Test Circuit
Strobe Input to Logical "1" Output		22		ns		20 mV					AC Test Circuit
Strobe Input to Logical "0" Output		12	40	ns		20 mV					AC Test Circuit
Gate Input to Logical "1" Output		4		ns		20 mV					AC Test Circuit
Gate Input to Logical "0" Output		15	25	ns		20 mV					AC Test Circuit
Differential Input Overload Recovery Time		10		ns							
Common Mode Input Overload Recovery Time		5		ns							
Min. Cycle Time		200		ns							

Note 1: For $0^{\circ}\text{C} \leq T_A \leq 70^{\circ}\text{C}$ operation, electrical characteristics for LM5522 and LM5523 are guaranteed the same as LM7522 and LM7523, respectively.

Note 2: Limits in parentheses pertain to LM5523, other limits pertain to LM5522.

Note 3: Limits in parentheses pertain to LM7523, other limits pertain to LM7522.

Note 4: Positive current is defined as current into the referenced pin.

Note 5: Pin 1 to have $\geq 100\text{ pF}$ capacitor connected to ground.

LM5522/LM7522 and LM5523/LM7523

schematic diagram

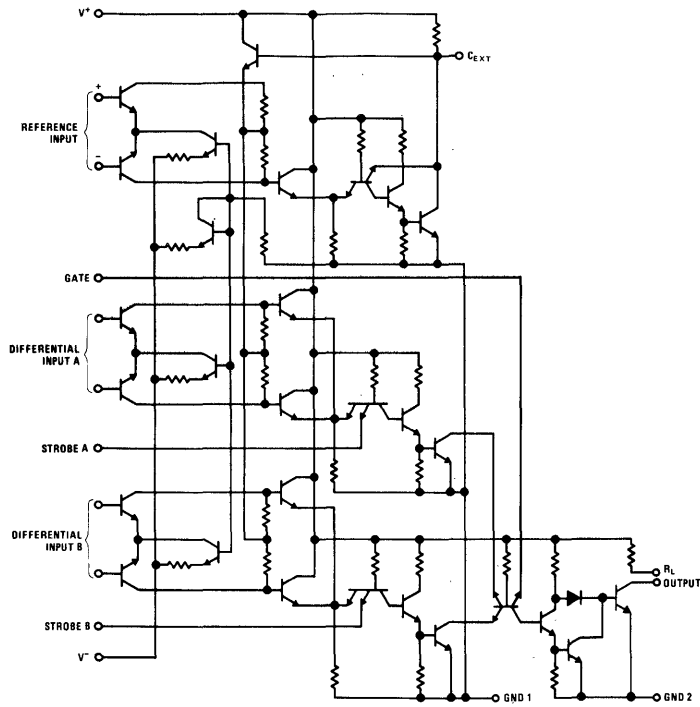

connection diagram

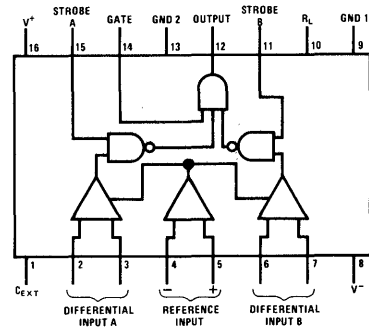

AC test circuit

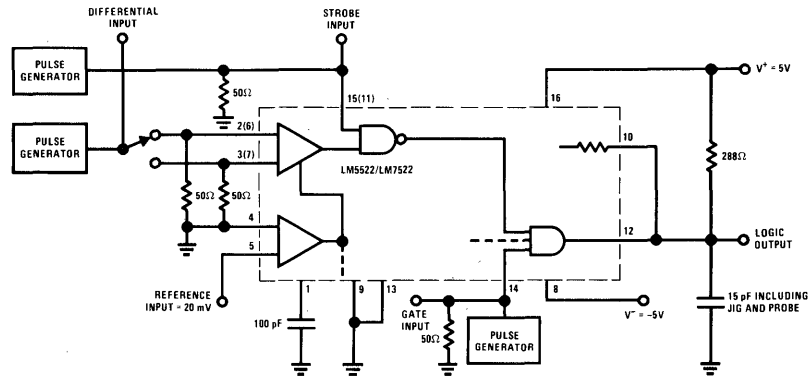

voltage waveforms

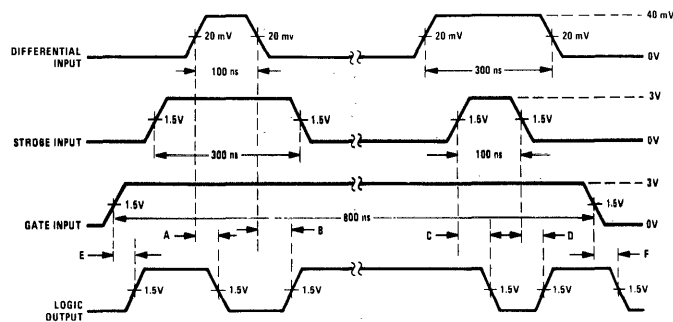

- One strobe is grounded when the other side is being tested
- Pulse generator characteristic:
 $Z_{OUT} = 50\Omega$, $t_r = t_f = 18.5\text{ ns}$, $PRR = 1\text{ MHz}$
- Propagation delays:
 A = Differential input to logical "0" output
 B = Differential input to logical "1" output
 C = Strobe input to logical "0" output
 D = Strobe input to logical "1" output
 E = Gate input to logical "1" output
 F = Gate input to logical "0" output

LM5524/LM7524 and LM5525/LM7525 electrical characteristics

LM5524/LM5525: The following apply for $-55^{\circ}\text{C} \leq T_A \leq 125^{\circ}\text{C}$, $V^+ = 5\text{V} \pm 5\%$, $V^- = -5\text{V} \pm 5\%$. (Note 1)

PARAMETER	MIN	TYP	MAX	UNIT	TEST CONDITIONS (EACH AMPLIFIER)					COMMENTS
					DIFF. INPUT	REF. INPUT	STROBE INPUT	LOGIC OUTPUT	SUPPLY VOLT.	
Differential Input Threshold Voltage (V_{TH}) (Note 2)	10(8) 35(33)	15	20(22) 45(47)	mV	$\pm V_{TH}$	15 mV	+5V	+16 mA	$\pm 5\text{V} \pm 5\%$	Logic Output <0.4V Logic Output >2.4V Logic Output <0.4V Logic Output >2.4V
		15		mV	$\pm V_{TH}$	15 mV	+5V	-400 μA	$\pm 5\text{V} \pm 5\%$	
		40		mV	$\pm V_{TH}$	40 mV	+5V	+16 mA	$\pm 5\text{V} \pm 5\%$	
		40		mV	$\pm V_{TH}$	40 mV	+5V	-400 μA	$\pm 5\text{V} \pm 5\%$	
Differential & Reference Input Bias Current		30	100	μA	0V	0V	+5.25V		$\pm 5.25\text{V}$	

LM7524/LM7525: The following apply for $0^{\circ}\text{C} \leq T_A \leq 70^{\circ}\text{C}$, $V^+ = 5\text{V} \pm 5\%$, $V^- = -5\text{V} \pm 5\%$

Differential Input Threshold Voltage (V_{TH}) (Note 3)	11(8) 36(33)	15	19(22) 44(47)	mV	$\pm V_{TH}$	15 mV	+5V	+16 mA	$\pm 5\text{V} \pm 5\%$	Logic Output <0.4V Logic Output >2.4V Logic Output <0.4V Logic Output >2.4V
		15		mV	$\pm V_{TH}$	15 mV	+5V	-400 μA	$\pm 5\text{V} \pm 5\%$	
		40		mV	$\pm V_{TH}$	40 mV	+5V	+16 mA	$\pm 5\text{V} \pm 5\%$	
		40		mV	$\pm V_{TH}$	40 mV	+5V	-400 μA	$\pm 5\text{V} \pm 5\%$	
Differential & Reference Input Bias Current		30	75	μA	0V	0V	+5.25V		$\pm 5.25\text{V}$	

LM5524/LM5525: The following apply for $-55^{\circ}\text{C} \leq T_A \leq 125^{\circ}\text{C}$, $V^+ = 5\text{V} \pm 5\%$, $V^- = -5\text{V} \pm 5\%$

LM7524/LM7525: The following apply for $0^{\circ}\text{C} \leq T_A \leq 70^{\circ}\text{C}$, $V^+ = 5\text{V} \pm 5\%$, $V^- = -5\text{V} \pm 5\%$

Diff. Input Offset Current		0.5		μA	0V	0V	+5.25V		$\pm 5.25\text{V}$	
Logic "1" Input Voltage	2			V	40 mV	20 mV	+2V	-400 μA	$\pm 4.75\text{V}$	Logic Output >2.4V
Logic "0" Input Voltage			0.8	V	40 mV	20 mV	+0.8V	+16 mA	$\pm 4.75\text{V}$	Logic Output <0.4V
Logic "0" Input Current		-1	-1.6	mA	40 mV	20 mV	+0.4V		$\pm 5.25\text{V}$	
Logic "1" Input Current		5	40	μA	0V	20 mV	+2.4V		$\pm 5.25\text{V}$	
		0.02	1	mA	0V	20 mV	+5.25V		$\pm 5.25\text{V}$	
Logic "1" Output Voltage	2.4	3.9		V	40 mV	20 mV	+2.0V	-400 μA	$\pm 4.75\text{V}$	
Logic "0" Output Voltage		0.25	0.40	V	40 mV	20 mV	+0.8V	+16 mA	$\pm 4.75\text{V}$	
Output Short Circuit Current	-2.1	-2.8	-3.5	mA	40 mV	20 mV	+5.25V	0V	$\pm 5.25\text{V}$	
V^+ Supply Current		29	40	mA	0V	20 mV	0V		$\pm 5.25\text{V}$	
V^- Supply Current		-13	-18	mA	0V	20 mV	0V		$\pm 5.25\text{V}$	

LM5524/LM5525 and LM7524/LM7525: The following apply for $T_A = 25^{\circ}\text{C}$, $V^+ = 5\text{V}$, $V^- = -5\text{V}$

AC Common-Mode Input Firing Voltage		± 2.5		V	PULSE	20 mV	+5V	SCOPE		
Propagation Delays:										
Differential Input to Logical "1" Output		20	40	ns		20 mV				AC Test Circuit
Differential Input to Logical "0" Output		28		ns		20 mV				AC Test Circuit
Strobe Input to Logical "1" Output		10	30	ns		20 mV				AC Test Circuit
Strobe Input to Logical "0" Output		20		ns		20 mV				AC Test Circuit
Differential Input Overload Recovery Time		10		ns						
Common-Mode Input Overload Recovery Time		5		ns						
Min. Cycle Time		200		ns						

Note 1: For $0^{\circ}\text{C} \leq T_A \leq 70^{\circ}\text{C}$ operation, electrical characteristics for LM5524 and LM5525 are guaranteed the same as LM7524 and LM7525 respectively.

Note 2: Limits in parentheses pertain to LM5525, other limits pertain to LM5524.

Note 3: Limits in parentheses pertain to LM7525, other limits pertain to LM7524.

Note 4: Positive current is defined as current into the referenced pin.

Note 5: Pin 1 to have ≥ 100 pF capacitor connected to ground.

LM5524/LM7524 and LM5525/LM7525

schematic diagram

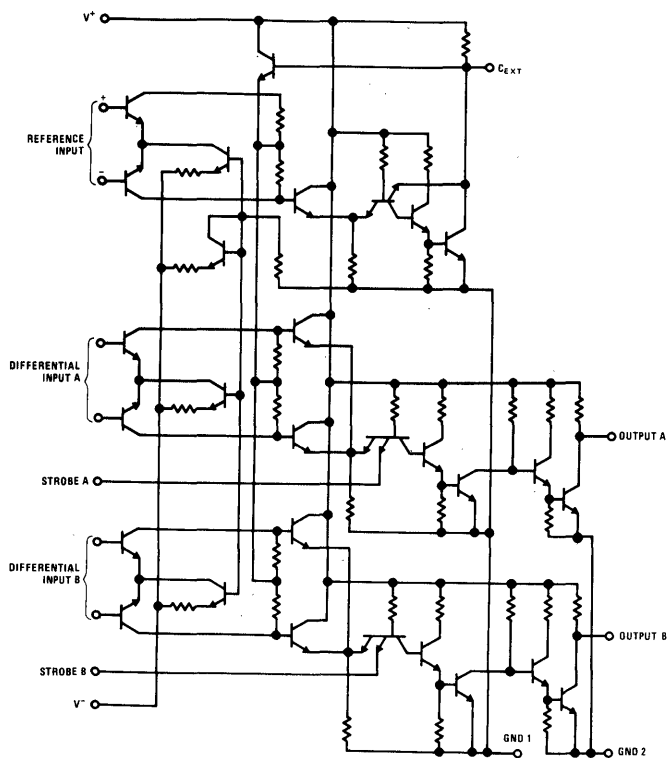

connection diagram

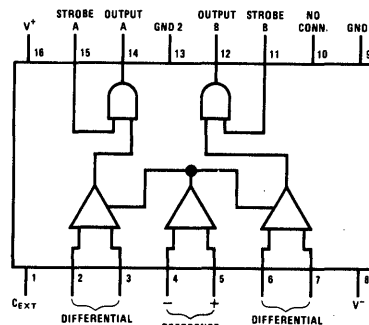

AC test circuit

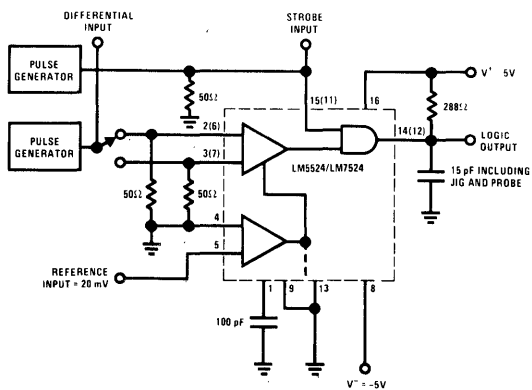

voltage waveforms

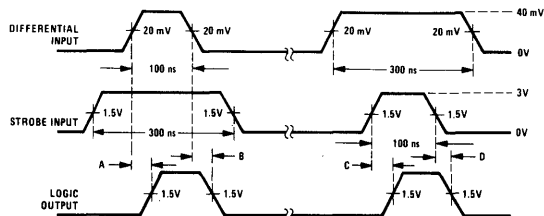

- Pulse generator characteristics:
 $Z_{OUT} = 50\Omega$, $t_r = 15 \pm 5$ ns, PRR = 1 MHz
- Propagation delays:
 A = Differential input to logical "1" output
 B = Differential input to logical "0" output
 C = Strobe input to logical "1" output
 D = Strobe input to logical "0" output

LM5528/LM7528 and LM5529/LM7529 electrical characteristics

LM5528/LM5529: The following apply for $-55^{\circ}\text{C} \leq T_A \leq 125^{\circ}\text{C}$, $V^+ = 5\text{V} \pm 5\%$, $V^- = -5\text{V} \pm 5\%$. (Note 1)

PARAMETER	MIN	TYP	MAX	UNIT	TEST CONDITIONS (EACH AMPLIFIER)					COMMENTS
					DIFF. INPUT	REF. INPUT	STROBE INPUT	LOGIC OUTPUT	SUPPLY VOLT.	
Differential Input Threshold Voltage (V_{TH}) (Note 2)	10(8)	15	20(22)	mV	$\pm V_{TH}$	15 mV	+5V	+16 mA	$\pm 5\text{V} \pm 5\%$	Logic Output <0.4V
	35(33)	15		mV	$\pm V_{TH}$	15 mV	+5V	-400 μA	$\pm 5\text{V} \pm 5\%$	Logic Output >2.4V
		40	40	mV	$\pm V_{TH}$	40 mV	+5V	+16 mA	$\pm 5\text{V} \pm 5\%$	Logic Output <0.4V
	40	45(47)	mV	$\pm V_{TH}$	40 mV	+5V	-400 μA	$\pm 5\text{V} \pm 5\%$	Logic Output >2.4V	
Differential & Reference Input Bias Current		30	100	μA	0V	0V	+5.25V		$\pm 5.25\text{V}$	

LM7528/LM7529: The following apply for $0^{\circ}\text{C} \leq T_A \leq 70^{\circ}\text{C}$, $V^+ = 5\text{V} \pm 5\%$, $V^- = -5\text{V} \pm 5\%$

Differential Input Threshold Voltage (V_{TH}) (Note 3)	11(8)	15	19(22)	mV	$\pm V_{TH}$	15 mV	+5V	+16 mA	$\pm 5\text{V} \pm 5\%$	Logic Output <0.4V
	36(33)	15		mV	$\pm V_{TH}$	15 mV	+5V	-400 μA	$\pm 5\text{V} \pm 5\%$	Logic Output >2.4V
		40	40	mV	$\pm V_{TH}$	40 mV	+5V	+16 mA	$\pm 5\text{V} \pm 5\%$	Logic Output <0.4V
	40	44(47)	mV	$\pm V_{TH}$	40 mV	+5V	-400 μA	$\pm 5\text{V} \pm 5\%$	Logic Output >2.4V	
Differential & Reference Input Bias Current		30	75	μA	0V	0V	+5.25V		$\pm 5.25\text{V}$	

LM5528/LM5529: The following apply for $-55^{\circ}\text{C} \leq T_A \leq 125^{\circ}\text{C}$, $V^+ = 5\text{V} \pm 5\%$, $V^- = -5\text{V} \pm 5\%$

LM7528/LM7529: The following apply for $0^{\circ}\text{C} \leq T_A \leq 70^{\circ}\text{C}$, $V^+ = 5\text{V} \pm 5\%$, $V^- = -5\text{V} \pm 5\%$

Diff. Input Offset Current		0.5		μA	0V	0V	+5.25V		$\pm 5.25\text{V}$	
Logic "1" Input Voltage	2			V	40 mV	20 mV	+2V	-400 μA	$\pm 4.75\text{V}$	Logic Output >2.4V
Logic "0" Input Voltage			0.8	V	40 mV	20 mV	+0.8V	+16 mA	$\pm 4.75\text{V}$	Logic Output <0.4V
Logic "0" Input Current		-1	-1.6	mA	40 mV	20 mV	+0.4V		$\pm 5.25\text{V}$	
Logic "1" Input Current		5	40	μA	0V	20 mV	+2.4V		$\pm 5.25\text{V}$	
Logic "1" Input Current		0.02	1	mA	0V	20 mV	+5.25V		$\pm 5.25\text{V}$	
Logic "1" Output Voltage	2.4	3.9		V	40 mV	20 mV	+2.0V	-400 μA	$\pm 4.75\text{V}$	
Logic "0" Output Voltage		0.25	0.40	V	40 mV	20 mV	+0.8V	+16 mA	$\pm 4.75\text{V}$	
Output Short Circuit Current	-2.1	-2.8	-3.5	mA	40 mV	20 mV	+5.25V	0V	$\pm 5.25\text{V}$	
V^+ Supply Current		29	40	mA	0V	20 mV	0V		$\pm 5.25\text{V}$	
V^- Supply Current		-13	-18	mA	0V	20 mV	0V		$\pm 5.25\text{V}$	

LM5528/LM5529 and LM7528/LM7529: The following apply for $T_A = 25^{\circ}\text{C}$, $V^+ = 5\text{V}$, $V^- = -5\text{V}$

AC Common-Mode Input Firing Voltage		± 2.5		V	PULSE	20 mV	+5V	SCOPE		
Propagation Delays:										
Differential Input to Logical "1" Output		20	40	ns		20 mV				AC Test Circuit
Differential Input to Logical "0" Output		28		ns		20 mV				AC Test Circuit
Strobe Input to Logical "1" Output		10	30	ns		20 mV				AC Test Circuit
Strobe Input to Logical "0" Output		20		ns		20 mV				AC Test Circuit
Differential Input Overload Recovery Time		10		ns						
Common-Mode Input Overload Recovery Time		5		ns						
Min. Cycle Time		200		ns						

Note 1: For $0^{\circ}\text{C} \leq T_A \leq 70^{\circ}\text{C}$ operation, electrical characteristics for LM5528 and LM5529 are guaranteed the same as LM7528 and LM7529 respectively.

Note 2: Limits in parentheses pertain to LM5529, other limits pertain to LM5528.

Note 3: Limits in parentheses pertain to LM7529, other limits pertain to LM7528.

Note 4: Positive current is defined as current into the referenced pin.

Note 5: Pin 1 to have $\geq 100\text{ pF}$ capacitor connected to ground.

Note 6: Each test point to have $\leq 15\text{ pF}$ capacitive load to ground.

LM5528/LM7528 and LM5529/LM7529

schematic diagram

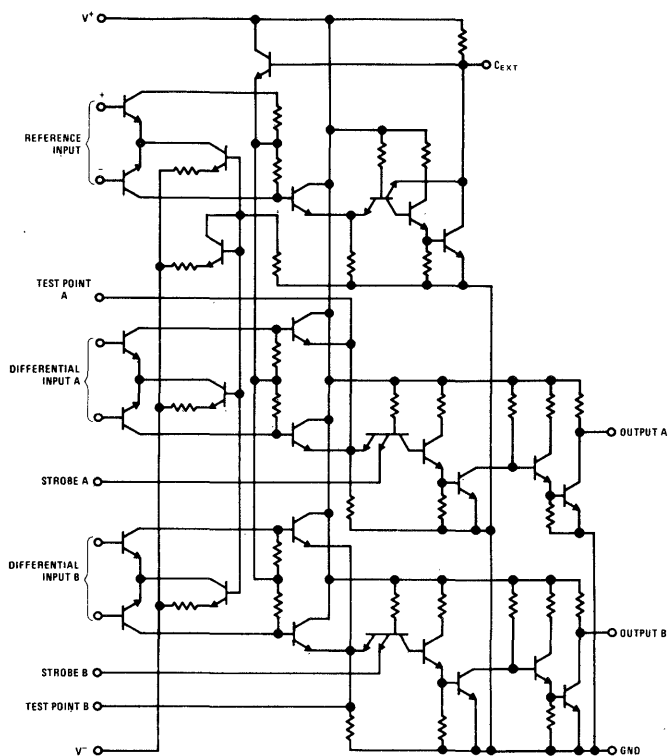

connection diagram

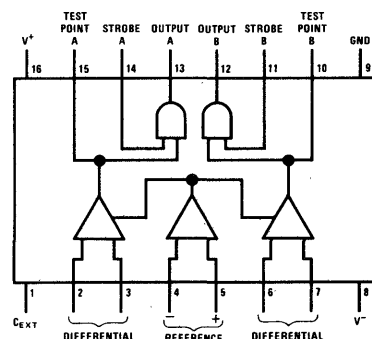

AC test circuit

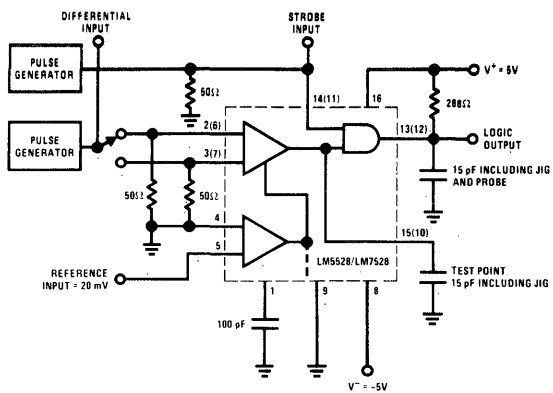

voltage waveforms

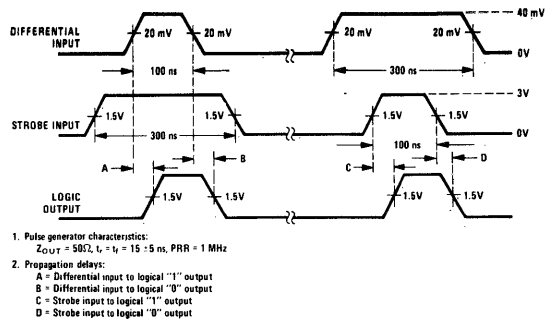

LM5534/LM7534 and LM5535/LM7535 electrical characteristics

LM5534/LM5535: The following apply for $-55^{\circ}\text{C} \leq T_A \leq 125^{\circ}\text{C}$, $V^+ = 5\text{V} \pm 5\%$, $V^- = -5\text{V} \pm 5\%$ (Note 1)

PARAMETER	MIN	TYP	MAX	UNIT	TEST CONDITIONS (EACH AMPLIFIER)					
					DIFF. INPUT	REF. INPUT	STROBE INPUT	LOGIC OUTPUT	SUPPLY VOLT.	COMMENTS
Differential Input Threshold Voltage (V_{TH}) (Note 2)	10(8)	15		mV	$\pm V_{TH}$	15 mV	+5V	+5.25V	$\pm 5\text{V} \pm 5\%$	Logic Output $< 250 \mu\text{A}$
		15	20(22)	mV	$\pm V_{TH}$	15 mV	+5V	+20 mA	$\pm 5\text{V} \pm 5\%$	Logic Output $< 0.4\text{V}$
	35(33)	40		mV	$\pm V_{TH}$	40 mV	+5V	+5.25V	$\pm 5\text{V} \pm 5\%$	Logic Output $< 250 \mu\text{A}$
		40	45(47)	mV	$\pm V_{TH}$	40 mV	+5V	+20 mA	$\pm 5\text{V} \pm 5\%$	Logic Output $< 0.4\text{V}$
Differential & Reference Input Bias Current		30	100	μA	0V	0V	+5.25V		$\pm 5.25\text{V}$	

LM7534/LM7535: The following apply for $0^{\circ}\text{C} \leq T_A \leq 70^{\circ}\text{C}$, $V^+ = 5\text{V} \pm 5\%$, $V^- = -5\text{V} \pm 5\%$

Differential Input Threshold Voltage (V_{TH}) (Note 3)	11(8)	15		mV	$\pm V_{TH}$	15 mV	+5V	+5.25V	$\pm 5\text{V} \pm 5\%$	Logic Output $< 250 \mu\text{A}$
		15	19(22)	mV	$\pm V_{TH}$	15 mV	+5V	+20 mA	$\pm 5\text{V} \pm 5\%$	Logic Output $< 0.4\text{V}$
	36(33)	40		mV	$\pm V_{TH}$	40 mV	+5V	+5.25V	$\pm 5\text{V} \pm 5\%$	Logic Output $< 250 \mu\text{A}$
		40	44(47)	mV	$\pm V_{TH}$	40 mV	+5V	+20 mA	$\pm 5\text{V} \pm 5\%$	Logic Output $< 0.4\text{V}$
Differential & Reference Input Bias Current		30	75	μA	0V	0V	+5.25V		$\pm 5.25\text{V}$	

LM5534/LM5535: The following apply for $-55^{\circ}\text{C} \leq T_A \leq 125^{\circ}\text{C}$, $V^+ = 5\text{V} \pm 5\%$, $V^- = -5\text{V} \pm 5\%$

LM7534/LM7535: The following apply for $0^{\circ}\text{C} \leq T_A \leq 70^{\circ}\text{C}$, $V^+ = 5\text{V} \pm 5\%$, $V^- = -5\text{V} \pm 5\%$

Diff. Input Offset Current		0.5		μA	0V	0V	+5.25V		$\pm 5.25\text{V}$	
Logic "0" Input Voltage			0.8	V	40 mV	20 mV	+0.8V	+5.25V	$\pm 4.75\text{V}$	Logic Output $< 250 \mu\text{A}$
Logic "1" Input Voltage	2.0			V	40 mV	20 mV	+2.0V	+20 mA	$\pm 4.75\text{V}$	Logic Output $< 0.4\text{V}$
Logic "0" Input Current		-1	-1.6	mA	40 mV	20 mV	+0.4V		$\pm 5.25\text{V}$	
Logic "1" Input Current		5	40	μA	0V	20 mV	+2.4V		$\pm 5.25\text{V}$	
Logic "1" Input Current		0.02	1	mA	0V	20 mV	+5.25V		$\pm 5.25\text{V}$	
Logic "0" Output Voltage		0.25	0.40	V	40 mV	20 mV	+2V	+20 mA	$\pm 4.75\text{V}$	
Output Leakage Current		0.01	250	μA	40 mV	20 mV	+0.8V	+5.25V	$\pm 4.75\text{V}$	
V^+ Supply Current		28	38	mA	0V	20 mV	0V		$\pm 5.25\text{V}$	
V^- Supply Current		-13	-18	mA	0V	20 mV	0V		$\pm 5.25\text{V}$	

LM5534/LM5535 and LM7534/LM7535: The following apply for $T_A = 25^{\circ}\text{C}$, $V^+ = 5\text{V}$, $V^- = -5\text{V}$

AC Common-Mode Input Firing Voltage		± 2.5		V	PULSE	20 mV	+5V	SCOPE		
Propagation Delays:										
Differential Input to Logical "1" Output		24		ns		20 mV				AC Test Circuit
Differential Input to Logical "0" Output		20	40	ns		20 mV				AC Test Circuit
Strobe Input to Logical "1" Output		16		ns		20 mV				AC Test Circuit
Strobe Input to Logical "0" Output		10	30	ns		20 mV				AC Test Circuit
Differential Input Overload Recovery Time		10		ns						
Common-Mode Input Overload Recovery Time		5		ns						
Min. Cycle Time		200		ns						

Note 1: For $0^{\circ}\text{C} \leq T_A \leq 70^{\circ}\text{C}$ operation, electrical characteristics for LM5534 and LM5535 are guaranteed the same as LM7534 and LM7535 respectively.

Note 2: Limits in parentheses pertain to LM5535, other limits pertain to LM5534.

Note 3: Limits in parentheses pertain to LM7535, other limits pertain to LM7534.

Note 4: Positive current is defined as current into the referenced pin.

Note 5: Pin 1 to have $\geq 100 \text{ pF}$ capacitor connected to ground.

LM5534/LM7534 and LM5535/LM7535

schematic diagram

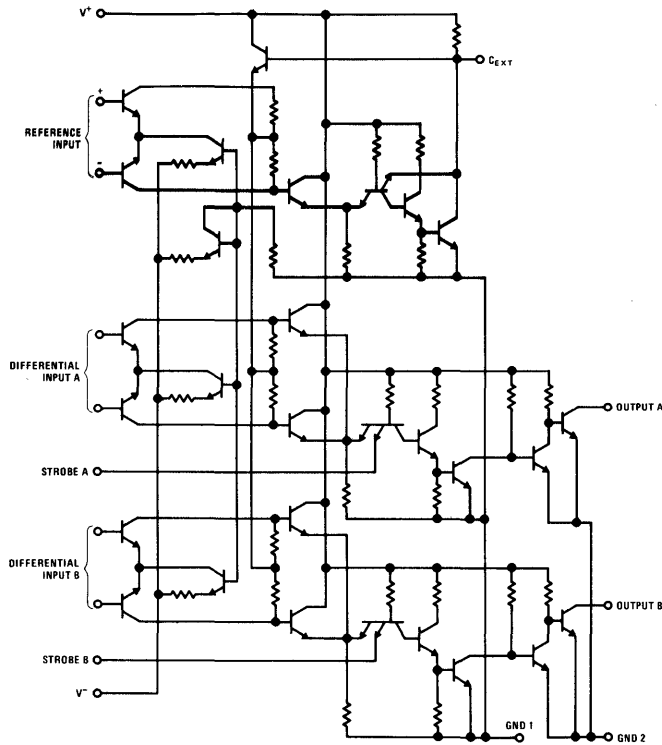

connection diagram

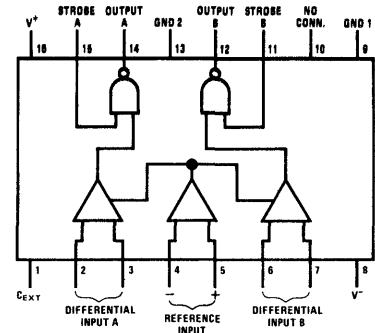

AC test circuit

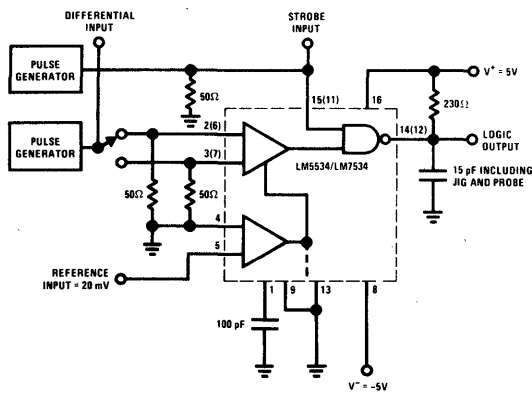

voltage waveforms

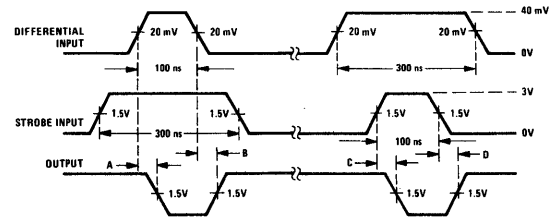

1. Pulse generators have the following characteristics:
 $Z_{OUT} = 50\Omega$, $t_r = t_f = 15(\pm 5)$ ns, PRR = 1 MHz
2. Propagation delays:
 A = Differential input to logical "0" output
 B = Differential input to logical "1" output
 C = Strobe input to logical "0" output
 D = Strobe input to logical "1" output

LM5538/LM7538 and LM5539/LM7539 electrical characteristics

LM5538/LM5539: The following apply for $-55^{\circ}\text{C} \leq T_A \leq 125^{\circ}\text{C}$, $V^+ = 5\text{V} \pm 5\%$, $V^- = -5\text{V} \pm 5\%$ (Note 1)

PARAMETER	MIN	TYP	MAX	UNIT	TEST CONDITIONS (EACH AMPLIFIER)					COMMENTS
					DIFF. INPUT	REF. INPUT	STROBE INPUT	LOGIC OUTPUT	SUPPLY VOLT.	
Differential Input Threshold Voltage (V_{TH}) (Note 2)	10(8)	15		mV	$\pm V_{TH}$	15 mV	+5V	+5.25V	$\pm 5\text{V} \pm 5\%$	Logic Output $< 250 \mu\text{A}$
		15	20(22)	mV	$\pm V_{TH}$	15 mV	+5V	+20 mA	$\pm 5\text{V} \pm 5\%$	Logic Output $< 0.4\text{V}$
	35(33)	40		mV	$\pm V_{TH}$	40 mV	+5V	+5.25V	$\pm 5\text{V} \pm 5\%$	Logic Output $< 250 \mu\text{A}$
		40	45(47)	mV	$\pm V_{TH}$	40 mV	+5V	+20 mA	$\pm 5\text{V} \pm 5\%$	Logic Output $< 0.4\text{V}$
Differential & Reference Input Bias Current		30	100	μA	0V	0V	+5.25V		$\pm 5.25\text{V}$	

LM7538/LM7539: The following apply for $0^{\circ}\text{C} \leq T_A \leq 70^{\circ}\text{C}$, $V^+ = 5\text{V} \pm 5\%$, $V^- = -5\text{V} \pm 5\%$

Differential Input Threshold Voltage (V_{TH}) (Note 3)	11(8)	15		mV	$\pm V_{TH}$	15 mV	+5V	+5.25V	$\pm 5\text{V} \pm 5\%$	Logic Output $< 250 \mu\text{A}$
		15	19(22)	mV	$\pm V_{TH}$	15 mV	+5V	+20 mA	$\pm 5\text{V} \pm 5\%$	Logic Output $< 0.4\text{V}$
	36(33)	40		mV	$\pm V_{TH}$	40 mV	+5V	+5.25V	$\pm 5\text{V} \pm 5\%$	Logic Output $< 250 \mu\text{A}$
		40	44(47)	mV	$\pm V_{TH}$	40 mV	+5V	+20 mA	$\pm 5\text{V} \pm 5\%$	Logic Output $< 0.4\text{V}$
Differential & Reference Input Bias Current		30	75	μA	0V	0V	+5.25V		$\pm 5.25\text{V}$	

LM5538/LM5539: The following apply for $-55^{\circ}\text{C} \leq T_A \leq 125^{\circ}\text{C}$, $V^+ = 5\text{V} \pm 5\%$, $V^- = -5\text{V} \pm 5\%$
LM7538/LM7539: The following apply for $0^{\circ}\text{C} \leq T_A \leq 70^{\circ}\text{C}$, $V^+ = 5\text{V} \pm 5\%$, $V^- = -5\text{V} \pm 5\%$

Diff. Input Offset Current		0.5		μA	0V	0V	+5.25V		$\pm 5.25\text{V}$	
Logic "1" Input Voltage	2			V	40 mV	20 mV	+2V	+20 mA	$\pm 4.75\text{V}$	Logic Output $< 0.4\text{V}$
Logic "0" Input Voltage			0.8	V	40 mV	20 mV	+0.8V	+5.25V	$\pm 4.75\text{V}$	Logic Output $< 250 \mu\text{A}$
Logic "0" Input Current		-1	-1.6	mA	40 mV	20 mV	+0.4V		$\pm 5.25\text{V}$	
Logic "1" Input Current		5	40	μA	0V	20 mV	+2.4V		$\pm 5.25\text{V}$	
		0.02	1	mA	0V	20 mV	+5.25V		$\pm 5.25\text{V}$	
Logic "0" Output Voltage		0.25	0.40	V	40 mV	20 mV	+2.0V	+20 mA	$\pm 4.75\text{V}$	
Output Leakage Current		0.01	250	μA	40 mV	20 mV	+0.8V	+5.25V	$\pm 4.75\text{V}$	
V^+ Supply Current		28	38	mA	0V	20 mV	0V		$\pm 5.25\text{V}$	
V^- Supply Current		-13	-18	mA	0V	20 mV	0V		$\pm 5.25\text{V}$	

LM5538/LM5539 and LM7538/LM7539: The following apply for $T_A = 25^{\circ}\text{C}$, $V^+ = 5\text{V}$, $V^- = -5\text{V}$

AC Common-Mode Input Firing Voltage		± 2.5		V	PULSE	20 mV	+5V	SCOPE		
Propagation Delays:										
Differential Input to Logical "1" Output		24		ns		20 mV				AC Test Circuit
Differential Input to Logical "0" Output		20	40	ns		20 mV				AC Test Circuit
Strobe Input to Logical "1" Output		16		ns		20 mV				AC Test Circuit
Strobe Input to Logical "0" Output		10	30	ns		20 mV				AC Test Circuit
Differential Input Overload Recovery Time		10		ns						
Common-Mode Input Overload Recovery Time		5		ns						
Min. Cycle Time		200		ns						

Note 1: For $0^{\circ}\text{C} \leq T_A \leq 70^{\circ}\text{C}$ operation, electrical characteristics for LM5538 and LM5539 are guaranteed the same as LM7538 and LM7539 respectively.

Note 2: Limits in parentheses pertain to LM5539, other limits pertain to LM5538.

Note 3: Limits in parentheses pertain to LM7539, other limits pertain to LM7538.

Note 4: Positive current is defined as current into the referenced pin.

Note 5: Pin 1 to have $\geq 100 \text{ pF}$ capacitor connected to ground.

Note 6: Each test point to have $\leq 15 \text{ pF}$ capacitive load to ground.

LM5538/LM7538 and LM5539/LM7539

schematic diagram

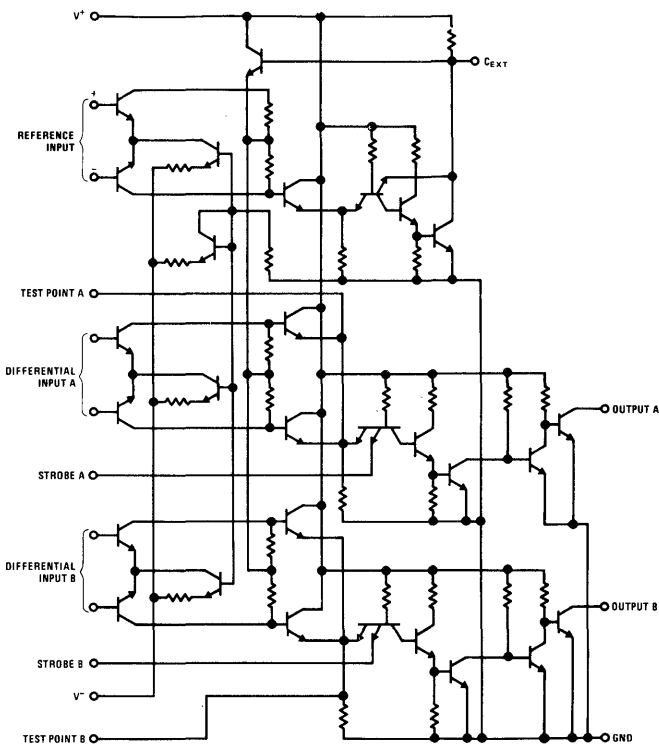

connection diagram

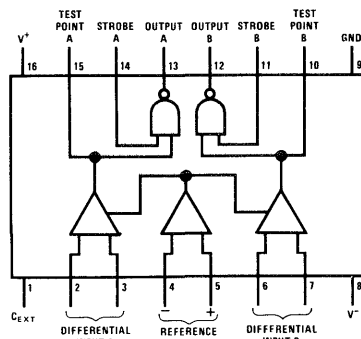

AC test circuit

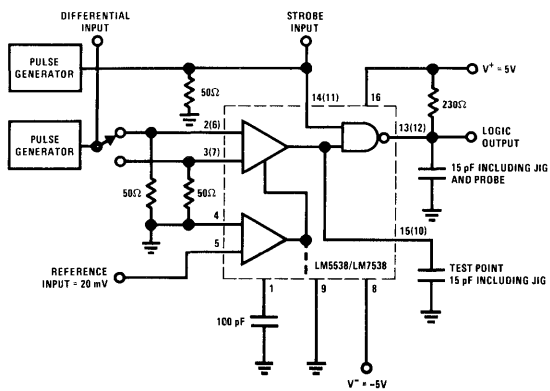

voltage waveforms

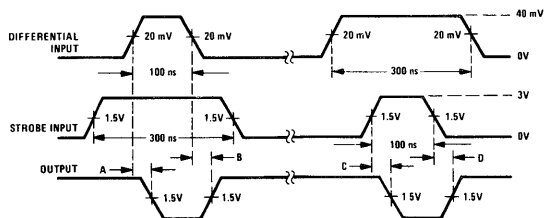

- Pulse generators have the following characteristics:
 $Z_{OUT} = 50\Omega$, $t_r = t_f = 15(-5)$ ns, PRR = 1 MHz
- Propagation delays:
 A = Differential input to logical "0" output
 B = Differential input to logical "1" output
 C = Strobe input to logical "0" output
 D = Strobe input to logical "1" output

guaranteed performance

Differential Input Threshold Voltage

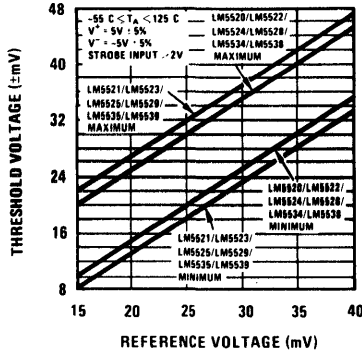

Differential Input Threshold Voltage

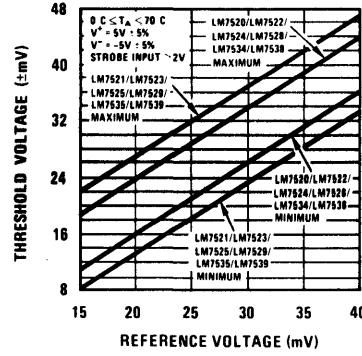

typical performance

Transfer Characteristics

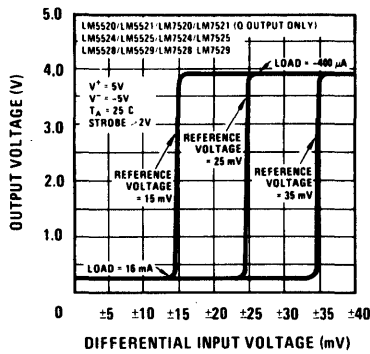

Transfer Characteristics

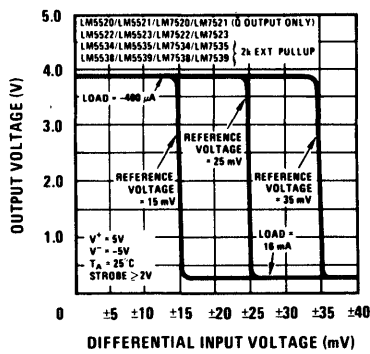

Power Supply Rejection

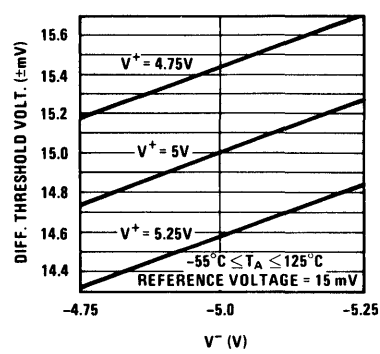

Temperature Coefficient

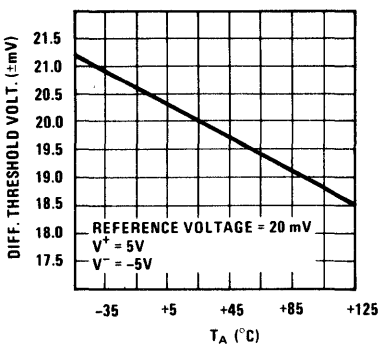

Differential Input Frequency Response

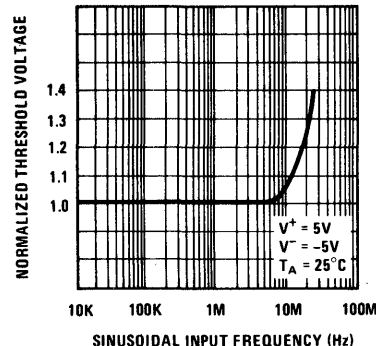

Differential Input Bias Current

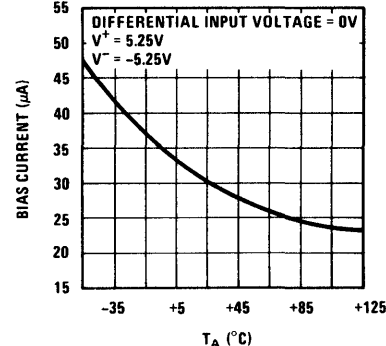

typical performance (cont.)

Differential Input Offset Current

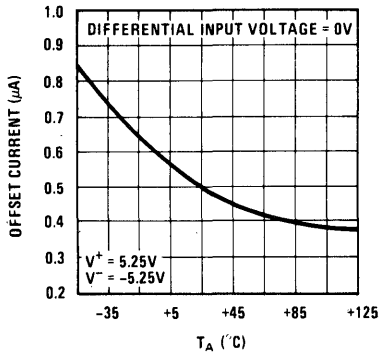

Power Supply Currents

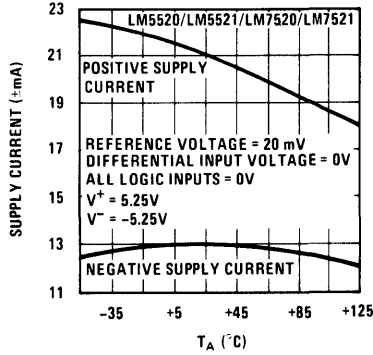

Power Supply Currents

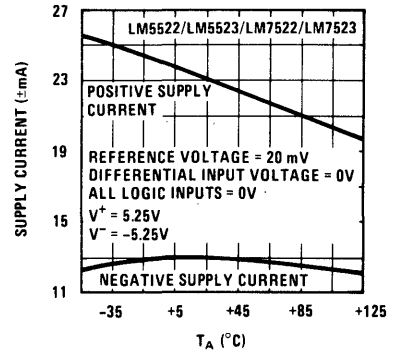

Power Supply Currents

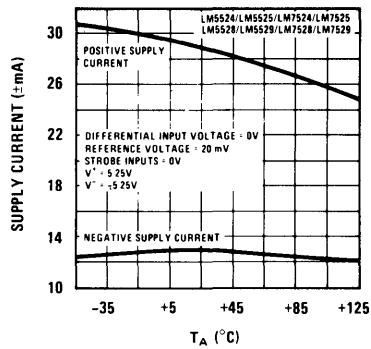

Power Supply Currents

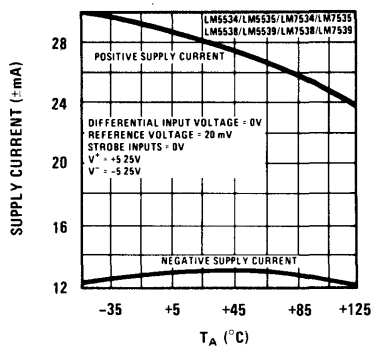

AC Common-Mode Firing Voltage

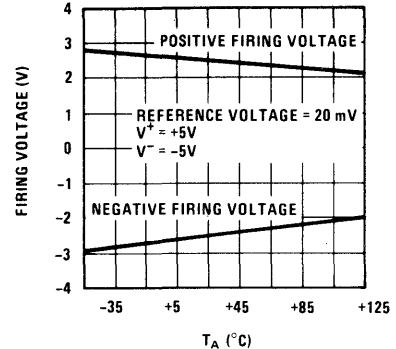

Differential Input to Output Propagation Delays

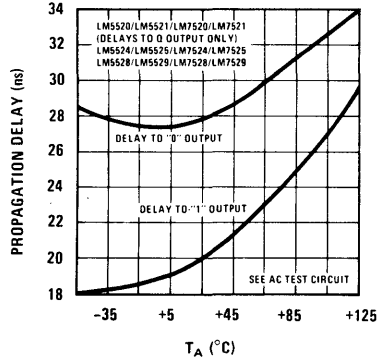

Differential Input to Output Propagation Delays

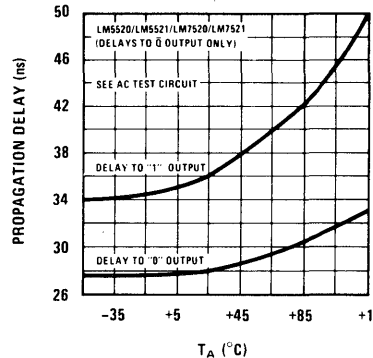

Differential Input to Output Propagation Delays

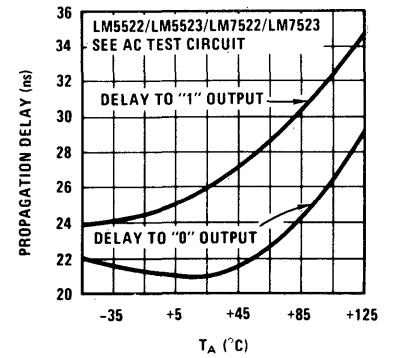

Differential Input to Output Propagation Delays

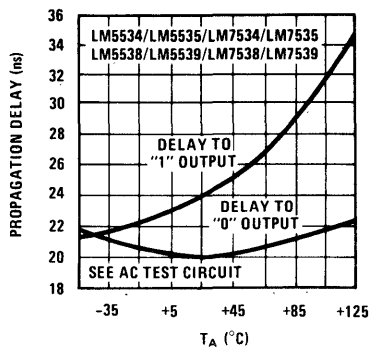

Strobe to Output Propagation Delays

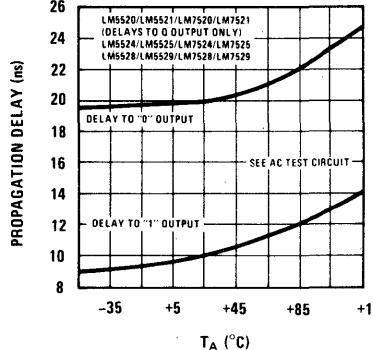

Strobe to Output Propagation Delays

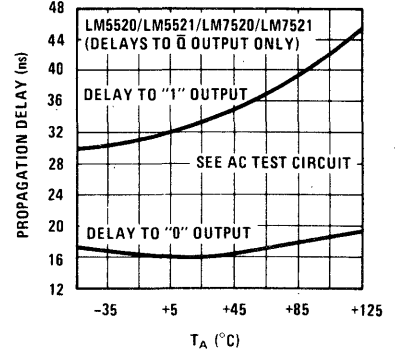

typical performance (cont.)

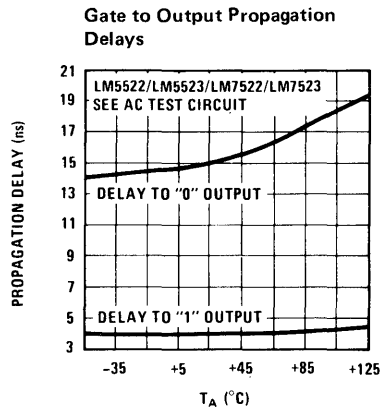
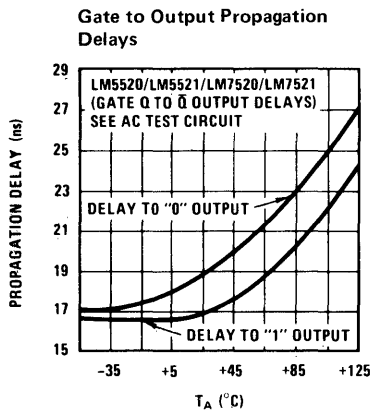
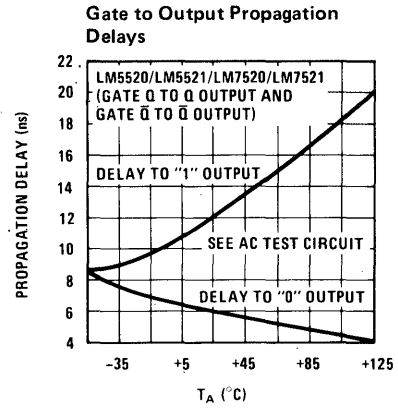
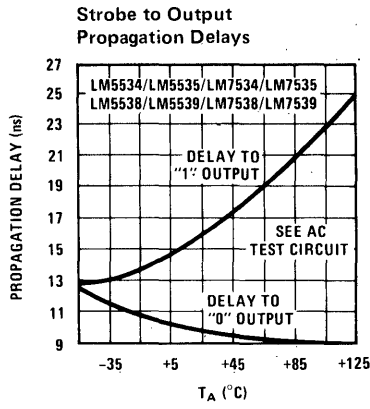
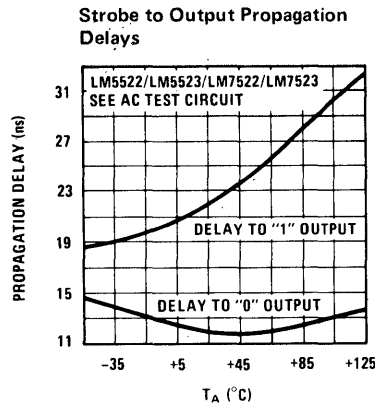

typical applications

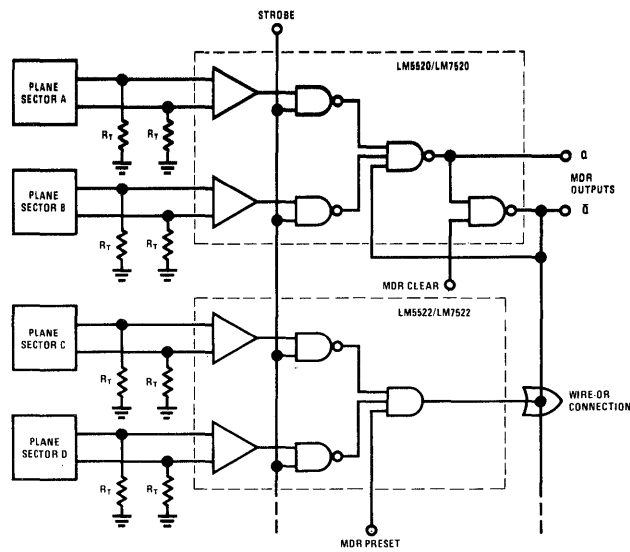

Large Memory System with Sectored Core Planes

typical applications (cont.)

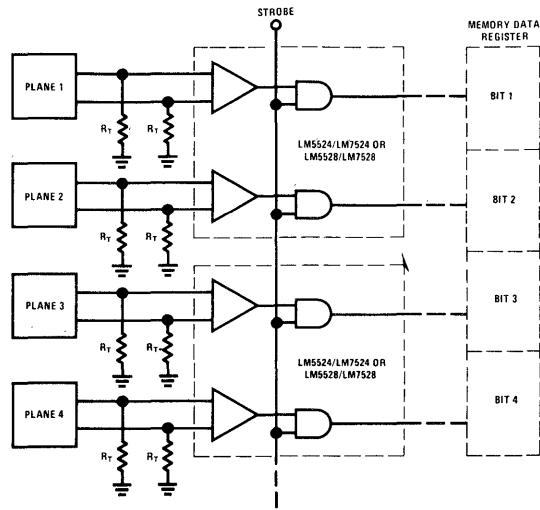

Small Memory System

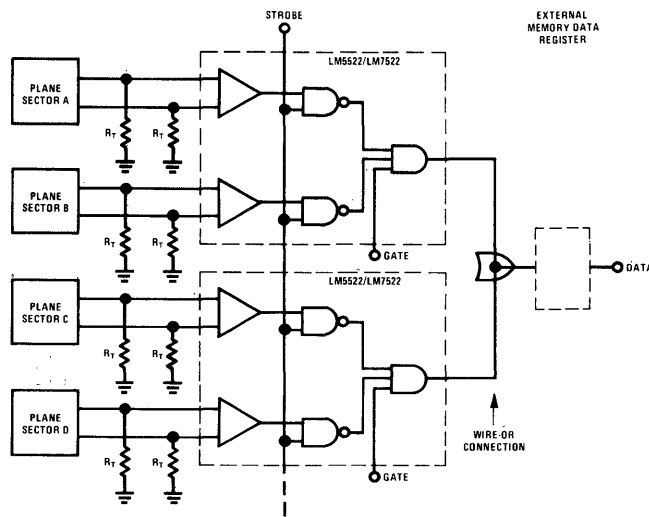

Large Memory System





Definition of Terms

voltage regulators

Input Voltage Range: The range of dc input voltages over which the regulator will operate within specifications.

Output Voltage Range: The range of regulated output voltages over which the specifications apply.

Output-Input Voltage Differential: The voltage difference between the unregulated input voltage and the regulated output voltage for which the regulator will operate within specifications.

Line Regulation: The percentage change in regulated output voltage for a change in input voltage.

Ripple Rejection: The line regulation for ac input signals at or above a given frequency with a specified value of bypass capacitor on the reference bypass terminal.

Load Regulation: The percentage change in regulated output voltage for a change in load from zero to the maximum load current specified.

Current-Limit Sense Voltage: The voltage across the current limit terminals required to cause the regulator to current-limit with a short circuited output. This voltage is used to determine the value of the external current-limit resistor when external booster transistors are used.

Temperature Stability: The percentage change in output voltage for a thermal variation from room temperature to either temperature extreme.

Feedback Sense Voltage: The voltage, referred to ground, on the feedback terminal of the regulator while it is operating in regulation.

Output Voltage Scale Factor: The output voltage obtained for a unit value of resistance between the adjustment terminal and ground.

Output Noise Voltage: The average ac voltage at the output with constant load and no input ripple.

Standby Current Drain: That part of the operating current of the regulator which does not contribute to the load current.

Long Term Stability: Output voltage stability under accelerated life-test conditions at 125°C with maximum rated voltages and power dissipation for 1000 hours.

Dropout Voltage: The input-output voltage differential at which the circuit ceases to regulate against further reductions in input voltage.

Maximum Power Dissipation: The maximum total device dissipation for which the regulator will operate within specifications.

Quiescent Current: That part of input current to the regulator that is not delivered to the load.

operational amplifiers

Input Offset Voltage: That voltage which must be applied between the input terminals through two equal resistances to obtain zero output voltage.

Input Offset Current: The difference in the currents into the two input terminals when the output is at zero.

Input Bias Current: The average of the two input currents.

Input Voltage Range: The range of voltages on the input terminals for which the amplifier operates within specifications.

Common Mode Rejection Ratio: The ratio of the input voltage range to the peak-to-peak change in input offset voltage over this range.

Input Resistance: The ratio of the change in input voltage to the change in input current on either input with the other grounded.

Supply Current: The current required from the power supply to operate the amplifier with no load and the output at zero.

Output Voltage Swing: The peak output voltage swing, referred to zero, that can be obtained without clipping.

Output Resistance: The ratio of the change in output voltage to the change in output current with the output around zero.

Large-Signal Voltage Gain: The ratio of the output voltage swing to the change in input voltage required to drive the output from zero to this voltage.

Power Supply Rejection: The ratio of the change in input offset voltage to the change in power supply voltages producing it.

operational amplifiers (cont.)

Transient Response: The closed-loop step-function response of the amplifier under small-signal conditions.

Slew Rate: The internally-limited rate of change in output voltage with a large-amplitude step function applied to the input.

Offset Voltage Temperature Drift: The average drift rate of offset voltage for a thermal variation from room temperature to the indicated temperature extreme.

Voltage Gain: The ratio of output voltage to input voltage under the stated conditions for source resistance (R_S) and load resistance (R_L).

Input Impedance: The ratio of input voltage to input current under the stated conditions for source resistance (R_S) and load resistance (R_L).

Output Impedance: The ratio of output voltage to output current under the stated conditions for source resistance (R_S) and load resistance (R_L).

Bandwidth: That frequency at which the voltage gain reduces to one over the square root of two, with the voltage gain being referenced to a specified frequency under the stated conditions for the source resistance (R_S) and load resistance (R_L).

voltage comparators/buffers

Logic Threshold Voltage: The voltage at the output of the comparator at which the loading logic circuitry changes its digital state.

Input Offset Voltage: The absolute value of the voltage between the input terminals required to make the output voltage greater than or less than specified voltages.

Input Offset Current: The absolute value of the difference between the two input currents for which the output will be driven higher than or lower than specified voltages.

Input Bias Current: The average of the two input currents.

Input Voltage Range: The range of voltage on the input terminals (common mode) over which the offset specifications apply.

Voltage Gain: The ratio of the change in output voltage to the change in voltage between the input terminals producing it.

Response Time: The interval between the application of an input step function and the time when the output crosses the logic threshold voltage. The input step drives the comparator from some initial,

Harmonic Distortion: That percentage of harmonic distortion being defined as one-hundred times the ratio of the root-mean-square (rms) sum of the harmonics to the fundamental. % harmonic distortion =

$$\frac{(V_2^2 + V_3^2 + V_4^2 + \dots)^{1/2}}{V_1} (100)\%$$

where V_1 is the rms amplitude of the fundamental and V_2, V_3, V_4, \dots are the rms amplitudes of the individual harmonics.

DC Input Offset Voltage: The average value of voltage that occurs across a specified source resistor (R_S) with the input signal voltage at zero potential under the stated condition for a load resistor (R_L).

DC Output Offset Voltage: The average value of voltage that occurs across a specified load resistor (R_L) with the input signal voltage at zero potential under the stated condition for a source resistor (R_S).

DC Input Offset Current: The average value of current that flows through a specified source resistor (R_S) with the input signal voltage at zero potential under the stated condition for a load resistor (R_L).

saturated input voltage to an input level just barely in excess of that required to bring the output from saturation to the logic threshold voltage. This excess is referred to as the voltage overdrive.

Saturation Voltage: The low output voltage level with the input drive equal to or greater than a specified value.

Positive Output Level: The high output voltage level with a given load and the input drive equal to or greater than a specified value.

Negative Output Level: The negative dc output voltage with the comparator saturated by a differential input equal to or greater than a specified voltage.

Output Sink Current: The maximum negative current that can be delivered by the comparator.

Output Resistance: The resistance seen looking into the output terminal with the dc output level at the logic threshold voltage.

Power Consumption: The power required to operate the comparator with no output load. The power will vary with signal level, but is specified as a maximum for the entire range of input signal conditions.

voltage comparators/buffers (cont.)

Output Leakage Current: The current into the output terminal with the output voltage within a given range and the input drive equal to or greater than a given value.

Strobe ON Voltage: The maximum voltage on either strobe terminal required to force the output to the specified high state independent of the input voltage.

Strobe OFF Voltage: The minimum voltage on the strobe terminal that will guarantee that it does not interfere with the operation of the comparator.

Supply Current: The current required from the positive or negative supply to operate the com-

parator with no output load. The power will vary with input voltage, but is specified as a maximum for the entire range of input voltage conditions.

Strobe Release Time: The time required for the output to rise to the logic threshold voltage after the strobe terminal has been driven from zero to the one logic level.

Strobed Output Level: The dc output voltage, independent of input conditions, with the voltage on the strobe terminal equal to or less than the specified low state.

Strobe Current: The current out of the strobe terminal when it is at the zero logic level.

sense amplifiers

Differential Input Threshold Voltage: The dc input voltage which forces the logic output to the logic threshold voltage (~1.5V) level.

Input bias Current: The dc current which flows into each input pin with differential input of 0V.

Differential Input Offset Current: The absolute difference in the two input bias currents of one differential input.

Supply Current: The total dc current per package drawn from the voltage supply.

AC Common-Mode Input Firing Voltage: The

peak level of a common-mode pulse which will exceed the input dynamic range and cause the logic output to switch. Pulse characteristics: $t_r = t_f \leq 15$ ns, $PW = 50$ ns.

Differential Input Overload Recovery Time: The time necessary for the device to recover from a 2V differential pulse ($t_r = t_f = 20$ ns) prior to the strobe enable signal.

Common-Mode Input Overload Recovery Time: The time necessary for the device to recover from a $\pm 2V$ common-mode pulse ($t_r = t_f = 20$ ns) prior to the strobe enable signal.

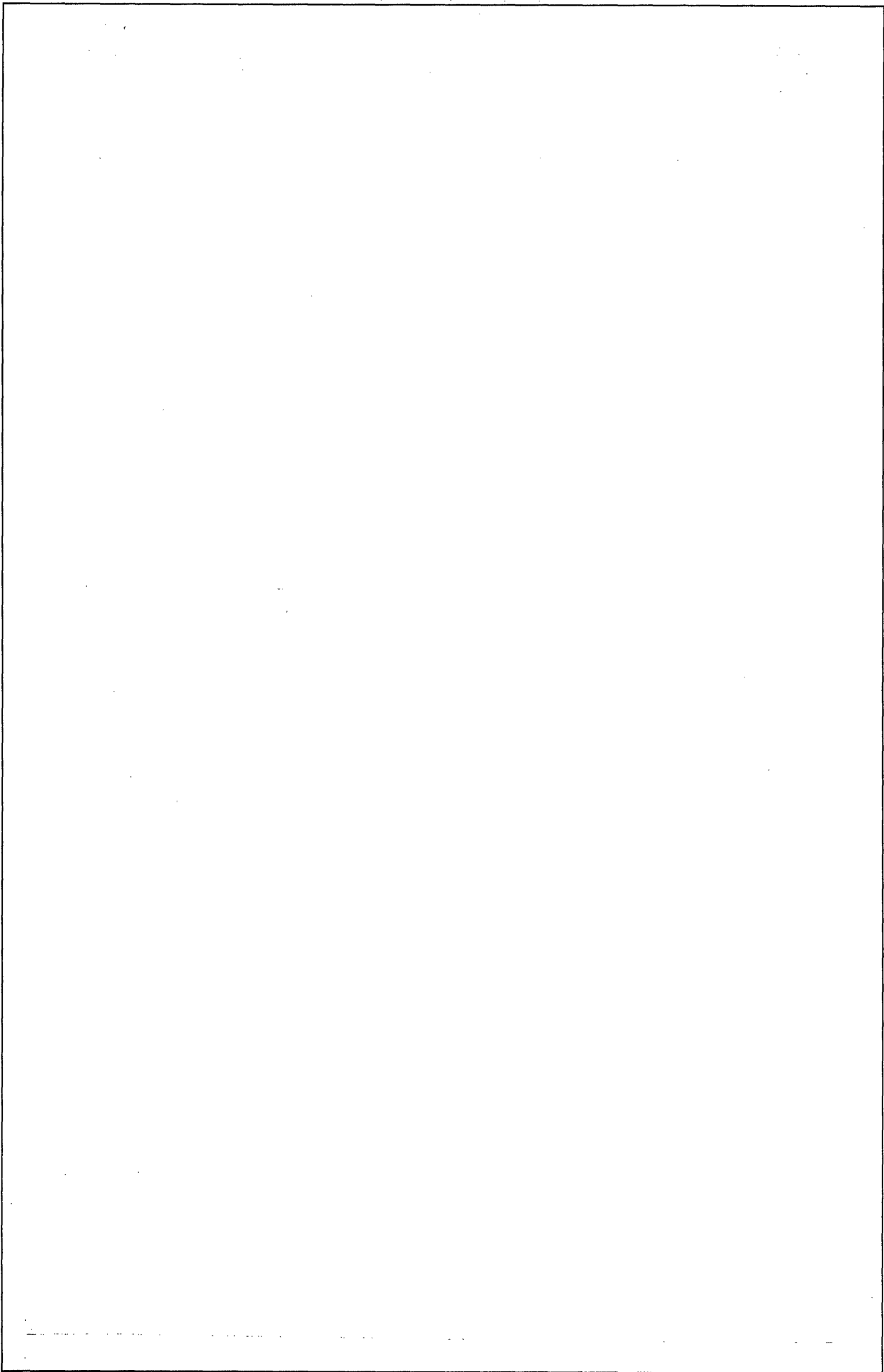



Physical Dimensions

physical dimensions

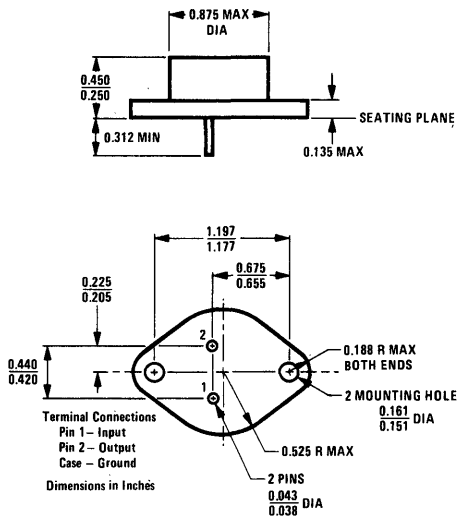

TO-3 Power Package

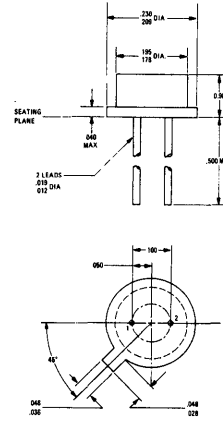

2 Lead Metal Can Package
(Modified 3 Lead)

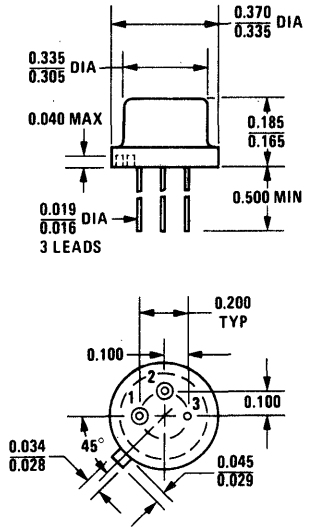

3 Lead Metal Can Package

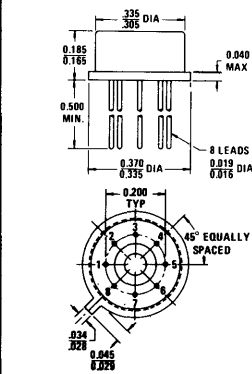

8 Lead Metal Can Package
(Hybrids Only)

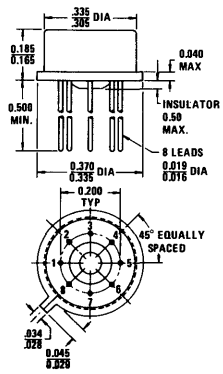

8 Lead Metal Can Package

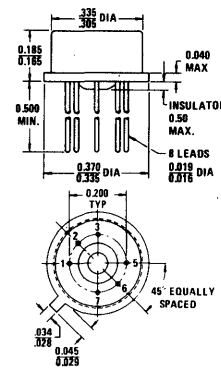

6 Lead Metal Can Package
(Modified 8 Lead)

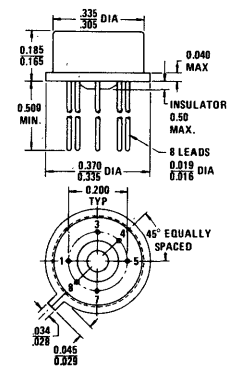

6 Lead Metal Can Package
(Modified 8 Lead)

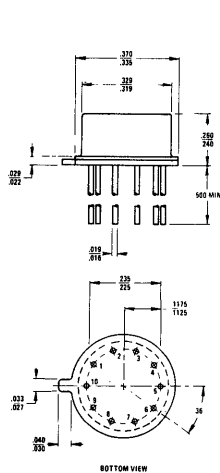

10 Lead Metal Can Package
(Hybrids Only)

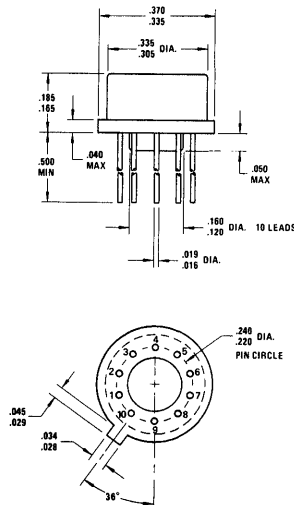

10 Lead Metal Can Package

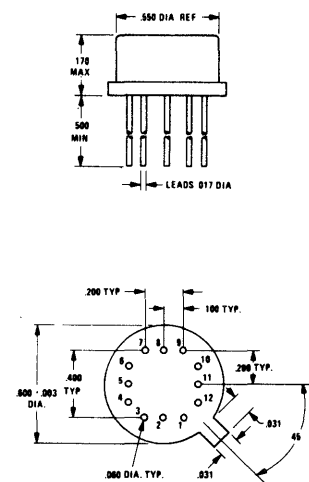

12 Lead Metal Can Package
(Hybrids only)

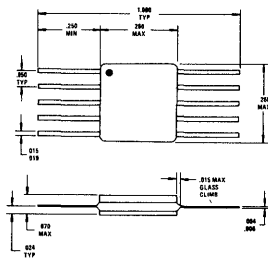

10 Pin Flat Package

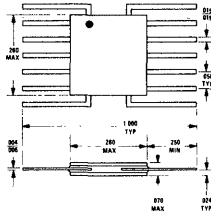

14 Pin Flat Package

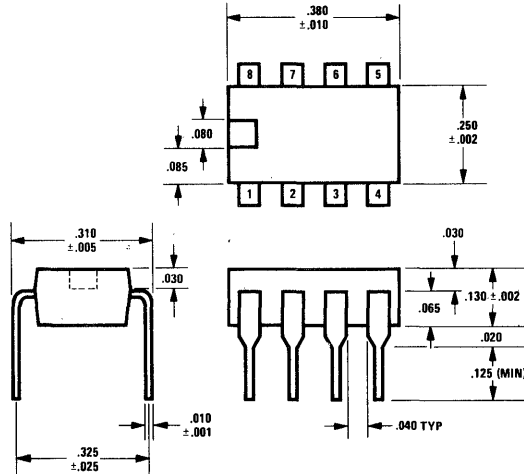

8 Pin Molded Dual-In-Line Package

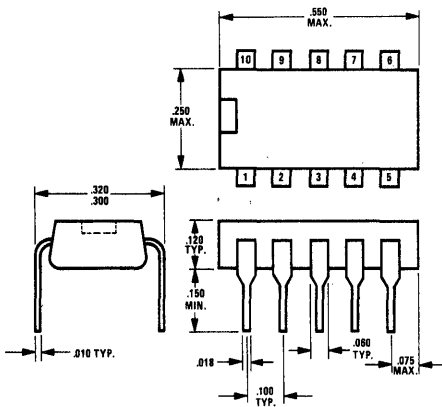

10 Pin Molded Dual-In-Line Package

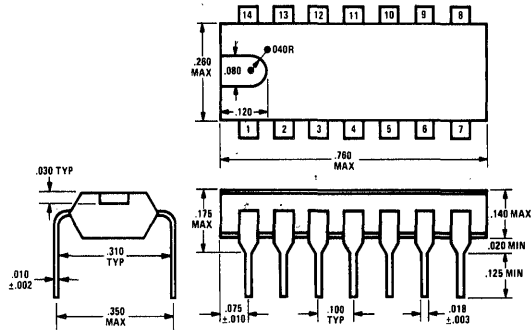

14 Pin Molded Dual-In-Line Package

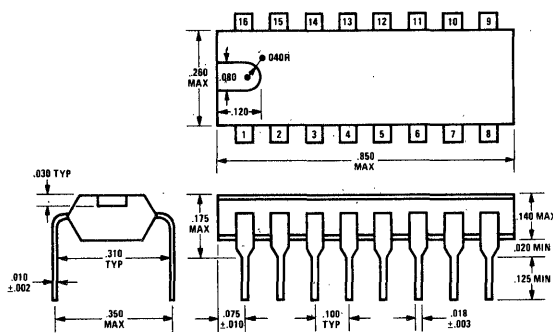

16 Pin Molded Dual-In-Line Package

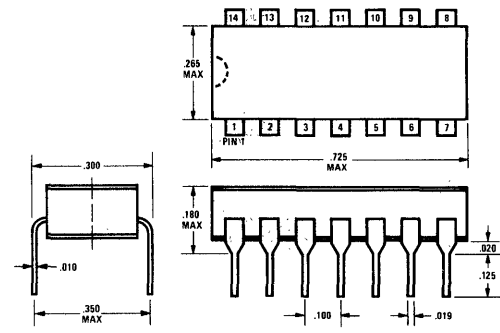

14 Pin Cavity Dual-In-Line Package

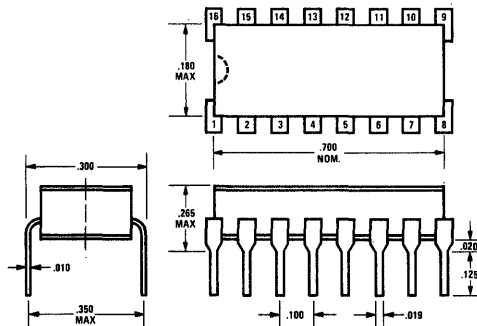

16 Pin Cavity Dual-In-Line Package



Available Linear Applications Literature

The following is a listing of Linear applications literature. This literature, plus information on National's other product lines, is available through our sales offices, representatives, distributors, or our headquarters in Santa Clara.

application notes

- AN-5 A fast integrated voltage follower with low input current
- AN-20 An applications guide for operational amplifiers
- AN-21 Designs for negative voltage regulators
- AN-23 The LM105-an improved positive regulator
- AN-24 A simplified test set for operational amplifier characterization
- AN-29 IC op amp beats FETs on input current
- AN-30 Logarithmic converters
- AN-41 Precision IC comparator runs from 5V supply

technical papers

- TP-5 A new low voltage breakdown diode
- TP-8 A low-power rf/lf amplifier
- TP-9 IC op amps close the performance gap on discretes
- TP-11 Super gain transistors for IC's
- TP-12 Design techniques for monolithic operational amplifiers

linear briefs

- LB-1 Instrumentation amplifier
- LB-5 High Q notch filter
- LB-7 Tracking voltage regulators
- LB-8 Precision ac/dc converters
- LB-9 Universal balancing techniques
- LB-10 IC regulators simplify power supply design
- LB-11 The LM110-an improved IC voltage follower
- LB-12 An IC voltage comparator for high impedance circuitry
- LB-13 Applications of the LM173/LM273/LM373
- LB-14 Speed up the LM108 with feedforward compensation

brochures

Linear Reliability Report



National Semiconductor Corporation
2900 Semiconductor Drive, Santa Clara, California 95051
(408) 732-5000/TWX (910) 339-9240

National Semiconductor GmbH
891 Landsberg/Lech
Lechstrasse 255
West Germany
Telephone: (08191) 3573 Telex: 527 223

National Semiconductor (UK) Ltd.
Larkfield Industrial Estates
Greenock, Scotland
Telephone: 33251 Telex: 778 632

REGIONAL AND DISTRICT SALES OFFICES

CALIFORNIA

NORTH-WEST REGIONAL OFFICE
2680 Bayshore Frontage Rd., Suite 112
Mountain View, California 94040
(415) 961-4740
TWX: 910-379-6432

SOUTH-WEST REGIONAL OFFICE
Valley Freeway Center Building
15300 Ventura Blvd., Suite 305
Sherman Oaks, California 91403
(213) 783-8272
TWX: 910-495-1773

FLORIDA

SOUTH-EAST REGIONAL OFFICE
2721 South Bayshore Drive
Suite 107
Miami, Florida 33133
(305) 446-8309

ILLINOIS

WEST-CENTRAL REGIONAL OFFICE
8550 W. Bryn Mawr
Chicago, Illinois 60631
(312) 693-2660
TWX: 910-221-0999

MASSACHUSETTS

NORTH-EAST REGIONAL OFFICE
391 Totten Pond Rd.
Waltham, Massachusetts 02154
(617) 891-0510
TWX: 710-326-7578

NEW JERSEY

MID-ATLANTIC REGIONAL OFFICE
West Cliff House
2375 Hudson Terrace
Fort Lee, New Jersey 07024
(201) 461-6111
TWX: 710-991-9795

NEW YORK

NEW YORK DISTRICT OFFICE
129 Pickard Bldg.
East Molloy Road
Syracuse, New York 13211
(315) 455-5858

OHIO

EAST-CENTRAL REGIONAL OFFICE
3540 Ridge Road
Cleveland, Ohio 44102
(216) 961-4441
Telex: 98-0103

TEXAS

SOUTH-CENTRAL REGIONAL OFFICE
5925 Forest Lane
Suite 205
Dallas, Texas 75230
(214) 233-6801
TWX: 910-860-5091

INTERNATIONAL SALES OFFICES

ENGLAND

NATIONAL SEMICONDUCTOR (UK) LTD.
The Precinct
Broxbourne, Hertfordshire
England
Telephone: 69571
Telex: 267 204

WEST GERMANY

NATIONAL SEMICONDUCTOR GMBH
8 Munchen 22
Herzog-Rudolfstrasse 3
West Germany
Telephone: (0811) 220 702

FRANCE

NATIONAL SEMICONDUCTOR FRANCE, S.A.R.L.
40 Boulevard Felix Faure
92. Chatillon Sous Bagneux
France
Telephone: 253 60 50
Telex: 25956 F

DENMARK

NATIONAL SEMICONDUCTOR SCANDINAVIA
Vordingborggade 22
2100 Copenhagen
Denmark
Telephone: (01) 92-OBRO-5610
Telex: DK 6827 MAGNA

SWEDEN

NATIONAL SEMICONDUCTOR SWEDEN
Sikvagen 17
13500 Tyreso
Stockholm
Sweden
Telephone 712-04-80