

TMS320 Family Development Support Reference Guide

Digital Signal Processor
Products



TEXAS
INSTRUMENTS

TMS320 Family Development Support Reference Guide



**TEXAS
INSTRUMENTS**

IMPORTANT NOTICE

Texas Instruments (TI) reserves the right to make changes in the devices or the device specifications identified in this publication without notice. TI advises its customers to obtain the latest version of device specifications to verify, before placing orders, that the information being relied upon by the customer is current.

In the absence of written agreement to the contrary, TI assumes no liability for TI applications assistance, customer's product design, or infringement of patents or copyrights of third parties by or arising from use of semiconductor devices described herein. Nor does TI warrant or represent that any license, either express or implied, is granted under any patent right, copyright, or other intellectual property right of TI covering or relating to any combination, machine, or process in which such semiconductor devices might be or are used.

Copyright © 1986, Texas Instruments Incorporated

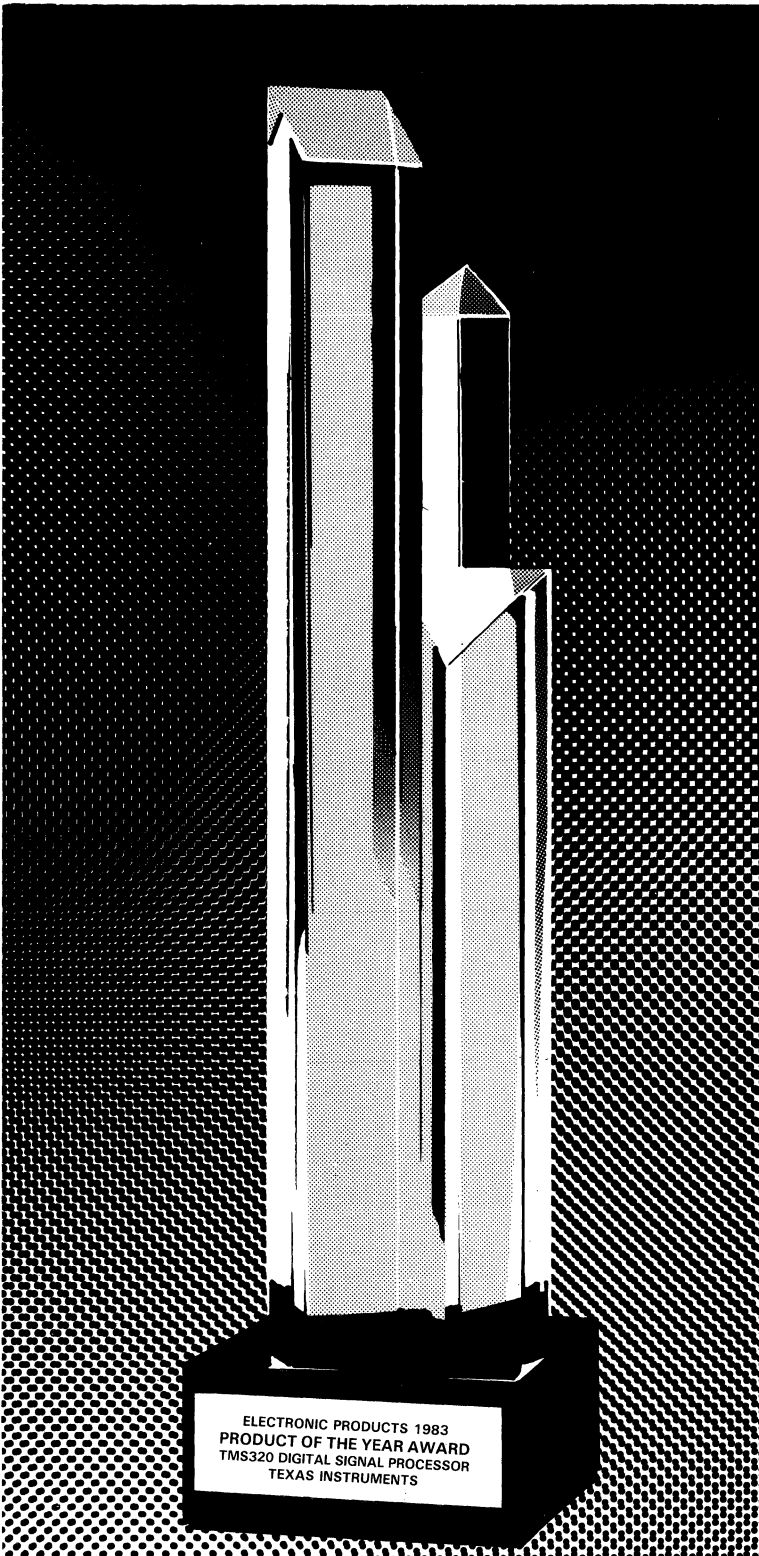

ELECTRONIC PRODUCTS 1983
PRODUCT OF THE YEAR AWARD
TMS320 DIGITAL SIGNAL PROCESSOR
TEXAS INSTRUMENTS

Quick Reference for This Document

TITLE	SECTION
Introduction	1
The TMS320 Digital Signal Processor Family	2
ROM Codes	3
Quality and Reliability	4
TMS320 Development Support Products	5
Software Support Products	6
Hardware Development Tools	7
RTC TMS320 Seminar and Workshops	8
TMS320 Documentation Support	9
TMS320 University Program	10
TMS320 Third-Party Support	11

TITLE	APPENDIX
TMS320 Product Order Information	A
TI Factory Repair and Exchange Policy	B
TI Program License Agreement	C

Contents

<i>Section</i>		<i>Page</i>
1	Introduction	1-1
1.1	How to Use This Manual	1-3
2	The TMS320 Digital Signal Processor Family	2-1
2.1	First-Generation Devices	2-4
2.2	Second-Generation Devices	2-9
2.3	Typical Applications	2-12
3	ROM Codes	3-1
4	Quality and Reliability	4-1
4.1	Reliability Stress Tests	4-2
5	TMS320 Development Support Products	5-1
6	Software Support Products	6-1
6.1	TMS320 Macro Assembler/Linker	6-2
6.2	TMS320 Simulator	6-5
6.3	SoftWare Development System (SWDS)	6-7
6.4	Digital Filter Design Package (DFDP)	6-10
6.5	Digital Signal Processing Software Library	6-13
6.6	TMS320 Bell 212A Modem Software	6-15
7	Hardware Development Tools	7-1
7.1	TMS320 Evaluation Module (EVM)	7-2
7.1.1	System Configuration	7-5
7.1.2	Communication	7-6
7.1.3	Debugging	7-7
7.1.4	Equipment List	7-8
7.2	TMS320 Emulator (XDS)	7-9
7.2.1	System Configurations	7-13
7.2.2	Communication	7-15
7.2.3	Debugging	7-15
7.2.4	Equipment List	7-16
7.3	TMS320 XDS Upgrade Program	7-17
7.3.1	TI Factory Upgrade	7-19
7.3.2	Customer Upgrade	7-20
7.4	TMS320 Analog Interface Board (AIB)	7-21
7.4.1	System Configuration	7-22
7.4.2	Equipment List	7-23
7.5	TMS320 DSP Design Kit	7-25

8	RTC TMS320 Seminar and Workshops	8-1
8.1	TMS320 Product Seminar	8-2
8.2	DSP Design Workshops	8-3
8.3	RTC Locations	8-4
9	TMS320 Documentation Support	9-1
9.1	Product Descriptions and Product Bulletins	9-2
9.2	User's Guides	9-3
9.3	Data Sheets	9-4
9.4	DSP Applications Book	9-5
9.4.1	Implementation of FIR/IIR Filters with the TMS32010/TMS32020	9-6
9.4.2	Fast Fourier Transform Algorithms with the TMS32020	9-7
9.4.3	Companding Routines for the TMS32010/TMS32020	9-7
9.4.4	Floating-Point Arithmetic with the TMS32010	9-7
9.4.5	Floating-Point Arithmetic with the TMS32020	9-7
9.4.6	Precision Digital Sine-Wave Generation with the TMS32010	9-8
9.4.7	Matrix Multiplication with the TMS32010 and TMS32020	9-8
9.4.8	Interfacing to Asynchronous Inputs with the TMS32010	9-8
9.4.9	Interfacing External Memory to the TMS32010	9-9
9.4.10	Hardware Interfacing to the TMS32020	9-9
9.4.11	TMS32020 and MC68000 Interface	9-9
9.4.12	Telecommunications Interfacing to the TMS32010	9-10
9.4.13	Digital Voice Echo Canceller with a TMS32020	9-10
9.4.14	Implementation of Data Encryption Standard Using TMS32010	9-10
9.4.15	32-kbit/s ADPCM with the TMS32010	9-11
9.4.16	A Graphics Implementation Using the TMS32020 and TMS34061	9-11
9.4.17	Control System Compensation and Implementation with TMS32010	9-12
9.5	University Textbooks	9-13
9.5.1	DFT/FFT and Convolution Algorithms	9-13
9.5.2	Digital Filter Design	9-14
9.5.3	Practical Approaches to Speech Coding	9-14
9.5.4	A Practical Guide to Adaptive Filter Design	9-14
9.5.5	A Digital Signal Processing Laboratory Using the TMS32010	9-15
9.6	Technical Articles	9-16
9.7	TMS320 Quarterly Newsletter	9-23
9.8	TMS320 DSP Bulletin Board Service	9-24
9.8.1	How to Access the TMS320 DSP Bulletin Board Service	9-24
9.9	TMS320 DSP Hotline	9-27
10	TMS320 University Program	10-1
10.1	TMS320 Hardware/Software Available to Universities	10-2
10.2	DSP Station Recommendations	10-2
11	TMS320 Third-Party Support	11-1
11.1	Allen Ashley	11-2
11.2	Atlanta Signal Processors, Inc. (ASPI)	11-3
11.3	Avocet Systems, Inc.	11-5
11.4	Bedford Research	11-5
11.5	Burr Brown Corp.	11-6
11.6	Computalker	11-8
11.7	Crowell, Inc.	11-9
11.8	Cybernetic Micro Systems	11-10
11.9	Daisy Systems Corp.	11-10

11.10 Dalanco Spry	11-11
11.11 Digital Audio Corp.	11-12
11.12 Digital Signal Processing Software, Inc. (DSPS)	11-12
11.13 Digital Sound Corp.	11-13
11.14 DSP Technology Corp.	11-14
11.15 Forth, Inc.	11-15
11.16 Gas Light Software	11-15
11.17 Hewlett-Packard	11-16
11.18 Hyperception	11-18
11.19 Kontron Electronics	11-19
11.20 Loughborough Sound Images Ltd.	11-19
11.21 Microcraft Corp.	11-20
11.22 Microstuf, Inc.	11-21
11.23 PH Associates	11-21
11.24 Pacific Microcircuits Ltd.	11-22
11.25 Pratica SRL	11-25
11.26 Racal Microelectronics Systems Ltd.	11-25
11.27 Sentry Test Systems	11-26
11.28 Signal Technology, Inc. (STI)	11-26
11.29 Signix Corp.	11-27
11.30 SIGnology, Inc.	11-28
11.31 SKY Computers, Inc.	11-29
11.32 TelePhoto Communications	11-33
11.33 Televic	11-34
11.34 Texas Instruments, Inc.	11-35
11.35 Thorn EMI Electronics	11-36
11.36 TIAC Manufacturing, Inc.	11-37
11.37 Valid Logic Systems	11-38
11.38 Votan	11-38
11.39 Whitman Engineering, Inc.	11-39
11.40 Third-Party Address, Phone, and Product Support List	11-41
11.41 Third-Party Consultants	11-47
11.42 Trademarks	11-49
A Product Order Information	A-1
B Texas Instruments Factory Repair and Exchange Policy	B-1
C Texas Instruments Program License Agreement	C-1

Illustrations

<i>Figure</i>	<i>Page</i>
1-1. TMS320 Family Development Support	1-2
2-1. The TMS320 Family Roadmap	2-2
2-2. TMS32010, TMS32010-14, TMS32010-25, TMS320C10, TMS320C10-25 Block Diagram	2-6
2-3. TMS320C15/E15, TMS320C15-25 Block Diagram	2-6
2-4. TMS32011 Block Diagram	2-8
2-5. TMS320C17/E17, TMS320C17-25 Block Diagram	2-8
2-6. TMS32020 Block Diagram	2-11
2-7. TMS320C25 Block Diagram	2-11
3-1. TMS320 ROM Code Flowchart	3-2
5-1. TMS320 Development Product Integration	5-2
5-2. Typical TMS320 Application Development Flow	5-3
6-1. Assembly with a Single-Source Module	6-3
6-2. Linked Assembly with Multiple-Source Modules	6-4
6-3. Simulator Screen Example	6-6
6-4. SoftWare Development System (SWDS)	6-8
6-5. SWDS Screen Example	6-9
6-6. Digital Filter Design Package (DFDP)	6-10
6-7. DFDP Plot Examples	6-12
7-1. TMS32010 Evaluation Module (EVM)	7-3
7-2. TMS32020/C25 Evaluation Module (EVM)	7-4
7-3. TMS320 EVM Host Computer Mode	7-5
7-4. TMS320 EVM/Single-User System	7-5
7-5. TMS32010 EVM with Audio Cassette Interface	7-6
7-6. TMS320C10 Emulator (XDS/22)	7-10
7-7. TMS320C25 Emulator (XDS/22)	7-11
7-8. TMS320C25 Emulator Target Connector	7-12
7-9. TMS320 XDS Host Computer Mode	7-13
7-10. TMS320 XDS/Single-User System	7-14
7-11. TMS320 XDS Multiprocessor Mode	7-14
7-12. TMS320C10 XDS/22 Display Example	7-15
7-13. XDS Upgrade Configurations	7-18
7-14. TMS320 Analog Interface Board	7-21
7-15. TMS320 AIB System Configuration	7-22
7-16. TMS320 AIB Adaptor Board	7-23
7-17. TMS320 DSP Design Kit	7-26
11-1. ASPI's Algorithm Development Package (ADP)	11-4
11-2. Burr Brown's VMEdsp SPV100 Board	11-7
11-3. Burr Brown's VMEdsp MPV960 Analog Input and DSP Board	11-8
11-4. Dalanco Spry's Model 10 Digital Signal Processor	11-11
11-5. HP 64285S Emulation Subsystem	11-17
11-6. Pacific Microcircuits' PD32HC01 Interface IC	11-23
11-7. Pacific Microcircuits' SuPPort 320 DB01 Development Board	11-24
11-8. SIGnology's SP-20 DSP Development/Measurement System	11-29
11-9. SKY320-PC DSP Board	11-31
11-10. SKY320-Q DSP Board	11-32
11-11. SKY Challenger VMEbus DSP Board	11-33
11-12. TI-Speech Development System	11-36

A-1.	TMS320 Device Nomenclature	A-5
A-2.	TMS320 Development Tool Nomenclature	A-6

Tables

<i>Table</i>	<i>Page</i>	
2-1.	TMS320 Family Overview	2-3
2-2.	Typical Applications of the TMS320 Family	2-12
2-3.	TMS320 DSP Family Benchmarks	2-13
2-4.	TMS320 DSP System Benchmarks	2-13
4-1.	Microprocessor and Microcontroller Tests	4-5
5-1.	Feature Matrix of TMS320 Development Tools	5-4
6-1.	Software Library Contents	6-14
7-1.	XDS Upgrade Process	7-17
7-2.	TMS320 XDS Upgrade Kit Contents	7-19
9-1.	TMS320 Product Bulletins and Product Descriptions	9-2
9-2.	TMS320 User's Guides	9-3
9-3.	TMS320 Data Sheets	9-4
9-4.	Application Reports in the DSP Applications Book	9-6
9-5.	DSP Textbooks	9-13
11-1.	Third-Party Address/Phone/Product Support List	11-41
11-2.	Third-Party Reference List	11-45
11-3.	Third-Party Consultant List	11-47
11-4.	Trademark List	11-49
A-1.	TMS320 Digital Signal Processor Part Numbers	A-1
A-2.	TMS320 Support Tool Part Numbers	A-2
A-3.	Development Tool Connections to a Target System	A-3
B-1.	Repair and Replacement Charges	B-4

1. Introduction

Texas Instruments, long recognized as a market leader in the area of digital electronics, has strengthened its position with the emergence of a powerful group of VLSI microprocessors – the TMS320 family of Digital Signal Processors.

The TMS32010, the first digital signal processor in the TMS320 family, was introduced in 1983. During that year, the TMS32010 was named "Product of the Year" by the magazine, *Electronic Products*. Its powerful instruction set, inherent flexibility, high-speed number-crunching capabilities, and innovative architecture have made this high-performance, cost-effective processor the ideal solution to many telecommunications, computer, commercial, industrial, and military applications.

Since that time, Texas Instruments has demonstrated an unsurpassed dedication to the advancement of digital signal processing (DSP) and its applications through extensive development support and expansion of the TMS320 family. The members of the two generations of the TMS320 family include:

- First-Generation Devices:
 - TMS32010, the first 20-MHz digital signal processor
 - TMS32010-14, a 14-MHz version of the TMS32010
 - TMS32010-25, a 25-MHz version of the TMS32010
 - TMS32011, a TMS32010 with serial interface
 - TMS320C10, a CMOS 20-MHz version of the TMS32010
 - TMS320C10-25, a 25-MHz version of the TMS320C10
 - TMS320C15, a TMS320C10 with expanded ROM and RAM
 - TMS320E15, an EPROM version of the TMS320C15
 - TMS320C15-25, a 25-MHz version of the TMS320C15
 - TMS320C17, a TMS320C15 with serial interface
 - TMS320E17, an EPROM version of the TMS320C17
 - TMS320C17-25, a 25-MHz version of the TMS320C17.

- Second-Generation Devices:
 - TMS32020, an NMOS 20-MHz device capable of twice the performance of the first-generation devices
 - TMS320C25, a 40-MHz CMOS version of the TMS32020 with twice the performance of the TMS32020.

Plans for expansion of the TMS320 family include more spinoffs of the existing generations as well as more powerful future generations of digital signal processors.

The TMS320 family combines the high performance and specialized features necessary in DSP applications with an extensive program of development support, including hardware and software development products, product documentation, textbooks, newsletters, DSP design workshops, and a variety of application reports. Figure 1-1 shows the wide range of development tools available.



Figure 1-1. TMS320 Family Development Support

1.1 How to Use This Manual

The TMS320 Family Development Support Reference Guide details the vast development support available for the TMS320 family of digital signal processors. Information concerning all aspects is consolidated into this document making it an effective reference guide to assist the user in selecting the necessary tools for design and development of TMS320 applications. Note that TMS320 refers to both the first and second generations of DSP devices.

Sections 1 and 2 provide an overview of the TMS320 family and its capabilities for the user unfamiliar with digital signal processing and investigating it for the first time. Sections 5, 6, and 7 describe the software and hardware development products and Section 9 the extensive documentation available to support the wide range of applications using the TMS320 family.

Sections 5, 6, and 7 describe the development products available to support each phase of DSP design. These sections also provide information that can assist in selecting which product(s) to use. Section 8 describes the seminar and workshops that provide hands-on experience using the development tools. Appendix A gives ordering information.

- Section 2.** The TMS320 Digital Signal Processor Family. Description, key features, and block diagram of TMS320 family members. List of possible applications.
- Section 3.** ROM Codes. Discussion of ROM codes (mask options) and the procedure for implementation.
- Section 4.** Quality and Reliability. Discussion of Texas Instruments quality and reliability criteria for evaluating performance.
- Section 5.** TMS320 Development Support Products. Discussion of TMS320 software and hardware development flow.
- Section 6.** Software Support Products. Information on software development and the following products:
- TMS320 Macro Assembler/Linker
 - TMS320 Simulator
 - SoftWare Development System (SWDS)
 - Digital Filter Design Package (DFDP)
 - Digital Signal Processing Software Library
 - TMS320 Bell 212A Modem Software.
- Section 7.** Hardware Development Tools. Information on hardware development and the following tools:
- TMS320 Evaluation Module (EVM)
 - TMS320 Emulator (XDS)
 - TMS320 XDS Upgrade Program
 - TMS320 Analog Interface Board (AIB)
 - TMS320 DSP Design Kit.

Introduction

- Section 8.** RTC TMS320 Seminar and Workshops. Description of the half-day technical seminar and three-day workshops sponsored by the TI Regional Technology Centers (RTC). Address list of the worldwide RTCs.
- Section 9.** TMS320 Documentation Support. Discussion of TMS320 documentation available, including data sheets, user's guides, application reports, textbooks, technical articles, newsletters, bulletin board, and hotline.
- Section 10.** TMS320 University Program. Information about the TMS320 hardware and software products offered at a discount to universities. List of textbooks written by university professors on DSP theories and applications using the TMS320 devices. Recommendations on establishing DSP lab workstations and research stations in universities.
- Section 11.** TMS320 Third-Party Support. Description of products manufactured by other companies, which can assist in TMS320 development. Address list of third parties. List of digital signal processing consultants.
- Appendix A.** TMS320 Product Order Information. Device packaging information and product part numbers. Explanation of TMS320 device and development support prefixes and nomenclature.
- Appendix B.** Texas Instruments Factory Repair and Exchange Policy. Outline of policies and procedures for repairing or exchanging a damaged system.
- Appendix C.** Texas Instruments Program License Agreement.

2. The TMS320 Digital Signal Processor Family

The TMS320 family of 16/32-bit single-chip digital signal processors combines the flexibility of a high-speed controller with the numerical capability of an array processor, offering an inexpensive alternative to custom VLSI and multichip bit-slice processors.

The combination of the TMS320's Harvard-type architecture (program and data buses separated) and its special digital signal processing (DSP) instruction set provide speed and flexibility to produce a MOS microprocessor family capable of executing ten MIPS (million instructions per second). The TMS320 family optimizes speed by implementing functions in hardware that other processors implement through software. This hardware-intensive approach provides the design engineer with power previously unavailable on a single chip.

The TMS320 family consists of two generations of digital signal processors. The first generation contains the TMS32010 and its spinoffs: TMS32010-14, TMS32010-25, TMS32011, TMS320C10, TMS320C10-25, TMS320C15/E15, TMS320C15-25, TMS320C17/E17, and TMS320C17-25. The TMS32020 and TMS320C25 are the second-generation processors. Many features are common among the TMS320 processors. (Note that when TMS320 is used, it refers to both the first and second generations of DSP devices.) Some specific features are added in each processor to provide different cost/performance tradeoffs. Software compatibility is maintained throughout the family to protect the user's investment in architecture. Each processor has software and hardware tools to facilitate rapid design.

This section describes each member of the first and second generations, lists key features, and provides functional block diagrams. Typical applications are also suggested. Two tables provide comparisons of device performance for some fundamental DSP operations. Included in this section are the following major topics:

- First-Generation Devices (Section 2.1 on page 2-4)
- Second-Generation Devices (Section 2.2 on page 2-9)
- Typical Applications (Section 2.3 on page 2-12)

Figure 2-1 shows the generations of processors on a TMS320 family roadmap, plotted on a hypothetical performance versus technology scale. Table 2-1 provides an overview of the TMS320 family of processors with comparisons of memory, I/O, cycle timing, package type, technology, and military support.

The TMS320 Digital Signal Processor Family

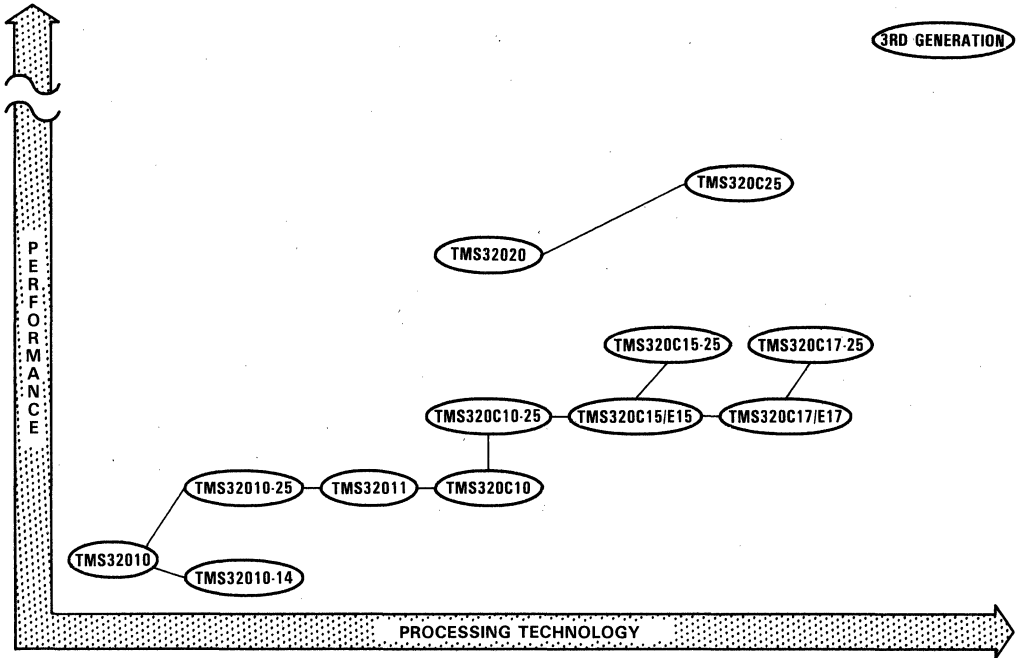

Figure 2-1. The TMS320 Family Roadmap

The TMS320 Digital Signal Processor Family

Table 2-1. TMS320 Family Overview

DEVICE	MEMORY			I/O*	CYCLE TIME (ns)	PACKAGE TYPE		
	ON-CHIP RAM	OFF-CHIP ROM	OFF-CHIP PROG DATA			SER	PAR	DIP
TMS32010-14 (NMOS)	144	1.5K	4K	8x16	280	40		
TMS32010† (NMOS)	144	1.5K	4K	8x16	200	40		
TMS32010-25 (NMOS)	144	1.5K	4K	8x16	160	40		
TMS32011 (NMOS)	144	1.5K		2 6x16	200	40		
TMS320C10‡ (CMOS)	144	1.5K	4K	8x16	200	40	44	
TMS320C10-25 (CMOS)	144	1.5K	4K	8x16	160	40	44	
TMS320C15 (CMOS)	256	4K	4K	8x16	200	40	44	
TMS320C15-25 (CMOS)	256	4K	4K	8x16	160	40	44	
TMS320E15 (CMOS)	256	4K**	4K	8x16	200	40		
TMS320C17 (CMOS)	256	4K		2 6x16	200	40	44	
TMS320C17-25 (CMOS)	256	4K		2 6x16	160	40	44	
TMS320E17 (CMOS)	256	4K**		2 6x16	200	40		
TMS32020‡ (NMOS)	544		64K	64K	1 16x16	200		68
TMS320C25‡ (CMOS)	544	4K	64K	64K	1 16x16	100	68	68

*SER = serial; PAR = parallel.

**On-chip EPROM.

†Military version available.

‡Military versions planned; contact nearest sales office for availability.

2.1 First-Generation Devices

The first generation of the TMS320 family includes the TMS32010, TMS32010-14, TMS32010-25, and TMS32011, which are processed in 2.4- μm NMOS technology, and the TMS320C10, TMS320C10-25, TMS320C15/E15, TMS320C15-25, TMS320C17/E17, and TMS320C17-25, processed in 2.0- μm CMOS technology. This section briefly describes each member of the first generation, lists key features, and provides block diagrams.

The **TMS32010**, the first TMS320 family member, is a microprocessor capable of achieving a 16 x 16-bit multiply in a single 200-ns cycle. On-chip data memory of 144 words is available. Full-speed execution from up to 4K words of off-chip program memory is possible. The TMS32010 is also available in a microcomputer version, with 1.5K words of program ROM on-chip and up to 2.5K words of off-chip program memory for a total of 4K words. This ROM-code version can also operate entirely from off-chip ROM for ease of prototyping, code update, and field upgradeability.

The **TMS32010-14**, a 14-MHz version of the TMS32010, provides a low-cost alternative for DSP applications not requiring the maximum operating frequency of the TMS32010. Some applications for which the TMS32010-14 is well suited include servo control, high-speed controllers, low-end modems, audio processing, data encryption, and vibration analysis. The device can execute 3.5 million instructions per second and perform a 16 x 16-bit multiply in 280 ns. The TMS32010-14 provides a direct EPROM interface for single-cycle program memory access, thereby offering a cost-effective method for system development and modification. The device is pin-for-pin and software compatible with the higher-frequency, 20-MHz TMS32010 and its development tools.

The **TMS32010-25**, a 160-ns instruction cycle time version of the TMS32010, is intended for higher-performance applications that use off-chip program memory and require 25 percent greater processor throughput (6.25 million instructions per second) than the TMS32010. Existing TMS32010 designs can take advantage of the enhanced throughput simply by increasing the input clock cycle time to 25 MHz without rewriting software.

The **TMS320C10** has a 200-ns instruction cycle time and is object-code and pin-for-pin compatible with the TMS32010. The TMS320C10 is processed in 2.0- μm CMOS technology, achieving a power dissipation less than one-sixth that of the NMOS device. Because of its low-power dissipation (165 mW), the TMS320C10 is ideal for power-sensitive applications such as digital telephony and portable consumer products. A masked ROM option is available for the TMS320C10.

The **TMS320C10-25**, a 25-MHz version of the TMS320C10, has a 160-ns instruction cycle time. Its lower power and higher speed make it well suited for high-performance DSP applications.

The **TMS320C15** and **TMS320E15** are fully object-code and pin-for-pin compatible with the TMS32010 and offer expanded on-chip RAM of 256 words and on-chip program ROM (TMS320C15) or EPROM (TMS320E15) of 4K words. The devices are processed in 2.0- μm CMOS technology. The TMS320C15 is also available in a 160-ns version, the **TMS320C15-25**.

The TMS320 Family - First-Generation Devices

Some of the key features of the TMS32010, TMS32010-14, TMS32010-25, TMS320C10, TMS320C10-25, TMS320C15/E15, and TMS320C15-25 are:

- Instruction cycle timing:
 - 160 ns (TMS32010-25, TMS320C10-25, TMS320C15-25)
 - 200 ns (TMS32010/C10, TMS320C15/E15)
 - 280 ns (TMS32010-14)
- On-chip data RAM:
 - 144 words
 - 256 words (TMS320C15/E15, TMS320C15-25)
- On-chip program ROM:
 - 1.5K words (optional)
 - 4K words (TMS320C15, TMS320C15-25)
- 4K words of on-chip program EPROM (TMS320E15)
- 16 x 16-bit parallel multiplier with 32-bit result
- External memory expansion up to 4K words at full speed
- Barrel shifter
- On-chip clock generator
- Single 5-V supply
- Device packaging (see Table 2-1):
 - 40-pin DIP
 - 44-lead PLCC
- Technology:
 - 2.4- μ m NMOS: TMS32010, TMS32010-14, TMS32010-25
 - 2.0- μ m CMOS: TMS320C10/C10-25, TMS320C15/E15/C15-25.

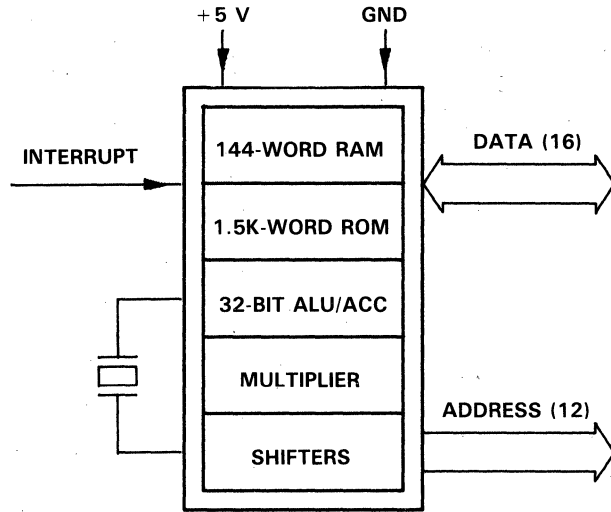

Figure 2-2. TMS32010, TMS32010-14, TMS32010-25, TMS320C10, TMS320C10-25 Block Diagram

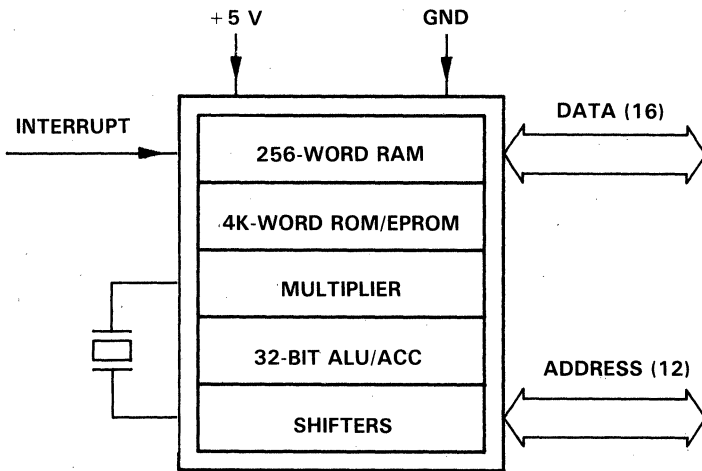

Figure 2-3. TMS320C15/E15, TMS320C15-25 Block Diagram

The TMS320 Family – First-Generation Devices

The **TMS32011** is a dedicated microcomputer with 1.5K words of on-chip program ROM (and no external memory expansion) intended for high-volume applications. The device is object-code compatible with the TMS32010, and includes a dual-channel serial interface, on-chip companding hardware (μ -law/A-law), serial port timer, and a peripheral mode for prototyping.

The **TMS320C17** and **TMS320E17** are dedicated microcomputers with 4K words of on-chip program ROM (TMS320C17) or EPROM (TMS320E17), a dual-channel serial interface, on-chip companding hardware (μ -law/A-law), and a serial port timer. The devices are object-code compatible with the TMS32010, and processed in 2.0- μ m CMOS technology. The TMS320C17 is also available in a 160-ns version, the **TMS320C17-25**.

Many key features are common to all first-generation devices. Some key features of the TMS32011, TMS320C17/E17, and TMS320C17-25 are:

- Instruction cycle timing:
 - 160 ns (TMS320C17-25)
 - 200 ns (TMS32011, TMS320C17/E17)
- On-chip data RAM:
 - 144 words (TMS32011)
 - 256 words (TMS320C17/E17, TMS320C17-25)
- On-chip program ROM:
 - 1.5K words (TMS32011)
 - 4K words (TMS320C17, TMS320E17)
- 4K words of on-chip program EPROM (TMS320E17)
- Dual-channel serial port for full-duplex serial communication
- Direct interface to combo-codec
- Serial port timer for standalone serial communications
- On-chip companding hardware for μ -law and A-law PCM conversions
- Object-code compatible with the TMS32010 instruction set
- Compatible with TMS32010 development support tools
- Peripheral mode to TMS32010 for application development (TMS32011)
- Device packaging (see Table 2-1):
 - 40-pin DIP
 - 44-lead PLCC
- Technology:
 - 2.4- μ m NMOS: TMS32011
 - 2.0- μ m CMOS: TMS320C17/E17, TMS320C17-25.

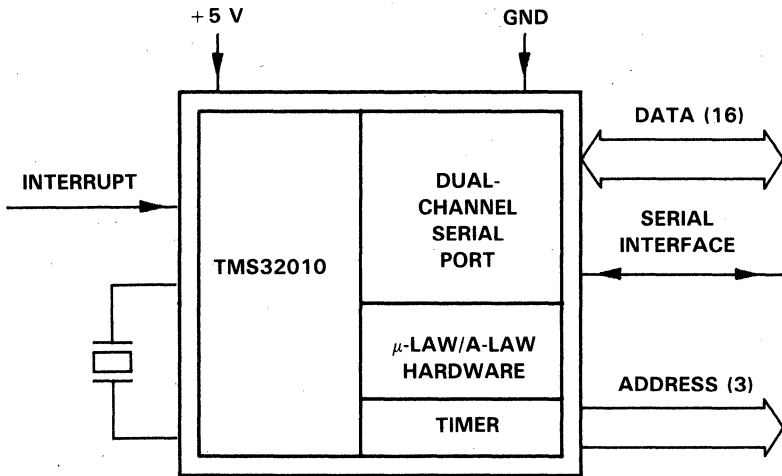

Figure 2-4. TMS32011 Block Diagram

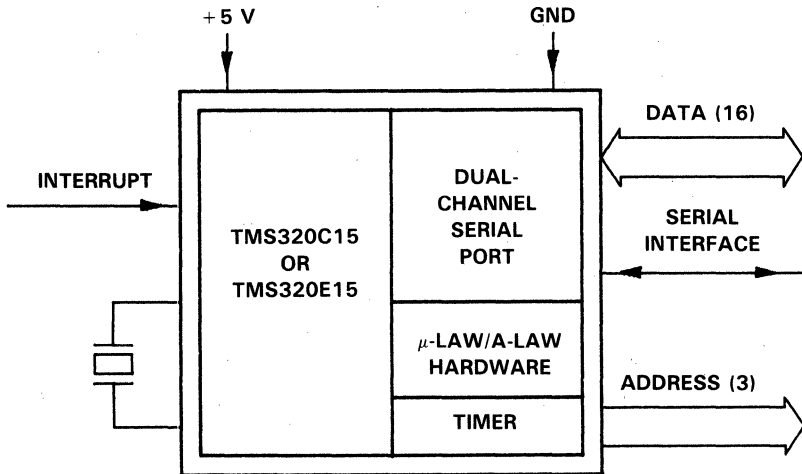

Figure 2-5. TMS320C17/E17, TMS320C17-25 Block Diagram

2.2 Second-Generation Devices

The second generation of the TMS320 family of digital signal processors includes two members, the TMS32020 and the TMS320C25. The architecture of these devices is based upon that of the TMS32010, the first member of the TMS320 family. This section briefly describes each device, lists its key features, and provides a block diagram.

The **TMS32020**, processed in 2.4- μm NMOS technology, is source-code compatible with the TMS32010 and in many applications is capable of two times the throughput of the first-generation devices. Its enhanced instruction set (109 instructions), large on-chip data memory (544 words), large memory spaces, on-chip serial port, and hardware timer make the TMS32020 a powerful addition to the TMS320 family.

Some key features of the TMS32020 are:

- 200-ns instruction cycle time
- 544 words of on-chip data RAM
- 128K words of total data and program memory space
- Wait states for communication to slower off-chip memories
- TMS32010 software compatibility
- Single-cycle multiply/accumulate instructions
- Repeat instructions
- Global data memory interface
- Block moves for data/program management
- Five auxiliary registers with dedicated arithmetic unit
- Serial port for multiprocessing or interfacing to codecs, serial analog-to-digital converters, etc.
- On-chip clock generator
- Single 5-V supply
- 2.4- μm NMOS technology, 68-pin grid array (PGA) package.

The TMS320 Family - Second-Generation Devices

The **TMS320C25** is the newest member of the TMS320 second generation. It is processed in 1.8- μm CMOS technology and is capable of an instruction cycle time of 100 ns. The TMS320C25's enhanced feature set greatly increases the functionality of the device over the TMS32020. Enhancements include 24 additional instructions, eight auxiliary registers, an eight-level hardware stack, 4K words of on-chip program ROM, a bit-reversed indexed-addressing mode, and the low-power dissipation inherent to the CMOS process. All of these improvements have been achieved while maintaining pin-for-pin and object-code compatibility with the TMS32020.

Some key features of the TMS320C25 are:

- 100-ns instruction cycle time
- 4K words of on-chip program ROM (microcomputer version)
- 544 words of on-chip RAM
- 128K words of total program and data memory space
- Wait states for communication to slower off-chip memories
- Object-code compatible with the TMS32020
- 24 additional instructions to support adaptive filtering, FFTs, and extended-precision arithmetic
- Block moves for data/program management
- Single-cycle multiply/accumulate instructions
- Eight auxiliary registers with dedicated arithmetic unit
- Bit-reversed indexed-addressing mode for radix-2 FFTs
- Double-buffered serial port
- On-chip clock generator
- Synchronization capability between multiple processors
- Single 5-V supply
- 1.8- μm CMOS technology: 68-pin grid array (PGA) package and 68-lead chip carrier (PLCC) package.

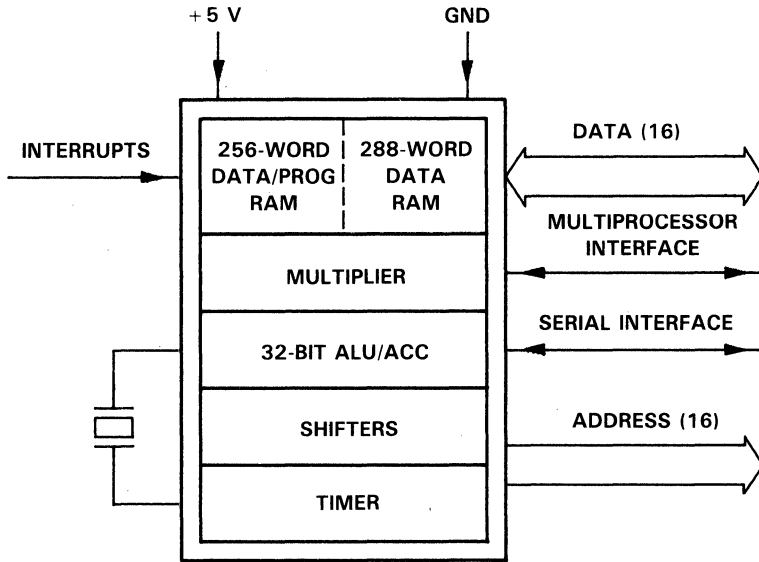

Figure 2-6. TMS32020 Block Diagram

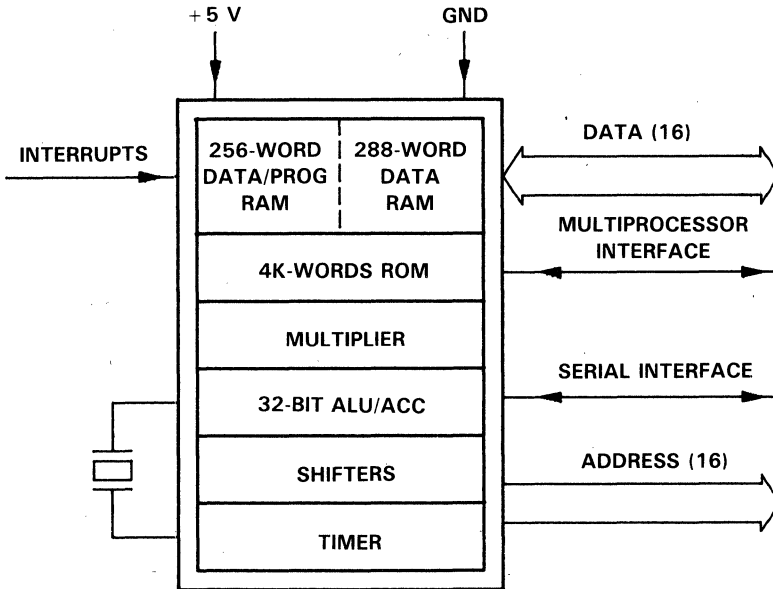

Figure 2-7. TMS320C25 Block Diagram

2.3 Typical Applications

The TMS320 family's unique versatility and realtime performance offer flexible design approaches in a variety of applications. In addition, TMS320 devices can simultaneously provide the multiple functions often required in those complex applications. For example, a single TMS32020 can be used to enhance the capabilities of a professional computer by providing text-to-speech, speech recognition, speech synthesis, and DTMF encoding and decoding, as well as internal modem functions. Table 2-2 lists typical TMS320 family applications.

Table 2-2. Typical Applications of the TMS320 Family

GENERAL-PURPOSE DSP	GRAPHICS/IMAGING	INSTRUMENTATION
Digital Filtering Convolution Correlation Hilbert Transforms Fast Fourier Transforms Adaptive Filtering Windowing Waveform Generation	3-D Rotation Robot Vision Image Transmission/ Compression Pattern Recognition Image Enhancement Homomorphic Processing Workstations Animation/Digital Map	Spectrum Analysis Function Generation Pattern Matching Seismic Processing Transient Analysis Digital Filtering Phase-Locked Loops
VOICE/SPEECH	CONTROL	MILITARY
Voice Mail Speech Vocoding Speech Recognition Speaker Verification Speech Enhancement Speech Synthesis Text-to-Speech	Disk Control Servo Control Robot Control Laser Printer Control Engine Control Motor Control	Secure Communications Radar Processing Sonar Processing Image Processing Navigation Missile Guidance Radio Frequency Modems
TELECOMMUNICATIONS		AUTOMOTIVE
Echo Cancellation ADPCM Transcoders Digital PBXs Line Repeaters Channel Multiplexing 1200 to 19200-bps Modems Adaptive Equalizers DTMF Encoding/Decoding Data Encryption	FAX Cellular Telephones Speaker Phones Digital Speech Interpolation (DSI) X.25 Packet Switching Video Conferencing Spread Spectrum Communications	Engine Control Vibration Analysis Antiskid Brakes Adaptive Ride Control Global Positioning Navigation Voice Commands Digital Radio Cellular Telephones
CONSUMER	INDUSTRIAL	MEDICAL
Radar Detectors Power Tools Digital Audio/TV Music Synthesizer Educational Toys	Robotics Numeric Control Security Access Power Line Monitors	Hearing Aids Patient Monitoring Ultrasound Equipment Diagnostic Tools Prosthetics Fetal Monitors

Table 2-3 provides a comparison of performance for some of the fundamental DSP operations when using either a TMS32010, a TMS32020, or a TMS320C25. Table 2-4 shows the benchmarks for the same three devices in providing cost-effective solutions to a wide range of applications. These

The TMS320 Family - Typical Applications

performance figures can be further improved by additional optimization of the algorithms for specific design goals, such as CPU loading and program space requirements.

Table 2-3. TMS320 DSP Family Benchmarks

FUNCTION	TMS32010	TMS32020	TMS320C25	UNIT
Sample Time:				
FIR filter tap	0.4	0.2	0.1	µs
Biquad IIR filter tap	2	2	1	µs
LMS adaptive filter tap (filter and update)	1.4	1.2	0.4	µs
Sample Rate:				
256-tap FIR filter:				
Without companded I/O	9.6	18.5	37	kHz
With companded I/O	9.1	15.75	31.5	kHz
256-tap adaptive FIR filter:				
Without companded I/O	2.7	3.2	9.5	kHz
With companded I/O	2.7	3.1	9.1	kHz
Fast Fourier Transforms:				
64 complex-point	555	434	217	µs
256 complex-point:				
Radix-4 straightline	N/A	2.44	1.5	ms
Radix-2 looped	N/A	6.88	3.44	ms
1024 complex-point:				
Radix-4 straightline	N/A	14.18	7.1	ms
Radix-2 looped	69.4	45	22.5	ms
Matrix multiplication [1 x 3] [3 x 1]	5.4	5.4	2.7	µs

Table 2-4. TMS320 DSP System Benchmarks

APPLICATION	PERFORMANCE STANDARD	TMS32010	TMS32020†	TMS320C25
Echo cancellation (CCITT G.165)	Echo length (16 ms)	N/A	100	50
Data encryption (ANSI X3.92-1981)	Data rate (42 kbps)	100		84 42
Split-band modem (CCITT V.22/212A)	(full-duplex)	CPU loading	80	60 30
32-kbps ADPCM (CCITT G.721)	(half-duplex)	CPU loading	100	90 50
2400-bps LPC-10 40 ‡ (DOD 45)	(half-duplex)	CPU loading	95	‡ 75
16-kbps subband coder	(full-duplex)	CPU loading	80	‡ 70 35

†Requires external program memory.

‡Requires external data memory.

3. ROM Codes

Board space is often a critical concern in many DSP applications. In order to reduce chip count and provide the customer with a single-chip solution, Texas Instruments offers microcomputer versions for many of the TMS320 family members. The on-chip ROM of these processors can be masked with the customer's own code. This allows the user to take advantage of the general-purpose features of TI's digital signal processors while at the same time customizing the processor to suit a specific application.

To facilitate design, all prototype work is performed using a standard TMS320 microprocessor. (Note that TMS320 refers to both the first and second generations of DSP devices.) TMS320 development tools permit a designer to test and refine algorithms for immediate results. When the algorithm has been finalized, the customer can submit the code to Texas Instruments to be masked into the on-chip ROM of the device.

The MC/MP (microcomputer/microprocessor) mode, offered on maskable TMS320 family members (excluding the TMS32011, TMS320C17/E17, and TMS320C17-25), often shortens design and field upgrade cycle times, thereby reducing expense. This mode permits the customer to use the TMS320 as a standard device operating out of external program memory. When TMS320 code is altered during design, the delays associated with new silicon processing are avoided. Field upgrade cycle times and the associated expense of inventory obsolescence when the code is altered are also avoided.

An entire algorithm or an often-used routine may be masked into the on-chip ROM space of a TMS320 DSP. TMS320 programs can also be expanded using external memory. With a reduced chip count and this program memory flexibility, multiple functions can be more easily implemented in a single hardware device, thus enhancing a product's capabilities.

The first-generation TMS320 DSPs with mask option include the TMS32010, TMS320C10, and TMS32011 with 1.5K words of on-chip ROM, and the TMS320C15 and TMS320C17 with 4K words of on-chip ROM. The second-generation TMS320C25 with 4K words of on-chip ROM can also be ordered as a masked device. The customer's code must fit within the specified ROM size of the chosen processor.

Figure 3-1 illustrates the procedure flow for implementing TMS320 masked parts. With any masked device order, there is a one-time charge of \$5500 for mask tooling which includes 25 prototypes. A non-cancellable minimum production order per year of 5000 units is required for the TMS32010, TMS320C10, TMS320C15, and TMS320C17. The TMS32011 is intended for high-volume usage with a minimum production order per year of 10,000 units. The masked TMS320C25 will be available in 1987.

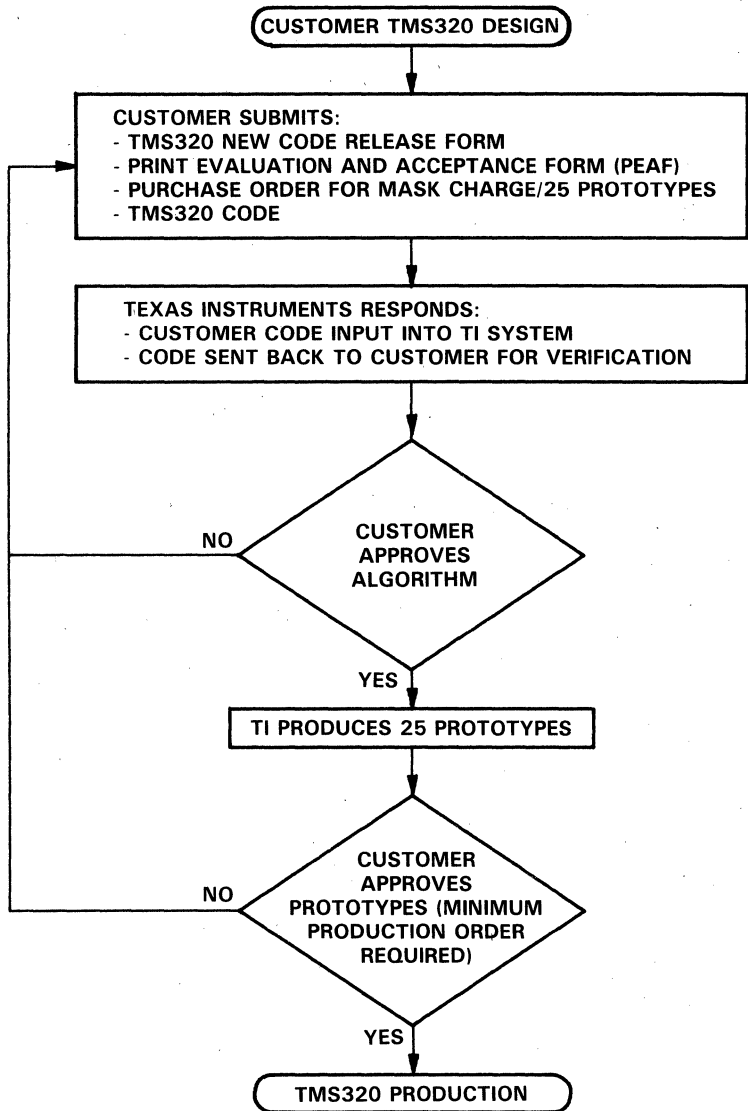

Figure 3-1. TMS320 ROM Code Flowchart

ROM Codes

Leadtimes for the first 25 prototype units begin when the customer has formally verified that TI has recorded his code correctly. Leadtimes for the first production order begin once the customer formally approves the masked prototypes. The typical leadtime for masked TMS320 prototypes is 8 weeks and for masked TMS320 production 10 to 12 weeks. Texas Instruments constantly strives to improve these leadtimes and reserves the right to make changes at any time. Please contact the nearest TI Sales Office for current leadtimes, further information on these procedures, and confirmation of the mask/production requirements.

A TMS320 ROM code may be submitted in one of the following formats (the preferred media is 5 1/4" floppies):

PROM: TBP28S166, TBP28S86
EPROM: TMS2764, TMS2508, TMS2516, TMS2532, TMS2564
FLOPPY: TI Cross-Assembler Format

When a code is submitted to Texas Instruments for a masked device, the code is reformatted to accommodate the TI mask generation system. System level verification by the customer is therefore necessary. Although the code has been reformatted, it is important that the changes remain transparent to the user and not affect the execution of the algorithm. The formatting changes made involve deletion of all address tags (unnecessary in a ROM code device) and addition of data in the reserved locations of the ROM for device ROM test. Note that because these changes have been made, a checksum comparison is not a valid means of verification.

ROM code algorithms may also be submitted by secure electronic transfer via a modem. Contact the nearest TI sales office for further information.

With each masked device order, the customer must sign a disclaimer stating:

"The units to be shipped against this order were assembled, for expediency purposes, on a prototype (i.e., non-production qualified) manufacturing line, the reliability of which is not fully characterized. Therefore, the anticipated inherent reliability of these prototype units cannot be expressly defined."

and a release stating:

"Any masked ROM device may be resymbolized as TI standard product and resold as though it were an unprogrammed version of the device at the convenience of Texas Instruments."

ROM codes will be deleted from the TI system after one year from the last delivery.

4. Quality and Reliability

The quality and reliability performance of Texas Instruments Microprocessor and Microcontroller Products, which includes the TMS320 family of digital signal processors, relies on feedback from:

- Our customers
- Our total manufacturing operation from front-end wafer fabrication to final shipping inspection
- Product quality and reliability monitoring.

Our customer's perception of quality must be the governing criterion for judging performance. This concept is the basis for Texas Instruments Corporate Quality Policy, which is as follows:

"For every product or service we offer, we shall define the requirements that solve the customer's problems, and we shall conform to those requirements without exception."

Quality and reliability programs at TI are therefore based on customer input and internal information to achieve constant improvement in quality and reliability.

Texas Instruments offers a leadership reliability qualification system, based on years of experience with leading-edge memory technology as well as years of research into customer requirements. This system provides more than just reliable products; feedback of results to manufacturing and design leads to continuing improvements in TI products. Data generated by the system is always available to aid customers in qualifying TI products. Although it is the last input received for any product delivery cycle, customer-perceived performance is the most important quality and reliability measurement.

4.1 Reliability Stress Tests

Accelerated stress tests are performed on new semiconductor products and process changes to ensure product reliability excellence. The typical test environments used to qualify new products or major changes in processing are:

- High-temperature operating life
- Storage life
- Temperature cycling
- Biased humidity
- Autoclave
- Electrostatic discharge
- Package integrity
- Electromigration
- Channel-hot electrons (performed on geometries less than 2.0 μm).

Typical events or changes that require internal requalification of product include:

- New die design, shrink, or layout
- Wafer process (baseline/control systems, flow, mask, chemicals, gases, dopants, passivation, or metal systems)
- Packaging assembly (baseline control systems or critical assembly equipment)
- Piece parts (such as lead frame, mold compound, mount material, bond wire, or lead finish)
- Manufacturing site.

TI reliability control systems extend beyond qualification. Total reliability controls and management include product ramp monitor as well as final product release controls. MOS memories, utilizing high-density active elements, serve as the leading indicator in wafer-process integrity at TI MOS fabrication sites, enhancing all MOS logic device yields and reliability. TI places more than 200,000 MOS devices per month on reliability test to ensure and sustain built-in product excellence.

Table 4-1 lists the microprocessor and microcontroller reliability tests, the duration of the test, and sample size. The following defines and describes those tests in the table.

AOQ (Average Outgoing Quality) Amount of defective product in a population, usually expressed in terms of parts per million (PPM).

FIT (Failure In Time) Estimated field failure rate in number of failures per billion power-on device hours; 1000 FITS equals 0.1 percent fail per 1000 device hours.

Operating lifetest Device dynamically exercised at a high ambient temperature (usually 125°C) to simulate field usage that would

	expose the device to a much lower ambient temperature (such as 55°C). Using a derived high temperature, a 55°C ambient failure rate can be calculated.
High-temperature storage	Device exposed to 150°C unbiased condition. Bond integrity is stressed in this environment.
Biased humidity	Moisture and bias used to accelerate corrosion-type failures in plastic packages. Conditions include 85°C ambient temperature with 85-percent relative humidity (RH). Typical bias voltage is +5 V and ground on alternating pins.
Autoclave (pressure cooker)	Plastic-packaged devices exposed to moisture at 121°C using a pressure of one atmosphere above normal pressure. The pressure forces moisture permeation of the package and accelerates corrosion mechanisms (if present) on the device. External package contaminants can also be activated and caused to generate inter-pin current leakage paths.
Temperature cycle	Device exposed to severe temperature extremes in an alternating fashion (-65°C for 15 minutes and 150°C for 15 minutes per cycle) for at least 1000 cycles. Package strength, bond quality, and consistency of assembly process are stressed in this environment.
Thermal shock	Test similar to the temperature cycle test, but involving a liquid-to-liquid transfer, per MIL-STD-883C, Method 1011.
PIND	Particle Impact Noise Detection test. A non-destructive test to detect loose particles inside a device cavity.
Mechanical Sequence:	
Fine and gross leak	Per MIL-STD-883C, Method 1014.5
Mechanical shock	Per MIL-STD-883C, Method 2002.3, 1500 g, 0.5 ms, Condition B
PIND (optional)	Per MIL-STD-883C, Method 2020.4
Vibration, variable frequency	Per MIL-STD-883C, Method 2007.1, 20 g, Condition A
Constant acceleration	Per MIL-STD-883C, Method 2001.2, 20 kg, Condition D, Y1 Plane min
Fine and gross leak	Per MIL-STD-883C, Method 1014.5

Quality and Reliability

Electrical test	To data sheet limits
Thermal Sequence:	
Fine and gross leak	Per MIL-STD-883C, Method 1014.5
Solder heat (optional)	Per MIL-STD-750C, Method 1014.5
Temperature cycle (10 cycles minimum)	Per MIL-STD-883C, Method 1010.5, -65 to +150°C, Condition C
Thermal shock (10 cycles minimum)	Per MIL-STD-883C, Method 1011.4, -55 to +125°C, Condition B
Moisture resistance	Per MIL-STD-883C, Method 1004.4
Fine and gross leak	Per MIL-STD-883C, Method 1014.5
Electrical test	To data sheet limits
Thermal/Mechanical Sequence:	
Fine and gross leak	Per MIL-STD-883C, Method 1014.5
Temperature cycle (10 cycles minimum)	Per MIL-STD-883C, Method 1010.5, -65 to +150°C, Condition C
Constant acceleration	Per MIL-STD-883C, Method 2001.2, 30 kg, Y1 Plane
Fine and gross leak	Per MIL-STD-883C, Method 1014.5
Electrical test	To data sheet limits
Electrostatic discharge	Per MIL-STD-883C, Method 3015
Solderability	Per MIL-STD-883C, Method 2003.3
Solder heat	Per MIL-STD-750C, Method 2031, 10 sec
Salt atmosphere	Per MIL-STD-883C, Method 1009.4, Condition A, 24 hrs min
Lead pull	Per MIL-STD-883C, Method 2004.4, Condition A
Lead integrity	Per MIL-STD-883C, Method 2004.4, Condition B1
Electromigration	Accelerated stress testing of con- ductor patterns to ensure acceptable lifetime of power-on operation
Resistance to solvents	Per MIL-STD-883C, Method 2015.4

Table 4-1. Microprocessor and Microcontroller Tests

TEST	DURATION	SAMPLE SIZE	
		PLASTIC	CERAMIC
Operating life, 125°C, 5.0 V	1000 hrs	195	195
Operating life, 150°C, 5.0 V	1000 hrs	77*	77
Storage life, 150°C	1000 hrs	129	129
Biased 85°C/85 percent RH, 5.0 V	1000 hrs	129	-
Autoclave, 121°C, 1 ATM	240 hrs	105	-
Temperature cycle, -65 to 150°C	1000 cyc	129	129
Thermal shock, -65 to 150°C	500 cyc	129	129
Electrostatic discharge, ±2 kV		12	12
Latch-up (CMOS devices only)		5	5
Mechanical sequence		-	38
Thermal sequence		-	38
Thermal/mechanical sequence		-	38
PIND		-	15
Internal water vapor		-	5
Solderability		22	22
Solder heat		22	22
Resistance to solvents		12	12
Lead integrity		15	15
Lead pull		15	-
Lead finish adhesion		15	15
Salt atmosphere		15	15
Flammability (UL94-V0)		3	-
Thermal impedance		5	5

*If junction temperature does not exceed plasticity of package.

TI Qualification test updates are available upon request at no charge. TI will consider performing any additional reliability test(s), if requested. For more information on TI quality and reliability programs, contact the nearest TI field sales office.

Note:

Texas Instruments reserves the right to make changes in MOS Semiconductor test limits, procedures, or processing without notice. Unless prior arrangements for notification have been made, TI advises all customers to reverify current test and manufacturing conditions prior to relying on published data.

5. TMS320 Development Support Products

Texas Instruments offers an extensive line of development support products to assist the user in all aspects of TMS320 design and development. These products range from development and application software to complete hardware development and integration systems such as the XDS/22.

System development begins with the use of the TMS320 Evaluation Module (EVM) or Emulator (XDS). These support tools allow the designer to evaluate the processor's performance, benchmark time-critical code, and determine the feasibility of using a TMS320 device to implement a specific algorithm. Extensive documentation provides information concerning device specifications and capabilities. The TI Regional Technology Centers (RTCs) offer three-day DSP design workshops that provide hands-on experience with TMS320 development tools (see Section 8.2).

Software and hardware can be developed in parallel by using the macro assembler/linker and simulator for software development and the XDS for hardware development. The assembler/linker translates the system's assembly source program into an object module that can be executed by the simulator, XDS, or EVM. The XDS provides realtime in-circuit emulation and is a powerful tool for debugging and integrating software and hardware modules.

Figure 5-1 shows development product integration, and Figure 5-2 shows typical application development. The appropriate TMS320 support product is indicated for each stage of development. Table 5-1 provides a feature matrix of the TMS320 development tools, comparing capabilities such as development purpose, software and hardware features, and amount of memory.

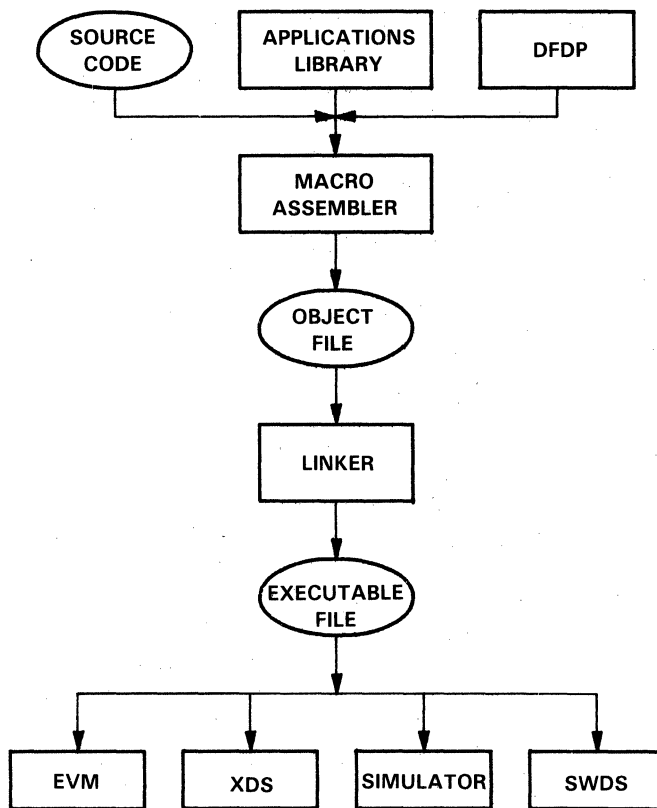

Figure 5-1. TMS320 Development Product Integration

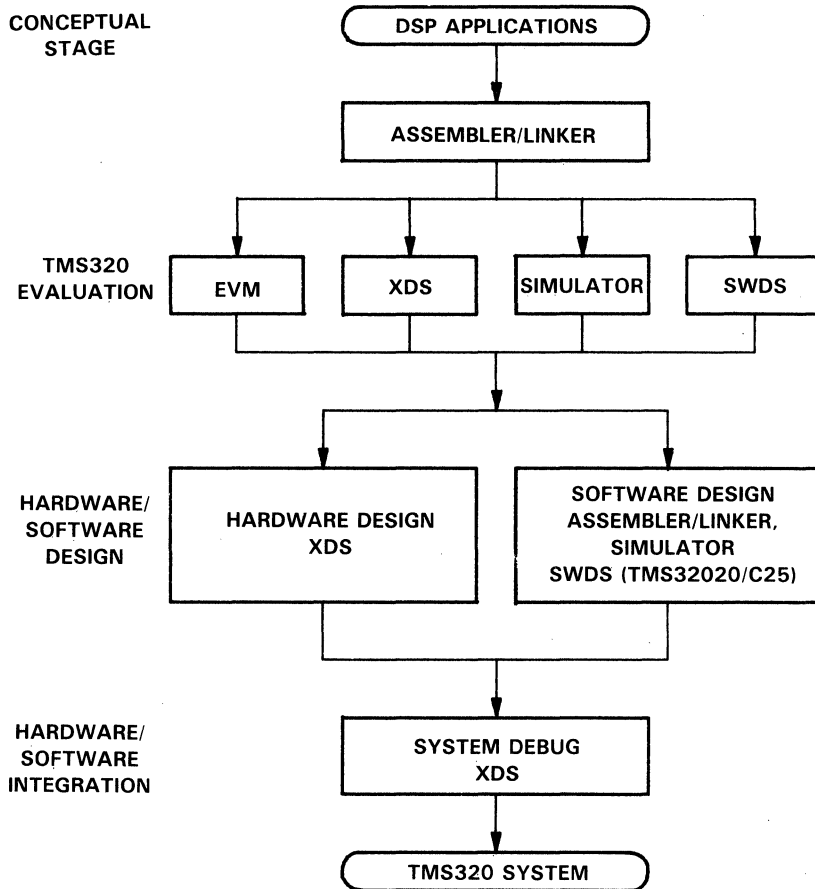

Figure 5-2. Typical TMS320 Application Development Flow

TMS320 Development Support Products

Table 5-1. Feature Matrix of TMS320 Development Tools

FEATURES	EVM	SIMULATOR	SWDS	XDS
Development Purpose:				
Evaluation/benchmarking	Yes	Yes	Yes	Yes
Software development	No	Yes	Yes	Yes
Hardware design	No	No	No	Yes
Line-by-line assembler/reverse assembler	Yes	No	Yes	Yes
Modify/display memory and registers	Yes	Yes	Yes	Yes
Single-stepping	Yes	Yes	Yes	Yes
Breakpoint on address	Yes	Yes	Yes	Yes
Breakpoint on memory access/read/write	No	Yes	No	Yes
Time-stamping/clock counter	No	Yes	Yes	Yes
Real-time trace samples	No	No	No	Yes
Full-speed in-circuit emulation:				
From on-board memory	Yes	N/A	Yes	Yes
From target memory	No	N/A	No	Yes
Multi-user system	No	Yes	No	No
Built-in system interface	No	No	Yes	No
Files associated to I/O ports	No	Yes	Yes	No
Amount of memory:				
On-board program/data (TMS32010/C10)	4K/-	N/A	N/A	4K/-
On-board program/data (TMS32020/C25)	4K/4K	N/A	24K	4K/4K
Program/data expansion (TMS320C25)	16K/16K	N/A	N/A	64K*

* Memory expansion board allows for memory expansion to 64K words total of program and data memory, configurable in 1K blocks.

6. Software Support Products

Many support products are offered for the TMS320 family of digital signal processors. This section discusses the software support products, which include a macro assembler/linker, simulator, SoftWare Development System (SWDS), Digital Filter Design Package (DFDP), DSP Software Library, and TMS320 Bell 212A Modem Software. These products are described in the sections listed below.

- TMS320 Macro Assembler/Linker (Section 6.1 on page 6-2)
- TMS320 Simulator (Section 6.2 on page 6-5)
- SoftWare Development System (SWDS) (Section 6.3 on page 6-7)
- Digital Filter Design Package (DFDP) (Section 6.4 on page 6-10)
- Digital Signal Processing Software Library (Section 6.5 on page 6-13)
- TMS320 Bell 212A Modem Software (Section 6.6 on page 6-15)

6.1 TMS320 Macro Assembler/Linker

The TMS320 Macro Assembler is a two-pass assembler that translates TMS320 assembly language instructions and directives into executable object code. The assembler allows the programmer to use mnemonics rather than hexadecimal machine instructions and to reference memory locations with symbolic addresses. A source file can contain either absolute or relocatable code. When several components of a source program are assembled individually, the TMS320 Link Editor links together the object code produced by the program modules to form one complete executable program.

The following versatile features distinguish the TMS320 Macro Assembler/Linker:

- Macro capabilities
- Macro definition library
- Macro-conditional assembly
- Relocatable modules
- Complete error diagnostics
- Symbol and cross-reference tables.

The TMS320 Macro Assembler/Linker is currently available for the VAX/VMS (1600 BPI mag tape) and TI/IBM PC MS/PC-DOS (5 1/4-inch floppy) operating systems. The PC configuration requires a minimum of 256K RAM.

In the assembler, directives control the assembly process rather than produce object code. The assembler supports directives that affect the location counter and the assembler output, initialize constants, and resolve external references.

The assembler uses TMS320 source code as input. Each source statement in this file may contain either an assembler directive, a machine instruction, or a comment. The assembler produces two output files: (1) a source listing file that shows the source statement number, a location counter value, the object code assembled, and the source statement as entered; and (2) an object file that contains the actual object code that can be executed by the TMS320. The assembler also provides a complete set of error messages and an optional symbol table and cross-reference listing.

The assembler supports macro calls and definitions as well as macro-conditional assembly to simplify programming and consolidate frequently repeated source code. Macros may be defined with the assembler source code or in a library (directory) of external files to be included at link time.

The TMS320 Link Editor permits modular programming; a program can be designed and implemented in separate modules that can be individually assembled and then linked to form a complete executable program. The link editor's major function is to resolve external symbolic references and definitions. As input, the link editor uses a link control file that specifies the task name, defines the starting location for the data and program segments, and indicates which object files are to be linked. The link editor produces two output files: (1) a listing of the command control file that includes a map of the segments and modules, which were linked, and a cross-reference listing of the externally defined variables; and (2) a file that contains the actual load module of linked object code, which can be executed by the TMS320.

Software Development Tools - Macro Assembler/Linker

TMS320 source code can be written in a single source file, assembled, linked, and then downloaded to the TMS320 program memory, simulator, evaluation module, or XDS emulator. Figure 6-1 shows an assembly with a single-source module.

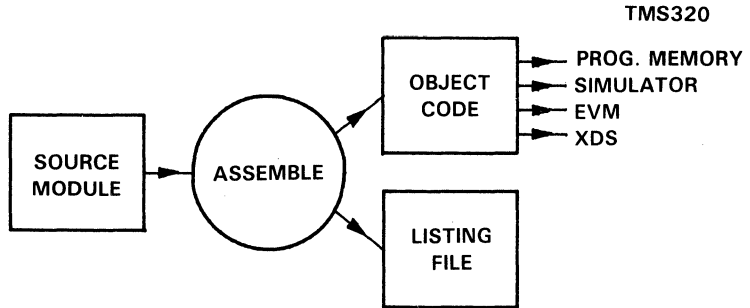

Figure 6-1. Assembly with a Single-Source Module

A TMS320 program can also be separated into two or more source modules. Figure 6-2 shows how these modules are assembled individually, linked via a link control file, and then downloaded to the TMS320 program memory, simulator, evaluation module, or XDS emulator.

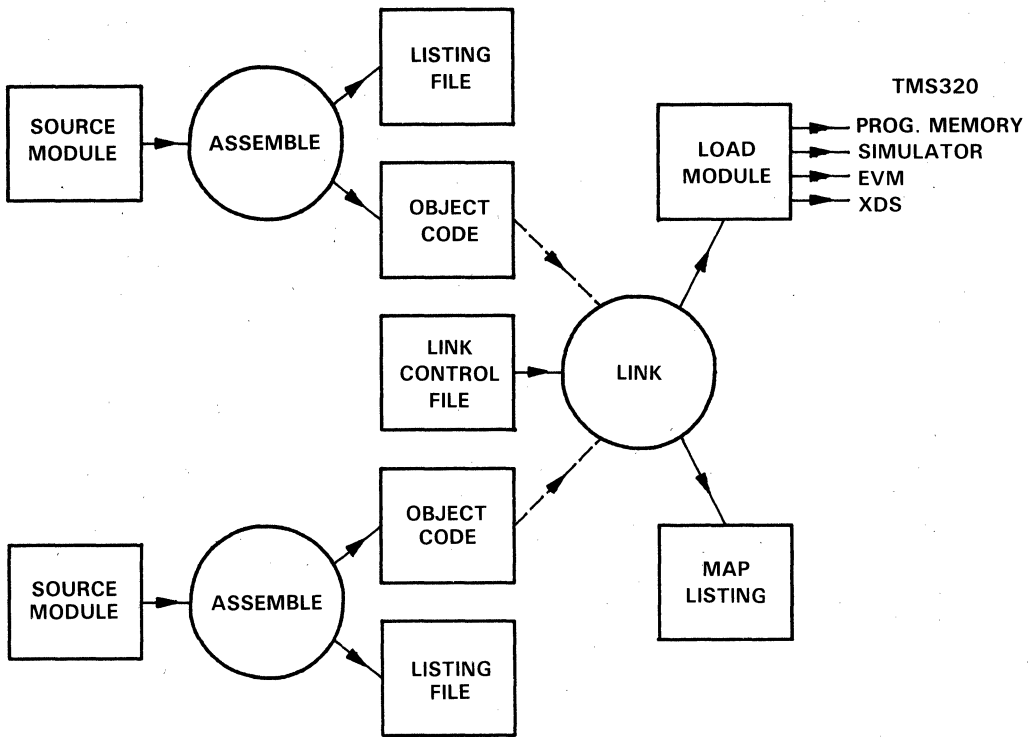

Figure 6-2. Linked Assembly with Multiple-Source Modules

The latest revision number of the TMS320 assembler/linker software can be referenced through the TMS320 DSP Bulletin Board Service (see Section 9.8).

6.2 TMS320 Simulator

The TMS320 Simulator is a software program that simulates the TMS320 microprocessor and microcomputer modes for cost-effective TMS320 software development and program verification in nonrealtime. Using the inexpensive software simulator allows debugging without the requirement of hardware. Files may be associated with I/O ports so that specific I/O values may be used during test and debug. Time-critical code can be tested, as well as individual portions of the program. The clock counter allows loop timing during code optimization. Breakpoints can be established, based on read and write execution with internal data RAM.

Significant key features of the simulator are:

- Interrupt generation at user-defined intervals
- File-associated I/O with 8 ports (TMS32010) or 16 ports (TMS32020/C25)
- Programmable breakpoints on:
 - Instruction acquisition
 - Memory reads or writes (data or program)
 - Data patterns on the D-bus or the P-bus
 - Error conditions.
- Timing analysis relative to clock rate
- Trace on accumulator, program counter, and auxiliary registers
- Immediate execution of an interrupt or instruction
- Data and program memory modification and display:
 - Changing an entire block at any time
 - Initializing memory before a program is loaded.
- Error messages for illegal opcodes and invalid data entry
- Command execution from a journal file
- Modification and inspection of registers
- Multiple-user configuration (VAX/VMS system).

The TMS320 Simulator is currently available for the VAX/VMS (1600 BPI mag tape) and TI/IBM MS/PC-DOS (5 1/4-inch floppy) operating systems. The PC configuration requires a minimum of 256K RAM for the TMS32010 Simulator and 512K RAM for the TMS32020/C25 Simulator.

The simulator uses TMS320 object code produced by the TMS320 Macro Assembler/Linker. Input and output files may be associated with the port addresses of the I/O instructions, simulating I/O devices connected to the processor. The interrupt flag can be set periodically at programmed intervals to simulate an interrupt signal. Before initiating program execution, breakpoints and traces may be defined and enabled. Figure 6-3 shows an example of a simulator screen display.

```

OPC: 6905 DIR          RPTC: 0   CLK : 1831          CWD
                                     NP mode
PC-: 13  ADD          TOS : 0   IFR:000000 INTN:1
PC : 14  SACH        DF  : 4   INR:000000 OUTP: 0

AR0:      0          DRB : 0   OVM: 0   OV : 0
*AR1:    200          DRP : 0   SKN: 1   CY : 0
AR2:      0          TIM : FD16 PM : 0   TC : 0
AR3:      0
AR4:      0
AR5:      0          TREG: 5A82
AR6:      0          PREG: 0
AR7:      0          ACC : 0
-----
Enter start PROGRAM address (in Hex) : 0
0  CE06 CE07 CE02 C004 D001 5A82 6010 C008
8  D106 200 5589 C007 0080 2E04 E06 6304
16 1F06 6906 2E05 E07 6905 1F07 6907 2E00
18 E02 6906 1F02 F07 6902 4407 5806 6806
20 2E01 E03 6901 1F03 1F07 6803 4907 6807
28 2F06 F04 0000 4404 6004 2F01 F05 6801
30 4405 6805 2E0C E0E 690C 1F0E 690E 2E0D
38 EOF 690D 1F0F 690F 2E08 E0A 6908 1F0A
Command: █
    
```

Figure 6-3. Simulator Screen Example

During program execution, the internal registers and memory of the simulated TMS320 are modified as the host computer interprets each instruction. Execution is suspended when a breakpoint or error is encountered, a branch to 'self' is detected, or a breakpoint from the keyboard is entered by the user.

Once program execution is suspended, the internal registers and both program and data memories can be inspected and/or modified. The trace memory can also be displayed. A record of the simulation session can be maintained in a journal file so that it may be re-executed to regain the same machine state during another simulation session.

Before beginning a debugging session, TMS320 source code must first be written and assembled. If there are multiple modules, then they must be linked. The linked absolute object code is loaded into the simulator and executed during simulation.

6.3 SoftWare Development System (SWDS)

The SoftWare Development System (SWDS), shown in Figure 6-4, is a PC-resident tool that provides software simulation in realtime for the TMS32020 and TMS320C25. The SWDS offers a user the system interface necessary to write, assemble/link, load, and debug the TMS32020/C25 code on a PC workstation. The debug capabilities of the SWDS allow the user to single-step through the code or to set software breakpoints for monitoring register or memory contents during execution. It is also possible to associate files with I/O ports so that specific I/O values may be used during test and debug. Figure 6-5 provides an example of a SWDS screen display.

A circuit board, resident in the PC, contains the TMS32020 or TMS320C25 and program and data memory. Two small cable adaptor boards are situated outside the PC and connect to the SWDS via two 40-conductor ribbon cables. The cable adaptor boards included with the system are: (1) the PGA Adaptor Connector that connects the SWDS to a TMS32020 or TMS320C25 target system via a 68-pin grid array footprint, and (2) the Analog Interface Board (AIB) Adaptor Connector that connects the SWDS directly to the TMS32010 AIB. The TMS32020/C25 assembler/linker software and the DSP Software Library (see Section 6.5) are included in the SWDS package.

The SWDS is designed to function in any TI PC environment (including the TI Business Pro), as well as in the IBM-PC/AT and compatible environment. MS-DOS version 2.0 or later is required.

The development system occupies 64K bytes of PC memory. It is equipped with 24K words (48 kbytes) of static RAM, and allows the TMS32020/C25 to execute at full speed.

The SWDS is configured to emulate the TMS320C25 upon shipment; i.e., a TMS320C25 and a 40-MHz oscillator are on-board. A TMS32020 and a 20-MHz crystal are included with the system to accommodate TMS32020 emulation. The target system may supply a TTL clock source, in which case the upper limit on the clock speed is dictated by the speed of the processor on the PC board. If the user's target system has no provision for a clock source, the external clock is specified in the debug monitor initialization command and an external crystal is connected to the SWDS.

Texas Instruments constantly strives to improve its products, reserving the right to make changes at any time in the specifications of this SoftWare Development System.

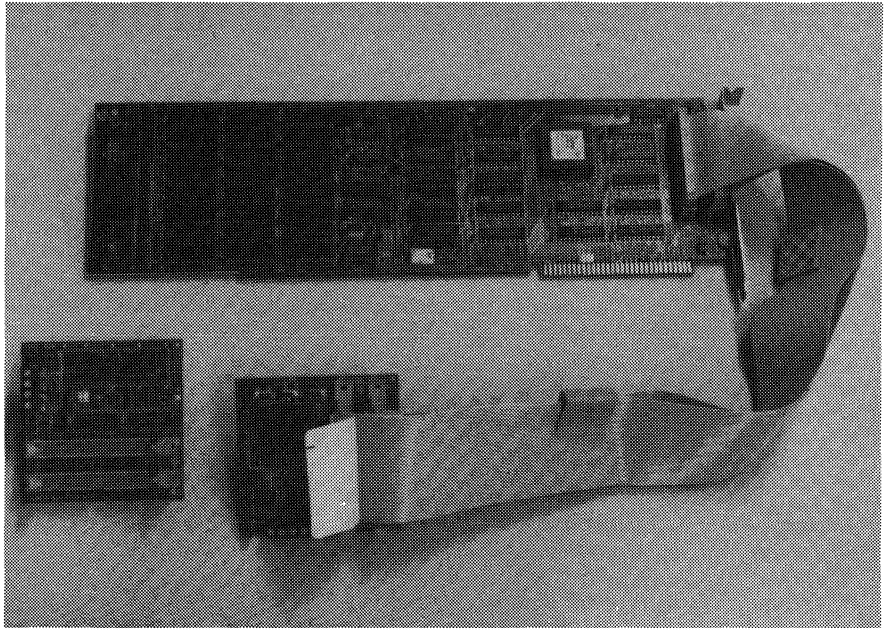

Figure 6-4. SoftWare Development System (SWDS)

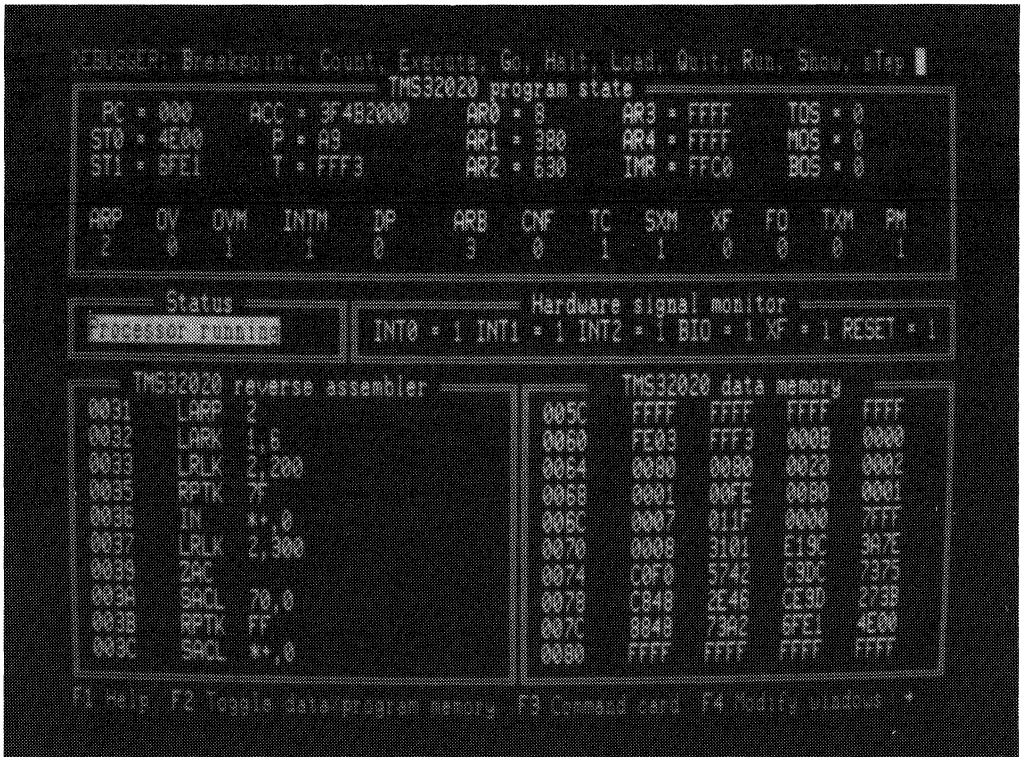

Figure 6-5. SWDS Screen Example

6.4 Digital Filter Design Package (DFDP)

The Digital Filter Design Package (DFDP) from Atlanta Signal Processors, Inc. (ASPI) is a user-friendly, menu-driven software package intended to speed design of digital filters with floating-point accuracy or fixed-point economy in a variety of filter structures.

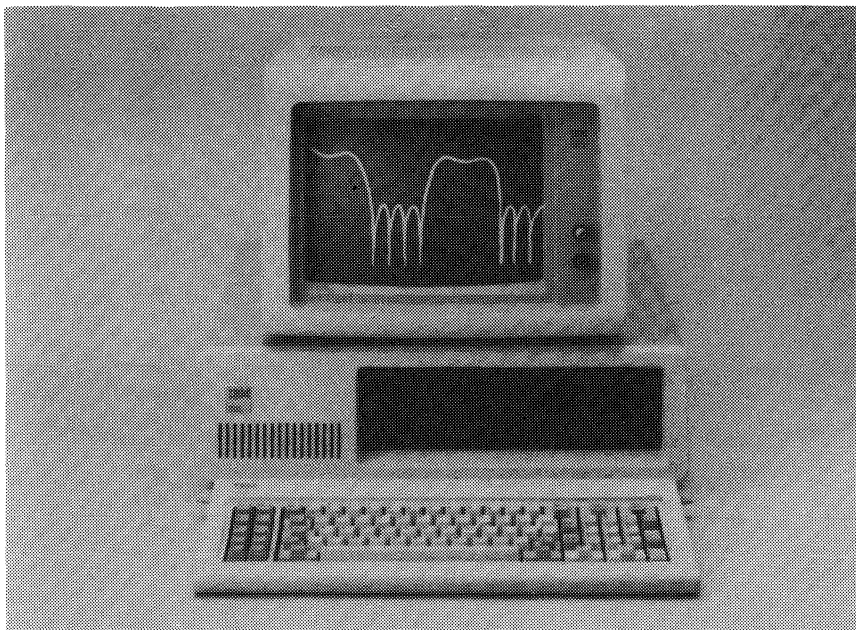

Figure 6-6. Digital Filter Design Package (DFDP)

Software Development Tools - Digital Filter Design Package

The package consists of four interactive filter design modules capable of performing the following functions:

- 1) Designing FIR filters (Kaiser window)
- 2) Designing FIR filters (Parks-McClellan)
- 3) Designing IIR filters (Butterworth, Chebychev I and II, and elliptic)
- 4) Generating TMS320 assembly code by converting the ASCII file containing the filter coefficients into fully commented assembly language code for the TMS32010 and TMS32020.

Cascade and parallel structures as well as higher-performance lattice, normalized lattice, and orthogonal forms are included in the modules.

The DFDP can design filters to meet any piecewise linear response specification, evaluate filter characteristics before and after coefficient quantization, and design special-purpose FIR filters, such as multiband filters, differentiators, Hilbert transformers, and raised-cosine filters. The DFDP can also generate coefficients for filter implementations on any general-purpose processor or signal processing chip, as well as fully commented assembly language code for a variety of DSP chips. Magnitude, log magnitude, and impulse responses can be plotted for printer or screen display (see Figure 6-7); in addition, the phase, group delay, and pole-zero map can be plotted for IIR filters.

The DFDP design modules present menus and queries so that the designer can specify the type of filter, sampling frequency, and filter cutoff frequencies and attenuation requirements. The program estimates the required filter order or impulse response length and asks the user to select the filter length to be used. The program then attempts to calculate the coefficients; using these coefficients, it calculates the response characteristics of the realizable filter. A screen message may warn that specifications are unrealizable or that the designed filter does not meet specifications.

If the designed filter does not meet specifications, the user may examine the table of poles and zeros or impulse response coefficients of the filter generated by the program as well as the frequency response plots. The user may also examine the response over the full relevant spectrum (zero to one-half the sampling frequency) or over any narrower frequency limits chosen. Amplitude is automatically scaled within such a frequency band in order to utilize the full height of the graph. Every plot, whether of the full relevant spectrum or the expansion of a narrower band, is displayed on the monitor and may also be directed to the printer.

After the filter is designed, the user can generate code associated with the filter using the CGEN design module.

The DFDP runs on the TI PC, IBM PC/XT/AT, and compatible systems. Operating systems must have 192 kbytes of memory available. For more information, contact Atlanta Signal Processors, Inc. (see Section 11) or the nearest TI field sales office.

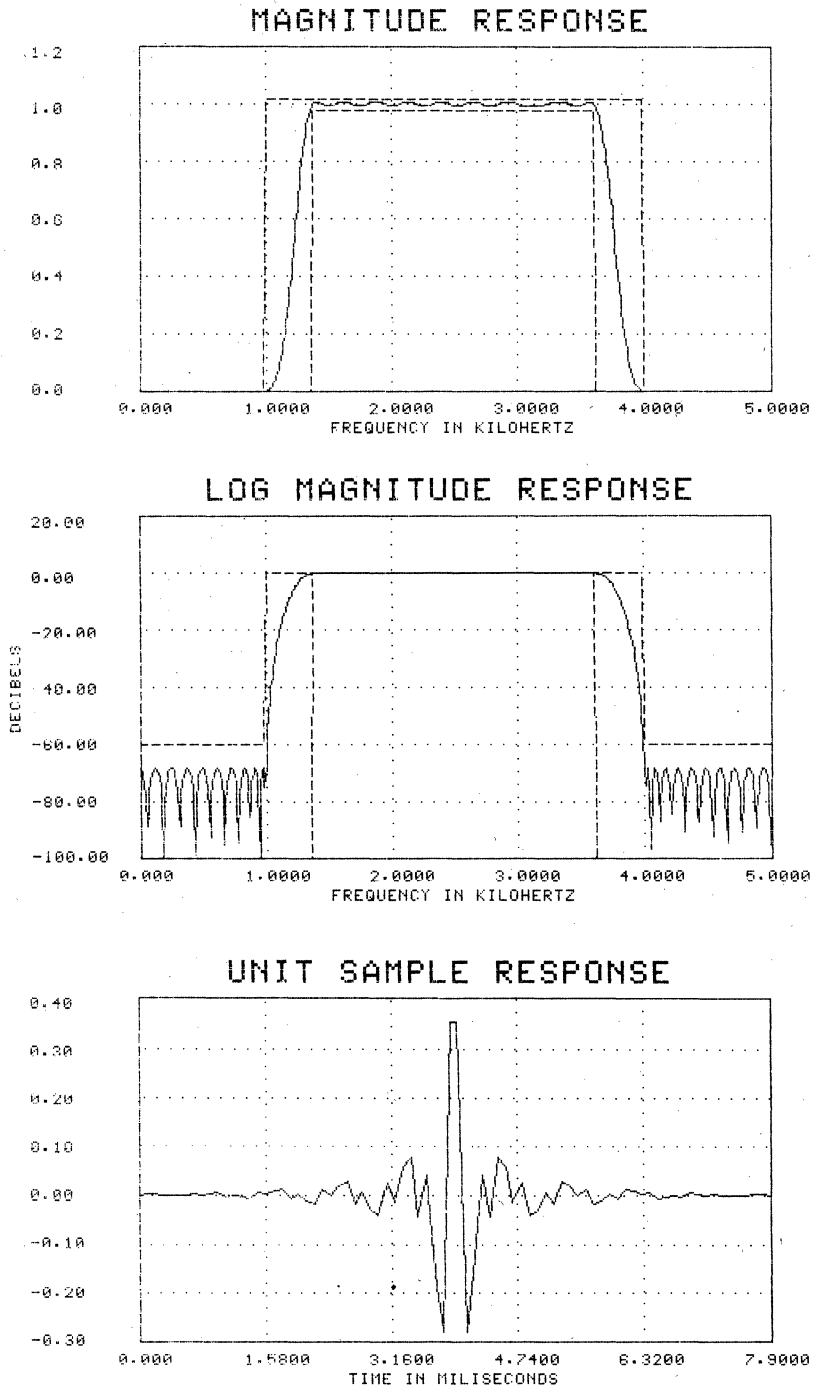

Figure 6-7. DFD Plot Examples

6.5 Digital Signal Processing Software Library

The Digital Signal Processing Software Library contains the major DSP routines (FFT, FIR/IIR filtering, and floating-point operations) and application algorithms (echo cancellation, ADPCM, and DTMF coding/decoding) presented in the book, *Digital Signal Processing Applications with the TMS320 Family*. These routines and algorithms are written in either TMS32010 and/or TMS32020 source code. In addition, macros for the TMS32010 are included in the library.

The software package consists of four diskettes for use with the TI/IBM MS/PC-DOS (version 1.1 or later) or a 1600 BPI magnetic tape for the VAX/VMS version. For the MS/PC-DOS version, Table 6-1 briefly describes the contents of each diskette. All the directories listed are contained on the magnetic tape for the VMS version. Each directory contains a README.LIS file briefly describing the contents of the files in the directory and the reference to the code. The book, *Digital Signal Processing Applications with the TMS320 Family*, is the major reference for the theory and algorithms, and also provides printed code in the appendices of each application report. Table 6-1 indicates the section in the applications book where the user can find the theory behind the source code.

The software library and applications book are included in the purchase of a TMS320 Design Kit (see Section 7.5). The library can also be ordered separately through TI (see Appendix A for ordering information).

All the software in the library is copyrighted by Texas Instruments (see Appendix C for the Program License Agreement). The library is continually being updated; therefore, check the TMS320 DSP Bulletin Board (see Section 9.8) for update information.

Table 6-1. Software Library Contents

DISK #	DIRECTORY	# OF FILES†	DESCRIPTION	APP. BK. SECTION
1	README.LIS	1	Description of product	
	INSTALL.BAT	1	S/W installation procedures	
	LOAD.BAT	1	Loading S/W onto hard disk	
	FFT32010.DIR	10	FFT routines in TMS32010 (source) code (from Burrus and Parks' <i>DFT/FFT and Convolution Algorithms</i>)	
	FFT32020.DIR	10	FFT routines in TMS32020 (source) code	4
2	ADPCMCCI.DIR	9	CCITT-compatible ADPCM code in TMS32010	17
	ADPCMNON.DIR	5	Non-CCITT ADPCM code in TMS32010	17
	COMPND10.DIR	5	Companding routines in TMS32010	5
	COMPND20.DIR	4	Companding routines in TMS32020	5
	COMPNDHW.DIR	3	FORTRAN programs to generate companding tables for implementing companding in hardware	14
	DTMF10.DIR	4	Single-channel DTMF code in TMS32010	19
	ECHO128.DIR	2	16-ms echo cancellation code in TMS32020	15
	FIR-IIR.DIR	7	FIR/IIR filter code in TMS32010/20	3
	GRAPHICS.DIR	20	Graphics routines in TMS32020	23
3	FLTGPT10.DIR	3	Floating-point routines in TMS32010	6
	FLTGPT20.DIR	4	Floating-point routines in TMS32020	7
	MACROS.DIR	60	TMS32010 Macros	
	MATRIX.DIR	3	Matrix multiplication routines in TMS32010/20	9
4	ADPTVFLT.DIR	2	Adaptive filter routine in TMS32020	
	DATAIO.DIR	2	Conversion routines from TMS320/9900/7000 code into binary format	
	MACROSRC.DIR	37	More TMS32010 macros	

†Total: 4 disks, 18 directories, 191 files.

6.6 TMS320 Bell 212A Modem Software

Texas Instruments is offering a software package containing source code and documentation for the design and implementation of a 1200-bps Bell 212A modem with the TMS32011 digital signal processor and the TMS7041 microcontroller.

The documentation included in the package consists of two reports. One report discusses in detail the theory behind the design of the modem, as well as the functions implemented. The second report describes the hardware, algorithms, and coding techniques used in the implementation of a Bell 212A modem demonstration unit. This implementation has been built and tested to verify its operation. After reading this report, the user should be able to design and build a similar unit as well as understand some tradeoffs involved in making custom modifications.

The source code for the TMS320 Bell 212A Modem Software package is provided on a 5 1/4" floppy for MS/PC-DOS or compatible operating systems. Contact the nearest TI field sales office for further information.

7. Hardware Development Tools

The hardware development support tools for the TMS320 family of digital signal processors include the Evaluation Module (EVM), Emulator (XDS Extended Development Support System), Analog Interface Board (AIB), and DSP Design Kit. These tools are described in the sections listed below.

- TMS320 Evaluation Module (EVM) (Section 7.1 on page 7-2)
- TMS320 Emulator (XDS) (Section 7.2 on page 7-9)
- TMS320 XDS Upgrade Package (Section 7.3 on page 7-17)
- TMS320 Analog Interface Board (AIB) (Section 7.4 on page 7-21)
- TMS320 DSP Design Kit (Section 7.5 on page 7-25)

7.1 TMS320 Evaluation Module (EVM)

The TMS320 Evaluation Module (EVM) is a low-cost development board used for full-speed in-circuit emulation and hardware debugging. It consists of a single board that enables a designer to evaluate certain characteristics of the TMS320 processor to determine if it meets the requirements of an application.

The powerful firmware package of the TMS320 EVM contains a debug monitor, assembler/reverse assembler, and software communication via two EIA ports. The EVM can communicate to a host computer and several peripherals. Dual EIA ports allow the EVM to be connected to a terminal and a host computer. The EVM accepts either source or object code downloaded from the host computer. The resident assembler converts incoming source text in one pass by automatically resolving labels as defined. When a session is complete, code may be uploaded to the host computer.

Two EVM models support first- and second-generation family member in-circuit emulation: the TMS32010 EVM and the TMS32020/C25 EVM, respectively (see Figure 7-1 and Figure 7-2).

Some key features of the TMS32010 EVM are:

- On-board TMS32010
- 20-MHz operation
- Event counter for one breakpoint
- Text editor
- On-board EPROM programmer
- Audio cassette interface
- 4K words of on-board program RAM
- Target connector for full-speed in-circuit emulation from EVM memory
- Debug monitor including commands with full prompting
- Line-by-line assembler/reverse assembler
- Transparency mode for host CPU upload/download
- Eight instruction breakpoints available
- Single-step execution with software trace
- Standalone or host CPU configurable.

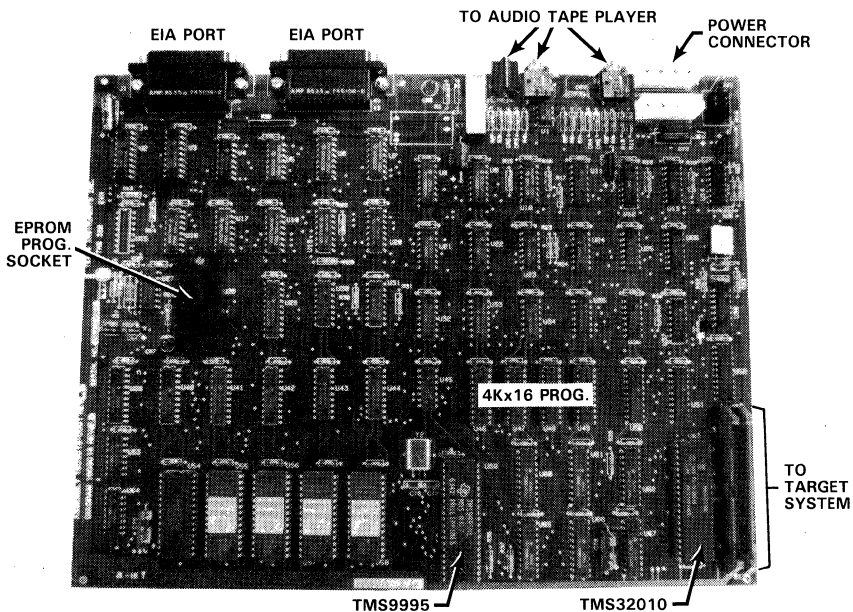

Figure 7-1. TMS32010 Evaluation Module (EVM)

Key features of the TMS32020/C25 EVM are:

- On-board TMS320C25 (with TMS32020 option)
- 40-MHz operation
- Enhanced decimal parameter and data display support
- 4K words each of on-board program and data RAM
- Program and data memory expansion to 16K words each
- Macro commands and looping capability
- Target interface for full-speed in-circuit emulation
- Debug monitor including commands with full prompting
- Line-by-line assembler/reverse assembler
- Transparency mode for host CPU upload/download
- Ten instruction breakpoints available

Hardware Development Tools - Evaluation Module (EVM)

- Single-step execution with software trace
- Standalone or host CPU configurable.

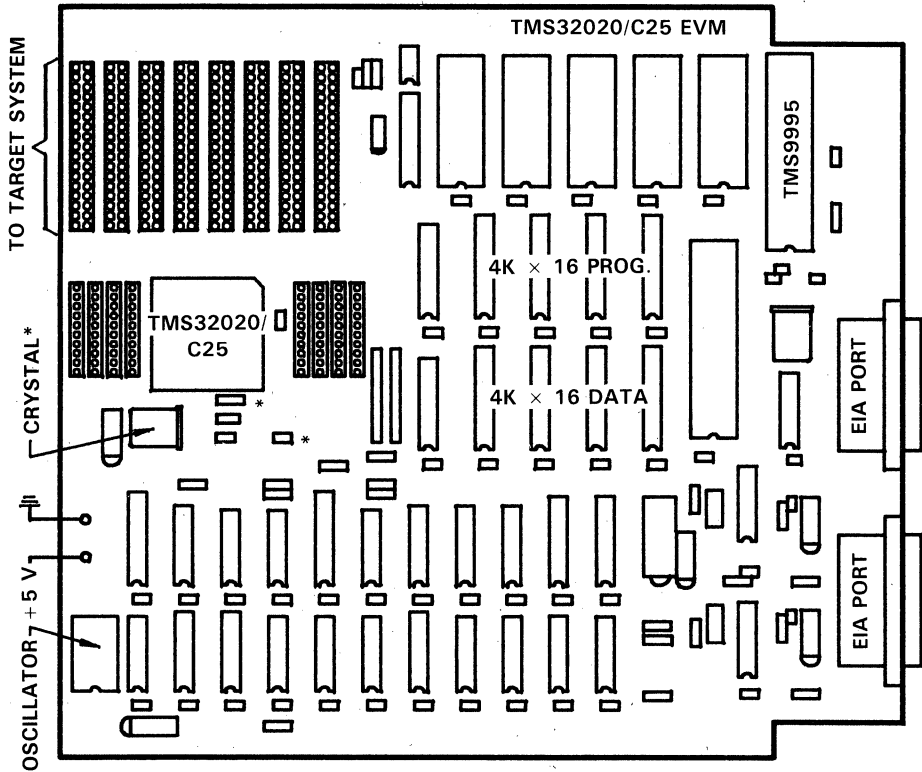

*Socketed components must be changed with a change of crystal (see the EVM User's Guide for further information).

Figure 7-2. TMS32020/C25 Evaluation Module (EVM)

The resident TMS320C25 may be exchanged for a TMS32020 to provide TMS32020 emulation. Connection to the target system is made possible via four ribbon cables. An optional PGA/PLCC target connector is available with the TMS32020/C25 EVM.

7.1.1 System Configuration

The TMS320 EVM functions in two modes: host computer mode or PC mode (single-user system). In the host computer mode, object and source code can be uploaded/downloaded between the host computer and EVM, as shown in Figure 7-3.

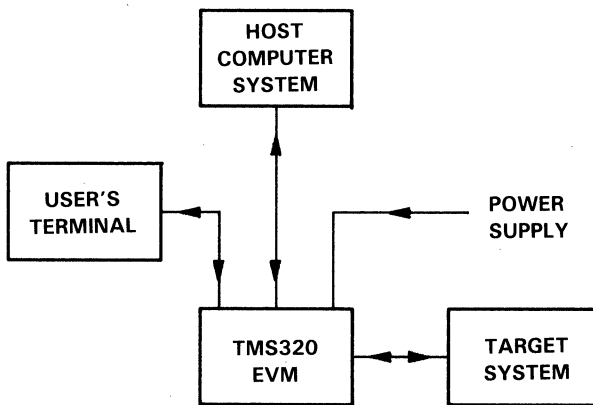

Figure 7-3. TMS320 EVM Host Computer Mode

In the PC mode, the TMS320 EVM can support host uploads/downloads over a single port to allow a single-user system, such as a TI or IBM PC, to function as both a terminal and a host (see Figure 7-4). Terminal emulation software for the single-user system is required in this configuration. Communications software packages are commercially available, such as CROSSTALK XVI by Microstuf (see Section 11), which allow a TI/IBM PC to function as both a terminal and a host for the EVM.

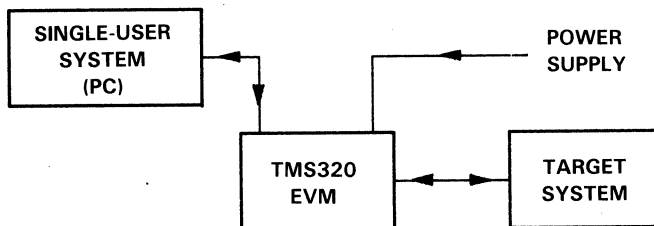

Figure 7-4. TMS320 EVM/Single-User System

In addition, the TMS32010 EVM can be configured as a standalone system with an interface to an audio cassette or EPROM to provide mass storage, as shown in Figure 7-5. However, the audio cassette device has limited directory and file search capabilities.

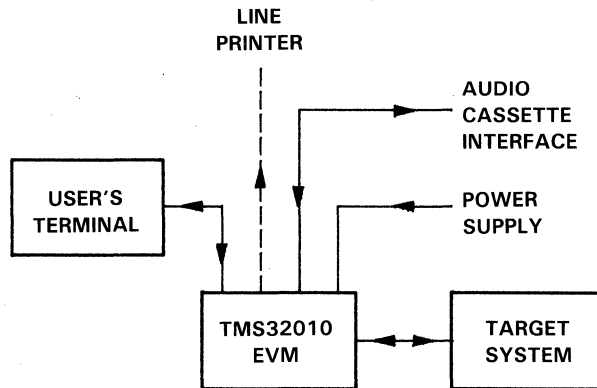

Figure 7-5. TMS32010 EVM with Audio Cassette Interface

7.1.2 Communication

The TMS320 EVM supports baud rates of 110, 300, 600, 1200, 4800, 9600, and 19200 bps. The baud rate of port 1 (terminal) is determined automatically at powerup. The baud rate of port 2 (host or printer) on the TMS32010 EVM defaults to 9600 bps at reset, and baud rates of either ports 1 or 2 may be altered through monitor commands. The baud rate of port 2 on the TMS32020/C25 EVM is configured to the same baud rate as port 1 during the powerup sequences. Only the configuration of port 2 may be altered through monitor commands.

The transparency mode provides a means of communication between a host (a system connected to the EVM) and the EVM downlink software by allowing the user to logon to a host CPU and the EVM from one terminal. This mode allows the EVM terminal to emulate a host terminal and simulate the host to upload/download file to/from the EVM.

The TMS32010 EVM supports three ports for communication with a designer's terminal, a host computer, a printing device, or audio cassette. In addition, the EVM also supports an onboard PROM utility for programming TMS2764 EPROMs. This utility programs an EPROM with the contents of memory, compares the contents of the EPROM to memory to verify the copy, reads the EPROM contents into memory, and verifies the EPROM has been erased. EPROMs are used for mass program storage.

The TMS32010 EVM provides a text editor with line numbering and general editing features. This editor builds assembly language source files as well as general text files. TMS32010 source code, object code, or the machine state may be uploaded/downloaded to the EVM from the terminal, host computer,

or audio tape. (The machine state consists of the current contents of all the registers in the TMS32010 and of a selected block of program memory.) When interfacing with an audio tape, the TMS32010 prompts for a filename.

The TMS32020/C25 EVM firmware provides communication linkages to two EIA ports used to load and dump data (text or object code) for storage and/or display. One port communicates with the user's terminal (supporting both hardware and software handshaking protocols for terminals operating in full-duplex mode), and a second port communicates with a host computer (supporting uplink/downlink).

The TMS32020/C25 EVM provides debugging capabilities by means of an assembler and monitor. The user's program may be edited on a host device, such as a PC, and downloaded to the EVM for assembly. Subsequent debugging is performed on the EVM. The EVM supports mass storage upload to the host computer and to PROM programmers.

7.1.3 Debugging

The following components of the TMS320 EVM firmware provide flexibility in evaluating TMS320 applications:

- Assembler/reverse assembler/patch assembler
- Debug monitor
- Text editor (TMS32010 only).

The TMS320 EVM assembles source code created on a host computer (or text editor (TMS32010)). The EVM has a one-pass assembler, which resolves both forward and reverse labels and converts the incoming text into executable code. The TMS320 EVM does not support macro definitions or relocatable code, and is most suitable for benchmarking of critical segments of code in evaluating TMS32010 performance. If macro capabilities are desired, the TMS320 assembler/linker can be used.

Object code produced by the TMS320 EVM assembler is stored in memory. The reverse assembler converts object code back to TMS320 assembly language mnemonics, and the patch assembler allows modification of the code. Source can be assembled line-by-line.

The TMS320 EVM's debug monitor has full prompting and contains commands with the following capabilities:

- Execution of assembler/reverse assembler
- Modification and display of memory
- Software breakpoint manipulation
- Software trace of up to six registers or memory locations (TMS32010 EVM only)
- Software trace of up to ten registers or memory locations (TMS32020/C25 EVM only)
- Realtime code execution
- Single-step execution
- Decimal/hexadecimal number representation
- Scaling of numbers (TMS32010 EVM only)

Hardware Development Tools - Evaluation Module (EVM)

- Commands for communication
- Execution of text editor and EPROM programmer (TMS32010 EVM only)
- Execution of command strings.

The TMS32010 EVM's text editor is a line-numbered editor with character-editing capabilities. Assembly language source files can be written using the editor, then output to a host or audio tape, and finally re-input and assembled.

7.1.4 Equipment List

The following equipment is required to use the TMS320 EVM:

Power Supply

+5 V @ 3 A
-12 V @ 0.1 A (TMS32010 EVM only)
+12 V @ 0.1 A (TMS32010 EVM only)

Terminal

RS-232-C compatible

25-pin RS-232-C male plug,
type DB25P

Cables

For terminal/host or
printer

Two standard RS-232-C cables with
male connectors on the EVM end

For audio tape
(TMS32010 EVM only)

Two standard mini-to-mini cables
and one sub-mini-to-sub-mini cable

For power supply

Standard cable with four-prong
male connector for EVM end

Audio Tape Recorder
(TMS32010 EVM only)
(optional)

Radio Shack CTR-41 or equivalent

7.2 TMS320 Emulator (XDS)

The TMS320 Emulator is a self-contained, extended development system (XDS), which has all the features necessary for full-speed in-circuit emulation. The emulator provides a full-speed target RAM for program memory. Realtime hardware breakpoint/trace and program execution capability from target memory allow hardware and software integration in the debug stage of system development.

Three EIA ports provide an interface to a host computer, terminal, and printer or PROM programmer. A fourth port is reserved for future expansion. The object file produced by the TMS320 macro assembler/linker can be downloaded into the emulator through an EIA port, and then be controlled through a terminal. Source code can also be downloaded into the emulator. A one-pass, line-by-line XDS assembler with forward and reverse referencing labels assembles the source.

Sequential hardware breakpoints, full-speed trace, time-stamping capabilities, single-step execution, performance of a single read or write to an I/O port (used to test peripheral devices in the prototype system), and a reverse assembler that translates machine code back into assembly instructions – all greatly enhance the emulator's debugging capabilities.

The descriptions in the following paragraphs refer to the first-generation (TMS320C10 XDS/22) and second-generation (TMS320C25 XDS/22) emulators designed to emulate all first- and second-generation devices, respectively. Early systems (the TMS32010 XDS/22 for TMS32010 emulation only and the TMS32020 XDS/11 and XDS/22 for TMS32020 emulation only) may be upgraded to provide the functionality of the systems described here. See Section 7.3 for specific TMS320 XDS upgrade information.

TMS320C10 Emulator (XDS/22)

The TMS320C10 Emulator has been designed to emulate operation of all first-generation TMS320 family devices (TMS32010, TMS32010-14, TMS32010-25, TMS32011, TMS320C10, TMS320C10-25, TMS320C15/E15, TMS320C15-25, TMS320C17/E17, and TMS320C17-25), and to accommodate emulation of future first-generation spinoff devices. The TMS320C10-25 and TMS32011 devices (selectable via a jumper block) reside on the TMS320C10 Emulator. The TMS320C10 Emulator target connector is a 40-pin DIP with an optional 44-lead PLCC target connector for surface mount emulation.

The TMS320C10 Emulator, with 4K words of fast static RAM, operates in one of three program memory modes:

- Software development mode (entire 4K words reside within the emulator)
- Microcomputer mode (1.5K words reside within the emulator and 2.5K words reside on the target system)
- Microprocessor mode (entire 4K words reside on the target system).

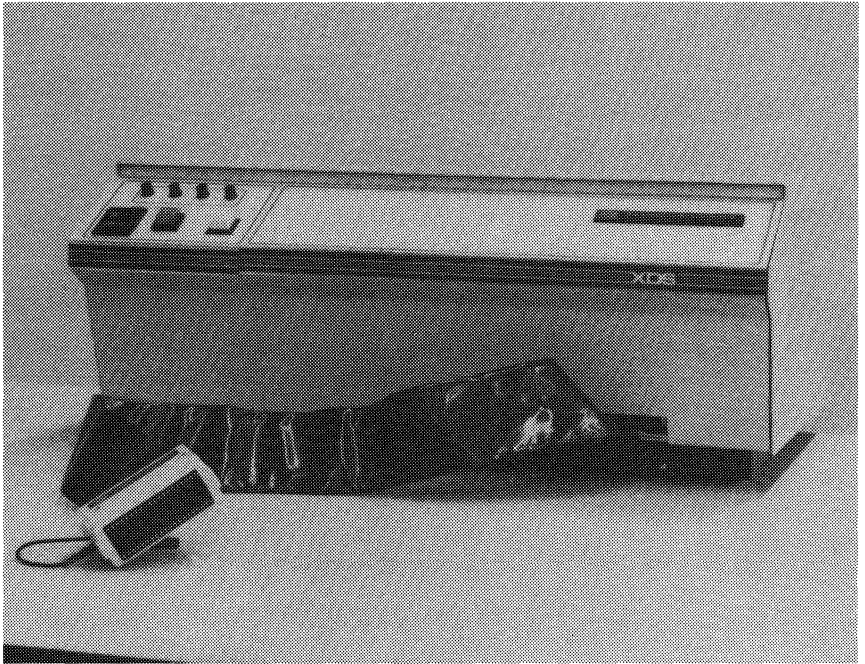

Figure 7-6. TMS320C10 Emulator (XDS/22)

Some key features of the TMS320C10 Emulator are:

- 25-MHz full-speed in-circuit emulation (future expansion to 40 MHz)
- Supports all first-generation TMS320 family members
- Dual-in-line target connector with optional PLCC target connector
- Breakpoint, trace, and timing (BTT) capabilities
- Single-step execution
- Line-by-line assembler/reverse assembler
- Enhanced decimal parameter entry and display
- All levels of stack available to user
- Use of target system crystal (with DIP target connector) or internal crystal
- Host-independent upload/download to/from program/data memory
- Ability to inspect/modify all internal registers, program/data memory

Hardware Development Tools - Emulator (XDS)

- Supports multiprocessor configurations
- Logic tracing with extended data/address probes.

TMS320C25 Emulator (XDS/22)

The TMS320C25 Emulator accommodates emulation of the second-generation TMS320 family members (TMS32020 and TMS320C25), as well as future second-generation spinoff devices. A TMS320C25 resides on the TMS320C25 Emulator. A pin-compatible target connector plugs into the TMS320 socket on the target system for realtime emulation. The TMS320C25 Emulator target connector is a 68-lead connector with PLCC and PGA adaptors included (see Figure 7-8).

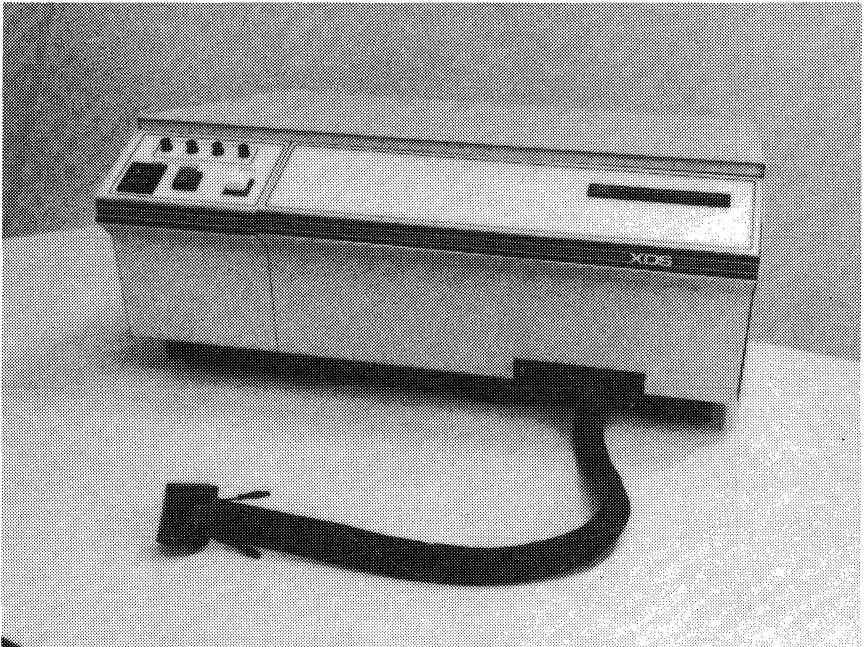

Figure 7-7. TMS320C25 Emulator (XDS/22)



Figure 7-8. TMS320C25 Emulator Target Connector

The TMS320C25 Emulator has 8K x 16 words (4K program and 4K data) of high-speed static RAM (zero wait states) for program and data memory. The memory expansion board offers 64K words of DRAM, which can be configured as all program memory, all data memory, or a combination of both.

Key features of the TMS32020/C25 Emulator are:

- 40-MHz full-speed in-circuit emulation
- Supports all second-generation TMS320 family members
- PLCC target connector with pin grid array (PGA) adaptor
- 4K words each of program and data memory
- 64K-word memory expansion board
- Breakpoint, trace, and timing (BTT) capabilities
- Single-step execution
- Line-by-line assembler/reverse assembler

Hardware Development Tools - Emulator (XDS)

- Enhanced decimal parameter entry and display
- Use of target system CLKIN signal or internal crystal
- Host-independent upload/download capabilities to/from program/data memory
- Ability to inspect and modify all internal registers, program and data memory
- Supports multiprocessor configurations
- Logic tracing with extended data/address logic analyzer interface.

7.2.1 System Configurations

The XDS can be configured to operate in one of four modes:

- Standalone mode
- Host computer mode
- PC mode (single-user system)
- Multiprocessor mode.

The standalone mode or minimal configuration requires only the XDS and the user's terminal. However, the XDS is best used with a host computer (see Figure 7-9), where TMS320 programs can be written on a familiar editor and then downloaded to the XDS. Once a debugging session is complete, TMS320 code can be uploaded to the host computer for storage.

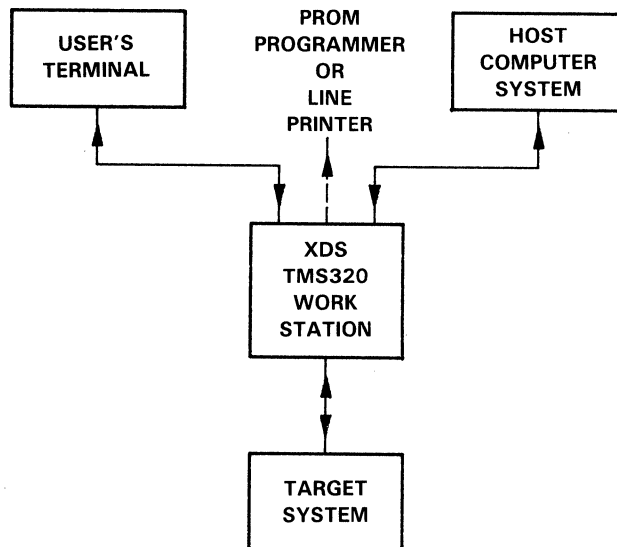

Figure 7-9. TMS320 XDS Host Computer Mode

Hardware Development Tools - Emulator (XDS)

In the PC mode, the TMS320 XDS can support host uploads/downloads over a single port to allow a single-user system, such as a TI or IBM PC, to function as both a terminal and a host when connected to the XDS (see Figure 7-10). Terminal emulation software for the single-user system is required in this configuration. Communications software packages are commercially available, such as CROSSTALK XVI by Microstuf (see Section 11), which allow a TI/IBM PC to function as both a terminal and a host for the XDS.

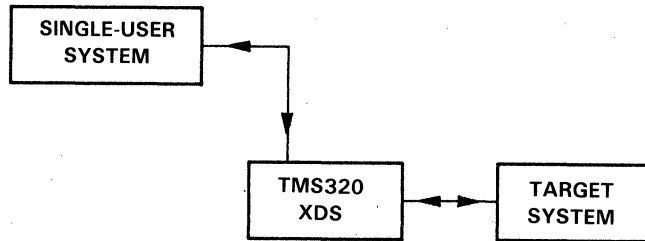

Figure 7-10. TMS320 XDS/Single-User System

The emulator's multiprocessor mode allows up to nine XDSs to be connected together in a daisy-chain fashion and controlled by a single terminal, as shown in Figure 7-11. A single host computer can also be connected.

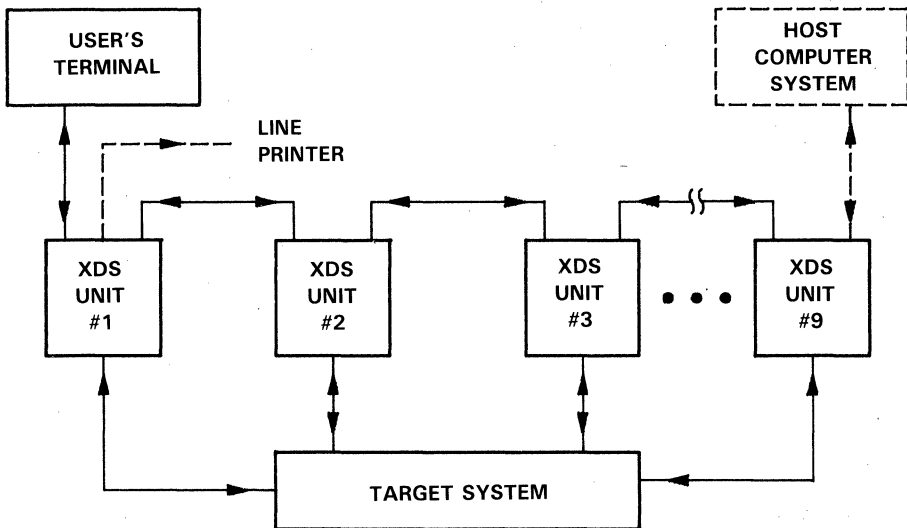

Figure 7-11. TMS320 XDS Multiprocessor Mode

7.2.2 Communication

The TMS320 Emulator provides communication links to standard EIA ports and debugging capabilities with a prompting XDS monitor and full-speed hardware breakpoints and trace. The communication system establishes linkage with the user's terminal, a PROM programmer or printer, and a host computer system. The functions of this communication link are:

- To transmit data files from the emulator to an external device (upload).
- To receive data files from an external device and store them in the emulator's memory (download).
- To pass downloaded data received from an external device to a PROM programmer or logging device.
- To transmit data stored in the emulator's memory to a PROM programmer or logging device.

Each TMS320 XDS/22 unit is equipped with four standard EIA ports for communication with external devices. Only three ports are used; the fourth port is reserved for future expansion.

7.2.3 Debugging

The XDS monitor provides a simple yet powerful set of commands for full debug of the target system. Monitor commands provide complete control of both the emulator functions and the target system. The monitor uses extensive prompt menus for commands and parameter definition. Registers are readily accessible through the use of variable names assigned to each register. Debugging sessions can also be logged for further analysis via a line printer. The XDS monitor displays a menu of emulator commands and variables to guide the debugging session. As an example, Figure 7-12 shows the screen when the DPS command to display the processor status is entered on the TMS320C10 XDS/22.

```
DPS
PC =022      ARO =0000      T =0000      TOS =000
ST =3EFC    AR1 =0000      P =00000000  MOSH =000
ACC=00000000      MOSL =000
                                   BOS =000

OV  OVM  INTM  ARP  DP
0   0    1    0   0
```

Figure 7-12. TMS320C10 XDS/22 Display Example

Emulator commands provide extraordinary flexibility in defining the test conditions for emulation sessions. Commands can be combined in a variety of ways to form short procedures that allow several commands to be executed sequentially. Repeat functions allow procedures or individual commands to

be executed indefinitely until stopped by the user or a user-defined breakpoint condition.

The XDS/22 supports important breakpoint, trace, and time-stamping (BTT) capabilities. Up to ten software breakpoints and four sequential hardware breakpoints may be defined. This provides a method for testing and debugging small segments of programs. In the monitor mode, all registers and memory locations can be inspected and modified.

In addition to hardware breakpoints, the TMS320C10 and TMS320C25 Emulators support full-speed trace capability. Each traceable machine cycle is sampled, recorded, and stored in the 2K-word trace buffer so that it can later be recalled for display or printing.

Time-stamping is a feature, in which a time value is associated with each trace sample so that the time between breakpoints can be calculated. This allows the user to determine the amount of time spent in a certain portion (e.g., a loop) of code.

7.2.4 Equipment List

The following equipment is required for use with the TMS320 Emulator:

Terminal

RS-232-C compatible

25-pin RS-232-C male plug,
type DB25P

Cables

For terminal/host or
printer

Two standard RS-232-C cables with
male connectors on the XDS end

Host Computer (optional)

RS-232-C compatible

Line Printer or Other Logging Device (optional)

7.3 TMS320 XDS Upgrade Program

As Texas Instruments directs its efforts toward TMS320 family enhancement and expansion, development support must parallel. For this reason, TI not only offers newly enhanced first-generation and second-generation XDS Extended Development Support systems, but also offers upgrade kits for early systems. For a discussion of the new systems, see Section 7.2.

TMS320 XDS upgrade kits are intended to extend the functionality of existing development systems at a minimum of cost through an enhancement of current customer equipment. For example, a first-generation upgrade kit can enable a TMS32010 XDS/22 to emulate operation of all first-generation products, such as the NMOS TMS32010, TMS32010-14, TMS32010-25, TMS32011, the CMOS TMS320C10, TMS320C10-25, TMS320C15/E15, TMS320C15-25, TMS320C17/E17, and TMS320C17-25. Note that early systems support TMS32010, TMS32010-14, and TMS320C10 performance. A second-generation upgrade kit can enable a TMS32020 XDS/11 or XDS/22 to emulate either the NMOS TMS32020 or the CMOS TMS320C25. Upgrade kits allow upgrade only within a generation, not from a first- to a second-generation XDS.

Figure 7-13 shows the addition of the upgrade kit to the early system to give an enhanced XDS system. Table 7-1 lists the part numbers for the early system, the upgrade kit, and the enhanced system to assist the user in understanding the procedure.

Table 7-1. XDS Upgrade Process

EARLY SYSTEM	+	UPGRADE KIT	=	ENHANCED SYSTEM
TMS32010 XDS/22 (PN: TMDS3262210) Accommodates the TMS32010/C10, TMS32010-14	+	TMS320C10 XDS/22 Upgrade Kit (PN: TMDS3282215 or PN: TMDS3282216)	=	TMS320C10 1st-Generation XDS/22 (PN: TMDS3262211) Accommodates all 1st-generation devices
TMS32020 XDS/22 (PN: TMDS3262220) Accommodates the TMS32020	+	TMS320C25 XDS/22 Upgrade Kit (PN: TMDS3282225 or PN: TMDS3282226)	=	TMS320C25 2nd-Generation XDS/22 (PN: TMDS3262221) Accommodates all 2nd-generation devices
TMS32020 XDS/11 (PN: TMDS3261120) Accommodates the TMS32020	+	TMS32020 XDS/11 Upgrade Kit (PN: TMDS3281125 or PN: TMDS3281126)	=	TMS32020/C25 XDS/11 Accommodates all 2nd-generation devices

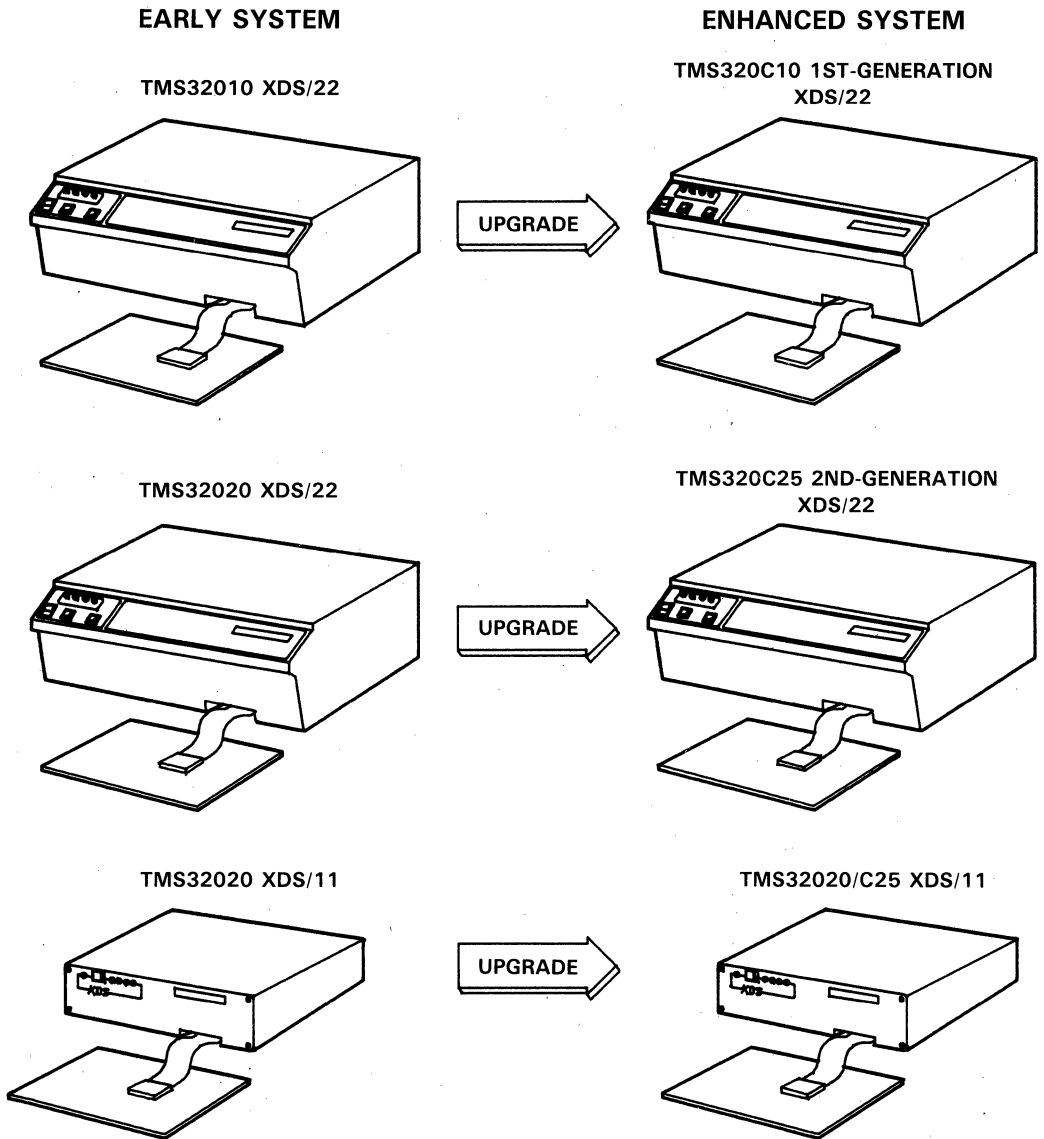

Figure 7-13. XDS Upgrade Configurations

Table 7-2 lists the contents of the first- and second-generation upgrade kits for the XDS models. Note that the 40-MHz breakpoint, trace, and timing board contained in the first-generation upgrade kit allows for upgrade to 40-MHz operation to accommodate future first-generation spinoffs; present first-generation members require only 25-MHz operation. The TMS320C25 emulation requires 40-MHz operation. Optional PLCC target connectors are available for upgrade of TMS32010 and TMS32020 systems.

Table 7-2. TMS320 XDS Upgrade Kit Contents

GENERATION	MODEL	CONTENTS
First	XDS/22	Emulator board and 40-MHz breakpoint, trace, timing board, and DIP target connector.
Second	XDS/22	2 PALs, 2 EPROMs, 2 RAMs, crystal, TMS320C25, and 40-MHz breakpoint, trace, timing board, and PGA/PLCC target connector.
	XDS/11	2 PALs, 2 EPROMs, 2 RAMs, crystal, TMS320C25, and PGA/PLCC target connector.

Two options are available for TMS320 XDS upgrade kit installation:

- 1) **Factory Upgrade.** The customer sends his XDS to TI Factory Upgrade for installation.
- 2) **Customer Upgrade.** The customer implements the system upgrade.

7.3.1 TI Factory Upgrade

All XDS systems are tested upon arrival at TI Factory Upgrade to ensure they are in working order. If a system is not in working order, Factory Upgrade will contact the customer. With the customer's verbal approval, the system will be transferred to Factory Repair. If the system malfunction involves a board that will be replaced with the upgrade, the upgrade procedure will continue. Two options are then available to the customer regarding original board return: (1) the malfunctioning board is transferred to Factory Repair, or (2) all boards are returned as is. If the system is not complete (e.g., the ROM or target connector is missing), Factory Upgrade will contact the customer, and either return the XDS to the customer or transfer the XDS to Factory Repair for replacement of missing parts.

Complete board and system level testing is conducted following upgrade. All XDS chassis and board serial numbers are recorded by Factory Upgrade to prevent confusion with new XDS systems. Original boards involved in the upgrade are returned to the customer. A 90-day system warranty on all parts and labor applies to factory upgrades. In the event that a factory upgrade fails during the warranty period, the standard factory repair procedures should be followed (see Appendix B).

In order to ensure timely upgrade completion and system return, these guidelines should be followed:

Hardware Development Tools - XDS Upgrade Program

- The appropriate TMS320 XDS factory upgrade kit is purchased from Texas Instruments. The serial number of the XDS to be returned should be included in the variable data section of the Order Entry Form.
- The customer contacts factory upgrade for a return authorization number.
- The customer returns the XDS to Texas Instruments freight prepaid F.O.B. to:

Texas Instruments Incorporated
Microprocessor and Microcontroller Division
DSP XDS Upgrade Program, M/S 6430
9901 S. Wilcrest
Houston, TX 77099

- The following specific information must accompany the returned product:
 - Customer name, phone number, and address
 - Purchase order number (referenced in the upper right corner of the Order Entry Form)
 - Model number (XDS/11 or XDS/22)
 - System serial number
 - Type of upgrade (first or second generation)
 - Return authorization number.

Factory upgrade of an XDS will normally involve a 2 to 4-week leadtime from receipt of the system. Expedited upgrade service is available; contact TI factory upgrade for more information.

7.3.2 Customer Upgrade

The alternative to TI upgrade of a system is customer upgrade, in which the customer makes the necessary modifications to the system with the TMS320 XDS customer upgrade kit. This may be desirable if the customer cannot do without the XDS for the specified factory upgrade leadtime and if the technical expertise for upgrade is available.

A major advantage to customer upgrade is the lower cost since the handling, testing, and warranty costs associated with Factory Upgrade do not apply. Although there is no warranty on upgrades performed by the customer, a board level test is performed by the factory on each board prior to shipment of the customer upgrade kit. The standard TI 90-day parts warranty applies provided the configuration of parts upon shipment has not been altered.

Please note that the TI standard warranty does not allow for customer upgrade to a system still under the 90-day warranty period. According to that warranty, any change or modification to a system still under warranty voids that warranty.

TMS320 XDS customer upgrade kits are available through authorized distributors or directly from TI. Contact the nearest TI Field Sales Office for further information.

7.4 TMS320 Analog Interface Board (AIB)

The TMS320 Analog Interface Board (AIB) is an analog-to-digital, digital-to-analog conversion board used as a preliminary target system with the TMS320 EVM and XDS. The AIB is an educational tool that provides a simple, inexpensive way to become familiar with digital signal processing (DSP) techniques.

The AIB allows testing of application programs with analog I/O by providing an interface to the TMS320. The AIB provides 12-bit A/D and D/A converters with expansion ports for additional A/D and D/A converters.

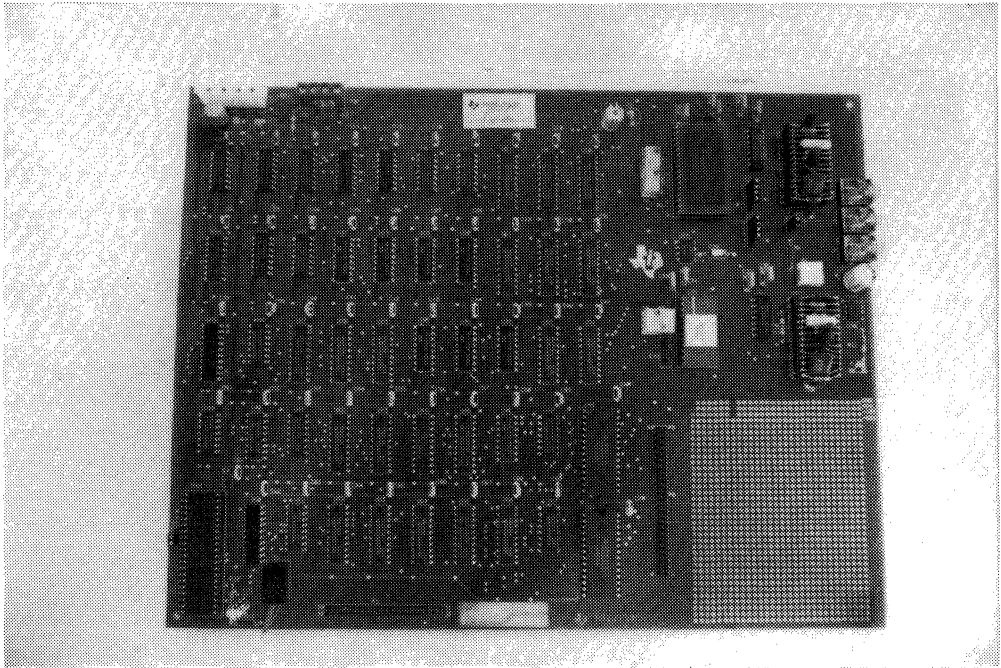

Figure 7-14. TMS320 Analog Interface Board

The sample rate clock on the AIB is derived from the CLKOUT signal on the TMS320 and may be programmed to provide periodic analog input, output, or both. There are two analog lowpass filters on the AIB. One filter on the A/D input band limits the input to minimize aliasing effects. The other filter smooths the output of the D/A. The frequency response of the filters is con-

Hardware Development Tools - Analog Interface Board (AIB)

trolled by varying the external components in the filter stages. The cutoff of these filters is set to 4.7 kHz, but may be (plug) programmed. An audio amplifier that will drive an 8-ohm speaker is provided for applications with audio output. Sockets for 8K words of expansion memory are also provided. This memory is addressed through I/O and can support manual or auto addressing. Up to 64K words of memory may be addressed using the memory expansion connector.

Key features of the AIB are as follows:

- 12-bit analog-to-digital converter with sample and hold
- 12-bit digital-to-analog converter
- One 16-bit output port for additional D/A or user-defined application
- One 16-bit input port for additional A/D or user-defined application
- Two lowpass filters
- Audio amplifier
- TBLW (table write) decode
- Extended I/O data memory
- Prototyping area for user applications.

7.4.1 System Configuration

The AIB can be configured to operate as a preliminary target system with the TMS320 XDS, EVM, or other emulator (see Figure 7-15). Note that the AIB adaptor board (see Figure 7-16) is necessary to convert the 40-pin dual-inline socket for the TMS32010 to accommodate the 68-pin grid array package of the TMS32020. An additional adaptor socket is necessary for TMS320C25 operation. Contact the nearest TI Sales Office for a list of commercially available adaptor socket vendors.

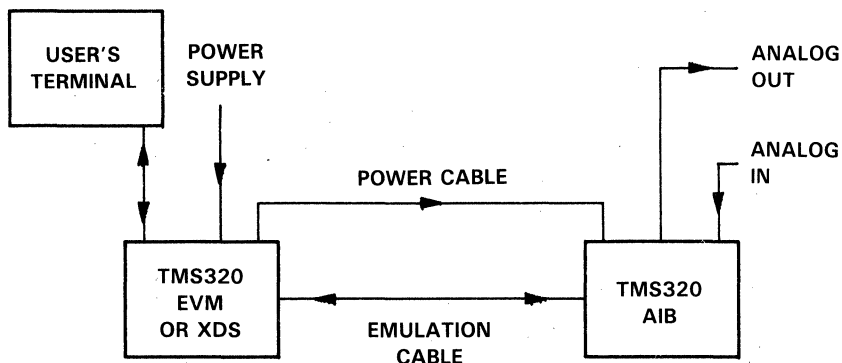

Figure 7-15. TMS320 AIB System Configuration

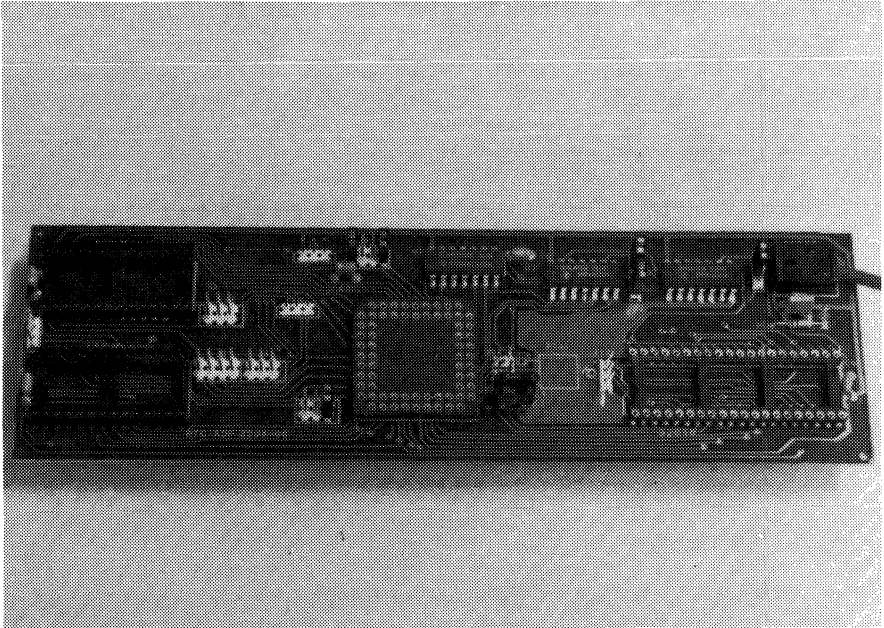

Figure 7-16. TMS320 AIB Adaptor Board

7.4.2 Equipment List

The following equipment is required for use with the AIB:

Power Supply

(for AIB only; may be
daisy-chained to EVM)

- +5 V @ 1.2 A
- 12 V @ 0.25 A
- +12 V @ 0.25 A

Terminal

RS-232-C compatible
(for EVM or XDS)

25-pin RS-232-C male plug
type DB25P

EVM or XDS

TMS320 development support
system

Hardware Development Tools - Analog Interface Board (AIB)

Cables

Emulation cable to AIB
Power cable from EVM

Included with EVM or XDS
Included with AIB

Adaptor Board

40-pin DIP to 68-pin PGA
socket converter

For use with TMS32020/C25

7.5 TMS320 DSP Design Kit

The TMS320 DSP Design Kit has been created by Texas Instruments to aid the user in becoming familiar with the TMS320 family of digital signal processors, thus accelerating the evaluation of these devices. The kit contains the following:

- Samples: one TMS32020GBL, one TMS32010NL, one Codec (TCM2916), and four preprogrammed PROMs (TBP38L165-45).
- ADPCM Design Example using the TMS32010.
- FFT Design Example using the TMS32020.
- *Digital Signal Processing Applications with the TMS320 Family*, a comprehensive 750-page book filled with applications for the TMS320 family.
- Digital Signal Processing Software Library, containing source code for most of the DSP applications discussed in the Applications Book as well as other valuable routines.
- TMS32010 and TMS32020 User's Guides.
- Latest copy of the TMS320 quarterly newsletter, *Details on Signal Processing*.

The Design Kit is available through local TI authorized distributors or directly from Texas Instruments. Contact the nearest TI Sales Office for more information.

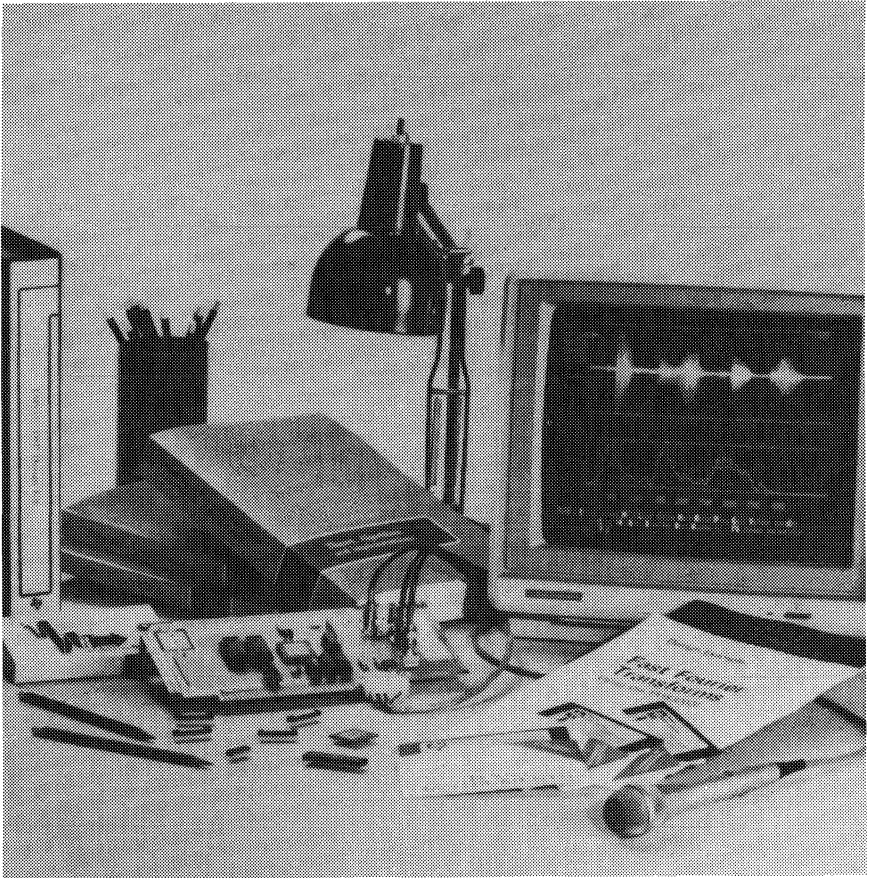

Figure 7-17. TMS320 DSP Design Kit

8. RTC TMS320 Seminar and Workshops

The Texas Instruments Regional Technology Centers (RTC) in North America, Canada, Europe, and Asia are staffed with system analysts, providing technical information and assistance in the development of TMS320-based designs. The RTCs offer an unmatched array of up-to-date technical product seminars and design workshops.

The TMS320 product seminar is a half-day technical seminar intended to keep system architects and decision makers up to date on the growing family of TMS320 products. Valuable time can be saved and more informed decisions can be made through attending these technical sessions. Audience size is limited to promote meaningful discussions before, during, and after the seminar.

The DSP design workshops give design engineers hands-on experience using the latest TMS320 products, development tools, and design techniques. These three-day workshops go beyond the standard lecture format. The exercises and lab experiments start with the basics and move quickly into realtime examples. The student interacts with expert instructors who teach design techniques gained from experience. In these workshops, the student learns by doing, not just listening or observing.

This section describes the seminar and workshops offered in North America. Further information about them can be obtained by contacting the nearest RTC. A list of the worldwide RTC locations is also provided so that the appropriate one can be contacted for information about the seminar and workshops offered abroad.

8.1 TMS320 Product Seminar

The half-day TMS320 product seminar, held at seven RTC locations across North America, provides an overview of the TMS320 family. The first- and second-generation products are introduced along with a complete discussion of all available development tools. Certain development tools are also demonstrated.

Design engineers, system architects, and decision makers investigating the possible use of the TMS320 family can benefit from attending this concise overview. Complete sets of documentation are given to those attending.

The seminar outline is as follows:

- **INTRODUCTION**
 - DSP applications
 - Types of processors
 - DSP chip advantages

- **FIRST-GENERATION TMS320**
 - Architecture and features
 - Instruction set
 - Digital FIR filter coding example
 - Interface and I/O

- **SECOND-GENERATION TMS320**
 - Comparison to first-generation devices
 - Additional features
 - Digital FIR filter coding example

- **DEVELOPMENT TOOLS**
 - Assembler/linker
 - Simulator
 - Evaluation Module (EVM)
 - Emulator (XDS extended development system)
 - Analog Interface Board (AIB)
 - Third-party tools

- **DEMONSTRATIONS**
 - XDS extended development system
 - Digital Filter Design Package (DFDP)

8.2 DSP Design Workshops

The Regional Technology Centers (RTC) offer two three-day DSP Design Workshops, held either at the RTC location or off-site, to assist users in the development of TMS320-based designs. One of the workshops supports design for the first-generation processors and the other workshop for the second-generation devices.

The main objective of the workshop is to demonstrate hardware and software techniques for implementing current DSP algorithms using a TMS320 digital signal processor. Exercises provide hands-on experience in TMS320 design.

Topics covered in the First-Generation DSP Design Workshop include:

- Using the TMS32010 Evaluation Module (EVM)
- First-generation architecture and instruction set
- Fractional binary arithmetic and scaling
- Coding of difference equations
- First-generation development tools
- Hardware interfacing
- Subroutines and macros
- Implementation of a DTMF encoder.

The Second-Generation DSP Design Workshop is tailored for design engineers in the early stages of TMS32020 and/or TMS320C25 application development. The workshop enables the designer to more effectively use the second-generation digital signal processors through hands-on practice of design skills. He also is introduced to numerous hardware and software techniques for application of current DSP algorithms. Previous experience with assembly language programming and DSP knowledge is necessary, and prior completion of the first-generation DSP workshop is desired. Topics covered in this workshop include:

- Using the second-generation TMS320 XDS emulator with a PC
- Second-generation architecture and instruction set
- Binary arithmetic, scaling, and difference equations
- Floating-point arithmetic
- System memory configurations
- Parallel interface timings
- Memory, I/O interfacing, interrupts, and multiprocessing.

Class size for these workshops is limited to ten students. To register, contact the nearest TI RTC. A 15-percent discount is available when three or more engineers from the same company enroll in the same course.

8.3 RTC Locations

Further information about the TMS320 product seminar and DSP Design Workshops can be obtained by contacting the nearest Regional Technology Center (RTC). The following list gives the worldwide locations of the TI RTCs.

North American Locations:

Atlanta

5515 Spalding Drive
Norcross, GA 30092
(404) 662-7945

Boston

400-2 Totten Pond Road
Waltham, MA 02154
(617) 895-9196

Chicago

515 W. Algonquin Road
Arlington Heights, IL 60005
(312) 640-2909

Canada

301 Moodie Drive
Mallorn Centre
Nepean (Ottawa), Canada
K2H 9C4 337
(613) 726-1970

European Locations:

Denmark

Marielundvej 46 E
DK-2730 Herlev
Copenhagen, Denmark
45-2-917-400

France

8-10 Avenue Morane Saulnier
Boite Postale 67
Velizy-Villacoublay Cedex
Paris, France
33-3-946-9712

Dallas

1001 E. Campbell Road
Richardson, TX 75081
(214) 680-5066

Northern California

5353 Betsy Ross Drive
Santa Clara, CA 95054
(408) 748-2220

Southern California

17891 Cartwright Road
Irvine, CA 92714
(714) 660-8140

Holland

P.O. Box 12995
1100 AZ Amsterdam Zuid-Oost
Amsterdam, Holland
31-20-560-2911

Sweden

Norra Hamnvagen 3
Box 39103
S-100 54
Stockholm, Sweden
46-8-615-448

RTC TMS320 Seminar and Workshops

Germany

Mexikoring 19
2000 Hamburg 60, Germany
49-40-220-2230

Kirchhorster Strasse 2
3000 Hannover 51, Germany
49-511-648-021

N.W. Germany

Maybachstr, 11
7302 Ostfildern 2-Nellingen
N.W. Germany
49-711-34030

Asian Locations:

Osaka, Japan 541

Nissho Iwai Bldg 5F
30 Imabashi 3-Chome
Higashi-Ku
81-6-204-1884

Tokyo, Japan 107

Aoyama Fuji Bldg. 4F
6-12 Kita-Aoyama 3-Chome
Minato-Ku
81-3-498-2111

Italy

Viale Europa, 38/44
20093 Cologno Monzese
Milano, Italy
39-2-253-2541

Viale Delle Scienze, 1
02014 Cittaducale
Rieti, Italy
39-746-6941

United Kingdom

Manton Lane
Bedford, England MK417PA
(44) 0234-224-825

Nagoya, Japan 450

Daini Toyota West Bldg. 7F
10-27 Meieki 4-Chome
Nakamura-Ku
81-52-583-8691

Hong-Kong

8th Floor, World Shipping Centre
Harbour City 7, Canton Road
Kowloon
852-3-7221223

9. TMS320 Documentation Support

Texas Instruments provides extensive documentation to support the TMS320 family from product announcement through applications development. Documents vary from brief product descriptions to user's guides, from application reports to applications books, and from technical articles to textbooks. The latest product and documentation updates are given in the TMS320 quarterly newsletter, *Details on Signal Processing*, and the TMS320 DSP bulletin board service. Technical questions regarding the TMS320 family may be directed to the TMS320 DSP hotline (see Section 9.9).

This section discusses the various documents listed below.

- Product Descriptions and Product Bulletins (Section 9.1 on page 9-2)
- User's Guides (Section 9.2 on page 9-3)
- Data Sheets (Section 9.3 on page 9-4)
- DSP Applications Book (Section 9.4 on page 9-5)
- University Textbooks (Section 9.5 on page 9-13)
- Technical Articles (Section 9.6 on page 9-16)
- TMS320 Quarterly Newsletter (Section 9.7 on page 9-23)
- TMS320 DSP Bulletin Board Service (Section 9.8 on page 9-24)
- TMS320 DSP Hotline (Section 9.9 on page 9-27)

To receive copies of available TMS320 literature, complete the literature request card at the back of this document or call the Customer Response Center at 1-800-232-3200.

9.1 Product Descriptions and Product Bulletins

Product descriptions and product bulletins are the first documents published when a new product is being announced. Later these documents are replaced by the product user's guide.

A product description briefly describes the new device, presents key features and block diagrams, and suggests applications. Product bulletins are periodically published to give updated information on the TMS320 family of digital signal processors. Product descriptions are longer and more detailed than product bulletins.

Table 9-1 lists the product descriptions and product bulletins available to support the TMS320 family. They can be ordered using the literature number indicated.

Table 9-1. TMS320 Product Bulletins and Product Descriptions

PRODUCT	DOCUMENT	LITERATURE NUMBER
TMS320C25	TMS320C25 Product Description	SPRV006
TMS320	TMS320 Digital Signal Processors Product Bulletin	SPRT013

9.2 User's Guides

A user's guide for a TMS320 processor provides detailed information regarding the architecture of the device, its operation, assembly language instructions, and hardware and software applications. Table 9-2 lists the user's guides available for the TMS320 family of processors.

Table 9-2. TMS320 User's Guides

PRODUCT	DOCUMENT	LITERATURE NUMBER
TMS32010	TMS32010 User's Guide	SPRU001B
TMS32011	TMS32011 User's Guide	SPRU010
TMS32020	TMS32020 User's Guide	SPRU004B
TMS320C25	TMS320C25 User's Guide	SPRU012
TMS320	TMS320 Family Development Support Reference Guide	SPRU011

9.3 Data Sheets

The chief purpose of a data sheet is to provide the electrical specifications, timing, and mechanical data for the device. It also includes a brief description of the device architecture, a list of key features, a block diagram, and an instruction set summary. A data sheet may be included in a user's guide as an appendix. Table 9-3 lists the TMS320 data sheets available.

Table 9-3. TMS320 Data Sheets

PRODUCT	DOCUMENT	LITERATURE NUMBER
TMS32010	TMS32010 Data Sheet	SPRS02A
TMS32010-14	TMS32010-14 Data Sheet	SPRS008
TMS32011	TMS32011 Data Sheet	SPRS005
TMS320C10	TMS320C10 Data Sheet	SPRS006
TMS32020	TMS32020 Data Sheet	SPRS003A
TMS320C25	TMS320C25 Data Sheet (included in TMS320C25 User's Guide)	SPRS007

NOTE: The TMS32010-25 and TMS320C10-25 specifications are covered in the TMS32010 and TMS320C10 data sheets, respectively.

9.4 DSP Applications Book

The TMS320 engineers are constantly developing application reports as they assist customers in designing DSP applications using the TMS320 family. New application reports are announced through the TMS320 DSP Bulletin Board Service (see Section 9.8) and in the TMS320 quarterly newsletter, *Details on Signal Processing*.

Seventeen application reports, which cover generic DSP routines, telecommunications, and computer applications, are included in the recently published book, *Digital Signal Processing Applications with the TMS320 Family*. This book combines application reports on the TMS32010 and TMS32020 into a 750-page volume, thus providing users a single source for finding information on the most common applications of the TMS320 family.

The DSP Applications Book is divided into three major parts. The first part briefly introduces the device architectures, characteristics, support, and development tools for the first two generations of TMS320 processors. The second part covers some of the common DSP routines, such as Finite Impulse Response (FIR) and Infinite Impulse Response (IIR) filters and Fast Fourier Transforms (FFT), implemented using the TMS320 devices. Hardware interfacing and multiprocessing with these devices are also included. The last part of the book is applications specific. Some typical DSP applications are selected and thoroughly discussed. These applications are divided into two categories: telecommunications, and computers and peripherals (including speech coding/recognition, image/graphics, and digital control).

The materials included in this book are primarily application reports, which have been generated by the DSP engineering staff of Texas Instruments Semiconductor Group. Some published articles and a technical report have been reprinted in the book to supplement the 17 application reports in order to provide completeness of the subject matter. The application reports contain more complete theory and implementations (consisting of algorithms, TMS320 code, and/or schematics) than the reprinted articles.

Table 9-4 lists the application reports in the order in which they appear in the Applications Book. The following subsections give a brief description of each application report.

Table 9-4. Application Reports in the DSP Applications Book

APPLICATION AREA	DEVICE	SUBJECT
DSP Routines	TMS32010/20	FIR/IIR Filters
	TMS32020	FFT
	TMS32010/20	Companding Routines
	TMS32010	Floating-Point Arithmetic
	TMS32020	Floating-Point Arithmetic
	TMS32010	Precision Digital Sine-Wave Generation
	TMS32010/20	Matrix Multiplication
DSP Interface	TMS32010	Asynchronous Input Interface
	TMS32010	External Memory Interface
	TMS32020	Hardware Interface
	TMS32020	MC68000 Interface
Telecommunications	TMS32010	Telecommunications Interfaces
	TMS32020	Digital Voice Echo Cancellation
	TMS32010	Data Encryption
	TMS32010	ADPCM (CCITT/Non-CCITT)
Image/Graphics	TMS32020	Graphics Implementation
Digital Control	TMS32010	Control System Implementation

Included in the Applications Book is the source code for the applications discussed. This code can be used to reduce design time and move TMS320-based products to market faster. The routines are also available in a software library making it easy for users to apply the software to their own applications. See Section 6.5 for a description of the DSP Software Library.

9.4.1 Implementation of FIR/IIR Filters with the TMS32010/TMS32020

Many signal processing applications require that digital filters be used in place of analog filters. Digital filters can meet tight specifications on magnitude and phase characteristics and eliminate voltage drift, temperature drift, and noise problems associated with analog filter components.

This application report describes a variety of methods for implementing Finite Impulse Response (FIR) and Infinite Impulse Response (IIR) digital filters with the TMS320 family. Emphasis is on minimizing both the execution time and the number of data memory locations required. Tradeoffs between several different structures of the two classes of digital filters are also discussed. TMS32010 source code examples implement two FIR filters and three IIR filters (direct, cascade, and parallel) based on the techniques described in this application report. Plots of the frequency response, log-magnitude response, unit sample response, and other pertinent data accompany each of the filter implementations. The methods presented for implementing the different types of filters can be readily extended to any desired order of filter.

9.4.2 Fast Fourier Transform Algorithms with the TMS32020

Recent advances in VLSI hardware, such as the TMS320 family of processors, have further enhanced the popularity of the Fast Fourier Transform (FFT). This application report describes the implementation of FFT algorithms using the TMS32020 processor that has features particularly suited to digital signal processing.

This report discusses the development of the DFT algorithm, leading to the derivation of the FFT algorithm. Special attention is given to various FFT implementation aspects such as scaling. To expedite TMS32020 FFT code development, two macro libraries are included in the appendices for both the direct and indirect memory addressing modes. TMS32020 source code examples are also given for a 256-point (both radix-2 and radix-4) and a 1024-point complex FFT, along with some system memory considerations for implementing large FFTs.

9.4.3 Companding Routines for the TMS32010/TMS32020

Companding is required for applications that use codec devices, such as in public and private telephone networks. The speed and versatility of the TMS320 allow companding to be performed in either software or hardware.

This application report describes both the A-law and μ -law software companding methods. Sample programs are included to show how companding can be performed using the computational power of the TMS32010 and the TMS32020.

9.4.4 Floating-Point Arithmetic with the TMS32010

This application report analyzes an implementation of floating-point addition and multiplication on the TMS32010. The floating-point single-precision standard proposed by the IEEE is specifically examined. Using this standard, the TMS32010 performs a floating-point multiplication in 8.4 microseconds and a floating-point addition in 17.2 microseconds. These computation speeds are comparable to dedicated floating-point processors.

For illustration of floating-point formats and the tradeoffs involved in making a choice between different floating-point formats, a review of floating-point arithmetic notation and of addition and multiplication algorithms is presented.

9.4.5 Floating-Point Arithmetic with the TMS32020

In this application report, an implementation of floating-point addition, multiplication, and division on the TMS32020 is analyzed. Using the floating-point single-precision standard proposed by the IEEE, the TMS32020 performs a floating-point multiplication in 7.8 microseconds, a floating-point addition in 15.4 microseconds, and a floating-point division in 22.8 microseconds.

A review of floating-point notation and of addition, multiplication, and division algorithms is also presented.

9.4.6 Precision Digital Sine-Wave Generation with the TMS32010

Sine-wave generators are fundamental building blocks of signal processing systems, which are used in diverse applications such as communication, instrumentation, and control. In the past, engineers usually designed these oscillators with analog circuitry. Now, however, new high-speed digital signal processors like the TMS32010 present designers with an alternative that in many cases is superior. The TMS32010 provides the speed and accuracy to produce stable, low-distortion sine-waves over a wide range of frequencies.

This application report describes two different methods for implementing a digital sine-wave generator using the TMS32010. The first method is a fast direct table lookup scheme suitable for applications not requiring extreme accuracy. The second approach, an enhancement of the first, includes linear interpolation to provide sine waveforms with a minimum of harmonic distortion. Sample subroutines for implementing each scheme are presented.

9.4.7 Matrix Multiplication with the TMS32010 and TMS32020

Matrix multiplication is useful in applications such as graphics, numerical analysis, or high-speed control. This application report illustrates matrix multiplication on two digital signal processors, the TMS32010 and the TMS32020. Both the TMS32010 and TMS32020 can multiply any two matrices of size $M \times N$ and $N \times P$. The programs for the TMS32010 and TMS32020, included in the appendices, can multiply large matrices and are only limited by the amount of internal data RAM available. Assuming a 200-ns cycle time, the TMS32010 and TMS32020 can calculate $[1 \times 3] \times [3 \times 3]$ in 5.4 microseconds.

Before discussing the two versions of implementing a matrix multiplication algorithm, a brief review of matrix multiplication is presented along with three examples of graphics applications.

9.4.8 Interfacing to Asynchronous Inputs with the TMS32010

Interrupt (\overline{INT}), Reset (\overline{RS}) and Branch on I/O (\overline{BIO}) are inputs to the TMS32010 microprocessor that are typically provided from asynchronous sources within a system. These three inputs are subject to certain considerations in addition to those relevant signals that are synchronized to TMS32010 operation. Observation of these considerations, as described in this application report, is important to insure reliable operation of these three input functions.

Several aspects of interrupt operation are important for proper implementation of the interrupt function within a system. These fall into three basic categories: interrupt input synchronization, internal interrupt control logic, and interrupt programming. Each category is discussed in detail in this report.

9.4.9 Interfacing External Memory to the TMS32010

External ROM or RAM can be interfaced to the memory bus of the TMS32010 microprocessor in applications that require additional RAM or program memory. This application report describes two basic low-cost methods for expanding the TMS32010's memory configuration: (1) direct expansion, utilizing a standard memory cycle for memory access, and (2) extended memory interface, utilizing an address (latched using a standard memory cycle) that automatically increments or decrements after each access. Of the two methods, the first method is very efficient for program and small data memory expansion, whereas the second method is more useful for large data memory expansion.

The design techniques presented can easily be extended to encompass interface of other devices to the TMS32010. Each of the circuits discussed has been built and tested to verify its operation.

A description of a hardware peripheral interface device produced by Pacific Microcircuits is also included, which eases the TMS32010 interface to both external memory and codec devices.

9.4.10 Hardware Interfacing to the TMS32020

This application report suggests hardware design techniques for interfacing memory devices and peripherals to the TMS32020. Examples of PROM, EPROM, static RAM, and dynamic RAM circuits built around the TMS32020 are demonstrated, with consideration given to the timing requirements of the processor and external devices.

A memory-mapped UART (Universal Asynchronous Receiver-Transmitter) interface for communication with a host computer is presented, as well as an interface to a combo-codec (coder-decoder + filter) device for analog signal acquisition. All circuits in this report have been built and their operation verified at room temperature.

9.4.11 TMS32020 and MC68000 Interface

This application report describes how the MC68000-10 can be used as a host processor with the TMS32020 serving as a numeric coprocessor to implement numeric-intensive algorithms often required in computer systems. Applications for such a system include graphic workstations, speech processing, spectrum analysis, and other computation-intensive applications.

The interface and communication techniques presented in the report are generic and directly applicable to other host processors. The schematic presented in the appendix has been fully built and tested and has proven functional.

9.4.12 Telecommunications Interfacing to the TMS32010

This application report describes a method of providing a standard telecommunications interface and a realistic medium for implementing DSP algorithms based on TMS32010 assembly code. Standard serial and parallel interfaces permit connection to most digital PBX backplanes and TDM systems. Standard combo-codec filters provide analog interfaces that conform to CCITT recommendations. A circuit is included to perform companding functions for time-critical telecommunications applications.

Seven system configurations for some telecommunications applications using these interface circuits are described. These configurations provide the following interfaces: (1) standalone analog, (2) telephony test-set, (3) PBX backplane, (4) 2/4-wire transformer, (5) 3-way conference, (6) ADPCM, and (7) DTMF detection.

9.4.13 Digital Voice Echo Canceller with a TMS32020

Echo cancellation is an application of adaptive filtering to the control of echoes in the telephone network. This application report describes the implementation of a single-chip digital voice echo canceller on the TMS32020 digital signal processor. The single-chip system can perform a 128-tap (16-ms span) echo cancellation for telephone network applications.

This implementation is covered in detail and is in accordance with the CCITT (International Telegraph and Telephone Consultative Committee) recommendation applicable to the design of voice echo cancellers. A simulation has been performed to test the echo canceller, and the result exceeds the CCITT requirements. The complete algorithm and source code are provided.

9.4.14 Implementation of Data Encryption Standard Using TMS32010

This application report describes the implementation of a data encryption method on the TMS32010. An example is provided of encryption used in conjunction with speech coding to achieve secure communication over voice channels. The algorithm chosen for the encryption is the Data Encryption Standard (DES) defined by the National Bureau of Standards.

Processor resource requirements are also provided for applying the DES to speech coding at different bit rates. For a 2.4-kbit/s LPC vocoder application, the DES only requires six percent of the TMS32010 CPU loading. The encryption scheme is used to encrypt a stream of bits that represent text, computer files, or anything else presented in a binary form. The result is directly applicable to the design of any secure data/voice communications system.

Prior to exportation of any product that is subject to export license control by the U.S. government, the purchaser of that product shall be responsible for obtaining any licenses required under the applicable laws of the U.S., including the Export Administration Act and Regulations.

Note that the export of cryptographic devices and software is controlled as specified in Title 22, Code of Federal Regulations, Parts 121 et seq. For more information on the export of any cryptologic commodity, contact:

Office of Munitions Control
Bureau of Politico-Military Affairs
Department of State
Washington, DC 20520

9.4.15 32-kbit/s ADPCM with the TMS32010

Digital voice communication is typically transmitted in a 64-kbit/s PCM bit stream. Voice and data communications demand increasing capacities for signal transmission without significant degradation in the quality of the transmitted signal. One of the recommended solutions for accomplishing this task is that of the Adaptive Differential Pulse Code Modulation (ADPCM). This solution has been reviewed by CCITT (International Telegraph and Telephone Consultative Committee), and a specific standard has been recommended.

Two solutions, a full-duplex solution and a half-duplex solution, are discussed in this application report. Both follow the model recommended by CCITT for 32-kbit/s ADPCM, although only the half-duplex solution provides a bit-for-bit compatible data stream as required by the recommendation. At 32-kbit/s, the ADPCM solution provides double the channel capacity of the current 64-kbit/s PCM technique. Each solution has been totally incorporated in the internal memory space of the TMS32010. This application report presents a brief review of the basic principles of PCM and ADPCM. Hardware requirements, software logic flow, and key features of the TMS32010 for the implementation of ADPCM are also given. Source code is provided for the implementation and creation of an ADPCM transmission channel.

9.4.16 A Graphics Implementation Using the TMS32020 and TMS34061

An example of a graphics display subsystem based on a raster-scan display is described in this application report. The system consists of the TMS32020 functioning as the image control processor, dynamic video memories (VRAMs), and a display/memory controller (TMS34061). The TMS32020 serving as the graphics engine performs tasks such as image scaling, translation, and rotation.

A proposed system configuration is presented and discussed from both hardware and software viewpoints, including some of the necessary tradeoffs and some available options. When integrating such a system into PC or work stations, the TMS32020 reduces the host processor burden of performing intensive graphics data computations, thus allowing the host processor to concentrate on other important system and I/O tasks. This report also includes a working schematic and the software used to test the design.

9.4.17 Control System Compensation and Implementation with TMS32010

The increasing availability and decreasing cost of digital hardware has encouraged the use of microprocessors, such as the TMS32010, in algorithms for the control of feedback systems. This application report provides examples of structures used in digital control systems: first- and second-order compensators (lowpass filters) and notch filters. The report also highlights the tradeoffs in developing algorithms, hardware, and software for a digital control system. Control applications using the TMS32010 may include computer disk control, laser print-head control, robotic control, automobile-engine systems control, flight control, and autopilot systems.

An example TMS32010 program that uses the first- and second-order filter routine to compute several elements of a digital control system is provided in the appendix.

9.5 University Textbooks

A series of DSP textbooks is being published to support digital signal processing research and education. These textbooks are designed to aid in the understanding of DSP applications and implementations using the TMS320 family. Table 9-5 provides a list in chronological order of the textbook title, author(s), and availability. The following subsections give a brief description of each book.

Table 9-5. DSP Textbooks

TITLE	AUTHOR	PUBLISHER	AVAILABLE
Theory and Implementation of DFT/FFT and Convolution Algorithms	C.S. Burrus, T.W. Parks	John Wiley and Sons	Now
Digital Filter Design	T.W. Parks, C.S. Burrus	John Wiley and Sons	Early 1987
Practical Approaches to Speech Coding	P. Papamichalis	Prentice-Hall	Early 1987
A Practical Guide to Adaptive Filter Design	J.R. Treichler, C.R. Johnson, Jr., M.G. Larimore	John Wiley and Sons	Early 1987
A DSP Laboratory Using the TMS32010	T.W. Parks, D.L. Jones	Prentice-Hall	Early 1987

For ordering information, contact the publisher:

John Wiley and Sons, Inc.
605 Third Avenue
New York, NY 10158
(800) 526-5368

Prentice-Hall
Route 9W
Englewood Cliffs, NJ 07632
(201) 767-9520

9.5.1 DFT/FFT and Convolution Algorithms

The Theory and Implementation of DFT/FFT and Convolution Algorithms (C.S. Burrus and T.W. Parks of Rice University) has been written for the scientist or engineer who has a good understanding of continuous-time signals and who has been introduced to discrete-time signal analysis.

The book begins with a review of continuous- and discrete-time transform analysis of signals and describes the properties of the Discrete Fourier Transform (DFT). Efficient algorithms have been provided for computing the DFT at a few frequencies (direct, Goertzel, and chirp transforms). The three main approaches to a Fast Fourier Transform (FFT), the Cooley-Tukey, prime-factor, and Winograd transforms, are described in considerable detail. FORTRAN statements are used to explain concepts. Linear and circular convolution of discrete-time signals is presented including a discussion of efficient ways to compute a convolution.

Also presented in this algorithm handbook is a collection of FORTRAN programs for the DFT which may be used directly or as a basis for custom program development for special applications. These programs use floating-point

arithmetic and are intended for general-purpose computers. In addition, a collection of FFT programs for the TMS320 is provided, along with timings and comparisons of the different algorithms that have been programmed.

9.5.2 Digital Filter Design

Digital Filter Design (T. W. Parks and C. S. Burrus of Rice University) has been written for the reader who is thoroughly familiar with the techniques of digital signal processing. The text is a comprehensive guide to digital filter design methodologies, and begins with a brief introduction to digital filters. Properties, design, approximations, and implementations of Finite Impulse Response (FIR) and Infinite Impulse Response (IIR) filters are covered in detail. A comparison of filtering alternatives, specifically when to use FIR and when to use IIR, is included.

The appendix contains filter design software that can be used to solve most practical problems. Also included is comprehensive referencing of other readily available software for design. An added emphasis is placed on implementing TMS320-based hardware designs, an area of study rapidly permeating many electrical engineering curricula.

9.5.3 Practical Approaches to Speech Coding

Practical Approaches to Speech Coding (P. Papamichalis) provides the reader with a conceptual understanding of speech coding techniques through practical examples of systems that integrate speech coding technology. The book is written primarily for the engineer, speech researcher, or scientist versed in the techniques of digital signal processing.

The text begins with an introduction to speech coding tools and discusses general considerations of speech coding, digital speech, and speech digitization. Static and dynamic strategies to code the speech waveform, pitch detection and its importance in speech coding, and measurement of speech coder performance are covered. Some examples of speech coding applications are given, and the TMS320 is described as an example of a programmable digital signal processor used in the implementation of a Fast Fourier Transform (FFT) algorithm. Quality, cost, complexity, and reliability considerations are discussed, and a detailed list of references is also presented.

9.5.4 A Practical Guide to Adaptive Filter Design

The purpose of *A Practical Guide to Adaptive Filter Design* (J. R. Treichler, C. R. Johnson, Jr., and M. G. Larimore) is to familiarize the reader with adaptive filter implementations using digital signal processing. This applications textbook is written for the reader who is thoroughly familiar with DSP techniques.

The text begins with a brief introduction to adaptive filtering and continues with a description of practical applications requiring adaptive filtering and some basic principles of adaptive filtering. Finite Impulse Response (FIR) adaptive algorithms, Infinite Impulse Response (IIR) filters, and property-restoring concepts and algorithms are discussed. Also covered are adaptive filter implementation issues and several software examples of adaptive filtering using TMS320 source code.

9.5.5 A Digital Signal Processing Laboratory Using the TMS32010

A Digital Signal Processing Laboratory Using the TMS32010, written by T.W. Parks and D.L. Jones, is a tutorial designed to introduce the reader to realtime digital signal processing using the TMS320. The tutorial is written primarily for those with a basic knowledge of both digital signal processing and microprocessors.

The lab manual presents in a step-by-step manner the commonly used commands and capabilities of the TMS32010 Evaluation Module (EVM) and Analog Interface Board (AIB). The architecture and instruction set of the TMS32010 are introduced with an emphasis on the special features of the TMS32010 that enhance its capabilities as a digital signal processor. Finite Impulse Response (FIR) and Infinite Impulse Response (IIR) filters with the TMS32010 are discussed, and many suggestions for student projects are included.

9.6 Technical Articles

Since the TMS32010 was disclosed in 1982, the TMS320 family has received an ever-increasing amount of recognition. The number of outside parties contributing to the extensive development support offered by Texas Instruments is rapidly growing. Many technical articles are being written about TMS320 applications in the field of digital signal processing.

The following articles and papers have been published since 1982 regarding the Texas Instruments TMS320 Digital Signal Processors. They are listed here for readers who are interested in gaining further information about these processors and their applications.

1982

- 1) K. McDonough, E. Caudel, S. Magar, and A. Leigh, "Microcomputer with 32-Bit Arithmetic Does High-Precision Number Crunching," *Electronics*, Vol. 55, No. 4, 105-10 (February 1982).
- 2) T. Schalk and M. McMahan, "Firmware-Programmable μ Aids Speech Recognition," *Electronic Design*, Vol. 30, No. 15, 143-7 (July 1982).
- 3) S. Magar, R. Hester, and R. Simpson, "Signal-Processing μ Builds FFT-Based Spectrum Analyzer," *Electronic Design*, Vol. 30, No. 17, 149-54 (August 1982).
- 4) G. Farber, "Microelectronics-Developmental Trends and Effects on Automation Techniques," *Regelungstechnik Praxis* (Germany), Vol. 24, No. 10, 326-36 (October 1982).
- 5) K. McDonough and S. Magar, "A Single Chip Microcomputer Architecture Optimized for Signal Processing," *Electro/82 Conference Record* (1982).
- 6) S. Magar, "Trends in Digital Signal Processing Architectures," *Wescon/82 Conference Record* (1982).
- 7) L. Kaplan, "Signal Processing with the TMS320 Family," *Midcon/82 Conference Record* (1982).

1983

- 1) L. Dusek, T. Schalk, and M. McMahan, "Voice Recognition Joins Speech on Programmable Board," *Electronics*, Vol 56, No. 8, 128-32 (April 1983).
- 2) R. Wyckoff, "A Forth Simulator for the TMS320 IC," *Rochester Forth Applications Conference*, 141-50 (June 1983).
- 3) R. Cushman, "Sophisticated Development Tool Simplifies DSP-Chip Programming," *Electronic Design*, Vol. 28, No. 20, 165-78 (September 1983).
- 4) W. Loges, "Digital Controls Using Signal Processors," *Elektronik* (Germany), Vol. 32, No. 19, 51-4 (September 1983).
- 5) J. Elder and S. Magar, "Single-Chip Approach to Digital Signal Processing," *Wescon/83 Electronic Show and Convention* (November 1983).
- 6) M. Malcangi, "VLSI Technology for Signal Processing. III," *Electronica Oggi* (Italy), No. 11, 129-38 (November 1983).
- 7) P. Strzelcki, "Digital Filtering," *Systems International* (Great Britain), Vol. 11, No. 11, 116-17 (November 1983).
- 8) J. So, "TMS320 - A Step Forward in Digital Signal Processing," *Microprocessors and Microsystems* (Great Britain), Vol. 7, No. 10, 451-60 (December 1983).

Documentation Support - Technical Articles

- 9) W. Loges, "Higher-Order Control Systems with Signal Processor TMS320," *Elektronik* (Germany), Vol. 32, No. 25, 53-5 (December 1983).
- 10) A. Kumarkanchan, "Microprocessors Provide Speech to Instruments," *Journal of Institute of Electronic and Telecommunication Engineers* (India), Vol. 29, No. 12 (December 1983).
- 11) D. Daly and L. Bergeron, "A Programmable Voice Digitizer Using the TI TMS320 Microcomputer," *Proceedings of IEEE International Conference on Acoustics, Speech and Signal Processing* (1983).
- 12) L. Morris, "A Tale of Two Architectures: TI TMS 320 SPC VS. DEC Micro/J-11," *Proceedings of IEEE International Conference on Acoustics, Speech and Signal Processing* (1983).
- 13) L. Pagnucco and D. Garcia, "A 16/32 Bit Architecture for Signal Processing," *Mini/Micro West 1983 Computer Conference and Exhibition* (1983).
- 14) L. Adams, "TMS320 Family 16/32-Bit Digital Signal Processor, An Architecture for Breaking Performance Barriers," *Mini/Micro West 1983 Computer Conference and Exhibition* (1983).
- 15) C. Erskine, "New VLSI Co-Processors Increase System Throughput," *Mini/Micro Midwest Conference Record* (1983).
- 16) R. Simar, "Performance of Harvard Architecture in TMS320," *Mini/Micro West 1983 Computer Conference and Exhibition* (1983).
- 17) W. Gass, "The TMS32010 Provides Speech I/O for the Personal Computer," *Mini/Micro Northeast Electronics Show and Convention* (1983).
- 18) J. Potts, "A Versatile High Performance Digital Signal Processor," *Ohmcon/83 Conference Record* (1983).
- 19) A. Holck, "Low-Cost Speech Processing with TMS32010," *Midcon/83 Conference Record* (1983).
- 20) S. Mehrgardt, "Signal Processing with a Fast Microcomputer System," *Proceedings of Eusipco-83 Second European Signal Processing Conference*, Netherlands (1983).
- 21) H. Strube, R. Wilhelms, and P. Meyer, "Towards Quasiarticulatory Speech Synthesis in Real Time," *Proceedings of Eusipco-83 Second European Signal Processing Conference*, Netherlands (1983).
- 22) R. Blasco, "Floating-Point Digital Signal Processing Using a Fixed-Point Processor," *Southcon/83 Electronics Show and Convention* (1983).
- 23) W. Gass and M. McMahan, "Software Development Techniques for the TMS320," *Southcon/83 Electronics Show and Convention* (1983).
- 24) L. Kaplan, "Flexible Single Chip Solution Paves Way for Low Cost DSP," *Northcon/83 Electronics Show and Convention* (1983).
- 25) J. Potts, "New 16/32-Bit Microcomputer Offers 200-ns Performance," *Northcon/83 Electronics Show and Convention* (1983).
- 26) R. Dratch, "A Practical Approach to Digital Signal Processing Using an Innovative Digital Microcomputer in Advanced Applications," *Electro '83 Electronics Show and Convention* (1983).
- 27) L. Kaplan, "The TMS32010: A New Approach to Digital Signal Processing," *Electro '83 Electronics Show and Convention* (1983).

1984

- 1) O. Ericsson, "Special Processor Did Not Meet Requirements - Built Own Synthesizer," *Elteknik Aktuell Elektronik* (Sweden), No. 3, 32-6 (February 1984).

Documentation Support - Technical Articles

- 2) S. Mehrgardt, "General-Purpose Processor System for Digital Signal Processing," *Elektronik* (Germany), Vol. 33, No. 3, 49-53 (February 1984).
- 3) H. Strube, "Synthesis Part of a 'Log Area Ratio' Vocoder Implemented on a Signal-Processing Microcomputer," *IEEE Transaction on Acoustics, Speech and Signal Processing*, Vol. ASSP-32, No. 1, 183-5 (February 1984).
- 4) E. Catier, "Listening Cards or Speech Recognition," *Electronique Industrielle* (France), No. 67, 72-6 (March 1984).
- 5) J. Bucy, W. Anderson, M. McMahan, R. Tarrant, and H. Tennant, "Ease-of-Use Features in the Texas Instruments Professional Computer," *Proceedings of IEEE*, Vol. 72, No. 3, 269-82 (March 1984).
- 6) S. Magar, "Signal Processing Chips Invite Design Comparisons," *Computer Design*, Vol. 23, No. 4, 179-86 (April 1984).
- 7) S. Mehrgardt, "32-Bit Processor Produces Analog Signals," *Elektronik* (Germany), Vol. 33, No. 7, 77-82 (April 1984).
- 8) M. Hutchins and L. Dusek, "Advanced ICs Spawn Practical Speech Recognition," *Computer Design*, Vol. 23, No. 5, 133-9, (May 1984).
- 9) R. Cushman, "Easy-to-Use DSP Converter ICs Simplify Industrial-Control Tasks," *Electronic Design*, Vol. 29, No. 17, 218-28 (August 1984).
- 10) P. Rojek and W. Wetzel, "Multiprocessor Concept for Industrial Robots: Multivariable Control with Signal Processors," *Elektronik* (Germany), Vol. 33, No. 16, 109-13 (August 1984).
- 11) D. Lee, T. Moran, and R. Crane, "Practical Considerations for Estimating Flaw Sizes from Ultrasonic Data," *Materials Evaluation*, Vol. 42, No. 9, 1150-8 (August 1984).
- 12) P.K. Rajasekaran and G.R. Doddington, "Real-Time Factoring of the Linear Prediction Polynomial of Speech Signals," *Digital Signal Processing - 1984: Proceedings of the International Conference*, 405-10 (September 1984).
- 13) A. Casini, G. Castellini, P.L. Emiliani, and S. Rocchi, "An Auxiliary Processor for Biomedical Signals Based on a Signal Processing Chip," *Digital Signal Processing - 1984: Proceedings of the International Conference* 228-32 (September 1984).
- 14) Keun-Ho Ryoo, "On the Recent Digital Signal Processors," *Journal of Korean Institute of Electrical Engineering* (Korean), Vol. 33, No. 9, 540-9 (September 1984).
- 15) G. Pawle and T. Faherty, "DSP/Development Board Offers Host Independence," *Computer Design*, Vol. 23, No. 12, 109-16 (October 15, 1984).
- 16) V. Kroneck, "Conversing with the Computer," *Elektrotechnik* (Germany), Vol. 66, No. 20, 16-18 (October 1984).
- 17) M. Malcangi, "Programmable VLSI's for Vocal Signals," *Electronica Oggi* (Italy), No. 10, 103-13 (October 1984).
- 18) G. Gaillat, "The CAPITAN Parallel Processor: 600 MIPS for Use in Real Time Imagery," *Traitement de Signal* (France), Vol. 1, No. 1, 19-30 (October-December 1984).
- 19) W. Loges, "A Code Generator Sets up the Automatic Controller Program for the TMS320," *Elektronik* (Germany), Vol. 33, No. 22, 154-8 (November 1984).
- 20) H. Volkers, "Fast Fourier Transforms with the TMS320 as Coprocessor," *Elektronik* (Germany), Vol. 33, No. 23, 109-12 (November 1984).
- 21) R. Schafer, R. Merseraeau, and T. Barnwell, "Software Package Brings Filter Design to PCs," *Computer Design*, Vol. 23, No. 13, 119-25 (November 1984).

Documentation Support - Technical Articles

- 22) W. Gass and M. Arjmand, "Real-Time 9600 Bits/sec Speech Coding on the TI Professional Computer," *Proceedings of IEEE International Conference on Acoustics, Speech and Signal Processing* (1984).
- 23) M. Dankberg, R. Iltis, D. Saxton, and P. Wilson, "Implementation of the RELP Vocoder Using the TMS320," *Proceedings of IEEE International Conference on Acoustics, Speech and Signal Processing* (1984).
- 24) A. Holck and W. Anderson, "A Single-Processor LPC Vocoder," *Proceedings of IEEE International Conference on Acoustics, Speech and Signal Processing* (1984).
- 25) B. Bryden and H. Hassanein, "Implementation of Full Duplex 2.4 kbps LPC Vocoder on a Single TMS320 Microprocessor Chip," *Proceedings of IEEE International Conference on Acoustics, Speech and Signal Processing* (1984).
- 26) S. Magar, "Architecture and Applications of a Programmable Monolithic Digital Signal Processor - A Tutorial Review," *Proceedings of IEEE International Symposium on Circuits and Systems* (1984).
- 27) E. Fernandez, "Comparison and Evaluation of 32-Bit Microprocessors," *Mini/Micro Southeast Computer Conference and Exhibition* (1984).
- 28) J. Perl, "Channel Coding in a Self-Optimizing HF Modem," *International Zurich Seminar on Digital Communications; Applications of Source Coding, Channel Coding and Secrecy Coding: Proceedings*, 101-6 (1984).
- 29) D. Quarmby (Editor), *Signal Processor Chips*, Granada, England (1984).
- 30) W. Loges, "Signal Processor as High-Speed Digital Controller," *Elektronik Industrie* (Germany), Vol. 15, No. 5, 30-2 (1984).
- 31) R. Mersereau, R. Schafer, T. Barnwell, and D. Smith, "A Digital Filter Design Package for PCs and TMS320," *Midcon/84 Electronic Show and Convention* (1984).
- 32) J. Bradley and P. Ehlig, "Applications of the TMS32010 Digital Signal Processor and Their Tradeoffs," *Midcon/84 Electronic Show and Convention* (1984).
- 33) R. Steves, "A Signal Processor with Distributed Control and Multidimensional Scalability," *Proceedings of IEEE National Aerospace and Electronics Conference* (1984).
- 34) N. Morgan, *Talking Chips*, McGraw-Hill (1984).
- 35) V. Vagarshakyan and L. Gustin, "On A Single Class of Continuous Systems - A Solution to the Problem on the Diagnosis of Output Signal Characteristics Recognition Procedures," *IZV. AKAD. NAUK ARM. SSR, SER. TEKH. NAUK* (USSR), Vol. 37, No. 3, 22-7 (1984).
- 36) T.R. Myers, "A Portable Digital Speech Processor for an Auditory Prosthesis," *Wescon/84 Conference Record* (1984).
- 37) J. Bradley and P. Ehlig, "Tradeoffs in the Use of the TMS32010 as a Digital Signal Processing Element," *Wescon/84 Conference Record* (1984).
- 38) D. Garcia, "Multiprocessing with the TMS32010," *Wescon/84 Conference Record* (1984).

1985

- 1) C. Erskine, S. Magar, E. Caudel, D. Essig, and A. Levinspuhl, "A Second-Generation Digital Signal Processor TMS32020: Architecture and Applications," *Traitement de Signal* (France), Vol. 2, No. 1, 79-83 (January-March 1985).
- 2) "TI 'Shiva' Chip Outlined," *Electronic Engineering Times*, 15 (February 18, 1985).

Documentation Support - Technical Articles

- 3) V. Milutinovic, "4800 Bit/s Microprocessor-Based CCITT Compatible Data Modem," *Microprocessing and Microprogramming*, Vol. 15, No. 2, 57-74 (February 1985).
- 4) S. Magar, D. Essig, E. Caudel, S. Marshall and R. Peters, "An NMOS Digital Signal Processor with Multiprocessing Capability," *Digest of IEEE International Solid-State Circuits Conference* (February 1985).
- 5) S. Magar, E. Caudel, D. Essig, and C. Erskine, "Digital Signal Processor Borrows from μ P to Step up Performance," *Electronic Design*, Vol. 33, No. 4, 175-84 (February 21, 1985).
- 6) S. Magar, S.J. Robertson, and W. Gass, "Interface Arrangement Suits Digital Processor to Multiprocessing," *Electronic Design*, Vol. 33, No. 5, 189-98 (March 7, 1985).
- 7) G. Kropp, "Signal Processor Offers Multiprocessor Capability," *Elektronik* (Germany), Vol. 34, No. 6, 53-8 (March 1985).
- 8) P. Mock, "Add DTMF Generation and Decoding to DSP- μ P Designs," *Electronic Design*, Vol. 30, No. 6, 205-20 (March 1985).
- 9) C. D. Crowell and R. Simar, "Digital Signal Processor Boosts Speed of Graphics Display Systems," *Electronic Design*, Vol. 33, No. 7, 205-9 (March 1985).
- 10) K. Lin and G. Frantz, "Speech Applications with a General Purpose Digital Signal Processor," *IEEE Region 5 Conference Record* (March 1985).
- 11) B. Bryden and H.R. Hassanein "Implementation of a Hybrid Pitch-Excited/Multipulse Vocoder for Cost-Effective Mobile Communications," *Proceedings of Speech Technology 85*, (April 1985).
- 12) G. Frantz and K. Lin, "The TMS320 Family Design Tools," *Proceedings of Speech Tech 85*, 238-40 (April 1985).
- 13) M. McMahan, "A Complete Speech Application Development Environment," *Proceedings of Speech Tech 85*, 293-95 (April 1985).
- 14) J. Reimer, M. McMahan and M. Arjmand, "ADPCM on a TMS320 DSP Chip," *Proceedings of Speech Tech 85*, 246-49 (April 1985).
- 15) W.J. Christmas, "A Microprocessor-Based Digital Audio Coder and Decoder," *International Conference on Digital Processing of Signals in Communications*, No. 62, 22-26 (April 1985).
- 16) P. Ehlig, "DSP Chip Adds Multitasking Telecomm Capability to Engineering Workstation," *Electronic Design*, Vol. 33, No. 10, 173-84 (May 2, 1985).
- 17) W.W. Smith, Jr., "Agile Development System, Running on PCs, Builds TMS320-Based FIR Filter," *Electronic Design* Vol. 33, No. 13, 129-38 (June 6, 1985).
- 18) R.H. Cushman, "Third-Generation DSPs Put Advanced Functions On-Chip," *EDN*, Vol. 30, No. 16, 58-68 (July 11, 1985).
- 19) L. Gutcho, "DEctalk-a Year Later," *Speech Technology*, Vol. 3, No. 1, 98-102 (August-September 1985).
- 20) "Signal Processor ICs: Highly Integrated ICs Making DSP More Attractive," *Electronic Engineering Times*, 37-8 (September 2, 1985).
- 21) K.E. Marrin, "VLSI and Software Move DSP Techniques into Mainstream," *Computer Design* (September 1985).
- 22) C.F. Howard, "A High-Level Approach to Digital Processing Design," *Proceedings of MILCOMP/85 Military Computers, Graphics, and Software Conference* (Iikley, England), 344-9 (October 1985).

Documentation Support - Technical Articles

- 23) N.K. Riedel, D.A. McAninch, C. Fisher, and N.B. Goldstein, "A Signal Processing Implementation for an IBM PC-Based Workstation," *IEEE Micro*, Vol. 5, No.5, 52-67 (October 1985).
- 24) D.M. Holburn and I.D. Sommerville, "A High-Speed Image Processing System Using the TMS32010," *Software and Microsystems* (Great Britain), Vol. 4, No. 5-6, 102-8 (October-December 1985).
- 25) "Sleeper Product - A Combo Voice/Data I/O Card - Awakens Interest," *Electronic Engineering Times*, 80-1 (November 11, 1985).
- 26) "Innovations: Digital Hearing Aid," *IEEE Spectrum*, 22 (December 1985).
- 27) K. Lin and G. Frantz, "Speech Applications Created by a Microcomputer," *IEEE Potentials* (December 1985).
- 28) C. Erskine and S. Magar, "Architecture and Applications of A Second-Generation Digital Signal Processor," *Proceedings of IEEE International Conference on Acoustics, Speech and Signal Processing* (1985).
- 29) J. Reimer and A. Lovrich, "Graphics with the TMS32020," *Wescon/85 Conference Record* (1985).
- 30) H. Hassanein and B. Bryden, "Implementation of the Gold-Rabiner Pitch Detector in a Real Time Environment Using an Improved Voicing Detector," *Proceedings of IEEE International Conference on Acoustics, Speech and Signal Processing, ASSP-33* No. 1, 319-20 (1985).
- 31) T. Fjallbrant, "A TMS320 Implementation of a Short Primary Block ATC-System with Pitch Analysis," *International Conference on Digital Processing of Signals in Communications*, No. 62, 93-96 (1985).
- 32) H. Megal and A. Heiman, "Image Coding System - A Single Processor Implementation," *MILCOM/85 IEEE Military Communications Conference Record* (Sponsor: Tadiran Ltd., Holon, Israel), Vol. 3, 628-34 (1985).
- 33) G. Corsini and P. Terreni, "A Radar Echo Simulator Based on μ P TMS320," *Proceedings of MELECON/85 IEEE Mediterranean Electrotechnical Conference* (Sponsors: Mayor of Madrid, Ministers of Industry and Energy, Spanish National Telephone Co.), Vol. 2, 327-30 (1985).
- 34) D.P. Kelly and J.L. Melsa, "Syllabic Companding and 32 kb/s ADPCM Performance," *IEEE International Conference on Communications*, Vol. 1, 414-17 (1985).
- 35) A. Vaghar, and V. Milutinovic, "An Analysis of Algorithms for Microprocessor Implementation of High-Speed Data Modems," *Proceedings of IEEE International Conference on Acoustics, Speech and Signal Processing*, Vol. 4, 1656-9 (1985).
- 36) D.P. Morgan and H.F. Silverman, "An Investigation into the Efficiency of a Parallel TMS320 Architecture: DFT and Speech Filterbank Applications," *Proceedings of IEEE International Conference on Acoustics, Speech and Signal Processing*, Vol. 4, 1601-4 (1985).

1986

- 1) "TI Chip Heads for Fast Lane of Digital Signal Processing," *Electronics*, 9 (January 27, 1986).
- 2) R.D. Campbell and S.R. McGeoch, "The TMS32010 Digital Signal Processor - An Educational Viewpoint," *International Journal for Electrical Engineering Education* (Great Britain), Vol. 23, No.1, 21-31 (January 1986).
- 3) "TI Preps CMOS Versions of Signal-Processor Chips," *Electronic Engineering Times*, 6 (February 3, 1986).
- 4) "TI Set To Show 2nd-Generation DSP," *Electronics*, 23-4 (February 3, 1986).

Documentation Support - Technical Articles

- 5) D. Essig, C. Erskine, E. Caudel, and S. Magar, "A Second-Generation Digital Signal Processor," *IEEE Journal of Solid-State Circuits*, Vol. SC-21, No.1, 86-91 (February 1986).
- 6) W.W. Smith, "Playing to Win: Product Development with the TMS320 Chip," *Speech Technology Magazine*, (March/April 1986).
- 7) T.P. Barnwell, "Algorithm Development and Multiprocessing Issues for DSP Chips," *Proceedings of Speech Technology 86* (April 1986).
- 8) Kun-Shan Lin and G.A. Frantz, "A Survey of Available Speech Hardware for Computer Systems," *Proceedings of Speech Technology 86* (April 1986).
- 9) W. Gass, "TMS32020 - The Quick and Easy Solution to DSP Problems," *Proceedings of Speech Technology 86* (April 1986).
- 10) L.R. Morris, "Software Engineering for an IBM PC/XT-SPEECH Realtime Digital Speech Spectrogram Production System," *Proceedings of Speech Technology 86* (April 1986).
- 11) C.H. Lee, D.Y. Cheng, D.A. Russo et al, "An Integrated Voice-Controlled Voice Messaging System," *Proceedings of Speech Technology 86* (April 1986).
- 12) H. Harrison, "A High-Level Language Programming Environment for Speech and Signal Processing," *Proceedings of Speech Technology 86* (April 1986).
- 13) R.E. Morley, A.M. Engebretson, and J.G. Trotta, "A Multiprocessor Digital Signal Processing System for Real-Time Audio Applications," *IEEE Transaction on Acoustics, Speech and Signal Processing*, Vol. ASSP-34, No. 2 (April 1986).
- 14) C.R. Cole, A. Haoui, P.L. Winship, "A High-Performance Digital Voice Echo Canceller on a Single TMS32020," *Proceedings of IEEE International Conference on Acoustics, Speech and Signal Processing* (1986).

9.7 TMS320 Quarterly Newsletter

The TMS320 newsletter, *Details on Signal Processing*, is published quarterly and distributed to update TMS320 customers on product information. Topics that are presented in the newsletter include new TMS320 products, new documentation, new third-party support, technical information about TMS320 products, mini application reports, development tool updates, contacts for needed support, future courses, design workshops, seminars, conferences, and the TMS320 university program.

To be added to the TMS320 mailing list and receive future copies of this newsletter, please mark the appropriate block on the Literature Request Card at the back of the book.

9.8 TMS320 DSP Bulletin Board Service

The TMS320 Digital Signal Processor Bulletin Board Service is a telephone-line computer bulletin board that provides access to large amounts of information pertaining to the TMS320 family. The bulletin board is an excellent means of communicating specification updates for current or new TMS320 devices and development tools, and new DSP application reports as they become available. It also allows a means to trade programs with other TMS320 users.

The bulletin board contains TMS320 source code from the 750 pages of application reports written to date. These programs include macro definitions, FFT algorithms, filter programs, ADPCM algorithms, echo cancelling, graphics, control, companding routines, and sine-wave generators. ROM code algorithms may be submitted by secure electronic transfer via the TMS320 bulletin board service.

The bulletin board can be accessed by users with a terminal or PC and a modem. The modem used must be able to communicate in Bell 212A format at a data rate of either 300 or 1200 bps. A character length of eight bits is required, with one stop bit and no parity. Once connected, a user may view and/or retrieve any of the program source listings desired. This code has been copyrighted by Texas Instruments for use only with a TMS320 device. The telephone number of the bulletin board is (713) 879-2091. There is a 60-minute access limit on the bulletin board per day.

When entering the bulletin board for the first time, only limited access may be made to its contents. A User ID must be obtained for full access to all of the bulletin board's features. This is accomplished by making an entry with the Feedback (F) command, and providing the user's name, company name, address, and phone number. Within approximately 48 hours, a User ID is assigned and unlimited access may be made to the bulletin board. Any of the programs on the bulletin board may then be downloaded to the user's system.

9.8.1 How to Access the TMS320 DSP Bulletin Board Service

The DSP bulletin board can be easily accessed by a TI/IBM (MS/PS-DOS) personal computer or compatible with a minimum of 96K RAM, a 300- or 1200-baud modem, a software communications package, and any text editor. CROSSTALK XVI Data Communications Software from Microstuf, Inc. (404/998-3998) is an example of a software package that can handle the data communications requirements. Since this is a commonly used software package among TI customers, it is used in the example given below on how to access the DSP bulletin board. After booting up the system, the following steps should be executed:

- 1) Enter CROSSTALK. If using a TI PC with an internal modem, enter the command XTALK-TI. When working from a computer other than a TI PC, enter XTALK.

Note that with a TI PC, the XTALK file uses the computer's RS-232 communications interface and works with Hayes Smartmodem, Racal-Vadic 3450, or Novation Smart-Cat, or it can be used to interface the PC to the TMS320 XDS Emulator or other computers.

Documentation Support - Bulletin Board Service

- 2) Initialize the NEWUSER file, which saves a telephone number and baud rate. After the copyright notice and greeting appear on the screen, the CROSSTALK status screen is displayed. The banner at the bottom will either request the file number to use, in which case the number corresponding to the NEWUSER file is entered, or it will show the Command? prompt, in which case LO NEWUSER to LOad this file is entered, and return. To follow the prompts given by the NEWUSER file, enter the following information:

Telephone number	713-8792091
Service being dialed	TI-HOUSTON DSP BULLETIN BOARD
Baud rate	300 or 1200

When prompted about saving the file, enter Y and supply a name.

- 3) Exit CROSSTALK by entering QU after the Command? prompt and edit the file just created. Verify that the following parameters have the correct information:

MOde	Call
POrt	A or B to specify the RS-232 interface on the PC
PArity	None
DAta	8
SPeed	300 or 1200
STop	1

Some optional parameters that are useful include:

GO	R20/30 (redials every 30 seconds until connection made, then issues a beep to notify the user)
FK 1	^ [(CROSSTALK uses the ESC key. It is useful to program a function key to act as an escape when in the bulletin board.)
FK 2	< password assigned by TI >
FK 3	< User ID assigned by TI >

Note that the HOME key is used to switch between the bulletin board display and the CROSSTALK status screen. Pressing a carriage return after a Command? prompt in CROSSTALK allows a command to be entered on the bulletin board. Anything typed then goes to the bulletin board. Cntrl-H acts as a backspace in CROSSTALK.

- 4) Call the DSP Bulletin Board. Enter CROSSTALK (see Step 1). When prompted, enter the number of the file created (or LO file after a Command? prompt). CROSSTALK will begin dialing. When answered, the bulletin board will give logon directions.
- 5) Transfer file. If desiring to receive a file while in the DSP Bulletin Board system, use the R command. The system will next ask for transmission protocol choice: ASCII, Xmodem, or Xmodem-CRC. Press the attention key (see Step 3, FK 1) to enter the XTALK command mode. For Xmodem, enter the RX command. For ASCII, enter CAP ON to CAPture the incoming data. Once complete, return to XTALK command mode (FK 1) and enter CAP OFF. At this point, XTALK will ask if the data in the buffer is to be saved. Type YES and enter the file name where it is to be saved on the PC.

Documentation Support - Bulletin Board Service

To send a file to the bulletin board, use the **S** (send) command, and enter the proper transmission protocol. With ASCII transfers, use the **SE** command.

- 6) Hang up. After exiting the bulletin board, press the FK 1 key or the user-defined attention key to get the CROSSTALK Command? prompt. Enter **QU** to hang up the modem.

9.9 TMS320 DSP Hotline

The TMS320 group at Texas Instruments offers a DSP Hotline to answer TMS320 technical questions. Specific questions regarding device problems, TMS320 development tools, third-party support, consultants, TMS320 documentation, upgrades, and new TMS320 products are handled. Questions on pricing, delivery, and availability should be directed to the nearest TI Field Sales office or the Customer Response Center at 1-800-232-3200.

The TMS320 DSP Hotline is open five days a week from 8:00 AM to 4:30 PM Central Time. The phone number for the hotline in Houston is:

(713) TRY-A 320
(713) 879-2320

10. TMS320 University Program

Texas Instruments has established a TMS320 university program, which allows a university to utilize the numerous resources that TI has to offer in the rapidly advancing field of digital signal processing. The purpose of the program is to assist in incorporating the TMS320 family into electrical engineering research and course curricula. Universities have the opportunity to receive considerable cost savings through the program. Many universities are already taking advantage of this program.

Assistance to universities through the TMS320 university program includes hardware/software price reductions, lab package deals, software donations, newsletter distribution, and engineering assistance in university research. TMS320 family documentation is also made available to universities.

In addition, a series of DSP textbooks and a DSP lab manual are being published to support digital signal processing research and education at the graduate and undergraduate levels. The textbooks are designed to aid in the understanding of DSP theory, applications, and implementations using the TMS320 family. They cover a wide range of topics from digital filter design to speech coding. A DSP lab manual for the TMS32010 is also available. See Section 9.5 for a description of each textbook and availability information.

The TMS320 university program includes hardware and software offered at a price reduction. Also, when a university purchases five TMS320 evaluation modules (EVMs), it qualifies for a lab package discount. This consists of an additional EVM and an analog interface board (AIB) donated by Texas Instruments to the university laboratory facilities. The TMS320 family's second-generation products are also offered to universities at discount prices.

As a supplement to any TMS320 hardware development tool purchased by a university, Texas Instruments will donate the appropriate assembler/linker and simulator software free of charge.

In the following sections, the TMS320 hardware/software available to universities at a discount is discussed and recommendations are made for establishing a DSP lab workstation or DSP research station in a university.

10.1 TMS320 Hardware/Software Available to Universities

All of the TMS320 hardware is available to universities at a discount. Included in the hardware offered are the digital signal processing chips, the Evaluation Modules (EVM), emulators (XDS), and Analog Interface Board (AIB). This hardware is described in Section 7.

The software available to universities consists of TMS320 macro assemblers/linkers and simulators on 1600 BPI MAG tape for VAX/VMS operating systems and on 5 1/4-inch floppy disks for the TI/IBM PC MS/PC-DOS operating systems. Universities can purchase the software at a discount. However, this charge is incurred only when software alone is being purchased. If a piece of hardware is purchased, the appropriate software is donated free of charge. The assemblers/linkers and simulators are described in Section 6.

Additional development software available to universities at a discount price is the Digital Filter Design Package (DFDP) produced by Atlanta Signal Processors Inc. (ASPI), and the SoftWare Development System (SWDS), a PC-resident software development tool (see Section 6). The TMS320 Design Kit, described in Section 7.5, is also available to universities at a discount. The use of this design kit can accelerate the design and evaluation of the TMS320 family of digital signal processors.

10.2 DSP Station Recommendations

For universities desiring to establish DSP stations in their engineering department, Texas Instruments provides recommendations for two kinds of stations:

- DSP lab workstation
- DSP research station.

The **DSP lab workstation**, designed for use at the third- and fourth-year undergraduate or first-year graduate level, allows students to practice the theory learned in a DSP course. Students can design DSP systems using real-world examples and perform realtime DSP simulation. The lab workstation should consist of the following:

Hardware:

PC or terminal
Evaluation Module (EVM)
Analog Interface Board (AIB)

Software:

Assembler/Linker
Simulator
Digital Filter Design Package (DFDP)

DSP Design Kit

Documentation:

Device User's Guides
Lab Manual: *A Digital Signal Processing Laboratory Using the TMS320* by Parks and Jones (Prentice-Hall).

TMS320 University Program

The **DSP research station** is designed for graduate students and professors who desire to do research projects on any scale. The research station allows the use of state-of-the-art architectures and the opportunity to simulate and implement advanced DSP algorithms and applications. In addition to the components of the lab workstation, the research station should include the following:

Hardware:

- PC or terminal
- Emulator (XDS)
- Analog Interface Board (AIB)

Software:

- Assembler/Linker
- Simulator
- Digital Filter Design Package (DFDP)
- SoftWare Development Station (SWDS)
- DSP Software Library

Applications Book and Textbooks:

- Digital Signal Processing Applications with the TMS320 Family* (Texas Instruments)
- DFT/FFT and Convolution Algorithms* by Burrus and Parks (Wiley and Sons)
- Digital Filter Design* by Parks and Burrus (Wiley and Sons)
- Practical Approaches to Speech Coding* by Papamichalis (Prentice-Hall)
- A Practical Guide to Adaptive Filter Design* by Treichler, Johnson, and Larimore (Wiley and Sons).

Following the establishment of the DSP lab workstation or the DSP research station, Texas Instruments will provide continued support to the university in the form of suggestions for DSP projects, up-to-date documentation, TMS320 bulletin board service, hotline, newsletter, and the upgrade of TMS320 software and hardware with the latest version or generation.

For more information about the university program and associated pricing, contact the nearest TI Sales Office (listed in the back of this document) or write directly to:

Texas Instruments Incorporated
P.O. Box 1443
Houston, Texas 77001

Attn: TMS320 Marketing University Program Coordinator

In Europe, contact:

Texas Instruments France
Boite Postale 5
06270 Villeneuve-Loubet
Nice, France

Attn: TMS320 Marketing University Program Coordinator

Note:

Texas Instruments reserves the right to make changes at any time in its TMS320 University Program policies.

11. TMS320 Third-Party Support

The TMS320 family of digital signal processors is supported by product and service offerings from many independent vendors and consultants, known as third parties. These support products take many forms (both software and hardware) from cross assemblers, simulators, and DSP utility packages to logic analyzers and emulators. The expertise of those involved in support services ranges from speech encoding and vector quantization to software/hardware design and system analysis.

This section describes a number of tools and services that augment the TMS320 support provided by Texas Instruments. Inclusion of a product in this section does not constitute product endorsement on the part of Texas Instruments, but merely an attempt at product awareness. The products listed here are representative of independent vendor-supplied products that support the TMS320 family, and are not intended to be an all-inclusive list of independent vendor-supplied support tools. Many other products offered by third parties are not included in this document since they do not directly support the TMS320 family. If more information is desired about a product line, the third party can be contacted directly.

The information on the products presented in this section is based on that provided by the third party. All third parties were afforded the opportunity to submit information and encouraged to include photos. Due to space limitations, a synopsis of each product is presented. Further information about a product may be obtained by contacting the third party directly. An attempt has been made to identify all trademarks and list them at the end of this section; any omissions have occurred inadvertently.

A description of each vendor-supplied support tool is provided in the subsequent sections. As a quick reference, a brief list is provided directly following the name of the third party. This list consists of the nature of the product(s), the functional system(s) where applicable (i.e., the software operating system or the hardware computer station), and the TMS320 device(s) supported.

In addition to the third-party product descriptions, the following lists are provided:

- Third-Party Address, Phone, and Product Support List (Section 11.40 on page 11-41)
- Third-Party Consultants (Section 11.41 on page 11-47)
- Trademarks (Section 11.42 on page 11-49)

A third party requesting to be included in updated versions of this document or in the quarterly newsletter may send the name, address, phone number, and information about the TMS320 development support to:

Texas Instruments Incorporated
P.O. Box 1443, MS 6437
Houston, Texas 77001

Attn: TMS320 Marketing Third-Party Coordinator

11.1 Allen Ashley

Nature of Product(s): Macro Assemblers, Simulator
Functional System(s): TI/IBM PC, CP/M-80
Device(s) Supported: TMS32010, TMS32020

- **MAC320 and MAC32020**

MAC320 enables any MS/PC-DOS system to serve as a development station for the TMS32010. MAC32020 serves the same purpose for the TMS32020. The software system features a macro assembler, cross-reference generator, hex file converter, screen editor, and offloading facilities. The assembler mnemonics adhere to the assembly language defined by Texas Instruments. The macro assembler includes full macro and conditional assembly features, as well as the ability to chain a series of source files together during a single assembly. Note that programs developed under MAC320 must be offloaded to the target processor for testing. A user-configurable downloader is provided, as well as a downloader configured specifically for the TMS32010 XDS. MAC320 and MAC32020 are available on IBM PC-DOS and TI MS-DOS 5-1/4" or MS-DOS 8" (NEC APC) disks.

- **SYSTEM-320**

SYSTEM-320 operates under CP/M-80. It includes an interactive assembler/editor, macro assembler, text editor, cross-reference generator, and offloading facilities. The interactive assembler/editor is intended for the rapid creation, modification, storage and testing of shorter programs or program modules. The macro assembler includes full macro and conditional assembly features, as well as the ability to chain a series of source files together during a single assembly. Facilities are provided to offload the developed program as a direct transfer from memory via a byte stream over a CPU port or via .COM or .HEX files. An offloader for .HEX files is included, as well as a downloader for the TMS32010 XDS. SYSTEM-320 is available on 8" SSSD disk or on a variety of 5-1/4" disk formats.

- **EMU320**

The EMU320 simulator allows any TI or IBM compatible microcomputer to simulate TMS32010 processor operation for program testing. The simulator works together with the MAC320 assembler to provide symbolic debugging of program logic. EMU320 features an inline assembler, up to 10 breakpoints, address trapping, single-step or free-run operation, mnemonic instruction disassembly, symbolic access to assembly values, and trace operation. Interrupts are not implemented, and the simulator is not optimized for testing I/O-intensive programs. The strength of the simulator lies in the representation and control of program logic. EMU320 provides an inexpensive alternative/adjunct to hardware emulation.

11.2 Atlanta Signal Processors, Inc. (ASPI)

Nature of Product(s): Digital Filter Design, Algorithm Development, Subband Coder
Functional System(s): TI PC, IBM PC/XT/AT, BIOS-compatibles
Device(s) Supported: TMS32010, TMS32020

- **Digital Filter Design Package (DFDP)**

ASPI's Digital Filter Design Package (DFDP) is a DSP software tool that supports the design of floating-point and fixed-point digital filters, including multiband filters, Hilbert transformers, and differentiators. Coefficients are provided for filter implementation using any CPU with signal-processing capability. The coefficient file may be converted to TMS320 assembly code using the Code Generator (CGEN) design module of the package. See Section 6.4 for a detailed description of the DFDP.

- **Algorithm Development Package (ADP)**

The ASPI Algorithm Development Package (ADP) places a highly controlled algorithm development environment in an IBM PC. Single-channel analog data input and output plus direct access to selected data, address, and control lines are available to the developer. Integrated development software provides an engineer with the tools to perform complete algorithm development on the TMS32010 and TMS32020.

The PC-bus resident hardware component of the Algorithm Development Package incorporates a TMS32010 or TMS32020 along with analog-to-digital and digital-to-analog conversion. A programmable clock, digital I/O, external flag and interrupt, synchronization, and (for TMS32020) serial port access are provided.

The TMS32010 is supported with 4K words of dual-ported program memory; the TMS32020 is supported with up to 64K words of program memory and up to 64K words of data memory. Dual-ported program memory and utilities included in the package allow multiple-location algorithm changes. The absence of predetermined frequency roll-off characteristics has allowed the ADP to be used in applications such as control, signal simulation, signal analysis, medical instrumentation, and speech.

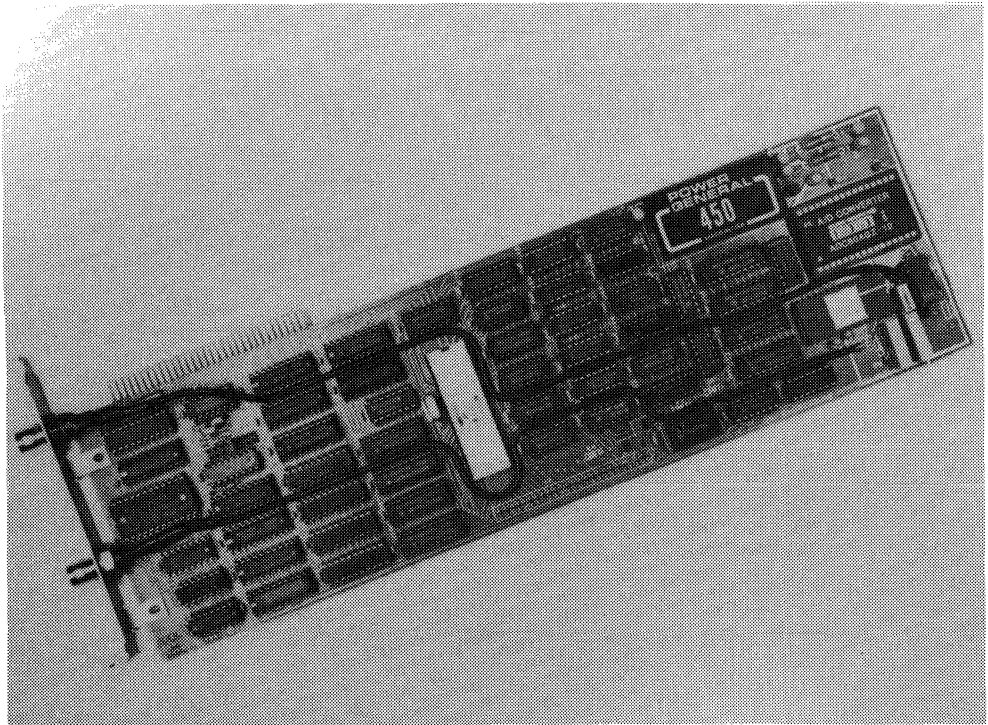

Figure 11-1. ASPI's Algorithm Development Package (ADP)

- **Realtime Subband Coder Algorithm**

ASPI offers a full-duplex 16-kbit/s subband coder that can be implemented using a single TMS32010 (without external program memory) with a 1K-word off-chip RAM data buffer. Because of the compactness of the subband coding, it only requires 80 percent of the TMS32010 CPU utilization, thus allowing the processor to perform other tasks in addition to speech coding.

This realtime speech compression algorithm can be used in many applications, such as telecommunications and computers, which require high-quality voice response, medium-bit-rate digital voice transmission, digital radio, and secure communications. The subband coder provides an efficient tradeoff between speech quality and data rate. In addition, the use of a single TMS32010 coder allows a cost-effective system implementation.

11.3 Avocet Systems, Inc.

Nature of Product(s): Macro Assembler
Functional System(s): VAX UNIX, IBM PC and compatibles
Device(s) Supported: TMS32010, TMS32020

- **AVMAC Macro Assembler**

Avocet Systems offers the AVMAC321 and AVMAC322 macro assemblers, designed to aid in the development of TMS32010 and TMS32020 code, respectively. AVMAC's powerful macro facility offers a familiar architecture, augmented with modern structured control statements. The Advanced Object Format supports complex relocatable expressions and user-defined segments, with a full range of segment classes and attributes. Extensive command-line options give the user complete control over assembler operation. Informative error messages and cross-reference reports make debugging and documentation easy.

AVMAC supports the TMS32010 and TMS32020 processors with instruction validation and detailed address space checking. A common underlying syntax makes it easy to switch from one AVMAC target version to another, while version-specific enhancements provide compatibility with TMS320 assembly language.

AVMAC includes all the tools needed for assembly language development: AVLINK (linker), AVLIB (librarian), AVREF (cross-reference generator), and various utility programs such as HEXBIN that converts hexadecimal object files to binary. AVLINK combines relocatable object modules produced by the assembler, generating an executable file in Intel, Motorola, or Tektronix format. It can search relocatable libraries constructed with AVLIB, and gives the user complete control over segment combination and placement. AVREF generates cross-reference reports for debugging and documentation.

Avocet Systems also offers a complete line of AVSIM simulator/debuggers for the IBM PC and compatibles. AVSIM supports both the TMS32010 and TMS32020 devices.

11.4 Bedford Research

Nature of Product(s): Interactive Signal Processing Software
Functional System(s): IBM PC, PDP-11, VAX
Device(s) Supported: TMS32010, TMS32020

- **I*S*P**

The I*S*P software package provides a fully integrated interactive signal processing system for developing customer-unique DSP application programs in a minimum amount of time. As an easy-to-use, high-level, signal processing programming language, I*S*P includes signal processing, graphics, and data management functions. Among the signal processing functions supported are transform functions, such as FFT and Walsh transforms, IIR and FIR filter design/implementation functions, linear-prediction functions, and all mathematical functions for standard array processing. I*S*P also supports real/complex floating-point and finite wordlength data formats.

Graphics capabilities include parameter-driven 2D and 3D displays with automatic/manual scaling and labeling as well as zoom and histogram displays. Comprehensive data and file management functions allow easy access to data files and programs in the I*S*P files. New signal processing and graphics functions can be interactively designed by using the I*S*P command language.

Bedford Research specializes in providing interactive signal-processing software for use in development and evaluation of advanced DSP products, such as the TMS320 family. Consulting and contract development support is also offered in the areas of theoretical and practical application of modern signal processing principles.

11.5 Burr Brown Corp.

Nature of Product(s): Analog Input and DSP Boards
Functional System(s): VMEbus
Device(s) Supported: TMS32010

- VMEdsp SPV100

The VMEdsp SPV100 is a VMEbus DSP board that has as its core the TMS32010 digital signal processing chip. (A TMS32020-based VMEbus board will be released in September 1986.) Two 4K x 16-bit "swinging" buffer memories speed operation by allowing one set of data to be manipulated in one buffer while data enters or exits the other. When data processing in one buffer is complete, the data from the second buffer is ready for processing. The maximum transfer rate for 16 bits into or out of the board's memory is 4 Mword/second. Two separate program memories are provided. A 4K x 16-bit RAM allows user-developed programs to be downloaded onto the board, and a 4K x 16-bit PROM is used for specific application programs.

Burr Brown offers PROM-based routines for such functions as Fast Fourier Transforms (FFT), digital filtering (FIR), and auto- and cross-correlation. For complex data radix-4 FFTs, execution times as follows:

900 μ s	64-point FFT
7.2 ms	256-point FFT
17.6 ms	512-point FFT
36.4 ms	1024-point FFT

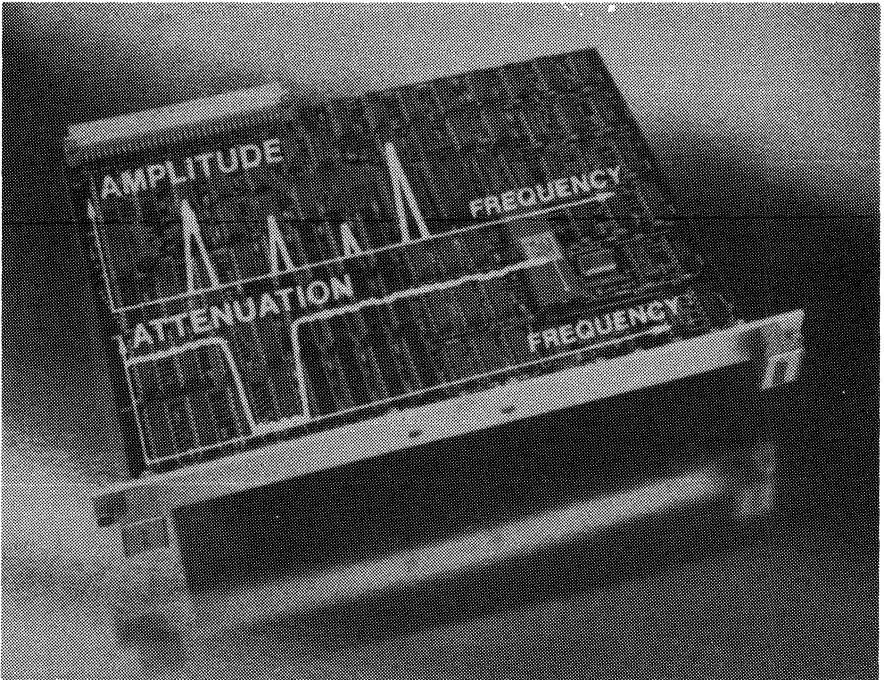

Figure 11-2. Burr Brown's VMEdsp SPV100 Board

- VMEdsp MPV960

The VMEdsp MPV960 combines analog input with high-performance DSP functionality. It incorporates the TMS32010 digital signal processor onboard. Because the TMS32010 is significantly faster than traditional microprocessors, it allows the MPV960 to feature realtime digital signal processing of the analog input signals.

Some features of the VMEdsp MPV960 include:

- Simultaneous sampling on all four channels
- High-speed signal input (86 kHz max)
- Flexible triggering modes
- Dual-port memory for on-board data storage (8K x 16-bit)
- Optical isolation between analog signals and VMEbus
- 12-bit resolution.

Two 4K x 16-bit "swinging" buffer memories are included on the board to allow dual-port access. The board also contains a number of PROM-based data acquisition and signal processing routines. An accessory daughter board (ACX960) provides downloadable program RAM for custom software development.

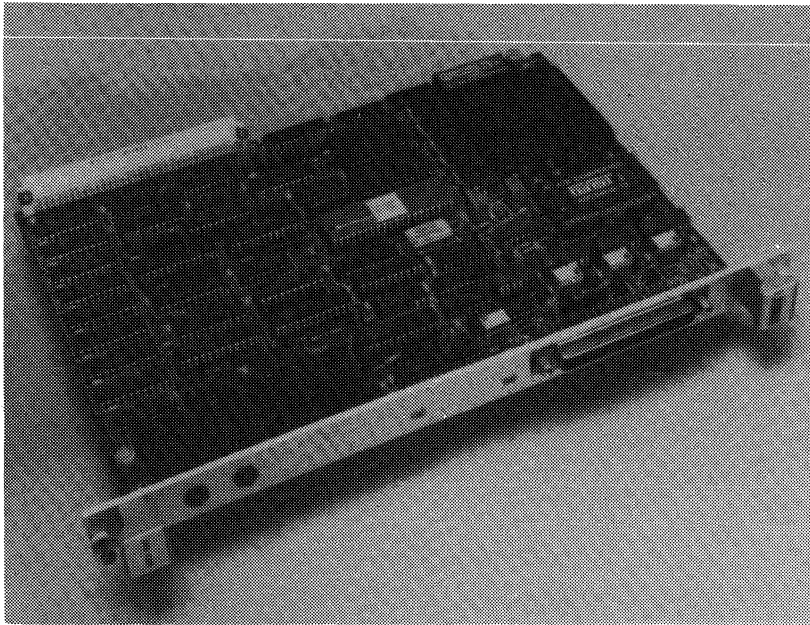

Figure 11-3. Burr Brown's VMEdsp MPV960 Analog Input and DSP Board

11.6 Computalker

Nature of Product(s): Assembler, Simulator, and Compiler
Functional System(s): IBM PC/XT/AT, CP/M, Apple II+/e/c, Amiga
Device(s) Supported: TMS32010, TMS32020, TMS320C25

- TASSM – TMS32010 Assembler
- TAS20 – TMS32020 Assembler
- TAS25 – TMS320C25 Assembler

These three assemblers for the TMS320 family of digital signal processors are fast, non-macro assemblers. They use standard Texas Instruments syntax and produce an object module file directly with no linking step. Full pathname support and many listing options are provided.

- S320 – TMS32010 Simulator

S320 is a complete interactive software simulation of the TMS32010, with a full-screen display of all registers during program execution or single-stepping. S320 includes a wide variety of breakpoint options, an execution cycle counter, a programmable simulated interrupt generator, and allows files to be as-

TMS320 Third-Party Support

signed to I/O ports. S320 is not available for the Amiga. The CP/M-80 version requires a Z-80 processor.

- **SPL - TMS320 Series Compiler**

The SPL-function compiler is designed to be used with Computalker's TMS320 series of assemblers. It uses the Signal Processing Language (SPL), a concise, high-level programming language based on signal processing functions. The compiler allows rapid construction and modification of elaborate waveform processors or sound generators. Functions are compiled from a user-expandable macro-like library. The compiler handles all variable allocation and initialization, and builds the interrupt handler. An elapsed cycles report shows the percentage of interrupt time used. Available functions include a wide variety of waveform generators, filters, gain controls, arithmetic functions, and a means to execute blocks of code conditionally or under counter control. Assembly language may be intermixed with function statements. SPL is available for the IBM PC/XT/AT only.

Computalker has a variety of TMS320 series applications software, including Fourier transforms, telephone tone decoding, speech synthesizers of several varieties, speech analysis filter bank, and LPC speech analysis. Computalker provides programming services to adapt these programs to a specific application or to design custom signal processing routines.

11.7 Crowell, Inc.

Nature of Product(s): Assembler
Functional System(s): IBM PC and compatibles
Device(s) Supported: TMS32020

- **EASYAS Assembler**

Crowell, Inc. introduces a TMS32020 assembler, EASYAS, that supports the modified Harvard architecture of the digital signal processor. EASYAS, like all standard TMS32020 assemblers, converts TMS32020 source code into object code. In addition, EASYAS provides the capability of manipulating data memory separately from the source program. EASYAS is written in BASIC and can be run by the BASIC interpreter on an IBM PC or most compatibles, or compiled by an IBM BASIC compiler. The BASIC source code of EASYAS is provided so that the assembler can be tailored to specific system applications.

Accompanying the EASYAS software is a user's manual that guides the user through the use of the software in a step-by-step fashion. Included in the appendix of the manual is the BASIC source listing of the EASYAS assembler.

11.8 Cybernetic Micro Systems

Nature of Product(s): Assembler, EPROM Programmer
Functional System(s): IBM PC and compatibles
Device(s) Supported: TMS32010

- **CYS320 Cross Assembler**

The CYS320 is an assembler package for development of TMS32010 assembly language programs. It accepts TMS32010 source code and outputs a list file and an Intel hexadecimal file. The assembler provides macros and nested conditional assembly directives as well as segment directives for symbol typing. Names and variables are not restricted in length, and the assembler is written in assembly language for fast execution (600 lines/minute). DOS commands can be issued within the cross assembler. The software package includes utility commands for saving hexadecimal files from internal memory, displaying internal memory, typing a file, and setting operating parameters.

- **CYP-EPROM Programmer Board**

The CYS320 package provides support routines for the CYP-EPROM Programmer Board. The board is designed to program standard EPROMs for use as external program memory. It connects to the host computer via a RS-232 port, and uses the hexadecimal file generated by the assembler to program the EPROM.

11.9 Daisy Systems Corp.

Nature of Product(s): Engineering Workstation
Functional System(s): LOGICIAN workstation, IBM AT
Device(s) Supported: TMS32010, TMS32020

- **LOGICIAN Workstation**

Daisy Systems Corporation supports the design of TMS32010-based applications on their LOGICIAN and Personal LOGICIAN workstations via the PMX (Physical Modeling Extension). The PMX unit functions as a systems engineering tool to accurately depict complex VLSI devices, such as the TMS32010 and TMS32020, to the workstation for simulation. By using actual devices as models that are plugged into the PMX, designers can fully simulate microprocessor-based systems. The logical behavior is obtained directly from the processors and integrated into the LOGICIAN simulation.

11.10 Dalanco Spry

Nature of Product(s): DSP Board
Functional System(s): IBM PC/XT/AT and compatibles
Device(s) Supported: TMS32010

- **Model 10 Digital Signal Processor**

The Model 10 Digital Signal Processor is a coprocessor board that features the TMS32010 operating at 20 or 25 MHz, 4K words of dual-ported RAM, three 16-bit timers to provide sampling rates ranging from 0.001 Hz to 200 kHz, a two-way 16-bit register for communications between the TMS32010 and the IBM CPU, and mutual interrupt capabilities between the two processors. The board is available with or without on-board 12-bit 40-kHz A/D and D/A converters. An external I/O bus connector permits the addition of piggyback boards of varying functions and capabilities. A user can design and build his own modules to suit his application, e.g., a counter-driven MHz range A/D converter or a modem interface.

Software includes a debugger, inline assembler, disassembler, signal and spectrum display software for the IBM Color Card, and applications examples, some of which are taken from TI Application Reports.

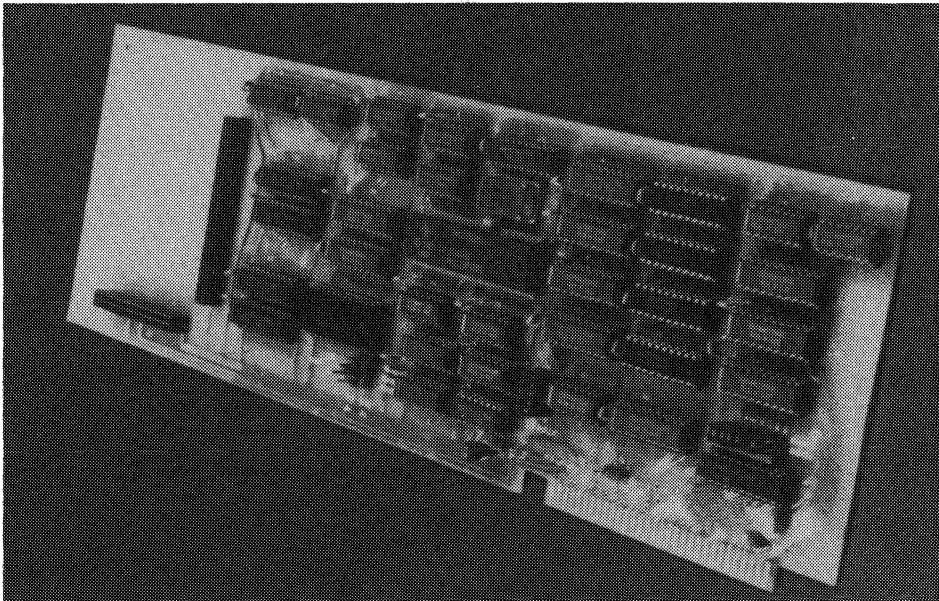

Figure 11-4. Dalanco Spry's Model 10 Digital Signal Processor

11.11 Digital Audio Corp.

Nature of Product(s): DSP Lab (with voice enhancement)
Functional System(s): N/A
Device(s) Supported: TMS32010

- RCW320 Laboratory Digital Signal Processor

The RCW320 is a powerful multifunction voice-enhancement and signal-processing instrument, based on the TMS32010. It combines the high-speed 20-MHz microprocessor along with high-resolution analog conversion to produce outstanding signal-processing performance. With the RCW320, many DSP functions are directly implementable with TMS320 code.

The RCW320 is completely controlled by the operator from the front panel. The desired function is selected and appropriate values set on the numeric LED displays. The displays precisely specify the instrument's operation, allowing the operator to accurately control processing. Some of the functions that can be performed are:

- 1) Digital filters (highpass, lowpass, bandpass, and bandstop).
- 2) Adaptive filters (33rd-order), which reduce time-correlated noises such as tones, soft music, microphone muffling, and room resonances on voice signals.
- 3) Automatic gain control, thus allowing a signal free of distortion or annoying artifacts.
- 4) Comb filters to cancel 50-Hz and 60-Hz powerline-induced hum.
- 5) Peak and zero clippers to limit and reduce low-level background noise during signal silences.
- 6) Expansion for up to eight additional modes of operation or custom signal processing functions by replacing plug-in PROMs.

Multiple signal processing functions may be performed by a sequence of RCW320s. Rear-panel digital connectors allow direct cascading without degradations due to analog cabling.

11.12 Digital Signal Processing Software, Inc. (DSPS)

Nature of Product(s): Assemblers, Speech Algorithms, Signal Lab
Functional System(s): PDP-11, VAX VMS, TI/IBM PC
Device(s) Supported: TMS32010

- DSPS-3 Tutorial Package

The DSPS-3 software package provides a macro assembler and a program loader for the TMS32010 Evaluation Module (EVM) and Emulator (XDS). Also included in the package is a 500-page, tutorially-oriented softcover book, *Digital Signal Processing Software* by L. Robert Morris, which provides numerous TMS32010 program examples. To illustrate these examples, the package also contains a PDP-11 or IBM PC format floppy-disk with sources for all of the book's software (about 50 FORTRAN, PDP-11, and TMS32010 programs). Algorithms for Linear Predictive Coding (LPC) of speech guide TMS32010 users in applications such as LPC vocoders, parameter extraction

TMS320 Third-Party Support

for speech recognition, speaker verification, format and pitch tracking, and vocal tract estimation.

- **DSPS-2 FFT Package**

The DSPS-2 software package is a combination of the DSPS-3 software package plus TMS32010 FFT programs that use radix-4 for high precision. To supplement the macro assembler and TMS32010 algorithm examples provided in DSPS-3, DSPS-2 expands the range of applications to include spectral and cepstral analysis, DFT-based vocoders, speech scramblers, FFT modems, and frequency compression. For 64-, 128-, and 256-point complex DFT transforms, benchmarks are 0.54, 2.4, and 6.2 ms, respectively. It is also possible to effect time-efficient 64-, 128-, 256-, and 512-point real transforms.

- **RSL Spectrogram Generator**

RSL (Realtime Signal Lab) is a software package that generates realtime, high-definition, multi-intensity, simultaneous wideband and narrowband speech spectrograms (two-dimensional displays of the changing intensity of the speech amplitude spectrum as a function of time). RSL samples up to two seconds of speech at an 8-kHz rate. It then processes and displays dual spectrograms, each consisting of 256 spectral cross-sections of 128 16-intensity spectral samples, in only 5 seconds. Times quoted include pre-emphasis to compensate for the spectral falloff of speech at higher frequencies and windowing to provide spectral smoothing and determination of effective filter analysis bandwidth. When the full two seconds of sampled speech is specified for analysis and display, RSL is indeed realtime.

The combination of the RSL software with the TMS32010-based TI-Speech PC plug-in board provides the speed and functionality of hardware devices that cost at least ten times more than the RSL package. The graphics board supported is the Tecmar Graphics Master for TI/IBM PCs or compatibles. (RSL also runs on the older TI-Speech Command System board). The screen may be photographed or sent to an Epson FX-80/80+/85+/180/180+/185 or TI 850 series printer.

11.13 Digital Sound Corp.

Nature of Product(s): Audio Conversion System for Speech Devt.
Functional System(s): ILS, SPIRE, and I*S*P
Device(s) Supported: TMS32010

- **DSC-200**

The DSC-200 is a unique computer peripheral subsystem specifically designed to provide accurate, convenient, and versatile input and output of audio data. The DSC-200 integrates 16-bit analog-to-digital (A/D) and digital-to-analog (D/A) converters, lowpass filters, audio amplifiers, a data-chaining DMA computer interface, and remote audio consoles in a low-noise and low-distortion system architecture.

To illustrate the DSC-200's role in speech/voice development, assume that a new coding (compression) algorithm for a digital signal processing (DSP) chip, such as the TMS32010, is being developed. After conceptualization, a mathematical model of the algorithm is programmed for execution on a host computer simulating the operation of the target DSP, such as a TMS32010

simulator. A speech data base of sample vocabularies is created using the DSC-200's A/D converter(s). This test data is processed by the simulation program, and aurally evaluated (listened to) via the DSC-200's D/A converters. The test data, before and after processing, may also be transformed and visually analyzed using such software tools as ILS, SPIRE, and ISP. This process is repeated until satisfactory performance is achieved.

Upon completion of the simulation, the DSP program is loaded into the ROM (or RAM) of the prototype speech module, and accessory circuits are attached (including the module's own A/D component). The original test data is output (D/A'd), again via the DSC-200, as input to the free-standing coder. The digital output of the encoder can be input to a matching decoder whose analog output may be fed back to the host CPU via the DSC-200 for further analysis (e.g., spectral) when testing has been completed.

11.14 DSP Technology Corp.

Nature of Product(s): DTMF Detector, MF Decoder, Conferencing
Functional System(s): N/A
Device(s) Supported: TMS32010

- **DSP8501**

The DSP8501 is a digital DTMF detector based on the TMS32010. The single chip is capable of detecting four channels simultaneously, and directly interfaces with μ -law/A-law PCM data, thus avoiding the need for a codec used in conventional analog tone detection. The tone-detection algorithm uses an optimal signal-detection filter for each of the eight frequencies used in DTMF signaling. The tone-decode decision logic uses data-adaptive thresholds for reliable detection of the DTMF digit. The chip performs reliably in the presence of noise and dropouts, and requires no adjustments of external components. The DSP8501 is ideal for applications such as digital switching systems, PBX, central offices, key systems, and remote data entry.

- **DSP8502**

The DSP8502 is a four-channel digital MF Decoder based on the TMS32010, which meets the Bell MFR1 and CCITT #5 specifications. Its features are similar to those of the DSP8501. It also provides coded output of the MF digit and error code for improper tone combination. Applications for this chip include central office, toll office, specialized common carrier switch, and equal access system.

- **CONFER**

CONFER, a multiparty digital audio conferencing bridge, provides a full-duplex voice communication facility for interconnection of up to six parties. The bridge is used in conjunction with any of the electronic key systems. It is located on the trunk side of the key system control unit and is transparent to the key system's normal use. CONFER can be attached to any electronic key system that requires an advanced conferencing system.

The conferencing bridge uses a TMS32010 to implement sophisticated digital signal processing algorithms, enabling the users to have a natural interactive conversation. It allows any speaker to interrupt at any time during the conversation. The voice levels are automatically adjusted for normal volume. This

compensates for weak sound levels due to trunk loss encountered in long-distance connections, so that all the parties can hear each other clearly regardless of location.

11.15 Forth, Inc.

Nature of Product(s): DSP Software Prototyping System
Functional System(s): IBM XT and compatibles
Device(s) Supported: TMS32020

- DSP Software Prototyping System

Forth, Inc. offers a high-level software prototyping system for DSP applications. The system runs interactively and at full speed on the TMS32020. This shortens the time required to develop and test programs by as much as a factor of ten compared to traditional cross-development systems.

Key features of the prototyping system are:

- Immediate compilation of source to executable code without separate steps for linking and downloading
- A complete TMS32020 macro assembler
- Special high-speed implementation of the interactive high-level Forth programming language
- DSP extensions for waveform generation, FFTs, and digital filter design
- Resident debugger, editor, and other programming aids
- Use of an inexpensive host computer, such as the IBM XT, for terminal and disk services to the target hardware
- Extensions for the TMS320C25.

The DSP Software Prototyping System will be available the first quarter of 1987.

11.16 Gas Light Software

Nature of Product(s): Digital Filtering Program
Functional System(s): TI PC, IBM PC/XT/AT and compatibles, 8087
Device(s) Supported: TMS32010

- Z-EDIT Digital Filtering Program

Gas Light Software offers a digital filter editing program, Z-EDIT, that may be used alone to manually design and edit digital filters or as a manual postediting system used in conjunction with any automatic filter design system. Z-EDIT allows either pole/zero or coefficient input and output in ASCII files for simple intrasystem communications. The 8087 coprocessor is also supported to allow faster root-factoring or FFT filter analysis on larger filters. User-friendly interface and HELP message options make this system easy to use.

Z-EDIT allows an engineer to manually edit poles or zeros in either the S plane (analog domain) or Z plane (digital domain), and quickly observe spectral or temporal filter response changes in numeric or plotted form. Bilinear mapping in Z-EDIT allows conversion of an S-plane filter to a Z-plane filter. Root components in real or imaginary filters may independently be edited in either Cartesian or two-polar coordinate formats. Editing features include adding, deleting, copying, and radius inversion. Filters with up to 101 coefficients (in

either numerator, denominator, or both) are allowed. A specially designed robust root-finder permits the factoring of coefficients where no poles or zeroes are given. Z-EDIT also allows filter inversion and/or stabilization. Final design coefficients may be converted to integer format (4 to 16 bits) and special stability verified to facilitate integer-arithmetic hardware implementations on the TMS32010.

11.17 Hewlett-Packard

Nature of Product(s): Emulator, Analyzers, Assembler/Linker
Functional System(s): HP 64000 LDS
Device(s) Supported: TMS32010

- HP 64285S Emulation Subsystem

Hewlett-Packard provides microprocessor support tools for all development phases of TMS32010-based systems with emulation and analysis subsystems for the HP 64000 Logic Development System (LDS). The HP 64285S Emulation Subsystem provides realtime, transparent emulation at up to 20 MHz with no wait states. Nonintrusive, realtime traces of all TMS32010 memory activity and instruction set disassembly further simplify development work. Directed-syntax soft keys and an easy-to-use editor streamline development and documentation. Logic state, performance, and timing analysis can be combined with emulation for a variety of interactive, cross-triggered measurements.



Figure 11-5. HP 64285S Emulation Subsystem

- **HP 64302A Emulation Bus Analyzer**

Information monitored by the emulator is passed to the HP 64302A Emulation Bus Analyzer where triggered and storage directives are applied. Storage qualifiers specify the types of events captured and stored in analyzer memory.

- **HP 64610S High-Speed, Timing/State Analyzer**

The HP 64610S may be used to check timing relationships at speeds up to 400 MHz (locating glitches and identifying marginal signals). Postprocessing of stored timing traces provides detailed comparisons, statistical calculations, and documentation. State analysis of 32 channels is available at clock speeds of up to 125 MHz with an external clock.

TMS320 Third-Party Support

- HP 64620S Logic/State Software Analyzer

The HP 64620S supports intricate state analysis of up to 120 input channels, 15 levels of sequential triggering, broad definitions for storage qualifiers, and window specifications.

- HP 64310A Software Performance Analyzer

This performance analyzer provides a macro view of total system performance by activity, interaction, or duration, thus simplifying the optimization and characterization of software performance. The analyzer becomes an integral part of the emulation subsystem as program optimization parallels code development.

- HP 64858 Assembler/Linker

The HP 64858 Cross Assembler/Linker provides assembly language software development support for the TMS32010 microprocessor. The assembler uses TMS32010 instruction mnemonics, generates code for all TMS32010 instructions, and generates the necessary information for symbolic debug in emulation. Troubleshooting of code is accomplished using source program global symbols, thus eliminating the task of address lookup. The assembler/linker supports the three TMS32010 memory addressing modes: direct, indirect, and immediate.

11.18 Hyperception

Nature of Product(s): DSP Software, Assembler, VMEbus Card
Functional System(s): IBM PC and compatibles, VMEbus
Device(s) Supported: TMS320 family

- HYPERSIGNAL

HYPERSIGNAL is a general-purpose DSP software package providing a complete signal processing environment on the IBM PC and compatibles for the design of FFTs, inverse FFTs, Kaiser-window filters, and convolution algorithms. File management is transparent to the user. Superior graphics offer over 20 different graphics display capabilities, such as time- and frequency-domain display, 3-D spectrograms, and zoom. Efficient menu-driven operation, on-line help, and user-configured files facilitate operation.

Hyperception also offers a TMS32010 assembler for the IBM PC and compatibles, and a 20-MHz, interrupt-driven, TMS32010 VMEbus card that includes I/O command ports and 4K words each of program and data memory dual-ported to the VMEbus master.

11.19 Kontron Electronics

Nature of Product(s): Logic Analyzer, Disassembler
Functional System(s): N/A
Device(s) Supported: TMS32010

- LA TMS32010 Disassembler

The Kontron Logic Analyzer (LA) is a general-purpose logic analyzer that features up to 64 channels, a memory depth up to 8K per channel, and a maximum clock rate of up to 100 MHz (500 MHz with an optional high-speed module). Capabilities include recording with four separate clocks (qualified by six external signals each), separate glitch memory, glitch triggering, sequential triggering with up to 14 levels, and transition/data-qualified recording. A trace disassembler option is particularly useful for microprocessor development.

The LA TMS32010 Disassembler converts the traced data recorded by the logic analyzer (LA) into TMS32010 mnemonics. The disassembler displays all instructions fetched from external program memory during the program execution. (Program modules contained in the on-chip masked program ROM of the TMS32010 microcomputer cannot be recorded and disassembled.) By doing a reverse assembly, sections of TMS32010 code pertaining to the triggered events can be examined for software/hardware analysis. The Kontron LA can only trigger on recorded clock-qualified data, user-specified with trigger words and sequence menus. Predefined trigger words set up the logic analyzer to search for a hardware reset, interrupt acknowledge, port read or write cycle, table read (TBLR), and/or an instruction fetch.

When used in conjunction with the Kontron LA TMS32010 Disassembler, the TMS32010 Evaluation Module incorporates the powerful trace features of most emulators. With a Kontron Logic Analyzer already present in a development station, this configuration provides an inexpensive alternative for emulator capability and performance.

11.20 Loughborough Sound Images Ltd.

Nature of Product(s): DSP Board, Monitor Program
Functional System(s): IBM PC
Device(s) Supported: TMS32020

- TMS32020 Board

The TMS32020 Board, designed as an IBM PC plug-in card, utilizes a bidirectional port to interface to the PC-bus, thus providing the ideal environment for speech, audio, and control applications. Turned-pin sockets are included so that 128 kilobytes of memory can be used as either program or data memory. In most situations, this will be populated with high-speed static RAM devices, allowing the processor to run without wait states. It is possible to replace the RAM with EPROM, thus allowing operation with one wait state. The memory is dual-ported to permit program loading, monitor access, and rapid interchange of large blocks of data.

TMS320 Third-Party Support

Sixteen-bit A/D and D/A converters are provided on the board, accessible via BNC sockets and supporting sampling rates up to 50 kHz. Clocking can be internal (crystal-controlled) or external. The serial input and output lines of the TMS32020 are brought to external connectors and arranged to facilitate the linking of two or more boards. An additional connector is provided to allow for global memory expansion and for full use of the 16 parallel input/output ports.

- **TMS32020 Monitor Program**

Loughborough Sound Images provides a Monitor program for the TMS32020 Macro Assembler/Linker, which takes the output of the linker and loads it to the board. The Monitor program supports single-step, breakpoint, or full-speed operation. It permits the examination and changing of registers and memory using a variety of formats, and includes a disassembler. Also included in the package is software to convert the TMS32020 object code to Intel hexadecimal format for EPROM programming.

Note:

Pacific Microcircuits (see Section 11.24) holds the exclusive North American rights for the distribution of Loughborough Sound Images's TMS32020 development system. For ordering information in North America, contact Pacific Microcircuits.

11.21 Microcraft Corp.

Nature of Product(s): DSP Development Board
Functional System(s): TI/IBM PC
Device(s) Supported: TMS32010

- **DSP-320 Development System**

The DSP-320 is a cost-effective DSP development system for the TMS32010, ideal for research labs, colleges, and universities desiring to explore and study DSP applications. A DSP-320 consists of a digital board (DSP-D) and an analog board (DSP-A). A CRT terminal or personal computer, power supply, and other instruments such as signal sources and oscilloscopes are supplied by the user as needed. Comprehensive manuals are provided with the boards.

The DSP-D contains all the relevant digital circuits to load, store, and run programs for the TMS32010. It incorporates an 8039 microprocessor, fast static RAM, and system ROM. Communications to the DSP-D via an RS-232 port and a three-wire connection (TX, RX, and GND) allow a variety of CRTs and PCs to communicate with the system. The DSP-D can be interfaced to analog subsystems via a 40-pin IDC connector.

The DSP-A is an economical companion board to the DSP-D board. It enables the user to begin applications development immediately without the manufacturing delay associated with specialized analog interfaces. The DSP-A also includes low-resolution data converters and port decoders for expansion.

TMS320 Third-Party Support

A set of DSP experiments for the DSP-320, including A/D conversion, signal generation, modulation, FIR/IIR filters, DFT, adaptive filters, and a low-cost TMS32010 assembler, will be available late 1986.

11.22 Microstuf, Inc.

Nature of Product(s): Data Communications Software
Functional System(s): TI/IBM PC, CP/M, CP/M-86, MP/M
Device(s) Supported: TMS320 Family

- **CROSSTALK XVI**

CROSSTALK XVI, the 16-bit MS/PC-DOS version of CROSSTALK, is a complete, self-contained data communications program that fully utilizes the additional memory and computing power of the new 16-bit microcomputers. Features include XMODEM file transfer capabilities, improved file transfer protocols, an improved VT-100 emulation mode, a new VT-52 terminal emulation mode, and expanded string-handling facilities in script files. CROSSTALK XVI requires at least 192K of RAM.

CROSSTALK provides the following two major functions:

- A terminal program used to dial into a host computer system, allowing a PC to act as a terminal to that system.
- A file transfer program used to gain access to other CROSSTALK-compatible systems, edit and store the information, and exchange files with that system. (Systems exchanging files do not require the same type of computer nor need to run on the same operating system.)

The CROSSTALK XVI package also includes a user-friendly tutorial manual and a combination menu-driven/command-driven program. In support of a TMS320 digital signal processor, it allows the PC to act as both a terminal and a host when connected to a single port of the TMS320 XDS or EVM.

11.23 PH Associates

Nature of Product(s): Assembler
Functional System(s): IBM PC, CP/M, TurboDos, PDP-11, UNIX, Tektronix 8560
Device(s) Supported: TMS32010, TMS32020

- **TMS320 Assembler**

The PH Associates' TMS320 software package assembles all legal TMS32010 and TMS32020 instructions and includes download capabilities to the TMS320 Evaluation Module and XDS Emulators. The assembler is written in C and generates the entire assembly in memory, thereby resulting in faster execution times. The assembler output can be either a memory image of the code for the TMS32010, TMS32020, or converted to any other format with little difficulty. TEKHEX and ASCII-coded binary are currently provided.

The package also offers output control to redirect both the listing and the memory image to different files or the standard output device. Special listing controls increase readability by (1) printing an optional symbol table, (2)

TMS320 Third-Party Support

providing a title and subtitle, (3) ejecting the paper, and (4) placing a blank line after each branch instruction.

The TMS320 Assembler by PH Associates is available on floppy disk (various formats) and on 9-track 1600 BPI tape. Source code software licenses are available for special adaptations or to allow for the inclusion of special operators.

11.24 Pacific Microcircuits Ltd.

Nature of Product(s): Interface ICs, Development Boards
Functional System(s): IBM PC
Device(s) Supported: TMS32010

- **PD32HC01 Interface IC**

The PD32HC01 is an interface IC for the TMS32010, designed for audioband signal processing and interface with specific codecs. The chip provides a flexible, low-cost solution for a wide spectrum of TMS32010 applications. Its features include:

- Serial codec port
- Serial datacommunications port
- I/O and interrupt control
- Decoding for external RAM and ROM
- I/O expansion interface
- 2400-Hz bit-rate generator
- Low-power CMOS.

- **PD32HC02 Interface IC**

The PD32HC02 interface IC is designed for use in audioband signal processing applications using the TMS32010. In addition to the features of the PD32HC01, the PD32HC02 provides a programmable sampling rate and a universal codec interface.

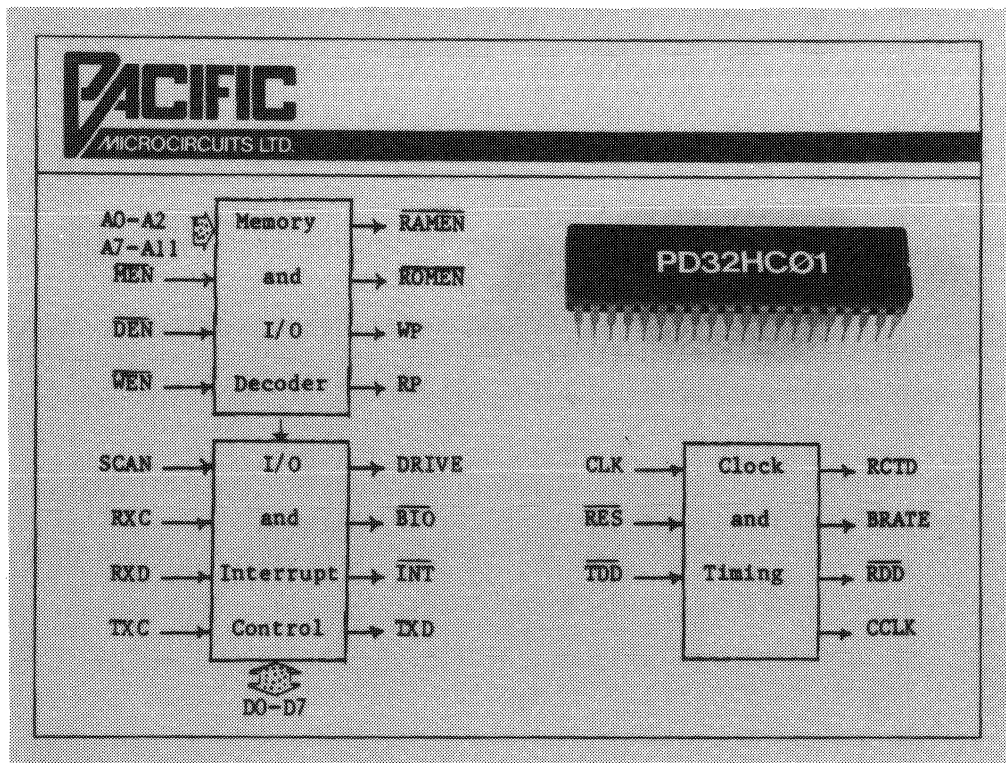

Figure 11-6. Pacific Microcircuits' PD32HC01 Interface IC

- PD32C116 Interface IC

This interface IC is a high-speed, low-power bidirectional FIFO, ideally suited to high-speed interprocessor communications. Its features include:

- Two independent 16-word by 17-bit FIFOs
- 16-bit bidirectional Mailbox register
- 40-ns speed (no wait states on either port)
- Internal FIFO and Mailbox status registers
- Flexible interrupt control
- Low-power CMOS.

- SuPPort 320 DB01 Development Board

The SuPPort 320 DB01 development board complements the PD32HC01 interface IC. It plugs directly into the TMS32010 EVM/XDS system and includes RAM, ROM, serial codec, and a prototyping area. It can be converted to a

TMS320 Third-Party Support

standalone TMS320-based digital signal processor, capable of performing modem, vocoder, or a host of other functions. Comprehensive documentation and Software (IBM PC-based) are included with the board.

- **SuPPort 320 DB02 Development Board**

The DB02 development board complements the PD32HC02 interface IC. It plugs directly into the TMS32010 EVM/XDS system and provides the the same functions as the DB01 development board.

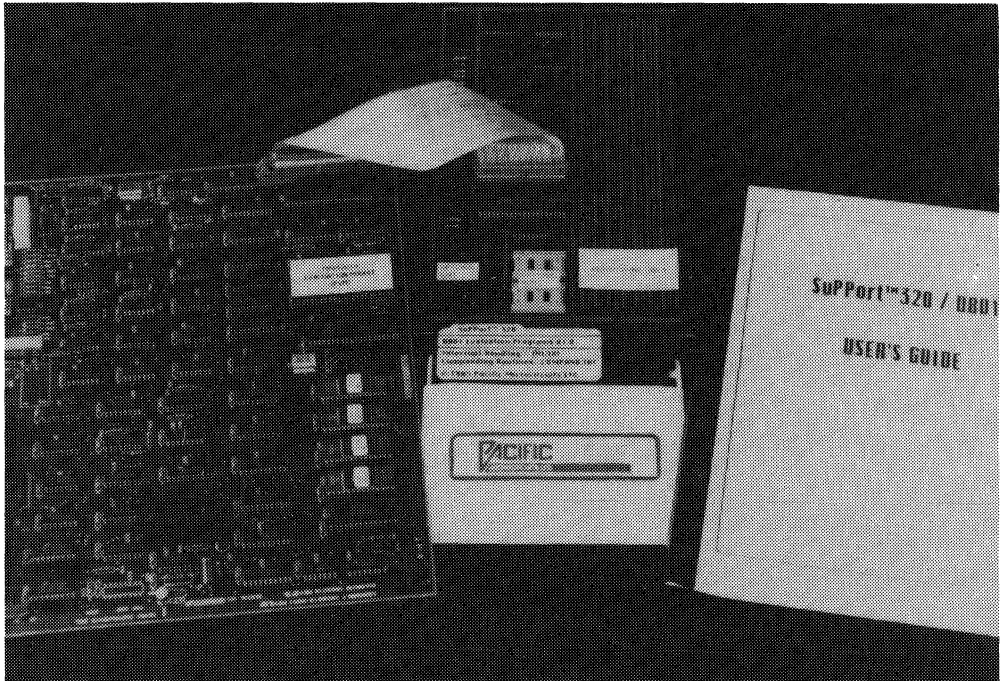

Figure 11-7. Pacific Microcircuits' SuPPort 320 DB01 Development Board

Note:

Pacific Microcircuits holds the exclusive North American rights for the distribution of Loughborough Sound Images's TMS32020 development system, described in Section 11.20. For ordering information in North America, contact Pacific Microcircuits.

11.25 Pratica SRL

Nature of Product(s): Software Development System
Functional System(s): Olivetti M20/21/24 PC, IBM PC/XT/AT,
VAX VMS/UNIX/MICROVAX/XENIX, PDP-11,
RSX-11M/PLUS, ATT 3B2
Device(s) Supported: TMS32010

- PDS-20 Development System

The PDS-20 universal microprocessor development system supports many 8- and 16-bit CPUs on systems compatible with the TMS32010 XDS Emulator. Emulation and programming of PROM memories is possible using external standalone systems. Software tools include a high-level editor, a cross assembler with nested macros, and symbols/arithmetic/logic expressions, a linker, and up/down loaders for emulators and PROM programmers.

11.26 Racal Microelectronics Systems Ltd.

Nature of Product(s): DSP Card
Functional System(s): VMEbus
Device(s) Supported: TMS32020

- RME320 DSP Card

The RME320 from Racal Microelectronics Systems is a VME Rev C TMS32020-based card for digital signal processing applications. It has been designed to exploit the state-of-the-art features incorporated in the TMS32020 and is suitable for a wide range of DSP and arithmetic-intensive applications. The RME320 processor runs with a 200-ns instruction cycle.

The card includes a 64-pin connector fitted to the front panel to provide direct access to all of the TMS32020 pins. This enables immediate connection of development systems or logic analyzers for development and diagnostics.

Local interface is provided on the P2 connector for adding independent links into associated system components. The interface includes 16-bit data, 4-bit address, read/write, and handshake control lines, allowing up to 8 different operating modes. A data transfer rate of 2.5 Mwords/second is possible. In addition, the two TMS32020 serial lines are fully buffered to the P2 connector.

The board is intended to be used as a secondary (slave) processor to which programs are downloaded from the master. However, a minimal system may consist of the RME320 board and an I/O board, with operation controlled by an on-board program resident in EPROM.

The RME320 in basic form is equipped with 16K words of high-speed RAM (zero wait states). Upgrade kits are available to increase RAM size to 64K words. Sockets are provided for up to 8K words of program PROM.

11.27 Sentry Test Systems

Nature of Product(s): Test Programs
Functional System(s): Sentry 7/8/10/20/21 test system
Device(s) Supported: TMS32010, TMS32020

- Sentry Test Programs

Sentry Test Systems provides a ready-made solution to a TMS32010 or TMS32020 customer's incoming test procedure with TMS32010 and TMS32020 test programs for Sentry 7/8/10/20/21 test systems using either a 60- or 120-pin high-speed or high-voltage test head. The program tests DC parameters (V_{IH} , V_{IL} , V_{OH} , V_{OL} , I_{CC} , and input leakage current), and verifies device functionality at full frequency and V_{CC} extremes. Specific device attributes tested include the arithmetic logic unit (ALU), auxiliary registers (ARs), branch instructions, program counter (PC), status register, general registers, general I/O, interrupts, multiply, internal RAM, and device timings. TMS32020 features, such as the repeat (RPT) instruction, HOLD, READY/HOLD, READY, serial mode, and timer, are also tested. In addition, device functionality with an external 8-MHz crystal oscillator is verified.

The TMS32010 and TMS32020 Sentry test software includes the test program, test patterns, performance board, and documentation.

11.28 Signal Technology, Inc. (STI)

Nature of Product(s): DSP/Speech Software
Functional System(s): IBM PC/XT, VAX VMS/UNIX, PDP-11, RT-11, RSX-11
Device(s) Supported: TMS32010

- ILS/DSP

Signal Technology, Inc. (STI) offers two separate Interactive Laboratory System (ILS) packages tailored toward the specific application needs of digital signal processing and speech processing. The ILS/DSP package contains programs for advanced digital signal processing such as FFT, convolution, correlation, and spectral density estimation. The advanced DSP capabilities allow the processing and display of real and complex data types.

- ILS/Speech

The ILS/Speech package consists of speech processing programs that provide various types of speech analysis, parameter editing, formant tracking, pitch extraction, spectrogram displays, and autoregressive spectral displays. It also allows the use of dynamic programming for template generation and distance evaluation in word recognition experiments.

- DACS

DACS is a set of FORTRAN main programs and callable subroutines for analog-to-digital conversions directly to disk files, digital-to-analog conversions directly from disk files, and data compression/expansion for the efficient stor-

age of digitized data. Both A-law and μ -255-law compression tables are provided with DACS.

11.29 Signix Corp.

Nature of Product(s): Digital Filter Design, DSP System Simulation
Functional System(s): IBM PC, 8087
Device(s) Supported: TMS320 family

- **DISPRO**

The DISPRO software system provides the capability of designing, simulating, and evaluating digital filter operations for implementation on VLSI devices such as the members of the TMS320 family. The software system uses an IBM PC with graphics capability, and an optional 8087.

DISPRO is completely interactive, with a mixture of commands, menus, and screen displays for flexible development of designs for Butterworth, Chebyshev, and elliptic-function IIR filters, and for Parks-McClellan and Kaiser-window FIR filters. Frequency responses are calculated and plotted for coefficient wordlengths from 1 to 23 bits plus sign. The functional simulation of digital filtering is performed in two's-complement, fixed-point arithmetic for wordlengths of 2 to 24 bits.

The features of the DISPRO software system include:

- Double-length accumulation
- Overflow saturation
- Time-breakpoint settings
- Filter-response snapshot display
- Storage for output samples for processing with the general-purpose FFT-based spectral analysis and graphics modules
- Capability of transferring all screen graphics for time and frequency plots to an Epson-compatible printer.

- **SPECTIM**

SPECTIM is an expandable collection of modules used on DSP systems, such as TMS320-based systems, for simulation, signal analysis, and laboratory data processing; an 8087 is required. Each module in SPECTIM is invoked by a DOS command containing all file references and option switches in a standard DOS command string. This DOS command-oriented structure permits the creation of macro commands through the use of DOS batch files with replaceable parameters. User-created programs can be intermixed with SPECTIM commands. The SPECTIM system contains commands to implement the following functions:

- Forward and inverse FFT of real and complex data
- Power spectral density estimation
- Correlation
- Filtering using fast convolution or FIR filters designed by SPECTIM
- Data file arithmetic and manipulation
- Time and frequency plotting
- Utility operations to interface with user programs
- Verify mode for optional checking of command sequences before data values are processed.

11.30 SIGnology, Inc.

Nature of Product(s): DSP Development/Measurement System
Functional System(s): IBM PC/XT/AT or compatibles
Device(s) Supported: TMS320 family

- SP-20

SIGnology has developed a signal processing peripheral, the SP-20, that allows both analog and digital data to be generated, acquired, analyzed, and displayed. The system includes a unique and powerful combination of measurement capabilities for testing and debugging the digital and analog portions of a DSP-based design.

The analog system includes a Fourier analyzer with two or four channels and an integrated function generator. With it, an analog circuit can be simulated and fully characterized. The output signal types available are sine, square, triangle, saw, narrow band, and burst or flat random. A variety of distortion, frequency response, and phase measurements can be made. The graphics routines built into the software allow results to be plotted in a wide variety of formats and scales. The analog system has a fixed 20-kHz analog filter and samples data at 51.2 kHz/channel.

The digital system includes a word generator and a logic analyzer style pod for digital data capture. This capability allows Fourier analysis techniques to be extended to digital systems. The word generator can be used to feed digital samples into a TMS320-based design. The digital data capture pod can read processed results from a TMS320 output port, and display the results as time-domain samples or after an FFT in the frequency domain. This allows a designer to probe nodes in his DSP algorithm as if he had an oscilloscope and spectrum analyzer and the design were implemented with discrete analog components. Measurements on data conversion devices (A/D, D/A, and S/H) can also be made by using the analog and digital measurement systems together. Linearity, noise, and frequency response measurements on these devices can be made. The digital I/O system can generate and capture data at a 5-MHz rate, thus making it compatible with all members of the TMS320 family. The measurement pod directly decodes port addresses with a PAL. The system may also be used with bit-slice or multiplier/accumulator-based designs by providing external decoding for data input and output strobes.

For custom applications and algorithm development, full access to all SP-20 functions is provided by a set of high-level interface routines. The SP-20 contains up to six TMS320 devices (one for each input channel, one for FFTs, and one for output function generation).

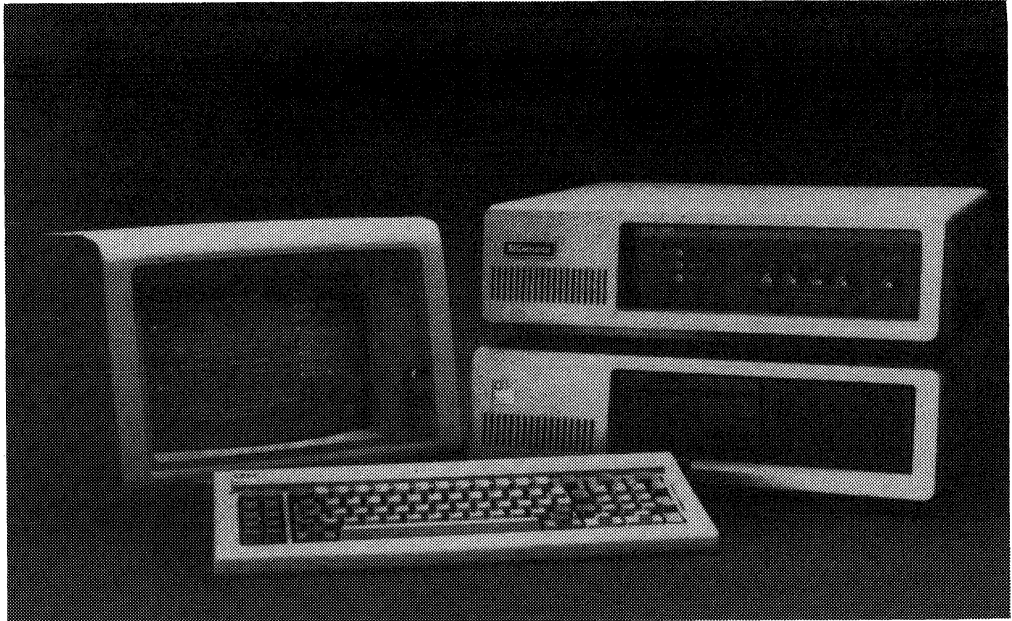

Figure 11-8. SIGnology's SP-20 DSP Development/Measurement System

11.31 SKY Computers, Inc.

Nature of Product(s): DSP Boards (with C Compiler)
Functional System(s): IBM PC/AT, PDP-11 Q-bus, VMEbus
Device(s) Supported: TMS32010, TMS32020

- SKY320-PC

The SKY320-PC is a realtime DSP board that incorporates a TMS32010. The communication focus of this board is a four-ported 64K data memory connected to the TMS32010 block, two 16-bit parallel I/O auxiliary ports, and an IBM PC-bus. The IBM PC is used as an I/O processor to perform initialization, switch analog test points in process control, act as system manager for several SKY320-PCs, and provide display control. The PC is also used as an image system, process controller, fast fixed-point array processor, and speech analysis system. Data memory is mapped to appear as host memory for both pro-

gram and data. When coupled to an A/D board, the SKY320-P aids in the design of realtime experiments and products.

The TMS32010 block on this board consists of the TMS32010 microprocessor with its program, data, and arithmetic sections, SKY-supplied 4K-word static program memory, along with some special function logic to augment the TMS32010 processor. The four-ported data memory uses a 200-ns cycle time to match TMS32010 performance. This fast cycle time eliminates the need to modify the TMS32010's clock impulses to hold back a cycle while a data memory access is in process. The SKY320 I/O auxiliary ports linked to the data memory provide the following flexibility:

- Use of ports as local data memory at a 5-Mword (16-bit word) rate
- Special designs to interface with A/D and D/A conversion devices
- Linkage to camera and special input devices
- Ability to chain together a series of SKY320 signal processor boards (output of first board into input of second board).

Included in the standard SKY320 package are complete diagnostic software and documentation. One of the most important tools is a C compiler that allows fast algorithm development in the high-level C language for direct use of many of the high-speed features in the TMS320. The C compiler allows access to hardware features by providing a set of built-in functions that are replaced by code when invoked. These are used to directly access the large external data memory and program memory, directly use the I/O ports and any of the internal TMS320 registers, and check the condition codes.

The software package also includes a macro preprocessor, an assembler, a symbolic debugger, host and SKY320 operating environments, and a large library of common mathematical functions. The macro preprocessor may be used prior to either compilation or assembly to generate sophisticated code such as FFT or fast 2-D convolution routines. The assembler can accept input directly from an assembly language source, the macro preprocessor, or the C compiler. The output of the assembler is directly executable TMS320 machine language code that can be downloaded to the SKY320. The debugger can be used interactively to debug both assembly language routines and C programs.

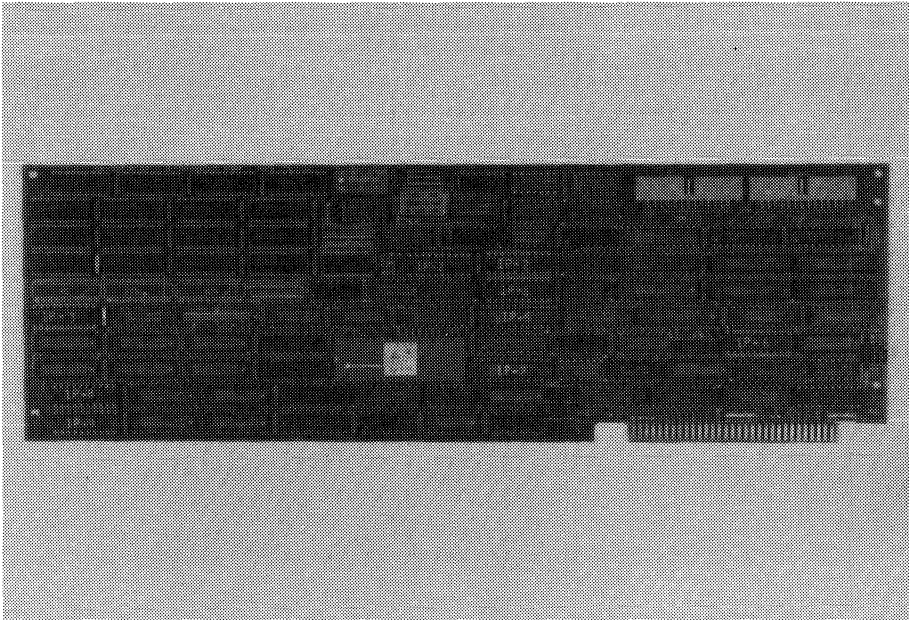

Figure 11-9. SKY320-PC DSP Board

- **SKY320-Q**

The SKY320-Q is a DSP board operating on the DEC Q-bus, which allows the use of a DEC PDP-11 computer as the host machine for initialization, process control, coordination, and display. The Q-bus interface for the SKY320-Q provides a realtime software environment for TMS32010 applications. All of the features of the SKY320-PC board, including the software package, apply to the SKY320-Q board. Future plans include the development of similar boards for other bus structures and systems.

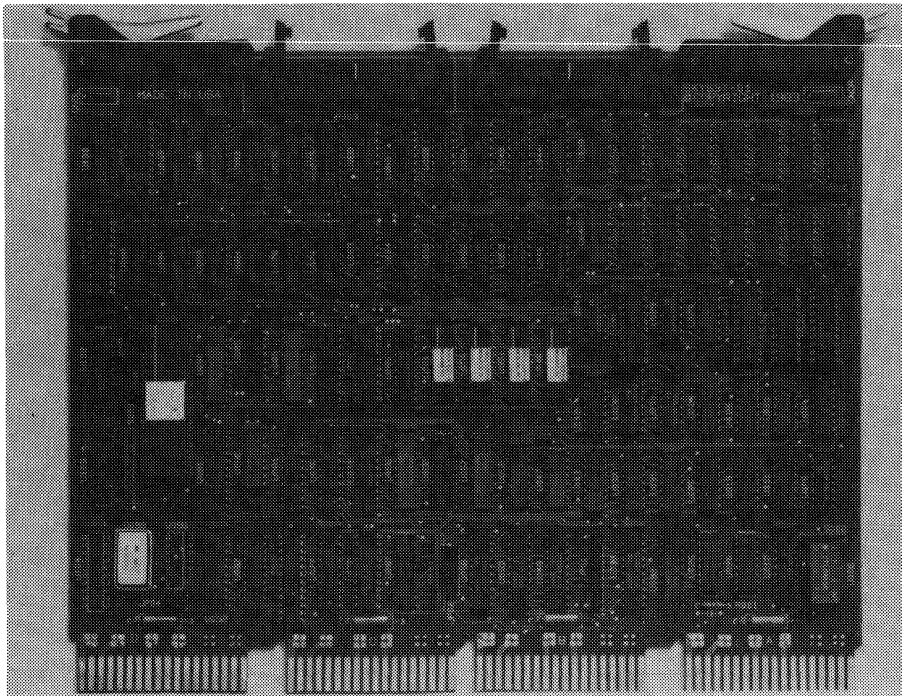

Figure 11-10. SKY320-Q DSP Board

- **SKY Challenger**

SKY Computers also supports a VMEbus board, the SKY Challenger, which is a fixed-point digital signal processor especially designed for high-speed applications, such as speech and image processing, digital filtering, data compression, vibration analysis, and realtime control.

The heart of the SKY Challenger's computation power is the TMS32020 DSP chip. The Challenger uses two TMS32020s and matches them with static RAMs to provide exceptionally high-speed arithmetic and signal processing power. The TMS32020s are configured in a master-slave arrangement. The master processor controls all the Challenger's operational functions in addition to providing arithmetic processing. The slave processor is dedicated to running arithmetic data and as such provides a flexible resource for other functions. In addition to the two TMS32020s, other hardware features include separate high-speed program and data memory (64K words each), bus interface, auxiliary ports for off-bus data acquisition, and a high-speed auxiliary bus for block data transfers.

SKY Challenger comes fully software-supported with a C compiler and a host of well-described macros and subroutines. Helpful signal and image process-

ing libraries are also included. The software environment of the Challenger consists of an assembler (SKYASM), a linker (SKYLINK), debugger (SKY-DEB), and a macro preprocessor (SKYMPP).

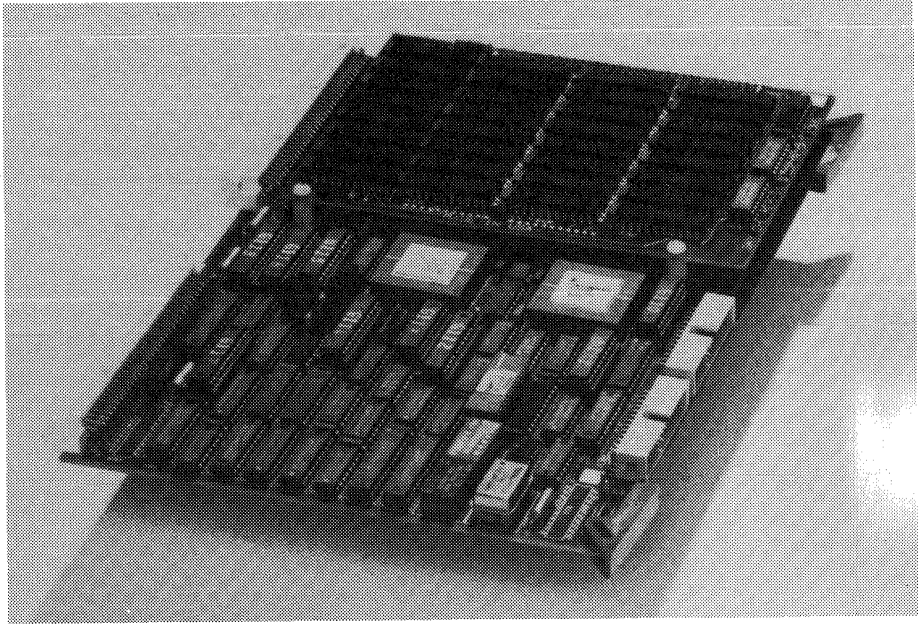

Figure 11-11. SKY Challenger VMEbus DSP Board

11.32 TelePhoto Communications

Nature of Product(s): Development System
Functional System(s): IBM PC/XT/AT and compatibles
Device(s) Supported: TMS32020

- TMS32020 Development System

TelePhoto Communications' TMS32020 Development System is ideal for applications such as image processing (compression, overlay, merge, enhancement, and recognition), speech processing (pitch detection and phoneme recognition), natural language processing, and scientific and artificial intelligence research. The system consists of a single full-size card and the software required for loading, running, and debugging TMS32020 application programs. A powerful debugger offers the capabilities of a software simulator in hardware for realtime program execution.

The development system, based on the TMS32020, offers 16 kbytes of high-speed (50-ns) RAM, expandable to 128 kbytes (64K words of data memory). It also offers operation with no wait states. The TMS32020 RAM can be mapped into a 64-kbyte address space in the IBM PC and accessed directly by the PC for program and data load. Data can be transferred to and from the TMS32020 RAM via an IBM PC DMA channel. An on-board selectable clock allows operation at 14 MHz and 20 MHz (other speeds attainable with a user-supplied crystal). A large prototyping area is available on the board for custom circuit development.

The system supports the TMS32020 assembler/linker and object code, and includes a TMS32020 object code loader and executor. An optional debugger with single-step, breakpoint/trace, assembly/disassembly, and memory/register dump capability is available. Color image compression software for the development system is also available.

11.33 Televic

Nature of Product(s): DSPL Compiler, Linker, Library
Functional System(s): VAX, PDP-11, TI/IBM PC
Device(s) Supported: TMS32010

- DSPL 1010 Compiler

Televic offers a compiler for DSPL, a high-level language for the TMS32010. Some of the features of DSPL include:

- All standard Pascal instructions
- Most standard Pascal data types
- Special constructs for signal processing, such as fast fractional arithmetic, shift operators, etc.
- Internal and external data variables with initialization (tables)
- Realtime facilities (vectored or nonvectored interrupt, wait)
- Separate compilation units, including import and export of variables.)

The DSPL 1010 Compiler is written in Pascal and highly optimized for the TMS32010. It also provides a disassembler output facility.

- DSPL 1020 Linker

The DSPL 1020 links DSPL and assembler modules (TI format), computes overlay for internal variables, and generates TI and Intel hexadecimal files.

- DSPL 1030 Library

The DSPL 1030 Library provides the standard functions, such as sine, cosine, and floating-point routines.

11.34 Texas Instruments, Inc.

Nature of Product(s): Speech Development System
Functional System(s): TI/IBM PC and compatibles
Device(s) Supported: TMS32010

- TI-Speech

The Texas Instruments speech development system, TI-Speech, is an advanced voice interface and communications package that provides a base for sophisticated voice and data integration. The piggybacked, two-board speech processing system is built around the TMS32010, occupies one of the PC's expandable slots, and provides a combination of communications functions never before offered to a PC user. These functions include:

- Speaker-dependent speech recognition
- Voice store-and-forward at 2.4/9.6/16/32-kbps data rates
- Text-to-speech
- Speaker verification
- Integrated telephone functions
- Pulse or tone dialing
- Dual-tone multifrequency decoding (DTMF)
- Selection of communications channels.

By combining these functions with the proper software, voice commands can be given to any application, thereby providing an intelligent telephone, a sophisticated telephone answering machine, or more.

TI-Speech has three major components: system hardware, system software, and transparent keyboard software. These components work together to combine the functions described above into useful tools. In addition, TI offers a speech design kit to software developers for designing additional applications around the hardware component.

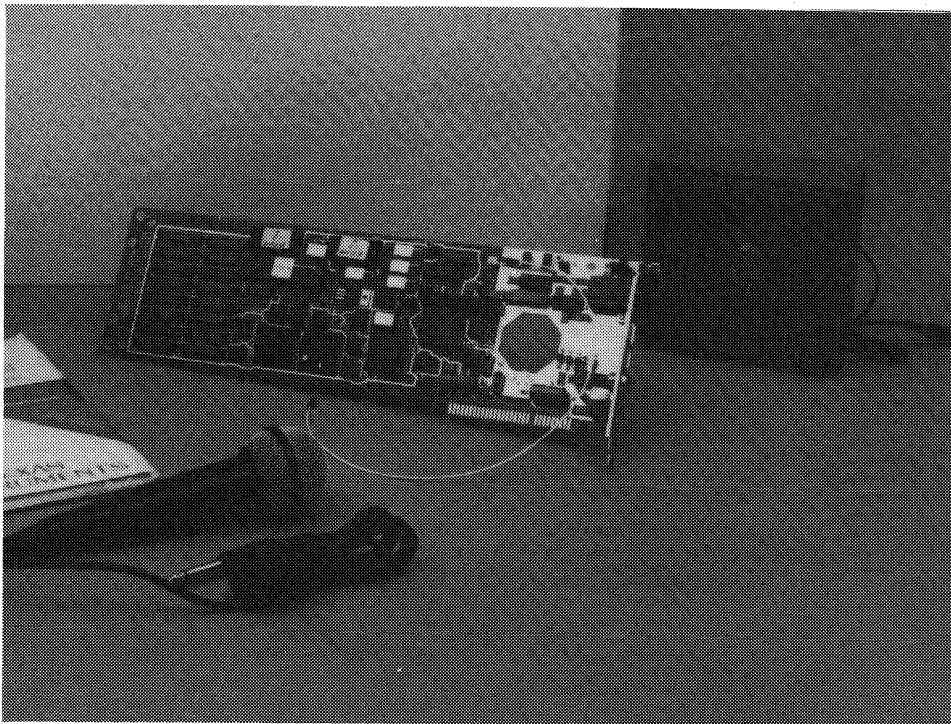

Figure 11-12. TI-Speech Development System

11.35 Thorn EMI Electronics

Nature of Product(s): Software Support Package
Functional System(s): Eclipse S130 AOS
Device(s) Supported: TMS32010

- **Software Support Package**

Thorn EMI Electronics offers a software support package that runs on any 16-bit Eclipse system that has a floating-point instruction set and uses the Data General AOS operating system. This complete software package can be supplied either as a magnetic tape or diskette to Data General formats.

The software package consists of:

- A symbol file that enables the Eclipse assembler to assemble TMS32010 code

- Operating-system command macros to provide assembly and linking
- A simulator.

11.36 TIAC Manufacturing, Inc.

Nature of Product(s): DSP Mainframe, Analog I/O Board, Software
Functional System(s): IBM PC/AT/XT
Device(s) Supported: TMS32010

- **PC-320 Digital Signal Coprocessor**

The PC-320 is a complete digital signal processing mainframe that is capable of performing a wide variety of realtime digital signal processing tasks. Utilizing the TMS32010 technology, the system can be tailored to specific applications. The coprocessor nature of the PC-320 design allows the desired signal processing to be run in parallel with other PC applications. In some applications, the PC may act as a user interface that monitors the selection of processing tasks for the PC-320, the display of results, and the storage and retrieval of data. In other applications, once a task is loaded from the PC host onto the PC-320, the signal processing runs concurrently with the host machine.

- **IPC-102 Data Acquisition Daughter Board**

The IPC-102, designed as a daughter board for the PC-320, is an analog I/O board with programmable selection of gain, and input/output channel selection. It uses two I/O chip selects (selectable by strapping), and provides an independent register I/O for digital input and output, and digital-to-analog conversion input values and analog-to-digital conversion output values.

- **TPC-320 Application Development**

The TPC-320 application development tool kit assists developers in gaining familiarity with the PC-320, TMS32010 assembly language programming, and the PC-320/host PC interface. The kit contains information regarding assembly language programming so that a user can gain sufficient familiarity with the PC-320 programming environment to begin writing applications in one day. The TPC-320 contains an absolute assembler, text routines with source code, a rudimentary debugger, a hardware test program, example host source programs, an applications development user's guide, and executable load module utilities.

- **T320-SAB Signal Analysis BIOS**

The signal analysis basic input/output system (SABIOS) is designed to simplify the creation of realtime signal analysis applications. The SABIOS is a set of driver calls that perform a complete set of signal processing functions. These functions vary from simple data movement operations, such as moving a block of sample data between the PC-320 and the host PC, to complex signal processing functions such as the FFT. SAB functions are invoked using software interrupts, thus providing simple interface compatibility for several application languages. Function classes contained in the package include correlation analysis, waveform generation, spectrum analysis, parameter array data management, and waveform display.

11.37 Valid Logic Systems

Nature of Product(s): Simulator Systems
Functional System(s): Valid Workstation
Device(s) Supported: TMS320 Family

- **REALCHIP Hardware Modeling System**

The REALCHIP hardware modeling system accommodates VLSI devices with up to 128 active signals, such as the TMS320 family of digital signal processors. Included in its key features are:

- Programmable clock rates up to 16 million clock edges per second
- Maximum capacity of 4096 bidirectional signal channels
- Simulations of 2 million clock edges (typical) for dynamic devices
- 32 Mbyte/second data transfer rate with accelerator for fastest simulation speed.

- **REALFAST Simulator Accelerator System**

The features of the simulator accelerator system, designed for acceleration of REALCHIP, include:

- Up to 500,000 events/second simulation speed (equivalent to 1.25-million evaluations/second)
- 3.2-million gate maximum capacity
- Integrated with Valid's simulation environment
- Parallel acceleration processor task-sharing for high performance.

- **REALMODEL Simulation System**

Valid Logic Systems supports the TMS32010 with the REALMODEL simulation system to be used on Valid workstations. REALMODEL combines simulation acceleration with VLSI, PCB, and subsystem modeling in a single high-performance system. Although user-transparent, it accelerates design simulation for designs containing switch, gate, functional, behavioral, and hardware models. The system is backward-compatible with the REALCHIP simulator system and the REALFAST simulator accelerator system.

11.38 Votan

Nature of Product(s): Speech Board
Functional System(s): IBM PC and compatibles
Device(s) Supported: TMS32010

- **VPC2000 Voice Card**

The VPC2000 Voice Card from Votan is a hardware and software system, based on the TMS32010. The voice card, featuring continuous speech recognition, enables the user to speak in a natural conversational flow rather than pausing between each word as required in most recognition systems.

The VPC2000 consists of a printed circuit board, microphone, speaker, software, and documentation. It is designed to add voice I/O and telephone

management capabilities to the IBM PC and compatibles. The voice card has the following capabilities:

- Voice store-and-forward at 4 kbps to 14.4 bps (software selectable) data rates
- Speaker-independent speech recognition
- Continuous speaker-dependent speech recognition
- Integrated telephone functions, such as telephone interface, pulse or tone dialing, call progress, and DTMF encoding/decoding.
- Software for development, voice mail, telephone management, and VoiceKey.

11.39 Whitman Engineering, Inc.

Nature of Product(s): Product Devt. System, DSP Workstation
Functional System(s): TI PC, IBM PC/XT, 8087
Device(s) Supported: TMS32010, TMS32020

- **Product Development System**

Whitman Engineering provides a PC-based product development system for both the TMS32010 and TMS32020. The basic software includes the firm's MADCAP package, plus five preprogrammed links to the TMS32010 or TMS32020 assembler/linker/simulator software, ASPI's digital filter design package, and a standard MS-DOS text editor. A main menu selection is also labeled for linking in the software driver for the user's data acquisition hardware. Three user-defined module links allow interface of additional hardware and software. The TI-Speech board has been interfaced as one of these modules to allow the designer to download TMS32010 code and data to a plug-in peripheral. The option also provides the software for developing and interfacing an end product that is a TI-Speech board adapted to be a TMS32010 plug-in peripheral.

- **MADCAP DSP Workstation**

The MADCAP software system is useful as a design station and for product development from design through production quality control. The system also serves as a basic signal processing workstation with the following main features:

- Signal and special function generation
- 32-bit floating-point FFT routines for forward and inverse transforms on real or complex data
- Standard power-of-two and Whitman's proprietary mixed-radix FFT algorithm with 94 extra transform lengths
- High-resolution graphics, stripchart and numerical display options
- Fully-automated filing for 3200 files and the ability to transfer files from outside sources.

The significant advantage in using the mixed-radix FFT algorithm when developing TMS320 designs is to be able to more accurately measure the frequency response and quantization characteristics of the TMS320 code. Mixed-radix FFT filters can be placed in seven times as many locations as standard FFTs.

TMS320 Third-Party Support

The internal synthesizer, keyboard entry, external source, and FFT/IFFT selections from the main menu allow test sequences to be developed and test results to be analyzed and displayed for:

- Software simulation
- TMS32010 and TMS32020 code simulation
- Code run on the TI-Speech board's TMS32010 chip
- Code run on dedicated prototype hardware
- Code run on production hardware.

Third-Party Support - Address/Phone List

11.40 Third-Party Address, Phone, and Product Support List

Table 11-1 lists all the third parties mentioned in this section who provide a TMS320 support product. This is a comprehensive reference list that gives the company names, addresses, phone numbers, nature of product support, the functional system(s) used by the product, and the TMS320 device(s) supported. Table 11-2 lists the third parties, cross-referenced by the type of support offered.

Table 11-1. Third-Party Address/Phone/Product Support List

COMPANY	ADDRESS/PHONE	PRODUCT SUPPORT
Allen Ashley	395 Sierra Madre Villa Pasadena, CA 91107-2902 (818) 793-5748	TMS32010, TMS32020: Macro Assemblers, Simulator (TI/IBM PC, CP/M-80)
Atlanta Signal Processors, Inc. (ASPI)	770 Spring Street, NW Suite 208 Atlanta, GA 30308 (404) 892-7265 (or contact TI Sales Office)	TMS32010, TMS32020: Algorithm Development Package, Digital Filter Design Package, Subband Coder (TI PC, IBM PC/XT/AT, BIOS-compatibles)
Avocet Systems, Inc.	P.O. Box 490 Rockport, ME 04856 (207) 236-9055 (800) 448-8500 Telex: 467210 AVOCET CI	TMS32010, TMS32020: Macro Assembler (VAX UNIX, IBM PC)
Bedford Research	4 De Angelo Drive Bedford, MA 01730 (617) 275-7246	TMS32010, TMS32020: Interactive Signal Processing Software (IBM PC, PDP-11, VAX)
Burr Brown Corp.	P.O. Box 11400 Tucson, Arizona 85734 (602) 746-1111	TMS32010: Analog Input and DSP Boards (VMEbus)
Computalker	1730 21st Street Santa Monica, CA 90404 (213) 828-6546	TMS32010, TMS32020, TMS320C25: Assembler, Simulator, Compiler (IBM PC/XT/AT, Apple II+/e/c, Amiga, CP/M)
Crowell, Inc.	P.O. Box 3314 Huntsville, AL 35810 (205) 837-8233	TMS32020: Assembler (IBM PC)
Cybernetic Micro Systems	P.O. Box 3000 San Gregorio, CA 94074 (415) 726-3000 Telex: 910 350 5842	TMS32010: Assembler, EPROM Programmer (IBM PC)
Daisy Systems Corp.	700 Middlefield Rd. P.O. Box 7006 Mountainview, CA 94039 (415) 960-0123 Hampshire, England (44) 256-464-061 Tokyo 105, Japan (03) 432-3321	TMS32010, TMS32020: Engineering Workstation (LOGICIAN, Personal LOGICIAN, IBM AT)

Third-Party Support - Address/Phone List

Table 11-1. Third-Party Address/Phone/Product Support List (Continued)

COMPANY	ADDRESS/PHONE	PRODUCT SUPPORT
Dalanco Spry	2900 Connecticut Ave.NW Suite 241 Washington, D.C. 20008 (202) 232-7999	TMS32010: DSP Board (IBM PC/XT/AT)
Digital Audio Corp.	6512 Six Forks Road Suite 203B Raleigh, NC 27609-2946 (919) 848-0845 Telex: 80-4294 SPEDEX ATL	TMS32010: DSP Lab with Voice Enhancement (N/A)
Digital Signal Processing Software, Inc. (DSPS)	P.O. Box 5348 Station F Ottawa, Canada K2C3J1 (613) 825-5476	TMS32010: Assemblers, FFT/LPC Speech Algorithms, Signal Lab (PDP-11, VAX VMS, TI/IBM PC)
Digital Sound Corp.	2030 Alameda Padra Serra Santa Barbara, CA 93103 (805) 569-0700	TMS32010: Audio Conversion System for Speech Development (ILS, SPIRE, I*S*P)
DSP Technology Corp.	2105 Luna Road Carrollton, TX 75066 (214) 247-8831	TMS32010: DTMF Detector, MF Decoder, Conferencing System (N/A)
Forth, Inc.	111 N. Sepulveda Blvd. Suite 300 Manhattan Beach, CA 90266 (213) 372-8493	TMS32020: DSP Software Prototyping System (IBM XT)
Gas Light Software	5211 Yarwell Houston, TX 77096 (713) 729-1257	TMS32010: Digital Filtering Program (TI PC, IBM PC/XT/AT, 8087)
Hewlett-Packard	1507 Page Mill Palo Alto, CA 94304 (800) 447-3282 (303) 590-3340 (Colorado)	TMS32010: Emulator, Analyzers, Assembler/Linker (HP 64000 LDS)
Hyperception	9550 Skillman LB125 Dallas, TX 75243 (214) 828-3508	TMS320 Family: DSP Software, Assembler, VMEbus Card (IBM PC, VMEbus)
Kontron Electronics	1230 Charleston Road Mountain View, CA 94039 (415) 965-7020 (800) 227-8834	TMS32010: Logic Analyzer, Disassembler (N/A)
Loughborough Sound Images Ltd.	Attn: Dr. David Quarmby The Technology Centre Epinal Way, Loughborough Leicestershire, UK LE11 0QE (44) 509 231 843 Telex: 312242 MIDTLX G	TMS32020: DSP Board, Monitor Program (IBM PC)
Microcraft Corp.	P.O. Box 513 Thiensville, WI 53092 (414) 241-8144	TMS32010: DSP Development Board (TI/IBM PC)
Microstuf, Inc.	1000 Holcomb Woods Pkwy. Suite 440 Roswell, GA 30076 (404) 998-3998	TMS320 Family: Data Communications Software (TI/IBM PC, CP/M, CP/M-86, MP/M)

Third-Party Support - Address/Phone List

Table 11-1. Third-Party Address/Phone/Product Support List (Continued)

COMPANY	ADDRESS/PHONE	PRODUCT SUPPORT
PH Associates	8720 Old Courthouse Rd. Vienna, VA 22180 (703) 281-5762	TMS32010, TMS32020: Assembler (IBM PC, CP/M, TurboDos, PDP-11, UNIX, Tektronix 8560)
Pacific Micro- circuits Ltd.	Attn: Tom Foxall 240 H. Street Blaine, WA 98230 (604) 536-1886	TMS32010: Interface ICs, Development Boards (IBM PC)
Pratica SRL	79 C.50 Re Umberto 10128 Torino, Italy 11/503427/592989	TMS32010: Software Development System (Olivetti M20/21/24 PC, IBM PC/XT/AT, VAX VMS/UNIX/XENIX/MICROVAX, PDP-11, ATT 3B2)
Racal Micro- electronics Systems Ltd.	Microsystems Prod. Sales Worton Drive Worton Grange Ind. Estate Reading, Berkshire RG2 OSB England (44) 0734 868601 Telex: 847043 Fax: (44) 0734 752300	TMS32020: DSP Card (VMEbus)
Sentry Test Systems	Attn: Eric Palmer 1601 Technology Drive San Jose, CA 95115 (408) 947-3626	TMS32010, TMS32020: Test Programs (Sentry 7/8/10/20/21 test system)
Signal Technology Inc. (STI)	5951 Encina Road Goleta, CA 93117 (805) 683-3771 (800) 235-5787 (not CA)	TMS32010: DSP/Speech Software (IBM PC/XT, VAX VMS, UNIX, PDP-11, RT-11, RSX-11)
Signix Corp.	19 Pelham Island Rd. Wayland, MA 01778 (617) 358-5955	TMS320 Family: Digital Filter Design, DSP System Simulation (IBM PC, 8087)
SIGnology, Inc.	1750 Silacci Dr. Campbell, CA 95008 (408) 374-6464	TMS320 Family: DSP Development/ Measurement System (IBM PC/XT/AT)
SKY Computers, Inc.	Foot of John Street Lowell, MA 01852 (617) 454-6200 Telex: 499 1331 SKYMNK	TMS32010, TMS32020: DSP Boards with C Compiler (IBM PC, PDP-11, Q-Bus, VMEbus)
TelePhoto Communications	Attn: Dave Eriqat 11722 Sorrento Valley Rd. Suite D San Diego, CA 92121-1084 (619) 452-0903	TMS32020: Development System, Color Image Compression Software (IBM PC/XT/AT)
Televic	Leo Bekaertlaan 1 B-8701 Izegem, Belgium 32-51-30-30-45 Telex: 81 586	TMS32010: DSP Compiler, Linker, Library (VAX, PDP-11, TI/IBM PC)
Texas Instruments, Inc.	Contact TI Sales Office (800) 527-3500	TMS32010: Speech Development System (TI/IBM PC)

Third-Party Support - Address/Phone List

Table 11-1. Third-Party Address/Phone/Product Support List (Concluded)

COMPANY	ADDRESS/PHONE	PRODUCT SUPPORT
Thorn EMI Electronics	Attn: Kevin Hauser P.O. Box 161 Elizabeth, South Australia 5112 61-8-256-0229	TMS32010: Software Support Package (Eclipse S130 AOS)
TIAC Manufacturing, Inc.	3080 Spring Street Port Moody, B.C. Canada V3H 1Z8 (604) 461-0120	TMS32010: DSP Mainframe, Analog I/O Board, Software Package (IBM PC/AT/XT)
Valid Logic Systems	Attn: Mike Glenn 2820 Orchard Parkway San Jose, CA 95134 (408) 945-9400 Telex: 471 9004	TMS320 Family: Simulation Systems (Valid Workstation)
Votan	Attn: Marketing Mgr. 4487 Technology Dr. Fremont, CA 94538 (415) 490-7600 Telex: 176274	TMS32010: Speech Board (IBM PC)
Whitman Engineering	P.O. Box 9675 Fort Collins, CO 80525 (303) 493-1797	TMS32010, TMS32020: Product Development System, DSP Workstation (TI PC, 8087, IBM PC/XT)

Table 11-2 consists of a quick-reference listing of the third parties according to first- or second-generation products and the software operating systems and product types available.

To locate a particular software product using this table, follow the sequence below.

- 1) Locate the desired operating system and identify the associated reference number.
- 2) Scan the column beneath the product desired (either first or second generation) for the appropriate reference number of the operating system.
- 3) Identify the third party and refer to Table 11-1 for the specific operating system.
- 4) Refer to the product descriptions, listed alphabetically by third parties in Sections 11.1 through 11.39.

If development or application hardware is desired, scan those columns for third parties offering hardware support. Next, refer to the appropriate third party in Table 11-1 for the specific hardware. Finally, refer to the product descriptions, listed alphabetically by third parties in Sections 11.1 through 11.39.

Third-Party Support - Address/Phone List

Table 11-1. Third-Party Reference List

FIRST-GENERATION TMS320						
COMPANY	ASSM/ LNK	SIM	CMPLR	DEV/APP S/W	DEV H/W	APP H/W
Allen Ashley	1,3	1,3				
ASPI				1,5		
Avocet Systems	1,2					
Bedford Research				1,2		
Burr Brown						X
Computaker	1,3,4	1,3,4	1,3,4			
Cybernetic Micro Systems	1				X	
Daisy Systems					X	
Dalanco Spry						X
Digital Audio					X	
DSPS	1,2			1,2		
Digital Sound				5		
DSP Technology						X
Gas Light Software				2,5		
Hewlett-Packard					X	
Hyperception				1	X	
Kontron Electronics					X	
Microcraft					X	
Microstuf				1,2,3,5		
PH Associates	1,2,3,5					
Pacific Microcircuits					X	X
Pratica SRL				1,2,3,4		
Sentry Test Systems				6		
Signal Technology				1,2,3		
Signix				2,5		
SIGNology					X	
SKY Computers			1,2		X	
Televic			1,2	1,2		
Texas Instruments						X
Thorn EMI Electronics				6		
TIAC Manufacturing					X	X
Valid Logic Systems					X	
Votan						X
Whitman Engineering				1,5		

Legend for Operating Systems:

- 1 = TI PC, IBM PC/AT/XT
- 2 = VAX VMS/UNIX/XENIX/MICROVAX, PDP-11
- 3 = CP/M, MP/M, TurboDos, RT-11, RSX-11
- 4 = Apple, Amiga, ATT3B2, Olivetti PC
- 5 = BIOS, ILS, SPIRE, I*S*P, 8087, Tektronix 8560
- 6 = Sentry test system, Eclipse S130 AOS

Third-Party Support - Address/Phone List

Table 11-1. Third-Party Reference List (Concluded)

SECOND-GENERATION TMS320						
COMPANY	ASSM/ LNK	SIM	CMPLR	DEV/APP S/W	DEV H/W	APP H/W
Allen Ashley	1,3					
ASPI				1,5		
Avocet Systems	1,2					
Bedford Research				1,2		
Computalker	1,3,4		1,3,4			
Crowell	1					
Daisy Systems					X	
Forth				1		
Hyperception				1	X	
Loughborough Sound				1		X
Mirostuf				1,2,3,5		
Pro Associates	1,2,3,5					
Racal Microelectronics						X
Sentry Test Systems				6		
Signix				2,5		
SIGNology					X	
SKY Computers			1,2		X	
TelePhoto Communications					X	
Valid Logic Systems					X	
Whitman Engineering				1,5		

Legend for Operating Systems:

- 1 = TI PC, IBM PC/AT/XT
- 2 = VAX VMS/UNIX/XENIX/MICROVAX, PDP-11
- 3 = CP/M, MP/M, TurboDos, RT-11, RSX-11
- 4 = Apple, Amiga, ATT3B2, Olivetti PC
- 5 = BIOS, ILS, SPIRE, I*S*P, 8087, Tektronix 8560
- 6 = Sentry test system, Eclipse S130 AOS

11.41 Third-Party Consultants

Many third parties serve as consultants, offering comprehensive technical support services to clients. They may custom design and develop hardware and software systems, contract research efforts, and/or offer general consulting services. Each third party consultant specializes in some area of digital signal processing applications. Table 11-3 lists the name, phone number, and area of expertise for those individuals and companies that offer consulting services.

Table 11-3. Third-Party Consultant List

NAME	AREA OF EXPERTISE
Dr. Huseyin Abut (619) 265-3702	Speech Encoding, Vector Quantization
Bedford Research (617) 275-7246	Interactive Signal Processing
Charles Davis (408) 946-2227	Telecommunications
Tom Delmer (619) 454-5383	Software and Numerical Analysis
Digital Audio Corp. (919) 848-0845	DSP Hardware and Software Devt.
Dragon Systems (617) 965-5200	Dependent Speech Recognition
Forth, Inc. (213) 372-8493	DSP Software Design and Programming
C. Gold Associates (802) 333-4769	DSP, Instrumentation, and Control
James Gunn, Ph.D. (214) 669-9350	Modems and Telecommunications
Frederick M. Kruger (516) 543-5392	Realtime Signal Processing
David Langmann (202) 232-7999	DSP Hardware and Software
Bob Morris, Ph.D. (613) 825-5476	FFTs, Speech, and Signal Processing
William M. Norr, Inc. (201) 852-6650	DSP, Radar, Sonar, and Voice
Paul Pandian (214) 960-2747	Telecommunications, Instrumentation
S. S. Reddi, Ph.D. (714) 250-4193	Signal and Image Processing
Dana Redington (415) 369-8741	Realtime Signal Processing

Table 11-3. Third-Party Consultant List (Concluded)

NAME	AREA OF EXPERTISE
D. Lloyd Rice (213) 828-6546	Speech, Telecommunications, DSP
Gary A. Sitton (713) 729-1257	Time Series, Speech, Numer. Analysis
Sorrento Valley Associates (619) 452-0102	Speech and Image Processing
Spectrum Management (408) 296-5736	DSP Design/System Analysis
Judith Tauber-Lovik (415) 967-6566	Software Design/System Analysis
Technology International (617) 237-5997	Implementation of DSP Algorithms
Dhadesugoor Vaman (201) 420-5849	Signal Processing
Voice Control Systems (214) 248-8244	Speech Development
Mike Weltman (800) 445-5506	Minisystems

11.42 Trademarks

The trademarks that have been mentioned in this document are credited to the respective corporation in Table 11-4

Table 11-4. Trademark List

TRADEMARK	CORPORATION
Apple	Apple Computers, Inc.
AOS	Data General
AT, XT	International Business Machines Corp.
AVLIB, AVLINK, AVMAC	Avocet Systems, Inc.
Avocet, AVREF, AVSIM	Avocet Systems, Inc.
CP/M, CP/M-80, CP/M-86	Digital Research, Inc.
CROSSTALK, CROSSTALK XVI	Microstuf, Inc.
DEC, DEC-10	Digital Equipment Corp.
DFDP	Atlanta Signal Processors, Inc.
DISPRO, SPECTIM	Signix Corp.
DSPL	Televic
DSPS	Digital Signal Processing Software
IBM	International Business Machines Corp.
ILS	Signal Technology, Inc.
Intel	Intel Corp.
I*S*P	Bedford Research
LOGICIAN, PMX	Daisy Systems Corp.
Microstuf	Microstuf, Inc.
MICROVAX, MICRO-11	Digital Equipment Corp.
MP/M	Digital Research, Inc.
MS-DOS	Microsoft, Inc.
PC-DOS	International Business Machines Corp.
PDP, PDP-11, Q-Bus	Digital Equipment Corp.
RSL	Digital Signal Processing Software
RT-11, RSX-11	Digital Equipment Corp.
SPIRE	Massachusetts Institute of Technology
SuPPort	Pacific Microcircuits, Ltd.
TEKHEX	Tektronix Corp.
TI-Speech	Texas Instruments, Inc.
TurboDos	Software 2000, Inc.
UNIX	Bell Laboratories
VAX, VMS, VT-52, VT-100	Digital Equipment Corp.
VMEbus	Motorola, Inc.
VMEdsp	Burr Brown Corp.
VoiceKey	Votan
Z-EDIT	Gas Light Software

A. Product Order Information

This section provides TMS320 family development support information, device part numbers, and support tool order information for all TMS320 products. Table A-1 lists important information about each DSP chip. Table A-2 gives the ordering information for all the TMS320 hardware and software support tools available. Table A-3 provides a list and description of the development tool connections to a target system.

A discussion of the TMS320 device and development support tool prefix and suffix designators is included to assist in understanding the TMS320 product numbering system.

Table A-1. TMS320 Digital Signal Processor Part Numbers

DEVICE NAME	TECHNOLOGY	OPERATING FREQUENCY	PACKAGE TYPE	TYPICAL DISSIPATION
TMS32010NL	2.4- μ m NMOS	20 MHz [†]	Plastic	900 mW
TMS32010NL-14	2.4- μ m NMOS	14 MHz	40-pin DIP	900 mW
TMS32010NL-25	2.4- μ m NMOS	25 MHz		900 mW
TMS32011NL	2.4- μ m NMOS	20 MHz	Plastic 40-pin DIP	900 mW
TMS320C10NL	2.0- μ m CMOS	20 MHz [‡]	Plastic	165 mW
TMS320C10NL-25	2.0- μ m CMOS	25 MHz	40-pin DIP	165 mW
TMS320C10FNL	2.0- μ m CMOS	20 MHz	Plastic 44-lead PLCC	165 mW
TMS320C15NL	2.0- μ m CMOS	20 MHz [‡]	Plastic	165 mW
TMS320C15NL-25	2.0- μ m CMOS	25 MHz	40-pin DIP	165 mW
TMS320E15JDL	2.0- μ m CMOS	20 MHz	Ceramic 40-pin DIP	165 mW
TMS320C17NL	2.0- μ m CMOS	20 MHz [‡]	Plastic	165 mW
TMS320C17NL-25	2.0- μ m CMOS	25 MHz	40-pin DIP	165 mW
TMS320E17JDL	2.0- μ m CMOS	20 MHz	Ceramic 40-pin DIP	165 mW
TMS32020GBL	2.4- μ m NMOS	20 MHz [‡]	Ceramic 68-pin PGA	1200 mW
TMS320C25GBL	1.8- μ m CMOS	40 MHz [‡]	Ceramic 68-pin PGA	450 mW
TMS320C25FNL	1.8- μ m CMOS	40 MHz [‡]	Plastic 68-lead PLCC	450 mW

[†]Military version available

[‡]Military versions planned; contact nearest sales office for availability.

Appendix A - Product Order Information

Table A-2. TMS320 Support Tool Part Numbers

TOOL DESCRIPTION	1ST GENERATION	2ND GENERATION	TMS320 FAMILY
SOFTWARE			
Macro Assembler/Linker VAX VMS TI/IBM MS/PC-DOS	TMDS3240210-08 TMDS3240810-02	TMDS3242210-08 TMDS3242810-02	
Simulator VAX VMS TI/IBM MS/PC-DOS	TMDS3240211-08 TMDS3240811-02	TMDS3242211-08 TMDS3242811-02	
SoftWare Development System† TI/IBM MS/PC-DOS		TMDS3268821	
Digital Filter Design Package TI PC MS-DOS IBM PC PC-DOS			DFDP/TI001 DFDP/IBM001
DSP Software Library VAX VMS TI/IBM MS/PC-DOS			TMDC3240212-18 TMDC3240812-12
TMS320 Bell 212A Modem S/W TI/IBM PC/MS-DOS	TMDX3240813-12		
HARDWARE			
Evaluation Module (EVM)†	RTC/EVM320A-03	TMDS3268822	
XDS/22 Emulator†	TMDS3262211	TMDS3262221	
XDS/22 Upgrade Factory Upgrade† Customer Upgrade†	TMDS3282215 TMDS3282216	TMDS3282225 TMDS3282226	
XDS/11 Upgrade Factory Upgrade† Customer Upgrade†		TMDS3281125 TMDS3281126	
Analog Interface Board			RTC/EVM320C-06
Analog I/F Bd. Adaptor		RTC/ADP320A-06	
TMS320 Design Kit			TMS320DDK

†See Table A-3 for a list of connections to a target system.

Appendix A - Product Order Information

Table A-3. Development Tool Connections to a Target System

TOOL	TARGET CONN.	INCL.	OPT.	PART NUMBER
TMS320C10 XDS/22	40-pin DIP 44-lead PLCC	X	X	TMDS3288810
TMS320C10 XDS/22 Upgrade	40-pin DIP 44-lead PLCC	X	X	TMDS3288810
TMS32010 EVM	40-pin DIP	X		
TMS320C25 XDS/22	PGA/PLCC PGA/PLCC PGA	X	X X	TMDS3288825 TMDS3288820
TMS320C25 XDS/22 and XDS/11 Upgrade	PGA/PLCC PGA/PLCC PGA	X	X X	TMDS3288825 TMDS3288820
TMS32020/C25 EVM	Ribbon cable PGA/PLCC PGA	X	X X	TMDS3288825 TMDS3288820

A.1 Device and Development Support Tool Prefix Designators

To assist the user in understanding the stages in the product development cycle, Texas Instruments assigns prefix designators in the part number nomenclature. A device prefix designator has three options: TMX, TMP, and TMS, and a development support tool prefix designator has two options: TMDX and TMDS. These prefixes are representative of the evolutionary stages of product development from engineering prototypes (TMX/TMDX) through fully qualified production devices (TMS/TMDS). This development flow is defined below.

Device Development Evolutionary Flow:

- TMX** Experimental device that is not representative of the final device's electrical specifications.
- TMP** Final silicon die that conforms to the device's electrical specifications but has not completed quality and reliability verification.
- TMS** Fully qualified production device.

Support Tool Development Evolutionary Flow:

- TMDX** Development support product that has not yet completed Texas Instruments internal qualification testing.
- TMDS** Fully qualified development support product.

TMX and TMP devices and TMDX development support tools are shipped against the following disclaimer:

"Developmental product is intended for internal evaluation purposes."

Note:

Texas Instruments recommends that prototype devices (TMX or TMP) not be used in production systems since their expected end-use failure rate is undefined but predicted to be greater than standard qualified production devices.

TMS devices and TMDS development support tools have been fully characterized and the quality and reliability of the device has been fully demonstrated. Texas Instruments standard warranty applies.

A.2 Device and Development Support Tool Nomenclature

In addition to the prefix, the device nomenclature includes a suffix that follows the device family name. This suffix indicates the package type (e.g., N, FN, or GB) and temperature range (e.g., L). Figure A-1 provides a legend for reading the complete device name for any TMS320 family member.

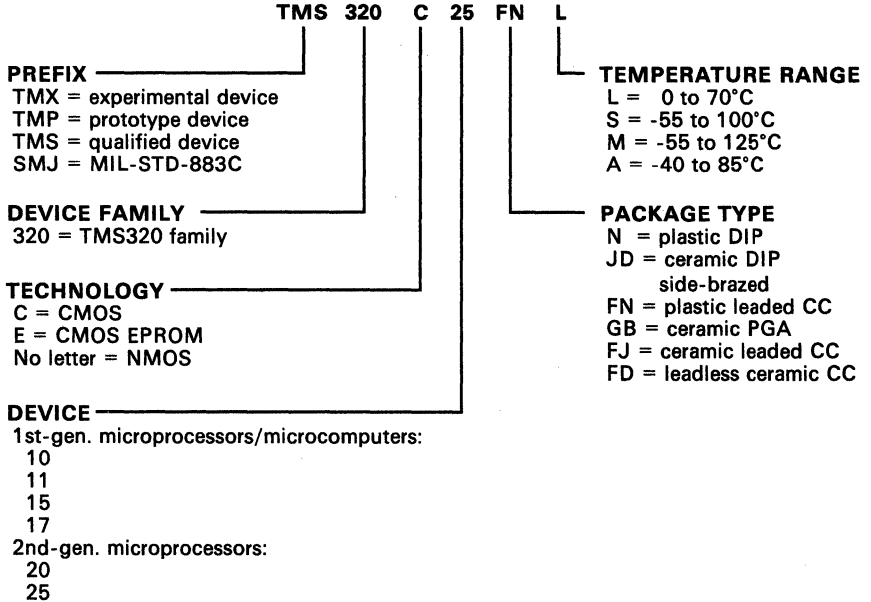
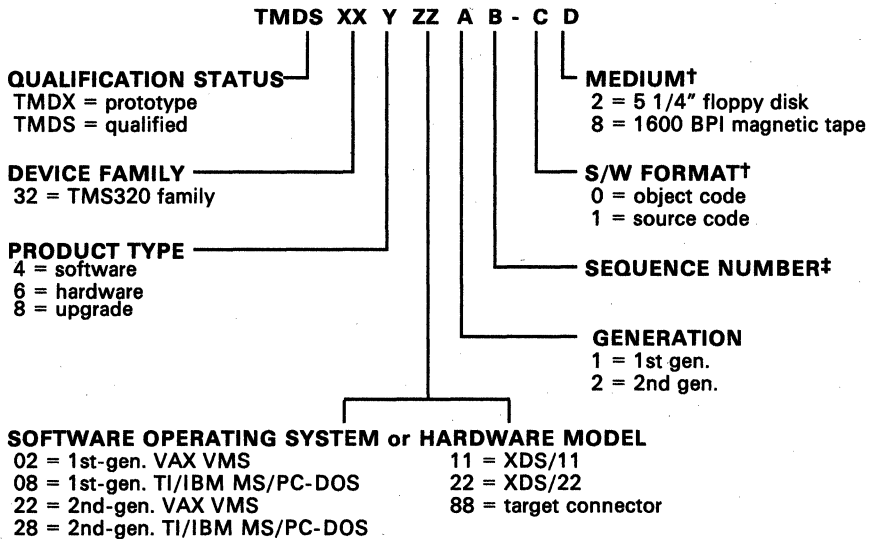

Figure A-1. TMS320 Device Nomenclature

Appendix A - Product Order Information

Figure A-2 provides a legend for reading the part number for any TMS320 hardware or software development tool.



† Software only.
 ‡ Hardware only.

Figure A-2. TMS320 Development Tool Nomenclature

B. Texas Instruments Factory Repair and Exchange Policy

This section specifies the conditions under which a Microprocessor and Microcontroller Products Division (MMPD)¹ systems product may be returned by an end user for repair subject to the terms of the warranty for such product.

Before returning any product for repair, the Factory Repair Center must be contacted at (713) 879-2285, and a return authorization number obtained (and entered on the Exchange/Repair Questionnaire that must be completed and returned with the product).

Texas Instruments shall not be responsible for any product returned without prior authorization from the Factory Repair Center.

When a product returned to TI for repair is deemed acceptable for repair by TI and no request has been made for the return of the same serial-numbered product, TI reserves the option to repair or exchange the product.

Exchanged products will be replaced with refurbished units that meet TI workmanship standards for refurbished products. Such products may have minor visual blemishes, such as touched-up scratches.

Texas Instruments accepts no responsibility for EPROMs containing customer-generated software, which are part of any unit to be repaired.

¹ Formerly Programmable Products Division.

B.1 Normal Warranty Exchange or Repair

Repair or exchange will be made free of charge, provided:

- 1) The customer notifies TI of product failure within the applicable warranty period (90 days from the date of purchase from TI or from a TI authorized distributor).
- 2) TI inspection discloses that the product is defective and that the defect is not the result of accident, misuse, neglect, alteration, improper installation, unauthorized repair, or improper testing.
- 3) The product is restored to the TI standard configuration for that product.

The customer shall be responsible for providing proof of the date of purchase.

B.2 Non-Warranty Exchange or Repair

Non-warranty factory repair or exchange is available on all Microprocessor and Microcontroller Products Division systems products currently being manufactured by MMPD; consult the factory for availability on discontinued products.

Non-warranty exchanges or repairs will be made provided such returned product is repairable. A product is deemed repairable when the cost of repair does not exceed cost of replacement. If a product is not repairable, the customer will be advised that repair cannot be effected and the product returned to the customer at the customer's expense.

The minimum standard charge for non-warranty repairs is given in the price schedule listed in Section 12.5. TI will notify the customer for approval prior to effecting any repair or replacement that exceeds the minimum standard charge.

B.3 Shipping Instructions

The following shipping instructions should be followed to ensure the desired service:

- 1) Before returning any product for repair, the Factory Repair Center must be contacted at (713) 879-2285, and a return authorization number obtained (and entered on the Exchange/Repair Questionnaire).

TI shall not be responsible for any product returned without prior authorization by the factory repair center.

- 2) The following information must accompany the returned product. The TI Factory Repair and Exchange Questionnaire should be used to ensure that the required information is provided:

- Factory Repair Center return authorization number
- Customer name and phone number
- Purchase order number (if applicable)
- Model number

Appendix B - TI Factory Repair and Exchange Policy

- Serial number
- "Ship to" address; instruction for insurance and method of shipment (unless otherwise specified, TI will ship UPS insured for the minimum)
- "Invoice to" address
- Description of symptoms of malfunction
- Type of service requested.

Note:

The customer should retain a copy of the Exchange Questionnaire and shipping documentation in the event that tracing of the product should be necessary.

- 3) The product must be returned freight prepaid, F.O.B. TI Factory Repair Center at:

Texas Instruments Incorporated
Microprocessor and Microcontroller Products Division
Factory Repair Center, MS 6400
9901 South Wilcrest
Houston, Texas 77099

(713) 879-2285

- 4) If the customer has any questions regarding this policy or the returned product status, he may contact the Factory Repair Center directly.

B.4 Customer Configuration

When the customer has made modifications to the product, repair or replacement is considered "non-warranty."

TI will attempt the repair of such a product provided the customer has restored the product to its standard configuration. Labor and material will be charged at the TI then-current standard rate for all necessary removals or repairs to customer-made modifications, if such is required to test the returned product in accordance with the TI specification for that product. TI reserves the right to refuse the repair of any product that has been modified such that the configuration as changed is untestable.

TI shall accept no responsibility for additional components or other devices added to a particular configuration by the customer on a product to be repaired.

Appendix B - TI Factory Repair and Exchange Policy

B.5 Charges, Turnaround Time, and Method of Payment

System level pricing applies when a complete system is returned for repair or exchange. Board level pricing applies only for single boards. Complete systems returned for repair or exchange are normally upgraded to the latest revision; therefore, it is advantageous to return complete systems for repair.

The customer must send payment, either in the form of a money order or check (company, cashier, or certified) with the product to be repaired or exchanged, unless a purchase order is submitted; otherwise, shipment will be C.O.D. Payment must be made payable to Texas Instruments Incorporated.

The customer must prepay transportation and insurance charges for products going to the repair facility. Product returns from the repair facility shall be made F.O.B. TI repair facility. Transportation and insurance charges (if applicable) are added on the invoice (the customer pays freight both ways).

TI shall invoice the customer on the date TI returns the repaired or exchanged product to the customer.

Table B-1 lists the charges for repair or exchange of returned products. The estimated maximum turnaround time given is from receipt of the returned product at the Factory Repair Center. The non-warranty charges are the minimum standard repair charges and subject to change without notice. When the total estimated repair charge exceeds the standard charge, such repair shall have prior approval of the customer.

Table B-1. Repair and Replacement Charges

SERVICE	IN-WARRANTY CHARGE	NON-WARRANTY CHARGE	ESTIMATED MAX. TURNAROUND TIME
SYSTEM LEVEL			
Normal repair	N/C	\$350.00	45 working days
Normal exchange	N/C	\$350.00	10 working days
Expedited exchange	\$200.00	\$500.00	1 working day
BOARD LEVEL			
Normal repair	N/C	\$200.00	45 working days
Normal exchange	N/C	\$350.00	10 working days
Expedited exchange	\$200.00	\$500.00	1 working day

B.6 Expedited Requests

Expedited requests will be accepted when the product submitted for exchange is available from Factory Repair Center inventory. Normal turnaround time for expedited requests is one (1) working day from receipt of the returned product at the Factory Repair Center.

Requests to ship replacement product prior to receipt of the returned unit by the Factory Repair Center will be honored if a purchase order is issued for the current retail price of the product (in addition to the appropriate exchange and shipping charges). Upon receipt of the returned unit at the Factory Repair Center and verification of repairability, credit will be issued in the amount of the price invoiced for the exchange product. A purchase order cannot be accepted for this purpose if the customer does not have credit established with Texas Instruments Incorporated, Semiconductor Group.

B.7 Warranty

Repaired or exchanged assemblies may contain either new parts or refurbished parts of like quality and are warranted to be free of defects in material and workmanship for a period of 30 days from date of shipment, provided such warranty repair shall not operate to reduce the original product warranty. The foregoing warranties for goods are in lieu of all warranties, express, implied, or statutory, including but not limited to, any implied warranties of merchantability and fitness for a particular purpose, and of any other warranty obligation on the part of TI.

C. Texas Instruments Program License Agreement

The following is an example of the program license agreement associated with software development tools available from Texas Instruments. It is included here for information only. Terms and conditions vary slightly depending on the medium of use (i.e., Professional Computer or VAX) and the country of distribution.

TEXAS INSTRUMENTS PROGRAM LICENSE AGREEMENT

This program license agreement is displayed conspicuously in the package so that you can read it before opening the package. Retaining possession of the package and using the program and materials contained in it indicate that you have agreed to the terms and conditions of this agreement. If you do not agree with them, you should promptly return the package unopened to the seller from whom you obtained possession and your money will be refunded.

LICENSE AND TERM

Texas Instruments Incorporated, its subsidiaries (TI), and any applicable licensors grant to you a nonexclusive, nontransferable license to use the software program and related documentation in this package (collectively referred to as the "Program") on a single-user computer. Any attempted sublicense, assignment, or other transfer of the Program or the rights or obligations of this Agreement without the prior written consent of TI shall be void. This license will terminate if you fail to comply with its terms. Use of the Program on a multiple-user system requires payment of additional fees.

Object files designated with the file extension .RTS (RTS Libraries) may be modified and/or merged into another program for your use on a single machine. Any part of the RTS libraries merged into another program will continue to be subject to the terms and conditions of this Agreement, except as expressly provided herein. RTS libraries may be used to create user programs. Such user programs may include copies of code derived from the RTS libraries and/or modifications of these libraries. Such user programs shall not be subject to any restrictions on copying or use.

The Program and documentation are copyrighted. You may make two (2) copies of the Program for backup, modification, and archival purposes. Unauthorized copying, reverse compiling, and disassembling are prohibited. Title to the Program is not transferred to you by this license.

PROGRAM LIMITATIONS

TI does not warrant that the Program will be free from error or will meet your specific requirements. You assume complete responsibility for decisions made or actions taken based on information obtained using the Program. Any statements made concerning the utility of the Program are not to be construed as expressed or implied warranties.

TI makes no warranty or condition, either expressed or implied, including, but not limited to, any implied warranties of merchanta-

Appendix C - TI Program License Agreement

bility and fitness for a particular purpose, regarding the Program and makes the Program available solely on an "as is" basis.

LIMITED WARRANTY ON MEDIA AND DAMAGES DISCLAIMER

The media (not the Program) is warranted to the original purchaser against defects in material and workmanship for a period of three (3) months from the date of original purchase.

Defective media under warranty will be replaced when it is returned postage paid with a copy of the purchase receipt to the TI Semiconductor Group located in Houston, Texas. The replacement media is warranted for three (3) months from date of replacement. Other than the postage requirement (when allowed by law), no charge will be made for the replacement. **This paragraph expresses TI's sole liability and your exclusive remedy.**

Neither TI nor any applicable licensor shall be responsible for incidental or consequential damages. This warranty gives you specific legal rights and you may also have other rights which vary from state to state. Some states do not allow the exclusion or limitations of incidental or consequential damages or limitations on how long an implied warranty lasts, so above limitations or exclusions may not apply to you.

EXPORT CONTROL

The re-export of United States origin software is subject to United States laws under the Export Administration Act of 1969 as amended. Any further sale of the Program shall be in compliance with the United States Department of Commerce administration regulations. Compliance with such regulations is your responsibility and not the responsibility of TI.

Index

A

adaptive filter design (TMS32020) 9-14
ADPCM (TMS32010) 9-11
Allen Ashley 11-2
analog interface board (AIB) 7-21
application reports 9-5
applications 2-12
articles 9-16
ASPI
 ADP (algorithm development
 package) 11-3
 DFDP (digital filter design
 package) 6-10
asynchronous input interface
 (TMS32010) 9-8
Atlanta Signal Processors, Inc.
 (ASPI) 11-3
Avocet Systems, Inc. 11-5

B

Bedford Research 11-5
bulletin board (TMS320) 9-24
Burr Brown Corp. 11-6

C

CMOS devices
 TMS320C10 2-4
 TMS320C10-25 2-4
 TMS320C15/E15 2-4
 TMS320C15-25 2-4
 TMS320C17/E17 2-7

 TMS320C17-25 2-7
 TMS320C25 2-10
companding
 (TMS32010/TMS32020) 9-7
Computalker 11-8
consultants 11-47
control system (TMS32010) 9-12
Crowell, Inc. 11-9
Cybernetic Micro Systems 11-10

D

Daisy Systems Corp. 11-10
Dalanco Spry 11-11
data encryption (TMS32010) 9-10
data sheets 9-4
design kit 7-25
Details on Signal Processing
 newsletter 9-23
development support products 5-1
DFDP (digital filter design
 package) 6-10
DFT/FFT and convolution algorithms
 (TMS32010) 9-13
Digital Audio Corp. 11-12
digital filter design (TMS32010) 9-14
Digital Signal Processing Software, Inc.
 (DSPS) 11-12
Digital Sound Corp. 11-13
documentation 9-1
DSP applications book 9-5
DSP design kit 7-25
DSP design workshops 8-1, 8-3
DSP lab manual (TMS32010) 9-15
DSP lab workstation 10-2
DSP research station 10-3
DSP Software Library 6-13
DSP Technology Corp. 11-14

Index

E

echo cancellation (TMS32020) 9-10
emulator (XDS) 7-9
 upgrade program 7-17
evaluation module (EVM) 7-2
exchange policies B-1
external memory interface
 (TMS32010) 9-9

F

factory repair B-1
FFT implementation (TMS32020) 9-7
FIR/IIR filters
 (TMS32010/TMS32020) 9-6
first-generation devices
 TMS320C10 2-4
 TMS320C10-25 2-4
 TMS320C15/E15 2-4
 TMS320C15-25 2-4
 TMS320C17/E17 2-7
 TMS320C17-25 2-7
 TMS32010 2-4
 TMS32010-14 2-4
 TMS32010-25 2-4
 TMS32011 2-7
floating-point arithmetic
 (TMS32010) 9-7
floating-point arithmetic
 (TMS32020) 9-7
Forth, Inc. 11-15

G

Gas Light Software 11-15
graphics implementation
 (TMS32020) 9-11

H

hardware interface (TMS32020) 9-9
hardware support 7-1
 analog interface board (AIB) 7-21
 DSP design kit 7-25
 emulator (XDS) 7-9
 evaluation module (EVM) 7-2

XDS upgrade program 7-17
Harvard architecture 2-1
Hewlett-Packard 11-16
hotline (TMS320) 9-27
Hyperception 11-18

K

Kontron Electronics 11-19

L

license agreement C-1
linker 6-2
literature 9-1
Loughborough Sound Images Ltd. 11-19

M

macro assembler 6-2
mask options 3-1
matrix multiplication
 (TMS32010/TMS32020) 9-8
MC68000 interface (TMS32020) 9-9
Microcraft Corp. 11-20
Microstuf, Inc. 11-21
modem software (TMS320 Bell
 212A) 6-15
MS/PC-DOS 6-2, 6-5, 6-13

N

newsletter 9-23
nomenclature A-5

O

ordering information A-1

Index

P

Pacific Microcircuits Ltd. 11-22
part numbers A-1
PH Associates 11-21
Pratica SRL 11-25
product bulletins 9-2
product descriptions 9-2
product quality/reliability 4-1
program license agreement C-1
prototype devices 3-1

R

Racal Microelectronics Systems
Ltd. 11-25
reliability tests 4-2
repair policies B-1
ROM codes 3-1
RTC locations 8-4
RTC TMS320 product seminar 8-1

S

second-generation devices
 TMS320C25 2-10
 TMS32020 2-9
seminar 8-2
Sentry Test Systems 11-26
Signal Technology, Inc. 11-26
Signix Corp. 11-27
SIGnology, Inc 11-28
simulator 6-5
sine-wave generation (TMS32010) 9-8
SKY Computers, Inc. 11-29
SoftWare Development System
 (SWDS) 6-7
software library 6-13
software support 6-1
 DFDP (digital filter design
 package) 6-10
 DSP Software Library 6-13
 linker 6-2
 macro assembler 6-2
 simulator 6-5
 SoftWare Development System
 (SWDS) 6-7
 TMS320 Bell 212A modem
 software 6-15

speech coding (TMS32010) 9-14

T

technical articles 9-16
telecom interface (TMS32010) 9-10
TelePhoto Communications 11-33
Televic 11-34
Texas Instruments, Inc. 11-35
textbooks 9-13
third-party address/phone list 11-41
third-party consultants 11-47
third-party support 11-1
 Allen Ashley 11-2
 Atlanta Signal Processors, Inc.
 (ASPI) 11-3
 Avocet Systems, Inc. 11-5
 Bedford Research 11-5
 Burr Brown Corp. 11-6
 Computalker 11-8
 Crowell, Inc 11-9
 Cybernetic Micro Systems 11-10
 Daisy Systems Corp. 11-10
 Dalanco Spry 11-11
 Digital Audio Corp. 11-12
 Digital Signal Processing Software,
 Inc. (DSPS) 11-12
 Digital Sound Corp. 11-13
 DSP Technology Corp. 11-14
 Forth, Inc. 11-15
 Gas Light Software 11-15
 Hewlett-Packard 11-16
 Hyperception 11-18
 Kontron Electronics 11-19
 Loughborough Sound Images
 Ltd. 11-19
 Microcraft Corp. 11-20
 Microstuf, Inc. 11-21
 Pacific Microcircuits Ltd. 11-22
 PH Associates 11-21
 Pratica SRL 11-25
 Racal Microelectronics Systems
 Ltd. 11-25
 Sentry Test Systems 11-26
 Signal Technology, Inc. 11-26
 Signix Corp. 11-27
 SIGnology, Inc 11-28
 SKY Computers, Inc. 11-29
 TelePhoto Communications 11-33
 Televic 11-34
 Texas Instruments, Inc. 11-35
 Thorn EMI Electronics 11-36
 TIAC Manufacturing, Inc. 11-37

Index

Valid Logic Systems 11-38
Votan 11-38
Whitman Engineering, Inc. 11-39
third-party trademarks 11-49
Thorn EMI Electronics 11-36
TI program license agreement C-1
TIAC Manufacturing, Inc. 11-37
TMS320 Bell 212A modem
software 6-15
TMS320 development tool
nomenclature A-6
TMS320 device nomenclature A-5
TMS320 DSP bulletin board 9-24
TMS320 DSP hotline 9-27
TMS320 family members 1-1
first-generation devices 2-4
second-generation devices 2-9
TMS320 product seminar 8-2
TMS320C10 2-4
TMS320C10-25 2-4
TMS320C15/E15 2-4
TMS320C15-25 2-4
TMS320C17/E17 2-7
TMS320C17-25 2-7
TMS320C25 2-10
TMS32010 2-4
TMS32010-14 2-4
TMS32010-25 2-4
TMS32011 2-7
TMS32020 2-9

U

university program 10-1
upgrade program (XDS) 7-17
user's guides 9-3

V

Valid Logic Systems 11-38
VAX/VMS 6-2, 6-5, 6-13
Votan 11-38

W

warranties 7-17, B-1, B-5
Whitman Engineering, Inc. 11-39
workshops 8-3

X

XDS emulator 7-9
upgrade program 7-17

TI Sales Offices

ALABAMA: Huntsville (205) 837-7530.

ARIZONA: Phoenix (602) 995-1007;
Tucson (602) 624-3276.

CALIFORNIA: Irvine (714) 660-8187;
Sacramento (916) 929-1521;
San Diego (619) 278-9601;
Santa Clara (408) 980-9000;
Torrance (213) 217-7010;
Woodland Hills (818) 704-7759.

COLORADO: Aurora (303) 868-8000.

CONNECTICUT: Wallingford (203) 269-0074.

FLORIDA: Ft. Lauderdale (305) 973-8502;
Maitland (305) 660-4600; Tampa (813) 870-6420.

GEORGIA: Norcross (404) 662-7900.

ILLINOIS: Arlington Heights (312) 640-2925.

INDIANA: Ft. Wayne (219) 424-5174;
Indianapolis (317) 246-8555.

IOWA: Cedar Rapids (319) 395-9650.

MARYLAND: Baltimore (301) 944-8600.

MASSACHUSETTS: Waltham (617) 895-9100.

MICHIGAN: Farmington Hills (313) 553-1500;
Grand Rapids (616) 957-4200.

MINNESOTA: Eden Prairie (612) 828-9300.

MISSOURI: Kansas City (816) 523-2500;
St. Louis (314) 569-7600.

NEW JERSEY: Iselin (201) 750-1050.

NEW MEXICO: Albuquerque (505) 345-2555.

NEW YORK: East Syracuse (315) 463-9291;
Endicott (607) 754-3900; Melville (516) 454-6600;
Pittsford (716) 385-6770;
Poughkeepsie (914) 473-2900.

NORTH CAROLINA: Charlotte (704) 527-0930;
Raleigh (919) 876-2725.

OHIO: Beachwood (216) 464-6100;
Dayton (513) 258-3877.

OREGON: Beaverton (503) 643-6758.

PENNSYLVANIA: Ft. Washington (215) 643-6450;
Coraopolis (412) 771-8550.

PUERTO RICO: Hato Rey (809) 753-8700.

TEXAS: Austin (512) 250-7655;
Houston (713) 778-6592; Richardson (214) 680-5082;
San Antonio (512) 496-1779.

UTAH: Murray (801) 266-8972.

VIRGINIA: Fairfax (703) 849-1400.

WASHINGTON: Redmond (206) 881-3080.

WISCONSIN: Brookfield (414) 785-7140.

CANADA: Nepean, Ontario (613) 726-1970;
Richmond Hill, Ontario (416) 884-9181;
St. Laurent, Quebec (514) 335-8392.

TI Regional Technology Centers

CALIFORNIA: Irvine (714) 660-8140,
Santa Clara (408) 748-2220.

GEORGIA: Norcross (404) 662-7945.

ILLINOIS: Arlington Heights (312) 640-2909.

MASSACHUSETTS: Waltham (617) 895-9197.

TEXAS: Richardson (214) 680-5066.

CANADA: Nepean, Ontario (613) 726-1970.

Customer Response Center

TOLL FREE: (800) 232-3200

OUTSIDE USA: (214) 995-6611

(8:00 a.m. — 5:00 p.m. CST)

TI Distributors

TI AUTHORIZED DISTRIBUTORS IN USA

Arrow Electronics
Diplomat Electronics
General Radio Supply Company
Graham Electronics
Kierulff Electronics
Hall-Mark Electronics
Hall-Mark Electronics
Kierulff Electronics
Marshall Industries
Milgray Electronics
Newark Electronics
Time Electronics
R.V. Weatherford Co.
Wyle Laboratories
Zeus Component, Inc. (Military)

TI AUTHORIZED DISTRIBUTORS IN CANADA

Arrow Electronics Canada
Future Electronics

TI AUTHORIZED DISTRIBUTORS IN USA

— OBSOLETE PRODUCT ONLY —
Rochester Electronics, Inc.
Newburyport, Massachusetts
(617) 462-9332

ALABAMA: Arrow (205) 837-6955;
Hall-Mark (205) 837-8700; Kierulff (205) 883-6070;
Marshall (205) 881-9235.

ARIZONA: Arrow (602) 968-4800;
Hall-Mark (602) 437-1200; Kierulff (602) 437-0750;
Marshall (602) 968-6181; Wyle (602) 866-2888.

CALIFORNIA: Los Angeles/Orange County:
Arrow (818) 701-7500, (714) 838-5422;
Hall-Mark (818) 716-7300, (714) 669-4700,
(213) 217-8400; Kierulff (213) 725-0325, (714) 731-5711,
(714) 220-6300; Marshall (818) 407-0101,
(818) 442-7204, (714) 660-0951.

R.V. Weatherford (714) 966-1447, (213) 849-3451,
Wyle (213) 322-8100, (818) 880-9001, (714) 863-9953;
Zeus (714) 632-6880;
Sacramento: Arrow (916) 925-7456;
Hall-Mark (916) 722-8600; Marshall (916) 635-9700;
Wyle (916) 638-5282;

San Diego: Arrow (619) 565-4800;
Hall-Mark (619) 268-1201; Kierulff (619) 278-2112;
Marshall (619) 578-9600; Wyle (619) 565-9171;
San Francisco Bay Area: Arrow (408) 745-6600;
(415) 487-4600; Hall-Mark (408) 946-0300;
Kierulff (408) 971-2600; Marshall (408) 943-4600;
Wyle (408) 727-2500; Zeus (408) 998-5121.

COLORADO: Arrow (303) 696-1111;
Hall-Mark (303) 790-1662; Kierulff (303) 790-4444;
Wyle (303) 457-9953.

CONNECTICUT: Arrow (203) 265-7741;
Diplomat (203) 797-9674; Hall-Mark (203) 269-0100;
Kierulff (203) 265-1115; Marshall (203) 265-3822;
Milgray (203) 795-0714.

FLORIDA: Ft. Lauderdale: Arrow (305) 429-8200;
Diplomat (305) 974-8700; Hall-Mark (305) 971-9280;
Kierulff (305) 486-4004; Marshall (305) 928-0661;
Orlando: Arrow (305) 725-1480;
Hall-Mark (305) 865-4022; Marshall (305) 841-1878;
Milgray (305) 847-5747; Zeus (305) 365-3000;
Tampa: Arrow (813) 576-8995;
Diplomat (813) 443-4514; Hall-Mark (813) 530-4543;
Kierulff (813) 576-1966.

GEORGIA: Arrow (404) 449-8252;
Hall-Mark (404) 447-8000; Kierulff (404) 447-5254;
Marshall (404) 923-5750.

ILLINOIS: Arrow (312) 397-3440;
Diplomat (312) 595-1000; Hall-Mark (312) 860-3800;
Kierulff (312) 250-0500; Marshall (312) 490-0155;
Newark (312) 784-5100.

INDIANA: Indianapolis: Arrow (317) 243-9353;
Graham (317) 634-8202; Hall-Mark (317) 872-8875;
Marshall (317) 297-0483;
Ft. Wayne: Graham (219) 423-3422.

IOWA: Arrow (319) 395-7230.

KANSAS: Kansas City: Arrow (913) 541-9542;
Hall-Mark (913) 888-4747; Marshall (913) 492-3121.

MARYLAND: Arrow (301) 995-0003;
Diplomat (301) 995-1226; Hall-Mark (301) 988-9800;
Kierulff (301) 636-5800; Milgray (301) 995-6169;
Marshall (301) 840-9450; Zeus (301) 997-1118.

MASSACHUSETTS: Arrow (617) 933-8130;
Diplomat (617) 667-4670; Hall-Mark (617) 667-0902;
Kierulff (617) 667-8331; Marshall (617) 272-8200;
Time (617) 532-6200; Zeus (617) 863-8600.

MICHIGAN: Detroit: Arrow (313) 971-8220;
Marshall (313) 525-5850; Newark (313) 967-0600;
Grand Rapids: Arrow (616) 243-0912.

MINNESOTA: Arrow (612) 830-1800;
Hall-Mark (612) 941-2600; Kierulff (612) 941-7500;
Marshall (612) 559-2211.

MISSOURI: St. Louis: Arrow (314) 567-6888;
Hall-Mark (314) 291-5350; Kierulff (314) 739-0855.

NEW HAMPSHIRE: Arrow (603) 668-6968.

NEW JERSEY: Arrow (201) 575-5300, (609) 596-8000; Diplomat (201) 785-1830; General Radio (609) 964-8560; Hall-Mark (201) 575-4415, (609) 235-1900; Kierulff (201) 575-6750, (609) 235-1444; Marshall (201) 582-0320, (609) 234-9100; Milgray (609) 983-5010.

NEW MEXICO: Arrow (505) 243-4566.

NEW YORK: Long Island: Arrow (516) 231-1000;
Diplomat (516) 454-6400;
Hall-Mark (516) 737-0600; Marshall (516) 273-2053;
Milgray (516) 428-8900; Zeus (516) 937-7400;
Rochester: Arrow (716) 427-0300;
Marshall (716) 235-7620; Diplomat (716) 359-4400;
Syracuse: Arrow (315) 652-1000;
Marshall (607) 798-1611.

NORTH CAROLINA: Arrow (919) 876-3132,
(919) 725-8711; Hall-Mark (919) 872-0712;
Kierulff (919) 872-8410; Marshall (919) 878-9882.

OHIO: Cleveland: Arrow (216) 248-3990;
Hall-Mark (216) 349-4632; Kierulff (216) 831-5222;
Marshall (216) 248-1788.

Columbus: Arrow (614) 885-8362;
Hall-Mark (614) 888-3313;
Dayton: Arrow (513) 435-5563;
Graham (513) 435-8660; Kierulff (513) 439-0045;
Marshall (513) 236-8088.

OKLAHOMA: Arrow (918) 665-7700;
Kierulff (918) 252-7537.

OREGON: Arrow (503) 684-1690;
Kierulff (503) 641-9153; Wyle (503) 640-6000;
Marshall (503) 644-5050.

PENNSYLVANIA: Arrow (412) 856-7000,
(215) 928-1800; General Radio (215) 922-7037.

RHODE ISLAND: Arrow (401) 431-0980.

TEXAS: Austin: Arrow (512) 835-4180;
Hall-Mark (512) 258-8848; Kierulff (512) 835-2090;
Marshall (512) 337-1991; Wyle (512) 834-9957;
Dallas: Arrow (214) 380-6464;
Hall-Mark (214) 553-4300; Kierulff (214) 343-2400;
Marshall (214) 233-5200; Wyle (214) 235-9953;
Zeus (214) 783-7010;

Houston: Arrow (713) 530-4700;
Hall-Mark (713) 781-6100; Kierulff (713) 530-7030;
Marshall (713) 895-9200; Wyle (713) 879-9903.

UTAH: Arrow (801) 972-0044;
Diplomat (801) 486-4134;
Hall-Mark (801) 268-3779; Kierulff (801) 973-6913;
Wyle (801) 974-9953.

WASHINGTON: Arrow (206) 643-4800;
Kierulff (206) 575-4420; Wyle (206) 408-453-8300;
Marshall (206) 747-9100.

WISCONSIN: Arrow (414) 792-0150;
Hall-Mark (414) 797-7844; Kierulff (414) 784-8160;
Marshall (414) 797-8400.

CANADA: Calgary: Future (403) 235-5325;
Edmonton: Future (403) 438-2858;
Montreal: Arrow Canada (514) 735-5511;
Future (514) 694-7710;

Ottawa: Arrow Canada (613) 226-6903;
Future (613) 820-8313;
Quebec City: Arrow Canada (418) 687-4231;
Toronto: Arrow Canada (416) 661-0220;
Future (416) 638-4774;

Vancouver: Future (604) 294-1166
Winnipeg: Future (204) 339-0554



TEXAS INSTRUMENTS

TI Worldwide Sales Offices

ALABAMA: Huntsville: 500 Wynn Drive, Suite 514, Huntsville, AL 35805, (205) 837-7530.

ARIZONA: Phoenix: 8825 N. 23rd Ave., Phoenix, AZ 85021, (602) 995-1007.

CALIFORNIA: Irvine: 17891 Cartwright Rd., Irvine, CA 92714, (714) 860-8187; Sacramento: 1900 Point West Way, Suite 171, Sacramento, CA 95815, (916) 929-1521; San Diego: 4333 View Ridge Ave., Suite B., San Diego, CA 92123, (619) 278-9601; Santa Clara: 5353 Betsy Ross Dr., Santa Clara, CA 95054, (408) 980-9000; Torrance: 690 Knox St., Torrance, CA 90502, (213) 217-7010; Woodland Hills: 21220 Erwin St., Woodland Hills, CA 91367, (818) 704-7559.

COLORADO: Aurora: 1400 S. Potomac Ave., Suite 101, Aurora, CO 80012, (303) 368-8000.

CONNECTICUT: Wallingford: 9 Barnes Industrial Park Rd., Barnes Industrial Park, Wallingford, CT 06492, (203) 269-0074.

FLORIDA: Ft. Lauderdale: 2765 N.W. 62nd St., Ft. Lauderdale, FL 33309, (305) 973-8502; Maitland: 2601 Maitland Center Parkway, Maitland, FL 32751, (305) 660-4600; Tampa: 5010 W. Kennedy Blvd., Suite 101, Tampa, FL 33609, (813) 870-6420.

GEORGIA: Norcross: 5515 Spalding Drive, Norcross, GA 30092, (404) 662-7900.

ILLINOIS: Arlington Heights: 515 W. Algonquin, Arlington Heights, IL 60005, (312) 640-2925.

INDIANA: Ft. Wayne: 2020 Inwood Dr., Ft. Wayne, IN 46815, (219) 424-5174; Indianapolis: 2346 S. Lynhurst, Suite J-400, Indianapolis, IN 46241, (317) 248-8555.

IOWA: Cedar Rapids: 373 Collins Rd. NE, Suite 200, Cedar Rapids, IA 52402, (319) 395-9550.

MARYLAND: Baltimore: 1 Rutherford Pl., 7133 Rutherford Rd., Baltimore, MD 21207, (301) 944-8600.

MASSACHUSETTS: Waltham: 504 Totten Pond Rd., Waltham, MA 02154, (617) 895-9100.

MICHIGAN: Farmington Hills: 33737 W. 12 Mile Rd., Farmington Hills, MI 48018, (313) 553-1500.

MINNESOTA: Eden Prairie: 11000 W. 78th St., Eden Prairie, MN 55344, (612) 828-9300.

MISSOURI: Kansas City: 8080 Ward Pkwy., Kansas City, MO 64114, (816) 523-2500; St. Louis: 11816 Borman Drive, St. Louis, MO 63146, (314) 569-7600.

NEW JERSEY: Isselin: 485 E. U.S. Route 1 South, Parkway Towers, Isselin, NJ 08830, (201) 750-1050.

NEW MEXICO: Albuquerque: 2820-D Broadbent Pkwy NE, Albuquerque, NM 87107, (505) 345-2555.

NEW YORK: East Syracuse: 6365 Collamer Dr., East Syracuse, NY 13057, (315) 463-9291; Endicott: 112 Nanticoke Ave., P.O. Box 618, Endicott, NY 13760, (607) 754-3300; Melville: 1 Huntington Quadrangle, Suite 3C10, P.O. Box 2936, Melville, NY 11747, (516) 454-6600; Pittsford: 2851 Clover St., Pittsford, NY 14534, (716) 385-6770; Poughkeepsie: 385 South Rd., Poughkeepsie, NY 12601, (914) 473-2900.

NORTH CAROLINA: Charlotte: 8 Woodlawn Green, Woodlawn Rd., Charlotte, NC 28210, (704) 527-0930; Raleigh: 2809 Highlands Blvd., Suite 100, Raleigh, NC 27625, (919) 876-2725.

OHIO: Beachwood: 23408 Commerce Park Rd., Beachwood, OH 44122, (216) 464-6100; Dayton: Kingsley Bldg., 4124 Linden Ave., Dayton, OH 45432, (513) 258-3877.

OREGON: Beaverton: 6700 SW 105th St., Suite 110, Beaverton, OR 97005, (503) 643-6758.

PENNSYLVANIA: Ft. Washington: 260 New York Dr., Ft. Washington, PA 19034, (215) 643-6450; Coraopolis: 420 Rouser Rd., 3 Airport Office Park, Coraopolis, PA 15108, (412) 771-8550.

PUERTO RICO: Hato Rey: Mercantil Plaza Bldg., Suite 505, Hato Rey, PR 00919, (809) 753-8700.

TEXAS: Austin: P.O. Box 2909, Austin, TX 78769, (512) 250-7655; Houston: 1001 E. Campbell Rd., Houston, TX 77060, (214) 680-5082; Richardson: 9100 Southwest Fryw., Suite 237, Houston, TX 77036, (713) 778-6592; San Antonio: 1000 Central Parkway South, San Antonio, TX 78232, (512) 496-1779.

UTAH: Murray: 5201 South Green SE, Suite 200, Murray, UT 84107, (801) 266-8972.

VIRGINIA: Fairfax: 2750 Sperry, Fairfax, VA 22031, (703) 849-1400.

WASHINGTON: Redmond: 5010 148th NE, Bldg B, Suite 107, Redmond, WA 98052, (206) 881-3080.

WISCONSIN: Brookfield: 4800 N. Sunny Slope, Suite 150, Brookfield, WI 53005, (414) 785-7140.

CANADA: Nepean: 301 Moodie Drive, Mallorn Centre, Nepean, Ontario, Canada, K2H9C4, (613) 726-1970; Richmond Hill: 280 Centre St. E., Richmond Hill L4C1B1, Ontario, Canada (416) 884-9181; St. Laurent: Ville St. Laurent Quebec, 9460 Trans Canada Hwy., St. Laurent, Quebec, Canada H4S1R7, (514) 335-8392.

ARGENTINA: Texas Instruments Argentina S.A.I.C.F.: Esmeralda 130, 15th Floor, 1035 Buenos Aires, Argentina, 1 + 394-3008.

AUSTRALIA (& NEW ZEALAND): Texas Instruments Australia Ltd.: 6-10 Talavera Rd., North Ryde (Sydney), New South Wales, Australia 2113, 2 + 887-1122; 5th Floor, 418 St. Kilda Road, Melbourne, Victoria, Australia 3004, 3 + 267-4677; 171 Philip Highway, Elizabeth, South Australia 5112, 8 + 255-2066.

AUSTRIA: Texas Instruments Ges.m.b.H.: Industriestrasse B/16, A-2345 Brunn/Gebirge, 2236-846210.

BELGIUM: Texas Instruments N.V. Belgium S.A.: Mercure Centre, Raketstraat 100, Rue de la Fusee, 1130 Brussels, Belgium, 21720.80.00.

BRAZIL: Texas Instruments Electronicos do Brasil Ltda.: Rua Paes Leme, 524-7, Andar Pinheiros, 05424 Sao Paulo, Brazil, 0815-6166.

DENMARK: Texas Instruments A/S, Mairerundvej 46E, DK-2730 Herlev, Denmark, 2 - 91 74 00.

FINLAND: Texas Instruments Finland OY: Teollisuuskatu 19D 00511 Helsinki S1, Finland, (90) 701-3133.

FRANCE: Texas Instruments France: Headquarters and Prod. Plant, BP 05, 06270 Villeneuve-Loubet, (03) 20-01-01; Paris Office, BP 67 10 Avenue Morane-Saulnier, 78141 Velizy-Villacoublay, (3) 946-97-12; Lyon Sales Office, L'Oree D'Ecully, Batiment B, Chemin de la Foresterie, 69130 Ecully, (7) 833-04-40; Strasbourg Sales Office, Le Sebastopol 3, Quai Kleber, 67055 Strasbourg Cedex, (88) 22-12-66; Rennes, 23-25 Rue du Puits Mauget, 35100 Rennes, (99) 31-54-86; Toulouse Sales Office, Le Peripole-2, Chemin du Pigeonnier de la Cepiere, 31100 Toulouse, (61) 44-18-19; Marseille Sales Office, Nolly Paradis-146 Rue Paradis, 13006 Marseille, (91) 37-25-30.

GERMANY (Fed. Republic of Germany): Texas Instruments Deutschland GmbH: Hauptgertstrasse 1, D-9050 Freising, 8161 + 80-4591; Kurtgerstendamm 195/196, D-1000 Berlin 15, 30 + 882-7365; III, Hagen 43/Kibbelstrasse, 19, D-4300 Essen, 201-24250; Frankfurter Allee 6-8, D-6236 Eschborn 1, 06196 + 8070; Hamburgerstrasse 11, D-2000 Hamburg 76, 040 + 220-1154; Kirchhorsterstrasse 2, D-3000 Hannover 51, 511 + 64821; Maybachstrasse 11, D-7302 Ostfildern 2-Neilingen, 111 + 547001; Mixkiron 19, D-2000 Hamburg 60, 40 + 637 + 0061; Postfach 1309, Roonstrasse 16, D-5400 Koblenz, 261 + 35044.

HONG KONG (+ PEOPLES REPUBLIC OF CHINA): Texas Instruments Asia Ltd., 8th Floor, World Shipping Centre, Harbour City, 7 Canton Rd., Kowloon, Hong Kong, 3 + 722-1223.

IRELAND: Texas Instruments (Ireland) Limited: Brewery Rd., Stillorgan, County Dublin, Eire, 1 831311.

ITALY: Texas Instruments Semiconduttori Italia Spa: Viale Delle Scienze 1, 02015 Cittaducale (Rieti), 0746 684 1; Via Salaria Km 24, (Palazzo Cosma), Monterotondo Scalo (Rome), Italy, 6 + 9003241; Viale Europa, 38-44, 20093 Cologno Monzese (Milano), 2 2532541; Corso Svizzera, 185, 10100 Torino, Italy, 11 77455; Via J. Barozzi 6, 40100 Bologna, Italy, 51 35585.

JAPAN: Texas Instruments Asia Ltd.: 4F Aoyama Fuji Bldg., 6-12, Kita Aoyama 3-Chome, Minato-ku, Tokyo, Japan 107, 3-498-2111; Osaka Branch, 5F, Nishisho Iwai Bldg., 30 Imabashi 3-Chome, Higashi-ku, Osaka, Japan 541, 06-204-1881; Nagoya Branch, 7F Daini Toyota West Bldg., 10-27, Meieki 4-Chome, Nakamura-ku Nagoya, Japan 460, 52-583-8691.

KOREA: Texas Instruments Supply Co.: 3rd Floor, Samon Bldg., Yuksam-Dong, Gangnam-ku, 135 Seoul, Korea, 2 + 462-8001.

MEXICO: Texas Instruments de Mexico S.A.: Mexico City, AV Reforma No. 450 - 10th Floor, Mexico, D.F., 06600, 5 + 514-3003.

MIDDLE EAST: Texas Instruments: No. 13, 1st Floor Mannai Bldg., Diplomatic Area, P.O. Box 26335, Manama Bahrain, Arabian Gulf, 973 + 274681.

NETHERLANDS: Texas Instruments Holland B.V., P.O. Box 12995, (Bullewijk) 1100 CB Amsterdam, Zuid-Oost, Holland 20 + 5602911.

NORWAY: Texas Instruments Norway A/S: PB106, Refstad 131, Oslo 1, Norway, (2) 155090.

PHILIPPINES: Texas Instruments Asia Ltd.: 14th Floor, Ba- Lepanto Bldg., 8477 Paseo de Roxas, Makati, Metro Manila, Philippines, 2 + 9189897.

PORTUGAL: Texas Instruments Equipamento Electronico (Portugal), Lda.: Rua Eng. Frederico Ulrich, 2650 Moreira Da Maia, 4470 Maia, Portugal, 2-948-1003.

SINGAPORE (+ INDIA, INDONESIA, MALAYSIA, THAILAND): Texas Instruments Asia Ltd.: 12 Lorong Bakar Batu, Unit 01/02, Kolam Ayer Industrial Estate, Republic of Singapore, 747-2255.

SPAIN: Texas Instruments Espana, S.A.: C/ Jose Lazaro Galdiano No. 6, Madrid 16, 1458-1458.

SWEDEN: Texas Instruments International Trade Corporation (Sverigefilialen): Box 39103, 10054 Stockholm, Sweden, 8 - 235480.

SWITZERLAND: Texas Instruments, Inc., Reidstrasse 6, CH-8953 Dietikon (Zuerich) Switzerland, 1-740 2220.

TAIWAN: Texas Instruments Supply Co.: Room 903, 205 Tun Hwan Rd., 71 Sung-Kiang Road, Taipei, Taiwan, Republic of China, 2 + 521-9321.

UNITED KINGDOM: Texas Instruments Limited: Manton Lane, Bedford, MK41 7PA, England, 0234 67466; St. James House, Wellington Road North, Stockport, SK4 2RT, England, 61 + 442-7162.



TEXAS INSTRUMENTS

Creating useful products and services for you

BM

Development Support Tools List (Cont)

TOOL	DESCRIPTION
ALL TMS320 DEVICES	
DFDP/IBM001	DFDP (IBM PC)
DFDP/TI001	DFDP (TI PC)
TMDC3240212-18	S/W Library (VAX VMS)
TMDC3240812-12	S/W Library (TI/IBM PC)
TMS320DDK	TMS320 Design Kit

Target Connector List

TARGET CONNECTOR	PART NUMBER
C10 XDS: 40-pin DIP (incl) 44-lead PLCC (opt)	TMDS3288810
C10 XDS Upgrade: 40-pin DIP (incl) 44-lead PLCC (opt)	TMDS3288810
10 EVM: Ribbon cable (incl)	
C25 XDS: PGA/PLCC (incl) PGA/PLCC (opt) PGA (opt)	TMDS3288825 TMDS3288820
C25 XDS Upgrade: PGA/PLCC (incl) PGA/PLCC (opt) PGA (opt)	TMDS3288825 TMDS3288820
20/C25 EVM: Ribbon cable (incl) PGA/PLCC (opt) PGA (opt)	TMDS3288825 TMDS3288820

To order literature:

TI Customer Response Center (CRC)
Hotline Number 1-800-232-3200.

For technical updates:

TMS320 DSP Bulletin Board Service
(713) 879-2091.

For technical support:

TMS320 DSP Hotline
(713) TRY-A 320.

For course and workshop information:

RTC Telephone Numbers:

Atlanta	(404) 662-7945
Boston	(617) 895-9196
Chicago	(312) 640-2909
Dallas	(214) 680-5066
N. Calif.	(408) 748-2220
S. Calif.	(714) 660-8140
Canada	(613) 726-1970

TMS320 DEVELOPMENT SUPPORT Reference Card

TMS320 Device List

DEVICE	FREQ. (MHz)	MEMORY		
		ON-CHIP RAM	CHIP ROM	OFF-CHIP PROG
TMS32010NL	20	144	1.5K	4K
TMS32010NL-14	14	144	1.5K	4K
TMS32010NL-25	25	144	1.5K	4K
TMS32011NL	20	144	1.5K	
TMS320C10NL	20	144	1.5K	4K
TMS320C10NL-25	25	144	1.5K	4K
TMS320C10FNL	20	144	1.5K	4K
TMS320C15NL	20	256	4K	4K
TMS320C15NL-25	25	256	4K	4K
TMS320E15JDL	20	256	4K	4K
TMS320C17NL	20	256	4K	
TMS320C17NL-25	25	256	4K	
TMS320E17JDL	20	256	4K	
TMS32020GBL	20	544		64K*
TMS320C25GBL	40	544	4K	64K*
TMS320C25FNL	40	544	4K	64K*

*64K program and data memory.

Legend:

C=CMOS, E=CMOS EPROM, others=NMOS.

N=pl.DIP, JD=cer.DIP, FN=PLCC, GB=PGA.

L=std. temp. range $T_A=0-70^{\circ}\text{C}$.

Development Support Tools List

TOOL	DESCRIPTION
FIRST GENERATION	
TMDS3240210-08	Assm/Lnk (VAX/VMS)
TMDS3240810-02	Assm/Lnk (TI/IBM PC)
TMDS3240211-08	Simulator (VAX/VMS)
TMDS3240811-02	Simulator (TI/IBM PC)
TMDX3240813-12	Modem S/W (TI/IBM PC)
RTC/EVM320A-03	EVM
TMDS3262211	XDS/22
TMDS3282215	XDS/22 Factory Upgrade
TMDS3282216	XDS/22 Cust. Upgrade
RTC/EVM320C-06	AIB
SECOND GENERATION	
TMDS3242210-08	Assm/Lnk (VAX VMS)
TMDS3242810-02	Assm/Lnk (TI/IBM PC)
TMDS3242211-08	Simulator (VAX VMS)
TMDS3242811-02	Simulator (TI/IBM PC)
TMDS3268821	SWDS (TI/IBM PC)
TMDS3268822	EVM
TMDS3262221	XDS/22
TMDS3282225	XDS/22 Factory Upgrade
TMDS3282226	XDS/22 Cust. Upgrade
TMDS3281125	XDS/11 Factory Upgrade
TMDS3281126	XDS/11 Cust. Upgrade
RTC/ADP320A-06	AIB Adaptor

Third-Party/Product Support List

COMPANY	PRODUCT SUPPORT
Allen Ashley (818) 793-5748	TMS32010/20: Assm, Sim (TI/IBM PC, CP/M-80)
Atlanta Signal Processors (404) 892-7265	TMS32010/20: Algo Devt Pkg, Dig Filter Design Pkg, Subband Coder (TI PC, IBM PC/XT/AT, BIOS)
Avocet Systems (800) 448-8500	TMS32010/20: Assm (VAX UNIX, IBM PC)
Bedford Research (617) 275-7246	TMS32010/20: Interactive Signal Proc S/W (IBM PC, PDP-11, VAX)
Burr Brown (602) 746-1111	TMS32010: Analog Input Bd, DSP Bd (VMEbus)
Computalker (213) 828-6546	TMS32010/20/C25: Assm, Sim, Comp (IBM PC/XT/AT, Apple, Amiga, CP/M)
Crowell, Inc. (205) 837-8233	TMS32020: Assm (IBM PC)
Cybernetic Micro Systems (415) 726-3000	TMS32010: Assm, EPROM Programmer (IBM PC)
Daisy Systems (415) 960-0123	TMS32010/20: Eng Wkstn (LOGICIAN, IBM AT)
Dalanco Spry (202) 232-7999	TMS32010: DSP Bd (IBM PC/XT/AT)
Digital Audio (919) 848 0845	TMS32010: DSP Lab with Voice Enhancement (N/A)
Digital Signal Processing Software (613) 825-5476	TMS32010: Assm, FFT/LPC Speech Algo, Signal Lab (PDP-11, VAX VMS, TI/IBM PC)
Digital Sound (805) 569-0700	TMS32010: Audio Conv Sys (ILS, SPIRE, I*S*P)
DSP Technology (214) 247-8831	TMS32010: DTMF Detector, MF Decoder, Conf Sys (N/A)
Forth (213) 372-8493	TMS32020: DSP S/W Proto- typing Sys (IBM XT)
Gas Light Software (713) 729-1257	TMS32010: Dig Filtering Prog (TI PC, IBM PC/XT/ AT, 8087)
Hewlett-Packard (800) 447-3282	TMS32010: Emulator, Analyzers, Assm/Lnk (HP 64000 LDS)
Hyperception (214) 828-3508	TMS320: DSP S/W, Assm, VMEbus Card (IBM PC, VMEbus)
Kontron Electronics (800) 227-8834	TMS32010: Logic Analyzer, Disassm (N/A)
Loughborough Sound Images (44) 509 231843	TMS32020: DSP Bd, Monitor Prog (IBM PC)

Third-Party/Product Support List (Cont)

COMPANY	PRODUCT SUPPORT
Microcraft (414) 241-8144	TMS32010 DSP Devt Bd (TI/IBM PC)
Microstuf (404) 998-3998	TMS320: Data Comm S/W (TI/IBM PC, CP/M, MP/M)
PH Associates (703) 281-5762	TMS32010/20: Assm (IBM PC, CP/M, TurboDos, PDP-11, UNIX, Tektronix 8560)
Pacific Micro- circuits (604) 536-1886	TMS32010: I/F ICs, Devt Bd (IBM PC)
Pratica SRL 11/503427	TMS32010: S/W Devt Sys (Olivetti PC, IBM PC/XT/AT, VAX VMS/UNIX/XENIX/ MICROVAX, PDP-11, ATT 3B2)
Racal Micro- electronics Systems (44) 0734 868601	TMS32020: DSP Card (VMEbus)
Sentry Test Systems (408) 947-3626	TMS32010/20: Test Prog (Sentry test sys)
Signal Tech- nology (800) 235-5787	TMS32010: DSP/Speech S/W (IBM PC/XT, VAX VMS, UNIX, PDP-11, RT-11, RSX-11)
Signix (617) 358-5955	TMS320: Dig Filter Design, Sys Sim (IBM PC, 8087)
SIGNology (408) 374-6464	TMS320: DSP Devt/Meas Sys (IBM PC/XT/AT)
SKY Computers, (617) 454-6200	TMS32010/20: DSP Bd w/ C Comp (IBM PC, PDP-11, Q-Bus, VMEbus)
TelePhoto Communications (619) 452-0903	TMS32020: Devt Sys, Color Image Compression S/W (IBM PC/XT/AT)
Televic 32-51-30-30-45	TMS32010: DSP Comp, Lnk, Lib (VAX, PDP-11, TI/IBM PC)
Texas Instru- ments (800) 527-3500	TMS32010: Speech Devt Sys (TI/IBM PC)
Thorn EMI Electronics 61-8-256-0229	TMS32010: S/W Spt Pkg (Eclipse S130 AOS)
TIAC Manufactur- ing (604) 461-0120	TMS32010: DSP Mainframe, Analog I/O Bd, S/W Pkg (IBM PC/AT/XT)
Valid Logic Systems (408) 945-9400	TMS320: Sim Sys (Valid Wkstn)
Votan (415) 490-7600	TMS32010: Speech Bd (IBM PC)
Whitman Engineering (303) 493-1797	TMS32010/20: Product Devt Sys, DSP Wkstn (TI PC, 8087, IBM PC/XT)

December 1986
Printed in U.S.A.



SPRU011