

Word Processing System Communications Options User's Manual

Preliminary, December 1978
1st Edition, February 1979

Copyright © 1979 by Digital Equipment Corporation

The information in this document is subject to change without notice and should not be construed as a commitment by Digital Equipment Corporation. Digital Equipment Corporation assumes no responsibility for any errors that may appear in this document.

The software described in this document is furnished under a license and may not be used or copied except in accordance with the terms of such license.

Digital Equipment Corporation assumes no responsibility for the use or reliability of its software on equipment that is not supplied by DIGITAL.

Printed in U.S.A.

The following are trademarks of Digital Equipment Corporation:

COMPUTER LABS	DIBOL	OS/8
COMTEX	DIGITAL	PDP
DDT	EDUSYSTEM	PHA
DEC	FLIP CHIP	RSTS
DECCOMM	FOCAL	RSX
DECsystem-10	INDAC	TYPESET-8
DECSYSTEM-20	LAB-8	TYPESET-10
DECtape	MASSBUS	TYPESET-11
DECUS	OMNIBUS	UNIBUS

CONTENTS

	Page
PREFACE	
CHAPTER 1 INTRODUCTION	
1.1 DOCUMENT TRANSMISSION COMMUNICATIONS OPTION	1-1
1.2 AUTOMATIC DOCUMENT TRANSMISSION COMMUNICATIONS OPTION	1-2
1.3 CHARACTER TRANSMISSION COMMUNICATIONS OPTION	1-2
1.4 DOCUMENT COMMUNICATIONS PRODUCTS	1-3
CHAPTER 2 ESTABLISHING A CONNECTION	
2.1 ESTABLISHING A CONNECTION WITH A BELL DATA PHONE	2-1
2.2 ESTABLISHING A CONNECTION WITH AN ACOUSTIC COUPLER	2-4
2.3 ESTABLISHING A CONNECTION WITH A NULL MODEM	2-5
CHAPTER 3 COMMUNICATION WITH A WORD STATION OR WORD TERMINAL	
3.1 DOCUMENT TRANSMISSION (DX)	3-1
3.2 AUTOMATIC DOCUMENT TRANSMISSION (AX)	3-14
3.2.1 Placing a System in Automatic Transmission	3-14
3.2.2 Communicating with a System Placed in AX	3-19
3.2.3 Sending a Document to a System Placed in AX	3-23
3.2.4 Fetching a Document from a System Placed in AX	3-32
3.3 CHARACTER TRANSMISSION (CX)	3-35
3.3.1 How To Use CX	3-35
3.3.1.1 Originating the Call	3-35
3.3.1.2 Using the Commands	3-37
3.3.1.3 Changing the Commands	3-37
3.3.1.4 Pausing in Mid-Operation with a Host	3-38
3.3.1.5 Shutting Down	3-38
3.3.2 Commands Involving Documents	3-38
3.3.2.1 Keyboard to Document (KD) or Host to Document (HD)	3-38
3.3.2.2 Document to Screen, Printer, or Host (DS, DP, DH)	3-40
CHAPTER 4 ERROR MESSAGES	

CONTENTS (Cont)

	Page
APPENDIX A COMMUNICATIONS CONFIGURATIONS	
A.1 DEFINITION OF A COMMUNICATIONS CONFIGURATION	A-1
A.2 DEFINITION OF A MODEM	A-1
A.3 CONFIGURATIONS	A-3
APPENDIX B CHANGING THE COMMUNICATIONS CHARACTERISTICS	
APPENDIX C COMMUNICATING WITH AN IBM COMMUNICATING MAG CARD I	
C.1 INTRODUCTION	C-1
C.2 SENDING A DOCUMENT TO A MAG CARD I	C-2
C.3 RECEIVING A DOCUMENT FROM A MAG CARD I	C-7
C.4 ERROR RECOVERY	C-12
C.5 SPECIAL SIGNIFICANCE OF SOME CHARACTERS	C-12
COMMUNICATIONS OPTIONS GLOSSARY	

INDEX

FIGURES

Figure No.	Title	Page
2-1	Bell Data Phone	2-2
2-2	Buttons on the BELL 103A Data Phone	2-2
2-3	The DF01	2-4
2-4	The DEC Model H312A Null Modem	2-5
3-1	Document Transfer Display Appearing While the System Is Making a Connection	3-2
3-2	Example of the Document Transfer Display When Connection Is Established ...	3-3
3-3	Example of the Document Transfer Display Requesting the Message To Be Sent	3-4
3-4	Example of Document Transfer Display Notifying Sender That Message Has Been Received	3-5
3-5	Example of Document Transfer Receiver's Display Depicting the Message	3-5
3-6	Example of Document Transfer Sender's Display Requesting the Name of the Document To Be Sent	3-6
3-7	Example of Document Transfer Sender's Display During the Interval Between Contact and Receiver's Response	3-7
3-8	Example of Document Transfer Receiver's Display Requesting the Name of the Receiving Document	3-7

FIGURES (Cont)

Figure No.	Title	Page
3-9	Example of Document Transfer Receiver's Display When an Existing Document Is Specified as the Receiving Document	3-8
3-10	Example of Document Transfer Receiver's Display Requesting the Name of the Receiving Document	3-9
3-11	Example of Document Transfer Receiver's Display When an Existing Document Is Specified as the Receiving Document	3-10
3-12	Example of Document Transfer Display for Sender and Receiver While Transfer Is in Progress	3-10
3-13	Example of Document Transfer Display for Sender and Receiver When Transfer Is Completed	3-11
3-14	Example of Document Transfer Display Requesting the Bye Message When Transfer Is Ended Before an Entire Document Is Transferred	3-13
3-15	An Example of Document Transfer Sender's Display When Transfer of a Document Has Been Aborted	3-13
3-16	Example of Document Transfer Receiver's Display When Transfer of a Document Has Been Aborted	3-14
3-17	Document Transfer Display When an Existing Log Document Is Specified ...	3-16
3-18	Automatic Document Transfer Menu	3-17
3-19	Automatic Document Transfer Menu Displayed When Changing of Settings Is Specified	3-19
3-20	Automatic Document Transfer Display Appearing While the System Is Making the Connection	3-20
3-21	Example of Automatic Document Transfer Display Requesting a Password ...	3-20
3-22	Example of Automatic Document Transfer Display Requesting Identification .	3-22
3-23	Example of Automatic Document Transfer Display Indicating the System Is Ready To Send or Receive	3-22
3-24	Example of Automatic Document Transfer Display When a Message Is To Be Sent	3-24
3-25	Example of Automatic Document Transfer Display Notifying Sender That the Message Has Been Received	3-24
3-26	Example of Automatic Document Transfer Display Depicting Message on Receiver's Screen	3-25
3-27	Example of Automatic Document Transfer Display Requesting the Name of the Document To Be Sent	3-25
3-28	Example of Automatic Document Transfer Display Requesting the Name of the Receiving Document	3-26
3-29	Example of Automatic Document Transfer Display When an Existing Receiving Document is Specified	3-27
3-30	Example of Automatic Document Transfer Display While Transfer Is in Progress	3-28
3-31	Example of Automatic Document Transfer Display Appearing on the Sender's Screen When Transfer Is Completed	3-29
3-32	Example of Automatic Document Transfer Display Appearing on the Receiver's (the System Set of AX) Screen When Transfer Is Completed	3-29

FIGURES (Cont)

Figure No.	Title	Page
3-33	Example of Automatic Document Transfer Display Requesting the Bye Message, When Transfer Is Ended Before an Entire Document Is Transferred . . .	3-30
3-34	Example of Automatic Document Transfer Display Notifying the Sender (the System Set for Document Transfer) That Transfer Has Been Aborted	3-31
3-35	Example of Automatic Document Transfer Display Notifying the Receiver (the System Set for AX) That Transfer Has Been Aborted	3-31
3-36	Example of Automatic Document Transfer Display Requesting the Name of the Receiving Document	3-32
3-37	Example of Automatic Document Transfer Display Appearing When an Existing Receiving Document Has Been Specified	3-33
3-38	Example of Automatic Document Transfer Display Requesting the Name of the Document To Be Fetched	3-34
3-39	Example of Automatic Document Transfer Display Appearing While the System Is Awaiting a Response	3-34
3-40	Character Transfer Menu Displaying Communicating Options	3-36
3-41	Character Transfer Display Requesting the Name of the Document to Receive the Characters	3-39
3-42	Character Transfer Display Appearing When an Existing Document is Specified To Receive the Characters	3-39
3-43	Character Transfer Display Requesting the Name of the Document To Be Sent	3-40
A-1	Example of a Configuration Using a Null Modem, for Transmission for Distances Up to 50 Feet	A-3
A-2	Example of a Configuration Using Short-haul Modems for Transmission Over Private Lines for Distances over 50 Feet Up to 5 Miles	A-3
A-3	Example of a Configuration Using an Originate-only Acoustic Coupler for Transmission Over Company Telephone Lines	A-4
A-4	Example of a Configuration Using Data Phones Only	A-4
B-1	System Communications Menu Options	B-3
B-2	Communications Setting Menu Appearing When a Change in Protocol Is Specified	B-3
B-3	Communications Setting Menu Appearing When a Change in Buffer Control Is Specified	B-4
B-4	The Communications Setting Menu Appearing When a Change in Other Transmission Characteristics Is Specified	B-4
C-1	Mag Card Communications Menu	C-3
C-2	Mag Card Communications Display Requesting the Name of the Document To Be Sent	C-4
C-3	Mag Card Communications Display Requesting the User to Specify How Carriage Returns Are To Be Sent	C-4
C-4	Card Communications Display Depicting an Example of a Ruler in a Document Being Sent	C-5

FIGURES (Cont)

Figure No.	Title	Page
C-5	Mag Card Communications Menu	C-8
C-6	Mag Card Communications Display Requesting the Name of the Document To Be Sent	C-8
C-7	A Mag Card Communications Display Appearing When an Existing Receiving Document Is Specified	C-9
C-8	A Mag Card Communications Display Requesting the Ruler in the Receiving Document To Be Specified	C-10
C-9	A Mag Card Communications Display Requesting the User To Specify How Carriage Returns Are To Be Received	C-11

CONFIDENTIAL

The following information is being furnished to you for your information only. It is not to be used for any other purpose. This information is being furnished to you under a confidentiality agreement. It is not to be disclosed to any other person without the express written consent of the originator. This information is being furnished to you for your information only. It is not to be used for any other purpose. This information is being furnished to you under a confidentiality agreement. It is not to be disclosed to any other person without the express written consent of the originator.



PREFACE

The *Word Processing System Communications Options User's Manual* is intended for the person who is familiar with using a Digital Equipment Corporation word processing system and wishes to send documents or messages between word processing systems.

Information described in this manual is applicable to DIGITAL's WS100, WS102, WS78, and WPS-11M word processing systems, version 3.0 or more recent.

Knowledge of other word processing functions can be obtained from

- *Operator Training Manual*, part number JB034-1,
- *WPS-8 Word Processing System Reference Manual (Version 2.7 and 3.0)*, part number AA-5267C-TA, or *WPS-11M Word Processing System Reference Manual*, part number AA-D727B-TC.

This manual supplies the additional information necessary to operate the word processing communications options. The manual is organized as follows.

- Chapter 1, System Descriptions, describes the communications options and the systems on which they are available.
- Chapter 2, Establishing the Connection, describes the techniques necessary to transmit and receive documents and messages.
- Chapter 3, Communication with a Word Station or Word Terminal, describes how to use the options to communicate with a DIGITAL word station or word terminal.
- Chapter 4, Error Recovery Techniques, gives an alphabetic list of communications error messages, the conditions that caused the error, and recovery techniques.

- Appendix A, Communications Configurations, describes the equipment configurations required to use the options. This information is intended for the manager rather than the operator.
- Appendix B, Changing the Communications Characteristics, describes how to adjust your system for different line characteristics and protocols.
- Appendix C, IBM Communicating Mag Card I Emulator, contains instructions for communication between a word processing system and an IBM communicating Mag Card I.
- The glossary provides definitions of special communications terms used in this manual.

If you have never used this manual before, read Chapter 1 for general information. When you are ready to transmit data, turn to the instructions in Chapters 2 and 3, or Chapter 2 and Appendix C or D for the appropriate option. If an error occurs, try to recover using the procedures in Chapter 4. If repeated attempts at recovery fail, call your System Manager, if you have one, or else your assigned marketing support representative.

CHAPTER 1 INTRODUCTION

The word processing system provides three communications options for transferring messages and documents from one system to another: Document Transmission, Automatic Document Transmission, and Character Transmission. Each option may be invoked from the word processing Main Menu by typing the letters DX (document transmission), AX (automatic document transmission), or CX (character transmission) respectively.

1.1 DOCUMENT TRANSMISSION COMMUNICATIONS OPTION

The document transmission communications option allows a document to be transferred from one DIGITAL word station or terminal to another. An operator is necessary at both systems. Both operators coordinate their actions to send and receive the message or document. When using the document transfer option (DX), a complete copy of a document is sent, including all special word processing characteristics such as the ruler settings, boldfaced characters, and underlines. This method should be used to send documents and messages between two DIGITAL word processing systems.

The DX option is available in all word processing systems. In a WS102 system, only one terminal can communicate over the telephone at a particular time. However, while one terminal is communicating, the other terminals may be used for other word processing purposes.

In a WPS-11M system, any number of terminals can communicate over telephones. Each terminal requires its own telephone. The other terminals can be used for editing.

Settings displayed in the document's word processing Print Menu are sent only if the document has been printed at some time. If it has not, the settings of the receiving document are used. If the receiving document has never been printed either, system-supplied settings are used.

Every telephone line has unwanted signals caused by switching, the proximity of other electrical equipment, and natural factors such as lightning. The signals can cause errors and are called noise. The DX option offers a built-in protection against errors caused by noise. A document is broken up into a number of "packets" or bundles of characters for transmission. Each packet is checked as it arrives. If it does not

contain an error, the next packet is sent. If it does contain an error, the packet is retransmitted. After five tries, a "bad connection" message is displayed and the transfer is discontinued.

1.2 AUTOMATIC DOCUMENT TRANSMISSION COMMUNICATIONS OPTION

Like document transmission, the automatic document transmission option (AX) permits an entire document to be sent. However, an operator is needed at only one system. Rulers and other special word processing characters are retained. Protection against errors caused by noise on the telephone line is also supplied.

When using the automatic transmission option, one system can either receive or both send and receive documents automatically on request from another system depending on the password used by the other system. The system set for automatic transmission does not require an operator. It is used as a central storage system for documents received from or sent to other systems. Only one system at a time can send a document to the central system or fetch a document from it. "Fetch" is used in this manual to signify that an operator is causing the document to be sent without the cooperation of any other operator.

To send a document to or fetch a document from a system set in AX, you must place your system in DX. The DX option used with the AX option differs from just the DX option in that a password or other identification may be required before transfer can start.

A log document can be set up on the system in AX. The log document records each document transferred for future reference.

An identification message (ID) can be set up on the AX system. This message will appear to the DX user on establishing the connection.

1.3 CHARACTER TRANSMISSION COMMUNICATIONS OPTION

When using the character transmission option, a command or message is sent one character at a time. Although a complete document can be sent, the special word processing characters specifying the ruler settings, Print Menu settings, boldface, underscore, superscripts, and subscripts are omitted. In addition, tabs are changed to spaces, and spaces are inserted to preserve margins. The CX option is used for establishing communication with a computer system or communicating IBM Mag Card I, or with some other device termed the "host."

Other devices can be used in place of the host; for example, an optical character reader (OCR), a phototypesetter, or a DIGITAL LA36 typewriter terminal. These devices, in effect, become remote terminals when used with the CX option.

Errors caused by line noise are not corrected during CX transmission.

In order to receive data sent with the CX option, the receiving software or hardware (in the case of an OCR and other data entry or output devices) must conform to (1) the ASCII code sent by a word processing system, or (2) the codes sent by an IBM Mag Card I. ASCII and Mag Card I codes are two of many different codes in which data are recorded in computer-readable form.

1.4 DOCUMENT COMMUNICATIONS PRODUCTS

DIGITAL offers two software products that allow document transfer between word processing systems and a PDP-11 using the RSX-11M or the RSTS/E operating system: DX-11M for communication with RSX-11M, and DX/RSTS for communication with RSTS/E. These products are installed as part of the RSX-11M or RSTS/E system.

Refer to the following documents for additional information:

- *DX/RSTS Installation Guide*, part number AA-5262C-TC.
- *DX-11M Installation Guide*, part number AA-D997A-TC.
- *DX Products User's Guide*, part number AA-5476C-TC.
- *DX Products Programmer's Reference Manual*, part number AA-5469C-TC.



CHAPTER 2

ESTABLISHING A CONNECTION

At some point in the operating instructions presented in Chapters 3 and 4, you will be instructed to “establish the connection.” “Establishing the connection” means establishing the ability to communicate successfully with the other system over a communications link. This chapter explains how to establish a connection. Once you are familiar with the procedure, you may use this chapter for reference.

In order for computers to communicate over telephone lines, the computer signals must be converted to telephone-type signals. This conversion is accomplished by a device called a modem. Modems must be used at both ends of the telephone line as the signals must be converted for transmission and then reconverted for reception. Procedures for using three types of modems are contained in this chapter: acoustic couplers, Data phones, and null modems.

2.1 ESTABLISHING A CONNECTION WITH A BELL DATA PHONE

A Bell Data phone (Figure 2-1) can be used to originate a call or answer a call. To originate a call, follow the steps below.



Figure 2-1 Bell Data Phone

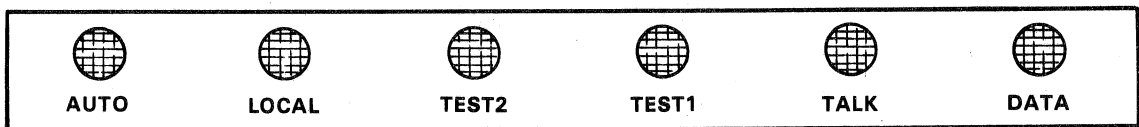

CP-2907

Figure 2-2 Buttons on the BELL 103A Data Phone

1. Press the TALK button (Figure 2-2).

Lift the telephone receiver off the hook and dial the number of the receiving system.

CAUTION

Do not attempt to dial a telephone used with a DF01 acoustic coupler because it cannot answer but only originate calls. If a message or document is to be sent to a system with a DF01 acoustic coupler, talk to the other operator over the telephone and have him or her originate the data call.

2. When you hear the loud, high-pitched tone, press the DATA button on the data phone and hang up the receiver. The connection is established.

To break the connection, simply press the TALK button. You then can use the telephone for regular voice calls.

When the data phone is not being used, it can be left either in the TALK mode or in the AUTO ANSWER mode by pressing the TALK or AUTO buttons respectively. The AUTO button lights but does not stay down.

Through use of the AUTO ANSWER mode, a connection can be established without human intervention. In this mode, the DATA button will light up when the data phone is called and the telephone will ring. A connection will be established and will stay open indefinitely (unless you have chosen the option to disconnect).

If your data phone has the option to disconnect in case of loss of carrier, the connection will not stay open indefinitely. The telephone company sets this option when the data phone is installed. If it is set, the data phone will disconnect three seconds after the other party has disconnected and the DATA button light will go out.

If the telephone receiver is going to be used for voice communication, press the TALK button. Unless you arrange an automatic document transmission beforehand, it is a good idea to leave the data phone in the TALK mode, permitting voice calls to be made.

2.2 ESTABLISHING A CONNECTION WITH AN ACOUSTIC COUPLER

Most acoustic couplers can be used to originate a call, but not to receive one. To originate a call with an originate-only acoustic coupler (Figure 2-3), use the following procedure.



Figure 2-3 The DF01

1. Turn the power switch of the acoustic coupler to ON.
2. Lift the telephone off the hook and dial the number of the receiving modem.
3. When you hear a high-pitched tone, place the telephone receiver in the acoustic coupler with the cord end towards the OFF/ON switch. The connection is established if the CARRIER light comes on and stays on.

To break the connection, simply remove the telephone receiver from the coupler and hang it up.

2.3 ESTABLISHING A CONNECTION WITH A NULL MODEM

For a null modem (Figure 2-4), no special action is necessary because the connection already exists. If you are using a null modem, skip the step of the unit's operating instructions concerned with establishing the connection.

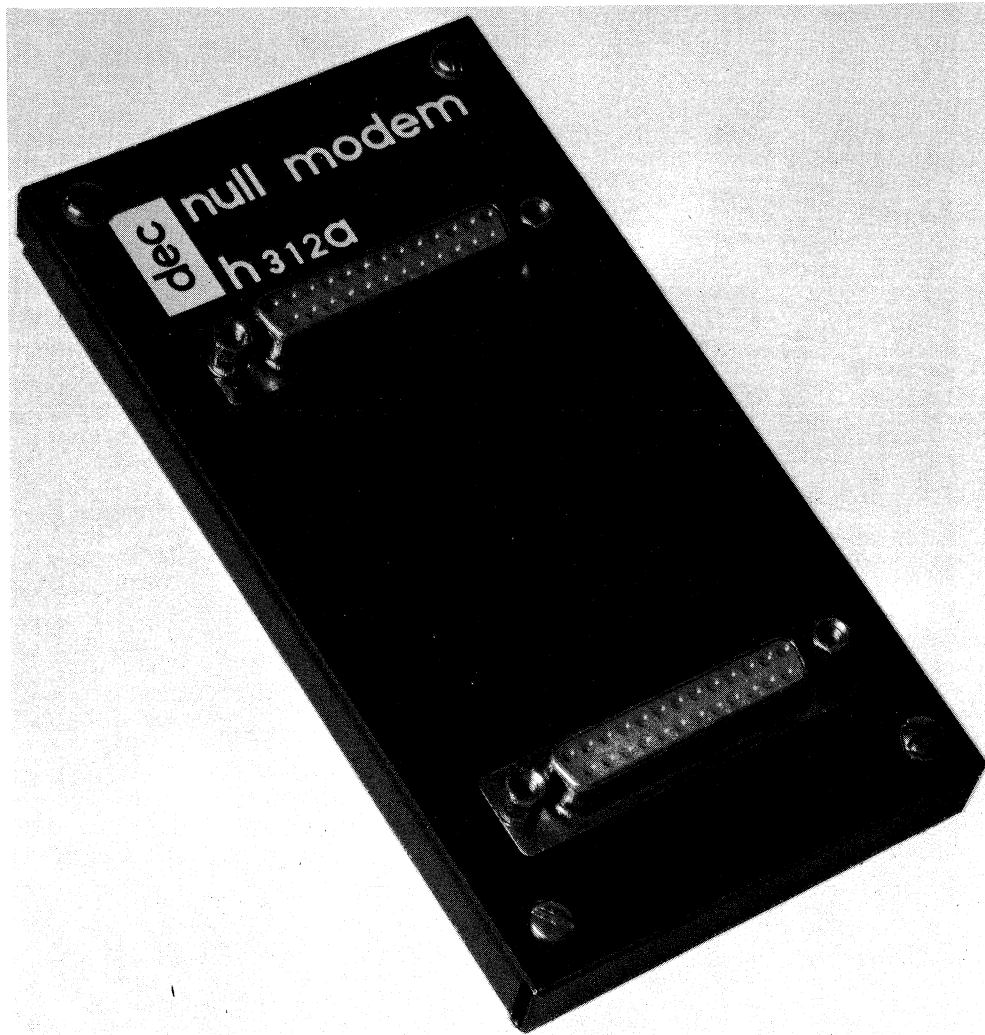

8316-69

Figure 2-4 The DEC Model H312A Null Modem



CHAPTER 3

COMMUNICATION WITH A WORD STATION OR WORD TERMINAL

This chapter supplies the operating instructions for DX, AX, and CX word processing communications options. These options permit communication between any two DIGITAL word stations or terminals. This chapter is organized as follows:

Communications Option	Location
DX	Section 3.1
AX	Section 3.2
CX	Section 3.3

3.1 DOCUMENT TRANSMISSION (DX)

Document transmission permits you to transfer a document from one DIGITAL word station or terminal to another.

Start when any page of the Main Menu is displayed on the screen.

STEP 1 (BOTH SEND AND RECEIVE)

Sender and receiver must both type DX and press the RETURN key. You will see the display in Figure 3-1.

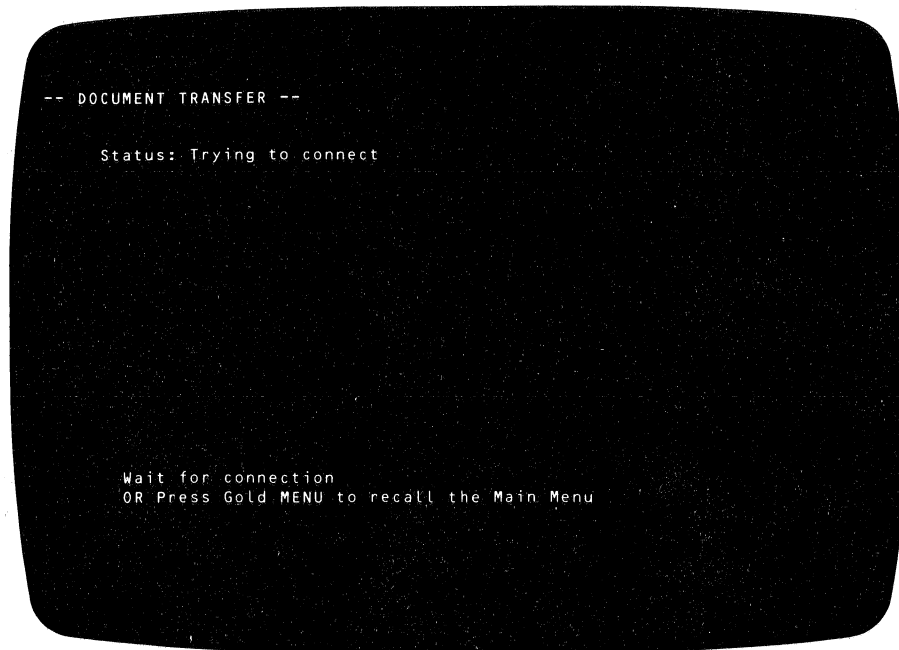

Figure 3-1 Document Transfer Display Appearing While the System Is Making a Connection

STEP 2 (EITHER SEND OR RECEIVE)

Either the sender or the receiver originates the call or has the person at the other end do so (see Section 2.2). When the call is successful, you will see the display in Figure 3-2.

NOTE

If the connection cannot be made because of faulty modems or some other physical reason, the notification *****ERROR***** will appear on the screen with the message "Problem: Bad connection, try again." If the bad connection is only a temporary situation, trying again will lead to success. If not, then you will not be able to transmit until the connection is repaired. Return to the Main Menu. The blank portion of line 1 of the display varies according to the system to which the connection is established.

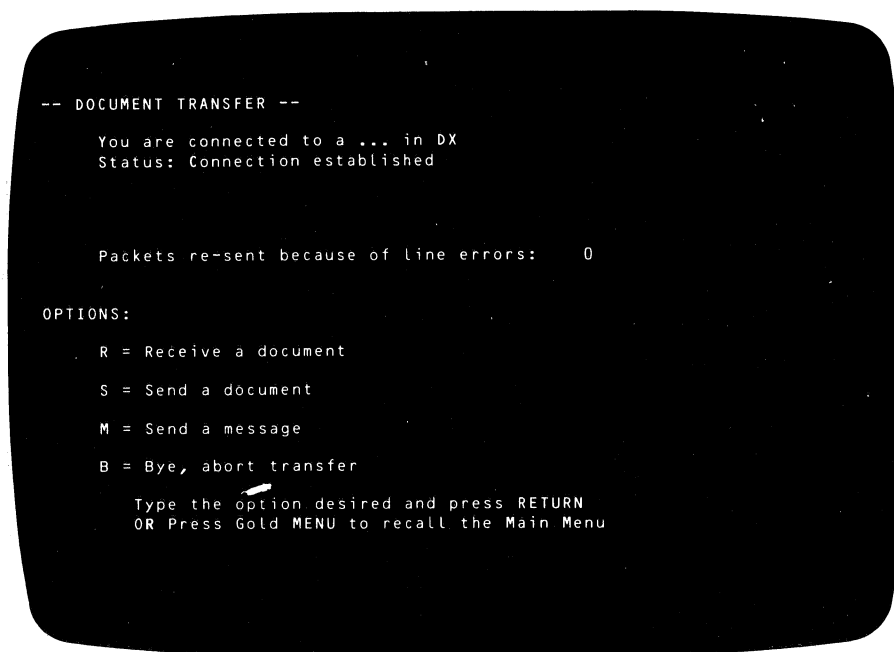

MK-0485

Figure 3-2 Example of the Document Transfer
Display When Connection Is Established

STEP 3 (EITHER SEND OR RECEIVE)

Once a connection is established, you may send a message anytime the system displays, "M = SEND A MESSAGE," as one of the choices, even when document transmission is occurring.

You may send any number of messages; each must contain no more than 64 characters. If more than 64 characters are entered, only the first 64 will be sent. The messages will not be recorded on disk or diskette.

Type the letter M and press the RETURN key. You will see the display in Figure 3-3.

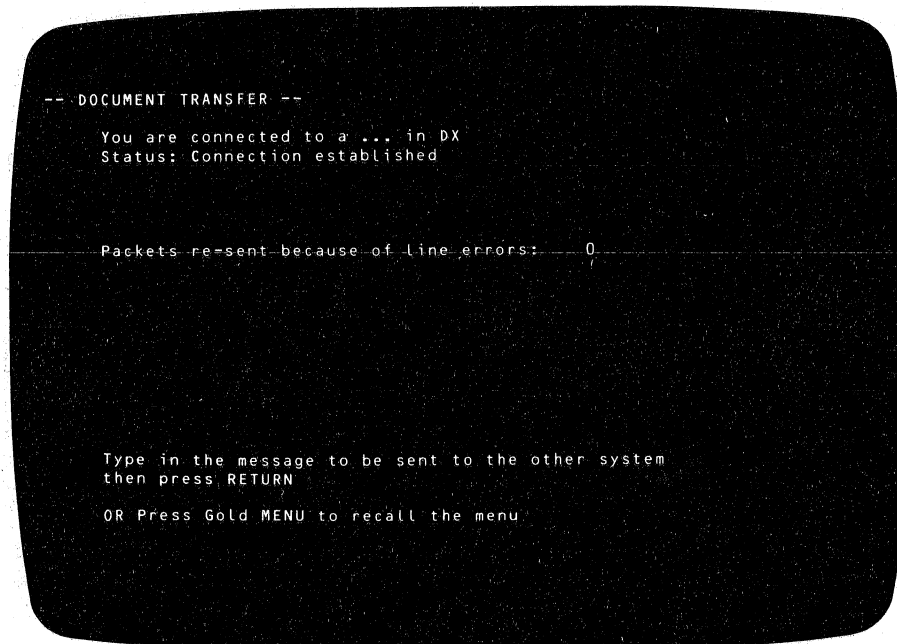

Figure 3-3 Example of the Document Transfer Display
Requesting the Message To Be Sent

Now type the message and press the RETURN key.

NOTE

This step can be shortened by typing the letter M, a space, the message, and pressing the RETURN key.

The message sender and receiver will see displays such as those shown in Figures 3-4 and 3-5 respectively.

You now have a choice: you can next perform either steps 4 and 5 or their alternates. Steps 4 and 5 permit the sender of the document to initiate the sending process. Alternate steps 4 and 5 permit the receiver of the document to initiate the sending process. Both steps 4, 5 and alternate steps 4, 5 require a sending operator and a receiving operator. The difference between them is in who starts the procedure.

```
-- DOCUMENT TRANSFER --  
  
You are connected to a ... in DX  
Status: Connection established  
  
Message sent-received  
  
Packets re-sent because of line errors: 0  
  
OPTIONS:  
  
R = Receive a document  
S = Send a document  
M = Send a message  
B = Bye, abort a transfer  
  
Type the option desired and press RETURN  
OR Press Gold MENU to recall the Main Menu
```

MK-0470

Figure 3-4 Example of Document Transfer Display Notifying Sender That Message Has Been Received

```
-- DOCUMENT TRANSFER --  
  
You are connected to a ... in DX  
Status: Connection established  
  
Message: This is a message  
  
Packets re-sent because of line errors: 0  
  
OPTIONS:  
  
R = Receive a document  
S = Send a document  
M = Send a message  
B = Bye, abort transfer  
  
Type the option desired and press RETURN  
OR Press Gold MENU to recall the Main Menu
```

MK-0466

Figure 3-5 Example of Document Transfer Receiver's Display Depicting the Message

STEP 4 (SEND ONLY)

Now you are ready to send the document. **Type the letter S and press the RETURN key.** You will see the display in Figure 3-6.

Type the name of the document to be sent (or the number) and press the RETURN key.

NOTE

This step can be shortened by typing merely S, a space, the document name, and pressing the RETURN key.

Sender and receiver will see displays such as those shown in Figures 3-7 and 3-8 respectively.

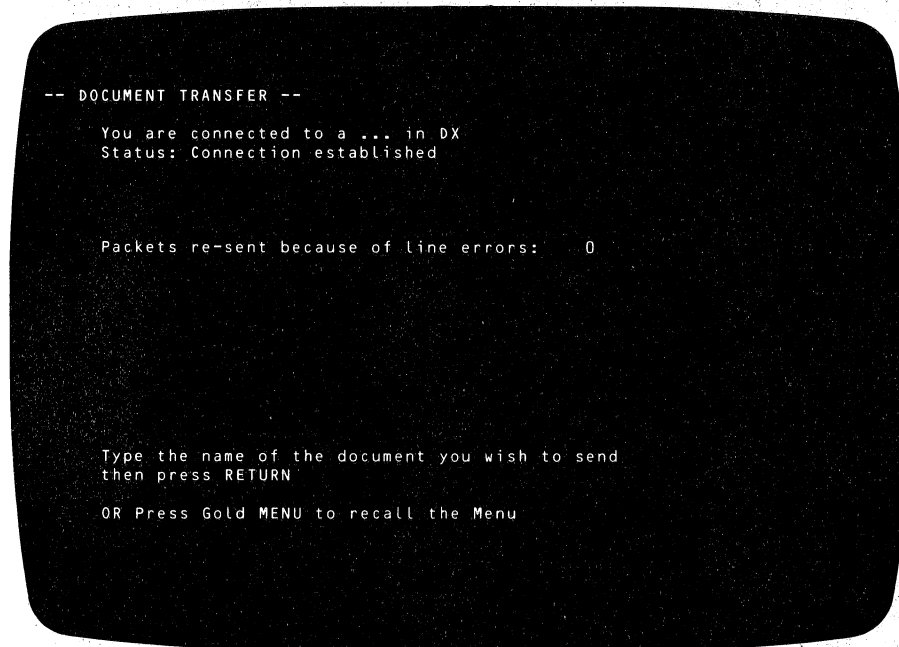

MK-0465

Figure 3-6 Example of Document Transfer Sender's Display
Requesting the Name of the Document To Be Sent

```
-- DOCUMENT TRANSFER --

You are connected to a ... in DX
Status: Waiting for a response

Message sent-received

Packets re-sent because of line error: 0

OPTIONS:

M = Send a message
B = Bye, abort transfer

Type the option desired and press RETURN
OR Press Gold MENU to recall the Main Menu
```

MK-0468

Figure 3-7 Example of Document Transfer Sender's Display During the Interval Between Contact and Receiver's Response

```
-- DOCUMENT TRANSFER --

You are connected to a ... in DX
Status: Connection established

Packets re-sent because of line errors: 0

Type the name of the document which is to receive the document sent
then Press RETURN

OR just press RETURN to use the document name given on the next line
SALES PLAN MEMO

OR Press Gold MENU to recall the Main Menu
```

MK-0483

Figure 3-8 Example of Document Transfer Receiver's Display Requesting the Name of the Receiving Document

STEP 5 (RECEIVE ONLY)

As a receiving operator, you are asked to type the name of a document to receive the one being sent. The name you supply will not cause a document of that name to be sent. It is merely the name of the document in which the text you receive will be placed.

Type the document name (or just the number) and press the RETURN key, or just press the RETURN key to use the document name shown on the screen.

If the document does not exist, it will be created. If the document does exist, you will see the display shown in Figure 3-9.

Type the letter T, A or O and press the RETURN key.

CAUTION

Once you press the RETURN key after typing the letter O, the text in the document will be overwritten and lost. Be sure that is what you want before pressing RETURN.

Skip alternate steps 4 and 5 and go on to step 6.

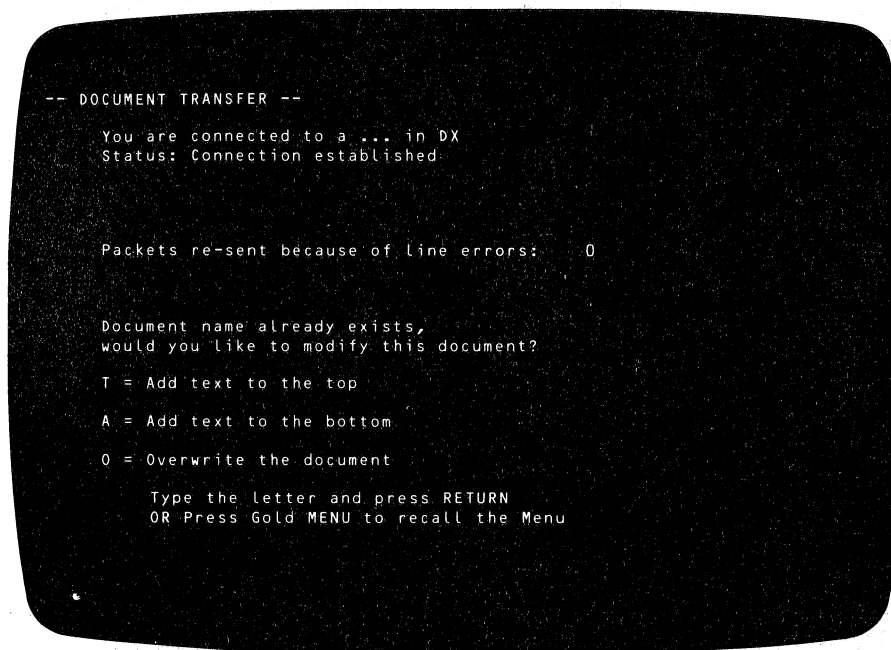

MK-0484

Figure 3-9 Example of Document Transfer Receiver's Display When an Existing Document Is Specified as the Receiving Document

ALTERNATE STEP 4 (RECEIVE ONLY)

You may ask the sender to send the document and set your system to receive it. **Type the letter R and press the RETURN key.** You will see the display in Figure 3-10.

If you type the name of a document that already exists, you will see the display shown in Figure 3-11.

Type the letter T, A or O and press the RETURN key. Sender and receiver will see displays such as those shown in Figures 3-12 and 3-13 respectively.

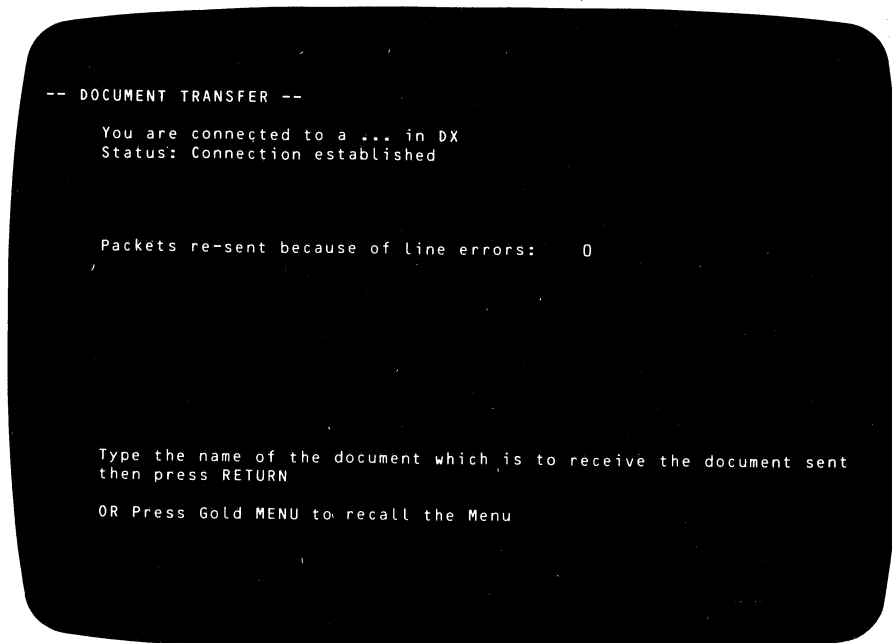

MK-0481

Figure 3-10 Example of Document Transfer Receiver's Display Requesting the Name of the Receiving Document

```
-- DOCUMENT TRANSFER --  
  
You are connected to a ... in DX  
Status: Connection established  
  
Packets re-sent because of line errors: 0  
  
Document name already exists,  
would you like to modify this document?  
  
T = Add text to the top  
A = Add text to the bottom  
O = Overwrite the document  
  
Type the letter and press RETURN  
OR Press Gold MENU to recall the Menu
```

MK-0482

Figure 3-11 Example of Document Transfer Receiver's Display When an Existing Document Is Specified as the Receiving Document

```
-- DOCUMENT TRANSFER --  
  
You are connected to a ... in DX  
Status: Transfer in progress  
  
Message sent-received  
  
Packets re-sent because of line errors: 0  
Packets in document transferred: 39  
(Approximate) Packets in document: 128  
  
OPTIONS:  
  
M = Send a message  
B = Bye, abort transfer  
  
Type the option desired and press RETURN  
OR Press Gold MENU to recall the Main Menu
```

MK-0500

Figure 3-12 Example of Document Transfer Display for Sender and Receiver While Transfer Is in Progress

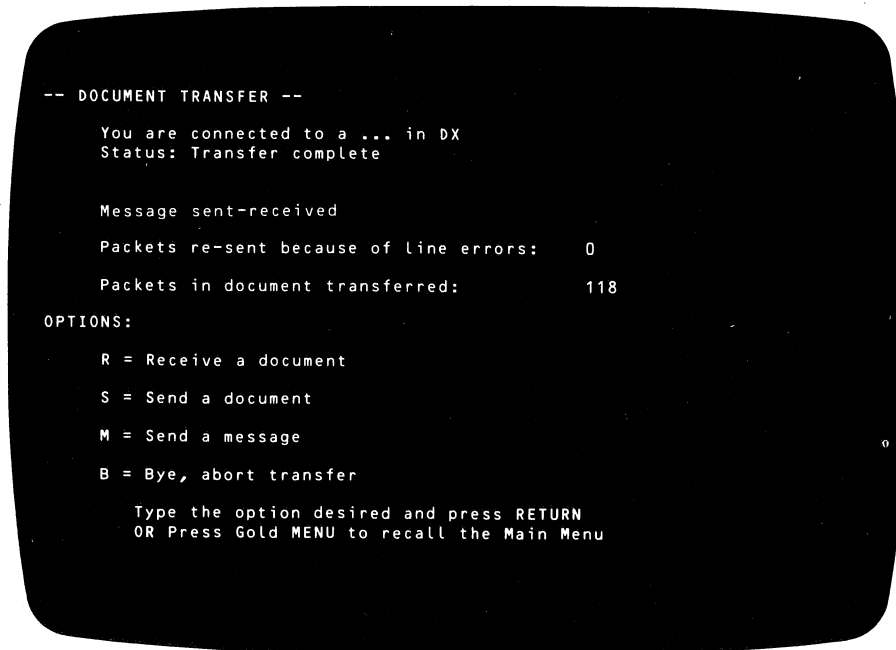

MK-0489

Figure 3-13 Example of Document Transfer Display for Sender and Receiver When Transfer Is Completed

ALTERNATE STEP 5 (SEND ONLY)

Type the document name (or just the number) and press the RETURN key, or just press the RETURN key to send the document whose name appears on the screen.

STEP 6 (BOTH SEND AND RECEIVE)

Both sender and receiver will see displays similar to Figure 3-12.

NOTE

If you are trying to place a document on a disk or diskette which does not have enough room for it, the notification *****ERROR***** will appear on the screen with the message "Problem: not enough room on diskette to receive document." You cannot send or receive that document, but you can still use any of the options displayed on the screen.

Observe that the screen display indicating the number of packets transferred changes as more and more packets are transferred. Wait for this number to stop changing; this indicates the end of the transfer. The end of transfer is also indicated by the Transfer Complete message.

NOTE

If an error occurs on your disk or diskette, the notification *****ERROR***** will appear on the screen with the message: "Problem: Cannot continue, disk error." You cannot continue to transfer that document, but you can still use any of the options displayed on the screen.

ALTERNATE STEP 7 (BOTH SEND AND RECEIVE)

When the transfer is complete, the display shown in Figure 3-13 will appear. Now you can send another document.

STEP 7 (BOTH SEND AND RECEIVE)

You can end the transmission before the entire document is transmitted. **Type the letter B and press the RETURN key.** You will see a display such as that shown in Figure 3-14. **Type a message and press the RETURN key.**

NOTE

This step can be shortened by typing the letter B, a space, the message, and pressing the RETURN key.

Sender and receiver will see displays such as those shown in Figures 3-15 and 3-16, respectively. Now you can send another document.

```
-- DOCUMENT TRANSFER --

You are connected to a ... in DX
Status: Transfer in progress

Message sent-received

Packets re-sent because of line errors:    0
Packets in document transferred:          5

Type in the message to be sent to the other system
then press RETURN

OR Press Gold MENU to recall the Menu
```

MK-0464

Figure 3-14 Example of Document Transfer Display Requesting the Bye Message When Transfer Is Ended Before an Entire Document Is Transferred

```
-- DOCUMENT TRANSFER --

You are connected to a ... in DX
Status: TRANSFER ABORTED

Message sent-received

Packets re-sent because of line errors:    0

OPTIONS:

R = Receive a document
S = Send a document
M = Send a message
B = Bye, abort transfer

Type the option desired and press RETURN
OR Press Gold MENU to recall the Main Menu
```

MK-0497

Figure 3-15 An Example of Document Transfer Sender's Display When Transfer of a Document Has Been Aborted

```
-- DOCUMENT TRANSFER --

You are connected to a ... in DX
Status: TRANSFER ABORTED

Bye: Wrong document-am stopping
Message sent-received

Packets re-sent because of line errors: 0

OPTIONS:

R = Receive a document
S = Send a document
M = Send a message
B = Bye, abort transfer

Type the option desired and press RETURN
OR Press Gold MENU to recall the Main Menu
```

MK-0498

Figure 3-16 Example of Document Transfer Receiver's Display When Transfer of a Document Has Been Aborted

3.2 AUTOMATIC DOCUMENT TRANSMISSION (AX)

Automatic document transmission permits you to transfer a document from one DIGITAL word station or terminal to another with only one system attended by an operator.

3.2.1 Placing a System in Automatic Transmission

This section describes how to place a system in automatic transmission. Once in automatic transmission, a system does not require the attention of an operator because documents are sent and received automatically.

Placing a document in automatic transmission means giving the system from one to four pieces of information, called the *settings*: a terminal identification message, a log document, a send-only password, and a send-and-receive password.

The terminal identification message will appear when someone makes a connection with your system when it is placed in automatic transmission. If no message is typed, none will be displayed upon connection.

Your message may contain as many as 64 letters, numbers, other printing characters, or spaces. If more than 64 are typed, only the first 64 will be used.

The log is a document in which the system will keep a record of all documents received when the system is placed in automatic transmission. It can be printed or displayed on the screen. Listed for each document received is the following information:

- Sender identification,
- The time,
- The name of the document, and
- An indication whether this is a new document or an addition to an existing document. The letter C means a new document was created. The letter A means text was added to the bottom of an old document; T, to the top.

An example of a log entry follows:

```
<from> Documentation Station #4  
<time> 6/16/78 thu 10:19:41  
<n> Sales Plan Memo <#>1.11<m>C<>
```

The sample log entry records the transmission of a document named "Sales Plan Memo" on 6/16/78, Thursday, at 10:19 and 41 seconds. The time is the time when transmission began. "Documentation Station #4" is the identification typed in by the sender at log-in time. The number 1.11 indicates that "Sales Plan Memo" is document number 11 in the index and was sent from drive number 1. The letter C means that the document transmitted was placed in a new document specially created for it.

The letters and other symbols placed within angle brackets are part of the format and have no significance to the user.

To create a log document, the AX operator must type the name of the document. You may specify a new document or one which already exists. If the name is new, the system will create a document of that name. No log will be kept if no name is typed.

If the log document already exists, you will see the display shown in Figure 3-17. You then must choose whether to use A, T, or O.

The send-only password authorizes the user only to send a document to the system placed in automatic transmission and not to fetch one from it. Typing in a send-only password will require the user at the DX side of the line to type the same password before sending documents. The sender must know by prearrangement that a password is required and what it is. Otherwise, it will not be possible to send the document.

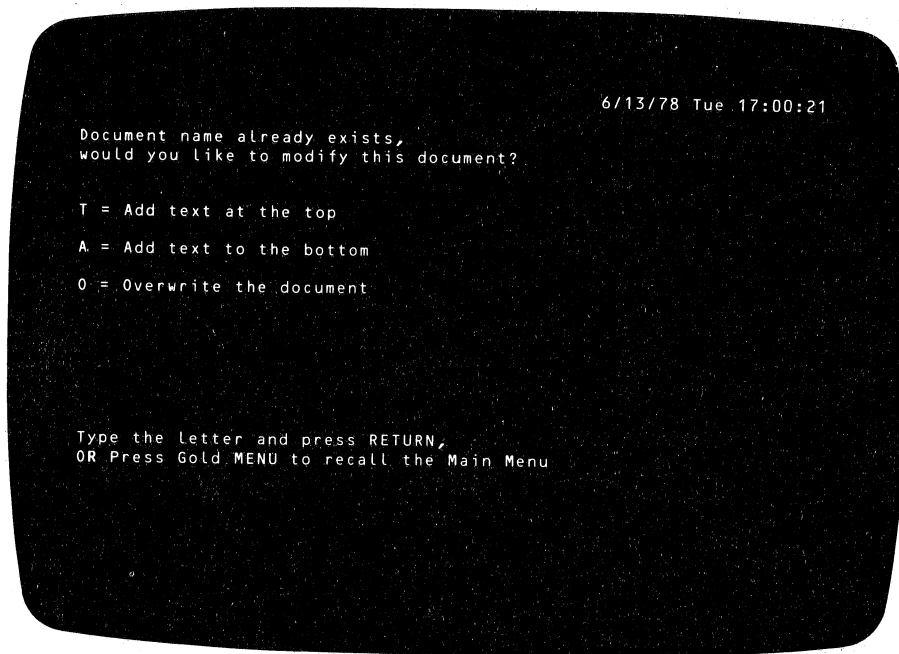

Figure 3-17 Document Transfer Display When an Existing Log Document Is Specified

A send-only password can have as many as 64 letters, spaces, numbers or other printable characters. If more than 64 are typed, only the first 64 will be used.

Typing in a send-and-receive password will require the user at the DX side to type the same password before fetching documents. The DX user must know by prearrangement that a password is required and what it is. Otherwise, it will not be possible to send or fetch documents. A document can be sent with either password.

Your send-and-receive password can have as many as 64 letters, spaces, numbers, or other printable characters. If more than 64 are typed, only the first 64 will be used.

If no password is typed, the DX user will not be asked for one.

NOTE

Before you begin, set the phone or modem on auto (refer to Section 2.1). Automatic document transfer will not work if your modem has no AUTO capability.

STEP 1

Type the letters **AX** and press the **RETURN** key. You will see a display similar to Figure 3-18.

The last settings used appear in the display. Settings not used before will not appear. If the screen appears blank, no settings were used.

If you are satisfied with the settings displayed on the screen, type **YES** (or just **Y**) and press the **RETURN** key. Skip to Step 3. If you wish to change the settings, type **NO** (or just **N**) and press the **RETURN** key. Go on to the next step.

NOTE

If you are using a different document disk or diskette from the one used when the settings were created, the message "Log Document . . . does not exist" may appear. This message signifies that the log document is not on the disk or diskette being used. Press **RETURN** to display the **AX** Menu, and reset the name of the log document.

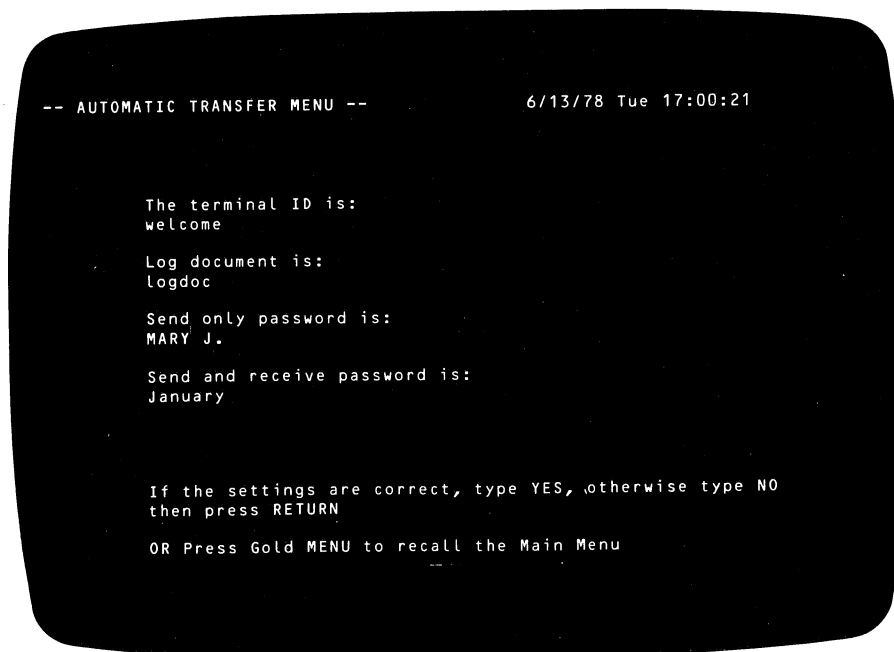

MK-0508

Figure 3-18 Automatic Document Transfer Menu

STEP 2

You will see a display on the screen similar to Figure 3-19. The following table describes the four options and how to change each.

Option	Explanation	Action
ID	Allows a greeting to be displayed at the other system upon successful connection.	Type the letters ID, a space, the greeting message (up to 64 characters) and press the RETURN key.
LD	Allows all document transmissions to be recorded in a log document.	Type the letters LD, a space, the name of the document, and press the RETURN KEY.
SP	Requires a password to be typed before allowing users to send a document.	Type the letters SP, a space, the password (up to 64 characters) and press the RETURN key.
BP	Requires a password to be typed before allowing users to send or fetch a document.	Type the letters BP, a space, the password (up to 64 characters) and press the RETURN key.

The settings may also be made blank again by typing either ID, LD, SP, or BP, and pressing the RETURN key twice without entering any new settings.

When you have finished inspecting or changing the settings, press the gold and MENU keys. You will be located at Step 1.

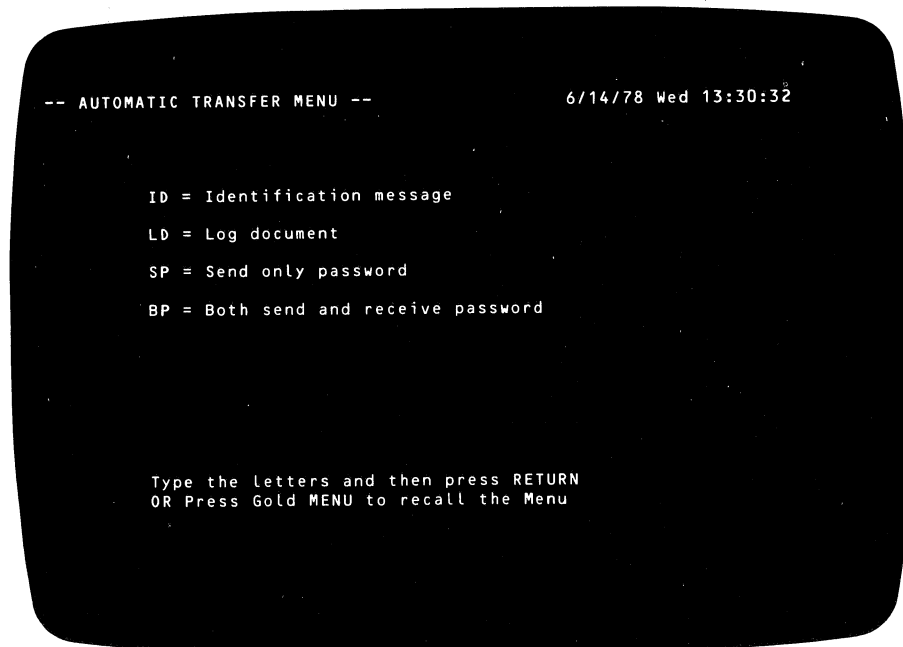

MK-0509

Figure 3-19 Automatic Document Transfer Menu Displayed When Changing of Settings Is Specified

STEP 3

You will see the display shown in Figure 3-20 on the screen. You may now leave the system because transfer will be controlled from another system.

To take the system out of AX, press the gold and the MENU keys. The Main Menu will be displayed once again.

3.2.2 Communicating with a System Placed in AX

This section describes communicating with DX to another system set up for automatic document transmission (AX).

You may need one or two pieces of information before starting: (1) a send-only password or (2) a send-and-receive password. The send-only password authorizes you only to send documents. The send-and-receive password authorizes you both to send documents to the system set in AX and to fetch documents from it. You must know beforehand whether a password is required and what it is. You can find out by calling the System Manager of the system set in automatic.

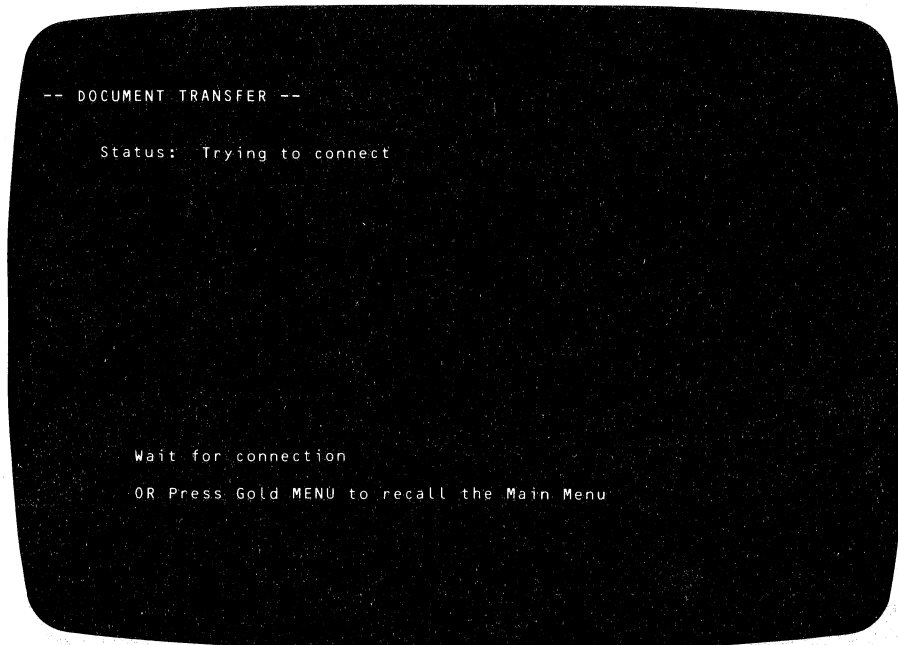

MK-0610

Figure 3-20 Automatic Document Transfer Display Appearing While the System Is Making the Connection

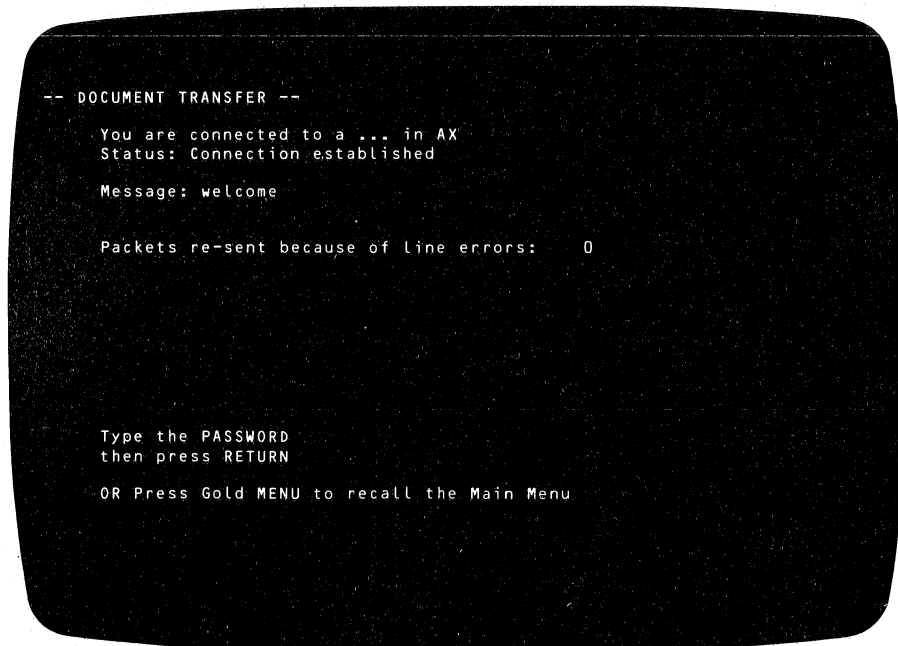

MK-0463

Figure 3-21 Example of Automatic Document Transfer Display Requesting a Password

STEP 1

Type the letters DX and press the RETURN key. You will see the display in Figure 3-20.

As soon as the connection is established, you will see a display similar to the one shown in Figure 3-21. The exact display depends on the system to which the connection is made, whether there is a greeting message, what it is, and whether a password is required. If a password is required, go on to the next step. If a password is not required, skip to Step 3.

NOTE

If the connection cannot be made because of faulty modems or some other physical reason, the notification *****ERROR***** will appear on the screen with the message "Problem: Bad connection, try again." If the bad connection is only a temporary situation, trying again will lead to success. If not, then you will not be able to transmit until the connection is repaired. Return to the Main Menu.

STEP 2

Here you may use either the send-only password or the send-and-receive password depending on your requirements and what is allowed by the AX system.

Type the password and press the RETURN key. For security purposes, the password that you type will not appear on the screen. Instead, solid squares will appear. If the password is not accurate, including spaces, the message "INCORRECT PASSWORD" and a request to type it again will be displayed.

You are allowed three tries. If you fail on the third attempt, you will see the message "ILLEGAL USER." At that point, you can only press the gold and the MENU keys. Then you must start again at step 1.

Once the password is accepted, you will see a display such as the one shown in Figure 3-22, provided a log document has been created on the system set in automatic document transmission. Go on to the next step. If no log document exists, skip to step 4.

STEP 3

Sender identification will be placed in the log document next to the entry for this transmission for identification purposes. You can type as many as 64 characters, including letters, numbers, spaces and special characters. If you type more than 64, only the first 64 will be used.

```
-- DOCUMENT TRANSFER --  
  
You are connected to a ... in AX  
Status: Connection established  
  
Message: welcome  
Message sent-received  
  
Packets re-sent because of line errors: 0  
  
  
Type your ID  
then press RETURN  
  
OR Press Gold MENU to recall the Main Menu
```

MK-0499

Figure 3-22 Example of Automatic Document Transfer Display Requesting Identification

```
-- DOCUMENT TRANSFER --  
  
You are connected to a ... in AX  
Status: Connection established  
  
Message: welcome  
Message sent-received  
  
Packets re-sent because of line errors: 0  
  
OPTIONS:  
  
R = Receive a document  
S = Send a document  
M = Send a message  
B = Bye, abort transfer  
  
Type the option desired and press RETURN  
OR Press Gold MENU to recall the Main Menu
```

MK-0493

Figure 3-23 Example of Automatic Document Transfer Display Indicating the System Is Ready To Send or Receive

Identification must be typed. If you press RETURN without typing any identification, you must then press the gold and MENU keys in order to return to the Main Menu and start over.

Type the identification and press the RETURN key.

STEP 4

You will see a display on the screen similar to Figure 3-23. Now you are ready to transfer a document. To send a document to the system set in automatic document transmission, go on to Section 3.2.3 below. To fetch a document from the system set in automatic document transmission, skip to Section 3.2.4.

3.2.3 Sending a Document to a System Placed in AX

Steps 1 through 4 are found in Section 3.2.2.

STEP 5

You may send a message anytime the system displays "M = SEND A MESSAGE" as one of the options, even when document transmission is occurring. If you are not interested in sending a message, go on to the next step.

You may send any number of messages; each must contain no more than 64 characters. If more than 64 characters are entered, only the first 64 will be sent. The messages will not be recorded.

Type the letter M and press the RETURN key. You will see the display in Figure 3-24.

Now type the message and press the RETURN key.

NOTE

This step can be shortened by typing the letter M, a space, the message, and pressing the RETURN key.

Sender and receiver will see displays such as those shown in Figures 3-25 and 3-26 respectively.

STEP 6

Now you are ready to send the document. **Type the letter S and press the RETURN key.** You will see the display in Figure 3-27.

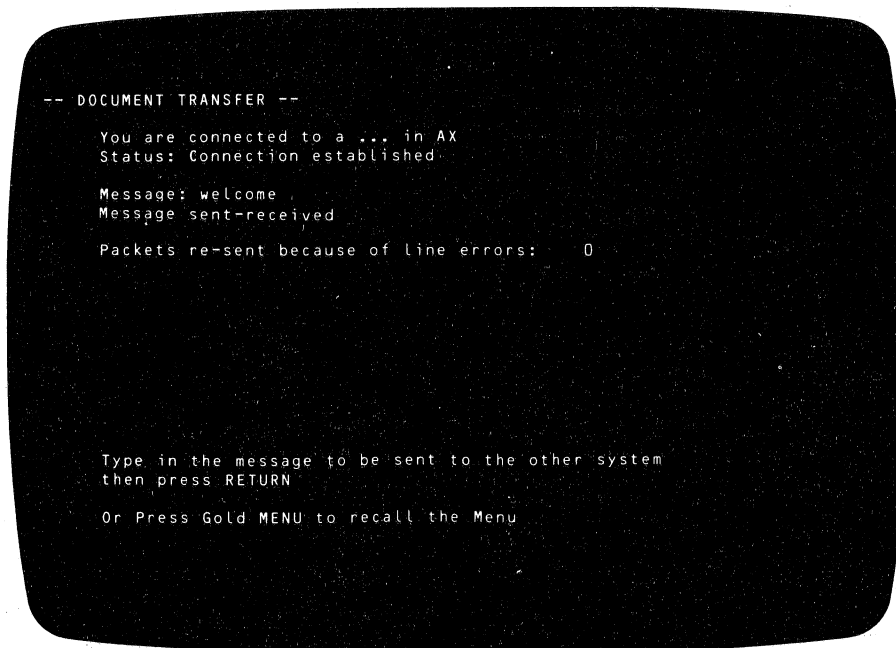

MK-0494

Figure 3-24 Example of Automatic Document Transfer Display When a Message Is To Be Sent

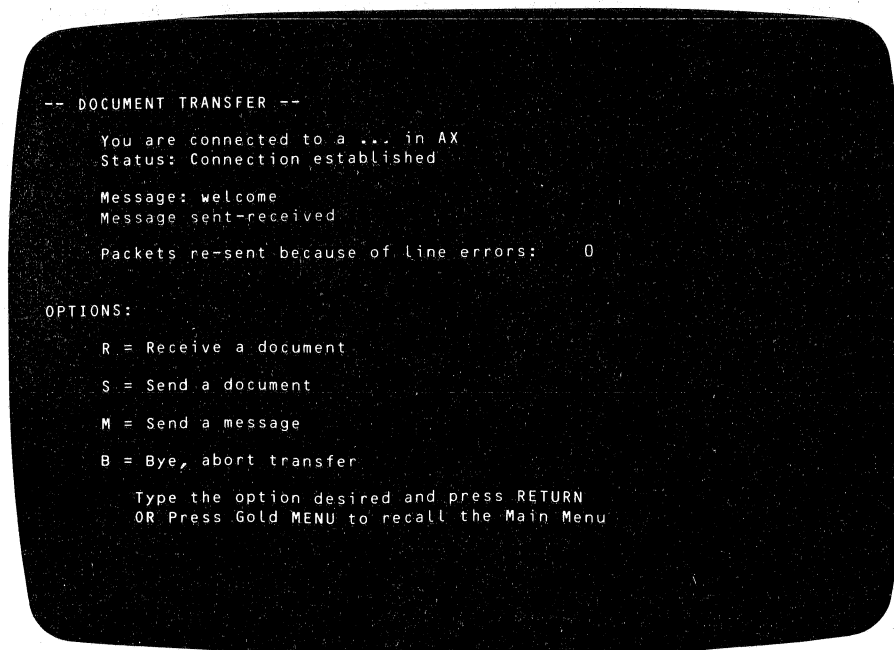

MK-0495

Figure 3-25 Example of Automatic Document Transfer Display Notifying Sender That the Message Has Been Received

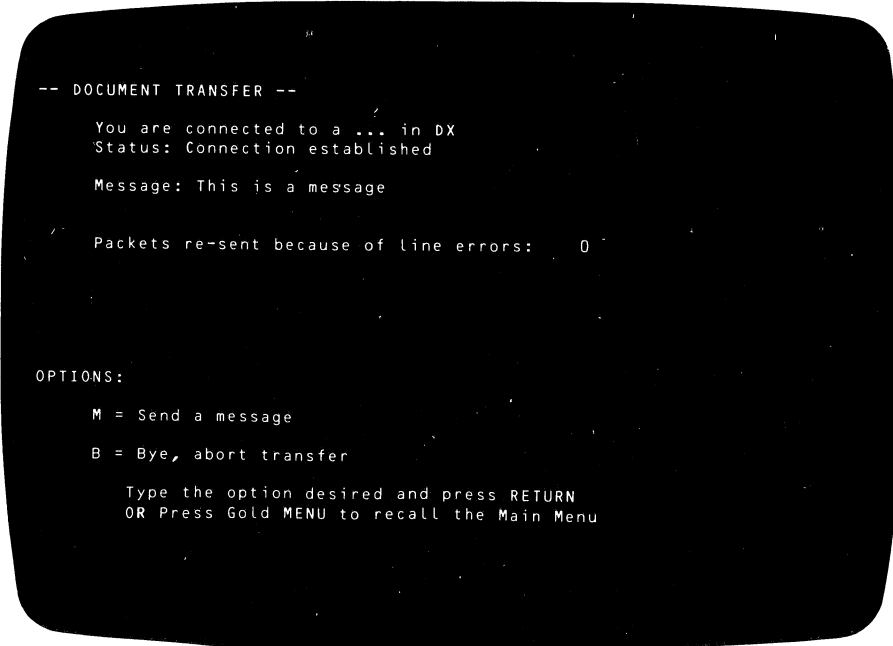

MK-0496

Figure 3-26 Example of Automatic Document Transfer Display Depicting Message on Receiver's Screen

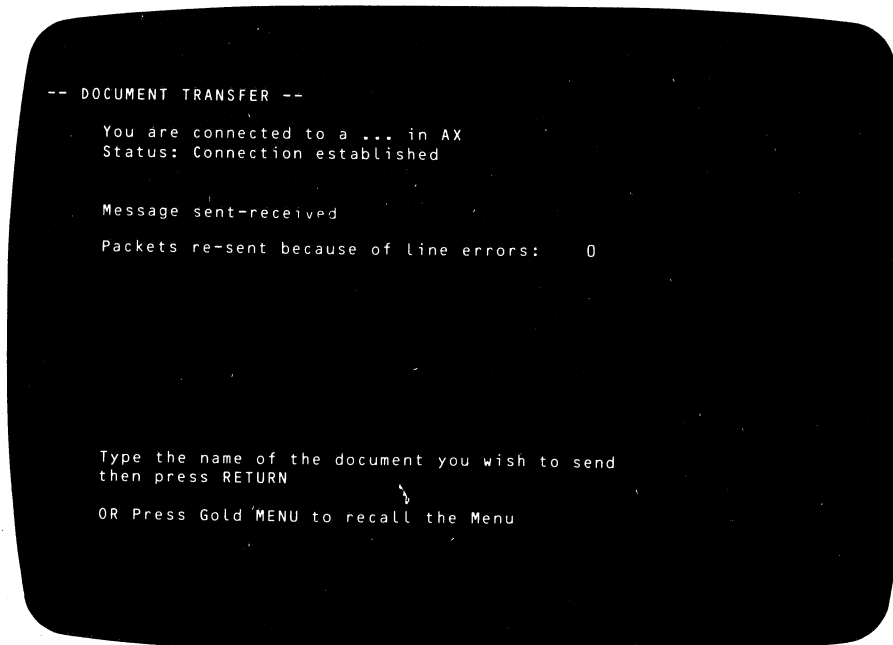

MK-0492

Figure 3-27 Example of Automatic Document Transfer Display Requesting the Name of the Document To Be Sent

Type the name of the document to be sent (or just the number) and press the RETURN key.

NOTE

This step can be shortened by typing merely S, a space, the document name, and pressing the RETURN key.

You will see a display such as the one shown in Figure 3-28.

You are asked to type the name of a document on the AX side of the line to receive the document sent. The name you supply will not cause a document of that name to be sent. It is merely the name of the document in the AX system in which the text you send will be placed.

Type the document name (or just the number) and press the RETURN key, or just press the RETURN key to use the name shown on the screen.

If the document exists on the AX system, you will see the display shown in Figure 3-29.

Type either the letter T or A and press the RETURN key.

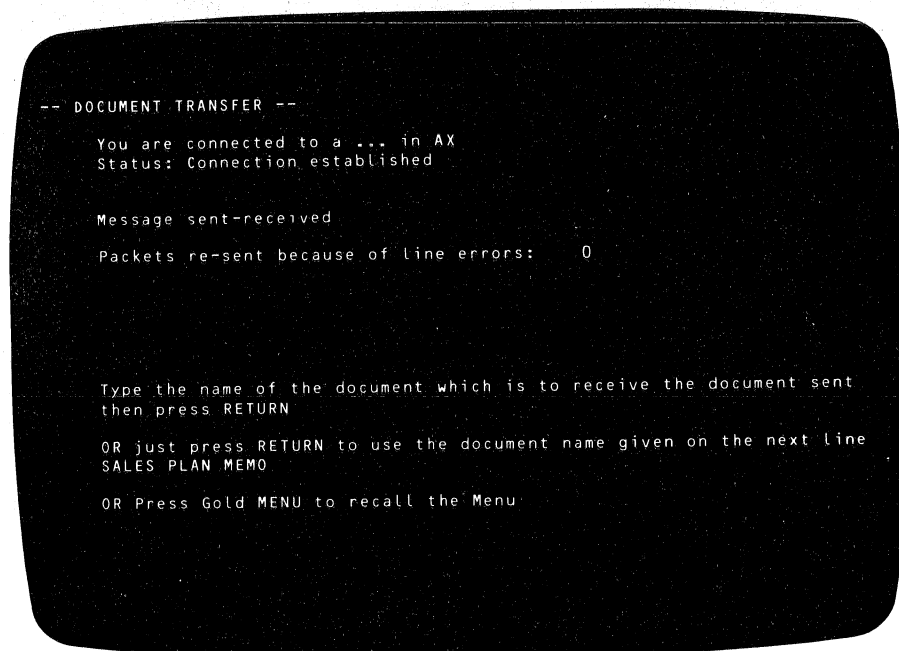

MK-0474

Figure 3-28 Example of Automatic Document Transfer Display Requesting the Name of the Receiving Document

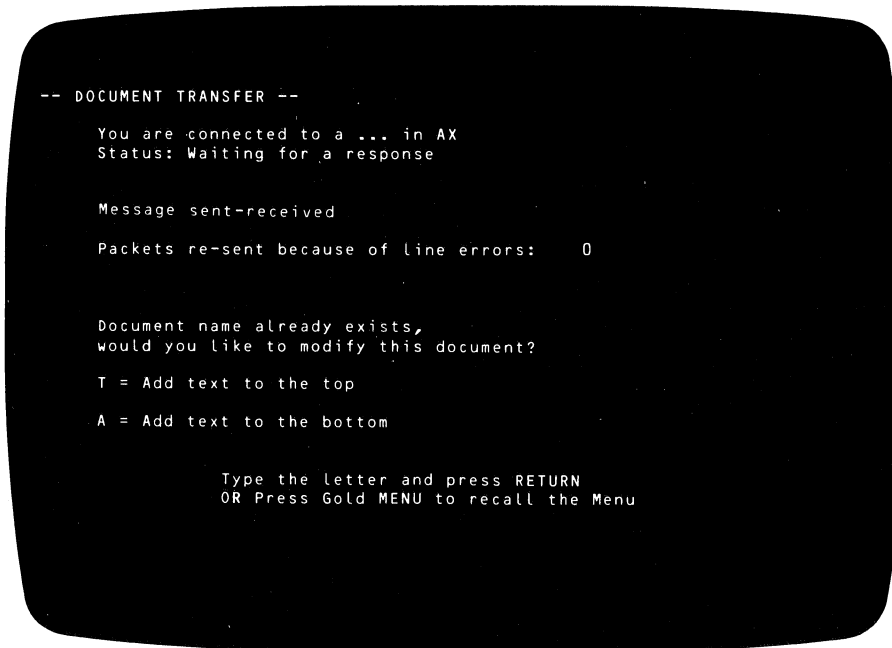

MK-0473

Figure 3-29 Example of Automatic Document Transfer Display When an Existing Receiving Document Is Specified

STEP 7

Sender and receiver will see a display similar to the one shown in Figure 3-30.

NOTE

If you are trying to place a document on a disk or diskette which does not have enough room for it, the notification *****ERROR***** will appear on the screen with the message "Problem: not enough room on diskette to receive document." You cannot send that document, but you can still use any of the options displayed.

```
-- DOCUMENT TRANSFER --

You are connected to a ... in AX (or DX)
Status: Transfer in progress

Message sent-received

Packets re-sent because of line errors:    0
Packets in document transferred:          42
(Approximate) Packets in document:        184

OPTIONS:

M = Send a message
B = Bye, abort transfer

Type the option desired and press RETURN
OR Press Gold MENU to recall the Main Menu
```

MK-0462

Figure 3-30 Example of Automatic Document Transfer Display While Transfer Is in Progress

Notice that the number of transferred packets displayed on the screen changes as more and more packets are transferred. Wait for this number to stop changing, an event which indicates the end of the transfer.

NOTE

If an error occurs on your disk or diskette, the notification *****ERROR***** will appear on the screen with the message: "Problem: cannot continue, disk error." You cannot continue to transfer that document, but you can still use any of the options displayed on the screen.

When the transfer is complete, the display shown in Figure 3-31 will appear on the sender system. The display shown in Figure 3-32 will appear on the system set in AX. Note that the AX display records in the upper right corner the number of documents transferred so far.

The system set in DX may now send another document.

```

-- DOCUMENT TRANSFER --

You are connected to a ... in AX
Status: Transfer complete

Message sent-received

Packets re-sent because of line errors:    0
Packets in document transferred:          167

OPTIONS:

R = Receive a document
S = Send a document
M = Send a message
B = Bye, abort transfer

Type the option desired and press RETURN
OR Press Gold MENU to recall the Main Menu

```

MK-0472

Figure 3-31 Example of Automatic Document Transfer Display Appearing on the Sender's Screen When Transfer Is Completed

```

-- DOCUMENT TRANSFER --                                Documents processed:  1

You are connected to a ... in DX
Status: Transfer complete

Message sent-received

Packets re-sent because of line errors:    0
Packets in document transferred:          167

OPTIONS:

M = Send a message
B = Bye, abort transfer

Type the option desired and press RETURN
OR Press Gold MENU to recall the Main Menu

```

MK-0491

Figure 3-32 Example of Automatic Document Transfer Display Appearing on the Receiver's (the System Set in AX) Screen When Transfer Is Completed

ALTERNATE STEP 7

You can end the transmission before the entire document is transmitted. **Type the letter B and press the RETURN key.** You will see a display such as that shown in Figure 3-33. **Type a message and press the RETURN key.**

NOTE

This step can be shortened by typing the letter B, a space, the message, and pressing the RETURN key.

The DX system and AX system both will show displays such as Figures 3-34 and 3-35 respectively. Now you can send another document.

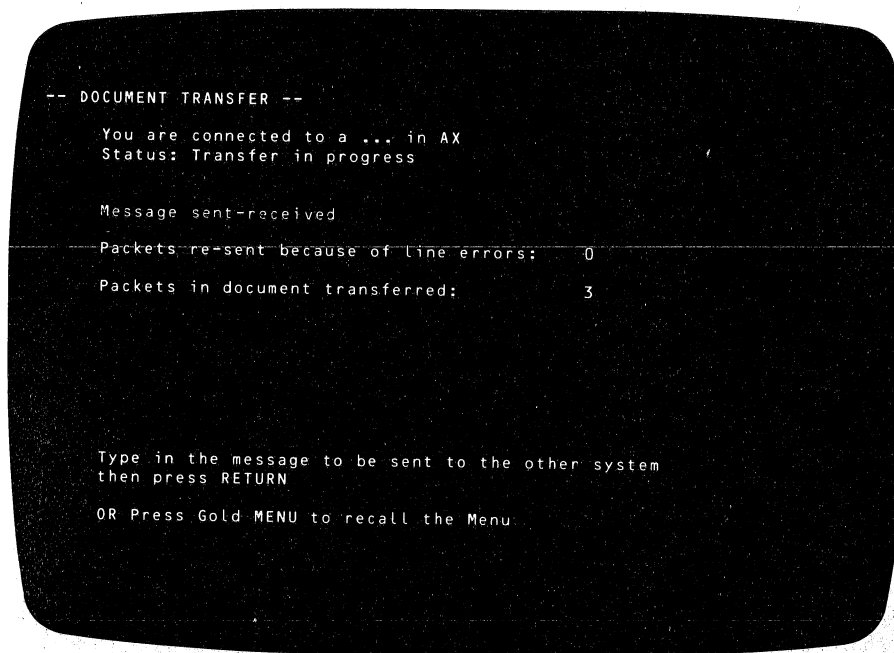

MK-0490

Figure 3-33 Example of Automatic Document Transfer Display Requesting the Bye Message, When Transfer Is Ended Before an Entire Document Is Transferred

```
0
-- DOCUMENT TRANSFER --

You are connected to a ... in AX
Status: TRANSFER ABORTED

Message sent-received
Packets re-sent because of line errors: 0

OPTIONS:

R = Receive a document
S = Send a document
M = Send a message
B = Bye, abort transfer

Type the option desired and press RETURN
OR Press Gold MENU to recall the Main Menu
```

MK-0489

Figure 3-34 Example of Automatic Document Transfer Display Notifying the Sender (the System Set for Document Transfer) That Transfer Has Been Aborted

```
-- DOCUMENT TRANSFER -- Documents processed: ...

You are connected to a ... in DX
Status: TRANSFER ABORTED

Bye: Wrong document - am stopping
Message sent-received

Packets re-sent because of line errors: 0

OPTIONS:

M = Send a message
B = Bye, abort transfer

Type the option desired and press RETURN
OR Press Gold MENU to recall the Main Menu
```

MK-0488

Figure 3-35 Example of Automatic Document Transfer Display Notifying the Receiver (the System Set in AX) That Transfer Has Been Aborted

3.2.4 Fetching a Document from a System Placed in AX

Steps 1 through 4 are found in Section 3.2.2.

STEP 5

You may send a message anytime the system displays "M = SEND A MESSAGE" as one of the options, even when document transmission is occurring.

To send a message, simply type the letter M, a space, the message, and press the RETURN key. Full details are given in Section 3.1, step 3, and again in Section 3.2.3, step 5.

STEP 6

Now you are ready to request the document. Type the letter R and press the RETURN key. You will see the display in Figure 3-36.

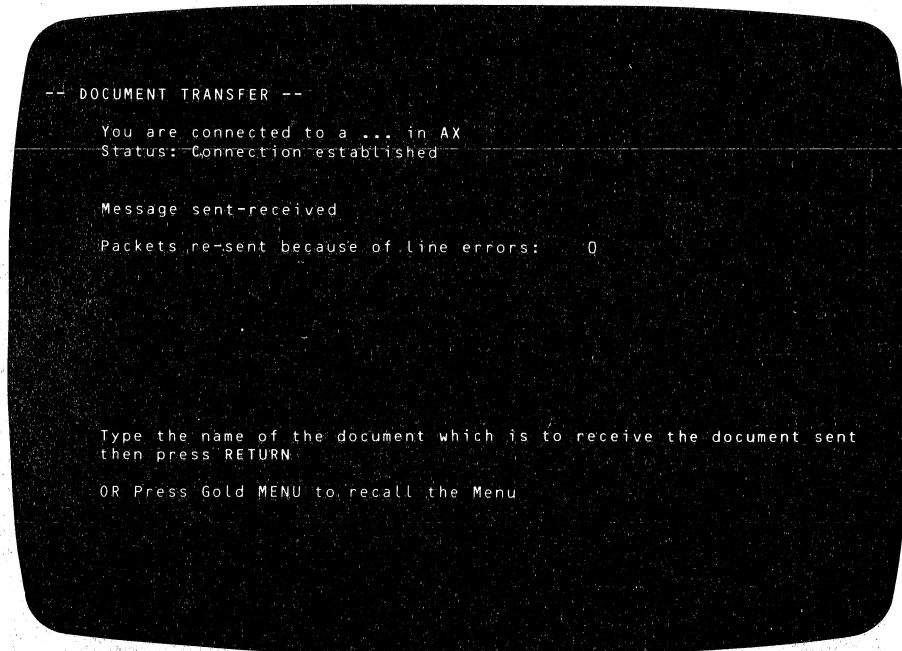

MK-0511

Figure 3-36 Example of Automatic Document Transfer Display Requesting the Name of the Receiving Document

Type the name (or just the number) of the document to hold the document to be fetched from the AX system, and press the RETURN key.

NOTE

This step can be shortened by typing R, a space, the document name, and pressing the RETURN key.

If the name you type in is the same as a document already on your diskette, you will see the display shown in Figure 3-37.

Type the letter T, A or O and press the RETURN key. You will see the display shown in Figure 3-38.

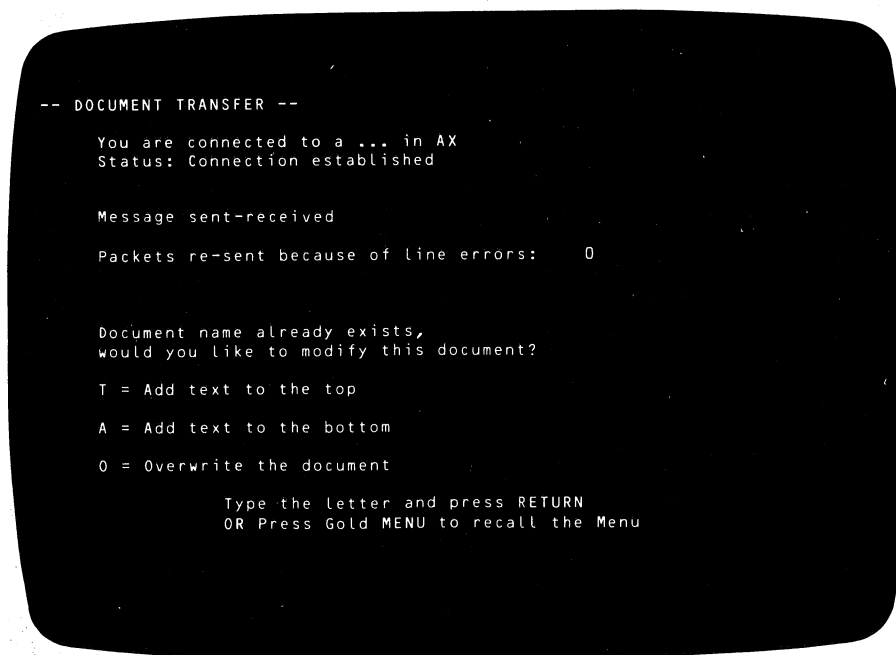

MK-0487

Figure 3-37 Example of Automatic Document Transfer Display Appearing When an Existing Receiving Document Has Been Specified

```
-- DOCUMENT TRANSFER --

You are connected to a ... in AX
Status: Connection established

Message sent-received

Packets re-sent because of line errors: 0

Type the name of the document you wish to receive from the system in AX
then press RETURN

OR just Press RETURN to use the document name given on the next line
SALES PLAN MEMO

OR Press Gold MENU to recall the Menu
```

MK-0461

Figure 3-38 Example of Automatic Document Transfer Display Requesting the Name of the Document To Be Fetched

```
-- DOCUMENT TRANSFER --

You are connected to a ... in AX
Status: Waiting for a response

Message sent-received

Packets re-sent because of line errors: 0

OPTIONS:

M = Send a message
B = Bye, abort transfer

Type the option desired and press RETURN
OR Press Gold MENU to recall the Main Menu
```

MK-0477

Figure 3-39 Example of Automatic Document Transfer Display Appearing While the System Is Awaiting a Response

STEP 7

Type the name of the document (or just the number) on the AX system and press the RETURN key, or just press the RETURN key to fetch the document whose name appears on the screen. You will see the display shown in Figure 3-39.

NOTE

If you specified a document which does not exist on the other system, the notification "CANNOT TRANSFER DOCUMENT" will appear on the screen. You cannot fetch that document, but you can still use any of the options displayed.

Your system is now preparing to transfer the document. There will be a short pause. When transmission begins, displays similar to Figure 3-30 will appear on the DX and AX systems. The rest of the transfer will occur automatically and is described in Section 3.2.3, step 7.

ALTERNATE STEP 7

You can end the transmission before the entire document is transmitted by typing the letter B, a space, a message, and pressing the RETURN key. Further information is given in Section 3.1, alternate step 7, and again in Section 3.2.3, alternate step 7.

3.3 CHARACTER TRANSMISSION (CX)

3.3.1 How To Use CX

This section describes the word processing CX character transmission option. It permits communications between a DIGITAL word processing system and a computer system or other device that transmits and receives ASCII characters. The computer system or other device is called the "host."

Before using the CX option, you may wish to determine by a telephone call or other method that the host is operating and able to be called. If you do not, and the host is not able to be called, you may waste time trying to make a connection.

3.3.1.1 Originating the Call - First, originate the call to the host modem. If the other system is a time-sharing system, you may log into and use it. If there is a host greeting message, it should appear on the screen as soon as the connection is established. If it does not, the connection is not established. Keep trying. After a few minutes, you can assume that the connection cannot be made, and stop trying.

If you are using a DIGITAL host system and the screen does not change, keep pressing the RETURN key or keep holding the CTRL key down while typing the letter C. The greeting message should appear. If it does not, the connection is not established. Try again. If after repeated attempts you are still unable to establish a connection, the settings in your word processing System Options Menu may not be correct (see Appendix B). If they are correct, contact a DIGITAL Field Service representative to determine whether the equipment is malfunctioning.

Now type the letters CX and press the RETURN key. You will see the display shown in Figure 3-40. Each command consists of two letters. Notice that the letters KH HS appear at the bottom. Those commands will be used if you do not erase them and type others in.

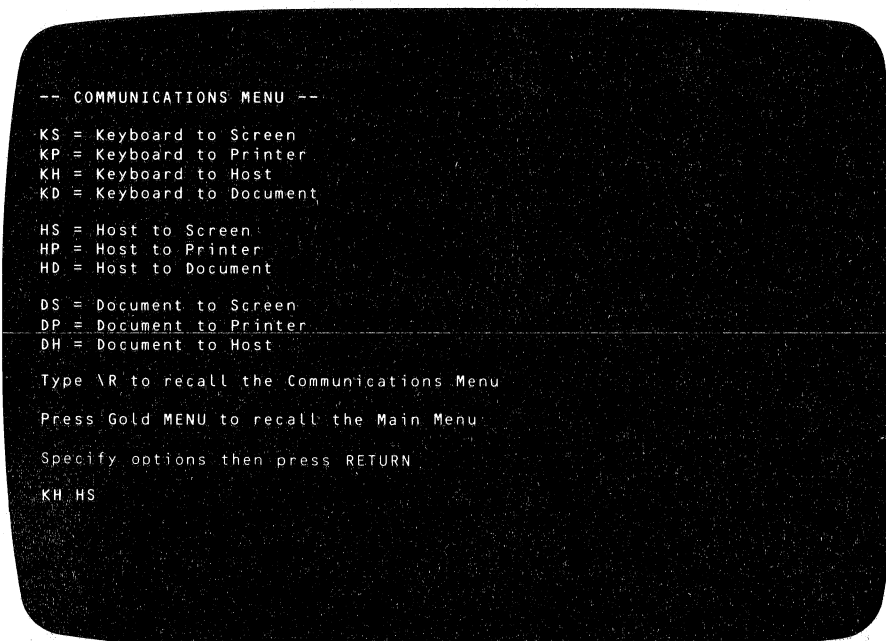

MK-0476

Figure 3-40 Character Transfer Menu Displaying Communicating Options

3.3.1.2 Using the Commands - Commands beginnings with the letter K mean that data taken from the keyboard will be transferred to the screen (KS), printer (KP), or document (KD) of the same system, or to the host (KH) at the other end of the line.

Commands beginning with the letter H mean that data transferred from the host over the line will be sent to your screen (HS), your printer (HP), or a document (HD) of your system.

Commands beginnings with the letter D mean that data will be transferred from a document of your system to your screen (DS), your printer (DP), or to the host (DH) at the other end of the line.

All commands involving documents require you to type in the names of the documents (refer to Section 3.3.2).

Type in a string of commands to accomplish the actions that you wish. First, break down what you wish to do into steps allowed by the commands. Then type the commands in any sequence.

For example, to have a message printed on your printer and then sent to the host, type the following:

KP KH

KP directs the message from the keyboard to the printer, and KH directs it from the keyboard to the host.

As another example, to keep a record of a session of communication with a DIGITAL time-sharing system, the commands are as follows.

Example 1: KH HS HD

Whatever you type on the keyboard will be sent to the host. What is received from the host will be displayed on your screen and stored in the document. (If you are going to receive a document, use some other method of keeping a record. The document would be stored along with the record of the session of communication.)

In a time-sharing system, what is typed on the keyboard is often displayed automatically on the screen. This feature is called a "visual echo." If the host has it, what you type in and send to the host will bounce back and be displayed on your screen even if you did not use KS. If you did use KS, it may appear twice.

3.3.1.3 Changing the Commands - To change the commands, type the two characters \r. The Communications Menu will appear on the screen with the current settings. Use the **RUB WORD OUT** or **RUB CHAR OUT** to erase the old settings and then type in the new settings. When you press the RETURN key, the new settings will take effect.

3.3.1.4 Pausing in Mid-operation with a Host - To pause in mid-operation, type the characters \s. To resume, type the two characters \q. This will work only if the host is set up to respond to XON/XOF protocol (refer to Appendix B). Pausing in mid-operation may be used for an emergency (for example, if the paper on the printer runs out).

3.3.1.5 Shutting Down - To shut down, first log out from the host system, then break the connection according to the modem on your system. For example, press the TALK button on a data phone or hang up from an acoustic coupler (refer to Chapter 2). Display the CX Menu again by typing the two characters \r. Then display the Main Menu by pressing the gold and the MENU keys.

3.3.2 Commands Involving Documents

3.3.2.1 Keyboard to Document (KD) or Host to Document (HD) - When you press the RETURN key after having typed the letters KD or HD, a display similar to the one shown in Figure 3-41 will appear.

Type the name of the document on your system in which you want the characters placed and press the RETURN key. If the document is new, the system will create it for you. If the document already exists, you will see the display in Figure 3-42.

Type the letter, T, A, or O and press the RETURN key. Now you may type on the keyboard (if you specified KD).

NOTE

To have what you type on the keyboard also appear on the screen, you must previously have typed the letters KS.

If you specified HD, the host must initiate the sending of the document. Simply wait for it to be transmitted. (Be certain to arrange sending with the host operator.)

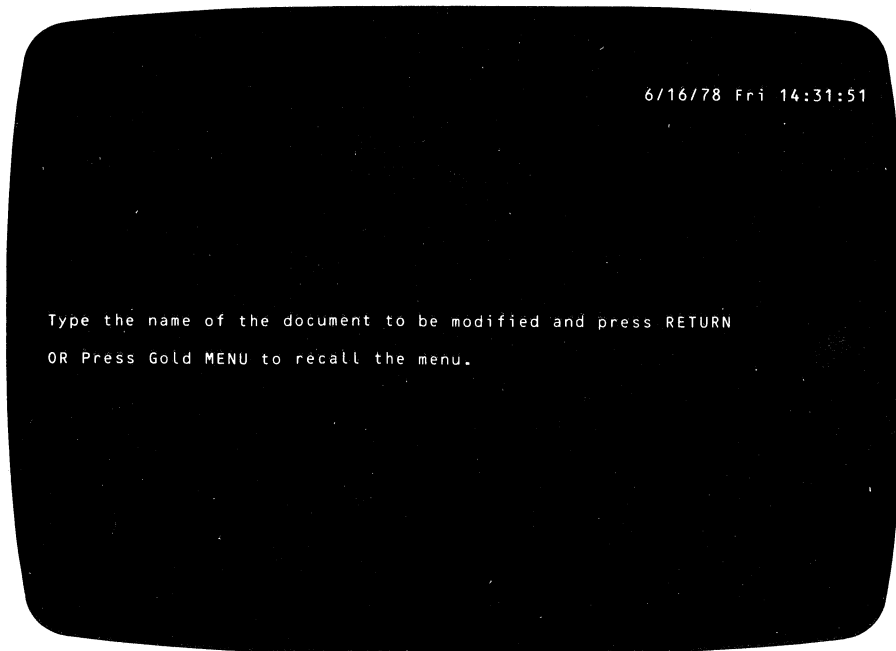

Figure 3-41 Character Transfer Display Requesting the Name of the Document To Receive the Characters

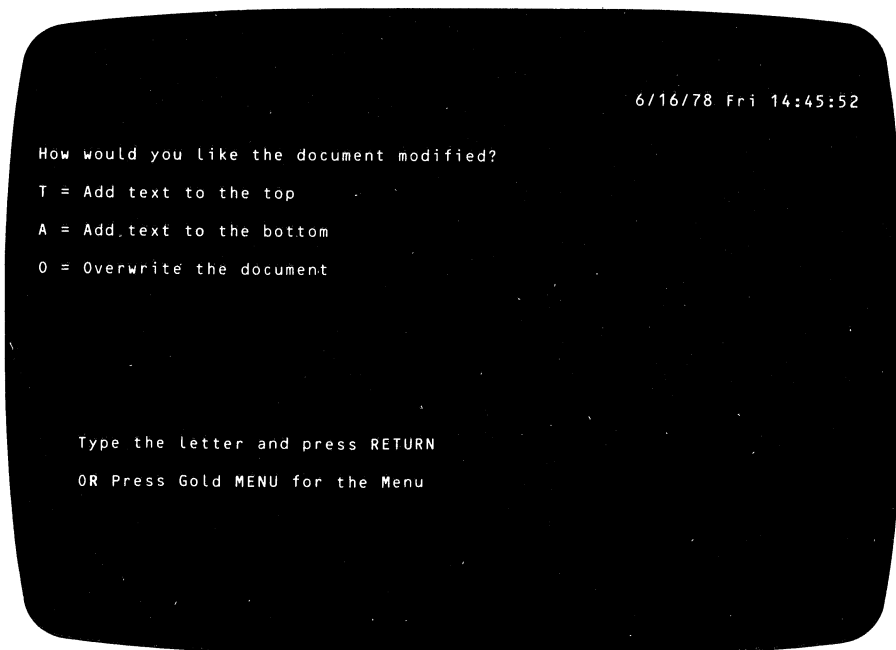

Figure 3-42 Character Transfer Display Appearing When an Existing Document is Specified To Receive the Characters

3.3.2.2 Document to Screen, Printer, or Host (DS, DP, DH)

When you press the RETURN key after having typed the letters DS, DP, or DH, a display similar to the one shown in Figure 3-43 will appear.

Type the name of the document and press the RETURN key. The document will now be displayed, printed, transmitted, or appropriately processed according to the commands specified.

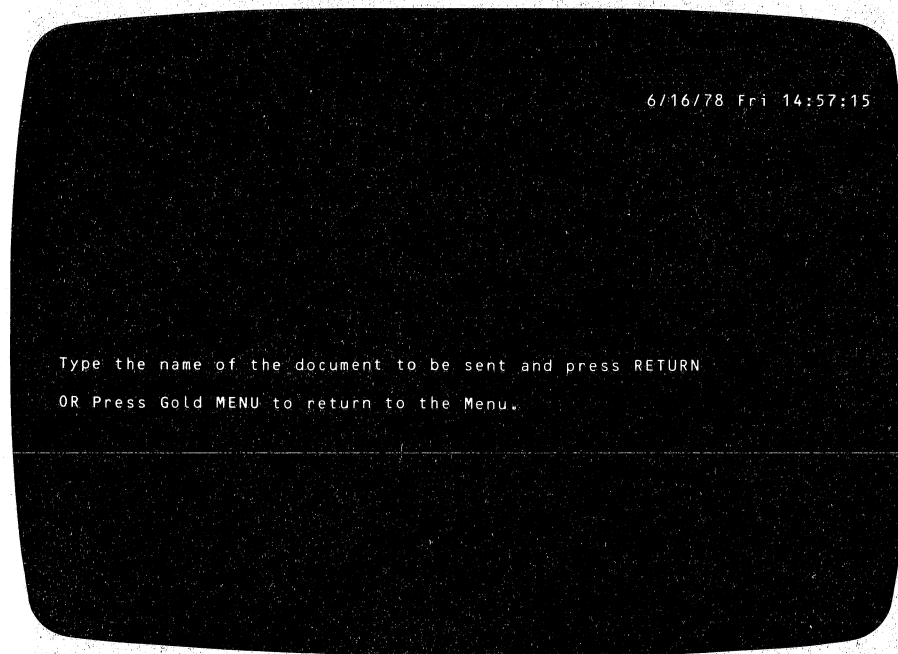

Figure 3-43 Character Transfer Display Requesting the Name of the Document To Be Sent

CHAPTER 4 ERROR MESSAGES

This chapter is an alphabetic list of error messages that may be displayed on the screens of two systems during use of the communications options. The causes of the errors and recovery procedures are presented below. The error messages are also presented at the appropriate places in Chapter 3, the operating instructions.

Bad connection; try again.

CAUSE: The problem is probably in the functioning of the modem or its connections, or in the telephone line.

RECOVERY ACTION: First return to the Main Menu and try again. If you do not succeed, check all the connections to make sure they are tight. Return to the Main Menu and try again. If you do not succeed, call your DIGITAL representative.

Cannot continue, disk error.

CAUSE: Either the surface of the disk or diskette has a damaged or worn spot on it, so that data cannot be read from it or written upon it at that point, or data has not been written in the proper place in the format of the disk.

RECOVERY ACTION: Do not attempt to send the document. Remove the diskette because the contents of the document beyond the bad spot are not recoverable. If you have a duplicate backup copy available, use it. If not, you must reconstruct the document. Transfer all the other documents on the disk or diskette to a fresh disk or diskette. Then try to save the first part of the document up to the bad spot by cutting and pasting.

Once a duplicate has been constructed, the disk or diskette can be tested. A disk error should be checked by a DIGITAL representative. You can test a diskette yourself. Simply reformat the diskette. If the error persists after reformatting, throw away the diskette because the surface is worn.

Cannot transfer document.

CAUSE: You requested the AX system to send you a document which does not exist. Perhaps you have misspelled the name of the document. Blanks between words are also part of the document name.

RECOVERY ACTION: Check your spelling and try again. If you do not succeed this time, call the manager of the system set in AX and find out if the document is on the disk or diskette under the name that was given to you.

Illegal user.

CAUSE: You have attempted to enter the correct password three times and have failed on the fourth try.

RECOVERY ACTION: Press the gold and MENU keys to return to the Main Menu and start again. This time, find out what the password is. If you are not an authorized user, you will never get past this point.

Incorrect password.

CAUSE: You have not typed the correct password. The spelling must be exact. Blanks count, although capitalization does not.

RECOVERY ACTION: Find out exactly what the password is and type it correctly. You will have three tries in all. After that, you will be an "illegal user" and will not be able to use the system at all.

Not enough room on diskette to receive document.

CAUSE: You have attempted to transfer a document to a disk or diskette which did not have adequate capacity for it.

RECOVERY ACTIONS: You can move documents off the desired disk or diskette so that the document to be transferred will fit. Or you can use another disk or diskette.

Use the disk or diskette index to see the size of each document and the space remaining on the disk. Compare the size of the document to the space remaining on the disk or diskette. The number representing the document size must be at least 15 less than the number representing the available space.

APPENDIX A COMMUNICATIONS CONFIGURATIONS

This appendix describes the equipment that may be used with the communications options.

A.1 DEFINITION OF A COMMUNICATIONS CONFIGURATION

A communications configuration is an arrangement of equipment necessary to transfer documents from one system to another. The configuration of the equipment used in a word processing system or host computer itself is the same whether it is used in the communications options or not. Two or more systems are arranged to make a communications configuration. Most communications configurations require the presence of a modem.

A.2 DEFINITION OF A MODEM

Just as people need telephones to translate voice messages into a pattern of electrical signals sent over the telephone line, computers need a device called a *modem* to translate their messages. The process of translating the data coming from the computer into a pattern of electrical signals sent over the line is called "modulation." At the other end of the line, the data is reconstructed. This process is called "demodulation." The word "modem" is a contraction of Modulator/Demodulator.

For telephone transmission, two modems are required: one between the line and the sending system, and one between the line and the receiving system. The sending modem modulates coded messages coming from the sending system and sends them over the line. The receiving system modem receives the line signals and demodulates them back into coded messages that can be used by the receiving system.

Different varieties of modems exist. Two types used with DIGITAL word processing systems are the data phone and the acoustic coupler. A data phone changes coded messages directly into modulated electrical signals that are sent over the line without the intermediary use of the telephone receiver. On receiving modulated electrical signals, the data phone changes them back to coded messages, again without using the receiver.

The adjective "acoustic" in "acoustic coupler" is derived from a Greek word meaning "to hear." An acoustic coupler changes coded messages into coded tones which are beeped into the microphone in the phone receiver. They are "heard" just as a human voice is heard. For reception, an acoustic coupler listens to the coded tones and converts them back into coded messages.

A typical data phone is the Bell Data phone consisting of the Data Set 103A and the Data Auxiliary Set 804B used together as a single modem on one side of the line (Figure 2-1). The Bell Data phone must be installed by the Bell Telephone Company, and is not sold as part of DIGITAL's word processing system.

DIGITAL offers an acoustic coupler, the DF01 (Figure 2-3), which can be used to originate calls. A DF01 cannot communicate with another DF01. The DF01 may be used with a Bell Data phone.

A system must be specially designed to use a modem. A word processing system is designed to talk to a modem. In some situations, however, as when the two computers are located in the same building, communication via the telephone may not be necessary or desirable. In this case, a direct link is the best way to communicate, but the fact that the system has been designed for a modem and will not transmit without a modem presents a problem.

The problem is solved by a piece of equipment called a null modem. "Null" is Latin for "no." A null modem is a connector that takes the place of two modems and a telephone line so that two systems which normally communicate only across a phone line and are designed to connect to modems can be connected directly to each other. A null modem "looks" like a modem to the word processing system, but in fact is "no" modem.

For a direct link, the DEC Model H312A null modem (Figure 2-4) can be installed by Digital Equipment Corporation.

Three different modems have been described above, but many types exist. For purposes of deciding which is best for a particular application, modems can be divided into three categories: modems, short-haul modems, and null modems. Modems are the most expensive; short-haul modems are much less expensive, and null modems are the least expensive.

The criterion for deciding which category to use and therefore what the cost will be is the distance between the sending system and the receiving system. For distances up to 50 feet, use a null modem; for distances over 50 feet up to five miles or over a private (non-telephone company) line, use short-haul modems; and for transmission over telephone company lines, use modems.

A.3 CONFIGURATIONS

Communicating systems may be connected as illustrated in Figures A-1 through A-4.

Modems are connected through the communications ports of the terminals. Only one modem per terminal is allowed. For the WS100 or WS102, the KL8-JA communications interface is required. For the WS202, the KL8-A communications interface is required.

Figure A-1 is an example of a communicating configuration to be used for distances up to fifty feet.

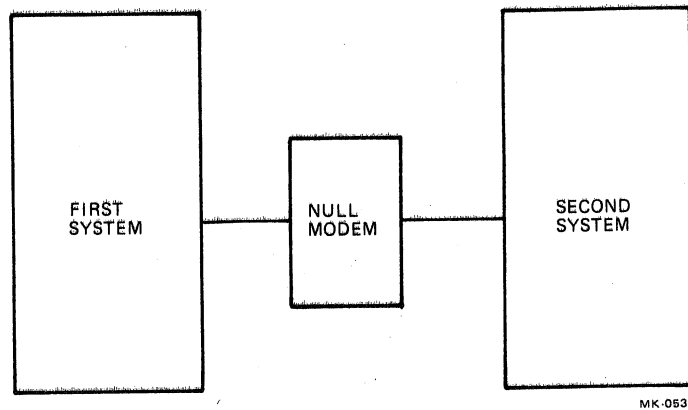

Figure A-1 Example of a Configuration Using a Null Modem, for Transmission for Distances Up to 50 Feet

Figure A-2 is an example of a communicating configuration to be used over private lines for distances between fifty feet and five miles.

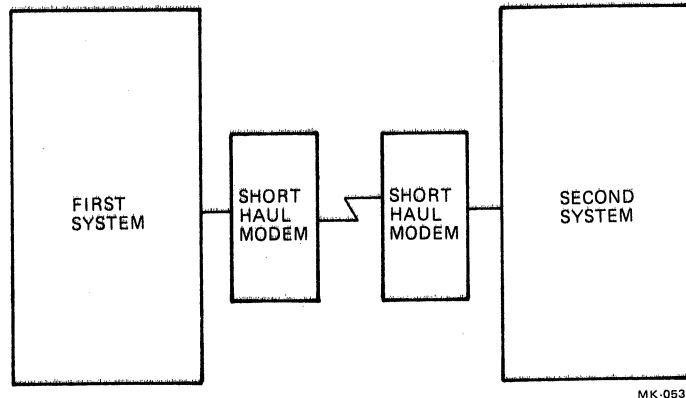

Figure A-2 Example of a Configuration Using Short-haul Modems for Transmission Over Private Lines for Distances Over 50 Feet Up to 5 Miles

Figure A-3 is an example of a communicating configuration for transmission over telephone company lines in which calls may be originated only on one side.

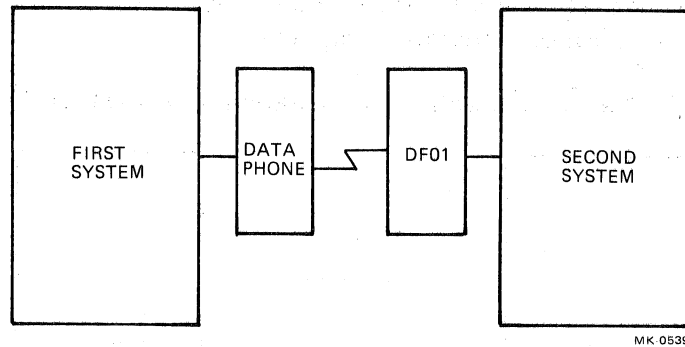

Figure A-3 Example of a Configuration Using an Originate-only Acoustic Coupler for Transmission Over Company Telephone Lines

- Note:** An Acoustic Coupler May:
- 1) Originate Calls on One Side Only
 - 2) Originate Calls on Either Side

Figure A-4 is an example of a communicating configuration for transmission over telephone company lines in which originating calls may be originated on two sides.

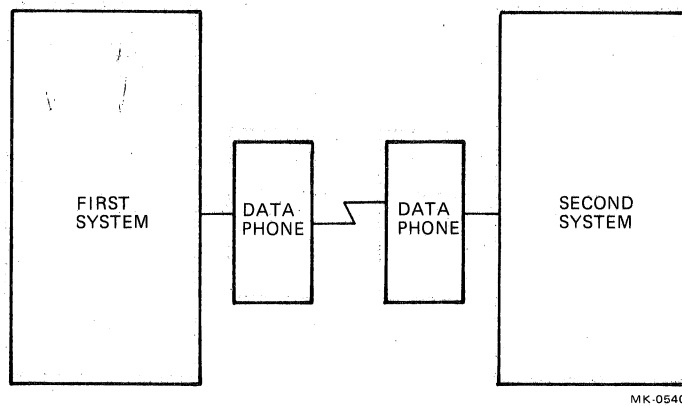

Figure A-4 Example of a Configuration Using Data Phones Only

APPENDIX B

CHANGING THE COMMUNICATIONS CHARACTERISTICS

The word processing System Options Menu permits you to change the CX transmission characteristics to conform to your system or computer-related equipment. Changing them is not recommended unless you are a programmer or a System Manager. Here are the characteristics you can modify:

Characteristics	Choices
Protocol	A <i>protocol</i> is a set of rules that govern transmission. Two protocols are available in CX transmission: one for the IBM Mag Card I, and one for all other systems or computer-related equipment. The latter protocol is called "standard" in this manual and in displays.
Buffer Control	Data coming in over the line is placed in a temporary storage area called a <i>buffer</i> . The buffer is a device for controlling the rate at which characters are sent. When the buffer is full, a stop character (XOF) is sent to the sender. When the buffer is almost empty, a start character (XON) is sent to the sender. Two choices are available in CX transmission: not to use XOF and XON or to use XOF and XON.
Baud Rate	The speed at which data is sent over the line (not to be confused with the regulation of data flow by buffers) is measured by the <i>Baud rate</i> . The Baud rates available are 50, 75, 110, 134.5, 150, 300, 600, 1200, 1800, 2000, 2400, 3600, 4800, 7200, 9600, and 19200 (if using a WT78 only).
Parity	Three parities are available: even, odd, and no parity (i.e., the parity bit is set at 0).
Data Bits	The size of the data byte can be varied from 5 to 8 bits.
Stop Bits	A stop bit or stop bits signify the end of a character being transmitted over the line. Different systems may require a different number of stop bits. Two choices are available in the CX option: one or two stop bits.

To change the characteristics, follow the instructions below.

STEP 1

Type the letters **SO** and press the **RETURN** key when any **Main Menu** page is displayed.

STEP 2

You will see a display on the screen similar to Figure B-1. Notice that the options currently in effect are shown within parentheses. The following table describes the three options and how to change each.

Option	Explanation	Action
CP	Allows you to select "standard" or IBM MAG CARD I protocol.	Type the letters CP and press the RETURN key. You will see the display shown in Figure B-2. Type SP or MC and press the RETURN key or press the gold and the MENU keys.
BC	Allows you to select overflow control or no control.	Type the letters BC and press the RETURN key. You will see the display shown in Figure B-3. Type YES or NO and press the RETURN key or press the gold and the MENU keys.
CC	Allows you to select Baud rate, ports, data bits, and stop bits. This option exists only on WS78s and WT78s.	Type the letters CC and press the RETURN key. You will see the display shown in Figure B-4. Now type B, P, D or S and press the RETURN key. You will see a message on the screen listing and choices for the letter you typed. Type the choice and press the RETURN key. You can also set the Baud rate for the secondary data port, if you are using it, by typing the letters DP2 and pressing the RETURN key, typing the Baud rate, and pressing the RETURN key. You will see the choices you have made displayed in parentheses. If you are satisfied with them, press the gold and MENU keys.

STEP 3

You will see the CP and BC choices you have made displayed in parentheses. **If you are satisfied with them, press the gold and MENU keys to return to the Main Menu.**

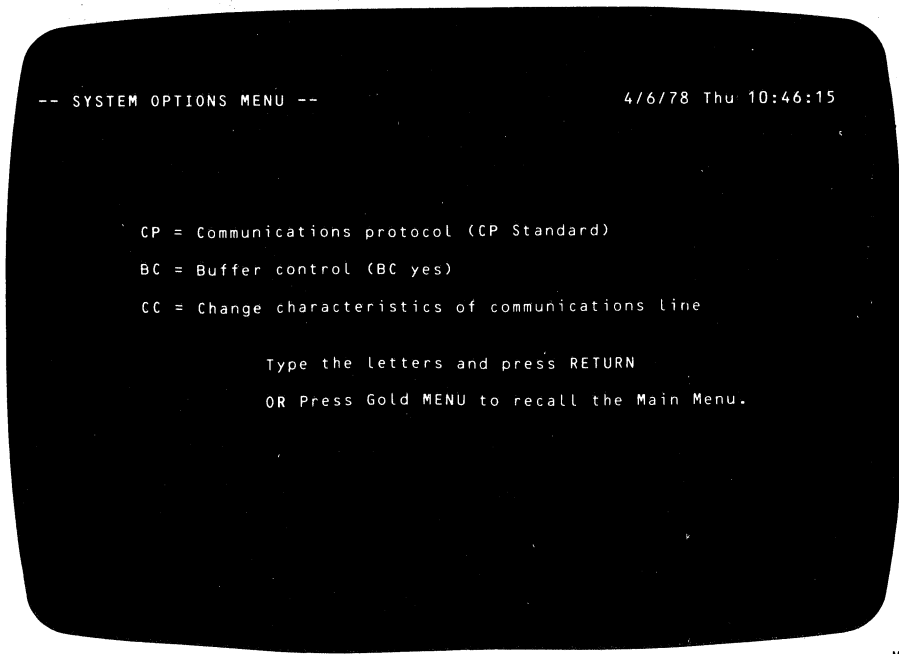

MK-0479

Figure B-1 System Communications Menu Options

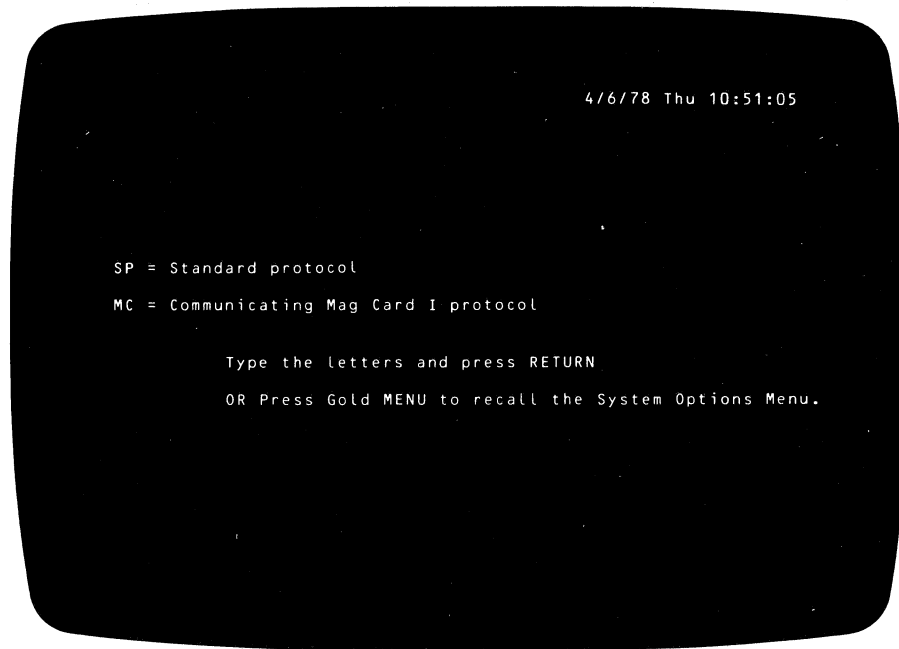

MK-0501

Figure B-2 Communications Setting Menu Appearing When a Change in Protocol Is Specified

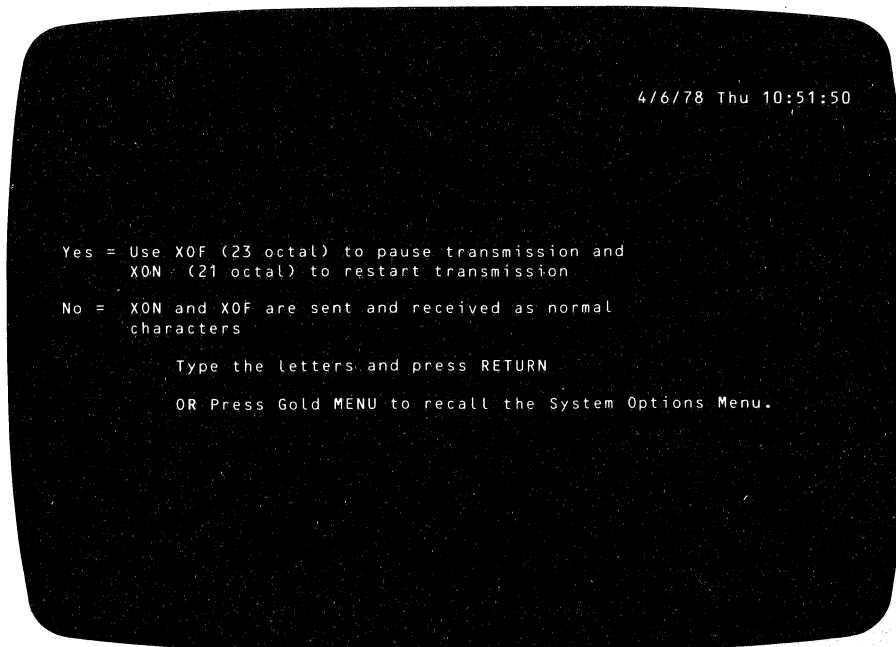

MK-0602

Figure B-3 Communications Setting Menu Appearing When a Change in Buffer Control Is Specified

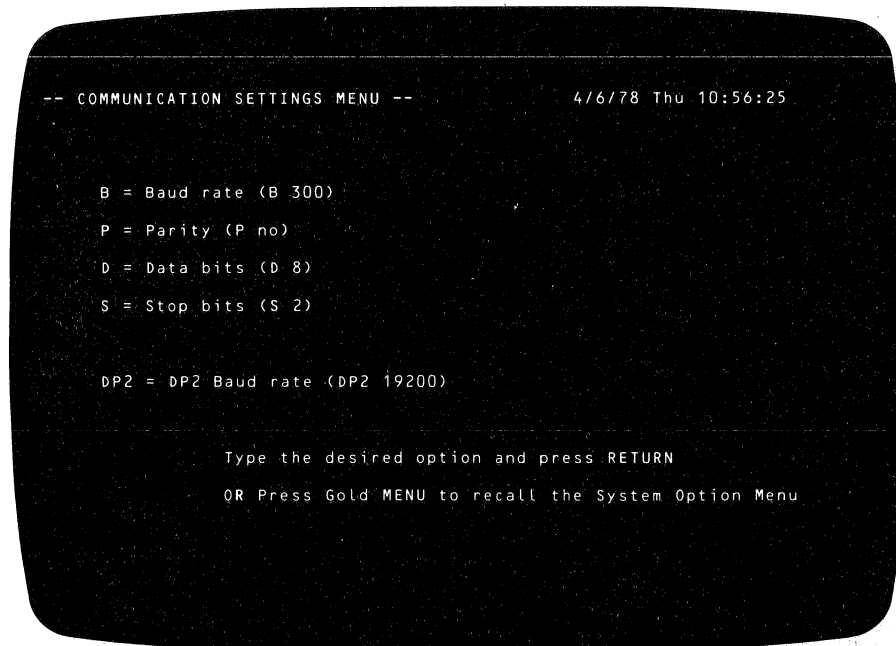

MK-0471

Figure B-4 The Communications Setting Menu Appearing When a Change in Other Transmission Characteristics Is Specified

APPENDIX C

COMMUNICATING WITH AN IBM COMMUNICATING MAG CARD I

C.1 INTRODUCTION

DIGITAL offers the capability of communicating with an IBM Communicating Mag Card I (CMC), a typewriter that can receive input from magnetic cards and also place output on them. Documents can be sent to a Mag Card I from a word processing system or vice versa. The Mag Card I has no disk-storage capability nor memory in which the document can be placed. Text received goes directly to the Mag Card I.

DIGITAL's Key	Function When Used for Communicating with an IBM Mag Card I
ADVANCE	Starts transmission. Same as pressing the START key on the CMC.
gold + HALT	Stops transmission. Same as pulling the plug of the CMC. If you inadvertently hit these keys, recover by turning the CMC off and then on and starting over.
gold + MENU	These keys work only when the two machines are in standby mode; that is, when the number sign (#) appears on your screen. (This is the same as when both lights are lit on the CMC.)
HALT	Acts like the ATTN key. Use it whenever you would press ATTN, such as at the end of a card (when you are receiving a document).
RUB CHAR OUT	Equivalent to BACKSPACE.
Shift/HALT	Acts like CODE/ATTN. You type it by pressing the HALT key while holding down the SHIFT key. You can use Shift/HALT to stop transmission for some reason.

During transmission, the word processing system displays three special characters that stand for the lights on a CMC.

DIGITAL's Character

Significance When Communicating with an IBM Mag Card I

(pound sign, number sign, or sharp sign)

Indicates the system is in standby mode; it is the same as if both lights on the CMC were lit. When you see the # character, you can use the gold and the MENU keys to return to the Communications Menu.

\$ (dollar sign)

Indicates the system is in standby mode when not intended. Such action would possibly occur when the CMC operator is sending a document and temporarily stops sending for an instant, or when the connection is lost.

___ (non-blinking underscore)

Occurs during reception to indicate a CARD EJECT has occurred (usually). You should press HALT, which is equivalent to ATTN, to continue reception.

Before you begin transmission, note that a carriage return on a word processing system is called a carrier return on the CMC. For the sake of uniformity, carrier returns are called carriage returns in this manual.

C.2 SENDING A DOCUMENT TO A MAG CARD I

NOTE

Before trying to send a document, check that the Mag Card I protocol is in effect. You can do this by inspecting the System Options Menu (see Appendix B).

STEP 1

When any page of the Main Menu is displayed, type the letters CX and press the RETURN key. You will see the display shown in Figure C-1. Notice that the letters KH HS appear at the bottom. These commands will be used if you do not erase them and type in others.

NOTE

If you do not see the display shown in Figure C-1, your system is not using the Mag Card I protocol. Place the protocol in effect by using the System Options Menu (see Appendix B).

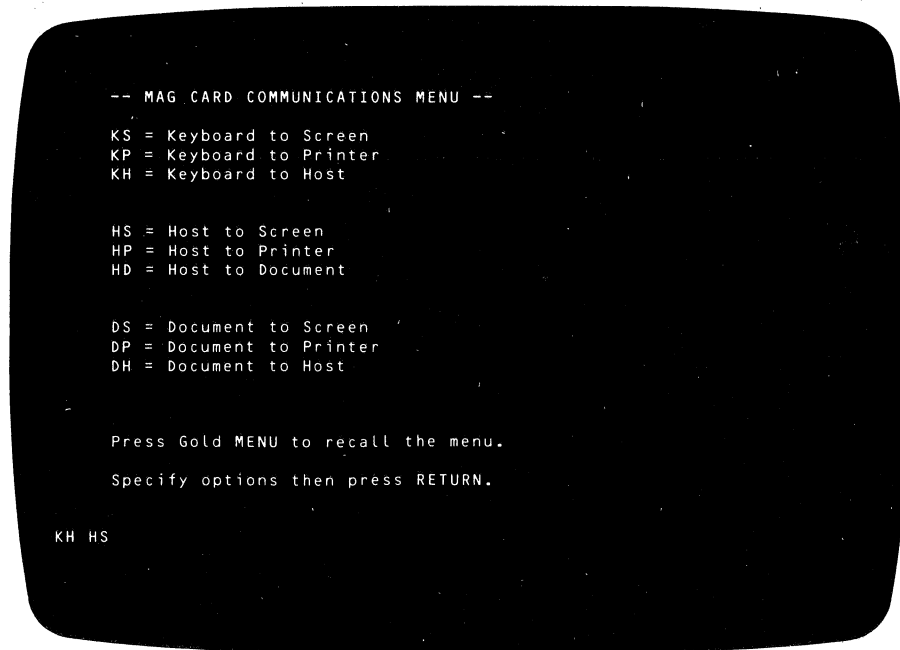

Figure C-1 Mag Card Communications Menu

STEP 2

Using the RUB CHAR key, erase the letters KH HS at the bottom of Figure C-1. Now type the letters DS DH and press the RETURN key. You will see the display shown in Figure C-2.

NOTE

You may wish to investigate the uses of the other commands shown on the screen in Figure C-1. For example, the document can be printed at the same time it is being sent. Further information can be found in Section 3.3.1.2.

STEP 3

Type the name (or number) of the document to be sent and press the RETURN key. You will see the display shown in Figure C-3.

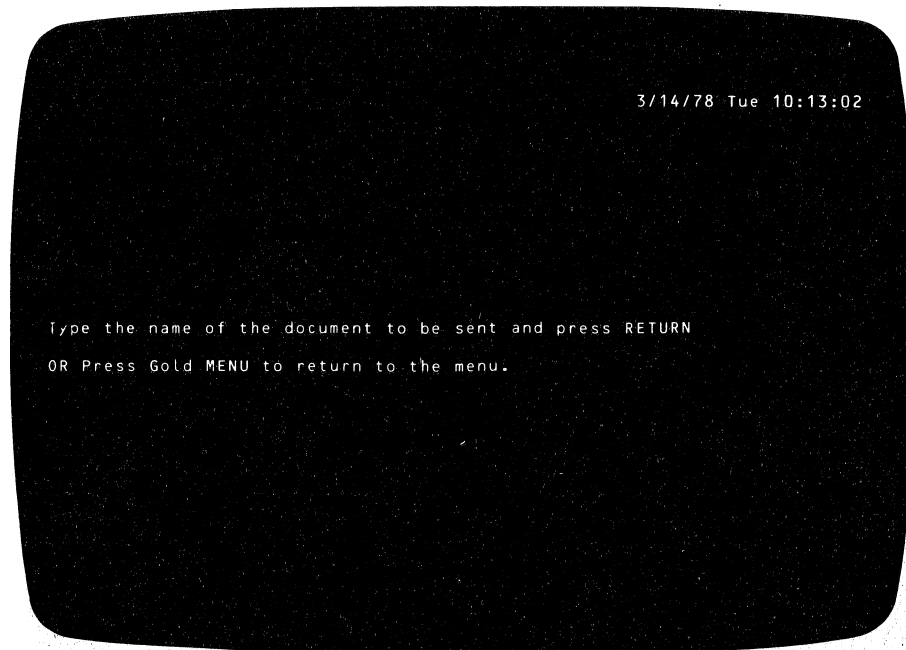

MK-0503

Figure C-2 Mag Card Communications Display Requesting the Name of the Document To Be Sent

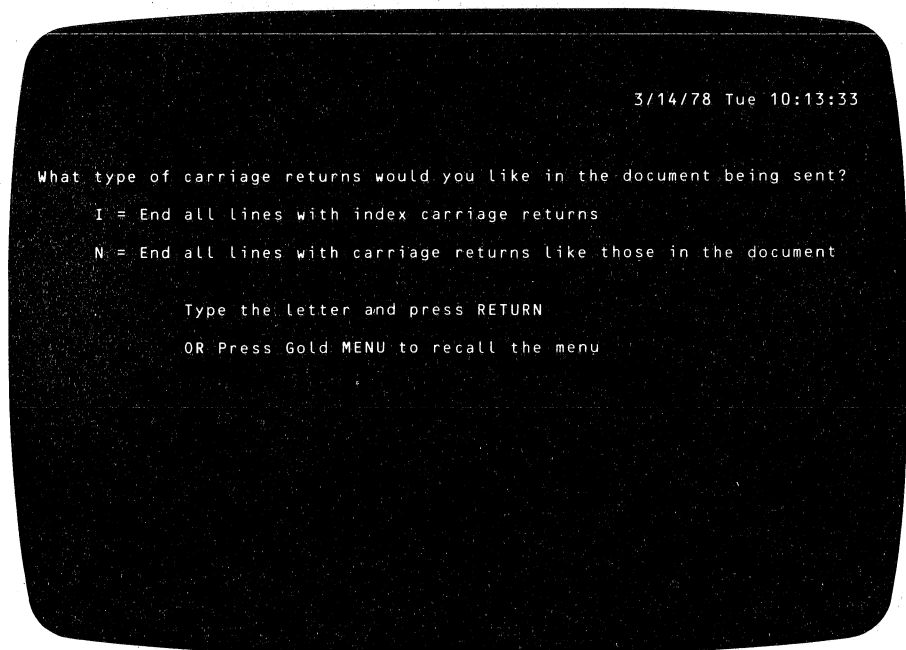

MK-0504

Figure C-3 Mag Card Communications Display Requesting the User To Specify How Carriage Returns Are To Be Sent

STEP 4

If you have to pack many characters onto a magnetic card (for example, if you are sending a legal document), type the letter I and press the RETURN key to end all lines with index carriage returns. The index carriage return affects only the printer, and does not affect the magnetic card. The printer's carriage returns to the left and the paper moves up one line, but the magnetic card does not move to the next track.

To end all lines with carriage returns like those in the document, type the letter N and press the RETURN key. The carriage returns in the document both return the printer's carriage and move the magnetic card to the next track.

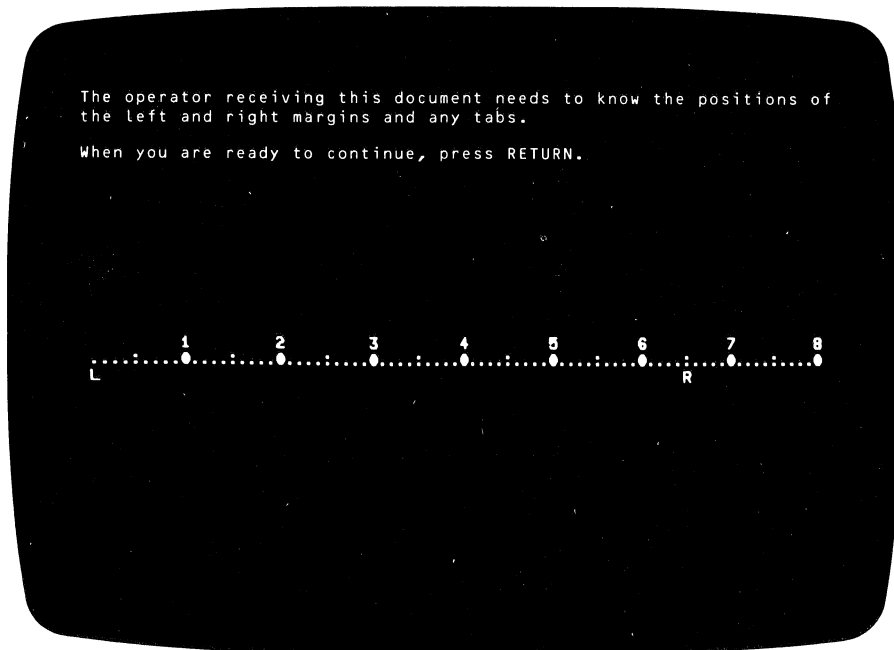

MK-0486

Figure C-4 Card Communications Display Depicting an Example of a Ruler in a Document Being Sent

STEP 5

You will see a display similar to the one shown in Figure C-4. The display shows a ruler typical of the first ruler in the document to be sent. You must call the CMC operator and give the settings you see on the screen.

Subsequent rulers are handled automatically; only the first has to be phoned in.

The proper settings for the CMC operator must be calculated (they are not what is displayed on the screen). The following steps describe how to calculate ruler settings:

1. Read the settings from the screen and write them down. For example, you might read L at 1, R at 65. Note that the dot on the far left is one rather than zero.
2. Change tab settings by subtracting the left margin setting from the tab setting. For example, if the left margin is at 10 and a tab is at 15, the new tab setting is 5. Tabs start from the left margin on the CMC.

Change margin settings by subtracting one from the settings to account for the fact that the word processing scale begins at one rather than zero. For example, one and 65 becomes zero and 64.

3. Call the CMC operator and obtain the CMC's left margin setting. Add this setting to your settings. For example, if the CMC's left margin setting is 30, the tab setting in step 2 above is 35. The margin settings in step 2 above are 30 and 94.

If your document has a wide ruler (that is, one whose right margin is set beyond position 79), the word processing system will display the right margin setting, but no tab settings beyond position 80.

In order to determine correct tabs beyond position 80, you must return to the Main Menu and edit the document. The first ruler you see has the correct tabs. Once you know them, file your document, and start over.

When the CMC operator has set up the margins and tabs, press the RETURN key. The screen will go blank with only the number sign (#) displayed in the upper left corner.

STEP 6

Make the connection to the CMC (see Chapter 2).

STEP 7

Press the ADVANCE key to start the transmission. An occasional buzzing sound may be observed as transmission progresses and may be ignored.

CARD EJECT characters will be transmitted in lieu of the following word processing information: PAGE MARKER, NEW PAGE, START PRINT CONTROL, END PRINT CONTROL, or END OF DOCUMENT.

When transmission stops and a number sign (#) is displayed on the screen after the last character transmitted, the operator has to change cards. Press the HALT key (HALT is the equivalent of ATTN).

STEP 8

When transmission is finished, press the gold and the MENU keys to return to the Communications Menu. If you want to transmit another document, just press RETURN, and the system will ask you for the name of the next document. Give the name, and continue as before.

NOTE

If the next document has a different ruler, you will have to break the current connection, in order to let the CMC operator change the margins and tab settings. Lift the receiver from an acoustic coupler or press the TALK button on a Bell 103 dataset. This action is a CMC requirement, not a word processing system requirement.

C.3 RECEIVING A DOCUMENT FROM A MAG CARD I

NOTE

Before trying to receive a document, check that the Mag Card I protocol is in effect. You can do this by using the System Options Menu (see Appendix B).

STEP 1

When any page of the Main Menu is displayed, type the letters CX and press the RETURN key. You will see the display shown in Figure C-5.

NOTE

If you do not see the display shown in Figure C-5, your system is not using the Mag Card I protocol. Place the protocol in effect by using the System Options Menu (see Appendix B).

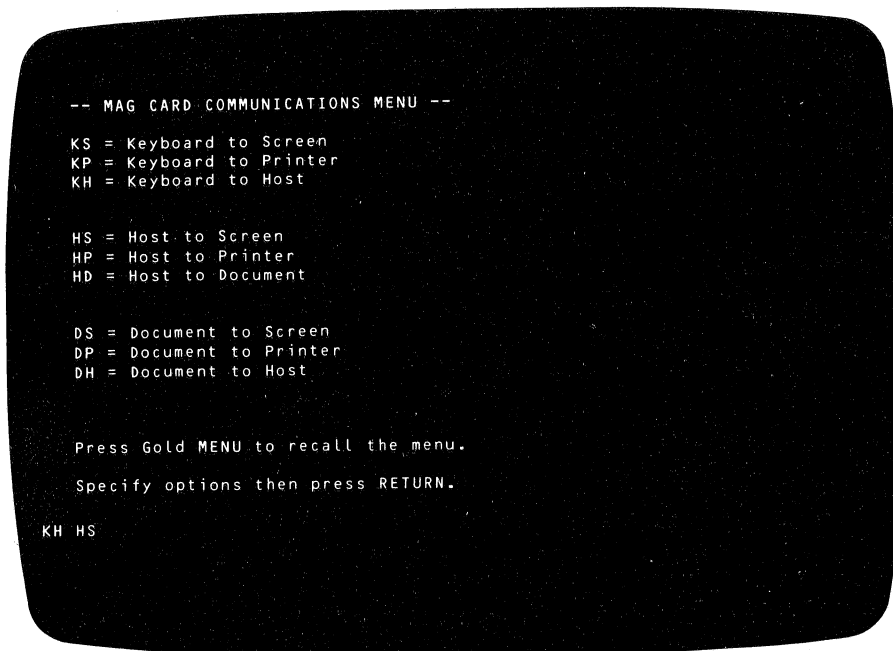

Figure C-5 Mag Card Communications Menu

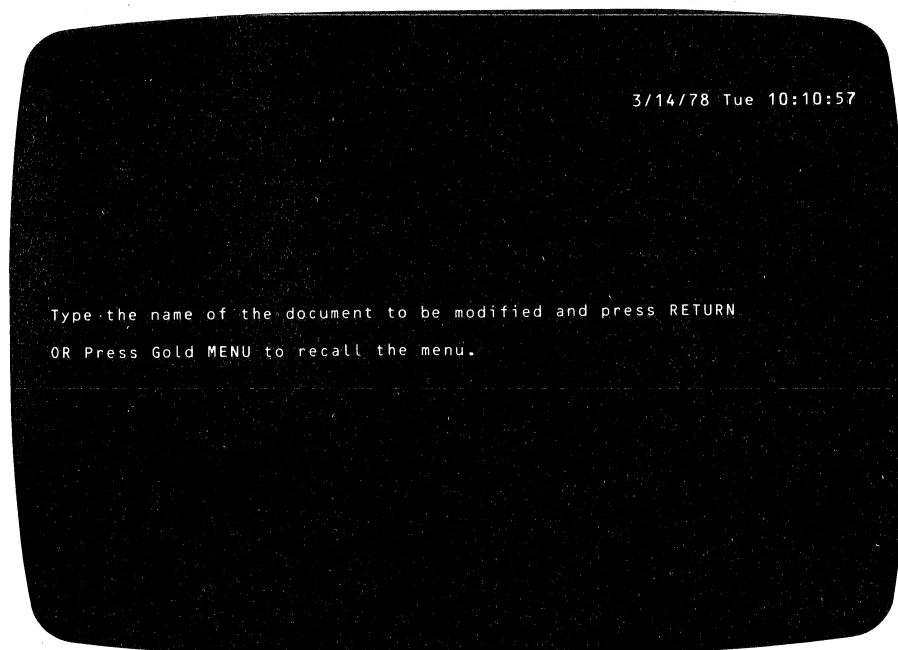

Figure C-6 Mag Card Communications Display Requesting the Name of the Document To Be Sent

STEP 2

Using the RUB CHAR key, erase the KH HS at the bottom of Figure C-5. Now type the letters HD and press the RETURN key. You will see the display shown in Figure C-6.

NOTE

You may wish to investigate the uses of the other commands shown on the screen in Figure C-5. For example, the document can be printed at the same time it is being received. Further information can be found in Section 3.3.1.2.

STEP 3

Type the name of the document on your system in which you want the characters placed, and press the RETURN key. If the document is new, the system will create it for you. If the document already exists, you will see the display in Figure C-7.

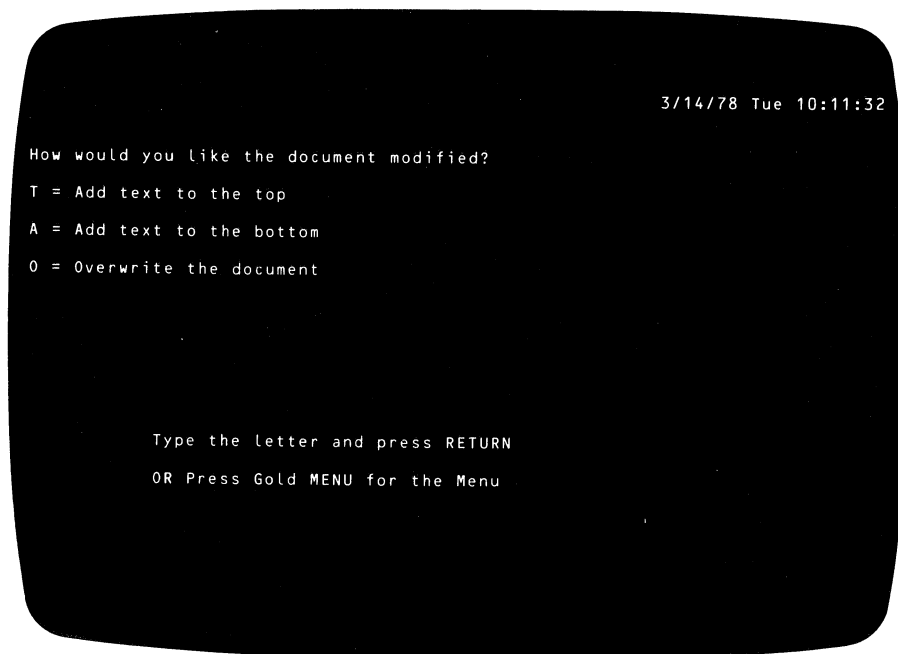

MK-0515

Figure C-7 A Mag Card Communications Display Appearing When an Existing Receiving Document Is Specified



MK-0467

Figure C-8 A Mag Card Communications Display Requesting the Ruler in the Receiving Document To Be Specified

STEP 4

Type the letter **T**, **A**, or **O** and press the **RETURN** key.

STEP 5

You will see a display similar to the one shown in Figure C-8. Set the word processing ruler as follows:

1. Call the CMC operator and obtain the left and right margin settings and tab settings of the document to be received. Write them down. For example, you might receive left and right margin settings of 10 and 90, and tabs of 15 and 20.
2. Obtain the word processing tab settings by subtracting the CMC left margin from any CMC tab settings and adding one to each setting (to compensate for the fact that the word processing scale begins at one, while the CMC scale begins at zero). You are limited to nine tabs on the word processing system. In the example above, the word processing tab settings would be six and eleven.

3. Use one as your word processing left margin. Calculate your right margin by subtracting the CMC left margin from the CMC right margin and adding one. In the example above, the right margin would be 81. You are limited to a word processing right margin of 79. If the calculated right margin exceeds 79, use 79. The resulting errors in format will be corrected later.

When you are ready, press the RETURN key. You will see the display shown in Figure C-9.

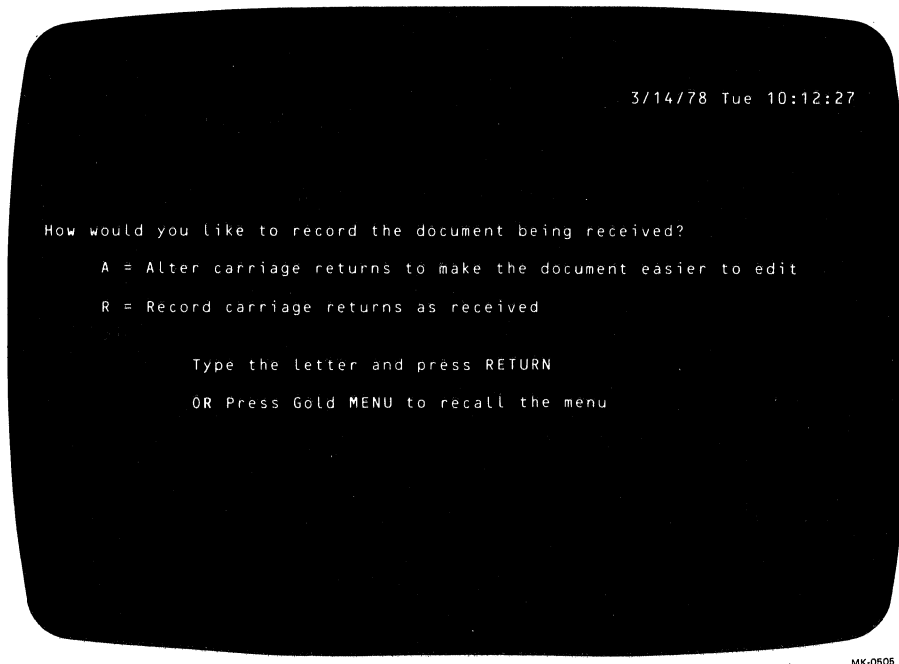

Figure C-9 A Mag Card Communications Display Requesting the User To Specify How Carriage Returns Are To Be Received

If the CMC document was typed in the standard IBM format, type the letter R and press the RETURN key. If the CMC document was not typed in the standard IBM format, type the letter A and press the RETURN key. The screen will go blank except for the number sign (#) in the upper left corner. In either case, the system will create a document whose format approximates the CMC document format.

STEP 6

Now make the connection to the CMC (refer to Chapter 2). Reception should start immediately.

STEP 7

When the transmission is finished, press the gold and the MENU keys to file the document. Then press the gold and the MENU keys to return to the Communications Menu.

STEP 8

If the right margin calculated in step 5 exceed 79, and 79 was used, all lines in the document longer than 79 were pushed onto the next line, so that the margins were disarranged. To fix this, simply edit the document, change the ruler to the correct width, and scroll through the document (using gold ADVANCE) in order to word-wrap it appropriately.

C.4 ERROR RECOVERY

ERROR: Pressing the wrong key.

RECOVERY ACTION: Press the gold and the HALT keys to return to the Communications Menu, and start over. Ask the CMC operator to turn the CMC machine off and then on to clear it.

ERROR: Interference with the transmission by line noise. This condition is indicated on the word processing system by some characters with question marks (?). A question mark indicates that the character replaced was obliterated by line noise. The CMC uses Z's for the same purpose.

RECOVERY ACTION: Hang up and re-dial the connection. If that does not work, the hardware is probably faulty. Call the appropriate service representative for assistance.

ERROR: The two systems are not communicating properly. This condition is identified by the presence of dollar signs (\$) in lieu of characters.

RECOVERY ACTION: If the dollar signs do not go away, restart the transmission.

C.5 SPECIAL SIGNIFICANCE OF SOME CHARACTERS

The effects of some word processing characters as received on the CMC are listed below. In cases where more than one effect is listed, the effects occur sequentially in the order listed.

**WORD PROCESSING SYSTEM
CHARACTER**

CMC CHARACTER

BOLD CHARACTER

**REQUIRED BACKSPACE CHARACTER
CHARACTER BOLDED
REQUIRED BACKSPACE CHARACTER**

CENTER MARK

REQUIRED CARRIER RETURN

DEAD KEY CHARACTERS

**REQUIRED BACKSPACE CHARACTER
CHARACTER DEADED**

**WORD PROCESSING SYSTEM
CHARACTER**

CMC CHARACTER

END PRINT CONTROL

CARD EJECT

HARD RETURN

CARRIER RETURN

NEW PAGE

CARD EJECT

PAGE MARKER

CARD EJECT

PARAGRAPH MARKER

RETURN TAB

RULER CODE >

IGNORED

RULER CODE .

IGNORED

RULER CODE C

IGNORED

RULER CODE D

RULER DISPLAY L*

RULER CODE F

RULER DISPLAY L*

RULER CODE H

IGNORED

RULER CODE J

RULER DISPLAY R

RULER CODE L

RULER DISPLAY L*

RULER CODE N

RULER DISPLAY L*

RULER CODE P

RULER DISPLAY TAB**

RULER CODE R

RULER DISPLAY R

RULER CODE T

RULER DISPLAY TAB

RULER CODE W

RULER DISPLAY TAB**

**WORD PROCESSING SYSTEM
CHARACTER**

START PRINT CONTROL

SUPERSCRIPIT OR SUBSCRIPT
CHARACTER

TAB

UNDERSCORED CHARACTER

CMC CHARACTER

CARD EJECT

REQUIRED BACKSPACE CHARACTER
UNDERSCORE

TAB***

CHARACTER CODE/BACKSPACE
UNDERSCORE

- * If ruler codes P or W are to the left of L, D, N or F, a T is displayed.
- ** If ruler codes P or W are to the left of L, D, N or F, an L is displayed.
- *** Provided the original ruler is in effect.

COMMUNICATIONS OPTIONS GLOSSARY

ACOUSTIC COUPLER:

A portable type of modem used for terminal to computer communication.

ASCII:

(American Standard Code for Information Interchange) The name of a code in which data is often formatted for computer storage and transfer.

AUTOMATIC TRANSFER:

Transfer between two word processing systems in which one system is set to send or receive documents automatically when requested to do so by the other system.

AUTO ANSWER MODE:

A state in which a data phone can automatically answer a telephone call.

AX:

The word processing automatic document transfer option.

COMMUNICATIONS OPTIONS:

Three choices, AX, DX and CX, on the word processing Main Menu which permit communication between word processing systems or between word processing systems and time-sharing systems.

CONNECTION:

The ability of one system to communicate with another via a transmission line, usually the telephone line.

CX:

The character transfer option.

DATA PHONE:

A modem used as an interface between a computer and the phone line.

DX:

The word processing document transfer option.

DX/11M:

A set of computer programs permitting communication between a word processing system and an RSX-11M operating system.

DX/RSTS:

A set of computer programs permitting communication between a word processing system and a RSTS/E operating system.

FETCH:

To cause a document to be sent to you from a system set in AX.

HOST:

The computer or other device communicating with a word processing system in the CX option.

MODEM:

A device to translate computer signals into a pattern of electrical signals sent over the telephone line and vice versa.

NOISE:

Unwanted signals on the communications line which can cause errors in the information transmitted.

NULL MODEM:

A connector that takes the place of two modems and a telephone line.

OPERATING SYSTEM:

A set of computer programs that controls a larger system.

ORIGINATE-ONLY ACOUSTIC COUPLER:

An acoustic coupler which can originate a call but not receive one (as can a dataphone).

OVERWRITE:

Replacing old text with new text in a word processing document.

PACKET:

One of the bundles of characters into which a document is decomposed for transmission in DX and AX.

PROTOCOL:

The data transfer conventions followed by the systems in communication with each other.

RSTS/E:

A DIGITAL time-sharing operating system used to control a PDP-11.

RSX-11M:

A DIGITAL real-time multi-programmed operating system used to control a PDP-11.

SEND-AND-RECEIVE PASSWORD:

A word processing password whose use authorizes you to send documents to or fetch documents from a system AX.

SEND PASSWORD:

A password whose use authorizes you to send documents to a system set in AX.

SHORT HAUL MODEM:

A relatively inexpensive modem used for communicating over short distances.

SYSTEM MANAGER:

The person who is responsible for total operation of a word processing system.

TALK MODE:

A state in which a data phone can be left so that it can be used for voice communication.

WORD PROCESSING SYSTEM:

A computerized system to accomplish the typing, storage, retrieval, editing, transfer, and printing of human-language information.



INDEX

A

Acoustic coupler, 2-1
AUTO ANSWER mode, 2-3
Automatic Transmission Option (AX), 1-2
 Operating instructions, 3-14 to 3-35
 Communicating with a system in AX, 3-19 to 3-23, Figures 3-20 through 3-23
 Ending transmission before entire document is transmitted, 3-30, 3-35, Figures 3-33 through 3-35
 Fetching a document from a system placed in AX, 3-32 to 3-35, Figures 3-30, 3-36 through 3-39
 Illegal user, 3-21
 Incorrect password, 3-21
 Logon document, 3-14 to 3-15, Figure 3-17
 Number of transferred packets, 3-28, Figure 3-32
 Placing a system in AX, 3-14 to 3-19
 Send and receive password, 3-14, 3-16, 3-19 to 3-21
 Sender identification, 3-21 to 3-23, Figure 3-22
 Sending a document to a system placed in AX, 3-23 to 3-31, Figures 3-24 through 3-35
 Send-only password, 3-14, 3-15 to 3-16, 3-19 to 3-21, Figure 3-21
 Settings available, 3-14 to 3-18, Figures 3-17 through 3-19
 Terminal identification message, 3-14 to 3-15
 Transfer completed, 3-28, Figures 3-31, 3-22

B

Baud rate, B-1
Bell Data Phone, 2-1, Figure 2-1
Buffer control, B-1

C

Changing the communications characteristics,
 B-1 to B-4 Figures B-1 to B-4
 Baud rate (option CC), B-1
 Buffer control (option BC), B-1

Data bits, B-1
Parity, B-1
Protocol (option CP), B-1
Stop bits, B-1
System Communications menu options, B-2
 Figure B-1
Character Transmission Option (CX), 1-2
 Operating instructions, 3-35 to 3-40
 ASCII characters, 3-35
 Commands, 3-37 to 3-40
 Keyboard commands, 3-36 to 3-38
 Host commands, 3-37
 Data commands, 3-37 to 3-40
 Display of, 3-36, Figure 3-40
 Changing of, 3-37
 Involving documents, 3-38 to 3-40
 Host greeting message, 3-35 to 3-36
 Originating the call, 3-35 to 3-36
 Pausing in mid-operation with a host, 3-38
 Shutting down, 3-38
 Visual echo, 3-37
Communicating with an IBM Mag Card, C-1 to C-16, Figures C-1 to C-9
Error recovery, C-14
Function of word processing keys, C-1 to C-2
 ADVANCE, C-1
 Dollar sign (\$), C-2
 Gold HALT, C-1
 Gold MENU, C-1
 HALT, C-1
 Pound sign, number sign, or sharp sign (#), C-2
 RUB CHAR OUT, C-1
 Shift/HALT, C-1
Receiving a document from, C-8 to C-14
Sending a document to, C-2 to C-8
Word processing character significance, C-14 to C-16
 Bold, C-14
 Center mark, C-14
 Dead key, C-14
 Hard return, C-15
 New page, C-15

- Page marker, C-15
- Paragraph marker, C-15
- Ruler codes, C-15
- Start print control, C-16
- Super- or subscripted, C-16
- Tab, C-16
- Underscore, C-16
- Communications configurations, A-1 to A-6,
 - Figures A-1 through A-4
 - Definition of, A-1
 - Examples of, A-3 to A-6, Figures A-1 through A-4
 - Modem, A-1 to A-2
 - Null modem, A-2, Figure A-1
 - Short-haul modem, A-2, Figure A-2
 - Using an originate-only coupler, A-5, Figure A-3
 - Using data phones only, A-6, Figure A-4
- Communication with a Word Station or Word Terminal, 3-1

D

- Data bits, B-1
- Data phone, 2-1
- DF01 acoustic coupler, 2-3
- Document Communications Products, 1-3
- Document Transmission Option (DX), 1-1, 3-1 to 3-13
 - Operating instructions, 3-1 to 3-13
 - Receiving only, 3-8 to 3-10, Figures 3-9 through 3-13
 - Sending and receiving, 3-1, 3-11 to 3-13, Figures 3-1, 3-12 through 3-16
 - Sending only, 3-6 to 3-11, Figures 3-6 through 3-8
 - Sending or receiving, 3-2 to 3-5, Figures 3-2 through 3-5

E

- Ending the transmission before the entire document is transmitted, 3-12, Figures 3-14 through 3-16

- End of transfer, 3-12
- Error messages, 4-1 to 4-2
 - Bad connection, 3-2, 3-21, 4-1
 - Cannot transfer document, 3-35, 4-2
 - Causes of error messages, 4-1 to 4-2
 - Disk error, 3-12, 3-28, 4-1
 - Illegal user, 3-21, 4-2
 - Incorrect password, 3-21, 4-2
 - Not enough room on diskette to receive document, 3-11, 3-27, 4-2
 - Recovery action for error messages, 4-1 to 4-2

F

- Fetch, 1-2

I

- Identification message (ID), 1-2

L

- Log document, 1-2, 3-14 to 3-15
 - Already existing, 3-15, Figure 3-17
 - Creating, 3-15
 - Example of entry, 3-15

M

- Message displays, 3-3, Figure 3-3
 - For message receiver, Figure 3-5
 - For message sender, Figure 3-4
- Modem, 2-1, A-1 to A-2

N

- Null modem, 2-1, 2-5, Figure 2-4

O

- Originate-only coupler, 2-3, 2-4, Figure 2-3

P

- Packet, 1-1 to 1-2
 - Number transferred, 3-12, 3-28
- Parity, B-1
- Print Menu Settings, 1-1
- Protection against errors caused by noise, 1-1, 1-2
- Protocol, B-1

R

Receiving only, 3-8 to 3-11, Figures 3-9 through 3-13

S

Sending and receiving, 3-11 to 3-14, Figures 3-12 through 3-16

Sending only, 3-6 to 3-7, 3-11, Figures 3-6 through 3-8

Sending or receiving, 3-2 to 3-5, Figures 3-2 through 3-5

Stop bits, B-1

System Options Menu, B-2 to B-3, Figure B-1

T

TALK button, 2-3, Figure 2-2

TALK mode, 2-3

Transfer complete message, 3-12



Your comments and suggestions will help us in our continuous effort to improve the quality and usefulness of our publications.

What is your general reaction to this manual? In your judgment is it complete, accurate, well organized, well written, etc.? Is it easy to use? _____

What features are most useful? _____

What faults or errors have you found in the manual? _____

Does this manual satisfy the need you think it was intended to satisfy? _____

Does it satisfy *your* needs? _____ Why? _____

Please send me the current copy of the *Technical Documentation Catalog*, which contains information on the remainder of DIGITAL's technical documentation.

Name _____ Street _____

Title _____ City _____

Company _____ State/Country _____

Department _____ Zip _____

Additional copies of this document are available from:

Digital Equipment Corporation
444 Whitney Street
Northboro, Ma 01532
Attention: Communications Services (NR2/M15)
Customer Services Section

Order No. AA-5264C-TK

Fold Here

Do Not Tear - Fold Here and Staple

**FIRST CLASS
PERMIT NO. 33
MAYNARD, MASS.**

**BUSINESS REPLY MAIL
NO POSTAGE STAMP NECESSARY IF MAILED IN THE UNITED STATES**

Postage will be paid by:

**Digital Equipment Corporation
Technical Documentation Department
Merrimack, New Hampshire 03054**

