

PHILCO 2000 - 210

Philco Corporation
(A Subsidiary of Ford Motor Company)

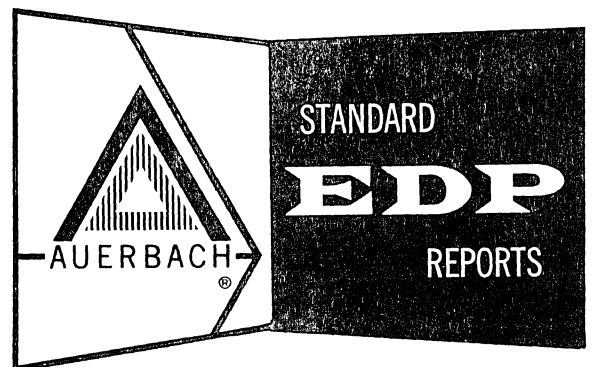

AUERBACH INFO, INC.

PRINTED IN U. S. A.



CONTENTS

- 1. Introduction 651:011
- 2. Data Structure 651:021
- 3. System Configuration
 - VII B, 10-Tape General System (Paired) 651:031.3
 - VIII B, 20-Tape General System (Paired) 651:031.4
- 4. Internal Storage
 - 2200-Series 10 μ s Core Storage 651:041
 - 272, 275 Magnetic Drum System 651:044
- 5. Central Processor - Model 210 651:051
- 6. Console 651:061
- 7. Input-Output: Punched Tape and Card
 - 240 Paper Tape System 651:071
 - 241 Paper Tape System 651:072
 - 258 Card Reader 651:073
 - Punch Card Controller 651:073.4
 - 265 Card Punch 651:074
- 8. Input-Output: Printers
 - 256 Printer 651:081
 - 254 Printer Control Unit 651:081.4
- 9. Input-Output: Magnetic Tape
 - 234 Magnetic Tape 651:091
- 10. Input-Output: Other
 - 235, 236, 237, 238 Input-Output Processors (90KC) 651:101
 - 252 Universal Buffer Controller 651:102
 - 280 Universal Buffer Controller 651:102
 - 309 Console Typewriter Buffer 651:103
 - 2281, 2282, 2283, 2284 Digital Incremental Recorders 651:104
 - 293 Accounting Clock 651:105
- 11. Simultaneous Operations 651:111
- 12. Instruction List 651:121
- 13. Coding Specimens
 - ALTAC 651:131
 - TOPS 651:132
 - TAC 651:133
- 14. Data Codes
 - Internal, Magnetic Tape and Printer Binary
 - Coded Characters 651:141
 - Card 651:142
- 15. Problem Oriented Facilities
 - Sort Generator 651:151.13
 - Sort (Interpretive) 651:151.13
 - PERT 651:151.17
 - Linear Programming 651:151.17
 - Statistical System - STAT 651:151.17
 - Input-Output Programming System (IOPS) 651:151.17

CONTENTS (Contd.)

16. Process Oriented Language	
ALTAC 3	651:161
TOPS 2	651:162
COBOL-61	651:163
17. Machine Oriented Languages	
TAC	651:171
18. Program Translators	
ALTAC 3	651:181
TOPS 2	651:182
TAC	651:184
19. Operating Environment	
SYSD	651:191
TOPS 2	651:192
20. System Performance	
Worksheet Data	651:201.011
Generalized File Processing	651:201.1
Sorting	651:201.2
Matrix Inversion	651:201.3
Generalized Mathematical Processing	651:201.4
Generalized Statistical Processing	651:201.5
21. Physical Characteristics	651:211
22. Price Data	651:221



INTRODUCTION

§ 011.

The Philco 2000 is actually a series of three computer systems. There are three prime systems distinguished by different central processors: 210, 211, and 212. The differences in performance and price of the different systems are significant as shown in the respective Systems Performance Sections, 651:201, 652:201, and 653:201. There is a large body of common units, common interfaces, and common software. The following description applies generally to all the series; however, the final paragraph notes the major differences of the 2000-210.

The computer system is in the large-scale scientific and real-time class. Its design is oriented toward flexible off-line operations, with fast tape units, simultaneous operations and concern for fast processing speeds. The central processors have a range of 50,000 to 500,000 instructions per second and rentals in the order of \$40,000 and up.

The Philco 2000 is designed for off-line operation of peripheral devices. The off-line operations may be executed by a separate computer, the Philco 1000, or by the special Universal Buffer Controllers (UBC).

The UBC unit is a versatile device, which contains a 1,024 word buffer store. The UBC may control any card, punched tape, magnetic tape, or printer off-line transcription, including magnetic-tape-to-magnetic-tape. A UBC can be used on-line to control data transfers to any one of seven peripheral units attached to it. In addition to the usual peripheral devices there is a high speed (2,000 cards per minute) reader.

Each 2000 computer configuration has one IOP (Input-Output Processor). This unit can control up to 16 input-output units. There may be up to four UBC's, and the remaining units may be magnetic tape. An IOP may contain from one to four assemblers. An assembler provides for independent simultaneous input-output transfers. In effect, each UBC can provide an extra simultaneous input-output transfer to any unit except magnetic tape, because loading or unloading a UBC buffer requires little time, and the UBC controls the peripheral device at its own pace.

One especially convenient feature of the IOP is the automatic assignment of any idle assembler to a data transfer request, thus relieving the programmer of optimizing assignments.

The Model 234 Magnetic Tape Units which must be used on the 2000-210 and 2000-211 operate at a peak speed of 90,000 characters per second. The block size is fixed at 1,024 characters. At full speed, using full blocks, the effective speed is 54,600 characters per second. Usually the standard problems have been timed for two cases: (1) blocked records and (2) unblocked records. On the 2000-212 an alternative tape unit, Model 334, is available with a peak speed of 240,000 characters per second.

All three central processors operate in parallel on 48-bit words. Single address instructions are packed two to a word. The number of index registers is optional on the 210 and 211 but in practice is standardized at eight. Eight registers, however, are standard on the 212. When an instruction uses a special bit to denote indexing, three bits of the high order end of the address are used to specify the register. This limits the value of the base address, but not the modifier.

There is a wide variety of fixed and floating point arithmetic instructions, but no editing or conversion facilities. Special two instruction loops can be performed very rapidly with no repeated access for instructions.

The computer operates asynchronously in all units and basic times vary from machine to machine, and in different cases similar instructions require different execution times. This report quotes ranges or averages of these times.

INTRODUCTION--Contd.

§ 011.

There are several varieties of core store available. They have different cycle times, and can be further varied by use of overlapped access. Drums are available on the systems and data transfers are arranged to be parallel by word, at high data rates, but may not be overlapped with other operations. Disc storage is available on the 2000-212.

The three central processors, 210, 211, and 212, are upward compatible for instruction repertoire and functional facilities. Therefore, all software is written to be used on all models, with some limitations on minimum configurations.

The main languages are TAC, ALTAC, and TOPS. TAC is a sophisticated symbolic machine oriented language including macros and facilities for generators. The generators include SORT and IOPS, an input-output system. ALTAC is a dialect of FORTRAN II. The ALTAC translator can translate FORTRAN II programs with usually few changes. Its major incompatibilities are Boolean operations and CHAIN functions. On the other hand, it includes extended conditionals. TOPS is a macro oriented language for file manipulation; it includes such facilities as updating and sorting. For individual data manipulation, TAC coding is used. TOPS includes its own operating environment.

There is an automatic supervisor routine, SYSD. This routine covers running, translating, and debugging. In fact, it is probably not reasonable to operate a 2000 without a supervisor.

There is a users' group called TUG. The library of routines is generally available and includes a large selection in the field of nuclear code programs.

The Philco 2000-210 in particular:

- uses only the 10 microsecond non-overlapped store.
- has no real-time facilities.
- has usually lower performance and price compared to the others.



DATA STRUCTURE

§ 021.

.1 STORAGE LOCATIONS

<u>Name of Location</u>	<u>Size</u>	<u>Purpose or Use</u>
Character:	6 bits	alphanumeric.
Frame:	14 bits	magnetic tape.
Word:	48 bits	location in core storage, magnetic drum.
Block:	128 words	magnetic tape, core storage, programmed.
Band:	4,096 words	magnetic drum.

.2 DATA FORMATS

<u>Type of Information</u>	<u>Representation</u>
Alphabetic:	1 char.
Instruction:	24 bits.
Instruction (input-output): . . .	48 bits.
Number	
Fixed Point:	48 bits.
Floating Point	
Exponent:	12 bits.
Fixed point part:	36 bits.
BCD:	6 bit group.
Block:	128 words.



SYSTEM CONFIGURATIONS

§ .031

.3 VII B 10-TAPE GENERAL, PAIRED CONFIGURATION

Deviations from Standard Configuration

- On-line: 2 more index registers.
magnetic tape, 30,000 char/sec faster.
card reader can be switched from off-line UBC.
- Off-line: magnetic tape, 60,000 char/sec faster.
printer faster by 400 lines/min.
card reader by 1,500 cards/min.
1,024 characters only in UBC.

On-Line Equipment

Equipment

Rental

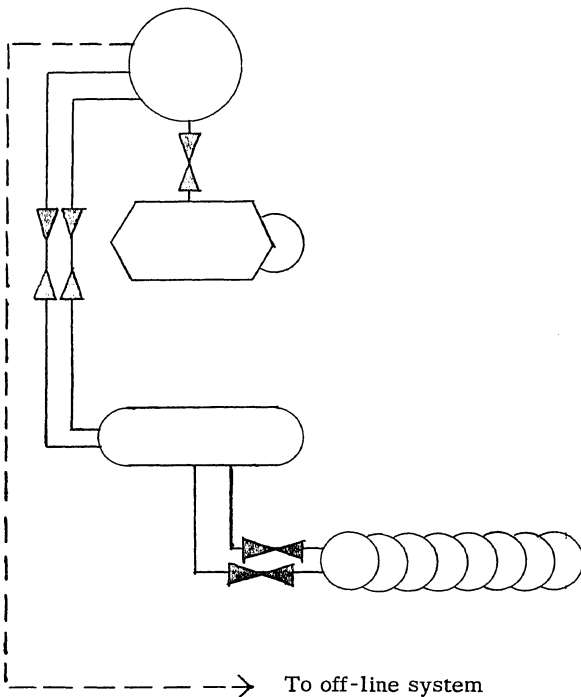

Core Storage:
8,192 words 5,800

Model 210 Central Processor and Console } 7,100
Typewriter } 900

Input-Output Processor:
two multiplexed transmissions to and from magnetic tape. 4,400

8 Magnetic Tapes:
90,000 char/second 6,800

Total 25,650

Total, including off-line equipment: \$ 33,765

§ 031.

.3 VII B 10 - TAPE GENERAL, PAIRED CONFIGURATION (Contd.)

Off-line Equipment

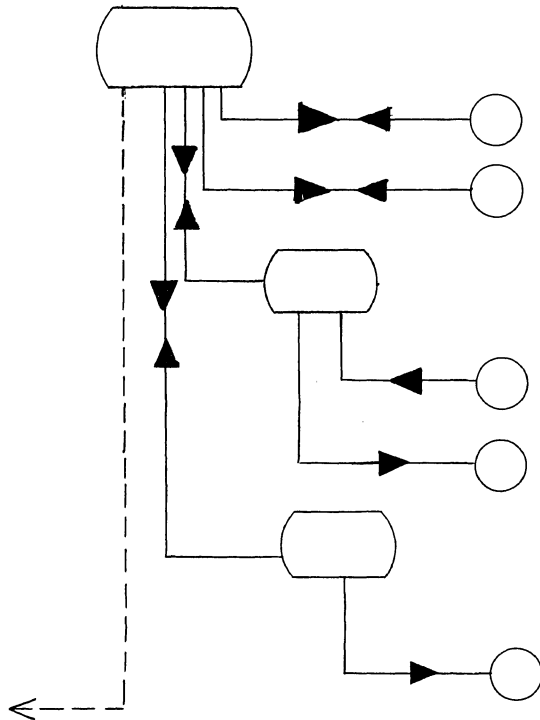

<u>Equipment</u>	<u>Rental</u>
Universal Buffer Controller:	1,560
2 Magnetic Tapes: 90,000 char/second	1,700
Punch Card Controller:	1,365
Card Reader: 2,000 cards/minute	800
Card Punch: 100 cards/minute	350
Printer Controller:	} 2,340
High Speed Printer: 900 lines/minute	
Total	\$ 8,115

Note: Off-line system may be replaced by the Philco 1000 computer system. This will permit more powerful off-line editing and computing capabilities, relieving the central processor of much of this work.

§ 031.

.4 VIII B 20-TAPE GENERAL, PAIRED CONFIGURATION

Deviations from Standard Configuration

- On-line: 2 less index registers.
magnetic tape 30,000 char/second slower.
card reader can be switched from off-line UBC.
- Off-line: magnetic tape 30,000 char/second faster.
card reader faster by 1,000 cards/minute.
card punch slower by 100 cards/minute.

On-Line Equipment

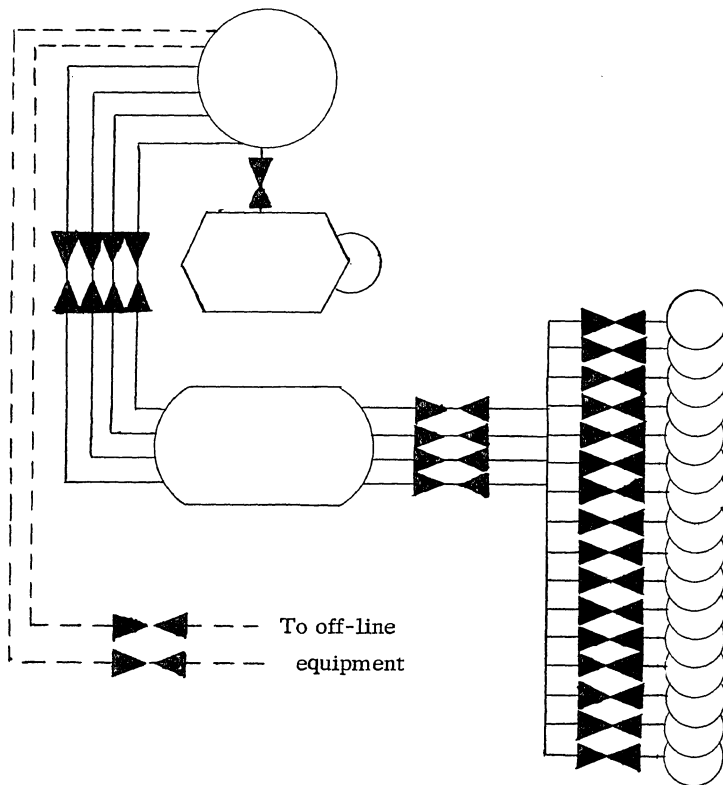

<u>Equipment</u>	<u>Rental</u>
Core Storage:	11,000
Central Processor and Console:	7,100
Typewriter	650
Typewriter	900
Input-Output Processor: Four multiplexed transmissions to and from magnetic tape.	8,400
16 Magnetic Tapes: 90,000 char/second	13,600
 Total	 41,650
Total, including off-line equipment:	\$ 53,025

§ 031.

.4 VIII B 20-TAPE GENERAL, PAIRED CONFIGURATION (Contd.)

Off-Line Equipment

	<u>Equipment</u>	<u>Rental</u>
	Buffer Controller, Model 252:	1,560
	2 Magnetic Tapes: 90,000 char/second	1,700
	Punch Card Controller:	1,365
	Card Reader: 2,000 cards/minute	800
	Card Punch: 100 cards/minute	350
	Buffer Controller, Model 252:	1,560
	2 Magnetic Tapes: 90,000 char/second	1,700
	Printer Controller:	2,340
	High Speed Printer: 900 lines/minute	2,340
	Total	\$ 11,375



INTERNAL STORAGE: CORE STORAGE

§ 041.

.1 GENERAL

.11 Identity: Core Storage.
10 μsec memory.
Models 2208, 2216, 2232.

.12 Basic Use: working storage.

.13 Description

Each core storage location in the 10-microsecond memory system holds a 48-bit word which may contain a fixed or floating point number, eight alpha-numeric characters, two instructions, or one input-output instruction. A complete core storage cycle for one word is 10 microseconds. The cycle is split into two parts: 4 microseconds read and 6 microseconds write/restore. Both the store and the central processor have been designed to take advantage of split cycles, for example, when executing an "add to memory" instruction, only one access is made, and after the read, the store waits while the addition is performed and then the write/restore completes the cycle. All transfers are parallel by word. All banks of 8,192 words of storage use a common access control. Sequentially addressed locations are successively distributed throughout alternate memory banks, but there is no overlapping of access times.

Core storage access is shared with the central processor by four channels which gain access through an intermediate one word buffer. The priority for memory sharing by these channels is Input-Output Processor, Real-Time Channel, Word-at-a-Time Channel (Paper Tape Channel) and Magnetic Drum Channel.

Model 2208 Core Storage Memory contains 8,192 words. This is expandable to 16,384 words in the Model 2216 and a maximum of 32,768 words in the Model 2232 memory. The Model 2208 or 2216 may be expanded in the field.

.14 Availability: 12 months.
.15 First Delivery: December, 1959.
.16 Reserved Storage: none.

.2 PHYSICAL FORM

.21 Storage Medium: magnetic core.
.22 Physical Dimensions
.221 Magnetic core type storage
Array size: 64 bits by 64 bits.

.23 Storage phenomenon: . . direction of magnetization.

.24 Recording Permanence

.241 Data erasable by instructions: yes.
.242 Data regenerated constantly: no.
.243 Data volatile: no.
.244 Data permanent: no.
.245 Storage changeable: no.

.28 Access Techniques

.281 Recording method: . . coincident current.
.283 Type of access: . . . uniform with split cycle.

.29 Potential Transfer Rates

.292 Peak data rates
Cycling rates: 100,000 cps.
Unit of data: word.
Conversion factor: . . . 48 bits/word.
Data rate: 100,000 words/sec.
Compound data rate: 100,000 words/sec.

.3 DATA CAPACITY

.31 Module and System Sizes

	Minimum Storage		Maximum Storage
Identity:	Model 2208	Model 2216	Model 2232
Words:	8,192	16,384	32,768
Characters:	65,536	131,072	262,144
Instructions:	16,384	32,768	65,536
Bits:	393,216	786,432	1,572,864
Modules (8,192):	1	2	4

.32 Rules for Combining

Modules: all combinations are shown above.

.4 CONTROLLER

.41 Identity: built into core storage.

.42 Connection to System

.421 On-Line: 1.
.422 Off-Line: none.

.43 Connection to Device

.431 Devices per controller: 1, 2, or 4
8,192 word modules.
.432 Restrictions: none.

§ 041.

.5 ACCESS TIMING

.51 Arrangement of Heads

- .511 Number of Stacks: . . . 1.
- .512 Stack movement: . . . none.
- .513 Stacks that can access any particular location: 1.
- .514 Accessible locations
By single stack: . . . all.

.52 Simultaneous Operations: none.

.53 Access Time Parameters and Variations

- .531 For uniform access
Access time: 4 μ sec.
Cycle time: 10 μ sec.
For data unit of: 48-bit word.
- .532 Variation in access time: second repeated access to one location in an instruction may be zero, due to split access.

.6 CHANGEABLE STORAGE: none.

.7 PERFORMANCE

.71 Data Transfer

- Pair of storage units possibilities
With self: yes.
With drum: yes.

.72 Transfer Load Size

- With self: 1 word, or up to 4,095 words using repeat.
- With drum: 4,096 words.

.73 Effective Transfer Rate

- With self: 48,000 words/sec.
- With drum: 58,500 words/sec.

.8 ERRORS, CHECKS AND ACTION

<u>Error</u>	<u>Check or Interlock</u>	<u>Action</u>
Invalid address:	none	modulo size of store.
Receipt of data:	none.	
Recording of data:	none.	
Recovery of data:	none.	



INTERNAL STORAGE: MAGNETIC DRUM SYSTEM

§ 044.

.1 GENERAL

.11 Identity: Magnetic Drum Unit.
Model 272.
Magnetic Drum Controller.
Model 275.

.12 Basic Use: auxiliary storage.

.13 Description

The magnetic Drum System provides an auxiliary storage system connected directly to the working core storage. The system may consist of from 1 to 4 drums, each holding 32,768 48-bit words. Loads of 1 to 4,096 words are transferred via the lowest priority channel. Transmission of words is not interrupted until completion of the drum instruction.

A drum consists of eight bands of 4,096 words each. Sequentially addressed words are in alternating locations, requiring two drum revolutions for transmission of an entire band. The drum instruction may specify any word in the band as the first of a load; automatic stepping to the first word of the next band takes place automatically.

Each band of 4,096 words is recorded on 48-tracks, parallel by word. This arrangement produces a high transfer rate of 58,500 words per second. This rate can be maintained for several successive bands without loss of time. In order to avoid conflicts for core store access, a drum transfer instruction waits until all current input-output transfers are complete. Then the central processor operation is delayed until the drum transfer is complete, to prevent other input-output transfers from being initiated.

From 1 to 4 drums may be connected to the Model 275 Drum Controller for a maximum drum storage capacity of 131,072 words. Each Drum Controller contains provision for locking out transmission to: all of drum 1; all of drums 1 through 4; any band on drum 1; or the same band on drums 1 through 4.

.14 Availability: 12 months.

.15 First Delivery: June, 1960.

.16 Reserved Storage: none.

.2 PHYSICAL FORM

.21 Storage Medium: magnetic drum.

.22 Physical Dimensions

.222 Drum
Diameter: 18.5 inches.
Length: 24 inches.
Number on shaft: 1.

.23 Storage phenomenon: . . magnetization.

.24 Recording Permanence

.241 Data erasable by instructions: yes, but write lockout available.

.242 Data regenerated constantly: no.

.243 Data volatile: no.

.244 Data permanent: no.

.245 Storage changeable: no.

.25 Data volume per band

Words: 4,096.
Characters: 32,768.
Instructions: 8,192.
Bits: 196,608.

.26 Bands per physical unit: 8 plus spare tracks.

.27 Interleaving Levels: 2.

.28 Access Techniques

.281 Recording method: fixed heads.

.282 Reading method: same.

.283 Type of access
Description of stage Possible starting stage
Select drum and band: yes.
Wait for drum rotation: yes.
*Read or write word: no.

.29 Potential Transfer Rates

.291 Peak bit rates
Cycling rates: 1,750 rpm.
Track/head speed: 169.5 inches/sec.
Bit rate per track: 119,000 bits/sec/track.

.292 Peak data rates
Cycling rates: 29 cps.
Unit of data: 4,096 words.
Loss factor: 2.
Data rate: 119,000 words/sec.
Compound data rate: 119,000 words/sec.

§ 044.

.3 DATA CAPACITY

.31 Module and System Sizes

	Minimum Storage	Maximum Storage
Identity: Model 275		
Drums: 1		4.
Words: 32,768		131,072.
Characters: 262,144		1,048,567.
Instructions: 65,536		262,144.
Bits: 1,572,864		6,191,456.
Modules: 1		4

.32 Rules for Combining Modules

The drum system may consist of from 1 to 4 Model 272 Magnetic Drum Units. A Model 275 Magnetic Drum Controller can control from 1 to 4 drums.

.4 CONTROLLER

.41 Identity: Magnetic Drum Controller. Model 275.

.42 Connection to System

.421 On-line: 1.
 .422 Off-line: none.

.43 Connection to Device

.431 Devices per controller: 4 drums.

.44 Data Transfer Control

.441 Size of load: 4,096 words.
 .442 Input-output area: . . . core storage.
 .443 Input-output area access: 1 word.
 .444 Input-output area lockout: yes, until transmission is complete.
 .445 Synchronization: automatic.
 .447 Table control: none.
 .448 Testable conditions: . . transfer error.

.5 ACCESS TIMING

.51 Arrangement of Heads

.511 Number of stacks
 Stacks per system: . . 8 to 256 in increments of 8.
 Stacks per module: . . 8.
 .512 Stack movement: none.
 .513 Stacks that can access any particular location: 1.

.514 Accessible locations

By single stack
 With no movement: . 4,096.
 By all stacks
 With no movement: . 32,768 per module.

.515 Relationship between stacks and locations: . band (0 to 7). band position address (modulo 4,096).

.52 Simultaneous Operations: none.

.53 Access Time Parameters and Variations

.532 For variable access
 Stage Time, μ sec.
 Select drum: 25,000 or 34,000.
 Wait for drum rotation: 8 to 32,760.
 Read or write word: 16.8.
 Read or write band: 68,813.

.6 CHANGEABLE STORAGE: none.

.7 AUXILIARY STORAGE PERFORMANCE

.71 Data Transfer

Pair of storage units possibilities
 With self: no.
 With core: yes.

.72 Transfer Load Size

With core: 4,096 words.

.73 Effective Transfer Rate

With core: 58,500 words/sec.

.8 ERRORS, CHECKS AND ACTION

<u>Error</u>	<u>Check or Interlock</u>	<u>Action</u>
Recording of data (amplification):	check	indicator; testable by program.
Timing conflicts:	check	indicator; testable by program.

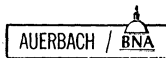



CENTRAL PROCESSOR

§ 051.

.1 GENERAL

.11 Identity: Central Processor.
Model 210.

.12 Description

The 210 is an asynchronous, single address, binary mode processor that maintains arithmetic and program control in a Philco 2000 system. Word length is fixed at 48 bits. Parallel transfers occur between registers and storage. Arithmetic operations are performed with operands of 47 bits plus a sign bit; negative numbers are represented in two's complement form. All arithmetic operations are performed in an adder network utilizing shifting and binary addition. An Accumulator, Quotient and Data Register comprise the program-addressable arithmetic registers; a Jump Address Register, Repeat Counter, and up to 32 optional index registers are addressable for program control.

A total of 225 instructions is provided for arithmetic, control, and logical functions, including floating point operations, when optional floating point hardware is installed. These functions are stored two instructions per word. A lack of editing instructions necessitates additional programming effort for output formatting. Programming systems are available as part of the standard library provided.

Fixed point arithmetic (and optional floating point) provides single and double length products, and division with rounded quotients or remainders.

Logical operations include both exclusive and inclusive OR operations.

Fixed point addition and multiplication take, on the average, 15 and 92 microseconds respectively, and about 70,000 instructions per second can be executed. Floating point times are not significantly different.

Input-output instructions require a full 48-bit word. The particular function to be performed and the input or output channel to be used are specified by varying the bit configuration within designated fields of the word. Simultaneous compute-read-write is possible, the extent of this overlapping being determined by the particular model Input-Output Processor in the system. A special repeat instruction which can include control of index register stepping, provides for rapid running of loops of one or two instructions held in a single word.

Optional Features

Index Registers: 8, 16, or 32 index registers, each capable of retaining a 15-bit address which may be

.12 Description (Contd.)

Optional Features (Contd.)

automatically incremented by one each time that register is referenced. A 16th bit indicates the automatic incrementing mode when set to one. Index registers function modulo 32,767.

When index registers are used, there is an alternative instruction format. One bit indicates if indexing is specified, in which case the 15 bit address is divided into two parts: 3 bits to specify one of 8 index registers, and 12 to specify the value to be added to the index value. In general, all Philco 2000 installations obtain the option of 8 index registers. If 16 or 32 are obtained, the instruction format is 4 and 11 or 5 and 10 bits, respectively. The use of index registers therefore restricts the value of the address part in an instruction, particularly negative values.

Floating Point: Floating point circuitry allows all arithmetic operations to be performed in floating point mode, utilizing an operand containing a 36-bit fixed point part and a 12-bit exponent. Normalization is automatic. Exponent overflow and underflow is detected, causing automatic transfer of control to a fixed memory location.

.13 Availability: 12 months.

.14 First Delivery: December, 1959.

.2 PROCESSING FACILITIES

.21 Operations and Operands

Operation and Variation	Provision	Radix	Size
.211 Fixed point			
Add-Subtract:	automatic	binary	48-bit.
Multiply			
Short-rounded:	automatic	binary	48-bit.
Long:	automatic	binary	96-bit.
Divide			
No remainder-rounded:	automatic	binary	48-bit.
Remainder:	automatic	binary	96-bit.
.212 Floating point			
Add-Subtract:	automatic	binary	12 & 36-bit.
Multiply			
Short:	automatic	binary	12 & 36-bit.
Long:	automatic	binary	12 & 72-bit.
No remainder-rounded:	automatic	binary	12 & 36-bit.
Remainder			
Quotient:	automatic	binary	12 & 36-bit.
Remainder:	automatic	binary	12 & 36-bit.
.213 Boolean			
AND:	automatic	binary	0 to 48 bits.
Inclusive OR:	automatic	binary	0 to 48 bits.
Exclusive OR:	automatic	binary	0 to 48 bits.

§ 051.

.214 Comparison

Numbers: automatic equal, 1 word.
 Absolute: none { greater } 1 word.
 Letters: automatic { than or } 1 word.
 Mixed: automatic { equal } 1 word.
 Collating sequence: 0 to 9, A to Z with special characters interspersed; see Data Code Table No. 1.

.215 Code translation: . . . automatic translation between Hollerith and internal Philco code provided in input-output equipment. Other translations (e. g., binary to octal, etc.) are programmed functions via standard subroutines.

.216 Radix conversion

Provision	From	To	Size
Subroutine	fixed point	floating point	48-bit.
Subroutine	floating point	fixed point	48-bit.
Subroutine	decimal	binary	48-bit.
Subroutine	binary	decimal	48-bit.

.217 Edit format

	Provision	Size
Alter size:	none.	
Round off:	none.	
Insert point:	none.	
Insert spaces:	none.	
Insert:	none.	
Float:	none.	
Protection:	none.	

.218 Table look-up

Equality:	subroutine	1 word.
Greater than:	none.	
Greatest:	none.	
Least:	none.	

.219 Others

Repeat: repeat 1 or 2 instructions, 0 to 4, 095 times.
 Branch on odd or even, positive or negative numbers: automatic 1 bit shift, 0 to 63 times.
 Check status of counters and fault registers in input-output system (skip instructions): . . . allows determination of acceptance and/or status of input-output order and status of input-output equipment on-line.

.22 Special Cases of Operands

.221 Negative numbers: . . . two's complement with sign as most significant bit in word.
 .222 Zero: positive only; fixed point is 48 zeros in word; floating point zero contains a 1 bit in exponent sign.
 .223 Operand size determination: fixed.

.23 Instruction Formats

.231 Instruction structure: . . half word; 1 word for input-output orders.
 .232 Instruction layout:

NAME	S	A	F	C
SIZE, BITS	1	15	1	7

Non-indexable

NAME	S	N	V	F	C
SIZE, BITS	1	3-5	10-12	1	7

Indexable

NAME	Not used	NBS	Not Used	IOP CH.	Not Used	NBP	FROM	TO
SIZE, BITS	12	4	4	4	12	4	4	4

Input-Output (tape)

NAME	S	UNIT	SC	CQ	F	C
SIZE, BITS	1	4	2	9	1	7

Skip

.233 Instruction parts

Name	Purpose
S :	selector list set to 1 indicates the instruction is indexable and the reduced address field is used; if set to 0, the full address field is used.
A :	address field.
F :	F bit is 1 in floating point instr. or in branch to instruction in right half of word.
N :	specifies index register referenced - field size varies with number of index registers in Central Processor.

.233 Instruction parts (Contd.)

Name	Purpose
V :	value added to contents of specified index register to form operand's effective addresses.
C :	command includes F-bit.
NBS :	number of blocks on MT to space over.
IOP CH :	logical MT number.
NBP :	number of blocks of MT to transfer.
FROM :	from device.
TO :	to device.
UNIT :	unit to check for count or faults.
SC :	subcommand of skip instruction.
CQ :	comparison quantity.

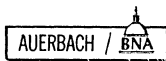

§ 051.

- .234 Basic address structure: 1 + 0.
- .235 Literals
 - Arithmetic: none.
 - Comparisons and tests: none.
 - Incrementing modifiers (repeat and index register control): 12 bits (maximum value, 4, 095).
- .236 Directly addressed operands
- .2361 Internal Storage type: core.
 - Minimum size: 1 word.
 - Maximum size: 1 word.
 - Volume accessible: 32,768 words.
- .2362 Increased address capacity: none.
- .237 Address indexing
- .2371 Number of methods: 1.
- .2372 Names: indexing.
- .2373 Indexing rule: addition, modulo 32,767.
- .2374 Index specification: N field of indexable instruction.
- .2375 Number of potential indexers: 8, 16, or 32 optional index registers.
- .2376 Addresses which can be indexed: all instructions except repeat, skip, and input-output.
- .2377 Cumulative indexing: none.
- .2378 Combined index and step: yes; index register can be automatically incremented by one if counter bit is set to 1.
- .238 Indirect addressing: none.
- .239 Stepping
- .2391 Specification of increment: index register counter bit specifies automatic increment of 1 as referencing indexable instruction is executed. stepping index register instructions hold increment or decrement to maximum value of 4,095, data register may hold increment or decrement of 0 to 32,767.
- .2392 Increment sign: none; considered absolute value.
- .2393 Size of increment: 0 to 32,767.
- .2394 End value: specified in test instruction.
- .2395 Combined step and test: for increment or decrement of up to 32,767.

.24 Special Processor Storage

Category of storage	Number of locations	Size in bits	Program usage
Processor:	3	48	arithmetic, data manipulation.
Processor:	2	15	program control.
Processor:	1	16	program control.
Processor:	8, 16, or 32	16	indexing
Processor:	1	48	instruction register.
Processor:	1	18	repeat control.
Processor:	1	48	hold input-output order.
I/O Processor:	1	8	assembler availability.
I/O Processor:	1, 2, 3, or 4	10	assembler fault.
I/O Processor:	1, 2, 3, or 4	12	assembler counter.
I/O Processor:	16	4	unit availability.

Note: I/O Processor counters and fault registers may be interrogated from the Central Processor.

Category of storage	Total number locations	Physical form	Access time, μ sec
Processor:	17 to 41	flip-flop	approx. 0.1
I/O Processor:	4 to 25	flip-flop	approx. 0.1

.242

.3 SEQUENCE CONTROL FEATURES

.31 Instruction Sequencing

- .311 Number of sequence control facilities: 1.
- .314 Special sub-sequence counters
 - Number: 1.
 - Purpose: repeat counter.
- .315 Sequence control
 - step size: instruction pairs.
- .316 Accessibility to routines: available immediately after a jump is performed.
- .317 Permanent or optional modifier: none.
- .32 Look-Ahead: none.
- .33 Interrupt: none.
- .34 Multirunning: none.
- .35 Multi-sequencing: none.

.4 PROCESSOR SPEEDS

.41 Instruction Times in μ sec.

- .411 Fixed point
 - Add-subtract: 15.0.
 - Multiply (Average): 92.2.
 - Divide (average): 93.3.

§ 051.

.412 Floating point
 Add-subtract
 (average): 21.9.
 Multiply (average): 69.9.
 Divide (average): 73.8.

.413 Additional allowance
 for indexing: 0.0.

.414 Control
 Compare and
 branch (GO): 11.3.

.415 Counter control
 Step: 9.6 in separate instruction.
 0.0 in indexed instruction.
 Step and test: 9.6.
 Edit: none.

.417 Convert: none.

.418 Shift, N bit positions: 8.5 + 1.6 N.

.42 Processor Performance in μ secs

.412 For random addresses Fixed point Floating point
 c = a + b: 45.0 51.9.
 b = a + b: 34.8 41.9.
 Sum N items: 15.0 21.9.
 c = ab: 122.2 99.9.
 c = a/b: 123.3 103.8.

.422 For arrays of data Fixed point Floating point
 c_i = a_j + b_j: 63.9 70.8.
 b_j = a_i + b_j: 24.8 31.9.
 Sum N items (under
 repeat control): 10.0 10.0.
 c = c + a_ib_j: 113.4 99.8.

.423 Branch based on comparison
 Numeric data: 93.9.
 Alphabetic data: 103.2.

.424 Switching
 Unchecked: 56.3.
 Checked: 116.9.
 List search: 14.0.

.425 Format control per character
 Unpack: 7.8 + 104 if converted.
 Compose: 90.5 + 209 if converted.

.426 Table look up per comparison
 For a match: 14.0.
 For least or greatest: 21.1.
 For interpolation
 point: 14.0.

.427 Bit indicators
 Set bit in separate
 location: 11.1.
 Set bit in pattern: 11.1.
 Test bit in separate
 location: 11.3.
 Test bit in pattern: 140.6.

.428 Moving
 (word; register to
 register): 9.3.
 (word; core to core): 30.0.
 (N words; core to
 core): 20.8 + 20.0 N.

.5 ERRORS, CHECKS, AND ACTION

<u>Error</u>	<u>Check or Interlock</u>	<u>Action</u>
Overflow:	check	indicator.
Underflow:	check	error jump and alarm.
Zero divisor:	check	signal and indicator.
Invalid data:	none.	
Invalid operation:	check	stop.
Arithmetic error:	none.	
Invalid address:	check	stop and alarm.
Receipt of data:	parity check	indicator and alarm.
Dispatch of data:	parity check	indicator and alarm.

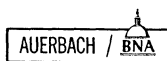



CONSOLE

§ 061.

.1 GENERAL

.11 Identity: Central Processor Console.

.12 Associated Units: . . . console typewriter, stands on console desk.

.13 Description:

The Console is mounted on the central processor desk type cabinet, and consists of an operating and display panel, and a console typewriter. The display panel is mounted vertically with a slanted operating control panel extending outward toward the operator. The console typewriter is located on an angled extension of the desk to the left of the operator.

All arithmetic and control registers are displayed, as well as a usual complement of fault indicators. Data and instructions may be entered manually from the console, requiring that the operator be familiar with the command configurations of all instructions. Supplementary display information is obtained from the Input-Output Processor (IOP) control panel; the system is inconvenient if placed anywhere the operator cannot see and easily reach both the console and IOP control panel.

The console typewriter is a modified Friden Flexowriter with the punched paper tape reader and punch made inoperative or removed. Entry and exit of data through the console typewriter is accomplished by programmed routines.

Output on the typewriter is rated by the manufacturer at 10 characters per second. Data to be typed or entered is sent in BCD form through the Data register one character at a time. The typewriter keyboard contains 64 Philco characters plus 3 control characters.

.2 CONTROLS

.21 Power

<u>Name</u>	<u>Form</u>	<u>Function</u>
Start:	button	starts power-on cycle.
Stop:	button	starts turn-off cycle in central processor.

.22 Connections: none. Connection plugs and switches are located on I/O Processor control panel.

.23 Stops and Restarts

<u>Name</u>	<u>Form</u>	<u>Function</u>
Stop:	button	stops central processor at end of instruction being executed.
Advance:	button	starts central processor when Run or Step buttons have been depressed.

.24 Stepping

Step:	button	allows execution of one instruction at a time each time Advance button is depressed.
Run:	button	sets automatic running mode.
Speed:	dial	when turned to off, processor is in Step mode.
I Control	button	next programmed instruction pair is to be transferred to the Program Register when Advance button is depressed. Used in Step mode.
IL Control	button	left instruction in Program Register is to be executed when Advance button is depressed. Used in Step mode.
IR Control	button	right instruction in Program Register is to be executed when Advance button is depressed. Used in Step mode.

.25 Resets

<u>Name</u>	<u>Form</u>	<u>Function</u>
Clear D Controls:	buttons	clear left and right address field, left and right command field of word in Data Register.
Clear PR Controls:	buttons	clear left and right address field, left and right command field of Program Register.
Pre-Clear Control:	button	clear all controls and error circuits; cause carriage return on console typewriter; set initial conditions for IOP and device on Paper Tape Channel.

§ 061.

.26 Loading: none.

.27 Sense Switches

<u>Name</u>	<u>Form</u>	<u>Function</u>
Break Control: Overflow On-Off Control:	switch	allows breakpoint option.
TR Controls:	switches	causes program to stop on overflow detection when switch is set to On and the next instruction is not an overflow branch.
		allows manual setting of bit pattern to be transferred to Data Register at point specified in program by special transfer instruction. Forty-eight two-way toggle switches are provided.

.28 Special

<u>Name</u>	<u>Form</u>	<u>Comment</u>
MP Control:	switches	causes display of address of core storage location specified by switches when that location is accessed.
MP On-Off Control:	switch	stops central processor when address determined by MP control is accessed.
Jump control:		allows execution of jump instruction without affecting the contents of the Jump Register.
Index Selector Controls:	buttons	allows display of any eight index registers.

The following controls are on the Input-Output Processor control panel:

Assigned Address Controls:	16 plug-in controls	assigns the input-output channel number to the physical I/O unit.
Initiate Control:	button	executes an I/O instruction set up on the IOP control panel.
System Clear:	button	clears all IOP registers and counters, releases all assemblers.

.28 Special (Contd.)

<u>Name</u>	<u>Form</u>	<u>Comment</u>
Read FWD 1 Block Controls:	4 buttons	sets up a command to read one block of data in a forward direction from the indicated unit.
Space FWD 1 Block Controls:	4 buttons	sets up a command to space one block of data in a forward direction on the indicated unit.
Space BWD 1 Block Controls:	4 buttons	sets up a command to space one block of data in a backward direction on the indicated unit.
Clear Faults Controls	4 buttons	clears I/O errors in the specified assembler.
Assembler Displayed Control:	rotary switch	determines which assembler's registers will be displayed.
Assign Controls	20 buttons	assigns any assembler to any I/O channel.

.3 DISPLAY

.31 Alarms: four fault lights indicate: command fault; non-acceptance of I/O instruction; core storage temperature trouble; and floating point exponent overflow. An additional light indicates arithmetic overflow.

.32 Conditions: none.

.33 Control Registers

<u>Name</u>	<u>Information displayed; form displayed</u>
I/O Display:	most recent I/O instruction executed; displayed in binary.
A Register Display:	contents of Accumulator Register; displayed in binary.
Q Register Display:	contents of Quotient Register; displayed in binary.

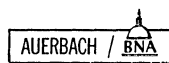

§ 061.

.33 Control Registers (Contd.)

<u>Name</u>	<u>Information displayed; form displayed</u>
Data Register Display:	contents of Data Register; displayed in binary, separated and color coded by instruction address and command fields.
JA Display:	contents of Jump Address Register; displayed in binary.
MA Display:	address of core storage location most recently accessed; displayed in binary.
Program Register Display:	contents of Program Register (instruction pair being processed); displayed in binary, separated and color coded by address and command fields.
PA Display:	address of next instruction word to go to Program Register; displayed in binary.
Index Display:	contents of any eight index registers; displayed in binary.
I Cycle Display:	indicates next part of instruction cycle to perform; displayed in three single lights.
Jump Indicator:	indicates Jump Control is depressed.

.34 Storage

<u>Name</u>	<u>Information Displayed</u>
M Display:	contents of core storage location whose address is determined by the Memory Preset switches.
	Individual core storage locations are displayed by operator entering transfer instruction to an arithmetic register into the Program Register via Program Register Control buttons, depressing appropriate I Cycle button and Advance button.

.4 ENTRY OF DATA

.41 Into Control Registers

- (a) Enter appropriate transfer instruction into Program Register by keying-in on Program Register Control buttons.
- (b) Enter data into Data Register by keying-in on Data Register Control buttons.
- (c) Depress Advance button to execute transfer instruction. One 48-bit word is transferred.

.42 Into Storage: same as control registers.

.5 CONVENIENCES

.51 Communications: none.

.52 Clock: program time display on console provides running time of a program in seconds; manually reset to zero.

.53 Desk Space: adequate free work space in front of operating panel.

.54 View: unobstructed view in all directions by person seated at console.



INPUT-OUTPUT: 240 PAPER TAPE SYSTEM

§ 071.

. 1 GENERAL

. 11 Identity: Paper Tape System.
Model 240.

. 12 Description

The paper tape reader and punch are two separate units housed in the same cabinet with their controller. The photoelectric reader operates at 1,000 characters per second with a slower speed of 500 characters per second achieved by a switch control. This is a Burroughs reader. When reading strips, the 1,000 character per second speed cannot be used. Tape used is standard 11/16- or 7/8-inch opaque, non-oiled paper tape. The punch is a Teletype unit which operates at 60 characters per second. Optional features permit 5- or 7-level paper tape reading and punching, and 6-level tape reading by setting a parity check bypass switch. The external code is the same as the internal code. From 1 to 4,096 characters can be read or punched by one I/O instruction. No interblock gaps are required. The reader halts on the character following the last character transmitted or sensed. The five-bit code is treated as a six-bit character in a read operation by adding a zero bit in the most significant bit position.

. 13 Availability: 12 months.

. 14 First Delivery: February, 1960.

. 2 PHYSICAL FORM

. 21 Drive Mechanism

. 211 Drive past the head: . . pressure roller (reader);
sprocket drive (punch).

. 212 Reservoirs
Number: 2.
Form: swinging arm.
Capacity: 1.5 to 2.0 ft.

. 213 Feed drive: electric motor.

. 214 Take-up drive: electric motor.

. 22 Sensing and Recording Systems

. 221 Recording system: . . . die punch.
. 222 Sensing system: . . . photoelectric.
. 223 Common system: . . . no; separate read and
punch units.

. 23 Multiple Copies: none.

. 24 Arrangement of Heads

Use of station: reading.
Stacks: 1.
Heads/stack: 7.
Method of use: reads 1 row at a time.

Use of station: punching.
Stacks: 1.
Heads/stack: 7.
Method of use: punches 1 row at a time.

. 25 Range of Symbols

Numerals: 10 0 to 9.
Letters: 26 A to Z.
Special: 28 special characters.
Total: 64.

. 3 EXTERNAL STORAGE

. 31 Form of Storage

. 311 Medium: paper tape, opaque.
. 312 Phenomenon: punched holes.

. 32 Positional Arrangement

. 321 Serial by: 1 to 32,768 rows at 10
rows/inch.
. 322 Parallel by: 5 or 7 tracks at standard
spacing (5 or 7 tracks
read or punched; parity
punch ignored for 6-track
tape).

. 324 Track use

	7-level	6-level	5-level
Data:	6	6	5.
Redundancy check:	1	0	0.
Timing:	1(sprocket track)	1(sprocket track)	1(sprocket track).
Control signals:	0	0	0.
Unused:	0	0	0.
Total:	7(plus sprocket track).	6(plus sprocket track).	5(plus sprocket track).

. 325 Row use

Data: all.
Redundancy check: . . 0.
Timing: 0.
Control signals: . . . 1 (end transmission prior
to end of specified number
of words to transmit).
Unused: 0.
Gap: 0.

§ 071.

- .33 Coding: 6- and 7-level tape as in Data Code Table No. 1, one character to a row; 5-level type - any 5-bit code.
- .34 Format Compatibility: . any paper tape device accepting standard 0.6875 inch 5-level or 0.875 inch 7-level tape.
- .35 Physical Dimensions
- .351 Overall width: 0.6875 or 0.875 inch.
- .352 Length: 350 or 700 foot reels for reader; also short lengths (reader); 1,000 foot reels for punch.
- .4 CONTROLLER
- .41 Identity: no separate identity; part of Model 240 Paper Tape System.
- .42 Connection to System
- .421 On-line: 1; may not transmit during magnetic drum transmission.
- .422 Off-line: none.
- .43 Connection to Device
- .431 Devices per controller: 2 (1 reader, 1 punch).
- .432 Restrictions: none.
- .44 Data Transfer Control
- .441 Size of load: 4,096 rows.
- .442 Input-output areas: . . core storage.
- .443 Input-output area access: 1 word.
- .444 Input-output area lockout: none.
- .445 Table control: none.
- .446 Synchronization: automatic.
- .5 PROGRAM FACILITIES AVAILABLE
- .51 Blocks: none.
- .52 Input-Output Operations
- .521 Input: 1 to 4,096 characters; cut-off by I/O instruction or "stop" character.
- .522 Output: 1 to 4,096 characters; cut-off by I/O instruction or "stop" character.
- .523 Stepping: none.
- .524 Skipping: none.
- .525 Marking: end of record by "stop" character, coded.
- .526 Searching: none.

- .53 Code Translation: none.
- .54 Format Control: none.
- .55 Control Operations
- Disable: no.
- Request interrupt: no.
- Select format: no.
- Select code: yes.
- Rewind: yes.
- Unload: yes.
- .56 Testable Conditions
- Disabled: yes.
- Busy device: yes.
- Nearly exhausted: no.
- Busy controller: yes.
- End of medium marks: yes.
- Parity check: yes.
- .6 PERFORMANCE
- .61 Conditions
- I: 1,000 char/sec. reading.
- II: 500 char/sec. reading.
- .62 Speeds
- .621 Nominal or peak speed: 1,000 char/sec. read; 60 char/sec. punch.
- .622 Important parameters
- Start-stop time: 1 millisecond on reading.
- .623 Overhead: none.
- .624 Effective speeds: 989 char/sec. reading, 60 char/sec. punching for on-line and off-line operations.
- .63 Demands on System: 0.1 percent reading 1,000 char/sec. on 2000-210, less on others.
- .7 EXTERNAL FACILITIES
- .71 Adjustments
- Adjustment: tape width guide.
- Method: movable guide.
- Comment: mechanical indented slide.

§ 071.

.72 Other Controls

Reader

Function	Form	Comment
Select on-line or off-line mode of operation:	switch.	
Set speed to 1,000 char/sec or 500 char/sec:	switch.	
Determine 5- or 7-level tape:	switch.	
Rewind paper tape:	button	
Stop reading:	button.	
Resume forward reading:	button.	
Allow stop on parity error or bypass error:	switch	set to Bypass for 6-level tape.
Stop for or bypass "stop" character:	switch.	

Punch

Determine 5- or 7-level punching mode:	switch.
--	---------

Controller

Set controller for new paper tape operation:	button	clears counters and fault registers.
--	--------	--------------------------------------

.73 Loading and Unloading

.731 Volumes handled	Capacity
Storage	
Reel:	700 ft.
.732 Replenishment time: . . .	0.5 to 1.0 minute; unit needs to be stopped.
.733 Adjustment time: . . .	0.5 min. to adjust tape with guide.
.734 Optimum reloading period:	1.4 min. for reader; 33 min. for punch.

.8 ERRORS, CHECKS AND ACTION

<u>Error</u>	<u>Check or Interlock</u>	<u>Action</u>
Recording (parity):	check	alarm, stop.
Reading:	check	alarm, stop.
Input area overflow:	none.	
Output block size:	none.	
Invalid code:	none.	
Exhausted medium:	check	automatic rewind or stop after rewind.
Imperfect medium:	none.	
Timing conflicts	none.	



INPUT-OUTPUT: 241 PAPER TAPE SYSTEM

§ 072.

.1 GENERAL

.11 Identity: Paper Tape System.
Model 241.

.12 Description

The paper tape reader and punch are two separate units housed in the same cabinet with the controller. The performance characteristics of the 241 are identical with the Model 240 Paper Tape System with respect to reading and punching speed. This device operates through a Universal Buffer Controller (UBC) allowing transfers of up to 128 words only.

Reading and punching of 5-, 6-, 7-, or 8- channel tape is permitted. The paper tape used is standard 11/16-, 7/8-, or 1-inch opaque, non oiled tape. The punch is a Tally Register Corporation Series 420 perforator. Reading halts on the character immediately following the last characters sensed. During the read operation, the five-bit code is treated as a six-bit character by adding a one-bit in the most significant bit position. The eight-bit code is placed in core storage as 12-bit coded characters containing four leading zeros.

.13 Availability: 12 months.

.14 First Delivery: June, 1960.

.2 PHYSICAL FORM

.21 Drive Mechanism

.211 Drive past the head: . . pressure roller (reader).
sprocket drive (punch).

.212 Reservoirs

Number: 2 on reader.
Form: swinging arm.
Capacity: 1.5 to 2.0 ft.

.213 Feed drive: electric motor.

.214 Take-up drive: electric motor.

.22 Sensing and Recording Systems

.221 Recording system: . . . die punch.
.222 Sensing system: photoelectric.
.223 Common system: no; separate read and
punch units.

.23 Multiple Copies: none.

.24 Arrangement of Heads

Use of station: reading.
Stacks: 1.
Heads/stack: 8.
Method of use: reads 1 row at a time.

Use of station: punching.
Stacks: 1.
Heads/stack: 8.
Method of use: punches 1 row at a time.

.3 EXTERNAL STORAGE

.31 Form of Storage

.311 Medium: paper tape, opaque.
.312 Phenomenon: punched holes.

.32 Positional Arrangement

.321 Serial by: 1 to 128 rows at 10 per
inch.
.322 Parallel by: 5, 7, or 8 tracks at
standard spacing.

.324 Track use

	8-level	7-level	6-level	5-level
Data:	8	6	6	5.
Redundancy check:	0	1	0	0.
Timing:	1 (sprocket track)	1 (sprocket track)	1 (sprocket track)	1 (sprocket track).
Control Signals:	0	0	0	0.
Unused:	0	0	0	0.
Total:	8 (plus sprocket track)	7 (plus sprocket track)	6 (plus sprocket track)	5 (plus sprocket track).

.325 Row use

Data: all.
Redundancy check: . . 0.
Timing: 0 (end of transmission prior to end of specified number of words to transmit).
Control signals: . . . 1.
Unused: 0.
Gap: 0.

.33 Coding: 6- and 7-level tape as in Data Code Table No. 1, one character to a row; 5- and 8-bit tapes may have any coding or binary representation.

.34 Format Compatibility: . any paper tape device accepting standard 11/16-inch, 7/8-inch or 1-inch paper tape.

§ 072.

.35 Physical Dimensions

- .351 Overall width: 11/16, 7/8, or 1 inch.
 .352 Length: 350 or 700 foot reels for reader, also short lengths (strips); 1,000 foot reels for punch.

.4 CONTROLLER

- .41 Identity: no separate identity; part of Model 241 Paper Tape System.

.42 Connection to System

- .421 On-line: 7 per UBC; only one controller may be active for UBC data transmission.

.422 Off-line

- Use Associated equipment
 Punch card to paper tape to card: UBC, and Punch Card System.
 Paper tape to magnetic tape or magnetic tape to paper tape: UBC, and Magnetic Tape Unit.
 Paper tape to printer: UBC, and Printer System.

.43 Connection to Device

- .431 Devices per controller: 2 (1 reader, 1 punch).
 .432 Restrictions: none.

.44 Data Transfer Control

- .441 Size of load: 128 words.
 .442 Input-output areas: UBC, for off-line; core storage for on-line operation.
 .443 Input-output area access: full.
 .444 Input-output area lockout: none.
 .445 Table control: none.
 .446 Synchronization: automatic.

.5 PROGRAM FACILITIES AVAILABLE.51 Blocks

- .511 Size of block: 1,024 characters.
 .512 Block demarcation: none at end of 1,024 characters; may be transmitted earlier by "stop" character.

.52 Input-Output Operations

- .521 Input: 1 to 128 words; cutoff by I/O instruction or "stop" character.
 .522 Output: 1 to 128 words; cutoff by I/O instruction or "stop" character.
 .523 Stepping: none.
 .524 Skipping: none.
 .525 Marking: end of record by "stop" character, coded.
 .526 Searching: none.

.53 Code Translation: none..54 Format Control: none..55 Control Operations

- Disable: no.
 Request interrupt: no.
 Select format: no.
 Select code level: yes.
 Rewind reader: yes.
 Unload reader: yes.

.56 Testable Conditions

- Disabled: yes.
 Busy device: yes.
 Nearly exhausted: no.
 Busy controller: yes.
 End of medium marks: yes.
 Parity check: yes.

.6 PERFORMANCE.61 Conditions

- I: 1,000 char/sec reading.
 II: 500 char/sec reading.

.62 Speeds

- .621 Nominal or peak speed: 1,000 char/sec read; 60 char/sec punch.
 .622 Important parameters:
 Start-stop time: 1 m. sec. for reading.
 UBC transfer time to IOP (off-line only): 11.4 m. sec.
 .623 Overhead: none.
 .624 Effective speeds: 1,000 char/sec reading, 60 char/sec punching for on-line operations; 989 char/sec reading, 60 char/sec punching for off-line operations.

- .63 Demands on System: 0.1 percent reading 1,000 char/sec on 2000-210, less on others.

§ 072.

.7 EXTERNAL FACILITIES

.71 Adjustments

Adjustment: tape width guide.
 Method: movable guide.
 Comment: mechanical indent slide.

.72 Other Controls

Reader

Reader controls are identical to those of Model 240 with the following controls not present in the Model 241 reader:

5- or 7-level tape mode switch, parity error bypass switch, "stop" character bypass switch.

The following additional controls are present:

Function	Form
Select mode of reading 5-level binary, or 5-, 6-, 7-, and 8-level paper tape:	dial.
Control entry of "stop" characters to normal or override mode:	switches.

Punch

Function	Form
Select mode of punching 5-level binary, or 5-, 6-, 7-, and 8-level paper tape:	dial.

.73 Loading and Unloading

- .731 Volumes handled
 - Storage Capacity
 - Reel: 700 feet.
- .732 Replenishment time: . . . 0.5 to 1.0 minute.
unit needs to be stopped.
- .733 Adjustment time: . . . 0.5 min. to adjust tape width guide.
- .734 Optimum reloading period: 1.42 minutes for reader; 33 minutes for punch.

.8 ERRORS, CHECKS AND ACTION

<u>Error</u>	<u>Check or Interlock</u>	<u>Action</u>
Recording:	check	alarm, stop.
Receipt of data:	parity check	alarm, stop.
Input area overflow:	none.	
Output block size:	none.	
Invalid code:	none.	
Exhausted medium:	check	automatic rewind or stop after rewind.
Imperfect medium:	none.	
Timing conflicts	none.	



INPUT-OUTPUT: 258 CARD READER

§ 073.

.1 GENERAL

.11 Identity: Dual Station Card Reader.
Model 258

.12 Description

The reader reads standard 80-column cards at a peak speed of 2,000 cards per minute. Code translation is performed by the Model 259 Punch Card Controller upon an expanded Hollerith code set of 64 possible characters. This reader is manufactured by Philco, and is based on the Uptime reader. There are two important extensions to the facilities: the incorporation of a plugboard, and a specially designed dual reading station.

Reading is accomplished photoelectrically with a comparison check made at the read station. Both readings occur at the same position. There is one lamp, but two photocells, for each column position. Parity checking occurs after translation; an override control in the controller allows parity error bypassing. A check for skewed cards is also made, and another control is provided to override this condition when desired. A 4,000 card capacity hopper and the same capacity stacker are provided.

Format control is provided in a small reader plugboard, fixed in the card controller. Up to eight fixed characters can be introduced into the controller buffer as part of the card information. The reader and controller may be used on-line or off-line through the Universal Buffer Controller (UBC). When on-line, the reader plugboard is overridden by the I/O instruction specifying the record sizes to become the block of 128 words in the UBC and internal core storage.

.13 Availability: 12 months.

.14 First Delivery: December, 1959.

.2 PHYSICAL FORM

.21 Drive Mechanism

.211 Drive past the head: . . picker (cam action).

.212 Reservoirs: none.

.22 Sensing and Recording Systems

.221 Recording system: . . . none.

.222 Sensing system: Photoelectric.

.23 Multiple Copies: none.

.24 Arrangement of Heads

Use of station: reading.

Stacks: 1.

Heads/stack: 80.

Method of use: 1 row at a time.

Use of Station: checking.

Distance: virtually same position.

Stacks: 1.

Heads/stack: 80, another dual set of photocells, reading same row.

.3 EXTERNAL STORAGE

.31 Form of Storage

.311 Medium: standard 80-column cards.

.312 Phenomenon: rectangular holes.

.32 Positional Arrangement

.321 Serial by: 12 rows at standard spacing.

.322 Parallel by: 80 columns at standard spacing.

.324 Track use: all for data.

.325 Row use: all for data.

.33 Coding: expanded Hollerith code as in Data Code Table No. 2; binary coded characters as in Data Code Table No. 1; or other binary data.

.34 Format Compatibility

Other device or system Code translation

All devices or systems using standard 80-column cards: . . . not required with Hollerith-coded punched cards.

.35 Physical Dimensions: . . standard 80-column cards.

.4 CONTROLLER

.41 Identity: Punch Card Controller.
Model 259.

.42 Connection to System

.421 On-line: 7 with UBC; 1 controller only may be operating on-line per UBC.

§ 073.

.422 Off-line

Use	Associated equipment
Punch card to magnetic tape:	Universal Buffer Controller. Magnetic Tape Unit.

.43 Connection to Device

.431 Devices per controller: . 1.
.432 Restrictions: none.

.44 Data Transfer Control

.441 Size of load: off-line, 128 words from multiple cards under plug-board control specifying number of words per block.
on-line, 128 words under program specification of number of words per card and number of cards per block.
.442 Input-output areas: . . core storage.
.443 Input-output area access: 1 word.
.444 Input-output area lockout: no.
.445 Table control: none.
.446 Synchronization: automatic.

.5 PROGRAM FACILITIES AVAILABLE

.51 Blocks

.511 Size of block: 1 card of 1 to 10 words.
.512 Block demarcation
Input: off-line, specified by plug-board: on-line, specified by I/O instruction.

.52 Input-Output Operations

.521 Input: read variable number of words into UBC buffer storage and fill remainder of storage with null characters. Cut off is available by control character recognition.
.522 Output: none.
.523 Stepping: none.
.524 Skipping: none.
.525 Marking: none.
.526 Searching: none.

.53 Code Translation: automatic.

.54 Format Control

Control: off-line under plugboard control.
Format alternatives: . . indefinite.
Rearrangement: yes.
Suppress zeros: yes.
Insert point: yes.
Insert spaces: yes.

.55 Control Operations

Disable: yes.
Request interrupt: no.
Offset card: no.
Select stacker: no.
Select format: yes.
Select code: yes; binary, binary coded characters.

.56 Testable Conditions

Disabled: yes.
Busy device: yes.
Nearly exhausted: no.
Busy controller: yes.
Hopper empty: yes.
Stacker full: yes.

.6 PERFORMANCE

.61 Conditions: none.

.62 Speeds

.621 Nominal or peak speed: .2,000 cards/min.
.622 Important parameters: . none.
.623 Overhead: asynchronous clutch.
.624 Effective speeds: 2,000 cards/min.

.63 Demands on System

Type of store
I: 10.0 μ .sec on 210, 211.
II: 10.0 μ .sec partitioned on 211
III: 1.5 μ . sec on 211.
IV: 1.0 μ . sec on 212.

	I	II	III	IV
μ . sec per full card:	0.1	0.8	0.02	0.01.
Percentage:	0.33	0.25	0.05	0.03.

.7 EXTERNAL FACILITIES

.71 Adjustments: none.

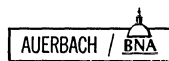

§ 073.

.72 Other Controls

Punched Card Controller - Read Controls

Function	Form	Comment
Off-line format control:	plugboard.	allows rearrangement and omission of columns and fields; permits up to 8 additional characters of fixed data to be substituted for data received from cards; specifies the number of words per card and cards per block to comprise the data entering the UBC buffer storage.
Place system in ready condition:	button.	clears fault and error indicators.
Allows operation to continue when skew error is detected:	button.	
Allow operation to continue when parity error is detected:	button.	
Allow reading instead of bypassing first card of every group to be transferred to the UBC:	button.	
Determine whether blank column should be read as a space character or zero character during code translation:	switch.	
Resume reader operation after non-mechanical fault is detected:	switch.	
Ignore control characters:	switch.	
Determine whether code translation is to occur:	switch.	
Halt reader:	button.	

.72 Other Controls (Continued)

Card Reader

Function	Form	Comment
Allow removal of output tray:	button.	
Cause ready motor to be turned off:	key.	
Starts reader motor:	key	
Permit continuation after a halt:	key.	
Interrupt a read operation:	key.	
Provide count of cards read:	counter with dial reset.	

.73 Loading and Unloading

.731 Volumes handled		
Storage	Capacity	
Stacker:	4,000 cards.	
Hopper:	4,000 cards.	
.732 Replenishment time:	0.5 minute; unit needs to be stopped when output tray is full.	
.733 Adjustment time:	0.5 to 1.0 minute.	
.734 Optimum reloading period:	2.0 minutes.	

.8 ERRORS, CHECKS, AND ACTION

Error	Check or Interlock	Action
Reading:	check	alarm, stop.
Input area overflow:	none.	
Invalid code:	yes	alarm, stop.
Exhausted medium:	interlock	alarm, stop.
Imperfect medium:	check	alarm, stop.
Timing conflicts	none.	
Card skew:	check	alarm, stop.



INPUT-OUTPUT: 265 CARD PUNCH

§ 074.

.1 GENERAL

.11 Identity: Card Punch.
Model 265.

.12 Description

This unit is a modified IBM 523 Summary Gang Punch. Cards may be punched in column alphanumeric or in column binary. The mode to be used is determined by a switch on the Punch Card Controller. Data punched is checked against the data in the buffer matrix of the controller.

The card punch is always used off-line with the Universal Buffer Controller (UBC) although provision exists for on-line operation. The format and block demarcation are controlled by a plugboard. Up to eight fixed characters can be supplied by plugboard wiring.

.13 Availability: 12 months.

.14 First Delivery: December, 1959.

.2 PHYSICAL FORM

.21 Drive Mechanism

.211 Drive past the head: . . pinch roller friction.
.212 Reservoirs: none.

.22 Sensing and Recording Systems

.221 Recording system: . . . die punch.
.222 Sensing system: . . . brush.
.223 Common system: . . . no.

.23 Multiple Copies: none.

.24 Arrangement of Heads

Use of station: punching.
Stacks: 1.
Heads/stack: 80.
Method of use: 1 row at a time.

Use of station: punching.
Distance: 1 card.
Stacks: 1.
Heads/stack: 80.
Method of use: compares punched data
against buffer storage in
Punch Card Controller.

.3 EXTERNAL STORAGE

.31 Form of Storage

.311 Medium: standard 80-column punch
cards.
.312 Phenomenon: rectangular holes.

.32 Positional Arrangement

.321 Serial by: 12 rows at standard
spacing.
.322 Parallel by: 80 columns at standard
spacing.
.324 Track use: all for data.
.325 Row use: all for data.

.33 Coding

Alphanumeric: column code as in Data
Code Table No. 2.
Binary: 4 card columns per 48-bit
core storage word.

.34 Format Compatibility

Other device or system Code translation

All devices using
standard 80-column
cards: automatically provided by
Punch Card Controller
when code mode required.

.35 Physical Dimensions: . standard 80-column cards.

.4 CONTROLLER

.41 Identity: Punch Card Controller.
Model 259.

.42 Connection to System

.421 On-line: 7 with UBC; 1 controller
only may be operating on-
line per UBC.
.422 Off-line
Use Associated equipment
Magnetic tape to
punch card: UBC, Magnetic Tape Unit.

.43 Connection to Device

.431 Devices per controller: 1.
.432 Restrictions: none.

§ 074.

.44 Data Transfer Control

- .441 Size of load: off-line; 128 words to multiple cards under plugboard control specifying number of words per card and number of cards per block.
on-line; 128 words under program specification of number of words per card and number of cards per block.
- .442 Input-output areas: . . core storage.
- .443 Input-output area access: 1 word.
- .444 Input-output area lockout: no.
- .445 Table control: none.
- .446 Synchronization: automatic.

.5 PROGRAM FACILITIES AVAILABLE

.51 Blocks

- .511 Size of block: 1 card of 1 to 10 words in column code mode; 1 to 20 words in column binary mode.
- .512 Block demarcation
Output: off-line, specified by plugboard; on-line, specified by I/O instruction.

.52 Input-Output Operations

- .521 Input: none.
- .522 Output: punch variable number of words from UBC buffer storage. Cutoff is available by control character recognition.
- .523 Stepping: none.
- .524 Skipping: none.
- .525 Marking: none.
- .526 Searching: none.

- .53 Code Translation: automatic.

.54 Format Control

- Control: off-line under plugboard control; on-line under program control.
- Format alternatives: . . indefinite.
- Rearrangement: yes.
- Suppress zeros: yes.
- Insert point: yes.
- Insert spaces: yes.

.55 Control Operations

- Disable: yes.
- Request interrupt: no.
- Offset card: no.
- Select stacker: no.
- Select format: yes.
- Select code: yes.

.56 Testable Conditions

- Disabled: yes.
- Busy device: yes.
- Output lock: no.
- Nearly exhausted: no.
- Busy controller: yes.
- Hopper empty: yes.
- Stacker full: yes.

.6 PERFORMANCE

- .61 Conditions: none.

.62 Speeds

- .621 Nominal or peak speed: 100 cards/min.
- .622 Important parameters: none.
- .623 Overhead: single clutch point.
- .624 Effective speeds: 100 cards/min.

.63 Demands on System

Type of store				
I :	10.0 μsec	on 210, 211.		
II :	10.0 μsec	partitioned on 211.		
III:	1.5 μsec	on 211.		
IV:	1.0 μsec	on 212.		
	I	II	III	IV
M. sec per card:	0.1	0.8	0.02	0.01.
Percentage:	0.017	0.013	0.003	0.002.

.7 EXTERNAL FACILITIES

- .71 Adjustments: none.
- .72 Other Controls

Punched Card Controller - punch controls

Function	Form	Comment
Off-line format control:	plugboard	allows rearrangement and omission of columns and fields; permits up to 8 additional characters of fixed data to be punched on cards; specifies the number of words per card and cards per block to comprise the data to be punched.
Place system in ready condition:	button	clears fault and error indicators.
Allow operation to continue when parity error is detected:	button.	

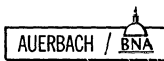

§ 074.

.72 Other Controls (Cont'd)

Function	Form	Comment
Resume punch operation if fault other than mechanical fault is detected:	switch.	
Disregard control characters:	switch.	
Determine card punching to be code mode or image (binary) mode:	switch.	

Card Punch

Feed cards without punching them:	button.
Interrupt punch operation:	button.
Allow restart after a halt:	button.

.73 Loading and Unloading

.731 Volumes handled	
Storage	Capacity
Hopper:	700 cards.
Stacker:	700 cards.
.732 Replenishment time: . .	0.25 to 0.50 mins.
	punch does not need to be stopped.
.734 Optimum reloading period:	7 mins.

.8 ERRORS, CHECKS AND ACTION

<u>Error</u>	<u>Check or Interlock</u>	<u>Action</u>
Recording:	read-after-punch	stop, alarm on controller.
Parity on data to punch:	check	stop, alarm.
Output block size:	counter.	
Invalid code:	check	stop, alarm.
Exhausted medium:	check	stop, alarm.
Imperfect medium:	none.	
Timing conflicts:	skew check	stop, alarm.



INPUT-OUTPUT: 2256 PRINTER SYSTEM

§ 081

.1 GENERAL

- .11 Identity: Printer Unit.
Model 256.
- Printer Control Unit.
Model 254.

.12 Description

The 2256 Printer System is a pair of units, a printer and a controller.

The Model 256 Printer is an Anelex Printer built into a cabinet with control circuitry. The printer requires an additional Printer Control Unit, Model 254, which in turn operates only through a Universal Buffer Controller (UBC). Maximum print speed is 900 lines per minute for alphameric data with the option of a slower operating speed of 600 lines per minute. Skipping occurs at 9,000 lines per minute. Each line prints a maximum of 120 characters from a set of 64 printable characters, four of which normally exercise control functions only.

The print line is of variable length when assembled in internal storage by the programmer. Each block of data, written on magnetic tape or transmitted on-line to a UBC, can be any number of lines the programmer desires, with a restriction that a line cannot be carried over into the next block.

The format of output may be controlled by program and by plugboard. The first character of each line specifies any paper movement before the associated line is printed, either no movement, one-line feed, or a skip to the next control hole in a selected channel of the paper tape loop. In addition to the control characters "end of line" and "end of block," there is a null character which is ignored by the printer and does not result in a space. The plugboard provides a facility to rearrange or duplicate positions on a line. It operates on all lines, and is therefore usually plugged in a one-to-one convention.

- .13 Availability: 12 months.
- .14 First Delivery: December 1959.

.2 PHYSICAL FORM

.21 Drive Mechanism

- .211 Drive past the head: . . . sprocket drive - paper punch both sides.
- .212 Reservoirs: none.

.22 Sensing and Recording Systems

- .221 Recording system: on-the-fly hammer stroke against engraved, sectioned print cylinder.
- .222 Sensing system: none.

.23 Multiple Copies

- .231 Maximum number Interleaved carbon: 6 (8 to 9 pound bond with 1 mil thick carbon paper).
- .232 Types of master
 - Multilith: yes.
 - Zerex: no.
 - Spirit: no.

.24 Arrangement of Heads

- Use of station: printing.
- Stacks: 1.
- Heads/stack: 120.
- Method of use: prints 1 line at a time.

.25 Range of Symbols

- Numerals: 10 0 - 9.
- Letters: 26 A - Z.
- Special: 28 @ = ; = & 1 + n .) % ?
" - \$ * < # Δ / 1 , (>
: e ∩ ∪
- FORTRAN set: yes.
- Basic COBOL set: yes.
- Total: 64.

.3 EXTERNAL STORAGE

.31 Form of Storage

- .311 Medium: continuous fanfold sprocket punched forms.
- .312 Phenomenon: printing.

.32 Positional Arrangement

- .321 Serial by: 1 line at 6 per inch.
- .322 Parallel by: 120 characters at 10 per inch.
- .324 Track use: all for data.
- .325 Row use: all for data.

.33 Coding: 6 bits per character as in Data Code Table No. 1.

.34 Format Compatibility: none.

§ 081

.35 Physical Dimensions

- .351 Overall width: 4.0 to 20.0 inches.
- .352 Length: indefinite, by one-sixth inch increments.
- .353 Maximum margins
 - Left: 4 inches.
 - Right: 4 inches.

.4 CONTROLLER

- .41 Identity: Printer Control Unit. Model 254.
- .42 Connection to System
 - .421 On-line: 1 per Universal Buffer Controller.
 - .422 Off-line

Use	Associated equipment
Printing:	Printer Control Unit, Model 254. Universal Buffer Controller, Model 252 or Model 280. Printer, Model 256.
- .43 Connection to Device
 - .431 Devices per controller: 1.
 - .432 Restrictions: none.
- .44 Data Transfer Control
 - .441 Size of load: 1 block of a variable number of lines.
 - .442 Input-output areas: . . core storage in the UBC.
 - .443 Input-output area access: all of UBC core storage only (128 words).
 - .444 Input-output area lockout: automatic in UBC.
 - .445 Table control: none.
 - .446 Synchronization: automatic.

.5 PROGRAM FACILITIES AVAILABLE

- .51 Blocks
 - .511 Size of block: up to 120 characters per line.
 - .512 Block demarcation
 - Output: end-of-line character, programmer-specified.
- .52 Input-Output Operations
 - .521 Input: none.
 - .522 Output: output 1 block of a variable number of lines.
 - .523 Stepping: programmer causes stepping by giving control character with no printable characters as a line.

- .524 Skipping: advances, then prints; advancing controlled by 7-channel paper tape loop in conjunction with first character of line acting as a vertical format control character.
- .525 Marking: all control characters can be printed in "Write-all" mode.
- .53 Code Translation: none.
- .54 Format Control
 - Control: generally program control with fixed plugboard wiring.
 - Format alternatives: indefinite. null character code. end of line character code.

.55 Control Operations

- Disable: yes, from UBC.
- Request interrupt: no.
- Select format: no.
- Select code: no.

.56 Testable Conditions

- Disabled: yes.
- Busy device: yes.
- Nearly exhausted: no.
- Busy controller: yes.
- End of medium marks: no.
- Hopper empty: yes.
- Stacker full: no.
- Edit error: yes.
- Parity error: yes.
- Counter error: yes.
- Ribbon alignment: yes.

.6 PERFORMANCE

- .61 Conditions
 - I: 900 lines/min.
 - II: 600 lines/min.
- .62 Speeds
 - .621 Nominal or peak speed:
 - I 900 lines/min.
 - II 600 lines/min.
 - .622 Important parameters:
 - Drum revolution
 - I 48.5 msec.
 - II 72.7 msec.
 - Paper stop + start time 18.0 msec.
 - Full paper speed 25 inch/sec. 6.66 msec/line.

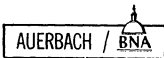

§ 081

- .623 Overhead: asynchronous clutch.
- .624 Effective speeds:
 - I 9,000/(9 + N) lines/min.
 - II 9,000/(14 + N) lines/min.
 - N number of lines advanced between prints.

.63 Demands on System

Type of store				
I	10.0 μ,sec	on 210, 211.		
II	10.0 μ,sec	partitioned on 211.		
III	1.5 μ,sec	on 211.		
IV	1.0 μ,sec	on 212.		
	I	II	III	IV
msec per full line	0.15	0.12	0.022	0.015
Percentage at 900 lines/min	0.22	0.18	0.033	0.022

.7 EXTERNAL FACILITIES

.71 Adjustments

Adjustment	Method
Paper tape loop: . .	change loop.
Horizontal adjustment: . . .	lateral adjustment crank.
Vertical:	micrometer.

.72 Other Controls

Function	Form
Resets printer: . .	button.
Clears fault registers:	button.
Provides a means of setting advance based on specific loop channel: . .	dial.
Edit error override:	toggle.
Parity check override:	toggle.

.73 Loading and Unloading

- .731 Volumes handled
 - Storage: input hopper.
 - Capacity: 10-inch stack of paper.
- .732 Replenishment time: 0.5 to 1.0 min. printer needs to be stopped.
- .733 Adjustment time: . . 1.0 to 2.0 min.
- .734 Optimum reloading period: 147 min.

.8 ERRORS, CHECKS AND ACTION

<u>Error</u>	<u>Check or Interlock</u>	<u>Action</u>
Recording:	none.	
Receipt of data:	parity check	alarm, stop.
Output block size:	check	alarm, stop.
Invalid code:	check	alarm, stop.
Exhausted medium:	interlock	alarm, stop.
Imperfect medium:	none.	
Timing conflicts:	none.	

§ 081.

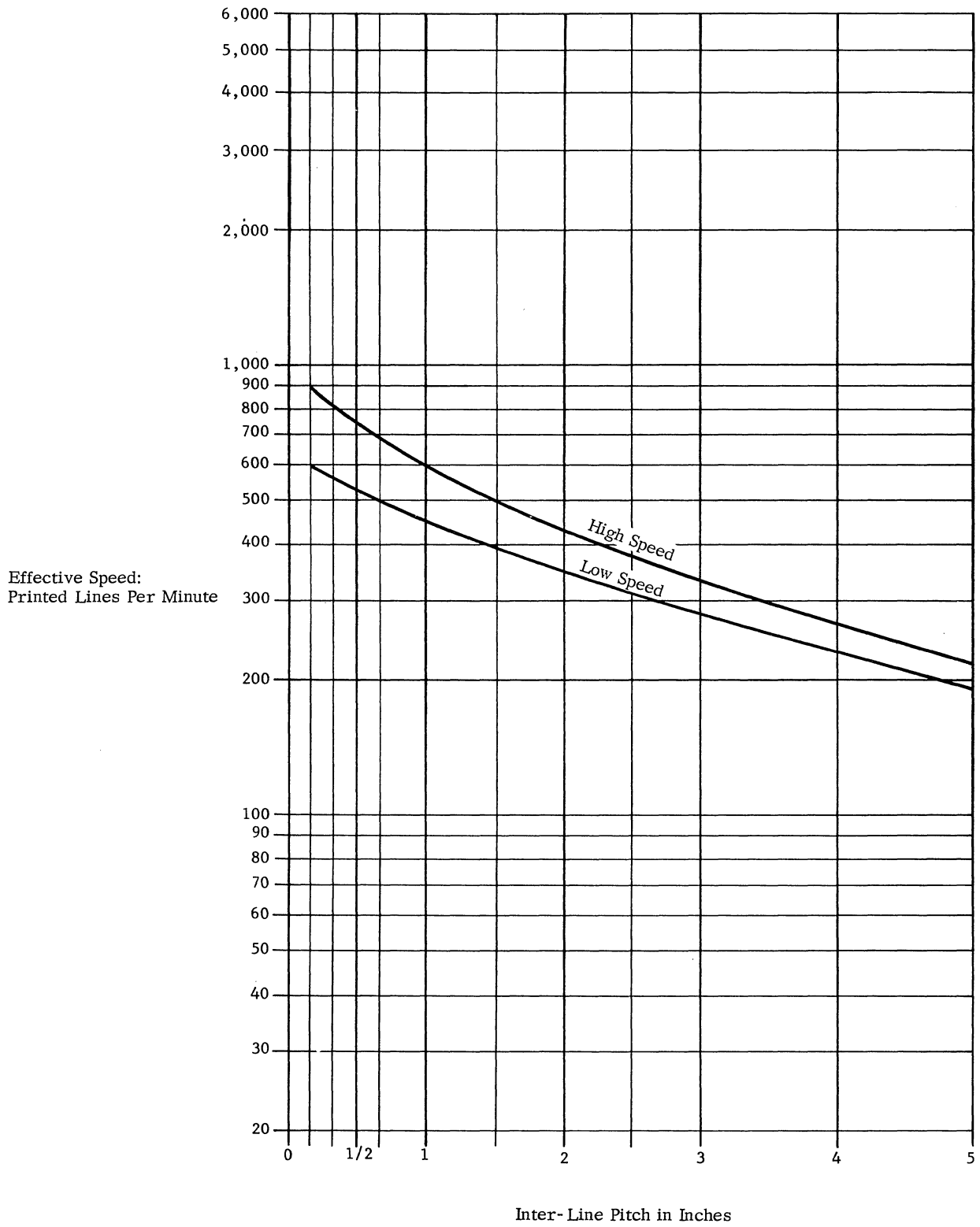

Effective Speed:
Printed Lines Per Minute

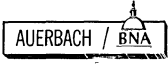



INPUT-OUTPUT: 90 KC MAGNETIC TAPE

§ 091.

.1 GENERAL

.11 Identity: 90 KC Magnetic Tape Transport.
Model 234.

.12 Description

These tape units are used in all Philco 2000 systems employing the Models 235, 236, 237, or 238 Input-Output Processor (IOP). They are also used on the Models 252 and 280 Universal Buffer Controller. The Model 234 (Ampex TM 2) tape units use one inch tape, which has a 750-character-per-inch longitudinal density. Tape is moved across the read-write heads at a speed of 120 inches per second. Record length is fixed in blocks of 512 data frames or rows (1,024 binary coded characters) plus longitudinal parity and block mark recording. Reels of tape are supplied pre-recorded with the necessary "sprocket tracks" and block marks which indicate the fixed block sizes and positions. An erase instruction is provided to erase the sprocket tracks and block marks for one block. An edit instruction is provided for re-recording of beginning and end-block marks from the point started to the end of tape. Editing of tape is more efficiently provided at the manufacturer's facilities. Data recorded may be any binary information held in the storage medium since no conversions occur during reading or recording.

Up to 16 tape units can be physically connected to an Input-Output Processor. Logical tape assignment is easily changed by assignment plugs on the IOP control panel. A varying degree of simultaneous tape operation is provided by the different IOP models; the Model 238 allowing four reads and/or writes to proceed simultaneously with central processor operation and on-line paper tape transmission.

The instantaneous transmission rate is 90,000 characters per second, with an effective transfer of about 54,600 characters per second. A 3,600 foot reel is capable of storing up to 19,200,000 binary coded characters. Forward and backward read is provided as well as the ability to space over blocks prior to reading or recording; the spacing and reading or recording being specified in one input-output instruction.

Checking features include character and channel parity, sprocket bit errors (timing or skew), missing beginning and end-block marks, and beginning and end-of-tape. All of these conditions set bits in the IOP fault registers and can be detected by the program. Parity and sprocket errors initiate automatic error cycles which attempt to overcome the errors. Two modes of error cycle are available in

.12 Description (Contd.)

both reading and recording; the programmer specifying the particular mode in the input-output order initiated. When an error occurs in reading there is an automatic re-read. If this is also faulty, one mode stops the unit, the other does not. When an error occurs on recording, there is automatic re-write. If this re-write is also in error: one mode stops the unit; the other mode erases that block position, removing the position from further use, and tries at the next position. If the writing fails twice at the next position, this mode stops the unit. A program can test for these situations and release the unit.

Optional

One magnetic tape unit may be switchable on-line/off-line with the Model 280 Universal Buffer Controller.

.13 Availability: 12 months.

.14 First Delivery: December, 1959 (FR 300).
late 1961 (TM 2).

.2 PHYSICAL FORM

.21 Drive Mechanism

- .211 Drive past the head: . . . pinch roller friction.
- .212 Reservoirs
 - Number: 2.
 - Form: vacuum.
 - Capacity: each about 5.5 feet.
- .213 Feed drive: motor.
- .214 Take-up drive: motor.

.22 Sensing and Recording Systems

- .221 Recording system: . . . magnetic heads.
- .222 Sensing system: . . . magnetic heads.
- .223 Common system: . . . two gap head provides read-after-write checking.

.23 Multiple Copies: none.

.24 Arrangement of Heads

Use of station: recording.
Stacks: 1.
Heads/stack: 16.
Method of use: 1 row at a time.

Use of station: sensing.
Distance: 0.39 inches.
Stacks: 1.
Heads/stack: 16.
Method of use: 1 row at a time.

§ 091.

.3 EXTERNAL STORAGE

.31 Form of Storage

- .311 Medium: plastic tape with magnetizable surface.
- .312 Phenomenon: magnetization.

.32 Positional Arrangement

- .321 Serial by: 514 rows at 375 rows/inch; includes 512 data rows of 2 characters each, 1 channel parity and 1 dummy row; two bits for timing and skew detection appear between each 2 rows.
- .322 Parallel by: 16 tracks.
- .323 Bands: 2; 2 char/row.
- .324 Track use
 - Data: 12.
 - Redundancy check: 2.
 - Timing: 2.
 - Control signals: 0.
 - Unused: 0.
 - Total: 16.
- .325 Row use
 - Data: 12.
 - Redundancy check: 2.
 - Timing: 2.
 - Control signals: appear in same row as timing bits; signal beginning and ending block.
 - Unused: 0.
 - Gap: 0.9 inches.

- .33 Coding: as in Data Code Table No. 1.

.34 Format Compatibility

- Other devices or system Code translation
- Model 256 Printer system: not required.
- Models 258, 259, 265 Punched card system through Universal Buffer Controller: by Punched Card Controller.

.35 Physical Dimensions

- .351 Overall width: 1.0 inch.
- .352 Length
 - Reel: 600, 2,400 or 3,600 feet/reel, pre-recorded with block marks and sprocket tracks.

.4 CONTROLLER

- .41 Identity: Input-Output Processor.
 - Model 235 (16 x 1). ‡
 - Model 236 (16 x 2). ‡
 - Model 237 (16 x 3). ‡
 - Model 238 (16 x 4). ‡
 - IOP.

‡ The first number in parentheses indicates the number of channels and the second number indicates the maximum number of data assemblers for the processor.

.42 Connection to System

- .421 On-line: 1 IOP.

.43 Connection to Device

- .431 Devices per controller: 16.
- .432 Restrictions: up to 4 on/off-line Universal Buffer Controllers can be connected; reduces number of tape units by from 1 to 4.

.44 Data Transfer Control

- .441 Size of load: 1 to 16 blocks as specified by input-output instruction.
- .442 Input-output areas: core storage.
- .443 Input-output area access: 1 word.
- .444 Input-output area lockout: none.
- .445 Table control: none.
- .446 Synchronization: automatic.

.5 PROGRAM FACILITIES AVAILABLE

.51 Blocks

- .511 Size of block: 128 words, 1,024 characters.
- .512 Block demarcation
 - Input: begin and end-block marks, and interblock gap on magnetic tape; word count from core storage.
 - Output: same as input.

.52 Input-Output Operations

- .521 Input: read from 1 to 16 blocks, forward or backward, from magnetic tape or 1 block from on-line Universal Buffer Controller; block inverted in core storage on backward read.
- .522 Output: write from 1 to 16 blocks to magnetic tape or transmit 1 block to on-line Universal Buffer Controller.
- .523 Stepping: none.
- .524 Skipping: space forward or backward, 1 to 15 blocks, prior to reading forward or backward from magnetic tape; space forward 1 to 15 blocks prior to writing on magnetic tape; space 0 and read or write 0 if I/O instruction is interpreted as 16 blocks read or write.

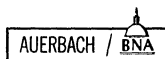

§ 091.

- .525 Marking: none.
- .526 Searching: none.
- .53 Code Translation: . . . automatic, Hollerith to codes in Data Code Table No. 1, by 259 Punch Card Controller.
- .54 Format Control: none.
- .55 Control Operations
 - Rewind: yes, independent of assemblers.
 - Unload: yes, independent of assemblers.
- .56 Testable Conditions
 - Disabled (device on any of 16 channels): yes.
 - Busy device: yes.
 - Output lock: yes.
 - Nearly exhausted: no.
 - Busy controller (assembler assigned to logical channel number): yes.
 - End of medium marks: yes, beginning and ending of magnetic tape reel indicators.
 - Missing block demarcation: yes.
 - Parity error: yes.
 - Skew: yes, detected on magnetic tape.
 - Rewind: yes, any of 16 tape transports in a rewind status.
 - Count: yes, remaining blocks and words remaining to be processed.
 - Processor available: yes, assembler available and/or transmitting.

.6 PERFORMANCE

- .61 Conditions: none.
- .62 Speeds
 - .621 Nominal or peak speed: 90,000 char./sec.
 - .622 Important parameters
 - Density: 750 char/inch.
 - Tape speed: 120 inches/sec.
 - Start-stop time: 2.5 m. sec.
 - Full rewind time: 4.0 minutes/3,600 foot reel.
 - Interblock gap: 0.9 inches.
 - Fixed block length (including block markers): 1.90 inches
 - .624 Effective speeds: 54,600 char/sec for full blocks.

.63 Demands on System

- Type of store
- I: 10.0 μ. sec on 210,211.
 - II: 10.0 μ. sec partitioned on 211.
 - III: 1.5 μ. sec on 211.
 - IV: 1.0 μ. sec on 212.

- Type of measurement
- V: peak penalty.
 - VI: effective penalty.

	I	II	III	IV
M. sec per block	1.28	0.95(**)	0.192	0.128
Percentage				
V	11.2	8.4(**)	1.68	1.12
VI	6.7	5.1(**)	1.01	0.67

(**) Estimate based on nearly complete data and probably reliable.

.7 EXTERNAL FACILITIES

- .71 Adjustments: none.

.72 Other Controls

Function	Form	Comment
Indicates unit has re-wound tape without it locking out and requiring operator intervention:	button-indicator	button turns off indicator.
Indicates unit cannot be controlled remotely:	button-indicator	button turns off indicator.
Allows reducing or increasing re-wind speed:	button-indicator.	
Allows recording on tape:	ring on tape reel.	
Releases tape reel brakes to allow manual reel turning:	buttons.	

.73 Loading and Unloading

- .731 Volumes handled: 18,750 blocks (19,000,000 char. approx.) potential maximum per 3,600 foot reel.
- .732 Replenishment time: 0.5 to 1.0 mins. device needs to be stopped.
- .734 Optimum reloading period: 6.3 mins.

§ 091.

.8 ERRORS, CHECKS AND ACTION

<u>Error</u>	<u>Check or Interlock</u>	<u>Action</u>
Recording:	character and longitudinal parity	automatic error correction. ‡
Reading:	character and longitudinal parity	automatic error correction. ‡
Input area overflow:	not possible	
Output block size:	not possible.	
Invalid code:	not possible.	
Exhausted medium:	mechanical	turns on indicator, terminates transmission, and inhibits further I/O processing for that channel. Operator or program intervention necessary for restart.
Imperfect medium:	check	‡‡
Timing conflicts:	check	automatic error correction. ‡
Unit disabled:	interlock	operator intervention.
Record enable:	check	set indicator.
Unit busy:	check	set indicator.
Unit rewinding:	check	set indicator.

‡ Parity and timing errors during recording or reading cause initiation of an automatic error cycle, the particular sequence depending upon the mode specified for this cycle by the programmer. Imperfect areas on tape are erased (block marks removed) during recording if a re-recording is unsuccessful so that they are bypassed in subsequent tape operations. Re-reading is attempted in an error cycle occurring in a read operation. If successful, a fault indicator is set and is detectable, or the I/O operation continues; the I/O order given specifying which mode error cycle to carry out.

‡‡ If detected as parity or timing error, tape undergoes automatic correction cycle; if detected as missing block mark, an indicator is set for program detection.

§ 091.

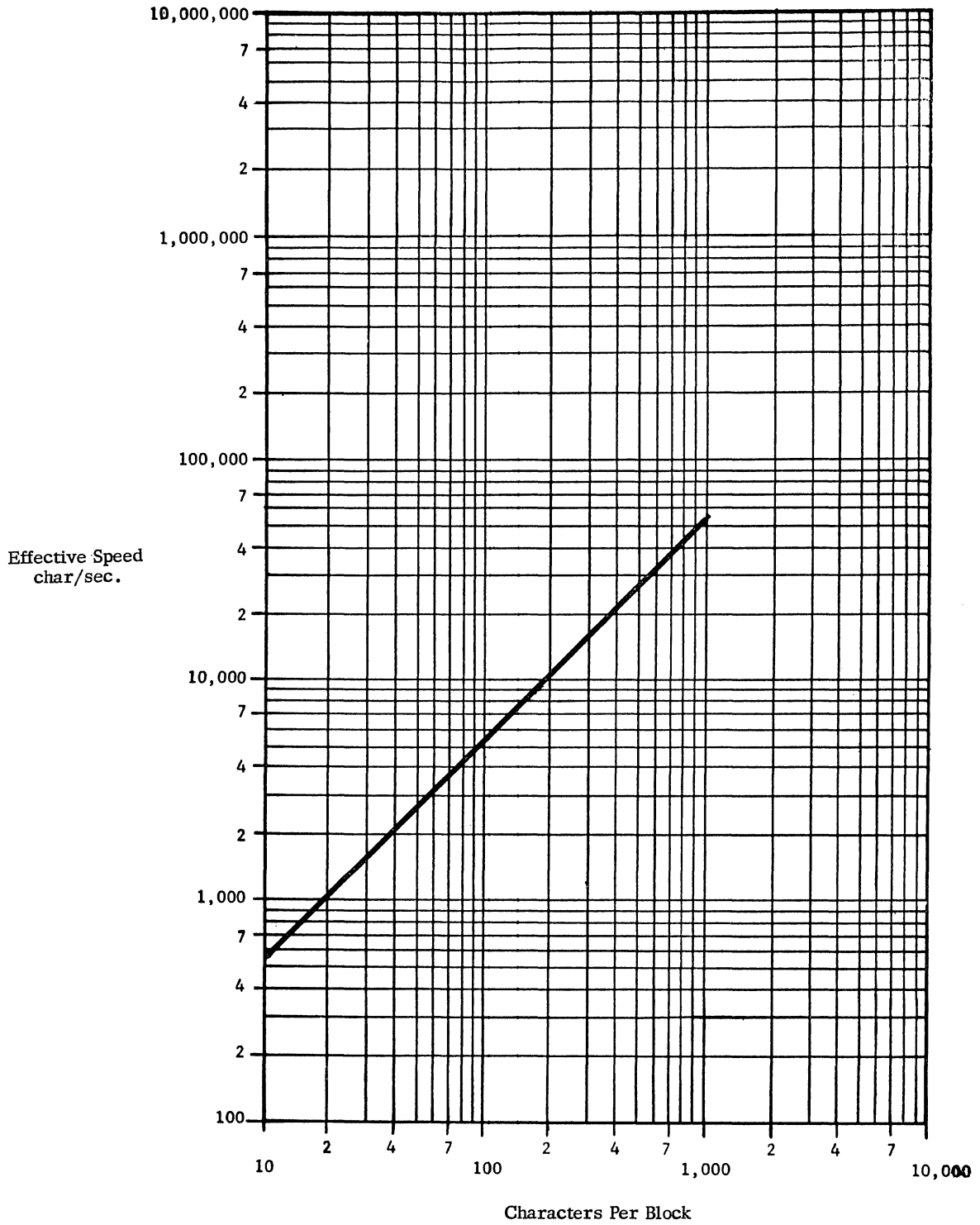



INPUT-OUTPUT: INPUT-OUTPUT PROCESSOR

§ 101.

.1 GENERAL

.11 Identity: Input-Output Processor,
 Model 235 (16x1)
 Model 236 (16x2)
 Model 237 (16x3)
 Model 238 (16x4)
 IOP.

‡ The first number in parentheses indicates the number of channels and the second number specifies the maximum number of data assemblers for that processor.

.12 Description

One Input-Output Processor (IOP) is contained in each configuration.

An IOP can have a total of 16 devices attached to it. The devices may be any mixture of Model 234 Magnetic Tape Units or on/off-line Universal Buffer Controllers (UBC). There is a limit of four UBC's, (see diagram in Section 651:102.9).

An IOP may contain from 1 to 4 assemblers. Each assembler can independently control a data transfer. Thus from 1 to 4 data transfers can be multiplexed into core storage at a time.

There is no restriction on the freedom of any assembler to control any device. An automatic assignment of one of the idle assemblers is made for each data transfer. This feature does make efficient use of simultaneous operations much easier, often requiring no thought.

Each assembler operates at about 90,000 characters per second, or 11,000 words per second, whether from tape or a UBC.

The demands made on core storage depend upon the model of store used in the system. For each type of store, four demands are quoted in percentages for the four combinations of two pairs of alternatives. The first alternative is one or four assemblers running at a time. The second alternative is either peak demand over a period of less than a block time, or

.12 Description (Contd.)

effective demand over several consecutive blocks allowing for inter-block gaps.

Types of store

I: 10.0 μ sec on 210 or 211.
 II: 10.0 μ sec partitioned on 211.
 III: 1.5 μ sec on 211.
 IV: 1.0 μ sec on 212.

	I	II	III	IV
One assembler				
Peak	11	8(**)	1.7	1.1.
Effective	7	5(**)	1.0	0.7.
Four assemblers				
Peak	45	34(**)	6.7	4.5
Effective	28	21(**)	4.1	2.8

Counter and fault registers in each data assembler allow program interrogation of the status of an I/O instruction. Data validity is checked during IOP transmission with parity errors being detected and automatic error correction attempted (see 651:091.12). I/O unit and assembler status registers in the IOP give the programmer flexible checking facilities.

(**) Estimate based on nearly complete data and probably reliable.

.13 Availability: 12 months.

.14 First Delivery: December, 1959.

.4 CONTROLLER: discussed in Section 651:091.4.

.5 PROGRAM FACILITIES: discussed in Section 651:091.4.

.6 PERFORMANCE: discussed in Section 651:091.4.

.7 EXTERNAL FACILITIES: discussed in Section 651:061.

.8 ERRORS, CHECKS AND ACTION: discussed in Section 651:091.8.



INPUT-OUTPUT: UNIVERSAL BUFFER CONTROLLER

§ 102.

.1 GENERAL

.11 Identity: Universal Buffer Controller.
Model 252.
Model 280.
UBC.

.12 Description

The Universal Buffer Controller (UBC) provides the Philco 2000 system with an on-line or off-line data transcription capability using I/O devices of different operating speeds. It serves as a buffer device for one block of data at a time which it transmits either to another I/O device or to the Input-Output Processor (IOP). Up to seven devices, exclusive of the IOP when on-line, can be connected to the controller, (see figure 651:091.12). Suppose the device connecting positions are numbered 1 through 7. A printer or punched card, paper tape or similar unit can be attached to any position, usually positions 1 through 5. Position 6 can be used for off-line transcription with any other position and usually has a magnetic tape unit attached. A magnetic tape unit in this position can only be used off-line. Position 7 can be switched, in either direction, to connect directly to the IOP and release the UBC from the IOP. When a magnetic tape unit is attached, it can be switched to the IOP or to off-line transcription with any device attached to the UBC. In particular tape-to-tape transcription can be performed between positions 6 and 7.

In most installations, UBC's are used only as off-line controllers. While two devices may be operative at one time in an off-line data transcription, only one may be doing an on-line transfer.

A useful feature of the UBC is its ability to separate and further transmit blocks containing a control character which equals any one of 16 possible data select codes.* A switch can be set so that all blocks in an off-line transcription are examined for the value of their one-character data select code. Only those equal to the selected value, out of 16 possible values, are transcribed. The others are discarded.

This feature allows for printing of up to 16 different reports from a reel of magnetic tape produced by one or more computer runs, and contributes to economy of magnetic tape operation.

The Model 280 differs from the Model 252 UBC in that it provides switching for two tape units to make either of them on-line to the Input-Output Processor. In all other respects the two models are identical. The operating speed of the UBC is restricted to the speed of the slowest I/O device concerned in operation during any one data transcription. The one

.12 Description (Cont'd)

block buffer core storage is capable of transferring data at the magnetic tape peak speed of 90,000 characters per second. The buffer has a capacity of 128 words.

When the UBC is used on-line, there is a program selection of the particular unit to be controlled. This selection means that only as many UBC's as are required for simultaneous operations need be installed, not one for each unit to be used.

Because it is only a buffering device, off-line data editing and formatting is not available. All such tasks must be performed by the central processor. Future replacement of the UBC system by the Philco 1000 System will provide greater off-line conversion power.

.13 Availability: 12 months.

.14 First Delivery: December, 1959.

.4 CONTROLLER

.42 Connection to System

.421 On-line: 4, restricted by number of assemblers in Input-Output Processor.

.422 Off-line Use Associated equipment
Magnetic tape to magnetic tape transcription: . . . Model 234 Magnetic Tape Unit.
Card to magnetic tape transcription and magnetic tape to card: Model 234 Magnetic Tape Unit, Model 258 Card Reader, Model 259 Punch Card Controller, and Model 265 Card Punch.
Magnetic tape to printer: Model 234 Magnetic Tape Unit, and Model 256 Printer System.

.43 Connection to Device

.431 Devices per controller: 7.
.432 Restrictions: only 2 may be tape units. Tape unit needs special switch to be used on-line.

.44 Data Transfer Control

.441 Size of load: 1 block.
.442 Input-output areas: . . core storage.

- § 102.
- .443 Input-output area
access: 1 word.
- .444 Input-output area
lockout: none.
- .445 Table control: none.
- .446 Synchronization: automatic.
- .5 PROGRAM FACILITIES AVAILABLE
- .51 Blocks
- .511 Size of block: 1,024 characters.
- .52 Input-Output Operations
- .521 Input: 1 block.
- .522 Output: 1 block to magnetic tape unit, Punch Card Controller or Printer Controller. Record designators interpreted by these units.
- .523 Stepping: 1 block, forward or reverse.
- .524 Skipping: space over 1 block at a time under manual control; transmit or bypass a block under data select feature.
- .525 Marking: second character of first word of block is a data select and/or stop code.
- .526 Searching: data select code equal to number of data select button depressed on UBC operating panel; predetermined stop-code values.
- .53 Code Translation: . . . none, provided by Punch Card Controller or program.
- .54 Format Control: none.
- .55 Control Operations
- Disable: yes.
- Unload: yes, transmit core storage buffer to receiving device.
- .56 Testable Conditions (On-line)
- Disabled: yes.
- Busy device: yes.
- Output lock: yes.
- Busy controller: yes.
- .6 PERFORMANCE
- .61 Conditions: none.
- .62 Speeds
- .621 Nominal or peak speed: 90,000 char/sec.

- .624 Effective speeds: . . . speed of peripheral device during on-line operation; speed of slowest peripheral device during off-line operation.

.7 EXTERNAL FACILITIES

- .71 Adjustments: none.

.72 Other Controls

<u>Name</u>	<u>Form</u>	<u>Function</u>
On-line control	button	places UBC into on-line status.
Off-line control	button	places UBC into off-line status.
Magnetic tape controls	buttons	places either switchable on-line magnetic tapes on Model 280 UBC into on-line status.
Ready control	button	places UBC in ready mode.
Load cycle control	button	starts buffer load cycle.
Unload cycle control	button	starts unload cycle, resets indicators.
From device control	dial	assigns input device.
To device	dial	assigns output device.
Data select code controls	15 buttons	places UBC in data select mode and indicates data select code number to search for in each block.
Magnetic tape erase control	button	erases one block of magnetic tape in a reverse direction.
Execute control	button	performs operations set on control panel.
Continuous cycle control	button	provides continuous operation.
Tape rewind control	button	rewinds magnetic tape without lockout.
Conditional stop control	button	stops UBC when conditional stop character found.
Stop override control	button	prevents stop character from halting UBC during continuous mode operation.
Parity override control	button	prevents UBC stopping on parity error.
Write all control	button	permits all characters to be reproduced by designated I/O device.
Space forward control	button	fills buffer with one block from magnetic tape, but does not transmit the block.
Space reverse control	button	transmits a block to the UBC while magnetic tape is moving in the reverse direction.

.8 ERRORS, CHECKS AND ACTION

<u>Error</u>	<u>Check or Interlock</u>	<u>Action</u>
Recording (parity):	check	1 automatic retry with magnetic tape, halt with other I/O devices.
Reading (parity):	check	same as for recording.
Invalid code:	check	alarm, stop.

§ 102.

.9 FIGURE

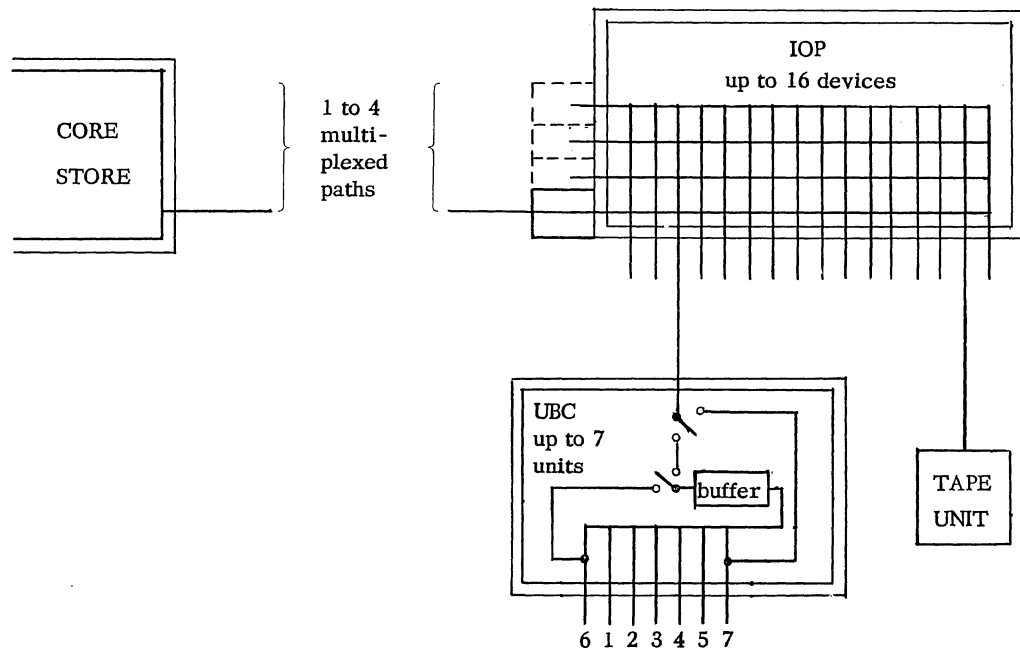



INPUT-OUTPUT: CONSOLE TYPEWRITER BUFFER

§ 103.

.1 GENERAL

.11 Identity: Console Typewriter Buffer.
Model 209.

.12 Description

The Console Typewriter Buffer is an optional unit that is used to prevent the central processor from being delayed while the typewriter is in a type-out cycle. It consists of a 16-character buffer inserted

.12 Description (Contd.)

between the central processor and the typewriter. Characters are shifted sequentially through the 16 positions as the preceding characters are transferred to the typewriter. The central processor is released immediately upon transfer of a character to the buffer. If the buffer is filled, transfer to the buffer does not occur until a character is transferred from the buffer to the typewriter.

.14 First Delivery: . . . March, 1962.



INPUT-OUTPUT: ACCOUNTING CLOCK

§ 105.

.1 GENERAL

.11 Identity: Accounting Clock System.
Model 293.

.12 Description

The Accounting Clock System provides a time reference available to the program via the Paper Tape Channel. This clock transmits in one word the month, day, hour, minute and tenth of minute. It automatically corrects the date for the length of month and has a switch to correct for the odd day during a leap year.

.12 Description (Contd.)

The Accounting Clock is controlled by the Paper Tape Controller. One bit in the I/O instruction designates whether the Paper Tape System or Clock is being referenced. Transmission of the time word cannot occur if the Paper Tape System is busy. The transmission register of the Paper Tape System is used to determine whether or not the transfer of the clock word is completed.

The clock word occupies the least significant 36 bits of the 48-bit word. All quantities are 4-bit binary coded decimal characters.



SIMULTANEOUS OPERATIONS

§ 111.

.1 SPECIAL UNITS: . . . none.

.12 Description

The amount of simultaneous operations in a configuration can be high, due to the flexible I/O arrangements. Each configuration must be considered separately. The number of simultaneously operating units is then limited by the following criteria:

- o A drum data transfer inhibits all other-unit-data transfers.
- o The central processor is limited by the sum of the demands on the store by other units, see Sections 651: 071 to 651: 104.
- o There may be one unit other than magnetic tape operating for each Universal Buffer Controller (UBC). There is a limit of four UBC's.
- o There may be one magnetic tape unit operating for each assembler in an Input-Output Processor (IOP). There is a limit of four assemblers.
- o A separate paper tape system, in addition to those operating off the UBC's, can be operating one input or output unit.
- o A typewriter output either occupies the central processor full time or operates independently if a typewriter buffer is used.
- o Magnetic tape rewind operations are independent of the IOP. Although it is possible for up to four tape units to be operating through the IOP and up to four UBC's to be controlling other units, some time must be given up by the IOP to providing, via assemblers, data transfers that empty or fill the UBC buffers. Nevertheless, in the most extreme case (i.e., four high speed card readers) the effective throughput of the IOP can be equivalent to 4 card readers and 3.75 tape units. Therefore, this penalty can usually be ignored.

The IOP makes automatic allocation of an idle assembler to each new input-output request. Assemblers become idle immediately after completing a UBC or magnetic tape transfer. This system frees the programmer from the need to plan assembler assignments in magnetic tape or other operations.

.2 CONFIGURATION CONDITIONS

.21 Conditions

- U: number of UBC's,
- P: number of assemblers in the IOP.
- N: number of magnetic tape units.

.3 CLASSES OF OPERATIONS

- | <u>Class</u> | <u>Member</u> |
|---------------|---|
| A : | transmit to or from magnetic drum. |
| B : | compute. |
| C : | any input-output function on an on-line Universal Buffer Controller (i.e., read cards, punch cards, print). |
| D : | read or write on magnetic tape. |
| E : | read or punch paper tape. |
| F : | input or output on console typewriter. |
| G : | rewind magnetic tape. |

.4 RULES

- a (b + c + d + e + f + g): =0.
- b: =at most 1.
- c: =at most U.
- d: =at most P.
- e: =at most 1.
- f: =at most 1.
- g: =at most N.

.5 TABLE OF POSSIBLE SETS OF SIMULTANEOUS OPERATIONS

Class	Possible Modes of Simultaneous Operation				
	1	1	1	1	1
A	1				
B		1	1	1	1
C		U	U	U	U
D		P	P	P	P
E		1	1	1	1
F		1	1	1	1
G		N-d	N-d	N-d	N-d



INSTRUCTION LIST

§ 121.

INSTRUCTION				OPERATION	
F	OP CODE		ADDRESS		
F				<u>ARITHMETIC</u>	
				<u>Add-Subtract</u>	
				Indicates floating point operations; blank for fixed point.	
	μ	π	Ω	M	These are a string of characters that specify an op-code by compounding each part. See below:
	A	π	Ω	M	Add (π) to (A).
	CA	π	Ω	M	Place (π) in A.
	S	π	Ω	M	Subtract (π) from (A).
	CS	π	Ω	M	Place - (π) in A.
	μ	Q	Ω	M	(π) is contents of Q.
	μ	M	Ω		(π) is contents of M.
	μ	D	Ω		(π) is contents of D (Note: + cannot be CA, CS, FCA or FCS when " π " is "D").
	μ	π		M	No options.
	μ	π	A	M	Take absolute value of (π).
	μ	π	S	M	Copy result in A to M.
	μ	π	AS	M	Take absolute value of (π) and copy result in A to M (Note: A and S options cannot be used when " π " is "D").
F	AD		M	Examples (out of the 68 possible): floating (A) + (D) \rightarrow A. fixed (A) - M \rightarrow A, M. Note: Any inter-register or store transfer operation affects the contents of the D register.	
	SMAS				
F				<u>Multiply</u>	
				Indicates floating point operations; blank for fixed point.	
	μ	π	Ω	M	These are a string of characters that specify an op-code by compounding each part. See below.
	M	π	Ω		Multiply (Q) by (π), product in A and Q.
	μ	A	Ω	M	(π) is contents of A.
	μ	M	Ω		(π) is contents of M.
	μ	π		M	No options.
	μ	π	A	M	Take absolute value of (π).
	μ	π	R	M	Round result in A and Q to result in A.
	μ	π	S	M	Copy partial result or rounded result in A to M.
	μ	π	AR	M	Take absolute value of (π) and round result to A.
	μ	π	AS	M	Take absolute value of (π) and copy partial result to M.
	μ	π	RS	M	Round result in A and Q to A and copy A to M.
μ	π	ARS	M	Take absolute value of (π), round result and copy to M.	

INSTRUCTION LIST-Contd.

§ 121.

INSTRUCTION				ADDRESS	OPERATION
F	OP CODE				
F	MMRS MAR			M	<p>Examples (out of the 16 possible): floating (Q) * (M) → A_R → M. fixed (Q) * (A) → A_R, (Q) restored to Q. Note: Any inter-register or store transfer affects the contents of the D register.</p> <p><u>Special Multiply Instructions</u></p>
F	M μ μ	π AD SU		M M	<p>Indicates floating point operations; blank for fixed point. Multiply (Q). Multiply (Q) by (M) and add to (A); result appears in A. Multiply (Q) by (M) and subtract (A); final result appears in A.</p> <p><u>Divide</u></p>
F	D μ μ μ	π AQ A π	Ω	M M M M	<p>Indicates floating point operations; blank for fixed point. Divide (π) by (M); quotient in Q, remainder in A. Divide (A and Q) by (M); quotient in Q, remainder in A. Divide (A) by (M); quotient in Q, remainder in A. Divide (π) by (M) and copy quotient from A to M.</p>
F	D D	A A	S Q	M	<p>Examples (out of the 8 possible): floating (A) / (M), quotient in Q → M. fixed (A, Q) / (M), quotient in Q.</p> <p><u>LOGIC</u></p>
	μ	π	Ω	M	<p>These are a string of characters that specify an op-code by compounding each part. See below.</p> <p><u>Logical AND</u></p>
	E μ	π T	Ω	M M	<p>Extract from (M) according to a mask in Q. Extract from (M) according to a mask in Q and transfer extracted bits to Ω. Other bits in A are zero.</p>
	μ μ μ	π π A	A D	M M M	<p>Ω is A register (D contains same extracted fields). Ω is D register. Extract from (M) according to a mask in Q and add extracted bits to corresponding bit positions in A.</p>
	μ	S		M	<p>Extract from (M) according to a mask in Q and subtract extracted bits from corresponding bit positions in A.</p>
	π	I		M	<p>Extract from (M) according to a mask in Q and replace corresponding bits in A by extracted bits; other bits in A remain unaffected.</p>
	μ	I	S	M	<p>Copy (A) to M after insertion of extracted bits into A. Note: Ω = S may only be used with insert.</p>
	E	T	A	M	<p>Example (out of the 6 possible): Extract from A according to mask in Q, transfer to A, remainder of A being zeros.</p> <p><u>Exclusive OR</u></p>
	A W C S			M	<p>(A) + (M), result in D, (D) copied to M; addition occurs without carries; (A) not affected.</p> <p><u>Inclusive OR</u></p>
	D O R M S			M	<p>A one bit in corresponding positions of either D or M or both results in a one bit in the corresponding position in M.</p>

INSTRUCTION LIST-Contd.

§ 121.

INSTRUCTION				ADDRESS	OPERATION
	OP CODE				
	J	π	Ω	M	<u>Jumps</u> Conditional or unconditional transfer of program control to instruction in M.
	μ	MP	Ω	M	Unconditional transfer of control to instruction in M. Jump to M if condition below is met; if not, proceed sequentially:
	μ	AEQ	Ω	M	(A) equal (Q).
	μ	AED	Ω	M	(A) equal (D).
	μ	AGQ	Ω	M	(A) greater than or equal (Q).
	μ	AGQF	Ω	M	(A) greater than or equal (Q), floating point comparison.
	μ	AGD	Ω	M	(A) greater than or equal (D).
	μ	AN	Ω	M	(A) are negative (less than zero).
	μ	AP	Ω	M	(A) are positive (includes zero).
	μ	AZ	Ω	M	(A) are zero.
	μ	QN	Ω	M	(Q) are less than zero, automatic left circular shift of (Q).
	μ	QP	Ω	M	(Q) are positive (includes zero), automatic left circular shift of (Q).
	μ	QE	Ω	M	(Q) are even, automatic right circular shift of (Q).
	μ	QO	Ω	M	(Q) are odd, automatic right circular shift of (Q).
	μ	DP	Ω	M	(D) are positive (includes zero).
	μ	O		M	overflow indicator is set to 1.
	μ	NO		M	overflow indicator is not set to 1.
	μ	BT		M	console breakpoint switch is set to JUMP; if set to HALT, halts and jumps when console ADVANCE is depressed; if switch set to IGNORE, proceeds sequentially.
	μ	π	L	M	Jump to left instruction in M.
	μ	π	R	M	Jump to right instruction in M.
	JMPL			M	Examples (out of the 34 possible): Jump unconditionally to the left instruction in M.
	JAGQL			M	Jump to left instruction in M if (A) greater than or equal (Q); if neither, proceed to next sequential instruction.
					<u>INDEX REGISTER CONTROL</u>
	μ	π	Ω	#	These are a string of characters that specify an op-code by compounding each part. See below.
					<u>Set and preserve contents of index registers</u>
	T	π	Ω		Transfer a value into or from an index register:
	μ	IX		N, X	From the reduced address field of the instruction to index register.
	μ	CX	Ω	, X	To counter bit of the index register.
	μ	π	S	, X	1 to index register counter bit.
	μ	π	Z	, X	0 to index register counter bit.
	μ	DX	Ω	#	From a full address field of word in the D register.
	μ	XD	Ω	#	From an index register to a full address field of the D register.
	μ	π	R	#	To or from right half full address field of D register.
	μ	π	Ω	C	F-bit to counter bit or counter bit to F-bit in D register - if not specified, neither bit is affected.
					<u>Modify and Test Index Registers</u>
	A	π	Ω	N, X	Add value to contents of index register.
	S	π	Ω	N, X	Subtract value from contents of index register.

INSTRUCTION LIST-Contd.

§ 121.

INSTRUCTION			ADDRESS	OPERATION
	OP CODE			
μ	DX	Ω	N, X	Value to modify index register is in an address field of D. Value to modify index register is in reduced instruction address field. Overflow indicator is set to 1 when (X) is equal to address in Ω half of D register.
μ	IXO	Ω	N, X	
μ	π	L	N, X	Left address in D register word. Right address in D register word.
μ	π	R	N, X	
μ	IXJ		N, X	Value added to or subtracted from index register, if (X) not equal to address field in left half of D, jump to instruction whose address is specified in right half of D register.
	TXDLC		, X	Example (out of 22 possible): Transfer (X) to left address field of D register, Xc to left F-bit.
				<u>Repeat</u>
μ	π			These are a string of characters specifying repeat mode of one instruction up to 4,095 times.
RPT	π		N	Repeat the next sequential instruction N times.
μ	N		N	If the next instruction is indexable, perform in normal manner.
T	A		N	If next instruction is indexable, disregard automatic increment, use (X) + v as effective address, place (X) + v into X.
μ	S		N	If next instruction is indexable, disregard automatic increment, use (X) - v as effective address, place (X) - v into X.
RPT	π		N	Repeat the next two sequential instruction N times.
μ	NN			First character of π refers to first instruction in repeat loop, second character to second instruction;
μ	NA			
μ	NS			
μ	AN		N	N: no modification to normal indexable instruction operation.
μ	AA			
μ	AS			
μ	SN			A: Effective address = (X) + Iv, place (X) + Iv into X.
μ	SA			S: Effective address = (X) - Iv, place (X) - Iv into X.
μ	SS			
				<u>Shift</u>
μ	π	Ω		String of characters specifying an op-code by compounding. See below.
SR	π	Ω	N	Shift the contents of a register N bit positions to the right.
SL	π	Ω	N	Shift the contents of a register N bit positions to the left.
μ	A	Ω	N	Shift A register.
μ	Q	Ω	N	Shift Q register.
μ	AQ	Ω	N	Shift both A and Q.
μ	D	Ω	N	Shift D register (see note).
μ	π	N	N	When blank - shift as indicated above, includes sign bit; when N - numeric shift, sign bit not disturbed, right shift generates leading bits of same value as sign bit, trailing bits brought in as zeros.
S	CD		N	Circular shift of N bit positions in D register; leading bits brought into trailing bit positions.
				Note: Shifts in D register may only be to the right.

INSTRUCTION LIST-Contd.

§ 121.

INSTRUCTION		ADDRESS	OPERATION
OP CODE			
			<u>Special Logic Instructions</u>
SWD		M	If (M) is smaller than (A), place (M) into A, address of M into Jump Address register, O into F-bit of register.
LWD		M	If (M) is greater than (A), place (M) into A, address of M into Jump Address register, O into F-bit of register.
ICOS			Set inhibition on clearing overflow indicator before arithmetic instruction performance.
ICOZ			Remove inhibition on clearing overflow indicator.
INCAL		M	Increase left address field of M by 1.
INCAR		M	Increase right address field of M by 1.
NOPL		M	No operation.
NOPR		M	No operation.
HLTL		M	Halt.
HLTR		M	Halt.
			<u>Test Status of I/O System</u>
μ	π		String of characters comprising an I/O status test instruction.
SK	π		Perform status test by comparison of the contents of some register against a predetermined comparison quantity. If condition is met, skips next sequential instruction.
μ	CA	Unit; Comparison quantity	IOP Assembler Counter.
μ	CUA	Unit; Comparison quantity	IOP Unit Availability.
μ	CAA	Unit; Comparison quantity	IOP Assembler Availability.
μ	CPT	Unit; Comparison quantity	Paper Tape Transmission.
μ	CRTI	Unit; Comparison quantity	Real-time input *
μ	CRTO	Unit; Comparison quantity	Real-time output *
μ	FA	Unit; Comparison quantity	IOP Assembler Fault.
μ	FB	Unit; Comparison quantity	Buffer Controller Fault.
μ	FD	Comparison quantity	Magnetic Drum Fault.
μ	FPT	Comparison quantity	Paper Tape Fault.
			Note: The above are macro forms equivalent to machine instructions.
			<u>DATA TRANSFERS</u>
μ	π		String of characters to define a clear operation.
C	π		Place zero in register.
μ	A		A register.
	Q		Q register.
	D		D register.
	M	M	Core storage location.
			* Note: Present, but not used on Model 210 with 10 μsec core storage because of absence of real-time units on this system.

INSTRUCTION LIST-Contd.

§ 121.

INSTRUCTION			ADDRESS	OPERATION																																																			
OP CODE																																																							
μ	π	Ω	M	String of characters to define transfer operations. Copy contents of a register into another register. From: core storage. A register. Q register. D register.																																																			
T	π	Ω																																																					
μ	M	Ω																																																					
	A	Ω																																																					
	Q	Ω																																																					
	D	Ω	M	To: core storage. A register. Q register. D register.																																																			
μ	π	M																																																					
μ	π	A																																																					
μ	π	Q																																																					
μ	π	D																																																					
TIO			M	<p>Note: M to M A to A Q to Q D to D are not allowed combinations.</p> <p><u>INPUT-OUTPUT</u></p> <p>Transfer I/O order in D register to I/O register and attempt to initiate the order. M designates core storage start location to or from which data is transferred.</p> <p>All Input-Output orders other than TIO occur in a standard format described in Section :051.23. No standard mnemonics exist. The op-code consists of binary patterns for the "From" and "To" device. These are:</p> <table> <tr> <td>Core storage</td> <td>0001</td> <td></td> </tr> <tr> <td>Magnetic tape</td> <td>1001</td> <td>- mode 1</td> </tr> <tr> <td>Magnetic tape</td> <td>1010</td> <td>- mode 2</td> </tr> <tr> <td>Magnetic tape</td> <td>1011</td> <td>- mode 3</td> </tr> <tr> <td>Magnetic tape</td> <td>1101</td> <td>- mode 1, reverse</td> </tr> <tr> <td>Magnetic tape</td> <td>1110</td> <td>- mode 2, reverse</td> </tr> <tr> <td>Magnetic tape</td> <td>1111</td> <td>- mode 3, reverse</td> </tr> </table> <table> <tr> <td>I/O unit (on UBC)</td> <td>0111</td> <td></td> </tr> <tr> <td>UBC</td> <td>0011</td> <td></td> </tr> <tr> <td>Paper Tape System</td> <td>0100</td> <td></td> </tr> <tr> <td>Magnetic drum</td> <td>0010</td> <td></td> </tr> <tr> <td>Real-Time Scanner</td> <td>0101</td> <td>(Present, but not used on Model 210 with 10 μsec core storage).</td> </tr> </table> <p>Special I/O control orders are used for the following:</p> <table> <thead> <tr> <th>Name</th> <th>Command Configuration</th> <th>Function</th> </tr> </thead> <tbody> <tr> <td>Stop</td> <td>1111 1000</td> <td>Releases an assembler in the IOP after any fault.</td> </tr> <tr> <td>Resume</td> <td>1000 1001</td> <td>Continue order from point at which error occurred.</td> </tr> <tr> <td>Rewind</td> <td>1000 1010</td> <td>Rewind magnetic tape unit.</td> </tr> <tr> <td>Rewind with lockout</td> <td>1000 1011</td> <td>Rewind and lock out tape unit.</td> </tr> </tbody> </table>	Core storage	0001		Magnetic tape	1001	- mode 1	Magnetic tape	1010	- mode 2	Magnetic tape	1011	- mode 3	Magnetic tape	1101	- mode 1, reverse	Magnetic tape	1110	- mode 2, reverse	Magnetic tape	1111	- mode 3, reverse	I/O unit (on UBC)	0111		UBC	0011		Paper Tape System	0100		Magnetic drum	0010		Real-Time Scanner	0101	(Present, but not used on Model 210 with 10 μ sec core storage).	Name	Command Configuration	Function	Stop	1111 1000	Releases an assembler in the IOP after any fault.	Resume	1000 1001	Continue order from point at which error occurred.	Rewind	1000 1010	Rewind magnetic tape unit.	Rewind with lockout	1000 1011	Rewind and lock out tape unit.
Core storage	0001																																																						
Magnetic tape	1001	- mode 1																																																					
Magnetic tape	1010	- mode 2																																																					
Magnetic tape	1011	- mode 3																																																					
Magnetic tape	1101	- mode 1, reverse																																																					
Magnetic tape	1110	- mode 2, reverse																																																					
Magnetic tape	1111	- mode 3, reverse																																																					
I/O unit (on UBC)	0111																																																						
UBC	0011																																																						
Paper Tape System	0100																																																						
Magnetic drum	0010																																																						
Real-Time Scanner	0101	(Present, but not used on Model 210 with 10 μ sec core storage).																																																					
Name	Command Configuration	Function																																																					
Stop	1111 1000	Releases an assembler in the IOP after any fault.																																																					
Resume	1000 1001	Continue order from point at which error occurred.																																																					
Rewind	1000 1010	Rewind magnetic tape unit.																																																					
Rewind with lockout	1000 1011	Rewind and lock out tape unit.																																																					

INSTRUCTION LIST-Contd.

§ 121.

INSTRUCTION		ADDRESS	OPERATION		
	OP CODE				
			Release	1100 1100	Releases an assembler in the IOP if only parity or sprocket errors occur.
			-1 Read	1100 1100	Replace word in core storage with -1 whenever parity or sprocket error occurs during read.
			Erase	1100 1110	Erase one block with its block marks on magnetic tape.
			Edit	1100 1111	Erase magnetic tape and place new block marks on non-defective portions of tape.
TCM		M	Transfer one character from console typewriter into six right bit positions of M and D.		
TDC			Transfer left six-bit character to console typewriter.		

INSTRUCTION LIST NOMENCLATURE

Symbol

M	Address of core storage location.
A	Accumulator register.
Q	Quotient register.
D	Data register.
M	Absolute value of contents of core storage location.
→	Place in.
(X)	Contents of X.
nX	Index register n.
nX _c	Index register n counter bit.
I	Instruction address.
I _v	Instruction address V field (refer to Section 651:051.232).
I _n	Instruction address N field (refer to Section 651:051.232).



DATA CODE TABLE NO. 1

§ 141.

.1 USE OF CODE internal alphameric data;
control characters for
printer and card
controller.

.2 STRUCTURE OF CODE

.21 Character Size: 6 bits/char.

.22 Character Structure

.221 More significant
pattern: 2 bits; 32, 16.

.222 Less significant
pattern: 4 bits; 8, 4, 2, 1.

.23 Character Codes

LESS SIGNIFICANT PATTERN	MORE SIGNIFICANT PATTERN			
	0	16	32	48
0	0	+	-	Δ
1	1	A	J	/
2	2	B	K	S
3	3	C	L	T
4	4	D	M	U
5	5	E	N	V
6	6	F	O	W
7	7	G	P	X
8	8	H	Q	Y
9	9	I	R	Z
10	@	n	⌋	⌈
11	=	.	\$,
12	;)	*	(
13	≡	%	<	>
14	&	?	#	:
15	'	"	⌊	e

Control Characters

End of line: e.
End of block: ⌋
Null character: n.
Stop: l



DATA CODE TABLE NO. 2

§ 142.

.1 USE OF CODE punched cards.

.2 STRUCTURE OF CODE

.21 Character Size: 1 column.

.23 Character Codes

UNDERPUNCH	OVERPUNCH			
	None	12	11	0
None	BLANK OR Δ	+	-	
12				
11				
0	0			
1	1	A	J	/
2	2	B	K	S
3	3	C	L	T
4	4	D	M	U
5	5	E	N	V
6	6	F	O	W
7	7	G	P	X
8	8	H	Q	Y
9	9	I	R	Z
8-2	@	n	∟	l
8-3	=	.	\$,
8-4	;)	*	(
8-5	≡	%	<	>
8-6	&	?	#	:
8-7	'	"	⌋	e



PROBLEM ORIENTED FACILITIES

§ 151.

.1 UTILITY ROUTINES

.11 Simulators of Other Computers: none.

.12 Simulation by Other Computers: none.

.13 Data Sorting and Merging

Sort Generator

- Reference: TM-17, Philco 2000 Sort Generator.
- Record size: 1 to 192 words.
- I/O load size: 2, 3, or 5 blocks of 128 words each.
- Key size: 1 to N keys, each up to one full word (48 bits).
- File size: 1 reel; multiple reels if own coding used.
- Number of tapes: 2-way sort requires 5 tapes, 3-way sort requires 7 tapes; more tapes may be used if own coding is included.
- Data available: 1961.

Description

This routine generates 2- or 3-way sorts from a SORT statement in which 10 required and 3 optional parameters are specified. The statement may be written in long form using English words, or in an abbreviated "short" form. The programmer can include TAC coding for pre-sort and post-sort record manipulation, checking input labels and writing output labels, and to handle multiple reel input and output. These facilities are provided by the optional parameters in the SORT statement creating linkages to the TAC coding. The generator is included in TAC.

.15 Data Transcription: . . none.

.16 File Maintenance: . . none; refer to Process Oriented Language, TOPS II, Section 651:162.100.

.17 Other

PERT

- Reference: TM-19, Philco 2000 PERT System.
- Date available: 1962.

Description

This is a full PERT system which is capable of handling projects consisting of up to 7,000 activi-

.17 Other (Contd.)

PERT (Contd.)

ties and 3,500 events. It allows activities to be submitted in random order. It re-sequences them and creates the project network. Event names may be symbolic. One, two, or three time estimates for each event are optional.

The system provides a complete set of diagnostic and service routines. It checks each activity for a predecessor and successor and detects open-end events. A history tape is maintained, permitting modification and updating on subsequent runs. The input for subsequent runs may be obtained from this history tape or from punched cards. Changes to the initial data can be made by the use of a new ID card without destroying the original data.

The output includes, for each activity, the expected date, latest date, slack, scheduled date, actual completion date, and duration of an activity and its variance.

The maximum size of a project is a function of the size of core storage available on the particular Philco 2000 system running the PERT analysis. These are:

Store Size (Words)	Max. Number of Activities	Max. Number of Events
8,192	1,000	500
16,384	3,000	1,500
32,768	7,000	3,500

Linear Programming System (LP-2000)

- Reference: TM-7, Philco 2000 Linear Programming System.
- Date available: March, 1961.

Description:

This system provides for the solution of a linear programming problem. It accepts input data in the standard SHARE format with, at most, four cards added to the standard SHARE deck. Separate versions exist for Philco 2000 systems with 8,192, 16,384, and 32,768 words of core storage. They may be incorporated into any operating system or monitor. Internal storage is used rather than tape storage. This allows problems with up to 200 restraints to be solved on a 32,768-word system.

Single precision floating point arithmetic is used. Automatic switching to double precision occurs if numerical accuracy degenerates. The change in mode can also be made by use of control cards.

Parametric programming, multiple objective functions and requirement vectors, alteration of re-statement equations or cost functions, and the resump-

§ 151.

.17 Other (Contd.)

PERT (Contd.)

tion of a problem from a history tape or binary deck are permitted.

Statistical System (STAT)

Reference: TM-20, Philco 2000 Statistical System-STAT.

Date available: . . . July, 1962.

Description

This system computes standard statistical values. Simple regression computations provide correlation coefficients and standard error of estimates. Multiple regression obtains regression coefficients and standard F-test values. Polynomial and exponential approximations are also provided.

.17 Other (Contd.)

PERT (Contd.)

Input-Output Programming System (IOPS)

Reference: TM-18, Philco 2000 Input-Output Programming System (IOPS).

Date available: . . . September, 1961.

Description

This system allows the programmer to incorporate input-output statements within TAC coding and have the necessary instructions generated during a TAC assembly. Input and output formats are described by format type statements similar to those in ALTAC. A full array of data conversion and editing is provided by descriptors and modifiers. Input and output is automatically buffered.



PROCESS ORIENTED LANGUAGE: ALTAC 3

§ 161.

.1 GENERAL

.11 Identity: Algebraic Translator to TAC.
ALTAC 3.

.12 Origin: Philco Computer Division,
Programming R & D.

.13 Reference: ALTAC Manual.

.14 Description

Although similar to FORTRAN II in many respects, with minor modifications needed to make FORTRAN programs acceptable, ALTAC 3 is a more powerful system. ALTAC 3 contains several additional features not found in FORTRAN:

- Four dimension arrays are permitted.
- Subscripts may be any (not necessarily linear) fixed point expressions.
- Subscripts may themselves be subscripted.
- Compound statements, including a fairly general class of conditional statements, are permitted.
- Statement labels may be numeric or symbolic.
- A TABLEDEF statement allows array definition by means of TAC statements.

ALTAC 3 does not permit the Boolean operations that are part of FORTRAN II on the 7090, nor does it contain the CHAIN feature.

Additional features are a more general IF statement, and more SENSE statements. The methods of indicating comment cards is different from that of FORTRAN.

ALTAC statements may be of unlimited length, being terminated by a dollar sign. Statement numbers may be numeric or symbolic. Compound statements are permitted, several statements separated by semicolons appearing on one line. Both fixed and floating point variables can be used in a single expression. The range of floating point variables is substantially greater, varying from 10⁻⁶⁰⁰ to 10⁺⁶⁰⁰.

Despite a difference in coding format between ALTAC and FORTRAN, FORTRAN II programs can be translated by ALTAC without a change in format by the use of an IDENTIFY statement.

In most cases the changes that must be made in FORTRAN II programs to permit them to be compiled by ALTAC 3 are the obvious ones that reflect machine differences. There is no minus zero in the Philco 2000, and programs which use tests on minus zero must be altered. Some other changes must be made in input-output statements because of the 48-bit word length as compared to the 36-bit word on the IBM 704/9/90 series.

.14 Description (Contd.)

ALTAC 3 requires that all EQUIVALENCE, COMMON and DIMENSION statements appear at the beginning of the source deck, in that sequence.

ALTAC 3 permits the very easy incorporation of TAC language inserts. Of course it cannot accept any programs containing SAP, FAP, or other machine language coding for another machine.

The translating and target computer configurations may be specified by an IDENTIFY statement.

.15 Publication Date: June, 1962.

.2 PROGRAM STRUCTURE

.21 Divisions

Procedure Statements: . algebraic formulae.
comparisons and jumps.
input and output.

Data Statements: FORMAT: describes the layout, size, scaling, and code of input-output data.
EQUIVALENCE: used to cause two variables to have the same location or to specify synonyms.
COMMON: used to cause a name to be common to more than one segment rather than local to each.
DIMENSION: lists the dimensions of one or more arrays.
TABLEDEF: permits definition of an array in intermediate TAC language coding (same format as DIMENSION).

.22 Procedure Entities

Program: statements.
functions.
subroutines.
Subroutine: statements.
Statement: characters; all blanks are ignored.
Function: statements.

.23 Data Entities

Arrays: all variables.
Items: floating point variables or constants.
fixed point integer variables or constants.
Hollerith item.
alphanumeric item.

§ 161.

- .348 Item size
 - Variable size: fixed.
 - Designation: none.
 - Range
 - Fixed point numeric: fixed, 1 word.
 - Floating point numeric: fixed, 1 word.
 - Alphameric: fixed, 1 word.
- .349 Sign provision: optional.
- .35 Data Values:
- .351 Constants
 - Possible sizes
 - Integer: yes, -32, 767 to +32, 767.
 - Fixed point: no.
 - Floating point: yes, $\pm 10^{-600}$ to $\pm 10^{+600}$ (approx.)
 - Alphabetic: no.
 - Alphameric: no.
 - Subscriptable: no.
 - Sign provision: optional.
- .352 Literals: only Hollerith fields in a FORMAT statement, or an alphameric argument.
 - Alphabetic: as in paragraph .351.
 - Alphameric: as in paragraph .351.
 - Designation: implied for numerics.
 - Sign provision: optional.
- .353 Figuratives: none.
- .354 Conditional variables: computed GO TO.

.36 Special Description Facilities

- .361 Duplicate format: none.
- .362 Re-definition: COMMON statement. EQUIVALENCE statement.
- .363 Table description
 - Subscription: yes.
 - Multi-subscripts: separated by commas; each subscript can be a fixed point expression, including subscripted subscripts.
 - Level of item: variables.
 - Implied subscript at lower level: no.
- .364 Other subscriptible entities: tape units.

.4 OPERATION REPERTOIRE

.41 Formulae

.411 Operator List

- + : addition, also unary.
- : subtraction, also unary.
- * : multiplication.
- / : division.
- ** : exponentiation.
- = : replacement.
- ABSF () : absolute value.
- INTF () : integral part of.
- MODF (A, B) : remainder $A \div B$.
- MAXF (A, . . .) : maximum value.
- MINF (A, . . .) : minimum value.
- DIMF (A, B) : $A - \text{MINF}(A, B, \dots)$.
- LOGF () : natural log.

.41 Operator List (Contd.)

- SINF () : sine.
- COSF () : cosine.
- EXPF () : exponential (e).
- SQRTF () : square root.
- ATANF () : arctangent.
- TANHF () : hyperbolic tangent.
- FLOATF () : float.
- XFIXF () : fix.

.412 Operands allowed

- Classes: numeric only.
- Mixed scaling: yes.
- Mixed classes: yes.
- Mixed radices: no.
- Literals: yes.

.413 Statement structure

- Parentheses
 - a - b - c means: . . . (a-b) - c.
 - a + b x c means: . . . a + (bxc).
 - a ÷ b ÷ c means: . . . (a÷b)÷c.
 - a^bc means: a** b** c is illegal; parentheses must be used.
- Size limit: none.
- Multi-results: no.

.414 Rounding of results: truncation of integers at each step in expression.

.415 Special cases

- | | | |
|---|------------|--------------|
| | fixed | floating |
| x = -x: | K=-K | X=-X. |
| x = x + 1: | K=K + 1 | X=X + 1. |
| x = 4.7 y: | K=47*K/10 | X=4.7 * Y. |
| x = 5x10 ⁷ +y ² : | too large | X=5.E7+Y**2. |
| x = y : | K=XABS(L) | X=ABS(Y). |
| x = integral part (3.5): | K=XINTF(L) | X=INTF(Y). |

.42 Operations on Arrays

- .421 Matrix operations: none.
- .422 Logical operations: none.
- .423 Scanning: none.

.43 Other Computation: none.

.44 Data Movement and Format

- .441 Data copy example: Y = X.
- .442 Levels possible: items.
- .443 Multiple results: none.
- .444 Missing Operands: not possible.
- .445 Size of operands

Exact match: implied, except for alpha or input-output.

Alignment rule

Numbers (integers): right justified in left hand address of word.

Alpha: left justified.

Filler rule

Numbers: blanks.

Alpha: blanks.

Truncating rule

Numbers: truncate at left.

Alpha: truncate at right.

Variable size

destination: no.

.446 Editing possible

Change class: yes.

Change radix: yes.

Delete editing

symbols: automatic.

§ 161.

.446 Editing possible (Contd.)

Insert editing symbols
 Actual point: automatic.
 Suppress zeroes: . . . automatic.
 Insert: automatic point.
 Float: +, - signs only.

- .447 Special moves: none.
- .448 Code translation: . . . automatic.
- .449 Character manipulation: none.

.45 File Manipulation

Open: own coding.
 Close: own coding.
 Advance to next record: READ, WRITE, PUNCH,
 PRINT.
 Step back a record: . . BACKSPACE.
 Set restart point: . . . none.
 Restart: none.
 Start new reel: own coding.
 Start new block: implied.
 Search on key: none.
 Rewind: REWIND.
 Unload: none.

.46 Operating Communication

- .461 Log of progress: error messages on console typewriter and translation listing on off-line printer.
- .462 Messages to operator: . . console typewriter.
- .463 Offer options: PAUSE and octal display.
- .464 Accept option: use SENSE switch.

.47 Object Program Errors

Error	Discovery	Special Actions
Overflow:	IF clause	own coding.
In-out:	I/O package check on tape operation	type message and retry or halt.
Invalid data:	I/O package check.	type message and halt.

.5 PROCEDURE SEQUENCE CONTROL

.51 Jumps

- .511 Destinations allowed: . . statement.
- .512 Unconditional jump: . . . GO TO N.
- .513 Switch: GO TO M, (11, 21, 130).
- .514 Setting a switch: ASSIGN 21 TO M.
- .515 Switch on data: GO TO (35, 47, 18), I.

.52 Conditional Procedures

- .521 Designators
 Condition: IF.
 Procedure: implied.
- .522 Simple Conditions
 Expression v Expression: yes.
 Expression v Variable: . . yes.
 Expression v Literal: . . yes.
 Expression v Figurative: always zero.
 Expression v Condition: . no.
 Variable v Variable: . yes.
 Variable v Literal: . . yes.
 Variable v Figurative: always zero.
 Variable v Condition: . no.
 Conditional value: no.

.523 Conditional relations

Equal: yes.
 Greater than: yes.
 Less than: yes.
 Greater than or equal: yes.
 Less than or equal: . yes.

.524 Variable conditions: . . always zero.

.525 Compound conditionals: no.

.528 Typical Examples: . . . IF (X**2.5 - 3.0) 29, 37, 18; go to 29, 37 or 18 if x²-3 is respectively less than, equal to or greater than zero.
 IF (X** 2.) E (3.), GO TO 37;
 IF (X** 2.) GT (3.), GO TO 18; GO TO 29.

.53 Subroutines

.531 Designation

Single statement: . . . same as set.
 Set of statements
 First: SUBROUTINE.
 Last: END.

.532 Possible subroutines: . . any number of statements.

.533 Use in-line in program: no.

.534 Mechanism

Cue with parameters: CALL XXX (X, Y, Z).
 Number of parameters: depends on source machine size.
 Cue without parameter: CALL XXX.
 Formal return: RETURN at least once.
 Alternative return: . . any number of RETURN statements allowed.

.535 Names

Parameter call by value: none.
 Parameter call by name: yes.
 Non-local names: . . use COMMON.
 Local names: all.
 Preserved own variables: all.

.536 Nesting limit: no limit on nesting of sub-routines or functions.

.537 Automatic recursion

allowed: none.

.54 Function Definition by Procedure

.541 Designation

Single statement: . . . same as set.
 Set of statements
 First: FUNCTION.
 Last: END.

.542 Level of procedure: . . any number of statements.

.543 Mechanism

Cue: by name in expression.
 Formal return: RETURN.

.544 Names

Parameter call by value: none.
 Parameter call by name: yes.
 Non-local names: . . use COMMON.
 Local names: all.
 Preserved own variables: all.

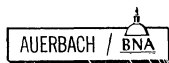

- § 161.
- .55 Operand Definition by Procedure: none.
- .56 Loop Control
- .561 Designation of loop
Single procedure: . . . none.
First and last procedures: current place to named end.
DO 173 I = 1, N, 2.
- .562 Control by count: . . . none.
- .563 Control by step
Parameter
Special index: no.
Any variable: integer only.
Step: positive integers.
Criteria: greater than.
Multiple parameters: no.
- .564 Control by condition: . . . no.
- .565 Control by list: no.
- .566 Nesting limit: 63, nests must be arranged physically as well as logically.
- .567 Jump out allowed: yes.
- .568 Control variable exit status: yes.
- .6 EXTENSION OF THE LANGUAGE: can write new function in library.
- .7 LIBRARY FACILITIES
- .71 Identity: TAC library.
- .72 Kinds of libraries
- .721 Fixed master: no.
- .722 Expandable master: yes.
- .73 Storage Form: magnetic tape.
- .74 Varieties of Contents: . . . subroutines.
functions.
macros.
generators.
- .75 Mechanism
- .751 Insertion of new item: . . . separate run.
- .752 Language of new item: . . . binary relocatable, TAC or ALTAC language.
- .753 Method of call: named in procedures.
- .76 Types of Routine
- .761 Open routines exist: yes.
- .762 Closed routines exist: yes.
- .763 Open-closed is variable: no.
- .8 TRANSLATOR CONTROL
- .81 Transfer to Another Language: yes; TAC.
- .82 Optimizing Information Statements
- .821 Process usage statement: none.
- .822 Data usage statements: COMMON, EQUIVALENCE, TABLEDEF.
- .83 Translator Environment: no.
- .84 Target Computer Environment: IDENTIFY, or automatic.
- .85 Program Documentation Control: no.
- .9 TARGET COMPUTER ALLOCATION CONTROL
- .91 Choice of Storage Level: none; DRUM statement not permitted.
- .92 Address Allocation: none.
- .93 Arrangement of Items in Word in Unpacked Form: none.
- .94 Assignment of Input-Output Devices: yes.
- .95 Input-Output Areas: automatic



PROCESS ORIENTED LANGUAGE: TOPS

§ 162.

.1 GENERAL

- .11 Identity: TOPS 2.
- .12 Origin: Philco Computer Division.
- .13 Reference: TM 12-B.
- .14 Description

TOPS is a sophisticated macro language for file maintenance operations, with elementary facilities for computation. It is mainly suitable for sorting, merging, updating files, and preparing tapes for off-line operations as in reports, etc. A TOPS program has two parts: a description of the files, records, sections and fields involved; and a program of macro statements.

TOPS is really an extension to TAC. It is designed to provide additional facilities to TAC and to utilize TAC coding as a part of TOPS programs as extensively as necessary. Therefore, there is little duplication of facilities over the two languages.

The data description, called the Dictionary, can be easily changed by substitution cards. Then the relevant programs must be recompiled but do not need alteration of the macros.

The macro statements are stylistically similar to complex macro codes. The operations provided range from sorts of a complete file to table lookup and decimal shifts. There is no use of subscripts for arrays.

A special LOAD macro can be used to call and enter new programs from the library tape, and is a simple way to implement segmenting.

See also the reports 651:133 (Coding Specimen), 651:182 (Translator), 651:192 (Operating Environment).

The layouts of the labels are compatible with the requirements of SYSD.

- .15 Publication Date: TOPS 1, end 1960.
TOPS 2, November, 1961.

.2 PROGRAM STRUCTURE

.21 Divisions

Dictionary: a data description of all record layouts, one for each file.

.21 Divisions (Contd.)

Modal Statements: define types of files, input, output, and working areas; control index assignments, buffering, and procedure when files are closed. control statements to be used by operating system, for normal running or debugging, error exits, and rerun entries.

File Statements: file, record, section, and field operations and decisions to be executed, including interspersed TAC coding if required.

.22 Procedure Entities

Program: macro and file statements.

Modal statements: dictionary name and parameters.

File statements: macro name and parameters.

.23 Data Entities

File: many records.

Record: several sections or fields.

Section: one or more fields, variable length.

Field: basic item; existence can be conditional on another field.

.24 Names

.241 Simple name formation

Alphabet: A to Z, 0 to 9.

Size: 1 to 7 char.

Avoid key words: no.

Formation rule: first char must be a letter.

.242 Designators

Procedures: key names.

PROGRAM: beginning of Modal statements.

ENDMODE: end of Modal statements.

Statement: ends with \$.

END RUN: end of program.

Data: two names; e.g., FILE FIELD.

INPUT: input buffer area, not Hollerith.

INPUTH: input buffer area, Hollerith.

INTERNAL: working area.

LIST: totals area.

OUTPUT: output buffer area.

OUTPUTH: output buffer area, for files with integral number of records per block.

§ 162.

.242 Designators (Contd.)

Data (Contd.)

OFFLINE: output buffer area for off-line results.

UPDATE: input-output joint buffer-area.

Equipment: tape implied by any file modal statement.

Comments: asterisk in column 9.

Translator control: key words; PROGRAM, TESTRUN, ENDMODE, ENDRUN, DEPART, RETURN.

TESTRUN: calls special Monitor.

GPF: controls insertions deletions to library tape GPF, General Program File.

.25 Structure of Data Names

.251 Qualified names

Example: FANFIELD.

Multiple qualifiers: always file name and section or field name.

Complete sequence: always.

.252 Subscripts: none, but record index registers can be controlled.

.253 Synonyms: PRESET ONLY.

.26 Number of Names

Items: See TAC, Paragraph 651:184.234.

Data: no practical limit for data names.

.27 Region of Meaning ofNames: universal to all programs using same data dictionary.
local within subprogram for symbolic addresses..3 DATA DESCRIPTION FACILITIES.31 Methods of Direct Data Description

.311 Concise item picture: no.

.312 List by kind: no.

.313 Qualify by adjective: no.

.314 Qualify by phrase: no.

.315 Qualify by code: yes; e.g., SB, signed binary.

.316 Hierarchy by list: yes, within file.

.317 Level by indenting: no.

.318 Level by coding: yes; e.g., SECTION, with record.

.32 Files and Reels

.321 File labels: automatic, compatible with SYS.

.322 Reel labels: automatic, compatible with SYS.

.33 Records and Blocks

.331 Variable record size: yes, preset or dynamic using IF statement in description.

.332 Variable block size: none.

.333 Record size range: variable, 128 words for sort restriction.

.334 Block size range: fixed; 1,024 char.

.335 Choice of record size: description.

.336 Choice of block size: fixed.

.337 Sequence control: none.

.338 In-out error control: automatic.

.339 Blocking control: automatic.

.34 Data Items

.341 Designation of class: description.

.342 Possible classes

Integer: yes.

Fixed point: yes.

Floating point: no.

Alphabetic: no.

Alphameric: yes.

.343 Choice of external

radix: description.

.344 Possible radices

Decimal: optional sign.

Binary: optional sign.

Octal: unsigned.

Hexadecimal: unsigned.

.345 Justification: align to right, truncate to left if destination smaller; do not alter excess positions if destination larger than source.

.346 Choice of code: description.

.347 Possible codes

Hollerith: see Data Code Table No. 2 (651:152).

BCD: see Data Code Table No. 1 (651:151).

.348 Item size

Variable size: preset.

Designation: description.

Range

Fixed point numeric: 4,095 bits.

Floating point

numeric: none.

Alphameric: 4,095 bits.

.349 Sign provision: optional.

.35 Data Values

.351 Constants

Possible sizes

Integer: 1 to 4,095 bits.

Fixed point: 1 to 4,095 bits.

Floating point: none.

Alphabetic: none.

Alphameric: 4,095 bits.

Octal binary: 4,095 bits.

Subscriptable: no.

Sign provision: optional.

.352 Literals: same as constants.

.353 Figuratives: none.

.354 Conditional variables: none.

.36 Special Description Facilities

.361 Duplicate format: no.

.362 Re-definition: yes.

- § 162.
- .363 Table description
 - Subscription: none, only used in table look-up.
 - Level of item: field, preset common number of words for all entries.
- .364 Other subscriptable entries: none.
- .4 OPERATION REPERTOIRE
- .41 Formulae: none.
- .42 Operations on Arrays
 - .421 Matrix operations: . . . none.
 - .422 Logical operations: . . none.
 - .423 Scanning
 - Step size: preset in description, field.
 - Criteria: equal.
- .43 Other Computation
 - .431 Operator List
 - EFA: edit field to A register.
 - EAF: edit A register to field.
 - INSERT: set field equal to constant.
 - SEB: set indicator bit.
 - CEB: clear indicator bit.
 - DSX: decimal "shift" (multiplication) of A register, holding binary.
 - GSS: put record size in A register.
 - IRS: set record size equal to value in location.
 - DRS: set record size A equal to record size B.
 - TLU: gives address found in table look-up.
 - ALTER: inserts address into an instruction.
 - .432 Operands allowed: . . . items, records.
 - .433 Statement: only single simple statements.
 - .434 Rounding of results: . . only integers, none required.
 - .435 Special cases: use TAC coding.
- .44 Data Movement and Format
 - .441 Data copy example: . . MOVE FAN.RECORD; FANS.
 - .442 Levels possible: record section field.
 - .443 Multiple results: no.
 - .444 Missing operands
 - Excess sources: . . . ESS, yes.
 - Excess destinations: . ESS, yes.
 - .445 Size of operands
 - Exact match: no.
 - Alignment rule: . . . align to right, truncate to left if destination smaller; do not alter excess positions if destination larger than source.

- .446 Editing possible
 - Change class: ESS, edit section to section.
 - Change radix: DECEdit, binary to decimal, insert point and suppress zeroes.
 - DBT, decimal to binary.
 - BTD, binary to decimal.
 - ESS, edit section to section.
 - HTB, BTH, HTD, DTH, DTS, STD, subroutines provide conversion between Hollerith, decimal and binary.
 - Delete editing symbols: no.
 - Insert editing symbols
 - Actual points: DECEdit.
 - Suppress zeroes: DECEdit and ZSP.
 - Insert other: none.
 - Float: none.
- .447 Special moves
 - FILL: to fill fixed size record or section with specified char.
 - CF: clear field.
 - .448 Code translation: . . . uniform internal code.
 - .449 Character manipulation: edit moves or, when named, as separate fields.
- .45 File Manipulation
 - Open: AFF; on first TFM.
 - Close: EPF.
 - Advance to next record: TWM, copy remainder of record into work area.
 - DFF, jump forward to start of next record or section.
 - TFM, copy one record or section into work area.
 - ANR, copy file to start of next record.
 - DNR, same as ANR without copy.
 - WFF, write file forward a record or section.
 - Step back a record: . . see Paragraph .56.
 - Set restart point: . . . none.
 - Restart: none.
 - Start new reel: yes.
 - Rewind: automatic by EPF if in file description.
 - Unload: automatic by EPF if in file description.
 - AIDSS: complete sort of file, internal.
 - SEQUENCE: complete sort of file, 2-way merge.
 - AORTA, SORTBC: . . . complete sort of file, split 2-way merge.
- .46 Operating Communication
 - .461 Log of progress: . . . automatic by supervisor.
 - .462 Messages to operator: . TYPEOUT.
 - .463 Offer options: TYPEOUT.

- § 162.
- .464 Accept option: TYPEIN allows acceptance of words from console typewriter.
- .47 Object Program Errors
- | Error | Discovery | Special Action |
|-----------------------|-----------|--|
| In-out: | automatic | attempt recovery and jump to preset address. |
| Invalid data: | automatic | label and edit checking. |
| File area inadequate: | automatic | jump to preset address when too many files open. |
- .5 PROCEDURE SEQUENCE CONTROL
- .51 Jumps
- .511 Destinations allowed: . any macro statement.
- .512 Unconditional jump: . . GOTO.
- .513 Switch: GOTO and ALTER.
- .52 Conditional Procedures
- .521 Designators
- Condition: GOIF.
- Procedure: name of destination.
- .522 Simple Conditions
- Expression v Expression: . no.
- Expression v Variable: . . no.
- Expression v Literal: . . no.
- Expression v Figurative: . no.
- Expression v Condition: . no.
- Variable v Variable: . . yes.
- Variable v Literal: . . yes.
- Variable v Figurative: . no.
- Variable v Condition: . zero GOIFZ, or any constant.
- Condition value: yes; GOLFE, jump if field exists.
- .523 Conditional relations
- Equal: implied.
- Greater than: implied.
- Less than: implied.
- Greater than or equal: implied.
- Less than or equal: . implied.
- .524 Variable conditions: . . zero, using GOIFZ.
- .525 Compound Conditionals: none.
- .526 Alternative designator: none.
- .527 Condition on alternative: none.
- .528 Typical examples: . . . GOIF FAN, FIELD1;FAN, FIELD2;X;Y;Z\$ means go to X, Y, or Z depending on whether Field 1 is less, equal to, or greater than Field 2, which could also be any constant.
- .53 Subroutines: using TAC TJM operator to form link. can call standard routines to be included by SUBR operator from library.
- .54 Function Definition by Procedure: none.
- .55 Operand Definition by Procedure: none.
- .56 Loop Control
- .561 Designation of loop: . . from loop statement to specified symbolic name.
- .562 Control by count
- Literal: ?
- Data: ?
- Example: ?
- .563 Control by step: no.
- .564 Control by condition: . no.
- .565 Control by list: no.
- .566 Nesting limit: none.
- .567 Jump out allowed: . . . yes.
- .568 Control variable exit status: no.
- .6 EXTENSION OF THE LANGUAGE: . . full provision for programmer to write and use new macro statements which are then available for general use.
- .7 LIBRARY FACILITIES
- .71 Identity: GPF - system & object programs.
COMPDCCT - file descriptions.
COMPLIB - macros & subroutines.
- .72 Kinds of Libraries
- .721 Fixed master: no.
- .722 Expandable master: . . yes.
- .723 Private: optional.
- .73 Storage Form: magnetic tape.
- .74 Varieties of Contents: . programs.
dictionaries.
macros, modal statements, subroutines.
- .75 Mechanism
- .751 Insertion of new item: . code columns in cards.
- .752 Language of new item: . special format except for programs for which use TOPS or TAC.
- .753 Method of call: load macro.
file name list.
SUBR operator.
macro name.
- .76 Types of Routine
- .761 Open routines exist: . . yes.
- .762 Closed routines exist: . yes.
- .763 Open-closed is variable: no.

- § 162.
- .8 TRANSLATOR CONTROL
- .81 Transfer to Another Language: DEPART (usually TAC coding, others possible), RETURN, or T in special column.
- .82 Optimizing Information Statements
- .821 Process usage statements: none.
- .822 Data usage statements: implied by macro statement; tends to eliminate some coding.
- .83 Translator Environment: none.
- .84 Target Computer Environment: none.
- .85 Program Documentation Controls: none.
- .9 TARGET COMPUTER ALLOCATION CONTROL
- .91 Choice of Storage Level: by breakup into small programs and data loads, segmenting on tape can be accomplished using LOAD macros.
- .92 Address Allocation: . . . start of program can be specified; other programs can be specified by using PROGRAM. ADDRESS.
- .93 Arrangement of Items in Words in Unpacked Form: none.
- .94 Assignment of Input-Output Devices: . . . automatic by supervisor.
- .95 Input-Output Areas: . . . automatic by supervisor for all working and multiple input-output areas.



PROCESS ORIENTED LANGUAGE: COBOL-61

§ 163.

.1 GENERAL

- .11 Identity: COBOL-61.
- .12 Origin: CODASYL committee.
- .13 Reference: no manual released.
- .14 Description

A COBOL-61 Translator for the Philco 2000 has been announced. It has not yet been released. The language specification is stated to be all of Required COBOL-61 plus the following electives. The numbers refer to the notation used in the Users Guide 4:161.3, COBOL Electives.

<u>Characters and Words</u>	<u>Comment</u>
#3 Semicolon	;, always ignored.
#4 Long literals	up to (?) characters long.
#5 Figurative Constants	HIGH-BOUND(S); LOW-BOUND(S).
#6 Figurative Constants	HIGH-VALUE(S); LOW-VALUE(S).

.14 Description (Contd.)

Characters and Words Comment

Verbs

- #24 ENTER Non-COBOL computer language.
- #25 INCLUDE calls library routines.

Verb Options

- #34 Relationship IS UNEQUAL TO, EQUALS, and EXCEEDS.

Environment Division Options

- #43 File Description can be taken from library.
- #45 I/O Control can be taken from library.

Special Features

- #48 LIBRARY allows calls of library routines.



MACHINE-ORIENTED LANGUAGE: TAC

§ 171.

.1 GENERAL

- .11 Identity: Philco 2000.
Translator-Assembler-Compiler. TAC.
- .12 Origin: Philco Computer Division,
Programming R & D.
- .13 Reference: . . . TAC Manual - Translator-
Assembler-Compiler.

.14 Description

TAC is a basic assembly language which may be used on all Philco 2000 systems (210, 211, and 212) having a minimum of 8,192 core storage locations and five magnetic tapes. In addition to machine equivalent instructions, a series of macros, subroutines, and generators are provided in the standard TAC library. Binary subroutines from the library may be incorporated into the program during assembly, or called from a library tape at running time.

The mnemonics employed are well structured and easily remembered because of their "building-block" nature. Constants may be specified either in the address field of an instruction or as a labeled value. The designation of constants is fully provided by both value indicators and placement indicators, which position the values within the Philco 2000 word. Composite words can be formed by compounding several of the same or mixed constant types on one line of coding. A constant list or "Pool" is searched during assembly to avoid duplication of identical constants; the same address is assigned to all of the same symbolically written values. The ability to override the "Pooling" of constants is provided. There are special arrangements to deal with constants in "instruction" format.

Pseudos are employed to establish communication with other separately assembled relocatable programs. The final communication is established at running time by a loader to give an integrated, complete program. This permits the use of binary relocatable routines from a library tape, or in punched card form at running time. Common storage facility is also available. Generators are provided in the standard library to handle input-output, sorting, and report writing (see Section 651:151).

- .15 Publication Date: . January, 1960.

.2 LANGUAGE FORMAT

- .21 Diagram: refer to specimen TAC coding sheet at end of this Section.

.22 Legend

- Identity and sequence: . . . program identification and instruction sequencing (optional).
- L (label): contains control characters for program identifier, common symbol assignment, subroutine calls, specification of left or right hand instruction, and remark identification.
- Location: symbolic addresses of instructions or constants; should not begin with a numeric character.
- Command: mnemonic code for operation to be performed; beginning of constant.
- Address and remarks: actual or symbolic addresses of data to be operated upon, including specification of indexing; constants, remarks.

- .23 Corrections: . . . spare lines on coding sheet and gaps in sequence numbers.

.24 Special Conventions

- .241 Compound addresses: . . . addition, subtraction, multiplication, and/or division is permitted. The individual components may be symbols and/or absolute values (decimal or octal). No restrictions on the number of individual components, but no parentheses may be used.
- .242 Multi-addresses: in macro instructions.
- .243 Litérals: yes, refer to description of constants.
- .244 Special coded addresses: . . . (P) refers to address of present instruction.
- .245 Other Actual core storage addresses: . . up to 5 decimal digit numbers, no justification needed.

.3 LABELS

- .31 General
- .311 Maximum number of labels: 1,500 for 8,192 word core store.
5,500 for 16,384 word core store.
13,500 for 32,768 word core store.

§ 171.

- .312 Common label formation
label: yes.
- .313 Reserved labels: 1SUBERR, 0x, 1x, 2x, 3x, 4x, 5x, 6x, 7x, (PMAX) are only standard reserved labels; others may be added or these can be deleted.
- .314 Other restrictions: none.
- .315 Designators: none.
- .316 Synonyms permitted: by use of Same or ASGN pseudo-operation.
- .32 Universal Labels
- .321 Labels for procedures - program routines
Existence: mandatory when referenced by other procedures.
First character: alphabetic.
Others: alphanumeric.
Number of characters: 1 to 8.
- .322 Labels for library routines
Existence: mandatory.
Formation rule: same as procedures.
- .323 Labels for constants (specified in "Location" field of coding form; for constants in "Address")
Existence: optional.
Formation rule
First character: alphanumeric (exclusive of special characters).
Last character: alphanumeric.
Others: alphanumeric (at least 1 alphabetic character; spaces not significant).
- .324 Labels for files: none.
- .325 Labels for records: none.
- .326 Labels for variables
Existence: mandatory.
Formation rule
First character: alphanumeric (exclusive of special characters).
Last character: alphanumeric.
Others: alphanumeric.
Number of characters: 1 to 23 characters (at least one alphabetic char; spaces are not significant).
- .327 Labels for procedures - instructions
Existence: mandatory when referenced by other instructions.
Formation rule
First character: alphabetic.
Last character: alphanumeric.
Others: alphanumeric.
Number of characters: 1 to 7 characters.

.33 Local Labels

- .331 Region: started by each NAME pseudo, but note that "C" in label column suppresses the NAME pseudo.
- .332 Labels for procedures: same as universals.

.4 DATA.41 Constants

.411 Maximum size constants

- | Machine Form | Coding Sheet Form |
|--|---|
| Integer | |
| Binary: | 15 decimal digits. |
| Binary: | 16 octal digits. |
| Binary: | 12 hex digits. |
| Binary: | 48 binary digits. |
| Fixed numeric | |
| Binary: | 15 decimal digits. |
| Binary: | 16 octal digits. |
| Binary: | 12 hex digits. |
| Binary: | 48 binary digits. |
| Floating numeric | |
| Floating point | |
| binary: | fixed point part - 35 fractional decimal digits.
exponent part - 3 decimal digits. |
| Alphanumeric (6-bit binary coded): | |
| | 8 alphanumeric characters, or an indefinite number of alphanumeric characters. |

Instructions

- 24-bit instruction, instruction pair, or 48-bit I/O instruction: mnemonic op-code and symbolic address.

15-bit address:

- symbolic address.

Patterns

- Binary pattern: 16 octal, 12 hex or 48 binary digits.

- .412 Maximum size literals: same as "Maximum size constants."

- .413 Constants or literals per line: constants or literals may be compounded on a line of coding to form composite words consisting of several specified patterns. Patterns should not overlap. Values may be packed into single words by ability to specify termination location within the word for each literal or part of the constant.

.42 Working Areas

- .421 Data layout: implied by coding; if I/O Programming System was used, data will be in layout form specified by sequence of conversion descriptions.

- §171.
- .422 Data type: . . . implied in program; if I/O Programming System was used, data will be in form specified by conversion descriptors.
- .423 Redefinition: . . . yes, COMMON pseudo.
- .43 Input-Output Areas
- .431 Data layout: . . . same as "Working Areas."
- .432 Data type: . . . same as "Working Areas."
- .433 Copy layout: . . . no.
- .5 PROCEDURES
- .51 Direct Operation Codes
- .511 Mnemonic
Existence: . . . mandatory.
Number: . . . 400.
Comment: . . . refer to Instruction List, Section :121.
- .512 Absolute: . . . 225.
- .513 Command or literal specified (Input-Output orders)
Existence: . . . mandatory.
Number: . . . indefinite.
Comment: . . . refer to Section : 051.23.
- .52 Macro-Codes
- .521 Number available
Input-output: . . 45.
Arithmetic: . . none.
Math functions: . 1.
Error control: . 1.
Restarts: . . . none.
File Control: . . 10.
Others: . . . 1.
Note: in addition, library permits addition or deletion of macros at any given time.
- .522 Examples
Simple: . . . PROCESS.
Elaborate: . . . RDFF.
- .523 New Macros: . . librarian run.
- .53 Interludes: . . . none.
- .54 Translator Control
- .541 Method of control
Allocation counter: . . . pseudo-operations.
Label adjustment: . . . pseudo-operations.
Annotation: . . . pseudo-op or following instruction line terminator.
- .542 Allocation counter
Set to absolute: yes.
Set to label: . . yes.
Step forward: . yes.
Step backward: . yes.
Reserve area: . yes.
- .542 Label adjustment
Set labels
equal: yes.
Set absolute value: yes.
Clear label table: no.
- .544 Annotation
Comment phrase: yes.
Title phrase: . . yes.
- .6 SPECIAL ROUTINES AVAILABLE
- .61 Special Arithmetic
- .611 Facilities: . . . library subroutines for data conversions, BCD arithmetic, special purpose arithmetic such as double-precision floating point.
- .612 Method of call: . subroutine call.
- .62 Special Functions
- .621 Facilities: . . . trig. functions.
log and exponential.
roots and powers.
numerical integration and differentiation.
statistics.
matrix.
linear programming and transportation problem.
interpolation.
solution of equations.
special mathematical functions.
- .622 Method of call: . subroutine call.
- .63 Overly Control: . controlled by Operating Environment, Section :191.
- .64 Data Editing: . . in I/O Programming System; performs standard FORTRAN conversions plus several additional conversions on data for input and output.
- .642 Format control
Zero suppression: yes.
Size Control: yes.
Sign control: yes.
Special characters: no.
- .643 Method of call: . specification of units for I/O, format statement descriptors.
- .65 Input-Output Control
- .651 File labels: . . . no.
- .652 Reel labels: . . . yes, by I/O Programming System.
- .653 Blocking: yes, by I/O Programming System.
- .654 Error control: . . . yes.
- .655 Method of call: . macro statement or automatic correction attempt in I/O Programming System generated coding.
- .66 Sorting
- .661 Facilities: . . . sort generator to produce 2 or 3 way merge; sort keys of partial or full words which may be scattered throughout the record; keys may be alphanumeric, binary, floating point or any combination; provision for own coded pre- and post-merge editing and file modification.
- .662 Method of call: . "SORT" statement.
- .67 Diagnostics: . . refer to Operating Environment, Section :191.

§ 171.

.7 LIBRARY FACILITIES

.71 Identity: TAC library.

.72 Kinds of Libraries

- .721 Fixed master: . . no.
- .722 Expandable master: yes.
- .723 Private: optional.

.74 Varieties of Contents:

open and closed subroutines, complete programs for operating system use, diagnostic routines, supervisor systems and interpreters, generators.

.75 Mechanism

- .751 Insertion of new item: yes, macros, generators, and subroutines.
- .752 Language of new item: symbolic or binary.
- .753 Method of call: mnemonic all with parameters in address fields.

.76 Insertion in Program

- .761 Open routines exist: yes.
- .762 Closed routines exist: yes.
- .763 Open-closed is optional: yes.
- .764 Closed routines appear once: yes.

.8 MACRO AND PSEUDO TABLES

.81 Macros

Code	Description
CHKCOMP:	check for completion of PROC I/O instruction.
CHKMT:	check status of PROC magnetic tape instruction.
DELCO:	delete complete I/O instructions from PROC list.
DELIN:	delete incomplete I/O instructions from PROC list.
DRUM:	generate magnetic drum instruction.
ERRORS:	try recovery from parity or sprocket errors.
INIT:	initialize PROC.
POLYVAL:	polynomial evaluation.
PRINT:	transmit edited block to on line printer.
PROCESS:	cause search of PROC list to keep I/O functioning during long computation sequence.
RBFILE:	issues 2 backward read instructions and checks first for completion.
RBITEM:	checks for end of logical block on backward read after record has been read in.

.81 Macros (Continued)

- RBRUNOUT: checks for completion of last backward read instruction.
- RDBUFF: transmit block from on-line UBC to core storage.
- RDCD: read a card from on-line reader into UBC.
- RDFB: controls backward reading of a tape with label blocks and fixed length record.
- RDFE: controls reading of a tape with label blocks and fixed length records.
- RDMTB: read n blocks in reverse mode from magnetic tape.
- RDMTF: read n blocks forward from magnetic tape.
- RDPT: read 1 block from paper tape system to UBC.
- READPT: read n words from on-line paper tape system into core storage.
- RFFILE: issues 2 read instructions and checks first for completion.
- RFITEM: checks for end of logical block after record has been read in.
- RFRUNOUT: check for completion of last read forward order.
- RWDLO: rewind magnetic tape unit with lockout.
- RWD: rewind magnetic tape unit.
- SENTFILE: fills remainder of output record block with sentinel words, or writes full block of sentinel words if previous block completely filled by records.
- SKCAA: skip check assembler availability register.
- SKCA: skip check assembler counter.
- SKCRTI: skip check real-time input.
- SKCRTO: skip check real-time output.
- SKCUA: skip check unit availability register.
- SKFA: skip fault assembler fault register.
- SKFB: skip fault on-line UBC fault register.
- SKFD: skip fault magnetic drum fault register.
- SKFPT: skip fault on paper tape fault register.
- SKFRTI: skip fault on real-time input.
- SKFRTO: skip fault on real-time output.
- TLUEQ: table look-up for equality.
- WRC: punch one card on-line card system.
- WRFILE: writes block of records into magnetic tape.
- WRF: collects items in buffer area until block is filled, then writes out.
- WRITEM: checks for logical end of block before records are written out.
- WRMT: write n blocks on magnetic tape (PROC).
- WRPT: write n words on paper tape.
- WRRUNOUT: check for completion of last write instruction given.

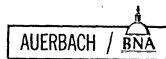

§ 171.

.82 Pseudos

Code	Description
NAME:	assign alphanumeric name to programmed sequence.
AFEND:	allows omitting instruction line terminator.
ASGN: ‡	allows definition of a symbol.
SAME:	same as ASGN.
ASTOR:	reserves specified number of core storage words.
END:	end of assembly.
ENDGIN:	end of coding for a generator routine.
ENDSUB:	end of coding for a library subroutine.
ENDMACRO:	end of coding for a library macro.
SET: ‡	set specified value in allocation counter.
PAGE:	advance assembly listing to beginning of next page.

.82 Pseudos (Contd.)

SPACE:	skip specified number of lines on assembly listing.
SUBR:	subroutine call.
COMSTOR: ‡	produces common working areas in core storage.
SYMBOUT:	designates symbol as one which will be referenced from outside the bounds of the coded "NAME" sequence.
REFOUT:	designates symbol as one to be referenced in a coded "NAME" sequence other than the one in which the pseudo appears.
DEFINE:	allows normal mnemonics to be redefined as other mnemonics, or new mnemonics to be defined.

‡ ASGN, ASTOR, COMSTOR and SET may involve unrestricted arithmetic on symbolic and/or absolute quantities.



PROGRAM TRANSLATOR: ALTAC 3

§ 181.

.1 GENERAL

.11 Identity: ALTAC 3.

.12 Description

The ALTAC translator translates programs written in ALTAC 3, first into TAC and then immediately into any of the optional TAC translator outputs. The listings produced are the same as those produced by TAC together with the interspersed ALTAC statements. Independently written or compiled subprograms can be compiled or loaded together.

The ALTAC 3 translator supersedes ALTAC 2. In addition to the language extensions, the compiler implements the input-output statements in an interpretive mode (as in 7090 FORTRAN) rather than generating routines at compile time. The object programs produced are more compatible to FORTRAN produced programs.

This translator is not compatible with programs written for ALTAC 2. However, the programs do not require extensive alteration. The alteration mainly involves changes to the input-output statements.

Programs written in FORTRAN II can be translated by ALTAC 3 provided a restricted number of changes are made. The compiler will adapt to many changes of format automatically when a FORTRAN indicator is included. In fact, ALTAC and FORTRAN II coding can be interspersed, with appropriate designations.

.13 Originator: Philco Computer Division, Programming R and D.

.14 Maintainer: Philco Computer Division, Programming R and D.

.15 Availability: June, 1962

.2 INPUT

.21 Language

.211 Name: ALTAC 3.

.212 Exemptions: none.

.22 Form

.221 Input media: off-line punched card or binary format on magnetic tape.

.222 Obligatory ordering: . . logical ordering.

.223 Obligatory grouping: . . none.

.23 Size Limitations

.231 Maximum number of source statements: . . depends upon target computer size (in assembly phase).

.232 Maximum size source statements: unlimited.

.233 Maximum number of data items: depends upon table sizes.

.234 Others			
Store size:	8,192	16,384	32,768.
Max. DO's in program:	106	200	200.
Max. variables in EQUIVALENCE/COMMON:	258	750	750.
Max. unknowns in S/R or Function S/R: . .	31	255	255.
Approx. max. arrays in DIMENSION tables: .	200	400	400.
TAC limitation on names:	1,500	5,500	13,000.

.3 OUTPUT

.31 Object Program

.311 Language name: binary machine language.

.312 Language style: absolute or relocatable.

.313 Output media: magnetic tape, punched cards (off-line).

.32 Conventions

.321 Standard inclusions: . . PIOS, interpretive Programming Input-Output Subroutines.

.322 Compatible with: SYSD and all current operating systems.

.33 Documentation

Subject	Provision
Source program: . . .	listing 1 off-line.
Object program: . . .	listing 1 off-line.
Storage map (symbol table):	listing 2 off-line.
Restart point list: . .	no.
Language errors: . . .	listing 1 off-line.
Constant table:	listing 3 off-line.

§ 181.

.4 TRANSLATING PROCEDURE

.41 Phases and Passes

First phase
 First pass: translate to intermediate TAC with symbolic references to index registers, builds "DO nest" table.
 Second pass: DO analysis, index assignment, loop housekeeping, general clean up.
 Second phase: TAC assembly.

.42 Optional Mode

.421 Translate: yes.
 .422 Translate and run: no. ‡
 .423 Check only: no. ‡
 .424 Patching: no. ‡
 .425 Up-dating: no. ‡

‡Available when used in operating system.

.43 Special Features

.431 Alter to check only: no.
 .432 Fast unoptimized translate: no.
 .433 Short translate on restricted program: no.
 .44 Bulk Translating: only for one main program and its sub-programs.

.45 Program Diagnostics: available in operating environment "SYS" incorporating ALTAC.

.46 Translator Library

.461 Identity: TAC library.
 .462 User restriction: special group.
 .463 Form
 Storage medium: magnetic tape.
 Organization: binary relocatable.
 .464 Contents
 Routines: open and/or closed, variable.
 Functions: yes.
 Data Descriptions: no.
 .465 Librarianship
 Insertion: under special maintenance routine (PLUM).
 Amendment: PLUM routine.
 Call Procedure: name of item recognized by translator.

.5 TRANSLATOR PERFORMANCE

.51 Object Program Space

.511 Fixed overhead: depends on installation - flexible.
 .512 Space required for each input-output file: variable.
 .513 Approximate expansion of procedures: variable 6 (* *).

.52 Translation Time (* *)

.521 Normal translating
 2000-210: 0.25 + 0.005 S min.
 2000-211
 10 µ. sec store: 0.20 + 0.004 S min.
 10 µ. sec partition-
 ed: 0.15 + 0.0017 S min.
 1.5 µ. sec store: 0.15 + 0.0005 S min.
 2000-212: 0.15 + 0.0003 S min.

.53 Optimizing Data: none.

.54 Object Program Performance

Type	Time	Space
Elementary algebra	unaffected	unaffected.
Complex formulae	unaffected	unaffected.
Deep nesting	increased	increased.
Heavy branching	unaffected	unaffected.
Complex subscripts	increased	increased.
Data editing	unaffected	unaffected.
Overlapping operations	none.	

.6 COMPUTER CONFIGURATIONS

.61 Translating Computer

.611 Minimum configuration: 8,192 word core storage, 7 magnetic tape units, 8 index registers.
 .612 Larger configuration advantages: greater table space.

.62 Target Computer

.621 Minimum configuration: 8,192 word core storage, Input-Output Processor (1 assembler), 8 index registers, floating point arithmetic, magnetic tapes as required by target program, off-line system for card, tape, printer transcription.
 .622 Usable extra facilities: 16,384 or 32,768 word core storage.

.7 ERRORS, CHECKS AND ACTION

Error	Check or Interlock	Action
Missing entries:	check	printed message.
Unsequenced entries:	none.	
Duplicate names:	check	printed message.
Improper format:	check	printed message.
Incomplete entries:	check	printed message.
Target computer overflow:	check	printed message.
Inconsistent program:	check	printed message.
Source program format:	check	printed message.
Allowed DO loops exceeded:	check	printed message.

.8 ALTERNATIVE TRANSLATORS: none.

(* *) estimate that is probably reliable based on incomplete evidence.





PROGRAM TRANSLATOR: TOPS

§ 182.

.1 GENERAL

.11 Identity: TOPS 2.

.12 Description

The TOPS translator is designed to produce efficient object routines and rapid translation. The translator is held on a master program file called GPF. The translation is divided into four phases: preparation of input data, systems updating, dictionary updating, translation with listing. An enforced interval between translation and systems updating allows for desk-checking of the listing produced in pass 3, phase 4.

The translator uses an intermediate TAC language and gives the final listing in CODEDIT, in TAC assembler format. The source statements are incorporated in the object program listing as comments.

.13 Originator: Philco.

.14 Maintainer: Philco.

.15 Availability: November, 1961.

.2 INPUT

.21 Language

.211 Name: TOPS.

.212 Exemptions: none.

.22 Form

.221 Input media: punched cards transcribed to magnetic tape.

.222 Obligatory ordering: . . program cards must be in required sequence.

.223 Obligatory grouping: . . all modal statements must precede all file and field statements.

.23 Size Limitations

.231 Maximum number of source statements: . . unlimited.

.232 Maximum size source statements: determined by particular macro.

.233 Maximum number of data items: see TAC (651:184.233) and by entries in File Description - 1300 for 8K, 9000 for 32K.

.3 OUTPUT

.31 Object Program

.311 Language name: Running Program Language.

.312 Language style: binary machine code.

.313 Output media: magnetic tape.

.32 Conventions

.321 Standard inclusions: . . linkages to Monitor.

.322 Compatible with: TOPS Monitor (COPS).

.33 Documentation

Subject Provision

Source program: . . . as comments on listing 2.

Object program: . . . listing 2.

Storage map: listing 2.

Restart point list: . . none.

Language errors: . . listing 2.

List of data descriptions: listing 1, optional.

.4 TRANSLATING PROCEDURE

.41 Phases and Passes

Phase 1, Pass 1

Inputs: Dictionary cards.

Program cards.

Library cards.

System cards.

Function: off-line conversion.

Output: AIDSINN tape.

Phase 1, Pass 2

Initiate: automatic by type-in.

Inputs: AIDSINN tape.

GPF tape, or PIT tape.

2 scratch tapes.

Function: sort and edit AIDSINN file.

Outputs: AIDSINP tape.

TOPSEDTIT tape (errors,

PIT log, COMPDCT

listing, etc.).

Phase 1, Pass 3 (optional, can use GPF rather than PIT as systems tape)

Initiate: automatic by type-in.

Inputs: AIDSINP tape.

GPF tape and PIT tape.

Function: produce file of only those

GPF programs as are

necessary to process the

AIDSINP file.

Outputs: PIT tape (schedules and

programs).

TOPSEDTIT tape.

§ 182.

.41 Phases and Passes (Contd.)

Phase 2, Pass 1

Initiate: automatic by systems
schedule or type-in.
Inputs: GPF tape (general program
file).
PRL tape (from prior phase
4).
AIDSINP tape.
Function: update GPF file in alpha-
betic sequence.
Outputs: updated GPF tape and
duplicate (backup).
TOPSEEDIT tape.

Phase 2, Pass 2 (optional)

Initiate: automatic by type-in.
Inputs: GPF tape, or PIT tape.
AIDSINP tape.
COMPLIB tape (library file
of modals, macros and
subroutines).
Function: update library file.
Outputs: COMPLIB tape (updated
library).
TOPSEEDIT tape.

Phase 3, Pass 1 (all of phase 3 optional, if no dic-
tionary entries in AIDSINP file)

Initiate: automatic by systems
schedule, or type-in.
Inputs: (GPF tape, or PIT tape).
AIDSINP tape.
Function: validates and edits changes
to dictionary.
Outputs: COMPINP tape (special for-
mat input to next pass).

Phase 3, Pass 2

Initiate: automatic from pass 1.
Inputs: (GPF tape, or PIT tape).
COMPDCCT tape (dictionary
file).
COMPINP tape.
Function: computes new or changed
dictionary items.
Outputs: COMPINQ tape (dictionary
format input to next pass).

Phase 3, Pass 3

Initiate: automatic from pass 2.
Inputs: (GPF tape, or PIT tape).
COMPDCCT tape.
COMPINQ tape.
Function: merge, change and delete
to produce new dictionary.
Outputs: COMPDCCT tape (updated
dictionary).
TOPSEEDIT.

Phase 4, Pass 1

Initiate: automatic by system
schedule or type-in.
Inputs: (GPF tape, or PIT tape).
AIDSINP tape.
COMPLIB tape.
COMPDCCT tape.

.41 Phases and Passes (Contd.)

Function: generate TAC coding from
TOPS statements.
Outputs: COMPOUT tape (TAC lan-
guage input to pass 2).

Phase 4, Pass 2

Initiate: automatic from pass 1.
Inputs: (GPF tape, or PIT tape).
COMPOUT tape.
1 scratch tape.
Function: TAC identifier and
generator.
Outputs: RELCODE tape (relative
coding input to pass 3).

Phase 4, Pass 3

Initiate: automatic from pass 2.
Inputs: (GPF tape, or PIT tape).
RELCODE tape.
Function: translate to machine lan-
guage-produce listing.
Outputs: RPL tape, (running pro-
gram language).
CODEEDIT tape (listing of
object program with
original TOPS statements
as comments).

.42 Optional Mode

.421 Translate: yes.
.422 Translate and run: no.
.423 Check only: no.
.424 Patching: TOM cards can be used to
patch in TAC coding dur-
ing TESTRUN and GPF
update run.
.425 Updating: dictionary and library GPF.

.43 Special Features

.431 Alter to check only: no.
.432 Fast unoptimized
translate: no.
.433 Short translate on
restricted program: no.

.44 Bulk Translating: yes, all loaded together in
Run 1 (see 651:182.41).

.45 Program Diagnostics: effective in special TEST-
RUN compilation of pro-
gram. Features are
omitted when compiled for
RUN monitor.

.451 Tracers: TRACE, print of all jumps
executed from one speci-
fied address to another,
active for a specified
number of executions
after a specified number
of inactive executions.

.452 Snapshots: DUMP specifies a print of
an area in core; SNAP
specifies a print of regis-
ters. These are made for
a specified number of ex-
ecutions after a specified
number of inactive
executions.

§ 182.

- .453 Dumps: manual or error jump at end of run to complete dump.
- .46 Translator Library
- .461 Identity: COMPDCT.
COMPLIB.
GPF.
- .462 User restriction: . . . none.
- .463 Form
Storage medium: . . . magnetic tape.
Organization: alphabetical by entry name in unique format.
- .464 Contents
Routines: COMPLIB.
Functions: COMPLIB.
Data Descriptions: . . . COMPDCT.
Programs: GPF.
- .465 Librarianship
Insertion and
Deletions: automatic in translator by control cards.
Amendment: automatic in translator by control cards.
Call Procedure: . . . automatic in translator by usage, or in case of the GPF, by control card.

.5 TRANSLATOR PERFORMANCE

.51 Object Program Space

- .511 Fixed overhead
Name Space Comment
COPS (RUN Monitor): 800 words contains program loader, file initializer, tape control, error control, interrupt control.

COPS (TESTRUN Monitor): 1800 words contains TRACE, DUMP and SNAP-SHOT features.
- .512 Space required for each input-output file: 256 words per active file.
- .513 Approximate expansion of procedures: 5 to 50.
- .52 Translation Time: 0.1 + 0.005S mins.
S = number of cards.
- .53 Optimizing Data: several statements have parameters which allow the translator to reduce the amount of coding generated.

.54 Object Program Performance

Type	Time	Space
Elementary algebra:	not provided.	
Complex formulae:	not provided.	
Deep nesting:	unaffected	unaffected.
Heavy branching:	unaffected	increased.
Complex subscripts:	not provided.	
Data editing:	increased	increased.
Overlapping operations:	unaffected	unaffected.

.6 COMPUTER CONFIGURATIONS

.61 Translating Computer

- .611 Minimum configuration: 8,192 words storage.
5 tape units.
1 assembler.
- .612 Larger configuration advantages: additional core or more assemblers will handle larger programs somewhat faster; more tape units reduce times significantly.

.62 Target Computer

- .621 Minimum configuration: 8,192 words storage.
2 tape units.
1 assembler.
- .622 Usable extra facilities: 32K core storage.
up to 16 tape units.
extra assemblers.

.7 ERRORS, CHECKS AND ACTION

Error	Check or Interlock	Action
Missing entries:	none	continue,
Unsequenced entries:	check	accepted as read,
Duplicate names:	check	continue - insert message in listing,
Improper format:	some checks	continue - insert message in listing,
Incomplete entries:	some checks	continue - insert message in listing,
Target computer overflow:	some checks	continue - insert message in listing,
Inconsistent program:	some checks	continue - insert message in listing,

.8 ALTERNATIVE TRANSLATORS: . . . none.



PROGRAM TRANSLATOR: TAC

§ 184.

.1 GENERAL

.11 Identity: Philco 2000.
Translator-Assembler-
Compiler.
TAC.

.12 Description

TAC is a magnetic tape oriented system which may be easily incorporated into any current operating environment for the Philco 2000 series. It is probably not reasonable to use it without an operating system. The input to the translator may be in symbolic machine oriented code, TAC, and/or in a form previously translated into absolute or relocatable binary format. This last form of input enables library or other subroutines to be incorporated. The object routines produced can be recorded on a master tape in fixed or relocatable binary form ready for loading, or recorded on tape for off-line conversion to cards, in either fixed or relocatable binary form. All the different types can be used to load the program at run time.

There is a single integrated listing including the source program, the corresponding instructions in octal, error notations, sorted lists of references, and the table of POOL constants.

The various formats of input and output as well as the options required are either specified by the operating system in use, or by the operator through the console toggle switches. Any system errors in the translator are printed out on the typewriter.

Independently written subroutines can be translated together, and independently translated subroutines can be loaded together, provided that the proper cross-references have been noted.

The TAC translator has been altered to extend its facilities, but all previous programs are still compatible.

.13 Originator: Philco Computer Division,
Programming R & D.

.14 Maintainer: Philco Computer Division.

.15 Availability: January, 1960.

.2 INPUT

.21 Language

.211 Name: TAC.

.212 Exemptions: none.

.22 Form

.221 Input media: punched card images on
magnetic tape.

.222 Obligatory ordering: logical ordering.

.223 Obligatory grouping: logical grouping.

.23 Size Limitations

.231 Maximum number of source statements: varies with size of object
machine.

.232 Maximum size source statements: unlimited, usually one line
for mnemonics and pseudo-
dos; variable for sort and
library statements.

.233 Maximum number of data items: see next entry.

.234 Others
Maximum number of labels: 1,500 for 8,192 word core
store.
5,500 for 16,384 word
core store.
13,500 for 32,768 word
core store.

.3 OUTPUT

.31 Object Program

.311 Language name: binary machine language.

.312 Language style: binary; absolute or relo-
catable.

.313 Output media: magnetic tape; optional off-
line punched card for bi-
nary relocatable pro-
grams.

.32 Conventions

.321 Standard inclusions: jumps to operating environ-
ment.

.322 Compatible with: binary relocatable compati-
ble with other binary re-
locatable routines having
proper controls.

.33 Documentation

Subject	Provision
Source program:	. . . off-line listing 1.
Object program:	. . . off-line listing 1.
Storage map (symbol tape): off-line listing 2.
Restart point list:	. . . none.
Language errors:	. . . off-line listing 1.
Constant table:	. . . off-line listing 3.

§ 184.

.4 TRANSLATING PROCEDURE.41 Phases and Passes

First Pass: translates commands and assigns storage allocation; builds symbol tables; stores generator, macro, and subroutine calls.

Library Phase: calls in generators and macros, generates coding, returns to first pass. First Pass returns back to library phase which then satisfies subroutine calls.

Second Pass: produces program listing, and binary format for running program.

Note: The first pass and library phase may alternate many times because generators, macros and subroutines may themselves call on other entries in the library.

.42 Optional Mode

- .421 Translate: yes.
 .422 Translate and run: . . . no. ‡
 .423 Check only: no. ‡
 .424 Patching: no. ‡
 .425 Up-dating: no. ‡

‡ Included within operating systems.

.43 Special Features: . . . none..44 Bulk Translating: . . . none..45 Program Diagnostics: . refer to Operating Environment, section :191..46 Translator Library

.461 Identity: TAC library.

.462 User restriction: . . . none.

.463 Form

Storage medium: . . . magnetic tape and punched cards.

Organization: alphabetic order by routine name; each routine preceded by 3 to 8 character alphanumeric name.

.464 Contents

Routines: open and closed subroutines, complete programs for operating system use, diagnostic routines, supervisor systems and interpreters, generators.

Functions: no.

Data Descriptions: . . . no.

.465 Librarianship

Insertion: by library maintenance routine (PLUM).

Amendment: PLUM routine.

Call Procedure: name of item recognized by translator.

.5 TRANSLATOR PERFORMANCE.51 Object Program Space.511 Fixed overhead

Name: Interim Operating System (SYSD).

Space: 512 words, lower core storage.

.512 Space required for each

input-output file: . . . variable, according to object program.

.513 Approximate expansion

of procedures: 1, exclusive of macros and generated coding.

.52 Translation Time (* *)

2000-210: 8 + 0.05 S sec.

2000-211

10 μ .sec store: 7 + 0.04 S sec.

10 μ .sec partitioned: 6 + 0.02 S sec.

1.5 μ .sec store: 5 + 0.006 S sec.

2000-212: 3 + 0.003 S sec.

.53 Optimizing Data: . . . none..54 Object Program Performance: unaffected.

(* *) estimate that is probably reliable based on incomplete evidence.

.6 COMPUTER CONFIGURATION.61 Translating Computer

.611 Minimum configuration: 8,192 word core storage, 7 magnetic tapes, 8 index registers (only 5 tapes if no operating system is used).

.612 Larger configuration

advantages: greater table space.

.62 Target Computer

.621 Minimum configuration: 8,192 word core storage, Input-Output Processor (1 assembler), magnetic tapes as required by target program, 8 index register off-line system for card-to-tape transcription.

.622 Usable extra facilities:

16,384 or 32,768 word core storage.

§ 184.

.7 ERRORS, CHECKS AND ACTION

<u>Error</u>	<u>Check or Interlock</u>	<u>Action</u>
Missing entries: Unsequenced entries:	check no.	printed message.
Duplicate names:	check	printed message.
Improper format: Incomplete entries	check check	printed message. printed message.
Target computer overflow:	check	printed message.
Inconsistent pro- gram:	check	printed message.
Lack of definition:	check	printed message.
Constant incorrect- ly specified:	check	printed message.
Line end symbol missing:	check	printed message.

.8 ALTERNATIVETRANSLATORS: . . . none.



OPERATING ENVIRONMENT: SYS D

§ 191.

.1 GENERAL

.11 Identity: SYS D

.12 Description

Completely automatic operating features are provided by this extensive system which eliminate much operating overhead. Translation, running and debugging of programs can be controlled. There is continuous run-to-run control, and programs can be loaded from individual tapes or from the RPL (Running Program Library) tape. In addition there are several diagnostic aids, tracing, snapshots and post mortems. A logging facility is included plus utility routines for tape-to-tape transcription, tape checking, etc.

The system may be used on any Philco 2000 configuration with at least 8 magnetic tapes or 7 magnetic tapes and a Model 240 Paper Tape System. SYS D permanently occupies 512 locations of core storage. As sections, which are not part of the basic program, are required, they are read from the SYS program tape as one-block-length routines into a reserved 128-word core storage area within the SYS D area, and are then executed. The remainder of core storage is available to the programmer.

All operations are specified by control cards submitted by the programmer, or much less efficiently by control instructions entered via the console typewriter. Any succession of programs requiring translation and/or running is acceptable. Dumps or snapshots are provided in case of program failure. The system provides debugging aids such as selective dump, trace, and snapshot routines without recourse to external subroutines.

SYS D permits segmenting of binary relocatable programs which are too large for available core storage. The segments used in a running program may contain cross-referencing of one another, but this must be done either through the COMMON area of memory or via a master segment located in core storage during the segmentation process.

Routines for the handling of magnetic tapes, performing reading, writing, sentinel location and writing, and copying tapes are available. Automatic time logging of each job is provided, and accounting cards are produced for off-line card punching.

.13 Availability: currently available.

.14 Originator: Philco Computer Division,
Programming R&D.

.15 Maintainer: Philco Computer Division,
Programming R&D.

.16 First Use: ?

.2 PROGRAM LOADING

.21 Source of Programs

- .211 Programs from on-line libraries: programs to be executed are loaded from a master tape of programs (RPL).
- .212 Independent programs: from system input tape containing absolute or relocatable binary programs in punched card image form.
- .214 Master routines: SYS D is initially loaded by operator manually entering a read instruction via the central processor console.

.22 Library Subroutines: . called from library tape at loading time or included with program deck as a relocatable binary deck.

.23 Loading Sequence: . . . determined by sequence called for on system control instructions and/or physical sequence of binary decks transcribed to system input tape.

.3 HARDWARE ALLOCATION

.31 Storage

.311 Sequencing of program for movement between levels: segmenting relocatable binary programs too large for available core storage into programs which can be overlaid.

.312 Occupation of working storage: incorporated in program; may be designated at loading time for relocatable program.

.32 Input-Output Units

.321 Initial assignment: incorporated symbolically in program.

.322 Alternation: incorporated symbolically in program.

.323 Reassignment: change physical tape assignment on IOP and place reel on other unit.

.4 RUNNING SUPERVISION

.41 Simultaneous Working: incorporated in program.

§ 191.

.42 Multi-programming: . . none.

.43 Multi-sequencing: . . . none.

.44 Errors, Checks, and Action

<u>Error</u>	<u>Check or Interlock</u>	<u>Action</u>
Loading input error:	checks	alarm, automatic rejection.
Allocation impossible:	check	alarm, automatic rejection.
In-out error; single:	check	automatic tape error cycle.
In-out error; persistent:	check	alarm, automatic rejection.
Storage overflow:	check	alarm, automatic rejection.
Invalid instructions to operating system:	check	alarm, automatic rejection.
Program conflicts:	program check	program defined.
Overflow and underflow:	program check with fixed point arithmetic; check and interlock with floating point	program defined with fixed point, jump to fixed location with floating point.
Invalid operation:	check	alarm, stop.
Improper format:	check	alarm, automatic rejection.
Invalid address:	none.	
Reference to forbidden area:	none.	

.45 Restarts

.451 Establishing restart points: fixed system entries.

.452 Restarting process: . . automatic and/or console or typewriter entries.

.5 PROGRAM DIAGNOSTICS

.51 Dynamic

.511 Tracing: complete and/or selective tracing, chosen by programmer.

.512 Snapshots: yes, selected by programmer.

.52 Post Mortem: automatic dump of specific data area when program trouble occurs; programmer specified various format post mortem dumps.

.6 OPERATOR CONTROL

.61 Signals to Operator

.611 Decision required by operator: yes, console type-outs.

.612 Action required by operator: yes, console type-outs.

.613 Reporting progress of run: yes, console type-outs of all job functions, error messages and time data.

.62 Operator's Decisions: type-ins. console forced jumps. toggles.

.63 Operator's Signals

.631 Inquiry: none.

.632 Change of normal progress: methods are available to abandon a run and re-allocate equipment.

.7 LOGGING

.71 Operator Signals: . . . console typewriter.

.72 Operator Decisions: . . console typewriter.

.73 Run Progress: console typewriter.

.74 Errors: console typewriter.

.75 Running Times: console typewriter and system produced accounting cards punched off-line.

.76 Multi-running Status: . none.

.8 PERFORMANCE

.81 System Requirements

.811 Minimum configuration: 8, 192 word core storage, Input-Output Processor (1 assembler), 8 magnetic tapes or 1 Model 240 paper tape unit and 7 magnetic tape units. 8 index registers.

.812 Usable extra facilities: additional facilities only affect size of program which may be loaded.

.813 Reserved equipment: logical tape units 1, 2, 3, 4, 5, 6, 7, 8; additional tapes are required for data, and library and program tapes in excess of those included in the reserved 8 tapes; 512 core storage locations.

.82 System Overhead

.821 Loading time: negligible.

.822 Reloading frequency: . system need not be re-loaded for each new job to be performed.

.83 Program Space Available: all core storage except first 512 locations.

.84 Program Loading Time: 5, 000 words/sec (**).

.85 Program Performance: running overhead completely variable and is a function of the programmer specified operations to perform.

(**) Estimate based on nearly complete data and probably reliable.



OPERATING ENVIRONMENT: TOPS

§ 192.

.1 GENERAL

.11 Identity: TOPS 2.
COPS.
Complete Operating
Procedures System.

.12 Description

The COPS supervisor for TOPS is a complete operating system that covers not only the running of programs, but also the various phases of translation. One master PIT tape is generated at the start. The master routine accepts card input and produces a new PIT tape which contains a session's schedule of runs. Special runs and test programs are run from the GPF. The programs can be run without PIT, or only using PIT in part giving any degree of automatic operation.

COPS provides complete run-to-run control, special diagnostic control, translation control, and input-output magnetic tape error control, operator communication, data label checking, and logging.

Facilities other than core storage and magnetic tape can be used only by incorporating TAC coding. COPS and SYSD are presently incompatible operating systems.

.13 Availability

TOPS 1: end 1960.
TOPS 2: November, 1961.

.14 Originator: Philco Computer Division.

.15 Maintainer: Philco Computer Division.

.16 First Use: 1960.

.2 PROGRAM LOADING

.21 Source of Programs

.211 Programs from on-line
libraries: magnetic tape "General
Program File",
GPF.

.212 Independent programs: none.

.213 Data: normal, magnetic tape
only.

.214 Master routines: PIT magnetic tape.

.22 Library subroutines: . already incorporated in
translation.

.23 Loading Sequence: . . . control cards, transcribed
during prerun to AIDSINN
tape containing one inte-
grated schedule, also
LOAD macros in
programs.

.3 HARDWARE ALLOCATION

.31 Storage: no relocatable provisions,
but there is provision for
overlays using LOAD
macro.

.32 Input-Output Units: . . automatic floating tape
assignment.

.4 RUNNING SUPERVISION

.41 Simultaneous Working: automatic.

.42 Multi-programming: . . none.

.43 Multi-sequencing: . . . none.

.44 Errors, Checks and Action

Error	Check or Interlock	Action
Loading input error:	automatic COPS label check	type out.
Allocation impossible:	automatic COPS	type out,
In-out error - single:	hardware	see 651:091.8,
In-out error - persistent:	automatic COPS	retry, or erase,
Storage overflow:	none	modulo store size,
Invalid instructions:	stall processor	alarm.
Arithmetic overflow:	none,	
Underflow:	none,	
Invalid address:	none	modulo store size.
Reference to forbidden area:	none,	

.45 Restarts

.451 Establishing restart
points: own code.

.452 Restarting process: . . rewind all tapes, relabel
and enter restart
program named.

.5 PROGRAM DIAGNOSTICS

.51 Dynamic

.511 Tracing: TRACE, print of all jumps
executed from one spec-
ified address to another,
active for a specified
number of executions
after a specified number
of inactive executions.

.512 Snapshots: DUMP specifies a print of
an area in core storage;
SNAP specifies a print of
registers. These are
made for a specified num-
ber of executions after a
specified number of
inactive executions.

- § 192.
- .52 Post Mortem: manual or error jump at end of run to complete dump.
- .6 OPERATOR CONTROL
- .61 Signals to Operator
- .611 Decision required by operator: TYPE OUT.
- .612 Action required by operator: TYPE OUT, TOGGLE SWITCH.
- .613 Reporting Progress of run: TYPE OUT.
- .62 Operator's Decisions: . TYPE IN or forced jump.
- .63 Operator's Signals
- .631 Inquiry: none.
- .632 Change of normal progress: forced jump.
- .7 LOGGING
- .71 Operator Signals: . . . TYPE OUT.
- .72 Operator Decisions: . . TYPE OUT.
- .73 Run Progress: types out ID at start and end.
- .74 Errors: TYPE OUT.
- .75 Running Times: subroutine available using internal clock.
- .8 PERFORMANCE
- .81 System Requirements
- .811 Minimum configuration: 5 tapes. 8K storage.
- .812 Usable extra facilities: extra storage, 16 tapes. others only by own coding in TAC.
- .813 Reserved equipment: 800 words, normal, 1 tape. 1,800 words, testrun, 2 tapes.
- .82 System Overhead
- .821 Loading Time: 15 sec. max.
- .822 Reloading Frequency: . not necessary.
- .83 Program Space Available: variable.
- .84 Program Loading Time: 2,500 words/sec plus tape searching.
- .85 Program Performance: negligible overhead.



651:201.011

**Philco 2000-210
System Performance**

**PHILCO 2000-210
SYSTEM PERFORMANCE**

PHILCO 2000 - 210 SYSTEM PERFORMANCE

WORKSHEET DATA TABLE 1							
Worksheet	Item		Configuration				Reference
			VII B	VIII B			
1	Char/block	(File 1)	128 words		128 words		4:200.112
	Records/block	K (File 1)	10		10		
	m.sec/block	File 1 = File 2	11.4		11.4		
		File 3	11.4		11.4		
		File 4	11.4		11.4		
	m.sec/switch	File 1 = File 2	0		0		
		File 3	0		0		
		File 4	0		0		
	m.sec penalty	File 1 = File 2	1.28		1.28		
		File 3	1.28		1.28		
File 4		1.28		1.28			
2	m.sec/block	a1	0.241		0.241		4:200.1132
	m.sec/record	a2	0.694		0.694		
	m.sec/detail	b6	0.720		0.720		
	m.sec/work	b5 + b9	3.972		3.972		
	m.sec/report	b7 + b8	21.996		21.996		
3	m.sec for C.P. and dominant column.	a1	0.24		0.24		4:200.114
		a2K	6.94		6.94		
		a3K	266.88		266.88		
		File 1 Master In	1.28	11.4	1.28		
		File 2 Master Out	1.28		1.28		
		File 3 Details	1.28		1.28		
		File 4 Reports	1.28	22.8	1.28	22.8	
		Total	279.28	34.2	279.28	22.8	
4	Unit of measure	(word)					4:200.1151
	Standard Problem A Space	Std. routines	187		187		
		Fixed	0		0		
		3 (Blocks 1 to 23)	87		87		
		6 (Blocks 24 to 48)	684		684		
		Files	1024		1024		
		Working	100		100		
		Total	2082		2082		

PHILCO 2000-210 SYSTEM PERFORMANCE -Contd.

WORKSHEET DATA TABLE 2						
Worksheet	Item		Configuration			Reference
			VII B, VIII B blocked	not blocked		
5	Fixed/Floating point		Float	Float		4:200.413
	Unit name	input	tape 234	tape 234		
		output	tape 234	tape 234		
	Size of record	input	10 w	10 w		
		output	23 w	23 w		
	m.sec/block	input T1	11.4	0.95		
		output T2	11.4	2.28		
	m.sec. penalty	input T3	1.28	0.11		
		output T4	1.28	0.26		
	m.sec/record T5		0.72	0.72		
m.sec/5 loops T6		3.967	3.967			
m.sec/report T7		2.611	2.591			
7	Unit name		tape 234	tape 234		4:200.512
	Size of block		128 words	128 words		
	Records/block B		12	12		
	m.sec/block T1		11.4	11.4		
	m.sec penalty T3		0.1	0.1		
	C. P.	m.sec/block T5	0.039	0.039		
		m.sec/record T6	0.160	0.160		
m.sec/table T7		0.453	0.453			



SYSTEM PERFORMANCE

§ 201.

.1 GENERALIZED FILE PROCESSING

.11 Standard File Problem A

.111 Record Sizes

- Master File: 108 characters.
- Detail File: 1 card.
- Report File: 1 line.

- .112 Computation: standard.
- .113 Timing Basis: using estimating procedure outlined in Users' Guide, 4:200.113.
- .114 Graph: see graph below.
- .115 Storage Space Required
 - Configuration VII B: . 3,000 words.
 - Configuration VIII B: . 3,000 words.

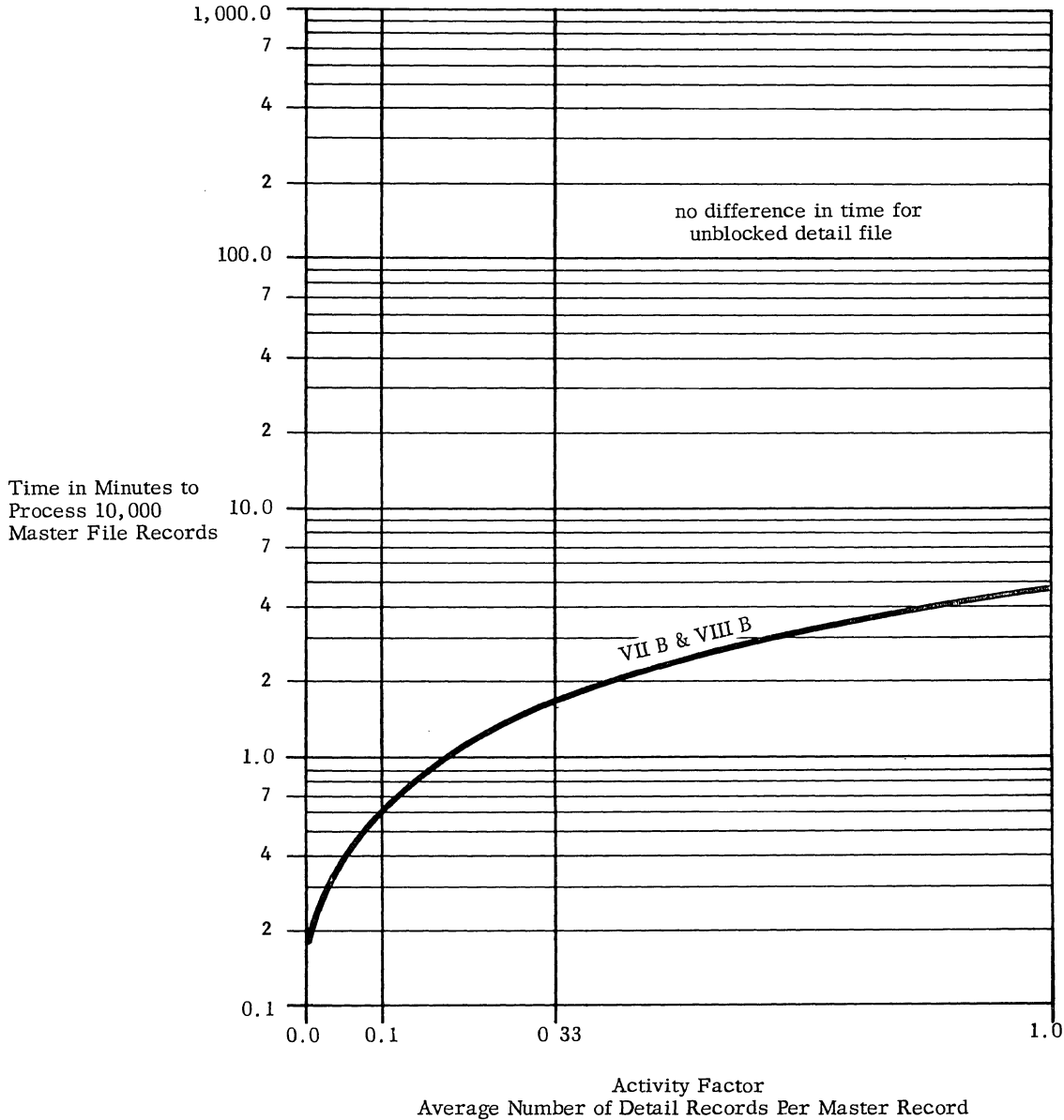

§ 201.

.12 Standard File Problem B

.121 Record Sizes

- Master File: 54 characters.
- Detail File: 1 card.
- Report File: 1 line.

- .122 Computation: standard
- .123 Timing Basis: using estimating procedure outlined in Users' Guide, 4:200.12.
- .124 Graph: see graph below.

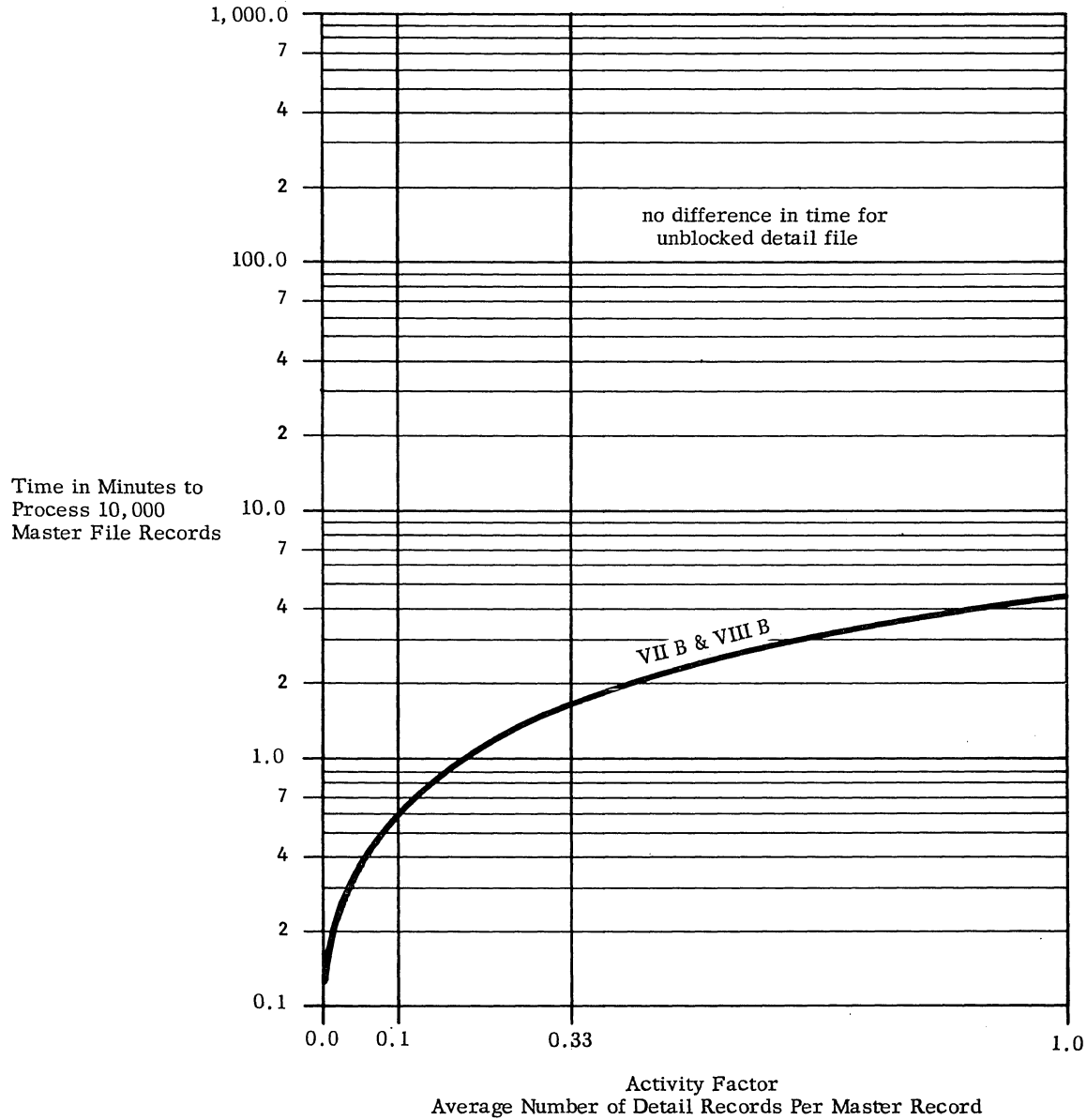

§ 201.

.13 Standard File Problem C

.131 Record Sizes

Master File: 216 characters.
 Detail File: 1 card.
 Report File: 1 line.

.132 Computation: standard.
 .133 Timing Basis: using estimated procedure
 outlined in Users' Guide,
 4:200.13.
 .134 Graph: see graph below.

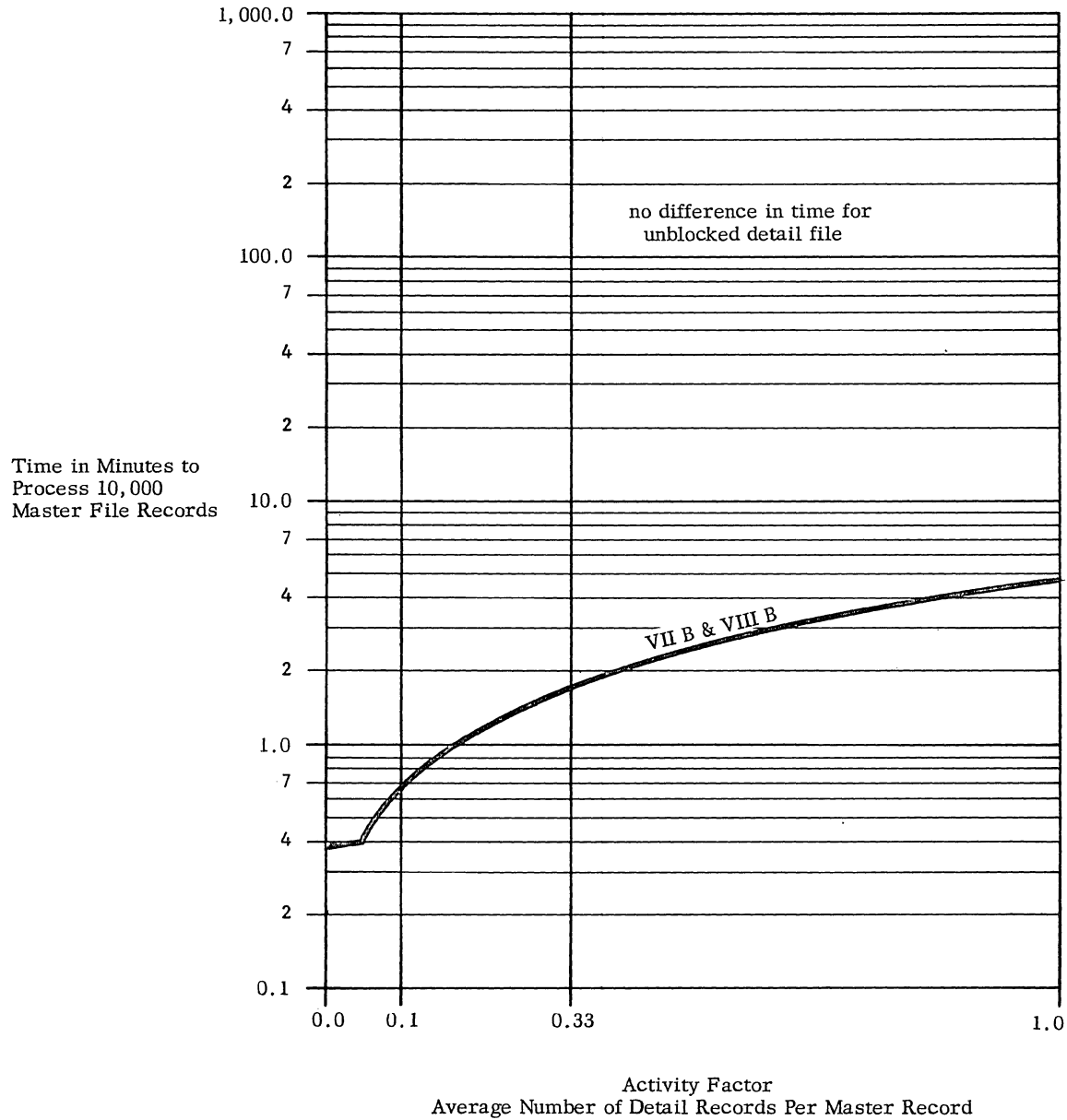

§ 201.

.14 Standard File Problem D

.141 Record Sizes

Master File: 108 characters.
Detail File: 1 card.
Report File: 1 line.

.142 Computation: trebled.

.143 Timing Basis: using estimated procedure
outlined in Users' Guide,
4:200.13.

.144 Graph: see graph below.

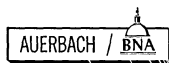
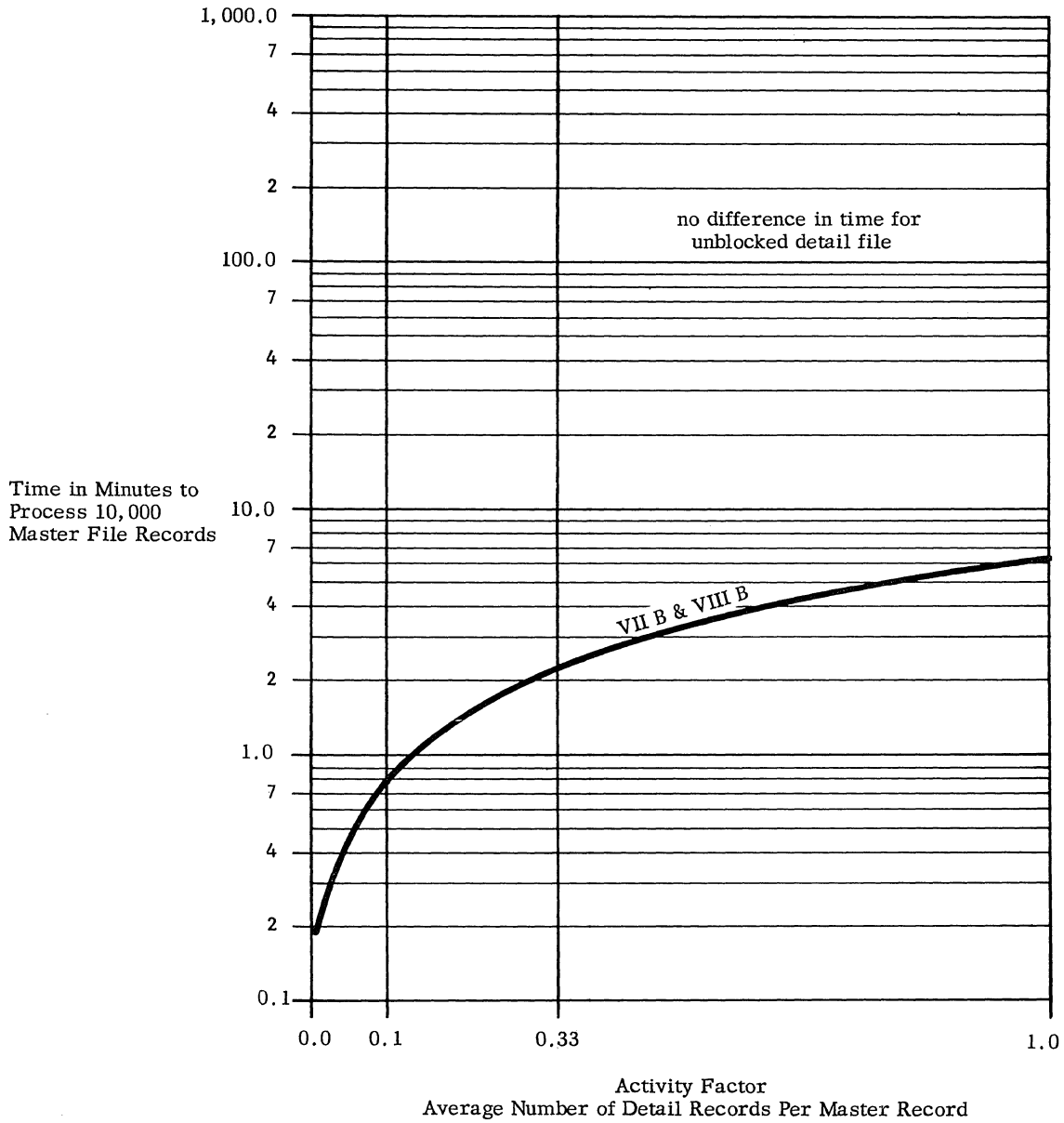

§ 201.

.2 SORTING

.21 Standard Problem Estimates

.211 Record size: 80 characters.

.212 Key Size: 8 characters.

.213 Timing Basis: using estimated procedure outlined in Users' Guide, 4:200.213.

.214 Graph: see graph below.

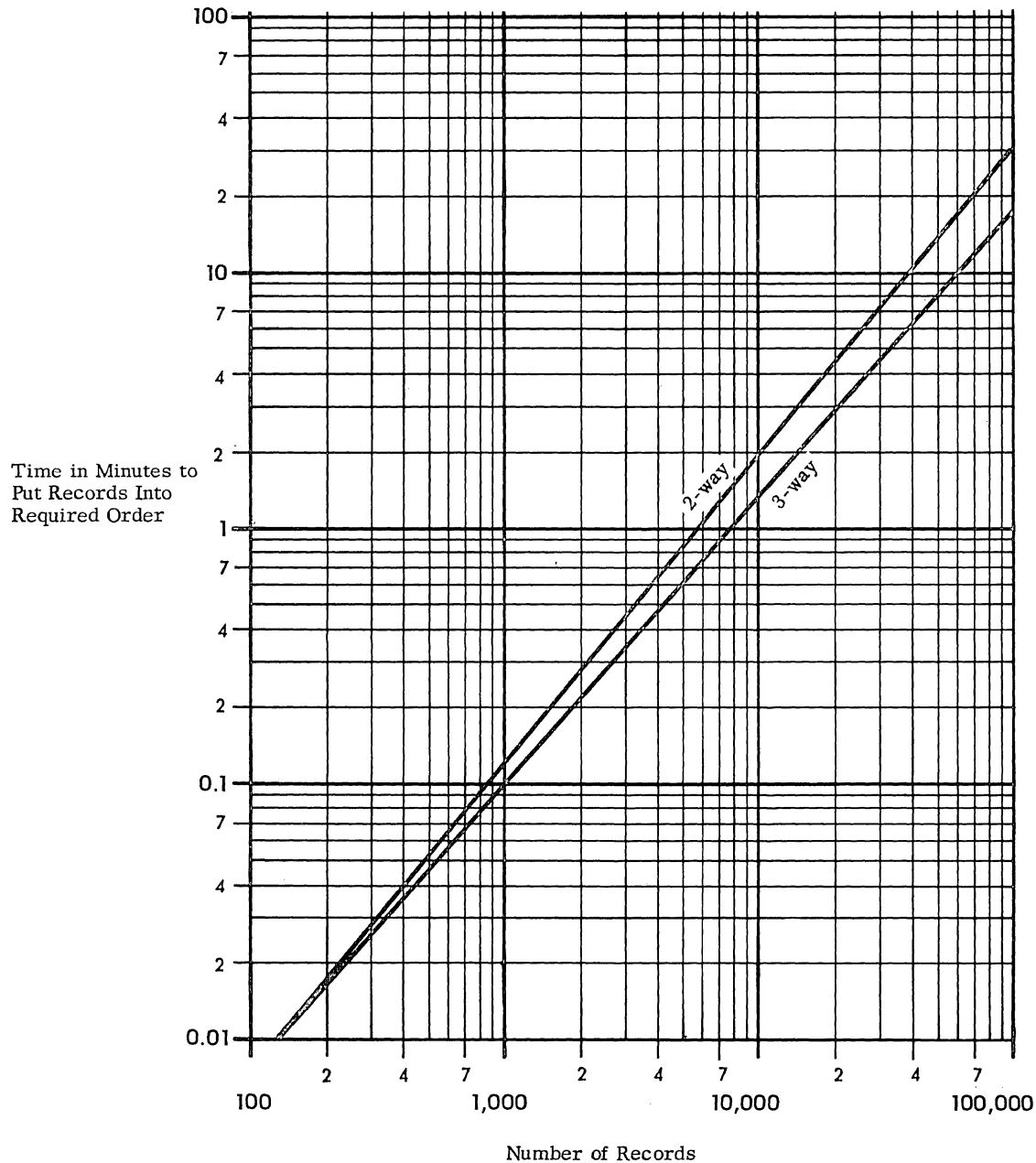

§ 201.

.3 MATRIX INVERSION

.31 Standard Problem Estimates

.311 Basic Parameters: . . . general, non-symmetric matrices, using floating point to at least 8 decimal digits.

.312 Timing Basis: using estimated procedure outlined in Users' Guide, 4:200.312.

.313 Graph: see graph below.

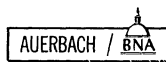
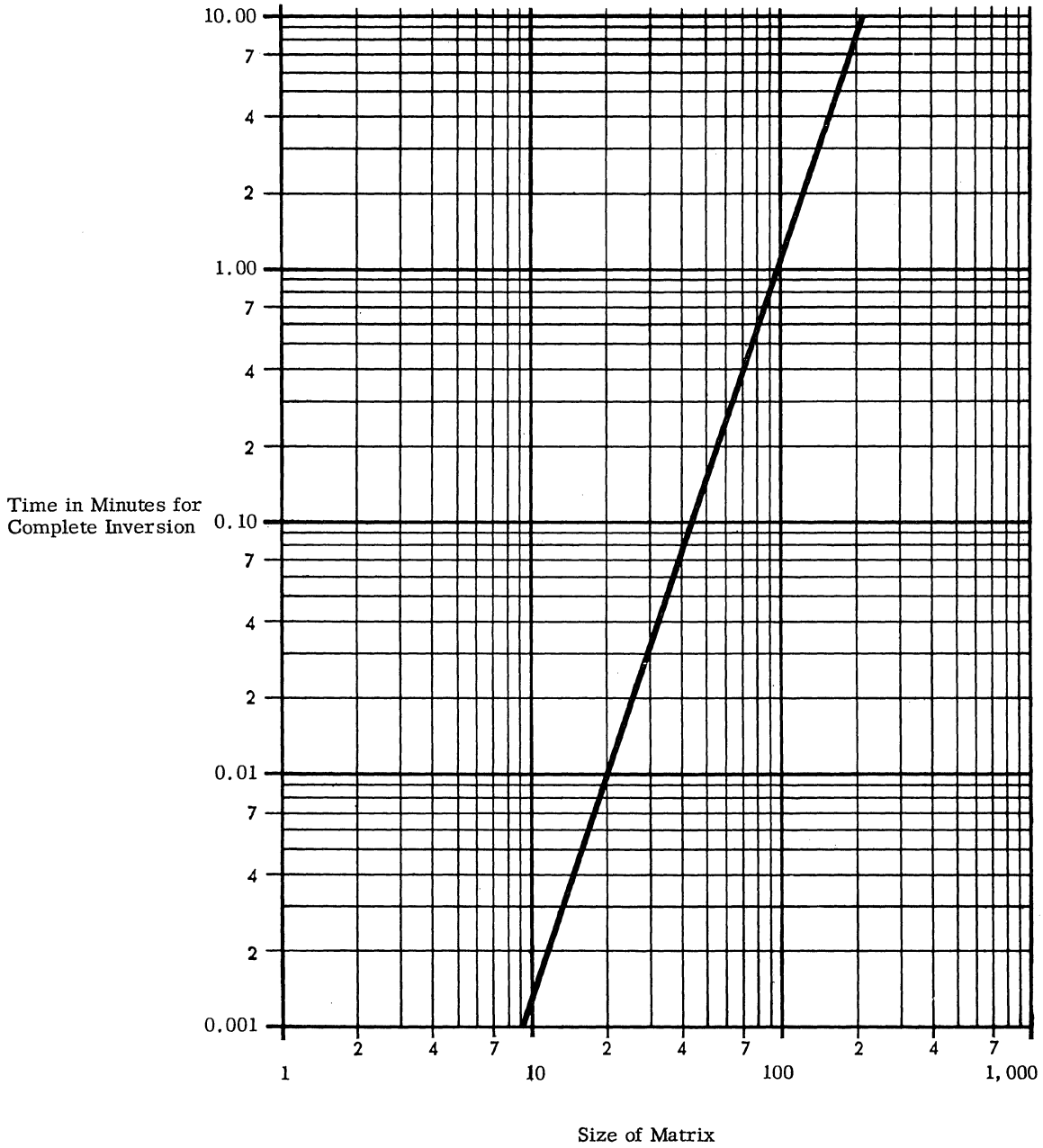

§ 201.

.32 Single Precision and Matrix Inversion Times

.321 Basic Parameters: . . . general, non-symmetric matrices, using floating point to at least 8 decimal digits.

.322 Timing Basis: Philco Computer Division
Programming R & D
Willow Grove, Pa.

.323 Graph: see graph below.

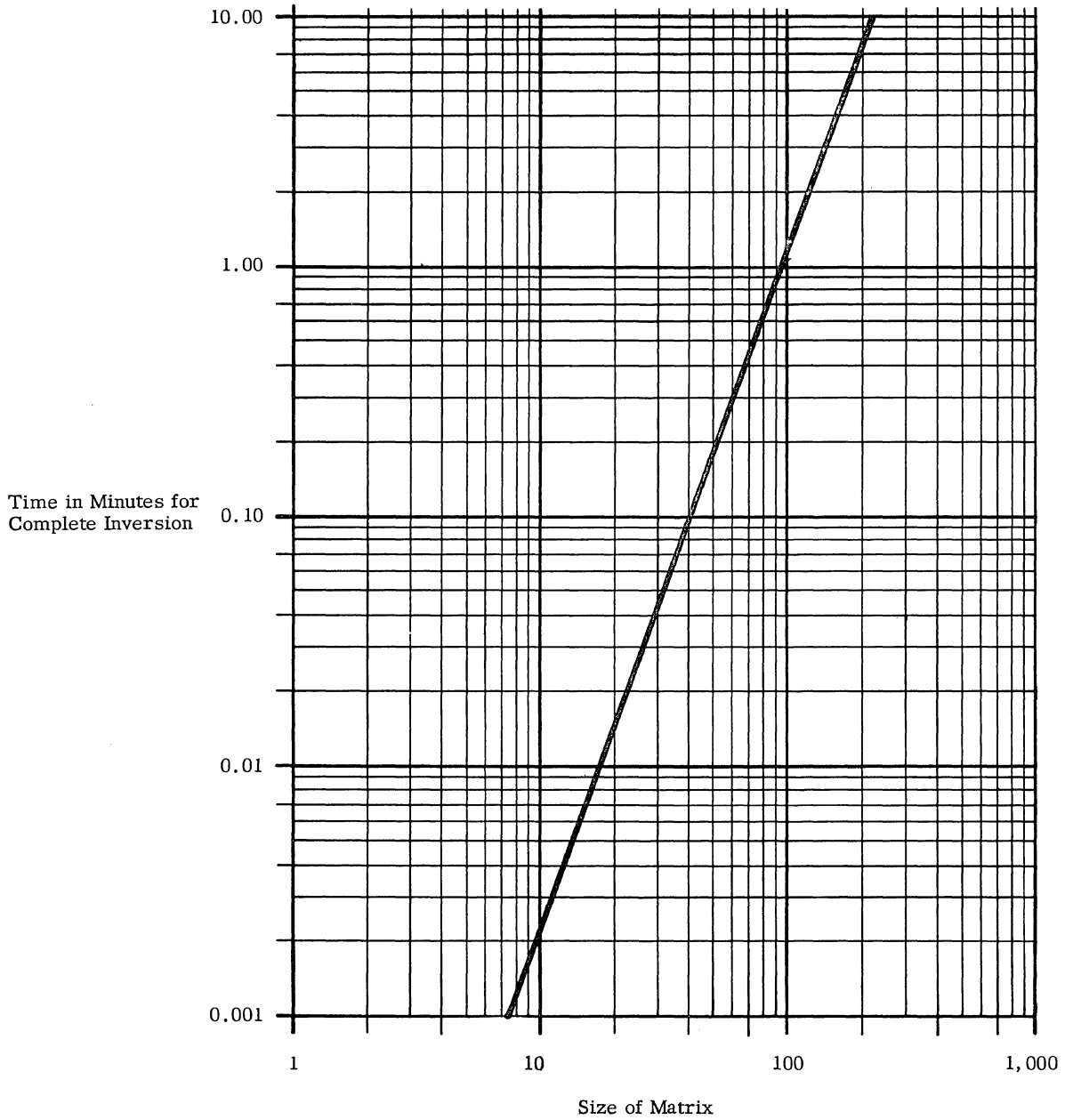

§ 201.

.4 GENERALIZED MATHEMATICAL PROCESSING

.41 Standard Mathematical Problem A Estimates

.411 Record sizes: 10 signed numbers, avg. size 5 digits, max. size 8 digits.

.412 Computation: 5 fifth-order polynomials. 5 divisions. 1 square root.

.413 Timing basis: using estimating procedure outlined in Users' Guide, 4:200.413.

.414 Graph: see graph below.

Configuration VIIB, VIIB; Single Length (12 digit precision); floating point.

R = Number of Output Records per Input Record

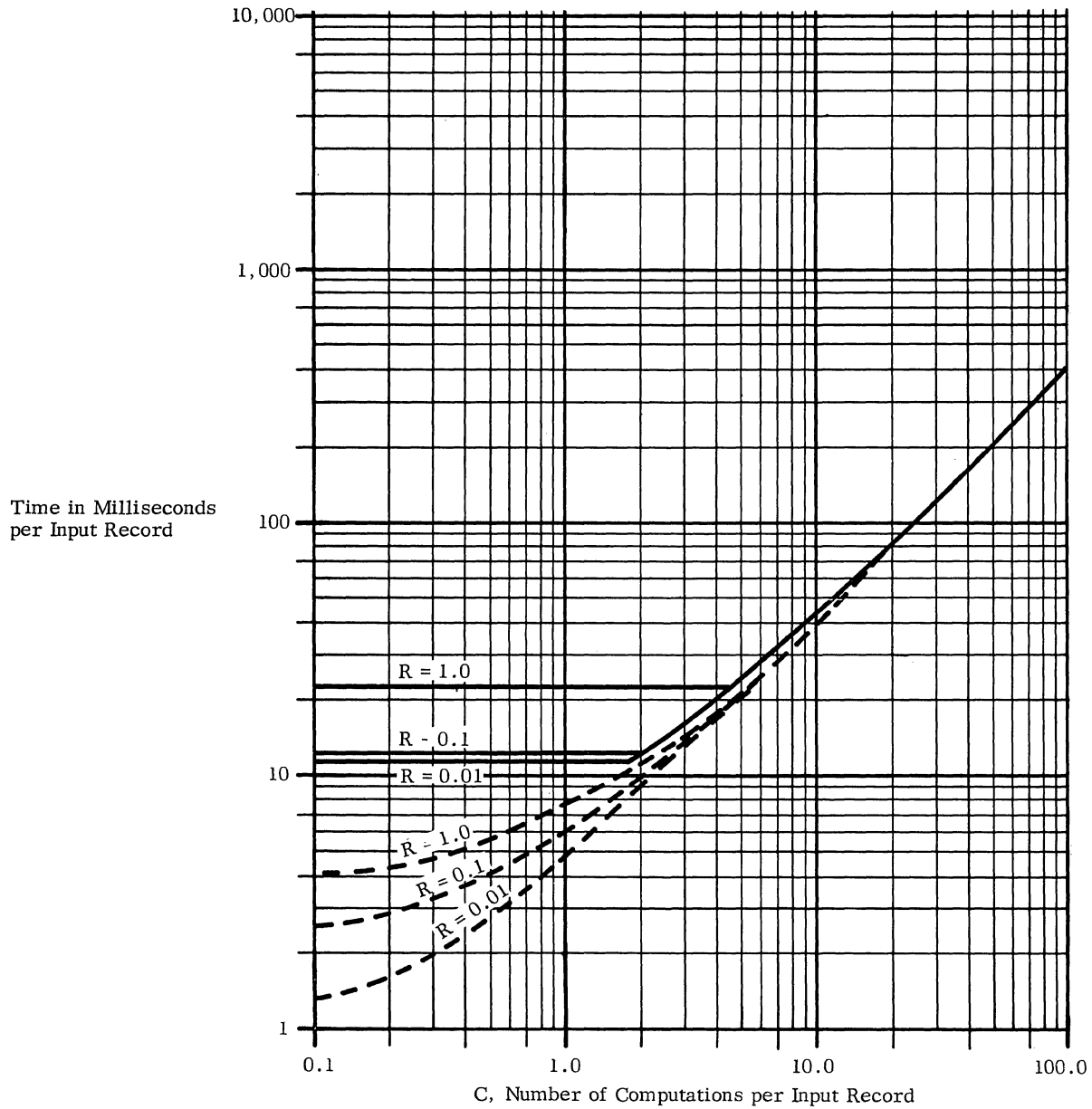

Broken lines indicate blocked records.

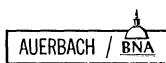

§ 201.

.5 GENERALIZED STATISTICAL PROCESSING

.51 Standard Statistical Problem A Estimates

.511 Record size: thirty 2-digit integral numbers.

.512 Computation: augment T elements in cross-tabulation tables.

.513 Timing basis: using estimating procedure outlined in Users' Guide, 4:200.513.

.514 Graph: see graph below.

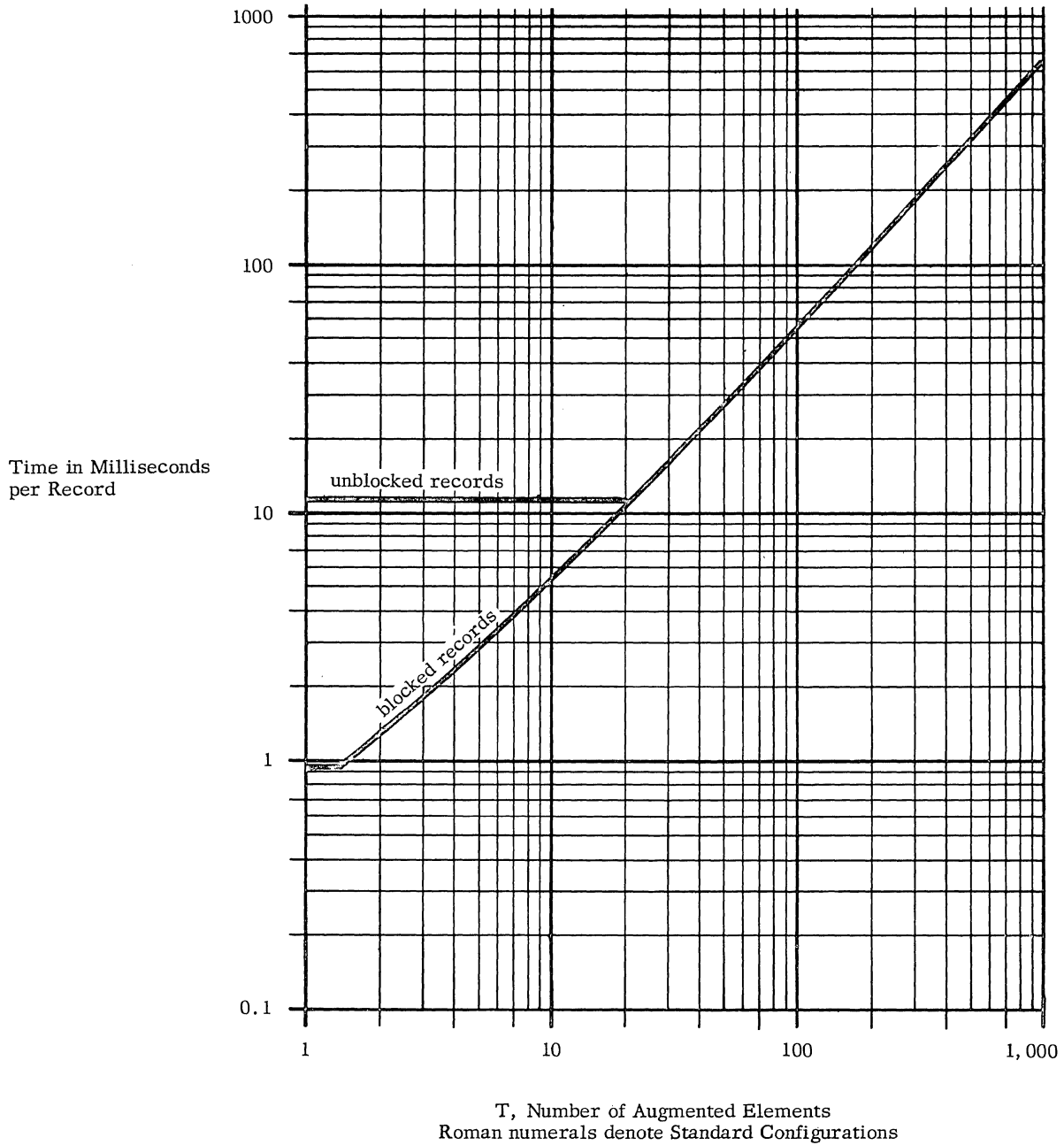



651:211.101

**Philco 2000-210/211/212
Physical Characteristics**

**PHILCO 2000-210/211/212
PHYSICAL CHARACTERISTICS**

PHILCO 2000-210/211/212 PHYSICAL CHARACTERISTICS

IDENTITY	Unit Name		Arithmetic and Control			Core Storage	Core Storage	Core Storage	Core Storage
			Central Processor	Power Supply	Typewriter Control				
	Model Number		210	210	210	2208	2216	2232	222
PHYSICAL	Height × Width × Depth, in.		44 × 108 × 34	57 × 32 × 18	36 × 36 × 34	57 × 90 × 18.6	57 × 158 × 18	57 × 281 × 18	57 × 32 × 18
	Weight, lbs.		1,413	504	206	1,677	3,077	5,877	400
	Maximum Cable Lengths		?	?	?	?	?	?	?
ATMOSPHERE	Storage Ranges	Temperature, °F.		?					
		Humidity, %		?					
	Working Ranges	Temperature, °F.		*					
		Humidity, %		*					
	Heat Dissipated, BTU/hr.		← 6,130 (total 210) →			6,070	9,950	17,600	200
	Air Flow, cfm.			?					
	Internal Filters			?					
ELECTRICAL	Voltage	Nominal		**					
		Tolerance		**					
	Cycles	Nominal		**					
		Tolerance		**					
	Phases and Lines			**					
	Load KVA			1.840 total		1.783	2.933	5.175	0.060
NOTES	<p>* The total System must be maintained at a working temperature of 60 to 80°F. and humidity of 45 to 65%.</p> <p>** The entire System operates from either a 208-volt AC, 60-cycle, 3 phase, 4-wire power source or from a 115-volt, 60-cycle, single phase, 3-wire service. A voltage tolerance of ±10% and a frequency tolerance of ±0.5 cycle are permitted.</p>								

PHILCO 2000-210/211/212 PHYSICAL CHARACTERISTICS-Contd.

IDENTITY	Unit Name	Core Storage Unit with Control	Magnetic Drum	Magnetic Drum Controller	Paper Tape System	Paper Tape System	Punched Card Controller	Punched Card Reader	Punched Card Punch	Printer Control Unit	Printer	Magnetic Tape Unit	Magnetic Tape Unit	Input-Output Processor	Input-Output Processor	Input-Output Processor	Input-Output Processor	Universal Buffer Controller	Universal Buffer Controller	Accounting Clock	Console Type-writer Buffer	Digital Incremental Recorder	Digital Incremental Recorder	Digital Incremental Recorder	Digital Incremental Recorder	
	Model Number	228	272	275	240	241	259	258	265	254	256	234	234 Off-line only	235	236	237	238	252	280	293	309	2281	2282	2283	2284	
PHYSICAL	Height x Width x Depth, in.	57x97x40	57x45x39	57x32x18	57x61x18	57x61x18	57x61x18	49x68x18	51x40x26	57x90x18	57x48x42	75x23x24	75x23x24	57x90x18	57x90x18	57x118x18	57x118x18	57x61x18	57x61x18	32x32x18	?	?	?	?	?	
	Weight, lbs.	2,307	1,800	700	860	860	1,147	773	624	1,485	1,800	604	680	1,400	1,400	2,039	2,039	1,020	1,080	150	?	?	?	?	?	
	Maximum Cable Lengths	?	?	?	?	?	?	?	?	?	?	?	?	?	?	?	?									
ATMOSPHERE	Storage Ranges	Temperature, °F.																								
		Humidity, %																								
	Working Ranges	Temperature, °F.																								
		Humidity, %																								
	Heat Dissipated, BTU/hr.	16,100	2,930	4,300	6,070	6,250	5,090	2,740	4,700	19,600	Incl. in 254	7,150	9,000	3,920	3,920	5,660	5,660	2,740	2,740	340	?	?	?	?	?	
	Air Flow, cfm.	?	?	?	?	?	?	?	?	?	?	?	?	?	?	?	?	?	?	?	?	?	?	?	?	?
	Internal Filters	?	?	?	?	?	?	?	?	?	?	?	?	?	?	?	?	?	?	?	?	?	?	?	?	?
ELECTRICAL	Voltage	Nominal																								
		Tolerance																								
	Cycles	Nominal																								
		Tolerance																								
	Phases and Lines																									
Load KVA	4.84	0.863	1.265	1.783	1.783	1.495	0.805	1.380	5.750	Incl. in 254	2,100	2.645	1.150	1.150	1.668	1.668	0.805	0.805	0.100	?	?					
NOTES																										



§ 221.

PRICE DATA

CLASS	IDENTITY OF UNIT		PRICES	
	No.	Name	Monthly Rental \$	Purchase \$
CENTRAL PROCESSOR	Model 210	<u>Central Processor</u>		
	210	Arithmetic and Control Unit	7,100	320,000
	1000	Optional Features 210 Floating Point Option	650	30,000
	1011	210 Index Registers (8)	900	40,000
STORAGE		<u>10μs Core Storage</u>		
	2208	8,192 words	5,800	260,000
	2216	16,384 words	11,000	500,000
	2232	32,768 words	20,500	925,000
		<u>Magnetic Drum Storage</u>		
	272	Magnetic Drum Unit	1,600	72,000
275	Magnetic Drum Controller	2,900	130,000	
INPUT-OUTPUT	234	Magnetic Tape Unit (90KC)	850	38,000
	235	Input-Output Processor - 90KC (1 assembler)	3,300	150,000
	236	Input-Output Processor - 90KC (2 assembler)	4,400	200,000
	237	Input-Output Processor - 90KC (3 assembler)	6,500	300,000
	288	Input-Output Processor - 90KC (4 assembler)	8,400	380,000
	252	Off-Line Universal Buffer Controller	1,430	100,000
	280	On/Off-Line Universal Buffer Controller	1,560	110,000
	240	On-Line Paper Tape System	1,800	80,000
	241	Off-Line Paper Tape System	1,800	80,000
	2256	Printer System	2,340	160,000
	258	Dual Station Card Reader	800	48,000
	259	Punch Card Controller	1,365	95,000
	265	Card Punch (100 CPM)	350	15,000
	309	Typewriter Buffer	500	21,000
	2281	Digital Incremental Recorder	275	11,700
	2282	Digital Incremental Recorder	405	17,200
2283	Digital Incremental Recorder	535	22,700	
2284	Digital Incremental Recorder	665	28,200	

Note: The monthly maintenance rate is individually negotiated for purchased equipment. See Special Report, Section 23:010.100, second paragraph.

PHILCO 2000 - 211

Philco Corporation
(A Subsidiary of Ford Motor Company)

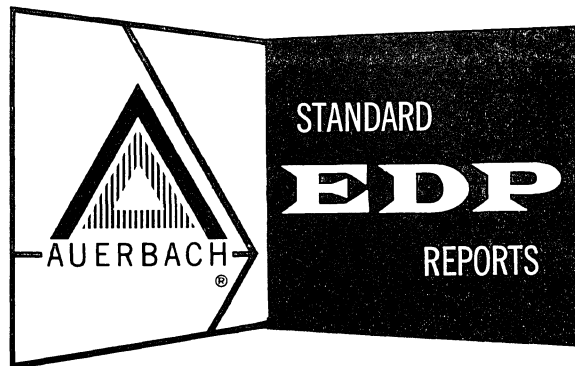

AUERBACH INFO, INC.



CONTENTS

- 1. Introduction 652:011
- 2. Data Structure 651:021 (Philco 2000-210)
- 3. System Configuration
 - VII B, 10-Tape General System (Paired) 652:031.3
 - VIII B, 20-Tape General System (Paired) 652:031.4
- 4. Internal Storage
 - 2200 Series 10 μ s Core Storage 651:041 (Philco 2000-210)
 - 220 Partition for 10 μ s Core Storage 652:042
 - 2100 Series 1.5 μ s Core Storage 652:043
 - 272, 275 Magnetic Drum System 651:044 (Philco 2000-210)
- 5. Central Processor - Model 211 652:051
- 6. Console 651:061 (Philco 2000-210)
- 7. Input-Output: Punched Tape and Card
 - 240 Paper Tape System 651:071 (Philco 2000-210)
 - 241 Paper Tape System 651:072 (Philco 2000-210)
 - 258 Card Reader 651:073 (Philco 2000-210)
 - Punch Card Controller 651:073.4 (Philco 2000-210)
 - 265 Card Punch 651:074 (Philco 2000-210)
- 8. Input-Output: Printers
 - 256 Printer 651:081 (Philco 2000-210)
 - 254 Printer Control Unit 651:081.4 (Philco 2000-210)
- 9. Input-Output: Magnetic Tape
 - 234 Magnetic Tape 651:091 (Philco 2000-210)
- 10. Input-Output: Other
 - 235, 236, 237, 238 Input-Output Processors (90KC) 651:101 (Philco 2000-210)
 - 252 Universal Buffer Controller 651:102 (Philco 2000-210)
 - 280 Universal Buffer Controller 651:102 (Philco 2000-210)
 - 309 Console Typewriter Buffer 651:103 (Philco 2000-210)
 - 2281, 2282, 2283, 2284 Digital Incremental
Recorders 651:104 (Philco 2000-210)
 - 293 Accounting Clock 651:105 (Philco 2000-210)
 - 401, 404, 408 Auto-Control Units 652:106
 - Real-Time Scanner 652:106.12
 - 402 Interval Timer 652:107
- 11. Simultaneous Operations 651:111 (Philco 2000-210)
- 12. Instruction List 652:121
- 13. Coding Specimens
 - ALTAC 651:131 (Philco 2000-210)
 - TOPS 651:132 (Philco 2000-210)
 - TAC 651:133 (Philco 2000-210)
- 14. Data Codes
 - Internal, Magnetic Tape and Printer Binary
Coded Characters 651:141 (Philco 2000-210)
 - Card 651:142 (Philco 2000-210)

CONTENTS (Contd.)

15.	Problem Oriented Facilities	
	Sort Generator	651:151.13 (Philco 2000-210)
	Sort (Interpretive)	651:151.13 (Philco 2000-210)
	PERT	651:151.17 (Philco 2000-210)
	Linear Programming	651:151.17 (Philco 2000-210)
	Input-Output Programming System (IOPS)	651:151.17 (Philco 2000-210)
16.	Process Oriented Language	
	ALTAC 3	651:161 (Philco 2000-210)
	TOPS 2	651:162 (Philco 2000-210)
	COBOL-61	651:163 (Philco 2000-210)
17.	Machine Oriented Languages	
	TAC	651:171 (Philco 2000-210)
18.	Program Translators	
	ALTAC 3	651:181 (Philco 2000-210)
	TOPS 2	651:182 (Philco 2000-210)
	TAC	651:184 (Philco 2000-210)
19.	Operating Environment	
	SYSD	651:191 (Philco 2000-210)
	TOPS 2	651:192 (Philco 2000-210)
20.	System Performance	
	Worksheet Data	652:201.011
	Generalized File Processing	652:201.1
	Sorting	652:201.2
	Matrix Inversion	652:201.3
	Generalized Mathematical Processing	652:201.4
	Generalized Statistical Processing	652:201.5
21.	Physical Characteristics	651:211
22.	Price Data	652:221



INTRODUCTION

§ 011.

The Philco 2000 is actually a series of three computer systems. There are three prime systems distinguished by different central processors: 210, 211, and 212. The differences in performance and price of the different systems are significant as shown in the respective Systems Performance Sections, 651:201, 652:201, and 653:201. There is a large body of common units, common interfaces, and common software. The following description applies generally to all the series; however, the final paragraph notes the major differences of the 2000-211.

The computer system is in the large-scale scientific and real-time class. Its design is oriented toward flexible off-line operations, with fast tape units, simultaneous operations and concern for fast processing speeds. The central processors have a range of 50,000 to 500,000 instructions per second and rentals in the order of \$40,000 and up.

The Philco 2000 is designed for off-line operation of peripheral devices. The off-line operations may be executed by a separate computer, the Philco 1000, or by the special Universal Buffer Controllers (UBC).

The UBC unit is a versatile device, which contains a 1,024 word buffer store. The UBC may control any card, punched tape, magnetic tape, or printer off-line transcription, including magnetic-tape-to-magnetic-tape. A UBC can be used on-line to control data transfers to any one of seven peripheral units attached to it. In addition to the usual peripheral devices there is a high speed (2,000 cards per minute) reader.

Each 2000 computer configuration has one IOP (Input-Output Processor). This unit can control up to 16 input-output units. There may be up to four UBC's and the remaining units may be magnetic tape. An IOP may contain from one to four assemblers. An assembler provides for independent simultaneous input-output transfers. In effect, each UBC can provide an extra simultaneous input-output transfer to any unit except magnetic tape, because loading or unloading a UBC buffer requires little time, and the UBC controls the peripheral device at its own pace.

One especially convenient feature of the IOP is the automatic assignment of any idle assembler to a data transfer request, thus relieving the programmer of optimizing assignments.

The Model 234 Magnetic Tape Units which must be used on the 2000-210 and 2000-211 operate at a peak speed of 90,000 characters per second. The block size is fixed at 1,024 characters. At full speed, using full blocks, the effective speed is 54,600 characters per second. Usually the standard problems have been timed for two cases: (1) blocked records and (2) unblocked records. On the 2000-212 an alternative tape unit, Model 334, is available with a peak speed of 240,000 characters per second.

All three central processors operate in parallel on 48-bit words. Single address instructions are packed two to a word. The number of index registers is optional on the 210 and 211 but in practice is standardized at eight. Eight registers, however, are standard on the 212. When an instruction uses a special bit to denote indexing, three bits of the high order end of the address are used to specify the register. This limits the value of the base address, but not the modifier.

There is a wide variety of fixed and floating point arithmetic instructions, but no editing or conversion facilities. Special two instruction loops can be performed very rapidly with no repeated access for instructions.

INTRODUCTION—Contd.

§ 011.

The computer operates asynchronously in all units and basic times vary from machine to machine, and in different cases similar instructions require different execution times. This report quotes ranges or averages of these times.

There are several varieties of core store available. They have different cycle times, and can be further varied by use of overlapped access. Drums are available on the systems and data transfers are arranged to be parallel by word, at high data rates, but may not be overlapped with other operations. Disc storage is available on the 2000-212.

The three central processors, 210, 211, and 212, are upward compatible for instruction repertoire and functional facilities. Therefore, all software is written to be used on all models, with some limitations on minimum configurations.

The main languages are TAC, ALTAC, and TOPS. TAC is a sophisticated symbolic machine oriented language including macros and facilities for generators. The generators include SORT and IOPS, an input-output system. ALTAC is a dialect of FORTRAN II. The ALTAC translator can translate FORTRAN II programs with usually few changes. Its major incompatibilities are Boolean operations and CHAIN functions. On the other hand, it includes extended conditionals. TOPS is a macro oriented language for file manipulation; it includes such facilities as updating and sorting. For individual data manipulation, TAC coding is used. TOPS includes its own operating environment.

There is an automatic supervisor routine, SYSD. This routine covers running, translating, and debugging. In fact, it is probably not reasonable to operate a 2000 without a supervisor.

There is a users' group called TUG. The library of routines is generally available and includes a large selection in the field of nuclear code programs.

The Philco 2000-211 in particular:

- . uses either a 10 μ sec store, partitioned or not, or a 1.5 μ sec store.
- . central processor times are closely related to core store times.
- . real-time facilities are available.
- . is significantly faster than the 210, but slower than the 212.

SYSTEM CONFIGURATION

§ 031.

.3 VII B 10-TAPE GENERAL, PAIRED CONFIGURATION

Deviations from Standard Configuration

On-line: 2 more index registers.
magnetic tape, 30,000 char/sec faster.
card reader can be switched from off-
line UBC.

Off-line: magnetic tape, 60,000 char/sec faster.
printer faster by 400 lines/min.
card reader by 1,500 cards/min.
1,024 characters only in UBC.

On-line Equipment

Equipment

Rental

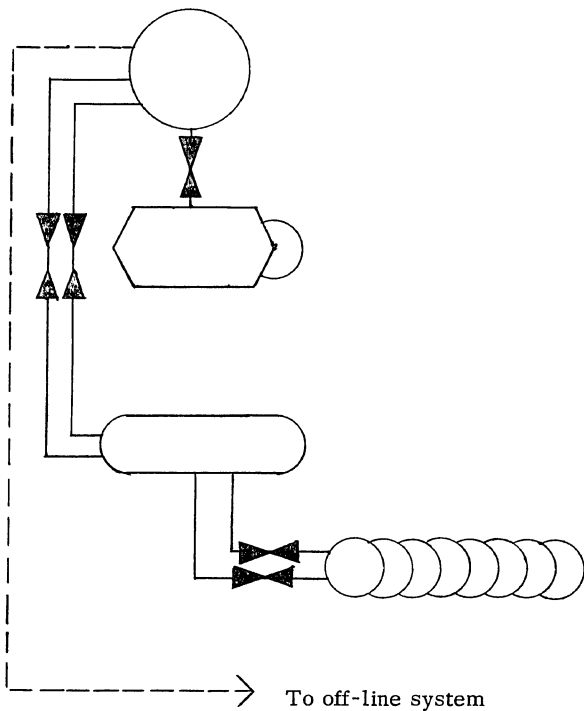

Core Storage:
8,192 words 5,800

Model 211 Central Processor and Console } 11,000
Typewriter } 900
1,300

Input-Output Processor:
two multiplexed transmissions to and from magnetic tape. 4,400

8 Magnetic Tapes:
90,000 char/second 6,800

Total 30,200

Total, including off-line equipment: \$ 38,315

§ 031.

.3 VII B 10 - TAPE GENERAL, PAIRED CONFIGURATION (Contd.)

Off-line Equipment

	<u>Equipment</u>	<u>Rental</u>
	Universal Buffer Controller:	1,560
	2 Magnetic Tapes: 90,000 char/second	1,700
	Punch Card Controller:	1,365
	Card Reader: 2,000 cards/minute	800
	Card Punch: 100 cards/minute	350
	Printer Controller:	} 2,340
	High Speed Printer: 900 lines/minute	
	Total	\$ 8,115

Note: Off-line system may be replaced by the Philco 1000 computer system. This will permit more powerful off-line editing and computing capabilities, relieving the central processor of much of this work.

§ 031.

.4 VIII B 20-TAPE GENERAL, PAIRED CONFIGURATION

Deviations from Standard Configuration

On-Line:	2 fewer index registers. magnetic tape 30,000 char/second slower. card reader can be switched from off-line UBC.
Off-line:	magnetic tape 30,000 char/second faster. card reader faster by 1,000 cards/minute. card punch slower by 100 cards/minute.

On-Line Equipment

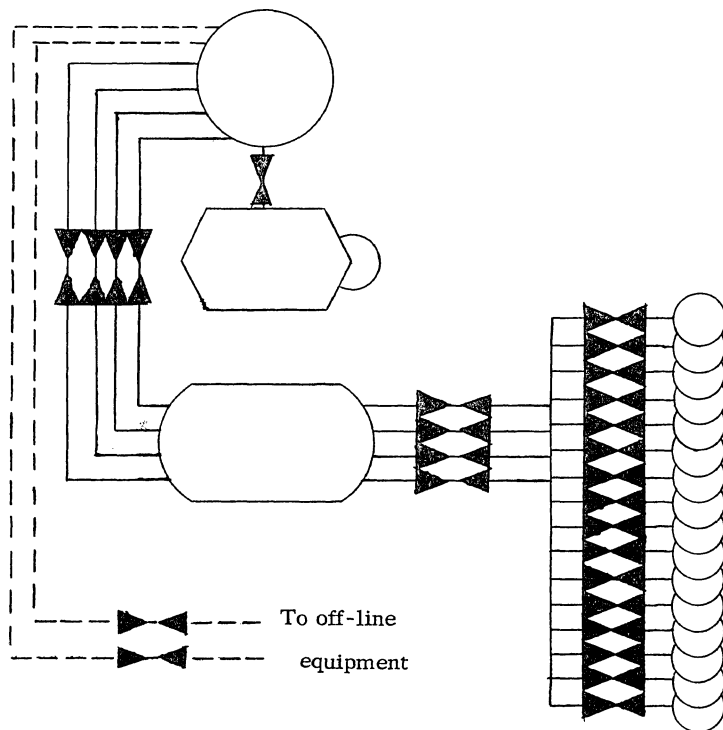

<u>Equipment</u>	<u>Rental</u>
1.5 μ sec. Core Storage:	17,900
Central Processor and Console: Typewriter	11,000 900 1,300
Input-Output Proc- essor: Four multiplexed transmissions to and from magnetic tape.	8,400
16 Magnetic Tapes: 90,000 char/second	13,600
<hr/>	
Total	53,100
Total, including off-line equip- ment:	\$ 64,475

§ 031.

.4 VIII B 20-TAPE GENERAL, PAIRED CONFIGURATION (Contd.)

Off-Line Equipment

	<u>Equipment</u>	<u>Rental</u>
	Buffer Controller, Model 252:	1,560
	2 Magnetic Tapes: 90,000 char/second	1,700
	Punch Card Controller:	1,365
	Card Reader: 2,000 cards/minute	800
	Card Punch: 100 cards/minute	350
	Buffer Controller, Model 252:	1,560
	2 Magnetic Tapes: 90,000 char/ second	1,700
	Printer Controller:	2,340
	High Speed Printer: 900 lines/minute	2,340
	Total	\$ 11,375



INTERNAL STORAGE: CORE STORAGE PARTITION

§ 042.

.1 GENERAL

.11 Identity: Partitioned 10 μsec Core Storage.
P-10 Model 220.
Model 2216.
Model 2232.

.12 Basic Use: working storage.

.13 Description:

This is a partitioned version of the 16,384 or 32,768 word, 10 microsecond store. The access to each module of the store is independent, and a read phase of one access cycle in one part of the store can be overlapped with a write phase in another part. Otherwise, the operation and function is identical to the 10 microsecond store. The main differences, due to partitioning, are a reduction in the percentage demands by all peripheral units and an increase in speed of the central processor of about 25 to 40 per cent.

.14 Availability: 12 months.

.15 First Delivery: May 1961.

.16 Reserved Storage: . . none.

.2 PHYSICAL FORM

.21 Storage Medium: . . . magnetic core.

.22 Physical Dimensions

.221 Magnetic core type storage
Array size: 64 bits by 64 bits.

.23 Storage Phenomenon: direction of magnetization.

.24 Recording Performance

.241 Data erasable by instruction: yes.

.242 Data regenerated constantly: no.

.243 Data volatile: no.

.244 Data permanent: no.

.245 Storage changeable: . . no.

.28 Access Techniques

.281 Recording method: . . . coincident current.

.283 Type of access: uniform with overlap.

.29 Potential Transfer Rates

.292 Peak data rates
Cycling rates: 100,000 cps.
Unit of data: word.
Conversion factor: . . . 48 bits/word.
Data rate: 100,000 words/sec.
Compound data rate: 100,000 words/sec.

.3 DATA CAPACITY

.31 Module and System Sizes

	Maximum	Minimum
Identity:	Model 2232.	Model 2216.
Words:	32,768.	16,384
Characters:	262,144.	131,072.
Instructions:	65,536.	32,768.
Bits:	1,572,864.	786,432.
Modules:	4	2.

.32 Rules for Combining

Modules: only combinations as shown above.

.4 CONTROLLER

.41 Identity: Model 220-1 and 220-2; partition for Model 2216 and Model 2232 Core Storage respectively.

.42 Connection to System

.421 On-Line: 1.
.422 Off-Line: none.

.43 Connection to Device

.431 Devices per controller: 2 or 4, 8, 192 word modules.
.432 Restrictions: none.

.5 ACCESS TIMING

.51 Arrangement of Heads

.511 Number of Stacks: . . . 2 or 4.
.512 Stack movement: . . . none.
.513 Stacks that can access any particular locations: 8, 192.
.514 Accessible locations
By single stack: . . . all.

.52 Simultaneous Operations

: none.

§ 042.

.53 Access Time Parameters and Variations

.531 For uniform access
 Access time: 4 μ sec.
 Cycle time: 10 μ sec.
 For data unit of: . . . 48-bit word.

.532 Variation in access time: access to separate modules may be overlapped.

.6 CHANGEABLE STORAGE: none.

.7 PERFORMANCE

.71 Data Transfer

Pair of storage units possibilities
 With self: yes.
 With drum: yes.

.72 Transfer Load Size

With self: 1 word, or up to 4,095 words using repeat.
 With drum: 4,096 words.

.73 Effective Transfer Rate

With self: 70,000 words/sec (**).
 With drum: 58,500 words/sec.

.8 ERRORS, CHECKS AND ACTION

<u>Error</u>	<u>Check or Interlock</u>	<u>Action</u>
Invalid address:	none.	modulo size of store.
Receipt of data:	none.	
Recording of data:	none.	
Recovery of data:	none.	

(**) Estimate based on nearly complete data and probably reliable.



INTERNAL STORAGE: 1.5 μ SEC. CORE STORAGE

§ 043.

.1 GENERAL

.11 Identity: 1.5 μ sec. Core Storage.
Model 2108.
Model 2116.
Model 2132.

.12 Basic Use: working storage.

.13 Description:

This is a partitioned core store identical in operation and function to the 10 microsecond partitioned store (Section 262:042). The only differences are in timing. These differences reduce the percentage demands on the store by all peripheral units and increase the speed of operation of the central processor by a factor of about three over the 10 microsecond partitioned store.

.14 Availability: 12 months.

.15 First Delivery: February 1962.

.16 Reserved Storage: . . . none.

.2 PHYSICAL FORM

.21 Storage Medium: . . . magnetic core.

.22 Physical Dimensions

.221 Magnetic core type storage: 48 + 8 bits/word.
2 words/strip.
1,024 strips/section.
4 sections/module.

.23 Storage Phenomenon: direction of magnetization.

.24 Recording Performance

.241 Data erasable by instructions: yes.

.242 Data regenerated constantly: no.

.243 Data volatile: no.

.244 Data permanent: no.

.245 Storage changeable: no.

.28 Access Techniques

.281 Recording method: . . . linear select.

.283 Type of access: uniform with overlap.

.29 Potential Transfer Rates

.292 Peak data rates

Cycling rates: 666,666 cps.

Unit of data: 48-bit word.

Conversion factor (bits for unit): 8 char/word.

Gain factor: 2.

Data rate: 666,666 words/sec.

Compound data rate: 1,333,333 words/sec.

.3 DATA CAPACITY

.31 Module and System Sizes

	Minimum Storage	Maximum Storage
Identity:	Model 2108	Model 2116 Model 2132
Words:	8,192	16,384 32,768
Characters:	65,536	131,072 262,144
Instructions:	16,384	32,768 65,536
Bits:	393,216	786,432 1,572,864
Modules (8,192 words)	1	2 4

.32 Rules for Combining

Modules: all combinations are shown above.

.4 CONTROLLER

.41 Identity: built into core storage.

.42 Connection to System

.421 On-Line: 1.

.422 Off-Line: none.

.43 Connection to Device

.431 Devices per controller: 1, 2, or 4, 8,192 word modules.

.432 Restrictions: none.

.5 ACCESS TIMING

.51 Arrangement of Heads

.511 Number of Stacks: . . . 1, 2 or 4.

.512 Stack movement: . . . none.

.513 Stacks that can access any particular location: 8,192.

.514 Accessible locations By single stack: . . . all.

.52 Simultaneous Operations: none.

§ 043.

.53 Access Time Parameters and Variations

.531 For uniform access
 Access time: 0.6 to 0.7 μ sec.
 Cycle time: 1.5 μ sec.
 For data unit of: . . . 48-bit word.

.532 Variation in access
 time: access to separate modules
 may be overlapped.

.6 CHANGEABLE STORAGE: none.

.7 PERFORMANCE

.71 Data Transfer

Pair of storage units
 possibilities
 With self: yes.
 With drum: yes.

.72 Transfer Load Size
 With self: 1 word, or up to 4,095
 words using repeat.
 With drum: 4,096 words.

.73 Effective Transfer Rate
 With self: 111,111 words/sec.
 With drum: 58,500 words/sec.

.8 ERRORS, CHECKS AND ACTION

<u>Error</u>	<u>Check or Interlock</u>	<u>Action</u>
Invalid address:	none.	modulo size of store.
Receipt of data:	none.	
Recording of data:	none.	
Recovery of data:	none.	



CENTRAL PROCESSOR

§ 051.

.1 GENERAL

.11 Identity: Central Processor.
Model 211.

.12 Description

The Model 211 Central Processor is a faster version of the Model 210. The increase in speed is accomplished by use of faster circuitry. In all programming aspects, the two central processors are identical, with upward compatibility of programs and software systems. The only paragraphs that differ from those describing the 210 are 652:051.33, .134, and .4.

The Model 211 can utilize any of several core storage systems: the 10 microsecond store, the partitioned 10 microsecond store (using the Model 220 Partition Controller), or the 1.5 microsecond store. By using the partitioned 10 microsecond or the 1.5 microsecond device, real-time data access and automatic interrupt can be incorporated into the 211 system. The Real-Time Scanner, Auto-Control Unit and Interval Timer provide this facility.

All other input-output devices as used in the 210 systems are employed in the 211 systems in an identical manner. The central processor console and operating controls are identical to the Model 210.

.13 Availability: 12 months.

.14 First Delivery: late 1960.

.2 PROCESSING FACILITIES

.21 Operations and Operands

Operation and Variation	Provision	Radix	Size
.211 Fixed point			
Add-Subtract:	automatic	binary	48-bit.
Multiply			
Short-rounded:	automatic	binary	48-bit.
Long:	automatic	binary	96-bit.
Divide			
No remainder-rounded:	automatic	binary	48-bit.
Remainder:	automatic	binary	96-bit.
.212 Floating point			
Add-Subtract:	automatic	binary	12 & 36-bit.
Multiply			
Short:	automatic	binary	12 & 36-bit.
Long:	automatic	binary	12 & 72-bit.
No remainder-rounded:	automatic	binary	12 & 36-bit.
Remainder			
Quotient:	automatic	binary	12 & 36-bit.
Remainder:	automatic	binary	12 & 36-bit.

.213 Boolean

AND:	automatic	binary	0 to 48 bits.
Inclusive OR:	automatic	binary	0 to 48 bits.
Exclusive OR:	automatic	binary	0 to 48 bits.

.214 Comparison

Numbers:	automatic	} equal,	} 1 word.
Absolute:	none		
Letters:	automatic	} than or	} 1 word.
Mixed:	automatic		
Collating sequence:	0 to 9, A to Z with special characters interspersed; see Data Code Table No. 1.		

.215 Code translation: . . . automatic translation between Hollerith and internal Philco code provided in input-output equipment. Other translations (e.g., binary to octal, etc.) are programmed functions via standard subroutines.

.216 Radix conversion

Provision	From	To	Size
Subroutine	fixed point	floating point	48-bit.
Subroutine	floating point	fixed point	48-bit.
Subroutine	decimal	binary	48-bit.
Subroutine	binary	decimal	48-bit.

.217 Edit format

	Provision	Size
Alter size:	none	1 word.
Round off:	none.	
Insert point:	none.	
Insert spaces:	none.	
Insert:	none.	
Float:	none.	
Protection:	none.	

.218 Table look-up

Equality:	subroutine.
Greater than:	none.
Greatest:	none.
Least:	none.

.219 Others

Repeat: repeat 1 or 2 instructions, 0 to 4,095 times.

Branch on odd or even, positive or negative numbers: automatic 1 bit shift, 0 to 63 times.

Check status of counters and fault registers in input-output system (skip instructions): allows determination of acceptance and/or status of input-output order and status of input-output equipment on-line.

.22 Special Cases of Operands

.221 Negative numbers: . . . two's complement with sign as most significant bit in word.

§ 051.

- .222 Zero: positive only; fixed point is 48 zeros in word; floating point zero contains a 1 bit in exponent sign.
- .223 Operand size determination: fixed.

.23 Instruction Formats

- .231 Instruction structure: half word; 1 word for input-output orders.
- .232 Instruction layout:

NAME	S	A	F	C	Non-indexable
SIZE, BITS	1	15	1	7	

NAME	S	N	V	F	C	Indexable
SIZE, BITS	1	3-5	10-12	1	7	

NAME	Not used	NBS	Not Used	IOP CH.	Not used	NBP	FROM	TO	Input-Output (tape)
SIZE, BITS	12	4	4	4	12	4	4	4	

NAME	S	UNIT	SC	CQ	F	C	Skip
SIZE, BITS	1	4	2	9	1	7	

- .233 Instruction parts
 - Name Purpose
 - S : selector list set to 1 indicates the instruction is indexable and the reduced address field is used; if set to 0, the full address field is used.
 - A : address field.
 - F : F bit is 1 in floating point instr. or in branch to instruction in right half of word.
 - N : specifies index register referenced - field size varies with number of index registers in central processor.
 - V : value added to contents of specified index register to form operand's effective addresses.
 - C : command includes F-bit.
 - NBS : number of blocks on MT to space over.
 - IOP CH : logical MT number.
 - NBP : number of blocks of MT to transfer.
 - FROM : from device.
 - TO : to device.
 - UNIT : unit to check for count or faults.
 - SC : subcommand of skip instruction.
 - CQ : comparison quantity.

- .2361 Internal storage type: core.
 - Minimum size: 1 word.
 - Maximum size: 1 word.
 - Volume accessible: . . 32,768 words.
- .2362 Increased address capacity: none.
- .237 Address indexing
 - .2371 Number of methods: . 1.
 - .2372 Names: indexing.
 - .2373 Indexing rule: addition, modulo 32,767.
 - .2374 Index specification: . . N field of indexable instruction.
- .2375 Number of potential indexers: 8, 16, or 32 optional index registers.
- .2376 Addresses which can be indexed: all instructions except repeat, skip, and input-output.
- .2377 Cumulative indexing: . none.
- .2378 Combined index and step: yes; index register can be automatically incremented by one if counter bit is set to 1.
- .238 Indirect addressing: . . none.
- .239 Stepping
- .2391 Specification of increment: index register counter bit specifies automatic increment of 1 as referencing indexable instruction is executed. Stepping index register instructions hold increment or decrement to maximum value of 4,095. Data register may hold increment or decrement of 0 to 32,767.
- .2392 Increment sign: none; considered absolute value.
- .2393 Size of increment: . . 0 to 32,767.
- .2394 End value: specified in test instruction.
- .2395 Combined step and test: for increment or decrement of up to 5 digits (maximum value of 32,767).

- .234 Basic address structure: 1 + 0.
- .235 Literals
 - Arithmetic: none.
 - Comparisons and tests: none.
 - Incrementing modifiers (repeat and index register control): . . 12 bits (maximum value 4,095).
- .236 Directly addressed operands

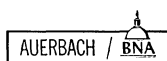

§ 051.

.24 Special Processor Storage

Category of storage	Number of locations	Size in bits	Program usage
Processor:	3	48	arithmetic, data manipulation.
Processor:	2	15	program control.
Processor:	1	16	program control.
Processor:	8, 16, or 32	16	indexing.
Processor:	1	48	instruction register.
Processor:	1	18	repeat control.
Processor:	1	48	hold input-output order.
I/O Processor:	1	8	assembler availability.
I/O Processor:	1, 2, 3, or 4	10	assembler fault.
I/O Processor:	1, 2, 3, or 4	12	assembler counter.
I/O Processor:	16	4	unit availability.

Note: I/O Processor counters and fault registers may be interrogated from the Central Processor.

Category of storage	Total number locations	Physical form	Access time, μ sec
Processor:	17 to 41	flip-flop	approx. 0.1
I/O Processor:	4 to 25	flip-flop	approx. 0.1

.3 SEQUENCE CONTROL FEATURES

.31 Instruction Sequencing

- .311 Number of sequence control facilities: . . . 1.
- .314 Special sub-sequence counters
 - Number: 1.
 - Purpose: repeat counter.
- .315 Sequence control step size: instruction pairs.
- .316 Accessibility to routines: available immediately after a jump is performed.
- .317 Permanent or optional modifier: none.
- .32 Look-Ahead: none.
- .33 Interruption
- .331 Possible causes: any of 48 conditions in central processor, input-output, and/or real-time devices capable of emitting a signal are possible interrupt criteria. Interrupt occurs via the Model 401, 404 or 408 Auto-Control Unit.

- .332 Control by routine
 - Individual control: . . . interrupt by from 1 to 48 possible conditions.
 - Method: programmer sets mask in Auto-Control Unit.
 - Restriction: none.

- .333 Operator control: . . . operator may enter instruction via central processor console to set new mask in Auto-Control Mask Register.

- .334 Interruption conditions: mask bits set to one; no interrupt if mask bit is zero.

- .335 Interruption process: refer to Auto-Control Unit description, Section 652:106.

- .336 Control methods
 - Determine cause: . . . masked interrupt bits from Auto-Control register are automatically transferred to core storage location MASK + 1 and may be examined by an executive routine to determine the particular interrupt condition.
 - Enable interruption: . . an executive routine preserves and restores all registers, allowing a return to an interruptable routine.

- .34 Multi-running: none².

- .35 Multi-sequencing: . . . none.

.4 PROCESSOR SPEEDS

Conditions

- I : 1.5 μ sec store.
- II : 10.0 μ sec partitioned store, would have intermediate values.
- III: 10.0 μ sec store.

.41 Instruction Times in μ secs

	I	II	III
.411 Fixed point			
Add-subtract:	3.6		15.0
Multiply:	44.5		53.0
Divide:	45.6		54.1
.412 Floating point			
Add-subtract:	7.6		16.1
Multiply:	34.4		42.9
Divide:	36.2		44.7
.413 Additional allowance for			
Indexing:	0.0		0.0
.414 Control			
Branch:	4.5		8.8
Compare and branch:	4.5		8.8
.415 Counter control			
Step:	3.0		7.3
Step and test:	3.0		7.3
.418 Shift:	2.7+0.85N		2.0+0.85N

.42 Processor Performance in μ secs

	I		III	
	Fixed point		Floating point	
.421 For random addresses				
c = a + b:	8.0	45.0	12.0	46.1
b = a + b:	6.5	32.1	10.5	36.1
Sum N items:	3.6	10.0	7.6	11.1
c = ab:	48.9	83.0	38.8	72.9
c = a/b:	50.0	84.7	40.6	74.7
.422 For arrays of data				
c _i = a _i + b _j :	13.8	59.4	17.8	60.5
b _j = a _i + b _j :	5.1	22.1	9.1	26.1
Sum N items:	2.8	10.0	6.8	10.0
c = c + a _i b _j :	54.8	71.8	50.1	67.1

§ 051.

.423	Branch based on comparison		
		I	III
	Numeric data:	7.4+19.9 N	37.9+89.1 N.
	Alphabetic data:	7.4+22.1 N	37.9+96.4 N.
.424	Switching		
	Unchecked:	12.5	53.8.
	Checked:	29.2	102.4.
	List search:	4.0	11.8.
.425	Format control per character		
	Unpack:	3.0	6.6.
	Compose:	42.1	149.6.
.426	Table look-up per comparison		
	For a match:	4.0	11.8.
	For least or greatest:	1.5	10.0.
	For interpolation point:	4.7	11.8.
.427	Bit indicator		
	Set bit in separate location:	2.8	10.6.
	Test bit in separate location:	4.5	8.8.
.428	Moving:	4.5	20.0.

.5 ERRORS, CHECKS AND ACTION

<u>Error</u>	<u>Check or Interlock</u>	<u>Action</u>
Overflow:	check	indicator.
Underflow:	check	error jump and alarm.
Zero divisor:	check	signal and indicator.
Invalid data:	none.	
Invalid operation:	check	stop.
Arithmetic error:	none.	
Invalid address:	check	stop and alarm.
Receipt of data:	parity check	indicator and alarm.
Dispatch of data:	parity check	indicator and alarm.

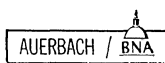



INPUT-OUTPUT: AUTO CONTROL UNIT

§ 106.

.1 GENERAL

- .11 Identity: Auto Control Unit.
Model 401.
Model 404.
Model 408.
ACU.

.12 Description

A Philco 211 system using either the partitioned 10 microsecond or the 1.5 microsecond core storage can incorporate real time capabilities by use of an Auto-Control Unit. This unit provides for automatic interrupt based on any of 48 different conditions arising within the computer system or some external source. A Real-Time Scanner associated with the Auto-Control unit is capable of scanning 1, 4 or 8

.12 Description (Contd.)

real time channels in the Models 401, 404 and 408, respectively. Scan time is 0.2 microseconds between successive channels. The acceptance or rejection of an interrupt is specified by the programmer setting a mask in the Auto-Control register. Receipt of an acceptable interrupt signal causes that corresponding bit, or bits, in the Auto-Control register to be cleared, and the remainder of the mask preserved in core storage. An executive routine is thus permitted to retain interrupt priorities. All central processor registers must be preserved and restored by the executive routine.

Two additional jump instructions are provided in the Model 211 Central Processor when used with the Auto-Control Unit. These permit unconditional jumps without disturbing the contents of the central processor Jump Address Register, allowing easy return to the interrupted routine.



INPUT-OUTPUT: INTERVAL TIMER

§ 107.

.1 GENERAL

.11 Identity: Interval Timer.
Model 402.

.12 Description

The Model 402 Interval Timer allows programmed reference to time information transmitted via the Auto-Control Unit. The Interval Timer can be set

.12 Description (Contd.)

by program to any value not exceeding 25 bits, allowing up to 9.32 hours decrementing time. Once set, automatic one millisecond decrementing occurs until the timer is decremented to zero; then the Auto-Control Unit is signaled. In addition, the timer may be read out by issuance of a real-time I/O instruction.



§ 121.

INSTRUCTION LIST

NOTE: Two additional instructions are provided in the Model 211 for use with the Auto-Control Unit in real-time processing. All other instructions of the Model 211 Central Processor are identical with the Model 210. (See 651:121.101)

INSTRUCTION			OPERATION
F	OP CODE	ADDRESS	
	JL	M	Unconditional jump to left hand instruction in M; Jump Address Register is not disturbed. Unconditional jump to right hand instruction in M; Jump Address Register is not disturbed.
	JR	M	



652:201.011

**Philco 2000 - 211
System Performance**

**PHILCO 2000 - 211
SYSTEM PERFORMANCE**

PHILCO 2000 - 211 SYSTEM PERFORMANCE

WORKSHEET DATA TABLE I											
Worksheet	Item		Configuration								Reference
			VIII B unblocked		VIII B blocked		VII B unblocked		VII B blocked		
1	Char/block	(File 1)	1,024		1,024		1,024		1,024		4:200.112
	Records/block	K (File 1)	10		10		10		10		
	m.sec/block	File 1 = File 2	11.4		11.4		11.4		11.4		
		File 3	11.4		11.4†		11.4		11.4†		
		File 4	11.4		11.4††		11.4		11.4††		
	m. sec/switch	File 1 = File 2	0		0		0		0		
		File 3	0		0		0		0		
		File 4	0		0		0		0		
	m. sec penalty	File 1 = File 2	0.92		0.92		1.28		1.28		
		File 3	0.92		0.07		1.28		0.11		
File 4		0.92		0.03		1.28		0.22			
2	m. sec/block	a1	0.056		0.056		0.205		0.205		4:200.1132
	m. sec/record	a2	0.189		0.189		0.658		0.658		
	m. sec/detail	b6	0.264		0.264		0.614		0.614		
	m. sec/work	b5 + b9	1.168		1.168		3.165		3.165		
	m. sec/report	b7 + b8	5.146		5.146		18.488		18.488		
3	m. sec for C. P. and dominant column.	a1	0.1		0.1		0.20		0.20		4:200.114
		a2 K	1.9		1.9		6.58		6.58		
		a3 K	66.1		66.1		222.67		222.67		
		File 1 Master In	0.9		0.2		1.28		11.4		
		File 2 Master Out	0.9		0.2		1.28		1.28		
		File 3 Details	9.2		114.0		0.2		11.4		
		File 4 Reports	9.2				0.7		12.8		
		Total	88.3		114.0		69.4		11.4		
4	Unit of measure	(words)									4:200.1151
		Std. routines	187		187		187		187		
		Fixed	0		0		0		0		
		3 (Blocks 1 to 23)	87		87		87		87		
		6 (Blocks 24 to 48)	684		684		684		684		
		Files	1,024		1,024		1,024		1,024		
		Working	100		100		100		100		
		Total	2,082		2,082		2,082		2,082		

† 10 details per block.

†† 5 reports per block.

PHILCO 2000-211 SYSTEM PERFORMANCE—Contd.

WORKSHEET DATA TABLE 2							
Worksheet	Item		Configuration				Reference
			VII B unblocked	VII B blocked	VIII B unblocked	VIII B blocked	
5	Fixed/Floating point		Floating	Floating	Floating	Floating	4:200.413
	Unit name	input	234	234			
		output	234	234			
	Size of record, words	input	10	10			
		output	23	23			
	m. sec/record	input T1	11.4	0.95	11.4	0.95	
		output T2	11.4	2.28			
	m. sec penalty	input T3	1.28	0.11			
		output T4	1.28	0.26			
	m. sec/record	T5	0.58	0.58	0.23	0.23	
m. sec/5 loops	T6	1.84	1.84	0.73	0.73		
m. sec/report	T7	1.91	1.91	0.74	0.74		
7	Unit name			234			4:200.512
	Size of block, words			128			
	Records/block		B	12		12	
	m. sec/block		T1		11.4	11.4	
	m. sec penalty		T3		0.1	0.02	
	C. P.	m. sec block	T5		0.044	0.010	
		m. sec record	T6		0.152	0.029	
m. sec table		T7		0.320	0.163		



SYSTEM PERFORMANCE

§ 201.

.1 GENERALIZED FILE PROCESSING

.11 Standard File Problem A

.111 Record Sizes

Master File: 108 characters.
Detail File: 1 card.
Report File: 1 line.

.112 Computation: standard.
.113 Timing Basis: using estimating procedure outlined in Users' Guide, 4:200.113.
.114 Graph: see graph below.
.115 Storage Space Required
Configuration VII B . . 3,000 words.
Configuration VIII B . 3,000 words.

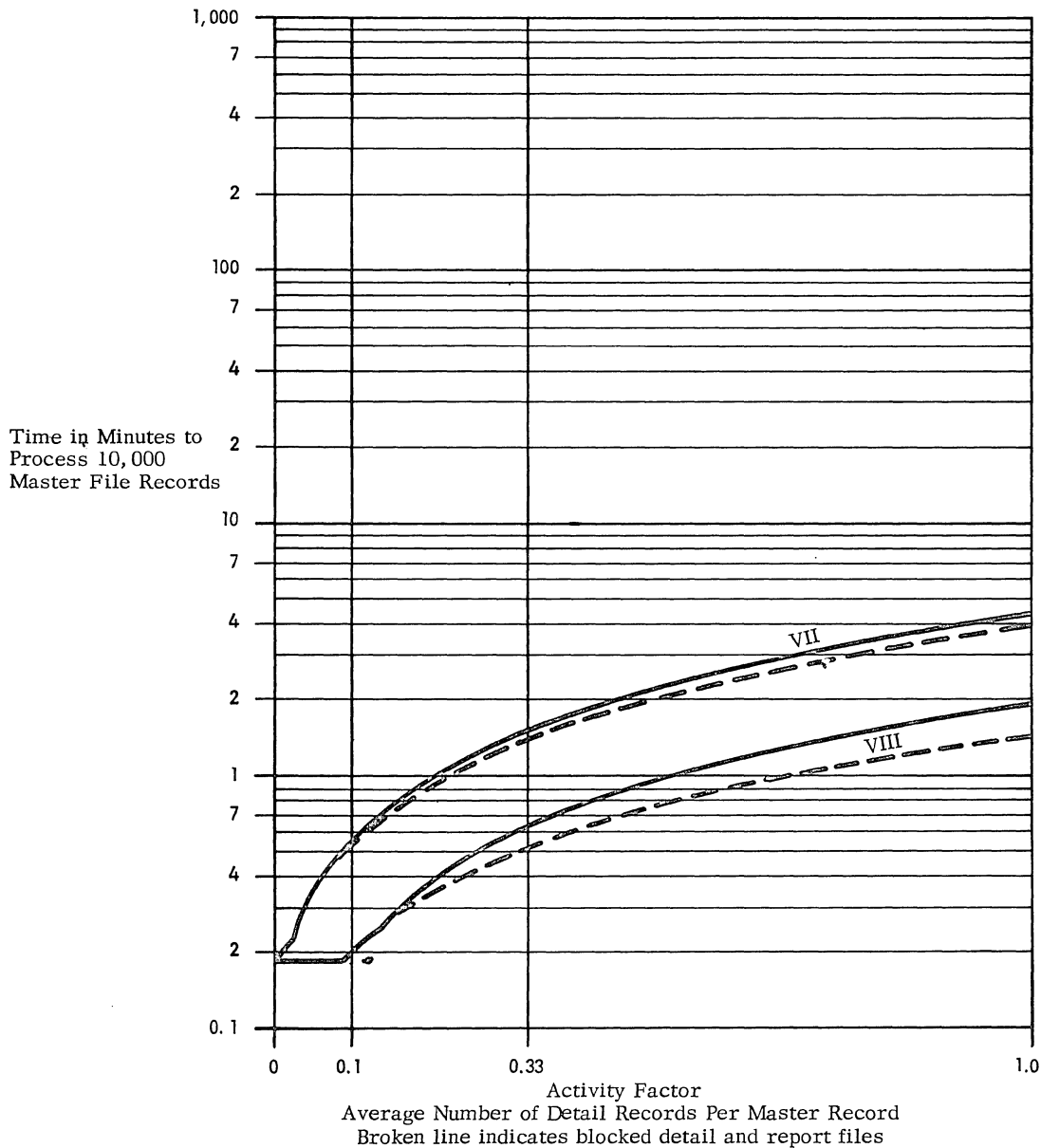

§ 201.

.12 Standard File Problem B

.121 Record Sizes

Master File: 54 characters.
Detail File: 1 card.
Report File: 1 line.

.122 Computation: standard.
.123 Timing Basis: using estimating procedure
outlined in Users' Guide,
4:200.12.
.124 Graph: see graph below.

Time in Minutes to
Process 10,000
Master File Records

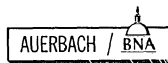
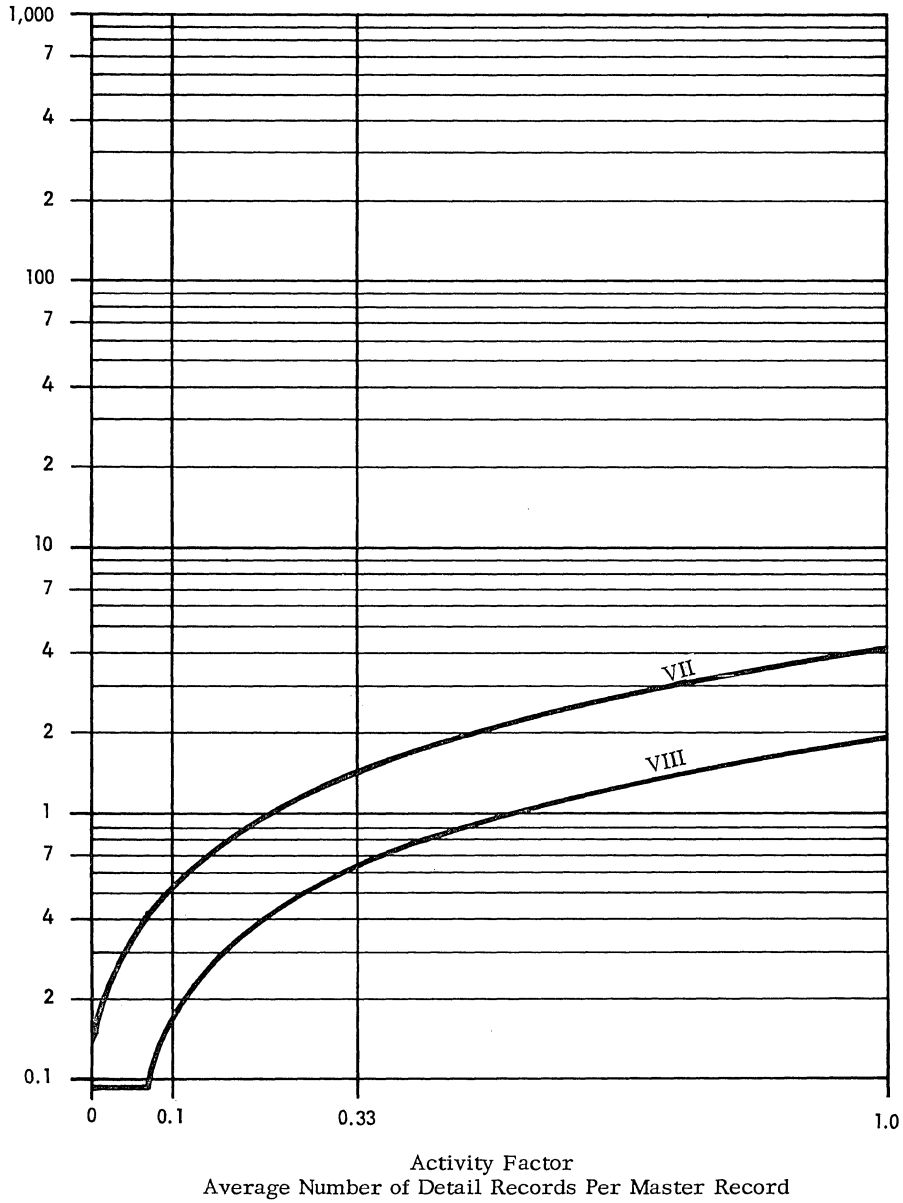

§ 201.

.13 Standard File Problem C

.131 Record Sizes

Master File: 216 characters.
 Detail File: 1 card.
 Report File: 1 line.

.132 Computation: standard.
 .133 Timing Basis: using estimated procedure
 outlined in Users' Guide,
 4:200.13.
 .134 Graph: see graph below.

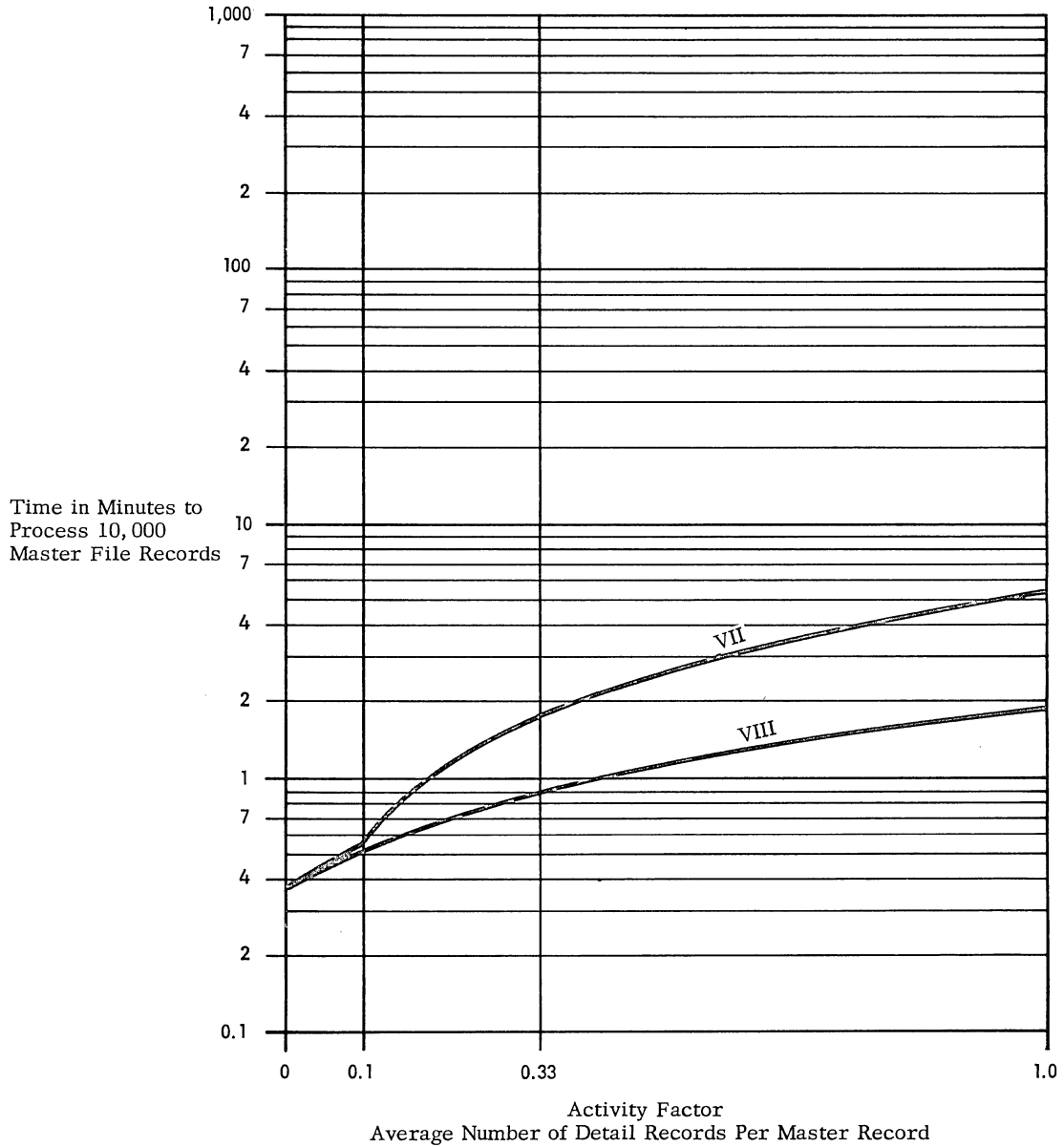

§ 201.

.14 Standard File Problem D

.141 Record Sizes

Master File: 108 characters.
Detail File: 1 card.
Report File: 1 line.

.142 Computation: trebled.
.143 Timing Basis: using estimated procedure
outlined in Users' Guide,
4:200.13
.144 Graph: see graph below.

Time in Minutes to
Process 10,000
Master File Records

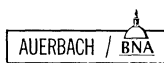
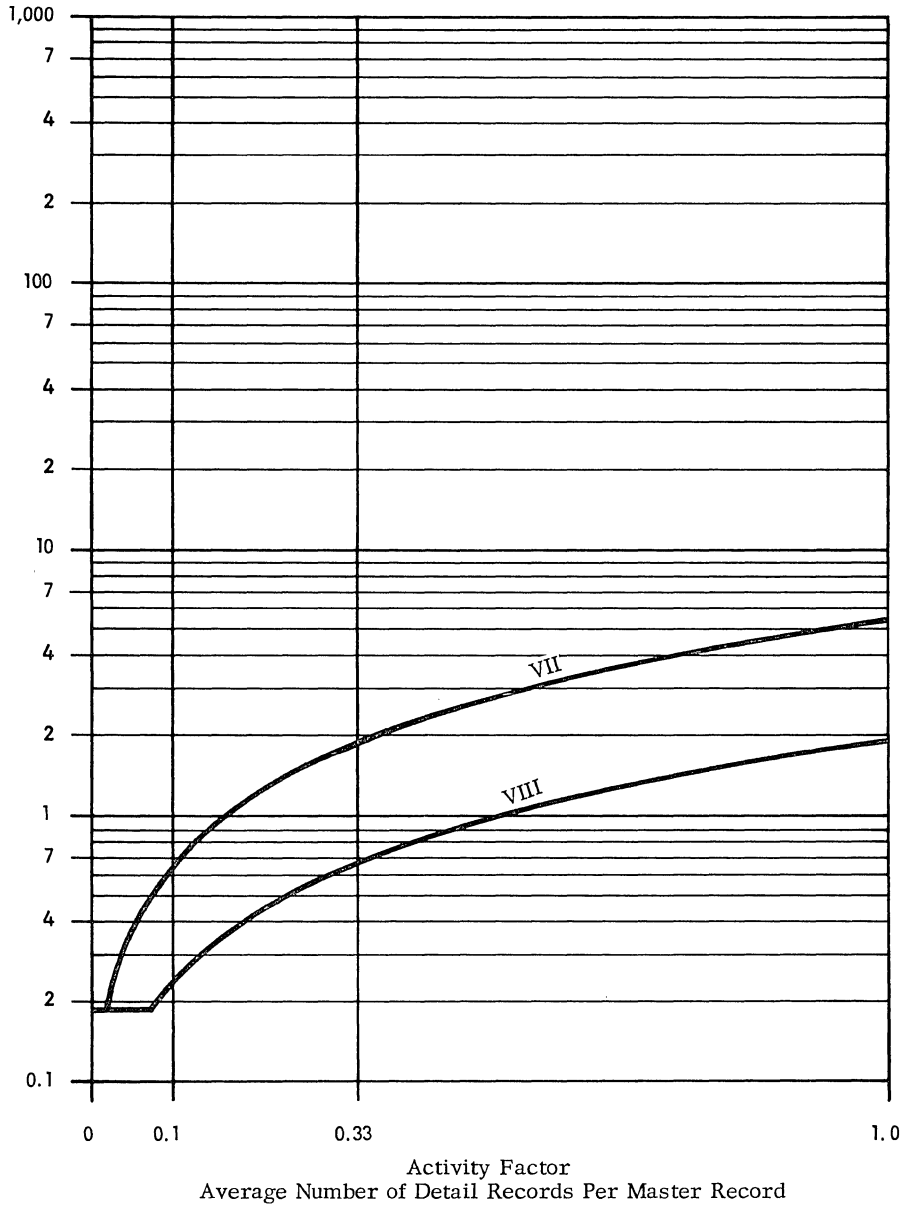

§ 201.

.2 SORTING

.21 Standard Problem Estimates

- .211 Record size: 80 characters.
- .212 Key size: 8 characters.

- .213 Timing basis: using estimated procedure outlined in User's Guide, 4:200.213.
- .214 Graph: see graph below.

Time in Minutes to Put Records Into Required Order

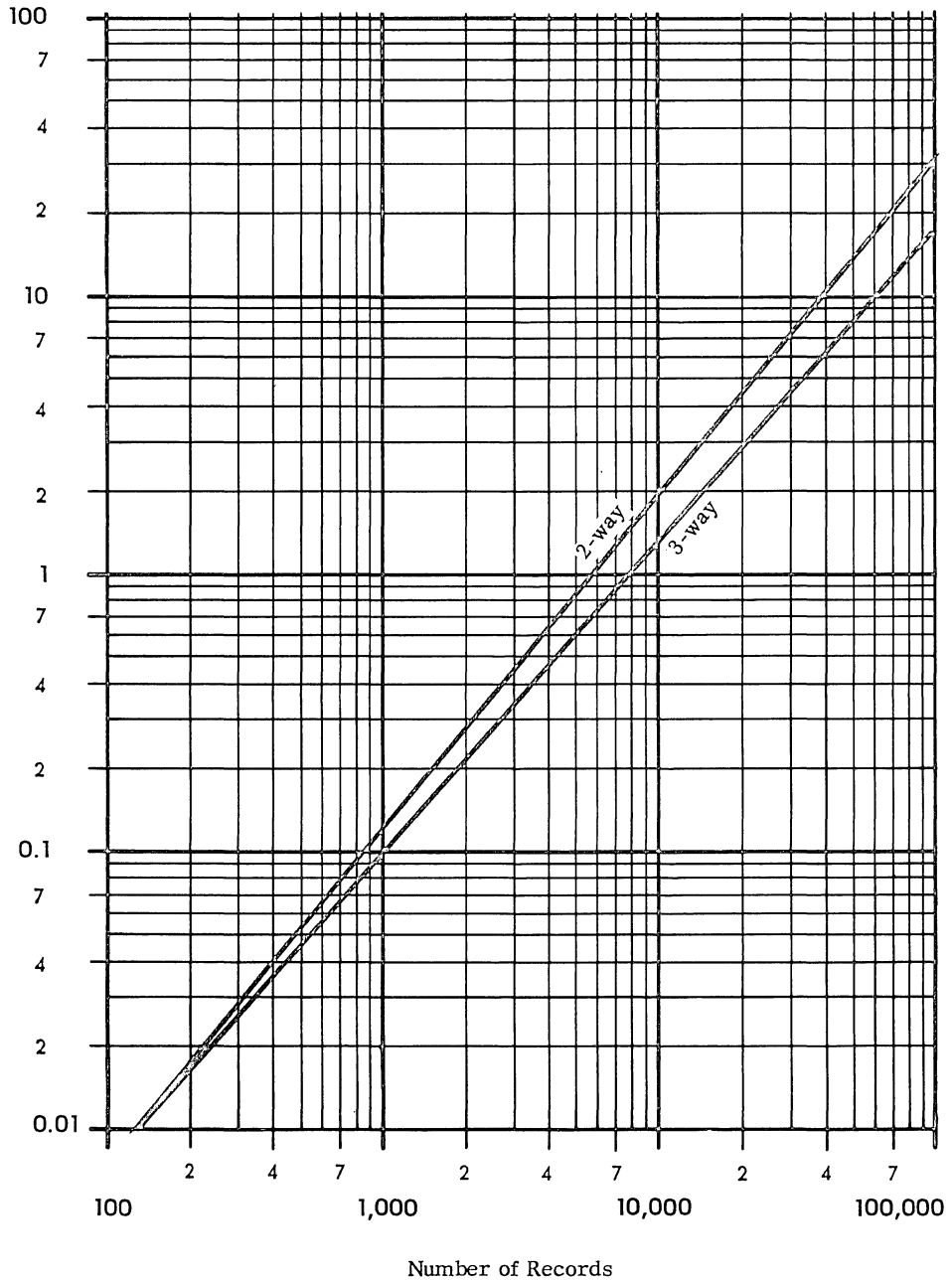

§ 201.

.3 MATRIX INVERSION

.31 Standard Problem Estimates

.311 Basic Parameters: . . . general, non-symmetric matrices, using floating point to at least 8 decimal digits.

.312 Timing Basis: using estimated procedure outlined in Users' Guide, 4:200.312.

.313 Graph: see graph below.

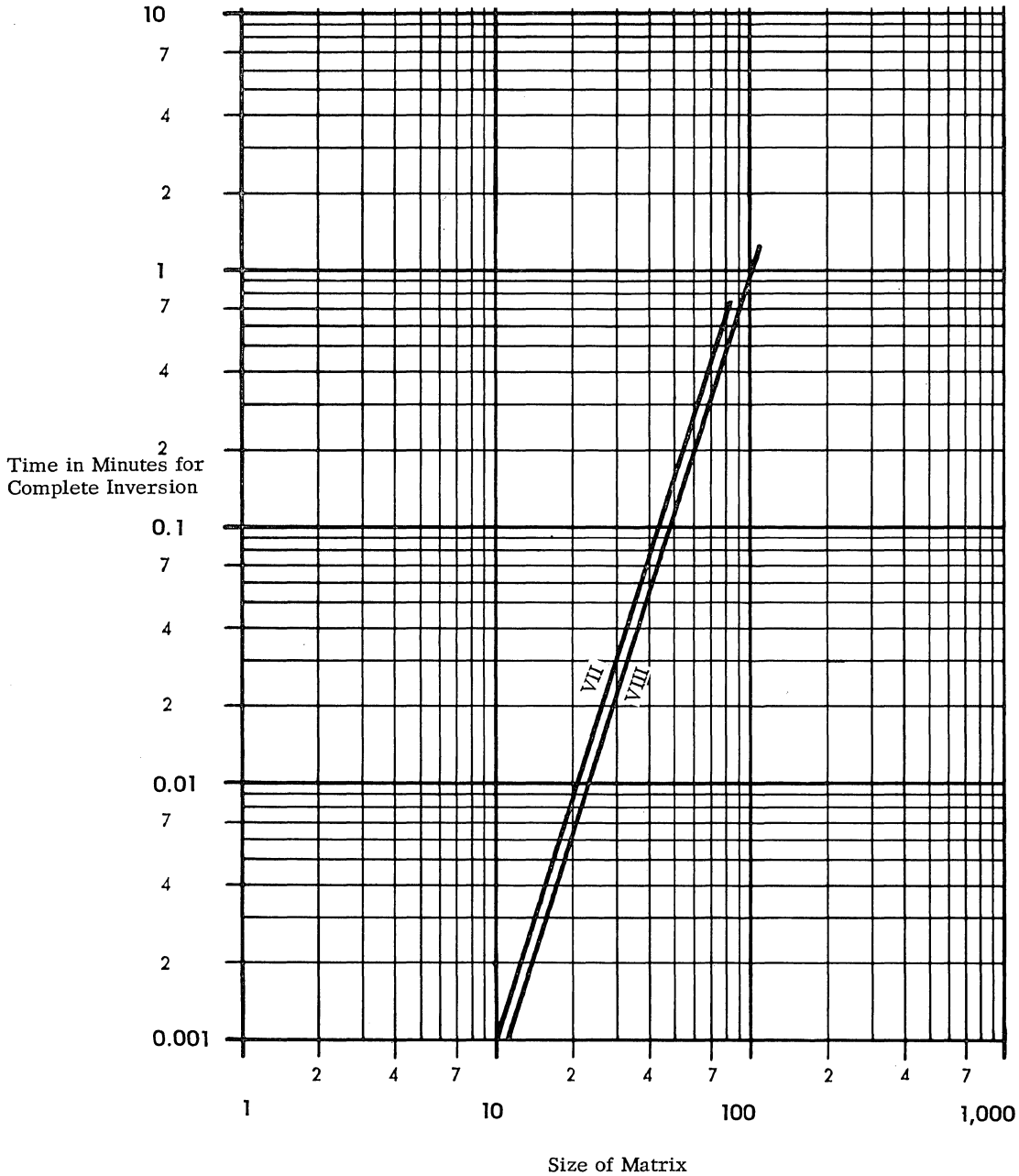

§ 201.

.2 SORTING

.21 Standard Problem Estimates

- .211 Record size: 80 characters.
- .212 Key size: 8 characters.

- .213 Timing basis: using estimated procedure outlined in User's Guide, 4:200.213.
- .214 Graph: see graph below.

Time in Minutes to Put Records Into Required Order

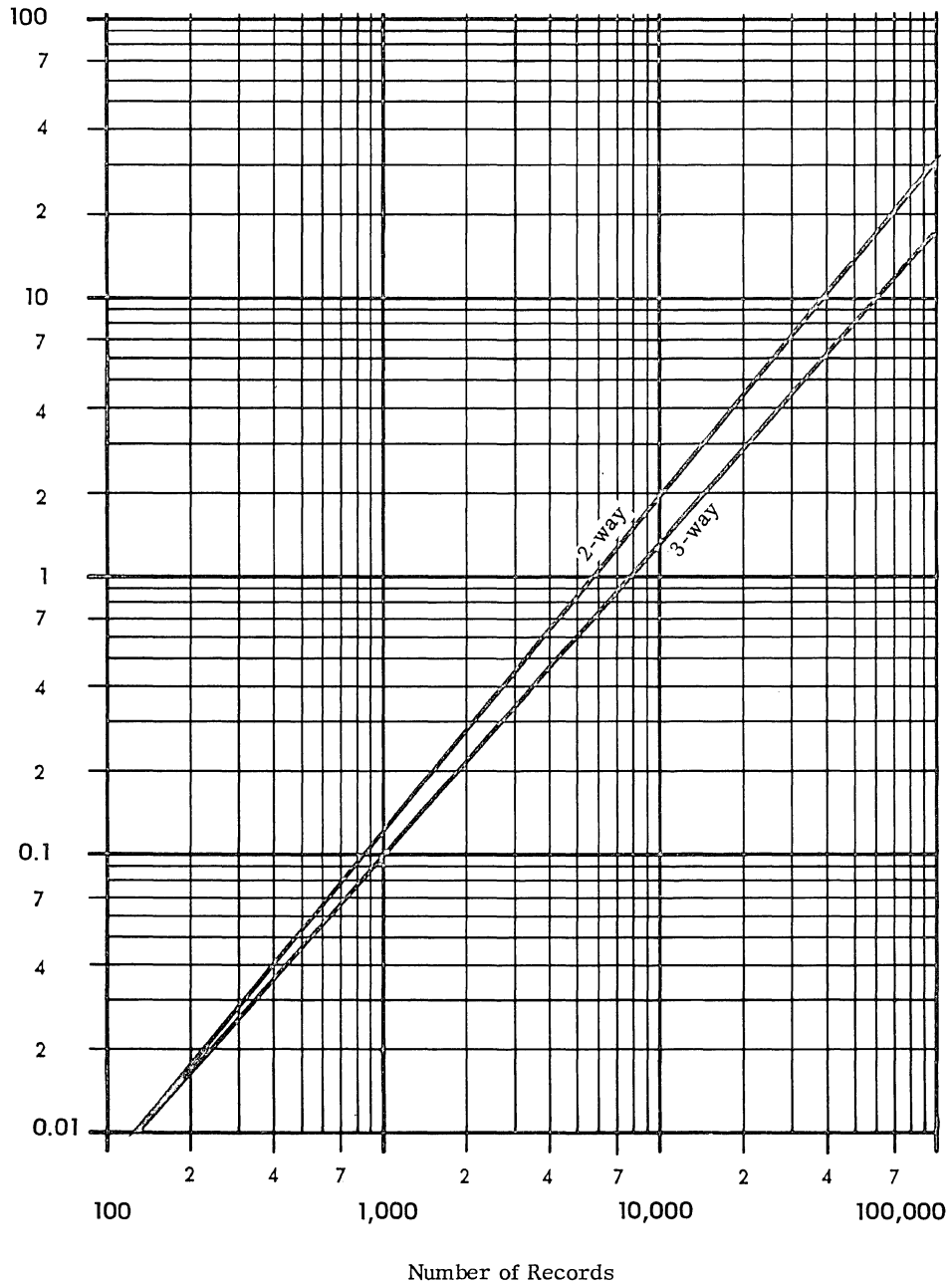

§ 201.

.3 MATRIX INVERSION

.31 Standard Problem Estimates

.311 Basic Parameters: . . . general, non-symmetric matrices, using floating point to at least 8 decimal digits.

.312 Timing Basis: using estimated procedure outlined in Users' Guide, 4:200.312.

.313 Graph: see graph below.

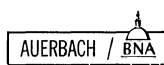
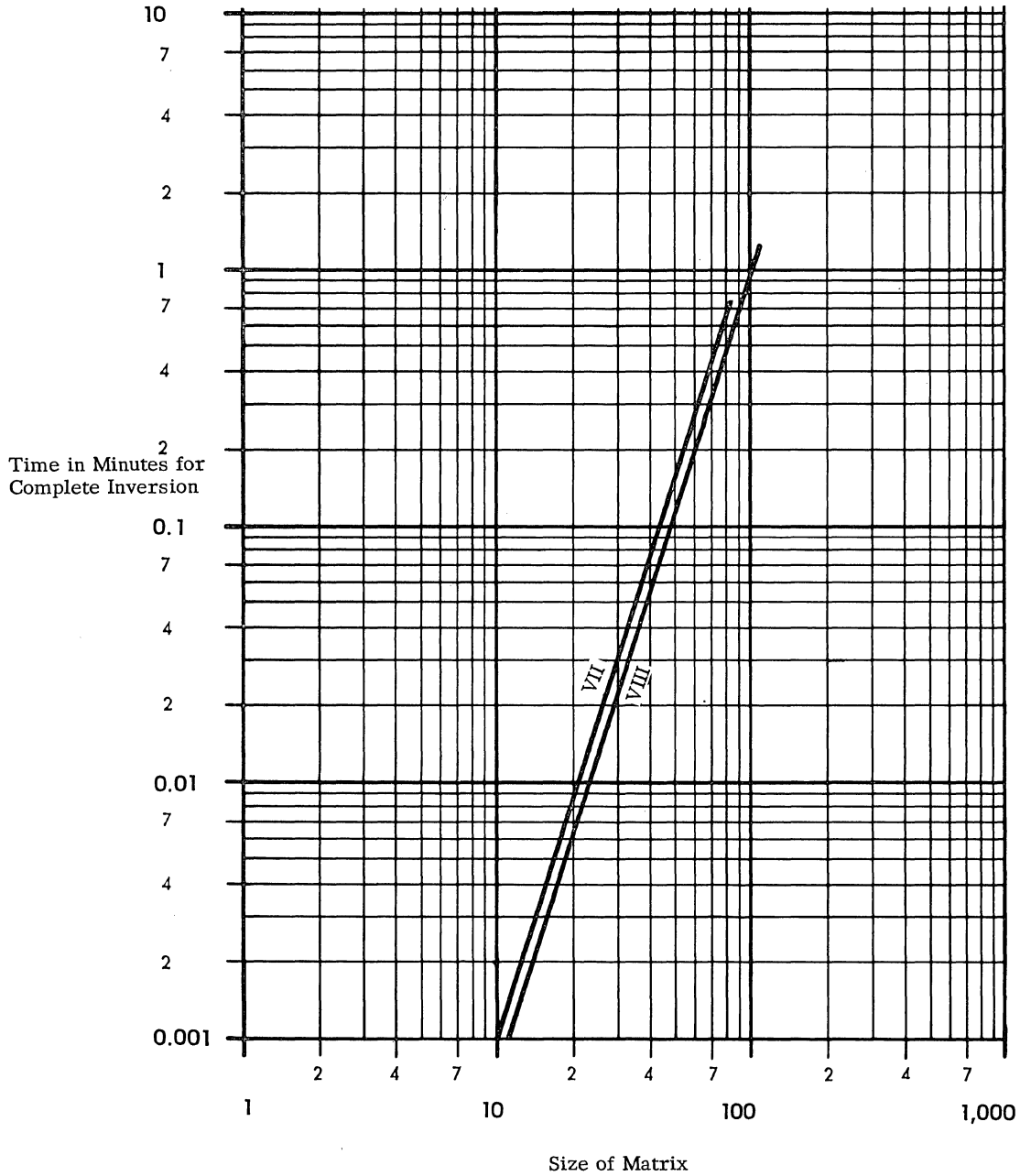

§ 201.

.32 Standard Routine Times

.321 Basic Parameters: . . . general, non-symmetric matrices, using floating point to at least 8 decimal digits.

.322 Timing Basis: standard floating point.

.323 Graph: see graph below.

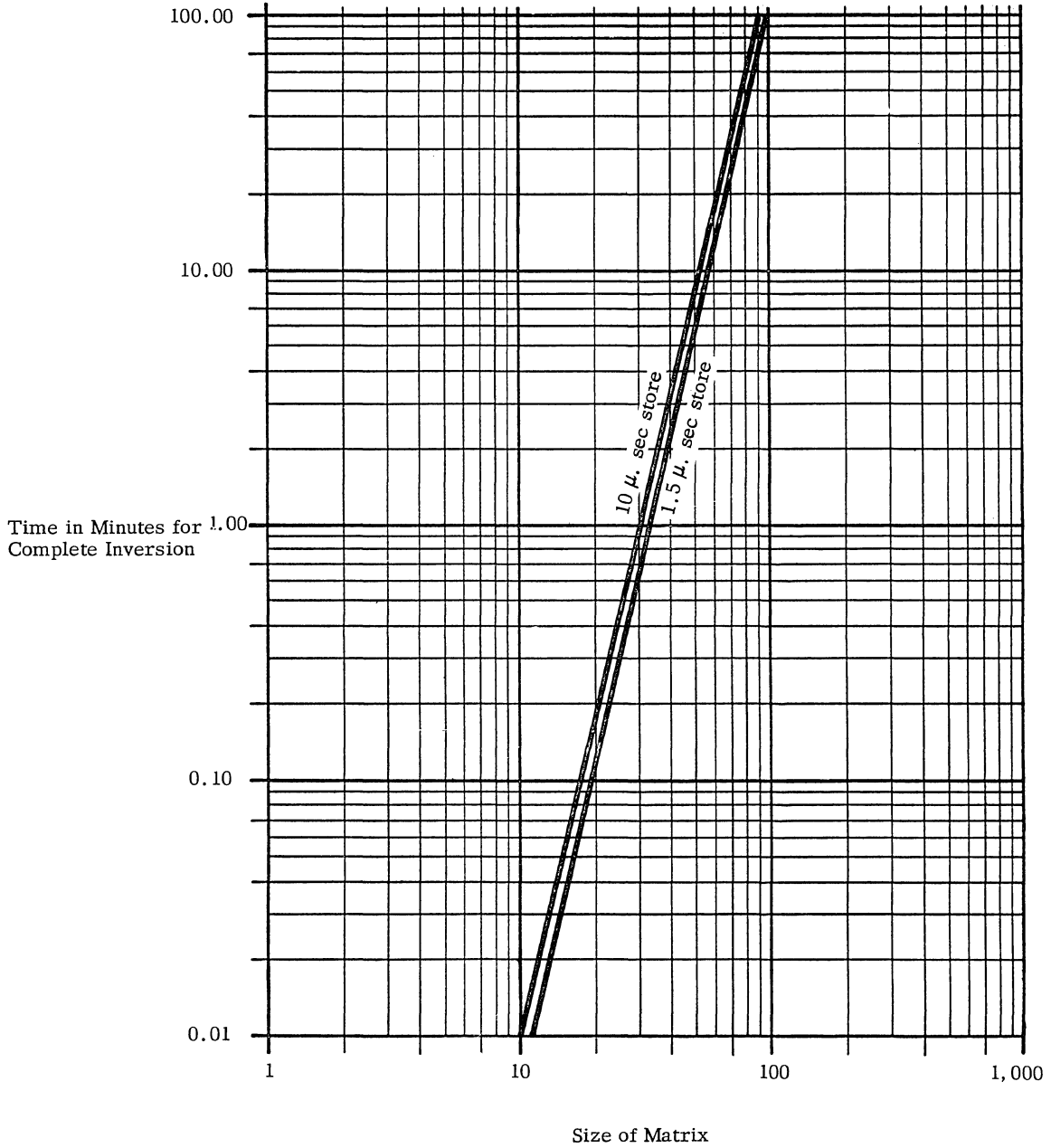

- § 201.
- .4 .412 Computation: 5 fifth-order polynomials.
5 divisions.
1 square root.
- .41 GENERALIZED MATHEMATICAL PROCESSING .413 Timing basis: using estimating procedure
outlined in Users' Guide,
4:200.413.
- .41 Standard Mathematical Problem A Estimates .414 Graph: see graph below.
- .411 Record sizes: 10 signed numbers, avg.
size 5 digits, max. size
8 digits.

Configuration VIIB 10 u sec store; Single Length (12 digit precision); floating point.
R = Number of Output Records per Input Record

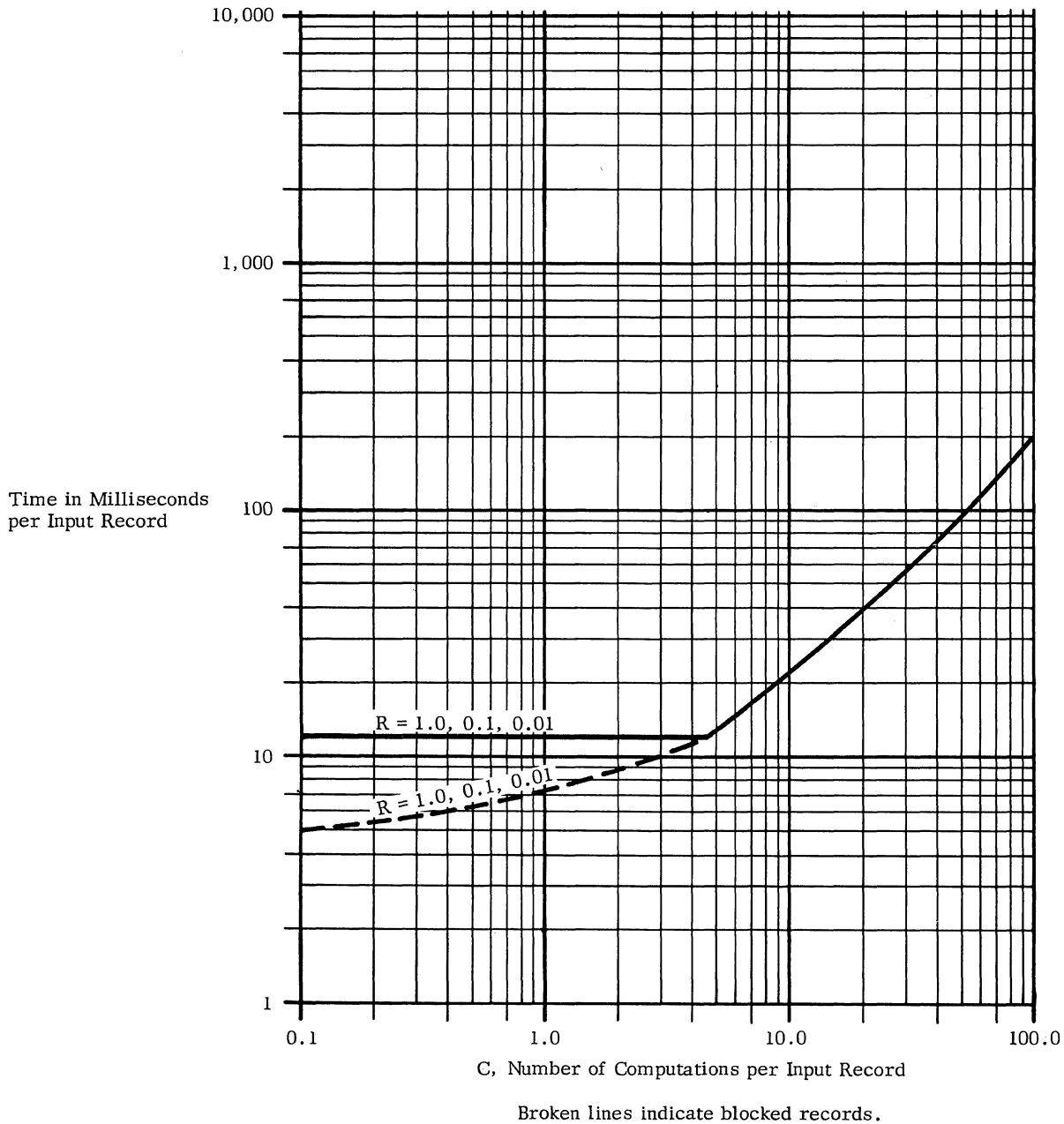

§ 201.

.415 Graph: see graph below.

Configuration VIII B 1.5 u.sec store; Single Length (12 digit precision); floating point.

R = Number of Output Records per Input Record

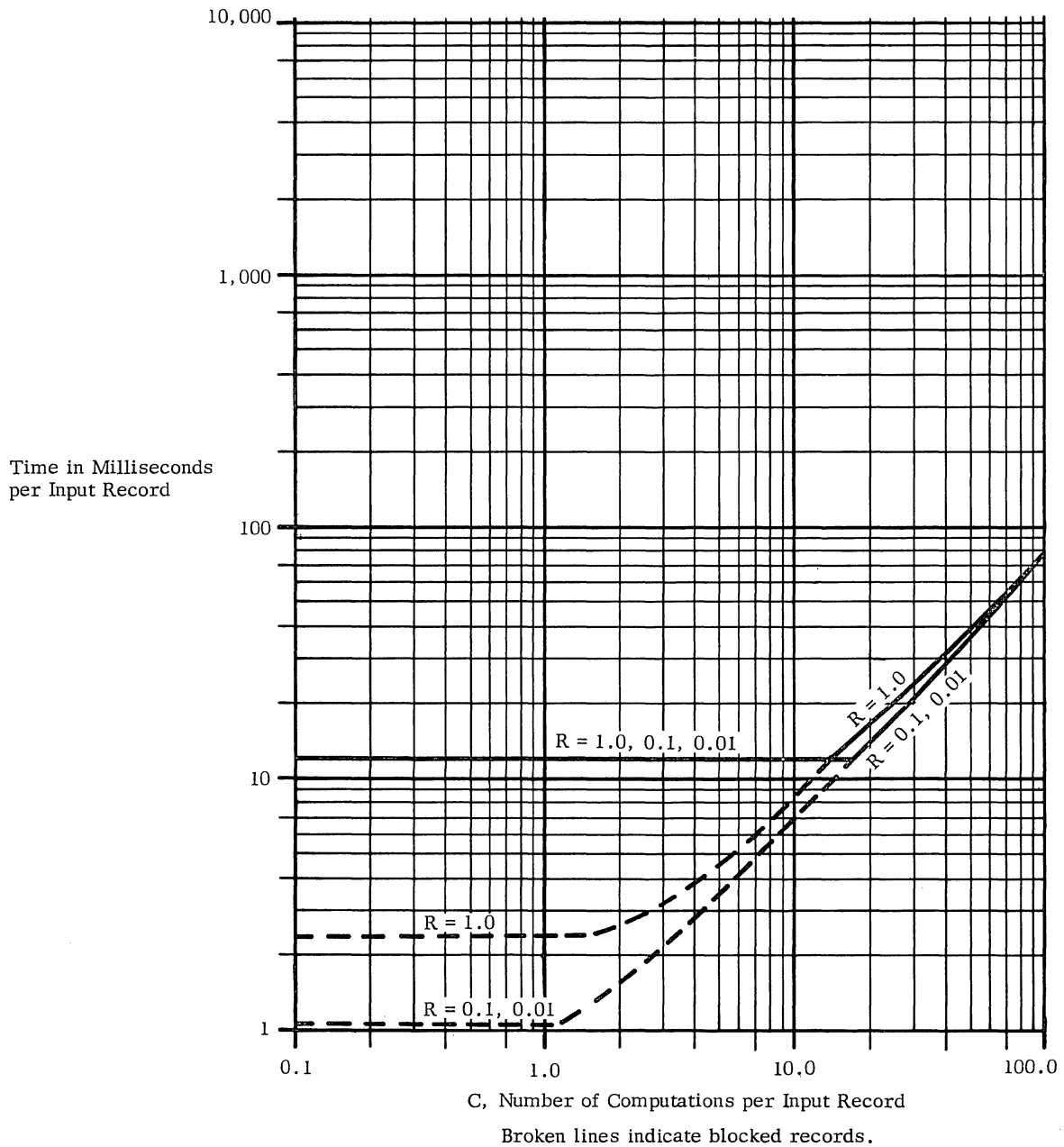

§ 201.

.5 GENERALIZED STATISTICAL PROCESSING

.51 Standard Statistical Problem A Estimates

.511 Record size: thirty 2-digit integral numbers.

- .512 Computation: augment T elements in cross-tabulation tables.
- .513 Timing basis: using estimating procedure outlined in Users' Guide, 4:200.513.
- .514 Graph: see below.

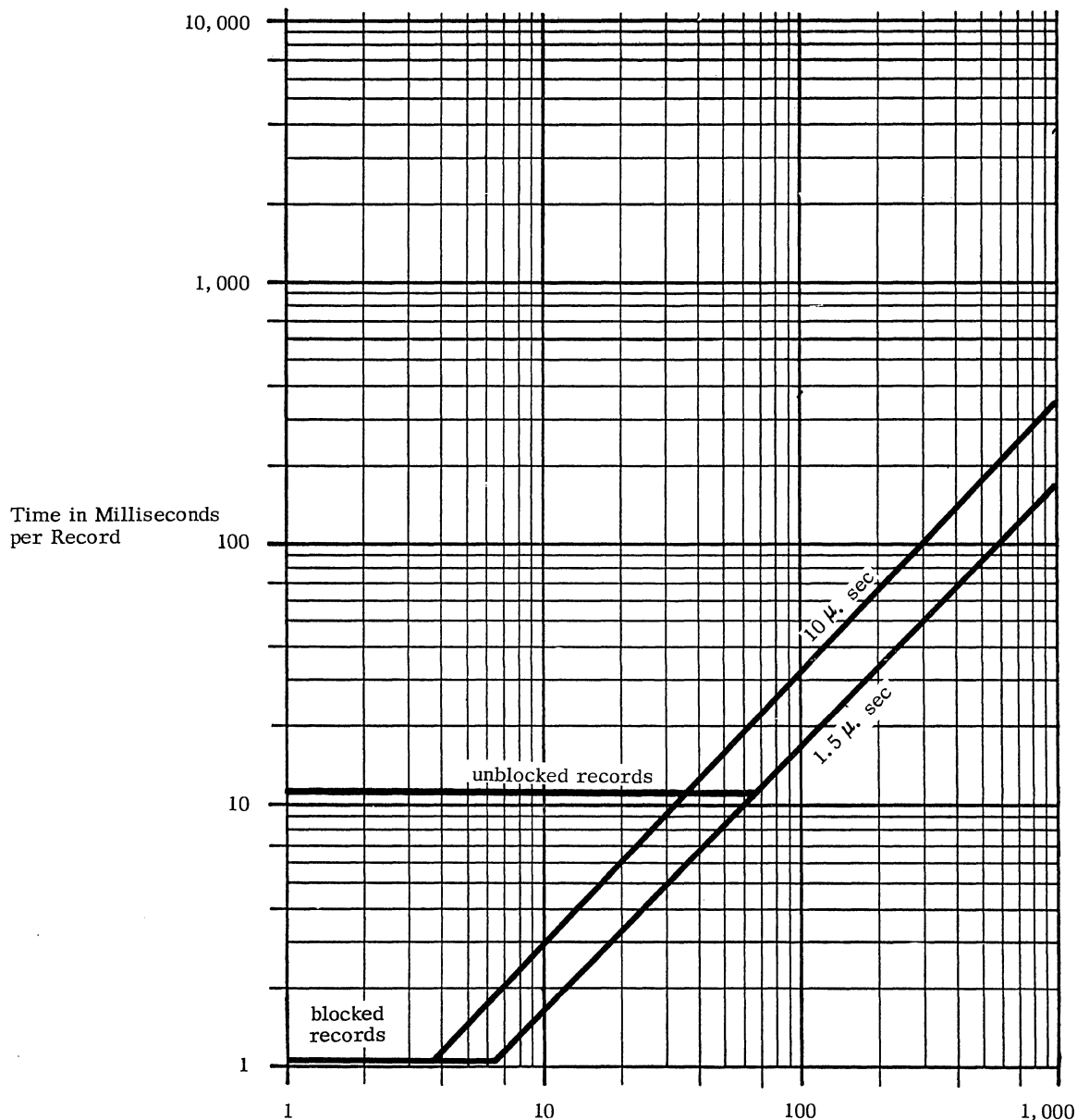

T, Number of Augmented Elements
Roman numerals denote Standard Configurations

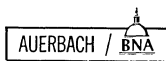



652:211.101

Philco 2000 - 211
Physical Characteristics

PHILCO 2000 - 211
PHYSICAL CHARACTERISTICS

PHILCO 2000-211 PHYSICAL CHARACTERISTICS

IDENTITY	Unit Name		Central Processor	Real Time Unit* (x1 Scanner)	Auto Control Unit (x4 Scanner)	Auto Control Unit (x8 Scanner)	1.5 μ sec Core Store
		Model Number		211	401	404	408
PHYSICAL	Height x Width x Depth, in.		44 x 108 x 34	75 x 61 x 24	75 x 61 x 24	75 x 61 x 24	?
	Weight, lbs.		1,413	500	650	800	
	Distance (feet) to other unit*						
ATMOSPHERE	Storage Ranges	Temperature, °F.					
		Humidity, %					
	Working Ranges	Temperature, °F.					
		Humidity, %					
	Heat Dissipated, BTU/hr.		9,775	4,430	6,130	7,830	
	Air Flow, cfm.						
	Internal Filters						
ELECTRICAL	Voltage	Nominal					
		Tolerance					
	Cycles	Nominal					
		Tolerance					
	Phases and Lines						
	Load KVA		2.875	1.300	1.800	2.300	
NOTES	*Max. physical distance from hole to hole in false floor (not cable length) using standard length cables.			*Includes Model 402 Interval Timer			

PHILCO 2000-211 PHYSICAL CHARACTERISTICS -Contd.

IDENTITY	Unit Name		Core Storage Adapter (16K)	Core Storage Adapter (32K)	Core Storage (1.5 μsec)	8K Remote Core Storage (1.5 μsec)	Digital Incremental Recorder
	Model Number		220-1	220-2	222	225	289
PHYSICAL	Height × Width × Depth, in.		75 × 32 × 24	74 × 61 × 24	57 × 32 × 18	75 × 49 × 28	10 × 18 × 15
	Weight, lbs.		500	1,000	496	1,600	33
	Distance (feet) to other unit*						
ATMOSPHERE	Storage Ranges	Temperature, °F.					
		Humidity, %					
	Working Ranges	Temperature, °F.					
		Humidity, %					
	Heat Dissipated, BTU/hr.		5,100	10,200	204	8,200	
	Air Flow, cfm.						
	Internal Filters						
ELECTRICAL	Voltage	Nominal					
		Tolerance					
	Cycles	Nominal					
		Tolerance					
	Phases and Lines						
	Load KVA		1.500	3.000	0.060	2.400	1.000
NOTES							



PRICE DATA

Only devices used in the 211 system and not used in the 210 system are given. Refer to the 210 system for prices of equipment which can also be part of the 211 system, Section 651:221.

CLASS	IDENTITY OF UNIT		PRICES		
	No.	Name	Monthly Rental \$	Monthly Maintenance \$	Purchase \$
CENTRAL PROCESSOR	Model 211	<u>Central Processor</u>			
	211	Arithmetic and Control Unit	11,000		500,000
	1100	Optional Features	900		40,000
	1111	211 Floating Point Option 211 Index Registers (8)	1,300		60,000
STORAGE	220	Partition for 2232 Core Storage (P-10)	6,000		263,000
		1.5 μ s Core Storage			
	2108	8,192 words	9,350		395,000
	2116	16,384 words	17,900		755,000
	2132	32,768 words	30,000		1,350,000
INPUT-OUTPUT		<u>Real Time Devices</u>			
	401	Auto Control Unit (x1 Scanner)	‡		‡
	404	Auto Control Unit (x4 Scanner)	2,950		133,500
	408	Auto Control Unit (x8 Scanner)	3,550		159,000
	402	Interval Timer	400		19,000

‡ Prices not yet available.

Note: The monthly maintenance rate is individually negotiated for purchased equipment. See Special Report, Section 23:010.100, second paragraph.

PHILCO 2000 - 212

Philco Corporation
(A Subsidiary of Ford Motor Company)

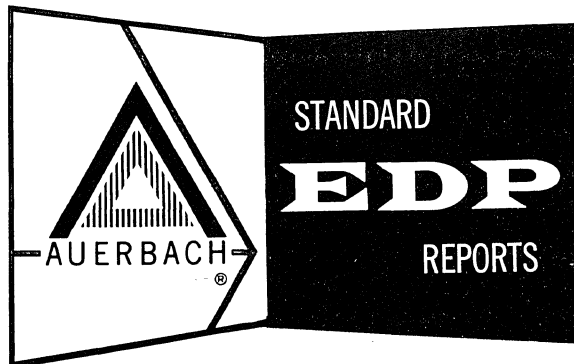

AUERBACH INFO, INC.



CONTENTS

- 1. Introduction 653:011
- 2. Data Structure 651:021 (Philco 2000-210)
- 3. System Configuration
 - VII B, 10-Tape General System (Paired) 653:031.3
 - VIII B, 20-Tape General System (Paired) 653:031.4
- 4. Internal Storage
 - 311, 312, 313, 314 Disc Systems 653:042
 - 2100 Series 1.5 μ s Core Storage 652:043 (Philco 2000-211)
- 5. Central Processor - Model 212 653:051
- 6. Console 651:061 (Philco 2000-210)
- 7. Input-Output: Punched Tape and Card
 - 240 Paper Tape System 651:071 (Philco 2000-210)
 - 241 Paper Tape System 651:072 (Philco 2000-210)
 - 258 Card Reader 651:073 (Philco 2000-210)
 - Punch Card Controller 652:073.4 (Philco 2000-211)
 - 265 Card Punch 651:074 (Philco 2000-210)
- 8. Input-Output: Printers
 - 256 Printer 651:081 (Philco 2000-210)
 - 254 Printer Control Unit 651:081.4 (Philco 2000-210)
- 9. Input-Output: Magnetic Tape
 - 234 Magnetic Tape 90KC 651:091 (Philco 2000-210)
 - 334 Magnetic Tape 240KC 653:091
 - 336, 338 653:091.4
- 10. Input-Output: Other
 - 235, 236, 237, 238 Input-Output Processors (90KC) 651:101 (Philco 2000-210)
 - 252 Universal Buffer Controller 651:102 (Philco 2000-210)
 - 280 Universal Buffer Controller 651:102 (Philco 2000-210)
 - 309 Console Typewriter Buffer 651:103 (Philco 2000-210)
 - 2281, 2282, 2283, 2284 Digital Incremental Recorders 651:104 (Philco 2000-210)
 - 293 Accounting Clock 651:105 (Philco 2000-210)
 - 401, 404, 408 Auto-Control Units 652:106 (Philco 2000-211)
 - Real-Time Scanner 652:106.12 (Philco 2000-211)
 - 402 Interval Timer 652:107 (Philco 2000-211)
- 11. Simultaneous Operations 653:111
- 12. Instruction List 651:121 (Philco 2000-210)
652:121 (Philco 2000-211)
653:121
- 13. Coding Specimens
 - ALTAC 651:131 (Philco 2000-210)
 - TOPS 651:132 (Philco 2000-210)
 - TAC 651:133 (Philco 2000-210)
- 14. Data Codes
 - Internal, Magnetic Tape and Printer Binary Coded Characters 651:141 (Philco 2000-210)
 - Card 651:142 (Philco 2000-210)

CONTENTS (Contd.)

15.	Problem Oriented Facilities	
	Sort Generator	651:151.13 (Philco 2000-210)
	Sort (Interpretive)	651:151.13 (Philco 2000-210)
	PERT	651:151.17 (Philco 2000-210)
	Linear Programming	651:151.17 (Philco 2000-210)
	Input-Output Programming System (IOPS)	651:151.17 (Philco 2000-210)
16.	Process Oriented Language	
	ALTAC 3	651:161 (Philco 2000-210)
	TOPS 2	651:162 (Philco 2000-210)
	COBOL-61	651:163 (Philco 2000-210)
17.	Machine Oriented Languages	
	TAC	651:171 (Philco 2000-210)
18.	Program Translators	
	ALTAC 3	651:181 (Philco 2000-210)
	TOPS 2	651:182 (Philco 2000-210)
	COBOL 61	651:183 (Philco 2000-210)
	TAC	651:184 (Philco 2000-210)
19.	Operating Environment	
	SYSD	651:191 (Philco 2000-210)
	TOPS 2	651:192 (Philco 2000-210)
20.	System Performance	653:201.001
	Worksheet Data	653:201.011
	Generalized File Processing	653:201.1
	Sorting	653:201.2
	Matrix Inversion	653:201.3
	Generalized Mathematical Processing	653:201.4
	Generalized Statistical Processing	653:201.5
21.	Physical Characteristics	653:211
22.	Price Data	653:221



INTRODUCTION

§011.

The Philco 2000 is actually a series of three computer systems. There are three prime systems distinguished by different central processors; 210, 211, and 212. The differences in performance and price of the different systems are significant as shown in the respective Systems Performance Sections, 651:201, 652:201, and 653:201. There is a large body of common units, common interfaces, and common software. The following description applies generally to all the series; however, the final paragraph notes the major differences of the 2000-212.

The computer system is in the large-scale scientific and real-time class. Its design is oriented toward flexible off-line operations, with fast tape units, simultaneous operations and concern for fast processing speeds. The central processors have a range of 50,000 to 500,000 instructions per second and rentals in the order of \$40,000 and up.

The Philco 2000 is designed for off-line operation of peripheral devices. The off-line operations may be executed by a separate computer, the Philco 1000, or by the special Universal Buffer Controllers (UBC).

The UBC unit is a versatile device, which contains a 1,024 work buffer store. The UBC may control any card, punched tape, magnetic tape, or printer off-line transcription, including magnetic-tape-to-magnetic-tape. A UBC can be used on-line to control data transfers to any one of seven peripheral units attached to it. In addition to the usual peripheral devices there is a high speed (2,000 cards per minute) reader.

Each 2000 computer configuration has one IOP (Input-Output Processor). This unit can control up to 16 input-output units. There may be up to four UBC's and the remaining units may be magnetic tape. An IOP may contain from one to four assemblers. An assembler provides for independent simultaneous input-output transfers. In effect, each UBC can provide an extra simultaneous input-output transfer to any unit except magnetic tape, because loading or unloading a UBC buffer requires little time, and the UBC controls the peripheral device at its own pace.

One especially convenient feature of the IOP is the automatic assignment of any idle assembler to a data transfer request, thus relieving the programmer of optimizing assignments.

The Model 234 Magnetic Tape Units which must be used on the 2000-210 and 2000-211 operate at a peak speed of 90,000 characters per second. The block size is fixed at 1,024 characters. At full speed, using full blocks, the effective speed is 54,600 characters per second. Usually the standard problems have been time for two cases: (1) blocked records and (2) unblocked records. On the 2000-212 an alternative tape unit, Model 334, is available with a peak speed of 240,000 characters per second.

All three central processors operate in parallel on 48-bit words. Single address instructions are packed two to a word. The number of index registers is optional on the 210 and 211 but in practice is standardized at eight. Eight registers, however, are standard on the 212. When an instruction uses a special bit to denote indexing, three bits of the high order end of the address are used to specify the register. This limits the value of the base address, but not the modifier.

There is a wide variety of fixed and floating point arithmetic instructions, but no editing or conversion facilities. Special one or two instruction loops can be performed very rapidly with no repeated access for instructions.

INTRODUCTION—Contd.

§011.

The computer operates asynchronously in all units and basic times vary from machine to machine, and in different cases similar instructions require different execution times. This report quotes ranges or averages of these times.

There are several varieties of core store available. They have different cycle times, and can be further varied by use of overlapped access. Drums are available on the systems and data transfers are arranged to be parallel by word, at high data rates, but may not be overlapped with other operations. Disc storage is available on the 2000-212.

The three central processors, 210, 211, and 212, are upward compatible for instruction repertoire and functional facilities. Therefore, all software is written to be used on all models, with some limitations on minimum configurations.

The main languages are TAC, ALTAC, and TOPS. TAC is a sophisticated symbolic machine oriented language including macros and facilities for generators. The generators include SORT and IOPS, an input-output system. ALTAC is a dialect of FORTRAN II. The ALTAC translator can translate FORTRAN II programs with usually few changes. Its major incompatibilities are Boolean operations and CHAIN functions. On the other hand, it includes extended conditionals. TOPS is a macro oriented language for file manipulation; it includes such facilities as updating and sorting. For individual data manipulation, TAC coding is used. TOPS includes its own operating environment.

There is an automatic supervisor routine, SYSD. This routine covers running, translating, and debugging. In fact, it is probably not reasonable to operate a 2000 without a supervisor.

There is a users' group called TUG. The library of routines is generally available and includes a large selection in the field of nuclear code programs.

The Philco 2000-212 in particular:

- uses a 1.5 μ sec overlapped store, which can be extended to 65,536 words, and includes parity checks.
- a special instruction format can be used to address directly all the core storage.
- disc storage can be added.
- has the fastest central processor of the group, ten times the speed of the 210.
- alternative 240 KC tapes are available with variable size recording loads.
- can have two IOP's, each with up to 4 assemblers.
- the 240 KC tapes can only be used off-line with a Philco 1000 computer.
- real-time facilities are available.
- can have a direct data transmission channel from its store to the store of a Philco 1000 computer.
- has only a few incompatibilities; division is exact, and "correction" sequences are not required, overflow fault logic is improved.
- the central processor overlaps instruction execution by a look-ahead of approximately four instructions.
- there are 14 additional instructions, including a repeat that can control 3 or 4 instructions.
- there is an additional Y bit in each index register to control the formation of effective addresses.

SYSTEM CONFIGURATION

§ 031.

.3 VII B 10-TAPE GENERAL, PAIRED CONFIGURATION

Deviations from Standard Configuration

- On-line: 2 more index registers.
magnetic tape, 30,000 char/sec faster.
card reader can be switched from off-
line UBC.
- Off-line: magnetic tape, 60,000 char/sec faster.
printer faster by 400 lines/min.
card reader by 1,500 cards/min.
1,024 characters only in UBC.

On-line Equipment

Equipment Rental

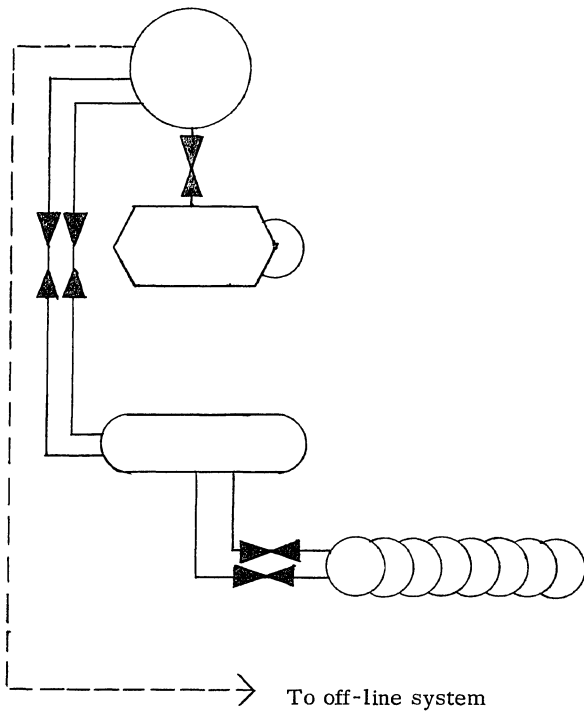

1.5 μ sec Core Storage: \$ 11,000
16,384 words

Model 212 Central Processor and Console }
Typewriter } 22,000

Input-Output Processor: 4,400
two multiplexed trans-
missions to and from
magnetic tape.

8 Magnetic Tapes: 6,800
90,000 char/second

Total \$ 44,200

Total, including off-line
equipment: \$ 52,315

§ 031.

.3 VII B 10 - TAPE GENERAL, PAIRED CONFIGURATION (Contd.)

Off-line Equipment

	<u>Equipment</u>	<u>Rental</u>
	Universal Buffer Controller:	\$ 1,560
	2 Magnetic Tapes: 90,000 char/second	1,700
	Punch Card Controller:	1,365
	Card Reader: 2,000 cards/minute	800
	Card Punch: 100 cards/minute	350
	Printer Controller:	} 2,340
	High Speed Printer: 900 lines/minute	
	Total	\$ 8,115

Note: Off-line system may be replaced by the Philco 1000 computer system. This will permit more powerful off-line editing and computing capabilities, relieving the central processor of much of this work.

§ 031.

.4 VIII B 20-TAPE GENERAL, PAIRED CONFIGURATION

Deviations from Standard Configuration

- On-line: 2 less index registers.
magnetic tape 120,000 char/second faster.
card reader can be switched from off-line UBC.
- Off-line: magnetic tape 180,000 char/second faster.
card reader faster by 1,000 cards/minute.
card punch slower by 100 cards/minute.

On-Line Equipment

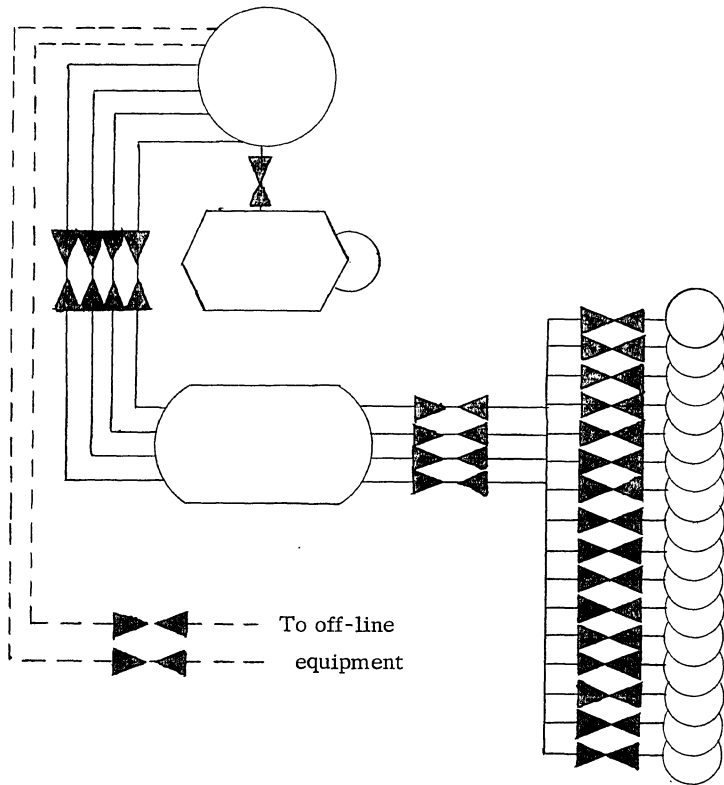

<u>Equipment</u>	<u>Rental</u>
1.5 μ sec. Core Storage: 16,324 words	\$ 11,000
212 Central Processor and Console: Typewriter	22,000
Magnetic Tape Controller: Four multiplexed transmissions to and from magnetic tape.	16,000 (**)
16 Magnetic Tapes: 90,000 char/second	19,200
 	<hr/>
Total	\$ 68,200
Total, including off-line equip- ment:	\$ 87,145

(**) Estimate by Editorial Staff based on nearly complete data and probably reliable.

§ 031.

.4 20-TAPE GENERAL, PAIRED CONFIGURATION VIII B (Contd.)

Off-line Equipment

Philco 1000

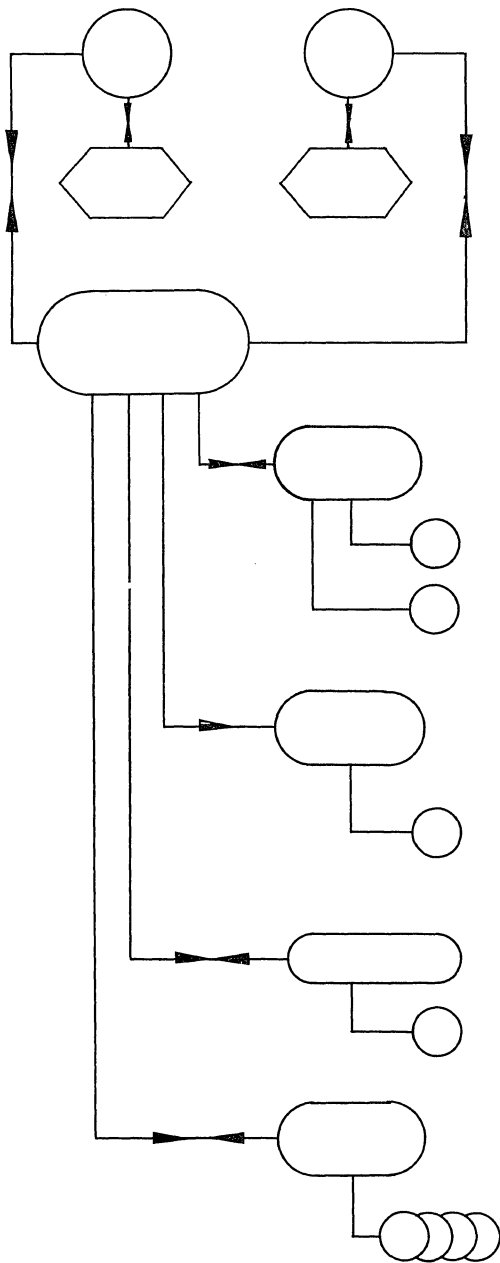

<u>Equipment</u>	<u>Rental</u>
Two 8,192 character core stores	\$ 2,700
Two 101 Processors and Arithmetic Units	4,520 1,350
124 2x4 I/O Switch	250
160 Card Control	550
258 Card Reader 2000 cards/min.	800
265 Card Punch 100 cards/min.	350
150 Printer Control	275
151 Printer 900 lines/min.	1,800
180 Typewriter Control	400 (**)
134 Magnetic Tape Control	750 (**)
Four Magnetic Tape Units 240 KC	4,800
Total Rental:	\$ 18,945

(**) Estimate by Editorial Staff based on nearly complete data and probably reliable.



CENTRAL PROCESSOR

§ 051.

.1 GENERAL

.11 Identity: Central Processor.
Model 212.

.12 Description

The Model 212 is currently the fastest and most powerful central processor in the Philco 2000 series. Programs written for the 210 and 211 are generally compatible with the 212. A few special cases must be considered, and extra facilities have been added.

The 212 is approximately 10 times faster than the 210. The times are not significantly different when using the 1.0 m. sec store rather than the 1.5 m. sec store.

In this section the paragraphs that have been changed are .23; instruction format and indexing; .32, look-ahead; .4, processor speeds.

There are a few new instructions. The most important is EXTEND, which enables the instruction address to specify any location in the store, directly or when it is to be modified. EXTEND also provides indirect addressing.

There are new facilities for stepping index registers, which include using an instruction address as an increment or decrement.

There is a "double repeat" operation to allow 3 or 4 instruction loops to be repeated.

When transferring programs from a 210 or 211, the following points must be considered, apart from the obvious ones of compatible configurations.

- Division has been altered to produce exact quotients; correction routines should be removed.
- False multiplication overflows have been eliminated.
- Exponent fault results are slightly different.
- There is an extra "Y" bit in index registers.

.14 First Delivery: January, 1963.

.23 Instruction Formats

.231 Instruction structure: . half word usually.
one word for input-output.
one word for EXTEND to provide extra address length in instruction.

.232 Instruction layout:

NAME	S	A	F	C	
SIZE, BITS	1	15	1	7	Non-indexable

NAME	S	N	V	F	C	
SIZE, BITS	1	3-5	10-12	1	7	Indexable

NAME	Not used	NBS	Not Used	IOP CH.	Not used	NBP	FROM	TO	Input-Output (tape)
SIZE, BITS	12	4	4	4	12	4	4	4	

NAME	S	UNIT	SC	CQ	F	C	
SIZE, BITS	1	4	2	9	1	7	Skip

In addition to those instruction formats as used in the 210 and 211, the following format is also used on the 212 when addresses greater than 32,767 are referenced.

NAME	S	N	not used	RC =0	ID	C="EXTEND"	V	C	no repeat control	EXTEND instruction pair, not necessarily in same word, but adjacent half words
SIZE, BITS	1	3	9	1	2	8	16	8		
NAME	RM	not used	RC =0	ID	C="EXTEND"	V	C	repeat control		
SIZE, BITS	8	5	1	2	8	16	8			

§ 051.

.233 Instruction parts

Name	Purpose
S:	selector list set to 1 indicates the instruction is indexable and the reduced address field is used; if set to 0, the full address field is used.
A:	address field.
F:	F bit is 1 in floating point instr. or in branch to instruction in right half of word.
N:	specifies index register referenced - field size varies with number of index registers in central processor.
V:	value added to contents of specified index register to form operand's effective addresses.
C:	command, includes F-bit.
NBS:	number of blocks on MT to space over.
IOP CH:	logical MT number.
NBP:	number of blocks of MT to transfer.
FROM:	from device.
TO:	to device.
UNIT:	unit to check for count or faults.
SC:	subcommand of skip instruction.
CQ:	comparison quantity.
RC:	specifies whether EXTEND format specifies Repeat Control of next instruction.
ID:	indirect address V.
RM:	repeat modification, 4 pairs of bits for up to 4 repeated instructions; 1 bit specifies normal/special, in special cases index register modifier is effective address; other bit specifies V is increment added to or subtracted from modifier.

.234 Basic address

structure: 1 + 0.

.235 Literals

Arithmetic: none.

Comparisons and tests: none.

Incrementing

modifiers: 12 bits (maximum value 4,095).

.236 Directly addressed operands

.2361 Internal Storage type: core.

Minimum size: . . . 1 word.

Maximum size: . . . 1 word.

Volume accessible: . 32,768 words.

.2362 Increased address capacity

Method	Volume accessible
EXTEND instruction modification:	65,536 words.

.237 Address Indexing

.2371 Number of methods: . 3.

.2372 Names

I:	Normal.
II:	Normal with step +1.
III:	Replace with step +V or -V (uses control bits in index register).

.2373 Indexing rule

I, II: V + I.R.

III: I.R.

.2374 Index specification

I: instruction, and C = 0, Y = 0.

II: instruction, and C = 1, Y = 0.

III: instruction, and Y = 1.

Note: C and Y bits held in index register except for EXTEND instruction (See RM part, Paragraph .232).

.2375 Number of potential indexers: 8.

.2376 Addresses which can be indexed: all instructions except repeat, skip and input-output.

.2377 Cumulative indexing: none.

.2378 Combined index and step: yes; index register can be automatically incremented by one if counter bit is set to 1, or by address V of instruction.

.238 Indirect addressing

.2381 Recursive: yes.

.2382 Designation: ID bits in EXTEND instruction format.

.2383 Control: until no ID bits set, or no EXTEND format.

.2384 Indexing with indirect addressing: after indexing.

.239 Stepping

.2391 Specification of increment: index register counter bit specifies automatic increment of 1 as referencing indexable instruction is executed. Stepping in index register instruction holds increment or decrement to maximum value of 4,095. Data registers may hold increment or decrement of 0 to 32,767. EXTEND can specify address V as increment or decrement.

.2392 Increment sign: none; considered absolute value.

.2393 Size of increment: . . 0 to 32,767.

.2394 End value: specified in test instruction.

.2395 Combined step and test: for increment or decrement of up to 5 digits (maximum value of 32,767).

§ 051.

.24 Special Processor Storage

.241 Category of storage	Number of locations	Size in bits	Program usage
Processor:	3	48	arithmetic, data manipulation.
Processor:	2	15	program control.
Processor:	1	16	program control.
Processor:	8, 16, or 32	16	indexing.
Processor:	1	48	instruction register.
Processor:	1	18	repeat control.
Processor:	1	48	hold input-output order.
I/O Processor:	1	8	assembler availability.
I/O Processor:	1, 2, 3, or 4	10	assembler fault.
I/O Processor:	1, 2, 3, or 4	12	assembler counter.
I/O Processor:	16	4	unit availability.

Note: I/O Processor counters and fault registers may be interrogated from the Central Processor.

.242 Category of storage	Total number locations	Physical form	Access time, μ sec
Processor:	17 to 41	flip-flop	approx. 0.1
I/O Processor:	4 to 25	flip-flop	approx. 0.1

.3 SEQUENCE CONTROL FEATURES

.31 Instruction Sequencing

- .311 Number of sequence control facilities: . . . 1.
- .314 Special sub-sequence counters
 - Number: 1.
 - Purpose: repeat counter.
- .315 Sequence control step size: instruction pairs.
- .316 Accessibility to routines: available immediately after a jump is performed.
- .317 Permanent or optional modifier: none.

.32 Look-Ahead

.321 Length of queue: approx. 4 instructions.

.33 Interruption

- .331 Possible causes: any of 48 conditions in central processor, input-output, and/or real-time devices capable of emitting a signal are possible interrupt criteria. Interrupt occurs via the Model 401, 404, or 408 Auto-Control Unit.
- .332 Control by routine
 - Individual control: . . interrupt by from 1 to 48 possible conditions.
 - Method: programmer sets mask in Auto-Control Unit.
 - Restriction: none.
- .333 Operator control: . . . operator may enter instruction via central processor console to set new mask in Auto-Control Mask Register.
- .334 Interruption conditions: mask bits set to one; no interrupt if mask bit is zero.

.335 Interruption process: . refer to Auto-Control Unit description, Section 652:106.

.336 Control methods

- Determine cause: . . . masked interrupt bits from Auto-Control register are automatically transferred to core storage location MASK +1 and may be examined by an executive routine to determine the particular interrupt condition.
- Enable interruption: . an executive routine preserves and restores all registers, allowing a return to an interruptable routine.

.34 Multi-running: none.

.35 Multi-sequencing: . . . none.

.4 PROCESSOR SPEEDS

Conditions: using either 1.0 or 1.5 μ sec core stores.

.41 Instruction Times in μ sec

- .411 Fixed point
 - Add-subtract: 1.55.
 - Multiply: 4.50.
 - Divide: 9.80.
- .412 Floating point
 - Add-subtract: 1.55.
 - Multiply: 4.70.
 - Divide: 12.30.
- .413 Additional allowance for
 - Indexing: usually 0.2.
 - Indirect addressing: . 1.0.
 - Operand in register: . -1.0.
 - Re-complementing: . 0.
- .414 Control
 - Branch: 2.55.
 - Compare and Branch: 3.55.
- .415 Counter control
 - Step: 1.15.
 - Step and test: 1.25.
- .416 Edit: none.
- .417 Convert: none.
- .418 Shift: 0.3 + 0.18 N.

.42 Processor Performance in μ sec

- .421 For random addresses

	Fixed point	Floating point
c = a + b:	4.65	4.65.
b = a + b:	3.35	4.10.
Sum N items:	1.55	1.55.
c = ab:	7.60	7.60.
c = a/b:	12.90	15.40.
- .422 For arrays of data

	Fixed point	Floating point
c _i = a _i + b _j :	7.95	8.95.
b _j = a _i + b _j :	3.50	3.50.
Sum N items:	1.75	1.75.
c = c + a _i b _j :	6.75	7.75.
- .423 Branch based on comparison
 - Numeric data: 11.90.
 - Alphabetic data: . . . 12.45.

§ 051.

- .424 Switching
 - Unchecked: 6.40.
 - Checked: 10.85.
 - List search: 2.50.
- .425 Format control per character
 - Unpack: 0.71.
 - Compose: 1.00 + 19.20 (mathematical and conversions).
- .426 Table look up per comparison
 - For a match: 2.50.
 - For least or greatest: 1.75.
 - For interpolation point: 2.50.
- .427 Bit indicators
 - Set bit in separate location: 1.75.
 - Test bit in separate location: 0.70.

.428 Moving: 0.75.

.5 ERRORS, CHECKS AND ACTION

<u>Error</u>	<u>Check or Interlock</u>	<u>Action</u>
Overflow:	check	indicator.
Underflow:	check	error jump and alarm.
Zero divisor:	check	signal and indicator.
Invalid data:	none.	
Invalid operation:	check	stop.
Arithmetic error:	none.	
Invalid address:	check	stop and alarm.
Receipt of data:	parity check	indicator and alarm.
Dispatch of data:	parity check	indicator and alarm.



INPUT-OUTPUT: 240 KC MAGNETIC TAPE UNIT

§ 091.

.1 GENERAL

.11 Identity: Magnetic Tape Unit.
240 KC.
334.

.12 Description

These Ampex TM 5 tape units operate at peak speeds of 240,000 characters per second. They have special facilities available (see third paragraph), but programs written for the Model 234 can be run on them without changes.

The Model 334 unit uses 1-inch wide magnetic tape with no prerecorded sprocket and block marks. Data is recorded in rows of 12 data bits or 2 characters. Packing density and tape speed will be arranged to produce a transfer rate of 120,000 rows per second. For the purpose of this report, it has been estimated that the minimum likely performance can be calculated from an assumed packing density of 1,000 rows per inch.

In addition to Model 234-compatible instructions to write or read fixed 128-word blocks, there are instructions to write or read a load of 1 to 16 blocks, each of a common size in the range 1 to 4,096 words (i.e., a load of up to 65,536 words in steps of one word). Between individual blocks written, where the tape does not stop, there is a gap of 0.45 inch; at the end of a load there is a gap of 0.65 inch. When reading, the tape may be stopped at the end of a load in any gap. At the start of a read operation, up to 15 blocks can be skipped.

Up to 32 Model 334 tape units can be connected to each 240 KC Tape Controller (TC). This unit has the same function as the Input-Output Processor (IOP). See Paragraph 651:101.

Extra tracks are recorded to provide error detection for 2 bits and error correction for 1 bit. There is a read-after-write check.

Effective speeds depend upon the grouping of input and output blocks. The maximum speed attainable is approximately 230,000 characters per second. (**)

.13 Availability: ?

.14 First Delivery: ?

.2 PHYSICAL FORM

.21 Drive Mechanism

(**) Estimate made by analyst and probably reliable.

- .211 Drive past the head: . . pinch roller friction.
- .212 Reservoirs
 - Number: 2.
 - Form: vacuum.
 - Capacity: each about 5.5 feet.
- .213 Feed drive: motor.
- .214 Take-up drive: motor.

.22 Sensing and Recording Systems

- .221 Recording system: . . . magnetic heads.
- .222 Sensing system: . . . magnetic heads.
- .223 Common system: . . . two gap head provides read-after-write checking.

.23 Multiple Copies: none.

.24 Arrangement of Heads

Use of station: recording.
Stacks: 1.
Heads/stack: 16.
Method of use: 1 row at a time.

Use of station: sensing.
Distance: 0.39 inch.
Stacks: 1.
Heads/stack: 16.
Method of use: 1 row at a time.

.3 EXTERNAL STORAGE

.31 Form of Storage

- .311 Medium: plastic tape with magnetizable surface.
- .312 Phenomenon: magnetization.

.32 Positional Arrangement

- .321 Serial by: 1,000 rows/inch (**).
- .322 Parallel by: 16 tracks.
- .324 Track use
 - Data: 12.
 - Redundancy check: . . 4, single error correct, double error detect.
 - Timing: 0, self-clocking.
 - Control Signals: . . . 0.
 - Total: 16.

.325 Row use
Data: all.
Redundancy check: . . none.

.33 Coding: see Data Code Table No. 1 (651:141).

.34 Format Compatibility: . none.

(**) Estimate made by analyst and probably reliable.

§ 091.

.35 Physical Dimensions

- .351 Overall width: 1 inch.
- .352 Length: up to 3, 600 feet.

.4 CONTROLLER

- .41 Identity: 240 KC Tape Controller.
Model 334.
TC.

.42 Connection to System

- .421 On-line: 2 max, containing 2 or 4
independent assemblers,
assigned automatically as
required to each transfer
request.
- .422 Off-line: none.

.43 Connection to Device

- .431 Devices per controller: up to 32 tape units.
- .432 Restrictions: no other units.

.44 Data Transfer Control

- .441 Size of load: 1 to 16 blocks, each 1 to
4, 096 words.
- .442 Input-output areas: . . core storage.
- .443 Input-output area
access: each word.
- .444 Input-output area
lockout: none.
- .445 Table Control: none.
- .446 Synchronization: automatic.

.5 PROGRAM FACILITIES AVAILABLE

.51 Blocks

- .511 Size of block: 1 to 4, 096 words.
alternative fixed 128 words.
- .512 Block demarcation
Input: lesser block recorded or
count in instruction.
Output: count in instruction.

.52 Input-Output Operations

- .521 Input: 1 to 16 blocks.
- .522 Output: 1 to 16 blocks.
- .523 Stepping: up to 15 blocks preceding
a read operation.
- .524 Skipping: none.
- .525 Marking: none.
- .526 Searching: none.

.53 Code Translation: matched codes.

.54 Format Control

- Control: program.
- Rearrangement: no.
- Suppress zeros: no.
- Insert point: no.
- Insert spaces: no.
- Recording density: no.
- Section sizes: 1 to 4, 096 words.

.55 Control Operations

- Disable: no.
- Request interrupt: no.
- Rewind: yes.
- Unload: yes.

.56 Testable Conditions

- Disabled: yes.
- Busy device: yes.
- Output lock: yes.
- Nearly exhausted: no.
- Busy controller: yes.
- End of medium marks: at both ends.
- Parity error: yes.
- Rewinding: yes.

.6 PERFORMANCE

.61 Conditions

- I: recorded as I block loads.
- II: recorded as B block loads.
- III: read as I block loads.
- IV: read as B block loads.
- N: number of characters per
block.

.62 Speeds

- .621 Nominal or peak speed: 240, 000 char/sec.
- .622 Important parameters
Full rewind time: ? min.
Block gap: 0.45 inches (= 900 char).
Load gap: 0.65 inch (= 1, 300 char).
Packing density: 2, 000 char/inch (**).
Speed: 120 inch/sec (**).
- .623 Overhead: 2.5 m.sec extra time to
stop and then start in a
gap (= 600 char).
- .624 Effective speed (**)
I: 240, 000 N/(N + 1, 900)
char/sec.
II: 240, 000 NB/(NB + 900B +
1, 000) char/sec.
I & III: same as I.
I & IV: 240, 000 NB/(NB + 1, 300B +
600) char/sec.
II & III: 240, 000 N/(N + 1, 500B +
300) char/sec.
II & IV: same as II.

.63 Demands on System

Component	Condition	m. sec per word	Percentage
Core store:	during transfer	0.00075 (**)	2.3.
	during gaps	0.0	0.0.

.7 EXTERNAL FACILITIES

- .71 Adjustments: none.

(**) Estimate made by analyst and probably reliable.

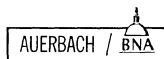

§ 091.

.72 Other Controls

Function	Form	Comment
Indicates unit has re-wound tape without it locking and requiring operator intervention:	button indicator	button turns off indicator.
Indicates unit cannot be controlled remotely:	button indicator	button turns off indicator.
Allows reducing or increasing rewind speed:	button indicator.	
Allows recording on tape:	ring on tape reel.	
Releases tape reel brakes to allow manual reel turning:	buttons.	

.73 Loading and Unloading

.731 Volumes handled

Storage: 3,600 reel.
 Capacity: 20,000,000 char recorded
 in 1,000-char blocks.

.732 Replenishment time: . . . 0.5 to 1.0 min.
 unit needs to be stopped.

.733 Adjustment time: 0 min.

.734 Optimum reloading period: 6 min.

.8 ERRORS, CHECKS AND ACTION

<u>Error</u>	<u>Check or Interlock</u>	<u>Action</u>
Recording:	read after write	auto-correction.
Reading:	4-bit redundancy	1-bit correction. 2-bit indicator.
Input area overflow:	interlock	cut-off, indicator.
Output block size:	not possible.	
Invalid code:	not possible.	
Exhausted medium:	mechanical	turns on indicator, terminates transmission, and inhibits further I/O processing for that channel. Operator or program intervention necessary for restart.
Imperfect medium:	check.	
Timing conflicts:	check	automatic error correction.
Unit disabled:	interlock	operator intervention.
Record enable:	check	set indicator.
Unit busy:	check	set indicator.
Unit rewinding:	check	set indicator.

§ 091.

EFFECTIVE SPEED

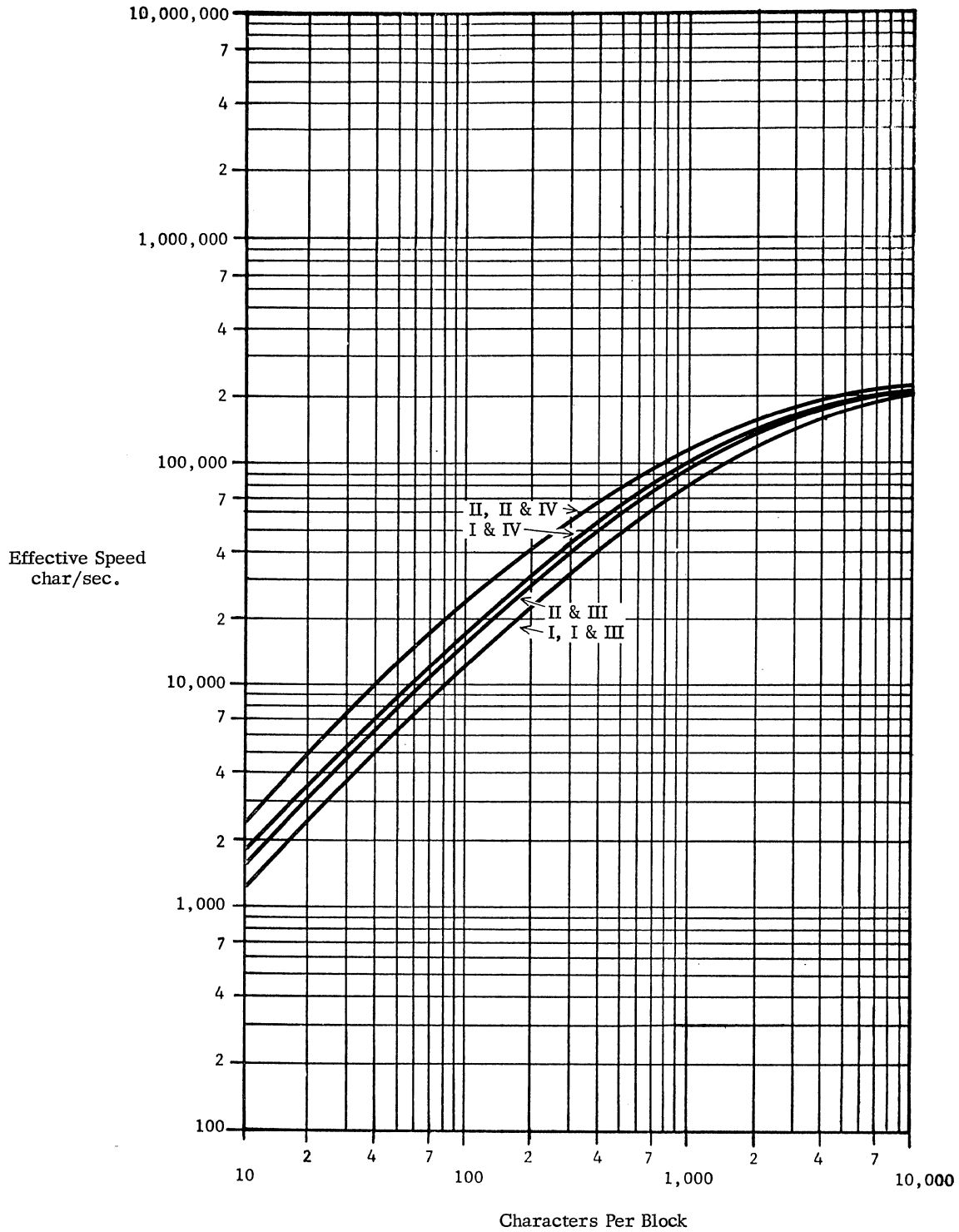

I recorded as 1 block loads
II recorded as 16 block loads
III read as 1 block loads
IV read as 16 block loads



SIMULTANEOUS OPERATIONS

§ 111

.1 SPECIAL UNITS: . . . none.

.12 Description

When using 90KC magnetic tapes, the conditions and performance are not different from those specified for the 210 in 651:111.1. When using 240KC tapes, no other input-output units are connected.

The volume of simultaneous operations in a configuration can be high, due to the flexible I/O arrangements. Each configuration must be considered separately. The number of simultaneously operating units is then limited by the following criteria:

- The central processor is limited by the sum of the demands on the store by other units, see Sections 653:031 and 653:091.
- There may be one magnetic tape unit operating for each assembler in a Magnetic Tape Controller. There may be two or four assemblers in each of one or two controllers.
- A typewriter output either occupies the central processor full time or operates independently if a typewriter buffer is used.
- Magnetic tape rewind operations are independent of the IOP.
- Disc transfers are independent.

The controller makes automatic allocation of an idle assembler to each new input-output request. Assemblers become idle immediately after completing a magnetic tape transfer. This system frees the programmer from the need to plan assembler assignments in magnetic tape operations.

.2 CONFIGURATION CONDITIONS

.21 Conditions

- C: number of Magnetic Tape Controllers.
- P: number of assemblers in each controller.
- N: number of magnetic tape units.

.3 CLASSES OF OPERATIONS

- | <u>Class</u> | <u>Member</u> |
|--------------|--|
| A: | transmit to or from magnetic disc. |
| B: | compute. |
| C: | read or write on magnetic tape. |
| D: | input or output on console typewriter. |
| E: | rewind magnetic tape. |

.4 RULES

- a(b + c + d + e + f + g): = 0.
- b: =at most 1.
- c: =at most U.
- d: =at most P.
- e: =at most 1.
- f: =at most 1.
- g: =at most N.

.5 TABLE OF POSSIBLE SETS OF SIMULTANEOUS OPERATIONS

Class	Possible Modes of Simultaneous Operation			
A	1	1	1	1
B	1	1	1	1
C	CP	CP	CP	CP
D	1	1	1	1
E	N-c	N-c	N-c	N-c



§ 121.

INSTRUCTION LIST

INSTRUCTION			OPERATION
F	OP CODE	ADDRESS	
	DRPT (LDRPT or RDRPT)	V	<p><u>To be able to repeat up to 4 instructions</u></p> <p>Double repeat V times. Affects the next 3 or 4 instructions if held in the left or right position of a word. V may not exceed 255. The high order bits of the address specify indexing of repeated instructions 2 bits each, either</p> <p>00 normal. 01 normal. 10 as if C=0, Y=1. 11 as if C=1, Y=1.</p>
	AXJL	M	<p><u>To improve index stepping and testing</u></p> <p>Increment index register I_n by (M). Jump to (right D) if (IRN) less than (left D).</p>
	AXJG	V	<p>Increment index register I_n by (V). Jump to (right D) if (I_n) not less than (left D).</p>
	SXJL	V	Same as AXJL except "decrement".
	SXJG	V	Same as AXJG except "decrement".
	TXDLY	V	Copy I_y to left D.
	TXDRY	V	Copy I_y to right D.
	TDXLY	V	Copy (left D) to I_y .
	TDXRY	V	Copy (right D) to I_y .
	TYXZ TYXS TCXZ TCXS		<p><u>To set C and Y bits</u></p> <p>Set C=0, Y=1 in I_n. Set C=1, Y=1 in I_n. Set C=0, Y=0 in I_n. Set C=1, Y=0 in I_n.</p>
	JL JR	M M	<p><u>Unconditional Jumps</u></p> <p>Jump to left M. Jump to right M.</p>
	TIS	$V_1 V_2 V_3$	<p><u>To Fast Access to Stores Larger than 32,768</u></p> <p>Set Memory Select Register to required 32,768 word blocks, V_1, V_2, and V_3 for I/O Operands, and Instructions respectively.</p>
	TSM	M	Set contents of V_1 , V_2 , V_3 addresses parts of word in M to current values of Memory Select register.
	EXT		Extension to next instruction to provide indirect and direct addressing to 65,536 words, (see 653:051.232)



NOTES ON SYSTEM PERFORMANCE

§ 201.

The times used for estimates are based on both the 1.0 and 1.5 μ sec stores. The differences are not significant. The allowances for Central Processor penalties have been estimated for the 1.0 μ sec store.

There is a distinct difference in operation between the 90KC (#234) and 240KC (#334) Tape Units used in configurations VIIB and VIIIB respectively. The #234 is restricted to fixed block lengths.

Where the standard problems specify one record per block in the Generalized File Problems, the problems have also been timed for blocked records on the detail and report files.



653:201.011

**Philco 2000 - 212
System Performance**

**PHILCO 2000 - 212
SYSTEM PERFORMANCE**

PHILCO 2000 - 212 SYSTEM PERFORMANCE

WORKSHEET DATA TABLE 1

Worksheet	Item		Configuration								Reference
			VII B unblocked		VII B blocked		VIII B unblocked		VIII B blocked		
1	Char/block	(File 1)	1,024		1,024		35,536		35,536		4:200.112
	Records/block	K (File 1)	10		10, 12, 6		320		320, 100, 50		
	m. sec/block	File 1 = File 2	11.4		11.4		140.0		140.0		
		File 3	11.4		0.9 †		5.7		1.4 †		
		File 4	11.4		1.8 ††		4.6		2.8 ††		
	m. sec/switch	File 1 = File 2	0		0		0		0		
		File 3	0		0		0		0		
		File 4	0		0		0		0		
	m. sec penalty	File 1 = File 2	0.128		0.128		5.3		5.3		
		File 3	0.128		0.011		0.011		0.011		
File 4		0.128		0.022		0.022		0.022			
2	m. sec/block	a1	0.058		0.058		0.058		0.058		4:200.1132
	m. sec/record	a2	0.080		0.080		0.080		0.080		
	m. sec/detail	b6	0.080		0.080		0.080		0.080		
	m. sec/work	b5 + b9	0.422		0.422		0.422		0.422		
	m. sec/report	b7 + b8	2.523		2.523		2.523		2.523		
3	m. sec for C. P. and dominant column.	a1	0.06		0.1		0.1		0		4:200.114
		a2 K	0.80		0.8		25.6		25		
		a3 K	30.23		30.2		966.4		966		
		File 1 Master In	0.13	11.4	0.1	11.4	5.3		5		
		File 2 Master Out	0.13		0.1		5.3		5		
		File 3 Details	1.28	114.0	0.1	57.0	3.7	1820	3		
		File 4 Reports	1.28		0.2		7.0		7	576	
		Total	33.9	125.4	31.6	68.4	1013.2	1820	1012	576	
4	Unit of measure	(word)									4:200.1151
		Std. routines	187		187		187		187		
		Fixed	0		0		0		0		
		3 (Blocks 1 to 23)	87		87		87		87		
		6 (Blocks 24 to 48)	684		684		684		684		
		Files	1,024		1,024		1,024		1,024		
		Working	100		100		100		100		
		Total	2,082		2,082		2,082		2,082		

† 12 details per block. †† 6 reports per block

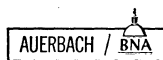

PHILCO 2000-212 SYSTEM PERFORMANCE -Contd.

WORKSHEET DATA TABLE 2								
Worksheet	Item		Configuration				Reference	
			VII B unblocked	VII B blocked	VIII B unblocked	VIII B blocked		
5	Fixed/Floating point		Floating				4:200.413	
	Unit name	input	234	234	334	334		
		output	234	234	334	334		
	Size of record, words	input	10	10	10	10		
		output	23	23	23	23		
	m. sec/block	input T1	11.4	0.95	5.7	141		
		output T2	11.4	2.28	4.6	141		
	m. sec penalty	input T3	0.13	0.01	0.005	2		
		output T4	0.13	0.01	0.012	2		
	m. sec/record		T5	0.07	0.07	0.07		0.07
m. sec/5 loops		T6	0.40	0.40	0.40	0.40		
m. sec/report		T7	0.26	0.26	0.26	0.26		
7	Unit name		↑	234	↑	334	4:200.512	
	Size of block, words			128		4,096		
	Records/block		B	12		400		
	m. sec/block		T1	None	11.4	None		141 ÷ 400
	m. sec penalty		T3		0.01			2
	C. P.	m. sec block	T5		0.004			0.004
		m. sec record	T6		0.016			0.016
m. sec table		T7	↓	0.045	↓	0.045		

K



SYSTEM PERFORMANCE

§ 201.

.1 GENERALIZED FILE PROCESSING

.11 Standard File Problem A

.111 Record Sizes

- Master File: 108 characters.
- Detail File: 1 card.
- Report File: 1 line.

- .112 Computation: standard.
- .113 Timing Basis: using estimating procedure outlined in Users' Guide, 4:200.113.
- .114 Graph: see graph below.

Time in Minutes to Process 10,000 Master File Records

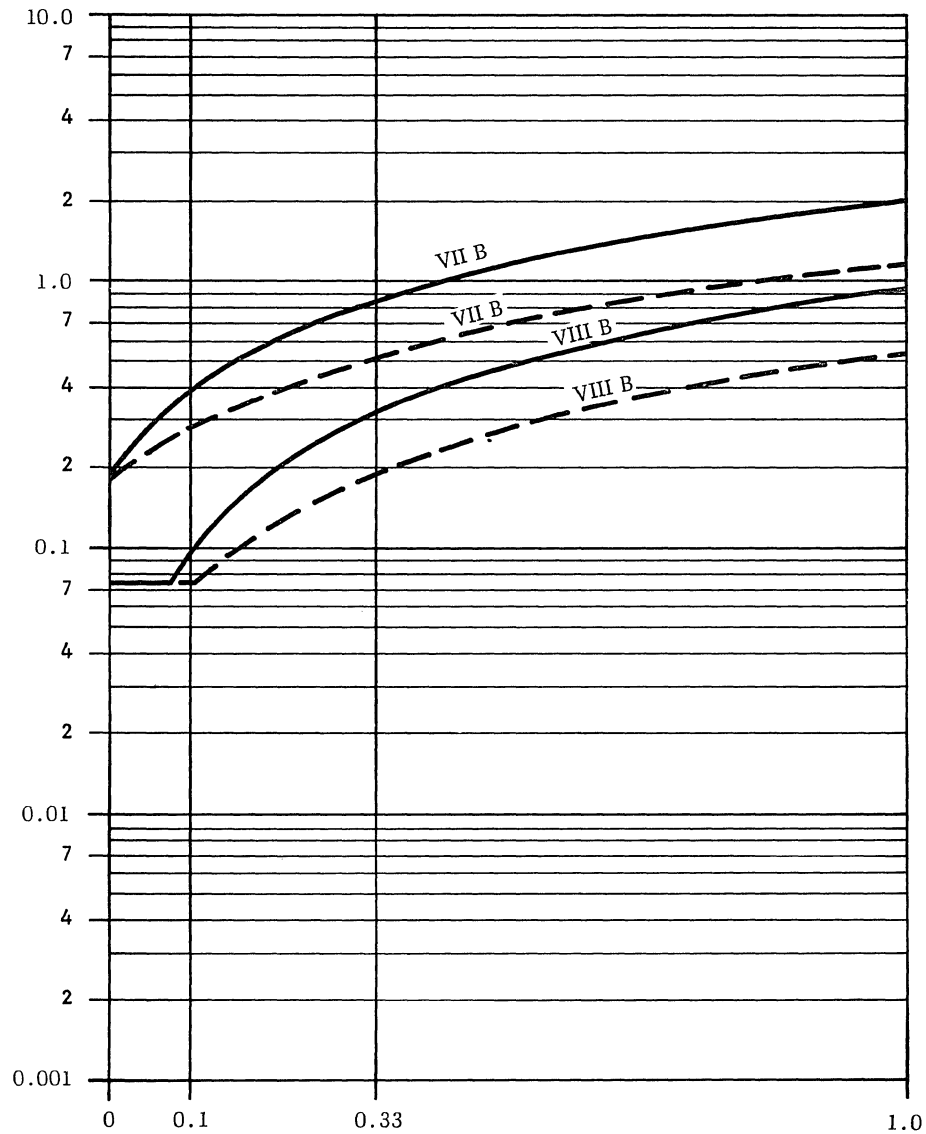

Activity Factor
Average Number of Detail Records Per Master Record
Broken line indicates blocked detail and report files

§ 201.

.12 Standard File Problem B

.121 Record Sizes

Master File: 54 characters.
Detail File: 1 card.
Report File: 1 line.

.122 Computation: standard.

.123 Timing Basis: using estimating procedure
outlined in Users' Guide,
4:200.12.

.124 Graph: see graph below.

Time in Minutes to
Process 10,000
Master File Records

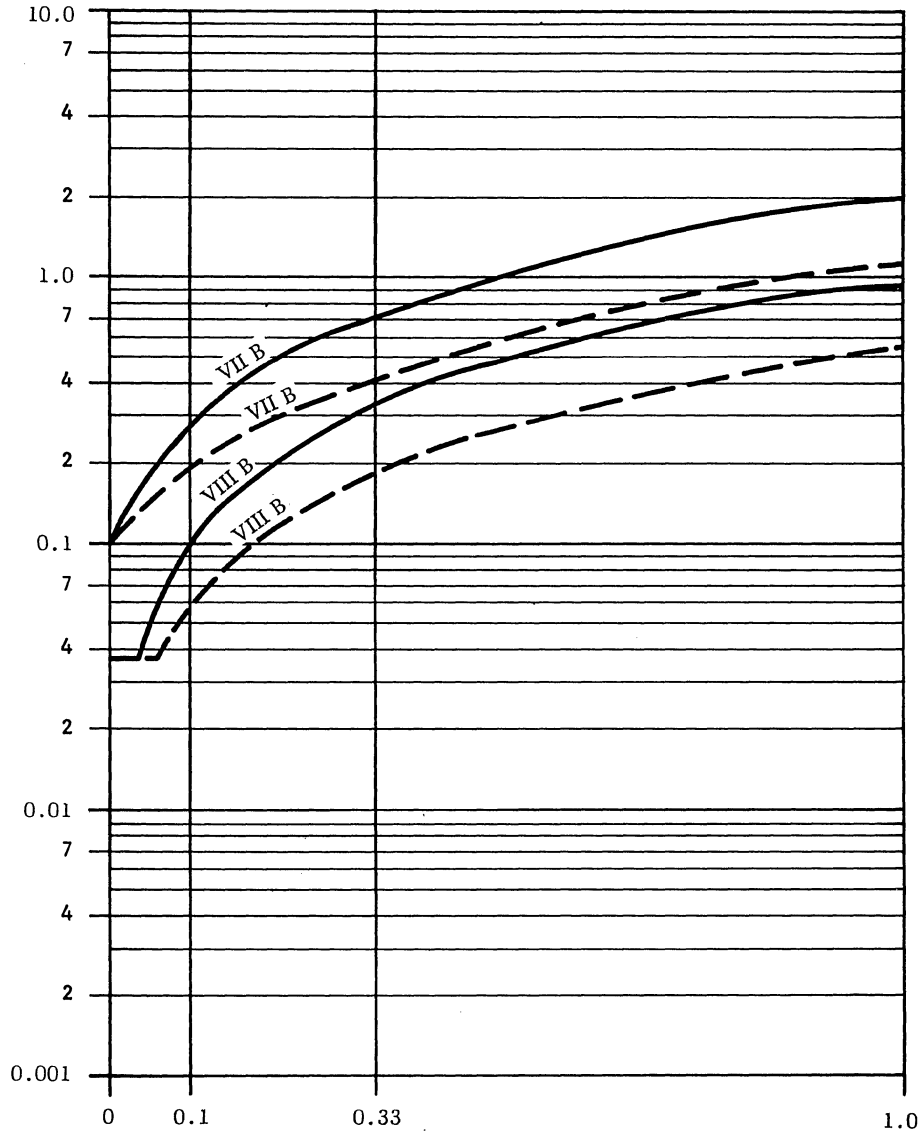

Activity Factor
Average Number of Detail Records Per Master Record
Broken line indicates blocked detail and report files

§ 201.

.13 Standard File Problem C

.131 Record Sizes

Master File: 216 characters.
 Detail File: 1 card.
 Report File: 1 line.

.132 Computation: standard.

.133 Timing Basis: using estimated procedure
 outlined in Users' Guide,
 4:200.13.

.134 Graph: see graph below.

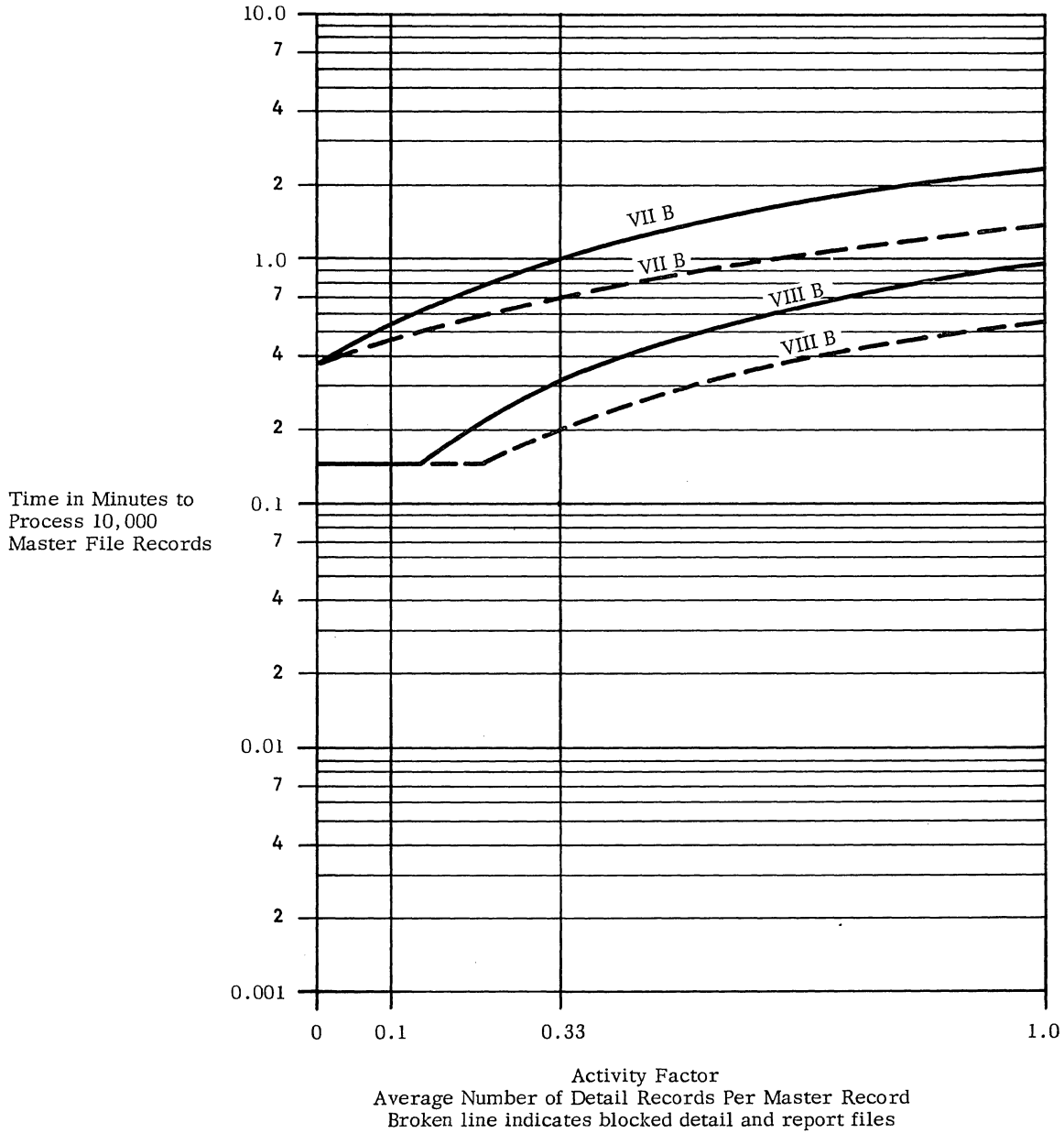

§ 201.

.14 Standard File Problem D

.141 Record Sizes

- Master File: 108 characters.
- Detail File: 1 card.
- Report File: 1 line.

- .142 Computation: trebled.
- .143 Timing Basis: using estimated procedure outlined in Users' Guide, 4:200.14.
- .144 Graph: see graph below.

Time in Minutes to Process 10,000 Master File Records

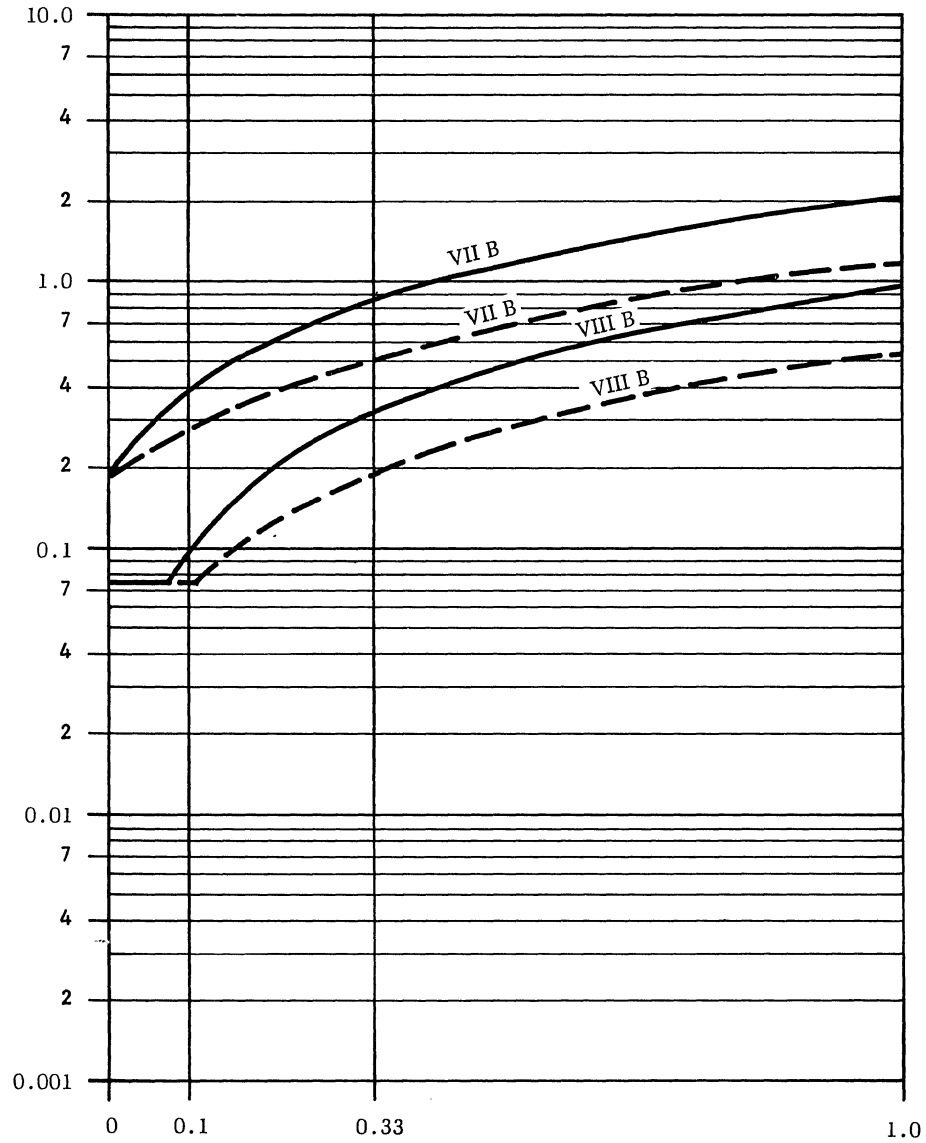

Activity Factor
Average Number of Detail Records Per Master Record
Broken line indicates blocked detail and report files

§ 201.

.2 SORTING

.21 Standard Problem Estimates

.211 Record Size: 80 characters.

- .212 Key Size: 8 characters.
- .213 Timing Basis: using estimated procedure outlined in Users' Guide, 4:200.213.
- .214 Graph: see graph below.

Time in Minutes to Put Records Into Required Order

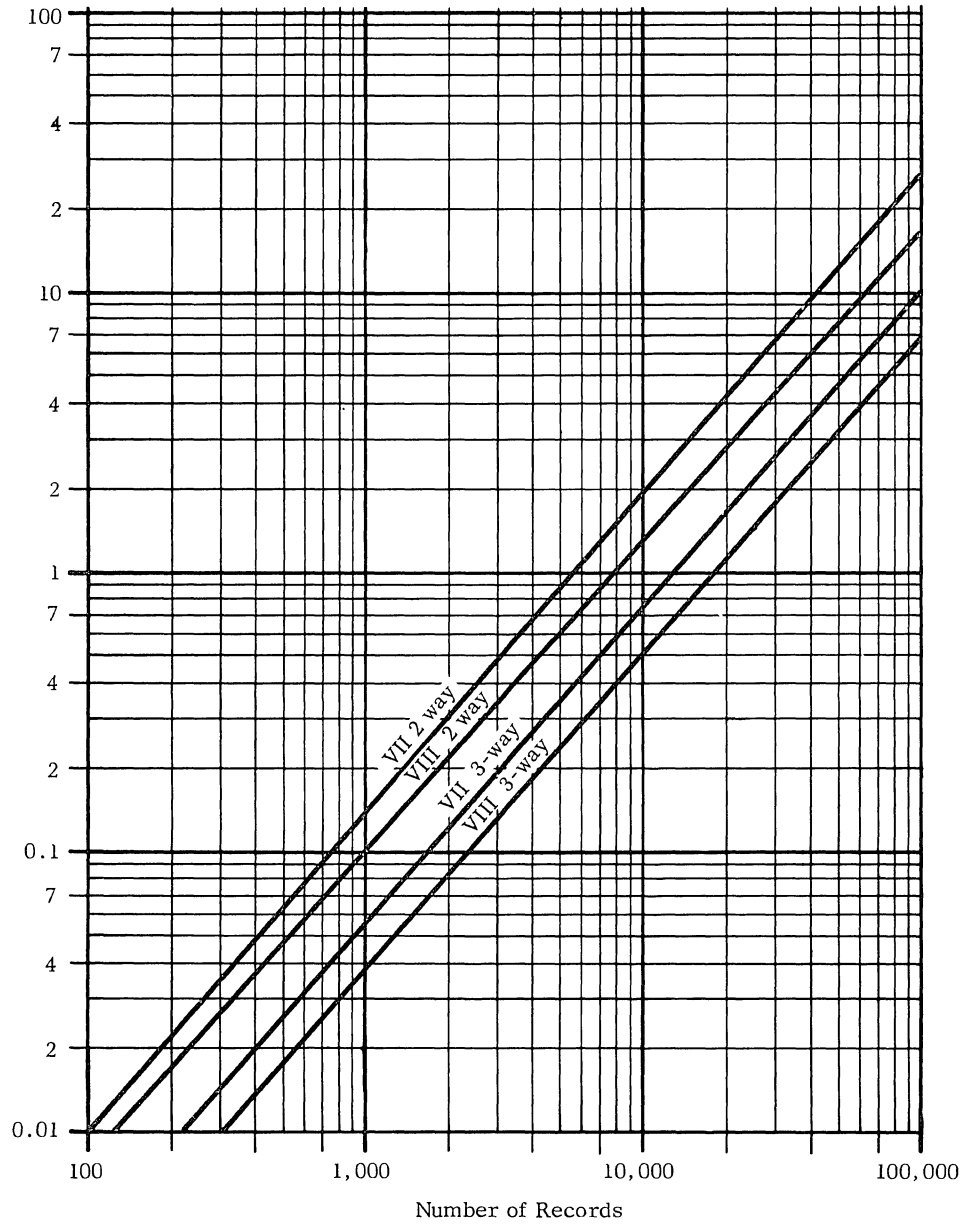

§ 201.

.3 MATRIX INVERSION

.31 Standard Problem Estimates

.311 Basic Parameters: . . . general, non-symmetric matrices, using floating point to at least 8 decimal digits.

.312 Timing Basis: using estimated procedure outlined in Users' Guide, 4:200.312.

.313 Graph: see graph below.

Time in Minutes for Complete Inversion

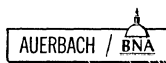
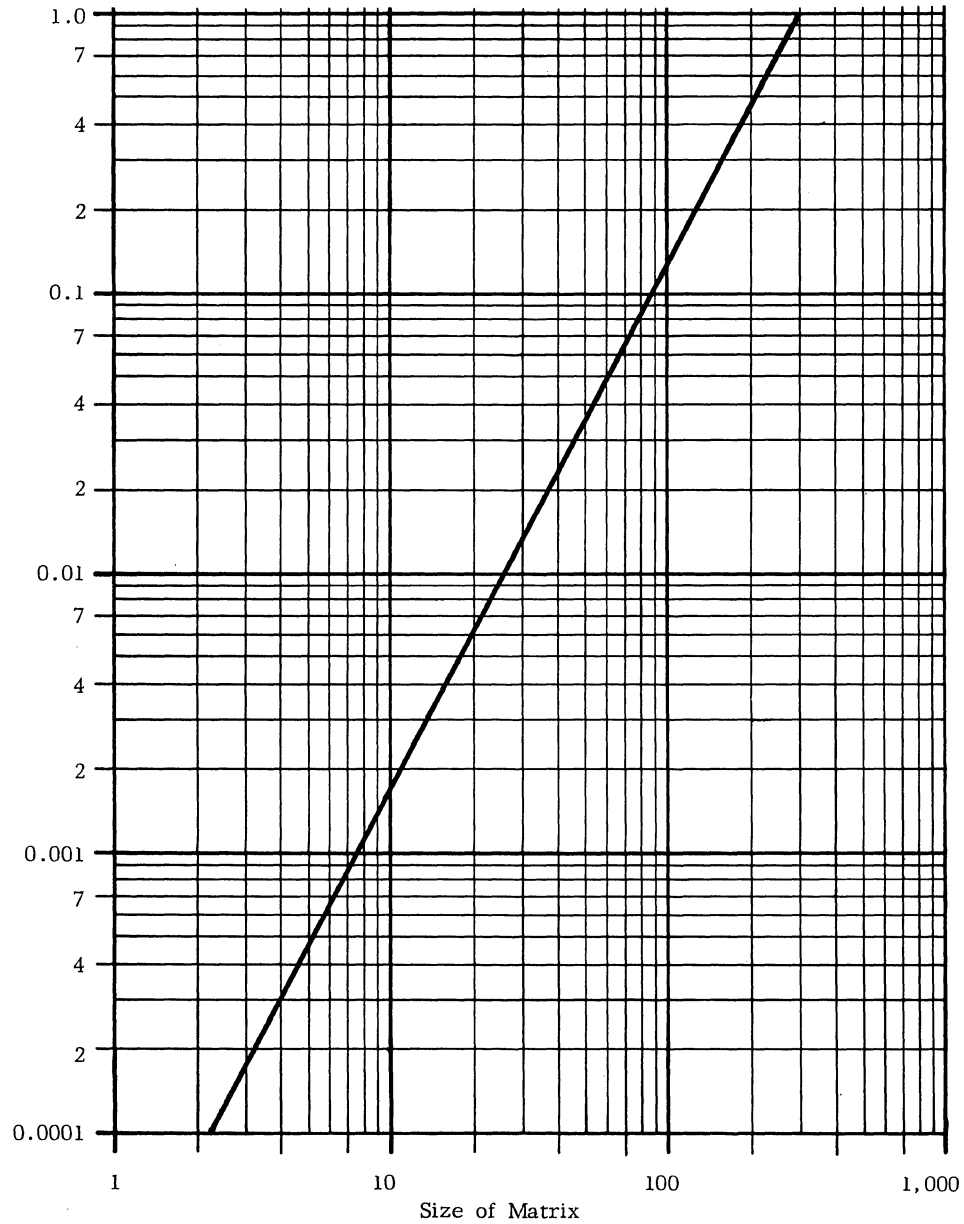

§ 201.

.4 GENERALIZED MATHEMATICAL PROCESSING

.41 Standard Mathematical Problem A Estimates

.411 Record sizes: 10 signed numbers, avg. size 5 digits, max. size 8 digits.

- .412 Computation: 5 fifth-order polynomials.
5 divisions.
1 square root.
- .413 Timing basis: using estimating procedure outlined in Users' Guide, 4:200.413.
- .414 Graph: see graph below.

Configuration VIIB; 1 word Length (12 digit precision); floating point.

R = Number of Output Records per Input Record

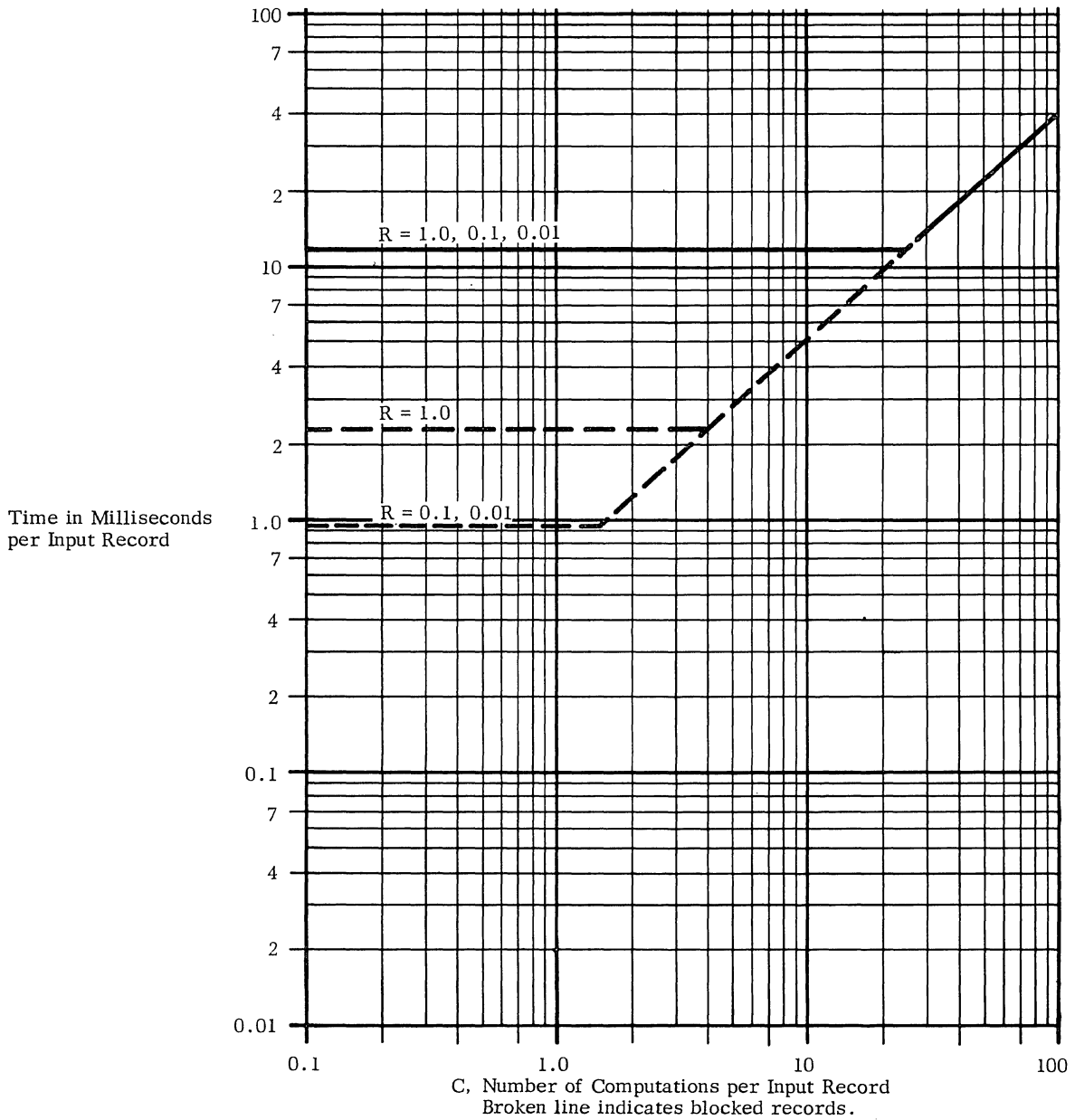

§ 201.

.415 Graph: see graph below.

Configuration VIII B; 1 word Length (12 digit precision); floating point.

R = Number of Output Records per Input Record

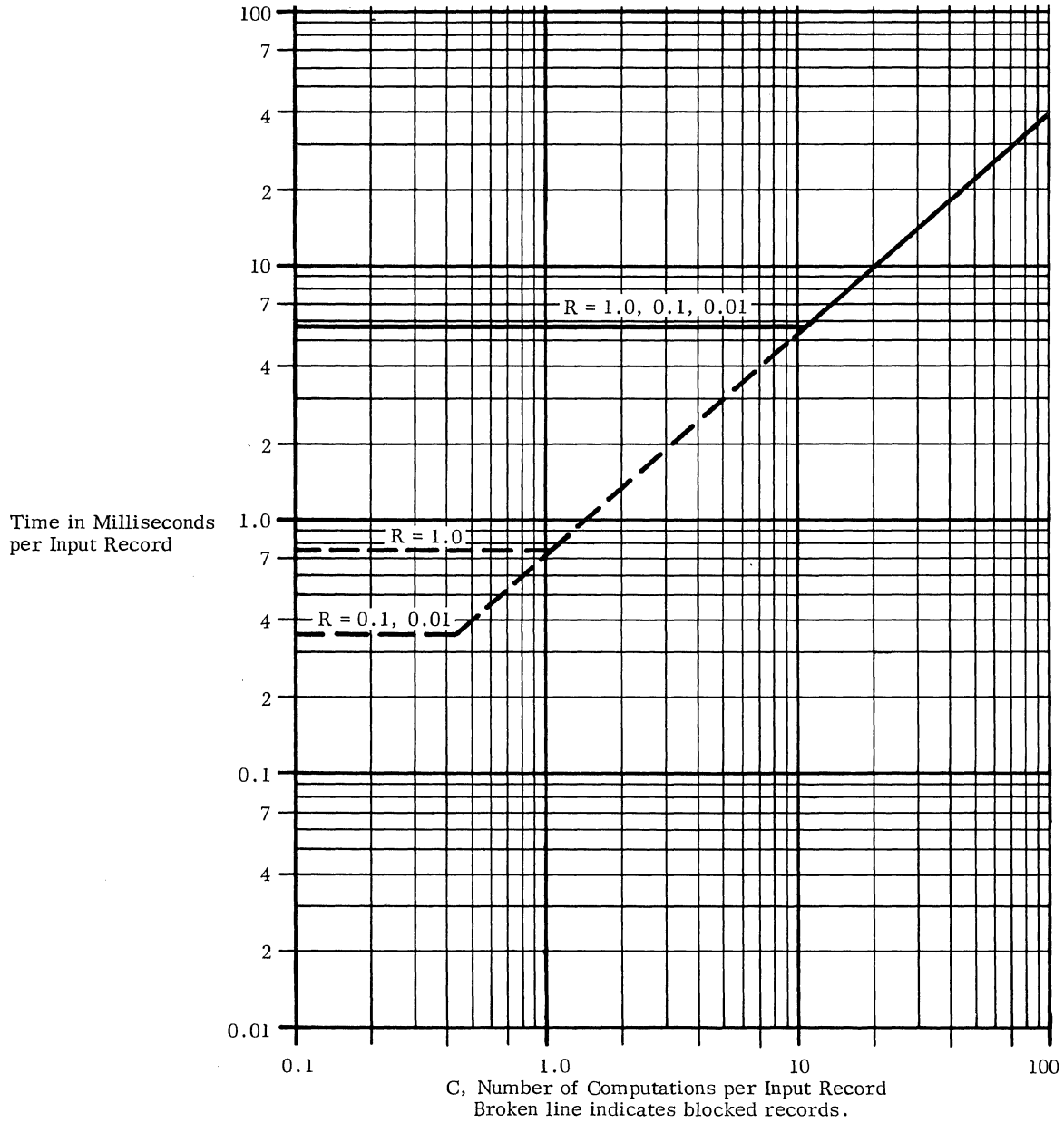

§ 201.

.5 GENERALIZED STATISTICAL PROCESSING

.511 Record size: thirty 2-digit integral numbers.

- .512 Computation: augment T elements in cross-tabulation tables.
- .513 Timing basis: using estimating procedure outlined in Users' Guide, 4:200.513.
- .514 Graph: see graph below.

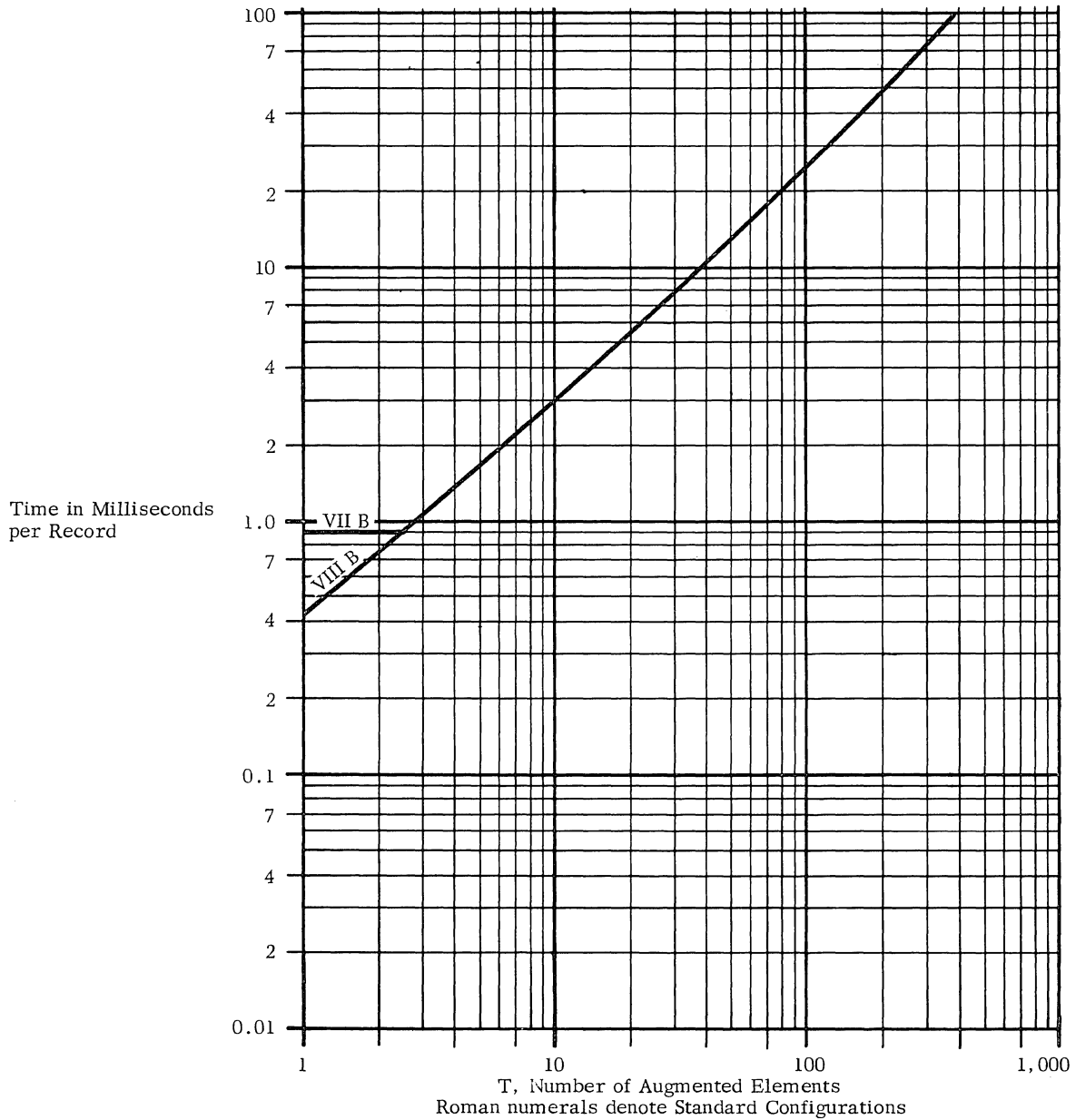



653:211.101

Philco 2000 - 212
Physical Characteristics

PHILCO 2000 - 212
PHYSICAL CHARACTERISTICS

PHILCO 2000 - 212 PHYSICAL CHARACTERISTICS

IDENTITY	Unit Name		Central Processor*	1 μ sec Core Store	Magnetic Tape Unit	240 KC Input-Output Processor		Disc System
	Model Number		212	2016, 2032, 2065	334	336	338	2311, 2312, 2313, 2314
PHYSICAL	Height \times Width \times Depth, in.		75 \times 144 \times 39	68 \times 24 \times 25	68 \times 26 \times 31	68 \times 77 \times 31	68 \times 130 \times 31	?
	Weight, lbs.		4,500	600	900*	2,700	3,600	
	Distance (feet) to other units*		17 to 2032 Core Storage 15 to 2332 Core Storage 42 to Oper. Console 12 to 212 IOCU	22 To Central Processor	140 To 240KC I/O Processor			
ATMOSPHERE	Storage Ranges	Temperature, °F.						
		Humidity, %						
	Working Ranges	Temperature, °F.						
		Humidity, %						
	Heat Dissipated, BTU/hr.		20,500					
	Air Flow, cfm.							
	Internal Filters							
ELECTRICAL	Voltage	Nominal						
		Tolerance						
	Cycles	Nominal						
		Tolerance						
	Phases and Lines							
	Load KVA		6.000		NA**	NA	NA	
NOTES	*Max. physical distance from hole to hole in false floor (not cable length) using standard length cables		*Includes Power Supply.		*Estimated. **Not Available.			

PHILCO 2000 - 212 PHYSICAL CHARACTERISTICS -Contd.

IDENTITY	Unit Name		Core Storage	Additional 8K Units	Core Storage (1.0 μ sec)	Disc Controller	Disc Unit	Disc Auxiliary Unit
		Model Number		2032	2032	221	310	315
PHYSICAL	Height \times Width \times Depth, in.		68 \times 96 \times 25	68 \times 24 \times 25	68 \times 24 \times 25	37 \times 61 \times 75	52 \times 70 \times 46	52 \times 22 \times 46
	Weight, lbs.		1,800*	600*	600*	1,000	3,000	1,000
	Distance (feet) to other units*		17 To 212 Central Processor				80 To I/O Control Unit	80 To Disc Controller
ATMOS- PHERE	Storage Ranges	Temperature, $^{\circ}$ F.						
		Humidity, %						
	Working Ranges	Temperature, $^{\circ}$ F.						
		Humidity, %						
	Heat Dissipated, BTU/hr.				10,200	7,100	9,850	1,960
	Air Flow, cfm.							
	Internal Filters							
ELECTRI- CAL	Voltage	Nominal						
		Tolerance						
	Cycles	Nominal						
		Tolerance						
	Phases and Lines							
	Load KVA				3,000	2,070	Run 2.875 Start 13.225	Run 0.575 Start 2.080
NOTES			*Estimated.	*Estimated.	*Estimated.			



§ 221.

PRICE DATA

Other prices are the same as listed in 651:221 and 652:221.

CLASS	IDENTITY OF UNIT		PRICES		
	No.	Name	Monthly Rental \$	Monthly Maintenance \$	Purchase \$
CENTRAL PROCESSOR	212	Central Processor	22,000		950,000
STORAGE		1 μ sec Memory			
	2016	(16 K)	+		
	2032	(32K)	+		
	2065	(65 K)	+		
		Disc System			
	2311	X1	11,000		500,000
	2312	X2	+		
2313	X3	+			
2314	X4	+			
INPUT-OUTPUT	334	240 KC Magnetic Tape Unit	1,200		54,000
	336	Magnetic Tape Controller (32x2)	8,500		385,000
	338	Magnetic Tape Controller (32x4)	+		

+ Prices not yet available

Note: The monthly maintenance rate is individually negotiated for purchased equipment. See Special Report, Section 23:010.100, second paragraph.

