Model 771 Intelligent Data Terminal Upgrade Instructions to DS990 System Model 1



**(Includes Instructions For Conversions
From 1 to 2 Drives, 2 to 3 Drives,
and 3 to 4 Drives)**

Part No. 2262327-9701
31 March 1979



TEXAS INSTRUMENTS

© Texas Instruments Incorporated 1977, 1979

All Rights Reserved, Printed in U.S.A.

The information and/or drawings set forth in this document and all rights in and to inventions disclosed herein and patents which might be granted thereon disclosing or employing the materials, methods, techniques or apparatus described herein, are the exclusive property of Texas Instruments Incorporated.

MANUAL REVISION HISTORY

Model 771 Intelligent Data Terminal Upgrade Instructions to DS990 System
Model 1 (2262327-9701)

Original Issue31 March 1979

**TABLE OF CONTENTS**

Paragraph	Title	Page
SECTION I. MODEL 771 INTELLIGENT DATA TERMINAL UPGRADE INSTRUCTIONS TO DS990 SYSTEM MODEL 1		
1.1	General	1
1.2	Disassembly of Model 771	2
1.3	Assembly of DS990/1 System with Two FD1000 Diskette Drives	4
1.4	Addition of an FD1000 Assembly with one or Two Drives to a DS990/1 System	10
1.5	Addition of Drives Numbers 2 or 4 to a DS990/1 System	13
1.6	DS990/1 System Checkout	17
1.7	Upgrade Parts List	17

APPENDIXES

Appendix	Title	Page
A	Configuration Comparison Chart	20
B	Option List for Shugart SA850 Drives	21
C	Option List for Qume DT, 8 Drives	22

LIST OF ILLUSTRATIONS

Figure	Title	Page
1-1	DS990 System Model 1	iv
1-2	Rear View of Model 771 Intelligent Terminal System	3
1-3	Terminal Cover Assembly Release	4
1-4	Internal View of Terminal Assembly	5
1-5	H1 32K-Byte RAM Circuit Board	6
1-6	Diskette Drive I/O Processor Circuit Board	7
1-7	Diskette Drive Interface Circuit Board	7
1-8	Rear View of DS990/1 System	9
1-9	Terminal Configuration Chart for DS990/1 Upgrade	9
1-10	Typical Floor Plan Layout of the DS990/1 System with One FD1000 Assembly	11
1-11	Typical Connection Diagram for the DS990/1 System with One FD1000 Assembly	11
1-12	Typical Floor Plan Layout of the DS990/1 System with Two FD1000 Assemblies	12
1-13	Typical Connection Diagram for the DS990/1 System with Two FD1000 Assemblies	12





LIST OF ILLUSTRATIONS (Continued)

Figure	Title	Page
1-14	FD1000 Assembly Cover Removal	14
1-15	FD1000 Assembly Base Plate Removal	14
1-16	FD1000 Assembly Internal Top View	15
1-17	FD1000 Assembly Diskette Drive Removal	16
1-18	FD1000 Assembly Internal Rear View	17

LIST OF TABLES

Table	Title	Page
1-1	Jumper Assignments for Model 771 and the DS990/1 System on Diskette Drive Controller Circuit Boards	8
1-2	Parts List Required to Upgrade Model 771 to DS990/1	18

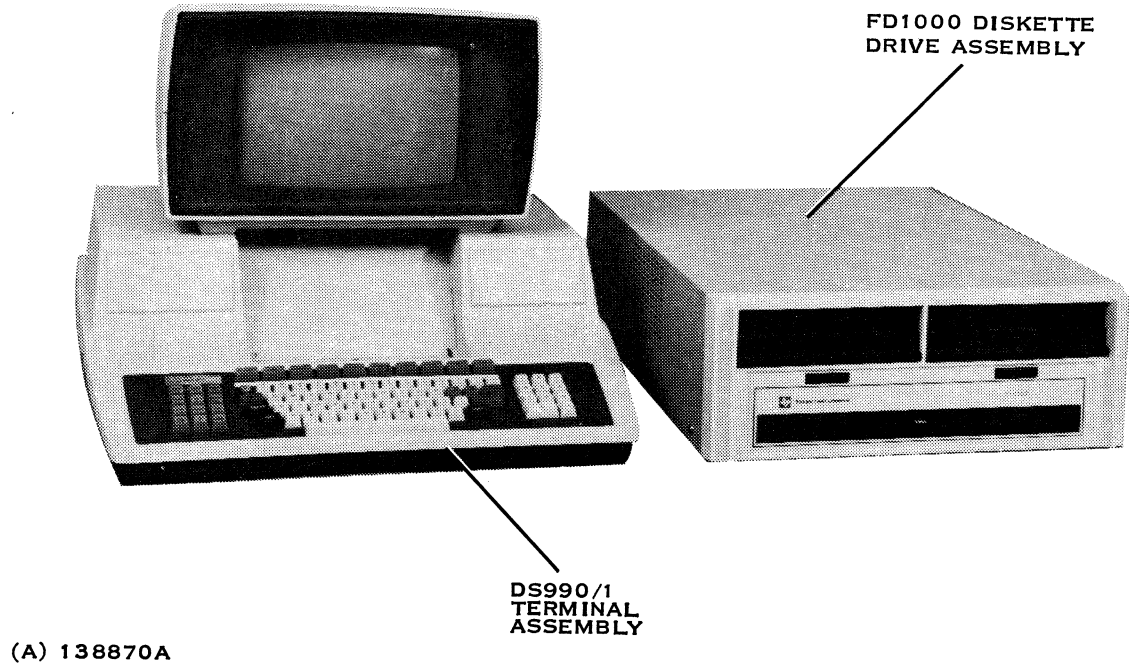

Figure 1-1. DS990 System Model 1



MODEL 771 INTELLIGENT DATA TERMINAL UPGRADE INSTRUCTIONS TO DS990 SYSTEM MODEL 1

1.1 GENERAL

This manual contains instructions to upgrade a Model 771 Intelligent Data Terminal to a DS990 System Model 1 (DS990/1), figure I-1. Instructions are also included for the addition of more diskette drives to an existing DS990/1.

These instructions are presented under the following headings:

Paragraph	Heading
1.2	Disassembly of Model 771
1.3	Assembly of DS990/1 System with Two FD1000 diskette drives
1.4	Addition of a Second FD1000 Assembly with One or Two Drives to a DS990/1 System
1.5	Addition of Drive Number 2 or 4 to a DS990/1 System
1.6	DS990/1 System Checkout
1.7	Upgrade Parts List

The upgrade consists primarily of increasing the mass-storage capacity of the terminal system from .5 megabytes with two single-sided, single-density (SSSD) drives to 4.6 megabytes with four double-sided, double-density (DSDD) drives. This is done by replacing the existing DDDS diskette drive assembly with a DSDD diskette drive assembly(s). The associated diskette drive I/O processor and interface circuit boards in the terminal assembly are also replaced or have jumper changes when upgrading from a Model 771.

NOTE

For Model 771s with I/O processor board part number 2263550-0001 and interface board part number 2263560-0001 prior to upgrade, it will be necessary to replace these boards with I/O processor board part number 2267355-0001 and interface board part number 2267350-0001. For Model 771s with I/O processor board part number 2267355-0001 and interface board part number 2267350-0001 prior to upgrade, it will be necessary to change the jumpers on these boards per table I-1. These boards will be reinstalled in the DS990 Model 1.



The standard DS990/1 system contains one FD1000 DSDD diskette drive assembly with two drives. As an option, the DS990/1 system may have one, three, or four drives in one or two diskette drive assemblies. Locate the delivered upgrade kit in the following kit descriptions. Check the parts list in paragraph 1.7 for kit item identification prior to performing the conversion on any Model 771.

- Upgrade it to convert a standard two drive U.S.A. Model 771 to a DS990/1. Kit part number 2267373-0002, items 3, 4, 6, 21, 22, 23, 28, 31, 32, 33, and 36 (2267370-0001).
- Upgrade kit to add drive number 3 to a U.S.A. DS990/1. Kit part number 2267373-0003, items 23, 31, 34, and 36 (2267370-0009).
- Upgrade kit to add drive numbers 3 and 4 to a U.S.A. DS990/1. Kit part number 2267373-0004, items 23, 31, 34, and 36 (2267370-0013).
- Upgrade kit to add drive number 2 to a U.S.A. DS990/1. Kit part number 2267373-0005, items 23, 31, and 37 (2261686-0004).
- Upgrade kit to add drive number 4 to a U.S.A. DS990/1. Kit part number 2267373-0006, items 23, 31, and 37 (2261686-0004).
- Upgrade kit to convert a standard two drive international Model 771 to a DS990/1. Kit part number 2267378-0002, items 3, 4, 6, 21, 22, 23, 28, 29, 31, 32, 33, and 36 (2267370-0002, -0003, or -0004).
- Upgrade kit to add drive number 3 to an international DS990/1. Kit part number 2267378-0003, items 23, 31, 34, and 36 (2267370-0010, -0011, or -0012).
- Upgrade kit to add drive numbers 3 and 4 to an international DS990/1. Kit part number 2267378-0004, items 23, 31, 34, and 36 (2267370-0014, -0015, or -0016).
- Upgrade kit to add drive number 2 to an international DS990/1. Kit part number 2267378-0005, items 23, 31, and 37 (2261686-0005, -0006, or -0007).
- Upgrade kit to add drive number 4 to an international DS990/1. Kit part number 2267378-0006, items 23, 31, and 37 (2261686-0005, -0006, or -0007).

1.2 DISASSEMBLY OF MODEL 771

Perform the following procedure to disassemble the Model 771 Intelligent Data System for conversion to the DS990/1 system:

WARNING

Dangerous ac voltages exist within the terminal assembly when ac power is applied. Do not open the terminal cover assembly without first removing the ac power from the terminal assembly.

1. Set the AC POWER ON/OFF switches on the rear of the Model 771 terminal assembly and the diskette drive assembly to OFF (figure 1-2).
2. Disconnect the ac power cables at the wall plug.

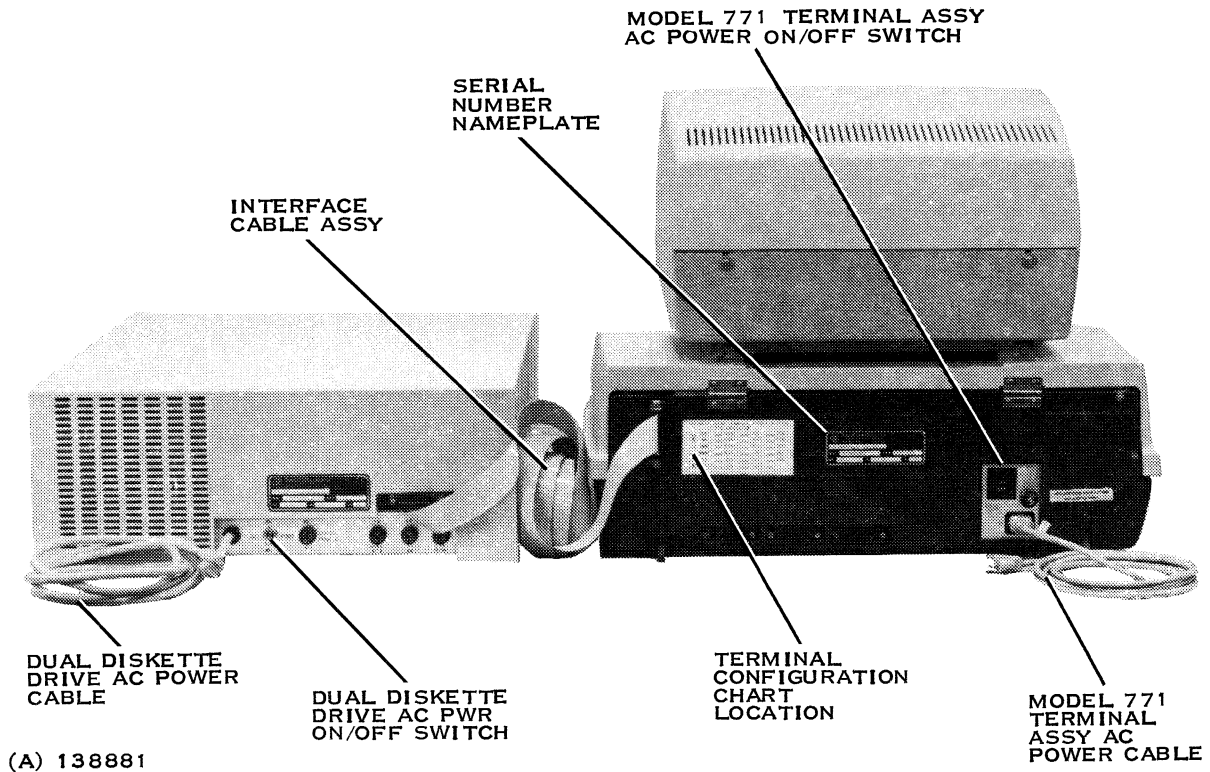

Figure 1-2. Rear View of Model 771 Intelligent Terminal System

3. Open the terminal cover assembly by performing the following steps (figure 1-3):
 - a. On terminals with an internal printer, slide the paper-loading access door up to the open position.
 - b. Insert a flat-bladed screwdriver into the cover latch-opening slot on one side of the terminal until it makes contact with the cover latch spring.

CAUTION

Do not apply excessive pressure to the screwdriver as the cover latch spring may be damaged.

- c. Gently apply horizontal pressure to the screwdriver until the side of the cover is released from the cover latch spring.
- d. Lift the released side of the cover and insert a small screwdriver between the cover and the base to keep the cover latch released.
- e. Repeat steps b, c, and d to release the cover latch on the opposite side of the terminal.

CAUTION

When opening the terminal cover assembly, ensure that it is in its full, open position so that it will not drop closed.

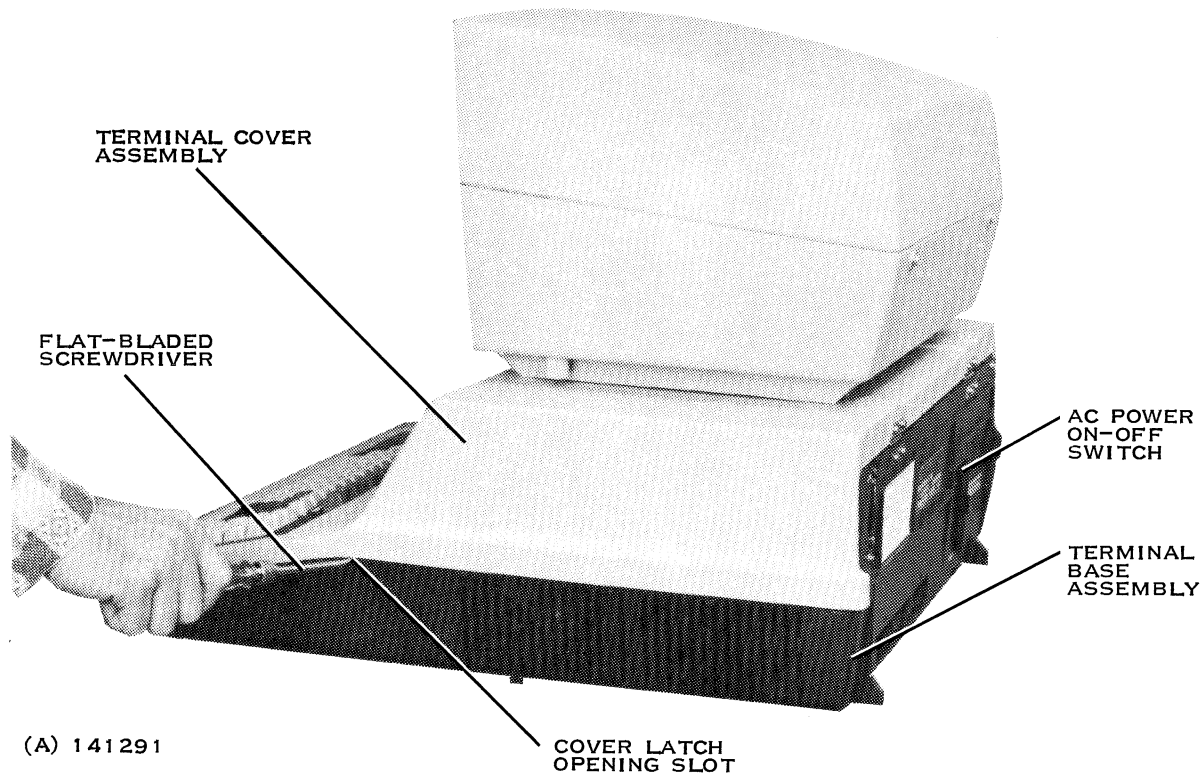

Figure 1-3. Terminal Cover Assembly Release

- f. Lift the terminal cover assembly to its full open position (figure 1-4).
4. Disconnect the interface cable assembly at the circuit board connector (figure 1-4) on the diskette-drive interface board in slot A3 at the orange mark.

NOTE

Since the slot identification number A2, A3, etc., is not readily visible, colored marks are used to help show slot locations. The location of these colored marks is shown in figure 1-4.

5. Pull up on the circuit board ejectors and then lift the following circuit boards from their slots:
 - a. Diskette-drive I/O processor board, part numbers 2263550-0001 or 2267355-0001, slot A2 at the red mark.
 - b. Diskette-drive interface board, part number 2267350-0001 or 2263560-0001, slot A3 at the orange mark.
 - c. HI 32K-byte RAM board, part number 2263555-0003, slot A7 at the purple mark.
6. Disconnect the interface cable assembly at the diskette-drive interface connector on the rear of the Model 771 terminal assembly and remove the dual diskette drive assembly with the interface cable.

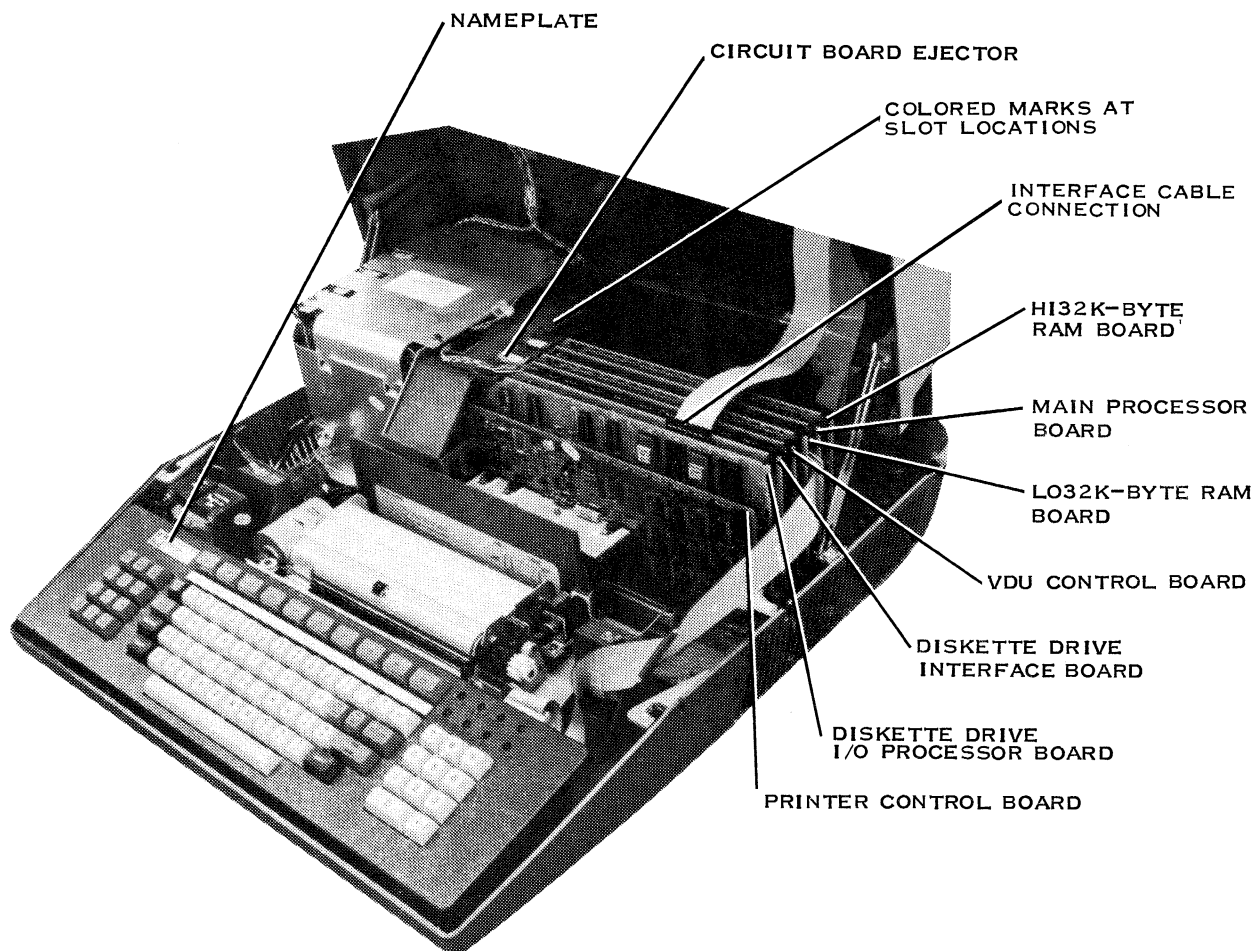

(A) 141292

Figure 1-4. Internal View of Terminal Assembly

1.3 ASSEMBLY OF DS990/1 SYSTEM WITH TWO FD1000 DISKETTE DRIVES

Perform the following procedure to install the components required to upgrade a Model 771 to a DS990/1 system with two DSDD FD1000 diskette drives. Refer to table 1-1 for item number references.

1. Replace ROM diskette loader chips U58 and U59, part numbers 2263593-0001 and -0002, on the HI 32K-byte RAM circuit board (figure 1-5), with new ROM diskette loader chips (items 32 and 33) as follows:

NOTE

Make sure pin 1 of the ROM is pointing down toward the circuit board edge connector.

Item	Part Number	Socket
32	2267371-0001	U58
33	2267371-0001	U59

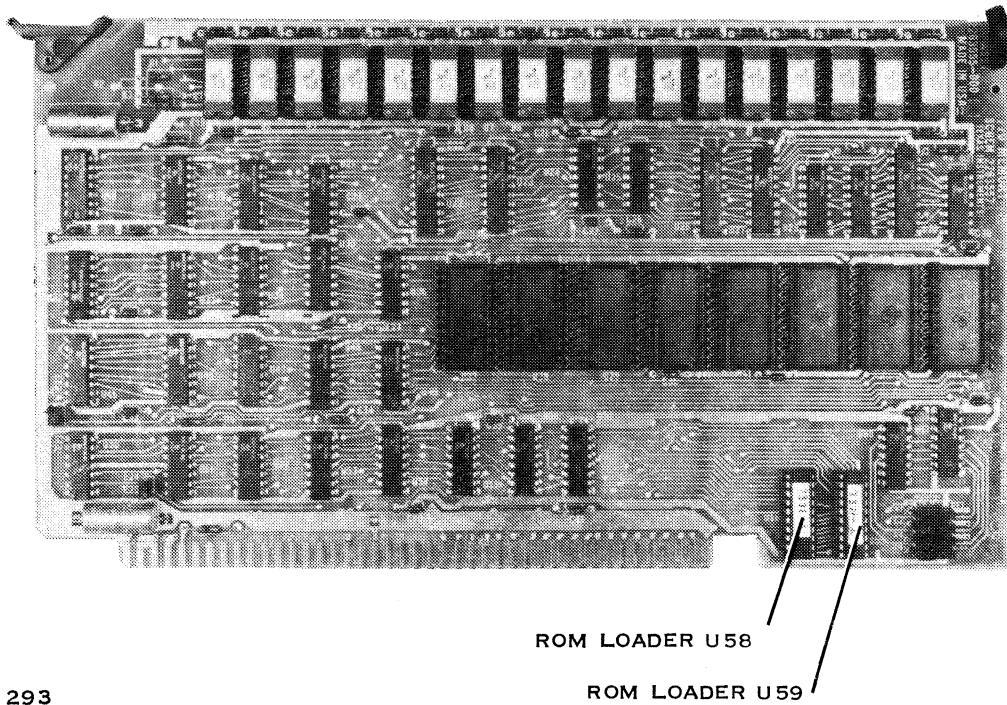

(A) 141293

Figure 1-5. HI 32K-Byte RAM Circuit Board

2. Change the part number on the HI 32K-byte RAM circuit board from 2263555-0003 to 2263555-0005.
3. Install the HI 32K-byte RAM circuit board, part number 2263555-0005, with the new ROM diskette loader chips installed in step 1, into slot A7 at the purple mark.
4. Change jumpers per table 1-1, figures 1-6 and 1-7, and the following note when applicable.

NOTE

For Model 771s with I/O processor board part number 2263550-0001 and interface board part number 2263560-0001 prior to upgrade, it will be necessary to replace these boards with I/O processor board part number 2267355-0001 and interface board part number 2267350-0001. For Model 771s with I/O processor board part number 2267355-0001 and interface board part number 2267350-0001 prior to upgrade, it will be necessary to change the jumpers on these boards per table 1-1. These boards will be reinstalled in the DS990 Model 1.

Install the following new circuit boards (figure 1-4):

Item	Part Number	Slot	Description
3	2267355-0001	A2 (red)	Diskette-drive I/O processor circuit board
4	2267350-0001	A3 (orange)	Diskette-drive interface circuit board

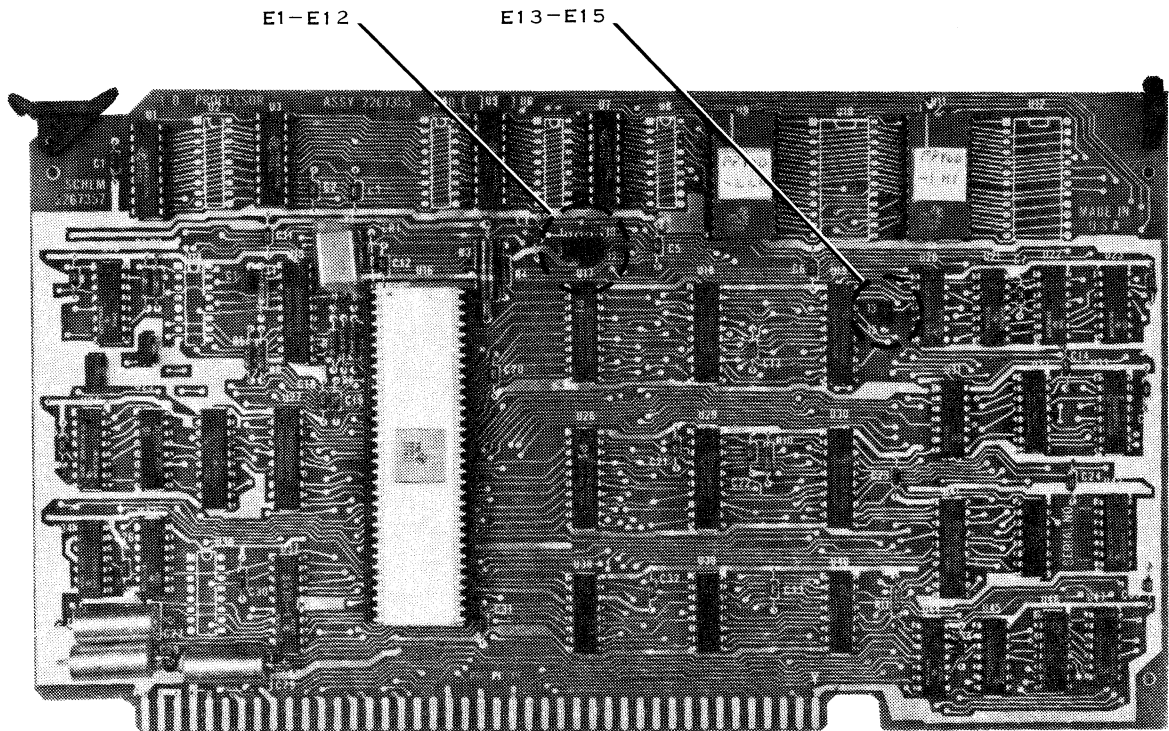

(A) 141331

Figure 1-6. Diskette Drive I/O Processor Circuit Board

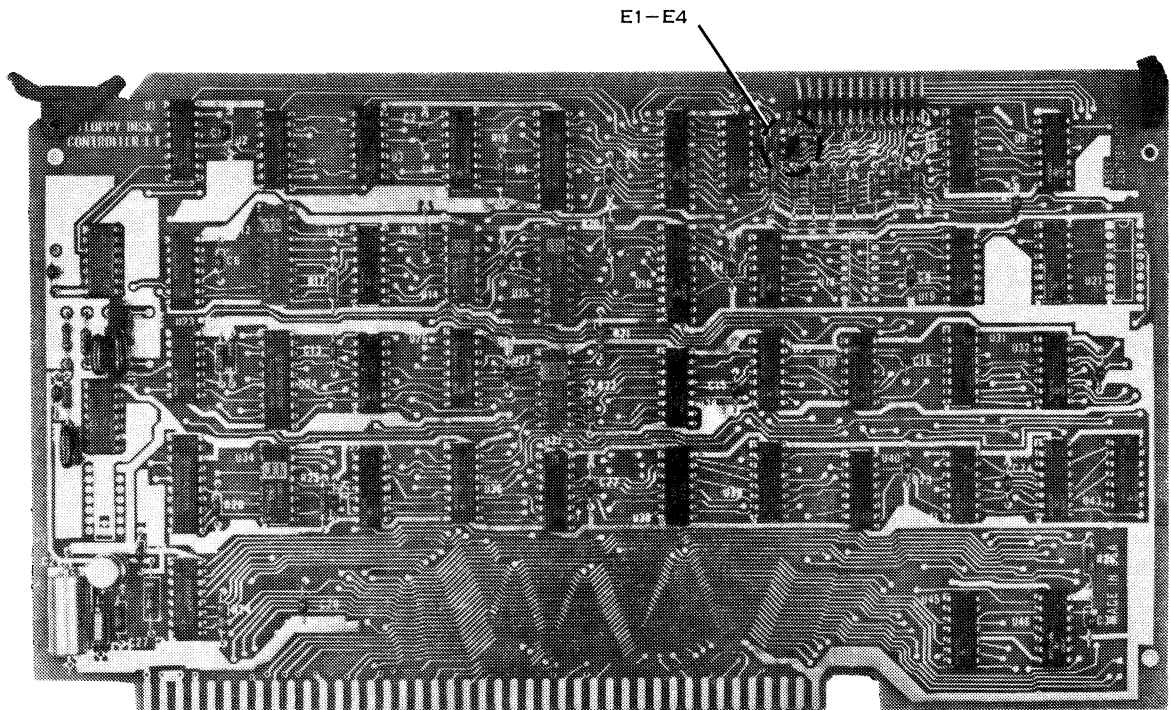

(A) 141332

Figure 1-7. Diskette Drive Interface Circuit Board



Table 1-1. Jumper Assignments for Model 771 and the DS990/1 System on Diskette Drive Controller Circuit Boards

Terminal System	I/O Processor Board Part Number 2267355-0001 Jumpers		Interface Board Part Number 2267350-0001 Jumpers	
	From	To	From	To
DS990/1 System	E1	E2	E1	E3
	E4	E5	E2	E4
	E7	E8		
	E10	E11		
	E14	E15		
Model 771	E1	E2	E1	E2
	E4	E5	E3	E4
	E7	E8		
	E10	E11		
	E13	E14		

5. Reconnect the interface cable assembly at the circuit board connector (figure 1-4) on the diskette drive interface board in slot A3 at the orange mark.
6. Close the terminal cover assembly by carefully lowering the cover and pressing down on each side of the cover to engage the cover latches.
7. Peel the backing off the new nameplate (item 21), part number 2267384-0001. Align the new nameplate over the old nameplate on the bezel located as shown in figure 1-4 and firmly press the new nameplate into place.
8. Replace the old terminal configuration label on the back of the 771 terminal assembly (figure 1-2) with item 31, part number 2263584-0003 (figure 1-8). Use the following procedure to fill in the DS990/1 configuration label (figure 1-9):
 - a. Fill in the dash number on the part number with:
 - (1) Part Number 2263582-4 if upgrading a U.S.A. unit
 - (2) Part Number 2263583-4 if upgrading an international unit
 - b. Fill in the 85___ option with the numbers of FD1000 diskette drives on the upgraded unit.
 - c. Fill in the M___ option with 64.
 - d. Fill in the 7___S option with a 1 if the upgraded unit does not have an internal printer.
 - e. Fill in the 7___P option with a 1 if the upgraded unit has an internal printer.
 - f. Transfer all "write in" and "checked" options from the old configuration label to the new configuration label. Refer to Appendix A for configuration comparison between labels.

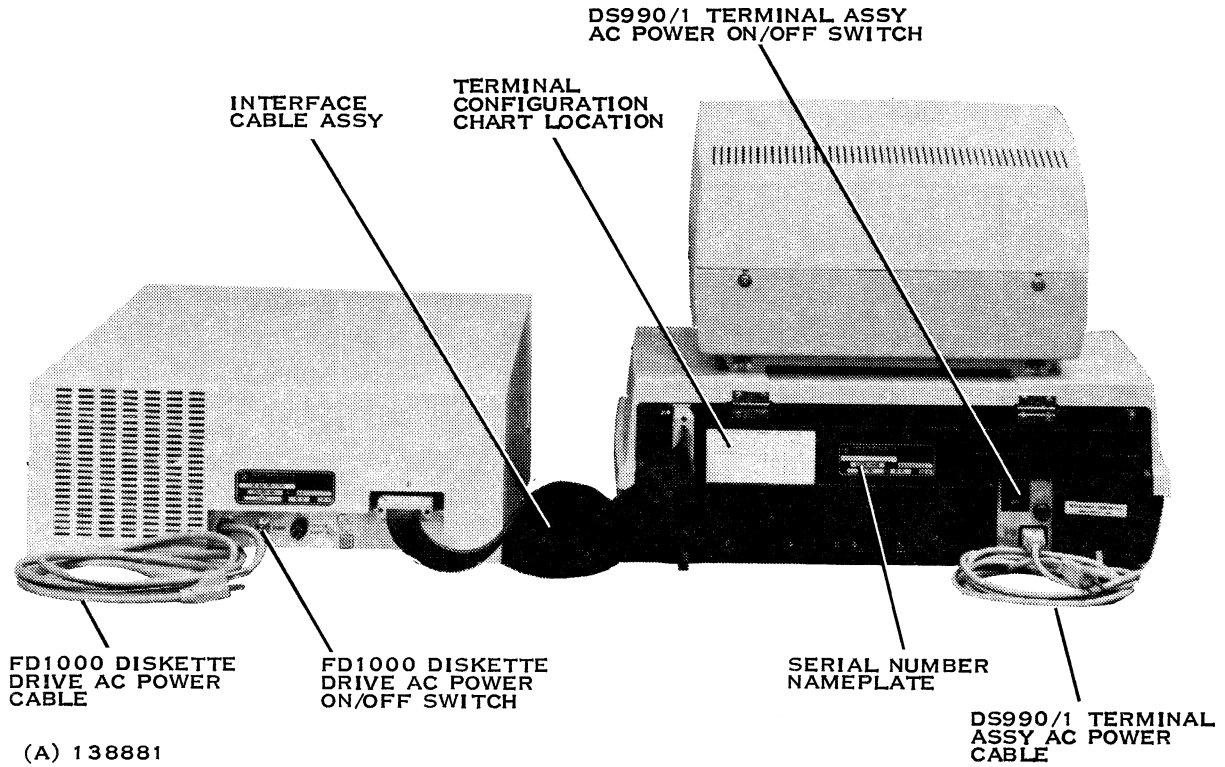

Figure 1-8. Rear View of DS990/1 System

DS990/1 INTELLIGENT TERMINAL CONFIGURATION					
P/N 2267375	_____	7 _____	S _____	E _____	N MC _____
P/N 2263582	_____	7 _____	P _____	E _____	A O _____
P/N 2263583	_____	_____	100 _____	I _____	N _____
		_____	200 _____	I _____	A _____
		M _____	I _____	D _____	
		85 _____	S _____	N _____	
		_____	_____	_____	

(A) 140995

Figure 1-9. Terminal Configuration Chart for DS990/1 Upgrade



9. Remove the old 771 serial number nameplate (figure 1-2) and replace with item 28 if the unit is a 110-volt model (U.S.A.), or item 29 if the unit is a 230-volt model (International). See figure 1-8. Discard old serial number nameplate. This completes the upgrade of the 771 terminal assembly to a DS990/1 terminal assembly.
10. Place the DS990/1 terminal assembly and one FD1000 diskette drive assembly, part number 2267370-0001, -0002, -0003, or -0004, on a table or desk in position for operation (figure 1-10).
11. Connect the DS990/1 terminal assembly to the FD1000 diskette-drive assembly, using interface cable assembly (item 6), part number 2267374-0001. The cable connects between the diskette-drive interface connector on the rear of the terminal and connector J1 on the rear of the FD1000 diskette-drive assembly (figure 1-11).
12. Reconnect the ac power cable associated with the DS990/1 terminal assembly between the ac power connector on the rear of the terminal and the selected ac power source.
13. To complete the DS990/1 assembly, connect the FD1000 diskette-drive assembly ac power cord to the same ac power source to which the DS990/1 terminal assembly is connected.
14. Refer to paragraph 1.6 for checkout instructions.

1.4 ADDITION OF AN FD1000 ASSEMBLY WITH ONE OR TWO DRIVES TO A DS990/1 SYSTEM

Perform the following procedure to add an FD1000 assembly with drive number 3 or drives numbers 3 and 4 to a DS990/1 system with drives numbers 1 and 2 installed:

1. Set the AC POWER ON/OFF switches on the rear of the DS990/1 terminal assembly and the FD1000 diskette drive assembly to OFF (figure 1-8).
2. Disconnect and remove the interface cable assembly, part number 2267374-0001, between the DS990/1 terminal assembly and the FD1000 diskette drive assembly.

NOTE

The added FD1000 diskette drive assembly containing drive number 3 or drives numbers 3 and 4 must be connected to the middle connector on the interface cable assembly.

3. Place the new FD1000 diskette drive assembly with drive number 3 or drives numbers 3 and 4, (item 36) part number 2267370-0009 through -0016, on a table or desk between the DS990/1 terminal assembly and the existing FD1000 diskette drive assembly as shown in figure 1-12.
4. Connect the interface cable assembly (item 34), part number 2267376-0001, between the DS990/1 terminal assembly and the two FD1000 diskette drive assemblies as shown in figure 1-13.
5. Replace the old terminal configuration label on the back of the DS990/1 terminal assembly (figure 1-8) with item 31, part number 2263584-0003 (figure 1-9). Refer to paragraph 1.3, step 8 to fill in the new configuration label.

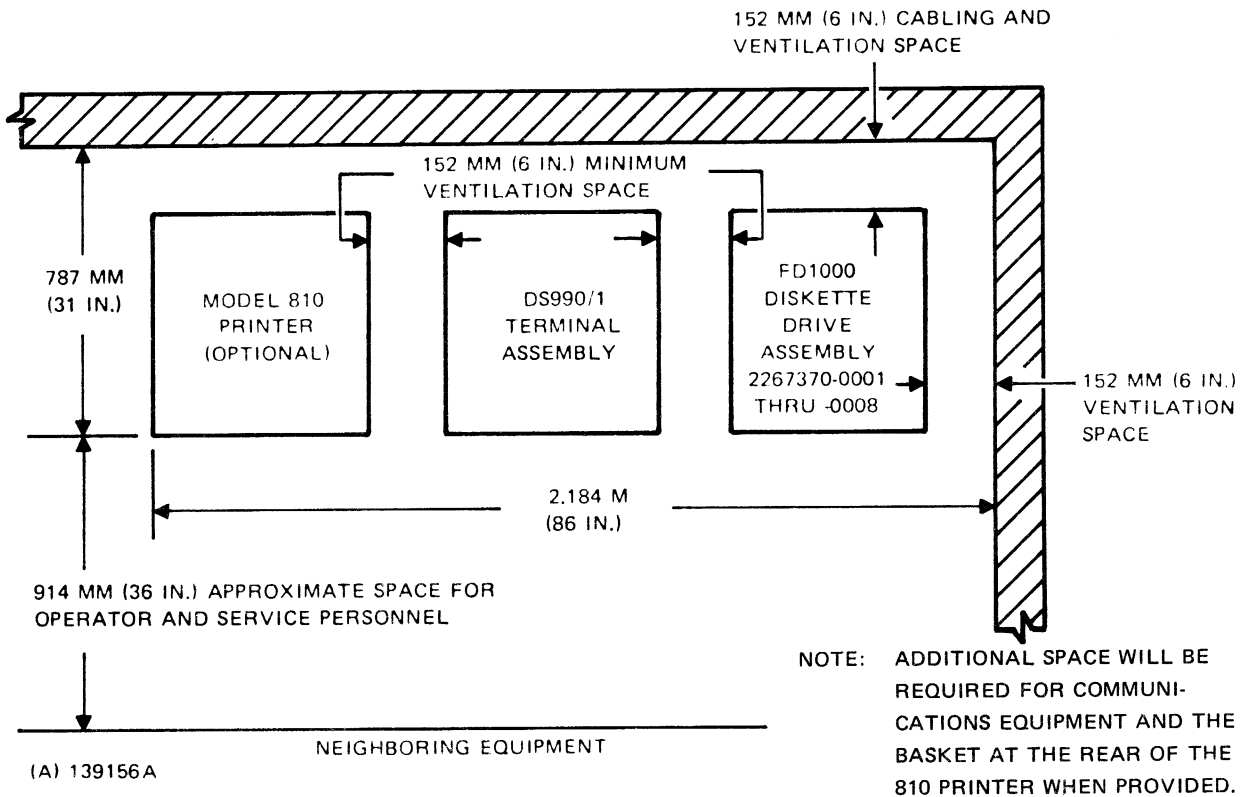

Figure 1-10. Typical Floor Plan Layout of the DS990/1 System With One FD1000 Assembly

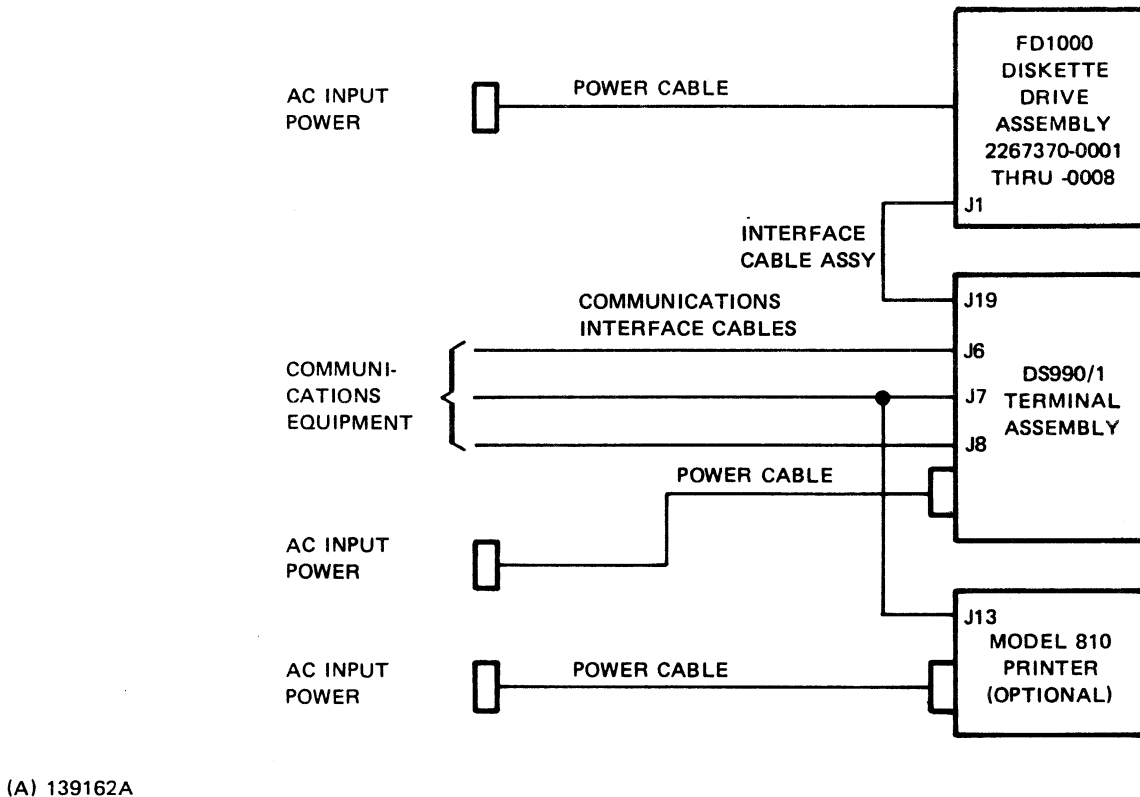
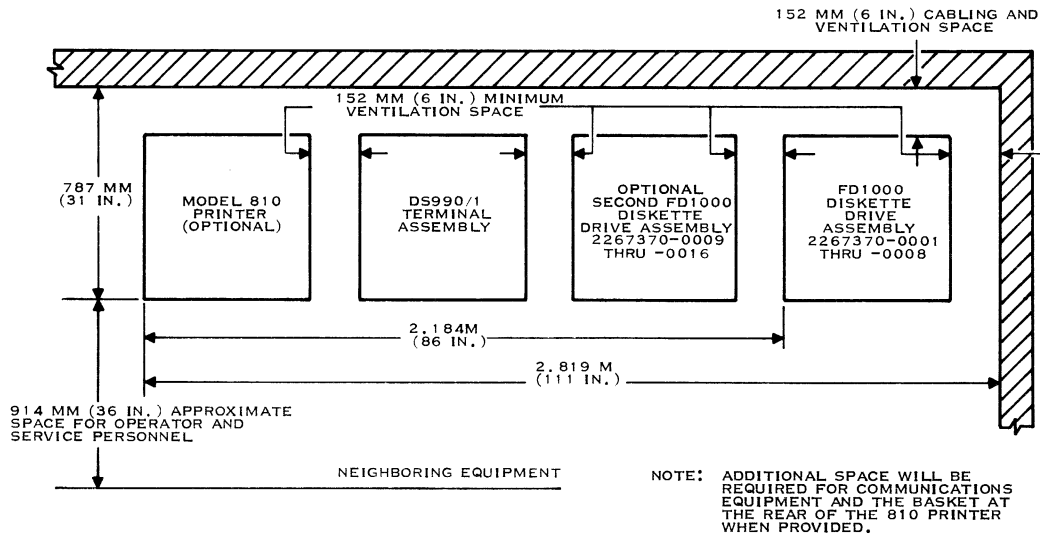
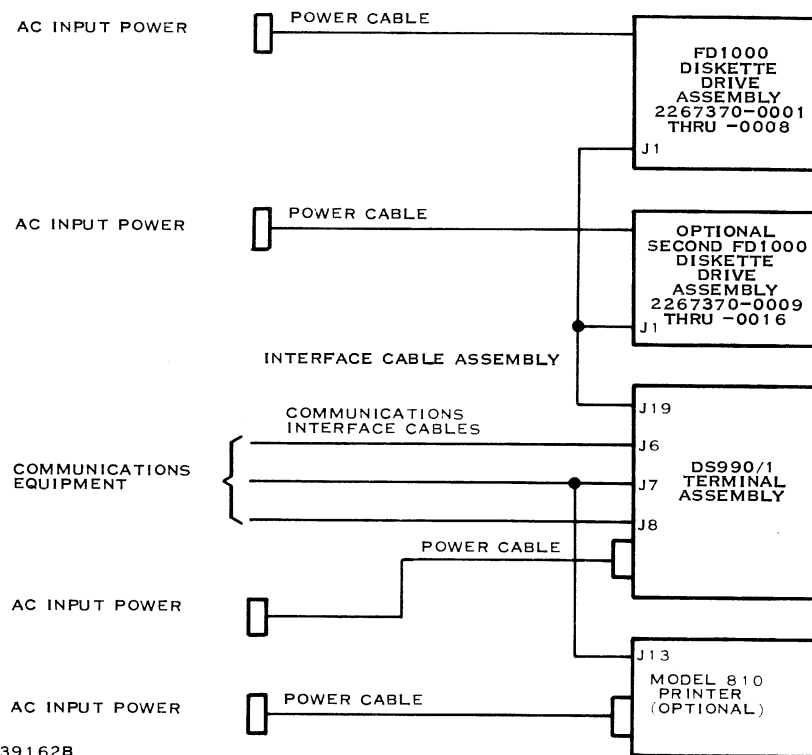

Figure 1-11. Typical Connection Diagram for the DS990/1 System With One FD1000 Assembly



(A) 139156A

Figure 1-12. Typical Floor Plan Layout of the DS990/1 System With Two FD1000 Assemblies



(A) 139162B

Figure 1-13. Typical Connection Diagram for the DS990/1 System With Two FD1000 Assemblies



6. Connect the ac power cable for the added FD1000 diskette drive assembly to the same ac power source to which the existing DS990/1 terminal assembly and FD1000 diskette drive assembly are connected.
7. Refer to paragraph 1.6 for checkout instructions.

1.5 ADDITION OF DRIVE NUMBERS 2 OR 4 TO A DS990/1 SYTEM

Perform the following procedure to add drive number 2 or 4 to a DS990/1 system with drive number 1 installed or drives numbers 1, 2, and 3 installed, respectively:

1. Set the AC POWER ON/OFF switches on the rear of the DS990/1 terminal assembly and the FD1000 diskette drive assembly(s) to OFF (figure 1-8).
2. Disconnect the FD1000 diskette drive ac power cable from the ac power source on the assembly to which a drive is to be added.
3. Disconnect the interface cable assembly from the FD1000 diskette drive assembly to which the drive is to be added.
4. Remove six cover retaining screws (figure 1-14) and lift the cover from the FD1000 diskette drive assembly that is having a drive added.
5. Stand the FD1000 diskette drive assembly on its side with the cover removed. Remove six base plate mounting screws (figure 1-15) and lift the base plate from the FD1000 diskette drive assembly.
6. Remove the five diskette drive mounting screws (figure 1-16) that hold the blank panel in the vacant drive position and lift the blank panel from the diskette drive assembly.
7. Before installing the new drive, check that the proper jumpers are installed, per Appendixes B or C as applicable.
8. Place drive number 2 or 4 (item 37) in position in the drive assembly (figure 1-17) and secure with five diskette mounting screws (figure 1-15).
9. Connect dc power connector J5 and ac power connector J0 (figure 1-17) to the drive just installed.
10. Connect interface cable connector J1 (figures 1-17 and 1-18) to drive number 2 or 4 as applicable.
11. Place the base plate in position and secure it with six base plate mounting screws (figure 1-15).
12. Place the diskette drive assembly cover in position and secure it with six cover retaining screws (figure 1-14).
13. Connect the interface cable assembly disconnected in step 3 to the FD1000 diskette drive assembly (figure 1-11 or 1-13 as applicable).
14. Connect the FD1000 diskette drive ac power cable to the same ac power source it was disconnected from in step 2.
15. Refer to paragraph 1.6 for checkout instructions.

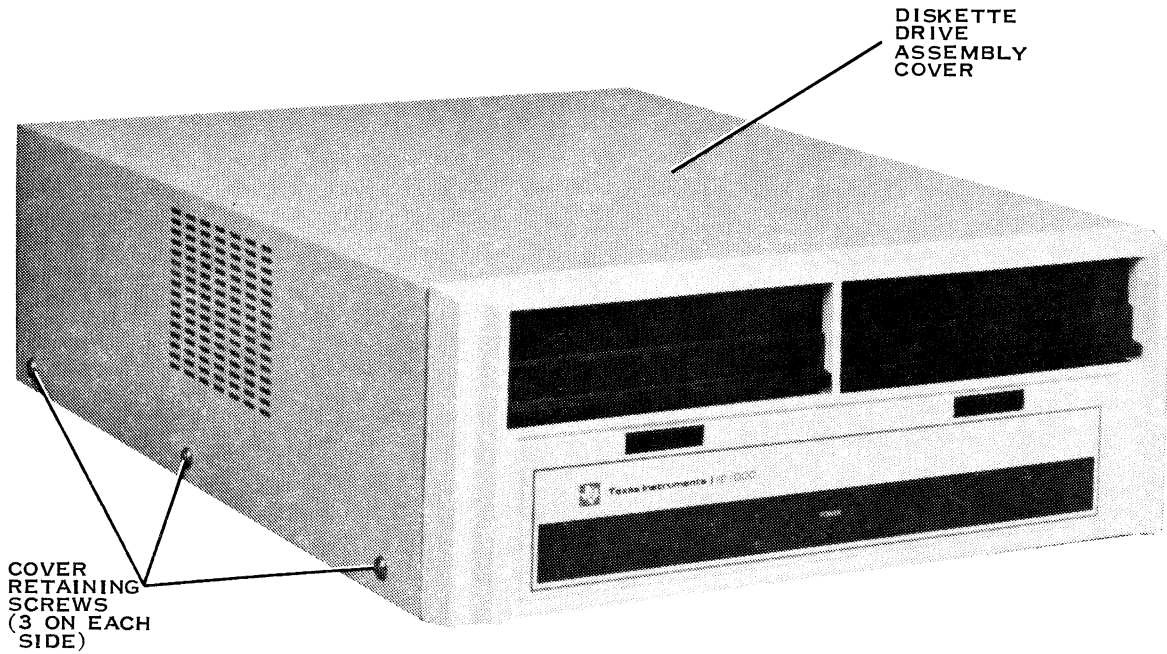

(A) 141294

Figure 1-14. FD1000 Assembly Cover Removal

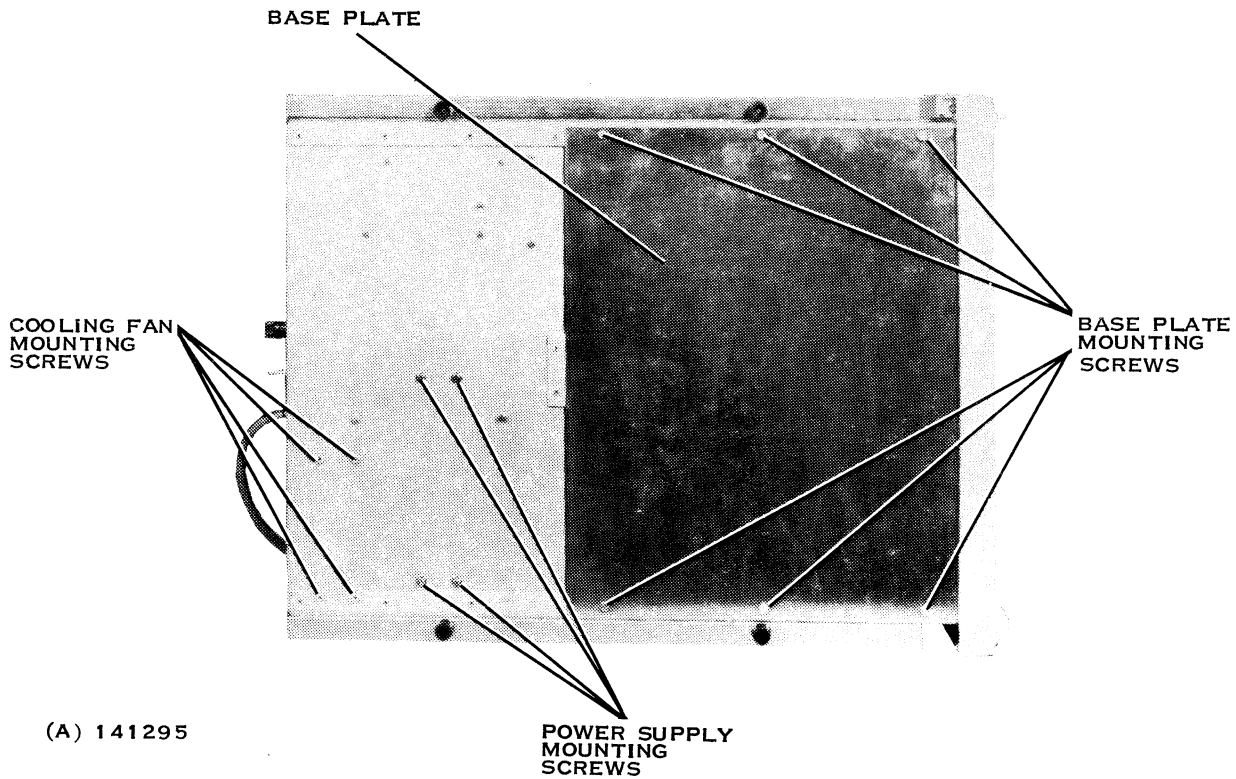

(A) 141295

Figure 1-15. FD1000 Assembly Base Plate Removal

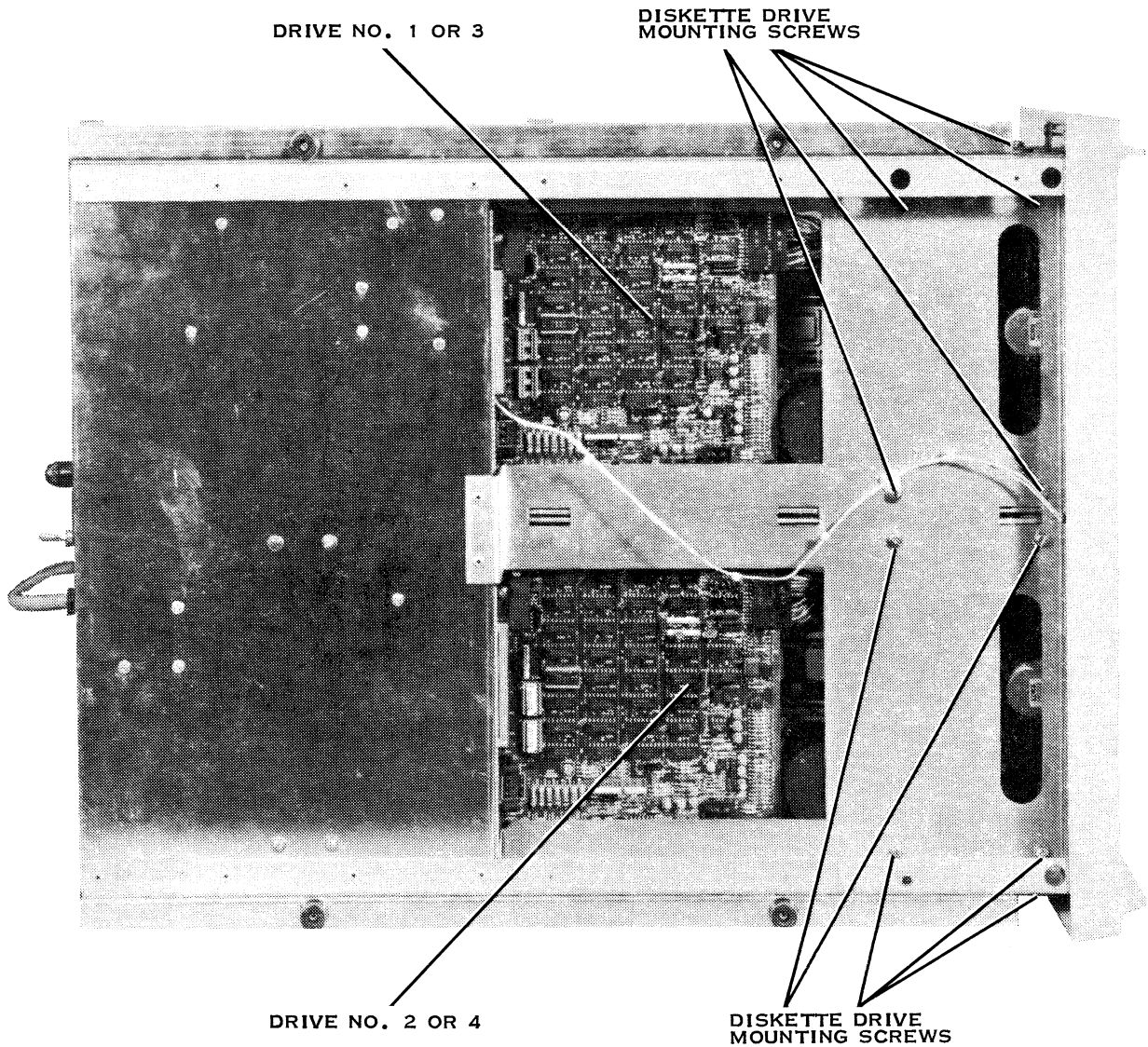

(A) 141297

Figure 1-16. FD1000 Assembly Internal Top View

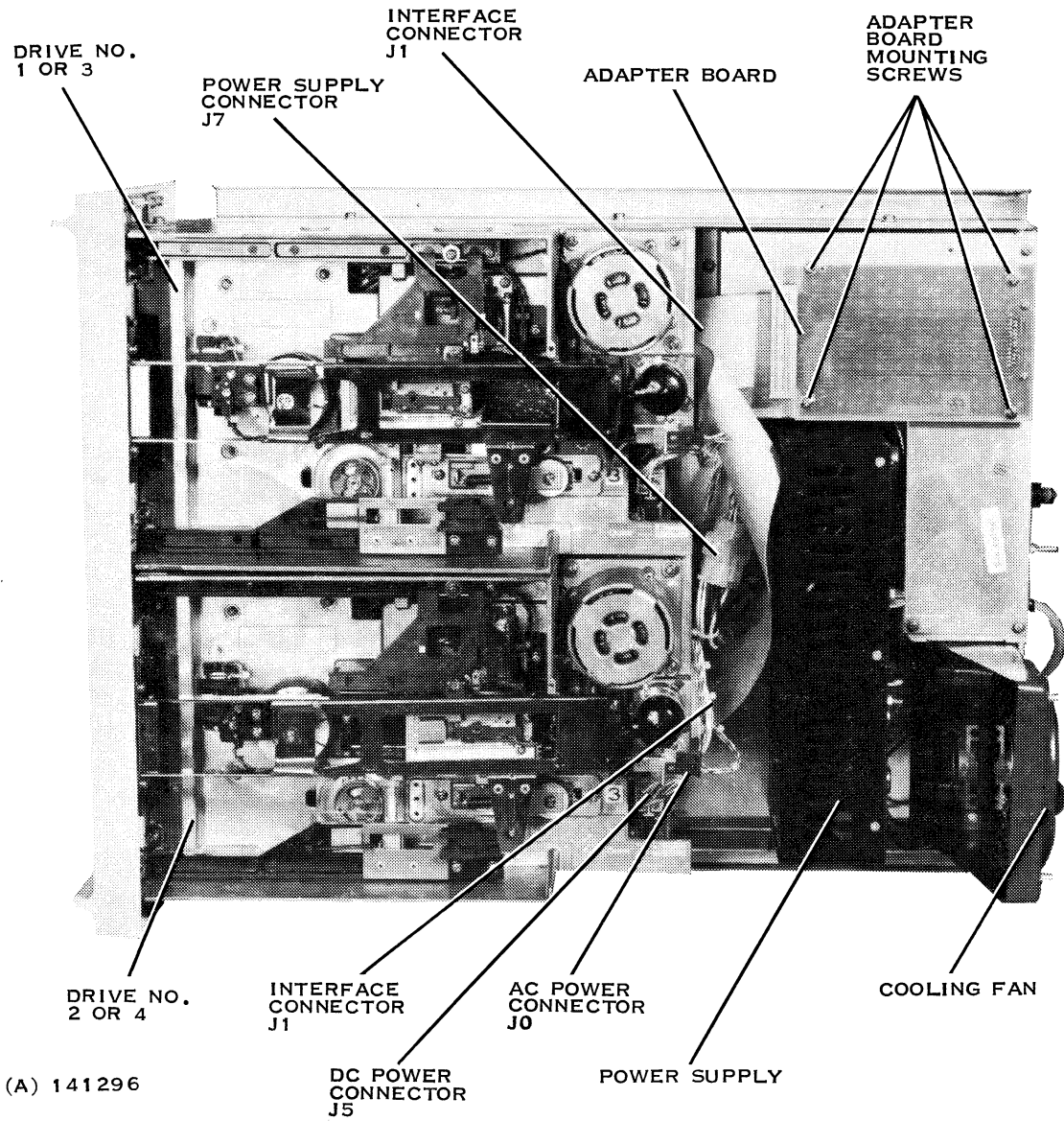
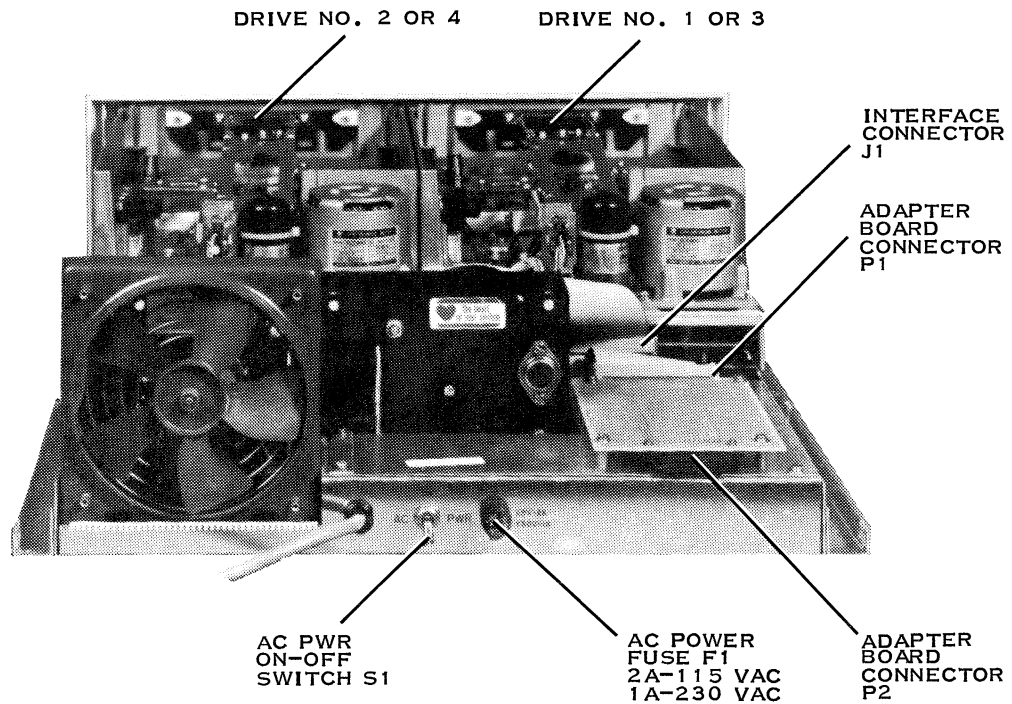

Figure 1-17. FD1000 Assembly Diskette Drive Removal



(A) 141298

Figure 1-18. FD1000 Assembly Internal Rear View**1.6 DS990/1 SYSTEM CHECKOUT**

In order to verify that the Model 771 to DS990/1 upgrade procedures were successful, the field maintenance test (FMT) operating procedures, part number 2262570-9701, should be performed. If any problems occur during checkout, verify that all jumpers are properly installed per Appendixes B or C as applicable. Refer to the *DS990 System Model 1 Maintenance Supplement*, manual number 993024-9704, for additional information to help correct any problems.

1.7 UPGRADE PARTS LIST

All the parts and assemblies require to upgrade a Model 771 system to a DS990/1 system are listed in table 1-2. This parts list is based on the following conversion kits (see paragraph 1-1) and product indexes:

Geographic Location	Conversion Kits	Product Indexes
U.S.A.	2267373-0002 through -0006	2267380
International	2267378-0002 through -0006	2267381



Table 1-2. Parts List Required to Upgrade Model 771 to DS990/1

Item	Quantity	Part Number	Description
NOTE			
The item numbers in this table agree with the item numbers in upgrade LMs 2267373 (U.S.A.) and 2267378 (International) for the 771 to DS990/1 conversions.			
3	1	2267355-0001	Diskette drive I/O processor circuit board
4	1	2267350-0001	Diskette drive interface circuit board
6	1	2267374-0001	Interface cable assembly, terminal assembly to one FD1000 assembly
21	1	2267384-0001	Nameplate, DS990/1 intelligent terminal
22	1	2262403-0001	Operator's maintenance kit (DS990/1) consisting of: <ul style="list-style-type: none"> • One <i>Field Service Flyer</i>, manual number 999457-9701 • One <i>Information Request Form</i>, manual number 999456-9701 • One Function 771 Terminal Keystrip, part number 993240-0004 • One <i>Site Log</i>, manual number 946263-9701 • One <i>DS990/1 Operator Service Manual</i>, part number 2262331-9701 • One <i>Site Preparation and Installation Manual</i>, part number 2262325-9701
23	REF	2262327-9701	Model 771 intelligent data terminal upgrade instruction to DS990 system Model 1
28	1	2267382-0003	I. D. plate (U.S.A.)
29	1	2267383-0003	I. D. plate (International)
31	1	2263584-0003	Configuration label, DS990/1
32	1	2267371-0001	PROM diskette loader, 4K byte HI
33	1	2267371-0002	PROM diskette loader, 4K byte LO
34	1	2267376-0001	Interface cable assembly, terminal assembly to two FD1000 assemblies



Table 1-2. Parts List Required to Upgrade Model 771 to DS990/1 (Continued)

Item	Quantity	Part Number	Description
36	1 or 2	-	Tabletop FD1000 diskette drive assembly(s) as follows:
		2267370-0001	115V, 60 Hz, drives 1 and 2
		2267370-0002	230V, 50 Hz, drives 1 and 2
		2267370-0003	100V, 50 Hz, drives 1 and 2
		2267370-0004	100V, 60 Hz, drives 1 and 2
		2267370-0005	115V, 60 Hz, drive 1
		2267370-0006	230V, 50 Hz, drive 1
		2267370-0007	100V, 50 Hz, drive 1
		2267370-0008	100V, 60 Hz, drive 1
		2267370-0009	115V, 60 Hz, drive 3
		2267370-0010	250V, 50 Hz, drive 3
		2267370-0011	100V, 50 Hz, drive 3
		2267370-0012	100V, 60 Hz, drive 3
		2267370-0013	115V, 60 Hz, drives 3 and 4
		2267370-0014	230V, 50 Hz, drives 3 and 4
		2267370-0015	100V, 50 Hz, drives 3 and 4
		2267370-0016	100V, 60 Hz, drives 3 and 4
37	1	-	FD1000 diskette drive as follows:
		2261686-0004	90-110V, 60 Hz (Qume P/N DT8A6B2)
		2261686-0005	90-110V, 50 Hz (Qume P/N DT8A5B2)
		2261686-0006	103-127V, 60 Hz (Qume P/N DT8A2B)
		2261686-0007	207-253V, 50 Hz (Qume P/N DT8A3B2)



APPENDIX A
CONFIGURATION COMPARISON CHART

The following configuration comparison chart is provided to aid in transferring the markings from existing configuration labels to the new configuration labels.

Old 771/Label	New 771/Label	DS990/1 Label
7/S	7_ _S	7_ _S
7/P	7_ _P	7_ _P
100	_ _100*	_ _100*
--	_ _200*	_ _200*
M08	M_ _	M_ _
M16		
GPH	_ _GPH*	_ _GPH*
E3N	E_ _N	E_ _N
E2N		
E1N		
E3A	E_ _A	E_ _A
E2A		
E1A		
I2N	I_ _N	I_ _N
I1N		
I2A	I_ _A	I_ _A
I1A		
I1D	I_ _D	I_ _D
S3N	S_ _N	S_ _N
S2N		
S1N		
OAC	O_ _C	O_ _C
OSC		
	MC_ _	MC_ _
	80_ _	85_ _

*Note: These options are checked instead of filled in.



APPENDIX B

OPTION LIST FOR SHUGART SA850 DRIVES

Table A-1 lists the available jumper options for the Shugart SA850 drives that may be part of the FD1000 diskette drive assembly. Under normal conditions, the option jumpers will be installed correctly and no further changes will be needed. The list of jumper options is provided for reference only.

Table B-1. Option List for Shugart SA850 Drives

Option Designator	DS01 (As Only Drive)	DS01 (Not Only Drive)	DS02	DS03	DS04
Terminator (3H)	X		X		
DS1	X	X			
DS2			X		
DS3				X	
DS4					X
A (SHUNT 4H)	X	X	X	X	X
B (SHUNT 4H)					
I (SHUNT 4H)	X	X	X	X	X
R (SHUNT 4H)	X	X	X	X	X
S (SHUNT 4H)	X	X	X	X	X
X (SHUNT 4H)	X	X	X	X	X
Z (SHUNT 4H)	X	X	X	X	X
HL (SHUNT 4H)					
2S	X	X	X	X	X
C					
D					
Y					
HI	X	X	X	X	X
DC	X	X	X	X	X
DL	X	X	X	X	X
DS					
HLL	X	X	X	X	X
S1	X	X	X	X	X
S2					
S3					
IW					
IT					
RM	X	X	X	X	X
RS					
850/851	850	850	850	850	850
-5/-15v	-5	-5	-5	-5	-5

NOTE: X indicates jumper present.



APPENDIX C

OPTION LIST FOR QUME DT/8 DRIVES

Table C-1 lists the available jumper options for the Qume DT/8 drives that may be part of the FD1000 diskette drive assembly. Under normal conditions, the option jumpers will be installed correctly and no further changes will be needed. The list of jumper options is provided for reference only.

Table C-1. Option List for Qume DT/8 Drives

Option Designator	DS01 (As Only Drive)	DS01 (Not Only Drive)	DS02	DS03	DS04
Terminators (1TM, 2TM)	X		X		
DS1	X	X			
DS2			X		
DS3				X	
DS4					X
A (SHUNT PACK)	X	X	X	X	X
B (SHUNT PACK)					
I (SHUNT PACK)	X	X	X	X	X
R (SHUNT PACK)	X	X	X	X	X
S (SHUNT PACK)	X	X	X	X	X
X (SHUNT PACK)	X	X	X	X	X
Z (SHUNT PACK)	X	X	X	X	X
HL (SHUNT PACK)					
2S	X	X	X	X	X
Y					
DC	X	X	X	X	X
DL	X	X	X	X	X
DS					
S1	X	X	X	X	X
S2					
S3					
NP					
RR	X	X	X	X	X
RI	X	X	X	X	X
WP	X	X	X	X	X

NOTE: X indicates jumper present.

FOLD



NO POSTAGE
NECESSARY
IF MAILED
IN THE
UNITED STATES

BUSINESS REPLY MAIL
FIRST CLASS PERMIT NO. 7284 DALLAS, TX

POSTAGE WILL BE PAID BY ADDRESSEE

TEXAS INSTRUMENTS INCORPORATED
DIGITAL SYSTEMS GROUP

ATTN: TECHNICAL PUBLICATIONS
P.O. Box 2909 M/S 2146
Austin, Texas 78769

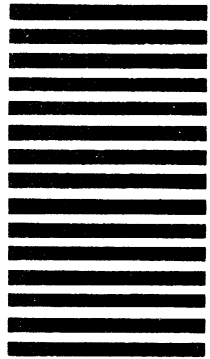

FOLD





TEXAS INSTRUMENTS

INCORPORATED

DIGITAL SYSTEMS GROUP

POST OFFICE BOX 2909

AUSTIN, TEXAS