

SPERRY
UTS 30
Single Station
Operator's Reference

This document contains the latest information available at the time of preparation. Therefore, it may contain descriptions of functions not implemented at manual distribution time. To ensure that you have the latest information regarding levels of implementation and functional availability, please consult the appropriate release documentation or contact your local Sperry representative.

Sperry reserves the right to modify or revise the content of this document. No contractual obligation by Sperry regarding level, scope, or timing of functional implementation is either expressed or implied in this document. It is further understood that in consideration of the receipt or purchase of this document, the recipient or purchaser agrees not to reproduce or copy it by any means whatsoever, nor to permit such action by others, for any purpose without prior written permission from Sperry.

FASTRAND, SPERRY, SPERRY UNIVAC, UNISCOPE, UNISERVO, and UNIVAC are registered trademarks of the Sperry Corporation. ESCORT, MAPPER, PAGEWRITER, PIXIE, SPERRYLINK, and UNIS are additional trademarks of the Sperry Corporation.



SPERRY UNIVAC
6TH FLOOR
8008 WESTPARK DRIVE
MCLEAN VA

Z2 UAS

22102

PUBLICATIONS REVISION	
UTS 30	
SPERRY® UTS 30 Single Station Operator's Reference	
UP-9798 Rev. 1	

This library memo announces the release and availability of "SPERRY UTS 30 Single Station Operator's Reference," UP-9798 Revision 1. It is a Standard Library Item (SLI).

The UTS 30 is a low-cost, intelligent display terminal specially tailored in two different versions for sending, receiving, manipulating, and displaying data. The powerful UTS 30 capabilities are provided by either a program cartridge, which is easily installed through a door in the top of the terminal, or by a program diskette, loaded from a SPERRY 8439 Double-Sided Diskette Subsystem. The functions of the UTS 30 can be further enhanced by program products and user programmability implemented through the low-cost 8439 diskette subsystem.

This manual provides both complete reference information on the features and functions of the UTS 30 and a quick reference guide to specific terminal operating procedures.

This revision adds reference information and instructions for the programmable version of the UTS 30.

This book is included in the standard library for the UTS 30. Copies also may be ordered by your Sperry representative.

Destruction Notice: This revision supersedes and replaces "SPERRY UTS 30 Single Station Operator's Reference," UP-9798, released under library memo dated September 1983. Please destroy all copies of UP-9798 and its library memo.

LIBRARY MEMO ONLY	LIBRARY MEMO AND ATTACHMENTS	THIS SHEET IS
Lists MAC, MCZ, MMZ, 8, 9, 9U, 10, 11, 18, 19, 20, 21, 30, 31U, 37, 37U, 38, 60, 61, 62, 63, 63U, 64, 64U, 65, 66, 75, 76, 77, 78, 81, 81U, 83, 83U, 89, 89U, MBR, MBSU	Lists MZZ, MCS, MCT, 82 (185 pages plus library memo)	Library Memo for UP-9798 Rev. 1
		RELEASE DATE: May 1984

**PUBLICATIONS
RELEASE**

UTS 30

**SPERRY UTS 30
Single Station**

Operator's Reference

UP-9798

This library memo announces the release and availability of "SPERRY® UTS 30 Single Station Operator's Reference," UP-9798. It is a Standard Library Item (SLI).

The UTS 30 is a low-cost intelligent display terminal specially tailored for sending, receiving, manipulating, and displaying data. The powerful UTS 30 capabilities are provided by a program cartridge that is easily installed through a door in the top of the terminal. The basic version of the UTS 30 operates online with a central processor.

This manual provides both complete reference information on the features and functions of the UTS 30, and a quick reference guide to specific terminal operating procedures.

This book is included in the standard library for the UTS 30. Copies also may be ordered by your local Sperry representative.

LIBRARY MEMO ONLY	LIBRARY MEMO AND ATTACHMENTS	THIS SHEET IS
<p>Lists AC, CZ, MZ, 8, 9, 9U, 10, 11, 18, 19, 20, 21, 30, 31U, 37, 37U, 38, 60, 61, 62, 63, 63U, 64, 64U, 65, 66, 75, 76, 77, 78, 81, 81U, 83, 83U, 89, 89U</p>	<p>Lists ZZ, MCS, MCT, 82 (136 pages plus library memo)</p>	<p>Library Memo for UP-9798</p> <hr/> <p>RELEASE DATE:</p> <p>September 1983</p>

Contents

CONTENTS

REFERENCE INFORMATION

1. INTRODUCTION

1.1.	YOUR ROLE AS AN OPERATOR	2
1.2.	HOW TO USE THIS GUIDE	2
1.3.	RELATED GUIDES	2

2. GETTING STARTED

2.1.	TURNING ON THE UTS 30	5
	POWER	6
	Keylock	6
	RESET PUSH	6
2.2.	THE UTS 30 CONTROL SOFTWARE	7
	For the Basic UTS 30	7
	For the Programmable UTS 30	7
2.3.	THE SCREEN DISPLAY	8
2.3.1.	Screen Display Controls	8
	Brightness	8
	Contrast	9
2.3.2.	Screen Display Indicators	9
	Cursor	9
	Indicator Line	9
	Power-On Symbol	11
	Alternate Screen	11
2.4.	VOLUME CONTROL AND ALARM	11
2.5.	THE UTS 30 KEYBOARD	12
	The FCTN (Function) Key	12
	Automatic Cycling	13
	Nonfunctional Keys	13

3. USING THE CONTROL PAGE

3.1.	THE CONTROL PAGE DISPLAY	15
	Displaying and Removing the Control Page	17
	Entering Codes in the Control Page	17
	Using Screen 1 and Screen 2 Control Pages	18
3.2.	INFORMATION FIELDS OF THE CONTROL PAGE	18
	STA- Field	18
	ADR- Field	19
	Special Code Field	19

4. SETTING PARAMETERS AND CONFIGURING DEVICES

4.1.	PARAMETERS	22
4.2.	SETTING PARAMETERS ON THE PROGRAMMABLE UTS 30	22
	Terminal Characteristics Menu	23
	System Characteristics Menu	24
	Storage Device (Drive) Configuration Menu	24
	Printer Configuration Menu	26
4.3.	DISPLAYING AND CHANGING PARAMETERS ON THE BASIC UTS 30	26
4.4.	CONFIGURING THE PRINTER ON THE BASIC UTS 30	28

5. USING COMMAND MODE

5.1.	USING THE COMMAND MODE DISPLAY	30
5.2.	FORMAT OF COMMAND STATEMENTS	30
	Command	31
	Device	32
	File Name Extension	32

6. STORING DATA ON DISKETTE

6.1.	HOW DATA IS STORED ON DISKETTE	33
	Special File Types	33
6.2.	SETTING UP THE CONTROL PAGE	34
	"From" Subfield	34
	"To" Subfield	34
	"Function" Subfield	34
	Differences between the (**PRINT*) and (**XFER**) Fields	34
	FCCs	35
	Special Emphasis Characters	35
6.3.	TRANSFERRING DATA TO AND FROM DISKETTE	36
	Writing to Diskette	36
	Reading from Diskette	36
	Copying and Editing Diskettes	36
6.4.	DEFINING DATA ON DISKETTE	36
6.5.	LOCATING DATA ON DISKETTE	37
	Search Diskettes	37
	Homing Diskettes	37
	Using the BOB Key	37
6.6.	FORMATTING OPTIONS	37
6.7.	DISKETTE SUBSYSTEM STATUS CODES	38

7. PRINTING

7.1.	SETTING UP THE CONTROL PAGE FOR PRINTING	39
7.2.	PRINT FORMAT OPTIONS	40
7.3.	PRINTER STATUS CODES	40

8. FORMATTING THE SCREEN WITH FCCS

8.1.	INTENSITY VARIATIONS	41
8.2.	TAB STOP	42
8.3.	RESTRICTIONS ON TYPE OF DATA ENTRY ALLOWED	43
	Protected Fields	43
	Protected Special Emphasis Characters	44
	Alphabetic-Only Data	44
	Numeric-Only Data	44
	Unrestricted Data	45
8.4.	RIGHT-JUSTIFIED FIELDS	45

PROCEDURES

A. BASIC OPERATIONS AND EQUIPMENT MAINTENANCE

A1.	TURNING ON THE UTS 30	50
A2.	ESTABLISHING COMMUNICATION WITH THE HOST	51
A3.	DISPLAYING/REMOVING THE CONTROL PAGE	52
A4.	ENTERING/EXITING COMMAND MODE	53
A5.	LOADING PROGRAMS	54
A6.	PREPPING DISKETTES	55
A7.	CLEANING THE UTS 30 AIR FILTER	56
A8.	CLEANING THE DISKETTE DRIVES	57
A9.	BACKING UP A SYSTEM DISKETTE	58

B. SETTING PARAMETERS/ CONFIGURING DEVICES

B1.	REVIEWING/CHANGING PARAMETERS (BASIC)	60
B2.	REVIEWING/CHANGING PARAMETERS (PROGRAMMABLE)	62
B3.	CONFIGURING THE PRINTER (BASIC)	63
B4.	CONFIGURING THE PRINTER (PROGRAMMABLE)	64
B5.	CONFIGURING THE DISKETTE SUBSYSTEM	65

C. BASIC FILE OPERATIONS

C1.	ASSIGNING A USER NUMBER	68
C2.	CREATING A NEW FILE	68
C3.	OPENING A FILE	69
C4.	CLOSING A FILE	69
C5.	ERASING A FILE	70
C6.	PURGING A FILE	70
C7.	RENAMING A FILE	71
C8.	USING THE DIRECTORY	72

D. STORING DATA ON DISKETTE

D1.	SELECTING TYPE OF DATA FOR TRANSFER	74
D2.	WRITING TO DISKETTE	75
D3.	READING FROM DISKETTE	76
D4.	COPYING FROM DISKETTE	77
D5.	EDITING FROM DISKETTE	79
D6.	REPORTING DISKETTE ADDRESS	82
D7.	SEARCHING A FILE	83
D8.	HOMING A FILE	85

E. PRINTING

E1.	SELECTING PRINT FORMAT OPTIONS	88
E2.	PRINTING SCREEN DATA	89
E3.	PRINTING FROM DISKETTE	90

F. HOST OPERATIONS

F1.	SPECIFYING TYPE OF DATA TRANSMISSION	92
F2.	SENDING DATA TO THE HOST	93
F3.	TRANSMITTING DATA FROM THE HOST	94

G. MAGNETIC STRIPE READER OPERATIONS

G1.	AUTOMATIC TRANSMISSION OF MAGNETIC CARD DATA	98
G2.	MANUAL TRANSMISSION OF MAGNETIC CARD DATA	100

H. SPECIAL OPERATIONS

H1.	USING SPECIAL EMPHASIS CHARACTERS	104
H2.	USING THE OPTIONAL CHARACTER SET	105
H3.	CHECKING PERIPHERAL DEVICE STATUS	106
H4.	USING THE ALTERNATE SCREEN	109
H5.	CHANGING THE PROGRAM CARTRIDGE	110

I. USING FCC KEYS

I1.	GENERATING AND ENABLING FCCs	116
I2.	LOCATING AN FCC	118
I3.	CHANGING AN FCC	119
I4.	CLEARING AN FCC	120
I5.	ELIMINATING FCCs	121
I6.	DUPLICATING FCCs	122

APPENDIXES

A. LOAD MESSAGES

B. ALARM CONDITIONS

B.1. SHORT ALARM 125
Normal Conditions 125
Error Conditions 125
B.2. REPEATED ALARM 126
Normal Conditions 126
Error Conditions 126

C. KEYBOARD REFERENCE CHART

C.1. CURSOR CONTROL KEYS 127
C.2. EDITING KEYS 129
C.3. FUNCTION KEYS 132
C.4. PERIPHERAL KEYS 133
C.5. DATA TRANSFER KEYS 134
C.6. FIELD CONTROL KEYS 135
C.7. PROGRAM ATTENTION KEYS 137
C.8. SPECIAL FUNCTION KEYS 138
Special Emphasis Character Keys 138
Optional Character Set Access Key 139

D. COMMAND MODE ERROR MESSAGES

E. THE (PARAM) FIELD

E.1. USING THE (PARAM) FIELD 143
Accessing the (PARAM) Field 143
Entering Codes in the (PARAM) Field 144
E.2. PARAMETER TYPES AND OPTIONS 144
Remote Identifier (RID) 149
Station Identifier (SID) 149
Lines per Screen and Columns per Line (Screen Size) 149
Control Page Line Number 150
Video-Off Timer 150
Space Bar 150
Keyboard Click 150
Communications Mode 150
Direct Connect Rate 150
Screen Control Alarm 151
Repeated Alarm 151
Uppercase Only 151
Character Cycle Speed 151
Load Drive 151
Host POC 151
Blinking Markers 151
System Response Mode 152
Display Control Characters 152
Automatic Transmission of Magnetic Stripe Reader Data 152
Transmit Expanded FCCs 152
Automatic Hangup 152
Cursor Return 152
Printer Speed 153
Emphasis Character 153
Indicator Line 153

	Screen Video Intensity	153
	National Character Set	153
E.3.	CONFIGURING PERIPHERAL DEVICES THROUGH THE (PARAM) FIELD	154

F. MAINTENANCE MODE FIELD ENTRIES

G. CODE CONVERSION CHARTS

GLOSSARY

INDEX

USER COMMENT SHEET

FIGURES

1-1.	SPERRY UTS 30 Single Station	1
2-1.	UTS 30 Power Controls	5
2-2.	Screen Display Controls	8
2-3.	UTS 30 Indicator Line	9
2-4.	Indicator Line Messages	10
2-5.	Screen Number Indicator	11
2-6.	FCTN and UNLOCK Keys	11
2-7.	UTS 30 Keyboard	12
2-8.	FCTN and SHIFT Keys	13
2-9.	Keys That Do Not Cycle	13
2-10.	SY MD and WS MD Keys	14
3-1.	Control Page Fields	15
3-2.	Control Page Key	17
3-3.	First Unprotected Position in Control Page	17
3-4.	Screen Display Indicator	18
3-5.	STA- Field	18
3-6.	ADR- Field	19
3-7.	Report of Diskette Address	19
3-8.	Special Code Field	19
4-1.	Keylock in SET UP Position	21
4-2.	Parameter/Configuration	22
4-3.	Terminal Characteristics	23
4-4.	System Characteristics Menu	24
4-5.	Drive Configuration Menu	25
4-6.	Printer Configuration Menu	26
4-7.	MM Field	26
4-8.	Display of Parameter Options	27
5-1.	Command Mode Display	29
5-2.	FCTN and M Keys	30

6-1.	(**PRINT*) and (**XFER**) Fields	34
6-2.	Difference Between (**PRINT*) and (**XFER**) Fields	35
6-3.	Sending a Partial Screen of Data	36
6-4.	SEARCH() Field	37
6-5.	XFER() Field	37
6-6.	STA- Field	38
7-1.	The (**PRINT*) Field	39
7-2.	The PRNT() Field	40
7-3.	STA- Field	40
8-1.	Entries Allowed in an Alphabetic-Only Field	44
8-2.	Entries Allowed in an Numeric-Only Field	45
8-3.	Right-Justified Field	45
8-4.	Entering Data in a Full Right-Justified Field	46
E-1.	(PARAM) Field	143

TABLES

2-1.	Meaning of Indicator Line Messages	10
3-1.	Operations Performed Using Control Page	16
5-1.	Valid Command Names	31
5-2.	Commands	31
8-1.	FCC Code Selection	42
A-1.	Load Error Messages	123
A-2.	UNISCOPE Mode Load Messages	124
C-1.	Cursor Control Keys	127
C-2.	Erase Keys	129
C-3.	Delete Keys	130
C-4.	Insert Keys	130
C-5.	Formatting Keys	131
C-6.	Function Keys	132
C-7.	Peripheral Keys	133
C-8.	Data Transfer Keys	134
C-9.	Field Control Keys	135
C-10.	Program Attention Keys	137
C-11.	Special Emphasis Keys	138
C-12.	Optional Character Set Access Key	139
D-1.	Command Mode Error Message	141
E-1.	Parameter Types and Options	145
G-1.	Code Conversion Chart	159
G-2.	National Use Code Chart	160

1. Introduction

This reference guide introduces you to a computer terminal called the SPERRY UTS 30 Single Station (Figure 1-1).

Figure 1-1. SPERRY UTS 30 Single Station

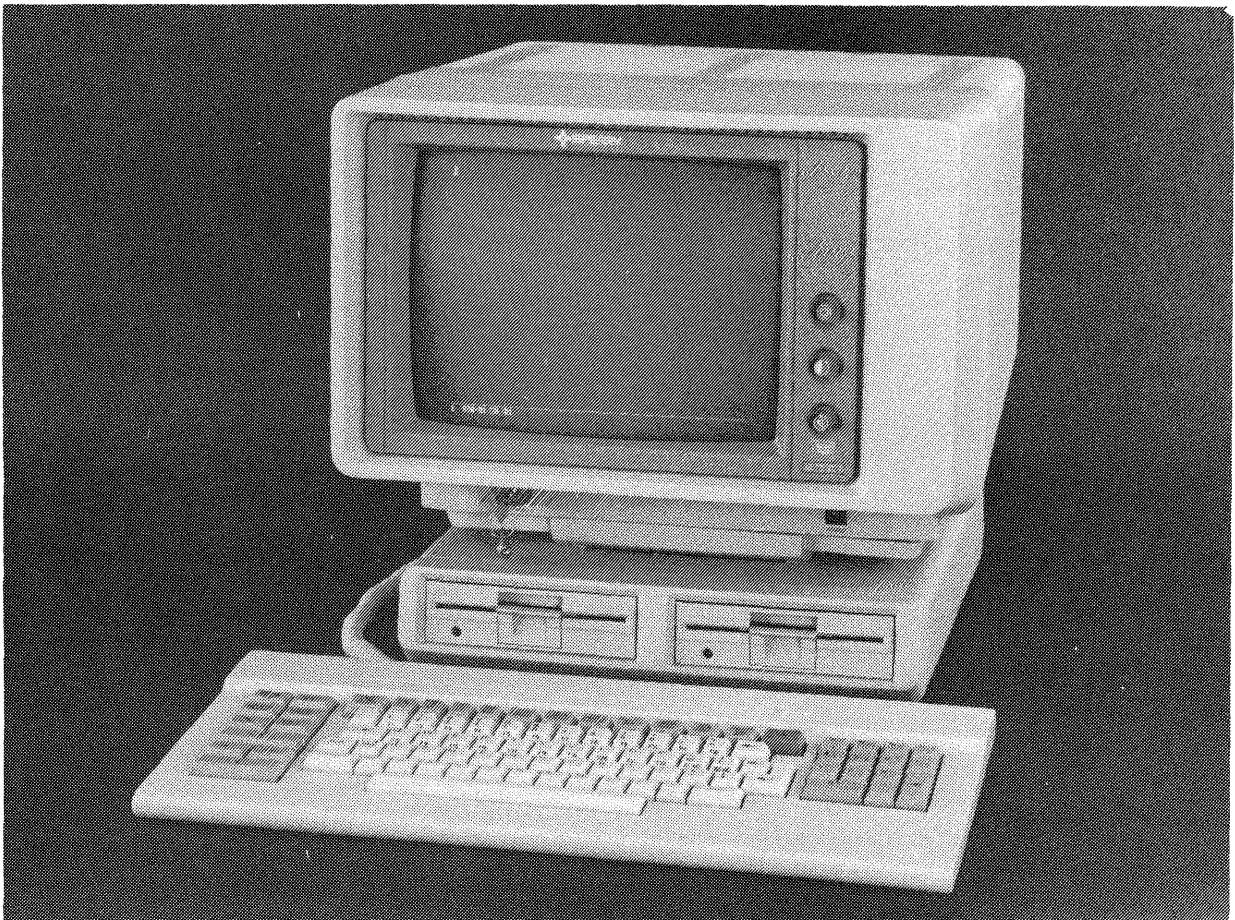

There are two types of UTS 30: a basic and a programmable version. The two types look identical; the difference is that only the programmable version can use a *diskette subsystem* for storing information or loading programs. If you have a basic UTS 30, you can send screen data to a printer, but you can only store information in the *host processor*.

1.1. YOUR ROLE AS AN OPERATOR

As a UTS 30 operator, you will be able to create, edit, update, and store data through a typewriter-like keyboard attached to the terminal. You will also be able to print copies of that data.

Learning to work on the UTS 30 takes a bit of concentrated time and practice, but once you learn the location of the keys and practice the various functions, it will become almost a reflex action.

1.2. HOW TO USE THIS GUIDE

This guide explains all the features and functions of the UTS 30, some of which you will use more frequently than others. It also contains a condensed procedures section for quick reference.

The book is divided into three main parts:

- Reference

Sections 1 through 8 present an overview of the major functions of the terminal. These sections should give you a feel for what the terminal can do for you and what operations you will use most frequently to accomplish your job. You will get the necessary background information for carrying out instructions in the procedures part of the book.

- Procedures

Procedural Sections A through I present step-by-step instructions for performing the operations described in the reference portion of the book. The procedures part of the book is meant to be used after you have reviewed the material in the reference sections.

- Appendixes

Appendixes A through G provide additional information that may be helpful once you have become familiar with basic terminal operations.

Key words used for the first time are italicized to indicate that their definitions appear in the glossary at the back of the book.

1.3. RELATED GUIDES

If you are completely unfamiliar with terminal equipment, you should first do the exercises in the UTS 30 introduction for operators (UP-9797), which gives hands-on exercises for all of the basic operations of the UTS 30. Other related UTS 30 publications that you may find useful are:

- UTS 30 Installation Guide, UP-9803

Provides instructions for installing the UTS 30 and its related equipment.

- UTS 30 Verification Guide, UP-9804

Presents information for verifying that the UTS 30 is operating properly.

- UTS 30 System Reference, UP-9789

Provides instructions for programming a host system for use with the UTS 30.

In addition, the UTS 4000 peripheral devices operator's guide supplement, UP-9219, contains operating instructions for the printers and diskette subsystem, or *peripheral devices*, used with the terminal.

2. Getting Started

Getting started on the UTS 30 takes only a few simple steps, which will quickly become automatic to you. This section will introduce you to the UTS 30 controls and screen display, and provide general keyboard information.

2.1. TURNING ON THE UTS 30

Locate the two controls in the recessed area beneath the screen and the RESET PUSH button on the front of the terminal (Figure 2-1). Before you do anything else, you must check to see that the POWER switch is in the ON position, and that the keylock is in the NORMAL or SET UP position. You cannot begin any activity unless these two tasks are completed.

Figure 2-1. UTS 30 Power Controls

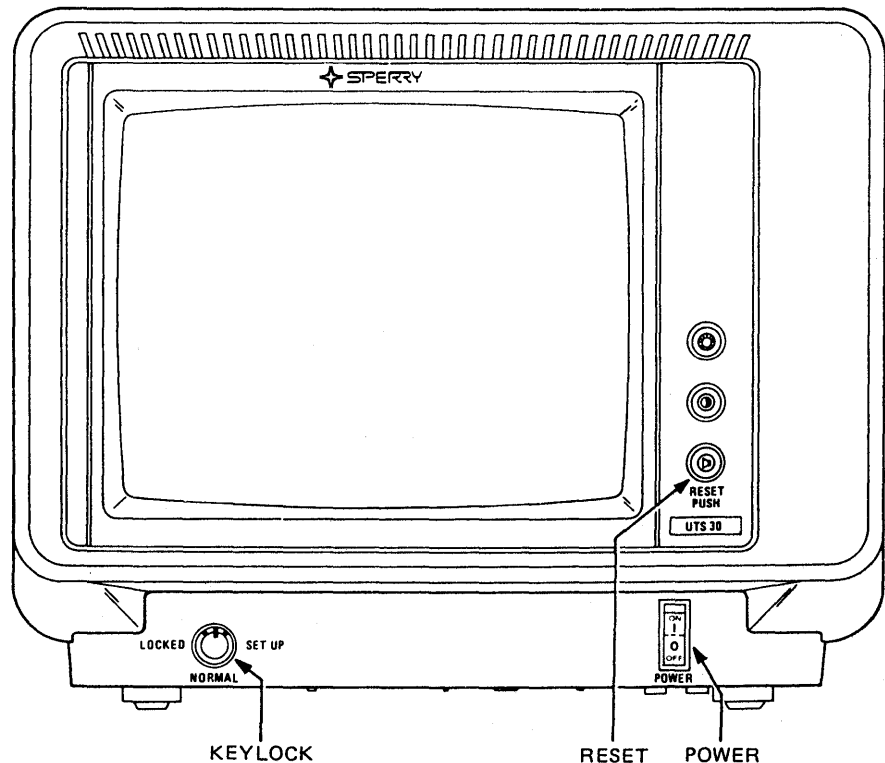

The terminal controls operate as follows:

POWER

The POWER switch turns the terminal on and off. In addition, the switch acts as a circuit protector; the terminal will automatically shut itself off if there is a problem in the power supply. If the terminal overheats, power will also be turned off. (To prevent overheating, refer to Section A7.)

When power is turned off, then on, a series of tests called the *power-on-confidence test (POC)* will flash by on the screen. The POC test items will remain on the screen only if one or more items fail or if the keylock is in the locked position. In the case of a hardware failure, you can first try pressing the RESET button. If that does not clear the display, you or your supervisor should consult the UTS 30 verification guide, UP-9804.

Keylock

The keylock controls access to the keyboard. If the keylock is in the LOCKED position, the terminal cannot operate. You can receive incoming messages from the host, but you cannot send any messages.

Generally, the keylock is left in the NORMAL position. This allows you to use the keyboard and the magnetic stripe reader.

The SET UP position gives you the same access to the keyboard and magnetic stripe reader as the NORMAL position, but allows you to perform additional operations. When the keylock is in the SET UP position, you can set up or change various operating characteristics (*parameters*) of the terminal and also perform diagnostic tests. (Refer to Section 4 or Appendix E for information on changing the operating characteristics of the terminal. Appendix F describes the use of the SET UP position for diagnostic testing.)

RESET PUSH

Once you have turned on the UTS 30, you should be aware that another control to the right of the screen, labeled RESET PUSH (Figure 2-1), can be used instead of the POWER switch to reload the *system control software* (the terminal's operating instructions) if there is some problem. (Throughout this book, RESET PUSH will be referred to simply as the RESET button.) This control is actually two controls in one: if you press the button, you are exercising the RESET function, and if you turn it, you are adjusting the volume of the keyboard click (sound of key being pressed) and alarm.

Remember that the POWER switch must be on for the RESET button to operate. You will want to use the RESET button for various loading problems because it's faster than turning power off, then on. Pressing the RESET button erases any existing data on the screen and reloads the terminal with its control software without running the POC test, as does the POWER switch.

Another important function of the RESET button is for implementing changes in certain operating characteristics (parameters) or address codes (*configuration*) of printers and diskette subsystems. (Refer to Section 4 and Appendix E for more information on parameters and configuration).

2.2. THE UTS 30 SYSTEM CONTROL SOFTWARE

For The Basic UTS 30

After power is turned on and the POC test passes, or when the RESET button is pressed, the terminal *loads* (transfers) a system control software from the program cartridge into its memory. The basic UTS 30 operates with the UNISCOPE mode control program.

If the load of the control software is successful, the terminal is ready to operate, as indicated by the following message:

```
UNISCOPE MODE (FXXXX-XX) READY - RR
```

If a different message appears, refer to Appendix A.

For The Programmable UTS 30

The system control software for the programmable UTS 30 does not load automatically when power is turned on. You must insert a *system diskette* containing the control software into a diskette drive. The terminal will then load the control software.

The programmable UTS 30 can operate with other control software besides UNISCOPE mode: SPERRY CP/M Plus™ SPERRY Text Processing Utility, SPERRYLINK, or SPERRY Distributed Data Processing 4000; however, this guide describes only the UNISCOPE mode of operation. The terminal will always load the system diskette in the lowest-numbered drive. So, if you have more than one system diskette in the drives, be sure that the one you want to load is in the drive with the lowest number.

If you are loading the UNISCOPE mode control software into the programmable terminal, the "READY" message you should see is:

```
UNISCOPE MODE (FXXXX-XX) READY - RR
```

If you have a programmable terminal without graphics capability, you will see the message "GRAPHICS INOPERATIVE" above the "READY" message. If a different message appears, refer to Appendix A.

If you are operating with a different control software, consult the appropriate user guide for indication of terminal readiness.

CP/M Plus™ is a trademark of Digital Research, Inc.

2.3. THE SCREEN DISPLAY

The data you enter through the keyboard or receive from the host or diskette appears on the screen display. The amount of data that can fit on the screen is equivalent to about one double-spaced typewritten page.

This section describes the following features of the screen display:

- Screen display controls: brightness, contrast
- Screen display indicators: cursor, indicator line, power-on symbol
- Alternate screen

2.3.1. Screen Display Controls

Two controls to the right of the screen (Figure 2-2) allow you to control the appearance of the screen and adjust it to a comfortable level: brightness and contrast.

Figure 2-2. Screen Display Controls

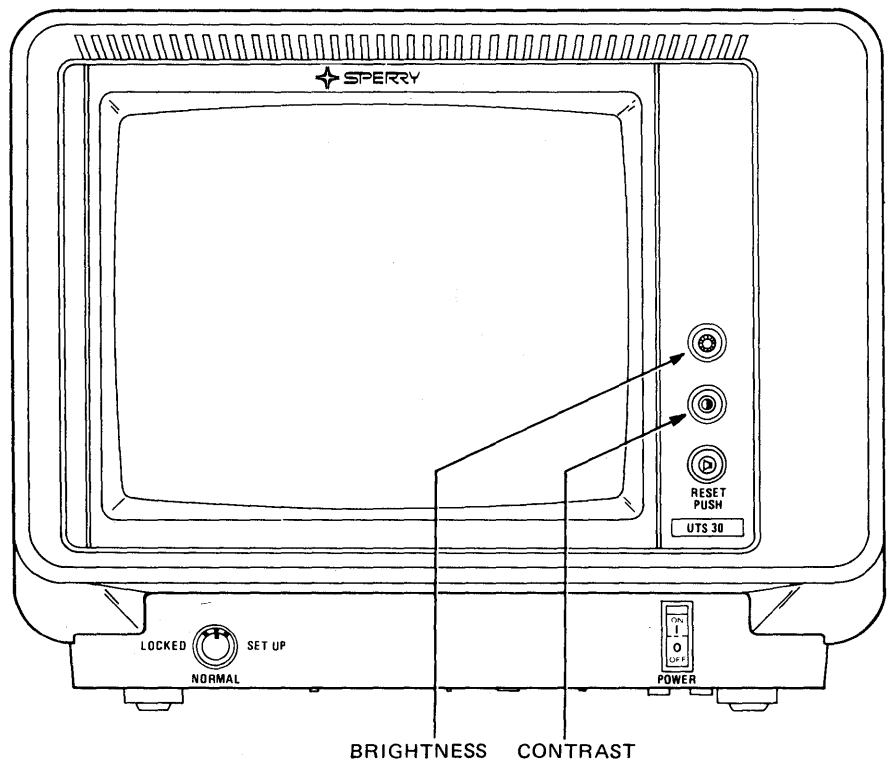

Brightness

You can adjust the intensity of the screen display with this control. Turning the control clockwise increases the brightness or intensity of characters on the screen.

Contrast

This control adjusts the contrast between characters and the screen display background. Turning the control clockwise increases the brightness or intensity of the background.

2.3.2. System Display Indicators

Cursor

The *cursor* (█), a rectangular figure on the screen, will become a familiar symbol to you. Like a pointer, the cursor shows you where the next character entered will be displayed. After a character is entered, the cursor moves one position to the right. By using the cursor control keys (→, ←, ↑, ↓), you can move the cursor horizontally or vertically across the screen to the character position you choose without destroying or changing characters on the screen.

Indicator Line

The last row on the display screen always contains the *indicator line* (Figure 2-3). You cannot enter any data in this area since it is reserved for messages concerning the current operating conditions of the terminal and the attached printer and diskette subsystems. You can change the appearance of the indicator line (separating line, normal intensity, or reverse video) through a parameter selection (Section 4 or Appendix E).

Figure 2-3. UTS 30 Indicator Line

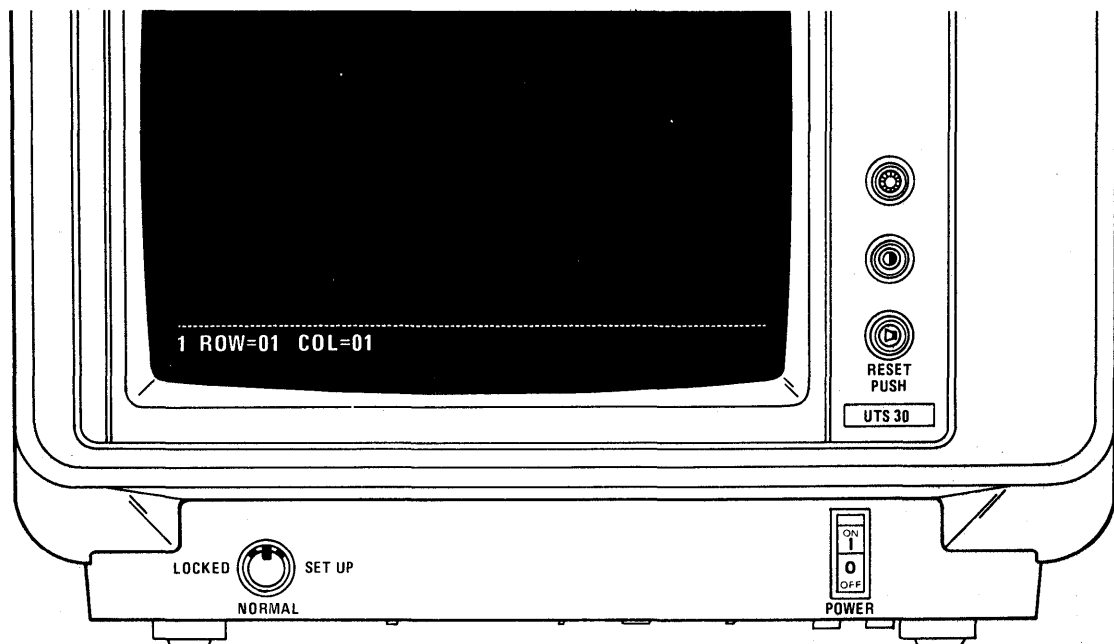

If all messages on the indicator line were displayed at once, which would not happen, it would appear as in Figure 2-4. Table 2-1 gives the meaning of each message.

Figure 2-4. Indicator Line Messages

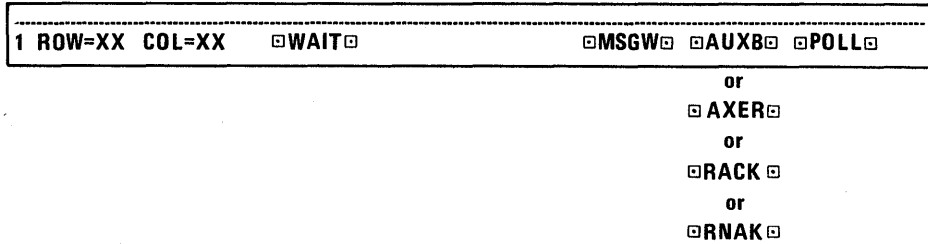

Table 2-1. Meaning of Indicator Line Messages

Message	Meaning
1 or 2 (column 1)	Shows which screen, 1 or 2, is currently displayed. After the terminal is loaded, screen 1 is always displayed. The alternate screen is described later in this section.
ROW = XX COL = XX	Shows the exact row and column location of the cursor at all times. The ROW values range from 01 (top row) to 24 (bottom row). The COL (column) values range from 01 (far left character position) to 80 (far right character position).
WAIT	Appears when the keyboard is locked and cannot accept data entry. The keyboard locks when data is being transmitted to or from the host, when a function key is pressed, and when a peripheral device is in operation.
MSGW	(Message waiting) Indicates that a message has been sent to the UTS 30 from the host. The alarm sounds when "MSGW" is displayed. Pressing the MSG WAIT key displays the message on the screen and silences the alarm.
AUXB	(Auxiliary busy) Appears when the terminal is occupied with a peripheral operation. The message is removed when the operation is complete.
AXER	(Auxiliary error) Indicates an error during data transfer between the terminal and a peripheral device. The alarm sounds when this message is displayed. Pressing FCTN UNLOCK silences the alarm and removes the message.
RACK	(Read acknowledged) Indicates that data has been successfully read from the magnetic stripe reader.
RNAK	(Read not acknowledged) Appears when an attempt to read data from the magnetic stripe reader fails. "RNAK" is displayed until a successful read occurs or FCTN UNLOCK is pressed.
POLL	Shows that the host will accept data transmissions from the terminal.

NOTES:

1. You can choose to have blinking markers on either side of the indicator line messages through a parameter selection. (Refer to Section 4 or Appendix E.)
2. Two additional messages (SYS MOD and SYS MSG) appear in the indicator line during *system response mode* operation. This type of operation is applicable only to systems with a SPERRY System 80 host. (Refer to the System 80 local workstation operator's guide, UP-8910.)

Power-On Symbol (⏻)

This symbol will appear at the bottom of the screen if the display has gone blank. When the screen goes blank, power is still on, and no data has been lost. Pressing any key restores the screen display. (Section 4 and Appendix E explain the parameter which determines the period of time before the screen goes blank.)

The power-on symbol blinks if an error message or message waiting is received on the current screen.

Alternate Screen

The UTS 30 actually has two functional screen displays. If you are in UNISCOPE mode, you can press the DISP 1-2 key to access another screen, with its own indicator line and *control page*. The number (1 or 2) before the ROW= COL= message in the indicator line tells you which screen the cursor is on (Figure 2-5). The advantage of two screens is that you can begin an operation on one screen — printing, perhaps — and then go to the other screen to continue data entry.

Figure 2-5. Screen Number Indicator

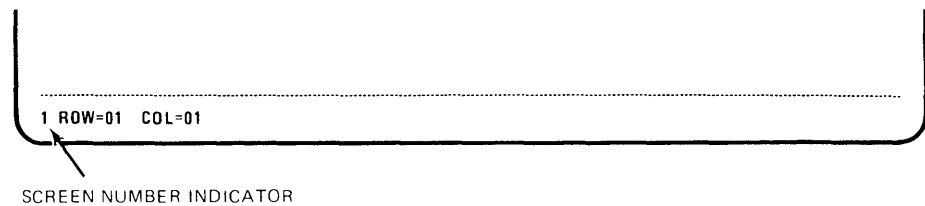

2.4. VOLUME CONTROL AND ALARM

The volume control to the right of the screen (), which is also the RESET button, controls both the alarm and the keyboard click (sound of key being pressed). Turning the knob clockwise increases the volume. The alarm can alert you to an operation that is not performing properly, so be sure to set the volume loud enough to hear it. The alarm will sound as either one short beep or a repeated beep, depending upon the cause, and is used to signal both normal and error conditions. In almost all cases, a repeated beep signals an error, and can be silenced by pressing FCTN UNLOCK (Figure 2-6).

Figure 2-6. FCTN and UNLOCK Keys



Refer to Appendix B for conditions under which the alarm sounds.

2.5. THE UTS 30 KEYBOARD

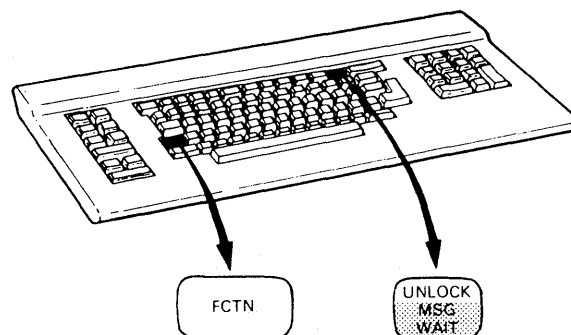
The keyboard attached to the UTS 30 (Figure 2-7) is your means of "talking" to the terminal, the host, and peripheral devices. The keyboard consists of data and control keys. Data keys are the alphabetic, numeric, punctuation, and symbolic keys found on a typewriter. Control keys perform editing and formatting operations and initiate special functions.

The control keys are the ones you will want to become familiar with most quickly. In most cases, you will learn how to use the control keys when you are ready to perform a particular operation. But the cursor control keys and the editing keys are two categories of keys you may want to familiarize yourself with immediately since they are so frequently used. The current version of the UTS 30 introduction for operators, UP-9797, can help you gain facility with these keys quite rapidly.

Figure 2-7. UTS 30 Keyboard

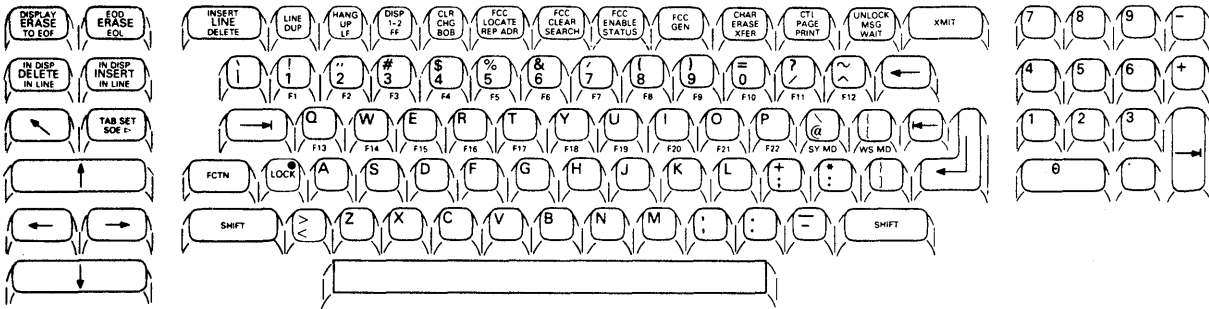

A brief description of special keyboard features follows. Appendix C contains a reference chart of all the keys.

The FCTN (Function) Key

Many control keys perform two different control functions. To select the uppermost function on the keycap, press and hold the FCTN key, and then press the desired control key. For example, in Figure 2-8, the left key controls both the DELETE IN DISP (delete in display) and the DELETE IN LINE functions. To select the upper function, DELETE IN DISP, press and hold the FCTN key and then press the DELETE IN DISP/LINE key. To select the lower function, DELETE IN LINE, simply press the control key.

Do not confuse the FCTN key with the SHIFT key. The FCTN key selects the upper function of a control key (left key in Figure 2-8) or the front face of a data key (right key in Figure 2-8). The functions assigned to the front faces of data keys are determined through the host software at your site. The SHIFT key activates the uppercase character on the data key only.

The convention used in this book for indicating when the FCTN key must be pressed with another key is:

Press FCTN UNLOCK

Figure 2-8. FCTN and SHIFT Keys

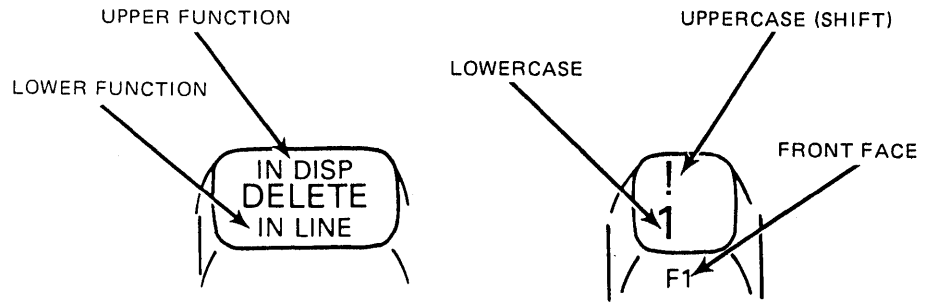

Automatic Cycling

Cycling is the rapid, automatic repetition of a single keystroke caused by pressing a key down and holding it for more than 1/2 second. Releasing the key or pressing another key stops the cycling. The cycling function allows you to easily repeat a data key entry or perform a repetitious editing function. The keys that do not cycle are highlighted in Figure 2-9.

Figure 2-9. Keys That Do Not Cycle

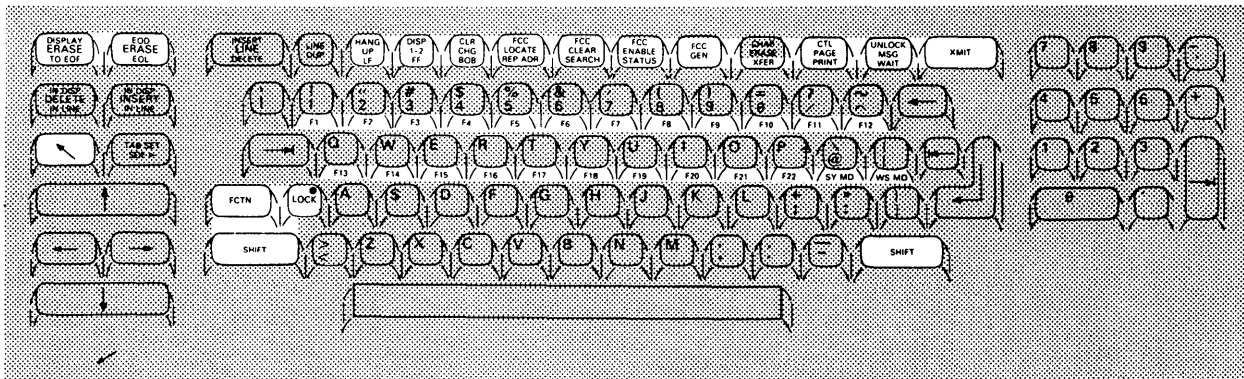

Nonfunctional Keys

The SY MD and WS MD keys (Figure 2-10) on the UTS 30 keyboard are nonfunctional, unless the host processor in your system is a SPERRY System 80. If the UTS 30 is operating with a System 80, refer to the System 80 local workstation operator's guide, UP-8910, for information on system response mode operating procedures. In addition, the HANG UP key is only operational if your UTS 30 is on a switched line, and you must dial up communication with the host. (Refer to Section A2 for dialing instructions.)

Figure 2-10. SY MD, WS MD, and HANG UP Keys

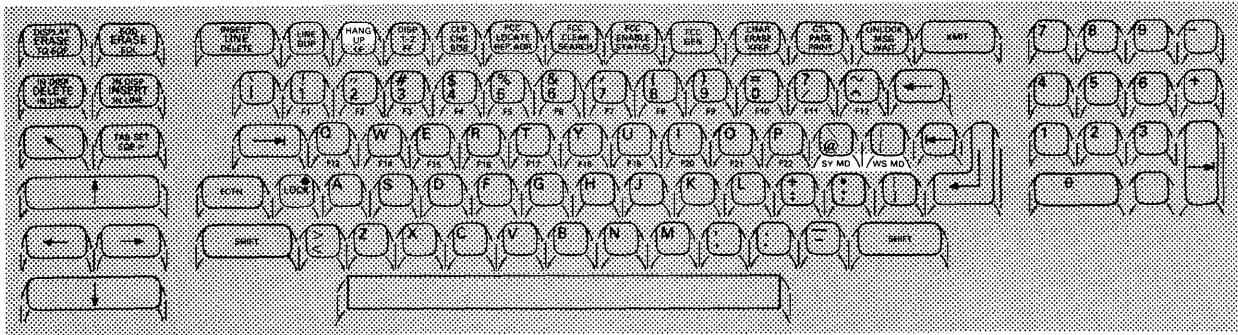

If you have a basic UTS 30, the REP ADR and BOB keys, which are used for diskette subsystem operations, are also nonfunctional.

3. Using the Control Page

This section describes a feature of the UTS 30 which you will frequently use to accomplish tasks on the terminal: the control page.

Through the control page display, you can accomplish basic tasks such as printing data from the screen or from diskette, or sending data to the host. The purpose of this section is to acquaint you with the full range of control page functions.

3.1. THE CONTROL PAGE DISPLAY

The control page is divided into *fields*, indicated by letters in Figure 3-1. These are areas in which you either enter or receive codes. The rest of the control page, usually displayed in an alternate intensity, is protected from data entry. These protected areas of the display name the fields you will be entering codes into or reading information from.

Figure 3-1. Control Page Fields

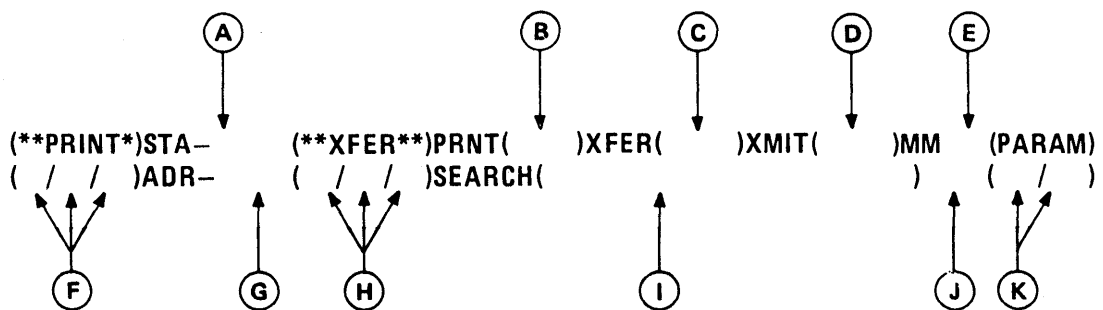

Table 3-1 lists all operations that can be performed by using the control page. Also described in this section are those fields — STA- (A), ADR- (G), and special code (I) — which require no data entry, but provide useful information.

Table 3-1. Operations Performed Using Control Page

Letter Reference (Figure 3-1)	Fields	Operations Performed	References
A	STA-	Report of printer or diskette subsystem status	3.2. 4.3.
B	PRNT()	Specify type of data transfer to printer or diskette subsystem	E1
C	XFER	Specify type of data transfer to printer or diskette subsystem	D1
D	XMIT	Specify type of data transmission to host	F1
E	MM	Perform maintenance mode functions	Appendix F
F	(**PRINT*)	Write from screen to printer or diskette subsystem	E2 E3
		Copy or edit from diskette file to printer or diskette subsystem	D4 D5
		Read files on diskette	D3
		Home diskette	D8
		Check printer or diskette subsystem status	H3
		Report diskette address	D6
		G	ADR-
H	(**XFER**)	Write from screen to printer or diskette subsystem	E2 E3
		Copy or edit from diskette file to printer or diskette subsystem	D4 D5
		Read files on diskette	D3
		Home diskette	D8
		Search files on diskette	D7
		Check printer or diskette subsystem status	H3
		Report diskette address	D6
I	SEARCH()	Search files on diskette Indicate end of a copy operation	D7
J	Special Code	Report terminal address (RID and SID) and communication link	3.2.
K	(PARAM)	Select terminal operating parameters	Appendix E
		Configure printer or diskette subsystem	Appendix E

*Used only with programmable UTS 30.

Displaying and Removing the Control Page

The CTL PAGE key (Figure 3-2) is used to display the control page on the screen or remove it from the screen and store it in the terminal's memory. When the control page is displayed, it will temporarily displace any data that may have been occupying those two lines. (Normally, the control page occupies the first two lines on the screen. Refer to Section 4 or Appendix E for information on changing the control page location.) You need not worry that data on the screen will be lost by displaying or removing the control page; data and the cursor will be restored when the control page is removed. The cursor automatically moves to the first unprotected field each time the control page is displayed (Figure 3-3).

Figure 3-2. Control Page Key

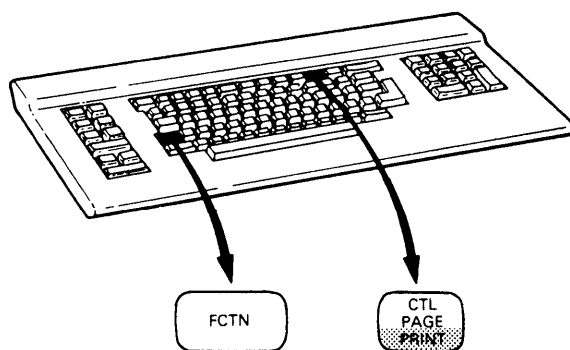

Figure 3-3. First Unprotected Position in Control Page

CURSOR
(**PRINT*)STA- (**XFER**)PRNT(PRNT)XFER(VAR)XMIT(VAR)MM (PARAM)
(/ /)ADR- (/ /)SEARCH() X(/)

Entering Codes in the Control Page

Entering codes in the control page involves only a few steps:

1. Display the control page by pressing FCTN CTL PAGE.
2. Use a tab key to position the cursor in the appropriate field.
3. Enter the codes associated with the desired operation. You can type the codes in either uppercase or lowercase.

Depending on the task to be performed, the operation will be activated by removing the control page from the screen, and then by pressing the appropriate peripheral control key (PRINT, XFER, XMIT, or STATUS).

You will be alerted to an error either by a single alarm (when the control page is removed) or by a repeated alarm (when a peripheral control key is pressed). More information on error conditions is provided in Appendix B.

Using Screen 1 and Screen 2 Control Pages

The alternate screen capability of the UTS 30 provides you with two screens, each with its own control page. The first number in the indicator line shows which screen is currently being displayed (Figure 3-4). Pressing the DISP 1-2 key causes the alternate screen to be displayed.

Figure 3-4. Screen Number Indicator

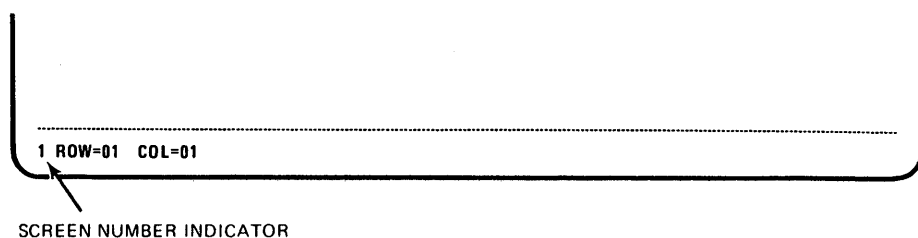

The control page you display is for the current screen. This control page controls the transfer and transmit operations for this screen only, and can be coded independently from the other control page, with the exception of the (PARAM) field, which establishes operating parameters for both screens. (Parameters governing screen size can vary for each screen. Refer to Appendix E.)

3.2. INFORMATION FIELDS OF THE CONTROL PAGE

The STA-, ADR-, and special code fields report information and require no data entry. For certain operations, such as checking device status, additional keys besides the CTL PAGE key must be pressed to activate the functions. The information these fields provide is described in the following paragraphs.

STA- Field

The STA- field (Figure 3-5) is a 6-character field which displays the operating condition of the printer or diskette subsystem used with the UTS 30 when the STATUS key is pressed. (Refer to Section H3 for instructions on using the STATUS key.)

Figure 3-5. STA- Field

```
(**PRINT*)STA- (**XFER**)PRNT(PRNT)XFER(VAR )XMIT(VAR )MM (PARAM)
( / / )ADR- ( / / )SEARCH( ) ( / )
```

The STA- field reports the 2-character device mnemonic (P1 or PR; D1 through D4) and a 3-character status code. (Section H3 lists the meaning of each status code that might appear in the STA- field.) For example, if "P1 200" appears in the STA- field, this means that the printer is out of paper. The status codes may be combined to indicate more than one error. For example, P1 100 and P1 200 could be combined to report a status of P1 300.

ADR- Field

If you are operating a programmable UTS 30, you can use the ADR- field (Figure 3-6) to determine the exact *address* of information on a diskette. The address will be reported in the ADR- field as a record number from 0001 to 9999.

Figure 3-6. ADR- Field

```
(**PRINT*)STA-      (**XFER**)PRNT(      )XFER(      )XMIT(      )MM (PARAM)
( / / )ADR-      ( / / )SEARCH(      ) ( / )
```

Instructions for requesting the diskette address are detailed in Section D6.

An example of a reported diskette address is shown in Figure 3-7.

Figure 3-7. Report of Diskette Address

```
(**PRINT*)STA-      (**XFER**)PRNT(PRNT)XFER(VAR )XMIT(VAR )MM (PARAM)
( / / )ADR- 9999 ( / / )SEARCH(      ) ( / )
```

Special Code Field

The 3-character field below the MM field is a special code field (Figure 3-8). This field displays the *ASCII* representation of the RID and SID (the terminal's address; explained in Appendix E), and the type of communications link to the host processor. An ASCII code conversion chart for the RID and SID is provided in Appendix G. The communications mode codes are X, multiplexer; M, modem or SPERRY Direct Connection Module (DCM); and D, direct connection. Generally, a supervisor is responsible for entering the correct RID, SID, and communications mode code.

Figure 3-8. Special Code Field

```
(**PRINT*)STA-      (**XFER**)PRNT(PRNT)XFER(VAR )XMIT(VAR )MM (PARAM)
( / / )ADR-      ( / / )SEARCH(      ) ( / )
```

For example, assume that the link to the communications line is a modem. If you enter a RID of 24 and a SID of 64, you will see the following characters in the special code field of the screen 1 control page:

\$dM

Press the DISP 1-2 key to display screen 2; then display the control page. The following codes appear in the special code field of the screen 2 control page:

\$eM

Displays 1 and 2 share the same RID of 24, represented by the character "\$." Since display 1 was assigned a SID of 64, represented by the "d" character, display 2 was automatically assigned a SID of 65, specified by the "e" character. The "M" code refers to the modem connecting the UTS 30 to the communications line. This character corresponds to the modem selection for the communications mode parameter.

4. Setting Parameters and Configuring Devices

In this section you will learn how to set parameters (operating features) of the UTS 30, and how to set up your printer and diskette subsystem for operation (configuration). The basic and programmable terminals use different screen displays to change parameters and configure devices. In addition, the (PARAM) field of the control page may be used (on either the basic or programmable UTS 30) to change parameters and configure peripheral devices. This alternate method is described in Appendix E.

To change parameters or configure the printer or diskette subsystem, the terminal keylock must be in the SET UP position (Figure 4-1). If you just wish to review current parameter settings, the keylock position need not be changed.

Figure 4-1. Keylock in SET UP Position

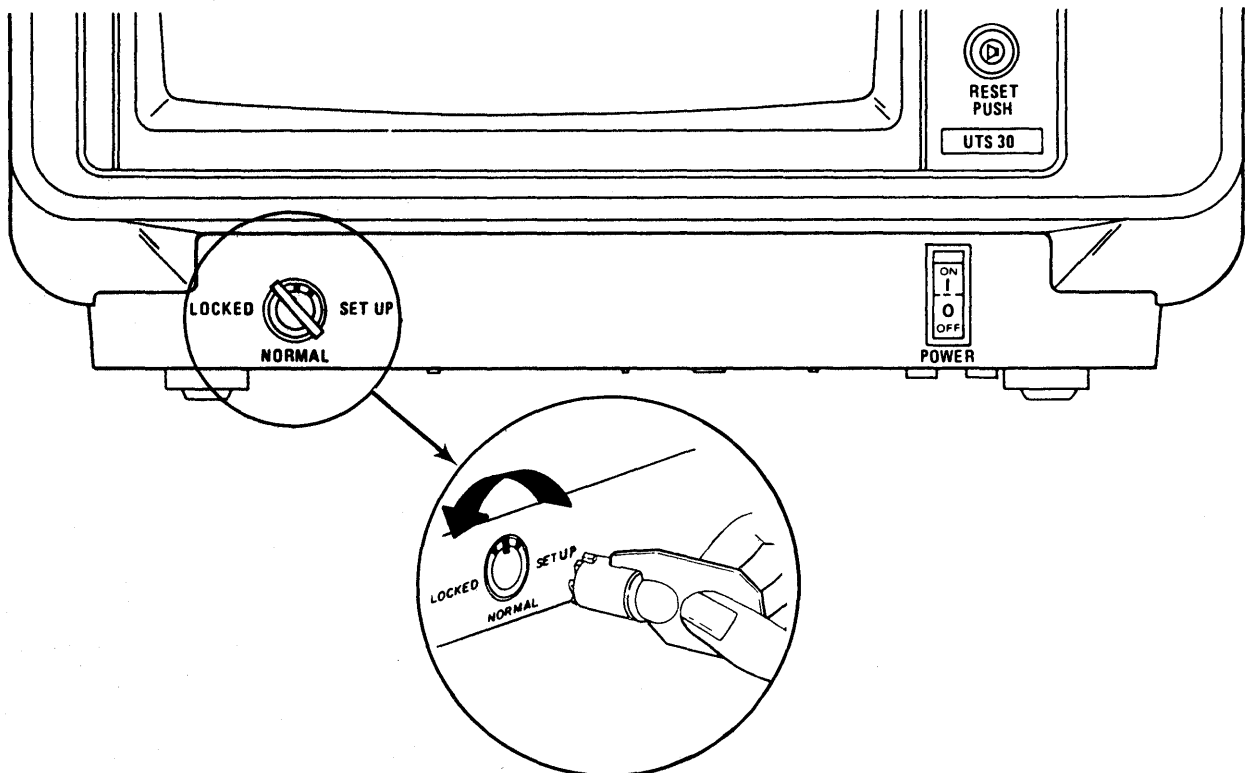

4.1. PARAMETERS

Parameters are operating characteristics of the UTS 30 which affect how the information that you type at the terminal is handled. For instance, there is a parameter which determines whether your space bar is destructive or nondestructive. When it passes over a character, a destructive space bar will erase the character; a nondestructive space bar will not. Most parameters are seldom, if ever, changed.

Every time the terminal is reloaded with its control program, parameters are set at the last-entered parameter settings (Appendix E). If the POC test display produces the message "PARAMETERS DEFAULTED—CONFIGURE DEVICES & ENTER COMM RI, SI, CM," all parameters revert to their *default* conditions. Whenever this message appears, the RID, SID, and CM (if communications mode is not a multiplexer) must be reentered and the RESET button pressed. If you are operating in a language other than U.S.A. English, you will need to enter the national character set parameter also. Any other parameters you have changed also need to be reentered.

4.2. SETTING PARAMETERS ON THE PROGRAMMABLE UTS 30

The easiest way to set parameters on the UTS 30 is through a series of screen displays (also called *menus*) which present all of the available choices to you. To access these displays, you must activate a feature of the terminal called *command mode* (fully described in Section 5), by pressing FCTN M. You will then enter a command to load the *utility* (or instructions) that will bring these menus up on the screen (Section B2). The first display to appear after you enter the command (Figure 4-2) allows you to choose which of four displays you would like to review for possible changes.

Figure 4-2. Parameter/Configurator Utility

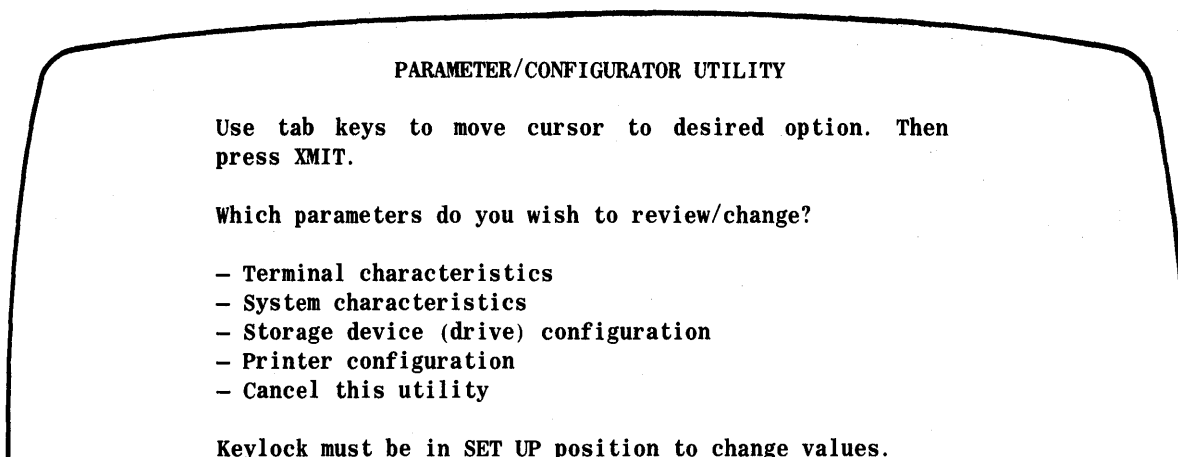

After you have selected which characteristics to review and pressed XMIT, you can cycle through the four displays by pressing F4. Pressing F5 or RESET exits command mode. You can also exit command mode by choosing the "cancel this utility" option on the first display.

If a problem should occur, one of the following error messages will appear:

<u>Message</u>	<u>Meaning</u>
NUMBER OUT OF RANGE	The number you entered is not within the allowable range.
SET UP KEY REQUIRED	The keylock must be in the SET UP position to change parameters.
INVALID ENTRY	An unacceptable value has been entered.

Terminal Characteristics Menu

The terminal characteristics menu (Figure 4-3) displays the parameters most often changed for operator convenience and preference. Refer to Table E-1 for descriptions of each parameter.

Figure 4-3. Terminal Characteristics Menu

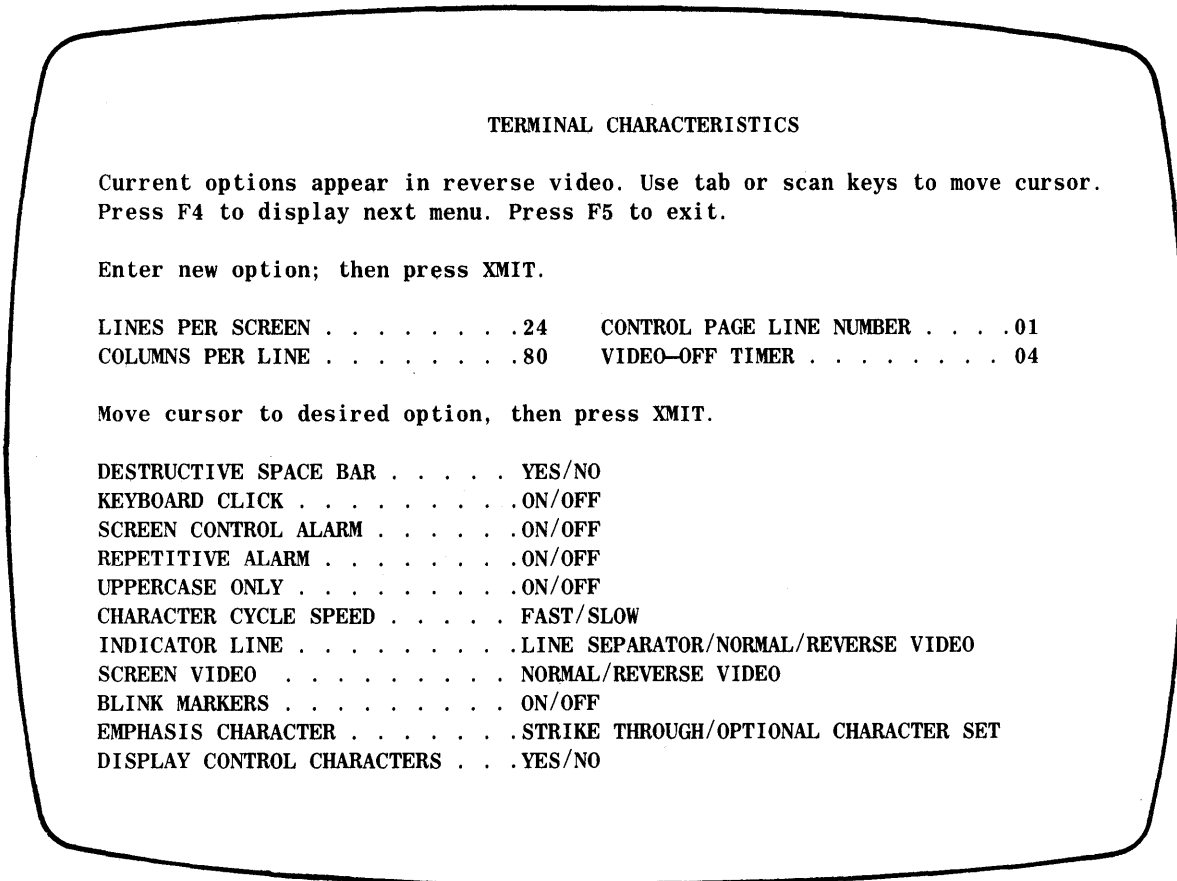

Systems Characteristics Menu

The systems characteristics menu (Figure 4-4) displays those parameters which can affect or are determined by the host system. Many of these parameters (noted by an asterisk in the display) require that the RESET button be pressed to implement the change.

Figure 4-4. System Characteristics Menu

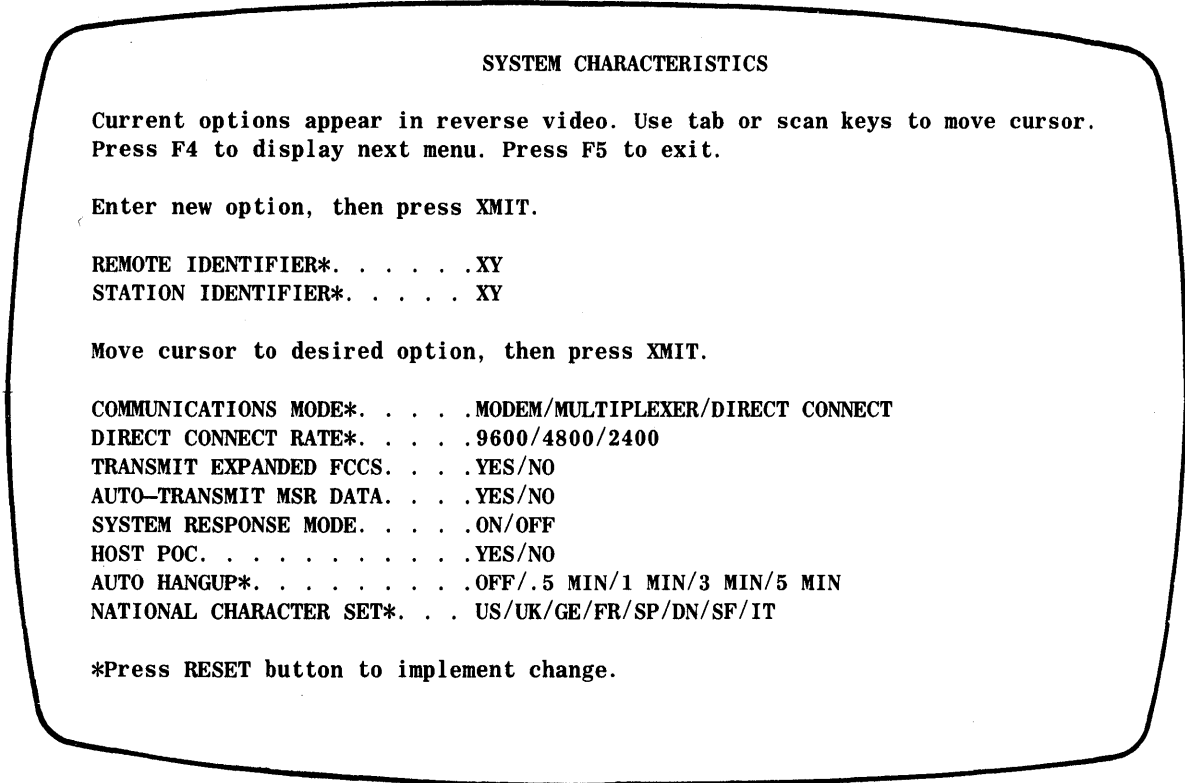

Storage Device (Drive) Configuration Menu

The storage device (drive) configuration menu (Figure 4-5) allows you to configure each diskette subsystem attached to your terminal. Valid DIDs (device identifiers) are 20 to 7F (hexadecimal). However, if the terminal is used for online operations with the host, the following DIDs should be avoided since they have special host functions: 70, 71, 72, and 7F.

Figure 4-5. Drive Configuration Menu

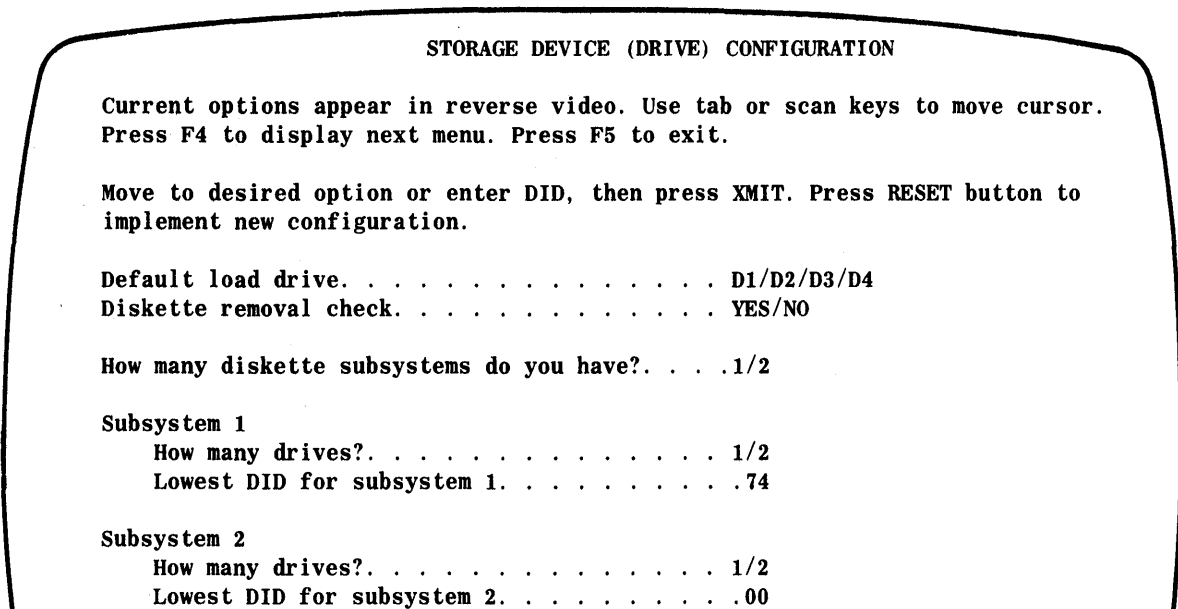

A single-drive diskette subsystem requires two DIDs: you enter the write DID and the system assigns the next higher number as the read DID. A dual-drive diskette requires four DIDs: the operator enters the write DID for the left drive and the system assigns the next three higher DIDs as the read DID for the left drive and the write and read DIDs for the right drive. The default for the lowest write DID on a subsystem is 74.

An identical menu for configuring subsystem 2 is displayed only if the question on the first device configuration menu: "How many diskette subsystems do you have?" is answered "2." If subsystem 2 has not been configured, the lowest write DID will appear as "FF." When you are assigning the lowest DID for subsystem 2, make sure that the DID you assign does not duplicate any of the DIDs previously assigned to subsystem 1.

On this menu, you can also select a default load drive so that you do not have to reenter the diskette drive number each time you enter a command statement.

The "diskette removal check" option gives you the choice of being alerted if a diskette is replaced with another diskette after a file has been opened.

Printer Configuration Menu

The printer configuration menu (Figure 4-6) allows you to configure the printer. Valid DIDs are 20 to 7F (hexadecimal). However, if the terminal is used for online operation with the host, the following DIDs should be avoided because they have special host functions: 70, 71, 72, and 7F. If the printer has not been configured, the printer DID will appear as "FF."

Figure 4-6. Printer Configuration Menu

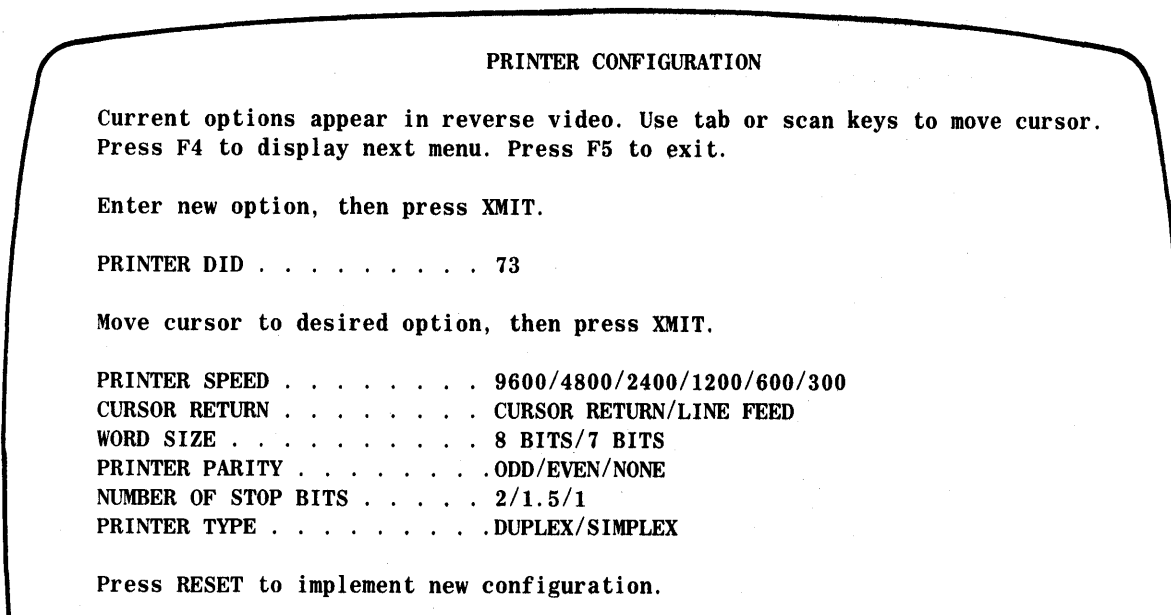

4.3. DISPLAYING AND CHANGING PARAMETERS ON THE BASIC UTS 30

On the basic UTS 30, you can display the current parameter options by entering "DP" (display parameters) in the MM field of the control page (Figure 4-7).

Figure 4-7. MM Field



When you remove the control page, the screen is cleared (any data on the screen is erased), and the parameter options are displayed in the format shown in Figure 4-8. The current parameter options are displayed in reverse video. The keyboard is locked except for the CTL PAGE and F5 keys.

To change a parameter, the keylock must be in the SET UP position. Use the scan and tab keys to move the cursor from option to option. Move the cursor to the desired option field and press the XMIT key. For the parameters with "xy" as the option (Figure 4-8), enter a numeric value, then press XMIT. (Refer to Table E-1 for the range of values allowed.) The option you select takes effect immediately and is displayed in reverse video, except for those parameters that require you to press the RESET button.

The display is removed by pressing FCTN F5, which erases the screen and unlocks the keyboard. Pressing the RESET button, which is required to implement changes to certain parameters (marked by asterisks in Figure 4-8), is an alternative means of exiting the display. (For other uses of the MM field, refer to Appendix F.)

NOTES:

1. For a complete description of each parameter option, refer to Appendix E.
2. Every parameter type has a default option (shown in Table E-1). The terminal is set for that default option, unless otherwise changed.

Figure 4-8. Display of Parameter Options

CURRENT OPTIONS APPEAR IN REVERSE VIDEO. TO CHANGE A PARAMETER, USE SCAN OR TAB KEYS TO MOVE CURSOR TO DESIRED OPTION, THEN PRESS XMIT TO EXIT, PRESS F5.

REMOTE IDENTIFIER*.....XY	PRINTER DID*.....XY
STATION IDENTIFIER*.....XY	LINES PER SCREEN.....XY
CONTROL PAGE LINE NUMBER....XY	COLUMNS PER LINE.....XY
CHARACTER CYCLE SPEED.....FAST/SLOW	VIDEO OFF TIMER.....XY
DESTRUCTIVE SPACE BAR.....YES/NO	KEYBOARD CLICK.....ON/OFF
SCREEN CONTROL ALARM.....ON/OFF	REPETITIVE ALARM.....ON/OFF
DISPLAY CONTROL CHARACTERS..YES/NO	UPPERCASE ONLY.....YES/NO
COMMUNICATIONS MODE*.....MODEM/MUX/DC	DIRECT CONNECT RATE*..9600/4800/2400
TRANSMIT EXPANDED FCCS.....YES/NO	BLINK MARKERS.....ON/OFF
AUTO-TRANSMIT MSR DATA.....YES/NO	AUTO HANGUP*.....OFF/.5/1/3/5
SYSTEM RESPONSE MODE.....ON/OFF	HOST POC.....YES/NO

CURSOR RETURN.....CURSOR RETURN/LINE FEED
PRINTER SPEED.....9600/4800/2400/1200/600/300
EMPHASIS CHARACTER.....STRIKE THROUGH/OPTIONAL CHARACTER SET
INDICATOR LINE.....LINE SEPARATOR/NORMAL/REVERSE VIDEO
SCREEN VIDEO.....NORMAL/REVERSE VIDEO
NATIONAL CHARACTER SET*.....US/UK/GE/FR/SP/DN/SF/IT
PRINTER TYPE.....DUPLEX/SIMPLEX

*PUSH RESET TO IMPLEMENT CHANGE.

1 ROW=01 COL=01

4.4. CONFIGURING THE PRINTER ON THE BASIC UTS 30

The parameter display is also used to configure the printer attached to the UTS 30. Configuring the printer establishes communication among the host processor, the terminal, and the printer. This configuration procedure is followed when the equipment is first installed, and you should not have to alter these entries unless the "PARAMETERS DEFAULTED" message is displayed. Refer to Section B3 for instructions on configuring the printer.

NOTES:

1. *The printer configuration becomes effective only after the RESET button is pressed.*
2. *The keylock must be in the SET UP position to configure the printer.*

5. Using Command Mode

A diskette subsystem attached to a programmable UTS 30 allows you to store data on diskettes and load programs. Storing and managing data on diskettes requires the use of a feature of the programmable UTS 30 called command mode. Section 4 touched briefly on the concept of command mode to enable you to load the parameter/configurator utility. Figure 5-1 is an illustration of the command mode display, which summarizes the possible diskette operations you can initiate through command mode.

Figure 5-1. Command Mode Display

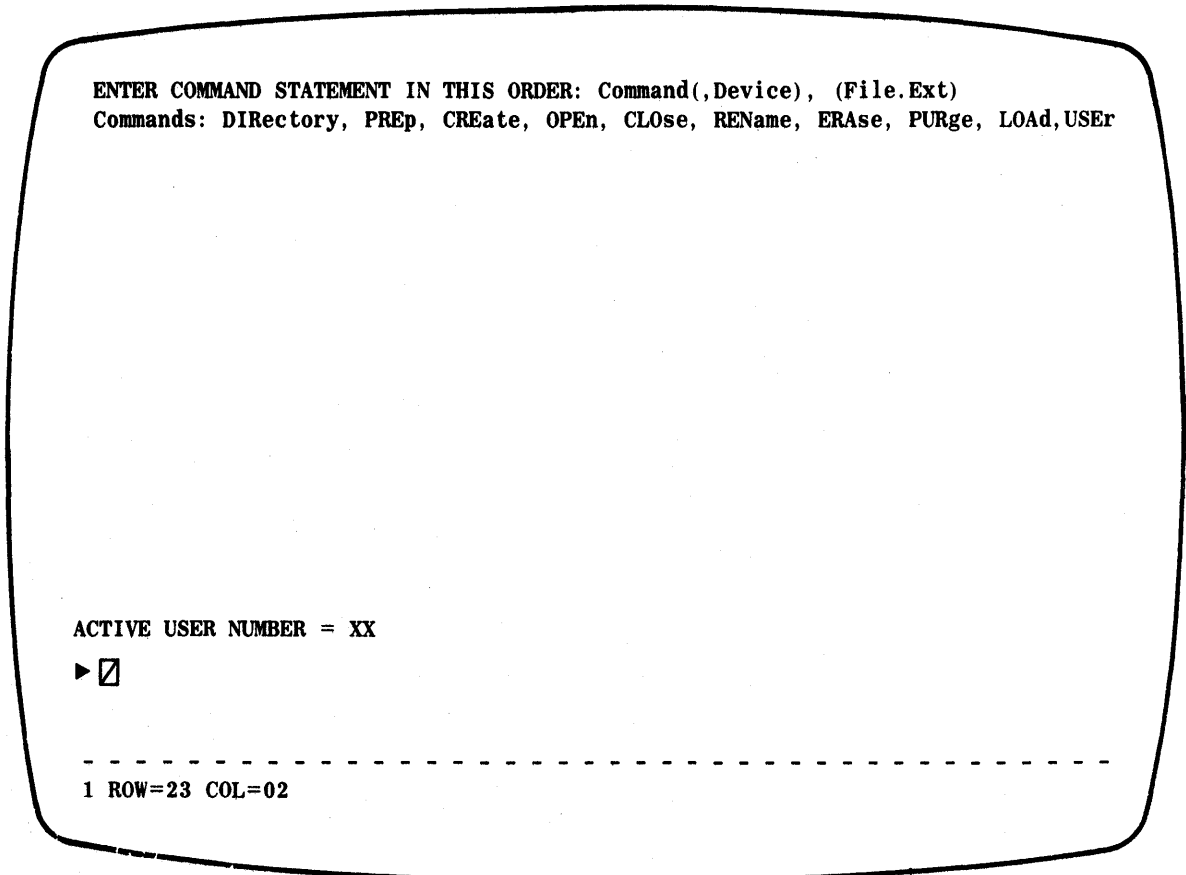

5.1. USING THE COMMAND MODE DISPLAY

You enter command mode by pressing FCTN M (Figure 5-2). All data is erased from the screen and the 2-line command mode display appears at the top of the screen, summarizing your choices.

Figure 5-2. FCTN and M Keys

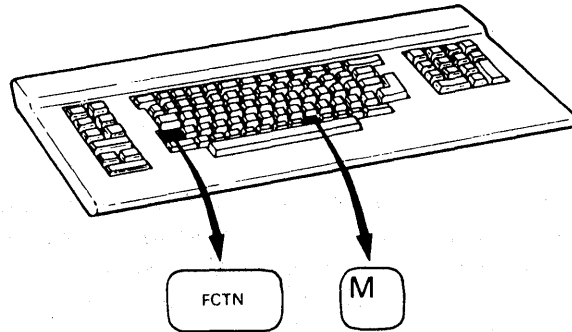

An SOE and the cursor appear on line 23 for you to input a command statement. Command statements can be entered elsewhere on the screen by typing an SOE, immediately followed by the command statement. Characters entered on line 24 of the screen are not scrolled up; therefore, this area could be used for command statements which are used repeatedly. When you are in command mode, you can still display the control page to set up operations such as printing or reading a file.

After you have entered the command statement, you press the XMIT key, and the information between the cursor and the nearest SOE to the left of the cursor is processed. If the command statement is valid, the function is performed, data between lines 23 and 3 scrolls up, and an SOE appears on line 23. If the command statement is invalid, an error message is displayed (refer to Appendix D).

You exit command mode by pressing FCTN M.

5.2. FORMAT OF COMMAND STATEMENTS

A command statement contains a command (Table 5-1), options, a device identifier if necessary, and for some commands, a file name and optional extension. The rules for entering the command statement are:

1. Statements can be typed in uppercase or lowercase characters.
2. Statements must begin in the position immediately after an SOE.
3. The items in line 1 of the command mode display that are in parentheses can be omitted under some conditions. (See the requirements for each command in the procedures section.)
4. Elements of the statement must be separated either by commas or by one or more spaces between each element. No commas or spaces are allowed within elements.

5. Options within an element are separated from the element name by a slash (/).
6. A tab stop can be placed at the end of a command statement. This allows you to tab back to frequently used command statements.

The elements of the command statement are summarized in the following paragraphs.

Command

The command defines the function to be performed. The display at the top of the screen summarizes the allowable commands. At least the first three characters of the command (shown in capitals) are required. Most of the commands have one or more secondary names (Table 5-1); either the primary or one of the secondary names will be accepted as a valid command.

Table 5-1. Valid Command Names

Primary Name	Secondary Name
DIRectory	CATalog
CREate	NEW
OPen	ATTach, OLD, ASSign
CLOse	DETach, REPLace, FREe
REName	CHAnge
ERASE	DELeTe
PURge	
LOAd	EXEcute, RUN, XQT
PREp	FORmat
USEr	

Table 5-2 briefly describes each command. For a complete description and instructions on using these commands, refer to the procedures section.

Table 5-2. Commands (Part 1 of 2)

Command	Operation
PREP	Prepares and formats a new diskette for file storage. Erases any data on the diskette.
USER	Assigns a user number to a file. Thereafter, the file can only be accessed when that particular user number is active. This lets you partition the files on a diskette, assigning all files of a certain type to a certain user number.
CREATE	Creates a new file on the specified diskette.
OPEN	Opens a specified file for input and output.

Table 5-2. Commands (Part 2 of 2)

Command	Operation
CLOSE	Closes a specified file for input and output.
LOAD	Loads a program or utility.
ERASE	Erases a file name from the directory.
PURGE	Deletes all data within a file, but does not remove the file name from the directory.
DIRECTORY	Displays a list of file names on the designated diskette.
RENAME	Changes the file name; allows you to specify the file as a particular type; and assigns a new user number to it.

Device

The device is the diskette drive containing the diskette to be used. Allowable device entries are D1 through D4. You can set the load drive (LD) parameter for a specific drive where you will put your data diskette, and then omit the drive number from your command statement. The terminal will perform the operation on the diskette assigned for the LD parameter. (Refer to Section 4 or Appendix E for information on setting this parameter.)

File Name and Extension

You select a file name to identify the file. The file name contains 1 to 8 alphanumeric characters (dollar signs, asterisks, @ signs, periods, spaces, and commas are not allowed). The file name can be followed by a period and a 3-character extension.

An extension is a qualifier which in some systems has an assigned definition. For nonsystem use, the extension can be any three alphanumeric characters, with the restriction that an extension can only be used once. If the file will be used with a system, the extension must meet the requirements of that system. Extensions used in CP/M systems are shown in the following list:

ASM	BAK	BAS	COM	DAT	HEX
INT	PLI	PRL	PRN	REL	SPR
SYM	SYS	TEX	\$\$\$		

File names and extensions are required for the following commands:

CREate
 OPEn
 REName
 ERAse
 PURge
 LOAd

6. Storing Data on Diskette

If you have a programmable UTS 30, the diskette subsystem attached to your terminal plays an important part in the jobs you can perform. This section provides an overview of diskette subsystem operations.

For general information on the mechanical operation of the subsystem and the care of diskettes, refer to the current version of the 8439 double-sided diskette subsystem installation/operation guide, UP-9884.

6.1. HOW DATA IS STORED ON DISKETTE

Before you actually begin storing data on diskette, you must perform certain command mode operations discussed in Section 5. When you enter the command to *prep* (prepare) a diskette, that diskette will be prepped as a *file-formatted diskette*. That means you must provide a file, a location on that diskette for your data. You create a new file or open an existing file, using command mode.

Because the diskette is file-formatted, it keeps a record or a directory of all the files you have created. This makes keeping track of your data quite easy. One diskette can contain several files. For example, you may have one file of programs, another file of reports, and another file of memos, all on the same diskette. Other command mode functions such as assigning a user number, purging, erasing, and renaming files help keep your files up-to-date and manageable.

Special File Types

You can designate a file as a special type through the rename command (Section C7). The three types, which can be used in any combination, are:

- System File

This type of file can only be listed in the directory display by entering a special option (Section C8), thus increasing file privacy. Also, system files with user number 0 can be accessed by all operators, allowing a single file (particularly a program file) to be accessed from any user number. Otherwise, the program would have to be repeated on the file under each user number.

- Archived File

Typically, a file marked as archived indicates that the file has already been copied onto a backup diskette.

- Read-Only File

Marking a file as read-only protects it from being overwritten. The file can be read, copied, or transmitted to the host, but cannot be changed.

6.2. SETTING UP THE CONTROL PAGE

After a file has been created or opened, diskette operations can be initiated by codes entered in either the (**PRINT*) or (**XFER**) field (Figure 6-1). Codes entered in the (**PRINT*) field are activated by pressing the PRINT key; codes entered in the (**XFER**) field are activated by pressing the XFER key. Normally, when transferring data to diskette, you should use the (**XFER**) field. The difference between the two fields is explained later in this section.

Figure 6-1. (**PRINT*) and (**XFER**) Fields

```
(**PRINT*)STA- (**XFER**)PRNT(PRNT)XFER(VAR )XMIT(VAR )MM (PARAM)
( / / )ADR- ( / / )SEARCH( ) ( / )
```

Both the (**PRINT*) and (**XFER**) fields are divided into the following subfields where you will enter codes to perform operations:

(**PRINT*) or (**XFER**)

(fr/to/fu) (fr/to/fu)

Thinking of these subfields as the "from," "to," and "function" fields will help you remember where to enter codes.

"From" Subfield

Identifies where information is being sent *from*. The choices are the diskette (enter a drive number, D1 to D4) or the screen (leave the subfield blank).

"To" Subfield

Identifies where information is being sent *to*. The choices are the diskette (enter a drive number, D1 to D4), the printer (enter P1 or PR), or the screen (no entry necessary).

"Function" Subfield

Indicates what operation, or *function*, is to be performed. This section and Section 7 describe the functions, and the procedures describe exactly what codes to enter.

Differences Between the (**PRINT*) and (**XFER**) Fields

While the (**PRINT*) and (**XFER**) fields have similar formats and functions, they differ significantly in the way they handle the data you transfer, and their functions are activated by different keys.

The significant difference between the two fields is based on whether or not you have used *field control characters* (FCCs) or special emphasis characters in your screen data.

FCCs

A complete description of FCCs is in Section 8, but for now, simply keep in mind that FCCs create invisible codes in the display. These codes become visible if you transfer data to a printer by using the (**XFER**) field, and the printout will be difficult to read.

However, if you use the (**PRINT*) field, the FCCs will not be printed and the format of the screen data will be preserved. Figure 6-2 illustrates the difference in using these two fields.

Figure 6-2. Difference Between (PRINT*) and (**XFER**) Fields**

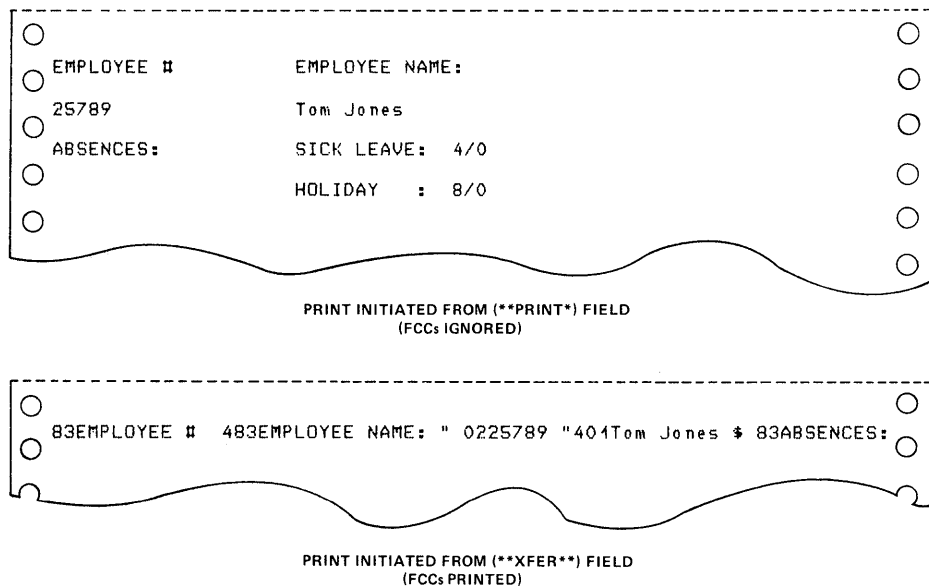

If you have an FCC-formatted screen you wish to transfer to diskette and later call back to the screen, use the (**XFER**) field so that you can later read the data back to the screen in the original format.

Special Emphasis Characters

The two fields also handle special emphasis characters (the underscore, strike-through, and column separator) differently. If you print special emphasis characters using the (**PRINT*) field, the special emphasis characters will be ignored; if they occupy a screen position alone (with no data character), a space will be printed.

If you use the (**XFER**) field to transfer the same data, various control codes will be printed wherever a special emphasis character occurs.

General rules:

When printing, use the (**PRINT*) field. When writing to, copying, or editing files on diskette, use the (**XFER**) field.

6.3. TRANSFERRING DATA TO AND FROM DISKETTE

After a file has been created or opened, most diskette operations can be initiated by codes entered in either the (**PRINT*) or (**XFER**) fields of the control page. Normally, however, writing to, copying, and editing diskettes should be done from the (**XFER**) field.

Detailed instructions for performing all of these operations are in Section D1 through D8. Here is a brief overview of the data transfer operations you can perform:

Writing To Diskette

Once you have created or opened a file, writing to diskette is accomplished by entering the write command in the (**XFER**) field. (Refer to Section D2 for instructions.)

Reading From Diskette

If you want to recall data from a diskette file and display it on the screen, you use the read command in the (**PRINT*) or (**XFER**) field. (Refer to Section D3 for instructions.)

Copying and Editing Diskettes

Diskette data can be sent to a printer, or back to the same or another diskette by entering the copy or edit command in the (**XFER**) field. (Refer to Sections D4 and D5 for instructions.)

6.4. DEFINING DATA ON DISKETTE

Whenever you transfer screen data to a diskette or printer, you can specify how much of that screen data to send by placing an SOE (start-of-entry) character at the beginning of the data to be sent and the cursor at the end (Figure 6-3). If no SOE is on the screen, home position is assumed to be the start of the data transfer.

Figure 6-3. Sending a Partial Screen of Data

The data to be included in a transfer to a peripheral device must be preceded by an SOE character. In this example, only this sentence will appear on the printed copy, because it is preceded by an SOE character and followed by the cursor. This sentence will not be included outside the SOE character and cursor.

6.5 LOCATING DATA ON A DISKETTE

In order to read and copy data from a diskette, you must first locate the data you want and designate how much you want copied.

Search Diskettes

You search a diskette when the information you wish to locate is not at the beginning of the file. The SEARCH () field (Figure 6-4) in the control page is used to locate specific data in a file.

Figure 6-4. SEARCH() Field

```
(**PRINT*)STA- (**XFER**)PRNT( )XFER( )XMIT( )MM (PARAM)
( / / )ADR- ( / / )SEARCH( ) ( / )
```

You also use the SEARCH () field to indicate where in the file you want the copy to end. For instructions on how to search a diskette, refer to Section D7.

Homing Diskettes

This is a simple procedure which causes the diskette to "home" to the beginning of a file. Refer to Section D8 for instructions.

Using the BOB Key

You can use the BOB (backward one block) key to search for information on a file. Each time you press the BOB key, the previous screen of data (from your current location in the file) is displayed.

6.6. FORMATTING OPTIONS

There are certain formatting options available to you when you are transferring data to and from diskette. If you are going to do a write, copy, or edit operation in the (**XFER**) field, then you must make an entry in the XFER() field (Figure 6-5) of the control page. Refer to Section D1 or a list of options.

Figure 6-5. XFER() Field

```
(**PRINT*)STA- (**XFER**)PRNT( )XFER( )XMIT( )MM (PARAM)
( / / )ADR- ( / / )SEARCH( ) ( / )
```

6.7. DISKETTE SUBSYSTEM STATUS CODES

If you have difficulty with any diskette operation, you may want to first check the STA- field of the control page (Figure 6-6), which reports the status of the subsystem when the STATUS key is pressed. (Refer to Section H3 for instructions.) The 6-character code in the STA- field includes a 2-character device mnemonic (D1 to D4) plus a 3-character code identifying the status or condition of the diskette subsystem. Codes may also be combined to indicate that more than one error is causing difficulty. The table in Section H3 lists the codes and their meanings.

Figure 6-6. STA- Field

(**PRINT*)STA-	(**XFER**)PRNT()XFER()XMIT()MM	(PARAM)
(/ /)ADR-	(/ /)SEARCH())	(/))

7. Printing

This section describes how data from the terminal screen or from a diskette is sent to a printer.

Your printer must be prepared for operation before it can print (power must be turned on, paper installed, ribbon checked, etc.). Refer to the operating guide for the particular printer attached to your terminal.

7.1. SETTING UP THE CONTROL PAGE FOR PRINTING

Normally, printing is done from the (**PRINT*) field of the control page (Figure 7-1). Under exceptional circumstances, you may want to print from the (**XFER**) field. (Refer to 6.2 for the distinction between the (**PRINT*) and (**XFER**) fields.)

Figure 7-1. The (**PRINT*) Field

```
(**PRINT*)STA- (**XFER**)PRNT( )XFER( )XMIT( )MM (PARAM)
( / / )ADR- ( / / )SEARCH( ) ( / )
```

After you have identified where the data is coming from in the "from" subfield, and where the data is going to in the "to" subfield, you must define what function you want to perform in the "function" subfield. (Refer to 6.2 for a complete definition of these subfields.) For instructions on how to print from the screen and from diskette, refer to Sections E2 and E3.

7.2. PRINT FORMAT OPTIONS

The format of data you send to a printer or diskette is affected by codes entered in the PRNT() field of the control page (Figure 7-2). The print format options available are described in Section E1.

Figure 7-2. The PRNT() Field

```
(**PRINT*)STA- (**XFER**)PRNT( )XFER( )XMIT( )MM (PARAM)
( / / )ADR- ( / / )SEARCH( ) ( / )
```

7.3. PRINTER STATUS CODES

If you have difficulties getting the printer to operate properly, you may be able to determine the cause of the problem with the help of the information provided in the STA () field of the control page (Figure 7-3).

The STA- field reports the condition of the printer; the 6-character code includes the device mnemonic plus a 3-character code identifying the source of any problem. (Refer to Section H3 for checking status.)

Figure 7-3. STA- Field

```
(**PRINT*)STA- (**XFER**)PRNT( )XFER( )XMIT( )MM (PARAM)
( / / )ADR- ( / / )SEARCH( ) ( / )
```

8. Formatting the Screen with FCCs

This section contains information on using field control characters (FCCs) to format the display into distinct fields. Fields are locations defined on the screen to accept specific data, such as an employee name, address, or social security number. Specific instructions for using FCC-related keys are provided in Sections I1 through I6.

In most applications, FCCs are established by the host or a user program. However, if required, the terminal operator can generate FCCs by a sequence of codes entered through the keyboard. Each code selected corresponds to a unique characteristic of the field, such as: field intensity, setting of a tab stop to flag the location of the field, special emphasis or field protection, restriction on type of data, and field justification.

An FCC code does not occupy a screen location; it is stored in the UTS 30 memory. Therefore, data can be entered in the same position as an FCC, unless the field is defined as protected. An FCC defines the first position of a field, and the field extends to the end of the screen or to the left of the next FCC, whichever comes first. FCCs remain in effect until they are redefined, disabled, or erased.

8.1. INTENSITY VARIATIONS

All characters in a field are displayed in the same intensity; different fields, however, can be displayed in varying intensities. Nine field intensity options are available:

- Character appears in normal intensity
- Character appears in low intensity
- Character blinks from normal to low intensity
- Character is in "off-intensity*"
- Character is displayed against a high-intensity, reverse-video background

**"Off-intensity" means that characters do not appear on the screen as they are entered, but the cursor moves with each keystroke to indicate that data is received by the screen memory. This option is normally selected for security reasons, such as the transfer of confidential information to a printer or a host file.*

- Character is displayed against a low-intensity, reverse-video background
- Character is displayed against a background that blinks from high-intensity reverse video to low-intensity reverse video
- Character is displayed against a background that blinks from low-intensity reverse video to off
- Character blinks from normal to high intensity against a reverse-video background

8.2. TAB STOP

You can quickly locate specific FCC-defined fields by one of two methods.

- FCC LOCATE Key

Pressing this key in conjunction with the FCTN key places the cursor at the first position of the nearest FCC field to the right of the cursor, whether or not that position is an FCC tab stop. This method should be used only to find and change an FCC since it disables certain FCC characteristics (character protection, alphabetic entry only, numeric entry only, and right-justification). The FCC ENABLE key must be pressed to reenable these fields.

- Tab Forward/Tab Back Key

The tab forward or tab back key positions the cursor at the beginning of any field defined with an FCC tab stop. An advantage of using an FCC tab stop is that it does not occupy a screen location, as does the conventional tab stop. To set an FCC tab stop, you need to enter an FCC code sequence (Table 8-1).

Table 8-1. FCC Code Selection (Part 1 of 2)

FCC Type	Data Key	Field Characteristic
Step 1: Intensity	Space or N	Normal display intensity
	L	Low display intensity
	B	Blinks from normal to low intensity
	O	Off-intensity (not displayed)
	1*	Character displayed against a high-intensity, reverse-video background
	2*	Character displayed against a low-intensity, reverse-video background
	3*	Character displayed against a background that blinks from high-intensity reverse video to low-intensity reverse video
	4*	Character displayed against a background that blinks from low-intensity reverse video to off
	5*	Blinks from normal to high intensity against a reverse-video background

Table 8-1. FCC Code Selection (Part 2 of 2)

FCC Type	Data Key	Field Characteristic
Step 2: Tab stop and special FCC-defined tab stop character position	Space or S	No
	T	Tab stop
	6*	Tab stop; special characters protected
	7*	No tab stop; special characters protected
Step 3: Data entry	Space or U	Unrestricted entry
	P	Protected (no keyboard entry allowed)
	A	Alphabetic entries only
	N	Numeric entries only
Step 4: Field justification	Space	Normal justification
	R	Right-justification of all data entered
Step 5: Sequence complete	Space or any alphanumeric character	Completes the FCC sequence

8.3 RESTRICTIONS ON TYPE OF DATA ENTRY ALLOWED

When defining fields with FCCs, you can choose unrestricted or restricted data entry. Options for restricting the type of data entered in a field are: alphabetic only, numeric only, protected data characters, and protected special characters. These characteristics are not in effect until FCCs are enabled by pressing FCC ENABLE.

Protected Fields

The protected-field characteristic prevents data from being entered in a field. A blank portion of the screen or a block of data can be protected to prevent modification or erasure of the data. An example of a protected field may be seen in an employee record, where the field names "Name," "Address," and "Social Security Number" are protected from change.

When a field is protected, the operator can scan the cursor through the field, but cannot position the cursor within the field. The cursor will automatically move right to the first unprotected position after the scan key is released.

When you generate an FCC with the protected-field characteristic, you may enter, change, or delete data in that field until the FCC is enabled. Once enabled, the field restricts additional input until the field is redefined or the FCC is disabled. The FCC LOCATE key can be used to move the cursor to the beginning of an enabled protected field; all FCCs are then disabled.

Protected Special Emphasis Characters

A field can be generated to contain protected special characters (underscore, strike-through, and column separator) without protecting the field from accepting data. (Refer to Appendix C for information on special characters.) For example, a field can be formatted with a protected, nondestructive underline to indicate a blank space to be filled. This type of field will allow the operator to enter data or erase the field without destroying the protected underline character. A typical use of protected special characters for screen formatting is shown in Appendix C.

Special emphasis characters are protected as soon as FCCs are enabled; therefore, no subsequent entry or editing of special characters is allowed without first disabling the FCCs.

Alphabetic-Only Data

Only alphabetic characters are accepted in this type of field. If you attempt to enter a numeric character in this field, the alarm sounds once, the cursor remains stationary, and the keystroke is ignored.

Figure 8-1 shows the characters that are defined as alphabetic.

Figure 8-1. Entries Allowed in an Alphabetic-Only Field

Aa	-	Zz
▶	\	!
•	—	~
,		^
@	,	Space
[}	
]	}	

Numeric-Only Data

Only numeric characters are accepted in this field. If you attempt to enter an alphabetic character, the alarm sounds once, the cursor remains stationary, and the keystroke is ignored.

The characters defined as numeric are shown in Figure 8-2.

Figure 8-2. Entries Allowed in a Numeric-Only Field

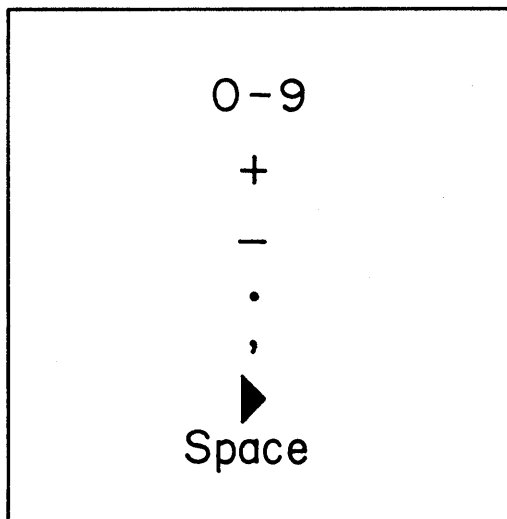

Unrestricted Data

A field defined as unrestricted allows any type of data entry.

8.4. RIGHT-JUSTIFIED FIELDS

As an alternative to normal data justification (the cursor moves from left to right as data is entered on the screen), you may need to right-justify data so it is entered from right to left. The entry of data on a calculator display is a typical application of right justification. A calculator-like function is provided by right justification, as shown in Figure 8-3.

Figure 8-3. Right-Justified Field

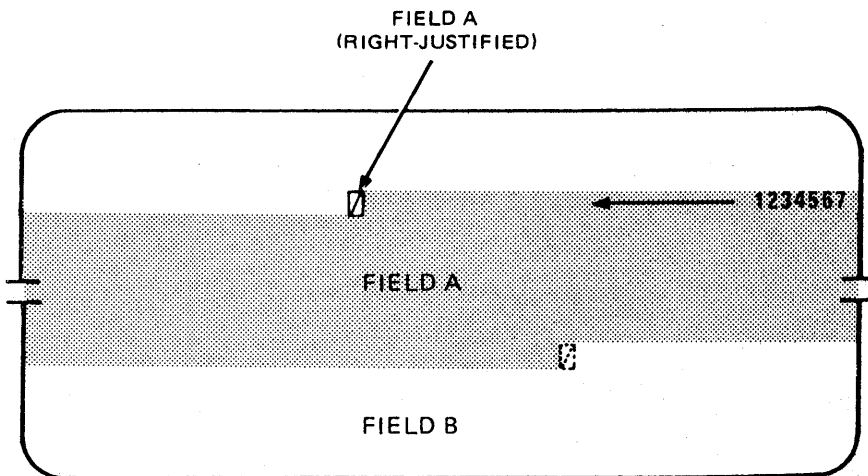

A field functions as a right-justified field only when the cursor is located in the first position of the field. Right justification occurs only within the first line of the field, even if the field extends beyond one line.

With the cursor in the first position of the field, the first character you enter appears in the last position of the field on that line. As each subsequent character is entered, the block of characters preceding the last character entered moves to the left. This movement continues until the field is full. When the final character is entered (causing the first character entered to move into the position occupied by the cursor), the cursor immediately moves to the first unprotected position of the next field.

An additional character can be entered at the right end of the field by returning the cursor to the first position of the right-justified field and continuing data entry. However, this causes the character located at the cursor position to be deleted and the cursor automatically moves to the first unprotected position of the next field (Figure 8-4).

Figure 8-4. Entering Data in a Full Right-Justified Field

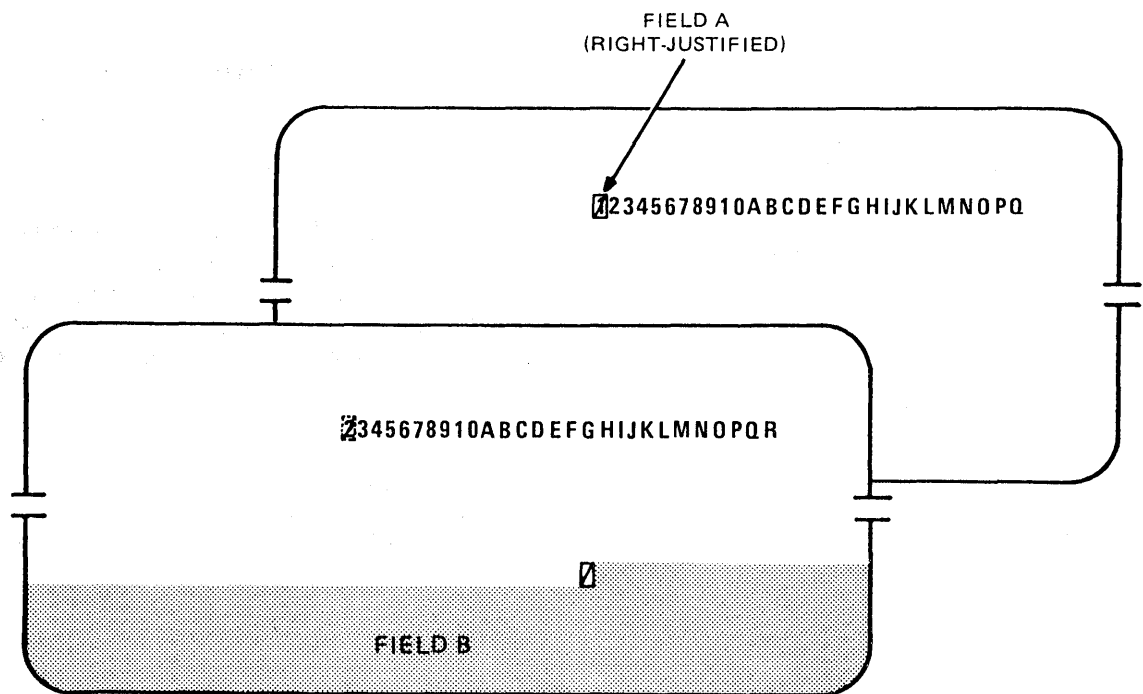

The cursor can be moved to any position in the first line of the field using the scan keys. If corrections to field entries are required, the editing keys can be used and characters can be overwritten. Once the cursor is in the field, however, it moves from left to right and corrections are entered at the cursor position. Data entry is not allowed in the area to the left of a partially filled field or in subsequent lines of the field. If you attempt to enter data in this area, the alarm sounds once, the cursor remains stationary, and the data will not be entered.

Generating a new FCC anywhere on the screen or pressing the FCTN key and the FCC LOCATE key disables right-justification. You must press the FCC ENABLE key to reenable the characteristic.

If you are transmitting several entries from a right-justified field, you can press the CLR CHG key or reposition the cursor at the beginning of the field and press the FCTN ERASE EOD, ERASE EOL, or ERASE TO EOF key to clear the changed-field indicators before entering additional data.

1. Turning on the UTS 30
2. Establishing communication with the host
3. Displaying/removing the control page
4. Entering/exiting command mode
5. Loading programs
6. Prepping diskettes
7. Cleaning the UTS 30 air filter
8. Cleaning diskette drives
9. Backing up a system diskette

A1 Turning on the UTS 30

1. If you're operating a programmable UTS 30, insert the system diskette containing the system control software (e.g., UNISCOPE mode or CP/M Plus™) in a diskette drive.
2. Turn on diskette subsystem power if necessary.
3. Push in on the keylock and turn the key to the NORMAL or SET UP position. (Only the key labeled SPE, with no number following, turns the keylock to SET UP.)
4. Press the POWER switch to the ON position.

NOTE: On the programmable UTS 30, if you insert the system diskette after turning the power on, you must press the RESET button to load the control program.

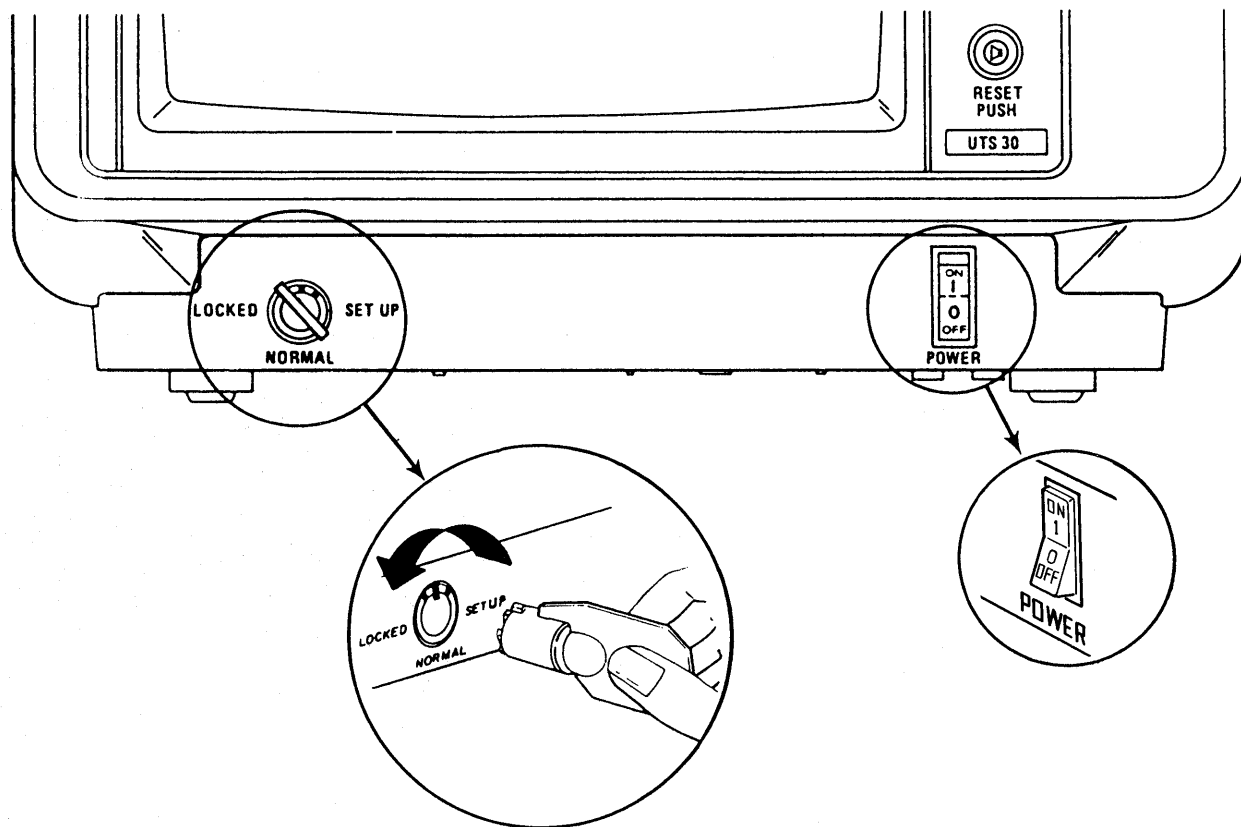

Observe:

The indicator on the magnetic stripe reader, if attached, lights immediately. After about 6 seconds, you will hear a short beep. This means that the POC test has been completed.

If you are in UNISCOPE mode, the "READY" message appears on line 23 of the display. (If any other message appears, refer to Appendix A.)

5. If the system load is unsuccessful, an error message appears on line 25 of the display. Refer to Appendix A for interpretation of the message and alternative steps to take.
6. Press any key to clear the screen. Pressing the cursor to home key will place the cursor in home position (ROW 01, COL 01).

Establishing Communication with the Host

A2

If you wish to work online, and you have a switched line or dial-up communication with the host, you will need to perform additional hookup operations. Those terminals operating on a dedicated line are in direct communication with the host, and become part of the active communication network whenever the terminal is turned on. So if you are on a dedicated line, you need not be concerned with additional hookup instructions. Simply turn on the UTS 30 according to the instructions given in Section A1.

Dialing Instructions

Several types of dialed connections are available with the UTS 30. Check with your supervisor about the exact type that you have and how to operate it. The following instructions relate to the Bell System DATAPHONE*, one of the most widely used dialed connections.

These instructions for use of the DATAPHONE will give you an idea of how to dial in any connection.

1. Press the TALK pushbutton on the DATAPHONE.
2. Lift the handset and dial the number as though you were making a regular telephone call.
3. When you have finished dialing, listen for the line to ring once or twice.

Observe:

When the processor answers the call, the ringing will stop and you will hear a continuous tone, called a carrier.

4. Press the DATA pushbutton and replace the handset in its cradle.

Observe:

The DATA pushbutton indicator will light and will remain lit while your connection is active.

*DATAPHONE is a registered trademark of the Bell System.

A2 Establishing Communication with the Host

Hanging Up a Switched Line

Your UTS 30 may have a communication interface that automatically disconnects the communication line to the host if a specified time period elapses without line activity. However, you also have the option of hanging up the connection by using the HANG UP key.

Press FCTN HANG UP.

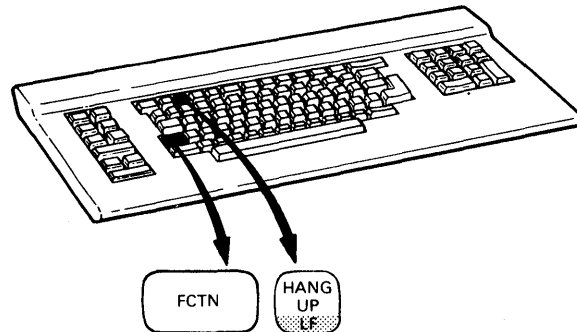

A3 Displaying/Removing the Control Page

To display the control page, press FCTN CTL PAGE.

To remove the control page, press FCTN CTL PAGE again.

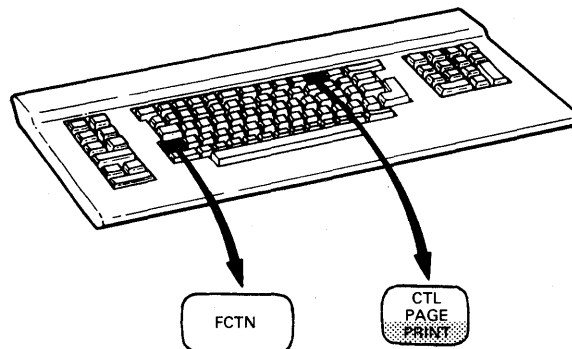

```
(**PRINT*)STA-      (**XFER**)PRNT(  )XFER(  )XMIT(  )MM (PARAM)
( / / )ADR-        ( / / )SEARCH(  ) ( / / )
```

Entering/Exiting Command Mode **A4**

1. To enter command mode, press FCTN M.

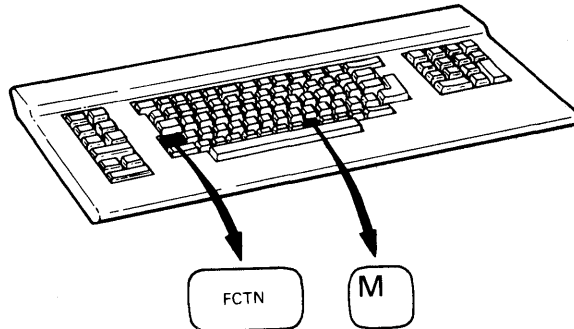

Observe:

The screen is erased and the 2-line command mode display appears at the top of the screen.

An SOE and the cursor appear on line 23 for you to input a command statement. The active user number appears on line 22.

```
ENTER COMMAND STATEMENT IN THIS ORDER: Command(,Device), (File.Ext)
Commands: DIRectory, PREp, CREate, OPEn, CLoSe, REName, ERAse, PURge, LOAd,USER
```

```
ACTIVE USER NUMBER = XX
```

```
▶ 
```

```
-----
1 ROW=23 COL=02
```

A4 Entering/Exiting Command Mode

2. Enter the command statement.
3. Press XMIT.

Observe:

Data between lines 23 and 3 scroll up, and another SOE is placed on line 23.

4. To exit command mode, press FCTN M.

A5 Loading Programs

1. Press FCTN M to enter command mode.
2. Enter the load command statement as follows:

`LOA,D#,File.Ext,option fields`

Entering the drive number is optional if you have set the default load drive parameter for the drive you are loading from. "File.Ext" is the name of the program or utility; for example, "config.sys" is the name of the parameter/configurator utility on the UNISCOPE system diskette. Option fields, if any, contain information required by the program being loaded.

3. Press XMIT.

Observe:

The red indicator light in the drive door lights, and the "WAIT" and "AUXB" messages are displayed. When the program or utility is finished loading, the messages are removed and the first display of the program or utility appears on the screen.

1. Press FCTN M to enter command mode.
2. Enter the prep command as follows:

PRE, D#

The drive number is optional if you have set the default load drive parameter for the drive containing the diskette.

3. Press XMIT.

Observe:

The red indicator light in the drive door goes on, and the "WAIT" and "AUXB" messages appear. When the prep is complete (after about 2 minutes), the indicator light goes off, and the alarm sounds once.

NOTE: If the diskette has already been prepped and you attempt to reprep it, this message will appear:

DISK ALREADY FORMATTED – CONTINUE PREP (Y/N)?

If you enter "Y," the diskette is prepped. Entering "N" stops the prep.

If the diskette you attempt to prep is damaged, one of the following messages will be displayed:

DISK ERROR – PREP UNSUCCESSFUL

DISK ERROR – DATA ERROR

Use a different diskette.

A7 Cleaning the UTS 30 Air Filter

The air filter on the UTS 30 must be cleaned periodically to prevent overheating of the terminal. If the terminal power is on continuously, clean the air filter about once every month. If the terminal is exposed to an unusual amount of dust, more frequent cleaning may be necessary. Replacement air filters (part number 4956810-07) can be obtained from your Sperry customer services representative.

1. Turn the POWER switch to OFF.
2. Locate the edge of the air filter tray on the left side of the terminal, at its base.
3. Slide the air filter tray out.

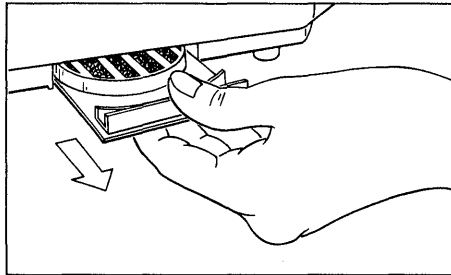

4. Turn the air filter tray over and remove the filter.

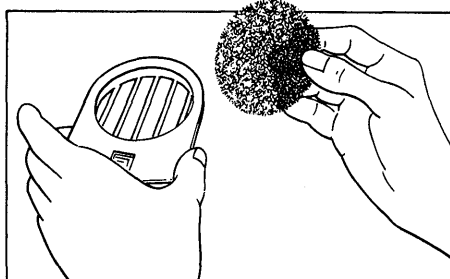

5. Clean the air filter by brushing out the dust or rinsing it with water.
6. Place the cleaned filter in the tray and reinstall it to its original position.

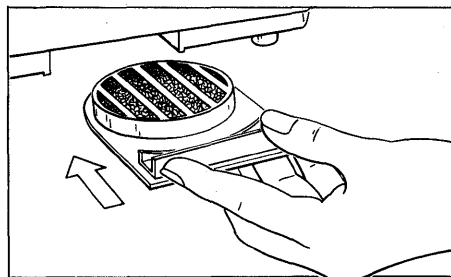

Cleaning the Diskette Drive **A8**

Normal use of diskettes causes a gradual buildup of dirt on the read/write head. To minimize diskette wear, the diskette drive should be cleaned about every two weeks. The cleaning utility is loaded from the UNISCOPE system diskette.

You will need to obtain a diskette drive cleaning kit (part number 2894105) from your Sperry customer services representative.

1. Press FCTN M to enter command mode.
2. Enter the command to load the cleaning utility as follows:

LOA, D#, Clean.USR

Entering the drive number is optional if you have set the default load drive parameter for the drive from which you're loading the utility.

3. Press XMIT.

Observe:

The red indicator in the drive door goes on, and the "WAIT" and "AUXB" messages appear. When the utility is loaded, the messages are removed, and the first display of the utility appears.

HEAD CLEANING UTILITY (RELEASE LEVEL XX)

UTS 30 5¼ DISKETTE DRIVES

PREPARE THE CLEANING DISKETTE (FOLLOWING DIRECTIONS ON BOX) AND INSERT IT IN THE DRIVE TO BE CLEANED.

PRESS FCTN AND PROGRAM ATTENTION KEY ASSOCIATED WITH DRIVE:

PROGRAM ATTENTION KEY	DRIVE
F1	1
F2	2
F3	3
F4	4

PRESS FCTN AND F21 TO EXIT PROGRAM.

4. Prepare the cleaning diskette as directed by the utility, and insert it in the drive to be cleaned.

A8 Cleaning the Diskette Drive

5. Press the program attention key associated with the drive, as indicated by the utility.

Observe:

The message "CLEANING" flashes on the screen. After approximately 30 seconds, the original menu returns with the flashing message "DONE CLEANING" at the top of the screen.

6. Repeat steps 4 and 5 for each drive you want to clean.
7. Press FCTN F21 to exit the utility.

If something prevents the cleaning utility from running, one of the following error messages appears:

THAT DEVICE IS NOT CONFIGURED
DEVICE NOT READY - INSERT CLEANING DISKETTE IN DRIVE
WRONG DISKETTE - INSERT CLEANING DISKETTE IN DRIVE

A9 Backing Up a Diskette Subsystem

NOTE: The backup diskette should be newly prepped (Section A6). Do not use a diskette with other data on it.

1. Display the control page by pressing FCTN CTL PAGE.
2. Tab to the **XFER** field.
3. In the first subfield, enter the drive number (Dx) of the drive that has the system diskette.
4. In the second subfield, enter the drive number (Dy) of the drive that has the backup diskette.
5. In the third subfield, enter CD.
6. Remove the control page by pressing FCTN CTL PAGE.
7. Press the XFER key.

Observe:

The "AUXB" message appears in the indicator line. When the message disappears, the copying is completed.

Setting Parameters/Configuring Devices

B

1. Reviewing/changing parameters on the basic UTS 30
2. Reviewing/changing parameters on the programmable UTS 30
3. Configuring the printer on the basic UTS 30
4. Configuring the printer on the programmable UTS 30
5. Configuring the diskette subsystem

B1 Reviewing/Changing Parameters (Basic)

Make sure there is no data on the screen you wish to save because displaying the parameter values erases any data on the screen.

1. Display the control page.
2. Tab to the MM field.
3. Enter "DP" in the MM field.
4. Remove the control page.

Observe:

A list of parameter values is displayed on the screen with current values in reverse video. The screen is protected, and the keyboard is locked.

5. Turn the keylock to the SET UP position if you wish to change parameters. (The master key, labeled SPE with no number following, must be used to turn the keylock to SET UP.)
6. Tab or scan to the parameter option you want to select.
7. If a numeric value is to be entered, type in your selection. (Refer to Appendix E for possible value selections.)
8. With the cursor in the option field of your choice, press XMIT.
9. Press the RESET button if the option requires it (Appendix E). Make all your changes before pressing RESET since pressing this button erases the display.
10. Press FCTN F5 to exit the display.
11. Turn the keylock to the NORMAL position.

Reviewing/Changing Parameters (Basic)

B1

CURRENT OPTIONS APPEAR IN REVERSE VIDEO. TO CHANGE A PARAMETER, USE SCAN OR TAB KEYS TO MOVE CURSOR TO DESIRED OPTION, THEN PRESS XMIT TO EXIT, PRESS F5.

REMOTE IDENTIFIER*.....XY	PRINTER DID*.....XY
STATION IDENTIFIER*.....XY	LINES PER SCREEN.....XY
CONTROL PAGE LINE NUMBER.....XY	COLUMNS PER LINE.....XY
CHARACTER CYCLE SPEED.....FAST/SLOW	VIDEO OFF TIMER.....XY
DESTRUCTIVE SPACE BAR.....YES/NO	KEYBOARD CLICK.....ON/OFF
SCREEN CONTROL ALARM.....ON/OFF	REPETITIVE ALARM.....ON/OFF
DISPLAY CONTROL CHARACTERS..YES/NO	UPPERCASE ONLY.....YES/NO
COMMUNICATIONS MODE*.....MODEM/MUX/DC	DIRECT CONNECT RATE*..9600/4800/2400
TRANSMIT EXPANDED FCCS.....YES/NO	BLINK MARKERS.....ON/OFF
AUTO-TRANSMIT MSR DATA.....YES/NO	AUTO HANGUP*.....OFF/.5/1/3/5
SYSTEM RESPONSE MODE.....ON/OFF	HOST POC.....YES/NO

CURSOR RETURN.....CURSOR RETURN/LINE FEED
PRINTER SPEED.....9600/4800/2400/1200/600/300
EMPHASIS CHARACTER.....STRIKE THROUGH/OPTIONAL CHARACTER SET
INDICATOR LINE.....LINE SEPARATOR/NORMAL/REVERSE VIDEO
SCREEN VIDEO.....NORMAL/REVERSE VIDEO
NATIONAL CHARACTER SET*.....US/UK/GE/FR/SP/DN/SF/IT
PRINTER TYPE.....DUPLEX/SIMPLEX

*PUSH RESET TO IMPLEMENT CHANGE.

1 ROW=01 COL=01

B2 Reviewing/Changing Parameters (Programmable)

Make sure there is no data on the screen you wish to save because loading the parameter/configurator utility erases any data on the screen.

1. Press FCTN M to enter command mode.
2. Enter the command to load the parameter/configurator utility as follows:

LOA, D#, CONFIG. SYS

Entering the drive number is optional if you have set the default load drive parameter for the drive from which you are loading the utility.

3. Tab or scan to the name of the screen you wish to review.
4. Press XMIT.
5. Turn the keylock to the SET UP position if you want to change parameters.
6. Follow the instructions on the menu to alter parameters.
7. Press RESET, if required.

PARAMETER/CONFIGURATOR UTILITY

Use tab keys to move cursor to desired option. Then press XMIT.

Which parameters do you wish to review/change?

- Terminal characteristics
- System characteristics
- Storage device (drive) configuration
- Printer configuration
- Cancel this utility

Keylock must be in SET UP position to change values.

Configuring the Printer (Basic) **B3**

1. Turn the keylock to the SET UP position. (The master key, labeled SPE with no number following, must be used to turn the keylock to SET UP.)
2. Display the current parameter values (Section B1).
3. Tab or scan to the PRINTER DID option.
4. Enter a hexadecimal number between 20 and 7F. (Do not use 70, 71, 72, or 7F, which have special host functions.)
5. Press the RESET button.
6. Turn the keylock to the NORMAL position.

CURRENT OPTIONS APPEAR IN REVERSE VIDEO. TO CHANGE A PARAMETER, USE SCAN OR TAB KEYS TO MOVE CURSOR TO DESIRED OPTION, THEN PRESS XMIT TO EXIT, PRESS F5.

REMOTE IDENTIFIER*.....XY	PRINTER DID*.....XY
STATION IDENTIFIER*.....XY	LINES PER SCREEN.....XY
CONTROL PAGE LINE NUMBER.....XY	COLUMNS PER LINE.....XY
CHARACTER CYCLE SPEED.....FAST/SLOW	VIDEO OFF TIMER.....XY
DESTRUCTIVE SPACE BAR.....YES/NO	KEYBOARD CLICK.....ON/OFF
SCREEN CONTROL ALARM.....ON/OFF	REPETITIVE ALARM.....ON/OFF
DISPLAY CONTROL CHARACTERS..YES/NO	UPPERCASE ONLY.....YES/NO
COMMUNICATIONS MODE*.....MODEM/MUX/DC	DIRECT CONNECT RATE*..9600/4800/2400
TRANSMIT EXPANDED FCCS.....YES/NO	BLINK MARKERS.....ON/OFF
AUTO-TRANSMIT MSR DATA.....YES/NO	AUTO HANGUP*.....OFF/.5/1/3/5
SYSTEM RESPONSE MODE.....ON/OFF	HOST PGC.....YES/NO
CURSOR RETURN.....CURSOR RETURN/LINE FEED	
PRINTER SPEED.....9600/4800/2400/1200/600/300	
EMPHASIS CHARACTER.....STRIKE THROUGH/OPTIONAL CHARACTER SET	
INDICATOR LINE.....LINE SEPARATOR/NORMAL/REVERSE VIDEO	
SCREEN VIDEO.....NORMAL/REVERSE VIDEO	
NATIONAL CHARACTER SET*.....US/UK/GE/FR/SP/DN/SF/IT	
PRINTER TYPE.....DUPLEX/SIMPLEX	

*PUSH RESET TO IMPLEMENT CHANGE.

1 ROW=01 COL=01

B4 Configuring the Printer (Programmable)

1. Turn the keylock to the SET UP position. (The master key, labeled SPE with no number following, must be used to turn the keylock to SET UP.)
2. Press FCTN M to enter command mode.
3. Enter the command to load the parameter/configurator utility as follows:

LOA,D#,CONFIG.SYS

Entering the drive number is optional if you have set the default load drive parameter for the drive from which you are loading the utility.

4. Tab or scan to the printer configuration menu on the main selection menu.
5. Press XMIT.
6. Enter the printer DID. Valid DIDs are 20 to 7F (hexadecimal); avoid 70 71, 72, and 7F if working online. The default DID is 73.
7. Set the other printer characteristics.
8. Press the RESET button.

NOTE: Pressing RESET deactivates command mode.

Printer Configuration

Current options appear in reverse video. Use tab or scan keys to move cursor. Press F4 to display next menu. Press F5 to exit.

Enter new option, then press XMIT.

PRINTER DIDXY

Move cursor to desired option, then press XMIT.

PRINTER SPEED 9600/4800/2400/1200/600/300
CURSOR RETURN CURSOR RETURN/LINE FEED
WORD SIZE 8 BITS/7 BITS
PRINTER PARITY. ODD/EVEN/NONE
NUMBER OF STOP BITS 2/1.5/1
PRINTER TYPE. DUPLEX/SIMPLEX

Press RESET to implement new configuration.

Configuring the Diskette Subsystem

1. Turn the keylock to the SET UP position. (The master key, labeled SPE with no number following, turns the keylock to SET UP.)
2. Press FCTN M to enter command mode.
3. Enter the command to load the parameter/configurator utility as follows:

LOA,D#,CONFIG.SYS

Entering the drive number is optional if you have set the default load drive parameter for the drive from which you are loading the utility.

4. Tab or scan to the storage device (drive) configuration selection on the main menu.
5. Press XMIT.
6. Follow the instructions on the menu to configure drives. Valid DIDs are 20 to 7F (hexadecimal); avoid 70, 71, 72, and 7F if working online. The default configuration is one diskette subsystem with two drives. The default DID is 74, which will appear if the system has not been configured before.
7. Enter other diskette drive features.
8. Press the RESET button.

STORAGE DEVICE (DRIVE) CONFIGURATION

Current options appear in reverse video. Use tab or scan keys to move cursor. Press F4 to display next menu. Press F5 to exit.

Move to desired option or enter DID, then press XMIT. Press RESET button to implement new configuration.

Default load drive. D1/D2/D3/D4

Diskette removal check. YES/NO

How many diskette subsystems do you have?. . . .1/2

Subsystem 1

How many drives?. 1/2

Lowest DID for subsystem 1. 74

Subsystem 2

How many drives?. 1/2

Lowest DID for subsystem 2. 00

1. Assigning a user number
2. Creating a new file
3. Opening a file
4. Closing a file
5. Erasing a file
6. Purging a file
7. Renaming a file
8. Using the directory

C1 Assigning a User Number

This operation allows you to assign all files of a certain type to a specific user number (0 through 15). When the terminal is loaded with the UNISCOPE mode program, the active user number is 0. Thereafter, the number specified through this command is active. When a file is created, it is assigned the active user number; thereafter, it can only be accessed when that particular number is active. The only exception is that files designated as system files with user number 0 are available to all user numbers.

The active user number is displayed on the directory.

1. Press FCTN M to enter command mode.
2. Enter the command to assign a user number as follows:

USE, #

A 1-digit user number may be entered with or without a zero. For example, either 01 or 1 is acceptable.

3. Press XMIT.

C2 Creating a New File

Creating a new file automatically opens it. The directory is updated with the name of the new file.

1. Press FCTN M to enter command mode.
2. Enter the command to create a new file as follows:

CRE/S,D#,File.Ext

If you include the S option, the file is created as a system file. The D# is optional if you have set the default load drive parameter for the drive containing the diskette.

3. Press XMIT.

Observe:

The red indicator in the drive door lights, and the "WAIT" and "AUXB" messages appear momentarily. When the operation is complete, the messages are removed, and the SOE character and cursor reappear on line 23.

NOTE: If the diskette already contains a file with the same file name and extension, the following message is displayed:

DISK ERROR – FILE ALREADY EXISTS

Enter a different file name and extension.

1. Press FCTN M to enter command mode.
2. Enter the command to open the file as follows:

OPE,D#,File.Ext

The drive number is optional if you have set the default load drive parameter for the drive containing your diskette.

3. Press XMIT.

NOTE: If the file you attempt to open is not in the active user number, you will see the message:

DISK ERROR - WRONG USER NUMBER - FILE = XX

This message indicates which user number (xx) the file is in. Enter the USE command (Section C1) to change to the correct user number.

1. Press FCTN M to enter command mode.
2. Enter the command to close the file as follows:

CL0,D# Closes the file that is open on that diskette

The drive number is optional if you have set the default load drive parameter for the drive containing the diskette.

3. Press XMIT.

NOTE: If no file is open on the diskette, the following message is displayed:

FILE NOT OPENED

C5 Erasing a File

Erasing a file removes its name from the directory and makes the space used to store that file available for reuse.

1. Press FCTN M to enter command mode.
2. Enter the command to erase the file as follows:

`ERA, D#, File.Ext`

The drive number is optional if you have set the default load drive parameter for the drive containing the diskette.

3. Press XMIT.

C6 Purging a File

This operation deletes all the records within a file, but does not remove the file name from the directory.

1. Press FCTN M to enter command mode.
2. Enter the command to purge the file as follows:

`PUR, D#, File.Ext`

The D# is optional if you have set the default load drive parameter for the drive containing your diskette.

3. Press XMIT.

This operation allows you to change the name of a file. You may also choose to designate it as a read-only, system, or archived file, or change the user number of the file.

1. Press FCTN M to enter command mode.
2. Enter the command to rename the file as follows:

`REN/Options,D#,Oldfile.Ext,NewFile.Ext`

Options must be separated from the command by a slash, and can be entered in any order, with no spaces or commas between options. The options are:

R = Make the new file read-only

S = Make the new file a system file

A = Make the new file an archived file

0-15 = Assign file to this user number

Refer to 6.1 for a description of these types of files.

The drive number is optional if you have set the default load drive parameter for the drive containing the diskette.

3. Press XMIT.

C8 Using the Directory

This operation displays the contents of the directory on a diskette. The directory display begins on line 23 and scrolls up.

The directory is displayed in abbreviated form (five file names and extensions per line) unless the F (full) option is specified (file name and extension, size of file in hexadecimal, and file characteristics: read-only, system, or archived).

Only the files for the active user index are displayed, unless the A (all) option is specified.

System files are included in the directory only if the S (system) option is specified.

The first item displayed is the active user index number, followed by the directory. The last items displayed are the amount of space on the diskette which has been used and the amount still available (in hexadecimal).

1. Press FCTN M to enter command mode.
2. Enter the directory command in one of the following forms:
 - DIR,D# Displays files for active user index, excluding system files, in abbreviated form.
 - DIR/ASF,D# Displays files in the form specified by the options, where:
 - A displays the files for all user indexes
 - S includes the system files in the display
 - F displays the files in full form

If options (ASF) are included, they can be entered in any order, but with no spaces or commas between options.

The D# is optional if you have set the default load drive parameter for the drive containing the diskette.
3. Press XMIT.

1. Selecting type of data for transfer
2. Writing to diskette
3. Reading from diskette
4. Copying from diskette
5. Editing from diskette
6. Reporting diskette address
7. Searching a diskette
8. Homing a diskette

D1 Specifying Type of Data for Transfer

When you transfer data to and from diskette, you have a choice of what type of data you can send. For write, copy, and edit operations, the code entered in the XFER() field of the control page affects the type of data sent, particularly if the data is FCC-formatted. Generally, you will set this field with one option and seldom, if ever, change it.

1. Display the control page.
2. Tab to the XFER() field.
3. Enter one of the XFER field options shown in the following table.

Option	Description
ALL	Transfers exact screen data (with FCCs) All data and associated FCCs are transferred.
VAR	Transfers variable data (with FCCs) The VAR entry is the default condition. Only unprotected data and associated FCCs are transferred.
CHAN	Transfers only changed data (with FCCs) Only fields that have been changed, as indicated by the internal changed-field indicators, and associated FCCs are transferred.*

4. Remove the control page.

**The changed-field indicator, invisible to the operator, is an internal record of entered data kept by each field. As an example of the use of changed-field indicators: In a payroll application, most field data, such as name and social security number, will remain unchanged for each pay period. However, some data, such as payroll deductions, are subject to change. To transmit only the changed data, the operator uses the CHAN option. The changed-field indicators are erased by pressing the CLR CHG key.*

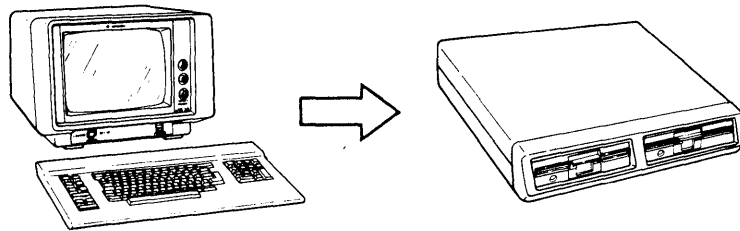

1. Press FCTN M to enter command mode.
2. Create or open the file to be written to:

Examples:

```
CRE, D1, RED. FOX
```

```
OPE, D1, RED. FOX
```

3. Press FCTN M to exit command mode.
4. Display the control page.
5. In the (**XFER**) field of the control page, enter the drive number containing the diskette:

Example:

```
(**XFER**)  
( /D1/ )
```

6. Specify the type of data you wish to transfer to diskette by entering a code in the XFER() field (refer to Section D1).
7. Remove the control page.
8. Enter the text you wish to transfer to diskette.
9. Position the cursor to the right of the last character you wish to send. Data between home position and the cursor will be transferred. If you enter an SOE character anywhere on the screen, data transfer will begin immediately to the right of the SOE.
10. Press the XFER key.
11. Press FCTN M to enter command mode.
12. Enter the command to close the file.

Example:

```
CLO, D1, RED. FOX
```

D3 Reading from Diskette

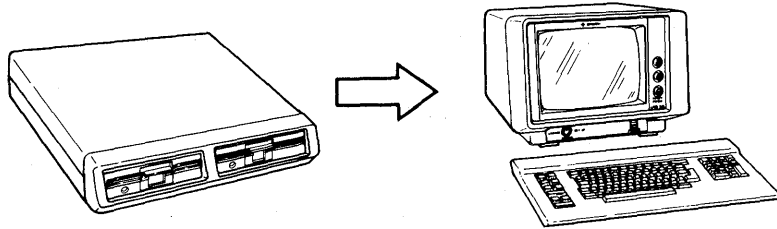

1. Press FCTN M to enter command mode.
2. Open the file to be read.

Example:

OPE, D#, RED. FOX

3. Press FCTN M to exit command mode.
4. Display the control page.
5. Opening a file homes it. Unless you wish to read from home position, search the file (Section D7) to locate the data you wish to read.
6. Enter the read code in either the (**PRINT*) or (**XFER**) field:

Example:

(**XFER**)
(D1/ /RD)

7. Remove the control page.
8. Position the SOE character at the location on the screen where you wish the start of data to begin. (If no SOE is entered, the data will be displayed starting at home position. Any existing data will be overwritten.)
9. Press the PRINT or XFER key, depending on which field you entered the read code in.

Observe:

Up to one screen of data at a time will be displayed each time the PRINT or XFER key is pressed.

10. Press FCTN M to enter command mode.
11. Close the file. (This is not necessary, but it is a good practice.)

NOTE: You may wish to use the BOB key to read backwards one block (one screen of data) in the file.

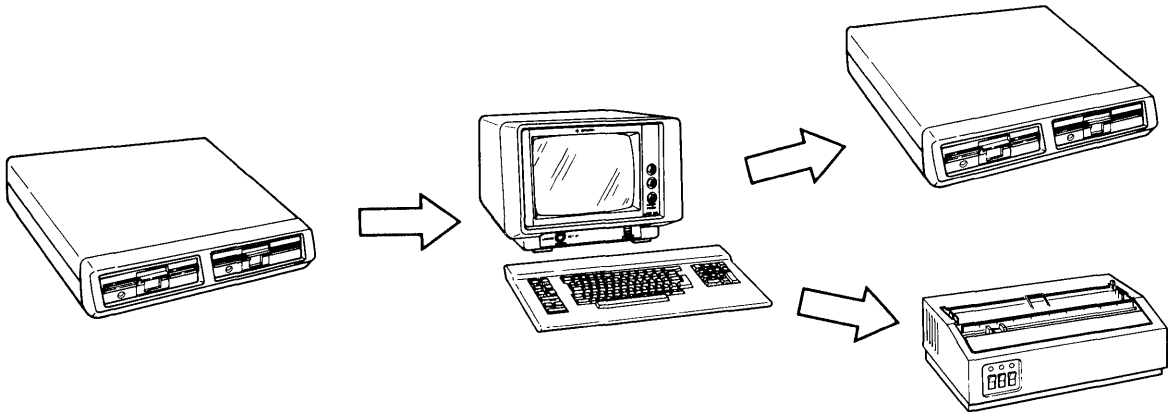

1. Press FCTN M to enter command mode.
2. Enter the command to open the file you wish to copy.

Example:

```
OPE, D1, RED. FOX
```

3. If you are copying to another diskette, open or create a file on the second diskette.

Example:

```
CRE, D2, COPY. FOX
```

4. Press FCTN M to exit command mode.
5. Display the control page.
6. Specify the type of data you wish to transfer in the XFER() field of the control page (Section D1).
7. Tab to the (**XFER**) field and enter the copy code:

Example:

```
(**XFER**)  
(D1/D2/C0)
```

8. Locate the start and the end of the data you wish to copy by searching the source file (Section D7).

D4 Copying from Diskette

9. Enter the ending record address of the data you want to copy (1rrrr) in the SEARCH() field.

Example:

SEARCH(10798)

10. Remove the control page.
11. Press the XFER key.
12. Press FCTN M to enter command mode.
13. Enter the command to close the file which has been copied to.

Example:

CLO,D2,COPY.FOX

It is also good practice to close the source file, even though it was not altered.

NOTE: The copy process can be stopped by pressing FCTN UNLOCK.

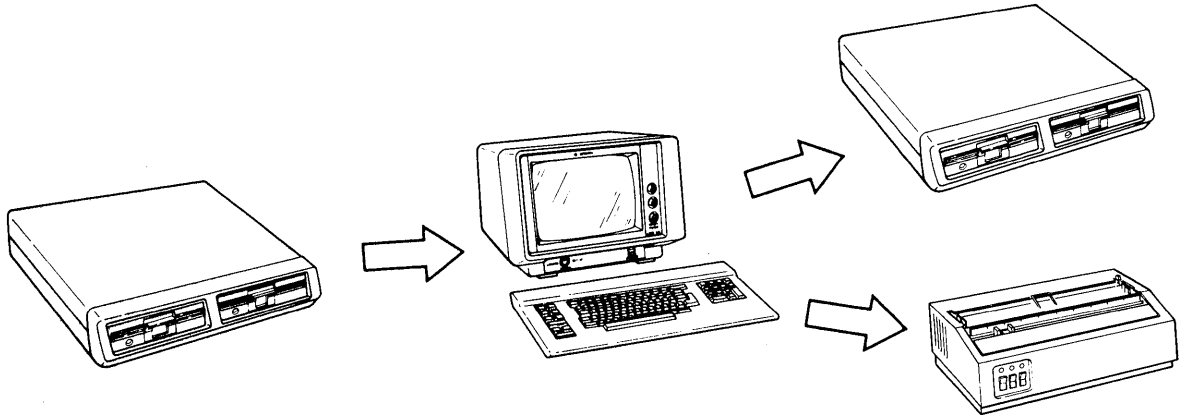

Editing a file on diskette gives you the chance to first edit the data before transferring it to a printer or diskette. There are two major uses of the edit function:

- You may want to enter corrections to a file and send the corrections back to the same file.
- You may have major revisions and want to create an entirely new version of a file by editing it on the screen and sending it to a file on a second diskette.

Sending Edited Data to Same File

1. Press FCTN M to enter command mode.
2. Open the file.

Example:

```
OPEN, D#, RED. FOX
```

3. Select the type of data you want to transfer in the XFER() field (Section D1).
4. Enter the code to read the file in either the (**PRINT*) or (**XFER**) field.

Example:

```
(**XFER**)  
(D1/ /RD)
```

5. Remove the control page.

D5 Editing from Diskette

6. Press the PRINT or XFER key, depending on which field you used in step 4.

Observe:

The first block of data is displayed.

7. Display the control page.
8. Enter the edit code and the device identifiers in the (**XFER**) field.

Example:

```
(**XFER**)  
(D1/D2/ED)
```

9. Remove the control page.
10. Enter your corrections to the text.
11. Press the BOB key.
12. Press the XFER key.

Observe:

The next block of data is read to the screen.

13. Repeat steps 10 through 12 for each block of data you want to change.
14. Press FCTN M to enter command mode.
15. Close the file.

Example:

```
CLO, D1, RED. FOX
```

Sending Edited Data to a New File

1. Press FCTN M to enter command mode.
2. Open the source file containing your original data and the file which will contain your new version.
3. Select the type of data you want to send in the XFER () field (Section D1).

4. Enter the code to read the source file in either the (**PRINT*) or (**XFER**) field.

Example:

```
(**XFER**)  
(D1/ /RD)
```

5. Remove the control page.
6. Press the PRINT or XFER key, depending on which field you used in step 4.

Observe:

The first block of data is displayed.

7. Display the control page.
8. Enter the edit code and the device identifiers in the (**XFER**) field.

Example:

```
(**XFER**)  
(D1/D2/ED)
```

9. Remove the control page.
10. Enter your corrections to the text.
11. Press the XFER key.

Observe:

The next block of data is read to the screen.

12. Repeat steps 10 through 12 for each block of data you want changed and transferred.
13. Press FCTN M to enter command mode.
14. Close the files on both diskettes.

D6 Reporting Diskette Address

1. Display the control page.
2. Enter the diskette drive number in either the (**PRINT*) or (**XFER**) field. (You may also simply type the drive number anywhere on the screen without using the control page.)

Example:

```
(**XFER**)  
(D1/ / )
```

3. Position the cursor over the second character of the drive number.

Example:

```
(**XFER**)  
(D1/ / )
```

4. Press the REP ADR key.

Observe:

The reported address (a record number from 0001 to 9999) appears in the ADR- field.

```
(**PRINT*)STA- (**XFER**)PRNT( )XFER( )XMIT( )MM (PARAM)  
( / / )ADR- ( / / )SEARCH( ) ( / )
```

The SEARCH() field of the control page is used to search a file and also to specify the end of a copy function (Section D4). The search format used is as follows:

SEARCH(bbbb) — Moves to the screen block number you specify (bbbb). Does not display the screen block.

SEARCH(bbbb/hhhhhhhhhhhhhhhhh) — Moves to the screen block number you specify (bbbb) and searches the beginning of each block, moving forward until a header is found (hhhhhhhhhhhhhhhh) that matches the characters in the header.

If a match is found, the screen block is displayed.

where:

bbbb — Specifies a screen block number within the file between 0001 and 9999.

/ — Separates the screen block and header.

hhhhhhhhhhhhhhhh — Indicates the header. The header may contain up to 16 characters.

NOTE: On the diskette, the header must begin in the first position of the block.

The search format may be entered in the SEARCH() field (option 1) or following an SOE at any location on the display (option 2).

1. Press FCTN M to enter command mode.
2. Open the file you wish to search.

Example:

OPE, D1, RED. FOX

3. Press FCTN M to exit command mode.
4. Display the control page.

D7 Searching a File

5. Enter the name of the diskette drive in the (**XFER**) field.

Example:

(**XFER**)
(D1/ /)

Option 1

6. Enter the search format in the SEARCH () field.
7. Remove the control page.
8. Enter an SOE symbol on the screen; press the back space key once to place the cursor over the SOE.
9. Press the SEARCH key.
10. When the "WAIT" and "AUXB" messages go out, proceed with your read, write, or copy operation.

Option 2

6. Remove the control page.
7. Enter an SOE character anywhere on the screen, followed immediately by the search statement.
8. Place the cursor immediately to the right of the statement.
9. Press the SEARCH key.
10. When the "WAIT" and "AUXB" messages go out, proceed with your read, write, or copy operation.

When you create a new file, open an existing one, or load one, the file is in home position (at record 0001). Another method of homing a file is to use the control page. The control page method assumes that you have already opened the file and have advanced the file beyond the home position.

1. Display the control page.
2. Enter the following codes in either the (**PRINT*) or (**XFER**) field:

Example:

```
(**XFER**)  
(D1/ /HO)
```

3. Remove the control page.
4. Press the PRINT or XFER key, depending on which field you used in step 2.

1. Selecting print format options
2. Printing screen data
3. Printing from diskette

E1 Selecting Print Format Options

Whenever you print data, you have a choice of three formats. Generally, you will print using the same format most of the time.

1. Display the control page.
2. Tab to the PRNT() field of the control page.
3. Enter one of the print options shown in the following table:

<u>Entry</u>	<u>Description</u>
PRNT	<p>Prints exact screen data.</p> <p>The PRNT entry is the default condition. Data is printed as it appears on the screen.</p>
XPAR	<p>Prints in a continuous stream.</p> <p>This selection ignores the carriage returns that occur automatically as you enter data on the screen and writes data in a continuous stream. The XPAR selection is useful when used with line feed (LF) or form feed (FF) codes to mark places within the data where a new line will start or a new form will begin.</p>
FORM	<p>Prints on preprinted forms.</p> <p>This selection replaces protected display characters with spaces in the output, and is commonly used for printing on preprinted forms.</p>

4. Remove the control page.

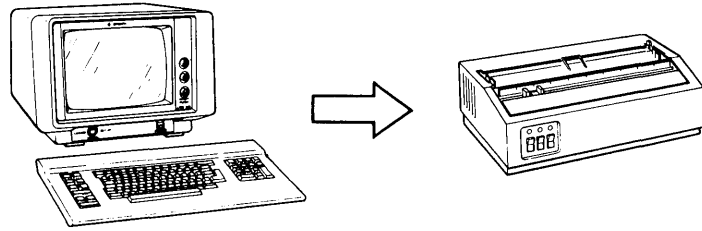

1. Display the control page.
2. Enter the name of the printer (P1 or PR) in the (**PRINT*) field of the control page.

Example:

```
(**PRINT)  
( /P1/ )
```

3. Specify the print format option in the PRNT() field (Section E1).
4. Remove the control page.
5. Indicate how much data is to be transferred to the printer. The start of data is indicated by entering an SOE character one space left of the first character to be sent. If no SOE is entered, home position is considered the start of data. To indicate the end of the data, place the cursor to the right of the last data character to be printed.

The data to be included in a transfer to a peripheral device must be preceded by an SOE character. ▸ In this example, only this sentence will appear on the printed copy, because it is preceded by an SOE character and followed by the cursor. ▹ This sentence will not be included outside the SOE character and cursor.

6. Press the PRINT key.

E3 Printing from Diskette

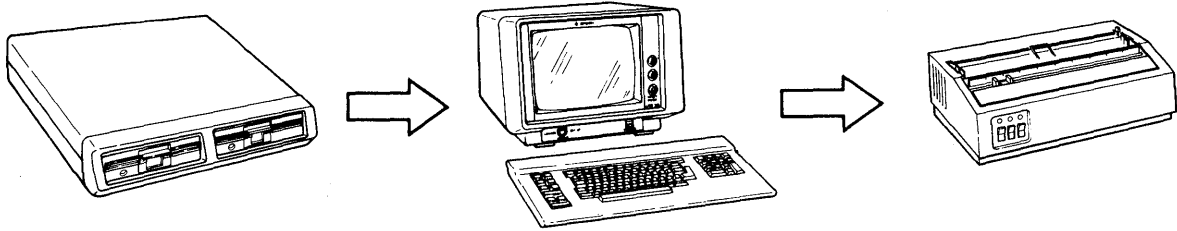

1. Press FCTN M to enter command mode.
2. Enter the command to open the file you wish to print from.

Example:

```
OPE, D1, RED. FOX
```

3. Press FCTN M to exit command mode.
4. Display the control page.
5. In the (**PRINT*) field, enter the following codes:

Example:

```
(**PRINT*)  
(D1/P1/C0)
```

6. If the print does not start from the beginning of the file, search the file for the start of the data (Section D7).
7. If you do not want the entire file printed, indicate the end of the print by entering the ending record address of the file (1rrrr) in the SEARCH() field.
8. Specify the print format option in the PRNT() field (Section E1).
9. Remove the control page.
10. Press the PRINT key.
11. Press FCTN M to enter command mode.
12. Close the file.

Example:

```
CLO, D1, RED. FOX
```

1. Specifying type of data transmission
2. Transmitting data to the host
3. Transmitting data from the host

F1 Specifying Type of Data Transmission

Online operations (in communication with the host) can only be described in general terms since procedures are determined in large part by the host operating system. However, there are certain control page fields which influence data transmission to the host.

Before any host operation can be performed, communication with the host must be established. Your supervisor should provide instructions for signing on with the host. If you are on a dial-up connection, refer to Section A2.

1. Display the control page.
2. Tab to the XMIT() field.
3. Enter one of the XMIT() field options shown as follows:

<u>Entry</u>	<u>Description</u>
ALL	<p>Sending all screen data (with FCCs).</p> <p>All data and FCCs from home position (or the SOE character) through the cursor position are transmitted.</p>
VAR	<p>Sending variable data (with FCCs).</p> <p>The VAR entry is the default condition. Only unprotected data and FCCs are transmitted. This option saves transmission time and is typically used for preprinted forms.</p>
CHAN	<p>Sending only changed data (with FCCs).</p> <p>Only fields that have been changed, as indicated by the internal changed-field indicators,* and associated FCCs are transmitted.</p>

4. Remove the control page.

*Refer to the discussion of changed-field indicators in Section D1.

Sending Data to the Host **F2**

You can send data to the host from your screen, from a diskette, or from a magnetic stripe reader. The XMIT key is used to initiate data transmission to the host. However, you can set up the terminal to automatically transmit data from a diskette to the host. If you wish to send expanded FCCs to the host, that parameter must be set through either the parameter/configurator utility or through the (PARAM) field of the control page. (Refer to Section 4 or Appendix E.)

Screen to Host

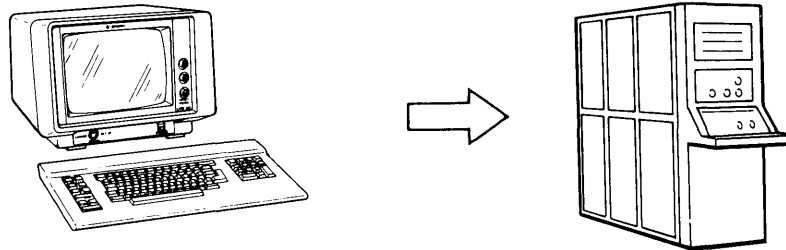

Steps

1. Establish communication with the host.
2. Specify type of data to be transmitted in XMIT() field.
3. Define data to be sent with SOE and cursor.
4. Press XMIT.

Further Information

F1

Diskette to Host

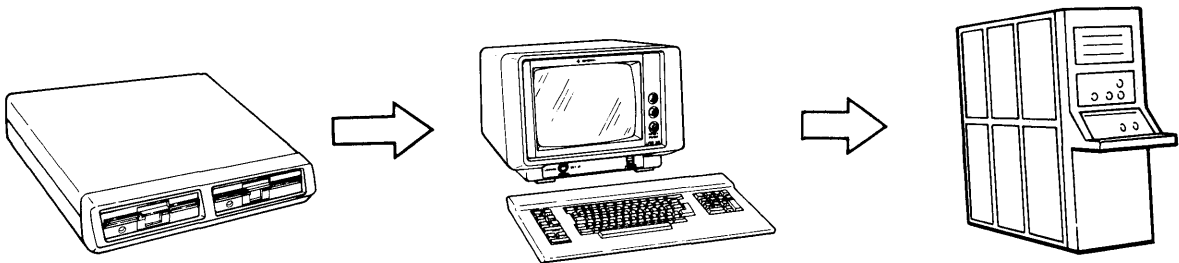

Steps

1. Establish communication with the host.
2. Press FCTN M to enter command mode.
3. Open the file you want sent to the host.
4. Press FCTN M to exit command mode.

Further Information

F2 Sending Data to the Host

<u>Steps</u>	<u>Further Information</u>
5. Display the control page.	
6. If the start of data you want transmitted is not in home position, search the file.	D3
7. Specify the type of data you want transmitted in the XMIT() field.	F1
8. Enter the autotransmit function in the (**XFER**) field.	

Example:

(**XFER**)
(D1/ /AT)

9. Remove the control page.
10. Press the XFER key.

F3 Transmitting Data from the Host

Host to Diskette

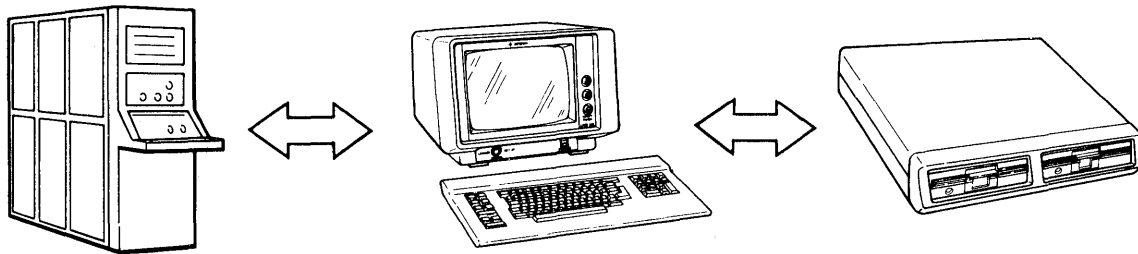

<u>Steps</u>	<u>Further Information</u>
1. Establish communication with the host.	

Transmitting Data from the Host **F3**

<u>Steps</u>	<u>Further Information</u>
2. Press FCTN M to enter command mode.	
3. Enter the command to open or create a file.	C3, C2
<i>Examples:</i>	
OPE, D1, RED. FOX	
CRE, D1, RED. FOX	
4. Press FCTN M to exit command mode.	
5. Enter a host-defined command to specify online operation.	
6. Press the XMIT key.	
7. Terminate online operation.	
8. Press FCTN M to exit command mode.	
9. Close the file.	C4

Host to Screen

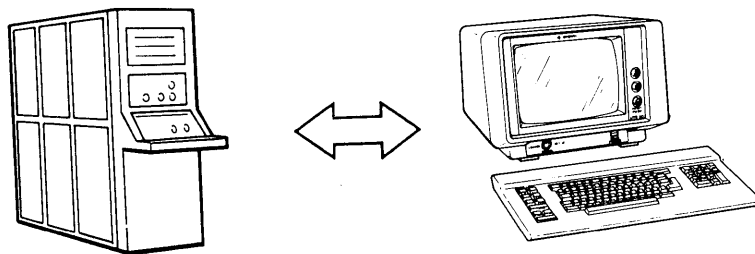

1. Establish communication with the host.
2. Enter a host-defined command to specify the desired online operation.
3. Press XMIT.
4. Enter a host-defined command to terminate online operation.

F3 Transmitting Data from the Host

Host to Printer

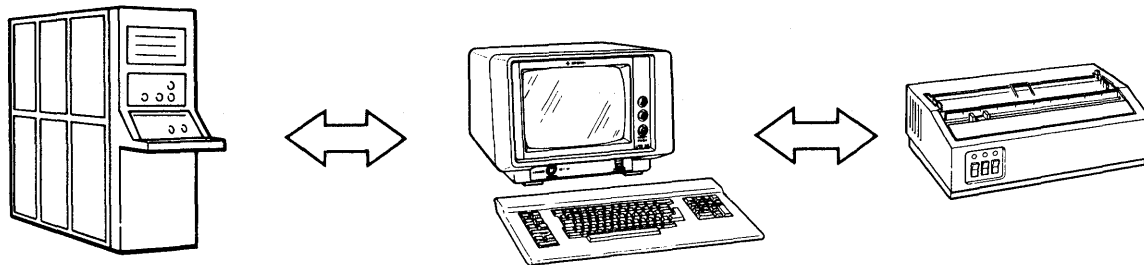

1. Establish communication with the host.
2. Prepare printer (turn power on, check ribbon, load paper).
3. Enter a host-defined command to specify the desired online operation.
4. Press XMIT.
5. Enter a host-defined command to terminate online operation.

Magnetic Stripe Reader Operations

G

1. Automatic transmission of magnetic card data
2. Manual transmission of magnetic card data

G1 Automatic Transmission of Magnetic Card Data

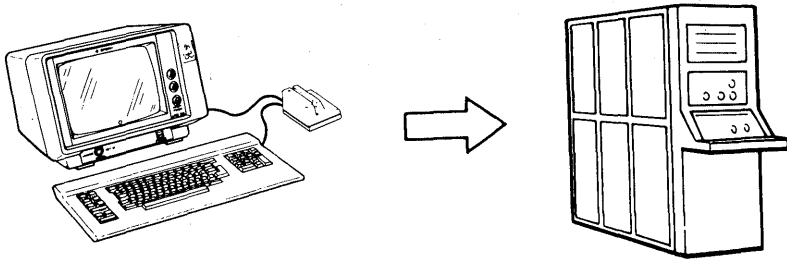

To operate the magnetic stripe reader, terminal power must be turned on, the green indicator on the reader must be lit, and the switches must be set for the appropriate card format. The read channel must be free of dirt or foreign material that could interfere with a successful reading of the card.

1. Verify that the parameter for transmitting magnetic stripe reader data automatically has been selected. (Refer to Section 4 or Appendix E.)
2. Hold the card with the magnetic stripe facing toward you and the stripe on the bottom.
3. Push the card through the read channel, pressing the card firmly against the bottom surface of the channel.

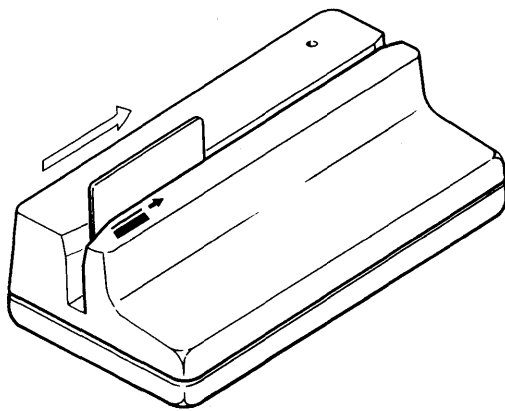

Observe:

When the card has passed the read head, located just beyond the middle of the read channel, you will hear a faint clicking sound.

The keyboard is locked from the time the leading edge of the card enters the read area until it exits the other side.

Automatic Transmission of Magnetic Card Data

G1

Until the host acknowledges the transmission, the "WAIT" message appears in the indicator line and the cursor disappears from the screen. (The magnetic stripe reader cannot read additional data while the "WAIT" message is displayed in the indicator line.) If the card is read successfully, a single alarm sounds, the "RACK" message replaces the "WAIT" message in the indicator line, and the cursor reappears.

.....		
1 ROW=XX COL=XX	▣ RACK ▣	▣ POLL ▣

If the reading is unsuccessful, the "RACK" message appears in the indicator line. Repeat the operation or press FCTN UNLOCK to clear the message.

G2 Manual Transmission of Magnetic Card Data

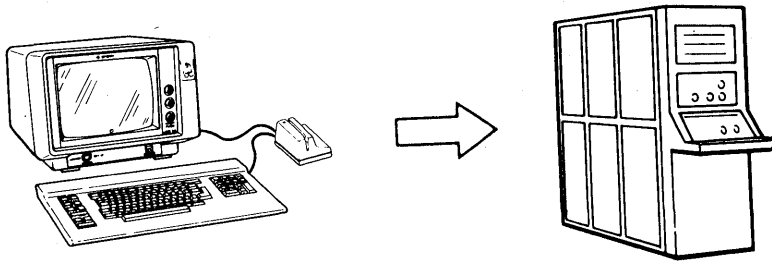

To operate the magnetic stripe reader, terminal power must be turned on, the green indicator on the reader must be lit, and the switches must be set for the appropriate card format. The read channel must be free of dirt or foreign material that could interfere with a successful reading of the card.

1. Verify that the desired transmission type (ALL, VAR, or CHAN) is entered in the XMIT() field of the control page (Section F1).
2. Verify that the parameter option for automatic transmission of magnetic stripe reader data is NO. (Refer to Section 4 or Appendix E.)
3. Position the cursor where you want the card data to be entered. (Be sure to allow sufficient room so that card data does not interfere with existing text on the screen.)
4. Hold the card with the magnetic stripe facing toward you and the stripe on the bottom.
5. Push the card through the read channel, pressing the card firmly against the bottom surface of the channel.

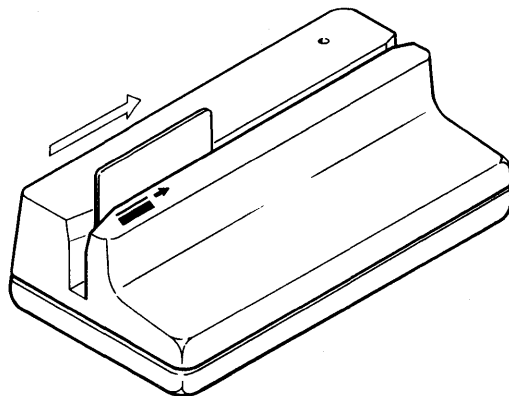

Observe:

When the card has passed the read head, located just beyond the middle of the read channel, you will hear a faint clicking sound.

The keyboard is locked from the time the leading edge of the card enters the read area until it exits the other side. The "WAIT" message appears in the indicator line.

If the card is read successfully, a single alarm sounds, and the "RACK" message replaces the "WAIT" message in the indicator line. The data appears on the screen in the location designated by the position of the cursor.

1 ROW=XX COL=XX	□ RACK □	□ POLL □
-----------------	----------	----------

If the reading was unsuccessful, the "RACK" message appears in the indicator line. Repeat the operation, or press FCTN UNLOCK to clear the message.

6. Enter any additional information to be transmitted.
7. If the message to be transmitted does not begin in home position on the screen, enter an SOE character immediately to the left of the first character to be sent.
8. Position the cursor after the last character to be sent.
9. Press XMIT to send the data to the host.

1. Using special emphasis characters
2. Using the optional character set
3. Checking peripheral device status
4. Using the alternate screen
5. Changing the program cartridge

H1 Using Special Emphasis Characters

1. Position the cursor at the location where you want to enter the nondestructive special emphasis character.
2. Press and hold the FCTN key, and then press the data key associated with the desired special emphasis character.

J = column separator

K = underscore

L = strike-through (full-width dash)

3. Cycle the key to generate as many special characters as needed.

NOTE: These special characters can all be entered in the same location. FCTN L is implemented only when the strike-through has been selected as the special emphasis character. (Refer to Section 4 or Appendix E.)

4. To protect the special characters, generate an FCC (Section I1), using selection 6 or 7 from Table 8-1.

UNDERLINE STRIKE THROUGH COLUMN SEPARATOR

Date Shipped	Agreement Number	Reference Number
No Day Year 03 10 83	00-00-13-27	T-15-07-04
FROM: Company Name SPERRY	Weight (lbs) 17 8	Order Number 134
Street Address 322 North 2200 West	Item No. 0791-99	Description 1. Printer 2. _____ 3. _____
City, State, Zip Salt Lake City, Ut. 84116		

1 ROW-01 COL-01

Using the Optional Character Set **H2**

Optional character sets are normally generated or selected by a system programmer or supervisor. The character set must first be downline loaded or loaded from diskette into UTS 30 memory before the character set can be accessed. Consult your supervisor for detailed instructions on loading the character set from the host file. You will also need the appropriate keyboard layout chart that shows the correspondence of the regular keyboard characters and the alternate characters.

1. Load the character set.
2. Verify that the emphasis parameter is set for the optional character set. (Refer to Section 4 or Appendix E.)
3. Position the cursor in the location where you want to begin data entry from the optional character set.
4. Press and hold the FCTN key and then press the semicolon key. Cycle the key for as many positions as required.
5. Reposition the cursor where you want to begin data entry, and press the keys associated with the desired optional characters.

NOTES:

1. *If a regular data character or space occupies the position at which the FCTN and semicolon keys are pressed, the previously entered data character is converted to its associated optional character.*
2. *To replace an optional character with a regular data character, use the erase or delete keys to eliminate unwanted optional characters. Then reposition the cursor to enter the desired regular data character.*
3. *Optional characters are destructive; that is, previously entered optional characters can be overwritten without first using the FCTN and semicolon keys.*
4. *The SHIFT key is used, as in regular keyboard activity, to select the uppercase character associated with the optional character.*

H3 Checking Peripheral Device Status

1. Enter the peripheral device mnemonic (P1 or PR for the printer; D1 to D4 for the diskette drive) in the "from" or "to" subfield of the (**PRINT*) or (**XFER**) field of the control page, or anywhere on the display screen.
2. Place the cursor over the second character of the device name.

Example:

```
(**XFER**)  
( /P1/ )
```

3. Press STATUS.

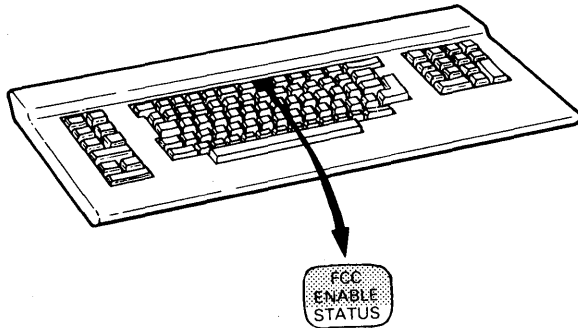

4. Display the control page.

Observe:

The status code appears in the STA- field of the control page.

NOTE: Status codes may be combined to create another code which describes a combination of conditions. For example, Pn 100 and Pn 200 may combine to create Pn 300; this means that the device is not ready because it is out of paper. Unique status codes are never combined; they always retain their independent meanings.

Checking Peripheral Device Status

H3

<u>Printer Status Code*</u>	<u>Meaning</u>
Pn 000	Device ready
Pn 001**	Data or parity error
Pn 004**	Control code error
Pn 005	Printer parameter code (0791 printer only)
Pn 100	Device not ready
Pn 200**	Out of paper or ribbon

*Pn = P1 or PR
**Reported only on duplex printers

<u>Diskette Subsystem Status Code*</u>	<u>Meaning</u>
Dn 000	Operation successful
Dn 001	Data error
Dn 002	End of diskette or file
Dn 003	Data error and end of diskette
Dn 004	CRC error
Dn 005	CRC error and data error
Dn 006	CRC error and end of diskette
Dn 007	CRC error, data error, and end of diskette
Dn 010	Diskette address error
Dn 020	Bad track 00 on prep
Dn 040	Write-protected diskette
Dn 050	Bad track 00 on prep and write-protected diskette
Dn 100	Diskette subsystem not ready

*Dn = D1 to D4

<u>Unique Status Code</u>	<u>Meaning</u>
Xn 366	File not opened
Xn 367	File already exists
Xn 370	Read-only file
Xn 371	File not found
Xn 372	Device not configured
Xn 373	Keyboard UNLOCK key pressed, terminating operation

H3 Checking Peripheral Device Status

Unique Status Code

Meaning

Xn 374

Invalid device, track, sector,
record, or data length

Xn 375

Timeout (no response)

Xn 376

Device busy (user program)

Xn 377

Device did not recognize a
command sent to it (user
program)

Using the Alternate Screen

H4

1. Observe which screen is displayed. (The screen number, 1 or 2, appears in the first column of the indicator line.)
2. Press FCTN DISP 1-2 to display the alternate screen.

Observe:

The alternate display appears, as indicated by the number in the first column of the indicator line.

NOTE: The DISP 1-2 key can be used while the "WAIT" message is displayed in the indicator line.

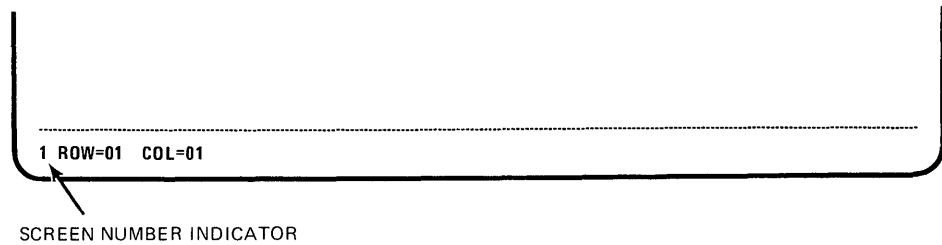
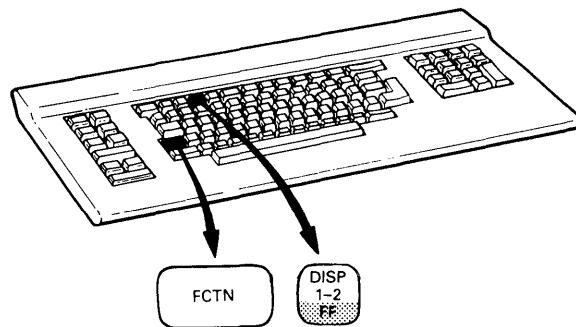

H5 Changing the Program Cartridge

If you are operating a basic UTS 30, you may periodically need to change the program cartridge. Inserting a different cartridge into the UTS 30 can substantially change the terminal's characteristics; therefore, the following procedure should be performed only as directed by your supervisor.

Removing the Program Cartridge

1. Press the POWER switch to OFF.
2. Open the door to slot A, located at the top of the terminal casing on the right side as you face the terminal.

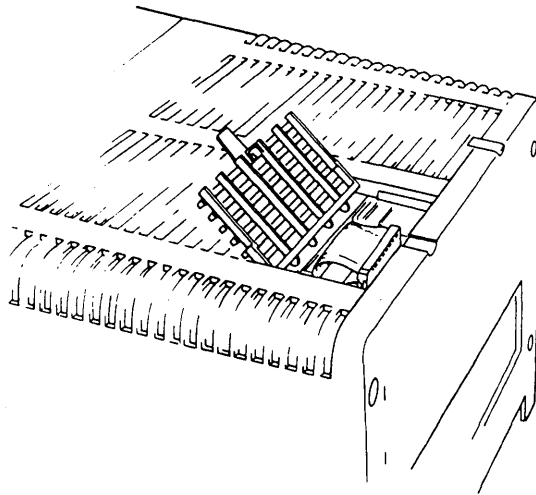

3. Press down on the clips on either side of the cartridge.

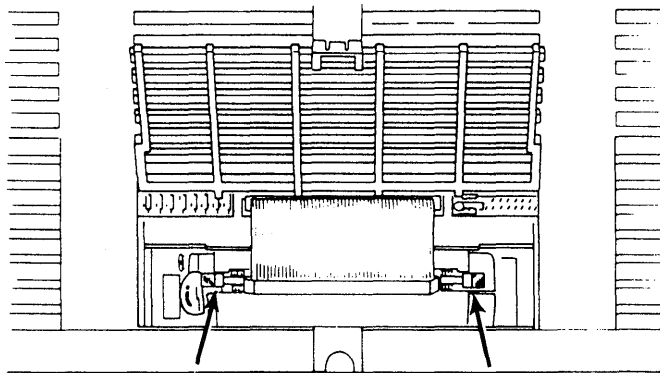

Changing the Program Cartridge

H5

4. Pull up gently on the ribbon cable, just enough to release it from the connector pins.

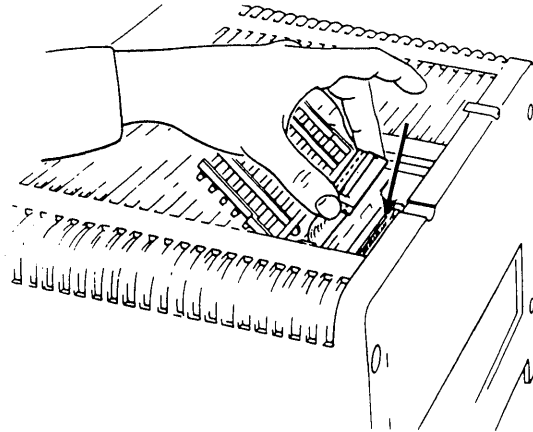

5. Press the black tab away from the program cartridge and hold it.

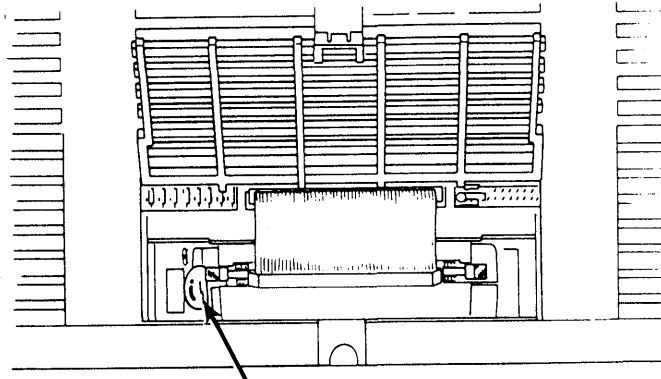

6. While still pressing the black tab, grasp the program cartridge on either side and begin to pull up to release it from the terminal casing.
7. Release the black tab, and pull the program cartridge completely up and out of the terminal.

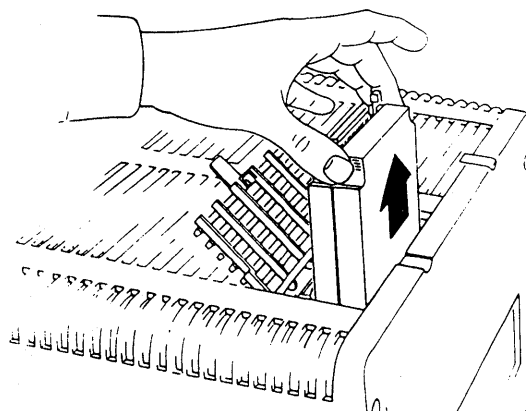

H5 Changing the Program Cartridge

Installing the Program Cartridge

1. Turn the POWER switch to OFF.
2. Open the door to slot A, located at the top the terminal casing on the right side as you face the terminal.
3. Press the black tab back, away from the program cartridge slot, and hold it.

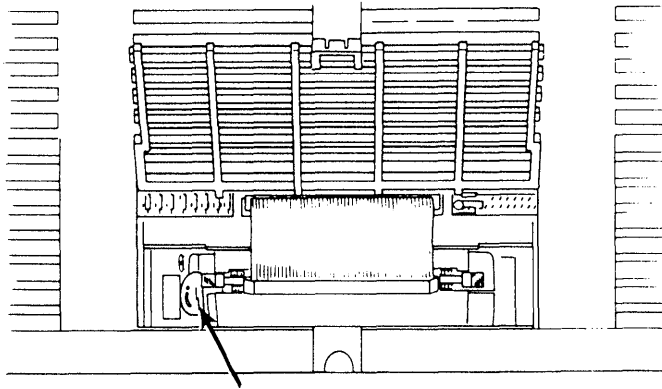

4. With the groove of the program cartridge on the right side, insert the cartridge into its slot.

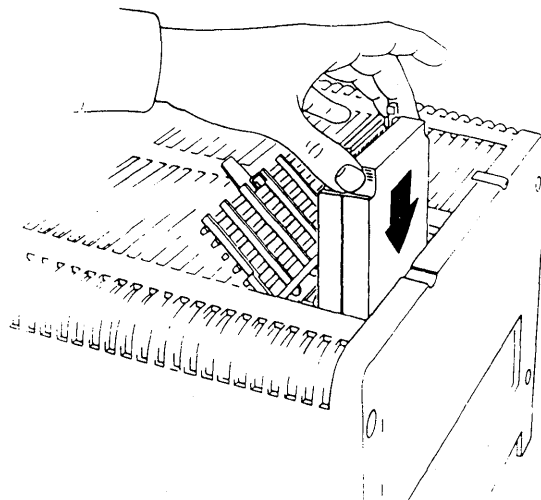

Changing the Program Cartridge

- 5. Gently press the ribbon cable into the connector pins.

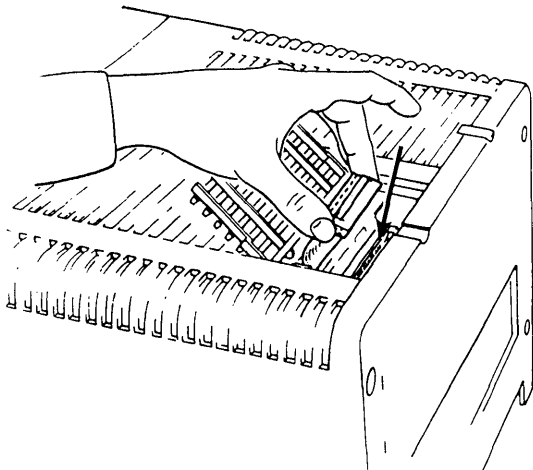

- 6. Press in the clips on either side of the cartridge to secure the cable.

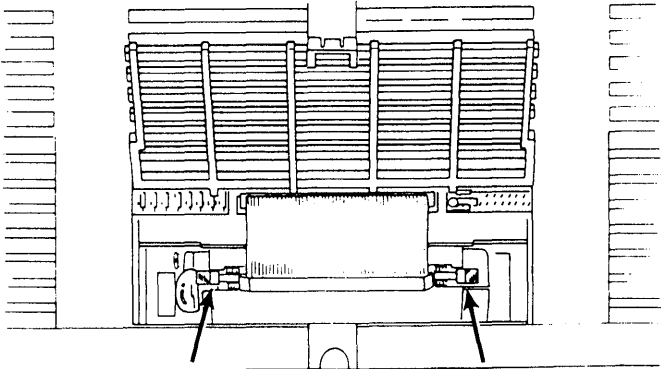

- 7. Close the door on the top of the terminal.

1. Generating and enabling FCCs
2. Locating an FCC
3. Changing an FCC
4. Clearing an FCC
5. Eliminating an FCC
6. Duplicating an FCC

I1 Generating and Enabling FCCs

1. Position the cursor in the location where the new field is to begin.
2. Press FCC GEN.
3. Enter the code sequence associated with the desired field characteristics from the following table.

Table 8-1. FCC Code Selection

FCC TYPE	Data Key	Field Characteristic
Step 1: Intensity	Space or N	Normal display intensity
	L	Low display intensity
	B	Blinks from normal to low intensity
	O	Off-intensity (not displayed)
	1*	Character displayed against a high-intensity, reverse-video background
	2*	Character displayed against a low-intensity, reverse-video background
	3*	Character displayed against a background that blinks from high-intensity reverse video to low-intensity reverse video
	4*	Character displayed against a background that blinks from low-intensity reverse video to off
Step 2: Tab stop and special FCC-defined tab stop character position	Space or S	No
	T	Tab stop
	6*	Tab stop: special characters protected
	7*	No tab stop; special characters protected
Step 3: Data entry	Space or U	Unrestricted entry
	P	Protected (no keyboard entry allowed)
	A	Alphabetic entries only
	No	Numeric entries only
Step 4: Field justification	Space	Normal justification
	R	Right-justification of all data entered
Step 5: Sequence complete	Space or any alphanumeric character	Completes the FCC sequence

Generating and Enabling FCCs

4. Repeat steps 1 to 3 to generate other desired FCCs for the display.
5. Enter any data needed in protected fields.
6. Press FCTN FCC ENABLE.

NOTES:

1. *If an error is made in the FCC code generation sequence, the alarm sounds once and the procedure is terminated automatically. The entire sequence must be reinitiated according to the identified steps.*
2. *The protect and right-justify characteristics cannot be selected for the same field.*
3. *Successfully generating an FCC disables all existing FCCs on the display. To save steps, wait until all FCCs for a screen have been generated before pressing FCC ENABLE. The cursor may be in any position on the screen when FCC ENABLE is pressed.*
4. *Displaying the control page immediately after generating an FCC enables FCCs that have been generated.*
5. *A "normal" FCC can be generated to end the previous field (such as protected, right-justified, or an alternate intensity) by pressing the space bar five times.*

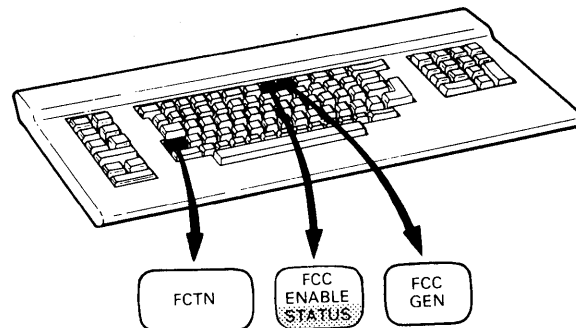

I2 Locating an FCC

The FCC LOCATE key locates the first position of all FCC-defined fields, whether or not they were defined with an FCC tab stop.

Pressing FCC LOCATE disables all previously enabled protected, right-justified, alphabetic-only, and numeric-only field selections. Any time you use FCC LOCATE, be sure to reenale the FCCs by pressing FCC ENABLE.

1. Press FCTN FCC LOCATE.

Observe:

The cursor moves immediately to the first position of the nearest FCC field to the right of the cursor. If there is no FCC to the right of the cursor, the cursor goes to home position.

2. Make any necessary changes to the field or generate a new FCC.
3. Press FCTN FCC ENABLE to reenale all FCCs.

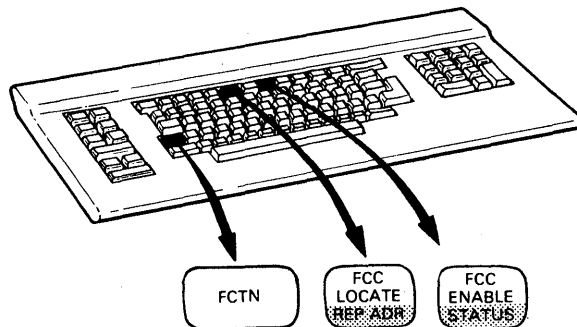

The only way to change characteristics of a field is to generate a new FCC for the field. FCCs can also be cleared (Section I4) or erased (Section I5).

1. Locate the existing FCC field by using the FCC LOCATE key. (Any other protected, right-justified, alphabetic-only, or numeric-only FCC selections on the screen will be disabled.)
2. Press FCC GEN.
3. Enter the code sequence associated with the desired characteristics according to the steps in the table in Section I1.
4. Press FCTN FCC ENABLE to reenale all fields.

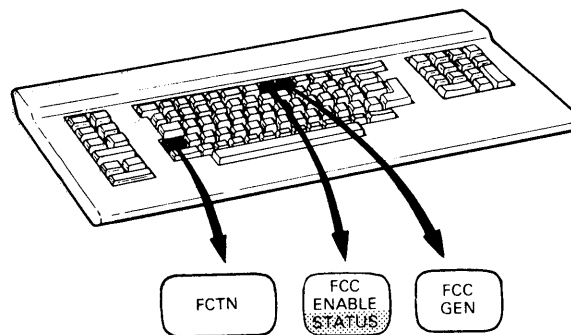
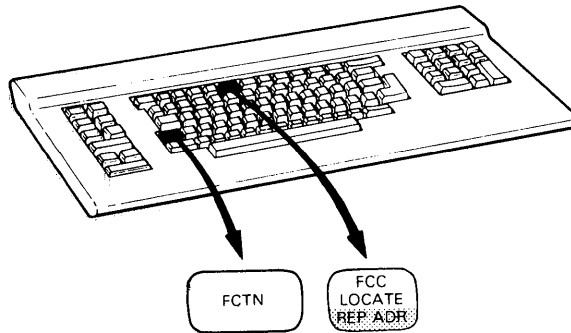

I4 Clearing an FCC

1. Locate the FCC field to be cleared (Section I2). (The cursor may be in any position within that field.)
2. Press FCTN FCC CLEAR.

Observe:

The FCC beneath or nearest to the left of the cursor location will be cleared. The cleared field becomes part of the preceding field and assumes the characteristics of that field until a new FCC is generated in that location.

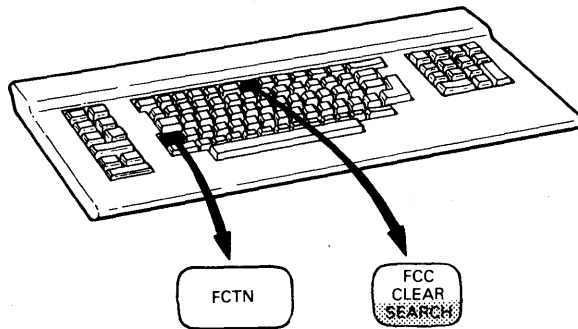

To erase all characters and FCCs from the cursor to the end of the display:

1. Move the cursor to the first position of the data to be erased.
2. Press ERASE DISPLAY.

To eliminate FCCs in a line:

1. Move the cursor to the line to be erased.
2. Press DELETE LINE.

Observe:

The FCCs in that line are gone. The bottom line of the display has no FCCs.

To insert a blank line without FCCs:

1. Move the cursor to the location where you want a blank line.
2. Press INSERT LINE.

Observe:

The blank line which is inserted does not have FCCs, although it will be part of the field of a previous FCC. Also, the FCCs previously on the bottom line of the screen are moved off.

To eliminate FCCs by overwriting them:

1. Position the cursor in the line immediately before the line containing the FCCs you wish to eliminate.
2. Press LINE DUP.

Observe:

The line containing the FCCs you wanted to eliminate has been overwritten by the line you duplicated.

I6 Duplicating FCCs

1. Position the cursor in the line containing the FCC-defined fields you wish to duplicate.
2. Press LINE DUP. Cycle the key for as many times as you wish to duplicate the FCCs.

Observe:

The line containing the FCCs is duplicated as many times as you pressed the LINE DUP key. Data and any associated FCCs previously contained in the lines are eliminated.

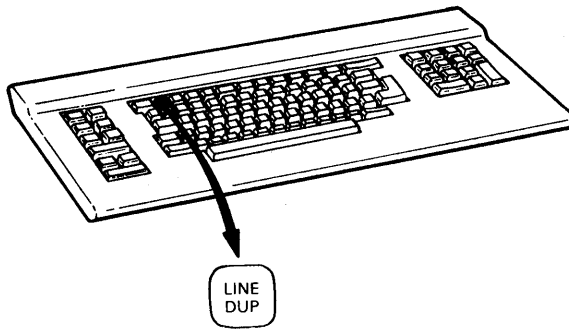

Appendix A. Load Messages

An unsuccessful load of the UTS 30 control program is indicated by one of the messages described in Table A-1.

Table A-1. Load Error Messages

Message	Meaning	Corrective Action
INSERT SYSTEM DISKETTE	No system diskette is in drive or Drive door is open or Diskette power is off or Diskette hardware has failed	Insert system diskette or Close drive door or Turn diskette subsystem power on (if you have version with a power switch) or Try another drive
READ ERROR	Diskette read error has occurred	Press RESET or Try a different system diskette or drive
LOAD FORMAT ERROR	The header on system diskette is invalid	Press RESET or Try a different system diskette or drive

When the UTS 30 is loaded with the UNISCOPE mode control program, a "READY" message should be displayed, which means that the terminal is set to operate. If you get a different message (Table A-2), then either the load was unsuccessful, or further steps are required.

Table A-2. UNISCOPE Mode Load Messages*

Message	Meaning	Corrective Action
PARAMETERS DEFAULTED— CONFIGURE DEVICES & ENTER COMM. RI, SI, CM	<p>The terminal is unable to communicate with the host or peripheral devices.</p> <p>Parameters have reverted to their default conditions (listed in Table E-1).</p>	<p>Enter the RI, SI, and CM parameters and configure the printer and diskette drives. (Refer to Section 4 or Appendix E.)</p> <p>If necessary, enter parameter changes. (Refer to Section 4 or Appendix E.)</p>
COMMUNICATION RI OR SI PARAMETER IS INVALID	<p>The terminal is unable to communicate with the host.</p>	<p>Enter RI and SI parameters. (Refer to Section 4 or Appendix E.)</p>
PROGRAM LOAD FAILURE— PRESS RESET	<p>The terminal is not ready because invalid data was loaded from the program cartridge or system diskette.</p>	<p>Press RESET.</p>

*Clear any of these messages by pressing the cursor to home key or any data key.

Appendix B. Alarm Conditions

B.1. SHORT ALARM

Normal Conditions

- The cursor moves into the eighth position from the end of the line.*
- The cursor enters any position in the last line.*
- The magnetic stripe reader successfully completes a read function.
- The POC test is successfully completed.
- A SPERRY System 80 host sends a system message to a UTS 30 operating in system response mode. (System response mode is discussed in the System 80 local workstation operator's guide, UP-8910, current version.)

Error Conditions

- Data is entered that does not conform to the FCC criteria set up for that field. For example, the alarm sounds if alphabetic keys are pressed in a numeric-only field.
- An unacceptable code is entered while generating an FCC.
- The control page is removed with an invalid entry in the (PARAM) or MM field.
- The XMIT key is pressed with an invalid entry in a parameter field of the parameter/configurator utility.
- A keyboard parity error occurs.

*You can silence this screen control alarm through a parameter selection. Refer to Section 4 or Appendix E.

- The FCTN (function) key is pressed with a data key that does not have an upper function.
- One or more characters are entered in the (PARAM) field of the control page when the keylock is not in the SET UP position. The alarm sounds once when the control page is removed.
- A parameter selection is made through the parameter/configurator utility when the keylock is not in the SET UP position. The alarm sounds once when the XMIT key is pressed.
- An unimplemented key is pressed. For example, when the strike-through emphasis character (FCTN L) is enabled, the optional character set (FCTN ;) is considered an unimplemented key.

B.2. REPEATED ALARM

Normal Conditions



The terminal has an incoming message to be displayed.*

Error Conditions

- A peripheral function cannot be started because an invalid code is entered in the control page. The alarm sounds when the XFER or PRINT key is pressed. (Refer to Section 7 for information on printing.)*
- A peripheral is unable to successfully complete the desired function and must be checked and restarted. You can silence the repeated alarm by pressing FCTN UNLOCK.*
- A RAM parity error occurs.

**You can replace the repeated alarm with a single alarm through a parameter selection. (Refer to Section 4 or Appendix E).*

Table C-1. Cursor Control Keys (Part 2 of 2)

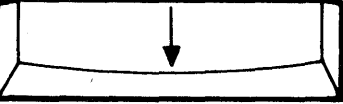
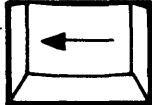
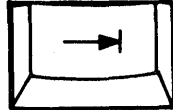
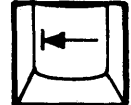
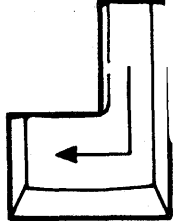
Name	Function	Erases Character?
Scan Backward 	Moves cursor to left, one space at a time. When cursor reaches beginning of a row, it wraps to last column position of previous row. After cursor reaches home position, it moves to end of the last row.	No
Scan Up 	Moves cursor upward one row at a time within a column. When cursor leaves first row, it wraps to same column in last row.	No
Scan Down 	Moves cursor downward, one row at a time within a column. When cursor leaves last row, it wraps around to same column in first row.	No
Space Bar	Moves cursor to right, one position at a time. Can be defined as destructive or nondestructive through parameter selections.	Yes, if space bar is defined as destructive. (Refer to Appendix E.)
Back Space 	Moves cursor to left, one position at a time.	No
Tab Forward 	Moves cursor to right of nearest tab stop set by TAB SET key. If an FCC tab stop has been defined, this key moves cursor directly over tab stop. If no tab stops are defined between cursor and end of screen, tab forward key moves cursor to home position.	No
Tab Back 	Moves cursor back to first position to right of a tab stop defined by TAB SET key. If an FCC tab stop has been defined, this key moves cursor directly over tab stop position. If no tab stops are defined between cursor and home position, or if entire screen is protected, tab back key moves cursor to home position.	No
Return 	Moves cursor from any column position in a row to first column position of next row. If cursor is in last row and column position when return key is pressed, cursor wraps to home position.	No

C.2. EDITING KEYS

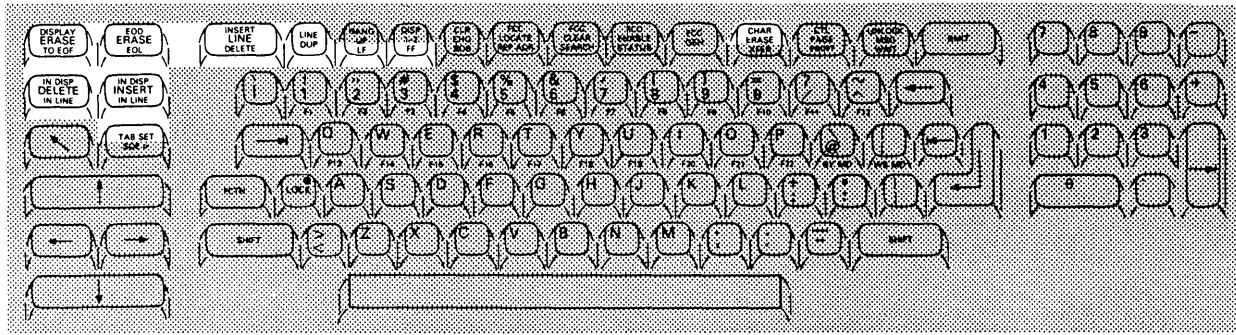

Editing keys (Tables C-2, C-3, and C-4) assist you in making changes to data. These keys enable you to perform such tasks as erasing data and entering other data in its place, or inserting and deleting data from the display without altering the entire display. All of these keys cycle. With the exception of the ERASE DISPLAY key, the editing keys do not function in a protected field.

Useful practice exercises with these keys are contained in the current version of the UTS 30 introduction for operators, UP-9797.

Table C-2. Erase Keys (Part 1 of 2)



Name	Function	Characters Wrap?	FCCs Erased?
ERASE DISPLAY 	Erases all data (protected, unprotected, FCCs) from cursor to end of screen.	No	Yes
ERASE EOD 	Erases only unprotected data from cursor to end of display. Also clears changed-field indicators for all unprotected fields that are erased.	No	No
ERASE EOL 	Erases all unprotected characters from cursor to end of row or end of field. Also clears changed-field indicators for an erased field.	No	No

Table C-2. Erase Keys (Part 2 of 2)



Name	Function	Characters Wrap?	FCCs Erased?
ERASE TO EOF 	Erases all unprotected characters from cursor to end of field or end of display. Also clears changed-field indicators for the erased field.	No	No
CHAR ERASE 	Erases unprotected character beneath cursor and moves cursor to next unprotected position. Does not erase protected characters or FCCs.	No	No

Table C-3. Delete Keys



Name	Function	Character Wrap?	FCCs Erased?
DELETE IN DISP 	Deletes character under cursor and places a space in last position of display or end of field. All characters from right of cursor to end of display are shifted one position to left while cursor remains stationary. A character in first column position of row will wrap around to last column position in preceding line.	Yes	No
DELETE IN LINE 	Deletes character under cursor and places a space in last position of row. All characters from right of cursor to end of line or field are shifted one position to left while cursor remains stationary.	Yes	No
DELETE LINE 	Deletes line in which cursor is located. Subsequent lines move up one line, filling deleted line and inserting a blank line at bottom of screen. Cursor remains stationary as successive lines move up screen.	No	No

Table C-4. Insert Keys (Part 1 of 2)

Name	Function	Character Wrap?	FCCs Erased?
LINE DUP 	Duplicates line in which cursor is located onto next row, moving cursor into same column of new line. Replaces whatever previously occupied that line, whether spaces, other data, or FCCs.	No	Yes or duplicated

Table C-4. Insert Keys (Part 2 of 2)





Name	Function	Character Wrap?	FCCs Erased?
INSERT IN DISP 	Inserts an unprotected space at cursor position and deletes last character of display or field. Characters between cursor and end of display or field are shifted one position to right each time key is pressed. Characters occupying last position in a line wrap to next line.	Yes	No
INSERT IN LINE 	Inserts an unprotected space at cursor position, deleting last character of line or field. Characters from cursor to end of line or field shift one position to right each time key is pressed.	No	No
INSERT LINE 	Inserts a blank line in row in which cursor is located, moving all lines (including FCCs) down the screen, below inserted line position. Last line of display is discarded.	No	Yes

Table C-5. Formatting Keys

Name	Function	Character Wrap?	FCCs Erased?
TAB SET 	Generates a tab stop for tab forward and tab back keys. Tab set character can be displayed through parameter selection. Tab set character occupies a screen position; when tab key is pressed, cursor moves to first unprotected position to right of tab stop character. Cursor blinks when positioned over tab stop code.		
LF 	Generates a line feed character at cursor location, causing printer to advance one line. LF character can be entered at any position in line during data entry. The LF character can be displayed through parameter selection.		
FF 	Generates a form feed character at cursor location, causing printer to advance to beginning of next form. The FF character can be displayed on screen through parameter selection.		

C.3. FUNCTION KEYS

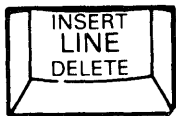

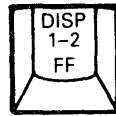
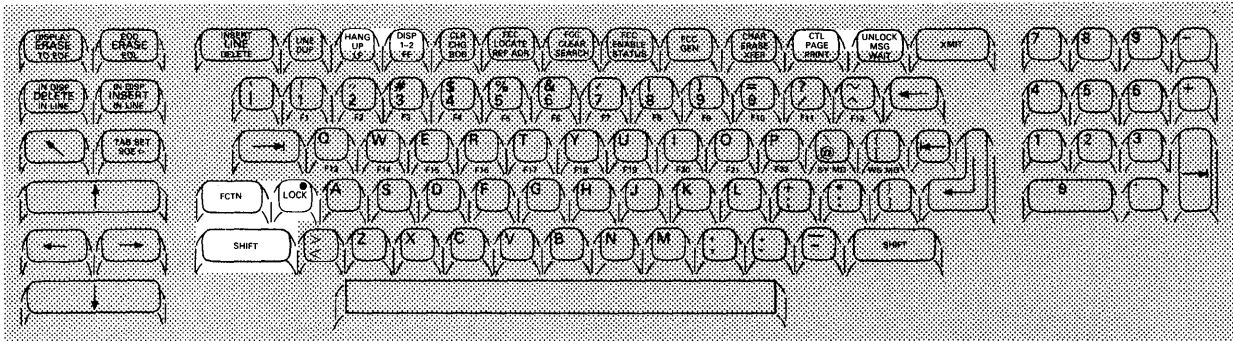
The function keys, described in Table C-6, allow you to control the way in which the data you enter will be manipulated by the UTS 30.

Table C-6. Function Keys (Part 1 of 2)





Name	Function	More Information
<p>SHIFT/LOCK</p> 	<p>Pressing SHIFT key while pressing data key produces uppercase character on keycap. Pressing LOCK holds UTS 30 in shift or uppercase mode. Green indicator on LOCK key remains lit as long as uppercase mode is in effect.</p>	2.4
<p>FCTN</p> 	<p>Used to activate upper function of control keys or front face of data keys.</p>	2.4
<p>CTL PAGE</p> 	<p>Displays 2-line control page; pressing it again removes control page and stores it in terminal's memory. Will not function if "WAIT" message is in indicator line.</p>	3.1
<p>UNLOCK</p> 	<p>Unlocks keyboard. Clears "WAIT" message from indicator line when keyboard is locked. Also silences repeated alarm.</p>	2.4

Table C-7. Peripheral Keys (Part 2 of 2)

Name	Function	More Information
<p>REP ADR*</p> 	Reports current address of specified diskette in ADR- field of control page.	D6
<p>BOB*</p> 	Used to locate data on specified diskette one block back from its current position. Automatically repositions drive read/write head to beginning of data block.	

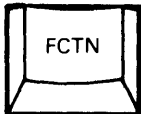
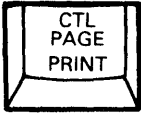
*Used only programmable UTS 30.

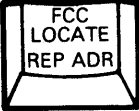
C.5. DATA TRANSFER KEYS

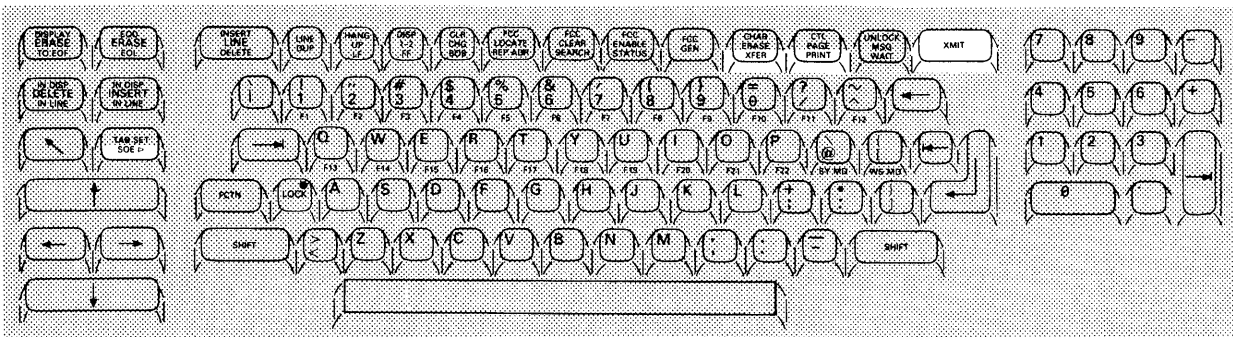

Data transfer keys, described in Table C-8, are used to initiate data transfer to peripheral devices and to the host processor.

Table C-8. Data Transfer Keys (Part 1 of 2)

Name	Function	Includes FCCs
<p>SOE</p> 	Identifies starting point of data sent to peripheral or host. If SOE is not entered, data is sent beginning at home position. Only data located between cursor and SOE nearest left of cursor is sent to designated destination.	N/A
<p>XMIT</p> 	Used to send data and FCCs located between SOE character and cursor to host.	Yes

Table C-8. Data Transfer Keys (Part 2 of 2)

Name	Function	Includes FCCs
<p>PRINT</p> 	<p>Initiates a peripheral operation specified by entries made in (**PRINT*) and PRNT() fields of control page. Sends up to one screen of data to peripheral device.</p>	No
<p>XFER</p> 	<p>Initiates a peripheral operation specified by entries made in (**XFER*) and XFER() fields. Sends up to one screen of data at a time to peripheral device. Includes FCCs in output.</p>	Yes*

*If expanded FCCs are being transferred (Table 8-1), the TF parameter selection must be YES. (Refer to Section 4 or Appendix E.)

C.6. FIELD CONTROL KEYS

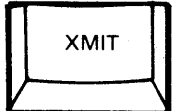
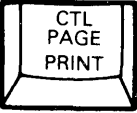
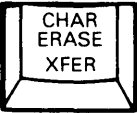
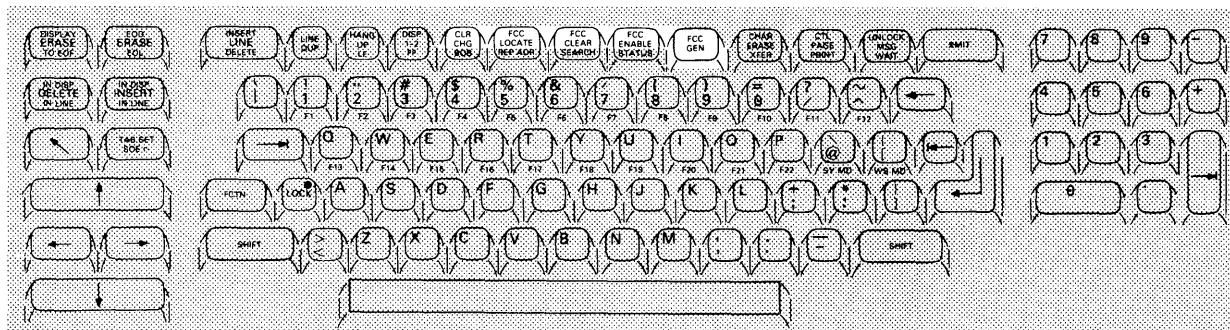

Field control keys, described in Table C-9, allow you to use field control characters (FCCs). FCCs are used to define screen intensity characteristics and to set restrictions on the type of data that may be entered in a given field. Most field control keys require the concurrent use of the FCTN key.

Table C-9. Field Control Keys (Part 1 of 2)





Name	Function
<p>FCC GEN</p> 	<p>Used to generate FCCs. Cursor must be in first character position of desired field.</p>
<p>FCC ENABLE</p> 	<p>Used to enable protect, right-justify, alphabetic-only, and numeric-only characteristics of all FCCs on screen.</p>

Table C-9. Field Control Keys (Part 2 of 2)

Name	Function
<p>FCC CLEAR</p> 	<p>Used to clear the FCC located at cursor position. If cursor is not located on an FCC, first FCC to left of cursor is cleared. Cursor remains in its original position. Cleared field becomes part of preceding field.</p>
<p>FCC LOCATE</p> 	<p>Used to locate FCCs on screen. Cursor moves to first position of next FCC-defined field. If no FCCs are located to right of cursor, it moves to home position. Pressing this key disables all protect, right-justify, alphabetic-only, and numeric-only characteristics on screen. After FCC LOCATE is pressed, FCC ENABLE must be pressed to reactivate FCC characteristics that were disabled.</p>
<p>CLR CHG</p> 	<p>Used to clear changed-field indicator codes. Used in conjunction with XFER() and XMIT() options for transfer of only changed data.</p>

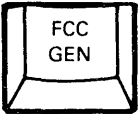
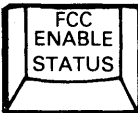
C.7. PROGRAM ATTENTION KEYS

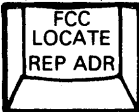

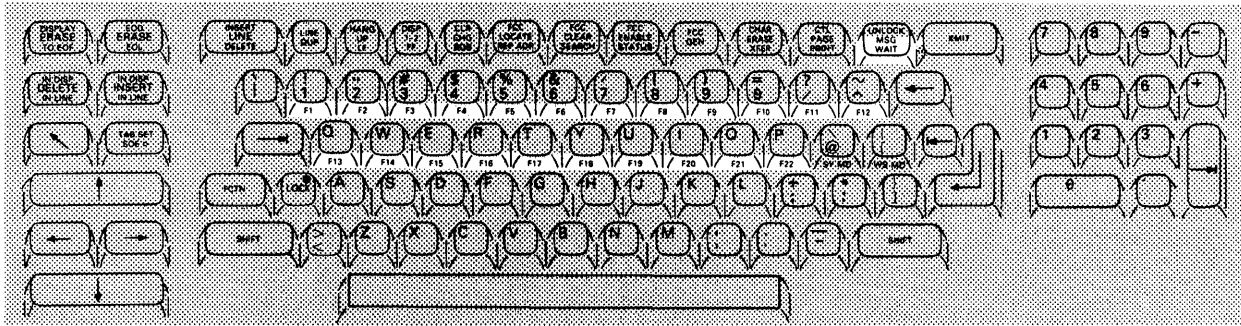
The program attention keys, described in Table C-10, are defined to your system's unique programming needs. The system programmer at your site will be responsible for determining the functions provided by these keys.

Table C-10. Program Attention Keys

Name	Function	Disables FCCs?
<p>MSG WAIT</p>  <p>F1 through F22</p>	<p>Normally used to display incoming message from host, as signaled by "MSGW" message in indicator line.</p> <p>Functions determined through host software or user program.</p>	

C.8. SPECIAL FUNCTION KEYS

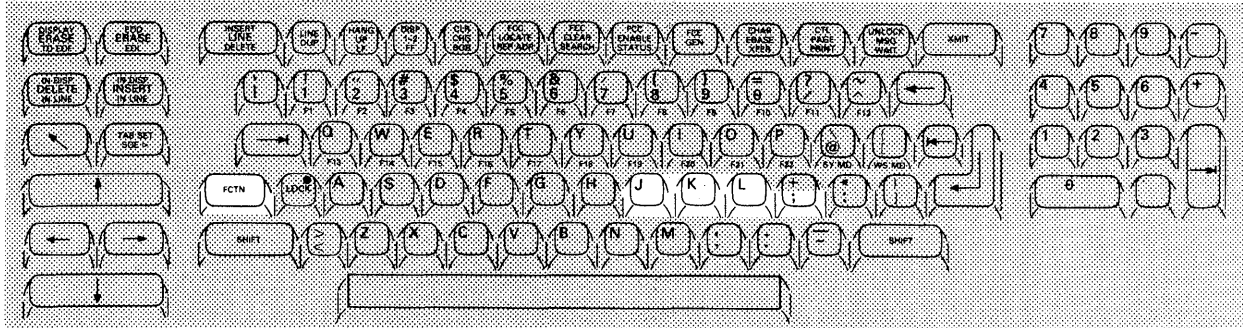

Special Emphasis Character Keys

Table C-11 describes the special emphasis character keys. Figure C-1 illustrates the use of special emphasis characters. These special function keys are nondestructive; that is, they can occupy the same position with a data character. They can also be protected by an FCC entry.

Because the special emphasis characters are used primarily for screen formatting, they are ignored (not printed), when you print using the PRINT key. If a character position contains only a special emphasis character, a space is printed. If you use the XFER key to print the characters, you will get codes in place of the emphasis characters which will make your printout confusing.

Table C-11. Special Emphasis Keys



Name	Function	More Information
FCTN J 	Generates nondestructive column separator (vertical line) to left of character position.	H1
FCTN K 	Generates nondestructive underscore.	H1
FCTN L 	Generates nondestructive strike-through (full-width dash). Must be selected through parameter since this key and optional character set access key (FCTN ;) are mutually exclusive. (Refer to Section 4 or Appendix E.)	H1

Figure C-1. Typical Use of Special Emphasis Characters

UNDERLINE
STRIKE THROUGH
COLUMN SEPARATOR

<p><u>5</u></p> <p>Date Shipped</p> <p>Mo Day Year</p> <p><u>03 — 10 — 83</u></p> <p>FROM:</p> <p>Company Name</p> <p><u>SPERRY</u></p> <p>Street Address</p> <p><u>322 North 2200 West</u></p> <p>City, State, Zip</p> <p><u>Salt Lake City, Ut. 84116</u></p>	<p>Agreement Number</p> <p><u>01—00—13—27</u></p> <p>Weight(lbs)</p> <p><u>17 . 8</u></p> <p>Item No.</p> <p><u>0791-99</u></p>	<p>Reference Number</p> <p><u>T—15—07—04</u></p> <p>Order Number</p> <p><u>134</u></p> <p>Description</p> <p><u>1. Printer</u></p> <p>2. _____</p> <p>3. _____</p>
---	---	--

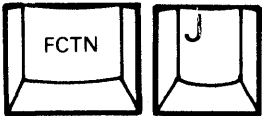
1 ROW=01 COL=01

Optional Character Set Access Key

Table C-12 describes the function of the optional character set access key.

Table C-12. Optional Character Set Access Key

Name	Function	More Information
<p>FCTN ;</p> <div style="display: flex; justify-content: space-around; align-items: center;"> <div style="border: 1px solid black; padding: 5px; width: 40px; text-align: center;">FCTN</div> <div style="border: 1px solid black; padding: 5px; width: 40px; text-align: center;">+ ;</div> </div>	<p>Selects character from optional character set and displays it at cursor position. Converts a previously typed regular data character to character from optional set. Or can be cycled on a blank screen; then desired optional characters can be typed in. Must be selected through parameter since its use is mutually exclusive with nondestructive strike-through (FCTN L). (Refer to Section 4 or Appendix E.)</p>	<p>H2</p>

Appendix D. Command Mode Error Messages

If an invalid command is entered, an error message appears on line 23 then scrolls up one line, displaying an SOE and the cursor on line 23. The operator can enter a new command or can move the cursor to the incorrect command statement, correct it, and press XMIT. The possible error messages are listed in Table D-1.

Table D-1. Command Mode Error Messages (Part 1 of 2)

Message	Meaning	Corrective Action
INVALID COMMAND	Command is not one of those in Table 5-1.	Reenter correct 3-character command code.
INVALID FORMAT	Elements of command not in proper order or incomplete.	Reenter statement in proper format.
INVALID DEVICE	Diskette drive is not configured or An incorrect drive number was used.	Configure diskette drive or Enter correct drive number.
DISK ERROR—FILE ALREADY EXISTS	The file name used for a create operation has already been used.	Use a different file name.
DISK ERROR—FILE NOT FOUND	File has not been created or File is on another diskette.	Create file or Open file on correct diskette.
DISK ERROR—TIMEOUT	Operation not completed within allotted time.	Restart operation.
DISK ERROR—ABORTED	Operation interrupted when UNLOCK key was pressed.	Restart operation.
DISK ERROR—WRONG USER NUMBER—FILE =xx	The file is not assigned to the user number of the file.	Change user number.
DISK ERROR—WRITE-PROTECTED	Diskette is write-protected	Remove write-protect tape from diskette or insert unprotected diskette.

Table D-1. Command Mode Error Messages (Part 2 of 2)

Message	Meaning	Corrective Action
DISK ERROR— NOT READY	Diskette subsystem is not ready.	Check diskette subsystem.
DISK ERROR— DATA ERROR	Diskette data cannot be read or written correctly.	Restart operation or Try a different diskette.
DISK ERROR— DISK FULL	Directory is full or Diskette has no more space for file data.	Use new diskette or Erase or purge file.

Appendix E. The (PARAM) Field

E.1. USING THE (PARAM) FIELD

In addition to the parameter/configurator utility (Section 4), you may also change parameters and configure the printer and diskette subsystems through the parameter field of the control page.

Directly below the protected field labeled (PARAM) is an area divided into two subfields (Figure E-1). In these subfields you can enter codes to alter your terminal's operating characteristics or to configure a peripheral device attached to the terminal. Once you make a selection, that choice is stored in the terminal's memory and remains in effect, even if the power is turned off or the RESET button is pressed.

Figure E-1. (PARAM) Field

```
(**PRINT*)STA- (**XFER**)PRNT( )XFER( )XMIT( )MM (PARAM)
( / / )ADR- ( / / )SEARCH( ) ( / )
```

Accessing the (PARAM) Field

You can make entries in the (PARAM) field only if the keylock is in the SET UP position; otherwise, the alarm will sound when you remove the control page, and the parameter you entered will not be activated. After the desired codes are entered in the (PARAM) field, the keylock can be turned to the NORMAL position, preventing unauthorized changes to those parameters.

Either the screen 1 or screen 2 control page can be used to make entries in the (PARAM) field since one set of entries establishes operating characteristics for both screens. One exception is screen size, which can be different for each screen.

Entering Codes in the (PARAM) Field

To select a parameter, you enter the code associated with the parameter type in the first subfield (before the slash mark), and a code identifying the parameter option in the second subfield (after the slash mark) of the (PARAM) field. Only one set of parameter type and option codes can be entered at a time. Removing the control page implements your selection. For example, if you choose the nondestructive space bar, the (PARAM) field of the control page will look like this:

(PARAM)
(SP/NS)

In this example, the parameter type is space bar (SP), and the parameter option is nondestructive (NS). The nondestructive space bar moves over previously entered data without destroying the data characters.

If you enter an incorrect code and then remove the control page, the alarm sounds once. The next time you display the control page, the incorrect entry will appear in the same location. The UTS 30 will not implement an incorrect parameter entry. If you do not redisplay the control page to correct the entry, the existing parameter option (the default or the last option selected) controls terminal operation.

As in other control page fields, the codes can be entered in either uppercase or lowercase characters.

E.2. PARAMETER TYPES AND OPTIONS

Each characteristic, or parameter type, defined in the (PARAM) field has two or more parameter options. Table E-1 lists all the parameter type and option codes; a description of each parameter follows the table.

NOTE:

Every parameter type has a default option (shown in Table E-1), which means that the terminal is set for that default option, unless otherwise changed. Also, if the POC test display produces the message, "PARAMETERS DEFAULTED — CONFIGURE DEVICES & ENTER COMM RI, SI, CM," all parameters revert to their default conditions. Whenever this message appears, the RID, SID, and CM (if communications mode is not a multiplexer) must be reentered and the RESET button pressed. If you are operating in a language other than U.S.A. English, you will need to change the national character set parameter. Any other changed parameters must also be reentered.

If the POC display produces the message, "COMMUNICATION RI OR SI PARAMETER IS INVALID," reenter the RID and SID and press RESET.

Table E-1. Parameter Types and Options (Part 1 of 4)

Parameters	Type Codes	Option Codes	Default Value	Function
Remote identifier	RI	Any hexadecimal number from 21 to 7F		Specifies the remote site transmission code (RID).
Station identifier*	SI	Any hexadecimal number from 20 to 7F		Specifies the terminal transmission code (SID).
Lines per screen	LN	02 through 24	24	Sets number of lines in display.
Columns per line	CL	01 through 80	80	Sets number of characters (positions) in each line.
Control page placement	CP	01 through 23	01	Specifies line on which first line of the control page will be displayed.
Video-off timer	VO	01 through 99	04	Causes screen display to go blank after specified period (number of minutes) of keyboard inactivity.
Space bar	SP	NS	NS	Defines space bar erase function.
		NS		Nondestructive space bar.
		DS		Destructive space bar.
Keyboard click	KK	ON	ON	Turns keyboard click on or off.
		ON		Keys click.
		OF		No click.
Communications mode*	CM		MX	Identifies the type of communications link to the host.
		MX		Multiplexer.
		MD		Modem or DCM.
		DC		Direct connection.
Direct connect rate* (Use only if CM = DC)	AR		96	Specifies the speed at which characters are transferred to and from the host.
		96		9600 baud.
		48		4800 baud.
		24		2400 baud.

*After entering these parameters, remove the control page from the screen and press the RESET button. These parameters are not changed until the RESET button is pressed. If you are entering more than one parameter that requires the RESET button, you can enter all of these parameters and then press the RESET button only once.

Table E-1. Parameter Types and Options (Part 2 of 4)

Parameters	Type Codes	Option Codes	Default Value	Function
Screen control alarm	SA	ON	ON	Determines whether or not screen control alarm sounds.
		OF		Alarm sounds once when cursor enters eighth position from the end of the line or when cursor enters last line of the display.
		OF		Turns off alarm for conditions described above.
Repeated alarm	RA	ON	ON	Determines whether or not the alarm sounds repeatedly.
		OF		Repeated alarm sounds for the conditions listed in Appendix B.
		OF		Alarm sounds only once.
Uppercase only	UC	NO	NO	Allows entry of uppercase alphabetic characters only from keyboard and magnetic stripe reader.
		YS		All alphabetic characters are entered in uppercase independent of SHIFT key.
		NO		Normal entry of uppercase and lowercase alphabetic characters.
Cycle speed	CS	LO	LO	Specifies the rate at which cycling keys will repeat.
		LO		Cycle rate of 12.5 characters per second.
		HI		Cycle rate of 25 characters per second.
Load drive	LD	D1 to D4	D1	Determines the drive which will be used for command mode functions if a drive is not specified in the command statement.
Host POC	HP	NO	NO	Specifies whether or not the terminal runs a POC test upon receipt of a POC command from the host.
		NO		No POC test.
		YS		Full POC test.

Table E-1. Parameter Types and Options (Part 3 of 4)

Parameters	Type Codes	Option Codes	Default Value	Function
Blinking markers	BM	ON	ON	Specifies whether blinking markers or blanks are displayed with certain indicator line messages.
		OF		Blinking markers displayed. Blanks displayed.
System response mode	SR	ON	OF	Enables operation in system response mode, if host processor is a System 80.
		OF		Operating in system response mode. Not operating in system response mode.
Control characters	CC	ON	OF	Specifies whether control characters are displayed.
		OF		Control characters displayed. Control characters not displayed.
Automatic transmission of magnetic stripe reader data	AT	YS	NO	Selects automatic or operator-initiated transmission of card data.
		NO		Automatic transmission to host. Data is not displayed on the screen. No automatic transmission. Data is displayed on screen and must be transmitted by operator.
Transmit expanded FCCs	TF	EF	EF	Specifies transmission of expanded FCCs.
		DF		Enables transmission of expanded FCCs. Disables transmission of expanded FCCs.
Automatic hangup*	AA	NO	NO	Disconnects communications line with host processor after a specified period of inactivity.
		NO		Does not hang up.

*After entering these parameters, remove the control page from the screen and press the RESET button. These parameters are not changed until the RESET button is pressed. If you are entering more than one parameter that requires the RESET button, you can enter all of these parameters and then press the RESET button only once.

Table E-1. Parameter Types and Options (Part 4 of 4)

Parameters	Type Codes	Option Codes	Default Value	Function
Printer speed	PS	Y1	96	Hangs up after: 30-second timeout.
		Y2		1-minute timeout.
		Y3		3-minute timeout.
		Y4		5-minute timeout.
				Sets data transfer rate from terminal to printer.
Emphasis character	EM	03	ST	300 baud
		06		600 baud
		12		1200 baud
		24		2400 baud
		48		4800 baud
		96		9600 baud
				(The 0797 and 0798 printers will function only at 9600 baud.)
Indicator line intensity	IL	ST	LS	Determines which key (FCTN L or FCTN ;) is enabled.
		OC		Strike-through character key (FCTN L) is enabled.
				Optional character set access key (FCTN ;) is enabled.
Screen video intensity	SV	LS	NI	Specifies appearance of indicator line.
		RV		Line separating indicator line from rest of screen.
		NI		Reverse video.
		RV		Normal intensity.
National character set*	NC	NI	US	Designates the intensity of the screen display background.
		RV		Normal intensity.
				Reverse video.
				Selects the displayed character set.
		US		United States
		UK		United Kingdom
		GE		Germany
FR	France			
SP	Spain			
DN	Denmark/Norway			
SF	Sweden/Finland			
IT	Italy			

Remote Identifier (RID)

The RI parameter specifies the remote transmission code, which is part of the UTS 30 address for host communications. Code options include any hexadecimal number from 21 through 7F. (Appendix G contains a list of hexadecimal code options.) Options may be restricted by the host system to 21 through 4F. Information for entering the RID should be provided by someone familiar with your host system configuration. Changing this parameter indiscriminately causes a breakdown in communication between the host and the terminal.

Station Identifier (SID)

The SI parameter specifies the terminal transmission code for host communications. Since the UTS 30 has two displays, each screen has a SID. Code options include any hexadecimal number from 20 through 7F. (Appendix G contains a list of hexadecimal code options.) Options may be restricted by the host system to 51 through 6F. Information for entering the SID should be provided by someone familiar with your host system configuration. Changing this parameter indiscriminately causes a breakdown in communication between the host and the terminal.

Whether you enter the SID on display 1 or 2, it is assigned to display 1, and display 2 is automatically assigned the next higher value.

Lines Per Screen and Columns Per Line (Screen Size)

By entering two codes (02 through 24 for number of lines; 01 through 80 for columns), you can structure the display format to suit a particular need. For example, you can specify a 4-line by 2-column format, a 10-line by 10-column format or any other format within the limits of 24 rows by 80 columns. If the number of lines per screen is less than 12, the display is double-spaced. The control page always takes up two full lines of 80 characters, regardless of the screen size setting. The indicator line always appears in the 25th line of the screen across all columns.

The number of lines and number of columns are the only parameters that can differ for screen 1 and screen 2. For example, you can set screen 1 at 24 lines by 80 columns and screen 2 at 12 lines by 12 columns. This is accomplished by making separate column and line number entries in the screen 1 and screen 2 control pages. However, if screen size is changed through the basic UTS 30's parameter display, both screens are the same size.

However, when the terminal is turned off or the RESET button is pressed, only the parameter entries from one screen remain in terminal memory. Consequently, when the terminal is reloaded, both screens will be the same size. The parameter codes that were last entered define screen size.

Control Page Line Number

This parameter positions the control page on the display line of your choice. The 2-digit code you enter is the screen line in which the first line of the control page will appear. The code entry should be at least one less than the total number of lines selected through the LN parameter.

Video-Off Timer

This parameter instructs the terminal to turn off the screen display after a specified time has elapsed with no activity from your station. Although the screen goes blank, power to the terminal remains on, as indicated by the power-on symbol () at the bottom of the screen.

If you leave the terminal and later return to a blank screen, press any data key to redisplay the screen. A host message to your terminal also displays the screen.

Space Bar

You can define the space bar as either destructive or nondestructive. Defining the space bar as destructive simplifies the erasure of single characters, but requires you to use the scan forward key instead of the space bar to space over characters.

Keyboard Click

The default condition for the keyboard click and alarm is ON. To silence the click and alarm, enter the code OF (off) for this parameter option. You can control the volume of the keyboard click and the alarm with the front panel volume control ().

Communications Mode

The UTS 30 can be linked to the host through a multiplexer, a modem, or direct connection. The information for setting this parameter must come from someone familiar with your system configuration. A SPERRY Direct Connection Module (DCM) is not the same as a direct connection. A DCM functions in the same manner as a modem, and if your system uses a DCM, you should enter the modem code.

The multiplexer code refers to a system that has both a multiplexer and a modem, whereas the modem code refers to a system that includes a modem but no multiplexer.

A direct connection can occur only when the terminal is located very near the host processor, and a line adapter is installed.

Direct Connect Rate

If DC (direct connection) was selected for the communication mode parameter, this parameter needs to be entered. This AR parameter specifies the speed at which characters are transmitted to and from the host. The information for setting this parameter must come from someone familiar with your system configuration.

Screen Control

The alarm on the UTS 30 sounds under a variety of conditions listed in Appendix B. The SA parameter determines whether or not you want the alarm to sound whenever the cursor moves into the eighth position from the end of the line, and when the cursor moves into the last line of the screen display. The default condition is ON.

Repeated Alarm

The alarm sounds repeatedly under certain conditions (listed in Appendix B). By selecting the OF option for this parameter, you can convert the repeated alarm to a single alarm sound.

Uppercase

Selecting the YS (yes) option causes the alphabetic data keys to enter the uppercase character, regardless of whether or not the SHIFT key is used. This parameter has no effect on data received from the host or on the numeric data keys. The uppercase range is automatically changed whenever the national character set is changed, so that the range includes all alphabetic characters in that character set with uppercase and lowercase equivalents.

NOTE:

This parameter also affects the optional character set.

Character Cycle Speed

This parameter determines the rate at which cycling keys will repeat.

Load Drive

The LD parameter determines which drive will be used for command mode functions when the drive is not specified in the command statement. Options are D1 to D4 with a default of D1.

Host POC

The HP parameter specifies whether or not the terminal runs a POC test upon receipt of a POC command from the host. Someone familiar with your system configuration should set this parameter.

Blinking Markers

The BM parameter determines whether or not blinking markers are displayed with indicator line messages.

System Response Mode

The SY MD key and WS MD keys can be used to change between UTS 400 mode and system response mode only if this parameter option is specified as "ON."

NOTE:

System response mode is applicable only to those systems operating with a SPERRY System 80 host. For information on operator procedures in system response mode, refer to the System 80 local workstation operator's guide, UP-8910 (current version).

Display Control Characters

The line feed, form feed, and tab stop characters can be displayed or nondisplayed characters depending upon your selection for this parameter type. If you are using line feed and form feed characters to format data, it is advisable to select ON for this parameter.

NOTE:

If ON is selected for this parameter, other control characters may appear briefly when you press the XMIT, PRINT, or XFER key.

Automatic Transmission of Magnetic Stripe Redata Entry

Setting this parameter to NO (the default condition) means that any card data read by the magnetic stripe reader is not automatically transmitted to the host. Instead, the data is displayed on the screen. You must manually transmit the data by pressing the XMIT key. The YS (yes) option selects the automatic transmit mode, which automatically transmits card data to the without displaying it on the screen.

Transmit Expanded FCCs

This parameter specifies whether expanded or regular FCCs (Table 8-1) are transmitted to the host and peripherals.

Automatic Hangup

These codes allow you to specify the time that may elapse between polls before the terminal automatically breaks connection with the host processor in dial-up connections.

Cursor Return

The CR parameter determines whether, during an output to a printer, a cursor return on the screen is output as a carriage return or a line feed. The purpose of this parameter is to adapt to printers which interpret a cursor return as a command to return to the left margin of the same line, rather than the next line. The parameter entry is in effect only when a printer has been defined as the "to" device in a peripheral operation; it has no effect during data entry.

Printer Speed

This parameter specifies the speed at which the terminal transfers characters to the printer. This parameter defaults to 9600 baud, the speed of the 0797 and 0798 printers. Changing this parameter is necessary only if the printer you are using is set for a different baud rate.

Emphasis Character

On the UTS 30, the strike-through emphasis key (FCTN L) and the loadable character set access key (FCTN ;) are mutually exclusive. The EM parameter determines which key (FCTN L or FCTN ;) is enabled; the other key is considered an unimplemented key, and the alarm will sound if that key is pressed. (Refer to Appendix C for more information on special emphasis characters.)

Indicator Line

The 25th line of the display is reserved for messages about various aspects of terminal operation. The default option (LS) displays the indicator line in normal intensity and separated from the rest of the screen by a line. The two other options for indicator line intensity are reverse video (RV) and normal intensity (NI).

Screen Video Intensity

The SV parameter designates the intensity of the screen display background. The options are normal intensity (NI), light characters against a dark background; and reverse video (RV), dark characters against a light background. Intensity of background can also be controlled with the contrast control () on the front panel of the terminal.

National Character Set

This parameter determines the displayed character set, and is usually selected to match keyboard keycaps. (Refer to the National Use Code Chart in Appendix G.)

E.3. CONFIGURING PERIPHERAL DEVICES THROUGH THE (PARAM) FIELD

Configuration of peripheral devices is a requirement for establishing communication among the host processor, the terminal, and the peripheral devices attached to the terminal. This configuration procedure is followed when the equipment is first installed, and you should not have to alter these entries unless the POC test results include the "PARAMETERS DEFAULTED" message. Your supervisor will give you specific instructions if, for any other reason, the device configuration needs to be changed.

As with changing parameters, you can configure peripheral devices through either the command mode display or the control page display.

The two subfields of the (PARAM) field are used to specify the type of peripheral device and to select the device identifier (DID). The first subfield identifies the type of peripheral device. The choices are:

- 1P = Printer
- ID = A single-drive primary diskette unit
- 2D = A dual-drive primary diskette unit
- 1S = A single-drive secondary diskette unit
- 2S = A dual-drive secondary diskette unit

NOTE:

The primary diskette unit is connected directly to the UTS 30. The secondary diskette unit is connected to the primary unit.

The second subfield is used for the device identifier, or DID, which can be any hexadecimal number between 20 and 7F, although the following DIDs should be avoided, as they have special host functions: 70, 71, 72, and 7F.

A printer requires only one DID. A single-drive diskette unit requires two DIDs: the operator enters the write DID and the system assigns the next higher DID as the read DID. A dual-drive diskette subsystem requires four DIDs: the operator enters the write DID for the left drive and the system assigns the next three higher DIDs as the read DID for the left drive and the write and read DIDs for the right drive.

NOTE:

The keylock must be in the SET UP position to configure the devices. The device configuration becomes effective only after the RESET button is pressed.

Appendix F. Maintenance Mode Field Entries

DB Enables the UTS 30 debug monitor routine, which is provided for customer engineers and UTS 30 user programmers. Entering "DB" in the MM field enables the FCTN H key, which is used to display the debug monitor. The keylock must be in the SET UP position to enable this function.

DO Disables the debug monitor routine and the FCTN H key sequence.

EL Displays the error log. The error log is not displayed if the screen size is less than four lines or 45 columns. The error log is a 2-line display in the following format:

```
00 00 00 00 00 00 00 00 00 00 00 00 00 00 00 00
00 00 00 00 00 00 00 00
```

The first line is not used. On the second line, the error counters are:

- 1st — Communications input parity error
- 2nd — Communications BCC error
- 3rd — Communications reply request sent
- 4th — Input queue overflow counter
- 5th — Not used
- 6th — Keyboard parity error
- 7th — Peripheral error counter
- 8th — Not used

CE Clears the error log. The only other ways to clear the error log are failure of the nonvolatile RAM (default values assumed) and a clear error log command from the host.

CY Causes the power-on confidence test to cycle (repeat continuously) for diagnostic purposes. To stop POC test cycling, press the RESET button. The "CY" entry clears the user memory.

LM Turns the line monitor on. Characters received by the UTS 30 are displayed in normal intensity. Characters sent from the UTS 30 are displayed in reverse video. Control characters are displayed in the line monitor, regardless of the CC (control character) parameter entry. The keylock must be in the SET UP position to enable this function.

The CP parameter must be set to display the control page on line 1 before entering "LM." Otherwise, the line monitor overwrites the control page. To turn off the line monitor, press the UNLOCK key, or enter the code "MO" in the MM field. After turning off the line monitor, use the ERASE DISPLAY key to clear the screen.

The terminal is fully functional while the line monitor is displayed, allowing use of the control page, peripherals, and the DISP 1-2 key. However, the host cannot transmit to or perform peripheral operations through a screen on which the line monitor is displayed, and only one screen at a time can display the line monitor.

MO Turns off the line monitor. Pressing the UNLOCK key also turns off the line monitor. Once the line monitor is turned off, any control characters on the screen will not be displayed if the CC parameter option is OF. In order to study the final display, the CC option must be ON.

RN Turns the record separator on. The record separator function translates certain keyboard-generated characters to control characters that can be stored and recalled from a diskette. The characters are:

{ — Start blink marker
} — End blink marker
~ — SOE character

When "RN" is entered, the second character of the MM field changes to an O, as an indication that the record separator function is on.

RF Turns the record separator off. The "MO" record separator indication changes back to the usual field indication of "MM."

LL Starts a series of external loopback diagnostic tests. These tests, which require the use of external test equipment, are not affected by the CM parameter. The test baud rate is determined by the AR parameter. The "LL" loopback tests operate as described under the "LX" entry.

LX Starts a series of external loopback diagnostic tests with the multiplexer, modem, or DCM. The CM parameter must be set to "MX," "MD," or "DC," as appropriate.

The terminal is not functional while the test is running. When "LL" or "LX" is entered, the screen is erased and any data on the screen is lost. The first two lines of the screen display the test characters. While the test is running, "LOOPBACK TEST" is displayed, followed by a number which identifies the internal test being run. If no error is encountered, the tests cycle, erasing the screen after each series, until the RESET button is pressed. If an error is encountered, "LOOPBACK TEST # FAILED" is displayed, in order to indicate the number of the test that failed. The last character displayed indicates where the error occurred. After the error, the terminal is not functional until the RESET button has been pressed.

NOTE:

Successful execution of the loopback tests requires the appropriate parameter settings and physical setup. Otherwise, "LOOPBACK TEST # FAILED" will be reported.

IP Inverts the polarity of the send data, request-to-send, and data-terminal-ready lines. The condition is cleared by pressing the RESET button.

Appendix G. Code Conversion Charts

Table G-1 lists ASCII characters and their hexadecimal, decimal, and octal equivalents.

Table G-1. Code Conversion Chart (Part 1 of 2)

CONTROL CHARACTERS			DATA CHARACTERS												
			64 CHARACTERS UPPERCASE				32 CHARACTERS LOWERCASE								
00 00 000	NUL	10 16 020	DLE	20 32 040	SP	30 48 060	0	40 64 100	@	50 80 120	P	60 96 140	\	70 112 160	p
01 01 001	SOH	11 17 021	DC1	21 33 041	!	31 49 061	1	41 65 101	A	51 81 121	Q	61 97 141	a	71 113 161	q
02 02 002	STX	12 18 022	DC2	22 34 042	"	32 50 062	2	42 66 102	B	52 82 122	R	62 98 142	b	72 114 162	r
03 03 003	ETX	13 19 023	DC3	23 35 043	#	33 51 063	3	43 67 103	C	53 83 123	S	63 99 143	c	73 115 163	s
04 04 004	EOT	14 20 024	DC4	24 36 044	\$	34 52 064	4	44 68 104	D	54 84 124	T	64 100 144	d	74 116 164	t
05 05 005	ENQ	15 21 025	NAK	25 37 045	%	35 53 065	5	45 69 105	E	55 85 125	U	65 101 145	e	75 117 165	u
06 06 006	ACK	16 22 026	SYN	26 38 046	&	36 54 066	6	46 70 106	F	56 86 126	V	66 102 146	f	76 118 166	v
07 07 007	BEL	17 23 027	ETB	27 39 047	'	37 55 067	7	47 71 107	G	57 87 127	W	67 103 147	g	77 119 167	w
08 08 010	BS	18 24 030	CAN	28 40 050	(38 56 070	8	48 72 110	H	58 88 130	X	68 104 150	h	78 120 170	x
09 09 011	HT	19 25 031	EM	29 41 051)	39 57 071	9	49 73 111	I	59 89 131	Y	69 105 151	i	79 121 171	y
0A 10 012	LF	1A 26 032	SUB	2A 42 052	*	3A 58 072	:	4A 74 112	J	5A 90 132	Z	6A 106 152	j	7A 122 172	z

Table G-1 Code Conversion Chart (Part 2 of 2)

CONTROL CHARACTERS		DATA CHARACTERS							
		64 CHARACTERS UPPERCASE				32 CHARACTERS LOWERCASE			
0B 11 013 VT	1B 27 033 ESC	2B 43 053 +	3B 59 073 ;	4B 75 113 K	5B 91 133 [6B 107 153 k	7B 123 173 {		
0C 12 014 FF	1C 28 034 FS	2C 44 054 ,	3C 60 074 <	4C 76 114 L	5C 92 134 \	6C 108 154 l	7C 124 174 		
0D 13 015 CR	1D 29 035 GS	2D 45 055 -	3D 61 075 =	4D 77 115 M	5D 93 135]	6D 109 155 m	7D 125 175 }		
0E 14 016 SO	1E 30 036 RS	2E 46 056 .	3E 62 076 >	4E 78 116 N	5E 94 136 ^	6E 110 156 n	7E 126 176 ~		
0F 15 017 SI	1F 31 037 US	2F 47 057 /	3F 63 077 ?	4F 79 117 O	5F 95 137 _	6F 111 157 o	7F 127 177 %		

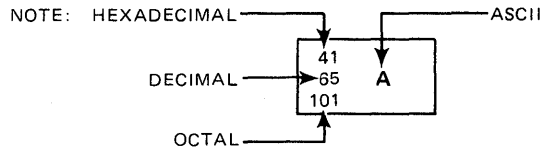

Table G-2 lists hexadecimal, decimal, and octal value locations in the ASCII code chart for national use selections.

Table G-2. National Use Code Chart

HEXADECIMAL, DECIMAL, AND OCTAL VALUE LOCATIONS IN ASCII CODE CHART													
STANDARD CHARACTER SETS	HEX DECIMAL OCTAL	23	24	40	5B	5C	5D	5E	60	7B	7C	7D	7E
		35	36	64	91	92	93	94	96	123	124	125	126
		043	044	100	133	134	135	136	140	173	174	175	176
DOMESTIC (USA)		#	\$	@	[\]	^	\	{		}	~
SPAIN		Pts	\$	§	i	Ñ	¿	^		°	ñ		~
DENMARK/NORWAY		#	\$	@	Æ	Ø	Å	^	\	æ	ø	å	—
FRANCE		£	\$	à	°	ç	§	^	\	é	ù	è	..
GERMANY		#	\$	§	Ä	Ö	Ü	^	\	ä	ö	ü	ß
SWEDEN/FINLAND		#	☉	É	Ä	Ö	Å	Ü	é	ä	ö	å	ü
UNITED KINGDOM		£	\$	@	[\]	^	\	{		}	~
ITALY		£	\$	§	°	#	é	^	ù	à	ò	è	Ì

Glossary

<i>Alternate screen</i>	A feature which provides the terminal with the capability of displaying and operating two separate, functional screens. The advantage of alternate screen capability is that two operations can be performed from the same terminal in parallel. For example, you can initiate and execute an operation on the first screen and then initiate another operation on the second screen.
<i>ASCII</i>	(American Standard Code for Information Interchange) This standardized code is used extensively for data transmission. Each character is encoded as a 7-bit binary number, which allows 128 uppercase and lowercase letters, numbers, and punctuation marks and leaves room for 32 special function control codes.
<i>bit</i>	Contraction of "binary digit;" the smallest quantity of digital information that can be stored. A bit is either a 1 or 0.
<i>block</i>	A collection of data (records, words, characters) handled and transferred as a unit. As defined for UTS 30 use, a block equals one screen of data, or approximately 15 records.
<i>byte</i>	A set of contiguous bits which is operated on as a unit. Communication is byte-oriented, using seven ASCII bits to define a character and adding one parity bit. A byte can also be a subset of a computer word.
<i>central processor</i>	Synonymous with central processing unit (CPU), main frame, or host; a unit of a computer that includes circuits controlling the interpretation and execution of instructions.
<i>changed-field indicator</i>	An internal flag that is set to indicate whether or not a change was made in a field after it was generated or to indicate that a flag has been cleared (CLR CHG key is pressed). This flag identifies the field as changed and causes only changed fields to be transmitted.
<i>command mode</i>	A function of the UTS 30 that provides for the use of file-formatted diskettes. Files can be created and maintained, and programs may be loaded through command statements.

<i>communications line</i>	The physical connection or link through which information between display terminals and a processor is transferred.
<i>control character</i>	A character interpreted by the host processor as a communications instruction, not part of the data message.
<i>control page</i>	A 2-line area on the display screen that can be displayed to set up peripheral operations, data transmissions to the host, and terminal operating parameters.
<i>control program</i>	Operating instructions loaded into the terminal either through a program cartridge (basic UTS 30) or system diskette (programmable UTS 30), which determine how information is handled (stored, accessed, transferred) in the system.
<i>cursor</i>	A symbol () used to mark the position of the next character to be entered into a display screen. Also, marks the last character of a message transmitted to a host processor or a peripheral device.
<i>cycling</i>	The rapid, automatic repetition of an operation by pressing and holding the key down for more than 1/2 second.
<i>DCM</i>	Abbreviation for "SPERRY Direct Connection Module."
<i>dedicated line</i>	Type of communication between the host processor and terminal which is permanently connected, requiring no dial-up procedure.
<i>default</i>	A predetermined variable that the terminal operates with unless the user selects another alternative. For example, the UTS 30 screen size is set at 24 rows by 80 columns unless the operator selects a different size.
<i>dial-up</i>	Type of communication between the terminal and the host processor requiring a telephone line hook up. See also switched line.
<i>DID</i>	Acronym for "device identifier," a transmission code assigned to a peripheral device to identify it for the terminal or host.
<i>direct connection</i>	A communications line interface that can be used instead of a modem or DCM, if the terminal is located more than 200 feet from the host processor.
<i>disable</i>	To deactivate an operation or a function, especially as it applies to FCCs.
<i>display</i>	The visual presentation of data on a workstation screen.
<i>enable</i>	To activate an operation or a function, especially as it applies to FCCs.
<i>field</i>	A specified area of the display screen used for a particular category of data.
<i>field control characters</i>	Control codes established from the host or through the keyboard that define fields for formatting and transmission of data in a field.

<i>file</i>	A collection of related data records treated as a single unit and grouped under a unique identifier called a file name (e.g. employee payroll records comprise a file called "MASTPAYROLL").
<i>hardware</i>	The physical devices and machine parts that comprise a processing system.
<i>host</i>	See central processor.
<i>indicator line</i>	The 25th row of the screen display, showing the current status of the terminal.
<i>input</i>	Data written to the screen or transmitted to the host processor for storage or processing.
<i>optional character set</i>	An alternate set of characters that can be loaded and stored in the terminal, and then accessed through the keyboard.
<i>mnemonic</i>	An acronym or abbreviation used to help remember something. As it applies to the UTS 30, the 2-character peripheral device codes.
<i>modem</i>	A contraction of "modulator-demodulator;" a device that modulates and demodulates signals transmitted over communications facilities. This device transforms data exchanges between the host and the terminal into mutually understandable messages.
<i>multiplexer</i>	A device that permits two or more terminals to be connected to the same communications line, each at a separate interface point. The multiplexer organizes messages transmitted from various terminals to the host, permitting each terminal to send data in turn.
<i>offline</i>	Terminal activities performed without host interaction.
<i>online</i>	Terminal activities performed requiring host interaction.
<i>output</i>	Processed data sent to a destination — printout, diskettes, or punched cards.
<i>parameter</i>	An operating characteristic, such as screen size or video timeout, that can be changed to meet the needs of specific user applications.
<i>peripheral</i>	A device attached to a terminal, such as a printer or diskette subsystem, which performs an input, output, or storage function.
<i>poll</i>	Indication that the host is ready to receive data from the terminal.
<i>power-on confidence (POC) test</i>	A series of internal tests that check the basic operating functions of the terminal.
<i>program</i>	A complete sequence of computer instructions to solve a problem, or perform an action in a prescribed manner.
<i>protected</i>	Portion of data entered through the keyboard or sent by the host which cannot be overwritten or changed by the operator.

<i>record</i>	A collection of related data fields treated as a unit.
<i>RID</i>	Acronym for "remote identifier"; a transmission code assigned to a location where a terminal or number of terminals reside.
<i>right-justification</i>	An FCC function that creates a 1-line field which displays data characters from right to left as they are keyed in. The last character entered in the field is always positioned directly against the right side of the field.
<i>SID</i>	Acronym for "station identifier;" a transmission code assigned an individual terminal.
<i>software</i>	The programs which control functions of hardware. See also program.
<i>switched line</i>	Type of communication that requires the dialing of a telephone number each time communications are established between the terminal and the host processor. Also called dialed line or dial-up communications.
<i>system diskette</i>	Diskette containing the control program, or operating software, for a terminal system.
<i>transfer</i>	Sending data between a terminal and a peripheral device across a peripheral interface. Communication with the host is not required.
<i>transmission</i>	Sending data and instructions between the host processor and the terminal over a communications line.
<i>unprotected</i>	A field that is available for data entry and change through the keyboard.
<i>user program</i>	A program written for a specific user application; for example, accounts receivable, or general ledger.

Index

Term	Reference	Page	Term	Reference	Page
A			B		
Air filter maintenance	A7	56	Back space key	Table C-1	128
Alarm			Blinking markers	Table E-1 Appendix E	147 151
conditions	2.4 Appendix B	11 125	Brightness control	2.3.1	8
increasing volume repeated	2.4 Appendix B Table E-1 Appendix E	11 126 146 150			
screen control	Table E-1 Appendix E	126 150	C		
silencing with UNLOCK key with indicator line messages	2.4 Table 2-1	11 10	CHAN code	D1	74
ALL code	D1	74	Changed-field indicator and CHAN code and CLR CHG key cleared with editing keys	D1 8.4 Appendix C	74 47 129
Alternate screen control pages	2.3.2 3.1	11 18	Changing FCCs	I3	119
Alphabetic-only data	8.3	44	Changing parameters basic	4.3 Appendix E	26 143
Archived file	6.1	33	programmable	B1 B2 Appendix E	60 62 143
ASCII code chart	Table G-1	157	CHAR ERASE key	Appendix C	130
Automatic hangup parameter	Table E-1 Appendix E	147 152	Character cycle speed, parameter	Appendix E	151
AUXB message	Table 2-1	10	Clear error log	Appendix F	155
AXER message	Table 2-1	10	Clearing FCCs	I4	130
			CLR CHG key	Appendix C	134

Term	Reference	Page	Term	Reference	Page
Column separator description procedure	Appendix C H1	138 104			
Columns per line	Table E-1 Appendix E	145 149			
Communications mode, codes	Table E-1 Appendix E 3.2	145 150 19			
Configuring peripheral devices, using (PARAM) field	Appendix E	152			
Contrast control	2.3.1	9			
Control characters	Table E-1 Appendix E	147 151			
Control page description displaying/removing location operations	3.1 A3 Table E-1 Appendix E Table 3-1	15 52 145 149 16			
Control programs	2.2	7			
Controls	2.1 2.3.1	5 8			
CTL PAGE key description using	Appendix C A3	132 52			
Cursor	2.3.2	9			
Cursor control keys	Appendix C	127			
Cursor to home key	Appendix C	127			
Cycle POC test	Appendix F	155			
Cycle speed parameter	Table E-1 Appendix E	146 151			
Cycling	2.5	13			
			D		
			Dataphone	A2	51
			DCM	Table E-1 Appendix E	145 150
			Debug monitor	Appendix F	155
			DELETE IN DISP key	Appendix C	130
			DELETE IN LINE key	Appendix C	130
			DELETE LINE key description used with FCCs	Appendix C I5	130 121
			Destructive space bar	Table E-1 Appendix E	145 150
			Device identifier	See DID.	
			Dial-up connections	See switched line.	
			DID		
			entering in (PARAM) field	Appendix E	152
			entering printer DID for basic	B3	63
			entering through parameter/configurator utility	4.2 B2	24 62
			Direct connect rate parameter	Table E-1	145
			Direct connection module	See DCM.	
			Directory, using	C8	72
			Diskette		
			copying	6.3 D4	36 77
			editing	6.3 D5	36 79
			homing	6.5 D8	37 85
			prepping	A6	55
			reading	6.3 D3	36 76
			reporting address	D6	82
			searching	6.5 D7	37 83
			writing	6.3 D2	36 75

Term	Reference	Page	Term	Reference	Page
M			P		
Maintenance mode functions	Appendix F	155	(PARAM) field	Appendix E	143
Magnetic stripe reader			Parameter utility	4.2	22
automatic transmission	G1	98	Parameter values	Table E-1	145
manual transmission	G2	100	PARAMETERS DEFAULTED message	Table A-2	124
Messages			Peripheral device status, procedure for checking	3.2 H3	18 106
errors during control program load	Table A-1	123	Peripheral keys	Appendix C	133
errors during UNISCOPE program load	Table A-1	124	POC		
command mode	Table D-1	141	cycling	Appendix F	155
in indicator line	Table 2-1	10	description	2.1	6
MM field	Table 3-1	16	host requested	Table E-1 Appendix E	146 151
Modem	3.2	19	POLL message	Table 2-1	10
See also glossary.			POWER control	2.1	6
MSG WAIT key	Appendix C	137	Power-on symbol	2.3.2	11
MSGW message	Table 2-1	10	PRINT key		
Multiplexer	3.2	19	description	Appendix C	135
See also glossary.			effect on FCCs	6.2	35
N			effect on special emphasis characters	6.2	35
National character set	Table E-1 Appendix E	148 152	Printer speed parameter	Table E-1 Appendix E	148 153
National use code chart	Table G-2	158	Printer status codes	H3	106
Nondestructive space bar	See destructive space bar.		Printing		
Nonfunctional keys	2.5	13	format options	E1	88
NORMAL keylock position	2.1	8	from diskette	E3	90
Numeric-only data	8.3	44	from screen	E2	89
O			setting up control page with FCCs	7.1 6.2	39 35
Off-intensity	8.1	41	PRNT() field		
Optional character set	H2	105	used for print format options	E1	88

Term	Reference	Page	Term	Reference	Page
to perform maintenance mode functions	Appendix F	155	SYS MOD message	2.3.2	10
SHIFT key	Appendix C	132	SYS MSG message	2.3.2	10
SID			System files	6.1	33
entering			System load	2.2	7
for basic	4.3	26	System response mode	Table E-1	147
for programmable	4.2	24		Appendix E	152
entering through (PARAM) field	Table E-1	145	T		
represented in special code field	3.2.	19	Tab back key		
SOE key			description	Appendix C	128
description	Appendix C	134	in FCC-defined fields	8.2	42
to send partial screen data	E2	89	Tab forward key, in FCC-defined fields	Appendix C	128
Space bar key	Appendix C	128		8.2	42
Space bar parameter	Table E-1	145	TAB SET key	Appendix C	131
	Appendix E	150	See also setting tabs.		
Special code field	3.2	19	Tab stop in FCC-defined fields	8.2	42
Special emphasis characters			Text processing utility	See TPU.	
printing	6.2	35	TPU	2.2	7
protecting	8.3	44	Transfer key	See XFER key.	
using	H1	104	Transmit key	See XMIT key.	
SPERRYLINK	2.2	7	Transmitting data to host	Section F	91
STA- field			Turning on the UTS 30	A1	51
description	3.2	18	U		
procedure for checking status	H3	106	Underscore character		
Station identifier (SID)	See SID.		description	Appendix C	138
STATUS key			procedure	H1	104
function	Appendix C	133	UNLOCK key,		
procedure	H3	106	description and alarm	H14	104
Strike-through character				Appendix C	138
function	Appendix C	138	Unrestricted data	8.3	45
procedure	H1	106	Uppercase-only parameter	Table E-1	146
selecting through special emphasis parameter	Appendix E	152		Appendix E	150
Switched line, dialing	A2	52			
SY MD key	2.5	13			

READER'S COMMENT SHEET

Your comments on this manual will help us improve it. Please fill in the requested information.

Name of manual: _____

Manual number: UP-_____ revision number_____, including update numbers _____

Name of your company: _____

Address of company: _____

What is your position? _____

Your level of experience: Professional _____ Knowledgeable _____ Novice _____

With what system is the equipment used? _____

How do you use this manual?

As a reference source

As a self-instructional text

As a classroom text

As _____

Please rate this manual

As a reference source: Good Adequate Not adequate

As a text: Good Adequate Not adequate

For other uses: Good Adequate Not adequate

Add your specific comments. Give page and paragraph references where appropriate.

Thank you for your cooperation.

PLEASE SEND US YOUR COMMENTS!

We feel that this manual is an essential part of our equipment. We want to be sure it is the best, most usable manual possible. Your comments will help us achieve this goal. When you have become familiar with the manual, please fill in the other side of this form and mail the form to us. Your reply will be carefully reviewed by the persons responsible for writing and publishing this manual.

FOLD

FIRST CLASS
PERMIT NO. 2540
SALT LAKE CITY,
UTAH

BUSINESS REPLY MAIL NO POSTAGE STAMP NECESSARY IF MAILED IN THE UNITED STATES

POSTAGE WILL BE PAID BY



SPERRY
322 NORTH 2200 WEST
SALT LAKE CITY, UTAH 84116

ATTN: MANAGER, GSD PUBLICATIONS

FOLD

NOTE:

Requests for copies of this manual and other Sperry publications and for assistance in getting the most use out of your Sperry equipment should be directed to your local Sperry representative.