

# communications



**OPERATING and SERVICE  
INSTRUCTIONS**



**the hallicrafters co.**

MANUFACTURERS OF RADIO, TELEVISION AND ELECTRONIC EQUIPMENT, CHICAGO 24, U. S. A.



92X2341

Fig. 1. Model S-85

## SECTION 1. GENERAL DESCRIPTION

Your new Hallicrafters S-85 Communications Receiver offers you the finest in world wide radio reception with continuous frequency coverage from 538 kilocycles to 34 megacycles. You'll hear foreign and domestic shortwave broadcasts, amateurs, police, aircraft, ships, and countless other exciting distant stations ... as well as all your favorite programs on standard broadcast. The receiver employs 7 tubes plus rectifier in the latest type super-heterodyne circuit and provides for the reception of voice and code signals over its entire tuning range. A powerful built-in Alnico V permanent magnet speaker and full range tone control assure lifelike reproduction.

Good reception is usually possible without an outside antenna or ground. In most localities, satisfactory results can be obtained with just the 15-foot antenna wire included with your receiver.

Special features incorporated in your receiver include calibrated electrical bandspread for fine tuning of the amateur and shortwave bands, an automatic series noise limiter circuit for reducing the effects of ignition noise and electrical interference, a front panel jack for headphones, a sensitivity control, an automatic volume control circuit, and a receive-standby switch which permits you to silence the receiver without turning it off.

### IMPORTANT

Your careful attention is especially invited to the installation and operating instructions. They have been provided to insure the satisfaction you have a right to expect from a Hallicrafters "Precision Built" product. Your receiver has an unusually high degree of sensitivity necessary to receive weak and distant stations. Careless operation of a high sensitivity receiver may result in excess noise or background hiss. These undesirable effects can be held to a minimum by careful adjustment of the sensitivity, tuning, and tone controls as well as the proper selection and arrangement of the antenna.



# SECTION 2. INSTALLATION

## 2-1. UNPACKING

After unpacking the receiver, examine it closely for damage which may have occurred in transit. Should any sign of damage be apparent, file a claim immediately with the carrier stating the extent of damage. Carefully check all shipping labels and tags for instructions before removing or destroying them.

## 2-2. LOCATION

The receiver is equipped with rubber mounting feet for table or shelf mounting. When locating the receiver, avoid excessively warm locations such as those near radiators and heating vents. Allow at least one inch of clearance between the back of the receiver and the wall for proper ventilation.

## 2-3. POWER SOURCE

The S-85 receiver is designed to operate from a 105-125 volt, 50-60 cycle AC power source. The universal model, the S-85U, is designed for operation from 110, 130, 150, 220, and 250 volt, 25-60 cycle AC sources. If in doubt about your power source, contact your local power company before plugging in the receiver.

**CAUTION:** The power selector switch on the S-85U is located on the top of the power transformer and is accessible by opening the hinged top cover of the cabinet. This switch must be set to correspond with the voltage at the power outlet before plugging in the receiver. Failure to observe this precaution may result in serious damage.

## 2-4. ANTENNAS

The r-f input of the receiver is designed for operation from either a single-wire antenna, or a half-wave doublet or other tuned antenna with transmission line impedances from 52 to 600 ohms. Antenna connections are made to a three-terminal strip at the rear of the receiver marked "A1", "A2", and "G".

### A. SINGLE WIRE ANTENNA

The simplest antenna and one which will provide satisfactory results throughout the entire tuning range is a conventional single-wire antenna. In most localities, good results can be obtained with just the 15-foot length of antenna wire supplied with the receiver. Simply attach one end of this wire to terminal "A1", connect the jumper link between terminals "A2" and "G", and then run the wire about the room in any convenient manner. (See Fig. 2.) If the receiver is operated in a steel constructed building or where receiving conditions are exceptionally poor, an outside antenna, 50 to 100 feet long, may be necessary. The outside antenna should be erected as high as possible and kept free from surrounding objects. In some locations, reception may be improved by connecting a ground wire (ordinary copper wire) from terminal "G" to a cold water pipe or outside ground rod. While the use of an outside ground rod installed in accordance with Insurance Underwriter's Laboratories requirements is adequate protection against lightning, we strongly recommend an additional connection to the nearest cold water pipe to eliminate any shock hazard.

### B. HALF-WAVE DOUBLET ANTENNA

For top performance, especially on the shortwave and amateur bands, the use of a half-wave doublet or other type of antenna employing a 52 to 600-ohm transmission line is recommended. A typical doublet antenna installation is shown in Fig. 3. The doublet antenna should be cut to the proper length for the most used frequency or band of frequencies. The overall length in feet of a doublet antenna is determined by the following formula:

$$\text{Length in feet} = \frac{468}{\text{Frequency in megacycles}}$$

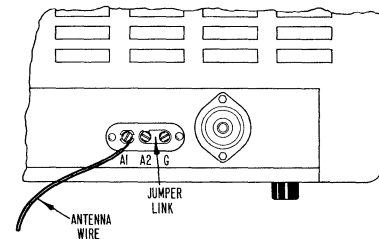

92B432-B

Fig. 2. Single Wire Antenna

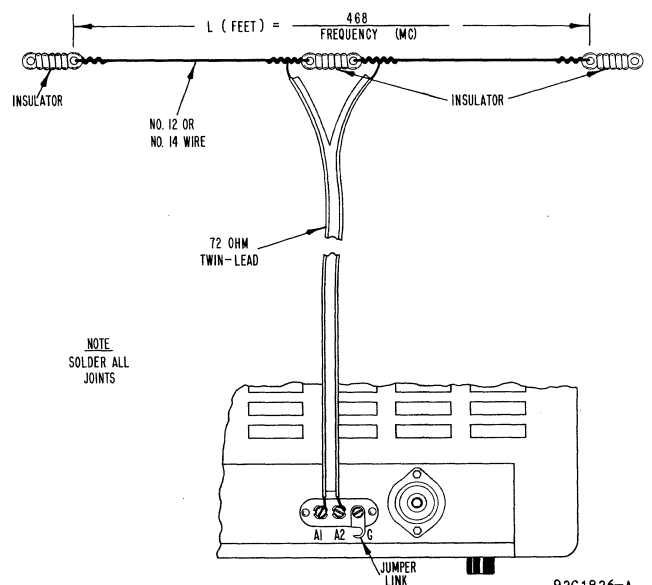

92C1826-A

Fig. 3. Doublet Antenna Using Twin-Lead Lead-In

When erecting the doublet antenna, it should be remembered that it displays directional properties broadside to its length and should be so oriented with respect to a desired station for maximum signal pickup.

The doublet antenna may be fed with either a balanced or unbalanced transmission line. When a balanced transmission line such as "twin-lead" or a twisted pair is used, the transmission line connects to terminals "A1" and "A2", and the jumper link between terminals "A2" and "G" is disconnected. When using an unbalanced transmission line such as coaxial cable, the inner conductor connects to terminal "A1", the outer braid connects to terminal "A2", and the jumper link connects between terminals "A2" and "G". A ground wire may improve reception when using an unbalanced transmission line.

The doublet antenna provides optimum performance only at the frequency for which it is cut. Therefore, it may be desirable for reception on frequencies remote from the antenna frequency to utilize the antenna as a single wire type. This is accomplished by connecting the two transmission line leads together and connecting them to terminal "A1". The jumper link in this case should be connected between terminals "A2" and "G".

In an installation where the receiver is used in conjunction with a transmitter, it may be advantageous to use the same antenna for receiving as for transmitting. This is especially true when a directive antenna is used since the directive effects and power gain of the transmitting antenna are the same for receiving as for transmitting. Switching of the antenna from the transmitter to the receiver may be accomplished with a double-pole, double-throw antenna changeover relay or knife switch connected in the antenna leads.

For further information regarding antennas, refer to the "Radio Amateur's Handbook" or the "A.R.R.L. Antenna Book", both published by the American Radio Relay League, West Hartford, Conn., U.S.A.

## 2-5. HEADPHONES

The headphone jack, marked "Phones", is located on the front panel of the receiver and is wired so that the speaker is automatically disabled when the headphones are plugged in. The headphone output impedance is not critical and any commercial headphones may be used, including crystal types, as no direct current flows in the headphone circuit. For maximum headphone output, the use of crystal phones or high-impedance magnetic phones (5000 ohms or higher) is recommended.

## SECTION 3. OPERATION

Each control of your receiver performs a definite function which contributes to its outstanding reception capabilities. Full appreciation of the receiver is to be expected only after you have become familiar with each of the controls and the effect each control has on the performance of the receiver.

As a special convenience for those not yet familiar with the full advantages of the various controls, the control settings commonly used for broadcast reception are marked with a dot.

**SENSITIVITY Control** — The Sensitivity control is used in conjunction with the Volume control to regulate receiver volume. The setting of the Sensitivity control determines the ability of the receiver to pick up weak distant stations.

For AM reception, the Sensitivity control should normally be set fully clockwise for maximum signal pickup. In some instances, the signal may be too strong with the control set at maximum and as a result, may sound distorted or cause excessive background noise or hiss. When this occurs, simply reduce the sensitivity of the receiver slightly by turning the control counterclockwise. If after decreasing the sensitivity you need more volume, use the Volume control.

For CW reception, set the Volume control at a well advanced position and vary the receiver volume level by means of the Sensitivity control, taking care not to advance the control to a point where strong signals will cause excessive "thumping". (overloading).

**BAND SELECTOR Control** — The Band Selector control should be set for the band you wish to tune. The four positions of this control correspond to the band numbers at the bottom of the left-hand or main tuning dial.

**VOLUME Control** — This control is used to regulate receiver volume. Clockwise rotation increases volume; counterclockwise rotation decreases volume.

**AVC Switch** — The AVC switch, when set at "ON", places the automatic volume control circuit in operation to maintain a uniform volume level regardless of variations in signal strength at the antenna. For AM reception, this switch should normally be set at "ON". For CW reception, the switch should be set at "OFF".

**NOISE LIMITER Switch** — This switch should normally be set at "OFF". If severe electrical disturbances, ignition noise, or other types of pulse-type noise interfere with reception, set the switch at "ON" to place the automatic noise limiter circuit in operation.

**AM-CW Switch** — Set this switch at "AM" to listen to voice broadcasts. Set it at "CW" only if you wish to hear code signals.

**TONE Control** — The Tone control is a combination receiver on-off switch and 3-position tone control. In the "PWR OFF" position, the receiver is inoperative. To turn the receiver on, simply rotate the control to any of its three remaining positions. For AM reception, set the control for the desired tonal quality. For CW reception, set the control at "LOW".

**PITCH Control** — This control is used to vary the pitch of code signals and should be set for the tone most pleasing to the operator. For this control to have any effect, the AM-CW switch must be set at "CW".

**STANDBY-REC Switch** — This switch, normally set at "REC", permits you to silence the receiver without turning it off. To silence the receiver, set the switch at "STANDBY". In this position, the r-f and i-f stages are cut off but the tube heaters remain at operating temperature for instant use. To resume reception at any time, simply return the switch to the "REC" position.

**TUNING and BANDSPREAD Controls** — The Tuning and Bandsread controls are used in conjunction with one another to tune in the desired signal. Wide tuning is performed with the Tuning control and fine tuning with the Bandsread control.

**Main Tuning Dial.** The main tuning or left-hand dial is operated by the Tuning control. This dial has four calibrated scales, one for each of the four frequency bands covered by the receiver. It also contains a 100-division logging scale for accurately logging and relocating stations of special interest. The main tuning dial should be set for the desired station frequency after the Bandsread control has been set fully clockwise (bandsread tuning capacitor set at minimum capacity).

**IMPORTANT:** The readings on the main tuning dial will correspond to the station frequencies only if the Bandsread control is set fully clockwise. If it is set at any other setting, the additional bandsread capacity added to the main tuning capacity will throw off the main tuning dial calibration because the receiver has been calibrated with the bandsread tuning capacitor set at minimum capacity.

The dial settings for the 80, 40, 20, 15, and 11-10 meter amateur bands are indicated on the main tuning dial by white dots. When tuning the amateur bands with the bandsread dial, the main tuning dial must be set at the dot corresponding to the desired amateur band. The 160 meter amateur band is indicated on the dial by three short double-weight lines.

**Bandsread Dial.** The bandsread or right-hand dial is operated by the Bandsread control. This dial contains five scales calibrated for the 80, 40, 20, 15, and 11-10 meter amateur bands. These five scales are calibrated to read receiver frequency directly when the main tuning dial has been set to the index dot of the desired amateur band. For convenience in tuning, the AM phone bands are indicated on the bandsread dial by double-weight lines.

In addition to its use on the amateur bands, the bandsread dial may also be utilized as a fine tuning adjustment over any portion of the receiver tuning range. Two methods of fine tuning are described below.

a. The first method of fine tuning is used when it is desired to tune in a single signal with precision accuracy. First the Bandsread control is set a few degrees from its full clockwise position, then the desired signal is located with the Tuning control, and finally the signal is accurately tuned in by "rocking" the Bandsread control (turning it slightly to the left and right) until the signal is loudest and clearest.

b. The second method of fine tuning is used when it is desired to tune through a range of frequencies, such as a group of shortwave stations. Set the Bandsread control fully clockwise, set the Tuning control for the high end of the selected range of frequencies, and then tune through the range with the Bandsread control. Turning the Bandsread control counterclockwise tunes the receiver progressively lower in frequency.

**SERVICE OR OPERATING QUESTIONS** — For any further information regarding operation or servicing of your receiver, contact your Hallicrafters dealer. The Hallicrafters Co. maintains an extensive system of authorized service centers where any required service will be performed promptly and efficiently at a nominal charge. All Hallicrafters Authorized Service Centers display the sign shown at the right. For the location of the one nearest you, consult your dealer or telephone directory.

The Hallicrafters Co. reserves the privilege of making revisions in current production of equipment and assumes no obligation to incorporate these revisions in earlier models.



92X1401-C

## SECTION 4. ALIGNMENT

This receiver has been carefully aligned at the factory by specially trained personnel using precision equipment. Alignment of the receiver should not be attempted until all other possible causes of faulty operation have been investigated. Alignment should not be required unless the receiver has been tampered with or component parts have been replaced in the r-f or i-f stages. Alignment should only be made by persons familiar with communications receivers and experienced in their alignment. Refer to Figs. 5 and 6 for location of all alignment adjustments.

### 4-1. EQUIPMENT REQUIRED

1. Signal generator covering 455 KC to 28 MC. Use modulated output for every step except step 2.
2. Output meter (or AC scale of VTVM). Connect meter across speaker voice coil terminals.
3. Non-metallic alignment tool.
4. Standard RTMA dummy antenna shown in Fig. 4.
5. 0.02 mfd. capacitor.

### 4-2. INITIAL CONTROL SETTINGS

Band Selector . . . . . As indicated in chart.  
Sensitivity and Volume . . . . . Maximum  
AM-CW . . . . . AM  
Noise Limiter and AVC . . . . . Off  
Rec-Standby . . . . . Rec  
Tone . . . . . High  
Bandsread . . . . . Fully clockwise  
Tuning . . . . . As indicated in chart.

### 4-3. ALIGNMENT PROCEDURE

- The local oscillator frequency is higher than the signal frequency on bands 1, 2, and 3, and lower than the signal frequency on band 4.
- RF alignment can be made with chassis in cabinet. Holes in bottom of cabinet provide access to all RF adjustments.
- For IF alignment, remove chassis from cabinet.
- Use just enough generator output to maintain a 500 milliwatt reading on the output meter.

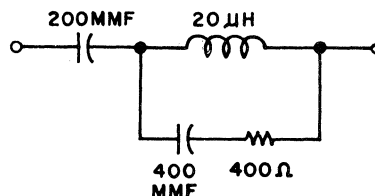

Fig. 4. RTMA Dummy Antenna

92A1549

#### IF ALIGNMENT

Step	Signal Generator Connections	Generator & Receiver Frequency	Band Selector Setting	Adjust for Maximum Output
1	High side thru .02 mfd capacitor to pin 8 of 6SA7 converter tube (V-2); low side to chassis.	Gen - 455 KC Rec - 1.0 MC	1	Top and bottom slugs of T1 (1st IF), T2 (2nd IF), and T3 (3rd IF).
2	"	" (Unmod.)	"	Remove Pitch Control knob and set AM-CW switch at "CW". Using speaker as indicator, adjust L11 (BFO) for "zero beat". After completing the adjustment replace knob with indicator line in top center position and return AM-CW switch to "AM".

#### RF ALIGNMENT

3	High side thru RTMA dummy antenna (Fig. 4) to antenna terminal "A1"; low side to "A2". Jumper between "A2" and "G".	28.0 MC	4	C19 (osc. trimmer), C12 (mixer trimmer), and C1 (antenna trimmer)
		14.0 MC	"	L7 (osc. slug), L4 (mixer slug), and L1 (antenna slug)
4	"	11.0 MC	3	C20 (osc. trimmer), C13 (mixer trimmer), and C2 (antenna trimmer)
		5.1 MC	"	L8 (osc. slug), L5 (mixer slug), and L2 (antenna slug)
5	"	4.0 MC	2	C21 (osc. trimmer), C14 (mixer trimmer), and C3 (antenna trimmer)
		1.8 MC	"	L9 (osc. slug)
6	"	1.4 MC	1	C22 (osc. trimmer), C15 (mixer trimmer), and C4 (antenna trimmer)
		.6 MC	"	C25 (osc. padder)

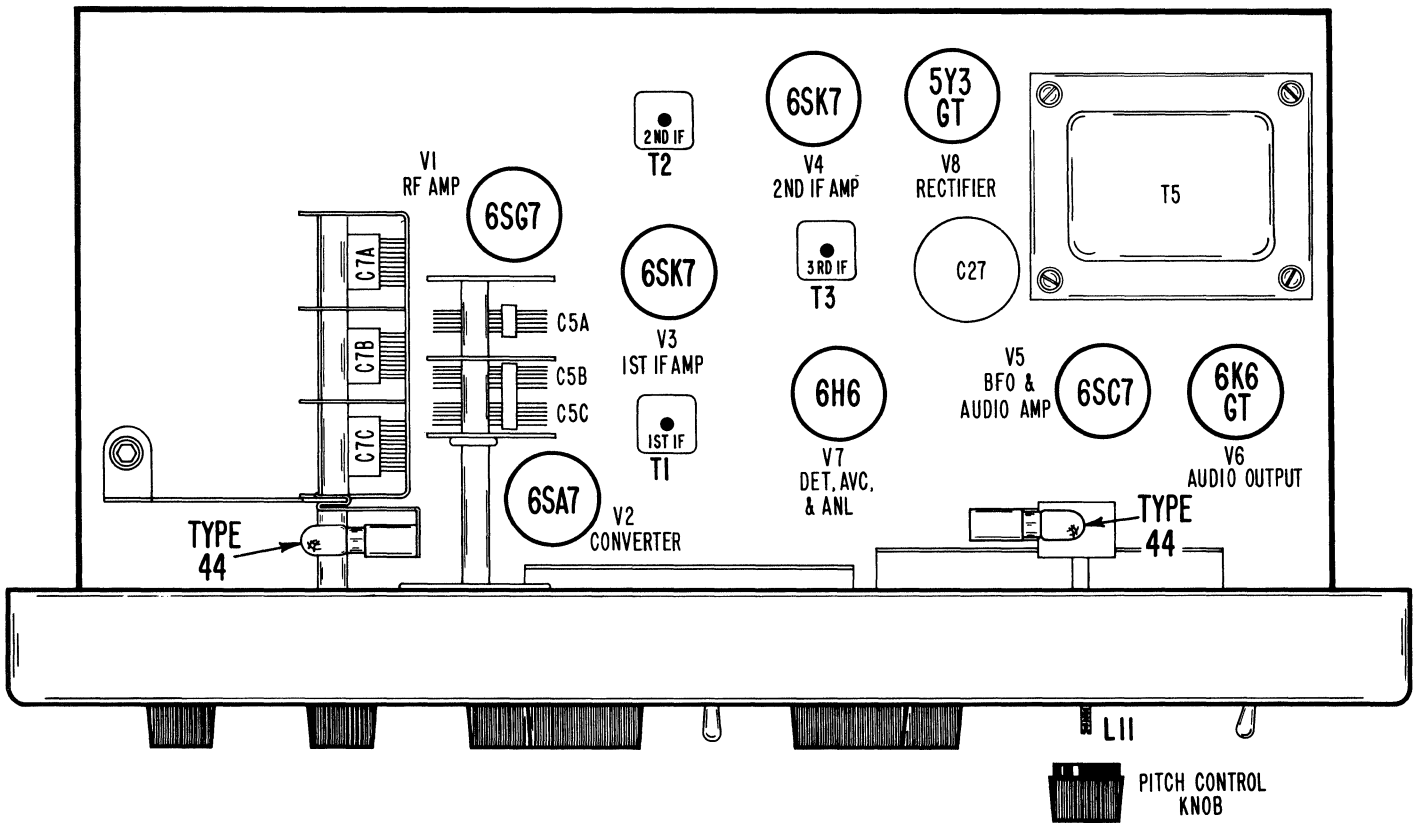

92C2340

Fig. 5. Top View of Chassis Showing Tube Locations and Alignment Adjustments

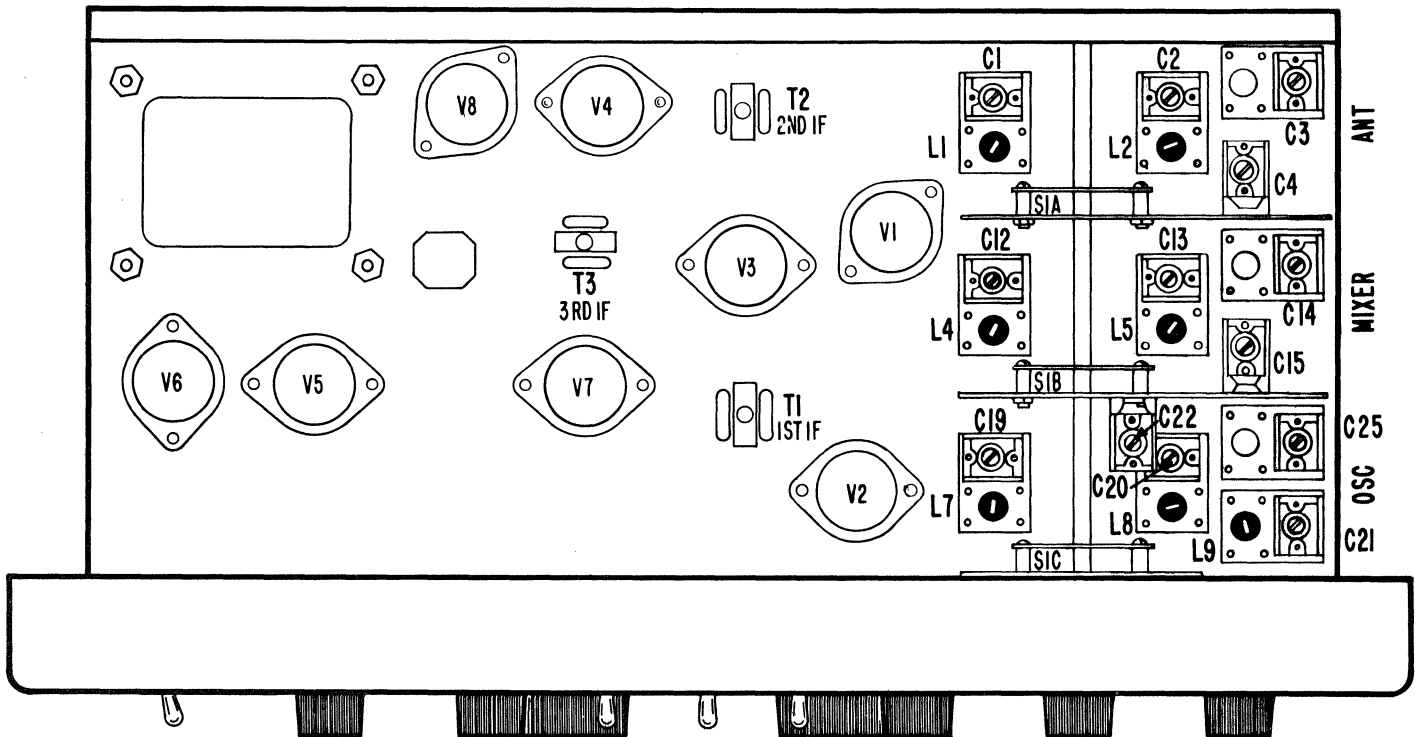

92C2342

Fig. 6. Bottom View of Chassis Showing Tube Locations and Alignment Adjustments

# SECTION 5. SERVICE DATA

## 5-1. TECHNICAL SPECIFICATIONS

TUBES: . . . . . Eight including rectifier  
 SPEAKER: . . . . . 5-inch PM; 3.2-ohm voice coil  
 HEADPHONE OUTPUT: . . . . . High impedance  
 (See Section 2-5.)  
 ANTENNA INPUT: . . . . . For single wire or 52-600  
 ohm balanced or unbalanced line.  
 POWER SOURCE:  
 Model S-85 . . . 105-125 volts, 50-60 cycles AC  
 Model S-85U . . 100-250 volts, 25-60 cycles AC  
 POWER CONSUMPTION: . . . . . 75 watts  
 RECEPTION: . . . . . AM and CW  
 INTERMEDIATE FREQUENCY: . . . . . 455 KC  
 SIZE: . . . . . 18-1/2 x 9 x 10-5/8" deep  
 WEIGHT: . . . . . Net-27 1/2 lb., Shipping-32 lb.

### FREQUENCY COVERAGE

Band	Frequency Range	Calibrated Band Spread
1	.538 - 1.6 MC	-
2	1.55 - 4.6 MC	80M
3	4.6 - 13.0 MC	40M
4	12.0 - 34.0 MC	20, 15, and 11-10M

## 5-2. TUBE and DIAL LAMP REPLACEMENT

To gain access to the tubes and dial lamps, raise the hinged top cover of the cabinet. The tube locations, as well as their functions, are shown in Fig. 5.

## 5-3. CHASSIS REMOVAL

The chassis and front panel assembly are removable from the cabinet as a unit by removing the two screws at each side of the front panel and the six screws on the underside of the cabinet. When removing the chassis from the cabinet, care should be taken not to damage the brass adjusting screws on the oscillator slugs (L-7-8-9-10). Refer to Figure 6 for location.

## 5-4. DIAL CORD RESTRINGING

To restring the tuning or bandspread dials, first remove the front panel from the cabinet by removing the control knobs, the toggle switch and Phones jack mounting nuts, the two screws at each side of the front panel, and the three screws on the underside of the front panel. Then remove the tuning dials to gain access to the drive pulleys. For stringing details, refer to Fig. 7. Note that stringing is done with the tuning and bandspread gangs fully meshed. After stringing is completed, cut off the excess dial cord and apply a drop of quick drying cement to the knots.

With the tuning and bandspread gangs fully meshed, replace the dials so that the index marks at the low frequency end of the dial are in line with the hairline on the dial window.

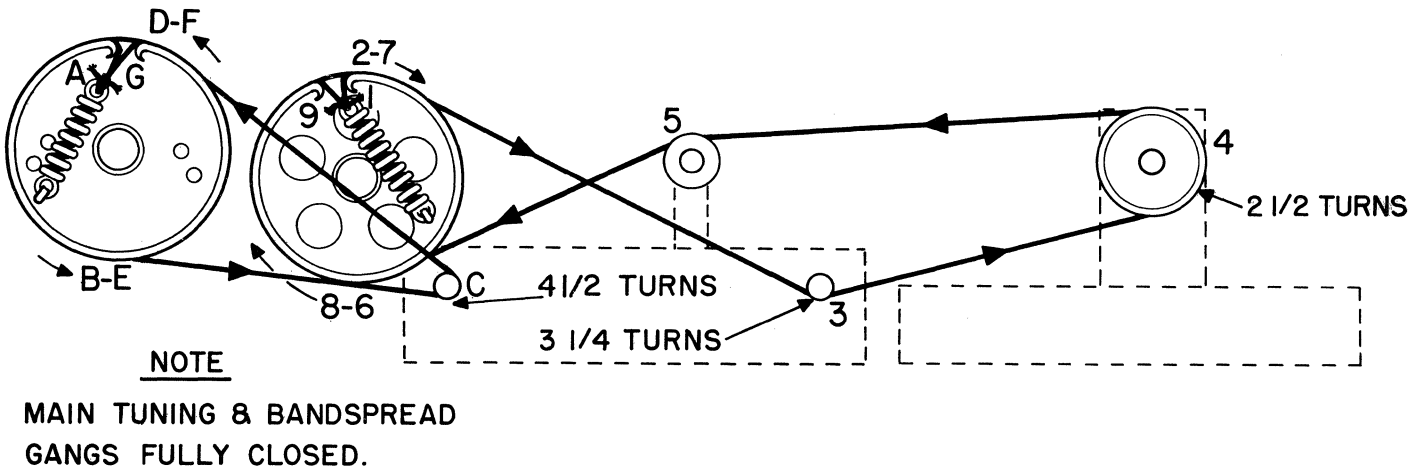

Fig. 7. Dial Cord Stringing Diagram

092-302339-B



# SERVICE PARTS LIST

Schematic Symbol	Description	Hallicrafters Part Number	Schematic Symbol	Description	Hallicrafters Part Number	Schematic Symbol	Description	Hallicrafters Part Number
<b>CAPACITORS</b>			<b>*RESISTORS (CON'T)</b>			<b>TUBES AND LAMPS (CON'T)</b>		
C-1, 12	4-80 mmf, mica trimmer	044-100395	R-30, 68	10 ohms, 20%, 1/2 watt	451-253100	V-7	6H6, detector, ANL, and AVC	090-900847
C-2, 13	3-30 mmf, mica trimmer	044-100396	R-32	1.5K ohms, 10%, 10 watts	453-062152	V-8	5Y3GT, rectifier	090-901111
C-3, 14	1.5-15 mmf, mica trimmer	044-200147	R-33	15 megohms, 20%, 1/2 watt	451-253156	LM-1, 2	Lamp, dial; type 44	039-100003
C-4, 15, 22	2-20 mmf, mica trimmer	044-100191	R-34	10K ohms, 20%, 1/2 watt	451-253103	<b>MISCELLANEOUS</b>		
C-5	Variable capacitor, 3 sections; bandspread tuning (includes pulley)	048-300342	R-35	27 ohms	451-252270			
C-7	Variable capacitor, 3 section main tuning (includes pulley)	048-300341	R-62	560K ohms	451-252564			
C-8, 32, 35, 58, 60	0.05 mfd., 200V., molded paper	499-012503	R-63	6.8 ohms, 10%, 1 watt	451-352068			
C-9, 28	0.05 mfd., 600V., molded paper	499-032503	R-64	330 ohms	451-252331			
C-10	22 mmf., 500V., cer.	491-107220-95	R-67	330K ohms	451-252334			
C-11	2.2 mmf., 500V., bakelite	047-100160-04	<b>**All resistors 10%, 1/2 watt, carbon type unless otherwise specified.</b>					
C-16	390 mmf., 10%, 500V.; mica	470-213391	<b>***Some units have a 12K ohm, 4 watt, ww resistor replacing R-10, 69 . . . . . 024-101062.</b>					
C-17, 53	0.01 mfd., 600V., molded paper	499-032103	<b>***COILS AND TRANSFORMERS</b>					
C-18	150 mmf., 5% 500V.; mica	470-222151	<b>Coil, antenna</b>					
C-19	4-70 mmf., mica trimmer	044-100149	L-1, C-1	Band 4	051-201907	Cabinet, front panel (Mark 1B Only)	068-500612	
C-20, 21	2-30 mmf., mica trimmer	044-100148	L-2, C-2	Band 3	051-201908	Cabinet bottom section	066-401074	
C-23	3300 mmf., 5% 500V.; mica	470-422332	L-3, C-3	Bands 1 and 2	051-201909	Cabinet top cover	066-401073	
C-24	1500 mmf., 2% 500V.; mica	470-421152	<b>Coil, mixer</b>			Cabinet front panel (Mark 1A Only)	068-500336	
C-25	320-520 mmf., mica padder	044-100394	L-4, C-12	Band 4	051-201905	Clip, mtg.; for T-1, T-2, and T-3	076-100385	
C-27	30-10-10 mfd. @450V., electrolytic	045-100062	L-5, C-13	Band 3	051-201906	Clip, tubular; for mtg. medallion	076-100637	
C-29, 33	220 mmf., 10%, 500V.; mica	470-213221	L-6, C-14	Bands 1 and 2	051-201904	Dial cord (specify length)	038-100026	
C-31, 43	0.02 mfd, 200V., molded paper	499-012203	<b>Coil, oscillator</b>			Dial, bandspread	083-400561	
C-38	2 mmf., wire gimmick	-----	L-7, C-19	Band 4	051-201900	Dial, tuning	083-400560	
C-39	0.1 mfd, 600V., molded paper	499-032104	L-8, C-20	Band 3	051-201899	Foot, mounting	016-100007	
C-41, 42	47 mmf., 20%, 500V.; mica	470-214470	L-9, C-21	Band 2	051-201898	rubber	016-100007	
C-44, 45	270 mmf., 10%, 500V.; mica	470-213271	L-10, C-22	Band 1	051-201897	Gasket, rubber	016-200929	
C-45, 48, 52, 63	0.02 mfd., 600V.; molded paper	499-032203	<b>Coil, BFO</b>			Grommet, rubber	016-100034	
C-47	0.0022 mfd., 20%, 1000 V. molded paper	499-042222	T-1, 2	Transformer, 1st and 2nd IF	050-300243	tuning gang front mtg.	016-100014	
C-54	470 mmf., 5% 500V.; mica	470-212471	T-3	Transformer, IF; detector stage	050-300242	tuning gang rear mtg. speaker mtg.	016-100128	
C-56	0.01 mfd. 600V., molded tubular	499-034103	T-4	Transformer, audio output	055-200093	"h" medallion	007-100588	
C-57	0.001 mfd. 20%, 500V.; mica	470-314102	T-5	Transformer, power for Model S-85	052-100209	Knob, Band Selector and Pwr. Off-Tone	015-200791	
C-61	0.25 mfd. 200V., molded paper	499-012254	<b>Transformer, power for Model S-85U</b>			Knob, Pitch Control	015-200788	
C-64	10 mfd. 25V., electrolytic	045-100121	<b>***Coils L-1 thru L-10 are supplied complete with trimmer capacitor. Trimmers are also available separately. See "Capacitors".</b>			Knob, Sensitivity and Volume	015-200322	
<b>*RESISTORS</b>			<b>SWITCHES</b>			<b>LS-1</b>		
R-1, 61	1 megohm, 20%, 1/2 watt	451-253105	S-1A	antenna stage	060-200389	Spacer, bakelite; .156" id, 1/2" od, 1/4" th.	008-100723	
R-2	120 ohms	451-252121	S-1B	mixer stage	062-200039	Speaker, 5-inch PM;	085-200050	
R-3	10K ohms, Variable (Sensitivity)	025-200590	S-1C	oscillator stage	062-200044	3.2 ohm voice coil	085-200050	
R-4, 31	22 ohms, 20%, 1/2 watt	451-253220	S-2, 3, 5	Switch, spst toggle; Standby-Rec.	060-100138	Spring, dial cord tension	075-100163	
R-5	39K ohms, 10%, 1 watt	451-352393	6	Noise Limiter, AVC, and AM-CW	060-100225	Terminal strip, antenna	088-100032	
R-6, 26	6.8K ohms, 1 watt	451-352682	S-4	Switch, rotary; Pwr Off-Tone	060-100225	Tuning slug for antenna, mixer, and oscillator coils	077-100068	
R-7, 28	22K ohms	451-252223	<b>Selector Switch</b>			Washer, spring type; .27" id, .495" od	004-100043	
R-8	10K ohms, 10%, 2 watts	451-552103	<b>JACKS, PLUGS, AND SOCKETS</b>			Washer, spring type; 3/16" id, 3/8" od	004-101557	
R-9, 11	470 ohms	451-252471	J-1	Jack, Phones	036-100002	Window, bandspread dial (Mark 1A Only)	022-200432	
** R-10, 69	24K ohms, 5%, 2 watts	451-551243	PL-1	Line cord and plug	087-100078	Window, tuning dial (Mark 1A Only)	022-200427	
R-11, 18, 65	1K ohm	451-252102	<b>Socket, dial lamp (with lead)</b>			Window, bandspread dial (Mark 1B Only)	022-200565	
R-12	2.2 megohms, 20%, 1/2 watt	451-253225	<b>Socket, tube; octal</b>			Window, tuning dial (Mark 1B Only)	022-200562	
R-14	47K ohms, 20%, 1/2 watt	451-253473	<b>TUBES AND DIAL LAMPS</b>			<b>V-1</b> 6SG7; RF amplifier 090-901181 <b>V-2</b> 6SA7; converter 090-901180 <b>V-3, 4</b> 6SK7; 1st and 2nd IF amplifiers 090-901233 <b>V-5</b> 6SC7; BFO and audio amplifier 090-900874 <b>V-6</b> 6K6GT; audio output 090-900856		
R-15, 29, 58	100K ohms, 20%, 1/2 watt	451-253104	<b>V-1</b>					
R-20	500K ohms, Variable (Volume)	025-100534	<b>V-2</b>					
R-21	150 ohms, 20%, 1/2 watt	451-253151	<b>V-3, 4</b>					
R-22, 60	270K ohms	451-252274	<b>V-5</b>					
R-23	470K ohms, 20%, 1/2 watt	451-253474	<b>V-6</b>					
R-24	270 ohms, 10%, 1 watt	451-352271	<b>V-1</b>					
R-25	15K ohms, 20%, 1 watt	451-353153	<b>V-2</b>					
R-27, 66	47K ohms, 10%, 1 watt	451-352473	<b>V-3, 4</b>					

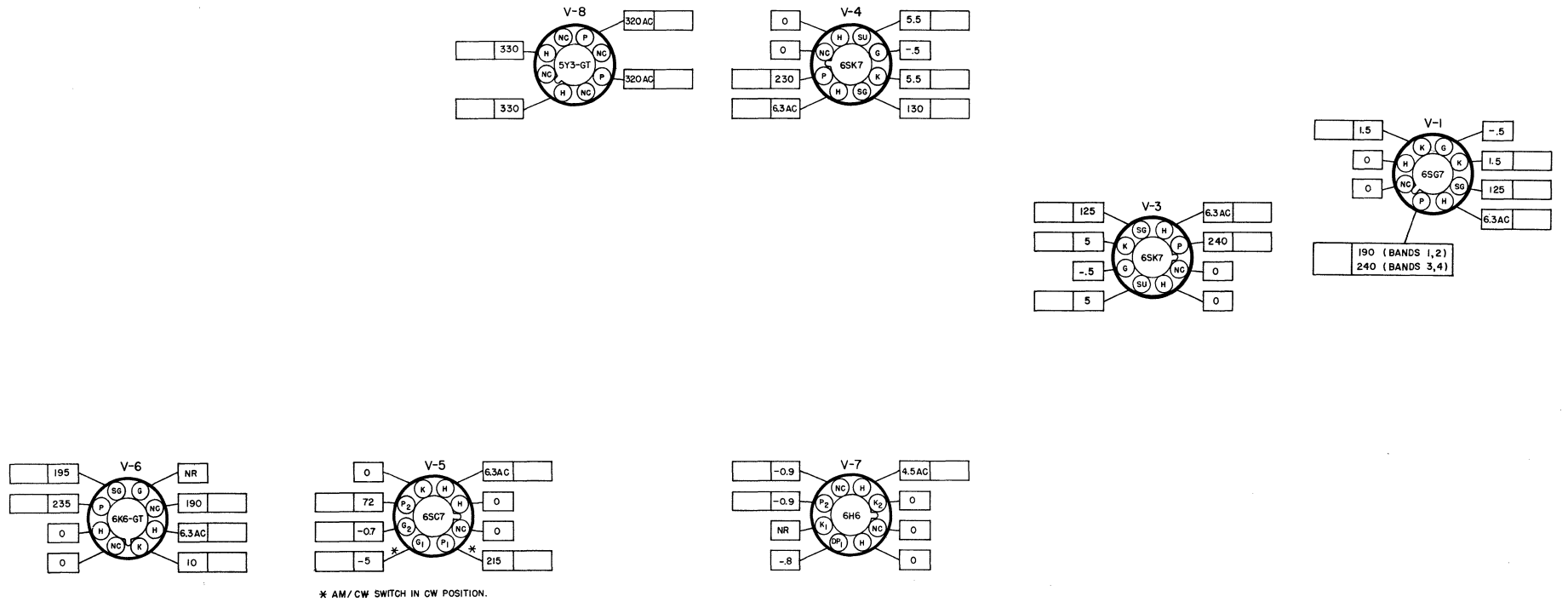

\* AM/CW SWITCH IN CW POSITION.

CONTROL	SETTING
SENSITIVITY	FULL CLOCKWISE
AVC	ON
CW/AM	AM
NOISE LIMITER	OFF
STANDBY/RECEIVE	RECEIVE

NOTES-

1. SOCKET VIEWS ARE BOTTOM VIEWS.
2. ALL VOLTAGES ARE MEASURED BETWEEN TUBE SOCKET TERMINALS AND CHASSIS WITH ZERO SIGNAL INPUT.
3. LINE VOLTAGE 117 V, 60 CYCLES AC.
4. ALL VOLTAGES ARE DC UNLESS OTHERWISE SPECIFIED.
5. DC VOLTAGES SHOWN WERE MEASURED WITH A VACUUM TUBE VOLTMETER.
6. \*NC\*-NO CONNECTION (VOLTAGE SHOWN FOR THIS TERMINAL IS USED AS A TIE LUG)
7. \*NR\*-NOT READABLE (READING GENERALLY MEANINGLESS)
8. □ SPACE PROVIDED FOR SERVICE METER READINGS.

FRONT APRON  
BOTTOM VIEW OF CHASSIS

Fig. 8. Voltage Chart

**NOTES**

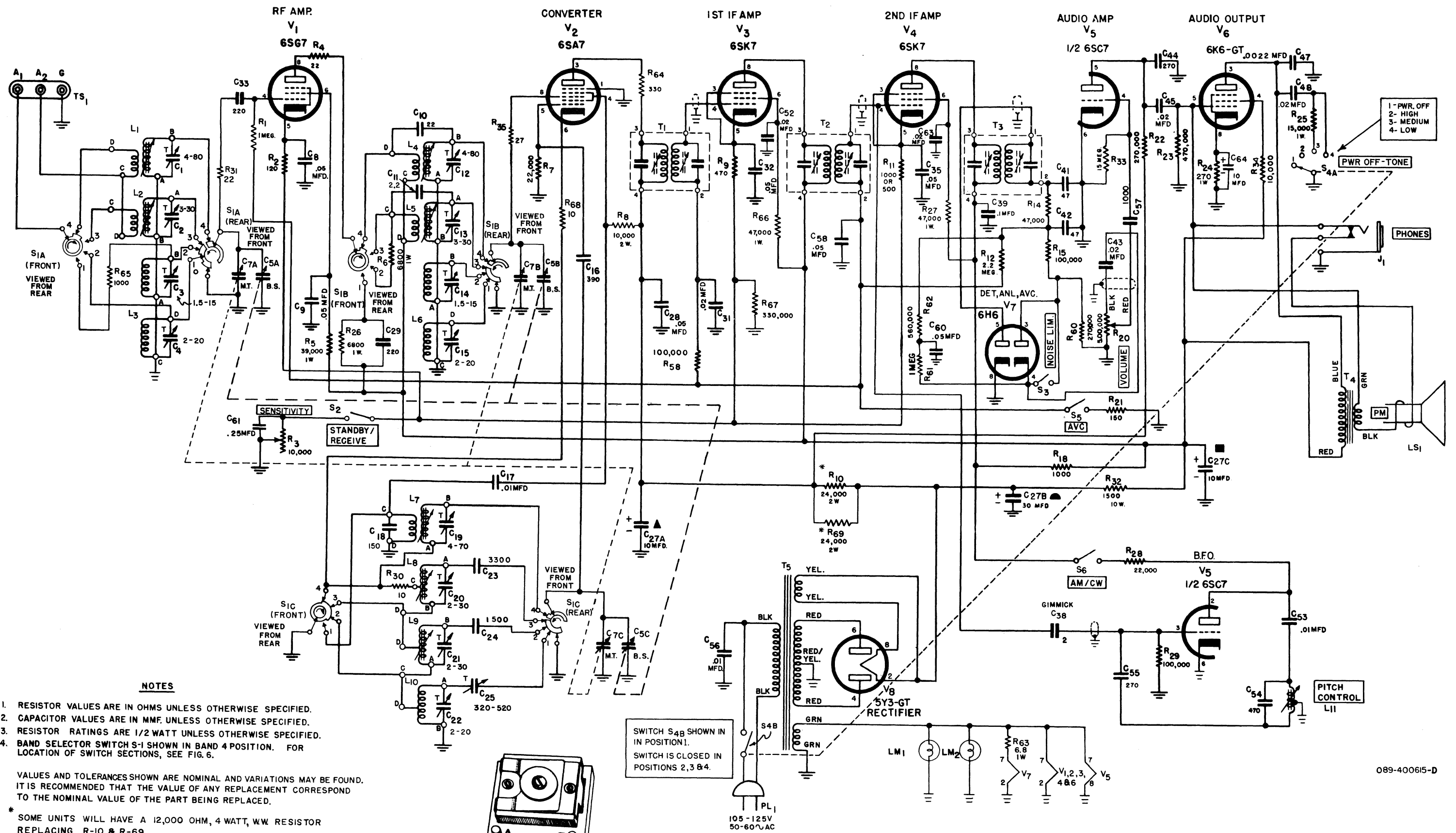

**NOTES**

1. RESISTOR VALUES ARE IN OHMS UNLESS OTHERWISE SPECIFIED.
2. CAPACITOR VALUES ARE IN MMF. UNLESS OTHERWISE SPECIFIED.
3. RESISTOR RATINGS ARE 1/2 WATT UNLESS OTHERWISE SPECIFIED.
4. BAND SELECTOR SWITCH S-1 SHOWN IN BAND 4 POSITION. FOR LOCATION OF SWITCH SECTIONS, SEE FIG. 6.

VALUES AND TOLERANCES SHOWN ARE NOMINAL AND VARIATIONS MAY BE FOUND. IT IS RECOMMENDED THAT THE VALUE OF ANY REPLACEMENT CORRESPOND TO THE NOMINAL VALUE OF THE PART BEING REPLACED.

\* SOME UNITS WILL HAVE A 12,000 OHM, 4 WATT, WW RESISTOR REPLACING R-10 & R-69.

LAST R SYMBOL R-69  
LAST C SYMBOL C-64

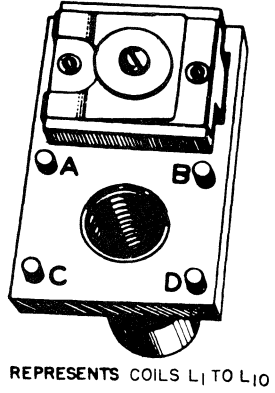

SWITCH S4B SHOWN IN POSITION 1. SWITCH IS CLOSED IN POSITIONS 2, 3 & 4.

089-400615-D

**MODELS S-85 & S-85U  
MARK 1A & 1B**



## Warranty

*"The Hallicrafter's Company warrants each new radio product manufactured by it to be free from defective material and workmanship and agrees to remedy any such defect or to furnish a new part in exchange for any part of any unit of its manufacture which under normal installation, use and service discloses such defect, provided the unit is delivered by the owner to our authorized radio dealer, wholesaler, from whom purchased, or, authorized service center, intact, for examination, with all transportation charges prepaid within ninety days from the date of sale to original purchaser and provided that such examination discloses in our judgment that it is thus defective.*

*This warranty does not extend to any of our radio products which have been subjected to misuse, neglect, accident, incorrect wiring not our own, improper installation, or to use in violation of instructions furnished by us, nor extend to units which have been repaired or altered outside of our factory or authorized service center, nor to cases where the serial number thereof has been removed, defaced or changed, nor to accessories used therewith not of our own manufacture.*

*Any part of a unit approved for remedy or exchange hereunder will be remedied or exchanged by the authorized radio dealer or wholesaler without charge to the owner.*

*This warranty is in lieu of all other warranties expressed or implied and no representative or person is authorized to assume for us any other liability in connection with the sale of our radio products."*

Form No. 94X622

*the Hallicrafters co.*