



communications

**OPERATING and SERVICE
INSTRUCTIONS**

**SX-99
&
SX-99U**
Mark IB,
IC & ID

the hallicrafters co.

MANUFACTURERS OF RADIO, TELEVISION AND ELECTRONIC EQUIPMENT, CHICAGO 24 U. S. A.



92X2385

Fig. 1. Model SX-99

SECTION 1. GENERAL DESCRIPTION

Your new Hallicrafters Model SX-99 is a precision built, highly sensitive, communications receiver providing complete coverage in the frequency range of 538 kilocycles to 34 megacycles. Eight tubes, including one rectifier, are employed in the latest superheterodyne circuit and provision is made for the reception of AM or CW signals over the entire tuning range.

For ease and flexibility of operation two large circular dials are provided. One provides the general frequency coverage and the electrical BANDSPREAD control provides a vernier tuning adjustment throughout the entire tuning range of the receiver. The bandspread dial is specifically calibrated for the 80, 40, 20, 15 and 10 meter bands.

For the ultimate in selectivity a variable crystal filter system and crystal phasing control can be peak adjusted to receive those "hard to get signals". In addition an automatic noise limiter circuit can be switched into operation. This combination provides the means of receiving many signals that would be lost in background noise with ordinary receiving equipment.

A new smartly styled "S" meter provides a professional aid for accurate tuning and a means of determining the relative strength of received signals.

Other special features include full range tone control, sensitivity control with provision for the optional use of AVC, a receive - standby switch that permits silencing the receiver while maintaining it ready for instant use without waiting for the tubes to warm up, output connections to match either an external speaker or 500 ohm line and a headphone jack mounted on the front panel. To permit adjustment for optimum performance with a variety of antenna systems a special antenna trimmer control has been included on the front panel.

IMPORTANT

Your careful attention is especially invited to the installation and operating instructions. They have been provided to insure the satisfaction you have a right to expect from any Hallicrafters "Precision Built" product. Your receiver has an unusually high degree of sensitivity necessary to receive weak and distant stations. Careless operation of a high sensitivity receiver may result in excess noise or background hiss. These undesirable effects can be held to a minimum by careful adjustment of the sensitivity, tuning, and tone controls as well as the proper selection and arrangement of the antenna.

SECTION 2. INSTALLATION

2-1. UNPACKING

After unpacking the receiver, examine it closely for damage which may have occurred in transit. Should any sign of damage be apparent, file a claim immediately with the carrier stating the extent of damage. Carefully check all shipping labels and tags for instructions before removing or destroying them.

2-2. LOCATION

The receiver is equipped with rubber mounting feet for table or shelf mounting. When locating the receiver, avoid excessively warm locations such as those near radiators and heating vents. Allow at least one inch of clearance between the back of the receiver and the wall for proper ventilation.

2-3. POWER SOURCE

The SX-99 receiver is designed to operate from a 105-125 volt, 50-60 cycle AC power source. The universal model, the SX-99U, is designed for operation from 110, 130, 150, 220, and 250 volt, 25-60 cycle AC sources. If in doubt about your power source, contact your local power company before plugging in the receiver.

CAUTION : The power selector switch on the SX-99U is located on the top of the power transformer and is accessible by opening the hinged top cover of the cabinet. This switch must be set to correspond with the voltage at the power outlet before plugging in the receiver. Failure to observe this precaution may result in serious damage.

2-4. ANTENNAS

The r-f input of the receiver is designed for operation from either a single-wire antenna, or a half-wave doublet or other tuned antenna with transmission line impedances from 52 to 600 ohms. Antenna connections are made to a three-terminal strip at the rear of the receiver marked "A1", "A2", and "G".

A. SINGLE WIRE ANTENNA

The simplest antenna and one which will provide satisfactory results throughout the entire tuning range is a conventional single-wire antenna. In most localities, good results can be obtained with just the 15-foot length of antenna wire supplied with the receiver. Simply attach one end of this wire to terminal "A1", connect the jumper link between terminals "A2" and "G", and then run the wire about the room in any convenient manner. (See Fig. 2.) If the receiver is operated in a steel constructed building or where receiving conditions are exceptionally poor, an outside antenna should be erected as high as possible and kept free from surrounding objects. In some locations, reception may be improved by connecting a ground wire (ordinary copper wire) from terminal "G" to a cold water pipe or outside ground rod. While the use of an outside ground rod installed in accordance with Insurance Underwriter's Laboratories requirements is adequate protection against lightning, we strongly recommend an additional connection to the nearest cold water pipe to eliminate any shock hazard.

B. HALF-WAVE DOUBLET ANTENNA

For top performance, especially on the shortwave and amateur bands, the use of a half-wave doublet or other type of antenna employing a 52 to 600-ohm transmission line is recommended. A typical doublet antenna installation is shown in Fig. 3. The doublet antenna should be cut to the proper length for the most used frequency or band of frequencies. The overall length in feet of a doublet antenna is determined by the following formula:

$$\text{Length in feet} = \frac{468}{\text{Frequency in megacycles}}$$

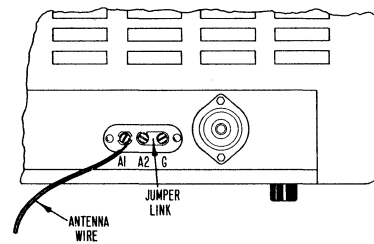

Fig. 2. Single Wire Antenna

92B432-B

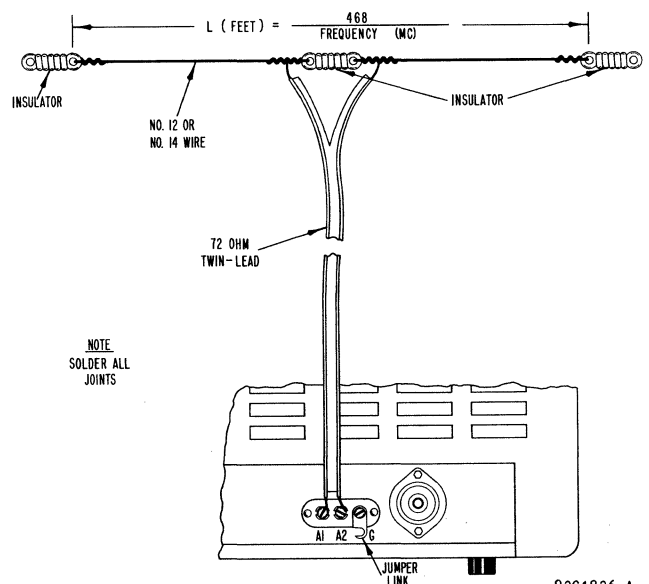

Fig. 3. Doublet Antenna Using Twin-Lead Lead-In

92C1826-A

When erecting the doublet antenna, it should be remembered that it displays directional properties broadside to its length and should be so oriented with respect to a desired station for maximum signal pickup.

The doublet antenna may be fed with either a balanced or unbalanced transmission line. When a balanced transmission line such as "twin-lead" or a twisted pair is used, the transmission line connects to terminals "A1" and "A2", and the jumper link between terminals "A2" and "G" is disconnected. When using an unbalanced transmission line such as coaxial cable, the inner conductor connects to terminal "A1", the outer braid connects to terminal "A2", and the jumper link connects between terminals "A2" and "G". A ground wire may improve reception when using an unbalanced transmission line.

The doublet antenna provides optimum performance only at the frequency for which it is cut. Therefore, it may be desirable for reception on frequencies remote from the antenna frequency to utilize the antenna as a single wire type. This is accomplished by connecting the two transmission line leads together and connecting them to terminal "A1". The jumper link in this case should be connected between terminals "A2" and "G".

In an installation where the receiver is used in conjunction with a transmitter, it may be advantageous to use the same antenna for receiving as for transmitting. This is especially true when a directive antenna is used since the directive effects and power gain of the transmitting antenna are the same for receiving as for transmitting. Switching of the antenna from the transmitter to the receiver may be accomplished with a double-pole, double-throw antenna changeover relay or knife switch connected in the antenna leads.

For further information regarding antennas, refer to the "Radio Amateur's Handbook" or the "A.R.R.L. Antenna Book", both published by the American Radio Relay League, West Hartford, Conn., U.S.A.

2-5. SPEAKER CONNECTION

Three screw type terminals, marked 3.2, 500 and G, are provided on the rear apron of the chassis for connection to an external 3.2 or 500 ohm speaker. It is recommended that the Hallicrafters R-46 or R-46A speaker be employed.

2-6. HEADPHONES

The headphone jack, marked "Phones", is located on the front panel of the receiver and is wired so that the speaker is automatically disabled when the headphones are plugged in. The headphone output impedance is not critical and any commercial headphones may be used, including crystal types, as no direct current flows in the headphone circuit. For maximum headphone output, the use of high-impedance magnetic (5000 ohms) or crystal phones is recommended.

SECTION 3. OPERATION

Each control of your receiver performs a definite function which contributes to its outstanding reception capabilities. Full appreciation of the receiver is to be expected only after you have become familiar with each of the controls and the effect each control has on the performance of the receiver.

As a special convenience for those not yet familiar with the full advantages of the various controls, the control settings commonly used for broadcast reception are marked with a dot.

SENSITIVITY Control & AVC Switch — The Sensitivity control is used in combination with the Volume control to regulate the level of receiver output. The Automatic Volume Control circuit is turned "ON" when the Sensitivity control is set to its maximum clockwise position. The AVC switch has a definite "snap type" action and a click will be heard as the "AVC ON" position is reached.

The setting of the Sensitivity control determines the ability of the receiver to pick up weak or distant stations. This control is normally set to the "AVC ON" position when receiving AM signals and at some other position when receiving CW signals. Maximum sensitivity may be used while tuning across the frequency range but if the station selected has too strong a signal excessive background hiss or distortion may be present. If this undesirable effect is produced it can be greatly reduced by turning the Sensitivity control in the counterclockwise direction to a slightly lower setting. If after reducing the sensitivity more volume is needed advance the Volume control. When receiving CW signals a setting of the sensitivity control that is too high will be evidenced by "thumping" (overloading).

BAND SELECTOR Control — The Band Selector control should be set for the band you wish to tune. The four positions of this control correspond to the band numbers at the bottom of the left-hand or main tuning dial.

SELECTIVITY Control — Set this control to the "NORMAL" position. If a greater degree of selectivity is required to overcome noise or separate close signals turn this control to either of the crystal positions as required. It will then be necessary to adjust the Crystal Phasing control. See "USE OF CRYSTAL PHASING CONTROL" for details.

RECEPTION Switch — Set this switch at "AM" to listen to voice broadcasts. Set it at "CW" only if you wish to hear code signals.

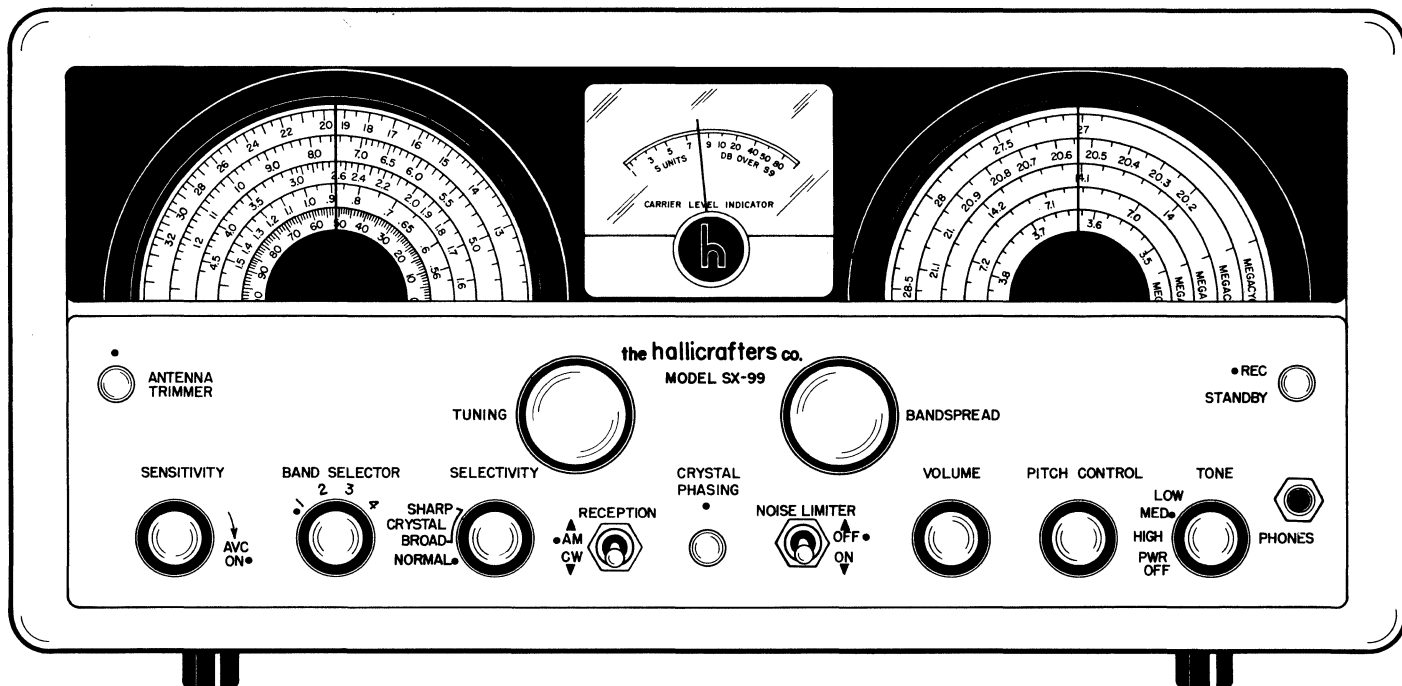

92C2388

Fig. 4. Operating Controls

USE OF CRYSTAL PHASING CONTROL — This control permits the discrimination of interfering signals whose frequencies are very near the desired signal. To attain single signal reception, first set the **SELECTIVITY** control to either **BROAD CRYSTAL** or **SHARP CRYSTAL**. Choose a strong signal, preferably a commercial station because a commercial station is likely to remain on long enough for you to complete the phasing adjustment for single signal reception.

You will find on tuning across this signal that it has two amplitudes. Turn the **CRYSTAL PHASING** control until the weaker of the two amplitudes is reduced to a minimum. Then, tune to the stronger of the two amplitudes and adjust the **PITCH** control (for c-w reception) to a tone most pleasing to you. This adjustment for single signal selectivity will require no further adjustment unless you change the **CRYSTAL PHASING** control. See Fig. 5 for an illustration of single signal operation.

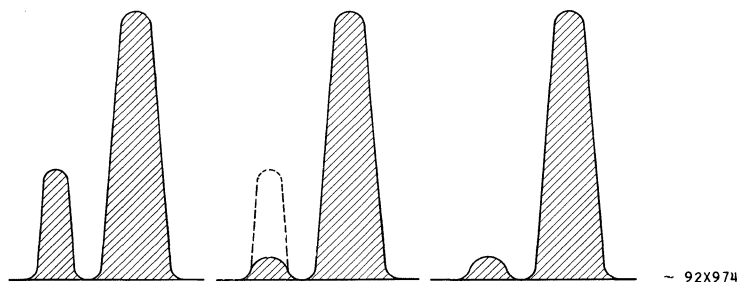

92X974

Fig. 5. Single Signal Operation

NOISE LIMITER Switch — This switch should normally be set at "OFF". If severe electrical disturbances, ignition noise, or other types of pulse-type noise interfere with reception, set the switch at "ON" to place the automatic noise limiter circuit in operation.

VOLUME Control — This control is used to regulate receiver volume. Clockwise rotation increases volume; counter-clockwise rotation decreases volume.

PITCH Control — This control is used to vary the pitch of code signals and should be set for the tone most pleasing to the operator. For this control to have any effect, the **RECEPTION** switch must be set at "CW".

TONE Control — The Tone control is a combination receiver on-off switch and 3-position tone control. In the "PWR OFF" position, the receiver is inoperative. To turn the receiver on, simply rotate the control to any of its three remaining positions. For AM reception, set the control for the desired tonal quality. For CW reception, set the control at "LOW".

ANTENNA TRIMMER Control — The Antenna Trimmer control permits tuning of the antenna to provide the best possible reception. Antenna tuning is desirable as the electrical characteristics of any antenna system will vary somewhat over the wide range of frequencies that may be tuned by this receiver. When the receiver is placed in operation this control should be set for maximum signal as indicated on the "S" meter and thereafter may be used as the final tuning adjustment when changing stations.

TUNING and BANDSPREAD Controls — The Tuning and Bandsread controls are used in conjunction with one another to tune in the desired signal. Wide tuning is performed with the Tuning control and fine tuning with the Bandsread control.

Main Tuning Dial. The main tuning or left-hand dial is operated by the Tuning control. This dial has four calibrated scales, one for each of the four frequency bands covered by the receiver. It also contains a 100-division logging scale for accurately logging and relocating stations of special interest. The main tuning dial should be set for the desired station frequency after the Bandsread control has been set fully clockwise (minimum bandsread tuning capacity).

IMPORTANT: The receiver frequency readings or calibration on the main tuning dial will be correct only if the Bandsread control has been set fully clockwise. If it is set at any other setting, the additional bandsread capacity added to the main tuning capacity will throw off the main tuning dial calibration because the receiver has been calibrated with the bandsread tuning capacitor set at minimum.

The dial settings for the 80, 40, 20, 15, and 11-10 meter amateur bands are indicated on the main tuning dial by white dots. When tuning the amateur bands with the bandsread dial, the main tuning dial must be set at the dot corresponding to the desired amateur band. The 160 meter amateur band is indicated on the dial by three short double-weight lines.

Bandsread Dial. The bandsread or right-hand dial is operated by the Bandsread control. This dial contains five scales calibrated for the 80, 40, 20, 15, and 11-10 meter amateur bands. These five scales are calibrated to read receiver frequency directly when the main tuning dial has been set to the index dot of the desired amateur band. For convenience in tuning, the AM phone bands are indicated on the bandsread dial by double-weight lines.

In addition to its use on the amateur bands, the bandsread dial may also be utilized as a fine tuning adjustment over any portion of the receiver tuning range. Two methods of fine tuning are described below.

a. The first method of fine tuning is used when it is desired to tune in a single signal with precision accuracy. First the Bandsread control is set a few degrees from its full clockwise position, then the desired signal is located with the Tuning control, and finally the signal is accurately tuned in by "rocking" the Bandsread control (turning it slightly to the left and right) until the signal is loudest and clearest.

b. The second method of fine tuning is used when it is desired to tune through a group of signals. With the Bandsread control set fully clockwise, adjust the Tuning control to tune in the highest-frequency signal in the group. The other signals can then be heard by slowly turning the Bandsread control in a counterclockwise direction.

STANDBY-REC Switch — This switch, normally set at "REC", permits you to silence the receiver without turning it off. To silence the receiver, set the switch at "STANDBY". In this position, the r-f and i-f stages are cut off but the tube heaters remain at operating temperature for instant use. To resume reception at any time, simply return the switch to the "REC" position.

USE OF THE "S" METER — The "S" meter is normally useful only when the Sensitivity control is set to the "AVC ON" position. Sharp accurate tuning can be easily accomplished by carefully observing the meter and tuning for maximum indication. The meter is calibrated in "S" units and db over S-9. The calibration serves as a method of comparing the relative strength of received signals.

SERVICE OR OPERATING QUESTIONS — For any further information regarding operation or servicing of your receiver, contact your Hallicrafters dealer. The Hallicrafters Co. maintains an extensive system of authorized service centers where any required service will be performed promptly and efficiently at a nominal charge. All Hallicrafters Authorized Service Centers display the sign shown at the right. For the location of the one nearest you, consult your dealer or telephone directory.

The Hallicrafters Co. reserves the privilege of making revisions in current production of equipment and assumes no obligation to incorporate these revisions in earlier models.



92X1401-C

SECTION 4.

SERVICE DATA

4-1. TECHNICAL SPECIFICATIONS

TUBES: Eight including rectifier
 HEADPHONE OUTPUT: High impedance
 (See Par. 2-6, Page 4)
 ANTENNA INPUT: For single wire or 52-600
 ohm balanced or unbalanced line.
 POWER SOURCE:
 Model SX-99 . . .105-125 volts, 50-60 cycles AC
 Model SX-99U . .100-250 volts, 25-60 cycles AC
 POWER CONSUMPTION: 75 watts
 RECEPTION: AM and CW
 INTERMEDIATE FREQUENCY: 455 KC
 AUDIO OUTPUT IMPEDANCE . . .Matches 3.2 ohms
 or 500 ohms
 DIMENSIONS . . 18 3/4" wide x 10 3/4" deep x 9" high
 WEIGHT, Net 28 lbs., 4 oz.
 WEIGHT, Shipping 32 lbs.

FREQUENCY COVERAGE

| Band | Frequency Range | Calibrated Band Spread |
|------|-----------------|------------------------|
| 1 | .538 - 1.6 MC | - |
| 2 | 1.55 - 4.6 MC | 80M |
| 3 | 4.6 - 13.0 MC | 40M |
| 4 | 12.0 - 34.0 MC | 20, 15, and 11-10M |

4-2. TUBE and DIAL LAMP REPLACEMENT

To gain access to the tubes and dial lamps, raise the hinged top cover of the cabinet. The tube locations, as well as their functions, are shown in Fig. 7.

4-3. CHASSIS REMOVAL

The chassis and front panel assembly are removable from the cabinet as a unit by removing the two screws at each side of the front panel and the six screws on the underside of the cabinet. When removing the chassis from the cabinet, care should be taken not to damage the brass adjusting screws on the oscillator slugs (L-7-8-9-10). Refer to Figure 8 for location.

4-4. "S" METER ADJUSTMENTS

MECHANICAL ADJ. - Turn the receiver "OFF". Directly below the "S" meter on the front panel is a round metal medallion that is pivoted so that it may be rotated to provide access to the "S" meter adjusting screw. Carefully rotate this adjustment until the pointer is in line with the right index mark on the dial scale.

ELECTRICAL ADJ. -

1. Short the antenna terminals to the chassis.
2. Set the RECEIVE/STANDBY at "RECEIVE", RECEPTION switch at "AM". SENSITIVITY switch fully clockwise (AVC ON) position, and the NOISE LIMITER switch at "OFF".
3. Turn the receiver on and turn the "S" meter adjustment, that is located on the rear apron of the chassis (see fig. 7), until the pointer indicates zero.

4-5. DIAL CORD RESTRINGING

To restring the tuning or bandspread dials, first remove the front panel from the cabinet by removing the control knobs, the two toggle switches and the Phones jack and sensitivity control mounting nuts, the two screws at each side of the front panel, and the three screws on the underside of the front panel. Then remove the tuning dials to gain access to the drive pulleys. For stringing details, refer to Fig. 6. Note that stringing is done with the tuning and bandspread gangs fully meshed. After stringing is completed, cut off the excess dial cord and apply a drop of quick drying cement to the knots.

With the tuning and bandspread gangs fully meshed, replace the dials so that the index marks at the low frequency end of the dial are in line with the hairline on the dial window.

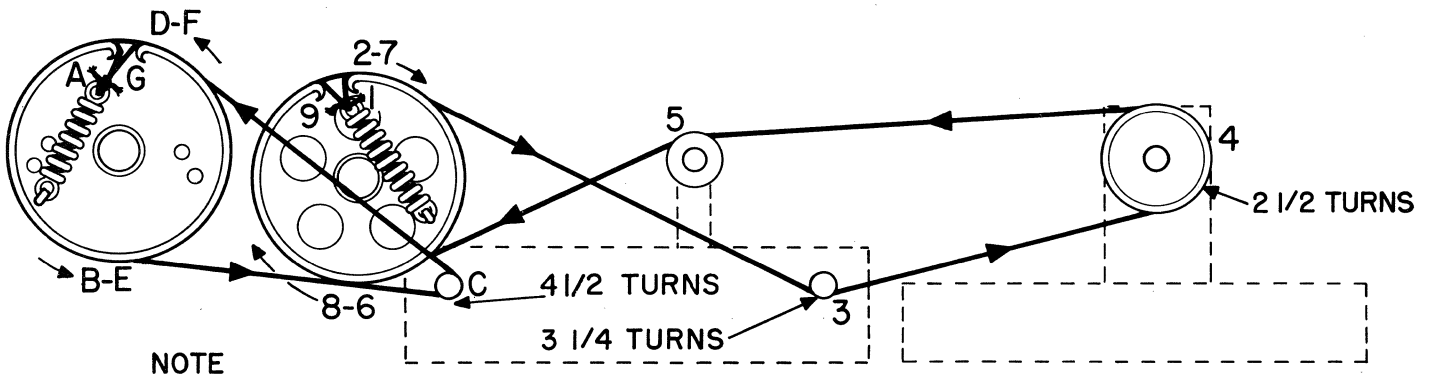

MAIN TUNING & BANDSPREAD
 GANGS FULLY CLOSED.

Fig. 6. Dial Cord Stringing Diagram

092-302339-B

SECTION 5. ALIGNMENT

This receiver has been carefully aligned at the factory by specially trained personnel using precision equipment. Alignment of the receiver should not be attempted until all other possible causes of faulty operation have been investigated. Alignment should not be required unless the receiver has been tampered with or component parts have been replaced in the r-f or i-f stages. Alignment should only be made by persons familiar with communications receivers and experienced in their alignment. Refer to Figs. 7 and 8 for location of all alignment adjustments.

5-1. EQUIPMENT REQUIRED

1. Signal generator covering 455 KC to 28 MC.
2. Output meter (or AC scale of VTVM). Connect meter from 500 ohm speaker terminal to ground.
3. Non-metallic alignment tool.
4. Standard RTMA dummy antenna shown in Fig. 9.
5. 0.02 mfd. capacitor

5-2. INITIAL CONTROL SETTINGS

Sensitivity Maximum but with AVC off
 Volume Maximum
 Noise Limiter Off
 Standby-Receive Receive
 Tone High

Other controls to be set as indicated by the alignment chart.

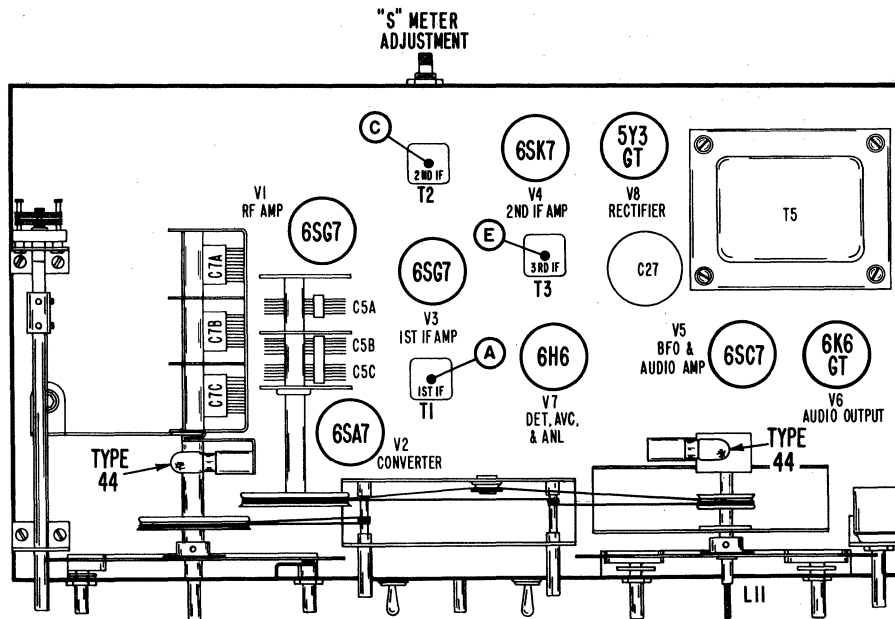

92C2386

Fig. 7. Top View of Chassis Showing Tube Locations and Alignment Adjustments

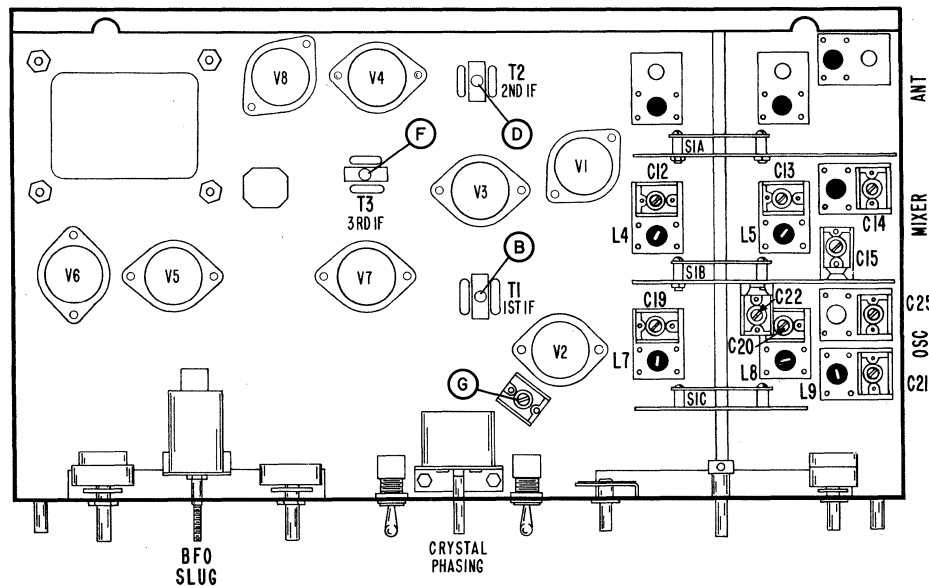

92D2387

Fig. 8. Bottom View of Chassis Showing Tube Locations and Alignment Adjustments

5-3. ALIGNMENT PROCEDURE

- The local oscillator frequency is higher than the signal frequency on bands 1, 2, and 3, and lower than the signal frequency on band 4.
- RF alignment can be made with chassis in cabinet. Holes in bottom of cabinet provide access in all RF adjustments.
- For IF alignment, remove chassis from cabinet.
- Use just enough generator output to maintain a 500 milliwatt reading on the output meter

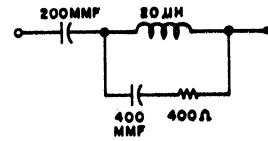

92A1549

Fig. 9. RTMA Dummy Antenna

IF ALIGNMENT

| Step | Signal Generator Coupling | Signal Gen. Frequency | Receiver Control Settings | Receiver Dial Settings | Adjust | Remarks |
|---|---|-----------------------------------|--|---|----------------------------|---|
| *1 | Connect gen. to stator of gang (center section) through a .02 mfd. capacitor. | 455 KC No Modulation | BAND SELECTOR at 2. SELECTIVITY SWITCH at BROAD CRYSTAL. RECEPTION switch at CW. | Tuning: 50 on logging scale Bandsread: 30 on outer scale | BFO Slug | Remove PITCH control knob and set shaft for a zero beat. Do not replace knob. |
| *2 | Same as Step 1 | 455 KC (approx.) No Modulation | Adjust PITCH for a 400-1000 cycle note. Other controls same as Step 1. | Same as Step 1 | A | While turning the slug very slowly in one direction, slowly "rock" the signal generator. As the adjustment passes through the response of the crystal filter, the output goes through a maximum, dips down, and starts going up again. The correct setting of this slug is in the center of the observed dip. A swishing note, in contrast to the sharp crystal tone will be apparent when the correct adjustment has been reached. |
| <p>*NOTE: The crystal filter I-F transformer secondary winding (adjustment A) is carefully adjusted at the factory to the frequency of the crystal. A signal generator which may be accurately set to within .25 KC of any frequency between 450 to 460 KC is required to make this adjustment. Since the average service signal generator will not meet this requirement, DO NOT attempt to make this adjustment unless a suitable signal generator is available. Start the I-F alignment with Step 3 when a standard type of signal generator is used.</p> | | | | | | |
| 3 | Same as Step 1 | Crystal Frequency | SELECTIVITY SWITCH at SHARP CRYSTAL. Other controls same as Step 1. | Same as Step 1 | Signal Generator | Adjust the generator frequency for maximum output. This will be the exact frequency of the crystal. A slight reduction in output will be noted when switching from BROAD to SHARP CRYSTAL. |
| 4 | Same as Step 1 | Same as Step 3 | Same as Step 1 | Same as Step 1 | BFO slug | Rotate shaft of PITCH control until a zero beat is obtained. Replace knob with zero in line with the panel index mark. |
| 5 | Same as Step 1 | Same as Step 3 (Modulated) | SELECTIVITY SWITCH at NORMAL, RECEPTION switch at AM. Other controls same as Step 1. | Same as Step 1 | B C D E F G | Maximum output Maximum output Maximum output Maximum output Maximum output Repeat above steps for maximum gain. |

R-F, MIXER, & OSCILLATOR ALIGNMENT

The following adjustments are made with VOLUME, TONE, and SENSITIVITY controls fully clockwise, but with AVC off, NOISE LIMITER switch at OFF, SELECTIVITY switch at NORMAL, and RECEPTION switch at AM. Refer to Fig. 8 for location of all adjustments.

| Step | Signal Generator Coupling | Receiver Dial Settings | Band Selector Setting Band | Adjust | Remarks |
|------|---|--|----------------------------|--|---------------------------|
| 6 | High side thru RTMA dummy antenna (Fig. 9) to antenna terminal "A1"; low side to "A2". Jumper between "A2" and "G". | Tuning: 28.0 MC Bandsread: 30 on Outer scale. | 4 | C19 (osc. trimmer) C12 (mixer trimmer) | Adjust for maximum output |
| | | Tuning: 14.0 MC Bandsread: 30 on Outer Scale | 4 | L7 (osc. slug), L4 (mixer slug) | Same as Step 6 |
| 7 | Same as Step 6 | Tuning: 11.0 MC Bandsread: 30 on Outer Scale | 3 | C20 (osc. trimmer), C13 (mixer trimmer) | Same as Step 6 |
| | | Tuning: 5.1 MC Bandsread: 30 on Outer Scale | 3 | L8 (osc. slug), L5 (mixer slug) | Same as Step 6 |
| 8 | Same as Step 6 | Tuning: 4.0 MC Bandsread: 30 on Outer Scale | 2 | C21 (osc. trimmer), C14 (mixer trimmer) | Same as Step 6 |
| | | Tuning: 1.8 MC Bandsread: 30 on Outer Scale | 2 | L9 (osc. slug) | Same as Step 6. |
| 9 | Same as Step 6 | Tuning: 1.4 MC Bandsread: 30 on Outer Scale | 1 | C22 (osc. trimmer), C15 (mixer trimmer) | Same as Step 6 |
| | | Tuning: .6 MC Bandsread: 30 on Outer Scale | 1 | C25 (osc. padder) | Same as Step 6. |

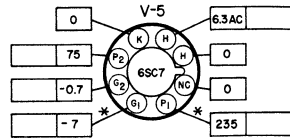
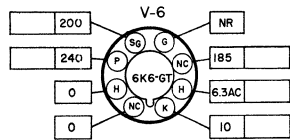
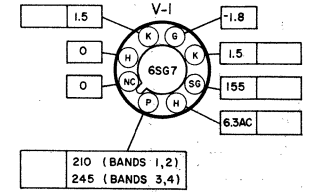
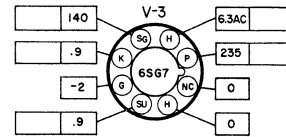
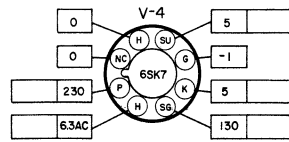
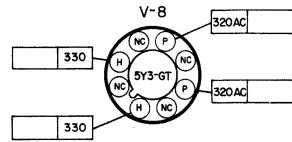

* AM / CW SWITCH IN CW POSITION.

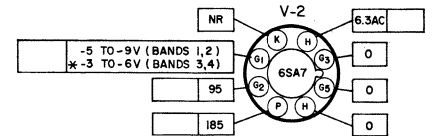
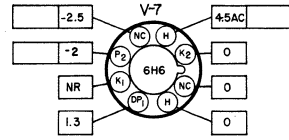

* VOLTAGE VARIES WITH SETTING OF TUNING GANG.

| CONTROL | SETTING |
|-----------------|----------------------------------|
| SENSITIVITY | FULL CLOCKWISE (AVC ON POSITION) |
| RECEPTION | AM |
| NOISE LIMITER | OFF |
| STANDBY/RECEIVE | RECEIVE |

NOTES-

1. SOCKET VIEWS ARE BOTTOM VIEWS.
2. ALL VOLTAGES ARE MEASURED BETWEEN TUBE SOCKET TERMINALS AND CHASSIS WITH NORMAL SIGNAL INPUT
3. LINE VOLTAGE 117V, 60 CYCLES AC.
4. ALL VOLTAGES ARE DC UNLESS OTHERWISE SPECIFIED
5. DC VOLTAGES SHOWN WERE MEASURED WITH A VACUUM TUBE VOLTMETER.
6. "NC"-NO CONNECTION (VOLTAGE SHOWN FOR THIS TERMINAL IS USED AS A TIE LUG.)
7. "NR"-NOT READABLE (READING GENERALLY MEANINGLESS)
8. □ SPACE PROVIDED FOR SERVICE METER READINGS.

FRONT APRON
BOTTOM VIEW OF CHASSIS

Fig. 10. Voltage Chart

SERVICE PARTS LISTS

| Schematic Symbol | Description | Hallcrafters Part Number | Schematic Symbol | Description | Hallcrafters Part Number | Schematic Symbol | Description | Hallcrafters Part Number |
|----------------------|--|--------------------------|----------------------------------|---|--------------------------|----------------------------------|--|--------------------------|
| CAPACITORS | | | *RESISTORS (CON'T.) | | | SWITCHES (CON'T.) | | |
| C-1 | 3-25 mmf. air trimmer; Antenna Trimmer Control | 048-100182 | R-9 | 2.2K ohms | 451-252222 | S-5 | Switch, AVC, part of R-3 | ----- |
| C-5 | Variable capacitor, 3 section; bandspread tuning (pulley included) | 048-300342 | R-10 | 12K ohms, 4 Watts WW | 024-101062 | S-6 | Switch, spst toggle; BFO | 060-100138 |
| C-7 | Variable capacitor, 3 section; main tuning (pulley included) | 048-300341 | R-11 | 470 ohms | 451-252471 | S-7 | Switch, Selectivity | 060-200681 |
| C-8, 35, 58, 60, 65 | 0.047 mfd., 20%, 200V.; molded paper | 499-014473 | R-12 | 2.2 megohms 20% | 451-253225 | | Shaft, Bandswitch and Index plate | 060-200392 |
| C-9, 28 | 0.047 mfd., 20%, 600V.; molded paper | 499-034473 | R-13 | 68 ohms | 451-252680 | JACKS, PLUGS, AND SOCKETS | | |
| C-10 | 22 mmf., 20% 500V.; ceramic | 491-107220-95 | R-14 | 47K ohms 20% | 451-253473 | J-1 | Jack, Phone | 036-200048 |
| C-11 | 2.2 mmf., neutralizing | 047-100160-04 | R-15, 29 | 100K ohms 20% | 451-253104 | PL-1 | Line cord and plug assembly | 087-100078 |
| C-12 | 4-80 mmf., mica trimmer | 044-100395 | R-16 | 560 ohms 10% 1W | 451-352561 | | Socket, dial lamp (with lead) | 086-200049 |
| C-13 | 3-30 mmf., mica trimmer | 044-100396 | R-17 | 500 ohms, variable; "S" meter adjustment | 025-300022 | | Socket, tube; octal | 006-100250 |
| C-14 | 1.5-15 mmf., mica trimmer | 044-200147 | R-18, 65 | 1K ohm | 451-252102 | | Socket, octal | 006-200315 |
| C-15, 22 | 2-20 mmf., mica trimmer | 044-100191 | R-19 | 27K ohms, 10%, 1W | 451-352273 | | TUBES AND DIAL LAMPS | |
| C-16 | 390 mmf., 10% 500V.; mica | 470-213391 | R-20 | 500K ohms, variable; Volume Control | 025-100534 | V-1 | 6SG7; RF amplifier | 090-901181 |
| C-17, 53, 56 | 0.01 mfd. 600V.; molded paper | 499-034103 | R-21 | 150 ohms 20% | 451-253151 | V-2 | 6SA7; converter | 090-901180 |
| C-18 | 150 mmf., 5% 500V.; molded mica | 470-222151 | R-22, 60 | 270K ohms | 451-252274 | V-3 | 6SG7; 1st I-F amplifier | 090-901181 |
| C-19 | 4-70 mmf., mica trimmer | 044-100149 | R-23 | 470K ohms 20% | 451-253474 | V-4 | 6SK7; 2nd I-F amplifier | 090-901233 |
| C-20, 21 | 2-30 mmf., mica trimmer | 044-100148 | R-24 | 270 ohms, 10%, 1 Watt | 451-352271 | V-5 | 6SC7; BFO and audio amplifier | 090-900874 |
| C-23 | 3300 mmf., 5%, 500V.; molded mica | 470-422332 | R-25 | 15K ohms, 20%, 1 Watt | 451-353153 | V-6 | 6K6GT; audio output | 090-900856 |
| C-24 | 1500 mmf., 2%, 500V.; mica | 470-421152 | R-26 | 47K ohms, 10%, 1 Watt | 451-352473 | V-7 | 6H6; detector, ANL and AVC | 090-900847 |
| C-25 | 320-520 mmf.; mica padder | 044-100394 | R-27 | 22K ohms, 20% | 451-253223 | V-8 | 5Y3GT; rectifier | 090-901111 |
| C-26 | 2-30 mmf.; Crystal I-F trimmer | 044-100047 | R-30, 68 | 10 ohms 20% | 451-253100 | LM-1-2 | Lamp, dial; type 44 | 039-100003 |
| C-27 | 30-10-10 mfd. 450V.; electrolytic | 045-100062 | R-32 | 1.5K ohms, 10%, 10 Watts wirewound | 453-062152 | MISCELLANEOUS | | |
| C-29, 33 | 220 mmf, 10%, 500V.; mica | 470-213221 | R-33 | 15 megohms 20% | 451-253156 | | Cabinet bottom section | 066-401074 |
| C-30 | 3-25 mmf.; Crystal phasing trimmer | 048-100351 | R-34 | 10K ohms, 20% | 451-253103 | | Cabinet top cover | 066-401110 |
| C-31, 43, 45, 48, 63 | 0.022 mfd. 20%, 600V.; molded paper | 499-034223 | R-35 | 27 ohms | 451-252270 | | Cabinet front panel (Mark 1B & 1C only) | 068-500378 |
| C-32, 44, 55 | 270 mmf., 10%, 500V.; mica | 470-213271 | R-62 | 560K ohms | 451-252561 | | Cabinet front panel (Mark 1D only) | 068-500614 |
| C-36 | 10 mmf, 10%, 500V.; ceramic | 491-006100-95 | R-63 | 6.8 ohms, 10%, 1 Watt | 451-352068 | | Clip, mtg.; for T-1, T-2, and T-3 | 076-100385 |
| C-38 | 2 mmf.; wire gimmick | ----- | R-64 | 330 ohms | 451-252331 | X-1 | Crystal (455 KC) | 019-100123 |
| C-39 | 0.1 mfd. 20%, 600V.; molded paper | 499-034104 | R-66 | 15K ohms, 10%, 2 Watts | 451-552153 | | Dial cord (specify length) | 038-100026 |
| C-41, 42 | 47 mmf, 20%, 500V.; mica | 470-214470 | R-67 | 330K ohms | 451-252334 | | Dial, bandspread | 083-400489 |
| C-47 | 0.0022 mfd., 20%, 1000V molded paper | 499-044222 | ** COILS AND TRANSFORMERS | | | | Dial, tuning | 083-400488 |
| C-52 | 0.02 mfd., +80-20% 500V.; ceramic disc | 047-100242 | L-1, C-1 | Coil, antenna | 051-201939 | | Foot, mounting- rubber | 016-100007 |
| C-54 | 470 mmf., 5%, 500V.; mica | 470-212471 | L-2, C-2 | Band 4 | 051-201938 | | Grommet, rubber | 016-100034 |
| C-57 | 0.001 mfd. 10%, 500V.; mica | 470-213102 | L-3, C-3 | Bands 1 and 2 | 051-201937 | | tuning gang front mtg. | 016-100014 |
| C-61 | 0.22 mfd., 20% 200V.; molded paper | 499-014224 | L-4, C-12 | Coil, mixer | 051-201905 | | tuning gang rear mtg. | 016-100014 |
| C-64 | 10 mfd., 25V.; electrolytic | 045-100121 | L-5, C-13 | Band 4 | 051-201906 | | Knob, Band Selector, Selectivity, Pwr. Off-Tone, Sensitivity, and Volume | 015-200791 |
| R-1, 61, 70 | 1 megohm, 20% | 451-253105 | L-6, C-14 | Band 3 | 051-201904 | | Knob, Pitch Control | 015-200788 |
| R2, 71 | 120 ohms | 451-252121 | L-7, C-19 | Bands 1 and 2 | 051-201904 | | Knob, Tuning and Bandspread | 015-200802 |
| R-3 | 10K ohms, variable; Sensitivity control | 025-200607 | L-8, C-20 | Coil, oscillator | 051-201900 | | Knob, Standby-Receive, Crystal Phasing, Antenna Trimmer | 015-200835 |
| R-4, 31 | 22 ohms, 20% | 451-253220 | L-9, C-21 | Band 4 | 051-201909 | | Lock, Line cord male section | 076-100397-01 |
| R-5 | 39K ohms, 10%, 1 Watt | 451-352393 | L-10, C-25 | Band 3 | 051-201899 | | female section | 076-100397-02 |
| R-6, 26 | 6.8K ohms, 10%, 1 Watt | 451-352682 | L-11 | Band 2 | 051-201898 | | Pulley, 1-1/8" string dia. | 028-100200 |
| R-7 | 22K ohms | 451-252223 | T-1 | Band 1 | 051-201897 | M-1 | "S" meter assembly complete | 082-000283 |
| R-8 | 10K ohms, 10% 2 Watts | 451-552103 | T-2 | Transformer, 1st Crystal | 050-000656 | | "S" meter front cover only, clear plastic | 082-302612 |
| | | | T-3 | Transformer, 2nd I-F | 050-000657 | | "S" meter medallion, "h" only | 007-100592 |
| | | | T-4 | Transformer, I-F; detector stage | 050-300242 | | Snap-in trimount | 005-100006 |
| | | | T-5 | Transformer, audio output | 055-200265 | | Spacer, bakelite; .156 id, 1/2" od, 1/4" th. | 008-100723 |
| | | | | Transformer, power for Model SX-99 | 052-100209 | | Terminal strip, antenna | 088-100032 |
| | | | | for Model SX-99U | 052-300210 | | Terminal strip, audio output | 088-100578 |
| | | | | **Coils L-4 thru L-10 are supplied complete with trimmer capacitor. Trimmers are also available separately. See "Capacitors". | | | Tuning slug for mixer, and oscillator coils | 077-100068 |
| | | | | | | | Washer, spring type; 3/16" id, 3/8" od | 004-101557 |
| | | | | | | | Window, bandspread dial (Mark 1B and 1C Only) | 022-200432 |
| | | | | | | | Window, bandspread dial (Mark 1D Only) | 022-200565 |
| | | | | | | | Window, main tuning dial | 022-200562 |

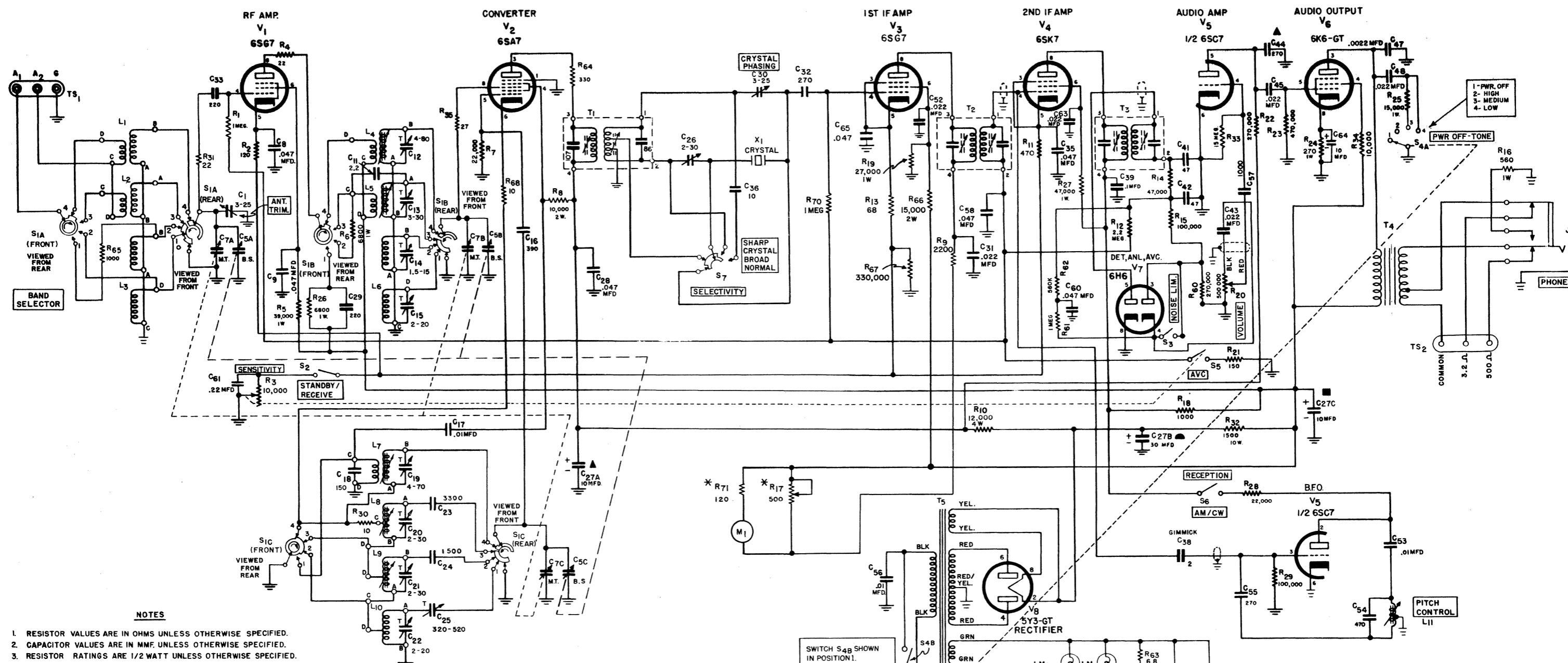

NOTES

1. RESISTOR VALUES ARE IN OHMS UNLESS OTHERWISE SPECIFIED.
2. CAPACITOR VALUES ARE IN MMF. UNLESS OTHERWISE SPECIFIED.
3. RESISTOR RATINGS ARE 1/2 WATT UNLESS OTHERWISE SPECIFIED.
4. BAND SELECTOR SWITCH S-1 SHOWN IN BAND 4 POSITION.

VALUES AND TOLERANCES SHOWN ARE NOMINAL AND VARIATIONS MAY BE FOUND. IT IS RECOMMENDED THAT THE VALUE OF ANY REPLACEMENT CORRESPOND TO THE NOMINAL VALUE OF THE PART BEING REPLACED.

***"S" METER ZERO ADJUSTMENT**

Alternate values of resistance were used in some receivers for R-17 ("S" meter zero adjustment) and R-71. (The associated current limiting resistor.) The alternate values were as follows:

| SYMBOL | VALUE | HALLICRAFTERS PART NUMBER |
|--------|----------|---------------------------|
| R-17 | 200 ohms | .25B714 |
| R-71 | 56 ohms | .23X20X560K |

Either the alternate values or the original values as shown in your service parts list may be used for replacement. It is important however that if one of the alternate values is used the other must also be used.

▲ C-44 is deleted on Mark I-C chassis.

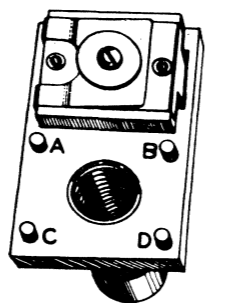

REPRESENTS COILS L1 TO L10

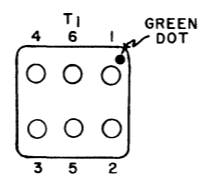

SWITCH S4B SHOWN IN POSITION 1. SWITCH IS CLOSED IN POSITIONS 2, 3 & 4.

MODELS SX-99 & SX-99U
Mark 1B, 1C & 1D

89E641-D

Warranty

"The Hallicrafter's Company warrants each new radio product manufactured by it to be free from defective material and workmanship and agrees to remedy any such defect or to furnish a new part in exchange for any part of any unit of its manufacture which under normal installation, use and service discloses such defect, provided the unit is delivered by the owner to our authorized radio dealer, wholesaler, from whom purchased, or, authorized service center, intact, for examination, with all transportation charges prepaid within ninety days from the date of sale to original purchaser and provided that such examination discloses in our judgment that it is thus defective.

This warranty does not extend to any of our radio products which have been subjected to misuse, neglect, accident, incorrect wiring not our own, improper installation, or to use in violation of instructions furnished by us, nor extend to units which have been repaired or altered outside of our factory or authorized service center, nor to cases where the serial number thereof has been removed, defaced or changed, nor to accessories used therewith not of our own manufacture.

Any part of a unit approved for remedy or exchange hereunder will be remedied or exchanged by the authorized radio dealer or wholesaler without charge to the owner.

This warranty is in lieu of all other warranties expressed or implied and no representative or person is authorized to assume for us any other liability in connection with the sale of our radio products."

Form No. 94X622

the Hallicrafters co.