

H8/300H Series

Programming Manual

HITACHI

ADE-602-053A

Major Revisions and Additions in this Version

| Page | Item | Description |
|------|---|--|
| P27 | Figure 1-12 Instruction Formats | Figure (4) amended |
| P33 | Table 1-6 Effective Address Calculation (8) | Table amended |
| P51 | 2.2.6 BAND | Notes added |
| P58 | 2.2.11 BIOR | Operand Format and Number of States Required for Execution |
| | | Register direct 1st byte amended |
| P67 | 2.2.18 BSR | Notes description added |
| P74 | 2.2.22 (3) CMP (L) | Operand Format and Number of States Required for Execution |
| | | Operands amended |
| P86 | 2.2.26 (3) DIVXS | Description amended |
| P87 | DIVXS Example 2 | Example 2 added |
| P106 | 2.2.33 JSR Cautions | Description added |
| P108 | 2.2.34 (1) LDC (B) | Description amended /added |
| P110 | 2.2.34 (2) LDC (W) | Operand Format and Number of States Required for Execution |
| | | Mnemonic amended |
| P114 | 2.2.35 (4) MOV (B) | Description |
| | | Description amended |
| P117 | 2.2.35 (5) MOV (W) | Operand Format and Number of States Required for Execution |
| | | Table contents amended |
| P119 | 2.2.35 (6) MOV (L) | Operand Format and Number of States Required for Execution |
| | | Table contents amended |
| P123 | 2.2.35 (8) MOV (W) | Operand Format and Number of States Required for Execution |
| | | Table contents amended |
| P125 | 2.2.35 (9) MOV (L) | Operand Format and Number of States Required for Execution |
| | | Table contents amended |
| P129 | 2.2.38 (2) MULXS (W) | Figure amended |
| P144 | 2.2.45 (2) POP (L) | Number of execution states amended |
| P146 | 2.2.46 (2) PUSH (L) | Number of execution states amended |
| P160 | 2.2.52 RTS | Figure amended |
| P174 | 2.2.58 (1) STC (B) | Assembly-Language Format |
| | | Assembler format amended |
| | 2.2.58 (1) STC (B) | Operand Format and Number of States Required for Execution |
| | | Mnemonic amended |

| Page | Item | Description |
|---------------|---|--|
| P175 | 2.2.58 (2) STC (W) | Instruction amended |
| | 2.2.58 (2) STC (W) Assembler Format | Assembler format amended |
| P176 | 2.2.58 (2) STC (W) Operand Format and Number of States Required for Execution | Mnemonic amended |
| P180 | 2.2.60 SUBS Operation | Operation amended |
| P189 | (1) Data Transfer Instructions MOV.W @ERs+,Rd | Operation amended |
| | (1) Data Transfer Instructions MOV.W Rs,@ERd | Operation amended |
| | (1) Data Transfer Instructions MOV.W Rs,@(d:24,ERd) | Number of execution states amended |
| | (1) Data Transfer Instructions MOV.L #xx:32,ERd | Operation and number of execution states amended |
| P190 | (1) Data Transfer Instructions MOV.L @ERs+,ERd | Operation amended |
| | (1) Data Transfer Instructions POP.L ERn | Number of execution states amended |
| | (1) Data Transfer Instructions PUSH.L ERn | Number of execution states amended |
| P191 | (2) Arithmetic Operation Instructions DAA Rd | Condition code amended |
| P192 | (2) Arithmetic Operation Instructions CMP.L #xx:32,ERd | Number of execution states amended |
| P196 | (5) Bit Manipulation Instructions | Table amended |
| P197, P198 | (6) Branch Instructions | Added |
| P198 | (7) System Control Instructions LDC @ERs,CCR | Operation amended |
| | (7) System Control Instructions LDC @(d:16,ERs),CCR | Operation amended |
| | (7) System Control Instructions LDC @(d:24,ERs),CCR | Operation amended |
| | (7) System Control Instructions LDC @ERs+,CCR | Operation amended |
| P204 | Table 2-3 Instruction Codes (4) MOV.B@aa:16,Rd | Instruction format amended |
| P231 | Table 2-8 Bus States BSR d:16 | Execution order nos.2 to 5 amended |
| P234, P235 | Table 2-8 Bus States POP.W Rn to PUSH.L ERn | Instruction added |
| P240 | Figure 3-2 State Transitions | Figure amended |

Contents

| | | |
|-----------|--|----|
| Section 1 | CPU | 1 |
| 1.1 | Overview..... | 1 |
| 1.1.1 | Features..... | 1 |
| 1.1.2 | Differences from H8/300 CPU | 2 |
| 1.2 | CPU Operating Modes..... | 3 |
| 1.3 | Address Space..... | 7 |
| 1.4 | Register Configuration..... | 8 |
| 1.4.1 | Overview..... | 8 |
| 1.4.2 | General Registers..... | 9 |
| 1.4.3 | Control Registers | 10 |
| 1.4.4 | Initial Register Values..... | 11 |
| 1.5 | Data Formats..... | 12 |
| 1.5.1 | General Register Data Formats..... | 12 |
| 1.5.2 | Memory Data Formats..... | 13 |
| 1.6 | Instruction Set..... | 15 |
| 1.6.1 | Overview..... | 15 |
| 1.6.2 | Instructions and Addressing Modes..... | 16 |
| 1.6.3 | Tables of Instructions Classified by Function | 18 |
| 1.6.4 | Basic Instruction Formats | 27 |
| 1.6.5 | Addressing Modes and Effective Address Calculation | 28 |
| Section 2 | Instruction Descriptions | 35 |
| 2.1 | Tables and Symbols | 35 |
| 2.1.1 | Assembler Format..... | 36 |
| 2.1.2 | Operation | 37 |
| 2.1.3 | Condition Code..... | 38 |
| 2.1.4 | Instruction Format | 38 |
| 2.1.5 | Register Specification..... | 39 |
| 2.1.6 | Bit Data Access in Bit Manipulation Instructions | 40 |
| 2.2 | Instruction Descriptions..... | 41 |
| 2.2.1 (1) | ADD (B)..... | 42 |
| 2.2.1 (2) | ADD (W)..... | 43 |
| 2.2.1 (3) | ADD (L) | 44 |
| 2.2.2 | ADDS | 45 |
| 2.2.3 | ADDX..... | 46 |
| 2.2.4 (1) | AND (B)..... | 47 |
| 2.2.4 (2) | AND (W)..... | 48 |
| 2.2.4 (3) | AND (L) | 49 |
| 2.2.5 | ANDC..... | 50 |

| | | |
|------------|-----------------|-----|
| 2.2.6 | BAND..... | 51 |
| 2.2.7 | Bcc..... | 52 |
| 2.2.8 | BCLR..... | 54 |
| 2.2.9 | BIAND..... | 56 |
| 2.2.10 | BILD..... | 57 |
| 2.2.11 | BIOR..... | 58 |
| 2.2.12 | BIST..... | 59 |
| 2.2.13 | BIXOR..... | 60 |
| 2.2.14 | BLD..... | 61 |
| 2.2.15 | BNOT..... | 62 |
| 2.2.16 | BOR..... | 64 |
| 2.2.17 | BSET..... | 65 |
| 2.2.18 | BSR..... | 67 |
| 2.2.19 | BST..... | 68 |
| 2.2.20 | BTST..... | 69 |
| 2.2.21 | BXOR..... | 71 |
| 2.2.22 (1) | CMP (B)..... | 72 |
| 2.2.22 (2) | CMP (W)..... | 73 |
| 2.2.22 (3) | CMP (L)..... | 74 |
| 2.2.23 | DAA..... | 75 |
| 2.2.24 | DAS..... | 77 |
| 2.2.25 (1) | DEC (B)..... | 79 |
| 2.2.25 (2) | DEC (W)..... | 80 |
| 2.2.25 (3) | DEC (L)..... | 81 |
| 2.2.26 (1) | DIVXS (B)..... | 82 |
| 2.2.26 (2) | DIVXS (W)..... | 84 |
| 2.2.26 (3) | DIVXS..... | 86 |
| 2.2.27 (1) | DIVXU (B)..... | 90 |
| 2.2.27 (2) | DIVXU (W)..... | 91 |
| 2.2.28 (1) | EEPMOV (B)..... | 95 |
| 2.2.28 (2) | EEPMOV (W)..... | 96 |
| 2.2.29 (1) | EXTS (W)..... | 98 |
| 2.2.29 (2) | EXTS (L)..... | 99 |
| 2.2.30 (1) | EXTU (W)..... | 100 |
| 2.2.30 (2) | EXTU (L)..... | 101 |
| 2.2.31 (1) | INC (B)..... | 102 |
| 2.2.31 (2) | INC (W)..... | 103 |
| 2.2.31 (3) | INC (L)..... | 104 |
| 2.2.32 | JMP..... | 105 |
| 2.2.33 | JSR..... | 106 |
| 2.2.34 (1) | LDC (B)..... | 108 |

| | |
|----------------------------|-----|
| 2.2.34 (2) LDC (W)..... | 109 |
| 2.2.35 (1) MOV (B) | 111 |
| 2.2.35 (2) MOV (W) | 112 |
| 2.2.35 (3) MOV (L)..... | 113 |
| 2.2.35 (4) MOV (B) | 114 |
| 2.2.35 (5) MOV (W) | 116 |
| 2.2.35 (6) MOV (L)..... | 118 |
| 2.2.35 (7) MOV (B) | 120 |
| 2.2.35 (8) MOV (W) | 122 |
| 2.2.35 (9) MOV (L)..... | 124 |
| 2.2.36 MOVFPE..... | 126 |
| 2.2.37 MOVTPE..... | 127 |
| 2.2.38 (1) MULXS (B)..... | 128 |
| 2.2.38 (2) MULXS (W)..... | 129 |
| 2.2.39 (1) MULXU (B) | 130 |
| 2.2.39 (2) MULXU (W) | 131 |
| 2.2.40 (1) NEG (B)..... | 132 |
| 2.2.40 (2) NEG (W) | 133 |
| 2.2.40 (3) NEG (L)..... | 134 |
| 2.2.41 NOP | 135 |
| 2.2.42 (1) NOT (B)..... | 136 |
| 2.2.42 (2) NOT (W) | 137 |
| 2.2.42 (3) NOT (L)..... | 138 |
| 2.2.43 (1) OR (B) | 139 |
| 2.2.43 (2) OR (W) | 140 |
| 2.2.43 (3) OR (L) | 141 |
| 2.2.44 ORC..... | 142 |
| 2.2.45 (1) POP (W) | 143 |
| 2.2.45 (2) POP (L)..... | 144 |
| 2.2.46 (1) PUSH (W) | 145 |
| 2.2.46 (2) PUSH (L)..... | 146 |
| 2.2.47 (1) ROTL (B) | 147 |
| 2.2.47 (2) ROTL (W) | 148 |
| 2.2.47 (3) ROTL (L)..... | 149 |
| 2.2.48 (1) ROTR (B)..... | 150 |
| 2.2.48 (2) ROTR (W)..... | 151 |
| 2.2.48 (3) ROTR (L) | 152 |
| 2.2.49 (1) ROTXL (B) | 153 |
| 2.2.49 (2) ROTXL (W) | 154 |
| 2.2.49 (3) ROTXL (L)..... | 155 |
| 2.2.50 (1) ROTXR (B) | 156 |

| | |
|---|------------|
| 2.2.50 (2) ROTXR (W) | 157 |
| 2.2.50 (3) ROTXR (L) | 158 |
| 2.2.51 RTE | 159 |
| 2.2.52 RTS | 160 |
| 2.2.53 (1) SHAL (B) | 161 |
| 2.2.53 (2) SHAL (W) | 162 |
| 2.2.53 (3) SHAL (L) | 163 |
| 2.2.54 (1) SHAR (B) | 164 |
| 2.2.54 (2) SHAR (W) | 165 |
| 2.2.54 (3) SHAR (L) | 166 |
| 2.2.55 (1) SHLL (B) | 167 |
| 2.2.55 (2) SHLL (W) | 168 |
| 2.2.55 (3) SHLL (L) | 169 |
| 2.2.56 (1) SHLR (B) | 170 |
| 2.2.56 (2) SHLR (W) | 171 |
| 2.2.56 (3) SHLR (L) | 172 |
| 2.2.57 SLEEP | 173 |
| 2.2.58 (1) STC (B) | 174 |
| 2.2.58 (2) STC (W) | 175 |
| 2.2.59 (1) SUB (B) | 177 |
| 2.2.59 (2) SUB (W) | 178 |
| 2.2.59 (3) SUB (L) | 179 |
| 2.2.60 SUBS | 180 |
| 2.2.61 SUBX | 181 |
| 2.2.62 TRAPA | 182 |
| 2.2.63 (1) XOR (B) | 183 |
| 2.2.63 (2) XOR (W) | 184 |
| 2.2.63 (3) XOR (L) | 185 |
| 2.2.64 XORC | 186 |
| 2.3 Instruction Set Summary | 187 |
| 2.4 Instruction Codes | 200 |
| 2.5 Operation Code Map | 209 |
| 2.6 Number of States Required for Instruction Execution | 212 |
| 2.7 Condition Code Modification | 221 |
| 2.8 Bus cycles During Instruction Execution | 226 |
| Section 3 Processing States | 239 |
| 3.1 Overview | 239 |
| 3.2 Program Execution State | 241 |
| 3.3 Exception-Handling State | 241 |
| 3.3.1 Types of Exception Handling and Their Priority | 241 |

| | | |
|------------------|------------------------------------|------------|
| 3.3.2 | Exception-Handling Sequences | 242 |
| 3.4 | Bus-Released State | 244 |
| 3.5 | Reset State | 244 |
| 3.6 | Power-Down State | 244 |
| 3.6.1 | Sleep Mode | 244 |
| 3.6.2 | Software Standby Mode | 244 |
| 3.6.3 | Hardware Standby Mode | 244 |
| Section 4 | Basic Timing | 245 |
| 4.1 | Overview..... | 245 |
| 4.2 | On-Chip Memory (RAM, ROM)..... | 245 |
| 4.3 | On-Chip Supporting Modules..... | 247 |
| 4.4 | External Data Bus | 248 |

Section 1 CPU

1.1 Overview

The H8/300H CPU is a high-speed central processing unit with an internal 32-bit architecture that is upward-compatible with the H8/300 CPU. The H8/300H CPU has sixteen 16-bit general registers, can address a 16-Mbyte linear address space, and is ideal for realtime control.

1.1.1 Features

The H8/300H CPU has the following features.

- Upward-compatible with H8/300 CPU
 - Can execute H8/300 object programs
- General-register architecture
 - Sixteen 16-bit general registers (also usable as sixteen 8-bit registers or eight 32-bit registers)
- Sixty-two basic instructions
 - 8/16/32-bit arithmetic and logic instructions
 - Multiply and divide instructions
 - Powerful bit-manipulation instructions
- Eight addressing modes
 - Register direct [Rn]
 - Register indirect [@ERn]
 - Register indirect with displacement [@(d:16,ERn) or @(d:24,ERn)]
 - Register indirect with post-increment or pre-decrement [@ERn+ or @-ERn]
 - Absolute address [@aa:8, @aa:16, or @aa:24]
 - Immediate [#xx:8, #xx:16, or #xx:32]
 - Program-counter relative [@(d:8,PC) or @(d:16,PC)]
 - Memory indirect [@@aa:8]
- 16-Mbyte address space
- High-speed operation
 - All frequently-used instructions execute in two to four states
 - Maximum clock frequency: 16 MHz

- 8/16/32-bit register-register add/subtract: 125 ns
- 8×8 -bit register-register multiply: 875 ns
- $16 \div 8$ -bit register-register divide: 875 ns
- 16×16 -bit register-register multiply: 1375 ns
- $32 \div 16$ -bit register-register divide: 1375 ns
- Two CPU operating modes
 - Normal mode
 - Advanced mode
- Low-power mode
 - Transition to power-down state by SLEEP instruction

1.1.2 Differences from H8/300 CPU

In comparison to the H8/300 CPU, the H8/300H CPU has the following enhancements.

- More general registers

Eight 16-bit registers have been added.
- Expanded address space

Normal mode supports the same 64-kbyte address space as the H8/300 CPU.

Advanced mode supports a maximum 16-Mbyte address space.
- Enhanced addressing

The addressing modes have been enhanced to make effective use of the 16-Mbyte address space.
- Enhanced instructions

Signed multiply/divide instructions and other instructions have been added.

1.2 CPU Operating Modes

The H8/300H CPU has two operating modes: normal and advanced. Normal mode supports a maximum 64-kbyte address space. Advanced mode supports up to 16 Mbytes. The mode is selected at the mode pins of the microcontroller. For further information, refer to the relevant hardware manual.

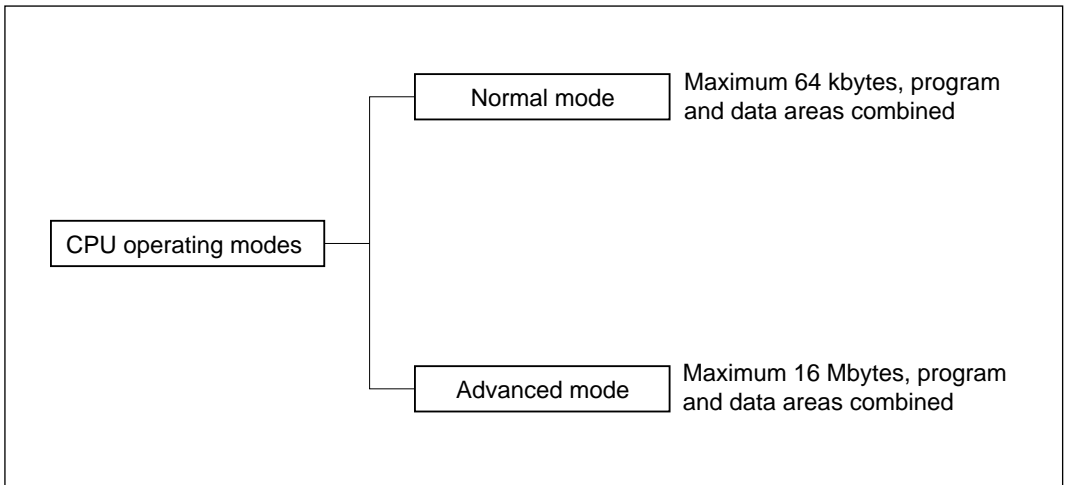

Figure 1-1 CPU Operating Modes

(1) Normal Mode: The exception vector table and stack have the same structure as in the H8/300 CPU.

Address Space: A maximum address space of 64 kbytes can be accessed, as in the H8/300 CPU.

Extended Registers (En): The extended registers (E0 to E7) can be used as 16-bit data registers, or they can be combined with the general registers (R0 to R7) for use as 32-bit data registers. When En is used as a 16-bit register it can contain any value, even when the corresponding general register (R0 to R7) is used as an address register. If the general register is referenced in the register indirect addressing mode with pre-decrement (@-Rn) or post-increment (@Rn+) and a carry or borrow occurs, however, the value in the corresponding extended register will be affected.

Instruction Set: All additional instructions and addressing modes of the H8/300 CPU can be used. If a 24-bit effective address (EA) is specified, only the lower 16 bits are used.

Exception Vector Table and Memory Indirect Branch Addresses: In normal mode the top area starting at H'0000 is allocated to the exception vector table. One branch address is stored per 16 bits (figure 1-2). The exception vector table differs depending on the microcontroller, so see the microcontroller hardware manual for further information.

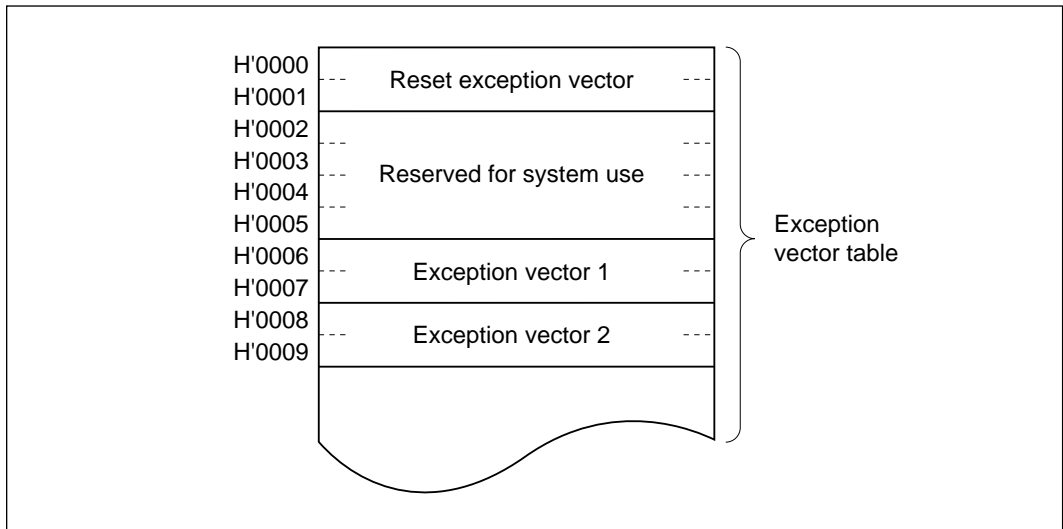

Figure 1-2 Exception Vector Table (normal mode)

The memory indirect addressing mode (@@aa:8) employed in the JMP and JSR instructions uses an 8-bit absolute address to specify a memory operand that contains a branch address. In normal mode the operand is a 16-bit word operand, providing a 16-bit branch address. Branch addresses can be stored in the top area from H'0000 to H'00FF. Note that this area is also used for the exception vector table.

Stack Structure: When the program counter (PC) is pushed on the stack in a subroutine call, and the PC and condition-code register (CCR) are pushed on the stack in exception handling, they are stored in the same way as in the H8/300 CPU. See figure 1-3.

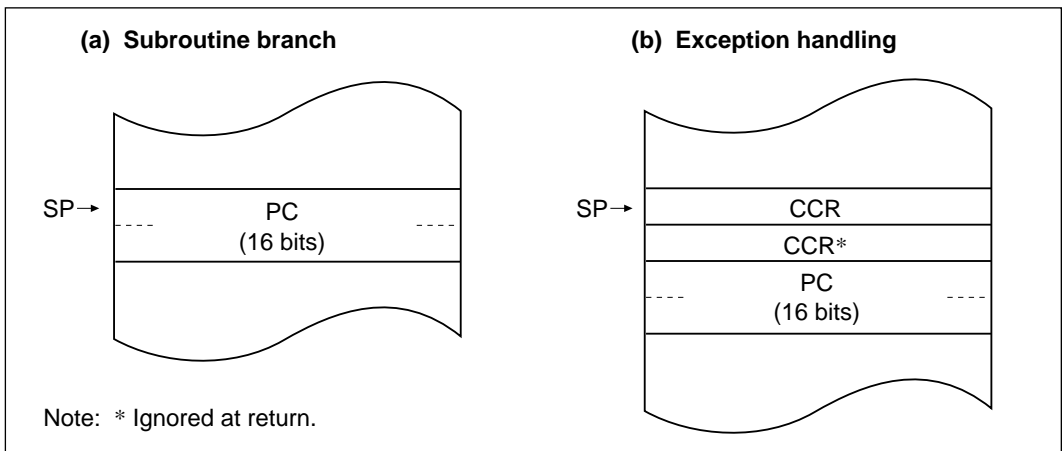

Figure 1-3 Stack Structure (normal mode)

(2) Advanced Mode: In advanced mode the exception vector table and stack structure differ from the H8/300 CPU.

Address Space: Up to 16 Mbytes can be accessed linearly.

Extended Registers (En): The extended registers (E0 to E7) can be used as 16-bit data registers, or they can be combined with the general registers (R0 to R7) for use as 32-bit data registers. When a 32-bit register is used as an address register, the upper 8 bits are ignored.

Instruction Set: All additional instructions and addressing modes of the H8/300H can be used.

Exception Vector Table and Memory Indirect Branch Addresses: In advanced mode the top area starting at H'000000 is allocated to the exception vector table in units of 32 bits. In each 32 bits, the upper 8 bits are ignored and a branch address is stored in the lower 24 bits (figure 1-4). The exception vector table differs depending on the microcontroller, so see the relevant hardware manual for further information.

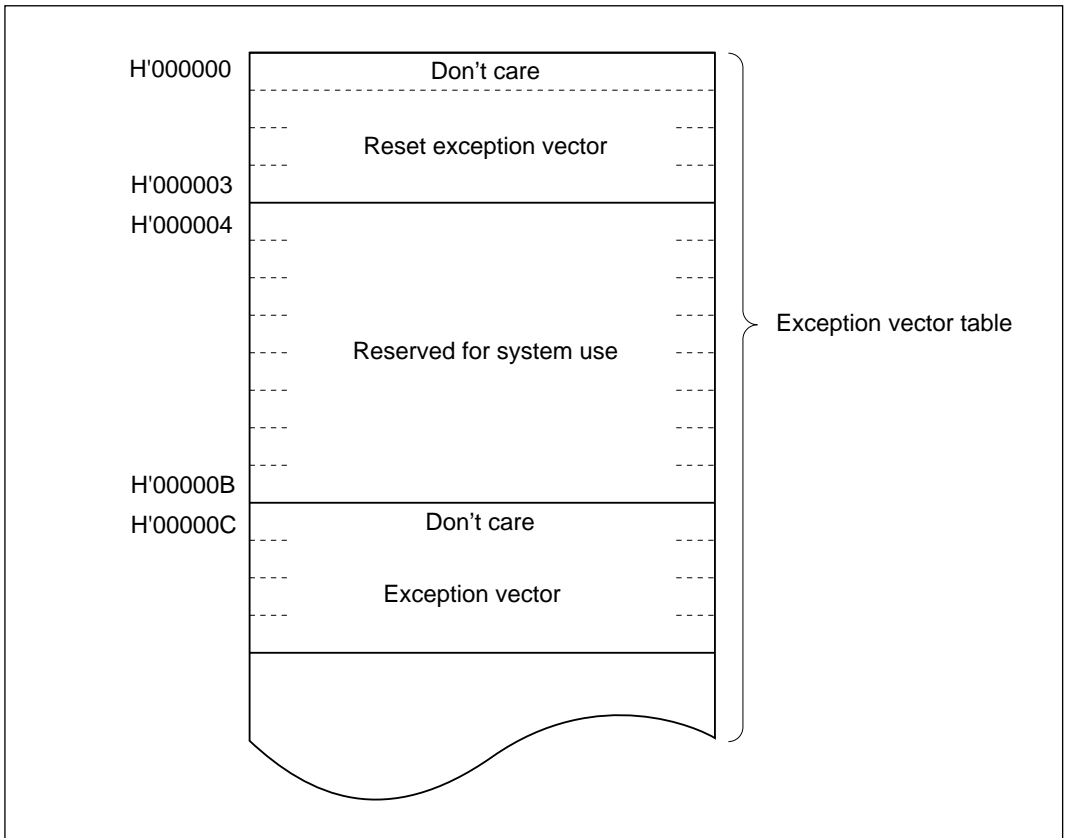

Figure 1-4 Exception Vector Table (advanced mode)

The memory indirect addressing mode (@@aa:8) employed in the JMP and JSR instructions uses an 8-bit absolute address to specify a memory operand that contains a branch address. In advanced mode the operand is a 32-bit longword operand, of which the lower 24 bits are the branch address. Branch addresses can be stored in the top area from H'000000 to H'0000FF. Note that this area is also used for the exception vector table.

Stack Structure: When the program counter (PC) is pushed on the stack in a subroutine call, and the PC and condition-code register (CCR) are pushed on the stack in exception handling, they are stored as shown in figure 1-5.

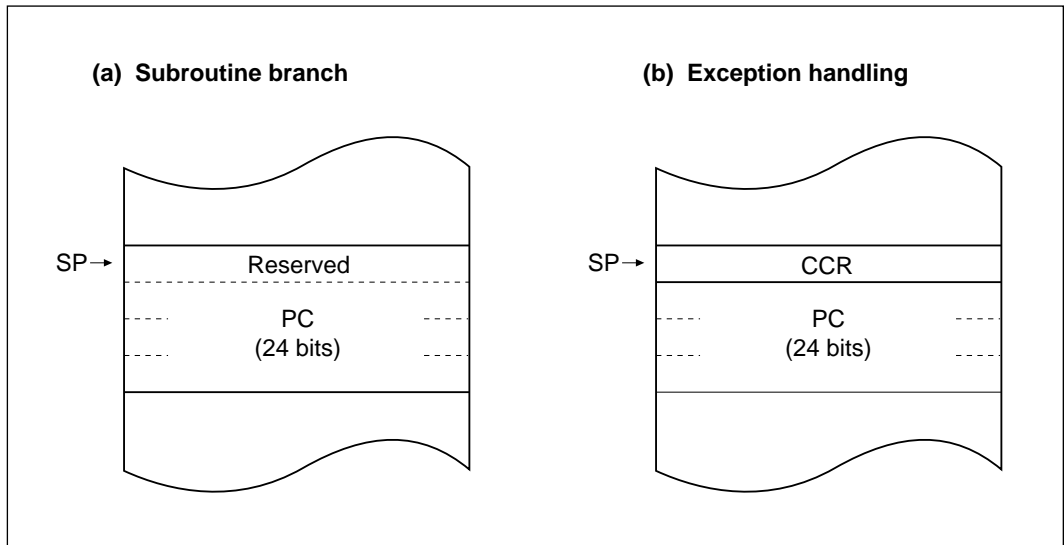

Figure 1-5 Stack Structure (advanced mode)

1.3 Address Space

Figure 1-6 shows a memory map of the H8/300H CPU.

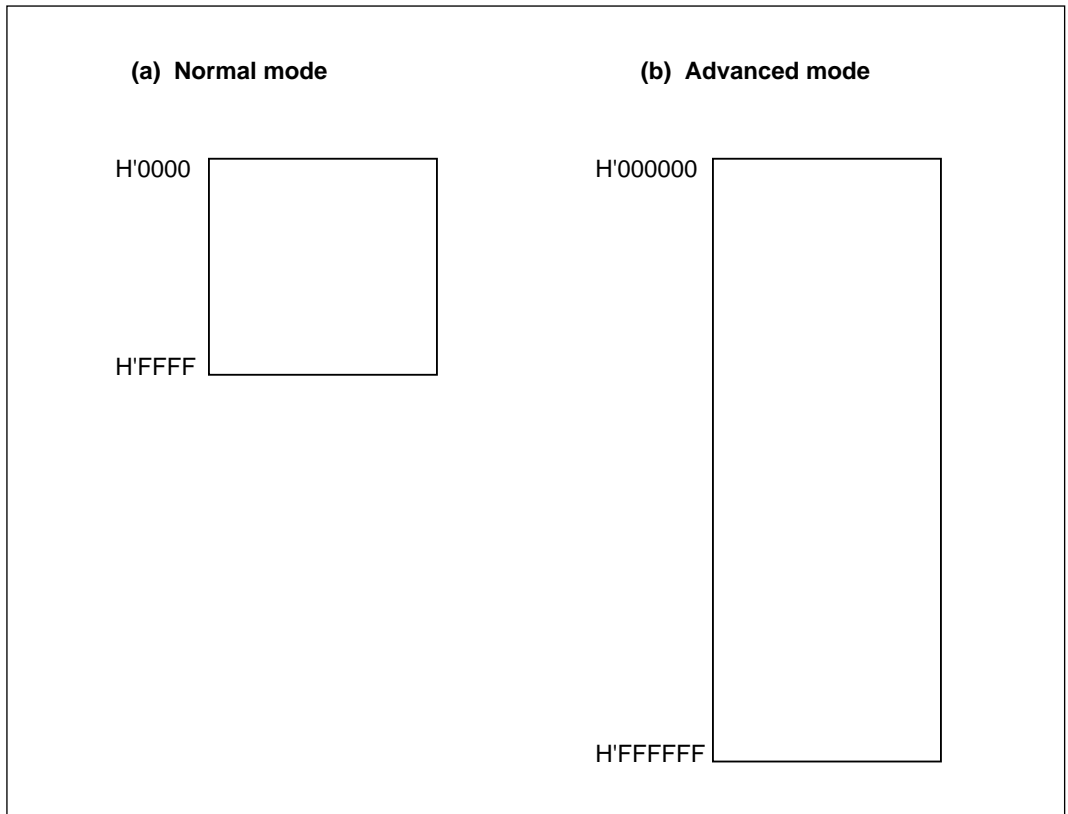

Figure 1-6 Memory Map

1.4 Register Configuration

1.4.1 Overview

The H8/300H CPU has the internal registers shown in figure 1-7. There are two types of registers: general and extended registers, and control registers.

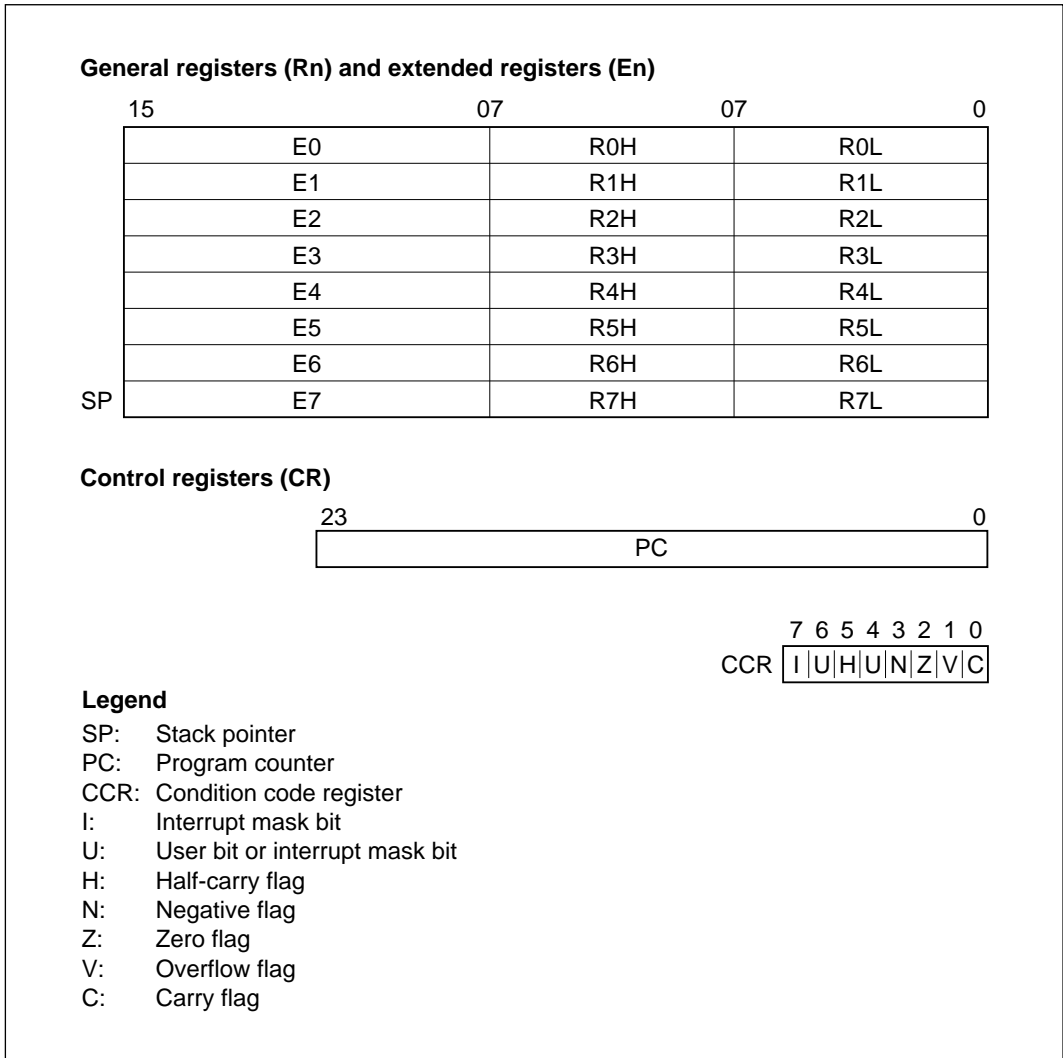

Figure 1-7 CPU Registers

1.4.2 General Registers

The H8/300H CPU has eight 32-bit general registers. These general registers are all functionally alike and can be used without distinction between data registers and address registers. When a general register is used as a data register, it can be accessed as a 32-bit, 16-bit, or 8-bit register. When the general registers are used as 32-bit registers or as address registers, they are designated by the letters ER (ER0 to ER7).

The ER registers divide into 16-bit general registers designated by the letters E (E0 to E7) and R (R0 to R7). These registers are functionally equivalent, providing a maximum sixteen 16-bit registers. The E registers (E0 to E7) are also referred to as extended registers.

The R registers divide into 8-bit general registers designated by the letters RH (R0H to R7H) and RL (R0L to R7L). These registers are functionally equivalent, providing a maximum sixteen 8-bit registers.

Figure 1-8 illustrates the usage of the general registers. The usage of each register can be selected independently.

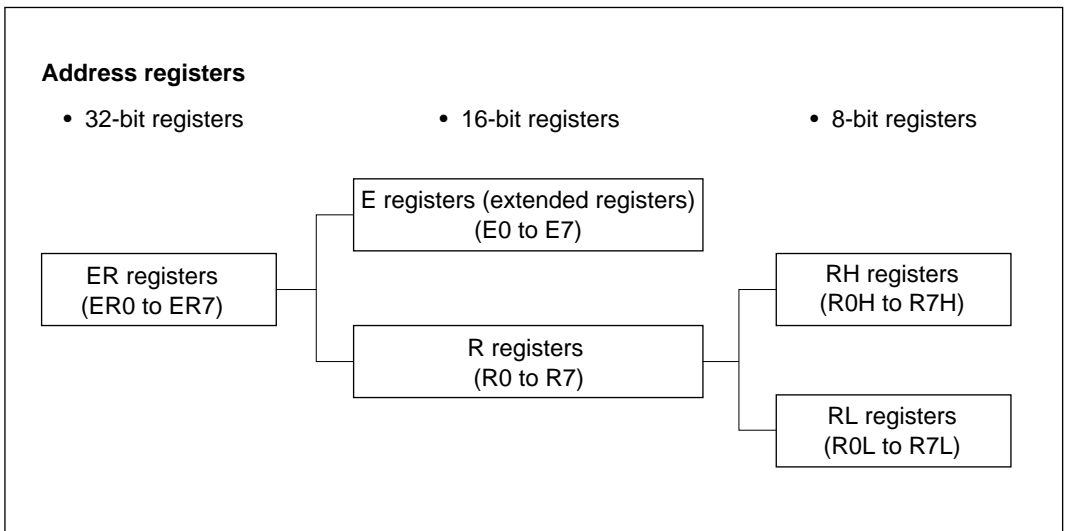

Figure 1-8 Usage of General Registers

General register ER7 has the function of stack pointer (SP) in addition to its general-register function, and is used implicitly in exception handling and subroutine calls. Figure 1-9 shows the stack.

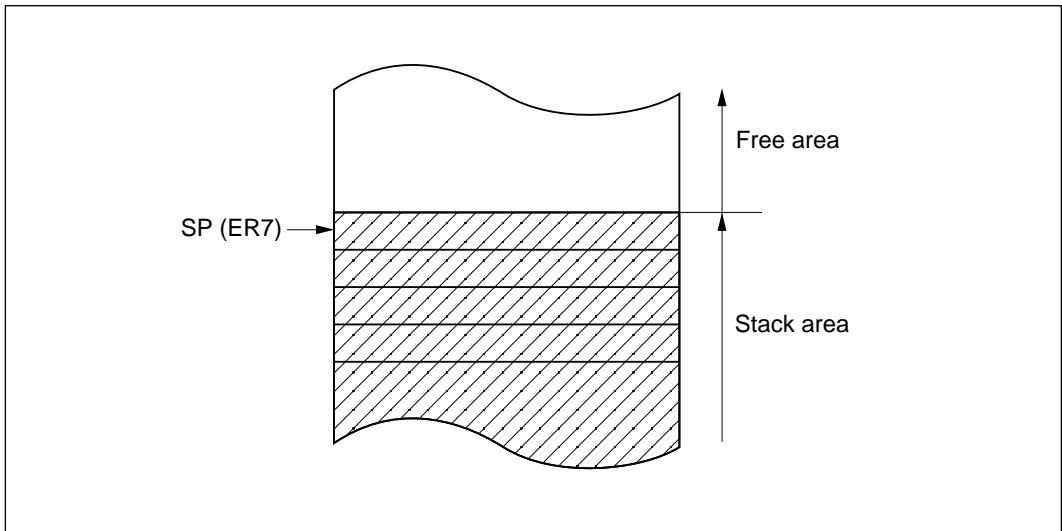

Figure 1-9 Stack

1.4.3 Control Registers

The control registers are the 24-bit program counter (PC) and the 8-bit condition-code register (CCR).

(1) Program Counter (PC): This 24-bit counter indicates the address of the next instruction the CPU will execute. The length of all CPU instructions is 16 bits (one word) or a multiple of 16 bits, so the least significant PC bit is ignored. When an instruction is fetched, the least significant PC bit is regarded as 0.

(2) Condition Code Register (CCR): This 8-bit register contains internal CPU status information, including the interrupt mask bit (I) and half-carry (H), negative (N), zero (Z), overflow (V), and carry (C) flags.

Bit 7—Interrupt Mask Bit (I): Masks interrupts other than NMI when set to 1. (NMI is accepted regardless of the I bit setting.) The I bit is set to 1 by hardware at the start of an exception-handling sequence.

Bit 6—User Bit (U): Can be written and read by software using the LDC, STC, ANDC, ORC, and XORC instructions. This bit can also be used as an interrupt mask bit. For details see the relevant microcontroller hardware manual.

Bit 5—Half-Carry Flag (H): When the ADD.B, ADDX.B, SUB.B, SUBX.B, CMP.B, or NEG.B instruction is executed, this flag is set to 1 if there is a carry or borrow at bit 3, and cleared to 0 otherwise. When the ADD.W, SUB.W, CMP.W, or NEG.W instruction is executed, the H flag is set to 1 if there is a carry or borrow at bit 11, and cleared to 0 otherwise. When the ADD.L, SUB.L, CMP.L, or NEG.L instruction is executed, the H flag is set to 1 if there is a carry or borrow at bit 27, and cleared to 0 otherwise.

Bit 4—User Bit (U): Can be written and read by software using the LDC, STC, ANDC, ORC, and XORC instructions.

Bit 3—Negative Flag (N): Indicates the most significant bit (sign bit) of the result of an instruction.

Bit 2—Zero Flag (Z): Set to 1 to indicate a zero result, and cleared to 0 to indicate a non-zero result.

Bit 1—Overflow Flag (V): Set to 1 when an arithmetic overflow occurs, and cleared to 0 at other times.

Bit 0—Carry Flag (C): Set to 1 when a carry occurs, and cleared to 0 otherwise. Used by:

- Add instructions, to indicate a carry
- Subtract instructions, to indicate a borrow
- Shift and rotate instructions, to store the value shifted out of the end bit

The carry flag is also used as a bit accumulator by bit manipulation instructions. Some instructions leave some or all of the flag bits unchanged. For the action of each instruction on the flag bits, refer to the detailed descriptions of the instructions starting in section 2.2.1.

Operations can be performed on the CCR bits by the LDC, STC, ANDC, ORC, and XORC instructions. The N, Z, V, and C flags are used as branching conditions for conditional branch (Bcc) instructions.

1.4.4 Initial Register Values

When the CPU is reset, the program counter (PC) is loaded from the vector table and the I bit in the condition-code register (CCR) is set to 1. The other CCR bits and the general registers and extended registers are not initialized. In particular, the stack pointer (extended register E7 and general register R7) is not initialized. The stack pointer must therefore be initialized by an MOV.L instruction executed immediately after a reset.

1.5 Data Formats

The H8/300H CPU can process 1-bit, 4-bit, 8-bit (byte), 16-bit (word), and 32-bit (longword) data. Bit-manipulation instructions operate on 1-bit data by accessing bit n ($n = 0, 1, 2, \dots, 7$) of byte operand data. The DAA and DAS decimal-adjust instructions treat byte data as two digits of 4-bit BCD data.

1.5.1 General Register Data Formats

Figure 1-10 shows the data formats in general registers.

| Data type | Register number | Data format |
|----------------|-----------------|---|
| 1-bit data | RnH | <p>7 0 7 6 5 4 3 2 1 0 Don't care</p> |
| 1-bit data | RnL | <p>7 0 Don't care 7 6 5 4 3 2 1 0</p> |
| 4-bit BCD data | RnH | <p>7 4 3 0 Upper Lower Don't care</p> |
| 4-bit BCD data | RnL | <p>7 4 3 0 Don't care Upper Lower</p> |
| Byte data | RnH | <p>7 0 MSB LSB Don't care</p> |
| Byte data | RnL | <p>7 0 Don't care MSB LSB</p> |

Figure 1-10 General Register Data Formats

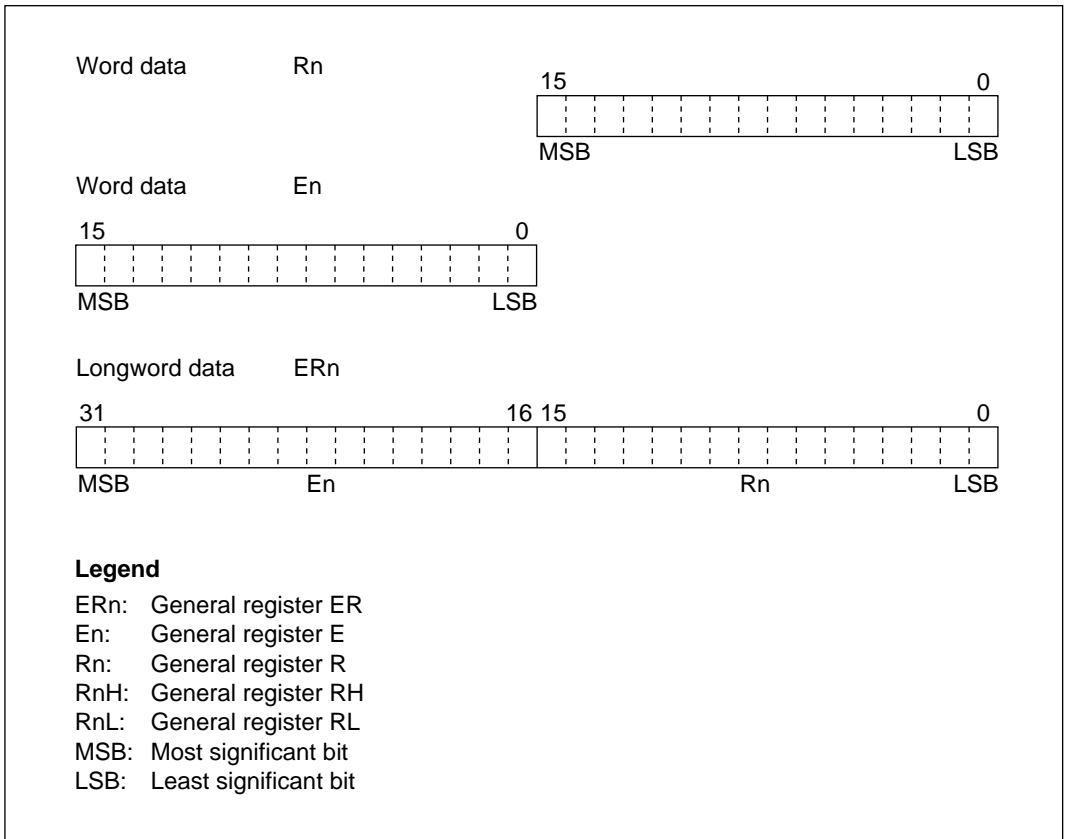

Figure 1-10 General Register Data Formats (cont)

1.5.2 Memory Data Formats

Figure 1-11 shows the data formats on memory. The H8/300H CPU can access word data and longword data on memory, but word or longword data must begin at an even address. If an attempt is made to access word or longword data at an odd address, no address error occurs but the least significant bit of the address is regarded as 0, so the access starts at the preceding address. This also applies to instruction fetches.

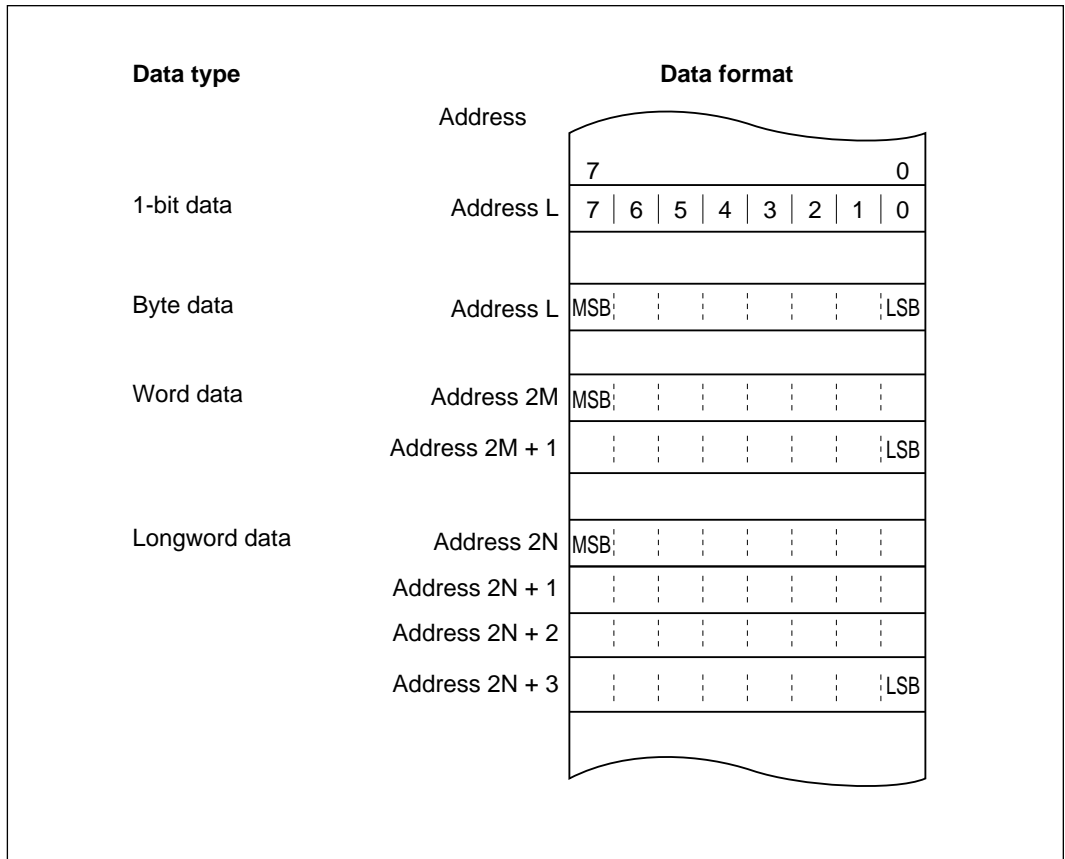

Figure 1-11 Memory Data Formats

When ER7 is used as an address register to access the stack, the operand size should be word size or longword size.

1.6 Instruction Set

1.6.1 Overview

The H8/300H CPU has 62 types of instructions, which are classified by function in table 1-1. For a detailed description of each instruction see section 2.2, Instruction Descriptions.

Table 1-1 Instruction Classification

| Function | Instructions | Number |
|-----------------------|--|--------|
| Data transfer | MOV, PUSH* ¹ , POP* ² , MOVTPE, MOVFPE | 3 |
| Arithmetic operations | ADD, SUB, ADDX, SUBX, INC, DEC, ADDS, SUBS, DAA, DAS, MULXU, MULXS, DIVXU, DIVXS, CMP, NEG, EXTS, EXTU | 18 |
| Logic operations | AND, OR, XOR, NOT | 4 |
| Shift | SHAL, SHAR, SHLL, SHLR, ROTL, ROTR, ROTXL, ROTXR | 8 |
| Bit manipulation | BSET, BCLR, BNOT, BTST, BAND, BIAND, BOR, BIOR, BXOR, BIXOR, BLD, BILD, BST, BIST | 14 |
| Branch | Bcc* ² , JMP, BSR, JSR, RTS | 5 |
| System control | TRAPA, RTE, SLEEP, LDC, STC, ANDC, ORC, XORC, NOP | 9 |
| Block data transfer | EEPMOV | 1 |

Total 62 types

Notes: The shaded instructions are not present in the H8/300 instruction set.

1. POP.W Rn and PUSH.W Rn are identical to MOV.W @SP+, Rn and MOV.W Rn, @-SP. POP.L ERn and PUSH.L ERn are identical to MOV.L @SP+, ERn and MOV.L ERn, @-SP.
2. Bcc is the generic designation of a conditional branch instruction.

1.6.2 Instructions and Addressing Modes

Table 1-2 indicates the instructions available in the H8/300H CPU.

Table 1-2 Instruction Set Overview

| Function | Instruction | Addressing Modes | | | | | | | | | | | | | |
|-----------------------|------------------|------------------|-----------------|------|-------------|-------------|-------------|-------|--------|--------|-----------|------------|--------|----|---|
| | | #xx | Rn | @ERn | @(d:16,ERn) | @(d:24,ERn) | @ERn+/@-ERn | @aa:8 | @aa:16 | @aa:24 | @(d:8,PC) | @(d:16,PC) | @@aa:8 | | |
| Data transfer | MOV | BWL | BWL | BWL | BWL | BWL | BWL | B | BWL | BWL | — | — | — | — | |
| | POP, PUSH | — | — | — | — | — | — | — | — | — | — | — | — | WL | |
| | MOVFP, MOVTPE | — | — | — | — | — | — | — | B | — | — | — | — | — | |
| Arithmetic operations | ADD, CMP | BWL | BWL | — | — | — | — | — | — | — | — | — | — | — | |
| | SUB | WL | BWL | — | — | — | — | — | — | — | — | — | — | — | |
| | ADDX, SUBX | B | B | — | — | — | — | — | — | — | — | — | — | — | |
| | ADDS, SUBS | — | L ^{*1} | — | — | — | — | — | — | — | — | — | — | — | |
| | INC, DEC | — | BWL | — | — | — | — | — | — | — | — | — | — | — | |
| | DAA, DAS | — | B | — | — | — | — | — | — | — | — | — | — | — | |
| | MULXU, DIVXU | — | BW | — | — | — | — | — | — | — | — | — | — | — | |
| | MULXS, DIVXS | — | BW | — | — | — | — | — | — | — | — | — | — | — | |
| | NEG | — | BWL | — | — | — | — | — | — | — | — | — | — | — | |
| | EXTU, EXTS | — | WL | — | — | — | — | — | — | — | — | — | — | — | |
| | Logic operations | AND, OR, XOR | BWL | BWL | — | — | — | — | — | — | — | — | — | — | — |
| | | NOT | — | BWL | — | — | — | — | — | — | — | — | — | — | — |
| | Shift | — | BWL | — | — | — | — | — | — | — | — | — | — | — | — |
| Bit manipulation | — | B | B | — | — | — | — | B | — | — | — | — | — | — | |

Table 1-2 Instruction Set Overview (cont)

| Function | Instruction | Addressing Modes | | | | | | | | | | | | | |
|---------------------|-----------------------|------------------|----|------|-------------|-------------|-------------|-------|--------|--------|-----------|------------|--------|---|---|
| | | #xx | Rn | @ERn | @(d:16,ERn) | @(d:24,ERn) | @ERn+/@-ERn | @aa:8 | @aa:16 | @aa:24 | @(d:8,PC) | @(d:16,PC) | @@aa:8 | | |
| Branch | Bcc, BSR | — | — | — | — | — | — | — | — | — | ○ | ○ | — | — | |
| | JMP, JSR | — | — | ○ | — | — | — | — | — | ○*2 | — | — | ○ | — | |
| | RTS | — | — | — | — | — | — | — | — | — | — | — | — | ○ | |
| System control | TRAPA | — | — | — | — | — | — | — | — | — | — | — | — | ○ | |
| | RTE | — | — | — | — | — | — | — | — | — | — | — | — | ○ | |
| | SLEEP | — | — | — | — | — | — | — | — | — | — | — | — | ○ | |
| | LDC | B | B | W | W | W | W | — | W | W | — | — | — | — | |
| | STC | — | B | W | W | W | W | — | W | W | — | — | — | — | |
| | ANDC, ORC, XORC | B | — | — | — | — | — | — | — | — | — | — | — | — | — |
| | NOP | — | — | — | — | — | — | — | — | — | — | — | — | — | ○ |
| Block data transfer | EEPMOV.B | — | — | — | — | — | — | — | — | — | — | — | — | ○ | |
| | EEPMOV.W | — | — | — | — | — | — | — | — | — | — | — | — | ○ | |

Legend

B: Byte

W: Word

L: Longword

■ : Newly added instruction in H8/300H CPU

- Notes: 1. The operand size of the ADDS and SUBS instructions of the H8/300H CPU has been changed to longword size. (In the H8/300 CPU it was word size.)
2. Because of its larger address space, the H8/300H CPU uses a 24-bit absolute address for the JMP and JSR instructions. (The H8/300 CPU used 16 bits.)

1.6.3 Tables of Instructions Classified by Function

Table 1-3 summarizes the instructions in each functional category. The notation used in table 1-3 is defined next.

Operation Notation

| | |
|---------------|------------------------------------|
| Rd | General register (destination)* |
| Rs | General register (source)* |
| Rn | General register* |
| ERn | General register (32-bit register) |
| (EAd) | Destination operand |
| (EAs) | Source operand |
| CCR | Condition code register |
| N | N (negative) bit of CCR |
| Z | Z (zero) bit of CCR |
| V | V (overflow) bit of CCR |
| C | C (carry) bit of CCR |
| PC | Program counter |
| SP | Stack pointer |
| #IMM | Immediate data |
| disp | Displacement |
| + | Addition |
| - | Subtraction |
| × | Multiplication |
| ÷ | Division |
| ^ | AND logical |
| ∨ | OR logical |
| ⊕ | Exclusive OR logical |
| → | Move |
| ¬ | Not |
| :3/:8/:16/:24 | 3-, 8-, 16-, or 24-bit length |

Note: * General registers include 8-bit registers (R0H/R0L to R7H/R7L), 16-bit registers (R0 to R7, E0 to E7), and 32-bit registers (ER0 to ER7).

Table 1-3 Instructions Classified by Function

| Type | Instruction | Size* | Function |
|---------------|--------------------|--------------|---|
| Data transfer | MOV | B/W/L | (EAs) → Rd, Rs → (EAd) Moves data between two general registers or between a general register and memory, or moves immediate data to a general register. |
| | MOVFP | B | (EAs) → Rd Moves external memory contents (addressed by @aa:16) to a general register in synchronization with an E clock. |
| | MOVTP | B | Rs → (EAd) Moves general register contents to an external memory location (addressed by @aa:16) in synchronization with an E clock. |
| | POP | W/L | @SP+ → Rn Pops a register from the stack. POP.W Rn is identical to MOV.W @SP+, Rn. POP.L ERn is identical to MOV.L @SP+, ERn. |
| | PUSH | W/L | Rn → @-SP Pushes a register onto the stack. PUSH.W Rn is identical to MOV.W Rn, @-SP. PUSH.L ERn is identical to MOV.L ERn, @-SP. |

Note: * Size refers to the operand size.

B: Byte

W: Word

L: Longword

Table 1-3 Instructions Classified by Function (cont)

| Type | Instruction | Size* | Function |
|-----------------------|--------------|-------|--|
| Arithmetic operations | ADD SUB | B/W/L | $Rd \pm Rs \rightarrow Rd$, $Rd \pm \#IMM \rightarrow Rd$ Performs addition or subtraction on data in two general registers, or on immediate data and data in a general register. (Immediate byte data cannot be subtracted from data in a general register. Use the SUBX or ADD instruction.) |
| | ADDX SUBX | B | $Rd \pm Rs \pm C \rightarrow Rd$, $Rd \pm \#IMM \pm C \rightarrow Rd$ Performs addition or subtraction with carry or borrow on byte data in two general registers, or on immediate data and data in a general register. |
| | INC DEC | B/W/L | $Rd \pm 1 \rightarrow Rd$, $Rd \pm 2 \rightarrow Rd$ Increments or decrements a general register by 1 or 2. (Byte operands can be incremented or decremented by 1 only.) |
| | ADDS SUBS | L | $Rd \pm 1 \rightarrow Rd$, $Rd \pm 2 \rightarrow Rd$, $Rd \pm 4 \rightarrow Rd$ Adds or subtracts the value 1, 2, or 4 to or from data in a 32-bit register. |
| | DAA DAS | B | Rd decimal adjust $\rightarrow Rd$ Decimal-adjusts an addition or subtraction result in a general register by referring to the CCR to produce 4-bit BCD data. |
| | MULXS | B/W | $Rd \times Rs \rightarrow Rd$ Performs signed multiplication on data in two general registers: either 8 bits \times 8 bits \rightarrow 16 bits or 16 bits \times 16 bits \rightarrow 32 bits. |
| | MULXU | B/W | $Rd \times Rs \rightarrow Rd$ Performs unsigned multiplication on data in two general registers: either 8 bits \times 8 bits \rightarrow 16 bits or 16 bits \times 16 bits \rightarrow 32 bits. |
| | DIVXS | B/W | $Rd \div Rs \rightarrow Rd$ Performs signed division on data in two general registers: either 16 bits \div 8 bits \rightarrow 8-bit quotient and 8-bit remainder or 32 bits \div 16 bits \rightarrow 16-bit quotient and 16-bit remainder. |

Note: * Size refers to the operand size.

B: Byte

W: Word

L: Longword

Table 1-3 Instructions Classified by Function (cont)

| Type | Instruction | Size* | Function |
|-----------------------|-------------|-------|---|
| Arithmetic operations | DIVXU | B/W | $Rd \div Rs \rightarrow Rd$ Performs unsigned division on data in two general registers: either 16 bits \div 8 bits \rightarrow 8-bit quotient and 8-bit remainder or 32 bits \div 16 bits \rightarrow 16-bit quotient and 16-bit remainder. |
| | CMP | B/W/L | $Rd - Rs, Rd - \#IMM$ Compares data in a general register with data in another general register or with immediate data, and sets the CCR according to the result. |
| | NEG | B/W/L | $0 - Rd \rightarrow Rd$ Takes the two's complement (arithmetic complement) of data in a general register. |
| | EXTS | W/L | Rd (sign extension) $\rightarrow Rd$ Extends byte data in the lower 8 bits of a 16-bit register to word data, or extends word data in the lower 16 bits of a 32-bit register to longword data, by extending the sign bit. |
| | EXTU | W/L | Rd (zero extension) $\rightarrow Rd$ Extends byte data in the lower 8 bits of a 16-bit register to word data, or extends word data in the lower 16 bits of a 32-bit register to longword data, by padding with zeros. |
| Logic operations | AND | B/W/L | $Rd \wedge Rs \rightarrow Rd, Rd \wedge \#IMM \rightarrow Rd$ Performs a logical AND operation on a general register and another general register or immediate data. |
| | OR | B/W/L | $Rd \vee Rs \rightarrow Rd, Rd \vee \#IMM \rightarrow Rd$ Performs a logical OR operation on a general register and another general register or immediate data. |
| | XOR | B/W/L | $Rd \oplus Rs \rightarrow Rd, Rd \oplus \#IMM \rightarrow Rd$ Performs a logical exclusive OR operation on a general register and another general register or immediate data. |
| | NOT | B/W/L | $\neg (Rd) \rightarrow (Rd)$ Takes the one's complement of general register contents. |

Note: * Size refers to the operand size.

B: Byte

W: Word

L: Longword

Table 1-3 Instructions Classified by Function (cont)

| Type | Instruction | Size* | Function |
|-------------------------------|----------------|-------|--|
| Shift operations | SHAL SHAR | B/W/L | Rd (shift) → Rd Performs an arithmetic shift on general register contents. |
| | SHLL SHLR | B/W/L | Rd (shift) → Rd Performs a logical shift on general register contents. |
| | ROTL ROTR | B/W/L | Rd (rotate) → Rd Rotates general register contents. |
| | ROTXL ROTXR | B/W/L | Rd (rotate) → Rd Rotates general register contents through the carry bit. |
| Bit-manipulation instructions | BSET | B | 1 → (<bit-No.> of <EAd>) Sets a specified bit in a general register or memory operand to 1. The bit number is specified by 3-bit immediate data or the lower three bits of a general register. |
| | BCLR | B | 0 → (<bit-No.> of <EAd>) Clears a specified bit in a general register or memory operand to 0. The bit number is specified by 3-bit immediate data or the lower three bits of a general register. |
| | BNOT | B | \neg (<bit-No.> of <EAd>) → (<bit-No.> of <EAd>) Inverts a specified bit in a general register or memory operand. The bit number is specified by 3-bit immediate data or the lower three bits of a general register. |
| | BTST | B | \neg (<bit-No.> of <EAd>) → Z Tests a specified bit in a general register or memory operand and sets or clears the Z flag accordingly. The bit number is specified by 3-bit immediate data or the lower three bits of a general register. |
| | BAND | B | $C \wedge$ (<bit-No.> of <EAd>) → C ANDs the carry flag with a specified bit in a general register or memory operand and stores the result in the carry flag. |
| | BIAND | B | $C \wedge \neg$ (<bit-No.> of <EAd>) → C ANDs the carry flag with the inverse of a specified bit in a general register or memory operand and stores the result in the carry flag. The bit number is specified by 3-bit immediate data. |

Note: * Size refers to the operand size.

B: Byte

W: Word

L: Longword

Table 1-3 Instructions Classified by Function (cont)

| Type | Instruction | Size* | Function |
|-------------------------------|-------------|-------|--|
| Bit-manipulation instructions | BOR | B | $C \vee \langle \text{bit-No.} \rangle \text{ of } \langle \text{EAd} \rangle \rightarrow C$ ORs the carry flag with a specified bit in a general register or memory operand and stores the result in the carry flag. |
| | BIOR | B | $C \vee [\neg \langle \text{bit-No.} \rangle \text{ of } \langle \text{EAd} \rangle] \rightarrow C$ ORs the carry flag with the inverse of a specified bit in a general register or memory operand and stores the result in the carry flag. The bit number is specified by 3-bit immediate data. |
| | BXOR | B | $C \oplus \langle \text{bit-No.} \rangle \text{ of } \langle \text{EAd} \rangle \rightarrow C$ Exclusive-ORs the carry flag with a specified bit in a general register or memory operand and stores the result in the carry flag. |
| | BIXOR | B | $C \oplus [\neg \langle \text{bit-No.} \rangle \text{ of } \langle \text{EAd} \rangle] \rightarrow C$ Exclusive-ORs the carry flag with the inverse of a specified bit in a general register or memory operand and stores the result in the carry flag. The bit number is specified by 3-bit immediate data. |
| | BLD | B | $\langle \text{bit-No.} \rangle \text{ of } \langle \text{EAd} \rangle \rightarrow C$ Transfers a specified bit in a general register or memory operand to the carry flag. |
| | BILD | B | $\neg \langle \text{bit-No.} \rangle \text{ of } \langle \text{EAd} \rangle \rightarrow C$ Transfers the inverse of a specified bit in a general register or memory operand to the carry flag. The bit number is specified by 3-bit immediate data. |
| | BST | B | $C \rightarrow \langle \text{bit-No.} \rangle \text{ of } \langle \text{EAd} \rangle$ Transfers the carry flag value to a specified bit in a general register or memory operand. |
| | BIST | B | $\neg C \rightarrow \langle \text{bit-No.} \rangle \text{ of } \langle \text{EAd} \rangle$ Transfers the inverse of the carry flag value to a specified bit in a general register or memory operand. The bit number is specified by 3-bit immediate data. |

Note: * Size refers to the operand size.

B: Byte

Table 1-3 Instructions Classified by Function (cont)

| Type | Instruction | Size* | Function | | |
|------------------------|-------------|--|--|----------------------------|--|
| Branching instructions | Bcc | — | Branches to a specified address if a specified condition is true. The branching conditions are listed below. | | |
| | | | Mnemonic | Description | Condition |
| | | | BRA(BT) | Always (true) | Always |
| | | | BRN(BF) | Never (false) | Never |
| | | | BHI | High | $C \vee Z = 0$ |
| | | | BLS | Low or same | $C \vee Z = 1$ |
| | | | Bcc(BHS) | Carry clear (high or same) | $C = 0$ |
| | | | BCS(BLO) | Carry set (low) | $C = 1$ |
| | | | BNE | Not equal | $Z = 0$ |
| | | | BEQ | Equal | $Z = 1$ |
| | | | BVC | Overflow clear | $V = 0$ |
| | | | BVS | Overflow set | $V = 1$ |
| | | | BPL | Plus | $N = 0$ |
| | | | BMI | Minus | $N = 1$ |
| | | | BGE | Greater or equal | $N \oplus V = 0$ |
| | | | BLT | Less than | $N \oplus V = 1$ |
| | | | BGT | Greater than | $Z \vee (N \oplus V) = 0$ |
| | | | BLE | Less or equal | $Z \vee (N \oplus V) = 1$ |
| | | | JMP | — | Branches unconditionally to a specified address. |
| BSR | — | Branches to a subroutine at a specified address. | | | |
| JSR | — | Branches to a subroutine at a specified address. | | | |
| RTS | — | Returns from a subroutine. | | | |

Note: * Size refers to the operand size.

Table 1-3 Instructions Classified by Function (cont)

| Type | Instruction | Size* | Function |
|-----------------------------|-------------|-------|---|
| System control instructions | TRAPA | — | Starts trap-instruction exception handling. |
| | RTE | — | Returns from an exception-handling routine. |
| | SLEEP | — | Causes a transition to the power-down state. |
| | LDC | B/W | (EAs) → CCR Moves the source operand contents to the condition code register. Byte transfer is performed in the #xx:8, Rs addressing mode and word transfer in other addressing modes. |
| | STC | B/W | CCR → (EAd) Transfers the CCR contents to a destination location. Byte transfer is performed in the Rd addressing mode and word transfer in other addressing modes. |
| | ANDC | B | CCR ∧ #IMM → CCR Logically ANDs the condition code register with immediate data. |
| | ORC | B | CCR ∨ #IMM → CCR Logically ORs the condition code register with immediate data. |
| | XORC | B | CCR ⊕ #IMM → CCR Logically exclusive-ORs the condition code register with immediate data. |
| | NOP | — | PC + 2 → PC Only increments the program counter. |

Note: * Size refers to the operand size.

B: Byte

W: Word

Table 1-3 Instructions Classified by Function (cont)

| Type | Instruction | Size* | Function |
|---------------------------------|-------------|-------|--|
| Block data transfer instruction | EEPMOV.B | — | if R4L ≠ 0 then Repeat @ER5 +→ @ER6 + R4L – 1→R4L Until R4L = 0 else next; |
| | EEPMOV.W | — | if R4 ≠ 0 then Repeat @ER5 +→ @ER6 + R4 – 1→R4L Until R4 = 0 else next; Transfers a data block according to parameters set in general registers R4L or R4, ER5, and R6. R4L or R4: size of block (bytes) ER5: starting source address R6: starting destination address Execution of the next instruction begins as soon as the transfer is completed. |

Note: * Size refers to the operand size.

1.6.4 Basic Instruction Formats

The H8/300H instructions consist of 2-byte (1-word) units. An instruction consists of an operation field (OP field), a register field (r field), an effective address extension (EA field), and a condition field (cc).

Operation Field: Indicates the function of the instruction, the effective address, and the operation to be carried out on the operand. The operation field always includes the first four bits of the instruction. Some instructions have two operation fields.

Register Field: Specifies a general register. Address registers are specified by 3 bits, data registers by 3 bits or 4 bits. Some instructions have two register fields. Some have no register field.

Effective Address Extension: Eight, 16, or 32 bits specifying immediate data, an absolute address, or a displacement. A 24-bit address or a displacement is treated as 32-bit data in which the first 8 bits are 0.

Condition Field: Specifies the branching condition of Bcc instructions.

Figure 1-12 shows examples of instruction formats.

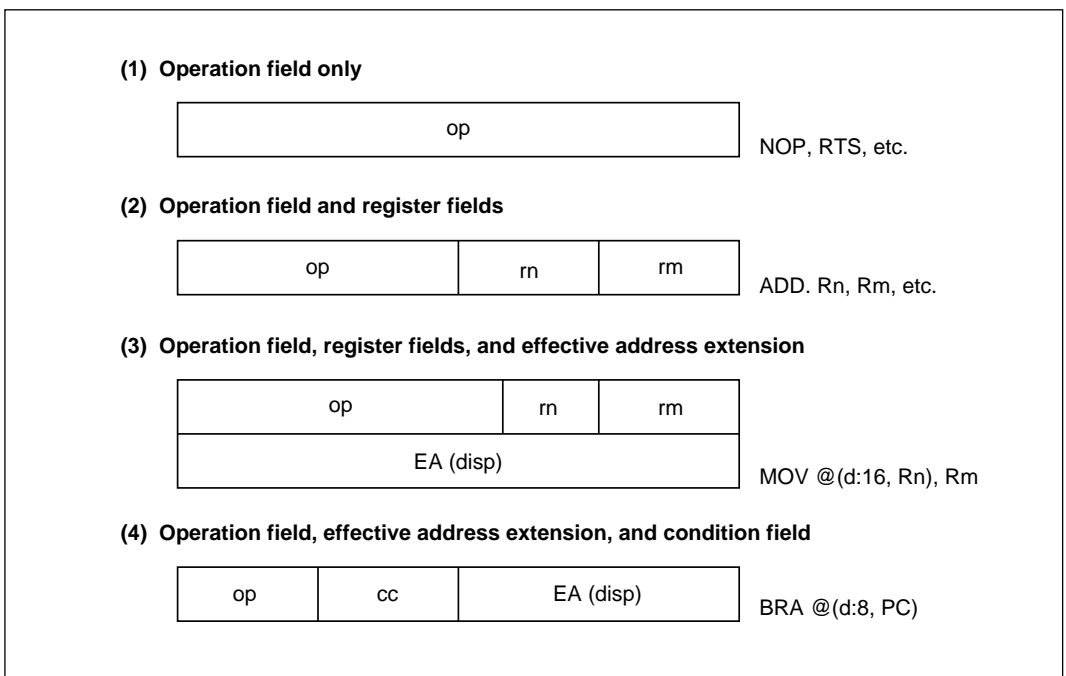

Figure 1-12 Instruction Formats

1.6.5 Addressing Modes and Effective Address Calculation

(1) Addressing Modes: The H8/300H CPU supports the eight addressing modes listed in table 1-4. Each instruction uses a subset of these addressing modes. Arithmetic and logic instructions can use the register direct and immediate modes. Data transfer instructions can use all addressing modes except program-counter relative and memory indirect. Bit manipulation instructions use register direct, register indirect, or absolute (8-bit) addressing mode to specify an operand, and register direct (BSET, BCLR, BNOT, and BTST instructions) or immediate (3-bit) addressing mode to specify a bit number in the operand.

Table 1-4 Addressing Modes

| No. | Addressing Mode | Symbol |
|-----|---|-------------------------|
| 1 | Register direct | Rn |
| 2 | Register indirect | @ERn |
| 3 | Register indirect with displacement | @(d:16,ERn)/@(d:24,ERn) |
| 4 | Register indirect with post-increment Register indirect with pre-decrement | @ERn+ @-ERn |
| 5 | Absolute address | @aa:8/@aa:16/@aa:24 |
| 6 | Immediate | #xx:8/#xx:16/#xx:32 |
| 7 | Program-counter relative | @(d:8,PC)/@(d:16,PC) |
| 8 | Memory indirect | @@aa:8 |

1 Register Direct—Rn: The register field of the instruction specifies an 8-, 16-, or 32-bit general register containing the operand. R0H to R7H and R0L to R7L can be specified as 8-bit registers. R0 to R7 and E0 to E7 can be specified as 16-bit registers. ER0 to ER7 can be specified as 32-bit registers.

2 Register Indirect—@ERn: The register field of the instruction code specifies an address register (ERn), the lower 24 bits of which contain the address of a memory operand.

3 Register Indirect with Displacement—@(d:16, ERn) or @(d:24, ERn): A 16-bit or 24-bit displacement contained in the instruction is added to an address register (an extended register paired with a general register) specified by the register field of the instruction, and the lower 24 bits of the sum specify the address of a memory operand. A 16-bit displacement is sign-extended when added.

4 Register Indirect with Post-Increment or Pre-Decrement—@ERn+ or @-ERn:

- Register indirect with post-increment—@ERn+

The register field of the instruction code specifies an address register (ERn), the lower 24 bits of which contain the address of a memory operand. After the operand is accessed, 1, 2, or 4 is added to the address register contents (32 bits) and the sum is stored in the address register. The value added is 1 for byte access, 2 for word access, or 4 for longword access. For word or longword access, the register value should be even.

- Register indirect with pre-decrement—@-ERn

The value 1, 2, or 4 is subtracted from an address register (ERn) specified by the register field in the instruction code, and the lower 24 bits of the result becomes the address of a memory operand. The result is also stored in the address register. The value subtracted is 1 for byte access, 2 for word access, or 4 for longword access. For word or longword access, the resulting register value should be even.

5 Absolute Address—@aa:8, @aa:16, or @aa:24: The instruction code contains the absolute address of a memory operand. The absolute address may be 8 bits long (@aa:8), 16 bits long (@aa:16), or 24 bits long (@aa:24). For an 8-bit absolute address, the upper 16 bits are all assumed to be 1 (H'FFFF). For a 16-bit absolute address the upper 8 bits are a sign extension. A 24-bit absolute address can access the entire address space. Table 1-5 indicates the accessible address ranges.

Table 1-5 Absolute Address Access Ranges

| | Normal Mode | Advanced Mode |
|---------------------|--|---|
| 8 bits (@aa:8) | H'FF00 to H'FFFF (65,280 to 65,535) | H'FFFF00 to H'FFFFF (16,776,960 to 16,777,215) |
| 16 bits (@aa:16) | H'0000 to H'FFFF (0 to 65,535) | H'000000 to H'007FFF, H'FF8000 to H'FFFFFF (0 to 32,767, 16,744,448 to 16,777,215) |
| 24 bits (@aa:24) | H'0000 to H'FFFF (0 to 65,535) | H'00000 to H'FFFFF (0 to 16,777,215) |

For further details on the accessible range, see the relevant microcontroller hardware manual.

6 Immediate—#xx:8, #xx:16, or #xx:32: The instruction contains 8-bit (#xx:8), 16-bit (#xx:16), or 32-bit (#xx:32) immediate data as an operand.

The ADDS, SUBS, INC, and DEC instructions contain immediate data implicitly. Some bit manipulation instructions contain 3-bit immediate data in the second or fourth byte of the instruction, specifying a bit number. The TRAPA instruction contains 2-bit immediate data in the second byte of the instruction, specifying a vector address.

7 Program-Counter Relative—@(d:8, PC) or @(d:16, PC): This mode is used in the Bcc and BSR instructions. An 8-bit or 16-bit displacement contained in the instruction is sign-extended and added to the 24-bit program counter (PC) contents to generate a branch address. The PC value to which the displacement is added is the address of the first byte of the next instruction, so the possible branching range is –126 to +128 bytes (–63 to +64 words) or –32766 to +32768 bytes (–16383 to +16384 words) from the branch instruction. The resulting value should be an even number.

8 Memory Indirect—@@aa:8: This mode can be used by the JMP and JSR instructions. The second byte of the instruction specifies a memory operand by an 8-bit absolute address. This memory operand contains a branch address. The upper 8 bits of the absolute address are assumed to be 0 (H'00), so the address range is 0 to 255 (H'0000 to H'00FF in normal mode, H'000000 to H'0000FF in advanced mode). In normal mode the memory operand is a word operand and the branch address is 16 bits long. In advanced mode the memory operand is a longword operand. The first byte is ignored and the branch address is 24 bits long. Note that the first part of the address range is also the exception vector area. For further details see the relevant microcontroller hardware manual.

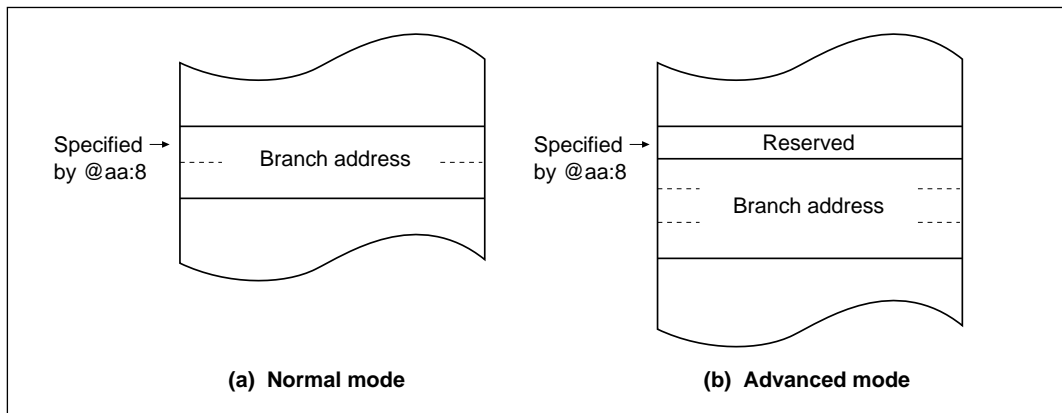

Figure 1-13 Branch Address Specification in Memory Indirect Mode

If an odd address is specified in word or longword memory access, or as a branch address, the least significant bit is regarded as 0, causing access to be performed at the address preceding the specified address. [See (2) Memory Data Formats in section 1.5.2 for further information.]

(2) Effective Address Calculation: Table 1-6 indicates how effective addresses are calculated in each addressing mode. In normal mode the upper 8 bits of the effective address are ignored in order to generate a 16-bit address.

Table 1-6 Effective Address Calculation







| No. | Addressing Mode and Instruction Format | Effective Address Calculation | Effective Address (EA) | | | | | | | | |
|--------------|---|---|---|-------------|------|---|------|---|----------|---|---|
| (1) | Register direct Rn  | | Operands are contents of regm and regn | | | | | | | | |
| (2) | Register indirect @ERn  |  |  | | | | | | | | |
| (3) | Register indirect with displacement @:d:16, ERn  |  |  | | | | | | | | |
| (4) | Register indirect with post-increment or pre-decrement <ul style="list-style-type: none"> • Register indirect with post-increment @ERn+ • Register indirect with pre-decrement @-ERn   |  <table border="1" data-bbox="749 1070 982 1173"> <thead> <tr> <th>Operand Size</th> <th>Added Value</th> </tr> </thead> <tbody> <tr> <td>Byte</td> <td>1</td> </tr> <tr> <td>Word</td> <td>2</td> </tr> <tr> <td>Longword</td> <td>4</td> </tr> </tbody> </table> | Operand Size | Added Value | Byte | 1 | Word | 2 | Longword | 4 |   |
| Operand Size | Added Value | | | | | | | | | | |
| Byte | 1 | | | | | | | | | | |
| Word | 2 | | | | | | | | | | |
| Longword | 4 | | | | | | | | | | |

Table 1-6 Effective Address Calculation (cont)

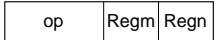
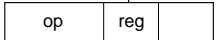
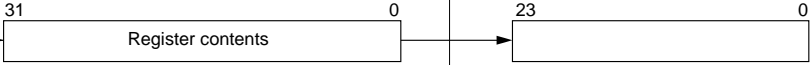
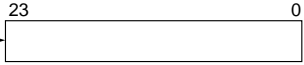

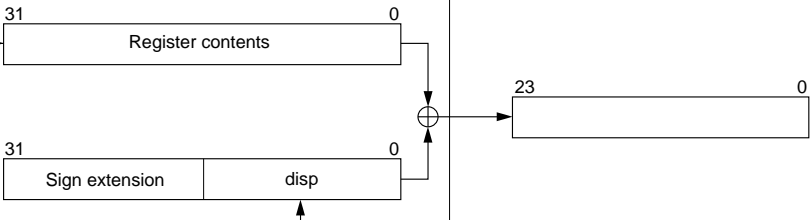

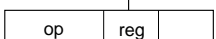
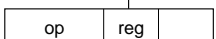
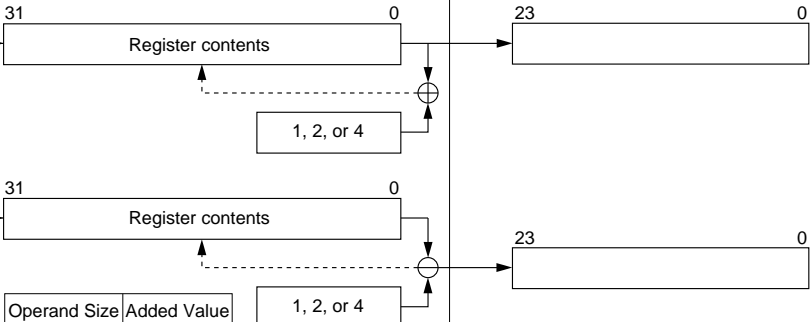

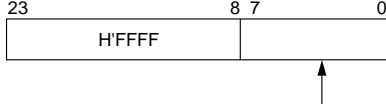

| No. | Addressing Mode and Instruction Format | Effective Address Calculation | Effective Address (EA) |
|-----|--|-------------------------------|---|
| (5) | <p>Absolute address</p> <p>@aa:8</p>  | |  |
| | <p>@aa:16</p>  | |  |
| | <p>@aa:24</p>  | |  |
| (6) | <p>Immediate #xx:8/#xx:16/#xx:32</p>  | | <p>Operand is immediate data.</p> |

Table 1-6 Effective Address Calculation (cont)

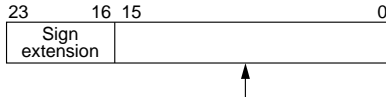
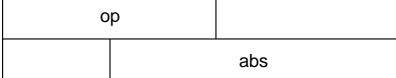
| No. | Addressing Mode and Instruction Format | Effective Address Calculation | Effective Address (EA) |
|-----|--|---|---|
| (7) | <p>Program-counter relative</p> <p>@(d:8, PC)/@(d:16, PC)</p>  |  |  |
| (8) | <p>Memory indirect @aa:8</p> <p>Normal mode</p>  <p>Advanced mode</p>  |  |  |

Legend

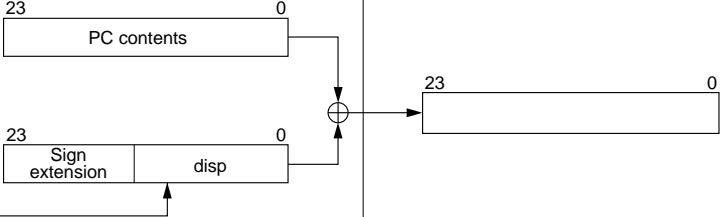
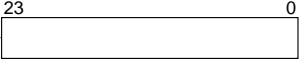
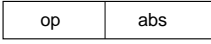
reg, regm, regn: General registers

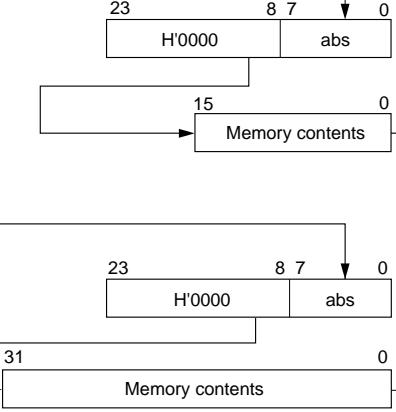
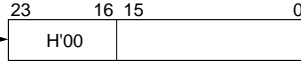
op: Operation field

disp: Displacement

abs: Absolute address

IMM: Immediate data

Section 2 Instruction Descriptions

2.1 Tables and Symbols

This section explains how to read the tables describing each instruction. Note that the descriptions of some instructions extend over two pages or more.

Mnemonic (full name): Gives the full and mnemonic names of the instruction.

Type: Indicates the type of instruction.

Operation: Describes the instruction in symbolic notation. (See section 2.1.2, Operation.)

Assembly-Language Format: Indicates the assembly-language format of the instruction. (See section 2.1.1, Assembler Format.)

Operand Size: Indicates the available operand sizes.

Condition Code: Indicates the effect of instruction execution on the flag bits in the CCR. (See section 2.1.3, Condition Code.)

Description: Describes the operation of the instruction in detail.

Available Registers: Indicates which registers can be specified in the register field of the instruction.

Operand Format and Number of States Required for Execution: Shows the addressing modes and instruction format together with the number of states required for execution.

Notes: Gives notes concerning execution of the instruction.

2.1.1 Assembler Format

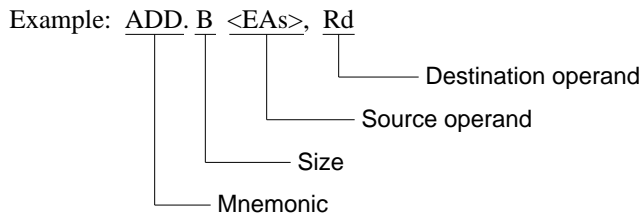

The operand size is byte (B), word (W), or longword (L). Some instructions are restricted to a limited set of operand sizes.

The symbol <EA> indicates that two or more addressing modes can be used. The H8/300H CPU supports the eight addressing modes listed next. Effective address calculation is described in section 1.7, Effective Address Calculation.

| Symbol | Addressing Mode |
|---------------------------|--|
| Rn | Register direct |
| @ERn | Register indirect |
| @(d:16, ERn)/@(d:24, ERn) | Register indirect with displacement (16-bit or 24-bit) |
| @ERn+, @-ERn | Register indirect with post-increment or pre-decrement |
| @aa:8/16/24 | Absolute address (8-bit, 16-bit, or 24-bit) |
| #xx:8/16/32 | Immediate (8-bit, 16-bit, or 32-bit) |
| @(d:8, PC)/@(d:16, PC) | Program-counter relative (8-bit or 16-bit) |
| @@aa:8 | Memory indirect |

2.1.2 Operation

The symbols used in the operation descriptions are defined as follows.

| Symbol | Meaning |
|---------------|---|
| Rd | General destination register* |
| Rs | General source register* |
| Rn | General register* |
| ERd | General destination register (address register or 32-bit register) |
| ERs | General source register (address register or 32-bit register) |
| ERn | General register (32-bit register) |
| (EAd) | Destination operand |
| (EAs) | Source operand |
| PC | Program counter |
| SP | Stack pointer |
| CCR | Condition-code register |
| N | N (negative) flag in CCR |
| Z | Z (zero) flag in CCR |
| V | V (overflow) flag in CCR |
| C | C (carry) flag in CCR |
| disp | Displacement |
| → | Transfer from the operand on the left to the operand on the right, or transition from the state on the left to the state on the right |
| + | Addition of the operands on both sides |
| − | Subtraction of the operand on the right from the operand on the left |
| × | Multiplication of the operands on both sides |
| ÷ | Division of the operand on the left by the operand on the right |
| ^ | Logical AND of the operands on both sides |
| ∨ | Logical OR of the operands on both sides |
| ⊕ | Logical exclusive OR of the operands on both sides |
| ¬ | Logical NOT (logical complement) |
| () < > | Contents of effective address of the operand |

Note: * General registers include 8-bit registers (R0H to R7H and R0L to R7L), 16-bit registers (R0 to R7 and E0 to E7) and 32-bit registers.

2.1.3 Condition Code

The symbols used in the condition-code description are defined as follows.

| Symbol | Meaning |
|---------------|--|
| ↑ | Changes according to the result of the instruction |
| * | Undetermined (no guaranteed value) |
| 0 | Always cleared to 0 |
| – | Not affected by execution of the instruction |
| Δ | Varies depending on conditions; see the notes. |

2.1.4 Instruction Format

The symbols used in the instruction format descriptions are listed below.

| Symbol | Meaning |
|---------------|--|
| IMM | Immediate data (2, 3, 8, 16, or 32 bits) |
| abs | Absolute address (8, 16, or 24 bits) |
| disp | Displacement (8, 16, or 24 bits) |
| rs, rd, rn | Register number (4 bits. The symbol rs corresponds to operand symbols such as Rs. The symbol rd corresponds to operand symbols such as Rd. The symbol rn corresponds to the operand symbol Rn.) |
| ers, erd, ern | Register number (3 bits. The symbol ers corresponds to operand symbols such as ERs. The symbol erd corresponds to operand symbols such as ERd and @ERd. The symbol ern corresponds to the operand symbol ERn.) |

2.1.5 Register Specification

Address Register Specification: When a general register is used as an address register [$@ERn$, $@(d:16, ERn)$, $@(d:24, ERn)$, $@ERn+$, or $@-ERn$], the register is specified by a 3-bit register field (ers or erd). The lower 24 bits of the register are valid.

Data Register Specification: A general register can be used as a 32-bit, 16-bit, or 8-bit data register, which is specified by a 3-bit register number. When a 32-bit register (ERn) is used as a longword data register, it is specified by a 3-bit register field (ers, erd, or ern). When a 16-bit register is used as a word data register, it is specified by a 4-bit register field (rs, rd, or rn). The lower 3 bits specify the register number. The upper bit is set to 1 to specify an extended register (En) or cleared to 0 to specify a general register (Rn). When an 8-bit register is used as a byte data register, it is specified by a 4-bit register field (rs, rd, or rn). The lower 3 bits specify the register number. The upper bit is set to 1 to specify a low register (RnL) or cleared to 0 to specify a high register (RnH). This is shown next.

| Address Register 32-bit Register | | 16-bit Register | | 8-bit Register | |
|-------------------------------------|------------------|-----------------|------------------|----------------|------------------|
| Register Field | General Register | Register Field | General Register | Register Field | General Register |
| 000 | ER0 | 0000 | R0 | 0000 | R0H |
| 001 | ER1 | 0001 | R1 | 0001 | R1H |
| ⋮ | ⋮ | ⋮ | ⋮ | ⋮ | ⋮ |
| 111 | ER7 | 0111 | R7 | 0111 | R7H |
| | | 1000 | E0 | 1000 | E0L |
| | | 1001 | E1 | 1001 | E1L |
| | | ⋮ | ⋮ | ⋮ | ⋮ |
| | | 1111 | E7 | 1111 | E7L |

2.1.6 Bit Data Access in Bit Manipulation Instructions

Bit data is accessed as the n-th bit ($n = 0, 1, 2, 3, \dots, 7$) of a byte operand in a general register or memory. The bit number is given by 3-bit immediate data, or by the lower 3 bits of a general register value.

Example 1: To set bit 3 in R2H to 1

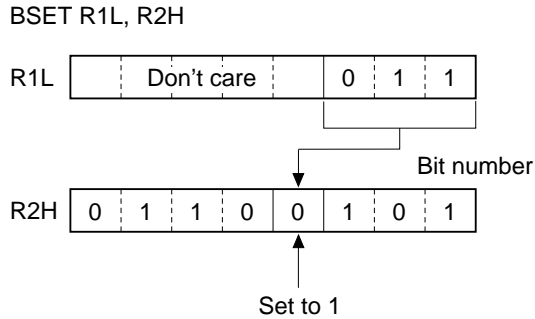

Example 2: To load bit 5 at address H'FFFF02 into the bit accumulator

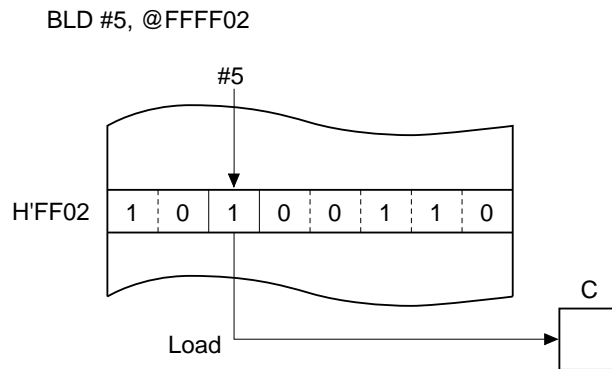

The operand size and addressing mode are as indicated for register or memory operand data.

2.2 Instruction Descriptions

The instructions are described starting in section 2.2.1.

2.2.1 (1) ADD (B)

ADD (ADD binary)

Add Binary

Operation

Rd + (EAs) → Rd

Assembly-Language Format

ADD.B <EAs>, Rd

Operand Size

Byte

Condition Code

| | | | | | | | |
|---|----|---|---|---|---|---|---|
| I | UI | H | U | N | Z | V | C |
| — | — | ↑ | — | ↑ | ↑ | ↑ | ↑ |

- H: Set to 1 if there is a carry at bit 3; otherwise cleared to 0.
- N: Set to 1 if the result is negative; otherwise cleared to 0.
- Z: Set to 1 if the result is zero; otherwise cleared to 0.
- V: Set to 1 if an overflow occurs; otherwise cleared to 0.
- C: Set to 1 if there is a carry at bit 7; otherwise cleared to 0.

Description

This instruction adds the source operand to the contents of an 8-bit register Rd (destination operand) and stores the result in the 8-bit register Rd.

Available Registers

Rd: R0L to R7L, R0H to R7H

Rs: R0L to R7L, R0H to R7H

Operand Format and Number of States Required for Execution

| Addressing Mode | Mnemonic | Operands | Instruction Format | | | | No. of States |
|-----------------|----------|-----------|--------------------|----------|----------|----------|---------------|
| | | | 1st byte | 2nd byte | 3rd byte | 4th byte | |
| Immediate | ADD.B | #xx:8, Rd | 8 | rd | IMM | | 2 |
| Register direct | ADD.B | Rs, Rd | 0 | 8 | rs | rd | 2 |

Notes

2.2.1 (2) ADD (W)

ADD (ADD binary)

Add Binary

Operation

Rd + (EAs) → Rd

Assembly-Language Format

ADD.W <EAs>, Rd

Operand Size

Word

Condition Code

| | | | | | | | |
|---|----|---|---|---|---|---|---|
| I | UI | H | U | N | Z | V | C |
| — | — | ↑ | — | ↑ | ↑ | ↑ | ↑ |

H: Set to 1 if there is a carry at bit 11; otherwise cleared to 0.

N: Set to 1 if the result is negative; otherwise cleared to 0.

Z: Set to 1 if the result is zero; otherwise cleared to 0.

V: Set to 1 if an overflow occurs; otherwise cleared to 0.

C: Set to 1 if there is a carry at bit 15; otherwise cleared to 0.

Description

This instruction adds the source operand to the contents of a 16-bit register Rd (destination operand) and stores the result in the 16-bit register Rd.

Available Registers

Rd: R0 to R7, E0 to E7

Rs: R0 to R7, E0 to E7

Operand Format and Number of States Required for Execution

| Addressing Mode | Mnemonic | Operands | Instruction Format | | | | No. of States | |
|-----------------|----------|------------|--------------------|----------|----------|----------|---------------|---|
| | | | 1st byte | 2nd byte | 3rd byte | 4th byte | | |
| Immediate | ADD.W | #xx:16, Rd | 7 | 9 | 1 | rd | IMM | 4 |
| Register direct | ADD.W | Rs, Rd | 0 | 9 | rs | rd | | 2 |

Notes

2.2.1 (3) ADD (L)

ADD (ADD binary)

Add Binary

Operation

ERd + (EAs) → ERd

Assembly-Language Format

ADD.L <EAs>, ERd

Operand Size

Longword

Condition Code

| | | | | | | | |
|---|----|---|---|---|---|---|---|
| I | UI | H | U | N | Z | V | C |
| — | — | ↑ | — | ↑ | ↑ | ↑ | ↑ |

- H: Set to 1 if there is a carry at bit 27; otherwise cleared to 0.
- N: Set to 1 if the result is negative; otherwise cleared to 0.
- Z: Set to 1 if the result is zero; otherwise cleared to 0.
- V: Set to 1 if an overflow occurs; otherwise cleared to 0.
- C: Set to 1 if there is a carry at bit 31; otherwise cleared to 0.

Description

This instruction adds the source operand to the contents of a 32-bit register ERd (destination operand) and stores the result in the 32-bit register ERd.

Available Registers

ERd: ER0 to ER7

ERs: ER0 to ER7

Operand Format and Number of States Required for Execution

| Addressing Mode | Mnemonic | Operands | Instruction Format | | | | | | No. of States |
|-----------------|----------|-------------|--------------------|--------------|----------|----------|----------|----------|---------------|
| | | | 1st byte | 2nd byte | 3rd byte | 4th byte | 5th byte | 6th byte | |
| Immediate | ADD.L | #xx:32, ERd | 7 A | 1 :0:erd | IMM | | | | 6 |
| Register direct | ADD.L | Rs, ERd | 0 A | 1 :ers:0:erd | | | | | 2 |

Notes

2.2.2 ADDS

ADDS (ADD with Sign extension)

Add Binary Address Data

Operation

Rd + 1 → ERd

Rd + 2 → ERd

Rd + 4 → ERd

Condition Code

| | | | | | | | |
|---|----|---|---|---|---|---|---|
| I | UI | H | U | N | Z | V | C |
| — | — | — | — | — | — | — | — |

Assembly-Language Format

ADDS #1, ERd

ADDS #2, ERd

ADDS #4, ERd

H: Previous value remains unchanged.

N: Previous value remains unchanged.

Z: Previous value remains unchanged.

V: Previous value remains unchanged.

C: Previous value remains unchanged.

Operand Size

Longword

Description

This instruction adds the immediate value 1, 2, or 4 to the contents of a 32-bit register ERd. Differing from the ADD instruction, it does not affect the condition code flags.

Available Registers

ERd: ER0 to ER7

Operand Format and Number of States Required for Execution

| Addressing Mode | Mnemonic | Operands | Instruction Format | | | | No. of States |
|-----------------|----------|----------|--------------------|----------|----------|----------|---------------|
| | | | 1st byte | 2nd byte | 3rd byte | 4th byte | |
| Register direct | ADDS | #1, ERd | 0 B | 0 0:erd | | | 2 |
| Register direct | ADDS | #2, ERd | 0 B | 8 0:erd | | | 2 |
| Register direct | ADDS | #4, ERd | 0 B | 9 0:erd | | | 2 |

Notes

2.2.3 ADDX

ADDX (ADD with eXtend carry)

Add with Carry

Operation

$Rd + (EAs) + C \rightarrow Rd$

Assembly-Language Format

ADDX <EAs>, Rd

Operand Size

Byte

Condition Code

| I | UI | H | U | N | Z | V | C |
|---|----|---|---|---|---|---|---|
| — | — | ↑ | — | ↑ | ↑ | ↑ | ↑ |

- H: Set to 1 if there is a carry at bit 3; otherwise cleared to 0.
- N: Set to 1 if the result is negative; otherwise cleared to 0.
- Z: Previous value remains unchanged if the result is zero; otherwise cleared to 0.
- V: Set to 1 if an overflow occurs; otherwise cleared to 0.
- C: Set to 1 if there is a carry at bit 7; otherwise cleared to 0.

Description

This instruction adds the source operand and carry flag to the contents of an 8-bit register Rd (destination register) and stores the result in the 8-bit register Rd.

Available Registers

Rd: R0L to R7L, R0H to R7H

Rs: R0L to R7L, R0H to R7H

Operand Format and Number of States Required for Execution

| Addressing Mode | Mnemonic | Operands | Instruction Format | | | | No. of States |
|-----------------|----------|-----------|--------------------|----------|----------|----------|---------------|
| | | | 1st byte | 2nd byte | 3rd byte | 4th byte | |
| Immediate | ADDX | #xx:8, Rd | 9 rd | IMM | | | 2 |
| Register direct | ADDX | Rs, Rd | 0 E | rs rd | | | 2 |

Notes

2.2.4 (1) AND (B)

AND (AND logical)

Logical AND

Operation

$Rd \wedge (EAs) \rightarrow Rd$

Assembly-Language Format

AND .B <EAs>, Rd

Operand Size

Byte

Condition Code

| | | | | | | | |
|---|----|---|---|---|---|---|---|
| I | UI | H | U | N | Z | V | C |
| — | — | — | — | ↑ | ↑ | 0 | — |

H: Previous value remains unchanged.

N: Set to 1 if the result is negative; otherwise cleared to 0.

Z: Set to 1 if the result is zero; otherwise cleared to 0.

V: Always cleared to 0.

C: Previous value remains unchanged.

Description

This instruction ANDs the source operand with the contents of an 8-bit register Rd (destination register) and stores the result in the 8-bit register Rd.

Available Registers

Rd: R0L to R7L, R0H to R7H

Rs: R0L to R7L, R0H to R7H

Operand Format and Number of States Required for Execution

| Addressing Mode | Mnemonic | Operands | Instruction Format | | | | No. of States |
|-----------------|----------|-----------|--------------------|----------|----------|----------|---------------|
| | | | 1st byte | 2nd byte | 3rd byte | 4th byte | |
| Immediate | AND.B | #xx:8, Rd | E .. rd | IMM | | | 2 |
| Register direct | AND.B | Rs, Rd | 1 .. 6 | rs .. rd | | | 2 |

Notes

2.2.4 (2) AND (W)

AND (AND logical)

Logical AND

Operation

$Rd \wedge (EAs) \rightarrow Rd$

Assembly-Language Format

AND.W <EAs>, Rd

Operand Size

Word

Condition Code

| I | UI | H | U | N | Z | V | C |
|---|----|---|---|---|---|---|---|
| — | — | — | — | ↑ | ↓ | 0 | — |

H: Previous value remains unchanged.

N: Set to 1 if the result is negative; otherwise cleared to 0.

Z: Set to 1 if the result is zero; otherwise cleared to 0.

V: Always cleared to 0.

C: Previous value remains unchanged.

Description

This instruction ANDs the source operand with the contents of a 16-bit register Rd (destination register) and stores the result in the 16-bit register Rd.

Available Registers

Rd: R0 to R7, E0 to E7

Rs: R0 to R7, E0 to E7

Operand Format and Number of States Required for Execution

| Addressing Mode | Mnemonic | Operands | Instruction Format | | | | No. of States | |
|-----------------|----------|------------|--------------------|----------|----------|----------|---------------|---|
| | | | 1st byte | 2nd byte | 3rd byte | 4th byte | | |
| Immediate | AND.W | #xx:16, Rd | 7 | 9 | 6 | rd | IMM | 4 |
| Register direct | AND.W | Rs, Rd | 6 | 6 | rs | rd | | 2 |

Notes

2.2.4 (3) AND (L)

AND (AND logical)

Logical AND

Operation

$ERd \wedge (EAs) \rightarrow ERd$

Assembly-Language Format

AND.L <EAs>, ERd

Operand Size

Longword

Condition Code

| | | | | | | | |
|---|----|---|---|---|---|---|---|
| I | UI | H | U | N | Z | V | C |
| — | — | — | — | ↑ | ↑ | 0 | — |

H: Previous value remains unchanged.

N: Set to 1 if the result is negative; otherwise cleared to 0.

Z: Set to 1 if the result is zero; otherwise cleared to 0.

V: Always cleared to 0.

C: Previous value remains unchanged.

Description

This instruction ANDs the source operand with the contents of a 32-bit register ERd (destination register) and stores the result in the 32-bit register ERd.

Available Registers

ERd: ER0 to ER7

ERs: ER0 to ER7

Operand Format and Number of States Required for Execution

| Addressing Mode | Mnemonic | Operands | Instruction Format | | | | | | No. of States | |
|-----------------|----------|-------------|--------------------|----------|----------|----------|----------|----------|---------------|---|
| | | | 1st byte | 2nd byte | 3rd byte | 4th byte | 5th byte | 6th byte | | |
| Immediate | AND.L | #xx:32, ERd | 7 | A | 6 | 0:erd | IMM | | | 6 |
| Register direct | AND.L | Rs, ERd | 0 | 1 | F | 0 | 6 | 6 | 0:ers:0:erd | 4 |

Notes

2.2.5 ANDC

ANDC (AND Control register)

Logical AND with CCR

Operation

CCR \wedge #IMM \rightarrow CCR

Assembly-Language Format

ANDC #xx:8, CCR

Operand Size

Byte

Condition Code

| | | | | | | | |
|---|----|---|---|---|---|---|---|
| I | UI | H | U | N | Z | V | C |
| ↓ | ↓ | ↓ | ↓ | ↓ | ↓ | ↓ | ↓ |

- I: Stores the corresponding bit of the result.
- UI: Stores the corresponding bit of the result
- H: Stores the corresponding bit of the result.
- U: Stores the corresponding bit of the result
- N: Stores the corresponding bit of the result.
- Z: Stores the corresponding bit of the result.
- V: Stores the corresponding bit of the result.
- C: Stores the corresponding bit of the result.

Description

This instruction ANDs the contents of the condition-code register (CCR) with immediate data and stores the result in the condition-code register. No interrupt requests, including NMI, are accepted immediately after execution of this instruction.

Operand Format and Number of States Required for Execution

| Addressing Mode | Mnemonic | Operands | Instruction Format | | | | No. of States |
|-----------------|----------|------------|--------------------|----------|----------|----------|---------------|
| | | | 1st byte | 2nd byte | 3rd byte | 4th byte | |
| Immediate | ANDC | #xx:8, CCR | 0 .. 6 | IMM | | | 2 |

Notes

2.2.6 BAND

BAND (Bit AND)

Bit Logical AND

Operation

$C \wedge (\text{<bit No.> of <EAd>}) \rightarrow C$

Assembly-Language Format

BAND #xx:3, <EAd>

Operand Size

Byte

Condition Code

| | | | | | | | |
|---|----|---|---|---|---|---|---|
| I | UI | H | U | N | Z | V | C |
| — | — | — | — | — | — | — | ↕ |

H: Previous value remains unchanged.

N: Previous value remains unchanged.

Z: Previous value remains unchanged.

V: Previous value remains unchanged.

C: Stores the result of the operation.

Description

This instruction ANDs a specified bit in the destination operand with the carry bit and stores the result in the carry bit. The bit number is specified by 3-bit immediate data. The destination operand contents remain unchanged.

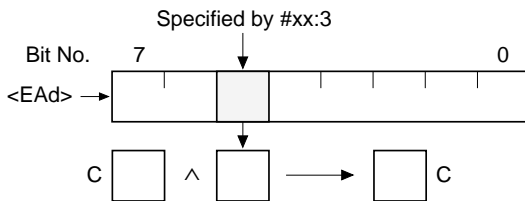

Available Registers

Rd: R0L to R7L, R0H to R7H

ERd: ER0 to ER7

Operand Format and Number of States Required for Execution

| Addressing Mode* | Mnemonic | Operands | Instruction Format | | | | No. of States |
|-------------------|----------|-------------|--------------------|----------|----------|-------------|---------------|
| | | | 1st byte | 2nd byte | 3rd byte | 4th byte | |
| Register direct | BAND | #xx:3.Rd | 7 | 6 | 0:IMM:rd | | 2 |
| Register indirect | BAND | #xx:3.@ERd | 7 | C | 0:erd:0 | 7:6:0:IMM:0 | 6 |
| Absolute address | BAND | #xx:3.@aa:8 | 7 | E | abs | 7:6:0:IMM:0 | 6 |

Note: * The addressing mode is the addressing mode of the destination operand <EAd>.

Notes

See the corresponding LSI hardware manual for details on the access range for @aa : 8.

2.2.7 Bcc

Bcc (Branch conditionally)

Conditional Branch

Operation

If condition is true, then
 $PC + disp \rightarrow PC$
 else next;

Condition Code

| | | | | | | | |
|---|----|---|---|---|---|---|---|
| I | UI | H | U | N | Z | V | C |
| — | — | — | — | — | — | — | — |

Assembly-Language Format

Bcc disp
 → Condition field

H: Previous value remains unchanged.
 N: Previous value remains unchanged.
 Z: Previous value remains unchanged.
 V: Previous value remains unchanged.
 C: Previous value remains unchanged.

Operand Size

—

Description

If the condition specified in the condition field (cc) is true, a displacement is added to the program counter (PC) and execution branches to the resulting address. The PC value used in the address calculation is the starting address of the instruction immediately following the Bcc instruction. The displacement is a signed 8-bit or 16-bit value. The branch destination address can be located in the range from -126 to +128 bytes or -32766 to +32768 bytes from the Bcc instruction.

| Mnemonic | Meaning | cc | Condition | Signed/Unsigned* |
|-----------|----------------------------|------|---------------------------|---------------------------------|
| BRA (BT) | Always (true) | 0000 | True | |
| BRn (BF) | Never (false) | 0001 | False | |
| BHI | High | 0010 | $C \vee Z = 0$ | $X > Y$ (unsigned) |
| BLS | Low or Same | 0011 | $C \vee Z = 1$ | $X \leq Y$ (unsigned) |
| BCC (BHS) | Carry Clear (High or Same) | 0100 | $C = 0$ | $X \geq Y$ (unsigned) |
| BCS (BLO) | Carry Set (Low) | 0101 | $C = 1$ | $X < Y$ (unsigned) |
| BNE | Not Equal | 0110 | $Z = 0$ | $X \neq Y$ (unsigned or signed) |
| BEQ | Equal | 0111 | $Z = 1$ | $X > Y$ (unsigned or signed) |
| BVC | oVerflow Clear | 1000 | $V = 0$ | |
| BVS | oVerflow Set | 1001 | $V = 1$ | |
| BPL | PLus | 1010 | $N = 0$ | |
| BMI | Minus | 1011 | $N = 1$ | |
| BGE | Greater or Equal | 1100 | $N \oplus V = 0$ | $X \geq Y$ (signed) |
| BLT | Less Than | 1101 | $N \oplus V = 1$ | $X < Y$ (signed) |
| BGT | Greater Than | 1110 | $Z \vee (N \oplus V) = 0$ | $X > Y$ (signed) |
| BLE | Less or Equal | 1111 | $Z \vee (N \oplus V) = 1$ | $X \leq Y$ (signed) |

Note: * If the immediately preceding instruction is a CMP instruction, X is the destination operand and Y is the source operand.

Operand Format and Number of States Required for Execution

| Addressing Mode | Mnemonic | Operands | Instruction Format | | | | No. of States |
|--------------------------|-----------|----------|--------------------|----------|----------|----------|---------------|
| | | | 1st byte | 2nd byte | 3rd byte | 4th byte | |
| Program-counter relative | BRA (BT) | d:8 | 4 | 0 | disp | | 4 |
| | | d:16 | 5 | 8 | 0 | 0 | disp |
| Program-counter relative | BRN (BF) | d:8 | 4 | 1 | disp | | 4 |
| | | d:16 | 5 | 8 | 1 | 0 | disp |
| Program-counter relative | BHI | d:8 | 4 | 2 | disp | | 4 |
| | | d:16 | 5 | 8 | 2 | 0 | disp |
| Program-counter relative | BLS | d:8 | 4 | 3 | disp | | 4 |
| | | d:16 | 5 | 8 | 3 | 0 | disp |
| Program-counter relative | Bcc (BHS) | d:8 | 4 | 4 | disp | | 4 |
| | | d:16 | 5 | 8 | 4 | 0 | disp |
| Program-counter relative | BCS (BLO) | d:8 | 4 | 5 | disp | | 4 |
| | | d:16 | 5 | 8 | 5 | 0 | disp |
| Program-counter relative | BNE | d:8 | 4 | 6 | disp | | 4 |
| | | d:16 | 5 | 8 | 6 | 0 | disp |
| Program-counter relative | BEQ | d:8 | 4 | 7 | disp | | 4 |
| | | d:16 | 5 | 8 | 7 | 0 | disp |
| Program-counter relative | BVC | d:8 | 4 | 8 | disp | | 4 |
| | | d:16 | 5 | 8 | 8 | 0 | disp |
| Program-counter relative | BVS | d:8 | 4 | 9 | disp | | 4 |
| | | d:16 | 5 | 8 | 9 | 0 | disp |
| Program-counter relative | BPL | d:8 | 4 | A | disp | | 4 |
| | | d:16 | 5 | 8 | A | 0 | disp |
| Program-counter relative | BMI | d:8 | 4 | B | disp | | 4 |
| | | d:16 | 5 | 8 | B | 0 | disp |
| Program-counter relative | BGE | d:8 | 4 | C | disp | | 4 |
| | | d:16 | 5 | 8 | C | 0 | disp |
| Program-counter relative | BLT | d:8 | 4 | D | disp | | 4 |
| | | d:16 | 5 | 8 | D | 0 | disp |
| Program-counter relative | BGT | d:8 | 4 | E | disp | | 4 |
| | | d:16 | 5 | 8 | E | 0 | disp |
| Program-counter relative | BLE | d:8 | 4 | F | disp | | 4 |
| | | d:16 | 5 | 8 | F | 0 | disp |

Notes

1. The branch destination address must be even.
2. In machine language BRA, BRN, BCC, and BCS are identical to BT, BF, BHS, and BLO, respectively. The number of execution states for BRn (BF) is the same as for two NOP instructions.

2.2.8 BCLR

BCLR (Bit CLearR)

Bit Clear

Operation

0 → (<bit No.> of <EAd>)

Assembly-Language Format

BCLR #xx:3, <EAd>

BCLR Rn, <EAd>

Operand Size

Byte

Condition Code

| | | | | | | | |
|---|----|---|---|---|---|---|---|
| I | UI | H | U | N | Z | V | C |
| — | — | — | — | — | — | — | — |

H: Previous value remains unchanged.

N: Previous value remains unchanged.

Z: Previous value remains unchanged.

V: Previous value remains unchanged.

C: Previous value remains unchanged.

Description

This instruction clears a specified bit in the destination operand to 0. The bit number can be specified by 3-bit immediate data, or by the lower three bits of a general register (Rn). The specified bit is not tested. The condition-code flags are not altered.

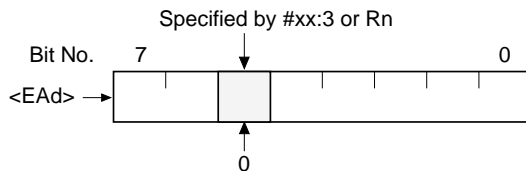

Available Registers

Rd: R0L to R7L, R0H to R7H

Rn: R0L to R7L, R0H to R7H

ERd: ER0 to ER7

Operand Format and Number of States Required for Execution

| Addressing Mode* | Mnemonic | Operands | Instruction Format | | | | No. of States | |
|-------------------|----------|--------------|--------------------|----------|----------|----------|---------------|---|
| | | | 1st byte | 2nd byte | 3rd byte | 4th byte | | |
| Register direct | BCLR | #xx:3, Rd | 7 | 2 | 0 IMM rd | | 2 | |
| Register indirect | BCLR | #xx:3, @ERd | 7 | D | 0 ERd 0 | 7 2 | 0 IMM 0 | 8 |
| Absolute address | BCLR | #xx:3, @aa:8 | 7 | F | abs | 7 2 | 0 IMM 0 | 8 |
| Register direct | BCLR | Rn, Rd | 6 | 2 | rn rd | | | 2 |
| Register indirect | BCLR | Rn, @ERd | 7 | D | 0 ERd 0 | 6 2 | rn 0 | 8 |
| Absolute address | BCLR | Rn, @aa:8 | 7 | F | abs | 6 2 | rn 0 | 8 |

Note: * The addressing mode is the addressing mode of the destination operand <EAd>.

Notes

For the @aa:8 access range, refer to the relevant microcontroller hardware manual.

2.2.9 BIAND

BIAND (Bit Invert AND)

Bit Logical AND

Operation

$C \wedge [\neg (\text{<bit No.> of <EAd>})] \rightarrow C$

Assembly-Language Format

BIAND #xx:3, <EAd>

Operand Size

Byte

Condition Code

| | | | | | | | |
|---|----|---|---|---|---|---|---|
| I | UI | H | U | N | Z | V | C |
| — | — | — | — | — | — | — | ↕ |

H: Previous value remains unchanged.

N: Previous value remains unchanged.

Z: Previous value remains unchanged.

V: Previous value remains unchanged.

C: Stores the result of the operation.

Description

This instruction ANDs the inverse of a specified bit in the destination operand with the carry bit and stores the result in the carry bit. The bit number is specified by 3-bit immediate data. The destination operand contents remain unchanged.

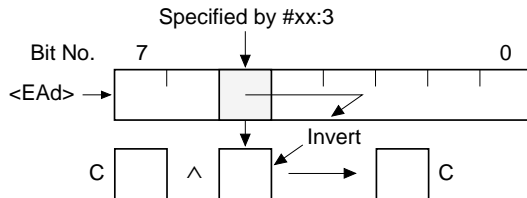

Available Registers

Rd: R0L to R7L, R0H to R7H

ERd: ER0 to ER7

Operand Format and Number of States Required for Execution

| Addressing Mode* | Mnemonic | Operands | Instruction Format | | | | No. of States |
|-------------------|----------|-------------|--------------------|----------|----------|-------------|---------------|
| | | | 1st byte | 2nd byte | 3rd byte | 4th byte | |
| Register direct | BIAND | #xx:3.Rd | 7 | 6 | 1 IMM rd | | 2 |
| Register indirect | BIAND | #xx:3.@ERd | 7 | C | 0 erd 0 | 7 6 1 IMM 0 | 6 |
| Absolute address | BIAND | #xx:3.@aa:8 | 7 | E | abs | 7 6 1 IMM 0 | 6 |

Note: * The addressing mode is the addressing mode of the destination operand <EAd>.

Notes

For the @aa:8 access range, refer to the relevant microcontroller hardware manual.

2.2.10 BILD

BILD (Bit Invert Load)

Bit Load

Operation

\neg (<bit No.> of <EAd>) \rightarrow C

Condition Code

| | | | | | | | |
|---|----|---|---|---|---|---|---|
| I | UI | H | U | N | Z | V | C |
| — | — | — | — | — | — | — | ↓ |

Assembly-Language Format

BILD #xx:3, <EAd>

Operand Size

Byte

H: Previous value remains unchanged.
 N: Previous value remains unchanged.
 Z: Previous value remains unchanged.
 V: Previous value remains unchanged.
 C: Loaded with the inverse of the specified bit.

Description

This instruction loads the inverse of a specified bit from the destination operand into the carry bit. The bit number is specified by 3-bit immediate data. The destination operand contents remain unchanged.

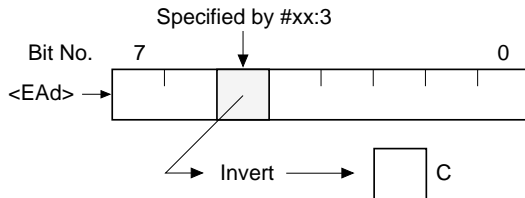

Available Registers

Rd: R0L to R7L, R0H to R7H

ERd: ER0 to ER7

Operand Format and Number of States Required for Execution

| Addressing Mode* | Mnemonic | Operands | Instruction Format | | | | No. of States | |
|-------------------|----------|-------------|--------------------|----------|----------|----------|---------------|---|
| | | | 1st byte | 2nd byte | 3rd byte | 4th byte | | |
| Register direct | BILD | #xx:3.Rd | 7 | 7 | 1 IMM rd | | 2 | |
| Register indirect | BILD | #xx:3.@ERd | 7 | C | 0 erd 0 | 7 7 | 1 IMM 0 | 6 |
| Absolute address | BILD | #xx:3.@aa:8 | 7 | E | abs | 7 7 | 1 IMM 0 | 6 |

Note: * The addressing mode is the addressing mode of the destination operand <EAd>.

Notes

For the @aa:8 access range, refer to the relevant microcontroller hardware manual.

2.2.11 BIOR

BIOR (Bit Invert inclusive OR)

Bit Logical OR

Operation

$C \vee [\neg (\text{<bit No.> of <EAd>})] \rightarrow C$

Assembly-Language Format

BIOR #xx:3, <EAd>

Operand Size

Byte

Condition Code

| | | | | | | | |
|---|----|---|---|---|---|---|---|
| I | UI | H | U | N | Z | V | C |
| — | — | — | — | — | — | — | ↕ |

H: Previous value remains unchanged.

N: Previous value remains unchanged.

Z: Previous value remains unchanged.

V: Previous value remains unchanged.

C: Stores the result of the operation.

Description

This instruction ORs the inverse of a specified bit in the destination operand with the carry bit and stores the result in the carry bit. The bit number is specified by 3-bit immediate data. The destination operand contents remain unchanged.

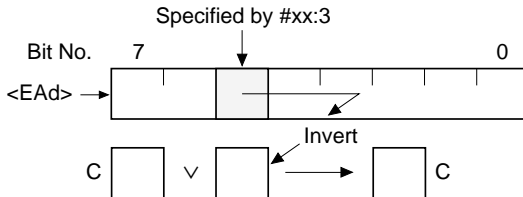

Available Registers

Rd: R0L to R7L, R0H to R7H

ERd: ER0 to ER7

Operand Format and Number of States Required for Execution

| Addressing Mode* | Mnemonic | Operands | Instruction Format | | | | No. of States | |
|-------------------|----------|-------------|--------------------|----------|----------|----------|---------------|---|
| | | | 1st byte | 2nd byte | 3rd byte | 4th byte | | |
| Register direct | BIOR | #xx:3.Rd | 7 | 4 | 1 IMM rd | | 2 | |
| Register indirect | BIOR | #xx:3.@ERd | 7 | C | 0:erd 0 | 7 4 | 1 IMM 0 | 6 |
| Absolute address | BIOR | #xx:3.@aa:8 | 7 | E | abs | 7 4 | 1 IMM 0 | 6 |

Note: * The addressing mode is the addressing mode of the destination operand <EAd>.

Notes

For the @aa:8 access range, refer to the relevant microcontroller hardware manual.

2.2.12 BIST

BIST (Bit Invert STore)

Bit Store

Operation

$\neg C \rightarrow$ (<bit No.> of <EAd>)

Condition Code

| | | | | | | | |
|---|----|---|---|---|---|---|---|
| I | UI | H | U | N | Z | V | C |
| — | — | — | — | — | — | — | — |

Assembly-Language Format

BIST #xx:3, <EAd>

Operand Size

Byte

H: Previous value remains unchanged.
 N: Previous value remains unchanged.
 Z: Previous value remains unchanged.
 V: Previous value remains unchanged.
 C: Previous value remains unchanged.

Description

This instruction stores the inverse of the carry bit in a specified bit location in the destination operand. The bit number is specified by 3-bit immediate data. Other bits in the destination operand remain unchanged.

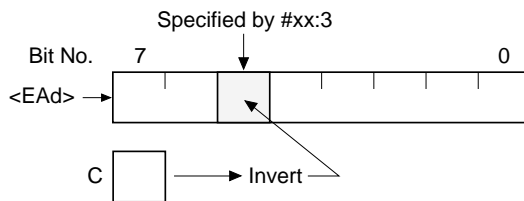

Available Registers

Rd: R0L to R7L, R0H to R7H

ERd: ER0 to ER7

Operand Format and Number of States Required for Execution

| Addressing Mode* | Mnemonic | Operands | Instruction Format | | | | No. of States | |
|-------------------|----------|-------------|--------------------|----------|-----------|----------|---------------|---|
| | | | 1st byte | 2nd byte | 3rd byte | 4th byte | | |
| Register direct | BIST | #xx:3,Rd | 6 | 7 | 1 IMM: rd | | 2 | |
| Register indirect | BIST | #xx:3,@ERd | 7 | D | 0:erd 0 | 6 7 | 1 IMM: 0 | 8 |
| Absolute address | BIST | #xx:3,@aa:8 | 7 | F | abs | 6 7 | 1 IMM: 0 | 8 |

Note: * The addressing mode is the addressing mode of the destination operand <EAd>.

Notes

For the @aa:8 access range, refer to the relevant microcontroller hardware manual.

2.2.13 BIXOR

BIXOR (Bit Invert eXclusive OR)

Bit Exclusive Logical OR

Operation

$C \oplus [\neg(\text{<bit No.> of <EAd>})] \rightarrow C$

Assembly-Language Format

BIXOR #xx:3, <EAd>

Operand Size

Byte

Condition Code

| | | | | | | | |
|---|----|---|---|---|---|---|---|
| I | UI | H | U | N | Z | V | C |
| — | — | — | — | — | — | — | ↕ |

H: Previous value remains unchanged.

N: Previous value remains unchanged.

Z: Previous value remains unchanged.

V: Previous value remains unchanged.

C: Stores the result of the operation.

Description

This instruction exclusively ORs the inverse of a specified bit in the destination operand with the carry bit and stores the result in the carry bit. The bit number is specified by 3-bit immediate data. The destination operand contents remain unchanged.

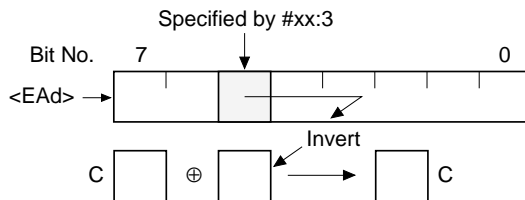

Available Registers

Rd: R0L to R7L, R0H to R7H

ERd: ER0 to ER7

Operand Format and Number of States Required for Execution

| Addressing Mode* | Mnemonic | Operands | Instruction Format | | | | No. of States | | |
|-------------------|----------|-------------|--------------------|----------|--------------|----------|---------------|-------------|---|
| | | | 1st byte | 2nd byte | 3rd byte | 4th byte | | | |
| Register direct | BIXOR | #xx:3,Rd | 7 | 5 | 1 IMM rd | | 2 | | |
| Register indirect | BIXOR | #xx:3,@ERd | 7 | C | 0 erd 0 | 7 | 5 | 1 IMM 0 | 6 |
| Absolute address | BIXOR | #xx:3,@aa:8 | 7 | E | abs | 7 | 5 | 1 IMM 0 | 6 |

Note: * The addressing mode is the addressing mode of the destination operand <EAd>.

Notes

For the @aa:8 access range, refer to the relevant microcontroller hardware manual.

2.2.14 BLD

BLD (Bit Load)

Bit Load

Operation

(<Bit No.> of <EAd>) → C

Assembly-Language Format

BLD #xx:3, <EAd>

Operand Size

Byte

Condition Code

| | | | | | | | |
|---|----|---|---|---|---|---|----|
| I | UI | H | U | N | Z | V | C |
| — | — | — | — | — | — | — | ↑↓ |

H: Previous value remains unchanged.

N: Previous value remains unchanged.

Z: Previous value remains unchanged.

V: Previous value remains unchanged.

C: Loaded from the specified bit.

Description

This instruction loads a specified bit from the destination operand into the carry bit. The bit number is specified by 3-bit immediate data. The destination operand contents remain unchanged.

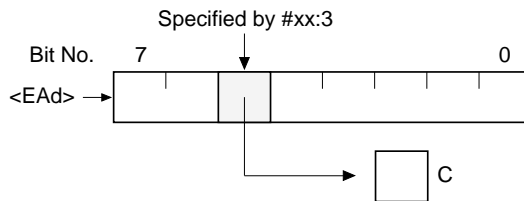

Available Registers

Rd: R0L to R7L, R0H to R7H

ERd: ER0 to ER7

Operand Format and Number of States Required for Execution

| Addressing Mode* | Mnemonic | Operands | Instruction Format | | | | No. of States | |
|-------------------|----------|-------------|--------------------|----------|----------|----------|---------------|---|
| | | | 1st byte | 2nd byte | 3rd byte | 4th byte | | |
| Register direct | BLD | #xx:3,Rd | 7 | 7 | 0 IMM rd | | 2 | |
| Register indirect | BLD | #xx:3,@ERd | 7 | C | 0 ERd 0 | 7 7 | 0 IMM 0 | 6 |
| Absolute address | BLD | #xx:3,@aa:8 | 7 | E | abs | 7 7 | 0 IMM 0 | 6 |

Note: * The addressing mode is the addressing mode of the destination operand <EAd>.

Notes

For the @aa:8 access range, refer to the relevant microcontroller hardware manual.

2.2.15 BNOT

BNOT (Bit NOT)

Bit NOT

Operation

\neg (<bit No.> of <EAd>) \rightarrow (<bit No.> of <EAd>)

Condition Code

| I | UI | H | U | N | Z | V | C |
|---|----|---|---|---|---|---|---|
| — | — | — | — | — | — | — | — |

Assembly-Language Format

BNOT #xx:3, <EAd>

BNOT Rn, <EAd>

H: Previous value remains unchanged.

N: Previous value remains unchanged.

Z: Previous value remains unchanged.

V: Previous value remains unchanged.

C: Previous value remains unchanged.

Operand Size

Byte

Description

This instruction inverts a specified bit in the destination operand. The bit number is specified by 3-bit immediate data or by the lower 3 bits of a general register. The specified bit is not tested. The condition code remains unchanged.

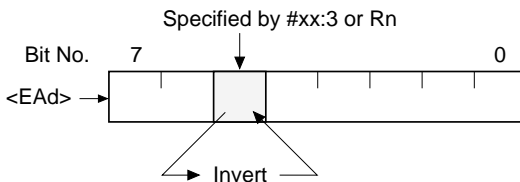

Available Registers

Rd: R0L to R7L, R0H to R7H

Rn: R0L to R7L, R0H to R7H

ERd: ER0 to ER7

Operand Format and Number of States Required for Execution

| Addressing Mode* | Mnemonic | Operands | Instruction Format | | | | No. of States | |
|-------------------|----------|--------------|--------------------|----------|----------|----------|---------------|---|
| | | | 1st byte | 2nd byte | 3rd byte | 4th byte | | |
| Register direct | BNOT | #xx:3, Rd | 7 | 1 | 0 IMM rd | | 2 | |
| Register indirect | BNOT | #xx:3, @ERd | 7 | D | 0 ERd 0 | 7 1 | 0 IMM 0 | 8 |
| Absolute address | BNOT | #xx:3, @aa:8 | 7 | F | abs | 7 1 | 0 IMM 0 | 8 |
| Register direct | BNOT | Rn, Rd | 6 | 1 | rn rd | | | 2 |
| Register indirect | BNOT | Rn, @ERd | 7 | D | 0 ERd 0 | 6 1 | rn 0 | 8 |
| Absolute address | BNOT | Rn, @aa:8 | 7 | F | abs | 6 1 | rn 0 | 8 |

Note: * The addressing mode is the addressing mode of the destination operand <EAd>.

Notes

For the @aa:8 access range, refer to the relevant microcontroller hardware manual.

2.2.16 BOR

BOR (bit inclusive OR)

Bit Logical OR

Operation

$C \vee [(\text{<bit No.> of <EAd>}] \rightarrow C$

Assembly-Language Format

BOR #xx:3, <EAd>

Operand Size

Byte

Condition Code

| | | | | | | | |
|---|----|---|---|---|---|---|---|
| I | UI | H | U | N | Z | V | C |
| — | — | — | — | — | — | — | ↕ |

H: Previous value remains unchanged.

N: Previous value remains unchanged.

Z: Previous value remains unchanged.

V: Previous value remains unchanged.

C: Stores the result of the operation.

Description

This instruction ORs a specified bit in the destination operand with the carry bit and stores the result in the carry bit. The bit number is specified by 3-bit immediate data. The destination operand contents remain unchanged.

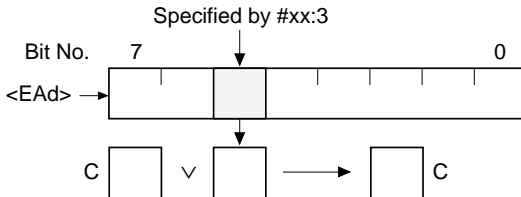

Available Registers

Rd: R0L to R7L, R0H to R7H

ERd: ER0 to ER7

Operand Format and Number of States Required for Execution

| Addressing Mode* | Mnemonic | Operands | Instruction Format | | | | No. of States | |
|-------------------|----------|-------------|--------------------|----------|----------|----------|---------------|---|
| | | | 1st byte | 2nd byte | 3rd byte | 4th byte | | |
| Register direct | BOR | #xx:3,Rd | 7 | 4 | 0 IMM rd | | 2 | |
| Register indirect | BOR | #xx:3,@ERd | 7 | C | 0 erd 0 | 7 4 | 0 IMM 0 | 6 |
| Absolute address | BOR | #xx:3,@aa:8 | 7 | E | abs | 7 4 | 0 IMM 0 | 6 |

Note: * The addressing mode is the addressing mode of the destination operand <EAd>.

Notes

For the @aa:8 access range, refer to the relevant microcontroller hardware manual.

2.2.17 BSET

BSET (Bit SET)

Bit Set

Operation

1 → (<bit No.> of <EAd>)

Assembly-Language Format

BSET #xx:3, <EAd>

BSET Rn, <EAd>

Operand Size

Byte

Condition Code

| | | | | | | | |
|---|----|---|---|---|---|---|---|
| I | UI | H | U | N | Z | V | C |
| — | — | — | — | — | — | — | — |

H: Previous value remains unchanged.

N: Previous value remains unchanged.

Z: Previous value remains unchanged.

V: Previous value remains unchanged.

C: Previous value remains unchanged.

Description

This instruction sets a specified bit in the destination operand to 1. The bit number can be specified by 3-bit immediate data, or by the lower three bits of a general register. The specified bit is not tested. The condition code flags are not altered.

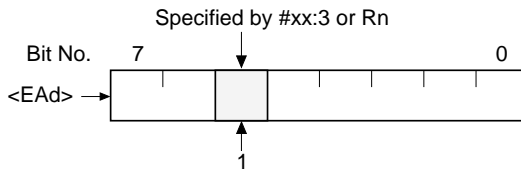

Available Registers

Rd: R0L to R7L, R0H to R7H

Rn: R0L to R7L, R0H to R7H

ERd: ER0 to ER7

Operand Format and Number of States Required for Execution

| Addressing Mode* | Mnemonic | Operands | Instruction Format | | | | No. of States | | |
|-------------------|----------|--------------|--------------------|----------|-----------|----------|---------------|----------|---|
| | | | 1st byte | 2nd byte | 3rd byte | 4th byte | | | |
| Register direct | BSET | #xx:3, Rd | 7 | 0 | 0 IMM: rd | | 2 | | |
| Register indirect | BSET | #xx:3, @ERd | 7 | D | 0:erd: 0 | 7 | 0 | 0 IMM: 0 | 8 |
| Absolute address | BSET | #xx:3, @aa:8 | 7 | F | abs | 7 | 0 | 0 IMM: 0 | 8 |
| Register direct | BSET | Rn, Rd | 6 | 0 | rn rd | | | | 2 |
| Register indirect | BSET | Rn, @ERd | 7 | D | 0:erd: 0 | 6 | 0 | rn 0 | 8 |
| Absolute address | BSET | Rn, @aa:8 | 7 | F | abs | 6 | 0 | rn 0 | 8 |

Note: * The addressing mode is the addressing mode of the destination operand <EAd>.

Notes

For the @aa:8 access range, refer to the relevant microcontroller hardware manual.
 <EAd> is byte data in a register or on memory.

2.2.18 BSR

BSR (Branch to SubRoutine)

Branch to Subroutine

Operation

PC → @-SP

PC + disp → PC

Condition Code

| | | | | | | | |
|---|----|---|---|---|---|---|---|
| I | UI | H | U | N | Z | V | C |
| — | — | — | — | — | — | — | — |

Assembly-Language Format

BSR disp

Operand Size

—

H: Previous value remains unchanged.

N: Previous value remains unchanged.

Z: Previous value remains unchanged.

V: Previous value remains unchanged.

C: Previous value remains unchanged.

Description

This instruction branches to a subroutine at a specified address. It pushes the program counter (PC) value onto the stack as a restart address, then adds a specified displacement to the PC value and branches to the resulting address. The PC value pushed onto the stack is the address of the instruction following the BSR instruction. The displacement is a signed 8-bit or 16-bit value, so the possible branching range is -126 to +128 bytes or -32766 to +32768 bytes from the address of the BSR instruction.

Operand Format and Number of States Required for Execution

| Addressing Mode | Mnemonic | Operands | Instruction Format | | | | No. of States | |
|--------------------------|----------|----------|--------------------|----------|----------|----------|---------------|----------|
| | | | 1st byte | 2nd byte | 3rd byte | 4th byte | Normal | Advanced |
| Program-counter relative | BSR | d:8 | 5 | 5 | disp | | 6 | 8 |
| | | d:16 | 5 | C | 0 | 0 | disp | 8 |

Notes

The stack structure differs between normal mode and advanced mode. In normal mode only the lower 16 bits of the program counter are pushed on the stack.

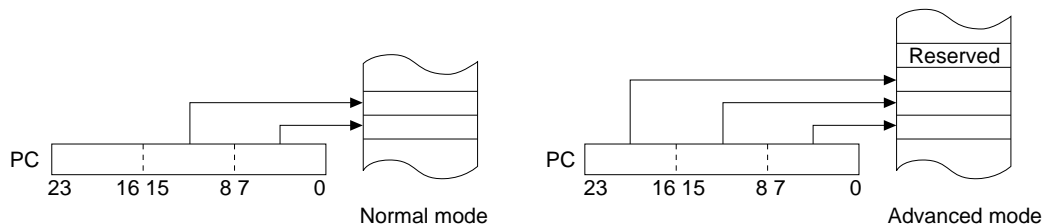

The branch address must be even.

2.2.19 BST

BST (Bit Store)

Bit Store

Operation

C → (<bit No.> of <EAd>)

Condition Code

| | | | | | | | |
|---|----|---|---|---|---|---|---|
| I | UI | H | U | N | Z | V | C |
| — | — | — | — | — | — | — | — |

Assembly-Language Format

BST #xx:3, <EAd>

Operand Size

Byte

H: Previous value remains unchanged.

N: Previous value remains unchanged.

Z: Previous value remains unchanged.

V: Previous value remains unchanged.

C: Previous value remains unchanged.

Description

This instruction stores the carry bit in a specified bit location in the destination operand. The bit number is specified by 3-bit immediate data. Other bits in the destination operand remain unchanged.

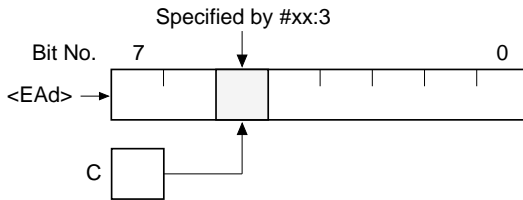

Available Registers

Rd: R0L to R7L, R0H to R7H

ERd: ER0 to ER7

Operand Format and Number of States Required for Execution

| Addressing Mode* | Mnemonic | Operands | Instruction Format | | | | No. of States | |
|-------------------|----------|-------------|--------------------|----------|----------|----------|---------------|---|
| | | | 1st byte | 2nd byte | 3rd byte | 4th byte | | |
| Register direct | BST | #xx:3,Rd | 6 | 7 | 0 IMM rd | | 2 | |
| Register indirect | BST | #xx:3,@ERd | 7 | D | 0 erd 0 | 6 7 | 0 IMM 0 | 8 |
| Absolute address | BST | #xx:3,@aa:8 | 7 | F | abs | 6 7 | 0 IMM 0 | 8 |

Note: * The addressing mode is the addressing mode of the destination operand <EAd>.

Notes

For the @aa:8 access range, refer to the relevant microcontroller hardware manual.

2.2.20 BTST

BTST (Bit TeST)

Bit Test

Operation

\neg (<Bit No.> of <EAd>) \rightarrow Z

Assembly-Language Format

BTST #xx:3, <EAd>

BTST Rn, <EAd>

Operand Size

Byte

Condition Code

| I | UI | H | U | N | Z | V | C |
|---|----|---|---|---|---|---|---|
| — | — | — | — | — | ↕ | — | — |

H: Previous value remains unchanged.

N: Previous value remains unchanged.

Z: Set to 1 if the specified bit is zero; otherwise cleared to 0.

V: Previous value remains unchanged.

C: Previous value remains unchanged.

Description

This instruction tests a specified bit in the destination operand and sets or clears the Z flag according to the result. The bit number can be specified by 3-bit immediate data, or by the lower three bits of a general register. The destination operand remains unchanged.

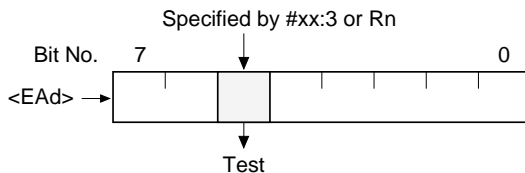

Available Registers

Rd: R0L to R7L, R0H to R7H

Rn: R0L to R7L, R0H to R7H

ERd: ER0 to ER7

Operand Format and Number of States Required for Execution

| Addressing Mode* | Mnemonic | Operands | Instruction Format | | | | No. of States | | |
|-------------------|----------|--------------|--------------------|----------|-----------|----------|---------------|----------|---|
| | | | 1st byte | 2nd byte | 3rd byte | 4th byte | | | |
| Register direct | BTST | #xx:3, Rd | 7 | 3 | 0 IMM: rd | | 2 | | |
| Register indirect | BTST | #xx:3, @ERd | 7 | C | 0:erd: 0 | 7 | 3 | 0 IMM: 0 | 6 |
| Absolute address | BTST | #xx:3, @aa:8 | 7 | E | abs | 7 | 3 | 0 IMM: 0 | 6 |
| Register direct | BTST | Rn, Rd | 6 | 3 | rn rd | | | | 2 |
| Register indirect | BTST | Rn, @ERd | 7 | C | 0:erd: 0 | 6 | 3 | rn 0 | 6 |
| Absolute address | BTST | Rn, @aa:8 | 7 | E | abs | 6 | 3 | rn 0 | 6 |

Note: * The addressing mode is the addressing mode of the destination operand <EAd>.

Notes

For the @aa:8 access range, refer to the relevant microcontroller hardware manual.

2.2.21 BXOR

BXOR (Bit eXclusive OR)

Bit Exclusive Logical OR

Operation

$C \oplus (\text{<bit No.> of <EAd>}) \rightarrow C$

Assembly-Language Format

BXOR #xx:3, <EAd>

Operand Size

Byte

Condition Code

| | | | | | | | |
|---|----|---|---|---|---|---|---|
| I | UI | H | U | N | Z | V | C |
| — | — | — | — | — | — | — | ↕ |

H: Previous value remains unchanged.

N: Previous value remains unchanged.

Z: Previous value remains unchanged.

V: Previous value remains unchanged.

C: Stores the result of the operation.

Description

This instruction exclusively ORs a specified bit in the destination operand with the carry bit and stores the result in the carry bit. The bit number is specified by 3-bit immediate data. The destination operand contents remain unchanged.

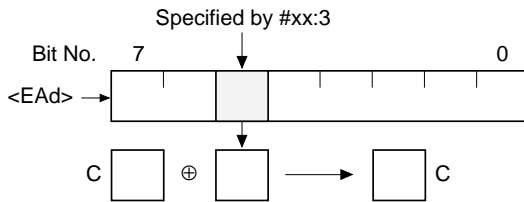

Available Registers

Rd: R0L to R7L, R0H to R7H

ERd: ER0 to ER7

Operand Format and Number of States Required for Execution

| Addressing Mode* | Mnemonic | Operands | Instruction Format | | | | No. of States | |
|-------------------|----------|-------------|--------------------|----------|----------|----------|---------------|---|
| | | | 1st byte | 2nd byte | 3rd byte | 4th byte | | |
| Register direct | BXOR | #xx:3,Rd | 7 | 5 | 0 IMM rd | | 2 | |
| Register indirect | BXOR | #xx:3,@ERd | 7 | C | 0 erd 0 | 7 5 | 0 IMM 0 | 6 |
| Absolute address | BXOR | #xx:3,@aa:8 | 7 | E | abs | 7 5 | 0 IMM 0 | 6 |

Note: * The addressing mode is the addressing mode of the destination operand <EAd>.

Notes

For the @aa:8 access range, refer to the relevant microcontroller hardware manual.

2.2.22 (1) CMP (B)

CMP (CoMPare)

Compare

Operation

Rd – (EAs), set or clear CCR

Assembly-Language Format

CMP.B <EAs>, Rd

Operand Size

Byte

Condition Code

| | | | | | | | |
|---|----|---|---|---|---|---|---|
| I | UI | H | U | N | Z | V | C |
| — | — | ↑ | — | ↑ | ↑ | ↑ | ↑ |

- H: Set to 1 if there is a borrow at bit 3; otherwise cleared to 0.
- N: Set to 1 if the result is negative; otherwise cleared to 0.
- Z: Set to 1 if the result is zero; otherwise cleared to 0.
- V: Set to 1 if an overflow occurs; otherwise cleared to 0.
- C: Set to 1 if there is a borrow at bit 7; otherwise cleared to 0.

Description

This instruction subtracts the source operand from the contents of an 8-bit register Rd (destination register) and sets or clears the CCR bits according to the result. The destination register contents remain unchanged.

Available Registers

Rd: R0L to R7L, R0H to R7H

Rs: R0L to R7L, R0H to R7H

Operand Format and Number of States Required for Execution

| Addressing Mode | Mnemonic | Operands | Instruction Format | | | | No. of States |
|-----------------|----------|-----------|--------------------|----------|----------|----------|---------------|
| | | | 1st byte | 2nd byte | 3rd byte | 4th byte | |
| Immediate | CMP.B | #xx:8, Rd | A rd | IMM | | | 2 |
| Register direct | CMP.B | Rs, Rd | 1 C | rs rd | | | 2 |

Notes

2.2.22 (2) CMP (W)

CMP (CoMPare)

Compare

Operation

Rd – (EAs), set CCR

Assembly-Language Format

CMP.W <EAs>, Rd

Operand Size

Word

Condition Code

| | | | | | | | |
|---|----|---|---|---|---|---|---|
| I | UI | H | U | N | Z | V | C |
| — | — | ↕ | — | ↕ | ↕ | ↕ | ↕ |

- H: Set to 1 if there is a borrow at bit 11; otherwise cleared to 0.
- N: Set to 1 if the result is negative; otherwise cleared to 0.
- Z: Set to 1 if the result is zero; otherwise cleared to 0.
- V: Set to 1 if an overflow occurs; otherwise cleared to 0.
- C: Set to 1 if there is a borrow at bit 15; otherwise cleared to 0.

Description

This instruction subtracts the source operand from the contents of a 16-bit register Rd (destination register) and sets or clears the CCR bits according to the result. The contents of the 16-bit register Rd remain unchanged.

Available Registers

Rd: R0 to R7, E0 to E7

Rs: R0 to R7, E0 to E7

Operand Format and Number of States Required for Execution

| Addressing Mode | Mnemonic | Operands | Instruction Format | | | | No. of States |
|-----------------|----------|------------|--------------------|----------|----------|----------|---------------|
| | | | 1st byte | 2nd byte | 3rd byte | 4th byte | |
| Immediate | CMP.W | #xx:16, Rd | 7 : 9 | 2 : rd | IMM | | 4 |
| Register direct | CMP.W | Rs, Rd | 1 : D | rs : rd | | | 2 |

Notes

2.2.22 (3) CMP (L)

CMP (CoMPare)

Compare

Operation

ERd – (EAs), set CCR

Assembly-Language Format

CMP.L <EAs>, ERd

Operand Size

Longword

Condition Code

| | | | | | |
|---|---|---|---|---|---|
| I | H | N | Z | V | C |
| — | — | ↑ | — | ↑ | ↑ |

- I: Previous value remains unchanged.
- H: Set to 1 if there is a borrow at bit 27; otherwise cleared to 0.
- N: Set to 1 if the result is negative; otherwise cleared to 0.
- Z: Set to 1 if the result is zero; otherwise cleared to 0.
- V: Set to 1 if an overflow occurs; otherwise cleared to 0.
- C: Set to 1 if there is a borrow at bit 31; otherwise cleared to 0.

Description

This instruction subtracts the source operand from the contents of a 32-bit register ERd (destination register) and sets or clears the CCR bits according to the result. The contents of the 32-bit register ERd remain unchanged.

Available Registers

ERd: ER0 to ER7

ERs: ER0 to ER7

Operand Format and Number of States Required for Execution

| Addressing Mode | Mnemonic | Operands | Instruction Format | | | | | | No. of States | |
|-----------------|----------|-------------|--------------------|----------|----------|----------|----------|----------|---------------|---|
| | | | 1st byte | 2nd byte | 3rd byte | 4th byte | 5th byte | 6th byte | | |
| Immediate | CMP.L | #xx:32, ERd | 7 | A | 2 | 0:erd | IMM | | | 6 |
| Register direct | CMP.L | ERs, ERd | 1 | F | 1:ers | 0:erd | | | | 2 |

Notes

2.2.23 DAA

DAA (Decimal Adjust Add)

Decimal Adjust

Operation

Rd (decimal adjust) → Rd

Assembly-Language Format

DAA Rd

Operand Size

Byte

Condition Code

| I | UI | H | U | N | Z | V | C |
|---|----|---|---|---|---|---|---|
| — | — | * | — | ↑ | ↑ | * | ↑ |

- H: Undetermined (no guaranteed value).
- N: Set to 1 if the adjusted result is negative; otherwise cleared to 0.
- Z: Set to 1 if the adjusted result is zero; otherwise cleared to 0.
- V: Undetermined (no guaranteed value).
- C: Set to 1 if there is a carry at bit 7; otherwise left unchanged.

Description

Given that the result of an addition operation performed by an ADD.B or ADDX instruction on 4-bit BCD data is contained in an 8-bit register Rd (destination register) and the carry and half-carry flags, the DAA instruction adjusts the general register contents by adding H'00, H'06, H'60, or H'66 according to the table below.

| C Flag before Adjustment | Upper 4 Bits before Adjustment | H Flag before Adjustment | Lower 4 Bits before Adjustment | Value Added (hexadecimal) | C Flag after Adjustment |
|--------------------------|--------------------------------|--------------------------|--------------------------------|---------------------------|-------------------------|
| 0 | 0 to 9 | 0 | 0 to 9 | 00 | 0 |
| 0 | 0 to 8 | 0 | A to F | 06 | 0 |
| 0 | 0 to 9 | 1 | 0 to 3 | 06 | 0 |
| 0 | A to F | 0 | 0 to 9 | 60 | 1 |
| 0 | 9 to F | 0 | A to F | 66 | 1 |
| 0 | A to F | 1 | 0 to 3 | 66 | 1 |
| 1 | 1 to 2 | 0 | 0 to 9 | 60 | 1 |
| 1 | 1 to 2 | 0 | A to F | 66 | 1 |
| 1 | 1 to 3 | 1 | 0 to 3 | 66 | 1 |

DAA (Decimal Adjust Add)**Decimal Adjust****Available Registers**

Rd: R0L to R7L, R0H to R7H

Operand Format and Number of States Required for Execution

| Addressing Mode | Mnemonic | Operands | Instruction Format | | | | No. of States |
|-----------------|----------|----------|--------------------|----------|----------|----------|---------------|
| | | | 1st byte | 2nd byte | 3rd byte | 4th byte | |
| Register direct | DAA | Rd | 0 : F | 0 : rd | | | 2 |

Notes

Valid results (8-bit register Rd contents and C, V, Z, N, and H flags) are not assured if this instruction is executed under conditions other than those described above.

2.2.24 DAS

DAS (Decimal Adjust Subtract)

Decimal Adjust

Operation

Rd (decimal adjust) → Rd

Assembly-Language Format

DAS Rd

Operand Size

Byte

Condition Code

| I | UI | H | U | N | Z | V | C |
|---|----|---|---|---|---|---|---|
| — | — | * | — | ↕ | ↕ | * | — |

- H: Undetermined (no guaranteed value).
- N: Set to 1 if the adjusted result is negative; otherwise cleared to 0.
- Z: Set to 1 if the adjusted result is zero; otherwise cleared to 0.
- V: Undetermined (no guaranteed value).
- C: Previous value remains unchanged.

Description

Given that the result of a subtraction operation performed by a SUB.B, SUBX.B, or NEG.B instruction on 4-bit BCD data is contained in an 8-bit register Rd (destination register) and the carry and half-carry flags, the DAS instruction adjusts the general register contents by adding H'00, H'FA, H'A0, or H'9A according to the table below.

| C Flag before Adjustment | Upper 4 Bits before Adjustment | H Flag before Adjustment | Lower 4 Bits before Adjustment | Value Added (hexadecimal) | C Flag after Adjustment |
|--------------------------|--------------------------------|--------------------------|--------------------------------|---------------------------|-------------------------|
| 0 | 0 to 9 | 0 | 0 to 9 | 00 | 0 |
| 0 | 0 to 8 | 1 | 6 to F | FA | 0 |
| 1 | 7 to F | 0 | 0 to 9 | A0 | 1 |
| 1 | 6 to F | 1 | 6 to F | 9A | 1 |

Available Registers

Rd: R0L to R7L, R0H to R7H

Operand Format and Number of States Required for Execution

| Addressing Mode | Mnemonic | Operands | Instruction Format | | | | No. of States |
|-----------------|----------|----------|--------------------|----------|----------|----------|---------------|
| | | | 1st byte | 2nd byte | 3rd byte | 4th byte | |
| Register direct | DAS | Rd | 1 F | 0 rd | | | 2 |

Notes

Valid results (8-bit register Rd contents and C, V, Z, N, and H flags) are not assured if this instruction is executed under conditions other than those described above.

2.2.25 (1) DEC (B)

DEC (DECrement)

Decrement

Operation

Rd – 1 → Rd

Assembly-Language Format

DEC.B Rd

Operand Size

Byte

Condition Code

| | | | | | | | |
|---|----|---|---|----|----|----|---|
| I | UI | H | U | N | Z | V | C |
| — | — | — | — | ↑↓ | ↑↓ | ↑↓ | — |

H: Previous value remains unchanged.

N: Set to 1 if the result is negative; otherwise cleared to 0.

Z: Set to 1 if the result is zero; otherwise cleared to 0.

V: Set to 1 if an overflow occurs (the previous value in Rd was H'80); otherwise cleared to 0.

C: Previous value remains unchanged.

Description

This instruction decrements an 8-bit register Rd (destination register) and stores the result in the 8-bit register Rd.

Available Registers

Rd: R0L to R7L, R0H to R7H

Operand Format and Number of States Required for Execution

| Addressing Mode | Mnemonic | Operands | Instruction Format | | | | No. of States |
|-----------------|----------|----------|--------------------|----------|----------|----------|---------------|
| | | | 1st byte | 2nd byte | 3rd byte | 4th byte | |
| Register direct | DEC.B | Rd | 1 ∴ A | 0 ∴ rd | | | 2 |

Notes

An overflow is caused by the operation H'80 – 1 → H'7F.

2.2.25 (2) DEC (W)

DEC (DECrement)

Decrement

Operation

Rd – 1 → Rd

Rd – 2 → Rd

Condition Code

| | | | | | | | |
|---|----|---|---|---|---|---|---|
| I | UI | H | U | N | Z | V | C |
| — | — | — | — | ↑ | ↑ | ↑ | — |

Assembly-Language Format

DEC.W #1, Rd

DEC.W #2, Rd

- H: Previous value remains unchanged.
- N: Set to 1 if the result is negative; otherwise cleared to 0.
- Z: Set to 1 if the result is zero; otherwise cleared to 0.
- V: Set to 1 if an overflow occurs (the previous value in Rd was H'8000); otherwise cleared to 0.
- C: Previous value remains unchanged.

Operand Size

Word

Description

This instruction subtracts the immediate value 1 or 2 from the contents of a 16-bit register Rd (destination register) and stores the result in the 16-bit register Rd.

Available Registers

Rd: R0 to R7, E0 to E7

Operand Format and Number of States Required for Execution

| Addressing Mode | Mnemonic | Operands | Instruction Format | | | | No. of States |
|-----------------|----------|----------|--------------------|----------|----------|----------|---------------|
| | | | 1st byte | 2nd byte | 3rd byte | 4th byte | |
| Register direct | DEC.W | #1, Rd | 1 | B | 5 | rd | 2 |
| Register direct | DEC.W | #2, Rd | 1 | B | D | rd | 2 |

Notes

An overflow is caused by the operations H'8000 – 1 → H'7FFF, H'8000 – 2 → H'7FFE, and H'8001 – 2 → H'7FFF.

2.2.25 (3) DEC (L)

DEC (DECrement)

Decrement

Operation

ERd – 1 → ERd

ERd – 2 → ERd

Condition Code

| | | | | | | | |
|---|----|---|---|---|---|---|---|
| I | UI | H | U | N | Z | V | C |
| — | — | — | — | ↑ | ↑ | ↑ | — |

Assembly-Language Format

DEC.L #1, ERd

DEC.L #2, ERd

H: Previous value remains unchanged.

N: Set to 1 if the result is negative; otherwise cleared to 0.

Z: Set to 1 if the result is zero; otherwise cleared to 0.

V: Set to 1 if an overflow occurs; otherwise cleared to 0.

C: Previous value remains unchanged.

Operand Size

Longword

Description

This instruction subtracts the immediate value 1 or 2 from the contents of a 32-bit register ERd (destination register) and stores the result in the 32-bit register ERd.

Available Registers

ERd: ER0 to ER7

Operand Format and Number of States Required for Execution

| Addressing Mode* | Mnemonic | Operands | Instruction Format | | | | No. of States |
|------------------|----------|----------|--------------------|----------|----------|----------|---------------|
| | | | 1st byte | 2nd byte | 3rd byte | 4th byte | |
| Register direct | DEC.L | #1, ERd | 1 | B | 7 | 0:erd | 2 |
| Register direct | DEC.L | #2, ERd | 1 | B | F | 0:erd | 2 |

Notes

An overflow is caused by the operations H'80000000 – 1 → H'7FFFFFFF, H'80000000 – 2 → H'7FFFFFFE, and H'80000001 – 2 → H'7FFFFFFF.

2.2.26 (1) DIVXS (B)

DIVXS (DIVide eXtend as Signed)

Divide Signed

Operation

$Rd \div Rs \rightarrow Rd$

Assembly-Language Format

DIVXS.B Rs, Rd

Operand Size

Byte

Condition Code

| I | UI | H | U | N | Z | V | C |
|---|----|---|---|----|----|---|---|
| — | — | — | — | ↑↓ | ↑↓ | — | — |

- H: Previous value remains unchanged.
- N: Set to 1 if the quotient is negative; otherwise cleared to 0.
- Z: Set to 1 if the divisor is zero; otherwise cleared to 0.
- V: Previous value remains unchanged.
- C: Previous value remains unchanged.

Description

This instruction divides the contents of a 16-bit register Rd (destination register) by the contents of an 8-bit register Rs (source register) and stores the result in the 16-bit register Rd. The division is signed. The operation performed is 16 bits \div 8 bits \rightarrow 8-bit quotient and 8-bit remainder. The quotient is placed in the lower 8 bits of Rd. The remainder is placed in the upper 8 bits of Rd.

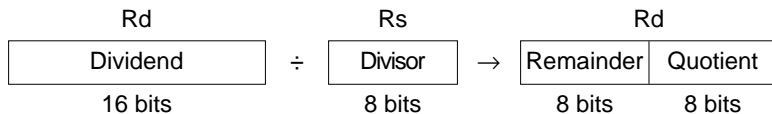

Valid results are not assured if division by zero is attempted or an overflow occurs. For information on avoiding overflow, see DIVXS Instruction, Zero Divide, and Overflow.

Available Registers

Rd: R0 to R7, E0 to E7

Rs: R0L to R7L, R0H to R7H

DIVXS (B)

DIVXS (DIVide eXtend as Signed)

Divide Signed

Operand Format and Number of States Required for Execution

| Addressing Mode | Mnemonic | Operands | Instruction Format | | | | | | | | No. of States |
|-----------------|----------|----------|--------------------|---|----------|---|----------|---|----------|----|---------------|
| | | | 1st byte | | 2nd byte | | 3rd byte | | 4th byte | | |
| Register direct | DIVXS.B | Rs, Rd | 0 | 1 | D | 0 | 5 | 1 | rs | rd | 16 |

Notes

The N flag is set to 1 if the dividend and divisor have different signs, and cleared to 0 if they have the same sign. The N flag may therefore be set to 1 when the quotient is zero.

2.2.26 (2) DIVXS (W)

DIVXS (DIVide eXtend as Signed)

Divide Signed

Operation

$ERd \div Rs \rightarrow ERd$

Assembly-Language Format

`DIVXS.W Rs, ERd`

Operand Size

Word

Condition Code

| I | UI | H | U | N | Z | V | C |
|---|----|---|---|---|---|---|---|
| — | — | — | — | ↑ | ↓ | — | — |

- H: Previous value remains unchanged.
- N: Set to 1 if the quotient is negative; otherwise cleared to 0.
- Z: Set to 1 if the divisor is zero; otherwise cleared to 0.
- V: Previous value remains unchanged.
- C: Previous value remains unchanged.

Description

This instruction divides the contents of a 32-bit register ERd (destination register) by the contents of a 16-bit register Rs (source register) and stores the result in the 32-bit register ERd. The division is signed. The operation performed is 32 bits \div 16 bits \rightarrow 16-bit quotient and 16-bit remainder. The quotient is placed in the lower 16 bits (Rd) of the 32-bit register ERd. The remainder is placed in the upper 16 bits (Ed).

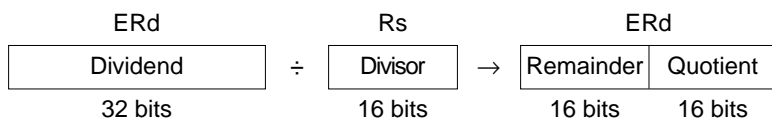

Valid results are not assured if division by zero is attempted or an overflow occurs. For information on avoiding overflow, see DIVXS Instruction, Zero Divide, and Overflow.

Available Registers

ERd: ER0 to ER7

Rs: R0 to R7, E0 to E7

DIVXS (W)

DIVXS (DIVide eXtend as Signed)

Divide Signed

Operand Format and Number of States Required for Execution

| Addressing Mode | Mnemonic | Operands | Instruction Format | | | | No. of States |
|-----------------|----------|----------|--------------------|----------|----------|--------------|---------------|
| | | | 1st byte | 2nd byte | 3rd byte | 4th byte | |
| Register direct | DIVXS.W | Rs, ERd | 0 : 1 | D : 0 | 5 : 3 | rs : 0 : erd | 24 |

Notes

The N flag is set to 1 if the dividend and divisor have different signs, and cleared to 0 if they have the same sign. The N flag may therefore be set to 1 when the quotient is zero.

2.2.26 (3) DIVXS

DIVXS (DIVide eXtend as Signed)

Divide Signed

DIVXS instruction, Division by Zero, and Overflow

Since the DIVXS instruction does not detect division by zero or overflow, applications should detect and handle division by zero and overflow using techniques similar to those used in the following program.

1. Programming solution for DIVXS.B R0L, R1

Example 1: Convert dividend and divisor to non-negative numbers, then use DIVXU programming solution for zero divide and overflow

```

MOV.B    R0L, R0L    ; Test divisor
BEQ     ZERODIV     ; Branch to ZERODIV if R0L = 0
ANDC    #AF, CCR    ; Clear CCR user bits (bits 6 and 4) to 0
BPL     L1          ; Branch to L1 if N flag = 0 (positive divisor)
NEG.B   R0L         ; Take 2's complement of R0L to make sign positive
ORC     #10, CCR    ; Set CCR bit 4 to 1

L1: MOV.W  R1, R1    ; Test dividend
BPL     L2          ; Branch to L2 if N flag = 0 (positive dividend)
NEG.W   R1          ; Take 2's complement of R1 to make sign positive
XORC    #50, CCR    ; Invert CCR bits 6 and 4

L2: MOV.B  R1H, R2L  ;
EXTU.W  R2          ;
DIVXU.B R0L, R2     ; Use DIVXU.B instruction to divide non-negative dividend
MOV.B   R2H, R1H    ; by positive divisor
DIVXU.B R0L, R1     ; 16 bits ÷ 8 bits → quotient (16 bits) and remainder (8 bits)
MOV.B   R2L, R2H    ; (See DIVXU Instruction, Zero Divide, and Overflow)
MOV.B   R1L, R2L    ;

STC     CCR, R1L    ; Copy CCR contents to R1L
BTST    #6, R1L     ; Test CCR bit 6
BEQ     L3          ; Branch to L3 if bit 6 = 1
NEG.B   R1H         ; Take 2's complement of R1H to make sign of remainder negative

L3: BTST    #4, R1L  ; Test CCR bit 4
BEQ     L4          ; Branch to L4 if bit 4 = 1
NEG.W   R2          ; Take 2's complement of R2 to make sign of quotient negative

L4: RTS

ZERODIV: ; Zero-divide handling routine

```

This program leaves a 16-bit quotient in R2 and an 8-bit remainder in R1H.

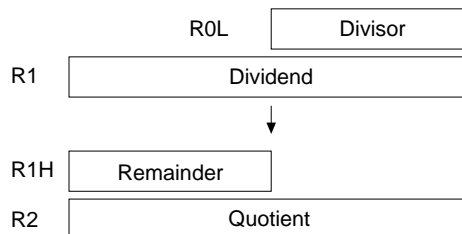

DIVXS

DIVXS (DIVide eXtend as Signed)

Divide Signed

Example 2: Sign extend the 8-bit divisor to 16 bits, sign extend the 16-bit dividend to 32 bits, and then use DIVXS to divide

```
EXTS.W    R0
BEQ       ZERODIV
EXTS.L    ER1
DIVXS.L   R0, ER1
RTS
ZERODIV:
```

This program leaves the 16-bit quotient in R1 and the 8-bit remainder in E1 (in a 16-bit sign extended format).

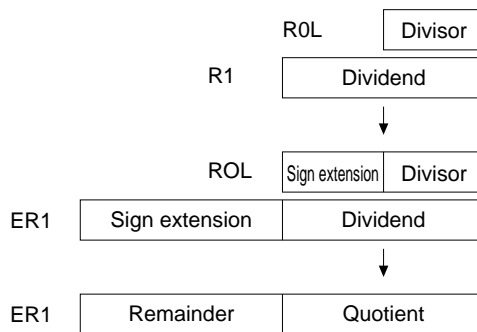

DIVXS

DIVXS (DIVide eXtend as Signed)

Divide Signed

2. Programming solution for DIVXS.W R0, ER1

Example: Convert dividend and divisor to non-negative numbers, then use DIVXU programming solution for zero divide and overflow

```
        MOV.W    R0, R0      ; Test divisor
        BEQ     ZERODIV     ; Branch to ZERODIV if R0 = 0
        ANDC   #AF, CCR     ; Clear CCR user bits (bits 6 and 4) to 0
        BPL    L1           ; Branch to L1 if N flag = 0 (positive divisor)
        NEG.W   R0          ; Take 2's complement of R0 to make sign positive
        ORC    #10, CCR     ; Set CCR bit 4 to 1

L1:     MOV.L    ER1, ER1    ; Test dividend
        BPL    L2           ; Branch to L2 if N flag = 0 (positive dividend)
        NEG.L   ER1        ; Take 2's complement of ER1 to make sign positive
        XORC   #50, CCR     ; Invert CCR bits 6 and 4

L2:     MOV.W    E1, R2      ;
        EXTU.L  ER2         ;
        DIVXU.W R0, E2      ; Use DIVXU.W instruction to divide non-negative dividend
        MOV.W   E2, R1      ; by positive divisor
        DIVXU.W R0, ER1     ; 32 bits ÷ 16 bits → quotient (32 bits) and remainder
        MOV.W   R2, E2      ; (16 bits)
        MOV.W   R1, R2      ; (See DIVXU Instruction, Zero Divide, and Overflow)

        STC     CCR, R1L    ; Copy CCR contents to R1L
        BTST   #6, R1L     ; Test CCR bit 6
        BEQ    L3          ; Branch to L3 if bit 6 = 1
        NEG.W   E1         ; Take 2's complement of E1 to make sign of remainder negative

L3:     BTST   #4, R1L     ; Test CCR bit 4
        BEQ    L4          ; Branch to L4 if bit 4 = 1
        NEG.L   ER2        ; Take 2's complement of ER2 to make sign of quotient negative

L4:     RTS

ZERODIV: ; Zero-divide handling routine
```

This program leaves a 32-bit quotient in ER2 and a 16-bit remainder in E1.

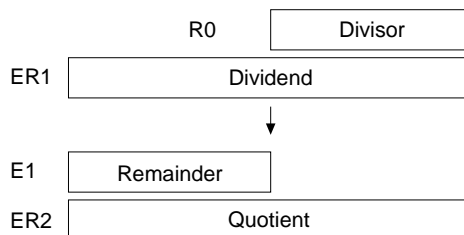

DIVXS (W)

DIVXS (DIVide eXtend as Signed)

Divide Signed

The preceding two examples flag the status of the divisor and dividend in the UI and U bits in the CCR, and modify the sign of the quotient and remainder in the unsigned division result of the DIVXU instruction as shown next.

| UI | U | Divisor | Dividend | Remainder | Quotient | Sign Modification |
|----|---|----------|----------|-----------|----------|---|
| 0 | 0 | Positive | Positive | Positive | Positive | No sign modification |
| 0 | 1 | Negative | Positive | Positive | Negative | Sign of quotient is reversed |
| 1 | 0 | Negative | Negative | Negative | Positive | Sign of remainder is reversed |
| 1 | 1 | Positive | Negative | Negative | Negative | Signs of quotient and remainder are both reversed |

2.2.27 (1) DIVXU (B)

DIVXU (DIVide eXtend as Unsigned)

Divide

Operation

$Rd \div Rs \rightarrow Rd$

Assembly-Language Format

DIVXU.B Rs, Rd

Operand Size

Byte

Condition Code

| | | | | | | | |
|---|----|---|---|---|---|---|---|
| I | UI | H | U | N | Z | V | C |
| — | — | — | — | ↑ | ↓ | — | — |

H: Previous value remains unchanged.

N: Set to 1 if the divisor is negative; otherwise cleared to 0.

Z: Set to 1 if the divisor is zero; otherwise cleared to 0.

V: Previous value remains unchanged.

C: Previous value remains unchanged.

Description

This instruction divides the contents of a 16-bit register Rd (destination register) by the contents of an 8-bit register Rs (source register) and stores the result in the 16-bit register Rd. The division is unsigned. The operation performed is 16 bits \div 8 bits \rightarrow 8-bit quotient and 8-bit remainder. The quotient is placed in the lower 8 bits of Rd. The remainder is placed in the upper 8 bits of Rd.

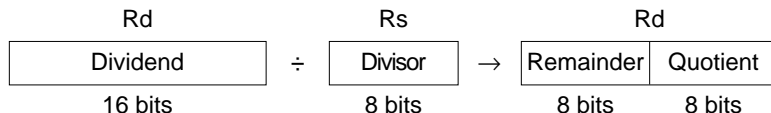

Valid results are not assured if division by zero is attempted or an overflow occurs. For information on avoiding overflow, see DIVXU Instruction, Zero Divide, and Overflow.

Available Registers

Rd: R0 to R7, E0 to E7

Rs: R0L to R7L, R0H to R7H

Operand Format and Number of States Required for Execution

| Addressing Mode | Mnemonic | Operands | Instruction Format | | | | No. of States |
|-----------------|----------|----------|--------------------|----------|----------|----------|---------------|
| | | | 1st byte | 2nd byte | 3rd byte | 4th byte | |
| Register direct | DIVXU.B | Rs, Rd | 5 1 | rs rd | | | 14 |

Notes

2.2.27 (2) DIVXU (W)

DIVXU (DIVide eXtend as Unsigned)

Divide

Operation

$ERd \div Rs \rightarrow ERd$

Assembly-Language Format

`DIVXU.W Rs, ERd`

Operand Size

Word

Condition Code

| I | UI | H | U | N | Z | V | C |
|---|----|---|---|----|----|---|---|
| — | — | — | — | ↑↓ | ↑↓ | — | — |

H: Previous value remains unchanged.

N: Set to 1 if the divisor is negative; otherwise cleared to 0.

Z: Set to 1 if the divisor is zero; otherwise cleared to 0.

V: Previous value remains unchanged.

C: Previous value remains unchanged.

Description

This instruction divides the contents of a 32-bit register ERd (destination register) by the contents of a 16-bit register Rs (source register) and stores the result in the 32-bit register ERd. The division is unsigned. The operation performed is 32 bits \div 16 bits \rightarrow 16-bit quotient and 16-bit remainder. The quotient is placed in the lower 16 bits (Rd) of the 32-bit register ERd. The remainder is placed in the upper 8 bits of (Ed).

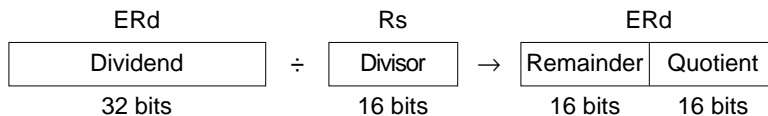

Valid results are not assured if division by zero is attempted or an overflow occurs. For information on avoiding overflow, see DIVXU Instruction, Zero Divide, and Overflow.

Available Registers

ERd: ER0 to ER7

Rs: R0 to R7, E0 to E7

Operand Format and Number of States Required for Execution

| Addressing Mode | Mnemonic | Operands | Instruction Format | | | | No. of States |
|-----------------|----------|----------|--------------------|----------|----------|----------|---------------|
| | | | 1st byte | 2nd byte | 3rd byte | 4th byte | |
| Register direct | DIVXU.W | Rs, ERd | 5 | 3 | rs 0:ERd | | 22 |

Notes

DIVXU

DIVXU (DIVide eXtend as Unsigned)

Divide

DIVXU Instruction, Zero Divide, and Overflow

Zero divide and overflow are not detected in the DIVXU instruction. A program like the following can detect zero divisors and avoid overflow.

1. Programming solutions for DIVXU.B R0L, R1

Example 1: Divide upper 8 bits and lower 8 bits of 16-bit dividend separately and obtain 16-bit quotient

```
CMP.B    #0, R0L          ; R0L = 0? (Zero divisor?)
BEQ     ZERODIV          ; Branch to ZERODIV if R0L = 0
MOV.B   R1H, R2L         ; Copy upper 8 bits of dividend to R2L and
EXTU.W  R2 (*1).         ; zero-extend to 16 bits
DIVXU.B R0L, R2 (*2)     ; Divide upper 8 bits of dividend
MOV.B   R2H, R1H (*3)    ; R2H → R1H (store partial remainder in R1H)
DIVXU.B R0L, R1 (*4)     ; Divide lower 8 bits of dividend (including repeated division of
                        ; upper 8 bits)
MOV.B   R2L, R2H         ; Store upper part of quotient in R2H
MOV.B   R1L, R2L (*5)    ; Store lower part of quotient in R2L
RTS
ZERODIV: ; Zero-divide handling routine
```

The resulting operation is 16 bits ÷ 8 bits → quotient (16 bits) and remainder (8 bits), and no overflow occurs. The 16-bit quotient is stored in R2, the 8-bit remainder in R1H.

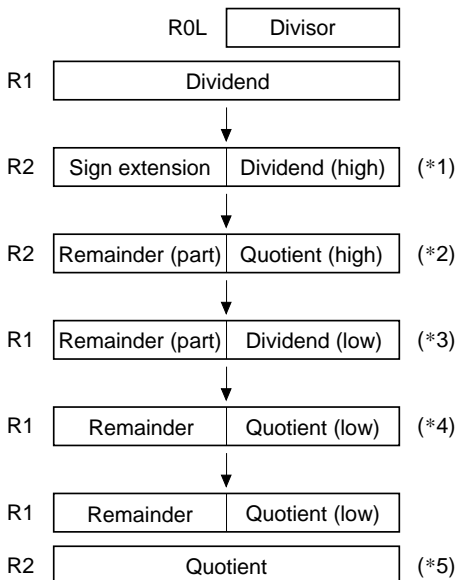

DIVXU

DIVXU (DIVide eXtend as Unsigned)

Divide

Example 2: Zero-extend divisor from 8 to 16 bits and dividend from 16 to 32 bits before dividing

```
EXTU.W    R0          ; Zero-extend 8-bit divisor to 16 bits
BEQ       ZERODIV    ; Branch to ZERODIV if R0 = 0
EXTU.L    ER1        ; Zero-extend 16-bit dividend to 32 bits
EXTU.W    R0, ER1    ; Divide using DIVXU.W
RTS
ZERODIV:   ; Zero-divide handling routine
```

Instead of 16 bits \div 8 bits, the operation performed is 32 bits \div 16 bits \rightarrow quotient (16 bits) and remainder (16 bits), and no overflow occurs. The 16-bit quotient is stored in R1 and the 8-bit remainder in the lower 8 bits of E1. The upper 8 bits of E1 are all 0.

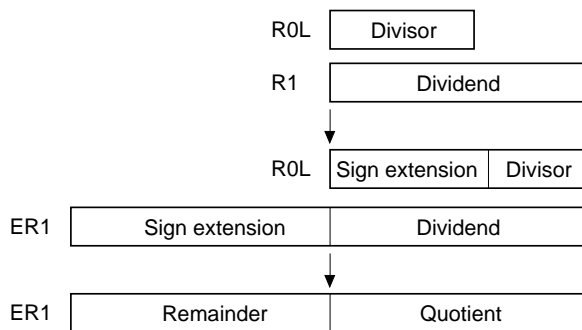

DIVXU

DIVXU (DIVide eXtend as Unsigned)

Divide

2. Programming solution for DIVXU.W R0, ER1

Example 1: Divide upper 16 bits and lower 16 bits of 32-bit dividend separately and obtain 32-bit quotient

```
MOV.W    R0, R0        ; R0 = 0? (Zero divisor?)
BEQ      ZERODIV      ; Branch to ZERODIV if R0 = 0
MOV.W    E1, E2        ; Copy upper 16 bits of dividend to R2 and
EXTU.L   ER2          (*1) ; zero-extend to 32 bits
DIVXU.W  R0, ER2      (*2) ; Divide upper 16 bits of dividend
MOV.W    E2, E1      (*3) ; E2 → E1 (store partial remainder in E1)
DIVXU.W  R0, ER1      (*4) ; Divide lower 16 bits of dividend (including repeated division of
                           ; upper 16 bits)
MOV.W    R2, E2        ; Store upper part of quotient in E2
MOV.W    R1, R2      (*5) ; Store lower part of quotient in R2
RTS
ZERODIV: ; Zero-divide handling routine
```

The resulting operation is 32 bits ÷ 16 bits → quotient (32 bits) and remainder (16 bits), and no overflow occurs. The 32-bit quotient is stored in ER2, the 16-bit remainder in E1.

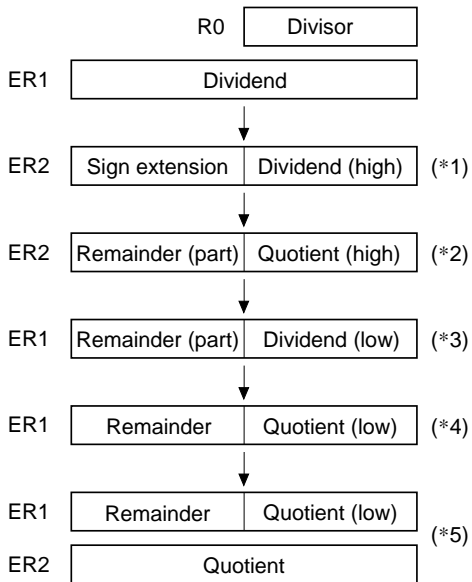

2.2.28 (1) EEPMOV (B)

EEPMOV (MOVE data to EEPROM)

Block Data Transfer

Operation

if R4L \neq 0 then
 repeat @ER5+ \rightarrow @ER6+
 R4L - 1 \rightarrow R4L
 until R4L = 0
 else next;

Condition Code

| I | UI | H | U | N | Z | V | C |
|---|----|---|---|---|---|---|---|
| — | — | — | — | — | — | — | — |

H: Previous value remains unchanged.

N: Previous value remains unchanged.

Z: Previous value remains unchanged.

V: Previous value remains unchanged.

C: Previous value remains unchanged.

Assembly-Language Format

EEPMOV . B

Operand Size

—

Description

This instruction performs a block memory transfer. It moves data from the memory location specified in ER5 to the memory location specified in ER6, increments ER5 and ER6, decrements R4L, and repeats these operations until R4L reaches zero. Execution then proceeds to the next instruction. No interrupts are detected while the block transfer is in progress. When the EEPMOV instruction ends, R4L contains 0, and ER5 and ER6 contain the last transfer address + 1. The data transfer is performed a byte at a time, with R4L indicating the number of bytes to be transferred. The byte symbol in the assembly-language format designates the size of R4L (and limits the maximum number of bytes that can be transferred to 255).

Operand Format and Number of States Required for Execution

| Addressing Mode | Mnemonic | Operands | Instruction Format | | | | No. of States |
|-----------------|----------|----------|--------------------|----------|----------|----------|---------------|
| | | | 1st byte | 2nd byte | 3rd byte | 4th byte | |
| — | EEPMOV.B | | 7 B | 5 C | 5 9 | 8 F | 8+4n* |

Note: * n is the initial value of R4L. Although n bytes of data are transferred, memory is accessed 2(n + 1) times, requiring 4(n + 1) states. (n = 0, 1, 2, ..., 255).

Notes

This instruction first reads the memory locations indicated by ER5 and ER6, then performs the data transfer. The number of states required for execution differs from the H8/300 CPU.

2.2.28 (2) EEPMOV (W)

EEPMOV (MOVE data to EEPROM)

Block Data Transfer

Operation

if R4 ≠ 0 then
 repeat @ER5+ → @ER6+
 R4 - 1 → R4
 until R4 = 0
 else next;

Condition Code

| I | UI | H | U | N | Z | V | C |
|---|----|---|---|---|---|---|---|
| — | — | — | — | — | — | — | — |

H: Previous value remains unchanged.
 N: Previous value remains unchanged.
 Z: Previous value remains unchanged.
 V: Previous value remains unchanged.
 C: Previous value remains unchanged.

Assembly-Language Format

EEPMOV.W

Operand Size

—

Description

This instruction performs a block memory transfer. It moves data from the memory location specified in ER5 to the memory location specified in ER6, increments ER5 and ER6, decrements R4, and repeats these operations until R4 reaches zero. Execution then proceeds to the next instruction. No interrupts except NMI are detected while the block transfer is in progress. When the EEPMOV instruction ends, R4 contains 0, and ER5 and ER6 contain the last transfer address + 1. The data transfer is performed a byte at a time, with R4 indicating the number of bytes to be transferred. The word symbol in the assembly-language format designates the size of R4 (allowing a maximum 65535 bytes to be transferred).

Operand Format and Number of States Required for Execution

| Addressing Mode | Mnemonic | Operands | Instruction Format | | | | No. of States |
|-----------------|----------|----------|--------------------|----------|----------|----------|---------------|
| | | | 1st byte | 2nd byte | 3rd byte | 4th byte | |
| — | EEPMOV.W | | 7 B | D 4 | 5 9 | 8 F | 8+4n |

Note: n is the initial value of R4. Although n bytes of data are transferred, memory is accessed 2(n + 1) times, requiring 4(n + 1) states. (n = 0, 1, 2, ..., 65535).

Notes

This instruction first reads memory at the addresses indicated by ER5 and ER6, then carries out the block data transfer.

EEPMOV (W)

EEPMOV (MOVE data to EEPROM)

Block Data Transfer

EEPMOV.W Instruction and NMI Interrupt

If an NMI request occurs while the EEPMOV.W instruction is being executed, NMI interrupt exception handling is carried out at the end of the current read-write cycle. Register contents are then as follows:

ER5: address of the next byte to be transferred

ER6: destination address of the next byte

R4: number of bytes remaining to be transferred

The program counter value pushed on the stack in NMI interrupt exception handling is the address of the next instruction after the EEPMOV.W instruction. Programs should be coded as follows to allow for NMI interrupts during execution of the EEPMOV.W instruction.

Example:

```
L1: EEPMOV.W
      MOV.W    R4, R4
      BNE     L1
```

During execution of the EEPMOV.B instruction no interrupts are accepted, including NMI.

2.2.29 (1) EXTS (W)

EXTS (EXTend as Signed)

Sign Extension

Operation

(<Bit 7> of Rd) → (<bits 15 to 8> of Rd)

Assembly-Language Format

EXTS.W Rd

Operand Size

Word

Condition Code

| I | UI | H | U | N | Z | V | C |
|---|----|---|---|---|---|---|---|
| — | — | — | — | ↑ | ↓ | 0 | — |

- H: Previous value remains unchanged.
- N: Set to 1 if the result is negative; otherwise cleared to 0.
- Z: Set to 1 if the result is zero; otherwise cleared to 0.
- V: Always cleared to 0.
- C: Previous value remains unchanged.

Description

This instruction copies the sign of the lower 8 bits in a 16-bit register Rd in the upward direction (copies Rd bit 7 to bits 15 to 8) to extend the data to signed word data.

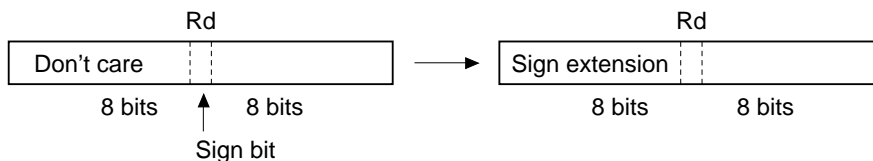

Available Registers

Rd: R0 to R7, E0 to E7

Operand Format and Number of States Required for Execution

| Addressing Mode | Mnemonic | Operands | Instruction Format | | | | No. of States |
|-----------------|----------|----------|--------------------|----------|----------|----------|---------------|
| | | | 1st byte | 2nd byte | 3rd byte | 4th byte | |
| Register direct | EXTS.W | Rd | 1 : 7 | D : rd | | | 2 |

Notes

2.2.29 (2) EXTS (L)

EXTS (EXTend as Signed)

Sign Extension

Operation

(<Bit 15> of ERd) → (<bits 31 to 16> of ERd)

Assembly-Language Format

EXTS.L ERd

Operand Size

Longword

Condition Code

| | | | | | | | |
|---|----|---|---|---|---|---|---|
| I | UI | H | U | N | Z | V | C |
| — | — | — | — | ↑ | ↑ | 0 | — |

- I: Previous value remains unchanged.
- H: Previous value remains unchanged.
- N: Set to 1 if the result is negative; otherwise cleared to 0.
- Z: Set to 1 if the result is zero; otherwise cleared to 0.
- V: Always cleared to 0.
- C: Previous value remains unchanged.

Description

This instruction copies the sign of the lower 16 bits (general register Rd) in a 32-bit register ERd in the upward direction (copies ERd bit 15 to bits 31 to 16) to extend the data to signed longword data.

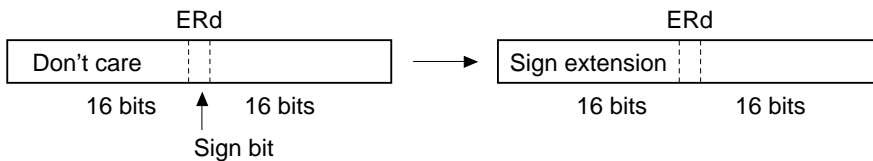

Available Registers

ERd: ER0 to ER7

Operand Format and Number of States Required for Execution

| Addressing Mode | Mnemonic | Operands | Instruction Format | | | | No. of States |
|-----------------|----------|----------|--------------------|----------|----------|----------|---------------|
| | | | 1st byte | 2nd byte | 3rd byte | 4th byte | |
| Register direct | EXTS.L | ERd | 1 : 7 | F 0: erd | | | 2 |

Notes

2.2.30 (1) EXTU (W)

EXTU (EXTend as Unsigned)

Zero Extension

Operation

0 → (<bits 15 to 8> of Rd)

Zero extend

Condition Code

| | | | | | | | |
|---|----|---|---|---|---|---|---|
| I | UI | H | U | N | Z | V | C |
| — | — | — | — | 0 | ↓ | 0 | — |

Assembly-Language Format

EXTU.W Rd

Operand Size

Word

H: Previous value remains unchanged.

N: Always cleared to 0.

Z: Set to 1 if the result is zero; otherwise cleared to 0.

V: Always cleared to 0.

C: Previous value remains unchanged.

Description

This instruction extends the lower 8 bits in a 16-bit register Rd to word data by padding with zeros. That is, it clears the upper 8 bits of Rd (bits 15 to 8) to 0.

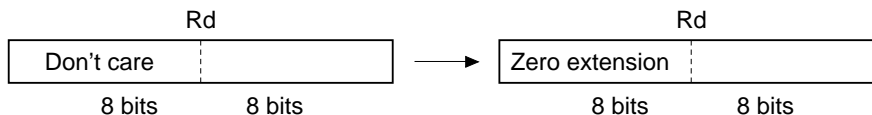

Available Registers

Rd: R0 to R7, E0 to E7

Operand Format and Number of States Required for Execution

| Addressing Mode | Mnemonic | Operands | Instruction Format | | | | No. of States |
|-----------------|----------|----------|--------------------|----------|----------|----------|---------------|
| | | | 1st byte | 2nd byte | 3rd byte | 4th byte | |
| Register direct | EXTU.W | Rd | 1 : 7 | 5 : rd | | | 2 |

Notes

2.2.30 (2) EXTU (L)

EXTU (EXTend as Unsigned)

Zero Extension

Operation

0 → (<bits 31 to 16> of ERd)
Zero extend

Condition Code

| | | | | | | | |
|---|----|---|---|---|---|---|---|
| I | UI | H | U | N | Z | V | C |
| — | — | — | — | 0 | ↑ | 0 | — |

Assembly-Language Format

EXTU.L ERd

Operand Size

Longword

H: Previous value remains unchanged.

N: Always cleared to 0.

Z: Set to 1 if the result is zero; otherwise cleared to 0.

V: Always cleared to 0.

C: Previous value remains unchanged.

Description

This instruction extends the lower 16 bits (general register Rd) in a 32-bit register ERd to longword data by padding with zeros. That is, it clears the upper 16 bits of ERd (bits 31 to 16) to 0.

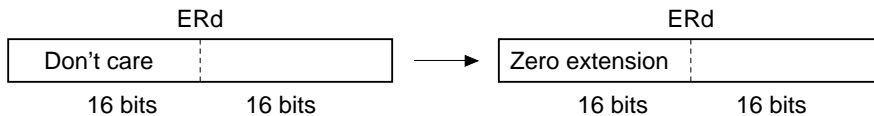

Available Registers

ERd: ER0 to ER7

Operand Format and Number of States Required for Execution

| Addressing Mode | Mnemonic | Operands | Instruction Format | | | | No. of States |
|-----------------|----------|----------|--------------------|------------|----------|----------|---------------|
| | | | 1st byte | 2nd byte | 3rd byte | 4th byte | |
| Register direct | EXTU.L | ERd | 1 : 7 | 7 : 0: erd | | | 2 |

Notes

2.2.31 (1) INC (B)

INC (INCRement)

Increment

Operation

$Rd + 1 \rightarrow Rd$

Assembly-Language Format

INC.B Rd

Operand Size

Byte

Condition Code

| I | UI | H | U | N | Z | V | C |
|---|----|---|---|---|---|---|---|
| — | — | — | — | ↑ | ↑ | ↑ | — |

- H: Previous value remains unchanged.
N: Set to 1 if the result is negative; otherwise cleared to 0.
Z: Set to 1 if the result is zero; otherwise cleared to 0.
V: Set to 1 if an overflow occurs; otherwise cleared to 0.
C: Previous value remains unchanged.

Description

This instruction increments an 8-bit register Rd (destination register) and stores the result in the 8-bit register Rd.

Available Registers

Rd: R0L to R7L, R0H to R7H

Operand Format and Number of States Required for Execution

| Addressing Mode | Mnemonic | Operands | Instruction Format | | | | No. of States |
|-----------------|----------|----------|--------------------|----------|----------|----------|---------------|
| | | | 1st byte | 2nd byte | 3rd byte | 4th byte | |
| Register direct | INC.B | Rd | 0 : A | 0 : rd | | | 2 |

Notes

An overflow is caused by the operation $H'7F + 1 \rightarrow H'80$.

2.2.31 (2) INC (W)

INC (INCRement)

Increment

Operation

Rd + 1 → Rd

Rd + 2 → Rd

Condition Code

| | | | | | | | |
|---|----|---|---|---|---|---|---|
| I | UI | H | U | N | Z | V | C |
| — | — | — | — | ↑ | ↑ | ↑ | — |

Assembly-Language Format

INC.W #1, Rd

INC.W #2, Rd

H: Previous value remains unchanged.

N: Set to 1 if the result is negative; otherwise cleared to 0.

Z: Set to 1 if the result is zero; otherwise cleared to 0.

V: Set to 1 if an overflow occurs; otherwise cleared to 0.

C: Previous value remains unchanged.

Operand Size

Word

Description

This instruction adds the immediate value 1 or 2 to the contents of a 16-bit register Rd (destination register) and stores the result in the 16-bit register Rd.

Available Registers

Rd: R0 to R7, E0 to E7

Operand Format and Number of States Required for Execution

| Addressing Mode | Mnemonic | Operands | Instruction Format | | | | No. of States |
|-----------------|----------|----------|--------------------|----------|----------|----------|---------------|
| | | | 1st byte | 2nd byte | 3rd byte | 4th byte | |
| Register direct | INC.W | #1, Rd | 0 B | 5 rd | | | 2 |
| Register direct | INC.W | #2, Rd | 0 B | D rd | | | 2 |

Notes

An overflow is caused by the operations H'7FFF + 1 → H'8000, H'7FFF + 2 → H'8001, and H'7FFE + 2 → H'8000.

2.2.31 (3) INC (L)

INC (INCRe ment)

Increment

Operation

$ERd + 1 \rightarrow ERd$

$ERd + 2 \rightarrow ERd$

Condition Code

| I | UI | H | U | N | Z | V | C |
|---|----|---|---|---|---|---|---|
| — | — | — | — | ↑ | ↑ | ↑ | — |

Assembly-Language Format

`INC.L #1, ERd`

`INC.L #2, ERd`

Operand Size

Longword

- H: Previous value remains unchanged.
- N: Set to 1 if the result is negative; otherwise cleared to 0.
- Z: Set to 1 if the result is zero; otherwise cleared to 0.
- V: Set to 1 if an overflow occurs; otherwise cleared to 0.
- C: Previous value remains unchanged.

Description

This instruction adds the immediate value 1 or 2 to the contents of a 32-bit register ERd (destination register) and stores the result in the 32-bit register ERd.

Available Registers

ERd: ER0 to ER7

Operand Format and Number of States Required for Execution

| Addressing Mode | Mnemonic | Operands | Instruction Format | | | | No. of States |
|-----------------|----------|----------|--------------------|----------|----------|----------|---------------|
| | | | 1st byte | 2nd byte | 3rd byte | 4th byte | |
| Register direct | INC.L | #1, ERd | 0 B | 7 0 erd | | | 2 |
| Register direct | INC.L | #2, ERd | 0 B | F 0 erd | | | 2 |

Notes

An overflow is caused by the operations $H'7FFFFFFF + 1 \rightarrow H'80000000$, $H'7FFFFFFF + 2 \rightarrow H'80000001$, and $H'7FFFFFFE + 2 \rightarrow H'80000000$.

2.2.32 JMP

JMP (JuMP)

Unconditional Branch

Operation

Effective address → PC

Condition Code

| | | | | | | | |
|---|----|---|---|---|---|---|---|
| I | UI | H | U | N | Z | V | C |
| — | — | — | — | — | — | — | — |

Assembly-Language Format

JMP <EA>

Operand Size

—

H: Previous value remains unchanged.
N: Previous value remains unchanged.
Z: Previous value remains unchanged.
V: Previous value remains unchanged.
C: Previous value remains unchanged.

Description

This instruction branches unconditionally to a specified address

Available Registers

ERn: ER0 to ER7

Operand Format and Number of States Required for Execution

| Addressing Mode | Mnemonic | Operands | Instruction Format | | | | No. of State | |
|-------------------|----------|----------|--------------------|----------|----------|----------|--------------|----------|
| | | | 1st byte | 2nd byte | 3rd byte | 4th byte | Normal | Advanced |
| Register indirect | JMP | @ERn | 5 | 9 | 0 | 0 | 4 | |
| Absolute address | JMP | @aa:24 | 5 | A | abs | | 6 | |
| Memory indirect | JMP | @@aa:8 | 5 | B | abs | | 8 | 10 |

Notes

The structure of the branch address and the number of states required for execution differ between normal mode and advanced mode.

The branch address must be even.

2.2.33 JSR

JSR (Jump to SubRoutine)

Jump to Subroutine

Operation

PC → @-SP

Effective address → PC

Condition Code

| | | | | | | | |
|---|----|---|---|---|---|---|---|
| I | UI | H | U | N | Z | V | C |
| — | — | — | — | — | — | — | — |

Assembly-Language Format

JSR <EA>

H: Previous value remains unchanged.

N: Previous value remains unchanged.

Z: Previous value remains unchanged.

V: Previous value remains unchanged.

C: Previous value remains unchanged.

Operand Size

—

Description

This instruction pushes the program counter on the stack as a return address, then branches to a specified effective address. The program counter value pushed on the stack is the address of the instruction following the JSR instruction.

Available Registers

ERn: ER0 to ER7

Operand Format and Number of States Required for Execution

| Addressing Mode | Mnemonic | Operands | Instruction Format | | | | No. of State | | |
|-------------------|----------|----------|--------------------|----------|----------|----------|--------------|----------|----|
| | | | 1st byte | 2nd byte | 3rd byte | 4th byte | Normal | Advanced | |
| Register indirect | JSR | @ERn | 5 | D | 0 | ern | 0 | 6 | 8 |
| Absolute address | JSR | @aa:24 | 5 | E | abs | | | 8 | 10 |
| Memory indirect | JSR | @@aa:8 | 5 | F | abs | | | 8 | 12 |

JSR

JSR (Jump to SubRoutine)

Jump to Subroutine

Notes

Note that the structures of the stack and branch addresses differ between normal and advanced mode. Only the lower 16 bits of the PC are saved in normal mode.

The branch address must be even.

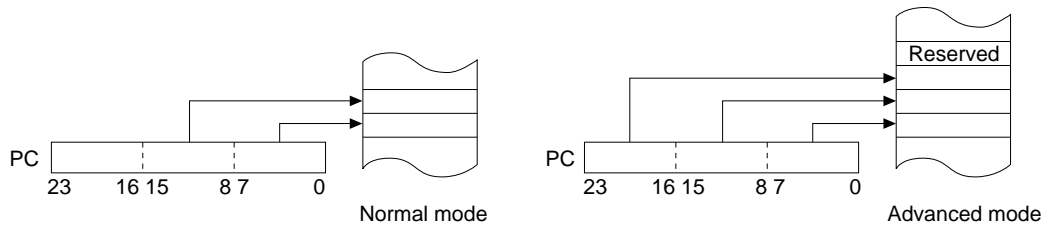

2.2.34 (1) LDC (B)

LDC (Load to Control register)

Load CCR

Operation

(EAs) → CCR

Assembly-Language Format

LDC.B <EAs>, CCR

Operand Size

Byte

Condition Code

| | | | | | | | |
|---|----|---|---|---|---|---|---|
| I | UI | H | U | N | Z | V | C |
| ↓ | ↓ | ↓ | ↓ | ↓ | ↓ | ↓ | ↓ |

- I: Loaded from the corresponding bit in the source operand.
- H: Loaded from the corresponding bit in the source operand.
- N: Loaded from the corresponding bit in the source operand.
- Z: Loaded from the corresponding bit in the source operand.
- V: Loaded from the corresponding bit in the source operand.
- C: Loaded from the corresponding bit in the source operand.

Description

This instruction loads the source operand into the CCR.

Note that no interrupts, even NMI interrupts, will be accepted at the point that this instruction completes.

Available Registers

Rs: R0L to R7L, R0H to R7H

Operand Format and Number of States Required for Execution

| Addressing Mode | Mnemonic | Operands | Instruction Format | | | | No. of States |
|-----------------|----------|------------|--------------------|----------|----------|----------|---------------|
| | | | 1st byte | 2nd byte | 3rd byte | 4th byte | |
| Immediate | LDC.B | #xx:8, CCR | 0 .. 7 | IMM | | | 2 |
| Register direct | LDC.B | Rs, CCR | 0 .. 3 | 0 .. rs | | | 2 |

Notes

2.2.34 (2) LDC (W)

LDC (Load to Control register)

Load CCR

Operation

(EAs) → CCR

Assembly-Language Format

LDC.W <EAs>, CCR

Operand Size

Word

Condition Code

| | | | | | | | |
|---|----|---|---|---|---|---|---|
| I | UI | H | U | N | Z | V | C |
| ↑ | ↑ | ↑ | ↑ | ↑ | ↑ | ↑ | ↑ |

- I: Loaded from the corresponding bit in the source operand.
- H: Loaded from the corresponding bit in the source operand.
- N: Loaded from the corresponding bit in the source operand.
- Z: Loaded from the corresponding bit in the source operand.
- V: Loaded from the corresponding bit in the source operand.
- C: Loaded from the corresponding bit in the source operand.

Description

This instruction loads the source operand contents into the condition-code register (CCR). Although CCR is a byte register, the source operand is word size. The contents of the even address are loaded into CCR.

No interrupt requests, including NMI, are accepted immediately after execution of this instruction.

Available Registers

ERs: ER0 to ER7

Operand Format and Number of States Required for Execution

| Addressing Mode | Mnemonic | Operands | Instruction Format | | | | | | | | | | No. of States | | | | | |
|---------------------------------------|----------|-----------------|--------------------|----------|----------|----------|----------|----------|----------|----------|----------|-----------|---------------|---|---|---|---|------|
| | | | 1st byte | 2nd byte | 3rd byte | 4th byte | 5th byte | 6th byte | 7th byte | 8th byte | 9th byte | 10th byte | | | | | | |
| Register indirect | LDC.W | @ERs,CCR | 0 | 1 | 4 | 0 | 6 | 9 | 0 | ers | 0 | | | | | | | 6 |
| Register indirect with displacement | LDC.W | @(d:16,ERs),CCR | 0 | 1 | 4 | 0 | 6 | F | 0 | ers | 0 | disp | | | | | | 8 |
| | LDC.W | @(d:24,ERs),CCR | 0 | 1 | 4 | 0 | 7 | 8 | 0 | ers | 0 | 6 | B | 2 | 0 | 0 | 0 | disp |
| Register indirect with post-increment | LDC.W | @ERs+,CCR | 0 | 1 | 4 | 0 | 6 | D | 0 | ers | 0 | | | | | | | 8 |
| Absolute address | LDC.W | @aa:16,CCR | 0 | 1 | 4 | 0 | 6 | B | 0 | 0 | abs | | | | | | | 8 |
| | LDC.W | @aa:24,CCR | 0 | 1 | 4 | 0 | 6 | B | 2 | 0 | 0 | 0 | abs | | | | | 10 |

Notes

2.2.35 (1) MOV (B)

MOV (MOVE data)

Move

Operation

$R_s \rightarrow R_d$

Assembly-Language Format

MOV.B R_s, R_d

Operand Size

Byte

Condition Code

| I | UI | H | U | N | Z | V | C |
|---|----|---|---|---|---|---|---|
| — | — | — | — | ↑ | ↑ | 0 | — |

H: Previous value remains unchanged.

N: Set to 1 if the data value is negative; otherwise cleared to 0.

Z: Set to 1 if the data value is zero; otherwise cleared to 0.

V: Always cleared to 0.

C: Previous value remains unchanged.

Description

This instruction transfers one byte of data from an 8-bit register R_s to an 8-bit register R_d , tests the transferred data, and sets condition-code flags according to the result.

Available Registers

Rd: R0L to R7L, R0H to R7H

Rs: R0L to R7L, R0H to R7H

Operand Format and Number of States Required for Execution

| Addressing Mode | Mnemonic | Operands | Instruction Format | | | | No. of States |
|-----------------|----------|------------|--------------------|----------|----------|----------|---------------|
| | | | 1st byte | 2nd byte | 3rd byte | 4th byte | |
| Register direct | MOV.B | R_s, R_d | 0 ∴ C | rs ∴ rd | | | 2 |

Notes

2.2.35 (2) MOV (W)

MOV (MOVE data)

Move

Operation

$R_s \rightarrow R_d$

Assembly-Language Format

MOV.W Rs, Rd

Operand Size

Word

Condition Code

| I | UI | H | U | N | Z | V | C |
|---|----|---|---|---|---|---|---|
| — | — | — | — | ↑ | ↓ | 0 | — |

- H: Previous value remains unchanged.
- N: Set to 1 if the data value is negative; otherwise cleared to 0.
- Z: Set to 1 if the data value is zero; otherwise cleared to 0.
- V: Always cleared to 0.
- C: Previous value remains unchanged.

Description

This instruction transfers one word of data from a 16-bit register R_s to a 16-bit register R_d , tests the transferred data, and sets condition-code flags according to the result.

Available Registers

Rd: R0 to R7, E0 to E7

Rs: R0 to R7, E0 to E7

Operand Format and Number of States Required for Execution

| Addressing Mode | Mnemonic | Operands | Instruction Format | | | | No. of States |
|-----------------|----------|------------|--------------------|----------|----------|----------|---------------|
| | | | 1st byte | 2nd byte | 3rd byte | 4th byte | |
| Register direct | MOV.W | R_s, R_d | 0 : D | rs : rd | | | 2 |

Notes

2.2.35 (3) MOV (L)

MOV (MOVE data)

Move

Operation

ERs → ERd

Assembly-Language Format

MOV.L ERs, ERd

Operand Size

Longword

Condition Code

| | | | | | | | |
|---|----|---|---|----|----|---|---|
| I | UI | H | U | N | Z | V | C |
| — | — | — | — | ↑↓ | ↑↓ | 0 | — |

H: Previous value remains unchanged.

N: Set to 1 if the data value is negative; otherwise cleared to 0.

Z: Set to 1 if the data value is zero; otherwise cleared to 0.

V: Always cleared to 0.

C: Previous value remains unchanged.

Description

This instruction transfers one longword of data from a 32-bit register ERs to a 32-bit register ERd, tests the transferred data, and sets condition-code flags according to the result.

Available Registers

ERd: ER0 to ER7

ERs: ER0 to ER7

Operand Format and Number of States Required for Execution

| Addressing Mode | Mnemonic | Operands | Instruction Format | | | | No. of States |
|-----------------|----------|----------|--------------------|---------------|----------|----------|---------------|
| | | | 1st byte | 2nd byte | 3rd byte | 4th byte | |
| Register direct | MOV.L | ERs, ERd | 0 : F | 1 :ers 0 :erd | | | 2 |

Notes

2.2.35 (4) MOV (B)

MOV (MOVE data)

Move

Operation

(EAs) → Rd

Assembly-Language Format

MOV.B <EAs>, Rd

Operand Size

Byte

Condition Code

| I | UI | H | U | N | Z | V | C |
|---|----|---|---|---|---|---|---|
| — | — | — | — | ↑ | ↓ | 0 | — |

- H: Previous value remains unchanged.
N: Set to 1 if the data value is negative; otherwise cleared to 0.
Z: Set to 1 if the data value is zero; otherwise cleared to 0.
V: Always cleared to 0.
C: Previous value remains unchanged.

Description

This instruction transfers the source operand contents to an 8-bit register Rs, tests the transferred data, and sets condition-code flags according to the result.

Available Registers

Rd: R0L to R7L, R0H to R7H

ERs: ER0 to ER7

Operand Format and Number of States Required for Execution

| Addressing Mode | Mnemonic | Operands | Instruction Format | | | | | | | | No. of States | | |
|---------------------------------------|----------|----------------|--------------------|----------|----------|----------|----------|----------|----------|----------|---------------|---|------|
| | | | 1st byte | 2nd byte | 3rd byte | 4th byte | 5th byte | 6th byte | 7th byte | 8th byte | | | |
| Immediate | MOV.B | #xx:8,Rd | F | rd | IMM | | | | | | | 2 | |
| Register indirect | MOV.B | @ERs,Rd | 6 | 8 | 0:ers | rd | | | | | | 4 | |
| Register indirect with displacement | MOV.B | @(d:16,ERs),Rd | 6 | E | 0:ers | rd | disp | | | | 6 | | |
| | MOV.B | @(d:24,ERs),Rd | 7 | 8 | 0:ers | 0 | 6 | A | 2 | rd | 0 | 0 | disp |
| Register indirect with post-increment | MOV.B | @ERs+,Rd | 6 | C | 0:ers | rd | | | | | | 6 | |
| Absolute address | MOV.B | @aa:8,Rd | 2 | rd | abs | | | | | | | 4 | |
| | MOV.B | @aa:16,Rd | 6 | A | 0 | rd | abs | | | | | 6 | |
| | MOV.B | @aa:24,Rd | 6 | A | 2 | rd | 0 | 0 | abs | | | 8 | |

Notes

The MOV.B @ER7+, Rd instruction should never be used, because it leaves an odd value in the stack pointer (ER7). For details refer to section 3.3.2, Exception Processing, or to the hardware manual.

For the @aa:8 access range, refer to the relevant microcontroller hardware manual.

2.2.35 (5) MOV (W)

MOV (MOVE data)

Move

Operation

(EAs) → Rd

Assembly-Language Format

MOV.W <EAs>, Rd

Operand Size

Word

Condition Code

| I | UI | H | U | N | Z | V | C |
|---|----|---|---|---|---|---|---|
| — | — | — | — | ↑ | ↑ | 0 | — |

H: Previous value remains unchanged.

N: Set to 1 if the data value is negative; otherwise cleared to 0.

Z: Set to 1 if the data value is zero; otherwise cleared to 0.

V: Always cleared to 0.

C: Previous value remains unchanged.

Description

This instruction transfers the source operand contents to a 16-bit register Rd, tests the transferred data, and sets condition-code flags according to the result.

Available Registers

Rd: R0 to R7, E0 to E7

ERs: ER0 to ER7

Operand Format and Number of States Required for Execution

| Addressing Mode | Mnemonic | Operands | Instruction Format | | | | | | | | No. of States | | | |
|---------------------------------------|----------|----------------|--------------------|----------|----------|----------|----------|----------|----------|----------|---------------|---|---|------|
| | | | 1st byte | 2nd byte | 3rd byte | 4th byte | 5th byte | 6th byte | 7th byte | 8th byte | | | | |
| Immediate | MOV.W | #xx:16,Rd | 7 | 9 | 0 | rd | IMM | | | | | | 4 | |
| Register indirect | MOV.W | @ERs,Rd | 6 | 9 | 0 | ers | rd | | | | | | 4 | |
| Register indirect with displacement | MOV.W | @(d:16,ERs),Rd | 6 | F | 0 | ers | rd | disp | | | | | 6 | |
| | MOV.W | @(d:24,ERs),Rd | 7 | 8 | 0 | ers | 0 | 6 | B | 2 | rd | 0 | 0 | disp |
| Register indirect with post-increment | MOV.W | @ERs+,Rd | 6 | D | 0 | ers | rd | | | | | | 6 | |
| Absolute address | MOV.W | @aa:16,Rd | 6 | B | 0 | rd | abs | | | | | | 6 | |
| | MOV.W | @aa:24,Rd | 6 | B | 2 | rd | 0 | 0 | abs | | | | 8 | |

Notes

1. The source operand <EAs> must be located at an even address.
2. In machine language, MOV.W @R7+, Rd is identical to POP.W Rd.

2.2.35 (6) MOV (L)

MOV (MOVE data)

Move

Operation

(EAs) → ERd

Assembly-Language Format

MOV.L <EAs>, ERd

Operand Size

Longword

Condition Code

| I | UI | H | U | N | Z | V | C |
|---|----|---|---|---|---|---|---|
| — | — | — | — | ↑ | ↓ | 0 | — |

H: Previous value remains unchanged.

N: Set to 1 if the data value is negative; otherwise cleared to 0.

Z: Set to 1 if the data value is zero; otherwise cleared to 0.

V: Always cleared to 0.

C: Previous value remains unchanged.

Description

This instruction transfers the source operand contents to a specified 32-bit register (ERd), tests the transferred data, and sets condition-code flags according to the result. The first memory word located at the effective address is stored in extended register Ed. The next word is stored in general register Rd.

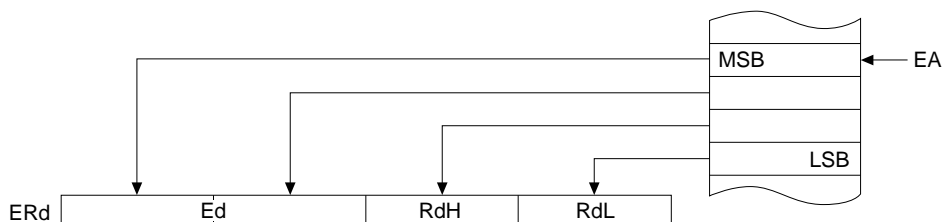

Available Registers

ERd: ER0 to ER7

ERs: ER0 to ER7

Operand Format and Number of States Required for Execution

| Addressing Mode | Mnemonic | Operands | Instruction Format | | | | | | | | | | No. of States | | | | | | | | |
|---------------------------------------|----------|-----------------|--------------------|----------|----------|----------|----------|----------|----------|----------|----------|-----------|---------------|-----|---|----|-----|---|----|------|--|
| | | | 1st byte | 2nd byte | 3rd byte | 4th byte | 5th byte | 6th byte | 7th byte | 8th byte | 9th byte | 10th byte | | | | | | | | | |
| Immediate | MOV.L | #xx:32,Rd | 7 | A | 0 | 0 | ers | IMM | | | | | | | 6 | | | | | | |
| Register indirect | MOV.L | @ERs,ERd | 0 | 1 | 0 | 0 | 6 | 9 | 0 | ers | 0 | erd | | | | 8 | | | | | |
| Register indirect with displacement | MOV.L | @(d:16,ERs),ERd | 0 | 1 | 0 | 0 | 6 | F | 0 | ers | 0 | erd | disp | | | 10 | | | | | |
| | MOV.L | @(d:24,ERs),ERd | 0 | 1 | 0 | 0 | 7 | 8 | 0 | ers | 0 | | 6 | B | 2 | 0 | erd | 0 | 0 | disp | |
| Register indirect with post-increment | MOV.L | @ERs+,ERd | 0 | 1 | 0 | 0 | 6 | D | 0 | ers | 0 | erd | | | | | | | | 10 | |
| Absolute address | MOV.L | @aa:16,ERd | 0 | 1 | 0 | 0 | 6 | B | 0 | 0 | erd | abs | | | | | | | 10 | | |
| | MOV.L | @aa:24,ERd | 0 | 1 | 0 | 0 | 6 | B | 2 | 0 | erd | 0 | 0 | abs | | | | | | 12 | |

Notes

1. The source operand <EAs> must be located at an even address.
2. In machine language, MOV.L @ER7+, ERd is identical to POP.L ERd.

2.2.35 (7) MOV (B)

MOV (MOVE data)

Move

Operation

Rs → (EAd)

Assembly-Language Format

MOV .B Rs, <EAd>

Operand Size

Byte

Condition Code

| I | UI | H | U | N | Z | V | C |
|---|----|---|---|---|---|---|---|
| — | — | — | — | ↑ | ↓ | 0 | — |

H: Previous value remains unchanged.

N: Set to 1 if the data value is negative; otherwise cleared to 0.

Z: Set to 1 if the data value is zero; otherwise cleared to 0.

V: Always cleared to 0.

C: Previous value remains unchanged.

Description

This instruction transfers the contents of an 8-bit register Rs (source operand) to a destination location, tests the transferred data, and sets condition-code flags according to the result.

Available Registers

Rs: R0L to R7L, R0H to R7H

ERd: ER0 to ER7

Operand Format and Number of States Required for Execution

| Addressing Mode | Mnemonic | Operands | Instruction Format | | | | | | | | No. of States | | |
|--------------------------------------|----------|----------------|--------------------|----------|----------|----------|----------|----------|----------|----------|---------------|---|------|
| | | | 1st byte | 2nd byte | 3rd byte | 4th byte | 5th byte | 6th byte | 7th byte | 8th byte | | | |
| Register indirect | MOV.B | Rs,@ERd | 6 | 8 | 1:erd | rs | | | | | | | 4 |
| Register indirect with displacement | MOV.B | Rs,@(d:16,ERd) | 6 | E | 1:erd | rs | disp | | | | | | 6 |
| | MOV.B | Rs,@(d:24,ERd) | 7 | 8 | 0:erd | 0 | 6 | A | A | rs | 0 | 0 | disp |
| Register indirect with pre-decrement | MOV.B | Rs,@-ERd | 6 | C | 1:erd | rs | | | | | | | 6 |
| Absolute address | MOV.B | Rs,@aa:8 | 3 | rs | abs | | | | | | | | 4 |
| | MOV.B | Rs,@aa:16 | 6 | A | 8 | rs | abs | | | | | | 6 |
| | MOV.B | Rs,@aa:24 | 6 | A | A | rs | 0 | 0 | abs | | | | 8 |

Notes

1. The MOV.B Rs, @-ER7 instruction should never be used, because it leaves an odd value in the stack pointer (ER7). For details refer to section 3.3.2, Exception Processing, or to the hardware manual.
2. Execution of MOV.B RnL, @-ERn or MOV.B RnH, @-ERn first decrements ERn by one, then transfers the designated part (RnL or RnH) of the resulting ERn value.

2.2.35 (8) MOV (W)

MOV (MOVE data)

Move

Operation

Rs → (EAd)

Assembly-Language Format

MOV .w Rs, <EAd>

Operand Size

Word

Condition Code

| I | UI | H | U | N | Z | V | C |
|---|----|---|---|---|---|---|---|
| — | — | — | — | ↑ | ↓ | 0 | — |

H: Previous value remains unchanged.

N: Set to 1 if the data value is negative; otherwise cleared to 0.

Z: Set to 1 if the data value is zero; otherwise cleared to 0.

V: Always cleared to 0.

C: Previous value remains unchanged.

Description

This instruction transfers the contents of a 16-bit register Rs (source operand) to a destination location, tests the transferred data, and sets condition-code flags according to the result.

Available Registers

Rs: R0 to R7, E0 to E7

ERd: ER0 to ER7

Operand Format and Number of States Required for Execution

| Addressing Mode | Mnemonic | Operands | Instruction Format | | | | | | | | No. of States | | |
|---------------------------------------|----------|----------------|--------------------|----------|-----------|----------|----------|----------|----------|----------|---------------|------|----|
| | | | 1st byte | 2nd byte | 3rd byte | 4th byte | 5th byte | 6th byte | 7th byte | 8th byte | | | |
| Register indirect | MOV.W | Rs,@ERd | 6 | 9 | 1:erd: rs | | | | | | | | 4 |
| Register indirect with displacement | MOV.W | Rs,@(d:16,ERd) | 6 | F | 1:erd: rs | disp | | | | | | | 6 |
| | MOV.W | Rs,@(d:24,ERd) | 7 | 8 | 0:erd: 0 | 6 | B | A | rs | 0 | 0 | disp | 10 |
| Register indirect with post-increment | MOV.W | Rs,@-ERd | 6 | D | 1:erd: rs | | | | | | | | 6 |
| Absolute address | MOV.W | Rs,@aa:16 | 6 | B | 8 | rs | abs | | | | | | 6 |
| | MOV.W | Rs,@aa:24 | 6 | B | A | rs | 0 | 0 | abs | | | | 8 |

Notes

1. The destination operand <EAd> must be located at an even address.
2. In machine language, MOV.W Rs, @-R7 is identical to PUSH.W Rs.
3. Execution of MOV.W Rn, @-ERn first decrements ERn by 2, then transfers the resulting value.

2.2.35 (9) MOV (L)

MOV (MOVE data)

Move

Operation

ERs → (EAd)

Assembly-Language Format

MOV.L ERs, <EAd>

Operand Size

Longword

Condition Code

| I | UI | H | U | N | Z | V | C |
|---|----|---|---|---|---|---|---|
| — | — | — | — | ↑ | ↓ | 0 | — |

H: Previous value remains unchanged.

N: Set to 1 if the data value is negative; otherwise cleared to 0.

Z: Set to 1 if the data value is zero; otherwise cleared to 0.

V: Always cleared to 0.

C: Previous value remains unchanged.

Description

This instruction transfers the contents of a 32-bit register ERs (source operand) to a destination location, tests the transferred data, and sets condition-code flags according to the result. The extended register (Es) contents are stored at the first word indicated by the effective address. The general register (Rs) contents are stored at the next word.

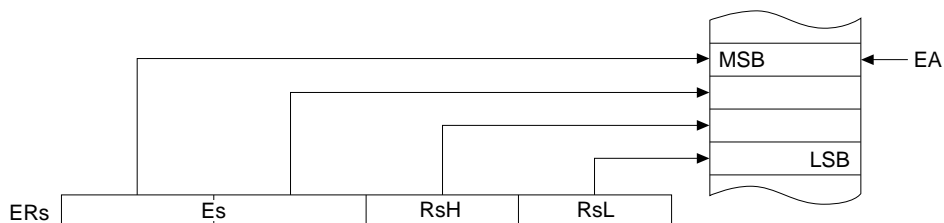

Available Registers

ERs: ER0 to ER7

ERd: ER0 to ER7

Operand Format and Number of States Required for Execution

| Addressing Mode | Mnemonic | Operands | Instruction Format | | | | | | | | | | No. of States | | | | | | | | |
|--------------------------------------|----------|------------------|--------------------|----------|----------|----------|----------|----------|----------|----------|----------|-----------|---------------|-----|---|---|-----|----|----|------|--|
| | | | 1st byte | 2nd byte | 3rd byte | 4th byte | 5th byte | 6th byte | 7th byte | 8th byte | 9th byte | 10th byte | | | | | | | | | |
| Register indirect | MOV.L | ERs, @ERd | 0 | 1 | 0 | 0 | 6 | 9 | 1 | erd | 0 | ers | | | | | | | 8 | | |
| Register indirect with displacement | MOV.L | ERs, @(d:16,ERd) | 0 | 1 | 0 | 0 | 6 | F | 1 | erd | 0 | ers | disp | | | | | | 10 | | |
| | MOV.L | ERs, @(d:24,ERd) | 0 | 1 | 0 | 0 | 7 | 8 | 1 | erd | 0 | ers | 6 | B | A | 0 | ers | 0 | 0 | disp | |
| Register indirect with pre-decrement | MOV.L | ERs, @-ERd | 0 | 1 | 0 | 0 | 6 | D | 1 | erd | 0 | ers | | | | | | | 10 | | |
| Absolute address | MOV.L | ERs, @aa:16 | 0 | 1 | 0 | 0 | 6 | B | 8 | 0 | ers | abs | | | | | | 10 | | | |
| | MOV.L | ERs, @aa:24 | 0 | 1 | 0 | 0 | 6 | B | A | 0 | ers | 0 | 0 | abs | | | | | | 12 | |

Notes

1. The destination operand <EAd> must be located at an even address.
2. In machine language, MOV.L ERs, @-ER7 is identical to PUSH.L ERs.
3. Execution of MOV.L ERn, @-ERn first decrements ERn by 4, then transfers the resulting value.

2.2.36 MOVFPE

MOVFPE (MOVE From Peripheral with E clock)

Move Data with E Clock

Operation

(EAs) → Rd
Synchronized with E clock

Condition Code

| | | | | | | | |
|---|----|---|---|---|---|---|---|
| I | UI | H | U | N | Z | V | C |
| — | — | — | — | ↑ | ↑ | 0 | — |

Assembly-Language Format

MOVFPE @aa:16, Rd

Operand Size

Byte

H: Previous value remains unchanged.
N: Set to 1 if the data value is negative; otherwise cleared to 0.
Z: Set to 1 if the data value is zero; otherwise cleared to 0.
V: Always cleared to 0.
C: Previous value remains unchanged.

Description

This instruction transfers memory contents specified by a 16-bit absolute address to a general register Rd in synchronization with an E clock, tests the transferred data, and sets condition-code flags according to the result.

Note: Avoid using this instruction in microcontrollers not having an E clock output pin, or in single-chip mode.

Available Registers

Rd: R0L to R7L, R0H to R7H

Operand Format and Number of States Required for Execution

| Addressing Mode | Mnemonic | Operands | Instruction Format | | | | No. of States | |
|------------------|----------|------------|--------------------|----------|----------|----------|---------------|---|
| | | | 1st byte | 2nd byte | 3rd byte | 4th byte | | |
| Absolute address | MOVFPE | @aa:16, Rd | 6 | A | 4 | rd | abs | * |

Notes

1. This instruction cannot be used with addressing modes other than the above, and cannot transfer word data or longword data.
2. Data transfer by this instruction requires 9 to 16 states, so the execution time is variable. For details, refer to the relevant microcontroller hardware manual.

2.2.37 MOVTPE

MOVTPE (MOVE To Peripheral with E clock)

Move Data with E Clock

Operation

$R_s \rightarrow (EAd)$

Synchronized with E clock

Condition Code

| I | UI | H | U | N | Z | V | C |
|---|----|---|---|---|---|---|---|
| — | — | — | — | ↑ | ↑ | 0 | — |

Assembly-Language Format

MOVTPE R_s , @aa:16

H: Previous value remains unchanged.

N: Set to 1 if the data value is negative; otherwise cleared to 0.

Z: Set to 1 if the data value is zero; otherwise cleared to 0.

V: Always cleared to 0.

C: Previous value remains unchanged.

Operand Size

Byte

Description

This instruction transfers the contents of a general register R_s (source operand) to a destination location specified by a 16-bit absolute address in synchronization with an E clock, tests the transferred data, and sets condition-code flags according to the result.

Note: Avoid using this instruction in microcontrollers not having an E clock output pin, or in single-chip mode.

Available Registers

R_s : R0L to R7L, R0H to R7H

Operand Format and Number of States Required for Execution

| Addressing Mode | Mnemonic | Operands | Instruction Format | | | | No. of States |
|------------------|----------|----------------|--------------------|--------------|----------|----------|---------------|
| | | | 1st byte | 2nd byte | 3rd byte | 4th byte | |
| Absolute address | MOVTPE | R_s , @aa:16 | 6 ⋮ A | C ⋮ rs | abs | | * |

Notes

1. This instruction cannot be used with addressing modes other than the above, and cannot transfer word data or longword data.
2. Data transfer by this instruction requires 9 to 16 states, so the execution time is variable. For details, refer to the relevant microcontroller hardware manual.

2.2.38 (1) MULXS (B)

MULXS (MULTIPLY eXtend as Signed)

Multiply Signed

Operation

$Rd \times Rs \rightarrow Rd$

Condition Code

| I | UI | H | U | N | Z | V | C |
|---|----|---|---|---|---|---|---|
| — | — | — | — | ↑ | ↑ | — | — |

Assembly-Language Format

MULXS.B Rs, Rd

Operand Size

Byte

- H: Previous value remains unchanged.
- N: Set to 1 if the result is negative; otherwise cleared to 0.
- Z: Set to 1 if the result is zero; otherwise cleared to 0.
- V: Previous value remains unchanged.
- C: Previous value remains unchanged.

Description

This instruction multiplies the lower 8 bits of a 16-bit register Rd (destination operand) by the contents of an 8-bit register Rs (source operand) as signed data and stores the result in the 16-bit register Rd. If Rd is a general register, Rs can be the upper part (RdH) or lower part (RdL) of Rd. The operation performed is 8-bit \times 8-bit \rightarrow 16-bit signed multiplication.

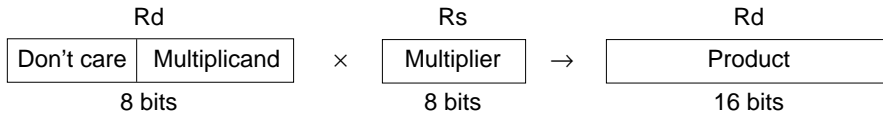

Available Registers

Rd: R0 to R7, E0 to E7

Rs: R0L to R7L, R0H to R7H

Operand Format and Number of States Required for Execution

| Addressing Mode | Mnemonic | Operands | Instruction Format | | | | No. of States |
|-----------------|----------|----------|--------------------|----------|----------|----------|---------------|
| | | | 1st byte | 2nd byte | 3rd byte | 4th byte | |
| Register direct | MULXS.B | Rs, Rd | 0 1 | C 0 | 5 0 | rs rd | 16 |

Notes

2.2.38 (2) MULXS (W)

MULXS (MULTIPLY eXtend as Signed)

Multiply Signed

Operation

$ERd \times Rs \rightarrow ERd$

Assembly-Language Format

MULXS.W Rs, ERd

Operand Size

Word

Condition Code

| | | | | | | | |
|---|----|---|---|---|---|---|---|
| I | UI | H | U | N | Z | V | C |
| — | — | — | — | ↑ | ↑ | — | — |

H: Previous value remains unchanged.

N: Set to 1 if the result is negative; otherwise cleared to 0.

Z: Set to 1 if the result is zero; otherwise cleared to 0.

V: Previous value remains unchanged.

C: Previous value remains unchanged.

Description

This instruction multiplies the lower 16 bits of a 32-bit register ERd (destination operand) by the contents of a 16-bit register Rs (source operand) as signed data and stores the result in the 32-bit register ERd. Rs can be the upper part (Ed) or lower part (Rd) of ERd. The operation performed is 16-bit \times 16-bit \rightarrow 32-bit signed multiplication.

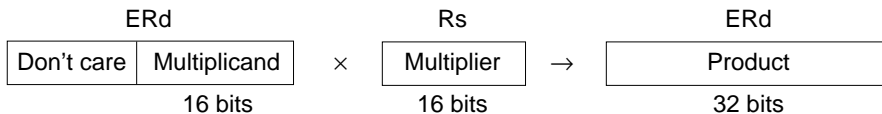

Available Registers

ERd: ER0 to ER7

Rs: R0 to R7, E0 to E7

Operand Format and Number of States Required for Execution

| Addressing Mode | Mnemonic | Operands | Instruction Format | | | | No. of States |
|-----------------|----------|----------|--------------------|----------|----------|--------------|---------------|
| | | | 1st byte | 2nd byte | 3rd byte | 4th byte | |
| Register direct | MULXS.W | Rs, ERd | 0 : 1 | C : 0 | 5 : 2 | rs : 0 : erd | 24 |

Notes

2.2.39 (1) MULXU (B)

MULXU (MULTIPLY eXtend as Unsigned)

Multiply

Operation

$Rd \times Rs \rightarrow Rd$

Condition Code

| | | | | | | | |
|---|----|---|---|---|---|---|---|
| I | UI | H | U | N | Z | V | C |
| — | — | — | — | — | — | — | — |

Assembly-Language Format

MULXU.B Rs, Rd

Operand Size

Byte

- H: Previous value remains unchanged.
- N: Previous value remains unchanged.
- Z: Previous value remains unchanged.
- V: Previous value remains unchanged.
- C: Previous value remains unchanged.

Description

This instruction multiplies the lower 8 bits of a 16-bit register Rd (destination operand) by the contents of an 8-bit register Rs (source operand) and stores the result in the 16-bit register Rd. If Rd is a general register, Rs can be the upper part (RdH) or lower part (RdL) of Rd. The operation performed is 8-bit \times 8-bit \rightarrow 16-bit multiplication.

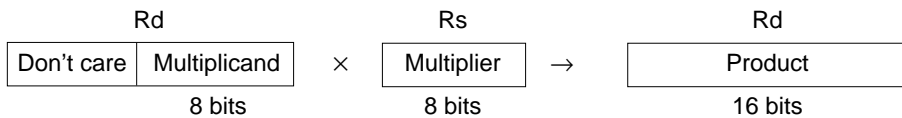

Available Registers

Rd: R0 to R7, E0 to E7

Rs: R0L to R7L, R0H to R7H

Operand Format and Number of States Required for Execution

| Addressing Mode | Mnemonic | Operands | Instruction Format | | | | No. of States |
|-----------------|----------|----------|--------------------|----------|----------|----------|---------------|
| | | | 1st byte | 2nd byte | 3rd byte | 4th byte | |
| Register direct | MULXU.B | Rs, Rd | 5 : 0 | rs : rd | | | 14 |

Notes

2.2.39 (2) MULXU (W)

MULXU (MULTIPLY eXtend as Unsigned)

Multiply

Operation

$ERd \times Rs \rightarrow ERd$

Condition Code

| | | | | | | | |
|---|----|---|---|---|---|---|---|
| I | UI | H | U | N | Z | V | C |
| — | — | — | — | — | — | — | — |

Assembly-Language Format

MULXU.W Rs, ERd

Operand Size

Word

H: Previous value remains unchanged.

N: Previous value remains unchanged.

Z: Previous value remains unchanged.

V: Previous value remains unchanged.

C: Previous value remains unchanged.

Description

This instruction multiplies the lower 16 bits of a 32-bit register ERd (destination operand) by the contents of a 16-bit register Rs (source operand) and stores the result in the 32-bit register ERd. Rs can be the upper part (Ed) or lower part (Rd) of ERd. The operation performed is 16-bit \times 16-bit \rightarrow 32-bit multiplication.

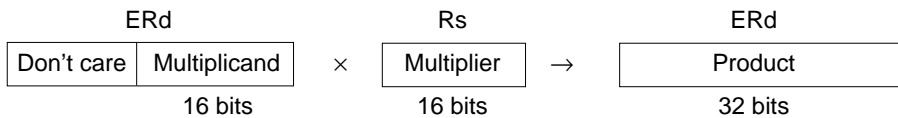

Available Registers

ERd: ER0 to ER7

Rs: R0 to R7, E0 to E7

Operand Format and Number of States Required for Execution

| Addressing Mode | Mnemonic | Operands | Instruction Format | | | | No. of States |
|-----------------|----------|----------|--------------------|----------|----------|----------|---------------|
| | | | 1st byte | 2nd byte | 3rd byte | 4th byte | |
| Register direct | MULXU.W | Rs, ERd | 5 | 2 | rs 0:erd | | 22 |

Notes

2.2.40 (1) NEG (B)

NEG (NEGate)

Negate Binary Signed

Operation

0 – Rd → Rd

Assembly-Language Format

NEG.B Rd

Operand Size

Byte

Condition Code

| | | | | | | | |
|---|----|---|---|---|---|---|---|
| I | UI | H | U | N | Z | V | C |
| — | — | ↑ | — | ↑ | ↑ | ↑ | ↑ |

- H: Set to 1 if there is a borrow at bit 3; otherwise cleared to 0.
- N: Set to 1 if the result is negative; otherwise cleared to 0.
- Z: Set to 1 if the result is zero; otherwise cleared to 0.
- V: Set to 1 if an overflow occurs; otherwise cleared to 0.
- C: Set to 1 if there is a borrow at bit 7; otherwise cleared to 0.

Description

This instruction takes the two's complement of the contents of an 8-bit register Rd (destination operand) and stores the result in the 8-bit register Rd (subtracting the register contents from H'00). If the original contents of Rd was H'80, however, the result remains H'80.

Available Registers

Rd: R0L to R7L, R0H to R7H

Operand Format and Number of States Required for Execution

| Addressing Mode | Mnemonic | Operands | Instruction Format | | | | No. of States |
|-----------------|----------|----------|--------------------|----------|----------|----------|---------------|
| | | | 1st byte | 2nd byte | 3rd byte | 4th byte | |
| Register direct | NEG.B | Rd | 1 : 7 | 8 : rd | | | 2 |

Notes

An overflow occurs if the previous contents of Rd was H'80.

2.2.40 (2) NEG (W)

NEG (NEGate)

Negate Binary Signed

Operation

0 – Rd → Rd

Assembly-Language Format

NEG.W Rd

Operand Size

Word

Condition Code

| | | | | | | | |
|---|----|---|---|---|---|---|---|
| I | UI | H | U | N | Z | V | C |
| — | — | ↑ | — | ↑ | ↑ | ↑ | ↑ |

H: Set to 1 if there is a borrow at bit 11; otherwise cleared to 0.

N: Set to 1 if the result is negative; otherwise cleared to 0.

Z: Set to 1 if the result is zero; otherwise cleared to 0.

V: Set to 1 if an overflow occurs; otherwise cleared to 0.

C: Set to 1 if there is a borrow at bit 15; otherwise cleared to 0.

Description

This instruction takes the two's complement of the contents of a 16-bit register Rd (destination operand) and stores the result in the 16-bit register Rd (subtracting the register contents from H'0000). If the original contents of Rd was H'8000, however, the result remains H'8000.

Available Registers

Rd: R0 to R7, E0 to E7

Operand Format and Number of States Required for Execution

| Addressing Mode | Mnemonic | Operands | Instruction Format | | | | No. of States |
|-----------------|----------|----------|--------------------|----------|----------|----------|---------------|
| | | | 1st byte | 2nd byte | 3rd byte | 4th byte | |
| Register direct | NEG.W | Rd | 1 : 7 | 9 : rd | | | 2 |

Notes

An overflow occurs if the previous contents of Rd was H'8000.

2.2.40 (3) NEG (L)

NEG (NEGate)

Negate Binary Signed

Operation

0 – ERd → ERd

Assembly-Language Format

NEG.L ERd

Operand Size

Longword

Condition Code

| I | UI | H | U | N | Z | V | C |
|---|----|---|---|---|---|---|---|
| — | — | ↑ | — | ↑ | ↑ | ↑ | ↑ |

- H: Set to 1 if there is a borrow at bit 27; otherwise cleared to 0.
- N: Set to 1 if the result is negative; otherwise cleared to 0.
- Z: Set to 1 if the result is zero; otherwise cleared to 0.
- V: Set to 1 if an overflow occurs; otherwise cleared to 0.
- C: Set to 1 if there is a borrow at bit 31; otherwise cleared to 0.

Description

This instruction takes the two's complement of the contents of a 32-bit register ERd (destination operand) and stores the result in the 32-bit register ERd (subtracting the register contents from H'00000000). If the original contents of ERd was H'80000000, however, the result remains H'80000000.

Available Registers

ERd: ER0 to ER7

Operand Format and Number of States Required for Execution

| Addressing Mode | Mnemonic | Operands | Instruction Format | | | | No. of States |
|-----------------|----------|----------|--------------------|----------|----------|----------|---------------|
| | | | 1st byte | 2nd byte | 3rd byte | 4th byte | |
| Register direct | NEG.L | ERd | 1 | 7 | B 0:erd | | 2 |

Notes

An overflow occurs if the previous contents of ERd was H'80000000.

2.2.41 NOP

NOP (No OPeration)

No Operation

Operation

PC + 2 → PC

Condition Code

| | | | | | | | |
|---|----|---|---|---|---|---|---|
| I | UI | H | U | N | Z | V | C |
| — | — | — | — | — | — | — | — |

Assembly-Language Format

NOP

Operand Size

—

H: Previous value remains unchanged.

N: Previous value remains unchanged.

Z: Previous value remains unchanged.

V: Previous value remains unchanged.

C: Previous value remains unchanged.

Description

This instruction only increments the program counter, causing the next instruction to be executed. The internal state of the CPU does not change.

Available Registers

—

Operand Format and Number of States Required for Execution

| Addressing Mode | Mnemonic | Operands | Instruction Format | | | | No. of States |
|-----------------|----------|----------|--------------------|----------|----------|----------|---------------|
| | | | 1st byte | 2nd byte | 3rd byte | 4th byte | |
| — | NOP | | 0 ∴ 0 | 0 ∴ 0 | | | 2 |

Notes

2.2.42 (1) NOT (B)

NOT (NOT = logical complement)

Logical Complement

Operation

$\neg Rd \rightarrow Rd$

Assembly-Language Format

NOT.B Rd

Operand Size

Byte

Condition Code

| I | UI | H | U | N | Z | V | C |
|---|----|---|---|---|---|---|---|
| — | — | — | — | ↑ | ↓ | 0 | — |

- H: Previous value remains unchanged.
- N: Set to 1 if the result is negative; otherwise cleared to 0.
- Z: Set to 1 if the result is zero; otherwise cleared to 0.
- V: Always cleared to 0.
- C: Previous value remains unchanged.

Description

This instruction takes the one's complement of the contents of an 8-bit register Rd (destination operand) and stores the result in the 8-bit register Rd.

Available Registers

Rd: R0L to R7L, R0H to R7H

Operand Format and Number of States Required for Execution

| Addressing Mode | Mnemonic | Operands | Instruction Format | | | | No. of States |
|-----------------|----------|----------|--------------------|----------|----------|----------|---------------|
| | | | 1st byte | 2nd byte | 3rd byte | 4th byte | |
| Register direct | NOT.B | Rd | 1 : 7 | 0 : rd | | | 2 |

Notes

2.2.42 (2) NOT (W)

NOT (NOT = logical complement)

Logical Complement

Operation

$\neg Rd \rightarrow Rd$

Assembly-Language Format

NOT.W Rd

Operand Size

Word

Condition Code

| I | UI | H | U | N | Z | V | C |
|---|----|---|---|---|---|---|---|
| — | — | — | — | ↑ | ↑ | 0 | — |

H: Previous value remains unchanged.

N: Set to 1 if the result is negative; otherwise cleared to 0.

Z: Set to 1 if the result is zero (the previous Rd value was H'FFFF'); otherwise cleared to 0.

V: Always cleared to 0.

C: Previous value remains unchanged.

Description

This instruction takes the one's complement of the contents of a 16-bit register Rd (destination operand) and stores the result in the 16-bit register Rd.

Available Registers

Rd: R0 to R7, E0 to E7

Operand Format and Number of States Required for Execution

| Addressing Mode | Mnemonic | Operands | Instruction Format | | | | No. of States |
|-----------------|----------|----------|--------------------|----------|----------|----------|---------------|
| | | | 1st byte | 2nd byte | 3rd byte | 4th byte | |
| Register direct | NOT.W | Rd | 1 : 7 | 1 : rd | | | 2 |

Notes

2.2.42 (3) NOT (L)

NOT (NOT = logical complement)

Logical Complement

Operation

$\neg \text{ERd} \rightarrow \text{ERd}$

Assembly-Language Format

NOT.L ERd

Operand Size

Longword

Condition Code

| I | UI | H | U | N | Z | V | C |
|---|----|---|---|---|---|---|---|
| — | — | — | — | ↑ | ↓ | 0 | — |

- I: Previous value remains unchanged.
- H: Previous value remains unchanged.
- N: Set to 1 if the result is negative; otherwise cleared to 0.
- Z: Set to 1 if the result is zero; otherwise cleared to 0.
- V: Always cleared to 0.
- C: Previous value remains unchanged.

Description

This instruction takes the one's complement of the contents of a 32-bit register ERd (destination operand) and stores the result in the 32-bit register ERd.

Available Registers

ERd: ER0 to ER7

Operand Format and Number of States Required for Execution

| Addressing Mode | Mnemonic | Operands | Instruction Format | | | | No. of States |
|-----------------|----------|----------|--------------------|----------|----------|----------|---------------|
| | | | 1st byte | 2nd byte | 3rd byte | 4th byte | |
| Register direct | NOT.L | ERd | 1 | 7 | 3 | 0:erd | 2 |

Notes

2.2.43 (1) OR (B)

OR (inclusive OR logical)

Logical OR

Operation

Rd \vee (EAs) \rightarrow Rd

Assembly-Language Format

OR.B <EAs>, Rd

Operand Size

Byte

Condition Code

| | | | | | | | |
|---|----|---|---|---|---|---|---|
| I | UI | H | U | N | Z | V | C |
| — | — | — | — | ↑ | ↑ | 0 | — |

H: Previous value remains unchanged.

N: Set to 1 if the result is negative; otherwise cleared to 0.

Z: Set to 1 if the result is zero; otherwise cleared to 0.

V: Always cleared to 0.

C: Previous value remains unchanged.

Description

This instruction ORs the source operand with the contents of an 8-bit register Rd (destination register) and stores the result in the 8-bit register Rd.

Available Registers

Rd: R0L to R7L, R0H to R7H

Rs: R0L to R7L, R0H to R7H

Operand Format and Number of States Required for Execution

| Addressing Mode | Mnemonic | Operands | Instruction Format | | | | No. of States |
|-----------------|----------|-----------|--------------------|----------|----------|----------|---------------|
| | | | 1st byte | 2nd byte | 3rd byte | 4th byte | |
| Immediate | OR.B | #xx:8, Rd | C rd | IMM | | | 2 |
| Register direct | OR.B | Rs, Rd | 1 4 | rs rd | | | 2 |

Notes

2.2.43 (2) OR (W)

OR (inclusive OR logical)

Logical OR

Operation

Rd \vee (EAs) \rightarrow Rd

Assembly-Language Format

OR.W <EAs>, Rd

Operand Size

Word

Condition Code

| | | | | | | | |
|---|----|---|---|---|---|---|---|
| I | UI | H | U | N | Z | V | C |
| — | — | — | — | ↑ | ↓ | 0 | — |

H: Previous value remains unchanged.

N: Set to 1 if the result is negative; otherwise cleared to 0.

Z: Set to 1 if the result is zero; otherwise cleared to 0.

V: Always cleared to 0.

C: Previous value remains unchanged.

Description

This instruction ORs the source operand with the contents of a 16-bit register Rd (destination register) and stores the result in the 16-bit register Rd.

Available Registers

Rd: R0 to R7, E0 to E7

Rs: R0 to R7, E0 to E7

Operand Format and Number of States Required for Execution

| Addressing Mode | Mnemonic | Operands | Instruction Format | | | | No. of States |
|-----------------|----------|------------|--------------------|----------|----------|----------|---------------|
| | | | 1st byte | 2nd byte | 3rd byte | 4th byte | |
| Immediate | OR.W | #xx:16, Rd | 7 : 9 | 4 : rd | IMM | | 4 |
| Register direct | OR.W | Rs, Rd | 6 : 4 | rs : rd | | | 2 |

Notes

2.2.43 (3) OR (L)

OR (inclusive OR logical)

Logical OR

Operation

ERd \vee (EAs) \rightarrow ERd

Assembly-Language Format

OR.L <EAs>, ERd

Operand Size

Longword

Condition Code

| | | | | | | | |
|---|----|---|---|---|---|---|---|
| I | UI | H | U | N | Z | V | C |
| — | — | — | — | ↑ | ↑ | 0 | — |

H: Previous value remains unchanged.

N: Set to 1 if the result is negative; otherwise cleared to 0.

Z: Set to 1 if the result is zero; otherwise cleared to 0.

V: Always cleared to 0.

C: Previous value remains unchanged.

Description

This instruction ORs the source operand with the contents of a 32-bit register ERd (destination register) and stores the result in the 32-bit register ERd.

Available Registers

ERd: ER0 to ER7

ERs: ER0 to ER7

Operand Format and Number of States Required for Execution

| Addressing Mode | Mnemonic | Operands | Instruction Format | | | | | | No. of States | | | |
|-----------------|----------|------------|--------------------|----------|----------|----------|----------|----------|---------------|-------|-----|---|
| | | | 1st byte | 2nd byte | 3rd byte | 4th byte | 5th byte | 6th byte | | | | |
| Immediate | OR.L | #xx:32,ERd | 7 | A | 4 | 0 | IMM | | | 6 | | |
| Register direct | OR.L | ERs, ERd | 0 | 1 | F | 0 | 6 | 4 | 0 | ers:0 | erd | 4 |

Notes

2.2.44 ORC

ORC (inclusive OR Control register)

Logical OR with CCR

Operation

CCR \vee #IMM \rightarrow CCR

Assembly-Language Format

ORC #xx:8, CCR

Operand Size

Byte

Condition Code

| | | | | | | | |
|---|----|---|---|---|---|---|---|
| I | UI | H | U | N | Z | V | C |
| ↓ | ↓ | ↓ | ↓ | ↓ | ↓ | ↓ | ↓ |

- I: Stores the corresponding bit of the result.
- UI: Stores the corresponding bit of the result.
- H: Stores the corresponding bit of the result.
- U: Stores the corresponding bit of the result.
- N: Stores the corresponding bit of the result.
- Z: Stores the corresponding bit of the result.
- V: Stores the corresponding bit of the result.
- C: Stores the corresponding bit of the result.

Description

This instruction ORs the contents of the condition-code register (CCR) with immediate data and stores the result in the condition-code register. No interrupt requests, including NMI, are accepted immediately after execution of this instruction.

Operand Format and Number of States Required for Execution

| Addressing Mode | Mnemonic | Operands | Instruction Format | | | | No. of States |
|-----------------|----------|------------|--------------------|----------|----------|----------|---------------|
| | | | 1st byte | 2nd byte | 3rd byte | 4th byte | |
| Immediate | ORC | #xx:8, CCR | 0 ... 4 | IMM | | | 2 |

Notes

2.2.45 (1) POP (W)

POP (POP data)

Pop Data from Stack

Operation

@SP+ → Rn

Assembly-Language Format

POP.W Rn

Operand Size

Word

Condition Code

| I | UI | H | U | N | Z | V | C |
|---|----|---|---|---|---|---|---|
| — | — | — | — | ↑ | ↓ | 0 | — |

H: Previous value remains unchanged.

N: Set to 1 if the data value is negative; otherwise cleared to 0.

Z: Set to 1 if the data value is zero; otherwise cleared to 0.

V: Always cleared to 0.

C: Previous value remains unchanged.

Description

This instruction restores data from the stack to a 16-bit general register Rn, tests the restored data, and sets condition-code flags according to the result.

Available Registers

Rn: R0 to R7, E0 to E7

Operand Format and Number of States Required for Execution

| Addressing Mode | Mnemonic | Operands | Instruction Format | | | | No. of States |
|-----------------|----------|----------|--------------------|----------|----------|----------|---------------|
| | | | 1st byte | 2nd byte | 3rd byte | 4th byte | |
| — | POP.W | Rn | 6 ∴ D | 7 ∴ rn | | | 6 |

Notes

POP.W Rn is identical to MOV.W @SP+, Rn.

2.2.45 (2) POP (L)

POP (POP data)

Pop Data from Stack

Operation

@SP+ → ERn

Condition Code

| I | UI | H | U | N | Z | V | C |
|---|----|---|---|---|---|---|---|
| — | — | — | — | ↑ | ↓ | 0 | — |

Assembly-Language Format

POP.L ERn

Operand Size

Longword

- H: Previous value remains unchanged.
- N: Set to 1 if the data value is negative; otherwise cleared to 0.
- Z: Set to 1 if the data value is zero; otherwise cleared to 0.
- V: Always cleared to 0.
- C: Previous value remains unchanged.

Description

This instruction restores data from the stack to a 32-bit general register ERn, tests the restored data, and sets condition-code flags according to the result.

Available Registers

ERn: ER0 to ER7

Operand Format and Number of States Required for Execution

| Addressing Mode | Mnemonic | Operands | Instruction Format | | | | No. of States |
|-----------------|----------|----------|--------------------|----------|----------|----------|---------------|
| | | | 1st byte | 2nd byte | 3rd byte | 4th byte | |
| — | POPL | ERn | 0 1 | 0 0 | 6 D | 7 0:ern | 10 |

Notes

POPL ERn is identical to MOV.L @SP+, ERn.

2.2.46 (1) PUSH (W)

PUSH (PUSH data)

Push Data on Stack

Operation

Rn → @-SP

Assembly-Language Format

PUSH.W Rn

Operand Size

Word

Condition Code

| | | | | | | | |
|---|----|---|---|---|---|---|---|
| I | UI | H | U | N | Z | V | C |
| — | — | — | — | ↑ | ↑ | 0 | — |

H: Previous value remains unchanged.

N: Set to 1 if the data value is negative; otherwise cleared to 0.

Z: Set to 1 if the data value is zero; otherwise cleared to 0.

V: Always cleared to 0.

C: Previous value remains unchanged.

Description

This instruction saves data from a 16-bit register Rn onto the stack, tests the saved data, and sets condition-code flags according to the result.

Available Registers

Rn: R0 to R7, E0 to E7

Operand Format and Number of States Required for Execution

| Addressing Mode | Mnemonic | Operands | Instruction Format | | | | No. of States |
|-----------------|----------|----------|--------------------|----------|----------|----------|---------------|
| | | | 1st byte | 2nd byte | 3rd byte | 4th byte | |
| — | PUSH.W | Rn | 6 : D | F : rn | | | 6 |

Notes

1. PUSH.W Rn is identical to MOV.W Rn, @-SP.
2. When PUSH.W R7 or PUSH.W E7 is executed, the value saved on the stack is the lower part (R7) or upper part (E7) of the value of ER7 before execution minus two.

2.2.46 (2) PUSH (L)

PUSH (PUSH data)

Push Data on Stack

Operation

ERn → @-SP

Condition Code

| | | | | | | | |
|---|----|---|---|---|---|---|---|
| I | UI | H | U | N | Z | V | C |
| — | — | — | — | ↑ | ↓ | 0 | — |

Assembly-Language Format

PUSH.L ERn

Operand Size

Longword

- H: Previous value remains unchanged.
 N: Set to 1 if the data value is negative; otherwise cleared to 0.
 Z: Set to 1 if the data value is zero; otherwise cleared to 0.
 V: Always cleared to 0.
 C: Previous value remains unchanged.

Description

This instruction pushes data from a 32-bit register ERn onto the stack, tests the saved data, and sets condition-code flags according to the result.

Available Registers

ERn: ER0 to ER7

Operand Format and Number of States Required for Execution

| Addressing Mode | Mnemonic | Operands | Instruction Format | | | | No. of States | | | | |
|-----------------|----------|----------|--------------------|----------|----------|----------|---------------|---|---|-------|----|
| | | | 1st byte | 2nd byte | 3rd byte | 4th byte | | | | | |
| — | PUSH.L | ERn | 0 | 1 | 0 | 0 | 6 | D | F | 0:ern | 10 |

Notes

1. PUSH.L ERn is identical to MOV.L ERn, @-SP.
2. When PUSH.L ER7 is executed, the value saved on the stack is the value of ER7 before execution minus four.

2.2.47 (1) ROTL (B)

ROTL (ROTate Left)

Rotate

Operation

Rd (left rotation) → Rd

Condition Code

| I | UI | H | U | N | Z | V | C |
|---|----|---|---|---|---|---|---|
| — | — | — | — | ↑ | ↑ | 0 | ↑ |

Assembly-Language Format

ROTL.B Rd

Operand Size

Byte

- H: Previous value remains unchanged.
 N: Set to 1 if the result is negative; otherwise cleared to 0.
 Z: Set to 1 if the result is zero; otherwise cleared to 0.
 V: Always cleared to 0.
 C: Receives the previous value in bit 7.

Description

This instruction rotates the bits in an 8-bit register Rd (destination register) one bit to the left. The most significant bit is rotated to the least significant bit (bit 0), and also copied to the carry flag.

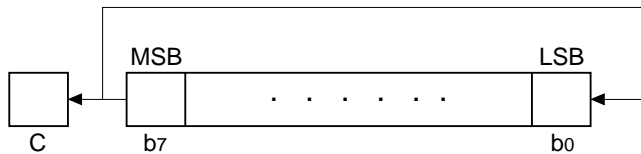

Available Registers

Rd: R0L to R7L, R0H to R7H

Operand Format and Number of States Required for Execution

| Addressing Mode | Mnemonic | Operands | Instruction Format | | | | No. of States |
|-----------------|----------|----------|--------------------|--------------|----------|----------|---------------|
| | | | 1st byte | 2nd byte | 3rd byte | 4th byte | |
| Register direct | ROTL.B | Rd | 1 ⋮ 2 | 8 ⋮ rd | | | 2 |

Notes

2.2.47 (2) ROTL (W)

ROTL (ROTate Left)

Rotate

Operation

Rd (left rotation) → Rd

Condition Code

| | | | | | | | |
|---|----|---|---|---|---|---|---|
| I | UI | H | U | N | Z | V | C |
| — | — | — | — | ↑ | ↑ | 0 | ↑ |

Assembly-Language Format

ROTL.W Rd

Operand Size

Word

H: Previous value remains unchanged.

N: Set to 1 if the result is negative; otherwise cleared to 0.

Z: Set to 1 if the result is zero; otherwise cleared to 0.

V: Always cleared to 0.

C: Receives the previous value in bit 15.

Description

This instruction rotates the bits in a 16-bit register Rd (destination register) one bit to the left. The most significant bit is rotated to the least significant bit (bit 0), and also copied to the carry flag.

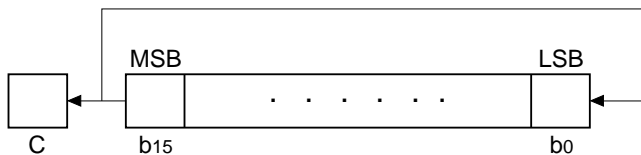

Available Registers

Rd: R0 to R7, E0 to E7

Operand Format and Number of States Required for Execution

| Addressing Mode | Mnemonic | Operands | Instruction Format | | | | No. of States |
|-----------------|----------|----------|--------------------|----------|----------|----------|---------------|
| | | | 1st byte | 2nd byte | 3rd byte | 4th byte | |
| Register direct | ROTL.W | Rd | 1 : 2 | 9 : rd | | | 2 |

Notes

2.2.47 (3) ROTL (L)

ROTL (ROTate Left)

Rotate

Operation

ERd (left rotation) → ERd

Assembly-Language Format

ROTL.L ERd

Operand Size

Longword

Condition Code

| | | | | | | | |
|---|----|---|---|---|---|---|---|
| I | UI | H | U | N | Z | V | C |
| — | — | — | — | ↑ | ↑ | 0 | — |

H: Previous value remains unchanged.

N: Set to 1 if the result is negative; otherwise cleared to 0.

Z: Set to 1 if the result is zero; otherwise cleared to 0.

V: Always cleared to 0.

C: Receives the previous value in bit 31.

Description

This instruction rotates the bits in a 32-bit register ERd (destination register) one bit to the left. The most significant bit is rotated to the least significant bit (bit 0), and also copied to the carry flag.

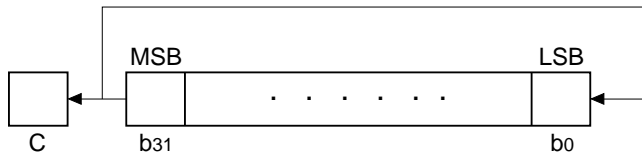

Available Registers

ERd: ER0 to ER7

Operand Format and Number of States Required for Execution

| Addressing Mode | Mnemonic | Operands | Instruction Format | | | | No. of States |
|-----------------|----------|----------|--------------------|----------|----------|----------|---------------|
| | | | 1st byte | 2nd byte | 3rd byte | 4th byte | |
| Register direct | ROTL.L | ERd | 1 | 2 | B 0:erd | | 2 |

Notes

2.2.48 (1) ROTR (B)

ROTR (ROTate Right)

Rotate

Operation

Rd (right rotation) → Rd

Assembly-Language Format

ROTR.B Rd

Operand Size

Byte

Condition Code

| I | UI | H | U | N | Z | V | C |
|---|----|---|---|---|---|---|---|
| — | — | — | — | ↑ | ↑ | 0 | ↑ |

H: Previous value remains unchanged.

N: Set to 1 if the result is negative; otherwise cleared to 0.

Z: Set to 1 if the result is zero; otherwise cleared to 0.

V: Always cleared to 0.

C: Receives the previous value in bit 0.

Description

This instruction rotates the bits in an 8-bit register Rd (destination register) one bit to the right. The least significant bit is rotated to the most significant bit (bit 7), and also copied to the carry flag.

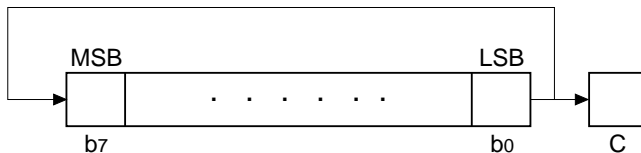

Available Registers

Rd: R0L to R7L, R0H to R7H

Operand Format and Number of States Required for Execution

| Addressing Mode | Mnemonic | Operands | Instruction Format | | | | No. of States |
|-----------------|----------|----------|--------------------|----------|----------|----------|---------------|
| | | | 1st byte | 2nd byte | 3rd byte | 4th byte | |
| Register direct | ROTR.B | Rd | 1 : 3 | 8 : rd | | | 2 |

Notes

2.2.48 (2) ROTR (W)

ROTR (ROTate Right)

Rotate

Operation

Rd (right rotation) → Rd

Assembly-Language Format

ROTR.W Rd

Operand Size

Word

Condition Code

| I | UI | H | U | N | Z | V | C |
|---|----|---|---|---|---|---|---|
| — | — | — | — | ↑ | ↑ | 0 | ↑ |

H: Previous value remains unchanged.

N: Set to 1 if the result is negative; otherwise cleared to 0.

Z: Set to 1 if the result is zero; otherwise cleared to 0.

V: Always cleared to 0.

C: Receives the previous value in bit 0.

Description

This instruction rotates the bits in a 16-bit register Rd (destination register) one bit to the right. The least significant bit is rotated to the most significant bit (bit 15), and also copied to the carry flag.

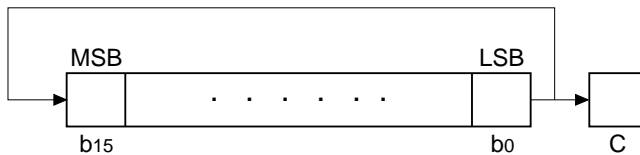

Available Registers

Rd: R0 to R7, E0 to E7

Operand Format and Number of States Required for Execution

| Addressing Mode | Mnemonic | Operands | Instruction Format | | | | No. of States |
|-----------------|----------|----------|--------------------|------------|----------|----------|---------------|
| | | | 1st byte | 2nd byte | 3rd byte | 4th byte | |
| Register direct | ROTR.W | Rd | 1 3 | 9 rd | | | 2 |

Notes

2.2.48 (3) ROTR (L)

ROTR (ROTate Right)

Rotate

Operation

ERd (right rotation) → ERd

Assembly-Language Format

ROTR.L ERd

Operand Size

Longword

Condition Code

| | | | | | | | |
|---|----|---|---|---|---|---|---|
| I | UI | H | U | N | Z | V | C |
| — | — | — | — | ↑ | ↑ | 0 | ↑ |

- H: Previous value remains unchanged.
- N: Set to 1 if the result is negative; otherwise cleared to 0.
- Z: Set to 1 if the result is zero; otherwise cleared to 0.
- V: Always cleared to 0.
- C: Receives the previous value in bit 0.

Description

This instruction rotates the bits in a 32-bit register ERd (destination register) one bit to the right. The least significant bit is rotated to the most significant bit (bit 31), and also copied to the carry flag.

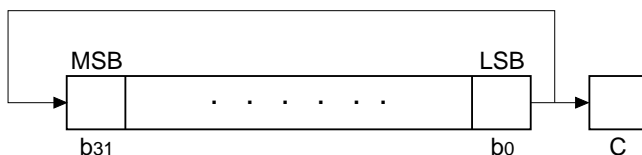

Available Registers

ERd: ER0 to ER7

Operand Format and Number of States Required for Execution

| Addressing Mode | Mnemonic | Operands | Instruction Format | | | | No. of States |
|-----------------|----------|----------|--------------------|-------------|----------|----------|---------------|
| | | | 1st byte | 2nd byte | 3rd byte | 4th byte | |
| Register direct | ROTR.L | ERd | 1 . . . 3 | B . . 0:erd | | | 2 |

Notes

2.2.49 (1) ROTXL (B)

ROTXL (ROTate with eXtend carry Left)

Rotate through Carry

Operation

Rd (left rotation through carry bit) → Rd

Assembly-Language Format

ROTXL.B Rd

Operand Size

Byte

Condition Code

| | | | | | | | |
|---|----|---|---|---|---|---|---|
| I | UI | H | U | N | Z | V | C |
| — | — | — | — | ↑ | ↓ | 0 | ↑ |

H: Previous value remains unchanged.

N: Set to 1 if the result is negative; otherwise cleared to 0.

Z: Set to 1 if the result is zero; otherwise cleared to 0.

V: Always cleared to 0.

C: Receives the previous value in bit 7.

Description

This instruction rotates the bits in an 8-bit register Rd (destination register) one bit to the left through the carry flag. The carry flag is rotated into the least significant bit (bit 0). The most significant bit rotates into the carry flag.

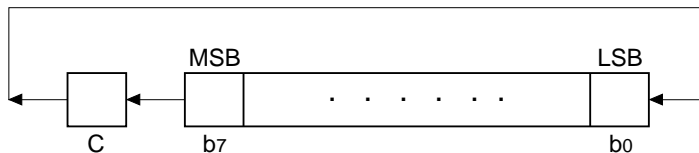

Available Registers

Rd: R0L to R7L, R0H to R7H

Operand Format and Number of States Required for Execution

| Addressing Mode | Mnemonic | Operands | Instruction Format | | | | No. of States |
|-----------------|----------|----------|--------------------|----------|----------|----------|---------------|
| | | | 1st byte | 2nd byte | 3rd byte | 4th byte | |
| Register direct | ROTXL.B | Rd | 1 ∴ 2 | 0 ∴ rd | | | 2 |

Notes

2.2.49 (2) ROTXL (W)

ROTXL (ROtate with eXtend carry Left)

Rotate through Carry

Operation

Rd (left rotation through carry bit) → Rd

Assembly-Language Format

ROTXL.W Rd

Operand Size

Word

Condition Code

| | | | | | | | |
|---|----|---|---|---|---|---|---|
| I | UI | H | U | N | Z | V | C |
| — | — | — | — | ↑ | ↓ | 0 | ↑ |

H: Previous value remains unchanged.

N: Set to 1 if the result is negative; otherwise cleared to 0.

Z: Set to 1 if the result is zero; otherwise cleared to 0.

V: Always cleared to 0.

C: Receives the previous value in bit 15.

Description

This instruction rotates the bits in a 16-bit register Rd (destination register) one bit to the left through the carry flag. The carry flag is rotated into the least significant bit (bit 0). The most significant bit rotates into the carry flag.

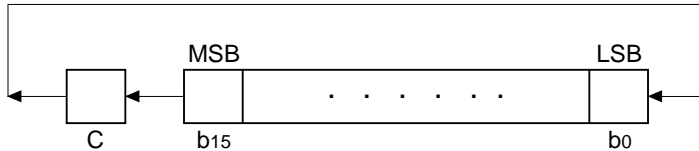

Available Registers

Rd: R0 to R7, E0 to E7

Operand Format and Number of States Required for Execution

| Addressing Mode | Mnemonic | Operands | Instruction Format | | | | No. of States |
|-----------------|----------|----------|--------------------|----------|----------|----------|---------------|
| | | | 1st byte | 2nd byte | 3rd byte | 4th byte | |
| Register direct | ROTXL.W | Rd | 1 | 2 | 1 | rd | 2 |

Notes

2.2.49 (3) ROTXL (L)

ROTXL (ROtate with eXtend carry Left)

Rotate through Carry

Operation

ERd (left rotation through carry bit) → ERd

Assembly-Language Format

ROTXL.L ERd

Operand Size

Longword

Condition Code

| | | | | | | | |
|---|----|---|---|---|---|---|---|
| I | UI | H | U | N | Z | V | C |
| — | — | — | — | ↑ | ↑ | 0 | ↑ |

H: Previous value remains unchanged.

N: Set to 1 if the result is negative; otherwise cleared to 0.

Z: Set to 1 if the result is zero; otherwise cleared to 0.

V: Always cleared to 0.

C: Receives the previous value in bit 31.

Description

This instruction rotates the bits in a 32-bit register ERd (destination register) one bit to the left through the carry flag. The carry flag is rotated into the least significant bit (bit 0). The most significant bit rotates into the carry flag.

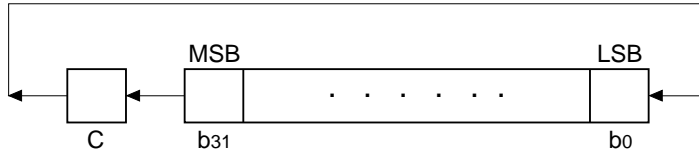

Available Registers

ERd: ER0 to ER7

Operand Format and Number of States Required for Execution

| Addressing Mode | Mnemonic | Operands | Instruction Format | | | | No. of States |
|-----------------|----------|----------|--------------------|----------|----------|----------|---------------|
| | | | 1st byte | 2nd byte | 3rd byte | 4th byte | |
| Register direct | ROTXL.L | ERd | 1 | 2 | 3 | 0:erd | 2 |

Notes

2.2.50 (1) ROTXR (B)

ROTXR (ROtate with eXtend carry Right)

Rotate through Carry

Operation

Rd (right rotation through carry bit) → Rd

Assembly-Language Format

ROTXR.B Rd

Operand Size

Byte

Condition Code

| | | | | | | | |
|---|----|---|---|---|---|---|---|
| I | UI | H | U | N | Z | V | C |
| — | — | — | — | ↑ | ↓ | 0 | ↑ |

- H: Previous value remains unchanged.
- N: Set to 1 if the result is negative; otherwise cleared to 0.
- Z: Set to 1 if the result is zero; otherwise cleared to 0.
- V: Always cleared to 0.
- C: Receives the previous value in bit 0.

Description

This instruction rotates the bits in an 8-bit register Rd (destination register) one bit to the right through the carry flag. The carry flag is rotated into the most significant bit (bit 7). The least significant bit rotates into the carry flag.

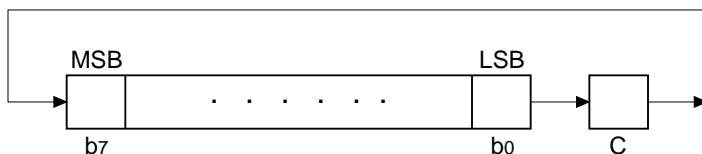

Available Registers

Rd: R0L to R7L, R0H to R7H

Operand Format and Number of States Required for Execution

| Addressing Mode | Mnemonic | Operands | Instruction Format | | | | No. of States |
|-----------------|----------|----------|--------------------|----------|----------|----------|---------------|
| | | | 1st byte | 2nd byte | 3rd byte | 4th byte | |
| Register direct | ROTXR.B | Rd | 1 : 3 | 0 : rd | | | 2 |

Notes

2.2.50 (2) ROTXR (W)

ROTXR (ROTate with eXtend carry Right)

Rotate through Carry

Operation

Rd (right rotation through carry bit) → Rd

Assembly-Language Format

ROTXR.W Rd

Operand Size

Word

Condition Code

| I | UI | H | U | N | Z | V | C |
|---|----|---|---|---|---|---|---|
| — | — | — | — | ↑ | ↑ | 0 | ↑ |

H: Previous value remains unchanged.

N: Set to 1 if the result is negative; otherwise cleared to 0.

Z: Set to 1 if the result is zero; otherwise cleared to 0.

V: Always cleared to 0.

C: Receives the previous value in bit 0.

Description

This instruction rotates the bits in a 16-bit register Rd (destination register) one bit to the right through the carry flag. The carry flag is rotated into the most significant bit (bit 15). The least significant bit rotates into the carry flag.

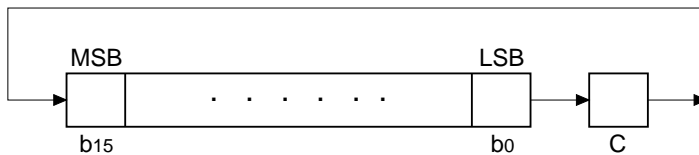

Available Registers

Rd: R0 to R7, E0 to E7

Operand Format and Number of States Required for Execution

| Addressing Mode | Mnemonic | Operands | Instruction Format | | | | No. of States |
|-----------------|----------|----------|--------------------|----------|----------|----------|---------------|
| | | | 1st byte | 2nd byte | 3rd byte | 4th byte | |
| Register direct | ROTXR.W | Rd | 1 : 3 | 1 : rd | | | 2 |

Notes

2.2.50 (3) ROTXR (L)

ROTXR (ROtate with eXtend carry Right)

Rotate through Carry

Operation

ERd (right rotation through carry bit) → ERd

Assembly-Language Format

ROTXR.L ERd

Operand Size

Longword

Condition Code

| | | | | | | | |
|---|----|---|---|---|---|---|---|
| I | UI | H | U | N | Z | V | C |
| — | — | — | — | ↑ | ↓ | 0 | ↑ |

H: Previous value remains unchanged.

N: Set to 1 if the result is negative; otherwise cleared to 0.

Z: Set to 1 if the result is zero; otherwise cleared to 0.

V: Always cleared to 0.

C: Receives the previous value in bit 0.

Description

This instruction rotates the bits in a 32-bit register ERd (destination register) one bit to the right through the carry flag. The carry flag is rotated into the most significant bit (bit 31). The least significant bit rotates into the carry flag.

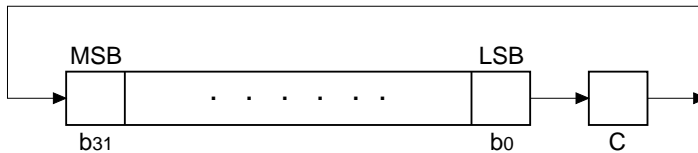

Available Registers

ERd: ER0 to ER7

Operand Format and Number of States Required for Execution

| Addressing Mode | Mnemonic | Operands | Instruction Format | | | | No. of States |
|-----------------|----------|----------|--------------------|----------|----------|----------|---------------|
| | | | 1st byte | 2nd byte | 3rd byte | 4th byte | |
| Register direct | ROTXR.L | ERd | 1 3 | 3 0 | erd | | 2 |

Notes

2.2.51 RTE

RTE (ReTurn from Exception)

Return from Exception Handling

Operation

@SP+ → CCR

@SP+ → PC

Condition Code

| | | | | | | | |
|---|----|---|---|---|---|---|---|
| I | UI | H | U | N | Z | V | C |
| ↕ | ↕ | ↕ | ↕ | ↕ | ↕ | ↕ | ↕ |

Assembly-Language Format

RTE

Operand Size

—

- I: Restored from the corresponding bit on the stack.
- UI: Restored from the corresponding bit on the stack.
- H: Restored from the corresponding bit on the stack.
- U: Restored from the corresponding bit on the stack.
- N: Restored from the corresponding bit on the stack.
- Z: Restored from the corresponding bit on the stack.
- V: Restored from the corresponding bit on the stack.
- C: Restored from the corresponding bit on the stack.

Description

This instruction returns from an exception-handling routine by restoring the condition-code register (CCR) and program counter (PC) from the stack. Program execution continues from the address restored to the program counter. The CCR and PC contents at the time of execution of this instruction are lost.

Operand Format and Number of States Required for Execution

| Addressing Mode | Mnemonic | Operands | Instruction Format | | | | No. of States |
|-----------------|----------|----------|--------------------|----------|----------|----------|---------------|
| | | | 1st byte | 2nd byte | 3rd byte | 4th byte | |
| — | RTE | | 5 : 6 | 7 : 0 | | | 10 |

Notes

The stack structure differs between normal mode and advanced mode.

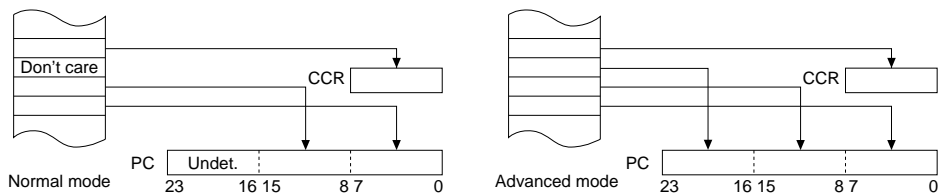

2.2.52 RTS

RTS (ReTurn from Subroutine)

Return from Subroutine

Operation

@SP+ → PC

Assembly-Language Format

RTS

Operand Size

—

Condition Code

| | | | | | | | |
|---|----|---|---|---|---|---|---|
| I | UI | H | U | N | Z | V | C |
| — | — | — | — | — | — | — | — |

H: Previous value remains unchanged.

N: Previous value remains unchanged.

Z: Previous value remains unchanged.

V: Previous value remains unchanged.

C: Previous value remains unchanged.

Description

This instruction returns from a subroutine by restoring the program counter (PC) from the stack. Program execution continues from the address restored to the program counter. The PC contents at the time of execution of this instruction are lost.

Available Registers

—

Operand Format and Number of States Required for Execution

| Addressing Mode | Mnemonic | Operands | Instruction Format | | | | No. of States | |
|-----------------|----------|----------|--------------------|----------|----------|----------|---------------|----------|
| | | | 1st Byte | 2nd Byte | 3rd Byte | 4th Byte | Normal | Advanced |
| — | RTS | | 5 | 4 | 7 | 0 | 8 | 10 |

Notes

The stack structure and number of states required for execution differ between normal mode and advanced mode.

In normal mode, only the lower 16 bits of the program counter are restored.

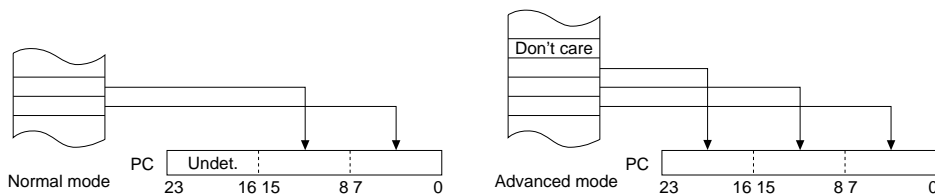

2.2.53 (1) SHAL (B)

SHAL (SHift Arithmetic Left)

Shift Arithmetic

Operation

Rd (left arithmetic shift) → Rd

Assembly-Language Format

SHAL.B Rd

Operand Size

Byte

Condition Code

| I | UI | H | U | N | Z | V | C |
|---|----|---|---|----|----|----|----|
| — | — | — | — | ↑↓ | ↑↓ | ↑↓ | ↑↓ |

H: Previous value remains unchanged.

N: Set to 1 if the result is negative; otherwise cleared to 0.

Z: Set to 1 if the result is zero; otherwise cleared to 0.

V: Set to 1 if an overflow occurs; otherwise cleared to 0.

C: Receives the previous value in bit 7.

Description

This instruction shifts the bits in an 8-bit register Rd (destination operand) one bit to the left. The most significant bit shifts into the carry flag. The least significant bit (bit 0) is cleared to 0.

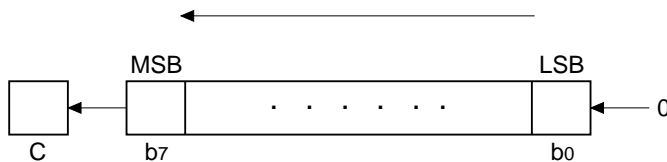

Available Registers

Rd: R0L to R7L, R0H to R7H

Operand Format and Number of States Required for Execution

| Addressing Mode | Mnemonic | Operands | Instruction Format | | | | No. of States |
|-----------------|----------|----------|--------------------|----------|----------|----------|---------------|
| | | | 1st byte | 2nd byte | 3rd byte | 4th byte | |
| Register direct | SHAL.B | Rd | 1 .. 0 | 8 .. rd | | | 2 |

Notes

The SHAL instruction differs from the SHLL instruction in its effect on the overflow flag.

2.2.53 (2) SHAL (W)

SHAL (SHift Arithmetic Left)

Shift Arithmetic

Operation

Rd (left arithmetic shift) → Rd

Assembly-Language Format

SHAL.W Rd

Operand Size

Word

Condition Code

| | | | | | | | |
|---|----|---|---|----|----|----|----|
| I | UI | H | U | N | Z | V | C |
| — | — | — | — | ↑↓ | ↑↓ | ↑↓ | ↑↓ |

- H: Previous value remains unchanged.
- N: Set to 1 if the result is negative; otherwise cleared to 0.
- Z: Set to 1 if the result is zero; otherwise cleared to 0.
- V: Set to 1 if an overflow occurs; otherwise cleared to 0.
- C: Receives the previous value in bit 15.

Description

This instruction shifts the bits in a 16-bit register Rd (destination operand) one bit to the left. The most significant bit shifts into the carry flag. The least significant bit (bit 0) is cleared to 0.

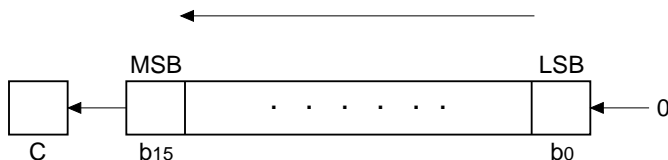

Available Registers

Rd: R0 to R7, E0 to E7

Operand Format and Number of States Required for Execution

| Addressing Mode | Mnemonic | Operands | Instruction Format | | | | No. of States |
|-----------------|----------|----------|--------------------|----------|----------|----------|---------------|
| | | | 1st byte | 2nd byte | 3rd byte | 4th byte | |
| Register direct | SHAL.W | Rd | 1 0 | 9 rd | | | 2 |

Notes

The SHAL instruction differs from the SHLL instruction in its effect on the overflow flag.

2.2.53 (3) SHAL (L)

SHAL (SHift Arithmetic Left)

Shift Arithmetic

Operation

ERd (left arithmetic shift) → ERd

Assembly-Language Format

SHAL.L ERd

Operand Size

Longword

Condition Code

| | | | | | | | |
|---|----|---|---|----|----|----|----|
| I | UI | H | U | N | Z | V | C |
| — | — | — | — | ↑↓ | ↑↓ | ↑↓ | ↑↓ |

- H: Previous value remains unchanged.
- N: Set to 1 if the result is negative; otherwise cleared to 0.
- Z: Set to 1 if the result is zero; otherwise cleared to 0.
- V: Set to 1 if an overflow occurs; otherwise cleared to 0.
- C: Receives the previous value in bit 31.

Description

This instruction shifts the bits in a 32-bit register ERd (destination operand) one bit to the left. The most significant bit shifts into the carry flag. The least significant bit (bit 0) is cleared to 0.

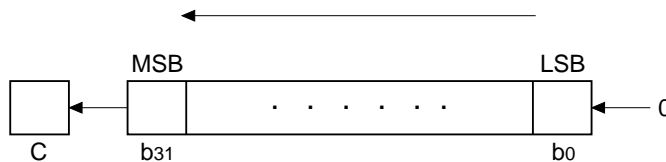

Available Registers

ERd: ER0 to ER7

Operand Format and Number of States Required for Execution

| Addressing Mode | Mnemonic | Operands | Instruction Format | | | | No. of States |
|-----------------|----------|----------|--------------------|----------|----------|----------|---------------|
| | | | 1st byte | 2nd byte | 3rd byte | 4th byte | |
| Register direct | SHAL.L | ERd | 1 0 | B 0:erd | | | 2 |

Notes

The SHAL instruction differs from the SHLL instruction in its effect on the overflow flag.

2.2.54 (1) SHAR (B)

SHAR (SHift Arithmetic Right)

Shift Arithmetic

Operation

Rd (right arithmetic shift) → Rd

Assembly-Language Format

SHAR.B Rd

Operand Size

Byte

Condition Code

| I | UI | H | U | N | Z | V | C |
|---|----|---|---|---|---|---|---|
| — | — | — | — | ↑ | ↓ | 0 | ↑ |

- H: Previous value remains unchanged.
- N: Set to 1 if the result is negative; otherwise cleared to 0.
- Z: Set to 1 if the result is zero; otherwise cleared to 0.
- V: Set to 1 if an overflow occurs; otherwise cleared to 0.
- C: Receives the previous value in bit 0.

Description

This instruction shifts the bits in an 8-bit register Rd (destination operand) one bit to the right. Bit 0 shifts into the carry flag. Bit 7 shifts into itself. Since bit 7 remains unaltered, the sign does not change.

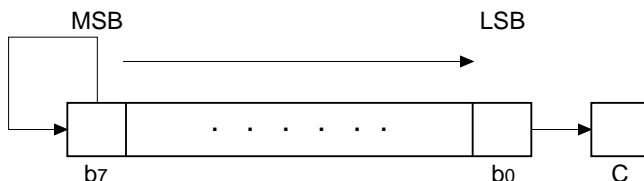

Available Registers

Rd: R0L to R7L, R0H to R7H

Operand Format and Number of States Required for Execution

| Addressing Mode | Mnemonic | Operands | Instruction Format | | | | No. of States |
|-----------------|----------|----------|--------------------|----------|----------|----------|---------------|
| | | | 1st byte | 2nd byte | 3rd byte | 4th byte | |
| Register direct | SHAR.B | Rd | 1 | 1 | 8 | rd | 2 |

Notes

2.2.54 (2) SHAR (W)

SHAR (SHift Arithmetic Right)

Shift Arithmetic

Operation

Rd (right arithmetic shift) → Rd

Assembly-Language Format

SHAR.W Rd

Operand Size

Word

Condition Code

| | | | | | | | |
|---|----|---|---|---|---|---|---|
| I | UI | H | U | N | Z | V | C |
| — | — | — | — | ↑ | ↑ | 0 | — |

H: Previous value remains unchanged.

N: Set to 1 if the result is negative; otherwise cleared to 0.

Z: Set to 1 if the result is zero; otherwise cleared to 0.

V: Set to 1 if an overflow occurs; otherwise cleared to 0.

C: Receives the previous value in bit 0.

Description

This instruction shifts the bits in a 16-bit register Rd (destination operand) one bit to the right. Bit 0 shifts into the carry flag. Bit 15 shifts into itself. Since bit 15 remains unaltered, the sign does not change.

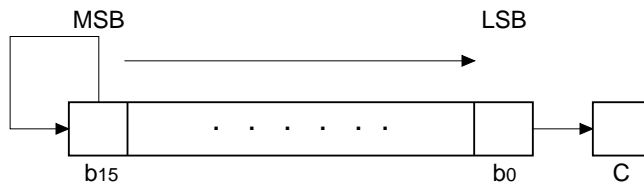

Available Registers

Rd: R0 to R7, E0 to E7

Operand Format and Number of States Required for Execution

| Addressing Mode | Mnemonic | Operands | Instruction Format | | | | No. of States |
|-----------------|----------|----------|--------------------|------------|----------|----------|---------------|
| | | | 1st byte | 2nd byte | 3rd byte | 4th byte | |
| Register direct | SHAR.W | Rd | 1 1 | 9 rd | | | 2 |

Notes

2.2.54 (3) SHAR (L)

SHAR (SHift Arithmetic Right)

Shift Arithmetic

Operation

ERd (right arithmetic shift) → ERd

Assembly-Language Format

SHAR.L ERd

Operand Size

Longword

Condition Code

| | | | | | | | |
|---|----|---|---|---|---|---|---|
| I | UI | H | U | N | Z | V | C |
| — | — | — | — | ↑ | ↑ | 0 | ↑ |

- H: Previous value remains unchanged.
- N: Set to 1 if the result is negative; otherwise cleared to 0.
- Z: Set to 1 if the result is zero; otherwise cleared to 0.
- V: Set to 1 if an overflow occurs; otherwise cleared to 0.
- C: Receives the previous value in bit 0.

Description

This instruction shifts the bits in a 32-bit register ERd (destination operand) one bit to the right. Bit 0 shifts into the carry flag. Bit 31 shifts into itself. Since bit 31 remains unaltered, the sign does not change.

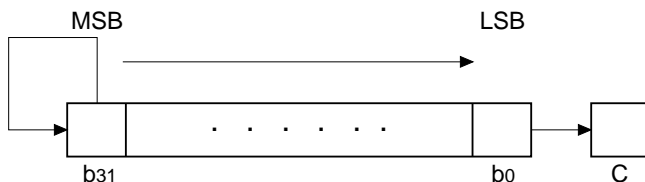

Available Registers

ERd: ER0 to ER7

Operand Format and Number of States Required for Execution

| Addressing Mode | Mnemonic | Operands | Instruction Format | | | | No. of States |
|-----------------|----------|----------|--------------------|----------|----------|----------|---------------|
| | | | 1st byte | 2nd byte | 3rd byte | 4th byte | |
| Register direct | SHAR.L | ERd | 1 | 1 | B 0:erd | | 2 |

Notes

2.2.55 (1) SHLL (B)

SHLL (SHift Logical Left)

Shift Logical

Operation

Rd (left logical shift) → Rd

Assembly-Language Format

SHLL.B Rd

Operand Size

Byte

Condition Code

| | | | | | | | |
|---|----|---|---|---|---|---|---|
| I | UI | H | U | N | Z | V | C |
| — | — | — | — | ↑ | ↓ | 0 | — |

H: Previous value remains unchanged.

N: Set to 1 if the result is negative; otherwise cleared to 0.

Z: Set to 1 if the result is zero; otherwise cleared to 0.

V: Always cleared to 0.

C: Receives the previous value in bit 7.

Description

This instruction shifts the bits in an 8-bit register Rd (destination operand) one bit to the left. The most significant bit shifts into the carry flag. The least significant bit (bit 0) is cleared to 0.

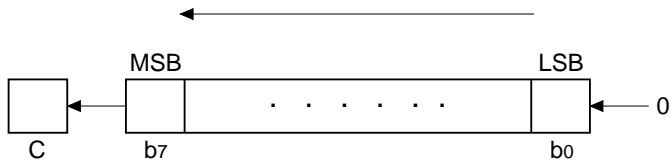

Available Registers

Rd: R0L to R7L, R0H to R7H

Operand Format and Number of States Required for Execution

| Addressing Mode | Mnemonic | Operands | Instruction Format | | | | No. of States |
|-----------------|----------|----------|--------------------|----------|----------|----------|---------------|
| | | | 1st byte | 2nd byte | 3rd byte | 4th byte | |
| Register direct | SHLL.B | Rd | 1 0 | 0 rd | | | 2 |

Notes

The SHLL instruction differs from the SHAL instruction in its effect on the overflow flag.

2.2.55 (2) SHLL (W)

SHLL (SHift Logical Left)

Shift Logical

Operation

Rd (left logical shift) → Rd

Condition Code

| | | | | | | | |
|---|----|---|---|---|---|---|---|
| I | UI | H | U | N | Z | V | C |
| — | — | — | — | ↑ | ↑ | 0 | ↑ |

Assembly-Language Format

SHLL.W Rd

Operand Size

Word

H: Previous value remains unchanged.

N: Set to 1 if the result is negative; otherwise cleared to 0.

Z: Set to 1 if the result is zero; otherwise cleared to 0.

V: Always cleared to 0.

C: Receives the previous value in bit 15.

Description

This instruction shifts the bits in a 16-bit register Rd (destination operand) one bit to the left. The most significant bit shifts into the carry flag. The least significant bit (bit 0) is cleared to 0.

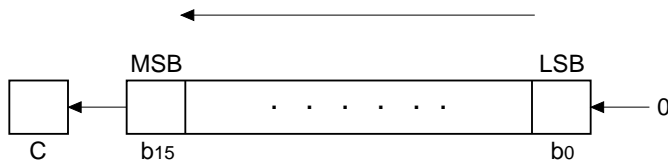

Available Registers

Rd: R0 to R7, E0 to E7

Operand Format and Number of States Required for Execution

| Addressing Mode | Mnemonic | Operands | Instruction Format | | | | No. of States |
|-----------------|----------|----------|--------------------|----------|----------|----------|---------------|
| | | | 1st byte | 2nd byte | 3rd byte | 4th byte | |
| Register direct | SHLL.W | Rd | 1 0 | 1 rd | | | 2 |

Notes

The SHLL instruction differs from the SHAL instruction in its effect on the overflow flag.

2.2.55 (3) SHLL (L)

SHLL (SHift Logical Left)

Shift Logical

Operation

ERd (left logical shift) → ERd

Assembly-Language Format

SHLL.L ERd

Operand Size

Longword

Condition Code

| | | | | | | | |
|---|----|---|---|---|---|---|---|
| I | UI | H | U | N | Z | V | C |
| — | — | — | — | ↑ | ↓ | 0 | ↑ |

- H: Previous value remains unchanged.
- N: Set to 1 if the result is negative; otherwise cleared to 0.
- Z: Set to 1 if the result is zero; otherwise cleared to 0.
- V: Always cleared to 0.
- C: Receives the previous value in bit 31.

Description

This instruction shifts the bits in a 32-bit register ERd (destination operand) one bit to the left. The most significant bit shifts into the carry flag. The least significant bit (bit 0) is cleared to 0.

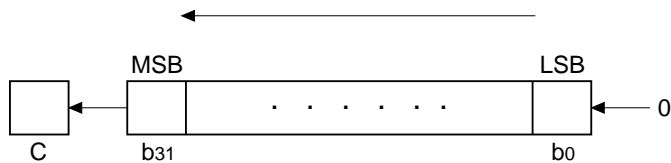

Available Registers

ERd: ER0 to ER7

Operand Format and Number of States Required for Execution

| Addressing Mode | Mnemonic | Operands | Instruction Format | | | | No. of States |
|-----------------|----------|----------|--------------------|----------|----------|----------|---------------|
| | | | 1st byte | 2nd byte | 3rd byte | 4th byte | |
| Register direct | SHLL.L | ERd | 1 0 | 3 0:erd | | | 2 |

Notes

The SHLL instruction differs from the SHAL instruction in its effect on the overflow flag.

2.2.56 (1) SHLR (B)

SHLR (SHift Logical Right)

Shift Logical

Operation

Rd (right logical shift) → Rd

Assembly-Language Format

SHLR.B Rd

Operand Size

Byte

Condition Code

| | | | | | | | |
|---|----|---|---|---|---|---|---|
| I | UI | H | U | N | Z | V | C |
| — | — | — | — | 0 | ↓ | 0 | ↓ |

H: Previous value remains unchanged.

N: Set to 1 if the result is negative; otherwise cleared to 0.

Z: Set to 1 if the result is zero; otherwise cleared to 0.

V: Always cleared to 0.

C: Receives the previous value in bit 0.

Description

This instruction shifts the bits in an 8-bit register Rd (destination operand) one bit to the right. The least significant bit shifts into the carry flag. The most significant bit (bit 7) is cleared to 0.

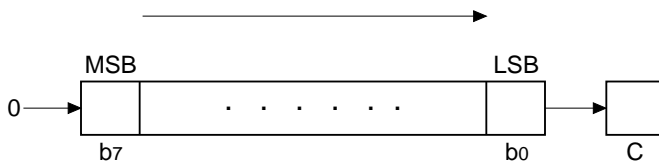

Available Registers

Rd: R0L to R7L, R0H to R7H

Operand Format and Number of States Required for Execution

| Addressing Mode | Mnemonic | Operands | Instruction Format | | | | No. of States |
|-----------------|----------|----------|--------------------|----------|----------|----------|---------------|
| | | | 1st byte | 2nd byte | 3rd byte | 4th byte | |
| Register direct | SHLR.B | Rd | 1 1 | 0 rd | | | 2 |

Notes

2.2.56 (2) SHLR (W)

SHLR (SHift Logical Right)

Shift Logical

Operation

Rd (right logical shift) → Rd

Condition Code

| | | | | | | | |
|---|----|---|---|---|---|---|---|
| I | UI | H | U | N | Z | V | C |
| — | — | — | — | 0 | ↑ | 0 | ↑ |

Assembly-Language Format

SHLR.W Rd

Operand Size

Word

H: Previous value remains unchanged.

N: Always cleared to 0.

Z: Set to 1 if the result is zero; otherwise cleared to 0.

V: Always cleared to 0.

C: Receives the previous value in bit 0.

Description

This instruction shifts the bits in a 16-bit register Rd (destination operand) one bit to the right. The least significant bit shifts into the carry flag. The most significant bit (bit 15) is cleared to 0.

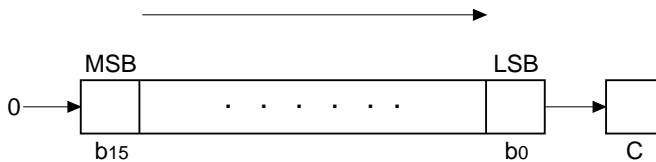

Available Registers

Rd: R0 to R7, E0 to E7

Operand Format and Number of States Required for Execution

| Addressing Mode | Mnemonic | Operands | Instruction Format | | | | No. of States |
|-----------------|----------|----------|--------------------|----------|----------|----------|---------------|
| | | | 1st byte | 2nd byte | 3rd byte | 4th byte | |
| Register direct | SHLR.W | Rd | 1 | 1 | rd | | 2 |

Notes

2.2.56 (3) SHLR (L)

SHLR (SHift Logical Right)

Shift Logical

Operation

ERd (right logical shift) → ERd

Assembly-Language Format

SHLR.L ERd

Operand Size

Longword

Condition Code

| | | | | | | | |
|---|----|---|---|---|---|---|---|
| I | UI | H | U | N | Z | V | C |
| — | — | — | — | 0 | ↑ | 0 | ↑ |

H: Previous value remains unchanged.

N: Always cleared to 0.

Z: Set to 1 if the result is zero; otherwise cleared to 0.

V: Always cleared to 0.

C: Receives the previous value in bit 0.

Description

This instruction shifts the bits in a 32-bit register ERd (destination operand) one bit to the right. The least significant bit shifts into the carry flag. The most significant bit (bit 31) is cleared to 0.

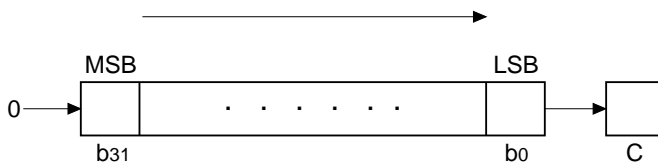

Available Registers

ERd: ER0 to ER7

Operand Format and Number of States Required for Execution

| Addressing Mode | Mnemonic | Operands | Instruction Format | | | | No. of States |
|-----------------|----------|----------|--------------------|----------|----------|----------|---------------|
| | | | 1st byte | 2nd byte | 3rd byte | 4th byte | |
| Register direct | SHLR.L | ERd | 1 | 1 | 3 | 0:erd | 2 |

Notes

2.2.57 SLEEP

SLEEP (SLEEP)

Power-Down Mode

Operation

Program execution state → power-down mode

Assembly-Language Format

SLEEP

Operand Size

—

Condition Code

| I | UI | H | U | N | Z | V | C |
|---|----|---|---|---|---|---|---|
| — | — | — | — | — | — | — | — |

H: Previous value remains unchanged.

N: Previous value remains unchanged.

Z: Previous value remains unchanged.

V: Previous value remains unchanged.

C: Previous value remains unchanged.

Description

When the SLEEP instruction is executed, the CPU enters a power-down state. Its internal state remains unchanged, but the CPU stops executing instructions and waits for an exception-handling request. When it receives an exception-handling request, the CPU exits the power-down state and begins the exception-handling sequence. Interrupt requests other than NMI cannot end the power-down state if they are masked in the CPU.

Available Registers

—

Operand Format and Number of States Required for Execution

| Addressing Mode | Mnemonic | Operands | Instruction Format | | | | No. of States | |
|-----------------|----------|----------|--------------------|----------|----------|----------|---------------|---|
| | | | 1st byte | 2nd byte | 3rd byte | 4th byte | | |
| — | SLEEP | | 0 | 1 | 8 | 0 | | 2 |

Notes

For information about the power-down state, see the relevant microcontroller hardware manual.

2.2.58 (1) STC (B)

STC (STore from Control register)

Store CCR

Operation

CCR → Rd

Condition Code

| | | | | | | |
|---|----|---|---|---|---|---|
| I | UI | H | U | Z | V | C |
| — | — | — | — | — | — | — |

Assembly-Language Format

STC.B CCR, Rd

H: Previous value remains unchanged.
N: Previous value remains unchanged.
Z: Previous value remains unchanged.
V: Previous value remains unchanged.
C: Previous value remains unchanged.

Operand Size

Byte

Description

This instruction copies the CCR contents to an 8-bit register Rd.

Available Registers

Rd: R0L to R7L, R0H to R7H

Operand Format and Number of States Required for Execution

| Addressing Mode | Mnemonic | Operands | Instruction Format | | | | No. of States |
|-----------------|----------|----------|--------------------|----------|----------|----------|---------------|
| | | | 1st byte | 2nd byte | 3rd byte | 4th byte | |
| Register direct | STC.B | CCR, Rd | 0 2 | 0 rd | | | 2 |

Notes

2.2.58 (2) STC (W)

STC (STore from Control register)

Store CCR

Operation

CCR → (EAd)

Condition Code

| | | | | | | | |
|---|----|---|---|---|---|---|---|
| I | UI | H | U | N | Z | V | C |
| — | — | — | — | — | — | — | — |

Assembly-Language Format

STC.W CCR, <EAd>

H: Previous value remains unchanged.

N: Previous value remains unchanged.

Z: Previous value remains unchanged.

V: Previous value remains unchanged.

C: Previous value remains unchanged.

Operand Size

Word

Description

This instruction copies the CCR contents to a destination location. Although CCR is a byte register, the destination operand is a word operand. The CCR contents are stored at the even address.

Available Registers

ERd: ER0 to ER7

Operand Format and Number of States Required for Execution

| Addressing Mode | Mnemonic | Operands | Instruction Format | | | | | | | | | | No. of States | | | |
|--------------------------------------|----------|-----------------|--------------------|----------|----------|----------|----------|----------|----------|----------|----------|-----------|---------------|---|---|------|
| | | | 1st byte | 2nd byte | 3rd byte | 4th byte | 5th byte | 6th byte | 7th byte | 8th byte | 9th byte | 10th byte | | | | |
| Register indirect | STC.W | CCR,@ERd | 0 | 1 | 4 | 0 | 6 | 9 | 1:erd: 0 | | | | | | | 6 |
| Register indirect with displacement | STC.W | CCR,@(d:16,ERd) | 0 | 1 | 4 | 0 | 6 | F | 1:erd: 0 | disp | | | | | | 8 |
| | STC.W | CCR,@(d:24,ERd) | 0 | 1 | 4 | 0 | 7 | 8 | 0:erd: 0 | 6 | B | A | 0 | 0 | 0 | disp |
| Register indirect with pre-decrement | STC.W | CCR,@-ERd | 0 | 1 | 4 | 0 | 6 | D | 1:erd: 0 | | | | | | | 8 |
| Absolute address | STC.W | CCR,@aa:16 | 0 | 1 | 4 | 0 | 6 | B | 8 | 0 | abs | | | | | 8 |
| | STC.W | CCR,@aa:24 | 0 | 1 | 4 | 0 | 6 | B | A | 0 | 0 | 0 | abs | | | 10 |

Notes

2.2.59 (1) SUB (B)

SUB (SUBtract binary)

Subtract Binary

Operation

$Rd - Rs \rightarrow Rd$

Assembly-Language Format

SUB.B Rs, Rd

Operand Size

Byte

Condition Code

| I | UI | H | U | N | Z | V | C |
|---|----|---|---|---|---|---|---|
| — | — | ↑ | — | ↑ | ↑ | ↑ | ↑ |

H: Set to 1 if there is a borrow at bit 3; otherwise cleared to 0.

N: Set to 1 if the result is negative; otherwise cleared to 0.

Z: Set to 1 if the result is zero; otherwise cleared to 0.

V: Set to 1 if an overflow occurs; otherwise cleared to 0.

C: Set to 1 if there is a borrow at bit 7; otherwise cleared to 0.

Description

This instruction subtracts the contents of an 8-bit register Rs (source operand) from the contents of an 8-bit register Rd (destination operand) and stores the result in the 8-bit register Rd.

Available Registers

Rd: R0L to R7L, R0H to R7H

Rs: R0L to R7L, R0H to R7H

Operand Format and Number of States Required for Execution

| Addressing Mode | Mnemonic | Operands | Instruction Format | | | | No. of States |
|-----------------|----------|----------|--------------------|----------|----------|----------|---------------|
| | | | 1st byte | 2nd byte | 3rd byte | 4th byte | |
| Register direct | SUB.B | Rs, Rd | 1 : 8 | rs : rd | | | 2 |

Notes

The SUB.B instruction can operate only on general registers. Immediate data can be subtracted from general register contents by using the SUBX instruction. Before executing SUBX #xx:8, Rd, first set the Z flag to 1 and clear the C flag to 0. The following coding examples can also be used to subtract nonzero immediate data #IMM.

- (1) ORC #H'05, CCR
SUBX #(IMM01), Rd
- (2) ADD #(0EIMM), Rd
XORC #H'01, CCR

2.2.59 (2) SUB (W)

SUB (SUBtract binary)

Subtract Binary

Operation

Rd – (EAs) → Rd

Assembly-Language Format

SUB.W <EAs>, Rd

Operand Size

Word

Condition Code

| | | | | | | | |
|---|----|---|---|---|---|---|---|
| I | UI | H | U | N | Z | V | C |
| — | — | ↑ | — | ↑ | ↑ | ↑ | ↑ |

- H: Set to 1 if there is a borrow at bit 11; otherwise cleared to 0.
- N: Set to 1 if the result is negative; otherwise cleared to 0.
- Z: Set to 1 if the result is zero; otherwise cleared to 0.
- V: Set to 1 if an overflow occurs; otherwise cleared to 0.
- C: Set to 1 if there is a borrow at bit 15; otherwise cleared to 0.

Description

This instruction subtracts a source operand from the contents of a 16-bit register Rd (destination operand) and stores the result in the 16-bit register Rd.

Available Registers

Rd: R0 to R7, E0 to E7

Rs: R0 to R7, E0 to E7

Operand Format and Number of States Required for Execution

| Addressing Mode | Mnemonic | Operands | Instruction Format | | | | No. of States |
|-----------------|----------|------------|--------------------|----------|----------|----------|---------------|
| | | | 1st byte | 2nd byte | 3rd byte | 4th byte | |
| Immediate | SUB.W | #xx:16, Rd | 7 : 9 | 3 : rd | IMM | | 4 |
| Register direct | SUB.W | Rs, Rd | 1 : 9 | rs : rd | | | 2 |

Notes

2.2.59 (3) SUB (L)

SUB (SUBtract binary)

Subtract Binary

Operation

ERd – <EAs> → ERd

Assembly-Language Format

SUB.L <EAs>, ERd

Operand Size

Longword

Condition Code

| I | UI | H | U | N | Z | V | C |
|---|----|---|---|---|---|---|---|
| — | — | ↑ | — | ↑ | ↑ | ↑ | ↑ |

H: Set to 1 if there is a borrow at bit 27; otherwise cleared to 0.

N: Set to 1 if the result is negative; otherwise cleared to 0.

Z: Set to 1 if the result is zero; otherwise cleared to 0.

V: Set to 1 if an overflow occurs; otherwise cleared to 0.

C: Set to 1 if there is a borrow at bit 31; otherwise cleared to 0.

Description

This instruction subtracts a source operand from the contents of a 32-bit register ERd (destination operand) and stores the result in the 32-bit register ERd.

Available Registers

ERd: ER0 to ER7

ERs: ER0 to ER7

Operand Format and Number of States Required for Execution

| Addressing Mode | Mnemonic | Operands | Instruction Format | | | | | | No. of States | |
|-----------------|----------|-------------|--------------------|----------|----------|-----------|----------|----------|---------------|---|
| | | | 1st byte | 2nd byte | 3rd byte | 4th byte | 5th byte | 6th byte | | |
| Immediate | SUB.L | #xx:32, ERd | 7 | A | 3 | 0:erd | IMM | | | 6 |
| Register direct | SUB.L | ERs, ERd | 1 | A | 1 | ers:0:erd | | | | 2 |

Notes

2.2.60 SUBS

SUBS (SUBtract with Sign extension)

Subtract Binary Address Data

Operation

ERd – 1 → ERd

ERd – 2 → ERd

ERd – 4 → ERd

Assembly-Language Format

SUBS #1, ERd

SUBS #2, ERd

SUBS #4, ERd

Operand Size

Longword

Condition Code

| | | | | | | | |
|---|----|---|---|---|---|---|---|
| I | UI | H | U | N | Z | V | C |
| — | — | — | — | — | — | — | — |

H: Previous value remains unchanged.

N: Previous value remains unchanged.

Z: Previous value remains unchanged.

V: Previous value remains unchanged.

C: Previous value remains unchanged.

Description

This instruction subtracts the immediate value 1, 2, or 4 from the contents of a 32-bit register ERd (destination register). Differing from the SUB instruction, it does not affect the condition-code flags.

Available Registers

ERd: ER0 to ER7

Operand Format and Number of States Required for Execution

| Addressing Mode* | Mnemonic | Operands | Instruction Format | | | | No. of States |
|------------------|----------|----------|--------------------|----------|----------|----------|---------------|
| | | | 1st byte | 2nd byte | 3rd byte | 4th byte | |
| Register direct | SUBS | #1, ERd | 1 | B | 0 0 | erd | 2 |
| Register direct | SUBS | #2, ERd | 1 | B | 8 0 | erd | 2 |
| Register direct | SUBS | #4, ERd | 1 | B | 9 0 | erd | 2 |

Notes

2.2.61 SUBX

SUBX (SUBtract with eXtend carry)

Subtract with Borrow

Operation

$Rd - (EAs) - C \rightarrow Rd$

Assembly-Language Format

SUBX <EAs>, Rd

Operand Size

Byte

Condition Code

| I | UI | H | U | N | Z | V | C |
|---|----|---|---|---|---|---|---|
| — | — | ↑ | — | ↑ | ↑ | ↑ | ↑ |

- H: Set to 1 if there is a borrow from bit 3; otherwise cleared to 0.
- N: Set to 1 if the result is negative; otherwise cleared to 0.
- Z: Set to 1 if the result is zero; otherwise cleared to 0.
- V: Set to 1 if an overflow occurs; otherwise cleared to 0.
- C: Set to 1 if there is a borrow from bit 7; otherwise cleared to 0.

Description

This instruction subtracts the source operand and carry flag from the contents of an 8-bit register Rd (destination operand) and stores the result in the 8-bit register Rd.

Available Registers

Rd: R0L to R7L, R0H to R7H

Operand Format and Number of States Required for Execution

| Addressing Mode | Mnemonic | Operands | Instruction Format | | | | No. of States |
|-----------------|----------|-----------|--------------------|----------|----------|----------|---------------|
| | | | 1st byte | 2nd byte | 3rd byte | 4th byte | |
| Immediate | SUBX | #xx:8, Rd | B | rd | IMM | | 2 |
| Register direct | SUBX | Rs, Rd | 1 | E | rs | rd | 2 |

Notes

2.2.62 TRAPA

TRAPA (TRAP Always)

Trap Unconditionally

Operation

PC → @-SP
 CCR → @-SP
 <Vector> → PC

Condition Code

| | | | | | | | |
|---|-----|---|---|---|---|---|---|
| I | UI | H | U | N | Z | V | C |
| 1 | Δ*1 | — | — | — | — | — | — |

Assembly-Language Format

TRAPA #x:2

Operand Size

—

I: Always set to 1.
 U: See notes.
 H: Previous value remains unchanged.
 N: Previous value remains unchanged.
 Z: Previous value remains unchanged.
 V: Previous value remains unchanged.
 C: Previous value remains unchanged.

Description

This instruction pushes the program counter (PC) and condition-code register (CCR) on the stack, then sets the I bit to 1 and branches to a new address. The new address is the contents of the vector address corresponding to the specified vector number. The PC value pushed on the stack is the starting address of the next instruction after the TRAPA instruction.

| #x | Vector Address | |
|----|------------------|----------------------|
| | Normal Mode | Advanced Mode |
| 0 | H'0010 to H'0011 | H'000020 to H'000023 |
| 1 | H'0012 to H'0013 | H'000024 to H'000027 |
| 2 | H'0014 to H'0015 | H'000028 to H'00002B |
| 3 | H'0016 to H'0017 | H'00002C to H'00002F |

Operand Format and Number of States Required for Execution

| Addressing Mode | Mnemonic | Operands | Instruction Format | | | | No. of States |
|-----------------|----------|----------|--------------------|----------|----------|----------|---------------|
| | | | 1st byte | 2nd byte | 3rd byte | 4th byte | |
| Register direct | TRAPA | #x:2 | 5 | 7 | 00IMM: 0 | | 14 |

Notes

1. CCR bit 6 is set to 1 when used as an interrupt mask bit, but retains its previous value when used as a user bit.
2. The stack and vector structure differ between normal mode and advanced mode.

2.2.63 (1) XOR (B)

XOR (eXclusive OR logical)

Exclusive Logical OR

Operation

$Rd \oplus (EAs) \rightarrow Rd$

Assembly-Language Format

`XOR.B <EAs>, Rd`

Operand Size

Byte

Condition Code

| | | | | | | | |
|---|----|---|---|---|---|---|---|
| I | UI | H | U | N | Z | V | C |
| — | — | — | — | ↑ | ↑ | 0 | — |

H: Previous value remains unchanged.

N: Set to 1 if the result is negative; otherwise cleared to 0.

Z: Set to 1 if the result is zero; otherwise cleared to 0.

V: Always cleared to 0.

C: Previous value remains unchanged.

Description

This instruction exclusively ORs the source operand with the contents of an 8-bit register Rd (destination register) and stores the result in the 8-bit register Rd.

Available Registers

Rd: R0L to R7L, R0H to R7H

Rs: R0L to R7L, R0H to R7H

Operand Format and Number of States Required for Execution

| Addressing Mode | Mnemonic | Operands | Instruction Format | | | | No. of States |
|-----------------|----------|-----------|--------------------|----------|----------|----------|---------------|
| | | | 1st byte | 2nd byte | 3rd byte | 4th byte | |
| Immediate | XOR.B | #xx:8, Rd | D : rd | IMM | | | 2 |
| Register direct | XOR.B | Rs, Rd | 1 : 5 | rs : rd | | | 2 |

Notes

2.2.63 (2) XOR (W)

XOR (eXclusive OR logical)

Exclusive Logical OR

Operation

$Rd \oplus (EAs) \rightarrow Rd$

Assembly-Language Format

XOR.W <EAs>, Rd

Operand Size

Word

Condition Code

| | | | | | | | |
|---|----|---|---|---|---|---|---|
| I | UI | H | U | N | Z | V | C |
| — | — | — | — | ↑ | ↓ | 0 | — |

- H: Previous value remains unchanged.
- N: Set to 1 if the result is negative; otherwise cleared to 0.
- Z: Set to 1 if the result is zero; otherwise cleared to 0.
- V: Always cleared to 0.
- C: Previous value remains unchanged.

Description

This instruction exclusively ORs the source operand with the contents of a 16-bit register Rd (destination register) and stores the result in the 16-bit register Rd.

Available Registers

Rd: R0 to R7, E0 to E7

Rs: R0 to R7, E0 to E7

Operand Format and Number of States Required for Execution

| Addressing Mode | Mnemonic | Operands | Instruction Format | | | | No. of States |
|-----------------|----------|------------|--------------------|----------|----------|----------|---------------|
| | | | 1st byte | 2nd byte | 3rd byte | 4th byte | |
| Immediate | XOR.W | #xx:16, Rd | 7 : 9 | 5 : rd | IMM | | 4 |
| Register direct | XOR.W | Rs, Rd | 6 : 5 | rs : rd | | | 2 |

Notes

2.2.63 (3) XOR (L)

XOR (eXclusive OR logical)

Exclusive Logical OR

Operation

$ERd \oplus (EAs) \rightarrow ERd$

Assembly-Language Format

XOR.L <EAs>, ERd

Operand Size

Longword

Condition Code

| I | UI | H | U | N | Z | V | C |
|---|----|---|---|---|---|---|---|
| — | — | — | — | ↑ | ↑ | 0 | — |

H: Previous value remains unchanged.

N: Set to 1 if the result is negative; otherwise cleared to 0.

Z: Set to 1 if the result is zero; otherwise cleared to 0.

V: Always cleared to 0.

C: Previous value remains unchanged.

Description

This instruction exclusively ORs the source operand with the contents of a 32-bit register ERd (destination register) and stores the result in the 32-bit register ERd.

Available Registers

ERd: ER0 to ER7

ERs: ER0 to ER7

Operand Format and Number of States Required for Execution

| Addressing Mode | Mnemonic | Operands | Instruction Format | | | | | | No. of States | | |
|-----------------|----------|-------------|--------------------|----------|----------|----------|----------|----------|---------------|-------|---|
| | | | 1st byte | 2nd byte | 3rd byte | 4th byte | 5th byte | 6th byte | | | |
| Immediate | XOR.L | #xx:32, ERd | 7 | A | 5 | 0:erd | IMM | | | 6 | |
| Register direct | XOR.L | ERs, ERd | 0 | 1 | F | 0 | 6 | 5 | 0:ers | 0:erd | 4 |

Notes

2.2.64 XORC

XORC (eXclusive OR Control register)

Exclusive Logical OR with CCR

Operation

$CCR \oplus \#IMM \rightarrow CCR$

Assembly-Language Format

XORC #xx:8, CCR

Operand Size

Byte

Condition Code

| | | | | | | | |
|---|----|---|---|---|---|---|---|
| I | UI | H | U | N | Z | V | C |
| ↑ | ↑ | ↑ | ↑ | ↑ | ↑ | ↑ | ↑ |

- I: Stores the corresponding bit of the result.
- UI: Stores the corresponding bit of the result.
- H: Stores the corresponding bit of the result.
- U: Stores the corresponding bit of the result.
- N: Stores the corresponding bit of the result.
- Z: Stores the corresponding bit of the result.
- V: Stores the corresponding bit of the result.
- C: Stores the corresponding bit of the result.

Description

This instruction exclusively ORs the contents of the condition-code register (CCR) with immediate data and stores the result in the condition-code register. No interrupt requests, including NMI, are accepted immediately after execution of this instruction.

Operand Format and Number of States Required for Execution

| Addressing Mode | Mnemonic | Operands | Instruction Format | | | | No. of States |
|-----------------|----------|------------|--------------------|----------|----------|----------|---------------|
| | | | 1st byte | 2nd byte | 3rd byte | 4th byte | |
| Immediate | XORC | #xx:8, CCR | 0 : 5 | IMM | | | 2 |

Notes

2.3 Instruction Set Summary

Table 2-1 Instruction Set Summary

| Function | Instruction | Addressing Mode | | | | | | | | | | | | | |
|-----------------------|--------------------------------------|-----------------|-----|------|-------------|-------------|-------------|-------|--------|--------|-----------|------------|--------|----|---|
| | | #xx | Rn | @ERn | @(d:16,ERn) | @(d:24,ERn) | @ERn+/@-ERn | @aa:8 | @aa:16 | @aa:24 | @(d:8,PC) | @(d:16,PC) | @@aa:8 | — | |
| Data transfer | MOV | BWL | BWL | BWL | BWL | BWL | BWL | B | BWL | BWL | — | — | — | — | |
| | POP, PUSH | — | — | — | — | — | — | — | — | — | — | — | — | WL | |
| | MOVEPE, MOVTPPE | — | — | — | — | — | — | — | B | — | — | — | — | — | |
| | | | | | | | | | | | | | | | |
| Arithmetic operations | ADD, CMP | BWL | BWL | — | — | — | — | — | — | — | — | — | — | — | |
| | SUB | WL | BWL | — | — | — | — | — | — | — | — | — | — | — | |
| | ADDX, SUBX | B | B | — | — | — | — | — | — | — | — | — | — | — | |
| | ADDS, SUBS | — | L | — | — | — | — | — | — | — | — | — | — | — | |
| | INC, DEC | — | BWL | — | — | — | — | — | — | — | — | — | — | — | |
| | DAA, DAS | — | B | — | — | — | — | — | — | — | — | — | — | — | |
| | MULXU, DIVXU, MULXS, DIVXS, | — | BW | — | — | — | — | — | — | — | — | — | — | — | — |
| | NEG | — | BWL | — | — | — | — | — | — | — | — | — | — | — | — |
| | EXTU, EXTS | — | WL | — | — | — | — | — | — | — | — | — | — | — | — |
| | | | | | | | | | | | | | | | |
| Logic operations | AND, OR, XOR | BWL | BWL | — | — | — | — | — | — | — | — | — | — | — | |
| | NOT | — | BWL | — | — | — | — | — | — | — | — | — | — | — | |
| Shift operations | | — | BWL | — | — | — | — | — | — | — | — | — | — | — | |
| Bit manipulation | | — | B | B | — | — | — | B | — | — | — | — | — | — | |

Table 2-1 Instruction Set Summary (cont)

| Function | Instruction | Addressing Mode | | | | | | | | | | | | |
|----------------|-------------------------|-----------------|----|------|-------------|-------------|-------------|-------|--------|--------|-----------|------------|--------|---|
| | | #xx | Rn | @ERn | @(d:16,ERn) | @(d:24,ERn) | @ERn+/@-ERn | @aa:8 | @aa:16 | @aa:24 | @(d:8,PC) | @(d:16,PC) | @@aa:8 | — |
| Branch | Bcc, BSR | — | — | — | — | — | — | — | — | — | ○ | ○ | — | — |
| | JMP, JSR | — | — | ○ | — | — | — | — | — | ○ | — | — | ○ | — |
| | RTS | — | — | — | — | — | — | — | — | — | — | — | — | ○ |
| System control | TRAPA, RTE, SLEEP | — | — | — | — | — | — | — | — | — | — | — | — | ○ |
| | LDC | B | B | W | W | W | W | — | W | W | — | — | — | — |
| | STC | — | B | W | W | W | W | — | W | W | — | — | — | — |
| | ANDC, ORC, XORC | B | — | — | — | — | — | — | — | — | — | — | — | — |
| | NOP | — | — | — | — | — | — | — | — | — | — | — | — | ○ |
| | Block data transfer | — | — | — | — | — | — | — | — | — | — | — | — | — |

Legend

B: Byte

W: Word

L: Longword

Table 2-2 Instruction Set

(1) Data Transfer Instructions

| Mnemonic | Addressing Mode and Instruction Length (bytes) | | | | | | | Operation | Condition Code | | | | | No. of States | | | | |
|----------------------|--|-----|----|------|----------|-------------|-----|-----------|----------------|------|---|---|---|---------------|---|---|--------|---------------|
| | Size | #xx | Rn | @ERn | @(d,ERn) | @ERn+/@-ERn | @aa | | @(d,PC) | @@aa | I | H | N | Z | V | C | Normal | Ad- vanced |
| MOV | MOV.B #xx:8,Rd | B | 2 | | | | | | | | | | ↓ | ↓ | 0 | — | 2 | 2 |
| | MOV.B Rs,Rd | B | | 2 | | | | | | | | | ↓ | ↓ | 0 | — | 2 | 2 |
| | MOV.B @ERs,Rd | B | | | 2 | | | | | | | | ↓ | ↓ | 0 | — | 4 | 4 |
| | MOV.B @(d:16,ERs),Rd | B | | | | 4 | | | | | | | ↓ | ↓ | 0 | — | 6 | 6 |
| | MOV.B @(d:24,ERs),Rd | B | | | | | 8 | | | | | | ↓ | ↓ | 0 | — | 10 | 10 |
| | MOV.B @ERs+,Rd | B | | | | | | 2 | | | | | ↓ | ↓ | 0 | — | 6 | 6 |
| | MOV.B @aa:8,Rd | B | | | | | | | 2 | | | | ↓ | ↓ | 0 | — | 4 | 4 |
| | MOV.B @aa:16,Rd | B | | | | | | | | 4 | | | ↓ | ↓ | 0 | — | 6 | 6 |
| | MOV.B @aa:24,Rd | B | | | | | | | | | 6 | | ↓ | ↓ | 0 | — | 8 | 8 |
| | MOV.B Rs,@ERd | B | | | 2 | | | | | | | | ↓ | ↓ | 0 | — | 4 | 4 |
| | MOV.B Rs,@(d:16,ERd) | B | | | | 4 | | | | | | | ↓ | ↓ | 0 | — | 6 | 6 |
| | MOV.B Rs,@(d:24,ERd) | B | | | | | 8 | | | | | | ↓ | ↓ | 0 | — | 10 | 10 |
| | MOV.B Rs,@-ERd | B | | | | | | 2 | | | | | ↓ | ↓ | 0 | — | 6 | 6 |
| | MOV.B Rs,@aa:8 | B | | | | | | | 2 | | | | ↓ | ↓ | 0 | — | 4 | 4 |
| | MOV.B Rs,@aa:16 | B | | | | | | | | 4 | | | ↓ | ↓ | 0 | — | 6 | 6 |
| | MOV.B Rs,@aa:24 | B | | | | | | | | | 6 | | ↓ | ↓ | 0 | — | 8 | 8 |
| | MOV.W #xx:16,Rd | W | 4 | | | | | | | | | | ↓ | ↓ | 0 | — | 4 | 4 |
| | MOV.W Rs,Rd | W | | 2 | | | | | | | | | ↓ | ↓ | 0 | — | 2 | 2 |
| | MOV.W @ERs,Rd | W | | | 2 | | | | | | | | ↓ | ↓ | 0 | — | 4 | 4 |
| | MOV.W @(d:16,ERs),Rd | W | | | | 4 | | | | | | | ↓ | ↓ | 0 | — | 6 | 6 |
| | MOV.W @(d:24,ERs),Rd | W | | | | | 8 | | | | | | ↓ | ↓ | 0 | — | 10 | 10 |
| | MOV.W @ERs+,Rd | W | | | | | | 2 | | | | | ↓ | ↓ | 0 | — | 6 | 6 |
| | MOV.W @aa:16,Rd | W | | | | | | | 4 | | | | ↓ | ↓ | 0 | — | 6 | 6 |
| MOV.W @aa:24,Rd | W | | | | | | | | 6 | | | ↓ | ↓ | 0 | — | 8 | 8 | |
| MOV.W Rs,@ERd | W | | | 2 | | | | | | | | ↓ | ↓ | 0 | — | 4 | 4 | |
| MOV.W Rs,@(d:16,ERd) | W | | | | 4 | | | | | | | ↓ | ↓ | 0 | — | 6 | 6 | |
| MOV.W Rs,@(d:24,ERd) | W | | | | | 8 | | | | | | ↓ | ↓ | 0 | — | 8 | 10 | |
| MOV.W Rs,@-ERd | W | | | | | | 2 | | | | | ↓ | ↓ | 0 | — | 6 | 6 | |
| MOV.W Rs,@aa:16 | W | | | | | | | 4 | | | | ↓ | ↓ | 0 | — | 6 | 6 | |
| MOV.W Rs,@aa:24 | W | | | | | | | | 6 | | | ↓ | ↓ | 0 | — | 8 | 8 | |
| MOV.L #xx:32,ERd | L | 6 | | | | | | | | | | ↓ | ↓ | 0 | — | 8 | 6 | |
| MOV.L ERs,ERd | L | | 2 | | | | | | | | | ↓ | ↓ | 0 | — | 2 | 2 | |
| MOV.L @ERs,ERd | L | | | 4 | | | | | | | | ↓ | ↓ | 0 | — | 8 | 8 | |

Table 2-2 Instruction Set (cont)

(1) Data Transfer Instructions

| Mnemonic | Addressing Mode and Instruction Length (bytes) | | | | | | | Operation | Condition Code | | | | | No. of States | | |
|------------------|--|-----|----|------|----------|-------------|--|--------------------------|----------------|---|---|---|---|---------------|--------|---------------|
| | Size | #xx | Rn | @ERn | @(d,ERn) | @ERn+/@-ERn | @aa @(d,PC) @@@a | | I | H | N | Z | V | C | Normal | Ad- vanced |
| MOV | MOV.L @(d:16,ERs),ERd | L | | | 6 | | | @(d:16,ERs)→ERd32 | — | — | ↓ | ↓ | 0 | — | 10 | 10 |
| | MOV.L @(d:24,ERs),ERd | L | | | 10 | | | @(d:24,ERs)→ERd32 | — | — | ↓ | ↓ | 0 | — | 14 | 14 |
| | MOV.L @ERs+,ERd | L | | | | 4 | | ERs→ERd32,ERs32+4→@ERs32 | — | — | ↓ | ↓ | 0 | — | 10 | 10 |
| | MOV.L @aa:16,ERd | L | | | | | 6 | @aa:16→ERd32 | — | — | ↓ | ↓ | 0 | — | 10 | 10 |
| | MOV.L @aa:24,ERd | L | | | | | 8 | @aa:24→ERd32 | — | — | ↓ | ↓ | 0 | — | 12 | 12 |
| | MOV.L ERs,@ERd | L | | | 4 | | | ERs32→@ERd24 | — | — | ↓ | ↓ | 0 | — | 8 | 8 |
| | MOV.L ERs,@(d:16,ERd) | L | | | 6 | | | ERs32→@(d:16,ERd) | — | — | ↓ | ↓ | 0 | — | 10 | 10 |
| | MOV.L ERs,@(d:24,ERd) | L | | | 10 | | | ERs32→@(d:24,ERd) | — | — | ↓ | ↓ | 0 | — | 14 | 14 |
| | MOV.L ERs,@-ERd | L | | | | 4 | | ERd32-4→ERd32,ERs32→@ERd | — | — | ↓ | ↓ | 0 | — | 10 | 10 |
| MOV.L ERs,@aa:16 | L | | | | | 6 | ERs32→@aa:16 | — | — | ↓ | ↓ | 0 | — | 10 | 10 | |
| MOV.L ERs,@aa:24 | L | | | | | 8 | ERs32→@aa:24 | — | — | ↓ | ↓ | 0 | — | 12 | 12 | |
| POP | POP.W Rn | W | | | | | 2 | @SP→Rn16,SP+2→SP | — | — | ↓ | ↓ | 0 | — | 6 | 6 |
| | POPL ERn | L | | | | | 4 | @SP→ERn32,SP+4→SP | — | — | ↓ | ↓ | 0 | — | 8 | 10 |
| PUSH | PUSH.W Rn | W | | | | | 2 | SP-2→SP,Rn16→@SP | — | — | ↓ | ↓ | 0 | — | 6 | 6 |
| | PUSH.L ERn | L | | | | | 4 | SP-4→SP,ERn32→@SP | — | — | ↓ | ↓ | 0 | — | 8 | 10 |
| MOVFPE | MOVFPE@aa:16,Rd | B | | | | 4 | @aa:16→Rd (synchronized with E clock) | — | — | ↓ | ↓ | 0 | — | ⑥ | ⑥ | |
| MOVTPE | MOVTPE Rs,@aa:16 | B | | | | 4 | Rs→@aa:16 (synchronized with E clock)R | — | — | ↓ | ↓ | 0 | — | ⑥ | ⑥ | |

(2) Arithmetic Operation Instructions

| Mnemonic | Addressing Mode and Instruction Length (bytes) | | | | | | | Operation | Condition Code | | | | | No. of States | | |
|---------------|--|-----|----|------|----------|-------------|-------------------|--------------------|----------------|---|---|---|---|---------------|--------|---------------|
| | Size | #xx | Rn | @ERn | @(d,ERn) | @ERn+/@-ERn | @aa @(d,PC) @@@a | | I | H | N | Z | V | C | Normal | Ad- vanced |
| ADD | ADD.B #xx:8,Rd | B | 2 | | | | | Rd8+#xx:8→Rd8 | — | ↓ | ↓ | ↓ | ↓ | ↓ | 2 | 2 |
| | ADD.B Rs,Rd | B | | 2 | | | | Rd8+Rs8→Rd8 | — | ↓ | ↓ | ↓ | ↓ | ↓ | 2 | 2 |
| | ADD.W #xx:16,Rd | W | 4 | | | | | Rd16+#xx:16→Rd16 | — | ① | ↓ | ↓ | ↓ | ↓ | 4 | 4 |
| | ADD.W Rs,Rd | W | | 2 | | | | Rd16+Rs16→Rd16 | — | ① | ↓ | ↓ | ↓ | ↓ | 2 | 2 |
| | ADD.L #xx:32,ERd | L | 6 | | | | | ERd32+#xx:32→ERd32 | — | ② | ↓ | ↓ | ↓ | ↓ | 6 | 6 |
| ADD.L ERs,ERd | L | | 2 | | | | ERd32+ERs32→ERd32 | — | ② | ↓ | ↓ | ↓ | ↓ | 2 | 2 | |
| ADDX | ADDX #xx:8,Rd | B | 2 | | | | | Rd8+#xx:8+C→Rd8 | — | ↓ | ↓ | ③ | ↓ | ↓ | 2 | 2 |
| | ADDX Rs,Rd | B | | 2 | | | | Rd8+Rs8+C→Rd8 | — | ↓ | ↓ | ③ | ↓ | ↓ | 2 | 2 |

Table 2-2 Instruction Set (cont)

(2) Arithmetic Operation Instructions

| Mnemonic | Addressing Mode and Instruction Length (bytes) | | | | | | Operation | Condition Code | | | | | No. of States | | | | |
|----------|--|-----|----|------|----------|-------------|-----------|----------------|---------|------|---|---|---------------|---|---|---|--------|
| | Size | #xx | Rn | @ERn | @(d,ERn) | @ERn+/@-ERn | | @aa | @(d,PC) | @@aa | I | H | N | Z | V | C | Normal |
| ADDS | ADDS.L #1,ERd | L | 2 | | | | | | | | | | | | | 2 | 2 |
| | ADDS.L #2,ERd | L | 2 | | | | | | | | | | | | | 2 | 2 |
| | ADDS.L #4,ERd | L | 2 | | | | | | | | | | | | | 2 | 2 |
| INC | INC.B Rd | B | 2 | | | | | | | | | | | | | 2 | 2 |
| | INC.W #1,Rd | W | 2 | | | | | | | | | | | | | 2 | 2 |
| | INC.W #2,Rd | W | 2 | | | | | | | | | | | | | 2 | 2 |
| | INC.L #1,ERd | L | 2 | | | | | | | | | | | | | 2 | 2 |
| | INC.L #2,ERd | L | 2 | | | | | | | | | | | | | 2 | 2 |
| DAA | DAA Rd | B | 2 | | | | | | | | * | | | | | 2 | 2 |
| SUB | SUB.B Rs,Rd | B | 2 | | | | | | | | | | | | | 2 | 2 |
| | SUB.W #xx:16,Rd | W | 4 | | | | | | | | ① | | | | | 4 | 4 |
| | SUB.W Rs,Rd | W | 2 | | | | | | | | ① | | | | | 2 | 2 |
| | SUB.L #xx:32,ERd | L | 6 | | | | | | | | ② | | | | | 6 | 6 |
| | SUB.L ERs,ERd | L | 2 | | | | | | | | ② | | | | | 2 | 2 |
| SUBX | SUBX.B #xx:8,Rd | B | 2 | | | | | | | | | | ③ | | | 2 | 2 |
| | SUBX.B Rs,Rd | B | 2 | | | | | | | | | | ③ | | | 2 | 2 |
| SUBS | SUBS.L #1,ERd | L | 2 | | | | | | | | | | | | | 2 | 2 |
| | SUBS.L #2,ERd | L | 2 | | | | | | | | | | | | | 2 | 2 |
| | SUBS.L #4,ERd | L | 2 | | | | | | | | | | | | | 2 | 2 |
| DEC | DEC.B Rd | B | 2 | | | | | | | | | | | | | 2 | 2 |
| | DEC.W #1,Rd | W | 2 | | | | | | | | | | | | | 2 | 2 |
| | DEC.W #2,Rd | W | 2 | | | | | | | | | | | | | 2 | 2 |
| | DEC.L #1,ERd | L | 2 | | | | | | | | | | | | | 2 | 2 |
| | DEC.L #2,ERd | L | 2 | | | | | | | | | | | | | 2 | 2 |
| DAS | DAS Rd | B | 2 | | | | | | | | * | | | | | 2 | 2 |
| NEG | NEG.B Rd | B | 2 | | | | | | | | | | | | | 2 | 2 |
| | NEG.W Rd | W | 2 | | | | | | | | | | | | | 2 | 2 |
| | NEG.L ERd | L | 2 | | | | | | | | | | | | | 2 | 2 |

Table 2-2 Instruction Set (cont)

(2) Arithmetic Operation Instructions

| Mnemonic | Addressing Mode and Instruction Length (bytes) | | | | | | | Operation | Condition Code | | | | | | No. of States | | |
|----------|--|-----|----|------|----------|-------------|-----|-----------|----------------|------|---|---|---|---|---------------|----|--------|
| | Size | #xx | Rn | @ERn | @(d,ERn) | @ERn+/@-ERn | @aa | | @(d,PC) | @@aa | I | H | N | Z | V | C | Normal |
| CMP | CMP.B #xx:8,Rd | B | 2 | | | | | | | | | | | | | 2 | 2 |
| | CMP.B Rs,Rd | B | 2 | | | | | | | | | | | | | 2 | 2 |
| | CMP.W #xx:16,Rd | W | 4 | | | | | | | | | | | | | 4 | 4 |
| | CMP.W Rs,Rd | W | 2 | | | | | | | | | | | | | 2 | 2 |
| | CMP.L #xx:32,ERd | L | 6 | | | | | | | | | | | | | 4 | 6 |
| | CMP.L ERs,ERd | L | 2 | | | | | | | | | | | | | 2 | 2 |
| MULXU | MULXU.B Rs,Rd | B | 2 | | | | | | | | | | | | | 14 | 14 |
| | MULXU.W Rs,ERd | W | 2 | | | | | | | | | | | | | 22 | 22 |
| MULXS | MULXS.B Rs,Rd | B | 4 | | | | | | | | | | | | | 16 | 16 |
| | MULXS.W Rs,ERd | W | 4 | | | | | | | | | | | | | 24 | 24 |
| DIVXU | DIVXU.B Rs,Rd | B | 2 | | | | | | | | | | | | | 14 | 14 |
| | DIVXU.W Rs,ERd | W | 2 | | | | | | | | | | | | | 22 | 22 |
| DIVXS | DIVXS.B Rs,Rd | B | 4 | | | | | | | | | | | | | 16 | 16 |
| | DIVXS.W Rs,ERd | W | 4 | | | | | | | | | | | | | 24 | 24 |
| EXTU | EXTU.W Rd | W | 2 | | | | | | | | | | | | | 2 | 2 |
| | EXTU.L ERd | L | 2 | | | | | | | | | | | | | 2 | 2 |
| EXTS | EXTS.W Rd | W | 2 | | | | | | | | | | | | | 2 | 2 |
| | EXTS.L ERd | L | 2 | | | | | | | | | | | | | 2 | 2 |

Table 2-2 Instruction Set (cont)

(3) Logic Operation Instructions

| Mnemonic | Addressing Mode and Instruction Length (bytes) | | | | | | | Operation | Condition Code | | | | | No. of States | | | | |
|----------|--|-----|----|------|----------|-------------|-----|-----------|----------------|------|---|---|---|---------------|---|---|--------|---------------|
| | Size | #xx | Rn | @ERn | @(d,ERn) | @ERn+/@-ERn | @aa | | @(d,PC) | @@aa | I | H | N | Z | V | C | Normal | Ad- vanced |
| AND | AND.B #xx:8,Rd | B | 2 | | | | | | | | | | ↓ | ↓ | 0 | — | 2 | 2 |
| | AND.B Rs,Rd | B | | 2 | | | | | | | | | ↓ | ↓ | 0 | — | 2 | 2 |
| | AND.W #xx:16,Rd | W | 4 | | | | | | | | | | ↓ | ↓ | 0 | — | 4 | 4 |
| | AND.W Rs,Rd | W | | 2 | | | | | | | | | ↓ | ↓ | 0 | — | 2 | 2 |
| | AND.L #xx:32,ERd | L | 6 | | | | | | | | | | ↓ | ↓ | 0 | — | 6 | 6 |
| | AND.L ERs,ERd | L | | 4 | | | | | | | | | ↓ | ↓ | 0 | — | 4 | 4 |
| OR | OR.B #xx:8,Rd | B | 2 | | | | | | | | | | ↓ | ↓ | 0 | — | 2 | 2 |
| | OR.B Rs,Rd | B | | 2 | | | | | | | | | ↓ | ↓ | 0 | — | 2 | 2 |
| | OR.W #xx:16,Rd | W | 4 | | | | | | | | | | ↓ | ↓ | 0 | — | 4 | 4 |
| | OR.W Rs,Rd | W | | 2 | | | | | | | | | ↓ | ↓ | 0 | — | 2 | 2 |
| | OR.L #xx:32,ERd | L | 6 | | | | | | | | | | ↓ | ↓ | 0 | — | 6 | 6 |
| | OR.L ERs,ERd | L | | 4 | | | | | | | | | ↓ | ↓ | 0 | — | 4 | 4 |
| XOR | XOR.B #xx:8,Rd | B | 2 | | | | | | | | | | ↓ | ↓ | 0 | — | 2 | 2 |
| | XOR.B Rs,Rd | B | | 2 | | | | | | | | | ↓ | ↓ | 0 | — | 2 | 2 |
| | XOR.W #xx:16,Rd | W | 4 | | | | | | | | | | ↓ | ↓ | 0 | — | 4 | 4 |
| | XOR.W Rs,Rd | W | | 2 | | | | | | | | | ↓ | ↓ | 0 | — | 2 | 2 |
| | XOR.L #xx:32,ERd | L | 6 | | | | | | | | | | ↓ | ↓ | 0 | — | 6 | 6 |
| | XOR.L ERs,ERd | L | | 4 | | | | | | | | | ↓ | ↓ | 0 | — | 4 | 4 |
| NOT | NOT.B Rd | B | 2 | | | | | | | | | | ↓ | ↓ | 0 | — | 2 | 2 |
| | NOT.W Rd | W | 2 | | | | | | | | | | ↓ | ↓ | 0 | — | 2 | 2 |
| | NOT.L ERd | L | 2 | | | | | | | | | | ↓ | ↓ | 0 | — | 2 | 2 |

Table 2-2 Instruction Set (cont)

(4) Shift Instructions

| Mnemonic | Size #xx | Rn | Addressing Mode and Instruction Length (bytes) | | | | Operation | Condition Code | | | | | | No. of States | | | | | |
|----------|-------------|----|--|----------|-------------|-------------|-----------|----------------|---|---|---|---|---|---------------|--------|---------------|--|--|--|
| | | | @ERn | @(d,ERn) | @ERn+/@-ERn | @aa @(d,PC) | | @@aa | I | H | N | Z | V | C | Normal | Ad- vanced | | | |
| SHAL | SHAL.B Rd | B | 2 | | | | | | | | | | | | | | | | |
| | SHAL.W Rd | W | 2 | | | | | | | | | | | | | | | | |
| | SHAL.L ERd | L | 2 | | | | | | | | | | | | | | | | |
| SHAR | SHAR.B Rd | B | 2 | | | | | | | | | | | | | | | | |
| | SHAR.W Rd | W | 2 | | | | | | | | | | | | | | | | |
| | SHAR.L ERd | L | 2 | | | | | | | | | | | | | | | | |
| SHLL | SHLL.B Rd | B | 2 | | | | | | | | | | | | | | | | |
| | SHLL.W Rd | W | 2 | | | | | | | | | | | | | | | | |
| | SHLL.L ERd | L | 2 | | | | | | | | | | | | | | | | |
| SHLR | SHLR.B Rd | B | 2 | | | | | | | | | | | | | | | | |
| | SHLR.W Rd | W | 2 | | | | | | | | | | | | | | | | |
| | SHLR.L ERd | L | 2 | | | | | | | | | | | | | | | | |
| ROTXL | ROTXL.B Rd | B | 2 | | | | | | | | | | | | | | | | |
| | ROTXL.W Rd | W | 2 | | | | | | | | | | | | | | | | |
| | ROTXL.L ERd | L | 2 | | | | | | | | | | | | | | | | |
| ROTXR | ROTXR.B Rd | B | 2 | | | | | | | | | | | | | | | | |
| | ROTXR.W Rd | W | 2 | | | | | | | | | | | | | | | | |
| | ROTXR.L ERd | L | 2 | | | | | | | | | | | | | | | | |
| ROTL | ROTL.B Rd | B | 2 | | | | | | | | | | | | | | | | |
| | ROTL.W Rd | W | 2 | | | | | | | | | | | | | | | | |
| | ROTL.L ERd | L | 2 | | | | | | | | | | | | | | | | |
| ROTR | ROTR.B Rd | B | 2 | | | | | | | | | | | | | | | | |
| | ROTR.W Rd | W | 2 | | | | | | | | | | | | | | | | |
| | ROTR.L ERd | L | 2 | | | | | | | | | | | | | | | | |

Table 2-2 Instruction Set (cont)

(5) Bit Manipulation Instructions

| Mnemonic | Addressing Mode and Instruction Length (bytes) | | | | | | | Condition Code | | | | | No. of States | | | | | | |
|----------|--|-----|----|------|----------|-------------|-----|----------------|------|---|-----------|---|---------------|---|---|---|---|--------|---------------|
| | Size | #xx | Rn | @ERn | @(d,ERn) | @ERn+/@-ERn | @aa | @(d,PC) | @@aa | — | Operation | I | H | N | Z | V | C | Normal | Ad- vanced |
| BSET | BSET #xx:3,Rd | B | 2 | | | | | | | | | — | — | — | — | — | 2 | 2 | |
| | BSET #xx:3,@ERd | B | | 4 | | | | | | | | — | — | — | — | — | 8 | 8 | |
| | BSET #xx:3,@aa:8 | B | | | | 4 | | | | | | — | — | — | — | — | 8 | 8 | |
| | BSET Rn,Rd | B | 2 | | | | | | | | | — | — | — | — | — | 2 | 2 | |
| | BSET Rn,@ERd | B | | 4 | | | | | | | | — | — | — | — | — | 8 | 8 | |
| | BSET Rn,@aa:8 | B | | | | 4 | | | | | | — | — | — | — | — | 8 | 8 | |
| BCLR | BCLR #xx:3,Rd | B | 2 | | | | | | | | | — | — | — | — | — | 2 | 2 | |
| | BCLR #xx:3,@ERd | B | | 4 | | | | | | | | — | — | — | — | — | 8 | 8 | |
| | BCLR #xx:3,@aa:8 | B | | | | 4 | | | | | | — | — | — | — | — | 8 | 8 | |
| | BCLR Rn,Rd | B | 2 | | | | | | | | | — | — | — | — | — | 2 | 2 | |
| | BCLR Rn,@ERd | B | | 4 | | | | | | | | — | — | — | — | — | 8 | 8 | |
| | BCLR Rn,@aa:8 | B | | | | 4 | | | | | | — | — | — | — | — | 8 | 8 | |
| BNOT | BNOT #xx:3,Rd | B | 2 | | | | | | | | | — | — | — | — | — | 2 | 2 | |
| | BNOT #xx:3,@ERd | B | | 4 | | | | | | | | — | — | — | — | — | 8 | 8 | |
| | BNOT #xx:3,@aa:8 | B | | | | 4 | | | | | | — | — | — | — | — | 8 | 8 | |
| | BNOT Rn,Rd | B | 2 | | | | | | | | | — | — | — | — | — | 2 | 2 | |
| | BNOT Rn,@ERd | B | | 4 | | | | | | | | — | — | — | — | — | 8 | 8 | |
| | BNOT Rn,@aa:8 | B | | | | 4 | | | | | | — | — | — | — | — | 8 | 8 | |
| BTST | BTST #xx:3,Rd | B | 2 | | | | | | | | | — | — | — | ↑ | — | 2 | 2 | |
| | BTST #xx:3,@ERd | B | | 4 | | | | | | | | — | — | — | ↑ | — | 6 | 6 | |
| | BTST #xx:3,@aa:8 | B | | | | 4 | | | | | | — | — | — | ↑ | — | 6 | 6 | |
| | BTST Rn,Rd | B | 2 | | | | | | | | | — | — | — | ↑ | — | 2 | 2 | |
| | BTST Rn,@ERd | B | | 4 | | | | | | | | — | — | — | ↑ | — | 6 | 6 | |
| | BTST Rn,@aa:8 | B | | | | 4 | | | | | | — | — | — | ↑ | — | 6 | 6 | |
| BLD | BLD #xx:3,Rd | B | 2 | | | | | | | | | — | — | — | — | ↑ | 2 | 2 | |
| | BLD #xx:3,@ERd | B | | 4 | | | | | | | | — | — | — | — | ↑ | 6 | 6 | |
| | BLD #xx:3,@aa:8 | B | | | | 4 | | | | | | — | — | — | — | ↑ | 6 | 6 | |
| BILD | BILD #xx:3,Rd | B | 2 | | | | | | | | | — | — | — | — | ↑ | 2 | 2 | |
| | BILD #xx:3,@ERd | B | | 4 | | | | | | | | — | — | — | — | ↑ | 6 | 6 | |
| | BILD #xx:3,@aa:8 | B | | | | 4 | | | | | | — | — | — | — | ↑ | 6 | 6 | |

Table 2-2 Instruction Set (cont)

(5) Bit Manipulation Instructions

| Mnemonic | Size | #xx | Rn | Addressing Mode and Instruction Length (bytes) | | | | Operation | Condition Code | | | | | No. of States | | |
|----------|-------------------|-----|----|--|----------|-------------|-----|-----------|----------------|------|---|---|---|---------------|---|---|
| | | | | @ERn | @(d,ERn) | @ERn+/@-ERn | @aa | | @(d,PC) | @@aa | I | H | N | Z | V | C |
| BST | BST #xx:3,Rd | B | 2 | | | | | | | | | | | | 2 | 2 |
| | BST #xx:3,@ERd | B | | 4 | | | | | | | | | | | 8 | 8 |
| | BST #xx:3,@aa:8 | B | | | | 4 | | | | | | | | | 8 | 8 |
| BIST | BIST #xx:3,Rd | B | 2 | | | | | | | | | | | | 2 | 2 |
| | BIST #xx:3,@ERd | B | | 4 | | | | | | | | | | | 8 | 8 |
| | BIST #xx:3,@aa:8 | B | | | | 4 | | | | | | | | | 8 | 8 |
| BAND | BAND #xx:3,Rd | B | 2 | | | | | | | | | | | ↓ | 2 | 2 |
| | BAND #xx:3,@ERd | B | | 4 | | | | | | | | | | ↓ | 6 | 6 |
| | BAND #xx:3,@aa:8 | B | | | | 4 | | | | | | | | ↓ | 6 | 6 |
| BIAND | BIAND #xx:3,Rd | B | 2 | | | | | | | | | | | ↓ | 2 | 2 |
| | BIAND #xx:3,@ERd | B | | 4 | | | | | | | | | | ↓ | 6 | 6 |
| | BIAND #xx:3,@aa:8 | B | | | | 4 | | | | | | | | ↓ | 6 | 6 |
| BOR | BOR #xx:3,Rd | B | 2 | | | | | | | | | | | ↓ | 2 | 2 |
| | BOR #xx:3,@ERd | B | | 4 | | | | | | | | | | ↓ | 6 | 6 |
| | BOR #xx:3,@aa:8 | B | | | | 4 | | | | | | | | ↓ | 6 | 6 |
| BIOR | BIOR #xx:3,Rd | B | 2 | | | | | | | | | | | ↓ | 2 | 2 |
| | BIOR #xx:3,@ERd | B | | 4 | | | | | | | | | | ↓ | 6 | 6 |
| | BIOR #xx:3,@aa:8 | B | | | | 4 | | | | | | | | ↓ | 6 | 6 |
| BXOR | BXOR #xx:3,Rd | B | 2 | | | | | | | | | | | ↓ | 2 | 2 |
| | BXOR #xx:3,@ERd | B | | 4 | | | | | | | | | | ↓ | 6 | 6 |
| | BXOR #xx:3,@aa:8 | B | | | | 4 | | | | | | | | ↓ | 6 | 6 |
| BIXOR | BIXOR #xx:3,Rd | B | 2 | | | | | | | | | | | ↓ | 2 | 2 |
| | BIXOR #xx:3,@ERd | B | | 4 | | | | | | | | | | ↓ | 6 | 6 |
| | BIXOR #xx:3,@aa:8 | B | | | | 4 | | | | | | | | ↓ | 6 | 6 |

(6) Branch Instructions

| Mnemonic | Addressing Mode and Instruction Length (bytes) | | | | | | Operation | Branch condition | Condition Code | | | | | | No. of States | | |
|----------|--|-----|----|------|----------|-------------|-----------|---------------------------|----------------|---------|------|---|---|---|---------------|---|----|
| | Size | #xx | Rn | @ERn | @(d,ERn) | @ERn+/@-ERn | | | @aa | @(d,PC) | @@aa | I | H | N | Z | V | C |
| Bcc | BRA d:8(BTd:8) | — | | | | | 2 | if condition is true then | Always | — | — | — | — | — | — | 4 | 4 |
| | BRA d:16(BTd:16) | — | | | | | 4 | PC←-PC+d | | — | — | — | — | — | — | 6 | 6 |
| | BRN d:8(BFd:8) | — | | | | | 2 | else next; | Never | — | — | — | — | — | — | 4 | 4 |
| | BRN d:16(BFd:16) | — | | | | | 4 | | | — | — | — | — | — | — | 6 | 6 |
| | BHI d:8 | — | | | | | 2 | | C V Z = 0 | — | — | — | — | — | — | 4 | 4 |
| | BHI d:16 | — | | | | | 4 | | | — | — | — | — | — | — | 6 | 6 |
| | BLS d:8 | — | | | | | 2 | | C V Z = 1 | — | — | — | — | — | — | 4 | 4 |
| | BLS d:16 | — | | | | | 4 | | | — | — | — | — | — | — | 6 | 6 |
| | BCC d:8(BHS d:8) | — | | | | | 2 | | C = 0 | — | — | — | — | — | — | 4 | 4 |
| | BCC d:16(BHS d:16) | — | | | | | 4 | | | — | — | — | — | — | — | 6 | 6 |
| | BCS d:8(BLO d:8) | — | | | | | 2 | | C = 1 | — | — | — | — | — | — | 4 | 4 |
| | BCS d:16(BLO d:16) | — | | | | | 4 | | | — | — | — | — | — | — | 6 | 6 |
| | BNE d:8 | — | | | | | 2 | | Z = 0 | — | — | — | — | — | — | 4 | 4 |
| | BNE d:16 | — | | | | | 4 | | | — | — | — | — | — | — | 6 | 6 |
| | BEQ d:8 | — | | | | | 2 | | Z = 1 | — | — | — | — | — | — | 4 | 4 |
| | BEQ d:16 | — | | | | | 4 | | | — | — | — | — | — | — | 6 | 6 |
| | BVC d:8 | — | | | | | 2 | | V = 0 | — | — | — | — | — | — | 4 | 4 |
| | BVC d:16 | — | | | | | 4 | | | — | — | — | — | — | — | 6 | 6 |
| | BVS d:8 | — | | | | | 2 | | V = 1 | — | — | — | — | — | — | 4 | 4 |
| | BVS d:16 | — | | | | | 4 | | | — | — | — | — | — | — | 6 | 6 |
| | BPL d:8 | — | | | | | 2 | | N = 0 | — | — | — | — | — | — | 4 | 4 |
| | BPL d:16 | — | | | | | 4 | | | — | — | — | — | — | — | 6 | 6 |
| | BMI d:8 | — | | | | | 2 | | N = 1 | — | — | — | — | — | — | 4 | 4 |
| | BMI d:16 | — | | | | | 4 | | | — | — | — | — | — | — | 6 | 6 |
| BGE d:8 | — | | | | | 2 | | N ⊕ V = 0 | — | — | — | — | — | — | 4 | 4 | |
| BGE d:16 | — | | | | | 4 | | | — | — | — | — | — | — | 6 | 6 | |
| BLT d:8 | — | | | | | 2 | | N ⊕ V = 1 | — | — | — | — | — | — | 4 | 4 | |
| BLT d:16 | — | | | | | 4 | | | — | — | — | — | — | — | 6 | 6 | |
| BGT d:8 | — | | | | | 2 | | Z V (N ⊕ V) = 0 | — | — | — | — | — | — | 4 | 4 | |
| BGT d:16 | — | | | | | 4 | | | — | — | — | — | — | — | 6 | 6 | |
| BLE d:8 | — | | | | | 2 | | Z V (N ⊕ V) = 1 | — | — | — | — | — | — | 4 | 4 | |
| BLE d:16 | — | | | | | 4 | | | — | — | — | — | — | — | 6 | 6 | |
| JMP | JMP @ERn | — | | 2 | | | | PC←ERn | | — | — | — | — | — | — | 4 | 4 |
| | JMP @aa:24 | — | | | | | 4 | PC←aa:24 | | — | — | — | — | — | — | 6 | 6 |
| | JMP @@aa:8 | — | | | | | | 2 | PC←@@aa:8 | | — | — | — | — | — | 8 | 10 |

Table 2-2 Instruction Set (cont)

(6) Branch Instructions

| Mnemonic | Addressing Mode and Instruction Length (bytes) | | | | | | | | Operation | Branch condition | Condition Code | | | | | No. of States | |
|----------|--|-----|----|------|----------|-------------|-----|---------|--------------------|------------------|----------------|---|---|---|---|---------------|----|
| | Size | #xx | Rn | @ERn | @(d,ERn) | @ERn+/@-ERn | @aa | @(d,PC) | | | @@aa | I | H | N | Z | V | C |
| BSR | BSR d:8 | — | | | | | | 2 | PC→@-SP,PC←PC+d:8 | — | — | — | — | — | — | 6 | 8 |
| | BSR d:16 | — | | | | | | 4 | PC→@-SP,PC←PC+d:16 | — | — | — | — | — | — | 8 | 10 |
| JSR | JSR @ERn | — | | 2 | | | | | PC→@-SP,PC←ERn | — | — | — | — | — | — | 6 | 8 |
| | JSR @aa:24 | — | | | | | | 4 | PC→@-SP,PC←aa:24 | — | — | — | — | — | — | 8 | 10 |
| | JSR @ @aa:8 | — | | | | | | 2 | PC→@-SP,PC← @aa:8 | — | — | — | — | — | — | 8 | 12 |
| RTS | RTS | — | | | | | | 2 | PC←@SP+ | — | — | — | — | — | — | 8 | 10 |

(7) System Control Instructions

| Mnemonic | Addressing Mode and Instruction Length (bytes) | | | | | | | | Operation | Condition Code | | | | | No. of States | | | |
|----------|--|-----|----|------|----------|-------------|-----|---------|-----------|----------------------------------|------------|---|---|---|---------------|---|--------|---------------|
| | Size | #xx | Rn | @ERn | @(d,ERn) | @ERn+/@-ERn | @aa | @(d,PC) | | @@aa | I | H | N | Z | V | C | Normal | Ad- vanced |
| TRAPA | TRAPA #x:2 | — | | | | | | | 2 | PC→@-SP, CCR→@-SP, <vector> → PC | ① | — | — | — | — | — | 14 | 14 |
| RTE | RTE | — | | | | | | | | CCR←@SP+,PC←@SP+ | ‡ | ‡ | ‡ | ‡ | ‡ | ‡ | 10 | 10 |
| SLEEP | SLEEP | — | | | | | | | | Transition to power-down state | — | — | — | — | — | — | 2 | 2 |
| LDC | LDC #xx:8,CCR | B | 2 | | | | | | | #xx:8→CCR | ‡ | ‡ | ‡ | ‡ | ‡ | ‡ | 2 | 2 |
| | LDC Rs,CCR | B | | 2 | | | | | | Rs8→CCR | ‡ | ‡ | ‡ | ‡ | ‡ | ‡ | 2 | 2 |
| | LDC @ERs,CCR | W | | | 4 | | | | | @ERs→CCR | ‡ | ‡ | ‡ | ‡ | ‡ | ‡ | 6 | 6 |
| | LDC @(d:16,ERs),CCR | W | | | | 6 | | | | @(d:16,ERs)→CCR | ‡ | ‡ | ‡ | ‡ | ‡ | ‡ | 8 | 8 |
| | LDC @(d:16,ERs),CCR | W | | | | | 10 | | | @(d:24,ERs)→CCR | ‡ | ‡ | ‡ | ‡ | ‡ | ‡ | 12 | 12 |
| | LDC @ERs+,CCR | W | | | | | | 4 | | @ERs→CCR,ERs32+2→ERs32 | ‡ | ‡ | ‡ | ‡ | ‡ | ‡ | 8 | 8 |
| | LDC @aa:16,CCR | W | | | | | | | 6 | @aa:16→CCR | ‡ | ‡ | ‡ | ‡ | ‡ | ‡ | 8 | 8 |
| | LDC @aa:24,CCR | W | | | | | | | | 8 | @aa:24→CCR | ‡ | ‡ | ‡ | ‡ | ‡ | ‡ | 10 |
| STC | STC CCR,Rd | B | | 2 | | | | | | CCR→Rd8 | — | — | — | — | — | — | 2 | 2 |
| | STC CCR,@ERd | W | | | 4 | | | | | CCR→@ERd | — | — | — | — | — | — | 6 | 6 |
| | STC CCR,@(d:16,ERs) | W | | | | 6 | | | | CCR→@(d:16,ERs24) | — | — | — | — | — | — | 8 | 8 |
| | STC CCR,@(d:24,ERs) | W | | | | | 10 | | | CCR→@(d:24,ERs24) | — | — | — | — | — | — | 12 | 12 |
| | STC CCR,@-ERs | W | | | | | | 4 | | ERd32-2→ERd24,CCR→@ERd24 | — | — | — | — | — | — | 8 | 8 |
| | STC CCR,@aa:16 | W | | | | | | | 6 | CCR→@aa:16 | — | — | — | — | — | — | 8 | 8 |
| | STC CCR,@aa:24 | W | | | | | | | | 8 | CCR→@aa:24 | — | — | — | — | — | 10 | 10 |
| ANDC | ANDC #xx:8,CCR | B | 2 | | | | | | | CCR ∧#xx:8→CCR | ‡ | ‡ | ‡ | ‡ | ‡ | ‡ | 2 | 2 |
| ORC | ORC #xx:8,CCR | B | 2 | | | | | | | CCR V#xx:8→CCR | ‡ | ‡ | ‡ | ‡ | ‡ | ‡ | 2 | 2 |
| XORC | XORC #xx:8,CCR | B | 2 | | | | | | | CCR ⊕#xx:8→CCR | ‡ | ‡ | ‡ | ‡ | ‡ | ‡ | 2 | 2 |
| NOP | NOP | — | | | | | | | 2 | PC←PC+2 | — | ‡ | — | — | — | — | 2 | 2 |

Table 2-2 Instruction Set (cont)

(8) Block Transfer Instructions

| Mnemonic | Addressing Mode and Instruction Length (bytes) | | | | | | | Operation | Condition Code | | | | | | No. of States | | |
|-----------------|--|-----|----|------|----------|-------------|-----|-----------|--|-----|---|---|---|---|---------------|--------------------|--------------------|
| | Size | #xx | Rn | @ERn | @(d,ERn) | @ERn+/@-ERn | @aa | | @(d,PC) | @aa | I | H | N | Z | V | C | Normal |
| EEPMOV.EEPMOV.B | — | | | | | | | 4 | if R4L ≠ 0 Repeat @R5→@R6 R5+1→R5 R6+1→R6 R4L-1→R4L Until R4L = 0 else next; | — | — | — | — | — | — | 8+4n ^{*2} | 8+4n ^{*2} |
| EEPMOV.W | — | | | | | | | 4 | if R4 ≠ 0 Repeat @R5→@R6 R5+1→R5 R6+1→R6 R4L-1→R4L Until R4 = 0 else next; | — | — | — | — | — | — | 8+4n ^{*2} | 8+4n ^{*2} |

Notes: *1 The number of states is the number of states required for execution when the instruction and its operands are located in on-chip memory. For other cases see section 2.6, Number of States Required for Execution.

*2 n is the value set in register R4L or R4.

- ① Set to 1 when a carry or borrow occurs at bit 11; otherwise cleared to 0.
- ② Set to 1 when a carry or borrow occurs at bit 27; otherwise cleared to 0.
- ③ Retains its previous value when the result is zero; otherwise cleared to 0.
- ④ Set to 1 when the adjustment produces a carry; otherwise retains its previous value.
- ⑤ The number of states required for execution of an instruction that transfers data in synchronization with the E clock is variable.
- ⑥ Set to 1 when the divisor is negative; otherwise cleared to 0.
- ⑦ Set to 1 when the divisor is zero; otherwise cleared to 0.
- ⑧ Set to 1 when the quotient is negative; otherwise cleared to 0.

2.4 Instruction Codes

Table 2-3 Instruction Codes

| Instruction | Mnemonic | Size | Instruction Format | | | | | | | | | | | |
|-------------------|---------------------|------|--------------------|----------|----------|----------|----------|----------|----------|----------|----------|-----------|--|--|
| | | | 1st byte | 2nd byte | 3rd byte | 4th byte | 5th byte | 6th byte | 7th byte | 8th byte | 9th byte | 10th byte | | |
| ADD | ADD.B #xx:8,Rd | B | 8 | rd | IMM | | | | | | | | | |
| | ADD.B Rs,Rd | B | 0 | 8 | rs | rd | | | | | | | | |
| | ADD.W #xx:16,Rd | W | 7 | 9 | 1 | rd | IMM | | | | | | | |
| | ADD.W Rs,Rd | W | 0 | 9 | rs | rd | | | | | | | | |
| | ADD.L #xx:32,ERd | L | 7 | A | 1 | 0 | erd | IMM | | | | | | |
| ADD.L ERs,ERd | L | 0 | A | 1 | ers | 0 | erd | | | | | | | |
| ADDS | ADDS #1,ERd | L | 0 | B | 0 | 0 | erd | | | | | | | |
| | ADDS #2,ERd | L | 0 | B | 8 | 0 | erd | | | | | | | |
| | ADDS #4,ERd | L | 0 | B | 9 | 0 | erd | | | | | | | |
| ADDX | ADDX #xx:8,Rd | B | 9 | rd | IMM | | | | | | | | | |
| | ADDX Rs,Rd | B | 0 | E | rs | rd | | | | | | | | |
| AND | AND.B #xx:8,Rd | B | E | rd | IMM | | | | | | | | | |
| | AND.B Rs,Rd | B | 1 | 6 | rs | rd | | | | | | | | |
| | AND.W #xx:16,Rd | W | 7 | 9 | 6 | rd | IMM | | | | | | | |
| | AND.W Rs,Rd | W | 6 | 6 | rs | rd | | | | | | | | |
| | AND.L #xx:32,ERd | L | 7 | A | 6 | 0 | erd | IMM | | | | | | |
| AND.L ERs,ERd | L | 0 | 1 | F | 0 | 6 | 6 | 0 | ers | 0 | erd | | | |
| ANDC | ANDC #xx:8,CCR | B | 0 | 6 | IMM | | | | | | | | | |
| BAND | BAND #xx:3,Rd | B | 7 | 6 | 0 | IMM | rd | | | | | | | |
| | BAND #xx:3,@ERd | B | 7 | C | 0 | erd | 0 | 7 | 6 | 0 | IMM | 0 | | |
| | BAND #xx:3,@aa:8 | B | 7 | E | abs | 7 | 6 | 0 | IMM | 0 | | | | |
| Bcc | BRA d:8 (BT d:8) | — | 4 | 0 | disp | | | | | | | | | |
| | BRA d:16 (BT d:16) | — | 5 | 8 | 0 | 0 | disp | | | | | | | |
| | BRN d:8 (BF d:8) | — | 4 | 1 | disp | | | | | | | | | |
| | BRN d:16 (BF d:16) | — | 5 | 8 | 1 | 0 | disp | | | | | | | |
| | BHI d:8 | — | 4 | 2 | disp | | | | | | | | | |
| | BHI d:16 | — | 5 | 8 | 2 | 0 | disp | | | | | | | |
| | BLS d:8 | — | 4 | 3 | disp | | | | | | | | | |
| | BLS d:16 | — | 5 | 8 | 3 | 0 | disp | | | | | | | |
| | BCC d:8 (BHS d:8) | — | 4 | 4 | disp | | | | | | | | | |
| | BCC d:16 (BHS d:16) | — | 5 | 8 | 4 | 0 | disp | | | | | | | |
| BCC d:8 (BLO d:8) | — | 4 | 5 | disp | | | | | | | | | | |

Table 2-3 Instruction Codes (cont)

| Instruction | Mnemonic | Size | Instruction Format | | | | | | | | | | | |
|-------------|---------------------|------|--------------------|----------|----------|----------|----------|----------|----------|----------|----------|-----------|--|--|
| | | | 1st byte | 2nd byte | 3rd byte | 4th byte | 5th byte | 6th byte | 7th byte | 8th byte | 9th byte | 10th byte | | |
| Bcc | BCS d:16 (BLO d:16) | — | 5 | 8 | 5 | 0 | disp | | | | | | | |
| | BNE d:8 | — | 4 | 6 | disp | | | | | | | | | |
| | BNE d:16 | — | 5 | 8 | 6 | 0 | disp | | | | | | | |
| | BEQ d:8 | — | 4 | 7 | disp | | | | | | | | | |
| | BEQ d:16 | — | 5 | 8 | 7 | 0 | disp | | | | | | | |
| | BVC d:8 | — | 4 | 8 | disp | | | | | | | | | |
| | BVC d:16 | — | 5 | 8 | 8 | 0 | disp | | | | | | | |
| | BVS d:8 | — | 4 | 9 | disp | | | | | | | | | |
| | BVS d:16 | — | 5 | 8 | 9 | 0 | disp | | | | | | | |
| | BPL d:8 | — | 4 | A | disp | | | | | | | | | |
| | BPL d:16 | — | 5 | 8 | A | 0 | disp | | | | | | | |
| | BMI d:8 | — | 4 | B | disp | | | | | | | | | |
| | BMI d:16 | — | 5 | 8 | B | 0 | disp | | | | | | | |
| | BGE d:8 | — | 4 | C | disp | | | | | | | | | |
| | BGE d:16 | — | 5 | 8 | C | 0 | disp | | | | | | | |
| | BLT d:8 | — | 4 | D | disp | | | | | | | | | |
| | BLT d:16 | — | 5 | 8 | D | 0 | disp | | | | | | | |
| | BGT d:8 | — | 4 | E | disp | | | | | | | | | |
| | BGT d:16 | — | 5 | 8 | E | 0 | disp | | | | | | | |
| | BLE d:8 | — | 4 | F | disp | | | | | | | | | |
| BLE d:16 | — | 5 | 8 | F | 0 | disp | | | | | | | | |
| BCLR | BCLR #xx:3,Rd | B | 7 | 2 | 0 | IMM | rd | | | | | | | |
| | BCLR #xx:3,@ERd | B | 7 | D | 0 | erd | 0 | 7 | 2 | 0 | IMM | 0 | | |
| | BCLR #xx:3,@aa:8 | B | 7 | F | abs | | | 7 | 2 | 0 | IMM | 0 | | |
| | BCLR Rn,Rd | B | 6 | 2 | rn | rd | | | | | | | | |
| | BCLR Rn,@ERd | B | 7 | D | 0 | erd | 0 | 6 | 2 | rn | 0 | | | |
| | BCLR Rn,@aa:8 | B | 7 | F | abs | | | 6 | 2 | rn | 0 | | | |
| BIAND | BIAND #xx:3,Rd | B | 7 | 6 | 1 | IMM | rd | | | | | | | |
| | BIAND #xx:3,@ERd | B | 7 | C | 0 | erd | 0 | 7 | 6 | 1 | IMM | 0 | | |
| | BIAND #xx:3,@aa:8 | B | 7 | E | abs | | | 7 | 6 | 1 | IMM | 0 | | |
| BILD | BILD #xx:3,Rd | B | 7 | 7 | 1 | IMM | rd | | | | | | | |
| | BILD #xx:3,@ERd | B | 7 | C | 0 | erd | 0 | 7 | 7 | 1 | IMM | 0 | | |
| | BILD #xx:3,@aa:8 | B | 7 | E | abs | | | 7 | 7 | 1 | IMM | 0 | | |

Table 2-3 Instruction Codes (cont)

| Instruction | Mnemonic | Size | Instruction Format | | | | | | | | | | | | | | | | | |
|-------------|-------------------|------|--------------------|----------|----------|----------|----------|----------|----------|----------|----------|-----------|--|--|--|--|--|--|--|--|
| | | | 1st byte | 2nd byte | 3rd byte | 4th byte | 5th byte | 6th byte | 7th byte | 8th byte | 9th byte | 10th byte | | | | | | | | |
| BIOR | BIOR #xx:3,Rd | B | 7 | 4 | 1 | IMM | rd | | | | | | | | | | | | | |
| | BIOR #xx:3,@ERd | B | 7 | C | 0 | erd | 0 | 7 | 4 | 1 | IMM | 0 | | | | | | | | |
| | BIOR #xx:3,@aa:8 | B | 7 | E | | abs | | 7 | 4 | 1 | IMM | 0 | | | | | | | | |
| BIST | BIST #xx:3,Rd | B | 6 | 7 | 1 | IMM | rd | | | | | | | | | | | | | |
| | BIST #xx:3,@ERd | B | 7 | D | 0 | erd | 0 | 6 | 7 | 1 | IMM | 0 | | | | | | | | |
| | BIST #xx:3,@aa:8 | B | 7 | F | | abs | | 6 | 7 | 1 | IMM | 0 | | | | | | | | |
| BIXOR | BIXOR #xx:3,Rd | B | 7 | 5 | 1 | IMM | rd | | | | | | | | | | | | | |
| | BIXOR #xx:3,@ERd | B | 7 | C | 0 | erd | 0 | 7 | 5 | 1 | IMM | 0 | | | | | | | | |
| | BIXOR #xx:3,@aa:8 | B | 7 | E | | abs | | 7 | 5 | 1 | IMM | 0 | | | | | | | | |
| BLD | BLD #xx:3,Rd | B | 7 | 7 | 0 | IMM | rd | | | | | | | | | | | | | |
| | BLD #xx:3,@ERd | B | 7 | C | 0 | erd | 0 | 7 | 7 | 0 | IMM | 0 | | | | | | | | |
| | BLD #xx:3,@aa:8 | B | 7 | E | | abs | | 7 | 7 | 0 | IMM | 0 | | | | | | | | |
| BNOT | BNOT #xx:3,Rd | B | 7 | 1 | 0 | IMM | rd | | | | | | | | | | | | | |
| | BNOT #xx:3,@ERd | B | 7 | D | 0 | erd | 0 | 7 | 1 | 0 | IMM | 0 | | | | | | | | |
| | BNOT #xx:3,@aa:8 | B | 7 | F | | abs | | 7 | 1 | 0 | IMM | 0 | | | | | | | | |
| | BNOT Rn,Rd | B | 6 | 1 | rn | rd | | | | | | | | | | | | | | |
| | BNOT Rn,@ERd | B | 7 | D | 0 | erd | 0 | 6 | 1 | rn | 0 | | | | | | | | | |
| | BNOT Rn,@aa:8 | B | 7 | F | | abs | | 6 | 1 | rn | 0 | | | | | | | | | |
| BOR | BOR #xx:3,Rd | B | 7 | 4 | 0 | IMM | rd | | | | | | | | | | | | | |
| | BOR #xx:3,@ERd | B | 7 | C | 0 | erd | 0 | 7 | 4 | 0 | IMM | 0 | | | | | | | | |
| | BOR #xx:3,@aa:8 | B | 7 | E | | abs | | 7 | 4 | 0 | IMM | 0 | | | | | | | | |
| BSET | BSET #xx:3,Rd | B | 7 | 0 | 0 | IMM | rd | | | | | | | | | | | | | |
| | BSET #xx:3,@ERd | B | 7 | D | 0 | erd | 0 | 7 | 0 | 0 | IMM | 0 | | | | | | | | |
| | BSET #xx:3,@aa:8 | B | 7 | F | | abs | | 7 | 0 | 0 | IMM | 0 | | | | | | | | |
| | BSET Rn,Rd | B | 6 | 0 | rn | rd | | | | | | | | | | | | | | |
| | BSET Rn,@ERd | B | 7 | D | 0 | erd | 0 | 6 | 0 | rn | 0 | | | | | | | | | |
| | BSET Rn,@aa:8 | B | 7 | F | | abs | | 6 | 0 | rn | 0 | | | | | | | | | |
| BSR | BSR d:8 | — | 5 | 5 | disp | | | | | | | | | | | | | | | |
| | BSR d:16 | — | 5 | C | 0 | 0 | disp | | | | | | | | | | | | | |
| BST | BST #xx:3,Rd | B | 6 | 7 | 0 | IMM | rd | | | | | | | | | | | | | |
| | BST #xx:3,@ERd | B | 7 | D | 0 | erd | 0 | 6 | 7 | 0 | IMM | 0 | | | | | | | | |
| | BST #xx:3,@aa:8 | B | 7 | F | | abs | | 6 | 7 | 0 | IMM | 0 | | | | | | | | |

Table 2-3 Instruction Codes (cont)

| Instruction | Mnemonic | Size | Instruction Format | | | | | | | | | | | | | | | | | | |
|---------------|------------------|------|--------------------|----------|----------|----------|----------|----------|----------|----------|----------|-----------|--|--|--|--|--|--|--|--|--|
| | | | 1st byte | 2nd byte | 3rd byte | 4th byte | 5th byte | 6th byte | 7th byte | 8th byte | 9th byte | 10th byte | | | | | | | | | |
| BTST | BTST #xx:3,Rd | B | 7 | 3 | 0 | IMM | rd | | | | | | | | | | | | | | |
| | BTST #xx:3,@ERd | B | 7 | C | 0 | erd | 0 | 7 | 3 | 0 | IMM | 0 | | | | | | | | | |
| | BTST #xx:3,@aa:8 | B | 7 | E | | abs | | 7 | 3 | 0 | IMM | 0 | | | | | | | | | |
| | BTST Rn,Rd | B | 6 | 3 | rn | rd | | | | | | | | | | | | | | | |
| | BTST Rn,@ERd | B | 7 | C | 0 | erd | 0 | 6 | 3 | rn | 0 | | | | | | | | | | |
| BXOR | BXOR #xx:3,Rd | B | 7 | 5 | 0 | IMM | rd | | | | | | | | | | | | | | |
| | BXOR #xx:3,@ERd | B | 7 | C | 0 | erd | 0 | 7 | 5 | 0 | IMM | 0 | | | | | | | | | |
| | BXOR #xx:3,@aa:8 | B | 7 | E | | abs | | 7 | 5 | 0 | IMM | 0 | | | | | | | | | |
| CMP | CMP.B #xx:8,Rd | B | A | rd | | IMM | | | | | | | | | | | | | | | |
| | CMP.B Rs,Rd | B | 1 | C | rs | rd | | | | | | | | | | | | | | | |
| | CMP.W #xx:16,Rd | W | 7 | 9 | 2 | rd | | | | IMM | | | | | | | | | | | |
| | CMP.W Rs,Rd | W | 1 | D | rs | rd | | | | | | | | | | | | | | | |
| | CMP.L #xx:32,ERd | L | 7 | A | 2 | 0 | erd | | | | | | | | | | | | | | |
| CMP.L ERs,ERd | L | 1 | F | 1 | ers | 0 | erd | | | | | | | | | | | | | | |
| DAA | DAA Rd | B | 0 | F | 0 | rd | | | | | | | | | | | | | | | |
| DAS | DAS Rd | B | 1 | F | 0 | rd | | | | | | | | | | | | | | | |
| DEC | DEC.B Rd | B | 1 | A | 0 | rd | | | | | | | | | | | | | | | |
| | DEC.W #1,Rd | W | 1 | B | 5 | rd | | | | | | | | | | | | | | | |
| | DEC.W #2,Rd | W | 1 | B | D | rd | | | | | | | | | | | | | | | |
| | DEC.L #1,ERd | L | 1 | B | 7 | 0 | erd | | | | | | | | | | | | | | |
| DEC.L #2,ERd | L | 1 | B | F | 0 | erd | | | | | | | | | | | | | | | |
| DIVXS | DIVXS.B Rs,Rd | B | 0 | 1 | D | 0 | 5 | 1 | rs | rd | | | | | | | | | | | |
| | DIVXS.W Rs,ERd | W | 0 | 1 | D | 0 | 5 | 3 | rs | 0 | erd | | | | | | | | | | |
| DIVXU | DIVXU.B Rs,Rd | B | 5 | 1 | rs | rd | | | | | | | | | | | | | | | |
| | DIVXU.W Rs,ERd | W | 5 | 3 | rs | 0 | erd | | | | | | | | | | | | | | |
| EEMOV | EEMOV.B | — | 7 | B | 5 | C | 5 | 9 | 8 | F | | | | | | | | | | | |
| | EEMOV.W | — | 7 | B | D | 4 | 5 | 9 | 8 | F | | | | | | | | | | | |
| EXTS | EXTS.W Rd | W | 1 | 7 | D | rd | | | | | | | | | | | | | | | |
| | EXTS.L ERd | L | 1 | 7 | F | 0 | erd | | | | | | | | | | | | | | |
| EXTU | EXTU.W Rd | W | 1 | 7 | 5 | rd | | | | | | | | | | | | | | | |
| | EXTU.L ERd | L | 1 | 7 | 7 | 0 | erd | | | | | | | | | | | | | | |
| INC | INC.B Rd | B | 0 | A | 0 | rd | | | | | | | | | | | | | | | |
| | INC.W #1,Rd | W | 0 | B | 5 | rd | | | | | | | | | | | | | | | |
| | INC.W #2,Rd | W | 0 | B | D | rd | | | | | | | | | | | | | | | |

Table 2-3 Instruction Codes (cont)

| Instruction | Mnemonic | Size | Instruction Format | | | | | | | | | | | | | | | |
|----------------|----------------------|------|--------------------|----------|----------|----------|----------|----------|----------|----------|----------|-----------|---|------|---|---|---|------|
| | | | 1st byte | 2nd byte | 3rd byte | 4th byte | 5th byte | 6th byte | 7th byte | 8th byte | 9th byte | 10th byte | | | | | | |
| INC | INC.L #1,ERd | L | 0 | B | 7 | 0 | erd | | | | | | | | | | | |
| | INC.L #2,ERd | L | 0 | B | F | 0 | erd | | | | | | | | | | | |
| JMP | JMP @ERn | — | 5 | 9 | 0 | ern | 0 | | | | | | | | | | | |
| | JMP @aa:24 | — | 5 | A | abs | | | | | | | | | | | | | |
| | JMP @aa:8 | — | 5 | B | abs | | | | | | | | | | | | | |
| JSR | JSR @ERn | — | 5 | D | 0 | ern | 0 | | | | | | | | | | | |
| | JSR @aa:24 | — | 5 | E | abs | | | | | | | | | | | | | |
| | JSR @aa:8 | — | 5 | F | abs | | | | | | | | | | | | | |
| LDC | LDC #xx:8,CCR | B | 0 | 7 | IMM | | | | | | | | | | | | | |
| | LDC Rs,CCR | B | 0 | 3 | 0 | rs | | | | | | | | | | | | |
| | LDC @ERs,CCR | W | 0 | 1 | 4 | 0 | 6 | 9 | 0 | ers | 0 | | | | | | | |
| | LDC @(d:16,ERs),CCR | W | 0 | 1 | 4 | 0 | 6 | F | 0 | ers | 0 | disp | | | | | | |
| | LDC @(d:24,ERs),CCR | W | 0 | 1 | 4 | 0 | 7 | 8 | 0 | ers | 0 | 6 | B | 2 | 0 | 0 | 0 | disp |
| | LDC @ERs+,CCR | W | 0 | 1 | 4 | 0 | 6 | D | 0 | ers | 0 | | | | | | | |
| | LDC @aa:16,CCR | W | 0 | 1 | 4 | 0 | 6 | B | 0 | 0 | abs | | | | | | | |
| LDC @aa:24,CCR | W | 0 | 1 | 4 | 0 | 6 | B | 2 | 0 | 0 | 0 | abs | | | | | | |
| MOV | MOV.B #xx:8,Rd | B | F | rd | IMM | | | | | | | | | | | | | |
| | MOV.B Rs,Rd | B | 0 | C | rs | rd | | | | | | | | | | | | |
| | MOV.B @ERs,Rd | B | 6 | 8 | 0 | ers | rd | | | | | | | | | | | |
| | MOV.B @(d:16,ERs),Rd | B | 6 | E | 0 | ers | rd | disp | | | | | | | | | | |
| | MOV.B @(d:24,ERs),Rd | B | 7 | 8 | 0 | ers | 0 | 6 | A | 2 | rd | 0 | 0 | disp | | | | |
| | MOV.B @ERs+,Rd | B | 6 | C | 0 | ers | rd | | | | | | | | | | | |
| | MOV.B @aa:8,Rd | B | 2 | rd | abs | | | | | | | | | | | | | |
| | MOV.B @aa:16,Rd | B | 6 | A | 0 | rd | abs | | | | | | | | | | | |
| | MOV.B @aa:24,Rd | B | 6 | A | 2 | rd | 0 | 0 | abs | | | | | | | | | |
| | MOV.B Rs,@ERd | B | 6 | 8 | 1 | erd | rs | | | | | | | | | | | |
| | MOV.B Rs,@(d:16,ERd) | B | 6 | E | 1 | erd | rs | disp | | | | | | | | | | |
| | MOV.B Rs,@(d:24,ERd) | B | 7 | 8 | 0 | erd | 0 | 6 | A | A | rs | 0 | 0 | disp | | | | |
| | MOV.B Rs,@-ERd | B | 6 | C | 1 | erd | rs | | | | | | | | | | | |
| | MOV.B Rs,@aa:8 | B | 3 | rs | abs | | | | | | | | | | | | | |
| | MOV.B Rs,@aa:16 | B | 6 | A | 8 | rs | abs | | | | | | | | | | | |
| | MOV.B Rs,@aa:24 | B | 6 | A | A | rs | 0 | 0 | abs | | | | | | | | | |
| | MOV.W #xx:16,Rd | W | 7 | 9 | 0 | rd | IMM | | | | | | | | | | | |
| | MOV.W Rs,Rd | W | 0 | D | rs | rd | | | | | | | | | | | | |
| MOV.W @ERs,Rd | W | 6 | 9 | 0 | ers | rd | | | | | | | | | | | | |

Table 2-3 Instruction Codes (cont)

| Instruction | Mnemonic | Size | Instruction Format | | | | | | | | | | | | | | | | | |
|----------------------|----------------------|------|--------------------|----------|----------|----------|----------|----------|----------|----------|----------|-----------|------|------|-----|-----|---|------|------|--|
| | | | 1st byte | 2nd byte | 3rd byte | 4th byte | 5th byte | 6th byte | 7th byte | 8th byte | 9th byte | 10th byte | | | | | | | | |
| MOV | MOV.W @(d:16,ERs),Rd | W | 6 | F | 0 | ers | rd | disp | | | | | | | | | | | | |
| | MOV.W @(d:24,ERs),Rd | W | 7 | 8 | 0 | ers | 0 | 6 | B | 2 | rd | 0 | 0 | disp | | | | | | |
| | MOV.W @ERs+,Rd | W | 6 | D | 0 | ers | rd | | | | | | | | | | | | | |
| | MOV.W @aa:16,Rd | W | 6 | B | 0 | rd | abs | | | | | | | | | | | | | |
| | MOV.W @aa:24,Rd | W | 6 | B | 2 | rd | 0 | 0 | abs | | | | | | | | | | | |
| | MOV.W Rs,@ERd | W | 6 | 9 | 1 | erd | rs | | | | | | | | | | | | | |
| | MOV.W Rs,@(d:16,ERd) | W | 6 | F | 1 | erd | rs | disp | | | | | | | | | | | | |
| | MOV.W Rs,@(d:24,ERd) | W | 7 | 8 | 1 | erd | 0 | 6 | B | A | rs | 0 | 0 | disp | | | | | | |
| | MOV.W Rs,@-ERd | W | 6 | D | 1 | erd | rs | | | | | | | | | | | | | |
| | MOV.W Rs,@aa:16 | W | 6 | B | 8 | rs | abs | | | | | | | | | | | | | |
| | MOV.W Rs,@aa:24 | W | 6 | B | A | rs | 0 | 0 | abs | | | | | | | | | | | |
| | MOVL #xx:32,Rd | L | 7 | A | 0 | 0 | erd | IMM | | | | | | | | | | | | |
| | MOVL ERs,ERd | L | 0 | F | 1 | ers | 0 | erd | | | | | | | | | | | | |
| | MOVL @ERs,ERd | L | 0 | 1 | 0 | 0 | 6 | 9 | 0 | ers | 0 | erd | | | | | | | | |
| | MOVL @(d:16,ERs),ERd | L | 0 | 1 | 0 | 0 | 6 | F | 0 | ers | 0 | erd | disp | | | | | | | |
| | MOVL @(d:24,ERs),ERd | L | 0 | 1 | 0 | 0 | 7 | 8 | 0 | ers | 0 | 6 | B | 2 | 0 | erd | 0 | 0 | disp | |
| | MOVL @ERs+,ERd | L | 0 | 1 | 0 | 0 | 6 | D | 0 | ers | 0 | erd | | | | | | | | |
| | MOVL @aa:16,ERd | L | 0 | 1 | 0 | 0 | 6 | B | 0 | 0 | erd | abs | | | | | | | | |
| | MOVL @aa:24,ERd | L | 0 | 1 | 0 | 0 | 6 | B | 2 | 0 | erd | 0 | 0 | abs | | | | | | |
| | MOVL ERs,@ERd | L | 0 | 1 | 0 | 0 | 6 | 9 | 1 | erd | 0 | ers | | | | | | | | |
| MOVL ERs,@(d:16,ERd) | L | 0 | 1 | 0 | 0 | 6 | F | 1 | erd | 0 | ers | disp | | | | | | | | |
| MOVL ERs,@(d:24,ERd) | L | 0 | 1 | 0 | 0 | 7 | 8 | 0 | erd | 0 | 6 | B | A | 0 | ers | 0 | 0 | disp | | |
| MOVL ERs,@-ERd | L | 0 | 1 | 0 | 0 | 6 | D | 1 | erd | 0 | ers | | | | | | | | | |
| MOVL ERs,@aa:16 | L | 0 | 1 | 0 | 0 | 6 | B | 8 | 0 | ers | abs | | | | | | | | | |
| MOVL ERs,@aa:24 | L | 0 | 1 | 0 | 0 | 6 | B | A | 0 | ers | 0 | 0 | abs | | | | | | | |
| MOVFPE | MOVFPE @aa:16,Rd | B | 6 | A | 4 | rd | abs | | | | | | | | | | | | | |
| MOVTPPE | MOVTPPE Rs,@aa:16 | B | 6 | A | C | rs | abs | | | | | | | | | | | | | |
| MULXS | MULXS.B Rs,Rd | B | 0 | 1 | C | 0 | 5 | 0 | rs | rd | | | | | | | | | | |
| | MULXS.W Rs,ERd | W | 0 | 1 | C | 0 | 5 | 2 | rs | 0 | erd | | | | | | | | | |
| MULXU | MULXU.B Rs,Rd | B | 5 | 0 | rs | rd | | | | | | | | | | | | | | |
| | MULXU.W Rs,ERd | W | 5 | 2 | rs | 0 | erd | | | | | | | | | | | | | |
| NEG | NEG.B Rd | B | 1 | 7 | 8 | rd | | | | | | | | | | | | | | |
| | NEG.W Rd | W | 1 | 7 | 9 | rd | | | | | | | | | | | | | | |
| | NEG.L ERd | L | 1 | 7 | B | 0 | erd | | | | | | | | | | | | | |
| NOP | NOP | — | 0 | 0 | 0 | 0 | | | | | | | | | | | | | | |

Table 2-3 Instruction Codes (cont)

| Instruction | Mnemonic | Size | Instruction Format | | | | | | | | | | | | |
|-------------|-----------------|------|--------------------|----------|----------|----------|----------|----------|----------|----------|----------|-----------|--|--|--|
| | | | 1st byte | 2nd byte | 3rd byte | 4th byte | 5th byte | 6th byte | 7th byte | 8th byte | 9th byte | 10th byte | | | |
| NOT | NOT.B Rd | B | 1 | 7 | 0 | rd | | | | | | | | | |
| | NOT.W Rd | W | 1 | 7 | 1 | rd | | | | | | | | | |
| | NOT.L ERd | L | 1 | 7 | 3 | 0:erd | | | | | | | | | |
| OR | OR.B #xx:8,Rd | B | C | rd | IMM | | | | | | | | | | |
| | OR.B Rs,Rd | B | 1 | 4 | rs | rd | | | | | | | | | |
| | OR.W #xx:16,Rd | W | 7 | 9 | 4 | rd | IMM | | | | | | | | |
| | OR.W Rs,Rd | W | 6 | 4 | rs | rd | | | | | | | | | |
| | OR.L #xx:32,ERd | L | 7 | A | 4 | 0:erd | IMM | | | | | | | | |
| | OR.L ERs,ERd | L | 0 | 1 | F | 0 | 6 | 4 | 0:ers | 0:ers | | | | | |
| ORC | ORC #xx:8,CCR | B | 0 | 4 | IMM | | | | | | | | | | |
| POP | POP.W Rn | W | 6 | D | 7 | rn | | | | | | | | | |
| | POP.L ERn | L | 0 | 1 | 0 | 0 | 6 | D | 7 | 0:ern | | | | | |
| PUSH | PUSH.W Rn | W | 6 | D | F | rn | | | | | | | | | |
| | PUSH.L ERn | L | 0 | 1 | 0 | 0 | 6 | D | F | 0:ern | | | | | |
| ROTL | ROTL.B Rd | B | 1 | 2 | 8 | rd | | | | | | | | | |
| | ROTL.W Rd | W | 1 | 2 | 9 | rd | | | | | | | | | |
| | ROTL.L ERd | L | 1 | 2 | B | 0:erd | | | | | | | | | |
| ROTR | ROTR.B Rd | B | 1 | 3 | 8 | rd | | | | | | | | | |
| | ROTR.W Rd | W | 1 | 3 | 9 | rd | | | | | | | | | |
| | ROTR.L ERd | L | 1 | 3 | B | 0:erd | | | | | | | | | |
| ROTXL | ROTXL.B Rd | B | 1 | 2 | 0 | rd | | | | | | | | | |
| | ROTXL.W Rd | W | 1 | 2 | 1 | rd | | | | | | | | | |
| | ROTXL.L ERd | L | 1 | 2 | 3 | 0:erd | | | | | | | | | |
| ROTXR | ROTXR.B Rd | B | 1 | 3 | 0 | rd | | | | | | | | | |
| | ROTXR.W Rd | W | 1 | 3 | 1 | rd | | | | | | | | | |
| | ROTXR.L ERd | L | 1 | 3 | 3 | 0:erd | | | | | | | | | |
| RTE | RTE | — | 5 | 6 | 7 | 0 | | | | | | | | | |
| RTS | RTS | — | 5 | 4 | 7 | 0 | | | | | | | | | |
| SHAL | SHAL.B Rd | B | 1 | 0 | 8 | rd | | | | | | | | | |
| | SHAL.W Rd | W | 1 | 0 | 9 | rd | | | | | | | | | |
| | SHAL.L ERd | L | 1 | 0 | B | 0:erd | | | | | | | | | |
| SHAR | SHAR.B Rd | B | 1 | 1 | 8 | rd | | | | | | | | | |
| | SHAR.W Rd | W | 1 | 1 | 9 | rd | | | | | | | | | |
| | SHAR.L ERd | L | 1 | 1 | B | 0:erd | | | | | | | | | |

Table 2-3 Instruction Codes (cont)

| Instruction | Mnemonic | Size | Instruction Format | | | | | | | | | | | | | | | |
|-----------------|---------------------|------|--------------------|----------|----------|----------|----------|----------|----------|----------|----------|-----------|---|---|---|---|------|--|
| | | | 1st byte | 2nd byte | 3rd byte | 4th byte | 5th byte | 6th byte | 7th byte | 8th byte | 9th byte | 10th byte | | | | | | |
| SHLL | SHLL.B Rd | B | 1 | 0 | 0 | rd | | | | | | | | | | | | |
| | SHLL.W Rd | W | 1 | 0 | 1 | rd | | | | | | | | | | | | |
| | SHLL.L ERd | L | 1 | 0 | 3 | 0:erd | | | | | | | | | | | | |
| SHLR | SHLR.B Rd | B | 1 | 1 | 0 | rd | | | | | | | | | | | | |
| | SHLR.W Rd | W | 1 | 1 | 1 | rd | | | | | | | | | | | | |
| | SHLR.L ERd | L | 1 | 1 | 3 | 0:erd | | | | | | | | | | | | |
| SLEEP | SLEEP | — | 0 | 1 | 8 | 0 | | | | | | | | | | | | |
| STC | STC CCR,Rd | B | 0 | 2 | 0 | rd | | | | | | | | | | | | |
| | STC CCR,@ERd | W | 0 | 1 | 4 | 0 | 6 | 9 | 1:erd | 0 | | | | | | | | |
| | STC CCR,@(d:16,ERd) | W | 0 | 1 | 4 | 0 | 6 | F | 1:erd | 0 | disp | | | | | | | |
| | STC CCR,@(d:24,ERd) | W | 0 | 1 | 4 | 0 | 7 | 8 | 0:erd | 0 | 6 | B | A | 0 | 0 | 0 | disp | |
| | STC CCR,@-ERd | W | 0 | 1 | 4 | 0 | 6 | D | 1:erd | 0 | | | | | | | | |
| | STC CCR,@aa:16 | W | 0 | 1 | 4 | 0 | 6 | B | 8 | 0 | abs | | | | | | | |
| STC CCR,@aa:24R | W | 0 | 1 | 4 | 0 | 6 | B | A | 0 | 0 | 0 | abs | | | | | | |
| SUB | SUB.B Rs,Rd | B | 1 | 8 | rs | rd | | | | | | | | | | | | |
| | SUB.W #xx:16,Rd | W | 7 | 9 | 3 | rd | IMM | | | | | | | | | | | |
| | SUB.W Rs,Rd | W | 1 | 9 | rs | rd | | | | | | | | | | | | |
| | SUB.L #xx:32,ERd | L | 7 | A | 3 | 0:erd | IMM | | | | | | | | | | | |
| | SUB.L ERs,ERd | L | 1 | A | 1:ers | 0:erd | | | | | | | | | | | | |
| SUBS | SUBS #1,ERd | L | 1 | B | 0 | 0:erd | | | | | | | | | | | | |
| | SUBS #2,ERd | L | 1 | B | 8 | 0:erd | | | | | | | | | | | | |
| | SUBS #4,ERd | L | 1 | B | 9 | 0:erd | | | | | | | | | | | | |
| SUBX | SUBX #xx:8,Rd | B | B | rd | IMM | | | | | | | | | | | | | |
| | SUBX Rs,Rd | B | 1 | E | rs | rd | | | | | | | | | | | | |
| TRAPA | TRAPA #x:2 | — | 5 | 7 | 00:IMM | 0 | | | | | | | | | | | | |
| XOR | XOR.B #xx:8,Rd | B | D | rd | IMM | | | | | | | | | | | | | |
| | XOR.B Rs,Rd | B | 1 | 5 | rs | rd | | | | | | | | | | | | |
| | XOR.W #xx:16,Rd | W | 7 | 9 | 5 | rd | IMM | | | | | | | | | | | |
| | XOR.W Rs,Rd | W | 6 | 5 | rs | rd | | | | | | | | | | | | |
| | XOR.L #xx:32,ERd | L | 7 | A | 4 | 0:erd | IMM | | | | | | | | | | | |
| | XOR.L ERs,ERd | L | 0 | 1 | F | 0 | 6 | 5 | 0:ers | 0:erd | | | | | | | | |
| XORC | XORC #xx:8,CCR | B | 0 | 5 | IMM | | | | | | | | | | | | | |

Legend

- IMM: Immediate data (2, 3, 8, 16, or 32 bits)
- abs: Absolute address (8, 16, or 24 bits)
- disp: Displacement (8, 16, or 24 bits)
- rs, rd, rn: Register field (4 bits specifying an 8-bit or 16-bit register. rs corresponds to operand symbols such as Rs, rd corresponds to operand symbols such as Rd, and rn corresponds to the operand symbol Rn.)
- ers, erd, ern: Register field (3 bits specifying a 32-bit register. ers corresponds to operand symbols such as ERs, erd corresponds to operand symbols such as ERd, and ern corresponds to the operand symbol ERn.)

The register fields specify general registers as follows.

| Address Register 32-bit Register | | 16-bit Register | | 8-bit Register | |
|-------------------------------------|------------------|-----------------|------------------|----------------|------------------|
| Register Field | General Register | Register Field | General Register | Register Field | General Register |
| 000 | ER0 | 0000 | R0 | 0000 | R0H |
| 001 | ER1 | 0001 | R1 | 0001 | R1H |
| ⋮ | ⋮ | ⋮ | ⋮ | ⋮ | ⋮ |
| 111 | ER7 | 0111 | R7 | 0111 | R7H |
| | | 1000 | E0 | 1000 | R0L |
| | | 1001 | E1 | 1001 | R1L |
| | | ⋮ | ⋮ | ⋮ | ⋮ |
| | | 1111 | E7 | 1111 | R7L |

2.5 Operation Code Map

Tables 2-4 to 2-6 show an operation code map.

Table 2-4 Operation Code Map (1)

Operation Code:

| | | | |
|----------|----|----------|----|
| 1st byte | | 2nd byte | |
| AH | AL | BH | BL |

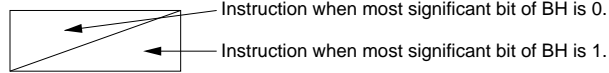

| AL \ AH | 0 | 1 | 2 | 3 | 4 | 5 | 6 | 7 | 8 | 9 | A | B | C | D | E | F |
|---------|-----------|-----------|-----------|-----------|------|-------|-------|-----------|-----------|-------|-----------|-----------|-----|-----|------|-----------|
| 0 | NOP | Table 2-5 | STC | LDC | ORG | XORG | ANDC | LDC | ADD | | Table 2-5 | Table 2-5 | MOV | | ADDX | Table 2-5 |
| 1 | Table 2-5 | Table 2-5 | Table 2-5 | Table 2-5 | OR.B | XOR.B | AND.B | Table 2-5 | SUB.B | SUB.W | Table 2-5 | Table 2-5 | CMP | | SUBX | Table 2-5 |
| 2 | MOV.B | | | | | | | | | | | | | | | |
| 3 | | | | | | | | | | | | | | | | |
| 4 | BRA | BRN | BHI | BLS | BCC | BCS | BNE | BEQ | BVC | BVS | BPL | BMI | BGE | BLT | BGT | BLE |
| 5 | MULXU | DIVXU | MULXU | DIVXU | RTS | BSR | RTE | TRAPA | Table 2-5 | JMP | | | BSR | JSR | | |
| 6 | BSET | BNOT | BCLR | BTST | OR.W | XOR.W | AND.W | BST | MOV | | | | | | | |
| 7 | | | | | BOR | BXOR | BAND | BLD | | | | | | | | |
| 8 | ADD | | | | | | | | | | | | | | | |
| 9 | ADDX | | | | | | | | | | | | | | | |
| A | CMP | | | | | | | | | | | | | | | |
| B | SUBX | | | | | | | | | | | | | | | |
| C | OR | | | | | | | | | | | | | | | |
| D | XOR | | | | | | | | | | | | | | | |
| E | AND | | | | | | | | | | | | | | | |
| F | MOV | | | | | | | | | | | | | | | |

Table 2-5 Operation Code Map (2)

Operation Code:

| | | | |
|----------|----|----------|----|
| 1st byte | | 2nd byte | |
| AH | AL | BH | BL |

| AH \ BH | 0 | 1 | 2 | 3 | 4 | 5 | 6 | 7 | 8 | 9 | A | B | C | D | E | F | |
|---------|-------|-----|-----|-------|-----|------|-----|------|-------|------|------|-----|-----------|-----------|-----|-----------|-----|
| 01 | MOV | | | | LDC | | | | SLEEP | | | | Table 2-6 | Table 2-6 | | Table 2-6 | |
| 0A | INC | | | | | | | | ADD | | | | | | | | |
| 0B | ADDS | | | | | INC | | INC | ADDS | ADDS | | | | INC | | | INC |
| 0F | DAA | | | | | | | | MOV | | | | | | | | |
| 10 | SHLL | | | SHLL | | | | | SHAL | | SHAL | | | | | | |
| 11 | SHLR | | | SHLR | | | | | SHAR | | SHAR | | | | | | |
| 12 | ROTXL | | | ROTXL | | | | | ROTL | | ROTL | | | | | | |
| 13 | ROTXR | | | ROTXR | | | | | ROTR | | ROTR | | | | | | |
| 17 | NOT | | | NOT | | EXTU | | EXTU | NEG | | NEG | | EXTS | | | EXTS | |
| 1A | DEC | | | | | | | | SUB | | | | | | | | |
| 1B | SUBS | | | | | DEC | | DEC | SUB | | | | DEC | | | DEC | |
| 1F | DAS | | | | | | | | CMP | | | | | | | | |
| 58 | BRA | BRN | BHI | BLS | BCC | BCS | BNE | BEQ | BVC | BVS | BPL | BMI | BGE | BLT | BGT | BLE | |
| 79 | MOV | ADD | CMP | SUB | OR | XOR | AND | | | | | | | | | | |
| 7A | MOV | ADD | CMP | SUB | OR | XOR | AND | | | | | | | | | | |

Table 2-6 Operation Code Map (3)

Operation Code:

| | | | | | | | |
|----------|----|----------|----|----------|----|----------|----|
| 1st byte | | 2nd byte | | 3rd byte | | 4th byte | |
| AH | AL | BH | BL | CH | CL | DH | DL |



Instruction when most significant bit of DH is 0.

Instruction when most significant bit of DH is 1.

| CL | 0 | 1 | 2 | 3 | 4 | 5 | 6 | 7 | 8 | 9 | A | B | C | D | E | F |
|-----------|-------|-------|-------|-------|-------------|---------------|---------------|-------------|---|---|---|---|---|---|---|---|
| AHALBHLCH | | | | | | | | | | | | | | | | |
| 01C05 | MULXS | | MULXS | | | | | | | | | | | | | |
| 01D05 | | DIVXS | | DIVXS | | | | | | | | | | | | |
| 01F06 | | | | | OR | XOR | AND | | | | | | | | | |
| 7Cr06*1 | | | | BTST | | | | | | | | | | | | |
| 7Cr07*1 | | | | BTST | BOR BIOR | BXOR BIXOR | BAND BIAND | BID BILD | | | | | | | | |
| 7Dr06*1 | BSET | BNOT | BCLR | | | | | BST BIST | | | | | | | | |
| 7Dr07*1 | BSET | BNOT | BCLR | | | | | | | | | | | | | |
| 7Eaa6*2 | | | | BTST | | | | | | | | | | | | |
| 7Eaa7*2 | | | | BTST | BOR BIOR | BXOR BIXOR | BAND BIAND | BID BILD | | | | | | | | |
| 7Faa6*2 | BSET | BNOT | BCLR | | | | | BST BIST | | | | | | | | |
| 7Faa7*2 | BSET | BNOT | BCLR | | | | | | | | | | | | | |

Notes: 1. r is a register field.

2. aa is an absolute address field.

2.6 Number of States Required for Instruction Execution

The tables in this section can be used to calculate the number of states required for instruction execution by the H8/300H CPU. Table 2-8 indicates the number of instruction fetch, data read/write, and other cycles occurring in each instruction. Table 2-7 indicates the number of states required for each size. The number of states required for execution of an instruction can be calculated from these two tables as follows:

$$\text{Execution states} = I \times S_I + J \times S_J + K \times S_K + L \times S_L + M \times S_M + N \times S_N$$

Examples: Advanced mode, stack located in external memory, on-chip supporting modules accessed with 8-bit bus width, external devices accessed in three states with one wait state and 16-bit bus width.

1. BSET #0, @FFFFC7:8

From table 2-8:

$$I = L = 2, \quad J = K = M = N = 0$$

From table 2-7:

$$S_I = 4, \quad S_L = 3$$

$$\text{Number of states required for execution} = 2 \times 4 + 2 \times 3 = 14$$

2. JSR @@30

From table 2-8:

$$I = J = K = 2, \quad L = M = N = 0$$

From table 2-7:

$$S_I = S_J = S_K = 4$$

$$\text{Number of states required for execution} = 2 \times 4 + 2 \times 4 + 2 \times 4 = 24$$

Table 2-7 Number of States per Cycle

| Cycle | | On-Chip Memory | Access Conditions | | | | | |
|---------------------|-------|----------------|---------------------------|------------|-----------------|----------------|----------------|----------------|
| | | | On-Chip Supporting Module | | External Device | | | |
| | | | 8-Bit Bus | 16-Bit Bus | 8-Bit Bus | | 16-Bit Bus | |
| | | | | | 2-State Access | 3-State Access | 2-State Access | 3-State Access |
| Instruction fetch | S_I | 2 | 6 | 3 | 4 | 6 + 2 m | 2 | 3 + m* |
| Branch address read | S_J | | | | | | | |
| Stack operation | S_K | | | | | | | |
| Byte data access | S_L | | 3 | | 2 | 3 + m | | |
| Word data access | S_M | | 6 | | 4 | 6 + 2 m | | |
| Internal operation | S_N | 1 | 1 | 1 | 1 | 1 | 1 | 1 |

Note: * For the MOVFPE and MOVTPE instructions, refer to the relevant microcontroller hardware manual.

Legend

m: Number of wait states inserted into external device access

Table 2-8 Number of Cycles in Instruction Execution

| Instruction | Mnemonic | Instruction | Branch | Stack | Byte Data | Word Data | Internal |
|---------------------|--------------------|-------------|---------|-----------|-----------|-----------|-----------|
| | | Fetch | Address | Operation | Access | Access | Operation |
| | | I | J | K | L | M | N |
| ADD | ADD.B #xx:8,Rd | 1 | | | | | |
| | ADD.B Rs,Rd | 1 | | | | | |
| | ADD.W #xx:16,Rd | 2 | | | | | |
| | ADD.W Rs,Rd | 1 | | | | | |
| | ADD.L #xx:32,ERd | 3 | | | | | |
| | ADD.L ERs,ERd | 1 | | | | | |
| ADDS | ADDS #1/2/4,ERd | 1 | | | | | |
| ADDX | ADDX #xx:8,Rd | 1 | | | | | |
| | ADDX Rs,Rd | 1 | | | | | |
| AND | AND.B #xx:8,Rd | 1 | | | | | |
| | AND.B Rs,Rd | 1 | | | | | |
| | AND.W #xx:16,Rd | 2 | | | | | |
| | AND.W Rs,Rd | 1 | | | | | |
| | AND.L #xx:32,ERd | 3 | | | | | |
| | AND.L ERs,ERd | 2 | | | | | |
| ANDC | ANDC #xx:8,CCR | 1 | | | | | |
| BAND | BAND #xx:3,Rd | 1 | | | | | |
| | BAND #xx:3,@ERd | 2 | | | 1 | | |
| | BAND #xx:3,@aa:8 | 2 | | | 1 | | |
| Bcc | BRA d:8 (BT d:8) | 2 | | | | | |
| | BRN d:8 (BF d:8) | 2 | | | | | |
| | BHI d:8 | 2 | | | | | |
| | BLS d:8 | 2 | | | | | |
| | BCC d:8 (BHS d:8) | 2 | | | | | |
| | BCS d:8 (BLO d:8) | 2 | | | | | |
| | BNE d:8 | 2 | | | | | |
| | BEQ d:8 | 2 | | | | | |
| | BVC d:8 | 2 | | | | | |
| | BVS d:8 | 2 | | | | | |
| | BPL d:8 | 2 | | | | | |
| | BMI d:8 | 2 | | | | | |
| | BGE d:8 | 2 | | | | | |
| | BLT d:8 | 2 | | | | | |
| | BGT d:8 | 2 | | | | | |
| | BLE d:8 | 2 | | | | | |
| | BRA d:16 (BT d:16) | 2 | | | | | 2 |
| | BRN d:16 (BF d:16) | 2 | | | | | 2 |
| | BHI d:16 | 2 | | | | | 2 |
| | BLS d:16 | 2 | | | | | 2 |
| BCC d:16 (BHS d:16) | 2 | | | | | 2 | |

Table 2-8 Number of Cycles in Instruction Execution (cont)

| Instruction | Mnemonic | Instruction | Branch | Stack | Byte Data | Word Data | Internal |
|-------------|---------------------|-------------|---------|-----------|-----------|-----------|-----------|
| | | Fetch | Address | Operation | Access | Access | Operation |
| | | I | J | K | L | M | N |
| Bcc | BCS d:16 (BLO d:16) | 2 | | | | | 2 |
| | BNE d:16 | 2 | | | | | 2 |
| | BEQ d:16 | 2 | | | | | 2 |
| | BVC d:16 | 2 | | | | | 2 |
| | BVS d:16 | 2 | | | | | 2 |
| | BPL d:16 | 2 | | | | | 2 |
| | BMI d:16 | 2 | | | | | 2 |
| | BGE d:16 | 2 | | | | | 2 |
| | BLT d:16 | 2 | | | | | 2 |
| | BGT d:16 | 2 | | | | | 2 |
| BLE d:16 | 2 | | | | | 2 | |
| BCLR | BCLR #xx:3,Rd | 1 | | | | | |
| | BCLR #xx:3,@ERd | 2 | | | 2 | | |
| | BCLR #xx:3,@aa:8 | 2 | | | 2 | | |
| | BCLR Rn,Rd | 1 | | | | | |
| | BCLR Rn,@ERd | 2 | | | 2 | | |
| | BCLR Rn,@aa:8 | 2 | | | 2 | | |
| BIAND | BIAND #xx:3,Rd | 1 | | | | | |
| | BIAND #xx:3,@ERd | 2 | | | 1 | | |
| | BIAND #xx:3,@aa:8 | 2 | | | 1 | | |
| BILD | BILD #xx:3,Rd | 1 | | | | | |
| | BILD #xx:3,@ERd | 2 | | | 1 | | |
| | BILD #xx:3,@aa:8 | 2 | | | 1 | | |
| BIOR | BIOR #xx:8,Rd | 1 | | | | | |
| | BIOR #xx:8,@ERd | 2 | | | 1 | | |
| | BIOR #xx:8,@aa:8 | 2 | | | 1 | | |
| BIST | BIST #xx:3,Rd | 1 | | | | | |
| | BIST #xx:3,@ERd | 2 | | | 2 | | |
| | BIST #xx:3,@aa:8 | 2 | | | 2 | | |
| BIXOR | BIXOR #xx:3,Rd | 1 | | | | | |
| | BIXOR #xx:3,@ERd | 2 | | | 1 | | |
| | BIXOR #xx:3,@aa:8 | 2 | | | 1 | | |
| BLD | BLD #xx:3,Rd | 1 | | | | | |
| | BLD #xx:3,@ERd | 2 | | | 1 | | |
| | BLD #xx:3,@aa:8 | 2 | | | 1 | | |
| BNOT | BNOT #xx:3,Rd | 1 | | | | | |
| | BNOT #xx:3,@ERd | 2 | | | 2 | | |
| | BNOT #xx:3,@aa:8 | 2 | | | 2 | | |
| | BNOT Rn,Rd | 1 | | | | | |
| | BNOT Rn,@ERd | 2 | | | 2 | | |

Table 2-8 Number of Cycles in Instruction Execution (cont)

| Instruction | Mnemonic | | Instruction | Branch | Stack | Byte Data | Word Data | Internal |
|-------------|------------------|----------|-------------|---------|-----------|-----------|-----------|-----------|
| | | | Fetch | Address | Operation | Access | Access | Operation |
| | | | I | J | K | L | M | N |
| BNOT | BNOT Rn,@aa:8 | | 2 | | | 2 | | |
| BOR | BOR #xx:3,Rd | | 1 | | | | | |
| | BOR #xx:3,@ERd | | 2 | | | 1 | | |
| | BOR #xx:3,@aa:8 | | 2 | | | 1 | | |
| BSET | BSET #xx:3,Rd | | 1 | | | | | |
| | BSET #xx:3,@ERd | | 2 | | | 2 | | |
| | BSET #xx:3,@aa:8 | | 2 | | | 2 | | |
| | BSET Rn,Rd | | 1 | | | | | |
| | BSET Rn,@ERd | | 2 | | | 2 | | |
| | BSET Rn,@aa:8 | | 2 | | | 2 | | |
| BSR | BSR d:8 | Advanced | 2 | | 2 | | | |
| | | Normal | 2 | | 1 | | | |
| | BSR d:16 | Advanced | 2 | | 2 | | | 2 |
| | | Normal | 2 | | 1 | | | 2 |
| BST | BST #xx:3,Rd | | 1 | | | | | |
| | BST #xx:3,@ERd | | 2 | | | 2 | | |
| | BST #xx:3,@aa:8 | | 2 | | | 2 | | |
| BTST | BTST #xx:3,Rd | | 1 | | | | | |
| | BTST #xx:3,@ERd | | 2 | | | 1 | | |
| | BTST #xx:3,@aa:8 | | 2 | | | 1 | | |
| | BTST Rn,Rd | | 1 | | | | | |
| | BTST Rn,@ERd | | 2 | | | 1 | | |
| | BTST Rn,@aa:8 | | 2 | | | 1 | | |
| BXOR | BXOR #xx:3,Rd | | 1 | | | | | |
| | BXOR #xx:3,@ERd | | 2 | | | 1 | | |
| | BXOR #xx:3,@aa:8 | | 2 | | | 1 | | |
| CMP | CMPB #xx:8,Rd | | 1 | | | | | |
| | CMPB Rs,Rd | | 1 | | | | | |
| | CMP.W #xx:16,Rd | | 2 | | | | | |
| | CMP.W Rs,Rd | | 1 | | | | | |
| | CMPL #xx:32,ERd | | 3 | | | | | |
| | CMPL ERs,ERd | | 1 | | | | | |
| DAA | DAA Rd | | 1 | | | | | |
| DAS | DAS Rd | | 1 | | | | | |
| DEC | DEC.B Rd | | 1 | | | | | |
| | DEC.W #1/2,Rd | | 1 | | | | | |
| | DEC.L #1/2,ERd | | 1 | | | | | |
| DIVXS | DIVXS.B Rs,Rd | | 2 | | | | | 12 |
| | DIVXS.W Rs,ERd | | 2 | | | | | 20 |

Table 2-8 Number of Cycles in Instruction Execution (cont)

| Instruction | Mnemonic | Instruction Fetch | Branch Address Read | | | Stack Operation | Byte Data Access | Word Data Access | Internal Operation |
|-------------|----------------------|-------------------|---------------------|---|---|-----------------|------------------|------------------|--------------------|
| | | | I | J | K | | | | |
| DIVXU | DIVXU.B Rs,Rd | 1 | | | | | | 12 | |
| | DIVXU.W Rs,ERd | 1 | | | | | | 20 | |
| EEPMOV | EEPMOV.B | 2 | | | | 2n + 2 *1 | | | |
| | EEPMOV.W | 2 | | | | 2n + 2 *1 | | | |
| EXTS | EXTS.W Rd | 1 | | | | | | | |
| | EXTS.L ERd | 1 | | | | | | | |
| EXTU | EXTU.W Rd | 1 | | | | | | | |
| | EXTU.L ERd | 1 | | | | | | | |
| INC | INC.B Rd | 1 | | | | | | | |
| | INC.W #1/2,Rd | 1 | | | | | | | |
| | INC.L #1/2,ERd | 1 | | | | | | | |
| JMP | JMP @ERn | 2 | | | | | | | |
| | JMP @aa:24 | 2 | | | | | | 2 | |
| | JMP @@aa:8 | Advanced | 2 | 2 | | | | | 2 |
| | | Normal | 2 | 1 | | | | | 2 |
| JSR | JSR @ERn | Advanced | 2 | | 2 | | | | |
| | | Normal | 2 | | 1 | | | | |
| | JSR @aa:24 | Advanced | 2 | | 2 | | | 2 | |
| | | Normal | 2 | | 1 | | | 2 | |
| | JSR @@aa:8 | Advanced | 2 | 2 | 2 | | | | |
| | | Normal | 2 | 1 | 1 | | | | |
| LDC | LDC #xx:8,CCR | 1 | | | | | | | |
| | LDC Rs,CCR | 1 | | | | | | | |
| | LDC @ERs,CCR | 2 | | | | | 1 | | |
| | LDC @(d:16,ERs),CCR | 3 | | | | | 1 | | |
| | LDC @(d:24,ERs),CCR | 5 | | | | | 1 | | |
| | LDC @ERs+,CCR | 2 | | | | | 1 | 2 | |
| | LDC @aa:16,CCR | 3 | | | | | 1 | | |
| | LDC @aa:24,CCR | 4 | | | | | 1 | | |
| MOV | MOV.B #xx:8,Rd | 1 | | | | | | | |
| | MOV.B Rs,Rd | 1 | | | | | | | |
| | MOV.B @ERs,Rd | 1 | | | | 1 | | | |
| | MOV.B @(d:16,ERs),Rd | 2 | | | | 1 | | | |
| | MOV.B @(d:24,ERs),Rd | 4 | | | | 1 | | | |
| | MOV.B @ERs+,Rd | 1 | | | | 1 | | 2 | |
| | MOV.B @aa:8,Rd | 1 | | | | 1 | | | |
| | MOV.B @aa:16,Rd | 2 | | | | 1 | | | |
| | MOV.B @aa:24,Rd | 3 | | | | 1 | | | |
| | MOV.B Rs,@ERd | 1 | | | | 1 | | | |
| | MOV.B Rs,@(d:16,ERd) | 2 | | | | 1 | | | |

Table 2-8 Number of Cycles in Instruction Execution (cont)

| Instruction | Mnemonic | Instruction | Branch | Stack | Byte Data | Word Data | Internal | | |
|-------------|-----------------------|--------------------|---------|-----------|-----------|-----------|-----------|---|---|
| | | Fetch | Address | Operation | Access | Access | Operation | | |
| | | I | J | K | L | M | N | | |
| MOV | MOV.B Rs,@(d:24,ERd) | 4 | | | 1 | | | | |
| | MOV.B Rs,@-ERd | 1 | | | 1 | | 2 | | |
| | MOV.B Rs,@aa:8 | 1 | | | 1 | | | | |
| | MOV.B Rs,@aa:16 | 2 | | | 1 | | | | |
| | MOV.B Rs,@aa:24 | 3 | | | 1 | | | | |
| | MOV.W #xx:16,Rd | 2 | | | | | | | |
| | MOV.W Rs,Rd | 1 | | | | | | | |
| | MOV.W @ERs,Rd | 1 | | | | | 1 | | |
| | MOV.W @(d:16,ERs),Rd | 2 | | | | | 1 | | |
| | MOV.W @(d:24,ERs),Rd | 4 | | | | | 1 | | |
| | MOV.W @ERs+,Rd | 1 | | | | | 1 | 2 | |
| | MOV.W @aa:16,Rd | 2 | | | | | 1 | | |
| | MOV.W @aa:24,Rd | 3 | | | | | 1 | | |
| | MOV.W Rs,@ERd | 1 | | | | | 1 | | |
| | MOV.W Rs,@(d:16,ERd) | 2 | | | | | 1 | | |
| | MOV.W Rs,@(d:24,ERd) | 4 | | | | | 1 | | |
| | MOV.W Rs,@-ERd | 1 | | | | | 1 | 2 | |
| | MOV.W Rs,@aa:16 | 2 | | | | | 1 | | |
| | MOV.W Rs,@aa:24 | 3 | | | | | 1 | | |
| | MOV.L #xx:32,ERd | 3 | | | | | | | |
| | MOV.L ERs,ERd | 1 | | | | | | | |
| | MOV.L @ERs,ERd | 2 | | | | | | 2 | |
| | MOV.L @(d:16,ERs),ERd | 3 | | | | | | 2 | |
| | MOV.L @(d:24,ERs),ERd | 5 | | | | | | 2 | |
| | MOV.L @ERs+,ERd | 2 | | | | | | 2 | 2 |
| | MOV.L @aa:16,ERd | 3 | | | | | | 2 | |
| | MOV.L @aa:24,ERd | 4 | | | | | | 2 | |
| | MOV.L ERs,@ERd | 2 | | | | | | 2 | |
| | MOV.L ERs,@(d:16,ERd) | 3 | | | | | | 2 | |
| | MOV.L ERs,@(d:24,ERd) | 5 | | | | | | 2 | |
| | MOV.L ERs,@-ERd | 2 | | | | | | 2 | 2 |
| | MOV.L ERs,@aa:16 | 3 | | | | | | 2 | |
| | MOV.L ERs,@aa:24 | 4 | | | | | | 2 | |
| | MOVFPPE | MOVFPPE @:aa:16,Rd | 2 | | | 1 *2 | | | |
| MOVTPPE | MOVTPPE Rs,@:aa:16 | 2 | | | 1 *2 | | | | |
| MULXS | MULXS.B Rs,Rd | 2 | | | | | 12 | | |
| | MULXS.W Rs,ERd | 2 | | | | | 20 | | |
| MULXU | MULXU.B Rs,Rd | 1 | | | | | 12 | | |
| | MULXU.W Rs,ERd | 1 | | | | | 20 | | |

Table 2-8 Number of Cycles in Instruction Execution (cont)

| Instruction | Mnemonic | Instruction | Branch | Stack | Byte Data | Word Data | Internal |
|-------------|-----------------|-------------|---------|-----------|-----------|-----------|-----------|
| | | Fetch | Address | Operation | Access | Access | Operation |
| | | I | J | K | L | M | N |
| NEG | NEG.B Rd | 1 | | | | | |
| | NEG.W Rd | 1 | | | | | |
| | NEG.L ERd | 1 | | | | | |
| NOP | NOP | 1 | | | | | |
| NOT | NOT.B Rd | 1 | | | | | |
| | NOT.W Rd | 1 | | | | | |
| | NOT.L ERd | 1 | | | | | |
| OR | OR.B #xx:8,Rd | 1 | | | | | |
| | OR.B Rs,Rd | 1 | | | | | |
| | OR.W #xx:16,Rd | 2 | | | | | |
| | OR.W Rs,Rd | 1 | | | | | |
| | OR.L #xx:32,ERd | 3 | | | | | |
| | OR.L ERs,ERd | 2 | | | | | |
| ORC | ORC #xx:8,CCR | 1 | | | | | |
| POP | POP.W Rn | 1 | | | | 1 | 2 |
| | POP.L ERn | 2 | | | | 2 | 2 |
| PUSH | PUSH.W Rn | 1 | | | | 1 | 2 |
| | PUSH.L ERn | 1 | | | | 2 | 2 |
| ROTL | ROTL.B Rd | 1 | | | | | |
| | ROTL.W Rd | 1 | | | | | |
| | ROTL.L ERd | 1 | | | | | |
| ROTR | ROTR.B Rd | 1 | | | | | |
| | ROTR.W Rd | 1 | | | | | |
| | ROTR.L ERd | 1 | | | | | |
| ROTXL | ROTXL.B Rd | 1 | | | | | |
| | ROTXL.W Rd | 1 | | | | | |
| | ROTXL.L ERd | 1 | | | | | |
| ROTXR | ROTXR.B Rd | 1 | | | | | |
| | ROTXR.W Rd | 1 | | | | | |
| | ROTXR.L ERd | 1 | | | | | |
| RTE | RTE | 2 | | 2 | | 2 | |
| RTS | RTS | Advanced | 2 | | 2 | | 2 |
| | | Normal | 2 | | 1 | | 2 |
| SHAL | SHAL.B Rd | 1 | | | | | |
| | SHAL.W Rd | 1 | | | | | |
| | SHAL.L ERd | 1 | | | | | |
| SHAR | SHAR.B Rd | 1 | | | | | |
| | SHAR.W Rd | 1 | | | | | |
| | SHAR.L ERd | 1 | | | | | |

Table 2-8 Number of Cycles in Instruction Execution (cont)

| Instruction | Mnemonic | Instruction Fetch | Branch | Stack Operation | Byte Data Access | Word Data Access | Internal Operation |
|-------------|---------------------|----------------------|-----------------|--------------------|---------------------|---------------------|-----------------------|
| | | | Address Read | | | | |
| | | I | J | K | L | M | N |
| SHLL | SHLL.B Rd | 1 | | | | | |
| | SHLL.W Rd | 1 | | | | | |
| | SHLL.L ERd | 1 | | | | | |
| SHLR | SHLR.B Rd | 1 | | | | | |
| | SHLR.W Rd | 1 | | | | | |
| | SHLR.L ERd | 1 | | | | | |
| SLEEP | SLEEP | 1 | | | | | |
| STC | STC CCR,Rd | 1 | | | | | |
| | STC CCR,@ERd | 2 | | | | 1 | |
| | STC CCR,@(d:16,ERd) | 3 | | | | 1 | |
| | STC CCR,@(d:24,ERd) | 5 | | | | 1 | |
| | STC CCR,@-ERd | 2 | | | | 1 | 2 |
| | STC CCR,@aa:16 | 3 | | | | 1 | |
| | STC CCR,@aa:24 | 4 | | | | 1 | |
| SUB | SUB.B Rs,Rd | 1 | | | | | |
| | SUB.W #xx:16,Rd | 2 | | | | | |
| | SUB.W Rs,Rd | 1 | | | | | |
| | SUB.L #xx:32,ERd | 3 | | | | | |
| | SUB.L ERs,ERd | 1 | | | | | |
| SUBS | SUBS #1/2/4,ERd | 1 | | | | | |
| SUBX | SUBX #xx:8,Rd | 1 | | | | | |
| | SUBX Rs,Rd | 1 | | | | | |
| TRAPA | TRAPA #x:2 | Advanced | 2 | 2 | 2 | | 4 |
| | | Normal | 2 | 1 | 2 | | 4 |
| XOR | XOR.B #xx:8,Rd | 1 | | | | | |
| | XOR.B Rs,Rd | 1 | | | | | |
| | XOR.W #xx:16,Rd | 2 | | | | | |
| | XOR.W Rs,Rd | 1 | | | | | |
| | XOR.L #xx:32,ERd | 3 | | | | | |
| | XOR.L ERs,ERd | 2 | | | | | |
| XORC | XORC #xx:8,CCR | 1 | | | | | |

2.7 Condition Code Modification

This section indicates the effect of each CPU instruction on the condition code. The notation used in the table is defined below.

m: 31 for longword operands, 15 for word operands, 7 for byte operands

S_i: The i-th bit of the source operand

D_i: The i-th bit of the destination operand

R_i: The i-th bit of the result

D_n: The specified bit in the destination operand

—: Not affected

↕: Modified according to the result of the instruction (see definition)

0: Always cleared to 0

1: Always set to 1

*: Undetermined (no guaranteed value)

Z': Z flag before instruction execution

C': C flag before instruction execution

Table 2-7 Condition Code Modification

| Instruction | H | N | Z | V | C | Definition |
|-------------|---|---|---|---|---|--|
| ADD | ↓ | ↓ | ↓ | ↓ | ↓ | $H = S_{m-4} \cdot D_{m-4} + D_{m-4} / R_{m-4} + S_{m-4} / R_{m-4}$ $N = R_m$ $Z = /R_m \cdot /R_{m-1} \cdot \dots \cdot /R_0$ $V = S_m \cdot D_m \cdot /R_m + /S_m \cdot /D_m \cdot R_m$ $C = S_m \cdot D_m + D_m / R_m + S_m \cdot /R_m$ |
| ADDS | — | — | — | — | — | |
| ADDX | ↓ | ↓ | ↓ | ↓ | ↓ | $H = S_{m-4} \cdot D_{m-4} + D_{m-4} / R_{m-4} + S_{m-4} / R_{m-4}$ $N = R_m$ $Z = Z' \cdot /R_m \cdot \dots \cdot /R_0$ $V = S_m \cdot D_m \cdot /R_m + /S_m \cdot /D_m \cdot R_m$ $C = S_m \cdot D_m + D_m / R_m + S_m \cdot /R_m$ |
| AND | — | ↓ | ↓ | O | — | $N = R_m$ $Z = /R_m \cdot /R_{m-1} \cdot \dots \cdot /R_0$ |
| ANDC | ↓ | ↓ | ↓ | ↓ | ↓ | Stores the corresponding bits of the result |
| BAND | — | — | — | — | ↓ | $C = C' \cdot D_n$ |
| Bcc | — | — | — | — | — | |
| BCLR | — | — | — | — | — | |
| BIAND | — | — | — | — | ↓ | $C = C' / D_n$ |
| BILD | — | — | — | — | ↓ | $C = /D_n$ |
| BIOR | — | — | — | — | ↓ | $C = C' + /D_n$ |
| BIST | — | — | — | — | — | |
| BIXOR | — | — | — | — | ↓ | $C = C' \cdot D_n + /C' \cdot /D_n$ |
| BLD | — | — | — | — | ↓ | $C = D_n$ |
| BNOT | — | — | — | — | — | |
| BOR | — | — | — | — | ↓ | $C = C' + D_n$ |
| BSET | — | — | — | — | — | |
| BSR | — | — | — | — | — | |
| BST | — | — | — | — | — | |
| BTST | — | — | ↓ | — | — | $Z = /D_n$ |
| BXOR | — | — | — | — | ↓ | $C = C' \cdot /D_n + /C' \cdot D_n$ |
| CMP | ↓ | ↓ | ↓ | ↓ | ↓ | $H = S_{m-4} / D_{m-4} + /D_{m-4} \cdot R_{m-4} + S_{m-4} \cdot R_{m-4}$ $N = R_m$ $Z = /R_m \cdot /R_{m-1} \cdot \dots \cdot /R_0$ $V = /S_m \cdot D_m \cdot /R_m + S_m \cdot /D_m \cdot R_m$ $C = S_m \cdot /D_m + /D_m \cdot R_m + S_m \cdot R_m$ |

Table 2-7 Condition Code Modification (cont)

| Instruction | H | N | Z | V | C | Definition |
|-------------|---|---|---|---|---|--|
| DAA | * | ↓ | ↓ | * | ↓ | $N = R_m$ $Z = /R_m \cdot /R_{m-1} \cdot \dots \cdot /R_0$ C: decimal arithmetic carry |
| DAS | * | ↓ | ↓ | * | ↓ | $N = R_m$ $Z = /R_m \cdot /R_{m-1} \cdot \dots \cdot /R_0$ C: decimal arithmetic borrow |
| DEC | — | ↓ | ↓ | ↓ | — | $N = R_m$ $Z = /R_m \cdot /R_{m-1} \cdot \dots \cdot /R_0$ $V = D_m \cdot /R_m$ |
| DIVXS | — | ↓ | ↓ | — | — | $N = S_m \cdot /D_m + /S_m \cdot D_m$ $Z = /S_m \cdot /S_{m-1} \cdot \dots \cdot /S_0$ |
| DIVXU | — | ↓ | ↓ | — | — | $N = S_m$ $Z = /S_m \cdot /S_{m-1} \cdot \dots \cdot /S_0$ |
| EEPMOV | — | — | — | — | — | |
| EXTS | — | ↓ | ↓ | O | — | $N = R_m$ $Z = /R_m \cdot /R_{m-1} \cdot \dots \cdot /R_0$ |
| EXTU | — | O | ↓ | O | — | $Z = /R_m \cdot /R_{m-1} \cdot \dots \cdot /R_0$ |
| INC | — | ↓ | ↓ | ↓ | — | $N = R_m$ $Z = /R_m \cdot /R_{m-1} \cdot \dots \cdot /R_0$ $V = D_m \cdot /R_m$ |
| JMP | — | — | — | — | — | |
| JSR | — | — | — | — | — | |
| LDC | ↓ | ↓ | ↓ | ↓ | ↓ | Stores the corresponding bits of the result |
| MOV | — | ↓ | ↓ | O | — | $N = R_m$ $Z = /R_m \cdot /R_{m-1} \cdot \dots \cdot /R_0$ |
| MOVFP | — | ↓ | ↓ | O | — | $N = R_m$ $Z = /R_m \cdot /R_{m-1} \cdot \dots \cdot /R_0$ |
| MOVTPE | — | ↓ | ↓ | O | — | $N = R_m$ $Z = /R_m \cdot /R_{m-1} \cdot \dots \cdot /R_0$ |
| MULXS | — | ↓ | ↓ | — | — | $N = R_{2m}$ $Z = \overline{R_{2m}} \cdot \overline{R_{2m-1}} \cdot \dots \cdot \overline{R_0}$ |
| MULXU | — | — | — | — | — | |
| NEG | ↓ | ↓ | ↓ | ↓ | ↓ | $H = D_{m-4} + R_{m-4}$ $N = R_m$ $Z = /R_m \cdot /R_{m-1} \cdot \dots \cdot /R_0$ $V = D_m \cdot R_m$ $C = D_m + R_m$ |

Table 2-7 Condition Code Modification (cont)

| Instruction | H | N | Z | V | C | Definition |
|-------------|---|---|---|---|---|---|
| NOP | — | — | — | — | — | |
| NOT | — | ↕ | ↕ | O | — | $N = R_m$ $Z = /R_m \cdot /R_{m-1} \cdot \dots \cdot /R_0$ |
| OR | — | ↕ | ↕ | O | — | $N = R_m$ $Z = /R_m \cdot /R_{m-1} \cdot \dots \cdot /R_0$ |
| ORC | ↕ | ↕ | ↕ | ↕ | ↕ | Stores the corresponding bits of the result |
| POP | — | ↕ | ↕ | O | — | $N = R_m$ $Z = /R_m \cdot /R_{m-1} \cdot \dots \cdot /R_0$ |
| PUSH | — | ↕ | ↕ | O | — | $N = R_m$ $Z = /R_m \cdot /R_{m-1} \cdot \dots \cdot /R_0$ |
| ROTL | — | ↕ | ↕ | O | ↕ | $N = R_m$ $Z = /R_m \cdot /R_{m-1} \cdot \dots \cdot /R_0$ $C = D_m$ |
| ROTR | — | ↕ | ↕ | O | ↕ | $N = R_m$ $Z = /R_m \cdot /R_{m-1} \cdot \dots \cdot /R_0$ $C = D_0$ |
| ROTXL | — | ↕ | ↕ | O | ↕ | $N = R_m$ $Z = /R_m \cdot /R_{m-1} \cdot \dots \cdot /R_0$ $C = D_m$ |
| ROTXR | — | ↕ | ↕ | O | ↕ | $N = R_m$ $Z = /R_m \cdot /R_{m-1} \cdot \dots \cdot /R_0$ $C = D_0$ |
| RTS | — | — | — | — | — | |
| RTE | ↕ | ↕ | ↕ | ↕ | ↕ | Stores the corresponding bits of the result |
| SHAL | — | ↕ | ↕ | ↕ | ↕ | $N = R_m$ $Z = /R_m \cdot /R_{m-1} \cdot \dots \cdot /R_0$ $V = D_m \cdot /D_{m-1} + /D_m \cdot D_{m-1}$ $C = D_m$ |
| SHAR | — | ↕ | ↕ | O | ↕ | $N = R_m$ $Z = /R_m \cdot /R_{m-1} \cdot \dots \cdot /R_0$ $C = D_0$ |
| SHLL | — | ↕ | ↕ | O | ↕ | $N = R_m$ $Z = /R_m \cdot /R_{m-1} \cdot \dots \cdot /R_0$ $C = D_m$ |

Table 2-7 Condition Code Modification (cont)

| Instruction | H | N | Z | V | C | Definition |
|-------------|---|---|---|---|---|---|
| SHLR | — | ↓ | ↓ | O | ↓ | $N = R_m$ $Z = /R_m \cdot /R_{m-1} \cdot \dots \cdot /R_0$ $C = D_0$ |
| SLEEP | — | — | — | — | — | |
| STC | — | — | — | — | — | |
| SUB | ↓ | ↓ | ↓ | ↓ | ↓ | $H = S_{m-4} \cdot /D_{m-4} + /D_{m-4} \cdot R_{m-4} + S_{m-4} \cdot R_{m-4}$ $N = R_m$ $Z = /R_m \cdot /R_{m-1} \cdot \dots \cdot /R_0$ $V = /S_m \cdot D_m \cdot /R_m + S_m \cdot /D_m \cdot R_m$ $C = S_m \cdot /D_m + /D_m \cdot R_m + S_m \cdot R_m$ |
| SUBS | — | — | — | — | — | |
| SUBX | ↓ | ↓ | ↓ | ↓ | ↓ | $H = S_{m-4} \cdot /D_{m-4} + /D_{m-4} \cdot R_{m-4} + S_{m-4} \cdot R_{m-4}$ $N = R_m$ $Z = Z' \cdot /R_m \cdot \dots \cdot /R_0$ $V = /S_m \cdot D_m \cdot /R_m + S_m \cdot /D_m \cdot R_m$ $C = S_m \cdot /D_m + /D_m \cdot R_m + S_m \cdot R_m$ |
| TRAPA | — | — | — | — | — | |
| XOR | — | ↓ | ↓ | O | — | $N = R_m$ $Z = /R_m \cdot /R_{m-1} \cdot \dots \cdot /R_0$ |
| XORC | ↓ | ↓ | ↓ | ↓ | ↓ | Stores the corresponding bits of the result |

2.8 Bus Cycles During Instruction Execution

Table 2-8 indicates the bus cycles during instruction execution by the H8/300H CPU. For the number of states per bus cycle, see table 2-7, Number of States per Cycle.

How to read the table:

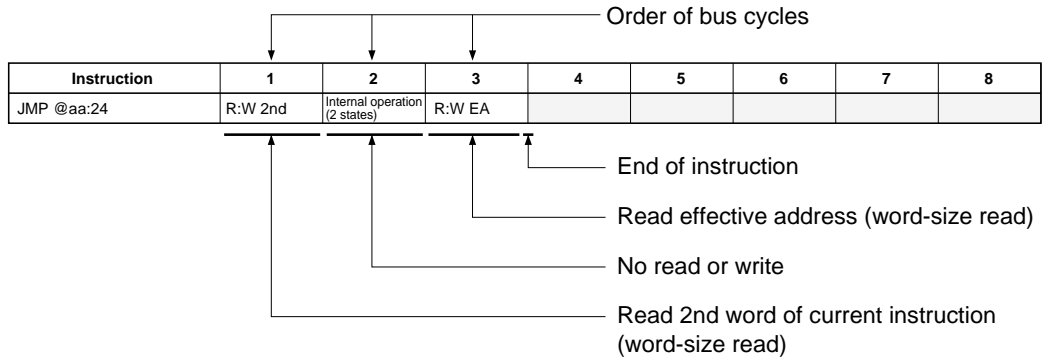

Legend

R:B Byte-size read

R:W Word-size read

W:B Byte-size write

W:W Word-size write

2nd Address of 2nd word (3rd and 4th bytes)

3rd Address of 3rd word (5th and 6th bytes)

4th Address of 4th word (7th and 8th bytes)

5th Address of 5th word (9th and 10th bytes)

NEXT Address of next instruction

EA Effective address

VEC Vector address

Figure 2-1 shows timing waveforms for the address bus and the \overline{RD} and \overline{WR} (\overline{HWR} or \overline{LWR}) signals during execution of the above instruction with an 8-bit bus, using 3-state access with no wait states.

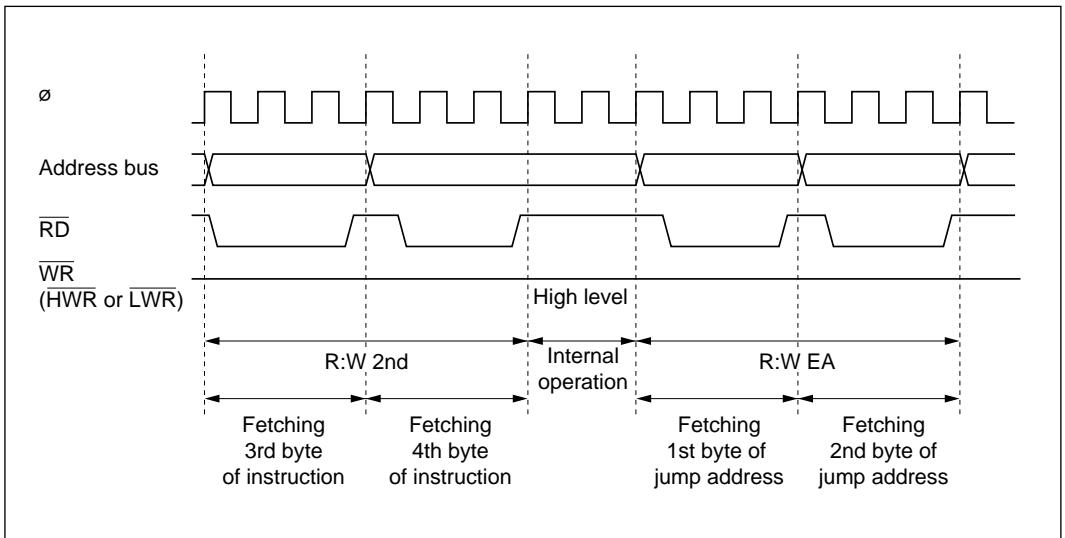

Figure 2-1 Address Bus, \overline{RD} , and \overline{WR} (\overline{HWR} or \overline{LWR}) Timing (8-bit bus, 3-state access, no wait states)

Table 2-8 Bus States

| Instruction | 1 | 2 | 3 | 4 | 5 | 6 | 7 | 8 |
|-------------------|----------|----------|----------|---|---|---|---|---|
| ADD.B #xx:8,Rd | R:W NEXT | | | | | | | |
| ADD.B Rs,Rd | R:W NEXT | | | | | | | |
| ADD.W #xx:16,Rd | R:W 2nd | R:W NEXT | | | | | | |
| ADD.W Rs,Rd | R:W NEXT | | | | | | | |
| ADD.L #xx:32,ERd | R:W 2nd | R:W 3rd | R:W NEXT | | | | | |
| ADD.L ERs,ERd | R:W NEXT | | | | | | | |
| ADDS #1/2/4,ERd | R:W NEXT | | | | | | | |
| ADDX #xx:8,Rd | R:W NEXT | | | | | | | |
| ADDX Rs,Rd | R:W NEXT | | | | | | | |
| AND.B #xx:8,Rd | R:W NEXT | | | | | | | |
| AND.B Rs,Rd | R:W NEXT | | | | | | | |
| AND.W #xx:16,Rd | R:W 2nd | R:W NEXT | | | | | | |
| AND.W Rs,Rd | R:W NEXT | | | | | | | |
| AND.L #xx:32,ERd | R:W 2nd | R:W 3rd | R:W NEXT | | | | | |
| AND.L ERs,ERd | R:W 2nd | R:W NEXT | | | | | | |
| ANDC #xx:8,CCR | R:W NEXT | | | | | | | |
| BAND #xx:3,Rd | R:W NEXT | | | | | | | |
| BAND #xx:3,@ERd | R:W 2nd | R:B EA | R:W NEXT | | | | | |
| BAND #xx:3,@aa:8 | R:W 2nd | R:B EA | R:W NEXT | | | | | |
| BRA d:8 (BT d;8) | R:W NEXT | R:W EA | | | | | | |
| BRN d:8 (BF d;8) | R:W NEXT | R:W EA | | | | | | |
| BHI d:8 | R:W NEXT | R:W EA | | | | | | |
| BLS d:8 | R:W NEXT | R:W EA | | | | | | |
| BCC d:8 (BHS d;8) | R:W NEXT | R:W EA | | | | | | |
| BCS d:8 (BLO d;8) | R:W NEXT | R:W EA | | | | | | |
| BNE d:8 | R:W NEXT | R:W EA | | | | | | |
| BEQ d:8 | R:W NEXT | R:W EA | | | | | | |
| BVC d:8 | R:W NEXT | R:W EA | | | | | | |
| BVS d:8 | R:W NEXT | R:W EA | | | | | | |
| BPL d:8 | R:W NEXT | R:W EA | | | | | | |
| BMI d:8 | R:W NEXT | R:W EA | | | | | | |

Table 2-8 Bus States (cont)

| Instruction | 1 | 2 | 3 | 4 | 5 | 6 | 7 | 8 |
|---------------------|----------|---------------------------------|--------|---|---|---|---|---|
| BGE d:8 | R:W NEXT | R:W EA | | | | | | |
| BLT d:8 | R:W NEXT | R:W EA | | | | | | |
| BGT d:8 | R:W NEXT | R:W EA | | | | | | |
| BLE d:8 | R:W NEXT | R:W EA | | | | | | |
| BRA d:16 (BT d:16) | R:W 2nd | Internal operation, 2 states | R:W EA | | | | | |
| BRN d:16 (BF d:16) | R:W 2nd | Internal operation, 2 states | R:W EA | | | | | |
| BHI d:16 | R:W 2nd | Internal operation, 2 states | R:W EA | | | | | |
| BLS d:16 | R:W 2nd | Internal operation, 2 states | R:W EA | | | | | |
| BCC d:16 (BHS d:16) | R:W 2nd | Internal operation, 2 states | R:W EA | | | | | |
| BCS d:16 (BLO d:16) | R:W 2nd | Internal operation, 2 states | R:W EA | | | | | |
| BNE d:16 | R:W 2nd | Internal operation, 2 states | R:W EA | | | | | |
| BEQ d:16 | R:W 2nd | Internal operation, 2 states | R:W EA | | | | | |
| BVC d:16 | R:W 2nd | Internal operation, 2 states | R:W EA | | | | | |
| BVS d:16 | R:W 2nd | Internal operation, 2 states | R:W EA | | | | | |
| BPL d:16 | R:W 2nd | Internal operation, 2 states | R:W EA | | | | | |
| BMI d:16 | R:W 2nd | Internal operation, 2 states | R:W EA | | | | | |
| BGE d:16 | R:W 2nd | Internal operation, 2 states | R:W EA | | | | | |
| BLT d:16 | R:W 2nd | Internal operation, 2 states | R:W EA | | | | | |
| BGT d:16 | R:W 2nd | Internal operation, 2 states | R:W EA | | | | | |
| BLE d:16 | R:W 2nd | Internal operation, 2 states | R:W EA | | | | | |

Table 2-8 Bus States (cont)

| Instruction | 1 | 2 | 3 | 4 | 5 | 6 | 7 | 8 |
|-------------------|----------|--------|----------|--------|---|---|---|---|
| BCLR #xx:3,Rd | R:W NEXT | | | | | | | |
| BCLR #xx:3,@ERd | R:W 2nd | R:B EA | R:W NEXT | W:B EA | | | | |
| BCLR #xx:3,@aa:8 | R:W 2nd | R:B EA | R:W NEXT | W:B EA | | | | |
| BCLR Rn,Rd | R:W NEXT | | | | | | | |
| BCLR Rn,@ERd | R:W 2nd | R:B EA | R:W NEXT | W:B EA | | | | |
| BCLR Rn,@aa:8 | R:W 2nd | R:B EA | R:W NEXT | W:B EA | | | | |
| BIAND #xx:3,Rd | R:W NEXT | | | | | | | |
| BIAND #xx:3,@ERd | R:W 2nd | R:B EA | R:W NEXT | | | | | |
| BIAND #xx:3,@aa:8 | R:W 2nd | R:B EA | R:W NEXT | | | | | |
| BILD #xx:3,Rd | R:W NEXT | | | | | | | |
| BILD #xx:3,@ERd | R:W 2nd | R:B EA | R:W NEXT | | | | | |
| BILD #xx:3,@aa:8 | R:W 2nd | R:B EA | R:W NEXT | | | | | |
| BIOR #xx:8,Rd | R:W NEXT | | | | | | | |
| BIOR #xx:8,@ERd | R:W 2nd | R:B EA | R:W NEXT | | | | | |
| BIOR #xx:8,@aa:8 | R:W 2nd | R:B EA | R:W NEXT | | | | | |
| BIST #xx:3,Rd | R:W NEXT | | | | | | | |
| BIST #xx:3,@ERd | R:W 2nd | R:B EA | R:W NEXT | W:B EA | | | | |
| BIST #xx:3,@aa:8 | R:W 2nd | R:B EA | R:W NEXT | W:B EA | | | | |
| BIXOR #xx:3,Rd | R:W NEXT | | | | | | | |
| BIXOR #xx:3,@ERd | R:W 2nd | R:B EA | R:W NEXT | | | | | |
| BIXOR #xx:3,@aa:8 | R:W 2nd | R:B EA | R:W NEXT | | | | | |
| BLD #xx:3,Rd | R:W NEXT | | | | | | | |
| BLD #xx:3,@ERd | R:W 2nd | R:B EA | R:W NEXT | | | | | |
| BLD #xx:3,@aa:8 | R:W 2nd | R:B EA | R:W NEXT | | | | | |
| BNOT #xx:3,Rd | R:W NEXT | | | | | | | |
| BNOT #xx:3,@ERd | R:W 2nd | R:B EA | R:W NEXT | W:B EA | | | | |
| BNOT #xx:3,@aa:8 | R:W 2nd | R:B EA | R:W NEXT | W:B EA | | | | |
| BNOT Rn,Rd | R:W NEXT | | | | | | | |
| BNOT Rn,@ERd | R:W 2nd | R:B EA | R:W NEXT | W:B EA | | | | |
| BNOT Rn,@aa:8 | R:W 2nd | R:B EA | R:W NEXT | W:B EA | | | | |
| BOR #xx:3,Rd | R:W NEXT | | | | | | | |
| BOR #xx:3,@ERd | R:W 2nd | R:B EA | R:W NEXT | | | | | |
| BOR #xx:3,@aa:8 | R:W 2nd | R:B EA | R:W NEXT | | | | | |
| BSET #xx:3,Rd | R:W NEXT | | | | | | | |
| BSET #xx:3,@ERd | R:W 2nd | R:B EA | R:W NEXT | W:B EA | | | | |
| BSET #xx:3,@aa:8 | R:W 2nd | R:B EA | R:W NEXT | W:B EA | | | | |

Table 2-8 Bus States (cont)

| Instruction | | 1 | 2 | 3 | 4 | 5 | 6 | 7 | 8 |
|------------------|----------|----------|-------------------------------|-------------------------------|---------------|---------------|----------|---|---|
| BSET Rn,Rd | | R:W NEXT | | | | | | | |
| BSET Rn,@ERd | | R:W 2nd | R:B EA | R:W NEXT | W:B EA | | | | |
| BSET Rn,@aa:8 | | R:W 2nd | R:B EA | R:W NEXT | W:B EA | | | | |
| BRS d:8 | Normal | R:W NEXT | R:W EA | W:W Stack | | | | | |
| | Advanced | R:W NEXT | R:W EA | W:W Stack (H) | W:W Stack (L) | | | | |
| BRS d:16 | Normal | R:W 2nd | Internal operation, 2 states | R:W EA | W:W Stack | | | | |
| | Advanced | R:W 2nd | Internal operation, 2 states | R:W EA | W:W Stack (H) | W:W Stack (L) | | | |
| BST #xx:3,Rd | | R:W NEXT | | | | | | | |
| BST #xx:3,@ERd | | R:W 2nd | R:B EA | R:W NEXT | W:B EA | | | | |
| BST #xx:3,@aa:8 | | R:W 2nd | R:B EA | R:W NEXT | W:B EA | | | | |
| BTST #xx:3,Rd | | R:W NEXT | | | | | | | |
| BTST #xx:3,@ERd | | R:W 2nd | R:B EA | R:W NEXT | | | | | |
| BTST #xx:3,@aa:8 | | R:W 2nd | R:B EA | R:W NEXT | | | | | |
| BTST Rn,Rd | | R:W NEXT | | | | | | | |
| BTST Rn,@ERd | | R:W 2nd | R:B EA | R:W NEXT | | | | | |
| BTST Rn,@aa:8 | | R:W 2nd | R:B EA | R:W NEXT | | | | | |
| BXOR #xx:3,Rd | | R:W NEXT | | | | | | | |
| BXOR #xx:3,@ERd | | R:W 2nd | R:B EA | R:W NEXT | | | | | |
| BXOR #xx:3,@aa:8 | | R:W 2nd | R:B EA | R:W NEXT | | | | | |
| CMP.B #xx:8,Rd | | R:W NEXT | | | | | | | |
| CMP.B Rs,Rd | | R:W NEXT | | | | | | | |
| CMP.W #xx:16,Rd | | R:W 2nd | R:W NEXT | | | | | | |
| CMP.W Rs,Rd | | R:W NEXT | | | | | | | |
| C MPL #xx:32,ERd | | R:W 2nd | R:W 3rd | R:W NEXT | | | | | |
| C MPL ERs,ERd | | R:W NEXT | | | | | | | |
| DAA Rd | | R:W NEXT | | | | | | | |
| DAS Rd | | R:W NEXT | | | | | | | |
| DEC.B Rd | | R:W NEXT | | | | | | | |
| DEC.W #1/2,Rd | | R:W NEXT | | | | | | | |
| DEC.L #1/2,ERd | | R:W NEXT | | | | | | | |
| DIVXS.B Rs,Rd | | R:W 2nd | R:W NEXT | Internal operation, 12 states | | | | | |
| DIVXS.W Rs,ERd | | R:W 2nd | R:W NEXT | Internal operation, 20 states | | | | | |
| DIVXU.B Rs,Rd | | R:W NEXT | Internal operation, 12 states | | | | | | |
| DIVXU.W Rs,ERd | | R:W NEXT | Internal operation, 20 states | | | | | | |
| EEPMOV.B | | R:W 2nd | R:B EAs *1 | R:B EAd *1 | R:B EAs *2 | W:B EAd *2 | R:W NEXT | | |
| EEPMOV.W | | R:W 2nd | R:B EAs *1 | R:B EAd *1 | R:B EAs *2 | W:B EAd *2 | R:W NEXT | | |

Table 2-8 Bus States (cont)

| Instruction | | 1 | 2 | 3 | 4 | 5 | 6 | 7 | 8 |
|----------------------|----------|----------|---------------------------------|---------------------------------|---------------------------------|---------------|--------|---|---|
| EXTS.W Rd | | R:W NEXT | | | | | | | |
| EXTS.L ERd | | R:W NEXT | | | | | | | |
| EXTU.W Rd | | R:W NEXT | | | | | | | |
| EXTU.L ERd | | R:W NEXT | | | | | | | |
| INC.B Rd | | R:W NEXT | | | | | | | |
| INC.W #1/2,Rd | | R:W NEXT | | | | | | | |
| INC.L #1/2,ERd | | R:W NEXT | | | | | | | |
| JMP @ERn | | R:W NEXT | R:W EA | | | | | | |
| JMP @aa:24 | | R:W 2nd | Internal operation, 2 states | R:W EA | | | | | |
| JMP @@@a:8 | Normal | R:W NEXT | R:W aa:8 | Internal operation, 2 states | R:W EA | | | | |
| | Advanced | R:W NEXT | R:W aa:8 | R:W aa:8 | Internal operation, 2 states | R:W EA | | | |
| JSR @ERn | Normal | R:W NEXT | R:W EA | W:W Stack | | | | | |
| | Advanced | R:W NEXT | R:W EA | W:W Stack (H) | W:W Stack (L) | | | | |
| JSR @aa:24 | Normal | R:W 2nd | Internal operation, 2 states | R:W EA | W:W Stack | | | | |
| | Advanced | R:W 2nd | Internal operation, 2 states | R:W EA | W:W Stack (H) | W:W Stack (L) | | | |
| JSR @@@a:8 | Normal | R:W NEXT | R:W aa:8 | W:W Stack | R:W EA | | | | |
| | Advanced | R:W NEXT | R:W aa:8 | R:W aa:8 | W:W Stack (H) | W:W Stack (L) | R:W EA | | |
| LDC #xx:8,CCR | | R:W NEXT | | | | | | | |
| LDC Rs,CCR | | R:W NEXT | | | | | | | |
| LDC @ERs,CCR | | R:W 2nd | R:W NEXT | R:W EA | | | | | |
| LDC @(d:16,ERs),CCR | | R:W 2nd | R:W 3rd | R:W NEXT | R:W EA | | | | |
| LDC @(d:24,ERs),CCR | | R:W 2nd | R:W 3rd | R:W 4th | R:W 5th | R:W NEXT | R:W EA | | |
| LDC @ERs+,CCR | | R:W 2nd | R:W NEXT | Internal operation, 2 states | R:W EA | | | | |
| LDC @aa:16,CCR | | R:W 2nd | R:W 3rd | R:W NEXT | R:W EA | | | | |
| LDC @aa:24,CCR | | R:W 2nd | R:W 3rd | R:W 4th | R:W NEXT | R:W EA | | | |
| MOV.B #xx:8,Rd | | R:W NEXT | | | | | | | |
| MOV.B Rs,Rd | | R:W NEXT | | | | | | | |
| MOV.B @ERs,Rd | | R:W NEXT | R:B EA | | | | | | |
| MOV.B @(d:16,ERs),Rd | | R:W 2nd | R:W NEXT | R:B EA | | | | | |
| MOV.B @(d:24,ERs),Rd | | R:W 2nd | R:W 3rd | R:W 4th | R:W NEXT | R:B EA | | | |

Table 2-8 Bus States (cont)

| Instruction | 1 | 2 | 3 | 4 | 5 | 6 | 7 | 8 |
|-----------------------|----------|---------------------------------|---------------------------------|----------|----------|--------|----------|---|
| MOV.B @ERs+,Rd | R:W NEXT | Internal operation, 2 states | R:B EA | | | | | |
| MOV.B @aa:8,Rd | R:W NEXT | R:B EA | | | | | | |
| MOV.B @aa:16,Rd | R:W 2nd | R:W NEXT | R:B EA | | | | | |
| MOV.B @aa:24,Rd | R:W 2nd | R:W 3rd | R:W NEXT | R:B EA | | | | |
| MOV.B Rs,@ERd | R:W NEXT | W:B EA | | | | | | |
| MOV.B Rs,@(d:16,ERd) | R:W 2nd | R:W NEXT | W:B EA | | | | | |
| MOV.B Rs,@(d:24,ERd) | R:W 2nd | R:W 3rd | R:W 4th | R:W NEXT | W:B EA | | | |
| MOV.B Rs,@-ERd | R:W NEXT | Internal operation, 2 states | W:B EA | | | | | |
| MOV.B Rs,@aa:8 | R:W NEXT | W:B EA | | | | | | |
| MOV.B Rs,@aa:16 | R:W 2nd | R:W NEXT | W:B EA | | | | | |
| MOV.B Rs,@aa:24 | R:W 2nd | R:W 3rd | R:W NEXT | W:B EA | | | | |
| MOV.W #xx:16,Rd | R:W 2nd | R:W NEXT | | | | | | |
| MOV.W Rs,Rd | R:W NEXT | | | | | | | |
| MOV.W @ERs,Rd | R:W NEXT | R:W EA | | | | | | |
| MOV.W @(d:16,ERs),Rd | R:W 2nd | R:W NEXT | R:W EA | | | | | |
| MOV.W @(d:24,ERs),Rd | R:W 2nd | R:W 3rd | R:W 4th | R:W NEXT | R:W EA | | | |
| MOV.W @ERs+,Rd | R:W NEXT | Internal operation, 2 states | R:W EA | | | | | |
| MOV.W @aa:16,Rd | R:W 2nd | R:W NEXT | R:W EA | | | | | |
| MOV.W @aa:24,Rd | R:W 2nd | R:W 3rd | R:W NEXT | R:B EA | | | | |
| MOV.W Rs,@ERd | R:W NEXT | W:W EA | | | | | | |
| MOV.W Rs,@(d:16,ERd) | R:W 2nd | R:W NEXT | W:W EA | | | | | |
| MOV.W Rs,@(d:24,ERd) | R:W 2nd | R:W 3rd | R:E 4th | R:W NEXT | W:W EA | | | |
| MOV.W Rs,@-ERd | R:W NEXT | Internal operation, 2 states | W:W EA | | | | | |
| MOV.W Rs,@aa:16 | R:W 2nd | R:W NEXT | W:W EA | | | | | |
| MOV.W Rs,@aa:24 | R:W 2nd | R:W 3rd | R:W NEXT | W:W EA | | | | |
| MOV.L #xx:32,ERd | R:W 2nd | R:W 3rd | R:W NEXT | | | | | |
| MOV.L ERs,ERd | R:W NEXT | | | | | | | |
| MOV.L @ERs,ERd | R:W 2nd | R:W NEXT | R:W EA | R:W EA+2 | | | | |
| MOV.L @(d:16,ERs),ERd | R:W 2nd | R:W 3rd | R:W NEXT | R:W EA | R:W EA+2 | | | |
| MOV.L @(d:24,ERs),ERd | R:W 2nd | R:W 3rd | R:W 4th | R:W 5th | R:W NEXT | R:W EA | R:W EA+2 | |
| MOV.L @ERs+,ERd | R:W 2nd | R:W NEXT | Internal operation, 2 states | R:W EA | R:W EA+2 | | | |

Table 2-8 Bus States (cont)

| Instruction | 1 | 2 | 3 | 4 | 5 | 6 | 7 | 8 |
|-----------------------|----------|---------------------------------|---------------------------------|---------------|---------------|----------|----------|---|
| MOV.L @aa:16,ERd | R:W 2nd | R:W 3rd | R:W NEXT | R:W EA | R:W EA+2 | | | |
| MOV.L @aa:24,ERd | R:W 2nd | R:W 3rd | R:W 4th | R:W NEXT | R:W EA | R:W EA+2 | | |
| MOV.L ERs,@ERd | R:W 2nd | R:W NEXT | W:W EA | W:W EA+2 | | | | |
| MOV.L ERs,@(d:16,ERd) | R:W 2nd | R:W 3rd | R:W NEXT | W:W EA | | | | |
| MOV.L ERs,@(d:24,ERd) | R:W 2nd | R:W 3rd | R:W 4th | R:W 5th | R:W NEXT | W:W EA | W:W EA+2 | |
| MOV.L ERs,@-ERd | R:W 2nd | R:W NEXT | Internal operation, 2 states | W:W EA | W:W EA+2 | | | |
| MOV.L ERs,@aa:16 | R:W 2nd | R:W 3rd | R:W NEXT | W:W EA | W:W EA+2 | | | |
| MOV.L ERs,@aa:24 | R:W 2nd | R:W 3rd | R:W 4th | R:W NEXT | W:W EA | W:W EA+2 | | |
| MOVFPPE @aa:16,Rd | R:W 2nd | Internal operation, 2 states | R:W *3 EA | | | | | |
| MOVTPPE Rs,@aa:16 | R:W 2nd | Internal operation, 2 states | W:B *3 EA | | | | | |
| MULXS.B Rs,Rd | R:W 2nd | R:W NEXT | Internal operation, 12 states | | | | | |
| MULXS.W Rs,ERd | R:W 2nd | R:W NEXT | Internal operation, 20 states | | | | | |
| MULXU.B Rs,Rd | R:W NEXT | Internal operation, 12 states | | | | | | |
| MULXU.W Rs,ERd | R:W NEXT | Internal operation, 20 states | | | | | | |
| NEG.B Rd | R:W NEXT | | | | | | | |
| NEG.W Rd | R:W NEXT | | | | | | | |
| NEG.L ERd | R:W NEXT | | | | | | | |
| NOP | R:W NEXT | | | | | | | |
| NOT.B Rd | R:W NEXT | | | | | | | |
| NOT.W Rd | R:W NEXT | | | | | | | |
| NOT.L ERd | R:W NEXT | | | | | | | |
| OR.B #xx:8,Rd | R:W NEXT | | | | | | | |
| OR.B Rs,Rd | R:W NEXT | | | | | | | |
| OR.W #xx:16,Rd | R:W 2nd | R:W NEXT | | | | | | |
| OR.W Rs,Rd | R:W NEXT | | | | | | | |
| OR.L #xx:32,ERd | R:W 2nd | R:W rd | R:W NEXT | | | | | |
| OR.L ERs,ERd | R:W 2nd | R:W NEXT | | | | | | |
| ORC #xx:8,CCR | R:W NEXT | | | | | | | |
| POP.W Rn | R:W NEXT | Internal operation, 2 states | R:W Stack | | | | | |
| POPL ERn | R:W 2nd | R:W NEXT | Internal operation, 2 states | R:W Stack (H) | R:W Stack (L) | | | |

Table 2-8 Bus States (cont)

| Instruction | | 1 | 2 | 3 | 4 | 5 | 6 | 7 | 8 |
|-------------|----------|----------|---------------------------------|---------------------------------|---------------------------------|---------------|---|---|---|
| PUSH.W Rn | | R:W NEXT | Internal operation, 2 states | W:W Stack | | | | | |
| PUSH.L ERn | | R:W 2nd | R:W NEXT | Internal operation, 2 states | W:W Stack (L) | W:W Stack (H) | | | |
| ROTL.B Rd | | R:W NEXT | | | | | | | |
| ROTL.W Rd | | R:W NEXT | | | | | | | |
| ROTL.L ERd | | R:W NEXT | | | | | | | |
| ROTR.B Rd | | R:W NEXT | | | | | | | |
| ROTR.W Rd | | R:W NEXT | | | | | | | |
| ROTR.L ERd | | R:W NEXT | | | | | | | |
| ROTXL.B Rd | | R:W NEXT | | | | | | | |
| ROTXL.W Rd | | R:W NEXT | | | | | | | |
| ROTXL.L ERd | | R:W NEXT | | | | | | | |
| ROTXR.B Rd | | R:W NEXT | | | | | | | |
| ROTXR.W Rd | | R:W NEXT | | | | | | | |
| ROTXR.L ERd | | R:W NEXT | | | | | | | |
| RTE | | R:W NEXT | R:W Stack (H) | R:W Stack (L) | Internal operation, 2 states | R:W (*4) | | | |
| RTS | Normal | R:W NEXT | R:W Stack | Internal operation, 2 states | R:W (*4) | | | | |
| | Advanced | R:W NEXT | R:W Stack (H) | R:W Stack (L) | Internal operation, 2 states | R:W (*4) | | | |
| SHAL.B Rd | | R:W NEXT | | | | | | | |
| SHAL.W Rd | | R:W NEXT | | | | | | | |
| SHAL.L ERd | | R:W NEXT | | | | | | | |
| SHAR.B Rd | | R:W NEXT | | | | | | | |
| SHAR.W Rd | | R:W NEXT | | | | | | | |
| SHAR.L ERd | | R:W NEXT | | | | | | | |
| SHLL.B Rd | | R:W NEXT | | | | | | | |
| SHLL.W Rd | | R:W NEXT | | | | | | | |
| SHLL.L ERd | | R:W NEXT | | | | | | | |
| SHLR.B Rd | | R:W NEXT | | | | | | | |
| SHLR.W Rd | | R:W NEXT | | | | | | | |
| SHLR.L ERd | | R:W NEXT | | | | | | | |
| SLEEP | | R:W NEXT | | | | | | | |
| STC CCR,Rd | | R:W NEXT | | | | | | | |

Table 2-8 Bus States (cont)

| Instruction | | 1 | 2 | 3 | 4 | 5 | 6 | 7 | 8 |
|------------------------------|----------|----------|---------------------------------|---------------------------------|---------------|----------|---------------------------------|---------------------------------|----------|
| STC CCR,@ERd | | R:W 2nd | R:W NEXT | W:W EA | | | | | |
| STC CCR,@(d:16,ERd) | | R:W 2nd | R:W 3rd | R:W NEXT | W:W EA | | | | |
| STC CCR,@(d:24,ERd) | | R:W 2nd | R:W 3rd | R:W 4th | R:W 5th | R:W NEXT | W:W EA | | |
| STC CCR,@-ERd | | R:W 2nd | R:W NEXT | Internal operation, 2 states | W:W EA | | | | |
| STC CCR,@aa:16 | | R:W 2nd | R:W 3rd | R:W NEXT | W:W EA | | | | |
| STC CCR,@aa:24 | | R:W 2nd | R:W 3rd | R:W 4th | R:W NEXT | W:W EA | | | |
| SUB.B Rs,Rd | | R:W NEXT | | | | | | | |
| SUB.W #xx:16,Rd | | R:W 2nd | R:W NEXT | | | | | | |
| SUB.W Rs,Rd | | R:W NEXT | | | | | | | |
| SUB.L #xx:32,ERd | | R:W 2nd | R:W 3rd | R:W NEXT | | | | | |
| SUB.L ERs,ERd | | R:W NEXT | | | | | | | |
| SUBS #1/2/4,ERd | | R:W NEXT | | | | | | | |
| SUBX #xx:8,Rd | | R:W NEXT | | | | | | | |
| SUBX Rs,Rd | | R:W NEXT | | | | | | | |
| TRAPA #x:2 | Normal | R:W NEXT | Internal operation, 2 states | W:W Stack (L) | W:W Stack (H) | R:W VEC | Internal operation, 2 states | R:W (*7) | |
| | Advanced | R:W NEXT | Internal operation, 2 states | W:W Stack (L) | W:W Stack (H) | R:W VEC | R:W VEC+2 | Internal operation, 2 states | R:W (*7) |
| XOR.B #xx8,Rd | | R:W NEXT | | | | | | | |
| XOR.B Rs,Rd | | R:W NEXT | | | | | | | |
| XOR.W #xx:16,Rd | | R:W 2nd | R:W NEXT | | | | | | |
| XOR.W Rs,Rd | | R:W NEXT | | | | | | | |
| XOR.L #xx:32,ERd | | R:W 2nd | R:W 3rd | R:W NEXT | | | | | |
| XOR.L ERs,ERd | | R:W 2nd | R:W NEXT | | | | | | |
| XORC #xx:8,CCR | | R:W NEXT | | | | | | | |
| Reset exception handling | Normal | R:W VEC | Internal operation, 2 states | R:W (*5) | | | | | |
| | Advanced | R:W VEC | R:W VEC+2 | Internal operation, 2 states | R:W (*5) | | | | |
| Interrupt exception handling | Normal | R:W (*6) | Internal operation, 2 states | W:W stack (L) | W:W stack (H) | R:W VEC | Internal operation, 2 states | R:W (*7) | |
| | Advanced | R:W (*6) | Internal operation, 2 states | W:W stack (L) | W:W stack (H) | R:W VEC | R:W VEC+2 | Internal operation, 2 states | R:W (*7) |

- Notes:
1. EAs is the contents of ER5. EAd is the contents of R6.
 2. EAs is the contents of ER5. EAd is the contents of R6. Both registers are incremented by 1 after execution of the instruction. n is the initial value of R4L or R4. If n = 0, these bus cycles are not executed.
 3. The number of states required for byte read or write varies from 9 to 16.
 4. Starting address after return.
 5. Starting address of the program.
 6. Prefetch address, equal to two plus the PC value pushed on the stack. In recovery from sleep mode or software standby mode the read operation is replaced by an internal operation.
 7. Starting address of the interrupt-handling routine.
 8. NEXT: Next address after the current instruction.
 - 2nd: Address of the second word of the current instruction.
 - 3rd: Address of the third word of the current instruction.
 - 4th: Address of the fourth word of the current instruction.
 - 5th: Address of the fifth word of the current instruction.
 - EA: Effective address.
 - VEC: Vector address.

Section 3 Processing States

3.1 Overview

The CPU has five main processing states: the program execution state, exception handling state, power-down state, reset state, and bus-released state. The power-down state includes sleep mode, software standby mode, and hardware standby mode. Figure 3-1 shows a diagram of the processing states. Figure 3-2 indicates the state transitions. For details, refer to the relevant microcontroller hardware manual.

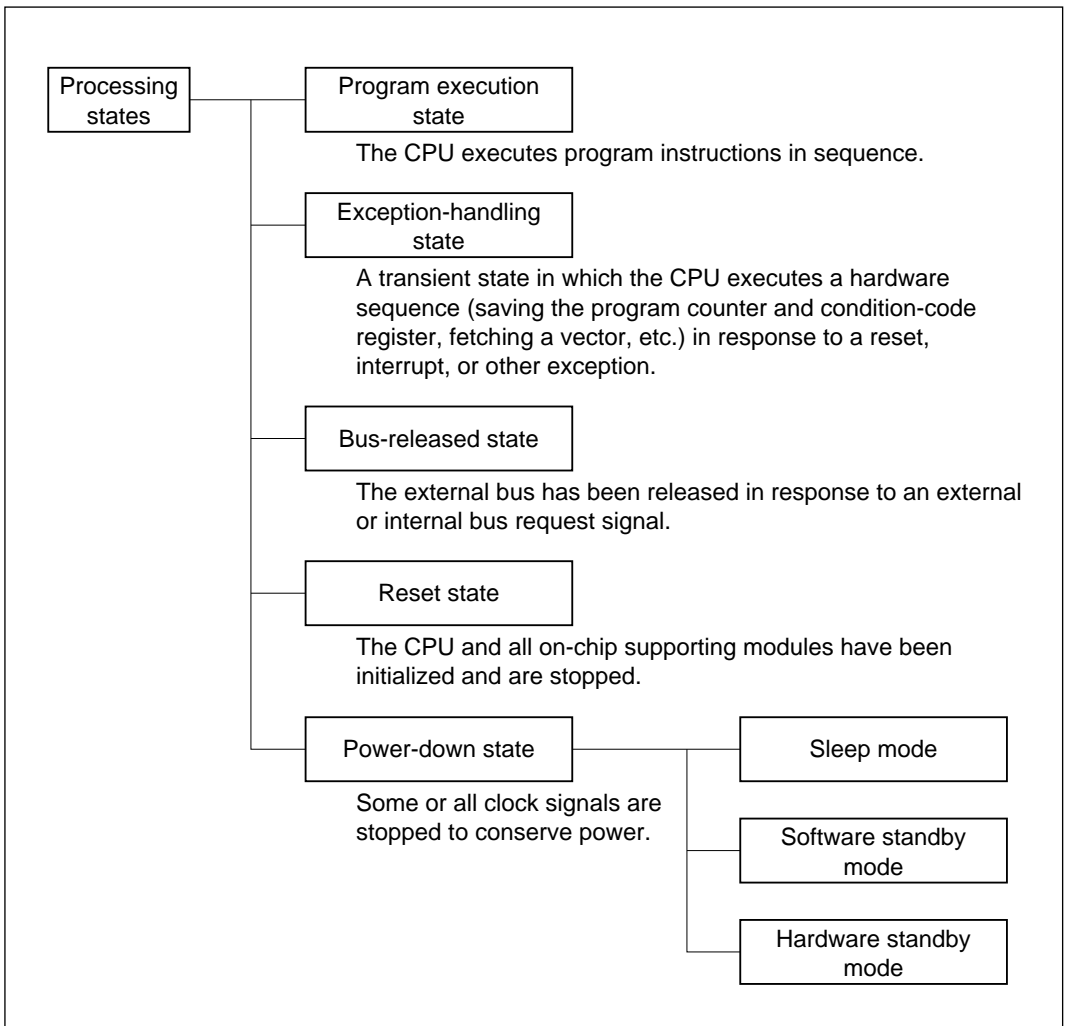

Figure 3-1 Processing States

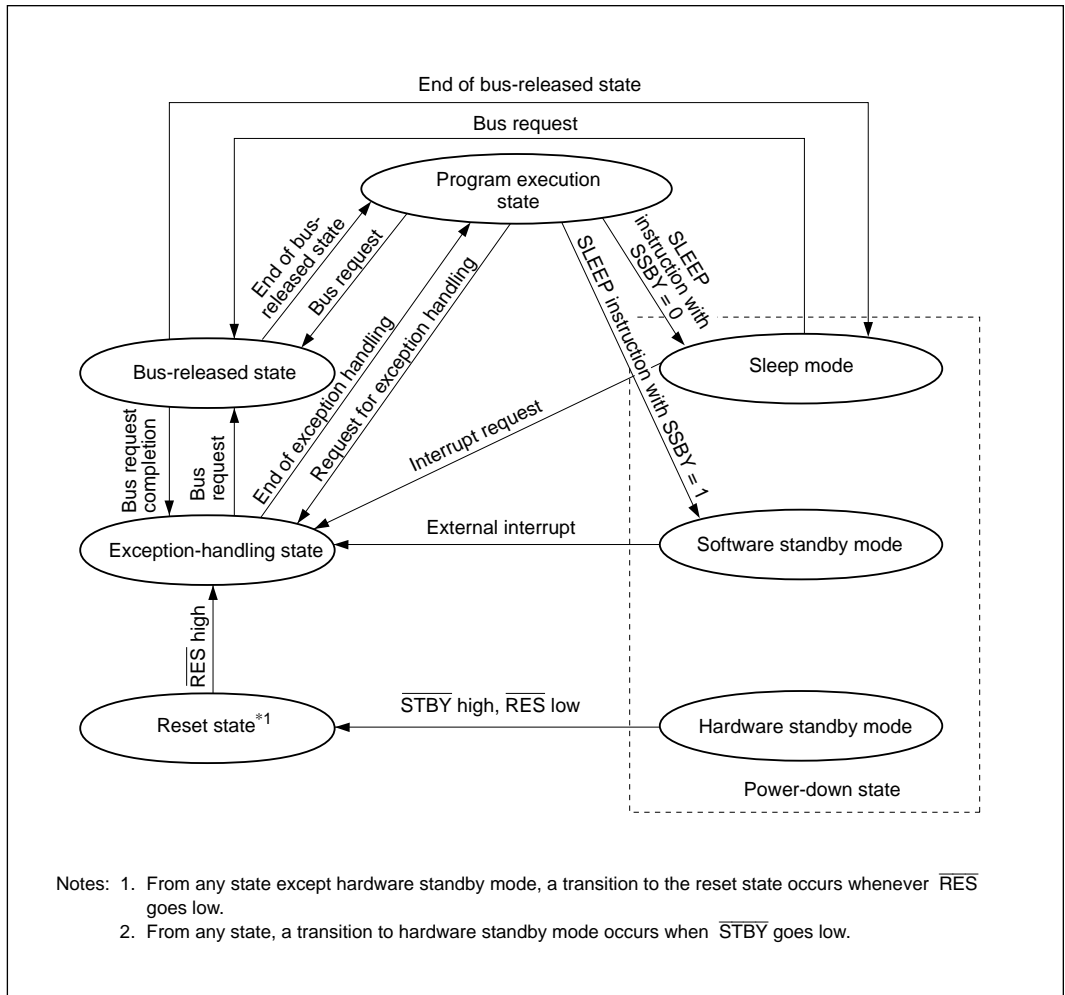

Figure 3-2 State Transitions

3.2 Program Execution State

In this state the CPU executes program instructions in normal sequence.

3.3 Exception-Handling State

The exception-handling state is a transient state that occurs when the CPU alters the normal program flow due to a reset, interrupt, or trap instruction. The CPU fetches a starting address from the exception vector table and branches to that address. In interrupt exception handling the CPU references the stack pointer (ER7) and saves the program counter and condition-code register.

3.3.1 Types of Exception Handling and Their Priority

Exception handling is performed for resets, interrupts, and trap instructions. Table 3-1 indicates the types of exception handling and their priority.

Table 3-1 Exception Handling Types and Priority

| Priority | Type of Exception | Detection Timing | Start of Exception Handling |
|-----------|-------------------|---|--|
| High ↑ | Reset | Synchronized with clock | Exception handling starts immediately when RES changes from low to high |
| | Interrupt | End of instruction execution (see note) | When an interrupt is requested, exception handling starts at the end of the current instruction or current exception-handling sequence |
| | Trap instruction | When TRAPA instruction is executed | Exception handling starts when a trap (TRAPA) instruction is executed |
| Low | | | |

Note: Interrupts are not detected at the end of the ANDC, ORC, XORC, and LDC instructions, or immediately after reset exception handling.

Figure 3-3 classifies the exception sources. For further details about exception sources, vector numbers, and vector addresses refer to the relevant microcontroller hardware manual.

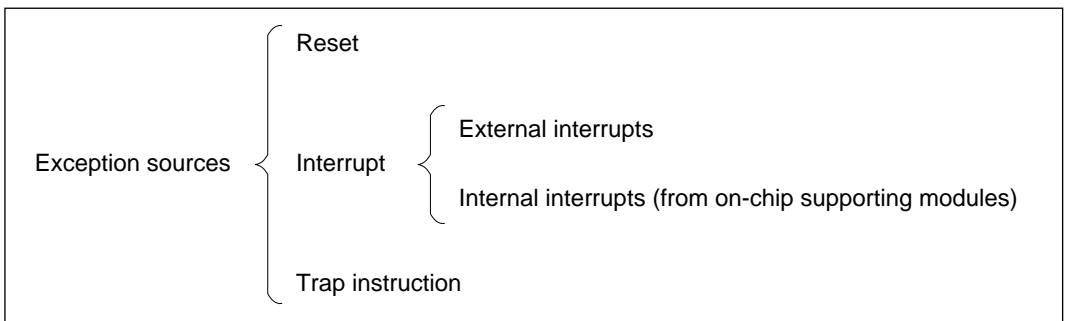

Figure 3-3 Classification of Exception Sources

3.3.2 Exception-Handling Sequences

Reset Exception Handling: Reset exception handling has the highest priority. The reset state is entered when the RES signal goes low. Then, if RES goes high again, reset exception handling starts when the reset condition is satisfied. Refer to the relevant microcontroller hardware manual for details about the reset condition. When reset exception handling starts the CPU fetches a start address from the exception vector table and starts program execution from that address. All interrupts, including NMI, are disabled during the reset exception-handling sequence and immediately after it ends.

Interrupt Exception Handling and Trap Instruction Exception Handling: When these exception-handling sequences begin, the CPU references the stack pointer (ER7) and pushes the program counter and condition-code register on the stack. Next, if the UE bit in the system control register (SYSCR) is set to 1, the CPU sets the I bit in the condition-code register to 1. If the UE bit is cleared to 0, the CPU sets both the I bit and the UI bit in the condition-code register to 1. Then the CPU fetches a start address from the exception vector table and execution branches to that address.

The program-counter value pushed on the stack and the start address fetched from the vector table are 16 bits long in normal mode and 24 bits long in advanced mode. Figure 3-4 shows the stack after the exception-handling sequence.

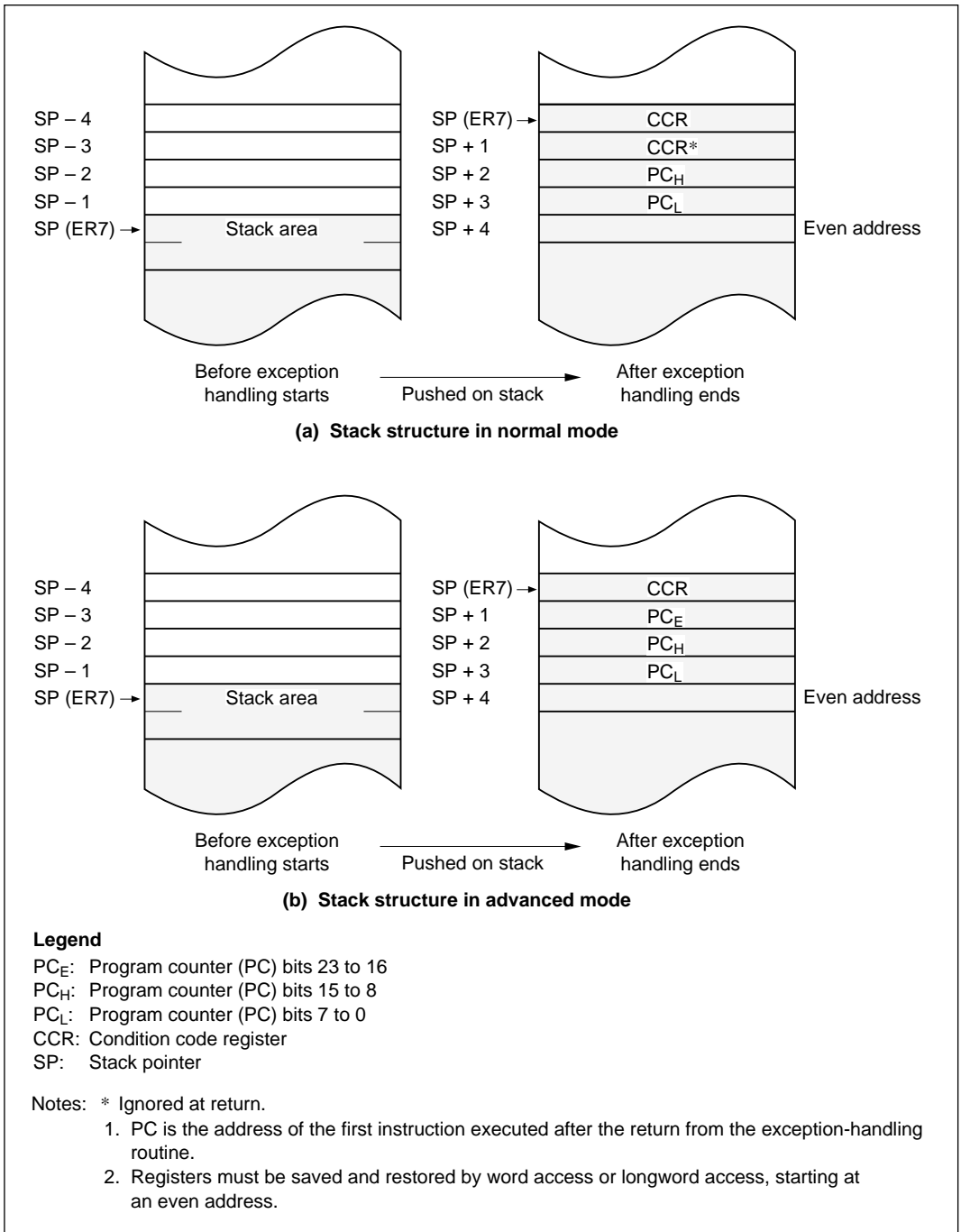

Figure 3-4 Stack Structure after Exception Handling

3.4 Bus-Released State

This is a state in which the bus has been released in response to a bus request from a bus master other than the CPU. While the bus is released, the CPU halts except for internal operations. For further details, refer to the relevant microcontroller hardware manual.

For further details, refer to the relevant microcontroller hardware manual.

3.5 Reset State

When the RES input goes low all current processing stops and the CPU enters the reset state. The I bit in the condition-code register is set to 1 by a reset. All interrupts are masked in the reset state. Reset exception handling starts when the RES signal changes from low to high.

3.6 Power-Down State

In the power-down state the CPU stops operating to conserve power. There are three modes: sleep mode, software standby mode, and hardware standby mode. For details, refer to the relevant microcontroller hardware manual.

3.6.1 Sleep Mode

A transition to sleep mode is made if the SLEEP instruction is executed while the software standby bit (SSBY) is cleared to 0.

CPU operations stop immediately after execution of the SLEEP instruction. The contents of CPU registers are retained.

3.6.2 Software Standby Mode

A transition to software standby mode is made if the SLEEP instruction is executed while the SSBY bit is set to 1.

The CPU and clock halt and all on-chip supporting modules stop operating. The on-chip supporting modules are reset, but as long as a specified voltage is supplied the contents of CPU registers and on-chip RAM are retained. The I/O ports also remain in their existing states.

3.6.3 Hardware Standby Mode

A transition to hardware standby mode is made when the STBY input goes low.

As in software standby mode, the CPU and clock halt and the on-chip supporting modules are reset, but as long as a specified voltage is supplied, on-chip RAM contents are retained.

Section 4 Basic Timing

4.1 Overview

The CPU is driven by a clock, denoted by the symbol ϕ . One cycle of the clock is referred to as a “state.” The memory cycle or bus cycle consists of two or three states. Different methods are used to access on-chip memory, on-chip supporting modules, and external devices. Refer to the relevant microcontroller hardware manual for details.

4.2 On-Chip Memory (RAM, ROM)

For high-speed processing, on-chip memory is accessed in two states. The data bus is 16 bits wide, permitting both byte and word access. Figure 4-1 shows the on-chip memory access cycle. Figure 4-2 shows the pin states.

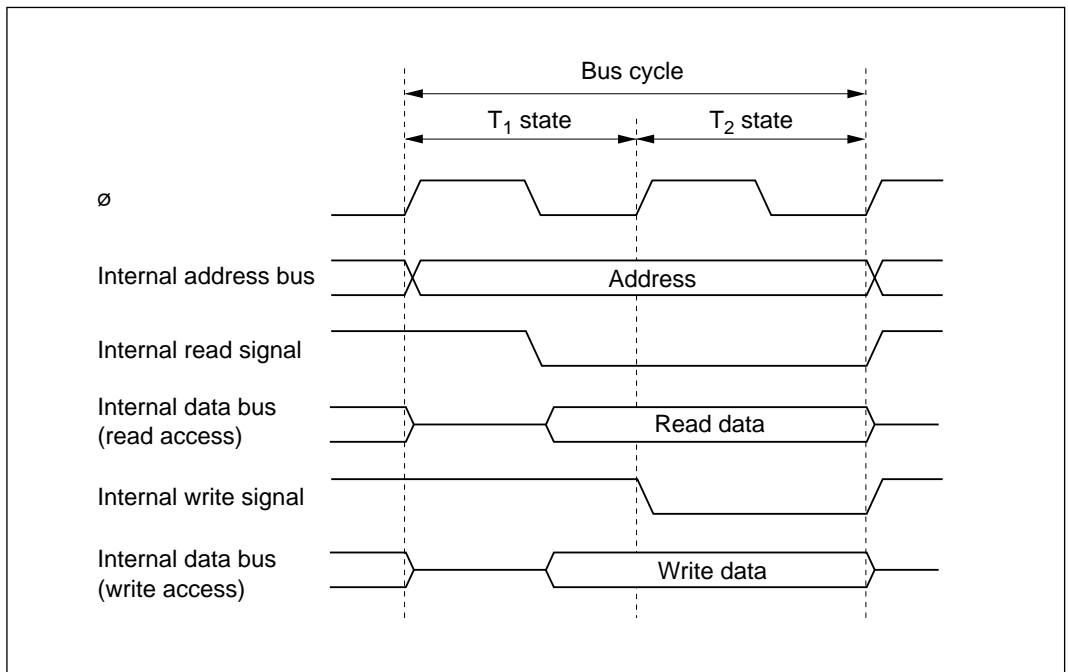

Figure 4-1 On-Chip Memory Access Cycle

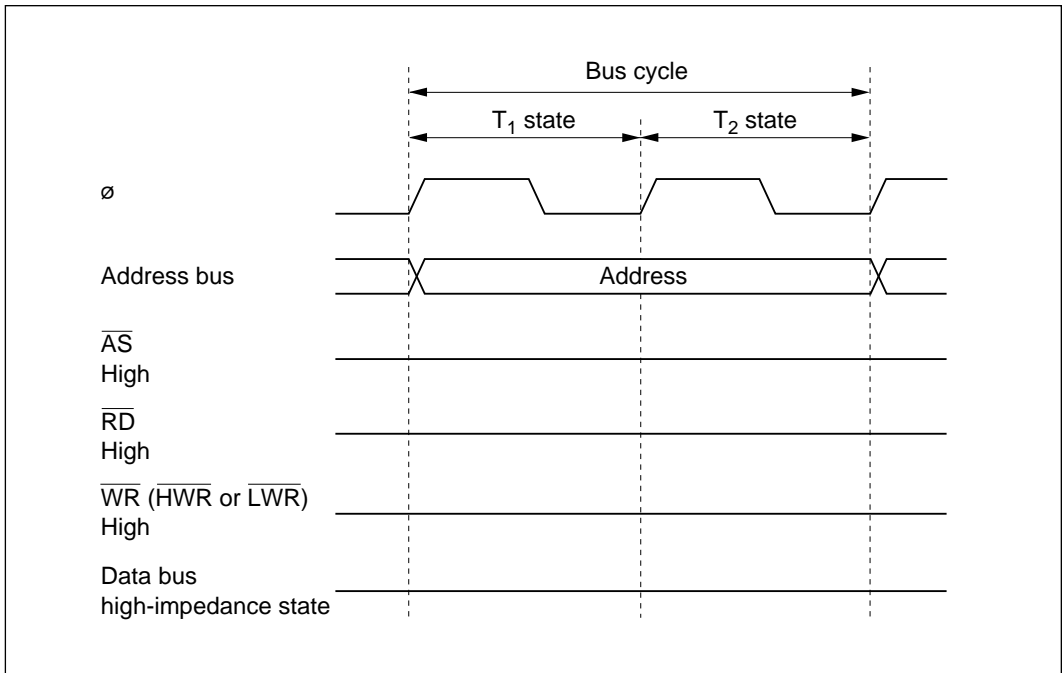

Figure 4-2 Pin States during On-Chip Memory Access

4.3 On-Chip Supporting Modules

The on-chip supporting modules are accessed in three states. The data bus is 8 bits or 16 bits wide. Figure 4-3 shows the access timing for the on-chip supporting modules. Figure 4-4 shows the pin states.

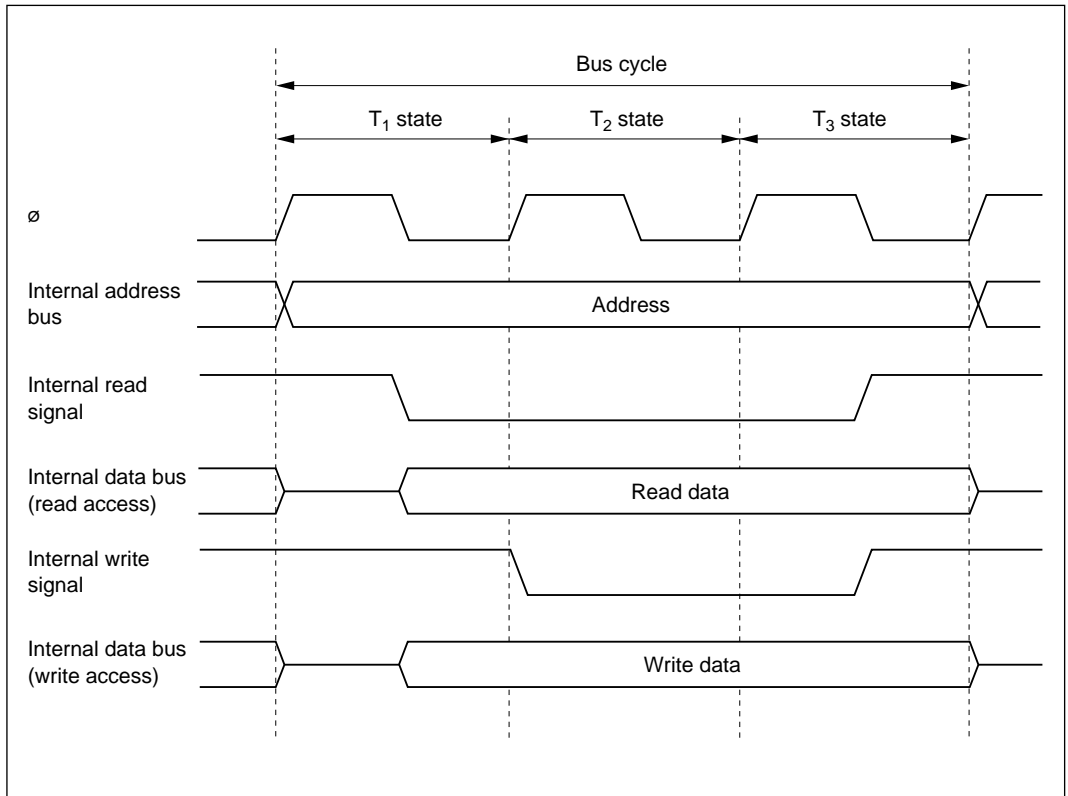

Figure 4-3 On-Chip Supporting Module Access Cycle

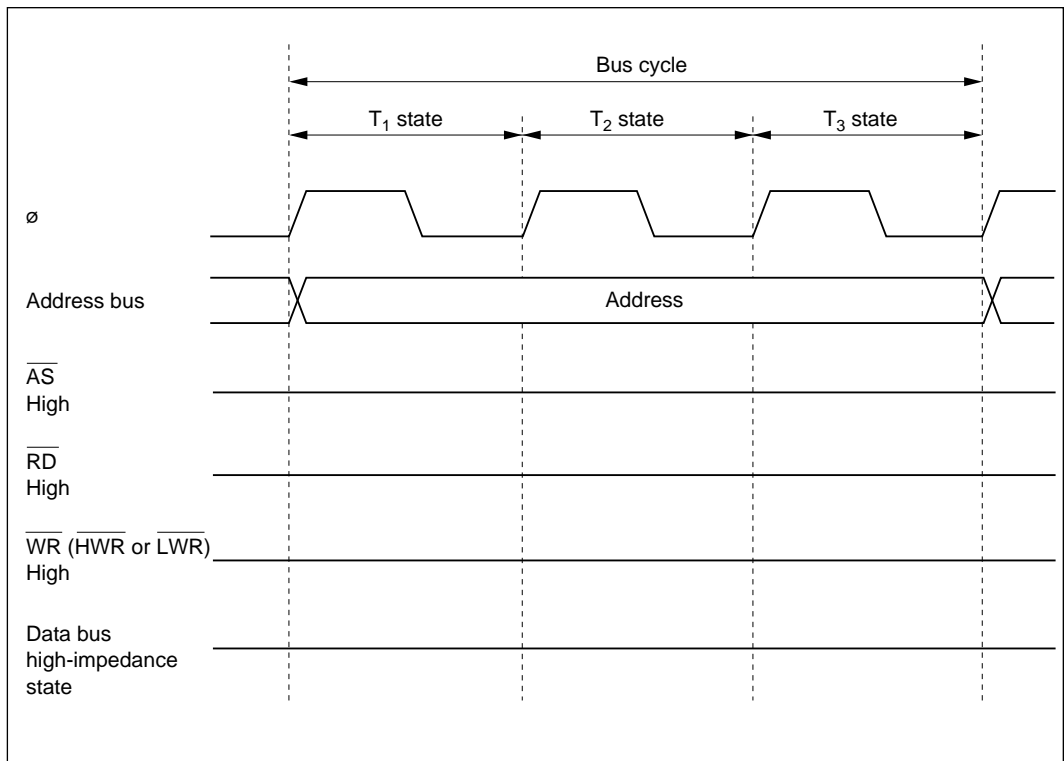

Figure 4-4 Pin States during On-Chip Supporting Module Access

4.4 External Data Bus

The external data bus is accessed with 8-bit or 16-bit bus width in two or three states. Figure 4-5 shows the read timing for two-state or three-state access. Figure 4-6 shows the write timing for two-state or three-state access. In three-state access, wait states can be inserted by the wait-state controller or other means. For further details refer to the relevant microcontroller hardware manual.

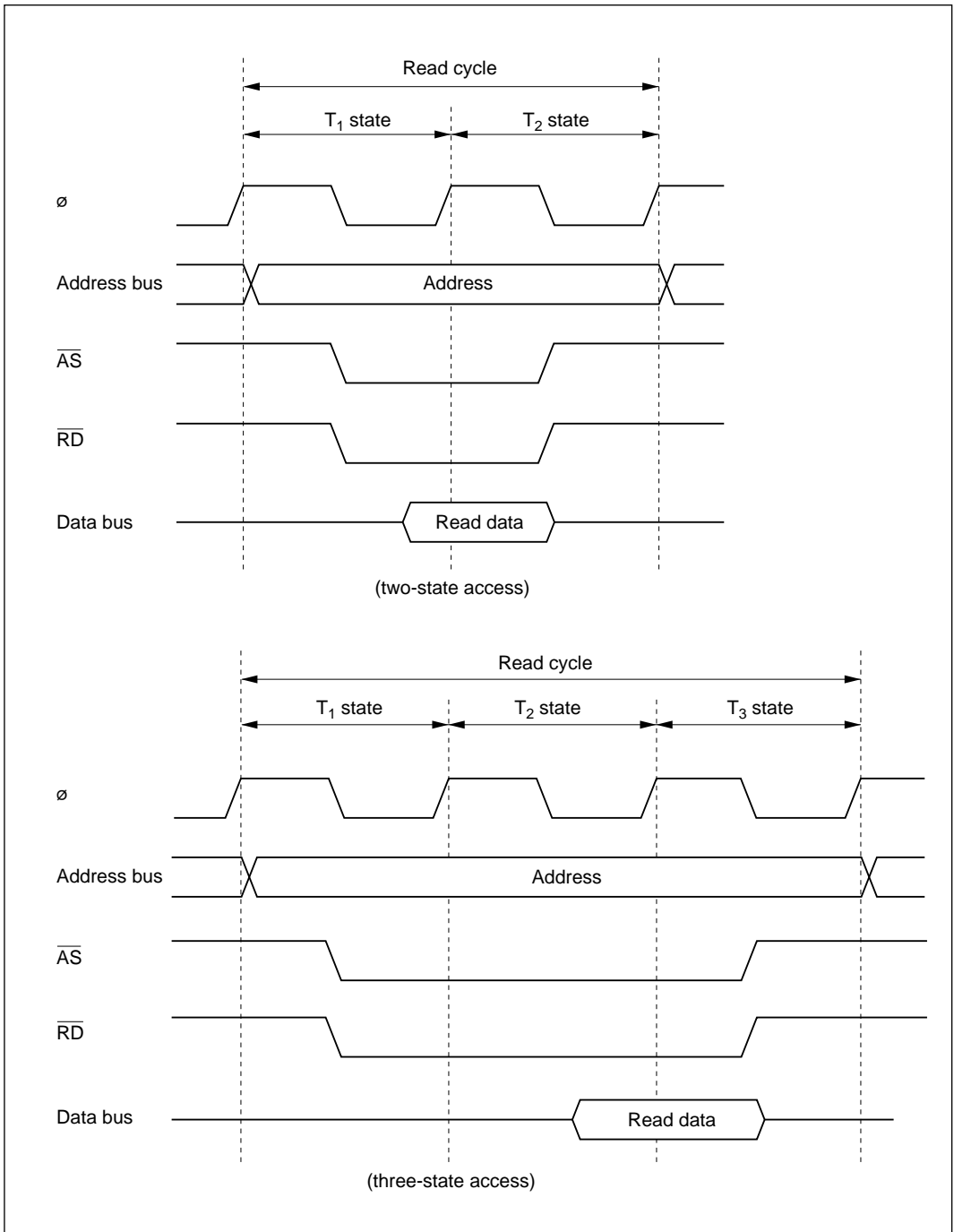

Figure 4-5 External Device Access Timing (1) Read Timing

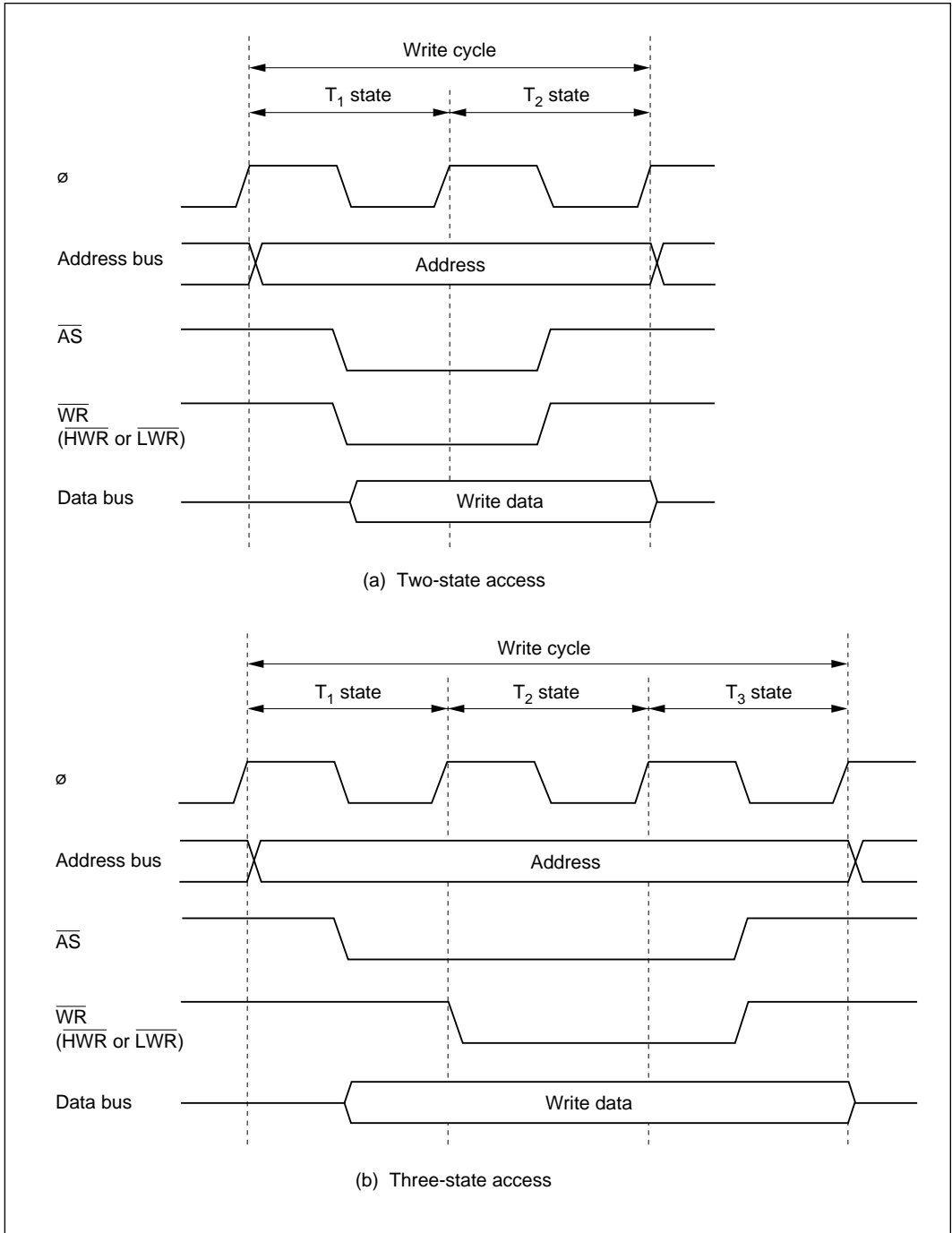

Figure 4-6 External Device Access Timing (2) Write Timing