



Intel[®] Itanium[®] Architecture Software Developer's Manual

Volume 3: Instruction Set Reference

Revision 2.1

October 2002





THIS DOCUMENT IS PROVIDED "AS IS" WITH NO WARRANTIES WHATSOEVER, INCLUDING ANY WARRANTY OF MERCHANTABILITY, FITNESS FOR ANY PARTICULAR PURPOSE, OR ANY WARRANTY OTHERWISE ARISING OUT OF ANY PROPOSAL, SPECIFICATION OR SAMPLE.

INFORMATION IN THIS DOCUMENT IS PROVIDED IN CONNECTION WITH INTEL® PRODUCTS. NO LICENSE, EXPRESS OR IMPLIED, BY ESTOPPEL OR OTHERWISE, TO ANY INTELLECTUAL PROPERTY RIGHTS IS GRANTED BY THIS DOCUMENT. EXCEPT AS PROVIDED IN INTEL'S TERMS AND CONDITIONS OF SALE FOR SUCH PRODUCTS, INTEL ASSUMES NO LIABILITY WHATSOEVER, AND INTEL DISCLAIMS ANY EXPRESS OR IMPLIED WARRANTY, RELATING TO SALE AND/OR USE OF INTEL PRODUCTS INCLUDING LIABILITY OR WARRANTIES RELATING TO FITNESS FOR A PARTICULAR PURPOSE, MERCHANTABILITY, OR INFRINGEMENT OF ANY PATENT, COPYRIGHT OR OTHER INTELLECTUAL PROPERTY RIGHT. INTEL PRODUCTS ARE NOT INTENDED FOR USE IN MEDICAL, LIFE SAVING, OR LIFE SUSTAINING APPLICATIONS.

Intel may make changes to specifications and product descriptions at any time, without notice.

Designers must not rely on the absence or characteristics of any features or instructions marked "reserved" or "undefined." Intel reserves these for future definition and shall have no responsibility whatsoever for conflicts or incompatibilities arising from future changes to them.

Intel processors based on the Itanium architecture may contain design defects or errors known as errata which may cause the product to deviate from published specifications. Current characterized errata are available on request.

Contact your local Intel sales office or your distributor to obtain the latest specifications and before placing your product order.

Copies of documents which have an order number and are referenced in this document, or other Intel literature, may be obtained by calling 1-800-548-4725, or by visiting Intel's website at <http://www.intel.com>.

Intel, Intel486, Itanium, Pentium, VTune and MMX are trademarks or registered trademarks of Intel Corporation or its subsidiaries in the United States and other countries.

Copyright © 2000-2002, Intel Corporation. All rights reserved.

*Other names and brands may be claimed as the property of others.



Contents

Part I: Intel® Itanium® Instruction Set Descriptions

| | | |
|----------|---|--------------|
| 1 | About this Manual | 3:1 |
| 1.1 | Overview of Volume 1: Application Architecture..... | 3:1 |
| 1.1.1 | Part 1: Application Architecture Guide | 3:1 |
| 1.1.2 | Part 2: Optimization Guide for the Intel® Itanium® Architecture | 3:2 |
| 1.2 | Overview of Volume 2: System Architecture | 3:2 |
| 1.2.1 | Part 1: System Architecture Guide | 3:2 |
| 1.2.2 | Part 2: System Programmer's Guide..... | 3:3 |
| 1.2.3 | Appendices..... | 3:4 |
| 1.3 | Overview of Volume 3: Instruction Set Reference..... | 3:4 |
| 1.3.1 | Part 1: Intel® Itanium® Instruction Set Descriptions | 3:4 |
| 1.3.2 | Part 2: IA-32 Instruction Set Descriptions..... | 3:4 |
| 1.4 | Terminology..... | 3:5 |
| 1.5 | Related Documents | 3:5 |
| 1.6 | Revision History | 3:6 |
| 2 | Instruction Reference | 3:9 |
| 2.1 | Instruction Page Conventions | 3:9 |
| 2.2 | Instruction Descriptions | 3:10 |
| 3 | Pseudo-Code Functions | 3:245 |
| 4 | Instruction Formats..... | 3:255 |
| 4.1 | Format Summary..... | 3:256 |
| 4.2 | A-Unit Instruction Encodings | 3:262 |
| 4.2.1 | Integer ALU | 3:262 |
| 4.2.2 | Integer Compare | 3:264 |
| 4.2.3 | Multimedia | 3:268 |
| 4.3 | I-Unit Instruction Encodings | 3:272 |
| 4.3.1 | Multimedia and Variable Shifts | 3:272 |
| 4.3.2 | Integer Shifts | 3:277 |
| 4.3.3 | Test Bit | 3:279 |
| 4.3.4 | Miscellaneous I-Unit Instructions..... | 3:280 |
| 4.3.5 | GR/BR Moves | 3:282 |
| 4.3.6 | GR/Predicate/IP Moves..... | 3:283 |
| 4.3.7 | GR/AR Moves (I-Unit)..... | 3:284 |
| 4.3.8 | Sign/Zero Extend/Compute Zero Index..... | 3:285 |
| 4.4 | M-Unit Instruction Encodings | 3:285 |
| 4.4.1 | Loads and Stores | 3:285 |
| 4.4.2 | Line Prefetch | 3:300 |
| 4.4.3 | Semaphores | 3:302 |
| 4.4.4 | Set/Get FR | 3:303 |
| 4.4.5 | Speculation and Advanced Load Checks..... | 3:303 |

| | | |
|----------|--|--------------|
| 4.4.6 | Cache/Synchronization/RSE/ALAT | 3:304 |
| 4.4.7 | GR/AR Moves (M-Unit) | 3:306 |
| 4.4.8 | GR/CR Moves | 3:307 |
| 4.4.9 | Miscellaneous M-Unit Instructions..... | 3:307 |
| 4.4.10 | System/Memory Management | 3:308 |
| 4.4.11 | Nop/Hint (M-Unit) | 3:313 |
| 4.5 | B-Unit Instruction Encodings..... | 3:313 |
| 4.5.1 | Branches | 3:314 |
| 4.5.2 | Branch Predict/Nop/Hint..... | 3:317 |
| 4.5.3 | Miscellaneous B-Unit Instructions | 3:319 |
| 4.6 | F-Unit Instruction Encodings | 3:320 |
| 4.6.1 | Arithmetic | 3:322 |
| 4.6.2 | Parallel Floating-point Select..... | 3:323 |
| 4.6.3 | Compare and Classify | 3:323 |
| 4.6.4 | Approximation | 3:325 |
| 4.6.5 | Minimum/Maximum and Parallel Compare | 3:326 |
| 4.6.6 | Merge and Logical..... | 3:327 |
| 4.6.7 | Conversion | 3:327 |
| 4.6.8 | Status Field Manipulation..... | 3:328 |
| 4.6.9 | Miscellaneous F-Unit Instructions | 3:329 |
| 4.7 | X-Unit Instruction Encodings..... | 3:329 |
| 4.7.1 | Miscellaneous X-Unit Instructions | 3:329 |
| 4.7.2 | Move Long Immediate ₆₄ | 3:330 |
| 4.7.3 | Long Branches | 3:331 |
| 4.7.4 | Nop/Hint (X-Unit)..... | 3:332 |
| 4.8 | Immediate Formation | 3:332 |
| 5 | Resource and Dependency Semantics | 3:335 |
| 5.1 | Reading and Writing Resources..... | 3:335 |
| 5.2 | Dependencies and Serialization..... | 3:335 |
| 5.3 | Resource and Dependency Table Format Notes | 3:336 |
| 5.3.1 | Special Case Instruction Rules | 3:338 |
| 5.3.2 | RAW Dependency Table..... | 3:338 |
| 5.3.3 | WAW Dependency Table..... | 3:346 |
| 5.3.4 | WAR Dependency Table..... | 3:350 |
| 5.3.5 | Listing of Rules Referenced in Dependency Tables | 3:350 |
| 5.4 | Support Tables..... | 3:352 |

Part II: IA-32 Instruction Set Descriptions

| | | |
|----------|--|--------------|
| 1 | Base IA-32 Instruction Reference..... | 3:361 |
| 1.1 | Additional Intel® Itanium® Faults..... | 3:361 |
| 1.2 | Interpreting the IA-32 Instruction Reference Pages | 3:362 |
| 1.2.1 | IA-32 Instruction Format..... | 3:362 |
| 1.2.2 | Operation..... | 3:365 |
| 1.2.3 | Flags Affected | 3:368 |
| 1.2.4 | FPU Flags Affected | 3:368 |
| 1.2.5 | Protected Mode Exceptions | 3:368 |



| | | |
|----------|---|--------------|
| 1.2.6 | Real-address Mode Exceptions | 3:369 |
| 1.2.7 | Virtual-8086 Mode Exceptions | 3:369 |
| 1.2.8 | Floating-point Exceptions | 3:369 |
| 1.3 | IA-32 Base Instruction Reference | 3:370 |
| 2 | IA-32 Intel[®] MMX[™] Technology Instruction Reference | 3:747 |
| 3 | IA-32 Streaming SIMD Extension Instruction Reference | 3:811 |
| 3.1 | IA-32 Streaming SIMD Extension Instructions | 3:811 |
| 3.2 | About the Intel [®] Architecture Streaming SIMD Extensions | 3:811 |
| 3.3 | Single Instruction Multiple Data | 3:812 |
| 3.4 | New Data Types | 3:812 |
| 3.5 | Streaming SIMD Extension Registers | 3:813 |
| 3.6 | Extended Instruction Set | 3:813 |
| 3.6.1 | Instruction Group Review | 3:814 |
| 3.7 | IEEE Compliance | 3:821 |
| 3.7.1 | Real Number System | 3:822 |
| 3.7.2 | Operating on NaNs | 3:827 |
| 3.8 | Data Formats | 3:828 |
| 3.8.1 | Memory Data Formats | 3:828 |
| 3.8.2 | Streaming SIMD Extension Register Data Formats | 3:828 |
| 3.9 | Instruction Formats | 3:830 |
| 3.10 | Instruction Prefixes | 3:830 |
| 3.11 | Reserved Behavior and Software Compatibility | 3:831 |
| 3.12 | Notations | 3:831 |
| 3.13 | SIMD Integer Instruction Set Extensions | 3:908 |
| 3.14 | Cacheability Control Instructions | 3:922 |

Figures

Part I: Intel[®] Itanium[®] Instruction Set Descriptions

| | | |
|------|---|-------|
| 2-1 | Add Pointer | 3:12 |
| 2-2 | Stack Frame | 3:13 |
| 2-3 | Operation of br.ctop and br.cexit | 3:20 |
| 2-4 | Operation of br.wtop and br.wexit | 3:20 |
| 2-5 | Deposit Example (merge_form) | 3:45 |
| 2-6 | Deposit Example (zero_form) | 3:45 |
| 2-7 | Extract Example | 3:48 |
| 2-8 | Floating-point Merge Negative Sign Operation | 3:72 |
| 2-9 | Floating-point Merge Sign Operation | 3:72 |
| 2-10 | Floating-point Merge Sign and Exponent Operation | 3:72 |
| 2-11 | Floating-point Mix Left | 3:75 |
| 2-12 | Floating-point Mix Right | 3:75 |
| 2-13 | Floating-point Mix Left-Right | 3:75 |
| 2-14 | Floating-point Pack | 3:86 |
| 2-15 | Floating-point Parallel Merge Negative Sign Operation | 3:96 |
| 2-16 | Floating-point Parallel Merge Sign Operation | 3:96 |
| 2-17 | Floating-point Parallel Merge Sign and Exponent Operation | 3:96 |
| 2-18 | Floating-point Swap | 3:118 |

| | | |
|------|---|-------|
| 2-19 | Floating-point Swap Negate Left..... | 3:118 |
| 2-20 | Floating-point Swap Negate Right..... | 3:118 |
| 2-21 | Floating-point Sign Extend Left..... | 3:120 |
| 2-22 | Floating-point Sign Extend Right..... | 3:120 |
| 2-23 | Function of getf.exp..... | 3:123 |
| 2-24 | Function of getf.sig..... | 3:123 |
| 2-25 | Mix Example..... | 3:147 |
| 2-26 | Mux1 Operation (8-bit elements)..... | 3:164 |
| 2-27 | Mux2 Examples (16-bit elements)..... | 3:165 |
| 2-28 | Pack Operation..... | 3:169 |
| 2-29 | Parallel Add Examples..... | 3:171 |
| 2-30 | Parallel Average Example..... | 3:174 |
| 2-31 | Parallel Average with Round Away from Zero Example..... | 3:175 |
| 2-32 | Parallel Average Subtract Example..... | 3:177 |
| 2-33 | Parallel Compare Example..... | 3:179 |
| 2-34 | Parallel Maximum Example..... | 3:181 |
| 2-35 | Parallel Minimum Example..... | 3:182 |
| 2-36 | Parallel Multiply Operation..... | 3:183 |
| 2-37 | Parallel Multiply and Shift Right Operation..... | 3:184 |
| 2-38 | Parallel Sum of Absolute Difference Example..... | 3:189 |
| 2-39 | Parallel Shift Left Example..... | 3:190 |
| 2-40 | Parallel Subtract Example..... | 3:195 |
| 2-41 | Function of setf.exp..... | 3:210 |
| 2-42 | Function of setf.sig..... | 3:210 |
| 2-43 | Shift Left and Add Pointer..... | 3:214 |
| 2-44 | Shift Right Pair..... | 3:216 |
| 2-45 | Unpack Operation..... | 3:236 |
| 4-1 | Bundle Format..... | 3:255 |

Part II: IA-32 Instruction Set Descriptions

| | | |
|------|--|-------|
| 1-1 | Bit Offset for BIT[EAX,21]..... | 3:367 |
| 1-2 | Memory Bit Indexing..... | 3:368 |
| 1-3 | Version Information in Registers EAX..... | 3:429 |
| 2-1 | Operation of the MOVD Instruction..... | 3:749 |
| 2-2 | Operation of the MOVQ Instruction..... | 3:751 |
| 2-3 | Operation of the PACKSSDW Instruction..... | 3:753 |
| 2-4 | Operation of the PACKUSWB Instruction..... | 3:756 |
| 2-5 | Operation of the PADDW Instruction..... | 3:758 |
| 2-6 | Operation of the PADDSW Instruction..... | 3:761 |
| 2-7 | Operation of the PADDUSB Instruction..... | 3:764 |
| 2-8 | Operation of the PAND Instruction..... | 3:767 |
| 2-9 | Operation of the PANDN Instruction..... | 3:769 |
| 2-10 | Operation of the PCMPEQW Instruction..... | 3:771 |
| 2-11 | Operation of the PCMPGTW Instruction..... | 3:774 |
| 2-12 | Operation of the PMADDWD Instruction..... | 3:777 |
| 2-13 | Operation of the PMULHW Instruction..... | 3:779 |
| 2-14 | Operation of the PMULLW Instruction..... | 3:781 |
| 2-15 | Operation of the POR Instruction..... | 3:783 |
| 2-16 | Operation of the PSLW Instruction..... | 3:785 |
| 2-17 | Operation of the PSRAW Instruction..... | 3:788 |
| 2-18 | Operation of the PSRLW Instruction..... | 3:791 |



| | | |
|------|---|-------|
| 2-19 | Operation of the PSUBW Instruction | 3:794 |
| 2-20 | Operation of the PSUBSW Instruction | 3:797 |
| 2-21 | Operation of the PSUBUSB Instruction | 3:800 |
| 2-22 | High-order Unpacking and Interleaving of Bytes with the PUNPCKHBW Instruction | 3:803 |
| 2-23 | Low-order Unpacking and Interleaving of Bytes with the PUNPCKLBW Instruction | 3:806 |
| 2-24 | Operation of the PXOR Instruction | 3:809 |
| 3-1 | Packed Single-FP Data Type | 3:812 |
| 3-2 | Streaming SIMD Extension Register Set | 3:813 |
| 3-3 | Packed Operation | 3:814 |
| 3-4 | Scalar Operation | 3:814 |
| 3-5 | Packed Shuffle Operation | 3:816 |
| 3-6 | Unpack High Operation | 3:817 |
| 3-7 | Unpack Low Operation | 3:817 |
| 3-8 | Binary Real Number System | 3:822 |
| 3-9 | Binary Floating-point Format | 3:823 |
| 3-10 | Real Numbers and NaNs | 3:825 |
| 3-11 | Four Packed FP Data in Memory (at address 1000H) | 3:828 |

Tables

Part I: Intel® Itanium® Instruction Set Descriptions

| | | |
|------|---|------|
| 2-1 | Instruction Page Description | 3:9 |
| 2-2 | Instruction Page Font Conventions | 3:9 |
| 2-3 | Register File Notation | 3:10 |
| 2-4 | C Syntax Differences | 3:10 |
| 2-5 | Pervasive Conditions Not Included in Instruction Description Code | 3:10 |
| 2-6 | Branch Types | 3:17 |
| 2-7 | Branch Whether Hint | 3:21 |
| 2-8 | Sequential Prefetch Hint | 3:21 |
| 2-9 | Branch Cache Deallocation Hint | 3:21 |
| 2-10 | Long Branch Types | 3:26 |
| 2-11 | IP-relative Branch Predict Whether Hint | 3:28 |
| 2-12 | Indirect Branch Predict Whether Hint | 3:28 |
| 2-13 | Importance Hint | 3:28 |
| 2-14 | ALAT Clear Completer | 3:31 |
| 2-15 | Comparison Types | 3:34 |
| 2-16 | 64-bit Comparison Relations for Normal and unc Compares | 3:35 |
| 2-17 | 64-bit Comparison Relations for Parallel Compares | 3:35 |
| 2-18 | Immediate Range for 32-bit Compares | 3:37 |
| 2-19 | Memory Compare and Exchange Size | 3:40 |
| 2-20 | Compare and Exchange Semaphore Types | 3:40 |
| 2-21 | Result Ranges for czx | 3:43 |
| 2-22 | Specified <i>pc</i> Mnemonic Values | 3:50 |
| 2-23 | <i>sf</i> Mnemonic Values | 3:50 |
| 2-24 | Floating-point Class Relations | 3:57 |
| 2-25 | Floating-point Classes | 3:57 |
| 2-26 | Floating-point Comparison Types | 3:60 |
| 2-27 | Floating-point Comparison Relations | 3:60 |
| 2-28 | Fetch and Add Semaphore Types | 3:67 |
| 2-29 | Floating-point Parallel Comparison Results | 3:89 |
| 2-30 | Floating-point Parallel Comparison Relations | 3:89 |

| | | |
|------|---|-------|
| 2-31 | Hint immediates | 3:125 |
| 2-32 | sz Completers | 3:131 |
| 2-33 | Load Types..... | 3:131 |
| 2-34 | Load Hints | 3:132 |
| 2-35 | fsz Completers | 3:135 |
| 2-36 | FP Load Types | 3:135 |
| 2-37 | <i>Iftype</i> Mnemonic Values | 3:141 |
| 2-38 | <i>Ifhint</i> Mnemonic Values | 3:142 |
| 2-39 | Move to BR Whether Hints..... | 3:151 |
| 2-40 | Indirect Register File Mnemonics | 3:156 |
| 2-41 | Mux Permutations for 8-bit Elements | 3:164 |
| 2-42 | Pack Saturation Limits..... | 3:169 |
| 2-43 | Parallel Add Saturation Completers | 3:171 |
| 2-44 | Parallel Add Saturation Limits | 3:171 |
| 2-45 | Pcmp Relations | 3:179 |
| 2-46 | PMPYSHR Shift Options | 3:184 |
| 2-47 | Parallel Subtract Saturation Completers | 3:195 |
| 2-48 | Parallel Subtract Saturation Limits | 3:195 |
| 2-49 | Store Types..... | 3:219 |
| 2-50 | Store Hints..... | 3:220 |
| 2-51 | xsz Mnemonic Values | 3:225 |
| 2-52 | Test Bit Relations for Normal and unc tbits | 3:228 |
| 2-53 | Test Bit Relations for Parallel tbits | 3:228 |
| 2-54 | Test NaT Relations for Normal and unc tnats | 3:231 |
| 2-55 | Test NaT Relations for Parallel tnats..... | 3:231 |
| 2-56 | Memory Exchange Size | 3:237 |
| 3-1 | Pseudo-Code Functions..... | 3:245 |
| 4-1 | Relationship between Instruction Type and Execution Unit Type | 3:255 |
| 4-2 | Template Field Encoding and Instruction Slot Mapping | 3:256 |
| 4-3 | Major Opcode Assignments | 3:257 |
| 4-4 | Instruction Format Summary | 3:258 |
| 4-5 | Instruction Field Color Key | 3:260 |
| 4-6 | Instruction Field Names..... | 3:260 |
| 4-7 | Special Instruction Notations..... | 3:261 |
| 4-8 | Integer ALU 2-bit+1-bit Opcode Extensions | 3:262 |
| 4-9 | Integer ALU 4-bit+2-bit Opcode Extensions | 3:263 |
| 4-10 | Integer Compare Opcode Extensions | 3:265 |
| 4-11 | Integer Compare Immediate Opcode Extensions | 3:265 |
| 4-12 | Multimedia ALU 2-bit+1-bit Opcode Extensions | 3:268 |
| 4-13 | Multimedia ALU Size 1 4-bit+2-bit Opcode Extensions | 3:269 |
| 4-14 | Multimedia ALU Size 2 4-bit+2-bit Opcode Extensions | 3:269 |
| 4-15 | Multimedia ALU Size 4 4-bit+2-bit Opcode Extensions | 3:270 |
| 4-16 | Multimedia and Variable Shift 1-bit Opcode Extensions | 3:272 |
| 4-17 | Multimedia Opcode 7 Size 1 2-bit Opcode Extensions | 3:272 |
| 4-18 | Multimedia Opcode 7 Size 2 2-bit Opcode Extensions | 3:273 |
| 4-19 | Multimedia Opcode 7 Size 4 2-bit Opcode Extensions | 3:273 |
| 4-20 | Variable Shift Opcode 7 2-bit Opcode Extensions | 3:274 |
| 4-21 | Integer Shift/Test Bit/Test NaT 2-bit Opcode Extensions | 3:277 |
| 4-22 | Deposit Opcode Extensions | 3:277 |
| 4-23 | Test Bit Opcode Extensions | 3:279 |
| 4-24 | Misc I-Unit 3-bit Opcode Extensions | 3:280 |
| 4-25 | Misc I-Unit 6-bit Opcode Extensions | 3:281 |



| | | |
|------|--|-------|
| 4-26 | Misc I-Unit 1-bit Opcode Extensions | 3:281 |
| 4-27 | Move to BR Whether Hint Completer | 3:282 |
| 4-28 | Integer Load/Store/Semaphore/Get FR 1-bit Opcode Extensions | 3:285 |
| 4-29 | Floating-point Load/Store/Load Pair/Set FR 1-bit Opcode Extensions | 3:285 |
| 4-30 | Integer Load/Store Opcode Extensions..... | 3:286 |
| 4-31 | Integer Load +Reg Opcode Extensions | 3:287 |
| 4-32 | Integer Load/Store +Imm Opcode Extensions | 3:287 |
| 4-33 | Semaphore/Get FR/16-Byte Opcode Extensions..... | 3:288 |
| 4-34 | Floating-point Load/Store/Lfetch Opcode Extensions | 3:288 |
| 4-35 | Floating-point Load/Lfetch +Reg Opcode Extensions | 3:289 |
| 4-36 | Floating-point Load/Store/Lfetch +Imm Opcode Extensions | 3:289 |
| 4-37 | Floating-point Load Pair/Set FR Opcode Extensions | 3:290 |
| 4-38 | Floating-point Load Pair +Imm Opcode Extensions | 3:290 |
| 4-39 | Load Hint Completer..... | 3:291 |
| 4-40 | Store Hint Completer | 3:291 |
| 4-41 | Line Prefetch Hint Completer | 3:300 |
| 4-42 | Opcode 0 System/Memory Management 3-bit Opcode Extensions..... | 3:309 |
| 4-43 | Opcode 0 System/Memory Management 4-bit+2-bit Opcode Extensions..... | 3:309 |
| 4-44 | Opcode 1 System/Memory Management 3-bit Opcode Extensions..... | 3:309 |
| 4-45 | Opcode 1 System/Memory Management 6-bit Opcode Extensions..... | 3:310 |
| 4-46 | Misc M-Unit 1-bit Opcode Extensions | 3:313 |
| 4-47 | IP-Relative Branch Types..... | 3:314 |
| 4-48 | Indirect/Miscellaneous Branch Opcode Extensions | 3:314 |
| 4-49 | Indirect Branch Types..... | 3:315 |
| 4-50 | Indirect Return Branch Types..... | 3:315 |
| 4-51 | Sequential Prefetch Hint Completer | 3:315 |
| 4-52 | Branch Whether Hint Completer..... | 3:315 |
| 4-53 | Indirect Call Whether Hint Completer | 3:316 |
| 4-54 | Branch Cache Deallocation Hint Completer | 3:316 |
| 4-55 | Indirect Predict/Nop/Hint Opcode Extensions | 3:318 |
| 4-56 | Branch Importance Hint Completer | 3:318 |
| 4-57 | IP-Relative Predict Whether Hint Completer | 3:318 |
| 4-58 | Indirect Predict Whether Hint Completer | 3:319 |
| 4-59 | Miscellaneous Floating-point 1-bit Opcode Extensions..... | 3:320 |
| 4-60 | Opcode 0 Miscellaneous Floating-point 6-bit Opcode Extensions | 3:321 |
| 4-61 | Opcode 1 Miscellaneous Floating-point 6-bit Opcode Extensions | 3:321 |
| 4-62 | Reciprocal Approximation 1-bit Opcode Extensions | 3:322 |
| 4-63 | Floating-point Status Field Completer | 3:322 |
| 4-64 | Floating-point Arithmetic 1-bit Opcode Extensions..... | 3:322 |
| 4-65 | Fixed-point Multiply Add and Select Opcode Extensions | 3:322 |
| 4-66 | Floating-point Compare Opcode Extensions..... | 3:324 |
| 4-67 | Floating-point Class 1-bit Opcode Extensions..... | 3:324 |
| 4-68 | Misc F-Unit 1-bit Opcode Extensions | 3:329 |
| 4-69 | Misc X-Unit 3-bit Opcode Extensions | 3:330 |
| 4-70 | Misc X-Unit 6-bit Opcode Extensions | 3:330 |
| 4-71 | Move Long 1-bit Opcode Extensions..... | 3:331 |
| 4-72 | Long Branch Types | 3:331 |
| 4-73 | Misc X-Unit 1-bit Opcode Extensions | 3:332 |
| 4-74 | Immediate Formation..... | 3:332 |
| 5-1 | Semantics of Dependency Codes | 3:337 |
| 5-2 | RAW Dependencies Organized by Resource | 3:339 |
| 5-3 | WAW Dependencies Organized by Resource..... | 3:346 |

| | | |
|-----|--|-------|
| 5-4 | WAR Dependencies Organized by Resource | 3:350 |
| 5-5 | Instruction Classes | 3:352 |

Part II: IA-32 Instruction Set Descriptions

| | | |
|------|---|-------|
| 1-1 | Register Encodings Associated with the +rb, +rw, and +rd Nomenclature | 3:363 |
| 1-2 | Exception Mnemonics, Names, and Vector Numbers | 3:369 |
| 1-3 | Floating-point Exception Mnemonics and Names | 3:370 |
| 1-4 | Information Returned by CPUID Instruction | 3:428 |
| 1-5 | Feature Flags Returned in EDX Register | 3:429 |
| 1-6 | FPATAN Zeros and NaNs | 3:497 |
| 1-7 | FPREM Zeros and NaNs | 3:499 |
| 1-8 | FPREM1 Zeros and NaNs | 3:502 |
| 1-9 | FSUB Zeros and NaNs | 3:531 |
| 1-10 | FSUBR Zeros and NaNs | 3:534 |
| 1-11 | FYL2X Zeros and NaNs | 3:547 |
| 1-12 | FYL2XP1 Zeros and NaNs | 3:549 |
| 1-13 | IDIV Operands | 3:552 |
| 1-14 | INT Cases | 3:566 |
| 1-15 | LAR Descriptor Validity | 3:601 |
| 1-16 | LEA Address and Operand Sizes | 3:606 |
| 1-17 | Repeat Conditions | 3:686 |
| 3-1 | Real Number Notation | 3:823 |
| 3-2 | Denormalization Process | 3:826 |
| 3-3 | Results of Operations with NAN Operands | 3:828 |
| 3-4 | Precision and Range of Streaming SIMD Extension Datatype | 3:829 |
| 3-5 | Real Number and NaN Encodings | 3:829 |
| 3-6 | Streaming SIMD Extension Instruction Behavior with Prefixes | 3:830 |
| 3-7 | SIMD Integer Instructions – Behavior with Prefixes | 3:830 |
| 3-8 | Cacheability Control Instruction Behavior with Prefixes | 3:831 |
| 3-9 | Key to Streaming SIMD Extension Naming Convention | 3:832 |



***Part I: Intel[®] Itanium[®] Instruction
Set Descriptions***

The Intel® Itanium® architecture is a unique combination of innovative features such as explicit parallelism, predication, speculation and more. The architecture is designed to be highly scalable to fill the ever increasing performance requirements of various server and workstation market segments. The Itanium architecture features a revolutionary 64-bit instruction set architecture (ISA), which applies a new processor architecture technology called EPIC, or Explicitly Parallel Instruction Computing. A key feature of the Itanium architecture is IA-32 instruction set compatibility.

The *Intel® Itanium® Architecture Software Developer's Manual* provides a comprehensive description of the programming environment, resources, and instruction set visible to both the application and system programmer. In addition, it also describes how programmers can take advantage of the features of the Itanium architecture to help them optimize code.

1.1 Overview of Volume 1: Application Architecture

This volume defines the Itanium application architecture, including application level resources, programming environment, and the IA-32 application interface. This volume also describes optimization techniques used to generate high performance software.

1.1.1 Part 1: Application Architecture Guide

[Chapter 1, “About this Manual”](#) provides an overview of all volumes in the *Intel® Itanium® Architecture Software Developer's Manual*.

[Chapter 2, “Introduction to the Intel® Itanium® Architecture”](#) provides an overview of the architecture.

[Chapter 3, “Execution Environment”](#) describes the Itanium register set used by applications and the memory organization models.

[Chapter 4, “Application Programming Model”](#) gives an overview of the behavior of Itanium application instructions (grouped into related functions).

[Chapter 5, “Floating-point Programming Model”](#) describes the Itanium floating-point architecture (including integer multiply).

[Chapter 6, “IA-32 Application Execution Model in an Intel® Itanium® System Environment”](#) describes the operation of IA-32 instructions within the Itanium System Environment from the perspective of an application programmer.

1.1.2 Part 2: Optimization Guide for the Intel® Itanium® Architecture

Chapter 1, “About the Optimization Guide” gives an overview of the optimization guide.

Chapter 2, “Introduction to Programming for the Intel® Itanium® Architecture” provides an overview of the application programming environment for the Itanium architecture.

Chapter 3, “Memory Reference” discusses features and optimizations related to control and data speculation.

Chapter 4, “Predication, Control Flow, and Instruction Stream” describes optimization features related to predication, control flow, and branch hints.

Chapter 5, “Software Pipelining and Loop Support” provides a detailed discussion on optimizing loops through use of software pipelining.

Chapter 6, “Floating-point Applications” discusses current performance limitations in floating-point applications and features that address these limitations.

1.2 Overview of Volume 2: System Architecture

This volume defines the Itanium system architecture, including system level resources and programming state, interrupt model, and processor firmware interface. This volume also provides a useful system programmer's guide for writing high performance system software.

1.2.1 Part 1: System Architecture Guide

Chapter 1, “About this Manual” provides an overview of all volumes in the *Intel® Itanium® Architecture Software Developer's Manual*.

Chapter 2, “Intel® Itanium® System Environment” introduces the environment designed to support execution of Itanium-based operating systems running IA-32 or Itanium-based applications.

Chapter 3, “System State and Programming Model” describes the Itanium architectural state which is visible only to an operating system.

Chapter 4, “Addressing and Protection” defines the resources available to the operating system for virtual to physical address translation, virtual aliasing, physical addressing, and memory ordering.

Chapter 5, “Interruptions” describes all interruptions that can be generated by a processor based on the Itanium architecture.

Chapter 6, “Register Stack Engine” describes the architectural mechanism which automatically saves and restores the stacked subset (GR32 – GR 127) of the general register file.

Chapter 7, “Debugging and Performance Monitoring” is an overview of the performance monitoring and debugging resources that are available in the Itanium architecture.

Chapter 8, “Interrupt Vector Descriptions” lists all interruption vectors.

Chapter 9, “[IA-32 Interruption Vector Descriptions](#)” lists IA-32 exceptions, interrupts and intercepts that can occur during IA-32 instruction set execution in the Itanium System Environment.

Chapter 10, “[Itanium®-based Operating System Interaction Model with IA-32 Applications](#)” defines the operation of IA-32 instructions within the Itanium System Environment from the perspective of an Itanium-based operating system.

Chapter 11, “[Processor Abstraction Layer](#)” describes the firmware layer which abstracts processor implementation-dependent features.

1.2.2 Part 2: System Programmer’s Guide

Chapter 1, “[About the System Programmer’s Guide](#)” gives an introduction to the second section of the system architecture guide.

Chapter 2, “[MP Coherence and Synchronization](#)” describes multi-processing synchronization primitives and the Itanium memory ordering model.

Chapter 3, “[Interruptions and Serialization](#)” describes how the processor serializes execution around interruptions and what state is preserved and made available to low-level system code when interruptions are taken.

Chapter 4, “[Context Management](#)” describes how operating systems need to preserve Itanium register contents and state. This chapter also describes system architecture mechanisms that allow an operating system to reduce the number of registers that need to be spilled/filled on interruptions, system calls, and context switches.

Chapter 5, “[Memory Management](#)” introduces various memory management strategies.

Chapter 6, “[Runtime Support for Control and Data Speculation](#)” describes the operating system support that is required for control and data speculation.

Chapter 7, “[Instruction Emulation and Other Fault Handlers](#)” describes a variety of instruction emulation handlers that Itanium-based operating systems are expected to support.

Chapter 8, “[Floating-point System Software](#)” discusses how processors based on the Itanium architecture handle floating-point numeric exceptions and how the software stack provides complete IEEE-754 compliance.

Chapter 9, “[IA-32 Application Support](#)” describes the support an Itanium-based operating system needs to provide to host IA-32 applications.

Chapter 10, “[External Interrupt Architecture](#)” describes the external interrupt architecture with a focus on how external asynchronous interrupt handling can be controlled by software.

Chapter 11, “[I/O Architecture](#)” describes the I/O architecture with a focus on platform issues and support for the existing IA-32 I/O port space.

Chapter 12, “[Performance Monitoring Support](#)” describes the performance monitor architecture with a focus on what kind of support is needed from Itanium-based operating systems.

Chapter 13, “[Firmware Overview](#)” introduces the firmware model, and how various firmware layers (PAL, SAL, EFI) work together to enable processor and system initialization, and operating system boot.

1.2.3 Appendices

Appendix A, “Code Examples” provides OS boot flow sample code.

1.3 Overview of *Volume 3: Instruction Set Reference*

This volume is a comprehensive reference to the Itanium and IA-32 instruction sets, including instruction format/encoding.

1.3.1 Part 1: Intel® Itanium® Instruction Set Descriptions

Chapter 1, “About this Manual” provides an overview of all volumes in the *Intel® Itanium® Architecture Software Developer’s Manual*.

Chapter 2, “Instruction Reference” provides a detailed description of all Itanium instructions, organized in alphabetical order by assembly language mnemonic.

Chapter 3, “Pseudo-Code Functions” provides a table of pseudo-code functions which are used to define the behavior of the Itanium instructions.

Chapter 4, “Instruction Formats” describes the encoding and instruction format instructions.

Chapter 5, “Resource and Dependency Semantics” summarizes the dependency rules that are applicable when generating code for processors based on the Itanium architecture.

1.3.2 Part 2: IA-32 Instruction Set Descriptions

Chapter 1, “Base IA-32 Instruction Reference” provides a detailed description of all base IA-32 instructions, organized in alphabetical order by assembly language mnemonic.

Chapter 2, “IA-32 Intel® MMX™ Technology Instruction Reference” provides a detailed description of all IA-32 Intel® MMX™ technology instructions designed to increase performance of multimedia intensive applications. Organized in alphabetical order by assembly language mnemonic.

Chapter 3, “IA-32 Streaming SIMD Extension Instruction Reference” provides a detailed description of all IA-32 Streaming SIMD Extension instructions designed to increase performance of multimedia intensive applications, and is organized in alphabetical order by assembly language mnemonic.

1.4 Terminology

The following definitions are for terms related to the Itanium architecture and will be used throughout this document:

Instruction Set Architecture (ISA) – Defines application and system level resources. These resources include instructions and registers.

Itanium Architecture – The new ISA with 64-bit instruction capabilities, new performance-enhancing features, and support for the IA-32 instruction set.

IA-32 Architecture – The 32-bit and 16-bit Intel® architecture as described in the *IA-32 Intel® Architecture Software Developer's Manual*.

Itanium System Environment – The operating system environment that supports the execution of both IA-32 and Itanium-based code.

IA-32 System Environment – The operating system privileged environment and resources as defined by the *IA-32 Intel® Architecture Software Developer's Manual*. Resources include virtual paging, control registers, debugging, performance monitoring, machine checks, and the set of privileged instructions.

Itanium-Based Firmware – The Processor Abstraction Layer (PAL) and System Abstraction Layer (SAL).

Processor Abstraction Layer (PAL) – The firmware layer which abstracts processor features that are implementation dependent.

System Abstraction Layer (SAL) – The firmware layer which abstracts system features that are implementation dependent.

1.5 Related Documents

The following documents can be downloaded at the Intel's Developer Site at <http://developer.intel.com>:

- **Intel® Itanium® 2 Processor Reference Manual for Software Development and Optimization** – This document describes model-specific architectural features incorporated into the Intel® Itanium® 2 processor, the second processor based on the Itanium architecture. (Document Number 251110)
- **Intel® Itanium® Processor Reference Manual for Software Development** – This document describes model-specific architectural features incorporated into the Intel® Itanium® processor, the first processor based on the Itanium architecture. (Document Number 245320)
- **IA-32 Intel® Architecture Software Developer's Manual** – This set of manuals describes the Intel 32-bit architecture. (Document Numbers 245470, 245471, and 245472)
- **Itanium™ Software Conventions and Runtime Architecture Guide** – This document defines general information necessary to compile, link, and execute a program on an Itanium-based operating system. (Document Number 245358)
- **Itanium® Processor Family System Abstraction Layer Specification** – This document specifies requirements to develop platform firmware for Itanium-based systems. (Document Number 245359)
- **Extensible Firmware Interface Specification** – This document defines a new model for the interface between operating systems and platform firmware.

1.6 Revision History

| Date of Revision | Revision Number | Description |
|------------------|-----------------|---|
| October 2002 | 2.1 | <p>Added New <code>fc.i</code> Instruction (Sections 4.4.6.1 and 4.4.6.2, Part I, Vol. 1; Sections 4.3.3, 4.4.1, 4.4.5, 4.4.7, 5.5.2, and 7.1.2, Part I, Vol. 2; Sections 2.5, 2.5.1, 2.5.2, 2.5.3, and 4.5.2.1, Part II, Vol. 2; and Sections 2.2, 3, 4.1, 4.4.6.5, and 4.4.10.10, Part I, Vol. 3).</p> <p>Added New Atomic Operations <code>ld16, st16, cmp8xchg16</code> (Sections 3.1.8, 3.1.8.6, 4.4.1, 4.4.2, and 4.4.3, Part I, Vol. 1; Section 4.5, Part I, Vol. 2; and Sections 2.2, 3, 5.3.2, and 5.4, Part I, Vol. 3).</p> <p>Added Spontaneous NaT Generation on Speculative Load (Sections 5.5.5 and 11.9, Part I, Vol. 2 and Sections 2.2 and 3, Part I, Vol. 3).</p> <p>Added New Hint Instruction (Section 2.2, Part I, Vol. 3).</p> <p>Added Fault Handling Semantics for <code>lfetch.fault</code> Instruction (Section 2.2, Part I, Vol. 3).</p> <p>Added Capability for Allowing Multiple <code>PAL_A_SPEC</code> and <code>PAL_B</code> Entries in the Firmware Interface Table (Section 11.1.6, Part I, Vol. 2).</p> <p>Added BR1 to Min-state Save Area and Clarified Alignment (Sections 11.3.2.3 and 11.3.3, Part I, Vol. 2).</p> <p>Added New PAL Procedures: <code>PAL_LOGICAL_TO_PHYSICAL</code> and <code>PAL_CACHE_SHARED_INFO</code> (Section 11.9.1, Part I, Vol. 2).</p> <p>Added Op Fields to <code>PAL_MC_ERROR_INFO</code> (Section 11.9, Part I, Vol. 2).</p> <p>Added New Error Exit States (Section 11.2.2.2, Part I, Vol. 2).</p> <p>Added Performance Counter Standardization (Sections 7.2.3 and 11.6, Part I, Vol. 2).</p> <p>Modified <code>CPUID[4]</code> for Atomic Operations and Spontaneous Deferral (Section 3.1.11, Part I, Vol. 1).</p> <p>Modified <code>PAL_FREQ_RATIOS</code> (Section 11.2.2, Part I, Vol. 2).</p> <p>Modified <code>PAL_VERSION</code> (Section 11.9, Part I, Vol. 2).</p> <p>Modified <code>PAL_CACHE_INFO</code> Store Hints (Section 11.9, Part I, Vol. 2).</p> <p>Modified <code>PAL_MC_RESUME</code> (Sections 11.3.3 and 11.4, Part I, Vol. 2).</p> <p>Modified <code>IA_32_Exception</code> (Debug) IIPA Description (Section 9.2, Part I, Vol. 2).</p> <p>Clarified Predicate Behavior of <code>alloc</code> Instruction (Section 4.1.2, Part I, Vol. 1 and Section 2.2, Part I, Vol. 3).</p> <p>Clarified ITC clocking (Section 3.1.8.10, Part I, Vol. 1; Section 3.3.4.2, Part I, Vol. 2; and Section 10.5.5, Part II, Vol. 2).</p> <p>Clarified Interval Time Counter (ITC) Fault (Section 3.3.2, Part I, Vol. 2).</p> <p>Clarified Interruption Control Registers (Section 3.3.5, Part I, Vol. 2).</p> <p>Clarified Freeze Bit Functionality in Context Switching and Interrupt Generation (Sections 7.2.1, 7.2.2, 7.2.4.1, and 7.2.4.2, Part I, Vol. 2).</p> <p>Clarified <code>PAL_BUS_GET/SET_FEATURES</code> (Section 11.9.3, Part I, Vol. 2).</p> <p>Clarified <code>PAL_CACHE_FLUSH</code> (Section 11.9, Part I, Vol. 2).</p> <p>Clarified Cache State upon Recovery Check (Section 11.2, Part I, Vol. 2).</p> <p>Clarified <code>PALE_INIT</code> Exit State (Section 11.4.2, Part I, Vol. 2).</p> <p>Clarified Processor State Parameter (Section 11.4.2.1, Part I, Vol. 2).</p> <p>Clarified Firmware Address Space at Reset (Section 11.1, Part I, Vol. 2).</p> <p>Clarified PAL PMI, AR.ITC, and PMD Register Values (Sections 11.3, 11.5.1, and 11.5.2, Part I, Vol. 2).</p> <p>Clarified Invalid Arguments to PAL (Section 11.9.2.4, Part I, Vol. 2).</p> <p>Clarified <code>itr/itc</code> Instructions (Section 2.2, Part I, Vol. 3).</p> |

| Date of Revision | Revision Number | Description |
|------------------|-----------------|---|
| December 2001 | 2.0 | <p>Volume 1:</p> <p>Faults in ld.c that hits ALAT clarification (Section 4.4.5.3.1).</p> <p>IA-32 related changes (Section 6.2.5.4, Section 6.2.3, Section 6.2.4, Section 6.2.5.3).</p> <p>Load instructions change (Section 4.4.1).</p> <p>Volume 2:</p> <p>Class pr-writers-int clarification (Table A-5).</p> <p>PAL_MC_DRAIN clarification (Section 4.4.6.1).</p> <p>VHPT walk and forward progress change (Section 4.1.1.2).</p> <p>IA-32 IBR/DBR match clarification (Section 7.1.1).</p> <p>ISR figure changes (pp. 8-5, 8-26, 8-33 and 8-36).</p> <p>PAL_CACHE_FLUSH return argument change - added new status return argument (Section 11.8.3).</p> <p>PAL self-test Control and PAL_A procedure requirement change - added new arguments, figures, requirements (Section 11.2).</p> <p>PAL_CACHE_FLUSH clarifications (Section 11).</p> <p>Non-speculative reference clarification (Section 4.4.6).</p> <p>RID and Preferred Page Size usage clarification (Section 4.1).</p> <p>VHPT read atomicity clarification (Section 4.1).</p> <p>IIP and WC flush clarification (Section 4.4.5).</p> <p>Revised RSE and PMC typographical errors (Section 6.4).</p> <p>Revised DV table (Section A.4).</p> <p>Memory attribute transitions - added new requirements (Section 4.4).</p> <p>MCA for WC/UC aliasing change (Section 4.4.1).</p> <p>Bus lock deprecation - changed behavior of DCR 'lc' bit (Section 3.3.4.1, Section 10.6.8, Section 11.8.3).</p> <p>PAL_PROC_GET/SET_FEATURES changes - extend calls to allow implementation-specific feature control (Section 11.8.3).</p> <p>Split PAL_A architecture changes (Section 11.1.6).</p> <p>Simple barrier synchronization clarification (Section 13.4.2).</p> <p>Limited speculation clarification - added hardware-generated speculative references (Section 4.4.6).</p> <p>PAL memory accesses and restrictions clarification (Section 11.9).</p> <p>PSP validity on INITs from PAL_MC_ERROR_INFO clarification (Section 11.8.3).</p> <p>Speculation attributes clarification (Section 4.4.6).</p> <p>PAL_A FIT entry, PAL_VM_TR_READ, PSP, PAL_VERSION clarifications (Sections 11.8.3 and 11.3.2.1).</p> <p>TLB searching clarifications (Section 4.1).</p> <p>IA-32 related changes (Section 10.3, Section 10.3.2, Section 10.3.2, Section 10.3.3.1, Section 10.10.1).</p> <p>IPSR.ri and ISR.ei changes (Table 3-2, Section 3.3.5.1, Section 3.3.5.2, Section 5.5, Section 8.3, and Section 2.2).</p> <p>Volume 3:</p> <p>IA-32 CPUID clarification (p. 5-71).</p> <p>Revised figures for extract, deposit, and alloc instructions (Section 2.2).</p> <p>RCPSS, RCPSS, RSQRTPS, and RSQRTSS clarification (Section 7.12).</p> <p>IA-32 related changes (Section 5.3).</p> <p>tak, tpa change (Section 2.2).</p> |

| Date of Revision | Revision Number | Description |
|------------------|-----------------|--|
| July 2000 | 1.1 | <p>Volume 1:</p> <p>Processor Serial Number feature removed (Chapter 3).</p> <p>Clarification on exceptions to instruction dependency (Section 3.4.3).</p> <p>Volume 2:</p> <p>Clarifications regarding “reserved” fields in ITIR (Chapter 3).</p> <p>Instruction and Data translation must be enabled for executing IA-32 instructions (Chapters 3,4 and 10).</p> <p>FCR/FDR mappings, and clarification to the value of PSR.ri after an RFI (Chapters 3 and 4).</p> <p>Clarification regarding ordering data dependency.</p> <p>Out-of-order IPI delivery is now allowed (Chapters 4 and 5).</p> <p>Content of EFLAG field changed in IIM (p. 9-24).</p> <p>PAL_CHECK and PAL_INIT calls – exit state changes (Chapter 11).</p> <p>PAL_CHECK processor state parameter changes (Chapter 11).</p> <p>PAL_BUS_GET/SET_FEATURES calls – added two new bits (Chapter 11).</p> <p>PAL_MC_ERROR_INFO call – Changes made to enhance and simplify the call to provide more information regarding machine check (Chapter 11).</p> <p>PAL_ENTER_IA_32_Env call changes – entry parameter represents the entry order; SAL needs to initialize all the IA-32 registers properly before making this call (Chapter 11).</p> <p>PAL_CACHE_FLUSH – added a new cache_type argument (Chapter 11).</p> <p>PAL_SHUTDOWN – removed from list of PAL calls (Chapter 11).</p> <p>Clarified memory ordering changes (Chapter 13).</p> <p>Clarification in dependence violation table (Appendix A).</p> <p>Volume 3:</p> <p>fmix instruction page figures corrected (Chapter 2).</p> <p>Clarification of “reserved” fields in ITIR (Chapters 2 and 3).</p> <p>Modified conditions for alloc/loadrs/flushrs instruction placement in bundle/ instruction group (Chapters 2 and 4).</p> <p>IA-32 JMPE instruction page typo fix (p. 5-238).</p> <p>Processor Serial Number feature removed (Chapter 5).</p> |
| January 2000 | 1.0 | Initial release of document. |

This chapter describes the function of each Itanium instruction. The pages of this chapter are sorted alphabetically by assembly language mnemonic.

2.1 Instruction Page Conventions

The instruction pages are divided into multiple sections as listed in [Table 2-1](#). The first three sections are present on all instruction pages. The last three sections are present only when necessary. [Table 2-2](#) lists the font conventions which are used by the instruction pages.

Table 2-1. Instruction Page Description

| Section Name | Contents |
|---------------|---|
| Format | Assembly language syntax, instruction type and encoding format |
| Description | Instruction function in English |
| Operation | Instruction function in C code |
| FP Exceptions | IEEE floating-point traps |
| Interruptions | Prioritized list of interruptions that may be caused by the instruction |
| Serialization | Serializing behavior or serialization requirements |

Table 2-2. Instruction Page Font Conventions

| Font | Interpretation |
|--------------------|---|
| regular | (Format section) Required characters in an assembly language mnemonic |
| <i>italic</i> | (Format section) Assembly language field name that must be filled with one of a range of legal values listed in the Description section |
| code | (Operation section) C code specifying instruction behavior |
| <i>code_italic</i> | (Operation section) Assembly language field name corresponding to a <i>italic</i> field listed in the Format section |

In the Format section, register addresses are specified using the assembly mnemonic field names given in the third column of [Table 2-3](#). For instructions that are predicated, the Description section assumes that the qualifying predicate is true (except for instructions that modify architectural state when their qualifying predicate is false). The test of the qualifying predicate is included in the Operation section (when applicable).

In the Operation section, registers are addressed using the notation `reg[addr].field`. The register file being accessed is specified by `reg`, and has a value chosen from the second column of [Table 2-3](#). The `addr` field specifies a register address as an assembly language field name or a register mnemonic. For the general, floating-point, and predicate register files which undergo register renaming, `addr` is the register address prior to renaming and the renaming is not shown. The `field` option specifies a named bit field within the register. If `field` is absent, then all fields of the register are accessed. The only exception is when referencing the data field of the general registers (64-bits not including the NaT bit) where the notation `GR[addr]` is used. The syntactical differences between the code found in the Operation section and ANSI C is listed in [Table 2-4](#).

Table 2-3. Register File Notation

| Register File | C Notation | Assembly Mnemonic | Indirect Access |
|---|------------|-------------------|-----------------|
| Application registers | AR | ar | |
| Branch registers | BR | b | |
| Control registers | CR | cr | |
| CPU identification registers | CPUID | cpuid | Y |
| Data breakpoint registers | DBR | dbr | Y |
| Instruction breakpoint registers | IBR | ibr | Y |
| Data TLB translation cache | DTC | n/a | |
| Data TLB translation registers | DTR | dtr | Y |
| Floating-point registers | FR | f | |
| General registers | GR | r | |
| Instruction TLB translation cache | ITC | n/a | |
| Instruction TLB translation registers | ITR | itr | Y |
| Protection key registers | PKR | pkr | Y |
| Performance monitor configuration registers | PMC | pmc | Y |
| Performance monitor data registers | PMD | pmd | Y |
| Predicate registers | PR | p | |
| Region registers | RR | rr | Y |

Table 2-4. C Syntax Differences

| Syntax | Function |
|------------------|--|
| {msb:lsb}, {bit} | Bit field specifier. When appended to a variable, denotes a bit field extending from the most significant bit specified by “msb” to the least significant bit specified by “lsb” including bits “msb” and “lsb”. If “msb” and “lsb” are equal then a single bit is accessed. The second form denotes a single bit. |
| u>, u>=, u<, u<= | Unsigned inequality relations. Variables on either side of the operator are treated as unsigned. |
| u>>, u>>= | Unsigned right shift. Zeroes are shifted into the most significant bit position. |
| u+ | Unsigned addition. Operands are treated as unsigned, and zero-extended. |
| u* | Unsigned multiplication. Operands are treated as unsigned. |

The Operation section contains code that specifies only the execution semantics of each instruction and does not include any behavior relating to instruction fetch (e.g., interrupts and faults caused during fetch). The Interruptions section does not list any faults that may be caused by instruction fetch or by mandatory RSE loads. The code to raise certain pervasive faults and actions is not included in the code in the Operation section. These faults and actions are listed in [Table 2-5](#). The Single step trap applies to all instructions and is not listed in the Interruptions section.

Table 2-5. Pervasive Conditions Not Included in Instruction Description Code

| Condition | Action |
|--|--|
| Read of a register outside the current frame. | An undefined value is returned (no fault). |
| Access to a banked general register (GR 16 through GR 31). | The GR bank specified by PSR.bn is accessed. |
| PSR.ss is set. | A Single Step trap is raised. |

2.2 Instruction Descriptions

The remainder of this chapter provides a description of each of the Itanium instructions.

add — Add

| | | | |
|----------------|--|---------------------------|----|
| Format: | <i>(qp)</i> add $r_1 = r_2, r_3$ | register_form | A1 |
| | <i>(qp)</i> add $r_1 = r_2, r_3, 1$ | plus1_form, register_form | A1 |
| | <i>(qp)</i> add $r_1 = imm, r_3$ | pseudo-op | |
| | <i>(qp)</i> adds $r_1 = imm_{14}, r_3$ | imm14_form | A4 |
| | <i>(qp)</i> addl $r_1 = imm_{22}, r_3$ | imm22_form | A5 |

Description: The two source operands (and an optional constant 1) are added and the result placed in GR r_1 . In the register form the first operand is GR r_2 ; in the imm_14 form the first operand is taken from the sign-extended imm_{14} encoding field; in the imm22_form the first operand is taken from the sign-extended imm_{22} encoding field. In the imm22_form, GR r_3 can specify only GRs 0, 1, 2 and 3.

The plus1_form is available only in the register_form (although the equivalent effect in the immediate forms can be achieved by adjusting the immediate).

The immediate-form pseudo-op chooses the imm14_form or imm22_form based upon the size of the immediate operand and the value of r_3 .

Operation:

```

if (PR[qp]) {
    check_target_register(r1);

    if (register_form) // register form
        tmp_src = GR[r2];
    else if (imm14_form) // 14-bit immediate form
        tmp_src = sign_ext(imm14, 14);
    else // 22-bit immediate form
        tmp_src = sign_ext(imm22, 22);

    tmp_nat = (register_form ? GR[r2].nat : 0);

    if (plus1_form)
        GR[r1] = tmp_src + GR[r3] + 1;
    else
        GR[r1] = tmp_src + GR[r3];

    GR[r1].nat = tmp_nat || GR[r3].nat;
}

```

Interruptions: Illegal Operation fault

addp4 — Add Pointer

Format: (qp) addp4 $r_1 = r_2, r_3$ register_form A1
 (qp) addp4 $r_1 = imm_{14}, r_3$ imm14_form A4

Description: The two source operands are added. The upper 32 bits of the result are forced to zero, and then bits {31:30} of GR r_3 are copied to bits {62:61} of the result. This result is placed in GR r_1 . In the register_form the first operand is GR r_2 ; in the imm14_form the first operand is taken from the sign-extended imm_{14} encoding field.

Figure 2-1. Add Pointer

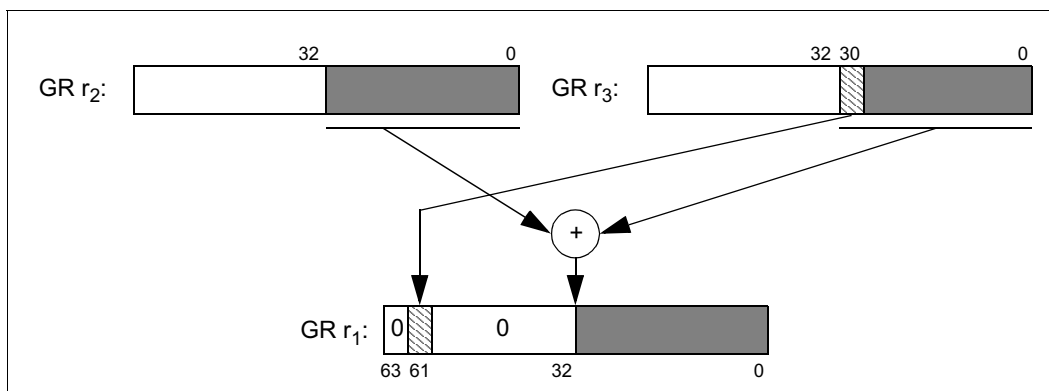

Operation:

```

if (PR[qp]) {
    check_target_register(r1);

    tmp_src = (register_form ? GR[r2] : sign_ext(imm14, 14));
    tmp_nat = (register_form ? GR[r2].nat : 0);

    tmp_res = tmp_src + GR[r3];
    tmp_res = zero_ext(tmp_res{31:0}, 32);
    tmp_res{62:61} = GR[r3]{31:30};
    GR[r1] = tmp_res;
    GR[r1].nat = tmp_nat || GR[r3].nat;
}
  
```

Interruptions: Illegal Operation fault

alloc — Allocate Stack Frame

Format: (qp) alloc $r_I = ar.pfs, i, l, o, r$

M34

Description: A new stack frame is allocated on the general register stack, and the Previous Function State register (PFS) is copied to GR r_I . The change of frame size is immediate. The write of GR r_I and subsequent instructions in the same instruction group use the new frame.

The four parameters, i (size of inputs), l (size of locals), o (size of outputs), and r (size of rotating) specify the sizes of the regions of the stack frame.

Figure 2-2. Stack Frame

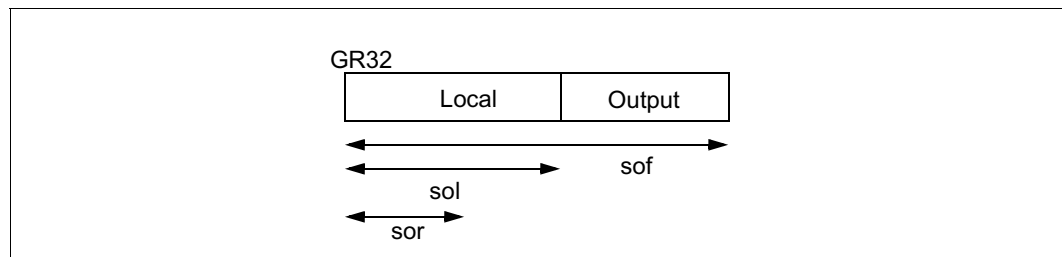

The size of the frame (sof) is determined by $i + l + o$. Note that this instruction may grow or shrink the size of the current register stack frame. The size of the local region (sol) is given by $i + l$. There is no real distinction between inputs and locals. They are given as separate operands in the instruction only as a hint to the assembler about how the local registers are to be used.

The rotating registers must fit within the stack frame and be a multiple of 8 in number. If this instruction attempts to change the size of CFM.sor, and the register rename base registers (CFM.rrb.gr, CFM.rrb.fr, CFM.rrb.pr) are not all zero, then the instruction will cause a Reserved Register/Field fault.

Although the assembler does not allow illegal combinations of operands for alloc, illegal combinations can be encoded in the instruction. Attempting to allocate a stack frame larger than 96 registers, or with the rotating region larger than the stack frame, or with the size of locals larger than the stack frame, or specifying a qualifying predicate other than PR 0, will cause an Illegal Operation fault.

This instruction must be the first instruction in an instruction group and must either be in instruction slot 0 or in instruction slot 1 of a template having a stop after slot 0; otherwise, the results are undefined.

If insufficient registers are available to allocate the desired frame alloc will stall the processor until enough dirty registers are written to the backing store. Such mandatory RSE stores may cause the data related faults listed below.

```

Operation: // tmp_sof, tmp_sol, tmp_sor are the fields encoded in the instruction
tmp_sof = i + l + o;
tmp_sol = i + l;
tmp_sor = r u>> 3;
check_target_register_sof(r1, tmp_sof);
if (tmp_sof u> 96 || r u> tmp_sof || tmp_sol u> tmp_sof || qp != 0)
    illegal_operation_fault();
if (tmp_sor != CFM.sor &&
    (CFM.rrb.gr != 0 || CFM.rrb.fr != 0 || CFM.rrb.pr != 0))
    reserved_register_field_fault();

alat_frame_update(0, tmp_sof - CFM.sof);
rse_new_frame(CFM.sof, tmp_sof); // Make room for new registers; Mandatory
                                // RSE stores can raise faults listed below.

CFM.sof = tmp_sof;
CFM.sol = tmp_sol;
CFM.sor = tmp_sor;

GR[r1] = AR[PFS];
GR[r1].nat = 0;

```

| | |
|---|---------------------------------|
| Interruptions: Illegal Operation fault | Data NaT Page Consumption fault |
| Reserved Register/Field fault | Data Key Miss fault |
| Unimplemented Data Address fault | Data Key Permission fault |
| VHPT Data fault | Data Access Rights fault |
| Data Nested TLB fault | Data Dirty Bit fault |
| Data TLB fault | Data Access Bit fault |
| Alternate Data TLB fault | Data Debug fault |
| Data Page Not Present fault | |

and — Logical And

Format: (qp) and $r_1 = r_2, r_3$ register_form [A1](#)
 (qp) and $r_1 = imm_8, r_3$ imm8_form [A3](#)

Description: The two source operands are logically ANDed and the result placed in GR r_1 . In the register_form the first operand is GR r_2 ; in the imm8_form the first operand is taken from the imm_8 encoding field.

Operation:

```

if (PR[qp]) {
    check_target_register(r1);

    tmp_src = (register_form ? GR[r2] : sign_ext(imm8, 8));
    tmp_nat = (register_form ? GR[r2].nat : 0);

    GR[r1] = tmp_src & GR[r3];
    GR[r1].nat = tmp_nat || GR[r3].nat;
}

```

Interruptions: Illegal Operation fault

br — Branch

| | | | |
|----------------|---|--------------------------------|----|
| Format: | (<i>qp</i>) <i>br.btype.bwh.ph.dh target₂₅</i> | ip_relative_form | B1 |
| | (<i>qp</i>) <i>br.btype.bwh.ph.dh b₁ = target₂₅</i> | call_form, ip_relative_form | B3 |
| | <i>br.btype.bwh.ph.dh target₂₅</i> | counted_form, ip_relative_form | B2 |
| | <i>br.ph.dh target₂₅</i> | pseudo-op | |
| | (<i>qp</i>) <i>br.btype.bwh.ph.dh b₂</i> | indirect_form | B4 |
| | (<i>qp</i>) <i>br.btype.bwh.ph.dh b₁ = b₂</i> | call_form, indirect_form | B5 |
| | <i>br.ph.dh b₂</i> | pseudo-op | |

Description: A branch condition is evaluated, and either a branch is taken, or execution continues with the next sequential instruction. The execution of a branch logically follows the execution of all previous non-branch instructions in the same instruction group. On a taken branch, execution begins at slot 0.

Branches can be either IP-relative, or indirect. For IP-relative branches, the *target₂₅* operand, in assembly, specifies a label to branch to. This is encoded in the branch instruction as a signed immediate displacement (*imm₂₁*) between the target bundle and the bundle containing this instruction ($imm_{21} = target_{25} - IP \gg 4$). For indirect branches, the target address is taken from BR *b₂*.

Table 2-6. Branch Types

| <i>btype</i> | Function | Branch Condition | Target Address |
|--------------|------------------------------|---------------------------------------|--------------------|
| cond or none | Conditional branch | Qualifying predicate | IP-rel or Indirect |
| call | Conditional procedure call | Qualifying predicate | IP-rel or Indirect |
| ret | Conditional procedure return | Qualifying predicate | Indirect |
| ia | Invoke IA-32 instruction set | Unconditional | Indirect |
| cloop | Counted loop branch | Loop count | IP-rel |
| ctop, cexit | Mod-scheduled counted loop | Loop count and epilog count | IP-rel |
| wtop, wexit | Mod-scheduled while loop | Qualifying predicate and epilog count | IP-rel |

There are two pseudo-ops for unconditional branches. These are encoded like a conditional branch (*btype* = cond), with the *qp* field specifying PR 0, and with the *bwh* hint of sptk.

The branch type determines how the branch condition is calculated and whether the branch has other effects (such as writing a link register). For the basic branch types, the branch condition is simply the value of the specified predicate register. These basic branch types are:

- **cond:** If the qualifying predicate is 1, the branch is taken. Otherwise it is not taken.
- **call:** If the qualifying predicate is 1, the branch is taken and several other actions occur:
 - The current values of the Current Frame Marker (CFM), the EC application register and the current privilege level are saved in the Previous Function State application register.
 - The caller's stack frame is effectively saved and the callee is provided with a frame containing only the caller's output region.
 - The rotation rename base registers in the CFM are reset to 0.
 - A return link value is placed in BR *b₁*.

- **return:** If the qualifying predicate is 1, the branch is taken and the following occurs:
 - CFM, EC, and the current privilege level are restored from PFS. (The privilege level is restored only if this does not increase privilege.)
 - The caller's stack frame is restored.
 - If the return lowers the privilege, and PSR.lp is 1, then a Lower-Privilege Transfer trap is taken.
- **ia:** The branch is taken unconditionally, if it is not intercepted by the OS. The effect of the branch is to invoke the IA-32 instruction set (by setting PSR.is to 1) and begin processing IA-32 instructions at the virtual linear target address contained in BR $b_2\{31:0\}$. If the qualifying predicate is not PR 0, an Illegal Operation fault is raised. If instruction set transitions are disabled (PSR.di is 1), then a Disabled Instruction Set Transition fault is raised. The IA-32 target effective address is calculated relative to the current code segment, i.e. $EIP\{31:0\} = BR\ b_2\{31:0\} - CSD.base$. The IA-32 instruction set can be entered at any privilege level, provided PSR.di is 0. If PSR.dfh is 1, a Disabled FP Register fault is raised on the target IA-32 instruction. No register bank switch nor change in privilege level occurs during the instruction set transition.

Software must ensure the code segment descriptor (CSD) and selector (CS) are loaded before issuing the branch. If the target EIP value exceeds the code segment limit or has a code segment privilege violation, an IA-32_Exception(GPFault) is raised on the target IA-32 instruction. For entry into 16-bit IA-32 code, if BR b_2 is not within 64K-bytes of CSD.base a GPFault is raised on the target instruction. EFLAG.rf is unmodified until the successful completion of the first IA-32 instruction. PSR.da, PSR.id, PSR.ia, PSR.dd, and PSR.ed are cleared to zero after `br . ia` completes execution and before the first IA-32 instruction begins execution. EFLAG.rf is not cleared until the target IA-32 instruction successfully completes.

Software must issue a `mfi` instruction before the branch if memory ordering is required between IA-32 processor consistent and Itanium unordered memory references. The processor does not ensure Itanium-instruction-set-generated writes into the instruction stream are seen by subsequent IA-32 instruction fetches. `br . ia` does not perform an instruction serialization operation. The processor does ensure that prior writes (even in the same instruction group) to GRs and FRs are observed by the first IA-32 instruction. Writes to ARs within the same instruction group as `br . ia` are not allowed, since `br . ia` may implicitly reads all ARs. If an illegal RAW dependency is present between an AR write and `br . ia`, the first IA-32 instruction fetch and execution may or may not see the updated AR value.

IA-32 instruction set execution leaves the contents of the ALAT undefined. Software can not rely on ALAT values being preserved across an instruction set transition. All registers left in the current register stack frame are undefined across an instruction set transition. On entry to IA-32 code, existing entries in the ALAT are ignored. If the register stack contains any dirty registers, an Illegal Operation fault is raised on the `br . ia` instruction. The current register stack frame is forced to zero. To flush the register file of dirty registers, the `flushrs` instruction must be issued in an instruction group preceding the `br . ia` instruction. To enhance the performance of the instruction set transition, software can start the register stack flush in parallel with starting the IA-32 instruction set by 1) ensuring `flushrs` is exactly one instruction group before the `br . ia`, and 2) `br . ia` is in the first B-slot. `br . ia` should always be executed in the first B-slot with a hint of "static-taken" (default), otherwise processor performance will be degraded.

If a `br . ia` causes any Itanium traps (e.g., Single Step trap, Taken Branch trap, or Unimplemented Instruction Address trap), IIP will contain the original 64-bit target IP. (The value will not have been zero extended from 32 bits.)

Another branch type is provided for simple counted loops. This branch type uses the Loop Count application register (LC) to determine the branch condition, and does not use a qualifying predicate:

- **loop:** If the LC register is not equal to zero, it is decremented and the branch is taken.

In addition to these simple branch types, there are four types which are used for accelerating modulo-scheduled loops (see also [Section 4.5.1, “Modulo-scheduled Loop Support” on page 1:66](#)). Two of these are for counted loops (which use the LC register), and two for while loops (which use the qualifying predicate). These loop types use register rotation to provide register renaming, and they use predication to turn off instructions that correspond to empty pipeline stages.

The Epilog Count application register (EC) is used to count epilog stages and, for some while loops, a portion of the prolog stages. In the epilog phase, EC is decremented each time around and, for most loops, when EC is one, the pipeline has been drained, and the loop is exited. For certain types of optimized, unrolled software-pipelined loops, the target of a `br.cexit` or `br.wexit` is set to the next sequential bundle. In this case, the pipeline may not be fully drained when EC is one, and continues to drain while EC is zero.

For these modulo-scheduled loop types, the calculation of whether the branch is taken or not depends on the kernel branch condition (LC for counted types, and the qualifying predicate for while types) and on the epilog condition (whether EC is greater than one or not).

These branch types are of two categories: top and exit. The top types (`ctop` and `wtop`) are used when the loop decision is located at the bottom of the loop body and therefore a taken branch will continue the loop while a fall through branch will exit the loop. The exit types (`cexit` and `wexit`) are used when the loop decision is located somewhere other than the bottom of the loop and therefore a fall through branch will continue the loop and a taken branch will exit the loop. The exit types are also used at intermediate points in an unrolled pipelined loop. (For more details, see [Section 4.5.1, “Modulo-scheduled Loop Support” on page 1:66](#)).

The modulo-scheduled loop types are:

- **ctop and cexit:** These branch types behave identically, except in the determination of whether to branch or not. For `br.ctop`, the branch is taken if either LC is non-zero or EC is greater than one. For `br.cexit`, the opposite is true. It is not taken if either LC is non-zero or EC is greater than one and is taken otherwise.

These branch types also use LC and EC to control register rotation and predicate initialization. During the prolog and kernel phase, when LC is non-zero, LC counts down. When `br.ctop` or `br.cexit` is executed with LC equal to zero, the epilog phase is entered, and EC counts down. When `br.ctop` or `br.cexit` is executed with LC equal to zero and EC equal to one, a final decrement of EC and a final register rotation are done. If LC and EC are equal to zero, register rotation stops. These other effects are the same for the two branch types, and are described in [Figure 2-3](#).

wtop and wexit: These branch types behave identically, except in the determination of whether to branch or not. For `br.wtop`, the branch is taken if either the qualifying predicate is one or EC is greater than one. For `br.wexit`, the opposite is true. It is not taken if either the qualifying predicate is one or EC is greater than one, and is taken otherwise.

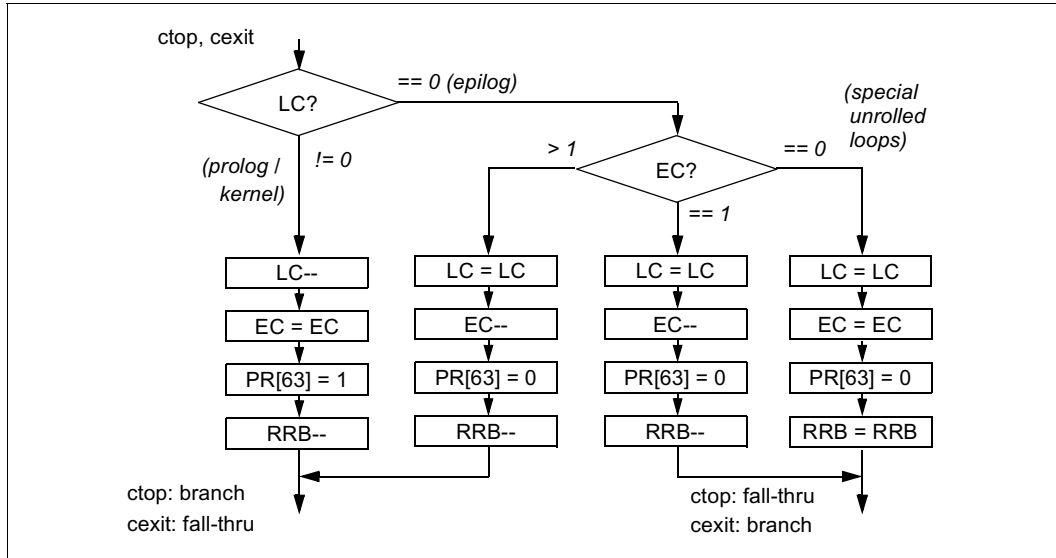
Figure 2-3. Operation of `br.ctop` and `br.cexit`

These branch types also use the qualifying predicate and EC to control register rotation and predicate initialization. During the prolog phase, the qualifying predicate is either zero or one, depending upon the scheme used to program the loop. During the kernel phase, the qualifying predicate is one. During the epilog phase, the qualifying predicate is zero, and EC counts down. When `br.wtop` or `br.wexit` is executed with the qualifying predicate equal to zero and EC equal to one, a final decrement of EC and a final register rotation are done. If the qualifying predicate and EC are zero, register rotation stops. These other effects are the same for the two branch types, and are described in Figure 2-4.

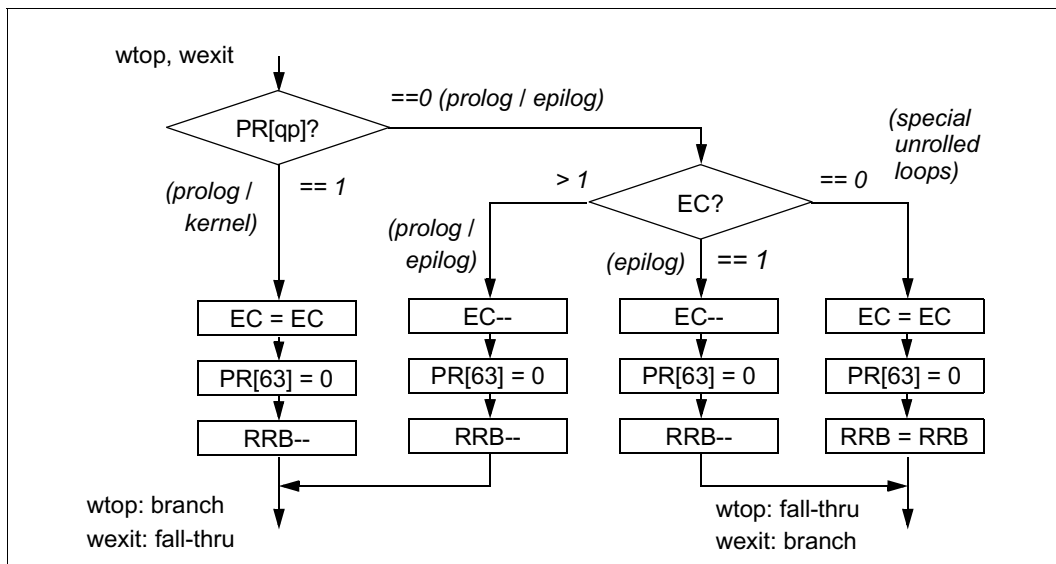
Figure 2-4. Operation of `br.wtop` and `br.wexit`

The loop-type branches (`br.cloop`, `br.ctop`, `br.cexit`, `br.wtop`, and `br.wexit`) are only allowed in instruction slot 2 within a bundle. Executing such an instruction in either slot 0 or 1 will cause an Illegal Operation fault, whether the branch would have been taken or not.

Read after Write (RAW) and Write after Read (WAR) dependency requirements are slightly different for branch instructions. Changes to BRs, PRs, and PFS by non-branch instructions are visible to a subsequent branch instruction in the same instruction group (i.e., a limited RAW is allowed for these resources). This allows for a low-latency compare-branch sequence, for example. The normal RAW requirements apply to the LC and EC application registers, and the RRBs.

Within an instruction group, a WAR dependency on PR 63 is not allowed if both the reading and writing instructions are branches. For example, a `br.wtop` or `br.wexit` may not use PR[63] as its qualifying predicate and PR[63] cannot be the qualifying predicate for any branch preceding a `br.wtop` or `br.wexit` in the same instruction group.

For dependency purposes, the loop-type branches effectively always write their associated resources, whether they are taken or not. The cloop type effectively always writes LC. When LC is 0, a cloop branch leaves it unchanged, but hardware may implement this as a re-write of LC with the same value. Similarly, `br.ctop` and `br.cexit` effectively always write LC, EC, the RRBs, and PR[63]. `br.wtop` and `br.wexit` effectively always write EC, the RRBs, and PR[63].

Values for various branch hint completers are shown in the following tables. Whether Prediction Strategy hints are shown in [Table 2-7](#). Sequential Prefetch hints are shown in [Table 2-8](#). Branch Cache Deallocation hints are shown in [Table 2-9](#). See [Section 4.5.2, “Branch Prediction Hints”](#) on page 1:68.

Table 2-7. Branch Whether Hint

| <i>bwh</i> Completer | Branch Whether Hint |
|----------------------|---------------------|
| spnt | Static Not-Taken |
| sptk | Static Taken |
| dpnt | Dynamic Not-Taken |
| dptk | Dynamic Taken |

Table 2-8. Sequential Prefetch Hint

| <i>ph</i> Completer | Sequential Prefetch Hint |
|---------------------|--------------------------|
| few or none | Few lines |
| many | Many lines |

Table 2-9. Branch Cache Deallocation Hint

| <i>dh</i> Completer | Branch Cache Deallocation Hint |
|---------------------|--------------------------------|
| none | Don't deallocate |
| clr | Deallocate branch information |

```

Operation:  if (ip_relative_form)                // determine branch target
                tmp_IP = IP + sign_ext((imm21 << 4), 25);
                else // indirect_form
                tmp_IP = BR[b2];

                if (btype != 'ia')                // for Itanium branches,
                tmp_IP = tmp_IP & ~0xf;           // ignore bottom 4 bits of target

                lower_priv_transition = 0;

                switch (btype) {
                case 'cond':                        // simple conditional branch
                tmp_taken = PR[qp];
                break;

```

```

case 'call':
    // call saves a return link
    tmp_taken = PR[qp];
    if (tmp_taken) {
        BR[b1] = IP + 16;

        AR[PFS].pfm = CFM;           // ... and saves the stack frame
        AR[PFS].pec = AR[EC];
        AR[PFS].ppl = PSR.cpl;

        alat_frame_update(CFM.sol, 0);
        rse_preserve_frame(CFM.sol);
        CFM.sof -= CFM.sol;           // new frame size is size of outs
        CFM.sol = 0;
        CFM.sor = 0;
        CFM.rrb.gr = 0;
        CFM.rrb.fr = 0;
        CFM.rrb.pr = 0;
    }
    break;

case 'ret':
    // return restores stack frame
    tmp_taken = PR[qp];
    if (tmp_taken) {
        // tmp_growth indicates the amount to move logical TOP *up*:
        // tmp_growth = sizeof(previous out) - sizeof(current frame)
        // a negative amount indicates a shrinking stack
        tmp_growth = (AR[PFS].pfm.sof - AR[PFS].pfm.sol) - CFM.sof;
        alat_frame_update(-AR[PFS].pfm.sol, 0);
        rse_fatal = rse_restore_frame(AR[PFS].pfm.sol, tmp_growth,
CFM.sof);
        if (rse_fatal) { // See Section 6.4, "RSE Operation" on
page 2:119
            CFM.sof = 0;
            CFM.sol = 0;
            CFM.sor = 0;
            CFM.rrb.gr = 0;
            CFM.rrb.fr = 0;
            CFM.rrb.pr = 0;
        } else // normal branch return
            CFM = AR[PFS].pfm;

        rse_enable_current_frame_load();
        AR[EC] = AR[PFS].pec;
        if (PSR.cpl < AR[PFS].ppl) { // ... and restores privilege
            PSR.cpl = AR[PFS].ppl;
            lower_priv_transition = 1;
        }
    }
    break;

case 'ia':
    // switch to IA mode
    tmp_taken = 1;
    if (qp != 0)
        illegal_operation_fault();
    if (AR[BSPSTORE] != AR[BSP])
        illegal_operation_fault();
    if (PSR.di)
        disabled_instruction_set_transition_fault();
    PSR.is = 1;                       // set IA-32 Instruction Set Mode
    CFM.sof = 0;                       //force current stack frame
    CFM.sol = 0;                       //to zero

```

```

CFM.sor = 0;
CFM.rrb.gr = 0;
CFM.rrb.fr = 0;
CFM.rrb.pr = 0;
rse_invalidate_non_current_regs();
//compute effective instruction pointer
EIP{31:0} = tmp_IP{31:0} - AR[CSD].Base;

// Note the register stack is disabled during IA-32 instruction
// set execution
break;

case 'cloop': // simple counted loop
    if (slot != 2)
        illegal_operation_fault();
    tmp_taken = (AR[LC] != 0);
    if (AR[LC] != 0)
        AR[LC]--;
    break;

case 'ctop':
case 'cexit': // SW pipelined counted loop
    if (slot != 2)
        illegal_operation_fault();
    if (btype == 'ctop') tmp_taken = ((AR[LC] != 0) || (AR[EC] u> 1));
    if (btype == 'cexit') tmp_taken = !((AR[LC] != 0) || (AR[EC] u> 1));
    if (AR[LC] != 0) {
        AR[LC]--;
        AR[EC] = AR[EC];
        PR[63] = 1;
        rotate_regs();
    } else if (AR[EC] != 0) {
        AR[LC] = AR[LC];
        AR[EC]--;
        PR[63] = 0;
        rotate_regs();
    } else {
        AR[LC] = AR[LC];
        AR[EC] = AR[EC];
        PR[63] = 0;
        CFM.rrb.gr = CFM.rrb.gr;
        CFM.rrb.fr = CFM.rrb.fr;
        CFM.rrb.pr = CFM.rrb.pr;
    }
    break;

case 'wtop':
case 'wexit': // SW pipelined while loop
    if (slot != 2)
        illegal_operation_fault();
    if (btype == 'wtop') tmp_taken = (PR[qp] || (AR[EC] u> 1));
    if (btype == 'wexit') tmp_taken = !(PR[qp] || (AR[EC] u> 1));
    if (PR[qp]) {
        AR[EC] = AR[EC];
        PR[63] = 0;
        rotate_regs();
    } else if (AR[EC] != 0) {
        AR[EC]--;
        PR[63] = 0;
        rotate_regs();
    } else {
        AR[EC] = AR[EC];

```

```

        PR[63] = 0;
        CFM.rrb.gr = CFM.rrb.gr;
        CFM.rrb.fr = CFM.rrb.fr;
        CFM.rrb.pr = CFM.rrb.pr;
    }
    break;
}
if (tmp_taken) {
    taken_branch = 1;
    IP = tmp_IP; // set the new value for IP
    if ((PSR.it && unimplemented_virtual_address(tmp_IP))
        || (!PSR.it && unimplemented_physical_address(tmp_IP)))
        unimplemented_instruction_address_trap(lower_priv_transition,
                                                tmp_IP);

    if (lower_priv_transition && PSR.lp)
        lower_privilege_transfer_trap();
    if (PSR.tb)
        taken_branch_trap();
}

```

| | | |
|-----------------------|---|-------------------------------|
| Interruptions: | Illegal Operation fault | Lower-Privilege Transfer trap |
| | Disabled Instruction Set Transition fault | Taken Branch trap |
| | Unimplemented Instruction Address trap | |

Additional Faults on IA-32 target instructions:
 IA-32_Exception(GPFault)
 Disabled FP Reg Fault if PSR.dfh is 1

break — Break

| | | | |
|----------------|--|-------------|-----|
| Format: | (<i>qp</i>) break <i>imm</i> ₂₁ | pseudo-op | |
| | (<i>qp</i>) break.i <i>imm</i> ₂₁ | i_unit_form | I19 |
| | (<i>qp</i>) break.b <i>imm</i> ₂₁ | b_unit_form | B9 |
| | (<i>qp</i>) break.m <i>imm</i> ₂₁ | m_unit_form | M37 |
| | (<i>qp</i>) break.f <i>imm</i> ₂₁ | f_unit_form | F15 |
| | (<i>qp</i>) break.x <i>imm</i> ₆₂ | x_unit_form | X1 |

Description: A Break Instruction fault is taken. For the i_unit_form, f_unit_form and m_unit_form, the value specified by *imm*₂₁ is zero-extended and placed in the Interruption Immediate control register (IIM).

For the b_unit_form, *imm*₂₁ is ignored and the value zero is placed in the Interruption Immediate control register (IIM).

For the x_unit_form, the lower 21 bits of the value specified by *imm*₆₂ is zero-extended and placed in the Interruption Immediate control register (IIM). The L slot of the bundle contains the upper 41 bits of *imm*₆₂.

A break.i instruction may be encoded in an MLI-template bundle, in which case the L slot of the bundle is ignored.

This instruction has five forms, each of which can be executed only on a particular execution unit type. The pseudo-op can be used if the unit type to execute on is unimportant.

Operation:

```

if (PR[qp]) {
    if (b_unit_form)
        immediate = 0;
    else if (x_unit_form)
        immediate = zero_ext(imm62, 21);
    else // i_unit_form || m_unit_form || f_unit_form
        immediate = zero_ext(imm21, 21);

    break_instruction_fault(immediate);
}

```

Interruptions: Break Instruction fault

brl — Branch Long

Format:

| | | |
|---|-----------|----|
| <i>(qp)</i> brl. <i>btype</i> . <i>bwh</i> . <i>ph</i> . <i>dh</i> <i>target</i> ₆₄ | | X3 |
| <i>(qp)</i> brl. <i>btype</i> . <i>bwh</i> . <i>ph</i> . <i>dh</i> <i>b_l</i> = <i>target</i> ₆₄ | call_form | X4 |
| brl. <i>ph</i> . <i>dh</i> <i>target</i> ₆₄ | pseudo-op | |

Description: A branch condition is evaluated, and either a branch is taken, or execution continues with the next sequential instruction. The execution of a branch logically follows the execution of all previous non-branch instructions in the same instruction group. On a taken branch, execution begins at slot 0.

Long branches are always IP-relative. The *target*₆₄ operand, in assembly, specifies a label to branch to. This is encoded in the long branch instruction as an immediate displacement (*imm*₆₀) between the target bundle and the bundle containing this instruction (*imm*₆₀ = *target*₆₄ – IP >> 4). The L slot of the bundle contains 39 bits of *imm*₆₀.

Table 2-10. Long Branch Types

| <i>btype</i> | Function | Branch Condition | Target Address |
|---------------------|----------------------------|----------------------|----------------|
| cond or <i>none</i> | Conditional branch | Qualifying predicate | IP-relative |
| call | Conditional procedure call | Qualifying predicate | IP-relative |

There is a pseudo-op for long unconditional branches, encoded like a conditional branch (*btype* = cond), with the *qp* field specifying PR 0, and with the *bwh* hint of sptk.

The branch type determines how the branch condition is calculated and whether the branch has other effects (such as writing a link register). For all long branch types, the branch condition is simply the value of the specified predicate register:

- **cond:** If the qualifying predicate is 1, the branch is taken. Otherwise it is not taken.
- **call:** If the qualifying predicate is 1, the branch is taken and several other actions occur:
 - The current values of the Current Frame Marker (CFM), the EC application register and the current privilege level are saved in the Previous Function State application register.
 - The caller’s stack frame is effectively saved and the callee is provided with a frame containing only the caller’s output region.
 - The rotation rename base registers in the CFM are reset to 0.
 - A return link value is placed in BR *b_l*.

Read after Write (RAW) and Write after Read (WAR) dependency requirements for long branch instructions are slightly different than for other instructions but are the same as for branch instructions. See [page 3:21](#) for details.

This instruction must be immediately followed by a stop; otherwise its behavior is undefined.

Values for various branch hint completers are the same as for branch instructions. Whether Prediction Strategy hints are shown in [Table 2-7 on page 3:21](#), Sequential Prefetch hints are shown in [Table 2-8 on page 3:21](#), and Branch Cache Deallocation hints are shown in [Table 2-9 on page 3:21](#). See [Section 4.5.2, “Branch Prediction Hints” on page 1:68](#).

This instruction is not implemented on the Itanium processor, which takes an Illegal Operation fault whenever a long branch instruction is encountered, regardless of whether the branch is taken or not. To support the Itanium processor, the operating system is required to provide an Illegal Operation fault handler which emulates taken and not-taken long branches. Presence of this instruction is indicated by a 1 in the lb bit of CPUID register 4. See [Section 3.1.11, “Processor Identification Registers” on page 1:29](#).

brp — Branch Predict

| | | | |
|----------------|--|---|----|
| Format: | <code>brp.ipwh.ih target₂₅, tag₁₃</code> | <code>ip_relative_form</code> | B6 |
| | <code>brp.indwh.ih b₂, tag₁₃</code> | <code>indirect_form</code> | B7 |
| | <code>brp.ret.indwh.ih b₂, tag₁₃</code> | <code>return_form, indirect_form</code> | B7 |

Description: This instruction can be used to provide to hardware early information about a future branch. It has no effect on architectural machine state, and operates as a `nop` instruction except for its performance effects.

The `tag13` operand, in assembly, specifies the address of the branch instruction to which this prediction information applies. This is encoded in the branch predict instruction as a signed immediate displacement (`imm9`) between the bundle containing the presaged branch and the bundle containing this instruction ($imm_9 = tag_{13} - IP \gg 4$).

The `target25` operand, in assembly, specifies the label that the presaged branch will have as its target. This is encoded in the branch predict instruction exactly as in branch instructions, with a signed immediate displacement (`imm21`) between the target bundle and the bundle containing this instruction ($imm_{21} = target_{25} - IP \gg 4$). The `indirect_form` can be used to presage an indirect branch. In the `indirect_form`, the target of the presaged branch is given by BR `b2`.

The `return_form` is used to indicate that the presaged branch will be a return.

Other hints can be given about the presaged branch. Values for various hint completers are shown in the following tables. For more details, refer to [Section 4.5.2, “Branch Prediction Hints” on page 1:68](#).

The `ipwh` and `indwh` completers provide information about how best the branch condition should be predicted, when the branch is reached.

Table 2-11. IP-relative Branch Predict Whether Hint

| <i>ipwh</i> Completer | IP-relative Branch Predict Whether Hint |
|-----------------------|--|
| sptk | Presaged branch should be predicted Static Taken |
| loop | Presaged branch will be <code>br.cloop</code> , <code>br.ctop</code> , or <code>br.wtop</code> |
| exit | Presaged branch will be <code>br.cexit</code> or <code>br.wexit</code> |
| dptk | Presaged branch should be predicted Dynamically |

Table 2-12. Indirect Branch Predict Whether Hint

| <i>indwh</i> Completer | Indirect Branch Predict Whether Hint |
|------------------------|--|
| sptk | Presaged branch should be predicted Static Taken |
| dptk | Presaged branch should be predicted Dynamically |

The `ih` completer can be used to mark a small number of very important branches (e.g., an inner loop branch). This can signal to hardware to use faster, smaller prediction structures for this information.

Table 2-13. Importance Hint

| <i>ih</i> Completer | Branch Predict Importance Hint |
|---------------------|--------------------------------|
| <code>none</code> | Less important |
| <code>imp</code> | More important |

Operation:

```
tmp_tag = IP + sign_ext((timm9 << 4), 13);
if (ip_relative_form) {
    tmp_target = IP + sign_ext((imm21 << 4), 25);
    tmp_wh = ipwh;
} else { // indirect_form
    tmp_target = BR[b2];
    tmp_wh = indwh;
}
branch_predict(tmp_wh, ih, return_form, tmp_target, tmp_tag);
```

Interruptions: None

chk — Speculation Check

| | | | |
|----------------|------------------------------------|------------------------------------|-----|
| Format: | (qp) chk.s $r_2, target_{25}$ | pseudo-op | |
| | (qp) chk.s.i $r_2, target_{25}$ | control_form, i_unit_form, gr_form | I20 |
| | (qp) chk.s.m $r_2, target_{25}$ | control_form, m_unit_form, gr_form | M20 |
| | (qp) chk.s $f_2, target_{25}$ | control_form, fr_form | M21 |
| | (qp) chk.a.aclr $r_1, target_{25}$ | data_form, gr_form | M22 |
| | (qp) chk.a.aclr $f_1, target_{25}$ | data_form, fr_form | M23 |

Description: The result of a control- or data-speculative calculation is checked for success or failure. If the check fails, a branch to $target_{25}$ is taken.

In the control_form, success is determined by a NaT indication for the source register. If the NaT bit corresponding to GR r_2 is 1 (in the gr_form), or FR f_2 contains a NaTVal (in the fr_form), the check fails.

In the data_form, success is determined by the ALAT. The ALAT is queried using the general register specifier r_1 (in the gr_form), or the floating-point register specifier f_1 (in the fr_form). If no ALAT entry matches, the check fails. An implementation may optionally cause the check to fail independent of whether an ALAT entry matches. A `chk.a` with general register specifier r0 or floating-point register specifiers f0 or f1 always fails.

The $target_{25}$ operand, in assembly, specifies a label to branch to. This is encoded in the instruction as a signed immediate displacement (imm_{21}) between the target bundle and the bundle containing this instruction ($imm_{21} = target_{25} - IP \gg 4$).

The branching behavior of this instruction can be optionally unimplemented. If the instruction would have branched, and the branching behavior is not implemented, then a Speculative Operation fault is taken and the value specified by imm_{21} is zero-extended and placed in the Interruption Immediate control register (IIM). The fault handler emulates the branch by sign-extending the IIM value, adding it to IIP and returning.

The control_form of this instruction for checking general registers can be encoded on either an I-unit or an M-unit. The pseudo-op can be used if the unit type to execute on is unimportant.

For the data_form, if an ALAT entry matches, the matching ALAT entry can be optionally invalidated, based on the value of the `aclr` completer (See [Table 2-14](#)).

Table 2-14. ALAT Clear Completer

| aclr Completer | Effect on ALAT |
|-----------------------|--------------------------------|
| clr | Invalidate matching ALAT entry |
| nc | Don't invalidate |

Note that if the `clr` value of the `aclr` completer is used and the check succeeds, the matching ALAT entry is invalidated. However, if the check fails (which may happen even if there is a matching ALAT entry), any matching ALAT entry may optionally be invalidated, but this is not required. Recovery code for data speculation, therefore, cannot rely on the absence of a matching ALAT entry.

```

Operation:  if (PR[qp]) {
                if (control_form) {
                    if (fr_form && (tmp_isrkode = fp_reg_disabled(f2, 0, 0, 0)))
                        disabled_fp_register_fault(tmp_isrkode, 0);
                    check_type = gr_form ? CHKS_GENERAL : CHKS_FLOAT;
                    fail = (gr_form && GR[r2].nat) || (fr_form && FR[f2] == NATVAL);
                } else {                                     // data_form
                    if (gr_form) {
                        reg_type = GENERAL;
                        check_type = CHKA_GENERAL;
                        alat_index = r1;
                        always_fail = (alat_index == 0);
                    } else {                                 // fr_form
                        reg_type = FLOAT;
                        check_type = CHKA_FLOAT;
                        alat_index = f1;
                        always_fail = ((alat_index == 0) || (alat_index == 1));
                    }
                    fail = (always_fail || (!alat_cmp(reg_type, alat_index)));
                }
                if (fail) {
                    if (check_branch_implemented(check_type)) {
                        taken_branch = 1;
                        IP = IP + sign_ext((imm21 << 4), 25);
                        if ((PSR.it && unimplemented_virtual_address(IP))
                            || (!PSR.it && unimplemented_physical_address(IP)))
                            unimplemented_instruction_address_trap(0, IP);
                        if (PSR.tb)
                            taken_branch_trap();
                    } else
                        speculation_fault(check_type, zero_ext(imm21, 21));
                } else if (data_form && (aclr == 'clr'))
                    alat_inval_single_entry(reg_type, alat_index);
            }

```

| | | |
|-----------------------|--|--|
| Interruptions: | Disabled Floating-point Register fault | Unimplemented Instruction Address trap |
| | Speculative Operation fault | Taken Branch trap |

clrrrb — Clear RRB

| | | | |
|----------------|-----------|-----------|----|
| Format: | clrrrb | all_form | B8 |
| | clrrrb.pr | pred_form | B8 |

Description: In the all_form, the register rename base registers (CFM.rrb.gr, CFM.rrb.fr, and CFM.rrb.pr) are cleared. In the pred_form, the single register rename base register for the predicates (CFM.rrb.pr) is cleared.

This instruction must be the last instruction in an instruction group, or an Illegal Operation fault is taken.

This instruction cannot be predicated.

Operation:

```

if (!followed_by_stop())
    illegal_operation_fault();

if (all_form) {
    CFM.rrb.gr = 0;
    CFM.rrb.fr = 0;
    CFM.rrb.pr = 0;
} else { // pred_form
    CFM.rrb.pr = 0;
}

```

Interruptions: Illegal Operation fault

cmp — Compare

| | | | |
|----------------|---|--------------------------|----|
| Format: | (<i>qp</i>) <i>cmp.crel ctype</i> $p_1, p_2 = r_2, r_3$ | register_form | A6 |
| | (<i>qp</i>) <i>cmp.crel ctype</i> $p_1, p_2 = imm_8, r_3$ | imm8_form | A8 |
| | (<i>qp</i>) <i>cmp.crel ctype</i> $p_1, p_2 = r0, r_3$ | parallel_inequality_form | A7 |
| | (<i>qp</i>) <i>cmp.crel ctype</i> $p_1, p_2 = r_3, r0$ | pseudo-op | |

Description: The two source operands are compared for one of ten relations specified by *crel*. This produces a boolean result which is 1 if the comparison condition is true, and 0 otherwise. This result is written to the two predicate register destinations, p_1 and p_2 . The way the result is written to the destinations is determined by the compare type specified by *ctype*.

The compare types describe how the predicate targets are updated based on the result of the comparison. The normal type simply writes the compare result to one target, and the complement to the other. The parallel types update the targets only for a particular comparison result. This allows multiple simultaneous OR-type or multiple simultaneous AND-type compares to target the same predicate register.

The *unc* type is special in that it first initializes both predicate targets to 0, *independent of the qualifying predicate*. It then operates the same as the normal type. The behavior of the compare types is described in [Table 2-15](#). A blank entry indicates the predicate target is left unchanged.

Table 2-15. Comparison Types

| <i>ctype</i> | pseudo-op of | PR[<i>qp</i>]==0 | | PR[<i>qp</i>]==1 | | | | | |
|-----------------|-----------------|--------------------|-------------|------------------------------|-------------|------------------------------|-------------|----------------------------|-------------|
| | | | | result==0, No Source NaTs | | result==1, No Source NaTs | | One or More Source NaTs | |
| | | PR[p_1] | PR[p_2] | PR[p_1] | PR[p_2] | PR[p_1] | PR[p_2] | PR[p_1] | PR[p_2] |
| <i>none</i> | | | | 0 | 1 | 1 | 0 | 0 | 0 |
| <i>unc</i> | | 0 | 0 | 0 | 1 | 1 | 0 | 0 | 0 |
| <i>or</i> | | | | | | 1 | 1 | | |
| <i>and</i> | | | | 0 | 0 | | | 0 | 0 |
| <i>or.andcm</i> | | | | | | 1 | 0 | | |
| <i>orcm</i> | <i>or</i> | | | 1 | 1 | | | | |
| <i>andcm</i> | <i>and</i> | | | | | 0 | 0 | 0 | 0 |
| <i>and.orcm</i> | <i>or.andcm</i> | | | 0 | 1 | | | | |

In the *register_form* the first operand is GR r_2 ; in the *imm8_form* the first operand is taken from the sign-extended *imm₈* encoding field; and in the *parallel_inequality_form* the first operand must be GR 0. The *parallel_inequality_form* is only used when the compare type is one of the parallel types, and the relation is an inequality (>, >=, <, <=). See below.

If the two predicate register destinations are the same (p_1 and p_2 specify the same predicate register), the instruction will take an Illegal Operation fault, if the qualifying predicate is 1, or if the compare type is *unc*.

Of the ten relations, not all are directly implemented in hardware. Some are actually pseudo-ops. For these, the assembler simply switches the source operand specifiers and/or switches the predicate target specifiers and uses an implemented relation. For some of the pseudo-op compares in the *imm8_form*, the assembler subtracts 1 from the immediate value, making the allowed immediate range slightly different. Of the six parallel compare types, three of the types are actually pseudo-ops. The assembler simply uses the negative relation with an implemented type. The implemented relations and how the pseudo-ops map onto them are shown in [Table 2-16](#) (for normal and *unc* type compares), and [Table 2-17](#) (for parallel type compares).

Table 2-16. 64-bit Comparison Relations for Normal and unc Compares

| <i>crel</i> | Compare Relation (<i>a rel b</i>) | Register Form is a Pseudo-op of | Immediate Form is a Pseudo-op of | Immediate Range |
|-------------|--|---|-------------------------------------|---------------------------------------|
| eq | $a == b$ | | | -128 .. 127 |
| ne | $a != b$ | eq $p_1 \leftrightarrow p_2$ | eq $p_1 \leftrightarrow p_2$ | -128 .. 127 |
| lt | $a < b$ signed | | | -128 .. 127 |
| le | $a <= b$ | lt $a \leftrightarrow b$ $p_1 \leftrightarrow p_2$ | lt $a-1$ | -127 .. 128 |
| gt | $a > b$ | lt $a \leftrightarrow b$ | lt $a-1$ $p_1 \leftrightarrow p_2$ | -127 .. 128 |
| ge | $a >= b$ | lt $p_1 \leftrightarrow p_2$ | lt $p_1 \leftrightarrow p_2$ | -128 .. 127 |
| ltu | $a < b$ unsigned | | | 0 .. 127, $2^{64}-128 .. 2^{64}-1$ |
| leu | $a <= b$ | ltu $a \leftrightarrow b$ $p_1 \leftrightarrow p_2$ | ltu $a-1$ | 1 .. 128, $2^{64}-127 .. 2^{64}$ |
| gtu | $a > b$ | ltu $a \leftrightarrow b$ | ltu $a-1$ $p_1 \leftrightarrow p_2$ | 1 .. 128, $2^{64}-127 .. 2^{64}$ |
| geu | $a >= b$ | ltu $p_1 \leftrightarrow p_2$ | ltu $p_1 \leftrightarrow p_2$ | 0 .. 127, $2^{64}-128 .. 2^{64}-1$ |

The parallel compare types can be used only with a restricted set of relations and operands. They can be used with equal and not-equal comparisons between two registers or between a register and an immediate, or they can be used with inequality comparisons between a register and GR 0. Unsigned relations are not provided, since they are not of much use when one of the operands is zero. For the parallel inequality comparisons, hardware only directly implements the ones where the first operand (GR r_2) is GR 0. Comparisons where the second operand is GR 0 are pseudo-ops for which the assembler switches the register specifiers and uses the opposite relation.

Table 2-17. 64-bit Comparison Relations for Parallel Compares

| <i>crel</i> | Compare Relation (<i>a rel b</i>) | Register Form is a pseudo-op of | Immediate Range |
|-------------|--|------------------------------------|--------------------|
| eq | $a == b$ | | -128 .. 127 |
| ne | $a != b$ | | -128 .. 127 |
| lt | $0 < b$ signed | | no immediate forms |
| lt | $a < 0$ | gt $a \leftrightarrow b$ | |
| le | $0 <= b$ | | |
| le | $a <= 0$ | ge $a \leftrightarrow b$ | |
| gt | $0 > b$ | | |
| gt | $a > 0$ | lt $a \leftrightarrow b$ | |
| ge | $0 >= b$ | | |
| ge | $a >= 0$ | le $a \leftrightarrow b$ | |

```

Operation:   if (PR[qp]) {
                if (p1 == p2)
                    illegal_operation_fault();

                tmp_nat = (register_form ? GR[r2].nat : 0) || GR[r3].nat;
                if (register_form)
                    tmp_src = GR[r2];
                else if (imm8_form)
                    tmp_src = sign_ext(imm8, 8);
                else // parallel_inequality_form
                    tmp_src = 0;

                if (crel == 'eq') tmp_rel = tmp_src == GR[r3];
                else if (crel == 'ne') tmp_rel = tmp_src != GR[r3];
                else if (crel == 'lt') tmp_rel = lesser_signed(tmp_src, GR[r3]);
                else if (crel == 'le') tmp_rel = lesser_equal_signed(tmp_src, GR[r3]);
                else if (crel == 'gt') tmp_rel = greater_signed(tmp_src, GR[r3]);
                else if (crel == 'ge') tmp_rel = greater_equal_signed(tmp_src, GR[r3]);
                else if (crel == 'ltu') tmp_rel = lesser(tmp_src, GR[r3]);
                else if (crel == 'leu') tmp_rel = lesser_equal(tmp_src, GR[r3]);
                else if (crel == 'gtu') tmp_rel = greater(tmp_src, GR[r3]);
                else
                    tmp_rel = greater_equal(tmp_src, GR[r3]); // 'geu'

                switch (ctype) {
                    case 'and': // and-type compare
                        if (tmp_nat || !tmp_rel) {
                            PR[p1] = 0;
                            PR[p2] = 0;
                        }
                        break;
                    case 'or': // or-type compare
                        if (!tmp_nat && tmp_rel) {
                            PR[p1] = 1;
                            PR[p2] = 1;
                        }
                        break;
                    case 'or.andcm': // or.andcm-type compare
                        if (!tmp_nat && tmp_rel) {
                            PR[p1] = 1;
                            PR[p2] = 0;
                        }
                        break;
                    case 'unc': // unc-type compare
                    default: // normal compare
                        if (tmp_nat) {
                            PR[p1] = 0;
                            PR[p2] = 0;
                        } else {
                            PR[p1] = tmp_rel;
                            PR[p2] = !tmp_rel;
                        }
                        break;
                }
            } else {
                if (ctype == 'unc') {
                    if (p1 == p2)
                        illegal_operation_fault();
                    PR[p1] = 0;
                    PR[p2] = 0;
                }
            }
        }

```

Interruptions: Illegal Operation fault

cmp4 — Compare 4 Bytes

| | | | |
|----------------|---|--------------------------|----|
| Format: | (qp) <i>cmp4.crel ctype</i> $p_1, p_2 = r_2, r_3$ | register_form | A6 |
| | (qp) <i>cmp4.crel ctype</i> $p_1, p_2 = imm_8, r_3$ | imm8_form | A8 |
| | (qp) <i>cmp4.crel ctype</i> $p_1, p_2 = r0, r_3$ | parallel_inequality_form | A7 |
| | (qp) <i>cmp4.crel ctype</i> $p_1, p_2 = r_3, r0$ | pseudo-op | |

Description: The least significant 32 bits from each of two source operands are compared for one of ten relations specified by *crel*. This produces a boolean result which is 1 if the comparison condition is true, and 0 otherwise. This result is written to the two predicate register destinations, p_1 and p_2 . The way the result is written to the destinations is determined by the compare type specified by *ctype*. See the Compare instruction and [Table 2-15 on page 3:34](#).

In the *register_form* the first operand is GR r_2 ; in the *imm8_form* the first operand is taken from the sign-extended *imm₈* encoding field; and in the *parallel_inequality_form* the first operand must be GR 0. The *parallel_inequality_form* is only used when the compare type is one of the parallel types, and the relation is an inequality (>, >=, <, <=). See the Compare instruction and [Table 2-17 on page 3:35](#).

If the two predicate register destinations are the same (p_1 and p_2 specify the same predicate register), the instruction will take an Illegal Operation fault, if the qualifying predicate is 1, or if the compare type is *unc*.

Of the ten relations, not all are directly implemented in hardware. Some are actually pseudo-ops. See the Compare instruction and [Table 2-16](#) and [Table 2-17 on page 3:35](#). The range for immediates is given below.

Table 2-18. Immediate Range for 32-bit Compares

| <i>crel</i> | Compare Relation (<i>a rel b</i>) | Immediate Range |
|-------------|--|------------------------------------|
| eq | $a == b$ | -128 .. 127 |
| ne | $a != b$ | -128 .. 127 |
| lt | $a < b$ signed | -128 .. 127 |
| le | $a <= b$ | -127 .. 128 |
| gt | $a > b$ | -127 .. 128 |
| ge | $a >= b$ | -128 .. 127 |
| ltu | $a < b$ unsigned | 0 .. 127, $2^{32}-128 .. 2^{32}-1$ |
| leu | $a <= b$ | 1 .. 128, $2^{32}-127 .. 2^{32}$ |
| gtu | $a > b$ | 1 .. 128, $2^{32}-127 .. 2^{32}$ |
| geu | $a >= b$ | 0 .. 127, $2^{32}-128 .. 2^{32}-1$ |

```

Operation:   if (PR[qp]) {
                if (p1 == p2)
                    illegal_operation_fault();

                tmp_nat = (register_form ? GR[r2].nat : 0) || GR[r3].nat;

                if (register_form)
                    tmp_src = GR[r2];
                else if (imm8_form)
                    tmp_src = sign_ext(imm8, 8);
                else // parallel_inequality_form
                    tmp_src = 0;

                if (crel == 'eq') tmp_rel = tmp_src{31:0} == GR[r3]{31:0};
                else if (crel == 'ne') tmp_rel = tmp_src{31:0} != GR[r3]{31:0};
                else if (crel == 'lt')
                    tmp_rel = lesser_signed(sign_ext(tmp_src, 32),
                                             sign_ext(GR[r3], 32));
                else if (crel == 'le')
                    tmp_rel = lesser_equal_signed(sign_ext(tmp_src, 32),
                                                    sign_ext(GR[r3], 32));
                else if (crel == 'gt')
                    tmp_rel = greater_signed(sign_ext(tmp_src, 32),
                                              sign_ext(GR[r3], 32));
                else if (crel == 'ge')
                    tmp_rel = greater_equal_signed(sign_ext(tmp_src, 32),
                                                    sign_ext(GR[r3], 32));
                else if (crel == 'ltu')
                    tmp_rel = lesser(zero_ext(tmp_src, 32),
                                     zero_ext(GR[r3], 32));
                else if (crel == 'leu')
                    tmp_rel = lesser_equal(zero_ext(tmp_src, 32),
                                           zero_ext(GR[r3], 32));
                else if (crel == 'gtu')
                    tmp_rel = greater(zero_ext(tmp_src, 32),
                                      zero_ext(GR[r3], 32));
                else // 'geu'
                    tmp_rel = greater_equal(zero_ext(tmp_src, 32),
                                             zero_ext(GR[r3], 32));

                switch (ctype) {
                    case 'and': // and-type compare
                        if (tmp_nat || !tmp_rel) {
                            PR[p1] = 0;
                            PR[p2] = 0;
                        }
                        break;
                    case 'or': // or-type compare
                        if (!tmp_nat && tmp_rel) {
                            PR[p1] = 1;
                            PR[p2] = 1;
                        }
                        break;
                    case 'or.andcm': // or.andcm-type compare
                        if (!tmp_nat && tmp_rel) {
                            PR[p1] = 1;
                            PR[p2] = 0;
                        }
                        break;
                    case 'unc': // unc-type compare
                    default: // normal compare
                        if (tmp_nat) {

```

```
        PR[p1] = 0;
        PR[p2] = 0;
    } else {
        PR[p1] = tmp_rel;
        PR[p2] = !tmp_rel;
    }
    break;
}
} else {
    if (ctype == 'unc') {
        if (p1 == p2)
            illegal_operation_fault();
        PR[p1] = 0;
        PR[p2] = 0;
    }
}
```

Interruptions: Illegal Operation fault

cmpxchg — Compare and Exchange

Format: *(qp) cmpxchgsz.sem.ldhint* $r_1 = [r_3], r_2, ar.ccv$ M16
(qp) cmp8xchg16.sem.ldhint $r_1 = [r_3], r_2, ar.csd, ar.ccv$ sixteen_byte_form M16

Description: A value consisting of *sz* bytes (8 bytes for `cmp8xchg16`) is read from memory starting at the address specified by the value in GR r_3 . The value is zero extended and compared with the contents of the `cmpxchg` Compare Value application register (AR[CCV]). If the two are equal, then the least significant *sz* bytes of the value in GR r_2 are written to memory starting at the address specified by the value in GR r_3 . For `cmp8xchg16`, if the two are equal, then 8-bytes from GR r_2 are stored at the specified address ignoring bit 3 (GR r_3 & $\sim 0x4$), and 8 bytes from the Compare and Store Data application register (AR[CSD]) are stored at that address + 8 ((GR r_3 & $\sim 0x4$) + 8). The zero-extended value read from memory is placed in GR r_1 and the NaT bit corresponding to GR r_1 is cleared.

The values of the *sz* completer are given in [Table 2-19](#). The *sem* completer specifies the type of semaphore operation. These operations are described in [Table 2-20](#). See [Section 4.4.7, “Sequentiality Attribute and Ordering”](#) on page 2:69 for details on memory ordering.

Table 2-19. Memory Compare and Exchange Size

| sz Completer | Bytes Accessed |
|---------------------|-----------------------|
| 1 | 1 |
| 2 | 2 |
| 4 | 4 |
| 8 | 8 |

Table 2-20. Compare and Exchange Semaphore Types

| sem Completer | Ordering Semantics | Semaphore Operation |
|----------------------|---------------------------|---|
| acq | Acquire | The memory read/write is made visible prior to all subsequent data memory accesses. |
| rel | Release | The memory read/write is made visible after all previous data memory accesses. |

If the address specified by the value in GR r_3 is not naturally aligned to the size of the value being accessed in memory, an Unaligned Data Reference fault is taken independent of the state of the User Mask alignment checking bit, UM.ac (PSR.ac in the Processor Status Register). For the `cmp8xchg16` instruction, the address specified must be 8-byte aligned.

The memory read and write are guaranteed to be atomic. For the `cmp8xchg16` instruction, the 8-byte memory read and the 16-byte memory write are guaranteed to be atomic.

Both read and write access privileges for the referenced page are required. The write access privilege check is performed whether or not the memory write is performed.

This instruction is only supported to cacheable pages with write-back write policy. Accesses to NaTPages cause a Data NaT Page Consumption fault. Accesses to pages with other memory attributes cause an Unsupported Data Reference fault.

The value of the *ldhint* completer specifies the locality of the memory access. The values of the *ldhint* completer are given in [Table 2-34 on page 3:132](#). Locality hints do not affect program functionality and may be ignored by the implementation. See [Section 4.4.6, “Memory Hierarchy Control and Consistency”](#) on page 1:60 for details.

```

Operation:  if (PR[qp]) {
                check_target_register(r1);

                if (GR[r3].nat || GR[r2].nat)
                    register_nat_consumption_fault(SEMAPHORE);

                if (sixteen_byte_form)
                    sz = 8;

                paddr = tlb_translate(GR[r3], sz, SEMAPHORE, PSR.cpl, &mattr,
                                     &tmp_unused);

                if (!ma_supports_semaphores(mattr))
                    unsupported_data_reference_fault(SEMAPHORE, GR[r3]);

                if (sixteen_byte_form) {
                    if (sem == 'acq')
                        val = mem_xchg16_cond(AR[CCV], GR[r2], AR[CSD], paddr, UM.be,
                                              mattr, ACQUIRE, ldhint);
                    else // 'rel'
                        val = mem_xchg16_cond(AR[CCV], GR[r2], AR[CSD], paddr, UM.be,
                                              mattr, RELEASE, ldhint);
                } else {
                    if (sem == 'acq')
                        val = mem_xchg_cond(AR[CCV], GR[r2], paddr, sz, UM.be, mattr,
                                           ACQUIRE, ldhint);
                    else // 'rel'
                        val = mem_xchg_cond(AR[CCV], GR[r2], paddr, sz, UM.be, mattr,
                                           RELEASE, ldhint);
                    val = zero_ext(val, sz * 8);
                }

                if (AR[CCV] == val)
                    alat_inval_multiple_entries(paddr, sz);

                GR[r1] = val;
                GR[r1].nat = 0;
            }

```

| | |
|---|----------------------------------|
| Interruptions: Illegal Operation fault | Data Key Miss fault |
| Register NaT Consumption fault | Data Key Permission fault |
| Unimplemented Data Address fault | Data Access Rights fault |
| Data Nested TLB fault | Data Dirty Bit fault |
| Alternate Data TLB fault | Data Access Bit fault |
| VHPT Data fault | Data Debug fault |
| Data TLB fault | Unaligned Data Reference fault |
| Data Page Not Present fault | Unsupported Data Reference fault |
| Data NaT Page Consumption fault | |

cover — Cover Stack Frame

Format: cover

B8

Description: A new stack frame of zero size is allocated which does not include any registers from the previous frame (as though all output registers in the previous frame had been locals). The register rename base registers are reset. If interruption collection is disabled (PSR.ic is zero), then the old value of the Current Frame Marker (CFM) is copied to the Interruption Function State register (IFS), and IFS.v is set to one.

A `cover` instruction must be the last instruction in an instruction group. Otherwise, an Illegal Operation fault is taken.

This instruction cannot be predicated.

Operation:

```

if (!followed_by_stop())
    illegal_operation_fault();

alat_frame_update(CFM.sof, 0);
rse_preserve_frame(CFM.sof);
if (PSR.ic == 0) {
    CR[IFS].ifm = CFM;
    CR[IFS].v = 1;
}

CFM.sof = 0;
CFM.sol = 0;
CFM.sor = 0;
CFM.rrb.gr = 0;
CFM.rrb.fr = 0;
CFM.rrb.pr = 0;

```

Interruptions: Illegal Operation fault

czx — Compute Zero Index

| | | | |
|----------------|-------------------------|---------------------------|-----|
| Format: | (qp) czx1.l $r_1 = r_3$ | one_byte_form, left_form | I29 |
| | (qp) czx1.r $r_1 = r_3$ | one_byte_form, right_form | I29 |
| | (qp) czx2.l $r_1 = r_3$ | two_byte_form, left_form | I29 |
| | (qp) czx2.r $r_1 = r_3$ | two_byte_form, right_form | I29 |

Description: GR r_3 is scanned for a zero element. The element is either an 8-bit aligned byte (one_byte_form) or a 16-bit aligned pair of bytes (two_byte_form). The index of the first zero element is placed in GR r_1 . If there are no zero elements in GR r_3 , a default value is placed in GR r_1 . Table 2-21 gives the possible result values. In the left_form, the source is scanned from most significant element to least significant element, and in the right_form it is scanned from least significant element to most significant element.

Table 2-21. Result Ranges for czx

| Size | Element Width | Range of Result if Zero Element Found | Default Result if No Zero Element Found |
|------|---------------|---------------------------------------|---|
| 1 | 8 bit | 0-7 | 8 |
| 2 | 16 bit | 0-3 | 4 |

Operation:

```

if (PR[qp]) {
    check_target_register(r1);

    if (one_byte_form) {
        if (left_form) { // scan from most significant down
            if ((GR[r3] & 0xff00000000000000) == 0) GR[r1] = 0;
            else if ((GR[r3] & 0x00ff000000000000) == 0) GR[r1] = 1;
            else if ((GR[r3] & 0x0000ff0000000000) == 0) GR[r1] = 2;
            else if ((GR[r3] & 0x000000ff00000000) == 0) GR[r1] = 3;
            else if ((GR[r3] & 0x00000000ff000000) == 0) GR[r1] = 4;
            else if ((GR[r3] & 0x0000000000ff0000) == 0) GR[r1] = 5;
            else if ((GR[r3] & 0x000000000000ff00) == 0) GR[r1] = 6;
            else if ((GR[r3] & 0x00000000000000ff) == 0) GR[r1] = 7;
            else GR[r1] = 8;
        } else { // right_form scan from least significant up
            if ((GR[r3] & 0x00000000000000ff) == 0) GR[r1] = 0;
            else if ((GR[r3] & 0x000000000000ff00) == 0) GR[r1] = 1;
            else if ((GR[r3] & 0x0000000000ff0000) == 0) GR[r1] = 2;
            else if ((GR[r3] & 0x00000000ff000000) == 0) GR[r1] = 3;
            else if ((GR[r3] & 0x000000ff00000000) == 0) GR[r1] = 4;
            else if ((GR[r3] & 0x0000ff0000000000) == 0) GR[r1] = 5;
            else if ((GR[r3] & 0x00ff000000000000) == 0) GR[r1] = 6;
            else if ((GR[r3] & 0xff00000000000000) == 0) GR[r1] = 7;
            else GR[r1] = 8;
        }
    } else { // two_byte_form
        if (left_form) { // scan from most significant down
            if ((GR[r3] & 0xffff000000000000) == 0) GR[r1] = 0;
            else if ((GR[r3] & 0x0000ffff00000000) == 0) GR[r1] = 1;
            else if ((GR[r3] & 0x00000000ffff0000) == 0) GR[r1] = 2;
            else if ((GR[r3] & 0x0000000000ffff) == 0) GR[r1] = 3;
            else GR[r1] = 4;
        } else { // right_form scan from least significant up
            if ((GR[r3] & 0x000000000000ffff) == 0) GR[r1] = 0;
            else if ((GR[r3] & 0x00000000ffff0000) == 0) GR[r1] = 1;
            else if ((GR[r3] & 0x0000ffff00000000) == 0) GR[r1] = 2;
            else if ((GR[r3] & 0xffff000000000000) == 0) GR[r1] = 3;
            else GR[r1] = 4;
        }
    }
}

```

```
    }  
  }  
  GR[r1].nat = GR[r3].nat;  
}
```

Interruptions: Illegal Operation fault

dep — Deposit

| | | | |
|----------------|--|---------------------------|-----|
| Format: | <i>(qp)</i> dep $r_1 = r_2, r_3, pos_6, len_4$ | merge_form, register_form | I15 |
| | <i>(qp)</i> dep $r_1 = imm_1, r_3, pos_6, len_6$ | merge_form, imm_form | I14 |
| | <i>(qp)</i> dep.z $r_1 = r_2, pos_6, len_6$ | zero_form, register_form | I12 |
| | <i>(qp)</i> dep.z $r_1 = imm_8, pos_6, len_6$ | zero_form, imm_form | I13 |

Description: In the merge_form, a right justified bit field taken from the first source operand is deposited into the value in GR r_3 at an arbitrary bit position and the result is placed in GR r_1 . In the register_form the first source operand is GR r_2 ; and in the imm_form it is the sign-extended value specified by imm_1 (either all ones or all zeroes). The deposited bit field begins at the bit position specified by the pos_6 immediate and extends to the left (towards the most significant bit) a number of bits specified by the len immediate. Note that len has a range of 1-16 in the register_form and 1-64 in the imm_form. The pos_6 immediate has a range of 0 to 63.

In the zero_form, a right justified bit field taken from either the value in GR r_2 (in the register_form) or the sign-extended value in imm_8 (in the imm_form) is deposited into GR r_1 and all other bits in GR r_1 are cleared to zero. The deposited bit field begins at the bit position specified by the pos_6 immediate and extends to the left (towards the most significant bit) a number of bits specified by the len immediate. The len immediate has a range of 1-64 and the pos_6 immediate has a range of 0 to 63.

In the event that the deposited bit field extends beyond bit 63 of the target, i.e., $len + pos_6 > 64$, the most significant $len + pos_6 - 64$ bits of the deposited bit field are truncated. The len immediate is encoded as len minus 1 in the instruction.

The operation of `dep $r_1 = r_2, r_3, 36, 16$` is illustrated in [Figure 2-5](#).

Figure 2-5. Deposit Example (merge_form)

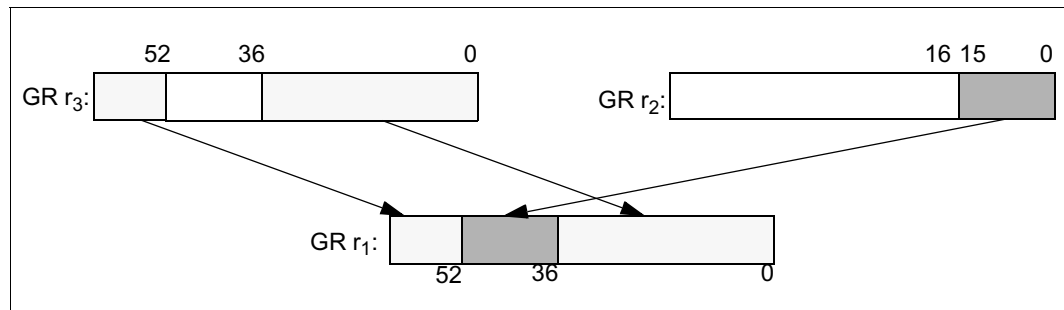

The operation of `dep.z $r_1 = r_2, 36, 16$` is illustrated in [Figure 2-6](#).

Figure 2-6. Deposit Example (zero_form)

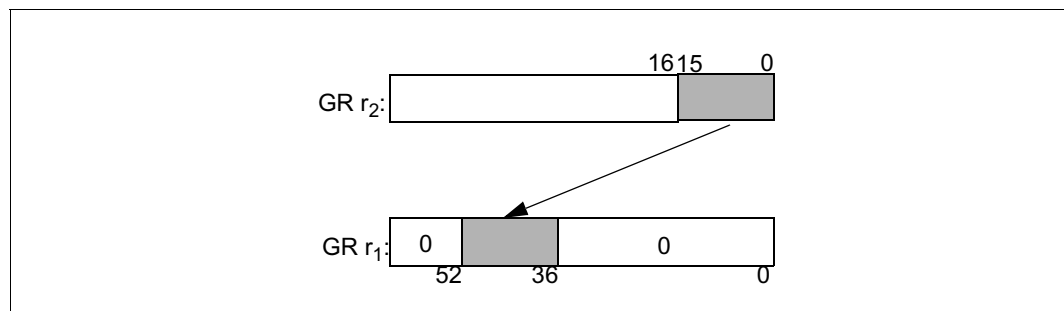

Operation:

```

if (PR[qp]) {
    check_target_register(r1);

    if (imm_form) {
        tmp_src = (merge_form ? sign_ext(imm1, 1) : sign_ext(imm8, 8));
        tmp_nat = merge_form ? GR[r3].nat : 0;
        tmp_len = len6 ;
    } else { // register_form
        tmp_src = GR[r2];
        tmp_nat = (merge_form ? GR[r3].nat : 0) || GR[r2].nat;
        tmp_len = merge_form ? len4 : len6 ;
    }
    if (pos6 + tmp_len > 64)
        tmp_len = 64 - pos6;

    if (merge_form)
        GR[r1] = GR[r3];
    else // zero_form
        GR[r1] = 0;

    GR[r1]{(pos6 + tmp_len - 1):pos6} = tmp_src{(tmp_len - 1):0};
    GR[r1].nat = tmp_nat;
}

```

Interruptions: Illegal Operation fault

epc — Enter Privileged Code

Format: epc

B8

Description: This instruction increases the privilege level. The new privilege level is given by the TLB entry for the page containing this instruction. This instruction can be used to implement calls to higher-privileged routines without the overhead of an interruption.

Before increasing the privilege level, a check is performed. The PFS.ppl (previous privilege level) is checked to ensure that it is not more privileged than the current privilege level. If this check fails, the instruction takes an Illegal Operation fault.

If the check succeeds, then the privilege is increased as follows:

- If instruction address translation is enabled and the page containing the `epc` instruction has execute-only page access rights and the privilege level assigned to the page is higher than (numerically less than) the current privilege level, then the current privilege level is set to the privilege level field in the translation for the page containing the `epc` instruction. This instruction can promote but cannot demote, and the new privilege comes from the TLB entry. If instruction address translation is disabled, then the current privilege level is set to 0 (most privileged).
Instructions after the `epc` in the same instruction group may be executed at the old privilege level or the new, higher privilege level. Instructions in subsequent instruction groups will be executed at the new, higher privilege level.
- If the page containing the `epc` instruction has any other access rights besides execute-only, or if the privilege level assigned to the page is lower or equal to (numerically greater than or equal to) the current privilege level, then no action is taken (the current privilege level is unchanged).

Note that the ITLB is actually only read once, at instruction fetch. Information from the access rights and privilege level fields from the translation is then used in executing this instruction.

This instruction cannot be predicated.

Operation:

```
if (AR[PFS].ppl < PSR.cpl)
    illegal_operation_fault();

if (PSR.it)
    PSR.cpl = tlb_enter_privileged_code();
else
    PSR.cpl = 0;
```

Interruptions: Illegal Operation fault

extr — Extract

Format: (qp) extr $r_1 = r_3, pos_6, len_6$ signed_form 111
 (qp) extr.u $r_1 = r_3, pos_6, len_6$ unsigned_form 111

Description: A field is extracted from GR r_3 , either zero extended or sign extended, and placed right-justified in GR r_1 . The field begins at the bit position given by the second operand and extends len_6 bits to the left. The bit position where the field begins is specified by the pos_6 immediate. The extracted field is sign extended in the signed_form or zero extended in the unsigned_form. The sign is taken from the most significant bit of the extracted field. If the specified field extends beyond the most significant bit of GR r_3 , the sign is taken from the most significant bit of GR r_3 . The immediate value len_6 can be any number in the range 1 to 64, and is encoded as len_6-1 in the instruction. The immediate value pos_6 can be any value in the range 0 to 63.

The operation of `extr $r_1 = r_3, 7, 50$` is illustrated in [Figure 2-7](#).

Figure 2-7. Extract Example



Operation:

```

if (PR[qp]) {
    check_target_register( $r_1$ );

    tmp_len =  $len_6$ ;

    if ( $pos_6 + tmp\_len > 64$ )
        tmp_len =  $64 - pos_6$ ;

    if (unsigned_form)
        GR[ $r_1$ ] = zero_ext(shift_right_unsigned(GR[ $r_3$ ],  $pos_6$ ), tmp_len);
    else // signed_form
        GR[ $r_1$ ] = sign_ext(shift_right_unsigned(GR[ $r_3$ ],  $pos_6$ ), tmp_len);

    GR[ $r_1$ ].nat = GR[ $r_3$ ].nat;
}

```

Interruptions: Illegal Operation fault

fabs — Floating-point Absolute Value

Format: (qp) fabs $f_1 = f_3$ pseudo-op of: (qp) fmerge.s $f_1 = f_0, f_3$

Description: The absolute value of the value in FR f_3 is computed and placed in FR f_1 .
If FR f_3 is a NaTVal, FR f_1 is set to NaTVal instead of the computed result.

Operation: See [“fmerge – Floating-point Merge”](#) on page 3:72.

fadd — Floating-point Add

Format: $(qp) \text{ fadd.pc.sf } f_1 = f_3, f_2$ pseudo-op of: $(qp) \text{ fma.pc.sf } f_1 = f_3, f_1, f_2$

Description: $FR.f_3$ and $FR.f_2$ are added (computed to infinite precision), rounded to the precision indicated by pc (and possibly $FPSR.sf.pc$ and $FPSR.sf.wre$) using the rounding mode specified by $FPSR.sf.rc$, and placed in $FR.f_1$. If either $FR.f_3$ or $FR.f_2$ is a NaTVal, $FR.f_1$ is set to NaTVal instead of the computed result.

The mnemonic values for the opcode's pc are given in [Table 2-22](#). The mnemonic values for sf are given in [Table 2-23](#). For the encodings and interpretation of the status field's pc , wre , and rc , refer to [Table 5-6](#) and [Table 5-5](#) on page 1:80.

Table 2-22. Specified pc Mnemonic Values

| pc Mnemonic | Precision Specified |
|---------------|--|
| .s | single |
| .d | double |
| <i>none</i> | dynamic (i.e. use pc value in status field) |

Table 2-23. sf Mnemonic Values

| sf Mnemonic | Status Field Accessed |
|--------------------|-----------------------|
| .s0 or <i>none</i> | sf0 |
| .s1 | sf1 |
| .s2 | sf2 |
| .s3 | sf3 |

Operation: See "fma — Floating-point Multiply Add" on page 3:70.

famax — Floating-point Absolute Maximum

Format: (qp) famax.*sf* $f_1 = f_2, f_3$ F8

Description: The operand with the larger absolute value is placed in $FR\ f_1$. If the magnitude of $FR\ f_2$ equals the magnitude of $FR\ f_3$, $FR\ f_1$ gets $FR\ f_3$.

If either $FR\ f_2$ or $FR\ f_3$ is a NaN, $FR\ f_1$ gets $FR\ f_3$.

If either $FR\ f_2$ or $FR\ f_3$ is a NaTVal, $FR\ f_1$ is set to NaTVal instead of the computed result.

This operation does not propagate NaNs the same way as other arithmetic floating-point instructions. The Invalid Operation is signaled in the same manner as the `fcmp.lt` operation.

The mnemonic values for *sf* are given in [Table 2-23 on page 3:50](#).

Operation:

```

if (PR[qp]) {
    fp_check_target_register(f1);
    if (tmp_israncode = fp_reg_disabled(f1, f2, f3, 0))
        disabled_fp_register_fault(tmp_israncode, 0);

    if (fp_is_natval(FR[f2]) || fp_is_natval(FR[f3])) {
        FR[f1] = NATVAL;
    } else {
        fminmax_exception_fault_check(f2, f3, sf, &tmp_fp_env);
        if (fp_raise_fault(tmp_fp_env))
            fp_exception_fault(fp_decode_fault(tmp_fp_env));

        tmp_right = fp_reg_read(FR[f2]);
        tmp_left = fp_reg_read(FR[f3]);
        tmp_right.sign = FP_SIGN_POSITIVE;
        tmp_left.sign = FP_SIGN_POSITIVE;
        tmp_bool_res = fp_less_than(tmp_left, tmp_right);
        FR[f1] = tmp_bool_res ? FR[f2] : FR[f3];

        fp_update_fpsr(sf, tmp_fp_env);
    }

    fp_update_psr(f1);
}

```

FP Exceptions: Invalid Operation (V)
Denormal/Unnormal Operand (D)
Software Assist (SWA) fault

Interruptions: Illegal Operation fault Floating-point Exception fault
Disabled Floating-point Register fault

famin — Floating-point Absolute Minimum

Format: (qp) `famin.sf f1=f2,f3` F8

Description: The operand with the smaller absolute value is placed in FR f_1 . If the magnitude of FR f_2 equals the magnitude of FR f_3 , FR f_1 gets FR f_3 .

If either FR f_2 or FR f_3 is a NaN, FR f_1 gets FR f_3 .

If either FR f_2 or FR f_3 is a NaTVal, FR f_1 is set to NaTVal instead of the computed result.

This operation does not propagate NaNs the same way as other arithmetic floating-point instructions. The Invalid Operation is signaled in the same manner as the `fcmp.lt` operation.

The mnemonic values for *sf* are given in [Table 2-23 on page 3:50](#).

Operation:

```

if (PR[qp]) {
    fp_check_target_register(f1);
    if (tmp_israncode = fp_reg_disabled(f1, f2, f3, 0))
        disabled_fp_register_fault(tmp_israncode, 0);

    if (fp_is_natval(FR[f2]) || fp_is_natval(FR[f3])) {
        FR[f1] = NATVAL;
    } else {
        fminmax_exception_fault_check(f2, f3, sf, &tmp_fp_env);
        if (fp_raise_fault(tmp_fp_env))
            fp_exception_fault(fp_decode_fault(tmp_fp_env));

        tmp_left = fp_reg_read(FR[f2]);
        tmp_right = fp_reg_read(FR[f3]);
        tmp_left.sign = FP_SIGN_POSITIVE;
        tmp_right.sign = FP_SIGN_POSITIVE;
        tmp_bool_res = fp_less_than(tmp_left, tmp_right);
        FR[f1] = tmp_bool_res ? FR[f2] : FR[f3];

        fp_update_fpsr(sf, tmp_fp_env);
    }

    fp_update_psr(f1);
}

```

FP Exceptions: Invalid Operation (V)
Denormal/Unnormal Operand (D)
Software Assist (SWA) fault

Interruptions: Illegal Operation fault Floating-point Exception fault
Disabled Floating-point Register fault

fand — Floating-point Logical And

Format: (qp) fand $f_1 = f_2, f_3$ F9

Description: The bit-wise logical AND of the significand fields of FR f_2 and FR f_3 is computed. The resulting value is stored in the significand field of FR f_1 . The exponent field of FR f_1 is set to the biased exponent for 2.0^{63} (0x1003E) and the sign field of FR f_1 is set to positive (0).

If either FR f_2 or FR f_3 is a NaTVal, FR f_1 is set to NaTVal instead of the computed result.

Operation:

```

if (PR[qp]) {
    fp_check_target_register(f1);
    if (tmp_israncode = fp_reg_disabled(f1, f2, f3, 0))
        disabled_fp_register_fault(tmp_israncode, 0);

    if (fp_is_natval(FR[f2]) || fp_is_natval(FR[f3])) {
        FR[f1] = NATVAL;
    } else {
        FR[f1].significand = FR[f2].significand & FR[f3].significand;
        FR[f1].exponent = FP_INTEGER_EXP;
        FR[f1].sign = FP_SIGN_POSITIVE;
    }
    fp_update_psr(f1);
}

```

FP Exceptions: None

Interruptions: Illegal Operation fault

Disabled Floating-point Register fault

fandcm — Floating-point And Complement

Format: (qp) fandcm $f_1 = f_2, f_3$ F9

Description: The bit-wise logical AND of the significand field of FR f_2 with the bit-wise complemented significand field of FR f_3 is computed. The resulting value is stored in the significand field of FR f_1 . The exponent field of FR f_1 is set to the biased exponent for 2.0^{63} (0x1003E) and the sign field of FR f_1 is set to positive (0).

If either FR f_2 or FR f_3 is a NaTVal, FR f_1 is set to NaTVal instead of the computed result.

Operation:

```

if (PR[qp]) {
    fp_check_target_register(f1);
    if (tmp_israncode = fp_reg_disabled(f1, f2, f3, 0))
        disabled_fp_register_fault(tmp_israncode, 0);

    if (fp_is_natval(FR[f2]) || fp_is_natval(FR[f3])) {
        FR[f1] = NATVAL;
    } else {
        FR[f1].significand = FR[f2].significand & ~FR[f3].significand;
        FR[f1].exponent = FP_INTEGER_EXP;
        FR[f1].sign = FP_SIGN_POSITIVE;
    }
    fp_update_psr(f1);
}

```

FP Exceptions: None

Interruptions: Illegal Operation fault

Disabled Floating-point Register fault

fc — Flush Cache

Format: `(qp) fc r3` invalidate_line_form [M28](#)
`(qp) fc.i r3` instruction_cache_coherent_form [M28](#)

Description: In the `invalidate_line_form`, the cache line associated with the address specified by the value of GR r_3 is invalidated from all levels of the processor cache hierarchy. The invalidation is broadcast throughout the coherence domain. If, at any level of the cache hierarchy, the line is inconsistent with memory it is written to memory before invalidation. The line size affected is at least 32-bytes (aligned on a 32-byte boundary). An implementation may flush a larger region.

In the `instruction_cache_coherent_form`, the cache line specified by GR r_3 is flushed in an implementation-specific manner that ensures that the instruction caches are coherent with the data caches. The `fc.i` instruction is not required to invalidate the targeted cache line nor write the targeted cache line back to memory if it is inconsistent with memory, but may do so if this is required to make the instruction caches coherent with the data caches. The `fc.i` instruction is broadcast throughout the coherence domain if necessary to make all instruction caches coherent. The line size affected is at least 32-bytes (aligned on a 32-byte boundary). An implementation may flush a larger region.

When executed at privilege level 0, `fc` and `fc.i` perform no access rights or protection key checks. At other privilege levels, `fc` and `fc.i` perform access rights checks as if they were 1-byte reads, but do not perform any protection key checks (regardless of PSR.pk).

The memory attribute of the page containing the affected line has no effect on the behavior of these instructions. The `fc` instruction can be used to remove a range of addresses from the cache by first changing the memory attribute to non-cacheable and then flushing the range.

These instructions follow data dependency rules; they are ordered with respect to preceding and following memory references to the same line. `fc` and `fc.i` have data dependencies in the sense that any prior stores by this processor will be included in the flush operation. `fc` and `fc.i` are unordered operations, and are not affected by a memory fence (`mf`) instruction. These instructions are ordered with respect to the `sync.i` instruction.

Operation:

```
if (PR[qp]) {
    itype = NON_ACCESS|FC|READ;
    if (GR[r3].nat)
        register_nat_consumption_fault(itype);
    tmp_paddr = tlb_translate_nonaccess(GR[r3], itype);

    if (invalidate_line_form)
        mem_flush(tmp_paddr);
    else // instruction_cache_coherent_form
        make_icache_coherent(tmp_paddr);
}
```

Interruptions:

| | |
|----------------------------------|---------------------------------|
| Register NaT Consumption fault | Data TLB fault |
| Unimplemented Data Address fault | Data Page Not Present fault |
| Data Nested TLB fault | Data NaT Page Consumption fault |
| Alternate Data TLB fault | Data Access Rights fault |
| VHPT Data fault | |

fchkf — Floating-point Check Flags

Format: (qp) fchkf.sf target₂₅

F14

Description: The flags in `FPSR.sf.flags` are compared with `FPSR.s0.flags` and `FPSR.traps`. If any flags set in `FPSR.sf.flags` correspond to `FPSR.traps` which are enabled, or if any flags set in `FPSR.sf.flags` are not set in `FPSR.s0.flags`, then a branch to `target25` is taken.

The `target25` operand, specifies a label to branch to. This is encoded in the instruction as a signed immediate displacement (`imm21`) between the target bundle and the bundle containing this instruction (`imm21 = target25 - IP >> 4`).

The branching behavior of this instruction can be optionally unimplemented. If the instruction would have branched, and the branching behavior is not implemented, then a Speculative Operation fault is taken and the value specified by `imm21` is zero-extended and placed in the Interruption Immediate control register (IIM). The fault handler emulates the branch by sign-extending the IIM value, adding it to IIP and returning.

The mnemonic values for `sf` are given in [Table 2-23 on page 3:50](#).

Operation:

```

if (PR[qp]) {
    switch (sf) {
        case 's0':
            tmp_flags = AR[FPSR].sf0.flags;
            break;
        case 's1':
            tmp_flags = AR[FPSR].sf1.flags;
            break;
        case 's2':
            tmp_flags = AR[FPSR].sf2.flags;
            break;
        case 's3':
            tmp_flags = AR[FPSR].sf3.flags;
            break;
    }
    if ((tmp_flags & ~AR[FPSR].traps) || (tmp_flags & ~AR[FPSR].sf0.flags)) {
        if (check_branch_implemented(FCHKF)) {
            taken_branch = 1;
            IP = IP + sign_ext((imm21 << 4), 25);
            if ((PSR.it && unimplemented_virtual_address(IP))
                || (!PSR.it && unimplemented_physical_address(IP)))
                unimplemented_instruction_address_trap(0, IP);
            if (PSR.tb)
                taken_branch_trap();
        } else
            speculation_fault(FCHKF, zero_ext(imm21, 21));
    }
}

```

FP Exceptions: None

Interruptions: Speculative Operation fault Taken Branch trap
 Unimplemented Instruction Address trap

fclass — Floating-point Class

Format: $(qp) \text{ fclass.fcrel.fctype } p_1, p_2 = f_2, fclass_9$ F5

Description: The contents of FR f_2 are classified according to the $fclass_9$ completer as shown in Table 2-25. This produces a boolean result based on whether the contents of FR f_2 agrees with the floating-point number format specified by $fclass_9$, as specified by the $fcrel$ completer. This result is written to the two predicate register destinations, p_1 and p_2 . The result written to the destinations is determined by the compare type specified by $fctype$.

The allowed types are Normal (or *none*) and *unc*. See Table 2-26 on page 3:60. The assembly syntax allows the specification of membership or non-membership and the assembler swaps the target predicates to achieve the desired effect.

Table 2-24. Floating-point Class Relations

| <i>fcrel</i> | Test Relation |
|--------------|--|
| m | FR f_2 agrees with the pattern specified by $fclass_9$ (is a member) |
| nm | FR f_2 does not agree with the pattern specified by $fclass_9$ (is not a member) |

A number agrees with the pattern specified by $fclass_9$ if:

- the number is NaTVal and $fclass_9 \{8\}$ is 1, or
- the number is a quiet NaN and $fclass_9 \{7\}$ is 1, or
- the number is a signaling NaN and $fclass_9 \{6\}$ is 1, or
- the sign of the number agrees with the sign specified by one of the two low-order bits of $fclass_9$, and the type of the number (disregarding the sign) agrees with the number-type specified by the next 4 bits of $fclass_9$, as shown in Table 2-25.

Note: An $fclass_9$ of 0x1FF is equivalent to testing for any supported operand. The class names used in Table 2-25 are defined in Table 5-2, “Floating-point Register Encodings” on page 1:77.

Table 2-25. Floating-point Classes

| <i>fclass_9</i> | Class | Mnemonic |
|--|---------------|----------|
| Either these cases can be tested for | | |
| 0x0100 | NaTVal | @nat |
| 0x080 | Quiet NaN | @qnan |
| 0x040 | Signaling NaN | @snan |
| or the OR of the following two cases | | |
| 0x001 | Positive | @pos |
| 0x002 | Negative | @neg |
| AND'ed with OR of the following four cases | | |
| 0x004 | Zero | @zero |
| 0x008 | Unnormalized | @unorm |
| 0x010 | Normalized | @norm |
| 0x020 | Infinity | @inf |

```

Operation:   if (PR[qp]) {
                if (p1 == p2)
                    illegal_operation_fault();

                if (tmp_isrkode = fp_reg_disabled(f2, 0, 0, 0))
                    disabled_fp_register_fault(tmp_isrkode, 0);

                tmp_rel = ((fclass9{0} && !FR[f2].sign || fclass9{1} && FR[f2].sign)
                           && ((fclass9{2} && fp_is_zero(FR[f2])) ||
                               (fclass9{3} && fp_is_unorm(FR[f2])) ||
                               (fclass9{4} && fp_is_normal(FR[f2])) ||
                               (fclass9{5} && fp_is_inf(FR[f2]))
                           )
                           || (fclass9{6} && fp_is_snan(FR[f2]))
                           || (fclass9{7} && fp_is_qnan(FR[f2]))
                           || (fclass9{8} && fp_is_natval(FR[f2]));

                tmp_nat = fp_is_natval(FR[f2]) && (!fclass9{8});

                if (tmp_nat) {
                    PR[p1] = 0;
                    PR[p2] = 0;
                } else {
                    PR[p1] = tmp_rel;
                    PR[p2] = !tmp_rel;
                }
            } else {
                if (fctype == 'unc') {
                    if (p1 == p2)
                        illegal_operation_fault();
                    PR[p1] = 0;
                    PR[p2] = 0;
                }
            }
        }

```

FP Exceptions: None

Interruptions: Illegal Operation fault

Disabled Floating-point Register fault

fclrf — Floating-point Clear Flags

Format: (qp) fclrf.sf

F13

Description: The status field's 6-bit flags field is reset to zero.
The mnemonic values for *sf* are given in [Table 2-23 on page 3:50](#).

Operation:

```
if (PR[qp]) {  
    fp_set_sf_flags(sf, 0);  
}
```

FP Exceptions: None

Interruptions: None

fcmp — Floating-point Compare

Format: $(qp) \text{ fcmp.frel.fctype.sf } p_1, p_2 = f_2, f_3$

F4

Description: The two source operands are compared for one of twelve relations specified by *frel*. This produces a boolean result which is 1 if the comparison condition is true, and 0 otherwise. This result is written to the two predicate register destinations, p_1 and p_2 . The way the result is written to the destinations is determined by the compare type specified by *fctype*. The allowed types are Normal (or *none*) and *unc*.

Table 2-26. Floating-point Comparison Types

| <i>fctype</i> | PR[qp]==0 | | PR[qp]==1 | | | | | |
|---------------|---------------------|---------------------|---------------------------------|---------------------|---------------------------------|---------------------|-------------------------------|---------------------|
| | | | result==0, No Source NaTVals | | result==1, No Source NaTVals | | One or More Source NaTVals | |
| | PR[p ₁] | PR[p ₂] | PR[p ₁] | PR[p ₂] | PR[p ₁] | PR[p ₂] | PR[p ₁] | PR[p ₂] |
| <i>none</i> | | | 0 | 1 | 1 | 0 | 0 | 0 |
| <i>unc</i> | 0 | 0 | 0 | 1 | 1 | 0 | 0 | 0 |

The mnemonic values for *sf* are given in Table 2-23 on page 3:50.

The relations are defined for each of the comparison types in Table 2-27. Of the twelve relations, not all are directly implemented in hardware. Some are actually pseudo-ops. For these, the assembler simply switches the source operand specifiers and/or switches the predicate target specifiers and uses an implemented relation.

Table 2-27. Floating-point Comparison Relations

| <i>frel</i> | <i>frel</i> Completer Unabbreviated | Relation | Pseudo-op of | Quiet NaN as Operand Signals Invalid |
|-------------|--|-------------------|--|--|
| eq | equal | $f_2 == f_3$ | | No |
| lt | less than | $f_2 < f_3$ | | Yes |
| le | less than or equal | $f_2 \leq f_3$ | | Yes |
| gt | greater than | $f_2 > f_3$ | lt $f_2 \leftrightarrow f_3$ | Yes |
| ge | greater than or equal | $f_2 \geq f_3$ | le $f_2 \leftrightarrow f_3$ | Yes |
| unord | unordered | $f_2 ? f_3$ | | No |
| neq | not equal | $!(f_2 == f_3)$ | eq $p_1 \leftrightarrow p_2$ | No |
| nlt | not less than | $!(f_2 < f_3)$ | lt $p_1 \leftrightarrow p_2$ | Yes |
| nle | not less than or equal | $!(f_2 \leq f_3)$ | le $p_1 \leftrightarrow p_2$ | Yes |
| ngt | not greater than | $!(f_2 > f_3)$ | lt $f_2 \leftrightarrow f_3$ $p_1 \leftrightarrow p_2$ | Yes |
| nge | not greater than or equal | $!(f_2 \geq f_3)$ | le $f_2 \leftrightarrow f_3$ $p_1 \leftrightarrow p_2$ | Yes |
| ord | ordered | $!(f_2 ? f_3)$ | unord $p_1 \leftrightarrow p_2$ | No |

```

Operation:   if (PR[qp]) {
                if (p1 == p2)
                    illegal_operation_fault();

                if (tmp_isrkode = fp_reg_disabled(f2, f3, 0, 0))
                    disabled_fp_register_fault(tmp_isrkode, 0);

                if (fp_is_natval(FR[f2]) || fp_is_natval(FR[f3])) {
                    PR[p1] = 0;
                    PR[p2] = 0;
                } else {
                    fcmp_exception_fault_check(f2, f3, frel, sf, &tmp_fp_env);
                    if (fp_raise_fault(tmp_fp_env))
                        fp_exception_fault(fp_decode_fault(tmp_fp_env));

                    tmp_fr2 = fp_reg_read(FR[f2]);
                    tmp_fr3 = fp_reg_read(FR[f3]);

                    if (frel == 'eq') tmp_rel = fp_equal(tmp_fr2,
                                                         tmp_fr3);
                    else if (frel == 'lt') tmp_rel = fp_less_than(tmp_fr2,
                                                                    tmp_fr3);
                    else if (frel == 'le') tmp_rel = fp_lesser_or_equal(tmp_fr2,
                                                                           tmp_fr3);
                    else if (frel == 'gt') tmp_rel = fp_less_than(tmp_fr3,
                                                                    tmp_fr2);
                    else if (frel == 'ge') tmp_rel = fp_lesser_or_equal(tmp_fr3,
                                                                           tmp_fr2);
                    else if (frel == 'unord') tmp_rel = fp_unordered(tmp_fr2,
                                                                      tmp_fr3);
                    else if (frel == 'neq') tmp_rel = !fp_equal(tmp_fr2,
                                                                tmp_fr3);
                    else if (frel == 'nlt') tmp_rel = !fp_less_than(tmp_fr2,
                                                                      tmp_fr3);
                    else if (frel == 'nle') tmp_rel = !fp_lesser_or_equal(tmp_fr2,
                                                                           tmp_fr3);
                    else if (frel == 'ngt') tmp_rel = !fp_less_than(tmp_fr3,
                                                                      tmp_fr2);
                    else if (frel == 'nge') tmp_rel = !fp_lesser_or_equal(tmp_fr3,
                                                                           tmp_fr2);
                    else
                        tmp_rel = !fp_unordered(tmp_fr2,
                                                 tmp_fr3); // 'ord'

                    PR[p1] = tmp_rel;
                    PR[p2] = !tmp_rel;

                    fp_update_fpsr(sf, tmp_fp_env);
                }
            } else {
                if (fctype == 'unc') {
                    if (p1 == p2)
                        illegal_operation_fault();
                    PR[p1] = 0;
                    PR[p2] = 0;
                }
            }
        }
    }

```

FP Exceptions: Invalid Operation (V)
Denormal/Unnormal Operand (D)
Software Assist (SWA) fault

Interruptions: Illegal Operation fault
Disabled Floating-point Register fault

Floating-point Exception fault

fcvt.fx — Convert Floating-point to Integer

| | | | |
|----------------|------------------------------------|---------------------------|-----|
| Format: | (qp) fcvt.fx.sf $f_1 = f_2$ | signed_form | F10 |
| | (qp) fcvt.fx.trunc.sf $f_1 = f_2$ | signed_form, trunc_form | F10 |
| | (qp) fcvt.fxu.sf $f_1 = f_2$ | unsigned_form | F10 |
| | (qp) fcvt.fxu.trunc.sf $f_1 = f_2$ | unsigned_form, trunc_form | F10 |

Description: FR f_2 is treated as a register format floating-point value and converted to a signed (signed_form) or unsigned integer (unsigned_form) using either the rounding mode specified in the FPSR.sf.rc, or using Round-to-Zero if the trunc_form of the instruction is used. The result is placed in the 64-bit significand field of FR f_1 . The exponent field of FR f_1 is set to the biased exponent for 2.0^{63} (0x1003E) and the sign field of FR f_1 is set to positive (0). If the result of the conversion cannot be represented as a 64-bit integer, the 64-bit integer indefinite value 0x8000000000000000 is used as the result, if the IEEE Invalid Operation Floating-point Exception fault is disabled.

If FR f_2 is a NaTVal, FR f_1 is set to NaTVal instead of the computed result.

The mnemonic values for sf are given in [Table 2-23 on page 3:50](#).

Operation:

```

if (PR[qp]) {
    fp_check_target_register(f1);
    if (tmp_israncode = fp_reg_disabled(f1, f2, 0, 0))
        disabled_fp_register_fault(tmp_israncode, 0);

    if (fp_is_natval(FR[f2])) {
        FR[f1] = NATVAL;
        fp_update_psr(f1);
    } else {
        tmp_default_result = fcvt_exception_fault_check(f2, signed_form,
            trunc_form, sf, &tmp_fp_env);

        if (fp_raise_fault(tmp_fp_env))
            fp_exception_fault(fp_decode_fault(tmp_fp_env));

        if (fp_is_nan(tmp_default_result)) {
            FR[f1].significand = INTEGER_INDEFINITE;
            FR[f1].exponent = FP_INTEGER_EXP;
            FR[f1].sign = FP_SIGN_POSITIVE;
        } else {
            tmp_res = fp_ieee_rnd_to_int(fp_reg_read(FR[f2]), &tmp_fp_env);
            if (tmp_res.exponent)
                tmp_res.significand = fp_U64_rsh(
                    tmp_res.significand, (FP_INTEGER_EXP - tmp_res.exponent));
            if (signed_form && tmp_res.sign)
                tmp_res.significand = (~tmp_res.significand) + 1;

            FR[f1].significand = tmp_res.significand;
            FR[f1].exponent = FP_INTEGER_EXP;
            FR[f1].sign = FP_SIGN_POSITIVE;
        }

        fp_update_fpsr(sf, tmp_fp_env);
        fp_update_psr(f1);
        if (fp_raise_traps(tmp_fp_env))
            fp_exception_trap(fp_decode_trap(tmp_fp_env));
    }
}

```

FP Exceptions: Invalid Operation (V)
Denormal/Unnormal Operand (D)
Software Assist (SWA) fault

Interruptions: Illegal Operation fault
Disabled Floating-point Register fault

Inexact (I)

Floating-point Exception fault
Floating-point Exception trap

fcvt.xf — Convert Signed Integer to Floating-point

Format: (qp) fcvt.xf $f_1 = f_2$

F11

Description: The 64-bit significand of FR f_2 is treated as a signed integer and its register file precision floating-point representation is placed in FR f_1 .

If FR f_2 is a NaTVal, FR f_1 is set to NaTVal instead of the computed result.

This operation is always exact and is unaffected by the rounding mode.

Operation:

```

if (PR[qp]) {
    fp_check_target_register( $f_1$ );
    if (tmp_israncode = fp_reg_disabled( $f_1$ ,  $f_2$ , 0, 0))
        disabled_fp_register_fault(tmp_israncode, 0);

    if (fp_is_natval(FR[ $f_2$ ])) {
        FR[ $f_1$ ] = NATVAL;
    } else {
        tmp_res = FR[ $f_2$ ];
        if (tmp_res.significand{63}) {
            tmp_res.significand = (~tmp_res.significand) + 1;
            tmp_res.sign = 1;
        } else
            tmp_res.sign = 0;

        tmp_res.exponent = FP_INTEGER_EXP;
        tmp_res = fp_normalize(tmp_res);

        FR[ $f_1$ ].significand = tmp_res.significand;
        FR[ $f_1$ ].exponent = tmp_res.exponent;
        FR[ $f_1$ ].sign = tmp_res.sign;
    }
    fp_update_psr( $f_1$ );
}

```

FP Exceptions: None

Interruptions: Illegal Operation fault

Disabled Floating-point Register fault

fcvt.xuf — Convert Unsigned Integer to Floating-point

Format: (qp) fcvt.xuf.pc.sf $f_1 = f_3$ pseudo-op of: (qp) fma.pc.sf $f_1 = f_3, f_1, f_0$

Description: FR f_3 is multiplied with FR 1, rounded to the precision indicated by pc (and possibly FPSR.sf.pc and FPSR.sf.wre) using the rounding mode specified by FPSR.sf.rc, and placed in FR f_1 .

Note: Multiplying FR f_3 with FR 1 (a 1.0) normalizes the canonical representation of an integer in the floating-point register file producing a normal floating-point value.

If FR f_3 is a NaTVal, FR f_1 is set to NaTVal instead of the computed result.

The mnemonic values for the opcode's pc are given in [Table 2-22 on page 3:50](#). The mnemonic values for sf are given in [Table 2-23 on page 3:50](#). For the encodings and interpretation of the status field's pc , wre , and rc , refer to [Table 5-6](#) and [Table 5-5 on page 1:80](#).

Operation: See "fma – Floating-point Multiply Add" on page 3:70.

fetchadd — Fetch and Add Immediate

Format: (qp) `fetchadd4.sem.lhint r1 = [r3], inc3` four_byte_form M17
 (qp) `fetchadd8.sem.lhint r1 = [r3], inc3` eight_byte_form M17

Description: A value consisting of four or eight bytes is read from memory starting at the address specified by the value in GR r_3 . The value is zero extended and added to the sign-extended immediate value specified by inc_3 . The values that may be specified by inc_3 are: -16, -8, -4, -1, 1, 4, 8, 16. The least significant four or eight bytes of the sum are then written to memory starting at the address specified by the value in GR r_3 . The zero-extended value read from memory is placed in GR r_1 and the NaT bit corresponding to GR r_1 is cleared.

The *sem* completer specifies the type of semaphore operation. These operations are described in [Table 2-28](#). See [Section 4.4.7, “Sequentiality Attribute and Ordering” on page 2:69](#) for details on memory ordering.

Table 2-28. Fetch and Add Semaphore Types

| <i>sem</i> Completer | Ordering Semantics | Semaphore Operation |
|----------------------|--------------------|---|
| acq | Acquire | The memory read/write is made visible prior to all subsequent data memory accesses. |
| rel | Release | The memory read/write is made visible after all previous data memory accesses. |

The memory read and write are guaranteed to be atomic for accesses to pages with cacheable, writeback memory attribute. For accesses to other memory types, atomicity is platform dependent. Details on memory attributes are described in [Section 4.4, “Memory Attributes” on page 2:63](#).

If the address specified by the value in GR r_3 is not naturally aligned to the size of the value being accessed in memory, an Unaligned Data Reference fault is taken independent of the state of the User Mask alignment checking bit, UM.ac (PSR.ac in the Processor Status Register).

Both read and write access privileges for the referenced page are required. The write access privilege check is performed whether or not the memory write is performed.

Only accesses to UCE pages or cacheable pages with write-back write policy are permitted. Accesses to NaTPages result in a Data NaT Page Consumption fault. Accesses to pages with other memory attributes cause an Unsupported Data Reference fault.

On a processor model that supports exported `fetchadd`, a `fetchadd` to a UCE page causes the fetch-and-add operation to be exported outside of the processor; if the platform does not support exported `fetchadd`, the operation is undefined. On a processor model that does not support exported `fetchadd`, a `fetchadd` to a UCE page causes an Unsupported Data Reference fault. See [Section 4.4.9, “Effects of Memory Attributes on Memory Reference Instructions” on page 2:73](#).

The value of the *ldhint* completer specifies the locality of the memory access. The values of the *ldhint* completer are given in [Table 2-34 on page 3:132](#). Locality hints do not affect program functionality and may be ignored by the implementation. See [Section 4.4.6, “Memory Hierarchy Control and Consistency” on page 1:60](#) for details.

```

Operation:   if (PR[qp]) {
                check_target_register(r1);

                if (GR[r3].nat)
                    register_nat_consumption_fault(SEMAPHORE);

                size = four_byte_form ? 4 : 8;

                paddr = tlb_translate(GR[r3], size, SEMAPHORE, PSR.cpl, &matr,
                                     &tmp_unused);
                if (!ma_supports_fetchadd(matr))
                    unsupported_data_reference_fault(SEMAPHORE, GR[r3]);

                if (sem == 'acq')
                    val = mem_xchg_add(inc3, paddr, size, UM.be, matr, ACQUIRE, ldhint);
                else // 'rel'
                    val = mem_xchg_add(inc3, paddr, size, UM.be, matr, RELEASE, ldhint);

                alat_inval_multiple_entries(paddr, size);

                GR[r1] = zero_ext(val, size * 8);
                GR[r1].nat = 0;
            }

```

| | |
|---|----------------------------------|
| Interruptions: Illegal Operation fault | Data Key Miss fault |
| Register NaT Consumption fault | Data Key Permission fault |
| Unimplemented Data Address fault | Data Access Rights fault |
| Data Nested TLB fault | Data Dirty Bit fault |
| Alternate Data TLB fault | Data Access Bit fault |
| VHPT Data fault | Data Debug fault |
| Data TLB fault | Unaligned Data Reference fault |
| Data Page Not Present fault | Unsupported Data Reference fault |
| Data NaT Page Consumption fault | |

flushrs — Flush Register Stack

Format: flushrs

M25

Description: All stacked general registers in the dirty partition of the register stack are written to the backing store before execution continues. The dirty partition contains registers from previous procedure frames that have not yet been saved to the backing store. For a description of the register stack partitions, refer to [Chapter 6, “Register Stack Engine” in Volume 2](#). A pending external interrupt can interrupt the RSE store loop when enabled.

After this instruction completes execution BSPSTORE is equal to BSP.

This instruction must be the first instruction in an instruction group and must either be in instruction slot 0 or in instruction slot 1 of a template having a stop after slot 0; otherwise, the results are undefined. This instruction cannot be predicated.

Operation:

```
while (AR[BSPSTORE] != AR[BSP]) {
    rse_store(MANDATORY);           // increments AR[BSPSTORE]
    deliver_unmasked_pending_external_interrupt();
}
```

Interruptions:

| | |
|----------------------------------|---------------------------|
| Unimplemented Data Address fault | Data Key Miss fault |
| VHPT Data fault | Data Key Permission fault |
| Data Nested TLB fault | Data Access Rights fault |
| Data TLB fault | Data Dirty Bit fault |
| Alternate Data TLB fault | Data Access Bit fault |
| Data Page Not Present fault | Data Debug fault |
| Data NaT Page Consumption fault | |

fma — Floating-point Multiply Add

Format: (qp) fma.pc.sf $f_1 = f_3, f_4, f_2$ F1

Description: The product of FR f_3 and FR f_4 is computed to infinite precision and then FR f_2 is added to this product, again in infinite precision. The resulting value is then rounded to the precision indicated by pc (and possibly FPSR.sf.pc and FPSR.sf.wre) using the rounding mode specified by FPSR.sf.rc. The rounded result is placed in FR f_1 .

If any of FR f_3 , FR f_4 , or FR f_2 is a NaTVal, FR f_1 is set to NaTVal instead of the computed result.

If f_2 is f0, an IEEE multiply operation is performed instead of a multiply and add. See “fmpy — Floating-point Multiply” on page 3:77.

The mnemonic values for the opcode’s pc are given in Table 2-22 on page 3:50. The mnemonic values for sf are given in Table 2-23 on page 3:50. For the encodings and interpretation of the status field’s pc , wre , and rc , refer to Table 5-6 and Table 5-5 on page 1:80.

Operation:

```

if (PR[qp]) {
    fp_check_target_register(f1);
    if (tmp_israncode = fp_reg_disabled(f1, f2, f3, f4))
        disabled_fp_register_fault(tmp_israncode, 0);

    if (fp_is_natval(FR[f2]) || fp_is_natval(FR[f3]) ||
        fp_is_natval(FR[f4])) {
        FR[f1] = NATVAL;
        fp_update_psr(f1);
    } else {
        tmp_default_result = fma_exception_fault_check(f2, f3, f4,
                                                       pc, sf, &tmp_fp_env);

        if (fp_raise_fault(tmp_fp_env))
            fp_exception_fault(fp_decode_fault(tmp_fp_env));

        if (fp_is_nan_or_inf(tmp_default_result)) {
            FR[f1] = tmp_default_result;
        } else {
            tmp_res = fp_mul(fp_reg_read(FR[f3]), fp_reg_read(FR[f4]));
            if (f2 != 0)
                tmp_res = fp_add(tmp_res, fp_reg_read(FR[f2]), tmp_fp_env);
            FR[f1] = fp_ieee_round(tmp_res, &tmp_fp_env);
        }

        fp_update_fpsr(sf, tmp_fp_env);
        fp_update_psr(f1);
        if (fp_raise_traps(tmp_fp_env))
            fp_exception_trap(fp_decode_trap(tmp_fp_env));
    }
}

```

| | |
|---|----------------------------|
| FP Exceptions: Invalid Operation (V) | Underflow (U) |
| Denormal/Unnormal Operand (D) | Overflow (O) |
| Software Assist (SWA) fault | Inexact (I) |
| | Software Assist (SWA) trap |

| | |
|---|--------------------------------|
| Interruptions: Illegal Operation fault | Floating-point Exception fault |
| Disabled Floating-point Register fault | Floating-point Exception trap |

fmerge — Floating-point Merge

Format:

| | | |
|--|---------------|----|
| <i>(qp)</i> fmerge.ns $f_1 = f_2, f_3$ | neg_sign_form | F9 |
| <i>(qp)</i> fmerge.s $f_1 = f_2, f_3$ | sign_form | F9 |
| <i>(qp)</i> fmerge.se $f_1 = f_2, f_3$ | sign_exp_form | F9 |

Description: Sign, exponent and significand fields are extracted from FR f_2 and FR f_3 , combined, and the result is placed in FR f_1 .

For the neg_sign_form, the sign of FR f_2 is negated and concatenated with the exponent and the significand of FR f_3 . This form can be used to negate a floating-point number by using the same register for FR f_2 and FR f_3 .

For the sign_form, the sign of FR f_2 is concatenated with the exponent and the significand of FR f_3 .

For the sign_exp_form, the sign and exponent of FR f_2 is concatenated with the significand of FR f_3 .

For all forms, if either FR f_2 or FR f_3 is a NaNVal, FR f_1 is set to NaNVal instead of the computed result.

Figure 2-8. Floating-point Merge Negative Sign Operation

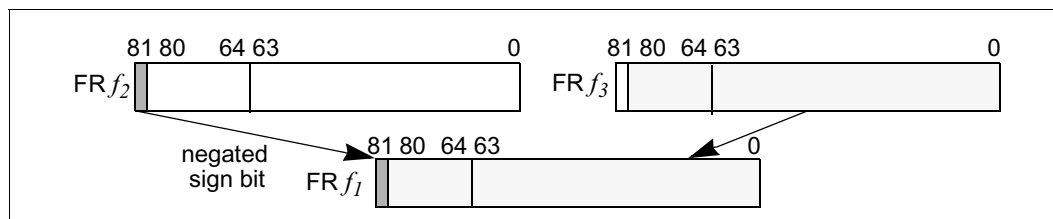

Figure 2-9. Floating-point Merge Sign Operation

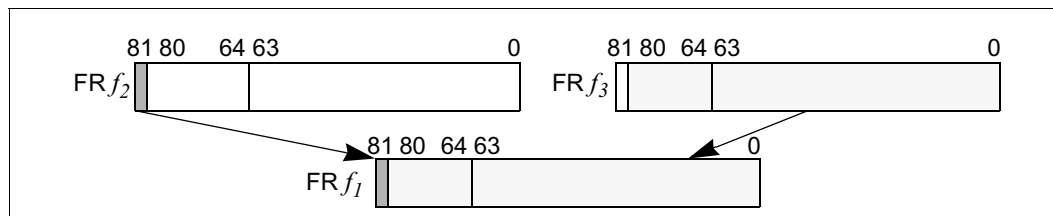
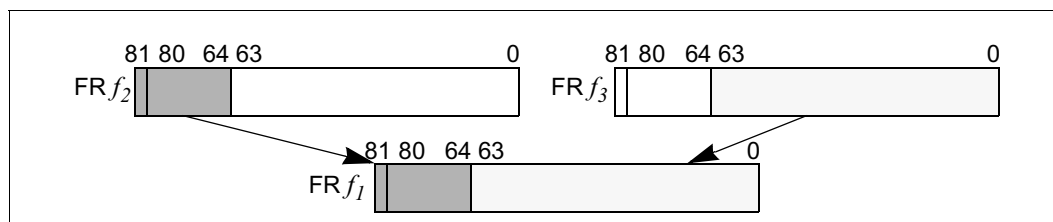

Figure 2-10. Floating-point Merge Sign and Exponent Operation



```

Operation:   if (PR[qp]) {
                fp_check_target_register(f1);
                if (tmp_isrcode = fp_reg_disabled(f1, f2, f3, 0))
                    disabled_fp_register_fault(tmp_isrcode, 0);

                if (fp_is_natval(FR[f2]) || fp_is_natval(FR[f3])) {
                    FR[f1] = NATVAL;
                } else {
                    FR[f1].significand = FR[f3].significand;
                    if (neg_sign_form) {
                        FR[f1].exponent = FR[f3].exponent;
                        FR[f1].sign = !FR[f2].sign;
                    } else if (sign_form) {
                        FR[f1].exponent = FR[f3].exponent;
                        FR[f1].sign = FR[f2].sign;
                    } else {
                        FR[f1].exponent = FR[f2].exponent;
                        FR[f1].sign = FR[f2].sign;
                    }
                }

                fp_update_psr(f1);
            }

```

FP Exceptions: None

Interruptions: Illegal Operation fault

Disabled Floating-point Register fault

fmin — Floating-point Minimum

Format: (qp) fmin.sf $f_1 = f_2, f_3$ F8

Description: The operand with the smaller value is placed in FR f_1 . If FR f_2 equals FR f_3 , FR f_1 gets FR f_3 .

If either FR f_2 or FR f_3 is a NaN, FR f_1 gets FR f_3 .

If either FR f_2 or FR f_3 is a NaTVal, FR f_1 is set to NaTVal instead of the computed result.

This operation does not propagate NaNs the same way as other arithmetic floating-point instructions. The Invalid Operation is signaled in the same manner as the `fcmlt` operation.

The mnemonic values for *sf* are given in [Table 2-23 on page 3:50](#).

Operation:

```

if (PR[qp]) {
    fp_check_target_register(f1);
    if (tmp_isrkode = fp_reg_disabled(f1, f2, f3, 0))
        disabled_fp_register_fault(tmp_isrkode, 0);

    if (fp_is_natval(FR[f2]) || fp_is_natval(FR[f3])) {
        FR[f1] = NATVAL;
    } else {
        fminmax_exception_fault_check(f2, f3, sf, &tmp_fp_env);
        if (fp_raise_fault(tmp_fp_env))
            fp_exception_fault(fp_decode_fault(tmp_fp_env));

        tmp_bool_res = fp_less_than(fp_reg_read(FR[f2]),
                                   fp_reg_read(FR[f3]));
        FR[f1] = tmp_bool_res ? FR[f2] : FR[f3];

        fp_update_fpsr(sf, tmp_fp_env);
    }
    fp_update_psr(f1);
}

```

FP Exceptions: Invalid Operation (V)
Denormal/Unnormal Operand (D)
Software Assist (SWA) fault

Interruptions: Illegal Operation fault Floating-point Exception fault
Disabled Floating-point Register fault

fmix — Floating-point Mix

| | | | |
|----------------|-------------------------------|-------------|----|
| Format: | (qp) fmix.l $f_1 = f_2, f_3$ | mix_l_form | F9 |
| | (qp) fmix.r $f_1 = f_2, f_3$ | mix_r_form | F9 |
| | (qp) fmix.lr $f_1 = f_2, f_3$ | mix_lr_form | F9 |

Description: For the mix_l_form (mix_r_form), the left (right) single precision value in FR_{f₂} is concatenated with the left (right) single precision value in FR_{f₃}. For the mix_lr_form, the left single precision value in FR_{f₂} is concatenated with the right single precision value in FR_{f₃}.

For all forms, the exponent field of FR_{f₁} is set to the biased exponent for 2.0⁶³ (0x1003E) and the sign field of FR_{f₁} is set to positive (0).

For all forms, if either FR_{f₂} or FR_{f₃} is a NaTVal, FR_{f₁} is set to NaTVal instead of the computed result.

Figure 2-11. Floating-point Mix Left

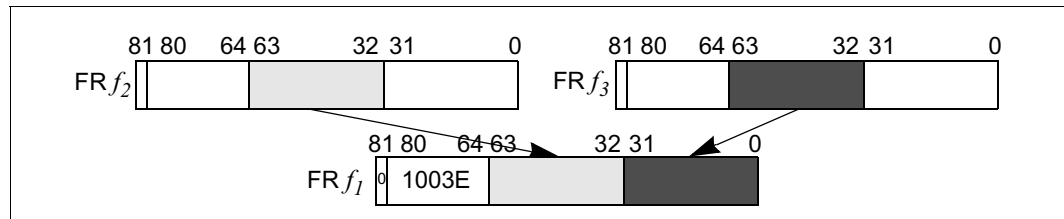

Figure 2-12. Floating-point Mix Right

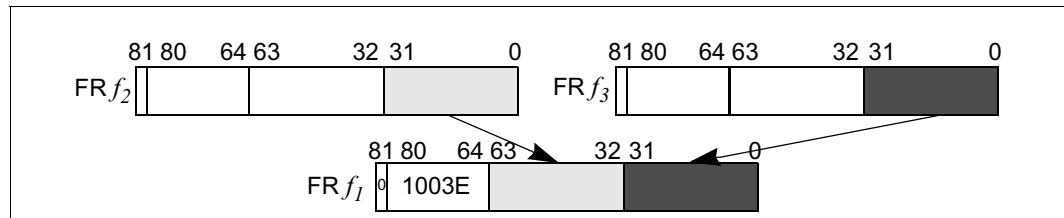
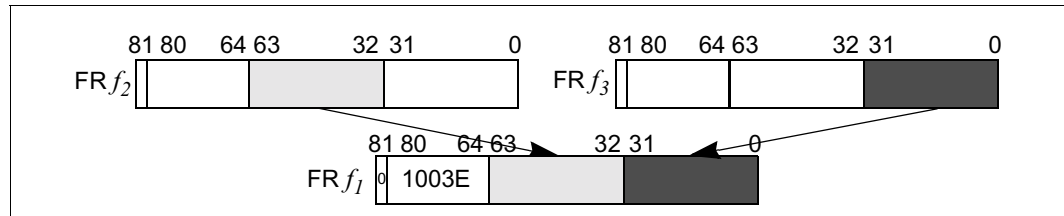

Figure 2-13. Floating-point Mix Left-Right



```

Operation:   if (PR[qp]) {
                fp_check_target_register(f1);
                if (tmp_israncode = fp_reg_disabled(f1, f2, f3, 0))
                    disabled_fp_register_fault(tmp_israncode, 0);

                if (fp_is_natval(FR[f2]) || fp_is_natval(FR[f3])) {
                    FR[f1] = NATVAL;
                } else {
                    if (mix_l_form) {
                        tmp_res_hi = FR[f2].significand{63:32};
                        tmp_res_lo = FR[f3].significand{63:32};
                    } else if (mix_r_form) {
                        tmp_res_hi = FR[f2].significand{31:0};
                        tmp_res_lo = FR[f3].significand{31:0};
                    } else { // mix_lr_form
                        tmp_res_hi = FR[f2].significand{63:32};
                        tmp_res_lo = FR[f3].significand{31:0};
                    }
                    FR[f1].significand = fp_concatenate(tmp_res_hi, tmp_res_lo);
                    FR[f1].exponent = FP_INTEGER_EXP;
                    FR[f1].sign = FP_SIGN_POSITIVE;
                }
                fp_update_psr(f1);
            }

```

FP Exceptions: None

Interruptions: Illegal Operation fault

Disabled Floating-point Register fault

fmpy — Floating-point Multiply

- Format:** $(qp) \text{ fmpy}.pc.sf \ f_1 = f_3, f_4$ pseudo-op of: $(qp) \text{ fma}.pc.sf \ f_1 = f_3, f_4, f_0$
- Description:** The product $FR\ f_3$ and $FR\ f_4$ is computed to infinite precision. The resulting value is then rounded to the precision indicated by pc (and possibly $FPSR.sf.pc$ and $FPSR.sf.wre$) using the rounding mode specified by $FPSR.sf.rc$. The rounded result is placed in $FR\ f_1$.
- If either $FR\ f_3$ or $FR\ f_4$ is a NaTVal, $FR\ f_1$ is set to NaTVal instead of the computed result.
- The mnemonic values for the opcode's pc are given in [Table 2-22 on page 3:50](#). The mnemonic values for sf are given in [Table 2-23 on page 3:50](#). For the encodings and interpretation of the status field's pc , wre , and rc , refer to [Table 5-6](#) and [Table 5-5 on page 1:80](#).
- Operation:** See "fma – Floating-point Multiply Add" on page 3:70.

fms — Floating-point Multiply Subtract

Format: (qp) fms.pc.sf $f_1 = f_3, f_4, f_2$ F1

Description: The product of FR f_3 and FR f_4 is computed to infinite precision and then FR f_2 is subtracted from this product, again in infinite precision. The resulting value is then rounded to the precision indicated by *pc* (and possibly FPCR.sf.pc and FPCR.sf.wre) using the rounding mode specified by FPCR.sf.rc. The rounded result is placed in FR f_1 .

If any of FR f_3 , FR f_4 , or FR f_2 is a NaTVal, a NaTVal is placed in FR f_1 instead of the computed result.

If f_2 is f0, an IEEE multiply operation is performed instead of a multiply and subtract. See “fmpy — Floating-point Multiply” on page 3:77.

The mnemonic values for the opcode’s *pc* are given in Table 2-22 on page 3:50. The mnemonic values for *sf* are given in Table 2-23 on page 3:50. For the encodings and interpretation of the status field’s *pc*, *wre*, and *rc*, refer to Table 5-6 and Table 5-5 on page 1:80.

Operation:

```

if (PR[qp]) {
    fp_check_target_register(f1);
    if (tmp_israncode = fp_reg_disabled(f1, f2, f3, f4))
        disabled_fp_register_fault(tmp_israncode, 0);

    if (fp_is_natval(FR[f2]) || fp_is_natval(FR[f3]) ||
        fp_is_natval(FR[f4])) {
        FR[f1] = NATVAL;
        fp_update_psr(f1);
    } else {
        tmp_default_result = fms_fnma_exception_fault_check(f2, f3, f4,
                                                            pc, sf, &tmp_fp_env);

        if (fp_raise_fault(tmp_fp_env))
            fp_exception_fault(fp_decode_fault(tmp_fp_env));

        if (fp_is_nan_or_inf(tmp_default_result)) {
            FR[f1] = tmp_default_result;
        } else {
            tmp_res = fp_mul(fp_reg_read(FR[f3]), fp_reg_read(FR[f4]));
            tmp_fr2 = fp_reg_read(FR[f2]);
            tmp_fr2.sign = !tmp_fr2.sign;
            if (f2 != 0)
                tmp_res = fp_add(tmp_res, tmp_fr2, tmp_fp_env);
            FR[f1] = fp_ieee_round(tmp_res, &tmp_fp_env);
        }

        fp_update_fpsr(sf, tmp_fp_env);
        fp_update_psr(f1);
        if (fp_raise_traps(tmp_fp_env))
            fp_exception_trap(fp_decode_trap(tmp_fp_env));
    }
}

```

| | |
|---|----------------------------|
| FP Exceptions: Invalid Operation (V) | Underflow (U) |
| Denormal/Unnormal Operand (D) | Overflow (O) |
| Software Assist (SWA) fault | Inexact (I) |
| | Software Assist (SWA) trap |

| | |
|---|--------------------------------|
| Interruptions: Illegal Operation fault | Floating-point Exception fault |
| Disabled Floating-point Register fault | Floating-point Exception trap |

fneg — Floating-point Negate

Format: $(qp) \text{ fneg } f_1 = f_3$ pseudo-op of: $(qp) \text{ fmerge.ns } f_1 = f_3, f_3$

Description: The value in $FR f_3$ is negated and placed in $FR f_1$.
If $FR f_3$ is a NaTVal, $FR f_1$ is set to NaTVal instead of the computed result.

Operation: See [“fmerge – Floating-point Merge”](#) on page 3:72.

fnegabs — Floating-point Negate Absolute Value

Format: (qp) fnegabs $f_1 = f_3$ pseudo-op of: (qp) fmerge.ns $f_1 = f_0, f_3$

Description: The absolute value of the value in FR f_3 is computed, negated, and placed in FR f_1 .
If FR f_3 is a NaTVal, FR f_1 is set to NaTVal instead of the computed result.

Operation: See ["fmerge – Floating-point Merge"](#) on page 3:72.

fnma — Floating-point Negative Multiply Add

Format: (qp) fnma.pc.sf $f_1 = f_3, f_4, f_2$ FI

Description: The product of FR f_3 and FR f_4 is computed to infinite precision, negated, and then FR f_2 is added to this product, again in infinite precision. The resulting value is then rounded to the precision indicated by *pc* (and possibly FPSR.*sf.pc* and FPSR.*sf.wre*) using the rounding mode specified by FPSR.*sf.rc*. The rounded result is placed in FR f_1 .

If any of FR f_3 , FR f_4 , or FR f_2 is a NaTVal, FR f_1 is set to NaTVal instead of the computed result.

If f_2 is f0, an IEEE multiply operation is performed, followed by negation of the product. See “fnmpy — Floating-point Negative Multiply” on page 3:82.

The mnemonic values for the opcode’s *pc* are given in Table 2-22 on page 3:50. The mnemonic values for *sf* are given in Table 2-23 on page 3:50. For the encodings and interpretation of the status field’s *pc*, *wre*, and *rc*, refer to Table 5-6 and Table 5-5 on page 1:80.

Operation:

```

if (PR[qp]) {
    fp_check_target_register( $f_1$ );
    if (tmp_israncode = fp_reg_disabled( $f_1, f_2, f_3, f_4$ ))
        disabled_fp_register_fault(tmp_israncode, 0);

    if (fp_is_natval(FR[ $f_2$ ]) || fp_is_natval(FR[ $f_3$ ]) ||
        fp_is_natval(FR[ $f_4$ ])) {
        FR[ $f_1$ ] = NATVAL;
        fp_update_psr( $f_1$ );
    } else {
        tmp_default_result = fms_fnma_exception_fault_check( $f_2, f_3, f_4,$ 
                                                             $pc, sf, &tmp\_fp\_env$ );

        if (fp_raise_fault(tmp_fp_env))
            fp_exception_fault(fp_decode_fault(tmp_fp_env));

        if (fp_is_nan_or_inf(tmp_default_result)) {
            FR[ $f_1$ ] = tmp_default_result;
        } else {
            tmp_res = fp_mul(fp_reg_read(FR[ $f_3$ ]), fp_reg_read(FR[ $f_4$ ]));
            tmp_res.sign = !tmp_res.sign;
            if ( $f_2 \neq 0$ )
                tmp_res = fp_add(tmp_res, fp_reg_read(FR[ $f_2$ ]), tmp_fp_env);
            FR[ $f_1$ ] = fp_ieee_round(tmp_res, &tmp_fp_env);
        }

        fp_update_fpsr(sf, tmp_fp_env);
        fp_update_psr( $f_1$ );
        if (fp_raise_traps(tmp_fp_env))
            fp_exception_trap(fp_decode_trap(tmp_fp_env));
    }
}

```

| | | |
|-----------------------|-------------------------------|----------------------------|
| FP Exceptions: | Invalid Operation (V) | Underflow (U) |
| | Denormal/Unnormal Operand (D) | Overflow (O) |
| | Software Assist (SWA) fault | Inexact (I) |
| | | Software Assist (SWA) trap |

| | | |
|--------------------|--|-------------------------------|
| Interrupts: | Disabled Floating-point Register fault | Floating-point Exception trap |
| | Floating-point Exception fault | |

fnmpy — Floating-point Negative Multiply

Format: $(qp) \text{ fnmpy.pc.sf } f_1 = f_3, f_4$ pseudo-op of: $(qp) \text{ fnma.pc.sf } f_1 = f_3, f_4, f_0$

Description: The product $FR f_3$ and $FR f_4$ is computed to infinite precision and then negated. The resulting value is then rounded to the precision indicated by pc (and possibly $FPSR.sf.pc$ and $FPSR.sf.wre$) using the rounding mode specified by $FPSR.sf.rc$. The rounded result is placed in $FR f_1$.

If either $FR f_3$ or $FR f_4$ is a NaTVal, $FR f_1$ is set to NaTVal instead of the computed result.

The mnemonic values for the opcode's pc are given in [Table 2-22 on page 3:50](#). The mnemonic values for sf are given in [Table 2-23 on page 3:50](#). For the encodings and interpretation of the status field's pc , wre , and rc , refer to [Table 5-6](#) and [Table 5-5 on page 1:80](#).

Operation: See "fnma – Floating-point Negative Multiply Add" on page 3:81.

fnorm — Floating-point Normalize

- Format:** $(qp) \text{ fnorm.pc.sf } f_1 = f_3$ pseudo-op of: $(qp) \text{ fma.pc.sf } f_1 = f_3, f_1, f_0$
- Description:** FR f_3 is normalized and rounded to the precision indicated by pc (and possibly FPSR. $sf.pc$ and FPSR. $sf.wre$) using the rounding mode specified by FPSR. $sf.rc$, and placed in FR f_1 .
If FR f_3 is a NaTVal, FR f_1 is set to NaTVal instead of the computed result.
The mnemonic values for the opcode's pc are given in [Table 2-22 on page 3:50](#). The mnemonic values for sf are given in [Table 2-23 on page 3:50](#). For the encodings and interpretation of the status field's pc , wre , and rc , refer to [Table 5-6](#) and [Table 5-5 on page 1:80](#).
- Operation:** See "fma – Floating-point Multiply Add" on page 3:70.

for — Floating-point Logical Or

Format: (qp) for $f_1 = f_2, f_3$ F9

Description: The bit-wise logical OR of the significand fields of FR f_2 and FR f_3 is computed. The resulting value is stored in the significand field of FR f_1 . The exponent field of FR f_1 is set to the biased exponent for 2.0^{63} (0x1003E) and the sign field of FR f_1 is set to positive (0).

If either FR f_2 or FR f_3 is a NaTVal, FR f_1 is set to NaTVal instead of the computed result.

Operation:

```

if (PR[qp]) {
    fp_check_target_register(f1);
    if (tmp_israncode = fp_reg_disabled(f1, f2, f3, 0))
        disabled_fp_register_fault(tmp_israncode, 0);

    if (fp_is_natval(FR[f2]) || fp_is_natval(FR[f3])) {
        FR[f1] = NATVAL;
    } else {
        FR[f1].significand = FR[f2].significand | FR[f3].significand;
        FR[f1].exponent = FP_INTEGER_EXP;
        FR[f1].sign = FP_SIGN_POSITIVE;
    }

    fp_update_psr(f1);
}

```

FP Exceptions: None

Interruptions: Illegal Operation fault

Disabled Floating-point Register fault

fpabs — Floating-point Parallel Absolute Value

- Format:** (qp) fpabs $f_1 = f_3$ pseudo-op of: (qp) fpmerge.s $f_1 = f_0, f_3$
- Description:** The absolute values of the pair of single precision values in the significand field of FR f_3 are computed and stored in the significand field of FR f_1 . The exponent field of FR f_1 is set to the biased exponent for 2.0^{63} (0x1003E) and the sign field of FR f_1 is set to positive (0).
If FR f_3 is a NaTVal, FR f_1 is set to NaTVal instead of the computed result.
- Operation:** See ["fpmerge – Floating-point Parallel Merge" on page 3:96](#).

fpack — Floating-point Pack

Format: (qp) fpack $f_1 = f_2, f_3$ pack_form F9

Description: The register format numbers in FR_{f_2} and FR_{f_3} are converted to single precision memory format. These two single precision numbers are concatenated and stored in the significand field of FR_{f_1} . The exponent field of FR_{f_1} is set to the biased exponent for 2.0^{63} (0x1003E) and the sign field of FR_{f_1} is set to positive (0).

If either FR_{f_2} or FR_{f_3} is a NaTVal, FR_{f_1} is set to NaTVal instead of the computed result.

Figure 2-14. Floating-point Pack

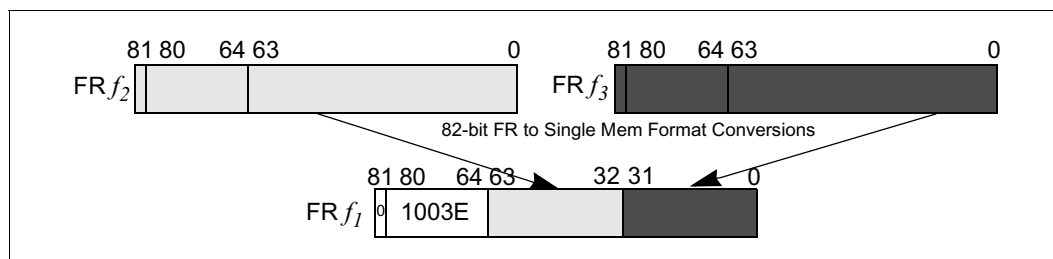

```

Operation:
if (PR[qp]) {
    fp_check_target_register( $f_1$ );
    if (tmp_israncode = fp_reg_disabled( $f_1, f_2, f_3, 0$ ))
        disabled_fp_register_fault(tmp_israncode, 0);

    if (fp_is_natval( $FR[f_2]$ ) || fp_is_natval( $FR[f_3]$ )) {
         $FR[f_1]$  = NATVAL;
    } else {
        tmp_res_hi = fp_single( $FR[f_2]$ );
        tmp_res_lo = fp_single( $FR[f_3]$ );

         $FR[f_1]$ .significand = fp_concatenate(tmp_res_hi, tmp_res_lo);
         $FR[f_1]$ .exponent = FP_INTEGER_EXP;
         $FR[f_1]$ .sign = FP_SIGN_POSITIVE;
    }
    fp_update_psr( $f_1$ );
}

```

FP Exceptions: None

Interruptions: Illegal Operation fault

Disabled Floating-point Register fault

fpamax — Floating-point Parallel Absolute Maximum

Format: (qp) fpamax.sf $f_1 = f_2, f_3$ F8

Description: The paired single precision values in the significands of FR f_2 and FR f_3 are compared. The operands with the larger absolute value are returned in the significand field of FR f_1 .

If the magnitude of high (low) FR f_3 is less than the magnitude of high (low) FR f_2 , high (low) FR f_1 gets high (low) FR f_2 . Otherwise high (low) FR f_1 gets high (low) FR f_3 .

If high (low) FR f_2 or high (low) FR f_3 is a NaN, and neither FR f_2 or FR f_3 is a NaTVal, high (low) FR f_1 gets high (low) FR f_3 .

The exponent field of FR f_1 is set to the biased exponent for 2.0⁶³ (0x1003E) and the sign field of FR f_1 is set to positive (0).

If either FR f_2 or FR f_3 is a NaTVal, FR f_1 is set to NaTVal instead of the computed result.

This operation does not propagate NaNs the same way as other arithmetic floating-point instructions. The Invalid Operation is signaled in the same manner as for the `fpcomp.lt` operation.

The mnemonic values for *sf* are given in [Table 2-23 on page 3:50](#).

Operation:

```

if (PR[qp]) {
    fp_check_target_register(f1);
    if (tmp_israncode = fp_reg_disabled(f1, f2, f3, 0))
        disabled_fp_register_fault(tmp_israncode, 0);

    if (fp_is_natval(FR[f2]) || fp_is_natval(FR[f3])) {
        FR[f1] = NATVAL;
    } else {
        fpminmax_exception_fault_check(f2, f3, sf, &tmp_fp_env);
        if (fp_raise_fault(tmp_fp_env))
            fp_exception_fault(fp_decode_fault(tmp_fp_env));

        tmp_fr2 = tmp_right = fp_reg_read_hi(f2);
        tmp_fr3 = tmp_left = fp_reg_read_hi(f3);
        tmp_right.sign = FP_SIGN_POSITIVE;
        tmp_left.sign = FP_SIGN_POSITIVE;
        tmp_bool_res = fp_less_than(tmp_left, tmp_right);
        tmp_res_hi = fp_single(tmp_bool_res ? tmp_fr2: tmp_fr3);

        tmp_fr2 = tmp_right = fp_reg_read_lo(f2);
        tmp_fr3 = tmp_left = fp_reg_read_lo(f3);
        tmp_right.sign = FP_SIGN_POSITIVE;
        tmp_left.sign = FP_SIGN_POSITIVE;
        tmp_bool_res = fp_less_than(tmp_left, tmp_right);
        tmp_res_lo = fp_single(tmp_bool_res ? tmp_fr2: tmp_fr3);

        FR[f1].significand = fp_concatenate(tmp_res_hi, tmp_res_lo);
        FR[f1].exponent = FP_INTEGER_EXP;
        FR[f1].sign = FP_SIGN_POSITIVE;

        fp_update_fpsr(sf, tmp_fp_env);
    }
    fp_update_psr(f1);
}

```

FP Exceptions: Invalid Operation (V)
Denormal/Unnormal Operand (D)
Software Assist (SWA) fault

Interruptions: Illegal Operation fault Floating-point Exception fault
Disabled Floating-point Register fault

fpamin — Floating-point Parallel Absolute Minimum

Format: (qp) fpamin.sf $f_1 = f_2, f_3$ F8

Description: The paired single precision values in the significands of FR f_2 or FR f_3 are compared. The operands with the smaller absolute value is returned in the significand of FR f_1 .

If the magnitude of high (low) FR f_2 is less than the magnitude of high (low) FR f_3 , high (low) FR f_1 gets high (low) FR f_2 . Otherwise high (low) FR f_1 gets high (low) FR f_3 .

If high (low) FR f_2 or high (low) FR f_3 is a NaN, and neither FR f_2 or FR f_3 is a NaTVal, high (low) FR f_1 gets high (low) FR f_3 .

The exponent field of FR f_1 is set to the biased exponent for 2.0⁶³ (0x1003E) and the sign field of FR f_1 is set to positive (0).

If either FR f_2 or FR f_3 is NaTVal, FR f_1 is set to NaTVal instead of the computed result.

This operation does not propagate NaNs the same way as other arithmetic floating-point instructions. The Invalid Operation is signaled in the same manner as for the `fpcomp.lt` operation.

The mnemonic values for *sf* are given in [Table 2-23 on page 3:50](#).

Operation:

```

if (PR[qp]) {
    fp_check_target_register(f1);
    if (tmp_israncode = fp_reg_disabled(f1, f2, f3, 0))
        disabled_fp_register_fault(tmp_israncode, 0);

    if (fp_is_natval(FR[f2]) || fp_is_natval(FR[f3])) {
        FR[f1] = NATVAL;
    } else {
        fpminmax_exception_fault_check(f2, f3, sf, &tmp_fp_env);
        if (fp_raise_fault(tmp_fp_env))
            fp_exception_fault(fp_decode_fault(tmp_fp_env));

        tmp_fr2 = tmp_left = fp_reg_read_hi(f2);
        tmp_fr3 = tmp_right = fp_reg_read_hi(f3);
        tmp_left.sign = FP_SIGN_POSITIVE;
        tmp_right.sign = FP_SIGN_POSITIVE;
        tmp_bool_res = fp_less_than(tmp_left, tmp_right);
        tmp_res_hi = fp_single(tmp_bool_res ? tmp_fr2: tmp_fr3);

        tmp_fr2 = tmp_left = fp_reg_read_lo(f2);
        tmp_fr3 = tmp_right = fp_reg_read_lo(f3);
        tmp_left.sign = FP_SIGN_POSITIVE;
        tmp_right.sign = FP_SIGN_POSITIVE;
        tmp_bool_res = fp_less_than(tmp_left, tmp_right);
        tmp_res_lo = fp_single(tmp_bool_res ? tmp_fr2: tmp_fr3);

        FR[f1].significand = fp_concatenate(tmp_res_hi, tmp_res_lo);
        FR[f1].exponent = FP_INTEGER_EXP;
        FR[f1].sign = FP_SIGN_POSITIVE;

        fp_update_fpsr(sf, tmp_fp_env);
    }
    fp_update_psr(f1);
}

```

FP Exceptions: Invalid Operation (V)
Denormal/Unnormal Operand (D)
Software Assist (SWA) fault

Interruptions: Illegal Operation fault Floating-point Exception fault
Disabled Floating-point Register fault

fpcmp — Floating-point Parallel Compare

Format: (qp) fpcmp.frel.sf f₁=f₂,f₃

F8

Description: The two pairs of single precision source operands in the significand fields of FR f₂ and FR f₃ are compared for one of twelve relations specified by *frel*. This produces a boolean result which is a mask of 32 1's if the comparison condition is true, and a mask of 32 0's otherwise. This result is written to a pair of 32-bit integers in the significand field of FR f₁. The exponent field of FR f₁ is set to the biased exponent for 2.0⁶³ (0x1003E) and the sign field of FR f₁ is set to positive (0).

Table 2-29. Floating-point Parallel Comparison Results

| PR[qp]==0 | PR[qp]==1 | | |
|-----------|-------------------------------------|------------------------------------|-------------------------------|
| | result==false, No Source NaTVals | result==true, No Source NaTVals | One or More Source NaTVals |
| unchanged | 0...0 | 1...1 | NaTVal |

The mnemonic values for *sf* are given in [Table 2-23 on page 3:50](#).

The relations are defined for each of the comparison types in [Table 2-29](#). Of the twelve relations, not all are directly implemented in hardware. Some are actually pseudo-ops. For these, the assembler simply switches the source operand specifiers and/or switches the predicate type specifiers and uses an implemented relation.

If either FR f₂ or FR f₃ is a NaTVal, FR f₁ is set to NaTVal instead of the computed result.

Table 2-30. Floating-point Parallel Comparison Relations

| <i>frel</i> | <i>frel</i> Completer Unabbreviated | Relation | Pseudo-op of | Quiet NaN as Operand Signals Invalid |
|-------------|--|--------------------------------------|-------------------------------------|--|
| eq | equal | f ₂ == f ₃ | | No |
| lt | less than | f ₂ < f ₃ | | Yes |
| le | less than or equal | f ₂ <= f ₃ | | Yes |
| gt | greater than | f ₂ > f ₃ | lt f ₂ ↔ f ₃ | Yes |
| ge | greater than or equal | f ₂ >= f ₃ | le f ₂ ↔ f ₃ | Yes |
| unord | unordered | f ₂ ? f ₃ | | No |
| neq | not equal | !(f ₂ == f ₃) | | No |
| nlt | not less than | !(f ₂ < f ₃) | | Yes |
| nle | not less than or equal | !(f ₂ <= f ₃) | | Yes |
| ngt | not greater than | !(f ₂ > f ₃) | nlt f ₂ ↔ f ₃ | Yes |
| nge | not greater than or equal | !(f ₂ >= f ₃) | nle f ₂ ↔ f ₃ | Yes |
| ord | ordered | !(f ₂ ? f ₃) | | No |

Operation:

```

if (PR[qp]) {
    fp_check_target_register(f1);
    if (tmp_israncode = fp_reg_disabled(f1, f2, f3, 0))
        disabled_fp_register_fault(tmp_israncode, 0);

    if (fp_is_natval(FR[f2]) || fp_is_natval(FR[f3])) {
        FR[f1] = NATVAL;
    } else {
        fpcmp_exception_fault_check(f2, f3, frel, sf, &tmp_fp_env);

        if (fp_raise_fault(tmp_fp_env))
            fp_exception_fault(fp_decode_fault(tmp_fp_env));

        tmp_fr2 = fp_reg_read_hi(f2);
    }
}

```

```

tmp_fr3 = fp_reg_read_hi(f3);

if      (frel == 'eq') tmp_rel = fp_equal(tmp_fr2, tmp_fr3);
else if (frel == 'lt') tmp_rel = fp_less_than(tmp_fr2, tmp_fr3);
else if (frel == 'le') tmp_rel = fp_lesser_or_equal(tmp_fr2,
                                                    tmp_fr3);
else if (frel == 'gt') tmp_rel = fp_less_than(tmp_fr3, tmp_fr2);
else if (frel == 'ge') tmp_rel = fp_lesser_or_equal(tmp_fr3,
                                                    tmp_fr2);
else if (frel == 'unord') tmp_rel = fp_unordered(tmp_fr2, tmp_fr3);
else if (frel == 'neq') tmp_rel = !fp_equal(tmp_fr2, tmp_fr3);
else if (frel == 'nlt') tmp_rel = !fp_less_than(tmp_fr2, tmp_fr3);
else if (frel == 'nle') tmp_rel = !fp_lesser_or_equal(tmp_fr2,
                                                    tmp_fr3);
else if (frel == 'ngt') tmp_rel = !fp_less_than(tmp_fr3, tmp_fr2);
else if (frel == 'nge') tmp_rel = !fp_lesser_or_equal(tmp_fr3,
                                                    tmp_fr2);
else      tmp_rel = !fp_unordered(tmp_fr2,
                                  tmp_fr3); // 'ord'

tmp_res_hi = (tmp_rel ? 0xFFFFFFFF : 0x00000000);

tmp_fr2 = fp_reg_read_lo(f2);
tmp_fr3 = fp_reg_read_lo(f3);

if      (frel == 'eq') tmp_rel = fp_equal(tmp_fr2, tmp_fr3);
else if (frel == 'lt') tmp_rel = fp_less_than(tmp_fr2, tmp_fr3);
else if (frel == 'le') tmp_rel = fp_lesser_or_equal(tmp_fr2,
                                                    tmp_fr3);
else if (frel == 'gt') tmp_rel = fp_less_than(tmp_fr3, tmp_fr2);
else if (frel == 'ge') tmp_rel = fp_lesser_or_equal(tmp_fr3,
                                                    tmp_fr2);
else if (frel == 'unord') tmp_rel = fp_unordered(tmp_fr2, tmp_fr3);
else if (frel == 'neq') tmp_rel = !fp_equal(tmp_fr2, tmp_fr3);
else if (frel == 'nlt') tmp_rel = !fp_less_than(tmp_fr2, tmp_fr3);
else if (frel == 'nle') tmp_rel = !fp_lesser_or_equal(tmp_fr2,
                                                    tmp_fr3);
else if (frel == 'ngt') tmp_rel = !fp_less_than(tmp_fr3, tmp_fr2);
else if (frel == 'nge') tmp_rel = !fp_lesser_or_equal(tmp_fr3,
                                                    tmp_fr2);
else      tmp_rel = !fp_unordered(tmp_fr2,
                                  tmp_fr3); // 'ord'

tmp_res_lo = (tmp_rel ? 0xFFFFFFFF : 0x00000000);

FR[f1].significand = fp_concatenate(tmp_res_hi, tmp_res_lo);
FR[f1].exponent = FP_INTEGER_EXP;
FR[f1].sign = FP_SIGN_POSITIVE;

    fp_update_fpsr(sf, tmp_fp_env);
}
fp_update_psr(f1);
}

```

FP Exceptions: Invalid Operation (V)
Denormal/Unnormal Operand (D)
Software Assist (SWA) fault

Interruptions: Illegal Operation fault
Disabled Floating-point Register fault

Floating-point Exception fault

fpcvt.fx — Convert Parallel Floating-point to Integer

| | | | |
|----------------|-------------------------------------|---------------------------|-----|
| Format: | (qp) fpcvt.fx.sf $f_1 = f_2$ | signed_form | F10 |
| | (qp) fpcvt.fx.trunc.sf $f_1 = f_2$ | signed_form, trunc_form | F10 |
| | (qp) fpcvt.fxu.sf $f_1 = f_2$ | unsigned_form | F10 |
| | (qp) fpcvt.fxu.trunc.sf $f_1 = f_2$ | unsigned_form, trunc_form | F10 |

Description: The pair of single precision values in the significand field of FR f_2 is converted to a pair of 32-bit signed integers (signed_form) or unsigned integers (unsigned_form) using either the rounding mode specified in the FPSR.sf.rc, or using Round-to-Zero if the trunc_form of the instruction is used. The result is written as a pair of 32-bit integers into the significand field of FR f_1 . The exponent field of FR f_1 is set to the biased exponent for 2.0^{63} (0x1003E) and the sign field of FR f_1 is set to positive (0). If the result of the conversion cannot be represented as a 32-bit integer, the 32-bit integer indefinite value 0x80000000 is used as the result, if the IEEE Invalid Operation Floating-point Exception fault is disabled.

If FR f_2 is a NaTVal, FR f_1 is set to NaTVal instead of the computed result.

The mnemonic values for *sf* are given in [Table 2-23 on page 3:50](#).

Operation:

```

if (PR[qp]) {
    fp_check_target_register( $f_1$ );
    if (tmp_israncode = fp_reg_disabled( $f_1$ ,  $f_2$ , 0, 0))
        disabled_fp_register_fault(tmp_israncode, 0);

    if (fp_is_natval(FR[ $f_2$ ])) {
        FR[ $f_1$ ] = NATVAL;
        fp_update_psr( $f_1$ );
    } else {
        tmp_default_result_pair = fpcvt_exception_fault_check( $f_2$ ,
            signed_form, trunc_form, sf, &tmp_fp_env);
        if (fp_raise_fault(tmp_fp_env))
            fp_exception_fault(fp_decode_fault(tmp_fp_env));

        if (fp_is_nan(tmp_default_result_pair.hi)) {
            tmp_res_hi = INTEGER_INDEFINITE_32_BIT;
        } else {
            tmp_res = fp_ieee_rnd_to_int_sp(fp_reg_read_hi( $f_2$ ), HIGH,
                &tmp_fp_env);

            if (tmp_res.exponent)
                tmp_res.significand = fp_U64_rsh(
                    tmp_res.significand, (FP_INTEGER_EXP - tmp_res.exponent));
            if (signed_form && tmp_res.sign)
                tmp_res.significand = (~tmp_res.significand) + 1;

            tmp_res_hi = tmp_res.significand{31:0};
        }

        if (fp_is_nan(tmp_default_result_pair.lo)) {
            tmp_res_lo = INTEGER_INDEFINITE_32_BIT;
        } else {
            tmp_res = fp_ieee_rnd_to_int_sp(fp_reg_read_lo( $f_2$ ), LOW,
                &tmp_fp_env);

            if (tmp_res.exponent)
                tmp_res.significand = fp_U64_rsh(
                    tmp_res.significand, (FP_INTEGER_EXP - tmp_res.exponent));
            if (signed_form && tmp_res.sign)
                tmp_res.significand = (~tmp_res.significand) + 1;

            tmp_res_lo = tmp_res.significand{31:0};
        }
    }
}

```

fpma — Floating-point Parallel Multiply Add

Format: (qp) fpma.sf $f_1 = f_3, f_4, f_2$ F1

Description: The pair of products of the pairs of single precision values in the significand fields of FR f_3 and FR f_4 are computed to infinite precision and then the pair of single precision values in the significand field of FR f_2 is added to these products, again in infinite precision. The resulting values are then rounded to single precision using the rounding mode specified by FPSR.sf.rc. The pair of rounded results are stored in the significand field of FR f_1 . The exponent field of FR f_1 is set to the biased exponent for 2.0⁶³ (0x1003E) and the sign field of FR f_1 is set to positive (0).

If any of FR f_3 , FR f_4 , or FR f_2 is a NaTVal, FR f_1 is set to NaTVal instead of the computed results.

Note: If f_2 is f0 in the fpma instruction, just the IEEE multiply operation is performed. (See “[fpmul — Floating-point Parallel Multiply](#)” on page 3:99.) FR f1, as an operand, is not a packed pair of 1.0 values, it is just the register file format’s 1.0 value.

The mnemonic values for sf are given in [Table 2-23 on page 3:50](#).

The encodings and interpretation for the status field’s rc are given in [Table 5-5 on page 1:80](#).

Operation:

```

if (PR[qp]) {
    fp_check_target_register(f1);
    if (tmp_isrkode = fp_reg_disabled(f1, f2, f3, f4))
        disabled_fp_register_fault(tmp_isrkode, 0);

    if (fp_is_natval(FR[f2]) || fp_is_natval(FR[f3]) ||
        fp_is_natval(FR[f4])) {
        FR[f1] = NATVAL;
        fp_update_psr(f1);
    } else {
        tmp_default_result_pair = fpma_exception_fault_check(f2,
            f3, f4, sf, &tmp_fp_env);
        if (fp_raise_fault(tmp_fp_env))
            fp_exception_fault(fp_decode_fault(tmp_fp_env));

        if (fp_is_nan_or_inf(tmp_default_result_pair.hi)) {
            tmp_res_hi = fp_single(tmp_default_result_pair.hi);
        } else {
            tmp_res = fp_mul(fp_reg_read_hi(f3), fp_reg_read_hi(f4));
            if (f2 != 0)
                tmp_res = fp_add(tmp_res, fp_reg_read_hi(f2), tmp_fp_env);
            tmp_res_hi = fp_ieee_round_sp(tmp_res, HIGH, &tmp_fp_env);
        }

        if (fp_is_nan_or_inf(tmp_default_result_pair.lo)) {
            tmp_res_lo = fp_single(tmp_default_result_pair.lo);
        } else {
            tmp_res = fp_mul(fp_reg_read_lo(f3), fp_reg_read_lo(f4));
            if (f2 != 0)
                tmp_res = fp_add(tmp_res, fp_reg_read_lo(f2), tmp_fp_env);
            tmp_res_lo = fp_ieee_round_sp(tmp_res, LOW, &tmp_fp_env);
        }

        FR[f1].significand = fp_concatenate(tmp_res_hi, tmp_res_lo);
        FR[f1].exponent = FP_INTEGER_EXP;
        FR[f1].sign = FP_SIGN_POSITIVE;

        fp_update_fpsr(sf, tmp_fp_env);
        fp_update_psr(f1);
        if (fp_raise_traps(tmp_fp_env))
            fp_exception_trap(fp_decode_trap(tmp_fp_env));
    }
}

```

}
}

FP Exceptions: Invalid Operation (V)
Denormal/Unnormal Operand (D)
Software Assist (SWA) Fault

Underflow (U)
Overflow (O)
Inexact (I)
Software Assist (SWA) trap

Interruptions: Illegal Operation fault
Disabled Floating-point Register fault

Floating-point Exception fault
Floating-point Exception trap

fpmax — Floating-point Parallel Maximum

Format: (qp) fpmax.sf $f_1 = f_2, f_3$ F8

Description: The paired single precision values in the significands of FR f_2 or FR f_3 are compared. The operands with the larger value is returned in the significand of FR f_1 .

If the value of high (low) FR f_3 is less than the value of high (low) FR f_2 , high (low) FR f_1 gets high (low) FR f_2 . Otherwise high (low) FR f_1 gets high (low) FR f_3 .

If high (low) FR f_2 or high (low) FR f_3 is a NaN, high (low) FR f_1 gets high (low) FR f_3 .

The exponent field of FR f_1 is set to the biased exponent for 2.0⁶³ (0x1003E) and the sign field of FR f_1 is set to positive (0).

If either FR f_2 or FR f_3 is NaTVal, FR f_1 is set to NaTVal instead of the computed result.

This operation does not propagate NaNs the same way as other arithmetic floating-point instructions. The Invalid Operation is signaled in the same manner as for the `fpcomp.lt` operation.

The mnemonic values for *sf* are given in [Table 2-23 on page 3:50](#).

Operation:

```

if (PR[qp]) {
    fp_check_target_register(f1);
    if (tmp_israncode = fp_reg_disabled(f1, f2, f3, 0))
        disabled_fp_register_fault(tmp_israncode, 0);

    if (fp_is_natval(FR[f2]) || fp_is_natval(FR[f3])) {
        FR[f1] = NATVAL;
    } else {
        fpminmax_exception_fault_check(f2, f3, sf, &tmp_fp_env);
        if (fp_raise_fault(tmp_fp_env))
            fp_exception_fault(fp_decode_fault(tmp_fp_env));

        tmp_fr2 = tmp_right = fp_reg_read_hi(f2);
        tmp_fr3 = tmp_left = fp_reg_read_hi(f3);
        tmp_bool_res = fp_less_than(tmp_left, tmp_right);
        tmp_res_hi = fp_single(tmp_bool_res ? tmp_fr2 : tmp_fr3);

        tmp_fr2 = tmp_right = fp_reg_read_lo(f2);
        tmp_fr3 = tmp_left = fp_reg_read_lo(f3);
        tmp_bool_res = fp_less_than(tmp_left, tmp_right);
        tmp_res_lo = fp_single(tmp_bool_res ? tmp_fr2 : tmp_fr3);

        FR[f1].significand = fp_concatenate(tmp_res_hi, tmp_res_lo);
        FR[f1].exponent = FP_INTEGER_EXP;
        FR[f1].sign = FP_SIGN_POSITIVE;

        fp_update_fpsr(sf, tmp_fp_env);
    }
    fp_update_psr(f1);
}

```

FP Exceptions: Invalid Operation (V)
Denormal/Unnormal Operand (D)
Software Assist (SWA) fault

Interruptions: Illegal Operation fault Floating-point Exception fault
Disabled Floating-point Register fault

fpmerge — Floating-point Parallel Merge

| | | | |
|----------------|----------------------------------|---------------|----|
| Format: | (qp) fpmerge.ns $f_1 = f_2, f_3$ | neg_sign_form | F9 |
| | (qp) fpmerge.s $f_1 = f_2, f_3$ | sign_form | F9 |
| | (qp) fpmerge.se $f_1 = f_2, f_3$ | sign_exp_form | F9 |

Description: For the neg_sign_form, the signs of the pair of single precision values in the significand field of FR f_2 are negated and concatenated with the exponents and the significands of the pair of single precision values in the significand field of FR f_3 and stored in the significand field of FR f_1 . This form can be used to negate a pair of single precision floating-point numbers by using the same register for f_2 and f_3 .

For the sign_form, the signs of the pair of single precision values in the significand field of FR f_2 are concatenated with the exponents and the significands of the pair of single precision values in the significand field of FR f_3 and stored in FR f_1 .

For the sign_exp_form, the signs and exponents of the pair of single precision values in the significand field of FR f_2 are concatenated with the pair of single precision significands in the significand field of FR f_3 and stored in the significand field of FR f_1 .

For all forms, the exponent field of FR f_1 is set to the biased exponent for 2.0^{63} (0x1003E) and the sign field of FR f_1 is set to positive (0).

For all forms, if either FR f_2 or FR f_3 is a NaNVal, FR f_1 is set to NaNVal instead of the computed result.

Figure 2-15. Floating-point Parallel Merge Negative Sign Operation

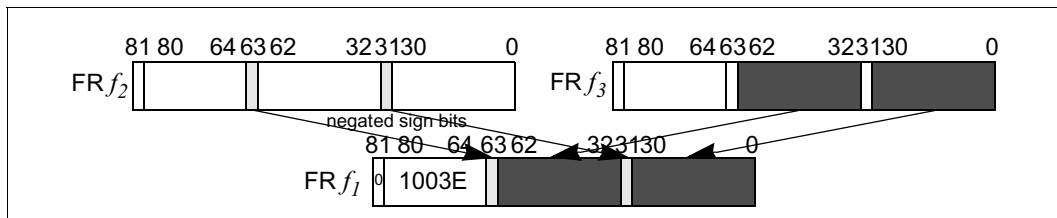

Figure 2-16. Floating-point Parallel Merge Sign Operation

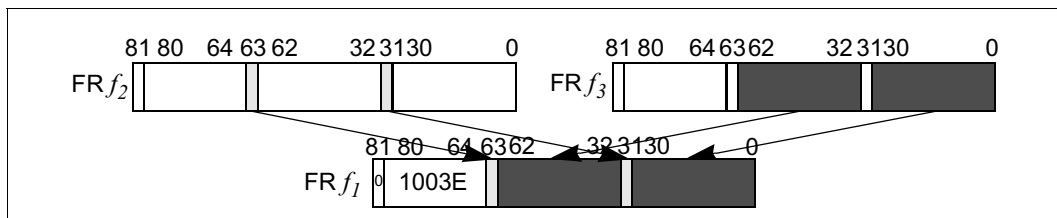
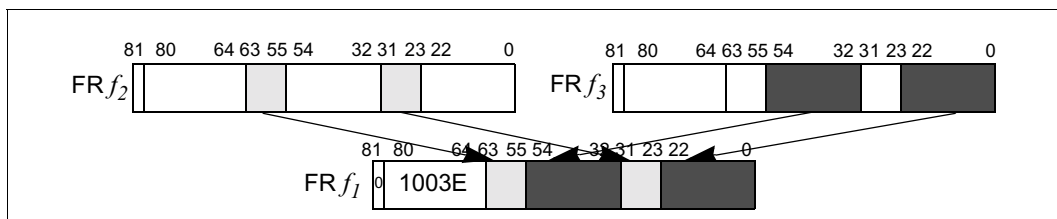

Figure 2-17. Floating-point Parallel Merge Sign and Exponent Operation



```

Operation:   if (PR[qp]) {
                fp_check_target_register(f1);
                if (tmp_israncode = fp_reg_disabled(f1, f2, f3, 0))
                    disabled_fp_register_fault(tmp_israncode, 0);

                if (fp_is_natval(FR[f2]) || fp_is_natval(FR[f3])) {
                    FR[f1] = NATVAL;
                } else {
                    if (neg_sign_form) {
                        tmp_res_hi = (!FR[f2].significand{63} << 31)
                                    | (FR[f3].significand{62:32});
                        tmp_res_lo = (!FR[f2].significand{31} << 31)
                                    | (FR[f3].significand{30:0});
                    } else if (sign_form) {
                        tmp_res_hi = (FR[f2].significand{63} << 31)
                                    | (FR[f3].significand{62:32});
                        tmp_res_lo = (FR[f2].significand{31} << 31)
                                    | (FR[f3].significand{30:0});
                    } else {
                        tmp_res_hi = (FR[f2].significand{63:55} << 23)
                                    | (FR[f3].significand{54:32});
                        tmp_res_lo = (FR[f2].significand{31:23} << 23)
                                    | (FR[f3].significand{22:0});
                    }

                    FR[f1].significand = fp_concatenate(tmp_res_hi, tmp_res_lo);
                    FR[f1].exponent = FP_INTEGER_EXP;
                    FR[f1].sign = FP_SIGN_POSITIVE;
                }

                fp_update_psr(f1);
            }

```

FP Exceptions: None

Interruptions: Illegal Operation fault

Disabled Floating-point Register fault

fpmin — Floating-point Parallel Minimum

Format: (qp) fpmin.sf $f_1 = f_2, f_3$ F8

Description: The paired single precision values in the significands of FR f_2 or FR f_3 are compared. The operands with the smaller value is returned in significand of FR f_1 .

If the value of high (low) FR f_2 is less than the value of high (low) FR f_3 , high (low) FR f_1 gets high (low) FR f_2 . Otherwise high (low) FR f_1 gets high (low) FR f_3 .

If high (low) FR f_2 or high (low) FR f_3 is a NaN, high (low) FR f_1 gets high (low) FR f_3 .

The exponent field of FR f_1 is set to the biased exponent for 2.0^{63} (0x1003E) and the sign field of FR f_1 is set to positive (0).

If either FR f_2 or FR f_3 is a NaTVal, FR f_1 is set to NaTVal instead of the computed result.

This operation does not propagate NaNs the same way as other arithmetic floating-point instructions. The Invalid Operation is signaled in the same manner as for the `fpcomp.lt` operation.

The mnemonic values for *sf* are given in [Table 2-23 on page 3:50](#).

Operation:

```

if (PR[qp]) {
    fp_check_target_register(f1);
    if (tmp_israncode = fp_reg_disabled(f1, f2, f3, 0))
        disabled_fp_register_fault(tmp_israncode, 0);

    if (fp_is_natval(FR[f2]) || fp_is_natval(FR[f3])) {
        FR[f1] = NATVAL;
    } else {
        fpminmax_exception_fault_check(f2, f3, sf, &tmp_fp_env);
        if (fp_raise_fault(tmp_fp_env))
            fp_exception_fault(fp_decode_fault(tmp_fp_env));

        tmp_fr2 = tmp_left = fp_reg_read_hi(f2);
        tmp_fr3 = tmp_right = fp_reg_read_hi(f3);
        tmp_bool_res = fp_less_than(tmp_left, tmp_right);
        tmp_res_hi = fp_single(tmp_bool_res ? tmp_fr2 : tmp_fr3);

        tmp_fr2 = tmp_left = fp_reg_read_lo(f2);
        tmp_fr3 = tmp_right = fp_reg_read_lo(f3);
        tmp_bool_res = fp_less_than(tmp_left, tmp_right);
        tmp_res_lo = fp_single(tmp_bool_res ? tmp_fr2 : tmp_fr3);

        FR[f1].significand = fp_concatenate(tmp_res_hi, tmp_res_lo);
        FR[f1].exponent = FP_INTEGER_EXP;
        FR[f1].sign = FP_SIGN_POSITIVE;

        fp_update_fpsr(sf, tmp_fp_env);
    }
    fp_update_psr(f1);
}

```

FP Exceptions: Invalid Operation (V)
Denormal/Unnormal Operand (D)
Software Assist (SWA) fault

Interruptions: Illegal Operation fault Floating-point Exception fault
Disabled Floating-point Register fault

fpm_{py} — Floating-point Parallel Multiply

- Format:** (qp) fpm_{py}.*sf* $f_1 = f_3, f_4$ pseudo-op of: (qp) fpma.*sf* $f_1 = f_3, f_4, f_0$
- Description:** The pair of products of the pairs of single precision values in the significand fields of FR f_3 and FR f_4 are computed to infinite precision. The resulting values are then rounded to single precision using the rounding mode specified by FPSR.*sf.rc*. The pair of rounded results are stored in the significand field of FR f_1 . The exponent field of FR f_1 is set to the biased exponent for 2.0^{63} (0x1003E) and the sign field of FR f_1 is set to positive (0).
- If either FR f_3 , or FR f_4 is a NaTVal, FR f_1 is set to NaTVal instead of the computed results.
- The mnemonic values for *sf* are given in [Table 2-23 on page 3:50](#).
- The encodings and interpretation for the status field's *rc* are given in [Table 5-5 on page 1:80](#).
- Operation:** See "fpma – Floating-point Parallel Multiply Add" on page 3:93.

fpms — Floating-point Parallel Multiply Subtract

Format: (qp) fpms.sf $f_1=f_3, f_4, f_2$ F1

Description: The pair of products of the pairs of single precision values in the significand fields of FR f_3 and FR f_4 are computed to infinite precision and then the pair of single precision values in the significand field of FR f_2 is subtracted from these products, again in infinite precision. The resulting values are then rounded to single precision using the rounding mode specified by FPSR.sf.rc. The pair of rounded results are stored in the significand field of FR f_1 . The exponent field of FR f_1 is set to the biased exponent for 2.0^{63} (0x1003E) and the sign field of FR f_1 is set to positive (0).

Note: If any of FR f_3 , FR f_4 , or FR f_2 is a NaTVal, FR f_1 is set to NaTVal instead of the computed results.

Mapping: If f_2 is f0 in the fpms instruction, just the IEEE multiply operation is performed.

The mnemonic values for *sf* are given in [Table 2-23 on page 3:50](#).

The encodings and interpretation for the status field's *rc* are given in [Table 5-5 on page 1:80](#).

Operation:

```

if (PR[qp]) {
    fp_check_target_register(f1);
    if (tmp_israncode = fp_reg_disabled(f1, f2, f3, f4))
        disabled_fp_register_fault(tmp_israncode, 0);

    if (fp_is_natval(FR[f2]) || fp_is_natval(FR[f3]) ||
        fp_is_natval(FR[f4])) {
        FR[f1] = NATVAL;
        fp_update_psr(f1);
    } else {
        tmp_default_result_pair = fpms_fpnma_exception_fault_check(f2, f3,
                                                                    f4, sf, &tmp_fp_env);

        if (fp_raise_fault(tmp_fp_env))
            fp_exception_fault(fp_decode_fault(tmp_fp_env));

        if (fp_is_nan_or_inf(tmp_default_result_pair.hi)) {
            tmp_res_hi = fp_single(tmp_default_result_pair.hi);
        } else {
            tmp_res = fp_mul(fp_reg_read_hi(f3), fp_reg_read_hi(f4));
            if (f2 != 0) {
                tmp_sub = fp_reg_read_hi(f2);
                tmp_sub.sign = !tmp_sub.sign;
                tmp_res = fp_add(tmp_res, tmp_sub, tmp_fp_env);
            }
            tmp_res_hi = fp_ieee_round_sp(tmp_res, HIGH, &tmp_fp_env);
        }

        if (fp_is_nan_or_inf(tmp_default_result_pair.lo)) {
            tmp_res_lo = fp_single(tmp_default_result_pair.lo);
        } else {
            tmp_res = fp_mul(fp_reg_read_lo(f3), fp_reg_read_lo(f4));
            if (f2 != 0) {
                tmp_sub = fp_reg_read_lo(f2);
                tmp_sub.sign = !tmp_sub.sign;
                tmp_res = fp_add(tmp_res, tmp_sub, tmp_fp_env);
            }
            tmp_res_lo = fp_ieee_round_sp(tmp_res, LOW, &tmp_fp_env);
        }

        FR[f1].significand = fp_concatenate(tmp_res_hi, tmp_res_lo);
        FR[f1].exponent = FP_INTEGER_EXP;
    }
}

```

```

FR[f1].sign = FP_SIGN_POSITIVE;

fp_update_fpsr(sf, tmp_fp_env);
fp_update_psr(f1);
if (fp_raise_traps(tmp_fp_env))
    fp_exception_trap(fp_decode_trap(tmp_fp_env));
    }
}

```

| | | |
|-----------------------|--|--------------------------------|
| FP Exceptions: | Invalid Operation (V) | Underflow (U) |
| | Denormal/Unnormal Operand (D) | Overflow (O) |
| | Software Assist (SWA) fault | Inexact (I) |
| | | Software Assist (SWA) trap |
| Interruptions: | Illegal Operation fault | Floating-point Exception fault |
| | Disabled Floating-point Register fault | Floating-point Exception trap |

fpneg — Floating-point Parallel Negate

Format: (qp) fpneg $f_1 = f_3$ pseudo-op of: (qp) fpmerge.ns $f_1 = f_3, f_3$

Description: The pair of single precision values in the significand field of FR f_3 are negated and stored in the significand field of FR f_1 . The exponent field of FR f_1 is set to the biased exponent for 2.0^{63} (0x1003E) and the sign field of FR f_1 is set to positive (0).

If FR f_3 is a NaTVal, FR f_1 is set to NaTVal instead of the computed result.

Operation: See ["fpmerge – Floating-point Parallel Merge"](#) on page 3:96.

fpnegabs — Floating-point Parallel Negate Absolute Value

- Format:** (qp) fpnegabs $f_1 = f_3$ pseudo-op of: (qp) fpmerge.ns $f_1 = f_0, f_3$
- Description:** The absolute values of the pair of single precision values in the significand field of FR f_3 are computed, negated and stored in the significand field of FR f_1 . The exponent field of FR f_1 is set to the biased exponent for 2.0^{63} (0x1003E) and the sign field of FR f_1 is set to positive (0).
If FR f_3 is a NaTVal, FR f_1 is set to NaTVal instead of the computed result.
- Operation:** See ["fpmerge – Floating-point Parallel Merge" on page 3:96](#).

fpnma — Floating-point Parallel Negative Multiply Add

Format: (qp) fpnma.sf $f_1 = f_3, f_4, f_2$ F1

Description: The pair of products of the pairs of single precision values in the significand fields of FR f_3 and FR f_4 are computed to infinite precision, negated, and then the pair of single precision values in the significand field of FR f_2 are added to these (negated) products, again in infinite precision. The resulting values are then rounded to single precision using the rounding mode specified by FPSR.sf.rc. The pair of rounded results are stored in the significand field of FR f_1 . The exponent field of FR f_1 is set to the biased exponent for 2.0^{63} (0x1003E) and the sign field of FR f_1 is set to positive (0).

If any of FR f_3 , FR f_4 , or FR f_2 is a NaTVal, FR f_1 is set to NaTVal instead of the computed result.

Note: If f_2 is f0 in the fpnma instruction, just the IEEE multiply operation (with the product being negated before rounding) is performed.

The mnemonic values for sf are given in [Table 2-23 on page 3:50](#).

The encodings and interpretation for the status field's rc are given in [Table 5-5 on page 1:80](#).

Operation:

```

if (PR[qp]) {
    fp_check_target_register(f1);
    if (tmp_israncode = fp_reg_disabled(f1, f2, f3, f4))
        disabled_fp_register_fault(tmp_israncode, 0);

    if (fp_is_natval(FR[f2]) || fp_is_natval(FR[f3]) ||
        fp_is_natval(FR[f4])) {
        FR[f1] = NATVAL;
        fp_update_psr(f1);
    } else {
        tmp_default_result_pair = fpms_fpnma_exception_fault_check(f2, f3,
                                                                    f4, sf, &tmp_fp_env);

        if (fp_raise_fault(tmp_fp_env))
            fp_exception_fault(fp_decode_fault(tmp_fp_env));

        if (fp_is_nan_or_inf(tmp_default_result_pair.hi)) {
            tmp_res_hi = fp_single(tmp_default_result_pair.hi);
        } else {
            tmp_res = fp_mul(fp_reg_read_hi(f3), fp_reg_read_hi(f4));
            tmp_res.sign = !tmp_res.sign;
            if (f2 != 0)
                tmp_res = fp_add(tmp_res, fp_reg_read_hi(f2), tmp_fp_env);
            tmp_res_hi = fp_ieee_round_sp(tmp_res, HIGH, &tmp_fp_env);
        }

        if (fp_is_nan_or_inf(tmp_default_result_pair.lo)) {
            tmp_res_lo = fp_single(tmp_default_result_pair.lo);
        } else {
            tmp_res = fp_mul(fp_reg_read_lo(f3), fp_reg_read_lo(f4));
            tmp_res.sign = !tmp_res.sign;
            if (f2 != 0)
                tmp_res = fp_add(tmp_res, fp_reg_read_lo(f2), tmp_fp_env);
            tmp_res_lo = fp_ieee_round_sp(tmp_res, LOW, &tmp_fp_env);
        }

        FR[f1].significand = fp_concatenate(tmp_res_hi, tmp_res_lo);
        FR[f1].exponent = FP_INTEGER_EXP;
        FR[f1].sign = FP_SIGN_POSITIVE;

        fp_update_fpsr(sf, tmp_fp_env);
        fp_update_psr(f1);
    }
}

```



```
        if (fp_raise_traps(tmp_fp_env))
            fp_exception_trap(fp_decode_trap(tmp_fp_env));
    }
```

| | |
|---|--------------------------------|
| FP Exceptions: Invalid Operation (V) | Underflow (U) |
| Denormal/Unnormal Operand (D) | Overflow (O) |
| Software Assist (SWA) fault | Inexact (I) |
| | Software Assist (SWA) trap |
| Interruptions: Illegal Operation fault | Floating-point Exception fault |
| Disabled Floating-point Register fault | Floating-point Exception trap |

fpmmpy — Floating-point Parallel Negative Multiply

- Format:** (qp) fpmmpy.sf $f_1 = f_3, f_4$ pseudo-op of: (qp) fpmma.sf $f_1 = f_3, f_4, f_0$
- Description:** The pair of products of the pairs of single precision values in the significand fields of FR f_3 and FR f_4 are computed to infinite precision and then negated. The resulting values are then rounded to single precision using the rounding mode specified by FPSR.sf.rc. The pair of rounded results are stored in the significand field of FR f_1 . The exponent field of FR f_1 is set to the biased exponent for 2.0^{63} (0x1003E) and the sign field of FR f_1 is set to positive (0).
- If either FR f_3 or FR f_4 is a NaTVal, FR f_1 is set to NaTVal instead of the computed results.
- The mnemonic values for sf are given in [Table 2-23 on page 3:50](#).
The encodings and interpretation for the status field's rc are given in [Table 5-5 on page 1:80](#).
- Operation:** See "fpmma – Floating-point Parallel Negative Multiply Add" on page 3:104.

fprcpa — Floating-point Parallel Reciprocal Approximation

Format: $(qp) \text{ fprcpa.sf } f_1, p_2 = f_2, f_3$ F6

Description: If PR qp is 0, PR p_2 is cleared and FR f_1 remains unchanged.

If PR qp is 1, the following will occur:

- Each half of the significand of FR f_1 is either set to an approximation (with a relative error $< 2^{-8.886}$) of the reciprocal of the corresponding half of FR f_3 , or set to the IEEE-754 mandated response for the quotient $\text{FR } f_2 / \text{FR } f_3$ of the corresponding half — if that half of FR f_2 or of FR f_3 is in the set $\{-\text{Infinity}, -0, +0, +\text{Infinity}, \text{NaN}\}$.
- If either half of FR f_1 is set to the IEEE-754 mandated quotient, or is set to an approximation of the reciprocal which may cause the Newton-Raphson iterations to fail to produce the correct IEEE-754 divide result, then PR p_2 is set to 0, otherwise it is set to 1.

For correct IEEE divide results, when PR p_2 is cleared, user software is expected to compute the quotient $(\text{FR } f_2 / \text{FR } f_3)$ for each half (using the non-parallel `frcpa` instruction), and merge the results into FR f_1 , keeping PR p_2 cleared.

- The exponent field of FR f_1 is set to the biased exponent for 2.0^{63} (0x1003E) and the sign field of FR f_1 is set to positive (0).
- If either FR f_2 or FR f_3 is a NaTVal, FR f_1 is set to NaTVal instead of the computed result, and PR p_2 is cleared.

The mnemonic values for sf are given in [Table 2-23 on page 3:50](#).

Operation:

```

if (PR[qp]) {
    fp_check_target_register(f1);
    if (tmp_israncode = fp_reg_disabled(f1, f2, f3, 0))
        disabled_fp_register_fault(tmp_israncode, 0);

    if (fp_is_natval(FR[f2]) || fp_is_natval(FR[f3])) {
        FR[f1] = NATVAL;
        PR[p2] = 0;
    } else {
        tmp_default_result_pair = fprcpa_exception_fault_check(f2, f3, sf,
                                                                &tmp_fp_env, &limits_check);

        if (fp_raise_fault(tmp_fp_env))
            fp_exception_fault(fp_decode_fault(tmp_fp_env));

        if (fp_is_nan_or_inf(tmp_default_result_pair.hi) ||
            limits_check.hi_fr3) {
            tmp_res_hi = fp_single(tmp_default_result_pair.hi);
            tmp_pred_hi = 0;
        } else {
            num = fp_normalize(fp_reg_read_hi(f2));
            den = fp_normalize(fp_reg_read_hi(f3));
            if (fp_is_inf(num) && fp_is_finite(den)) {
                tmp_res = FP_INFINITY;
                tmp_res.sign = num.sign ^ den.sign;
                tmp_pred_hi = 0;
            } else if (fp_is_finite(num) && fp_is_inf(den)) {
                tmp_res = FP_ZERO;
                tmp_res.sign = num.sign ^ den.sign;
                tmp_pred_hi = 0;
            } else if (fp_is_zero(num) && fp_is_finite(den)) {
                tmp_res = FP_ZERO;
                tmp_res.sign = num.sign ^ den.sign;
                tmp_pred_hi = 0;
            }
        }
    }
}

```

```

    } else {
        tmp_res = fp_ieee_recip(den);
        if (limits_check.hi_fr2_or_quot)
            tmp_pred_hi = 0;
        else
            tmp_pred_hi = 1;
    }
    tmp_res_hi = fp_single(tmp_res);
}
if (fp_is_nan_or_inf(tmp_default_result_pair.lo) ||
    limits_check.lo_fr3) {
    tmp_res_lo = fp_single(tmp_default_result_pair.lo);
    tmp_pred_lo = 0;
} else {
    num = fp_normalize(fp_reg_read_lo(f2));
    den = fp_normalize(fp_reg_read_lo(f3));
    if (fp_is_inf(num) && fp_is_finite(den)) {
        tmp_res = FP_INFINITY;
        tmp_res.sign = num.sign ^ den.sign;
        tmp_pred_lo = 0;
    } else if (fp_is_finite(num) && fp_is_inf(den)) {
        tmp_res = FP_ZERO;
        tmp_res.sign = num.sign ^ den.sign;
        tmp_pred_lo = 0;
    } else if (fp_is_zero(num) && fp_is_finite(den)) {
        tmp_res = FP_ZERO;
        tmp_res.sign = num.sign ^ den.sign;
        tmp_pred_lo = 0;
    } else {
        tmp_res = fp_ieee_recip(den);
        if (limits_check.lo_fr2_or_quot)
            tmp_pred_lo = 0;
        else
            tmp_pred_lo = 1;
    }
    tmp_res_lo = fp_single(tmp_res);
}

FR[f1].significand = fp_concatenate(tmp_res_hi, tmp_res_lo);
FR[f1].exponent = FP_INTEGER_EXP;
FR[f1].sign = FP_SIGN_POSITIVE;
PR[p2] = tmp_pred_hi && tmp_pred_lo;

    fp_update_fpsr(sf, tmp_fp_env);
}
fp_update_psr(f1);
} else {
    PR[p2] = 0;
}

```

FP Exceptions: Invalid Operation (V)
Zero Divide (Z)
Denormal/Unnormal Operand (D)
Software Assist (SWA) fault

Interruptions: Illegal Operation fault
Disabled Floating-point Register fault

Floating-point Exception fault

fprsqrrta — Floating-point Parallel Reciprocal Square Root Approximation

Format: (qp) fprsqrrta.sf $f_1, p_2 = f_3$

F7

Description: If PR qp is 0, PR p_2 is cleared and FR f_1 remains unchanged.

If PR qp is 1, the following will occur:

- Each half of the significand of FR f_1 is either set to an approximation (with a relative error $< 2^{-8.831}$) of the reciprocal square root of the corresponding half of FR f_3 , or set to the IEEE-754 compliant response for the reciprocal square root of the corresponding half of FR f_3 — if that half of FR f_3 is in the set $\{-Infinity, -Finite, -0, +0, +Infinity, NaN\}$.
- If either half of FR f_1 is set to the IEEE-754 mandated reciprocal square root, or is set to an approximation of the reciprocal square root which may cause the Newton-Raphson iterations to fail to produce the correct IEEE-754 square root result, then PR p_2 is set to 0, otherwise it is set to 1.

For correct IEEE square root results, when PR p_2 is cleared, user software is expected to compute the square root for each half (using the non-parallel `frsqrrta` instruction), and merge the results in FR f_1 , keeping PR p_2 cleared.

- The exponent field of FR f_1 is set to the biased exponent for 2.0^{63} (0x1003E) and the sign field of FR f_1 is set to positive (0).
- If FR f_3 is a NaNVal, FR f_1 is set to NaNVal instead of the computed result, and PR p_2 is cleared.

The mnemonic values for sf are given in [Table 2-23 on page 3:50](#).

Operation:

```

if (PR[qp]) {
    fp_check_target_register(f1);
    if (tmp_israncode = fp_reg_disabled(f1, f3, 0, 0))
        disabled_fp_register_fault(tmp_israncode, 0);

    if (fp_is_natval(FR[f3])) {
        FR[f1] = NATVAL;
        PR[p2] = 0;
    } else {
        tmp_default_result_pair = fprsqrrta_exception_fault_check(f3, sf,
                                                                    &tmp_fp_env, &limits_check);
        if (fp_raise_fault(tmp_fp_env))
            fp_exception_fault(fp_decode_fault(tmp_fp_env));

        if (fp_is_nan(tmp_default_result_pair.hi)) {
            tmp_res_hi = fp_single(tmp_default_result_pair.hi);
            tmp_pred_hi = 0;
        } else {
            tmp_fr3 = fp_normalize(fp_reg_read_hi(f3));
            if (fp_is_zero(tmp_fr3)) {
                tmp_res = FP_INFINITY;
                tmp_res.sign = tmp_fr3.sign;
                tmp_pred_hi = 0;
            } else if (fp_is_pos_inf(tmp_fr3)) {
                tmp_res = FP_ZERO;
                tmp_pred_hi = 0;
            } else {
                tmp_res = fp_ieee_recip_sqrt(tmp_fr3);
                if (limits_check.hi)
                    tmp_pred_hi = 0;
                else
                    tmp_pred_hi = 1;
            }
        }
    }
}

```

frcpa — Floating-point Reciprocal Approximation

Format: (qp) frcpa.sf $f_1, p_2 = f_2, f_3$

F6

Description: If PR qp is 0, PR p_2 is cleared and FR f_1 remains unchanged.

If PR qp is 1, the following will occur:

- FR f_1 is either set to an approximation (with a relative error $< 2^{-8.886}$) of the reciprocal of FR f_3 , or to the IEEE-754 mandated quotient of FR f_2 /FR f_3 — if either FR f_2 or FR f_3 is in the set {-Infinity, -0, Pseudo-zero, +0, +Infinity, NaN, Unsupported}.
- If FR f_1 is set to the approximation of the reciprocal of FR f_3 , then PR p_2 is set to 1; otherwise, it is set to 0.
- If FR f_2 and FR f_3 are such that the approximation of FR f_3 's reciprocal may cause the Newton-Raphson iterations to fail to produce the correct IEEE-754 result of FR f_2 /FR f_3 , then a Floating-point Exception fault for Software Assist occurs.
System software is expected to compute the IEEE-754 quotient (FR f_2 /FR f_3), return the result in FR f_1 , and set PR p_2 to 0.
- If either FR f_2 or FR f_3 is a NaTVal, FR f_1 is set to NaTVal instead of the computed result, and PR p_2 is cleared.

The mnemonic values for *sf* are given in [Table 2-23 on page 3:50](#).

Operation:

```

if (PR[qp]) {
    fp_check_target_register(f1);
    if (tmp_israncode = fp_reg_disabled(f1, f2, f3, 0))
        disabled_fp_register_fault(tmp_israncode, 0);

    if (fp_is_natval(FR[f2]) || fp_is_natval(FR[f3])) {
        FR[f1] = NATVAL;
        PR[p2] = 0;
    } else {
        tmp_default_result = frcpa_exception_fault_check(f2, f3, sf,
                                                         &tmp_fp_env);

        if (fp_raise_fault(tmp_fp_env))
            fp_exception_fault(fp_decode_fault(tmp_fp_env));

        if (fp_is_nan_or_inf(tmp_default_result)) {
            FR[f1] = tmp_default_result;
            PR[p2] = 0;
        } else {
            num = fp_normalize(fp_reg_read(FR[f2]));
            den = fp_normalize(fp_reg_read(FR[f3]));
            if (fp_is_inf(num) && fp_is_finite(den)) {
                FR[f1] = FP_INFINITY;
                FR[f1].sign = num.sign ^ den.sign;
                PR[p2] = 0;
            } else if (fp_is_finite(num) && fp_is_inf(den)) {
                FR[f1] = FP_ZERO;
                FR[f1].sign = num.sign ^ den.sign;
                PR[p2] = 0;
            } else if (fp_is_zero(num) && fp_is_finite(den)) {
                FR[f1] = FP_ZERO;
                FR[f1].sign = num.sign ^ den.sign;
                PR[p2] = 0;
            } else {
                FR[f1] = fp_ieee_recip(den);
                PR[p2] = 1;
            }
        }
    }
}

```

```

    }
    fp_update_fpsr(sf, tmp_fp_env);
  }
  fp_update_psr(f1);
} else {
  PR[p2] = 0;
}

// fp_ieee_recip()

fp_ieee_recip(den)
{
  RECIP_TABLE[256] = {
    0x3fc, 0x3f4, 0x3ec, 0x3e4, 0x3dd, 0x3d5, 0x3cd, 0x3c6,
    0x3be, 0x3b7, 0x3af, 0x3a8, 0x3a1, 0x399, 0x392, 0x38b,
    0x384, 0x37d, 0x376, 0x36f, 0x368, 0x361, 0x35b, 0x354,
    0x34d, 0x346, 0x340, 0x339, 0x333, 0x32c, 0x326, 0x320,
    0x319, 0x313, 0x30d, 0x307, 0x300, 0x2fa, 0x2f4, 0x2ee,
    0x2e8, 0x2e2, 0x2dc, 0x2d7, 0x2d1, 0x2cb, 0x2c5, 0x2bf,
    0x2ba, 0x2b4, 0x2af, 0x2a9, 0x2a3, 0x29e, 0x299, 0x293,
    0x28e, 0x288, 0x283, 0x27e, 0x279, 0x273, 0x26e, 0x269,
    0x264, 0x25f, 0x25a, 0x255, 0x250, 0x24b, 0x246, 0x241,
    0x23c, 0x237, 0x232, 0x22e, 0x229, 0x224, 0x21f, 0x21b,
    0x216, 0x211, 0x20d, 0x208, 0x204, 0x1ff, 0x1fb, 0x1f6,
    0x1f2, 0x1ed, 0x1e9, 0x1e5, 0x1e0, 0x1dc, 0x1d8, 0x1d4,
    0x1cf, 0x1cb, 0x1c7, 0x1c3, 0x1bf, 0x1bb, 0x1b6, 0x1b2,
    0x1ae, 0x1aa, 0x1a6, 0x1a2, 0x19e, 0x19a, 0x197, 0x193,
    0x18f, 0x18b, 0x187, 0x183, 0x17f, 0x17c, 0x178, 0x174,
    0x171, 0x16d, 0x169, 0x166, 0x162, 0x15e, 0x15b, 0x157,
    0x154, 0x150, 0x14d, 0x149, 0x146, 0x142, 0x13f, 0x13b,
    0x138, 0x134, 0x131, 0x12e, 0x12a, 0x127, 0x124, 0x120,
    0x11d, 0x11a, 0x117, 0x113, 0x110, 0x10d, 0x10a, 0x107,
    0x103, 0x100, 0x0fd, 0x0fa, 0x0f7, 0x0f4, 0x0f1, 0x0ee,
    0x0eb, 0x0e8, 0x0e5, 0x0e2, 0x0df, 0x0dc, 0x0d9, 0x0d6,
    0x0d3, 0x0d0, 0x0cd, 0x0ca, 0x0c8, 0x0c5, 0x0c2, 0x0bf,
    0x0bc, 0x0b9, 0x0b7, 0x0b4, 0x0b1, 0x0ae, 0x0ac, 0x0a9,
    0x0a6, 0x0a4, 0x0a1, 0x09e, 0x09c, 0x099, 0x096, 0x094,
    0x091, 0x08e, 0x08c, 0x089, 0x087, 0x084, 0x082, 0x07f,
    0x07c, 0x07a, 0x077, 0x075, 0x073, 0x070, 0x06e, 0x06b,
    0x069, 0x066, 0x064, 0x061, 0x05f, 0x05d, 0x05a, 0x058,
    0x056, 0x053, 0x051, 0x04f, 0x04c, 0x04a, 0x048, 0x045,
    0x043, 0x041, 0x03f, 0x03c, 0x03a, 0x038, 0x036, 0x033,
    0x031, 0x02f, 0x02d, 0x02b, 0x029, 0x026, 0x024, 0x022,
    0x020, 0x01e, 0x01c, 0x01a, 0x018, 0x015, 0x013, 0x011,
    0x00f, 0x00d, 0x00b, 0x009, 0x007, 0x005, 0x003, 0x001,
  };

  tmp_index = den.significand{62:55};
  tmp_res.significand = (1 << 63) | (RECIP_TABLE[tmp_index] << 53);
  tmp_res.exponent = FP_REG_EXP_ONES - 2 - den.exponent;
  tmp_res.sign = den.sign;
  return (tmp_res);
}

```

FP Exceptions: Invalid Operation (V)
 Zero Divide (Z)
 Denormal/Unnormal Operand (D)
 Software Assist (SWA) fault

Interruptions: Illegal Operation fault
 Disabled Floating-point Register fault

Floating-point Exception fault

frsqrrta — Floating-point Reciprocal Square Root Approximation

Format: (qp) frsqrrta.sf $f_1, p_2 = f_3$ F7

Description: If PR qp is 0, PR p_2 is cleared and FR f_1 remains unchanged.

If PR qp is 1, the following will occur:

- FR f_1 is either set to an approximation (with a relative error $< 2^{-8.831}$) of the reciprocal square root of FR f_3 , or set to the IEEE-754 mandated square root of FR f_3 — if FR f_3 is in the set {-Infinity, -Finite, -0, Pseudo-zero, +0, +Infinity, NaN, Unsupported}.
- If FR f_1 is set to an approximation of the reciprocal square root of FR f_3 , then PR p_2 is set to 1; otherwise, it is set to 0.
- If FR f_3 is such the approximation of its reciprocal square root may cause the Newton-Raphson iterations to fail to produce the correct IEEE-754 square root result, then a Floating-point Exception fault for Software Assist occurs.

System software is expected to compute the IEEE-754 square root, return the result in FR f_1 , and set PR p_2 to 0.

- If FR f_3 is a NaTVal, FR f_1 is set to NaTVal instead of the computed result, and PR p_2 is cleared.

The mnemonic values for *sf* are given in [Table 2-23 on page 3:50](#).

Operation:

```

if (PR[qp]) {
    fp_check_target_register(f1);
    if (tmp_israncode = fp_reg_disabled(f1, f3, 0, 0))
        disabled_fp_register_fault(tmp_israncode, 0);

    if (fp_is_natval(FR[f3])) {
        FR[f1] = NATVAL;
        PR[p2] = 0;
    } else {
        tmp_default_result = frsqrrta_exception_fault_check(f3, sf,
                                                             &tmp_fp_env);

        if (fp_raise_fault(tmp_fp_env))
            fp_exception_fault(fp_decode_fault(tmp_fp_env));

        if (fp_is_nan(tmp_default_result)) {
            FR[f1] = tmp_default_result;
            PR[p2] = 0;
        } else {
            tmp_fr3 = fp_normalize(fp_reg_read(FR[f3]));
            if (fp_is_zero(tmp_fr3)) {
                FR[f1] = tmp_fr3;
                PR[p2] = 0;
            } else if (fp_is_pos_inf(tmp_fr3)) {
                FR[f1] = tmp_fr3;
                PR[p2] = 0;
            } else {
                FR[f1] = fp_ieee_recip_sqrt(tmp_fr3);
                PR[p2] = 1;
            }
        }
        fp_update_fpsr(sf, tmp_fp_env);
    }
    fp_update_psr(f1);
} else {
    PR[p2] = 0;
}

```

fselect — Floating-point Select

Format: (qp) fselect $f_1 = f_3, f_4, f_2$ F3

Description: The significand field of FR f_3 is logically AND-ed with the significand field of FR f_2 and the significand field of FR f_4 is logically AND-ed with the one's complement of the significand field of FR f_2 . The two results are logically OR-ed together. The result is placed in the significand field of FR f_1 .

The exponent field of FR f_1 is set to the biased exponent for 2.0^{63} (0x1003E). The sign bit field of FR f_1 is set to positive (0).

If any of FR f_3 , FR f_4 , or FR f_2 is a NaTVal, FR f_1 is set to NaTVal instead of the computed result.

Operation:

```

if (PR[qp]) {
    fp_check_target_register(f1);
    if (tmp_israncode = fp_reg_disabled(f1, f2, f3, f4))
        disabled_fp_register_fault(tmp_israncode, 0);

    if (fp_is_natval(FR[f2]) || fp_is_natval(FR[f3]) ||
        fp_is_natval(FR[f4])) {
        FR[f1] = NATVAL;
    } else {
        FR[f1].significand = (FR[f3].significand & FR[f2].significand)
                            | (FR[f4].significand & ~FR[f2].significand);
        FR[f1].exponent = FP_INTEGER_EXP;
        FR[f1].sign = FP_SIGN_POSITIVE;
    }

    fp_update_psr(f1);
}

```

FP Exceptions: None

Interruptions: Illegal Operation fault

Disabled Floating-point Register fault

fsetc — Floating-point Set Controls

Format: (qp) fsetc.sf amask₇, omask₇ F12

Description: The status field's control bits are initialized to the value obtained by logically AND-ing the sf0.controls and amask₇ immediate field and logically OR-ing the omask₇ immediate field.
The mnemonic values for sf are given in [Table 2-23 on page 3:50](#).

Operation:

```

if (PR[qp]) {
    tmp_controls = (AR[FPSR].sf0.controls & amask7) | omask7;
    if (is_reserved_field(FSETC, sf, tmp_controls))
        reserved_register_field_fault();
    fp_set_sf_controls(sf, tmp_controls);
}

```

FP Exceptions: None

Interruptions: Reserved Register/Field fault

fsub — Floating-point Subtract

- Format:** $(qp) \text{ fsub}.pc.sf f_1 = f_3, f_2$ pseudo-op of: $(qp) \text{ fms}.pc.sf f_1 = f_3, f_1, f_2$
- Description:** FR f_2 is subtracted from FR f_3 (computed to infinite precision), rounded to the precision indicated by pc (and possibly $\text{FPSR}.sf.pc$ and $\text{FPSR}.sf.wre$) using the rounding mode specified by $\text{FPSR}.sf.rc$, and placed in FR f_1 .
- If either FR f_3 or FR f_2 is a NaTVal, FR f_1 is set to NaTVal instead of the computed result.
- The mnemonic values for the opcode's pc are given in [Table 2-22 on page 3:50](#). The mnemonic values for sf are given in [Table 2-23 on page 3:50](#). For the encodings and interpretation of the status field's pc , wre , and rc , refer to [Table 5-6](#) and [Table 5-5 on page 1:80](#).
- Operation:** See "fms – Floating-point Multiply Subtract" on page 3:78.

fswap — Floating-point Swap

Format:

| | | |
|--------------------------------|--------------|----|
| (qp) fswap $f_1 = f_2, f_3$ | swap_form | F9 |
| (qp) fswap.nl $f_1 = f_2, f_3$ | swap_nl_form | F9 |
| (qp) fswap.nr $f_1 = f_2, f_3$ | swap_nr_form | F9 |

Description: For the swap_form, the left single precision value in FR f_2 is concatenated with the right single precision value in FR f_3 . The concatenated pair is then swapped.

For the swap_nl_form, the left single precision value in FR f_2 is concatenated with the right single precision value in FR f_3 . The concatenated pair is then swapped, and the left single precision value is negated.

For the swap_nr_form, the left single precision value in FR f_2 is concatenated with the right single precision value in FR f_3 . The concatenated pair is then swapped, and the right single precision value is negated.

For all forms, the exponent field of FR f_1 is set to the biased exponent for 2.0^{63} (0x1003E) and the sign field of FR f_1 is set to positive (0).

For all forms, if either FR f_2 or FR f_3 is a NaNVal, FR f_1 is set to NaNVal instead of the computed result.

Figure 2-18. Floating-point Swap

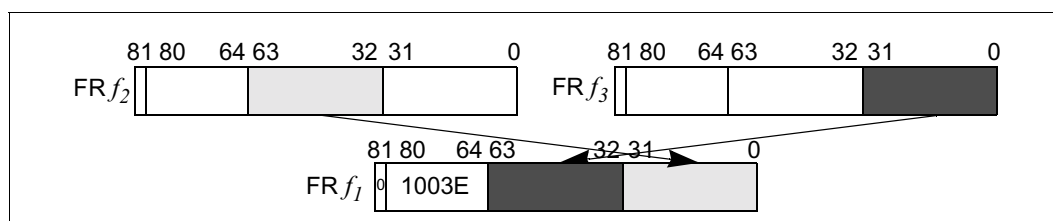

Figure 2-19. Floating-point Swap Negate Left

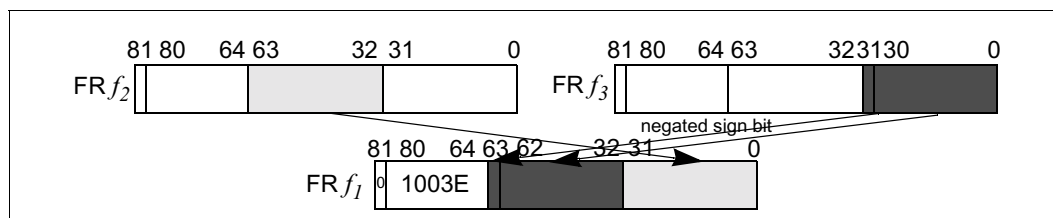
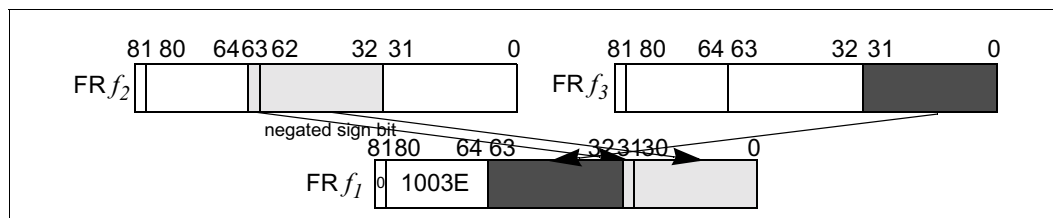

Figure 2-20. Floating-point Swap Negate Right



```

Operation:   if (PR[qp]) {
                fp_check_target_register(f1);
                if (tmp_isrkode = fp_reg_disabled(f1, f2, f3, 0))
                    disabled_fp_register_fault(tmp_isrkode, 0);

                if (fp_is_natval(FR[f2]) || fp_is_natval(FR[f3])) {
                    FR[f1] = NATVAL;
                } else {
                    if (swap_form) {
                        tmp_res_hi = FR[f3].significand{31:0};
                        tmp_res_lo = FR[f2].significand{63:32};
                    } else if (swap_nl_form) {
                        tmp_res_hi = (!FR[f3].significand{31} << 31)
                            | (FR[f3].significand{30:0});
                        tmp_res_lo = FR[f2].significand{63:32};
                    } else { // swap_nr_form
                        tmp_res_hi = FR[f3].significand{31:0};
                        tmp_res_lo = (!FR[f2].significand{63} << 31)
                            | (FR[f2].significand{62:32});
                    }

                    FR[f1].significand = fp_concatenate(tmp_res_hi, tmp_res_lo);
                    FR[f1].exponent = FP_INTEGER_EXP;
                    FR[f1].sign = FP_SIGN_POSITIVE;
                }

                fp_update_psr(f1);
            }

```

FP Exceptions: None

Interruptions: Illegal Operation fault

Disabled Floating-point Register fault

fsxt — Floating-point Sign Extend

Format: (qp) fsxt.l $f_1 = f_2, f_3$ sxt_l_form F9
 (qp) fsxt.r $f_1 = f_2, f_3$ sxt_r_form F9

Description: For the sxt_l_form (sxt_r_form), the sign of the left (right) single precision value in FR f_2 is extended to 32-bits and is concatenated with the left (right) single precision value in FR f_3 .

For all forms, the exponent field of FR f_1 is set to the biased exponent for 2.0^{63} (0x1003E) and the sign field of FR f_1 is set to positive (0).

For all forms, if either FR f_2 or FR f_3 is a NaNVal, FR f_1 is set to NaNVal instead of the computed result.

Figure 2-21. Floating-point Sign Extend Left

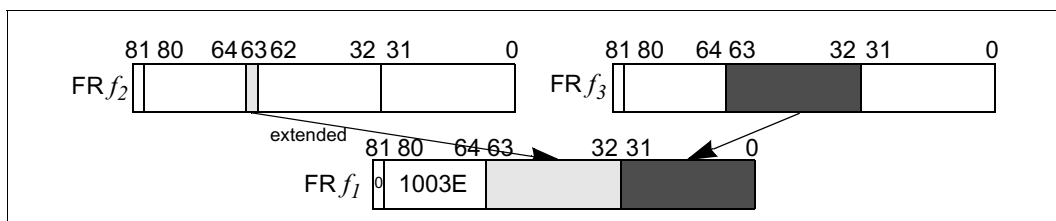
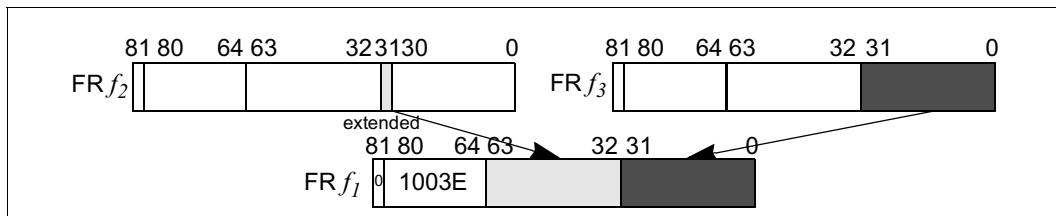

Figure 2-22. Floating-point Sign Extend Right



Operation:

```

if (PR[qp]) {
    fp_check_target_register(f1);
    if (tmp_israncode = fp_reg_disabled(f1, f2, f3, 0))
        disabled_fp_register_fault(tmp_israncode, 0);

    if (fp_is_natval(FR[f2]) || fp_is_natval(FR[f3])) {
        FR[f1] = NATVAL;
    } else {
        if (sxt_l_form) {
            tmp_res_hi = (FR[f2].significand{63} ? 0xFFFFFFFF : 0x00000000);
            tmp_res_lo = FR[f3].significand{63:32};
        } else {
            // sxt_r_form
            tmp_res_hi = (FR[f2].significand{31} ? 0xFFFFFFFF : 0x00000000);
            tmp_res_lo = FR[f3].significand{31:0};
        }

        FR[f1].significand = fp_concatenate(tmp_res_hi, tmp_res_lo);
        FR[f1].exponent = FP_INTEGER_EXP;
        FR[f1].sign = FP_SIGN_POSITIVE;
    }

    fp_update_psr(f1);
}

```

FP Exceptions: None

Interruptions: Illegal Operation fault

Disabled Floating-point Register fault

fwb — Flush Write Buffers

Format: (qp) fwb

M24

Description: The processor is instructed to expedite flushing of any pending stores held in write or coalescing buffers. Since this operation is a hint, the processor may or may not take any action and actually flush any outstanding stores. The processor gives no indication when flushing of any prior stores is completed. An `fwb` instruction does not ensure ordering of stores, since later stores may be flushed before prior stores.

To ensure prior coalesced stores are made visible before later stores, software must issue a release operation between stores (see [Table 4-14 on page 2:70](#) for a list of release operations).

This instruction can be used to help ensure stores held in write or coalescing buffers are not delayed for long periods or to expedite high priority stores out of the processors.

Operation:

```
if (PR[qp]) {  
    mem_flush_pending_stores();  
}
```

Interruptions: None

fxor — Floating-point Exclusive Or

Format: (qp) fxor $f_1 = f_2, f_3$ F9

Description: The bit-wise logical exclusive-OR of the significand fields of FR f_2 and FR f_3 is computed. The resulting value is stored in the significand field of FR f_1 . The exponent field of FR f_1 is set to the biased exponent for 2.0⁶³ (0x1003E) and the sign field of FR f_1 is set to positive (0).

If either of FR f_2 or FR f_3 is a NaTVal, FR f_1 is set to NaTVal instead of the computed result.

Operation:

```

if (PR[qp]) {
    fp_check_target_register(f1);
    if (tmp_israncode = fp_reg_disabled(f1, f2, f3, 0))
        disabled_fp_register_fault(tmp_israncode, 0);

    if (fp_is_natval(FR[f2]) || fp_is_natval(FR[f3])) {
        FR[f1] = NATVAL;
    } else {
        FR[f1].significand = FR[f2].significand ^ FR[f3].significand;
        FR[f1].exponent = FP_INTEGER_EXP;
        FR[f1].sign = FP_SIGN_POSITIVE;
    }

    fp_update_psr(f1);
}

```

FP Exceptions: None

Interruptions: Illegal Operation fault

Disabled Floating-point Register fault

getf — Get Floating-point Value or Exponent or Significand

| | | | |
|----------------|---------------------------|------------------|-----|
| Format: | (qp) getf.s $r_1 = f_2$ | single_form | M19 |
| | (qp) getf.d $r_1 = f_2$ | double_form | M19 |
| | (qp) getf.exp $r_1 = f_2$ | exponent_form | M19 |
| | (qp) getf.sig $r_1 = f_2$ | significand_form | M19 |

Description: In the single and double forms, the value in FR f_2 is converted into a single precision (single_form) or double precision (double_form) memory representation and placed in GR r_1 , as shown in [Figure 5-4 on page 1:82](#) and [Figure 5-5 on page 1:83](#), respectively. In the single_form, the most-significant 32 bits of GR r_1 are set to 0.

In the exponent_form, the exponent field of FR f_2 is copied to bits 16:0 of GR r_1 and the sign bit of the value in FR f_2 is copied to bit 17 of GR r_1 . The most-significant 46-bits of GR r_1 are set to zero.

Figure 2-23. Function of getf.exp

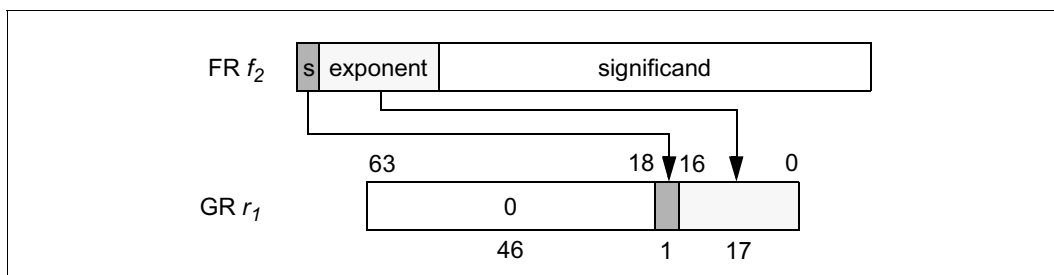

In the significand_form, the significand field of the value in FR f_2 is copied to GR r_1

Figure 2-24. Function of getf.sig

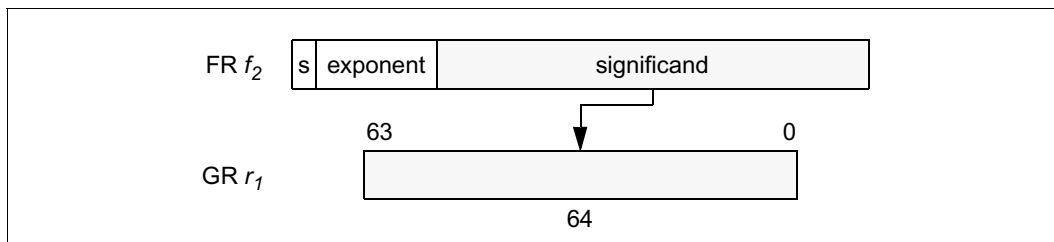

For all forms, if FR f_2 contains a NaNVal, then the NaN bit corresponding to GR r_1 is set to 1.

Operation:

```

if (PR[qp]) {
    check_target_register(r1);
    if (tmp_israncode = fp_reg_disabled(f2, 0, 0, 0))
        disabled_fp_register_fault(tmp_israncode, 0);

    if (single_form) {
        GR[r1]{31:0} = fp_fr_to_mem_format(FR[f2], 4, 0);
        GR[r1]{63:32} = 0;
    } else if (double_form) {
        GR[r1] = fp_fr_to_mem_format(FR[f2], 8, 0);
    } else if (exponent_form) {
        GR[r1]{63:18} = 0;
        GR[r1]{16:0} = FR[f2].exponent;
        GR[r1]{17} = FR[f2].sign;
    } else // significand_form
        GR[r1] = FR[f2].significand;
}

```

```
    if (fp_is_natval(FR[f2]))
        GR[r1].nat = 1;
    else
        GR[r1].nat = 0;
}
```

Interruptions: Illegal Operation fault

Disabled Floating-point Register fault

hint — Performance Hint

| | | | |
|----------------|--------------------------------------|-------------|-----|
| Format: | (qp) hint <i>imm</i> ₂₁ | pseudo-op | |
| | (qp) hint.i <i>imm</i> ₂₁ | i_unit_form | I18 |
| | (qp) hint.b <i>imm</i> ₂₁ | b_unit_form | B9 |
| | (qp) hint.m <i>imm</i> ₂₁ | m_unit_form | M48 |
| | (qp) hint.f <i>imm</i> ₂₁ | f_unit_form | F16 |
| | (qp) hint.x <i>imm</i> ₆₂ | x_unit_form | X5 |

Description: Provides a performance hint to the processor about the program being executed. It has no effect on architectural machine state, and operates as a `nop` instruction except for its performance effects.

The immediate, *imm*₂₁ or *imm*₆₂, specifies the hint. For the `x_unit_form`, the L slot of the bundle contains the upper 41 bits of *imm*₆₂.

This instruction has five forms, each of which can be executed only on a particular execution unit type. The pseudo-op can be used if the unit type to execute on is unimportant.

Table 2-31. Hint Immediates

| <i>imm</i> ₂₁ or <i>imm</i> ₆₂ | Mnemonic | Hint |
|--|----------|--|
| 0x0 | @pause | Indicates to the processor that the currently executing stream is waiting, spinning, or doing low priority tasks. This hint can be used by the processor to allocate more resources or time to another executing stream on the same processor. |
| 0x01-0x3f | | These values are available for future architected extensions and will execute as a <code>nop</code> on all current processors. Use of these values may cause unexpected performance issues on future processors and should not be used. |
| <i>other</i> | | Implementation-specific. Performs an implementation-specific hint action. Consult processor model-specific documentation for details. |

Operation:

```

if (PR[qp]) {
  if (x_unit_form)
    hint = imm62;
  else // i_unit_form || b_unit_form || m_unit_form || f_unit_form
    hint = imm21;

  if (is_supported_hint(hint))
    execute_hint(hint);
}

```

Interrupts: None

invala — Invalidate ALAT

| | | |
|----------------|---|---|
| Format: | (qp) invala (qp) invala.e r_1 (qp) invala.e f_1 | complete_form M24 gr_form, entry_form M26 fr_form, entry_form M27 |
|----------------|---|---|

Description: The selected entry or entries in the ALAT are invalidated.

In the complete_form, all ALAT entries are invalidated. In the entry_form, the ALAT is queried using the general register specifier r_1 (gr_form), or the floating-point register specifier f_1 (fr_form), and if any ALAT entry matches, it is invalidated.

Operation:

```

if (PR[qp]) {
    if (complete_form)
        alat_inval();
    else { // entry_form
        if (gr_form)
            alat_inval_single_entry(GENERAL, r1);
        else // fr_form
            alat_inval_single_entry(FLOAT, f1);
    }
}
    
```

Interruptions: None

itc — Insert Translation Cache

Format: (qp) itc.i r_2 instruction_form M41
(qp) itc.d r_2 data_form M41

Description: An entry is inserted into the instruction or data translation cache. GR r_2 specifies the physical address portion of the translation. ITIR specifies the protection key, page size and additional information. The virtual address is specified by the IFA register and the region register is selected by IFA{63:61}. The processor determines which entry to replace based on an implementation-specific replacement algorithm.

The visibility of the `itc` instruction to externally generated purges (`ptc.g`, `ptc.ga`) must occur before subsequent memory operations. From a software perspective, this is similar to acquire semantics. Serialization is still required to observe the side-effects of a translation being present.

`itc` must be the last instruction in an instruction group; otherwise, its behavior (including its ordering semantics) is undefined.

The TLB is first purged of any overlapping entries as specified by [Table 4-1 on page 2:43](#).

This instruction can only be executed at the most privileged level, and when PSR.ic is zero.

To ensure forward progress, software must ensure that PSR.ic remains 0 until `rfi`-ing to the instruction that requires the translation.

Operation:

```

if (PR[qp]) {
    if (!followed_by_stop())
        undefined_behavior();
    if (PSR.ic)
        illegal_operation_fault();
    if (PSR.cpl != 0)
        privileged_operation_fault(0);
    if (GR[r2].nat)
        register_nat_consumption_fault(0);

    tmp_size = CR[ITIR].ps;
    tmp_va = CR[IFA]{60:0};
    tmp_rid = RR[CR[IFA]{63:61}].rid;
    tmp_va = align_to_size_boundary(tmp_va, tmp_size);

    if (is_reserved_field(TLB_TYPE, GR[r2], CR[ITIR]))
        reserved_register_field_fault();
    if (unimplemented_virtual_address(CR[IFA]))
        unimplemented_data_address_fault(0);

    if (instruction_form) {
        tlb_must_purge_itc_entries(tmp_rid, tmp_va, tmp_size);
        tlb_may_purge_dtc_entries(tmp_rid, tmp_va, tmp_size);
        slot = tlb_replacement_algorithm(ITC_TYPE);
        tlb_insert_inst(slot, GR[r2], CR[ITIR], CR[IFA], tmp_rid, TC);
    } else { // data_form
        tlb_must_purge_dtc_entries(tmp_rid, tmp_va, tmp_size);
        tlb_may_purge_itc_entries(tmp_rid, tmp_va, tmp_size);
        slot = tlb_replacement_algorithm(DTC_TYPE);
        tlb_insert_data(slot, GR[r2], CR[ITIR], CR[IFA], tmp_rid, TC);
    }
}

```

Interruptions: Machine Check abort
Illegal Operation fault
Privileged Operation fault
Register NaT Consumption fault

Reserved Register/Field fault
Unimplemented Data Address fault

Serialization: For the instruction_form, software must issue an instruction serialization operation before a dependent instruction fetch access. For the data_form, software must issue a data serialization operation before issuing a data access or non-access reference dependent on the new translation.

itr — Insert Translation Register

Format: (qp) itr.i itr[r₃] = r₂ instruction_form M42
 (qp) itr.d dtr[r₃] = r₂ data_form M42

Description: A translation is inserted into the instruction or data translation register specified by the contents of GR r₃. GR r₂ specifies the physical address portion of the translation. ITIR specifies the protection key, page size and additional information. The virtual address is specified by the IFA register and the region register is selected by IFA{63:61}.

As described in [Table 4-1, “Purge Behavior of TLB Instructions” on page 2:43](#), the TLB is first purged of any entries that overlap with the newly inserted translation. The translation previously contained in the TR slot specified by GR r₃ is not necessarily purged from the processor's TLBs and may remain as a TC entry. To ensure that the previous TR translation is purged, software must use explicit ptr instructions before inserting the new TR entry.

This instruction can only be executed at the most privileged level, and when PSR.ic is zero.

Operation:

```

if (PR[qp]) {
    if (PSR.ic)
        illegal_operation_fault();
    if (PSR.cpl != 0)
        privileged_operation_fault(0);
    if (GR[r3].nat || GR[r2].nat)
        register_nat_consumption_fault(0);

    slot = GR[r3]{7:0};
    tmp_size = CR[ITIR].ps;
    tmp_va = CR[IFA]{60:0};
    tmp_rid = RR[CR[IFA]{63:61}].rid;
    tmp_va = align_to_size_boundary(tmp_va, tmp_size);

    tmp_tr_type = instruction_form ? ITR_TYPE : DTR_TYPE;

    if (is_reserved_reg(tmp_tr_type, slot))
        reserved_register_field_fault();
    if (is_reserved_field(TLB_TYPE, GR[r2], CR[ITIR]))
        reserved_register_field_fault();
    if (unimplemented_virtual_address(CR[IFA]))
        unimplemented_data_address_fault(0);

    if (instruction_form) {
        tlb_must_purge_itc_entries(tmp_rid, tmp_va, tmp_size);
        tlb_may_purge_dtc_entries(tmp_rid, tmp_va, tmp_size);
        tlb_insert_inst(slot, GR[r2], CR[ITIR], CR[IFA], tmp_rid, TR);
    } else { // data_form
        tlb_must_purge_dtc_entries(tmp_rid, tmp_va, tmp_size);
        tlb_may_purge_itc_entries(tmp_rid, tmp_va, tmp_size);
        tlb_insert_data(slot, GR[r2], CR[ITIR], CR[IFA], tmp_rid, TR);
    }
}

```

Interruptions: Machine Check abort Reserved Register/Field fault
 Illegal Operation fault Unimplemented Data Address fault
 Privileged Operation fault
 Register NaT Consumption fault

Serialization: For the `instruction_form`, software must issue an instruction serialization operation before a dependent instruction fetch access. For the `data_form`, software must issue a data serialization operation before issuing a data access or non-access reference dependent on the new translation.

Notes: The processor may use invalid translation registers for translation cache entries. Performance can be improved on some processor models by ensuring translation registers are allocated beginning at translation register zero and continuing contiguously upwards.

ld — Load

| | | | |
|----------------|---|--|----|
| Format: | (qp) ld.sz.ldtype.ldhint r ₁ = [r ₃] | no_base_update_form | M1 |
| | (qp) ld.sz.ldtype.ldhint r ₁ = [r ₃], r ₂ | reg_base_update_form | M2 |
| | (qp) ld.sz.ldtype.ldhint r ₁ = [r ₃], imm ₉ | imm_base_update_form | M3 |
| | (qp) ld16.ldhint r ₁ , ar.csd = [r ₃] | sixteen_byte_form, no_base_update_form | M1 |
| | (qp) ld16.acq.ldhint r ₁ , ar.csd = [r ₃] | sixteen_byte_form, acquire_form, no_base_update_form | M1 |
| | (qp) ld8.fill.ldhint r ₁ = [r ₃] | fill_form, no_base_update_form | M1 |
| | (qp) ld8.fill.ldhint r ₁ = [r ₃], r ₂ | fill_form, reg_base_update_form | M2 |
| | (qp) ld8.fill.ldhint r ₁ = [r ₃], imm ₉ | fill_form, imm_base_update_form | M3 |

Description: A value consisting of *sz* bytes is read from memory starting at the address specified by the value in GR *r*₃. The value is then zero extended and placed in GR *r*₁. The values of the *sz* completer are given in [Table 2-32](#). The NaT bit corresponding to GR *r*₁ is cleared, except as described below for speculative loads. The *ldtype* completer specifies special load operations, which are described in [Table 2-33](#).

For the *sixteen_byte_form*, two 8-byte values are loaded as a single, 16-byte memory read. The value at the lowest address is placed in GR *r*₁, and the value at the highest address is placed in the Compare and Store Data application register (AR[CSD]). The only load types supported for this *sixteen_byte_form* are *none* and *acq*.

For the *fill_form*, an 8-byte value is loaded, and a bit in the UNAT application register is copied into the target register NaT bit. This instruction is used for reloading a spilled register/NaT pair. See [Section 4.4.4, “Control Speculation” on page 1:51](#) for details.

In the base update forms, the value in GR *r*₃ is added to either a signed immediate value (*imm*₉) or a value from GR *r*₂, and the result is placed back in GR *r*₃. This base register update is done after the load, and does not affect the load address. In the *reg_base_update_form*, if the NaT bit corresponding to GR *r*₂ is set, then the NaT bit corresponding to GR *r*₃ is set and no fault is raised. Base register update is not supported for the *ld16* instruction.

Table 2-32. sz Completers

| sz Completer | Bytes Accessed |
|--------------|----------------|
| 1 | 1 byte |
| 2 | 2 bytes |
| 4 | 4 bytes |
| 8 | 8 bytes |

Table 2-33. Load Types

| ldtype Completer | Interpretation | Special Load Operation |
|------------------|------------------|--|
| <i>none</i> | Normal load | |
| s | Speculative load | Certain exceptions may be deferred rather than generating a fault. Deferral causes the target register's NaT bit to be set. The NaT bit is later used to detect deferral. |
| a | Advanced load | An entry is added to the ALAT. This allows later instructions to check for colliding stores. If the referenced data page has a non-speculative attribute, the target register and NaT bit is cleared, and the processor ensures that no ALAT entry exists for the target register. The absence of an ALAT entry is later used to detect deferral or collision. |

Table 2-33. Load Types (Continued)

| <i>ldtype</i> Completer | Interpretation | Special Load Operation |
|-------------------------|-------------------------------|--|
| sa | Speculative Advanced load | An entry is added to the ALAT, and certain exceptions may be deferred. Deferral causes the target register's NaT bit to be set, and the processor ensures that no ALAT entry exists for the target register. The absence of an ALAT entry is later used to detect deferral or collision. |
| c.nc | Check load - no clear | The ALAT is searched for a matching entry. If found, no load is done and the target register is unchanged. Regardless of ALAT hit or miss, base register updates are performed, if specified. An implementation may optionally cause the ALAT lookup to fail independent of whether an ALAT entry matches. If not found, a load is performed, and an entry is added to the ALAT (unless the referenced data page has a non-speculative attribute, in which case no ALAT entry is allocated). |
| c.clr | Check load - clear | The ALAT is searched for a matching entry. If found, the entry is removed, no load is done and the target register is unchanged. Regardless of ALAT hit or miss, base register updates are performed, if specified. An implementation may optionally cause the ALAT lookup to fail independent of whether an ALAT entry matches. If not found, a clear check load behaves like a normal load. |
| c.clr.acq | Ordered check load - clear | This type behaves the same as the unordered clear form, except that the ALAT lookup (and resulting load, if no ALAT entry is found) is performed with acquire semantics. |
| acq | Ordered load | An ordered load is performed with acquire semantics. |
| bias | Biased load | A hint is provided to the implementation to acquire exclusive ownership of the accessed cache line. |

For more details on ordered, biased, speculative, advanced and check loads see [Section 4.4.4, “Control Speculation” on page 1:51](#) and [Section 4.4.5, “Data Speculation” on page 1:55](#). For more details on ordered loads see [Section 4.4.7, “Memory Access Ordering” on page 1:63](#). See [Section 4.4.6, “Memory Hierarchy Control and Consistency” on page 1:60](#) for details on biased loads. Details on memory attributes are described in [Section 4.4, “Memory Attributes” on page 2:63](#).

For the non-speculative load types, if NaT bit associated with GR r_3 is 1, a Register NaT Consumption fault is taken. For speculative and speculative advanced loads, no fault is raised, and the exception is deferred. For the base-update calculation, if the NaT bit associated with GR r_2 is 1, the NaT bit associated with GR r_3 is set to 1 and no fault is raised.

The value of the *ldhint* completer specifies the locality of the memory access. The values of the *ldhint* completer are given in [Table 2-34](#). A prefetch hint is implied in the base update forms. The address specified by the value in GR r_3 after the base update acts as a hint to prefetch the indicated cache line. This prefetch uses the locality hints specified by *ldhint*. Prefetch and locality hints do not affect program functionality and may be ignored by the implementation. See [Section 4.4.6, “Memory Hierarchy Control and Consistency” on page 1:60](#) for details.

Table 2-34. Load Hints

| <i>ldhint</i> Completer | Interpretation |
|-------------------------|----------------------------------|
| <i>none</i> | Temporal locality, level 1 |
| nt1 | No temporal locality, level 1 |
| nta | No temporal locality, all levels |

In the `no_base_update` form, the value in GR r_3 is not modified and no prefetch hint is implied.

For the base update forms, specifying the same register address in r_1 and r_3 will cause an Illegal Operation fault.

Hardware support for `ld16` instructions that reference a page that is neither a cacheable page with write-back policy nor a NaTPage is optional. On processor models that do not support such `ld16` accesses, an Unsupported Data Reference fault is raised when an unsupported reference is attempted.

```

Operation:  if (PR[qp]) {
                size = fill_form ? 8 : (sixteen_byte_form ? 16 : sz);

                speculative = (ldtype == 's' || ldtype == 'sa');
                advanced = (ldtype == 'a' || ldtype == 'sa');
                check_clear = (ldtype == 'c.clr' || ldtype == 'c.clr.acq');
                check_no_clear = (ldtype == 'c.nc');
                check = check_clear || check_no_clear;
                acquire = (acquire_form || ldtype == 'acq' || ldtype == 'c.clr.acq');
                otype = acquire ? ACQUIRE : UNORDERED;
                bias = (ldtype == 'bias') ? BIAS : 0 ;

                itype = READ;
                if (speculative) itype |= SPEC ;
                if (advanced) itype |= ADVANCE ;
                if (size == 16) itype |= UNCACHE_OPT ;

                if ((reg_base_update_form || imm_base_update_form) && (r1 == r3))
                    illegal_operation_fault();
                check_target_register(r1);
                if (reg_base_update_form || imm_base_update_form)
                    check_target_register(r3);

                if (reg_base_update_form) {
                    tmp_r2 = GR[r2];
                    tmp_r2nat = GR[r2].nat;
                }

                if (!speculative && GR[r3].nat) // fault on NaT address
                    register_nat_consumption_fault(itype);
                defer = speculative && (GR[r3].nat || PSR.ed); // defer exception if spec

                if (check && alat_cmp(GENERAL, r1)) { // no load on ld.c & ALAT hit
                    if (check_clear) // remove entry on ld.c.clr or ld.c.clr.acq
                        alat_inval_single_entry(GENERAL, r1);
                } else {
                    if (!defer) {
                        paddr = tlb_translate(GR[r3], size, itype, PSR.cpl, &mattr,
                                             &defer);
                        spontaneous_deferral(paddr, size, UM.be, mattr, otype,
                                             bias | ldhint, &defer);
                    }
                    if (!defer) {
                        if (size == 16) {
                            mem_read_pair(&val, &val_ar, paddr, size, UM.be, mattr,
                                           otype, ldhint);
                        }
                        else {
                            val = mem_read(paddr, size, UM.be, mattr, otype,
                                           bias | ldhint);
                        }
                    }
                }
            }

```

```

    }
    if (check_clear || advanced) // remove any old ALAT entry
        alat_inval_single_entry(GENERAL, r1);
    if (defer) {
        if (speculative) {
            GR[r1] = natd_gr_read(paddr, size, UM.be, mattr, otype,
                                  bias | ldhint);
            GR[r1].nat = 1;
        } else {
            GR[r1] = 0; // ld.a to sequential memory
            GR[r1].nat = 0;
        }
    } else { // execute load normally
        if (fill_form) { // fill NaT on ld8.fill
            bit_pos = GR[r3]{8:3};
            GR[r1] = val;
            GR[r1].nat = AR[UNAT]{bit_pos};
        } else { // clear NaT on other types
            if (size == 16) {
                GR[r1] = val;
                AR[CSD] = val_ar;
            } else {
                GR[r1] = zero_ext(val, size * 8);
            }
            GR[r1].nat = 0;
        }
        if ((check_no_clear || advanced) && ma_is_speculative(mattr))
            // add entry to ALAT
            alat_write(GENERAL, r1, paddr, size);
    }
}

if (imm_base_update_form) { // update base register
    GR[r3] = GR[r3] + sign_ext(imm9, 9);
    GR[r3].nat = GR[r3].nat;
} else if (reg_base_update_form) {
    GR[r3] = GR[r3] + tmp_r2;
    GR[r3].nat = GR[r3].nat || tmp_r2nat;
}

if ((reg_base_update_form || imm_base_update_form) && !GR[r3].nat)
    mem_implicit_prefetch(GR[r3], ldhint | bias, itype);
}

```

| | |
|---|----------------------------------|
| Interruptions: Illegal Operation fault | Data NaT Page Consumption fault |
| Register NaT Consumption fault | Data Key Miss fault |
| Unimplemented Data Address fault | Data Key Permission fault |
| Data Nested TLB fault | Data Access Rights fault |
| Alternate Data TLB fault | Data Access Bit fault |
| VHPT Data fault | Data Debug fault |
| Data TLB fault | Unaligned Data Reference fault |
| Data Page Not Present fault | Unsupported Data Reference fault |

ldf — Floating-point Load

| | | | |
|----------------|--|---|----|
| Format: | (qp) <code>ldffsz.fldtype.ldhint f₁ = [r₃]</code> | <code>no_base_update_form</code> | M6 |
| | (qp) <code>ldffsz.fldtype.ldhint f₁ = [r₃], r₂</code> | <code>reg_base_update_form</code> | M7 |
| | (qp) <code>ldffsz.fldtype.ldhint f₁ = [r₃], imm₉</code> | <code>imm_base_update_form</code> | M8 |
| | (qp) <code>ldf8.fldtype.ldhint f₁ = [r₃]</code> | <code>integer_form, no_base_update_form</code> | M6 |
| | (qp) <code>ldf8.fldtype.ldhint f₁ = [r₃], r₂</code> | <code>integer_form, reg_base_update_form</code> | M7 |
| | (qp) <code>ldf8.fldtype.ldhint f₁ = [r₃], imm₉</code> | <code>integer_form, imm_base_update_form</code> | M8 |
| | (qp) <code>ldf.fill.ldhint f₁ = [r₃]</code> | <code>fill_form, no_base_update_form</code> | M6 |
| | (qp) <code>ldf.fill.ldhint f₁ = [r₃], r₂</code> | <code>fill_form, reg_base_update_form</code> | M7 |
| | (qp) <code>ldf.fill.ldhint f₁ = [r₃], imm₉</code> | <code>fill_form, imm_base_update_form</code> | M8 |

Description: A value consisting of *fsz* bytes is read from memory starting at the address specified by the value in GR *r₃*. The value is then converted into the floating-point register format and placed in FR *f₁*. See [Section 5.1, “Data Types and Formats” on page 1:75](#) for details on conversion to floating-point register format. The values of the *fsz* completer are given in [Table 2-35](#). The *fldtype* completer specifies special load operations, which are described in [Table 2-36](#).

For the `integer_form`, an 8-byte value is loaded and placed in the significand field of FR *f₁* without conversion. The exponent field of FR *f₁* is set to the biased exponent for 2.0⁶³ (0x1003E) and the sign field of FR *f₁* is set to positive (0).

For the `fill_form`, a 16-byte value is loaded, and the appropriate fields are placed in FR *f₁* without conversion. This instruction is used for reloading a spilled register. See [Section 4.4.4, “Control Speculation” on page 1:51](#) for details.

In the base update forms, the value in GR *r₃* is added to either a signed immediate value (*imm₉*) or a value from GR *r₂*, and the result is placed back in GR *r₃*. This base register update is done after the load, and does not affect the load address. In the `reg_base_update_form`, if the NaT bit corresponding to GR *r₂* is set, then the NaT bit corresponding to GR *r₃* is set and no fault is raised.

Table 2-35. fsz Completers

| <i>fsz</i> Completer | Bytes Accessed | Memory Format |
|----------------------|----------------|--------------------|
| s | 4 bytes | Single precision |
| d | 8 bytes | Double precision |
| e | 10 bytes | Extended precision |

Table 2-36. FP Load Types

| <i>fldtype</i> Completer | Interpretation | Special Load Operation |
|--------------------------|---------------------------|---|
| <i>none</i> | Normal load | |
| s | Speculative load | Certain exceptions may be deferred rather than generating a fault. Deferral causes NaTVal to be placed in the target register. The NaTVal value is later used to detect deferral. |
| a | Advanced load | An entry is added to the ALAT. This allows later instructions to check for colliding stores. If the referenced data page has a non-speculative attribute, no ALAT entry is added to the ALAT and the target register is set as follows: for the <code>integer_form</code> , the exponent is set to 0x1003E and the sign and significand are set to zero; for all other forms, the sign, exponent and significand are set to zero. The absence of an ALAT entry is later used to detect deferral or collision. |
| sa | Speculative Advanced load | An entry is added to the ALAT, and certain exceptions may be deferred. Deferral causes NaTVal to be placed in the target register, and the processor ensures that no ALAT entry exists for the target register. The absence of an ALAT entry is later used to detect deferral or collision. |

Table 2-36. FP Load Types (Continued)

| <i>fldtype</i> Completer | Interpretation | Special Load Operation |
|-----------------------------|--------------------------|--|
| c.nc | Check load - no clear | The ALAT is searched for a matching entry. If found, no load is done and the target register is unchanged. Regardless of ALAT hit or miss, base register updates are performed, if specified. An implementation may optionally cause the ALAT lookup to fail independent of whether an ALAT entry matches. If not found, a load is performed, and an entry is added to the ALAT (unless the referenced data page has a non-speculative attribute, in which case no ALAT entry is allocated). |
| c.clr | Check load – clear | The ALAT is searched for a matching entry. If found, the entry is removed, no load is done and the target register is unchanged. Regardless of ALAT hit or miss, base register updates are performed, if specified. An implementation may optionally cause the ALAT lookup to fail independent of whether an ALAT entry matches. If not found, a clear check load behaves like a normal load. |

For more details on speculative, advanced and check loads see [Section 4.4.4, “Control Speculation” on page 1:51](#) and [Section 4.4.5, “Data Speculation” on page 1:55](#). Details on memory attributes are described in [Section 4.4, “Memory Attributes” on page 2:63](#).

For the non-speculative load types, if NaT bit associated with GR r_3 is 1, a Register NaT Consumption fault is taken. For speculative and speculative advanced loads, no fault is raised, and the exception is deferred. For the base-update calculation, if the NaT bit associated with GR r_2 is 1, the NaT bit associated with GR r_3 is set to 1 and no fault is raised.

The value of the *ldhint* modifier specifies the locality of the memory access. The mnemonic values of *ldhint* are given in [Table 2-34 on page 3:132](#). A prefetch hint is implied in the base update forms. The address specified by the value in GR r_3 after the base update acts as a hint to prefetch the indicated cache line. This prefetch uses the locality hints specified by *ldhint*. Prefetch and locality hints do not affect program functionality and may be ignored by the implementation. See [Section 4.4.6, “Memory Hierarchy Control and Consistency” on page 1:60](#) for details.

In the *no_base_update* form, the value in GR r_3 is not modified and no prefetch hint is implied.

The PSR.mfl and PSR.mfh bits are updated to reflect the modification of FR f_j .

Hardware support for *ldfe* (10-byte) instructions that reference a page that is neither a cacheable page with write-back policy nor a NaTPage is optional. On processor models that do not support such *ldfe* accesses, an Unsupported Data Reference fault is raised when an unsupported reference is attempted. The fault is delivered only on the normal, advanced, and check load flavors. Control-speculative flavors of *ldfe* always defer the Unsupported Data Reference fault.

Operation:

```

if (PR[qp]) {
    size = (fill_form ? 16 : (integer_form ? 8 : fsz));
    speculative = (fldtype == 's' || fldtype == 'sa');
    advanced = (fldtype == 'a' || fldtype == 'sa');
    check_clear = (fldtype == 'c.clr' );
    check_no_clear = (fldtype == 'c.nc');
    check = check_clear || check_no_clear;

    itype = READ;
    if (speculative) itype |= SPEC;
    if (advanced) itype |= ADVANCE;
    if (size == 10) itype |= UNCACHE_OPT;

    if (reg_base_update_form || imm_base_update_form)
        check_target_register(r3);
}

```



```

fp_check_target_register(f1);
if (tmp_isrcode = fp_reg_disabled(f1, 0, 0, 0))
    disabled_fp_register_fault(tmp_isrcode, itype);

if (!speculative && GR[r3].nat) // fault on NaT address
    register_nat_consumption_fault(itype);

defer = speculative && (GR[r3].nat || PSR.ed); // defer exception if spec

if (check && alat_cmp(FLOAT, f1)) { // no load on ldf.c & ALAT hit
    if (check_clear) // remove entry on ldf.c.clr
        alat_inval_single_entry(FLOAT, f1);
} else {
    if (!defer) {
        paddr = tlb_translate(GR[r3], size, itype, PSR.cpl, &mattr,
                               &defer);
        spontaneous_deferral(paddr, size, UM.be, mattr, UNORDERED,
                               ldhint, &defer);

        if (!defer)
            val = mem_read(paddr, size, UM.be, mattr, UNORDERED, ldhint);
    }
    if (check_clear || advanced) // remove any old ALAT entry
        alat_inval_single_entry(FLOAT, f1);
    if (speculative && defer) {
        FR[f1] = NATVAL;
    } else if (advanced && !speculative && defer) {
        FR[f1] = (integer_form ? FP_INT_ZERO : FP_ZERO);
    } else { // execute load normally
        FR[f1] = fp_mem_to_fr_format(val, size, integer_form);

        if ((check_no_clear || advanced) && ma_is_speculative(mattr))
            // add entry to ALAT
            alat_write(FLOAT, f1, paddr, size);
    }
}

if (imm_base_update_form) { // update base register
    GR[r3] = GR[r3] + sign_ext(imm9, 9);
    GR[r3].nat = GR[r3].nat;
} else if (reg_base_update_form) {
    GR[r3] = GR[r3] + GR[r2];
    GR[r3].nat = GR[r3].nat || GR[r2].nat;
}

if ((reg_base_update_form || imm_base_update_form) && !GR[r3].nat)
    mem_implicit_prefetch(GR[r3], ldhint, itype);

fp_update_psr(f1);
}

```

| | |
|---|----------------------------------|
| Interruptions: Illegal Operation fault | Data NaT Page Consumption fault |
| Disabled Floating-point Register fault | Data Key Miss fault |
| Register NaT Consumption fault | Data Key Permission fault |
| Unimplemented Data Address fault | Data Access Rights fault |
| Data Nested TLB fault | Data Access Bit fault |
| Alternate Data TLB fault | Data Debug fault |
| VHPT Data fault | Unaligned Data Reference fault |
| Data TLB fault | Unsupported Data Reference fault |
| Data Page Not Present fault | |

ldfp — Floating-point Load Pair

| | | | |
|----------------|--|-----------------------------------|-----|
| Format: | <i>(qp)</i> ldfps. <i>fldtype</i> . <i>ldhint</i> $f_1, f_2 = [r_3]$ | single_form, no_base_update_form | M11 |
| | <i>(qp)</i> ldfps. <i>fldtype</i> . <i>ldhint</i> $f_1, f_2 = [r_3], 8$ | single_form, base_update_form | M12 |
| | <i>(qp)</i> ldfpd. <i>fldtype</i> . <i>ldhint</i> $f_1, f_2 = [r_3]$ | double_form, no_base_update_form | M11 |
| | <i>(qp)</i> ldfpd. <i>fldtype</i> . <i>ldhint</i> $f_1, f_2 = [r_3], 16$ | double_form, base_update_form | M12 |
| | <i>(qp)</i> ldfp8. <i>fldtype</i> . <i>ldhint</i> $f_1, f_2 = [r_3]$ | integer_form, no_base_update_form | M11 |
| | <i>(qp)</i> ldfp8. <i>fldtype</i> . <i>ldhint</i> $f_1, f_2 = [r_3], 16$ | integer_form, base_update_form | M12 |

Description: Eight (single_form) or sixteen (double_form/integer_form) bytes are read from memory starting at the address specified by the value in GR r_3 . The value read is treated as a contiguous pair of floating-point numbers for the single_form/double_form and as integer/Parallel FP data for the integer_form. Each number is converted into the floating-point register format. The value at the lowest address is placed in FR f_1 , and the value at the highest address is placed in FR f_2 . See [Section 5.1, “Data Types and Formats” on page 1:75](#) for details on conversion to floating-point register format. The *fldtype* completer specifies special load operations, which are described in [Table 2-36 on page 3:135](#).

For more details on speculative, advanced and check loads see [Section 4.4.4, “Control Speculation” on page 1:51](#) and [Section 4.4.5, “Data Speculation” on page 1:55](#).

For the non-speculative load types, if NaT bit associated with GR r_3 is 1, a Register NaT Consumption fault is taken. For speculative and speculative advanced loads, no fault is raised, and the exception is deferred.

In the base_update_form, the value in GR r_3 is added to an implied immediate value (equal to double the data size) and the result is placed back in GR r_3 . This base register update is done after the load, and does not affect the load address.

The value of the *ldhint* modifier specifies the locality of the memory access. The mnemonic values of *ldhint* are given in [Table 2-34 on page 3:132](#). A prefetch hint is implied in the base update form. The address specified by the value in GR r_3 after the base update acts as a hint to prefetch the indicated cache line. This prefetch uses the locality hints specified by *ldhint*. Prefetch and locality hints do not affect program functionality and may be ignored by the implementation. See [Section 4.4.6, “Memory Hierarchy Control and Consistency” on page 1:60](#) for details.

In the no_base_update form, the value in GR r_3 is not modified and no prefetch hint is implied.

The PSR.mfl and PSR.mfh bits are updated to reflect the modification of FR f_1 and FR f_2 .

There is a restriction on the choice of target registers. Register specifiers f_1 and f_2 must specify one odd-numbered physical FR and one even-numbered physical FR. Specifying two odd or two even registers will cause an Illegal Operation fault to be raised. The restriction is on physical register numbers after register rotation. This means that if f_1 and f_2 both specify static registers or both specify rotating registers, then f_1 and f_2 must be odd/even or even/odd. If f_1 and f_2 specify one static and one rotating register, the restriction depends on CFM.rrb.fr. If CFM.rrb.fr is even, the restriction is the same; f_1 and f_2 must be odd/even or even/odd. If CFM.rrb.fr is odd, then f_1 and f_2 must be even/even or odd/odd. Specifying one static and one rotating register should only be done when CFM.rrb.fr will have a predictable value (such as 0).

```

Operation:  if (PR[qp]) {
                size = single_form ? 8 : 16;

                speculative = (fldtype == 's' || fldtype == 'sa');
                advanced = (fldtype == 'a' || fldtype == 'sa');
                check_clear = (fldtype == 'c.clr');
                check_no_clear = (fldtype == 'c.nc');
                check = check_clear || check_no_clear;

                itype = READ;
                if (speculative) itype |= SPEC;
                if (advanced) itype |= ADVANCE;

                if (fp_reg_bank_conflict(f1, f2))
                    illegal_operation_fault();

                if (base_update_form)
                    check_target_register(r3);

                fp_check_target_register(f1);
                fp_check_target_register(f2);
                if (tmp_isrkode = fp_reg_disabled(f1, f2, 0, 0))
                    disabled_fp_register_fault(tmp_isrkode, itype);

                if (!speculative && GR[r3].nat) // fault on NaT address
                    register_nat_consumption_fault(itype);

                defer = speculative && (GR[r3].nat || PSR.ed); // defer exception if spec

                if (check && alat_cmp(FLOAT, f1)) { // no load on ldfp.c & ALAT hit
                    if (check_clear) // remove entry on ldfp.c.clr
                        alat_inval_single_entry(FLOAT, f1);
                } else {
                    if (!defer) {
                        paddr = tlb_translate(GR[r3], size, itype, PSR.cpl, &mattr,
                                             &defer);
                        spontaneous_deferral(paddr, size, UM.be, mattr, UNORDERED,
                                             ldhint, &defer);

                        if (!defer)
                            mem_read_pair(&f1_val, &f2_val, paddr, size, UM.be,
                                           mattr, UNORDERED, ldhint);
                    }
                    if (check_clear || advanced) // remove any old ALAT entry
                        alat_inval_single_entry(FLOAT, f1);
                    if (speculative && defer) {
                        FR[f1] = NATVAL;
                        FR[f2] = NATVAL;
                    } else if (advanced && !speculative && defer) {
                        FR[f1] = (integer_form ? FP_INT_ZERO : FP_ZERO);
                        FR[f2] = (integer_form ? FP_INT_ZERO : FP_ZERO);
                    } else { // execute load normally
                        FR[f1] = fp_mem_to_fr_format(f1_val, size/2, integer_form);
                        FR[f2] = fp_mem_to_fr_format(f2_val, size/2, integer_form);

                        if ((check_no_clear || advanced) && ma_is_speculative(mattr))
                            // add entry to ALAT
                            alat_write(FLOAT, f1, paddr, size);
                    }
                }

                if (base_update_form) { // update base register
                    GR[r3] = GR[r3] + size;
                }
            }

```

```

    GR[r3].nat = GR[r3].nat;
    if (!GR[r3].nat)
        mem_implicit_prefetch(GR[r3], ldhint, itype);
}

fp_update_psr(f1);
fp_update_psr(f2);
}

```

Interruptions:

| | |
|--|---------------------------------|
| Illegal Operation fault | Data Page Not Present fault |
| Disabled Floating-point Register fault | Data NaT Page Consumption fault |
| Register NaT Consumption fault | Data Key Miss fault |
| Unimplemented Data Address fault | Data Key Permission fault |
| Data Nested TLB fault | Data Access Rights fault |
| Alternate Data TLB fault | Data Access Bit fault |
| VHPT Data fault | Data Debug fault |
| Data TLB fault | Unaligned Data Reference fault |

lfetch — Line Prefetch

| | | | |
|----------------|--|--------------------------------------|-----|
| Format: | (qp) lfetch.lfctype.lfhint [r_3] | no_base_update_form | M13 |
| | (qp) lfetch.lfctype.lfhint [r_3], r_2 | reg_base_update_form | M14 |
| | (qp) lfetch.lfctype.lfhint [r_3], imm_9 | imm_base_update_form | M15 |
| | (qp) lfetch.lfctype.excl.lfhint [r_3] | no_base_update_form, exclusive_form | M13 |
| | (qp) lfetch.lfctype.excl.lfhint [r_3], r_2 | reg_base_update_form, exclusive_form | M14 |
| | (qp) lfetch.lfctype.excl.lfhint [r_3], imm_9 | imm_base_update_form, exclusive_form | M15 |

Description: The line containing the address specified by the value in GR r_3 is moved to the highest level of the data memory hierarchy. The value of the *lfhint* modifier specifies the locality of the memory access; see [Section 4.4, “Memory Access Instructions” on page 1:48](#) for details. The mnemonic values of *lfhint* are given in [Table 2-38](#).

The behavior of the memory read is also determined by the memory attribute associated with the accessed page. See [Chapter 4, “Addressing and Protection” in Volume 2](#). Line size is implementation dependent but must be a power of two greater than or equal to 32 bytes. In the exclusive form, the cache line is allowed to be marked in an exclusive state. This qualifier is used when the program expects soon to modify a location in that line. If the memory attribute for the page containing the line is not cacheable, then no reference is made.

The completer, *lfctype*, specifies whether or not the instruction raises faults normally associated with a regular load. [Table 2-37](#) defines these two options.

Table 2-37. lfctype Mnemonic Values

| <i>lfctype</i> Mnemonic | Interpretation |
|-------------------------|----------------|
| <i>none</i> | Ignore faults |
| <i>fault</i> | Raise faults |

In the base update forms, after being used to address memory, the value in GR r_3 is incremented by either the sign-extended value in imm_9 (in the *imm_base_update_form*) or the value in GR r_2 (in the *reg_base_update_form*). In the *reg_base_update_form*, if the NaT bit corresponding to GR r_2 is set, then the NaT bit corresponding to GR r_3 is set – no fault is raised.

In the *reg_base_update_form* and the *imm_base_update_form*, if the NaT bit corresponding to GR r_3 is clear, then the address specified by the value in GR r_3 after the post-increment acts as a hint to implicitly prefetch the indicated cache line. This implicit prefetch uses the locality hints specified by *lfhint*. The implicit prefetch does not affect program functionality, does not raise any faults, and may be ignored by the implementation.

In the *no_base_update_form*, the value in GR r_3 is not modified and no implicit prefetch hint is implied.

If the NaT bit corresponding to GR r_3 is set then the state of memory is not affected. In the *reg_base_update_form* and *imm_base_update_form*, the post increment of GR r_3 is performed and prefetch is hinted as described above.

lfetch instructions, like hardware prefetches, are not orderable operations, i.e., they have no order with respect to prior or subsequent memory operations.

Table 2-38. *lfhint* Mnemonic Values

| <i>lfhint</i> Mnemonic | Interpretation |
|------------------------|----------------------------------|
| <i>none</i> | Temporal locality, level 1 |
| nt1 | No temporal locality, level 1 |
| nt2 | No temporal locality, level 2 |
| nta | No temporal locality, all levels |

A faulting `lfetch` to an unimplemented address results in an Unimplemented Data Address fault. A non-faulting `lfetch` to an unimplemented address does not take the fault and will not issue a prefetch request, but, if specified, will perform a register post-increment.

Both the non-faulting and the faulting forms of `lfetch` can be used speculatively. The purpose of raising faults on the faulting form is to allow the operating system to resolve problems with the address to the extent that it can do so relatively quickly. If problems with the address cannot be resolved quickly, the OS simply returns to the program, and forces the data prefetch to be skipped over.

Specifically, if a faulting `lfetch` takes any of the listed faults (other than Illegal Operation fault), the operating system must handle this fault to the extent that it can do so relatively quickly and invisibly to the interrupted program. If the fault cannot be handled quickly or cannot be handled invisibly (e.g., if handling the fault would involve terminating the program), the OS must return to the interrupted program, skipping over the data prefetch. This can easily be done by setting the `IPSR.ed` bit to 1 before executing an `rfi` to go back to the process, which will allow the `lfetch.fault` to perform its base register post-increment (if specified), but will suppress any prefetch request and hence any prefetch-related fault. Note that the OS can easily identify that a faulting `lfetch` was the cause of the fault by observing that `ISR.na` is 1, and `ISR.code{3:0}` is 4. The one exception to this is the Illegal Operation fault, which can be caused by an `lfetch.fault` if base register post-increment is specified, and the base register is outside of the current stack frame, or is `GR0`. Since this one fault is not related to the prefetch aspect of `lfetch.fault`, but rather to the base update portion, Illegal Operation faults on `lfetch.fault` should be handled the same as for any other instruction.

```

Operation:  if (PR[gp]) {
                itype = READ|NON_ACCESS;
                itype |= (lftype == 'fault') ? LFETCH_FAULT : LFETCH;

                if (reg_base_update_form || imm_base_update_form)
                    check_target_register(r3);

                if (lftype == 'fault') { // faulting form
                    if (GR[r3].nat && !PSR.ed) // fault on NaT address
                        register_nat_consumption_fault(itype);
                }

                excl_hint = (exclusive_form) ? EXCLUSIVE : 0;

                if (!GR[r3].nat && !PSR.ed) { // faulting form already faulted if r3 is nat
                    paddr = tlb_translate(GR[r3], 1, itype, PSR.cpl, &mattr, &defer);
                    if (!defer)
                        mem_promote(paddr, mattr, lfhint | excl_hint);
                }

                if (imm_base_update_form) {
                    GR[r3] = GR[r3] + sign_ext(imm9, 9);
                    GR[r3].nat = GR[r3].nat;
                } else if (reg_base_update_form) {

```

```

    GR[r3] = GR[r3] + GR[r2];
    GR[r3].nat = GR[r2].nat || GR[r3].nat;
}

if ((reg_base_update_form || imm_base_update_form) && !GR[r3].nat)
    mem_implicit_prefetch(GR[r3], lfhint | excl_hint, itype);
}

```

| | | |
|-----------------------|----------------------------------|---------------------------------|
| Interruptions: | Illegal Operation fault | Data Page Not Present fault |
| | Register NaT Consumption fault | Data NaT Page Consumption fault |
| | Unimplemented Data Address fault | Data Key Miss fault |
| | Data Nested TLB fault | Data Key Permission fault |
| | Alternate Data TLB fault | Data Access Rights fault |
| | VHPT Data fault | Data Access Bit fault |
| | Data TLB fault | Data Debug fault |

loadrs — Load Register Stack

Format: loadrs

M25

Description: This instruction ensures that a specified number of bytes (registers values and/or NaT collections) below the current BSP have been loaded from the backing store into the stacked general registers. The loaded registers are placed into the dirty partition of the register stack. All other stacked general registers are marked as invalid, without being saved to the backing store.

The number of bytes to be loaded is specified in a sub-field of the RSC application register (RSC.loadrs). Backing store addresses are always 8-byte aligned, and therefore the low order 3 bits of the `loadrs` field (RSC.loadrs{2:0}) are ignored. This instruction can be used to invalidate all stacked registers outside the current frame, by setting RSC.loadrs to zero.

This instruction will fault with an Illegal Operation fault under any of the following conditions:

- the RSE is not in enforced lazy mode (RSC.mode is non-zero).
- CFM.sof and RSC.loadrs are both non-zero.
- an attempt is made to load up more registers than are available in the physical stacked register file.

This instruction must be the first instruction in an instruction group and must either be in instruction slot 0 or in instruction slot 1 of a template having a stop after slot 0; otherwise, the results are undefined. This instruction cannot be predicated.

Operation:

```

if (AR[RSC].mode != 0)
    illegal_operation_fault();

if ((CFM.sof != 0) && (AR[RSC].loadrs != 0))
    illegal_operation_fault();

rse_ensure_regs_loaded(AR[RSC].loadrs); // can raise faults listed below
AR[RNAT] = undefined();

```

| | |
|---|---------------------------------|
| Interruptions: Illegal Operation fault | Data NaT Page Consumption fault |
| Unimplemented Data Address fault | Data Key Miss fault |
| Data Nested TLB fault | Data Key Permission fault |
| Alternate Data TLB fault | Data Access Rights fault |
| VHPT Data fault | Data Access Bit fault |
| Data TLB fault | Data Debug fault |
| Data Page Not Present fault | |

mf — Memory Fence

Format: (qp) mf ordering_form [M24](#)
 (qp) mf.a acceptance_form [M24](#)

Description: This instruction forces ordering between prior and subsequent memory accesses. The ordering_form ensures all prior data memory accesses are made visible prior to any subsequent data memory accesses being made visible. It does not ensure prior data memory references have been accepted by the external platform, nor that prior data memory references are visible.

The acceptance_form prevents any subsequent data memory accesses by the processor from initiating transactions to the external platform until:

- all prior loads to sequential pages have returned data, and
- all prior stores to sequential pages have been accepted by the external platform.

The definition of “acceptance” is platform dependent. The acceptance_form is typically used to ensure the processor has “waited” until a memory-mapped I/O transaction has been “accepted”, before initiating additional external transactions. The acceptance_form does not ensure ordering, or acceptance to memory areas other than sequential pages.

Operation:

```
if (PR[qp]){
    if (acceptance_form)
        acceptance_fence();
    else // ordering_form
        ordering_fence();
}
```

Interruptions: None

mix — Mix

| | | | |
|----------------|------------------------------|----------------------------|----|
| Format: | (qp) mix1.l $r_1 = r_2, r_3$ | one_byte_form, left_form | I2 |
| | (qp) mix2.l $r_1 = r_2, r_3$ | two_byte_form, left_form | I2 |
| | (qp) mix4.l $r_1 = r_2, r_3$ | four_byte_form, left_form | I2 |
| | (qp) mix1.r $r_1 = r_2, r_3$ | one_byte_form, right_form | I2 |
| | (qp) mix2.r $r_1 = r_2, r_3$ | two_byte_form, right_form | I2 |
| | (qp) mix4.r $r_1 = r_2, r_3$ | four_byte_form, right_form | I2 |

Description: The data elements of GR r_2 and r_3 are mixed as shown in [Figure 2-25](#), and the result placed in GR r_1 . The data elements in the source registers are grouped in pairs, and one element from each pair is selected for the result. In the left_form, the result is formed from the leftmost elements from each of the pairs. In the right_form, the result is formed from the rightmost elements. Elements are selected alternately from the two source registers.

Figure 2-25. Mix Example

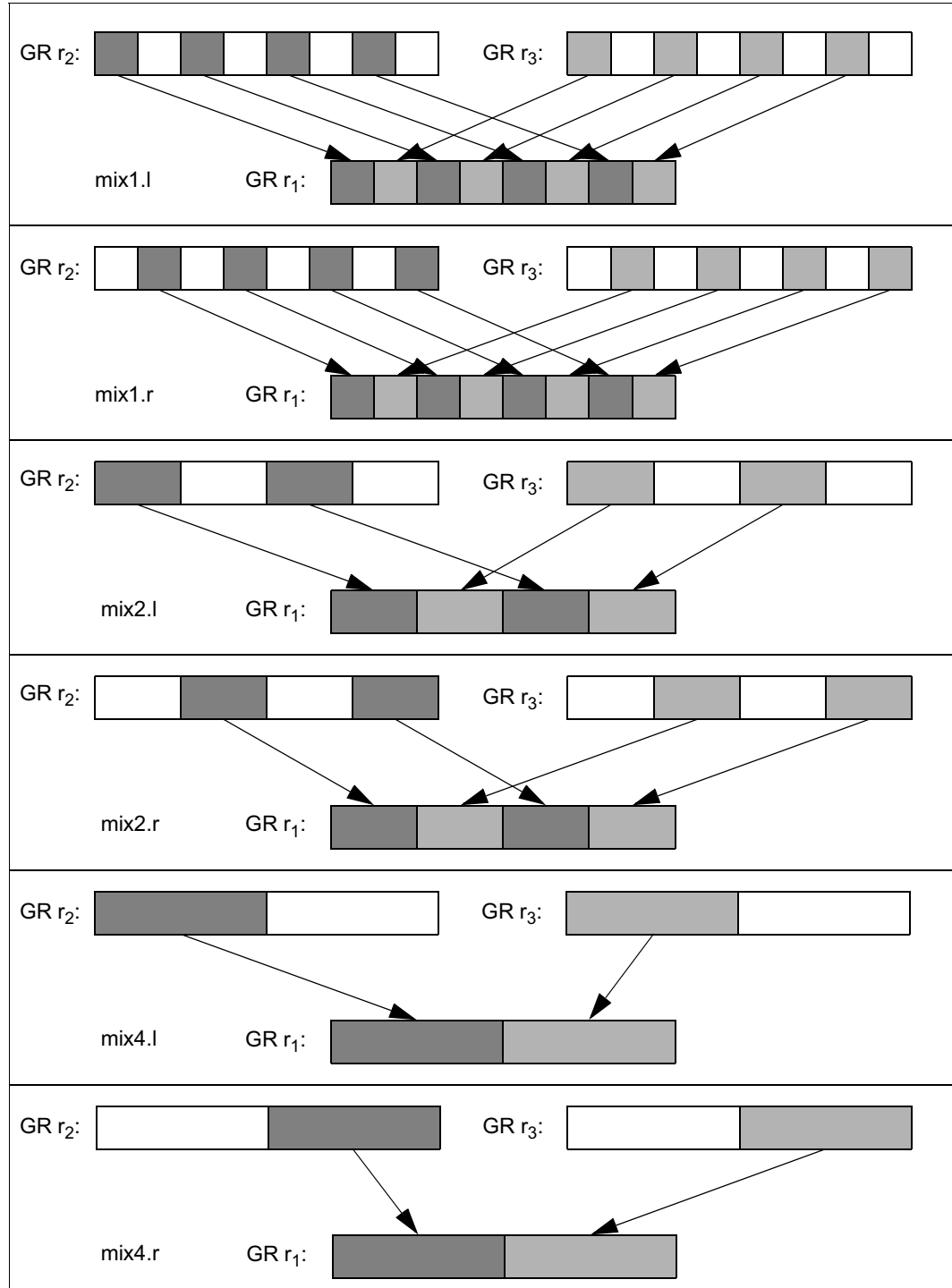

```

Operation:   if (PR[qp]) {
                check_target_register(r1);

                if (one_byte_form) { // one-byte elements
                    x[0] = GR[r2]{7:0};      y[0] = GR[r3]{7:0};
                    x[1] = GR[r2]{15:8};     y[1] = GR[r3]{15:8};
                    x[2] = GR[r2]{23:16};    y[2] = GR[r3]{23:16};
                    x[3] = GR[r2]{31:24};    y[3] = GR[r3]{31:24};
                    x[4] = GR[r2]{39:32};    y[4] = GR[r3]{39:32};
                    x[5] = GR[r2]{47:40};    y[5] = GR[r3]{47:40};
                    x[6] = GR[r2]{55:48};    y[6] = GR[r3]{55:48};
                    x[7] = GR[r2]{63:56};    y[7] = GR[r3]{63:56};

                    if (left_form)
                        GR[r1] = concatenate8(x[7], y[7], x[5], y[5],
                                                x[3], y[3], x[1], y[1]);
                    else // right_form
                        GR[r1] = concatenate8(x[6], y[6], x[4], y[4],
                                                x[2], y[2], x[0], y[0]);

                } else if (two_byte_form) { // two-byte elements
                    x[0] = GR[r2]{15:0};      y[0] = GR[r3]{15:0};
                    x[1] = GR[r2]{31:16};     y[1] = GR[r3]{31:16};
                    x[2] = GR[r2]{47:32};    y[2] = GR[r3]{47:32};
                    x[3] = GR[r2]{63:48};    y[3] = GR[r3]{63:48};

                    if (left_form)
                        GR[r1] = concatenate4(x[3], y[3], x[1], y[1]);
                    else // right_form
                        GR[r1] = concatenate4(x[2], y[2], x[0], y[0]);

                } else { // four-byte elements
                    x[0] = GR[r2]{31:0};      y[0] = GR[r3]{31:0};
                    x[1] = GR[r2]{63:32};     y[1] = GR[r3]{63:32};

                    if (left_form)
                        GR[r1] = concatenate2(x[1], y[1]);
                    else // right_form
                        GR[r1] = concatenate2(x[0], y[0]);
                }
                GR[r1].nat = GR[r2].nat || GR[r3].nat;
            }

```

Interruptions: Illegal Operation fault

mov — Move Application Register

| | | | |
|----------------|---|---------------------------------|---------------------|
| Format: | (qp) mov r ₁ = ar ₃ | pseudo-op | |
| | (qp) mov ar ₃ = r ₂ | pseudo-op | |
| | (qp) mov ar ₃ = imm ₈ | pseudo-op | |
| | (qp) mov.i r ₁ = ar ₃ | i_form, from_form | I28 |
| | (qp) mov.i ar ₃ = r ₂ | i_form, register_form, to_form | I26 |
| | (qp) mov.i ar ₃ = imm ₈ | i_form, immediate_form, to_form | I27 |
| | (qp) mov.m r ₁ = ar ₃ | m_form, from_form | M31 |
| | (qp) mov.m ar ₃ = r ₂ | m_form, register_form, to_form | M29 |
| | (qp) mov.m ar ₃ = imm ₈ | m_form, immediate_form, to_form | M30 |

Description: The source operand is copied to the destination register.

In the from_form, the application register specified by ar₃ is copied into GR r₁ and the corresponding NaT bit is cleared.

In the to_form, the value in GR r₂ (in the register_form), or the sign-extended value in imm₈ (in the immediate_form), is placed in AR ar₃. In the register_form if the NaT bit corresponding to GR r₂ is set, then a Register NaT Consumption fault is raised.

Only a subset of the application registers can be accessed by each execution unit (M or I). [Table 3-3 on page 1:23](#) indicates which application registers may be accessed from which execution unit type. An access to an application register from the wrong unit type causes an Illegal Operation fault.

This instruction has multiple forms with the pseudo operation eliminating the need for specifying the execution unit. Accesses of the ARs are always implicitly serialized. While implicitly serialized, read-after-write and write-after-write dependency violations must be avoided (e.g., setting CCV, followed by `cmpxchg` in the same instruction group, or simultaneous writes to the UNAT register by `ld.fill` and `mov` to UNAT).

```

Operation:   if (PR[qp]) {
                tmp_type = (i_form ? AR_I_TYPE : AR_M_TYPE);
                if (is_reserved_reg(tmp_type, ar3))
                    illegal_operation_fault();

                if (from_form) {
                    check_target_register(r1);
                    if ((ar3 == BSPSTORE) || (ar3 == RNAT) && (AR[RSC].mode != 0))
                        illegal_operation_fault();

                    if (ar3 == ITC && PSR.si && PSR.cpl != 0)
                        privileged_register_fault();

                    GR[r1] = (is_ignored_reg(ar3)) ? 0 : AR[ar3];
                    GR[r1].nat = 0;
                } else { // to_form
                    tmp_val = (register_form) ? GR[r2] : sign_ext(imm8, 8);

                    if (is_read_only_register(AR_TYPE, ar3) ||
                        ((ar3 == BSPSTORE) || (ar3 == RNAT)) && (AR[RSC].mode != 0))
                        illegal_operation_fault();

                    if (register_form && GR[r2].nat)
                        register_nat_consumption_fault(0);

                    if (is_reserved_field(AR_TYPE, ar3, tmp_val))
                        reserved_register_field_fault();

                    if ((is_kernel_reg(ar3) || ar3 == ITC) && (PSR.cpl != 0))
                        privileged_register_fault();

                    if (!is_ignored_reg(ar3)) {
                        tmp_val = ignored_field_mask(AR_TYPE, ar3, tmp_val);
                        // check for illegal promotion
                        if (ar3 == RSC && tmp_val{3:2} u< PSR.cpl)
                            tmp_val{3:2} = PSR.cpl;
                        AR[ar3] = tmp_val;

                        if (ar3 == BSPSTORE) {
                            AR[BSP] = rse_update_internal_stack_pointers(tmp_val);
                            AR[RNAT] = undefined();
                        }
                    }
                }
            }

```

Interruptions: Illegal Operation fault
 Register NaT Consumption fault

Reserved Register/Field fault
 Privileged Register fault

mov — Move Branch Register

| | | | |
|----------------|--|----------------------|-----|
| Format: | <i>(qp)</i> mov $r_1 = b_2$ | from_form | I22 |
| | <i>(qp)</i> mov $b_1 = r_2$ | pseudo-op | |
| | <i>(qp)</i> mov.mwh.ih $b_1 = r_2, tag_{13}$ | to_form | I21 |
| | <i>(qp)</i> mov.ret.mwh.ih $b_1 = r_2, tag_{13}$ | return_form, to_form | I21 |

Description: The source operand is copied to the destination register.

In the from_form, the branch register specified by b_2 is copied into GR r_1 . The NaT bit corresponding to GR r_1 is cleared.

In the to_form, the value in GR r_2 is copied into BR b_1 . If the NaT bit corresponding to GR r_2 is 1, then a Register NaT Consumption fault is taken.

A set of hints can also be provided when moving to a branch register. These hints are very similar to those provided on the brp instruction, and provide prediction information about a future branch which may use the value being moved into BR b_1 . The return_form is used to provide the hint that this value will be used in a return-type branch.

The values for the mwh whether hint completer are given in Table 2-39. For a description of the ih hint completer see the Branch Prediction instruction and Table 2-13 on page 3:28.

Table 2-39. Move to BR Whether Hints

| <i>mwh</i> Completer | Move to BR Whether Hint |
|----------------------|-------------------------|
| none | Ignore all hints |
| sptk | Static Taken |
| dptk | Dynamic |

A pseudo-op is provided for copying a general register into a branch register when there is no hint information to be specified. This is encoded with a value of 0 for tag_{13} and values corresponding to none for the hint completers.

Operation:

```

if (PR[qp]) {
  if (from_form) {
    check_target_register(r1);
    GR[r1] = BR[b2];
    GR[r1].nat = 0;
  } else { // to_form
    tmp_tag = IP + sign_ext((timm9 << 4), 13);
    if (GR[r2].nat)
      register_nat_consumption_fault(0);
    BR[b1] = GR[r2];
    branch_predict(mwh, ih, return_form, GR[r2], tmp_tag);
  }
}

```

Interruptions: Illegal Operation fault

Register NaT Consumption fault

mov — Move Control Register

Format: `(qp) mov r1 = cr3` from_form [M33](#)
`(qp) mov cr3 = r2` to_form [M32](#)

Description: The source operand is copied to the destination register.

For the from_form, the control register specified by `cr3` is read and the value copied into GR `r1`.

For the to_form, GR `r2` is read and the value copied into CR `cr3`.

Control registers can only be accessed at the most privileged level. Reading or writing an interruption control register (CR16-CR25), when the PSR.ic bit is one, will result in an Illegal Operation fault.

Operation:

```

if (PR[qp]) {
    if (is_reserved_reg(CR_TYPE, cr3)
        || to_form && is_read_only_reg(CR_TYPE, cr3)
        || PSR.ic && is_interruption_cr(cr3))
    {
        illegal_operation_fault();
    }

    if (from_form)
        check_target_register(r1);
    if (PSR.cpl != 0)
        privileged_operation_fault(0);

    if (from_form) {
        if (cr3 == IVR)
            check_interrupt_request();

        if (cr3 == ITIR)
            GR[r1] = impl_itir_cwi_mask(CR[ITIR]);
        else
            GR[r1] = CR[cr3];

        GR[r1].nat = 0;
    } else { // to_form
        if (GR[r2].nat)
            register_nat_consumption_fault(0);

        if (is_reserved_field(CR_TYPE, cr3, GR[r2]))
            reserved_register_field_fault();
        if (cr3 == EOI)
            end_of_interrupt();

        tmp_val = ignored_field_mask(CR_TYPE, cr3, GR[r2]);
        CR[cr3] = tmp_val;
        if (cr3 == IIPA)
            last_IP = tmp_val;
    }
}

```

Interruptions: Illegal Operation fault Register NaT Consumption fault
Privileged Operation fault Reserved Register/Field fault

Serialization: Reads of control registers reflect the results of all prior instruction groups and interruptions.

In general, writes to control registers do not immediately affect subsequent instructions. Software must issue a serialize operation before a dependent instruction uses a modified resource.

Control register writes are not implicitly synchronized with a corresponding control register read and requires data serialization.

mov — Move Floating-point Register

Format: $(qp) \text{ mov } f_1 = f_3$ pseudo-op of: $(qp) \text{ fmerge.s } f_1 = f_3, f_3$

Description: The value of FR f_3 is copied to FR f_1 .

Operation: See [“fmerge – Floating-point Merge” on page 3:72.](#)

mov — Move General Register

Format: (qp) mov $r_1 = r_3$

pseudo-op of: (qp) adds $r_1 = 0, r_3$

Description: The value of GR r_3 is copied to GR r_1 .

Operation: See ["add – Add" on page 3:11.](#)

mov — Move Immediate

Format: (qp) mov $r_1 = imm_{22}$ pseudo-op of: (qp) addl $r_1 = imm_{22}, r0$

Description: The immediate value, imm_{22} , is sign extended to 64 bits and placed in GR r_1 .

Operation: See "add — Add" on page 3:11.

mov — Move Indirect Register

Format: $(qp) \text{ mov } r_1 = \text{ireg}[r_3]$ from_form M43
 $(qp) \text{ mov } \text{ireg}[r_3] = r_2$ to_form M42

Description: The source operand is copied to the destination register.

For move from indirect register, GR r_3 is read and the value used as an index into the register file specified by *ireg* (see [Table 2-40](#) below). The indexed register is read and its value is copied into GR r_1 .

For move to indirect register, GR r_3 is read and the value used as an index into the register file specified by *ireg*. GR r_2 is read and its value copied into the indexed register.

Table 2-40. Indirect Register File Mnemonics

| <i>ireg</i> | Register File |
|-------------|--|
| cpuid | Processor Identification Register |
| dbr | Data Breakpoint Register |
| ibr | Instruction Breakpoint Register |
| pkc | Protection Key Register |
| pmc | Performance Monitor Configuration Register |
| pmd | Performance Monitor Data Register |
| rr | Region Register |

For all register files other than the region registers, bits {7:0} of GR r_3 are used as the index. For region registers, bits {63:61} are used. The remainder of the bits are ignored.

Instruction and data breakpoint, performance monitor configuration, protection key, and region registers can only be accessed at the most privileged level. Performance monitor data registers can only be written at the most privileged level.

The CPU identification registers can only be read. There is no to_form of this instruction.

For move to protection key register, the processor ensures uniqueness of protection keys by checking new valid protection keys against all protection key registers. If any matching keys are found, duplicate protection keys are invalidated.

Apart from the PMC and PMD register files, access of a non-existent register results in a Reserved Register/Field fault. All accesses to the implementation-dependent portion of PMC and PMD register files result in implementation dependent behavior but do not fault.

Modifying a region register or a protection key register which is being used to translate:

- the executing instruction stream when PSR.it == 1, or
- the data space for an eager RSE reference when PSR.rt == 1

is an undefined operation.

```

Operation:   if (PR[qp]) {
                if (ireg == RR_TYPE)
                    tmp_index = GR[r3]{63:61};
                else // all other register types
                    tmp_index = GR[r3]{7:0};

                if (from_form) {
                    check_target_register(r1);

                    if (PSR.cpl != 0 && !(ireg == PMD_TYPE || ireg == CPUID_TYPE))
                        privileged_operation_fault(0);

                    if (GR[r3].nat)
                        register_nat_consumption_fault(0);

                    if (is_reserved_reg(ireg, tmp_index))
                        reserved_register_field_fault();

                    if (ireg == PMD_TYPE) {
                        if ((PSR.cpl != 0) && ((PSR.sp == 1) ||
                            (tmp_index > 3 &&
                                tmp_index <= IMPL_MAXGENERIC_PMC_PMD &&
                                PMC[tmp_index].pm == 1)))
                            GR[r1] = 0;
                        else
                            GR[r1] = pmd_read(tmp_index);
                    } else
                        switch (ireg) {
                            case CPUID_TYPE: GR[r1] = CPUID[tmp_index]; break;
                            case DBR_TYPE:   GR[r1] = DBR[tmp_index]; break;
                            case IBR_TYPE:   GR[r1] = IBR[tmp_index]; break;
                            case PKR_TYPE:   GR[r1] = PKR[tmp_index]; break;
                            case PMC_TYPE:   GR[r1] = pmc_read(tmp_index); break;
                            case RR_TYPE:    GR[r1] = RR[tmp_index]; break;
                        }
                    GR[r1].nat = 0;
                } else { // to_form
                    if (PSR.cpl != 0)
                        privileged_operation_fault(0);

                    if (GR[r2].nat || GR[r3].nat)
                        register_nat_consumption_fault(0);

                    if (is_reserved_reg(ireg, tmp_index)
                        || is_reserved_field(ireg, tmp_index, GR[r2]))
                        reserved_register_field_fault();
                    if (ireg == PKR_TYPE && GR[r2]{0} == 1) { // writing valid prot key
                        if ((tmp_slot = tlb_search_pkr(GR[r2]{31:8})) != NOT_FOUND)
                            PKR[tmp_slot].v = 0; // clear valid bit of matching key reg
                    }
                    tmp_val = ignored_field_mask(ireg, tmp_index, GR[r2]);
                    switch (ireg) {
                        case DBR_TYPE:   DBR[tmp_index] = tmp_val; break;
                        case IBR_TYPE:   IBR[tmp_index] = tmp_val; break;
                        case PKR_TYPE:   PKR[tmp_index] = tmp_val; break;
                        case PMC_TYPE:   pmc_write(tmp_index, tmp_val); break;
                        case PMD_TYPE:   pmd_write(tmp_index, tmp_val); break;
                        case RR_TYPE:    RR[tmp_index] = tmp_val; break;
                    }
                }
            }

```

mov — Move Instruction Pointer

Format: (qp) mov r₁ = ip

125

Description: The Instruction Pointer (IP) for the bundle containing this instruction is copied into GR r₁.

Operation:

```
if (PR[qp]) {
    check_target_register(r1);

    GR[r1] = IP;
    GR[r1].nat = 0;
}
```

Interruptions: Illegal Operation fault

mov — Move Predicates

| | | | |
|----------------|---------------------------------------|----------------|-----|
| Format: | <i>(qp)</i> mov $r_1 = pr$ | from_form | I25 |
| | <i>(qp)</i> mov pr = $r_2, mask_{17}$ | to_form | I23 |
| | <i>(qp)</i> mov pr.rot = imm_{44} | to_rotate_form | I24 |

Description: The source operand is copied to the destination register.

For moving the predicates to a GR, PR i is copied to bit position i within GR r_1 .

For moving to the predicates, the source can either be a general register, or an immediate value. In the to_form, the source operand is GR r_2 and only those predicates specified by the immediate value $mask_{17}$ are written. The value $mask_{17}$ is encoded in the instruction in an imm_{16} field such that: $imm_{16} = mask_{17} \gg 1$. Predicate register 0 is always one. The $mask_{17}$ value is sign extended. The most significant bit of $mask_{17}$, therefore, is the mask bit for all of the rotating predicates. If there is a deferred exception for GR r_2 (the NaT bit is 1), a Register NaT Consumption fault is taken.

In the to_rotate_form, only the 48 rotating predicates can be written. The source operand is taken from the imm_{44} operand (which is encoded in the instruction in an imm_{28} field, such that: $imm_{28} = imm_{44} \gg 16$). The low 16-bits correspond to the static predicates. The immediate is sign extended to set the top 21 predicates. Bit position i in the source operand is copied to PR i .

This instruction operates as if the predicate rotation base in the Current Frame Marker (CFM.rrb.pr) were zero.

Operation:

```

if (PR[qp]) {
    if (from_form) {
        check_target_register(r1);
        GR[r1] = 1; // PR[0] is always 1
        for (i = 1; i <= 63; i++) {
            GR[r1]{i} = PR[pr_phys_to_virt(i)];
        }
        GR[r1].nat = 0;
    } else if (to_form) {
        if (GR[r2].nat)
            register_nat_consumption_fault(0);
        tmp_src = sign_ext(mask17, 17);
        for (i = 1; i <= 63; i++) {
            if (tmp_src{i})
                PR[pr_phys_to_virt(i)] = GR[r2]{i};
        }
    } else { // to_rotate_form
        tmp_src = sign_ext(imm44, 44);
        for (i = 16; i <= 63; i++) {
            PR[pr_phys_to_virt(i)] = tmp_src{i};
        }
    }
}

```

Interruptions: Illegal Operation fault

Register NaT Consumption fault

mov — Move Processor Status Register

Format: (qp) mov r_1 = psr from_form M36
 (qp) mov psr.l = r_2 to_form M35

Description: The source operand is copied to the destination register. See [Section 3.3.2, “Processor Status Register \(PSR\)”](#) on page 2:18.

For move from processor status register, PSR bits {36:35} and {31:0} are read, and copied into GR r_1 . All other bits of the PSR read as zero.

For move to processor status register, GR r_2 is read, bits {31:0} copied into PSR{31:0} and bits {45:32} are ignored. All bits of GR r_2 corresponding to reserved fields of the PSR must be 0 or a Reserved Register/Field fault will result.

Moves to and from the PSR can only be performed at the most privileged level.

The contents of the interruption resources (that are overwritten when the PSR.ic bit is 1) are undefined if an interruption occurs between the enabling of the PSR.ic bit and a subsequent instruction serialize operation.

Operation:

```

if (PR[qp]) {
    if (from_form)
        check_target_register( $r_1$ );
    if (PSR.cpl != 0)
        privileged_operation_fault(0);

    if (from_form) {
        tmp_val = zero_ext(PSR{31:0}, 32); // read lower 32 bits
        tmp_val |= PSR{36:35} << 35; // read mc and it bits
        GR[ $r_1$ ] = tmp_val; // other bits read as zero
        GR[ $r_1$ ].nat = 0;
    } else { // to_form
        if (GR[ $r_2$ ].nat)
            register_nat_consumption_fault(0);

        if (is_reserved_field(PSR_TYPE, PSR_MOVPART, GR[ $r_2$ ]))
            reserved_register_field_fault();

        PSR{31:0} = GR[ $r_2$ ]{31:0};
    }
}

```

Interruptions: Illegal Operation fault Register NaT Consumption fault
 Privileged Operation fault Reserved Register/Field fault

Serialization: Software must issue an instruction or data serialize operation before issuing instructions dependent upon the altered PSR bits. Unlike with the `rsm` instruction, the PSR.i bit is not treated specially when cleared.

movl — Move Long Immediate

Format: (qp) movl $r_1 = imm_{64}$ X2

Description: The immediate value imm_{64} is copied to GR r_1 . The L slot of the bundle contains 41 bits of imm_{64} .

Operation:

```
if (PR[qp]) {
    check_target_register( $r_1$ );

    GR[ $r_1$ ] =  $imm_{64}$ ;
    GR[ $r_1$ ].nat = 0;
}
```

Interruptions: Illegal Operation fault

mux — Mux

Format: (qp) mux1 $r_1 = r_2, mbyte_4$ one_byte_form I3
 (qp) mux2 $r_1 = r_2, mbyte_8$ two_byte_form I4

Description: A permutation is performed on the packed elements in a single source register, GR r_2 , and the result is placed in GR r_1 . For 8-bit elements, only some of all possible permutations can be specified. The five possible permutations are given in Table 2-41 and shown in Figure 2-26.

Table 2-41. Mux Permutations for 8-bit Elements

| $mbyte_4$ | Function |
|-----------|---|
| @rev | Reverse the order of the bytes |
| @mix | Perform a Mix operation on the two halves of GR r_2 |
| @shuf | Perform a Shuffle operation on the two halves of GR r_2 |
| @alt | Perform an Alternate operation on the two halves of GR r_2 |
| @brctst | Perform a Broadcast operation on the least significant byte of GR r_2 |

Figure 2-26. Mux1 Operation (8-bit elements)

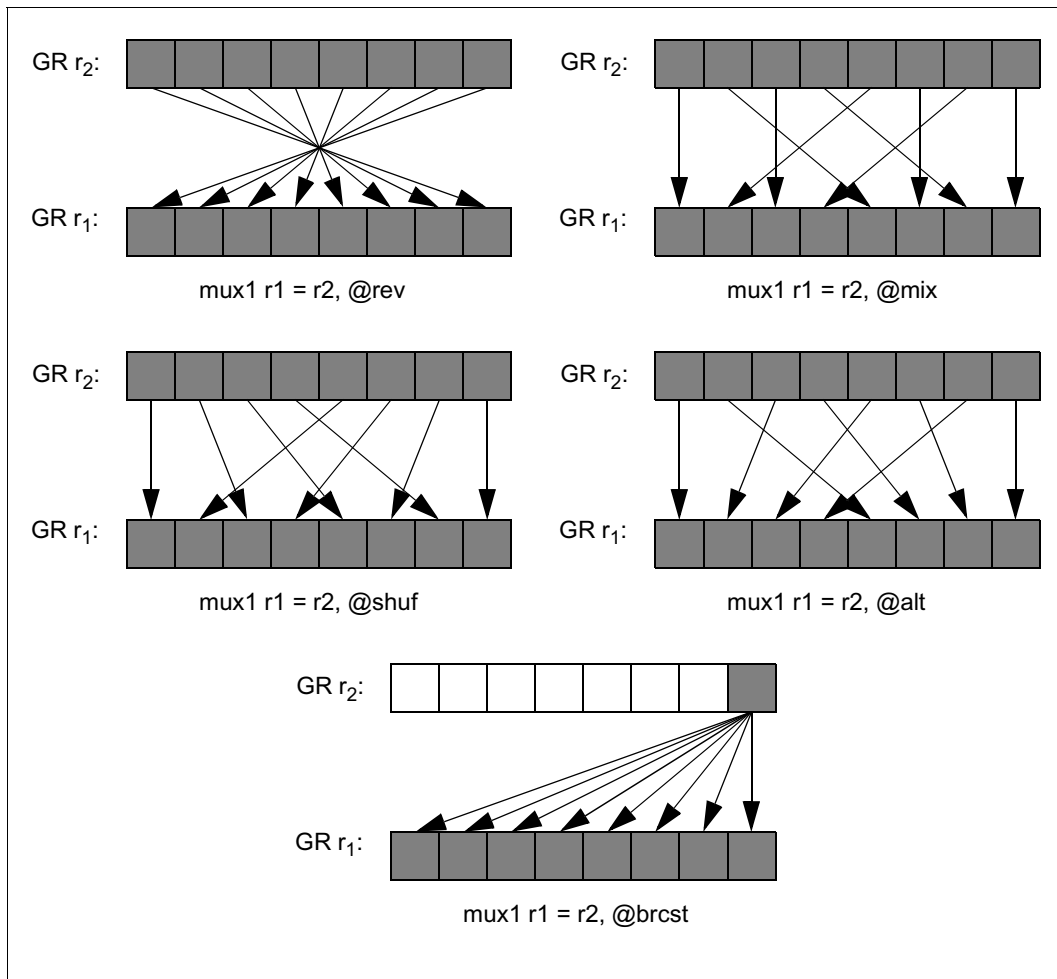

For 16-bit elements, all possible permutations, with and without repetitions can be specified. They are expressed with an 8-bit $mhtype_8$ field, which encodes the indices of the four 16-bit data elements. The indexed 16-bit elements of GR r_2 are copied to corresponding 16-bit positions in the target register GR r_1 . The indices are encoded in little-endian order. (The 8 bits of $mhtype_8[7:0]$ are grouped in pairs of bits and named $mhtype_8[3]$, $mhtype_8[2]$, $mhtype_8[1]$, $mhtype_8[0]$ in the Operation section).

Figure 2-27. Mux2 Examples (16-bit elements)

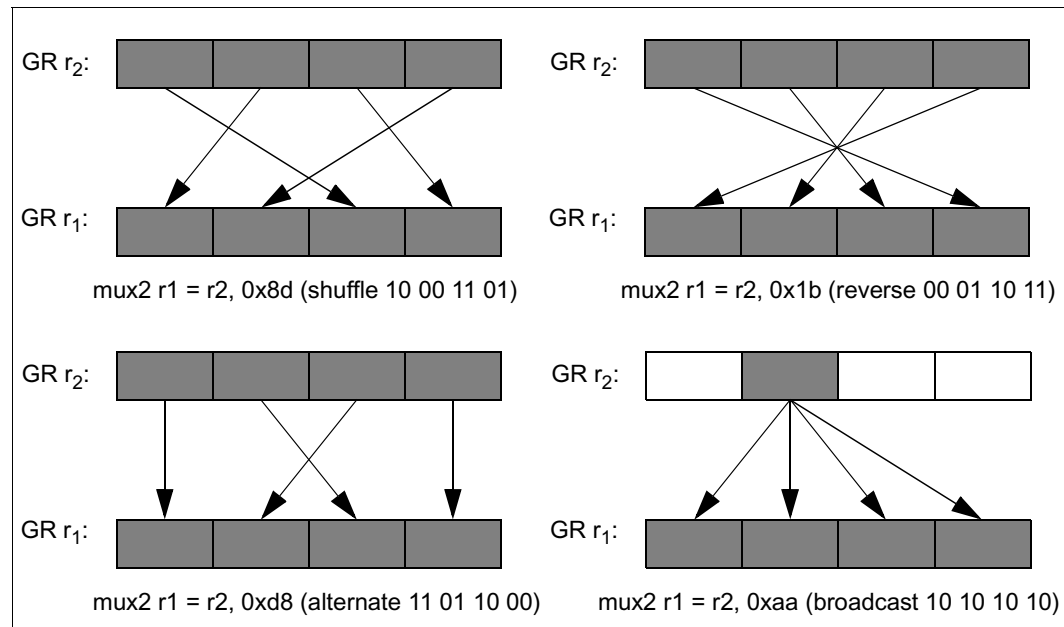

```

Operation:
if (PR[qp]) {
    check_target_register(r1);

    if (one_byte_form) {
        x[0] = GR[r2]{7:0};
        x[1] = GR[r2]{15:8};
        x[2] = GR[r2]{23:16};
        x[3] = GR[r2]{31:24};
        x[4] = GR[r2]{39:32};
        x[5] = GR[r2]{47:40};
        x[6] = GR[r2]{55:48};
        x[7] = GR[r2]{63:56};

        switch (mhtype) {
            case '@rev':
                GR[r1] = concatenate8(x[0], x[1], x[2], x[3],
                                      x[4], x[5], x[6], x[7]);
                break;

            case '@mix':
                GR[r1] = concatenate8(x[7], x[3], x[5], x[1],
                                      x[6], x[2], x[4], x[0]);
                break;

            case '@shuf':
                GR[r1] = concatenate8(x[7], x[3], x[6], x[2],
                                      x[5], x[1], x[4], x[0]);
        }
    }
}

```

```

        break;

    case '@alt':
        GR[r1] = concatenate8(x[7], x[5], x[3], x[1],
                               x[6], x[4], x[2], x[0]);
        break;

    case '@brdst':
        GR[r1] = concatenate8(x[0], x[0], x[0], x[0],
                               x[0], x[0], x[0], x[0]);
        break;
    }
} else { // two_byte_form
    x[0] = GR[r2]{15:0};
    x[1] = GR[r2]{31:16};
    x[2] = GR[r2]{47:32};
    x[3] = GR[r2]{63:48};

    res[0] = x[mhbyte8{1:0}];
    res[1] = x[mhbyte8{3:2}];
    res[2] = x[mhbyte8{5:4}];
    res[3] = x[mhbyte8{7:6}];

    GR[r1] = concatenate4(res[3], res[2], res[1], res[0]);
}
GR[r1].nat = GR[r2].nat;
}

```

Interruptions: Illegal Operation fault

nop — No Operation

| | | | |
|----------------|--|-------------|-----|
| Format: | <i>(qp)</i> nop <i>imm</i> ₂₁ | pseudo-op | |
| | <i>(qp)</i> nop.i <i>imm</i> ₂₁ | i_unit_form | I18 |
| | <i>(qp)</i> nop.b <i>imm</i> ₂₁ | b_unit_form | B9 |
| | <i>(qp)</i> nop.m <i>imm</i> ₂₁ | m_unit_form | M48 |
| | <i>(qp)</i> nop.f <i>imm</i> ₂₁ | f_unit_form | F16 |
| | <i>(qp)</i> nop.x <i>imm</i> ₆₂ | x_unit_form | X5 |

Description: No operation is done.

The immediate, *imm*₂₁ or *imm*₆₂, can be used by software as a marker in program code. It is ignored by hardware.

For the x_unit_form, the L slot of the bundle contains the upper 41 bits of *imm*₆₂.

A nop.i instruction may be encoded in an MLI-template bundle, in which case the L slot of the bundle is ignored.

This instruction has five forms, each of which can be executed only on a particular execution unit type. The pseudo-op can be used if the unit type to execute on is unimportant.

Operation:

```
if (PR[qp]) {
    ; // no operation
}
```

Interruptions: None

or — Logical Or

Format: (qp) or $r_1 = r_2, r_3$ register_form [A1](#)
 (qp) or $r_1 = imm_8, r_3$ imm8_form [A3](#)

Description: The two source operands are logically ORed and the result placed in GR r_1 . In the register form the first operand is GR r_2 ; in the immediate form the first operand is taken from the imm_8 encoding field.

Operation:

```

if (PR[qp]) {
    check_target_register(r1);

    tmp_src = (register_form ? GR[r2] : sign_ext(imm8, 8));
    tmp_nat = (register_form ? GR[r2].nat : 0);

    GR[r1] = tmp_src | GR[r3];
    GR[r1].nat = tmp_nat || GR[r3].nat;
}

```

Interruptions: Illegal Operation fault

pack — Pack

Format:

| | | |
|---------------------------------|---|----|
| (qp) pack2.sss $r_1 = r_2, r_3$ | two_byte_form, signed_saturation_form | 12 |
| (qp) pack2.uss $r_1 = r_2, r_3$ | two_byte_form, unsigned_saturation_form | 12 |
| (qp) pack4.sss $r_1 = r_2, r_3$ | four_byte_form, signed_saturation_form | 12 |

Description: 32-bit or 16-bit elements from GR r_2 and GR r_3 are converted into 16-bit or 8-bit elements respectively, and the results are placed GR r_1 . The source elements are treated as signed values. If a source element cannot be represented in the result element, then saturation clipping is performed. The saturation can either be signed or unsigned. If an element is larger than the upper limit value, the result is the upper limit value. If it is smaller than the lower limit value, the result is the lower limit value. The saturation limits are given in [Table 2-42](#).

Table 2-42. Pack Saturation Limits

| Size | Source Element Width | Result Element Width | Saturation | Upper Limit | Lower Limit |
|------|----------------------|----------------------|------------|-------------|-------------|
| 2 | 16 bit | 8 bit | signed | 0x7f | 0x80 |
| 2 | 16 bit | 8 bit | unsigned | 0xff | 0x00 |
| 4 | 32 bit | 16 bit | signed | 0x7fff | 0x8000 |

Figure 2-28. Pack Operation

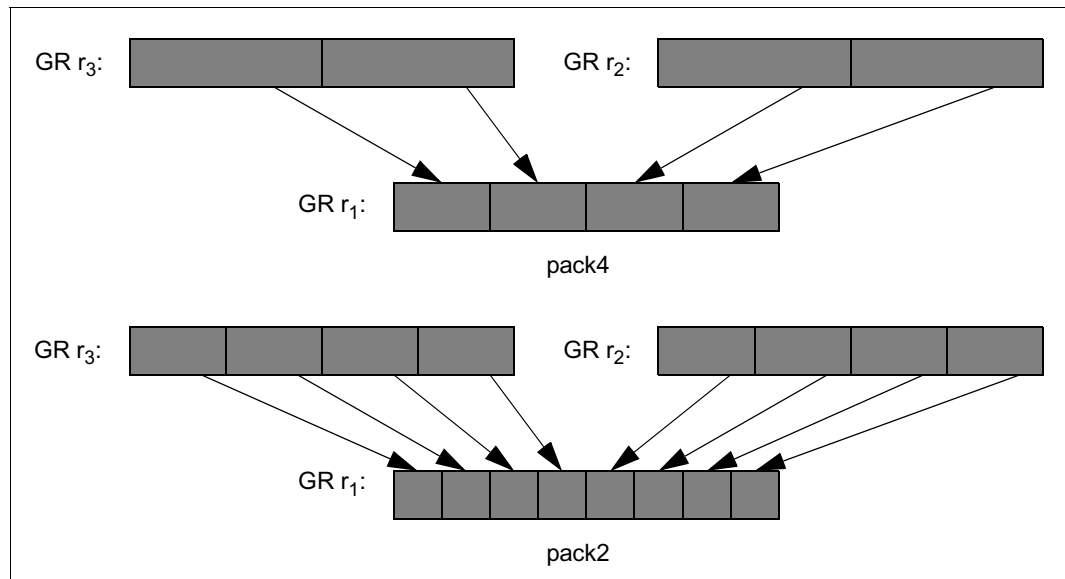

```

Operation:   if (PR[qp]) {
                check_target_register(r1);

                if (two_byte_form) {
                    if (signed_saturation_form) {
                        max = sign_ext(0x7f, 8);
                        min = sign_ext(0x80, 8);
                    } else {                                     // unsigned_saturation_form
                        max = 0xff;
                        min = 0x00;
                    }
                    temp[0] = sign_ext(GR[r2]{15:0}, 16);
                    temp[1] = sign_ext(GR[r2]{31:16}, 16);
                    temp[2] = sign_ext(GR[r2]{47:32}, 16);
                    temp[3] = sign_ext(GR[r2]{63:48}, 16);
                    temp[4] = sign_ext(GR[r3]{15:0}, 16);
                    temp[5] = sign_ext(GR[r3]{31:16}, 16);
                    temp[6] = sign_ext(GR[r3]{47:32}, 16);
                    temp[7] = sign_ext(GR[r3]{63:48}, 16);

                    for (i = 0; i < 8; i++) {
                        if (temp[i] > max)
                            temp[i] = max;

                        if (temp[i] < min)
                            temp[i] = min;
                    }

                    GR[r1] = concatenate8(temp[7], temp[6], temp[5], temp[4],
                                           temp[3], temp[2], temp[1], temp[0]);

                } else {                                       // four_byte_form
                                                                // signed_saturation_form
                    max = sign_ext(0x7fff, 16);
                    min = sign_ext(0x8000, 16);
                    temp[0] = sign_ext(GR[r2]{31:0}, 32);
                    temp[1] = sign_ext(GR[r2]{63:32}, 32);
                    temp[2] = sign_ext(GR[r3]{31:0}, 32);
                    temp[3] = sign_ext(GR[r3]{63:32}, 32);

                    for (i = 0; i < 4; i++) {
                        if (temp[i] > max)
                            temp[i] = max;

                        if (temp[i] < min)
                            temp[i] = min;
                    }

                    GR[r1] = concatenate4(temp[3], temp[2], temp[1], temp[0]);
                }
                GR[r1].nat = GR[r2].nat || GR[r3].nat;
            }

```

Interruptions: Illegal Operation fault

padd — Parallel Add

| | | | |
|----------------|---------------------------------|------------------------------------|----|
| Format: | (qp) padd1 $r_1 = r_2, r_3$ | one_byte_form, modulo_form | A9 |
| | (qp) padd1.sss $r_1 = r_2, r_3$ | one_byte_form, sss_saturation_form | A9 |
| | (qp) padd1.uus $r_1 = r_2, r_3$ | one_byte_form, uus_saturation_form | A9 |
| | (qp) padd1.uuu $r_1 = r_2, r_3$ | one_byte_form, uuu_saturation_form | A9 |
| | (qp) padd2 $r_1 = r_2, r_3$ | two_byte_form, modulo_form | A9 |
| | (qp) padd2.sss $r_1 = r_2, r_3$ | two_byte_form, sss_saturation_form | A9 |
| | (qp) padd2.uus $r_1 = r_2, r_3$ | two_byte_form, uus_saturation_form | A9 |
| | (qp) padd2.uuu $r_1 = r_2, r_3$ | two_byte_form, uuu_saturation_form | A9 |
| | (qp) padd4 $r_1 = r_2, r_3$ | four_byte_form, modulo_form | A9 |

Description: The sets of elements from the two source operands are added, and the results placed in GR r_1 .

If a sum of two elements cannot be represented in the result element and a saturation completer is specified, then saturation clipping is performed. The saturation can either be signed or unsigned, as given in Table 2-43. If the sum of two elements is larger than the upper limit value, the result is the upper limit value. If it is smaller than the lower limit value, the result is the lower limit value. The saturation limits are given in Table 2-44.

Table 2-43. Parallel Add Saturation Completers

| Completer | Result r_1 Treated as | Source r_2 Treated as | Source r_3 Treated as |
|-----------|-------------------------|-------------------------|-------------------------|
| sss | signed | signed | signed |
| uus | unsigned | unsigned | signed |
| uuu | unsigned | unsigned | unsigned |

Table 2-44. Parallel Add Saturation Limits

| Size | Element Width | Result r_1 signed | | Result r_1 unsigned | |
|------|---------------|---------------------|-------------|-----------------------|-------------|
| | | Upper Limit | Lower Limit | Upper Limit | Lower Limit |
| 1 | 8 bit | 0x7f | 0x80 | 0xff | 0x00 |
| 2 | 16 bit | 0x7fff | 0x8000 | 0xffff | 0x0000 |

Figure 2-29. Parallel Add Examples

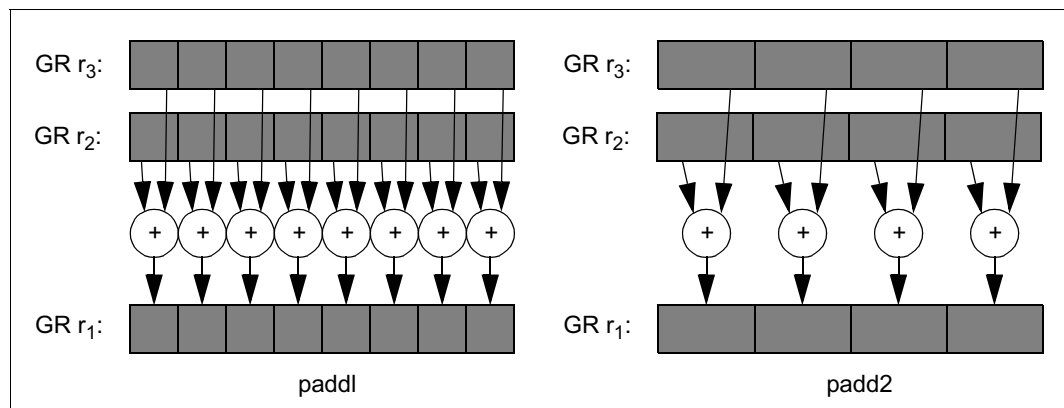

```

Operation:   if (PR[qp]) {
                check_target_register(r1);

                if (one_byte_form) {                                     // one-byte elements
                    x[0] = GR[r2]{7:0};           y[0] = GR[r3]{7:0};
                    x[1] = GR[r2]{15:8};          y[1] = GR[r3]{15:8};
                    x[2] = GR[r2]{23:16};         y[2] = GR[r3]{23:16};
                    x[3] = GR[r2]{31:24};         y[3] = GR[r3]{31:24};
                    x[4] = GR[r2]{39:32};         y[4] = GR[r3]{39:32};
                    x[5] = GR[r2]{47:40};         y[5] = GR[r3]{47:40};
                    x[6] = GR[r2]{55:48};         y[6] = GR[r3]{55:48};
                    x[7] = GR[r2]{63:56};         y[7] = GR[r3]{63:56};

                    if (sss_saturation_form) {
                        max = sign_ext(0x7f, 8);
                        min = sign_ext(0x80, 8);

                        for (i = 0; i < 8; i++) {
                            temp[i] = sign_ext(x[i], 8) + sign_ext(y[i], 8);
                        }
                    } else if (uus_saturation_form) {
                        max = 0xff;
                        min = 0x00;

                        for (i = 0; i < 8; i++) {
                            temp[i] = zero_ext(x[i], 8) + sign_ext(y[i], 8);
                        }
                    } else if (uuu_saturation_form) {
                        max = 0xff;
                        min = 0x00;

                        for (i = 0; i < 8; i++) {
                            temp[i] = zero_ext(x[i], 8) + zero_ext(y[i], 8);
                        }
                    } else {                                           // modulo_form
                        for (i = 0; i < 8; i++) {
                            temp[i] = zero_ext(x[i], 8) + zero_ext(y[i], 8);
                        }
                    }

                    if (sss_saturation_form || uus_saturation_form ||
                        uuu_saturation_form) {
                        for (i = 0; i < 8; i++) {
                            if (temp[i] > max)
                                temp[i] = max;

                            if (temp[i] < min)
                                temp[i] = min;
                        }
                    }
                    GR[r1] = concatenate8(temp[7], temp[6], temp[5], temp[4],
                                           temp[3], temp[2], temp[1], temp[0]);
                } else if (two_byte_form) {                             // 2-byte elements
                    x[0] = GR[r2]{15:0};           y[0] = GR[r3]{15:0};
                    x[1] = GR[r2]{31:16};          y[1] = GR[r3]{31:16};
                    x[2] = GR[r2]{47:32};         y[2] = GR[r3]{47:32};
                    x[3] = GR[r2]{63:48};         y[3] = GR[r3]{63:48};

                    if (sss_saturation_form) {
                        max = sign_ext(0x7fff, 16);
                        min = sign_ext(0x8000, 16);
                    }
                }
            }

```

```

        for (i = 0; i < 4; i++) {
            temp[i] = sign_ext(x[i], 16) + sign_ext(y[i], 16);
        }
    } else if (uus_saturation_form) {
        max = 0xffff;
        min = 0x0000;

        for (i = 0; i < 4; i++) {
            temp[i] = zero_ext(x[i], 16) + sign_ext(y[i], 16);
        }
    } else if (uuu_saturation_form) {
        max = 0xffff;
        min = 0x0000;

        for (i = 0; i < 4; i++) {
            temp[i] = zero_ext(x[i], 16) + zero_ext(y[i], 16);
        }
    } else {
        // modulo_form
        for (i = 0; i < 4; i++) {
            temp[i] = zero_ext(x[i], 16) + zero_ext(y[i], 16);
        }
    }
}

if (sss_saturation_form || uus_saturation_form ||
    uuu_saturation_form) {
    for (i = 0; i < 4; i++) {
        if (temp[i] > max)
            temp[i] = max;

        if (temp[i] < min)
            temp[i] = min;
    }
}
GR[r1] = concatenate4(temp[3], temp[2], temp[1], temp[0]);
} else {
    // four-byte elements
    x[0] = GR[r2]{31:0};    y[0] = GR[r3]{31:0};
    x[1] = GR[r2]{63:32};  y[1] = GR[r3]{63:32};

    for (i = 0; i < 2; i++) {
        // modulo_form
        temp[i] = zero_ext(x[i], 32) + zero_ext(y[i], 32);
    }

    GR[r1] = concatenate2(temp[1], temp[0]);
}
GR[r1].nat = GR[r2].nat || GR[r3].nat;
}

```

Interruptions: Illegal Operation fault

pavg — Parallel Average

| | | | |
|----------------|---------------------------------|----------------------------|----|
| Format: | (qp) pavg1 $r_1 = r_2, r_3$ | normal_form, one_byte_form | A9 |
| | (qp) pavg1.raz $r_1 = r_2, r_3$ | raz_form, one_byte_form | A9 |
| | (qp) pavg2 $r_1 = r_2, r_3$ | normal_form, two_byte_form | A9 |
| | (qp) pavg2.raz $r_1 = r_2, r_3$ | raz_form, two_byte_form | A9 |

Description: The unsigned data elements of GR r_2 are added to the unsigned data elements of GR r_3 . The results of the add are then each independently shifted to the right by one bit position. The high-order bits of each element are filled with the carry bits of the sums. To prevent cumulative round-off errors, an averaging is performed. The unsigned results are placed in GR r_1 .

The averaging operation works as follows. In the normal_form, the low-order bit of each result is set to 1 if at least one of the two least significant bits of the corresponding sum is 1. In the raz_form, the average rounds away from zero by adding 1 to each of the sums.

Figure 2-30. Parallel Average Example

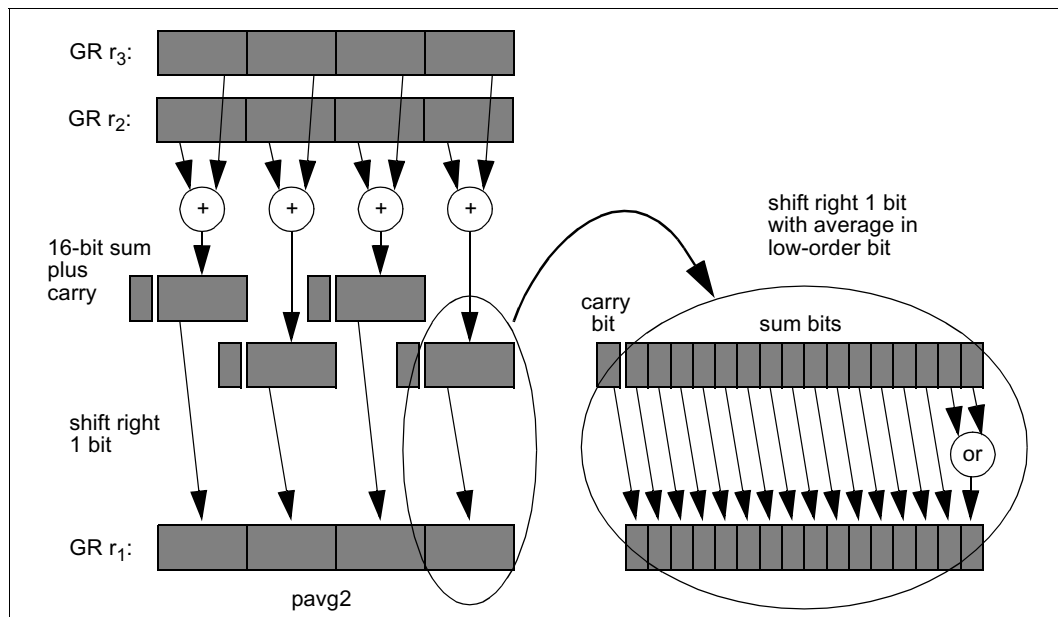
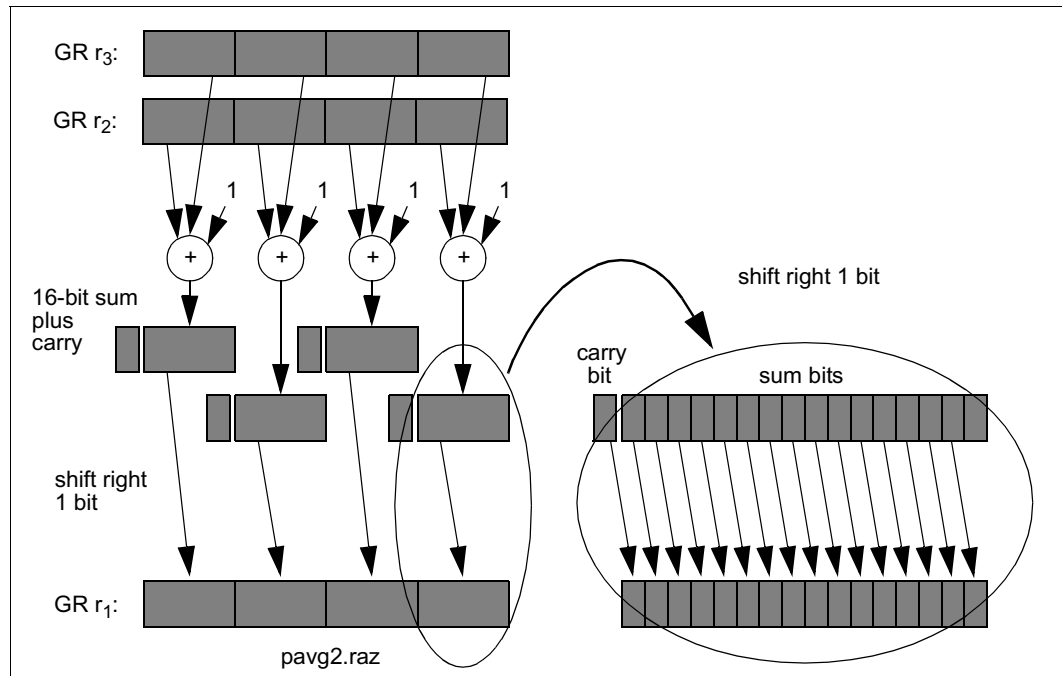

Figure 2-31. Parallel Average with Round Away from Zero Example



```

Operation:  if (PR[qp]) {
                check_target_register(r1);

                if (one_byte_form) {
                    x[0] = GR[r2]{7:0};    y[0] = GR[r3]{7:0};
                    x[1] = GR[r2]{15:8};   y[1] = GR[r3]{15:8};
                    x[2] = GR[r2]{23:16};  y[2] = GR[r3]{23:16};
                    x[3] = GR[r2]{31:24};  y[3] = GR[r3]{31:24};
                    x[4] = GR[r2]{39:32};  y[4] = GR[r3]{39:32};
                    x[5] = GR[r2]{47:40};  y[5] = GR[r3]{47:40};
                    x[6] = GR[r2]{55:48};  y[6] = GR[r3]{55:48};
                    x[7] = GR[r2]{63:56};  y[7] = GR[r3]{63:56};

                    if (raz_form) {
                        for (i = 0; i < 8; i++) {
                            temp[i] = zero_ext(x[i], 8) + zero_ext(y[i], 8) + 1;
                            res[i] = shift_right_unsigned(temp[i], 1);
                        }
                    } else { // normal form
                        for (i = 0; i < 8; i++) {
                            temp[i] = zero_ext(x[i], 8) + zero_ext(y[i], 8);
                            res[i] = shift_right_unsigned(temp[i], 1) | (temp[i]{0});
                        }
                    }
                    GR[r1] = concatenate8(res[7], res[6], res[5], res[4],
                                           res[3], res[2], res[1], res[0]);
                } else { // two_byte_form
                    x[0] = GR[r2]{15:0};    y[0] = GR[r3]{15:0};
                    x[1] = GR[r2]{31:16};   y[1] = GR[r3]{31:16};
                    x[2] = GR[r2]{47:32};   y[2] = GR[r3]{47:32};
                    x[3] = GR[r2]{63:48};   y[3] = GR[r3]{63:48};

                    if (raz_form) {

```

```
    for (i = 0; i < 4; i++) {
        temp[i] = zero_ext(x[i], 16) + zero_ext(y[i], 16) + 1;
        res[i] = shift_right_unsigned(temp[i], 1);
    }
} else {
    // normal form
    for (i = 0; i < 4; i++) {
        temp[i] = zero_ext(x[i], 16) + zero_ext(y[i], 16);
        res[i] = shift_right_unsigned(temp[i], 1) | (temp[i]{0});
    }
}
GR[r1] = concatenate4(res[3], res[2], res[1], res[0]);
}
GR[r1].nat = GR[r2].nat || GR[r3].nat;
}
```

Interruptions: Illegal Operation fault

pavgsub — Parallel Average Subtract

Format: (qp) pavgsub1 $r_1 = r_2, r_3$ one_byte_form A9
 (qp) pavgsub2 $r_1 = r_2, r_3$ two_byte_form A9

Description: The unsigned data elements of GR r_3 are subtracted from the unsigned data elements of GR r_2 . The results of the subtraction are then each independently shifted to the right by one bit position. The high-order bits of each element are filled with the borrow bits of the subtraction (the complements of the ALU carries). To prevent cumulative round-off errors, an averaging is performed. The low-order bit of each result is set to 1 if at least one of the two least significant bits of the corresponding difference is 1. The signed results are placed in GR r_1 .

Figure 2-32. Parallel Average Subtract Example

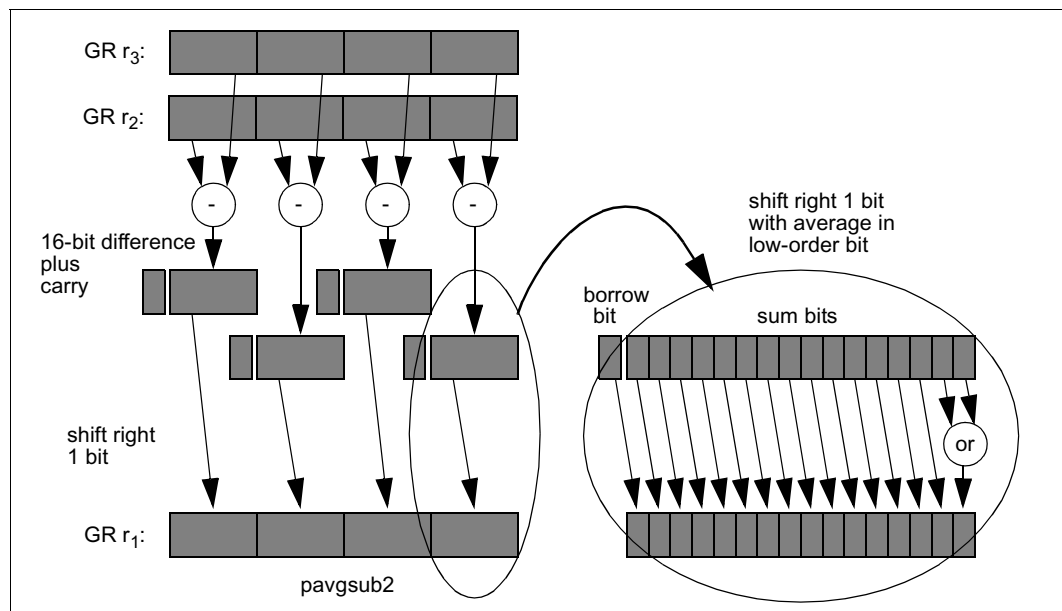

Operation:

```

if (PR[qp]) {
    check_target_register(r1);

    if (one_byte_form) {
        x[0] = GR[r2]{7:0};    y[0] = GR[r3]{7:0};
        x[1] = GR[r2]{15:8};  y[1] = GR[r3]{15:8};
        x[2] = GR[r2]{23:16}; y[2] = GR[r3]{23:16};
        x[3] = GR[r2]{31:24}; y[3] = GR[r3]{31:24};
        x[4] = GR[r2]{39:32}; y[4] = GR[r3]{39:32};
        x[5] = GR[r2]{47:40}; y[5] = GR[r3]{47:40};
        x[6] = GR[r2]{55:48}; y[6] = GR[r3]{55:48};
        x[7] = GR[r2]{63:56}; y[7] = GR[r3]{63:56};

        for (i = 0; i < 8; i++) {
            temp[i] = zero_ext(x[i], 8) - zero_ext(y[i], 8);
            res[i] = (temp[i]{8:0} u>> 1) | (temp[i]{0});
        }
        GR[r1] = concatenate8(res[7], res[6], res[5], res[4],
                               res[3], res[2], res[1], res[0]);
    } else {
        // two_byte_form
        x[0] = GR[r2]{15:0};    y[0] = GR[r3]{15:0};
    }
  
```

```
x[1] = GR[r2]{31:16};   y[1] = GR[r3]{31:16};
x[2] = GR[r2]{47:32};   y[2] = GR[r3]{47:32};
x[3] = GR[r2]{63:48};   y[3] = GR[r3]{63:48};

for (i = 0; i < 4; i++) {
    temp[i] = zero_ext(x[i], 16) - zero_ext(y[i], 16);
    res[i] = (temp[i]{16:0} u>> 1) | (temp[i]{0});
}
GR[r1] = concatenate4(res[3], res[2], res[1], res[0]);
}
GR[r1].nat = GR[r2].nat || GR[r3].nat;
}
```

Interruptions: Illegal Operation fault

pcmp — Parallel Compare

Format: (qp) pcmp1.prel $r_1 = r_2, r_3$ one_byte_form A9
 (qp) pcmp2.prel $r_1 = r_2, r_3$ two_byte_form A9
 (qp) pcmp4.prel $r_1 = r_2, r_3$ four_byte_form A9

Description: The two source operands are compared for one of the two relations shown in Table 2-45. If the comparison condition is true for corresponding data elements of GR r_2 and GR r_3 , then the corresponding data element in GR r_1 is set to all ones. If the comparison condition is false, then the corresponding data element in GR r_1 is set to all zeros. For the '>' relation, both operands are interpreted as signed.

Table 2-45. Pcmp Relations

| prel | Compare Relation (r_2 prel r_3) |
|------|---------------------------------------|
| eq | $r_2 == r_3$ |
| gt | $r_2 > r_3$ (signed) |

Figure 2-33. Parallel Compare Example

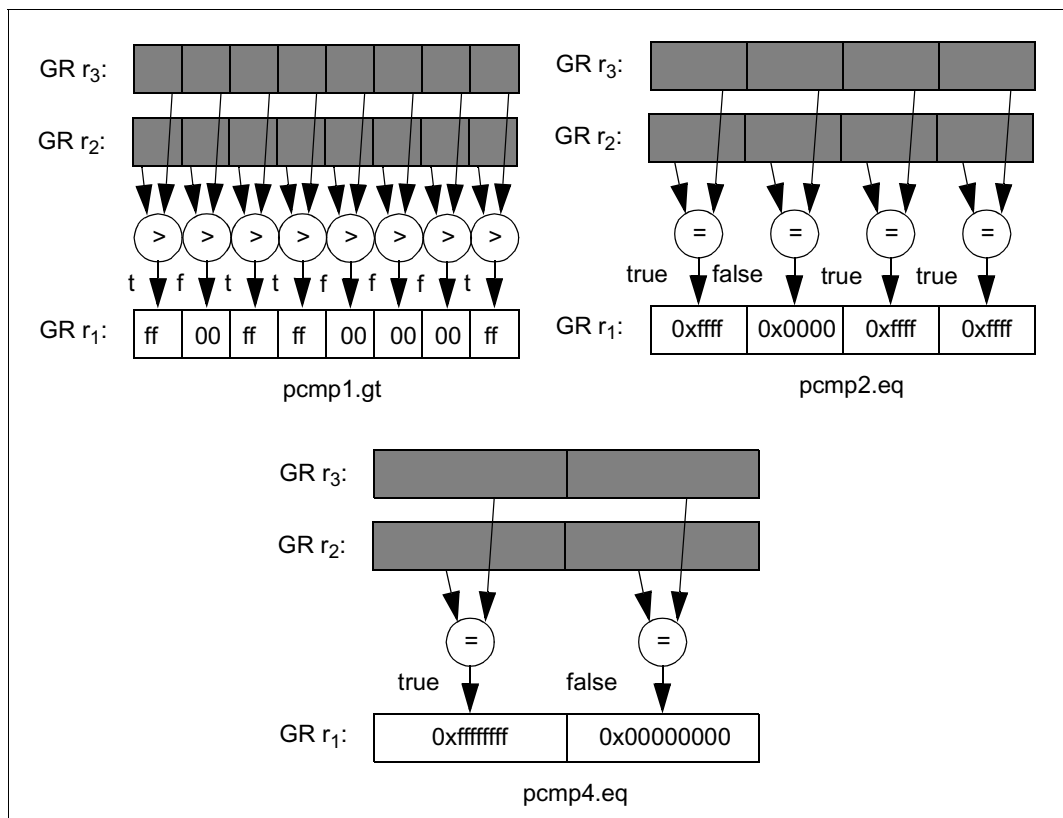

```

Operation:   if (PR[qp]) {
                check_target_register(r1);

                if (one_byte_form) { // one-byte elements
                    x[0] = GR[r2]{7:0};      y[0] = GR[r3]{7:0};
                    x[1] = GR[r2]{15:8};     y[1] = GR[r3]{15:8};
                    x[2] = GR[r2]{23:16};    y[2] = GR[r3]{23:16};
                    x[3] = GR[r2]{31:24};    y[3] = GR[r3]{31:24};
                    x[4] = GR[r2]{39:32};    y[4] = GR[r3]{39:32};
                    x[5] = GR[r2]{47:40};    y[5] = GR[r3]{47:40};
                    x[6] = GR[r2]{55:48};    y[6] = GR[r3]{55:48};
                    x[7] = GR[r2]{63:56};    y[7] = GR[r3]{63:56};
                    for (i = 0; i < 8; i++) {
                        if (prel == 'eq')
                            tmp_rel = x[i] == y[i];
                        else // 'gt'
                            tmp_rel = greater_signed(sign_ext(x[i], 8),
                                                       sign_ext(y[i], 8));

                        if (tmp_rel)
                            res[i] = 0xff;
                        else
                            res[i] = 0x00;
                    }
                    GR[r1] = concatenate8(res[7], res[6], res[5], res[4],
                                           res[3], res[2], res[1], res[0]);
                } else if (two_byte_form) { // two-byte elements
                    x[0] = GR[r2]{15:0};     y[0] = GR[r3]{15:0};
                    x[1] = GR[r2]{31:16};    y[1] = GR[r3]{31:16};
                    x[2] = GR[r2]{47:32};    y[2] = GR[r3]{47:32};
                    x[3] = GR[r2]{63:48};    y[3] = GR[r3]{63:48};
                    for (i = 0; i < 4; i++) {
                        if (prel == 'eq')
                            tmp_rel = x[i] == y[i];
                        else // 'gt'
                            tmp_rel = greater_signed(sign_ext(x[i], 16),
                                                       sign_ext(y[i], 16));

                        if (tmp_rel)
                            res[i] = 0xffff;
                        else
                            res[i] = 0x0000;
                    }
                    GR[r1] = concatenate4(res[3], res[2], res[1], res[0]);
                } else { // four-byte elements
                    x[0] = GR[r2]{31:0};     y[0] = GR[r3]{31:0};
                    x[1] = GR[r2]{63:32};    y[1] = GR[r3]{63:32};
                    for (i = 0; i < 2; i++) {
                        if (prel == 'eq')
                            tmp_rel = x[i] == y[i];
                        else // 'gt'
                            tmp_rel = greater_signed(sign_ext(x[i], 32),
                                                       sign_ext(y[i], 32));

                        if (tmp_rel)
                            res[i] = 0xffffffff;
                        else
                            res[i] = 0x00000000;
                    }
                    GR[r1] = concatenate2(res[1], res[0]);
                }
                GR[r1].nat = GR[r2].nat || GR[r3].nat;
            }

```

Interruptions: Illegal Operation fault

pmax — Parallel Maximum

Format: (qp) pmax1.u $r_1 = r_2, r_3$ one_byte_form 12
 (qp) pmax2 $r_1 = r_2, r_3$ two_byte_form 12

Description: The maximum of the two source operands is placed in the result register. In the `one_byte_form`, each unsigned 8-bit element of GR r_2 is compared with the corresponding unsigned 8-bit element of GR r_3 and the greater of the two is placed in the corresponding 8-bit element of GR r_1 . In the `two_byte_form`, each signed 16-bit element of GR r_2 is compared with the corresponding signed 16-bit element of GR r_3 and the greater of the two is placed in the corresponding 16-bit element of GR r_1 .

Figure 2-34. Parallel Maximum Example

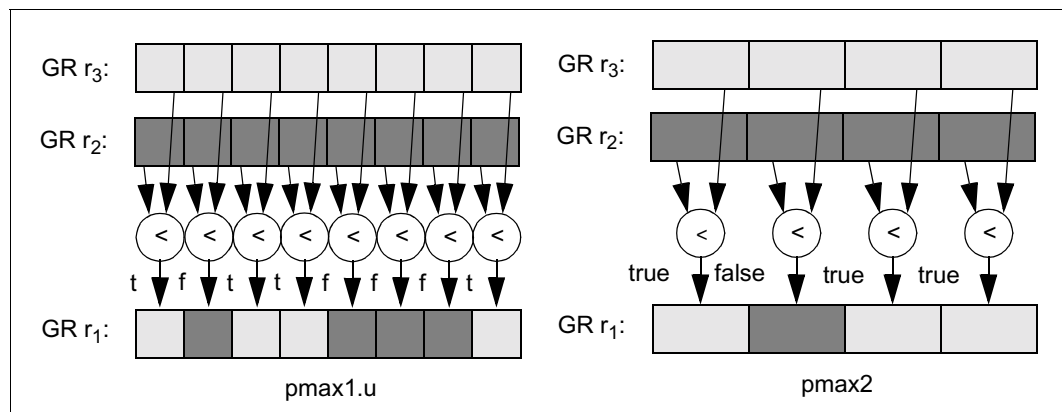

Operation:

```

if (PR[qp]) {
    check_target_register(r1);

    if (one_byte_form) {
        // one-byte elements
        x[0] = GR[r2]{7:0};      y[0] = GR[r3]{7:0};
        x[1] = GR[r2]{15:8};    y[1] = GR[r3]{15:8};
        x[2] = GR[r2]{23:16};   y[2] = GR[r3]{23:16};
        x[3] = GR[r2]{31:24};   y[3] = GR[r3]{31:24};
        x[4] = GR[r2]{39:32};   y[4] = GR[r3]{39:32};
        x[5] = GR[r2]{47:40};   y[5] = GR[r3]{47:40};
        x[6] = GR[r2]{55:48};   y[6] = GR[r3]{55:48};
        x[7] = GR[r2]{63:56};   y[7] = GR[r3]{63:56};
        for (i = 0; i < 8; i++) {
            res[i] = (zero_ext(x[i],8) < zero_ext(y[i],8)) ? y[i] : x[i];
        }
        GR[r1] = concatenate8(res[7], res[6], res[5], res[4],
                               res[3], res[2], res[1], res[0]);
    } else {
        // two-byte elements
        x[0] = GR[r2]{15:0};    y[0] = GR[r3]{15:0};
        x[1] = GR[r2]{31:16};   y[1] = GR[r3]{31:16};
        x[2] = GR[r2]{47:32};   y[2] = GR[r3]{47:32};
        x[3] = GR[r2]{63:48};   y[3] = GR[r3]{63:48};
        for (i = 0; i < 4; i++) {
            res[i] = (sign_ext(x[i],16) < sign_ext(y[i],16)) ? y[i] : x[i];
        }
        GR[r1] = concatenate4(res[3], res[2], res[1], res[0]);
    }
    GR[r1].nat = GR[r2].nat || GR[r3].nat;
}

```

Interruptions: Illegal Operation fault

pmin — Parallel Minimum

Format: (qp) pmin1.u $r_1 = r_2, r_3$ one_byte_form 12
 (qp) pmin2 $r_1 = r_2, r_3$ two_byte_form 12

Description: The minimum of the two source operands is placed in the result register. In the one_byte_form, each unsigned 8-bit element of GR r_2 is compared with the corresponding unsigned 8-bit element of GR r_3 and the smaller of the two is placed in the corresponding 8-bit element of GR r_1 . In the two_byte_form, each signed 16-bit element of GR r_2 is compared with the corresponding signed 16-bit element of GR r_3 and the smaller of the two is placed in the corresponding 16-bit element of GR r_1 .

Figure 2-35. Parallel Minimum Example

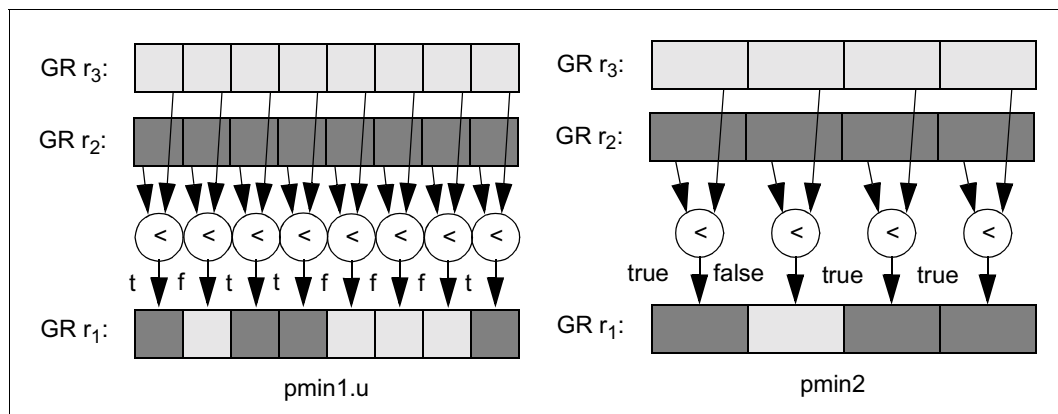

Operation:

```

if (PR[qp]) {
    check_target_register(r1);

    if (one_byte_form) {
        // one-byte elements
        x[0] = GR[r2]{7:0};      y[0] = GR[r3]{7:0};
        x[1] = GR[r2]{15:8};    y[1] = GR[r3]{15:8};
        x[2] = GR[r2]{23:16};   y[2] = GR[r3]{23:16};
        x[3] = GR[r2]{31:24};   y[3] = GR[r3]{31:24};
        x[4] = GR[r2]{39:32};   y[4] = GR[r3]{39:32};
        x[5] = GR[r2]{47:40};   y[5] = GR[r3]{47:40};
        x[6] = GR[r2]{55:48};   y[6] = GR[r3]{55:48};
        x[7] = GR[r2]{63:56};   y[7] = GR[r3]{63:56};
        for (i = 0; i < 8; i++) {
            res[i] = (zero_ext(x[i],8) < zero_ext(y[i],8)) ? x[i] : y[i];
        }
        GR[r1] = concatenate8(res[7], res[6], res[5], res[4],
                               res[3], res[2], res[1], res[0]);
    } else {
        // two-byte elements
        x[0] = GR[r2]{15:0};     y[0] = GR[r3]{15:0};
        x[1] = GR[r2]{31:16};    y[1] = GR[r3]{31:16};
        x[2] = GR[r2]{47:32};    y[2] = GR[r3]{47:32};
        x[3] = GR[r2]{63:48};    y[3] = GR[r3]{63:48};
        for (i = 0; i < 4; i++) {
            res[i] = (sign_ext(x[i],16) < sign_ext(y[i],16)) ? x[i] : y[i];
        }
        GR[r1] = concatenate4(res[3], res[2], res[1], res[0]);
    }
    GR[r1].nat = GR[r2].nat || GR[r3].nat;
}
  
```

Interruptions: Illegal Operation fault

pmpy — Parallel Multiply

Format: (qp) pmpy2.r $r_1 = r_2, r_3$ right_form 12
 (qp) pmpy2.l $r_1 = r_2, r_3$ left_form 12

Description: Two signed 16-bit data elements of GR r_2 are multiplied by the corresponding two signed 16-bit data elements of GR r_3 as shown in Figure 2-36. The two 32-bit results are placed in GR r_1 .

Figure 2-36. Parallel Multiply Operation

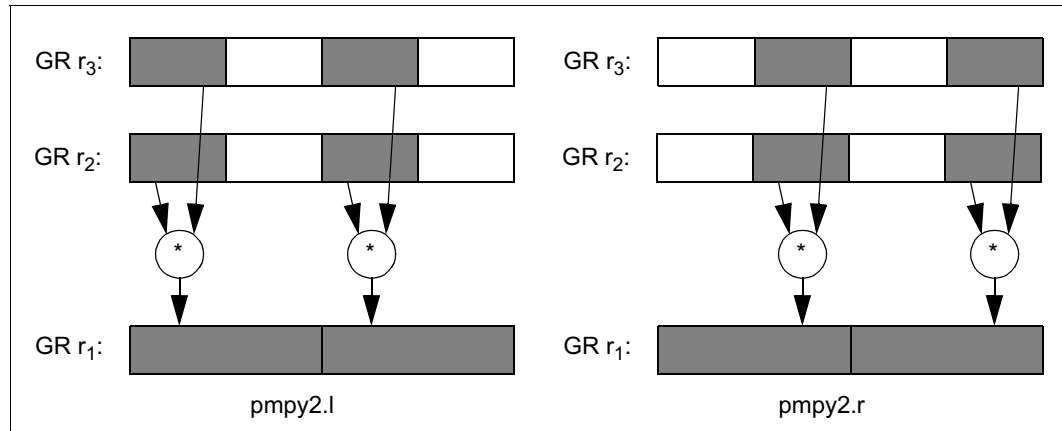

```

Operation:
if (PR[qp]) {
    check_target_register(r1);

    if (right_form) {
        GR[r1]{31:0} = sign_ext(GR[r2]{15:0}, 16) *
            sign_ext(GR[r3]{15:0}, 16);
        GR[r1]{63:32} = sign_ext(GR[r2]{47:32}, 16) *
            sign_ext(GR[r3]{47:32}, 16);
    } else { // left_form
        GR[r1]{31:0} = sign_ext(GR[r2]{31:16}, 16) *
            sign_ext(GR[r3]{31:16}, 16);
        GR[r1]{63:32} = sign_ext(GR[r2]{63:48}, 16) *
            sign_ext(GR[r3]{63:48}, 16);
    }

    GR[r1].nat = GR[r2].nat || GR[r3].nat;
}
    
```

Interruptions: Illegal Operation fault

pmpyshr — Parallel Multiply and Shift Right

Format: (qp) pmpyshr2 $r_1 = r_2, r_3, count_2$ signed_form II
 (qp) pmpyshr2.u $r_1 = r_2, r_3, count_2$ unsigned_form II

Description: The four 16-bit data elements of GR r_2 are multiplied by the corresponding four 16-bit data elements of GR r_3 as shown in Figure 2-37. This multiplication can either be signed (pmpyshr2), or unsigned (pmpyshr2.u). Each product is then shifted to the right $count_2$ bits, and the least-significant 16-bits of each shifted product form 4 16-bit results, which are placed in GR r_1 . A $count_2$ of 0 gives the 16 low bits of the results, a $count_2$ of 16 gives the 16 high bits of the results. The allowed values for $count_2$ are given in Table 2-46.

Table 2-46. PMPYSHR Shift Options

| $count_2$ | Selected Bit Field from Each 32-bit Product |
|-----------|---|
| 0 | 15:0 |
| 7 | 22:7 |
| 15 | 30:15 |
| 16 | 31:16 |

Figure 2-37. Parallel Multiply and Shift Right Operation

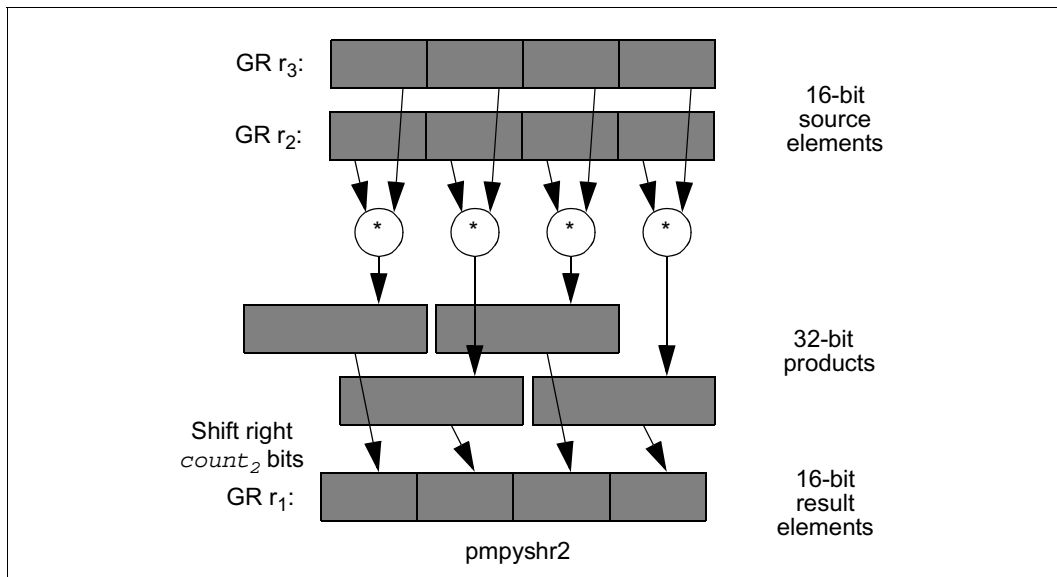

Operation:

```

if (PR[qp]) {
    check_target_register(r1);
    x[0] = GR[r2]{15:0};    y[0] = GR[r3]{15:0};
    x[1] = GR[r2]{31:16};   y[1] = GR[r3]{31:16};
    x[2] = GR[r2]{47:32};   y[2] = GR[r3]{47:32};
    x[3] = GR[r2]{63:48};   y[3] = GR[r3]{63:48};
    for (i = 0; i < 4; i++) {
        if (unsigned_form) // unsigned multiplication
            temp[i] = zero_ext(x[i], 16) * zero_ext(y[i], 16);
        else // signed multiplication
            temp[i] = sign_ext(x[i], 16) * sign_ext(y[i], 16);

        res[i] = temp[i]{(count2 + 15):count2};
    }

    GR[r1] = concatenate4(res[3], res[2], res[1], res[0]);
    GR[r1].nat = GR[r2].nat || GR[r3].nat;
}

```

Interruptions: Illegal Operation fault

popcnt — Population Count

Format: (qp) popcnt $r_1 = r_3$

19

Description: The number of bits in GR r_3 having the value 1 is counted, and the resulting sum is placed in GR r_1 .

Operation:

```
if (PR[qp]) {
    check_target_register(r1);

    res = 0;
    // Count up all the one bits
    for (i = 0; i < 64; i++) {
        res += GR[r3]{i};
    }

    GR[r1] = res;
    GR[r1].nat = GR[r3].nat;
}
```

Interruptions: Illegal Operation fault

probe — Probe Access

| | | | |
|----------------|---|---|-----|
| Format: | (<i>qp</i>) probe.r $r_1 = r_3, r_2$ | read_form, register_form | M38 |
| | (<i>qp</i>) probe.w $r_1 = r_3, r_2$ | write_form, register_form | M38 |
| | (<i>qp</i>) probe.r $r_1 = r_3, imm_2$ | read_form, immediate_form | M39 |
| | (<i>qp</i>) probe.w $r_1 = r_3, imm_2$ | write_form, immediate_form | M39 |
| | (<i>qp</i>) probe.r.fault r_3, imm_2 | fault_form, read_form, immediate_form | M40 |
| | (<i>qp</i>) probe.w.fault r_3, imm_2 | fault_form, write_form, immediate_form | M40 |
| | (<i>qp</i>) probe.rw.fault r_3, imm_2 | fault_form, read_write_form, immediate_form | M40 |

Description: This instruction determines whether read or write access, with a specified privilege level, to a given virtual address is permitted. GR r_1 is set to 1 if the specified access is allowed and to 0 otherwise. In the fault_form, if the specified access is allowed this instruction does nothing; if the specified access is not allowed, a fault is taken.

When PSR.dt is 1, the DTLB and the VHPT are queried for present translations to determine if access to the virtual address specified by GR r_3 bits {60:0} and the region register indexed by GR r_3 bits {63:61}, is permitted at the privilege level given by either GR r_2 bits {1:0} or imm_2 . If PSR.pk is 1, protection key checks are also performed. The read or write form specifies whether the instruction checks for read or write access, or both.

When PSR.dt is 0, a non-faulting probe uses its address operand as a virtual address to query the DTLB only, because the VHPT walker is disabled. If the probed address is found in the DTLB, the non-faulting probe returns the appropriate value, if not an Alternate Data TLB fault is raised.

When PSR.dt is 0, a faulting probe treats its address operand as a physical address, and takes no TLB related faults.

A non-faulting probe to an unimplemented virtual address returns 0. A faulting probe to an unimplemented virtual address (when PSR.dt is 1) or unimplemented physical address (when PSR.dt is 0) takes an Unimplemented Data Address fault.

If this instruction faults, then it will set the non-access bit in the ISR and set the ISR read or write bits depending on the completer. The following faults are taken by the faulting form of the probe instruction only (the non-faulting form of the instruction does not take them): Unimplemented Data Address fault, Data Key Permissions fault, Data Access Rights fault, Data Dirty Bit fault, Data Access Bit fault, and Data Debug fault.

This instruction can only probe with equal or lower privilege levels. If the specified privilege level is higher (lower number), then the probe is performed with the current privilege level.

```

Operation:   if (PR[qp]) {
                itype = NON_ACCESS;
                itype |= (read_write_form) ? READ|WRITE : ((write_form) ? WRITE : READ);
                itype |= (fault_form) ? PROBE_FAULT : PROBE;

                if (!fault_form)
                    check_target_register(r1);

                if (GR[r3].nat || (register_form ? GR[r2].nat : 0))
                    register_nat_consumption_fault(itype);

                tmp_pl = (register_form) ? GR[r2]{1:0} : imm2;
                if (tmp_pl < PSR.cpl)
                    tmp_pl = PSR.cpl;

                if (fault_form) {
                    tlb_translate(GR[r3], 1, itype, tmp_pl, &attr, &defer);
                } else {
                    GR[r1] = tlb_grant_permission(GR[r3], itype, tmp_pl);
                    GR[r1].nat = 0;
                }
            }

```

| | | |
|-----------------------|----------------------------------|---------------------------------|
| Interruptions: | Illegal Operation fault | Data NaT Page Consumption fault |
| | Register NaT Consumption fault | Data Key Miss fault |
| | Unimplemented Data Address fault | Data Key Permission fault |
| | Data Nested TLB fault | Data Access Rights fault |
| | Alternate Data TLB fault | Data Dirty Bit fault |
| | VHPT Data fault | Data Access Bit fault |
| | Data TLB fault | Data Debug fault |
| | Data Page Not Present fault | |

psad — Parallel Sum of Absolute Difference

Format: (qp) psadl $r_1 = r_2, r_3$

12

Description: The unsigned 8-bit elements of GR r_2 are subtracted from the unsigned 8-bit elements of GR r_3 . The absolute value of each difference is accumulated across the elements and placed in GR r_1 .

Figure 2-38. Parallel Sum of Absolute Difference Example

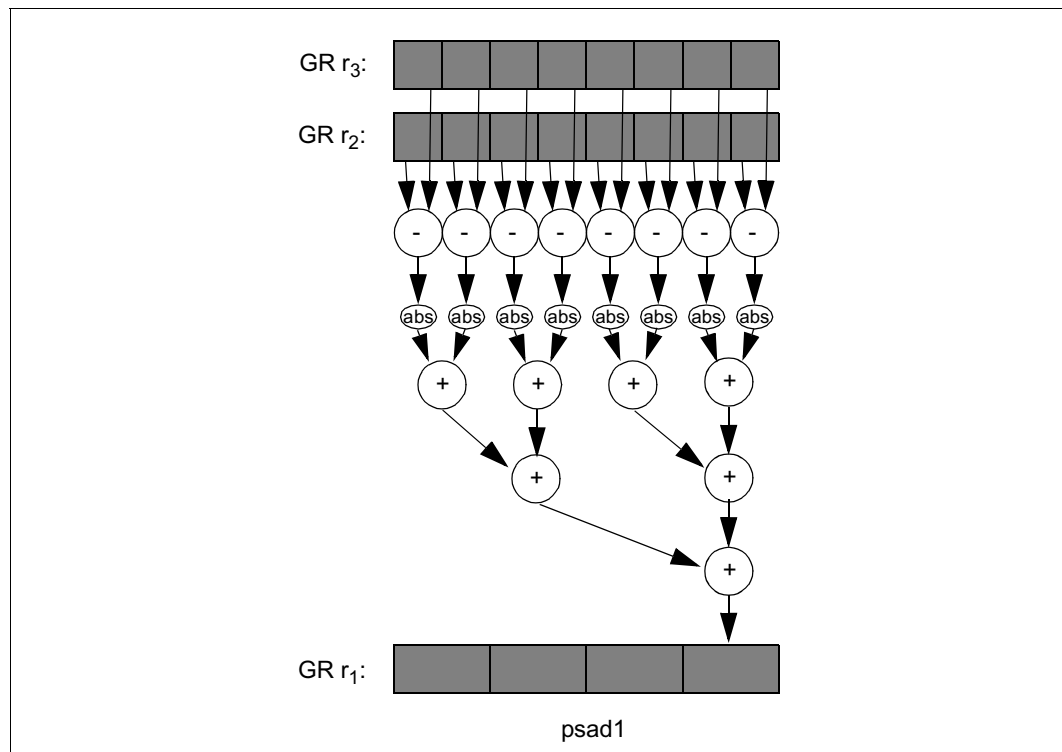

Operation:

```

if (PR[qp]) {
    check_target_register(r1);

    x[0] = GR[r2]{7:0};    y[0] = GR[r3]{7:0};
    x[1] = GR[r2]{15:8};  y[1] = GR[r3]{15:8};
    x[2] = GR[r2]{23:16}; y[2] = GR[r3]{23:16};
    x[3] = GR[r2]{31:24}; y[3] = GR[r3]{31:24};
    x[4] = GR[r2]{39:32}; y[4] = GR[r3]{39:32};
    x[5] = GR[r2]{47:40}; y[5] = GR[r3]{47:40};
    x[6] = GR[r2]{55:48}; y[6] = GR[r3]{55:48};
    x[7] = GR[r2]{63:56}; y[7] = GR[r3]{63:56};

    GR[r1] = 0;
    for (i = 0; i < 8; i++) {
        temp[i] = zero_ext(x[i], 8) - zero_ext(y[i], 8);
        if (temp[i] < 0)
            temp[i] = -temp[i];
        GR[r1] += temp[i];
    }

    GR[r1].nat = GR[r2].nat || GR[r3].nat;
}

```

Interruptions: Illegal Operation fault

pshl — Parallel Shift Left

| | | | |
|----------------|--|-------------------------------|----|
| Format: | (<i>qp</i>) pshl2 $r_1 = r_2, r_3$ | two_byte_form, variable_form | I7 |
| | (<i>qp</i>) pshl2 $r_1 = r_2, count_5$ | two_byte_form, fixed_form | I8 |
| | (<i>qp</i>) pshl4 $r_1 = r_2, r_3$ | four_byte_form, variable_form | I7 |
| | (<i>qp</i>) pshl4 $r_1 = r_2, count_5$ | four_byte_form, fixed_form | I8 |

Description: The data elements of GR r_2 are each independently shifted to the left by the scalar shift count in GR r_3 , or in the immediate field $count_5$. The low-order bits of each element are filled with zeros. The shift count is interpreted as unsigned. Shift counts greater than 15 (for 16-bit quantities) or 31 (for 32-bit quantities) yield all zero results. The results are placed in GR r_1 .

Figure 2-39. Parallel Shift Left Example

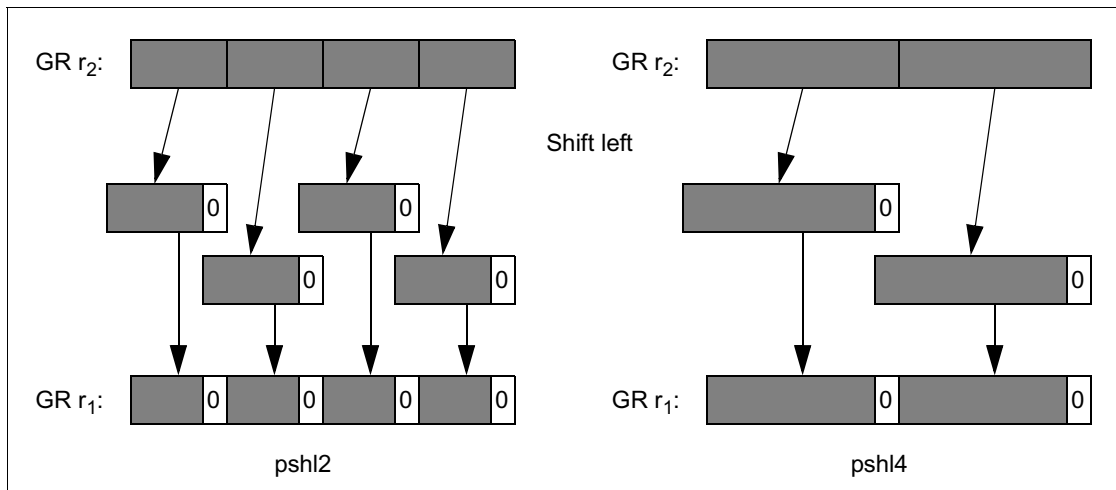

Operation:

```

if (PR[qp]) {
    check_target_register(r1);

    shift_count = (variable_form ? GR[r3] : count5);
    tmp_nat = (variable_form ? GR[r3].nat : 0);

    if (two_byte_form) { // two_byte_form
        if (shift_count > 16)
            shift_count = 16;
        GR[r1]{15:0} = GR[r2]{15:0} << shift_count;
        GR[r1]{31:16} = GR[r2]{31:16} << shift_count;
        GR[r1]{47:32} = GR[r2]{47:32} << shift_count;
        GR[r1]{63:48} = GR[r2]{63:48} << shift_count;
    } else { // four_byte_form
        if (shift_count > 32)
            shift_count = 32;
        GR[r1]{31:0} = GR[r2]{31:0} << shift_count;
        GR[r1]{63:32} = GR[r2]{63:32} << shift_count;
    }

    GR[r1].nat = GR[r2].nat || tmp_nat;
}

```

Interruptions: Illegal Operation fault

pshladd — Parallel Shift Left and Add

Format: (qp) pshladd2 $r_1 = r_2, count_2, r_3$

A10

Description: The four signed 16-bit data elements of GR r_2 are each independently shifted to the left by $count_2$ bits (shifting zeros into the low-order bits), and added to the four signed 16-bit data elements of GR r_3 . Both the left shift and the add operations are saturating: if the result of either the shift or the add is not representable as a signed 16-bit value, the final result is saturated. The four signed 16-bit results are placed in GR r_1 . The first operand can be shifted by 1, 2 or 3 bits.

Operation:

```

if (PR[qp]) {
    check_target_register(r1);

    x[0] = GR[r2]{15:0};    y[0] = GR[r3]{15:0};
    x[1] = GR[r2]{31:16};  y[1] = GR[r3]{31:16};
    x[2] = GR[r2]{47:32};  y[2] = GR[r3]{47:32};
    x[3] = GR[r2]{63:48};  y[3] = GR[r3]{63:48};

    max = sign_ext(0x7fff, 16);
    min = sign_ext(0x8000, 16);

    for (i = 0; i < 4; i++) {
        temp[i] = sign_ext(x[i], 16) << count2;

        if (temp[i] > max)
            res[i] = max;
        else if (temp[i] < min)
            res[i] = min;
        else {
            res[i] = temp[i] + sign_ext(y[i], 16);
            if (res[i] > max)
                res[i] = max;
            if (res[i] < min)
                res[i] = min;
        }
    }

    GR[r1] = concatenate4(res[3], res[2], res[1], res[0]);
    GR[r1].nat = GR[r2].nat || GR[r3].nat;
}

```

Interruptions: Illegal Operation fault

pshr — Parallel Shift Right

| | | | |
|----------------|-----------------------------------|--|----|
| Format: | (qp) pshr2 $r_1 = r_3, r_2$ | signed_form, two_byte_form, variable_form | I5 |
| | (qp) pshr2 $r_1 = r_3, count_5$ | signed_form, two_byte_form, fixed_form | I6 |
| | (qp) pshr2.u $r_1 = r_3, r_2$ | unsigned_form, two_byte_form, variable_form | I5 |
| | (qp) pshr2.u $r_1 = r_3, count_5$ | unsigned_form, two_byte_form, fixed_form | I6 |
| | (qp) pshr4 $r_1 = r_3, r_2$ | signed_form, four_byte_form, variable_form | I5 |
| | (qp) pshr4 $r_1 = r_3, count_5$ | signed_form, four_byte_form, fixed_form | I6 |
| | (qp) pshr4.u $r_1 = r_3, r_2$ | unsigned_form, four_byte_form, variable_form | I5 |
| | (qp) pshr4.u $r_1 = r_3, count_5$ | unsigned_form, four_byte_form, fixed_form | I6 |

Description: The data elements of GR r_3 are each independently shifted to the right by the scalar shift count in GR r_2 , or in the immediate field $count_5$. The high-order bits of each element are filled with either the initial value of the sign bits of the data elements in GR r_3 (arithmetic shift) or zeros (logical shift). The shift count is interpreted as unsigned. Shift counts greater than 15 (for 16-bit quantities) or 31 (for 32-bit quantities) yield all zero or all one results depending on the initial values of the sign bits of the data elements in GR r_3 and whether a signed or unsigned shift is done. The results are placed in GR r_1 .

Operation:

```

if (PR[qp]) {
    check_target_register(r1);

    shift_count = (variable_form ? GR[r2] : count5);
    tmp_nat = (variable_form ? GR[r2].nat : 0);

    if (two_byte_form) { // two_byte_form
        if (shift_count > 16)
            shift_count = 16;
        if (unsigned_form) { // unsigned shift
            GR[r1]{15:0} = shift_right_unsigned(zero_ext(GR[r3]{15:0}, 16),
                shift_count);
            GR[r1]{31:16} = shift_right_unsigned(zero_ext(GR[r3]{31:16}, 16),
                shift_count);
            GR[r1]{47:32} = shift_right_unsigned(zero_ext(GR[r3]{47:32}, 16),
                shift_count);
            GR[r1]{63:48} = shift_right_unsigned(zero_ext(GR[r3]{63:48}, 16),
                shift_count);
        } else { // signed shift
            GR[r1]{15:0} = shift_right_signed(sign_ext(GR[r3]{15:0}, 16),
                shift_count);
            GR[r1]{31:16} = shift_right_signed(sign_ext(GR[r3]{31:16}, 16),
                shift_count);
            GR[r1]{47:32} = shift_right_signed(sign_ext(GR[r3]{47:32}, 16),
                shift_count);
            GR[r1]{63:48} = shift_right_signed(sign_ext(GR[r3]{63:48}, 16),
                shift_count);
        }
    } else { // four_byte_form
        if (shift_count > 32)
            shift_count = 32;
        if (unsigned_form) { // unsigned shift
            GR[r1]{31:0} = shift_right_unsigned(zero_ext(GR[r3]{31:0}, 32),
                shift_count);
            GR[r1]{63:32} = shift_right_unsigned(zero_ext(GR[r3]{63:32}, 32),
                shift_count);
        } else { // signed shift
            GR[r1]{31:0} = shift_right_signed(sign_ext(GR[r3]{31:0}, 32),
                shift_count);
            GR[r1]{63:32} = shift_right_signed(sign_ext(GR[r3]{63:32}, 32),
                shift_count);
        }
    }
}

```



```
    }  
  }  
  GR[r1].nat = GR[r3].nat || tmp_nat;  
}
```

Interruptions: Illegal Operation fault

pshradd — Parallel Shift Right and Add

Format: `(qp) pshradd2 r1 = r2, count2, r3` A10

Description: The four signed 16-bit data elements of GR r_2 are each independently shifted to the right by $count_2$ bits, and added to the four signed 16-bit data elements of GR r_3 . The right shift operation fills the high-order bits of each element with the initial value of the sign bits of the data elements in GR r_2 . The add operation is performed with signed saturation. The four signed 16-bit results of the add are placed in GR r_1 . The first operand can be shifted by 1, 2 or 3 bits.

Operation:

```

if (PR[qp]) {
    check_target_register(r1);

    x[0] = GR[r2]{15:0};    y[0] = GR[r3]{15:0};
    x[1] = GR[r2]{31:16};   y[1] = GR[r3]{31:16};
    x[2] = GR[r2]{47:32};   y[2] = GR[r3]{47:32};
    x[3] = GR[r2]{63:48};   y[3] = GR[r3]{63:48};

    max = sign_ext(0x7fff, 16);
    min = sign_ext(0x8000, 16);

    for (i = 0; i < 4; i++) {
        temp[i] = shift_right_signed(sign_ext(x[i], 16), count2);

        res[i] = temp[i] + sign_ext(y[i], 16);
        if (res[i] > max)
            res[i] = max;
        if (res[i] < min)
            res[i] = min;
    }

    GR[r1] = concatenate4(res[3], res[2], res[1], res[0]);
    GR[r1].nat = GR[r2].nat || GR[r3].nat;
}

```

Interruptions: Illegal Operation fault

psub — Parallel Subtract

| | | | |
|----------------|---------------------------------|------------------------------------|----|
| Format: | (qp) psub1 $r_1 = r_2, r_3$ | one_byte_form, modulo_form | A9 |
| | (qp) psub1.sss $r_1 = r_2, r_3$ | one_byte_form, sss_saturation_form | A9 |
| | (qp) psub1.uus $r_1 = r_2, r_3$ | one_byte_form, uus_saturation_form | A9 |
| | (qp) psub1.uuu $r_1 = r_2, r_3$ | one_byte_form, uuu_saturation_form | A9 |
| | (qp) psub2 $r_1 = r_2, r_3$ | two_byte_form, modulo_form | A9 |
| | (qp) psub2.sss $r_1 = r_2, r_3$ | two_byte_form, sss_saturation_form | A9 |
| | (qp) psub2.uus $r_1 = r_2, r_3$ | two_byte_form, uus_saturation_form | A9 |
| | (qp) psub2.uuu $r_1 = r_2, r_3$ | two_byte_form, uuu_saturation_form | A9 |
| | (qp) psub4 $r_1 = r_2, r_3$ | four_byte_form, modulo_form | A9 |

Description: The sets of elements from the two source operands are subtracted, and the results placed in GR r_1 .

If the difference between two elements cannot be represented in the result element and a saturation completer is specified, then saturation clipping is performed. The saturation can either be signed or unsigned, as given in Table 2-47. If the difference of two elements is larger than the upper limit value, the result is the upper limit value. If it is smaller than the lower limit value, the result is the lower limit value. The saturation limits are given in Table 2-48.

Table 2-47. Parallel Subtract Saturation Completers

| Completer | Result r_1 Treated as | Source r_2 Treated as | Source r_3 Treated as |
|-----------|-------------------------|-------------------------|-------------------------|
| sss | signed | signed | signed |
| uus | unsigned | unsigned | signed |
| uuu | unsigned | unsigned | unsigned |

Table 2-48. Parallel Subtract Saturation Limits

| Size | Element Width | Result r_1 Signed | | Result r_1 Unsigned | |
|------|---------------|---------------------|-------------|-----------------------|-------------|
| | | Upper Limit | Lower Limit | Upper Limit | Lower Limit |
| 1 | 8 bit | 0x7f | 0x80 | 0xff | 0x00 |
| 2 | 16 bit | 0x7fff | 0x8000 | 0xffff | 0x0000 |

Figure 2-40. Parallel Subtract Example

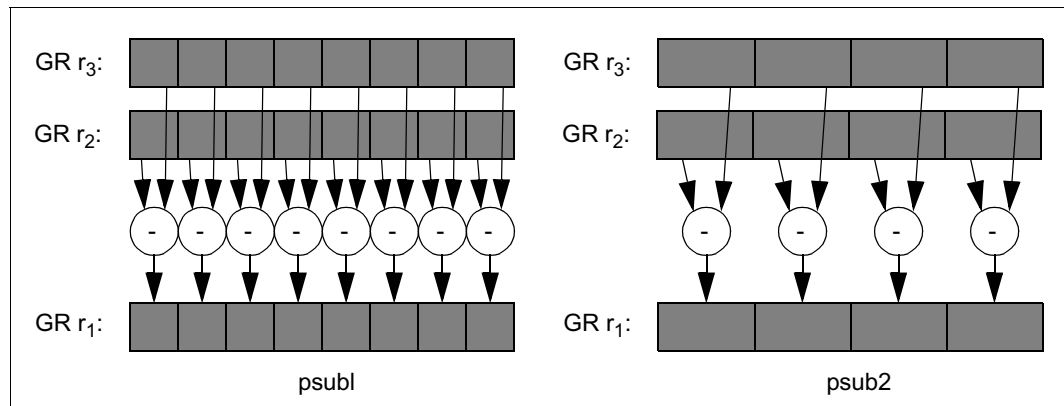

```

Operation:   if (PR[qp]) {
                check_target_register(r1);

                if (one_byte_form) {                                     // one-byte elements
                    x[0] = GR[r2]{7:0};           y[0] = GR[r3]{7:0};
                    x[1] = GR[r2]{15:8};          y[1] = GR[r3]{15:8};
                    x[2] = GR[r2]{23:16};          y[2] = GR[r3]{23:16};
                    x[3] = GR[r2]{31:24};          y[3] = GR[r3]{31:24};
                    x[4] = GR[r2]{39:32};          y[4] = GR[r3]{39:32};
                    x[5] = GR[r2]{47:40};          y[5] = GR[r3]{47:40};
                    x[6] = GR[r2]{55:48};          y[6] = GR[r3]{55:48};
                    x[7] = GR[r2]{63:56};          y[7] = GR[r3]{63:56};

                    if (sss_saturation_form) {                         // sss_saturation_form
                        max = sign_ext(0x7f, 8);
                        min = sign_ext(0x80, 8);
                        for (i = 0; i < 8; i++) {
                            temp[i] = sign_ext(x[i], 8) - sign_ext(y[i], 8);
                        }
                    } else if (uus_saturation_form) {                  // uus_saturation_form
                        max = 0xff;
                        min = 0x00;
                        for (i = 0; i < 8; i++) {
                            temp[i] = zero_ext(x[i], 8) - sign_ext(y[i], 8);
                        }
                    } else if (uuu_saturation_form) {                 // uuu_saturation_form
                        max = 0xff;
                        min = 0x00;
                        for (i = 0; i < 8; i++) {
                            temp[i] = zero_ext(x[i], 8) - zero_ext(y[i], 8);
                        }
                    } else {                                           // modulo_form
                        for (i = 0; i < 8; i++) {
                            temp[i] = zero_ext(x[i], 8) - zero_ext(y[i], 8);
                        }
                    }
                }

                if (sss_saturation_form || uus_saturation_form ||
                    uuu_saturation_form) {
                    for (i = 0; i < 8; i++) {
                        if (temp[i] > max)
                            temp[i] = max;
                        if (temp[i] < min)
                            temp[i] = min;
                    }
                }

                GR[r1] = concatenate8(temp[7], temp[6], temp[5], temp[4],
                                       temp[3], temp[2], temp[1], temp[0]);
            } else if (two_byte_form) {                                 // two-byte elements
                x[0] = GR[r2]{15:0};           y[0] = GR[r3]{15:0};
                x[1] = GR[r2]{31:16};          y[1] = GR[r3]{31:16};
                x[2] = GR[r2]{47:32};          y[2] = GR[r3]{47:32};
                x[3] = GR[r2]{63:48};          y[3] = GR[r3]{63:48};

                if (sss_saturation_form) {                             // sss_saturation_form
                    max = sign_ext(0x7fff, 16);
                    min = sign_ext(0x8000, 16);
                    for (i = 0; i < 4; i++) {
                        temp[i] = sign_ext(x[i], 16) - sign_ext(y[i], 16);
                    }
                } else if (uus_saturation_form) {                     // uus_saturation_form

```

```

        max = 0xffff;
        min = 0x0000;
        for (i = 0; i < 4; i++) {
            temp[i] = zero_ext(x[i], 16) - sign_ext(y[i], 16);
        }
    } else if (uuu_saturation_form) { // uuu_saturation_form
        max = 0xffff;
        min = 0x0000;
        for (i = 0; i < 4; i++) {
            temp[i] = zero_ext(x[i], 16) - zero_ext(y[i], 16);
        }
    } else { // modulo_form
        for (i = 0; i < 4; i++) {
            temp[i] = zero_ext(x[i], 16) - zero_ext(y[i], 16);
        }
    }

    if (sss_saturation_form || uus_saturation_form ||
        uuu_saturation_form) {
        for (i = 0; i < 4; i++) {
            if (temp[i] > max)
                temp[i] = max;
            if (temp[i] < min)
                temp[i] = min;
        }
    }

    GR[r1] = concatenate4(temp[3], temp[2], temp[1], temp[0]);
} else { // four-byte elements
    x[0] = GR[r2]{31:0};    y[0] = GR[r3]{31:0};
    x[1] = GR[r2]{63:32}; y[1] = GR[r3]{63:32};

    for (i = 0; i < 2; i++) { // modulo_form
        temp[i] = zero_ext(x[i], 32) - zero_ext(y[i], 32);
    }

    GR[r1] = concatenate2(temp[1], temp[0]);
}

GR[r1].nat = GR[r2].nat || GR[r3].nat;
}

```

Interruptions: Illegal Operation fault

rfi — Return From Interruption

Format: rfi

B8

Description: The machine context prior to an interruption is restored. PSR is restored from IPSR, IPSR is unmodified, and IP is restored from IIP. Execution continues at the bundle address loaded into the IP, and the instruction slot loaded into PSR.ri.

This instruction must be immediately followed by a stop. Otherwise, an Illegal Operation fault is taken. This instruction switches to the register bank specified by IPSR.bn. Instructions in the same instruction group that access GR16 to GR31 reference the previous register bank. Subsequent instruction groups reference the new register bank.

This instruction performs instruction serialization, which ensures:

- prior modifications to processor register resources that affect fetching of subsequent instruction groups are observed.
- prior modifications to processor register resources that affect subsequent execution or data memory accesses are observed.
- prior memory synchronization (`sync.i`) operations have taken effect on the local processor instruction cache.
- subsequent instruction group fetches (including the target instruction group) are re-initiated after `rfi` completes.

The `rfi` instruction must be in an instruction group after the instruction group containing the operation that is to be serialized.

This instruction can only be executed at the most privileged level. This instruction can not be predicated.

Execution of this instruction is undefined if PSR.ic or PSR.i are 1. Software must ensure that an interruption cannot occur that could modify IIP, IPSR, or IFS between when they are written and the subsequent `rfi`.

This instruction does not take Lower Privilege Transfer, Taken Branch or Single Step traps.

If this instruction sets PSR.ri to 2 and the target is an MLX bundle, then an Illegal Operation fault will be taken on the target bundle.

If IPSR.is is 1, control is resumed in the IA-32 instruction set at the virtual linear address specified by IIP{31:0}. PSR.di does not inhibit instruction set transitions for this instruction. If PSR.dfh is 1 after `rfi` completes execution, a Disabled FP Register fault is raised on the target IA-32 instruction.

If IPSR.is is 1 and an Unimplemented Instruction Address trap is taken, IIP will contain the original 64-bit target IP. (The value will not have been zero extended from 32 bits.)

When entering the IA-32 instruction set, the size of the current stack frame is set to zero, and all stacked general registers are left in an undefined state. Software can not rely on the value of these registers across an instruction set transition. Software must ensure that BSPSTORE==BSP on entry to the IA-32 instruction set, otherwise undefined behavior may result.

Software must issue a `mfi` instruction before this instruction if memory ordering is required between IA-32 processor-consistent and Itanium unordered memory references. The processor does not ensure Itanium-instruction-set-generated writes into the instruction stream are seen by subsequent IA-32 instructions.

Software must ensure the code segment descriptor and selector are loaded before issuing this instruction. If the target EIP value exceeds the code segment limit or has a code segment privilege violation, an IA-32_Exception(GPFault) exception is raised on the target IA-32 instruction. For entry into 16-bit IA-32 code, if IIP is not within 64K-bytes of CSD.base a GPFault is raised on the target instruction.

EFLAG.rf and PSR.id are unmodified until the successful completion of the target IA-32 instruction. PSR.da, PSR.dd, PSR.ia and PSR.ed are cleared to zero before the target IA-32 instruction begins execution.

IA-32 instruction set execution leaves the contents of the ALAT undefined. Software can not rely on ALAT state across an instruction set transition. On entry to IA-32 code, existing entries in the ALAT are ignored.

```

Operation:  if (!followed_by_stop())
                illegal_operation_fault();

                unimplemented_address = 0;
                if (PSR.cpl != 0)
                    privileged_operation_fault(0);

                taken_rfi = 1;

                PSR = CR[IPSR];
                if (CR[IPSR].is == 1) {           //resume IA-32 instruction set
                    tmp_IP = CR[IIP];
                    if ((CR[IPSR].it && unimplemented_virtual_address(tmp_IP))
                        || (!CR[IPSR].it && unimplemented_physical_address(tmp_IP)))
                        unimplemented_address = 1;
                                                    //compute effective instruction pointer
                    EIP{31:0} = CR[IIP]{31:0} - AR[CSD].Base;
                                                    //force zero-sized restored frame
                    rse_restore_frame(0, 0, CFM.sof);
                    CFM.sof = 0;
                    CFM.sol = 0;
                    CFM.sor = 0;
                    CFM.rrb.gr = 0;
                    CFM.rrb.fr = 0;
                    CFM.rrb.pr = 0;
                    rse_invalidate_non_current_regs();
                    //The register stack engine is disabled during IA-32
                    //instruction set execution.
                } else {                          //return to Itanium instruction set
                    tmp_IP = CR[IIP] & ~0xf;
                    slot = CR[IPSR].ri;
                    if ((CR[IPSR].it && unimplemented_virtual_address(tmp_IP))
                        || (!CR[IPSR].it && unimplemented_physical_address(tmp_IP)))
                        unimplemented_address = 1;
                    if (CR[IFS].v) {
                        tmp_growth = -CFM.sof;
                        alat_frame_update(-CR[IFS].ifm.sof, 0);
                        rse_restore_frame(CR[IFS].ifm.sof, tmp_growth, CFM.sof);
                        CFM = CR[IFS].ifm;
                    }
                    rse_enable_current_frame_load();
                }
                IP = tmp_IP;
                instruction_serialize();
                if (unimplemented_address)
                    unimplemented_instruction_address_trap(0, tmp_IP);

```

rsm — Reset System Mask

Format: `(qp) rsm imm24` M44

Description: The complement of the `imm24` operand is ANDed with the system mask (PSR{23:0}) and the result is placed in the system mask. See [Section 3.3.2, “Processor Status Register \(PSR\)”](#) on page 2:18.

The PSR system mask can only be written at the most privileged level.

When the current privilege level is zero (PSR.cpl is 0), an `rsm` instruction whose mask includes PSR.i may cause external interrupts to be disabled for an implementation-dependent number of instructions, even if the qualifying predicate for the `rsm` instruction is false. Architecturally, the extents of this external interrupt disabling “window” are defined as follows:

- External interrupts may be disabled for any instructions in the same instruction group as the `rsm`, including those that precede the `rsm` in sequential program order, regardless of the value of the qualifying predicate of the `rsm` instruction.
- If the qualifying predicate of the `rsm` is true, then external interrupts are disabled immediately following the `rsm` instruction.
- If the qualifying predicate of the `rsm` is false, then external interrupts may be disabled until the next data serialization operation that follows the `rsm` instruction.

The external interrupt disable window is guaranteed to be no larger than defined by the above criteria, but it may be smaller, depending on the processor implementation.

When the current privilege level is non-zero (PSR.cpl is not 0), an `rsm` instruction whose mask includes PSR.i may briefly disable external interrupts, regardless of the value of the qualifying predicate of the `rsm` instruction. However, processor implementations guarantee that non-privileged code cannot lock out external interrupts indefinitely (e.g., via an arbitrarily long sequence of `rsm` instructions with zero-valued qualifying predicates).

Operation:

```

if (PR[qp]) {
    if (PSR.cpl != 0)
        privileged_operation_fault();

    if (is_reserved_field(PSR_TYPE, PSR_SM, imm24))
        reserved_register_field_fault();

    if (imm24{1})    PSR{1} = 0;    // be
    if (imm24{2})    PSR{2} = 0;    // up
    if (imm24{3})    PSR{3} = 0;    // ac
    if (imm24{4})    PSR{4} = 0;    // mfl
    if (imm24{5})    PSR{5} = 0;    // mfh
    if (imm24{13})   PSR{13} = 0;   // ic
    if (imm24{14})   PSR{14} = 0;   // i
    if (imm24{15})   PSR{15} = 0;   // pk
    if (imm24{17})   PSR{17} = 0;   // dt
    if (imm24{18})   PSR{18} = 0;   // dfl
    if (imm24{19})   PSR{19} = 0;   // dfh
    if (imm24{20})   PSR{20} = 0;   // sp
    if (imm24{21})   PSR{21} = 0;   // pp
    if (imm24{22})   PSR{22} = 0;   // di
    if (imm24{23})   PSR{23} = 0;   // si
}

```

Interrupts: Privileged Operation fault

Reserved Register/Field fault

Serialization: Software must use a data serialize or instruction serialize operation before issuing instructions dependent upon the altered PSR bits – except the PSR.i bit. The PSR.i bit is implicitly serialized and the processor ensures that external interrupts are masked by the time the next instruction executes.

rum — Reset User Mask

Format: (qp) rum *imm*₂₄ M44

Description: The complement of the *imm*₂₄ operand is ANDed with the user mask (PSR{5:0}) and the result is placed in the user mask. See [Section 3.3.2, “Processor Status Register \(PSR\)”](#) on page 2:18.

PSR.up is only cleared if the secure performance monitor bit (PSR.sp) is zero. Otherwise PSR.up is not modified.

Operation:

```

if (PR[qp]) {
    if (is_reserved_field(PSR_TYPE, PSR_UM, imm24)
        reserved_register_field_fault();

    if (imm24{1})    PSR{1} = 0;    // be
    if (imm24{2} && PSR.sp == 0)    //non-secure perf monitor
        PSR{2} = 0;    // up
    if (imm24{3})    PSR{3} = 0;    // ac
    if (imm24{4})    PSR{4} = 0;    // mfl
    if (imm24{5})    PSR{5} = 0;    // mfh
}

```

Interruptions: Reserved Register/Field fault

Serialization: All user mask modifications are observed by the next instruction group.

setf — Set Floating-point Value, Exponent, or Significand

| | | | |
|----------------|----------------------------------|------------------|-----|
| Format: | <i>(qp)</i> setf.s $f_1 = r_2$ | single_form | M18 |
| | <i>(qp)</i> setf.d $f_1 = r_2$ | double_form | M18 |
| | <i>(qp)</i> setf.exp $f_1 = r_2$ | exponent_form | M18 |
| | <i>(qp)</i> setf.sig $f_1 = r_2$ | significand_form | M18 |

Description: In the single and double forms, GR r_2 is treated as a single precision (in the single_form) or double precision (in the double_form) memory representation, converted into floating-point register format, and placed in FR f_1 , as shown in Figure 5-7 and Figure 5-8 on page 1:85, respectively.

In the exponent_form, bits 16:0 of GR r_2 are copied to the exponent field of FR f_1 and bit 17 of GR r_2 is copied to the sign bit of FR f_1 . The significand field of FR f_1 is set to one (0x800...000).

Figure 2-41. Function of setf.exp

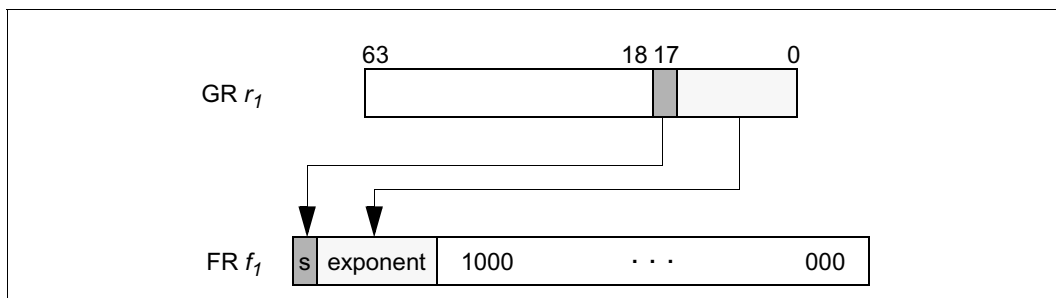

In the significand_form, the value in GR r_2 is copied to the significand field of FR f_1 .

The exponent field of FR f_1 is set to the biased exponent for 2.0^{63} (0x1003E) and the sign field of FR f_1 is set to positive (0).

Figure 2-42. Function of setf.sig

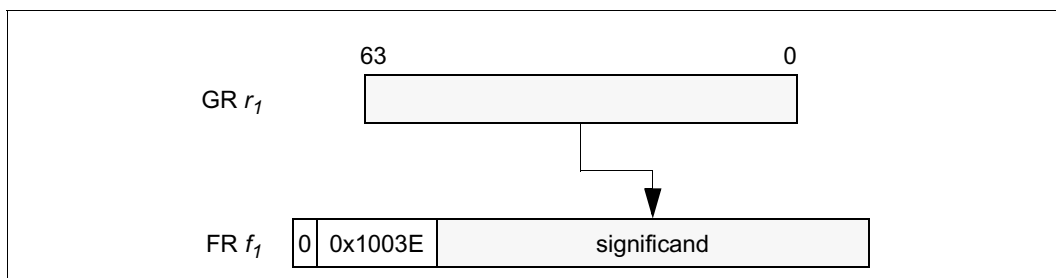

For all forms, if the NaT bit corresponding to r_2 is equal to 1, FR f_1 is set to NaTVal instead of the computed result.

```

Operation:   if (PR[qp]) {
                fp_check_target_register(f1);
                if (tmp_israncode = fp_reg_disabled(f1, 0, 0, 0))
                    disabled_fp_register_fault(tmp_israncode, 0);

                if (!GR[r2].nat) {
                    if (single_form)
                        FR[f1] = fp_mem_to_fr_format(GR[r2], 4, 0);
                    else if (double_form)
                        FR[f1] = fp_mem_to_fr_format(GR[r2], 8, 0);
                    else if (significand_form) {
                        FR[f1].significand = GR[r2];
                        FR[f1].exponent = FP_INTEGER_EXP;
                        FR[f1].sign = 0;
                    } else { // exponent_form
                        FR[f1].significand = 0x8000000000000000;
                        FR[f1].exp = GR[r2]{16:0};
                        FR[f1].sign = GR[r2]{17};
                    }
                } else
                    FR[f1] = NATVAL;

                fp_update_psr(f1);
            }

```

Interruptions: Illegal Operation fault

Disabled Floating-point Register fault

shl — Shift Left

Format: (qp) shl $r_1 = r_2, r_3$ 17
 (qp) shl $r_1 = r_2, count_6$ pseudo-op of: (qp) dep.z $r_1 = r_2, count_6, 64 - count_6$

Description: The value in GR r_2 is shifted to the left, with the vacated bit positions filled with zeroes, and placed in GR r_1 . The number of bit positions to shift is specified by the value in GR r_3 or by an immediate value $count_6$. The shift count is interpreted as an unsigned number. If the value in GR r_3 is greater than 63, then the result is all zeroes.

See “[dep — Deposit](#)” on page 3:45 for the immediate form.

Operation:

```

if (PR[qp]) {
    check_target_register(r1);

    count = GR[r3];
    GR[r1] = (count > 63) ? 0: GR[r2] << count;

    GR[r1].nat = GR[r2].nat || GR[r3].nat;
}

```

Interruptions: Illegal Operation fault

shladd — Shift Left and Add

Format: (qp) shladd $r_1 = r_2, count_2, r_3$

A2

Description: The first source operand is shifted to the left by $count_2$ bits and then added to the second source operand and the result placed in GR r_1 . The first operand can be shifted by 1, 2, 3, or 4 bits.

Operation:

```
if (PR[qp]) {
    check_target_register(r1);

    GR[r1] = (GR[r2] << count2) + GR[r3];
    GR[r1].nat = GR[r2].nat || GR[r3].nat;
}
```

Interruptions: Illegal Operation fault

shladdp4 — Shift Left and Add Pointer

Format: (qp) shladdp4 $r_1 = r_2, count_2, r_3$

A2

Description: The first source operand is shifted to the left by $count_2$ bits and then is added to the second source operand. The upper 32 bits of the result are forced to zero, and then bits {31:30} of GR r_3 are copied to bits {62:61} of the result. This result is placed in GR r_1 . The first operand can be shifted by 1, 2, 3, or 4 bits.

Figure 2-43. Shift Left and Add Pointer

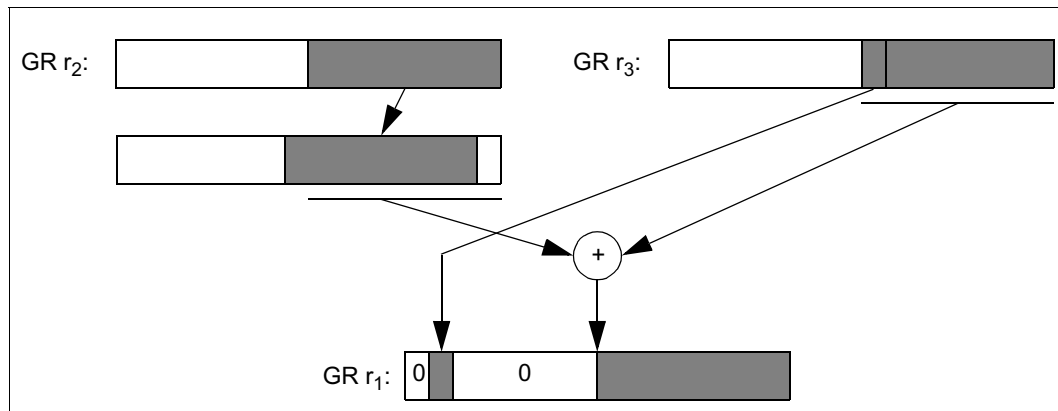

Operation:

```

if (PR[qp]) {
    check_target_register(r1);

    tmp_res = (GR[r2] << count2) + GR[r3];
    tmp_res = zero_ext(tmp_res{31:0}, 32);
    tmp_res{62:61} = GR[r3]{31:30};
    GR[r1] = tmp_res;
    GR[r1].nat = GR[r2].nat || GR[r3].nat;
}

```

Interruptions: Illegal Operation fault

shr — Shift Right

| | | | |
|----------------|-----------------------------------|--|----|
| Format: | (qp) shr $r_1 = r_3, r_2$ | signed_form | 15 |
| | (qp) shr.u $r_1 = r_3, r_2$ | unsigned_form | 15 |
| | (qp) shr $r_1 = r_3, count_6$ | pseudo-op of: (qp) extr $r_1 = r_3, count_6, 64-count_6$ | |
| | (qp) shr.u $r_1 = r_3, count_6$ | pseudo-op of: (qp) extr.u $r_1 = r_3, count_6, 64-count_6$ | |

Description: The value in GR r_3 is shifted to the right and placed in GR r_1 . In the signed_form the vacated bit positions are filled with bit 63 of GR r_3 ; in the unsigned_form the vacated bit positions are filled with zeroes. The number of bit positions to shift is specified by the value in GR r_2 or by an immediate value $count_6$. The shift count is interpreted as an unsigned number. If the value in GR r_2 is greater than 63, then the result is all zeroes (for the unsigned_form, or if bit 63 of GR r_3 was 0) or all ones (for the signed_form if bit 63 of GR r_3 was 1).

If the .u completer is specified, the shift is unsigned (logical), otherwise it is signed (arithmetic).

See “[extr — Extract](#)” on page 3:48 for the immediate forms.

Operation:

```

if (PR[qp]) {
    check_target_register(r1);

    if (signed_form) {
        count = (GR[r2] > 63) ? 63 : GR[r2];
        GR[r1] = shift_right_signed(GR[r3], count);
    } else {
        count = GR[r2];
        GR[r1] = (count > 63) ? 0 : shift_right_unsigned(GR[r3], count);
    }

    GR[r1].nat = GR[r2].nat || GR[r3].nat;
}

```

Interruptions: Illegal Operation fault

shrp — Shift Right Pair

Format: (qp) shrp $r_1 = r_2, r_3, count_6$

110

Description: The two source operands, GR r_2 and GR r_3 , are concatenated to form a 128-bit value and shifted to the right $count_6$ bits. The least-significant 64 bits of the result are placed in GR r_1 .

The immediate value $count_6$ can be any number in the range 0 to 63.

Figure 2-44. Shift Right Pair

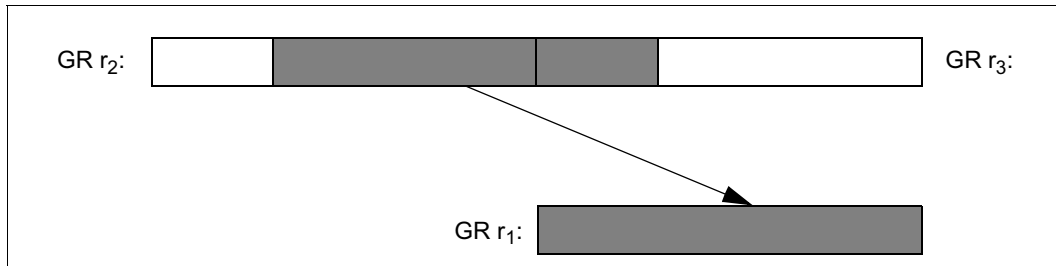

Operation:

```

if (PR[qp]) {
    check_target_register(r1);

    temp1 = shift_right_unsigned(GR[r3], count6);
    temp2 = GR[r2] << (64 - count6);
    GR[r1] = zero_ext(temp1, 64 - count6) | temp2;
    GR[r1].nat = GR[r2].nat || GR[r3].nat;
}

```

Interruptions: Illegal Operation fault

srlz — Serialize

| | | | |
|----------------|----------------------|------------------|-----|
| Format: | (<i>qp</i>) srlz.i | instruction_form | M24 |
| | (<i>qp</i>) srlz.d | data_form | M24 |

Description: Instruction serialization (`srlz.i`) ensures:

- prior modifications to processor register resources that affect fetching of subsequent instruction groups are observed,
- prior modifications to processor register resources that affect subsequent execution or data memory accesses are observed,
- prior memory synchronization (`sync.i`) operations have taken effect on the local processor instruction cache,
- subsequent instruction group fetches are re-initiated after `srlz.i` completes.

The `srlz.i` instruction must be in an instruction group after the instruction group containing the operation that is to be serialized. Operations dependent on the serialization must be in an instruction group after the instruction group containing the `srlz.i`.

Data serialization (`srlz.d`) ensures:

- prior modifications to processor register resources that affect subsequent execution or data memory accesses are observed.

The `srlz.d` instruction must be in an instruction group after the instruction group containing the operation that is to be serialized. Operations dependent on the serialization must follow the `srlz.d`, but they can be in the same instruction group as the `srlz.d`.

A `srlz` cannot be used to stall processor data memory references until prior data memory references, or memory fences are visible or “accepted” by the external platform.

The following processor resources require a serialize to ensure side-effects are observed; CRs, PSR, DBRs, IBRs, PMDs, PMCs, RRs, PKRs, TRs and TCs (refer to [Section 3.2, “Serialization” on page 2:13](#) for details).

Operation:

```

if (PR[qp]) {
    if (instruction_form)
        instruction_serialize();
    else // data_form
        data_serialize();
}

```

Interrupts: None

ssm — Set System Mask

Format: (qp) ssm imm₂₄

M44

Description: The imm₂₄ operand is ORed with the system mask (PSR{23:0}) and the result is placed in the system mask. See [Section 3.3.2, “Processor Status Register \(PSR\)” on page 2:18](#).

The PSR system mask can only be written at the most privileged level.

The contents of the interruption resources (that are overwritten when the PSR.ic bit is 1), are undefined if an interruption occurs between the enabling of the PSR.ic bit and a subsequent instruction serialize operation.

Operation:

```

if (PR[qp]) {
    if (PSR.cpl != 0)
        privileged_operation_fault(0);

    if (is_reserved_field(PSR_TYPE, PSR_SM, imm24))
        reserved_register_field_fault();

    if (imm24{1})    PSR{1} = 1;    // be
    if (imm24{2})    PSR{2} = 1;    // up
    if (imm24{3})    PSR{3} = 1;    // ac
    if (imm24{4})    PSR{4} = 1;    // mfl
    if (imm24{5})    PSR{5} = 1;    // mfh
    if (imm24{13})   PSR{13} = 1;   // ic
    if (imm24{14})   PSR{14} = 1;   // i
    if (imm24{15})   PSR{15} = 1;   // pk
    if (imm24{17})   PSR{17} = 1;   // dt
    if (imm24{18})   PSR{18} = 1;   // dfl
    if (imm24{19})   PSR{19} = 1;   // dfh
    if (imm24{20})   PSR{20} = 1;   // sp
    if (imm24{21})   PSR{21} = 1;   // pp
    if (imm24{22})   PSR{22} = 1;   // di
    if (imm24{23})   PSR{23} = 1;   // si
}

```

Interruptions: Privileged Operation fault

Reserved Register/Field fault

Serialization: Software must issue a data serialize or instruction serialize operation before issuing instructions dependent upon the altered PSR bits from the ssm instruction. Unlike with the rsm instruction, setting the PSR.i bit is not treated specially. Refer to [Section 3.2, “Serialization” on page 2:13](#) for a description of serialization.

st — Store

| | | | |
|----------------|---|--|----|
| Format: | (qp) stsz.sttype.sthint [r ₃] = r ₂ | normal_form, no_base_update_form | M4 |
| | (qp) stsz.sttype.sthint [r ₃] = r ₂ , imm ₉ | normal_form, imm_base_update_form | M5 |
| | (qp) st16.sttype.sthint [r ₃] = r ₂ , ar.csd | sixteen_byte_form, no_base_update_form | M4 |
| | (qp) st8.spill.sthint [r ₃] = r ₂ | spill_form, no_base_update_form | M4 |
| | (qp) st8.spill.sthint [r ₃] = r ₂ , imm ₉ | spill_form, imm_base_update_form | M5 |

Description: A value consisting of the least significant *sz* bytes of the value in GR *r*₂ is written to memory starting at the address specified by the value in GR *r*₃. The values of the *sz* completer are given in [Table 2-32 on page 3:131](#). The *sttype* completer specifies special store operations, which are described in [Table 2-49](#). If the NaT bit corresponding to GR *r*₃ is 1, or in sixteen_byte_form or normal_form, if the NaT bit corresponding to GR *r*₂ is 1, a Register NaT Consumption fault is taken.

In the sixteen_byte_form, two 8-byte values are stored as a single, 16-byte atomic memory write. The value in GR *r*₂ is written to memory starting at the address specified by the value in GR *r*₃. The value in the Compare and Store Data application register (AR[CSD]) is written to memory starting at the address specified by the value in GR *r*₃ plus 8.

In the spill_form, an 8-byte value is stored, and the NaT bit corresponding to GR *r*₂ is copied to a bit in the UNAT application register. This instruction is used for spilling a register/NaT pair. See [Section 4.4.4, “Control Speculation” on page 1:51](#) for details.

In the imm_base_update form, the value in GR *r*₃ is added to a signed immediate value (*imm*₉) and the result is placed back in GR *r*₃. This base register update is done after the store, and does not affect the store address, nor the value stored (for the case where *r*₂ and *r*₃ specify the same register). Base register update is not supported for the st16 instruction.

Table 2-49. Store Types

| <i>sttype</i> Completer | Interpretation | Special Store Operation |
|-------------------------|----------------|---|
| none | Normal store | |
| rel | Ordered store | An ordered store is performed with release semantics. |

For more details on ordered stores see [Section 4.4.7, “Memory Access Ordering” on page 1:63](#).

The ALAT is queried using the physical memory address and the access size, and all overlapping entries are invalidated.

The value of the *sthint* completer specifies the locality of the memory access. The values of the *sthint* completer are given in [Table 2-50](#). A prefetch hint is implied in the base update forms. The address specified by the value in GR *r*₃ after the base update acts as a hint to prefetch the indicated cache line. This prefetch uses the locality hints specified by *sthint*. See [Section 4.4.6, “Memory Hierarchy Control and Consistency” on page 1:60](#).

Hardware support for st16 instructions that reference a page that is neither a cacheable page with write-back policy nor a NaTPage is optional. On processor models that do not support such st16 accesses, an Unsupported Data Reference fault is raised when an unsupported reference is attempted.

Table 2-50. Store Hints

| <i>sthint</i> Completer | Interpretation |
|-------------------------|-----------------------------------|
| <i>none</i> | Temporal locality, level 1 |
| <i>nta</i> | Non-temporal locality, all levels |

Operation:

```

if (PR[qp]) {
    size = spill_form ? 8 : (sixteen_byte_form ? 16 : sz);
    itype = WRITE;
    if (size == 16) itype |= UNCACHE_OPT;
    otype = (sttype == 'rel') ? RELEASE : UNORDERED;

    if (imm_base_update_form)
        check_target_register(r3);
    if (GR[r3].nat || ((sixteen_byte_form || normal_form) && GR[r2].nat))
        register_nat_consumption_fault(WRITE);

    paddr = tlb_translate(GR[r3], size, itype, PSR.cpl, &matr,
                        &tmp_unused);
    if (spill_form && GR[r2].nat) {
        natd_gr_write(GR[r2], paddr, size, UM.be, matr, otype, sthint);
    }
    else {
        if (sixteen_byte_form)
            mem_writel6(GR[r2], AR[CSD], paddr, UM.be, matr, otype, sthint);
        else
            mem_write(GR[r2], paddr, size, UM.be, matr, otype, sthint);
    }

    if (spill_form) {
        bit_pos = GR[r3]{8:3};
        AR[UNAT]{bit_pos} = GR[r2].nat;
    }

    alat_inval_multiple_entries(paddr, size);

    if (imm_base_update_form) {
        GR[r3] = GR[r3] + sign_ext(imm9, 9);
        GR[r3].nat = 0;
        mem_implicit_prefetch(GR[r3], sthint, WRITE);
    }
}

```

Interruptions:

| | |
|----------------------------------|----------------------------------|
| Illegal Operation fault | Data Key Miss fault |
| Register NaT Consumption fault | Data Key Permission fault |
| Unimplemented Data Address fault | Data Access Rights fault |
| Data Nested TLB fault | Data Dirty Bit fault |
| Alternate Data TLB fault | Data Access Bit fault |
| VHPT Data fault | Data Debug fault |
| Data TLB fault | Unaligned Data Reference fault |
| Data Page Not Present fault | Unsupported Data Reference fault |
| Data NaT Page Consumption fault | |

stf — Floating-point Store

| | | | |
|----------------|--|------------------------------------|-----|
| Format: | (qp) $stf_{fsz}.sthint [r_3] = f_2$ | normal_form, no_base_update_form | M9 |
| | (qp) $stf_{fsz}.sthint [r_3] = f_2, imm_9$ | normal_form, imm_base_update_form | M10 |
| | (qp) $stf8.sthint [r_3] = f_2$ | integer_form, no_base_update_form | M9 |
| | (qp) $stf8.sthint [r_3] = f_2, imm_9$ | integer_form, imm_base_update_form | M10 |
| | (qp) $stf.spill.sthint [r_3] = f_2$ | spill_form, no_base_update_form | M9 |
| | (qp) $stf.spill.sthint [r_3] = f_2, imm_9$ | spill_form, imm_base_update_form | M10 |

Description: A value, consisting of fsz bytes, is generated from the value in FR f_2 and written to memory starting at the address specified by the value in GR r_3 . In the normal_form, the value in FR f_2 is converted to the memory format and then stored. In the integer_form, the significand of FR f_2 is stored. The values of the fsz completer are given in [Table 2-35 on page 3:135](#). In the normal_form or the integer_form, if the NaT bit corresponding to GR r_3 is 1 or if FR f_2 contains NaTVal, a Register NaT Consumption fault is taken. See [Section 5.1, “Data Types and Formats” on page 1:75](#) for details on conversion from floating-point register format.

In the spill_form, a 16-byte value from FR f_2 is stored without conversion. This instruction is used for spilling a register. See [Section 4.4.4, “Control Speculation” on page 1:51](#) for details.

In the imm_base_update form, the value in GR r_3 is added to a signed immediate value (imm_9) and the result is placed back in GR r_3 . This base register update is done after the store, and does not affect the store address.

The ALAT is queried using the physical memory address and the access size, and all overlapping entries are invalidated.

The value of the *sthint* completer specifies the locality of the memory access. The values of the *sthint* completer are given in [Table 2-50 on page 3:220](#). A prefetch hint is implied in the base update forms. The address specified by the value in GR r_3 after the base update acts as a hint to prefetch the indicated cache line. This prefetch uses the locality hints specified by *sthint*. See [Section 4.4.6, “Memory Hierarchy Control and Consistency” on page 1:60](#).

Hardware support for *stfe* (10-byte) instructions that reference a page that is neither a cacheable page with write-back policy nor a NaTPage is optional. On processor models that do not support such *stfe* accesses, an Unsupported Data Reference fault is raised when an unsupported reference is attempted.

```

Operation:   if (PR[qp]) {
                if (imm_base_update_form)
                    check_target_register(r3);
                if (tmp_isrcode = fp_reg_disabled(f2, 0, 0, 0))
                    disabled_fp_register_fault(tmp_isrcode, WRITE);

                if (GR[r3].nat || (!spill_form && (FR[f2] == NATVAL)))
                    register_nat_consumption_fault(WRITE);

                size = spill_form ? 16 : (integer_form ? 8 : fsz);
                itype = WRITE;
                if (size == 10) itype |= UNCACHE_OPT;

                paddr = tlb_translate(GR[r3], size, itype, PSR.cpl, &attr, &tmp_unused);
                val = fp_fr_to_mem_format(FR[f2], size, integer_form);
                mem_write(val, paddr, size, UM.be, attr, UNORDERED, sthint);

                alat_inval_multiple_entries(paddr, size);

                if (imm_base_update_form) {
                    GR[r3] = GR[r3] + sign_ext(imm9, 9);
                    GR[r3].nat = 0;
                    mem_implicit_prefetch(GR[r3], sthint, WRITE);
                }
            }

```

| | | |
|-----------------------|--|----------------------------------|
| Interruptions: | Illegal Operation fault | Data NaT Page Consumption fault |
| | Disabled Floating-point Register fault | Data Key Miss fault |
| | Register NaT Consumption fault | Data Key Permission fault |
| | Unimplemented Data Address fault | Data Access Rights fault |
| | Data Nested TLB fault | Data Dirty Bit fault |
| | Alternate Data TLB fault | Data Access Bit fault |
| | VHPT Data fault | Data Debug fault |
| | Data TLB fault | Unaligned Data Reference fault |
| | Data Page Not Present fault | Unsupported Data Reference fault |

sub — Subtract

| | | | |
|----------------|------------------------------|----------------------------|----|
| Format: | (qp) sub $r_1 = r_2, r_3$ | register_form | A1 |
| | (qp) sub $r_1 = r_2, r_3, 1$ | minus1_form, register_form | A1 |
| | (qp) sub $r_1 = imm_8, r_3$ | imm8_form | A3 |

Description: The second source operand (and an optional constant 1) are subtracted from the first operand and the result placed in GR r_1 . In the register form the first operand is GR r_2 ; in the immediate form the first operand is taken from the sign-extended imm_8 encoding field.

The minus1_form is available only in the register_form (although the equivalent effect can be achieved by adjusting the immediate).

Operation:

```

if (PR[qp]) {
    check_target_register(r1);

    tmp_src = (register_form ? GR[r2] : sign_ext(imm8, 8));
    tmp_nat = (register_form ? GR[r2].nat : 0);

    if (minus1_form)
        GR[r1] = tmp_src - GR[r3] - 1;
    else
        GR[r1] = tmp_src - GR[r3];

    GR[r1].nat = tmp_nat || GR[r3].nat;
}

```

Interruptions: Illegal Operation fault

sum — Set User Mask

Format: (qp) sum *imm*₂₄ M44

Description: The *imm*₂₄ operand is ORed with the user mask (PSR{5:0}) and the result is placed in the user mask. See [Section 3.3.2, “Processor Status Register \(PSR\)”](#) on page 2:18.

PSR.up can only be set if the secure performance monitor bit (PSR.sp) is zero. Otherwise PSR.up is not modified.

Operation:

```

if (PR[qp]) {
    if (is_reserved_field(PSR_TYPE, PSR_UM, imm24))
        reserved_register_field_fault();

    if (imm24{1})    PSR{1} = 1;    // be
    if (imm24{2} && PSR.sp == 0)    //non-secure perf monitor
        PSR{2} = 1;    // up
    if (imm24{3})    PSR{3} = 1;    // ac
    if (imm24{4})    PSR{4} = 1;    // mfl
    if (imm24{5})    PSR{5} = 1;    // mfh
}

```

Interruptions: Reserved Register/Field fault

Serialization: All user mask modifications are observed by the next instruction group.

sxt — Sign Extend

Format: (qp) sxtxsz $r_1 = r_3$

129

Description: The value in GR r_3 is sign extended from the bit position specified by xsz and the result is placed in GR r_1 . The mnemonic values for xsz are given in [Table 2-51](#).

Table 2-51. xsz Mnemonic Values

| xsz Mnemonic | Bit Position |
|--------------|--------------|
| 1 | 7 |
| 2 | 15 |
| 4 | 31 |

Operation:

```

if (PR[qp]) {
    check_target_register( $r_1$ );

    GR[ $r_1$ ] = sign_ext(GR[ $r_3$ ], xsz * 8);
    GR[ $r_1$ ].nat = GR[ $r_3$ ].nat;
}

```

Interruptions: Illegal Operation fault

sync — Memory Synchronization

Format: (qp) sync.i

M24

Description: `sync.i` ensures that when previously initiated Flush Cache (`fc`, `fc.i`) operations issued by the local processor become visible to local data memory references, prior Flush Cache operations are also observed by the local processor instruction fetch stream. `sync.i` also ensures that at the time previously initiated Flush Cache (`fc`, `fc.i`) operations are observed on a remote processor by data memory references they are also observed by instruction memory references on the remote processor. `sync.i` is ordered with respect to all cache flush operations as observed by another processor. A `sync.i` and a previous `fc` must be in separate instruction groups. If semantically required, the programmer must explicitly insert ordered data references (acquire, release or fence type) to appropriately constrain `sync.i` (and hence `fc` and `fc.i`) visibility to the data stream on other processors.

`sync.i` is used to maintain an ordering relationship between instruction and data caches on local and remote processors. An instruction serialize operation must be used to ensure synchronization initiated by `sync.i` on the local processor has been observed by a given point in program execution.

An example of self-modifying code (local processor):

```

    st [L1] = data //store into local instruction stream
    fc.i L1 //flush stale datum from instruction/data cache
    ;; //require instruction boundary between fc.i and sync.i
    sync.i //ensure local and remote data/inst caches
           //are synchronized
    ;;
    srlz.i //ensure sync has been observed by the local processor,
    ;; //ensure subsequent instructions observe
           //modified memory
L1: target //instruction modified

```

Operation: `if (PR[qp]) {`
 `instruction_synchronize();`
`}`

Interruptions: None

tak — Translation Access Key

Format: (qp) tak $r_1 = r_3$

M46

Description: The protection key for a given virtual address is obtained and placed in GR r_1 .

When PSR.dt is 1, the DTLB and the VHPT are searched for the virtual address specified by GR r_3 and the region register indexed by GR r_3 bits {63:61}. If a matching present translation is found the protection key of the translation is placed in GR r_1 . If a matching present translation is not found or if an unimplemented virtual address is specified by GR r_3 , the value 1 is returned.

When PSR.dt is 0, only the DTLB is searched, because the VHPT walker is disabled. If no matching present translation is found in the DTLB, the value 1 is returned.

A translation with the NaTPage attribute is not treated differently and returns its key field.

This instruction can only be executed at the most privileged level.

Operation:

```

if (PR[qp]) {
    itype = NON_ACCESS|TAK;
    check_target_register(r1);

    if (PSR.cpl != 0)
        privileged_operation_fault(itype);

    if (GR[r3].nat)
        register_nat_consumption_fault(itype);

    GR[r1] = tlb_access_key(GR[r3], itype);
    GR[r1].nat = 0;
}

```

Interruptions: Illegal Operation fault
Privileged Operation fault

Register NaT Consumption fault

tbit — Test Bit

Format: (qp) tbit.trel.ctype $p_1, p_2 = r_3, pos_6$

116

Description: The bit specified by the pos_6 immediate is selected from GR r_3 . The selected bit forms a single bit result either complemented or not depending on the *trel* completer. This result is written to the two predicate register destinations p_1 and p_2 . The way the result is written to the destinations is determined by the compare type specified by *ctype*. See the Compare instruction and [Table 2-15 on page 3:34](#).

The *trel* completer values *.nz* and *.z* indicate non-zero and zero sense of the test. For normal and unc types, only the *.z* value is directly implemented in hardware; the *.nz* value is actually a pseudo-op. For it, the assembler simply switches the predicate target specifiers and uses the implemented relation. For the parallel types, both relations are implemented in hardware.

Table 2-52. Test Bit Relations for Normal and unc tbits

| <i>trel</i> | Test Relation | Pseudo-op of |
|-------------|-------------------|------------------------------------|
| nz | selected bit == 1 | <i>z</i> $p_1 \leftrightarrow p_2$ |
| z | selected bit == 0 | |

Table 2-53. Test Bit Relations for Parallel tbits

| <i>trel</i> | Test Relation |
|-------------|-------------------|
| nz | selected bit == 1 |
| z | selected bit == 0 |

If the two predicate register destinations are the same (p_1 and p_2 specify the same predicate register), the instruction will take an Illegal Operation fault, if the qualifying predicate is set, or if the compare type is unc.

```

Operation:   if (PR[qp]) {
                if (p1 == p2)
                    illegal_operation_fault();

                if (trel == 'nz') // 'nz' - test for 1
                    tmp_rel = GR[r3]{pos6};
                else // 'z' - test for 0
                    tmp_rel = !GR[r3]{pos6};

                switch (ctype) {
                    case 'and': // and-type compare
                        if (GR[r3].nat || !tmp_rel) {
                            PR[p1] = 0;
                            PR[p2] = 0;
                        }
                        break;
                    case 'or': // or-type compare
                        if (!GR[r3].nat && tmp_rel) {
                            PR[p1] = 1;
                            PR[p2] = 1;
                        }
                        break;
                    case 'or.andcm': // or.andcm-type compare
                        if (!GR[r3].nat && tmp_rel) {
                            PR[p1] = 1;
                            PR[p2] = 0;
                        }
                        break;
                    case 'unc': // unc-type compare
                    default: // normal compare
                        if (GR[r3].nat) {
                            PR[p1] = 0;
                            PR[p2] = 0;
                        } else {
                            PR[p1] = tmp_rel;
                            PR[p2] = !tmp_rel;
                        }
                        break;
                }
            } else {
                if (ctype == 'unc') {
                    if (p1 == p2)
                        illegal_operation_fault();
                    PR[p1] = 0;
                    PR[p2] = 0;
                }
            }
        }

```

Interruptions: Illegal Operation fault

thash — Translation Hashed Entry Address

Format: (qp) thash $r_1 = r_3$

M46

Description: A Virtual Hashed Page Table (VHPT) entry address is generated based upon the specified virtual address and the result is placed in GR r_1 . The virtual address is specified by GR r_3 and the region register selected by GR r_3 bits {63:61}.

If thash is given a NaT input argument or an unimplemented virtual address as an input, the resulting target register value is undefined, and its NaT bit is set to one.

When the processor is configured to use the region-based short format VHPT (PTA.vf=0), the value returned by thash is defined by the architected short format hash function. See [Section 4.1.5.3, “Region-based VHPT Short Format” on page 2:52](#).

When the processor is configured to use the long format VHPT (PTA.vf=1), thash performs an implementation-specific long format hash function on the virtual address to generate a hash index into the long format VHPT.

In the long format, a translation in the VHPT must be uniquely identified by its hash index generated by this instruction and the hash tag produced from the ttag instruction.

The hash function must use all implemented region bits and only virtual address bits {60:0} to determine the offset into the VHPT. Virtual address bits {63:61} are used only by the short format hash to determine the region of the VHPT.

This instruction must be implemented on all processor models, even processor models that do not implement a VHPT walker.

Operation:

```

if (PR[qp]) {
    check_target_register(r1);

    if (GR[r3].nat || unimplemented_virtual_address(GR[r3])) {
        GR[r1] = undefined();
        GR[r1].nat = 1;
    } else {
        tmp_vr = GR[r3]{63:61};
        tmp_va = GR[r3]{60:0};
        GR[r1] = tlb_vhpt_hash(tmp_vr, tmp_va, RR[tmp_vr].rid,
                               RR[tmp_vr].ps);
        GR[r1].nat = 0;
    }
}

```

Interruptions: Illegal Operation fault

tнат — Test NaT

Format: (qp) tнат.trel.ctype $p_1, p_2 = r_3$

117

Description: The NaT bit from GR r_3 forms a single bit result, either complemented or not depending on the *trel* completer. This result is written to the two predicate register destinations, p_1 and p_2 . The way the result is written to the destinations is determined by the compare type specified by *ctype*. See the Compare instruction and [Table 2-15 on page 3:34](#).

The *trel* completer values .nz and .z indicate non-zero and zero sense of the test. For normal and unc types, only the .z value is directly implemented in hardware; the .nz value is actually a pseudo-op. For it, the assembler simply switches the predicate target specifiers and uses the implemented relation. For the parallel types, both relations are implemented in hardware.

Table 2-54. Test NaT Relations for Normal and unc tнатs

| <i>trel</i> | Test Relation | Pseudo-op of |
|-------------|-------------------|---------------------------|
| nz | selected bit == 1 | z |
| z | selected bit == 0 | $p_1 \leftrightarrow p_2$ |

Table 2-55. Test NaT Relations for Parallel tнатs

| <i>trel</i> | Test Relation |
|-------------|-------------------|
| nz | selected bit == 1 |
| z | selected bit == 0 |

If the two predicate register destinations are the same (p_1 and p_2 specify the same predicate register), the instruction will take an Illegal Operation fault, if the qualifying predicate is set, or if the compare type is unc.

```

Operation:   if (PR[qp]) {
                if (p1 == p2)
                    illegal_operation_fault();

                if (trel == 'nz') // 'nz' - test for 1
                    tmp_rel = GR[r3].nat;
                else // 'z' - test for 0
                    tmp_rel = !GR[r3].nat;

                switch (ctype) {
                    case 'and': // and-type compare
                        if (!tmp_rel) {
                            PR[p1] = 0;
                            PR[p2] = 0;
                        }
                        break;
                    case 'or': // or-type compare
                        if (tmp_rel) {
                            PR[p1] = 1;
                            PR[p2] = 1;
                        }
                        break;
                    case 'or.andcm': // or.andcm-type compare
                        if (tmp_rel) {
                            PR[p1] = 1;
                            PR[p2] = 0;
                        }
                        break;
                    case 'unc': // unc-type compare
                    default: // normal compare
                        PR[p1] = tmp_rel;
                        PR[p2] = !tmp_rel;
                        break;
                }
            } else {
                if (ctype == 'unc') {
                    if (p1 == p2)
                        illegal_operation_fault();
                    PR[p1] = 0;
                    PR[p2] = 0;
                }
            }
        }

```

Interruptions: Illegal Operation fault

tpa — Translate to Physical Address

Format: (qp) tpa $r_1 = r_3$

M46

Description: The physical address for the virtual address specified by GR r_3 is obtained and placed in GR r_1 .

When PSR.dt is 1, the DTLB and the VHPT are searched for the virtual address specified by GR r_3 and the region register indexed by GR r_3 bits {63:61}. If a matching present translation is found the physical address of the translation is placed in GR r_1 . If a matching present translation is not found the appropriate TLB fault is taken.

When PSR.dt is 0, only the DTLB is searched, because the VHPT walker is disabled. If no matching present translation is found in the DTLB, an Alternate Data TLB fault is raised if psr.ic is one or a Data Nested TLB fault is raised if psr.ic is zero.

If this instruction faults, then it will set the non-access bit in the ISR. The ISR read and write bits are not set.

This instruction can only be executed at the most privileged level.

Operation:

```

if (PR[qp]) {
    itype = NON_ACCESS|TPA;
    check_target_register(r1);

    if (PSR.cpl != 0)
        privileged_operation_fault(itype);

    if (GR[r3].nat)
        register_nat_consumption_fault(itype);

    GR[r1] = tlb_translate_nonaccess(GR[r3], itype);
    GR[r1].nat = 0;
}

```

| | | |
|-----------------------|----------------------------------|---------------------------------|
| Interruptions: | Illegal Operation fault | Alternate Data TLB fault |
| | Privileged Operation fault | VHPT Data fault |
| | Register NaT Consumption fault | Data TLB fault |
| | Unimplemented Data Address fault | Data Page Not Present fault |
| | Data Nested TLB fault | Data NaT Page Consumption fault |

ttag — Translation Hashed Entry Tag

Format: (qp) ttag $r_1 = r_3$

M46

Description: A tag used for matching during searches of the long format Virtual Hashed Page Table (VHPT) is generated and placed in GR r_1 . The virtual address is specified by GR r_3 and the region register selected by GR r_3 bits {63:61}.

If ttag is given a NaT input argument or an unimplemented virtual address as an input, the resulting target register value is undefined, and its NaT bit is set to one.

The tag generation function generates an implementation-specific long format VHPT tag. The tag generation function must use all implemented region bits and only virtual address bits {60:0}. PTA.vf is ignored by this instruction.

A translation in the long format VHPT must be uniquely identified by its hash index generated by the thash instruction and the tag produced from this instruction.

This instruction must be implemented on all processor models, even processor models that do not implement a VHPT walker.

Operation:

```

if (PR[qp]) {
    check_target_register(r1);

    if (GR[r3].nat || unimplemented_virtual_address(GR[r3])) {
        GR[r1] = undefined();
        GR[r1].nat = 1;
    } else {
        tmp_vr = GR[r3]{63:61};
        tmp_va = GR[r3]{60:0};
        GR[r1] = tlb_vhpt_tag(tmp_va, RR[tmp_vr].rid, RR[tmp_vr].ps);
        GR[r1].nat = 0;
    }
}

```

Interruptions: Illegal Operation fault

unpack — Unpack

| | | | |
|----------------|---------------------------------|---------------------------|----|
| Format: | (qp) unpack1.h $r_1 = r_2, r_3$ | one_byte_form, high_form | 12 |
| | (qp) unpack2.h $r_1 = r_2, r_3$ | two_byte_form, high_form | 12 |
| | (qp) unpack4.h $r_1 = r_2, r_3$ | four_byte_form, high_form | 12 |
| | (qp) unpack1.l $r_1 = r_2, r_3$ | one_byte_form, low_form | 12 |
| | (qp) unpack2.l $r_1 = r_2, r_3$ | two_byte_form, low_form | 12 |
| | (qp) unpack4.l $r_1 = r_2, r_3$ | four_byte_form, low_form | 12 |

Description: The data elements of GR r_2 and r_3 are unpacked, and the result placed in GR r_1 . In the high_form, the most significant elements of each source register are selected, while in the low_form the least significant elements of each source register are selected. Elements are selected alternately from the source registers.

Operation:

```

if (PR[qp]) {
    check_target_register(r1);

    if (one_byte_form) {
        // one-byte elements
        x[0] = GR[r2]{7:0};      y[0] = GR[r3]{7:0};
        x[1] = GR[r2]{15:8};    y[1] = GR[r3]{15:8};
        x[2] = GR[r2]{23:16};   y[2] = GR[r3]{23:16};
        x[3] = GR[r2]{31:24};   y[3] = GR[r3]{31:24};
        x[4] = GR[r2]{39:32};   y[4] = GR[r3]{39:32};
        x[5] = GR[r2]{47:40};   y[5] = GR[r3]{47:40};
        x[6] = GR[r2]{55:48};   y[6] = GR[r3]{55:48};
        x[7] = GR[r2]{63:56};   y[7] = GR[r3]{63:56};

        if (high_form)
            GR[r1] = concatenate8( x[7], y[7], x[6], y[6],
                                   x[5], y[5], x[4], y[4]);
        else // low_form
            GR[r1] = concatenate8( x[3], y[3], x[2], y[2],
                                   x[1], y[1], x[0], y[0]);
    } else if (two_byte_form) {
        // two-byte elements
        x[0] = GR[r2]{15:0};    y[0] = GR[r3]{15:0};
        x[1] = GR[r2]{31:16};   y[1] = GR[r3]{31:16};
        x[2] = GR[r2]{47:32};   y[2] = GR[r3]{47:32};
        x[3] = GR[r2]{63:48};   y[3] = GR[r3]{63:48};

        if (high_form)
            GR[r1] = concatenate4(x[3], y[3], x[2], y[2]);
        else // low_form
            GR[r1] = concatenate4(x[1], y[1], x[0], y[0]);
    } else {
        // four-byte elements
        x[0] = GR[r2]{31:0};    y[0] = GR[r3]{31:0};
        x[1] = GR[r2]{63:32};   y[1] = GR[r3]{63:32};

        if (high_form)
            GR[r1] = concatenate2(x[1], y[1]);
        else // low_form
            GR[r1] = concatenate2(x[0], y[0]);
    }
    GR[r1].nat = GR[r2].nat || GR[r3].nat;
}

```

Interruptions: Illegal Operation fault

Figure 2-45. Unpack Operation

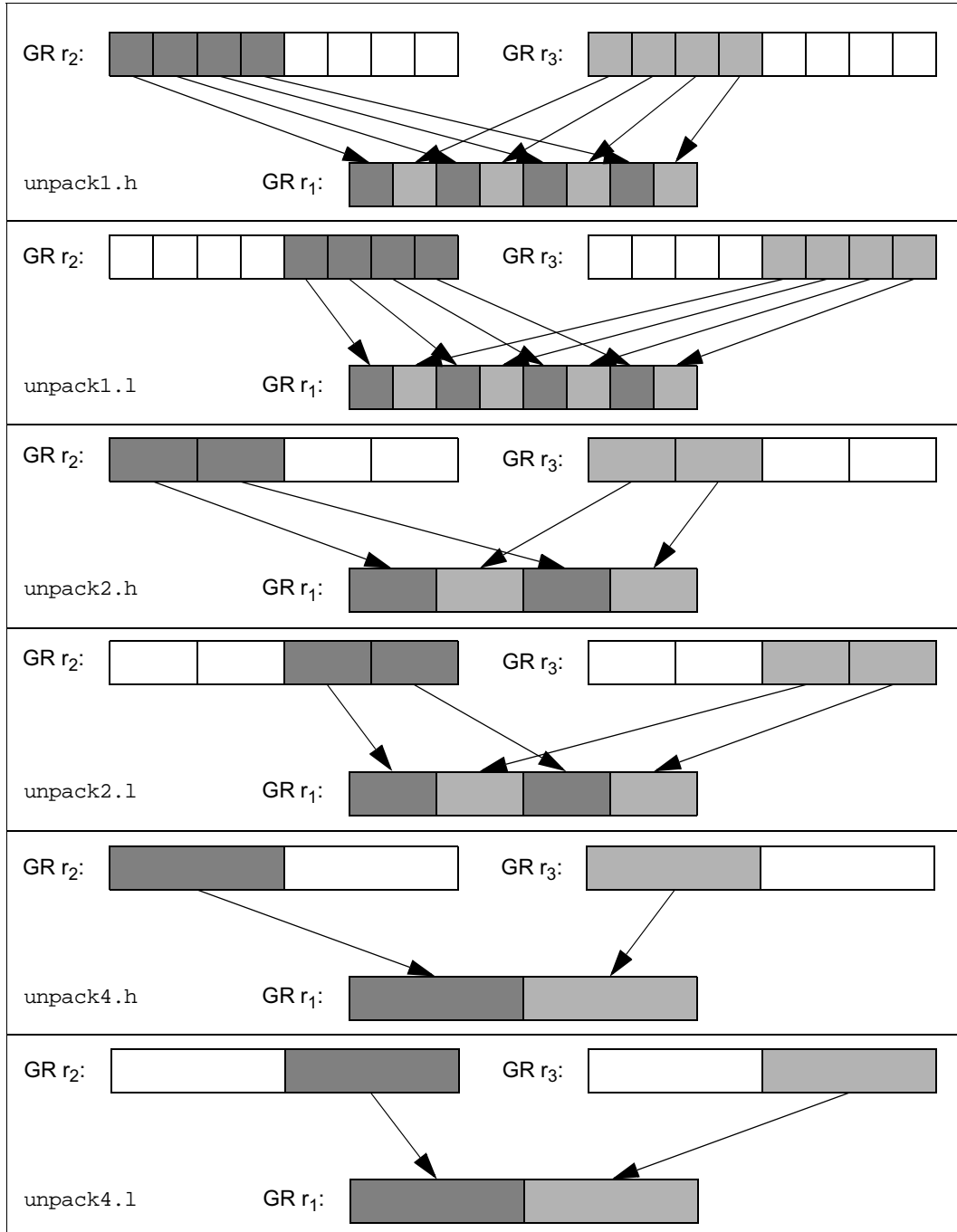

xchg — Exchange

Format: $(qp) \text{ xchgsz.lhint } r_1 = [r_3], r_2$ M16

Description: A value consisting of sz bytes is read from memory starting at the address specified by the value in GR r_3 . The least significant sz bytes of the value in GR r_2 are written to memory starting at the address specified by the value in GR r_3 . The value read from memory is then zero extended and placed in GR r_1 and the NaT bit corresponding to GR r_1 is cleared. The values of the sz completer are given in [Table 2-56](#).

If the address specified by the value in GR r_3 is not naturally aligned to the size of the value being accessed in memory, an Unaligned Data Reference fault is taken independent of the state of the User Mask alignment checking bit, UM.ac (PSR.ac in the Processor Status Register).

Both read and write access privileges for the referenced page are required.

Table 2-56. Memory Exchange Size

| sz Completer | Bytes Accessed |
|--------------|----------------|
| 1 | 1 byte |
| 2 | 2 bytes |
| 4 | 4 bytes |
| 8 | 8 bytes |

The exchange is performed with acquire semantics, i.e., the memory read/write is made visible prior to all subsequent data memory accesses. See [Section 4.4.7, “Sequentiality Attribute and Ordering” on page 2:69](#) for details on memory ordering.

The memory read and write are guaranteed to be atomic.

This instruction is only supported to cacheable pages with write-back write policy. Accesses to NaTPages cause a Data NaT Page Consumption fault. Accesses to pages with other memory attributes cause an Unsupported Data Reference fault.

The value of the *ldhint* completer specifies the locality of the memory access. The values of the *ldhint* completer are given in [Table 2-34 on page 3:132](#). Locality hints do not affect program functionality and may be ignored by the implementation. See [Section 4.4.6, “Memory Hierarchy Control and Consistency” on page 1:60](#) for details.

Operation:

```

if (PR[qp]) {
    check_target_register(r1);

    if (GR[r3].nat || GR[r2].nat)
        register_nat_consumption_fault(SEMAPHORE);

    paddr = tlb_translate(GR[r3], sz, SEMAPHORE, PSR.cpl, &mattr,
                        &tmp_unused);

    if (!ma_supports_semaphores(mattr))
        unsupported_data_reference_fault(SEMAPHORE, GR[r3]);

    val = mem_xchg(GR[r2], paddr, sz, UM.be, mattr, ACQUIRE, ldhint);

    alat_inval_multiple_entries(paddr, sz);

    GR[r1] = zero_ext(val, sz * 8);
    GR[r1].nat = 0;
}

```

Interruptions: Illegal Operation fault
Register NaT Consumption fault
Unimplemented Data Address fault
Data Nested TLB fault
Alternate Data TLB fault
VHPT Data fault
Data TLB fault
Data Page Not Present fault
Data NaT Page Consumption fault
Data Key Miss fault
Data Key Permission fault
Data Access Rights fault
Data Dirty Bit fault
Data Access Bit fault
Data Debug fault
Unaligned Data Reference fault
Unsupported Data Reference fault

xma — Fixed-Point Multiply Add

| | | | |
|----------------|--|---|----|
| Format: | <i>(qp)</i> xma.l $f_1 = f_3, f_4, f_2$ | low_form | F2 |
| | <i>(qp)</i> xma.lu $f_1 = f_3, f_4, f_2$ | pseudo-op of: <i>(qp)</i> xma.l $f_1 = f_3, f_4, f_2$ | |
| | <i>(qp)</i> xma.h $f_1 = f_3, f_4, f_2$ | high_form | F2 |
| | <i>(qp)</i> xma.hu $f_1 = f_3, f_4, f_2$ | high_unsigned_form | F2 |

Description: Two source operands (FR f_3 and FR f_4) are treated as either signed or unsigned integers and multiplied. The third source operand (FR f_2) is zero extended and added to the product. The upper or lower 64 bits of the resultant sum are selected and placed in FR f_1 .

In the high_unsigned_form, the significand fields of FR f_3 and FR f_4 are treated as unsigned integers and multiplied to produce a full 128-bit unsigned result. The significand field of FR f_2 is zero extended and added to the product. The most significant 64-bits of the resultant sum are placed in the significand field of FR f_1 .

In the high_form, the significand fields of FR f_3 and FR f_4 are treated as signed integers and multiplied to produce a full 128-bit signed result. The significand field of FR f_2 is zero extended and added to the product. The most significant 64-bits of the resultant sum are placed in the significand field of FR f_1 .

In the other forms, the significand fields of FR f_3 and FR f_4 are treated as signed integers and multiplied to produce a full 128-bit signed result. The significand field of FR f_2 is zero extended and added to the product. The least significant 64-bits of the resultant sum are placed in the significand field of FR f_1 .

In all forms, the exponent field of FR f_1 is set to the biased exponent for 2.0^{63} (0x1003E) and the sign field of FR f_1 is set to positive (0).

Note: fl as an operand is not an integer 1; it is just the register file format's 1.0 value.

In all forms, if any of FR f_3 , FR f_4 , or FR f_2 is a NaTVal, FR f_1 is set to NaTVal instead of the computed result.

Operation:

```

if (PR[qp]) {
    fp_check_target_register(f1);
    if (tmp_israncode = fp_reg_disabled(f1, f2, f3, f4))
        disabled_fp_register_fault(tmp_israncode, 0);

    if (fp_is_natval(FR[f2]) || fp_is_natval(FR[f3]) ||
        fp_is_natval(FR[f4])) {
        FR[f1] = NATVAL;
    } else {
        if (low_form || high_form)
            tmp_res_128 =
                fp_I64_x_I64_to_I128(FR[f3].significand, FR[f4].significand);
        else // high_unsigned_form
            tmp_res_128 =
                fp_U64_x_U64_to_U128(FR[f3].significand, FR[f4].significand);

        tmp_res_128 =
            fp_U128_add(tmp_res_128, fp_U64_to_U128(FR[f2].significand));

        if (high_form || high_unsigned_form)
            FR[f1].significand = tmp_res_128.hi;
        else // low_form
            FR[f1].significand = tmp_res_128.lo;

        FR[f1].exponent = FP_INTEGER_EXP;
    }
}

```

```
        FR[f1].sign = FP_SIGN_POSITIVE;  
    }  
    fp_update_psr(f1);  
}
```

Interruptions: Disabled Floating-point Register fault

xmpy — Fixed-Point Multiply

Format:

| | |
|---------------------------------|---|
| (qp) xmpy.l $f_1 = f_3, f_4$ | pseudo-op of: (qp) xma.l $f_1 = f_3, f_4, f_0$ |
| (qp) xmpy.lu $f_1 = f_3, f_4$ | pseudo-op of: (qp) xma.l $f_1 = f_3, f_4, f_0$ |
| (qp) xmpy.h $f_1 = f_3, f_4$ | pseudo-op of: (qp) xma.h $f_1 = f_3, f_4, f_0$ |
| (qp) xmpy.hu $f_1 = f_3, f_4$ | pseudo-op of: (qp) xma.hu $f_1 = f_3, f_4, f_0$ |

Description: Two source operands (FR f_3 and FR f_4) are treated as either signed or unsigned integers and multiplied. The upper or lower 64 bits of the resultant product are selected and placed in FR f_1 .

In the high_unsigned_form, the significand fields of FR f_3 and FR f_4 are treated as unsigned integers and multiplied to produce a full 128-bit unsigned result. The most significant 64-bits of the resultant product are placed in the significand field of FR f_1 .

In the high_form, the significand fields of FR f_3 and FR f_4 are treated as signed integers and multiplied to produce a full 128-bit signed result. The most significant 64-bits of the resultant product are placed in the significand field of FR f_1 .

In the other forms, the significand fields of FR f_3 and FR f_4 are treated as signed integers and multiplied to produce a full 128-bit signed result. The least significant 64-bits of the resultant product are placed in the significand field of FR f_1 .

In all forms, the exponent field of FR f_1 is set to the biased exponent for 2.0^{63} (0x1003E) and the sign field of FR f_1 is set to positive (0). Note: f1 as an operand is not an integer 1; it is just the register file format's 1.0 value.

Operation: See ["xma — Fixed-Point Multiply Add" on page 3:239](#).

zxt — Zero Extend

Format: $(qp) \text{ zxt}xsz \ r_1 = r_3$

129

Description: The value in GR r_3 is zero extended above the bit position specified by xsz and the result is placed in GR r_1 . The mnemonic values for xsz are given in [Table 2-51 on page 3:225](#).

Operation:

```
if (PR[qp]) {
    check_target_register(r1);

    GR[r1] = zero_ext(GR[r3], xsz * 8);
    GR[r1].nat = GR[r3].nat;
}
```

Interruptions: Illegal Operation fault

This chapter contains a table of all pseudo-code functions used on the Itanium instruction pages.

Table 3-1. Pseudo-Code Functions

| Function | Operation |
|---|---|
| <code>xxx_fault(parameters ...)</code> | There are several fault functions. Each fault function accepts parameters specific to the fault, e.g., exception code values, virtual addresses, etc. If the fault is deferred for speculative load exceptions the fault function will return with a deferral indication. Otherwise, fault routines do not return and terminate the instruction sequence. |
| <code>xxx_trap(parameters ...)</code> | There are several trap functions. Each trap function accepts parameters specific to the trap, e.g., trap code values, virtual addresses, etc. Trap routines do not return. |
| <code>acceptance_fence()</code> | Ensures prior data memory references to uncached ordered-sequential memory pages are "accepted", before subsequent data memory references are performed by the processor. |
| <code>alat_cmp(rtype, raddr)</code> | Returns a one if the implementation finds an ALAT entry which matches the register type specified by <code>rtype</code> and the register address specified by <code>raddr</code> , else returns zero. This function is implementation-specific. Note that an implementation may optionally choose to return zero (indicating no match) even if a matching entry exists in the ALAT. This provides implementation flexibility in designing fast ALAT lookup circuits. |
| <code>alat_frame_update(delta_bof, delta_sof)</code> | Notifies the ALAT of a change in the bottom of frame and/or size of frame. This allows management of the ALAT's tag bits or other management functions it might need. |
| <code>alat_inval()</code> | Invalidate all entries in the ALAT. |
| <code>alat_inval_multiple_entries(paddr, size)</code> | The ALAT is queried using the physical memory address specified by <code>paddr</code> and the access size specified by <code>size</code> . All matching ALAT entries are invalidated. No value is returned. |
| <code>alat_inval_single_entry(rtype, rega)</code> | The ALAT is queried using the register type specified by <code>rtype</code> and the register address specified by <code>rega</code> . At most one matching ALAT entry is invalidated. No value is returned. |
| <code>alat_write(rtype, raddr, paddr, size)</code> | Allocates a new ALAT entry using the register type specified by <code>rtype</code> , the register address specified by <code>raddr</code> , the physical memory address specified by <code>paddr</code> , and the access size specified by <code>size</code> . No value is returned. This function guarantees that only one ALAT entry exists for a given <code>raddr</code> . If a <code>ld.c.nc</code> , <code>ldf.c.nc</code> , or <code>ldfp.c.nc</code> instruction's <code>raddr</code> matches an existing ALAT entry's register tag, but the instruction's <code>size</code> and/or <code>paddr</code> are different than that of the existing entry's; then this function may either preserve the existing entry, or invalidate it and write a new entry with the instruction's specified <code>size</code> and <code>paddr</code> . |
| <code>align_to_size_boundary(vaddr, size)</code> | Returns <code>vaddr</code> aligned to the boundary specified by <code>size</code> . |
| <code>branch_predict(wh, ih, ret, target, tag)</code> | Implementation-dependent routine which updates the processor's branch prediction structures. |
| <code>check_branch_implemented(check_type)</code> | Implementation-dependent routine which returns TRUE or FALSE, depending on whether a failing check instruction causes a branch (TRUE), or a Speculative Operation fault (FALSE). The result may be different for different types of check instructions: CHKS_GENERAL, CHKS_FLOAT, CHKA_GENERAL, CHKA_FLOAT. In addition, the result may depend on other implementation-dependent parameters. |
| <code>check_target_register(r1)</code> | If <code>r1</code> targets an out-of-frame stacked register (as defined by CFM), an illegal operation fault is delivered, and this function does not return. |
| <code>check_target_register_sof(r1, newsof)</code> | If <code>r1</code> targets an out-of-frame stacked register (as defined by the <code>newsof</code> parameter), an illegal operation fault is delivered, and this function does not return. |
| <code>concatenate2(x1, x2)</code> | Concatenates the lower 32 bits of the 2 arguments, and returns the 64-bit result. |

Table 3-1. Pseudo-Code Functions (Continued)

| Function | Operation |
|---|---|
| concatenate4(x1, x2, x3, x4) | Concatenates the lower 16 bits of the 4 arguments, and returns the 64-bit result. |
| concatenate8(x1, x2, x3, x4, x5, x6, x7, x8) | Concatenates the lower 8 bits of the 8 arguments, and returns the 64-bit result. |
| data_serialize() | Ensures all prior register updates with side-effects are observed before subsequent execution and data memory references are performed. |
| deliver_unmasked_pending_interrupt() | This implementation-specific function checks whether any unmasked external interrupts are pending, and if so, transfers control to the external interrupt vector. |
| execute_hint(hint) | Executes the hint specified by <code>hint</code> . |
| fadd(fp_dp, fr2) | Adds a floating-point register value to the infinitely precise product and return the infinitely precise sum, ready for rounding. |
| fcmp_exception_fault_check(f2, f3, frel, sf, *tmp_fp_env) | Checks for all floating-point faulting conditions for the <code>fcmp</code> instruction. |
| fcvt_fx_exception_fault_check(fr2, signed_form, trunc_form, sf *tmp_fp_env) | Checks for all floating-point faulting conditions for the <code>fcvt.fx</code> , <code>fcvt.fxu</code> , <code>fcvt.fx.trunc</code> and <code>fcvt.fxu.trunc</code> instructions. It propagates NaNs. |
| fma_exception_fault_check(f2, f3, f4, pc, sf, *tmp_fp_env) | Checks for all floating-point faulting conditions for the <code>fma</code> instruction. It propagates NaNs and special IEEE results. |
| fminmax_exception_fault_check(f2, f3, sf, *tmp_fp_env) | Checks for all floating-point faulting conditions for the <code>famax</code> , <code>famin</code> , <code>fmax</code> , and <code>fmin</code> instructions. |
| fms_fnma_exception_fault_check(f2, f3, f4, pc, sf, *tmp_fp_env) | Checks for all floating-point faulting conditions for the <code>fms</code> and <code>fnma</code> instructions. It propagates NaNs and special IEEE results. |
| fmul(fr3, fr4) | Performs an infinitely precise multiply of two floating-point register values. |
| followed_by_stop() | Returns TRUE if the current instruction is followed by a stop; otherwise, returns FALSE. |
| fp_check_target_register(f1) | If the specified floating-point register identifier is 0 or 1, this function causes an illegal operation fault. |
| fp_decode_fault(tmp_fp_env) | Returns floating-point exception fault code values for <code>ISR.code</code> . |
| fp_decode_traps(tmp_fp_env) | Returns floating-point trap code values for <code>ISR.code</code> . |
| fp_is_nan_or_inf(freg) | Returns true if the floating-point exception_fault_check functions returned a IEEE fault disabled default result or a propagated NaN. |
| fp_equal(fr1, fr2) | IEEE standard equality relationship test. |
| fp_ieee_recip(num, den) | Returns the true quotient for special sets of operands, or an approximation to the reciprocal of the divisor to be used in the software divide algorithm. |
| fp_ieee_recip_sqrt(root) | Returns the true square root result for special operands, or an approximation to the reciprocal square root to be used in the software square root algorithm. |
| fp_is_nan(freg) | Returns true when floating register contains a NaN. |
| fp_is_natval(freg) | Returns true when floating register contains a NaTVal |
| fp_is_normal(freg) | Returns true when floating register contains a normal number. |
| fp_is_pos_inf(freg) | Returns true when floating register contains a positive infinity. |
| fp_is_qnan(freg) | Returns true when floating register contains a quiet NaN. |
| fp_is_snan(freg) | Returns true when floating register contains a signalling NaN. |
| fp_is_unorm(freg) | Returns true when floating register contains an unnormalized number. |
| fp_is_unsupported(freg) | Returns true when floating register contains an unsupported format. |
| fp_less_than(fr1, fr2) | IEEE standard less-than relationship test. |
| fp_lesser_or_equal(fr1, fr2) | IEEE standard less-than or equal-to relationship test |
| fp_normalize(fr1) | Normalizes an unnormalized fp value. This function flushes to zero any unnormal values which can not be represented in the register file |
| fp_raise_fault(tmp_fp_env) | Checks the local instruction state for any faulting conditions which require an interruption to be raised. |

Table 3-1. Pseudo-Code Functions (Continued)

| Function | Operation |
|---|--|
| fp_raise_traps(tmp_fp_env) | Checks the local instruction state for any trapping conditions which require an interruption to be raised. |
| fp_reg_bank_conflict(f1, f2) | Returns true if the two specified FRs are in the same bank. |
| fp_reg_disabled(f1, f2, f3, f4) | Check for possible disabled floating-point register faults. |
| fp_reg_read(freg) | Reads the FR and gives canonical double-extended denormals (and pseudo-denormals) their true mathematical exponent. Other classes of operands are unaltered. |
| fp_unordered(fr1, fr2) | IEEE standard unordered relationship |
| fp_fr_to_mem_format(freg, size) | Converts a floating-point value in register format to floating-point memory format. It assumes that the floating-point value in the register has been previously rounded to the correct precision which corresponds with the size parameter. |
| fpcmp_exception_fault_check(f2, f3, frel, sf, *tmp_fp_env) | Checks for all floating-point faulting conditions for the fpcmp instruction. |
| fpcvt_exception_fault_check(f2, signed_form, trunc_form, sf, *tmp_fp_env) | Checks for all floating-point faulting conditions for the fpcvt.fx, fpcvt.fxu, fpcvt.fx.trunc, and fpcvt.fxu.trunc instructions. It propagates NaNs. |
| fpma_exception_fault_check(f2, f3, f4, sf, *tmp_fp_env) | Checks for all floating-point faulting conditions for the fpma instruction. It propagates NaNs and special IEEE results. |
| fpminmax_exception_fault_check(f2, f3, sf, *tmp_fp_env) | Checks for all floating-point faulting conditions for the fpmin, fpmax, fpamin and fpamax instructions. |
| fpms_fpnma_exception_fault_check(f2, f3, f4, sf, *tmp_fp_env) | Checks for all floating-point faulting conditions for the fpms and fpnma instructions. It propagates NaNs and special IEEE results. |
| fprcpa_exception_fault_check(f2, f3, sf, *tmp_fp_env, *limits_check) | Checks for all floating-point faulting conditions for the fprcpa instruction. It propagates NaNs and special IEEE results. It also indicates operand limit violations. |
| fprsqta_exception_fault_check(f3, sf, *tmp_fp_env, *limits_check) | Checks for all floating-point faulting conditions for the fprsqta instruction. It propagates NaNs and special IEEE results. It also indicates operand limit violations. |
| frcpa_exception_fault_check(f2, f3, sf, *tmp_fp_env) | Checks for all floating-point faulting conditions for the frcpa instruction. It propagates NaNs and special IEEE results. |
| frsqta_exception_fault_check(f3, sf, *tmp_fp_env) | Checks for all floating-point faulting conditions for the frsqta instruction. It propagates NaNs and special IEEE results. |
| ignored_field_mask(regclass, reg, value) | Boolean function that returns value with bits cleared to 0 corresponding to ignored bits for the specified register and register type. |
| impl_itir_cwi_mask() | Implementation-specific function that either returns the value passed to it or the value passed to it masked with zeros in bit positions {63:32} and/or {1:0}. |
| instruction_serialize() | Ensures all prior register updates with side-effects are observed before subsequent instruction and data memory references are performed. Also ensures prior SYNC.i operations have been observed by the instruction cache. |
| instruction_synchronize() | Synchronizes the instruction and data stream for Flush Cache operations. This function ensures that when prior Flush Cache operations are observed by the local data cache they are observed by the local instruction cache, and when prior Flush Cache operations are observed by another processor's data cache they are observed within the same processor's instruction cache. |
| is_finite(freg) | Returns true when floating register contains a finite number. |
| is_ignored_reg(regnum) | Boolean function that returns true if regnum is an ignored application register, otherwise false. |
| is_inf(freg) | Returns true when floating register contains an infinite number. |
| is_interruption_cr(regnum) | Boolean function that returns true if regnum is one of the Interruption Control registers (see Section 3.3.5, "Interruption Control Registers" on page 2:29), otherwise false. |
| is_kernel_reg(ar_addr) | Returns a one if ar_addr is the address of a kernel register application register |

Table 3-1. Pseudo-Code Functions (Continued)

| Function | Operation |
|---|--|
| is_read_only_reg(rtype, raddr) | Returns a one if the register addressed by <code>raddr</code> in the register bank of type <code>rtype</code> is a read only register. |
| is_reserved_field(regclass, arg2, arg3) | Returns true if the specified data would write a one in a reserved field. |
| is_reserved_reg(regclass, regnum) | Returns true if register <code>regnum</code> is reserved in the <code>regclass</code> register file. |
| is_supported_hint(hint) | Returns true if the implementation supports the specified <code>hint</code> . This function may depend on factors other than the <code>hint</code> value, such as which execution unit it is executed on or the slot number the instruction was encoded in. |
| long_branch_implemented() | Implementation-dependent routine which returns TRUE or FALSE, depending on whether long branches are implemented. |
| make_icache_coherent(paddr) | The cache line addressed by the physical address <code>paddr</code> is flushed in an implementation-specific manner that ensures that the instruction cache is coherent with the data caches. |
| mem_flush(paddr) | The line addressed by the physical address <code>paddr</code> is invalidated in all levels of the memory hierarchy above memory and written back to memory if it is inconsistent with memory. |
| mem_flush_pending_stores() | The processor is instructed to start draining pending stores in write coalescing and write buffers. This operation is a "hint". There is no indication when prior stores have actually been drained. |
| mem_implicit_prefetch(vaddr, hint, type) | Moves the line addressed by <code>vaddr</code> to the location of the memory hierarchy specified by <code>hint</code> . This function is implementation dependent and can be ignored. The <code>type</code> allows the implementation to distinguish prefetches for different instruction types. |
| mem_promote(paddr, mtype, hint) | Moves the line addressed by <code>paddr</code> to the highest level of the memory hierarchy conditioned by the access hints specified by <code>hint</code> . Implementation dependent and can be ignored. |
| mem_read(paddr, size, border, mattr, otype, hint) | Returns the <code>size</code> bytes starting at the physical memory location specified by <code>paddr</code> with byte order specified by <code>border</code> , memory attributes specified by <code>mattr</code> , and access hint specified by <code>hint</code> . <code>otype</code> specifies the memory ordering attribute of this access, and must be UNORDERED or ACQUIRE. |
| mem_read_pair(*low_value, *high_value, paddr, size, border, mattr, otype, hint) | Reads the <code>size / 2</code> bytes of memory starting at the physical memory address specified by <code>paddr</code> into <code>low_value</code> , and the <code>size / 2</code> bytes of memory starting at the physical memory address specified by <code>(paddr + size / 2)</code> into <code>high_value</code> , with byte order specified by <code>border</code> , memory attributes specified by <code>mattr</code> , and access hint specified by <code>hint</code> . <code>otype</code> specifies the memory ordering attribute of this access, and must be UNORDERED or ACQUIRE. No value is returned. |
| fp_mem_to_fr_format(mem, size) | Converts a floating-point value in memory format to floating-point register format. |
| mem_write(value, paddr, size, border, mattr, otype, hint) | Writes the least significant <code>size</code> bytes of <code>value</code> into memory starting at the physical memory address specified by <code>paddr</code> with byte order specified by <code>border</code> , memory attributes specified by <code>mattr</code> , and access hint specified by <code>hint</code> . <code>otype</code> specifies the memory ordering attribute of this access, and must be UNORDERED or RELEASE. No value is returned. |
| mem_write16(gr_value, ar_value, paddr, border, mattr, otype, hint) | Writes the 8 bytes of <code>gr_value</code> into memory starting at the physical memory address specified by <code>paddr</code> , and the 8 bytes of <code>ar_value</code> into memory starting at the physical memory address specified by <code>(paddr + 8)</code> , with byte order specified by <code>border</code> , memory attributes specified by <code>mattr</code> , and access hint specified by <code>hint</code> . <code>otype</code> specifies the memory ordering attribute of this access, and must be UNORDERED or RELEASE. No value is returned. |

Table 3-1. Pseudo-Code Functions (Continued)

| Function | Operation |
|---|---|
| mem_xchg(data, paddr, size, byte_order, mattr, otype, hint) | Returns size bytes from memory starting at the physical address specified by paddr. The read is conditioned by the locality hint specified by hint. After the read, the least significant size bytes of data are written to size bytes in memory starting at the physical address specified by paddr. The read and write are performed atomically. Both the read and the write are conditioned by the memory attribute specified by mattr and the byte ordering in memory is specified by byte_order. otype specifies the memory ordering attribute of this access, and must be ACQUIRE. |
| mem_xchg_add(add_val, paddr, size, byte_order, mattr, otype, hint) | Returns size bytes from memory starting at the physical address specified by paddr. The read is conditioned by the locality hint specified by hint. The least significant size bytes of the sum of the value read from memory and add_val is then written to size bytes in memory starting at the physical address specified by paddr. The read and write are performed atomically. Both the read and the write are conditioned by the memory attribute specified by mattr and the byte ordering in memory is specified by byte_order. otype specifies the memory ordering attribute of this access, and has the value ACQUIRE or RELEASE. |
| mem_xchg_cond(cmp_val, data, paddr, size, byte_order, mattr, otype, hint) | Returns size bytes from memory starting at the physical address specified by paddr. The read is conditioned by the locality hint specified by hint. If the value read from memory is equal to cmp_val, then the least significant size bytes of data are written to size bytes in memory starting at the physical address specified by paddr. If the write is performed, the read and write are performed atomically. Both the read and the write are conditioned by the memory attribute specified by mattr and the byte ordering in memory is specified by byte_order. otype specifies the memory ordering attribute of this access, and has the value ACQUIRE or RELEASE. |
| mem_xchg16_cond(cmp_val, gr_data, ar_data, paddr, byte_order, mattr, otype, hint) | Returns 8 bytes from memory starting at the physical address specified by paddr. The read is conditioned by the locality hint specified by hint. If the value read from memory is equal to cmp_val, then the 8 bytes of gr_data are written to 8 bytes in memory starting at the physical address specified by (paddr & ~0x4), and the 8 bytes of ar_data are written to 8 bytes in memory starting at the physical address specified by ((paddr & ~0x4) + 8). If the write is performed, the read and write are performed atomically. Both the read and the write are conditioned by the memory attribute specified by mattr and the byte ordering in memory is specified by byte_order. The byte ordering only affects the ordering of bytes within each of the 8-byte values stored. otype specifies the memory ordering attribute of this access, and has the value ACQUIRE or RELEASE. |
| ordering_fence() | Ensures prior data memory references are made visible before future data memory references are made visible by the processor. |
| partially_implemented_ip() | Implementation-dependent routine which returns TRUE if the implementation, on an Unimplemented Instruction Address trap, writes IIP with the sign-extended virtual address or zero-extended physical address for what would have been the next value of IP. Returns FALSE if the implementation, on this trap, simply writes IIP with the full address which would have been the next value of IP. |
| pr_phys_to_virt(phys_id) | Returns the virtual register id of the predicate from the physical register id, phys_id of the predicate. |
| rotate_regs() | Decrements the Register Rename Base registers, effectively rotating the register files. CFM.rrb.gr is decremented only if CFM.sor is non-zero. |
| rse_enable_current_frame_load() | If the RSE load pointer (RSE.BSPLoad) is greater than AR[BSP], the RSE.CFLE bit is set to indicate that mandatory RSE loads are allowed to restore registers in the current frame (in no other case does the RSE spill or fill registers in the current frame). This function does not perform mandatory RSE loads. This procedure does not cause any interruptions. |

Table 3-1. Pseudo-Code Functions (Continued)

| Function | Operation |
|--|--|
| rse_ensure_regs_loaded(number_of_bytes) | All registers and NaT collections between AR[BSP] and (AR[BSP] - number_of_bytes) which are not already in stacked registers are loaded into the register stack with mandatory RSE loads. If the number of registers to be loaded is greater than RSE.N_STACK_PHYS an Illegal Operation fault is raised. All registers starting with backing store address (AR[BSP] - 8) and decrementing down to and including backing store address (AR[BSP] - number_of_bytes) are made part of the dirty partition. With exception of the current frame, all other stacked registers are made part of the invalid partition. Note that number_of_bytes may be zero. The resulting sequence of RSE loads may be interrupted. Mandatory RSE loads may cause an interruption; see Table 6-6 on page 2:126 . |
| rse_invalidate_non_current_regs() | All registers outside the current frame are invalidated. |
| rse_load (type) | Restores a register or NaT collection from the backing store (load_address = RSE.BspLoad - 8). If load_address{8:3} is equal to 0x3f then a NaT collection is loaded into a NaT dispersal register. (dispersal_register may not be the same as AR[RNAT].) If load_address{8:3} is not equal to 0x3f then the register RSE.LoadReg - 1 is loaded and the NaT bit for that register is set to dispersal_register{load_address{8:3}}. If the load is successful RSE.BspLoad is decremented by 8. If the load is successful and a register was loaded RSE.LoadReg is decremented by 1 (possibly wrapping in the stacked registers). The load moves a register from the invalid partition to the current frame if RSE.CFLE is 1, or to the clean partition if RSE.CFLE is 0. For mandatory RSE loads, type is MANDATORY. Mandatory RSE loads may cause interruptions. See Table 6-6 on page 2:126 . |
| rse_new_frame(current_frame_size, new_frame_size) | A new frame is defined without changing any register renaming. The new frame size is completely defined by the new_frame_size parameter (successive calls are not cumulative). If new_frame_size is larger than current_frame_size and the number of registers in the invalid and clean partitions is less than the size of frame growth then mandatory RSE stores are issued until enough registers are available. The resulting sequence of RSE stores may be interrupted. Mandatory RSE stores may cause interruptions; see Table 6-6 on page 2:126 . |
| rse_preserve_frame(preserved_frame_size) | The number of registers specified by preserved_frame_size are marked to be preserved by the RSE. Register renaming causes the preserved_frame_size registers after GR[32] to be renamed to GR[32]. AR[BSP] is updated to contain the backing store address where the new GR[32] will be stored. |
| rse_restore_frame(preserved_sol, growth, current_frame_size) | The first two parameters define how the current frame is about to be updated by a branch return or rfi: preserved_sol defines how many registers need to be restored below RSE.BOF; growth defines by how many registers the top of the current frame will grow (growth will generally be negative). The number of registers specified by preserved_sol are marked to be restored. Register renaming causes the preserved_sol registers before GR[32] to be renamed to GR[32]. AR[BSP] is updated to contain the backing store address where the new GR[32] will be stored. If the number of dirty and clean registers is less than preserved_sol then mandatory RSE loads must be issued before the new current frame is considered valid. This function does not perform mandatory RSE loads. This function returns TRUE if the preserved frame grows beyond the invalid and clean regions into the dirty region. In this case the third argument, current_frame_size, is used to force the returned to frame to zero (see Section 6.5.5, "Bad PFS Used by Branch Return" on page 2:124). |

Table 3-1. Pseudo-Code Functions (Continued)

| Function | Operation |
|---|---|
| rse_store(type) | Saves a register or NaT collection to the backing store (store_address = AR[BSPSTORE]). If store_address{8:3} is equal to 0x3f then the NaT collection AR[RNAT] is stored. If store_address{8:3} is not equal to 0x3f then the register RSE.StoreReg is stored and the NaT bit from that register is deposited in AR[RNAT]{store_address{8:3}}. If the store is successful AR[BSPSTORE] is incremented by 8. If the store is successful and a register was stored RSE.StoreReg is incremented by 1 (possibly wrapping in the stacked registers). This store moves a register from the dirty partition to the clean partition. For mandatory RSE stores, type is MANDATORY. Mandatory RSE stores may cause interruptions. See Table 6-6 “RSE Interruption Summary” on page 2:126 . |
| rse_update_internal_stack_pointers(new_store_pointer) | Given a new value for AR[BSPSTORE] (new_store_pointer) this function computes the new value for AR[BSP]. This value is equal to new_store_pointer plus the number of dirty registers plus the number of intervening NaT collections. This means that the size of the dirty partition is the same before and after a write to AR[BSPSTORE]. All clean registers are moved to the invalid partition. |
| sign_ext(value, pos) | Returns a 64 bit number with bits pos-1 through 0 taken from value and bit pos-1 of value replicated in bit positions pos through 63. If pos is greater than or equal to 64, value is returned. |
| spontaneous_deferral(paddr, size, border, matrx, otype, hint, *defer) | Implementation-dependent routine which optionally forces *defer to TRUE if all of the following are true: spontaneous deferral is enabled, spontaneous deferral is permitted by the programming model, and the processor determines it would be advantageous to defer the speculative load (e.g., based on a miss in some particular level of cache). |
| spontaneous_deferral_enabled() | Implementation-dependent routine which returns TRUE or FALSE, depending on whether spontaneous deferral of speculative loads is enabled or disabled in the processor. |
| tlb_access_key(vaddr) | This function returns the access key from the TLB for the entry corresponding to vaddr. |
| tlb_broadcast_purge(rid, vaddr, size, type) | Sends a broadcast purge DTC and ITC transaction to other processors in the multi-processor coherency domain, where the region identifier (rid), virtual address (vaddr) and page size (size) specify the translation entry to purge. The operation waits until all processors that receive the purge have completed the purge operation. The purge type (type) specifies whether the ALAT on other processors should also be purged in conjunction with the TC. |
| tlb_enter_privileged_code() | This function determines the new privilege level for epc from the TLB entry for the page containing this instruction. If the page containing the epc instruction has execute-only page access rights and the privilege level assigned to the page is higher than (numerically less than) the current privilege level, then the current privilege level is set to the privilege level field in the translation for the page containing the epc instruction. |
| tlb_grant_permission(vaddr, type, pl) | Returns a boolean indicating if read, write access is granted for the specified virtual memory address (vaddr) and privilege level (pl). The access type (type) specifies either read or write. The following faults are checked; VHPT Translation, TLB Miss, Nested TLB, Page Not Present, NaT Page Consumption, and Key Miss. If a fault is generated, this function does not return. |
| tlb_insert_data(slot, pte0, pte1, vaddr, rid, tr) | Inserts an entry into the DTLB, at the specified slot number. pte0, pte1 compose the translation. vaddr and rid specify the virtual address and region identifier for the translation. If tr is true the entry is placed in the TR section, otherwise the TC section. |
| tlb_insert_inst(slot, pte0, pte1, vaddr, rid, tr) | Inserts an entry into the ITLB, at the specified slot number. pte0, pte1 compose the translation. vaddr and rid specify the virtual address and region identifier for the translation. If tr is true, the entry is placed in the TR section, otherwise the TC section. |

Table 3-1. Pseudo-Code Functions (Continued)

| Function | Operation |
|--|--|
| tlb_may_purge_dtc_entries(rid, vaddr, size) | May locally purge DTC entries that match the specified virtual address (<i>vaddr</i>), region identifier (<i>rid</i>) and page size (<i>size</i>). May also invalidate entries that partially overlap the parameters. The extent of purging is implementation dependent. If the purge size is not supported, an implementation may generate a machine check abort or over purge the translation cache up to and including removal of all entries from the translation cache. |
| tlb_may_purge_itc_entries(rid, vaddr, size) | May locally purge ITC entries that match the specified virtual address (<i>vaddr</i>), region identifier (<i>rid</i>) and page size (<i>size</i>). May also invalidate entries that partially overlap the parameters. The extent of purging is implementation dependent. If the purge size is not supported, an implementation may generate a machine check abort or over purge the translation cache up to and including removal of all entries from the translation cache. |
| tlb_must_purge_dtc_entries(rid, vaddr, size) | Purges all local, possibly overlapping, DTC entries matching the specified region identifier (<i>rid</i>), virtual address (<i>vaddr</i>) and page size (<i>size</i>). <i>vaddr</i> {63:61} (VRN) is ignored in the purge, i.e all entries that match <i>vaddr</i> {60:0} must be purged regardless of the VRN bits. If the purge size is not supported, an implementation may generate a machine check abort or over purge the translation cache up to and including removal of all entries from the translation cache. If the specified purge values overlap with an existing DTR translation, an implementation may generate a machine check abort. |
| tlb_must_purge_itc_entries(rid, vaddr, size) | Purges all local, possibly overlapping, ITC entry matching the specified region identifier (<i>rid</i>), virtual address (<i>vaddr</i>) and page size (<i>size</i>). <i>vaddr</i> {63:61} (VRN) is ignored in the purge, i.e all entries that match <i>vaddr</i> {60:0} must be purged regardless of the VRN bits. If the purge size is not supported, an implementation may generate a machine check abort or over purge the translation cache up to and including removal of all entries from the translation cache. If the specified purge values overlap with an existing ITR translation, an implementation may generate a machine check abort. |
| tlb_must_purge_dtr_entries(rid, vaddr, size) | Purges all local, possibly overlapping, DTR entries matching the specified region identifier (<i>rid</i>), virtual address (<i>vaddr</i>) and page size (<i>size</i>). <i>vaddr</i> {63:61} (VRN) is ignored in the purge, i.e all entries that match <i>vaddr</i> {60:0} must be purged regardless of the VRN bits. If the purge size is not supported, an implementation may generate a machine check abort or over purge the translation cache up to and including removal of all entries from the translation cache. |
| tlb_must_purge_itr_entries(rid, vaddr, size) | Purges all local, possibly overlapping, ITR entry matching the specified region identifier (<i>rid</i>), virtual address (<i>vaddr</i>) and page size (<i>size</i>). <i>vaddr</i> {63:61} (VRN) is ignored in the purge, i.e all entries that match <i>vaddr</i> {60:0} must be purged regardless of the VRN bits. If the purge size is not supported, an implementation may generate a machine check abort or over purge the translation cache up to and including removal of all entries from the translation cache. |
| tlb_purge_translation_cache(loop) | Removes 1 to N translations from the local processor's ITC and DTC. The number of entries removed is implementation-specific. The parameter <i>loop</i> is used to generate an implementation-specific purge parameter. |
| tlb_replacement_algorithm(tlb) | Returns the next ITC or DTC slot number to replace. Replacement algorithms are implementation-specific. <i>tlb</i> specifies to perform the algorithm on the ITC or DTC. |
| tlb_search_pkr(key) | Searches for a valid protection key register with a matching protection <i>key</i> . The search algorithm is implementation-specific. Returns the PKR register slot number if found, otherwise returns Not Found. |

Table 3-1. Pseudo-Code Functions (Continued)

| Function | Operation |
|---|--|
| <code>tlb_translate(vaddr, size, type, cpl, *attr, *defer)</code> | <p>Returns the translated data physical address for the specified virtual memory address (<code>vaddr</code>) when translation enabled; otherwise, returns <code>vaddr</code>. <code>size</code> specifies the size of the access, <code>type</code> specifies the type of access (e.g., read, write, advance, spec). <code>cpl</code> specifies the privilege level for access checking purposes. <code>*attr</code> returns the mapped physical memory attribute. If any fault conditions are detected and deferred, <code>tlb_translate</code> returns with <code>*defer</code> set. If a fault is generated but the fault is not deferred, <code>tlb_translate</code> does not return. <code>tlb_translate</code> checks the following faults:</p> <ul style="list-style-type: none"> • VHPT Data fault • Data Nested TLB fault • Data TLB fault • Alternate Data TLB fault • Data page not present fault • Data NaT page consumption fault • Data key miss fault • Data key permission fault • Data access rights fault • Data dirty bit fault • Data access bit fault • Data debug fault • Unsupported Data Reference fault |
| <code>tlb_translate_nonaccess(vaddr, type)</code> | <p>Returns the translated data physical address for the specified virtual memory address (<code>vaddr</code>). <code>type</code> specifies the type of access (e.g., FC, TPA). If a fault is generated, <code>tlb_translate_nonaccess</code> does not return. The following faults are checked:</p> <ul style="list-style-type: none"> • VHPT data fault • Data TLB fault • Data Nested TLB fault • Data page not present fault • Data NaT page consumption fault |
| <code>tlb_vhpt_hash(vrn, vaddr61, rid, size)</code> | <p>Generates a VHPT entry address for the specified virtual region number (<code>vrn</code>) and 61-bit virtual offset (<code>vaddr61</code>), region identifier (<code>rid</code>) and page size (<code>size</code>). <code>Tlb_vhpt_hash</code> hashes <code>vaddr</code>, <code>rid</code> and <code>size</code> parameters to produce a hash index. The hash index is then masked based on <code>PTA.size</code> and concatenated with <code>PTA.base</code> to generate the VHPT entry address. The long format hash is implementation-specific.</p> |
| <code>tlb_vhpt_tag(vaddr, rid, size)</code> | <p>Generates a VHPT tag identifier for the specified virtual address (<code>vaddr</code>), region identifier (<code>rid</code>) and page size (<code>size</code>). <code>Tlb_vhpt_tag</code> hashes the <code>vaddr</code>, <code>rid</code> and <code>size</code> parameters to produce translation identifier. The tag in conjunction with the hash index is used to uniquely identify translations in the VHPT. Tag generation is implementation-specific. All processor models tag function must guarantee that bit 63 of the generated tag is zero (ti bit).</p> |
| <code>unimplemented_physical_address(paddr)</code> | <p>Return TRUE if the presented physical address is unimplemented on this processor model; FALSE otherwise. This function is model-specific.</p> |
| <code>undefined()</code> | <p>Returns an undefined 64-bit value.</p> |
| <code>undefined_behavior()</code> | <p>Causes undefined processor behavior. Extent of undefined behavior is described in Section 3.5, "Undefined Behavior" on page 1:38.</p> |
| <code>unimplemented_virtual_address(vaddr)</code> | <p>Return TRUE if the presented virtual address is unimplemented on this processor model; FALSE otherwise. This function is model-specific.</p> |
| <code>fp_update_fpsr(sf, tmp_fp_env)</code> | <p>Copies a floating-point instruction's local state into the global FPSR.</p> |
| <code>fp_update_psr(dest_freg)</code> | <p>Conditionally sets PSR.mfl or PSR.mfh based on <code>dest_freg</code>.</p> |
| <code>zero_ext(value, pos)</code> | <p>Returns a 64 bit unsigned number with bits <code>pos-1</code> through 0 taken from <code>value</code> and zeroes in bit positions <code>pos</code> through 63. If <code>pos</code> is greater than or equal to 64, <code>value</code> is returned.</p> |

Instruction Formats

Each Itanium instruction is categorized into one of six types; each instruction type may be executed on one or more execution unit types. Table 4-1 lists the instruction types and the execution unit type on which they are executed:

Table 4-1. Relationship between Instruction Type and Execution Unit Type

| Instruction Type | Description | Execution Unit Type |
|------------------|-----------------|----------------------------|
| A | Integer ALU | I-unit or M-unit |
| I | Non-ALU integer | I-unit |
| M | Memory | M-unit |
| F | Floating-point | F-unit |
| B | Branch | B-unit |
| L+X | Extended | I-unit/B-unit ^a |

a. L+X Major Opcodes 0 - 7 execute on an I-unit. L+X Major Opcodes 8 - F execute on a B-unit.

Three instructions are grouped together into 128-bit sized and aligned containers called **bundles**. Each bundle contains three 41-bit **instruction slots** and a 5-bit template field. The format of a bundle is depicted in Figure 4-1.

Figure 4-1. Bundle Format

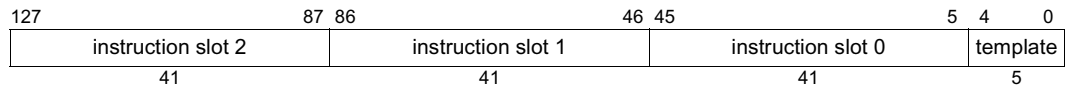

The template field specifies two properties: stops within the current bundle, and the mapping of instruction slots to execution unit types. Not all combinations of these two properties are allowed - Table 4-2 indicates the defined combinations. The three rightmost columns correspond to the three instruction slots in a bundle; listed within each column is the execution unit type controlled by that instruction slot for each encoding of the template field. A double line to the right of an instruction slot indicates that a stop occurs at that point within the current bundle. See “[Instruction Encoding Overview](#)” on page 32 for the definition of a stop. Within a bundle, execution order proceeds from slot 0 to slot 2. Unused template values (appearing as empty rows in Table 4-2) are reserved and cause an Illegal Operation fault.

Extended instructions, used for long immediate integer and long branch instructions, occupy two instruction slots. Depending on the major opcode, extended instructions execute on a B-unit (long branch/call) or an I-unit (all other L+X instructions).

Table 4-2. Template Field Encoding and Instruction Slot Mapping

| Template | Slot 0 | Slot 1 | Slot 2 |
|----------|--------|--------|---------------------|
| 00 | M-unit | I-unit | I-unit |
| 01 | M-unit | I-unit | I-unit |
| 02 | M-unit | I-unit | I-unit |
| 03 | M-unit | I-unit | I-unit |
| 04 | M-unit | L-unit | X-unit ^a |
| 05 | M-unit | L-unit | X-unit ^a |
| 06 | | | |
| 07 | | | |
| 08 | M-unit | M-unit | I-unit |
| 09 | M-unit | M-unit | I-unit |
| 0A | M-unit | M-unit | I-unit |
| 0B | M-unit | M-unit | I-unit |
| 0C | M-unit | F-unit | I-unit |
| 0D | M-unit | F-unit | I-unit |
| 0E | M-unit | M-unit | F-unit |
| 0F | M-unit | M-unit | F-unit |
| 10 | M-unit | I-unit | B-unit |
| 11 | M-unit | I-unit | B-unit |
| 12 | M-unit | B-unit | B-unit |
| 13 | M-unit | B-unit | B-unit |
| 14 | | | |
| 15 | | | |
| 16 | B-unit | B-unit | B-unit |
| 17 | B-unit | B-unit | B-unit |
| 18 | M-unit | M-unit | B-unit |
| 19 | M-unit | M-unit | B-unit |
| 1A | | | |
| 1B | | | |
| 1C | M-unit | F-unit | B-unit |
| 1D | M-unit | F-unit | B-unit |
| 1E | | | |
| 1F | | | |

a. The MLX template was formerly called MLI, and for compatibility, the X slot may encode `break.i` and `nop.i` in addition to any X-unit instruction.

4.1 Format Summary

All instructions in the instruction set are 41 bits in length. The leftmost 4 bits (40:37) of each instruction are the major opcode. [Table 4-3](#) shows the major opcode assignments for each of the 5 instruction types — ALU (A), Integer (I), Memory (M), Floating-point (F), and Branch (B). Bundle template bits are used to distinguish among the 4 columns, so the same major op values can be reused in each column.

Unused major ops (appearing as blank entries in [Table 4-3](#)) behave in one of four ways:

- Ignored major ops (white entries in [Table 4-3](#)) execute as `nop` instructions.
- Reserved major ops (light gray in the gray scale version of [Table 4-3](#), brown in the color version) cause an Illegal Operation fault.
- Reserved if PR[qp] is 1 major ops (dark gray in the gray scale version of [Table 4-3](#), purple in the color version) cause an Illegal Operation fault if the predicate register specified by the qp field of the instruction (bits 5:0) is 1 and execute as a `nop` instruction if 0.
- Reserved if PR[qp] is 1 B-unit major ops (medium gray in the gray scale version of [Table 4-3](#), cyan in the color version) cause an Illegal Operation fault if the predicate register specified by the qp field of the instruction (bits 5:0) is 1 and execute as a `nop` instruction if 0. These differ from the Reserved if PR[qp] is 1 major ops (purple) only in their RAW dependency behavior (see “RAW Dependency Table” on page 338).

Table 4-3. Major Opcode Assignments

| Major Op (Bits 40:37) | Instruction Type | | | | |
|--------------------------|------------------------------------|------------------------------------|--------------------------|-----------------------------------|--------------------------|
| | I/A | M/A | F | B | L+X |
| 0 | Misc ⁰ | Sys/Mem Mgmt ⁰ | FP Misc ⁰ | Misc/Indirect Branch ⁰ | Misc ⁰ |
| 1 | | Sys/Mem Mgmt ¹ | FP Misc ¹ | Indirect Call ¹ | |
| 2 | | | | Indirect Predict/Nop ² | |
| 3 | | | | | |
| 4 | Deposit ⁴ | Int Ld +Reg/getf ⁴ | FP Compare ⁴ | IP-relative Branch ⁴ | |
| 5 | Shift/Test Bit ⁵ | Int Ld/St +Imm ⁵ | FP Class ⁵ | IP-rel Call ⁵ | |
| 6 | | FP Ld/St +Reg/setf ⁶ | | | movl ⁶ |
| 7 | MM Mpy/Shift ⁷ | FP Ld/St +Imm ⁷ | | IP-relative Predict ⁷ | |
| 8 | ALU/MM ALU ⁸ | ALU/MM ALU ⁸ | fma ⁸ | e ⁸ | |
| 9 | Add Imm ₂₂ ⁹ | Add Imm ₂₂ ⁹ | fma ⁹ | e ⁹ | |
| A | | | fms ^A | e ^A | A ^A |
| B | | | fms ^B | e ^B | B ^B |
| C | Compare ^C | Compare ^C | fnma ^C | e ^C | Long Branch ^C |
| D | Compare ^D | Compare ^D | fnma ^D | e ^D | Long Call ^D |
| E | Compare ^E | Compare ^E | fselect/xma ^E | e ^E | E ^E |
| F | | | | e ^F | F ^F |

[Table 4-4](#) on page 4-258 summarizes all the instruction formats. The instruction fields are color-coded for ease of identification, as described in [Table 4-5](#) on page 4-260. A color version of this chapter is available for those heavily involved in working with the instruction encodings.

The instruction field names, used throughout this chapter, are described in [Table 4-6](#) on page 4-260. The set of special notations (such as whether an instruction is privileged) are listed in [Table 4-7](#) on page 4-261. These notations appear in the “Instruction” column of the opcode tables.

Most instruction containing immediates encode those immediates in more than one instruction field. For example, the 14-bit immediate in the Add Imm₁₄ instruction (format [A4](#)) is formed from the imm_{7b}, imm_{6d}, and s fields. [Table 4-74](#) on page 4-332 shows how the immediates are formed from the instruction fields for each instruction which has an immediate.

Table 4-4. Instruction Format Summary (Continued)

| | | 40 | 39 | 38 | 37 | 36 | 35 | 34 | 33 | 32 | 31 | 30 | 29 | 28 | 27 | 26 | 25 | 24 | 23 | 22 | 21 | 20 | 19 | 18 | 17 | 16 | 15 | 14 | 13 | 12 | 11 | 10 | 9 | 8 | 7 | 6 | 5 | 4 | 3 | 2 | 1 | 0 |
|------------------------------|-----|-------|----------------|-------------------|--------------------|--------------------|--------------------|--------------------|----|----|----|----|----|--------------------|--------------------------------|---------------------|---------------------|----------------|----------------|----|----|----|----|----|----------------|-------------------|-------------------|-------------------|----|----|----|----|---|---|---|---|----|---|---|---|---|---|
| FP Spec Check | M21 | 1 | s | x ₃ | imm _{13c} | | | | | | | | | | f ₂ | imm _{7a} | | | | | | | | | | qp | | | | | | | | | | | | | | | | |
| Int ALAT Check | M22 | 0 | s | x ₃ | imm _{20b} | | | | | | | | | | r ₁ | | | | | | | | | | | qp | | | | | | | | | | | | | | | | |
| FP ALAT Check | M23 | 0 | s | x ₃ | imm _{20b} | | | | | | | | | | f ₁ | | | | | | | | | | | qp | | | | | | | | | | | | | | | | |
| Sync/Sriz/ALAT | M24 | 0 | | x ₃ | x ₂ | x ₄ | | | | | | | | | | | | | | | | | | | | | qp | | | | | | | | | | | | | | | |
| RSE Control | M25 | 0 | | x ₃ | x ₂ | x ₄ | | | | | | | | | | | | | | | | | | | | | 0 | | | | | | | | | | | | | | | |
| Int ALAT Inval | M26 | 0 | | x ₃ | x ₂ | x ₄ | | | | | | | | | | | r ₁ | | | | | | | | | | | qp | | | | | | | | | | | | | | |
| FP ALAT Inval | M27 | 0 | | x ₃ | x ₂ | x ₄ | | | | | | | | | | | f ₁ | | | | | | | | | | | qp | | | | | | | | | | | | | | |
| Flush Cache | M28 | 1 | x | x ₃ | x ₆ | | | | | | | | | | r ₃ | | | | | | | | | | | qp | | | | | | | | | | | | | | | | |
| Move to AR | M29 | 1 | | x ₃ | x ₆ | | | | | | | | | | ar ₃ | r ₂ | | | | | | | | | | | qp | | | | | | | | | | | | | | | |
| Move to AR Imm ₈ | M30 | 0 | s | x ₃ | x ₂ | x ₄ | ar ₃ | | | | | | | | | | imm _{7b} | | | | | | | | | | qp | | | | | | | | | | | | | | | |
| Move from AR | M31 | 1 | | x ₃ | x ₆ | | | | | | | | | | ar ₃ | r ₁ | | | | | | | | | | qp | | | | | | | | | | | | | | | | |
| Move to CR | M32 | 1 | | x ₃ | x ₆ | | | | | | | | | | cr ₃ | r ₂ | | | | | | | | | | | qp | | | | | | | | | | | | | | | |
| Move from CR | M33 | 1 | | x ₃ | x ₆ | | | | | | | | | | cr ₃ | r ₁ | | | | | | | | | | qp | | | | | | | | | | | | | | | | |
| Alloc | M34 | 1 | | x ₃ | sor | | | | | | | | | | sol | sof | r ₁ | | | | | | | | | | | qp | | | | | | | | | | | | | | |
| Move to PSR | M35 | 1 | | x ₃ | x ₆ | | | | | | | | | | r ₂ | | | | | | | | | | qp | | | | | | | | | | | | | | | | | |
| Move from PSR | M36 | 1 | | x ₃ | x ₆ | | | | | | | | | | r ₁ | | | | | | | | | | qp | | | | | | | | | | | | | | | | | |
| Break | M37 | 0 | i | x ₃ | x ₂ | x ₄ | imm _{20a} | | | | | | | | | | | | | | | | | | | | qp | | | | | | | | | | | | | | | |
| Probe | M38 | 1 | | x ₃ | x ₆ | | | | | | | | | | r ₃ | r ₂ | r ₁ | | | | | | | | | | | qp | | | | | | | | | | | | | | |
| Probe Imm ₂ | M39 | 1 | | x ₃ | x ₆ | | | | | | | | | | r ₃ | i _{2b} | | | | | | | | | | r ₁ | qp | | | | | | | | | | | | | | | |
| Probe Fault Imm ₂ | M40 | 1 | | x ₃ | x ₆ | | | | | | | | | | r ₃ | i _{2b} | | | | | | | | | | qp | | | | | | | | | | | | | | | | |
| TC Insert | M41 | 1 | | x ₃ | x ₆ | | | | | | | | | | r ₂ | | | | | | | | | | qp | | | | | | | | | | | | | | | | | |
| Mv to Ind/TR Ins | M42 | 1 | | x ₃ | x ₆ | | | | | | | | | | r ₃ | r ₂ | | | | | | | | | | | qp | | | | | | | | | | | | | | | |
| Mv from Ind | M43 | 1 | | x ₃ | x ₆ | | | | | | | | | | r ₃ | r ₁ | | | | | | | | | | qp | | | | | | | | | | | | | | | | |
| Set/Reset Mask | M44 | 0 | i | x ₃ | i _{2d} | x ₄ | imm _{21a} | | | | | | | | | | | | | | | | | | | | qp | | | | | | | | | | | | | | | |
| Translation Purge | M45 | 1 | | x ₃ | x ₆ | | | | | | | | | | r ₃ | r ₂ | | | | | | | | | | | qp | | | | | | | | | | | | | | | |
| Translation Access | M46 | 1 | | x ₃ | x ₆ | | | | | | | | | | r ₃ | r ₁ | | | | | | | | | | qp | | | | | | | | | | | | | | | | |
| TC Entry Purge | M47 | 1 | | x ₃ | x ₆ | | | | | | | | | | r ₃ | | | | | | | | | | | qp | | | | | | | | | | | | | | | | |
| Nop/Hint | M48 | 0 | i | x ₃ | x ₂ | x ₄ | y | imm _{20a} | | | | | | | | | | | | | | | | | | | | qp | | | | | | | | | | | | | | |
| IP-Relative Branch | B1 | 4 | s | d | wh | imm _{20b} | | | | | | | | | | p | btype | | | | | | | | | | qp | | | | | | | | | | | | | | | |
| Counted Branch | B2 | 4 | s | d | wh | imm _{20b} | | | | | | | | | | p | btype | | | | | | | | | | 0 | | | | | | | | | | | | | | | |
| IP-Relative Call | B3 | 5 | s | d | wh | imm _{20b} | | | | | | | | | | p | b ₁ | | | | | | | | | | qp | | | | | | | | | | | | | | | |
| Indirect Branch | B4 | 0 | | d | wh | x ₆ | | | | | | | | | | b ₂ | p | btype | | | | | | | | | | qp | | | | | | | | | | | | | | |
| Indirect Call | B5 | 1 | | d | wh | | | | | | | | | | | b ₂ | p | b ₁ | | | | | | | | | | qp | | | | | | | | | | | | | | |
| IP-Relative Predict | B6 | 7 | s | ih | t _{2e} | imm _{20b} | | | | | | | | | | timm _{7a} | | | | | | | | | | wh | | | | | | | | | | | | | | | | |
| Indirect Predict | B7 | 2 | | ih | t _{2e} | x ₆ | | | | | | | | | | b ₂ | timm _{7a} | | | | | | | | | | wh | | | | | | | | | | | | | | | |
| Misc | B8 | 0 | | x ₆ | | | | | | | | | | | | | | | | | | | | 0 | | | | | | | | | | | | | | | | | | |
| Break/Nop/Hint | B9 | 0/2 | i | x ₆ | | | | | | | | | | imm _{20a} | | | | | | | | | | qp | | | | | | | | | | | | | | | | | | |
| FP Arithmetic | F1 | 8 - D | x | sf | f ₄ | | | | | | | | | | f ₃ | f ₂ | f ₁ | | | | | | | | | | qp | | | | | | | | | | | | | | | |
| Fixed Multiply Add | F2 | E | x | x ₂ | f ₄ | | | | | | | | | | f ₃ | f ₂ | f ₁ | | | | | | | | | | qp | | | | | | | | | | | | | | | |
| FP Select | F3 | E | x | f ₄ | | | | | | | | | | f ₃ | f ₂ | f ₁ | | | | | | | | | | qp | | | | | | | | | | | | | | | | |
| FP Compare | F4 | 4 | r _b | sf | r _a | p ₂ | f ₃ | | | | | | | | | | f ₂ | t _a | p ₁ | | | | | | | | | | qp | | | | | | | | | | | | | |
| FP Class | F5 | 5 | | fc ₂ | p ₂ | | | | | | | | | | fclass _{7c} | | | | | | | | | | f ₂ | t _a | p ₁ | | | | | | | | | | qp | | | | | |
| FP Recip Approx | F6 | 0 - 1 | q | sf | x | p ₂ | | | | | | | | | | f ₃ | f ₂ | f ₁ | | | | | | | | | | qp | | | | | | | | | | | | | | |
| FP Recip Sqrt App | F7 | 0 - 1 | q | sf | x | p ₂ | | | | | | | | | | f ₃ | f ₁ | | | | | | | | | | qp | | | | | | | | | | | | | | | |
| FP Min/Max/Pcmp | F8 | 0 - 1 | | sf | x | x ₆ | | | | | | | | | | f ₃ | f ₂ | f ₁ | | | | | | | | | | qp | | | | | | | | | | | | | | |
| FP Merge/Logical | F9 | 0 - 1 | | sf | x | x ₆ | | | | | | | | | | f ₃ | f ₂ | f ₁ | | | | | | | | | | qp | | | | | | | | | | | | | | |
| Convert FP to Fixed | F10 | 0 - 1 | | sf | x | x ₆ | | | | | | | | | | f ₂ | | | | | | | | | | f ₁ | qp | | | | | | | | | | | | | | | |
| Convert Fixed to FP | F11 | 0 | | sf | x | x ₆ | | | | | | | | | | f ₂ | | | | | | | | | | f ₁ | qp | | | | | | | | | | | | | | | |
| FP Set Controls | F12 | 0 | | sf | x | x ₆ | | | | | | | | | | omask _{7c} | amask _{7b} | | | | | | | | | | | qp | | | | | | | | | | | | | | |
| FP Clear Flags | F13 | 0 | | sf | x | x ₆ | | | | | | | | | | | | | | | | | | | | qp | | | | | | | | | | | | | | | | |
| FP Check Flags | F14 | 0 | s | sf | x | x ₆ | | | | | | | | | | imm _{20a} | | | | | | | | | | qp | | | | | | | | | | | | | | | | |
| Break | F15 | 0 | i | sf | x | x ₆ | | | | | | | | | | imm _{20a} | | | | | | | | | | qp | | | | | | | | | | | | | | | | |
| Nop/Hint | F16 | 0 | i | sf | x | x ₆ | | | | | | | | | | imm _{20a} | | | | | | | | | | qp | | | | | | | | | | | | | | | | |
| Break | X1 | 0 | i | x ₃ | x ₆ | | | | | | | | | | imm _{20a} | | | | | | | | | | qp | imm ₄₁ | | | | | | | | | | | | | | | | |
| Move Imm ₆₄ | X2 | 6 | i | imm _{9d} | | | | | | | | | | imm _{5c} | i _c v _c | imm _{7b} | | | | | | | | | | r ₁ | qp | imm ₄₁ | | | | | | | | | | | | | | |
| Long Branch | X3 | C | i | d | wh | imm _{20b} | | | | | | | | | | p | btype | | | | | | | | | | qp | imm ₃₉ | | | | | | | | | | | | | | |
| Long Call | X4 | D | i | d | wh | imm _{20b} | | | | | | | | | | p | b ₁ | | | | | | | | | | qp | imm ₃₉ | | | | | | | | | | | | | | |
| Nop/Hint | X5 | 0 | i | x ₃ | x ₆ | | | | | | | | | | y | imm _{20a} | | | | | | | | | | qp | imm ₄₁ | | | | | | | | | | | | | | | |

Table 4-5. Instruction Field Color Key

| Field & Color | |
|----------------------------|-------------------------------------|
| ALU Instruction | Opcode Extension |
| Integer Instruction | Opcode Hint Extension |
| Memory Instruction | Immediate |
| Branch Instruction | Indirect Source |
| Floating-point Instruction | Predicate Destination |
| Integer Source | Integer Destination |
| Memory Source | Memory Source & Destination |
| Shift Source | Shift Immediate |
| Special Register Source | Special Register Destination |
| Floating-point Source | Floating-point Destination |
| Branch Source | Branch Destination |
| Address Source | Branch Tag Immediate |
| Qualifying Predicate | Reserved Instruction |
| Ignored Field/Instruction | Reserved Inst if PR[qp] is 1 |
| | Reserved B-type Inst if PR[qp] is 1 |

Table 4-6. Instruction Field Names

| Field Name | Description |
|---|---|
| ar ₃ | application register source/target |
| b ₁ , b ₂ | branch register source/target |
| btype | branch type opcode extension |
| c | complement compare relation opcode extension |
| ccount _{5c} | multimedia shift left complemented shift count immediate |
| count _{5b} , count _{6d} | multimedia shift right/shift right pair shift count immediate |
| cpos _x | deposit complemented bit position immediate |
| cr ₃ | control register source/target |
| ct _{2d} | multimedia multiply shift/shift and add shift count immediate |
| d | branch cache deallocation hint opcode extension |
| f _n | floating-point register source/target |
| fc ₂ , fclass _{7c} | floating-point class immediate |
| hint | memory reference hint opcode extension |
| i, i _{2b} , i _{2d} , imm _x | immediate of length 1, 2, or x |
| ih | branch importance hint opcode extension |
| len _{4d} , len _{6d} | extract/deposit length immediate |
| m | memory reference post-modify opcode extension |
| mask _x | predicate immediate mask |
| mbt _{4c} , mht _{8c} | multimedia mux1/mux2 immediate |
| p | sequential prefetch hint opcode extension |
| p ₁ , p ₂ | predicate register target |
| pos _{6b} | test bit/extract bit position immediate |
| q | floating-point reciprocal/reciprocal square-root opcode extension |
| qp | qualifying predicate register source |
| r _n | general register source/target |
| s | immediate sign bit |
| sf | floating-point status field opcode extension |

Table 4-6. Instruction Field Names (Continued)

| Field Name | Description |
|-------------------------------------|--|
| sof, sol, sor | alloc size of frame, size of locals, size of rotating immediates |
| t _a , t _b | compare type opcode extension |
| t _{2e} , timm _x | branch predict tag immediate |
| v _x | reserved opcode extension field |
| wh | branch whether hint opcode extension |
| x, x _n | opcode extension of length 1 or <i>n</i> |
| y | extract/deposit/test bit/test NaT/hint opcode extension |
| z _a , z _b | multimedia operand size opcode extension |

Table 4-7. Special Instruction Notations

| Notation | Description |
|----------|---|
| e | instruction ends an instruction group when taken, or for Reserved if PR[qp] is 1 (cyan) encodings and non-branch instructions with a qualifying predicate, when its PR[qp] is 1, or for Reserved (brown) encodings, unconditionally |
| f | instruction must be the first instruction in an instruction group and must either be in instruction slot 0 or in instruction slot 1 of a template having a stop after slot 0 |
| i | instruction is allowed in the I slot of an MLI template |
| l | instruction must be the last in an instruction group |
| p | privileged instruction |
| t | instruction is only allowed in instruction slot 2 |

The remaining sections of this chapter present the detailed encodings of all instructions. The “A-Unit Instruction encodings” are presented first, followed by the “I-Unit Instruction Encodings” on page 272, “M-Unit Instruction Encodings” on page 285, “B-Unit Instruction Encodings” on page 313, “F-Unit Instruction Encodings” on page 320, and “X-Unit Instruction Encodings” on page 329.

Within each section, the instructions are grouped by function, and appear with their instruction format in the same order as in Table 4-4 “Instruction Format Summary” on page 3:258. The opcode extension fields are briefly described and tables present the opcode extension assignments. Unused instruction encodings (appearing as blank entries in the opcode extensions tables) behave in one of four ways:

- Ignored instructions (white color entries in the tables) execute as `nop` instructions.
- Reserved instructions (light gray color in the gray scale version of the tables, brown color in the color version) cause an Illegal Operation fault.
- Reserved if PR[qp] is 1 instructions (dark gray in the gray scale version of the tables, purple in the color version) cause an Illegal Operation fault if the predicate register specified by the qp field of the instruction (bits 5:0) is 1 and execute as a `nop` instruction if 0.
- Reserved if PR[qp] is 1 B-unit instructions (medium gray in the gray scale version of the tables, cyan in the color version) cause an Illegal Operation fault if the predicate register specified by the qp field of the instruction (bits 5:0) is 1 and execute as a `nop` instruction if 0. These differ from the Reserved if PR[qp] is 1 instructions (purple) only in their RAW dependency behavior (see “RAW Dependency Table” on page 338).

Some processors may implement the Reserved if PR[qp] is 1 (purple) and Reserved if PR[qp] is 1 B-unit (cyan) encodings in the L+X opcode space as Reserved (brown). These encodings appear in the L+X column of Table 4-3 on page 4-257, and in Table 4-69 on page 4-330, Table 4-70 on

page 4-330, Table 4-71 on page 4-331, and Table 4-72 on page 4-331. On processors which implement these encodings as Reserved (brown), the operating system is required to provide an Illegal Operation fault handler which emulates them as Reserved if PR[qp] is 1 (cyan/purple) by decoding the reserved opcodes, checking the qualifying predicate, and returning to the next instruction if PR[qp] is 0.

Constant 0 fields in instructions must be 0 or undefined operation results. The undefined operation may include checking that the constant field is 0 and causing an Illegal Operation fault if it is not. If an instruction having a constant 0 field also has a qualifying predicate (qp field), the fault or other undefined operation must not occur if PR[qp] is 0. For constant 0 fields in instruction bits 5:0 (normally used for qp), the fault or other undefined operation may or may not depend on the PR addressed by those bits.

Ignored (white space) fields in instructions should be coded as 0. Although ignored in this revision of the architecture, future architecture revisions may define these fields as hint extensions. These hint extensions will be defined such that the 0 value in each field corresponds to the default hint. It is expected that assemblers will automatically set these fields to zero by default.

4.2 A-Unit Instruction Encodings

4.2.1 Integer ALU

All integer ALU instructions are encoded within major opcode 8 using a 2-bit opcode extension field in bits 35:34 (x_{2a}) and most have a second 2-bit opcode extension field in bits 28:27 (x_{2b}), a 4-bit opcode extension field in bits 32:29 (x_4), and a 1-bit reserved opcode extension field in bit 33 (v_e). Table 4-8 shows the 2-bit x_{2a} and 1-bit v_e assignments, Table 4-9 shows the integer ALU 4-bit+2-bit assignments, and Table 4-12 on page 4-268 shows the multimedia ALU 1-bit+2-bit assignments (which also share major opcode 8).

Table 4-8. Integer ALU 2-bit+1-bit Opcode Extensions

| Opcode Bits 40:37 | x_{2a} Bits 35:34 | v_e Bit 33 | |
|----------------------|------------------------|---|---|
| | | 0 | 1 |
| 8 | 0 | Integer ALU 4-bit+2-bit Ext (Table 4-9) | |
| | 1 | Multimedia ALU 1-bit+2-bit Ext (Table 4-12) | |
| | 2 | adds – imm ₁₄ A4 | |
| | 3 | addp4 – imm ₁₄ A4 | |

Table 4-9. Integer ALU 4-bit+2-bit Opcode Extensions

| Opcode Bits 40:37 | x _{2a} Bits 35:34 | V _e Bit 33 | x ₄ Bits 32:29 | x _{2b} Bits 28:27 | | | |
|----------------------|----------------------------------|-----------------------------|---------------------------------|-------------------------------|-----------------------------|--------------------------|---------------------------|
| | | | | 0 | 1 | 2 | 3 |
| 8 | 0 | 0 | 0 | add A1 | add +1 A1 | | |
| | | | 1 | sub -1 A1 | sub A1 | | |
| | | | 2 | addp4 A1 | | | |
| | | | 3 | and A1 | andcm A1 | or A1 | xor A1 |
| | | | 4 | shladd A2 | | | |
| | | | 5 | | | | |
| | | | 6 | shladdp4 A2 | | | |
| | | | 7 | | | | |
| | | | 8 | | | | |
| | | | 9 | | sub - imm ₈ A3 | | |
| | | | A | | | | |
| | | | B | and - imm ₈ A3 | andcm - imm ₈ A3 | or - imm ₈ A3 | xor - imm ₈ A3 |
| | | | C | | | | |
| | | | D | | | | |
| | | | E | | | | |
| | | | F | | | | |

4.2.1.1 Integer ALU – Register-Register

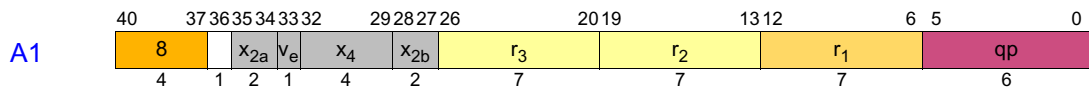

| Instruction | Operands | Opcode | Extension | | | |
|-------------|---|--------|-----------------|----------------|----------------|-----------------|
| | | | x _{2a} | V _e | x ₄ | x _{2b} |
| add | $r_1 = r_2, r_3$ $r_1 = r_2, r_3, 1$ | 8 | 0 | 0 | 0 | 0 |
| sub | $r_1 = r_2, r_3$ $r_1 = r_2, r_3, 1$ | | | | 1 | 1 |
| addp4 | | | | | 2 | 0 |
| and | | | | | 3 | 0 |
| andcm | $r_1 = r_2, r_3$ | | | | | 1 |
| or | | | | | | 2 |
| xor | | | | | 3 | 3 |

4.2.1.2 Shift Left and Add

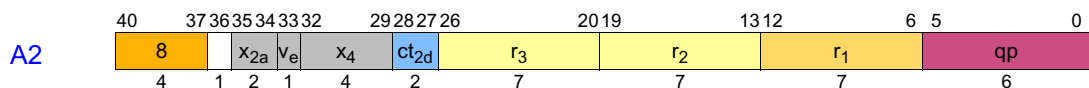

| Instruction | Operands | Opcode | Extension | | |
|-------------|---------------------------|--------|-----------------|----------------|----------------|
| | | | x _{2a} | V _e | x ₄ |
| shladd | $r_1 = r_2, count_2, r_3$ | 8 | 0 | 0 | 4 |
| shladdp4 | | | | | 6 |

4.2.1.3 Integer ALU – Immediate₈-Register

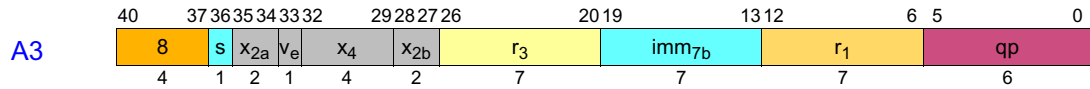

| Instruction | Operands | Opcode | Extension | | | |
|-------------|--------------------|--------|-----------------|----------------|----------------|-----------------|
| | | | x _{2a} | v _e | x ₄ | x _{2b} |
| sub | $r_1 = imm_8, r_3$ | 8 | 0 | 0 | 9 | 1 |
| and | | | | | B | 0 |
| andcm | | | | | | 1 |
| or | | | | | | 2 |
| xor | | | | | | 3 |

4.2.1.4 Add Immediate₁₄

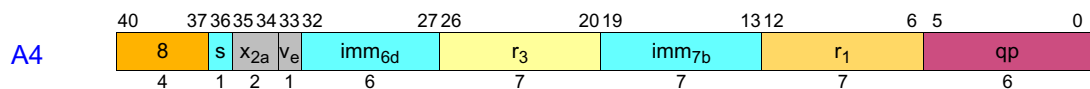

| Instruction | Operands | Opcode | Extension | |
|-------------|-----------------------|--------|-----------------|----------------|
| | | | x _{2a} | v _e |
| adds | $r_1 = imm_{14}, r_3$ | 8 | 2 | 0 |
| addp4 | | | 3 | |

4.2.1.5 Add Immediate₂₂

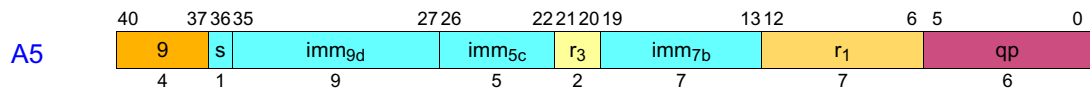

| Instruction | Operands | Opcode |
|-------------|-----------------------|--------|
| addl | $r_1 = imm_{22}, r_3$ | 9 |

4.2.2 Integer Compare

The integer compare instructions are encoded within major opcodes C – E using a 2-bit opcode extension field (x₂) in bits 35:34 and three 1-bit opcode extension fields in bits 33 (t_a), 36 (t_b), and 12 (c), as shown in [Table 4-10](#). The integer compare immediate instructions are encoded within major opcodes C – E using a 2-bit opcode extension field (x₂) in bits 35:34 and two 1-bit opcode extension fields in bits 33 (t_a) and 12 (c), as shown in [Table 4-11](#).

Table 4-10. Integer Compare Opcode Extensions

| x ₂ Bits 35:34 | t _b Bit 36 | t _a Bit 33 | c Bit 12 | Opcode Bits 40:37 | | |
|---------------------------------|-----------------------------|-----------------------------|----------------|----------------------|-----------------|---------------------|
| | | | | C | D | E |
| 0 | 0 | 0 | 0 | cmp.lt A6 | cmp.ltu A6 | cmp.eq A6 |
| | | | 1 | cmp.lt.unc A6 | cmp.ltu.unc A6 | cmp.eq.unc A6 |
| | | 1 | 0 | cmp.eq.and A6 | cmp.eq.or A6 | cmp.eq.or.andcm A6 |
| | | | 1 | cmp.ne.and A6 | cmp.ne.or A6 | cmp.ne.or.andcm A6 |
| | 1 | 0 | 0 | cmp.gt.and A7 | cmp.gt.or A7 | cmp.gt.or.andcm A7 |
| | | | 1 | cmp.le.and A7 | cmp.le.or A7 | cmp.le.or.andcm A7 |
| | | 1 | 0 | cmp.ge.and A7 | cmp.ge.or A7 | cmp.ge.or.andcm A7 |
| | | | 1 | cmp.lt.and A7 | cmp.lt.or A7 | cmp.lt.or.andcm A7 |
| 1 | 0 | 0 | 0 | cmp4.lt A6 | cmp4.ltu A6 | cmp4.eq A6 |
| | | | 1 | cmp4.lt.unc A6 | cmp4.ltu.unc A6 | cmp4.eq.unc A6 |
| | | 1 | 0 | cmp4.eq.and A6 | cmp4.eq.or A6 | cmp4.eq.or.andcm A6 |
| | | | 1 | cmp4.ne.and A6 | cmp4.ne.or A6 | cmp4.ne.or.andcm A6 |
| | 1 | 0 | 0 | cmp4.gt.and A7 | cmp4.gt.or A7 | cmp4.gt.or.andcm A7 |
| | | | 1 | cmp4.le.and A7 | cmp4.le.or A7 | cmp4.le.or.andcm A7 |
| | | 1 | 0 | cmp4.ge.and A7 | cmp4.ge.or A7 | cmp4.ge.or.andcm A7 |
| | | | 1 | cmp4.lt.and A7 | cmp4.lt.or A7 | cmp4.lt.or.andcm A7 |

Table 4-11. Integer Compare Immediate Opcode Extensions

| x ₂ Bits 35:34 | t _a Bit 33 | c Bit 12 | Opcode Bits 40:37 | | |
|---------------------------------|-----------------------------|----------------|-----------------------|------------------------|----------------------------|
| | | | C | D | E |
| 2 | 0 | 0 | cmp.lt – imm8 A8 | cmp.ltu – imm8 A8 | cmp.eq – imm8 A8 |
| | | 1 | cmp.lt.unc – imm8 A8 | cmp.ltu.unc – imm8 A8 | cmp.eq.unc – imm8 A8 |
| | 1 | 0 | cmp.eq.and – imm8 A8 | cmp.eq.or – imm8 A8 | cmp.eq.or.andcm – imm8 A8 |
| | | 1 | cmp.ne.and – imm8 A8 | cmp.ne.or – imm8 A8 | cmp.ne.or.andcm – imm8 A8 |
| 3 | 0 | 0 | cmp4.lt – imm8 A8 | cmp4.ltu – imm8 A8 | cmp4.eq – imm8 A8 |
| | | 1 | cmp4.lt.unc – imm8 A8 | cmp4.ltu.unc – imm8 A8 | cmp4.eq.unc – imm8 A8 |
| | 1 | 0 | cmp4.eq.and – imm8 A8 | cmp4.eq.or – imm8 A8 | cmp4.eq.or.andcm – imm8 A8 |
| | | 1 | cmp4.ne.and – imm8 A8 | cmp4.ne.or – imm8 A8 | cmp4.ne.or.andcm – imm8 A8 |

4.2.2.1 Integer Compare – Register-Register

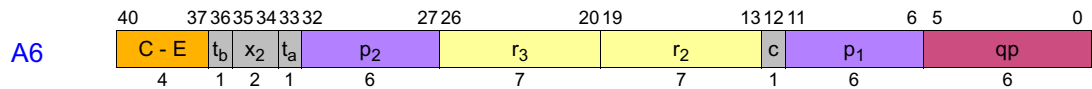

| Instruction | Operands | Opcode | Extension | | | | | |
|------------------|-----------------------|--------|-----------|-------|-------|-----|---|---|
| | | | x_2 | t_b | t_a | c | | |
| cmp.lt | $p_1, p_2 = r_2, r_3$ | C | 0 | 0 | 0 | 0 | | |
| cmp.ltu | | D | | | | | 1 | |
| cmp.eq | | E | | | | | | |
| cmp.lt.unc | | C | | | | | | 1 |
| cmp.ltu.unc | | D | | | | | | |
| cmp.eq.unc | | E | | | | | | |
| cmp.eq.and | | C | | | 0 | | | |
| cmp.eq.or | | D | | | | | | |
| cmp.eq.or.andcm | | E | | | | | | |
| cmp.ne.and | | C | | | | 1 | | |
| cmp.ne.or | | D | | | | | | |
| cmp.ne.or.andcm | | E | | | | | | |
| cmp4.lt | | C | 1 | 0 | 0 | | 0 | |
| cmp4.ltu | | D | | | | | | 1 |
| cmp4.eq | | E | | | | | | |
| cmp4.lt.unc | | C | | | | 1 | | |
| cmp4.ltu.unc | | D | | | | | | |
| cmp4.eq.unc | | E | | | | | | |
| cmp4.eq.and | | C | | | 0 | | | |
| cmp4.eq.or | | D | | | | | | |
| cmp4.eq.or.andcm | | E | | | | | | |
| cmp4.ne.and | | C | | | | 1 | | |
| cmp4.ne.or | | D | | | | | | |
| cmp4.ne.or.andcm | | E | | | | | | |

4.2.2.2 Integer Compare to Zero – Register

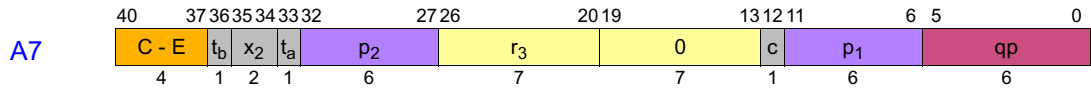

| Instruction | Operands | Opcode | Extension | | | | | |
|---|----------------------|-------------|-----------|-------|-------|---|---|---|
| | | | x_2 | t_b | t_a | c | | |
| cmp.gt.and cmp.gt.or cmp.gt.or.andcm | $p_1, p_2 = r0, r_3$ | C D E | 0 | 1 | 0 | 0 | | |
| cmp.le.and cmp.le.or cmp.le.or.andcm | | C D E | | | | 1 | | |
| cmp.ge.and cmp.ge.or cmp.ge.or.andcm | | C D E | | | | 1 | 0 | |
| cmp.lt.and cmp.lt.or cmp.lt.or.andcm | | C D E | | | | | 1 | |
| cmp4.gt.and cmp4.gt.or cmp4.gt.or.andcm | | C D E | | | | 1 | 0 | 0 |
| cmp4.le.and cmp4.le.or cmp4.le.or.andcm | | C D E | | | | | | 1 |
| cmp4.ge.and cmp4.ge.or cmp4.ge.or.andcm | | C D E | 1 | 0 | | | | |
| cmp4.lt.and cmp4.lt.or cmp4.lt.or.andcm | | C D E | | 1 | | | | |

4.2.2.3 Integer Compare – Immediate-Register

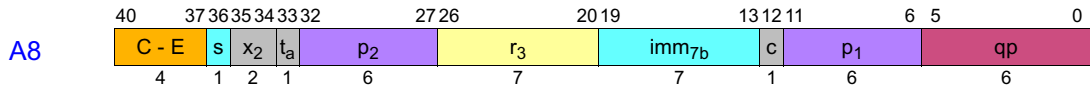

| Instruction | Operands | Opcode | Extension | | | |
|------------------|-------------------------|--------|----------------|----------------|---|---|
| | | | x ₂ | t _a | c | |
| cmp.lt | $p_1, p_2 = imm_8, r_3$ | C | 2 | 0 | 0 | |
| cmp.ltu | | D | | | | |
| cmp.eq | | E | | | | |
| cmp.lt.unc | | C | | | 1 | |
| cmp.ltu.unc | | D | | | | |
| cmp.eq.unc | | E | | | | |
| cmp.eq.and | | C | 1 | 0 | | |
| cmp.eq.or | | D | | | | |
| cmp.eq.or.andcm | | E | | | | |
| cmp.ne.and | | C | 1 | 1 | | |
| cmp.ne.or | | D | | | | |
| cmp.ne.or.andcm | | E | | | | |
| cmp4.lt | | | C | 3 | 0 | 0 |
| cmp4.ltu | | | D | | | |
| cmp4.eq | | | E | | | |
| cmp4.lt.unc | | | C | | | 1 |
| cmp4.ltu.unc | | | D | | | |
| cmp4.eq.unc | | | E | | | |
| cmp4.eq.and | | | C | 1 | 0 | |
| cmp4.eq.or | | | D | | | |
| cmp4.eq.or.andcm | | | E | | | |
| cmp4.ne.and | | | C | 1 | 1 | |
| cmp4.ne.or | | | D | | | |
| cmp4.ne.or.andcm | | | E | | | |

4.2.3 Multimedia

All multimedia ALU instructions are encoded within major opcode 8 using two 1-bit opcode extension fields in bits 36 (z_a) and 33 (z_b) and a 2-bit opcode extension field in bits 35:34 (x_{2a}) as shown in Table 4-12. The multimedia ALU instructions also have a 4-bit opcode extension field in bits 32:29 (x_4), and a 2-bit opcode extension field in bits 28:27 (x_{2b}) as shown in Table 4-13 on page 4-269.

Table 4-12. Multimedia ALU 2-bit+1-bit Opcode Extensions

| Opcode Bits 40:37 | x _{2a} Bits 35:34 | z _a Bit 36 | z _b Bit 33 | |
|----------------------|-------------------------------|--------------------------|--------------------------|------------------------------------|
| 8 | 1 | 0 | 0 | Multimedia ALU Size 1 (Table 4-13) |
| | | | 1 | Multimedia ALU Size 2 (Table 4-14) |
| | | 1 | 0 | Multimedia ALU Size 4 (Table 4-15) |
| | | | 1 | |

Table 4-13. Multimedia ALU Size 1 4-bit+2-bit Opcode Extensions

| Opcode Bits 40:37 | x _{2a} Bits 35:34 | z _a Bit 36 | z _b Bit 33 | x ₄ Bits 32:29 | x _{2b} Bits 28:27 | | | |
|----------------------|----------------------------------|-----------------------------|-----------------------------|---------------------------------|-------------------------------|--------------|--------------|--------------|
| | | | | | 0 | 1 | 2 | 3 |
| 8 | 1 | 0 | 0 | 0 | padd1 A9 | padd1.sss A9 | padd1.uuu A9 | padd1.uus A9 |
| | | | | 1 | psub1 A9 | psub1.sss A9 | psub1.uuu A9 | psub1.uus A9 |
| | | | | 2 | | | pavg1 A9 | pavg1.raz A9 |
| | | | | 3 | | | pavgsub1 A9 | |
| | | | | 4 | | | | |
| | | | | 5 | | | | |
| | | | | 6 | | | | |
| | | | | 7 | | | | |
| | | | | 8 | | | | |
| | | | | 9 | pcmp1.eq A9 | pcmp1.gt A9 | | |
| | | | | A | | | | |
| | | | | B | | | | |
| | | | | C | | | | |
| | | | | D | | | | |
| | | | | E | | | | |
| | | | | F | | | | |

Table 4-14. Multimedia ALU Size 2 4-bit+2-bit Opcode Extensions

| Opcode Bits 40:37 | x _{2a} Bits 35:34 | z _a Bit 36 | z _b Bit 33 | x ₄ Bits 32:29 | x _{2b} Bits 28:27 | | | |
|----------------------|----------------------------------|-----------------------------|-----------------------------|---------------------------------|-------------------------------|--------------|--------------|--------------|
| | | | | | 0 | 1 | 2 | 3 |
| 8 | 1 | 0 | 1 | 0 | padd2 A9 | padd2.sss A9 | padd2.uuu A9 | padd2.uus A9 |
| | | | | 1 | psub2 A9 | psub2.sss A9 | psub2.uuu A9 | psub2.uus A9 |
| | | | | 2 | | | pavg2 A9 | pavg2.raz A9 |
| | | | | 3 | | | pavgsub2 A9 | |
| | | | | 4 | pshladd2 A10 | | | |
| | | | | 5 | | | | |
| | | | | 6 | pshradd2 A10 | | | |
| | | | | 7 | | | | |
| | | | | 8 | | | | |
| | | | | 9 | pcmp2.eq A9 | pcmp2.gt A9 | | |
| | | | | A | | | | |
| | | | | B | | | | |
| | | | | C | | | | |
| | | | | D | | | | |
| | | | | E | | | | |
| | | | | F | | | | |

Table 4-15. Multimedia ALU Size 4 4-bit+2-bit Opcode Extensions

| Opcode Bits 40:37 | x _{2a} Bits 35:34 | z _a Bit 36 | z _b Bit 33 | x ₄ Bits 32:29 | x _{2b} Bits 28:27 | | | |
|----------------------|----------------------------------|-----------------------------|-----------------------------|---------------------------------|-------------------------------|-------------|---|---|
| | | | | | 0 | 1 | 2 | 3 |
| 8 | 1 | 1 | 0 | 0 | padd4 A9 | | | |
| | | | | 1 | psub4 A9 | | | |
| | | | | 2 | | | | |
| | | | | 3 | | | | |
| | | | | 4 | | | | |
| | | | | 5 | | | | |
| | | | | 6 | | | | |
| | | | | 7 | | | | |
| | | | | 8 | | | | |
| | | | | 9 | pcmp4.eq A9 | pcmp4.gt A9 | | |
| | | | | A | | | | |
| | | | | B | | | | |
| | | | | C | | | | |
| | | | | D | | | | |
| | | | | E | | | | |
| | | | | F | | | | |

4.2.3.1 Multimedia ALU

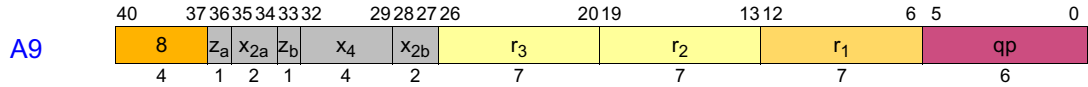

| Instruction | Operands | Opcode | Extension | | | | | | |
|-------------|------------------|--------|-----------------|----------------|----------------|----------------|-----------------|---|---|
| | | | X _{2a} | Z _a | Z _b | X ₄ | X _{2b} | | |
| padd1 | $r_1 = r_2, r_3$ | 8 | 1 | 0 | 0 | 1 | 0 | 0 | |
| padd2 | | | | | 1 | 0 | | | |
| padd4 | | | | | 0 | 0 | | | 1 |
| padd1.sss | | | | | 0 | 1 | | | |
| padd2.sss | | | | | 0 | 0 | | | 2 |
| padd1.uuu | | | | | 0 | 1 | | | |
| padd2.uuu | | | | | 0 | 0 | | | 3 |
| padd1.uus | | | | | 0 | 1 | | | |
| padd2.uus | | | | | 0 | 0 | | | 1 |
| psub1 | | | | | 0 | 1 | | | |
| psub2 | | | | | 1 | 0 | | | 1 |
| psub4 | | | | | 0 | 1 | | | |
| psub1.sss | | | | | 0 | 0 | | | 2 |
| psub2.sss | | | | | 0 | 1 | | | |
| psub1.uuu | | | | | 0 | 0 | | | 3 |
| psub2.uuu | | | | | 0 | 1 | | | |
| psub1.uus | | | | | 0 | 0 | | | 2 |
| psub2.uus | | | | | 0 | 1 | | | |
| pavg1 | | | | | 0 | 0 | | | 3 |
| pavg2 | | | | | 0 | 1 | | | |
| pavg1.raz | | | | | 0 | 0 | | | 2 |
| pavg2.raz | | | | | 0 | 1 | | | |
| pavgsub1 | | | | | 0 | 0 | | | 9 |
| pavgsub2 | | | | | 0 | 1 | | | |
| pcmp1.eq | 0 | 0 | 0 | | | | | | |
| pcmp2.eq | 1 | 0 | | | | | | | |
| pcmp4.eq | 0 | 0 | 1 | | | | | | |
| pcmp1.gt | 0 | 1 | | | | | | | |
| pcmp2.gt | 1 | 0 | | | | | | | |
| pcmp4.gt | | | | | | | | | |

4.2.3.2 Multimedia Shift and Add

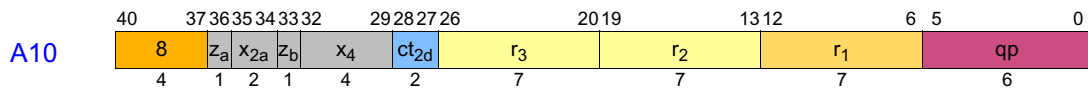

| Instruction | Operands | Opcode | Extension | | | |
|-------------|---------------------------|--------|-----------------|----------------|----------------|----------------|
| | | | X _{2a} | Z _a | Z _b | X ₄ |
| pshladd2 | $r_1 = r_2, count_2, r_3$ | 8 | 1 | 0 | 1 | 4 |
| pshradd2 | | | | | | 6 |

4.3 I-Unit Instruction Encodings

4.3.1 Multimedia and Variable Shifts

All multimedia multiply/shift/max/min/mix/mux/pack/unpack and variable shift instructions are encoded within major opcode 7 using two 1-bit opcode extension fields in bits 36 (z_a) and 33 (z_b) and a 1-bit reserved opcode extension in bit 32 (v_e) as shown in Table 4-16. They also have a 2-bit opcode extension field in bits 35:34 (x_{2a}) and a 2-bit field in bits 29:28 (x_{2b}) and most have a 2-bit field in bits 31:30 (x_{2c}) as shown in Table 4-17.

Table 4-16. Multimedia and Variable Shift 1-bit Opcode Extensions

| Opcode Bits 40:37 | z_a Bit 36 | z_b Bit 33 | v_e Bit 32 | |
|----------------------|--------------------|--------------------|--------------------------------|---|
| | | | 0 | 1 |
| 7 | 0 | 0 | Multimedia Size 1 (Table 4-17) | |
| | | 1 | Multimedia Size 2 (Table 4-18) | |
| | 1 | 0 | Multimedia Size 4 (Table 4-19) | |
| | | 1 | Variable Shift (Table 4-20) | |

Table 4-17. Multimedia Opcode 7 Size 1 2-bit Opcode Extensions

| Opcode Bits 40:37 | z_a Bit 36 | z_b Bit 33 | v_e Bit 32 | x_{2a} Bits 35:34 | x_{2b} Bits 29:28 | x_{2c} Bits 31:30 | | | | | | | |
|----------------------|--------------------|--------------------|--------------------|---------------------------|---------------------------|------------------------|---|---|---|--------------|--------------|-----------|--|
| | | | | | | 0 | 1 | 2 | 3 | | | | |
| 7 | 0 | 0 | 0 | 0 | 0 | 0 | | | | | | | |
| | | | | | | 1 | | | | | | | |
| | | | | | | 2 | | | | | | | |
| | | | | | | 3 | | | | | | | |
| | | | | | 1 | 0 | | | | | | | |
| | | | | | | 1 | | | | | | | |
| | | | | | | 2 | | | | | | | |
| | | | | | | 3 | | | | | | | |
| | | | | 2 | 0 | | | | | unpack1.h I2 | mix1.r I2 | | |
| | | | | | 1 | | | | | pmin1.u I2 | pmax1.u I2 | | |
| | | | | | 2 | | | | | | unpack1.l I2 | mix1.l I2 | |
| | | | | | 3 | | | | | | | psad1 I2 | |
| | | | | 3 | 0 | | | | | | | | |
| | | | | | 1 | | | | | | | | |
| | | | | | 2 | | | | | | | mux1 I3 | |
| | | | | | 3 | | | | | | | | |

Table 4-18. Multimedia Opcode 7 Size 2 2-bit Opcode Extensions

| Opcode Bits 40:37 | Z _a Bit 36 | Z _b Bit 33 | V _e Bit 32 | X _{2a} Bits 35:34 | X _{2b} Bits 29:28 | X _{2c} Bits 31:30 | | | |
|----------------------|--------------------------|--------------------------|--------------------------|-------------------------------|-------------------------------|-------------------------------|--------------------|--------------|------------|
| | | | | | | 0 | 1 | 2 | 3 |
| 7 | 0 | 1 | 0 | 0 | 0 | pshr2.u – var I5 | pshl2 – var I7 | | |
| | | | | | 1 | pmpyshr2.u I1 | | | |
| | | | | | 2 | pshr2 – var I5 | | | |
| | | | | | 3 | pmpyshr2 I1 | | | |
| | | | | | 1 | 0 | | | |
| | | | | | | 1 | pshr2.u – fixed I6 | | popcnt I9 |
| | | | | | | 2 | | | |
| | | | | | | 3 | pshr2 – fixed I6 | | |
| | | | | | 2 | 0 | pack2.uss I2 | unpack2.h I2 | mix2.r I2 |
| | | | | | | 1 | | | pmpy2.r I2 |
| | | | | | | 2 | pack2.sss I2 | unpack2.l I2 | mix2.l I2 |
| | | | | | | 3 | pmin2 I2 | pmax2 I2 | pmpy2.l I2 |
| | | | | 3 | 0 | | | | |
| | | | | | 1 | | pshl2 – fixed I8 | | |
| | | | | | 2 | | | mux2 I4 | |
| | | | | | 3 | | | | |

Table 4-19. Multimedia Opcode 7 Size 4 2-bit Opcode Extensions

| Opcode Bits 40:37 | Z _a Bit 36 | Z _b Bit 33 | V _e Bit 32 | X _{2a} Bits 35:34 | X _{2b} Bits 29:28 | X _{2c} Bits 31:30 | | | |
|----------------------|--------------------------|--------------------------|--------------------------|-------------------------------|-------------------------------|-------------------------------|--------------------|--------------|-----------|
| | | | | | | 0 | 1 | 2 | 3 |
| 7 | 1 | 0 | 0 | 0 | 0 | pshr4.u – var I5 | pshl4 – var I7 | | |
| | | | | | 1 | | | | |
| | | | | | 2 | pshr4 – var I5 | | | |
| | | | | | 3 | | | | |
| | | | | | 1 | 0 | | | |
| | | | | | | 1 | pshr4.u – fixed I6 | | |
| | | | | | | 2 | | | |
| | | | | | | 3 | pshr4 – fixed I6 | | |
| | | | | | 2 | 0 | | unpack4.h I2 | mix4.r I2 |
| | | | | | | 1 | | | |
| | | | | | | 2 | pack4.sss I2 | unpack4.l I2 | mix4.l I2 |
| | | | | | | 3 | | | |
| | | | | 3 | 0 | | | | |
| | | | | | 1 | | pshl4 – fixed I8 | | |
| | | | | | 2 | | | | |
| | | | | | 3 | | | | |

Table 4-20. Variable Shift Opcode 7 2-bit Opcode Extensions

| Opcode Bits 40:37 | z _a Bit 36 | z _b Bit 33 | v _e Bit 32 | x _{2a} Bits 35:34 | x _{2b} Bits 29:28 | x _{2c} Bits 31:30 | | | |
|----------------------|-----------------------------|-----------------------------|-----------------------------|----------------------------------|----------------------------------|-------------------------------|--------------|---|---|
| | | | | | | 0 | 1 | 2 | 3 |
| 7 | 1 | 1 | 0 | 0 | 0 | shr.u – var 15 | shl – var 17 | | |
| | | | | | 1 | | | | |
| | | | | | 2 | shr – var 15 | | | |
| | | | | | 3 | | | | |
| | | | | 1 | 0 | | | | |
| | | | | | 1 | | | | |
| | | | | | 2 | | | | |
| | | | | | 3 | | | | |
| | | | | 2 | 0 | | | | |
| | | | | | 1 | | | | |
| | | | | | 2 | | | | |
| | | | | | 3 | | | | |
| 3 | 0 | | | | | | | | |
| | 1 | | | | | | | | |
| | 2 | | | | | | | | |
| | 3 | | | | | | | | |

4.3.1.1 Multimedia Multiply and Shift

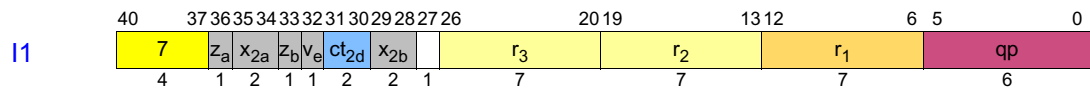

| Instruction | Operands | Opcode | Extension | | | | |
|-------------|---------------------------|--------|----------------|----------------|----------------|-----------------|-----------------|
| | | | z _a | z _b | v _e | x _{2a} | x _{2b} |
| pmpyshr2 | $r_1 = r_2, r_3, count_2$ | 7 | 0 | 1 | 0 | 0 | 3 |
| pmpyshr2.u | | | 0 | 1 | 0 | 0 | 1 |

4.3.1.2 Multimedia Multiply/Mix/Pack/Unpack

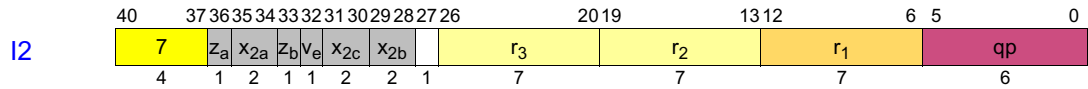

| Instruction | Operands | Opcode | Extension | | | | | | | |
|-------------|------------------|--------|----------------|----------------|----------------|-----------------|-----------------|-----------------|---|---|
| | | | Z _a | Z _b | V _e | X _{2a} | X _{2b} | X _{2c} | | |
| pmpy2.r | $r_1 = r_2, r_3$ | 7 | 0 | 1 | 0 | 2 | 1 | 3 | | |
| pmpy2.l | | | 0 | 0 | | | 0 | 3 | | |
| mix1.r | | | 0 | 1 | | | 0 | 2 | 0 | 1 |
| mix2.r | | | 0 | 1 | | | | | | |
| mix4.r | | | 1 | 0 | | | | | | |
| mix1.l | | | 0 | 0 | | | | | | |
| mix2.l | | | 0 | 1 | | | 0 | 2 | 0 | 1 |
| mix4.l | | | 1 | 0 | | | | | | |
| pack2.uss | | | 0 | 1 | | | | | | |
| pack2.sss | | | 0 | 1 | | | 0 | 2 | 0 | 1 |
| pack4.sss | | | 1 | 0 | | | | | | |
| unpack1.h | | | 0 | 0 | | | | | | |
| unpack2.h | | | 0 | 1 | | | 0 | 2 | 0 | 1 |
| unpack4.h | | | 1 | 0 | | | | | | |
| unpack1.l | | | 0 | 0 | | | | | | |
| unpack2.l | | | 0 | 1 | | | 0 | 2 | 0 | 1 |
| unpack4.l | | | 1 | 0 | | | | | | |
| pmin1.u | | | 0 | 0 | | | | | | |
| pmax1.u | | | 0 | 0 | | | 0 | 2 | 0 | 1 |
| pmin2 | | | 0 | 1 | | | | | | |
| pmax2 | 0 | 1 | 0 | 2 | 0 | 1 | | | | |
| psad1 | 0 | 0 | | | | | | | | |

4.3.1.3 Multimedia Mux1

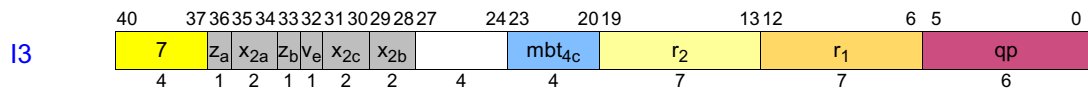

| Instruction | Operands | Opcode | Extension | | | | | |
|-------------|-----------------------|--------|----------------|----------------|----------------|-----------------|-----------------|-----------------|
| | | | Z _a | Z _b | V _e | X _{2a} | X _{2b} | X _{2c} |
| mux1 | $r_1 = r_2, mbtype_4$ | 7 | 0 | 0 | 0 | 3 | 2 | 2 |

4.3.1.4 Multimedia Mux2

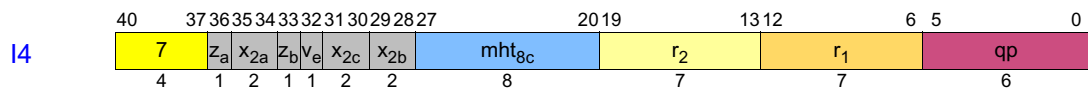

| Instruction | Operands | Opcode | Extension | | | | | |
|-------------|-----------------------|--------|----------------|----------------|----------------|-----------------|-----------------|-----------------|
| | | | Z _a | Z _b | V _e | X _{2a} | X _{2b} | X _{2c} |
| mux2 | $r_1 = r_2, mhtype_8$ | 7 | 0 | 1 | 0 | 3 | 2 | 2 |

4.3.1.5 Shift Right – Variable

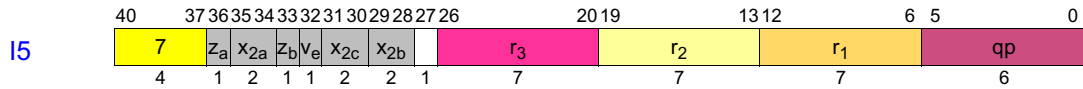

| Instruction | Operands | Opcode | Extension | | | | | |
|-------------|------------------|--------|----------------|----------------|----------------|-----------------|-----------------|-----------------|
| | | | Z _a | Z _b | V _e | X _{2a} | X _{2b} | X _{2c} |
| pshr2 | $r_1 = r_3, r_2$ | 7 | 0 | 1 | 0 | 0 | 2 | 0 |
| pshr4 | | | 1 | 0 | | | | |
| shr | | | 1 | 1 | | | | |
| pshr2.u | | | 0 | 1 | | | | |
| pshr4.u | | | 1 | 0 | | | | |
| shr.u | | | 1 | 1 | | | | |

4.3.1.6 Multimedia Shift Right – Fixed

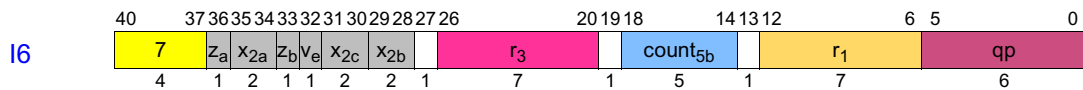

| Instruction | Operands | Opcode | Extension | | | | | |
|-------------|----------------------|--------|----------------|----------------|----------------|-----------------|-----------------|-----------------|
| | | | Z _a | Z _b | V _e | X _{2a} | X _{2b} | X _{2c} |
| pshr2 | $r_1 = r_3, count_5$ | 7 | 0 | 1 | 0 | 1 | 3 | 0 |
| pshr4 | | | 1 | 0 | | | | |
| pshr2.u | | | 0 | 1 | | | | |
| pshr4.u | | | 1 | 0 | | | | |

4.3.1.7 Shift Left – Variable

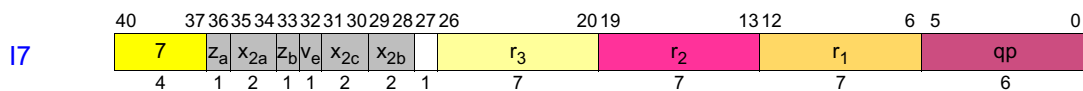

| Instruction | Operands | Opcode | Extension | | | | | |
|-------------|------------------|--------|----------------|----------------|----------------|-----------------|-----------------|-----------------|
| | | | Z _a | Z _b | V _e | X _{2a} | X _{2b} | X _{2c} |
| pshl2 | $r_1 = r_2, r_3$ | 7 | 0 | 1 | 0 | 0 | 0 | 1 |
| pshl4 | | | 1 | 0 | | | | |
| shl | | | 1 | 1 | | | | |

4.3.1.8 Multimedia Shift Left – Fixed

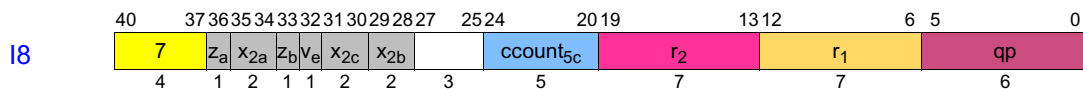

| Instruction | Operands | Opcode | Extension | | | | | |
|-------------|----------------------|--------|----------------|----------------|----------------|-----------------|-----------------|-----------------|
| | | | Z _a | Z _b | V _e | X _{2a} | X _{2b} | X _{2c} |
| pshl2 | $r_1 = r_2, count_5$ | 7 | 0 | 1 | 0 | 3 | 1 | 1 |
| pshl4 | | | 1 | 0 | | | | |

4.3.1.9 Population Count

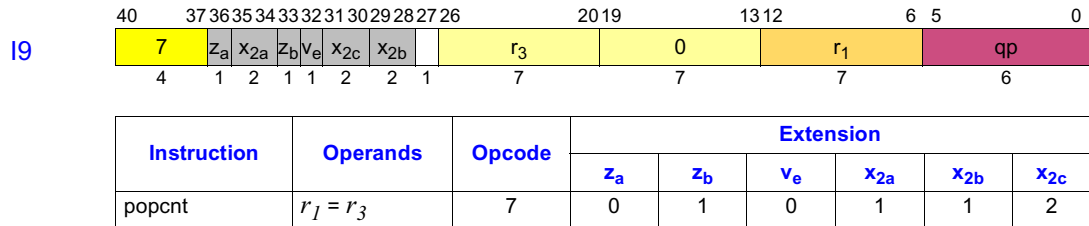

4.3.2 Integer Shifts

The integer shift, test bit, and test NaT instructions are encoded within major opcode 5 using a 2-bit opcode extension field in bits 35:34 (x_2) and a 1-bit opcode extension field in bit 33 (x). The extract and test bit instructions also have a 1-bit opcode extension field in bit 13 (y). Table 4-21 shows the test bit, extract, and shift right pair assignments.

Table 4-21. Integer Shift/Test Bit/Test NaT 2-bit Opcode Extensions

| Opcode Bits 40:37 | x_2 Bits 35:34 | x Bit 33 | y Bit 13 | |
|-------------------|------------------|------------|-----------------------|-----------------------|
| | | | 0 | 1 |
| 5 | 0 | 0 | Test Bit (Table 4-23) | Test NaT (Table 4-23) |
| | 1 | | extr.u l11 | extr l11 |
| | 2 | | | |
| | 3 | | shrp l10 | |

Most deposit instructions also have a 1-bit opcode extension field in bit 26 (y). Table 4-22 shows these assignments.

Table 4-22. Deposit Opcode Extensions

| Opcode Bits 40:37 | x_2 Bits 35:34 | x Bit 33 | y Bit 26 | |
|-------------------|------------------|------------|--------------------------------|------------------------------|
| | | | 0 | 1 |
| 5 | 0 | 1 | Test Bit/Test NaT (Table 4-23) | |
| | 1 | | dep.z l12 | dep.z – imm ₈ l13 |
| | 2 | | | |
| | 3 | | dep – imm ₁ l14 | |

4.3.2.1 Shift Right Pair

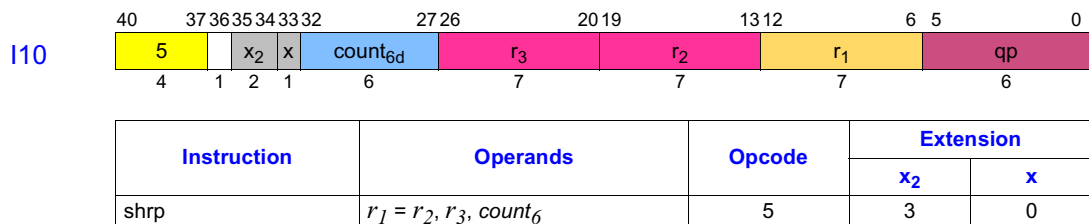

4.3.2.2 Extract

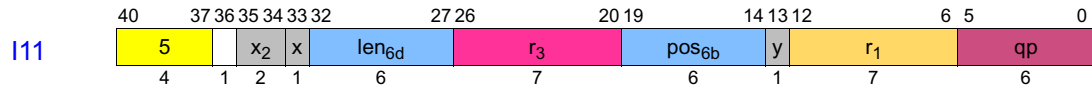

| Instruction | Operands | Opcode | Extension | | |
|-------------|---------------------------|--------|----------------|---|---|
| | | | x ₂ | x | y |
| extr.u | $r_1 = r_3, pos_6, len_6$ | 5 | 1 | 0 | 0 |
| extr | | | | | 1 |

4.3.2.3 Zero and Deposit

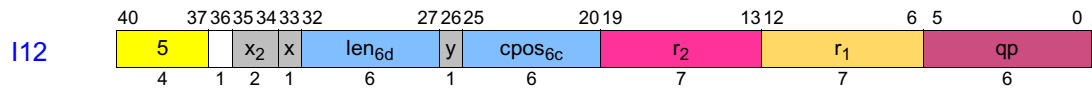

| Instruction | Operands | Opcode | Extension | | |
|-------------|---------------------------|--------|----------------|---|---|
| | | | x ₂ | x | y |
| dep.z | $r_1 = r_2, pos_6, len_6$ | 5 | 1 | 1 | 0 |

4.3.2.4 Zero and Deposit Immediate₈

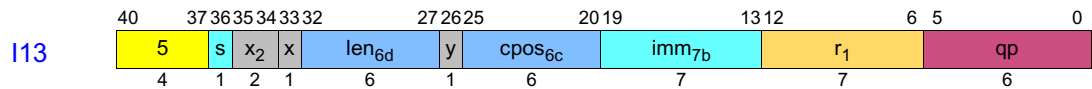

| Instruction | Operands | Opcode | Extension | | |
|-------------|-----------------------------|--------|----------------|---|---|
| | | | x ₂ | x | y |
| dep.z | $r_1 = imm_8, pos_6, len_6$ | 5 | 1 | 1 | 1 |

4.3.2.5 Deposit Immediate₁

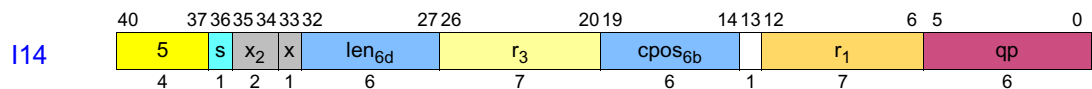

| Instruction | Operands | Opcode | Extension | |
|-------------|----------------------------------|--------|----------------|---|
| | | | x ₂ | x |
| dep | $r_1 = imm_1, r_3, pos_6, len_6$ | 5 | 3 | 1 |

4.3.2.6 Deposit

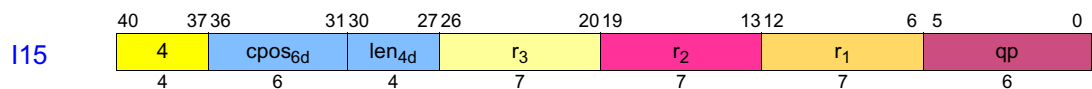

| Instruction | Operands | Opcode |
|-------------|--------------------------------|--------|
| dep | $r_1 = r_2, r_3, pos_6, len_4$ | 4 |

4.3.3 Test Bit

All test bit instructions are encoded within major opcode 5 using a 2-bit opcode extension field in bits 35:34 (x_2) plus four 1-bit opcode extension fields in bits 33 (t_a), 36 (t_b), 12 (c), and 19 (y).

Table 4-23 summarizes these assignments.

Table 4-23. Test Bit Opcode Extensions

| Opcode Bits 40:37 | x_2 Bits 35:34 | t_a Bit 33 | t_b Bit 36 | c Bit 12 | y Bit 13 | |
|----------------------|------------------------|-----------------|-----------------|---------------|----------------------|----------------------|
| | | | | | 0 | 1 |
| 5 | 0 | 0 | 0 | 0 | tbit.z I16 | tnat.z I17 |
| | | | | 1 | tbit.z.unc I16 | tnat.z.unc I17 |
| | | | 1 | 0 | tbit.z.and I16 | tnat.z.and I17 |
| | | | | 1 | tbit.nz.and I16 | tnat.nz.and I17 |
| | | 1 | 0 | 0 | tbit.z.or I16 | tnat.z.or I17 |
| | | | | 1 | tbit.nz.or I16 | tnat.nz.or I17 |
| | | | 1 | 0 | tbit.z.or.andcm I16 | tnat.z.or.andcm I17 |
| | | | | 1 | tbit.nz.or.andcm I16 | tnat.nz.or.andcm I17 |

4.3.3.1 Test Bit

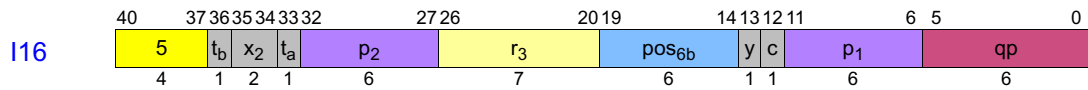

| Instruction | Operands | Opcode | Extension | | | | | |
|------------------|-------------------------|--------|-----------|-------|-------|-----|-----|---|
| | | | x_2 | t_a | t_b | y | c | |
| tbit.z | $p_1, p_2 = r_3, pos_6$ | 5 | 0 | 0 | 0 | 0 | 0 | |
| tbit.z.unc | | | | | 1 | | 1 | |
| tbit.z.and | | | | | 1 | | 0 | 0 |
| tbit.nz.and | | | | | | | 1 | 1 |
| tbit.z.or | | | | 1 | 0 | 0 | 0 | |
| tbit.nz.or | | | | | | 1 | 1 | |
| tbit.z.or.andcm | | | | | | 1 | 0 | 0 |
| tbit.nz.or.andcm | | | | | | | 1 | 1 |

4.3.3.2 Test NaT

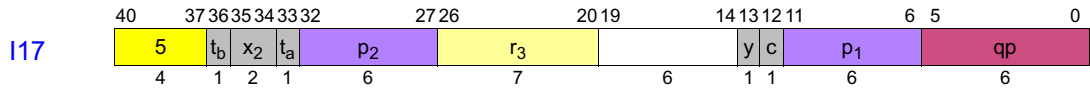

| Instruction | Operands | Opcode | Extension | | | | | | | |
|------------------|------------------|--------|-----------|-------|-------|-----|-----|---|---|---|
| | | | x_2 | t_a | t_b | y | c | | | |
| tnat.z | $p_1, p_2 = r_3$ | 5 | 0 | 0 | 0 | 1 | 0 | | | |
| tnat.z.unc | | | | | 1 | | 1 | | | |
| tnat.z.and | | | | | 0 | | 0 | 0 | | |
| tnat.nz.and | | | | | | | 1 | 1 | | |
| tnat.z.or | | | | 1 | 0 | 1 | 0 | 0 | | |
| tnat.nz.or | | | | | | | 1 | 1 | | |
| tnat.z.or.andcm | | | | | | | 1 | 1 | 0 | 0 |
| tnat.nz.or.andcm | | | | | | | | | 1 | 1 |

4.3.4 Miscellaneous I-Unit Instructions

The miscellaneous I-unit instructions are encoded in major opcode 0 using a 3-bit opcode extension field (x_3) in bits 35:33. Some also have a 6-bit opcode extension field (x_6) in bits 32:27. [Table 4-24](#) shows the 3-bit assignments and [Table 4-25](#) summarizes the 6-bit assignments.

Table 4-24. Misc I-Unit 3-bit Opcode Extensions

| Opcode Bits 40:37 | x_3 Bits 35:33 | |
|-------------------|------------------|--|
| 0 | 0 | 6-bit Ext (Table 4-25) |
| | 1 | chk.s.i – int I20 |
| | 2 | mov to pr.rot – imm ₄₄ I24 |
| | 3 | mov to pr I23 |
| | 4 | |
| | 5 | |
| | 6 | |
| | 7 | mov to b I21 |

Table 4-25. Misc I-Unit 6-bit Opcode Extensions

| Opcode Bits 40:37 | x ₃ Bits 35:33 | x ₆ | | | | |
|----------------------|---------------------------------|----------------|------------------------------------|------------|---|-------------------|
| | | Bits 30:27 | Bits 32:31 | | | |
| | | | 0 | 1 | 2 | 3 |
| 0 | 0 | 0 | break.i I19 | zxt1 I29 | | mov from ip I25 |
| | | 1 | 1-bit Ext (Table 4-26) | zxt2 I29 | | mov from b I22 |
| | | 2 | | zxt4 I29 | | mov.i from ar I28 |
| | | 3 | | | | mov from pr I25 |
| | | 4 | | sxt1 I29 | | |
| | | 5 | | sxt2 I29 | | |
| | | 6 | | sxt4 I29 | | |
| | | 7 | | | | |
| | | 8 | | czx1.l I29 | | |
| | | 9 | | czx2.l I29 | | |
| | | A | mov.i to ar – imm ₈ I27 | | | mov.i to ar I26 |
| | | B | | | | |
| | | C | | czx1.r I29 | | |
| | | D | | czx2.r I29 | | |
| | | E | | | | |
| | | F | | | | |

4.3.4.1 Nop/Hint (I-Unit)

I-unit nop and hint instructions are encoded within major opcode 0 using a 3-bit opcode extension field in bits 35:33 (x₃), a 6-bit opcode extension field in bits 32:27 (x₆), and a 1-bit opcode extension field in bit 26 (y), as shown in Table 4-26.

Table 4-26. Misc I-Unit 1-bit Opcode Extensions

| Opcode Bits 40:37 | x ₃ Bits 35:33 | x ₆ Bits 32:27 | y Bit 26 | |
|----------------------|---------------------------------|---------------------------------|----------------|--------|
| 0 | 0 | 01 | 0 | nop.i |
| | | | 1 | hint.i |

40 37 36 35 33 32 27 26 25 6 5 0

I18 0 i x₃ x₆ y imm_{20a} qp

4 1 3 6 1 20 6

| Instruction | Operands | Opcode | Extension | | |
|--------------------|-------------------|--------|----------------|----------------|---|
| | | | x ₃ | x ₆ | y |
| nop.i ¹ | imm ₂₁ | 0 | 0 | 01 | 0 |
| hint.i | | | 0 | 01 | 1 |

4.3.4.2 Break (I-Unit)

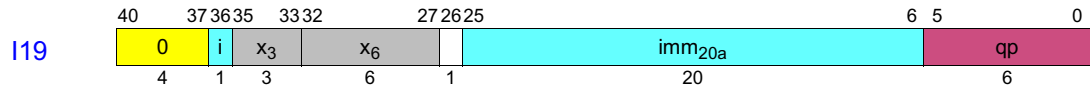

| Instruction | Operands | Opcode | Extension | |
|----------------------|-------------------|--------|----------------|----------------|
| | | | x ₃ | x ₆ |
| break.i ⁱ | imm ₂₁ | 0 | 0 | 00 |

4.3.4.3 Integer Speculation Check (I-Unit)

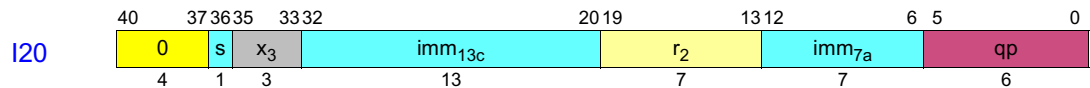

| Instruction | Operands | Opcode | Extension |
|-------------|---------------------------------------|--------|----------------|
| | | | x ₃ |
| chk.s.i | r ₂ , target ₂₅ | 0 | 1 |

4.3.5 GR/BR Moves

The GR/BR move instructions are encoded in major opcode 0. See “Miscellaneous I-Unit Instructions” on page 280 for a summary of the opcode extensions. The mov to BR instruction uses a 2-bit “whether” prediction hint field in bits 21:20 (wh) as shown in Table 4-27.

Table 4-27. Move to BR Whether Hint Completer

| wh Bits 21:20 | mwh |
|------------------|-------|
| 0 | .sptk |
| 1 | none |
| 2 | .dptk |
| 3 | |

The mov to BR instruction also uses a 1-bit opcode extension field (x) in bit 22 to distinguish the return form from the normal form, and a 1-bit hint extension in bit 23 (ih) (see Table 4-56 on page 4-318).

4.3.5.1 Move to BR

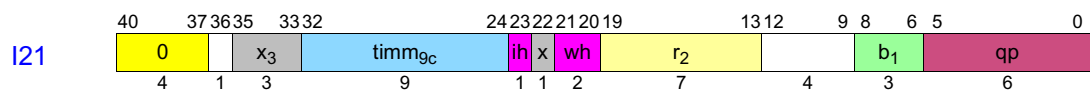

| Instruction | Operands | Opcode | Extension | | | |
|------------------------------|---|--------|----------------|--------|---------------------------------|---------------------------------|
| | | | x ₃ | x | ih | wh |
| mov.mwh.ih mov.ret.mwh.ih | b ₁ = r ₂ , tag ₁₃ | 0 | 7 | 0 1 | See Table 4-56 on page 4-318 | See Table 4-27 on page 4-282 |

4.3.5.2 Move from BR

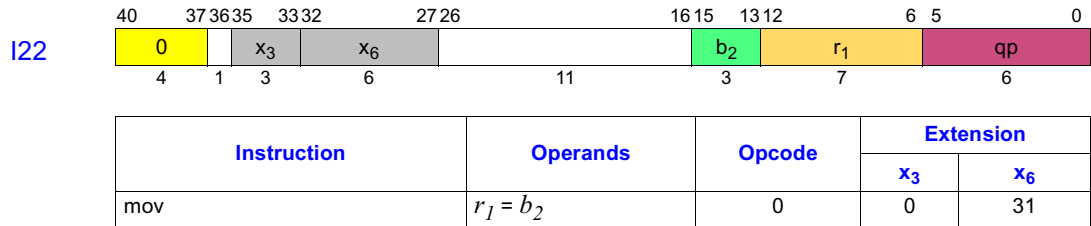

4.3.6 GR/Predicate/IP Moves

The GR/Predicate/IP move instructions are encoded in major opcode 0. See “Miscellaneous I-Unit Instructions” on page 280 for a summary of the opcode extensions.

4.3.6.1 Move to Predicates – Register

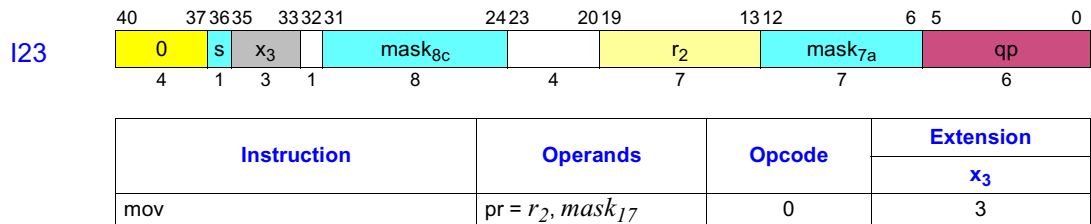

4.3.6.2 Move to Predicates – Immediate₄₄

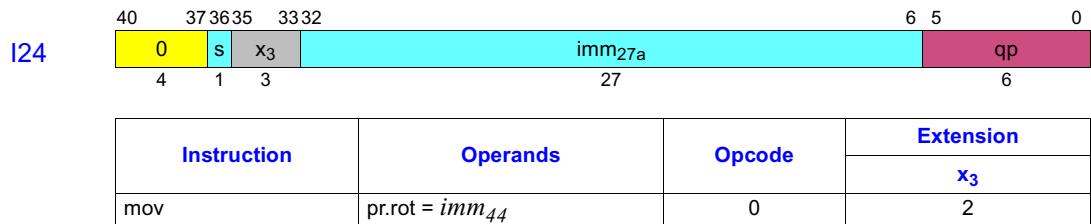

4.3.6.3 Move from Predicates/IP

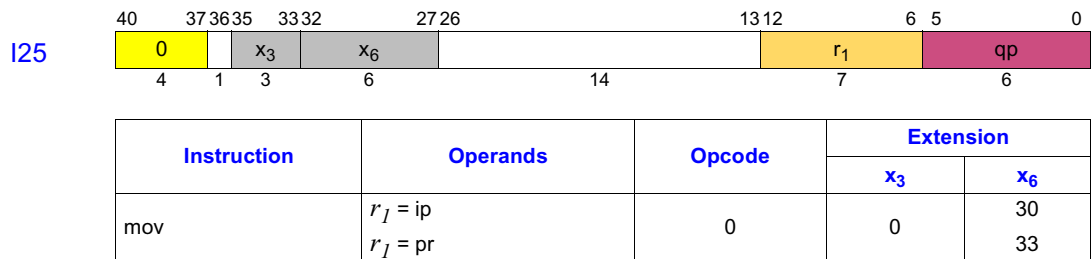

4.3.7 GR/AR Moves (I-Unit)

The I-Unit GR/AR move instructions are encoded in major opcode 0. (Some ARs are accessed using system/memory management instructions on the M-unit. See “GR/AR Moves (M-Unit)” on page 4-306.) See “Miscellaneous I-Unit Instructions” on page 280 for a summary of the I-Unit GR/AR opcode extensions.

4.3.7.1 Move to AR – Register (I-Unit)

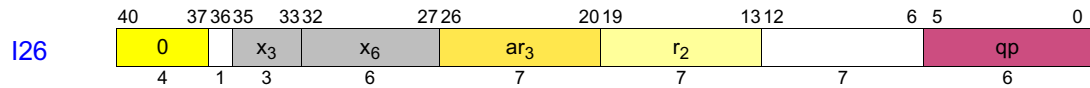

| Instruction | Operands | Opcode | Extension | |
|-------------|--------------|--------|----------------|----------------|
| | | | x ₃ | x ₆ |
| mov.i | $ar_3 = r_2$ | 0 | 0 | 2A |

4.3.7.2 Move to AR – Immediate₈ (I-Unit)

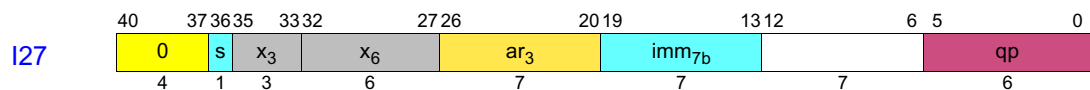

| Instruction | Operands | Opcode | Extension | |
|-------------|----------------|--------|----------------|----------------|
| | | | x ₃ | x ₆ |
| mov.i | $ar_3 = imm_8$ | 0 | 0 | 0A |

4.3.7.3 Move from AR (I-Unit)

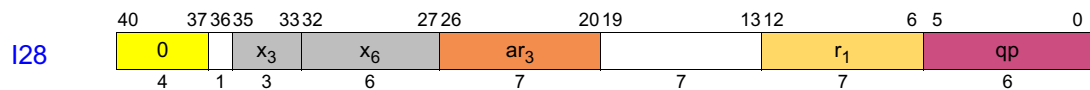

| Instruction | Operands | Opcode | Extension | |
|-------------|--------------|--------|----------------|----------------|
| | | | x ₃ | x ₆ |
| mov.i | $r_1 = ar_3$ | 0 | 0 | 32 |

4.3.8 Sign/Zero Extend/Compute Zero Index

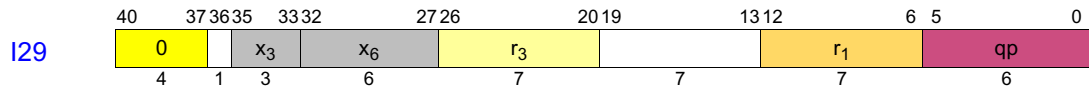

| Instruction | Operands | Opcode | Extension | |
|-------------|-------------|--------|----------------|----------------|
| | | | x ₃ | x ₆ |
| zxt1 | $r_1 = r_3$ | 0 | 0 | 10 |
| zxt2 | | | | 11 |
| zxt4 | | | | 12 |
| sxt1 | | | | 14 |
| sxt2 | | | | 15 |
| sxt4 | | | | 16 |
| czx1.l | | | | 18 |
| czx2.l | | | | 19 |
| czx1.r | | | | 1C |
| czx2.r | | | | 1D |

4.4 M-Unit Instruction Encodings

4.4.1 Loads and Stores

All load and store instructions are encoded within major opcodes 4, 5, 6, and 7 using a 6-bit opcode extension field in bits 35:30 (x_6). Instructions in major opcode 4 (integer load/store, semaphores, and get FR) use two 1-bit opcode extension fields in bit 36 (m) and bit 27 (x) as shown in [Table 4-28](#). Instructions in major opcode 6 (floating-point load/store, load pair, and set FR) use two 1-bit opcode extension fields in bit 36 (m) and bit 27 (x) as shown in [Table 4-29](#).

Table 4-28. Integer Load/Store/Semaphore/Get FR 1-bit Opcode Extensions

| Opcode Bits 40:37 | m Bit 36 | x Bit 27 | |
|-------------------|----------|----------|---|
| 4 | 0 | 0 | Load/Store (Table 4-30) |
| | 0 | 1 | Semaphore/get FR (Table 4-33) |
| | 1 | 0 | Load +Reg (Table 4-31) |
| | 1 | 1 | |

Table 4-29. Floating-point Load/Store/Load Pair/Set FR 1-bit Opcode Extensions

| Opcode Bits 40:37 | m Bit 36 | x Bit 27 | |
|-------------------|----------|----------|--|
| 6 | 0 | 0 | FP Load/Store (Table 4-34) |
| | 0 | 1 | FP Load Pair/set FR (Table 4-37) |
| | 1 | 0 | FP Load +Reg (Table 4-35) |
| | 1 | 1 | FP Load Pair +Imm (Table 4-38) |

The integer load/store opcode extensions are summarized in [Table 4-30 on page 4-286](#), [Table 4-31 on page 4-287](#), and [Table 4-32 on page 4-287](#), and the semaphore and get FR opcode extensions in [Table 4-33 on page 4-288](#). The floating-point load/store opcode extensions are summarized in [Table 4-34 on page 4-288](#), [Table 4-35 on page 4-289](#), and [Table 4-36 on page 4-289](#), the floating-point load pair and set FR opcode extensions in [Table 4-37 on page 4-290](#) and [Table 4-38 on page 4-290](#).

Table 4-30. Integer Load/Store Opcode Extensions

| Opcode Bits 40:37 | m Bit 36 | x Bit 27 | x ₆ | | | | |
|-------------------------|----------------|----------------|----------------|------------------|------------------|------------------|------------------|
| | | | Bits 35:32 | Bits 31:30 | | | |
| | | | | 0 | 1 | 2 | 3 |
| 4 | 0 | 0 | 0 | ld1 M1 | ld2 M1 | ld4 M1 | ld8 M1 |
| | | | 1 | ld1.s M1 | ld2.s M1 | ld4.s M1 | ld8.s M1 |
| | | | 2 | ld1.a M1 | ld2.a M1 | ld4.a M1 | ld8.a M1 |
| | | | 3 | ld1.sa M1 | ld2.sa M1 | ld4.sa M1 | ld8.sa M1 |
| | | | 4 | ld1.bias M1 | ld2.bias M1 | ld4.bias M1 | ld8.bias M1 |
| | | | 5 | ld1.acq M1 | ld2.acq M1 | ld4.acq M1 | ld8.acq M1 |
| | | | 6 | | | | ld8.fill M1 |
| | | | 7 | | | | |
| | | | 8 | ld1.c.clr M1 | ld2.c.clr M1 | ld4.c.clr M1 | ld8.c.clr M1 |
| | | | 9 | ld1.c.nc M1 | ld2.c.nc M1 | ld4.c.nc M1 | ld8.c.nc M1 |
| | | | A | ld1.c.clr.acq M1 | ld2.c.clr.acq M1 | ld4.c.clr.acq M1 | ld8.c.clr.acq M1 |
| | | | B | | | | |
| | | | C | st1 M4 | st2 M4 | st4 M4 | st8 M4 |
| | | | D | st1.rel M4 | st2.rel M4 | st4.rel M4 | st8.rel M4 |
| | | | E | | | | st8.spill M4 |
| | | | F | | | | |

Table 4-31. Integer Load +Reg Opcode Extensions

| Opcode Bits 40:37 | m Bit 36 | x Bit 27 | x ₆ | | | | |
|----------------------|-------------|-------------|----------------|------------------|------------------|------------------|------------------|
| | | | Bits 35:32 | Bits 31:30 | | | |
| | | | | 0 | 1 | 2 | 3 |
| 4 | 1 | 0 | 0 | ld1 M2 | ld2 M2 | ld4 M2 | ld8 M2 |
| | | | 1 | ld1.s M2 | ld2.s M2 | ld4.s M2 | ld8.s M2 |
| | | | 2 | ld1.a M2 | ld2.a M2 | ld4.a M2 | ld8.a M2 |
| | | | 3 | ld1.sa M2 | ld2.sa M2 | ld4.sa M2 | ld8.sa M2 |
| | | | 4 | ld1.bias M2 | ld2.bias M2 | ld4.bias M2 | ld8.bias M2 |
| | | | 5 | ld1.acq M2 | ld2.acq M2 | ld4.acq M2 | ld8.acq M2 |
| | | | 6 | | | | ld8.fill M2 |
| | | | 7 | | | | |
| | | | 8 | ld1.c.clr M2 | ld2.c.clr M2 | ld4.c.clr M2 | ld8.c.clr M2 |
| | | | 9 | ld1.c.nc M2 | ld2.c.nc M2 | ld4.c.nc M2 | ld8.c.nc M2 |
| | | | A | ld1.c.clr.acq M2 | ld2.c.clr.acq M2 | ld4.c.clr.acq M2 | ld8.c.clr.acq M2 |
| | | | B | | | | |
| | | | C | | | | |
| | | | D | | | | |
| | | | E | | | | |
| | | | F | | | | |

Table 4-32. Integer Load/Store +Imm Opcode Extensions

| Opcode Bits 40:37 | Bits 35:32 | x ₆ | | | |
|----------------------|---------------|------------------|------------------|------------------|------------------|
| | | Bits 31:30 | | | |
| | | 0 | 1 | 2 | 3 |
| 5 | 0 | ld1 M3 | ld2 M3 | ld4 M3 | ld8 M3 |
| | 1 | ld1.s M3 | ld2.s M3 | ld4.s M3 | ld8.s M3 |
| | 2 | ld1.a M3 | ld2.a M3 | ld4.a M3 | ld8.a M3 |
| | 3 | ld1.sa M3 | ld2.sa M3 | ld4.sa M3 | ld8.sa M3 |
| | 4 | ld1.bias M3 | ld2.bias M3 | ld4.bias M3 | ld8.bias M3 |
| | 5 | ld1.acq M3 | ld2.acq M3 | ld4.acq M3 | ld8.acq M3 |
| | 6 | | | | ld8.fill M3 |
| | 7 | | | | |
| | 8 | ld1.c.clr M3 | ld2.c.clr M3 | ld4.c.clr M3 | ld8.c.clr M3 |
| | 9 | ld1.c.nc M3 | ld2.c.nc M3 | ld4.c.nc M3 | ld8.c.nc M3 |
| | A | ld1.c.clr.acq M3 | ld2.c.clr.acq M3 | ld4.c.clr.acq M3 | ld8.c.clr.acq M3 |
| | B | | | | |
| | C | st1 M5 | st2 M5 | st4 M5 | st8 M5 |
| | D | st1.rel M5 | st2.rel M5 | st4.rel M5 | st8.rel M5 |
| | E | | | | st8.spill M5 |
| | F | | | | |

Table 4-33. Semaphore/Get FR/16-Byte Opcode Extensions

| Opcode Bits 40:37 | m Bit 36 | x Bit 27 | x ₆ | | | | |
|----------------------|-------------|-------------|----------------|--------------------|------------------|-------------------|-------------------|
| | | | Bits 35:32 | Bits 31:30 | | | |
| | | | | 0 | 1 | 2 | 3 |
| 4 | 0 | 1 | 0 | cmpxchg1.acq M16 | cmpxchg2.acq M16 | cmpxchg4.acq M16 | cmpxchg8.acq M16 |
| | | | 1 | cmpxchg1.rel M16 | cmpxchg2.rel M16 | cmpxchg4.rel M16 | cmpxchg8.rel M16 |
| | | | 2 | xchg1 M16 | xchg2 M16 | xchg4 M16 | xchg8 M16 |
| | | | 3 | | | | |
| | | | 4 | | | fetchadd4.acq M17 | fetchadd8.acq M17 |
| | | | 5 | | | fetchadd4.rel M17 | fetchadd8.rel M17 |
| | | | 6 | | | | |
| | | | 7 | getf.sig M19 | getf.exp M19 | getf.s M19 | getf.d M19 |
| | | | 8 | cmp8xchg16.acq M16 | | | |
| | | | 9 | cmp8xchg16.rel M16 | | | |
| | | | A | ld16 M1 | | | |
| | | | B | ld16.acq M1 | | | |
| | | | C | st16 M4 | | | |
| | | | D | st16.rel M4 | | | |
| | | | E | | | | |
| | | | F | | | | |

Table 4-34. Floating-point Load/Store/Lfetch Opcode Extensions

| Opcode Bits 40:37 | m Bit 36 | x Bit 27 | x ₆ | | | | |
|----------------------|-------------|-------------|----------------|---------------|-----------------|------------------|-----------------------|
| | | | Bits 35:32 | Bits 31:30 | | | |
| | | | | 0 | 1 | 2 | 3 |
| 6 | 0 | 0 | 0 | ldfe M6 | ldf8 M6 | ldfs M6 | ldfd M6 |
| | | | 1 | ldfe.s M6 | ldf8.s M6 | ldfs.s M6 | ldfd.s M6 |
| | | | 2 | ldfe.a M6 | ldf8.a M6 | ldfs.a M6 | ldfd.a M6 |
| | | | 3 | ldfe.sa M6 | ldf8.sa M6 | ldfs.sa M6 | ldfd.sa M6 |
| | | | 4 | | | | |
| | | | 5 | | | | |
| | | | 6 | | | | ldf.fill M6 |
| | | | 7 | | | | |
| | | | 8 | ldfe.c.clr M6 | ldf8.c.clr M6 | ldfs.c.clr M6 | ldfd.c.clr M6 |
| | | | 9 | ldfe.c.nc M6 | ldf8.c.nc M6 | ldfs.c.nc M6 | ldfd.c.nc M6 |
| | | | A | | | | |
| | | | B | lfetch M13 | lfetch.excl M13 | lfetch.fault M13 | lfetch.fault.excl M13 |
| | | | C | stfe M9 | stf8 M9 | stfs M9 | stfd M9 |
| | | | D | | | | |
| | | | E | | | | stf.spill M9 |
| | | | F | | | | |

Table 4-35. Floating-point Load/Lfetch +Reg Opcode Extensions

| Opcode Bits 40:37 | m Bit 36 | x Bit 27 | x ₆ | | | | |
|-------------------|----------|----------|----------------|---------------|-----------------|------------------|-----------------------|
| | | | Bits 35:32 | Bits 31:30 | | | |
| | | | | 0 | 1 | 2 | 3 |
| 6 | 1 | 0 | 0 | ldfe M7 | ldf8 M7 | ldfs M7 | ldfd M7 |
| | | | 1 | ldfe.s M7 | ldf8.s M7 | ldfs.s M7 | ldfd.s M7 |
| | | | 2 | ldfe.a M7 | ldf8.a M7 | ldfs.a M7 | ldfd.a M7 |
| | | | 3 | ldfe.sa M7 | ldf8.sa M7 | ldfs.sa M7 | ldfd.sa M7 |
| | | | 4 | | | | |
| | | | 5 | | | | |
| | | | 6 | | | | ldf.fill M7 |
| | | | 7 | | | | |
| | | | 8 | ldfe.c.clr M7 | ldf8.c.clr M7 | ldfs.c.clr M7 | ldfd.c.clr M7 |
| | | | 9 | ldfe.c.nc M7 | ldf8.c.nc M7 | ldfs.c.nc M7 | ldfd.c.nc M7 |
| | | | A | | | | |
| | | | B | lfetch M14 | lfetch.excl M14 | lfetch.fault M14 | lfetch.fault.excl M14 |
| | | | C | | | | |
| | | | D | | | | |
| | | | E | | | | |
| | | | F | | | | |

Table 4-36. Floating-point Load/Store/Lfetch +Imm Opcode Extensions

| Opcode Bits 40:37 | Bits 35:32 | x ₆ | | | |
|-------------------|------------|----------------|-----------------|------------------|-----------------------|
| | | Bits 31:30 | | | |
| | | 0 | 1 | 2 | 3 |
| 7 | 0 | ldfe M8 | ldf8 M8 | ldfs M8 | ldfd M8 |
| | 1 | ldfe.s M8 | ldf8.s M8 | ldfs.s M8 | ldfd.s M8 |
| | 2 | ldfe.a M8 | ldf8.a M8 | ldfs.a M8 | ldfd.a M8 |
| | 3 | ldfe.sa M8 | ldf8.sa M8 | ldfs.sa M8 | ldfd.sa M8 |
| | 4 | | | | |
| | 5 | | | | |
| | 6 | | | | ldf.fill M8 |
| | 7 | | | | |
| | 8 | ldfe.c.clr M8 | ldf8.c.clr M8 | ldfs.c.clr M8 | ldfd.c.clr M8 |
| | 9 | ldfe.c.nc M8 | ldf8.c.nc M8 | ldfs.c.nc M8 | ldfd.c.nc M8 |
| | A | | | | |
| | B | lfetch M15 | lfetch.excl M15 | lfetch.fault M15 | lfetch.fault.excl M15 |
| | C | stfe M10 | stf8 M10 | stfs M10 | stfd M10 |
| | D | | | | |
| | E | | | | stf.spill M10 |
| | F | | | | |

Table 4-37. Floating-point Load Pair/Set FR Opcode Extensions

| Opcode Bits 40:37 | m Bit 36 | x Bit 27 | x ₆ | | | | |
|-------------------------|----------------|----------------|----------------|--------------|-----------------|-----------------|-----------------|
| | | | Bits 35:32 | Bits 31:30 | | | |
| | | | | 0 | 1 | 2 | 3 |
| 6 | 0 | 1 | 0 | | ldfp8 M11 | ldfps M11 | ldfpd M11 |
| | | | 1 | | ldfp8.s M11 | ldfps.s M11 | ldfpd.s M11 |
| | | | 2 | | ldfp8.a M11 | ldfps.a M11 | ldfpd.a M11 |
| | | | 3 | | ldfp8.sa M11 | ldfps.sa M11 | ldfpd.sa M11 |
| | | | 4 | | | | |
| | | | 5 | | | | |
| | | | 6 | | | | |
| | | | 7 | setf.sig M18 | setf.exp M18 | setf.s M18 | setf.d M18 |
| | | | 8 | | ldfp8.c.clr M11 | ldfps.c.clr M11 | ldfpd.c.clr M11 |
| | | | 9 | | ldfp8.c.nc M11 | ldfps.c.nc M11 | ldfpd.c.nc M11 |
| | | | A | | | | |
| | | | B | | | | |
| | | | C | | | | |
| | | | D | | | | |
| | | | E | | | | |
| | | | F | | | | |

Table 4-38. Floating-point Load Pair +Imm Opcode Extensions

| Opcode Bits 40:37 | m Bit 36 | x Bit 27 | x ₆ | | | | |
|-------------------------|----------------|----------------|----------------|------------|-----------------|-----------------|-----------------|
| | | | Bits 35:32 | Bits 31:30 | | | |
| | | | | 0 | 1 | 2 | 3 |
| 6 | 1 | 1 | 0 | | ldfp8 M12 | ldfps M12 | ldfpd M12 |
| | | | 1 | | ldfp8.s M12 | ldfps.s M12 | ldfpd.s M12 |
| | | | 2 | | ldfp8.a M12 | ldfps.a M12 | ldfpd.a M12 |
| | | | 3 | | ldfp8.sa M12 | ldfps.sa M12 | ldfpd.sa M12 |
| | | | 4 | | | | |
| | | | 5 | | | | |
| | | | 6 | | | | |
| | | | 7 | | | | |
| | | | 8 | | ldfp8.c.clr M12 | ldfps.c.clr M12 | ldfpd.c.clr M12 |
| | | | 9 | | ldfp8.c.nc M12 | ldfps.c.nc M12 | ldfpd.c.nc M12 |
| | | | A | | | | |
| | | | B | | | | |
| | | | C | | | | |
| | | | D | | | | |
| | | | E | | | | |
| | | | F | | | | |

The load and store instructions all have a 2-bit opcode extension field in bits 29:28 (hint) which encodes locality hint information. [Table 4-39](#) and [Table 4-40](#) summarize these assignments.

Table 4-39. Load Hint Completer

| hint Bits 29:28 | <i>ldhint</i> |
|--------------------|---------------|
| 0 | <i>none</i> |
| 1 | <i>.nt1</i> |
| 2 | |
| 3 | <i>.nta</i> |

Table 4-40. Store Hint Completer

| hint Bits 29:28 | <i>sthint</i> |
|--------------------|---------------|
| 0 | <i>none</i> |
| 1 | |
| 2 | |
| 3 | <i>.nta</i> |

4.4.1.1 Integer Load

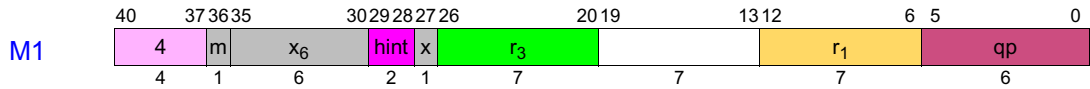

| Instruction | Operands | Opcode | Extension | | | |
|------------------------------|-----------------------|--------|-----------|---|----------------|---------------------------------|
| | | | m | x | x ₆ | hint |
| ld1. <i>ldhint</i> | $r_1 = [r_3]$ | 4 | 0 | 0 | 00 | See Table 4-39 on page 4-291 |
| ld2. <i>ldhint</i> | | | | | 01 | |
| ld4. <i>ldhint</i> | | | | | 02 | |
| ld8. <i>ldhint</i> | | | | | 03 | |
| ld1.s. <i>ldhint</i> | | | | | 04 | |
| ld2.s. <i>ldhint</i> | | | | | 05 | |
| ld4.s. <i>ldhint</i> | | | | | 06 | |
| ld8.s. <i>ldhint</i> | | | | | 07 | |
| ld1.a. <i>ldhint</i> | | | | | 08 | |
| ld2.a. <i>ldhint</i> | | | | | 09 | |
| ld4.a. <i>ldhint</i> | | | | | 0A | |
| ld8.a. <i>ldhint</i> | | | | | 0B | |
| ld1.sa. <i>ldhint</i> | | | | | 0C | |
| ld2.sa. <i>ldhint</i> | | | | | 0D | |
| ld4.sa. <i>ldhint</i> | | | | | 0E | |
| ld8.sa. <i>ldhint</i> | | | | | 0F | |
| ld1.bias. <i>ldhint</i> | | | | | 10 | |
| ld2.bias. <i>ldhint</i> | | | | | 11 | |
| ld4.bias. <i>ldhint</i> | | | | | 12 | |
| ld8.bias. <i>ldhint</i> | | | | | 13 | |
| ld1.acq. <i>ldhint</i> | | | | | 14 | |
| ld2.acq. <i>ldhint</i> | | | | | 15 | |
| ld4.acq. <i>ldhint</i> | | | | | 16 | |
| ld8.acq. <i>ldhint</i> | | | | | 17 | |
| ld8.fill. <i>ldhint</i> | | | | | 1B | |
| ld1.c.clr. <i>ldhint</i> | | | | | 20 | |
| ld2.c.clr. <i>ldhint</i> | | | | | 21 | |
| ld4.c.clr. <i>ldhint</i> | | | | | 22 | |
| ld8.c.clr. <i>ldhint</i> | | | | | 23 | |
| ld1.c.nc. <i>ldhint</i> | | | | | 24 | |
| ld2.c.nc. <i>ldhint</i> | | | | | 25 | |
| ld4.c.nc. <i>ldhint</i> | | | | | 26 | |
| ld8.c.nc. <i>ldhint</i> | 27 | | | | | |
| ld1.c.clr.acq. <i>ldhint</i> | 28 | | | | | |
| ld2.c.clr.acq. <i>ldhint</i> | 29 | | | | | |
| ld4.c.clr.acq. <i>ldhint</i> | 2A | | | | | |
| ld8.c.clr.acq. <i>ldhint</i> | 2B | | | | | |
| ld16. <i>ldhint</i> | $r_1, ar.csd = [r_3]$ | | 0 | 1 | 28 | |
| ld16.acq. <i>ldhint</i> | | | 2C | | | |

4.4.1.2 Integer Load – Increment by Register

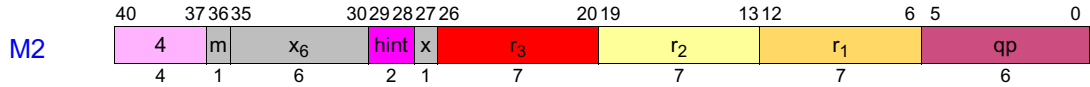

| Instruction | Operands | Opcode | Extension | | | |
|----------------------------------|--------------------|--------|-----------|---|----------------|---------------------------------|
| | | | m | x | x ₆ | hint |
| ld1.l _{dhint} | $r_1 = [r_3], r_2$ | 4 | 1 | 0 | 00 | See Table 4-39 on page 4-291 |
| ld2.l _{dhint} | | | | | 01 | |
| ld4.l _{dhint} | | | | | 02 | |
| ld8.l _{dhint} | | | | | 03 | |
| ld1.s.l _{dhint} | | | | | 04 | |
| ld2.s.l _{dhint} | | | | | 05 | |
| ld4.s.l _{dhint} | | | | | 06 | |
| ld8.s.l _{dhint} | | | | | 07 | |
| ld1.a.l _{dhint} | | | | | 08 | |
| ld2.a.l _{dhint} | | | | | 09 | |
| ld4.a.l _{dhint} | | | | | 0A | |
| ld8.a.l _{dhint} | | | | | 0B | |
| ld1.sa.l _{dhint} | | | | | 0C | |
| ld2.sa.l _{dhint} | | | | | 0D | |
| ld4.sa.l _{dhint} | | | | | 0E | |
| ld8.sa.l _{dhint} | | | | | 0F | |
| ld1.bias.l _{dhint} | | | | | 10 | |
| ld2.bias.l _{dhint} | | | | | 11 | |
| ld4.bias.l _{dhint} | | | | | 12 | |
| ld8.bias.l _{dhint} | | | | | 13 | |
| ld1.acq.l _{dhint} | | | | | 14 | |
| ld2.acq.l _{dhint} | | | | | 15 | |
| ld4.acq.l _{dhint} | | | | | 16 | |
| ld8.acq.l _{dhint} | | | | | 17 | |
| ld8.fill.l _{dhint} | | | | | 1B | |
| ld1.c.clr.l _{dhint} | | | | | 20 | |
| ld2.c.clr.l _{dhint} | | | | | 21 | |
| ld4.c.clr.l _{dhint} | | | | | 22 | |
| ld8.c.clr.l _{dhint} | | | | | 23 | |
| ld1.c.nc.l _{dhint} | | | | | 24 | |
| ld2.c.nc.l _{dhint} | | | | | 25 | |
| ld4.c.nc.l _{dhint} | | | | | 26 | |
| ld8.c.nc.l _{dhint} | 27 | | | | | |
| ld1.c.clr.acq.l _{dhint} | 28 | | | | | |
| ld2.c.clr.acq.l _{dhint} | 29 | | | | | |
| ld4.c.clr.acq.l _{dhint} | 2A | | | | | |
| ld8.c.clr.acq.l _{dhint} | 2B | | | | | |

4.4.1.3 Integer Load – Increment by Immediate



| Instruction | Operands | Opcode | Extension | |
|----------------------------------|----------------------|--------|----------------|------------------------------|
| | | | x ₆ | hint |
| ld1.l ^{dhint} | $r_1 = [r_3], imm_9$ | 5 | 00 | See Table 4-39 on page 4-291 |
| ld2.l ^{dhint} | | | 01 | |
| ld4.l ^{dhint} | | | 02 | |
| ld8.l ^{dhint} | | | 03 | |
| ld1.s.l ^{dhint} | | | 04 | |
| ld2.s.l ^{dhint} | | | 05 | |
| ld4.s.l ^{dhint} | | | 06 | |
| ld8.s.l ^{dhint} | | | 07 | |
| ld1.a.l ^{dhint} | | | 08 | |
| ld2.a.l ^{dhint} | | | 09 | |
| ld4.a.l ^{dhint} | | | 0A | |
| ld8.a.l ^{dhint} | | | 0B | |
| ld1.sa.l ^{dhint} | | | 0C | |
| ld2.sa.l ^{dhint} | | | 0D | |
| ld4.sa.l ^{dhint} | | | 0E | |
| ld8.sa.l ^{dhint} | | | 0F | |
| ld1.bias.l ^{dhint} | | | 10 | |
| ld2.bias.l ^{dhint} | | | 11 | |
| ld4.bias.l ^{dhint} | | | 12 | |
| ld8.bias.l ^{dhint} | | | 13 | |
| ld1.acq.l ^{dhint} | | | 14 | |
| ld2.acq.l ^{dhint} | | | 15 | |
| ld4.acq.l ^{dhint} | | | 16 | |
| ld8.acq.l ^{dhint} | | | 17 | |
| ld8.fill.l ^{dhint} | | | 1B | |
| ld1.c.clr.l ^{dhint} | | | 20 | |
| ld2.c.clr.l ^{dhint} | | | 21 | |
| ld4.c.clr.l ^{dhint} | | | 22 | |
| ld8.c.clr.l ^{dhint} | | | 23 | |
| ld1.c.nc.l ^{dhint} | | | 24 | |
| ld2.c.nc.l ^{dhint} | | | 25 | |
| ld4.c.nc.l ^{dhint} | | | 26 | |
| ld8.c.nc.l ^{dhint} | 27 | | | |
| ld1.c.clr.acq.l ^{dhint} | 28 | | | |
| ld2.c.clr.acq.l ^{dhint} | 29 | | | |
| ld4.c.clr.acq.l ^{dhint} | 2A | | | |
| ld8.c.clr.acq.l ^{dhint} | 2B | | | |

4.4.1.4 Integer Store

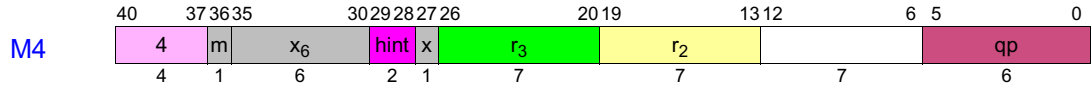

| Instruction | Operands | Opcode | Extension | | | |
|--------------------------|------------------------------------|--------|-----------|---|---|------------------------------|
| | | | m | x | x ₆ | hint |
| st1. <i>sthint</i> | [r ₃] = r ₂ | 4 | 0 | 0 | 30 | See Table 4-40 on page 4-291 |
| st2. <i>sthint</i> | | | | | 31 | |
| st4. <i>sthint</i> | | | | | 32 | |
| st8. <i>sthint</i> | | | | | 33 | |
| st1.rel. <i>sthint</i> | | | | | 34 | |
| st2.rel. <i>sthint</i> | | | | | 35 | |
| st4.rel. <i>sthint</i> | | | | | 36 | |
| st8.rel. <i>sthint</i> | | | | | 37 | |
| st8.spill. <i>sthint</i> | | | | | 3B | |
| st16. <i>sthint</i> | | | | | [r ₃] = r ₂ , ar.csd | |
| st16.rel. <i>sthint</i> | 34 | | | | | |

4.4.1.5 Integer Store – Increment by Immediate



| Instruction | Operands | Opcode | Extension | | | |
|--------------------------|---|--------|----------------|------|----|------------------------------|
| | | | x ₆ | hint | | |
| st1. <i>sthint</i> | [r ₃] = r ₂ , imm ₉ | 5 | | | 30 | See Table 4-40 on page 4-291 |
| st2. <i>sthint</i> | | | | | 31 | |
| st4. <i>sthint</i> | | | | | 32 | |
| st8. <i>sthint</i> | | | | | 33 | |
| st1.rel. <i>sthint</i> | | | | | 34 | |
| st2.rel. <i>sthint</i> | | | | | 35 | |
| st4.rel. <i>sthint</i> | | | | | 36 | |
| st8.rel. <i>sthint</i> | | | | | 37 | |
| st8.spill. <i>sthint</i> | | | | | 3B | |

4.4.1.6 Floating-point Load



| Instruction | Operands | Opcode | Extension | | | |
|--------------------------|---------------|--------|-----------|---|----------------|------------------------------|
| | | | m | x | x ₆ | hint |
| <i>ldfs.ldhint</i> | $f_1 = [r_3]$ | 6 | 0 | 0 | 02 | See Table 4-39 on page 4-291 |
| <i>ldfd.ldhint</i> | | | | | 03 | |
| <i>ldf8.ldhint</i> | | | | | 01 | |
| <i>ldfe.ldhint</i> | | | | | 00 | |
| <i>ldfs.s.ldhint</i> | | | | | 06 | |
| <i>ldfd.s.ldhint</i> | | | | | 07 | |
| <i>ldf8.s.ldhint</i> | | | | | 05 | |
| <i>ldfe.s.ldhint</i> | | | | | 04 | |
| <i>ldfs.a.ldhint</i> | | | | | 0A | |
| <i>ldfd.a.ldhint</i> | | | | | 0B | |
| <i>ldf8.a.ldhint</i> | | | | | 09 | |
| <i>ldfe.a.ldhint</i> | | | | | 08 | |
| <i>ldfs.sa.ldhint</i> | | | | | 0E | |
| <i>ldfd.sa.ldhint</i> | | | | | 0F | |
| <i>ldf8.sa.ldhint</i> | | | | | 0D | |
| <i>ldfe.sa.ldhint</i> | | | | | 0C | |
| <i>ldf.fill.ldhint</i> | | | | | 1B | |
| <i>ldfs.c.clr.ldhint</i> | | | | | 22 | |
| <i>ldfd.c.clr.ldhint</i> | | | | | 23 | |
| <i>ldf8.c.clr.ldhint</i> | | | | | 21 | |
| <i>ldfe.c.clr.ldhint</i> | | | | | 20 | |
| <i>ldfs.c.nc.ldhint</i> | | | | | 26 | |
| <i>ldfd.c.nc.ldhint</i> | | | | | 27 | |
| <i>ldf8.c.nc.ldhint</i> | | | | | 25 | |
| <i>ldfe.c.nc.ldhint</i> | | | | | 24 | |

4.4.1.7 Floating-point Load – Increment by Register

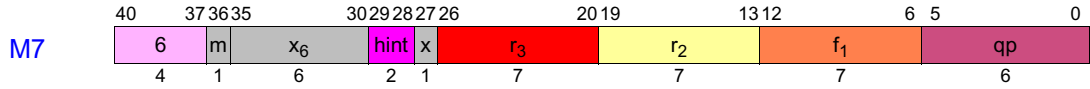

| Instruction | Operands | Opcode | Extension | | | |
|--------------------------|--------------------|--------|-----------|---|----------------|------------------------------|
| | | | m | x | x ₆ | hint |
| <i>ldfs.ldhint</i> | $f_1 = [r_3], r_2$ | 6 | 1 | 0 | 02 | See Table 4-39 on page 4-291 |
| <i>ldfd.ldhint</i> | | | | | 03 | |
| <i>ldf8.ldhint</i> | | | | | 01 | |
| <i>ldfe.ldhint</i> | | | | | 00 | |
| <i>ldfs.s.ldhint</i> | | | | | 06 | |
| <i>ldfd.s.ldhint</i> | | | | | 07 | |
| <i>ldf8.s.ldhint</i> | | | | | 05 | |
| <i>ldfe.s.ldhint</i> | | | | | 04 | |
| <i>ldfs.a.ldhint</i> | | | | | 0A | |
| <i>ldfd.a.ldhint</i> | | | | | 0B | |
| <i>ldf8.a.ldhint</i> | | | | | 09 | |
| <i>ldfe.a.ldhint</i> | | | | | 08 | |
| <i>ldfs.sa.ldhint</i> | | | | | 0E | |
| <i>ldfd.sa.ldhint</i> | | | | | 0F | |
| <i>ldf8.sa.ldhint</i> | | | | | 0D | |
| <i>ldfe.sa.ldhint</i> | | | | | 0C | |
| <i>ldf.fill.ldhint</i> | | | | | 1B | |
| <i>ldfs.c.clr.ldhint</i> | | | | | 22 | |
| <i>ldfd.c.clr.ldhint</i> | | | | | 23 | |
| <i>ldf8.c.clr.ldhint</i> | | | | | 21 | |
| <i>ldfe.c.clr.ldhint</i> | | | | | 20 | |
| <i>ldfs.c.nc.ldhint</i> | | | | | 26 | |
| <i>ldfd.c.nc.ldhint</i> | | | | | 27 | |
| <i>ldf8.c.nc.ldhint</i> | | | | | 25 | |
| <i>ldfe.c.nc.ldhint</i> | 24 | | | | | |

4.4.1.8 Floating-point Load – Increment by Immediate

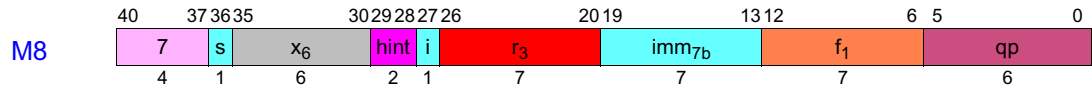

| Instruction | Operands | Opcode | Extension | |
|--------------------------|----------------------|--------|----------------|------------------------------|
| | | | x ₆ | hint |
| <i>ldfs.ldhint</i> | $f_1 = [r_3], imm_9$ | 7 | 02 | See Table 4-39 on page 4-291 |
| <i>ldfd.ldhint</i> | | | 03 | |
| <i>ldf8.ldhint</i> | | | 01 | |
| <i>ldfe.ldhint</i> | | | 00 | |
| <i>ldfs.s.ldhint</i> | | | 06 | |
| <i>ldfd.s.ldhint</i> | | | 07 | |
| <i>ldf8.s.ldhint</i> | | | 05 | |
| <i>ldfe.s.ldhint</i> | | | 04 | |
| <i>ldfs.a.ldhint</i> | | | 0A | |
| <i>ldfd.a.ldhint</i> | | | 0B | |
| <i>ldf8.a.ldhint</i> | | | 09 | |
| <i>ldfe.a.ldhint</i> | | | 08 | |
| <i>ldfs.sa.ldhint</i> | | | 0E | |
| <i>ldfd.sa.ldhint</i> | | | 0F | |
| <i>ldf8.sa.ldhint</i> | | | 0D | |
| <i>ldfe.sa.ldhint</i> | | | 0C | |
| <i>ldf.fill.ldhint</i> | | | 1B | |
| <i>ldfs.c.clr.ldhint</i> | | | 22 | |
| <i>ldfd.c.clr.ldhint</i> | | | 23 | |
| <i>ldf8.c.clr.ldhint</i> | | | 21 | |
| <i>ldfe.c.clr.ldhint</i> | | | 20 | |
| <i>ldfs.c.nc.ldhint</i> | | | 26 | |
| <i>ldfd.c.nc.ldhint</i> | | | 27 | |
| <i>ldf8.c.nc.ldhint</i> | | | 25 | |
| <i>ldfe.c.nc.ldhint</i> | 24 | | | |

4.4.1.9 Floating-point Store

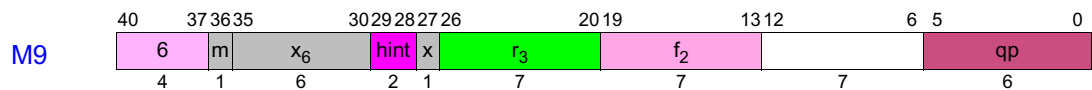

| Instruction | Operands | Opcode | Extension | | | |
|-------------------------|---------------|--------|-----------|---|----------------|------------------------------|
| | | | m | x | x ₆ | hint |
| <i>stfs.sthint</i> | $[r_3] = f_2$ | 6 | 0 | 0 | 32 | See Table 4-40 on page 4-291 |
| <i>stfd.sthint</i> | | | | | 33 | |
| <i>stf8.sthint</i> | | | | | 31 | |
| <i>stfe.sthint</i> | | | | | 30 | |
| <i>stf.spill.sthint</i> | | | | | 3B | |

4.4.1.10 Floating-point Store – Increment by Immediate

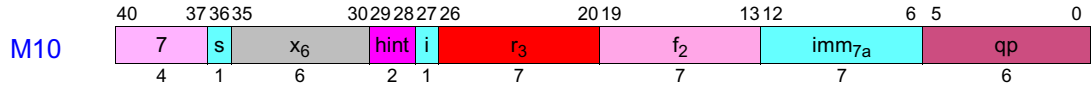

| Instruction | Operands | Opcode | Extension | |
|--------------------------|----------------------|--------|----------------|------------------------------|
| | | | x ₆ | hint |
| stfs. <i>sthint</i> | $[r_3] = f_2, imm_9$ | 7 | 32 | See Table 4-40 on page 4-291 |
| stfd. <i>sthint</i> | | | 33 | |
| stf8. <i>sthint</i> | | | 31 | |
| stfe. <i>sthint</i> | | | 30 | |
| stf.spill. <i>sthint</i> | | | 3B | |

4.4.1.11 Floating-point Load Pair

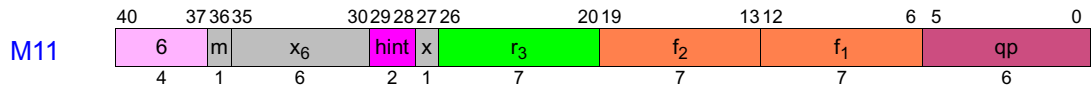

| Instruction | Operands | Opcode | Extension | | | |
|----------------------------|--------------------|--------|-----------|---|----------------|------------------------------|
| | | | m | x | x ₆ | hint |
| ldfps. <i>ldhint</i> | $f_1, f_2 = [r_3]$ | 6 | 0 | 1 | 02 | See Table 4-39 on page 4-291 |
| ldfpd. <i>ldhint</i> | | | | | 03 | |
| ldfp8. <i>ldhint</i> | | | | | 01 | |
| ldfps.s. <i>ldhint</i> | | | | | 06 | |
| ldfpd.s. <i>ldhint</i> | | | | | 07 | |
| ldfp8.s. <i>ldhint</i> | | | | | 05 | |
| ldfps.a. <i>ldhint</i> | | | | | 0A | |
| ldfpd.a. <i>ldhint</i> | | | | | 0B | |
| ldfp8.a. <i>ldhint</i> | | | | | 09 | |
| ldfps.sa. <i>ldhint</i> | | | | | 0E | |
| ldfpd.sa. <i>ldhint</i> | | | | | 0F | |
| ldfp8.sa. <i>ldhint</i> | | | | | 0D | |
| ldfps.c.clr. <i>ldhint</i> | | | | | 22 | |
| ldfpd.c.clr. <i>ldhint</i> | | | | | 23 | |
| ldfp8.c.clr. <i>ldhint</i> | | | | | 21 | |
| ldfps.c.nc. <i>ldhint</i> | | | | | 26 | |
| ldfpd.c.nc. <i>ldhint</i> | | | | | 27 | |
| ldfp8.c.nc. <i>ldhint</i> | | | | | 25 | |

4.4.1.12 Floating-point Load Pair – Increment by Immediate

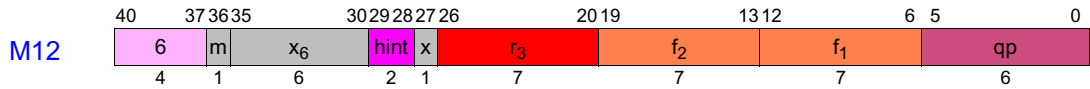

| Instruction | Operands | Opcode | Extension | | | |
|-----------------------|------------------------|--------|-----------|---|----------------|---------------------------------|
| | | | m | x | x ₆ | hint |
| ldfps.l $dhint$ | $f_1, f_2 = [r_3], 8$ | 6 | 1 | 1 | 02 | See Table 4-39 on page 4-291 |
| ldfpd.l $dhint$ | $f_1, f_2 = [r_3], 16$ | | | | 03 | |
| ldfp8.l $dhint$ | $f_1, f_2 = [r_3], 16$ | | | | 01 | |
| ldfps.s.l $dhint$ | $f_1, f_2 = [r_3], 8$ | | | | 06 | |
| ldfpd.s.l $dhint$ | $f_1, f_2 = [r_3], 16$ | | | | 07 | |
| ldfp8.s.l $dhint$ | $f_1, f_2 = [r_3], 16$ | | | | 05 | |
| ldfps.a.l $dhint$ | $f_1, f_2 = [r_3], 8$ | | | | 0A | |
| ldfpd.a.l $dhint$ | $f_1, f_2 = [r_3], 16$ | | | | 0B | |
| ldfp8.a.l $dhint$ | $f_1, f_2 = [r_3], 16$ | | | | 09 | |
| ldfps.sa.l $dhint$ | $f_1, f_2 = [r_3], 8$ | | | | 0E | |
| ldfpd.sa.l $dhint$ | $f_1, f_2 = [r_3], 16$ | | | | 0F | |
| ldfp8.sa.l $dhint$ | $f_1, f_2 = [r_3], 16$ | | | | 0D | |
| ldfps.c.clr.l $dhint$ | $f_1, f_2 = [r_3], 8$ | | | | 22 | |
| ldfpd.c.clr.l $dhint$ | $f_1, f_2 = [r_3], 16$ | | | | 23 | |
| ldfp8.c.clr.l $dhint$ | $f_1, f_2 = [r_3], 16$ | | | | 21 | |
| ldfps.c.nc.l $dhint$ | $f_1, f_2 = [r_3], 8$ | | | | 26 | |
| ldfpd.c.nc.l $dhint$ | $f_1, f_2 = [r_3], 16$ | | | | 27 | |
| ldfp8.c.nc.l $dhint$ | $f_1, f_2 = [r_3], 16$ | | | | 25 | |

4.4.2 Line Prefetch

The line prefetch instructions are encoded in major opcodes 6 and 7 along with the floating-point load/store instructions. See “Loads and Stores” on page 285 for a summary of the opcode extensions.

The line prefetch instructions all have a 2-bit opcode extension field in bits 29:28 (hint) which encodes locality hint information as shown in Table 4-41.

Table 4-41. Line Prefetch Hint Completer

| hint Bits 29:28 | <i>lfhint</i> |
|--------------------|---------------|
| 0 | <i>none</i> |
| 1 | <i>.nt1</i> |
| 2 | <i>.nt2</i> |
| 3 | <i>.nta</i> |

4.4.2.1 Line Prefetch

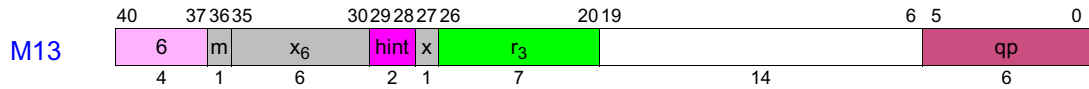

| Instruction | Operands | Opcode | Extension | | | |
|--|-------------------|--------|-----------|---|----------------------|------------------------------|
| | | | m | x | x ₆ | hint |
| lfetch.lfhint lfetch.excl.lfhint lfetch.fault.lfhint lfetch.fault.excl.lfhint | [r ₃] | 6 | 0 | 0 | 2C 2D 2E 2F | See Table 4-41 on page 4-300 |

4.4.2.2 Line Prefetch – Increment by Register

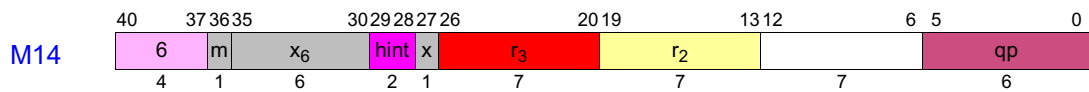

| Instruction | Operands | Opcode | Extension | | | |
|--|-----------------------------------|--------|-----------|---|----------------------|------------------------------|
| | | | m | x | x ₆ | hint |
| lfetch.lfhint lfetch.excl.lfhint lfetch.fault.lfhint lfetch.fault.excl.lfhint | [r ₃], r ₂ | 6 | 1 | 0 | 2C 2D 2E 2F | See Table 4-41 on page 4-300 |

4.4.2.3 Line Prefetch – Increment by Immediate



| Instruction | Operands | Opcode | Extension | |
|--|-------------------------------------|--------|----------------------|------------------------------|
| | | | x ₆ | hint |
| lfetch.lfhint lfetch.excl.lfhint lfetch.fault.lfhint lfetch.fault.excl.lfhint | [r ₃], imm ₉ | 7 | 2C 2D 2E 2F | See Table 4-41 on page 4-300 |

4.4.3 Semaphores

The semaphore instructions are encoded in major opcode 4 along with the integer load/store instructions. See “Loads and Stores” on page 285 for a summary of the opcode extensions.

4.4.3.1 Exchange/Compare and Exchange

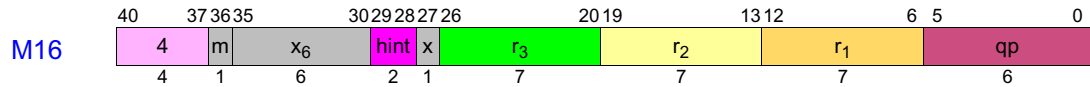

| Instruction | Operands | Opcode | Extension | | | |
|-----------------------------------|--|--------|-----------|---|----------------|------------------------------|
| | | | m | x | x ₆ | hint |
| cmpxchg1.acq.l ^{dhint} | $r_1 = [r_3], r_2, \text{ar.ccv}$ | 4 | 0 | 1 | 00 | See Table 4-39 on page 4-291 |
| cmpxchg2.acq.l ^{dhint} | | | | | 01 | |
| cmpxchg4.acq.l ^{dhint} | | | | | 02 | |
| cmpxchg8.acq.l ^{dhint} | | | | | 03 | |
| cmpxchg1.rel.l ^{dhint} | | | | | 04 | |
| cmpxchg2.rel.l ^{dhint} | | | | | 05 | |
| cmpxchg4.rel.l ^{dhint} | | | | | 06 | |
| cmpxchg8.rel.l ^{dhint} | | | | | 07 | |
| cmp8xchg16.acq.l ^{dhint} | $r_1 = [r_3], r_2, \text{ar.csd}, \text{ar.ccv}$ | 4 | 0 | 1 | 20 | |
| cmp8xchg16.rel.l ^{dhint} | | | | | 24 | |
| xchg1.l ^{dhint} | $r_1 = [r_3], r_2$ | 4 | 0 | 1 | 08 | |
| xchg2.l ^{dhint} | | | | | 09 | |
| xchg4.l ^{dhint} | | | | | 0A | |
| xchg8.l ^{dhint} | | | | | 0B | |

4.4.3.2 Fetch and Add – Immediate

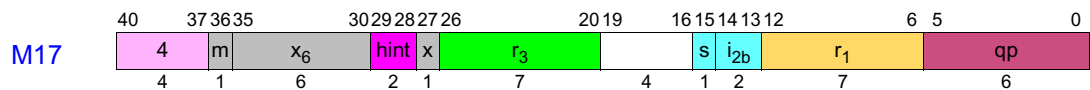

| Instruction | Operands | Opcode | Extension | | | |
|----------------------------------|-----------------------------|--------|-----------|---|----------------|------------------------------|
| | | | m | x | x ₆ | hint |
| fetchadd4.acq.l ^{dhint} | $r_1 = [r_3], \text{inc}_3$ | 4 | 0 | 1 | 12 | See Table 4-39 on page 4-291 |
| fetchadd8.acq.l ^{dhint} | | | | | 13 | |
| fetchadd4.rel.l ^{dhint} | | | | | 16 | |
| fetchadd8.rel.l ^{dhint} | | | | | 17 | |

4.4.4 Set/Get FR

The set FR instructions are encoded in major opcode 6 along with the floating-point load/store instructions. The get FR instructions are encoded in major opcode 4 along with the integer load/store instructions. See “Loads and Stores” on page 285 for a summary of the opcode extensions.

4.4.4.1 Set FR

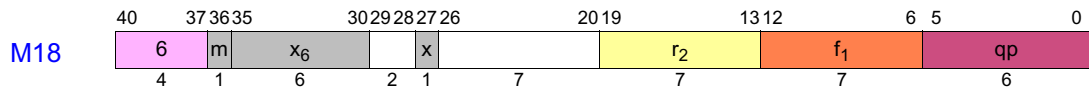

| Instruction | Operands | Opcode | Extension | | |
|--|-------------|--------|-----------|---|----------------------|
| | | | m | x | x ₆ |
| setf.sig setf.exp setf.s setf.d | $f_1 = r_2$ | 6 | 0 | 1 | 1C 1D 1E 1F |

4.4.4.2 Get FR

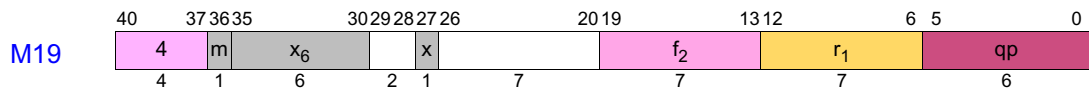

| Instruction | Operands | Opcode | Extension | | |
|--|-------------|--------|-----------|---|----------------------|
| | | | m | x | x ₆ |
| getf.sig getf.exp getf.s getf.d | $r_1 = f_2$ | 4 | 0 | 1 | 1C 1D 1E 1F |

4.4.5 Speculation and Advanced Load Checks

The speculation and advanced load check instructions are encoded in major opcodes 0 and 1 along with the system/memory management instructions. See “System/Memory Management” on page 308 for a summary of the opcode extensions.

4.4.5.1 Integer Speculation Check (M-Unit)

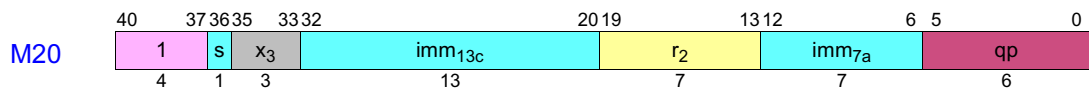

| Instruction | Operands | Opcode | Extension |
|-------------|--------------------|--------|----------------|
| | | | x ₃ |
| chk.s.m | $r_2, target_{25}$ | 1 | 1 |

4.4.5.2 Floating-point Speculation Check

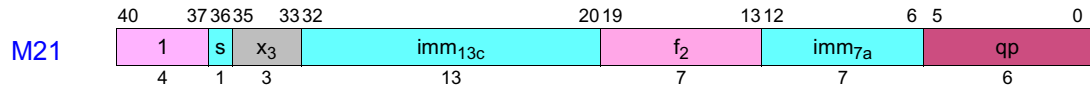

| Instruction | Operands | Opcode | Extension |
|-------------|--------------------|--------|-----------|
| | | | x_3 |
| chk.s | $f_2, target_{25}$ | 1 | 3 |

4.4.5.3 Integer Advanced Load Check

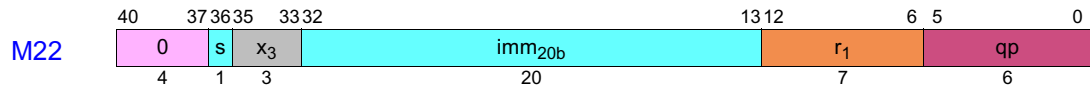

| Instruction | Operands | Opcode | Extension |
|-------------|--------------------|--------|-----------|
| | | | x_3 |
| chk.a.nc | $r_1, target_{25}$ | 0 | 4 |
| chk.a.clr | | | 5 |

4.4.5.4 Floating-point Advanced Load Check

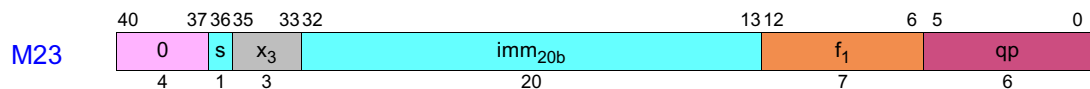

| Instruction | Operands | Opcode | Extension |
|-------------|--------------------|--------|-----------|
| | | | x_3 |
| chk.a.nc | $f_1, target_{25}$ | 0 | 6 |
| chk.a.clr | | | 7 |

4.4.6 Cache/Synchronization/RSE/ALAT

The cache/synchronization/RSE/ALAT instructions are encoded in major opcode 0 along with the memory management instructions. See “[System/Memory Management](#)” on page 308 for a summary of the opcode extensions.

4.4.6.1 Sync/Fence/Serialize/ALAT Control

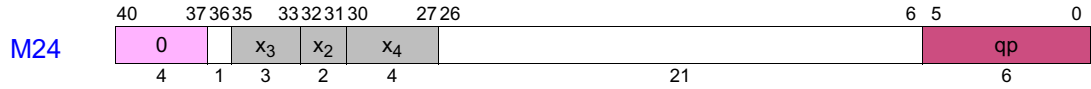

| Instruction | Opcode | Extension | | |
|-------------|--------|----------------|----------------|----------------|
| | | x ₃ | x ₄ | x ₂ |
| invala | 0 | 0 | 0 | 1 |
| fwb | | | 0 | 2 |
| mf | | | 2 | |
| mf.a | | | 3 | |
| sriz.d | | | 0 | 3 |
| sriz.i | | | 1 | |
| sync.i | 3 | | | |

4.4.6.2 RSE Control

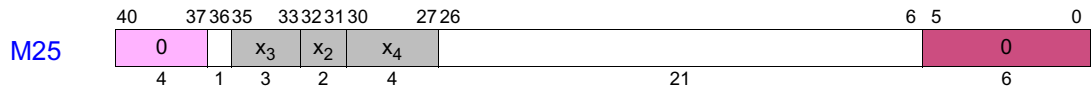

| Instruction | Opcode | Extension | | |
|----------------------|--------|----------------|----------------|----------------|
| | | x ₃ | x ₄ | x ₂ |
| flushrs ^f | 0 | 0 | C | 0 |
| loadrs ^f | | | A | |

4.4.6.3 Integer ALAT Entry Invalidate

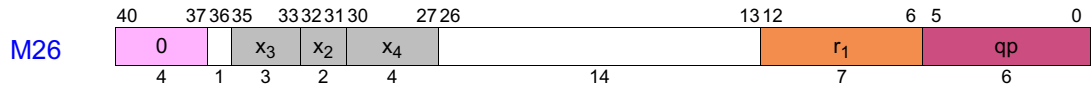

| Instruction | Operands | Opcode | Extension | | |
|-------------|----------------|--------|----------------|----------------|----------------|
| | | | x ₃ | x ₄ | x ₂ |
| invala.e | r _I | 0 | 0 | 2 | 1 |

4.4.6.4 Floating-point ALAT Entry Invalidate

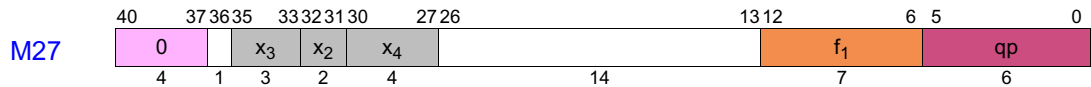

| Instruction | Operands | Opcode | Extension | | |
|-------------|----------------|--------|----------------|----------------|----------------|
| | | | x ₃ | x ₄ | x ₂ |
| invala.e | f _I | 0 | 0 | 3 | 1 |

4.4.6.5 Flush Cache

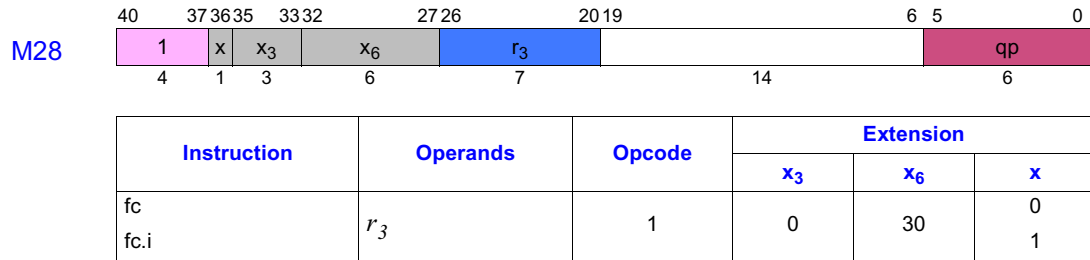

4.4.7 GR/AR Moves (M-Unit)

The M-Unit GR/AR move instructions are encoded in major opcode 0 along with the system/memory management instructions. (Some ARs are accessed using system control instructions on the I-unit. See “GR/AR Moves (I-Unit)” on page 4-284.) See “System/Memory Management” on page 308 for a summary of the M-Unit GR/AR opcode extensions.

4.4.7.1 Move to AR – Register (M-Unit)

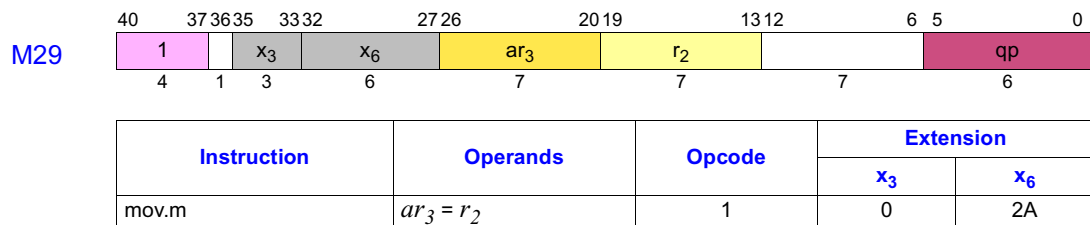

4.4.7.2 Move to AR – Immediate₈ (M-Unit)

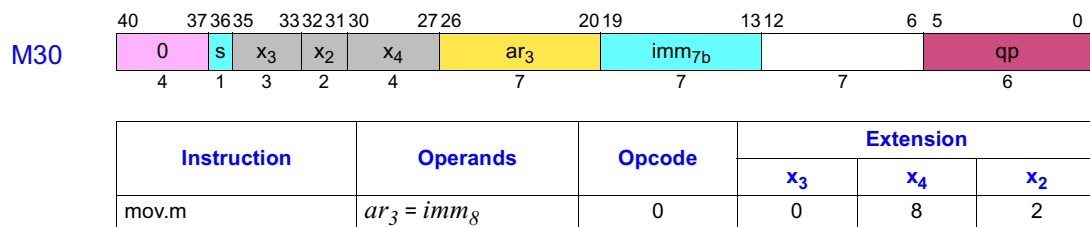

4.4.7.3 Move from AR (M-Unit)

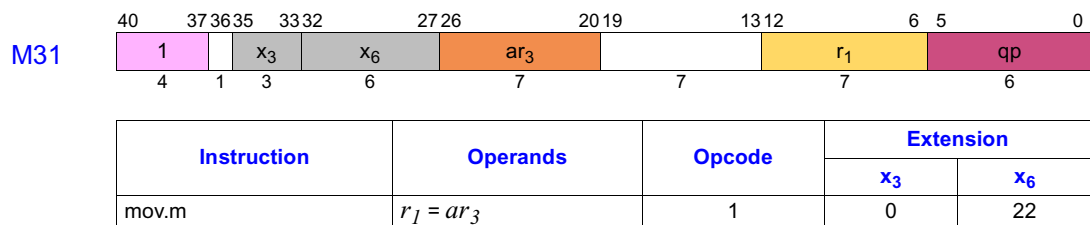

4.4.8 GR/CR Moves

The GR/CR move instructions are encoded in major opcode 0 along with the system/memory management instructions. See “System/Memory Management” on page 308 for a summary of the opcode extensions.

4.4.8.1 Move to CR

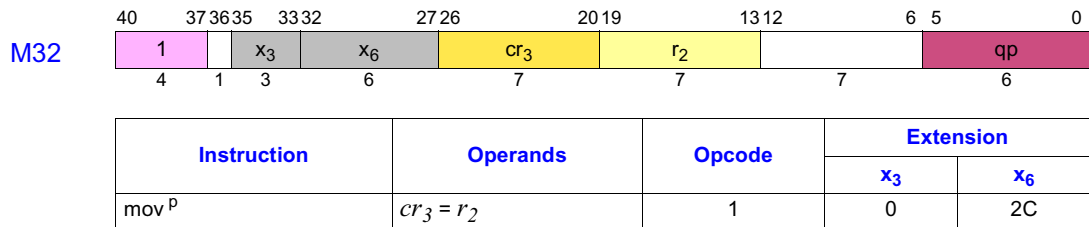

4.4.8.2 Move from CR

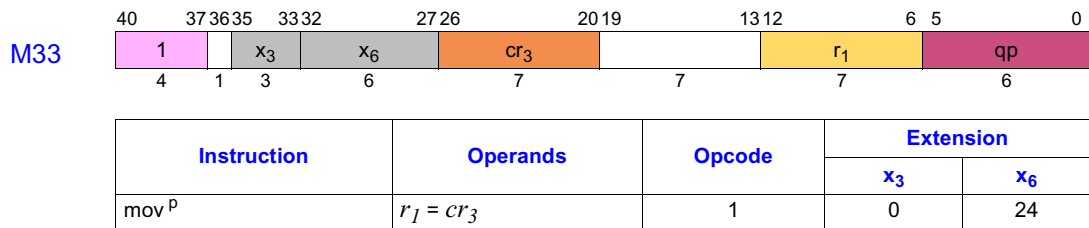

4.4.9 Miscellaneous M-Unit Instructions

The miscellaneous M-unit instructions are encoded in major opcode 0 along with the system/memory management instructions. See “System/Memory Management” on page 308 for a summary of the opcode extensions.

4.4.9.1 Allocate Register Stack Frame

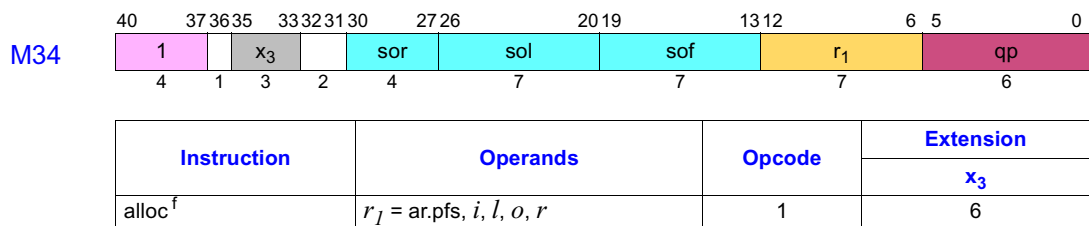

Note: The three immediates in the instruction encoding are formed from the operands as follows:

$$sof = i + l + o$$

$$sol = i + l$$

$$sor = r \gg 3$$

4.4.9.2 Move to PSR

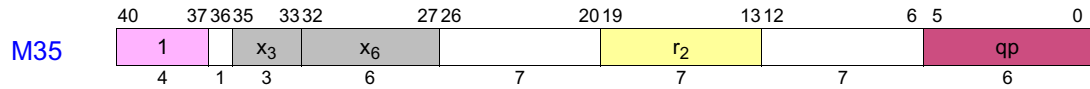

| Instruction | Operands | Opcode | Extension | |
|------------------|-------------------------|--------|----------------|----------------|
| | | | x ₃ | x ₆ |
| mov ^P | psr.l = r ₂ | 1 | 0 | 2D |
| mov | psr.um = r ₂ | 1 | 0 | 29 |

4.4.9.3 Move from PSR

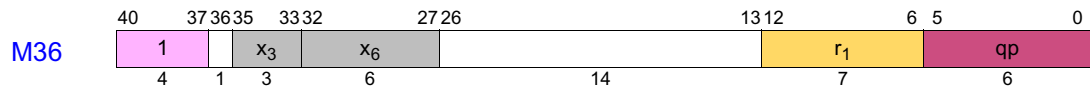

| Instruction | Operands | Opcode | Extension | |
|------------------|-------------------------|--------|----------------|----------------|
| | | | x ₃ | x ₆ |
| mov ^P | r ₁ = psr | 1 | 0 | 25 |
| mov | r ₁ = psr.um | 1 | 0 | 21 |

4.4.9.4 Break (M-Unit)

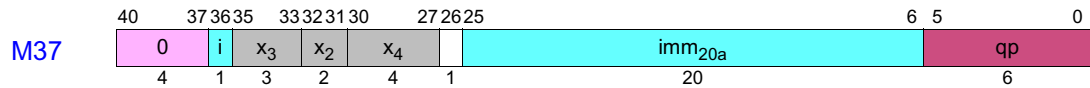

| Instruction | Operands | Opcode | Extension | | |
|-------------|-------------------|--------|----------------|----------------|----------------|
| | | | x ₃ | x ₄ | x ₂ |
| break.m | imm ₂₁ | 0 | 0 | 0 | 0 |

4.4.10 System/Memory Management

All system/memory management instructions are encoded within major opcodes 0 and 1 using a 3-bit opcode extension field (x₃) in bits 35:33. Some instructions also have a 4-bit opcode extension field (x₄) in bits 30:27, or a 6-bit opcode extension field (x₆) in bits 32:27. Most of the instructions having a 4-bit opcode extension field also have a 2-bit extension field (x₂) in bits 32:31. [Table 4-42](#) shows the 3-bit assignments for opcode 0, [Table 4-43](#) summarizes the 4-bit+2-bit assignments for opcode 0, [Table 4-44](#) shows the 3-bit assignments for opcode 1, and [Table 4-45](#) summarizes the 6-bit assignments for opcode 1.

Table 4-42. Opcode 0 System/Memory Management 3-bit Opcode Extensions

| Opcode Bits 40:37 | x ₃ Bits 35:33 | |
|-------------------|---------------------------|---|
| 0 | 0 | System/Memory Management 4-bit+2-bit Ext (Table 4-43) |
| | 1 | |
| | 2 | |
| | 3 | |
| | 4 | chk.a.nc – int M22 |
| | 5 | chk.a.clr – int M22 |
| | 6 | chk.a.nc – fp M23 |
| | 7 | chk.a.clr – fp M23 |

Table 4-43. Opcode 0 System/Memory Management 4-bit+2-bit Opcode Extensions

| Opcode Bits 40:37 | x ₃ Bits 35:33 | x ₄ Bits 30:27 | x ₂ Bits 32:31 | | | |
|-------------------|---------------------------|---------------------------|---------------------------|--------------------|------------------------------------|------------|
| | | | 0 | 1 | 2 | 3 |
| 0 | 0 | 0 | break.m M37 | invala M24 | fwb M24 | sriz.d M24 |
| | | 1 | 1-bit Ext (Table 4-46) | | | sriz.i M24 |
| | | 2 | | invala.e – int M26 | mf M24 | |
| | | 3 | | invala.e – fp M27 | mf.a M24 | sync.i M24 |
| | | 4 | sum M44 | | | |
| | | 5 | rum M44 | | | |
| | | 6 | ssm M44 | | | |
| | | 7 | rsm M44 | | | |
| | | 8 | | | mov.m to ar – imm ₈ M30 | |
| | | 9 | | | | |
| | | A | loadrs M25 | | | |
| | | B | | | | |
| | | C | flushrs M25 | | | |
| | | D | | | | |
| | | E | | | | |
| | | F | | | | |

Table 4-44. Opcode 1 System/Memory Management 3-bit Opcode Extensions

| Opcode Bits 40:37 | x ₃ Bits 35:33 | |
|-------------------|---------------------------|---|
| 1 | 0 | System/Memory Management 6-bit Ext (Table 4-45) |
| | 1 | chk.s.m – int M20 |
| | 2 | |
| | 3 | chk.s – fp M21 |
| | 4 | |
| | 5 | |
| | 6 | alloc M34 |
| | 7 | |

Table 4-45. Opcode 1 System/Memory Management 6-bit Opcode Extensions

| Opcode Bits 40:37 | x ₃ Bits 35:33 | x ₆ | | | | |
|----------------------|---------------------------------|----------------|----------------|--------------------------------|---------------------|---------------------------------------|
| | | Bits 30:27 | Bits 32:31 | | | |
| | | | 0 | 1 | 2 | 3 |
| 1 | 0 | 0 | mov to rr M42 | mov from rr M43 | | fc M28 |
| | | 1 | mov to dbr M42 | mov from dbr M43 | mov from psr.um M36 | probe.rw.fault – imm ₂ M40 |
| | | 2 | mov to ibr M42 | mov from ibr M43 | mov.m from ar M31 | probe.r.fault – imm ₂ M40 |
| | | 3 | mov to pkr M42 | mov from pkr M43 | | probe.w.fault – imm ₂ M40 |
| | | 4 | mov to pmc M42 | mov from pmc M43 | mov from cr M33 | ptc.e M47 |
| | | 5 | mov to pmd M42 | mov from pmd M43 | mov from psr M36 | |
| | | 6 | | | | |
| | | 7 | | mov from cpuid M43 | | |
| | | 8 | | probe.r – imm ₂ M39 | | probe.r M38 |
| | | 9 | ptc.l M45 | probe.w – imm ₂ M39 | mov to psr.um M35 | probe.w M38 |
| | | A | ptc.g M45 | thash M46 | mov.m to ar M29 | |
| | | B | ptc.ga M45 | ttag M46 | | |
| | | C | ptr.d M45 | | mov to cr M32 | |
| | | D | ptr.i M45 | | mov to psr.l M35 | |
| | | E | itr.d M42 | tpa M46 | itc.d M41 | |
| | | F | itr.i M42 | tak M46 | itc.i M41 | |

4.4.10.1 Probe – Register

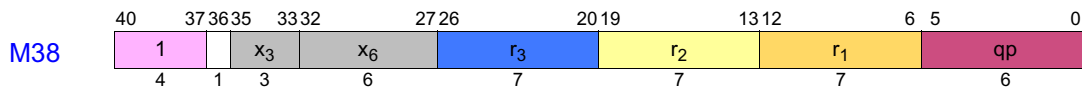

| Instruction | Operands | Opcode | Extension | |
|-------------|------------------|--------|----------------|----------------|
| | | | x ₃ | x ₆ |
| probe.r | $r_1 = r_3, r_2$ | 1 | 0 | 38 |
| probe.w | | | | 39 |

4.4.10.2 Probe – Immediate₂

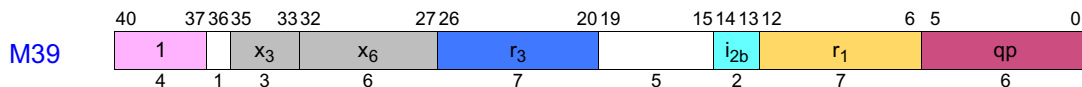

| Instruction | Operands | Opcode | Extension | |
|-------------|--------------------|--------|----------------|----------------|
| | | | x ₃ | x ₆ |
| probe.r | $r_1 = r_3, imm_2$ | 1 | 0 | 18 |
| probe.w | | | | 19 |

4.4.10.3 Probe Fault – Immediate₂

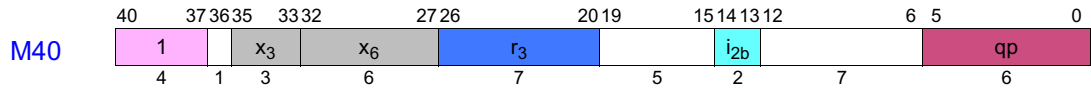

| Instruction | Operands | Opcode | Extension | |
|----------------|--------------|--------|----------------|----------------|
| | | | x ₃ | x ₆ |
| probe.rw.fault | r_3, imm_2 | 1 | 0 | 31 |
| probe.r.fault | | | 0 | 32 |
| probe.w.fault | | | 0 | 33 |

4.4.10.4 Translation Cache Insert

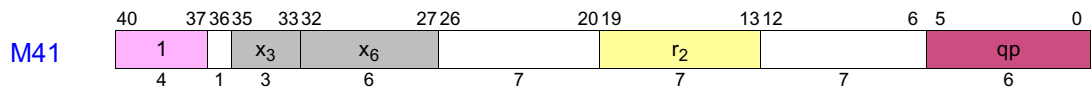

| Instruction | Operands | Opcode | Extension | |
|---------------------|----------|--------|----------------|----------------|
| | | | x ₃ | x ₆ |
| itc.d ^{!P} | r_2 | 1 | 0 | 2E |
| itc.i ^{!P} | | | 0 | 2F |

4.4.10.5 Move to Indirect Register/Translation Register Insert

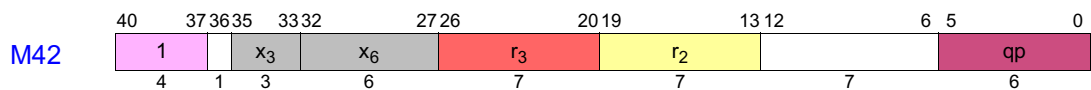

| Instruction | Operands | Opcode | Extension | |
|--------------------|-------------------|--------|----------------|----------------|
| | | | x ₃ | x ₆ |
| mov ^P | $rr[r_3] = r_2$ | 1 | 0 | 00 |
| | $dbr[r_3] = r_2$ | | | 01 |
| | $ibr[r_3] = r_2$ | | | 02 |
| | $pkrr[r_3] = r_2$ | | | 03 |
| | $pmc[r_3] = r_2$ | | | 04 |
| | $pmd[r_3] = r_2$ | | | 05 |
| itr.d ^P | $dtr[r_3] = r_2$ | 1 | 0 | 0E |
| | $itr[r_3] = r_2$ | | | 0F |

4.4.10.6 Move from Indirect Register

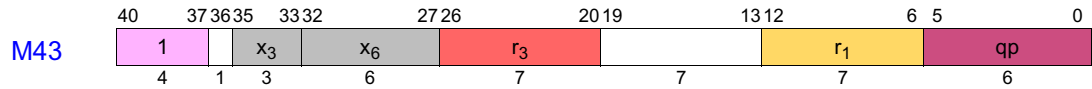

| Instruction | Operands | Opcode | Extension | |
|------------------|--------------------|--------|----------------|----------------|
| | | | x ₃ | x ₆ |
| mov ^P | $r_1 = rr[r_3]$ | 1 | 0 | 10 |
| | $r_1 = dbr[r_3]$ | | | 11 |
| | $r_1 = ibr[r_3]$ | | | 12 |
| | $r_1 = pkr[r_3]$ | | | 13 |
| | $r_1 = pmc[r_3]$ | | | 14 |
| mov | $r_1 = pmd[r_3]$ | | | 15 |
| | $r_1 = cpuid[r_3]$ | | | 17 |

4.4.10.7 Set/Reset User/System Mask

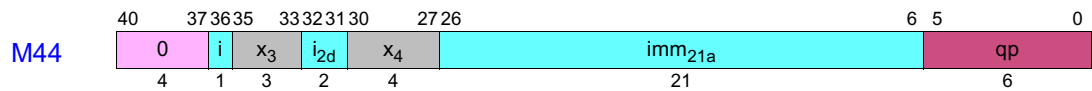

| Instruction | Operands | Opcode | Extension | |
|------------------|-------------------|--------|----------------|----------------|
| | | | x ₃ | x ₄ |
| sum | imm ₂₄ | 0 | 0 | 4 |
| rum | | | | 5 |
| ssm ^P | | | | 6 |
| rsm ^P | | | | 7 |

4.4.10.8 Translation Purge

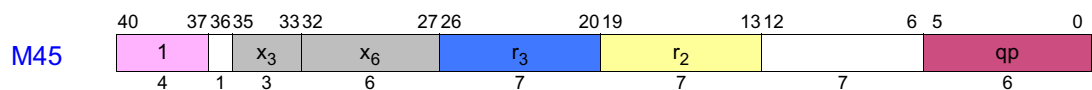

| Instruction | Operands | Opcode | Extension | |
|-----------------------|---------------------------------|--------|----------------|----------------|
| | | | x ₃ | x ₆ |
| ptc.l ^P | r ₃ , r ₂ | 1 | 0 | 09 |
| ptc.g.l ^P | | | | 0A |
| ptc.ga.l ^P | | | | 0B |
| ptr.d ^P | | | | 0C |
| ptr.i ^P | | | | 0D |

4.4.10.9 Translation Access

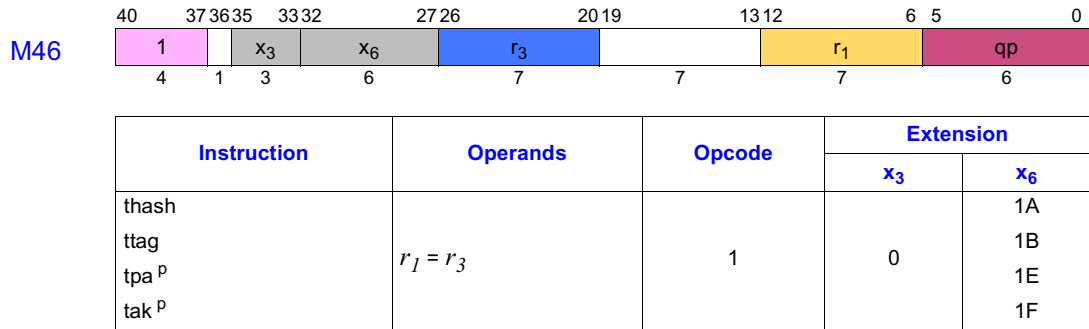

4.4.10.10 Purge Translation Cache Entry

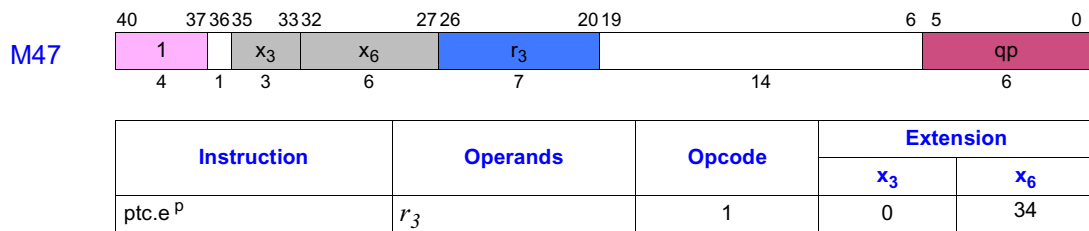

4.4.11 Nop/Hint (M-Unit)

M-unit nop and hint instructions are encoded within major opcode 0 using a 3-bit opcode extension field in bits 35:33 (x₃), a 2-bit opcode extension field in bits 32:31 (x₂), a 4-bit opcode extension field in bits 30:27 (x₄), and a 1-bit opcode extension field in bit 26 (y), as shown in Table 4-46.

Table 4-46. Misc M-Unit 1-bit Opcode Extensions

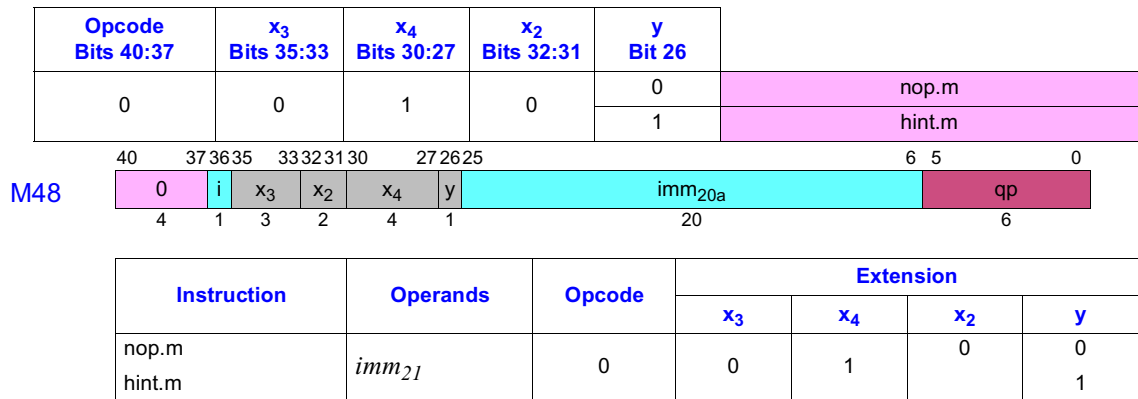

4.5 B-Unit Instruction Encodings

The branch-unit includes branch, predict, and miscellaneous instructions.

4.5.1 Branches

Opcode 0 is used for indirect branch, opcode 1 for indirect call, opcode 4 for IP-relative branch, and opcode 5 for IP-relative call.

The IP-relative branch instructions encoded within major opcode 4 use a 3-bit opcode extension field in bits 8:6 (btype) to distinguish the branch types as shown in [Table 4-47](#).

Table 4-47. IP-Relative Branch Types

| Opcode Bits 40:37 | btype Bits 8:6 | |
|----------------------|-------------------|-------------|
| 4 | 0 | br.cond B1 |
| | 1 | e |
| | 2 | br.wexit B1 |
| | 3 | br.wtop B1 |
| | 4 | e |
| | 5 | br.cloop B2 |
| | 6 | br.cexit B2 |
| | 7 | br.ctop B2 |

The indirect branch, indirect return, and miscellaneous branch-unit instructions are encoded within major opcode 0 using a 6-bit opcode extension field in bits 32:27 (x_6). [Table 4-48](#) summarizes these assignments.

Table 4-48. Indirect/Miscellaneous Branch Opcode Extensions

| Opcode Bits 40:37 | x_6 | | | | |
|----------------------|---------------|-------------|--------|---|---|
| | Bits 30:27 | Bits 32:31 | | | |
| | | 0 | 1 | 2 | 3 |
| 0 | 0 | break.b B9 | epc B8 | Indirect Branch (Table 4-49) | e |
| | 1 | | e | Indirect Return (Table 4-50) | e |
| | 2 | cover B8 | e | e | e |
| | 3 | e | e | e | e |
| | 4 | clrrb B8 | e | e | e |
| | 5 | clrrb.pr B8 | e | e | e |
| | 6 | e | e | e | e |
| | 7 | e | e | e | e |
| | 8 | rfi B8 | e | e | e |
| | 9 | | e | e | e |
| | A | e | e | e | e |
| | B | e | e | e | e |
| | C | bsw.0 B8 | e | e | e |
| | D | bsw.1 B8 | e | e | e |
| | E | e | e | e | e |
| | F | e | e | e | e |

The indirect branch instructions encoded within major opcodes 0 use a 3-bit opcode extension field in bits 8:6 (btype) to distinguish the branch types as shown in [Table 4-49](#).

Table 4-49. Indirect Branch Types

| Opcode Bits 40:37 | X ₆ Bits 32:27 | btype Bits 8:6 | |
|----------------------|------------------------------|-------------------|------------|
| 0 | 20 | 0 | br.cond B4 |
| | | 1 | br.ia B4 |
| | | 2 | e |
| | | 3 | e |
| | | 4 | e |
| | | 5 | e |
| | | 6 | e |
| | | 7 | e |

The indirect return branch instructions encoded within major opcodes 0 use a 3-bit opcode extension field in bits 8:6 (btype) to distinguish the branch types as shown in Table 4-50.

Table 4-50. Indirect Return Branch Types

| Opcode Bits 40:37 | X ₆ Bits 32:27 | btype Bits 8:6 | |
|----------------------|------------------------------|-------------------|-----------|
| 0 | 21 | 0 | e |
| | | 1 | e |
| | | 2 | e |
| | | 3 | e |
| | | 4 | br.ret B4 |
| | | 5 | e |
| | | 6 | e |
| | | 7 | e |

All of the branch instructions have a 1-bit opcode extension field, p, in bit 12 which provides a sequential prefetch hint. Table 4-51 summarizes these assignments.

Table 4-51. Sequential Prefetch Hint Completer

| p Bit 12 | ph |
|-------------|-------|
| 0 | .few |
| 1 | .many |

The IP-relative and indirect branch instructions all have a 2-bit opcode extension field in bits 34:33 (wh) which encodes branch prediction “whether” hint information as shown in Table 4-52. Indirect call instructions have a 3-bit opcode extension field in bits 34:32 (wh) for “whether” hint information as shown in Table 4-53.

Table 4-52. Branch Whether Hint Completer

| wh Bits 34:33 | bwh |
|------------------|-------|
| 0 | .sptk |
| 1 | .spnt |
| 2 | .dptk |
| 3 | .dpnt |

Table 4-53. Indirect Call Whether Hint Completer

| wh Bits 34:32 | <i>bwh</i> |
|-------------------------|------------|
| 0 | |
| 1 | .sptk |
| 2 | |
| 3 | .spnt |
| 4 | |
| 5 | .dptk |
| 6 | |
| 7 | .dpnt |

The branch instructions also have a 1-bit opcode extension field in bit 35 (d) which encodes a branch cache deallocation hint as shown in Table 4-54.

Table 4-54. Branch Cache Deallocation Hint Completer

| d Bit 35 | <i>dh</i> |
|--------------------|-------------|
| 0 | <i>none</i> |
| 1 | .clr |

4.5.1.1 IP-Relative Branch

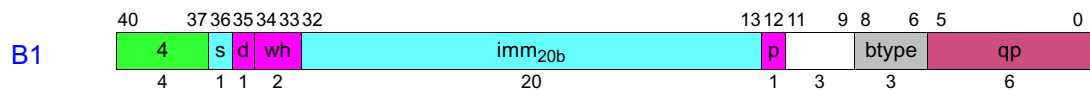

| Instruction | Operands | Opcode | Extension | | | |
|--|----------------------------|--------|-----------|------------------------------|------------------------------|------------------------------|
| | | | btype | p | wh | d |
| br.cond. <i>bwh.ph.dh</i> ^e | <i>target₂₅</i> | 4 | 0 | See Table 4-51 on page 4-315 | See Table 4-52 on page 4-315 | See Table 4-54 on page 4-316 |
| br.wexit. <i>bwh.ph.dh</i> ^{et} | | | 2 | | | |
| br.wtop. <i>bwh.ph.dh</i> ^{et} | | | 3 | | | |

4.5.1.2 IP-Relative Counted Branch

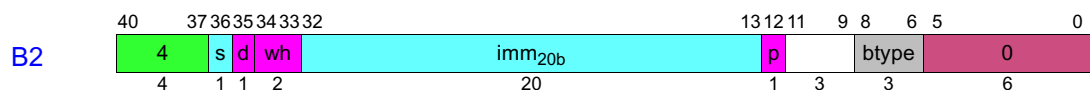

| Instruction | Operands | Opcode | Extension | | | |
|--|----------------------------|--------|-----------|------------------------------|------------------------------|------------------------------|
| | | | btype | p | wh | d |
| br.cloop. <i>bwh.ph.dh</i> ^{et} | <i>target₂₅</i> | 4 | 5 | See Table 4-51 on page 4-315 | See Table 4-52 on page 4-315 | See Table 4-54 on page 4-316 |
| br.cexit. <i>bwh.ph.dh</i> ^{et} | | | 6 | | | |
| br.ctop. <i>bwh.ph.dh</i> ^{et} | | | 7 | | | |

4.5.1.3 IP-Relative Call

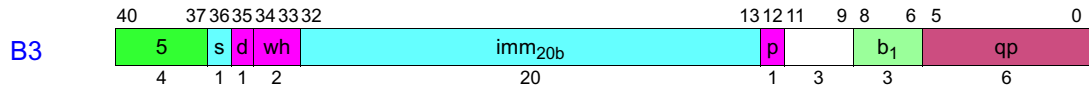

| Instruction | Operands | Opcode | Extension | | |
|--------------------------------|---------------------|--------|------------------------------|------------------------------|------------------------------|
| | | | p | wh | d |
| br.call.bwh.ph.dh ^e | $b_1 = target_{25}$ | 5 | See Table 4-51 on page 4-315 | See Table 4-52 on page 4-315 | See Table 4-54 on page 4-316 |

4.5.1.4 Indirect Branch



| Instruction | Operands | Opcode | Extension | | | | |
|--------------------------------|----------|--------|----------------|------------------------------|------------------------------|------------------------------|---|
| | | | x ₆ | btype | p | wh | d |
| br.cond.bwh.ph.dh ^e | b_2 | 0 | 0 | See Table 4-51 on page 4-315 | See Table 4-52 on page 4-315 | See Table 4-54 on page 4-316 | |
| br.ia.bwh.ph.dh ^e | | | 1 | | | | |
| br.ret.bwh.ph.dh ^e | | | 4 | | | | |

4.5.1.5 Indirect Call

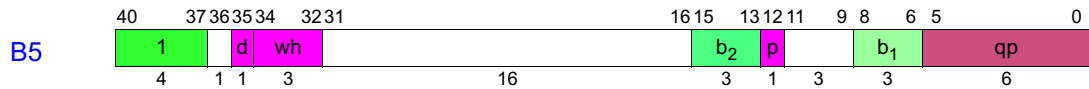

| Instruction | Operands | Opcode | Extension | | |
|--------------------------------|-------------|--------|------------------------------|------------------------------|------------------------------|
| | | | p | wh | d |
| br.call.bwh.ph.dh ^e | $b_1 = b_2$ | 1 | See Table 4-51 on page 4-315 | See Table 4-53 on page 4-316 | See Table 4-54 on page 4-316 |

4.5.2 Branch Predict/Nop/Hint

The branch predict, nop, and hint instructions are encoded in major opcodes 2 (Indirect Predict/Nop/Hint) and 7 (IP-relative Predict). The indirect predict, nop, and hint instructions in major opcode 2 use a 6-bit opcode extension field in bits 32:27 (x_6). [Table 4-55](#) summarizes these assignments.

Table 4-55. Indirect Predict/Nop/Hint Opcode Extensions

| Opcode Bits 40:37 | x ₆ | | | | |
|-------------------------|----------------|------------|------------|---|---|
| | Bits 30:27 | Bits 32:31 | | | |
| | | 0 | 1 | 2 | 3 |
| 2 | 0 | nop.b B9 | brp B7 | | |
| | 1 | hint.b B9 | brp.ret B7 | | |
| | 2 | | | | |
| | 3 | | | | |
| | 4 | | | | |
| | 5 | | | | |
| | 6 | | | | |
| | 7 | | | | |
| | 8 | | | | |
| | 9 | | | | |
| | A | | | | |
| | B | | | | |
| | C | | | | |
| | D | | | | |
| | E | | | | |
| | F | | | | |

The branch predict instructions all have a 1-bit opcode extension field in bit 35 (ih) which encodes a branch importance hint. The mov to BR instruction (page 4-282) also has this hint in bit 23. Table 4-56 shows these assignments.

Table 4-56. Branch Importance Hint Completer

| ih Bit 23 or Bit 35 | ih |
|---------------------------|------|
| 0 | none |
| 1 | .imp |

The IP-relative branch predict instructions have a 2-bit opcode extension field in bits 4:3 (wh) which encodes branch prediction “whether” hint information as shown in Table 4-57. Note that the combination of the .loop or .exit whether hint completer with the none importance hint completer is undefined.

Table 4-57. IP-Relative Predict Whether Hint Completer

| wh Bits 4:3 | ipwh |
|----------------|-------|
| 0 | .sptk |
| 1 | .loop |
| 2 | .dptk |
| 3 | .exit |

The indirect branch predict instructions have a 2-bit opcode extension field in bits 4:3 (wh) which encodes branch prediction “whether” hint information as shown in Table 4-58.

Table 4-58. Indirect Predict Whether Hint Completer

| wh Bits 4:3 | indwh |
|----------------|-------|
| 0 | .sptk |
| 1 | |
| 2 | .dptk |
| 3 | |

4.5.2.1 IP-Relative Predict

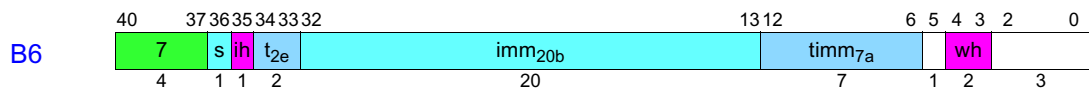

| Instruction | Operands | Opcode | Extension | |
|-------------|--|--------|------------------------------|------------------------------|
| | | | ih | wh |
| brp.ipwh.ih | target ₂₅ , tag ₁₃ | 7 | See Table 4-56 on page 4-318 | See Table 4-57 on page 4-318 |

4.5.2.2 Indirect Predict



| Instruction | Operands | Opcode | Extension | | |
|------------------|------------------------------------|--------|----------------|------------------------------|------------------------------|
| | | | x ₆ | ih | wh |
| brp.indwh.ih | b ₂ , tag ₁₃ | 2 | 10 | See Table 4-56 on page 4-318 | See Table 4-58 on page 4-319 |
| brp.ret.indwh.ih | | | 11 | | |

4.5.3 Miscellaneous B-Unit Instructions

The miscellaneous branch-unit instructions include a number of instructions encoded within major opcode 0 using a 6-bit opcode extension field in bits 32:27 (x₆) as described in [Table 4-48 on page 4-314](#).

4.5.3.1 Miscellaneous (B-Unit)

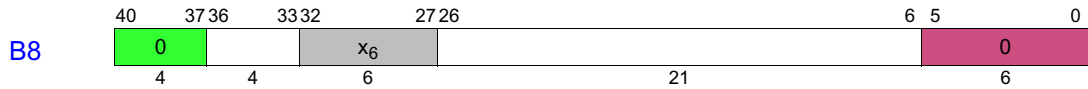

| Instruction | Opcode | Extension |
|------------------------|--------|-----------|
| | | x_6 |
| cover ^l | 0 | 02 |
| clrrrb ^l | | 04 |
| clrrrb.pr ^l | | 05 |
| rft ^{e p} | | 08 |
| bsw.0 ^{l p} | | 0C |
| bsw.1 ^{l p} | | 0D |
| epc | | 10 |

4.5.3.2 Break/Nop/Hint (B-Unit)

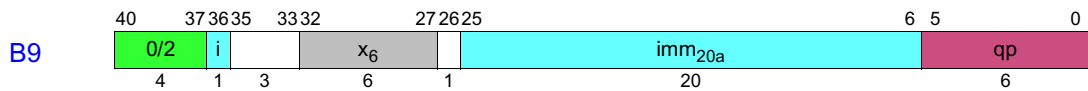

| Instruction | Operands | Opcode | Extension |
|----------------------|------------|--------|-----------|
| | | | x_6 |
| break.b ^e | imm_{21} | 0 | 00 |
| nop.b | | 2 | 01 |
| hint.b | | | |

4.6 F-Unit Instruction Encodings

The floating-point instructions are encoded in major opcodes 8 – E for floating-point and fixed-point arithmetic, opcode 4 for floating-point compare, opcode 5 for floating-point class, and opcodes 0 and 1 for miscellaneous floating-point instructions.

The miscellaneous and reciprocal approximation floating-point instructions are encoded within major opcodes 0 and 1 using a 1-bit opcode extension field (x) in bit 33 and either a second 1-bit extension field in bit 36 (q) or a 6-bit opcode extension field (x_6) in bits 32:27. [Table 4-59](#) shows the 1-bit x assignments, [Table 4-62](#) shows the additional 1-bit q assignments for the reciprocal approximation instructions; [Table 4-60](#) and [Table 4-61](#) summarize the 6-bit x_6 assignments.

Table 4-59. Miscellaneous Floating-point 1-bit Opcode Extensions

| Opcode Bits 40:37 | x Bit 33 | |
|-------------------|------------|---|
| 0 | 0 | 6-bit Ext (Table 4-60) |
| | 1 | Reciprocal Approximation (Table 4-62) |
| 1 | 0 | 6-bit Ext (Table 4-61) |
| | 1 | Reciprocal Approximation (Table 4-62) |

Table 4-60. Opcode 0 Miscellaneous Floating-point 6-bit Opcode Extensions

| Opcode Bits 40:37 | x Bit 33 | x ₆ | | | | |
|-------------------|----------|----------------|------------------------|--------------------|-----------|-------------|
| | | Bits 30:27 | Bits 32:31 | | | |
| | | | 0 | 1 | 2 | 3 |
| 0 | 0 | 0 | break.f F15 | fmerge.s F9 | | |
| | | 1 | 1-bit Ext (Table 4-68) | fmerge.ns F9 | | |
| | | 2 | | fmerge.se F9 | | |
| | | 3 | | | | |
| | | 4 | fsetc F12 | fmin F8 | | fswap F9 |
| | | 5 | fclrf F13 | fmax F8 | | fswap.nl F9 |
| | | 6 | | famin F8 | | fswap.nr F9 |
| | | 7 | | famax F8 | | |
| | | 8 | fchkf F14 | fcvt.fx F10 | fpack F9 | |
| | | 9 | | fcvt.fxu F10 | | fmix.lr F9 |
| | | A | | fcvt.fx.trunc F10 | | fmix.r F9 |
| | | B | | fcvt.fxu.trunc F10 | | fmix.l F9 |
| | | C | | fcvt.xf F11 | fand F9 | fsxt.r F9 |
| | | D | | | fandcm F9 | fsxt.l F9 |
| | | E | | | for F9 | |
| | | F | | | fxor F9 | |

Table 4-61. Opcode 1 Miscellaneous Floating-point 6-bit Opcode Extensions

| Opcode Bits 40:37 | x Bit 33 | x ₆ | | | | |
|-------------------|----------|----------------|------------|---------------------|---|----------------|
| | | Bits 30:27 | Bits 32:31 | | | |
| | | | 0 | 1 | 2 | 3 |
| 1 | 0 | 0 | | fpmerge.s F9 | | fpcmp.eq F8 |
| | | 1 | | fpmerge.ns F9 | | fpcmp.lt F8 |
| | | 2 | | fpmerge.se F9 | | fpcmp.le F8 |
| | | 3 | | | | fpcmp.unord F8 |
| | | 4 | | fpmmin F8 | | fpcmp.neq F8 |
| | | 5 | | fpmmax F8 | | fpcmp.nlt F8 |
| | | 6 | | fpamin F8 | | fpcmp.nle F8 |
| | | 7 | | fpamax F8 | | fpcmp.ord F8 |
| | | 8 | | fpcvt.fx F10 | | |
| | | 9 | | fpcvt.fxu F10 | | |
| | | A | | fpcvt.fx.trunc F10 | | |
| | | B | | fpcvt.fxu.trunc F10 | | |
| | | C | | | | |
| | | D | | | | |
| | | E | | | | |
| | | F | | | | |

Table 4-62. Reciprocal Approximation 1-bit Opcode Extensions

| Opcode Bits 40:37 | x Bit 33 | q Bit 36 | |
|-------------------|----------|------------|-----------|
| 0 | 1 | 0 | frcpa F6 |
| | | 1 | frsqta F7 |
| 0 | | fprcpa F6 | |
| 1 | | fprsqta F7 | |
| 1 | | | |

Most floating-point instructions have a 2-bit opcode extension field in bits 35:34 (*sf*) which encodes the FPSR status field to be used. [Table 4-63](#) summarizes these assignments.

Table 4-63. Floating-point Status Field Completer

| sf Bits 35:34 | <i>sf</i> |
|---------------|-----------|
| 0 | .s0 |
| 1 | .s1 |
| 2 | .s2 |
| 3 | .s3 |

4.6.1 Arithmetic

The floating-point arithmetic instructions are encoded within major opcodes 8 – D using a 1-bit opcode extension field (*x*) in bit 36 and a 2-bit opcode extension field (*sf*) in bits 35:34. The opcode and *x* assignments are shown in [Table 4-64](#).

Table 4-64. Floating-point Arithmetic 1-bit Opcode Extensions

| x Bit 36 | Opcode Bits 40:37 | | | | | |
|----------|-------------------|----------|----------|----------|-----------|-----------|
| | 8 | 9 | A | B | C | D |
| 0 | fma F1 | fma.d F1 | fms F1 | fms.d F1 | fnma F1 | fnma.d F1 |
| 1 | fma.s F1 | fpma F1 | fms.s F1 | fpms F1 | fnma.s F1 | fpnma F1 |

The fixed-point arithmetic and parallel floating-point select instructions are encoded within major opcode E using a 1-bit opcode extension field (*x*) in bit 36. The fixed-point arithmetic instructions also have a 2-bit opcode extension field (*x*₂) in bits 35:34. These assignments are shown in [Table 4-65](#).

Table 4-65. Fixed-point Multiply Add and Select Opcode Extensions

| Opcode Bits 40:37 | x Bit 36 | <i>x</i> ₂ Bits 35:34 | | | |
|-------------------|----------|----------------------------------|---|-----------|----------|
| | | 0 | 1 | 2 | 3 |
| E | 0 | fselect F3 | | | |
| | 1 | xma.l F2 | | xma.hu F2 | xma.h F2 |

4.6.1.1 Floating-point Multiply Add

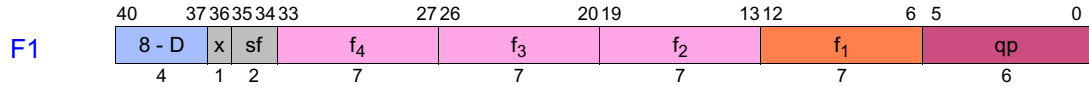

| Instruction | Operands | Opcode | Extension | |
|-------------|-----------------------|--------|-----------|------------------------------|
| | | | x | sf |
| fma.sf | $f_1 = f_3, f_4, f_2$ | 8 | 0 | See Table 4-63 on page 4-322 |
| fma.s.sf | | | 1 | |
| fma.d.sf | | 9 | 0 | |
| fpma.sf | | | 1 | |
| fms.sf | | A | 0 | |
| fms.s.sf | | | 1 | |
| fms.d.sf | | B | 0 | |
| fpms.sf | | | 1 | |
| fnma.sf | | C | 0 | |
| fnma.s.sf | | | 1 | |
| fnma.d.sf | | D | 0 | |
| fpnma.sf | | | 1 | |

4.6.1.2 Fixed-point Multiply Add

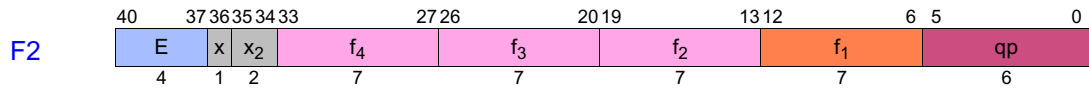

| Instruction | Operands | Opcode | Extension | |
|-------------|-----------------------|--------|-----------|----------------|
| | | | x | x ₂ |
| xma.l | $f_1 = f_3, f_4, f_2$ | E | 0 | 0 |
| xma.h | | | 1 | 3 |
| xma.hu | | | 1 | 2 |

4.6.2 Parallel Floating-point Select

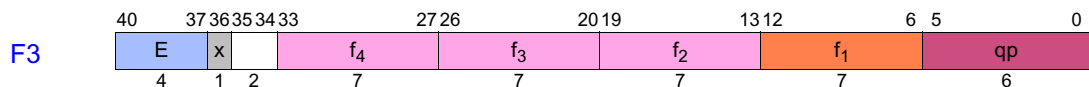

| Instruction | Operands | Opcode | Extension | |
|-------------|-----------------------|--------|-----------|--|
| | | | x | |
| fselect | $f_1 = f_3, f_4, f_2$ | E | 0 | |

4.6.3 Compare and Classify

The predicate setting floating-point compare instructions are encoded within major opcode 4 using three 1-bit opcode extension fields in bits 33 (r_a), 36 (r_b), and 12 (t_a), and a 2-bit opcode extension field (sf) in bits 35:34. The opcode, r_a , r_b , and t_a assignments are shown in Table 4-66. The sf assignments are shown in Table 4-63 on page 4-322.

The parallel floating-point compare instructions are described on page 4-326.

Table 4-66. Floating-point Compare Opcode Extensions

| Opcode Bits 40:37 | r_a Bit 33 | r_b Bit 36 | t_a Bit 12 | |
|-------------------|--------------|--------------|---------------|-------------------|
| | | | 0 | 1 |
| 4 | 0 | 0 | fcmp.eq F4 | fcmp.eq.unc F4 |
| | | 1 | fcmp.lt F4 | fcmp.lt.unc F4 |
| | 1 | 0 | fcmp.le F4 | fcmp.le.unc F4 |
| | | 1 | fcmp.unord F4 | fcmp.unord.unc F4 |

The floating-point class instructions are encoded within major opcode 5 using a 1-bit opcode extension field in bit 12 (t_a) as shown in Table 4-67.

Table 4-67. Floating-point Class 1-bit Opcode Extensions

| Opcode Bits 40:37 | t_a Bit 12 | |
|-------------------|--------------|-----------------|
| 5 | 0 | fclass.m F5 |
| | 1 | fclass.m.unc F5 |

4.6.3.1 Floating-point Compare

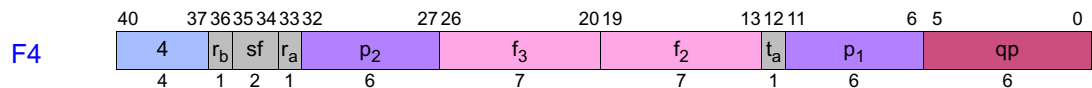

| Instruction | Operands | Opcode | Extension | | | |
|-------------------|-----------------------|--------|-----------|-------|-------|------------------------------|
| | | | r_a | r_b | t_a | sf |
| fcmp.eq.sf | $p_1, p_2 = f_2, f_3$ | 4 | 0 | 0 | 0 | See Table 4-63 on page 4-322 |
| fcmp.lt.sf | | | 1 | 1 | | |
| fcmp.le.sf | | | 0 | 0 | | |
| fcmp.unord.sf | | | 1 | 1 | | |
| fcmp.eq.unc.sf | | | 0 | 0 | 1 | |
| fcmp.lt.unc.sf | | | 1 | 1 | | |
| fcmp.le.unc.sf | | | 0 | 0 | | |
| fcmp.unord.unc.sf | | | 1 | 1 | | |

4.6.3.2 Floating-point Class

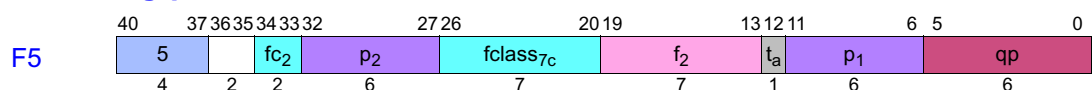

| Instruction | Operands | Opcode | Extension |
|--------------|----------------------------|--------|-----------|
| | | | t_a |
| fclass.m | $p_1, p_2 = f_2, fclass_9$ | 5 | 0 |
| fclass.m.unc | | | 1 |

4.6.4 Approximation

4.6.4.1 Floating-point Reciprocal Approximation

There are two Reciprocal Approximation instructions. The first, in major op 0, encodes the full register variant. The second, in major op 1, encodes the parallel variant.

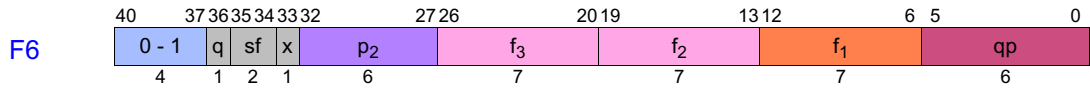

| Instruction | Operands | Opcode | Extension | | |
|------------------|-----------------------|--------|-----------|---|------------------------------|
| | | | x | q | sf |
| <i>frcpa.sf</i> | $f_1, p_2 = f_2, f_3$ | 0 | 1 | 0 | See Table 4-63 on page 4-322 |
| <i>fprcpa.sf</i> | | 1 | | | |

4.6.4.2 Floating-point Reciprocal Square Root Approximation

There are two Reciprocal Square Root Approximation instructions. The first, in major op 0, encodes the full register variant. The second, in major op 1, encodes the parallel variant.

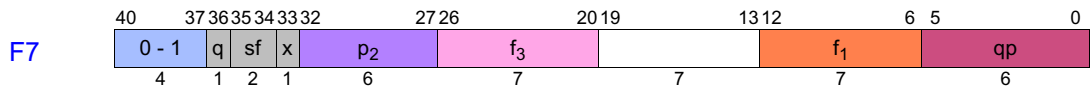

| Instruction | Operands | Opcode | Extension | | |
|--------------------|------------------|--------|-----------|---|------------------------------|
| | | | x | q | sf |
| <i>frsqrta.sf</i> | $f_1, p_2 = f_3$ | 0 | 1 | 1 | See Table 4-63 on page 4-322 |
| <i>fprsqrta.sf</i> | | 1 | | | |

4.6.5 Minimum/Maximum and Parallel Compare

There are two groups of Minimum/Maximum instructions. The first group, in major op 0, encodes the full register variants. The second group, in major op 1, encodes the parallel variants. The parallel compare instructions are all encoded in major op 1.

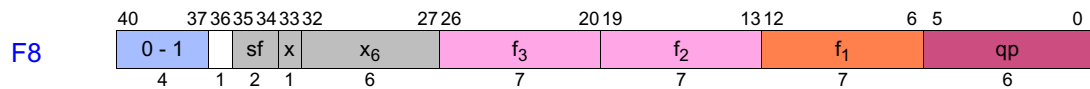

| Instruction | Operands | Opcode | Extension | | | |
|------------------------|------------------|--------|-----------|----------------|------------------------------|----|
| | | | x | x ₆ | sf | |
| fmin. <i>sf</i> | $f_1 = f_2, f_3$ | 0 | 0 | 14 | See Table 4-63 on page 4-322 | |
| fmax. <i>sf</i> | | | | 15 | | |
| famin. <i>sf</i> | | | | 16 | | |
| famax. <i>sf</i> | | | | 17 | | |
| fpmin. <i>sf</i> | | | | 14 | | |
| fpmax. <i>sf</i> | | | | 15 | | |
| fpamin. <i>sf</i> | | | | 16 | | |
| fpamax. <i>sf</i> | | | | 17 | | |
| fpcmp.eq. <i>sf</i> | | 1 | | | | 30 |
| fpcmp.lt. <i>sf</i> | | | | | | 31 |
| fpcmp.le. <i>sf</i> | | | | | | 32 |
| fpcmp.unord. <i>sf</i> | | | | | | 33 |
| fpcmp.neq. <i>sf</i> | | | | | | 34 |
| fpcmp.nlt. <i>sf</i> | | | | | | 35 |
| fpcmp.nle. <i>sf</i> | | | | | | 36 |
| fpcmp.ord. <i>sf</i> | | | | | | 37 |

4.6.6 Merge and Logical

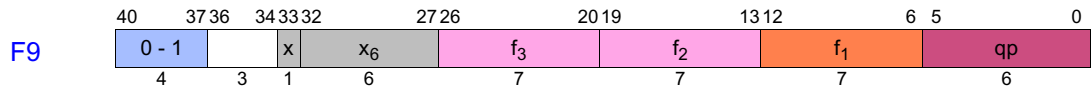

| Instruction | Operands | Opcode | Extension | |
|-------------|------------------|--------|-----------|----------------|
| | | | x | x ₆ |
| fmerge.s | $f_1 = f_2, f_3$ | 0 | 0 | 10 |
| fmerge.ns | | | | 11 |
| fmerge.se | | | | 12 |
| fmix.lr | | | | 39 |
| fmix.r | | | | 3A |
| fmix.l | | | | 3B |
| fsxt.r | | | | 3C |
| fsxt.l | | | | 3D |
| fpack | | | | 28 |
| fswap | | | | 34 |
| fswap.nl | | | | 35 |
| fswap.nr | | | | 36 |
| fand | | | | 2C |
| fandcm | | | | 2D |
| for | | | | 2E |
| fxor | | | | 2F |
| fpmerge.s | | 1 | | 10 |
| fpmerge.ns | | | | 11 |
| fpmerge.se | | | | 12 |

4.6.7 Conversion

4.6.7.1 Convert Floating-point to Fixed-point

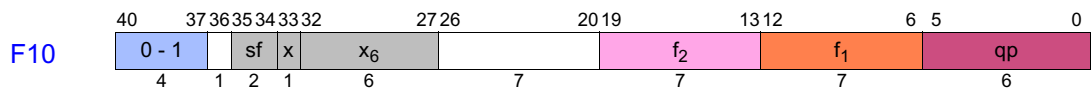

| Instruction | Operands | Opcode | Extension | | | |
|--------------------------------|-------------|--------|-----------|----------------|------------------------------|----|
| | | | x | x ₆ | sf | |
| fcvt.fx.s ^f | $f_1 = f_2$ | 0 | 0 | 18 | See Table 4-63 on page 4-322 | |
| fcvt.fxu.s ^f | | | | 19 | | |
| fcvt.fx.trunc.s ^f | | | | 1A | | |
| fcvt.fxu.trunc.s ^f | | | | 1B | | |
| fpcvt.fx.s ^f | | 1 | | 1 | | 18 |
| fpcvt.fxu.s ^f | | | | | | 19 |
| fpcvt.fx.trunc.s ^f | | | | | | 1A |
| fpcvt.fxu.trunc.s ^f | | | | | | 1B |

4.6.7.2 Convert Fixed-point to Floating-point

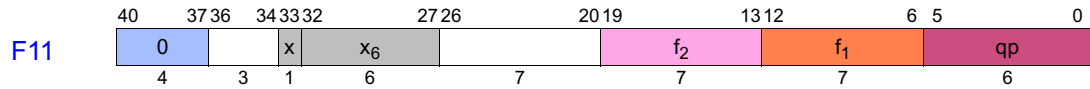

| Instruction | Operands | Opcode | Extension | |
|-------------|-------------|--------|-----------|----------------|
| | | | x | x ₆ |
| fcvt.xf | $f_1 = f_2$ | 0 | 0 | 1C |

4.6.8 Status Field Manipulation

4.6.8.1 Floating-point Set Controls

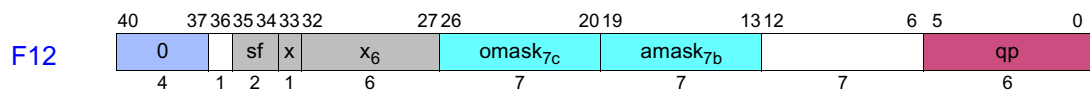

| Instruction | Operands | Opcode | Extension | | |
|-------------|--------------------|--------|-----------|----------------|------------------------------|
| | | | x | x ₆ | sf |
| fsetc.sf | $amask_7, omask_7$ | 0 | 0 | 04 | See Table 4-63 on page 4-322 |

4.6.8.2 Floating-point Clear Flags

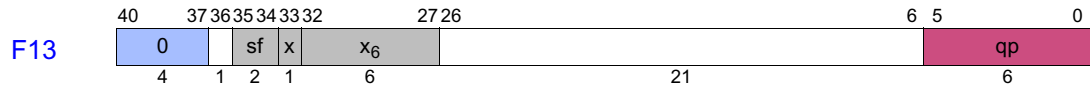

| Instruction | Opcode | Extension | | |
|-------------|--------|-----------|----------------|------------------------------|
| | | x | x ₆ | sf |
| fclrf.sf | 0 | 0 | 05 | See Table 4-63 on page 4-322 |

4.6.8.3 Floating-point Check Flags

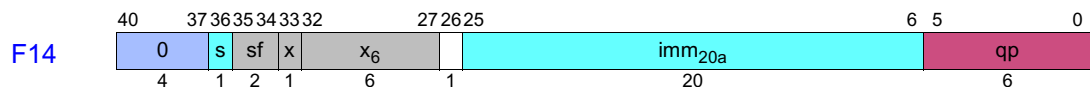

| Instruction | Operands | Opcode | Extension | | |
|-------------|---------------|--------|-----------|----------------|------------------------------|
| | | | x | x ₆ | sf |
| fchkf.sf | $target_{25}$ | 0 | 0 | 08 | See Table 4-63 on page 4-322 |

4.6.9 Miscellaneous F-Unit Instructions

4.6.9.1 Break (F-Unit)

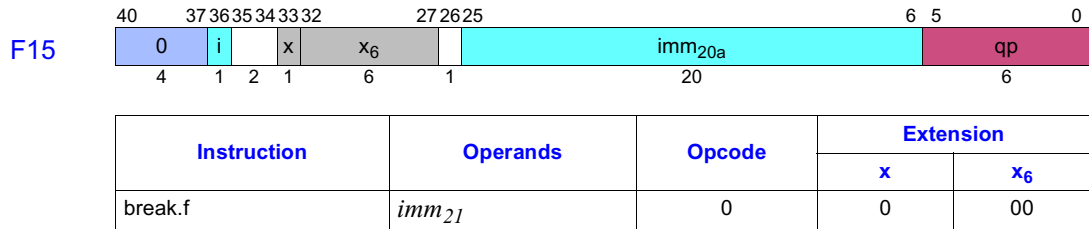

4.6.9.2 Nop/Hint (F-Unit)

F-unit nop and hint instructions are encoded within major opcode 0 using a 3-bit opcode extension field in bits 35:33 (x_3), a 6-bit opcode extension field in bits 32:27 (x_6), and a 1-bit opcode extension field in bit 26 (y), as shown in [Table 4-46](#).

Table 4-68. Misc F-Unit 1-bit Opcode Extensions

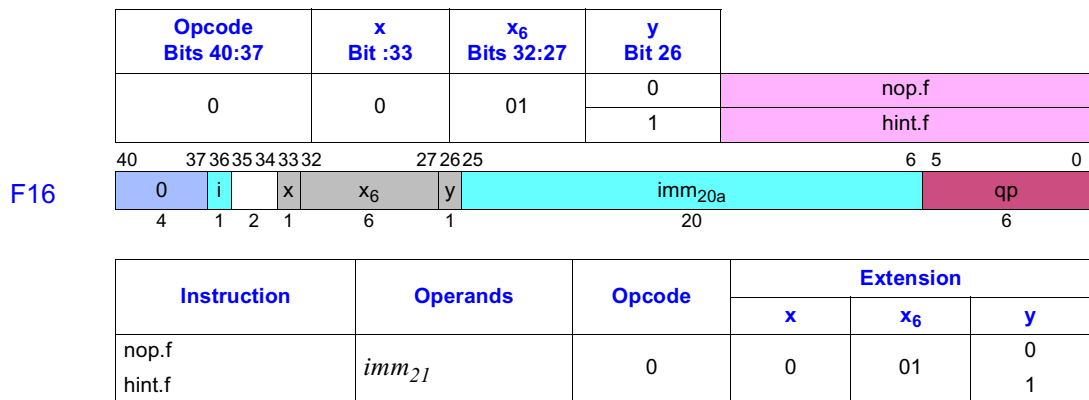

4.7 X-Unit Instruction Encodings

The X-unit instructions occupy two instruction slots, L+X. The major opcode, opcode extensions and hints, qp, and small immediate fields occupy the X instruction slot. For `movl`, `break.x`, and `nop.x`, the `imm`₄₁ field occupies the L instruction slot. For `brl`, the `imm`₃₉ field and a 2-bit Ignored field occupy the L instruction slot.

4.7.1 Miscellaneous X-Unit Instructions

The miscellaneous X-unit instructions are encoded in major opcode 0 using a 3-bit opcode extension field (x_3) in bits 35:33 and a 6-bit opcode extension field (x_6) in bits 32:27. [Table 4-69](#) shows the 3-bit assignments and [Table 4-70](#) summarizes the 6-bit assignments. These instructions are executed by an I-unit.

Table 4-69. Misc X-Unit 3-bit Opcode Extensions

| Opcode Bits 40:37 | x ₃ Bits 35:33 | |
|-------------------|---------------------------|------------------------|
| 0 | 0 | 6-bit Ext (Table 4-70) |
| | 1 | |
| | 2 | |
| | 3 | |
| | 4 | |
| | 5 | |
| | 6 | |
| | 7 | |

Table 4-70. Misc X-Unit 6-bit Opcode Extensions

| Opcode Bits 40:37 | x ₃ Bits 35:33 | x ₆ | | | | |
|-------------------|---------------------------|----------------|------------------------|---|---|---|
| | | Bits 30:27 | Bits 32:31 | | | |
| | | | 0 | 1 | 2 | 3 |
| 0 | 0 | 0 | break.x X1 | | | |
| | | 1 | 1-bit Ext (Table 4-73) | | | |
| | | 2 | | | | |
| | | 3 | | | | |
| | | 4 | | | | |
| | | 5 | | | | |
| | | 6 | | | | |
| | | 7 | | | | |
| | | 8 | | | | |
| | | 9 | | | | |
| | | A | | | | |
| | | B | | | | |
| | | C | | | | |
| | | D | | | | |
| | | E | | | | |
| | | F | | | | |

4.7.1.1 Break (X-Unit)

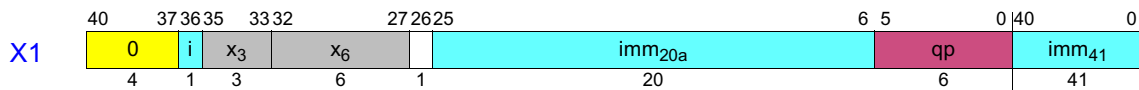

| Instruction | Operands | Opcode | Extension | |
|-------------|-------------------|--------|----------------|----------------|
| | | | x ₃ | x ₆ |
| break.x | imm ₆₂ | 0 | 0 | 00 |

4.7.2 Move Long Immediate₆₄

The move long immediate instruction is encoded within major opcode 6 using a 1-bit reserved opcode extension in bit 20 (v_c) as shown in Table 4-71. This instruction is executed by an I-unit.

Table 4-71. Move Long 1-bit Opcode Extensions

| Opcode Bits 40:37 | v_c Bit 20 | |
|-------------------|--------------|---------|
| 6 | 0 | movl X2 |
| | 1 | |

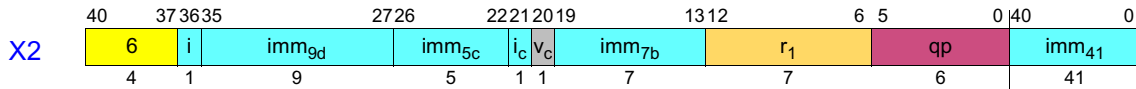

| Instruction | Operands | Opcode | Extension |
|-------------------|------------------|--------|-----------|
| | | | v_c |
| movl ⁱ | $r_1 = imm_{64}$ | 6 | 0 |

4.7.3 Long Branches

Long branches are executed by a B-unit. Opcode C is used for long branch and opcode D for long call.

The long branch instructions encoded within major opcode C use a 3-bit opcode extension field in bits 8:6 (btype) to distinguish the branch types as shown in Table 4-72.

Table 4-72. Long Branch Types

| Opcode Bits 40:37 | btype Bits 8:6 | |
|-------------------|----------------|-------------|
| C | 0 | brl.cond X3 |
| | 1 | |
| | 2 | |
| | 3 | |
| | 4 | |
| | 5 | |
| | 6 | |
| | 7 | |

The long branch instructions have the same opcode hint fields in bit 12 (p), bits 34:33 (wh), and bit 35 (d) as normal IP-relative branches. These are shown in Table 4-51 on page 4-315, Table 4-52 on page 4-315, and Table 4-54 on page 4-316.

4.7.3.1 Long Branch

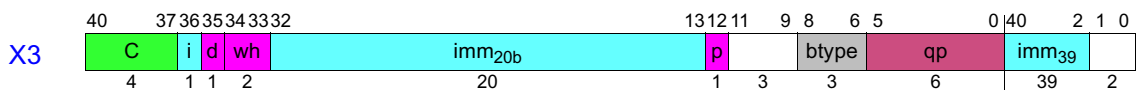

| Instruction | Operands | Opcode | Extension | | | |
|----------------------------------|----------------------|--------|-----------|------------------------------|------------------------------|------------------------------|
| | | | btype | p | wh | d |
| brl.cond.bwh.ph.dh ^{e1} | target ₆₄ | C | 0 | See Table 4-51 on page 4-315 | See Table 4-52 on page 4-315 | See Table 4-54 on page 4-316 |

4.7.3.2 Long Call

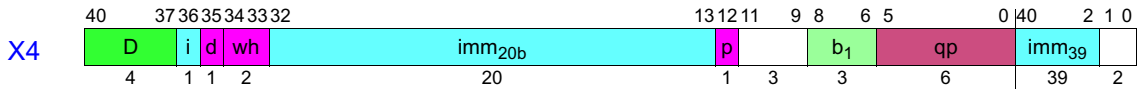

| Instruction | Operands | Opcode | Extension | | |
|----------------------------------|---------------------|--------|------------------------------|------------------------------|------------------------------|
| | | | p | wh | d |
| brl.call.bwh.ph.dh ^{e1} | $b_I = target_{64}$ | D | See Table 4-51 on page 4-315 | See Table 4-52 on page 4-315 | See Table 4-54 on page 4-316 |

4.7.4 Nop/Hint (X-Unit)

X-unit nop and hint instructions are encoded within major opcode 0 using a 3-bit opcode extension field in bits 35:33 (x_3), a 6-bit opcode extension field in bits 32:27 (x_6), and a 1-bit opcode extension field in bit 26 (y), as shown in Table 4-73. These instructions are executed by an I-unit.

Table 4-73. Misc X-Unit 1-bit Opcode Extensions

| Opcode Bits 40:37 | x_3 Bits 35:33 | x_6 Bits 32:27 | y Bit 26 | |
|-------------------|------------------|------------------|----------|--------|
| 0 | 0 | 01 | 0 | nop.m |
| | | | 1 | hint.m |

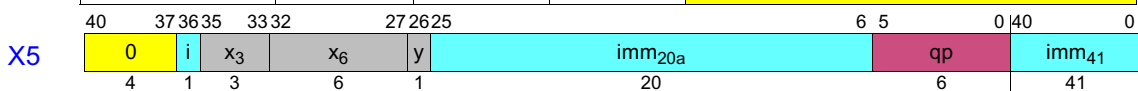

| Instruction | Operands | Opcode | Extension | | |
|-------------|------------|--------|-----------|-------|---|
| | | | x_3 | x_6 | y |
| nop.x | imm_{62} | 0 | 0 | 01 | 0 |
| hint.x | | | | | 1 |

4.8 Immediate Formation

Table 4-74 shows, for each instruction format that has one or more immediates, how those immediates are formed. In each equation, the symbol to the left of the equals is the assembly language name for the immediate. The symbols to the right are the field names in the instruction encoding.

Table 4-74. Immediate Formation

| Instruction Format | Immediate Formation |
|--------------------|---|
| A2 | $count_2 = ct_{2d} + 1$ |
| A3 A8 I27 M30 | $imm_8 = sign_ext(s \ll 7 \mid imm_{7b}, 8)$ |
| A4 | $imm_{14} = sign_ext(s \ll 13 \mid imm_{6d} \ll 7 \mid imm_{7b}, 14)$ |
| A5 | $imm_{22} = sign_ext(s \ll 21 \mid imm_{5c} \ll 16 \mid imm_{9d} \ll 7 \mid imm_{7b}, 22)$ |
| A10 | $count_2 = (ct_{2d} > 2) ? reservedQP^a : ct_{2d} + 1$ |
| I1 | $count_2 = (ct_{2d} == 0) ? 0 : (ct_{2d} == 1) ? 7 : (ct_{2d} == 2) ? 15 : 16$ |

Table 4-74. Immediate Formation (Continued)

| Instruction Format | Immediate Formation |
|--------------------|---|
| I3 | $mbtype_4 = (mbt_{4c} == 0) ? @brcst : (mbt_{4c} == 8) ? @mix : (mbt_{4c} == 9) ? @shuf : (mbt_{4c} == 0xA) ? @alt : (mbt_{4c} == 0xB) ? @rev : reservedQP^a$ |
| I4 | $mhtype_8 = mht_{8c}$ |
| I6 | $count_5 = count_{5b}$ |
| I8 | $count_5 = 31 - ccount_{5c}$ |
| I10 | $count_6 = count_{6d}$ |
| I11 | $len_6 = len_{6d} + 1$ $pos_6 = pos_{6b}$ |
| I12 | $len_6 = len_{6d} + 1$ $pos_6 = 63 - cpos_{6c}$ |
| I13 | $len_6 = len_{6d} + 1$ $pos_6 = 63 - cpos_{6c}$ $imm_8 = sign_ext(s \ll 7 imm_{7b}, 8)$ |
| I14 | $len_6 = len_{6d} + 1$ $pos_6 = 63 - cpos_{6b}$ $imm_1 = sign_ext(s, 1)$ |
| I15 | $len_4 = len_{4d} + 1$ $pos_6 = 63 - cpos_{6d}$ |
| I16 | $pos_6 = pos_{6b}$ |
| I18 I19 M37 M48 | $imm_{21} = i \ll 20 imm_{20a}$ |
| I21 | $tag_{13} = IP + (sign_ext(timm_{9c}, 9) \ll 4)$ |
| I23 | $mask_{17} = sign_ext(s \ll 16 mask_{8c} \ll 8 mask_{7a} \ll 1, 17)$ |
| I24 | $imm_{44} = sign_ext(s \ll 43 imm_{27a} \ll 16, 44)$ |
| M3 M8 M15 | $imm_9 = sign_ext(s \ll 8 i \ll 7 imm_{7b}, 9)$ |
| M5 M10 | $imm_9 = sign_ext(s \ll 8 i \ll 7 imm_{7a}, 9)$ |
| M17 | $inc_3 = sign_ext(((s) ? -1 : 1) * ((i_{2b} == 3) ? 1 : 1 \ll (4 - i_{2b})), 6)$ |
| I20 M20 M21 | $target_{25} = IP + (sign_ext(s \ll 20 imm_{13c} \ll 7 imm_{7a}, 21) \ll 4)$ |
| M22 M23 | $target_{25} = IP + (sign_ext(s \ll 20 imm_{20b}, 21) \ll 4)$ |
| M34 | $il = sol$ $o = sof - sol$ $r = sor \ll 3$ |
| M39 M40 | $imm_2 = i_{2b}$ |
| M44 | $imm_{24} = i \ll 23 i_{2d} \ll 21 imm_{21a}$ |
| B1 B2 B3 | $target_{25} = IP + (sign_ext(s \ll 20 imm_{20b}, 21) \ll 4)$ |
| B6 | $target_{25} = IP + (sign_ext(s \ll 20 imm_{20b}, 21) \ll 4)$ $tag_{13} = IP + (sign_ext(t_{2e} \ll 7 timm_{7a}, 9) \ll 4)$ |
| B7 | $tag_{13} = IP + (sign_ext(t_{2e} \ll 7 timm_{7a}, 9) \ll 4)$ |
| B9 | $imm_{21} = i \ll 20 imm_{20a}$ |
| F5 | $fclass_9 = fclass_{7c} \ll 2 fc_2$ |
| F12 | $amask_7 = amask_{7b}$ $omask_7 = omask_{7c}$ |
| F14 | $target_{25} = IP + (sign_ext(s \ll 20 imm_{20a}, 21) \ll 4)$ |
| F15 F16 | $imm_{21} = i \ll 20 imm_{20a}$ |
| X1 X5 | $imm_{62} = imm_{41} \ll 21 i \ll 20 imm_{20a}$ |
| X2 | $imm_{64} = i \ll 63 imm_{41} \ll 22 i_c \ll 21 imm_{5c} \ll 16 imm_{9d} \ll 7 imm_{7b}$ |
| X3 X4 | $target_{64} = IP + ((i \ll 59 imm_{39} \ll 20 imm_{20b}) \ll 4)$ |

a. This encoding causes an Illegal Operation fault if the value of the qualifying predicate is 1.

Resource and Dependency Semantics 5

5.1 Reading and Writing Resources

An Itanium instruction is said to be a **reader** of a resource if the instruction's qualifying predicate is 1 or it has no qualifying predicate or is one of the instructions that reads a resource even when its qualifying predicate is 0, and the execution of the instruction depends on that resource.

An Itanium instruction is said to be a **writer** of a resource if the instruction's qualifying predicate is 1 or it has no qualifying predicate or writes the resource even when the qualifying predicate is 0, and the execution of the instruction writes that resource.

An Itanium instruction is said to be a reader or writer of a resource even if it only sometimes depends on that resource and it cannot be determined statically whether the resource will be read or written. For example, `cover` only writes CR[IFS] when PSR.ic is 0, but for purposes of dependency, it is treated as if it always writes the resource since this condition cannot be determined statically. On the other hand, `rsm` conditionally writes several bits in the PSR depending on a mask which is encoded as an immediate in the instruction. Since the PSR bits to be written can be determined by examining the encoded instruction, the instruction is treated as only writing those bits which have a corresponding mask bit set. All exceptions to these general rules are described in this appendix.

5.2 Dependencies and Serialization

A **RAW** (Read-After-Write) dependency is a sequence of two events where the first is a writer of a resource and the second is a reader of the same resource. Events may be instructions, interruptions, or other 'uses' of the resource such as instruction stream fetches and VHPT walks. [Table 5-2](#) covers only dependencies based on instruction readers and writers.

A **WAW** (Write-After-Write) dependency is a sequence of two events where both events write the resource in question. Events may be instructions, interruptions, or other 'updates' of the resource. [Table 5-3](#) covers only dependencies based on instruction writers.

A **WAR** (Write-After-Read) dependency is a sequence of two instructions, where the first is a reader of a resource and the second is a writer of the same resource. Such dependencies are always allowed except as indicated in [Table 5-4](#) and only those related to instruction readers and writers are included.

A **RAR** (Read-After-Read) dependency is a sequence of two instructions where both are readers of the same resource. Such dependencies are always allowed.

RAW and WAW dependencies are generally not allowed without some type of serialization event (an implied, data, or instruction serialization after the first writing instruction. (See [Section 3.2, "Serialization" on page 2:13](#) for details on serialization.) The tables and associated rules in this appendix provide a comprehensive list of readers and writers of resources and describe the

serialization required for the dependency to be observed and possible outcomes if the required serialization is not met. Even when targeting code for machines which do not check for particular disallowed dependencies, such code sequences are considered architecturally undefined and may cause code to behave differently across processors, operating systems, or even separate executions of the code sequence during the same program run. In some cases, different serializations may yield different, but well-defined results.

The serialization of application level (non-privileged) resources is always implied. This means that if a writer of that resource and a subsequent read of that same resource are in different instruction groups, then the reader will see the value written. In addition, for dependencies on PRs and BRs, where the writer is a non-branch instruction and the reader is a branch instruction, the writer and reader may be in the same instruction group.

System resources generally require explicit serialization, i.e., the use of a `srlz.i` or `srlz.d` instruction, between the writing and the reading of that resource. Note that RAW accesses to CRs are not exceptional - they require explicit data or instruction serialization. However, in some cases (other than CRs) where pairs of instructions explicitly encode the same resource, serialization is implied.

There are cases where it is architecturally allowed to omit a serialization, and that the response from the CPU must be atomic (act as if either the old or the new state were fully in place). The tables in this appendix indicate dependency requirements under the assumption that the desired result is for the dependency to always be observed. In some such cases, the programmer may not care if the old or new state is used; such situations are allowed, but the value seen is not deterministic.

On the other hand, if an *impliedF* dependency is violated, then the program is incorrectly coded and the processor's behavior is undefined.

5.3 Resource and Dependency Table Format Notes

- The “Writers” and “Readers” columns of the dependency tables contain instruction class names and instruction mnemonic prefixes as given in the format section of each instruction page. To avoid ambiguity, instruction classes are shown in bold, while instruction mnemonic prefixes are in regular font. For instruction mnemonic prefixes, all instructions that exactly match the name specified or those that begin with the specified text and are followed by a ‘.’ and then followed by any other text will match.
- The dependency on a listed instruction is in effect no matter what values are encoded in the instruction or what dynamic values occur in operands, unless a superscript is present or one of the special case instruction rules in [Section 5.3.1](#) applies. Instructions listed are still subject to rules regarding qualifying predicates.
- Instruction classes are groups of related instructions. Such names appear in boldface for clarity. The list of all instruction classes is contained in [Table 5-5](#). Note that an instruction may appear in multiple instruction classes, instruction classes may expand to contain other classes, and that when fully expanded, a set of classes (e.g., the readers of some resource) may contain the same instruction multiple times.

- The syntax ‘x\y’ where x and y are both instruction classes, indicates an unnamed instruction class that includes all instructions in instruction class x but that are not in instruction class y. Similarly, the notation ‘x\y\z’ means all instructions in instruction class x, but that are not in either instruction class y or instruction class z.
- Resources on separate rows of a table are independent resources. This means that there are no serialization requirements for an event which references one of them followed by an event which uses a different resource. In cases where resources are broken into subrows, dependencies only apply between instructions within a subrow. Instructions that do not appear in a subrow together have no dependencies (reader/writer or writer/writer dependencies) for the resource in question, although they may still have dependencies on some other resource.
- The dependencies listed for pairs of instructions on each resource are not unique -- the same pair of instructions might also have a dependency on some other resource with a different semantics of dependency. In cases where there are multiple resource dependencies for the same pair of instructions, the most stringent semantics are assumed: *instr* overrides *data* which overrides *impliedF* which overrides *implied* which overrides *none*.
- Arrays of numbered resources are represented in a single row of a table using the % notation as a substitute for the number of the resource. In such cases, the semantics of the table are as if each numbered resource had its own row in that table and is thus an independent resource. The range of values that the % can take are given in the “Resource Name” column.
- An asterisk ‘*’ in the “Resource Name” column indicates that this resource may not have a physical resource associated with it, but is added to enforce special dependencies.
- A pound sign ‘#’ in the “Resource Name” column indicates that this resource is an array of resources that are indexed by a value in a GR. The number of individual elements in the array is described in the detailed description of each resource.
- The “Semantics of Dependency” column describes the outcome given various serialization and instruction group boundary conditions. The exact definition for each keyword is given in [Table 5-1](#).

Table 5-1. Semantics of Dependency Codes

| Semantics of Dependency Code | Serialization Type Required | Effects of Serialization Violation |
|------------------------------|---|--|
| instr | Instruction Serialization (See “Instruction Serialization” on page 2:14). | Atomic: Any attempt to read a resource after one or more insufficiently serialized writes is either the value previously in the register (before any of the unserialized writes) or the value of one of any unserialized writes. Which value is returned is unpredictable and multiple insufficiently serialized reads may see different results. No fault will be caused by the insufficient serialization. |
| data | Data Serialization (See “Data Serialization” on page 2:14) | |
| implied | Instruction Group Break. Writer and reader must be in separate instruction groups. (See “Instruction Sequencing Considerations” on page 1:33). | |
| impliedF | Instruction Group Break (same as above). | An undefined value is returned, or an Illegal Operation fault may be taken. If no fault is taken, the value returned is unpredictable, and may be unrelated to past writes, but will not be data which could not be accessed by the current process (e.g., if PSR.cpl != 0, the undefined value to return cannot be read from some control register). |
| stop | Stop. Writer and reader must be separated by a stop. | |
| none | None | N/A |
| specific | Implementation Specific | |
| SC | Special Case | Described elsewhere in book, see referenced section in the entry. |

5.3.1 Special Case Instruction Rules

The following rules apply to the specified instructions when they appear in [Table 5-2](#), [Table 5-3](#), [Table 5-4](#), or [Table 5-5](#):

- An instruction always reads a given resource if its qualifying predicate is 1 and it appears in the “Reader” column of the table (except as noted). An instruction always writes a given resource if its qualifying predicate is 1 and it appears in the “Writer” column of the table (except as noted). An instruction never reads or writes the specified resource if its qualifying predicate is 0 (except as noted). These rules include branches and their qualifying predicate. Instructions in the **unpredicable-instructions** class have no qualifying predicate and thus always read or write their resources (except as noted).
- An instruction of type **mov-from-PR** reads all PRs if its PR[qp] is true. If the PR[qp] is false, then only the PR[qp] is read.
- An instruction of type **mov-to-PR** writes only those PRs as indicated by the immediate mask encoded in the instruction.
- A `st8.spill` only writes AR[UNAT]{X} where X equals the value in bits 8:3 of the store’s data address. A `ld8.fill` instruction only reads AR[UNAT]{Y} where Y equals the value in bits 8:3 of the load’s data address.
- Instructions of type **mod-sched-brs** always read AR[EC] and the rotating register base registers in CFM, and always write AR[EC], the rotating register bases in CFM, and PR[63] even if they do not change their values or if their PR[qp] is false.
- Instructions of type **mod-sched-brs-counted** always read and write AR[LC], even if they do not change its value.
- For instructions of type **pr-or-writers** or **pr-and-writers**, if their completer is `or.andcm`, then only the first target predicate is an or-compare and the second target predicate is an and-compare. Similarly, if their completer is `and.orcm`, then only the second target predicate is an or-compare and the first target predicate is an and-compare.
- `rum` and `sum` only read PSR.sp when the bit corresponding to PSR.up (bit 2) is set in the immediate field of the instruction.

5.3.2 RAW Dependency Table

[Table 5-2](#) architecturally defines the following information:

- A list of all architecturally-defined, independently-writable resources in the Itanium architecture. Each row represents an ‘atomic’ resource. Thus, for each row in the table, hardware will probably require a separate write-enable control signal.
- For each resource, a complete list of readers and writers.
- For each instruction, a complete list of all resources read and written. Such a list can be obtained by taking the union of all the rows in which each instruction appears.

Table 5-2. RAW Dependencies Organized by Resource

| Resource Name | Writers | Readers | Semantics of Dependency |
|-----------------------|---|---|-------------------------|
| ALAT | chk.a.clr, mem-readers-arat, mem-writers, invala-all | mem-readers-arat, mem-writers, chk-a, invala.e | none |
| AR[BSP] | br.call, brl.call, br.ret, cover, mov-to-AR-BSPSTORE, rfi | br.call, brl.call, br.ia, br.ret, cover, flushrs, loadrs, mov-from-AR-BSP, rfi | impliedF |
| AR[BSPSTORE] | alloc, loadrs, flushrs, mov-to-AR-BSPSTORE | alloc, br.ia, flushrs, mov-from-AR-BSPSTORE | impliedF |
| AR[CCV] | mov-to-AR-CCV | br.ia, cmpxchg, mov-from-AR-CCV | impliedF |
| AR[CFLG] | mov-to-AR-CFLG | br.ia, mov-from-AR-CFLG | impliedF |
| AR[CSD] | ld16, mov-to-AR-CSD | br.ia, cmp8xchg16, mov-from-AR-CSD, st16 | impliedF |
| AR[EC] | mod-sched-brs, br.ret, mov-to-AR-EC | br.call, brl.call, br.ia, mod-sched-brs, mov-from-AR-EC | impliedF |
| AR[EFLAG] | mov-to-AR-EFLAG | br.ia, mov-from-AR-EFLAG | impliedF |
| AR[FCR] | mov-to-AR-FCR | br.ia, mov-from-AR-FCR | impliedF |
| AR[FDR] | mov-to-AR-FDR | br.ia, mov-from-AR-FDR | impliedF |
| AR[FIR] | mov-to-AR-FIR | br.ia, mov-from-AR-FIR | impliedF |
| AR[FPSR].sf0.controls | mov-to-AR-FPSR, fsetc.s0 | br.ia, fp-arith-s0, fcmp-s0, fpcmp-s0, fsetc, mov-from-AR-FPSR | impliedF |
| AR[FPSR].sf1.controls | mov-to-AR-FPSR, fsetc.s1 | br.ia, fp-arith-s1, fcmp-s1, fpcmp-s1, mov-from-AR-FPSR | |
| AR[FPSR].sf2.controls | mov-to-AR-FPSR, fsetc.s2 | br.ia, fp-arith-s2, fcmp-s2, fpcmp-s2, mov-from-AR-FPSR | |
| AR[FPSR].sf3.controls | mov-to-AR-FPSR, fsetc.s3 | br.ia, fp-arith-s3, fcmp-s3, fpcmp-s3, mov-from-AR-FPSR | |
| AR[FPSR].sf0.flags | fp-arith-s0, fclrf.s0, fcmp-s0, fpcmp-s0, mov-to-AR-FPSR | br.ia, fchkf, mov-from-AR-FPSR | impliedF |
| AR[FPSR].sf1.flags | fp-arith-s1, fclrf.s1, fcmp-s1, fpcmp-s1, mov-to-AR-FPSR | br.ia, fchkf.s1, mov-from-AR-FPSR | |
| AR[FPSR].sf2.flags | fp-arith-s2, fclrf.s2, fcmp-s2, fpcmp-s2, mov-to-AR-FPSR | br.ia, fchkf.s2, mov-from-AR-FPSR | |
| AR[FPSR].sf3.flags | fp-arith-s3, fclrf.s3, fcmp-s3, fpcmp-s3, mov-to-AR-FPSR | br.ia, fchkf.s3, mov-from-AR-FPSR | |
| AR[FPSR].traps | mov-to-AR-FPSR | br.ia, fp-arith, fchkf, fcmp, fpcmp, mov-from-AR-FPSR | impliedF |
| AR[FPSR].rv | mov-to-AR-FPSR | br.ia, fp-arith, fchkf, fcmp, fpcmp, mov-from-AR-FPSR | impliedF |
| AR[FSR] | mov-to-AR-FSR | br.ia, mov-from-AR-FSR | impliedF |
| AR[ITC] | mov-to-AR-ITC | br.ia, mov-from-AR-ITC | impliedF |
| AR[K%], % in 0 - 7 | mov-to-AR-K¹ | br.ia, mov-from-AR-K¹ | impliedF |
| AR[LC] | mod-sched-brs-counted, mov-to-AR-LC | br.ia, mod-sched-brs-counted, mov-from-AR-LC | impliedF |

Table 5-2. RAW Dependencies Organized by Resource (Continued)

| Resource Name | Writers | Readers | Semantics of Dependency |
|--|---|--|--|
| AR[PFS] | br.call, brl.call | alloc, br.ia, br.ret, epc, mov-from-AR-PFS | impliedF |
| | mov-to-AR-PFS | alloc, br.ia, epc, mov-from-AR-PFS | impliedF |
| | | br.ret | none |
| AR[RNAT] | alloc, flushrs, loadrs, mov-to-AR-RNAT , mov-to-AR-BSPSTORE | alloc, br.ia, flushrs, loadrs, mov-from-AR-RNAT | impliedF |
| AR[RSC] | mov-to-AR-RSC | alloc, br.ia, flushrs, loadrs, mov-from-AR-RSC , mov-from-AR-BSPSTORE , mov-to-AR-RNAT , mov-from-AR-RNAT , mov-to-AR-BSPSTORE | impliedF |
| AR[SSD] | mov-to-AR-SSD | br.ia, mov-from-AR-SSD | impliedF |
| AR[UNAT]{%}, % in 0 - 63 | mov-to-AR-UNAT , st8.spill | br.ia, ld8.fill, mov-from-AR-UNAT | impliedF |
| AR%, % in 8-15, 20, 22-23, 31, 33-35, 37-39, 41-43, 45-47, 67-111 | none | br.ia, mov-from-AR-rv ¹ | none |
| AR%, % in 48-63, 112-127 | mov-to-AR-ig ¹ | br.ia, mov-from-AR-ig ¹ | impliedF |
| BR%, % in 0 - 7 | br.call ¹ , brl.call ¹ | indirect-brs ¹ , indirect-brp ¹ , mov-from-BR ¹ | impliedF |
| | | mov-to-BR ¹ | none |
| | | indirect-brp ¹ , mov-from-BR ¹ | impliedF |
| CFM | mod-sched-brs | mod-sched-brs | impliedF |
| | | cover, alloc, rfi, loadrs, br.ret, br.call, brl.call | impliedF |
| | | cfm-readers ² | impliedF |
| | br.call, brl.call, br.ret, clrrrb, cover, rfi | cfm-readers | impliedF |
| | alloc | cfm-readers | none |
| CPUID# | none | mov-from-IND-CPUID ³ | specific |
| CR[CMCV] | mov-to-CR-CMCV | mov-from-CR-CMCV | data |
| CR[DCR] | mov-to-CR-DCR | mov-from-CR-DCR , mem-readers-spec | data |
| CR[EOI] | mov-to-CR-EOI | none | SC Section 5.8.3.4 on page 2:106 |
| CR[GPTA] | mov-to-CR-GPTA | mov-from-CR-GPTA , thash | data |
| CR[IFA] | mov-to-CR-IFA | itc.i, itc.d, itr.i, itr.d | implied |
| | | mov-from-CR-IFA | data |

Table 5-2. RAW Dependencies Organized by Resource (Continued)

| Resource Name | Writers | Readers | Semantics of Dependency |
|--|--|--|--|
| CR[IFS] | mov-to-CR-IFS cover | mov-from-CR-IFS | data |
| | | rfi | implied |
| | | rfi, mov-from-CR-IFS | implied |
| CR[IHA] | mov-to-CR-IHA | mov-from-CR-IHA | data |
| CR[IIM] | mov-to-CR-IIM | mov-from-CR-IIM | data |
| CR[IIP] | mov-to-CR-IIP | mov-from-CR-IIP | data |
| | | rfi | implied |
| CR[IIPA] | mov-to-CR-IIPA | mov-from-CR-IIPA | data |
| CR[IPSR] | mov-to-CR-IPSR | mov-from-CR-IPSR | data |
| | | rfi | implied |
| CR[IRR%], % in 0 - 3 | mov-from-CR-IVR | mov-from-CR-IRR ¹ | data |
| CR[ISR] | mov-to-CR-ISR | mov-from-CR-ISR | data |
| CR[ITIR] | mov-to-CR-ITIR | mov-from-CR-ITIR | data |
| | | itc.i, itc.d, itr.i, itr.d | implied |
| CR[ITM] | mov-to-CR-ITM | mov-from-CR-ITM | data |
| CR[ITV] | mov-to-CR-ITV | mov-from-CR-ITV | data |
| CR[IVA] | mov-to-CR-IVA | mov-from-CR-IVA | instr |
| CR[IVR] | none | mov-from-CR-IVR | SC Section 5.8.3.2 on page 2:105 |
| CR[LID] | mov-to-CR-LID | mov-from-CR-LID | SC Section 5.8.3.1 on page 2:104 |
| CR[LRR%], % in 0 - 1 | mov-to-CR-LRR ¹ | mov-from-CR-LRR ¹ | data |
| CR[PMV] | mov-to-CR-PMV | mov-from-CR-PMV | data |
| CR[PTA] | mov-to-CR-PTA | mov-from-CR-PTA, thash | data |
| CR[TPR] | mov-to-CR-TPR | mov-from-CR-TPR, mov-from-CR-IVR | data |
| | | mov-to-PSR-I, rfi, rsm, ssm | SC Section 5.8.3.3 on page 2:105 |
| CR%, % in 3-7, 10-15, 18, 26-63, 75-79, 82-127 | none | mov-from-CR-rv ¹ | none |
| DBR# | mov-to-IND-DBR ³ | mov-from-IND-DBR ³ | impliedF |
| | | probe-all, lfetch-all, mem-readers, mem-writers | data |
| DTC | ptc.e, ptc.g, ptc.ga, ptc.l, ptr.i, ptr.d, itc.i, itc.d, itr.i, itr.d | mem-readers, mem-writers, fc, probe-all, tak, tpa | data |
| | | itc.i, itc.d, itr.i, itr.d | ptc.e, ptc.g, ptc.ga, ptc.l, ptr.i, ptr.d, itc.i, itc.d, itr.i, itr.d |
| | ptc.e, ptc.g, ptc.ga, ptc.l, ptr.i, ptr.d | ptc.e, ptc.g, ptc.ga, ptc.l, ptr.i, ptr.d | none |
| | | itc.i, itc.d, itr.i, itr.d | impliedF |
| DTC_LIMIT* | ptc.g, ptc.ga | ptc.g, ptc.ga | impliedF |

Table 5-2. RAW Dependencies Organized by Resource (Continued)

| Resource Name | Writers | Readers | Semantics of Dependency |
|--|--|--|--|
| DTR | itr.d | mem-readers, mem-writers, fc, probe-all, tak, tpa | data |
| | | ptc.g, ptc.ga, ptc.l, ptr.d, itr.d | impliedF |
| | ptr.d | mem-readers, mem-writers, fc, probe-all, tak, tpa | data |
| | | ptc.g, ptc.ga, ptc.l, ptr.d itr.d, itc.d | none impliedF |
| FR%, % in 0 - 1 | none | fr-readers ¹ | none |
| FR%, % in 2 - 127 | fr-writers ¹ \ldf-c ¹ \ldfp-c ¹ | fr-readers ¹ | impliedF |
| | ldf-c ¹ , ldfp-c ¹ | fr-readers ¹ | none |
| GR0 | none | gr-readers ¹ | none |
| GR%, % in 1 - 127 | ld-c ^{1,13} | gr-readers ¹ | none |
| | gr-writers ¹ \ld-c ^{1,13} | gr-readers ¹ | impliedF |
| IBR# | mov-to-IND-IBR ³ | mov-from-IND-IBR ³ | impliedF |
| InService* | mov-to-CR-EOI | mov-from-CR-IVR | data |
| | mov-from-CR-IVR | mov-from-CR-IVR | impliedF |
| | mov-to-CR-EOI | mov-to-CR-EOI | impliedF |
| IP | all | all | none |
| ITC | ptc.e, ptc.g, ptc.ga, ptc.l, ptr.i, ptr.d | epc | instr |
| | | itc.i, itc.d, itr.i, itr.d | impliedF |
| | | ptr.i, ptr.d, ptc.e, ptc.g, ptc.ga, ptc.l | none |
| | itc.i, itc.d, itr.i, itr.d | epc | instr |
| itc.d, itc.i, itr.d, itr.i, ptr.d, ptr.i, ptc.g, ptc.ga, ptc.l | | impliedF | |
| ITC_LIMIT* | ptc.g, ptc.ga | ptc.g, ptc.ga | impliedF |
| ITR | itr.i | itr.i, itc.i, ptc.g, ptc.ga, ptc.l, ptr.i | impliedF |
| | | epc | instr |
| | ptr.i | itc.i, itr.i | impliedF |
| | | ptc.g, ptc.ga, ptc.l, ptr.i epc | none instr |
| memory | mem-writers | mem-readers | none |
| PKR# | mov-to-IND-PKR ³ | mem-readers, mem-writers, mov-from-IND-PKR ⁴ , probe-all | data |
| | | mov-to-IND-PKR ⁴ | none |
| | | mov-from-IND-PKR ³ | impliedF |
| | | mov-to-IND-PKR ³ | impliedF |
| PMC# | mov-to-IND-PMC ³ | mov-from-IND-PMC ³ | impliedF |
| | | mov-from-IND-PMD ³ | SC ³ Section 7.1.1 on page 2:132 |
| PMD# | mov-to-IND-PMD ³ | mov-from-IND-PMD ³ | impliedF |
| PR0 | pr-writers ¹ | pr-readers-br ¹ , pr-readers-nobr-nomovpr ¹ , mov-from-PR ¹² , mov-to-PR ¹² | none |

Table 5-2. RAW Dependencies Organized by Resource (Continued)

| Resource Name | Writers | Readers | Semantics of Dependency |
|----------------------|--|--|-------------------------|
| PR%, % in 1 - 15 | pr-writers ¹ , mov-to-PR-allreg ⁷ | pr-readers-nobr-nomovpr ¹ , mov-from-PR, mov-to-PR ¹² | impliedF |
| | pr-writers-fp ¹ | pr-readers-br ¹ | impliedF |
| | pr-writers-int ¹ , mov-to-PR-allreg ⁷ | pr-readers-br ¹ | none |
| PR%, % in 16 - 62 | pr-writers ¹ , mov-to-PR-allreg ⁷ , mov-to-PR-rotreg | pr-readers-nobr-nomovpr ¹ , mov-from-PR, mov-to-PR ¹² | impliedF |
| | pr-writers-fp ¹ | pr-readers-br ¹ | impliedF |
| | pr-writers-int ¹ , mov-to-PR-allreg ⁷ , mov-to-PR-rotreg | pr-readers-br ¹ | none |
| PR63 | mod-sched-brs, pr-writers ¹ , mov-to-PR-allreg ⁷ , mov-to-PR-rotreg | pr-readers-nobr-nomovpr ¹ , mov-from-PR, mov-to-PR ¹² | impliedF |
| | pr-writers-fp ¹ , mod-sched-brs | pr-readers-br ¹ | impliedF |
| | pr-writers-int ¹ , mov-to-PR-allreg ⁷ , mov-to-PR-rotreg | pr-readers-br ¹ | none |
| PSR.ac | user-mask-writers-partial ⁷ , mov-to-PSR-um | mem-readers, mem-writers | implied |
| | sys-mask-writers-partial ⁷ , mov-to-PSR-I, rfi | mem-readers, mem-writers | data |
| | user-mask-writers-partial ⁷ , mov-to-PSR-um, sys-mask-writers-partial ⁷ , mov-to-PSR-I, rfi | mov-from-PSR, mov-from-PSR-um | impliedF |
| PSR.be | user-mask-writers-partial ⁷ , mov-to-PSR-um | mem-readers, mem-writers | implied |
| | sys-mask-writers-partial ⁷ , mov-to-PSR-I, rfi | mem-readers, mem-writers | data |
| | user-mask-writers-partial ⁷ , mov-to-PSR-um, sys-mask-writers-partial ⁷ , mov-to-PSR-I, rfi | mov-from-PSR, mov-from-PSR-um | impliedF |
| PSR.bn | bsw, rfi | gr-readers ¹⁰ , gr-writers ¹⁰ | impliedF |
| PSR.cpl | epc, br.ret, rfi | priv-ops, br.call, brl.call, epc, mov-from-AR-ITC, mov-to-AR-ITC, mov-to-AR-RSC, mov-to-AR-K, mov-from-IND-PMD, probe-all, mem-readers, mem-writers, lfetch-all | implied |

Table 5-2. RAW Dependencies Organized by Resource (Continued)

| Resource Name | Writers | Readers | Semantics of Dependency |
|----------------------|--|---|--------------------------------|
| PSR.da | rfi | mem-readers, lfetch-fault, mem-writers, probe-fault | data |
| PSR.db | mov-to-PSR-l | mem-readers, mem-writers, probe-fault | data |
| | | mov-from-PSR | impliedF |
| | rfi | mem-readers, mem-writers, mov-from-PSR, probe-fault | data |
| PSR.dd | rfi | mem-readers, probe-fault, mem-writers, lfetch-fault | data |
| PSR.dfh | sys-mask-writers-partial ⁷ , mov-to-PSR-l, rfi | fr-readers ⁸ , fr-writers ⁸ | data |
| | | mov-from-PSR | impliedF |
| PSR.dfl | sys-mask-writers-partial ⁷ , mov-to-PSR-l, rfi | fr-writers ⁸ , fr-readers ⁸ | data |
| | | mov-from-PSR | impliedF |
| PSR.di | sys-mask-writers-partial ⁷ , mov-to-PSR-l, rfi | br.ia | data |
| | | mov-from-PSR | impliedF |
| PSR.dt | sys-mask-writers-partial ⁷ , mov-to-PSR-l, rfi | mem-readers, mem-writers | data |
| | | mov-from-PSR | impliedF |
| PSR.ed | rfi | lfetch-all, mem-readers-spec | data |
| PSR.i | sys-mask-writers-partial ⁷ , mov-to-PSR-l | mov-from-PSR | impliedF |
| | rfi | mov-from-PSR | data |
| PSR.ia | rfi | none | none |
| PSR.ic | sys-mask-writers-partial ⁷ , mov-to-PSR-l, rfi | mov-from-PSR | impliedF |
| | | cover, itc.i, itc.d, itr.i, itr.d, mov-from-CR-ITIR, mov-from-CR-IFS, mov-from-CR-IIM, mov-from-CR-IIP, mov-from-CR-IPSR, mov-from-CR-ISR, mov-from-CR-IFA, mov-from-CR-IHA, mov-from-CR-IIPA, mov-to-CR-ITIR, mov-to-CR-IFS, mov-to-CR-IIM, mov-to-CR-IIP, mov-to-CR-IPSR, mov-to-CR-ISR, mov-to-CR-IFA, mov-to-CR-IHA, mov-to-CR-IIPA | data |
| PSR.id | rfi | none | none |
| PSR.is | br.ia, rfi | none | none |

Table 5-2. RAW Dependencies Organized by Resource (Continued)

| Resource Name | Writers | Readers | Semantics of Dependency |
|---------------|---|--|-------------------------|
| PSR.it | rfi | branches, mov-from-PSR, chk, epc, fchkf | data |
| PSR.lp | mov-to-PSR-I | mov-from-PSR | impliedF |
| | rfi | br.ret | data |
| PSR.mc | rfi | mov-from-PSR, br.ret | data |
| PSR.mfh | rfi | mov-from-PSR | none |
| PSR.mfh | fr-writers ⁹ , user-mask-writers-partial ⁷ , mov-to-PSR-um, sys-mask-writers-partial ⁷ , mov-to-PSR-I, rfi | mov-from-PSR-um, mov-from-PSR | impliedF |
| PSR.mfl | fr-writers ⁹ , user-mask-writers-partial ⁷ , mov-to-PSR-um, sys-mask-writers-partial ⁷ , mov-to-PSR-I, rfi | mov-from-PSR-um, mov-from-PSR | impliedF |
| PSR.pk | sys-mask-writers-partial ⁷ , mov-to-PSR-I, rfi | mem-readers, mem-writers, probe-all | data |
| | | mov-from-PSR | impliedF |
| PSR.pp | sys-mask-writers-partial ⁷ , mov-to-PSR-I, rfi | mov-from-PSR | impliedF |
| PSR.ri | rfi | none | none |
| PSR.rt | mov-to-PSR-I | mov-from-PSR | impliedF |
| | rfi | alloc, flushrs, loadrs | data |
| PSR.si | sys-mask-writers-partial ⁷ , mov-to-PSR-I, rfi | mov-from-PSR, alloc, flushrs, loadrs | data |
| PSR.sp | sys-mask-writers-partial ⁷ , mov-to-PSR-I, rfi | mov-from-PSR | impliedF |
| | | mov-from-AR-ITC | data |
| PSR.sp | sys-mask-writers-partial ⁷ , mov-to-PSR-I, rfi | mov-from-PSR | impliedF |
| | | mov-from-IND-PMD, mov-to-PSR-um, rum, sum | data |
| PSR.ss | rfi | all | data |
| PSR.tb | mov-to-PSR-I, rfi | branches, chk, fchkf | data |
| | | mov-from-PSR | impliedF |
| PSR.up | user-mask-writers-partial ⁷ , mov-to-PSR-um, sys-mask-writers-partial ⁷ , mov-to-PSR-I, rfi | mov-from-PSR-um, mov-from-PSR | impliedF |
| RR# | mov-to-IND-RR ⁶ | mem-readers, mem-writers, itc.i, itc.d, itr.i, itr.d, probe-all, ptc.g, ptc.ga, ptc.l, ptr.i, ptr.d, tak, thash, tpa, ttag | data |
| | | mov-from-IND-RR ⁶ | impliedF |
| RSE | rse-writers ¹⁴ | rse-readers ¹⁴ | impliedF |

5.3.3 WAW Dependency Table

General rules specific to the WAW table:

- All resources require at most an instruction group break to provide sequential behavior.
- Some resources require no instruction group break to provide sequential behavior.
- There are a few special cases that are described in greater detail elsewhere in the manual and are indicated with an SC (special case) result.
- Each sub-row of writers represents a group of instructions that when taken in pairs in any combination has the dependency result indicated. If the column is split in sub-columns, then the dependency semantics apply to any pair of instructions where one is chosen from left sub-column and one is chosen from the right sub-column.

Table 5-3. WAW Dependencies Organized by Resource

| Resource Name | Writers | Semantics of Dependency |
|-----------------------|---|---------------------------------|
| ALAT | mem-readers-alat, mem-writers, chk.a.clr, invala-all | none |
| AR[BSP] | br.call, brl.call, br.ret, cover, mov-to-AR-BSPSTORE , rfi | impliedF |
| AR[BSPSTORE] | alloc, loadrs, flushrs, mov-to-AR-BSPSTORE | impliedF |
| AR[CCV] | mov-to-AR-CCV | impliedF |
| AR[CFLG] | mov-to-AR-CFLG | impliedF |
| AR[CSD] | ld16, mov-to-AR-CSD | impliedF |
| AR[EC] | br.ret, mod-sched-brs, mov-to-AR-EC | impliedF |
| AR[EFLAG] | mov-to-AR-EFLAG | impliedF |
| AR[FCR] | mov-to-AR-FCR | impliedF |
| AR[FDR] | mov-to-AR-FDR | impliedF |
| AR[FIR] | mov-to-AR-FIR | impliedF |
| AR[FPSR].sf0.controls | mov-to-AR-FPSR , fsetc.s0 | impliedF |
| AR[FPSR].sf1.controls | mov-to-AR-FPSR , fsetc.s1 | impliedF |
| AR[FPSR].sf2.controls | mov-to-AR-FPSR , fsetc.s2 | impliedF |
| AR[FPSR].sf3.controls | mov-to-AR-FPSR , fsetc.s3 | impliedF |
| AR[FPSR].sf0.flags | fp-arith-s0, fcmp-s0, fpcmp-s0 | none |
| | fclrf.s0, fcmp-s0, fp-arith-s0, fpcmp-s0, mov-to-AR-FPSR | fclrf.s0, mov-to-AR-FPSR |
| AR[FPSR].sf1.flags | fp-arith-s1, fcmp-s1, fpcmp-s1 | none |
| | fclrf.s1, fcmp-s1, fp-arith-s1, fpcmp-s1, mov-to-AR-FPSR | fclrf.s1, mov-to-AR-FPSR |
| AR[FPSR].sf2.flags | fp-arith-s2, fcmp-s2, fpcmp-s2 | none |
| | fclrf.s2, fcmp-s2, fp-arith-s2, fpcmp-s2, mov-to-AR-FPSR | fclrf.s2, mov-to-AR-FPSR |
| AR[FPSR].sf3.flags | fp-arith-s3, fcmp-s3, fpcmp-s3 | none |
| | fclrf.s3, fcmp-s3, fp-arith-s3, fpcmp-s3, mov-to-AR-FPSR | fclrf.s3, mov-to-AR-FPSR |
| AR[FPSR].rv | mov-to-AR-FPSR | impliedF |
| AR[FPSR].traps | mov-to-AR-FPSR | impliedF |
| AR[FSR] | mov-to-AR-FSR | impliedF |
| AR[ITC] | mov-to-AR-ITC | impliedF |

Table 5-3. WAW Dependencies Organized by Resource (Continued)

| Resource Name | Writers | Semantics of Dependency |
|--|--|---|
| AR[K%], % in 0 - 7 | mov-to-AR-K¹ | impliedF |
| AR[LC] | mod-sched-brs-counted, mov-to-AR-LC | impliedF |
| AR[PFS] | br.call, brl.call | none |
| | br.call, brl.call mov-to-AR-PFS | impliedF |
| AR[RNAT] | alloc, flushrs, loadrs, mov-to-AR-RNAT, mov-to-AR-BSPSTORE | impliedF |
| AR[RSC] | mov-to-AR-RSC | impliedF |
| AR[SSD] | mov-to-AR-SSD | impliedF |
| AR[UNAT]{%}, % in 0 - 63 | mov-to-AR-UNAT, st8.spill | impliedF |
| AR%, % in 8-15, 20, 22-23, 31, 33-35, 37-39, 41-43, 45-47, 67-111 | none | none |
| AR%, % in 48 - 63, 112-127 | mov-to-AR-ig¹ | impliedF |
| BR%, % in 0 - 7 | br.call ¹ , brl.call ¹ mov-to-BR¹ | impliedF |
| | mov-to-BR¹ | impliedF |
| | br.call ¹ , brl.call ¹ | none |
| CFM | mod-sched-brs, br.call, brl.call, br.ret, alloc, clrrrb, cover, rfi | impliedF |
| CPUID# | none | none |
| CR[CMCV] | mov-to-CR-CMCV | impliedF |
| CR[DCR] | mov-to-CR-DCR | impliedF |
| CR[EOI] | mov-to-CR-EOI | SC Section 5.8.3.4 on page 2:106 |
| CR[GPTA] | mov-to-CR-GPTA | impliedF |
| CR[IFA] | mov-to-CR-IFA | impliedF |
| CR[IFS] | mov-to-CR-IFS, cover | impliedF |
| CR[IHA] | mov-to-CR-IHA | impliedF |
| CR[IIM] | mov-to-CR-IIM | impliedF |
| CR[IIP] | mov-to-CR-IIP | impliedF |
| CR[IIPA] | mov-to-CR-IIPA | impliedF |
| CR[IPSR] | mov-to-CR-IPSR | impliedF |
| CR[IRR%], % in 0 - 3 | mov-from-CR-IVR | impliedF |
| CR[ISR] | mov-to-CR-ISR | impliedF |
| CR[ITIR] | mov-to-CR-ITIR | impliedF |
| CR[ITM] | mov-to-CR-ITM | impliedF |
| CR[ITV] | mov-to-CR-ITV | impliedF |
| CR[IVA] | mov-to-CR-IVA | impliedF |
| CR[IVR] | none | SC |
| CR[LID] | mov-to-CR-LID | SC |

Table 5-3. WAW Dependencies Organized by Resource (Continued)

| Resource Name | Writers | Semantics of Dependency | |
|--|---|--|----------|
| CR[LRR%], % in 0 - 1 | mov-to-CR-LRR¹ | impliedF | |
| CR[PMV] | mov-to-CR-PMV | impliedF | |
| CR[PTA] | mov-to-CR-PTA | impliedF | |
| CR[TPR] | mov-to-CR-TPR | impliedF | |
| CR%, % in 3-7, 10-15, 18, 26-63, 75-79, 82-127 | none | none | |
| DBR# | mov-to-IND-DBR³ | impliedF | |
| DTC | ptc.e, ptc.g, ptc.ga, ptc.l, ptr.i, ptr.d | none | |
| | ptc.e, ptc.g, ptc.ga, ptc.l, ptr.i, ptr.d, itc.i, itc.d, itr.i, itr.d | itc.i, itc.d, itr.i, itr.d | impliedF |
| DTC_LIMIT* | ptc.g, ptc.ga | impliedF | |
| DTR | itr.d | impliedF | |
| | itr.d | ptr.d | impliedF |
| | ptr.d | none | |
| FR%, % in 0 - 1 | none | none | |
| FR%, % in 2 - 127 | fr-writers¹, ldf-c¹, ld-fp-c¹ | impliedF | |
| GR0 | none | none | |
| GR%, % in 1 - 127 | ld-c¹, gr-writers¹ | impliedF | |
| IBR# | mov-to-IND-IBR³ | impliedF | |
| InService* | mov-to-CR-EOI, mov-from-CR-IVR | SC | |
| IP | all | none | |
| ITC | ptc.e, ptc.g, ptc.ga, ptc.l, ptr.i, ptr.d | none | |
| | ptc.e, ptc.g, ptc.ga, ptc.l, ptr.i, ptr.d, itc.i, itc.d, itr.i, itr.d | itc.i, itc.d, itr.i, itr.d | impliedF |
| ITR | itr.i | itr.i, ptr.i | impliedF |
| | ptr.i | none | |
| memory | mem-writers | none | |
| PKR# | mov-to-IND-PKR³ | mov-to-IND-PKR⁴ | none |
| | mov-to-IND-PKR³ | | impliedF |
| PMC# | mov-to-IND-PMC³ | impliedF | |
| PMD# | mov-to-IND-PMD³ | impliedF | |
| PR0 | pr-writers¹ | none | |
| PR%, % in 1 - 15 | pr-and-writers¹ | none | |
| | pr-or-writers¹ | none | |
| | pr-unc-writers-fp¹, pr-unc-writers-int¹, pr-norm-writers-fp¹, pr-norm-writers-int¹, pr-and-writers¹, mov-to-PR-allreg⁷ | pr-unc-writers-fp¹, pr-unc-writers-int¹, pr-norm-writers-fp¹, pr-norm-writers-int¹, pr-or-writers¹, mov-to-PR-allreg⁷ | impliedF |

Table 5-3. WAW Dependencies Organized by Resource (Continued)

| Resource Name | Writers | Semantics of Dependency |
|----------------------|--|---|
| PR%, % in 16 - 62 | pr-and-writers¹ | none |
| | pr-or-writers¹ | none |
| | pr-unc-writers-fp¹, pr-unc-writers-int¹, pr-norm-writers-fp¹, pr-norm-writers-int¹, pr-and-writers¹, mov-to-PR-allreg⁷, mov-to-PR-rotreg | pr-unc-writers-fp¹, pr-unc-writers-int¹, pr-norm-writers-fp¹, pr-norm-writers-int¹, pr-or-writers¹, mov-to-PR-allreg⁷, mov-to-PR-rotreg |
| PR63 | pr-and-writers¹ | none |
| | pr-or-writers¹ | none |
| | mod-sched-brs, pr-unc-writers-fp¹, pr-unc-writers-int¹, pr-norm-writers-fp¹, pr-norm-writers-int¹, pr-and-writers¹, mov-to-PR-allreg⁷, mov-to-PR-rotreg | mod-sched-brs, pr-unc-writers-fp¹, pr-unc-writers-int¹, pr-norm-writers-fp¹, pr-norm-writers-int¹, pr-or-writers¹, mov-to-PR-allreg⁷, mov-to-PR-rotreg |
| PSR.ac | user-mask-writers-partial⁷, mov-to-PSR-um, sys-mask-writers-partial⁷, mov-to-PSR-l, rfi | impliedF |
| PSR.be | user-mask-writers-partial⁷, mov-to-PSR-um, sys-mask-writers-partial⁷, mov-to-PSR-l, rfi | impliedF |
| PSR.bn | bsw, rfi | impliedF |
| PSR.cpl | epc, br.ret, rfi | impliedF |
| PSR.da | rfi | impliedF |
| PSR.db | mov-to-PSR-l, rfi | impliedF |
| PSR.dd | rfi | impliedF |
| PSR.dfh | sys-mask-writers-partial⁷, mov-to-PSR-l, rfi | impliedF |
| PSR.dfl | sys-mask-writers-partial⁷, mov-to-PSR-l, rfi | impliedF |
| PSR.di | sys-mask-writers-partial⁷, mov-to-PSR-l, rfi | impliedF |
| PSR.dt | sys-mask-writers-partial⁷, mov-to-PSR-l, rfi | impliedF |
| PSR.ed | rfi | impliedF |
| PSR.i | sys-mask-writers-partial⁷, mov-to-PSR-l, rfi | impliedF |
| PSR.ia | rfi | impliedF |
| PSR.ic | sys-mask-writers-partial⁷, mov-to-PSR-l, rfi | impliedF |
| PSR.id | rfi | impliedF |
| PSR.is | br.ia, rfi | impliedF |
| PSR.it | rfi | impliedF |
| PSR.lp | mov-to-PSR-l, rfi | impliedF |
| PSR.mc | rfi | impliedF |
| PSR.mfh | fr-writers⁹ | none |
| | user-mask-writers-partial⁷, mov-to-PSR-um, fr-writers⁹, sys-mask-writers-partial⁷, mov-to-PSR-l, rfi | user-mask-writers-partial⁷, mov-to-PSR-um, sys-mask-writers-partial⁷, mov-to-PSR-l, rfi |

Table 5-3. WAW Dependencies Organized by Resource (Continued)

| Resource Name | Writers | Semantics of Dependency |
|---------------|--|--|
| PSR.mfl | fr-writers ⁹ | none |
| | user-mask-writers-partial ⁷ , mov-to-PSR-um, fr-writers ⁹ , sys-mask-writers-partial ⁷ , mov-to-PSR-l, rfi | user-mask-writers-partial ⁷ , mov-to-PSR-um, sys-mask-writers-partial ⁷ , mov-to-PSR-l, rfi |
| PSR.pk | sys-mask-writers-partial ⁷ , mov-to-PSR-l, rfi | impliedF |
| PSR.pp | sys-mask-writers-partial ⁷ , mov-to-PSR-l, rfi | impliedF |
| PSR.ri | rfi | impliedF |
| PSR.rt | mov-to-PSR-l, rfi | impliedF |
| PSR.si | sys-mask-writers-partial ⁷ , mov-to-PSR-l, rfi | impliedF |
| PSR.sp | sys-mask-writers-partial ⁷ , mov-to-PSR-l, rfi | impliedF |
| PSR.ss | rfi | impliedF |
| PSR.tb | mov-to-PSR-l, rfi | impliedF |
| PSR.up | user-mask-writers-partial ⁷ , mov-to-PSR-um, sys-mask-writers-partial ⁷ , mov-to-PSR-l, rfi | impliedF |
| RR# | mov-to-IND-RR ⁶ | impliedF |
| RSE | rse-writers ¹⁴ | impliedF |

5.3.4 WAR Dependency Table

A general rule specific to the WAR table:

1. WAR dependencies are always allowed within instruction groups except for the entry in [Table 5-4](#) below. The readers and subsequent writers specified must be separated by a stop in order to have defined behavior.

Table 5-4. WAR Dependencies Organized by Resource

| Resource Name | Readers | Writers | Semantics of Dependency |
|---------------|----------------------------|---------------|-------------------------|
| PR63 | pr-readers-br ¹ | mod-sched-brs | stop |

5.3.5 Listing of Rules Referenced in Dependency Tables

The following rules restrict the specific instances in which some of the instructions in the tables cause a dependency and must be applied where referenced to correctly interpret those entries. Rules only apply to the instance of the instruction class, or instruction mnemonic prefix where the rule is referenced as a superscript. If the rule is referenced in [Table 5-5](#) where instruction classes are defined, then it applies to all instances of the instruction class.

- Rule 1. These instructions only write a register when that register's number is explicitly encoded as a target of the instruction and is only read when it is encoded as a source of the instruction (or encoded as its PR[qp]).
- Rule 2. These instructions only read CFM when they access a rotating GR, FR, or PR. **mov-to-PR** and **mov-from-PR** only access CFM when their qualifying predicate is in the rotating region.

- Rule 3. These instructions use a general register value to determine the specific indirect register accessed. These instructions only access the register resource specified by the value in bits {7:0} of the dynamic value of the index register.
- Rule 4. These instructions only read the given resource when bits {7:0} of the indirect index register value *does not* match the register number of the resource.
- Rule 5. All rules are implementation specific.
- Rule 6. There is a dependency only when both the index specified by the reader and the index specified by the writer have the same value in bits {63:61}.
- Rule 7. These instructions access the specified resource only when the corresponding mask bit is set.
- Rule 8. PSR.dfh is only read when these instructions reference FR32-127. PSR.dfl is only read when these instructions reference FR2-31.
- Rule 9. PSR.mfl is only written when these instructions write FR2-31. PSR.mfh is only written when these instructions write FR32-127.
- Rule 10. The PSR.bn bit is only accessed when one of GR16-31 is specified in the instruction.
- Rule 11. The target predicates are written independently of PR[qp], but source registers are only read if PR[qp] is true.
- Rule 12. This instruction only reads the specified predicate register when that register is the PR[qp].
- Rule 13. This reference to ld-c only applies to the GR whose value is loaded with data returned from memory, not the post-incremented address register. Thus, a stop is still required between a post-incrementing ld-c and a consumer that reads the post-incremented GR.
- Rule 14. The RSE resource includes implementation-specific internal state. At least one (and possibly more) of these resources are read by each instruction listed in the **rse-readers** class. At least one (and possibly more) of these resources are written by each instruction listed in the **rse-writers** class. To determine exactly which instructions read or write each individual resource, see the corresponding instruction pages.
- Rule 15. This class represents all instructions marked as Reserved if PR[qp] is 1 B-type instructions as described in [“Format Summary” on page 3:256](#).
- Rule 16. This class represents all instructions marked as Reserved if PR[qp] is 1 instructions as described in [“Format Summary” on page 3:256](#).

5.4 Support Tables

Table 5-5. Instruction Classes

| Class | Events/Instructions |
|--------------------|---|
| all | predicable-instructions, unpredicable-instructions |
| branches | indirect-brs, ip-rel-brs |
| cfm-readers | fr-readers, fr-writers, gr-readers, gr-writers, mod-sched-brs, predicable-instructions, pr-writers, alloc, br.call, brl.call, br.ret, cover, loadrs, rfi, chk-a, invala.e |
| chk-a | chk.a.clr, chk.a.nc |
| cmpxchg | cmpxchg1, cmpxchg2, cmpxchg4, cmpxchg8, cmp8xchg16 |
| czx | czx1, czx2 |
| fcmp-s0 | fcmp[Field(sf)==s0] |
| fcmp-s1 | fcmp[Field(sf)==s1] |
| fcmp-s2 | fcmp[Field(sf)==s2] |
| fcmp-s3 | fcmp[Field(sf)==s3] |
| fetchadd | fetchadd4, fetchadd8 |
| fp-arith | fadd, famax, famin, fcvt.fx, fcvt.fxu, fcvt.xuf, fma, fmax, fmin, fmpy, fms, fnma, fnmpy, fnorm, fpamax, fpamin, fpcvt.fx, fpcvt.fxu, fpma, fpmax, fpmin, fmpy, fms, fpnma, fpnmpy, fprcpa, fprsqrta, frcpa, frsqrta, fsub |
| fp-arith-s0 | fp-arith [Field(sf)==s0] |
| fp-arith-s1 | fp-arith [Field(sf)==s1] |
| fp-arith-s2 | fp-arith [Field(sf)==s2] |
| fp-arith-s3 | fp-arith [Field(sf)==s3] |
| fp-non-arith | fabs, fand, fandcm, fclass, fcvt.xf, fmerge, fmix, fneg, fnegabs, for, fpabs, fpmerge, fpack, fpneg, fpnegabs, fselect, fswap, fsxt, fxor, xma |
| fpcmp-s0 | fpcmp[Field(sf)==s0] |
| fpcmp-s1 | fpcmp[Field(sf)==s1] |
| fpcmp-s2 | fpcmp[Field(sf)==s2] |
| fpcmp-s3 | fpcmp[Field(sf)==s3] |
| fr-readers | fp-arith, fp-non-arith, pr-writers-fp, chk.s [Format in {M21}], getf |
| fr-writers | fp-arith, fp-non-arith \fclass, mem-readers-fp, setf |
| gr-readers | gr-readers-writers, mem-readers, mem-writers, chk.s, cmp, cmp4, fc, itc.i, itc.d, itr.i, itr.d, mov-to-AR-gr, mov-to-BR, mov-to-CR, mov-to-IND, mov-from-IND, mov-to-PR-allreg, mov-to-PSR-l, mov-to-PSR-um, probe-all, ptc.e, ptc.g, ptc.ga, ptc.l, ptr.i, ptr.d, setf, tbit, tnat |
| gr-readers-writers | mov-from-IND, add, addl, addp4, adds, and, andcm, czx, dep \dep[Format in {I13}], extr, mem-readers-int, ld-all-postinc, lfetch-postinc, mix, mux, or, pack, padd, pavg, pavgsub, pcmp, pmax, pmin, pmpy, pmpyshr, popcnt, probe-nofault, psad, pshl, pshladd, pshr, pshradd, psub, shl, shladd, shladdp4, shr, shrp, st-postinc, sub, sxt, tak, thash, tpa, ttag, unpack, xor, zxt |
| gr-writers | alloc, dep, getf, gr-readers-writers, mem-readers-int, mov-from-AR, mov-from-BR, mov-from-CR, mov-from-PR, mov-from-PSR, mov-from-PSR-um, mov-ip, movl |
| indirect-brp | brp[Format in {B7}] |
| indirect-brs | br.call[Format in {B5}], br.cond[Format in {B4}], br.ia, br.ret |
| invala-all | invala[Format in {M24}], invala.e |
| ip-rel-brs | mod-sched-brs , br.call[Format in {B3}], brl.call, brl.cond, br.cond[Format in {B1}], br.cloop |
| ld | ld1, ld2, ld4, ld8, ld8.fill, ld16 |
| ld-a | ld1.a, ld2.a, ld4.a, ld8.a |
| ld-all-postinc | ld [Format in {M2 M3}], ldfp [Format in {M12}], ldf [Format in {M7 M8}] |
| ld-c | ld-c-nc, ld-c-clr |

Table 5-5. Instruction Classes (Continued)

| Class | Events/Instructions |
|-----------------------|---|
| ld-c-clr | ld1.c.clr, ld2.c.clr, ld4.c.clr, ld8.c.clr, ld-c-clr-acq |
| ld-c-clr-acq | ld1.c.clr.acq, ld2.c.clr.acq, ld4.c.clr.acq, ld8.c.clr.acq |
| ld-c-nc | ld1.c.nc, ld2.c.nc, ld4.c.nc, ld8.c.nc |
| ld-s | ld1.s, ld2.s, ld4.s, ld8.s |
| ld-sa | ld1.sa, ld2.sa, ld4.sa, ld8.sa |
| ldf | ldfs, ldfd, ldfe, ld8, ldf.fill |
| ldf-a | ldfs.a, ldfd.a, ldfe.a, ld8.a |
| ldf-c | ldf-c-nc, ldf-c-clr |
| ldf-c-clr | ldfs.c.clr, ldfd.c.clr, ldfe.c.clr, ld8.c.clr |
| ldf-c-nc | ldfs.c.nc, ldfd.c.nc, ldfe.c.nc, ld8.c.nc |
| ldf-s | ldfs.s, ldfd.s, ldfe.s, ld8.s |
| ldf-sa | ldfs.sa, ldfd.sa, ldfe.sa, ld8.sa |
| ldfp | ldfps, ldfpd, ldfp8 |
| ldfp-a | ldfps.a, ldfpd.a, ldfp8.a |
| ldfp-c | ldfp-c-nc, ldfp-c-clr |
| ldfp-c-clr | ldfps.c.clr, ldfpd.c.clr, ldfp8.c.clr |
| ldfp-c-nc | ldfps.c.nc, ldfpd.c.nc, ldfp8.c.nc |
| ldfp-s | ldfps.s, ldfpd.s, ldfp8.s |
| ldfp-sa | ldfps.sa, ldfpd.sa, ldfp8.sa |
| lfetch-all | lfetch |
| lfetch-fault | lfetch[Field(lftype)==fault] |
| lfetch-nofault | lfetch[Field(lftype)==] |
| lfetch-postinc | lfetch[Format in {M14 M15}] |
| mem-readers | mem-readers-fp, mem-readers-int |
| mem-readers-alat | ld-a, ldf-a, ldfp-a, ld-sa, ldf-sa, ldfp-sa, ld-c, ldf-c, ldfp-c |
| mem-readers-fp | ldf, ldfp |
| mem-readers-int | cmpxchg, fetchadd, xchg, ld |
| mem-readers-spec | ld-s, ld-sa, ldf-s, ldf-sa, ldfp-s, ldfp-sa |
| mem-writers | mem-writers-fp, mem-writers-int |
| mem-writers-fp | stf |
| mem-writers-int | cmpxchg, fetchadd, xchg, st |
| mix | mix1, mix2, mix4 |
| mod-sched-brs | br.cexit, br.ctop, br.wexit, br.wtop |
| mod-sched-brs-counted | br.cexit, br.cloop, br.ctop |
| mov-from-AR | mov-from-AR-M, mov-from-AR-I, mov-from-AR-IM |
| mov-from-AR-BSP | mov-from-AR-M [Field(ar3) == BSP] |
| mov-from-AR-BSPSTORE | mov-from-AR-M [Field(ar3) == BSPSTORE] |
| mov-from-AR-CCV | mov-from-AR-M [Field(ar3) == CCV] |
| mov-from-AR-CFLG | mov-from-AR-M [Field(ar3) == CFLG] |
| mov-from-AR-CSD | mov-from-AR-M [Field(ar3) == CSD] |
| mov-from-AR-EC | mov-from-AR-I [Field(ar3) == EC] |
| mov-from-AR-EFLAG | mov-from-AR-M [Field(ar3) == EFLAG] |
| mov-from-AR-FCR | mov-from-AR-M [Field(ar3) == FCR] |
| mov-from-AR-FDR | mov-from-AR-M [Field(ar3) == FDR] |
| mov-from-AR-FIR | mov-from-AR-M [Field(ar3) == FIR] |
| mov-from-AR-FPSR | mov-from-AR-M [Field(ar3) == FPSR] |
| mov-from-AR-FSR | mov-from-AR-M [Field(ar3) == FSR] |

Table 5-5. Instruction Classes (Continued)

| Class | Events/Instructions |
|--------------------|--|
| mov-from-AR-I | mov_ar[Format in {128}] |
| mov-from-AR-ig | mov-from-AR-IM [Field(ar3) in {48-63 112-127}] |
| mov-from-AR-IM | mov_ar[Format in {128 M31}] |
| mov-from-AR-ITC | mov-from-AR-M [Field(ar3) == ITC] |
| mov-from-AR-K | mov-from-AR-M [Field(ar3) in {K0 K1 K2 K3 K4 K5 K6 K7}] |
| mov-from-AR-LC | mov-from-AR-I [Field(ar3) == LC] |
| mov-from-AR-M | mov_ar[Format in {M31}] |
| mov-from-AR-PFS | mov-from-AR-I [Field(ar3) == PFS] |
| mov-from-AR-RNAT | mov-from-AR-M [Field(ar3) == RNAT] |
| mov-from-AR-RSC | mov-from-AR-M [Field(ar3) == RSC] |
| mov-from-AR-rv | none |
| mov-from-AR-SSD | mov-from-AR-M [Field(ar3) == SSD] |
| mov-from-AR-UNAT | mov-from-AR-M [Field(ar3) == UNAT] |
| mov-from-BR | mov_br[Format in {122}] |
| mov-from-CR | mov_cr[Format in {M33}] |
| mov-from-CR-CMCV | mov-from-CR [Field(cr3) == CMCV] |
| mov-from-CR-DCR | mov-from-CR [Field(cr3) == DCR] |
| mov-from-CR-EOI | mov-from-CR [Field(cr3) == EOI] |
| mov-from-CR-GPTA | mov-from-CR [Field(cr3) == GPTA] |
| mov-from-CR-IFA | mov-from-CR [Field(cr3) == IFA] |
| mov-from-CR-IFS | mov-from-CR [Field(cr3) == IFS] |
| mov-from-CR-IHA | mov-from-CR [Field(cr3) == IHA] |
| mov-from-CR-IIM | mov-from-CR [Field(cr3) == IIM] |
| mov-from-CR-IIP | mov-from-CR [Field(cr3) == IIP] |
| mov-from-CR-IIPA | mov-from-CR [Field(cr3) == IIPA] |
| mov-from-CR-IPSR | mov-from-CR [Field(cr3) == IPSR] |
| mov-from-CR-IRR | mov-from-CR [Field(cr3) in {IRR0 IRR1 IRR2 IRR3}] |
| mov-from-CR-ISR | mov-from-CR [Field(cr3) == ISR] |
| mov-from-CR-ITIR | mov-from-CR [Field(cr3) == ITIR] |
| mov-from-CR-ITM | mov-from-CR [Field(cr3) == ITM] |
| mov-from-CR-ITV | mov-from-CR [Field(cr3) == ITV] |
| mov-from-CR-IVA | mov-from-CR [Field(cr3) == IVA] |
| mov-from-CR-IVR | mov-from-CR [Field(cr3) == IVR] |
| mov-from-CR-LID | mov-from-CR [Field(cr3) == LID] |
| mov-from-CR-LRR | mov-from-CR [Field(cr3) in {LRR0 LRR1}] |
| mov-from-CR-PMV | mov-from-CR [Field(cr3) == PMV] |
| mov-from-CR-PTA | mov-from-CR [Field(cr3) == PTA] |
| mov-from-CR-rv | none |
| mov-from-CR-TPR | mov-from-CR [Field(cr3) == TPR] |
| mov-from-IND | mov_indirect[Format in {M43}] |
| mov-from-IND-CPUID | mov-from-IND [Field(ireg) == cpuid] |
| mov-from-IND-DBR | mov-from-IND [Field(ireg) == dbr] |
| mov-from-IND-IBR | mov-from-IND [Field(ireg) == ibr] |
| mov-from-IND-PKR | mov-from-IND [Field(ireg) == pkr] |
| mov-from-IND-PMC | mov-from-IND [Field(ireg) == pmc] |
| mov-from-IND-PMD | mov-from-IND [Field(ireg) == pmd] |
| mov-from-IND-priv | mov-from-IND [Field(ireg) in {dbr ibr pkr pmc rr}] |

Table 5-5. Instruction Classes (Continued)

| Class | Events/Instructions |
|--------------------|--|
| mov-from-IND-RR | mov-from-IND [Field(ireg) == rr] |
| mov-from-PR | mov_pr[Format in {I25}] |
| mov-from-PSR | mov_psr[Format in {M36}] |
| mov-from-PSR-um | mov_um[Format in {M36}] |
| mov-ip | mov_ip[Format in {I25}] |
| mov-to-AR | mov-to-AR-M, mov-to-AR-I |
| mov-to-AR-BSP | mov-to-AR-M [Field(ar3) == BSP] |
| mov-to-AR-BSPSTORE | mov-to-AR-M [Field(ar3) == BSPSTORE] |
| mov-to-AR-CCV | mov-to-AR-M [Field(ar3) == CCV] |
| mov-to-AR-CFLG | mov-to-AR-M [Field(ar3) == CFLG] |
| mov-to-AR-CSD | mov-to-AR-M [Field(ar3) == CSD] |
| mov-to-AR-EC | mov-to-AR-I [Field(ar3) == EC] |
| mov-to-AR-EFLAG | mov-to-AR-M [Field(ar3) == EFLAG] |
| mov-to-AR-FCR | mov-to-AR-M [Field(ar3) == FCR] |
| mov-to-AR-FDR | mov-to-AR-M [Field(ar3) == FDR] |
| mov-to-AR-FIR | mov-to-AR-M [Field(ar3) == FIR] |
| mov-to-AR-FPSR | mov-to-AR-M [Field(ar3) == FPSR] |
| mov-to-AR-FSR | mov-to-AR-M [Field(ar3) == FSR] |
| mov-to-AR-gr | mov-to-AR-M [Format in {M29}], mov-to-AR-I [Format in {I26}] |
| mov-to-AR-I | mov_ar[Format in {I26 I27}] |
| mov-to-AR-ig | mov-to-AR-IM [Field(ar3) in {48-63 112-127}] |
| mov-to-AR-IM | mov_ar[Format in {I26 I27 M29 M30}] |
| mov-to-AR-ITC | mov-to-AR-M [Field(ar3) == ITC] |
| mov-to-AR-K | mov-to-AR-M [Field(ar3) in {K0 K1 K2 K3 K4 K5 K6 K7}] |
| mov-to-AR-LC | mov-to-AR-I [Field(ar3) == LC] |
| mov-to-AR-M | mov_ar[Format in {M29 M30}] |
| mov-to-AR-PFS | mov-to-AR-I [Field(ar3) == PFS] |
| mov-to-AR-RNAT | mov-to-AR-M [Field(ar3) == RNAT] |
| mov-to-AR-RSC | mov-to-AR-M [Field(ar3) == RSC] |
| mov-to-AR-SSD | mov-to-AR-M [Field(ar3) == SSD] |
| mov-to-AR-UNAT | mov-to-AR-M [Field(ar3) == UNAT] |
| mov-to-BR | mov_br[Format in {I21}] |
| mov-to-CR | mov_cr[Format in {M32}] |
| mov-to-CR-CMCV | mov-to-CR [Field(cr3) == CMCV] |
| mov-to-CR-DCR | mov-to-CR [Field(cr3) == DCR] |
| mov-to-CR-EOI | mov-to-CR [Field(cr3) == EOI] |
| mov-to-CR-GPTA | mov-to-CR [Field(cr3) == GPTA] |
| mov-to-CR-IFA | mov-to-CR [Field(cr3) == IFA] |
| mov-to-CR-IFS | mov-to-CR [Field(cr3) == IFS] |
| mov-to-CR-IHA | mov-to-CR [Field(cr3) == IHA] |
| mov-to-CR-IIM | mov-to-CR [Field(cr3) == IIM] |
| mov-to-CR-IIP | mov-to-CR [Field(cr3) == IIP] |
| mov-to-CR-IIPA | mov-to-CR [Field(cr3) == IIPA] |
| mov-to-CR-IPSR | mov-to-CR [Field(cr3) == IPSR] |
| mov-to-CR-IRR | mov-to-CR [Field(cr3) in {IRR0 IRR1 IRR2 IRR3}] |
| mov-to-CR-ISR | mov-to-CR [Field(cr3) == ISR] |
| mov-to-CR-ITIR | mov-to-CR [Field(cr3) == ITIR] |

Table 5-5. Instruction Classes (Continued)

| Class | Events/Instructions |
|---------------------|---|
| mov-to-CR-ITM | mov-to-CR [Field(cr3) == ITM] |
| mov-to-CR-ITV | mov-to-CR [Field(cr3) == ITV] |
| mov-to-CR-IVA | mov-to-CR [Field(cr3) == IVA] |
| mov-to-CR-IVR | mov-to-CR [Field(cr3) == IVR] |
| mov-to-CR-LID | mov-to-CR [Field(cr3) == LID] |
| mov-to-CR-LRR | mov-to-CR [Field(cr3) in {LRR0 LRR1}] |
| mov-to-CR-PMV | mov-to-CR [Field(cr3) == PMV] |
| mov-to-CR-PTA | mov-to-CR [Field(cr3) == PTA] |
| mov-to-CR-TPR | mov-to-CR [Field(cr3) == TPR] |
| mov-to-IND | mov_indirect[Format in {M42}] |
| mov-to-IND-CPUID | mov-to-IND [Field(ireg) == cpuid] |
| mov-to-IND-DBR | mov-to-IND [Field(ireg) == dbr] |
| mov-to-IND-IBR | mov-to-IND [Field(ireg) == ibr] |
| mov-to-IND-PKR | mov-to-IND [Field(ireg) == pkr] |
| mov-to-IND-PMC | mov-to-IND [Field(ireg) == pmc] |
| mov-to-IND-PMD | mov-to-IND [Field(ireg) == pmd] |
| mov-to-IND-priv | mov-to-IND |
| mov-to-IND-RR | mov-to-IND [Field(ireg) == rr] |
| mov-to-PR | mov-to-PR-allreg, mov-to-PR-rotreg |
| mov-to-PR-allreg | mov_pr[Format in {I23}] |
| mov-to-PR-rotreg | mov_pr[Format in {I24}] |
| mov-to-PSR-I | mov_psr[Format in {M35}] |
| mov-to-PSR-um | mov_um[Format in {M35}] |
| mux | mux1, mux2 |
| none | - |
| pack | pack2, pack4 |
| padd | padd1, padd2, padd4 |
| pavg | pavg1, pavg2 |
| pavgsub | pavgsub1, pavgsub2 |
| pcmp | pcmp1, pcmp2, pcmp4 |
| pmax | pmax1, pmax2 |
| pmin | pmin1, pmin2 |
| pmpy | pmpy2 |
| pmpyshr | pmpyshr2 |
| pr-and-writers | pr-gen-writers-int [Field(ctype) in {and andcm}], pr-gen-writers-int [Field(ctype) in {or.andcm and.orcm}] |
| pr-gen-writers-fp | fclass, fcmp |
| pr-gen-writers-int | cmp, cmp4, tbit, tnat |
| pr-norm-writers-fp | pr-gen-writers-fp [Field(ctype)==] |
| pr-norm-writers-int | pr-gen-writers-int [Field(ctype)==] |
| pr-or-writers | pr-gen-writers-int [Field(ctype) in {or orcm}], pr-gen-writers-int [Field(ctype) in {or.andcm and.orcm}] |
| pr-readers-br | br.call, br.cond, brl.call, brl.cond, br.ret, br.wexit, br.wtop, break.b, nop.b, ReservedBQP |

Table 5-5. Instruction Classes (Continued)

| Class | Events/Instructions |
|---------------------------|---|
| pr-readers-nobr-nomovpr | add, addl, addp4, adds, and, andcm, break.f, break.i, break.m, break.x, chk.s, chk-a , cmp, cmp4, cmpxchg , czx , dep, extr, fp-arith , fp-non-arith , fc, fchkf, fclrf, fcmp, fetchadd , fpcmp, fsetc, fwb, getf, invala-all , itc.i, itc.d, itr.i, itr.d, ld , ldf , ldfp , lfetch-all , mf, mix , mov-from-AR-M , mov-from-AR-IM , mov-from-AR-I , mov-to-AR-M , mov-to-AR-I , mov-to-AR-IM , mov-to-BR , mov-from-BR , mov-to-CR , mov-from-CR , mov-to-IND , mov-from-IND , mov-ip , mov-to-PSR-I , mov-to-PSR-um , mov-from-PSR , mov-from-PSR-um , movl, mux, nop.f, nop.i, nop.m, nop.x, or, pack , padd , pavg , pavgsub , pcmp , pmax , pmin , pmPy , pmPyshr , popcnt, probe-all , psad , pshl , pshladd , pshr , pshradd , psub , ptc.e, ptc.g, ptc.ga, ptc.l, ptr.d, ptr.i, ReservedQP , rsm, setf, shl, shladd, shladdp4, shr, shrp, srlz.i, srlz.d, ssm, st , stf , sub, sum, sxt , sync, tak, tbit, thash, tnat, tpa, ttag, unpack , xchg , xma, xmpy, xor, zxt |
| pr-unc-writers-fp | pr-gen-writers-fp [Field(ctype)==unc] ¹¹ , fprcpa ¹¹ , fprsqrta ¹¹ , frcpa ¹¹ , frsqrta ¹¹ |
| pr-unc-writers-int | pr-gen-writers-int [Field(ctype)==unc] ¹¹ |
| pr-writers | pr-writers-int , pr-writers-fp |
| pr-writers-fp | pr-norm-writers-fp , pr-unc-writers-fp |
| pr-writers-int | pr-norm-writers-int , pr-unc-writers-int , pr-and-writers , pr-or-writers |
| predicable-instructions | mov-from-PR , mov-to-PR , pr-readers-br , pr-readers-nobr-nomovpr |
| priv-ops | mov-to-IND-priv , bsw, itc.i, itc.d, itr.i, itr.d, mov-to-CR , mov-from-CR , mov-to-PSR-I , mov-from-PSR , mov-from-IND-priv , ptc.e, ptc.g, ptc.ga, ptc.l, ptr.i, ptr.d, rfi, rsm, ssm, tak, tpa |
| probe-all | probe-fault , probe-nofault |
| probe-fault | probe[Format in {M40}] |
| probe-nofault | probe[Format in {M38 M39}] |
| psad | psad1 |
| pshl | pshl2, pshl4 |
| pshladd | pshladd2 |
| pshr | pshr2, pshr4 |
| pshradd | pshradd2 |
| psub | psub1, psub2, psub4 |
| ReservedBQP | _15 |
| ReservedQP | _16 |
| rse-readers | alloc, br.call, br.ia, br.ret, brl.call, cover, flushrs, loadrs, mov-from-AR-BSP , mov-from-AR-BSPSTORE , mov-to-AR-BSPSTORE , mov-from-AR-RNAT , mov-to-AR-RNAT , rfi |
| rse-writers | alloc, br.call, br.ia, br.ret, brl.call, cover, flushrs, loadrs, mov-to-AR-BSPSTORE , rfi |
| st | st1, st2, st4, st8, st8.spill, st16 |
| st-postinc | stf [Format in {M10}], st [Format in {M5}] |
| stf | stfs, stfd, stfe, stf8, stf.spill |
| sxt | sxt1, sxt2, sxt4 |
| sys-mask-writers-partial | rsm, ssm |
| unpack | unpack1, unpack2, unpack4 |
| unpredicable-instructions | alloc, br.cloop, br.ctop, br.cexit, br.ia, brp, bsw, clrrb, cover, epc, flushrs, loadrs, rfi |
| user-mask-writers-partial | rum, sum |
| xchg | xchg1, xchg2, xchg4, xchg8 |
| zxt | zxt1, zxt2, zxt4 |



Part II: IA-32 Instruction Set Descriptions

This section lists all IA-32 instructions and their behavior in the Itanium System Environment and IA-32 System Environments on a processor based on the Itanium architecture. Unless noted otherwise all IA-32 and MMX and Streaming SIMD Extension instructions operate as defined in the *IA-32 Intel® Architecture Software Developer's Manual*.

This volume describes the complete IA-32 architecture instruction set, including the integer, floating-point, MMX technology and Streaming SIMD Extension technology, and system instructions. The instruction descriptions are arranged in alphabetical order. For each instruction, the forms are given for each operand combination, including the opcode, operands required, and a description. Also given for each instruction are a description of the instruction and its operands, an operational description, a description of the effect of the instructions on flags in the EFLAGS register, and a summary of the exceptions that can be generated.

For all IA-32 the following relationships hold:

- **Writes** – Writes of any IA-32 general purpose, floating-point or Streaming SIMD Extension, MMX technology registers by IA-32 instructions are reflected in the Itanium registers defined to hold that IA-32 state when IA-32 instruction set completes execution.
- **Reads** – Reads of any IA-32 general purpose, floating-point or Streaming SIMD Extension, MMX technology registers by IA-32 instructions see the state of the Itanium registers defined to hold the IA-32 state after entering the IA-32 instruction set.
- **State mappings** – IA-32 numeric instructions are controlled by and reflect their status in FCW, FSW, FTW, FCS, FIP, FOP, FDS and FEA. On exit from the IA-32 instruction set, Itanium numeric status and control resources defined to hold IA-32 state reflect the results of all IA-32 prior numeric instructions in FCR, FSR, FIR and FDR. Itanium numeric status and control resources defined to hold IA-32 state are honored by IA-32 numeric instructions when entering the IA-32 instruction set.

1.1 Additional Intel® Itanium® Faults

The following fault behavior is defined for all IA-32 instructions in the Itanium System Environment:

- **IA-32 Faults** – All IA-32 faults are performed as defined in the *IA-32 Intel® Architecture Software Developer's Manual*, unless otherwise noted. IA-32 faults are delivered on the IA-32_Exception interruption vector.
- **IA-32 GPFault** – Null segments are signified by the segment descriptor register's P-bit being set to zero. IA-32 memory references through DSD, ESD, FSD, and GSD with the P-bit set to zero result in an IA-32 GPFault.
- **Itanium Low FP Reg Fault** – If PSR.dfl is 1, execution of any IA-32 MMX technology, Streaming SIMD Extension or floating-point instructions results in a Disabled FP Register fault (regardless of whether FR2-31 is referenced).

- **Itanium High FP Reg Fault** – If PSR.dfh is 1, execution of the first target IA-32 instruction following an `br .ia` or `rfi` results in a Disabled FP Register fault (regardless of whether FR32-127 is referenced).
- **Itanium Instruction Mem Faults** – The following additional Itanium memory faults can be generated on each virtual page referenced when fetching IA-32 or MMX or Streaming SIMD Extension instructions for execution:
 - Alternative instruction TLB fault
 - VHPT instruction fault
 - Instruction TLB fault
 - Instruction Page Not Present fault
 - Instruction NaT Page Consumption Abort
 - Instruction Key Miss fault
 - Instruction Key Permission fault
 - Instruction Access Rights fault
 - Instruction Access Bit fault
- **Itanium Data Mem Faults** – The following additional Itanium memory faults can be generated on each virtual page touched when reading or writing memory operands from the IA-32 instruction set including MMX and Streaming SIMD Extension instructions:
 - Nested TLB fault
 - Alternative data TLB fault
 - VHPT data fault
 - Data TLB fault
 - Data Page Not Present fault
 - Data NaT Page Consumption Abort
 - Data Key Miss fault
 - Data Key Permission fault
 - Data Access Rights fault
 - Data Dirty bit fault
 - Data Access bit fault

1.2 Interpreting the IA-32 Instruction Reference Pages

This section describes the information contained in the various sections of the instruction reference pages that make up the majority of this chapter. It also explains the notational conventions and abbreviations used in these sections.

1.2.1 IA-32 Instruction Format

The following is an example of the format used for each Intel architecture instruction description in this chapter.

CMC—Complement Carry Flag

| Opcode | Instruction | Description |
|--------|-------------|-----------------------|
| F5 | CMC | Complement carry flag |

1.2.1.1 Opcode Column

The “Opcode” column gives the complete object code produced for each form of the instruction. When possible, the codes are given as hexadecimal bytes, in the same order in which they appear in memory. Definitions of entries other than hexadecimal bytes are as follows:

- **/digit** – A digit between 0 and 7 indicates that the ModR/M byte of the instruction uses only the r/m (register or memory) operand. The reg field contains the digit that provides an extension to the instruction's opcode.
- **/r** – Indicates that the ModR/M byte of the instruction contains both a register operand and an r/m operand.
- **cb, cw, cd, cp** – A 1-byte (cb), 2-byte (cw), 4-byte (cd), or 6-byte (cp) value following the opcode that is used to specify a code offset and possibly a new value for the code segment register.
- **ib, iw, id** – A 1-byte (ib), 2-byte (iw), or 4-byte (id) immediate operand to the instruction that follows the opcode, ModR/M bytes or scale-indexing bytes. The opcode determines if the operand is a signed value. All words and doublewords are given with the low-order byte first.
- **+rb, +rw, +rd** – A register code, from 0 through 7, added to the hexadecimal byte given at the left of the plus sign to form a single opcode byte. The register codes are given in [Table 1-1](#).
- **+i** – A number used in floating-point instructions when one of the operands is ST(i) from the FPU register stack. The number i (which can range from 0 to 7) is added to the hexadecimal byte given at the left of the plus sign to form a single opcode byte.

Table 1-1. Register Encodings Associated with the +rb, +rw, and +rd Nomenclature

| rb | | | rw | | | rd | | |
|-----------|---|---|-----------|---|---|-----------|---|---|
| AL | = | 0 | AX | = | 0 | EAX | = | 0 |
| CL | = | 1 | CX | = | 1 | ECX | = | 1 |
| DL | = | 2 | DX | = | 2 | EDX | = | 2 |
| BL | = | 3 | BX | = | 3 | EBX | = | 3 |
| rb | | | rw | | | rd | | |
| AH | = | 4 | SP | = | 4 | ESP | = | 4 |
| CH | = | 5 | BP | = | 5 | EBP | = | 5 |
| DH | = | 6 | SI | = | 6 | ESI | = | 6 |
| BH | = | 7 | DI | = | 7 | EDI | = | 7 |

1.2.1.2 Instruction Column

The “Instruction” column gives the syntax of the instruction statement as it would appear in an ASM386 program. The following is a list of the symbols used to represent operands in the instruction statements:

- **rel8** – A relative address in the range from 128 bytes before the end of the instruction to 127 bytes after the end of the instruction.
- **rel16 and rel32** – A relative address within the same code segment as the instruction assembled. The rel16 symbol applies to instructions with an operand-size attribute of 16 bits; the rel32 symbol applies to instructions with an operand-size attribute of 32 bits.

- **ptr16:16 and ptr16:32** – A far pointer, typically in a code segment different from that of the instruction. The notation *16:16* indicates that the value of the pointer has two parts. The value to the left of the colon is a 16-bit selector or value destined for the code segment register. The value to the right corresponds to the offset within the destination segment. The ptr16:16 symbol is used when the instruction's operand-size attribute is 16 bits; the ptr16:32 symbol is used when the operand-size attribute is 32 bits.
- **r8** – One of the byte general-purpose registers AL, CL, DL, BL, AH, CH, DH, or BH.
- **r16** – One of the word general-purpose registers AX, CX, DX, BX, SP, BP, SI, or DI.
- **r32** – One of the doubleword general-purpose registers EAX, ECX, EDX, EBX, ESP, EBP, ESI, or EDI.
- **imm8** – An immediate byte value. The imm8 symbol is a signed number between –128 and +127 inclusive. For instructions in which imm8 is combined with a word or doubleword operand, the immediate value is sign-extended to form a word or doubleword. The upper byte of the word is filled with the topmost bit of the immediate value.
- **imm16** – An immediate word value used for instructions whose operand-size attribute is 16 bits. This is a number between –32,768 and +32,767 inclusive.
- **imm32** – An immediate doubleword value used for instructions whose operand-size attribute is 32 bits. It allows the use of a number between +2,147,483,647 and –2,147,483,648 inclusive.
- **r/m8** – A byte operand that is either the contents of a byte general-purpose register (AL, BL, CL, DL, AH, BH, CH, and DH), or a byte from memory.
- **r/m16** – A word general-purpose register or memory operand used for instructions whose operand-size attribute is 16 bits. The word general-purpose registers are: AX, BX, CX, DX, SP, BP, SI, and DI. The contents of memory are found at the address provided by the effective address computation.
- **r/m32** – A doubleword general-purpose register or memory operand used for instructions whose operand-size attribute is 32 bits. The doubleword general-purpose registers are: EAX, EBX, ECX, EDX, ESP, EBP, ESI, and EDI. The contents of memory are found at the address provided by the effective address computation.
- **m** – A 16- or 32-bit operand in memory.
- **m8** – A byte operand in memory, usually expressed as a variable or array name, but pointed to by the DS:(E)SI or ES:(E)DI registers. This nomenclature is used only with the string instructions and the XLAT instruction.
- **m16** – A word operand in memory, usually expressed as a variable or array name, but pointed to by the DS:(E)SI or ES:(E)DI registers. This nomenclature is used only with the string instructions.
- **m32** – A doubleword operand in memory, usually expressed as a variable or array name, but pointed to by the DS:(E)SI or ES:(E)DI registers. This nomenclature is used only with the string instructions.
- **m64** – A memory quadword operand in memory. This nomenclature is used only with the CMPXCHG8B instruction.
- **m16:16, m16:32** – A memory operand containing a far pointer composed of two numbers. The number to the left of the colon corresponds to the pointer's segment selector. The number to the right corresponds to its offset.
- **m16&32, m16&16, m32&32** – A memory operand consisting of data item pairs whose sizes are indicated on the left and the right side of the ampersand. All memory addressing modes are allowed. The m16&16 and m32&32 operands are used by the BOUND instruction to provide

an operand containing an upper and lower bounds for array indices. The `m16&32` operand is used by LIDT and LGDT to provide a word with which to load the limit field, and a doubleword with which to load the base field of the corresponding GDTR and IDTR registers.

- **moffs8, moffs16, moffs32** – A simple memory variable (memory offset) of type byte, word, or doubleword used by some variants of the MOV instruction. The actual address is given by a simple offset relative to the segment base. No ModR/M byte is used in the instruction. The number shown with moffs indicates its size, which is determined by the address-size attribute of the instruction.
- **Sreg** – A segment register. The segment register bit assignments are ES=0, CS=1, SS=2, DS=3, FS=4, and GS=5.
- **m32real, m64real, m80real** – A single-, double-, and extended-real (respectively) floating-point operand in memory.
- **m16int, m32int, m64int** – A word-, short-, and long-integer (respectively) floating-point operand in memory.
- **ST or ST(0)** – The top element of the FPU register stack.
- **ST(i)** – The *i*th element from the top of the FPU register stack. (*i* = 0 through 7).
- **mm** – An MMX technology register. The 64-bit MMX technology registers are: MM0 through MM7.
- **mm/m32** – The low order 32 bits of an MMX technology register or a 32-bit memory operand. The 64-bit MMX technology registers are: MM0 through MM7. The contents of memory are found at the address provided by the effective address computation.
- **mm/m64** – An MMX technology register or a 64-bit memory operand. The 64-bit MMX technology registers are: MM0 through MM7. The contents of memory are found at the address provided by the effective address computation.

1.2.1.3 Description Column

The “Description” column following the “Instruction” column briefly explains the various forms of the instruction. The following “Description” and “Operation” sections contain more details of the instruction's operation.

1.2.1.4 Description

The “Description” section describes the purpose of the instructions and the required operands. It also discusses the effect of the instruction on flags.

1.2.2 Operation

The “Operation” section contains an algorithmic description (written in pseudo-code) of the instruction. The pseudo-code uses a notation similar to the Algol or Pascal language. The algorithms are composed of the following elements:

- Comments are enclosed within the symbol pairs “(*)” and “(*)”.
- Compound statements are enclosed in keywords, such as IF, THEN, ELSE, and FI for an if statement, DO and OD for a do statement, or CASE... OF and ESAC for a case statement.
- A register name implies the contents of the register. A register name enclosed in brackets implies the contents of the location whose address is contained in that register. For example,

ES:[DI] indicates the contents of the location whose ES segment relative address is in register DI. [SI] indicates the contents of the address contained in register SI relative to SI's default segment (DS) or overridden segment.

- Parentheses around the “E” in a general-purpose register name, such as (E)SI, indicates that an offset is read from the SI register if the current address-size attribute is 16 or is read from the ESI register if the address-size attribute is 32.
- Brackets are also used for memory operands, where they mean that the contents of the memory location is a segment-relative offset. For example, [SRC] indicates that the contents of the source operand is a segment-relative offset.
- $A \leftarrow B$; indicates that the value of B is assigned to A.
- The symbols =, \neq , \geq , and \leq are relational operators used to compare two values, meaning equal, not equal, greater or equal, less or equal, respectively. A relational expression such as $A = B$ is TRUE if the value of A is equal to B; otherwise it is FALSE.
- The expression “ \ll COUNT” and “ \gg COUNT” indicates that the destination operand should be shifted left or right, respectively, by the number of bits indicated by the count operand.

The following identifiers are used in the algorithmic descriptions:

- **OperandSize and AddressSize** – The OperandSize identifier represents the operand-size attribute of the instruction, which is either 16 or 32 bits. The AddressSize identifier represents the address-size attribute, which is either 16 or 32 bits. For example, the following pseudo-code indicates that the operand-size attribute depends on the form of the CMPS instruction used.

```
IF instruction = CMPSW
    THEN OperandSize  $\leftarrow$  16;
ELSE
    IF instruction = CMPSD
        THEN OperandSize  $\leftarrow$  32;
    FI;
FI;
```

See “Operand-Size and Address-Size Attributes” in Chapter 3 of the *IA-32 Intel® Architecture Software Developer's Manual, Volume 1*, for general guidelines on how these attributes are determined.

- **StackAddrSize** – Represents the stack address-size attribute associated with the instruction, which has a value of 16 or 32 bits (see “Address-Size Attribute for Stack” in Chapter 4 of the *IA-32 Intel® Architecture Software Developer's Manual, Volume 1*).
- **SRC** – Represents the source operand.
- **DEST** – Represents the destination operand.

The following functions are used in the algorithmic descriptions:

- **ZeroExtend(value)** – Returns a value zero-extended to the operand-size attribute of the instruction. For example, if the operand-size attribute is 32, zero extending a byte value of -10 converts the byte from F6H to a doubleword value of 000000F6H. If the value passed to the ZeroExtend function and the operand-size attribute are the same size, ZeroExtend returns the value unaltered.
- **SignExtend(value)** – Returns a value sign-extended to the operand-size attribute of the instruction. For example, if the operand-size attribute is 32, sign extending a byte containing the value -10 converts the byte from F6H to a doubleword value of FFFFFFF6H. If the value

passed to the SignExtend function and the operand-size attribute are the same size, SignExtend returns the value unaltered.

- **SaturateSignedWordToSignedByte** – Converts a signed 16-bit value to a signed 8-bit value. If the signed 16-bit value is less than –128, it is represented by the saturated value –128 (80H); if it is greater than 127, it is represented by the saturated value 127 (7FH).
- **SaturateSignedDwordToSignedWord** – Converts a signed 32-bit value to a signed 16-bit value. If the signed 32-bit value is less than –32768, it is represented by the saturated value –32768 (8000H); if it is greater than 32767, it is represented by the saturated value 32767 (7FFFH).
- **SaturateSignedWordToUnsignedByte** – Converts a signed 16-bit value to an unsigned 8-bit value. If the signed 16-bit value is less than zero, it is represented by the saturated value zero (00H); if it is greater than 255, it is represented by the saturated value 255 (FFH).
- **SaturateToSignedByte** – Represents the result of an operation as a signed 8-bit value. If the result is less than –128, it is represented by the saturated value –128 (80H); if it is greater than 127, it is represented by the saturated value 127 (7FH).
- **SaturateToSignedWord** – Represents the result of an operation as a signed 16-bit value. If the result is less than –32768, it is represented by the saturated value –32768 (8000H); if it is greater than 32767, it is represented by the saturated value 32767 (7FFFH).
- **SaturateToUnsignedByte** – Represents the result of an operation as a signed 8-bit value. If the result is less than zero it is represented by the saturated value zero (00H); if it is greater than 255, it is represented by the saturated value 255 (FFH).
- **SaturateToUnsignedWord** – Represents the result of an operation as a signed 16-bit value. If the result is less than zero it is represented by the saturated value zero (00H); if it is greater than 65535, it is represented by the saturated value 65535 (FFFFH).
- **LowOrderWord(DEST * SRC)** – Multiplies a word operand by a word operand and stores the least significant word of the doubleword result in the destination operand.
- **HighOrderWord(DEST * SRC)** – Multiplies a word operand by a word operand and stores the most significant word of the doubleword result in the destination operand.
- **Push(value)** – Pushes a value onto the stack. The number of bytes pushed is determined by the operand-size attribute of the instruction.
- **Pop()** – Removes the value from the top of the stack and returns it. The statement `EAX ← Pop()`; assigns to EAX the 32-bit value from the top of the stack. Pop will return either a word or a doubleword depending on the operand-size attribute.
- **PopRegisterStack** – Marks the FPU ST(0) register as empty and increments the FPU register stack pointer (TOP) by 1.
- **Switch-Tasks** – Performs a task switch.
- **Bit(BitBase, BitOffset)** – Returns the value of a bit within a bit string, which is a sequence of bits in memory or a register. Bits are numbered from low-order to high-order within registers and within memory bytes. If the base operand is a register, the offset can be in the range 0..31. This offset addresses a bit within the indicated register. An example, the function `Bit[EAX, 21]` is illustrated in [Figure 1-1](#).

Figure 1-1. Bit Offset for BIT[EAX,21]

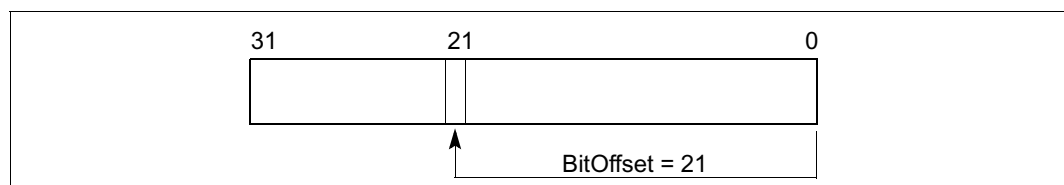

If BitBase is a memory address, BitOffset can range from -2 GBits to 2 GBits. The addressed bit is numbered (Offset MOD 8) within the byte at address (BitBase + (BitOffset DIV 8)), where DIV is signed division with rounding towards negative infinity, and MOD returns a positive number. This operation is illustrated in Figure 1-2.

Figure 1-2. Memory Bit Indexing

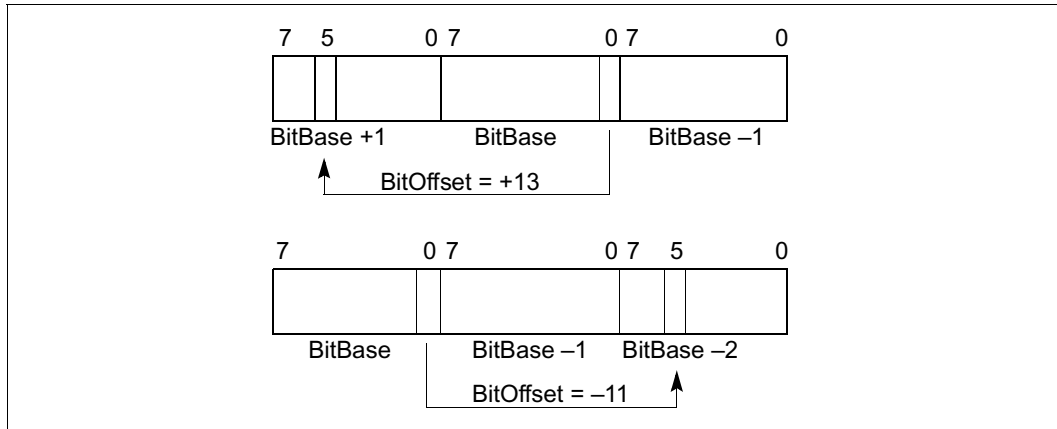

1.2.3 Flags Affected

The “Flags Affected” section lists the flags in the EFLAGS register that are affected by the instruction. When a flag is cleared, it is equal to 0; when it is set, it is equal to 1. The arithmetic and logical instructions usually assign values to the status flags in a uniform manner (see Appendix A, *EFLAGS Cross-Reference*, in the *IA-32 Intel® Architecture Software Developer’s Manual, Volume 1*). Non-conventional assignments are described in the “Operation” section. The values of flags listed as **undefined** may be changed by the instruction in an indeterminate manner. Flags that are not listed are unchanged by the instruction.

1.2.4 FPU Flags Affected

The floating-point instructions have an “FPU Flags Affected” section that describes how each instruction can affect the four condition code flags of the FPU status word.

1.2.5 Protected Mode Exceptions

The “Protected Mode Exceptions” section lists the exceptions that can occur when the instruction is executed in protected mode and the reasons for the exceptions. Each exception is given a mnemonic that consists of a pound sign (#) followed by two letters and an optional error code in parentheses. For example, #GP(0) denotes a general protection exception with an error code of 0. Table 1-2 associates each two-letter mnemonic with the corresponding interrupt vector number and exception name. See Chapter 5, *Interrupt and Exception Handling*, in the *IA-32 Intel® Architecture Software Developer’s Manual, Volume 3*, for a detailed description of the exceptions.

Application programmers should consult the documentation provided with their operating systems to determine the actions taken when exceptions occur.

1.2.6 Real-address Mode Exceptions

The “Real-Address Mode Exceptions” section lists the exceptions that can occur when the instruction is executed in real-address mode.

Table 1-2. Exception Mnemonics, Names, and Vector Numbers

| Vector No. | Mnemonic | Name | Source |
|------------|----------|--|---|
| 0 | #DE | Divide Error | DIV and IDIV instructions. |
| 1 | #DB | Debug | Any code or data reference. |
| 3 | #BP | Breakpoint | INT 3 instruction. |
| 4 | #OF | Overflow | INTO instruction. |
| 5 | #BR | BOUND Range Exceeded | BOUND instruction. |
| 6 | #UD | Invalid Opcode (Undefined Opcode) | UD2 instruction or reserved opcode. ^a |
| 7 | #NM | Device Not Available (No Math Coprocessor) | Floating-point or WAIT/FWAIT instruction. |
| 8 | #DF | Double Fault | Any instruction that can generate an exception, an NMI, or an INTR. |
| 10 | #TS | Invalid TSS | Task switch or TSS access. |
| 11 | #NP | Segment Not Present | Loading segment registers or accessing system segments. |
| 12 | #SS | Stack Segment Fault | Stack operations and SS register loads. |
| 13 | #GP | General Protection | Any memory reference and other protection checks. |
| 14 | #PF | Page Fault | Any memory reference. |
| 16 | #MF | Floating-point Error (Math Fault) | Floating-point or WAIT/FWAIT instruction. |
| 17 | #AC | Alignment Check | Any data reference in memory. ^b |
| 18 | #MC | Machine Check | Model dependent. ^c |

a. The UD2 instruction was introduced in the Pentium[®] Pro processor.

b. This exception was introduced in the Intel[®] 486 processor.

c. This exception was introduced in the Pentium processor and enhanced in the Pentium Pro processor.

1.2.7 Virtual-8086 Mode Exceptions

The “Virtual-8086 Mode Exceptions” section lists the exceptions that can occur when the instruction is executed in virtual-8086 mode.

1.2.8 Floating-point Exceptions

The “Floating-point Exceptions” section lists additional exceptions that can occur when a floating-point instruction is executed in any mode. All of these exception conditions result in a floating-point error exception (#MF, vector number 16) being generated. [Table 1-3](#) associates each one- or two-letter mnemonic with the corresponding exception name. See “Floating-Point Exception Conditions” in Chapter 7 of the *IA-32 Intel[®] Architecture Software Developer’s Manual, Volume 1*, for a detailed description of these exceptions.

Table 1-3. Floating-point Exception Mnemonics and Names

| Vector No. | Mnemonic | Name | Source |
|------------|------------|--|---|
| 16 | #IS #IA | Floating-point invalid operation: - Stack overflow or underflow - Invalid arithmetic operation | - FPU stack overflow or underflow - Invalid FPU arithmetic operation |
| 16 | #Z | Floating-point divide-by-zero | FPU divide-by-zero |
| 16 | #D | Floating-point denormalized operation | Attempting to operate on a denormal number |
| 16 | #O | Floating-point numeric overflow | FPU numeric overflow |
| 16 | #U | Floating-point numeric underflow | FPU numeric underflow |
| 16 | #P | Floating-point inexact result (precision) | Inexact result (precision) |

1.3 IA-32 Base Instruction Reference

The remainder of this chapter provides detailed descriptions of each of the Intel architecture instructions.

AAA—ASCII Adjust After Addition

| Opcode | Instruction | Description |
|--------|-------------|--------------------------------|
| 37 | AAA | ASCII adjust AL after addition |

Description

Adjusts the sum of two unpacked BCD values to create an unpacked BCD result. The AL register is the implied source and destination operand for this instruction. The AAA instruction is only useful when it follows an ADD instruction that adds (binary addition) two unpacked BCD values and stores a byte result in the AL register. The AAA instruction then adjusts the contents of the AL register to contain the correct 1-digit unpacked BCD result.

If the addition produces a decimal carry, the AH register is incremented by 1, and the CF and AF flags are set. If there was no decimal carry, the CF and AF flags are cleared and the AH register is unchanged. In either case, bits 4 through 7 of the AL register are cleared to 0.

Operation

```

IF ((AL AND FH) > 9) OR (AF = 1)
  THEN
    AL ← (AL + 6);
    AH ← AH + 1;
    AF ← 1;
    CF ← 1;
  ELSE
    AF ← 0;
    CF ← 0;
FI;
AL ← AL AND FH;

```

Flags Affected

The AF and CF flags are set to 1 if the adjustment results in a decimal carry; otherwise they are cleared to 0. The OF, SF, ZF, and PF flags are undefined.

Additional Itanium® System Environment Exceptions

Itanium Reg Faults NaT Register Consumption Abort.

Exceptions (All Operating Modes)

None.

AAD—ASCII Adjust AX Before Division

| Opcode | Instruction | Description |
|--------|-------------|---------------------------------|
| D5 0A | AAD | ASCII adjust AX before division |

Description

Adjusts two unpacked BCD digits (the least-significant digit in the AL register and the most-significant digit in the AH register) so that a division operation performed on the result will yield a correct unpacked BCD value. The AAD instruction is only useful when it precedes a DIV instruction that divides (binary division) the adjusted value in the AL register by an unpacked BCD value.

The AAD instruction sets the value in the AL register to $(AL + (10 * AH))$, and then clears the AH register to 00H. The value in the AX register is then equal to the binary equivalent of the original unpacked two-digit number in registers AH and AL.

Operation

```
tempAL ← AL;
tempAH ← AH;
AL ← (tempAL + (tempAH * imm8)) AND FFH;
AH ← 0
```

The immediate value (*imm8*) is taken from the second byte of the instruction, which under normal assembly is 0AH (10 decimal). However, this immediate value can be changed to produce a different result.

Flags Affected

The SF, ZF, and PF flags are set according to the result; the OF, AF, and CF flags are undefined.

Additional Itanium® System Environment Exceptions

Itanium Reg Faults NaT Register Consumption Abort.

Exceptions (All Operating Modes)

None.

AAM—ASCII Adjust AX After Multiply

| Opcode | Instruction | Description |
|--------|-------------|--------------------------------|
| D4 0A | AAM | ASCII adjust AX after multiply |

Description

Adjusts the result of the multiplication of two unpacked BCD values to create a pair of unpacked BCD values. The AX register is the implied source and destination operand for this instruction. The AAM instruction is only useful when it follows an MUL instruction that multiplies (binary multiplication) two unpacked BCD values and stores a word result in the AX register. The AAM instruction then adjusts the contents of the AX register to contain the correct 2-digit unpacked BCD result.

Operation

```
tempAL ← AL;
AH ← tempAL / imm8;
AL ← tempAL MOD imm8;
```

The immediate value (*imm8*) is taken from the second byte of the instruction, which under normal assembly is 0AH (10 decimal). However, this immediate value can be changed to produce a different result.

Flags Affected

The SF, ZF, and PF flags are set according to the result. The OF, AF, and CF flags are undefined.

Additional Itanium® System Environment Exceptions

Itanium Reg Faults NaT Register Consumption Abort.

Exceptions (All Operating Modes)

None.

AAS—ASCII Adjust AL After Subtraction

| Opcode | Instruction | Description |
|--------|-------------|-----------------------------------|
| 3F | AAS | ASCII adjust AL after subtraction |

Description

Adjusts the result of the subtraction of two unpacked BCD values to create a unpacked BCD result. The AL register is the implied source and destination operand for this instruction. The AAS instruction is only useful when it follows a SUB instruction that subtracts (binary subtraction) one unpacked BCD value from another and stores a byte result in the AL register. The AAA instruction then adjusts the contents of the AL register to contain the correct 1-digit unpacked BCD result.

If the subtraction produced a decimal carry, the AH register is decremented by 1, and the CF and AF flags are set. If no decimal carry occurred, the CF and AF flags are cleared, and the AH register is unchanged. In either case, the AL register is left with its top nibble set to 0.

Operation

```
IF ((AL AND FH) > 9) OR (AF = 1)
THEN
  AL ← AL – 6;
  AH ← AH – 1;
  AF ← 1;
  CF ← 1;
ELSE
  CF ← 0;
  AF ← 0;
FI;
AL ← AL AND FH;
```

Flags Affected

The AF and CF flags are set to 1 if there is a decimal borrow; otherwise, they are cleared to 0. The OF, SF, ZF, and PF flags are undefined.

Additional Itanium® System Environment Exceptions

Itanium Reg Faults NaT Register Consumption Abort.

Exceptions (All Operating Modes)

None.

ADC—Add with Carry

| Opcode | Instruction | Description |
|-----------------|---------------------------------|---|
| 14 <i>ib</i> | ADC AL, <i>imm8</i> | Add with carry <i>imm8</i> to AL |
| 15 <i>iw</i> | ADC AX, <i>imm16</i> | Add with carry <i>imm16</i> to AX |
| 15 <i>id</i> | ADC EAX, <i>imm32</i> | Add with carry <i>imm32</i> to EAX |
| 80 /2 <i>ib</i> | ADC <i>r/m8</i> , <i>imm8</i> | Add with carry <i>imm8</i> to <i>r/m8</i> |
| 81 /2 <i>iw</i> | ADC <i>r/m16</i> , <i>imm16</i> | Add with carry <i>imm16</i> to <i>r/m16</i> |
| 81 /2 <i>id</i> | ADC <i>r/m32</i> , <i>imm32</i> | Add with CF <i>imm32</i> to <i>r/m32</i> |
| 83 /2 <i>ib</i> | ADC <i>r/m16</i> , <i>imm8</i> | Add with CF sign-extended <i>imm8</i> to <i>r/m16</i> |
| 83 /2 <i>ib</i> | ADC <i>r/m32</i> , <i>imm8</i> | Add with CF sign-extended <i>imm8</i> into <i>r/m32</i> |
| 10 <i>lr</i> | ADC <i>r/m8</i> , <i>r8</i> | Add with carry byte register to <i>r/m8</i> |
| 11 <i>lr</i> | ADC <i>r/m16</i> , <i>r16</i> | Add with carry <i>r16</i> to <i>r/m16</i> |
| 11 <i>lr</i> | ADC <i>r/m32</i> , <i>r32</i> | Add with CF <i>r32</i> to <i>r/m32</i> |
| 12 <i>lr</i> | ADC <i>r8</i> , <i>r/m8</i> | Add with carry <i>r/m8</i> to byte register |
| 13 <i>lr</i> | ADC <i>r16</i> , <i>r/m16</i> | Add with carry <i>r/m16</i> to <i>r16</i> |
| 13 <i>lr</i> | ADC <i>r32</i> , <i>r/m32</i> | Add with CF <i>r/m32</i> to <i>r32</i> |

Description

Adds the destination operand (first operand), the source operand (second operand), and the carry (CF) flag and stores the result in the destination operand. The destination operand can be a register or a memory location; the source operand can be an immediate, a register, or a memory location. The state of the CF flag represents a carry from a previous addition. When an immediate value is used as an operand, it is sign-extended to the length of the destination operand format.

The ADC instruction does not distinguish between signed or unsigned operands. Instead, the processor evaluates the result for both data types and sets the OF and CF flags to indicate a carry in the signed or unsigned result, respectively. The SF flag indicates the sign of the signed result.

The ADC instruction is usually executed as part of a multibyte or multiword addition in which an ADD instruction is followed by an ADC instruction.

Operation

$DEST \leftarrow DEST + SRC + CF;$

Flags Affected

The OF, SF, ZF, AF, CF, and PF flags are set according to the result.

Additional Itanium® System Environment Exceptions

Itanium Reg Faults NaT Register Consumption Abort.

Itanium Mem Faults VHPT Data Fault, Nested TLB Fault, Data TLB Fault, Alternate Data TLB Fault, Data Page Not Present Fault, Data NaT Page Consumption Abort, Data Key Miss Fault, Data Key Permission Fault, Data Access Rights Fault, Data Access Bit Fault, Data Dirty Bit Fault

ADC—Add with Carry (Continued)

Protected Mode Exceptions

| | |
|-----------------|---|
| #GP(0) | If the destination is located in a nonwritable segment. If a memory operand effective address is outside the CS, DS, ES, FS, or GS segment limit. If the DS, ES, FS, or GS register is used to access memory and it contains a null segment selector. |
| #SS(0) | If a memory operand effective address is outside the SS segment limit. |
| #PF(fault-code) | If a page fault occurs. |
| #AC(0) | If alignment checking is enabled and an unaligned memory reference is made while the current privilege level is 3. |

Real Address Mode Exceptions

| | |
|-----|---|
| #GP | If a memory operand effective address is outside the CS, DS, ES, FS, or GS segment limit. |
| #SS | If a memory operand effective address is outside the SS segment limit. |

Virtual 8086 Mode Exceptions

| | |
|-----------------|---|
| #GP(0) | If a memory operand effective address is outside the CS, DS, ES, FS, or GS segment limit. |
| #SS(0) | If a memory operand effective address is outside the SS segment limit. |
| #PF(fault-code) | If a page fault occurs. |
| #AC(0) | If alignment checking is enabled and an unaligned memory reference is made. |

ADD—Add

| Opcode | Instruction | Description |
|-----------------|--------------------------------|--|
| 04 <i>ib</i> | ADD AL, <i>imm8</i> | Add <i>imm8</i> to AL |
| 05 <i>iw</i> | ADD AX, <i>imm16</i> | Add <i>imm16</i> to AX |
| 05 <i>id</i> | ADD EAX, <i>imm32</i> | Add <i>imm32</i> to EAX |
| 80 /0 <i>ib</i> | ADD <i>rm8</i> , <i>imm8</i> | Add <i>imm8</i> to <i>rm8</i> |
| 81 /0 <i>iw</i> | ADD <i>rm16</i> , <i>imm16</i> | Add <i>imm16</i> to <i>rm16</i> |
| 81 /0 <i>id</i> | ADD <i>rm32</i> , <i>imm32</i> | Add <i>imm32</i> to <i>rm32</i> |
| 83 /0 <i>ib</i> | ADD <i>rm16</i> , <i>imm8</i> | Add sign-extended <i>imm8</i> to <i>rm16</i> |
| 83 /0 <i>ib</i> | ADD <i>rm32</i> , <i>imm8</i> | Add sign-extended <i>imm8</i> to <i>rm32</i> |
| 00 <i>lr</i> | ADD <i>rm8</i> , <i>r8</i> | Add <i>r8</i> to <i>rm8</i> |
| 01 <i>lr</i> | ADD <i>rm16</i> , <i>r16</i> | Add <i>r16</i> to <i>rm16</i> |
| 01 <i>lr</i> | ADD <i>rm32</i> , <i>r32</i> | Add <i>r32</i> to <i>rm32</i> |
| 02 <i>lr</i> | ADD <i>r8</i> , <i>rm8</i> | Add <i>rm8</i> to <i>r8</i> |
| 03 <i>lr</i> | ADD <i>r16</i> , <i>rm16</i> | Add <i>rm16</i> to <i>r16</i> |
| 03 <i>lr</i> | ADD <i>r32</i> , <i>rm32</i> | Add <i>rm32</i> to <i>r32</i> |

Description

Adds the first operand (destination operand) and the second operand (source operand) and stores the result in the destination operand. The destination operand can be a register or a memory location; the source operand can be an immediate, a register, or a memory location. When an immediate value is used as an operand, it is sign-extended to the length of the destination operand format.

The ADD instruction does not distinguish between signed or unsigned operands. Instead, the processor evaluates the result for both data types and sets the OF and CF flags to indicate a carry in the signed or unsigned result, respectively. The SF flag indicates the sign of the signed result.

Operation

$DEST \leftarrow DEST + SRC;$

Flags Affected

The OF, SF, ZF, AF, CF, and PF flags are set according to the result.

Additional Itanium® System Environment Exceptions

Itanium Reg Faults NaT Register Consumption Abort.

Itanium Mem Faults VHPT Data Fault, Nested TLB Fault, Data TLB Fault, Alternate Data TLB Fault, Data Page Not Present Fault, Data NaT Page Consumption Abort, Data Key Miss Fault, Data Key Permission Fault, Data Access Rights Fault, Data Access Bit Fault, Data Dirty Bit Fault

ADD—Add (Continued)**Protected Mode Exceptions**

| | |
|-----------------|---|
| #GP(0) | If the destination is located in a nonwritable segment. If a memory operand effective address is outside the CS, DS, ES, FS, or GS segment limit. If the DS, ES, FS, or GS register is used to access memory and it contains a null segment selector. |
| #SS(0) | If a memory operand effective address is outside the SS segment limit. |
| #PF(fault-code) | If a page fault occurs. |
| #AC(0) | If alignment checking is enabled and an unaligned memory reference is made while the current privilege level is 3. |

Real Address Mode Exceptions

| | |
|-----|---|
| #GP | If a memory operand effective address is outside the CS, DS, ES, FS, or GS segment limit. |
| #SS | If a memory operand effective address is outside the SS segment limit. |

Virtual 8086 Mode Exceptions

| | |
|-----------------|---|
| #GP(0) | If a memory operand effective address is outside the CS, DS, ES, FS, or GS segment limit. |
| #SS(0) | If a memory operand effective address is outside the SS segment limit. |
| #PF(fault-code) | If a page fault occurs. |
| #AC(0) | If alignment checking is enabled and an unaligned memory reference is made. |

AND—Logical AND

| Opcode | Instruction | Description |
|-----------------|---------------------------------|-------------------------------|
| 24 <i>ib</i> | AND AL, <i>imm8</i> | AL AND <i>imm8</i> |
| 25 <i>iw</i> | AND AX, <i>imm16</i> | AX AND <i>imm16</i> |
| 25 <i>id</i> | AND EAX, <i>imm32</i> | EAX AND <i>imm32</i> |
| 80 /4 <i>ib</i> | AND <i>rlm8</i> , <i>imm8</i> | <i>rlm8</i> AND <i>imm8</i> |
| 81 /4 <i>iw</i> | AND <i>rlm16</i> , <i>imm16</i> | <i>rlm16</i> AND <i>imm16</i> |
| 81 /4 <i>id</i> | AND <i>rlm32</i> , <i>imm32</i> | <i>rlm32</i> AND <i>imm32</i> |
| 83 /4 <i>ib</i> | AND <i>rlm16</i> , <i>imm8</i> | <i>rlm16</i> AND <i>imm8</i> |
| 83 /4 <i>ib</i> | AND <i>rlm32</i> , <i>imm8</i> | <i>rlm32</i> AND <i>imm8</i> |
| 20 <i>lr</i> | AND <i>rlm8</i> , <i>r8</i> | <i>rlm8</i> AND <i>r8</i> |
| 21 <i>lr</i> | AND <i>rlm16</i> , <i>r16</i> | <i>rlm16</i> AND <i>r16</i> |
| 21 <i>lr</i> | AND <i>rlm32</i> , <i>r32</i> | <i>rlm32</i> AND <i>r32</i> |
| 22 <i>lr</i> | AND <i>r8</i> , <i>rlm8</i> | <i>r8</i> AND <i>rlm8</i> |
| 23 <i>lr</i> | AND <i>r16</i> , <i>rlm16</i> | <i>r16</i> AND <i>rlm16</i> |
| 23 <i>lr</i> | AND <i>r32</i> , <i>rlm32</i> | <i>r32</i> AND <i>rlm32</i> |

Description

Performs a bitwise AND operation on the destination (first) and source (second) operands and stores the result in the destination operand location. The source operand can be an immediate, a register, or a memory location; the destination operand can be a register or a memory location.

Operation

DEST ← DEST AND SRC;

Flags Affected

The OF and CF flags are cleared; the SF, ZF, and PF flags are set according to the result. The state of the AF flag is undefined.

Additional Itanium® System Environment Exceptions

Itanium Reg Faults NaT Register Consumption Abort.

Itanium Mem Faults VHPT Data Fault, Nested TLB Fault, Data TLB Fault, Alternate Data TLB Fault, Data Page Not Present Fault, Data NaT Page Consumption Abort, Data Key Miss Fault, Data Key Permission Fault, Data Access Rights Fault, Data Access Bit Fault, Data Dirty Bit Fault

Protected Mode Exceptions

- #GP(0) If the destination operand points to a nonwritable segment.
If a memory operand effective address is outside the CS, DS, ES, FS, or GS segment limit.
If the DS, ES, FS, or GS register contains a null segment selector.
- #SS(0) If a memory operand effective address is outside the SS segment limit.

AND—Logical AND (Continued)

| | |
|-----------------|--|
| #PF(fault-code) | If a page fault occurs. |
| #AC(0) | If alignment checking is enabled and an unaligned memory reference is made while the current privilege level is 3. |

Real Address Mode Exceptions

| | |
|-----|---|
| #GP | If a memory operand effective address is outside the CS, DS, ES, FS, or GS segment limit. |
| #SS | If a memory operand effective address is outside the SS segment limit. |

Virtual 8086 Mode Exceptions

| | |
|-----------------|---|
| #GP(0) | If a memory operand effective address is outside the CS, DS, ES, FS, or GS segment limit. |
| #SS(0) | If a memory operand effective address is outside the SS segment limit. |
| #PF(fault-code) | If a page fault occurs. |
| #AC(0) | If alignment checking is enabled and an unaligned memory reference is made. |

ARPL—Adjust RPL Field of Segment Selector

| Opcode | Instruction | Description |
|--------|----------------------|--|
| 63 /r | ARPL <i>rm16,r16</i> | Adjust RPL of <i>rm16</i> to not less than RPL of <i>r16</i> |

Description

Compares the RPL fields of two segment selectors. The first operand (the destination operand) contains one segment selector and the second operand (source operand) contains the other. (The RPL field is located in bits 0 and 1 of each operand.) If the RPL field of the destination operand is less than the RPL field of the source operand, the ZF flag is set and the RPL field of the destination operand is increased to match that of the source operand. Otherwise, the ZF flag is cleared and no change is made to the destination operand. (The destination operand can be a word register or a memory location; the source operand must be a word register.)

The ARPL instruction is provided for use by operating-system procedures (however, it can also be used by applications). It is generally used to adjust the RPL of a segment selector that has been passed to the operating system by an application program to match the privilege level of the application program. Here the segment selector passed to the operating system is placed in the destination operand and segment selector for the application program's code segment is placed in the source operand. (The RPL field in the source operand represents the privilege level of the application program.) Execution of the ARPL instruction then insures that the RPL of the segment selector received by the operating system is no lower (does not have a higher privilege) than the privilege level of the application program. (The segment selector for the application program's code segment can be read from the procedure stack following a procedure call.)

See the *IA-32 Intel® Architecture Software Developer's Manual, Volume 3* for more information about the use of this instruction.

Operation

```
IF DEST(RPL) < SRC(RPL)
THEN
    ZF ← 1;
    DEST(RPL) ← SRC(RPL);
ELSE
    ZF ← 0;
FI;
```

Flags Affected

The ZF flag is set to 1 if the RPL field of the destination operand is less than that of the source operand; otherwise, is cleared to 0.

Additional Itanium® System Environment Exceptions

Itanium Reg Faults NaT Register Consumption Abort.

Itanium Mem Faults VHPT Data Fault, Nested TLB Fault, Data TLB Fault, Alternate Data TLB Fault, Data Page Not Present Fault, Data NaT Page Consumption Abort, Data Key Miss Fault, Data Key Permission Fault, Data Access Rights Fault, Data Access Bit Fault, Data Dirty Bit Fault

ARPL—Adjust RPL Field of Segment Selector (Continued)

Protected Mode Exceptions

| | |
|-----------------|---|
| #GP(0) | If the destination is located in a nonwritable segment. If a memory operand effective address is outside the CS, DS, ES, FS, or GS segment limit. If the DS, ES, FS, or GS register is used to access memory and it contains a null segment selector. |
| #SS(0) | If a memory operand effective address is outside the SS segment limit. |
| #PF(fault-code) | If a page fault occurs. |
| #AC(0) | If alignment checking is enabled and an unaligned memory reference is made while the current privilege level is 3. |

Real Address Mode Exceptions

| | |
|-----|--|
| #UD | The ARPL instruction is not recognized in real address mode. |
|-----|--|

Virtual 8086 Mode Exceptions

| | |
|-----|--|
| #UD | The ARPL instruction is not recognized in virtual 8086 mode. |
|-----|--|

BOUND—Check Array Index Against Bounds

| Opcode | Instruction | Description |
|--------|------------------|---|
| 62 /r | BOUND r16,m16&16 | Check if r16 (array index) is within bounds specified by m16&16 |
| 62 /r | BOUND r32,m32&32 | Check if r32 (array index) is within bounds specified by m16&16 |

Description

Determines if the first operand (array index) is within the bounds of an array specified the second operand (bounds operand). The array index is a signed integer located in a register. The bounds operand is a memory location that points to a pair of signed doubleword-integers (when the operand-size attribute is 32) or a pair of signed word-integers (when the operand-size attribute is 16). The first doubleword (or word) is the lower bound of the array and the second doubleword (or word) is the upper bound of the array. The array index must be greater than or equal to the lower bound and less than or equal to the upper bound plus the operand size in bytes. If the index is not within bounds, a BOUND range exceeded exception (#BR) is signaled. (When a this exception is generated, the saved return instruction pointer points to the BOUND instruction.)

The bounds limit data structure (two words or doublewords containing the lower and upper limits of the array) is usually placed just before the array itself, making the limits addressable via a constant offset from the beginning of the array. Because the address of the array already will be present in a register, this practice avoids extra bus cycles to obtain the effective address of the array bounds.

Operation

```
IF (ArrayIndex < LowerBound OR ArrayIndex > (UpperBound + OperandSize/8))
  (* Below lower bound or above upper bound *)
  THEN
    #BR;
FI;
```

Flags Affected

None.

Additional Itanium® System Environment Exceptions

Itanium Reg Faults NaT Register Consumption Abort.

Itanium Mem Faults VHPT Data Fault, Nested TLB Fault, Data TLB Fault, Alternate Data TLB Fault, Data Page Not Present Fault, Data NaT Page Consumption Abort, Data Key Miss Fault, Data Key Permission Fault, Data Access Rights Fault, Data Access Bit Fault, Data Dirty Bit Fault

BOUND—Check Array Index Against Bounds (Continued)

Protected Mode Exceptions

| | |
|-----------------|--|
| #BR | If the bounds test fails. |
| #UD | If second operand is not a memory location. |
| #GP(0) | If a memory operand effective address is outside the CS, DS, ES, FS, or GS segment limit. If the DS, ES, FS, or GS register contains a null segment selector. |
| #SS(0) | If a memory operand effective address is outside the SS segment limit. |
| #PF(fault-code) | If a page fault occurs. |
| #AC(0) | If alignment checking is enabled and an unaligned memory reference is made while the current privilege level is 3. |

Real Address Mode Exceptions

| | |
|-----|---|
| #BR | If the bounds test fails. |
| #GP | If a memory operand effective address is outside the CS, DS, ES, FS, or GS segment limit. |
| #SS | If a memory operand effective address is outside the SS segment limit. |

Virtual 8086 Mode Exceptions

| | |
|-----------------|---|
| #BR | If the bounds test fails. |
| #GP(0) | If a memory operand effective address is outside the CS, DS, ES, FS, or GS segment limit. |
| #SS(0) | If a memory operand effective address is outside the SS segment limit. |
| #PF(fault-code) | If a page fault occurs. |
| #AC(0) | If alignment checking is enabled and an unaligned memory reference is made. |

BSF—Bit Scan Forward

| Opcode | Instruction | Description |
|--------|----------------------|----------------------------------|
| 0F BC | BSF <i>r16,r/m16</i> | Bit scan forward on <i>r/m16</i> |
| 0F BC | BSF <i>r32,r/m32</i> | Bit scan forward on <i>r/m32</i> |

Description

Searches the source operand (second operand) for the least significant set bit (1 bit). If a least significant 1 bit is found, its bit index is stored in the destination operand (first operand). The source operand can be a register or a memory location; the destination operand is a register. The bit index is an unsigned offset from bit 0 of the source operand. If the contents source operand are 0, the contents of the destination operand is undefined.

Operation

```

IF SRC = 0
  THEN
    ZF ← 1;
    DEST is undefined;
  ELSE
    ZF ← 0;
    temp ← 0;
    WHILE Bit(SRC, temp) = 0
    DO
      temp ← temp + 1;
      DEST ← temp;
    OD;
FI;

```

Flags Affected

The ZF flag is set to 1 if all the source operand is 0; otherwise, the ZF flag is cleared. The CF, OF, SF, AF, and PF, flags are undefined.

Additional Itanium® System Environment Exceptions

| | |
|--------------------|--|
| Itanium Reg Faults | NaT Register Consumption Abort. |
| Itanium Mem Faults | VHPT Data Fault, Nested TLB Fault, Data TLB Fault, Alternate Data TLB Fault, Data Page Not Present Fault, Data NaT Page Consumption Abort, Data Key Miss Fault, Data Key Permission Fault, Data Access Rights Fault, Data Access Bit Fault, Data Dirty Bit Fault |

BSF—Bit Scan Forward (Continued)

Protected Mode Exceptions

| | |
|-----------------|--|
| #GP(0) | If a memory operand effective address is outside the CS, DS, ES, FS, or GS segment limit. If the DS, ES, FS, or GS register contains a null segment selector. |
| #SS(0) | If a memory operand effective address is outside the SS segment limit. |
| #PF(fault-code) | If a page fault occurs. |
| #AC(0) | If alignment checking is enabled and an unaligned memory reference is made while the current privilege level is 3. |

Real Address Mode Exceptions

| | |
|-----|---|
| #GP | If a memory operand effective address is outside the CS, DS, ES, FS, or GS segment limit. |
| #SS | If a memory operand effective address is outside the SS segment limit. |

Virtual 8086 Mode Exceptions

| | |
|-----------------|---|
| #GP(0) | If a memory operand effective address is outside the CS, DS, ES, FS, or GS segment limit. |
| #SS(0) | If a memory operand effective address is outside the SS segment limit. |
| #PF(fault-code) | If a page fault occurs. |
| #AC(0) | If alignment checking is enabled and an unaligned memory reference is made. |

BSR—Bit Scan Reverse

| Opcode | Instruction | Description |
|--------|----------------------|----------------------------------|
| 0F BD | BSR <i>r16,r/m16</i> | Bit scan reverse on <i>r/m16</i> |
| 0F BD | BSR <i>r32,r/m32</i> | Bit scan reverse on <i>r/m32</i> |

Description

Searches the source operand (second operand) for the most significant set bit (1 bit). If a most significant 1 bit is found, its bit index is stored in the destination operand (first operand). The source operand can be a register or a memory location; the destination operand is a register. The bit index is an unsigned offset from bit 0 of the source operand. If the contents source operand are 0, the contents of the destination operand is undefined.

Operation

```

IF SRC = 0
  THEN
    ZF ← 1;
    DEST is undefined;
  ELSE
    ZF ← 0;
    temp ← OperandSize – 1;
    WHILE Bit(SRC, temp) = 0
    DO
      temp ← temp – 1;
      DEST ← temp;
    OD;
FI;

```

Flags Affected

The ZF flag is set to 1 if all the source operand is 0; otherwise, the ZF flag is cleared. The CF, OF, SF, AF, and PF, flags are undefined.

Additional Itanium® System Environment Exceptions

| | |
|--------------------|--|
| Itanium Reg Faults | NaT Register Consumption Abort. |
| Itanium Mem Faults | VHPT Data Fault, Nested TLB Fault, Data TLB Fault, Alternate Data TLB Fault, Data Page Not Present Fault, Data NaT Page Consumption Abort, Data Key Miss Fault, Data Key Permission Fault, Data Access Rights Fault, Data Access Bit Fault, Data Dirty Bit Fault |

BSR—Bit Scan Reverse (Continued)

Protected Mode Exceptions

| | |
|-----------------|--|
| #GP(0) | If a memory operand effective address is outside the CS, DS, ES, FS, or GS segment limit. If the DS, ES, FS, or GS register contains a null segment selector. |
| #SS(0) | If a memory operand effective address is outside the SS segment limit. |
| #PF(fault-code) | If a page fault occurs. |
| #AC(0) | If alignment checking is enabled and an unaligned memory reference is made while the current privilege level is 3. |

Real Address Mode Exceptions

| | |
|-----|---|
| #GP | If a memory operand effective address is outside the CS, DS, ES, FS, or GS segment limit. |
| #SS | If a memory operand effective address is outside the SS segment limit. |

Virtual 8086 Mode Exceptions

| | |
|-----------------|---|
| #GP(0) | If a memory operand effective address is outside the CS, DS, ES, FS, or GS segment limit. |
| #SS(0) | If a memory operand effective address is outside the SS segment limit. |
| #PF(fault-code) | If a page fault occurs. |
| #AC(0) | If alignment checking is enabled and an unaligned memory reference is made. |

BSWAP—Byte Swap

| Opcode | Instruction | Description |
|----------|-------------|---|
| 0F C8+rd | BSWAP r32 | Reverses the byte order of a 32-bit register. |

Description

Reverses the byte order of a 32-bit (destination) register: bits 0 through 7 are swapped with bits 24 through 31, and bits 8 through 15 are swapped with bits 16 through 23. This instruction is provided for converting little-endian values to big-endian format and vice versa.

To swap bytes in a word value (16-bit register), use the XCHG instruction. When the BSWAP instruction references a 16-bit register, the result is undefined.

Operation

```
TEMP ← DEST
DEST(7..0) ← TEMP(31..24)
DEST(15..8) ← TEMP(23..16)
DEST(23..16) ← TEMP(15..8)
DEST(31..24) ← TEMP(7..0)
```

Flags Affected

None.

Additional Itanium® System Environment Exceptions

Itanium Reg Faults NaT Register Consumption Abort.

Exceptions (All Operating Modes)

None.

Intel® Architecture Compatibility Information

The BSWAP instruction is not supported on Intel architecture processors earlier than the Intel486™ processor family. For compatibility with this instruction, include functionally-equivalent code for execution on Intel processors earlier than the Intel486 processor family.

BT—Bit Test

| Opcode | Instruction | Description |
|--------------------|---------------------|-------------------------------|
| 0F A3 | BT <i>rm16,r16</i> | Store selected bit in CF flag |
| 0F A3 | BT <i>rm32,r32</i> | Store selected bit in CF flag |
| 0F BA /4 <i>ib</i> | BT <i>rm16,imm8</i> | Store selected bit in CF flag |
| 0F BA /4 <i>ib</i> | BT <i>rm32,imm8</i> | Store selected bit in CF flag |

Description

Selects the bit in a bit string (specified with the first operand, called the bit base) at the bit-position designated by the bit offset operand (second operand) and stores the value of the bit in the CF flag. The bit base operand can be a register or a memory location; the bit offset operand can be a register or an immediate value. If the bit base operand specifies a register, the instruction takes the modulo 16 or 32 (depending on the register size) of the bit offset operand, allowing any bit position to be selected in a 16- or 32-bit register, respectively. If the bit base operand specifies a memory location, it represents the address of the byte in memory that contains the bit base (bit 0 of the specified byte) of the bit string. The offset operand then selects a bit position within the range -2^{31} to $2^{31} - 1$ for a register offset and 0 to 31 for an immediate offset.

Some assemblers support immediate bit offsets larger than 31 by using the immediate bit offset field in combination with the displacement field of the memory operand. In this case, the low-order 3 or 5 bits (3 for 16-bit operands, 5 for 32-bit operands) of the immediate bit offset are stored in the immediate bit offset field, and the high-order bits are shifted and combined with the byte displacement in the addressing mode by the assembler. The processor will ignore the high order bits if they are not zero.

When accessing a bit in memory, the processor may access 4 bytes starting from the memory address for a 32-bit operand size, using by the following relationship:

$$\text{Effective Address} + (4 * (\text{BitOffset DIV } 32))$$

Or, it may access 2 bytes starting from the memory address for a 16-bit operand, using this relationship:

$$\text{Effective Address} + (2 * (\text{BitOffset DIV } 16))$$

It may do so even when only a single byte needs to be accessed to reach the given bit. When using this bit addressing mechanism, software should avoid referencing areas of memory close to address space holes. In particular, it should avoid references to memory-mapped I/O registers. Instead, software should use the MOV instructions to load from or store to these addresses, and use the register form of these instructions to manipulate the data.

Operation

$$\text{CF} \leftarrow \text{Bit}(\text{BitBase}, \text{BitOffset})$$

Flags Affected

The CF flag contains the value of the selected bit. The OF, SF, ZF, AF, and PF flags are undefined.

BT—Bit Test (Continued)

Additional Itanium® System Environment Exceptions

| | |
|--------------------|--|
| Itanium Reg Faults | NaT Register Consumption Abort. |
| Itanium Mem Faults | VHPT Data Fault, Nested TLB Fault, Data TLB Fault, Alternate Data TLB Fault, Data Page Not Present Fault, Data NaT Page Consumption Abort, Data Key Miss Fault, Data Key Permission Fault, Data Access Rights Fault, Data Access Bit Fault, Data Dirty Bit Fault |

Protected Mode Exceptions

| | |
|-----------------|--|
| #GP(0) | If a memory operand effective address is outside the CS, DS, ES, FS, or GS segment limit. If the DS, ES, FS, or GS register contains a null segment selector. |
| #SS(0) | If a memory operand effective address is outside the SS segment limit. |
| #PF(fault-code) | If a page fault occurs. |
| #AC(0) | If alignment checking is enabled and an unaligned memory reference is made while the current privilege level is 3. |

Real Address Mode Exceptions

| | |
|-----|---|
| #GP | If a memory operand effective address is outside the CS, DS, ES, FS, or GS segment limit. |
| #SS | If a memory operand effective address is outside the SS segment limit. |

Virtual 8086 Mode Exceptions

| | |
|-----------------|---|
| #GP(0) | If a memory operand effective address is outside the CS, DS, ES, FS, or GS segment limit. |
| #SS(0) | If a memory operand effective address is outside the SS segment limit. |
| #PF(fault-code) | If a page fault occurs. |
| #AC(0) | If alignment checking is enabled and an unaligned memory reference is made. |

BTC—Bit Test and Complement

| Opcode | Instruction | Description |
|--------------------|-----------------------|--|
| 0F BB | BTC <i>r/m16,r16</i> | Store selected bit in CF flag and complement |
| 0F BB | BTC <i>r/m32,r32</i> | Store selected bit in CF flag and complement |
| 0F BA /7 <i>ib</i> | BTC <i>r/m16,imm8</i> | Store selected bit in CF flag and complement |
| 0F BA /7 <i>ib</i> | BTC <i>r/m32,imm8</i> | Store selected bit in CF flag and complement |

Description

Selects the bit in a bit string (specified with the first operand, called the bit base) at the bit-position designated by the bit offset operand (second operand), stores the value of the bit in the CF flag, and complements the selected bit in the bit string. The bit base operand can be a register or a memory location; the bit offset operand can be a register or an immediate value. If the bit base operand specifies a register, the instruction takes the modulo 16 or 32 (depending on the register size) of the bit offset operand, allowing any bit position to be selected in a 16- or 32-bit register, respectively. If the bit base operand specifies a memory location, it represents the address of the byte in memory that contains the bit base (bit 0 of the specified byte) of the bit string. The offset operand then selects a bit position within the range -2^{31} to $2^{31} - 1$ for a register offset and 0 to 31 for an immediate offset.

Some assemblers support immediate bit offsets larger than 31 by using the immediate bit offset field in combination with the displacement field of the memory operand. See [“BT—Bit Test” on page 3:390](#) for more information on this addressing mechanism.

Operation

$CF \leftarrow \text{Bit}(\text{BitBase}, \text{BitOffset})$
 $\text{Bit}(\text{BitBase}, \text{BitOffset}) \leftarrow \text{NOT } \text{Bit}(\text{BitBase}, \text{BitOffset});$

Flags Affected

The CF flag contains the value of the selected bit before it is complemented. The OF, SF, ZF, AF, and PF flags are undefined.

Additional Itanium® System Environment Exceptions

Itanium Reg Faults NaT Register Consumption Abort.
 Itanium Mem Faults VHPT Data Fault, Nested TLB Fault, Data TLB Fault, Alternate Data TLB Fault, Data Page Not Present Fault, Data NaT Page Consumption Abort, Data Key Miss Fault, Data Key Permission Fault, Data Access Rights Fault, Data Access Bit Fault, Data Dirty Bit Fault

BTC—Bit Test and Complement (Continued)

Protected Mode Exceptions

| | |
|-----------------|---|
| #GP(0) | <p>If the destination operand points to a non-writable segment.</p> <p>If a memory operand effective address is outside the CS, DS, ES, FS, or GS segment limit.</p> <p>If the DS, ES, FS, or GS register contains a null segment selector.</p> |
| #SS(0) | If a memory operand effective address is outside the SS segment limit. |
| #PF(fault-code) | If a page fault occurs. |
| #AC(0) | If alignment checking is enabled and an unaligned memory reference is made while the current privilege level is 3. |

Real Address Mode Exceptions

| | |
|-----|---|
| #GP | If a memory operand effective address is outside the CS, DS, ES, FS, or GS segment limit. |
| #SS | If a memory operand effective address is outside the SS segment limit. |

Virtual 8086 Mode Exceptions

| | |
|-----------------|---|
| #GP(0) | If a memory operand effective address is outside the CS, DS, ES, FS, or GS segment limit. |
| #SS(0) | If a memory operand effective address is outside the SS segment limit. |
| #PF(fault-code) | If a page fault occurs. |
| #AC(0) | If alignment checking is enabled and an unaligned memory reference is made. |

BTR—Bit Test and Reset

| Opcode | Instruction | Description |
|--------------------|----------------------|---|
| 0F B3 | BTR <i>rm16,r16</i> | Store selected bit in CF flag and clear |
| 0F B3 | BTR <i>rm32,r32</i> | Store selected bit in CF flag and clear |
| 0F BA /6 <i>ib</i> | BTR <i>rm16,imm8</i> | Store selected bit in CF flag and clear |
| 0F BA /6 <i>ib</i> | BTR <i>rm32,imm8</i> | Store selected bit in CF flag and clear |

Description

Selects the bit in a bit string (specified with the first operand, called the bit base) at the bit-position designated by the bit offset operand (second operand), stores the value of the bit in the CF flag, and clears the selected bit in the bit string to 0. The bit base operand can be a register or a memory location; the bit offset operand can be a register or an immediate value. If the bit base operand specifies a register, the instruction takes the modulo 16 or 32 (depending on the register size) of the bit offset operand, allowing any bit position to be selected in a 16- or 32-bit register, respectively. If the bit base operand specifies a memory location, it represents the address of the byte in memory that contains the bit base (bit 0 of the specified byte) of the bit string. The offset operand then selects a bit position within the range -2^{31} to $2^{31} - 1$ for a register offset and 0 to 31 for an immediate offset.

Some assemblers support immediate bit offsets larger than 31 by using the immediate bit offset field in combination with the displacement field of the memory operand. See [“BT—Bit Test” on page 3:390](#) for more information on this addressing mechanism.

Operation

$CF \leftarrow \text{Bit}(\text{BitBase}, \text{BitOffset})$
 $\text{Bit}(\text{BitBase}, \text{BitOffset}) \leftarrow 0;$

Flags Affected

The CF flag contains the value of the selected bit before it is cleared. The OF, SF, ZF, AF, and PF flags are undefined.

Additional Itanium® System Environment Exceptions

| | |
|--------------------|--|
| Itanium Reg Faults | NaT Register Consumption Abort. |
| Itanium Mem Faults | VHPT Data Fault, Nested TLB Fault, Data TLB Fault, Alternate Data TLB Fault, Data Page Not Present Fault, Data NaT Page Consumption Abort, Data Key Miss Fault, Data Key Permission Fault, Data Access Rights Fault, Data Access Bit Fault, Data Dirty Bit Fault |

BTR—Bit Test and Reset (Continued)

Protected Mode Exceptions

| | |
|-----------------|--|
| #GP(0) | <p>If the destination operand points to a nonwritable segment.</p> <p>If a memory operand effective address is outside the CS, DS, ES, FS, or GS segment limit.</p> <p>If the DS, ES, FS, or GS register contains a null segment selector.</p> |
| #SS(0) | If a memory operand effective address is outside the SS segment limit. |
| #PF(fault-code) | If a page fault occurs. |
| #AC(0) | If alignment checking is enabled and an unaligned memory reference is made while the current privilege level is 3. |

Real Address Mode Exceptions

| | |
|-----|---|
| #GP | If a memory operand effective address is outside the CS, DS, ES, FS, or GS segment limit. |
| #SS | If a memory operand effective address is outside the SS segment limit. |

Virtual 8086 Mode Exceptions

| | |
|-----------------|---|
| #GP(0) | If a memory operand effective address is outside the CS, DS, ES, FS, or GS segment limit. |
| #SS(0) | If a memory operand effective address is outside the SS segment limit. |
| #PF(fault-code) | If a page fault occurs. |
| #AC(0) | If alignment checking is enabled and an unaligned memory reference is made. |

BTS—Bit Test and Set

| Opcode | Instruction | Description |
|--------------------|-----------------------|---------------------------------------|
| 0F AB | BTS <i>r/m16,r16</i> | Store selected bit in CF flag and set |
| 0F AB | BTS <i>r/m32,r32</i> | Store selected bit in CF flag and set |
| 0F BA /5 <i>ib</i> | BTS <i>r/m16,imm8</i> | Store selected bit in CF flag and set |
| 0F BA /5 <i>ib</i> | BTS <i>r/m32,imm8</i> | Store selected bit in CF flag and set |

Description

Selects the bit in a bit string (specified with the first operand, called the bit base) at the bit-position designated by the bit offset operand (second operand), stores the value of the bit in the CF flag, and sets the selected bit in the bit string to 1. The bit base operand can be a register or a memory location; the bit offset operand can be a register or an immediate value. If the bit base operand specifies a register, the instruction takes the modulo 16 or 32 (depending on the register size) of the bit offset operand, allowing any bit position to be selected in a 16- or 32-bit register, respectively. If the bit base operand specifies a memory location, it represents the address of the byte in memory that contains the bit base (bit 0 of the specified byte) of the bit string. The offset operand then selects a bit position within the range -2^{31} to $2^{31} - 1$ for a register offset and 0 to 31 for an immediate offset.

Some assemblers support immediate bit offsets larger than 31 by using the immediate bit offset field in combination with the displacement field of the memory operand. See [“BT—Bit Test” on page 3:390](#) for more information on this addressing mechanism.

Operation

$CF \leftarrow \text{Bit}(\text{BitBase}, \text{BitOffset})$
 $\text{Bit}(\text{BitBase}, \text{BitOffset}) \leftarrow 1;$

Flags Affected

The CF flag contains the value of the selected bit before it is set. The OF, SF, ZF, AF, and PF flags are undefined.

Additional Itanium® System Environment Exceptions

| | |
|--------------------|--|
| Itanium Reg Faults | NaT Register Consumption Abort. |
| Itanium Mem Faults | VHPT Data Fault, Nested TLB Fault, Data TLB Fault, Alternate Data TLB Fault, Data Page Not Present Fault, Data NaT Page Consumption Abort, Data Key Miss Fault, Data Key Permission Fault, Data Access Rights Fault, Data Access Bit Fault, Data Dirty Bit Fault |

BTS—Bit Test and Set (Continued)

Protected Mode Exceptions

| | |
|-----------------|--|
| #GP(0) | <p>If the destination operand points to a nonwritable segment.</p> <p>If a memory operand effective address is outside the CS, DS, ES, FS, or GS segment limit.</p> <p>If the DS, ES, FS, or GS register contains a null segment selector.</p> |
| #SS(0) | If a memory operand effective address is outside the SS segment limit. |
| #PF(fault-code) | If a page fault occurs. |
| #AC(0) | If alignment checking is enabled and an unaligned memory reference is made while the current privilege level is 3. |

Real Address Mode Exceptions

| | |
|-----|---|
| #GP | If a memory operand effective address is outside the CS, DS, ES, FS, or GS segment limit. |
| #SS | If a memory operand effective address is outside the SS segment limit. |

Virtual 8086 Mode Exceptions

| | |
|-----------------|---|
| #GP | If a memory operand effective address is outside the CS, DS, ES, FS, or GS segment limit. |
| #SS | If a memory operand effective address is outside the SS segment limit. |
| #PF(fault-code) | If a page fault occurs. |
| #AC(0) | If alignment checking is enabled and an unaligned memory reference is made. |

CALL—Call Procedure

| Opcode | Instruction | Description |
|--------------|----------------------|--|
| E8 <i>cw</i> | CALL <i>rel16</i> | Call near, displacement relative to next instruction |
| E8 <i>cd</i> | CALL <i>rel32</i> | Call near, displacement relative to next instruction |
| FF /2 | CALL <i>r/m16</i> | Call near, <i>r/m16</i> indirect |
| FF /2 | CALL <i>r/m32</i> | Call near, <i>r/m32</i> indirect |
| 9A <i>cd</i> | CALL <i>ptr16:16</i> | Call far, to full pointer given |
| 9A <i>cp</i> | CALL <i>ptr16:32</i> | Call far, to full pointer given |
| FF /3 | CALL <i>m16:16</i> | Call far, address at <i>r/m16</i> |
| FF /3 | CALL <i>m16:32</i> | Call far, address at <i>r/m32</i> |

Description

Saves procedure linking information on the procedure stack and jumps to the procedure (called procedure) specified with the destination (target) operand. The target operand specifies the address of the first instruction in the called procedure. This operand can be an immediate value, a general-purpose register, or a memory location.

This instruction can be used to execute four different types of calls:

- Near call – A call to a procedure within the current code segment (the segment currently pointed to by the CS register), sometimes referred to as an intrasegment call.
- Far call – A call to a procedure located in a different segment than the current code segment, sometimes referred to as an intersegment call.
- Inter-privilege-level far call – A far call to a procedure in a segment at a different privilege level than that of the currently executing program or procedure. **Results in an IA-32_Interrupt(Gate) in Itanium System Environment.**
- Task switch – A call to a procedure located in a different task. **Results in an IA-32_Interrupt(Gate) in Itanium System Environment.**

The latter two call types (inter-privilege-level call and task switch) can only be executed in protected mode. See Chapter 6 in the *IA-32 Intel® Architecture Software Developer's Manual, Volume 3* for information on task switching with the CALL instruction.

When executing a near call, the processor pushes the value of the EIP register (which contains the address of the instruction following the CALL instruction) onto the procedure stack (for use later as a return-instruction pointer). The processor then jumps to the address specified with the target operand for the called procedure. The target operand specifies either an absolute address in the code segment (that is an offset from the base of the code segment) or a relative offset (a signed offset relative to the current value of the instruction pointer in the EIP register, which points to the instruction following the call). An absolute address is specified directly in a register or indirectly in a memory location (*r/m16* or *r/m32* target-operand form). (When accessing an absolute address indirectly using the stack pointer (ESP) as a base register, the base value used is the value of the ESP before the instruction executes.) A relative offset (*rel16* or *rel32*) is generally specified as a label in assembly code, but at the machine code level, it is encoded as a signed, 16- or 32-bit immediate value, which is added to the instruction pointer.

CALL—Call Procedure (Continued)

When executing a near call, the operand-size attribute determines the size of the target operand (16 or 32 bits) for absolute addresses. Absolute addresses are loaded directly into the EIP register. When a relative offset is specified, it is added to the value of the EIP register. If the operand-size attribute is 16, the upper two bytes of the EIP register are cleared to 0s, resulting in a maximum instruction pointer size of 16 bits. The CS register is not changed on near calls.

When executing a far call, the processor pushes the current value of both the CS and EIP registers onto the procedure stack for use as a return-instruction pointer. The processor then performs a far jump to the code segment and address specified with the target operand for the called procedure. Here the target operand specifies an absolute far address either directly with a pointer (*ptr16:16* or *ptr16:32*) or indirectly with a memory location (*m16:16* or *m16:32*). With the pointer method, the segment and address of the called procedure is encoded in the instruction using a 4-byte (16-bit operand size) or 6-byte (32-bit operand size) far address immediate. With the indirect method, the target operand specifies a memory location that contains a 4-byte (16-bit operand size) or 6-byte (32-bit operand size) far address. The operand-size attribute determines the size of the offset (16 or 32 bits) in the far address. The far address is loaded directly into the CS and EIP registers. If the operand-size attribute is 16, the upper two bytes of the EIP register are cleared to 0s.

Any far call from a 32-bit code segment to a 16-bit code segment should be made from the first 64 Kbytes of the 32-bit code segment, because the operand-size attribute of the instruction is set to 16, allowing only a 16-bit return address offset to be saved. Also, the call should be made using a 16-bit call gate so that 16-bit values will be pushed on the stack.

When the processor is operating in protected mode, a far call can also be used to access a code segment at a different privilege level or to switch tasks. Here, the processor uses the segment selector part of the far address to access the segment descriptor for the segment being jumped to. Depending on the value of the type and access rights information in the segment selector, the CALL instruction can perform:

- A far call to the same privilege level (described in the previous paragraph).
- An far call to a different privilege level. **Results in an IA-32_Interrupt(Gate) in Itanium System Environment.**
- A task switch. **Results in an IA-32_Interrupt(Gate) in Itanium System Environment.**

When executing an inter-privilege-level far call, the code segment for the procedure being called is accessed through a call gate. The segment selector specified by the target operand identifies the call gate. In executing a call through a call gate where a change of privilege level occurs, the processor switches to the stack for the privilege level of the called procedure, pushes the current values of the CS and EIP registers and the SS and ESP values for the old stack onto the new stack, then performs a far jump to the new code segment. The new code segment is specified in the call gate descriptor; the new stack segment is specified in the TSS for the currently running task. The jump to the new code segment occurs after the stack switch. On the new stack, the processor pushes the segment selector and stack pointer for the calling procedure's stack, a set of parameters from the calling procedure's stack, and the segment selector and instruction pointer for the calling procedure's code segment. (A value in the call gate descriptor determines how many parameters to copy to the new stack.)

Finally, the processor jumps to the address of the procedure being called within the new code segment. The procedure address is the offset specified by the target operand. Here again, the target operand can specify the far address of the call gate and procedure either directly with a pointer (*ptr16:16* or *ptr16:32*) or indirectly with a memory location (*m16:16* or *m16:32*).

CALL—Call Procedure (Continued)

Executing a task switch with the CALL instruction, is similar to executing a call through a call gate. Here the target operand specifies the segment selector of the task gate for the task being switched to and the address of the procedure being called in the task. The task gate in turn points to the TSS for the task, which contains the segment selectors for the task's code and stack segments. The CALL instruction can also specify the segment selector of the TSS directly. See the *IA-32 Intel® Architecture Software Developer's Manual, Volume 3* for detailed information on the mechanics of a task switch.

Operation

```

IF near call
  THEN IF near relative call
    IF the instruction pointer is not within code segment limit THEN #GP(0); FI;
    THEN IF OperandSize = 32
      THEN
        IF stack not large enough for a 4-byte return address THEN #SS(0); FI;
        Push(EIP);
        EIP ← EIP + DEST; (* DEST is rel32 *)
      ELSE (* OperandSize = 16 *)
        IF stack not large enough for a 2-byte return address THEN #SS(0); FI;
        Push(IP);
        EIP ← (EIP + DEST) AND 0000FFFFH; (* DEST is rel16 *)
      FI;
    FI;
  ELSE (* near absolute call *)
    IF the instruction pointer is not within code segment limit THEN #GP(0); FI;
    IF OperandSize = 32
      THEN
        IF stack not large enough for a 4-byte return address THEN #SS(0); FI;
        Push(EIP);
        EIP ← DEST; (* DEST is rlm32 *)
      ELSE (* OperandSize = 16 *)
        IF stack not large enough for a 2-byte return address THEN #SS(0); FI;
        Push(IP);
        EIP ← DEST AND 0000FFFFH; (* DEST is rlm16 *)
      FI;
    FI;
  IF Itanium System Environment AND PSR.tb THEN IA-32_Exception(Debug);
FI;
IF far call AND (PE = 0 OR (PE = 1 AND VM = 1)) (* real address or virtual 8086 mode *)
  THEN
    IF OperandSize = 32
      THEN
        IF stack not large enough for a 6-byte return address THEN #SS(0); FI;
        IF the instruction pointer is not within code segment limit THEN #GP(0); FI;
        Push(CS); (* padded with 16 high-order bits *)
        Push(EIP);
        CS ← DEST[47:32]; (* DEST is ptr16:32 or [m16:32] *)
        EIP ← DEST[31:0]; (* DEST is ptr16:32 or [m16:32] *)
      ELSE (* OperandSize = 16 *)
        IF stack not large enough for a 4-byte return address THEN #SS(0); FI;
        IF the instruction pointer is not within code segment limit THEN #GP(0); FI;
        Push(CS);
        Push(IP);
      FI;
    FI;
  FI;

```

CALL—Call Procedure (Continued)

```

        CS ← DEST[31:16]; (* DEST is ptr16:16 or [m16:16] *)
        EIP ← DEST[15:0]; (* DEST is ptr16:16 or [m16:16] *)
        EIP ← EIP AND 0000FFFFH; (* clear upper 16 bits *)
    FI;
    IF Itanium System Environment AND PSR.tb THEN IA-32_Exception(Debug);
FI;

IF far call AND (PE = 1 AND VM = 0) (* Protected mode, not virtual 8086 mode *)
THEN
    IF segment selector in target operand null THEN #GP(0); FI;
    IF segment selector index not within descriptor table limits
        THEN #GP(new code selector);
    FI;
    Read type and access rights of selected segment descriptor;
    IF segment type is not a conforming or nonconforming code segment, call gate,
        task gate, or TSS THEN #GP(segment selector); FI;
    Depending on type and access rights
        GO TO CONFORMING-CODE-SEGMENT;
        GO TO NONCONFORMING-CODE-SEGMENT;
        GO TO CALL-GATE;
        GO TO TASK-GATE;
        GO TO TASK-STATE-SEGMENT;
    FI;

CONFORMING-CODE-SEGMENT:
    IF DPL > CPL THEN #GP(new code segment selector); FI;
    IF not present THEN #NP(selector); FI;
    IF OperandSize = 32
        THEN
            IF stack not large enough for a 6-byte return address THEN #SS(0); FI;
            IF the instruction pointer is not within code segment limit THEN #GP(0); FI;
            Push(CS); (* padded with 16 high-order bits *)
            Push(EIP);
            CS ← DEST(NewCodeSegmentSelector);
            (* segment descriptor information also loaded *)
            CS(RPL) ← CPL
            EIP ← DEST(offset);
        ELSE (* OperandSize = 16 *)
            IF stack not large enough for a 4-byte return address THEN #SS(0); FI;
            IF the instruction pointer is not within code segment limit THEN #GP(0); FI;
            Push(CS);
            Push(IP);
            CS ← DEST(NewCodeSegmentSelector);
            (* segment descriptor information also loaded *)
            CS(RPL) ← CPL
            EIP ← DEST(offset) AND 0000FFFFH; (* clear upper 16 bits *)
        FI;
    IF Itanium System Environment AND PSR.tb THEN IA-32_Exception(Debug);
END;

NONCONFORMING-CODE-SEGMENT:
    IF (RPL > CPL) OR (DPL ≠ CPL) THEN #GP(new code segment selector); FI;
    IF stack not large enough for return address THEN #SS(0); FI;
    tempEIP ← DEST(offset)

```

CALL—Call Procedure (Continued)

```

IF OperandSize=16
  THEN
    tempEIP ← tempEIP AND 0000FFFFH; (* clear upper 16 bits *)
FI;
IF tempEIP outside code segment limit THEN #GP(0); FI;
IF OperandSize = 32
  THEN
    Push(CS); (* padded with 16 high-order bits *)
    Push(EIP);
    CS ← DEST(NewCodeSegmentSelector);
    (* segment descriptor information also loaded *)
    CS(RPL) ← CPL;
    EIP ← tempEIP;
  ELSE (* OperandSize = 16 *)
    Push(CS);
    Push(IP);
    CS ← DEST(NewCodeSegmentSelector);
    (* segment descriptor information also loaded *)
    CS(RPL) ← CPL;
    EIP ← tempEIP;
  FI;
IF Itanium System Environment AND PSR.tb THEN IA-32_Exception(Debug);
END;

CALL-GATE:
IF call gate DPL < CPL or RPL THEN #GP(call gate selector); FI;
IF not present THEN #NP(call gate selector); FI;
IF Itanium System Environment THEN IA-32_Intercept(Gate,CALL);
IF call gate code-segment selector is null THEN #GP(0); FI;
IF call gate code-segment selector index is outside descriptor table limits
  THEN #GP(code segment selector); FI;
Read code segment descriptor;
IF code-segment segment descriptor does not indicate a code segment
OR code-segment segment descriptor DPL > CPL
  THEN #GP(code segment selector); FI;
IF code segment not present THEN #NP(new code segment selector); FI;
IF code segment is non-conforming AND DPL < CPL
  THEN go to MORE-PRIVILEGE;
  ELSE go to SAME-PRIVILEGE;
FI;
END;

MORE-PRIVILEGE:
IF current TSS is 32-bit TSS
  THEN
    TSSstackAddress ← new code segment (DPL * 8) + 4
    IF (TSSstackAddress + 7) > TSS limit
      THEN #TS(current TSS selector); FI;
    newSS ← TSSstackAddress + 4;
    newESP ← stack address;
  ELSE (* TSS is 16-bit *)
    TSSstackAddress ← new code segment (DPL * 4) + 2
    IF (TSSstackAddress + 4) > TSS limit
      THEN #TS(current TSS selector); FI;

```

CALL—Call Procedure (Continued)

```

        newESP ← TSSstackAddress;
        newSS ← TSSstackAddress + 2;
FI;
IF stack segment selector is null THEN #TS(stack segment selector); FI;
IF stack segment selector index is not within its descriptor table limits
    THEN #TS(SS selector); FI
Read code segment descriptor;
IF stack segment selector's RPL ≠ DPL of code segment
    OR stack segment DPL ≠ DPL of code segment
    OR stack segment is not a writable data segment
    THEN #TS(SS selector); FI
IF stack segment not present THEN #SS(SS selector); FI;
IF CallGateSize = 32
    THEN
        IF stack does not have room for parameters plus 16 bytes
            THEN #SS(SS selector); FI;
        IF CallGate(InstructionPointer) not within code segment limit THEN #GP(0); FI;
        SS ← newSS;
        (* segment descriptor information also loaded *)
        ESP ← newESP;
        CS:EIP ← CallGate(CS:InstructionPointer);
        (* segment descriptor information also loaded *)
        Push(oldSS:oldESP); (* from calling procedure *)
        temp ← parameter count from call gate, masked to 5 bits;
        Push(parameters from calling procedure's stack, temp)
        Push(oldCS:oldEIP); (* return address to calling procedure *)
    ELSE (* CallGateSize = 16 *)
        IF stack does not have room for parameters plus 8 bytes
            THEN #SS(SS selector); FI;
        IF (CallGate(InstructionPointer) AND FFFFH) not within code segment limit
            THEN #GP(0); FI;
        SS ← newSS;
        (* segment descriptor information also loaded *)
        ESP ← newESP;
        CS:IP ← CallGate(CS:InstructionPointer);
        (* segment descriptor information also loaded *)
        Push(oldSS:oldESP); (* from calling procedure *)
        temp ← parameter count from call gate, masked to 5 bits;
        Push(parameters from calling procedure's stack, temp)
        Push(oldCS:oldEIP); (* return address to calling procedure *)
FI;
CPL ← CodeSegment(DPL)
CS(RPL) ← CPL
END;

SAME-PRIVILEGE:
IF CallGateSize = 32
    THEN
        IF stack does not have room for 8 bytes
            THEN #SS(0); FI;
        IF EIP not within code segment limit then #GP(0); FI;
        CS:EIP ← CallGate(CS:EIP) (* segment descriptor information also loaded *)
        Push(oldCS:oldEIP); (* return address to calling procedure *)
    ELSE (* CallGateSize = 16 *)

```

CALL—Call Procedure (Continued)

```

        IF stack does not have room for parameters plus 4 bytes
            THEN #SS(0); FI;
        IF IP not within code segment limit THEN #GP(0); FI;
        CS:IP ← CallGate(CS:instruction pointer)
        (* segment descriptor information also loaded *)
        Push(oldCS:oldIP); (* return address to calling procedure *)
    FI;
    CS(RPL) ← CPL
END;

TASK-GATE:
    IF task gate DPL < CPL or RPL
        THEN #GP(task gate selector);
    FI;
    IF task gate not present
        THEN #NP(task gate selector);
    FI;
IF Itanium System Environment THEN IA-32_Intercept(Gate,CALL);
    Read the TSS segment selector in the task-gate descriptor;
    IF TSS segment selector local/global bit is set to local
        OR index not within GDT limits
            THEN #GP(TSS selector);
    FI;
    Access TSS descriptor in GDT;

    IF TSS descriptor specifies that the TSS is busy (low-order 5 bits set to 00001)
        THEN #GP(TSS selector);
    FI;
    IF TSS not present
        THEN #NP(TSS selector);
    FI;
    SWITCH-TASKS (with nesting) to TSS;
    IF EIP not within code segment limit
        THEN #GP(0);
    FI;
END;

TASK-STATE-SEGMENT:
    IF TSS DPL < CPL or RPL
        OR TSS segment selector local/global bit is set to local
        OR TSS descriptor indicates TSS not available
            THEN #GP(TSS selector);
    FI;
    IF TSS is not present
        THEN #NP(TSS selector);
    FI;
IF Itanium System Environment THEN IA-32_Intercept(Gate,CALL);
    SWITCH-TASKS (with nesting) to TSS
    IF EIP not within code segment limit
        THEN #GP(0);
    FI;
END;

```

CALL—Call Procedure (Continued)

Flags Affected

All flags are affected if a task switch occurs; no flags are affected if a task switch does not occur.

Additional Itanium® System Environment Exceptions

| | |
|--------------------|--|
| Itanium Mem Faults | VHPT Data Fault, Nested TLB Fault, Data TLB Fault, Alternate Data TLB Fault, Data Page Not Present Fault, Data NaT Page Consumption Abort, Data Key Miss Fault, Data Key Permission Fault, Data Access Rights Fault, Data Access Bit Fault, Data Dirty Bit Fault |
| IA-32_Intercept | Gate Intercept for CALLs through CALL Gates, Task Gates and Task Segments |
| IA-32_Exception | Taken Branch Debug Exception if PSR.tb is 1 |

Protected Mode Exceptions

| | |
|---------------|--|
| #GP(0) | <p>If target offset in destination operand is beyond the new code segment limit.</p> <p>If the segment selector in the destination operand is null.</p> <p>If the code segment selector in the gate is null.</p> <p>If a memory operand effective address is outside the CS, DS, ES, FS, or GS segment limit.</p> <p>If the DS, ES, FS, or GS register is used to access memory and it contains a null segment selector.</p> |
| #GP(selector) | <p>If code segment or gate or TSS selector index is outside descriptor table limits.</p> <p>If the segment descriptor pointed to by the segment selector in the destination operand is not for a conforming-code segment, nonconforming-code segment, call gate, task gate, or task state segment.</p> <p>If the DPL for a nonconforming-code segment is not equal to the CPL or the RPL for the segment's segment selector is greater than the CPL.</p> <p>If the DPL for a conforming-code segment is greater than the CPL.</p> <p>If the DPL from a call-gate, task-gate, or TSS segment descriptor is less than the CPL or than the RPL of the call-gate, task-gate, or TSS's segment selector.</p> <p>If the segment descriptor for a segment selector from a call gate does not indicate it is a code segment.</p> <p>If the segment selector from a call gate is beyond the descriptor table limits.</p> <p>If the DPL for a code-segment obtained from a call gate is greater than the CPL.</p> <p>If the segment selector for a TSS has its local/global bit set for local.</p> <p>If a TSS segment descriptor specifies that the TSS is busy or not available.</p> |
| #SS(0) | <p>If pushing the return address, parameters, or stack segment pointer onto the stack exceeds the bounds of the stack segment, when no stack switch occurs.</p> <p>If a memory operand effective address is outside the SS segment limit.</p> |

CALL—Call Procedure (Continued)

| | |
|-----------------|---|
| #SS(selector) | <p>If pushing the return address, parameters, or stack segment pointer onto the stack exceeds the bounds of the stack segment, when a stack switch occurs.</p> <p>If the SS register is being loaded as part of a stack switch and the segment pointed to is marked not present.</p> <p>If stack segment does not have room for the return address, parameters, or stack segment pointer, when stack switch occurs.</p> |
| #NP(selector) | If a code segment, data segment, stack segment, call gate, task gate, or TSS is not present. |
| #TS(selector) | <p>If the new stack segment selector and ESP are beyond the end of the TSS.</p> <p>If the new stack segment selector is null.</p> <p>If the RPL of the new stack segment selector in the TSS is not equal to the DPL of the code segment being accessed.</p> <p>If DPL of the stack segment descriptor for the new stack segment is not equal to the DPL of the code segment descriptor.</p> <p>If the new stack segment is not a writable data segment.</p> <p>If segment-selector index for stack segment is outside descriptor table limits.</p> |
| #PF(fault-code) | If a page fault occurs. |
| #AC(0) | If an unaligned memory access occurs when the CPL is 3 and alignment checking is enabled. |

Real Address Mode Exceptions

| | |
|-----|--|
| #GP | <p>If a memory operand effective address is outside the CS, DS, ES, FS, or GS segment limit.</p> <p>If the target offset is beyond the code segment limit.</p> |
|-----|--|

Virtual 8086 Mode Exceptions

| | |
|-----------------|--|
| #GP(0) | <p>If a memory operand effective address is outside the CS, DS, ES, FS, or GS segment limit.</p> <p>If the target offset is beyond the code segment limit.</p> |
| #PF(fault-code) | If a page fault occurs. |
| #AC(0) | If an unaligned memory access occurs when alignment checking is enabled. |

CBW/CWDE—Convert Byte to Word/Convert Word to Doubleword

| Opcode | Instruction | Description |
|--------|-------------|-------------------------|
| 98 | CBW | AX ← sign-extend of AL |
| 98 | CWDE | EAX ← sign-extend of AX |

Description

Double the size of the source operand by means of sign extension. The CBW (convert byte to word) instruction copies the sign (bit 7) in the source operand into every bit in the AH register. The CWDE (convert word to doubleword) instruction copies the sign (bit 15) of the word in the AX register into the higher 16 bits of the EAX register.

The CBW and CWDE mnemonics reference the same opcode. The CBW instruction is intended for use when the operand-size attribute is 16 and the CWDE instruction for when the operand-size attribute is 32. Some assemblers may force the operand size to 16 when CBW is used and to 32 when CWDE is used. Others may treat these mnemonics as synonyms (CBW/CWDE) and use the current setting of the operand-size attribute to determine the size of values to be converted, regardless of the mnemonic used.

The CWDE instruction is different from the CWD (convert word to double) instruction. The CWD instruction uses the DX:AX register pair as a destination operand; whereas, the CWDE instruction uses the EAX register as a destination.

Operation

```
IF OperandSize = 16 (* instruction = CBW *)
    THEN AX ← SignExtend(AL);
ELSE (* OperandSize = 32, instruction = CWDE *)
    EAX ← SignExtend(AX);
FI;
```

Flags Affected

None.

Additional Itanium® System Environment Exceptions

Itanium Reg Faults NaT Register Consumption Abort.

Exceptions (All Operating Modes)

None.

CDQ—Convert Double to Quad

See entry for CWD/CDQ — Convert Word to Double/Convert Double to Quad.

CLC—Clear Carry Flag

| Opcode | Instruction | Description |
|--------|-------------|---------------|
| F8 | CLC | Clear CF flag |

Description

Clears the CF flag in the EFLAGS register.

Operation

$CF \leftarrow 0;$

Flags Affected

The CF flag is cleared to 0. The OF, ZF, SF, AF, and PF flags are unaffected.

Exceptions (All Operating Modes)

None.

CLD—Clear Direction Flag

| Opcode | Instruction | Description |
|--------|-------------|---------------|
| FC | CLD | Clear DF flag |

Description

Clears the DF flag in the EFLAGS register. When the DF flag is set to 0, string operations increment the index registers (ESI and/or EDI).

Operation

$DF \leftarrow 0;$

Flags Affected

The DF flag is cleared to 0. The CF, OF, ZF, SF, AF, and PF flags are unaffected.

Exceptions (All Operating Modes)

None.

CLI—Clear Interrupt Flag

| Opcode | Instruction | Description |
|--------|-------------|---|
| FA | CLI | Clear interrupt flag; interrupts disabled when interrupt flag cleared |

Description

Clears the IF flag in the EFLAGS register. No other flags are affected. Clearing the IF flag causes the processor to ignore maskable external interrupts. The IF flag and the CLI and STI instruction have no affect on the generation of exceptions and NMI interrupts. **In the Itanium System Environment, external interrupts are enabled for IA-32 instructions if PSR.i and (~CFLG.if or EFLAG.if) is 1 and for Itanium instructions if PSR.i is 1.**

The following decision table indicates the action of the CLI instruction (bottom of the table) depending on the processor's mode of operating and the CPL and IOPL of the currently running program or procedure (top of the table).

| | | | | | |
|--------|---|--------|-----|--------|-----|
| PE = | 0 | 1 | 1 | 1 | 1 |
| VM = | X | 0 | X | 0 | 1 |
| CPL | X | ≤ IOPL | X | > IOPL | X |
| IOPL | X | X | = 3 | X | < 3 |
| IF ← 0 | Y | Y | Y | N | N |
| #GP(0) | N | N | N | Y | Y |

Notes:

X Don't care.

N Action in column 1 not taken.

Y Action in column 1 taken.

Operation

OLD_IF ← IF;

```

IF PE = 0 (* Executing in real-address mode *)
  THEN
    IF ← 0;
  ELSE
    IF VM = 0 (* Executing in protected mode *)
      THEN
        IF CR4.PVI = 1
          THEN
            IF CPL = 3
              THEN
                IF IOPL < 3
                  THEN VIF ← 0;
                ELSE IF ← 0;
                FI;
            ELSE (*CPL < 3*)
              IF IOPL < CPL
                THEN #GP(0);
              ELSE IF ← 0;
          ELSE
            IF ← 0;
        ELSE
            IF ← 0;
      ELSE
        IF ← 0;
    ELSE
        IF ← 0;
  END IF

```

CLI—Clear Interrupt Flag (Continued)

```

        FI;
        FI;
        ELSE (*CR4.PVI==0 *)
        IF IOPL < CPL
        THEN #GP(0);
        ELSE IF <- 0;
        FI;
    FI;
ELSE (* Executing in Virtual-8086 mode *)
IF IOPL = 3
THEN
    IF <- 0;
ELSE
    IF CR4.VME= 0
    THEN #GP(0);
    ELSE VIF <- 0;
    FI;
FI;
FI;
IF Itanium System Environment AND CFLG.ii AND IF != OLD_IF
THEN IA-32_Intercept(System_Flag,CLI);

```

Flags Affected

The IF is cleared to 0 if the CPL is equal to or less than the IOPL; otherwise, the it is not affected. The other flags in the EFLAGS register are unaffected.

Additional Itanium® System Environment Exceptions

IA-32_Intercept System Flag Intercept Trap if CFLG.ii is 1 and the IF flag changes state.

Protected Mode Exceptions

#GP(0) If the CPL is greater (has less privilege) than the IOPL of the current program or procedure.

Real Address Mode Exceptions

None.

Virtual 8086 Mode Exceptions

#GP(0) If the CPL is greater (has less privilege) than the IOPL of the current program or procedure.

CLTS—Clear Task-Switched Flag in CR0

| Opcode | Instruction | Description |
|--------|-------------|-----------------------|
| 0F 06 | CLTS | Clears TS flag in CR0 |

Description

Clears the task-switched (TS) flag in the CR0 register. This instruction is intended for use in operating-system procedures. It is a privileged instruction that can only be executed at a CPL of 0. It is allowed to be executed in real-address mode to allow initialization for protected mode.

The processor sets the TS flag every time a task switch occurs. The flag is used to synchronize the saving of FPU context in multitasking applications. See the description of the TS flag in the *IA-32 Intel® Architecture Software Developer's Manual, Volume 3* for more information about this flag.

Operation

IF Itanium System Environment THEN IA-32_Interrupt(INST,CLTS);
CR0(TS) ← 0;

Flags Affected

The TS flag in CR0 register is cleared.

Additional Itanium® System Environment Exceptions

IA-32_Interrupt Mandatory Instruction Intercept fault.

Protected Mode Exceptions

#GP(0) If the CPL is greater than 0.

Real Address Mode Exceptions

None.

Virtual 8086 Mode Exceptions

#GP(0) If the CPL is greater than 0.

CMC—Complement Carry Flag

| Opcode | Instruction | Description |
|--------|-------------|--------------------|
| F5 | CMC | Complement CF flag |

Description

Complements the CF flag in the EFLAGS register.

Operation

$CF \leftarrow \text{NOT } CF;$

Flags Affected

The CF flag contains the complement of its original value. The OF, ZF, SF, AF, and PF flags are unaffected.

Exceptions (All Operating Modes)

None.

CMOVcc—Conditional Move

| Opcode | Instruction | Description |
|--------------------|---------------------------|--|
| 0F 47 <i>cw/cd</i> | CMOVA <i>r16, r/m16</i> | Move if above (CF=0 and ZF=0) |
| 0F 47 <i>cw/cd</i> | CMOVA <i>r32, r/m32</i> | Move if above (CF=0 and ZF=0) |
| 0F 43 <i>cw/cd</i> | CMOVAE <i>r16, r/m16</i> | Move if above or equal (CF=0) |
| 0F 43 <i>cw/cd</i> | CMOVAE <i>r32, r/m32</i> | Move if above or equal (CF=0) |
| 0F 42 <i>cw/cd</i> | CMOVB <i>r16, r/m16</i> | Move if below (CF=1) |
| 0F 42 <i>cw/cd</i> | CMOVB <i>r32, r/m32</i> | Move if below (CF=1) |
| 0F 46 <i>cw/cd</i> | CMOVBE <i>r16, r/m16</i> | Move if below or equal (CF=1 or ZF=1) |
| 0F 46 <i>cw/cd</i> | CMOVBE <i>r32, r/m32</i> | Move if below or equal (CF=1 or ZF=1) |
| 0F 42 <i>cw/cd</i> | CMOVC <i>r16, r/m16</i> | Move if carry (CF=1) |
| 0F 42 <i>cw/cd</i> | CMOVC <i>r32, r/m32</i> | Move if carry (CF=1) |
| 0F 44 <i>cw/cd</i> | CMOVE <i>r16, r/m16</i> | Move if equal (ZF=1) |
| 0F 44 <i>cw/cd</i> | CMOVE <i>r32, r/m32</i> | Move if equal (ZF=1) |
| 0F 4F <i>cw/cd</i> | CMOVG <i>r16, r/m16</i> | Move if greater (ZF=0 and SF=OF) |
| 0F 4F <i>cw/cd</i> | CMOVG <i>r32, r/m32</i> | Move if greater (ZF=0 and SF=OF) |
| 0F 4D <i>cw/cd</i> | CMOVGE <i>r16, r/m16</i> | Move if greater or equal (SF=OF) |
| 0F 4D <i>cw/cd</i> | CMOVGE <i>r32, r/m32</i> | Move if greater or equal (SF=OF) |
| 0F 4C <i>cw/cd</i> | CMOVL <i>r16, r/m16</i> | Move if less (SF<>OF) |
| 0F 4C <i>cw/cd</i> | CMOVL <i>r32, r/m32</i> | Move if less (SF<>OF) |
| 0F 4E <i>cw/cd</i> | CMOVLE <i>r16, r/m16</i> | Move if less or equal (ZF=1 or SF<>OF) |
| 0F 4E <i>cw/cd</i> | CMOVLE <i>r32, r/m32</i> | Move if less or equal (ZF=1 or SF<>OF) |
| 0F 46 <i>cw/cd</i> | CMOVNA <i>r16, r/m16</i> | Move if not above (CF=1 or ZF=1) |
| 0F 46 <i>cw/cd</i> | CMOVNA <i>r32, r/m32</i> | Move if not above (CF=1 or ZF=1) |
| 0F 42 <i>cw/cd</i> | CMOVNAE <i>r16, r/m16</i> | Move if not above or equal (CF=1) |
| 0F 42 <i>cw/cd</i> | CMOVNAE <i>r32, r/m32</i> | Move if not above or equal (CF=1) |
| 0F 43 <i>cw/cd</i> | CMOVNB <i>r16, r/m16</i> | Move if not below (CF=0) |
| 0F 43 <i>cw/cd</i> | CMOVNB <i>r32, r/m32</i> | Move if not below (CF=0) |
| 0F 47 <i>cw/cd</i> | CMOVNBE <i>r16, r/m16</i> | Move if not below or equal (CF=0 and ZF=0) |
| 0F 47 <i>cw/cd</i> | CMOVNBE <i>r32, r/m32</i> | Move if not below or equal (CF=0 and ZF=0) |
| 0F 43 <i>cw/cd</i> | CMOVNC <i>r16, r/m16</i> | Move if not carry (CF=0) |
| 0F 43 <i>cw/cd</i> | CMOVNC <i>r32, r/m32</i> | Move if not carry (CF=0) |
| 0F 45 <i>cw/cd</i> | CMOVNE <i>r16, r/m16</i> | Move if not equal (ZF=0) |
| 0F 45 <i>cw/cd</i> | CMOVNE <i>r32, r/m32</i> | Move if not equal (ZF=0) |
| 0F 4E <i>cw/cd</i> | CMOVNG <i>r16, r/m16</i> | Move if not greater (ZF=1 or SF<>OF) |
| 0F 4E <i>cw/cd</i> | CMOVNG <i>r32, r/m32</i> | Move if not greater (ZF=1 or SF<>OF) |
| 0F 4C <i>cw/cd</i> | CMOVNGE <i>r16, r/m16</i> | Move if not greater or equal (SF<>OF) |
| 0F 4C <i>cw/cd</i> | CMOVNGE <i>r32, r/m32</i> | Move if not greater or equal (SF<>OF) |
| 0F 4D <i>cw/cd</i> | CMOVNL <i>r16, r/m16</i> | Move if not less (SF=OF) |
| 0F 4D <i>cw/cd</i> | CMOVNL <i>r32, r/m32</i> | Move if not less (SF=OF) |
| 0F 4F <i>cw/cd</i> | CMOVNLE <i>r16, r/m16</i> | Move if not less or equal (ZF=0 and SF=OF) |
| 0F 4F <i>cw/cd</i> | CMOVNLE <i>r32, r/m32</i> | Move if not less or equal (ZF=0 and SF=OF) |

CMOV cc —Conditional Move (Continued)

| Opcode | Instruction | Description |
|--------------------|----------------------------|-----------------------------|
| 0F 41 <i>cw/cd</i> | CMOVNO <i>r16, r/m16</i> | Move if not overflow (OF=0) |
| 0F 41 <i>cw/cd</i> | CMOVNO <i>r32, r/m32</i> | Move if not overflow (OF=0) |
| 0F 4B <i>cw/cd</i> | CMOVNP <i>r16, r/m16</i> | Move if not parity (PF=0) |
| 0F 4B <i>cw/cd</i> | CMOVNP <i>r32, r/m32</i> | Move if not parity (PF=0) |
| 0F 49 <i>cw/cd</i> | CMOVNS <i>r16, r/m16</i> | Move if not sign (SF=0) |
| 0F 49 <i>cw/cd</i> | CMOVNS <i>r32, r/m32</i> | Move if not sign (SF=0) |
| 0F 45 <i>cw/cd</i> | CMOVNZ <i>r16, r/m16</i> | Move if not zero (ZF=0) |
| 0F 45 <i>cw/cd</i> | CMOVNZ <i>r32, r/m32</i> | Move if not zero (ZF=0) |
| 0F 40 <i>cw/cd</i> | CMOVO <i>r16, r/m16</i> | Move if overflow (OF=0) |
| 0F 40 <i>cw/cd</i> | CMOVO <i>r32, r/m32</i> | Move if overflow (OF=0) |
| 0F 4A <i>cw/cd</i> | CMOVP <i>r16, r/m16</i> | Move if parity (PF=1) |
| 0F 4A <i>cw/cd</i> | CMOVP <i>r32, r/m32</i> | Move if parity (PF=1) |
| 0F 4A <i>cw/cd</i> | CMOVPE <i>r16, r/m16</i> | Move if parity even (PF=1) |
| 0F 4A <i>cw/cd</i> | CMOVPE <i>r32, r/m32</i> | Move if parity even (PF=1) |
| 0F 4B <i>cw/cd</i> | CMOVPO <i>r16, r/m16</i> | Move if parity odd (PF=0) |
| 0F 4B <i>cw/cd</i> | CMOVPO <i>r32, r/m32</i> | Move if parity odd (PF=0) |
| 0F 48 <i>cw/cd</i> | CMOV S <i>r16, r/m16</i> | Move if sign (SF=1) |
| 0F 48 <i>cw/cd</i> | CMOV S <i>r32, r/m32</i> | Move if sign (SF=1) |
| 0F 44 <i>cw/cd</i> | CMOVZ <i>r16, r/m16</i> | Move if zero (ZF=1) |
| 0F 44 <i>cw/cd</i> | CMOVZ <i>r32, r/m32</i> | Move if zero (ZF=1) |

Description

The CMOV cc instructions check the state of one or more of the status flags in the EFLAGS register (CF, OF, PF, SF, and ZF) and perform a move operation if the flags are in a specified state (or condition). A condition code (cc) is associated with each instruction to indicate the condition being tested for. If the condition is not satisfied, a move is not performed and execution continues with the instruction following the CMOV cc instruction.

If the condition is false for the memory form, some processor implementations will initiate the load (and discard the loaded data), possible memory faults can be generated. Other processor models will not initiate the load and not generate any faults if the condition is false.

These instructions can move a 16- or 32-bit value from memory to a general-purpose register or from one general-purpose register to another. Conditional moves of 8-bit register operands are not supported.

The conditions for each CMOV cc mnemonic is given in the description column of the above table. The terms “less” and “greater” are used for comparisons of signed integers and the terms “above” and “below” are used for unsigned integers.

Because a particular state of the status flags can sometimes be interpreted in two ways, two mnemonics are defined for some opcodes. For example, the CMOVA (conditional move if above) instruction and the CMOVNBE (conditional move if not below or equal) instruction are alternate mnemonics for the opcode 0F 47H.

CMOV_{cc}—Conditional Move (Continued)

The CMOV_{cc} instructions are new for the Pentium Pro processor family; however, they may not be supported by all the processors in the family. Software can determine if the CMOV_{cc} instructions are supported by checking the processor’s feature information with the CPUID instruction (see “CPUID—CPU Identification” on page 3:428).

Operation

```
temp ← DEST
IF condition TRUE
  THEN
    DEST ← SRC
  ELSE
    DEST ← temp
FI;
```

Flags Affected

None.

If the condition is false for the memory form, some processor implementations will initiate the load (and discard the loaded data), possible memory faults can be generated. Other processor models will not initiate the load and not generate any faults if the condition is false.

Additional Itanium[®] System Environment Exceptions

Itanium Reg Faults NaT Register Consumption Abort.

Itanium Mem Faults VHPT Data Fault, Nested TLB Fault, Data TLB Fault, Alternate Data TLB Fault, Data Page Not Present Fault, Data NaT Page Consumption Abort, Data Key Miss Fault, Data Key Permission Fault, Data Access Rights Fault, Data Access Bit Fault, Data Dirty Bit Fault

Protected Mode Exceptions

| | |
|-----------------|--|
| #GP(0) | If a memory operand effective address is outside the CS, DS, ES, FS, or GS segment limit. If the DS, ES, FS, or GS register contains a null segment selector. |
| #SS(0) | If a memory operand effective address is outside the SS segment limit. |
| #PF(fault-code) | If a page fault occurs. |
| #AC(0) | If alignment checking is enabled and an unaligned memory reference is made while the current privilege level is 3. |

Real Address Mode Exceptions

| | |
|-----|---|
| #GP | If a memory operand effective address is outside the CS, DS, ES, FS, or GS segment limit. |
| #SS | If a memory operand effective address is outside the SS segment limit. |

CMOVcc—Conditional Move (Continued)

Virtual 8086 Mode Exceptions

| | |
|-----------------|---|
| #GP(0) | If a memory operand effective address is outside the CS, DS, ES, FS, or GS segment limit. |
| #SS(0) | If a memory operand effective address is outside the SS segment limit. |
| #PF(fault-code) | If a page fault occurs. |
| #AC(0) | If alignment checking is enabled and an unaligned memory reference is made. |

CMP—Compare Two Operands

| Opcode | Instruction | Description |
|-----------------|--------------------------------|---------------------------------------|
| 3C <i>ib</i> | CMP AL, <i>imm8</i> | Compare <i>imm8</i> with AL |
| 3D <i>iw</i> | CMP AX, <i>imm16</i> | Compare <i>imm16</i> with AX |
| 3D <i>id</i> | CMP EAX, <i>imm32</i> | Compare <i>imm32</i> with EAX |
| 80 <i>/7 ib</i> | CMP <i>rm8</i> , <i>imm8</i> | Compare <i>imm8</i> with <i>rm8</i> |
| 81 <i>/7 iw</i> | CMP <i>rm16</i> , <i>imm16</i> | Compare <i>imm16</i> with <i>rm16</i> |
| 81 <i>/7 id</i> | CMP <i>rm32</i> , <i>imm32</i> | Compare <i>imm32</i> with <i>rm32</i> |
| 83 <i>/7 ib</i> | CMP <i>rm16</i> , <i>imm8</i> | Compare <i>imm8</i> with <i>rm16</i> |
| 83 <i>/7 id</i> | CMP <i>rm32</i> , <i>imm8</i> | Compare <i>imm8</i> with <i>rm32</i> |
| 38 <i>/r</i> | CMP <i>rm8</i> , <i>r8</i> | Compare <i>r8</i> with <i>rm8</i> |
| 39 <i>/r</i> | CMP <i>rm16</i> , <i>r16</i> | Compare <i>r16</i> with <i>rm16</i> |
| 39 <i>/r</i> | CMP <i>rm32</i> , <i>r32</i> | Compare <i>r32</i> with <i>rm32</i> |
| 3A <i>/r</i> | CMP <i>r8</i> , <i>rm8</i> | Compare <i>rm8</i> with <i>r8</i> |
| 3B <i>/r</i> | CMP <i>r16</i> , <i>rm16</i> | Compare <i>rm16</i> with <i>r16</i> |
| 3B <i>/r</i> | CMP <i>r32</i> , <i>rm32</i> | Compare <i>rm32</i> with <i>r32</i> |

Description

Compares the first source operand with the second source operand and sets the status flags in the EFLAGS register according to the results. The comparison is performed by subtracting the second operand from the first operand and then setting the status flags in the same manner as the SUB instruction. When an immediate value is used as an operand, it is sign-extended to the length of the first operand.

The CMP instruction is typically used in conjunction with a conditional jump (*Jcc*), condition move (*CMOVcc*), or *SETcc* instruction. The condition codes used by the *Jcc*, *CMOVcc*, and *SETcc* instructions are based on the results of a CMP instruction.

Operation

$\text{temp} \leftarrow \text{SRC1} - \text{SignExtend}(\text{SRC2});$
 ModifyStatusFlags; (* Modify status flags in the same manner as the SUB instruction*)

Flags Affected

The CF, OF, SF, ZF, AF, and PF flags are set according to the result.

Additional Itanium® System Environment Exceptions

Itanium Reg Faults NaT Register Consumption Abort.

Itanium Mem Faults VHPT Data Fault, Nested TLB Fault, Data TLB Fault, Alternate Data TLB Fault, Data Page Not Present Fault, Data NaT Page Consumption Abort, Data Key Miss Fault, Data Key Permission Fault, Data Access Rights Fault, Data Access Bit Fault, Data Dirty Bit Fault

CMP—Compare Two Operands (Continued)

Protected Mode Exceptions

| | |
|-----------------|--|
| #GP(0) | If a memory operand effective address is outside the CS, DS, ES, FS, or GS segment limit. If the DS, ES, FS, or GS register contains a null segment selector. |
| #SS(0) | If a memory operand effective address is outside the SS segment limit. |
| #PF(fault-code) | If a page fault occurs. |
| #AC(0) | If alignment checking is enabled and an unaligned memory reference is made while the current privilege level is 3. |

Real Address Mode Exceptions

| | |
|-----|---|
| #GP | If a memory operand effective address is outside the CS, DS, ES, FS, or GS segment limit. |
| #SS | If a memory operand effective address is outside the SS segment limit. |

Virtual 8086 Mode Exceptions

| | |
|-----------------|---|
| #GP(0) | If a memory operand effective address is outside the CS, DS, ES, FS, or GS segment limit. |
| #SS(0) | If a memory operand effective address is outside the SS segment limit. |
| #PF(fault-code) | If a page fault occurs. |
| #AC(0) | If alignment checking is enabled and an unaligned memory reference is made. |

CMPS/CMPSB/CMPSW/CMPSD—Compare String Operands

| Opcode | Instruction | Description |
|--------|-------------------------|---|
| A6 | CMPS DS:(E)SI, ES:(E)DI | Compares byte at address DS:(E)SI with byte at address ES:(E)DI and sets the status flags accordingly |
| A7 | CMPS DS:SI, ES:DI | Compares byte at address DS:SI with byte at address ES:DI and sets the status flags accordingly |
| A7 | CMPS DS:ESI, ES:EDI | Compares byte at address DS:ESI with byte at address ES:EDI and sets the status flags accordingly |
| A6 | CMPSB | Compares byte at address DS:(E)SI with byte at address ES:(E)DI and sets the status flags accordingly |
| A7 | CMPSW | Compares word at address DS:SI with word at address ES:DI and sets the status flags accordingly |
| A7 | CMPSD | Compares doubleword at address DS:ESI with doubleword at address ES:EDI and sets the status flags accordingly |

Description

Compares the byte, word, or double word specified with the first source operand with the byte, word, or double word specified with the second source operand and sets the status flags in the EFLAGS register according to the results. The first source operand specifies the memory location at the address DS:ESI and the second source operand specifies the memory location at address ES:EDI. (When the operand-size attribute is 16, the SI and DI register are used as the source-index and destination-index registers, respectively.) The DS segment may be overridden with a segment override prefix, but the ES segment cannot be overridden.

The CMPSB, CMPSW, and CMPSD mnemonics are synonyms of the byte, word, and doubleword versions of the CMPS instructions. They are simpler to use, but provide no type or segment checking. (For the CMPS instruction, “DS:ESI” and “ES:EDI” must be explicitly specified in the instruction.)

After the comparison, the ESI and EDI registers are incremented or decremented automatically according to the setting of the DF flag in the EFLAGS register. (If the DF flag is 0, the ESI and EDI register are incremented; if the DF flag is 1, the ESI and EDI registers are decremented.) The registers are incremented or decremented by 1 for byte operations, by 2 for word operations, or by 4 for doubleword operations.

The CMPS, CMPSB, CMPSW, and CMPSD instructions can be preceded by the REP prefix for block comparisons of ECX bytes, words, or doublewords. More often, however, these instructions will be used in a LOOP construct that takes some action based on the setting of the status flags before the next comparison is made.

CMPS/CMPSB/CMPSW/CMPSD—Compare String Operands (Continued)

Operation

```

temp ← SRC1 – SRC2;
setStatusFlags(temp);
IF (byte comparison)
  THEN IF DF = 0
    THEN (E)DI ← 1; (E)SI ← 1;
    ELSE (E)DI ← -1; (E)SI ← -1;
  FI;
ELSE IF (word comparison)
  THEN IF DF = 0
    THEN DI ← 2; (E)SI ← 2;
    ELSE DI ← -2; (E)SI ← -2;
  FI;
ELSE (* doubleword comparison *)
  THEN IF DF = 0
    THEN EDI ← 4; (E)SI ← 4;
    ELSE EDI ← -4; (E)SI ← -4;
  FI;
FI;
FI;

```

Flags Affected

The CF, OF, SF, ZF, AF, and PF flags are set according to the temporary result of the comparison.

Additional Itanium® System Environment Exceptions

| | |
|--------------------|--|
| Itanium Reg Faults | NaT Register Consumption Abort. |
| Itanium Mem Faults | VHPT Data Fault, Nested TLB Fault, Data TLB Fault, Alternate Data TLB Fault, Data Page Not Present Fault, Data NaT Page Consumption Abort, Data Key Miss Fault, Data Key Permission Fault, Data Access Rights Fault, Data Access Bit Fault, Data Dirty Bit Fault |

Protected Mode Exceptions

| | |
|-----------------|--|
| #GP(0) | If a memory operand effective address is outside the CS, DS, ES, FS, or GS segment limit. If the DS, ES, FS, or GS register contains a null segment selector. |
| #SS(0) | If a memory operand effective address is outside the SS segment limit. |
| #PF(fault-code) | If a page fault occurs. |
| #AC(0) | If alignment checking is enabled and an unaligned memory reference is made while the current privilege level is 3. |

Real Address Mode Exceptions

| | |
|-----|---|
| #GP | If a memory operand effective address is outside the CS, DS, ES, FS, or GS segment limit. |
| #SS | If a memory operand effective address is outside the SS segment limit. |



CMPS/CMPSB/CMPSW/CMPSD—Compare String Operands (Continued)

Virtual 8086 Mode Exceptions

| | |
|-----------------|---|
| #GP(0) | If a memory operand effective address is outside the CS, DS, ES, FS, or GS segment limit. |
| #SS(0) | If a memory operand effective address is outside the SS segment limit. |
| #PF(fault-code) | If a page fault occurs. |
| #AC(0) | If alignment checking is enabled and an unaligned memory reference is made. |

CMPXCHG—Compare and Exchange

| Opcode | Instruction | Description |
|---------|--------------------------|--|
| 0F B0/r | CMPXCHG <i>r/m8,r8</i> | Compare AL with <i>r/m8</i> . If equal, ZF is set and <i>r8</i> is loaded into <i>r/m8</i> . Else, clear ZF and load <i>r/m8</i> into AL. |
| 0F B1/r | CMPXCHG <i>r/m16,r16</i> | Compare AX with <i>r/m16</i> . If equal, ZF is set and <i>r16</i> is loaded into <i>r/m16</i> . Else, clear ZF and load <i>r/m16</i> into AL. |
| 0F B1/r | CMPXCHG <i>r/m32,r32</i> | Compare EAX with <i>r/m32</i> . If equal, ZF is set and <i>r32</i> is loaded into <i>r/m32</i> . Else, clear ZF and load <i>r/m32</i> into AL. |

Description

Compares the value in the AL, AX, or EAX register (depending on the size of the operand) with the first operand (destination operand). If the two values are equal, the second operand (source operand) is loaded into the destination operand. Otherwise, the destination operand is loaded into the AL, AX, or EAX register.

This instruction can be used with a LOCK prefix to allow the instruction to be executed atomically. To simplify the interface to the processor's bus, the destination operand receives a write cycle without regard to the result of the comparison. The destination operand is written back if the comparison fails; otherwise, the source operand is written into the destination. (The processor never produces a locked read without also producing a locked write.)

Operation

(* accumulator = AL, AX, or EAX, depending on whether *)
 (* a byte, word, or doubleword comparison is being performed*)

**IF Itanium System Environment AND External_Atomic_Lock_Required AND DCR.Ic
 THEN IA-32_Intercept(LOCK,CMPXCHG);**

```
IF accumulator = DEST
  THEN
    ZF ← 1
    DEST ← SRC
  ELSE
    ZF ← 0
    accumulator ← DEST
```

FI;

Flags Affected

The ZF flag is set if the values in the destination operand and register AL, AX, or EAX are; otherwise it is cleared. The CF, PF, AF, SF, and OF flags are set according to the results of the comparison operation.

CMPXCHG—Compare and Exchange (Continued)

Additional Itanium® System Environment Exceptions

| | |
|--------------------|--|
| Itanium Reg Faults | NaT Register Consumption Abort. |
| Itanium Mem Faults | VHPT Data Fault, Nested TLB Fault, Data TLB Fault, Alternate Data TLB Fault, Data Page Not Present Fault, Data NaT Page Consumption Abort, Data Key Miss Fault, Data Key Permission Fault, Data Access Rights Fault, Data Access Bit Fault, Data Dirty Bit Fault |
| IA-32_Intercept | Lock Intercept - If an external atomic bus lock is required to complete this operation and DCR.lc is 1, no atomic transaction occurs, this instruction is faulted and an IA-32_Intercept(Lock) fault is generated. The software lock handler is responsible for the emulation of this instruction. |

Protected Mode Exceptions

| | |
|-----------------|--|
| #GP(0) | <p>If the destination is located in a nonwritable segment.</p> <p>If a memory operand effective address is outside the CS, DS, ES, FS, or GS segment limit.</p> <p>If the DS, ES, FS, or GS register contains a null segment selector.</p> |
| #SS(0) | If a memory operand effective address is outside the SS segment limit. |
| #PF(fault-code) | If a page fault occurs. |
| #AC(0) | If alignment checking is enabled and an unaligned memory reference is made while the current privilege level is 3. |

Real Address Mode Exceptions

| | |
|-----|---|
| #GP | If a memory operand effective address is outside the CS, DS, ES, FS, or GS segment limit. |
| #SS | If a memory operand effective address is outside the SS segment limit. |

Virtual 8086 Mode Exceptions

| | |
|-----------------|---|
| #GP(0) | If a memory operand effective address is outside the CS, DS, ES, FS, or GS segment limit. |
| #SS(0) | If a memory operand effective address is outside the SS segment limit. |
| #PF(fault-code) | If a page fault occurs. |
| #AC(0) | If alignment checking is enabled and an unaligned memory reference is made. |

Intel® Architecture Compatibility

This instruction is not supported on Intel processors earlier than the Intel486 processors.

CMPXCHG8B—Compare and Exchange 8 Bytes

| Opcode | Instruction | Description |
|--------------|---------------|---|
| 0F C7 /1 m64 | CMPXCHG8B m64 | Compare EDX:EAX with m64. If equal, set ZF and load ECX:EBX into m64. Else, clear ZF and load m64 into EDX:EAX. |

Description

Compares the 64-bit value in EDX:EAX with the operand (destination operand). If the values are equal, the 64-bit value in ECX:EBX is stored in the destination operand. Otherwise, the value in the destination operand is loaded into EDX:EAX. The destination operand is an 8-byte memory location. For the EDX:EAX and ECX:EBX register pairs, EDX and ECX contain the high-order 32 bits and EAX and EBX contain the low-order 32 bits of a 64-bit value.

This instruction can be used with a LOCK prefix to allow the instruction to be executed atomically. To simplify the interface to the processor's bus, the destination operand receives a write cycle without regard to the result of the comparison. The destination operand is written back if the comparison fails; otherwise, the source operand is written into the destination. (The processor never produces a locked read without also producing a locked write.)

Operation

**IF Itanium System Environment AND External_Atomic_Lock_Required AND DCR.lc
THEN IA-32_Intercept(LOCK,CMPXCHG);**

IF (EDX:EAX = DEST)

ZF ← 1

DEST ← ECX:EBX

ELSE

ZF ← 0

EDX:EAX ← DEST

Flags Affected

The ZF flag is set if the destination operand and EDX:EAX are equal; otherwise it is cleared. The CF, PF, AF, SF, and OF flags are unaffected.

Additional Itanium® System Environment Exceptions

| | |
|--------------------|---|
| Itanium Reg Faults | NaT Register Consumption Abort. |
| Itanium Mem Faults | VHPT Data Fault, Nested TLB Fault, Data TLB Fault, Alternate Data TLB Fault, Data Page Not Present Fault, Data NaT Page Consumption Abort, Data Key Miss Fault, Data Key Permission Fault, Data Access Rights Fault, Data Access Bit Fault, Data Dirty Bit Fault |
| IA-32_Intercept | Lock Intercept - If an external atomic bus lock is required to complete this operation and DCR.lc is 1, no atomic transaction occurs, this instruction is faulted and an IA-32_Intercept(Lock) fault is generated. The software lock handler is responsible for the emulation of this instruction |

CMPXCHG8B—Compare and Exchange 8 Bytes (Continued)

Protected Mode Exceptions

| | |
|-----------------|---|
| #UD | If the destination operand is not a memory location. |
| #GP(0) | If the destination is located in a nonwritable segment. If a memory operand effective address is outside the CS, DS, ES, FS, or GS segment limit. If the DS, ES, FS, or GS register contains a null segment selector. |
| #SS(0) | If a memory operand effective address is outside the SS segment limit. |
| #PF(fault-code) | If a page fault occurs. |
| #AC(0) | If alignment checking is enabled and an unaligned memory reference is made while the current privilege level is 3. |

Real Address Mode Exceptions

| | |
|-----|---|
| #GP | If a memory operand effective address is outside the CS, DS, ES, FS, or GS segment limit. |
| #SS | If a memory operand effective address is outside the SS segment limit. |

Virtual 8086 Mode Exceptions

| | |
|-----------------|---|
| #GP(0) | If a memory operand effective address is outside the CS, DS, ES, FS, or GS segment limit. |
| #SS(0) | If a memory operand effective address is outside the SS segment limit. |
| #PF(fault-code) | If a page fault occurs. |
| #AC(0) | If alignment checking is enabled and an unaligned memory reference is made. |

Intel® Architecture Compatibility

This instruction is not supported on Intel processors earlier than the Pentium processors.

CPUID—CPU Identification

| Opcode | Instruction | Description |
|--------|-------------|--|
| 0F A2 | CPUID | EAX ← Processor identification information |

Description

Provides processor identification information in registers EAX, EBX, ECX, and EDX. This information identifies Intel as the vendor, gives the family, model, and stepping of processor, feature information, and cache information. An input value loaded into the EAX register determines what information is returned, as shown in [Table 1-4](#).

Table 1-4. Information Returned by CPUID Instruction

| Initial EAX Value | Information Provided about the Processor | |
|-------------------|--|--|
| 0 | EAX | Maximum CPUID Input Value |
| | EBX | 756E6547H "Genu" (G in BL) |
| | ECX | 6C65746EH "ntel" (n in CL) |
| | EDX | 49656E69H "ineI" (i in DL) |
| 1 | EAX | Version Information (Family, Model, and Stepping ID) |
| | EBX | Reserved |
| | ECX | Reserved |
| | EDX | Feature Information |
| 2 | EAX | Cache Information |
| | EBX | Cache Information |
| | ECX | Cache Information |
| | EDX | Cache Information |

The CPUID instruction can be executed at any privilege level to serialize instruction execution. Serializing instruction execution guarantees that any modifications to flags, registers, and memory for previous instructions are completed before the next instruction is fetched and executed.

When the input value in register EAX is 0, the processor returns the highest value the CPUID instruction recognizes in the EAX register. For the Itanium processor, the highest recognized value is 2. A vendor identification string is returned in the EBX, EDX, and ECX registers. For Intel processors, the vendor identification string is "GenuineIntel" as follows:

```
EBX ← 756e6547h (* "Genu", with G in the low nibble of BL *)
EDX ← 49656e69h (* "ineI", with i in the low nibble of DL *)
ECX ← 6c65746eh (* "ntel", with n in the low nibble of CL *)
```

When the input value is 1, the processor returns version information in the EAX register and feature information in the EDX register.

CPUID—CPU Identification (Continued)

Figure 1-3. Version Information in Registers EAX

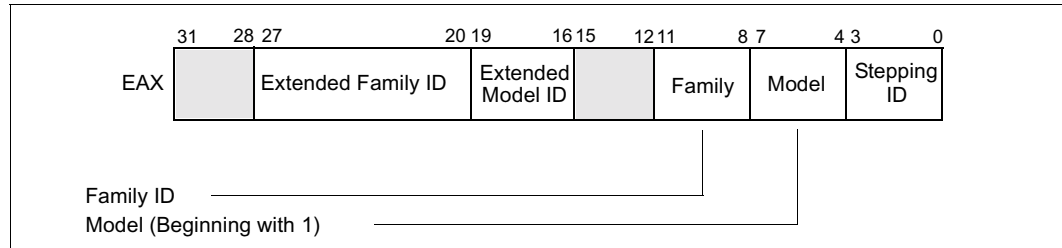

The version information consists of an Intel architecture extended family identifier, an extended model identifier, an Intel architecture family identifier, a model identifier and a stepping ID.

See “Intel Application Note 485 — Intel Processor Identification with the CPUID Instruction” for more information on identifying earlier Intel architecture processors. Intel releases information on stepping IDs as needed.

A feature flag set to 1 indicates the corresponding feature is supported. Software should identify Intel as the vendor to properly interpret the feature flags.

Note: IA-32 System Environment feature bits may be set in the Itanium System Environment even if that feature cannot be used within the Itanium System Environment.

Table 1-5. Feature Flags Returned in EDX Register

| Bit | IA-32 System Environment Feature | Intel® Itanium® System Environment Feature | Description |
|-----|------------------------------------|---|--|
| 0 | FPU—Floating-point Unit on Chip | Available | Processor contains an FPU and executes the Intel387 instruction set. |
| 1 | VME—Virtual 8086 Mode Enhancements | Available | Processor supports the following virtual 8086 mode enhancements: <ul style="list-style-type: none"> • CR4.VME bit enables virtual 8086 mode extensions. • CR4.PVI bit enables protected-mode virtual interrupts. • Expansion of the TSS with the software indirection bitmap. • EFLAGS.VIF bit enables the virtual interrupt flag. • EFLAGS.VIP bit enables the virtual interrupt pending flag. |
| 3 | PSE—Page Size Extensions | Not Available Paging in the Intel® Itanium® architecture supports a wide range of page sizes. | Processor supports 4-Mbyte pages, including the CR4.PSE bit for enabling page size extensions, the modified bit in page directory entries (PDEs), page directory entries, and page table entries (PTEs). |
| 4 | TSC—Time Stamp Counter | Available | Processor supports the RDTSC (read time stamp counter) instruction, including the CR4.TSD bit that, along with the CPL, controls whether the time stamp counter can be read. |
| 5 | MSR—Model Specific Registers | Not Available Use PAL interface to program model specific features. | Processor supports the RDMSR (read model-specific register) and WRMSR (write model-specific register) instructions. |
| 6 | PAE—Physical Address Extension | Not Available. The Itanium architecture always supports more than 32-bits of physical addressing | Processor supports physical addresses greater than 32 bits, the extended page-table-entry format, an extra level in the page translation tables, and 2-MByte pages. The CR4.PAE bit enables this feature. The number of address bits is implementation specific. |

Table 1-5. Feature Flags Returned in EDX Register (Continued)

| Bit | IA-32 System Environment Feature | Intel® Itanium® System Environment Feature | Description |
|-----|---|---|--|
| 7 | MCE—Machine Check Exception | Not Available. Processor uses PAL defined MCHK architecture. | Processor supports the CR4.MCE bit, enabling machine check exceptions. However, this feature does not define the model-specific implementations of machine-check error logging, reporting, or processor shutdowns. Machine-check exception handlers might have to check the processor version to do model-specific processing of the exception or check for the presence of the machine-check feature. |
| 8 | CX8—CMPXCHG8B Instruction | Available | Processor supports the CMPXCHG8B (compare and exchange 8 bytes) instruction. |
| 9 | APIC | Not Available. Replaced by the Itanium interrupt mechanism. | Processor contains an on-chip Advanced Programmable Interrupt Controller (APIC) and it has been enabled and is available for use. |
| 10 | Reserved | | returns zero |
| 12 | MTRR—Memory Type Range Registers | Not Available. Processor utilizes memory attributes from the TLB defined by the Itanium architecture | Processor supports machine-specific memory-type range registers (MTRRs). The MTRRs contains bit fields that indicate the processor's MTRR capabilities, including which memory types the processor supports, the number of variable MTRRs the processor supports, and whether the processor supports fixed MTRRs. |
| 13 | PGE—PTE Global Flag | Not available. Superseded by virtual regions defined in the Itanium architecture. | Processor supports the CR4.PGE flag enabling the global bit in both PTDEs and PTEs. These bits are used to indicate translation lookaside buffer (TLB) entries that are common to different tasks and need not be flushed when control register CR3 is written. |
| 14 | MCA—Machine Check Architecture | Not Available. Processor uses PAL defined MCHK architecture. | Processor supports the MCG_CAP (machine check global capability) MSR. The MCG_CAP register indicates how many banks of error reporting MSRs the processor supports. |
| 15 | CMOV—Conditional Move and Compare Instructions | Available | Processor supports the CMOV _{cc} instruction and, if the FPU feature flag (bit 0) is also set, supports the FCMOV _{cc} and FCOMI instructions. |
| 16 | PSE-36 - 36-bit Page Size Extensions | Not Available. The Itanium architecture always supports more than 32-bits of physical addressing | Indicates whether the processor supports 4-Mbyte pages that are capable of addressing physical memory beyond 4GB. This feature indicates that the upper four bits of the physical address of the 4-Mbyte page is encoded by bits 13-16 of the page directory entry. |
| 17 | PAT - Memory Attribute Palette | Not available for paging. Superseded by virtual regions defined in the Intel® Itanium® architecture. | Processors supports the IA-32 physical attribute table |
| 18 | PPN - Physical Processor Number | Not available. The Intel® Itanium® architecture does not support this feature. | Processor supports a Physical Processor Number for each manufactured processor |
| 23 | MMX - Intel® MMX™ Technology | Available | Processor supports the Architecture Intel® MMX™ Technology |
| 24 | FXSR | Available | Processor supports the Streaming SIMD Extension FXRSTOR and FXSAVE instruction |
| 25 | XMM - Streaming SIMD Extension Technology | Available | Processor supports the Intel® architecture Streaming SIMD Extension |
| 30 | Processor based on the Intel® Itanium® architecture | Available | The processor is based on the Intel® Itanium® architecture and is capable of executing the Intel® Itanium® instruction set. IA-32 application level software MUST also check with the running operating system to see if the system can also support Itanium®-based code before switching to the Intel® Itanium® instruction set. |

CPUID—CPU Identification (Continued)

When the input value is 2, the processor returns information about the processor's internal caches and TLBs in the EAX, EBX, ECX, and EDX registers. The encoding of these registers is as follows:

- The least-significant byte in register EAX (register AL) indicates the number of times the CPUID instruction must be executed with an input value of 2 to get a complete description of the processor's caches and TLBs.
- The most significant bit (bit 31) of each register indicates whether the register contains valid information (cleared to 0) or is reserved (set to 1).

Please see the processor specific supplement for further information on how to decode the return values for the processors internal caches and TLBs.

CPUID performs instruction serialization and a memory fence operation.

Operation

CASE (EAX) OF

EAX = 0:

EAX ← highest input value understood by CPUID; (* 2 for Itanium processor *)

EBX ← Vendor identification string;

EDX ← Vendor identification string;

ECX ← Vendor identification string;

BREAK;

EAX = 1:

EAX[3:0] ← Stepping ID;

EAX[7:4] ← Model;

EAX[11:8] ← Family;

EAX[15:12] ← Reserved;

EAX[19:16] ← Extended Model ID;

EAX[27:20] ← Extended Family ID;

EAX[31:28] ← Reserved;

EBX ← Reserved;

ECX ← Reserved;

EDX ← Feature flags;

BREAK;

EAX = 2:

EAX[7:0] ← N_Param_Descrip_Blocks = 1;

EAX[31:8], EBX, ECX, EDX = cache and TLB parameters

BREAK;

DEFAULT: (* EAX > highest value recognized by CPUID *)

EAX ← Reserved, Undefined;

EBX ← Reserved, Undefined;

ECX ← Reserved, Undefined;

EDX ← Reserved, Undefined;

BREAK;

ESAC;

memory_fence();

instruction_serialize();

Flags Affected

None.

CPUID—CPU Identification (Continued)

Additional Itanium[®] System Environment Exceptions

Itanium Reg Faults NaT Register Consumption Abort.

Exceptions (All Operating Modes)

None.

Intel[®] Architecture Compatibility

The CPUID instruction is not supported in early models of the Intel486 processor or in any Intel architecture processor earlier than the Intel486 processor. The ID flag in the EFLAGS register can be used to determine if this instruction is supported. If a procedure is able to set or clear this flag, the CPUID is supported by the processor running the procedure.

CWD/CDQ—Convert Word to Doubleword/Convert Doubleword to Quadword

| Opcode | Instruction | Description |
|--------|-------------|------------------------------|
| 99 | CWD | DX:AX ← sign-extend of AX |
| 99 | CDQ | EDX:EAX ← sign-extend of EAX |

Description

Doubles the size of the operand in register AX or EAX (depending on the operand size) by means of sign extension and stores the result in registers DX:AX or EDX:EAX, respectively. The CWD instruction copies the sign (bit 15) of the value in the AX register into every bit position in the DX register. The CDQ instruction copies the sign (bit 31) of the value in the EAX register into every bit position in the EDX register.

The CWD instruction can be used to produce a doubleword dividend from a word before a word division, and the CDQ instruction can be used to produce a quadword dividend from a doubleword before doubleword division.

The CWD and CDQ mnemonics reference the same opcode. The CWD instruction is intended for use when the operand-size attribute is 16 and the CDQ instruction for when the operand-size attribute is 32. Some assemblers may force the operand size to 16 when CWD is used and to 32 when CDQ is used. Others may treat these mnemonics as synonyms (CWD/CDQ) and use the current setting of the operand-size attribute to determine the size of values to be converted, regardless of the mnemonic used.

Operation

```
IF OperandSize = 16 (* CWD instruction *)
    THEN DX ← SignExtend(AX);
ELSE (* OperandSize = 32, CDQ instruction *)
    EDX ← SignExtend(EAX);
FI;
```

Additional Itanium® System Environment Exceptions

Itanium Reg Faults NaT Register Consumption Abort.

Flags Affected

None.

Exceptions (All Operating Modes)

None.

CWDE—Convert Word to Doubleword

See entry for CBW/CWDE—Convert Byte to Word/Convert Word to Doubleword.

DAA—Decimal Adjust AL after Addition

| Opcode | Instruction | Description |
|--------|-------------|----------------------------------|
| 27 | DAA | Decimal adjust AL after addition |

Description

Adjusts the sum of two packed BCD values to create a packed BCD result. The AL register is the implied source and destination operand. The DAA instruction is only useful when it follows an ADD instruction that adds (binary addition) two 2-digit, packed BCD values and stores a byte result in the AL register. The DAA instruction then adjusts the contents of the AL register to contain the correct 2-digit, packed BCD result. If a decimal carry is detected, the CF and AF flags are set accordingly.

Operation

```
IF (((AL AND 0FH) > 9) or AF = 1)
  THEN
    AL ← AL + 6;
    CF ← CF OR CarryFromLastAddition; (* CF OR carry from AL ← AL + 6 *)
    AF ← 1;
  ELSE
    AF ← 0;
FI;
IF ((AL AND F0H) > 90H) or CF = 1)
  THEN
    AL ← AL + 60H;
    CF ← 1;
  ELSE
    CF ← 0;
FI;
```

Example

```
ADD AL, BL      Before: AL=79H BL=35H EFLAGS(OSZAPC)=XXXXXX
                After: AL=AEH BL=35H EFLAGS(OSZAPC)=110000
DAA             Before: AL=79H BL=35H EFLAGS(OSZAPC)=110000
                After: AL=AEH BL=35H EFLAGS(OSZAPC)=X00111
```

Flags Affected

The CF and AF flags are set if the adjustment of the value results in a decimal carry in either digit of the result (see “Operation” above). The SF, ZF, and PF flags are set according to the result. The OF flag is undefined.

Additional Itanium® System Environment Exceptions

Itanium Reg Faults NaT Register Consumption Abort.

Exceptions (All Operating Modes)

None.

DAS—Decimal Adjust AL after Subtraction

| Opcode | Instruction | Description |
|--------|-------------|-------------------------------------|
| 2F | DAS | Decimal adjust AL after subtraction |

Description

Adjusts the result of the subtraction of two packed BCD values to create a packed BCD result. The AL register is the implied source and destination operand. The DAS instruction is only useful when it follows a SUB instruction that subtracts (binary subtraction) one 2-digit, packed BCD value from another and stores a byte result in the AL register. The DAS instruction then adjusts the contents of the AL register to contain the correct 2-digit, packed BCD result. If a decimal borrow is detected, the CF and AF flags are set accordingly.

Operation

```

IF (AL AND 0FH) > 9 OR AF = 1
  THEN
    AL ← AL – 6;
    CF ← CF OR BorrowFromLastSubtraction; (* CF OR borrow from AL ← AL – 6 *)
    AF ← 1;
  ELSE AF ← 0;
FI;
IF ((AL > 9FH) or CF = 1)
  THEN
    AL ← AL – 60H;
    CF ← 1;
  ELSE CF ← 0;
FI;

```

Example

```

SUB AL, BL      Before: AL=35H BL=47H EFLAGS(OSZAPC)=XXXXXX
                After: AL=EEH BL=47H EFLAGS(OSZAPC)=010111
DAA            Before: AL=EEH BL=47H EFLAGS(OSZAPC)=010111
                After: AL=88H BL=47H EFLAGS(OSZAPC)=X10111

```

Flags Affected

The CF and AF flags are set if the adjustment of the value results in a decimal borrow in either digit of the result (see “Operation” above). The SF, ZF, and PF flags are set according to the result. The OF flag is undefined.

Additional Itanium® System Environment Exceptions

Itanium Reg Faults NaT Register Consumption Abort.

Exceptions (All Operating Modes)

None.

DEC—Decrement by 1

| Opcode | Instruction | Description |
|--------|------------------|-----------------------------|
| FE /1 | DEC <i>r/m8</i> | Decrement <i>r/m8</i> by 1 |
| FF /1 | DEC <i>r/m16</i> | Decrement <i>r/m16</i> by 1 |
| FF /1 | DEC <i>r/m32</i> | Decrement <i>r/m32</i> by 1 |
| 48+rw | DEC <i>r16</i> | Decrement <i>r16</i> by 1 |
| 48+rd | DEC <i>r32</i> | Decrement <i>r32</i> by 1 |

Description

Subtracts 1 from the operand, while preserving the state of the CF flag. The source operand can be a register or a memory location. This instruction allows a loop counter to be updated without disturbing the CF flag. (Use a SUB instruction with an immediate operand of 1 to perform a decrement operation that does updates the CF flag.)

Operation

$DEST \leftarrow DEST - 1;$

Flags Affected

The CF flag is not affected. The OF, SF, ZF, AF, and PF flags are set according to the result.

Additional Itanium® System Environment Exceptions

Itanium Reg Faults NaT Register Consumption Abort.

Itanium Mem Faults VHPT Data Fault, Nested TLB Fault, Data TLB Fault, Alternate Data TLB Fault, Data Page Not Present Fault, Data NaT Page Consumption Abort, Data Key Miss Fault, Data Key Permission Fault, Data Access Rights Fault, Data Access Bit Fault, Data Dirty Bit Fault

Protected Mode Exceptions

- #GP(0) If the destination is located in a nonwritable segment.
If a memory operand effective address is outside the CS, DS, ES, FS, or GS segment limit.
If the DS, ES, FS, or GS register contains a null segment selector.
- #SS(0) If a memory operand effective address is outside the SS segment limit.
- #PF(fault-code) If a page fault occurs.
- #AC(0) If alignment checking is enabled and an unaligned memory reference is made while the current privilege level is 3.

Real Address Mode Exceptions

- #GP If a memory operand effective address is outside the CS, DS, ES, FS, or GS segment limit.
- #SS If a memory operand effective address is outside the SS segment limit.

DEC—Decrement by 1 (Continued)

Virtual 8086 Mode Exceptions

| | |
|-----------------|---|
| #GP(0) | If a memory operand effective address is outside the CS, DS, ES, FS, or GS segment limit. |
| #SS(0) | If a memory operand effective address is outside the SS segment limit. |
| #PF(fault-code) | If a page fault occurs. |
| #AC(0) | If alignment checking is enabled and an unaligned memory reference is made. |

DIV—Unsigned Divide

| Opcode | Instruction | Description |
|--------|------------------|---|
| F6 /6 | DIV <i>r/m8</i> | Unsigned divide AX by <i>r/m8</i> ; AL ← Quotient, AH ← Remainder |
| F7 /6 | DIV <i>r/m16</i> | Unsigned divide DX:AX by <i>r/m16</i> ; AX ← Quotient, DX ← Remainder |
| F7 /6 | DIV <i>r/m32</i> | Unsigned divide EDX:EAX by <i>r/m32</i> doubleword; EAX ← Quotient, EDX ← Remainder |

Description

Divides (unsigned) the value in the AL, AX, or EAX register (dividend) by the source operand (divisor) and stores the result in the AX, DX:AX, or EDX:EAX registers. The source operand can be a general-purpose register or a memory location. The action of this instruction depends on the operand size, as shown in the following table:

| Operand Size | Dividend | Divisor | Quotient | Remainder | Maximum Quotient |
|---------------------|----------|--------------|----------|-----------|------------------|
| Word/byte | AX | <i>r/m8</i> | AL | AH | 255 |
| Doubleword/word | DX:AX | <i>r/m16</i> | AX | DX | 65,535 |
| Quadword/doubleword | EDX:EAX | <i>r/m32</i> | EAX | EDX | $2^{32} - 1$ |

Non-integral results are truncated (chopped) towards 0. The remainder is always less than the divisor in magnitude. Overflow is indicated with the #DE (divide error) exception rather than with the CF flag.

Operation

```

IF SRC = 0
  THEN #DE; (* divide error *)
FI;
IF OperandSize = 8 (* word/byte operation *)
  THEN
    temp ← AX / SRC;
    IF temp > FFH
      THEN #DE; (* divide error *) ;
    ELSE
      AL ← temp;
      AH ← AX MOD SRC;
    FI;
  ELSE
    IF OperandSize = 16 (* doubleword/word operation *)
      THEN
        temp ← DX:AX / SRC;
        IF temp > FFFFH
          THEN #DE; (* divide error *) ;
        ELSE
          AX ← temp;
          DX ← DX:AX MOD SRC;
        FI;
      FI;

```

DIV—Unsigned Divide (Continued)

```

ELSE (* quadword/doubleword operation *)
  temp ← EDX:EAX / SRC;
  IF temp > FFFFFFFFH
    THEN #DE; (* divide error *);
    ELSE
      EAX ← temp;
      EDX ← EDX:EAX MOD SRC;
  FI;
FI;
FI;

```

Flags Affected

The CF, OF, SF, ZF, AF, and PF flags are undefined.

Additional Itanium® System Environment Exceptions

| | |
|--------------------|--|
| Itanium Reg Faults | NaT Register Consumption Abort. |
| Itanium Mem Faults | VHPT Data Fault, Nested TLB Fault, Data TLB Fault, Alternate Data TLB Fault, Data Page Not Present Fault, Data NaT Page Consumption Abort, Data Key Miss Fault, Data Key Permission Fault, Data Access Rights Fault, Data Access Bit Fault, Data Dirty Bit Fault |

Protected Mode Exceptions

| | |
|-----------------|--|
| #DE | If the source operand (divisor) is 0 If the quotient is too large for the designated register. |
| #GP(0) | If a memory operand effective address is outside the CS, DS, ES, FS, or GS segment limit. If the DS, ES, FS, or GS register contains a null segment selector. |
| #SS(0) | If a memory operand effective address is outside the SS segment limit. |
| #PF(fault-code) | If a page fault occurs. |
| #AC(0) | If alignment checking is enabled and an unaligned memory reference is made while the current privilege level is 3. |

Real Address Mode Exceptions

| | |
|-----|--|
| #DE | If the source operand (divisor) is 0. If the quotient is too large for the designated register. |
| #GP | If a memory operand effective address is outside the CS, DS, ES, FS, or GS segment limit. If the DS, ES, FS, or GS register contains a null segment selector. |

DIV—Unsigned Divide (Continued)

Virtual 8086 Mode Exceptions

| | |
|-----------------|--|
| #DE | If the source operand (divisor) is 0. If the quotient is too large for the designated register. |
| #GP(0) | If a memory operand effective address is outside the CS, DS, ES, FS, or GS segment limit. |
| #SS | If a memory operand effective address is outside the SS segment limit. |
| #PF(fault-code) | If a page fault occurs. |
| #AC(0) | If alignment checking is enabled and an unaligned memory reference is made. |

ENTER—Make Stack Frame for Procedure Parameters

| Opcode | Instruction | Description |
|----------|----------------------------------|---|
| C8 iw 00 | ENTER <i>imm16</i> ,0 | Create a stack frame for a procedure |
| C8 iw 01 | ENTER <i>imm16</i> ,1 | Create a nested stack frame for a procedure |
| C8 iw ib | ENTER <i>imm16</i> , <i>imm8</i> | Create a nested stack frame for a procedure |

Description

Creates a stack frame for a procedure. The first operand (size operand) specifies the size of the stack frame (that is, the number of bytes of dynamic storage allocated on the stack for the procedure). The second operand (nesting level operand) gives the lexical nesting level (0 to 31) of the procedure. The nesting level determines the number of stack frame pointers that are copied into the “display area” of the new stack frame from the preceding frame. Both of these operands are immediate values.

The stack-size attribute determines whether the BP (16 bits) or EBP (32 bits) register specifies the current frame pointer and whether SP (16 bits) or ESP (32 bits) specifies the stack pointer.

The ENTER and companion LEAVE instructions are provided to support block structured languages. They do not provide a jump or call to another procedure; they merely set up a new stack frame for an already called procedure. An ENTER instruction is commonly followed by a CALL, JMP, or *Jcc* instruction to transfer program control to the procedure being called.

If the nesting level is 0, the processor pushes the frame pointer from the EBP register onto the stack, copies the current stack pointer from the ESP register into the EBP register, and loads the ESP register with the current stack-pointer value minus the value in the size operand. For nesting levels of 1 or greater, the processor pushes additional frame pointers on the stack before adjusting the stack pointer. These additional frame pointers provide the called procedure with access points to other nested frames on the stack.

Operation

```

NestingLevel ← NestingLevel MOD 32
IF StackSize = 32
  THEN
    Push(EBP) ;
    FrameTemp ← ESP;
  ELSE (* StackSize = 16*)
    Push(BP);
    FrameTemp ← SP;
FI;
IF NestingLevel = 0
  THEN GOTO CONTINUE;
FI;
IF (NestingLevel > 0)
  FOR i ← 1 TO (NestingLevel - 1)
    DO
      IF OperandSize = 32
        THEN
          IF StackSize = 32
            EBP ← EBP - 4;

```

ENTER—Make Stack Frame for Procedure Parameters (Continued)

```

        Push([EBP]); (* doubleword push *)

    ELSE (* StackSize = 16*)
        BP ← BP – 4;
        Push([BP]); (* doubleword push *)
    FI;
ELSE (* OperandSize = 16 *)
    IF StackSize = 32
        THEN
            EBP ← EBP – 2;
            Push([EBP]); (* word push *)
        ELSE (* StackSize = 16*)
            BP ← BP – 2;
            Push([BP]); (* word push *)
        FI;
    FI;
OD;
IF OperandSize = 32
    THEN
        Push(FrameTemp); (* doubleword push *)
    ELSE (* OperandSize = 16 *)
        Push(FrameTemp); (* word push *)
    FI;
GOTO CONTINUE;
FI;
CONTINUE:
IF StackSize = 32
    THEN
        EBP ← FrameTemp
        ESP ← EBP – Size;
    ELSE (* StackSize = 16*)
        BP ← FrameTemp
        SP ← BP – Size;
    FI;
END;

```

Flags Affected

None.

Additional Itanium® System Environment Exceptions

Itanium Reg Faults NaT Register Consumption Abort.

Itanium Mem Faults VHPT Data Fault, Nested TLB Fault, Data TLB Fault, Alternate Data TLB Fault, Data Page Not Present Fault, Data NaT Page Consumption Abort, Data Key Miss Fault, Data Key Permission Fault, Data Access Rights Fault, Data Access Bit Fault, Data Dirty Bit Fault

ENTER—Make Stack Frame for Procedure Parameters (Continued)

Protected Mode Exceptions

- #SS(0) If the new value of the SP or ESP register is outside the stack segment limit.
#PF(fault-code) If a page fault occurs.

Real Address Mode Exceptions

None.

Virtual 8086 Mode Exceptions

None.

F2XM1—Compute 2^x-1

| Opcode | Instruction | Description |
|--------|-------------|---|
| D9 F0 | F2XM1 | Replace ST(0) with $(2^{\text{ST}(0)} - 1)$ |

Description

Calculates the exponential value of 2 to the power of the source operand minus 1. The source operand is located in register ST(0) and the result is also stored in ST(0). The value of the source operand must lie in the range -1.0 to $+1.0$. If the source value is outside this range, the result is undefined.

The following table shows the results obtained when computing the exponential value of various classes of numbers, assuming that neither overflow nor underflow occurs:

| ST(0) SRC | ST(0) DEST |
|----------------|----------------|
| -1.0 to -0 | -0.5 to -0 |
| -0 | -0 |
| $+0$ | $+0$ |
| $+0$ to $+1.0$ | $+0$ to 1.0 |

Values other than 2 can be exponentiated using the following formula:

$$x^y = 2^{(y * \log_2 x)}$$

Operation

$$\text{ST}(0) \leftarrow (2^{\text{ST}(0)} - 1);$$

FPU Flags Affected

| | |
|------------|---|
| C1 | Set to 0 if stack underflow occurred. Indicates rounding direction if the inexact-result exception (#P) is generated: 0 = not roundup; 1 = roundup. |
| C0, C2, C3 | Undefined. |

Additional Itanium® System Environment Exceptions

Itanium Reg Faults Disabled FP Register Fault if PSR.dfl is 1, NaT Register Consumption Abort.

Floating-point Exceptions

| | |
|-----|--|
| #IS | Stack underflow occurred. |
| #IA | Source operand is an SNaN value or unsupported format. |
| #D | Result is a denormal value. |
| #U | Result is too small for destination format. |
| #P | Value cannot be represented exactly in destination format. |

F2XM1—Compute 2^x-1 (Continued)**Protected Mode Exceptions**

#NM EM or TS in CR0 is set.

Real Address Mode Exceptions

#NM EM or TS in CR0 is set.

Virtual 8086 Mode Exceptions

#NM EM or TS in CR0 is set.

FABS—Absolute Value

| Opcode | Instruction | Description |
|--------|-------------|-------------------------------------|
| D9 E1 | FABS | Replace ST with its absolute value. |

Description

Clears the sign bit of ST(0) to create the absolute value of the operand. The following table shows the results obtained when creating the absolute value of various classes of numbers.

| ST(0) SRC | ST(0) DEST |
|-----------|------------|
| -∞ | +∞ |
| -F | +F |
| -0 | +0 |
| +0 | +0 |
| +F | +F |
| +∞ | +∞ |
| NaN | NaN |

Note:
F means finite-real number.

Operation

$ST(0) \leftarrow |ST(0)|$

FPU Flags Affected

C1 Set to 0 if stack underflow occurred; otherwise, cleared to 0.
C0, C2, C3 Undefined.

Additional Itanium® System Environment Exceptions

Itanium Reg Faults Disabled FP Register Fault if PSR.dfl is 1, NaT Register Consumption Abort.

Floating-point Exceptions

#IS Stack underflow occurred.

Protected Mode Exceptions

#NM EM or TS in CR0 is set.

Real Address Mode Exceptions

#NM EM or TS in CR0 is set.

Virtual 8086 Mode Exceptions

#NM EM or TS in CR0 is set.

FADD/FADDP/FIADD—Add

| Opcode | Instruction | Description |
|---------|-----------------------------|---|
| D8 /0 | FADD <i>m32real</i> | Add <i>m32real</i> to ST(0) and store result in ST(0) |
| DC /0 | FADD <i>m64real</i> | Add <i>m64real</i> to ST(0) and store result in ST(0) |
| D8 C0+i | FADD ST(0), ST(<i>i</i>) | Add ST(0) to ST(<i>i</i>) and store result in ST(0) |
| DC C0+i | FADD ST(<i>i</i>), ST(0) | Add ST(<i>i</i>) to ST(0) and store result in ST(<i>i</i>) |
| DE C0+i | FADDP ST(<i>i</i>), ST(0) | Add ST(0) to ST(<i>i</i>), store result in ST(<i>i</i>), and pop the register stack |
| DE C1 | FADDP | Add ST(0) to ST(1), store result in ST(1), and pop the register stack |
| DA /0 | FIADD <i>m32int</i> | Add <i>m32int</i> to ST(0) and store result in ST(0) |
| DE /0 | FIADD <i>m16int</i> | Add <i>m16int</i> to ST(0) and store result in ST(0) |

Description

Adds the destination and source operands and stores the sum in the destination location. The destination operand is always an FPU register; the source operand can be a register or a memory location. Source operands in memory can be in single-real, double-real, word-integer, or short-integer formats.

The no-operand version of the instruction adds the contents of the ST(0) register to the ST(1) register. The one-operand version adds the contents of a memory location (either a real or an integer value) to the contents of the ST(0) register. The two-operand version, adds the contents of the ST(0) register to the ST(*i*) register or vice versa. The value in ST(0) can be doubled by coding:

```
FADD ST(0), ST(0);
```

The FADDP instructions perform the additional operation of popping the FPU register stack after storing the result. To pop the register stack, the processor marks the ST(0) register as empty and increments the stack pointer (TOP) by 1. (The no-operand version of the floating-point add instructions always results in the register stack being popped. In some assemblers, the mnemonic for this instruction is FADD rather than FADDP.)

The FIADD instructions convert an integer source operand to extended-real format before performing the addition.

The table on the following page shows the results obtained when adding various classes of numbers, assuming that neither overflow nor underflow occurs.

When the sum of two operands with opposite signs is 0, the result is +0, except for the round toward $-\infty$ mode, in which case the result is -0 . When the source operand is an integer 0, it is treated as a +0.

When both operand are infinities of the same sign, the result is ∞ of the expected sign. If both operands are infinities of opposite signs, an invalid-operation exception is generated.

FADD/FADDP/FIADD—Add (Continued)

| | | DEST | | | | | | |
|-----|----------|------|----------|-----|-----|----------|-----|-----|
| | | -∞ | -F | -0 | +0 | +F | +∞ | NaN |
| SRC | -∞ | -∞ | -∞ | -∞ | -∞ | -∞ | * | NaN |
| | -F or -I | -∞ | -F | SRC | SRC | ±F or ±0 | +∞ | NaN |
| | -0 | -∞ | DEST | -0 | ±0 | DEST | +∞ | NaN |
| | +0 | -∞ | DEST | ±0 | +0 | DEST | +∞ | NaN |
| | +F or +I | -∞ | ±F or ±0 | SRC | SRC | +F | +∞ | NaN |
| | +∞ | * | +∞ | +∞ | +∞ | +∞ | +∞ | NaN |
| | NaN | NaN | NaN | NaN | NaN | NaN | NaN | NaN |

Notes:

F means finite-real number.

L means integer.

* indicates floating-point invalid-arithmetic-operand (#IA) exception.

Operation

IF instruction is FIADD

THEN

DEST ← DEST + ConvertExtendedReal(SRC);

ELSE (* source operand is real number *)

DEST ← DEST + SRC;

FI;

IF instruction = FADDP

THEN

PopRegisterStack;

FI;

FPU Flags Affected

C1 Set to 0 if stack underflow occurred.

Indicates rounding direction if the inexact-result exception (#P) is generated:
0 = not roundup; 1 = roundup.

C0, C2, C3 Undefined.

Additional Itanium® System Environment Exceptions

Itanium Reg Faults Disabled FP Register Fault if PSR.dfl is 1, NaT Register Consumption Abort.

Itanium Mem Faults VHPT Data Fault, Nested TLB Fault, Data TLB Fault, Alternate Data TLB Fault, Data Page Not Present Fault, Data NaT Page Consumption Abort, Data Key Miss Fault, Data Key Permission Fault, Data Access Rights Fault, Data Access Bit Fault, Data Dirty Bit Fault

FADD/FADDP/FIADD—Add (Continued)**Floating-point Exceptions**

| | |
|-----|--|
| #IS | Stack underflow occurred. |
| #IA | Operand is an SNaN value or unsupported format. Operands are infinities of unlike sign. |
| #D | Result is a denormal value. |
| #U | Result is too small for destination format. |
| #O | Result is too large for destination format. |
| #P | Value cannot be represented exactly in destination format. |

Protected Mode Exceptions

| | |
|-----------------|--|
| #GP(0) | If a memory operand effective address is outside the CS, DS, ES, FS, or GS segment limit. If the DS, ES, FS, or GS register contains a null segment selector. |
| #SS(0) | If a memory operand effective address is outside the SS segment limit. |
| #NM | EM or TS in CR0 is set. |
| #PF(fault-code) | If a page fault occurs. |
| #AC(0) | If alignment checking is enabled and an unaligned memory reference is made while the current privilege level is 3. |

Real Address Mode Exceptions

| | |
|-----|---|
| #GP | If a memory operand effective address is outside the CS, DS, ES, FS, or GS segment limit. |
| #SS | If a memory operand effective address is outside the SS segment limit. |
| #NM | EM or TS in CR0 is set. |

Virtual 8086 Mode Exceptions

| | |
|-----------------|---|
| #GP(0) | If a memory operand effective address is outside the CS, DS, ES, FS, or GS segment limit. |
| #SS(0) | If a memory operand effective address is outside the SS segment limit. |
| #NM | EM or TS in CR0 is set. |
| #PF(fault-code) | If a page fault occurs. |
| #AC(0) | If alignment checking is enabled and an unaligned memory reference is made. |

FBLD—Load Binary Coded Decimal

| Opcode | Instruction | Description |
|--------|---------------------|--|
| DF /4 | FBLD <i>m80 dec</i> | Convert BCD value to real and push onto the FPU stack. |

Description

Converts the BCD source operand into extended-real format and pushes the value onto the FPU stack. The source operand is loaded without rounding errors. The sign of the source operand is preserved, including that of -0 .

The packed BCD digits are assumed to be in the range 0 through 9; the instruction does not check for invalid digits (AH through FH). Attempting to load an invalid encoding produces an undefined result.

Operation

$TOP \leftarrow TOP - 1;$
 $ST(0) \leftarrow ExtendedReal(SRC);$

FPU Flags Affected

C1 Set to 1 if stack overflow occurred; otherwise, cleared to 0.
 C0, C2, C3 Undefined.

Floating-point Exceptions

#IS Stack overflow occurred.

Additional Itanium® System Environment Exceptions

Itanium Reg Faults Disabled FP Register Fault if PSR.dfl is 1, NaT Register Consumption Abort.
 Itanium Mem Faults VHPT Data Fault, Nested TLB Fault, Data TLB Fault, Alternate Data TLB Fault, Data Page Not Present Fault, Data NaT Page Consumption Abort, Data Key Miss Fault, Data Key Permission Fault, Data Access Rights Fault, Data Access Bit Fault, Data Dirty Bit Fault

Protected Mode Exceptions

#GP(0) If a memory operand effective address is outside the CS, DS, ES, FS, or GS segment limit.
 If the DS, ES, FS, or GS register contains a null segment selector.
 #SS(0) If a memory operand effective address is outside the SS segment limit.
 #NM EM or TS in CR0 is set.
 #PF(fault-code) If a page fault occurs.
 #AC(0) If alignment checking is enabled and an unaligned memory reference is made while the current privilege level is 3.

FBLD—Load Binary Coded Decimal (Continued)

Real Address Mode Exceptions

| | |
|-----|---|
| #GP | If a memory operand effective address is outside the CS, DS, ES, FS, or GS segment limit. |
| #SS | If a memory operand effective address is outside the SS segment limit. |
| #NM | EM or TS in CR0 is set. |

Virtual 8086 Mode Exceptions

| | |
|-----------------|---|
| #GP(0) | If a memory operand effective address is outside the CS, DS, ES, FS, or GS segment limit. |
| #SS(0) | If a memory operand effective address is outside the SS segment limit. |
| #NM | EM or TS in CR0 is set. |
| #PF(fault-code) | If a page fault occurs. |
| #AC(0) | If alignment checking is enabled and an unaligned memory reference is made. |

FBSTP—Store BCD Integer and Pop

| Opcode | Instruction | Description |
|--------|--------------|--------------------------------------|
| DF /6 | FBSTP m80bcd | Store ST(0) in m80bcd and pop ST(0). |

Description

Converts the value in the ST(0) register to an 18-digit packed BCD integer, stores the result in the destination operand, and pops the register stack. If the source value is a non-integral value, it is rounded to an integer value, according to rounding mode specified by the RC field of the FPU control word. To pop the register stack, the processor marks the ST(0) register as empty and increments the stack pointer (TOP) by 1.

The destination operand specifies the address where the first byte destination value is to be stored. The BCD value (including its sign bit) requires 10 bytes of space in memory.

The following table shows the results obtained when storing various classes of numbers in packed BCD format.

| ST(0) | DEST |
|--------------|------|
| -* | * |
| -F < -1 | -D |
| -1 < -F < -0 | ** |
| -0 | -0 |
| +0 | +0 |
| +0 < +F < +1 | ** |
| +F > +1 | +D |
| +∞ | * |
| NaN | * |

Notes:

- F means finite-real number.
- D means packed-BCD number.
- * indicates floating-point invalid-operation (#IA) exception.
- ** ±0 or ±1, depending on the rounding mode.

If the source value is too large for the destination format and the invalid-operation exception is not masked, an invalid-operation exception is generated and no value is stored in the destination operand. If the invalid-operation exception is masked, the packed BCD indefinite value is stored in memory.

If the source value is a quiet NaN, an invalid-operation exception is generated. Quiet NaNs do not normally cause this exception to be generated.

Operation

$DEST \leftarrow BCD(ST(0));$
 PopRegisterStack;

FBSTP—Store BCD Integer and Pop (Continued)

FPU Flags Affected

| | |
|------------|--|
| C1 | Set to 0 if stack underflow occurred. |
| | Indicates rounding direction if the inexact exception (#P) is generated: 0 = not roundup; 1 = roundup. |
| C0, C2, C3 | Undefined. |

Additional Itanium® System Environment Exceptions

| | |
|--------------------|--|
| Itanium Reg Faults | Disabled FP Register Fault if PSR.dfl is 1, NaT Register Consumption Abort. |
| Itanium Mem Faults | VHPT Data Fault, Nested TLB Fault, Data TLB Fault, Alternate Data TLB Fault, Data Page Not Present Fault, Data NaT Page Consumption Abort, Data Key Miss Fault, Data Key Permission Fault, Data Access Rights Fault, Data Access Bit Fault, Data Dirty Bit Fault |

Floating-point Exceptions

| | |
|-----|---|
| #IS | Stack underflow occurred. |
| #IA | Source operand is empty; contains a NaN, $\pm\infty$, or unsupported format; or contains value that exceeds 18 BCD digits in length. |
| #P | Value cannot be represented exactly in destination format. |

Protected Mode Exceptions

| | |
|-----------------|--|
| #GP(0) | If a segment register is being loaded with a segment selector that points to a nonwritable segment. |
| | If a memory operand effective address is outside the CS, DS, ES, FS, or GS segment limit. |
| | If the DS, ES, FS, or GS register contains a null segment selector. |
| #SS(0) | If a memory operand effective address is outside the SS segment limit. |
| #NM | EM or TS in CR0 is set. |
| #PF(fault-code) | If a page fault occurs. |
| #AC(0) | If alignment checking is enabled and an unaligned memory reference is made while the current privilege level is 3. |

Real Address Mode Exceptions

| | |
|-----|---|
| #GP | If a memory operand effective address is outside the CS, DS, ES, FS, or GS segment limit. |
| #SS | If a memory operand effective address is outside the SS segment limit. |
| #NM | EM or TS in CR0 is set. |

FBSTP—Store BCD Integer and Pop (Continued)

Virtual 8086 Mode Exceptions

| | |
|-----------------|---|
| #GP(0) | If a memory operand effective address is outside the CS, DS, ES, FS, or GS segment limit. |
| #SS(0) | If a memory operand effective address is outside the SS segment limit. |
| #NM | EM or TS in CR0 is set. |
| #PF(fault-code) | If a page fault occurs. |
| #AC(0) | If alignment checking is enabled and an unaligned memory reference is made. |

FCFS—Change Sign

| Opcode | Instruction | Description |
|--------|-------------|---------------------------|
| D9 E0 | FCFS | Complements sign of ST(0) |

Description

Complements the sign bit of ST(0). This operation changes a positive value into a negative value of equal magnitude or vice-versa. The following table shows the results obtained when creating the absolute value of various classes of numbers.

| ST(0) SRC | ST(0) DEST |
|-----------|------------|
| -∞ | +∞ |
| -F | +F |
| -0 | +0 |
| +0 | -0 |
| +F | -F |
| +∞ | -∞ |
| NaN | NaN |

Note:

F means finite-real number.

Operation

$\text{SignBit}(\text{ST}(0)) \leftarrow \text{NOT}(\text{SignBit}(\text{ST}(0)))$

FPU Flags Affected

C1 Set to 0 if stack underflow occurred; otherwise, cleared to 0.

C0, C2, C3 Undefined.

Additional Itanium[®] System Environment Exceptions

Itanium Reg Faults Disabled FP Register Fault if PSR.dfl is 1, NaT Register Consumption Abort.

Floating-point Exceptions

#IS Stack underflow occurred.

Protected Mode Exceptions

#NM EM or TS in CR0 is set.

Real Address Mode Exceptions

#NM EM or TS in CR0 is set.

Virtual 8086 Mode Exceptions

#NM EM or TS in CR0 is set.

FCLEX/FNCLEX—Clear Exceptions

| Opcode | Instruction | Description |
|----------|-------------|---|
| 9B DB E2 | FCLEX | Clear floating-point exception flags after checking for pending unmasked floating-point exceptions. |
| DB E2 | FNCLEX | Clear floating-point exception flags without checking for pending unmasked floating-point exceptions. |

Description

Clears the floating-point exception flags (PE, UE, OE, ZE, DE, and IE), the exception summary status flag (ES), the stack fault flag (SF), and the busy flag (B) in the FPU status word. The FCLEX instruction checks for and handles any pending unmasked floating-point exceptions before clearing the exception flags; the FNCLEX instruction does not.

Operation

$FPUStatusWord[0..7] \leftarrow 0;$
 $FPUStatusWord[15] \leftarrow 0;$

FPU Flags Affected

The PE, UE, OE, ZE, DE, IE, ES, SF, and B flags in the FPU status word are cleared. The C0, C1, C2, and C3 flags are undefined.

Floating-point Exceptions

None.

Additional Itanium® System Environment Exceptions

Itanium Reg Faults Disabled FP Register Fault if PSR.dfl is 1, NaT Register Consumption Abort.

Protected Mode Exceptions

#NM EM or TS in CR0 is set.

Real Address Mode Exceptions

#NM EM or TS in CR0 is set.

Virtual 8086 Mode Exceptions

#NM EM or TS in CR0 is set. /

FCMOV cc —Floating-point Conditional Move

| Opcode | Instruction | Description |
|---------|---------------------------|--|
| DA C0+i | FCMOVB ST(0), ST(i) | Move if below (CF=1) |
| DA C8+i | FCMOVE ST(0), ST(i) | Move if equal (ZF=1) |
| DA D0+i | FCMOVBE ST(0), ST(i) | Move if below or equal (CF=1 or ZF=1) |
| DA D8+i | FCMOVU ST(0), ST(i) | Move if unordered (PF=1) |
| DB C0+i | FCMOVNB ST(0), ST(i) | Move if not below (CF=0) |
| DB C8+i | FCMOVNE ST(0), ST(i) | Move if not equal (ZF=0) |
| DB D0+i | FCMOVNBE ST(0), ST(i) | Move if not below or equal (CF=0 and ZF=0) |
| DB D8+i | FCMOVNU ST(0), ST(i) | Move if not unordered (PF=0) |

Description

Tests the status flags in the EFLAGS register and moves the source operand (second operand) to the destination operand (first operand) if the given test condition is true. The source operand is always in the ST(i) register and the destination operand is always ST(0).

The FCMOV cc instructions are useful for optimizing small IF constructions. They also help eliminate branching overhead for IF operations and the possibility of branch mispredictions by the processor.

A processor in the Pentium Pro processor family may not support the FCMOV cc instructions. Software can check if the FCMOV cc instructions are supported by checking the processor's feature information with the CPUID instruction (see "[CPUID—CPU Identification](#)" on page 3:428). If both the CMOV and FPU feature bits are set, the FCMOV cc instructions are supported.

Operation

IF condition TRUE
 ST(0) \leftarrow ST(i)
 FI;

FPU Flags Affected

C1 Set to 0 if stack underflow occurred.
 C0, C2, C3 Undefined.

Additional Itanium[®] System Environment Exceptions

Itanium Reg Faults Disabled FP Register Fault if PSR.dfl is 1, NaT Register Consumption Abort.

Floating-point Exceptions

#IS Stack underflow occurred.

Integer Flags Affected

None.



FCMOVcc—Floating-point Conditional Move (Continued)

Protected Mode Exceptions

#NM EM or TS in CR0 is set.

Real Address Mode Exceptions

#NM EM or TS in CR0 is set.

Virtual 8086 Mode Exceptions

#NM EM or TS in CR0 is set.

FCOM/FCOMP/FCOMPP—Compare Real

| Opcode | Instruction | Description |
|---------|----------------------|---|
| D8 /2 | FCOM <i>m32real</i> | Compare ST(0) with <i>m32real</i> . |
| DC /2 | FCOM <i>m64real</i> | Compare ST(0) with <i>m64real</i> . |
| D8 D0+i | FCOM ST(i) | Compare ST(0) with ST(i). |
| D8 D1 | FCOM | Compare ST(0) with ST(1). |
| D8 /3 | FCOMP <i>m32real</i> | Compare ST(0) with <i>m32real</i> and pop register stack. |
| DC /3 | FCOMP <i>m64real</i> | Compare ST(0) with <i>m64real</i> and pop register stack. |
| D8 D8+i | FCOMP ST(i) | Compare ST(0) with ST(i) and pop register stack. |
| D8 D9 | FCOMP | Compare ST(0) with ST(1) and pop register stack. |
| DE D9 | FCOMPP | Compare ST(0) with ST(1) and pop register stack twice. |

Description

Compares the contents of register ST(0) and source value and sets condition code flags C0, C2, and C3 in the FPU status word according to the results (see the table below). The source operand can be a data register or a memory location. If no source operand is given, the value in ST(0) is compared with the value in ST(1). The sign of zero is ignored, so that $-0.0 = +0.0$.

| Condition | C3 | C2 | C0 |
|------------------------|----|----|----|
| ST(0) > SRC | 0 | 0 | 0 |
| ST(0) < SRC | 0 | 0 | 1 |
| ST(0) = SRC | 1 | 0 | 0 |
| Unordered ^a | 1 | 1 | 1 |

a. Flags not set if unmasked invalid-arithmetic-operand (#IA) exception is generated.

This instruction checks the class of the numbers being compared. If either operand is a NaN or is in an unsupported format, an invalid-arithmetic-operand exception (#IA) is raised and, if the exception is masked, the condition flags are set to “unordered.” If the invalid-arithmetic-operand exception is unmasked, the condition code flags are not set.

The FCOMP instruction pops the register stack following the comparison operation and the FCOMPP instruction pops the register stack twice following the comparison operation. To pop the register stack, the processor marks the ST(0) register as empty and increments the stack pointer (TOP) by 1.

The FCOM instructions perform the same operation as the FUCOM instructions. The only difference is how they handle QNaN operands. The FCOM instructions raise an invalid-arithmetic-operand exception (#IA) when either or both of the operands is a NaN value or is in an unsupported format. The FUCOM instructions perform the same operation as the FCOM instructions, except that they do not generate an invalid-arithmetic-operand exception for QNaNs.

FCOM/FCOMP/FCOMPP—Compare Real (Continued)

Operation

```

CASE (relation of operands) OF
  ST > SRC:      C3, C2, C0 ← 000;
  ST < SRC:      C3, C2, C0 ← 001;
  ST = SRC:      C3, C2, C0 ← 100;
ESAC;
IF ST(0) or SRC = NaN or unsupported format
  THEN
    #IA
    IF FPUControlWord.IM = 1
      THEN
        C3, C2, C0 ← 111;
    FI;
  FI;
IF instruction = FCOMP
  THEN
    PopRegisterStack;
  FI;
IF instruction = FCOMPP
  THEN
    PopRegisterStack;
    PopRegisterStack;
  FI;

```

FPU Flags Affected

C1 Set to 0 if stack underflow occurred; otherwise, cleared to 0.

C0, C2, C3 See table on previous page.

Additional Itanium® System Environment Exceptions

Itanium Reg Faults Disabled FP Register Fault if PSR.dfl is 1, NaT Register Consumption Abort.

Itanium Mem Faults VHPT Data Fault, Nested TLB Fault, Data TLB Fault, Alternate Data TLB Fault, Data Page Not Present Fault, Data NaT Page Consumption Abort, Data Key Miss Fault, Data Key Permission Fault, Data Access Rights Fault, Data Access Bit Fault, Data Dirty Bit Fault

Floating-point Exceptions

#IS Stack underflow occurred.

#IA One or both operands are NaN values or have unsupported formats.
 Register is marked empty.

#D One or both operands are denormal values.

FCOM/FCOMP/FCOMPP—Compare Real (Continued)

Protected Mode Exceptions

| | |
|-----------------|--|
| #GP(0) | If a memory operand effective address is outside the CS, DS, ES, FS, or GS segment limit. If the DS, ES, FS, or GS register contains a null segment selector. |
| #SS(0) | If a memory operand effective address is outside the SS segment limit. |
| #NM | EM or TS in CR0 is set. |
| #PF(fault-code) | If a page fault occurs. |
| #AC(0) | If alignment checking is enabled and an unaligned memory reference is made while the current privilege level is 3. |

Real Address Mode Exceptions

| | |
|-----|---|
| #GP | If a memory operand effective address is outside the CS, DS, ES, FS, or GS segment limit. |
| #SS | If a memory operand effective address is outside the SS segment limit. |
| #NM | EM or TS in CR0 is set. |

Virtual 8086 Mode Exceptions

| | |
|-----------------|---|
| #GP(0) | If a memory operand effective address is outside the CS, DS, ES, FS, or GS segment limit. |
| #SS(0) | If a memory operand effective address is outside the SS segment limit. |
| #NM | EM or TS in CR0 is set. |
| #PF(fault-code) | If a page fault occurs. |
| #AC(0) | If alignment checking is enabled and an unaligned memory reference is made. |

FCOMI/FCOMIP/FUCOMI/FUCOMIP—Compare Real and Set EFLAGS

| Opcode | Instruction | Description |
|---------|----------------------------|---|
| DB F0+i | FCOMI ST, ST(<i>i</i>) | Compare ST(0) with ST(<i>i</i>) and set status flags accordingly |
| DF F0+i | FCOMIP ST, ST(<i>i</i>) | Compare ST(0) with ST(<i>i</i>), set status flags accordingly, and pop register stack |
| DB E8+i | FUCOMI ST, ST(<i>i</i>) | Compare ST(0) with ST(<i>i</i>), check for ordered values, and set status flags accordingly |
| DF E8+i | FUCOMIP ST, ST(<i>i</i>) | Compare ST(0) with ST(<i>i</i>), check for ordered values, set status flags accordingly, and pop register stack |

Description

Compares the contents of register ST(0) and ST(*i*) and sets the status flags ZF, PF, and CF in the EFLAGS register according to the results (see the table below). The sign of zero is ignored for comparisons, so that $-0.0 = +0.0$.

| Comparison Results | ZF | PF | CF |
|------------------------|----|----|----|
| ST0 > ST(<i>i</i>) | 0 | 0 | 0 |
| ST0 < ST(<i>i</i>) | 0 | 0 | 1 |
| ST0 = ST(<i>i</i>) | 1 | 0 | 0 |
| Unordered ^a | 1 | 1 | 1 |

a. Flags not set if unmasked invalid-arithmetic-operand (#IA) exception is generated.

The FCOMI/FCOMIP instructions perform the same operation as the FUCOMI/FUCOMIP instructions. The only difference is how they handle QNaN operands. The FCOMI/FCOMIP instructions set the status flags to “unordered” and generate an invalid-arithmetic-operand exception (#IA) when either or both of the operands is a NaN value (SNaN or QNaN) or is in an unsupported format.

The FUCOMI/FUCOMIP instructions perform the same operation as the FCOMI/FCOMIP instructions, except that they do not generate an invalid-arithmetic-operand exception for QNaNs.

If invalid-operation exception is unmasked, the status flags are not set if the invalid-arithmetic-operand exception is generated.

The FCOMIP and FUCOMIP instructions also pop the register stack following the comparison operation. To pop the register stack, the processor marks the ST(0) register as empty and increments the stack pointer (TOP) by 1.

FCOMI/FCOMIP/FUCOMI/FUCOMIP—Compare Real and Set EFLAGS (Continued)

Operation

```

CASE (relation of operands) OF
  ST(0) > ST(j):  ZF, PF, CF ← 000;
  ST(0) < ST(j):  ZF, PF, CF ← 001;
  ST(0) = ST(j):  ZF, PF, CF ← 100;
ESAC;
IF instruction is FCOMI or FCOMIP
  THEN
    IF ST(0) or ST(j) = NaN or unsupported format
      THEN
        #IA
        IF FPUControlWord.IM = 1
          THEN
            ZF, PF, CF ← 111;
          FI;
        FI;
  FI;
IF instruction is FUCOMI or FUCOMIP
  THEN
    IF ST(0) or ST(j) = QNaN, but not SNaN or unsupported format
      THEN
        ZF, PF, CF ← 111;
      ELSE (* ST(0) or ST(j) is SNaN or unsupported format *)
        #IA;
        IF FPUControlWord.IM = 1
          THEN
            ZF, PF, CF ← 111;
          FI;
        FI;
  FI;
IF instruction is FCOMIP or FUCOMIP
  THEN
    PopRegisterStack;
  FI;

```

FPU Flags Affected

C1 Set to 0 if stack underflow occurred; otherwise, cleared to 0.
C0, C2, C3 Not affected.

Additional Itanium® System Environment Exceptions

Itanium Reg Faults Disabled FP Register Fault if PSR.dfl is 1, NaT Register Consumption Abort.

FCOMI/FCOMIP/FUCOMI/FUCOMIP—Compare Real and Set EFLAGS (Continued)

Floating-point Exceptions

| | |
|-----|--|
| #IS | Stack underflow occurred. |
| #IA | (FCOMI or FCOMIP instruction) One or both operands are NaN values or have unsupported formats. (FUCOMI or FUCOMIP instruction) One or both operands are SNaN values (but not QNaNs) or have undefined formats. Detection of a QNaN value does not raise an invalid-operand exception. |

Protected Mode Exceptions

| | |
|-----|-------------------------|
| #NM | EM or TS in CR0 is set. |
|-----|-------------------------|

Real Address Mode Exceptions

| | |
|-----|-------------------------|
| #NM | EM or TS in CR0 is set. |
|-----|-------------------------|

Virtual 8086 Mode Exceptions

| | |
|-----|--------------------------|
| #NM | EM or TS in CR0 is set./ |
|-----|--------------------------|

FCOS—Cosine

| Opcode | Instruction | Description |
|--------|-------------|-------------------------------|
| D9 FF | FCOS | Replace ST(0) with its cosine |

Description

Calculates the cosine of the source operand in register ST(0) and stores the result in ST(0). The source operand must be given in radians and must be within the range -2^{63} to $+2^{63}$. The following table shows the results obtained when taking the cosine of various classes of numbers, assuming that neither overflow nor underflow occurs.

| ST(0) SRC | ST(0) DEST |
|-----------|------------|
| $-\infty$ | * |
| -F | -1 to +1 |
| -0 | +1 |
| +0 | +1 |
| +F | -1 to +1 |
| $+\infty$ | * |
| NaN | NaN |

Notes:

F means finite-real number.

* indicates floating-point invalid-arithmetic-operand (#IA) exception.

If the source operand is outside the acceptable range, the C2 flag in the FPU status word is set, and the value in register ST(0) remains unchanged. The instruction does not raise an exception when the source operand is out of range. It is up to the program to check the C2 flag for out-of-range conditions. Source values outside the range -2^{63} to $+2^{63}$ can be reduced to the range of the instruction by subtracting an appropriate integer multiple of 2π or by using the FPREM instruction with a divisor of 2π .

Operation

```

IF |ST(0)| < 263
THEN
    C2 ← 0;
    ST(0) ← cosine(ST(0));
ELSE (*source operand is out-of-range *)
    C2 ← 1;
FI;

```

FCOS—Cosine (Continued)

FPU Flags Affected

| | |
|--------|--|
| C1 | Set to 0 if stack underflow occurred. Indicates rounding direction if the inexact-result exception (#P) is generated: 0 = not roundup; 1 = roundup. Undefined if C2 is 1. |
| C2 | Set to 1 if source operand is outside the range -2^{63} to $+2^{63}$; otherwise, cleared to 0. |
| C0, C3 | Undefined. |

Additional Itanium® System Environment Exceptions

Itanium Reg Faults Disabled FP Register Fault if PSR.dfl is 1, NaT Register Consumption Abort.

Floating-point Exceptions

| | |
|-----|--|
| #IS | Stack underflow occurred. |
| #IA | Source operand is an SNaN value, ∞ , or unsupported format. |
| #D | Result is a denormal value. |
| #U | Result is too small for destination format. |
| #P | Value cannot be represented exactly in destination format. |

Protected Mode Exceptions

| | |
|-----|-------------------------|
| #NM | EM or TS in CR0 is set. |
|-----|-------------------------|

Real Address Mode Exceptions

| | |
|-----|-------------------------|
| #NM | EM or TS in CR0 is set. |
|-----|-------------------------|

Virtual 8086 Mode Exceptions

| | |
|-----|-------------------------|
| #NM | EM or TS in CR0 is set. |
|-----|-------------------------|

FDECSTP—Decrement Stack-Top Pointer

| Opcode | Instruction | Description |
|--------|-------------|---|
| D9 F6 | FDECSTP | Decrement TOP field in FPU status word. |

Description

Subtracts one from the TOP field of the FPU status word (decrements the top-of-stack pointer). The contents of the FPU data registers and tag register are not affected.

Operation

```
IF TOP = 0
  THEN TOP ← 7;
  ELSE TOP ← TOP – 1;
FI;
```

FPU Flags Affected

The C1 flag is set to 0; otherwise, cleared to 0. The C0, C2, and C3 flags are undefined.

Floating-point Exceptions

None.

Additional Itanium® System Environment Exceptions

Itanium Reg Faults Disabled FP Register Fault if PSR.dfl is 1, NaT Register Consumption Abort.

Protected Mode Exceptions

#NM EM or TS in CR0 is set.

Real Address Mode Exceptions

#NM EM or TS in CR0 is set.

Virtual 8086 Mode Exceptions

#NM EM or TS in CR0 is set.

FDIV/FDIVP/FIDIV—Divide

| Opcode | Instruction | Description |
|---------|-----------------------------|--|
| D8 /6 | FDIV <i>m32real</i> | Divide ST(0) by <i>m32real</i> and store result in ST(0) |
| DC /6 | FDIV <i>m64real</i> | Divide ST(0) by <i>m64real</i> and store result in ST(0) |
| D8 F0+i | FDIV ST(0), ST(<i>i</i>) | Divide ST(0) by ST(<i>i</i>) and store result in ST(0) |
| DC F8+i | FDIV ST(<i>i</i>), ST(0) | Divide ST(<i>i</i>) by ST(0) and store result in ST(<i>i</i>) |
| DE F8+i | FDIVP ST(<i>i</i>), ST(0) | Divide ST(<i>i</i>) by ST(0), store result in ST(<i>i</i>), and pop the register stack |
| DE F9 | FDIVP | Divide ST(1) by ST(0), store result in ST(1), and pop the register stack |
| DA /6 | FIDIV <i>m32int</i> | Divide ST(0) by <i>m32int</i> and store result in ST(0) |
| DE /6 | FIDIV <i>m64int</i> | Divide ST(0) by <i>m64int</i> and store result in ST(0) |

Description

Divides the destination operand by the source operand and stores the result in the destination location. The destination operand (dividend) is always in an FPU register; the source operand (divisor) can be a register or a memory location. Source operands in memory can be in single-real, double-real, word-integer, or short-integer formats.

The no-operand version of the instruction divides the contents of the ST(1) register by the contents of the ST(0) register. The one-operand version divides the contents of the ST(0) register by the contents of a memory location (either a real or an integer value). The two-operand version, divides the contents of the ST(0) register by the contents of the ST(*i*) register or vice versa.

The FDIVP instructions perform the additional operation of popping the FPU register stack after storing the result. To pop the register stack, the processor marks the ST(0) register as empty and increments the stack pointer (TOP) by 1. The no-operand version of the floating-point divide instructions always results in the register stack being popped. In some assemblers, the mnemonic for this instruction is FDIV rather than FDIVP.

The FIDIV instructions convert an integer source operand to extended-real format before performing the division. When the source operand is an integer 0, it is treated as a +0.

If an unmasked divide by zero exception (#Z) is generated, no result is stored; if the exception is masked, an ∞ of the appropriate sign is stored in the destination operand.

The following table shows the results obtained when dividing various classes of numbers, assuming that neither overflow nor underflow occurs.

FDIV/FDIVP/FIDIV—Divide (Continued)

| | | DEST | | | | | | |
|-----|-----|------|-----|-----|-----|-----|-----|-----|
| | | -* | -F | -0 | +0 | +F | +∞ | NaN |
| SRC | -∞ | * | +0 | +0 | -0 | -0 | * | NaN |
| | -F | +∞ | +F | +0 | -0 | -F | -* | NaN |
| | -I | +∞ | +F | +0 | -0 | -F | -* | NaN |
| | -0 | +∞ | ** | * | * | ** | -* | NaN |
| | +0 | -* | ** | * | * | ** | +∞ | NaN |
| | +I | -* | -F | -0 | +0 | +F | +∞ | NaN |
| | +F | -* | -F | -0 | +0 | +F | +∞ | NaN |
| | +∞ | * | -0 | -0 | +0 | +0 | * | NaN |
| | NaN | NaN | NaN | NaN | NaN | NaN | NaN | NaN |

Notes:

F means finite-real number.

I means integer.

* indicates floating-point invalid-arithmetic-operand (#IA) exception.

** indicates floating-point zero-divide (#Z) exception.

Operation

IF SRC = 0

THEN

#Z

ELSE

IF instruction is FIDIV

THEN

DEST ← DEST / ConvertExtendedReal(SRC);

ELSE (* source operand is real number *)

DEST ← DEST / SRC;

FI;

FI;

IF instruction = FDIVP

THEN

PopRegisterStack

FI;

FPU Flags Affected

C1 Set to 0 if stack underflow occurred.

Indicates rounding direction if the inexact-result exception (#P) is generated:
0 = not roundup; 1 = roundup.

C0, C2, C3 Undefined.

FDIV/FDIVP/FIDIV—Divide (Continued)

Additional Itanium® System Environment Exceptions

| | |
|--------------------|--|
| Itanium Reg Faults | Disabled FP Register Fault if PSR.dfl is 1, NaT Register Consumption Abort. |
| Itanium Mem Faults | VHPT Data Fault, Nested TLB Fault, Data TLB Fault, Alternate Data TLB Fault, Data Page Not Present Fault, Data NaT Page Consumption Abort, Data Key Miss Fault, Data Key Permission Fault, Data Access Rights Fault, Data Access Bit Fault, Data Dirty Bit Fault |

Floating-point Exceptions

| | |
|-----|---|
| #IS | Stack underflow occurred. |
| #IA | Operand is an SNaN value or unsupported format. $\pm\infty / \pm\infty; \pm 0 / \pm 0$ |
| #D | Result is a denormal value. |
| #Z | DEST / ± 0 , where DEST is not equal to ± 0 . |
| #U | Result is too small for destination format. |
| #O | Result is too large for destination format. |
| #P | Value cannot be represented exactly in destination format. |

Protected Mode Exceptions

| | |
|-----------------|--|
| #GP(0) | If a memory operand effective address is outside the CS, DS, ES, FS, or GS segment limit. If the DS, ES, FS, or GS register contains a null segment selector. |
| #SS(0) | If a memory operand effective address is outside the SS segment limit. |
| #NM | EM or TS in CR0 is set. |
| #PF(fault-code) | If a page fault occurs. |
| #AC(0) | If alignment checking is enabled and an unaligned memory reference is made while the current privilege level is 3. |

Real Address Mode Exceptions

| | |
|-----|---|
| #GP | If a memory operand effective address is outside the CS, DS, ES, FS, or GS segment limit. |
| #SS | If a memory operand effective address is outside the SS segment limit. |
| #NM | EM or TS in CR0 is set. |

Virtual 8086 Mode Exceptions

| | |
|-----------------|---|
| #GP(0) | If a memory operand effective address is outside the CS, DS, ES, FS, or GS segment limit. |
| #SS(0) | If a memory operand effective address is outside the SS segment limit. |
| #NM | EM or TS in CR0 is set. |
| #PF(fault-code) | If a page fault occurs. |
| #AC(0) | If alignment checking is enabled and an unaligned memory reference is made. |

FDIVR/FDIVRP/FIDIVR—Reverse Divide

| Opcode | Instruction | Description |
|---------|------------------------------|--|
| D8 /7 | FDIVR <i>m32real</i> | Divide <i>m32real</i> by ST(0) and store result in ST(0) |
| DC /7 | FDIVR <i>m64real</i> | Divide <i>m64real</i> by ST(0) and store result in ST(0) |
| D8 F8+i | FDIVR ST(0), ST(<i>i</i>) | Divide ST(<i>i</i>) by ST(0) and store result in ST(0) |
| DC F0+i | FDIVR ST(<i>i</i>), ST(0) | Divide ST(0) by ST(<i>i</i>) and store result in ST(<i>i</i>) |
| DE F0+i | FDIVRP ST(<i>i</i>), ST(0) | Divide ST(0) by ST(<i>i</i>), store result in ST(<i>i</i>), and pop the register stack |
| DE F1 | FDIVRP | Divide ST(0) by ST(1), store result in ST(1), and pop the register stack |
| DA /7 | FIDIVR <i>m32int</i> | Divide <i>m32int</i> by ST(0) and store result in ST(0) |
| DE /7 | FIDIVR <i>m16int</i> | Divide <i>m16int</i> by ST(0) and store result in ST(0) |

Description

Divides the source operand by the destination operand and stores the result in the destination location. The destination operand (divisor) is always in an FPU register; the source operand (dividend) can be a register or a memory location. Source operands in memory can be in single-real, double-real, word-integer, or short-integer formats.

These instructions perform the reverse operations of the FDIV, FDIVP, and FIDIV instructions. They are provided to support more efficient coding.

The no-operand version of the instruction divides the contents of the ST(0) register by the contents of the ST(1) register. The one-operand version divides the contents of a memory location (either a real or an integer value) by the contents of the ST(0) register. The two-operand version, divides the contents of the ST(*i*) register by the contents of the ST(0) register or vice versa.

The FDIVRP instructions perform the additional operation of popping the FPU register stack after storing the result. To pop the register stack, the processor marks the ST(0) register as empty and increments the stack pointer (TOP) by 1. The no-operand version of the floating-point divide instructions always results in the register stack being popped. In some assemblers, the mnemonic for this instruction is FDIVR rather than FDIVRP.

The FIDIVR instructions convert an integer source operand to extended-real format before performing the division.

If an unmasked divide by zero exception (#Z) is generated, no result is stored; if the exception is masked, an ∞ of the appropriate sign is stored in the destination operand.

The following table shows the results obtained when dividing various classes of numbers, assuming that neither overflow nor underflow occurs.

FDIVR/FDIVRP/FIDIVR—Reverse Divide (Continued)

| | | DEST | | | | | | |
|-----|-----------|-----------|-----------|-----------|-----------|-----------|-----------|-----|
| | | $-\infty$ | -F | -0 | +0 | +F | $+\infty$ | NaN |
| SRC | $-\infty$ | * | $+\infty$ | $+\infty$ | -* | $-\infty$ | * | NaN |
| | -F | +0 | +F | ** | ** | -F | -0 | NaN |
| | -I | +0 | +F | ** | ** | -F | -0 | NaN |
| | -0 | +0 | +0 | * | * | -0 | -0 | NaN |
| | +0 | -0 | -0 | * | * | +0 | +0 | NaN |
| | +I | -0 | -F | ** | ** | +F | $+\infty$ | NaN |
| | +F | -0 | -F | ** | ** | +F | $+\infty$ | NaN |
| | $+\infty$ | * | $-\infty$ | $-\infty$ | $+\infty$ | $+\infty$ | * | NaN |
| | NaN | NaN | NaN | NaN | NaN | NaN | NaN | NaN |

Notes:

F means finite-real number.

I means integer.

* indicates floating-point invalid-arithmetic-operand (#IA) exception.

** indicates floating-point zero-divide (#Z) exception.

When the source operand is an integer 0, it is treated as a +0.

Operation

IF DEST = 0

THEN

#Z

ELSE

IF instruction is FIDIVR

THEN

DEST ← ConvertExtendedReal(SRC) / DEST;

ELSE (* source operand is real number *)

DEST ← SRC / DEST;

FI;

FI;

IF instruction = FDIVRP

THEN

PopRegisterStack

FI;

FPU Flags Affected

C1 Set to 0 if stack underflow occurred.

Indicates rounding direction if the inexact-result exception (#P) is generated:
0 = not roundup; 1 = roundup.

C0, C2, C3 Undefined.

FDIVR/FDIVRP/FIDIVR—Reverse Divide (Continued)

Additional Itanium® System Environment Exceptions

| | |
|--------------------|--|
| Itanium Reg Faults | Disabled FP Register Fault if PSR.dfl is 1, NaT Register Consumption Abort. |
| Itanium Mem Faults | VHPT Data Fault, Nested TLB Fault, Data TLB Fault, Alternate Data TLB Fault, Data Page Not Present Fault, Data NaT Page Consumption Abort, Data Key Miss Fault, Data Key Permission Fault, Data Access Rights Fault, Data Access Bit Fault, Data Dirty Bit Fault |

Floating-point Exceptions

| | |
|-----|---|
| #IS | Stack underflow occurred. |
| #IA | Operand is an SNaN value or unsupported format. $\pm\infty / \pm\infty; \pm 0 / \pm 0$ |
| #D | Result is a denormal value. |
| #Z | SRC / ± 0 , where SRC is not equal to ± 0 . |
| #U | Result is too small for destination format. |
| #O | Result is too large for destination format. |
| #P | Value cannot be represented exactly in destination format. |

Protected Mode Exceptions

| | |
|-----------------|--|
| #GP(0) | If a memory operand effective address is outside the CS, DS, ES, FS, or GS segment limit. If the DS, ES, FS, or GS register contains a null segment selector. |
| #SS(0) | If a memory operand effective address is outside the SS segment limit. |
| #NM | EM or TS in CR0 is set. |
| #PF(fault-code) | If a page fault occurs. |
| #AC(0) | If alignment checking is enabled and an unaligned memory reference is made while the current privilege level is 3. |

Real Address Mode Exceptions

| | |
|-----|---|
| #GP | If a memory operand effective address is outside the CS, DS, ES, FS, or GS segment limit. |
| #SS | If a memory operand effective address is outside the SS segment limit. |
| #NM | EM or TS in CR0 is set. |

Virtual 8086 Mode Exceptions

| | |
|-----------------|---|
| #GP(0) | If a memory operand effective address is outside the CS, DS, ES, FS, or GS segment limit. |
| #SS(0) | If a memory operand effective address is outside the SS segment limit. |
| #NM | EM or TS in CR0 is set. |
| #PF(fault-code) | If a page fault occurs. |
| #AC(0) | If alignment checking is enabled and an unaligned memory reference is made. |

FFREE—Free Floating-point Register

| Opcode | Instruction | Description |
|---------|----------------------|--------------------------------------|
| DD C0+i | FFREE ST(<i>i</i>) | Sets tag for ST(<i>i</i>) to empty |

Description

Sets the tag in the FPU tag register associated with register ST(*i*) to empty (11B). The contents of ST(*i*) and the FPU stack-top pointer (TOP) are not affected.

Operation

$TAG(i) \leftarrow 11B;$

FPU Flags Affected

C0, C1, C2, C3 undefined.

Floating-point Exceptions

None.

Additional Itanium[®] System Environment Exceptions

Itanium Reg Faults Disabled FP Register Fault if PSR.dfl is 1.

Protected Mode Exceptions

#NM EM or TS in CR0 is set.

Real Address Mode Exceptions

#NM EM or TS in CR0 is set.

Virtual 8086 Mode Exceptions

#NM EM or TS in CR0 is set.

FICOM/FICOMP—Compare Integer

| Opcode | Instruction | Description |
|--------|----------------------|---|
| DE /2 | FICOM <i>m16int</i> | Compare ST(0) with <i>m16int</i> |
| DA /2 | FICOM <i>m32int</i> | Compare ST(0) with <i>m32int</i> |
| DE /3 | FICOMP <i>m16int</i> | Compare ST(0) with <i>m16int</i> and pop stack register |
| DA /3 | FICOMP <i>m32int</i> | Compare ST(0) with <i>m32int</i> and pop stack register |

Description

Compares the value in ST(0) with an integer source operand and sets the condition code flags C0, C2, and C3 in the FPU status word according to the results (see table below). The integer value is converted to extended-real format before the comparison is made.

| Condition | C3 | C2 | C0 |
|-------------|----|----|----|
| ST(0) > SRC | 0 | 0 | 0 |
| ST(0) < SRC | 0 | 0 | 1 |
| ST(0) = SRC | 1 | 0 | 0 |
| Unordered | 1 | 1 | 1 |

These instructions perform an “unordered comparison.” An unordered comparison also checks the class of the numbers being compared. If either operand is a NaN or is in an undefined format, the condition flags are set to “unordered.”

The sign of zero is ignored, so that $-0.0 = +0.0$.

The FICOMP instructions pop the register stack following the comparison. To pop the register stack, the processor marks the ST(0) register empty and increments the stack pointer (TOP) by 1.

Operation

CASE (relation of operands) OF
 ST(0) > SRC: C3, C2, C0 ← 000;
 ST(0) < SRC: C3, C2, C0 ← 001;
 ST(0) = SRC: C3, C2, C0 ← 100;
 Unordered: C3, C2, C0 ← 111;

ESAC;

IF instruction = FICOMP

THEN

PopRegisterStack;

FI;

FPU Flags Affected

C1 Set to 0 if stack underflow occurred; otherwise, set to 0.

C0, C2, C3 See table on previous page.

FICOM/FICOMP—Compare Integer (Continued)

Additional Itanium® System Environment Exceptions

| | |
|--------------------|--|
| Itanium Reg Faults | Disabled FP Register Fault if PSR.dfl is 1, NaT Register Consumption Abort. |
| Itanium Mem Faults | VHPT Data Fault, Nested TLB Fault, Data TLB Fault, Alternate Data TLB Fault, Data Page Not Present Fault, Data NaT Page Consumption Abort, Data Key Miss Fault, Data Key Permission Fault, Data Access Rights Fault, Data Access Bit Fault, Data Dirty Bit Fault |

Floating-point Exceptions

| | |
|-----|--|
| #IS | Stack underflow occurred. |
| #IA | One or both operands are NaN values or have unsupported formats. |
| #D | One or both operands are denormal values. |

Protected Mode Exceptions

| | |
|-----------------|--|
| #GP(0) | If a memory operand effective address is outside the CS, DS, ES, FS, or GS segment limit. If the DS, ES, FS, or GS register contains a null segment selector. |
| #SS(0) | If a memory operand effective address is outside the SS segment limit. |
| #NM | EM or TS in CR0 is set. |
| #PF(fault-code) | If a page fault occurs. |
| #AC(0) | If alignment checking is enabled and an unaligned memory reference is made while the current privilege level is 3. |

Real Address Mode Exceptions

| | |
|-----|---|
| #GP | If a memory operand effective address is outside the CS, DS, ES, FS, or GS segment limit. |
| #SS | If a memory operand effective address is outside the SS segment limit. |
| #NM | EM or TS in CR0 is set. |

Virtual 8086 Mode Exceptions

| | |
|-----------------|---|
| #GP(0) | If a memory operand effective address is outside the CS, DS, ES, FS, or GS segment limit. |
| #SS(0) | If a memory operand effective address is outside the SS segment limit. |
| #NM | EM or TS in CR0 is set. |
| #PF(fault-code) | If a page fault occurs. |
| #AC(0) | If alignment checking is enabled and an unaligned memory reference is made. |

FILD—Load Integer

| Opcode | Instruction | Description |
|--------|--------------------|---|
| DF /0 | FILD <i>m16int</i> | Push <i>m16int</i> onto the FPU register stack. |
| DB /0 | FILD <i>m32int</i> | Push <i>m32int</i> onto the FPU register stack. |
| DF /5 | FILD <i>m64int</i> | Push <i>m64int</i> onto the FPU register stack. |

Description

Converts the signed-integer source operand into extended-real format and pushes the value onto the FPU register stack. The source operand can be a word, short, or long integer value. It is loaded without rounding errors. The sign of the source operand is preserved.

Operation

$TOP \leftarrow TOP - 1;$
 $ST(0) \leftarrow ExtendedReal(SRC);$

FPU Flags Affected

C1 Set to 1 if stack overflow occurred; cleared to 0 otherwise.
 C0, C2, C3 Undefined.

Additional Itanium® System Environment Exceptions

Itanium Reg Faults Disabled FP Register Fault if PSR.dfl is 1, NaT Register Consumption Abort.
 Itanium Mem Faults VHPT Data Fault, Nested TLB Fault, Data TLB Fault, Alternate Data TLB Fault, Data Page Not Present Fault, Data NaT Page Consumption Abort, Data Key Miss Fault, Data Key Permission Fault, Data Access Rights Fault, Data Access Bit Fault, Data Dirty Bit Fault

Floating-point Exceptions

#IS Stack overflow occurred.

Protected Mode Exceptions

#GP(0) If a memory operand effective address is outside the CS, DS, ES, FS, or GS segment limit.
 If the DS, ES, FS, or GS register contains a null segment selector.
 #SS(0) If a memory operand effective address is outside the SS segment limit.
 #NM EM or TS in CR0 is set.
 #PF(fault-code) If a page fault occurs.
 #AC(0) If alignment checking is enabled and an unaligned memory reference is made while the current privilege level is 3.

FILD—Load Integer (Continued)**Real Address Mode Exceptions**

| | |
|-----|---|
| #GP | If a memory operand effective address is outside the CS, DS, ES, FS, or GS segment limit. |
| #SS | If a memory operand effective address is outside the SS segment limit. |
| #NM | EM or TS in CR0 is set. |

Virtual 8086 Mode Exceptions

| | |
|-----------------|---|
| #GP(0) | If a memory operand effective address is outside the CS, DS, ES, FS, or GS segment limit. |
| #SS(0) | If a memory operand effective address is outside the SS segment limit. |
| #NM | EM or TS in CR0 is set. |
| #PF(fault-code) | If a page fault occurs. |
| #AC(0) | If alignment checking is enabled and an unaligned memory reference is made. |

FINCSTP—Increment Stack-Top Pointer

| Opcode | Instruction | Description |
|--------|-------------|--|
| D9 F7 | FINCSTP | Increment the TOP field in the FPU status register |

Description

Adds one to the TOP field of the FPU status word (increments the top-of-stack pointer). The contents of the FPU data registers and tag register are not affected. This operation is not equivalent to popping the stack, because the tag for the previous top-of-stack register is not marked empty.

Operation

```
IF TOP = 7
  THEN TOP ← 0;
  ELSE TOP ← TOP + 1;
FI;
```

FPU Flags Affected

The C1 flag is set to 0; otherwise, generates an #IS fault. The C0, C2, and C3 flags are undefined.

Floating-point Exceptions

#IS

Additional Itanium® System Environment Exceptions

Itanium Reg Faults Disabled FP Register Fault if PSR.dfl is 1.

Protected Mode Exceptions

#NM EM or TS in CR0 is set.

Real Address Mode Exceptions

#NM EM or TS in CR0 is set.

Virtual 8086 Mode Exceptions

#NM EM or TS in CR0 is set.

FINIT/FNINIT—Initialize Floating-point Unit

| Opcode | Instruction | Description |
|----------|-------------|---|
| 9B DB E3 | FINIT | Initialize FPU after checking for pending unmasked floating-point exceptions. |
| DB E3 | FNINIT | Initialize FPU without checking for pending unmasked floating-point exceptions. |

Description

Sets the FPU control, status, tag, instruction pointer, and data pointer registers to their default states. The FPU control word is set to 037FH (round to nearest, all exceptions masked, 64-bit precision). The status word is cleared (no exception flags set, TOP is set to 0). The data registers in the register stack are left unchanged, but they are all tagged as empty (11B). Both the instruction and data pointers are cleared.

The FINIT instruction checks for and handles any pending unmasked floating-point exceptions before performing the initialization; the FNINIT instruction does not.

Operation

$FPUControlWord \leftarrow 037FH;$
 $FPUStatusWord \leftarrow 0;$
 $FPUTagWord \leftarrow FFFFH;$
 $FPUDataPointer \leftarrow 0;$
 $FPUInstructionPointer \leftarrow 0;$
 $FPULastInstructionOpcode \leftarrow 0;$

FPU Flags Affected

C0, C1, C2, C3 cleared to 0.

Floating-point Exceptions

None.

Additional Itanium® System Environment Exceptions

Itanium Reg Faults Disabled FP Register Fault if PSR.dfl is 1.

Protected Mode Exceptions

#NM EM or TS in CR0 is set.

Real Address Mode Exceptions

#NM EM or TS in CR0 is set.

Virtual 8086 Mode Exceptions

#NM EM or TS in CR0 is set.

FIST/FISTP—Store Integer

| Opcode | Instruction | Description |
|--------|---------------------|---|
| DF /2 | FIST <i>m16int</i> | Store ST(0) in <i>m16int</i> |
| DB /2 | FIST <i>m32int</i> | Store ST(0) in <i>m32int</i> |
| DF /3 | FISTP <i>m16int</i> | Store ST(0) in <i>m16int</i> and pop register stack |
| DB /3 | FISTP <i>m32int</i> | Store ST(0) in <i>m32int</i> and pop register stack |
| DF /7 | FISTP <i>m64int</i> | Store ST(0) in <i>m64int</i> and pop register stack |

Description

The FIST instruction converts the value in the ST(0) register to a signed integer and stores the result in the destination operand. Values can be stored in word- or short-integer format. The destination operand specifies the address where the first byte of the destination value is to be stored.

The FISTP instruction performs the same operation as the FIST instruction and then pops the register stack. To pop the register stack, the processor marks the ST(0) register as empty and increments the stack pointer (TOP) by 1. The FISTP instruction can also store values in long-integer format.

The following table shows the results obtained when storing various classes of numbers in integer format.

| ST(0) | DEST |
|----------------|------|
| $-\infty$ | * |
| $-F < -1$ | - |
| $-1 < -F < -0$ | ** |
| -0 | 0 |
| +0 | 0 |
| $+0 < +F < +1$ | ** |
| $+F > +1$ | + |
| $+\infty$ | * |
| NaN | * |

Notes:

F means finite-real number.

| means integer.

* indicates floating-point invalid-operation (#IA) exception.

** ± 0 or ± 1 , depending on the rounding mode.

If the source value is a non-integral value, it is rounded to an integer value, according to the rounding mode specified by the RC field of the FPU control word.

If the value being stored is too large for the destination format, is an ∞ , is a NaN, or is in an unsupported format and if the invalid-arithmetic-operand exception (#IA) is unmasked, an invalid-operation exception is generated and no value is stored in the destination operand. If the invalid-operation exception is masked, the integer indefinite value is stored in the destination operand.

FIST/FISTP—Store Integer (Continued)

Operation

```
DEST ← Integer(ST(0));
IF instruction = FISTP
  THEN
    PopRegisterStack;
FI;
```

FPU Flags Affected

| | |
|------------|--|
| C1 | Set to 0 if stack underflow occurred. Indicates rounding direction of if the inexact exception (#P) is generated: 0 = not roundup; 1 = roundup. Cleared to 0 otherwise. |
| C0, C2, C3 | Undefined. |

Additional Itanium® System Environment Exceptions

| | |
|--------------------|--|
| Itanium Reg Faults | Disabled FP Register Fault if PSR.dfl is 1, NaT register Consumption Abort. |
| Itanium Mem Faults | VHPT Data Fault, Nested TLB Fault, Data TLB Fault, Alternate Data TLB Fault, Data Page Not Present Fault, Data NaT Page Consumption Abort, Data Key Miss Fault, Data Key Permission Fault, Data Access Rights Fault, Data Access Bit Fault, Data Dirty Bit Fault |

Floating-point Exceptions

| | |
|-----|--|
| #IS | Stack underflow occurred. |
| #IA | Source operand is too large for the destination format Source operand is a NaN value or unsupported format. |
| #P | Value cannot be represented exactly in destination format. |

Protected Mode Exceptions

| | |
|-----------------|---|
| #GP(0) | If the destination is located in a nonwritable segment. If a memory operand effective address is outside the CS, DS, ES, FS, or GS segment limit. If the DS, ES, FS, or GS register is used to access memory and it contains a null segment selector. |
| #SS(0) | If a memory operand effective address is outside the SS segment limit. |
| #NM | EM or TS in CR0 is set. |
| #PF(fault-code) | If a page fault occurs. |
| #AC(0) | If alignment checking is enabled and an unaligned memory reference is made while the current privilege level is 3. |

FIST/FISTP—Store Integer (Continued)

Real Address Mode Exceptions

| | |
|-----|---|
| #GP | If a memory operand effective address is outside the CS, DS, ES, FS, or GS segment limit. |
| #SS | If a memory operand effective address is outside the SS segment limit. |
| #NM | EM or TS in CR0 is set. |

Virtual 8086 Mode Exceptions

| | |
|-----------------|---|
| #GP(0) | If a memory operand effective address is outside the CS, DS, ES, FS, or GS segment limit. |
| #SS(0) | If a memory operand effective address is outside the SS segment limit. |
| #NM | EM or TS in CR0 is set. |
| #PF(fault-code) | If a page fault occurs. |
| #AC(0) | If alignment checking is enabled and an unaligned memory reference is made. |

FLD—Load Real

| Opcode | Instruction | Description |
|---------|--------------------|--|
| D9 /0 | FLD <i>m32real</i> | Push <i>m32real</i> onto the FPU register stack. |
| DD /0 | FLD <i>m64real</i> | Push <i>m64real</i> onto the FPU register stack. |
| DB /5 | FLD <i>m80real</i> | Push <i>m80real</i> onto the FPU register stack. |
| D9 C0+i | FLD ST(<i>i</i>) | Push ST(<i>i</i>) onto the FPU register stack. |

Description

Pushes the source operand onto the FPU register stack. If the source operand is in single- or double-real format, it is automatically converted to the extended-real format before being pushed on the stack.

The FLD instruction can also push the value in a selected FPU register [ST(*i*)] onto the stack. Here, pushing register ST(0) duplicates the stack top.

Operation

```

IF SRC is ST(i)
  THEN
    temp ← ST(i)
TOP ← TOP – 1;
IF SRC is memory-operand
  THEN
    ST(0) ← ExtendedReal(SRC);
  ELSE (* SRC is ST(i) *)
    ST(0) ← temp;
  
```

FPU Flags Affected

C1 Set to 1 if stack overflow occurred; otherwise, cleared to 0.
 C0, C2, C3 Undefined.

Additional Itanium® System Environment Exceptions

Itanium Reg Faults Disabled FP Register Fault if PSR.dfl is 1, NaT Register Consumption Abort.
 Itanium Mem Faults VHPT Data Fault, Nested TLB Fault, Data TLB Fault, Alternate Data TLB Fault, Data Page Not Present Fault, Data NaT Page Consumption Abort, Data Key Miss Fault, Data Key Permission Fault, Data Access Rights Fault, Data Access Bit Fault, Data Dirty Bit Fault

Floating-point Exceptions

#IS Stack overflow occurred.
 #IA Source operand is an SNaN value or unsupported format.
 #D Source operand is a denormal value. Does not occur if the source operand is in extended-real format.

FLD—Load Real (Continued)

Protected Mode Exceptions

| | |
|-----------------|---|
| #GP(0) | If destination is located in a nonwritable segment. If a memory operand effective address is outside the CS, DS, ES, FS, or GS segment limit. If the DS, ES, FS, or GS register is used to access memory and it contains a null segment selector. |
| #SS(0) | If a memory operand effective address is outside the SS segment limit. |
| #NM | EM or TS in CR0 is set. |
| #PF(fault-code) | If a page fault occurs. |
| #AC(0) | If alignment checking is enabled and an unaligned memory reference is made while the current privilege level is 3. |

Real Address Mode Exceptions

| | |
|-----|---|
| #GP | If a memory operand effective address is outside the CS, DS, ES, FS, or GS segment limit. |
| #SS | If a memory operand effective address is outside the SS segment limit. |
| #NM | EM or TS in CR0 is set. |

Virtual 8086 Mode Exceptions

| | |
|-----------------|---|
| #GP(0) | If a memory operand effective address is outside the CS, DS, ES, FS, or GS segment limit. |
| #SS(0) | If a memory operand effective address is outside the SS segment limit. |
| #NM | EM or TS in CR0 is set. |
| #PF(fault-code) | If a page fault occurs. |
| #AC(0) | If alignment checking is enabled and an unaligned memory reference is made. |

FLD1/FLDL2T/FLDL2E/FLDPI/FLDLG2/FLDLN2/FLDZ—Load Constant

| Opcode | Instruction | Description |
|--------|-------------|---|
| D9 E8 | FLD1 | Push +1.0 onto the FPU register stack. |
| D9 E9 | FLDL2T | Push $\log_2 10$ onto the FPU register stack. |
| D9 EA | FLDL2E | Push $\log_2 e$ onto the FPU register stack. |
| D9 EB | FLDPI | Push π onto the FPU register stack. |
| D9 EC | FLDLG2 | Push $\log_{10} 2$ onto the FPU register stack. |
| D9 ED | FLDLN2 | Push $\log_e 2$ onto the FPU register stack. |
| D9 EE | FLDZ | Push +0.0 onto the FPU register stack. |

Description

Push one of seven commonly-used constants (in extended-real format) onto the FPU register stack. The constants that can be loaded with these instructions include +1.0, +0.0, $\log_2 10$, $\log_2 e$, π , $\log_{10} 2$, and $\log_e 2$. For each constant, an internal 66-bit constant is rounded (as specified by the RC field in the FPU control word) to external-real format. The inexact-result exception (#P) is not generated as a result of the rounding.

Operation

$TOP \leftarrow TOP - 1;$
 $ST(0) \leftarrow CONSTANT;$

FPU Flags Affected

C1 Set to 1 if stack overflow occurred; otherwise, cleared to 0.
 C0, C2, C3 Undefined.

Additional Itanium® System Environment Exceptions

Itanium Reg Faults Disabled FP Register Fault if PSR.dfl is 1.

Floating-point Exceptions

#IS Stack overflow occurred.

Protected Mode Exceptions

#NM EM or TS in CR0 is set.

Real Address Mode Exceptions

#NM EM or TS in CR0 is set.

FLD1/FLDL2T/FLDL2E/FLDPI/FLDLG2/FLDLN2/FLDZ—Load Constant (Continued)

Virtual 8086 Mode Exceptions

#NM EM or TS in CR0 is set.

Intel® Architecture Compatibility Information

When the RC field is set to round-to-nearest, the FPU produces the same constants that is produced by the Intel 8087 and Intel287 math coprocessors.

FLDCW—Load Control Word

| Opcode | Instruction | Description |
|--------|---------------------|--|
| D9 /5 | FLDCW <i>m2byte</i> | Load FPU control word from <i>m2byte</i> . |

Description

Loads the 16-bit source operand into the FPU control word. The source operand is a memory location. This instruction is typically used to establish or change the FPU's mode of operation.

If one or more exception flags are set in the FPU status word prior to loading a new FPU control word and the new control word unmask one or more of those exceptions, a floating-point exception will be generated upon execution of the next floating-point instruction (except for the no-wait floating-point instructions). To avoid raising exceptions when changing FPU operating modes, clear any pending exceptions (using the FCLEX or FNCLEX instruction) before loading the new control word.

Operation

$FPUControlWord \leftarrow SRC;$

FPU Flags Affected

C0, C1, C2, C3 undefined.

Floating-point Exceptions

None; however, this operation might unmask a pending exception in the FPU status word. That exception is then generated upon execution of the next waiting floating-point instruction.

Additional Itanium® System Environment Exceptions

Itanium Reg Faults Disabled FP Register Fault if PSR.dfl is 1.

Itanium Mem Faults VHPT Data Fault, Nested TLB Fault, Data TLB Fault, Alternate Data TLB Fault, Data Page Not Present Fault, Data NaT Page Consumption Abort, Data Key Miss Fault, Data Key Permission Fault, Data Access Rights Fault, Data Access Bit Fault, Data Dirty Bit Fault

Protected Mode Exceptions

#GP(0) If a memory operand effective address is outside the CS, DS, ES, FS, or GS segment limit.

If the DS, ES, FS, or GS register is used to access memory and it contains a null segment selector.

#SS(0) If a memory operand effective address is outside the SS segment limit.

#NM EM or TS in CR0 is set.

#PF(fault-code) If a page fault occurs.

#AC(0) If alignment checking is enabled and an unaligned memory reference is made while the current privilege level is 3.

FLDCW—Load Control Word (Continued)

Real Address Mode Exceptions

| | |
|-----|---|
| #GP | If a memory operand effective address is outside the CS, DS, ES, FS, or GS segment limit. |
| #SS | If a memory operand effective address is outside the SS segment limit. |
| #NM | EM or TS in CR0 is set. |

Virtual 8086 Mode Exceptions

| | |
|-----------------|---|
| #GP(0) | If a memory operand effective address is outside the CS, DS, ES, FS, or GS segment limit. |
| #SS(0) | If a memory operand effective address is outside the SS segment limit. |
| #NM | EM or TS in CR0 is set. |
| #PF(fault-code) | If a page fault occurs. |
| #AC(0) | If alignment checking is enabled and an unaligned memory reference is made. |

FLDENV—Load FPU Environment

| Opcode | Instruction | Description |
|--------|--------------------------|--|
| D9 /4 | FLDENV <i>m14/28byte</i> | Load FPU environment from <i>m14byte</i> or <i>m28byte</i> . |

Description

Loads the complete FPU operating environment from memory into the FPU registers. The source operand specifies the first byte of the operating-environment data in memory. This data is typically written to the specified memory location by a FSTENV or FNSTENV instruction.

The FPU operating environment consists of the FPU control word, status word, tag word, instruction pointer, data pointer, and last opcode. See the *IA-32 Intel® Architecture Software Developer's Manual* for the layout in memory of the loaded environment, depending on the operating mode of the processor (protected or real) and the size of the current address attribute (16-bit or 32-bit). In virtual-8086 mode, the real mode layouts are used.

The FLDENV instruction should be executed in the same operating mode as the corresponding FSTENV/FNSTENV instruction.

If one or more unmasked exception flags are set in the new FPU status word, a floating-point exception will be generated upon execution of the next floating-point instruction (except for the no-wait floating-point instructions). To avoid generating exceptions when loading a new environment, clear all the exception flags in the FPU status word that is being loaded.

Operation

```
FPUControlWord ← SRC(FPUControlWord);
FPUStatusWord ← SRC(FPUStatusWord);
FPUTagWord ← SRC(FPUTagWord);
FPUDataPointer ← SRC(FPUDataPointer);
FPUInstructionPointer ← SRC(FPUInstructionPointer);
FPULastInstructionOpcode ← SRC(FPULastInstructionOpcode);
```

FPU Flags Affected

The C0, C1, C2, C3 flags are loaded.

Additional Itanium® System Environment Exceptions

| | |
|--------------------|--|
| Itanium Reg Faults | Disabled FP Register Fault if PSR.dfl is 1. |
| Itanium Mem Faults | VHPT Data Fault, Nested TLB Fault, Data TLB Fault, Alternate Data TLB Fault, Data Page Not Present Fault, Data NaT Page Consumption Abort, Data Key Miss Fault, Data Key Permission Fault, Data Access Rights Fault, Data Access Bit Fault, Data Dirty Bit Fault |

Floating-point Exceptions

None; however, if an unmasked exception is loaded in the status word, it is generated upon execution of the next waiting floating-point instruction.

FLDENV—Load FPU Environment (Continued)

Protected Mode Exceptions

| | |
|-----------------|--|
| #GP(0) | If a memory operand effective address is outside the CS, DS, ES, FS, or GS segment limit. If the DS, ES, FS, or GS register is used to access memory and it contains a null segment selector. |
| #SS(0) | If a memory operand effective address is outside the SS segment limit. |
| #NM | EM or TS in CR0 is set. |
| #PF(fault-code) | If a page fault occurs. |
| #AC(0) | If alignment checking is enabled and an unaligned memory reference is made while the current privilege level is 3. |

Real Address Mode Exceptions

| | |
|-----|---|
| #GP | If a memory operand effective address is outside the CS, DS, ES, FS, or GS segment limit. |
| #SS | If a memory operand effective address is outside the SS segment limit. |
| #NM | EM or TS in CR0 is set. |

Virtual 8086 Mode Exceptions

| | |
|-----------------|---|
| #GP(0) | If a memory operand effective address is outside the CS, DS, ES, FS, or GS segment limit. |
| #SS(0) | If a memory operand effective address is outside the SS segment limit. |
| #NM | EM or TS in CR0 is set. |
| #PF(fault-code) | If a page fault occurs. |
| #AC(0) | If alignment checking is enabled and an unaligned memory reference is made. |

FMUL/FMULP/FIMUL—Multiply

| Opcode | Instruction | Description |
|---------|---------------------|--|
| D8 /1 | FMUL <i>m32real</i> | Multiply ST(0) by <i>m32real</i> and store result in ST(0) |
| DC /1 | FMUL <i>m64real</i> | Multiply ST(0) by <i>m64real</i> and store result in ST(0) |
| D8 C8+i | FMUL ST(0), ST(i) | Multiply ST(0) by ST(i) and store result in ST(0) |
| DC C8+i | FMUL ST(i), ST(0) | Multiply ST(i) by ST(0) and store result in ST(i) |
| DE C8+i | FMULP ST(i), ST(0) | Multiply ST(i) by ST(0), store result in ST(i), and pop the register stack |
| DE C9 | FMULP | Multiply ST(0) by ST(1), store result in ST(0), and pop the register stack |
| DA /1 | FIMUL <i>m32int</i> | Multiply <i>m32int</i> by ST(0) and store result in ST(0) |
| DE /1 | FIMUL <i>m16int</i> | Multiply <i>m16int</i> by ST(0) and store result in ST(0) |

Description

Multiplies the destination and source operands and stores the product in the destination location. The destination operand is always an FPU data register; the source operand can be a register or a memory location. Source operands in memory can be in single-real, double-real, word-integer, or short-integer formats.

The no-operand version of the instruction multiplies the contents of the ST(0) register by the contents of the ST(1) register. The one-operand version multiplies the contents of a memory location (either a real or an integer value) by the contents of the ST(0) register. The two-operand version, multiplies the contents of the ST(0) register by the contents of the ST(i) register or vice versa.

The FMULP instructions perform the additional operation of popping the FPU register stack after storing the product. To pop the register stack, the processor marks the ST(0) register as empty and increments the stack pointer (TOP) by 1. The no-operand version of the floating-point multiply instructions always results in the register stack being popped. In some assemblers, the mnemonic for this instruction is FMUL rather than FMULP.

The FIMUL instructions convert an integer source operand to extended-real format before performing the multiplication.

The sign of the result is always the exclusive-OR of the source signs, even if one or more of the values being multiplied is 0 or ∞ . When the source operand is an integer 0, it is treated as a +0.

The following table shows the results obtained when multiplying various classes of numbers, assuming that neither overflow nor underflow occurs.

FMUL/FMULP/FIMUL—Multiply (Continued)

| | | DEST | | | | | | |
|-----|-----------|-----------|-----------|------|------|-----------|-----------|-----|
| | | $-\infty$ | $-F$ | -0 | $+0$ | $+F$ | $+\infty$ | NaN |
| SRC | $-\infty$ | $+\infty$ | $+\infty$ | * | * | $-\infty$ | $-\infty$ | NaN |
| | $-F$ | $+\infty$ | $+F$ | $+0$ | -0 | $-F$ | $-\infty$ | NaN |
| | $-I$ | $+\infty$ | $+F$ | $+0$ | -0 | $-F$ | $-\infty$ | NaN |
| | -0 | * | $+0$ | $+0$ | -0 | -0 | * | NaN |
| | $+0$ | * | -0 | -0 | $+0$ | $+0$ | * | NaN |
| | $+I$ | $-\infty$ | $-F$ | -0 | $+0$ | $+F$ | $+\infty$ | NaN |
| | $+F$ | $-\infty$ | $-F$ | -0 | $+0$ | $+F$ | $+\infty$ | NaN |
| | $+\infty$ | $-\infty$ | $-\infty$ | * | * | $+\infty$ | $+\infty$ | NaN |
| | NaN | NaN | NaN | NaN | NaN | NaN | NaN | NaN |

Notes:

F means finite-real number.

I means Integer.

* indicates invalid-arithmetic-operand (#IA) exception.

Operation

IF instruction is FIMUL

THEN

DEST \leftarrow DEST * ConvertExtendedReal(SRC);

ELSE (* source operand is real number *)

DEST \leftarrow DEST * SRC;

FI;

IF instruction = FMULP

THEN

PopRegisterStack

FI;

FPU Flags Affected

C1 Set to 0 if stack underflow occurred.

Indicates rounding direction if the inexact-result exception (#P) fault is generated: 0 = not roundup; 1 = roundup.

C0, C2, C3 Undefined.

Floating-point Exceptions

#IS Stack underflow occurred.

#IA Operand is an SNaN value or unsupported format.

One operand is ± 0 and the other is $\pm\infty$.

#D Source operand is a denormal value.

#U Result is too small for destination format.

#O Result is too large for destination format.

#P Value cannot be represented exactly in destination format.

FMUL/FMULP/FIMUL—Multiply (Continued)

Additional Itanium® System Environment Exceptions

| | |
|--------------------|--|
| Itanium Reg Faults | Disabled FP Register Fault if PSR.dfl is 1, NaT Register Consumption Abort. |
| Itanium Mem Faults | VHPT Data Fault, Nested TLB Fault, Data TLB Fault, Alternate Data TLB Fault, Data Page Not Present Fault, Data NaT Page Consumption Abort, Data Key Miss Fault, Data Key Permission Fault, Data Access Rights Fault, Data Access Bit Fault, Data Dirty Bit Fault |

Protected Mode Exceptions

| | |
|-----------------|--|
| #GP(0) | If a memory operand effective address is outside the CS, DS, ES, FS, or GS segment limit. If the DS, ES, FS, or GS register is used to access memory and it contains a null segment selector. |
| #SS(0) | If a memory operand effective address is outside the SS segment limit. |
| #NM | EM or TS in CR0 is set. |
| #PF(fault-code) | If a page fault occurs. |
| #AC(0) | If alignment checking is enabled and an unaligned memory reference is made while the current privilege level is 3. |

Real Address Mode Exceptions

| | |
|-----|---|
| #GP | If a memory operand effective address is outside the CS, DS, ES, FS, or GS segment limit. |
| #SS | If a memory operand effective address is outside the SS segment limit. |
| #NM | EM or TS in CR0 is set. |

Virtual 8086 Mode Exceptions

| | |
|-----------------|---|
| #GP(0) | If a memory operand effective address is outside the CS, DS, ES, FS, or GS segment limit. |
| #SS(0) | If a memory operand effective address is outside the SS segment limit. |
| #NM | EM or TS in CR0 is set. |
| #PF(fault-code) | If a page fault occurs. |
| #AC(0) | If alignment checking is enabled and an unaligned memory reference is made. |

FNOP—No Operation

| Opcode | Instruction | Description |
|--------|-------------|----------------------------|
| D9 D0 | FNOP | No operation is performed. |

Description

Performs no FPU operation. This instruction takes up space in the instruction stream but does not affect the FPU or machine context, except the EIP register.

FPU Flags Affected

C0, C1, C2, C3 undefined.

Floating-point Exceptions

None.

Additional Itanium® System Environment Exceptions

Itanium Reg Faults Disabled FP Register Fault if PSR.dfl is 1.

Protected Mode Exceptions

#NM EM or TS in CR0 is set.

Real Address Mode Exceptions

#NM EM or TS in CR0 is set.

Virtual 8086 Mode Exceptions

#NM EM or TS in CR0 is set.

FPATAN—Partial Arc tangent

| Opcode | Instruction | Description |
|--------|-------------|--|
| D9 F3 | FPATAN | Replace ST(1) with $\arctan(\text{ST}(1)/\text{ST}(0))$ and pop the register stack |

Description

Computes the arc tangent of the source operand in register ST(1) divided by the source operand in register ST(0), stores the result in ST(1), and pops the FPU register stack. The result in register ST(0) has the same sign as the source operand ST(1) and a magnitude less than $+\pi$.

The following table shows the results obtained when computing the arc tangent of various classes of numbers, assuming that underflow does not occur.

Table 1-6. FPATAN Zeros and NaNs

| | | ST(0) | | | | | | |
|-------|-----|-----------|--------------------|----------|----------|------------------|----------|-----|
| | | -∞ | -F | -0 | +0 | +F | +∞ | NaN |
| ST(1) | -∞ | $-3\pi/4$ | $-\pi/2$ | $-\pi/2$ | $-\pi/2$ | $-\pi/2$ | $-\pi/4$ | NaN |
| | -F | -p | $-\pi$ to $-\pi/2$ | $-\pi/2$ | $-\pi/2$ | $-\pi/2$ to -0 | -0 | NaN |
| | -0 | -p | -p | -p | -0 | -0 | -0 | NaN |
| | +0 | $+\pi$ | $+\pi$ | $+\pi$ | $+0$ | $+0$ | $+0$ | NaN |
| | +F | $+\pi$ | $+\pi$ to $+\pi/2$ | $+\pi/2$ | $+\pi/2$ | $+\pi/2$ to $+0$ | $+0$ | NaN |
| | +∞ | $+3\pi/4$ | $+\pi/2$ | $+\pi/2$ | $+\pi/2$ | $+\pi/2$ | $+\pi/4$ | NaN |
| | NaN | NaN | NaN | NaN | NaN | NaN | NaN | NaN |

Note:

F means finite-real number.

There is no restriction on the range of source operands that FPATAN can accept.

Operation

$\text{ST}(1) \leftarrow \arctan(\text{ST}(1) / \text{ST}(0));$

PopRegisterStack;

FPU Flags Affected

C1 Set to 0 if stack underflow occurred.

Indicates rounding direction if the inexact-result exception (#P) is generated:
0 = not roundup; 1 = roundup.

C0, C2, C3 Undefined.

Additional Itanium® System Environment Exceptions

Itanium Reg Faults Disabled FP Register Fault if PSR.dfl is 1, NaT Register Consumption Abort.

FPATAN—Partial Arctangent (Continued)

Floating-point Exceptions

| | |
|-----|--|
| #IS | Stack underflow occurred. |
| #IA | Source operand is an SNaN value or unsupported format. |
| #D | Source operand is a denormal value. |
| #U | Result is too small for destination format. |
| #P | Value cannot be represented exactly in destination format. |

Protected Mode Exceptions

| | |
|-----|-------------------------|
| #NM | EM or TS in CR0 is set. |
|-----|-------------------------|

Real Address Mode Exceptions

| | |
|-----|-------------------------|
| #NM | EM or TS in CR0 is set. |
|-----|-------------------------|

Virtual 8086 Mode Exceptions

| | |
|-----|-------------------------|
| #NM | EM or TS in CR0 is set. |
|-----|-------------------------|

Intel® Architecture Compatibility Information

The source operands for this instruction are restricted for the 80287 math coprocessor to the following range:

$$0 \leq |ST(1)| < |ST(0)| < +\infty$$

FPREM—Partial Remainder

| Opcode | Instruction | Description |
|--------|-------------|--|
| D9 F8 | FPREM | Replace ST(0) with the remainder obtained on dividing ST(0) by ST(1) |

Description

Computes the remainder obtained on dividing the value in the ST(0) register (the dividend) by the value in the ST(1) register (the divisor or *modulus*), and stores the result in ST(0). The remainder represents the following value:

$$\text{Remainder} = \text{ST}(0) - (N * \text{ST}(1))$$

Here, N is an integer value that is obtained by truncating the real-number quotient of [ST(0) / ST(1)] toward zero. The sign of the remainder is the same as the sign of the dividend. The magnitude of the remainder is less than that of the modulus, unless a partial remainder was computed (as described below).

This instruction produces an exact result; the precision (inexact) exception does not occur and the rounding control has no effect. The following table shows the results obtained when computing the remainder of various classes of numbers, assuming that underflow does not occur.

Table 1-7. FPREM Zeros and NaNs

| | | ST(1) | | | | | | |
|-------|-----------|-----------|----------|-----|-----|----------|-----------|-----|
| | | $-\infty$ | -F | -0 | +0 | +F | $+\infty$ | NaN |
| ST(0) | $-\infty$ | * | * | * | * | * | * | NaN |
| | -F | ST(0) | -F or -0 | ** | ** | -F or -0 | ST(0) | NaN |
| | -0 | -0 | -0 | * | * | -0 | -0 | NaN |
| | +0 | +0 | +0 | * | * | +0 | +0 | NaN |
| | +F | ST(0) | +F or +0 | ** | ** | +F or +0 | ST(0) | NaN |
| | $+\infty$ | * | * | * | * | * | * | NaN |
| | NaN | NaN | NaN | NaN | NaN | NaN | NaN | NaN |

Notes:

F means finite-real number.

* indicates floating-point invalid-arithmetic-operand (#IA) exception.

** indicates floating-point zero-divide (#Z) exception.

When the result is 0, its sign is the same as that of the dividend. When the modulus is ∞ , the result is equal to the value in ST(0).

The FPREM instruction does not compute the remainder specified in IEEE Std. 754. The IEEE specified remainder can be computed with the FPREM1 instruction. The FPREM instruction is provided for compatibility with the Intel 8087 and Intel287 math coprocessors.

FPREM—Partial Remainder (Continued)

The FPREM instruction gets its name “partial remainder” because of the way it computes the remainder. This instructions arrives at a remainder through iterative subtraction. It can, however, reduce the exponent of ST(0) by no more than 63 in one execution of the instruction. If the instruction succeeds in producing a remainder that is less than the modulus, the operation is complete and the C2 flag in the FPU status word is cleared. Otherwise, C2 is set, and the result in ST(0) is called the *partial remainder*. The exponent of the partial remainder will be less than the exponent of the original dividend by at least 32. Software can re-execute the instruction (using the partial remainder in ST(0) as the dividend) until C2 is cleared.

Note: While executing such a remainder-computation loop, a higher-priority interrupting routine that needs the FPU can force a context switch in-between the instructions in the loop.

An important use of the FPREM instruction is to reduce the arguments of periodic functions. When reduction is complete, the instruction stores the three least-significant bits of the quotient in the C3, C1, and C0 flags of the FPU status word. This information is important in argument reduction for the tangent function (using a modulus of $\pi/4$), because it locates the original angle in the correct one of eight sectors of the unit circle.

Operation

```

D ← exponent(ST(0)) – exponent(ST(1));
IF D < 64
  THEN
    Q ← Integer(TruncateTowardZero(ST(0) / ST(1)));
    ST(0) ← ST(0) – (ST(1) * Q);
    C2 ← 0;
    C0, C3, C1 ← LeastSignificantBits(Q); (* Q2, Q1, Q0 *)
  ELSE
    C2 ← 1;
    N ← an implementation-dependent number between 32 and 63;
    QQ ← Integer(TruncateTowardZero((ST(0) / ST(1)) / 2(D-N)));
    ST(0) ← ST(0) – (ST(1) * QQ * 2(D-N));
FI;

```

FPU Flags Affected

| | |
|----|---|
| C0 | Set to bit 2 (Q2) of the quotient. |
| C1 | Set to 0 if stack underflow occurred; otherwise, set to least significant bit of quotient (Q0). |
| C2 | Set to 0 if reduction complete; set to 1 if incomplete. |
| C3 | Set to bit 1 (Q1) of the quotient. |

Additional Itanium® System Environment Exceptions

Itanium Reg Faults Disabled FP Register Fault if PSR.dfl is 1, NaT Register Consumption Abort.

FPREM—Partial Remainder (Continued)

Floating-point Exceptions

| | |
|-----|--|
| #IS | Stack underflow occurred. |
| #IA | Source operand is an SNaN value, modulus is 0, dividend is ∞ , or unsupported format. |
| #D | Source operand is a denormal value. |
| #U | Result is too small for destination format. |

Protected Mode Exceptions

| | |
|-----|-------------------------|
| #NM | EM or TS in CR0 is set. |
|-----|-------------------------|

Real Address Mode Exceptions

| | |
|-----|-------------------------|
| #NM | EM or TS in CR0 is set. |
|-----|-------------------------|

Virtual 8086 Mode Exceptions

| | |
|-----|-------------------------|
| #NM | EM or TS in CR0 is set. |
|-----|-------------------------|

FPREM1—Partial Remainder

| Opcode | Instruction | Description |
|--------|-------------|---|
| D9 F5 | FPREM1 | Replace ST(0) with the IEEE remainder obtained on dividing ST(0) by ST(1) |

Description

Computes the IEEE remainder obtained on dividing the value in the ST(0) register (the dividend) by the value in the ST(1) register (the divisor or *modulus*), and stores the result in ST(0). The remainder represents the following value:

$$\text{Remainder} = \text{ST}(0) - (N * \text{ST}(1))$$

Here, N is an integer value that is obtained by rounding the real-number quotient of $[\text{ST}(0) / \text{ST}(1)]$ toward the nearest integer value. The sign of the remainder is the same as the sign of the dividend. The magnitude of the remainder is less than half the magnitude of the modulus, unless a partial remainder was computed (as described below).

This instruction produces an exact result; the precision (inexact) exception does not occur and the rounding control has no effect. The following table shows the results obtained when computing the remainder of various classes of numbers, assuming that underflow does not occur.

Table 1-8. FPREM1 Zeros and NaNs

| | | ST(1) | | | | | | NaN |
|-------|-----------|-----------|----------|-----|-----|----------|-----------|-----|
| | | $-\infty$ | -F | -0 | +0 | +F | $+\infty$ | |
| ST(0) | $-\infty$ | * | * | * | * | * | * | NaN |
| | -F | ST(0) | -F or -0 | ** | ** | -F or -0 | ST(0) | NaN |
| | -0 | -0 | -0 | * | * | -0 | -0 | NaN |
| | +0 | +0 | +0 | * | * | +0 | +0 | NaN |
| | +F | ST(0) | +F or +0 | ** | ** | +F or +0 | ST(0) | NaN |
| | $+\infty$ | * | * | * | * | * | * | NaN |
| | NaN | NaN | NaN | NaN | NaN | NaN | NaN | NaN |

Notes:

F means finite-real number.

* indicates floating-point invalid-arithmetic-operand (#IA) exception.

** indicates floating-point zero-divide (#Z) exception.

When the result is 0, its sign is the same as that of the dividend. When the modulus is ∞ , the result is equal to the value in ST(0).

The FPREM1 instruction computes the remainder specified in IEEE Std 754. This instruction operates differently from the FPREM instruction in the way that it rounds the quotient of ST(0) divided by ST(1) to an integer (see the “Operation” below).

FPREM1—Partial Remainder (Continued)

Like the FPREM instruction, the FPREM1 computes the remainder through iterative subtraction, but can reduce the exponent of ST(0) by no more than 63 in one execution of the instruction. If the instruction succeeds in producing a remainder that is less than one half the modulus, the operation is complete and the C2 flag in the FPU status word is cleared. Otherwise, C2 is set, and the result in ST(0) is called the *partial remainder*. The exponent of the partial remainder will be less than the exponent of the original dividend by at least 32. Software can re-execute the instruction (using the partial remainder in ST(0) as the dividend) until C2 is cleared.

Note: While executing such a remainder-computation loop, a higher-priority interrupting routine that needs the FPU can force a context switch in-between the instructions in the loop.

An important use of the FPREM1 instruction is to reduce the arguments of periodic functions. When reduction is complete, the instruction stores the three least-significant bits of the quotient in the C3, C1, and C0 flags of the FPU status word. This information is important in argument reduction for the tangent function (using a modulus of $\pi/4$), because it locates the original angle in the correct one of eight sectors of the unit circle.

Operation

```

D ← exponent(ST(0)) – exponent(ST(1));
IF D < 64
  THEN
    Q ← Integer(RoundTowardNearestInteger(ST(0) / ST(1)));
    ST(0) ← ST(0) – (ST(1) * Q);
    C2 ← 0;
    C0, C3, C1 ← LeastSignificantBits(Q); (* Q2, Q1, Q0 *)
  ELSE
    C2 ← 1;
    N ← an implementation-dependent number between 32 and 63;
    QQ ← Integer(TruncateTowardZero((ST(0) / ST(1)) / 2(D-N)));
    ST(0) ← ST(0) – (ST(1) * QQ * 2(D-N));
FI;

```

FPU Flags Affected

| | |
|----|---|
| C0 | Set to bit 2 (Q2) of the quotient. |
| C1 | Set to 0 if stack underflow occurred; otherwise, set to least significant bit of quotient (Q0). |
| C2 | Set to 0 if reduction complete; set to 1 if incomplete. |
| C3 | Set to bit 1 (Q1) of the quotient. |

Additional Itanium® System Environment Exceptions

Itanium Reg Faults Disabled FP Register Fault if PSR.dfl is 1, NaT Register Consumption Abort.

FPREM1—Partial Remainder (Continued)

Floating-point Exceptions

| | |
|-----|--|
| #IS | Stack underflow occurred. |
| #IA | Source operand is an SNaN value, modulus (divisor) is 0, dividend is ∞ , or unsupported format. |
| #D | Source operand is a denormal value. |
| #U | Result is too small for destination format. |

Protected Mode Exceptions

| | |
|-----|-------------------------|
| #NM | EM or TS in CR0 is set. |
|-----|-------------------------|

Real Address Mode Exceptions

| | |
|-----|-------------------------|
| #NM | EM or TS in CR0 is set. |
|-----|-------------------------|

Virtual 8086 Mode Exceptions

| | |
|-----|-------------------------|
| #NM | EM or TS in CR0 is set. |
|-----|-------------------------|

FPTAN—Partial Tangent

| Opcode | Instruction | Clocks | Description |
|--------|-------------|--------|---|
| D9 F2 | FPTAN | 17-173 | Replace ST(0) with its tangent and push 1 onto the FPU stack. |

Description

Computes the tangent of the source operand in register ST(0), stores the result in ST(0), and pushes a 1.0 onto the FPU register stack. The source operand must be given in radians and must be less than $\pm 2^{63}$. The following table shows the unmasked results obtained when computing the partial tangent of various classes of numbers, assuming that underflow does not occur.

| ST(0) SRC | ST(0) DEST |
|-----------|------------|
| $-\infty$ | * |
| -F | -F to +F |
| -0 | -0 |
| +0 | +0 |
| +F | -F to +F |
| $+\infty$ | * |
| NaN | NaN |

Notes:

F means finite-real number.

* indicates floating-point invalid-arithmetic-operand (#IA) exception.

If the source operand is outside the acceptable range, the C2 flag in the FPU status word is set, and the value in register ST(0) remains unchanged. The instruction does not raise an exception when the source operand is out of range. It is up to the program to check the C2 flag for out-of-range conditions. Source values outside the range -2^{63} to $+2^{63}$ can be reduced to the range of the instruction by subtracting an appropriate integer multiple of 2π or by using the FPREM instruction with a divisor of 2π .

The value 1.0 is pushed onto the register stack after the tangent has been computed to maintain compatibility with the Intel 8087 and Intel287 math coprocessors. This operation also simplifies the calculation of other trigonometric functions. For instance, the cotangent (which is the reciprocal of the tangent) can be computed by executing a FDIVR instruction after the FPTAN instruction.

Operation

IF

IF ST(0) < 2^{63}

THEN

C2 \leftarrow 0;

ST(0) \leftarrow tan(ST(0));

TOP \leftarrow TOP - 1;

ST(0) \leftarrow 1.0;

ELSE (*source operand is out-of-range *)

C2 \leftarrow 1;

FI;

FPTAN—Partial Tangent (Continued)

FPU Flags Affected

| | |
|--------|--|
| C1 | Set to 0 if stack underflow occurred; set to 1 if stack overflow occurred. Indicates rounding direction if the inexact-result exception (#P) is generated: 0 = not roundup; 1 = roundup. |
| C2 | Set to 1 if source operand is outside the range -2^{63} to $+2^{63}$; otherwise, cleared to 0. |
| C0, C3 | Undefined. |

Additional Itanium® System Environment Exceptions

Itanium Reg Faults Disabled FP Register Fault if PSR.dfl is 1, NaT Register Consumption Abort.

Floating-point Exceptions

| | |
|-----|--|
| #IS | Stack underflow occurred. |
| #IA | Source operand is an SNaN value, ∞ , or unsupported format. |
| #D | Source operand is a denormal value. |
| #U | Result is too small for destination format. |
| #P | Value cannot be represented exactly in destination format. |

Protected Mode Exceptions

| | |
|-----|-------------------------|
| #NM | EM or TS in CR0 is set. |
|-----|-------------------------|

Real Address Mode Exceptions

| | |
|-----|-------------------------|
| #NM | EM or TS in CR0 is set. |
|-----|-------------------------|

Virtual 8086 Mode Exceptions

| | |
|-----|-------------------------|
| #NM | EM or TS in CR0 is set. |
|-----|-------------------------|

FRNDINT—Round to Integer

| Opcode | Instruction | Description |
|--------|-------------|----------------------------|
| D9 FC | FRNDINT | Round ST(0) to an integer. |

Description

Rounds the source value in the ST(0) register to the nearest integral value, depending on the current rounding mode (setting of the RC field of the FPU control word), and stores the result in ST(0).

If the source value is ∞ , the value is not changed. If the source value is not an integral value, the floating-point inexact-result exception (#P) is generated.

Operation

$ST(0) \leftarrow \text{RoundToIntegralValue}(ST(0));$

FPU Flags Affected

| | |
|------------|--|
| C1 | Set to 0 if stack underflow occurred. |
| | Indicates rounding direction if the inexact-result exception (#P) is generated: 0 = not roundup; 1 = roundup. |
| C0, C2, C3 | Undefined. |

Floating-point Exceptions

| | |
|-----|--|
| #IS | Stack underflow occurred. |
| #IA | Source operand is an SNaN value or unsupported format. |
| #D | Source operand is a denormal value. |
| #P | Source operand is not an integral value. |

Additional Itanium[®] System Environment Exceptions

| | |
|--------------------|---|
| Itanium Reg Faults | Disabled FP Register Fault if PSR.dfl is 1, NaT Register Consumption Abort. |
|--------------------|---|

Protected Mode Exceptions

| | |
|-----|-------------------------|
| #NM | EM or TS in CR0 is set. |
|-----|-------------------------|

Real Address Mode Exceptions

| | |
|-----|-------------------------|
| #NM | EM or TS in CR0 is set. |
|-----|-------------------------|

Virtual 8086 Mode Exceptions

| | |
|-----|-------------------------|
| #NM | EM or TS in CR0 is set. |
|-----|-------------------------|

FRSTOR—Restore FPU State

| Opcode | Instruction | Description |
|--------|---------------------------|---|
| DD /4 | FRSTOR <i>m94/108byte</i> | Load FPU state from <i>m94byte</i> or <i>m108byte</i> . |

Description

Loads the FPU state (operating environment and register stack) from the memory area specified with the source operand. This state data is typically written to the specified memory location by a previous FSAVE/FNSAVE instruction.

The FPU operating environment consists of the FPU control word, status word, tag word, instruction pointer, data pointer, and last opcode. See the *IA-32 Intel® Architecture Software Developer's Manual* for the layout in memory of the stored environment, depending on the operating mode of the processor (protected or real) and the size of the current address attribute (16-bit or 32-bit). In virtual-8086 mode, the real mode layouts are used. The contents of the FPU register stack are stored in the 80 bytes immediately follow the operating environment image.

The FRSTOR instruction should be executed in the same operating mode as the corresponding FSAVE/FNSAVE instruction.

If one or more unmasked exception bits are set in the new FPU status word, a floating-point exception will be generated. To avoid raising exceptions when loading a new operating environment, clear all the exception flags in the FPU status word that is being loaded.

Operation

```

FPUControlWord ← SRC(FPUControlWord);
FPUStatusWord ← SRC(FPUStatusWord);
FPUTagWord ← SRC(FPUTagWord);
FPUDataPointer ← SRC(FPUDataPointer);
FPUInstructionPointer ← SRC(FPUInstructionPointer);
FPULastInstructionOpcode ← SRC(FPULastInstructionOpcode);
ST(0) ← SRC(ST(0));
ST(1) ← SRC(ST(1));
ST(2) ← SRC(ST(2));
ST(3) ← SRC(ST(3));
ST(4) ← SRC(ST(4));
ST(5) ← SRC(ST(5));
ST(6) ← SRC(ST(6));
ST(7) ← SRC(ST(7));

```

FPU Flags Affected

The C0, C1, C2, C3 flags are loaded.

Floating-point Exceptions

None; however, this operation might unmask an existing exception that has been detected but not generated, because it was masked. Here, the exception is generated at the completion of the instruction.

FRSTOR—Restore FPU State (Continued)

Additional Itanium® System Environment Exceptions

| | |
|--------------------|--|
| Itanium Reg Faults | Disabled FP Register Fault if PSR.dfl is 1. |
| Itanium Mem Faults | VHPT Data Fault, Nested TLB Fault, Data TLB Fault, Alternate Data TLB Fault, Data Page Not Present Fault, Data NaT Page Consumption Abort, Data Key Miss Fault, Data Key Permission Fault, Data Access Rights Fault, Data Access Bit Fault, Data Dirty Bit Fault |

Protected Mode Exceptions

| | |
|-----------------|--|
| #GP(0) | If a memory operand effective address is outside the CS, DS, ES, FS, or GS segment limit. If the DS, ES, FS, or GS register is used to access memory and it contains a null segment selector. |
| #SS(0) | If a memory operand effective address is outside the SS segment limit. |
| #NM | EM or TS in CR0 is set. |
| #PF(fault-code) | If a page fault occurs. |
| #AC(0) | If alignment checking is enabled and an unaligned memory reference is made while the current privilege level is 3. |

Real Address Mode Exceptions

| | |
|-----|---|
| #GP | If a memory operand effective address is outside the CS, DS, ES, FS, or GS segment limit. |
| #SS | If a memory operand effective address is outside the SS segment limit. |
| #NM | EM or TS in CR0 is set. |

Virtual 8086 Mode Exceptions

| | |
|-----------------|---|
| #GP(0) | If a memory operand effective address is outside the CS, DS, ES, FS, or GS segment limit. |
| #SS(0) | If a memory operand effective address is outside the SS segment limit. |
| #NM | EM or TS in CR0 is set. |
| #PF(fault-code) | If a page fault occurs. |
| #AC(0) | If alignment checking is enabled and an unaligned memory reference is made. |

FSAVE/FNSAVE—Store FPU State

| Opcode | Instruction | Description |
|----------|---------------------------|---|
| 9B DD /6 | FSAVE <i>m94/108byte</i> | Store FPU state to <i>m94byte</i> or <i>m108byte</i> after checking for pending unmasked floating-point exceptions. Then re-initialize the FPU. |
| DD /6 | FNSAVE <i>m94/108byte</i> | Store FPU environment to <i>m94byte</i> or <i>m108byte</i> without checking for pending unmasked floating-point exceptions. Then re-initialize the FPU. |

Description

Stores the current FPU state (operating environment and register stack) at the specified destination in memory, and then re-initializes the FPU. The FSAVE instruction checks for and handles pending unmasked floating-point exceptions before storing the FPU state; the FNSAVE instruction does not.

The FPU operating environment consists of the FPU control word, status word, tag word, instruction pointer, data pointer, and last opcode. See the *IA-32 Intel® Architecture Software Developer's Manual* for the layout in memory of the stored environment, depending on the operating mode of the processor (protected or real) and the size of the current address attribute (16-bit or 32-bit). In virtual-8086 mode, the real mode layouts are used. The contents of the FPU register stack are stored in the 80 bytes immediately follow the operating environment image.

The saved image reflects the state of the FPU after all floating-point instructions preceding the FSAVE/FNSAVE instruction in the instruction stream have been executed.

After the FPU state has been saved, the FPU is reset to the same default values it is set to with the FINIT/FNINIT instructions (see [“FINIT/FNINIT—Initialize Floating-point Unit”](#) on page 3:481).

The FSAVE/FNSAVE instructions are typically used when the operating system needs to perform a context switch, an exception handler needs to use the FPU, or an application program needs to pass a “clean” FPU to a procedure.

Operation

```
(* Save FPU State and Registers *)
DEST(FPUControlWord) ← FPUControlWord;
DEST(FPUStatusWord) ← FPUStatusWord;
DEST(FPUTagWord) ← FPUTagWord;
DEST(FPUDataPointer) ← FPUDataPointer;
DEST(FPUInstructionPointer) ← FPUInstructionPointer;
DEST(FPULastInstructionOpcode) ← FPULastInstructionOpcode;
DEST(ST(0)) ← ST(0);
DEST(ST(1)) ← ST(1);
DEST(ST(2)) ← ST(2);
DEST(ST(3)) ← ST(3);
DEST(ST(4)) ← ST(4);
DEST(ST(5)) ← ST(5);
DEST(ST(6)) ← ST(6);
DEST(ST(7)) ← ST(7);
(* Initialize FPU *)
FPUControlWord ← 037FH;
```

FSAVE/FNSAVE—Store FPU State (Continued)

```

FPUStatusWord ← 0;
FPUtagWord ← FFFFH;
FPUDataPointer ← 0;
FPUInstructionPointer ← 0;
FPULastInstructionOpcode ← 0;

```

FPU Flags Affected

The C0, C1, C2, and C3 flags are saved and then cleared.

Floating-point Exceptions

None.

Additional Itanium[®] System Environment Exceptions

| | |
|--------------------|--|
| Itanium Reg Faults | Disabled FP Register Fault if PSR.dfl is 1, NaT Register Consumption Abort. |
| Itanium Mem Faults | VHPT Data Fault, Nested TLB Fault, Data TLB Fault, Alternate Data TLB Fault, Data Page Not Present Fault, Data NaT Page Consumption Abort, Data Key Miss Fault, Data Key Permission Fault, Data Access Rights Fault, Data Access Bit Fault, Data Dirty Bit Fault |

Protected Mode Exceptions

| | |
|-----------------|--|
| #GP(0) | <p>If destination is located in a nonwritable segment.</p> <p>If a memory operand effective address is outside the CS, DS, ES, FS, or GS segment limit.</p> <p>If the DS, ES, FS, or GS register is used to access memory and it contains a null segment selector.</p> |
| #SS(0) | If a memory operand effective address is outside the SS segment limit. |
| #NM | EM or TS in CR0 is set. |
| #PF(fault-code) | If a page fault occurs. |
| #AC(0) | If alignment checking is enabled and an unaligned memory reference is made while the current privilege level is 3. |

Real Address Mode Exceptions

| | |
|-----|---|
| #GP | If a memory operand effective address is outside the CS, DS, ES, FS, or GS segment limit. |
| #SS | If a memory operand effective address is outside the SS segment limit. |
| #NM | EM or TS in CR0 is set. |

FSAVE/FNSAVE—Store FPU State (Continued)

Virtual 8086 Mode Exceptions

| | |
|-----------------|---|
| #GP(0) | If a memory operand effective address is outside the CS, DS, ES, FS, or GS segment limit. |
| #SS(0) | If a memory operand effective address is outside the SS segment limit. |
| #NM | EM or TS in CR0 is set. |
| #PF(fault-code) | If a page fault occurs. |
| #AC(0) | If alignment checking is enabled and an unaligned memory reference is made. |

Intel® Architecture Compatibility Information

For Intel math coprocessors and FPUs prior to the Pentium processor, an FWAIT instruction should be executed before attempting to read from the memory image stored with a prior FSAVE/FNSAVE instruction. This FWAIT instruction helps insure that the storage operation has been completed.

FSCALE—Scale

| Opcode | Instruction | Description |
|--------|-------------|-----------------------|
| D9 FD | FSCALE | Scale ST(0) by ST(1). |

Description

Multiplies the destination operand by 2 to the power of the source operand and stores the result in the destination operand. This instruction provides rapid multiplication or division by integral powers of 2. The destination operand is a real value that is located in register ST(0). The source operand is the nearest integer value that is smaller than the value in the ST(1) register (that is, the value in register ST(1) is truncate toward 0 to its nearest integer value to form the source operand). The actual scaling operation is performed by adding the source operand (integer value) to the exponent of the value in register ST(0). The following table shows the results obtained when scaling various classes of numbers, assuming that neither overflow nor underflow occurs.

| | | ST(1) | | |
|-------|-----------|-----------|-----------|-----------|
| | | -N | 0 | +N |
| ST(0) | $-\infty$ | $-\infty$ | $-\infty$ | $-\infty$ |
| | -F | -F | -F | -F |
| | -0 | -0 | -0 | -0 |
| | +0 | +0 | +0 | +0 |
| | +F | +F | +F | +F |
| | $+\infty$ | $+\infty$ | $+\infty$ | $+\infty$ |
| | NaN | NaN | NaN | NaN |

Notes:

F means finite-real number.

N means integer.

In most cases, only the exponent is changed and the mantissa (significand) remains unchanged. However, when the value being scaled in ST(0) is a denormal value, the mantissa is also changed and the result may turn out to be a normalized number. Similarly, if overflow or underflow results from a scale operation, the resulting mantissa will differ from the source's mantissa.

The FSCALE instruction can also be used to reverse the action of the FXTRACT instruction, as shown in the following example:

```
FXTRACT ;
FSCALE ;
FSTP ST(1) ;
```

In this example, the FXTRACT instruction extracts the significand and exponent from the value in ST(0) and stores them in ST(0) and ST(1) respectively. The FSCALE then scales the significand in ST(0) by the exponent in ST(1), recreating the original value before the FXTRACT operation was performed. The FSTP ST(1) instruction returns the recreated value to the FPU register where it originally resided.

FSCALE—Scale (Continued)

Operation

$ST(0) \leftarrow ST(0) * 2^{ST(1)}$;

FPU Flags Affected

| | |
|------------|---|
| C1 | Set to 0 if stack underflow occurred. Indicates rounding direction if the inexact-result exception (#P) is generated: 0 = not roundup; 1 = roundup. |
| C0, C2, C3 | Undefined. |

Floating-point Exceptions

| | |
|-----|--|
| #IS | Stack underflow occurred. |
| #IA | Source operand is an SNaN value or unsupported format. |
| #D | Source operand is a denormal value. |
| #U | Result is too small for destination format. |
| #O | Result is too large for destination format. |
| #P | Value cannot be represented exactly in destination format. |

Additional Itanium® System Environment Exceptions

Itanium Reg Faults Disabled FP Register Fault if PSR.dfl is 1, NaT Register Consumption Abort.

Protected Mode Exceptions

| | |
|-----|-------------------------|
| #NM | EM or TS in CR0 is set. |
|-----|-------------------------|

Real Address Mode Exceptions

| | |
|-----|-------------------------|
| #NM | EM or TS in CR0 is set. |
|-----|-------------------------|

Virtual 8086 Mode Exceptions

| | |
|-----|-------------------------|
| #NM | EM or TS in CR0 is set. |
|-----|-------------------------|

FSIN—Sine

| Opcode | Instruction | Description |
|--------|-------------|------------------------------|
| D9 FE | FSIN | Replace ST(0) with its sine. |

Description

Calculates the sine of the source operand in register ST(0) and stores the result in ST(0). The source operand must be given in radians and must be within the range -2^{63} to $+2^{63}$. The following table shows the results obtained when taking the sine of various classes of numbers, assuming that underflow does not occur.

| SRC (ST(0)) | DEST (ST(0)) |
|-------------|--------------|
| $-\infty$ | * |
| -F | -1 to +1 |
| -0 | -0 |
| +0 | +0 |
| +F | -1 to +1 |
| $+\infty$ | * |
| NaN | NaN |

Notes:

F means finite-real number.

* indicates floating-point invalid-arithmetic-operand (#IA) exception.

If the source operand is outside the acceptable range, the C2 flag in the FPU status word is set, and the value in register ST(0) remains unchanged. The instruction does not raise an exception when the source operand is out of range. It is up to the program to check the C2 flag for out-of-range conditions. Source values outside the range -2^{63} to $+2^{63}$ can be reduced to the range of the instruction by subtracting an appropriate integer multiple of 2π or by using the FPREM instruction with a divisor of 2π .

Operation

IF I

IF $ST(0) < 2^{63}$

THEN

C2 \leftarrow 0;

ST(0) \leftarrow sin(ST(0));

ELSE (* source operand out of range *)

C2 \leftarrow 1;

FI:

FSIN—Sine (Continued)**FPU Flags Affected**

| | |
|--------|--|
| C1 | Set to 0 if stack underflow occurred. |
| | Indicates rounding direction if the inexact-result exception (#P) is generated: 0 = not roundup; 1 = roundup. |
| C2 | Set to 1 if source operand is outside the range -2^{63} to $+2^{63}$; otherwise, cleared to 0. |
| C0, C3 | Undefined. |

Additional Itanium® System Environment Exceptions

Itanium Reg Faults Disabled FP Register Fault if PSR.dfl is 1, NaT Register Consumption Abort.

Floating-point Exceptions

| | |
|-----|--|
| #IS | Stack underflow occurred. |
| #IA | Source operand is an SNaN value, ∞ , or unsupported format. |
| #D | Source operand is a denormal value. |
| #P | Value cannot be represented exactly in destination format. |

Protected Mode Exceptions

| | |
|-----|-------------------------|
| #NM | EM or TS in CR0 is set. |
|-----|-------------------------|

Real Address Mode Exceptions

| | |
|-----|-------------------------|
| #NM | EM or TS in CR0 is set. |
|-----|-------------------------|

Virtual 8086 Mode Exceptions

| | |
|-----|-------------------------|
| #NM | EM or TS in CR0 is set. |
|-----|-------------------------|

FSINCOS—Sine and Cosine

| Opcode | Instruction | Description |
|--------|-------------|---|
| D9 FB | FSINCOS | Compute the sine and cosine of ST(0); replace ST(0) with the sine, and push the cosine onto the register stack. |

Description

Computes both the sine and the cosine of the source operand in register ST(0), stores the sine in ST(0), and pushes the cosine onto the top of the FPU register stack. (This instruction is faster than executing the FSIN and FCOS instructions in succession.)

The source operand must be given in radians and must be within the range -2^{63} to $+2^{63}$. The following table shows the results obtained when taking the sine and cosine of various classes of numbers, assuming that underflow does not occur.

| SRC | DEST | |
|-----------|--------------|------------|
| | ST(0) Cosine | ST(1) Sine |
| $-\infty$ | * | * |
| -F | -1 to +1 | -1 to +1 |
| -0 | +1 | -0 |
| +0 | +1 | +0 |
| +F | -1 to +1 | -1 to +1 |
| $+\infty$ | * | * |
| NaN | NaN | NaN |

Notes:

F means finite-real number.

* indicates floating-point invalid-arithmetic-operand (#IA) exception.

If the source operand is outside the acceptable range, the C2 flag in the FPU status word is set, and the value in register ST(0) remains unchanged. The instruction does not raise an exception when the source operand is out of range. It is up to the program to check the C2 flag for out-of-range conditions. Source values outside the range -2^{63} to $+2^{63}$ can be reduced to the range of the instruction by subtracting an appropriate integer multiple of 2π or by using the FPREM instruction with a divisor of 2π .

Operation

```

IF ST(0) < 263
THEN
  C2 ← 0;
  TEMP ← cosine(ST(0));
  ST(0) ← sine(ST(0));
  TOP ← TOP - 1;
  ST(0) ← TEMP;
ELSE (* source operand out of range *)
  C2 ← 1;
FI:

```

FSINCOS—Sine and Cosine (Continued)

FPU Flags Affected

| | |
|--------|--|
| C1 | Set to 0 if stack underflow occurred; set to 1 if stack overflow occurs. Indicates rounding direction if the inexact-result exception (#P) is generated: 0 = not roundup; 1 = roundup. |
| C2 | Set to 1 if source operand is outside the range -2^{63} to $+2^{63}$; otherwise, cleared to 0. |
| C0, C3 | Undefined. |

Additional Itanium® System Environment Exceptions

Itanium Reg Faults Disabled FP Register Fault if PSR.dfl is 1, NaT Register Consumption Abort.

Floating-point Exceptions

| | |
|-----|--|
| #IS | Stack underflow occurred. |
| #IA | Source operand is an SNaN value, ∞ , or unsupported format. |
| #D | Source operand is a denormal value. |
| #U | Result is too small for destination format. |
| #P | Value cannot be represented exactly in destination format. |

Protected Mode Exceptions

#NM EM or TS in CR0 is set.

Real Address Mode Exceptions

#NM EM or TS in CR0 is set.

Virtual 8086 Mode Exceptions

#NM EM or TS in CR0 is set.

FSQRT—Square Root

| Opcode | Instruction | Description |
|--------|-------------|--|
| D9 FA | FSQRT | Calculates square root of ST(0) and stores the result in ST(0) |

Description

Calculates the square root of the source value in the ST(0) register and stores the result in ST(0).

The following table shows the results obtained when taking the square root of various classes of numbers, assuming that neither overflow nor underflow occurs.

| SRC (ST(0)) | DEST (ST(0)) |
|-------------|--------------|
| $-\infty$ | * |
| -F | * |
| -0 | -0 |
| +0 | +0 |
| +F | +F |
| $+\infty$ | $+\infty$ |
| NaN | NaN |

Notes:

F means finite-real number.

* indicates floating-point invalid-arithmetic-operand (#IA) exception.

Operation

$ST(0) \leftarrow \text{SquareRoot}(ST(0));$

FPU Flags Affected

| | |
|------------|--|
| C1 | Set to 0 if stack underflow occurred. |
| | Indicates rounding direction if inexact-result exception (#P) is generated: 0 = not roundup; 1 = roundup. |
| C0, C2, C3 | Undefined. |

Floating-point Exceptions

| | |
|-----|--|
| #IS | Stack underflow occurred. |
| #IA | Source operand is an SNaN value or unsupported format. |
| | Source operand is a negative value (except for -0). |
| #D | Source operand is a denormal value. |
| #P | Value cannot be represented exactly in destination format. |

FSQRT—Square Root (Continued)

Additional Itanium® System Environment Exceptions

Itanium Reg Faults Disabled FP Register Fault if PSR.dfl is 1, NaT Register Consumption Abort.

Protected Mode Exceptions

#NM EM or TS in CR0 is set.

Real Address Mode Exceptions

#NM EM or TS in CR0 is set.

Virtual 8086 Mode Exceptions

#NM EM or TS in CR0 is set.

FST/FSTP—Store Real

| Opcode | Instruction | Description |
|---------|---------------------|---|
| D9 /2 | FST <i>m32real</i> | Copy ST(0) to <i>m32real</i> |
| DD /2 | FST <i>m64real</i> | Copy ST(0) to <i>m64real</i> |
| DD D0+i | FST ST(<i>i</i>) | Copy ST(0) to ST(<i>i</i>) |
| D9 /3 | FSTP <i>m32real</i> | Copy ST(0) to <i>m32real</i> and pop register stack |
| DD /3 | FSTP <i>m64real</i> | Copy ST(0) to <i>m64real</i> and pop register stack |
| DB /7 | FSTP <i>m80real</i> | Copy ST(0) to <i>m80real</i> and pop register stack |
| DD D8+i | FSTP ST(<i>i</i>) | Copy ST(0) to ST(<i>i</i>) and pop register stack |

Description

The FST instruction copies the value in the ST(0) register to the destination operand, which can be a memory location or another register in the FPU registers stack. When storing the value in memory, the value is converted to single- or double-real format.

The FSTP instruction performs the same operation as the FST instruction and then pops the register stack. To pop the register stack, the processor marks the ST(0) register as empty and increments the stack pointer (TOP) by 1. The FSTP instruction can also store values in memory in extended-real format.

If the destination operand is a memory location, the operand specifies the address where the first byte of the destination value is to be stored. If the destination operand is a register, the operand specifies a register in the register stack relative to the top of the stack.

If the destination size is single- or double-real, the significand of the value being stored is rounded to the width of the destination (according to rounding mode specified by the RC field of the FPU control word), and the exponent is converted to the width and bias of the destination format. If the value being stored is too large for the destination format, a numeric overflow exception (#O) is generated and, if the exception is unmasked, no value is stored in the destination operand. If the value being stored is a denormal value, the denormal exception (#D) is not generated. This condition is simply signaled as a numeric underflow exception (#U) condition.

If the value being stored is ± 0 , $\pm\infty$, or a NaN, the least-significant bits of the significand and the exponent are truncated to fit the destination format. This operation preserves the value's identity as a 0, ∞ , or NaN.

If the destination operand is a non-empty register, the invalid-operation exception is not generated.

Operation

```

DEST ← ST(0);
IF instruction = FSTP
  THEN
    PopRegisterStack;
FI;

```

FST/FSTP—Store Real (Continued)

FPU Flags Affected

| | |
|------------|--|
| C1 | Set to 0 if stack underflow occurred. |
| | Indicates rounding direction of if the floating-point inexact exception (#P) is generated: 0 = not roundup; 1 = roundup. |
| C0, C2, C3 | Undefined. |

Floating-point Exceptions

| | |
|-----|--|
| #IS | Stack underflow occurred. |
| #IA | Source operand is an SNaN value or unsupported format. |
| #U | Result is too small for the destination format. |
| #O | Result is too large for the destination format. |
| #P | Value cannot be represented exactly in destination format. |

Additional Itanium® System Environment Exceptions

| | |
|--------------------|--|
| Itanium Reg Faults | Disabled FP Register Fault if PSR.dfl is 1, NaT Register Consumption Abort. |
| Itanium Mem Faults | VHPT Data Fault, Nested TLB Fault, Data TLB Fault, Alternate Data TLB Fault, Data Page Not Present Fault, Data NaT Page Consumption Abort, Data Key Miss Fault, Data Key Permission Fault, Data Access Rights Fault, Data Access Bit Fault, Data Dirty Bit Fault |

Protected Mode Exceptions

| | |
|-----------------|---|
| #GP(0) | If the destination is located in a nonwritable segment. If a memory operand effective address is outside the CS, DS, ES, FS, or GS segment limit. If the DS, ES, FS, or GS register is used to access memory and it contains a null segment selector. |
| #SS(0) | If a memory operand effective address is outside the SS segment limit. |
| #NM | EM or TS in CR0 is set. |
| #PF(fault-code) | If a page fault occurs. |
| #AC(0) | If alignment checking is enabled and an unaligned memory reference is made while the current privilege level is 3. |

Real Address Mode Exceptions

| | |
|-----|---|
| #GP | If a memory operand effective address is outside the CS, DS, ES, FS, or GS segment limit. |
| #SS | If a memory operand effective address is outside the SS segment limit. |
| #NM | EM or TS in CR0 is set. |

FST/FSTP—Store Real (Continued)

Virtual 8086 Mode Exceptions

| | |
|-----------------|---|
| #GP(0) | If a memory operand effective address is outside the CS, DS, ES, FS, or GS segment limit. |
| #SS(0) | If a memory operand effective address is outside the SS segment limit. |
| #NM | EM or TS in CR0 is set. |
| #PF(fault-code) | If a page fault occurs. |
| #AC(0) | If alignment checking is enabled and an unaligned memory reference is made. |

FSTCW/FNSTCW—Store Control Word

| Opcode | Instruction | Description |
|----------|----------------------|--|
| 9B D9 /7 | FSTCW <i>m2byte</i> | Store FPU control word to <i>m2byte</i> after checking for pending unmasked floating-point exceptions. |
| D9 /7 | FNSTCW <i>m2byte</i> | Store FPU control word to <i>m2byte</i> without checking for pending unmasked floating-point exceptions. |

Description

Stores the current value of the FPU control word at the specified destination in memory. The FSTCW instruction checks for and handles pending unmasked floating-point exceptions before storing the control word; the FNSTCW instruction does not.

Operation

$DEST \leftarrow FPUControlWord;$

FPU Flags Affected

The C0, C1, C2, and C3 flags are undefined.

Floating-point Exceptions

None.

Additional Itanium® System Environment Exceptions

Itanium Reg Faults Disabled FP Register Fault if PSR.dfl is 1.

Itanium Mem Faults VHPT Data Fault, Nested TLB Fault, Data TLB Fault, Alternate Data TLB Fault, Data Page Not Present Fault, Data NaT Page Consumption Abort, Data Key Miss Fault, Data Key Permission Fault, Data Access Rights Fault, Data Access Bit Fault, Data Dirty Bit Fault

Protected Mode Exceptions

| | |
|-----------------|---|
| #GP(0) | If the destination is located in a nonwritable segment. If a memory operand effective address is outside the CS, DS, ES, FS, or GS segment limit. If the DS, ES, FS, or GS register is used to access memory and it contains a null segment selector. |
| #SS(0) | If a memory operand effective address is outside the SS segment limit. |
| #NM | EM or TS in CR0 is set. |
| #PF(fault-code) | If a page fault occurs. |
| #AC(0) | If alignment checking is enabled and an unaligned memory reference is made while the current privilege level is 3. |

FSTCW/FNSTCW—Store Control Word (Continued)**Real Address Mode Exceptions**

| | |
|-----|---|
| #GP | If a memory operand effective address is outside the CS, DS, ES, FS, or GS segment limit. |
| #SS | If a memory operand effective address is outside the SS segment limit. |
| #NM | EM or TS in CR0 is set. |

Virtual 8086 Mode Exceptions

| | |
|-----------------|---|
| #GP(0) | If a memory operand effective address is outside the CS, DS, ES, FS, or GS segment limit. |
| #SS(0) | If a memory operand effective address is outside the SS segment limit. |
| #NM | EM or TS in CR0 is set. |
| #PF(fault-code) | If a page fault occurs. |
| #AC(0) | If alignment checking is enabled and an unaligned memory reference is made. |

FSTENV/FNSTENV—Store FPU Environment

| Opcode | Instruction | Description |
|----------|---------------------------|---|
| 9B D9 /6 | FSTENV <i>m14/28byte</i> | Store FPU environment to <i>m14byte</i> or <i>m28byte</i> after checking for pending unmasked floating-point exceptions. Then mask all floating-point exceptions. |
| D9 /6 | FNSTENV <i>m14/28byte</i> | Store FPU environment to <i>m14byte</i> or <i>m28byte</i> without checking for pending unmasked floating-point exceptions. Then mask all floating-point exceptions. |

Description

Saves the current FPU operating environment at the memory location specified with the destination operand, and then masks all floating-point exceptions. The FPU operating environment consists of the FPU control word, status word, tag word, instruction pointer, data pointer, and last opcode. See the *IA-32 Intel® Architecture Software Developer's Manual* for the layout in memory of the stored environment, depending on the operating mode of the processor (protected or real) and the size of the current address attribute (16-bit or 32-bit). (In virtual-8086 mode, the real mode layouts are used.)

The FSTENV instruction checks for and handles any pending unmasked floating-point exceptions before storing the FPU environment; the FNSTENV instruction does not. The saved image reflects the state of the FPU after all floating-point instructions preceding the FSTENV/FNSTENV instruction in the instruction stream have been executed.

These instructions are often used by exception handlers because they provide access to the FPU instruction and data pointers. The environment is typically saved in the procedure stack. Masking all exceptions after saving the environment prevents floating-point exceptions from interrupting the exception handler.

Operation

DEST(FPUControlWord) ← FPUControlWord;
 DEST(FPUStatusWord) ← FPUStatusWord;
 DEST(FPUTagWord) ← FPUTagWord;
 DEST(FPUDataPointer) ← FPUDataPointer;
 DEST(FPUInstructionPointer) ← FPUInstructionPointer;
 DEST(FPULastInstructionOpcode) ← FPULastInstructionOpcode;

FPU Flags Affected

The C0, C1, C2, and C3 are undefined.

Floating-point Exceptions

None.

FSTENV/FNSTENV—Store FPU Environment (Continued)

Additional Itanium® System Environment Exceptions

| | |
|--------------------|--|
| Itanium Reg Faults | Disabled FP Register Fault if PSR.dfl is 1 |
| Itanium Mem Faults | VHPT Data Fault, Nested TLB Fault, Data TLB Fault, Alternate Data TLB Fault, Data Page Not Present Fault, Data NaT Page Consumption Abort, Data Key Miss Fault, Data Key Permission Fault, Data Access Rights Fault, Data Access Bit Fault, Data Dirty Bit Fault |

Protected Mode Exceptions

| | |
|-----------------|---|
| #GP(0) | If the destination is located in a nonwritable segment. If a memory operand effective address is outside the CS, DS, ES, FS, or GS segment limit. If the DS, ES, FS, or GS register is used to access memory and it contains a null segment selector. |
| #SS(0) | If a memory operand effective address is outside the SS segment limit. |
| #NM | EM or TS in CR0 is set. |
| #PF(fault-code) | If a page fault occurs. |
| #AC(0) | If alignment checking is enabled and an unaligned memory reference is made while the current privilege level is 3. |

Real Address Mode Exceptions

| | |
|-----|---|
| #GP | If a memory operand effective address is outside the CS, DS, ES, FS, or GS segment limit. |
| #SS | If a memory operand effective address is outside the SS segment limit. |
| #NM | EM or TS in CR0 is set. |

Virtual 8086 Mode Exceptions

| | |
|-----------------|---|
| #GP(0) | If a memory operand effective address is outside the CS, DS, ES, FS, or GS segment limit. |
| #SS(0) | If a memory operand effective address is outside the SS segment limit. |
| #NM | EM or TS in CR0 is set. |
| #PF(fault-code) | If a page fault occurs. |
| #AC(0) | If alignment checking is enabled and an unaligned memory reference is made. |

FSTSW/FNSTSW—Store Status Word

| Opcode | Instruction | Description |
|----------|----------------------|---|
| 9B DD /7 | FSTSW <i>m2byte</i> | Store FPU status word at <i>m2byte</i> after checking for pending unmasked floating-point exceptions. |
| 9B DF E0 | FSTSW AX | Store FPU status word in AX register after checking for pending unmasked floating-point exceptions. |
| DD /7 | FNSTSW <i>m2byte</i> | Store FPU status word at <i>m2byte</i> without checking for pending unmasked floating-point exceptions. |
| DF E0 | FNSTSW AX | Store FPU status word in AX register without checking for pending unmasked floating-point exceptions. |

Description

Stores the current value of the FPU status word in the destination location. The destination operand can be either a two-byte memory location or the AX register. The FSTSW instruction checks for and handles pending unmasked floating-point exceptions before storing the status word; the FNSTSW instruction does not.

The FNSTSW AX form of the instruction is used primarily in conditional branching (for instance, after an FPU comparison instruction or an FPREM, FPREM1, or FXAM instruction), where the direction of the branch depends on the state of the FPU condition code flags. This instruction can also be used to invoke exception handlers (by examining the exception flags) in environments that do not use interrupts. When the FNSTSW AX instruction is executed, the AX register is updated before the processor executes any further instructions. The status stored in the AX register is thus guaranteed to be from the completion of the prior FPU instruction.

Operation

$DEST \leftarrow FPUStatusWord;$

FPU Flags Affected

The C0, C1, C2, and C3 are undefined.

Floating-point Exceptions

None.

Additional Itanium® System Environment Exceptions

Itanium Reg Faults Disabled FP Register Fault if PSR.dfl is 1.

Itanium Mem Faults VHPT Data Fault, Nested TLB Fault, Data TLB Fault, Alternate Data TLB Fault, Data Page Not Present Fault, Data NaT Page Consumption Abort, Data Key Miss Fault, Data Key Permission Fault, Data Access Rights Fault, Data Access Bit Fault, Data Dirty Bit Fault

FSTSW/FNSTSW—Store Status Word (Continued)

Protected Mode Exceptions

| | |
|-----------------|---|
| #GP(0) | If the destination is located in a nonwritable segment. If a memory operand effective address is outside the CS, DS, ES, FS, or GS segment limit. If the DS, ES, FS, or GS register is used to access memory and it contains a null segment selector. |
| #SS(0) | If a memory operand effective address is outside the SS segment limit. |
| #NM | EM or TS in CR0 is set. |
| #PF(fault-code) | If a page fault occurs. |
| #AC(0) | If alignment checking is enabled and an unaligned memory reference is made while the current privilege level is 3. |

Real Address Mode Exceptions

| | |
|-----|---|
| #GP | If a memory operand effective address is outside the CS, DS, ES, FS, or GS segment limit. |
| #SS | If a memory operand effective address is outside the SS segment limit. |
| #NM | EM or TS in CR0 is set. |

Virtual 8086 Mode Exceptions

| | |
|-----------------|---|
| #GP(0) | If a memory operand effective address is outside the CS, DS, ES, FS, or GS segment limit. |
| #SS(0) | If a memory operand effective address is outside the SS segment limit. |
| #NM | EM or TS in CR0 is set. |
| #PF(fault-code) | If a page fault occurs. |
| #AC(0) | If alignment checking is enabled and an unaligned memory reference is made. |

FSUB/FSUBP/FISUB—Subtract

| Opcode | Instruction | Description |
|---------|-----------------------------|--|
| D8 /4 | FSUB <i>m32real</i> | Subtract <i>m32real</i> from ST(0) and store result in ST(0) |
| DC /4 | FSUB <i>m64real</i> | Subtract <i>m64real</i> from ST(0) and store result in ST(0) |
| D8 E0+i | FSUB ST(0), ST(<i>i</i>) | Subtract ST(<i>i</i>) from ST(0) and store result in ST(0) |
| DC E8+i | FSUB ST(<i>i</i>), ST(0) | Subtract ST(0) from ST(<i>i</i>) and store result in ST(<i>i</i>) |
| DE E8+i | FSUBP ST(<i>i</i>), ST(0) | Subtract ST(0) from ST(<i>i</i>), store result in ST(<i>i</i>), and pop register stack |
| DE E9 | FSUBP | Subtract ST(0) from ST(1), store result in ST(1), and pop register stack |
| DA /4 | FISUB <i>m32int</i> | Subtract <i>m32int</i> from ST(0) and store result in ST(0) |
| DE /4 | FISUB <i>m16int</i> | Subtract <i>m16int</i> from ST(0) and store result in ST(0) |

Description

Subtracts the source operand from the destination operand and stores the difference in the destination location. The destination operand is always an FPU data register; the source operand can be a register or a memory location. Source operands in memory can be in single-real, double-real, word-integer, or short-integer formats.

The no-operand version of the instruction subtracts the contents of the ST(0) register from the ST(1) register and stores the result in ST(1). The one-operand version subtracts the contents of a memory location (either a real or an integer value) from the contents of the ST(0) register and stores the result in ST(0). The two-operand version, subtracts the contents of the ST(0) register from the ST(*i*) register or vice versa.

The FSUBP instructions perform the additional operation of popping the FPU register stack following the subtraction. To pop the register stack, the processor marks the ST(0) register as empty and increments the stack pointer (TOP) by 1. The no-operand version of the floating-point subtract instructions always results in the register stack being popped. In some assemblers, the mnemonic for this instruction is FSUB rather than FSUBP.

The FISUB instructions convert an integer source operand to extended-real format before performing the subtraction.

The following table shows the results obtained when subtracting various classes of numbers from one another, assuming that neither overflow nor underflow occurs. Here, the SRC value is subtracted from the DEST value (DEST – SRC = result).

When the difference between two operands of like sign is 0, the result is +0, except for the round toward $-\infty$ mode, in which case the result is -0 . This instruction also guarantees that $+0 - (-0) = +0$, and that $-0 - (+0) = -0$. When the source operand is an integer 0, it is treated as a +0.

When one operand is ∞ , the result is ∞ of the expected sign. If both operands are ∞ of the same sign, an invalid-operation exception is generated.

FSUB/FSUBP/FISUB—Subtract (Continued)

Table 1-9. FSUB Zeros and NaNs

| | | SRC | | | | | | |
|------|-----------|-----------|--------------------|-----------|-----------|--------------------|-----------|-----|
| | | $-\infty$ | $-F$ or $-I$ | -0 | $+0$ | $+F$ or $+I$ | $+\infty$ | NaN |
| DEST | $-\infty$ | * | $-\infty$ | $-\infty$ | $-\infty$ | $-\infty$ | $-\infty$ | NaN |
| | $-F$ | $+\infty$ | $\pm F$ or ± 0 | DEST | DEST | $-F$ | $-\infty$ | NaN |
| | -0 | $+\infty$ | $-SRC$ | ± 0 | -0 | $-SRC$ | $-\infty$ | NaN |
| | $+0$ | $+\infty$ | $-SRC$ | $+0$ | ± 0 | $-SRC$ | $-\infty$ | NaN |
| | $+F$ | $+\infty$ | $+F$ | DEST | DEST | $\pm F$ or ± 0 | $-\infty$ | NaN |
| | $+\infty$ | $+\infty$ | $+\infty$ | $+\infty$ | $+\infty$ | $+\infty$ | * | NaN |
| | NaN | NaN | NaN | NaN | NaN | NaN | NaN | NaN |

Notes:

F means finite-real number.

I means integer.

* indicates floating-point invalid-arithmetic-operand (#IA) exception.

Operation

IF instruction is FISUB

THEN

DEST \leftarrow DEST – ConvertExtendedReal(SRC);

ELSE (* source operand is real number *)

DEST \leftarrow DEST – SRC;

FI;

IF instruction = FSUBP

THEN

PopRegisterStack

FI;

FPU Flags Affected

C1 Set to 0 if stack underflow occurred.

Indicates rounding direction if the inexact-result exception (#P) fault is generated: 0 = not roundup; 1 = roundup.

C0, C2, C3 Undefined.

Floating-point Exceptions

#IS Stack underflow occurred.

#IA Operand is an SNaN value or unsupported format.

Operands are infinities of like sign.

#D Source operand is a denormal value.

#U Result is too small for destination format.

#O Result is too large for destination format.

#P Value cannot be represented exactly in destination format.

FSUB/FSUBP/FISUB—Subtract (Continued)**Additional Itanium® System Environment Exceptions**

| | |
|--------------------|--|
| Itanium Reg Faults | Disabled FP Register Fault if PSR.dfl is 1, NaT Register Consumption Abort. |
| Itanium Mem Faults | VHPT Data Fault, Nested TLB Fault, Data TLB Fault, Alternate Data TLB Fault, Data Page Not Present Fault, Data NaT Page Consumption Abort, Data Key Miss Fault, Data Key Permission Fault, Data Access Rights Fault, Data Access Bit Fault, Data Dirty Bit Fault |

Protected Mode Exceptions

| | |
|-----------------|--|
| #GP(0) | If a memory operand effective address is outside the CS, DS, ES, FS, or GS segment limit. If the DS, ES, FS, or GS register is used to access memory and it contains a null segment selector. |
| #SS(0) | If a memory operand effective address is outside the SS segment limit. |
| #NM | EM or TS in CR0 is set. |
| #PF(fault-code) | If a page fault occurs. |
| #AC(0) | If alignment checking is enabled and an unaligned memory reference is made while the current privilege level is 3. |

Real Address Mode Exceptions

| | |
|-----|---|
| #GP | If a memory operand effective address is outside the CS, DS, ES, FS, or GS segment limit. |
| #SS | If a memory operand effective address is outside the SS segment limit. |
| #NM | EM or TS in CR0 is set. |

Virtual 8086 Mode Exceptions

| | |
|-----------------|---|
| #GP(0) | If a memory operand effective address is outside the CS, DS, ES, FS, or GS segment limit. |
| #SS(0) | If a memory operand effective address is outside the SS segment limit. |
| #NM | EM or TS in CR0 is set. |
| #PF(fault-code) | If a page fault occurs. |
| #AC(0) | If alignment checking is enabled and an unaligned memory reference is made. |

FSUBR/FSUBRP/FISUBR—Reverse Subtract

| Opcode | Instruction | Description |
|---------|------------------------------|--|
| D8 /5 | FSUBR <i>m32real</i> | Subtract ST(0) from <i>m32real</i> and store result in ST(0) |
| DC /5 | FSUBR <i>m64real</i> | Subtract ST(0) from <i>m64real</i> and store result in ST(0) |
| D8 E8+i | FSUBR ST(0), ST(<i>i</i>) | Subtract ST(0) from ST(<i>i</i>) and store result in ST(0) |
| DC E0+i | FSUBR ST(<i>i</i>), ST(0) | Subtract ST(<i>i</i>) from ST(0) and store result in ST(<i>i</i>) |
| DE E0+i | FSUBRP ST(<i>i</i>), ST(0) | Subtract ST(0) from ST(<i>i</i>), store result in ST(<i>i</i>), and pop register stack |
| DE E1 | FSUBRP | Subtract ST(1) from ST(0), store result in ST(1), and pop register stack |
| DA /5 | FISUBR <i>m32int</i> | Subtract ST(0) from <i>m32int</i> and store result in ST(0) |
| DE /5 | FISUBR <i>m16int</i> | Subtract ST(0) from <i>m16int</i> and store result in ST(0) |

Description

Subtracts the destination operand from the source operand and stores the difference in the destination location. The destination operand is always an FPU register; the source operand can be a register or a memory location. Source operands in memory can be in single-real, double-real, word-integer, or short-integer formats.

These instructions perform the reverse operations of the FSUB, FSUBP, and FISUB instructions. They are provided to support more efficient coding.

The no-operand version of the instruction subtracts the contents of the ST(1) register from the ST(0) register and stores the result in ST(1). The one-operand version subtracts the contents of the ST(0) register from the contents of a memory location (either a real or an integer value) and stores the result in ST(0). The two-operand version, subtracts the contents of the ST(*i*) register from the ST(0) register or vice versa.

The FSUBRP instructions perform the additional operation of popping the FPU register stack following the subtraction. To pop the register stack, the processor marks the ST(0) register as empty and increments the stack pointer (TOP) by 1. The no-operand version of the floating-point reverse subtract instructions always results in the register stack being popped. In some assemblers, the mnemonic for this instruction is FSUBR rather than FSUBRP.

The FISUBR instructions convert an integer source operand to extended-real format before performing the subtraction.

The following table shows the results obtained when subtracting various classes of numbers from one another, assuming that neither overflow nor underflow occurs. Here, the DEST value is subtracted from the SRC value (SRC – DEST = result).

FSUBR/FSUBRP/FISUBR—Reverse Subtract (Continued)

When the difference between two operands of like sign is 0, the result is +0, except for the round toward $-\infty$ mode, in which case the result is -0 . This instruction also guarantees that $+0 - (-0) = +0$, and that $-0 - (+0) = -0$. When the source operand is an integer 0, it is treated as a +0.

When one operand is ∞ , the result is ∞ of the expected sign. If both operands are ∞ of the same sign, an invalid-operation exception is generated.

Table 1-10. FSUBR Zeros and NaNs

| | | SRC | | | | | | |
|------|--------------|-----------|--------------------|-----------|-----------|--------------------|-----------|-----|
| | | $-\infty$ | $-F$ | -0 | $+0$ | $+F$ | $+\infty$ | NaN |
| DEST | $-\infty$ | * | $+\infty$ | $+\infty$ | $+\infty$ | $+\infty$ | $+\infty$ | NaN |
| | $-F$ or $-I$ | $-\infty$ | $\pm F$ or ± 0 | $-DEST$ | $-DEST$ | $+F$ | $+\infty$ | NaN |
| | -0 | $-\infty$ | SRC | ± 0 | $+0$ | SRC | $+\infty$ | NaN |
| | $+0$ | $-\infty$ | SRC | -0 | ± 0 | SRC | $+\infty$ | NaN |
| | $+F$ or $+I$ | $-\infty$ | $-F$ | $-DEST$ | $-DEST$ | $\pm F$ or ± 0 | $+\infty$ | NaN |
| | $+\infty$ | $-\infty$ | $-\infty$ | $-\infty$ | $-\infty$ | $-\infty$ | * | NaN |
| | NaN | NaN | NaN | NaN | NaN | NaN | NaN | NaN |

Notes:

F means finite-real number.

I means integer.

* indicates floating-point invalid-arithmetic-operand (#IA) exception.

Operation

IF instruction is FISUBR

THEN

DEST \leftarrow ConvertExtendedReal(SRC) $-$ DEST;

ELSE (* source operand is real number *)

DEST \leftarrow SRC $-$ DEST;

FI;

IF instruction = FSUBRP

THEN

PopRegisterStack

FI;

FPU Flags Affected

C1 Set to 0 if stack underflow occurred.

Indicates rounding direction if the inexact-result exception (#P) fault is generated: 0 = not roundup; 1 = roundup.

C0, C2, C3 Undefined.

FSUBR/FSUBRP/FISUBR—Reverse Subtract (Continued)

Floating-point Exceptions

| | |
|-----|--|
| #IS | Stack underflow occurred. |
| #IA | Operand is an SNaN value or unsupported format. Operands are infinities of like sign. |
| #D | Source operand is a denormal value. |
| #U | Result is too small for destination format. |
| #O | Result is too large for destination format. |
| #P | Value cannot be represented exactly in destination format. |

Additional Itanium® System Environment Exceptions

| | |
|--------------------|--|
| Itanium Reg Faults | Disabled FP Register Fault if PSR.dfl is 1, NaT Register Consumption Abort. |
| Itanium Mem Faults | VHPT Data Fault, Nested TLB Fault, Data TLB Fault, Alternate Data TLB Fault, Data Page Not Present Fault, Data NaT Page Consumption Abort, Data Key Miss Fault, Data Key Permission Fault, Data Access Rights Fault, Data Access Bit Fault, Data Dirty Bit Fault |

Protected Mode Exceptions

| | |
|-----------------|--|
| #GP(0) | If a memory operand effective address is outside the CS, DS, ES, FS, or GS segment limit. If the DS, ES, FS, or GS register is used to access memory and it contains a null segment selector. |
| #SS(0) | If a memory operand effective address is outside the SS segment limit. |
| #NM | EM or TS in CR0 is set. |
| #PF(fault-code) | If a page fault occurs. |
| #AC(0) | If alignment checking is enabled and an unaligned memory reference is made while the current privilege level is 3. |

Real Address Mode Exceptions

| | |
|-----|---|
| #GP | If a memory operand effective address is outside the CS, DS, ES, FS, or GS segment limit. |
| #SS | If a memory operand effective address is outside the SS segment limit. |
| #NM | EM or TS in CR0 is set. |

Virtual 8086 Mode Exceptions

| | |
|-----------------|---|
| #GP(0) | If a memory operand effective address is outside the CS, DS, ES, FS, or GS segment limit. |
| #SS(0) | If a memory operand effective address is outside the SS segment limit. |
| #NM | EM or TS in CR0 is set. |
| #PF(fault-code) | If a page fault occurs. |
| #AC(0) | If alignment checking is enabled and an unaligned memory reference is made. |

FTST—TEST

| Opcode | Instruction | Description |
|--------|-------------|-------------------------|
| D9 E4 | FTST | Compare ST(0) with 0.0. |

Description

Compares the value in the ST(0) register with 0.0 and sets the condition code flags C0, C2, and C3 in the FPU status word according to the results (see table below).

| Condition | C3 | C2 | C0 |
|-------------|----|----|----|
| ST(0) > 0.0 | 0 | 0 | 0 |
| ST(0) < 0.0 | 0 | 0 | 1 |
| ST(0) = 0.0 | 1 | 0 | 0 |
| Unordered | 1 | 1 | 1 |

This instruction performs an “unordered comparison.” An unordered comparison also checks the class of the numbers being compared (see “FXAM—Examine” on page 3:541). If the value in register ST(0) is a NaN or is in an undefined format, the condition flags are set to “unordered.”

The sign of zero is ignored, so that $-0.0 = +0.0$.

Operation

CASE (relation of operands) OF
 Not comparable: C3, C2, C0 ← 111;
 ST(0) > 0.0: C3, C2, C0 ← 000;
 ST(0) < 0.0: C3, C2, C0 ← 001;
 ST(0) = 0.0: C3, C2, C0 ← 100;
 ESAC;

FPU Flags Affected

C1 Set to 0 if stack underflow occurred; otherwise, cleared to 0.
 C0, C2, C3 See above table.

Floating-point Exceptions

#IS Stack underflow occurred.
 #IA One or both operands are NaN values or have unsupported formats.
 #D One or both operands are denormal values.

Additional Itanium® System Environment Exceptions

Itanium Reg Faults Disabled FP Register Fault if PSR.dfl is 1, NaT Register Consumption Abort.

Protected Mode Exceptions

#NM EM or TS in CR0 is set.



FTST—TEST (Continued)

Real Address Mode Exceptions

#NM EM or TS in CR0 is set.

Virtual 8086 Mode Exceptions

#NM EM or TS in CR0 is set.

FUCOM/FUCOMP/FUCOMPP—Unordered Compare Real

| Opcode | Instruction | Description |
|---------|--------------|---|
| DD E0+i | FUCOM ST(i) | Compare ST(0) with ST(i) |
| DD E1 | FUCOM | Compare ST(0) with ST(1) |
| DD E8+i | FUCOMP ST(i) | Compare ST(0) with ST(i) and pop register stack |
| DD E9 | FUCOMP | Compare ST(0) with ST(1) and pop register stack |
| DA E9 | FUCOMPP | Compare ST(0) with ST(1) and pop register stack twice |

Description

Performs an unordered comparison of the contents of register ST(0) and ST(i) and sets condition code flags C0, C2, and C3 in the FPU status word according to the results (see the table below). If no operand is specified, the contents of registers ST(0) and ST(1) are compared. The sign of zero is ignored, so that $-0.0 = +0.0$.

| Comparison Results | C3 | C2 | C0 |
|------------------------|----|----|----|
| ST0 > ST(i) | 0 | 0 | 0 |
| ST0 < ST(i) | 0 | 0 | 1 |
| ST0 = ST(i) | 1 | 0 | 0 |
| Unordered ^a | 1 | 1 | 1 |

a. Flags not set if unmasked invalid-arithmetic-operand (#IA) exception is generated.

An unordered comparison checks the class of the numbers being compared (see “[FXAM—Examine](#)” on page 3:541). The FUCOM instructions perform the same operation as the FCOM instructions. The only difference is that the FUCOM instruction raises the invalid-arithmetic-operand exception (#IA) only when either or both operands is an SNaN or is in an unsupported format; QNaNs cause the condition code flags to be set to unordered, but do not cause an exception to be generated. The FCOM instruction raises an invalid-operation exception when either or both of the operands is a NaN value of any kind or is in an unsupported format.

As with the FCOM instructions, if the operation results in an invalid-arithmetic-operand exception being raised, the condition code flags are set only if the exception is masked.

The FUCOMP instructions pop the register stack following the comparison operation and the FUCOMPP instructions pops the register stack twice following the comparison operation. To pop the register stack, the processor marks the ST(0) register as empty and increments the stack pointer (TOP) by 1.

Operation

CASE (relation of operands) OF

ST > SRC: C3, C2, C0 ← 000;

ST < SRC: C3, C2, C0 ← 001;

ST = SRC: C3, C2, C0 ← 100;

ESAC;

IF ST(0) or SRC = QNaN, but not SNaN or unsupported format

FUCOM/FUCOMP/FUCOMPP—Unordered Compare Real (Continued)

```

THEN
    C3, C2, C0 ← 111;
ELSE (* ST(0) or SRC is SNaN or unsupported format *)
    #IA;
    IF FPUControlWord.IM = 1
        THEN
            C3, C2, C0 ← 111;
        FI;
FI;
IF instruction = FUCOMP
    THEN
        PopRegisterStack;
FI;
IF instruction = FUCOMPP
    THEN
        PopRegisterStack;
        PopRegisterStack;
FI;

```

FPU Flags Affected

C1 Set to 0 if stack underflow occurred.

C0, C2, C3 See table on previous page.

Floating-point Exceptions

#IS Stack underflow occurred.

#IA One or both operands are SNaN values or have unsupported formats. Detection of a QNaN value in and of itself does not raise an invalid-operand exception.

#D One or both operands are denormal values.

Additional Itanium® System Environment Exceptions

Itanium Reg Faults Disabled FP Register Fault if PSR.dfl is 1, NaT Register Consumption Abort.

Protected Mode Exceptions

#NM EM or TS in CR0 is set.

Real Address Mode Exceptions

#NM EM or TS in CR0 is set.

Virtual 8086 Mode Exceptions

#NM EM or TS in CR0 is set.

FWAIT—Wait

See entry for WAIT.

FXAM—Examine

| Opcode | Instruction | Description |
|--------|-------------|-----------------------------------|
| D9 E5 | FXAM | Classify value or number in ST(0) |

Description

Examines the contents of the ST(0) register and sets the condition code flags C0, C2, and C3 in the FPU status word to indicate the class of value or number in the register (see the table below).

| Class | C3 | C2 | C0 |
|----------------------|----|----|----|
| Unsupported | 0 | 0 | 0 |
| NaN | 0 | 0 | 1 |
| Normal finite number | 0 | 1 | 0 |
| Infinity | 0 | 1 | 1 |
| Zero | 1 | 0 | 0 |
| Empty | 1 | 0 | 1 |
| Denormal number | 1 | 1 | 0 |

The C1 flag is set to the sign of the value in ST(0), regardless of whether the register is empty or full.

Operation

C1 ← sign bit of ST; (* 0 for positive, 1 for negative *)

CASE (class of value or number in ST(0)) OF

 Unsupported: C3, C2, C0 ← 000;

 NaN: C3, C2, C0 ← 001;

 Normal: C3, C2, C0 ← 010;

 Infinity: C3, C2, C0 ← 011;

 Zero: C3, C2, C0 ← 100;

 Empty: C3, C2, C0 ← 101;

 Denormal: C3, C2, C0 ← 110;

ESAC;

FPU Flags Affected

C1 Sign of value in ST(0).

C0, C2, C3 See table above.

Floating-point Exceptions

None.

Additional Itanium® System Environment Exceptions

Itanium Reg Faults Disabled FP Register Fault if PSR.dfl is 1, NaT Register Consumption Abort.

FXAM—Examine (Continued)**Protected Mode Exceptions**

#NM EM or TS in CR0 is set.

Real Address Mode Exceptions

#NM EM or TS in CR0 is set.

Virtual 8086 Mode Exceptions

#NM EM or TS in CR0 is set.

FXCH—Exchange Register Contents

| Opcode | Instruction | Description |
|---------|---------------------|---|
| D9 C8+i | FXCH ST(<i>i</i>) | Exchange the contents of ST(0) and ST(<i>i</i>) |
| D9 C9 | FXCH | Exchange the contents of ST(0) and ST(1) |

Description

Exchanges the contents of registers ST(0) and ST(*i*). If no source operand is specified, the contents of ST(0) and ST(1) are exchanged.

This instruction provides a simple means of moving values in the FPU register stack to the top of the stack [ST(0)], so that they can be operated on by those floating-point instructions that can only operate on values in ST(0). For example, the following instruction sequence takes the square root of the third register from the top of the register stack:

```
FXCH ST(3);
FSQRT;
FXCH ST(3);
```

Operation

IF number-of-operands is 1

THEN

```
temp ← ST(0);
ST(0) ← SRC;
SRC ← temp;
```

ELSE

```
temp ← ST(0);
ST(0) ← ST(1);
ST(1) ← temp;
```

FPU Flags Affected

C1 Set to 0 if stack underflow occurred; otherwise, cleared to 0.
 C0, C2, C3 Undefined.

Floating-point Exceptions

#IS Stack underflow occurred.

Additional Itanium® System Environment Exceptions

Itanium Reg Faults Disabled FP Register Fault if PSR.dfl is 1, NaT Register Consumption Abort.

Protected Mode Exceptions

#NM EM or TS in CR0 is set.

FXCH—Exchange Register Contents (Continued)

Real Address Mode Exceptions

#NM EM or TS in CR0 is set.

Virtual 8086 Mode Exceptions

#NM EM or TS in CR0 is set.

FXTRACT—Extract Exponent and Significand

| Opcode | Instruction | Description |
|--------|-------------|---|
| D9 F4 | FXTRACT | Separate value in ST(0) into exponent and significand, store exponent in ST(0), and push the significand onto the register stack. |

Description

Separates the source value in the ST(0) register into its exponent and significand, stores the exponent in ST(0), and pushes the significand onto the register stack. Following this operation, the new top-of-stack register ST(0) contains the value of the original significand expressed as a real number. The sign and significand of this value are the same as those found in the source operand, and the exponent is 3FFFH (biased value for a true exponent of zero). The ST(1) register contains the value of the original operand's true (unbiased) exponent expressed as a real number. (The operation performed by this instruction is a superset of the IEEE-recommended $\log_b(x)$ function.)

This instruction and the F2XM1 instruction are useful for performing power and range scaling operations. The FXTRACT instruction is also useful for converting numbers in extended-real format to decimal representations (e.g. for printing or displaying).

If the floating-point zero-divide exception (#Z) is masked and the source operand is zero, an exponent value of $-\infty$ is stored in register ST(1) and 0 with the sign of the source operand is stored in register ST(0).

Operation

```
TEMP ← Significand(ST(0));
ST(0) ← Exponent(ST(0));
TOP ← TOP - 1;
ST(0) ← TEMP;
```

FPU Flags Affected

C1 Set to 0 if stack underflow occurred; set to 1 if stack overflow occurred.
 C0, C2, C3 Undefined.

Floating-point Exceptions

#IS Stack underflow occurred.
 Stack overflow occurred.
 #IA Source operand is an SNaN value or unsupported format.
 #Z ST(0) operand is ± 0 .
 #D Source operand is a denormal value.

Additional Itanium® System Environment Exceptions

Itanium Reg Faults Disabled FP Register Fault if PSR.dfl is 1, NaT Register Consumption Abort.

FXTRACT—Extract Exponent and Significand (Continued)**Protected Mode Exceptions**

#NM EM or TS in CR0 is set.

Real Address Mode Exceptions

#NM EM or TS in CR0 is set.

Virtual 8086 Mode Exceptions

#NM EM or TS in CR0 is set.

FYL2X—Compute $y \times \log_2 x$

| Opcode | Instruction | Description |
|--------|-------------|--|
| D9 F1 | FYL2X | Replace ST(1) with $(ST(1) * \log_2 ST(0))$ and pop the register stack |

Description

Calculates $(ST(1) * \log_2 (ST(0)))$, stores the result in register ST(1), and pops the FPU register stack. The source operand in ST(0) must be a non-zero positive number.

The following table shows the results obtained when taking the log of various classes of numbers, assuming that neither overflow nor underflow occurs.

Table 1-11. FYL2X Zeros and NaNs

| | | ST(0) | | | | | | |
|-------|-----------|-----------|------|-----------|-----------|-----------|-----------|-----|
| | | $-\infty$ | $-F$ | $+0$ | $+0$ | $+F$ | $+\infty$ | NaN |
| ST(1) | $-\infty$ | * | * | $+\infty$ | $+\infty$ | $+\infty$ | $-\infty$ | NaN |
| | $-F$ | * | * | ** | ** | $\pm F$ | $-\infty$ | NaN |
| | -0 | * | * | * | * | $+0$ | * | NaN |
| | $+0$ | * | * | * | * | $+0$ | * | NaN |
| | $+F$ | * | * | ** | ** | $\pm F$ | $+\infty$ | NaN |
| | $+\infty$ | * | * | $-\infty$ | $-\infty$ | $-\infty$ | $+\infty$ | NaN |
| | NaN | NaN | NaN | NaN | NaN | NaN | NaN | NaN |

Notes:

F means finite-real number.

* indicates floating-point invalid-operation (#IA) exception.

** indicates floating-point zero-divide (#Z) exception.

If the divide-by-zero exception is masked and register ST(0) contains ± 0 , the instruction returns ∞ with a sign that is the opposite of the sign of the source operand in register ST(1).

The FYL2X instruction is designed with a built-in multiplication to optimize the calculation of logarithms with an arbitrary positive base (b):

$$\log_b x = (\log_2 b)^{-1} * \log_2 x$$

Operation

IF

$ST(1) \leftarrow ST(1) * \log_2 ST(0);$
PopRegisterStack;

FPU Flags Affected

C1 Set to 0 if stack underflow occurred.

Indicates rounding direction if the inexact-result exception (#P) is generated:
0 = not roundup; 1 = roundup.

C0, C2, C3 Undefined.

FYL2X—Compute $y \times \log_2 x$ (Continued)**Additional Itanium® System Environment Exceptions**

Itanium Reg Faults Disabled FP Register Fault if PSR.dfl is 1, NaT Register Consumption Abort.

Floating-point Exceptions

| | |
|-----|---|
| #IS | Stack underflow occurred. |
| #IA | Either operand is an SNaN or unsupported format. Source operand in register ST(0) is a negative finite value (not -0). |
| #Z | Source operand in register ST(0) is ± 0 . |
| #D | Source operand is a denormal value. |
| #U | Result is too small for destination format. |
| #O | Result is too large for destination format. |
| #P | Value cannot be represented exactly in destination format. |

Protected Mode Exceptions

#NM EM or TS in CR0 is set.

Real Address Mode Exceptions

#NM EM or TS in CR0 is set.

Virtual 8086 Mode Exceptions

#NM EM or TS in CR0 is set.

FYL2XP1—Compute $y * \log_2(x + 1)$

| Opcode | Instruction | Description |
|--------|-------------|---|
| D9 F9 | FYL2XP1 | Replace ST(1) with $ST(1) * \log_2(ST(0) + 1.0)$ and pop the register stack |

Description

Calculates the log epsilon ($ST(1) * \log_2(ST(0) + 1.0)$), stores the result in register ST(1), and pops the FPU register stack. The source operand in ST(0) must be in the range:

$$-(1 - \sqrt{2}/2) \text{ to } (1 - \sqrt{2}/2)$$

The source operand in ST(1) can range from $-\infty$ to $+\infty$. If either of the source operands is outside its acceptable range, the result is undefined and no exception is generated.

The following table shows the results obtained when taking the log epsilon of various classes of numbers, assuming that underflow does not occur:

Table 1-12. FYL2XP1 Zeros and NaNs

| | | ST(0) | | | | | | |
|-------|-----------|-----------|-------------------------------|------|------|-------------------------------|-----------|-----|
| | | $-\infty$ | $-(1 - (\sqrt{2}/2))$ to -0 | -0 | $+0$ | $+0$ to $+(1 - (\sqrt{2}/2))$ | $+\infty$ | NaN |
| ST(1) | $-\infty$ | * | $+\infty$ | * | * | $-\infty$ | $-\infty$ | NaN |
| | $-F$ | * | $+F$ | $+0$ | -0 | $-F$ | $-\infty$ | NaN |
| | -0 | * | $+0$ | $+0$ | -0 | -0 | * | NaN |
| | $+0$ | * | -0 | -0 | $+0$ | $+0$ | * | NaN |
| | $+F$ | * | $-F$ | -0 | $+0$ | $+F$ | $+\infty$ | NaN |
| | $+\infty$ | * | $-\infty$ | * | * | $+\infty$ | $+\infty$ | NaN |
| | NaN | NaN | NaN | NaN | NaN | NaN | NaN | NaN |

Notes:

F means finite-real number.

* indicates floating-point invalid-operation (#IA) exception.

This instruction provides optimal accuracy for values of epsilon [the value in register ST(0)] that are close to 0. When the epsilon value (ϵ) is small, more significant digits can be retained by using the FYL2XP1 instruction than by using $(\epsilon+1)$ as an argument to the FYL2X instruction. The $(\epsilon+1)$ expression is commonly found in compound interest and annuity calculations. The result can be simply converted into a value in another logarithm base by including a scale factor in the ST(1) source operand. The following equation is used to calculate the scale factor for a particular logarithm base, where n is the logarithm base desired for the result of the FYL2XP1 instruction:

$$\text{scale factor} = \log_n 2$$

Operation

I

$ST(1) \leftarrow ST(1) * \log_2(ST(0) + 1.0);$

PopRegisterStack;

FYL2XP1—Compute $y * \log_2(x + 1)$ (Continued)**FPU Flags Affected**

| | |
|------------|--|
| C1 | Set to 0 if stack underflow occurred. |
| | Indicates rounding direction if the inexact-result exception (#P) is generated: 0 = not roundup; 1 = roundup. |
| C0, C2, C3 | Undefined. |

Additional Itanium® System Environment Exceptions

Itanium Reg Faults Disabled FP Register Fault if PSR.dfl is 1, NaT Register Consumption Abort.

Floating-point Exceptions

| | |
|-----|--|
| #IS | Stack underflow occurred. |
| #IA | Either operand is an SNaN value or unsupported format. |
| #D | Source operand is a denormal value. |
| #U | Result is too small for destination format. |
| #O | Result is too large for destination format. |
| #P | Value cannot be represented exactly in destination format. |

Protected Mode Exceptions

| | |
|-----|-------------------------|
| #NM | EM or TS in CR0 is set. |
|-----|-------------------------|

Real Address Mode Exceptions

| | |
|-----|-------------------------|
| #NM | EM or TS in CR0 is set. |
|-----|-------------------------|

Virtual 8086 Mode Exceptions

| | |
|-----|-------------------------|
| #NM | EM or TS in CR0 is set. |
|-----|-------------------------|

HLT—Halt

| Opcode | Instruction | Description |
|--------|-------------|-------------|
| F4 | HLT | Halt |

Description

Stops instruction execution and places the processor in a HALT state. An enabled interrupt, NMI, or a reset will resume execution. If an interrupt (including NMI) is used to resume execution after a HLT instruction, the saved instruction pointer (CS:EIP) points to the instruction following the HLT instruction.

The HLT instruction is a privileged instruction. When the processor is running in protected or virtual 8086 mode, the privilege level of a program or procedure must be 0 to execute the HLT instruction.

Operation

IF Itanium System Environment THEN IA-32_Intercept(INST,HALT);

Enter Halt state;

Flags Affected

None.

Additional Itanium® System Environment Exceptions

IA-32_Intercept Mandatory Instruction Intercept.

Protected Mode Exceptions

#GP(0) If the current privilege level is not 0.

Real Address Mode Exceptions

None.

Virtual 8086 Mode Exceptions

#GP(0) If the current privilege level is not 0.

IDIV—Signed Divide

| Opcode | Instruction | Description |
|--------|------------------|--|
| F6 /7 | IDIV <i>rm8</i> | Signed divide AX (where AH must contain sign-extension of AL) by <i>rm</i> byte. (Results: AL=Quotient, AH=Remainder) |
| F7 /7 | IDIV <i>rm16</i> | Signed divide DX:AX (where DX must contain sign-extension of AX) by <i>rm</i> word. (Results: AX=Quotient, DX=Remainder) |
| F7 /7 | IDIV <i>rm32</i> | Signed divide EDX:EAX (where EDX must contain sign-extension of EAX) by <i>rm</i> doubleword. (Results: EAX=Quotient, EDX=Remainder) |

Description

Divides (signed) the value in the AL, AX, or EAX register by the source operand and stores the result in the AX, DX:AX, or EDX:EAX registers. The source operand can be a general-purpose register or a memory location. The action of this instruction depends on the operand size, as shown in the following table:

Table 1-13. IDIV Operands

| Operand Size | Dividend | Divisor | Quotient | Remainder | Quotient Range |
|---------------------|----------|--------------|----------|-----------|---|
| Word/byte | AX | <i>r/m8</i> | AL | AH | -128 to +127 |
| Doubleword/word | DX:AX | <i>r/m16</i> | AX | DX | -32,768 to +32,767 |
| Quadword/doubleword | EDX:EAX | <i>r/m32</i> | EAX | EDX | -2 ³¹ to 2 ³² - 1 |

Non-integral results are truncated (chopped) towards 0. The sign of the remainder is always the same as the sign of the dividend. The absolute value of the remainder is always less than the absolute value of the divisor. Overflow is indicated with the #DE (divide error) exception rather than with the OF flag.

Operation

```

IF SRC = 0
  THEN #DE; (* divide error *)
FI;
IF OpernadSize = 8 (* word/byte operation *)
  THEN
    temp ← AX / SRC; (* signed division *)
    IF (temp > 7FH) OR (temp < 80H)
      (* if a positive result is greater than 7FH or a negative result is less than 80H *)
      THEN #DE; (* divide error *);
    ELSE
      AL ← temp;
      AH ← AX SignedModulus SRC;
    FI;
  ELSE
    IF OpernadSize = 16 (* doubleword/word operation *)
      THEN

```

IDIV—Signed Divide (Continued)

```

temp ← DX:AX / SRC; (* signed division *)
IF (temp > 7FFFH) OR (temp < 8000H)
(* if a positive result is greater than 7FFFH *)
(* or a negative result is less than 8000H *)
    THEN #DE; (* divide error *) ;
    ELSE
        AX ← temp;
        DX ← DX:AX SignedModulus SRC;
    FI;
ELSE (* quadword/doubleword operation *)
temp ← EDX:EAX / SRC; (* signed division *)
IF (temp > 7FFFFFFFH) OR (temp < 80000000H)
(* if a positive result is greater than 7FFFFFFFH *)
(* or a negative result is less than 80000000H *)
    THEN #DE; (* divide error *) ;
    ELSE
        EAX ← temp;
        EDX ← EDX:EAX SignedModulus SRC;
    FI;
FI;
FI;

```

Flags Affected

The CF, OF, SF, ZF, AF, and PF flags are undefined.

Additional Itanium® System Environment Exceptions

Itanium Reg Faults NaT Register Consumption Abort.

Itanium Mem Faults VHPT Data Fault, Nested TLB Fault, Data TLB Fault, Alternate Data TLB Fault, Data Page Not Present Fault, Data NaT Page Consumption Abort, Data Key Miss Fault, Data Key Permission Fault, Data Access Rights Fault, Data Access Bit Fault, Data Dirty Bit Fault

Protected Mode Exceptions

| | |
|-----------------|--|
| #DE | If the source operand (divisor) is 0. The signed result (quotient) is too large for the destination. |
| #GP(0) | If a memory operand effective address is outside the CS, DS, ES, FS, or GS segment limit. If the DS, ES, FS, or GS register is used to access memory and it contains a null segment selector. |
| #SS(0) | If a memory operand effective address is outside the SS segment limit. |
| #PF(fault-code) | If a page fault occurs. |
| #AC(0) | If alignment checking is enabled and an unaligned memory reference is made while the current privilege level is 3. |

IDIV—Signed Divide (Continued)

Real Address Mode Exceptions

| | |
|-----|---|
| #DE | If the source operand (divisor) is 0. The signed result (quotient) is too large for the destination. |
| #GP | If a memory operand effective address is outside the CS, DS, ES, FS, or GS segment limit. |
| #SS | If a memory operand effective address is outside the SS segment limit. |

Virtual 8086 Mode Exceptions

| | |
|-----------------|---|
| #DE | If the source operand (divisor) is 0. The signed result (quotient) is too large for the destination. |
| #GP(0) | If a memory operand effective address is outside the CS, DS, ES, FS, or GS segment limit. |
| #SS(0) | If a memory operand effective address is outside the SS segment limit. |
| #PF(fault-code) | If a page fault occurs. |
| #AC(0) | If alignment checking is enabled and an unaligned memory reference is made. |

IMUL—Signed Multiply

| Opcode | Instruction | Description |
|----------|-----------------------------|--|
| F6 /5 | IMUL <i>r/m8</i> | AX ← AL * <i>r/m</i> byte |
| F7 /5 | IMUL <i>r/m16</i> | DX:AX ← AX * <i>r/m</i> word |
| F7 /5 | IMUL <i>r/m32</i> | EDX:EAX ← EAX * <i>r/m</i> doubleword |
| 0F AF /r | IMUL <i>r16,r/m16</i> | word register ← word register * <i>r/m</i> word |
| 0F AF /r | IMUL <i>r32,r/m32</i> | doubleword register ← doubleword register * <i>r/m</i> doubleword |
| 6B /r ib | IMUL <i>r16,r/m16,imm8</i> | word register ← <i>r/m16</i> * sign-extended immediate byte |
| 6B /r ib | IMUL <i>r32,r/m32,imm8</i> | doubleword register ← <i>r/m32</i> * sign-extended immediate byte |
| 6B /r ib | IMUL <i>r16,imm8</i> | word register ← word register * sign-extended immediate byte |
| 6B /r ib | IMUL <i>r32,imm8</i> | doubleword register ← doubleword register * sign-extended immediate byte |
| 69 /r iw | IMUL <i>r16,r/m16,imm16</i> | word register ← <i>r/m16</i> * immediate word |
| 69 /r id | IMUL <i>r32,r/m32,imm32</i> | doubleword register ← <i>r/m32</i> * immediate doubleword |
| 69 /r iw | IMUL <i>r16,imm16</i> | word register ← <i>r/m16</i> * immediate word |
| 69 /r id | IMUL <i>r32,imm32</i> | doubleword register ← <i>r/m32</i> * immediate doubleword |

Description

Performs a signed multiplication of two operands. This instruction has three forms, depending on the number of operands.

- One-operand form.** This form is identical to that used by the MUL instruction. Here, the source operand (in a general-purpose register or memory location) is multiplied by the value in the AL, AX, or EAX register (depending on the operand size) and the product is stored in the AX, DX:AX, or EDX:EAX registers, respectively.
- Two-operand form.** With this form the destination operand (the first operand) is multiplied by the source operand (second operand). The destination operand is a general-purpose register and the source operand is an immediate value, a general-purpose register, or a memory location. The product is then stored in the destination operand location.
- Three-operand form.** This form requires a destination operand (the first operand) and two source operands (the second and the third operands). Here, the first source operand (which can be a general-purpose register or a memory location) is multiplied by the second source operand (an immediate value). The product is then stored in the destination operand (a general-purpose register).

When an immediate value is used as an operand, it is sign-extended to the length of the destination operand format.

The CF and OF flags are set when significant bits are carried into the upper half of the result. The CF and OF flags are cleared when the result fits exactly in the lower half of the result.

IMUL—Signed Multiply (Continued)

The three forms of the IMUL instruction are similar in that the length of the product is calculated to twice the length of the operands. With the one-operand form, the product is stored exactly in the destination. With the two- and three- operand forms, however, result is truncated to the length of the destination before it is stored in the destination register. Because of this truncation, the CF or OF flag should be tested to ensure that no significant bits are lost.

The two- and three-operand forms may also be used with unsigned operands because the lower half of the product is the same regardless if the operands are signed or unsigned. The CF and OF flags, however, cannot be used to determine if the upper half of the result is non-zero.

Operation

```

IF (NumberOfOperands = 1)
  THEN IF (OperandSize = 8)
    THEN
      AX ← AL * SRC (* signed multiplication *)
      IF ((AH = 00H) OR (AH = FFH))
        THEN CF = 0; OF = 0;
        ELSE CF = 1; OF = 1;
      FI;
    ELSE IF OperandSize = 16
      THEN
        DX:AX ← AX * SRC (* signed multiplication *)
        IF ((DX = 0000H) OR (DX = FFFFH))
          THEN CF = 0; OF = 0;
          ELSE CF = 1; OF = 1;
        FI;
      ELSE (* OperandSize = 32 *)
        EDX:EAX ← EAX * SRC (* signed multiplication *)
        IF ((EDX = 00000000H) OR (EDX = FFFFFFFFH))
          THEN CF = 0; OF = 0;
          ELSE CF = 1; OF = 1;
        FI;
      FI;
  ELSE IF (NumberOfOperands = 2)
    THEN
      temp ← DEST * SRC (* signed multiplication; temp is double DEST size*)
      DEST ← DEST * SRC (* signed multiplication *)
      IF temp ≠ DEST
        THEN CF = 1; OF = 1;
        ELSE CF = 0; OF = 0;
      FI;
    ELSE (* NumberOfOperands = 3 *)
      DEST ← SRC1 * SRC2 (* signed multiplication *)
      temp ← SRC1 * SRC2 (* signed multiplication; temp is double SRC1 size *)
      IF temp ≠ DEST
        THEN CF = 1; OF = 1;
        ELSE CF = 0; OF = 0;
      FI;
  FI;
FI;

```

IMUL—Signed Multiply (Continued)

Flags Affected

For the one operand form of the instruction, the CF and OF flags are set when significant bits are carried into the upper half of the result and cleared when the result fits exactly in the lower half of the result. For the two- and three-operand forms of the instruction, the CF and OF flags are set when the result must be truncated to fit in the destination operand size and cleared when the result fits exactly in the destination operand size. The SF, ZF, AF, and PF flags are undefined.

Additional Itanium® System Environment Exceptions

Itanium Reg Faults NaT Register Consumption Abort.

Itanium Mem Faults VHPT Data Fault, Nested TLB Fault, Data TLB Fault, Alternate Data TLB Fault, Data Page Not Present Fault, Data NaT Page Consumption Abort, Data Key Miss Fault, Data Key Permission Fault, Data Access Rights Fault, Data Access Bit Fault, Data Dirty Bit Fault

Protected Mode Exceptions

| | |
|-----------------|--|
| #GP(0) | If a memory operand effective address is outside the CS, DS, ES, FS, or GS segment limit. If the DS, ES, FS, or GS register is used to access memory and it contains a null segment selector. |
| #SS(0) | If a memory operand effective address is outside the SS segment limit. |
| #PF(fault-code) | If a page fault occurs. |
| #AC(0) | If alignment checking is enabled and an unaligned memory reference is made while the current privilege level is 3. |

Real Address Mode Exceptions

| | |
|-----|---|
| #GP | If a memory operand effective address is outside the CS, DS, ES, FS, or GS segment limit. |
| #SS | If a memory operand effective address is outside the SS segment limit. |

Virtual 8086 Mode Exceptions

| | |
|-----------------|---|
| #GP(0) | If a memory operand effective address is outside the CS, DS, ES, FS, or GS segment limit. |
| #SS(0) | If a memory operand effective address is outside the SS segment limit. |
| #PF(fault-code) | If a page fault occurs. |
| #AC(0) | If alignment checking is enabled and an unaligned memory reference is made. |

IN—Input from Port

| Opcode | Instruction | Description |
|--------------|---------------------|---|
| E4 <i>ib</i> | IN AL, <i>imm8</i> | Input byte from <i>imm8</i> I/O port address into AL |
| E5 <i>ib</i> | IN AX, <i>imm8</i> | Input byte from <i>imm8</i> I/O port address into AX |
| E5 <i>ib</i> | IN EAX, <i>imm8</i> | Input byte from <i>imm8</i> I/O port address into EAX |
| EC | IN AL,DX | Input byte from I/O port in DX into AL |
| ED | IN AX,DX | Input word from I/O port in DX into AX |
| ED | IN EAX,DX | Input doubleword from I/O port in DX into EAX |

Description

Copies the value from the I/O port specified with the second operand (source operand) to the destination operand (first operand). The source operand can be a byte-immediate or the DX register; the destination operand can be register AL, AX, or EAX, depending on the size of the port being accessed (8, 16, or 32 bits, respectively). Using the DX register as a source operand allows I/O port addresses from 0 to 65,535 to be accessed; using a byte immediate allows I/O port addresses 0 to 255 to be accessed.

When accessing an 8-bit I/O port, the opcode determines the port size; when accessing a 16- and 32-bit I/O port, the operand-size attribute determines the port size.

At the machine code level, I/O instructions are shorter when accessing 8-bit I/O ports. Here, the upper eight bits of the port address will be 0.

This instruction is only useful for accessing I/O ports located in the processor's I/O address space.

I/O transactions are performed after all prior data memory operations. No subsequent data memory operations can pass an I/O transaction.

In the Itanium System Environment, I/O port references are mapped into the 64-bit virtual address pointed to by the IOBase register, with four ports per 4K-byte virtual page. Operating systems can utilize the TLB in the Itanium architecture to grant or deny permission to any four I/O ports. The I/O port space can be mapped into any arbitrary 64-bit physical memory location by operating system code. If CFLAG.io is 1 and CPL > IOPL, the TSS is consulted for I/O permission. If CFLAG.io is 0 or CPL ≤ IOPL, permission is granted regardless of the state of the TSS I/O permission bitmap (the bitmap is not referenced).

If the referenced I/O port is mapped to an unimplemented virtual address (via the I/O Base register) or if data translations are disabled (PSR.dt is 0) a GPFault is generated on the referencing IN instruction.

Operation

```
IF ((PE = 1) AND ((VM = 1) OR (CPL > IOPL)))
  THEN (* Protected mode or virtual-8086 mode with CPL > IOPL *)
    IF (CFLAG.io AND Any I/O Permission Bit for I/O port being accessed = 1)
      THEN #GP(0);
    FI;
  ELSE (* Real-address mode or protected mode with CPL ≤ IOPL *)
    (* or virtual-8086 mode with all I/O permission bits for I/O port cleared *)
```

IN—Input from Port (Continued)

```

FI;
IF (Itanium_System_Environment THEN
    SRC_VA = IOBase | (Port{15:2}<<12) | Port{11:0};
    SRC_PA = translate(SRC_VA);
    DEST ← [SRC_PA]; (* Reads from I/O port *)
FI;

memory_fence();
DEST <-SRC;
memory_fence();

```

Flags Affected

None.

Additional Itanium® System Environment Exceptions

| | |
|--------------------|--|
| Itanium Reg Faults | NaT Register Consumption Abort. |
| Itanium Mem Faults | VHPT Data Fault, Nested TLB Fault, Data TLB Fault, Alternate Data TLB Fault, Data Page Not Present Fault, Data NaT Page Consumption Abort, Data Key Miss Fault, Data Key Permission Fault, Data Access Rights Fault, Data Access Bit Fault, Data Dirty Bit Fault |
| IA-32_Exception | Debug traps for data breakpoints and single step |
| IA-32_Exception | Alignment faults |
| #GP(0) | Referenced Port is to an unimplemented virtual address or PSR.dt is zero. |

Protected Mode Exceptions

| | |
|--------|---|
| #GP(0) | If the CPL is greater than (has less privilege) the I/O privilege level (IOPL) and any of the corresponding I/O permission bits in TSS for the I/O port being accessed is 1 when CFLG.io is 1. |
|--------|---|

Real Address Mode Exceptions

None.

Virtual 8086 Mode Exceptions

| | |
|--------|--|
| #GP(0) | If any of the I/O permission bits in the TSS for the I/O port being accessed is 1. |
|--------|--|

INC—Increment by 1

| Opcode | Instruction | Description |
|---------------|------------------|--------------------------------------|
| FE /0 | INC <i>r/m8</i> | Increment <i>r/m</i> byte by 1 |
| FF /0 | INC <i>r/m16</i> | Increment <i>r/m</i> word by 1 |
| FF /0 | INC <i>r/m32</i> | Increment <i>r/m</i> doubleword by 1 |
| 40+ <i>rw</i> | INC <i>r16</i> | Increment word register by 1 |
| 40+ <i>rd</i> | INC <i>r32</i> | Increment doubleword register by 1 |

Description

Adds 1 to the operand, while preserving the state of the CF flag. The source operand can be a register or a memory location. This instruction allows a loop counter to be updated without disturbing the CF flag. (Use a ADD instruction with an immediate operand of 1 to perform a increment operation that does updates the CF flag.)

Operation

$DEST \leftarrow DEST + 1;$

Flags Affected

The CF flag is not affected. The OF, SF, ZF, AF, and PF flags are set according to the result.

Additional Itanium® System Environment Exceptions

Itanium Reg Faults NaT Register Consumption Abort.
 Itanium Mem Faults VHPT Data Fault, Nested TLB Fault, Data TLB Fault, Alternate Data TLB Fault, Data Page Not Present Fault, Data NaT Page Consumption Abort, Data Key Miss Fault, Data Key Permission Fault, Data Access Rights Fault, Data Access Bit Fault, Data Dirty Bit Fault

Protected Mode Exceptions

#GP(0) If the operand is located in a nonwritable segment.
 If a memory operand effective address is outside the CS, DS, ES, FS, or GS segment limit.
 If the DS, ES, FS, or GS register is used to access memory and it contains a null segment selector.
 #SS(0) If a memory operand effective address is outside the SS segment limit.
 #PF(fault-code) If a page fault occurs.
 #AC(0) If alignment checking is enabled and an unaligned memory reference is made while the current privilege level is 3.

Real Address Mode Exceptions

#GP If a memory operand effective address is outside the CS, DS, ES, FS, or GS segment limit.
 #SS If a memory operand effective address is outside the SS segment limit.

INC—Increment by 1 (Continued)

Virtual 8086 Mode Exceptions

| | |
|-----------------|---|
| #GP(0) | If a memory operand effective address is outside the CS, DS, ES, FS, or GS segment limit. |
| #SS(0) | If a memory operand effective address is outside the SS segment limit. |
| #PF(fault-code) | If a page fault occurs. |
| #AC(0) | If alignment checking is enabled and an unaligned memory reference is made. |

INS/INSB/INSW/INSD—Input from Port to String

| Opcode | Instruction | Description |
|--------|------------------|---|
| 6C | INS ES:(E)DI, DX | Input byte from port DX into ES:(E)DI |
| 6D | INS ES:DI, DX | Input word from port DX into ES:DI |
| 6D | INS ES:EDI, DX | Input doubleword from port DX into ES:EDI |
| 6C | INSB | Input byte from port DX into ES:(E)DI |
| 6D | INSW | Input word from port DX into ES:DI |
| 6D | INSD | Input doubleword from port DX into ES:EDI |

Description

Copies the data from the I/O port specified with the second operand (source operand) to the destination operand (first operand). The source operand must be the DX register, allowing I/O port addresses from 0 to 65,535 to be accessed. When accessing an 8-bit I/O port, the opcode determines the port size; when accessing a 16- and 32-bit I/O port, the operand-size attribute determines the port size.

The destination operand is a memory location at the address ES:EDI. (When the operand-size attribute is 16, the DI register is used as the destination-index register.) The ES segment cannot be overridden with a segment override prefix.

The INSB, INSW, and INSD mnemonics are synonyms of the byte, word, and doubleword versions of the INS instructions. (For the INS instruction, “ES:EDI” must be explicitly specified in the instruction.)

After the byte, word, or doubleword is transfer from the I/O port to the memory location, the EDI register is incremented or decremented automatically according to the setting of the DF flag in the EFLAGS register. (If the DF flag is 0, the EDI register is incremented; if the DF flag is 1, the EDI register is decremented.) The EDI register is incremented or decremented by 1 for byte operations, by 2 for word operations, or by 4 for doubleword operations.

The INS, INSB, INSW, and INSD instructions can be preceded by the REP prefix for block input of ECX bytes, words, or doublewords.

This instruction is only useful for accessing I/O ports located in the processor’s I/O address space.

I/O transactions are performed after all prior data memory operations. No subsequent data memory operations can pass an I/O transaction.

In the Itanium System Environment, I/O port references are mapped into the 64-bit virtual address pointed to by the IOBase register, with four ports per 4K-byte virtual page. Operating systems can utilize the TLBs in the Itanium architecture to grant or deny permission to any four I/O ports. The I/O port space can be mapped into any arbitrary 64-bit physical memory location by operating system code. If CFLG.io is 1 and CPL>IOPL, the TSS is consulted for I/O permission. If CFLG.io is 0 or CPL<=IOPL, permission is granted regardless of the state of the TSS I/O permission bitmap (the bitmap is not referenced).

If the referenced I/O port is mapped to an unimplemented virtual address (via the IOBase register) or if data translations are disabled (PSR.dt is 0) a GPFault is generated on the referencing INS instruction.

INS/INSB/INSW/INSD—Input from Port to String (Continued)

Operation

```

IF ((PE = 1) AND ((VM = 1) OR (CPL > IOPL)))
  THEN (* Protected mode or virtual-8086 mode with CPL > IOPL *)
    IF (CFLG.io AND Any I/O Permission Bit for I/O port being accessed = 1)
      THEN #GP(0);
    FI;
  ELSE (* I/O operation is allowed *)
    FI;
IF (Itanium_System_Environment) THEN
  SRC_VA = IOBase | (Port{15:2}<<12) | Port{11:0};
  SRC_PA = translate(SRC_VA);
  DEST ← [SRC_PA]; (* Reads from I/O port *)
FI;

memory_fence();
DEST ← SRC;
memory_fence();
IF (byte transfer)
  THEN IF DF = 0
    THEN (E)DI ← 1;
    ELSE (E)DI ← -1;
  FI;
  ELSE IF (word transfer)
    THEN IF DF = 0
      THEN DI ← 2;
      ELSE DI ← -2;
    FI;
    ELSE (* doubleword transfer *)
      THEN IF DF = 0
        THEN EDI ← 4;
        ELSE EDI ← -4;
      FI;
    FI;
  FI;
FI;

```

Flags Affected

None.

Additional Itanium® System Environment Exceptions

| | |
|--------------------|--|
| Itanium Reg Faults | NaT Register Consumption Abort. |
| Itanium Mem Faults | VHPT Data Fault, Nested TLB Fault, Data TLB Fault, Alternate Data TLB Fault, Data Page Not Present Fault, Data NaT Page Consumption Abort, Data Key Miss Fault, Data Key Permission Fault, Data Access Rights Fault, Data Access Bit Fault, Data Dirty Bit Fault |
| IA-32_Exception | Debug traps for data breakpoints and single step |
| IA-32_Exception | Alignment faults |
| #GP(0) | Referenced Port is to an unimplemented virtual address or PSR.dt is zero. |

INS/INSB/INSW/INSD—Input from Port to String (Continued)

Protected Mode Exceptions

| | |
|-----------------|--|
| #GP(0) | If the CPL is greater than (has less privilege) the I/O privilege level (IOPL) and any of the corresponding I/O permission bits in TSS for the I/O port being accessed is 1 and when CFLG.io is 1 . If the destination is located in a nonwritable segment. If an illegal memory operand effective address in the ES segments is given. |
| #PF(fault-code) | If a page fault occurs. |
| #AC(0) | If alignment checking is enabled and an unaligned memory reference is made while the current privilege level is 3. |

Real Address Mode Exceptions

| | |
|-----|---|
| #GP | If a memory operand effective address is outside the CS, DS, ES, FS, or GS segment limit. |
| #SS | If a memory operand effective address is outside the SS segment limit. |

Virtual 8086 Mode Exceptions

| | |
|-----------------|--|
| #GP(0) | If any of the I/O permission bits in the TSS for the I/O port being accessed is 1. |
| #PF(fault-code) | If a page fault occurs. |
| #AC(0) | If alignment checking is enabled and an unaligned memory reference is made. |

INT n /INTO/INT3—Call to Interrupt Procedure

| Opcode | Instruction | Description |
|--------------|-----------------|---|
| CC | INT3 | Interrupt 3—trap to debugger |
| CD <i>ib</i> | INT <i>imm8</i> | Interrupt vector numbered by immediate byte |
| CE | INTO | Interrupt 4—if overflow flag is 1 |

Description

The INT n instruction generates a call to the interrupt or exception handler specified with the destination operand. The destination operand specifies an interrupt vector from 0 to 255, encoded as an 8-bit unsigned intermediate value. The first 32 interrupt vectors are reserved by Intel for system use. Some of these interrupts are used for internally generated exceptions.

The INT n instruction is the general mnemonic for executing a software-generated call to an interrupt handler. The INTO instruction is a special mnemonic for calling overflow exception (#OF), interrupt vector 4. The overflow interrupt checks the OF flag in the EFLAGS register and calls the overflow interrupt handler if the OF flag is set to 1.

The INT3 instruction is a special mnemonic for calling the debug exception handler. The action of the INT3 instruction (opcode CC) is slightly different from the operation of the INT 3 instruction (opcode CC03), as follows:

- Interrupt redirection does not happen when in VME mode; the interrupt is handled by a protected-mode handler.
- The virtual-8086 mode IOPL checks do not occur. The interrupt is taken without faulting at any IOPL level.

The action of the INT n instruction (including the INTO and INT3 instructions) is similar to that of a far call made with the CALL instruction. The primary difference is that with the INT n instruction, the EFLAGS register is pushed onto the stack before the return address. (The return address is a far address consisting of the current values of the CS and EIP registers.) Returns from interrupt procedures are handled with the IRET instruction, which pops the EFLAGS information and return address from the stack.

The interrupt vector specifies an interrupt descriptor in the interrupt descriptor table (IDT); that is, it provides index into the IDT. The selected interrupt descriptor in turn contains a pointer to an interrupt or exception handler procedure. In protected mode, the IDT contains an array of 8-byte descriptors, each of which points to an interrupt gate, trap gate, or task gate. In real-address mode, the IDT is an array of 4-byte far pointers (2-byte code segment selector and a 2-byte instruction pointer), each of which point directly to procedure in the selected segment.

The following decision table indicates which action in the lower portion of the table is taken given the conditions in the upper portion of the table. Each Y in the lower section of the decision table represents a procedure defined in the “Operation” section for this instruction (except #GP).

INT_n/INTO/INT3—Call to Interrupt Procedure (Continued)

Table 1-14. INT Cases

| | | | | | | | | |
|----------------------------------|---|----------|------|-------------------|-------------------|-------------------|-------------------|-------------------|
| PE | 0 | 1 | 1 | 1 | 1 | 1 | 1 | 1 |
| VM | – | – | – | – | – | 0 | 1 | 1 |
| IOPL | – | – | – | – | – | – | <3 | =3 |
| DPL/CPL RELATIONSHIP | – | DPL< CPL | – | DPL> CPL | DPL= CPL or C | DPL< CPL & NC | – | – |
| INTERRUPT TYPE | – | S/W | – | – | – | – | – | – |
| GATE TYPE | – | – | Task | Trap or Interrupt | Trap or Interrupt | Trap or Interrupt | Trap or Interrupt | Trap or Interrupt |
| REAL-ADDRESS-MODE | Y | | | | | | | |
| PROTECTED-MODE | | Y | Y | Y | Y | Y | Y | Y |
| TRAP-OR-INTERRUPT-GATE | | | | Y | Y | Y | Y | Y |
| INTER-PRIVILEGE-LEVEL-INTERRUPT | | | | | | Y | | |
| INTRA-PRIVILEGE-LEVEL-INTERRUPT | | | | | Y | | | |
| INTERRUPT-FROM-VIRTUAL-8086-MODE | | | | | | | | Y |
| TASK-GATE | | | Y | | | | | |
| #GP | | Y | | Y | | | Y | |

Notes:

- Don't Care
- Y Yes, Action Taken
- Blank Action Not Taken

When the processor is executing in virtual-8086 mode, the IOPL determines the action of the INT_n instruction. If the IOPL is less than 3, the processor generates a general protection exception (#GP); if the IOPL is 3, the processor executes a protected mode interrupt to privilege level 0. The interrupt gate's DPL must be set to three and the target CPL of the interrupt handler procedure must be 0 to execute the protected mode interrupt to privilege level 0.

The interrupt descriptor table register (IDTR) specifies the base linear address and limit of the IDT. The initial base address value of the IDTR after the processor is powered up or reset is 0.

Operation

The following operational description applies not only to the INT_n and INTO instructions, but also to external interrupts and exceptions.

```

IF Itanium System Environment THEN
  IF INT3 Form THEN IA-32_Exception(3);
  IF INTO Form THEN IA-32_Exception(4);
  IF INT Form THEN IA-32_Interrupt(N);
FI;

```

INT n /INTO/INT3—Call to Interrupt Procedure (Continued)

```

/*IN the Itanium System Environment all of the following operations are intercepted*/
IF PE=0
  THEN
    GOTO REAL-ADDRESS-MODE;
  ELSE (* PE=1 *)
    GOTO PROTECTED-MODE;
FI;

REAL-ADDRESS-MODE:
IF ((DEST * 4) + 3) is not within IDT limit THEN #GP; FI;
IF stack not large enough for a 6-byte return information THEN #SS; FI;
Push (EFLAGS[15:0]);
IF ← 0; (* Clear interrupt flag *)
TF ← 0; (* Clear trap flag *)
AC ← 0; (* Clear AC flag *)
Push(CS);
Push(IP);
(* No error codes are pushed *)
CS ← IDT(Descriptor (vector * 4), selector);
EIP ← IDT(Descriptor (vector * 4), offset); (* 16 bit offset AND 0000FFFFH *)
END;

PROTECTED-MODE:
IF ((DEST * 8) + 7) is not within IDT limits
  OR selected IDT descriptor is not an interrupt-, trap-, or task-gate type
  THEN #GP((DEST * 8) + 2 + EXT);
  (* EXT is bit 0 in error code *)
FI;
IF software interrupt (* generated by INT $n$ , INT3, or INTO *)
  THEN
    IF gate descriptor DPL < CPL
      THEN #GP((vector number * 8) + 2);
      (* PE=1, DPL<CPL, software interrupt *)
    FI;
  FI;
  IF gate not present THEN #NP((vector number * 8) + 2 + EXT); FI;
  IF task gate (* specified in the selected interrupt table descriptor *)
    THEN GOTO TASK-GATE;
    ELSE GOTO TRAP-OR-INTERRUPT-GATE; (* PE=1, trap/interrupt gate *)
  FI;
END;

TASK-GATE: (* PE=1, task gate *)
Read segment selector in task gate (IDT descriptor);
IF local/global bit is set to local
  OR index not within GDT limits
  THEN #GP(TSS selector);
FI;
Access TSS descriptor in GDT;
IF TSS descriptor specifies that the TSS is busy (low-order 5 bits set to 00001)
  THEN #GP(TSS selector);
FI;
IF TSS not present

```

INTn/INTO/INT3—Call to Interrupt Procedure (Continued)

```

        THEN #NP(TSS selector);
    FI;
    SWITCH-TASKS (with nesting) to TSS;
    IF interrupt caused by fault with error code
    THEN
        IF stack limit does not allow push of two bytes
        THEN #SS(0);
        FI;
        Push(error code);
    FI;
    IF EIP not within code segment limit
    THEN #GP(0);
    FI;
END;
TRAP-OR-INTERRUPT-GATE
    Read segment selector for trap or interrupt gate (IDT descriptor);
    IF segment selector for code segment is null
    THEN #GP(0H + EXT); (* null selector with EXT flag set *)
    FI;
    IF segment selector is not within its descriptor table limits
    THEN #GP(selector + EXT);
    FI;
    Read trap or interrupt handler descriptor;
    IF descriptor does not indicate a code segment
    OR code segment descriptor DPL > CPL
    THEN #GP(selector + EXT);
    FI;
    IF trap or interrupt gate segment is not present,
    THEN #NP(selector + EXT);
    FI;
    IF code segment is non-conforming AND DPL < CPL
    THEN IF VM=0
    THEN
        GOTO INTER-PRIVILEGE-LEVEL-INTERRUPT;
        (* PE=1, interrupt or trap gate, nonconforming *)
        (* code segment, DPL<CPL, VM=0 *)
    ELSE (* VM=1 *)
        IF code segment DPL ≠ 0 THEN #GP(new code segment selector); FI;
        GOTO INTERRUPT-FROM-VIRTUAL-8086-MODE;
        (* PE=1, interrupt or trap gate, DPL<CPL, VM=1 *)
    FI;
    ELSE (* PE=1, interrupt or trap gate, DPL ≥ CPL *)
        IF VM=1 THEN #GP(new code segment selector); FI;
        IF code segment is conforming OR code segment DPL = CPL
        THEN
            GOTO INTRA-PRIVILEGE-LEVEL-INTERRUPT;
        ELSE
            #GP(CodeSegmentSelector + EXT);
            (* PE=1, interrupt or trap gate, nonconforming *)
            (* code segment, DPL>CPL *)
        FI;
    FI;
    FI;
END;

```

INTn/INTO/INT3—Call to Interrupt Procedure (Continued)

```

INTER-PRIVILEGE-LEVEL-INTERRUPT
(* PE=1, interrupt or trap gate, non-conforming code segment, DPL<CPL *)
(* Check segment selector and descriptor for stack of new privilege level in current TSS *)
IF current TSS is 32-bit TSS
  THEN
    TSSstackAddress ← new code segment (DPL * 8) + 4
    IF (TSSstackAddress + 7) > TSS limit
      THEN #TS(current TSS selector); FI;
    NewSS ← TSSstackAddress + 4;
    NewESP ← stack address;
  ELSE (* TSS is 16-bit *)
    TSSstackAddress ← new code segment (DPL * 4) + 2
    IF (TSSstackAddress + 4) > TSS limit
      THEN #TS(current TSS selector); FI;
    NewESP ← TSSstackAddress;
    NewSS ← TSSstackAddress + 2;
  FI;
IF segment selector is null THEN #TS(EXT); FI;
IF segment selector index is not within its descriptor table limits
  OR segment selector's RPL ≠ DPL of code segment,
  THEN #TS(SS selector + EXT);
FI;
Read segment descriptor for stack segment in GDT or LDT;
IF stack segment DPL ≠ DPL of code segment,
  OR stack segment does not indicate writable data segment,
  THEN #TS(SS selector + EXT);
FI;
IF stack segment not present THEN #SS(SS selector+EXT); FI;
IF 32-bit gate
  THEN
    IF new stack does not have room for 24 bytes (error code pushed)
      OR 20 bytes (no error code pushed)
      THEN #SS(segment selector + EXT);
    FI;
  ELSE (* 16-bit gate *)
    IF new stack does not have room for 12 bytes (error code pushed)
      OR 10 bytes (no error code pushed);
      THEN #SS(segment selector + EXT);
    FI;
  FI;
IF instruction pointer is not within code segment limits THEN #GP(0); FI;
SS:ESP ← TSS(SS:ESP) (* segment descriptor information also loaded *)
IF 32-bit gate
  THEN
    CS:EIP ← Gate(CS:EIP); (* segment descriptor information also loaded *)
  ELSE (* 16-bit gate *)
    CS:IP ← Gate(CS:IP); (* segment descriptor information also loaded *)
  FI;
IF 32-bit gate
  THEN
    Push(far pointer to old stack); (* old SS and ESP, 3 words padded to 4 *);
    Push(EFLAGS);
    Push(far pointer to return instruction); (* old CS and EIP, 3 words padded to 4*);
    Push(ErrorCode); (* if needed, 4 bytes *)
  
```

INTn/INTO/INT3—Call to Interrupt Procedure (Continued)

```

        ELSE(* 16-bit gate *)
            Push(far pointer to old stack); (* old SS and SP, 2 words *);
            Push(EFLAGS);
            Push(far pointer to return instruction); (* old CS and IP, 2 words *);
            Push(ErrorCode); (* if needed, 2 bytes *)
    FI;
    CPL ← CodeSegmentDescriptor(DPL);
    CS(RPL) ← CPL;
    IF interrupt gate
        THEN IF ← 0 (* interrupt flag to 0 (disabled) *); FI;
    TF ← 0;
    VM ← 0;
    RF ← 0;
    NT ← 0;
I  END;
INTERRUPT-FROM-VIRTUAL-8086-MODE:
(* Check segment selector and descriptor for privilege level 0 stack in current TSS *)
IF current TSS is 32-bit TSS
    THEN
        TSSstackAddress ← new code segment (DPL * 8) + 4
        IF (TSSstackAddress + 7) > TSS limit
            THEN #TS(current TSS selector); FI;
        NewSS ← TSSstackAddress + 4;
        NewESP ← stack address;
    ELSE (* TSS is 16-bit *)
        TSSstackAddress ← new code segment (DPL * 4) + 2
        IF (TSSstackAddress + 4) > TSS limit
            THEN #TS(current TSS selector); FI;
        NewESP ← TSSstackAddress;
        NewSS ← TSSstackAddress + 2;
    FI;
    IF segment selector is null THEN #TS(EXT); FI;
    IF segment selector index is not within its descriptor table limits
        OR segment selector's RPL ≠ DPL of code segment,
        THEN #TS(SS selector + EXT);
    FI;
    Access segment descriptor for stack segment in GDT or LDT;
    IF stack segment DPL ≠ DPL of code segment,
        OR stack segment does not indicate writable data segment,
        THEN #TS(SS selector + EXT);
    FI;
    IF stack segment not present THEN #SS(SS selector+EXT); FI;
    IF 32-bit gate
        THEN
            IF new stack does not have room for 40 bytes (error code pushed)
                OR 36 bytes (no error code pushed);
                THEN #SS(segment selector + EXT);
            FI;
        ELSE (* 16-bit gate *)
            IF new stack does not have room for 20 bytes (error code pushed)
                OR 18 bytes (no error code pushed);
                THEN #SS(segment selector + EXT);
            FI;
    FI;
    FI;

```

INTn/INTO/INT3—Call to Interrupt Procedure (Continued)

```

IF instruction pointer is not within code segment limits THEN #GP(0); FI;

IF CR4.VME = 0
  THEN
    IF IOPL=3
      THEN
        IF Gate DPL = 3
          THEN (*CPL=3, VM=1, IOPL=3, VME=0, gate DPL=3)
            IF Target CPL != 0
              THEN #GP(0);
            ELSE Goto VM86_INTERRUPT_TO_PRIV0;
          FI;
        ELSE (*Gate DPL < 3*)
          #GP(0);
        FI;
      ELSE (*IOPL < 3*)
        #GP(0);
      FI;
    ELSE (*VME = 1*)
      (*Check whether interrupt is directed for INT n instruction only,
      *executes virtual 8086 interrupt, protected mode interrupt or faults*)
      Ptr ← [TSS + 66];      (*Fetch IO permission bitmap pointer*)
      IF BIT[Ptr-32,N] = 0   (*software redirection bitmap is 32 bytes below IO
Permission*)
      THEN (*Interrupt redirected*)
        Goto VM86_INTERRUPT_TO_VM86;
      ELSE
        IF IOPL = 3
          THEN
            IF Gate DPL = 3
              THEN
                IF Target CPL != 0
                  THEN #GP(0);
                ELSE Goto VM86_INTERRUPT_TO_PRIV0;
              FI;
            ELSE #GP(0);
          FI;
        ELSE (*IOPL < 3*)
          #GP(0);
        FI;
      FI;
    FI;
  FI;
END;

VM86_INTERRUPT_TO_PRIV0:

tempEFLAGS ← EFLAGS;
VM ← 0;
TF ← 0;
RF ← 0;
IF service through interrupt gate THEN IF ← 0; FI;
TempSS ← SS;
TempESP ← ESP;

```

INTn/INTO/INT3—Call to Interrupt Procedure (Continued)

```

SS:ESP ← TSS(SS0:ESP0); (* Change to level 0 stack segment *)
(* Following pushes are 16 bits for 16-bit gate and 32 bits for 32-bit gates *)
(* Segment selector pushes in 32-bit mode are padded to two words *)
Push(GS);
Push(FS);
Push(DS);
Push(ES);
Push(TempSS);
Push(TempESP);
Push(TempEFlags);
Push(CS);
Push(EIP);
GS ← 0; (*segment registers nullified, invalid in protected mode *)
FS ← 0;
DS ← 0;
ES ← 0;
CS ← Gate(CS);
IF OperandSize=32
    THEN
        EIP ← Gate(instruction pointer);
    ELSE (* OperandSize is 16 *)
        EIP ← Gate(instruction pointer) AND 0000FFFFH;
FI;
(* Starts execution of new routine in Protected Mode *)
END;

VM86_INTERRUPT_TO_VM86:
IF IOPL = 3
    THEN
        push(FLAGS OR 3000H);          (*Push FLAGS w/ IOPL bits as 11B or IOPL 3*)
        push(CS);
        push(IP);
        CS ← [N*4 + 2];              (*N is vector num, read from interrupt table*)
        IP ← [N*4];
        FLAGS ← FLAGS AND 7CD5H;     (*Clear TF and IF in EFLAGS like 8086*)
    ELSE
        TempFlags ← FLAGS OR 3000H;  (*Set IOPL to 11B or IOPL 3*)
        TempFlags.IF ← EFLAGS.VIF;
        push(TempFlags);
        push(CS);
        push(IP);
        CS ← [N*4 + 2];              (*N is vector num, read from interrupt table*)
        IP ← [N*4];
        FLAGS ← FLAGS AND 77ED5H;    (*Clear VIF and TF and IF in EFLAGS like 8086*)
FI;
END;

INTRA-PRIVILEGE-LEVEL-INTERRUPT:
(* PE=1, DPL = CPL or conforming segment *)
IF 32-bit gate
    THEN
        IF current stack does not have room for 16 bytes (error code pushed)
            OR 12 bytes (no error code pushed); THEN #SS(0);
        FI;

```

INT n /INTO/INT3—Call to Interrupt Procedure (Continued)

```

ELSE (* 16-bit gate *)
  IF current stack does not have room for 8 bytes (error code pushed)
    OR 6 bytes (no error code pushed); THEN #SS(0);
  FI;
IF instruction pointer not within code segment limit THEN #GP(0); FI;
IF 32-bit gate
  THEN
    Push (EFLAGS);
    Push (far pointer to return instruction); (* 3 words padded to 4 *)
    CS:EIP ← Gate(CS:EIP); (* segment descriptor information also loaded *)
    Push (ErrorCode); (* if any *)
  ELSE (* 16-bit gate *)
    Push (FLAGS);
    Push (far pointer to return location); (* 2 words *)
    CS:IP ← Gate(CS:IP); (* segment descriptor information also loaded *)
    Push (ErrorCode); (* if any *)
  FI;
CS(RPL) ← CPL;
IF interrupt gate
  THEN
    IF ← 0; FI;
    TF ← 0;
    NT ← 0;
    VM ← 0;
    RF ← 0;
  FI;
END;

```

Flags Affected

The EFLAGS register is pushed onto stack. The IF, TF, NT, AC, RF, and VM flags may be cleared, depending on the mode of operation of the processor when the INT instruction is executed (see “Operation” section.)

Additional Itanium[®] System Environment Exceptions

| | |
|-----------------|--|
| IA-32_Exception | If INT3 or INTO form, vector numbers are 3 and 4 respectively. |
| IA-32_Interrupt | If INT n form, vector number is N . |

Protected Mode Exceptions

| | |
|---------------|--|
| #GP(0) | If the instruction pointer in the IDT or in the interrupt-, trap-, or task gate is beyond the code segment limits. |
| #GP(selector) | If the segment selector in the interrupt-, trap-, or task gate is null. If a interrupt-, trap-, or task gate, code segment, or TSS segment selector index is outside its descriptor table limits. If the interrupt vector is outside the IDT limits. If an IDT descriptor is not an interrupt-, trap-, or task-descriptor. If an interrupt is generated by the INT n instruction and the DPL of an interrupt-, trap-, or task-descriptor is less than the CPL. |

INTn/INTO/INT3—Call to Interrupt Procedure (Continued)

| | |
|-----------------|---|
| | If the segment selector in an interrupt- or trap-gate does not point to a segment descriptor for a code segment. |
| | If the segment selector for a TSS has its local/global bit set for local. |
| | If a TSS segment descriptor specifies that the TSS is busy or not available. |
| #SS(0) | If pushing the return address, flags, or error code onto the stack exceeds the bounds of the stack segment and no stack switch occurs. |
| #SS(selector) | If the SS register is being loaded and the segment pointed to is marked not present. |
| | If pushing the return address, flags, error code, or stack segment pointer exceeds the bounds of the stack segment. |
| #NP(selector) | If code segment, interrupt-, trap-, or task gate, or TSS is not present. |
| #TS(selector) | If the RPL of the stack segment selector in the TSS is not equal to the DPL of the code segment being accessed by the interrupt or trap gate. |
| | If DPL of the stack segment descriptor pointed to by the stack segment selector in the TSS is not equal to the DPL of the code segment descriptor for the interrupt or trap gate. |
| | If the stack segment selector in the TSS is null. |
| | If the stack segment for the TSS is not a writable data segment. |
| | If segment-selector index for stack segment is outside descriptor table limits. |
| #PF(fault-code) | If a page fault occurs. |

Real Address Mode Exceptions

| | |
|-----|--|
| #GP | If a memory operand effective address is outside the CS, DS, ES, FS, or GS segment limit. |
| | If the interrupt vector is outside the IDT limits. |
| #SS | If stack limit violation on push. |
| | If pushing the return address, flags, or error code onto the stack exceeds the bounds of the stack segment when a stack switch occurs. |

Virtual 8086 Mode Exceptions

| | |
|---------------|--|
| #GP(0) | (For INTn instruction) If the IOPL is less than 3 and the DPL of the interrupt-, trap-, or task-gate descriptor is not equal to 3. |
| | If the instruction pointer in the IDT or in the interrupt-, trap-, or task gate is beyond the code segment limits. |
| #GP(selector) | If the segment selector in the interrupt-, trap-, or task gate is null. |
| | If a interrupt-, trap-, or task gate, code segment, or TSS segment selector index is outside its descriptor table limits. |
| | If the interrupt vector is outside the IDT limits. |
| | If an IDT descriptor is not an interrupt-, trap-, or task-descriptor. |

INT n /INTO/INT3—Call to Interrupt Procedure (Continued)

| | |
|-----------------|---|
| | If an interrupt is generated by the INT n instruction and the DPL of an interrupt-, trap-, or task-descriptor is less than the CPL. |
| | If the segment selector in an interrupt- or trap-gate does not point to a segment descriptor for a code segment. |
| | If the segment selector for a TSS has its local/global bit set for local. |
| #SS(selector) | If the SS register is being loaded and the segment pointed to is marked not present. |
| | If pushing the return address, flags, error code, stack segment pointer, or data segments exceeds the bounds of the stack segment. |
| #NP(selector) | If code segment, interrupt-, trap-, or task gate, or TSS is not present. |
| #TS(selector) | If the RPL of the stack segment selector in the TSS is not equal to the DPL of the code segment being accessed by the interrupt or trap gate. |
| | If DPL of the stack segment descriptor for the TSS's stack segment is not equal to the DPL of the code segment descriptor for the interrupt or trap gate. |
| | If the stack segment selector in the TSS is null. |
| | If the stack segment for the TSS is not a writable data segment. |
| | If segment-selector index for stack segment is outside descriptor table limits. |
| #PF(fault-code) | If a page fault occurs. |
| #BP | If the INT3 instruction is executed. |
| #OF | If the INTO instruction is executed and the OF flag is set. |

INVD—Invalidate Internal Caches

| Opcode | Instruction | Description |
|--------|-------------|--|
| 0F 08 | INVD | Flush internal caches; initiate flushing of external caches. |

Description

Invalidates (flushes) the processor's internal caches and issues a special-function bus cycle that directs external caches to also flush themselves. Data held in internal caches is not written back to main memory.

After executing this instruction, the processor does not wait for the external caches to complete their flushing operation before proceeding with instruction execution. It is the responsibility of hardware to respond to the cache flush signal.

The INVD instruction is a privileged instruction. When the processor is running in protected mode, the CPL of a program or procedure must be 0 to execute this instruction. This instruction is also implementation-dependent; its function may be implemented differently on future Intel architecture processors.

Use this instruction with care. Data cached internally and not written back to main memory will be lost. Unless there is a specific requirement or benefit to flushing caches without writing back modified cache lines (for example, testing or fault recovery where cache coherency with main memory is not a concern), software should use the WBINVD instruction.

Operation

IF Itanium System Environment THEN IA-32_Intercept(INST,INVD);

Flush(InternalCaches);
SignalFlush(ExternalCaches);
Continue (* Continue execution);

Flags Affected

None.

Additional Itanium® System Environment Exceptions

IA-32_Intercept Mandatory Instruction Intercept

Protected Mode Exceptions

#GP(0) If the current privilege level is not 0.

Real Address Mode Exceptions

None.

Virtual 8086 Mode Exceptions

#GP(0) The INVD instruction cannot be executed at the virtual 8086 mode.



INVD—Invalidate Internal Caches (Continued)

Intel® Architecture Compatibility

This instruction is not supported on Intel architecture processors earlier than the Intel486 processor.

INVLPG—Invalidate TLB Entry

| Opcode | Instruction | Description |
|---------|-----------------|--|
| 0F 01/7 | INVLPG <i>m</i> | Invalidate TLB Entry for page that contains <i>m</i> |

Description

Invalidates (flushes) the translation lookaside buffer (TLB) entry specified with the source operand. The source operand is a memory address. The processor determines the page that contains that address and flushes the TLB entry for that page.

The INVLPG instruction is a privileged instruction. When the processor is running in protected mode, the CPL of a program or procedure must be 0 to execute this instruction. This instruction is also implementation-dependent; its function may be implemented differently on future Intel architecture processors.

The INVLPG instruction normally flushes the TLB entry only for the specified page; however, in some cases, it flushes the entire TLB.

Operation

IF Itanium System Environment THEN IA-32_Intercept(INST,INVLPG);

Flush(RelevantTLBEntries);

Continue (* Continue execution);

Flags Affected

None.

Additional Itanium® System Environment Exceptions

IA-32_Intercept Mandatory Instruction Intercept

Protected Mode Exceptions

#GP(0) If the current privilege level is not 0.

#UD Operand is a register.

Real Address Mode Exceptions

None.

Virtual 8086 Mode Exceptions

#GP(0) The INVLPG instruction cannot be executed at the virtual 8086 mode.

Intel® Architecture Compatibility

This instruction is not supported on Intel architecture processors earlier than the Intel486 processor.

IRET/IRETD—Interrupt Return

| Opcode | Instruction | Description |
|--------|-------------|--|
| CF | IRET | Interrupt return (16-bit operand size) |
| CF | IRETD | Interrupt return (32-bit operand size) |

Description

Returns program control from an exception or interrupt handler to a program or procedure that was interrupted by an exception, an external interrupt or, a software-generated interrupt, or returns from a nested task. IRET and IRETD are mnemonics for the same opcode. The IRETD mnemonic (interrupt return double) is intended for use when returning from an interrupt when using the 32-bit operand size; however, most assemblers use the IRET mnemonic interchangeably for both operand sizes.

In Real Address Mode, the IRET instruction performs a far return to the interrupted program or procedure. During this operation, the processor pops the return instruction pointer, return code segment selector, and EFLAGS image from the stack to the EIP, CS, and EFLAGS registers, respectively, and then resumes execution of the interrupted program or procedure.

In Protected Mode, the action of the IRET instruction depends on the settings of the NT (nested task) and VM flags in the EFLAGS register and the VM flag in the EFLAGS image stored on the current stack. Depending on the setting of these flags, the processor performs the following types of interrupt returns:

- Real Mode.
- Return from virtual-8086 mode.
- Return to virtual-8086 mode.
- Intra-privilege level return.
- Inter-privilege level return.

Return from nested task (task switch)

All forms of IRET result in an IA-32_Interrupt(Inst,IRET) in the Itanium System Environment.

If the NT flag (EFLAGS register) is cleared, the IRET instruction performs a far return from the interrupt procedure, without a task switch. The code segment being returned to must be equally or less privileged than the interrupt handler routine (as indicated by the RPL field of the code segment selector popped from the stack). As with a real-address mode interrupt return, the IRET instruction pops the return instruction pointer, return code segment selector, and EFLAGS image from the stack to the EIP, CS, and EFLAGS registers, respectively, and then resumes execution of the interrupted program or procedure. If the return is to another privilege level, the IRET instruction also pops the stack pointer and SS from the stack, before resuming program execution. If the return is to virtual-8086 mode, the processor also pops the data segment registers from the stack.

If the NT flag is set, the IRET instruction performs a return from a nested task (switches from the called task back to the calling task) or reverses the operation of an interrupt or exception that caused a task switch. The updated state of the task executing the IRET instruction is saved in its TSS. If the task is reentered later, the code that follows the IRET instruction is executed.

IRET performs an instruction serialization and a memory fence operation.

IRET/IRETD—Interrupt Return (Continued)

Operation

```

IF(Itanium System Environment)
    THEN IA-32_Intercept(Inst,IRET);
IF PE = 0
    THEN
        GOTO REAL-ADDRESS-MODE;;
    ELSE
        GOTO PROTECTED-MODE;
FI;

REAL-ADDRESS-MODE;
IF OperandSize = 32
    THEN
        IF top 12 bytes of stack not within stack limits THEN #SS; FI;
        IF instruction pointer not within code segment limits THEN #GP(0); FI;
        EIP ← Pop();
        CS ← Pop(); (* 32-bit pop, high-order 16-bits discarded *)
        tempEFLAGS ← Pop();
        EFLAGS ← (tempEFLAGS AND 257FD5H) OR (EFLAGS AND 1A0000H);
    ELSE (* OperandSize = 16 *)
        IF top 6 bytes of stack are not within stack limits THEN #SS; FI;
        IF instruction pointer not within code segment limits THEN #GP(0); FI;
        EIP ← Pop();
        EIP ← EIP AND 0000FFFFH;
        CS ← Pop(); (* 16-bit pop *)
        EFLAGS[15:0] ← Pop();
    FI;
END;

PROTECTED-MODE:
    IF VM = 1 (* Virtual-8086 mode: PE=1, VM=1 *)
        THEN
            GOTO RETURN-FROM-VIRTUAL-8086-MODE; (* PE=1, VM=1 *)
    FI;
    IF NT = 1
        THEN
            GOTO TASK-RETURN;(*PE=1, VM=0, NT=1 *)
    FI;

IF OperandSize=32
    THEN
        IF top 12 bytes of stack not within stack limits
            THEN #SS(0)
        FI;
        tempEIP ← Pop();
        tempCS ← Pop();
        tempEFLAGS ← Pop();
    ELSE (* OperandSize = 16 *)
        IF top 6 bytes of stack are not within stack limits
            THEN #SS(0);

```

IRET/IRETD—Interrupt Return (Continued)

```

    FI;
    tempEIP ← Pop();
    tempCS ← Pop();
    tempEFLAGS ← Pop();
    tempEIP ← tempEIP AND FFFFH;
    tempEFLAGS ← tempEFLAGS AND FFFFH;
  FI;
  IF tempEFLAGS(VM) = 1 AND CPL=0
  THEN
    GOTO RETURN-TO-VIRTUAL-8086-MODE;
    (* PE=1, VM=1 in EFLAGS image *)
  ELSE
    GOTO PROTECTED-MODE-RETURN;
    (* PE=1, VM=0 in EFLAGS image *)
  FI;

RETURN-FROM-VIRTUAL-8086-MODE:
(* Processor is in virtual-8086 mode when IRET is executed and stays in virtual-8086 mode *)

  IF CR4.VME = 0
  THEN
    IF IOPL=3 (* Virtual mode: PE=1, VM=1, IOPL=3 *)
    THEN
      IF OperandSize = 32
      THEN
        IF top 12 bytes of stack not within stack limits THEN #SS(0); FI;
        IF instruction pointer not within code segment limits THEN #GP(0); FI;
        EIP ← Pop();
        CS ← Pop(); (* 32-bit pop, high-order 16-bits discarded *)
        EFLAGS ← Pop();
        (*VM,IOPL,VIP,and VIF EFLAGS bits are not modified by pop *)
      ELSE (* OperandSize = 16 *)
        IF top 6 bytes of stack are not within stack limits THEN #SS(0); FI;
        IF instruction pointer not within code segment limits THEN #GP(0); FI;
        EIP ← Pop();
        EIP ← EIP AND 0000FFFFH;
        CS ← Pop(); (* 16-bit pop *)
        EFLAGS[15:0] ← Pop(); (* IOPL in EFLAGS is not modified by pop *)
      FI;
      ELSE #GP(0); (* trap to virtual-8086 monitor: PE=1, VM=1, IOPL<3 *)
    FI;
  ELSE (*VME is 1*)
    IF IOPL = 3
    THEN
      IF OperandSize = 32
      THEN
        EIP ← Pop();
        CS ← Pop(); (* 32-bit pop, high-order 16-bits discarded *)
        TempEFlags ← Pop();
        FLAGS = (EFLAGS AND 1B3000H) OR (TempEFlags AND 244FD7H)
        (*VM,IOPL,RF,VIP,and VIF EFLAGS bits are not modified by pop *)
      ELSE (* OperandSize = 16 *)
        EIP ← Pop();
        EIP ← EIP AND 0000FFFFH;

```

IRET/IRETD—Interrupt Return (Continued)

```

        CS ← Pop(); (* 16-bit pop *)
        TempFlags ← Pop();
        FLAGS = (FLAGS AND 3000H) OR (TempFlags AND 4FD5H)
        (*IOPL unmodified*)
    FI;
ELSE (*IOPL < 3*)
    IF OperandSize = 16
    THEN
        IF ((STACK.TF !=0) OR (EFLAGS.VIP=1 AND STACK.IF=1))
        THEN #GP(0);
        ELSE
            IP ← Pop();      (*Word Pops*)
            CS ← Pop(0);
            TempFlags ← Pop();
            (*FLAGS IOPL, IF and TF are not modified*)
            FLAGS = (FLAGS AND 3302H) OR (TempFlags AND 4CD5H)
            EFLAGS.VIF ← TempFlags.IF;
        FI;
    ELSE (*OperandSize = 32 *)
        #GP(0);
    FI;
FI;
END;

```

RETURN-TO-VIRTUAL-8086-MODE:

```

(* Interrupted procedure was in virtual-8086 mode: PE=1, VM=1 in flags image *)
    IF top 24 bytes of stack are not within stack segment limits
    THEN #SS(0);
    FI;
    IF instruction pointer not within code segment limits
    THEN #GP(0);
    FI;
    CS ← tempCS;
    EIP ← tempEIP;
    EFLAGS ← tempEFLAGS
    TempESP ← Pop();
    TempSS ← Pop();
    ES ← Pop(); (* pop 2 words; throw away high-order word *)
    DS ← Pop(); (* pop 2 words; throw away high-order word *)
    FS ← Pop(); (* pop 2 words; throw away high-order word *)
    GS ← Pop(); (* pop 2 words; throw away high-order word *)
    SS:ESP ← TempSS:TempESP;
    (* Resume execution in Virtual 8086 mode *)
END;

```

TASK-RETURN: (* PE=1, VM=1, NT=1 *)

```

    Read segment selector in link field of current TSS;
    IF local/global bit is set to local
    OR index not within GDT limits
    THEN #GP(TSS selector);
    FI;
    Access TSS for task specified in link field of current TSS;

```

IRET/IRETD—Interrupt Return (Continued)

```

    IF TSS descriptor type is not TSS or if the TSS is marked not busy
      THEN #GP(TSS selector);
    FI;
    IF TSS not present
      THEN #NP(TSS selector);
    FI;
    SWITCH-TASKS (without nesting) to TSS specified in link field of current TSS;
    Mark the task just abandoned as NOT BUSY;
    IF EIP is not within code segment limit
      THEN #GP(0);
    FI;
  END;

PROTECTED-MODE-RETURN: (* PE=1, VM=0 in flags image *)
  IF return code segment selector is null THEN GP(0); FI;
  IF return code segment selector addresses descriptor beyond descriptor table limit
    THEN GP(selector); FI;
  Read segment descriptor pointed to by the return code segment selector
  IF return code segment descriptor is not a code segment THEN #GP(selector); FI;
  IF return code segment selector RPL < CPL THEN #GP(selector); FI;
  IF return code segment descriptor is conforming
    AND return code segment DPL > return code segment selector RPL
    THEN #GP(selector); FI;
  IF return code segment descriptor is not present THEN #NP(selector); FI;
  IF return code segment selector RPL > CPL
    THEN GOTO RETURN-OUTER-PRIVILEGE-LEVEL;
    ELSE GOTO RETURN-TO-SAME-PRIVILEGE-LEVEL
  FI;
END;

RETURN-TO-SAME-PRIVILEGE-LEVEL: (* PE=1, VM=0 in flags image, RPL=CPL *)
  IF EIP is not within code segment limits THEN #GP(0); FI;
  EIP ← tempEIP;
  CS ← tempCS; (* segment descriptor information also loaded *)
  EFLAGS (CF, PF, AF, ZF, SF, TF, DF, OF, NT) ← tempEFLAGS;
  IF OperandSize=32
    THEN
      EFLAGS(RF, AC, ID) ← tempEFLAGS;
  FI;
  IF CPL ≤ IOPL
    THEN
      EFLAGS(IF) ← tempEFLAGS;
  FI;
  IF CPL = 0
    THEN
      EFLAGS(IOPL) ← tempEFLAGS;
      IF OperandSize=32
        THEN EFLAGS(VM, VIF, VIP) ← tempEFLAGS;
      FI;
  FI;
END;

RETURN-TO-OUTER-PRIVILEGE-LEVEL:

```

IRET/IRETD—Interrupt Return (Continued)

```

IF OperandSize=32
  THEN
    IF top 8 bytes on stack are not within limits THEN #SS(0); FI;
    ELSE (* OperandSize=16 *)
      IF top 4 bytes on stack are not within limits THEN #SS(0); FI;
  FI;
Read return segment selector;
IF stack segment selector is null THEN #GP(0); FI;
IF return stack segment selector index is not within its descriptor table limits
  THEN #GP(SSselector); FI;
Read segment descriptor pointed to by return segment selector;
IF stack segment selector RPL ≠ RPL of the return code segment selector
  IF stack segment selector RPL ≠ RPL of the return code segment selector
  OR the stack segment descriptor does not indicate a a writable data segment;
  OR stack segment DPL ≠ RPL of the return code segment selector
  THEN #GP(SS selector);
  FI;
  IF stack segment is not present THEN #NP(SS selector); FI;
IF tempEIP is not within code segment limit THEN #GP(0); FI;
EIP ← tempEIP;
CS ← tempCS;
EFLAGS (CF, PF, AF, ZF, SF, TF, DF, OF, NT) ← tempEFLAGS;
IF OperandSize=32
  THEN
    EFLAGS(RF, AC, ID) ← tempEFLAGS;
  FI;
IF CPO ≤ IOPL
  THEN
    EFLAGS(IF) ← tempEFLAGS;
  FI;
IF CPL = 0
  THEN
    EFLAGS(IOPL) ← tempEFLAGS;
    IF OperandSize=32
      THEN EFLAGS(VM, VIF, VIP) ← tempEFLAGS;
    FI;
  FI;
CPL ← RPL of the return code segment selector;
FOR each of segment register (ES, FS, GS, and DS)
  DO;
    IF segment register points to data or non-conforming code segment
    AND CPL > segment descriptor DPL (* stored in hidden part of segment register *)
    THEN (* segment register invalid *)
      SegmentSelector ← 0; (* null segment selector *)
    FI;
  OD;
END:

```

IRET/IRETD—Interrupt Return (Continued)

Flags Affected

All the flags and fields in the EFLAGS register are potentially modified, depending on the mode of operation of the processor.

Additional Itanium® System Environment Exceptions

| | |
|--------------------|--|
| Itanium Reg Faults | NaT Register Consumption Abort. |
| Itanium Mem Faults | VHPT Data Fault, Nested TLB Fault, Data TLB Fault, Alternate Data TLB Fault, Data Page Not Present Fault, Data NaT Page Consumption Abort, Data Key Miss Fault, Data Key Permission Fault, Data Access Rights Fault, Data Access Bit Fault, Data Dirty Bit Fault |
| IA-32_Intercept | Instruction Intercept Trap for ALL forms of IRET. |

Protected Mode Exceptions

| | |
|-----------------|---|
| #GP(0) | <p>If the return code or stack segment selector is null.</p> <p>If the return instruction pointer is not within the return code segment limit.</p> |
| #GP(selector) | <p>If a segment selector index is outside its descriptor table limits.</p> <p>If the return code segment selector RPL is greater than the CPL.</p> <p>If the DPL of a conforming-code segment is greater than the return code segment selector RPL.</p> <p>If the DPL for a nonconforming-code segment is not equal to the RPL of the code segment selector.</p> <p>If the stack segment descriptor DPL is not equal to the RPL of the return code segment selector.</p> <p>If the stack segment is not a writable data segment.</p> <p>If the stack segment selector RPL is not equal to the RPL of the return code segment selector.</p> <p>If the segment descriptor for a code segment does not indicate it is a code segment.</p> <p>If the segment selector for a TSS has its local/global bit set for local.</p> <p>If a TSS segment descriptor specifies that the TSS is busy or not available.</p> |
| #SS(0) | If the top bytes of stack are not within stack limits. |
| #NP(selector) | If the return code or stack segment is not present. |
| #PF(fault-code) | If a page fault occurs. |
| #AC(0) | If an unaligned memory reference occurs when the CPL is 3 and alignment checking is enabled. |

Real Address Mode Exceptions

| | |
|-----|--|
| #GP | If the return instruction pointer is not within the return code segment limit. |
| #SS | If the top bytes of stack are not within stack limits. |

IRET/IRETD—Interrupt Return (Continued)

Virtual 8086 Mode Exceptions

| | |
|-----------------|--|
| #GP(0) | If the return instruction pointer is not within the return code segment limit. IF IOPL not equal to 3 |
| #PF(fault-code) | If a page fault occurs. |
| #SS(0) | If the top bytes of stack are not within stack limits. |
| #AC(0) | If an unaligned memory reference occurs and alignment checking is enabled. |

Jcc—Jump if Condition Is Met

| Opcode | Instruction | Description |
|--------------------|---------------------|--|
| 77 <i>cb</i> | JA <i>rel8</i> | Jump short if above (CF=0 and ZF=0) |
| 73 <i>cb</i> | JAE <i>rel8</i> | Jump short if above or equal (CF=0) |
| 72 <i>cb</i> | JB <i>rel8</i> | Jump short if below (CF=1) |
| 76 <i>cb</i> | JBE <i>rel8</i> | Jump short if below or equal (CF=1 or ZF=1) |
| 72 <i>cb</i> | JC <i>rel8</i> | Jump short if carry (CF=1) |
| E3 <i>cb</i> | JCXZ <i>rel8</i> | Jump short if CX register is 0 |
| E3 <i>cb</i> | JECXZ <i>rel8</i> | Jump short if ECX register is 0 |
| 74 <i>cb</i> | JE <i>rel8</i> | Jump short if equal (ZF=1) |
| 7F <i>cb</i> | JG <i>rel8</i> | Jump short if greater (ZF=0 and SF=OF) |
| 7D <i>cb</i> | JGE <i>rel8</i> | Jump short if greater or equal (SF=OF) |
| 7C <i>cb</i> | JL <i>rel8</i> | Jump short if less (SF<>OF) |
| 7E <i>cb</i> | JLE <i>rel8</i> | Jump short if less or equal (ZF=1 or SF<>OF) |
| 76 <i>cb</i> | JNA <i>rel8</i> | Jump short if not above (CF=1 or ZF=1) |
| 72 <i>cb</i> | JNAE <i>rel8</i> | Jump short if not above or equal (CF=1) |
| 73 <i>cb</i> | JNB <i>rel8</i> | Jump short if not below (CF=0) |
| 77 <i>cb</i> | JNBE <i>rel8</i> | Jump short if not below or equal (CF=0 and ZF=0) |
| 73 <i>cb</i> | JNC <i>rel8</i> | Jump short if not carry (CF=0) |
| 75 <i>cb</i> | JNE <i>rel8</i> | Jump short if not equal (ZF=0) |
| 7E <i>cb</i> | JNG <i>rel8</i> | Jump short if not greater (ZF=1 or SF<>OF) |
| 7C <i>cb</i> | JNGE <i>rel8</i> | Jump short if not greater or equal (SF<>OF) |
| 7D <i>cb</i> | JNL <i>rel8</i> | Jump short if not less (SF=OF) |
| 7F <i>cb</i> | JNLE <i>rel8</i> | Jump short if not less or equal (ZF=0 and SF=OF) |
| 71 <i>cb</i> | JNO <i>rel8</i> | Jump short if not overflow (OF=0) |
| 7B <i>cb</i> | JNP <i>rel8</i> | Jump short if not parity (PF=0) |
| 79 <i>cb</i> | JNS <i>rel8</i> | Jump short if not sign (SF=0) |
| 75 <i>cb</i> | JNZ <i>rel8</i> | Jump short if not zero (ZF=0) |
| 70 <i>cb</i> | JO <i>rel8</i> | Jump short if overflow (OF=1) |
| 7A <i>cb</i> | JP <i>rel8</i> | Jump short if parity (PF=1) |
| 7A <i>cb</i> | JPE <i>rel8</i> | Jump short if parity even (PF=1) |
| 7B <i>cb</i> | JPO <i>rel8</i> | Jump short if parity odd (PF=0) |
| 78 <i>cb</i> | JS <i>rel8</i> | Jump short if sign (SF=1) |
| 74 <i>cb</i> | JZ <i>rel8</i> | Jump short if zero (ZF = 1) |
| 0F 87 <i>cw/cd</i> | JA <i>rel16/32</i> | Jump near if above (CF=0 and ZF=0) |
| 0F 83 <i>cw/cd</i> | JAE <i>rel16/32</i> | Jump near if above or equal (CF=0) |
| 0F 82 <i>cw/cd</i> | JB <i>rel16/32</i> | Jump near if below (CF=1) |
| 0F 86 <i>cw/cd</i> | JBE <i>rel16/32</i> | Jump near if below or equal (CF=1 or ZF=1) |
| 0F 82 <i>cw/cd</i> | JC <i>rel16/32</i> | Jump near if carry (CF=1) |
| 0F 84 <i>cw/cd</i> | JE <i>rel16/32</i> | Jump near if equal (ZF=1) |
| 0F 84 <i>cw/cd</i> | JZ <i>rel16/32</i> | Jump near if 0 (ZF=1) |
| 0F 8F <i>cw/cd</i> | JG <i>rel16/32</i> | Jump near if greater (ZF=0 and SF=OF) |

Jcc—Jump if Condition Is Met (Continued)

| Opcode | Instruction | Description |
|--------------------|----------------------|---|
| 0F 8D <i>cw/cd</i> | JGE <i>rel16/32</i> | Jump near if greater or equal (SF=OF) |
| 0F 8C <i>cw/cd</i> | JL <i>rel16/32</i> | Jump near if less (SF<>OF) |
| 0F 8E <i>cw/cd</i> | JLE <i>rel16/32</i> | Jump near if less or equal (ZF=1 or SF<>OF) |
| 0F 86 <i>cw/cd</i> | JNA <i>rel16/32</i> | Jump near if not above (CF=1 or ZF=1) |
| 0F 82 <i>cw/cd</i> | JNAE <i>rel16/32</i> | Jump near if not above or equal (CF=1) |
| 0F 83 <i>cw/cd</i> | JNB <i>rel16/32</i> | Jump near if not below (CF=0) |
| 0F 87 <i>cw/cd</i> | JNBE <i>rel16/32</i> | Jump near if not below or equal (CF=0 and ZF=0) |
| 0F 83 <i>cw/cd</i> | JNC <i>rel16/32</i> | Jump near if not carry (CF=0) |
| 0F 85 <i>cw/cd</i> | JNE <i>rel16/32</i> | Jump near if not equal (ZF=0) |
| 0F 8E <i>cw/cd</i> | JNG <i>rel16/32</i> | Jump near if not greater (ZF=1 or SF<>OF) |
| 0F 8C <i>cw/cd</i> | JNGE <i>rel16/32</i> | Jump near if not greater or equal (SF<>OF) |
| 0F 8D <i>cw/cd</i> | JNL <i>rel16/32</i> | Jump near if not less (SF=OF) |
| 0F 8F <i>cw/cd</i> | JNLE <i>rel16/32</i> | Jump near if not less or equal (ZF=0 and SF=OF) |
| 0F 81 <i>cw/cd</i> | JNO <i>rel16/32</i> | Jump near if not overflow (OF=0) |
| 0F 8B <i>cw/cd</i> | JNP <i>rel16/32</i> | Jump near if not parity (PF=0) |
| 0F 89 <i>cw/cd</i> | JNS <i>rel16/32</i> | Jump near if not sign (SF=0) |
| 0F 85 <i>cw/cd</i> | JNZ <i>rel16/32</i> | Jump near if not zero (ZF=0) |
| 0F 80 <i>cw/cd</i> | JO <i>rel16/32</i> | Jump near if overflow (OF=1) |
| 0F 8A <i>cw/cd</i> | JP <i>rel16/32</i> | Jump near if parity (PF=1) |
| 0F 8A <i>cw/cd</i> | JPE <i>rel16/32</i> | Jump near if parity even (PF=1) |
| 0F 8B <i>cw/cd</i> | JPO <i>rel16/32</i> | Jump near if parity odd (PF=0) |
| 0F 88 <i>cw/cd</i> | JS <i>rel16/32</i> | Jump near if sign (SF=1) |
| 0F 84 <i>cw/cd</i> | JZ <i>rel16/32</i> | Jump near if 0 (ZF=1) |

Description

Checks the state of one or more of the status flags in the EFLAGS register (CF, OF, PF, SF, and ZF) and, if the flags are in the specified state (condition), performs a jump to the target instruction specified by the destination operand. A condition code (*cc*) is associated with each instruction to indicate the condition being tested for. If the condition is not satisfied, the jump is not performed and execution continues with the instruction following the *Jcc* instruction.

The target instruction is specified with a relative offset (a signed offset relative to the current value of the instruction pointer in the EIP register). A relative offset (*rel8*, *rel16*, or *rel32*) is generally specified as a label in assembly code, but at the machine code level, it is encoded as a signed, 8-bit or 32-bit immediate value, which is added to the instruction pointer. Instruction coding is most efficient for offsets of –128 to +127. If the operand-size attribute is 16, the upper two bytes of the EIP register are cleared to 0s, resulting in a maximum instruction pointer size of 16 bits.

The conditions for each *Jcc* mnemonic are given in the “Description” column of the above table. The terms “less” and “greater” are used for comparisons of signed integers and the terms “above” and “below” are used for unsigned integers.

Jcc—Jump if Condition Is Met (Continued)

Because a particular state of the status flags can sometimes be interpreted in two ways, two mnemonics are defined for some opcodes. For example, the JA (jump if above) instruction and the JNBE (jump if not below or equal) instruction are alternate mnemonics for the opcode 77H.

The *Jcc* instruction does not support far jumps (jumps to other code segments). When the target for the conditional jump is in a different segment, use the opposite condition from the condition being tested for the *Jcc* instruction, and then access the target with an unconditional far jump (JMP instruction) to the other segment. For example, the following conditional far jump is illegal:

```
JZ FARLABEL;
```

To accomplish this far jump, use the following two instructions:

```
JNZ BEYOND;
JMP FARLABEL;
BEYOND:
```

The JECXZ and JCXZ instructions differs from the other *Jcc* instructions because they do not check the status flags. Instead they check the contents of the ECX and CX registers, respectively, for 0. These instructions are useful at the beginning of a conditional loop that terminates with a conditional loop instruction (such as LOOPNE). They prevent entering the loop when the ECX or CX register is equal to 0, which would cause the loop to execute 2^{32} or 64K times, respectively, instead of zero times.

All conditional jumps are converted to code fetches of one or two cache lines, regardless of jump address or cacheability.

Operation

```
IF condition
  THEN
    EIP ← EIP + SignExtend(DEST);
    IF OperandSize = 16
      THEN
        EIP ← EIP AND 0000FFFFH;
    FI;
  IF Itanium System Environment AND PSR.tb THEN IA-32_Exception(Debug);
FI;
```

Flags Affected

None.

Additional Itanium® System Environment Exceptions

IA-32_Exception Taken Branch Debug Exception if PSR.tb is 1

Protected Mode Exceptions

#GP(0) If the offset being jumped to is beyond the limits of the CS segment.

Jcc—Jump if Condition Is Met (Continued)

Real Address Mode Exceptions

#GP If the offset being jumped to is beyond the limits of the CS segment or is outside of the effective address space from 0 to FFFFH. This condition can occur if 32-address size override prefix is used.

Virtual 8086 Mode Exceptions

#GP(0) If the offset being jumped to is beyond the limits of the CS segment or is outside of the effective address space from 0 to FFFFH. This condition can occur if 32-address size override prefix is used.

JMP—Jump

| Opcode | Instruction | Description |
|--------------|---------------------|-----------------------------|
| EB <i>cb</i> | JMP <i>rel8</i> | Jump near, relative address |
| E9 <i>cw</i> | JMP <i>rel16</i> | Jump near, relative address |
| E9 <i>cd</i> | JMP <i>rel32</i> | Jump near, relative address |
| FF /4 | JMP <i>r/m16</i> | Jump near, indirect address |
| FF /4 | JMP <i>r/m32</i> | Jump near, indirect address |
| EA <i>cd</i> | JMP <i>ptr16:16</i> | Jump far, absolute address |
| EA <i>cp</i> | JMP <i>ptr16:32</i> | Jump far, absolute address |
| FF /5 | JMP <i>m16:16</i> | Jump far, indirect address |
| FF /5 | JMP <i>m16:32</i> | Jump far, indirect address |

Description

Transfers program control to a different point in the instruction stream without recording return information. The destination (target) operand specifies the address of the instruction being jumped to. This operand can be an immediate value, a general-purpose register, or a memory location.

- Near jump – A jump to an instruction within the current code segment (the segment currently pointed to by the CS register), sometimes referred to as an intrasegment call.
- Far jump – A jump to an instruction located in a different segment than the current code segment, sometimes referred to as an intersegment call.
- Task switch – A jump to an instruction located in a different task. (This is a form of a far jump.) **Results in an IA-32_Interrupt(Gate) in Itanium System Environment.**

A task switch can only be executed in protected mode (see Chapter 6 in the *IA-32 Intel® Architecture Software Developer's Manual, Volume 3* for information on task switching with the JMP instruction).

When executing a near jump, the processor jumps to the address (within the current code segment) that is specified with the target operand. The target operand specifies either an absolute address (that is an offset from the base of the code segment) or a relative offset (a signed offset relative to the current value of the instruction pointer in the EIP register). An absolute address is specified directly in a register or indirectly in a memory location (*r/m16* or *r/m32* operand form). A relative offset (*rel8*, *rel16*, or *rel32*) is generally specified as a label in assembly code, but at the machine code level, it is encoded as a signed, 8-bit or 32-bit immediate value, which is added to the value in the EIP register (that is, to the instruction following the JMP instruction). The operand-size attribute determines the size of the target operand (16 or 32 bits) for absolute addresses. Absolute addresses are loaded directly into the EIP register. When a relative offset is specified, it is added to the value of the EIP register. If the operand-size attribute is 16, the upper two bytes of the EIP register are cleared to 0s, resulting in a maximum instruction pointer size of 16 bits. The CS register is not changed on near jumps.

JMP—Jump (Continued)

When executing a far jump, the processor jumps to the code segment and address specified with the target operand. Here the target operand specifies an absolute far address either directly with a pointer (*ptr16:16* or *ptr16:32*) or indirectly with a memory location (*m16:16* or *m16:32*). With the pointer method, the segment and address of the called procedure is encoded in the instruction using a 4-byte (16-bit operand size) or 6-byte (32-bit operand size) far address immediate. With the indirect method, the target operand specifies a memory location that contains a 4-byte (16-bit operand size) or 6-byte (32-bit operand size) far address. The operand-size attribute determines the size of the offset (16 or 32 bits) in the far address. The far address is loaded directly into the CS and EIP registers. If the operand-size attribute is 16, the upper two bytes of the EIP register are cleared to 0s.

When the processor is operating in protected mode, a far jump can also be used to access a code segment through a call gate or to switch tasks. Here, the processor uses the segment selector part of the far address to access the segment descriptor for the segment being jumped to. Depending on the value of the type and access rights information in the segment selector, the JMP instruction can perform:

- A far jump to a conforming or non-conforming code segment (same mechanism as the far jump described in the previous paragraph, except that the processor checks the access rights of the code segment being jumped to).
- An far jump through a call gate.
- A task switch. **Results in an IA-32_Interrupt(Gate) in Itanium System Environment.**

The JMP instruction cannot be used to perform inter-privilege level jumps.

When executing an far jump through a call gate, the segment selector specified by the target operand identifies the call gate. (The offset part of the target operand is ignored.) The processor then jumps to the code segment specified in the call gate descriptor and begins executing the instruction at the offset specified in the gate. No stack switch occurs. Here again, the target operand can specify the far address of the call gate and instruction either directly with a pointer (*ptr16:16* or *ptr16:32*) or indirectly with a memory location (*m16:16* or *m16:32*).

Executing a task switch with the JMP instruction, is similar to executing a jump through a call gate. Here the target operand specifies the segment selector of the task gate for the task being switched to. (The offset part of the target operand is ignored). The task gate in turn points to the TSS for the task, which contains the segment selectors for the task's code, data, and stack segments and the instruction pointer to the target instruction. One form of the JMP instruction allows the jump to be made directly to a TSS, without going through a task gate. See Chapter 13 in *IA-32 Intel® Architecture Software Developer's Manual, Volume 3* for detailed information on the mechanics of a task switch.

All branches are converted to code fetches of one or two cache lines, regardless of jump address or cacheability.

JMP—Jump (Continued)

Operation

```

IF near jump
  THEN IF near relative jump
    THEN
      tempEIP ← EIP + DEST; (* EIP is instruction following JMP instruction*)
    ELSE (* near absolute jump *)
      tempEIP ← DEST;
  FI;
IF tempEIP is beyond code segment limit THEN #GP(0); FI;
IF OperandSize = 32
  THEN
    EIP ← tempEIP;
  ELSE (* OperandSize=16 *)
    EIP ← tempEIP AND 0000FFFFH;
  FI;
IF Itanium System Environment AND PSR.tb THEN IA-32_Exception(Debug);
FI;

IF far jump AND (PE = 0 OR (PE = 1 AND VM = 1)) (* real address or virtual 8086 mode *)
  THEN
    tempEIP ← DEST(offset); (* DEST is ptr16:32 or [m16:32] *)
    IF tempEIP is beyond code segment limit THEN #GP(0); FI;
    CS ← DEST(segment selector); (* DEST is ptr16:32 or [m16:32] *)
    IF OperandSize = 32
      THEN
        EIP ← tempEIP; (* DEST is ptr16:32 or [m16:32] *)
      ELSE (* OperandSize = 16 *)
        EIP ← tempEIP AND 0000FFFFH; (* clear upper 16 bits *)
      FI;
    IF Itanium System Environment AND PSR.tb THEN IA-32_Exception(Debug);
  FI;

IF far call AND (PE = 1 AND VM = 0) (* Protected mode, not virtual 8086 mode *)
  THEN
    IF effective address in the CS, DS, ES, FS, GS, or SS segment is illegal
      OR segment selector in target operand null
      THEN #GP(0);
    FI;
    IF segment selector index not within descriptor table limits
      THEN #GP(new selector);
    FI;
    Read type and access rights of segment descriptor;
    IF segment type is not a conforming or nonconforming code segment, call gate,
      task gate, or TSS THEN #GP(segment selector); FI;
    Depending on type and access rights
      GO TO CONFORMING-CODE-SEGMENT;
      GO TO NONCONFORMING-CODE-SEGMENT;
      GO TO CALL-GATE;
      GO TO TASK-GATE;
      GO TO TASK-STATE-SEGMENT;
    ELSE
      #GP(segment selector);
  FI;

```

JMP—Jump (Continued)**CONFORMING-CODE-SEGMENT:**

```

IF DPL > CPL THEN #GP(segment selector); FI;
IF segment not present THEN #NP(segment selector); FI;
tempEIP ← DEST(offset);
IF OperandSize=16
    THEN tempEIP ← tempEIP AND 0000FFFFH;
FI;
IF tempEIP not in code segment limit THEN #GP(0); FI;
CS ← DEST(SegmentSelector); (* segment descriptor information also loaded *)
CS(RPL) ← CPL
EIP ← tempEIP;
IF Itanium System Environment AND PSR.tb THEN IA-32_Exception(Debug);
END;

```

NONCONFORMING-CODE-SEGMENT:

```

IF (RPL > CPL) OR (DPL ≠ CPL) THEN #GP(code segment selector); FI;
IF segment not present THEN #NP(segment selector); FI;
IF instruction pointer outside code segment limit THEN #GP(0); FI;
tempEIP ← DEST(offset);
IF OperandSize=16
    THEN tempEIP ← tempEIP AND 0000FFFFH;
FI;
IF tempEIP not in code segment limit THEN #GP(0); FI;
CS ← DEST(SegmentSelector); (* segment descriptor information also loaded *)
CS(RPL) ← CPL
EIP ← tempEIP;
IF Itanium System Environment AND PSR.tb THEN IA-32_Exception(Debug);
END;

```

CALL-GATE:

```

IF call gate DPL < CPL
    OR call gate DPL < call gate segment-selector RPL
    THEN #GP(call gate selector); FI;
IF call gate not present THEN #NP(call gate selector); FI;
IF Itanium System Environment THEN IA-32_Intercept(Gate,JMP);
IF call gate code-segment selector is null THEN #GP(0); FI;
IF call gate code-segment selector index is outside descriptor table limits
    THEN #GP(code segment selector); FI;
Read code segment descriptor;
IF code-segment segment descriptor does not indicate a code segment
    OR code-segment segment descriptor is conforming and DPL > CPL
    OR code-segment segment descriptor is non-conforming and DPL ≠ CPL
    THEN #GP(code segment selector); FI;
IF code segment is not present THEN #NP(code-segment selector); FI;
IF instruction pointer is not within code-segment limit THEN #GP(0); FI;
tempEIP ← DEST(offset);
IF GateSize=16
    THEN tempEIP ← tempEIP AND 0000FFFFH;
FI;
IF tempEIP not in code segment limit THEN #GP(0); FI;
CS ← DEST(SegmentSelector); (* segment descriptor information also loaded *)
CS(RPL) ← CPL
EIP ← tempEIP;

```

JMP—Jump (Continued)

END;

TASK-GATE:

```

IF task gate DPL < CPL
    OR task gate DPL < task gate segment-selector RPL
        THEN #GP(task gate selector); FI;
IF task gate not present THEN #NP(gate selector); FI;
IF Itanium System Environment THEN IA-32_Interrupt(Gate,JMP);
Read the TSS segment selector in the task-gate descriptor;
IF TSS segment selector local/global bit is set to local
    OR index not within GDT limits
    OR TSS descriptor specifies that the TSS is busy
        THEN #GP(TSS selector); FI;
IF TSS not present THEN #NP(TSS selector); FI;
SWITCH-TASKS to TSS;
IF EIP not within code segment limit THEN #GP(0); FI;
END;
```

TASK-STATE-SEGMENT:

```

IF TSS DPL < CPL
    OR TSS DPL < TSS segment-selector RPL
    OR TSS descriptor indicates TSS not available
        THEN #GP(TSS selector); FI;
IF TSS is not present THEN #NP(TSS selector); FI;
IF Itanium System Environment THEN IA-32_Interrupt(Gate,JMP);
SWITCH-TASKS to TSS
IF EIP not within code segment limit THEN #GP(0); FI;
END;
```

Flags Affected

All flags are affected if a task switch occurs; no flags are affected if a task switch does not occur.

Additional Itanium® System Environment Exceptions

| | |
|--------------------|--|
| Itanium Mem Faults | VHPT Data Fault, Nested TLB Fault, Data TLB Fault, Alternate Data TLB Fault, Data Page Not Present Fault, Data NaT Page Consumption Abort, Data Key Miss Fault, Data Key Permission Fault, Data Access Rights Fault, Data Access Bit Fault, Data Dirty Bit Fault |
| IA-32_Interrupt | Gate Intercept for JMP through CALL Gates, Task Gates and Task Segments |
| IA-32_Exception | Taken Branch Debug Exception if PSR.tb is 1 |

Protected Mode Exceptions

| | |
|--------|---|
| #GP(0) | If offset in target operand, call gate, or TSS is beyond the code segment limits. If the segment selector in the destination operand, call gate, task gate, or TSS is null. If a memory operand effective address is outside the CS, DS, ES, FS, or GS segment limit. |
|--------|---|

JMP—Jump (Continued)

| | |
|-----------------|--|
| | If the DS, ES, FS, or GS register is used to access memory and it contains a null segment selector. |
| #GP(selector) | If segment selector index is outside descriptor table limits. If the segment descriptor pointed to by the segment selector in the destination operand is not for a conforming-code segment, nonconforming-code segment, call gate, task gate, or task state segment. If the DPL for a nonconforming-code segment is not equal to the CPL (When not using a call gate.) If the RPL for the segment's segment selector is greater than the CPL. If the DPL for a conforming-code segment is greater than the CPL. If the DPL from a call-gate, task-gate, or TSS segment descriptor is less than the CPL or than the RPL of the call-gate, task-gate, or TSS's segment selector. If the segment descriptor for selector in a call gate does not indicate it is a code segment. If the segment descriptor for the segment selector in a task gate does not indicate available TSS. If the segment selector for a TSS has its local/global bit set for local. If a TSS segment descriptor specifies that the TSS is busy or not available. |
| #SS(0) | If a memory operand effective address is outside the SS segment limit. |
| #NP (selector) | If the code segment being accessed is not present. |
| | If call gate, task gate, or TSS not present. |
| #PF(fault-code) | If a page fault occurs. |
| #AC(0) | If alignment checking is enabled and an unaligned memory reference is made while the current privilege level is 3. (Only occurs when fetching target from memory.) |

Real Address Mode Exceptions

| | |
|-----|--|
| #GP | If a memory operand effective address is outside the CS, DS, ES, FS, or GS segment limit. If a memory operand effective address is outside the CS, DS, ES, FS, or GS segment limit. |
| #SS | If a memory operand effective address is outside the SS segment limit. |

Virtual 8086 Mode Exceptions

| | |
|-----------------|---|
| #GP(0) | If the target operand is beyond the code segment limits. If a memory operand effective address is outside the CS, DS, ES, FS, or GS segment limit. |
| #SS(0) | If a memory operand effective address is outside the SS segment limit. |
| #PF(fault-code) | If a page fault occurs. |
| #AC(0) | If alignment checking is enabled and an unaligned memory reference is made. (Only occurs when fetching target from memory.) |

JMPE—Jump to Intel® Itanium® Instruction Set

| Opcode | Instruction | Description |
|----------|--------------------|--|
| 0F 00 /6 | JMPE <i>r/m16</i> | Jump to Intel® Itanium® instruction set, indirect address specified by <i>r/m16</i> |
| 0F 00 /6 | JMPE <i>r/m32</i> | Jump to Intel® Itanium® instruction set, indirect address specified by <i>r/m32</i> |
| 0F B8 | JMPE <i>disp16</i> | Jump to Intel® Itanium® instruction set, absolute address specified by <i>addr16</i> |
| 0F B8 | JMPE <i>disp32</i> | Jump to Intel® Itanium® instruction set, absolute address specified by <i>addr32</i> |

Description

This instruction is available only on processors based on the Itanium architecture in the Itanium System Environment. Otherwise, execution of this instruction at privilege levels 1, 2, and 3 results in an Illegal Opcode fault, and at privilege level 0, termination of the IA-32 System Environment on a processor based on the Itanium architecture.

JMPE switches the processor to the Itanium instruction set and starts execution at the specified target address. There are two forms; an indirect form, *r/mr16/32*, and an unsigned absolute form, *disp16/32*. Both 16 and 32-bit formats are supported.

The absolute form computes the 16-byte aligned 64-bit virtual target address in the Itanium instruction set by adding the unsigned 16 or 32-bit displacement to the current CS base ($IP\{31:0\} = \text{disp16/32} + \text{CSD.base}$). The indirect form specifies the virtual target address by the contents of a register or memory location ($IP\{31:0\} = [r/m16/32] + \text{CSD.base}$). Target addresses are constrained to the lower 4G-bytes of the 64-bit virtual address space within virtual region 0.

GR[1] is loaded with the next sequential instruction address following JMPE.

If PSR.di is 1, the instruction is nullified and a Disabled Instruction Set Transition fault is generated. If Itanium branch debugging is enabled, an IA-32_Exception(Debug) trap is taken after JMPE completes execution.

JMPE can be performed at any privilege level and does not change the privilege level of the processor.

JMPE performs a FWAIT operation, any pending IA-32 unmasked floating-point exceptions are reported as faults on the JMPE instruction.

JMPE does not perform a memory fence or serialization operation.

Successful execution of JMPE clears EFLAG.rf and PSR.id to zero.

If the register stack engine is enabled for eager execution, the register stack engine may immediately start loading registers when the processor enters the Itanium instruction set.

JMPE—Jump to Intel® Itanium® Instruction Set (Continued)

Operation

```

if (NOT Itanium System Environment) {
    if (PSR.cpl==0) Terminate_IA-32_System_Env();
    else IA_32_Exception(IllegalOpcode);
} else if (PSR.di==1) {
    Disabled_Instruction_Set_Transition_Fault();
} else if (pending_numeric_exceptions()) {
    IA_32_exception(FPEError);
} else {
    if (absolute_form) {
        //compute virtual target
        IP{31:0} = disp16/32 + AR[CSD].base; //disp is 16/32-bit unsigned value
    } else if (indirect_form) {
        IP{31:0} = [r/m16/32] + AR[CSD].base;
    }
    PSR.is = 0; //set Itanium Instruction Set bit
    IP{3:0} = 0; //Force 16-byte alignment
    IP{63:32} = 0; //zero extend from 32-bits to 64-bits
    GR[1]{31:0} = EIP + AR[CSD].base; //next sequential instruction address
    GR[1]{63:32} = 0;
    PSR.id = EFLAG.rf = 0;

    if (PSR.tb) //taken branch trap
        IA_32_Exception(Debug);
}

```

Flags Affected

None (other than EFLAG.rf)

Additional Itanium® System Environment Exceptions

| | |
|--------------------|--|
| Itanium Reg Faults | NaT Register Consumption Fault. |
| Disabled ISA | Disabled Instruction Set Transition Fault, if PSR.di is 1 |
| IA-32_Exception | Floating-point Error, if any floating-point exceptions are pending |
| IA-32_Exception | Taken Branch trap, if PSR.tb is 1. |

IA-32 System Environment Exceptions (All Operating Modes)

| | |
|-----|--|
| #UD | JMPE raises an invalid opcode exception at privilege levels 1, 2 and 3. Privilege level 0 results in termination of the IA-32 System Environment on a processor based on the Itanium architecture. |
|-----|--|

LAHF—Load Status Flags into AH Register

| Opcode | Instruction | Description |
|--------|-------------|---|
| 9F | LAHF | Load: AH = EFLAGS(SF:ZF:0:AF:0:PF:1:CF) |

Description

Moves the low byte of the EFLAGS register (which includes status flags SF, ZF, AF, PF, and CF) to the AH register. Reserved bits 1, 3, and 5 of the EFLAGS register are set in the AH register as shown in the “Operation” below.

Operation

$AH \leftarrow EFLAGS(SF:ZF:0:AF:0:PF:1:CF);$

Flags Affected

None (that is, the state of the flags in the EFLAGS register are not affected).

Additional Itanium® System Environment Exceptions

Itanium Reg Faults NaT Register Consumption Abort.

Exceptions (All Operating Modes)

None.

LAR—Load Access Rights Byte

| Opcode | Instruction | Description |
|-----------------|----------------------|---|
| 0F 02 <i>lr</i> | LAR <i>r16,r/m16</i> | <i>r16</i> ← <i>r/m16</i> masked by FF00H |
| 0F 02 <i>lr</i> | LAR <i>r32,r/m32</i> | <i>r32</i> ← <i>r/m32</i> masked by 00FxFF00H |

Description

Loads the access rights from the segment descriptor specified by the second operand (source operand) into the first operand (destination operand) and sets the ZF flag in the EFLAGS register. The source operand (which can be a register or a memory location) contains the segment selector for the segment descriptor being accessed. The destination operand is a general-purpose register.

The processor performs access checks as part of the loading process. Once loaded in the destination register, software can preform additional checks on the access rights information.

When the operand size is 32 bits, the access rights for a segment descriptor comprise the type and DPL fields and the S, P, AVL, D/B, and G flags, all of which are located in the second doubleword (bytes 4 through 7) of the segment descriptor. The doubleword is masked by 00FxFF00H before it is loaded into the destination operand. When the operand size is 16 bits, the access rights comprise the type and DPL fields. Here, the two lower-order bytes of the doubleword are masked by FF00H before being loaded into the destination operand.

This instruction performs the following checks before it loads the access rights in the destination register:

- Checks that the segment selector is not null.
- Checks that the segment selector points to a descriptor that is within the limits of the GDT or LDT being accessed.
- Checks that the descriptor type is valid for this instruction. All code and data segment descriptors are valid for (can be accessed with) the LAR instruction. The valid system segment and gate descriptor types are given in the following table.
- If the segment is not a conforming code segment, it checks that the specified segment descriptor is visible at the CPL (that is, if the CPL and the RPL of the segment selector are less than or equal to the DPL of the segment selector).

If the segment descriptor cannot be accessed or is an invalid type for the instruction, the ZF flag is cleared and no access rights are loaded in the destination operand.

The LAR instruction can only be executed in protected mode.

LAR—Load Access Rights Byte (Continued)

Table 1-15. LAR Descriptor Validity

| Type | Name | Valid |
|------|-------------------------|-------|
| 0 | Reserved | No |
| 1 | Available 16-bit TSS | Yes |
| 2 | LDT | Yes |
| 3 | Busy 16-bit TSS | Yes |
| 4 | 16-bit call gate | Yes |
| 5 | 16-bit/32-bit task gate | Yes |
| 6 | 16-bit trap gate | No |
| 7 | 16-bit interrupt gate | No |
| 8 | Reserved | No |
| 9 | Available 32-bit TSS | Yes |
| A | Reserved | No |
| B | Busy 32-bit TSS | Yes |
| C | 32-bit call gate | Yes |
| D | Reserved | No |
| E | 32-bit trap gate | No |
| F | 32-bit interrupt gate | No |

Operation

```

IF SRC(Offset) > descriptor table limit THEN ZF ← 0; FI;
Read segment descriptor;
IF SegmentDescriptor(Type) ≠ conforming code segment
  AND (CPL > DPL) OR (RPL > DPL)
  OR Segment type is not valid for instruction
  THEN
    ZF ← 0
  ELSE
    IF OperandSize = 32
      THEN
        DEST ← [SRC] AND 00FxFF00H;
      ELSE (*OperandSize = 16*)
        DEST ← [SRC] AND FF00H;
    FI;
  FI;

```

Flags Affected

The ZF flag is set to 1 if the access rights are loaded successfully; otherwise, it is cleared to 0.

Additional Itanium® System Environment Exceptions

Itanium Reg Faults NaT Register Consumption Abort.

Itanium Mem Faults VHPT Data Fault, Nested TLB Fault, Data TLB Fault, Alternate Data TLB Fault, Data Page Not Present Fault, Data NaT Page Consumption Abort, Data Key Miss Fault, Data Key Permission Fault, Data Access Rights Fault, Data Access Bit Fault, Data Dirty Bit Fault

LAR—Load Access Rights Byte (Continued)

Protected Mode Exceptions

| | |
|-----------------|--|
| #GP(0) | If a memory operand effective address is outside the CS, DS, ES, FS, or GS segment limit. If the DS, ES, FS, or GS register is used to access memory and it contains a null segment selector. |
| #SS(0) | If a memory operand effective address is outside the SS segment limit. |
| #PF(fault-code) | If a page fault occurs. |
| #AC(0) | If alignment checking is enabled and an unaligned memory reference is made while the current privilege level is 3. (Only occurs when fetching target from memory.) |

Real Address Mode Exceptions

| | |
|-----|---|
| #UD | The LAR instruction is not recognized in real address mode. |
|-----|---|

Virtual 8086 Mode Exceptions

| | |
|-----|--|
| #UD | The LAR instruction cannot be executed in virtual 8086 mode. |
|-----|--|

LDS/LES/LFS/LGS/LSS—Load Far Pointer

| Opcode | Instruction | Description |
|----------|-----------------------|--|
| C5 /r | LDS <i>r16,m16:16</i> | Load DS: <i>r16</i> with far pointer from memory |
| C5 /r | LDS <i>r32,m16:32</i> | Load DS: <i>r32</i> with far pointer from memory |
| 0F B2 /r | LSS <i>r16,m16:16</i> | Load SS: <i>r16</i> with far pointer from memory |
| 0F B2 /r | LSS <i>r32,m16:32</i> | Load SS: <i>r32</i> with far pointer from memory |
| C4 /r | LES <i>r16,m16:16</i> | Load ES: <i>r16</i> with far pointer from memory |
| C4 /r | LES <i>r32,m16:32</i> | Load ES: <i>r32</i> with far pointer from memory |
| 0F B4 /r | LFS <i>r16,m16:16</i> | Load FS: <i>r16</i> with far pointer from memory |
| 0F B4 /r | LFS <i>r32,m16:32</i> | Load FS: <i>r32</i> with far pointer from memory |
| 0F B5 /r | LGS <i>r16,m16:16</i> | Load GS: <i>r16</i> with far pointer from memory |
| 0F B5 /r | LGS <i>r32,m16:32</i> | Load GS: <i>r32</i> with far pointer from memory |

Description

Load a far pointer (segment selector and offset) from the second operand (source operand) into a segment register and the first operand (destination operand). The source operand specifies a 48-bit or a 32-bit pointer in memory depending on the current setting of the operand-size attribute (32 bits or 16 bits, respectively). The instruction opcode and the destination operand specify a segment register/general-purpose register pair. The 16-bit segment selector from the source operand is loaded into the segment register implied with the opcode (DS, SS, ES, FS, or GS). The 32-bit or 16-bit offset is loaded into the register specified with the destination operand.

If one of these instructions is executed in protected mode, additional information from the segment descriptor pointed to by the segment selector in the source operand is loaded in the hidden part of the selected segment register.

Also in protected mode, a null selector (values 0000 through 0003) can be loaded into DS, ES, FS, or GS registers without causing a protection exception. (Any subsequent reference to a segment whose corresponding segment register is loaded with a null selector, causes a general-protection exception (#GP) and no memory reference to the segment occurs.)

Operation

IF ProtectedMode

```

THEN IF SS is loaded
  THEN IF SegmentSelector = null
    THEN #GP(0);
  FI;
  ELSE IF Segment selector index is not within descriptor table limits
    OR Segment selector RPL ≠ CPL
    OR Access rights indicate nonwritable data segment
    OR DPL ≠ CPL
    THEN #GP(selector);
  FI;
  ELSE IF Segment marked not present
    THEN #SS(selector);
  FI;
  SS ← SegmentSelector(SRC);
  SS ← SegmentDescriptor([SRC]);

```

LDS/LES/LFS/LGS/LSS—Load Far Pointer (Continued)

```

ELSE IF DS, ES, FS, or GS is loaded with non-null segment selector
  THEN IF Segment selector index is not within descriptor table limits
  OR Access rights indicate segment neither data nor readable code segment
  OR (Segment is data or nonconforming-code segment
      AND both RPL and CPL > DPL)
      THEN #GP(selector);
FI;
ELSE IF Segment marked not present
  THEN #NP(selector);
FI;
SegmentRegister ← SegmentSelector(SRC) AND RPL;
SegmentRegister ← SegmentDescriptor([SRC]);
ELSE IF DS, ES, FS or GS is loaded with a null selector:
  SegmentRegister ← NullSelector;
  SegmentRegister(DescriptorValidBit) ← 0; (*hidden flag; not accessible by software*)
FI;
FI;
IF (Real-Address or Virtual 8086 Mode)
  THEN
    SS ← SegmentSelector(SRC);
FI;
DEST ← Offset(SRC);

```

Flags Affected

None.

Additional Itanium® System Environment Exceptions

| | |
|--------------------|--|
| Itanium Reg Faults | NaT Register Consumption Abort. |
| Itanium Mem Faults | VHPT Data Fault, Nested TLB Fault, Data TLB Fault, Alternate Data TLB Fault, Data Page Not Present Fault, Data NaT Page Consumption Abort, Data Key Miss Fault, Data Key Permission Fault, Data Access Rights Fault, Data Access Bit Fault, Data Dirty Bit Fault |

Protected Mode Exceptions

| | |
|---------------|---|
| #UD | If source operand is not a memory location. |
| #GP(0) | If a null selector is loaded into the SS register. If a memory operand effective address is outside the CS, DS, ES, FS, or GS segment limit. If the DS, ES, FS, or GS register is used to access memory and it contains a null segment selector. |
| #GP(selector) | If the SS register is being loaded and any of the following is true: the segment selector index is not within the descriptor table limits, the segment selector RPL is not equal to CPL, the segment is a nonwritable data segment, or DPL is not equal to CPL. |

LDS/LES/LFS/LGS/LSS—Load Far Pointer (Continued)

If the DS, ES, FS, or GS register is being loaded with a non-null segment selector and any of the following is true: the segment selector index is not within descriptor table limits, the segment is neither a data nor a readable code segment, or the segment is a data or nonconforming-code segment and both RPL and CPL are greater than DPL.

| | |
|-----------------|---|
| #SS(0) | If a memory operand effective address is outside the SS segment limit. |
| #SS(selector) | If the SS register is being loaded and the segment is marked not present. |
| #NP(selector) | If DS, ES, FS, or GS register is being loaded with a non-null segment selector and the segment is marked not present. |
| #PF(fault-code) | If a page fault occurs. |
| #AC(0) | If alignment checking is enabled and an unaligned memory reference is made while the current privilege level is 3. |

Real Address Mode Exceptions

| | |
|-----|---|
| #GP | If a memory operand effective address is outside the CS, DS, ES, FS, or GS segment limit. |
| #SS | If a memory operand effective address is outside the SS segment limit. |
| #UD | If source operand is not a memory location. |

Virtual 8086 Mode Exceptions

| | |
|-----------------|---|
| #UD | If source operand is not a memory location. |
| #GP(0) | If a memory operand effective address is outside the CS, DS, ES, FS, or GS segment limit. |
| #SS(0) | If a memory operand effective address is outside the SS segment limit. |
| #PF(fault-code) | If a page fault occurs. |
| #AC(0) | If alignment checking is enabled and an unaligned memory reference is made. |

LEA—Load Effective Address

| Opcode | Instruction | Description |
|--------|-------------|---|
| 8D /r | LEA r16,m | Store effective address for <i>m</i> in register <i>r16</i> |
| 8D /r | LEA r32,m | Store effective address for <i>m</i> in register <i>r32</i> |

Description

Computes the effective address of the second operand (the source operand) and stores it in the first operand (destination operand). The source operand is a memory address (offset part) specified with one of the processors addressing modes; the destination operand is a general-purpose register. The address-size and operand-size attributes affect the action performed by this instruction, as shown in the following table. The operand-size attribute of the instruction is determined by the chosen register; the address-size attribute is determined by the attribute of the code segment.

Table 1-16. LEA Address and Operand Sizes

| Operand Size | Address Size | Action Performed |
|--------------|--------------|--|
| 16 | 16 | 16-bit effective address is calculated and stored in requested 16-bit register destination. |
| 16 | 32 | 32-bit effective address is calculated. The lower 16 bits of the address are stored in the requested 16-bit register destination. |
| 32 | 16 | 16-bit effective address is calculated. The 16-bit address is zero-extended and stored in the requested 32-bit register destination. |
| 32 | 32 | 32-bit effective address is calculated and stored in the requested 32-bit register destination. |

Different assemblers may use different algorithms based on the size attribute and symbolic reference of the source operand.

Operation

```

IF OperandSize = 16 AND AddressSize = 16
  THEN
    DEST ← EffectiveAddress(SRC); (* 16-bit address *)
  ELSE IF OperandSize = 16 AND AddressSize = 32
    THEN
      temp ← EffectiveAddress(SRC); (* 32-bit address *)
      DEST ← temp[0..15]; (* 16-bit address *)
  ELSE IF OperandSize = 32 AND AddressSize = 16
    THEN
      temp ← EffectiveAddress(SRC); (* 16-bit address *)
      DEST ← ZeroExtend(temp); (* 32-bit address *)
  ELSE IF OperandSize = 32 AND AddressSize = 32
    THEN
      DEST ← EffectiveAddress(SRC); (* 32-bit address *)
  FI;
FI;

```



LEA—Load Effective Address (Continued)

Flags Affected

None.

Additional Itanium® System Environment Exceptions

Itanium Reg Faults NaT Register Consumption Abort.

Protected Mode Exceptions

#UD If source operand is not a memory location.

Real Address Mode Exceptions

#UD If source operand is not a memory location.

Virtual 8086 Mode Exceptions

#UD If source operand is not a memory location.

LEAVE—High Level Procedure Exit

| Opcode | Instruction | Description |
|--------|-------------|------------------------------|
| C9 | LEAVE | Set SP to BP, then pop BP |
| C9 | LEAVE | Set ESP to EBP, then pop EBP |

Description

Executes a return from a procedure or group of nested procedures established by an earlier ENTER instruction. The instruction copies the frame pointer (in the EBP register) into the stack pointer register (ESP), releasing the stack space used by a procedure for its local variables. The old frame pointer (the frame pointer for the calling procedure that issued the ENTER instruction) is then popped from the stack into the EBP register, restoring the calling procedure's frame.

A RET instruction is commonly executed following a LEAVE instruction to return program control to the calling procedure and remove any arguments pushed onto the stack by the procedure being returned from.

Operation

```

IF StackAddressSize = 32
  THEN
    ESP ← EBP;
  ELSE (* StackAddressSize = 16*)
    SP ← BP;
FI;
IF OperandSize = 32
  THEN
    EBP ← Pop();
  ELSE (* OperandSize = 16*)
    BP ← Pop();
FI;

```

Flags Affected

None.

Additional Itanium® System Environment Exceptions

Itanium Reg Faults NaT Register Consumption Abort.

Itanium Mem Faults VHPT Data Fault, Nested TLB Fault, Data TLB Fault, Alternate Data TLB Fault, Data Page Not Present Fault, Data NaT Page Consumption Abort, Data Key Miss Fault, Data Key Permission Fault, Data Access Rights Fault, Data Access Bit Fault, Data Dirty Bit Fault

Protected Mode Exceptions

#SS(0) If the EBP register points to a location that is not within the limits of the current stack segment.

LEAVE—High Level Procedure Exit (Continued)

Real Address Mode Exceptions

#GP If the EBP register points to a location outside of the effective address space from 0 to 0FFFFH.

Virtual 8086 Mode Exceptions

#GP(0) If the EBP register points to a location outside of the effective address space from 0 to 0FFFFH.

LES—Load Full Pointer

See entry for LDS/LES/LFS/LGS/LSS.



LFS—Load Full Pointer

See entry for LDS/LES/LFS/LGS/LSS.

LGDT/LIDT—Load Global/Interrupt Descriptor Table Register

| Opcode | Instruction | Description |
|----------|------------------------|-------------------------|
| 0F 01 /2 | LGDT <i>m16&32</i> | Load <i>m</i> into GDTR |
| 0F 01 /3 | LIDT <i>m16&32</i> | Load <i>m</i> into IDTR |

Description

Loads the values in the source operand into the global descriptor table register (GDTR) or the interrupt descriptor table register (IDTR). The source operand is a pointer to 6 bytes of data in memory that contains the base address (a linear address) and the limit (size of table in bytes) of the global descriptor table (GDT) or the interrupt descriptor table (IDT). If operand-size attribute is 32 bits, a 16-bit limit (lower 2 bytes of the 6-byte data operand) and a 32-bit base address (upper 4 bytes of the data operand) are loaded into the register. If the operand-size attribute is 16 bits, a 16-bit limit (lower 2 bytes) and a 24-bit base address (third, fourth, and fifth byte) are loaded. Here, the high-order byte of the operand is not used and the high-order byte of the base address in the GDTR or IDTR is filled with zeros.

The LGDT and LIDT instructions are used only in operating-system software; they are not used in application programs. They are the only instructions that directly load a linear address (that is, not a segment-relative address) and a limit in protected mode. They are commonly executed in real-address mode to allow processor initialization prior to switching to protected mode.

Operation

IF Itanium System Environment THEN IA-32_Intercept(INST, LGDT/LIDT);

IF instruction is LIDT

THEN

IF OperandSize = 16

THEN

IDTR(Limit) ← SRC[0:15];

IDTR(Base) ← SRC[16:47] AND 00FFFFFFH;

ELSE (* 32-bit Operand Size *)

IDTR(Limit) ← SRC[0:15];

IDTR(Base) ← SRC[16:47];

FI;

ELSE (* instruction is LGDT *)

IF OperandSize = 16

THEN

GDTR(Limit) ← SRC[0:15];

GDTR(Base) ← SRC[16:47] AND 00FFFFFFH;

ELSE (* 32-bit Operand Size *)

GDTR(Limit) ← SRC[0:15];

GDTR(Base) ← SRC[16:47];

FI;

FI;

Flags Affected

None.

LGDT/LIDT—Load Global/Interrupt Descriptor Table Register (Continued)

Additional Itanium® System Environment Exceptions

IA-32_Intercept Mandatory Instruction Intercept for LIDT and LGDT

Protected Mode Exceptions

| | |
|-----------------|--|
| #UD | If source operand is not a memory location. |
| #GP(0) | If the current privilege level is not 0. If a memory operand effective address is outside the CS, DS, ES, FS, or GS segment limit. If the DS, ES, FS, or GS register is used to access memory and it contains a null segment selector. |
| #SS(0) | If a memory operand effective address is outside the SS segment limit. |
| #PF(fault-code) | If a page fault occurs. |

Real Address Mode Exceptions

| | |
|-----|---|
| #UD | If source operand is not a memory location. |
| #GP | If a memory operand effective address is outside the CS, DS, ES, FS, or GS segment limit. |
| #SS | If a memory operand effective address is outside the SS segment limit. |

Virtual 8086 Mode Exceptions

| | |
|-----------------|---|
| #UD | If source operand is not a memory location. |
| #GP(0) | If a memory operand effective address is outside the CS, DS, ES, FS, or GS segment limit. |
| #SS(0) | If a memory operand effective address is outside the SS segment limit. |
| #PF(fault-code) | If a page fault occurs. |

LGS—Load Full Pointer

See entry for LDS/LES/LFS/LGS/LSS.

LLDT—Load Local Descriptor Table Register

| Opcode | Instruction | Description |
|----------|-------------------|--|
| 0F 00 /2 | LLDT <i>r/m16</i> | Load segment selector <i>r/m16</i> into LDTR |

Description

Loads the source operand into the segment selector field of the local descriptor table register (LDTR). The source operand (a general-purpose register or a memory location) contains a segment selector that points to a local descriptor table (LDT). After the segment selector is loaded in the LDTR, the processor uses the segment selector to locate the segment descriptor for the LDT in the global descriptor table (GDT). It then loads the segment limit and base address for the LDT from the segment descriptor into the LDTR. The segment registers DS, ES, SS, FS, GS, and CS are not affected by this instruction, nor is the LDTR field in the task state segment (TSS) for the current task.

If the source operand is 0, the LDTR is marked invalid and all references to descriptors in the LDT (except by the LAR, VERR, VERW or LSL instructions) cause a general protection exception (#GP).

The operand-size attribute has no effect on this instruction.

The LLDT instruction is provided for use in operating-system software; it should not be used in application programs. Also, this instruction can only be executed in protected mode.

Operation

IF Itanium System Environment THEN IA-32_Intercept(INST,LLDT);

IF SRC(Offset) > descriptor table limit THEN #GP(segment selector); FI;
 Read segment descriptor;
 IF SegmentDescriptor(Type) ≠ LDT THEN #GP(segment selector); FI;
 IF segment descriptor is not present THEN #NP(segment selector);
 LDTR(SegmentSelector) ← SRC;
 LDTR(SegmentDescriptor) ← GDTSegmentDescriptor;

Flags Affected

None.

Additional Itanium® System Environment Exceptions

IA-32_Intercept Instruction Intercept

Protected Mode Exceptions

#GP(0) If the current privilege level is not 0.
 If a memory operand effective address is outside the CS, DS, ES, FS, or GS segment limit.
 If the DS, ES, FS, or GS register contains a null segment selector.

LLDT—Load Local Descriptor Table Register (Continued)

| | |
|-----------------|--|
| #GP(selector) | If the selector operand does not point into the Global Descriptor Table or if the entry in the GDT is not a Local Descriptor Table. Segment selector is beyond GDT limit. |
| #SS(0) | If a memory operand effective address is outside the SS segment limit. |
| #NP(selector) | If the LDT descriptor is not present. |
| #PF(fault-code) | If a page fault occurs. |

Real Address Mode Exceptions

| | |
|-----|--|
| #UD | The LLDT instruction is not recognized in real address mode. |
|-----|--|

Virtual 8086 Mode Exceptions

| | |
|-----|--|
| #UD | The LLDT instruction is recognized in virtual 8086 mode. |
|-----|--|

LIDT—Load Interrupt Descriptor Table Register

See entry for LGDT/LIDT—Load Global Descriptor Table Register/Load Interrupt Descriptor Table Register.

LMSW—Load Machine Status Word

| Opcode | Instruction | Description |
|----------|-------------------|--|
| 0F 01 /6 | LMSW <i>r/m16</i> | Loads <i>r/m16</i> in machine status word of CR0 |

Description

Loads the source operand into the machine status word, bits 0 through 15 of register CR0. The source operand can be a 16-bit general-purpose register or a memory location. Only the low-order 4 bits of the source operand (which contains the PE, MP, EM, and TS flags) are loaded into CR0. The PG, CD, NW, AM, WP, NE, and ET flags of CR0 are not affected. The operand-size attribute has no effect on this instruction.

If the PE flag of the source operand (bit 0) is set to 1, the instruction causes the processor to switch to protected mode. The PE flag in the CR0 register is a sticky bit. Once set to 1, the LMSW instruction cannot be used clear this flag and force a switch back to real address mode.

The LMSW instruction is provided for use in operating-system software; it should not be used in application programs. In protected or virtual 8086 mode, it can only be executed at CPL 0.

This instruction is provided for compatibility with the Intel 286 processor; programs and procedures intended to run on processors more recent than the Intel 286 should use the MOV (control registers) instruction to load the machine status word.

This instruction is a serializing instruction.

Operation

IF Itanium System Environment THEN IA-32_Intercept(INST,LMSW);
CR0[0:3] ← SRC[0:3];

Flags Affected

None.

Additional Itanium® System Environment Exceptions

IA-32_Intercept Mandatory Instruction Intercept

Protected Mode Exceptions

| | |
|-----------------|--|
| #GP(0) | If the current privilege level is not 0. If a memory operand effective address is outside the CS, DS, ES, FS, or GS segment limit. If the DS, ES, FS, or GS register is used to access memory and it contains a null segment selector. |
| #SS(0) | If a memory operand effective address is outside the SS segment limit. |
| #PF(fault-code) | If a page fault occurs. |

LMSW—Load Machine Status Word (Continued)

Real Address Mode Exceptions

#GP If a memory operand effective address is outside the CS, DS, ES, FS, or GS segment limit.

Virtual 8086 Mode Exceptions

#GP(0) If the current privilege level is not 0.

If a memory operand effective address is outside the CS, DS, ES, FS, or GS segment limit.

#SS(0) If a memory operand effective address is outside the SS segment limit.

#PF(fault-code) If a page fault occurs.

LOCK—Assert LOCK# Signal Prefix

| Opcode | Instruction | Description |
|--------|-------------|---|
| F0 | LOCK | Asserts LOCK# signal for duration of the accompanying instruction |

Description

Causes the processor's LOCK# signal to be asserted during execution of the accompanying instruction (turns the instruction into an atomic instruction). In a multiprocessor environment, the LOCK# signal insures that the processor has exclusive use of any shared memory while the signal is asserted.

The LOCK prefix can be prepended only to the following instructions and to those forms of the instructions that use a memory operand: ADD, ADC, AND, BTC, BTR, BTS, CMPXCHG, DEC, INC, NEG, NOT, OR, SBB, SUB, XOR, XADD, and XCHG. An undefined opcode exception will be generated if the LOCK prefix is used with any other instruction. The XCHG instruction always asserts the LOCK# signal regardless of the presence or absence of the LOCK prefix.

The LOCK prefix is typically used with the BTS instruction to perform a read-modify-write operation on a memory location in shared memory environment.

The integrity of the LOCK prefix is not affected by the alignment of the memory field. Memory locking is observed for arbitrarily misaligned fields.

Operation

**IF Itanium System Environment AND External_Bus_Lock_Required AND DCR.lc
THEN IA-32_Intercept(LOCK);**

AssertLOCK#(DurationOfAccompanyingInstruction)

Flags Affected

None.

Additional Itanium® System Environment Exceptions

Itanium Mem Faults VHPT Data Fault, Nested TLB Fault, Data TLB Fault, Alternate Data TLB Fault, Data Page Not Present Fault, Data NaT Page Consumption Abort, Data Key Miss Fault, Data Key Permission Fault, Data Access Rights Fault, Data Access Bit Fault, Data Dirty Bit Fault

IA-32_Intercept Lock Intercept - If an external atomic bus lock is required to complete this operation and DCR.lc is 1, no atomic transaction occurs, the instruction is faulted and an IA-32_Intercept(Lock) fault is generated. The software lock handler is responsible for the emulation of the instruction.

Protected Mode Exceptions

#UD If the LOCK prefix is used with an instruction not listed in the "Description" section above. Other exceptions can be generated by the instruction that the LOCK prefix is being applied to.



LOCK—Assert LOCK# Signal Prefix (Continued)

Real Address Mode Exceptions

#UD If the LOCK prefix is used with an instruction not listed in the “Description” section above. Other exceptions can be generated by the instruction that the LOCK prefix is being applied to.

Virtual 8086 Mode Exceptions

#UD If the LOCK prefix is used with an instruction not listed in the “Description” section above. Other exceptions can be generated by the instruction that the LOCK prefix is being applied to.

LODS/LODSB/LODSW/LODSD—Load String Operand

| Opcode | Instruction | Description |
|--------|---------------|--|
| AC | LODS DS:(E)SI | Load byte at address DS:(E)SI into AL |
| AD | LODS DS:SI | Load word at address DS:SI into AX |
| AD | LODS DS:ESI | Load doubleword at address DS:ESI into EAX |
| AC | LODSB | Load byte at address DS:(E)SI into AL |
| AD | LODSW | Load word at address DS:SI into AX |
| AD | LODSD | Load doubleword at address DS:ESI into EAX |

Description

Load a byte, word, or doubleword from the source operand into the AL, AX, or EAX register, respectively. The source operand is a memory location at the address DS:ESI. (When the operand-size attribute is 16, the SI register is used as the source-index register.) The DS segment may be overridden with a segment override prefix.

The LODSB, LODSW, and LODSD mnemonics are synonyms of the byte, word, and doubleword versions of the LODS instructions. (For the LODS instruction, “DS:ESI” must be explicitly specified in the instruction.)

After the byte, word, or doubleword is transfer from the memory location into the AL, AX, or EAX register, the ESI register is incremented or decremented automatically according to the setting of the DF flag in the EFLAGS register. (If the DF flag is 0, the ESI register is incremented; if the DF flag is 1, the ESI register is decremented.) The ESI register is incremented or decremented by 1 for byte operations, by 2 for word operations, or by 4 for doubleword operations.

The LODS, LODSB, LODSW, and LODSD instructions can be preceded by the REP prefix for block loads of ECX bytes, words, or doublewords. More often, however, these instructions are used within a LOOP construct, because further processing of the data moved into the register is usually necessary before the next transfer can be made. See [“REP/REPE/REPZ/REPNE /REPNZ—Repeat String Operation Prefix” on page 3:685](#) for a description of the REP prefix.

Operation

```

IF (byte load)
  THEN
    AL ← SRC; (* byte load *)
    THEN IF DF = 0
      THEN (E)SI ← 1;
      ELSE (E)SI ← -1;
    FI;
  ELSE IF (word load)
    THEN
      AX ← SRC; (* word load *)
      THEN IF DF = 0
        THEN SI ← 2;
        ELSE SI ← -2;
      FI;
    ELSE (* doubleword transfer *)
      EAX ← SRC; (* doubleword load *)
      THEN IF DF = 0

```

LODS/LODSB/LODSW/LODSD—Load String Operand (Continued)

```
THEN ESI ← 4;
ELSE ESI ← -4;
```

```
FI;
FI;
```

Flags Affected

None.

Additional Itanium® System Environment Exceptions

Itanium Reg Faults NaT Register Consumption Abort.

Itanium Mem Faults VHPT Data Fault, Nested TLB Fault, Data TLB Fault, Alternate Data TLB Fault, Data Page Not Present Fault, Data NaT Page Consumption Abort, Data Key Miss Fault, Data Key Permission Fault, Data Access Rights Fault, Data Access Bit Fault, Data Dirty Bit Fault

Protected Mode Exceptions

#GP(0) If a memory operand effective address is outside the CS, DS, ES, FS, or GS segment limit.
If the DS, ES, FS, or GS register contains a null segment selector.

#SS(0) If a memory operand effective address is outside the SS segment limit.

#PF(fault-code) If a page fault occurs.

#AC(0) If alignment checking is enabled and an unaligned memory reference is made while the current privilege level is 3.

Real Address Mode Exceptions

#GP If a memory operand effective address is outside the CS, DS, ES, FS, or GS segment limit.

#SS If a memory operand effective address is outside the SS segment limit.

Virtual 8086 Mode Exceptions

#GP(0) If a memory operand effective address is outside the CS, DS, ES, FS, or GS segment limit.

#SS(0) If a memory operand effective address is outside the SS segment limit.

#PF(fault-code) If a page fault occurs.

#AC(0) If alignment checking is enabled and an unaligned memory reference is made.

LOOP/LOOP cc —Loop According to ECX Counter

| Opcode | Instruction | Description |
|--------------|--------------------|--|
| E2 <i>cb</i> | LOOP <i>rel8</i> | Decrement count; jump short if count \neq 0 |
| E1 <i>cb</i> | LOOPE <i>rel8</i> | Decrement count; jump short if count \neq 0 and ZF=1 |
| E1 <i>cb</i> | LOOPZ <i>rel8</i> | Decrement count; jump short if count \neq 0 and ZF=1 |
| E0 <i>cb</i> | LOOPNE <i>rel8</i> | Decrement count; jump short if count \neq 0 and ZF=0 |
| E0 <i>cb</i> | LOOPNZ <i>rel8</i> | Decrement count; jump short if count \neq 0 and ZF=0 |

Description

Performs a loop operation using the ECX or CX register as a counter. Each time the LOOP instruction is executed, the count register is decremented, then checked for 0. If the count is 0, the loop is terminated and program execution continues with the instruction following the LOOP instruction. If the count is not zero, a near jump is performed to the destination (target) operand, which is presumably the instruction at the beginning of the loop. If the address-size attribute is 32 bits, the ECX register is used as the count register; otherwise the CX register is used.

The target instruction is specified with a relative offset (a signed offset relative to the current value of the instruction pointer in the EIP register). This offset is generally specified as a label in assembly code, but at the machine code level, it is encoded as a signed, 8-bit immediate value, which is added to the instruction pointer. Offsets of -128 to $+127$ are allowed with this instruction.

Some forms of the loop instruction (LOOP cc) also accept the ZF flag as a condition for terminating the loop before the count reaches zero. With these forms of the instruction, a condition code (cc) is associated with each instruction to indicate the condition being tested for. Here, the LOOP cc instruction itself does not affect the state of the ZF flag; the ZF flag is changed by other instructions in the loop.

All branches are converted to code fetches of one or two cache lines, regardless of jump address or cacheability.

Operation

```

IF AddressSize = 32
  THEN
    Count is ECX;
  ELSE (* AddressSize = 16 *)
    Count is CX;
FI;
Count  $\leftarrow$  Count - 1;

IF instruction in not LOOP
  THEN
    IF (instruction = LOOPE) OR (instruction = LOOPZ)
      THEN
        IF (ZF = 1) AND (Count  $\neq$  0)
          THEN BranchCond  $\leftarrow$  1;
          ELSE BranchCond  $\leftarrow$  0;
        FI;
      FI;
    IF (instruction = LOOPNE) OR (instruction = LOOPNZ)

```

LOOP/LOOPcc—Loop According to ECX Counter (Continued)

```

        THEN
            IF (ZF = 0) AND (Count ≠ 0)
                THEN BranchCond ← 1;
                ELSE BranchCond ← 0;
            FI;
        FI;
    ELSE (* instruction = LOOP *)
        IF (Count ≠ 0)
            THEN BranchCond ← 1;
            ELSE BranchCond ← 0;
        FI;
    FI;
    IF BranchCond = 1
        THEN
            EIP ← EIP + SignExtend(DEST);
            IF OperandSize = 16
                THEN
                    EIP ← EIP AND 0000FFFFH;
            FI;
            IF Itanium System Environment AND PSR.tb THEN IA-32_Exception(Debug);
        ELSE
            Terminate loop and continue program execution at EIP;
    FI;

```

Flags Affected

None.

Additional Itanium® System Environment Exceptions

| | |
|--------------------|---|
| Itanium Reg Faults | NaT Register Consumption Abort. |
| IA-32_Exception | Taken Branch Debug Exception if PSR.tb is 1 |

Protected Mode Exceptions

| | |
|--------|---|
| #GP(0) | If the offset jumped to is beyond the limits of the code segment. |
|--------|---|

Real Address Mode Exceptions

None.

Virtual 8086 Mode Exceptions

None.

LSL—Load Segment Limit

| Opcode | Instruction | Description |
|-----------------|----------------------|---|
| 0F 03 <i>lr</i> | LSL <i>r16,r/m16</i> | Load: <i>r16</i> ← segment limit, selector <i>r/m16</i> |
| 0F 03 <i>lr</i> | LSL <i>r32,r/m32</i> | Load: <i>r32</i> ← segment limit, selector <i>r/m32</i> |

Description

Loads the unscrambled segment limit from the segment descriptor specified with the second operand (source operand) into the first operand (destination operand) and sets the ZF flag in the EFLAGS register. The source operand (which can be a register or a memory location) contains the segment selector for the segment descriptor being accessed. The destination operand is a general-purpose register.

The processor performs access checks as part of the loading process. Once loaded in the destination register, software can compare the segment limit with the offset of a pointer.

The segment limit is a 20-bit value contained in bytes 0 and 1 and in the first 4 bits of byte 6 of the segment descriptor. If the descriptor has a byte granular segment limit (the granularity flag is set to 0), the destination operand is loaded with a byte granular value (byte limit). If the descriptor has a page granular segment limit (the granularity flag is set to 1), the LSL instruction will translate the page granular limit (page limit) into a byte limit before loading it into the destination operand. The translation is performed by shifting the 20-bit “raw” limit left 12 bits and filling the low-order 12 bits with 1s.

When the operand size is 32 bits, the 32-bit byte limit is stored in the destination operand. When the operand size is 16 bits, a valid 32-bit limit is computed; however, the upper 16 bits are truncated and only the low-order 16 bits are loaded into the destination operand.

This instruction performs the following checks before it loads the segment limit into the destination register:

- Checks that the segment selector is not null.
- Checks that the segment selector points to a descriptor that is within the limits of the GDT or LDT being accessed.
- Checks that the descriptor type is valid for this instruction. All code and data segment descriptors are valid for (can be accessed with) the LSL instruction. The valid special segment and gate descriptor types are given in the following table.
- If the segment is not a conforming code segment, the instruction checks that the specified segment descriptor is visible at the CPL (that is, if the CPL and the RPL of the segment selector are less than or equal to the DPL of the segment selector).

If the segment descriptor cannot be accessed or is an invalid type for the instruction, the ZF flag is cleared and no value is loaded in the destination operand.

LSL—Load Segment Limit (Continued)

| Type | Name | Valid |
|------|-------------------------|-------|
| 0 | Reserved | No |
| 1 | Available 16-bit TSS | Yes |
| 2 | LDT | Yes |
| 3 | Busy 16-bit TSS | Yes |
| 4 | 16-bit call gate | No |
| 5 | 16-bit/32-bit task gate | No |
| 6 | 16-bit trap gate | No |
| 7 | 16-bit interrupt gate | No |
| 8 | Reserved | No |
| 9 | Available 32-bit TSS | Yes |
| A | Reserved | No |
| B | Busy 32-bit TSS | Yes |
| C | 32-bit call gate | No |
| D | Reserved | No |
| E | 32-bit trap gate | No |
| F | 32-bit interrupt gate | No |

Operation

```

IF SRC(Offset) > descriptor table limit
  THEN ZF ← 0; FI;
Read segment descriptor;
IF SegmentDescriptor(Type) ≠ conforming code segment
  AND (CPL > DPL) OR (RPL > DPL)
  OR Segment type is not valid for instruction
  THEN
    ZF ← 0
  ELSE
    temp ← SegmentLimit([SRC]);
    IF (G = 1)
      THEN
        temp ← ShiftLeft(12, temp) OR 00000FFFH;
    FI;
    IF OperandSize = 32
      THEN
        DEST ← temp;
      ELSE (*OperandSize = 16*)
        DEST ← temp AND FFFFH;
    FI;
  FI;

```

Flags Affected

The ZF flag is set to 1 if the segment limit is loaded successfully; otherwise, it is cleared to 0.

LSL—Load Segment Limit (Continued)

Additional Itanium® System Environment Exceptions

| | |
|--------------------|--|
| Itanium Reg Faults | NaT Register Consumption Abort. |
| Itanium Mem Faults | VHPT Data Fault, Nested TLB Fault, Data TLB Fault, Alternate Data TLB Fault, Data Page Not Present Fault, Data NaT Page Consumption Abort, Data Key Miss Fault, Data Key Permission Fault, Data Access Rights Fault, Data Access Bit Fault, Data Dirty Bit Fault |

Protected Mode Exceptions

| | |
|-----------------|--|
| #GP(0) | If a memory operand effective address is outside the CS, DS, ES, FS, or GS segment limit. If the DS, ES, FS, or GS register is used to access memory and it contains a null segment selector. |
| #SS(0) | If a memory operand effective address is outside the SS segment limit. |
| #PF(fault-code) | If a page fault occurs. |
| #AC(0) | If alignment checking is enabled and an unaligned memory reference is made while the current privilege level is 3. |

Real Address Mode Exceptions

| | |
|-----|---|
| #UD | The LSL instruction is not recognized in real address mode. |
|-----|---|

Virtual 8086 Mode Exceptions

| | |
|-----|---|
| #UD | The LSL instruction is not recognized in virtual 8086 mode. |
|-----|---|



LSS—Load Full Pointer

See entry for LDS/LES/LFS/LGS/LSS.

LTR—Load Task Register

| Opcode | Instruction | Description |
|----------|------------------|---------------------------|
| 0F 00 /3 | LTR <i>r/m16</i> | Load <i>r/m16</i> into TR |

Description

Loads the source operand into the segment selector field of the task register. The source operand (a general-purpose register or a memory location) contains a segment selector that points to a task state segment (TSS). After the segment selector is loaded in the task register, the processor uses to segment selector to locate the segment descriptor for the TSS in the global descriptor table (GDT). It then loads the segment limit and base address for the TSS from the segment descriptor into the task register. The task pointed to by the task register is marked busy, but a switch to the task does not occur.

The LTR instruction is provided for use in operating-system software; it should not be used in application programs. It can only be executed in protected mode when the CPL is 0. It is commonly used in initialization code to establish the first task to be executed.

The operand-size attribute has no effect on this instruction.

Operation

IF Itanium System Environment THEN IA-32_Intercept(INST,LTR);

**IF SRC(Offset) > descriptor table limit OR IF SRC(type) ≠ global
THEN #GP(segment selector);**

FI;

Reat segment descriptor;

IF segment descriptor is not for an available TSS THEN #GP(segment selector); FI;

IF segment descriptor is not present THEN #NP(segment selector);

TSSsegmentDescriptor(busy) ← 1;

(* Locked read-modify-write operation on the entire descriptor when setting busy flag *)

TaskRegister(SegmentSelector) ← SRC;

TaskRegister(SegmentDescriptor) ← TSSSegmentDescriptor;

Flags Affected

None.

Additional Itanium® System Environment Exceptions

IA-32_Intercept Mandatory Instruction Intercept.

Protected Mode Exceptions

| | |
|--------|---|
| #GP(0) | If the current privilege level is not 0. |
| | If a memory operand effective address is outside the CS, DS, ES, FS, or GS segment limit. |
| | If the DS, ES, FS, or GS register is used to access memory and it contains a null segment selector. |

LTR—Load Task Register (Continued)

| | |
|-----------------|--|
| #GP(selector) | If the source selector points to a segment that is not a TSS or to one for a task that is already busy. If the selector points to LDT or is beyond the GDT limit. |
| #NP(selector) | If the TSS is marked not present. |
| #SS(0) | If a memory operand effective address is outside the SS segment limit. |
| #PF(fault-code) | If a page fault occurs. |

Real Address Mode Exceptions

| | |
|-----|---|
| #UD | The LTR instruction is not recognized in real address mode. |
|-----|---|

Virtual 8086 Mode Exceptions

| | |
|-----|---|
| #UD | The LTR instruction is not recognized in virtual 8086 mode. |
|-----|---|

MOV—Move

| Opcode | Instruction | Description |
|---------------|--------------------------|---|
| 88 <i>lr</i> | MOV <i>rm8,r8</i> | Move <i>r8</i> to <i>rm8</i> |
| 89 <i>lr</i> | MOV <i>rm16,r16</i> | Move <i>r16</i> to <i>rm16</i> |
| 89 <i>lr</i> | MOV <i>rm32,r32</i> | Move <i>r32</i> to <i>rm32</i> |
| 8A <i>lr</i> | MOV <i>r8,rm8</i> | Move <i>rm8</i> to <i>r8</i> |
| 8B <i>lr</i> | MOV <i>r16,rm16</i> | Move <i>rm16</i> to <i>r16</i> |
| 8B <i>lr</i> | MOV <i>r32,rm32</i> | Move <i>rm32</i> to <i>r32</i> |
| 8C <i>lr</i> | MOV <i>rm16,Sreg**</i> | Move segment register to <i>rm16</i> |
| 8E <i>lr</i> | MOV <i>Sreg,rm16</i> | Move <i>rm16</i> to segment register |
| A0 | MOV AL, <i>moffs8*</i> | Move byte at (<i>seg:offset</i>) to AL |
| A1 | MOV AX, <i>moffs16*</i> | Move word at (<i>seg:offset</i>) to AX |
| A1 | MOV EAX, <i>moffs32*</i> | Move doubleword at (<i>seg:offset</i>) to EAX |
| A2 | MOV <i>moffs8*</i> ,AL | Move AL to (<i>seg:offset</i>) |
| A3 | MOV <i>moffs16*</i> ,AX | Move AX to (<i>seg:offset</i>) |
| A3 | MOV <i>moffs32*</i> ,EAX | Move EAX to (<i>seg:offset</i>) |
| B0+ <i>rb</i> | MOV <i>r8,imm8</i> | Move <i>imm8</i> to <i>r8</i> |
| B8+ <i>rw</i> | MOV <i>r16,imm16</i> | Move <i>imm16</i> to <i>r16</i> |
| B8+ <i>rd</i> | MOV <i>r32,imm32</i> | Move <i>imm32</i> to <i>r32</i> |
| C6 <i>l0</i> | MOV <i>rm8,imm8</i> | Move <i>imm8</i> to <i>rm8</i> |
| C7 <i>l0</i> | MOV <i>rm16,imm16</i> | Move <i>imm16</i> to <i>rm16</i> |
| C7 <i>l0</i> | MOV <i>rm32,imm32</i> | Move <i>imm32</i> to <i>rm32</i> |

Notes:

- * The *moffs8*, *moffs16*, and *moffs32* operands specify a simple offset relative to the segment base, where 8, 16, and 32 refer to the size of the data. The address-size attribute of the instruction determines the size of the offset, either 16 or 32 bits.
- ** In 32-bit mode, the assembler may require the use of the 16-bit operand size prefix (a byte with the value 66H preceding the instruction).

Description

Copies the second operand (source operand) to the first operand (destination operand). The source operand can be an immediate value, general-purpose register, segment register, or memory location; the destination register can be a general-purpose register, segment register, or memory location. Both operands must be the same size, which can be a byte, a word, or a doubleword.

The MOV instruction cannot be used to load the CS register. Attempting to do so results in an invalid opcode exception (#UD). To load the CS register, use the RET instruction.

MOV—Move (Continued)

If the destination operand is a segment register (DS, ES, FS, GS, or SS), the source operand must be a valid segment selector. In protected mode, moving a segment selector into a segment register automatically causes the segment descriptor information associated with that segment selector to be loaded into the hidden (shadow) part of the segment register. While loading this information, the segment selector and segment descriptor information is validated (see the “Operation” algorithm below). The segment descriptor data is obtained from the GDT or LDT entry for the specified segment selector.

A null segment selector (values 0000-0003) can be loaded into the DS, ES, FS, and GS registers without causing a protection exception. However, any subsequent attempt to reference a segment whose corresponding segment register is loaded with a null value causes a general protection exception (#GP) and no memory reference occurs.

Loading the SS register with a MOV instruction inhibits all external interrupts and traps until after the execution of the next instruction in the IA-32 System Environment. For the Itanium System Environment, MOV to SS results in a IA-32_Interrupt(SystemFlag) trap after the instruction completes. This operation allows a stack pointer to be loaded into the ESP register with the next instruction (MOV ESP, *stack-pointer value*) before an interrupt occurs. The LSS instruction offers a more efficient method of loading the SS and ESP registers.

When moving data in 32-bit mode between a segment register and a 32-bit general-purpose register, the Pentium Pro processor does not require the use of a 16-bit operand size prefix; however, some assemblers do require this prefix. The processor assumes that the sixteen least-significant bits of the general-purpose register are the destination or source operand. When moving a value from a segment selector to a 32-bit register, the processor fills the two high-order bytes of the register with zeros.

Operation

$DEST \leftarrow SRC;$

Loading a segment register while in protected mode results in special checks and actions, as described in the following listing. These checks are performed on the segment selector and the segment descriptor it points to.

```

IF SS is loaded;
  THEN
    IF segment selector is null
      THEN #GP(0);
    FI;
    IF segment selector index is outside descriptor table limits
      OR segment selector's RPL ≠ CPL
      OR segment is not a writable data segment
      OR DPL ≠ CPL
      THEN #GP(selector);
    FI;
    IF segment not marked present
      THEN #SS(selector);
  ELSE
    SS ← segment selector;
    SS ← segment descriptor;
  FI;

```

MOV—Move (Continued)

```

FI;
IF DS, ES, FS or GS is loaded with non-null selector;

THEN
  IF segment selector index is outside descriptor table limits
    OR segment is not a data or readable code segment
    OR ((segment is a data or nonconforming code segment)
        AND (both RPL and CPL > DPL))
      THEN #GP(selector);
  IF segment not marked present
    THEN #NP(selector);
ELSE
  SegmentRegister ← segment selector;
  SegmentRegister ← segment descriptor;
FI;
FI;
IF DS, ES, FS or GS is loaded with a null selector;
  THEN
    SegmentRegister ← null segment selector;
    SegmentRegister ← null segment descriptor;
FI;

```

Flags Affected

None.

Additional Itanium® System Environment Exceptions

| | |
|--------------------|--|
| IA-32_Intercept | System Flag Intercept trap for Move to SS |
| Itanium Reg Faults | NaT Register Consumption Abort. |
| Itanium Mem Faults | VHPT Data Fault, Nested TLB Fault, Data TLB Fault, Alternate Data TLB Fault, Data Page Not Present Fault, Data NaT Page Consumption Abort, Data Key Miss Fault, Data Key Permission Fault, Data Access Rights Fault, Data Access Bit Fault, Data Dirty Bit Fault |

Protected Mode Exceptions

| | |
|---------------|--|
| #GP(0) | <p>If attempt is made to load SS register with null segment selector.</p> <p>If the destination operand is in a nonwritable segment.</p> <p>If a memory operand effective address is outside the CS, DS, ES, FS, or GS segment limit.</p> <p>If the DS, ES, FS, or GS register contains a null segment selector.</p> |
| #GP(selector) | <p>If segment selector index is outside descriptor table limits.</p> <p>If the SS register is being loaded and the segment selector's RPL and the segment descriptor's DPL are not equal to the CPL.</p> <p>If the SS register is being loaded and the segment pointed to is a nonwritable data segment.</p> <p>If the DS, ES, FS, or GS register is being loaded and the segment pointed to is not a data or readable code segment.</p> |

MOV—Move (Continued)

| | |
|-----------------|--|
| | If the DS, ES, FS, or GS register is being loaded and the segment pointed to is a data or nonconforming code segment, but both the RPL and the CPL are greater than the DPL. |
| #SS(0) | If a memory operand effective address is outside the SS segment limit. |
| #SS(selector) | If the SS register is being loaded and the segment pointed to is marked not present. |
| #NP | If the DS, ES, FS, or GS register is being loaded and the segment pointed to is marked not present. |
| #PF(fault-code) | If a page fault occurs. |
| #AC(0) | If alignment checking is enabled and an unaligned memory reference is made while the current privilege level is 3. |
| #UD | If attempt is made to load the CS register. |

Real Address Mode Exceptions

| | |
|-----|---|
| #GP | If a memory operand effective address is outside the CS, DS, ES, FS, or GS segment limit. |
| #SS | If a memory operand effective address is outside the SS segment limit. |
| #UD | If attempt is made to load the CS register. |

Virtual 8086 Mode Exceptions

| | |
|-----------------|---|
| #GP(0) | If a memory operand effective address is outside the CS, DS, ES, FS, or GS segment limit. |
| #SS(0) | If a memory operand effective address is outside the SS segment limit. |
| #PF(fault-code) | If a page fault occurs. |
| #AC(0) | If alignment checking is enabled and an unaligned memory reference is made. |
| #UD | If attempt is made to load the CS register. |

MOV—Move to/from Control Registers

| Opcode | Instruction | Description |
|-----------------|---------------------|------------------------|
| 0F 22 <i>lr</i> | MOV CR0, <i>r32</i> | Move <i>r32</i> to CR0 |
| 0F 22 <i>lr</i> | MOV CR2, <i>r32</i> | Move <i>r32</i> to CR2 |
| 0F 22 <i>lr</i> | MOV CR3, <i>r32</i> | Move <i>r32</i> to CR3 |
| 0F 22 <i>lr</i> | MOV CR4, <i>r32</i> | Move <i>r32</i> to CR4 |
| 0F 20 <i>lr</i> | MOV <i>r32</i> ,CR0 | Move CR0 to <i>r32</i> |
| 0F 20 <i>lr</i> | MOV <i>r32</i> ,CR2 | Move CR2 to <i>r32</i> |
| 0F 20 <i>lr</i> | MOV <i>r32</i> ,CR3 | Move CR3 to <i>r32</i> |
| 0F 20 <i>lr</i> | MOV <i>r32</i> ,CR4 | Move CR4 to <i>r32</i> |

Description

Moves the contents of a control register (CR0, CR2, CR3, or CR4) to a general-purpose register or vice versa. The operand size for these instructions is always 32 bits, regardless of the operand-size attribute. (See the *IA-32 Intel® Architecture Software Developer's Manual, Volume 3* for a detailed description of the flags and fields in the control registers.)

When loading a control register, a program should not attempt to change any of the reserved bits; that is, always set reserved bits to the value previously read.

At the opcode level, the *reg* field within the ModR/M byte specifies which of the control registers is loaded or read. The 2 bits in the *mod* field are always 11B. The *r/m* field specifies the general-purpose register loaded or read.

These instructions have the following side effects:

- When writing to control register CR3, all non-global TLB entries are flushed (see the *IA-32 Intel® Architecture Software Developer's Manual, Volume 3*).
- When modifying any of the paging flags in the control registers (PE and PG in register CR0 and PGE, PSE, and PAE in register CR4), all TLB entries are flushed, including global entries. This operation is implementation specific for the Pentium Pro processor. Software should not depend on this functionality in future Intel architecture processors.
- If the PG flag is set to 1 and control register CR4 is written to set the PAE flag to 1 (to enable the physical address extension mode), the pointers (PDPTRs) in the page-directory pointers table will be loaded into the processor (into internal, non-architectural registers).
- If the PAE flag is set to 1 and the PG flag set to 1, writing to control register CR3 will cause the PDPTRs to be reloaded into the processor.
- If the PAE flag is set to 1 and control register CR0 is written to set the PG flag, the PDPTRs are reloaded into the processor.

Operation

IF Itanium System Environment AND Move To CR Form THEN IA-32_Intercept(INST,MOVCR);
DEST ← SRC;

Flags Affected

The OF, SF, ZF, AF, PF, and CF flags are undefined.



MOV—Move to/from Control Registers (Continued)

Additional Itanium® System Environment Exceptions

IA-32_Interrupt Move To CR#, Mandatory Instruction Intercept.
Move From CR#, read the virtualized control register values, CR0{15:6}
return zeros.

Protected Mode Exceptions

#GP(0) If the current privilege level is not 0.
If an attempt is made to write a 1 to any reserved bit in CR4.
If an attempt is made to write reserved bits in the page-directory pointers table
(used in the extended physical addressing mode) when the PAE flag in control
register CR4 and the PG flag in control register CR0 are set to 1.

Real Address Mode Exceptions

#GP If an attempt is made to write a 1 to any reserved bit in CR4.

Virtual 8086 Mode Exceptions

#GP(0) These instructions cannot be executed in virtual 8086 mode.

MOV—Move to/from Debug Registers

| Opcode | Instruction | Description |
|----------|------------------|-----------------------------|
| 0F 21/r | MOV r32, DR0-DR3 | Move debug registers to r32 |
| 0F 21/r | MOV r32, DR4-DR5 | Move debug registers to r32 |
| 0F 21/r | MOV r32, DR6-DR7 | Move debug registers to r32 |
| 0F 23 /r | MOV DR0-DR3, r32 | Move r32 to debug registers |
| 0F 23 /r | MOV DR4-DR5, r32 | Move r32 to debug registers |
| 0F 23 /r | MOV DR6-DR7, r32 | Move r32 to debug registers |

Description

Moves the contents of two or more debug registers (DR0 through DR3, DR4 and DR5, or DR6 and DR7) to a general-purpose register or vice versa. The operand size for these instructions is always 32 bits, regardless of the operand-size attribute. (See the *IA-32 Intel® Architecture Software Developer's Manual, Volume 3* for a detailed description of the flags and fields in the debug registers.)

The instructions must be executed at privilege level 0 or in real-address mode.

When the debug extension (DE) flag in register CR4 is clear, these instructions operate on debug registers in a manner that is compatible with Intel386™ and Intel486 processors. In this mode, references to DR4 and DR5 refer to DR6 and DR7, respectively. When the DE set in CR4 is set, attempts to reference DR4 and DR5 result in an undefined opcode (#UD) exception.

At the opcode level, the *reg* field within the ModR/M byte specifies which of the debug registers is loaded or read. The two bits in the *mod* field are always 11. The *r/m* field specifies the general-purpose register loaded or read.

Operation

IF Itanium System Environment THEN IA-32_Intercept(INST,MOVDR);

```
IF ((DE = 1) and (SRC or DEST = DR4 or DR5))
THEN
  #UD;
ELSE
  DEST ← SRC;
```

Flags Affected

The OF, SF, ZF, AF, PF, and CF flags are undefined.

Additional Itanium® System Environment Exceptions

IA-32_Intercept Mandatory Instruction Intercept.

Protected Mode Exceptions

#GP(0) If the current privilege level is not 0.

#UD If the DE (debug extensions) bit of CR4 is set and a MOV instruction is executed involving DR4 or DR5.

MOV—Move to/from Debug Registers (Continued)

#DB If any debug register is accessed while the GD flag in debug register DR7 is set.

Real Address Mode Exceptions

#UD If the DE (debug extensions) bit of CR4 is set and a MOV instruction is executed involving DR4 or DR5.

#DB If any debug register is accessed while the GD flag in debug register DR7 is set.

Virtual 8086 Mode Exceptions

#GP(0) The debug registers cannot be loaded or read when in virtual 8086 mode.

MOVS/MOVS_B/MOVSW/MOVSD—Move Data from String to String

| Opcode | Instruction | Description |
|--------|-------------------------|---|
| A4 | MOVS ES:(E)DI, DS:(E)SI | Move byte at address DS:(E)SI to address ES:(E)DI |
| A5 | MOVS ES:DI, DS:SI | Move word at address DS:SI to address ES:DI |
| A5 | MOVS ES:EDI, DS:ESI | Move doubleword at address DS:ESI to address ES:EDI |
| A4 | MOVSB | Move byte at address DS:(E)SI to address ES:(E)DI |
| A5 | MOVSW | Move word at address DS:SI to address ES:DI |
| A5 | MOVSD | Move doubleword at address DS:ESI to address ES:EDI |

Description

Moves the byte, word, or doubleword specified with the second operand (source operand) to the location specified with the first operand (destination operand). The source operand specifies the memory location at the address DS:ESI and the destination operand specifies the memory location at address ES:EDI. (When the operand-size attribute is 16, the SI and DI register are used as the source-index and destination-index registers, respectively.) The DS segment may be overridden with a segment override prefix, but the ES segment cannot be overridden.

The MOVSB, MOVSW, and MOVSD mnemonics are synonyms of the byte, word, and doubleword versions of the MOVS instructions. They are simpler to use, but provide no type or segment checking. (For the MOVS instruction, “DS:ESI” and “ES:EDI” must be explicitly specified in the instruction.)

After the transfer, the ESI and EDI registers are incremented or decremented automatically according to the setting of the DF flag in the EFLAGS register. (If the DF flag is 0, the ESI and EDI register are incremented; if the DF flag is 1, the ESI and EDI registers are decremented.) The registers are incremented or decremented by 1 for byte operations, by 2 for word operations, or by 4 for doubleword operations.

The MOVS, MOVSB, MOVSW, and MOVSD instructions can be preceded by the REP prefix (see “REP/REPE/REPZ/REPNE/REPNZ—Repeat Following String Operation” on “[REP/REPE/REPZ/REPNE/REPZ—Repeat String Operation Prefix](#)” on page 3:685) for block moves of ECX bytes, words, or doublewords.

Operation

```

DEST ← SRC;
IF (byte move)
  THEN IF DF = 0
    THEN (E)DI ← 1;
    ELSE (E)DI ← -1;
  FI;
ELSE IF (word move)
  THEN IF DF = 0
    THEN DI ← 2;
    ELSE DI ← -2;

```

MOVS/MOVSB/MOVSW/MOVSD—Move Data from String to String (Continued)

```

FI;
ELSE (* doubleword move*)
  THEN IF DF = 0

      THEN EDI ← 4;
      ELSE EDI ← -4;
FI;
FI;

```

Flags Affected

None.

Additional Itanium® System Environment Exceptions

Itanium Reg Faults NaT Register Consumption Abort.

Itanium Mem Faults VHPT Data Fault, Nested TLB Fault, Data TLB Fault, Alternate Data TLB Fault, Data Page Not Present Fault, Data NaT Page Consumption Abort, Data Key Miss Fault, Data Key Permission Fault, Data Access Rights Fault, Data Access Bit Fault, Data Dirty Bit Fault

Protected Mode Exceptions

#GP(0) If the destination is located in a nonwritable segment.
 If a memory operand effective address is outside the CS, DS, ES, FS, or GS segment limit.
 If the DS, ES, FS, or GS register contains a null segment selector.

#SS(0) If a memory operand effective address is outside the SS segment limit.

#PF(fault-code) If a page fault occurs.

#AC(0) If alignment checking is enabled and an unaligned memory reference is made while the current privilege level is 3.

Real Address Mode Exceptions

#GP If a memory operand effective address is outside the CS, DS, ES, FS, or GS segment limit.

#SS If a memory operand effective address is outside the SS segment limit.

Virtual 8086 Mode Exceptions

#GP(0) If a memory operand effective address is outside the CS, DS, ES, FS, or GS segment limit.

#SS(0) If a memory operand effective address is outside the SS segment limit.

#PF(fault-code) If a page fault occurs.

#AC(0) If alignment checking is enabled and an unaligned memory reference is made.

MOVSX—Move with Sign-Extension

| Opcode | Instruction | Description |
|----------|-----------------|---|
| 0F BE /r | MOVSX r16,r/m8 | Move byte to word with sign-extension |
| 0F BE /r | MOVSX r32,r/m8 | Move byte to doubleword, sign-extension |
| 0F BF /r | MOVSX r32,r/m16 | Move word to doubleword, sign-extension |

Description

Copies the contents of the source operand (register or memory location) to the destination operand (register) and sign extends the value to 16 or 32 bits. The size of the converted value depends on the operand-size attribute.

Operation

$DEST \leftarrow \text{SignExtend}(SRC);$

Flags Affected

None.

Additional Itanium® System Environment Exceptions

Itanium Reg Faults NaT Register Consumption Abort.

Itanium Mem Faults VHPT Data Fault, Nested TLB Fault, Data TLB Fault, Alternate Data TLB Fault, Data Page Not Present Fault, Data NaT Page Consumption Abort, Data Key Miss Fault, Data Key Permission Fault, Data Access Rights Fault, Data Access Bit Fault, Data Dirty Bit Fault

Protected Mode Exceptions

| | |
|-----------------|--|
| #GP(0) | If a memory operand effective address is outside the CS, DS, ES, FS, or GS segment limit. If the DS, ES, FS, or GS register contains a null segment selector. |
| #SS(0) | If a memory operand effective address is outside the SS segment limit. |
| #PF(fault-code) | If a page fault occurs. |
| #AC(0) | If alignment checking is enabled and an unaligned memory reference is made while the current privilege level is 3. |

Real Address Mode Exceptions

| | |
|-----|---|
| #GP | If a memory operand effective address is outside the CS, DS, ES, FS, or GS segment limit. |
| #SS | If a memory operand effective address is outside the SS segment limit. |

Virtual 8086 Mode Exceptions

| | |
|-----------------|---|
| #GP(0) | If a memory operand effective address is outside the CS, DS, ES, FS, or GS segment limit. |
| #SS(0) | If a memory operand effective address is outside the SS segment limit. |
| #PF(fault-code) | If a page fault occurs. |

MOVZX—Move with Zero-Extend

| Opcode | Instruction | Description |
|----------|-----------------|---|
| 0F B6 /r | MOVZX r16,r/m8 | Move byte to word with zero-extension |
| 0F B6 /r | MOVZX r32,r/m8 | Move byte to doubleword, zero-extension |
| 0F B7 /r | MOVZX r32,r/m16 | Move word to doubleword, zero-extension |

Description

Copies the contents of the source operand (register or memory location) to the destination operand (register) and sign extends the value to 16 or 32 bits. The size of the converted value depends on the operand-size attribute.

Copies the contents of the source operand (register or memory location) to the destination operand (register) and zero extends the value to 16 or 32 bits. The size of the converted value depends on the operand-size attribute.

Operation

$DEST \leftarrow ZeroExtend(SRC);$

Flags Affected

None.

Additional Itanium® System Environment Exceptions

Itanium Reg Faults NaT Register Consumption Abort.

Itanium Mem Faults VHPT Data Fault, Nested TLB Fault, Data TLB Fault, Alternate Data TLB Fault, Data Page Not Present Fault, Data NaT Page Consumption Abort, Data Key Miss Fault, Data Key Permission Fault, Data Access Rights Fault, Data Access Bit Fault, Data Dirty Bit Fault

Protected Mode Exceptions

| | |
|-----------------|--|
| #GP(0) | If a memory operand effective address is outside the CS, DS, ES, FS, or GS segment limit. If the DS, ES, FS, or GS register contains a null segment selector. |
| #SS(0) | If a memory operand effective address is outside the SS segment limit. |
| #PF(fault-code) | If a page fault occurs. |
| #AC(0) | If alignment checking is enabled and an unaligned memory reference is made while the current privilege level is 3. |

Real Address Mode Exceptions

| | |
|-----|---|
| #GP | If a memory operand effective address is outside the CS, DS, ES, FS, or GS segment limit. |
| #SS | If a memory operand effective address is outside the SS segment limit. |

MOVZX—Move with Zero-Extend (Continued)

Virtual 8086 Mode Exceptions

| | |
|-----------------|---|
| #GP(0) | If a memory operand effective address is outside the CS, DS, ES, FS, or GS segment limit. |
| #SS(0) | If a memory operand effective address is outside the SS segment limit. |
| #PF(fault-code) | If a page fault occurs. |
| #AC(0) | If alignment checking is enabled and an unaligned memory reference is made. |

MUL—Unsigned Multiplication of AL, AX, or EAX

| Opcode | Instruction | Description |
|--------|------------------|--|
| F6 /4 | MUL <i>r/m8</i> | Unsigned multiply ($AX \leftarrow AL * r/m8$) |
| F7 /4 | MUL <i>r/m16</i> | Unsigned multiply ($DX:AX \leftarrow AX * r/m16$) |
| F7 /4 | MUL <i>r/m32</i> | Unsigned multiply ($EDX:EAX \leftarrow EAX * r/m32$) |

Description

Performs an unsigned multiplication of the first operand (destination operand) and the second operand (source operand) and stores the result in the destination operand. The destination operand is an implied operand located in register AL, AX or EAX (depending on the size of the operand); the source operand is located in a general-purpose register or a memory location. The action of this instruction and the location of the result depends on the opcode and the operand size as shown in the following table.

| Operand Size | Source 1 | Source 2 | Destination |
|--------------|----------|--------------|-------------|
| Byte | AL | <i>r/m8</i> | AX |
| Word | AX | <i>r/m16</i> | DX:AX |
| Doubleword | EAX | <i>r/m32</i> | EDX:EAX |

The AH, DX, or EDX registers (depending on the operand size) contain the high-order bits of the product. If the contents of one of these registers are 0, the CF and OF flags are cleared; otherwise, the flags are set.

Operation

```

IF byte operation
  THEN
     $AX \leftarrow AL * SRC$ 
  ELSE (* word or doubleword operation *)
    IF OperandSize = 16
      THEN
         $DX:AX \leftarrow AX * SRC$ 
      ELSE (* OperandSize = 32 *)
         $EDX:EAX \leftarrow EAX * SRC$ 
    FI;
  FI;

```

Flags Affected

The OF and CF flags are cleared to 0 if the upper half of the result is 0; otherwise, they are set to 1. The SF, ZF, AF, and PF flags are undefined.

Additional Itanium® System Environment Exceptions

Itanium Reg Faults NaT Register Consumption Abort.

Itanium Mem Faults VHPT Data Fault, Nested TLB Fault, Data TLB Fault, Alternate Data TLB Fault, Data Page Not Present Fault, Data NaT Page Consumption Abort, Data Key Miss Fault, Data Key Permission Fault, Data Access Rights Fault, Data Access Bit Fault, Data Dirty Bit Fault

MUL—Unsigned Multiplication of AL, AX, or EAX (Continued)

Protected Mode Exceptions

| | |
|-----------------|--|
| #GP(0) | If a memory operand effective address is outside the CS, DS, ES, FS, or GS segment limit. If the DS, ES, FS, or GS register contains a null segment selector. |
| #SS(0) | If a memory operand effective address is outside the SS segment limit. |
| #PF(fault-code) | If a page fault occurs. |
| #AC(0) | If alignment checking is enabled and an unaligned memory reference is made while the current privilege level is 3. |

Real Address Mode Exceptions

| | |
|-----|---|
| #GP | If a memory operand effective address is outside the CS, DS, ES, FS, or GS segment limit. |
| #SS | If a memory operand effective address is outside the SS segment limit. |

Virtual 8086 Mode Exceptions

| | |
|-----------------|---|
| #GP(0) | If a memory operand effective address is outside the CS, DS, ES, FS, or GS segment limit. |
| #SS(0) | If a memory operand effective address is outside the SS segment limit. |
| #PF(fault-code) | If a page fault occurs. |
| #AC(0) | If alignment checking is enabled and an unaligned memory reference is made. |

NEG—Two's Complement Negation

| Opcode | Instruction | Description |
|--------|-----------------|-------------------------------------|
| F6 /3 | NEG <i>rm8</i> | Two's complement negate <i>rm8</i> |
| F7 /3 | NEG <i>rm16</i> | Two's complement negate <i>rm16</i> |
| F7 /3 | NEG <i>rm32</i> | Two's complement negate <i>rm32</i> |

Description

Replaces the value of operand (the destination operand) with its two's complement. The destination operand is located in a general-purpose register or a memory location.

Operation

```
IF DEST = 0
  THEN CF ← 0
  ELSE CF ← 1;
FI;
DEST ← -(DEST)
```

Flags Affected

The CF flag cleared to 0 if the source operand is 0; otherwise it is set to 1. The OF, SF, ZF, AF, and PF flags are set according to the result.

Additional Itanium® System Environment Exceptions

Itanium Reg Faults NaT Register Consumption Abort.

Itanium Mem Faults VHPT Data Fault, Nested TLB Fault, Data TLB Fault, Alternate Data TLB Fault, Data Page Not Present Fault, Data NaT Page Consumption Abort, Data Key Miss Fault, Data Key Permission Fault, Data Access Rights Fault, Data Access Bit Fault, Data Dirty Bit Fault

Protected Mode Exceptions

#GP(0) If the destination is located in a nonwritable segment.
 If a memory operand effective address is outside the CS, DS, ES, FS, or GS segment limit.
 If the DS, ES, FS, or GS register contains a null segment selector.

#SS(0) If a memory operand effective address is outside the SS segment limit.

#PF(fault-code) If a page fault occurs.

#AC(0) If alignment checking is enabled and an unaligned memory reference is made while the current privilege level is 3.

Real Address Mode Exceptions

#GP If a memory operand effective address is outside the CS, DS, ES, FS, or GS segment limit.

#SS If a memory operand effective address is outside the SS segment limit.

NEG—Two's Complement Negation (Continued)

Virtual 8086 Mode Exceptions

| | |
|-----------------|---|
| #GP(0) | If a memory operand effective address is outside the CS, DS, ES, FS, or GS segment limit. |
| #SS(0) | If a memory operand effective address is outside the SS segment limit. |
| #PF(fault-code) | If a page fault occurs. |
| #AC(0) | If alignment checking is enabled and an unaligned memory reference is made. |

NOP—No Operation

| Opcode | Instruction | Description |
|--------|-------------|--------------|
| 90 | NOP | No operation |

Description

Performs no operation. This instruction is a one-byte instruction that takes up space in the instruction stream but does not affect the machine context, except the EIP register.

The NOP instruction performs no operation, no registers are accessed and no faults are generated.

Flags Affected

None.

Exceptions (All Operating Modes)

None.

NOT—One's Complement Negation

| Opcode | Instruction | Description |
|--------|------------------|----------------------------------|
| F6 /2 | NOT <i>r/m8</i> | Reverse each bit of <i>r/m8</i> |
| F7 /2 | NOT <i>r/m16</i> | Reverse each bit of <i>r/m16</i> |
| F7 /2 | NOT <i>r/m32</i> | Reverse each bit of <i>r/m32</i> |

Description

Performs a bitwise NOT operation (1's complement) on the destination operand and stores the result in the destination operand location. The destination operand can be a register or a memory location.

Operation

DEST ← NOT **DEST**;

Flags Affected

None.

Additional Itanium® System Environment Exceptions

Itanium Reg Faults NaT Register Consumption Abort.

Itanium Mem Faults VHPT Data Fault, Nested TLB Fault, Data TLB Fault, Alternate Data TLB Fault, Data Page Not Present Fault, Data NaT Page Consumption Abort, Data Key Miss Fault, Data Key Permission Fault, Data Access Rights Fault, Data Access Bit Fault, Data Dirty Bit Fault

Protected Mode Exceptions

| | |
|-----------------|---|
| #GP(0) | If the destination operand points to a nonwritable segment. If a memory operand effective address is outside the CS, DS, ES, FS, or GS segment limit. If the DS, ES, FS, or GS register contains a null segment selector. |
| #SS(0) | If a memory operand effective address is outside the SS segment limit. |
| #PF(fault-code) | If a page fault occurs. |
| #AC(0) | If alignment checking is enabled and an unaligned memory reference is made while the current privilege level is 3. |

Real Address Mode Exceptions

| | |
|-----|---|
| #GP | If a memory operand effective address is outside the CS, DS, ES, FS, or GS segment limit. |
| #SS | If a memory operand effective address is outside the SS segment limit. |

NOT—One's Complement Negation (Continued)

Virtual 8086 Mode Exceptions

| | |
|-----------------|---|
| #GP(0) | If a memory operand effective address is outside the CS, DS, ES, FS, or GS segment limit. |
| #SS(0) | If a memory operand effective address is outside the SS segment limit. |
| #PF(fault-code) | If a page fault occurs. |
| #AC(0) | If alignment checking is enabled and an unaligned memory reference is made. |

OR—Logical Inclusive OR

| Opcode | Instruction | Description |
|-----------------|--------------------------------|------------------------------|
| 0C <i>ib</i> | OR AL, <i>imm8</i> | AL OR <i>imm8</i> |
| 0D <i>iw</i> | OR AX, <i>imm16</i> | AX OR <i>imm16</i> |
| 0D <i>id</i> | OR EAX, <i>imm32</i> | EAX OR <i>imm32</i> |
| 80 /1 <i>ib</i> | OR <i>r/m8</i> , <i>imm8</i> | <i>r/m8</i> OR <i>imm8</i> |
| 81 /1 <i>iw</i> | OR <i>r/m16</i> , <i>imm16</i> | <i>r/m16</i> OR <i>imm16</i> |
| 81 /1 <i>id</i> | OR <i>r/m32</i> , <i>imm32</i> | <i>r/m32</i> OR <i>imm32</i> |
| 83 /1 <i>ib</i> | OR <i>r/m16</i> , <i>imm8</i> | <i>r/m16</i> OR <i>imm8</i> |
| 83 /1 <i>ib</i> | OR <i>r/m32</i> , <i>imm8</i> | <i>r/m32</i> OR <i>imm8</i> |
| 08 <i>lr</i> | OR <i>r/m8</i> , <i>r8</i> | <i>r/m8</i> OR <i>r8</i> |
| 09 <i>lr</i> | OR <i>r/m16</i> , <i>r16</i> | <i>r/m16</i> OR <i>r16</i> |
| 09 <i>lr</i> | OR <i>r/m32</i> , <i>r32</i> | <i>r/m32</i> OR <i>r32</i> |
| 0A <i>lr</i> | OR <i>r8</i> , <i>r/m8</i> | <i>r8</i> OR <i>r/m8</i> |
| 0B <i>lr</i> | OR <i>r16</i> , <i>r/m16</i> | <i>r16</i> OR <i>r/m16</i> |
| 0B <i>lr</i> | OR <i>r32</i> , <i>r/m32</i> | <i>r32</i> OR <i>r/m32</i> |

Description

Performs a bitwise OR operation on the destination (first) and source (second) operands and stores the result in the destination operand location. The source operand can be an immediate, a register, or a memory location; the destination operand can be a register or a memory location.

Operation

DEST ← DEST OR SRC;

Flags Affected

The OF and CF flags are cleared; the SF, ZF, and PF flags are set according to the result. The state of the AF flag is undefined.

Additional Itanium® System Environment Exceptions

| | |
|--------------------|--|
| Itanium Reg Faults | NaT Register Consumption Abort. |
| Itanium Mem Faults | VHPT Data Fault, Nested TLB Fault, Data TLB Fault, Alternate Data TLB Fault, Data Page Not Present Fault, Data NaT Page Consumption Abort, Data Key Miss Fault, Data Key Permission Fault, Data Access Rights Fault, Data Access Bit Fault, Data Dirty Bit Fault |

OR—Logical Inclusive OR (Continued)

Protected Mode Exceptions

| | |
|-----------------|--|
| #GP(0) | <p>If the destination operand points to a nonwritable segment.</p> <p>If a memory operand effective address is outside the CS, DS, ES, FS, or GS segment limit.</p> <p>If the DS, ES, FS, or GS register contains a null segment selector.</p> |
| #SS(0) | If a memory operand effective address is outside the SS segment limit. |
| #PF(fault-code) | If a page fault occurs. |
| #AC(0) | If alignment checking is enabled and an unaligned memory reference is made while the current privilege level is 3. |

Real Address Mode Exceptions

| | |
|-----|---|
| #GP | If a memory operand effective address is outside the CS, DS, ES, FS, or GS segment limit. |
| #SS | If a memory operand effective address is outside the SS segment limit. |

Virtual 8086 Mode Exceptions

| | |
|-----------------|---|
| #GP(0) | If a memory operand effective address is outside the CS, DS, ES, FS, or GS segment limit. |
| #SS(0) | If a memory operand effective address is outside the SS segment limit. |
| #PF(fault-code) | If a page fault occurs. |
| #AC(0) | If alignment checking is enabled and an unaligned memory reference is made. |

OUT—Output to Port

| Opcode | Instruction | Description |
|--------------|-----------------------|---|
| E6 <i>ib</i> | OUT <i>imm8</i> , AL | Output byte AL to <i>imm8</i> I/O port address |
| E7 <i>ib</i> | OUT <i>imm8</i> , AX | Output word AX to <i>imm8</i> I/O port address |
| E7 <i>ib</i> | OUT <i>imm8</i> , EAX | Output doubleword EAX to <i>imm8</i> I/O port address |
| EE | OUT DX, AL | Output byte AL to I/O port address in DX |
| EF | OUT DX, AX | Output word AX to I/O port address in DX |
| EF | OUT DX, EAX | Output doubleword EAX to I/O port address in DX |

Description

Copies the value from the second operand (source operand) to the I/O port specified with the destination operand (first operand). The source operand can be register AL, AX, or EAX, depending on the size of the port being accessed (8, 16, or 32 bits, respectively); the destination operand can be a byte-immediate or the DX register. Using a byte immediate allows I/O port addresses 0 to 255 to be accessed; using the DX register as a source operand allows I/O ports from 0 to 65,535 to be accessed.

When accessing an 8-bit I/O port, the opcode determines the port size; when accessing a 16- and 32-bit I/O port, the operand-size attribute determines the port size.

At the machine code level, I/O instructions are shorter when accessing 8-bit I/O ports. Here, the upper eight bits of the port address will be 0.

This instruction is only useful for accessing I/O ports located in the processor's I/O address space.

I/O transactions are performed after all prior data memory operations. No subsequent data memory operations can pass an I/O transaction.

In the Itanium System Environment, I/O port references are mapped into the 64-bit virtual address pointed to by the IOBase register, with four ports per 4K-byte virtual page. Operating systems can utilize TLBs in the Itanium architecture to grant or deny permission to any four I/O ports. The I/O port space can be mapped into any arbitrary 64-bit physical memory location by operating system code. If CFLAG.io is 1 and CPL > IOPL, the TSS is consulted for I/O permission. If CFLAG.io is 0 or CPL ≤ IOPL, permission is granted regardless of the state of the TSS I/O permission bitmap (the bitmap is not referenced).

If the referenced I/O port is mapped to an unimplemented virtual address (via the I/O Base register) or if data translations are disabled (PSR.dt is 0) a GPFault is generated on the referencing OUT instruction.

Operation

```
IF ((PE = 1) AND ((VM = 1) OR (CPL > IOPL)))
  THEN (* Protected mode or virtual-8086 mode with CPL > IOPL *)
    IF (CFLAG.io AND Any I/O Permission Bit for I/O port being accessed = 1)
      THEN #GP(0);
    FI;
  ELSE (* Real-address mode or protected mode with CPL ≤ IOPL *)
    (* or virtual-8086 mode with all I/O permission bits for I/O port cleared *)
```

OUT—Output to Port (Continued)

```

FI;
IF (Itanium_System_Environment) THEN
    DEST_VA = IOBase | (Port{15:2}<<12) | Port{11:0};
    DEST_PA = translate(DEST_VA);

    [DEST_PA] ← SRC; (* Writes to selected I/O port *)
FI;

memory_fence();
[DEST_PA] ← SRC; (* Writes to selected I/O port *)
memory_fence();

```

Flags Affected

None.

Additional Itanium® System Environment Exceptions

| | |
|--------------------|--|
| Itanium Reg Faults | NaT Register Consumption Abort. |
| Itanium Mem Faults | VHPT Data Fault, Nested TLB Fault, Data TLB Fault, Alternate Data TLB Fault, Data Page Not Present Fault, Data NaT Page Consumption Abort, Data Key Miss Fault, Data Key Permission Fault, Data Access Rights Fault, Data Access Bit Fault, Data Dirty Bit Fault |
| IA-32_Exception | Debug traps for data breakpoints and single step |
| IA-32_Exception | Alignment faults |
| #GP(0) | Referenced Port is to an unimplemented virtual address or PSR.dt is zero. |

Protected Mode Exceptions

| | |
|--------|--|
| #GP(0) | If the CPL is greater than (has less privilege) the I/O privilege level (IOPL) and any of the corresponding I/O permission bits in TSS for the I/O port being accessed is 1 and when CFLG.io is 1 . |
|--------|--|

Real Address Mode Exceptions

None.

Virtual 8086 Mode Exceptions

| | |
|--------|--|
| #GP(0) | If any of the I/O permission bits in the TSS for the I/O port being accessed is 1. |
|--------|--|

OUTS/OUTSB/OUTSW/OUTSD—Output String to Port

| Opcode | Instruction | Description |
|--------|-------------------|---|
| 6E | OUTS DX, DS:(E)SI | Output byte at address DS:(E)SI to I/O port in DX |
| 6F | OUTS DX, DS:SI | Output word at address DS:SI to I/O port in DX |
| 6F | OUTS DX, DS:ESI | Output doubleword at address DS:ESI to I/O port in DX |
| 6E | OUTSB | Output byte at address DS:(E)SI to I/O port in DX |
| 6F | OUTSW | Output word at address DS:SI to I/O port in DX |
| 6F | OUTSD | Output doubleword at address DS:ESI to I/O port in DX |

Description

Copies data from the second operand (source operand) to the I/O port specified with the first operand (destination operand). The source operand is a memory location at the address DS:ESI. (When the operand-size attribute is 16, the SI register is used as the source-index register.) The DS register may be overridden with a segment override prefix.

The destination operand must be the DX register, allowing I/O port addresses from 0 to 65,535 to be accessed. When accessing an 8-bit I/O port, the opcode determines the port size; when accessing a 16- and 32-bit I/O port, the operand-size attribute determines the port size.

The OUTSB, OUTSW and OUTSD mnemonics are synonyms of the byte, word, and doubleword versions of the OUTS instructions. (For the OUTS instruction, “DS:ESI” must be explicitly specified in the instruction.)

After the byte, word, or doubleword is transfer from the memory location to the I/O port, the ESI register is incremented or decremented automatically according to the setting of the DF flag in the EFLAGS register. (If the DF flag is 0, the ESI register is incremented; if the DF flag is 1, the EDI register is decremented.) The ESI register is incremented or decremented by 1 for byte operations, by 2 for word operations, or by 4 for doubleword operations.

The OUTS, OUTSB, OUTSW, and OUTSD instructions can be preceded by the REP prefix for block input of ECX bytes, words, or doublewords. See [“REP/REPE/REPZ/REPNE /REPNZ—Repeat String Operation Prefix” on page 3:685](#) for a description of the REP prefix.

After an OUTS, OUTSB, OUTSW, or OUTSD instruction is executed, the processor waits for the acknowledgment of the OUT transaction before beginning to execute the next instruction. Note that the next instruction may be prefetched, even if the OUT transaction has not completed.

This instruction is only useful for accessing I/O ports located in the processor’s I/O address space.

I/O transactions are performed after all prior data memory operations. No subsequent data memory operations can pass an I/O transaction.

OUTS/OUTSB/OUTSW/OUTSD—Output String to Port (Continued)

In the Itanium System Environment, I/O port references are mapped into the 64-bit virtual address pointed to by the IOBase register, with four ports per 4K-byte virtual page. Operating systems can utilize TLBs in the Itanium architecture to grant or deny permission to any four I/O ports. The I/O port space can be mapped into any arbitrary 64-bit physical memory location by operating system code. If CFLAG.io is 1 and CPL > IOPL, the TSS is consulted for I/O permission. If CFLAG.io is 0 or CPL ≤ IOPL, permission is granted regardless of the state of the TSS I/O permission bitmap (the bitmap is not referenced).

If the referenced I/O port is mapped to an unimplemented virtual address (via the I/O Base register) or if data translations are disabled (PSR.dt is 0) a GPFault is generated on the referencing OUTS instruction.

Operation

```

IF ((PE = 1) AND ((VM = 1) OR (CPL > IOPL)))
    THEN (* Protected mode or virtual-8086 mode with CPL > IOPL *)
        IF (CFLAG.io AND Any I/O Permission Bit for I/O port being accessed = 1)
            THEN #GP(0);
            FI;
        ELSE (* I/O operation is allowed *)
            FI;

IF (Itanium_System_Environment) THEN
    DEST_VA = IOBase | (Port{15:2} << 12) | Port{11:0};
    DEST_PA = translate(DEST_VA);
    [DEST_PA] ← SRC; (* Writes to selected I/O port *)
    FI;
memory_fence();
[DEST_PA] ← SRC; (* Writes to selected I/O port *)
memory_fence();

IF (byte operation)
    THEN IF DF = 0
        THEN (E)DI ← 1;
        ELSE (E)DI ← -1;
        FI;
    ELSE IF (word operation)
        THEN IF DF = 0
            THEN DI ← 2;
            ELSE DI ← -2;
            FI;
        ELSE (* doubleword operation *)
            THEN IF DF = 0
                THEN EDI ← 4;
                ELSE EDI ← -4;
                FI;
            FI;
        FI;
    FI;
FI;

```

Flags Affected

None.

OUTS/OUTSB/OUTSW/OUTSD—Output String to Port (Continued)

Additional Itanium® System Environment Exceptions

| | |
|--------------------|--|
| Itanium Reg Faults | NaT Register Consumption Abort. |
| Itanium Mem Faults | VHPT Data Fault, Nested TLB Fault, Data TLB Fault, Alternate Data TLB Fault, Data Page Not Present Fault, Data NaT Page Consumption Abort, Data Key Miss Fault, Data Key Permission Fault, Data Access Rights Fault, Data Access Bit Fault, Data Dirty Bit Fault |
| IA-32_Exception | Debug traps for data breakpoints and single step |
| IA-32_Exception | Alignment faults |
| #GP(0) | Referenced Port is to an unimplemented virtual address or PSR.dt is zero. |

Protected Mode Exceptions

| | |
|-----------------|---|
| #GP(0) | <p>If the CPL is greater than (has less privilege) the I/O privilege level (IOPL) and any of the corresponding I/O permission bits in TSS for the I/O port being accessed is 1 and when CFLG.io is 1.</p> <p>If the destination is located in a nonwritable segment.</p> <p>If a memory operand effective address is outside the limit of the ES segment.</p> <p>If the ES register contains a null segment selector.</p> <p>If an illegal memory operand effective address in the ES segments is given.</p> |
| #PF(fault-code) | If a page fault occurs. |
| #AC(0) | If alignment checking is enabled and an unaligned memory reference is made while the current privilege level is 3. |

Real Address Mode Exceptions

| | |
|-----|---|
| #GP | If a memory operand effective address is outside the CS, DS, ES, FS, or GS segment limit. |
| #SS | If a memory operand effective address is outside the SS segment limit. |

Virtual 8086 Mode Exceptions

| | |
|-----------------|--|
| #GP(0) | If any of the I/O permission bits in the TSS for the I/O port being accessed is 1. |
| #PF(fault-code) | If a page fault occurs. |
| #AC(0) | If alignment checking is enabled and an unaligned memory reference is made. |

POP—Pop a Value from the Stack

| Opcode | Instruction | Description |
|---------------|----------------|--|
| 8F /0 | POP <i>m16</i> | Pop top of stack into <i>m16</i> ; increment stack pointer |
| 8F /0 | POP <i>m32</i> | Pop top of stack into <i>m32</i> ; increment stack pointer |
| 58+ <i>rw</i> | POP <i>r16</i> | Pop top of stack into <i>r16</i> ; increment stack pointer |
| 58+ <i>rd</i> | POP <i>r32</i> | Pop top of stack into <i>r32</i> ; increment stack pointer |
| 1F | POP DS | Pop top of stack into DS; increment stack pointer |
| 07 | POP ES | Pop top of stack into ES; increment stack pointer |
| 17 | POP SS | Pop top of stack into SS; increment stack pointer |
| 0F A1 | POP FS | Pop top of stack into FS; increment stack pointer |
| 0F A9 | POP GS | Pop top of stack into GS; increment stack pointer |

Description

Loads the value from the top of the procedure stack to the location specified with the destination operand and then increments the stack pointer. The destination operand can be a general-purpose register, memory location, or segment register.

The current address-size attribute for the stack segment and the operand-size attribute determine the amount the stack pointer is incremented (see the “Operation” below). For example, if 32-bit addressing and operands are being used, the ESP register (stack pointer) is incremented by 4 and, if 16-bit addressing and operands are being used, the SP register (stack pointer for 16-bit addressing) is incremented by 2. The B flag in the stack segment’s segment descriptor determines the stack’s address-size attribute.

If the destination operand is one of the segment registers DS, ES, FS, GS, or SS, the value loaded into the register must be a valid segment selector. In protected mode, popping a segment selector into a segment register automatically causes the descriptor information associated with that segment selector to be loaded into the hidden (shadow) part of the segment register and causes the selector and the descriptor information to be validated (see the “Operation” below).

A null value (0000-0003) may be popped into the DS, ES, FS, or GS register without causing a general protection fault. However, any subsequent attempt to reference a segment whose corresponding segment register is loaded with a null value causes a general protection exception (#GP). In this situation, no memory reference occurs and the saved value of the segment register is null.

The POP instruction cannot pop a value into the CS register. To load the CS register, use the RET instruction.

A POP SS instruction inhibits all external interrupts, including the NMI interrupt, and traps until after execution of the next instruction. **in the IA-32 System Environment. For the Itanium System Environment, POP SS results in an IA-32_Intercept(SystemFlag) trap after the instruction completes.** This operation allows a stack pointer to be loaded into the ESP register with the next instruction (MOV ESP, *stack-pointer value*) before an interrupt occurs. The LSS instruction offers a more efficient method of loading the SS and ESP registers.

POP—Pop a Value from the Stack (Continued)

This action allows sequential execution of POP SS and MOV ESP, EBP instructions without the danger of having an invalid stack during an interrupt. However, use of the LSS instruction is the preferred method of loading the SS and ESP registers.

If the ESP register is used as a base register for addressing a destination operand in memory, the POP instructions computes the effective address of the operand after it increments the ESP register.

The POP ESP instruction increments the stack pointer (ESP) before data at the old top of stack is written into the destination.

Operation

```

IF StackAddrSize = 32
  THEN
    IF OperandSize = 32
      THEN
        DEST ← SS:ESP; (* copy a doubleword *)
        ESP ← ESP + 4;
      ELSE (* OperandSize = 16*)
        DEST ← SS:ESP; (* copy a word *)
        ESP ← ESP + 2;
      FI;
    ELSE (* StackAddrSize = 16*)
      IF OperandSize = 16
        THEN
          DEST ← SS:SP; (* copy a word *)
          SP ← SP + 2;
        ELSE (* OperandSize = 32 *)
          DEST ← SS:SP; (* copy a doubleword *)
          SP ← SP + 4;
        FI;
      FI;
    FI;
  
```

Loading a segment register while in protected mode results in special checks and actions, as described in the following listing. These checks are performed on the segment selector and the segment descriptor it points to.

```

IF SS is loaded;
  THEN
    IF segment selector is null
      THEN #GP(0);
    FI;
    IF segment selector index is outside descriptor table limits
      OR segment selector's RPL ≠ CPL
      OR segment is not a writable data segment
      OR DPL ≠ CPL
      THEN #GP(selector);
    FI;
    IF segment not marked present
      THEN #SS(selector);
  ELSE
    SS ← segment selector;
    SS ← segment descriptor;
  FI;
  
```

POP—Pop a Value from the Stack (Continued)

```

FI;
IF DS, ES, FS or GS is loaded with non-null selector;
THEN
  IF segment selector index is outside descriptor table limits
    OR segment is not a data or readable code segment

    OR ((segment is a data or nonconforming code segment)
      AND (both RPL and CPL > DPL))
      THEN #GP(selector);
  IF segment not marked present
    THEN #NP(selector);
ELSE
  SegmentRegister ← segment selector;
  SegmentRegister ← segment descriptor;
FI;
FI;
IF DS, ES, FS or GS is loaded with a null selector;
THEN
  SegmentRegister ← null segment selector;
  SegmentRegister ← null segment descriptor;
FI;

```

Flags Affected

None.

Additional Itanium® System Environment Exceptions

| | |
|--------------------|--|
| IA-32_Interrupt | System Flag Intercept trap for POP SS |
| Itanium Reg Faults | NaT Register Consumption Abort. |
| Itanium Mem Faults | VHPT Data Fault, Nested TLB Fault, Data TLB Fault, Alternate Data TLB Fault, Data Page Not Present Fault, Data NaT Page Consumption Abort, Data Key Miss Fault, Data Key Permission Fault, Data Access Rights Fault, Data Access Bit Fault, Data Dirty Bit Fault |

Protected Mode Exceptions

| | |
|---------------|--|
| #GP(0) | <p>If attempt is made to load SS register with null segment selector.</p> <p>If the destination operand is in a nonwritable segment.</p> <p>If a memory operand effective address is outside the CS, DS, ES, FS, or GS segment limit.</p> <p>If the DS, ES, FS, or GS register is used to access memory and it contains a null segment selector.</p> |
| #GP(selector) | <p>If segment selector index is outside descriptor table limits.</p> <p>If the SS register is being loaded and the segment selector's RPL and the segment descriptor's DPL are not equal to the CPL.</p> <p>If the SS register is being loaded and the segment pointed to is a nonwritable data segment.</p> |

POP—Pop a Value from the Stack (Continued)

| | |
|-----------------|--|
| | If the DS, ES, FS, or GS register is being loaded and the segment pointed to is not a data or readable code segment. |
| | If the DS, ES, FS, or GS register is being loaded and the segment pointed to is a data or nonconforming code segment, but both the RPL and the CPL are greater than the DPL. |
| #SS(0) | If the current top of stack is not within the stack segment. |
| | If a memory operand effective address is outside the SS segment limit. |
| #SS(selector) | If the SS register is being loaded and the segment pointed to is marked not present. |
| #NP | If the DS, ES, FS, or GS register is being loaded and the segment pointed to is marked not present. |
| #PF(fault-code) | If a page fault occurs. |
| #AC(0) | If an unaligned memory reference is made while the current privilege level is 3 and alignment checking is enabled. |

Real Address Mode Exceptions

| | |
|-----|---|
| #GP | If a memory operand effective address is outside the CS, DS, ES, FS, or GS segment limit. |
|-----|---|

Virtual 8086 Mode Exceptions

| | |
|-----------------|---|
| #GP(0) | If a memory operand effective address is outside the CS, DS, ES, FS, or GS segment limit. |
| #PF(fault-code) | If a page fault occurs. |
| #AC(0) | If an unaligned memory reference is made while alignment checking is enabled. |

POPA/POPAD—Pop All General-Purpose Registers

| Opcode | Instruction | Description |
|--------|-------------|---|
| 61 | POPA | Pop DI, SI, BP, BX, DX, CX, and AX |
| 61 | POPAD | Pop EDI, ESI, EBP, EBX, EDX, ECX, and EAX |

Description

Pops doublewords (POPAD) or words (POPA) from the procedure stack into the general-purpose registers. The registers are loaded in the following order: EDI, ESI, EBP, EBX, EDX, ECX, and EAX (if the current operand-size attribute is 32) and DI, SI, BP, BX, DX, CX, and AX (if the operand-size attribute is 16). (These instructions reverse the operation of the PUSHA/PUSHAD instructions.) The value on the stack for the ESP or SP register is ignored. Instead, the ESP or SP register is incremented after each register is loaded (see the “Operation” below).

The POPA (pop all) and POPAD (pop all double) mnemonics reference the same opcode. The POPA instruction is intended for use when the operand-size attribute is 16 and the POPAD instruction for when the operand-size attribute is 32. Some assemblers may force the operand size to 16 when POPA is used and to 32 when POPAD is used. Others may treat these mnemonics as synonyms (POPA/POPAD) and use the current setting of the operand-size attribute to determine the size of values to be popped from the stack, regardless of the mnemonic used.

Operation

```
IF OperandSize = 32 (* instruction = POPAD *)
THEN
    EDI ← Pop();
    ESI ← Pop();
    EBP ← Pop();
    increment ESP by 4 (* skip next 4 bytes of stack *)
    EBX ← Pop();
    EDX ← Pop();
    ECX ← Pop();
    EAX ← Pop();
ELSE (* OperandSize = 16, instruction = POPA *)
    DI ← Pop();
    SI ← Pop();
    BP ← Pop();
    increment ESP by 2 (* skip next 2 bytes of stack *)
    BX ← Pop();
    DX ← Pop();
    CX ← Pop();
    AX ← Pop();
FI;
```

Flags Affected

None.

POPA/POPAD—Pop All General-Purpose Registers (Continued)

Additional Itanium® System Environment Exceptions

| | |
|--------------------|--|
| Itanium Reg Faults | NaT Register Consumption Abort. |
| Itanium Mem Faults | VHPT Data Fault, Nested TLB Fault, Data TLB Fault, Alternate Data TLB Fault, Data Page Not Present Fault, Data NaT Page Consumption Abort, Data Key Miss Fault, Data Key Permission Fault, Data Access Rights Fault, Data Access Bit Fault, Data Dirty Bit Fault |

Protected Mode Exceptions

| | |
|-----------------|--|
| #SS(0) | If the starting or ending stack address is not within the stack segment. |
| #PF(fault-code) | If a page fault occurs. |

Real Address Mode Exceptions

| | |
|-----|---|
| #GP | If a memory operand effective address is outside the CS, DS, ES, FS, or GS segment limit. |
| #SS | If a memory operand effective address is outside the SS segment limit. |

Virtual 8086 Mode Exceptions

| | |
|-----------------|---|
| #GP(0) | If a memory operand effective address is outside the CS, DS, ES, FS, or GS segment limit. |
| #SS(0) | If a memory operand effective address is outside the SS segment limit. |
| #PF(fault-code) | If a page fault occurs. |

POPF/POPFD—Pop Stack into EFLAGS Register

| Opcode | Instruction | Description |
|--------|-------------|------------------------------|
| 9D | POPF | Pop top of stack into EFLAGS |
| 9D | POPFD | Pop top of stack into EFLAGS |

Description

Pops a doubleword (POPFD) from the top of the stack (if the current operand-size attribute is 32) and stores the value in the EFLAGS register or pops a word from the top of the stack (if the operand-size attribute is 16) and stores it in the lower 16 bits of the EFLAGS register. (These instructions reverse the operation of the PUSHF/PUSHFD instructions.)

The POPF (pop flags) and POPFD (pop flags double) mnemonics reference the same opcode. The POPF instruction is intended for use when the operand-size attribute is 16 and the POPFD instruction for when the operand-size attribute is 32. Some assemblers may force the operand size to 16 when POPF is used and to 32 when POPFD is used. Others may treat these mnemonics as synonyms (POPF/POPFD) and use the current setting of the operand-size attribute to determine the size of values to be popped from the stack, regardless of the mnemonic used.

The effect of the POPF/POPFD instructions on the EFLAGS register changes slightly, depending on the mode of operation of the processor. When the processor is operating in protected mode at privilege level 0 (or in real-address mode, which is equivalent to privilege level 0), all the non-reserved flags in the EFLAGS register except the VIP and VIF flags can be modified. The VIP and VIF flags are cleared.

When operating in protected mode, but with a privilege level greater than 0, all the flags can be modified except the IOPL field and the VIP and VIF flags. Here, the IOPL flags are masked and the VIP and VIF flags are cleared.

When operating in virtual-8086 mode, the I/O privilege level (IOPL) must be equal to 3 to use POPF/POPFD instructions and the VM, RF, IOPL, VIP, and VIF flags are masked. If the IOPL is less than 3, the POPF/POPFD instructions cause a general protection exception (#GP).

The IOPL is altered only when executing at privilege level 0. The interrupt flag is altered only when executing at a level at least as privileged as the IOPL. (Real-address mode is equivalent to privilege level 0.) If a POPF/POPFD instruction is executed with insufficient privilege, an exception does not occur, but the privileged bits do not change.

Operation

```

OLD_IF <- IF; OLD_AC <- AC; OLD_TF <- TF;
IF CR0.PE = 0 (*Real Mode *)
  THEN
    IF OperandSize = 32;
      THEN
        EFLAGS ← Pop();
        (* All non-reserved flags except VM, RF, VIP and VIF can be modified; *)
      ELSE (* OperandSize = 16 *)
        EFLAGS[15:0] ← Pop(); (* All non-reserved flags can be modified; *)
      FI;
    ELSE (*In Protected Mode *)
      IF VM=0 (* Not in Virtual-8086 Mode *)
        THEN

```

POPF/POPFD—Pop Stack into EFLAGS Register (Continued)

```

IF CPL=0
  THEN
    IF OperandSize = 32;
      THEN
        EFLAGS ← Pop();
        (* All non-reserved flags except VM, RF, VIP and VIF can be *)
        (* modified; *)
      ELSE (* OperandSize = 16 *)
        EFLAGS[15:0] ← Pop(); (* All non-reserved flags can be modified; *)
    FI;
  ELSE (* CPL > 0 *)
    IF OperandSize = 32;
      THEN
        EFLAGS ← Pop()
        (* All non-reserved bits except IOPL, RF, VM, VIP, and VIF can *)
        (* be modified; *)
        (* IOPL is masked *)
      ELSE (* OperandSize = 16 *)
        EFLAGS[15:0] ← Pop();
        (* All non-reserved bits except IOPL can be modified; IOPL is
masked *)
    FI;
  FI;
ELSE (* In Virtual-8086 Mode *)
  IF IOPL=3
  THEN
    IF OperandSize=32
    THEN
      EFLAGS ← Pop()
      (* All non-reserved bits except VM, RF, IOPL, VIP, and VIF *)
      (* can be modified; VM, RF, IOPL, VIP, and VIF are masked*)
    ELSE
      EFLAGS[15:0] ← Pop()
      (* All non-reserved bits except IOPL can be modified; IOPL is *)
      (* masked *)
    FI;
  ELSE (* IOPL < 3 *)
    IF CR4.VME = 0
    THEN #GP(0);
    ELSE
      IF ((OperandSize = 32) OR (STACK.TF = 1) OR (EFLAGS.VIP = 1
AND STACK.IF = 1)
      THEN #GP(0);
      ELSE
        TempFlags ← pop();
        FLAGS ← TempFlags; (*IF and IOPL bits are unchanged*)
        EFLAGS.VIF ← TempFlags.IF;
      FI;
    FI;
  FI;
FI;

```

POPF/POPFD—Pop Stack into EFLAGS Register (Continued)

```

IF(Itanium System Environment AND (AC, TF != OLD_AC, OLD_TF)
  THEN IA-32_Intercept(System_Flag,POPF);
IF Itanium System Environment AND CFLG.ii AND IF != OLD_IF
  THEN IA-32_Intercept(System_Flag,POPF);

```

Flags Affected

All flags except the reserved bits.

Additional Itanium® System Environment Exceptions

| | |
|--------------------|--|
| Itanium Reg Faults | NaT Register Consumption Abort. |
| Itanium Mem Faults | VHPT Data Fault, Nested TLB Fault, Data TLB Fault, Alternate Data TLB Fault, Data Page Not Present Fault, Data NaT Page Consumption Abort, Data Key Miss Fault, Data Key Permission Fault, Data Access Rights Fault, Data Access Bit Fault, Data Dirty Bit Fault |
| IA-32_Intercept | System Flag Intercept Trap if CFLG.ii is 1 and the IF flag changes state or if the AC, RF or TF changes state. |

Protected Mode Exceptions

#SS(0) If the top of stack is not within the stack segment.

Real Address Mode Exceptions

#GP If a memory operand effective address is outside the CS, DS, ES, FS, or GS segment limit.

#SS If a memory operand effective address is outside the SS segment limit.

Virtual 8086 Mode Exceptions

#GP(0) If a memory operand effective address is outside the CS, DS, ES, FS, or GS segment limit.

If the I/O privilege level is less than 3.

If an attempt is made to execute the POPF/POPFD instruction with an operand-size override prefix.

#SS(0) If a memory operand effective address is outside the SS segment limit.

PUSH—Push Word or Doubleword Onto the Stack

| Opcode | Instruction | Description |
|---------------|-------------------|-------------------|
| FF /6 | PUSH <i>r/m16</i> | Push <i>r/m16</i> |
| FF /6 | PUSH <i>r/m32</i> | Push <i>r/m32</i> |
| 50+ <i>rw</i> | PUSH <i>r16</i> | Push <i>r16</i> |
| 50+ <i>rd</i> | PUSH <i>r32</i> | Push <i>r32</i> |
| 6A | PUSH <i>imm8</i> | Push <i>imm8</i> |
| 68 | PUSH <i>imm16</i> | Push <i>imm16</i> |
| 68 | PUSH <i>imm32</i> | Push <i>imm32</i> |
| 0E | PUSH CS | Push CS |
| 16 | PUSH SS | Push SS |
| 1E | PUSH DS | Push DS |
| 06 | PUSH ES | Push ES |
| 0F A0 | PUSH FS | Push FS |
| 0F A8 | PUSH GS | Push GS |

Description

Decrements the stack pointer and then stores the source operand on the top of the procedure stack. The current address-size attribute for the stack segment and the operand-size attribute determine the amount the stack pointer is decremented (see the “Operation” below). For example, if 32-bit addressing and operands are being used, the ESP register (stack pointer) is decremented by 4 and, if 16-bit addressing and operands are being used, the SP register (stack pointer for 16-bit addressing) is decremented by 2. Pushing 16-bit operands when the stack address-size attribute is 32 can result in a misaligned the stack pointer (that is, the stack pointer not aligned on a doubleword boundary).

The PUSH ESP instruction pushes the value of the ESP register as it existed before the instruction was executed. Thus, if a PUSH instruction uses a memory operand in which the ESP register is used as a base register for computing the operand address, the effective address of the operand is computed before the ESP register is decremented.

In the real-address mode, if the ESP or SP register is 1 when the PUSH instruction is executed, the processor shuts down due to a lack of stack space. No exception is generated to indicate this condition.

Operation

```

IF StackAddrSize = 32
THEN
  IF OperandSize = 32
  THEN
    ESP ← ESP – 4;
    SS:ESP ← SRC; (* push doubleword *)
  ELSE (* OperandSize = 16*)
    ESP ← ESP – 2;
    SS:ESP ← SRC; (* push word *)
  FI;
ELSE (* StackAddrSize = 16*)

```

PUSH—Push Word or Doubleword Onto the Stack (Continued)

```

IF OperandSize = 16
  THEN
    SP ← SP – 2;
    SS:SP ← SRC; (* push word *)
  ELSE (* OperandSize = 32*)
    SP ← SP – 4;
    SS:SP ← SRC; (* push doubleword *)
FI;
FI;

```

Flags Affected

None.

Additional Itanium® System Environment Exceptions

Itanium Reg Faults NaT Register Consumption Abort.

Itanium Mem Faults VHPT Data Fault, Nested TLB Fault, Data TLB Fault, Alternate Data TLB Fault, Data Page Not Present Fault, Data NaT Page Consumption Abort, Data Key Miss Fault, Data Key Permission Fault, Data Access Rights Fault, Data Access Bit Fault, Data Dirty Bit Fault

Protected Mode Exceptions

#GP(0) If a memory operand effective address is outside the CS, DS, ES, FS, or GS segment limit.
 If the DS, ES, FS, or GS register is used to access memory and it contains a null segment selector.

#SS(0) If a memory operand effective address is outside the SS segment limit.

#PF(fault-code) If a page fault occurs.

#AC(0) If alignment checking is enabled and an unaligned memory reference is made while the current privilege level is 3.

Real Address Mode Exceptions

#GP If a memory operand effective address is outside the CS, DS, ES, FS, or GS segment limit.

#SS If a memory operand effective address is outside the SS segment limit.
 If the new value of the SP or ESP register is outside the stack segment limit.

Virtual 8086 Mode Exceptions

#GP(0) If a memory operand effective address is outside the CS, DS, ES, FS, or GS segment limit.

PUSH—Push Word or Doubleword Onto the Stack (Continued)

| | |
|-----------------|---|
| #SS(0) | If a memory operand effective address is outside the SS segment limit. |
| #PF(fault-code) | If a page fault occurs. |
| #AC(0) | If alignment checking is enabled and an unaligned memory reference is made. |

Intel® Architecture Compatibility

For Intel architecture processors from the Intel 286 on, the PUSH ESP instruction pushes the value of the ESP register as it existed before the instruction was executed. (This is also true in the real-address and virtual-8086 modes.) For the Intel 8086 processor, the PUSH SP instruction pushes the new value of the SP register (that is the value after it has been decremented by 2).

PUSHA/PUSHAD—Push All General-Purpose Registers

| Opcode | Instruction | Description |
|--------|-------------|--|
| 60 | PUSHA | Push AX, CX, DX, BX, original SP, BP, SI, and DI |
| 60 | PUSHAD | Push EAX, ECX, EDX, EBX, original ESP, EBP, ESI, and EDI |

Description

Push the contents of the general-purpose registers onto the procedure stack. The registers are stored on the stack in the following order: EAX, ECX, EDX, EBX, EBP, ESP (original value), EBP, ESI, and EDI (if the current operand-size attribute is 32) and AX, CX, DX, BX, SP (original value), BP, SI, and DI (if the operand-size attribute is 16). (These instructions perform the reverse operation of the POPA/POPAD instructions.) The value pushed for the ESP or SP register is its value before prior to pushing the first register (see the “Operation” below).

The PUSHA (push all) and PUSHAD (push all double) mnemonics reference the same opcode. The PUSHA instruction is intended for use when the operand-size attribute is 16 and the PUSHAD instruction for when the operand-size attribute is 32. Some assemblers may force the operand size to 16 when PUSHA is used and to 32 when PUSHAD is used. Others may treat these mnemonics as synonyms (PUSHA/PUSHAD) and use the current setting of the operand-size attribute to determine the size of values to be pushed from the stack, regardless of the mnemonic used.

In the real-address mode, if the ESP or SP register is 1, 3, or 5 when the PUSHA/PUSHAD instruction is executed, the processor shuts down due to a lack of stack space. No exception is generated to indicate this condition.

Operation

```

IF OperandSize = 32 (* PUSHAD instruction *)
  THEN
    Temp ← (ESP);
    Push(EAX);
    Push(ECX);
    Push(EDX);
    Push(EBX);
    Push(Temp);
    Push(EBP);
    Push(ESI);
    Push(EDI);
  ELSE (* OperandSize = 16, PUSHA instruction *)
    Temp ← (SP);
    Push(AX);
    Push(CX);
    Push(DX);
    Push(BX);
    Push(Temp);
    Push(BP);
    Push(SI);
    Push(DI);
  FI;
  
```

PUSHA/PUSHAD—Push All General-Purpose Registers (Continued)

Flags Affected

None.

Additional Itanium® System Environment Exceptions

Itanium Reg Faults NaT Register Consumption Abort.

Itanium Mem Faults VHPT Data Fault, Nested TLB Fault, Data TLB Fault, Alternate Data TLB Fault, Data Page Not Present Fault, Data NaT Page Consumption Abort, Data Key Miss Fault, Data Key Permission Fault, Data Access Rights Fault, Data Access Bit Fault, Data Dirty Bit Fault

Protected Mode Exceptions

#SS(0) If the starting or ending stack address is outside the stack segment limit.

#PF(fault-code) If a page fault occurs.

Real Address Mode Exceptions

#GP If the ESP or SP register contains 7, 9, 11, 13, or 15.

Virtual 8086 Mode Exceptions

#GP(0) If the ESP or SP register contains 7, 9, 11, 13, or 15.

#PF(fault-code) If a page fault occurs.

PUSHF/PUSHFD—Push EFLAGS Register onto the Stack

| Opcode | Instruction | Description |
|--------|-------------|-------------|
| 9C | PUSHF | Push EFLAGS |
| 9C | PUSHFD | Push EFLAGS |

Description

Decrement the stack pointer by 4 (if the current operand-size attribute is 32) and push the entire contents of the EFLAGS register onto the procedure stack or decrement the stack pointer by 2 (if the operand-size attribute is 16) push the lower 16 bits of the EFLAGS register onto the stack. (These instructions reverse the operation of the POPF/POPFD instructions.)

When copying the entire EFLAGS register to the stack, bits 16 and 17, called the VM and RF flags, are not copied. Instead, the values for these flags are cleared in the EFLAGS image stored on the stack.

The PUSHF (push flags) and PUSHFD (push flags double) mnemonics reference the same opcode. The PUSHF instruction is intended for use when the operand-size attribute is 16 and the PUSHFD instruction for when the operand-size attribute is 32. Some assemblers may force the operand size to 16 when PUSHF is used and to 32 when PUSHFD is used. Others may treat these mnemonics as synonyms (PUSHF/PUSHFD) and use the current setting of the operand-size attribute to determine the size of values to be pushed from the stack, regardless of the mnemonic used.

When the I/O privilege level (IOPL) is less than 3 in virtual-8086 mode, the PUSHF/PUSHFD instructions causes a general protection exception (#GP). The IOPL is altered only when executing at privilege level 0. The interrupt flag is altered only when executing at a level at least as privileged as the IOPL. (Real-address mode is equivalent to privilege level 0.) If a PUSHF/PUSHFD instruction is executed with insufficient privilege, an exception does not occur, but the privileged bits do not change.

In the real-address mode, if the ESP or SP register is 1, 3, or 5 when the PUSHA/PUSHAD instruction is executed, the processor shuts down due to a lack of stack space. No exception is generated to indicate this condition.

Operation

```

IF VM=0 (* Not in Virtual-8086 Mode *)
  THEN
    IF OperandSize = 32
      THEN
        push(EFLAGS AND 00FCFFFFH);
        (* VM and RF EFLAG bits are cleared in image stored on the stack*)
      ELSE
        push(EFLAGS); (* Lower 16 bits only *)
    FI;
  ELSE (* In Virtual-8086 Mode *)
    IF IOPL=3
      THEN
        IF OperandSize = 32
          THEN push(EFLAGS AND 0FCFFFFH);
          (* VM and RF EFLAGS bits are cleared in image stored on the stack*)
          ELSE push(EFLAGS); (* Lower 16 bits only *)
        FI;
      FI;
    FI;
  
```

PUSHF/PUSHFD—Push EFLAGS Register onto the Stack (Continued)

```

    FI;
    ELSE (*IOPL < 3*)

        IF OperandSize =32 OR CR$.VME=0
            THEN #GP(0); (* Trap to virtual-8086 monitor *)
        ELSE
            TempFlags <- FLAGS OR 3000H; (*Set IOPL bits to 11B or IOPL 3 *)
            TempFlags.IF <- EFLAGS.VIF;
            push(TempFlags);

    FI;
FI;

```

Flags Affected

None.

Additional Itanium® System Environment Exceptions

Itanium Reg Faults NaT Register Consumption Abort.

Itanium Mem Faults VHPT Data Fault, Nested TLB Fault, Data TLB Fault, Alternate Data TLB Fault, Data Page Not Present Fault, Data NaT Page Consumption Abort, Data Key Miss Fault, Data Key Permission Fault, Data Access Rights Fault, Data Access Bit Fault, Data Dirty Bit Fault

Protected Mode Exceptions

#SS(0) If the new value of the ESP register is outside the stack segment boundary.

Real Address Mode Exceptions

None.

Virtual 8086 Mode Exceptions

#GP(0) If the I/O privilege level is less than 3.

RCL/RCR/ROL/ROR—Rotate

| Opcode | Instruction | Description |
|-----------------|-------------------------------|---|
| D0 /2 | RCL <i>rm8</i> ,1 | Rotate 9 bits (CF, <i>rm8</i>) left once |
| D2 /2 | RCL <i>rm8</i> ,CL | Rotate 9 bits (CF, <i>rm8</i>) left CL times |
| C0 /2 <i>ib</i> | RCL <i>rm8</i> , <i>imm8</i> | Rotate 9 bits (CF, <i>rm8</i>) left <i>imm8</i> times |
| D1 /2 | RCL <i>rm16</i> ,1 | Rotate 17 bits (CF, <i>rm16</i>) left once |
| D3 /2 | RCL <i>rm16</i> ,CL | Rotate 17 bits (CF, <i>rm16</i>) left CL times |
| C1 /2 <i>ib</i> | RCL <i>rm16</i> , <i>imm8</i> | Rotate 17 bits (CF, <i>rm16</i>) left <i>imm8</i> times |
| D1 /2 | RCL <i>rm32</i> ,1 | Rotate 33 bits (CF, <i>rm32</i>) left once |
| D3 /2 | RCL <i>rm32</i> ,CL | Rotate 33 bits (CF, <i>rm32</i>) left CL times |
| C1 /2 <i>ib</i> | RCL <i>rm32</i> , <i>imm8</i> | Rotate 33 bits (CF, <i>rm32</i>) left <i>imm8</i> times |
| D0 /3 | RCR <i>rm8</i> ,1 | Rotate 9 bits (CF, <i>rm8</i>) right once |
| D2 /3 | RCR <i>rm8</i> ,CL | Rotate 9 bits (CF, <i>rm8</i>) right CL times |
| C0 /3 <i>ib</i> | RCR <i>rm8</i> , <i>imm8</i> | Rotate 9 bits (CF, <i>rm8</i>) right <i>imm8</i> times |
| D1 /3 | RCR <i>rm16</i> ,1 | Rotate 17 bits (CF, <i>rm16</i>) right once |
| D3 /3 | RCR <i>rm16</i> ,CL | Rotate 17 bits (CF, <i>rm16</i>) right CL times |
| C1 /3 <i>ib</i> | RCR <i>rm16</i> , <i>imm8</i> | Rotate 17 bits (CF, <i>rm16</i>) right <i>imm8</i> times |
| D1 /3 | RCR <i>rm32</i> ,1 | Rotate 33 bits (CF, <i>rm32</i>) right once |
| D3 /3 | RCR <i>rm32</i> ,CL | Rotate 33 bits (CF, <i>rm32</i>) right CL times |
| C1 /3 <i>ib</i> | RCR <i>rm32</i> , <i>imm8</i> | Rotate 33 bits (CF, <i>rm32</i>) right <i>imm8</i> times |
| D0 /0 | ROL <i>rm8</i> ,1 | Rotate 8 bits <i>rm8</i> left once |
| D2 /0 | ROL <i>rm8</i> ,CL | Rotate 8 bits <i>rm8</i> left CL times |
| C0 /0 <i>ib</i> | ROL <i>rm8</i> , <i>imm8</i> | Rotate 8 bits <i>rm8</i> left <i>imm8</i> times |
| D1 /0 | ROL <i>rm16</i> ,1 | Rotate 16 bits <i>rm16</i> left once |
| D3 /0 | ROL <i>rm16</i> ,CL | Rotate 16 bits <i>rm16</i> left CL times |
| C1 /0 <i>ib</i> | ROL <i>rm16</i> , <i>imm8</i> | Rotate 16 bits <i>rm16</i> left <i>imm8</i> times |
| D1 /0 | ROL <i>rm32</i> ,1 | Rotate 32 bits <i>rm32</i> left once |
| D3 /0 | ROL <i>rm32</i> ,CL | Rotate 32 bits <i>rm32</i> left CL times |
| C1 /0 <i>ib</i> | ROL <i>rm32</i> , <i>imm8</i> | Rotate 32 bits <i>rm32</i> left <i>imm8</i> times |
| D0 /1 | ROR <i>rm8</i> ,1 | Rotate 8 bits <i>rm8</i> right once |
| D2 /1 | ROR <i>rm8</i> ,CL | Rotate 8 bits <i>rm8</i> right CL times |
| C0 /1 <i>ib</i> | ROR <i>rm8</i> , <i>imm8</i> | Rotate 8 bits <i>rm8</i> right <i>imm8</i> times |
| D1 /1 | ROR <i>rm16</i> ,1 | Rotate 16 bits <i>rm16</i> right once |
| D3 /1 | ROR <i>rm16</i> ,CL | Rotate 16 bits <i>rm16</i> right CL times |
| C1 /1 <i>ib</i> | ROR <i>rm16</i> , <i>imm8</i> | Rotate 16 bits <i>rm16</i> right <i>imm8</i> times |
| D1 /1 | ROR <i>rm32</i> ,1 | Rotate 32 bits <i>rm32</i> right once |
| D3 /1 | ROR <i>rm32</i> ,CL | Rotate 32 bits <i>rm32</i> right CL times |
| C1 /1 <i>ib</i> | ROR <i>rm32</i> , <i>imm8</i> | Rotate 32 bits <i>rm32</i> right <i>imm8</i> times |

RCL/RCR/ROL/ROR—Rotate (Continued)

Description

Shifts (rotates) the bits of the first operand (destination operand) the number of bit positions specified in the second operand (count operand) and stores the result in the destination operand. The destination operand can be a register or a memory location; the count operand is an unsigned integer that can be an immediate or a value in the CL register. The processor restricts the count to a number between 0 and 31 by masking all the bits in the count operand except the 5 least-significant bits.

The rotate left (ROL) and rotate through carry left (RCL) instructions shift all the bits toward more-significant bit positions, except for the most-significant bit, which is rotated to the least-significant bit location. The rotate right (ROR) and rotate through carry right (RCR) instructions shift all the bits toward less significant bit positions, except for the least-significant bit, which is rotated to the most-significant bit location.

The RCL and RCR instructions include the CF flag in the rotation. The RCL instruction shifts the CF flag into the least-significant bit and shifts the most-significant bit into the CF flag. The RCR instruction shifts the CF flag into the most-significant bit and shifts the least-significant bit into the CF flag. For the ROL and ROR instructions, the original value of the CF flag is not a part of the result, but the CF flag receives a copy of the bit that was shifted from one end to the other.

The OF flag is defined only for the 1-bit rotates; it is undefined in all other cases. For left rotates, the OF flag is set to the exclusive OR of the CF bit (after the rotate) and the most-significant bit of the result. For right rotates, the OF flag is set to the exclusive OR of the two most-significant bits of the result.

Operation

```

SIZE ← OperandSize
CASE (determine count) OF
  SIZE = 8:   tempCOUNT ← (COUNT AND 1FH) MOD 9;
  SIZE = 16:  tempCOUNT ← (COUNT AND 1FH) MOD 17;
  SIZE = 32:  tempCOUNT ← COUNT AND 1FH;
ESAC;
(* ROL instruction operation *)
WHILE (tempCOUNT ≠ 0)
  DO
    tempCF ← MSB(DEST);
    DEST ← (DEST * 2) + tempCF;
    tempCOUNT ← tempCOUNT - 1;
  OD;
ELIHW;
CF ← tempCF;
IF COUNT = 1
  THEN OF ← MSB(DEST) XOR CF;
  ELSE OF is undefined;
FI;
(* ROR instruction operation *)
WHILE (tempCOUNT ≠ 0)
  DO
    tempCF ← LSB(SRC);
    DEST ← (DEST / 2) + (tempCF * 2SIZE);

```

RCL/RCR/ROL/ROR—Rotate (Continued)

```

        tempCOUNT ← tempCOUNT – 1;
    OD;
    IF COUNT = 1
    THEN OF ← MSB(DEST) XOR MSB – 1(DEST);
    ELSE OF is undefined;
    FI;
    (* RCL instruction operation *)
    WHILE (tempCOUNT ≠ 0)
    DO
        tempCF ← MSB(DEST);
        DEST ← (DEST * 2) + tempCF;
        tempCOUNT ← tempCOUNT – 1;
    OD;
    ELIHW;
    CF ← tempCF;
    IF COUNT = 1
    THEN OF ← MSB(DEST) XOR CF;
    ELSE OF is undefined;
    FI;
    (* RCR instruction operation *)
    WHILE (tempCOUNT ≠ 0)
    DO
        tempCF ← LSB(SRC);
        DEST ← (DEST / 2) + (tempCF * 2SIZE);
        tempCOUNT ← tempCOUNT – 1;
    OD;
    IF COUNT = 1
    THEN OF ← MSB(DEST) XOR MSB – 1(DEST);
    ELSE OF is undefined;
    FI;

```

Flags Affected

The CF flag contains the value of the bit shifted into it. The OF flag is affected only for single-bit rotates (see “Description” above); it is undefined for multi-bit rotates. The SF, ZF, AF, and PF flags are not affected.

Additional Itanium® System Environment Exceptions

| | |
|--------------------|--|
| Itanium Reg Faults | NaT Register Consumption Abort. |
| Itanium Mem Faults | VHPT Data Fault, Nested TLB Fault, Data TLB Fault, Alternate Data TLB Fault, Data Page Not Present Fault, Data NaT Page Consumption Abort, Data Key Miss Fault, Data Key Permission Fault, Data Access Rights Fault, Data Access Bit Fault, Data Dirty Bit Fault |

RCL/RCR/ROL/ROR—Rotate (Continued)

Protected Mode Exceptions

| | |
|-----------------|--|
| #GP(0) | If the source operand is located in a nonwritable segment. If a memory operand effective address is outside the CS, DS, ES, FS, or GS segment limit. If the DS, ES, FS, or GS register contains a null segment selector. |
| #SS(0) | If a memory operand effective address is outside the SS segment limit. |
| #PF(fault-code) | If a page fault occurs. |
| #AC(0) | If alignment checking is enabled and an unaligned memory reference is made while the current privilege level is 3. |

Real Address Mode Exceptions

| | |
|-----|---|
| #GP | If a memory operand effective address is outside the CS, DS, ES, FS, or GS segment limit. |
| #SS | If a memory operand effective address is outside the SS segment limit. |

Virtual 8086 Mode Exceptions

| | |
|-----------------|---|
| #GP(0) | If a memory operand effective address is outside the CS, DS, ES, FS, or GS segment limit. |
| #SS(0) | If a memory operand effective address is outside the SS segment limit. |
| #PF(fault-code) | If a page fault occurs. |
| #AC(0) | If alignment checking is enabled and an unaligned memory reference is made. |

Intel® Architecture Compatibility

The 8086 does not mask the rotation count. All Intel architecture processors from the Intel386™ processor on do mask the rotation count in all operating modes.

RDMSR—Read from Model Specific Register

| Opcode | Instruction | Description |
|--------|-------------|--|
| 0F 32 | RDMSR | Load MSR specified by ECX into EDX:EAX |

Description

Loads the contents of a 64-bit model specific register (MSR) specified in the ECX register into registers EDX:EAX. The EDX register is loaded with the high-order 32 bits of the MSR and the EAX register is loaded with the low-order 32 bits. If less than 64 bits are implemented in the MSR being read, the values returned to EDX:EAX in unimplemented bit locations are undefined.

This instruction must be executed at privilege level 0 or in real-address mode; otherwise, a general protection exception #GP(0) will be generated. Specifying a reserved or unimplemented MSR address in ECX will also cause a general protection exception.

The MSRs control functions for testability, execution tracing, performance-monitoring and machine check errors.

The CPUID instruction should be used to determine whether MSRs are supported (EDX[5]=1) before using this instruction.

See model specific instructions for all the MSRs that can be written to with this instruction and their addresses

Operation

IF Itanium System Environment THEN IA-32_Intercept(INST,RDMSR);
EDX:EAX ← MSR[ECX];

Flags Affected

None.

Additional Itanium® System Environment Exceptions

IA-32_Intercept Mandatory Instruction Intercept.

Protected Mode Exceptions

#GP(0) If the current privilege level is not 0.
 If the value in ECX specifies a reserved or unimplemented MSR address.

Real Address Mode Exceptions

#GP If the current privilege level is not 0
 If the value in ECX specifies a reserved or unimplemented MSR address.

Virtual 8086 Mode Exceptions

#GP(0) The RDMSR instruction is not recognized in virtual 8086 mode.

RDMSR—Read from Model Specific Register (Continued)

Intel® Architecture Compatibility

The MSRs and the ability to read them with the RDMSR instruction were introduced into the Intel architecture with the Pentium processor. Execution of this instruction by an Intel architecture processor earlier than the Pentium processor results in an invalid opcode exception #UD.

RDPMC—Read Performance-Monitoring Counters

| Opcode | Instruction | Description |
|--------|-------------|---|
| 0F 33 | RDPMC | Read performance-monitoring counter specified by ECX into EDX:EAX |

Description

Loads the contents of the N-bit performance-monitoring counter specified in the ECX register into registers EDX:EAX. The EDX register is loaded with the high-order N-32 bits of the counter and the EAX register is loaded with the low-order 32 bits.

The RDPMC instruction allows application code running at a privilege level of 1, 2, or 3 to read the performance-monitoring counters if the PCE flag in the CR4 register is set for IA-32 System Environment operation or in the Itanium System Environment if the performance counters have been configured as user level counters. This instruction is provided to allow performance monitoring by application code without incurring the overhead of a call to an operating-system procedure.

The performance-monitoring counters are event counters that can be programmed to count events such as the number of instructions decoded, number of interrupts received, or number of cache loads.

The RDPMC instruction does not serialize instruction execution. That is, it does not imply that all the events caused by the preceding instructions have been completed or that events caused by subsequent instructions have not begun. If an exact event count is desired, software must use a serializing instruction (such as the CPUID instruction) before and/or after the execution of the RDPMC instruction.

The RDPMC instruction can execute in 16-bit addressing mode or virtual 8086 mode; however, the full contents of the ECX register are used to determine the counter to access and a full N-bit result is returned (the low-order 32 bits in the EAX register and the high-order N-32 bits in the EDX register).

Operation

```

IF (ECX != Implemented Counters) THEN #GP(0)
IF (Itanium System Environment)
THEN
    SECURED = PSR.sp || CR4.pce==0;
    IF ((PSR.cpl ==0) || (PSR.cpl!=0 && ~PMC[ECX].pm && ~SECURED))
        THEN
            EDX:EAX ← PMD[ECX+4];
        ELSE
            #GP(0)
    FI;
ELSE
    IF ((CR4.PCE = 1 OR ((CR4.PCE = 0 ) AND (CPL=0)))
        THEN
            EDX:EAX ← PMD[ECX+4];
        ELSE (* CR4.PCE is 0 and CPL is 1, 2, or 3 *)
            #GP(0)
    FI;
FI;

```

RDPMC—Read Performance-Monitoring Counters (Continued)

Flags Affected

None.

Additional Itanium® System Environment Exceptions

Itanium Reg Faults NaT Register Consumption Abort.

#GP(0) If the current privilege level is not 0 and the selected PMD register's PM bit is 1, or if PSR.sp is 1.

Protected Mode Exceptions

#GP(0) If the current privilege level is not 0 and the PCE flag in the CR4 register is clear
/*In IA-32 System Environment*/.

If the value in the ECX register does not match an implemented performance counter.

Real Address Mode Exceptions

#GP If the PCE flag in the CR4 register is clear. /*In the IA-32 System Environment*/

If the value in the ECX register does not match an implemented performance counter.

Virtual 8086 Mode Exceptions

#GP(0) If the PCE flag in the CR4 register is clear. /*In the IA-32 System Environment*/

If the value in the ECX register does not match an implemented performance counter.

RDTSC—Read Time-Stamp Counter

| Opcode | Instruction | Description |
|--------|-------------|--------------------------------------|
| 0F 31 | RDTSC | Read time-stamp counter into EDX:EAX |

Description

Loads the current value of the processor's time-stamp counter into the EDX:EAX registers. The time-stamp counter is contained in a 64-bit MSR. The high-order 32 bits of the MSR are loaded into the EDX register, and the low-order 32 bits are loaded into the EAX register. The processor increments the time-stamp counter MSR every clock cycle and resets it to 0 whenever the processor is reset.

In the IA-32 System Environment, the time stamp disable (TSD) flag in register CR4 restricts the use of the RDTSC instruction. When the TSD flag is clear, the RDTSC instruction can be executed at any privilege level; when the flag is set, the instruction can only be executed at privilege level 0. The time-stamp counter can also be read with the RDMSR instruction.

In the Itanium System Environment, PSR.si and CR4.TSD restricts the use of the RDTSC instruction. When PSR.si is clear and CR4.TSD is clear, the RDTSC instruction can be executed at any privilege level; when PSR.si is set or CR4.TSD is set, the instruction can only be executed at privilege level 0.

The RDTSC instruction is not serializing instruction. Thus, it does not necessarily wait until all previous instructions have been executed before reading the counter. Similarly, subsequent instructions may begin execution before the read operation is performed.

This instruction was introduced into the Intel architecture in the Pentium processor.

Operation

IF (IA-32 System Environment)

```
IF (CR4.TSD = 0) OR ((CR4.TSD = 1) AND (CPL=0))
    THEN
        EDX:EAX ← TimeStampCounter;
    ELSE (* CR4 is 1 and CPL is 1, 2, or 3 *)
        #GP(0)
```

FI;

ELSE /*Itanium System Environment*/

```
SECURED = PSR.si || CR4.TSD;
IF (!SECURED) OR (SECURED AND (CPL=0))
    THEN
        EDX:EAX ← TimeStampCounter;
    ELSE (* CR4 is 1 and CPL is 1, 2, or 3 *)
        #GP(0)
```

FI;

FI;

Flags Affected

None.

RDTSC—Read Time-Stamp Counter (Continued)

Additional Itanium® System Environment Exceptions

Itanium Reg Faults NaT Register Consumption Abort.

#GP(0) If PSR.si is 1 or CR4.TSD is 1 and the CPL is greater than 0.

Protected Mode Exceptions

#GP(0) If the TSD flag in register CR4 is set and the CPL is greater than 0.
/*For the IA-32 System Environment only*/

Real Address Mode Exceptions

#GP If the TSD flag in register CR4 is set. /*For the IA-32 System Environment
only*/

Virtual 8086 Mode Exceptions

#GP(0) If the TSD flag in register CR4 is set. /*For the IA-32 System Environment
only*/

REP/REPE/REPZ/REPNE/REPZ—Repeat String Operation Prefix

| | | |
|-------|---------------------------|---|
| F3 6C | REP INS <i>rm8,DX</i> | Input ECX bytes from port DX into ES:[EDI] |
| F3 6D | REP INS <i>rm16,DX</i> | Input ECX words from port DX into ES:[EDI] |
| F3 6D | REP INS <i>rm32,DX</i> | Input ECX doublewords from port DX into ES:[EDI] |
| F3 A4 | REP MOVS <i>m8,m8</i> | Move ECX bytes from DS:[ESI] to ES:[EDI] |
| F3 A5 | REP MOVS <i>m16,m16</i> | Move ECX words from DS:[ESI] to ES:[EDI] |
| F3 A5 | REP MOVS <i>m32,m32</i> | Move ECX doublewords from DS:[ESI] to ES:[EDI] |
| F3 6E | REP OUTS <i>DX,rm8</i> | Output ECX bytes from DS:[ESI] to port DX |
| F3 6F | REP OUTS <i>DX,rm16</i> | Output ECX words from DS:[ESI] to port DX |
| F3 6F | REP OUTS <i>DX,rm32</i> | Output ECX doublewords from DS:[ESI] to port DX |
| F3 AC | REP LODS AL | Load ECX bytes from DS:[ESI] to AL |
| F3 AD | REP LODS AX | Load ECX words from DS:[ESI] to AX |
| F3 AD | REP LODS EAX | Load ECX doublewords from DS:[ESI] to EAX |
| F3 AA | REP STOS <i>m8</i> | Fill ECX bytes at ES:[EDI] with AL |
| F3 AB | REP STOS <i>m16</i> | Fill ECX words at ES:[EDI] with AX |
| F3 AB | REP STOS <i>m32</i> | Fill ECX doublewords at ES:[EDI] with EAX |
| F3 A6 | REPE CMPS <i>m8,m8</i> | Find nonmatching bytes in ES:[EDI] and DS:[ESI] |
| F3 A7 | REPE CMPS <i>m16,m16</i> | Find nonmatching words in ES:[EDI] and DS:[ESI] |
| F3 A7 | REPE CMPS <i>m32,m32</i> | Find nonmatching doublewords in ES:[EDI] and DS:[ESI] |
| F3 AE | REPE SCAS <i>m8</i> | Find non-AL byte starting at ES:[EDI] |
| F3 AF | REPE SCAS <i>m16</i> | Find non-AX word starting at ES:[EDI] |
| F3 AF | REPE SCAS <i>m32</i> | Find non-EAX doubleword starting at ES:[EDI] |
| F2 A6 | REPNE CMPS <i>m8,m8</i> | Find matching bytes in ES:[EDI] and DS:[ESI] |
| F2 A7 | REPNE CMPS <i>m16,m16</i> | Find matching words in ES:[EDI] and DS:[ESI] |
| F2 A7 | REPNE CMPS <i>m32,m32</i> | Find matching doublewords in ES:[EDI] and DS:[ESI] |
| F2 AE | REPNE SCAS <i>m8</i> | Find AL, starting at ES:[EDI] |
| F2 AF | REPNE SCAS <i>m16</i> | Find AX, starting at ES:[EDI] |
| F2 AF | REPNE SCAS <i>m32</i> | Find EAX, starting at ES:[EDI] |

Description

Repeats a string instruction the number of times specified in the count register (ECX) or until the indicated condition of the ZF flag is no longer met. The REP (repeat), REPE (repeat while equal), REPNE (repeat while not equal), REPZ (repeat while zero), and REPZ (repeat while not zero) mnemonics are prefixes that can be added to one of the string instructions. The REP prefix can be added to the INS, OUTS, MOVS, LODS, and STOS instructions, and the REPE, REPNE, REPZ, and REPZ prefixes can be added to the CMPS and SCAS instructions. (The REPZ and REPZ prefixes are synonymous forms of the REPE and REPNE prefixes, respectively.) The behavior of the REP prefix is undefined when used with non-string instructions.

The REP prefixes apply only to one string instruction at a time. To repeat a block of instructions, use the LOOP instruction or another looping construct.

REP/REPE/REPZ/REPNE/REPZ—Repeat String Operation Prefix (Continued)

All of these repeat prefixes cause the associated instruction to be repeated until the count in register ECX is decremented to 0 (see the following table). The REPE, REPNE, REPZ, and REPZ prefixes also check the state of the ZF flag after each iteration and terminate the repeat loop if the ZF flag is not in the specified state. When both termination conditions are tested, the cause of a repeat termination can be determined either by testing the ECX register with a JECXZ instruction or by testing the ZF flag with a JZ, JNZ, and JNE instruction.

Table 1-17. Repeat Conditions

| Repeat Prefix | Termination Condition 1 | Termination Condition 2 |
|---------------|-------------------------|-------------------------|
| REP | ECX=0 | None |
| REPE/REPZ | ECX=0 | ZF=0 |
| REPNE/REPZ | ECX=0 | ZF=1 |

When the REPE/REPZ and REPNE/REPZ prefixes are used, the ZF flag does not require initialization because both the CMPS and SCAS instructions affect the ZF flag according to the results of the comparisons they make.

A repeating string operation can be suspended by an exception or interrupt. When this happens, the state of the registers is preserved to allow the string operation to be resumed upon a return from the exception or interrupt handler. The source and destination registers point to the next string elements to be operated on, the EIP register points to the string instruction, and the ECX register has the value it held following the last successful iteration of the instruction. This mechanism allows long string operations to proceed without affecting the interrupt response time of the system.

When a page fault occurs during CMPS or SCAS instructions that are prefixed with REPNE, the EFLAGS value may NOT be restored to the state prior to the execution of the instruction. Since SCAS and CMPS do not use EFLAGS as an input, the processor can resume the instruction after the page fault handler.

Use the REP INS and REP OUTS instructions with caution. Not all I/O ports can handle the rate at which these instructions execute.

A REP STOS instruction is the fastest way to initialize a large block of memory.

Operation

```

IF AddressSize = 16
  THEN
    use CX for CountReg;
  ELSE (* AddressSize = 32 *)
    use ECX for CountReg;
FI;
WHILE CountReg ≠ 0
  DO
    service pending interrupts (if any);
    execute associated string instruction;
    CountReg ← CountReg – 1;
    IF CountReg = 0
      THEN exit WHILE loop
    FI;

```

REP/REPE/REPZ/REPNE/REPZ—Repeat String Operation Prefix (Continued)

```

IF (repeat prefix is REPZ or REPE) AND (ZF=0)
OR (repeat prefix is REPZ or REPNE) AND (ZF=1)
    THEN exit WHILE loop
FI;
OD;

```

Flags Affected

None; however, the CMPS and SCAS instructions do set the status flags in the EFLAGS register.

Additional Itanium® System Environment Exceptions

Itanium Reg Faults NaT Register Consumption Abort.

Itanium Mem Faults VHPT Data Fault, Nested TLB Fault, Data TLB Fault, Alternate Data TLB Fault, Data Page Not Present Fault, Data NaT Page Consumption Abort, Data Key Miss Fault, Data Key Permission Fault, Data Access Rights Fault, Data Access Bit Fault, Data Dirty Bit Fault

Exceptions (All Operating Modes)

None; however, exceptions can be generated by the instruction a repeat prefix is associated with.

RET—Return from Procedure

| Opcode | Instruction | Description |
|--------------|------------------|--|
| C3 | RET | Near return to calling procedure |
| CB | RET | Far return to calling procedure |
| C2 <i>iw</i> | RET <i>imm16</i> | Near return to calling procedure and pop <i>imm16</i> bytes from stack |
| CA <i>iw</i> | RET <i>imm16</i> | Far return to calling procedure and pop <i>imm16</i> bytes from stack |

Description

Transfers program control to a return address located on the top of the stack. The address is usually placed on the stack by a CALL instruction, and the return is made to the instruction that follows the CALL instruction.

The optional source operand specifies the number of stack bytes to be released after the return address is popped; the default is none. This operand can be used to release parameters from the stack that were passed to the called procedure and are no longer needed.

The RET instruction can be used to execute three different types of returns:

- Near return – A return to a calling procedure within the current code segment (the segment currently pointed to by the CS register), sometimes referred to as an intrasegment return.
- Far return – A return to a calling procedure located in a different segment than the current code segment, sometimes referred to as an intersegment return.
- Inter-privilege-level far return – A far return to a different privilege level than that of the currently executing program or procedure.

The inter-privilege-level return type can only be executed in protected mode.

When executing a near return, the processor pops the return instruction pointer (offset) from the top of the procedure stack into the EIP register and begins program execution at the new instruction pointer. The CS register is unchanged.

When executing a far return, the processor pops the return instruction pointer from the top of the procedure stack into the EIP register, then pops the segment selector from the top of the stack into the CS register. The processor then begins program execution in the new code segment at the new instruction pointer.

The mechanics of an inter-privilege-level far return are similar to an intersegment return, except that the processor examines the privilege levels and access rights of the code and stack segments being returned to determine if the control transfer is allowed to be made. The DS, ES, FS, and GS segment registers are cleared by the RET instruction during an inter-privilege-level return if they refer to segments that are not allowed to be accessed at the new privilege level. Since a stack switch also occurs on an inter-privilege level return, the ESP and SS registers are loaded from the stack.

RET—Return from Procedure (Continued)

Operation

```
(* Near return *)
IF instruction = near return
  THEN;
    IF OperandSize = 32
      THEN
        IF top 12 bytes of stack not within stack limits THEN #SS(0); FI;
        EIP ← Pop();
      ELSE (* OperandSize = 16 *)
        IF top 6 bytes of stack not within stack limits
          THEN #SS(0)
        FI;
        tempEIP ← Pop();
        tempEIP ← tempEIP AND 0000FFFFH;
        IF tempEIP not within code segment limits THEN #GP(0); FI;
        EIP ← tempEIP;
      FI;
    IF instruction has immediate operand
      THEN IF StackAddressSize=32
        THEN
          ESP ← ESP + SRC;
        ELSE (* StackAddressSize=16 *)
          SP ← SP + SRC;
        FI;
      FI;
    IF Itanium System Environment AND PSR.tb THEN IA-32_Exception(Debug);
  FI;

(* Real-address mode or virtual-8086 mode *)
IF ((PE = 0) OR (PE = 1 AND VM = 1)) AND instruction = far return
  THEN;
    IF OperandSize = 32
      THEN
        IF top 12 bytes of stack not within stack limits THEN #SS(0); FI;
        EIP ← Pop();
        CS ← Pop(); (* 32-bit pop, high-order 16-bits discarded *)
      ELSE (* OperandSize = 16 *)
        IF top 6 bytes of stack not within stack limits THEN #SS(0); FI;
        tempEIP ← Pop();
        tempEIP ← tempEIP AND 0000FFFFH;
        IF tempEIP not within code segment limits THEN #GP(0); FI;
        EIP ← tempEIP;
        CS ← Pop(); (* 16-bit pop *)
      FI;
    IF instruction has immediate operand THEN SP ← SP + (SRC AND FFFFH); FI;
    IF Itanium System Environment AND PSR.tb THEN IA-32_Exception(Debug);
  FI;

(* Protected mode, not virtual 8086 mode *)
IF (PE = 1 AND VM = 0) AND instruction = far RET
  THEN
    IF OperandSize = 32
      THEN
```

RET—Return from Procedure (Continued)

```

        IF second doubleword on stack is not within stack limits THEN #SS(0); FI;
        ELSE (* OperandSize = 16 *)
            IF second word on stack is not within stack limits THEN #SS(0); FI;
        FI;
    IF return code segment selector is null THEN GP(0); FI;
    IF return code segment selector addresss descriptor beyond diescriptor table limit
        THEN GP(selector); FI;
    Obtain descriptor to which return code segment selector points from descriptor table
    IF return code segment descriptor is not a code segment THEN #GP(selector); FI;
    if return code segment selector RPL < CPL THEN #GP(selector); FI;
    IF return code segment descriptor is condorming
        AND return code segment DPL > return code segment selector RPL
        THEN #GP(selector); FI;
    IF return code segment descriptor is not present THEN #NP(selector); FI;
    IF return code segment selector RPL > CPL
        THEN GOTO RETURN-OUTER-PRIVILEGE-LEVEL;
        ELSE GOTO RETURN-TO-SAME-PRIVILEGE-LEVEL
    FI;
END;FI;

```

RETURN-SAME-PRIVILEGE-LEVEL:

```

    IF the return instruction pointer is not within ther return code segment limit
        THEN #GP(0);
    FI;
    IF OperandSize=32
        THEN
            EIP ← Pop();
            CS ← Pop(); (* 32-bit pop, high-order 16-bits discarded *)
            ESP ← ESP + SRC;
        ELSE (* OperandSize=16 *)
            EIP ← Pop();
            EIP ← EIP AND 0000FFFFH;
            CS ← Pop(); (* 16-bit pop *)
            ESP ← ESP + SRC;
        FI;

```

```

    IF Itanium System Environment AND PSR.tb THEN IA-32_Exception(Debug);

```

RETURN-OUTER-PRIVILEGE-LEVEL:

```

    IF top (16 + SRC) bytes of stack are not within stack limits (OperandSize=32)
        OR top (8 + SRC) bytes of stack are not within stack limits (OperandSize=16)
        THEN #SS(0); FI;
    FI;
    Read return segment selector;
    IF stack segment selector is null THEN #GP(0); FI;
    IF return stack segment selector index is not within its descriptor table limits
        THEN #GP(selector); FI;
    Read segment descriptor pointed to by return segment selector;
    IF stack segment selector RPL ≠ RPL of the return code segment selector
        OR stack segment is not a writable data segment
        OR stack segment descriptor DPL ≠ RPL of the return code segment selector
        THEN #GP(selector); FI;
    IF stack segment not present THEN #SS(StackSegmentSelector); FI;

```

RET—Return from Procedure (Continued)

```

IF the return instruction pointer is not within the return code segment limit THEN #GP(0); FI:
CPL ← ReturnCodeSegmentSelector(RPL);
IF OperandSize=32
  THEN
    EIP ← Pop();
    CS ← Pop(); (* 32-bit pop, high-order 16-bits discarded *)
    (* segment descriptor information also loaded *)
    CS(RPL) ← CPL;
    ESP ← ESP + SRC;
    tempESP ← Pop();
    tempSS ← Pop(); (* 32-bit pop, high-order 16-bits discarded *)
    (* segment descriptor information also loaded *)
    ESP ← tempESP;
    SS ← tempSS;
  ELSE (* OperandSize=16 *)
    EIP ← Pop();
    EIP ← EIP AND 0000FFFFH;
    CS ← Pop(); (* 16-bit pop; segment descriptor information also loaded *)
    CS(RPL) ← CPL;
    ESP ← ESP + SRC;
    tempESP ← Pop();
    tempSS ← Pop(); (* 16-bit pop; segment descriptor information also loaded *)
    (* segment descriptor information also loaded *)
    ESP ← tempESP;
    SS ← tempSS;
FI;
FOR each of segment register (ES, FS, GS, and DS)
  DO;
    IF segment register points to data or non-conforming code segment
    AND CPL > segment descriptor DPL; (* DPL in hidden part of segment register *)
    THEN (* segment register invalid *)
      SegmentSelector/Descriptor ← 0; (* null segment selector *)
  FI;
OD;
For each of ES, FS, GS, and DS
  DO
    IF segment descriptor indicates the segment is not a data or
    readable code segment
    OR if the segment is a data or non-conforming code segment and the segment
    descriptor's DPL < CPL or RPL of code segment's segment selector
    THEN
      segment selector register ← null selector;
  OD;

```

Flags Affected

None.

RET—Return from Procedure (Continued)

Additional Itanium® System Environment Exceptions

| | |
|--------------------|--|
| Itanium Mem Faults | VHPT Data Fault, Nested TLB Fault, Data TLB Fault, Alternate Data TLB Fault, Data Page Not Present Fault, Data NaT Page Consumption Abort, Data Key Miss Fault, Data Key Permission Fault, Data Access Rights Fault, Data Access Bit Fault, Data Dirty Bit Fault |
| IA-32_Exception | Taken Branch Debug Exception if PSR.tb is 1 |

Protected Mode Exceptions

| | |
|-----------------|---|
| #GP(0) | If the return code or stack segment selector null. If the return instruction pointer is not within the return code segment limit |
| #GP(selector) | If the RPL of the return code segment selector is less then the CPL. If the return code or stack segment selector index is not within its descriptor table limits. If the return code segment descriptor does not indicate a code segment. If the return code segment is non-conforming and the segment selector's DPL is not equal to the RPL of the code segment's segment selector If the return code segment is conforming and the segment selector's DPL greater than the RPL of the code segment's segment selector If the stack segment is not a writable data segment. If the stack segment selector RPL is not equal to the RPL of the return code segment selector. If the stack segment descriptor DPL is not equal to the RPL of the return code segment selector. |
| #SS(0) | If the top bytes of stack are not within stack limits. If the return stack segment is not present. |
| #NP(selector) | If the return code segment is not present. |
| #PF(fault-code) | If a page fault occurs. |
| #AC(0) | If an unaligned memory access occurs when the CPL is 3 and alignment checking is enabled. |

Real Address Mode Exceptions

| | |
|-----|---|
| #GP | If the return instruction pointer is not within the return code segment limit |
| #SS | If the top bytes of stack are not within stack limits. |

Virtual 8086 Mode Exceptions

| | |
|-----------------|---|
| #GP(0) | If the return instruction pointer is not within the return code segment limit |
| #SS(0) | If the top bytes of stack are not within stack limits. |
| #PF(fault-code) | If a page fault occurs. |
| #AC(0) | If an unaligned memory access occurs when alignment checking is enabled. |

ROL/ROR—Rotate

See entry for RCL/RCR/ROL/ROR.

RSM—Resume from System Management Mode

| Opcode | Instruction | Description |
|--------|-------------|---|
| 0F AA | RSM | Resume operation of interrupted program |

Description

Returns program control from system management mode (SMM) to the application program or operating system procedure that was interrupted when the processor received an SSM interrupt. The processor's state is restored from the dump created upon entering SMM. If the processor detects invalid state information during state restoration, it enters the shutdown state. The following invalid information can cause a shutdown:

- Any reserved bit of CR4 is set to 1.
- Any illegal combination of bits in CR0, such as (PG=1 and PE=0) or (NW=1 and CD=0).
- (Intel Pentium and Intel486 only.) The value stored in the state dump base field is not a 32-KByte aligned address.

The contents of the model-specific registers are not affected by a return from SMM.

See Chapter 9 in the *IA-32 Intel® Architecture Software Developer's Manual, Volume 3* for more information about SMM and the behavior of the RSM instruction.

Operation

IF Itanium System Environment THEN IA-32_Intercept(INST,RSM);

ReturnFromSSM;

ProcessorState ← Restore(SSMDump);

Flags Affected

All.

Additional Itanium® System Environment Exceptions

IA-32_Intercept Mandatory Instruction Intercept.

Protected Mode Exceptions

#UD If an attempt is made to execute this instruction when the processor is not in SMM.

Real Address Mode Exceptions

#UD If an attempt is made to execute this instruction when the processor is not in SMM.

Virtual 8086 Mode Exceptions

#UD If an attempt is made to execute this instruction when the processor is not in SMM.

SAHF—Store AH into Flags

| Opcode | Instruction | Clocks | Description |
|--------|-------------|--------|---|
| 9E | SAHF | 2 | Loads SF, ZF, AF, PF, and CF from AH into EFLAGS register |

Description

Loads the SF, ZF, AF, PF, and CF flags of the EFLAGS register with values from the corresponding bits in the AH register (bits 7, 6, 4, 2, and 0, respectively). Bits 1, 3, and 5 of register AH are ignored; the corresponding reserved bits (1, 3, and 5) in the EFLAGS registers are set as shown in the “Operation” below

Operation

$EFLAGS(SF:ZF:0:AF:0:PF:1:CF) \leftarrow AH;$

Flags Affected

The SF, ZF, AF, PF, and CF flags are loaded with values from the AH register. Bits 1, 3, and 5 of the EFLAGS register are set to 1, 0, and 0, respectively.

Additional Itanium® System Environment Exceptions

Itanium Reg Faults NaT Register Consumption Abort.

Exceptions (All Operating Modes)

None.

SAL/SAR/SHL/SHR—Shift Instructions

| Opcode | Instruction | Description |
|-----------------|-------------------------------|---|
| D0 /4 | SAL <i>rm8</i> ,1 | Multiply <i>rm8</i> by 2, once |
| D2 /4 | SAL <i>rm8</i> ,CL | Multiply <i>rm8</i> by 2, CL times |
| C0 /4 <i>ib</i> | SAL <i>rm8</i> , <i>imm8</i> | Multiply <i>rm8</i> by 2, <i>imm8</i> times |
| D1 /4 | SAL <i>rm16</i> ,1 | Multiply <i>rm16</i> by 2, once |
| D3 /4 | SAL <i>rm16</i> ,CL | Multiply <i>rm16</i> by 2, CL times |
| C1 /4 <i>ib</i> | SAL <i>rm16</i> , <i>imm8</i> | Multiply <i>rm16</i> by 2, <i>imm8</i> times |
| D1 /4 | SAL <i>rm32</i> ,1 | Multiply <i>rm32</i> by 2, once |
| D3 /4 | SAL <i>rm32</i> ,CL | Multiply <i>rm32</i> by 2, CL times |
| C1 /4 <i>ib</i> | SAL <i>rm32</i> , <i>imm8</i> | Multiply <i>rm32</i> by 2, <i>imm8</i> times |
| D0 /7 | SAR <i>rm8</i> ,1 | Signed divide* <i>rm8</i> by 2, once |
| D2 /7 | SAR <i>rm8</i> ,CL | Signed divide* <i>rm8</i> by 2, CL times |
| C0 /7 <i>ib</i> | SAR <i>rm8</i> , <i>imm8</i> | Signed divide* <i>rm8</i> by 2, <i>imm8</i> times |
| D1 /7 | SAR <i>rm16</i> ,1 | Signed divide* <i>rm16</i> by 2, once |
| D3 /7 | SAR <i>rm16</i> ,CL | Signed divide* <i>rm16</i> by 2, CL times |
| C1 /7 <i>ib</i> | SAR <i>rm16</i> , <i>imm8</i> | Signed divide* <i>rm16</i> by 2, <i>imm8</i> times |
| D1 /7 | SAR <i>rm32</i> ,1 | Signed divide* <i>rm32</i> by 2, once |
| D3 /7 | SAR <i>rm32</i> ,CL | Signed divide* <i>rm32</i> by 2, CL times |
| C1 /7 <i>ib</i> | SAR <i>rm32</i> , <i>imm8</i> | Signed divide* <i>rm32</i> by 2, <i>imm8</i> times |
| D0 /4 | SHL <i>rm8</i> ,1 | Multiply <i>rm8</i> by 2, once |
| D2 /4 | SHL <i>rm8</i> ,CL | Multiply <i>rm8</i> by 2, CL times |
| C0 /4 <i>ib</i> | SHL <i>rm8</i> , <i>imm8</i> | Multiply <i>rm8</i> by 2, <i>imm8</i> times |
| D1 /4 | SHL <i>rm16</i> ,1 | Multiply <i>rm16</i> by 2, once |
| D3 /4 | SHL <i>rm16</i> ,CL | Multiply <i>rm16</i> by 2, CL times |
| C1 /4 <i>ib</i> | SHL <i>rm16</i> , <i>imm8</i> | Multiply <i>rm16</i> by 2, <i>imm8</i> times |
| D1 /4 | SHL <i>rm32</i> ,1 | Multiply <i>rm32</i> by 2, once |
| D3 /4 | SHL <i>rm32</i> ,CL | Multiply <i>rm32</i> by 2, CL times |
| C1 /4 <i>ib</i> | SHL <i>rm32</i> , <i>imm8</i> | Multiply <i>rm32</i> by 2, <i>imm8</i> times |
| D0 /5 | SHR <i>rm8</i> ,1 | Unsigned divide <i>rm8</i> by 2, once |
| D2 /5 | SHR <i>rm8</i> ,CL | Unsigned divide <i>rm8</i> by 2, CL times |
| C0 /5 <i>ib</i> | SHR <i>rm8</i> , <i>imm8</i> | Unsigned divide <i>rm8</i> by 2, <i>imm8</i> times |
| D1 /5 | SHR <i>rm16</i> ,1 | Unsigned divide <i>rm16</i> by 2, once |
| D3 /5 | SHR <i>rm16</i> ,CL | Unsigned divide <i>rm16</i> by 2, CL times |
| C1 /5 <i>ib</i> | SHR <i>rm16</i> , <i>imm8</i> | Unsigned divide <i>rm16</i> by 2, <i>imm8</i> times |
| D1 /5 | SHR <i>rm32</i> ,1 | Unsigned divide <i>rm32</i> by 2, once |
| D3 /5 | SHR <i>rm32</i> ,CL | Unsigned divide <i>rm32</i> by 2, CL times |
| C1 /5 <i>ib</i> | SHR <i>rm32</i> , <i>imm8</i> | Unsigned divide <i>rm32</i> by 2, <i>imm8</i> times |

Note:

* Not the same form of division as IDIV; rounding is toward negative infinity.

SAL/SAR/SHL/SHR—Shift Instructions (Continued)

Description

Shift the bits in the first operand (destination operand) to the left or right by the number of bits specified in the second operand (count operand). Bits shifted beyond the destination operand boundary are first shifted into the CF flag, then discarded. At the end of the shift operation, the CF flag contains the last bit shifted out of the destination operand.

The destination operand can be a register or a memory location. The count operand can be an immediate value or register CL. The count is masked to 5 bits, which limits the count range to from 0 to 31. A special opcode encoding is provided for a count of 1.

The shift arithmetic left (SAL) and shift logical left (SHL) instructions perform the same operation; they shift the bits in the destination operand to the left (toward more significant bit locations). For each shift count, the most significant bit of the destination operand is shifted into the CF flag, and the least significant bit is cleared.

The shift arithmetic right (SAR) and shift logical right (SHR) instructions shift the bits of the destination operand to the right (toward less significant bit locations). For each shift count, the least significant bit of the destination operand is shifted into the CF flag, and the most significant bit is either set or cleared depending on the instruction type. The SHR instruction clears the most significant bit; the SAR instruction sets or clears the most significant bit to correspond to the sign (most significant bit) of the original value in the destination operand. In effect, the SAR instruction fills the empty bit position's shifted value with the sign of the unshifted value.

The SAR and SHR instructions can be used to perform signed or unsigned division, respectively, of the destination operand by powers of 2. For example, using the SAR instruction shift a signed integer 1 bit to the right divides the value by 2.

Using the SAR instruction to perform a division operation does not produce the same result as the IDIV instruction. The quotient from the IDIV instruction is rounded toward zero, whereas the “quotient” of the SAR instruction is rounded toward negative infinity. This difference is apparent only for negative numbers. For example, when the IDIV instruction is used to divide -9 by 4, the result is -2 with a remainder of -1. If the SAR instruction is used to shift -9 right by two bits, the result is -3 and the “remainder” is +3; however, the SAR instruction stores only the most significant bit of the remainder (in the CF flag).

The OF flag is affected only on 1-bit shifts. For left shifts, the OF flag is cleared to 0 if the most-significant bit of the result is the same as the CF flag (that is, the top two bits of the original operand were the same); otherwise, it is set to 1. For the SAR instruction, the OF flag is cleared for all 1-bit shifts. For the SHR instruction, the OF flag is set to the most-significant bit of the original operand.

Operation

```
tempCOUNT ← COUNT;
tempDEST ← DEST;
WHILE (tempCOUNT ≠ 0)
DO
  IF instruction is SAL or SHL
  THEN
    CF ← MSB(DEST);
```

SAL/SAR/SHL/SHR—Shift Instructions (Continued)

```

        ELSE (* instruction is SAR or SHR *)
            CF ← LSB(DEST);

FI;
IF instruction is SAL or SHL
    THEN
        DEST ← DEST * 2;
    ELSE
        IF instruction is SAR
            THEN
                DEST ← DEST / 2 (*Signed divide, rounding toward negative infinity*);
            ELSE (* instruction is SHR *)
                DEST ← DEST / 2 ; (* Unsigned divide *);

        FI;
    FI;
temp ← temp - 1;
OD;
(* Determine overflow for the various instructions *)
IF COUNT = 1
    THEN
        IF instruction is SAL or SHL
            THEN
                OF ← MSB(DEST) XOR CF;
            ELSE
                IF instruction is SAR
                    THEN
                        OF ← 0;
                    ELSE (* instruction is SHR *)
                        OF ← MSB(tempDEST);

                FI;
            FI;
        ELSE
            OF ← undefined;

    FI;

```

Flags Affected

The CF flag contains the value of the last bit shifted out of the destination operand; it is undefined for SHL and SHR instructions count is greater than or equal to the size of the destination operand. The OF flag is affected only for 1-bit shifts (see “Description” above); otherwise, it is undefined. The SF, ZF, and PF flags are set according to the result. If the count is 0, the flags are not affected.

Additional Itanium® System Environment Exceptions

| | |
|--------------------|--|
| Itanium Reg Faults | NaT Register Consumption Abort. |
| Itanium Mem Faults | VHPT Data Fault, Nested TLB Fault, Data TLB Fault, Alternate Data TLB Fault, Data Page Not Present Fault, Data NaT Page Consumption Abort, Data Key Miss Fault, Data Key Permission Fault, Data Access Rights Fault, Data Access Bit Fault, Data Dirty Bit Fault |

SAL/SAR/SHL/SHR—Shift Instructions (Continued)

Protected Mode Exceptions

| | |
|-----------------|---|
| #GP(0) | If the destination is located in a nonwritable segment. If a memory operand effective address is outside the CS, DS, ES, FS, or GS segment limit. If the DS, ES, FS, or GS register contains a null segment selector. |
| #SS(0) | If a memory operand effective address is outside the SS segment limit. |
| #PF(fault-code) | If a page fault occurs. |
| #AC(0) | If alignment checking is enabled and an unaligned memory reference is made while the current privilege level is 3. |

Real Address Mode Exceptions

| | |
|-----|---|
| #GP | If a memory operand effective address is outside the CS, DS, ES, FS, or GS segment limit. |
| #SS | If a memory operand effective address is outside the SS segment limit. |

Virtual 8086 Mode Exceptions

| | |
|-----------------|---|
| #GP(0) | If a memory operand effective address is outside the CS, DS, ES, FS, or GS segment limit. |
| #SS(0) | If a memory operand effective address is outside the SS segment limit. |
| #PF(fault-code) | If a page fault occurs. |
| #AC(0) | If alignment checking is enabled and an unaligned memory reference is made. |

Intel® Architecture Compatibility

The 8086 does not mask the shift count. All Intel architecture processors from the Intel386 processor on do mask the rotation count in all operating modes.

SBB—Integer Subtraction with Borrow

| Opcode | Instruction | Description |
|-----------------|-----------------------|---|
| 1C <i>ib</i> | SBB AL, <i>imm8</i> | Subtract with borrow <i>imm8</i> from AL |
| 1D <i>iw</i> | SBB AX, <i>imm16</i> | Subtract with borrow <i>imm16</i> from AX |
| 1D <i>id</i> | SBB EAX, <i>imm32</i> | Subtract with borrow <i>imm32</i> from EAX |
| 80 /3 <i>ib</i> | SBB <i>rm8,imm8</i> | Subtract with borrow <i>imm8</i> from <i>rm8</i> |
| 81 /3 <i>iw</i> | SBB <i>rm16,imm16</i> | Subtract with borrow <i>imm16</i> from <i>rm16</i> |
| 81 /3 <i>id</i> | SBB <i>rm32,imm32</i> | Subtract with borrow <i>imm32</i> from <i>rm32</i> |
| 83 /3 <i>ib</i> | SBB <i>rm16,imm8</i> | Subtract with borrow sign-extended <i>imm8</i> from <i>rm16</i> |
| 83 /3 <i>ib</i> | SBB <i>rm32,imm8</i> | Subtract with borrow sign-extended <i>imm8</i> from <i>rm32</i> |
| 18 /r | SBB <i>rm8,r8</i> | Subtract with borrow <i>r8</i> from <i>rm8</i> |
| 19 /r | SBB <i>rm16,r16</i> | Subtract with borrow <i>r16</i> from <i>rm16</i> |
| 19 /r | SBB <i>rm32,r32</i> | Subtract with borrow <i>r32</i> from <i>rm32</i> |
| 1A /r | SBB <i>r8,rm8</i> | Subtract with borrow <i>rm8</i> from <i>r8</i> |
| 1B /r | SBB <i>r16,rm16</i> | Subtract with borrow <i>rm16</i> from <i>r16</i> |
| 1B /r | SBB <i>r32,rm32</i> | Subtract with borrow <i>rm32</i> from <i>r32</i> |

Description

Adds the source operand (second operand) and the carry (CF) flag, and subtracts the result from the destination operand (first operand). The result of the subtraction is stored in the destination operand. The destination operand can be a register or a memory location; the source operand can be an immediate, a register, or a memory location. The state of the CF flag represents a borrow from a previous subtraction.

When an immediate value is used as an operand, it is sign-extended to the length of the destination operand format.

The SBB instruction does not distinguish between signed or unsigned operands. Instead, the processor evaluates the result for both data types and sets the OF and CF flags to indicate a borrow in the signed or unsigned result, respectively. The SF flag indicates the sign of the signed result.

The SBB instruction is usually executed as part of a multibyte or multiword subtraction in which a SUB instruction is followed by a SBB instruction.

Operation

$DEST \leftarrow DEST - (SRC + CF);$

Flags Affected

The OF, SF, ZF, AF, PF, and CF flags are set according to the result.

Additional Itanium® System Environment Exceptions

Itanium Reg Faults NaT Register Consumption Abort.

SBB—Integer Subtraction with Borrow (Continued)

Itanium Mem Faults VHPT Data Fault, Nested TLB Fault, Data TLB Fault, Alternate Data TLB Fault, Data Page Not Present Fault, Data NaT Page Consumption Abort, Data Key Miss Fault, Data Key Permission Fault, Data Access Rights Fault, Data Access Bit Fault, Data Dirty Bit Fault

Protected Mode Exceptions

| | |
|-----------------|--|
| #GP(0) | <p>If the destination is located in a nonwritable segment.</p> <p>If a memory operand effective address is outside the CS, DS, ES, FS, or GS segment limit.</p> <p>If the DS, ES, FS, or GS register contains a null segment selector.</p> |
| #SS(0) | If a memory operand effective address is outside the SS segment limit. |
| #PF(fault-code) | If a page fault occurs. |
| #AC(0) | If alignment checking is enabled and an unaligned memory reference is made while the current privilege level is 3. |

Real Address Mode Exceptions

| | |
|-----|---|
| #GP | If a memory operand effective address is outside the CS, DS, ES, FS, or GS segment limit. |
| #SS | If a memory operand effective address is outside the SS segment limit. |

Virtual 8086 Mode Exceptions

| | |
|-----------------|---|
| #GP(0) | If a memory operand effective address is outside the CS, DS, ES, FS, or GS segment limit. |
| #SS(0) | If a memory operand effective address is outside the SS segment limit. |
| #PF(fault-code) | If a page fault occurs. |
| #AC(0) | If alignment checking is enabled and an unaligned memory reference is made. |

SCAS/SCASB/SCASW/SCASD—Scan String Data

| Opcode | Instruction | Description |
|--------|---------------|--|
| AE | SCAS ES:(E)DI | Compare AL with byte at ES:(E)DI and set status flags |
| AF | SCAS ES:DI | Compare AX with word at ES:DI and set status flags |
| AF | SCAS ES:EDI | Compare EAX with doubleword at ES:EDI and set status flags |
| AE | SCASB | Compare AL with byte at ES:(E)DI and set status flags |
| AF | SCASW | Compare AX with word at ES:DI and set status flags |
| AF | SCASD | Compare EAX with doubleword at ES:EDI and set status flags |

Description

Compares the byte, word, or double word specified with the source operand with the value in the AL, AX, or EAX register, respectively, and sets the status flags in the EFLAGS register according to the results. The source operand specifies the memory location at the address ES:EDI. (When the operand-size attribute is 16, the DI register is used as the source-index register.) The ES segment cannot be overridden with a segment override prefix.

The SCASB, SCASW, and SCASD mnemonics are synonyms of the byte, word, and doubleword versions of the SCAS instructions. They are simpler to use, but provide no type or segment checking. (For the SCAS instruction, “ES:EDI” must be explicitly specified in the instruction.)

After the comparison, the EDI register is incremented or decremented automatically according to the setting of the DF flag in the EFLAGS register. (If the DF flag is 0, the EDI register is incremented; if the DF flag is 1, the EDI register is decremented.) The EDI register is incremented or decremented by 1 for byte operations, by 2 for word operations, or by 4 for doubleword operations.

The SCAS, SCASB, SCASW, and SCASD instructions can be preceded by the REP prefix for block comparisons of ECX bytes, words, or doublewords. More often, however, these instructions will be used in a LOOP construct that takes some action based on the setting of the status flags before the next comparison is made. See [“REP/REPE/REPZ/REPNE /REPNZ—Repeat String Operation Prefix” on page 3:685](#) for a description of the REP prefix.

Operation

```

IF (byte comparison)
  THEN
    temp ← AL – SRC;
    SetStatusFlags(temp);
    THEN IF DF = 0
      THEN (E)DI ← 1;
      ELSE (E)DI ← –1;
    FI;
ELSE IF (word comparison)
  THEN
    temp ← AX – SRC;
    SetStatusFlags(temp)
    THEN IF DF = 0

```

SCAS/SCASB/SCASW/SCASD—Scan String Data (Continued)

```

        THEN DI ← 2;
        ELSE DI ← -2;
    FI;
ELSE (* doubleword comparison *)
    temp ← EAX - SRC;
    SetStatusFlags(temp)
    THEN IF DF = 0
        THEN EDI ← 4;
        ELSE EDI ← -4;
    FI;
FI;
FI;

```

Flags Affected

The OF, SF, ZF, AF, PF, and CF flags are set according to the temporary result of the comparison.

Additional Itanium® System Environment Exceptions

Itanium Reg Faults NaT Register Consumption Abort.

Itanium Mem Faults VHPT Data Fault, Nested TLB Fault, Data TLB Fault, Alternate Data TLB Fault, Data Page Not Present Fault, Data NaT Page Consumption Abort, Data Key Miss Fault, Data Key Permission Fault, Data Access Rights Fault, Data Access Bit Fault, Data Dirty Bit Fault

Protected Mode Exceptions

#GP(0) If a memory operand effective address is outside the limit of the ES segment.
 If the ES register contains a null segment selector.
 If an illegal memory operand effective address in the ES segment is given.

#PF(fault-code) If a page fault occurs.

#AC(0) If alignment checking is enabled and an unaligned memory reference is made while the current privilege level is 3.

Real Address Mode Exceptions

#GP If a memory operand effective address is outside the CS, DS, ES, FS, or GS segment limit.

#SS If a memory operand effective address is outside the SS segment limit.

Virtual 8086 Mode Exceptions

#GP(0) If a memory operand effective address is outside the CS, DS, ES, FS, or GS segment limit.

#SS(0) If a memory operand effective address is outside the SS segment limit.

#PF(fault-code) If a page fault occurs.

#AC(0) If alignment checking is enabled and an unaligned memory reference is made.

SETcc—Set Byte on Condition

| Opcode | Instruction | Description |
|--------|-------------------|--|
| 0F 97 | SETA <i>rm8</i> | Set byte if above (CF=0 and ZF=0) |
| 0F 93 | SETAE <i>rm8</i> | Set byte if above or equal (CF=0) |
| 0F 92 | SETB <i>rm8</i> | Set byte if below (CF=1) |
| 0F 96 | SETBE <i>rm8</i> | Set byte if below or equal (CF=1 or (ZF=1)) |
| 0F 92 | SETC <i>rm8</i> | Set if carry (CF=1) |
| 0F 94 | SETE <i>rm8</i> | Set byte if equal (ZF=1) |
| 0F 9F | SETG <i>rm8</i> | Set byte if greater (ZF=0 and SF=OF) |
| 0F 9D | SETGE <i>rm8</i> | Set byte if greater or equal (SF=OF) |
| 0F 9C | SETL <i>rm8</i> | Set byte if less (SF<>OF) |
| 0F 9E | SETLE <i>rm8</i> | Set byte if less or equal (ZF=1 or SF<>OF) |
| 0F 96 | SETNA <i>rm8</i> | Set byte if not above (CF=1 or ZF=1) |
| 0F 92 | SETNAE <i>rm8</i> | Set byte if not above or equal (CF=1) |
| 0F 93 | SETNB <i>rm8</i> | Set byte if not below (CF=0) |
| 0F 97 | SETNBE <i>rm8</i> | Set byte if not below or equal (CF=0 and ZF=0) |
| 0F 93 | SETNC <i>rm8</i> | Set byte if not carry (CF=0) |
| 0F 95 | SETNE <i>rm8</i> | Set byte if not equal (ZF=0) |
| 0F 9E | SETNG <i>rm8</i> | Set byte if not greater (ZF=1 or SF<>OF) |
| 0F 9C | SETNGE <i>rm8</i> | Set if not greater or equal (SF<>OF) |
| 0F 9D | SETNL <i>rm8</i> | Set byte if not less (SF=OF) |
| 0F 9F | SETNLE <i>rm8</i> | Set byte if not less or equal (ZF=0 and SF=OF) |
| 0F 91 | SETNO <i>rm8</i> | Set byte if not overflow (OF=0) |
| 0F 9B | SETNP <i>rm8</i> | Set byte if not parity (PF=0) |
| 0F 99 | SETNS <i>rm8</i> | Set byte if not sign (SF=0) |
| 0F 95 | SETNZ <i>rm8</i> | Set byte if not zero (ZF=0) |
| 0F 90 | SETO <i>rm8</i> | Set byte if overflow (OF=1) |
| 0F 9A | SETP <i>rm8</i> | Set byte if parity (PF=1) |
| 0F 9A | SETPE <i>rm8</i> | Set byte if parity even (PF=1) |
| 0F 9B | SETPO <i>rm8</i> | Set byte if parity odd (PF=0) |
| 0F 98 | SETS <i>rm8</i> | Set byte if sign (SF=1) |
| 0F 94 | SETZ <i>rm8</i> | Set byte if zero (ZF=1) |

Description

Set the destination operand to the value 0 or 1, depending on the settings of the status flags (CF, SF, OF, ZF, and PF) in the EFLAGS register. The destination operand points to a byte register or a byte in memory. The condition code suffix (*cc*) indicates the condition being tested for.

The terms “above” and “below” are associated with the CF flag and refer to the relationship between two unsigned integer values. The terms “greater” and “less” are associated with the SF and OF flags and refer to the relationship between two signed integer values.

SETcc—Set Byte on Condition (Continued)

Many of the SETcc instruction opcodes have alternate mnemonics. For example, the SETG (set byte if greater) and SETNLE (set if not less or equal) both have the same opcode and test for the same condition: ZF equals 0 and SF equals OF. These alternate mnemonics are provided to make code more intelligible.

Some languages represent a logical one as an integer with all bits set. This representation can be arrived at by choosing the mutually exclusive condition for the SETcc instruction, then decrementing the result. For example, to test for overflow, use the SETNO instruction, then decrement the result.

Operation

```
IF condition
  THEN DEST ← 1
  ELSE DEST ← 0;
FI;
```

Flags Affected

None.

Additional Itanium® System Environment Exceptions

Itanium Reg Faults NaT Register Consumption Abort.

Itanium Mem Faults VHPT Data Fault, Nested TLB Fault, Data TLB Fault, Alternate Data TLB Fault, Data Page Not Present Fault, Data NaT Page Consumption Abort, Data Key Miss Fault, Data Key Permission Fault, Data Access Rights Fault, Data Access Bit Fault, Data Dirty Bit Fault

Protected Mode Exceptions

| | |
|-----------------|---|
| #GP(0) | If the destination is located in a nonwritable segment. If a memory operand effective address is outside the CS, DS, ES, FS, or GS segment limit. If the DS, ES, FS, or GS register contains a null segment selector. |
| #SS(0) | If a memory operand effective address is outside the SS segment limit. |
| #PF(fault-code) | If a page fault occurs. |
| #AC(0) | If alignment checking is enabled and an unaligned memory reference is made while the current privilege level is 3. |

Real Address Mode Exceptions

| | |
|-----|---|
| #GP | If a memory operand effective address is outside the CS, DS, ES, FS, or GS segment limit. |
| #SS | If a memory operand effective address is outside the SS segment limit. |

SETcc—Set Byte on Condition (Continued)

Virtual 8086 Mode Exceptions

| | |
|-----------------|---|
| #GP(0) | If a memory operand effective address is outside the CS, DS, ES, FS, or GS segment limit. |
| #SS(0) | If a memory operand effective address is outside the SS segment limit. |
| #PF(fault-code) | If a page fault occurs. |
| #AC(0) | If alignment checking is enabled and an unaligned memory reference is made. |

SGDT/SIDT—Store Global/Interrupt Descriptor Table Register

| Opcode | Instruction | Description |
|----------|---------------|------------------------|
| 0F 01 /0 | SGDT <i>m</i> | Store GDTR to <i>m</i> |
| 0F 01 /1 | SIDT <i>m</i> | Store IDTR to <i>m</i> |

Description

Stores the contents of the global descriptor table register (GDTR) or the interrupt descriptor table register (IDTR) in the destination operand. The destination operand is a pointer to 6-byte memory location. If the operand-size attribute is 32 bits, the 16-bit limit field of the register is stored in the lower 2 bytes of the memory location and the 32-bit base address is stored in the upper 4 bytes. If the operand-size attribute is 16 bits, the limit is stored in the lower 2 bytes and the 24-bit base address is stored in the third, fourth, and fifth byte, with the sixth byte is filled with 0s.

The SGDT and SIDT instructions are useful only in operating-system software; however, they can be used in application programs.

Operation

IF Itanium System Environment THEN IA-32_Intercept(INST,SGDT/SIDT);

IF instruction is IDTR

THEN

IF OperandSize = 16

THEN

DEST[0:15] ← IDTR(Limit);

DEST[16:39] ← IDTR(Base); (* 24 bits of base address loaded; *)

DEST[40:47] ← 0;

ELSE (* 32-bit Operand Size *)

DEST[0:15] ← IDTR(Limit);

DEST[16:47] ← IDTR(Base); (* full 32-bit base address loaded *)

FI;

ELSE (* instruction is SGDT *)

IF OperandSize = 16

THEN

DEST[0:15] ← GDTR(Limit);

DEST[16:39] ← GDTR(Base); (* 24 bits of base address loaded; *)

DEST[40:47] ← 0;

ELSE (* 32-bit Operand Size *)

DEST[0:15] ← GDTR(Limit);

DEST[16:47] ← GDTR(Base); (* full 32-bit base address loaded *)

FI;

FI;

Flags Affected

None.

Additional Itanium® System Environment Exceptions

IA-32_Intercept Instruction Intercept for SIDT and SGDT.

SGDT/SIDT—Store Global/Interrupt Descriptor Table Register (Continued)

Protected Mode Exceptions

| | |
|-----------------|---|
| #UD | If the destination operand is a register. |
| #GP(0) | If the destination is located in a nonwritable segment. If a memory operand effective address is outside the CS, DS, ES, FS, or GS segment limit. If the DS, ES, FS, or GS register is used to access memory and it contains a null segment selector. |
| #SS(0) | If a memory operand effective address is outside the SS segment limit. |
| #PF(fault-code) | If a page fault occurs. |
| #AC(0) | If an unaligned memory access occurs when the CPL is 3 and alignment checking is enabled. |

Real Address Mode Exceptions

| | |
|-----|---|
| #UD | If the destination operand is a register. |
| #GP | If a memory operand effective address is outside the CS, DS, ES, FS, or GS segment limit. |
| #SS | If a memory operand effective address is outside the SS segment limit. |

Virtual 8086 Mode Exceptions

| | |
|-----------------|---|
| #UD | If the destination operand is a register. |
| #GP(0) | If a memory operand effective address is outside the CS, DS, ES, FS, or GS segment limit. |
| #SS(0) | If a memory operand effective address is outside the SS segment limit. |
| #PF(fault-code) | If a page fault occurs. |
| #AC(0) | If an unaligned memory access occurs when alignment checking is enabled. |

Intel® Architecture Compatibility

The 16-bit forms of the SGDT and SIDT instructions are compatible with the Intel 286 processor, if the upper 8 bits are not referenced. The Intel 286 processor fills these bits with 1s; the Pentium Pro processor fills these bits with 0s.



SHL/SHR—Shift Instructions

See entry for SAL/SAR/SHL/SHR.

SHLD—Double Precision Shift Left

| Opcode | Instruction | Description |
|--------|---------------------------|--|
| 0F A4 | SHLD <i>rm16,r16,imm8</i> | Shift <i>rm16</i> to left <i>imm8</i> places while shifting bits from <i>r16</i> in from the right |
| 0F A5 | SHLD <i>rm16,r16,CL</i> | Shift <i>rm16</i> to left CL places while shifting bits from <i>r16</i> in from the right |
| 0F A4 | SHLD <i>rm32,r32,imm8</i> | Shift <i>rm32</i> to left <i>imm8</i> places while shifting bits from <i>r32</i> in from the right |
| 0F A5 | SHLD <i>rm32,r32,CL</i> | Shift <i>rm32</i> to left CL places while shifting bits from <i>r32</i> in from the right |

Description

Shifts the first operand (destination operand) to the left the number of bits specified by the third operand (count operand). The second operand (source operand) provides bits to shift in from the right (starting with bit 0 of the destination operand). The destination operand can be a register or a memory location; the source operand is a register. The count operand is an unsigned integer that can be an immediate byte or the contents of the CL register. Only bits 0 through 4 of the count are used, which masks the count to a value between 0 and 31. If the count is greater than the operand size, the result in the destination operand is undefined.

If the count is 1 or greater, the CF flag is filled with the last bit shifted out of the destination operand. For a 1-bit shift, the OF flag is set if a sign change occurred; otherwise, it is cleared. If the count operand is 0, the flags are not affected.

The SHLD instruction is useful for multi-precision shifts of 64 bits or more.

Operation

```

COUNT ← COUNT MOD 32;
SIZE ← OperandSize
IF COUNT = 0
  THEN
    no operation
  ELSE
    IF COUNT ≥ SIZE
      THEN (* Bad parameters *)
        DEST is undefined;
        CF, OF, SF, ZF, AF, PF are undefined;
      ELSE (* Perform the shift *)
        CF ← BIT[DEST, SIZE – COUNT];
        (* Last bit shifted out on exit *)
        FOR i ← SIZE – 1 DOWNTO COUNT
          DO
            Bit(DEST, i) ← Bit(DEST, i – COUNT);
        OD;
        FOR i ← COUNT – 1 DOWNTO 0

```

SHLD—Double Precision Shift Left (Continued)

```

DO
    BIT[DEST, i] ← BIT[SRC, i – COUNT + SIZE];
OD;
FI;
FI;

```

Flags Affected

If the count is 1 or greater, the CF flag is filled with the last bit shifted out of the destination operand and the SF, ZF, and PF flags are set according to the value of the result. For a 1-bit shift, the OF flag is set if a sign change occurred; otherwise, it is cleared. For shifts greater than 1 bit, the OF flag is undefined. If a shift occurs, the AF flag is undefined. If the count operand is 0, the flags are not affected. If the count is greater than the operand size, the flags are undefined.

Additional Itanium® System Environment Exceptions

| | |
|--------------------|--|
| Itanium Reg Faults | NaT Register Consumption Abort. |
| Itanium Mem Faults | VHPT Data Fault, Nested TLB Fault, Data TLB Fault, Alternate Data TLB Fault, Data Page Not Present Fault, Data NaT Page Consumption Abort, Data Key Miss Fault, Data Key Permission Fault, Data Access Rights Fault, Data Access Bit Fault, Data Dirty Bit Fault |

Protected Mode Exceptions

| | |
|-----------------|---|
| #GP(0) | If the destination is located in a nonwritable segment. If a memory operand effective address is outside the CS, DS, ES, FS, or GS segment limit. If the DS, ES, FS, or GS register contains a null segment selector. |
| #SS(0) | If a memory operand effective address is outside the SS segment limit. |
| #PF(fault-code) | If a page fault occurs. |
| #AC(0) | If alignment checking is enabled and an unaligned memory reference is made while the current privilege level is 3. |

Real Address Mode Exceptions

| | |
|-----|---|
| #GP | If a memory operand effective address is outside the CS, DS, ES, FS, or GS segment limit. |
| #SS | If a memory operand effective address is outside the SS segment limit. |

Virtual 8086 Mode Exceptions

| | |
|-----------------|---|
| #GP(0) | If a memory operand effective address is outside the CS, DS, ES, FS, or GS segment limit. |
| #SS(0) | If a memory operand effective address is outside the SS segment limit. |
| #PF(fault-code) | If a page fault occurs. |
| #AC(0) | If alignment checking is enabled and an unaligned memory reference is made. |

SHRD—Double Precision Shift Right

| Opcode | Instruction | Description |
|--------|----------------------------|---|
| 0F AC | SHRD <i>r/m16,r16,imm8</i> | Shift <i>r/m16</i> to right <i>imm8</i> places while shifting bits from <i>r16</i> in from the left |
| 0F AD | SHRD <i>r/m16,r16,CL</i> | Shift <i>r/m16</i> to right CL places while shifting bits from <i>r16</i> in from the left |
| 0F AC | SHRD <i>r/m32,r32,imm8</i> | Shift <i>r/m32</i> to right <i>imm8</i> places while shifting bits from <i>r32</i> in from the left |
| 0F AD | SHRD <i>r/m32,r32,CL</i> | Shift <i>r/m32</i> to right CL places while shifting bits from <i>r32</i> in from the left |

Description

Shifts the first operand (destination operand) to the right the number of bits specified by the third operand (count operand). The second operand (source operand) provides bits to shift in from the left (starting with the most significant bit of the destination operand). The destination operand can be a register or a memory location; the source operand is a register. The count operand is an unsigned integer that can be an immediate byte or the contents of the CL register. Only bits 0 through 4 of the count are used, which masks the count to a value between 0 and 31. If the count is greater than the operand size, the result in the destination operand is undefined.

If the count is 1 or greater, the CF flag is filled with the last bit shifted out of the destination operand. For a 1-bit shift, the OF flag is set if a sign change occurred; otherwise, it is cleared. If the count operand is 0, the flags are not affected.

The SHRD instruction is useful for multiprecision shifts of 64 bits or more.

Operation

```

COUNT ← COUNT MOD 32;
SIZE ← OperandSize
IF COUNT = 0
  THEN
    no operation
  ELSE
    IF COUNT ≥ SIZE
      THEN (* Bad parameters *)
        DEST is undefined;
        CF, OF, SF, ZF, AF, PF are undefined;
      ELSE (* Perform the shift *)
        CF ← BIT[DEST, COUNT – 1]; (* last bit shifted out on exit *)
        FOR i ← 0 TO SIZE – 1 – COUNT
          DO
            BIT[DEST, i] ← BIT[DEST, i – COUNT];
          OD;
        FOR i ← SIZE – COUNT TO SIZE – 1
          DO
            BIT[DEST, i] ← BIT[inBits, i + COUNT – SIZE];
          OD;
        FI;
      FI;
    FI;
  FI;

```

SHRD—Double Precision Shift Right (Continued)

Flags Affected

If the count is 1 or greater, the CF flag is filled with the last bit shifted out of the destination operand and the SF, ZF, and PF flags are set according to the value of the result. For a 1-bit shift, the OF flag is set if a sign change occurred; otherwise, it is cleared. For shifts greater than 1 bit, the OF flag is undefined. If a shift occurs, the AF flag is undefined. If the count operand is 0, the flags are not affected. If the count is greater than the operand size, the flags are undefined.

Additional Itanium® System Environment Exceptions

Itanium Reg Faults NaT Register Consumption Abort.

Itanium Mem Faults VHPT Data Fault, Nested TLB Fault, Data TLB Fault, Alternate Data TLB Fault, Data Page Not Present Fault, Data NaT Page Consumption Abort, Data Key Miss Fault, Data Key Permission Fault, Data Access Rights Fault, Data Access Bit Fault, Data Dirty Bit Fault

Protected Mode Exceptions

| | |
|-----------------|---|
| #GP(0) | If the destination is located in a nonwritable segment. If a memory operand effective address is outside the CS, DS, ES, FS, or GS segment limit. If the DS, ES, FS, or GS register contains a null segment selector. |
| #SS(0) | If a memory operand effective address is outside the SS segment limit. |
| #PF(fault-code) | If a page fault occurs. |
| #AC(0) | If alignment checking is enabled and an unaligned memory reference is made while the current privilege level is 3. |

Real Address Mode Exceptions

| | |
|-----|---|
| #GP | If a memory operand effective address is outside the CS, DS, ES, FS, or GS segment limit. |
| #SS | If a memory operand effective address is outside the SS segment limit. |

Virtual 8086 Mode Exceptions

| | |
|-----------------|---|
| #GP(0) | If a memory operand effective address is outside the CS, DS, ES, FS, or GS segment limit. |
| #SS(0) | If a memory operand effective address is outside the SS segment limit. |
| #PF(fault-code) | If a page fault occurs. |
| #AC(0) | If alignment checking is enabled and an unaligned memory reference is made. |

SIDT—Store Interrupt Descriptor Table Register

See entry for SGDT/SIDT.

SLDT—Store Local Descriptor Table Register

| Opcode | Instruction | Description |
|----------|-------------------|--|
| 0F 00 /0 | SLDT <i>r/m16</i> | Stores segment selector from LDTR in <i>r/m16</i> |
| 0F 00 /0 | SLDT <i>r/m32</i> | Store segment selector from LDTR in low-order 16 bits of <i>r/m32</i> ; high-order 16 bits are undefined |

Description

Stores the segment selector from the local descriptor table register (LDTR) in the destination operand. The destination operand can be a general-purpose register or a memory location. The segment selector stored with this instruction points to the LDT.

When the destination operand is a 32-bit register, the 16-bit segment selector is copied into the lower 16 bits of the register and the upper 16 bits of the register are cleared to 0s. With the destination operand is a memory location, the segment selector is written to memory as a 16-bit quantity, regardless of the operand size.

The SLDT instruction is only useful in operating-system software; however, it can be used in application programs. Also, this instruction can only be executed in protected mode.

Operation

IF Itanium System Environment THEN IA-32_Interrupt(INST,SLDT);

DEST ← LDTR(SegmentSelector);

Flags Affected

None.

Additional Itanium® System Environment Exceptions

IA-32_Interrupt SLDT results in an IA-32 Interrupt

Protected Mode Exceptions

| | |
|-----------------|---|
| #GP(0) | If the destination is located in a nonwritable segment. If a memory operand effective address is outside the CS, DS, ES, FS, or GS segment limit. If the DS, ES, FS, or GS register is used to access memory and it contains a null segment selector. |
| #SS(0) | If a memory operand effective address is outside the SS segment limit. |
| #PF(fault-code) | If a page fault occurs. |
| #AC(0) | If alignment checking is enabled and an unaligned memory reference is made while the current privilege level is 3. |

SLDT—Store Local Descriptor Table Register (Continued)

Real Address Mode Exceptions

#UD The SLDT instruction is not recognized in real address mode.

Virtual 8086 Mode Exceptions

#UD The SLDT instruction is not recognized in virtual 8086 mode.

SMSW—Store Machine Status Word

| Opcode | Instruction | Description |
|----------|---------------------|---|
| 0F 01 /4 | SMSW <i>r32/m16</i> | Store machine status word in low-order 16 bits of <i>r32/m16</i> ; high-order 16 bits of <i>r32</i> are undefined |

Description

Stores the machine status word (bits 0 through 15 of control register CR0) into the destination operand. The destination operand can be a 16-bit general-purpose register or a memory location.

When the destination operand is a 32-bit register, the low-order 16 bits of register CR0 are copied into the low-order 16 bits of the register and the upper 16 bits of the register are undefined. With the destination operand is a memory location, the low-order 16 bits of register CR0 are written to memory as a 16-bit quantity, regardless of the operand size.

The SMSW instruction is only useful in operating-system software; however, it is not a privileged instruction and can be used in application programs.

This instruction is provided for compatibility with the Intel 286 processor; programs and procedures intended to run on processors more recent than the Intel 286 should use the MOV (control registers) instruction to load the machine status word.

Operation

IF Itanium System Environment THEN IA-32_Interrupt(INST,SMSW);
DEST ← CR0[15:0]; (* MachineStatusWord *);

Flags Affected

None.

Additional Itanium® System Environment Exceptions

IA-32_Interrupt Mandatory Instruction Intercept.

Protected Mode Exceptions

| | |
|-----------------|---|
| #GP(0) | If the destination is located in a nonwritable segment. If a memory operand effective address is outside the CS, DS, ES, FS, or GS segment limit. If the DS, ES, FS, or GS register is used to access memory and it contains a null segment selector. |
| #SS(0) | If a memory operand effective address is outside the SS segment limit. |
| #PF(fault-code) | If a page fault occurs. |
| #AC(0) | If alignment checking is enabled and an unaligned memory reference is made while the current privilege level is 3. |

SMSW—Store Machine Status Word (Continued)

Real Address Mode Exceptions

#GP If a memory operand effective address is outside the CS, DS, ES, FS, or GS segment limit.

Virtual 8086 Mode Exceptions

#GP(0) If a memory operand effective address is outside the CS, DS, ES, FS, or GS segment limit.

#PF(fault-code) If a page fault occurs.

#AC(0) If alignment checking is enabled and an unaligned memory reference is made.

STC—Set Carry Flag

| Opcode | Instruction | Description |
|--------|-------------|-------------|
| F9 | STC | Set CF flag |

Description

Sets the CF flag in the EFLAGS register.

Operation

$CF \leftarrow 1;$

Flags Affected

The CF flag is set. The OF, ZF, SF, AF, and PF flags are unaffected.

Exceptions (All Operating Modes)

None.

STD—Set Direction Flag

| Opcode | Instruction | Description |
|--------|-------------|-------------|
| FD | STD | Set DF flag |

Description

Sets the DF flag in the EFLAGS register. When the DF flag is set to 1, string operations decrement the index registers (ESI and/or EDI).

Operation

$DF \leftarrow 1;$

Flags Affected

The DF flag is set. The CF, OF, ZF, SF, AF, and PF flags are unaffected.

Operation

$DF \leftarrow 1;$

Exceptions (All Operating Modes)

None.

STI—Set Interrupt Flag

| Opcode | Instruction | Description |
|--------|-------------|---|
| FB | STI | Set interrupt flag; interrupts enabled at the end of the next instruction |

Description

Sets the interrupt flag (IF) in the EFLAGS register. **In the IA-32 System Environment**, after the IF flag is set, the processor begins responding to external maskable interrupts after the next instruction is executed. If the STI instruction is followed by a CLI instruction (which clears the IF flag) the effect of the STI instruction is negated. **In the Itanium System Environment, the processor will immediately respond do interrupts after STI, unless execution of STI results in a trap or intercept. External interrupts are enabled for IA-32 instructions if PSR.i and (~CFLG.if or EFLAG.if).**

The IF flag and the STI and CLI instruction have no affect on the generation of exceptions and NMI interrupts.

The following decision table indicates the action of the STI instruction (bottom of the table) depending on the processor's mode of operating and the CPL and IOPL of the currently running program or procedure (top of the table).

| | | | | |
|--------|---|--------|--------|----|
| PE = | 0 | 1 | 1 | 1 |
| VM = | X | 0 | 0 | 1 |
| CPL | X | ≤ IOPL | > IOPL | =3 |
| IOPL | X | X | X | =3 |
| IF ← 1 | Y | Y | N | Y |
| #GP(0) | N | N | Y | N |

Notes:

X Don't care.

N Action in Column 1 not taken.

Y Action in Column 1 taken.

Operation

OLD_IF ← IF;

IF PE=0 (* Executing in real-address mode *)

THEN

IF ← 1; (* Set Interrupt Flag *)

ELSE (* Executing in protected mode or virtual-8086 mode *)

IF VM=0 (* Executing in protected mode*)

THEN

IF CR4.PVI = 0

THEN

IF CPL ≤ IOPL

THEN IF ← 1

ELSE #GP(0);

FI;

ELSE (*PVI is 1 *)

STI—Set Interrupt Flag (Continued)

```

IF CPL = 3
THEN STI—Set Interrupt Flag (Continued)

    IF IOPL < 3
    THEN
        IF VIP = 0
        THEN VIF <- 1;
        ELSE #GP(0);
        FI;
    ELSE (*IOPL = 3 *)
        IF <- 1;
        FI;
    ELSE (*CPL < 3*)
        IF IOPL < CPL THEN #GP(0); FI;
        IF IOPL >= CPL OR IOPL = 3 THEN IF <- 1; FI;
        FI;
    FI;
ELSE (*Executing in Virtual-8086 Mode*)
IF IOPL = 3
    THEN IF <- 1;
ELSE
    IF CR4.VME = 0
    THEN #GP(0);
    ELSE
        IF VIP = 1 (*virtual interrupt is pending*)
        THEN #GP(0);
        ELSE VIF <- 1;
        FI;
    FI;
FI;
FI;
FI;
FI;

```

```

IF Itanium System Environment AND CFLAG.ii AND IF != OLD_IF
    THEN IA-32_Intercept(System_Flag,STI);

```

Flags Affected

The IF flag is set to 1.

Additional Itanium® System Environment Exceptions

IA-32_Intercept System Flag Intercept Trap if CFLAG.ii is 1 and the IF flag changes state.

Protected Mode Exceptions

#GP(0) If the CPL is greater (has less privilege) than the IOPL of the current program or procedure.

STI—Set Interrupt Flag (Continued)

Real Address Mode Exceptions

None.

Virtual 8086 Mode Exceptions

| | |
|--------|---|
| #GP(0) | If the CPL is greater (has less privilege) than the IOPL of the current program or procedure. |
|--------|---|

STOS/STOSB/STOSW/STOSD—Store String Data

| Opcode | Instruction | Description |
|--------|---------------|------------------------------|
| AA | STOS ES:(E)DI | Store AL at address ES:(E)DI |
| AB | STOS ES:DI | Store AX at address ES:DI |
| AB | STOS ES:EDI | Store EAX at address ES:EDI |
| AA | STOSB | Store AL at address ES:(E)DI |
| AB | STOSW | Store AX at address ES:DI |
| AB | STOSD | Store EAX at address ES:EDI |

Description

Stores a byte, word, or doubleword from the AL, AX, or EAX register, respectively, into the destination operand. The destination operand is a memory location at the address ES:EDI. (When the operand-size attribute is 16, the DI register is used as the source-index register.) The ES segment cannot be overridden with a segment override prefix.

The STOSB, STOSW, and STOSD mnemonics are synonyms of the byte, word, and doubleword versions of the STOS instructions. They are simpler to use, but provide no type or segment checking. (For the STOS instruction, “ES:EDI” must be explicitly specified in the instruction.)

After the byte, word, or doubleword is transfer from the AL, AX, or EAX register to the memory location, the EDI register is incremented or decremented automatically according to the setting of the DF flag in the EFLAGS register. (If the DF flag is 0, the EDI register is incremented; if the DF flag is 1, the EDI register is decremented.) The EDI register is incremented or decremented by 1 for byte operations, by 2 for word operations, or by 4 for doubleword operations.

The STOS, STOSB, STOSW, and STOSD instructions can be preceded by the REP prefix for block loads of ECX bytes, words, or doublewords. More often, however, these instructions are used within a LOOP construct, because data needs to be moved into the AL, AX, or EAX register before it can be stored. See [“REP/REPE/REPZ/REPNE /REPNZ—Repeat String Operation Prefix” on page 3:685](#) for a description of the REP prefix.

Operation

```

IF (byte store)
  THEN
    DEST ← AL;
    THEN IF DF = 0
      THEN (E)DI ← 1;
      ELSE (E)DI ← -1;
    FI;
  ELSE IF (word store)
    THEN
      DEST ← AX;
      THEN IF DF = 0
        THEN DI ← 2;
        ELSE DI ← -2;
      FI;
    ELSE (* doubleword store *)
      DEST ← EAX;
      THEN IF DF = 0

```

STOS/STOSB/STOSW/STOSD—Store String Data (Continued)

```
THEN EDI ← 4;
ELSE EDI ← -4;
```

```
FI;
FI;
```

Flags Affected

None.

Additional Itanium® System Environment Exceptions

Itanium Reg Faults NaT Register Consumption Abort.

Itanium Mem Faults VHPT Data Fault, Nested TLB Fault, Data TLB Fault, Alternate Data TLB Fault, Data Page Not Present Fault, Data NaT Page Consumption Abort, Data Key Miss Fault, Data Key Permission Fault, Data Access Rights Fault, Data Access Bit Fault, Data Dirty Bit Fault

Protected Mode Exceptions

#GP(0) If the destination is located in a nonwritable segment.
 If a memory operand effective address is outside the limit of the ES segment.
 If the ES register contains a null segment selector.

#PF(fault-code) If a page fault occurs.

#AC(0) If alignment checking is enabled and an unaligned memory reference is made while the current privilege level is 3.

Real Address Mode Exceptions

#GP If a memory operand effective address is outside the CS, DS, ES, FS, or GS segment limit.

#SS If a memory operand effective address is outside the SS segment limit.

Virtual 8086 Mode Exceptions

#GP(0) If a memory operand effective address is outside the CS, DS, ES, FS, or GS segment limit.

#SS(0) If a memory operand effective address is outside the SS segment limit.

#PF(fault-code) If a page fault occurs.

#AC(0) If alignment checking is enabled and an unaligned memory reference is made.

STR—Store Task Register

| Opcode | Instruction | Description |
|----------|------------------|---|
| 0F 00 /1 | STR <i>r/m16</i> | Stores segment selector from TR in <i>r/m16</i> |

Description

Stores the segment selector from the task register (TR) in the destination operand. The destination operand can be a general-purpose register or a memory location. The segment selector stored with this instruction points to the task state segment (TSS) for the currently running task.

When the destination operand is a 32-bit register, the 16-bit segment selector is copied into the lower 16 bits of the register and the upper 16 bits of the register are cleared to 0s. With the destination operand is a memory location, the segment selector is written to memory as a 16-bit quantity, regardless of operand size.

The STR instruction is useful only in operating-system software. It can only be executed in protected mode.

Operation

IF Itanium System Environment THEN IA-32_Interrupt(INST,STR);

DEST ← TR(SegmentSelector);

Flags Affected

None.

Additional Itanium® System Environment Exceptions

IA-32_Interrupt Mandatory Instruction Intercept.

Protected Mode Exceptions

| | |
|-----------------|---|
| #GP(0) | If the destination is a memory operand that is located in a nonwritable segment or if the effective address is outside the CS, DS, ES, FS, or GS segment limit. |
| | If the DS, ES, FS, or GS register is used to access memory and it contains a null segment selector. |
| #SS(0) | If a memory operand effective address is outside the SS segment limit. |
| #PF(fault-code) | If a page fault occurs. |
| #AC(0) | If alignment checking is enabled and an unaligned memory reference is made while the current privilege level is 3. |

Real Address Mode Exceptions

#UD The STR instruction is not recognized in real address mode.

Virtual 8086 Mode Exceptions

#UD The STR instruction is not recognized in virtual 8086 mode.

SUB—Integer Subtraction

| Opcode | Instruction | Description |
|-----------------|---------------------------------|--|
| 2C <i>ib</i> | SUB AL, <i>imm8</i> | Subtract <i>imm8</i> from AL |
| 2D <i>iw</i> | SUB AX, <i>imm16</i> | Subtract <i>imm16</i> from AX |
| 2D <i>id</i> | SUB EAX, <i>imm32</i> | Subtract <i>imm32</i> from EAX |
| 80 /5 <i>ib</i> | SUB <i>r/m8</i> , <i>imm8</i> | Subtract <i>imm8</i> from <i>r/m8</i> |
| 81 /5 <i>iw</i> | SUB <i>r/m16</i> , <i>imm16</i> | Subtract <i>imm16</i> from <i>r/m16</i> |
| 81 /5 <i>id</i> | SUB <i>r/m32</i> , <i>imm32</i> | Subtract <i>imm32</i> from <i>r/m32</i> |
| 83 /5 <i>ib</i> | SUB <i>r/m16</i> , <i>imm8</i> | Subtract sign-extended <i>imm8</i> from <i>r/m16</i> |
| 83 /5 <i>ib</i> | SUB <i>r/m32</i> , <i>imm8</i> | Subtract sign-extended <i>imm8</i> from <i>r/m32</i> |
| 28 /r | SUB <i>r/m8</i> , <i>r8</i> | Subtract <i>r8</i> from <i>r/m8</i> |
| 29 /r | SUB <i>r/m16</i> , <i>r16</i> | Subtract <i>r16</i> from <i>r/m16</i> |
| 29 /r | SUB <i>r/m32</i> , <i>r32</i> | Subtract <i>r32</i> from <i>r/m32</i> |
| 2A /r | SUB <i>r8</i> , <i>r/m8</i> | Subtract <i>r/m8</i> from <i>r8</i> |
| 2B /r | SUB <i>r16</i> , <i>r/m16</i> | Subtract <i>r/m16</i> from <i>r16</i> |
| 2B /r | SUB <i>r32</i> , <i>r/m32</i> | Subtract <i>r/m32</i> from <i>r32</i> |

Description

Subtracts the second operand (source operand) from the first operand (destination operand) and stores the result in the destination operand. The destination operand can be a register or a memory location; the source operand can be an immediate, register, or memory location. When an immediate value is used as an operand, it is sign-extended to the length of the destination operand format.

The SUB instruction does not distinguish between signed or unsigned operands. Instead, the processor evaluates the result for both data types and sets the OF and CF flags to indicate a borrow in the signed or unsigned result, respectively. The SF flag indicates the sign of the signed result.

Operation

$DEST \leftarrow DEST - SRC;$

Flags Affected

The OF, SF, ZF, AF, PF, and CF flags are set according to the result.

Additional Itanium® System Environment Exceptions

Itanium Reg Faults NaT Register Consumption Abort.

Itanium Mem Faults VHPT Data Fault, Nested TLB Fault, Data TLB Fault, Alternate Data TLB Fault, Data Page Not Present Fault, Data NaT Page Consumption Abort, Data Key Miss Fault, Data Key Permission Fault, Data Access Rights Fault, Data Access Bit Fault, Data Dirty Bit Fault

SUB—Integer Subtraction (Continued)

Protected Mode Exceptions

| | |
|-----------------|---|
| #GP(0) | If the destination is located in a nonwritable segment. If a memory operand effective address is outside the CS, DS, ES, FS, or GS segment limit. If the DS, ES, FS, or GS register contains a null segment selector. |
| #SS(0) | If a memory operand effective address is outside the SS segment limit. |
| #PF(fault-code) | If a page fault occurs. |
| #AC(0) | If alignment checking is enabled and an unaligned memory reference is made while the current privilege level is 3. |

Real Address Mode Exceptions

| | |
|-----|---|
| #GP | If a memory operand effective address is outside the CS, DS, ES, FS, or GS segment limit. |
| #SS | If a memory operand effective address is outside the SS segment limit. |

Virtual 8086 Mode Exceptions

| | |
|-----------------|---|
| #GP(0) | If a memory operand effective address is outside the CS, DS, ES, FS, or GS segment limit. |
| #SS(0) | If a memory operand effective address is outside the SS segment limit. |
| #PF(fault-code) | If a page fault occurs. |
| #AC(0) | If alignment checking is enabled and an unaligned memory reference is made. |

TEST—Logical Compare

| Opcode | Instruction | Description |
|-----------------|---------------------------------|--|
| A8 <i>ib</i> | TEST AL, <i>imm8</i> | AND <i>imm8</i> with AL; set SF, ZF, PF according to result |
| A9 <i>iw</i> | TEST AX, <i>imm16</i> | AND <i>imm16</i> with AX; set SF, ZF, PF according to result |
| A9 <i>id</i> | TEST EAX, <i>imm32</i> | AND <i>imm32</i> with EAX; set SF, ZF, PF according to result |
| F6 <i>l0 ib</i> | TEST <i>rm8</i> , <i>imm8</i> | AND <i>imm8</i> with <i>rm8</i> ; set SF, ZF, PF according to result |
| F7 <i>l0 iw</i> | TEST <i>rm16</i> , <i>imm16</i> | AND <i>imm16</i> with <i>rm16</i> ; set SF, ZF, PF according to result |
| F7 <i>l0 id</i> | TEST <i>rm32</i> , <i>imm32</i> | AND <i>imm32</i> with <i>rm32</i> ; set SF, ZF, PF according to result |
| 84 <i>lr</i> | TEST <i>rm8</i> , <i>r8</i> | AND <i>r8</i> with <i>rm8</i> ; set SF, ZF, PF according to result |
| 85 <i>lr</i> | TEST <i>rm16</i> , <i>r16</i> | AND <i>r16</i> with <i>rm16</i> ; set SF, ZF, PF according to result |
| 85 <i>lr</i> | TEST <i>rm32</i> , <i>r32</i> | AND <i>r32</i> with <i>rm32</i> ; set SF, ZF, PF according to result |

Description

Computes the bit-wise logical AND of first operand (source 1 operand) and the second operand (source 2 operand) and sets the SF, ZF, and PF status flags according to the result. The result is then discarded.

Operation

```
TEMP ← SRC1 AND SRC2;
SF ← MSB(TEMP);
IF TEMP = 0
    THEN ZF ← 0;
    ELSE ZF ← 1;
FI:
PF ← BitwiseXNOR(TEMP[0:7]);
CF ← 0;
OF ← 0;
(*AF is Undefined*)
```

Flags Affected

The OF and CF flags are cleared to 0. The SF, ZF, and PF flags are set according to the result (see “Operation” above). The state of the AF flag is undefined.

Additional Itanium® System Environment Exceptions

| | |
|--------------------|--|
| Itanium Reg Faults | NaT Register Consumption Abort. |
| Itanium Mem Faults | VHPT Data Fault, Nested TLB Fault, Data TLB Fault, Alternate Data TLB Fault, Data Page Not Present Fault, Data NaT Page Consumption Abort, Data Key Miss Fault, Data Key Permission Fault, Data Access Rights Fault, Data Access Bit Fault, Data Dirty Bit Fault |

TEST—Logical Compare (Continued)

Protected Mode Exceptions

| | |
|-----------------|--|
| #GP(0) | If a memory operand effective address is outside the CS, DS, ES, FS, or GS segment limit. If the DS, ES, FS, or GS register contains a null segment selector. |
| #SS(0) | If a memory operand effective address is outside the SS segment limit. |
| #PF(fault-code) | If a page fault occurs. |
| #AC(0) | If alignment checking is enabled and an unaligned memory reference is made while the current privilege level is 3. |

Real Address Mode Exceptions

| | |
|-----|---|
| #GP | If a memory operand effective address is outside the CS, DS, ES, FS, or GS segment limit. |
| #SS | If a memory operand effective address is outside the SS segment limit. |

Virtual 8086 Mode Exceptions

| | |
|-----------------|---|
| #GP(0) | If a memory operand effective address is outside the CS, DS, ES, FS, or GS segment limit. |
| #SS(0) | If a memory operand effective address is outside the SS segment limit. |
| #PF(fault-code) | If a page fault occurs. |
| #AC(0) | If alignment checking is enabled and an unaligned memory reference is made. |

UD2—Undefined Instruction

| Opcode | Instruction | Description |
|--------|-------------|--------------------------------|
| 0F 0B | UD2 | Raise invalid opcode exception |

Description

Generates an invalid opcode. This instruction is provided for software testing to explicitly generate an invalid opcode. The opcode for this instruction is reserved for this purpose.

Other than raising the invalid opcode exception, this instruction is the same as the NOP instruction.

Operation

IF Itanium System Environment THEN IA-32_Intercept(INST,0F0B);

#UD (* Generates invalid opcode exception *);

Flags Affected

None.

Additional Itanium® System Environment Exceptions

IA-32_Intercept Mandatory Instruction Intercept.

Exceptions (All Operating Modes)

#UD Instruction is guaranteed to raise an invalid opcode exception in all operating modes).

VERR, VERW—Verify a Segment for Reading or Writing

| Opcode | Instruction | Description |
|----------|-------------------|--|
| 0F 00 /4 | VERR <i>r/m16</i> | Set ZF=1 if segment specified with <i>r/m16</i> can be read |
| 0F 00 /5 | VERW <i>r/m16</i> | Set ZF=1 if segment specified with <i>r/m16</i> can be written |

Description

Verifies whether the code or data segment specified with the source operand is readable (VERR) or writable (VERW) from the current privilege level (CPL). The source operand is a 16-bit register or a memory location that contains the segment selector for the segment to be verified. If the segment is accessible and readable (VERR) or writable (VERW), the ZF flag is set; otherwise, the ZF flag is cleared. Code segments are never verified as writable. This check cannot be performed on system segments.

To set the ZF flag, the following conditions must be met:

- The segment selector is not null.
- The selector must denote a descriptor within the bounds of the descriptor table (GDT or LDT).
- The selector must denote the descriptor of a code or data segment (not that of a system segment or gate).
- For the VERR instruction, the segment must be readable; the VERW instruction, the segment must be a writable data segment.
- If the segment is not a conforming code segment, the segment's DPL must be greater than or equal to (have less or the same privilege as) both the CPL and the segment selector's RPL.

The validation performed is the same as if the segment were loaded into the DS, ES, FS, or GS register, and the indicated access (read or write) were performed. The selector's value cannot result in a protection exception, enabling the software to anticipate possible segment access problems.

Operation

```

IF SRC(Offset) > (GDTR(Limit) OR (LDTR(Limit))
    THEN
        ZF ← 0
Read segment descriptor;
IF SegmentDescriptor(DescriptorType) = 0 (* system segment *)
    OR (SegmentDescriptor(Type) ≠ conforming code segment)
    AND (CPL > DPL) OR (RPL > DPL)
    THEN
        ZF ← 0
    ELSE
        IF ((Instruction = VERR) AND (segment = readable))
            OR ((Instruction = VERW) AND (segment = writable))
            THEN
                ZF ← 1;
        FI;
FI;

```

VERR, VERW—Verify a Segment for Reading or Writing (Continued)

Flags Affected

The ZF flag is set to 1 if the segment is accessible and readable (VERR) or writable (VERW); otherwise, it is cleared to 0.

Additional Itanium® System Environment Exceptions

Itanium Reg Faults NaT Register Consumption Abort.

Itanium Mem Faults VHPT Data Fault, Nested TLB Fault, Data TLB Fault, Alternate Data TLB Fault, Data Page Not Present Fault, Data NaT Page Consumption Abort, Data Key Miss Fault, Data Key Permission Fault, Data Access Rights Fault, Data Access Bit Fault, Data Dirty Bit Fault

Protected Mode Exceptions

The only exceptions generated for these instructions are those related to illegal addressing of the source operand.

| | |
|-----------------|--|
| #GP(0) | If a memory operand effective address is outside the CS, DS, ES, FS, or GS segment limit. If the DS, ES, FS, or GS register is used to access memory and it contains a null segment selector. |
| #SS(0) | If a memory operand effective address is outside the SS segment limit. |
| #PF(fault-code) | If a page fault occurs. |
| #AC(0) | If alignment checking is enabled and an unaligned memory reference is made while the current privilege level is 3. |

Real Address Mode Exceptions

| | |
|-----|---|
| #UD | The VERR and VERW instructions are not recognized in real address mode. |
|-----|---|

Virtual 8086 Mode Exceptions

| | |
|-----|---|
| #UD | The VERR and VERW instructions are not recognized in virtual 8086 mode. |
|-----|---|

WAIT/FWAIT—Wait

| Opcode | Instruction | Description |
|--------|-------------|---|
| 9B | WAIT | Check pending unmasked floating-point exceptions. |
| 9B | FWAIT | Check pending unmasked floating-point exceptions. |

Description

Causes the processor to check for and handle pending unmasked floating-point exceptions before proceeding. (FWAIT is an alternate mnemonic for the WAIT).

This instruction is useful for synchronizing exceptions in critical sections of code. Coding a WAIT instruction after a floating-point instruction insures that any unmasked floating-point exceptions the instruction may raise are handled before the processor can modify the instruction's results.

Operation

[CheckPendingUnmaskedFloatingPointExceptions;](#)

FPU Flags Affected

The C0, C1, C2, and C3 flags are undefined.

Floating-point Exceptions

None.

Protected Mode Exceptions

#NM MP and TS in CR0 is set.

Real Address Mode Exceptions

#NM MP and TS in CR0 is set.

Virtual 8086 Mode Exceptions

#NM MP and TS in CR0 is set.

WBINVD—Write-Back and Invalidate Cache

| Opcode | Instruction | Description |
|--------|-------------|--|
| 0F 09 | WBINVD | Write-back and flush Internal caches; initiate writing-back and flushing of external caches. |

Description

Writes back all modified cache lines in the processor's internal cache to main memory, invalidates (flushes) the internal caches, and issues a special-function bus cycle that directs external caches to also write back modified data.

After executing this instruction, the processor does not wait for the external caches to complete their write-back and flushing operations before proceeding with instruction execution. It is the responsibility of hardware to respond to the cache write-back and flush signals.

The WBINVD instruction is a privileged instruction. When the processor is running in protected mode, the CPL of a program or procedure must be 0 to execute this instruction. This instruction is also a serializing instruction.

In situations where cache coherency with main memory is not a concern, software can use the INVD instruction.

Operation

```
IF Itanium System Environment THEN IA-32_Intercept(INST,WBINVD);
WriteBack(InternalCaches);
Flush(InternalCaches);
SignalWriteBack(ExternalCaches);
SignalFlush(ExternalCaches);
Continue (* Continue execution);
```

Flags Affected

None.

Additional Itanium® System Environment Exceptions

IA-32_Intercept Mandatory Instruction Intercept.

Protected Mode Exceptions

#GP(0) If the current privilege level is not 0.

Real Address Mode Exceptions

None.

WBINVD—Write-Back and Invalidate Cache (Continued)

Virtual 8086 Mode Exceptions

#GP(0) The WBINVD instruction cannot be executed at the virtual 8086 mode.

Intel® Architecture Compatibility

The WBINVD instruction implementation-dependent; its function may be implemented differently on future Intel architecture processors. The instruction is not supported on Intel architecture processors earlier than the Intel486 processor.

WRMSR—Write to Model Specific Register

| Opcode | Instruction | Description |
|--------|-------------|--|
| 0F 30 | WRMSR | Write the value in EDX:EAX to MSR specified by ECX |

Description

Writes the contents of registers EDX:EAX into the 64-bit model specific register (MSR) specified in the ECX register. The high-order 32 bits are copied from EDX and the low-order 32 bits are copied from EAX. Always set undefined or reserved bits in an MSR to the values previously read.

This instruction must be executed at privilege level 0 or in real-address mode; otherwise, a general protection exception #GP(0) will be generated. Specifying a reserved or unimplemented MSR address in ECX will also cause a general protection exception.

When the WRMSR instruction is used to write to an MTRR, the TLBs are invalidated, including the global entries see the *IA-32 Intel® Architecture Software Developer's Manual, Volume 3*).

The MSRs control functions for testability, execution tracing, performance-monitoring and machine check errors. See model specific instructions for all the MSRs that can be written to with this instruction and their addresses.

The WRMSR instruction is a serializing instruction.

The CPUID instruction should be used to determine whether MSRs are supported (EDX[5]=1) before using this instruction.

Operation

IF Itanium System Environment THEN IA-32_ Intercept(INST,WRMSR);
MSR[ECX] ← EDX:EAX;

Flags Affected

None.

Additional Itanium® System Environment Exceptions

IA-32_ Intercept Mandatory Instruction Intercept.

Protected Mode Exceptions

#GP(0) If the current privilege level is not 0.
 If the value in ECX specifies a reserved or unimplemented MSR address.

Real Address Mode Exceptions

#GP If the current privilege level is not 0
 If the value in ECX specifies a reserved or unimplemented MSR address.

WRMSR—Write to Model Specific Register (Continued)

Virtual 8086 Mode Exceptions

#GP(0) The WRMSR instruction is not recognized in virtual 8086 mode.

Intel® Architecture Compatibility

The MSRs and the ability to read them with the WRMSR instruction were introduced into the Intel architecture with the Pentium processor. Execution of this instruction by an Intel architecture processor earlier than the Pentium processor results in an invalid opcode exception #UD.

XADD—Exchange and Add

| Opcode | Instruction | Description |
|---------|----------------|--|
| 0F C0/r | XADD r/m8,r8 | Exchange r8 and r/m8; load sum into r/m8. |
| 0F C1/r | XADD r/m16,r16 | Exchange r16 and r/m16; load sum into r/m16. |
| 0F C1/r | XADD r/m32,r32 | Exchange r32 and r/m32; load sum into r/m32. |

Description

Exchanges the first operand (destination operand) with the second operand (source operand), then loads the sum of the two values into the destination operand. The destination operand can be a register or a memory location; the source operand is a register.

This instruction can be used with a LOCK prefix.

Operation

**IF Itanium System Environment AND External_Bus_Lock_Required AND DCR.lc
THEN IA-32_Intercept(LOCK,XADD);**

TEMP ← SRC + DEST

SRC ← DEST

DEST ← TEMP

Flags Affected

The CF, PF, AF, SF, ZF, and OF flags are set according to the result stored in the destination operand.

Additional Itanium® System Environment Exceptions

Itanium Reg Faults NaT Register Consumption Abort.

Itanium Mem Faults VHPT Data Fault, Nested TLB Fault, Data TLB Fault, Alternate Data TLB Fault, Data Page Not Present Fault, Data NaT Page Consumption Abort, Data Key Miss Fault, Data Key Permission Fault, Data Access Rights Fault, Data Access Bit Fault, Data Dirty Bit Fault

IA-32_Intercept Lock Intercept - If an external atomic bus lock is required to complete this operation and DCR.lc is 1, no atomic transaction occurs, this instruction is faulted and an IA-32_Intercept(Lock) fault is generated. The software lock handler is responsible for the emulation of this instruction.

Protected Mode Exceptions

| | |
|-----------------|---|
| #GP(0) | If the destination is located in a nonwritable segment. If a memory operand effective address is outside the CS, DS, ES, FS, or GS segment limit. If the DS, ES, FS, or GS register contains a null segment selector. |
| #SS(0) | If a memory operand effective address is outside the SS segment limit. |
| #PF(fault-code) | If a page fault occurs. |
| #AC(0) | If alignment checking is enabled and an unaligned memory reference is made while the current privilege level is 3. |

XADD—Exchange and Add (Continued)

Real Address Mode Exceptions

| | |
|-----|---|
| #GP | If a memory operand effective address is outside the CS, DS, ES, FS, or GS segment limit. |
| #SS | If a memory operand effective address is outside the SS segment limit. |

Virtual 8086 Mode Exceptions

| | |
|-----------------|---|
| #GP(0) | If a memory operand effective address is outside the CS, DS, ES, FS, or GS segment limit. |
| #SS(0) | If a memory operand effective address is outside the SS segment limit. |
| #PF(fault-code) | If a page fault occurs. |
| #AC(0) | If alignment checking is enabled and an unaligned memory reference is made. |

Intel® Architecture Compatibility

Intel architecture processors earlier than the Intel486 processor do not recognize this instruction. If this instruction is used, you should provide an equivalent code sequence that runs on earlier processors.

XCHG—Exchange Register/Memory with Register

| Opcode | Instruction | Description |
|--------|----------------|-------------------------------------|
| 90+rw | XCHG AX,r16 | Exchange r16 with AX |
| 90+rw | XCHG r16,AX | Exchange r16 with AX |
| 90+rd | XCHG EAX,r32 | Exchange r32 with EAX |
| 90+rd | XCHG r32,EAX | Exchange r32 with EAX |
| 86 lr | XCHG r/m8,r8 | Exchange byte register with EA byte |
| 86 lr | XCHG r8,r/m8 | Exchange byte register with EA byte |
| 87 lr | XCHG r/m16,r16 | Exchange r16 with EA word |
| 87 lr | XCHG r16,r/m16 | Exchange r16 with EA word |
| 87 lr | XCHG r/m32,r32 | Exchange r32 with EA doubleword |
| 87 lr | XCHG r32,r/m32 | Exchange r32 with EA doubleword |

Description

Exchanges the contents of the destination (first) and source (second) operands. The operands can be two general-purpose registers or a register and a memory location. When the operands are two registers, one of the registers must be the EAX or AX register. If a memory operand is referenced, the LOCK# signal is automatically asserted for the duration of the exchange operation, regardless of the presence or absence of the LOCK prefix or of the value of the IOPL.

This instruction is useful for implementing semaphores or similar data structures for process synchronization. (See Chapter 5, *Processor Management and Initialization*, in the *IA-32 Intel® Architecture Software Developer's Manual, Volume 3* for more information on bus locking.)

The XCHG instruction can also be used instead of the BSWAP instruction for 16-bit operands.

Operation

**IF Itanium System Environment AND External_Atomic_Lock_Required AND DCR.lc
THEN IA-32_Intercept(LOCK,XCHG);**

TEMP ← DEST

DEST ← SRC

SRC ← TEMP

Flags Affected

None.

Additional Itanium® System Environment Exceptions

Itanium Reg Faults NaT Register Consumption Abort.

Itanium Mem Faults VHPT Data Fault, Nested TLB Fault, Data TLB Fault, Alternate Data TLB Fault, Data Page Not Present Fault, Data NaT Page Consumption Abort, Data Key Miss Fault, Data Key Permission Fault, Data Access Rights Fault, Data Access Bit Fault, Data Dirty Bit Fault

IA-32_Intercept Lock Intercept - If an external atomic bus lock is required to complete this operation and DCR.lc is 1, no atomic transaction occurs, this instruction is faulted and an IA-32_Intercept(Lock) fault is generated. The software lock handler is responsible for the emulation of this instruction.

XCHG—Exchange Register/Memory with Register (Continued)

Protected Mode Exceptions

| | |
|-----------------|--|
| #GP(0) | If either operand is in a nonwritable segment. If a memory operand effective address is outside the CS, DS, ES, FS, or GS segment limit. If the DS, ES, FS, or GS register contains a null segment selector. |
| #SS(0) | If a memory operand effective address is outside the SS segment limit. |
| #PF(fault-code) | If a page fault occurs. |
| #AC(0) | If alignment checking is enabled and an unaligned memory reference is made while the current privilege level is 3. |

Real Address Mode Exceptions

| | |
|-----|---|
| #GP | If a memory operand effective address is outside the CS, DS, ES, FS, or GS segment limit. |
| #SS | If a memory operand effective address is outside the SS segment limit. |

Virtual 8086 Mode Exceptions

| | |
|-----------------|---|
| #GP(0) | If a memory operand effective address is outside the CS, DS, ES, FS, or GS segment limit. |
| #SS(0) | If a memory operand effective address is outside the SS segment limit. |
| #PF(fault-code) | If a page fault occurs. |
| #AC(0) | If alignment checking is enabled and an unaligned memory reference is made. |

XLAT/XLATB—Table Look-up Translation

| Opcode | Instruction | Description |
|--------|----------------|--|
| D7 | XLAT <i>m8</i> | Set AL to memory byte DS:[(E)BX + unsigned AL] |
| D7 | XLATB | Set AL to memory byte DS:[(E)BX + unsigned AL] |

Description

Locates a byte entry in a table in memory, using the contents of the AL register as a table index, then copies the contents of the table entry back into the AL register. The index in the AL register is treated as unsigned integer. The XLAT and XLATB instructions get the base address of the table in memory from the DS:EBX registers (or the DS:BX registers when the address-size attribute of 16 bits.) The XLAT instruction allows a different segment register to be specified with a segment override. When assembled, the XLAT and XLATB instructions produce the same machine code.

Operation

```
IF AddressSize = 16
  THEN
    AL ← (DS:BX + ZeroExtend(AL))
  ELSE (* AddressSize = 32 *)
    AL ← (DS:EBX + ZeroExtend(AL));
FI;
```

Flags Affected

None.

Additional Itanium® System Environment Exceptions

Itanium Reg Faults NaT Register Consumption Abort.

Itanium Mem Faults VHPT Data Fault, Nested TLB Fault, Data TLB Fault, Alternate Data TLB Fault, Data Page Not Present Fault, Data NaT Page Consumption Abort, Data Key Miss Fault, Data Key Permission Fault, Data Access Rights Fault, Data Access Bit Fault, Data Dirty Bit Fault

Protected Mode Exceptions

| | |
|-----------------|--|
| #GP(0) | If a memory operand effective address is outside the CS, DS, ES, FS, or GS segment limit. If the DS, ES, FS, or GS register contains a null segment selector. |
| #SS(0) | If a memory operand effective address is outside the SS segment limit. |
| #PF(fault-code) | If a page fault occurs. |
| #AC(0) | If alignment checking is enabled and an unaligned memory reference is made while the current privilege level is 3. |

XLAT/XLATB—Table Look-up Translation (Continued)

Real Address Mode Exceptions

| | |
|-----|---|
| #GP | If a memory operand effective address is outside the CS, DS, ES, FS, or GS segment limit. |
| #SS | If a memory operand effective address is outside the SS segment limit. |

Virtual 8086 Mode Exceptions

| | |
|-----------------|---|
| #GP(0) | If a memory operand effective address is outside the CS, DS, ES, FS, or GS segment limit. |
| #SS(0) | If a memory operand effective address is outside the SS segment limit. |
| #PF(fault-code) | If a page fault occurs. |
| #AC(0) | If alignment checking is enabled and an unaligned memory reference is made. |

XOR—Logical Exclusive OR

| Opcode | Instruction | Description |
|-----------------|---------------------------------|-------------------------------|
| 34 <i>ib</i> | XOR AL, <i>imm8</i> | AL XOR <i>imm8</i> |
| 35 <i>iw</i> | XOR AX, <i>imm16</i> | AX XOR <i>imm16</i> |
| 35 <i>id</i> | XOR EAX, <i>imm32</i> | EAX XOR <i>imm32</i> |
| 80 /6 <i>ib</i> | XOR <i>rlm8</i> , <i>imm8</i> | <i>rlm8</i> XOR <i>imm8</i> |
| 81 /6 <i>iw</i> | XOR <i>rlm16</i> , <i>imm16</i> | <i>rlm16</i> XOR <i>imm16</i> |
| 81 /6 <i>id</i> | XOR <i>rlm32</i> , <i>imm32</i> | <i>rlm32</i> XOR <i>imm32</i> |
| 83 /6 <i>ib</i> | XOR <i>rlm16</i> , <i>imm8</i> | <i>rlm16</i> XOR <i>imm8</i> |
| 83 /6 <i>ib</i> | XOR <i>rlm32</i> , <i>imm8</i> | <i>rlm32</i> XOR <i>imm8</i> |
| 30 /r | XOR <i>rlm8</i> , <i>r8</i> | <i>rlm8</i> XOR <i>r8</i> |
| 31 /r | XOR <i>rlm16</i> , <i>r16</i> | <i>rlm16</i> XOR <i>r16</i> |
| 31 /r | XOR <i>rlm32</i> , <i>r32</i> | <i>rlm32</i> XOR <i>r32</i> |
| 32 /r | XOR <i>r8</i> , <i>rlm8</i> | <i>r8</i> XOR <i>rlm8</i> |
| 33 /r | XOR <i>r16</i> , <i>rlm16</i> | <i>r8</i> XOR <i>rlm8</i> |
| 33 /r | XOR <i>r32</i> , <i>rlm32</i> | <i>r8</i> XOR <i>rlm8</i> |

Description

Performs a bitwise exclusive-OR (XOR) operation on the destination (first) and source (second) operands and stores the result in the destination operand location. The source operand can be an immediate, a register, or a memory location; the destination operand can be a register or a memory location.

Operation

DEST ← **DEST XOR SRC**;

Flags Affected

The OF and CF flags are cleared; the SF, ZF, and PF flags are set according to the result. The state of the AF flag is undefined.

Additional Itanium® System Environment Exceptions

Itanium Reg Faults NaT Register Consumption Abort.

Itanium Mem Faults VHPT Data Fault, Nested TLB Fault, Data TLB Fault, Alternate Data TLB Fault, Data Page Not Present Fault, Data NaT Page Consumption Abort, Data Key Miss Fault, Data Key Permission Fault, Data Access Rights Fault, Data Access Bit Fault, Data Dirty Bit Fault

XOR—Logical Exclusive OR (Continued)

Protected Mode Exceptions

| | |
|-----------------|---|
| #GP(0) | If the destination operand points to a nonwritable segment. If a memory operand effective address is outside the CS, DS, ES, FS, or GS segment limit. If the DS, ES, FS, or GS register contains a null segment selector. |
| #SS(0) | If a memory operand effective address is outside the SS segment limit. |
| #PF(fault-code) | If a page fault occurs. |
| #AC(0) | If alignment checking is enabled and an unaligned memory reference is made while the current privilege level is 3. |

Real Address Mode Exceptions

| | |
|-----|---|
| #GP | If a memory operand effective address is outside the CS, DS, ES, FS, or GS segment limit. |
| #SS | If a memory operand effective address is outside the SS segment limit. |

Virtual 8086 Mode Exceptions

| | |
|-----------------|---|
| #GP(0) | If a memory operand effective address is outside the CS, DS, ES, FS, or GS segment limit. |
| #SS(0) | If a memory operand effective address is outside the SS segment limit. |
| #PF(fault-code) | If a page fault occurs. |
| #AC(0) | If alignment checking is enabled and an unaligned memory reference is made. |



IA-32 Intel[®] MMX[™] Technology Instruction Reference

2

This section lists the IA-32 MMX technology instructions designed to increase performance of multimedia intensive applications.

EMMS—Empty MMX State

| Opcode | Instruction | Description |
|--------|-------------|-------------------------------|
| 0F 77 | EMMS | Set the FP tag word to empty. |

Description

Sets the values of all the tags in the FPU tag word to empty (all ones). This operation marks the MMX technology registers as available, so they can subsequently be used by floating-point instructions. (See Figure 7-11 in the *IA-32 Intel® Architecture Software Developer's Manual*, for the format of the FPU tag word.) All other MMX instructions (other than the EMMS instruction) set all the tags in FPU tag word to valid (all zeros).

The EMMS instruction must be used to clear the MMX technology state at the end of all MMX technology routines and before calling other procedures or subroutines that may execute floating-point instructions. If a floating-point instruction loads one of the registers in the FPU register stack before the FPU tag word has been reset by the EMMS instruction, a floating-point stack overflow can occur that will result in a floating-point exception or incorrect result.

Operation

`FPUtagWord ← FFFFH;`

Flags Affected

None.

Additional Itanium® System Environment Exceptions

Itanium Reg Faults Disabled FP Register Fault if PSR.dfl is 1.

Protected Mode Exceptions

#UD If EM in CR0 is set.
 #NM If TS in CR0 is set.
 #MF If there is a pending FPU exception.

Real-Address Mode Exceptions

#UD If EM in CR0 is set.
 #NM If TS in CR0 is set.
 #MF If there is a pending FPU exception.

Virtual-8086 Mode Exceptions

#UD If EM in CR0 is set.
 #NM If TS in CR0 is set.
 #MF If there is a pending FPU exception.

MOVD—Move 32 Bits

| Opcode | Instruction | Description |
|----------|-------------------------------|--|
| 0F 6E /r | MOVD <i>mm</i> , <i>r/m32</i> | Move doubleword from <i>r/m32</i> to <i>mm</i> . |
| 0F 7E /r | MOVD <i>r/m32</i> , <i>mm</i> | Move doubleword from <i>mm</i> to <i>r/m32</i> . |

Description

Copies doubleword from the source operand (second operand) to the destination operand (first operand). Source and destination operands can be MMX technology registers, memory locations, or 32-bit general-purpose registers; however, data cannot be transferred from an MMX technology register to an MMX technology register, from one memory location to another memory location, or from one general-purpose register to another general-purpose register.

When the destination operand is an MMX technology register, the 32-bit source value is written to the low-order 32 bits of the 64-bit MMX technology register and zero-extended to 64 bits (see Figure 2-1). When the source operand is an MMX technology register, the low-order 32 bits of the MMX technology register are written to the 32-bit general-purpose register or 32-bit memory location selected with the destination operand.

Figure 2-1. Operation of the MOVD Instruction

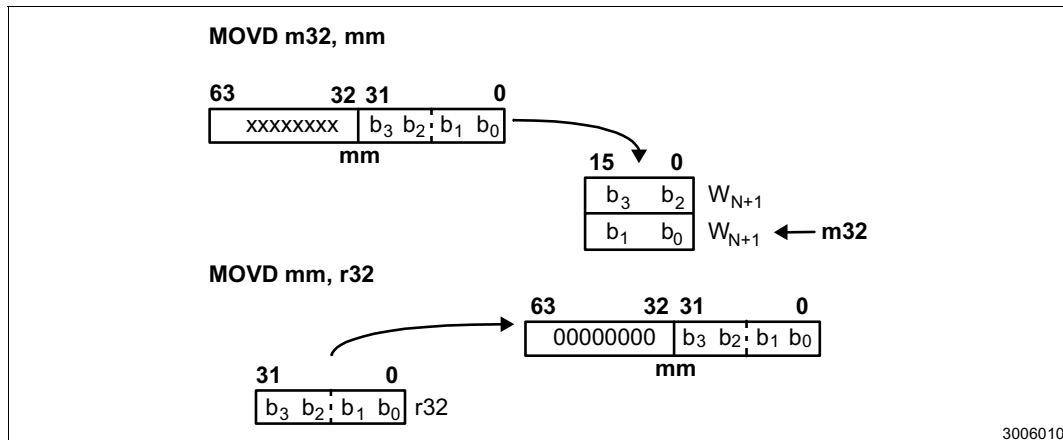

Operation

```

IF DEST is MMX register
  THEN
    DEST ← ZeroExtend(SRC);
  ELSE (* SRC is MMX register *)
    DEST ← LowOrderDoubleword(SRC);
  
```

MOVD—Move 32 Bits (Continued)**Flags Affected**

None.

Additional Itanium® System Environment Exceptions

Itanium Reg Faults Disabled FP Register Fault if PSR.dfl is 1, NaT Register Consumption Abort.

Itanium Mem Faults VHPT Data Fault, Nested TLB Fault, Data TLB Fault, Alternate Data TLB Fault, Data Page Not Present Fault, Data NaT Page Consumption Abort, Data Key Miss Fault, Data Key Permission Fault, Data Access Rights Fault, Data Access Bit Fault, Data Dirty Bit Fault

Protected Mode Exceptions

| | |
|-----------------|---|
| #GP(0) | If the destination operand is in a nonwritable segment. If a memory operand effective address is outside the CS, DS, ES, FS or GS segment limit. |
| #SS(0) | If a memory operand effective address is outside the SS segment limit. |
| #UD | If EM in CR0 is set. |
| #NM | If TS in CR0 is set. |
| #MF | If there is a pending FPU exception. |
| #PF(fault-code) | If a page fault occurs. |
| #AC(0) | If alignment checking is enabled and an unaligned memory reference is made while the current privilege level is 3. |

Real-Address Mode Exceptions

| | |
|-----|---|
| #GP | If any part of the operand lies outside of the effective address space from 0 to FFFFH. |
| #UD | If EM in CR0 is set. |
| #NM | If TS in CR0 is set. |
| #MF | If there is a pending FPU exception. |

Virtual-8086 Mode Exceptions

| | |
|-----------------|---|
| #GP | If any part of the operand lies outside of the effective address space from 0 to FFFFH. |
| #UD | If EM in CR0 is set. |
| #NM | If TS in CR0 is set. |
| #MF | If there is a pending FPU exception. |
| #PF(fault-code) | If a page fault occurs. |
| #AC(0) | If alignment checking is enabled and an unaligned memory reference is made. |

MOVQ—Move 64 Bits

| Opcode | Instruction | Description |
|----------|--------------------------------|---|
| 0F 6F /r | MOVQ <i>mm</i> , <i>mm/m64</i> | Move quadword from <i>mm/m64</i> to <i>mm</i> . |
| 0F 7F /r | MOVQ <i>mm/m64</i> , <i>mm</i> | Move quadword from <i>mm</i> to <i>mm/m64</i> . |

Description

Copies quadword from the source operand (second operand) to the destination operand (first operand). (See [Figure 2-2](#).) A source or destination operand can be either an MMX technology register or a memory location; however, data cannot be transferred from one memory location to another memory location. Data can be transferred from one MMX technology register to another MMX technology register.

Figure 2-2. Operation of the MOVQ Instruction

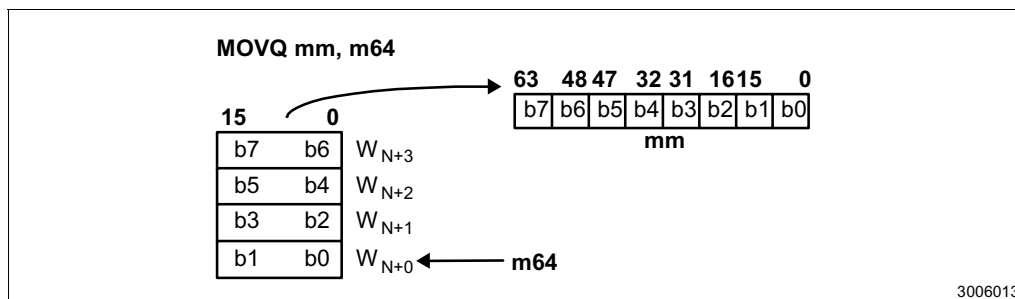

Operation

$DEST \leftarrow SRC;$

Flags Affected

None.

Additional Itanium® System Environment Exceptions

Itanium Reg Faults Disabled FP Register Fault if PSR.dfl is 1, NaT Register Consumption Abort.

Itanium Mem Faults VHPT Data Fault, Nested TLB Fault, Data TLB Fault, Alternate Data TLB Fault, Data Page Not Present Fault, Data NaT Page Consumption Abort, Data Key Miss Fault, Data Key Permission Fault, Data Access Rights Fault, Data Access Bit Fault, Data Dirty Bit Fault

MOVQ—Move 64 Bits (Continued)**Protected Mode Exceptions**

| | |
|-----------------|---|
| #GP(0) | If the destination operand is in a nonwritable segment. If a memory operand effective address is outside the CS, DS, ES, FS or GS segment limit. |
| #SS(0) | If a memory operand effective address is outside the SS segment limit. |
| #UD | If EM in CR0 is set. |
| #NM | If TS in CR0 is set. |
| #MF | If there is a pending FPU exception. |
| #PF(fault-code) | If a page fault occurs. |
| #AC(0) | If alignment checking is enabled and an unaligned memory reference is made while the current privilege level is 3. |

Real-Address Mode Exceptions

| | |
|-----|---|
| #GP | If any part of the operand lies outside of the effective address space from 0 to FFFFH. |
| #UD | If EM in CR0 is set. |
| #NM | If TS in CR0 is set. |
| #MF | If there is a pending FPU exception. |

Virtual-8086 Mode Exceptions

| | |
|-----------------|---|
| #GP | If any part of the operand lies outside of the effective address space from 0 to FFFFH. |
| #UD | If EM in CR0 is set. |
| #NM | If TS in CR0 is set. |
| #MF | If there is a pending FPU exception. |
| #PF(fault-code) | If a page fault occurs. |
| #AC(0) | If alignment checking is enabled and an unaligned memory reference is made. |

PACKSSWB/PACKSSDW—Pack with Signed Saturation

| Opcode | Instruction | Description |
|----------|--|--|
| 0F 63 /r | PACKSSWB <i>mm</i> , <i>mm</i> / <i>m64</i> | Packs and saturate pack 4 signed words from <i>mm</i> and 4 signed words from <i>mm/m64</i> into 8 signed bytes in <i>mm</i> . |
| 0F 6B /r | PACKSSDW <i>mm</i> , <i>mm</i> / <i>m64</i> | Pack and saturate 2 signed doublewords from <i>mm</i> and 2 signed doublewords from <i>mm/m64</i> into 4 signed words in <i>mm</i> . |

Description

Packs and saturates signed words into bytes (PACKSSWB) or signed doublewords into words (PACKSSDW). The PACKSSWB instruction packs 4 signed words from the destination operand (first operand) and 4 signed words from the source operand (second operand) into 8 signed bytes in the destination operand. If the signed value of a word is beyond the range of a signed byte (that is, greater than 7FH or less than 80H), the saturated byte value of 7FH or 80H, respectively, is stored into the destination.

The PACKSSDW instruction packs 2 signed doublewords from the destination operand (first operand) and 2 signed doublewords from the source operand (second operand) into 4 signed words in the destination operand (see Figure 2-3). If the signed value of a doubleword is beyond the range of a signed word (that is, greater than 7FFFH or less than 8000H), the saturated word value of 7FFFH or 8000H, respectively, is stored into the destination.

The destination operand for either the PACKSSWB or PACKSSDW instruction must be an MMX technology register; the source operand may be either an MMX technology register or a quadword memory location.

Figure 2-3. Operation of the PACKSSDW Instruction

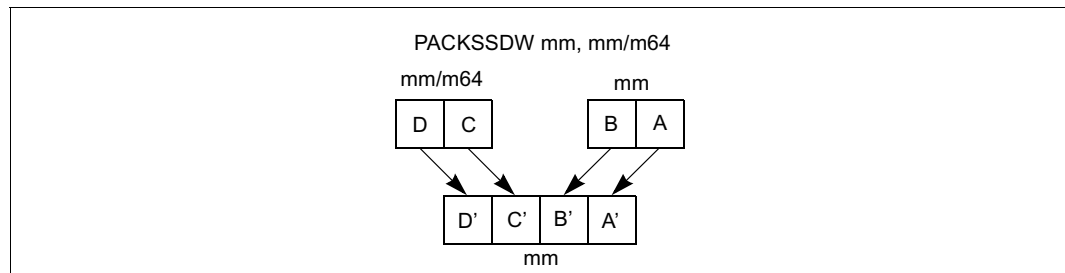

Operation

IF instruction is PACKSSWB
THEN

```

DEST(7..0) ← SaturateSignedWordToSignedByte DEST(15..0);
DEST(15..8) ← SaturateSignedWordToSignedByte DEST(31..16);
DEST(23..16) ← SaturateSignedWordToSignedByte DEST(47..32);
DEST(31..24) ← SaturateSignedWordToSignedByte DEST(63..48);
DEST(39..32) ← SaturateSignedWordToSignedByte SRC(15..0);
DEST(47..40) ← SaturateSignedWordToSignedByte SRC(31..16);
DEST(55..48) ← SaturateSignedWordToSignedByte SRC(47..32);
DEST(63..56) ← SaturateSignedWordToSignedByte SRC(63..48);

```

PACKSSWB/PACKSSDW—Pack with Signed Saturation (Continued)

```

ELSE (* instruction is PACKSSDW *)
    DEST(15..0) ← SaturateSignedDoublewordToSignedWord DEST(31..0);
    DEST(31..16) ← SaturateSignedDoublewordToSignedWord DEST(63..32);
    DEST(47..32) ← SaturateSignedDoublewordToSignedWord SRC(31..0);
    DEST(63..48) ← SaturateSignedDoublewordToSignedWord SRC(63..32);
FI;

```

Flags Affected

None.

Additional Itanium® System Environment Exceptions

Itanium Reg Faults Disabled FP Register Fault if PSR.dfl is 1, NaT Register Consumption Abort.

Itanium Mem Faults VHPT Data Fault, Nested TLB Fault, Data TLB Fault, Alternate Data TLB Fault, Data Page Not Present Fault, Data NaT Page Consumption Abort, Data Key Miss Fault, Data Key Permission Fault, Data Access Rights Fault, Data Access Bit Fault, Data Dirty Bit Fault

Protected Mode Exceptions

| | |
|-----------------|--|
| #GP(0) | If a memory operand effective address is outside the CS, DS, ES, FS or GS segment limit. |
| #SS(0) | If a memory operand effective address is outside the SS segment limit. |
| #UD | If EM in CR0 is set. |
| #NM | If TS in CR0 is set. |
| #MF | If there is a pending FPU exception. |
| #PF(fault-code) | If a page fault occurs. |
| #AC(0) | If alignment checking is enabled and an unaligned memory reference is made while the current privilege level is 3. |

Real-Address Mode Exceptions

| | |
|-----|---|
| #GP | If any part of the operand lies outside of the effective address space from 0 to FFFFH. |
| #UD | If EM in CR0 is set. |
| #NM | If TS in CR0 is set. |
| #MF | If there is a pending FPU exception. |



PACKSSWB/PACKSSDW—Pack with Signed Saturation (Continued)

Virtual-8086 Mode Exceptions

| | |
|-----------------|---|
| #GP | If any part of the operand lies outside of the effective address space from 0 to FFFFH. |
| #UD | If EM in CR0 is set. |
| #NM | If TS in CR0 is set. |
| #MF | If there is a pending FPU exception. |
| #PF(fault-code) | If a page fault occurs. |
| #AC(0) | If alignment checking is enabled and an unaligned memory reference is made. |

PACKUSWB—Pack with Unsigned Saturation

| Opcode | Instruction | Description |
|----------|----------------------------|--|
| 0F 67 /r | PACKUSWB <i>mm, mm/m64</i> | Pack and saturate 4 signed words from <i>mm</i> and 4 signed words from <i>mm/m64</i> into 8 unsigned bytes in <i>mm</i> . |

Description

Packs and saturates 4 signed words from the destination operand (first operand) and 4 signed words from the source operand (second operand) into 8 unsigned bytes in the destination operand (see [Figure 2-4](#)). If the signed value of a word is beyond the range of an unsigned byte (that is, greater than FFH or less than 00H), the saturated byte value of FFH or 00H, respectively, is stored into the destination.

The destination operand must be an MMX technology register; the source operand may be either an MMX technology register or a quadword memory location.

Figure 2-4. Operation of the PACKUSWB Instruction

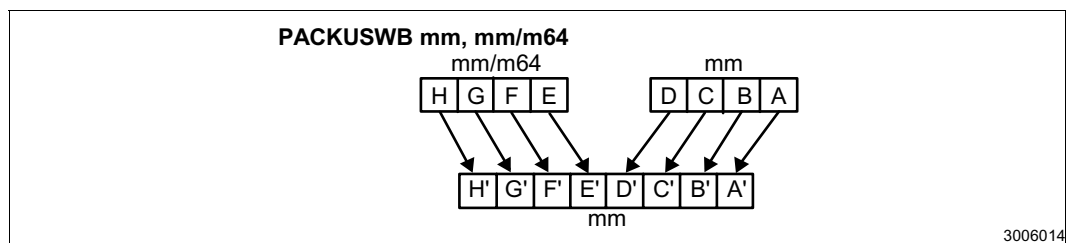

Operation

$DEST(7..0) \leftarrow \text{SaturateSignedWordToUnsignedByte } DEST(15..0);$
 $DEST(15..8) \leftarrow \text{SaturateSignedWordToUnsignedByte } DEST(31..16);$
 $DEST(23..16) \leftarrow \text{SaturateSignedWordToUnsignedByte } DEST(47..32);$
 $DEST(31..24) \leftarrow \text{SaturateSignedWordToUnsignedByte } DEST(63..48);$
 $DEST(39..32) \leftarrow \text{SaturateSignedWordToUnsignedByte } SRC(15..0);$
 $DEST(47..40) \leftarrow \text{SaturateSignedWordToUnsignedByte } SRC(31..16);$
 $DEST(55..48) \leftarrow \text{SaturateSignedWordToUnsignedByte } SRC(47..32);$
 $DEST(63..56) \leftarrow \text{SaturateSignedWordToUnsignedByte } SRC(63..48);$

Flags Affected

None.

Additional Itanium® System Environment Exceptions

Itanium Reg Faults Disabled FP Register Fault if PSR.dfl is 1, NaT Register Consumption Abort.
 Itanium Mem Faults VHPT Data Fault, Nested TLB Fault, Data TLB Fault, Alternate Data TLB Fault, Data Page Not Present Fault, Data NaT Page Consumption Abort, Data Key Miss Fault, Data Key Permission Fault, Data Access Rights Fault, Data Access Bit Fault, Data Dirty Bit Fault

PACKUSWB—Pack with Unsigned Saturation (Continued)

Protected Mode Exceptions

| | |
|-----------------|--|
| #GP(0) | If a memory operand effective address is outside the CS, DS, ES, FS or GS segment limit. |
| #SS(0) | If a memory operand effective address is outside the SS segment limit. |
| #UD | If EM in CR0 is set. |
| #NM | If TS in CR0 is set. |
| #MF | If there is a pending FPU exception. |
| #PF(fault-code) | If a page fault occurs. |
| #AC(0) | If alignment checking is enabled and an unaligned memory reference is made while the current privilege level is 3. |

Real-Address Mode Exceptions

| | |
|-----|---|
| #GP | If any part of the operand lies outside of the effective address space from 0 to FFFFH. |
| #UD | If EM in CR0 is set. |
| #NM | If TS in CR0 is set. |
| #MF | If there is a pending FPU exception. |

Virtual-8086 Mode Exceptions

| | |
|-----------------|---|
| #GP | If any part of the operand lies outside of the effective address space from 0 to FFFFH. |
| #UD | If EM in CR0 is set. |
| #NM | If TS in CR0 is set. |
| #MF | If there is a pending FPU exception. |
| #PF(fault-code) | If a page fault occurs. |
| #AC(0) | If alignment checking is enabled and an unaligned memory reference is made. |

PADDB/PADDW/PADD—Packed Add

| Opcode | Instruction | Description |
|----------|-------------------------|--|
| 0F FC /r | PADDB <i>mm, mm/m64</i> | Add packed bytes from <i>mm/m64</i> to packed bytes in <i>mm</i> . |
| 0F FD /r | PADDW <i>mm, mm/m64</i> | Add packed words from <i>mm/m64</i> to packed words in <i>mm</i> . |
| 0F FE /r | PADD <i>mm, mm/m64</i> | Add packed doublewords from <i>mm/m64</i> to packed doublewords in <i>mm</i> . |

Description

Adds the individual data elements (bytes, words, or doublewords) of the source operand (second operand) to the individual data elements of the destination operand (first operand). (See [Figure 2-5](#).) If the result of an individual addition exceeds the range for the specified data type (overflows), the result is wrapped around, meaning that the result is truncated so that only the lower (least significant) bits of the result are returned (that is, the carry is ignored).

The destination operand must be an MMX technology register; the source operand can be either an MMX technology register or a quadword memory location.

Figure 2-5. Operation of the PADDW Instruction

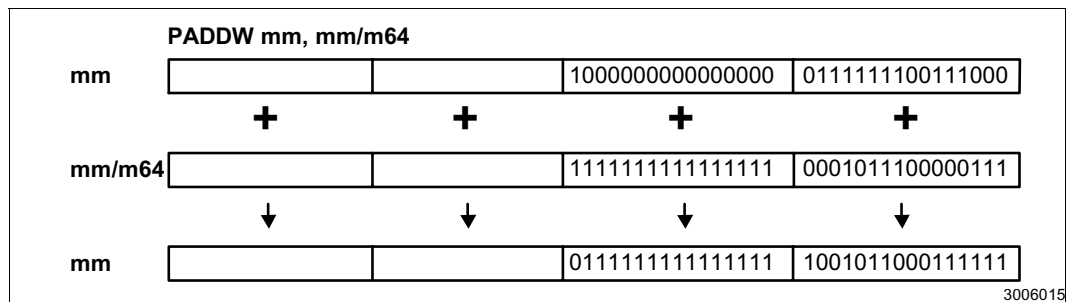

The PADDB instruction adds the bytes of the source operand to the bytes of the destination operand and stores the results to the destination operand. When an individual result is too large to be represented in 8 bits, the lower 8 bits of the result are written to the destination operand and therefore the result wraps around.

The PADDW instruction adds the words of the source operand to the words of the destination operand and stores the results to the destination operand. When an individual result is too large to be represented in 16 bits, the lower 16 bits of the result are written to the destination operand and therefore the result wraps around.

The PADD instruction adds the doublewords of the source operand to the doublewords of the destination operand and stores the results to the destination operand. When an individual result is too large to be represented in 32 bits, the lower 32 bits of the result are written to the destination operand and therefore the result wraps around.

PADDB/PADDW/PADDD—Packed Add (Continued)

Note that like the integer ADD instruction, the PADDB, PADDW, and PADDD instructions can operate on either unsigned or signed (two's complement notation) packed integers. Unlike the integer instructions, none of the MMX instructions affect the EFLAGS register. With MMX instructions, there are no carry or overflow flags to indicate when overflow has occurred, so the software must control the range of values or else use the “with saturation” MMX instructions.

Operation

IF instruction is PADDB

THEN

```
DEST(7..0) ← DEST(7..0) + SRC(7..0);
DEST(15..8) ← DEST(15..8) + SRC(15..8);
DEST(23..16) ← DEST(23..16) + SRC(23..16);
DEST(31..24) ← DEST(31..24) + SRC(31..24);
DEST(39..32) ← DEST(39..32) + SRC(39..32);
DEST(47..40) ← DEST(47..40) + SRC(47..40);
DEST(55..48) ← DEST(55..48) + SRC(55..48);
DEST(63..56) ← DEST(63..56) + SRC(63..56);
```

ELSEIF instruction is PADDW

THEN

```
DEST(15..0) ← DEST(15..0) + SRC(15..0);
DEST(31..16) ← DEST(31..16) + SRC(31..16);
DEST(47..32) ← DEST(47..32) + SRC(47..32);
DEST(63..48) ← DEST(63..48) + SRC(63..48);
```

ELSE (* instruction is PADDD *)

```
DEST(31..0) ← DEST(31..0) + SRC(31..0);
DEST(63..32) ← DEST(63..32) + SRC(63..32);
```

FI;

Flags Affected

None.

Additional Itanium® System Environment Exceptions

| | |
|--------------------|--|
| Itanium Reg Faults | Disabled FP Register Fault if PSR.dfl is 1, NaT Register Consumption Abort. |
| Itanium Mem Faults | VHPT Data Fault, Nested TLB Fault, Data TLB Fault, Alternate Data TLB Fault, Data Page Not Present Fault, Data NaT Page Consumption Abort, Data Key Miss Fault, Data Key Permission Fault, Data Access Rights Fault, Data Access Bit Fault, Data Dirty Bit Fault |

PADDB/PADDW/PADDD—Packed Add (Continued)**Protected Mode Exceptions**

| | |
|-----------------|--|
| #GP(0) | If a memory operand effective address is outside the CS, DS, ES, FS or GS segment limit. |
| #SS(0) | If a memory operand effective address is outside the SS segment limit. |
| #UD | If EM in CR0 is set. |
| #NM | If TS in CR0 is set. |
| #MF | If there is a pending FPU exception. |
| #PF(fault-code) | If a page fault occurs. |
| #AC(0) | If alignment checking is enabled and an unaligned memory reference is made while the current privilege level is 3. |

Real-Address Mode Exceptions

| | |
|-----|---|
| #GP | If any part of the operand lies outside of the effective address space from 0 to FFFFH. |
| #UD | If EM in CR0 is set. |
| #NM | If TS in CR0 is set. |
| #MF | If there is a pending FPU exception. |

Virtual-8086 Mode Exceptions

| | |
|-----------------|---|
| #GP | If any part of the operand lies outside of the effective address space from 0 to FFFFH. |
| #UD | If EM in CR0 is set. |
| #NM | If TS in CR0 is set. |
| #MF | If there is a pending FPU exception. |
| #PF(fault-code) | If a page fault occurs. |
| #AC(0) | If alignment checking is enabled and an unaligned memory reference is made. |

PADDSB/PADDSSW—Packed Add with Saturation

| Opcode | Instruction | Description |
|----------|---------------------------|--|
| 0F EC /r | PADDSB <i>mm, mm/m64</i> | Add signed packed bytes from <i>mm/m64</i> to signed packed bytes in <i>mm</i> and saturate. |
| 0F ED /r | PADDSSW <i>mm, mm/m64</i> | Add signed packed words from <i>mm/m64</i> to signed packed words in <i>mm</i> and saturate. |

Description

Adds the individual signed data elements (bytes or words) of the source operand (second operand) to the individual signed data elements of the destination operand (first operand). (See Figure 2-6.) If the result of an individual addition exceeds the range for the specified data type, the result is saturated. The destination operand must be an MMX technology register; the source operand can be either an MMX technology register or a quadword memory location.

Figure 2-6. Operation of the PADDSSW Instruction

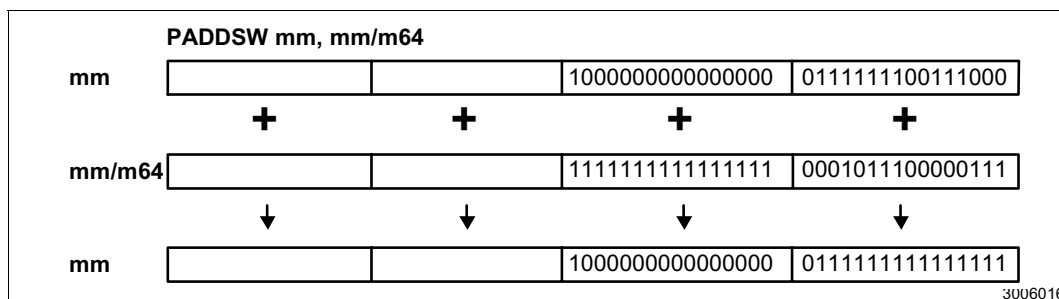

The PADDSB instruction adds the signed bytes of the source operand to the signed bytes of the destination operand and stores the results to the destination operand. When an individual result is beyond the range of a signed byte (that is, greater than 7FH or less than 80H), the saturated byte value of 7FH or 80H, respectively, is written to the destination operand.

The PADDSSW instruction adds the signed words of the source operand to the signed words of the destination operand and stores the results to the destination operand. When an individual result is beyond the range of a signed word (that is, greater than 7FFFH or less than 8000H), the saturated word value of 7FFFH or 8000H, respectively, is written to the destination operand.

Operation

IF instruction is PADDSB

THEN

```

DEST(7..0) ← SaturateToSignedByte(DEST(7..0) + SRC(7..0));
DEST(15..8) ← SaturateToSignedByte(DEST(15..8) + SRC(15..8));
DEST(23..16) ← SaturateToSignedByte(DEST(23..16) + SRC(23..16));
DEST(31..24) ← SaturateToSignedByte(DEST(31..24) + SRC(31..24));
DEST(39..32) ← SaturateToSignedByte(DEST(39..32) + SRC(39..32));
DEST(47..40) ← SaturateToSignedByte(DEST(47..40) + SRC(47..40));
DEST(55..48) ← SaturateToSignedByte(DEST(55..48) + SRC(55..48));
DEST(63..56) ← SaturateToSignedByte(DEST(63..56) + SRC(63..56));

```

ELSE { (* instruction is PADDSSW *)

PADDSB/PADDSW—Packed Add with Saturation (Continued)

$DEST(15..0) \leftarrow SaturateToSignedWord(DEST(15..0) + SRC(15..0));$

$DEST(31..16) \leftarrow SaturateToSignedWord(DEST(31..16) + SRC(31..16));$

$DEST(47..32) \leftarrow SaturateToSignedWord(DEST(47..32) + SRC(47..32));$

$DEST(63..48) \leftarrow SaturateToSignedWord(DEST(63..48) + SRC(63..48));$

FI;

Flags Affected

None.

Additional Itanium® System Environment Exceptions

Itanium Reg Faults Disabled FP Register Fault if PSR.dfl is 1, NaT Register Consumption Abort.

Itanium Mem Faults VHPT Data Fault, Nested TLB Fault, Data TLB Fault, Alternate Data TLB Fault, Data Page Not Present Fault, Data NaT Page Consumption Abort, Data Key Miss Fault, Data Key Permission Fault, Data Access Rights Fault, Data Access Bit Fault, Data Dirty Bit Fault

Protected Mode Exceptions

| | |
|-----------------|--|
| #GP(0) | If a memory operand effective address is outside the CS, DS, ES, FS or GS segment limit. |
| #SS(0) | If a memory operand effective address is outside the SS segment limit. |
| #UD | If EM in CR0 is set. |
| #NM | If TS in CR0 is set. |
| #MF | If there is a pending FPU exception. |
| #PF(fault-code) | If a page fault occurs. |
| #AC(0) | If alignment checking is enabled and an unaligned memory reference is made while the current privilege level is 3. |

Real-Address Mode Exceptions

| | |
|-----|---|
| #GP | If any part of the operand lies outside of the effective address space from 0 to FFFFH. |
| #UD | If EM in CR0 is set. |
| #NM | If TS in CR0 is set. |
| #MF | If there is a pending FPU exception. |



PADDSB/PADDSW—Packed Add with Saturation (Continued)

Virtual-8086 Mode Exceptions

| | |
|-----------------|---|
| #GP | If any part of the operand lies outside of the effective address space from 0 to FFFFH. |
| #UD | If EM in CR0 is set. |
| #NM | If TS in CR0 is set. |
| #MF | If there is a pending FPU exception. |
| #PF(fault-code) | If a page fault occurs. |
| #AC(0) | If alignment checking is enabled and an unaligned memory reference is made. |

PADDUSB/PADDUSW—Packed Add Unsigned with Saturation

| Opcode | Instruction | Description |
|----------|-----------------------------------|--|
| 0F DC /r | PADDUSB <i>mm</i> , <i>mm/m64</i> | Add unsigned packed bytes from <i>mm/m64</i> to unsigned packed bytes in <i>mm</i> and saturate. |
| 0F DD /r | PADDUSW <i>mm</i> , <i>mm/m64</i> | Add unsigned packed words from <i>mm/m64</i> to unsigned packed words in <i>mm</i> and saturate. |

Description

Adds the individual unsigned data elements (bytes or words) of the packed source operand (second operand) to the individual unsigned data elements of the packed destination operand (first operand). (See [Figure 2-7](#).) If the result of an individual addition exceeds the range for the specified unsigned data type, the result is saturated. The destination operand must be an MMX technology register; the source operand can be either an MMX technology register or a quadword memory location.

Figure 2-7. Operation of the PADDUSB Instruction

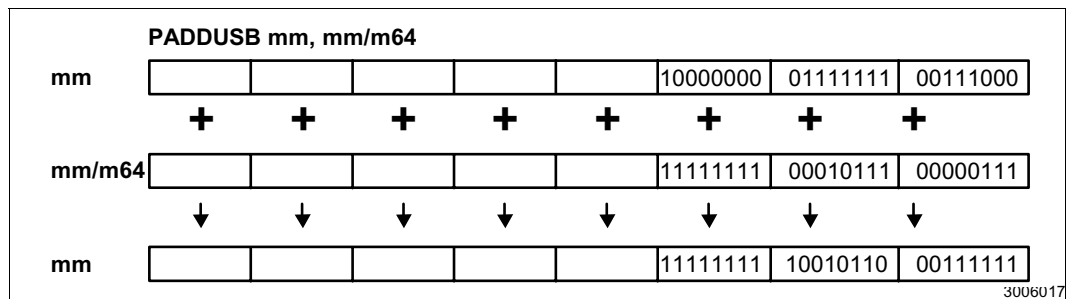

The PADDUSB instruction adds the unsigned bytes of the source operand to the unsigned bytes of the destination operand and stores the results to the destination operand. When an individual result is beyond the range of an unsigned byte (that is, greater than FFH), the saturated unsigned byte value of FFH is written to the destination operand.

The PADDUSW instruction adds the unsigned words of the source operand to the unsigned words of the destination operand and stores the results to the destination operand. When an individual result is beyond the range of an unsigned word (that is, greater than FFFFH), the saturated unsigned word value of FFFFH is written to the destination operand.

PADDUSB/PADDUSW—Packed Add Unsigned with Saturation (Continued)

Operation

IF instruction is PADDUSB

THEN

```
DEST(7..0) ← SaturateToUnsignedByte(DEST(7..0) + SRC(7..0) );
DEST(15..8) ← SaturateToUnsignedByte(DEST(15..8) + SRC(15..8) );
DEST(23..16) ← SaturateToUnsignedByte(DEST(23..16)+ SRC(23..16) );
DEST(31..24) ← SaturateToUnsignedByte(DEST(31..24) + SRC(31..24) );
DEST(39..32) ← SaturateToUnsignedByte(DEST(39..32) + SRC(39..32) );
DEST(47..40) ← SaturateToUnsignedByte(DEST(47..40)+ SRC(47..40) );
DEST(55..48) ← SaturateToUnsignedByte(DEST(55..48) + SRC(55..48) );
DEST(63..56) ← SaturateToUnsignedByte(DEST(63..56) + SRC(63..56) );
```

ELSE { (* instruction is PADDUSW *)

```
DEST(15..0) ← SaturateToUnsignedWord(DEST(15..0) + SRC(15..0) );
DEST(31..16) ← SaturateToUnsignedWord(DEST(31..16) + SRC(31..16) );
DEST(47..32) ← SaturateToUnsignedWord(DEST(47..32) + SRC(47..32) );
DEST(63..48) ← SaturateToUnsignedWord(DEST(63..48) + SRC(63..48) );
```

FI;

Flags Affected

None.

Additional Itanium® System Environment Exceptions

Itanium Reg Faults Disabled FP Register Fault if PSR.dfl is 1, NaT Register Consumption Abort.

Itanium Mem Faults VHPT Data Fault, Nested TLB Fault, Data TLB Fault, Alternate Data TLB Fault, Data Page Not Present Fault, Data NaT Page Consumption Abort, Data Key Miss Fault, Data Key Permission Fault, Data Access Rights Fault, Data Access Bit Fault, Data Dirty Bit Fault

Protected Mode Exceptions

| | |
|-----------------|--|
| #GP(0) | If a memory operand effective address is outside the CS, DS, ES, FS or GS segment limit. |
| #SS(0) | If a memory operand effective address is outside the SS segment limit. |
| #UD | If EM in CR0 is set. |
| #NM | If TS in CR0 is set. |
| #MF | If there is a pending FPU exception. |
| #PF(fault-code) | If a page fault occurs. |
| #AC(0) | If alignment checking is enabled and an unaligned memory reference is made while the current privilege level is 3. |

PADDUSB/PADDUSW—Packed Add Unsigned with Saturation (Continued)**Real-Address Mode Exceptions**

| | |
|-----|---|
| #GP | If any part of the operand lies outside of the effective address space from 0 to FFFFH. |
| #UD | If EM in CR0 is set. |
| #NM | If TS in CR0 is set. |
| #MF | If there is a pending FPU exception. |

Virtual-8086 Mode Exceptions

| | |
|-----------------|---|
| #GP | If any part of the operand lies outside of the effective address space from 0 to FFFFH. |
| #UD | If EM in CR0 is set. |
| #NM | If TS in CR0 is set. |
| #MF | If there is a pending FPU exception. |
| #PF(fault-code) | If a page fault occurs. |
| #AC(0) | If alignment checking is enabled and an unaligned memory reference is made. |

PAND—Logical AND

| Opcode | Instruction | Description |
|----------|------------------------|--|
| 0F DB /r | PAND <i>mm, mm/m64</i> | AND quadword from <i>mm/m64</i> to quadword in <i>mm</i> . |

Description

Performs a bitwise logical AND operation on the quadword source (second) and destination (first) operands and stores the result in the destination operand location (see [Figure 2-8](#)). The source operand can be an MMX technology register or a quadword memory location; the destination operand must be an MMX technology register. Each bit of the result of the PAND instruction is set to 1 if the corresponding bits of the operands are both 1; otherwise it is made zero

Figure 2-8. Operation of the PAND Instruction

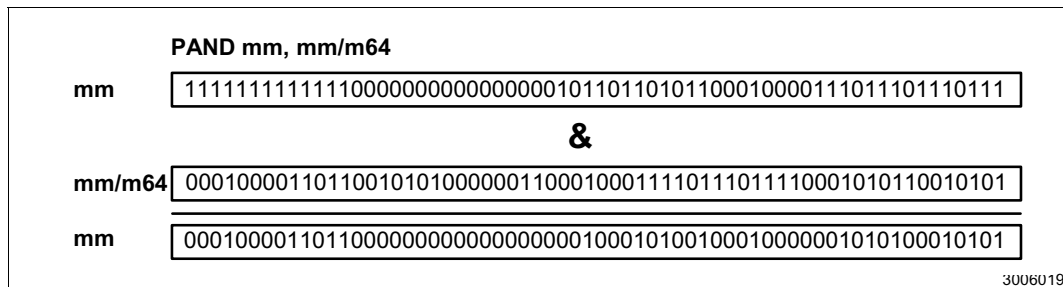

Operation

DEST ← DEST AND SRC;

Flags Affected

None.

Additional Itanium® System Environment Exceptions

- Itanium Reg Faults Disabled FP Register Fault if PSR.dfl is 1, NaT Register Consumption Abort.
- Itanium Mem Faults VHPT Data Fault, Nested TLB Fault, Data TLB Fault, Alternate Data TLB Fault, Data Page Not Present Fault, Data NaT Page Consumption Abort, Data Key Miss Fault, Data Key Permission Fault, Data Access Rights Fault, Data Access Bit Fault, Data Dirty Bit Fault

PAND—Logical AND (Continued)**Protected Mode Exceptions**

| | |
|-----------------|--|
| #GP(0) | If a memory operand effective address is outside the CS, DS, ES, FS or GS segment limit. |
| #SS(0) | If a memory operand effective address is outside the SS segment limit. |
| #UD | If EM in CR0 is set. |
| #NM | If TS in CR0 is set. |
| #MF | If there is a pending FPU exception. |
| #PF(fault-code) | If a page fault occurs. |
| #AC(0) | If alignment checking is enabled and an unaligned memory reference is made while the current privilege level is 3. |

Real-Address Mode Exceptions

| | |
|-----|---|
| #GP | If any part of the operand lies outside of the effective address space from 0 to FFFFH. |
| #UD | If EM in CR0 is set. |
| #NM | If TS in CR0 is set. |
| #MF | If there is a pending FPU exception. |

Virtual-8086 Mode Exceptions

| | |
|-----------------|---|
| #GP | If any part of the operand lies outside of the effective address space from 0 to FFFFH. |
| #UD | If EM in CR0 is set. |
| #NM | If TS in CR0 is set. |
| #MF | If there is a pending FPU exception. |
| #PF(fault-code) | If a page fault occurs. |
| #AC(0) | If alignment checking is enabled and an unaligned memory reference is made. |

PANDN—Logical AND NOT

| Opcode | Instruction | Description |
|----------|---------------------------------|--|
| 0F DF /r | PANDN <i>mm</i> , <i>mm/m64</i> | AND quadword from <i>mm/m64</i> to NOT quadword in <i>mm</i> . |

Description

Performs a bitwise logical NOT on the quadword destination operand (first operand). Then, the instruction performs a bitwise logical AND operation on the inverted destination operand and the quadword source operand (second operand). (See [Figure 2-9](#).) Each bit of the result of the AND operation is set to one if the corresponding bits of the source and inverted destination bits are one; otherwise it is set to zero. The result is stored in the destination operand location.

The source operand can be an MMX technology register or a quadword memory location; the destination operand must be an MMX technology register.

Figure 2-9. Operation of the PANDN Instruction

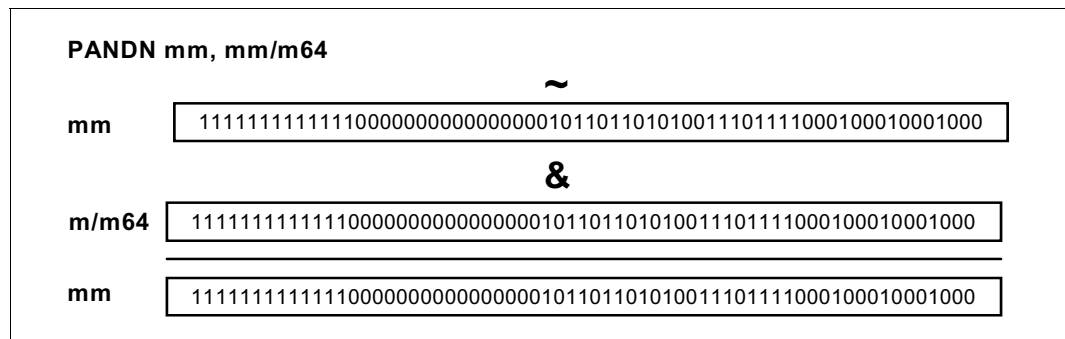

Operation

$DEST \leftarrow (NOT\ DEST)\ AND\ SRC;$

Flags Affected

None.

Additional Itanium® System Environment Exceptions

Itanium Reg Faults Disabled FP Register Fault if PSR.dfl is 1, NaT Register Consumption Abort.

Itanium Mem Faults VHPT Data Fault, Nested TLB Fault, Data TLB Fault, Alternate Data TLB Fault, Data Page Not Present Fault, Data NaT Page Consumption Abort, Data Key Miss Fault, Data Key Permission Fault, Data Access Rights Fault, Data Access Bit Fault, Data Dirty Bit Fault

PANDN—Logical AND NOT (Continued)**Protected Mode Exceptions**

| | |
|-----------------|--|
| #GP(0) | If a memory operand effective address is outside the CS, DS, ES, FS or GS segment limit. |
| #SS(0) | If a memory operand effective address is outside the SS segment limit. |
| #UD | If EM in CR0 is set. |
| #NM | If TS in CR0 is set. |
| #MF | If there is a pending FPU exception. |
| #PF(fault-code) | If a page fault occurs. |
| #AC(0) | If alignment checking is enabled and an unaligned memory reference is made while the current privilege level is 3. |

Real-Address Mode Exceptions

| | |
|-----|---|
| #GP | If any part of the operand lies outside of the effective address space from 0 to FFFFH. |
| #UD | If EM in CR0 is set. |
| #NM | If TS in CR0 is set. |
| #MF | If there is a pending FPU exception. |

Virtual-8086 Mode Exceptions

| | |
|-----------------|---|
| #GP | If any part of the operand lies outside of the effective address space from 0 to FFFFH. |
| #UD | If EM in CR0 is set. |
| #NM | If TS in CR0 is set. |
| #MF | If there is a pending FPU exception. |
| #PF(fault-code) | If a page fault occurs. |
| #AC(0) | If alignment checking is enabled and an unaligned memory reference is made. |

PCMPEQB/PCMPEQW/PCMPEQD—Packed Compare for Equal

| Opcode | Instruction | Description |
|----------|---------------------------|--|
| 0F 74 /r | PCMPEQB <i>mm, mm/m64</i> | Compare packed bytes in <i>mm/m64</i> with packed bytes in <i>mm</i> for equality. |
| 0F 75 /r | PCMPEQW <i>mm, mm/m64</i> | Compare packed words in <i>mm/m64</i> with packed words in <i>mm</i> for equality. |
| 0F 76 /r | PCMPEQD <i>mm, mm/m64</i> | Compare packed doublewords in <i>mm/m64</i> with packed doublewords in <i>mm</i> for equality. |

Description

Compares the individual data elements (bytes, words, or doublewords) in the destination operand (first operand) to the corresponding data elements in the source operand (second operand). (See [Figure 2-10](#).) If a pair of data elements are equal, the corresponding data element in the destination operand is set to all ones; otherwise, it is set to all zeros. The destination operand must be an MMX technology register; the source operand may be either an MMX technology register or a 64-bit memory location.

Figure 2-10. Operation of the PCMPEQW Instruction

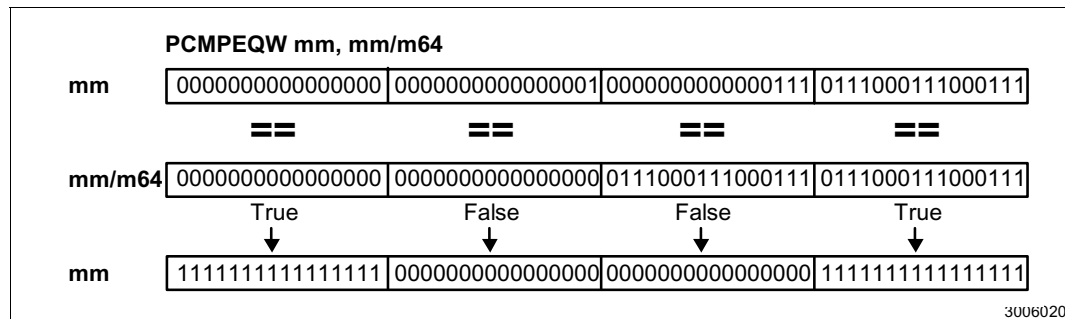

The PCMPEQB instruction compares the bytes in the destination operand to the corresponding bytes in the source operand, with the bytes in the destination operand being set according to the results.

The PCMPEQW instruction compares the words in the destination operand to the corresponding words in the source operand, with the words in the destination operand being set according to the results.

The PCMPEQD instruction compares the doublewords in the destination operand to the corresponding doublewords in the source operand, with the doublewords in the destination operand being set according to the results.

PCMPEQB/PCMPEQW/PCMPEQD—Packed Compare for Equal (Continued)

Operation

```

IF instruction is PCMPEQB
  THEN
    IF DEST(7..0) = SRC(7..0)
      THEN DEST(7..0) ← FFH;
      ELSE DEST(7..0) ← 0;
    * Continue comparison of second through seventh bytes in DEST and SRC *
    IF DEST(63..56) = SRC(63..56)
      THEN DEST(63..56) ← FFH;
      ELSE DEST(63..56) ← 0;
  ELSE IF instruction is PCMPEQW
    THEN
      IF DEST(15..0) = SRC(15..0)
        THEN DEST(15..0) ← FFFFH;
        ELSE DEST(15..0) ← 0;
      * Continue comparison of second and third words in DEST and SRC *
      IF DEST(63..48) = SRC(63..48)
        THEN DEST(63..48) ← FFFFH;
        ELSE DEST(63..48) ← 0;
    ELSE (* instruction is PCMPEQD *)
      IF DEST(31..0) = SRC(31..0)
        THEN DEST(31..0) ← FFFFFFFFH;
        ELSE DEST(31..0) ← 0;
      IF DEST(63..32) = SRC(63..32)
        THEN DEST(63..32) ← FFFFFFFFH;
        ELSE DEST(63..32) ← 0;
  FI;

```

Flags Affected

None:

Additional Itanium® System Environment Exceptions

| | |
|--------------------|--|
| Itanium Reg Faults | Disabled FP Register Fault if PSR.dfl is 1, NaT Register Consumption Abort. |
| Itanium Mem Faults | VHPT Data Fault, Nested TLB Fault, Data TLB Fault, Alternate Data TLB Fault, Data Page Not Present Fault, Data NaT Page Consumption Abort, Data Key Miss Fault, Data Key Permission Fault, Data Access Rights Fault, Data Access Bit Fault, Data Dirty Bit Fault |

Protected Mode Exceptions

| | |
|-----------------|--|
| #GP(0) | If a memory operand effective address is outside the CS, DS, ES, FS or GS segment limit. |
| #SS(0) | If a memory operand effective address is outside the SS segment limit. |
| #UD | If EM in CR0 is set. |
| #NM | If TS in CR0 is set. |
| #MF | If there is a pending FPU exception. |
| #PF(fault-code) | If a page fault occurs. |

PCMPEQB/PCMPEQW/PCMPEQD—Packed Compare for Equal (Continued)

#AC(0) If alignment checking is enabled and an unaligned memory reference is made while the current privilege level is 3.

Real-Address Mode Exceptions

#GP If any part of the operand lies outside of the effective address space from 0 to FFFFH.

#UD If EM in CR0 is set.

#NM If TS in CR0 is set.

#MF If there is a pending FPU exception.

Virtual-8086 Mode Exceptions

#GP If any part of the operand lies outside of the effective address space from 0 to FFFFH.

#UD If EM in CR0 is set.

#NM If TS in CR0 is set.

#MF If there is a pending FPU exception.

#PF(fault-code) If a page fault occurs.

#AC(0) If alignment checking is enabled and an unaligned memory reference is made.

PCMPGTB/PCMPGTW/PCMPGTD—Packed Compare for Greater Than

| Opcode | Instruction | Description |
|----------|---------------------------|---|
| 0F 64 /r | PCMPGTB <i>mm, mm/m64</i> | Compare packed bytes in <i>mm</i> with packed bytes in <i>mm/m64</i> for greater value. |
| 0F 65 /r | PCMPGTW <i>mm, mm/m64</i> | Compare packed words in <i>mm</i> with packed words in <i>mm/m64</i> for greater value. |
| 0F 66 /r | PCMPGTD <i>mm, mm/m64</i> | Compare packed doublewords in <i>mm</i> with packed doublewords in <i>mm/m64</i> for greater value. |

Description

Compare the individual signed data elements (bytes, words, or doublewords) in the destination operand (first operand) to the corresponding signed data elements in the source operand (second operand). (See [Figure 2-11](#).) If a data element in the destination operand is greater than its corresponding data element in the source operand, the data element in the destination operand is set to all ones; otherwise, it is set to all zeros. The destination operand must be an MMX technology register; the source operand may be either an MMX technology register or a 64-bit memory location.

Figure 2-11. Operation of the PCMPGTW Instruction

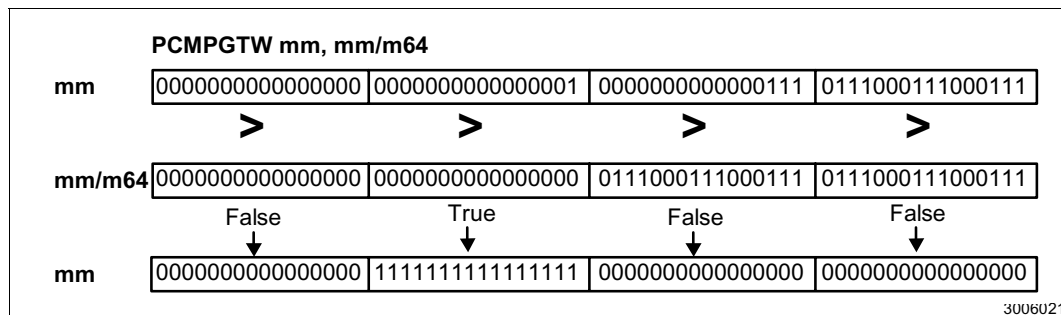

The PCMPGTB instruction compares the signed bytes in the destination operand to the corresponding signed bytes in the source operand, with the bytes in the destination operand being set according to the results.

The PCMPGTW instruction compares the signed words in the destination operand to the corresponding signed words in the source operand, with the words in the destination operand being set according to the results.

The PCMPGTD instruction compares the signed doublewords in the destination operand to the corresponding signed doublewords in the source operand, with the doublewords in the destination operand being set according to the results.

PCMPGTB/PCMPGTW/PCMPGTD—Packed Compare for Greater Than (Continued)

Operation

```

IF instruction is PCMPGTB
  THEN
    IF DEST(7..0) > SRC(7..0)
      THEN DEST(7..0) ← FFH;
      ELSE DEST(7..0) ← 0;
    * Continue comparison of second through seventh bytes in DEST and SRC *
    IF DEST(63..56) > SRC(63..56)
      THEN DEST(63..56) ← FFH;
      ELSE DEST(63..56) ← 0;
ELSE IF instruction is PCMPGTW
  THEN
    IF DEST(15..0) > SRC(15..0)
      THEN DEST(15..0) ← FFFFH;
      ELSE DEST(15..0) ← 0;
    * Continue comparison of second and third bytes in DEST and SRC *
    IF DEST(63..48) > SRC(63..48)
      THEN DEST(63..48) ← FFFFH;
      ELSE DEST(63..48) ← 0;
ELSE { (* instruction is PCMPGTD *)
  IF DEST(31..0) > SRC(31..0)
    THEN DEST(31..0) ← FFFFFFFFH;
    ELSE DEST(31..0) ← 0;
  IF DEST(63..32) > SRC(63..32)
    THEN DEST(63..32) ← FFFFFFFFH;
    ELSE DEST(63..32) ← 0;
}
FI;

```

Flags Affected

None.

Additional Itanium[®] System Environment Exceptions

| | |
|--------------------|--|
| Itanium Reg Faults | Disabled FP Register Fault if PSR.dfl is 1, NaT Register Consumption Abort. |
| Itanium Mem Faults | VHPT Data Fault, Nested TLB Fault, Data TLB Fault, Alternate Data TLB Fault, Data Page Not Present Fault, Data NaT Page Consumption Abort, Data Key Miss Fault, Data Key Permission Fault, Data Access Rights Fault, Data Access Bit Fault, Data Dirty Bit Fault |

PCMPGTB/PCMPGTW/PCMPGTD—Packed Compare for Greater Than (Continued)

Protected Mode Exceptions

| | |
|-----------------|--|
| #GP(0) | If a memory operand effective address is outside the CS, DS, ES, FS or GS segment limit. |
| #SS(0) | If a memory operand effective address is outside the SS segment limit. |
| #UD | If EM in CR0 is set. |
| #NM | If TS in CR0 is set. |
| #MF | If there is a pending FPU exception. |
| #PF(fault-code) | If a page fault occurs. |
| #AC(0) | If alignment checking is enabled and an unaligned memory reference is made while the current privilege level is 3. |

Real-Address Mode Exceptions

| | |
|-----|---|
| #GP | If any part of the operand lies outside of the effective address space from 0 to FFFFH. |
| #UD | If EM in CR0 is set. |
| #NM | If TS in CR0 is set. |
| #MF | If there is a pending FPU exception. |

Virtual-8086 Mode Exceptions

| | |
|-----------------|---|
| #GP | If any part of the operand lies outside of the effective address space from 0 to FFFFH. |
| #UD | If EM in CR0 is set. |
| #NM | If TS in CR0 is set. |
| #MF | If there is a pending FPU exception. |
| #PF(fault-code) | If a page fault occurs. |
| #AC(0) | If alignment checking is enabled and an unaligned memory reference is made. |

PMADDWD—Packed Multiply and Add

| Opcode | Instruction | Description |
|----------|-----------------------------------|--|
| 0F F5 /r | PMADDWD <i>mm</i> , <i>mm/m64</i> | Multiply the packed words in <i>mm</i> by the packed words in <i>mm/m64</i> . Add the 32-bit pairs of results and store in <i>mm</i> as doubleword |

Description

Multiplies the individual signed words of the destination operand by the corresponding signed words of the source operand, producing four signed, doubleword results (see [Figure 2-12](#)). The two doubleword results from the multiplication of the high-order words are added together and stored in the upper doubleword of the destination operand; the two doubleword results from the multiplication of the low-order words are added together and stored in the lower doubleword of the destination operand. The destination operand must be an MMX technology register; the source operand may be either an MMX technology register or a 64-bit memory location.

The PMADDWD instruction wraps around to 80000000H only when all four words of both the source and destination operands are 8000H.

Figure 2-12. Operation of the PMADDWD Instruction

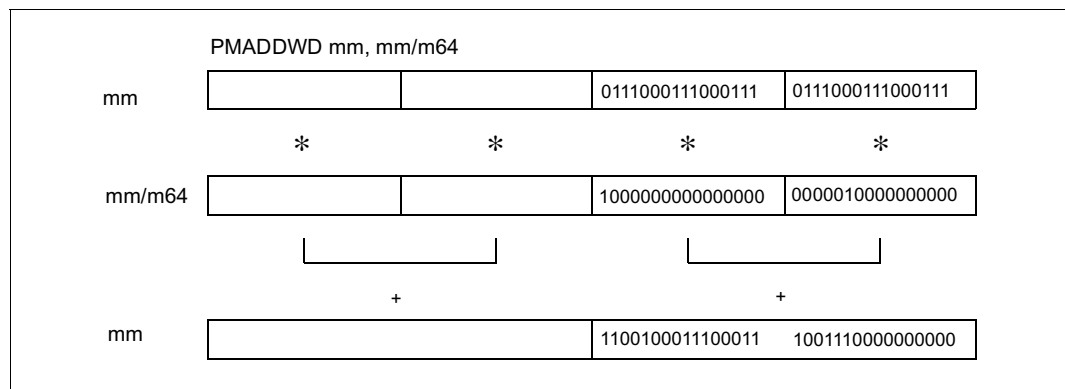

Operation

$$\text{DEST}(31..0) \leftarrow (\text{DEST}(15..0) * \text{SRC}(15..0)) + (\text{DEST}(31..16) * \text{SRC}(31..16));$$

$$\text{DEST}(63..32) \leftarrow (\text{DEST}(47..32) * \text{SRC}(47..32)) + (\text{DEST}(63..48) * \text{SRC}(63..48));$$

Flags Affected

None.

Additional Itanium® System Environment Exceptions

Itanium Reg Faults Disabled FP Register Fault if PSR.dfl is 1, NaT Register Consumption Abort.

Itanium Mem Faults VHPT Data Fault, Nested TLB Fault, Data TLB Fault, Alternate Data TLB Fault, Data Page Not Present Fault, Data NaT Page Consumption Abort, Data Key Miss Fault, Data Key Permission Fault, Data Access Rights Fault, Data Access Bit Fault, Data Dirty Bit Fault

PMADDWD—Packed Multiply and Add (Continued)

Protected Mode Exceptions

| | |
|-----------------|--|
| #GP(0) | If a memory operand effective address is outside the CS, DS, ES, FS or GS segment limit. |
| #SS(0) | If a memory operand effective address is outside the SS segment limit. |
| #UD | If EM in CR0 is set. |
| #NM | If TS in CR0 is set. |
| #MF | If there is a pending FPU exception. |
| #PF(fault-code) | If a page fault occurs. |
| #AC(0) | If alignment checking is enabled and an unaligned memory reference is made while the current privilege level is 3. |

Real-Address Mode Exceptions

| | |
|-----|---|
| #GP | If any part of the operand lies outside of the effective address space from 0 to FFFFH. |
| #UD | If EM in CR0 is set. |
| #NM | If TS in CR0 is set. |
| #MF | If there is a pending FPU exception. |

Virtual-8086 Mode Exceptions

| | |
|-----------------|---|
| #GP | If any part of the operand lies outside of the effective address space from 0 to FFFFH. |
| #UD | If EM in CR0 is set. |
| #NM | If TS in CR0 is set. |
| #MF | If there is a pending FPU exception. |
| #PF(fault-code) | If a page fault occurs. |
| #AC(0) | If alignment checking is enabled and an unaligned memory reference is made. |

PMULHW—Packed Multiply High

| Opcode | Instruction | Description |
|----------|----------------------------------|---|
| 0F E5 /r | PMULHW <i>mm</i> , <i>mm/m64</i> | Multiply the signed packed words in <i>mm</i> by the signed packed words in <i>mm/m64</i> , then store the high-order word of each doubleword result in <i>mm</i> . |

Description

Multiplies the four signed words of the source operand (second operand) by the four signed words of the destination operand (first operand), producing four signed, doubleword, intermediate results (see Figure 2-13). The high-order word of each intermediate result is then written to its corresponding word location in the destination operand. The destination operand must be an MMX technology register; the source operand may be either an MMX technology register or a 64-bit memory location.

Figure 2-13. Operation of the PMULHW Instruction

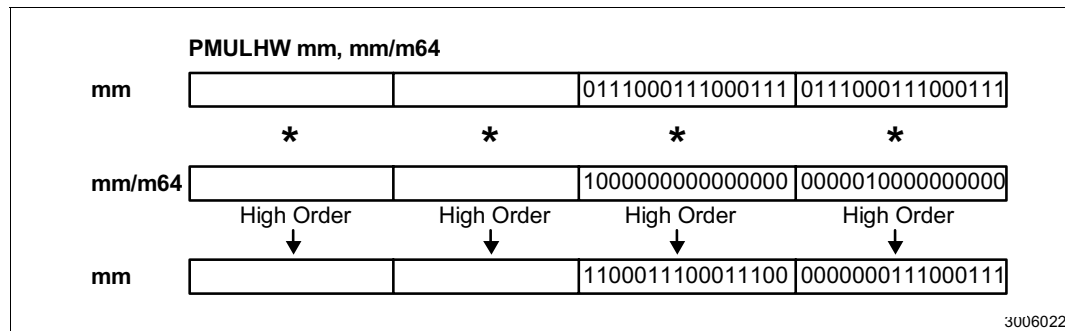

Operation

```
DEST(15..0) ← HighOrderWord(DEST(15..0) * SRC(15..0));
DEST(31..16) ← HighOrderWord(DEST(31..16) * SRC(31..16));
DEST(47..32) ← HighOrderWord(DEST(47..32) * SRC(47..32));
DEST(63..48) ← HighOrderWord(DEST(63..48) * SRC(63..48));
```

Flags Affected

None.

Additional Itanium® System Environment Exceptions

Itanium Reg Faults Disabled FP Register Fault if PSR.dfl is 1, NaT Register Consumption Abort.

Itanium Mem Faults VHPT Data Fault, Nested TLB Fault, Data TLB Fault, Alternate Data TLB Fault, Data Page Not Present Fault, Data NaT Page Consumption Abort, Data Key Miss Fault, Data Key Permission Fault, Data Access Rights Fault, Data Access Bit Fault, Data Dirty Bit Fault

PMULHW—Packed Multiply High (Continued)

Protected Mode Exceptions

| | |
|-----------------|--|
| #GP(0) | If a memory operand effective address is outside the CS, DS, ES, FS or GS segment limit. |
| #SS(0) | If a memory operand effective address is outside the SS segment limit. |
| #UD | If EM in CR0 is set. |
| #NM | If TS in CR0 is set. |
| #MF | If there is a pending FPU exception. |
| #PF(fault-code) | If a page fault occurs. |
| #AC(0) | If alignment checking is enabled and an unaligned memory reference is made while the current privilege level is 3. |

Real-Address Mode Exceptions

| | |
|-----|---|
| #GP | If any part of the operand lies outside of the effective address space from 0 to FFFFH. |
| #UD | If EM in CR0 is set. |
| #NM | If TS in CR0 is set. |
| #MF | If there is a pending FPU exception. |

Virtual-8086 Mode Exceptions

| | |
|-----------------|---|
| #GP | If any part of the operand lies outside of the effective address space from 0 to FFFFH. |
| #UD | If EM in CR0 is set. |
| #NM | If TS in CR0 is set. |
| #MF | If there is a pending FPU exception. |
| #PF(fault-code) | If a page fault occurs. |
| #AC(0) | If alignment checking is enabled and an unaligned memory reference is made. |

PMULLW—Packed Multiply Low

| Opcode | Instruction | Description |
|----------|----------------------------------|--|
| 0F D5 /r | PMULLW <i>mm</i> , <i>mm/m64</i> | Multiply the packed words in <i>mm</i> with the packed words in <i>mm/m64</i> , then store the low-order word of each doubleword result in <i>mm</i> . |

Description

Multiplies the four signed or unsigned words of the source operand (second operand) with the four signed or unsigned words of the destination operand (first operand), producing four doubleword, intermediate results (see Figure 2-14). The low-order word of each intermediate result is then written to its corresponding word location in the destination operand. The destination operand must be an MMX technology register; the source operand may be either an MMX technology register or a 64-bit memory location.

Figure 2-14. Operation of the PMULLW Instruction

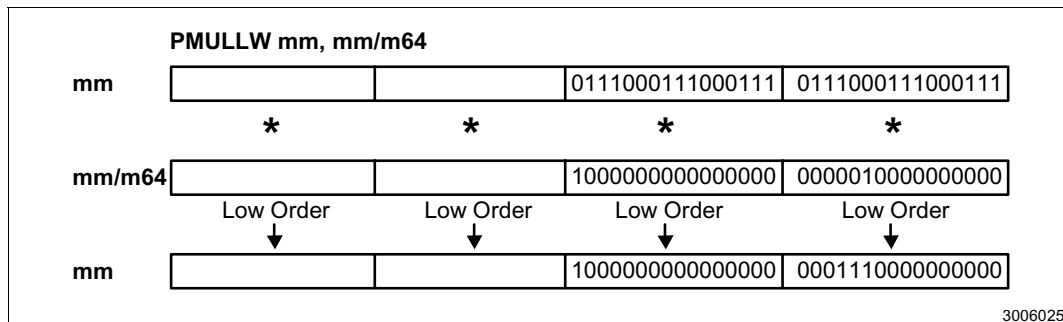

Operation

$DEST(15..0) \leftarrow LowOrderWord(DEST(15..0) * SRC(15..0));$
 $DEST(31..16) \leftarrow LowOrderWord(DEST(31..16) * SRC(31..16));$
 $DEST(47..32) \leftarrow LowOrderWord(DEST(47..32) * SRC(47..32));$
 $DEST(63..48) \leftarrow LowOrderWord(DEST(63..48) * SRC(63..48));$

Flags Affected

None.

Additional Itanium® System Environment Exceptions

Itanium Reg Faults Disabled FP Register Fault if PSR.dfl is 1, NaT Register Consumption Abort.

Itanium Mem Faults VHPT Data Fault, Nested TLB Fault, Data TLB Fault, Alternate Data TLB Fault, Data Page Not Present Fault, Data NaT Page Consumption Abort, Data Key Miss Fault, Data Key Permission Fault, Data Access Rights Fault, Data Access Bit Fault, Data Dirty Bit Fault

PMULLW—Packed Multiply Low (Continued)

Protected Mode Exceptions

| | |
|-----------------|--|
| #GP(0) | If a memory operand effective address is outside the CS, DS, ES, FS or GS segment limit. |
| #SS(0) | If a memory operand effective address is outside the SS segment limit. |
| #UD | If EM in CR0 is set. |
| #NM | If TS in CR0 is set. |
| #MF | If there is a pending FPU exception. |
| #PF(fault-code) | If a page fault occurs. |
| #AC(0) | If alignment checking is enabled and an unaligned memory reference is made while the current privilege level is 3. |

Real-Address Mode Exceptions

| | |
|-----|---|
| #GP | If any part of the operand lies outside of the effective address space from 0 to FFFFH. |
| #UD | If EM in CR0 is set. |
| #NM | If TS in CR0 is set. |
| #MF | If there is a pending FPU exception. |

Virtual-8086 Mode Exceptions

| | |
|-----------------|---|
| #GP | If any part of the operand lies outside of the effective address space from 0 to FFFFH. |
| #UD | If EM in CR0 is set. |
| #NM | If TS in CR0 is set. |
| #MF | If there is a pending FPU exception. |
| #PF(fault-code) | If a page fault occurs. |
| #AC(0) | If alignment checking is enabled and an unaligned memory reference is made. |

POR—Bitwise Logical OR

| Opcode | Instruction | Description |
|----------|-----------------------|---|
| 0F EB /r | POR <i>mm, mm/m64</i> | OR quadword from <i>mm/m64</i> to quadword in <i>mm</i> . |

Description

Performs a bitwise logical OR operation on the quadword source (second) and destination (first) operands and stores the result in the destination operand location (see Figure 2-15). The source operand can be an MMX technology register or a quadword memory location; the destination operand must be an MMX technology register. Each bit of the result is made 0 if the corresponding bits of both operands are 0; otherwise the bit is set to 1.

Figure 2-15. Operation of the POR Instruction.

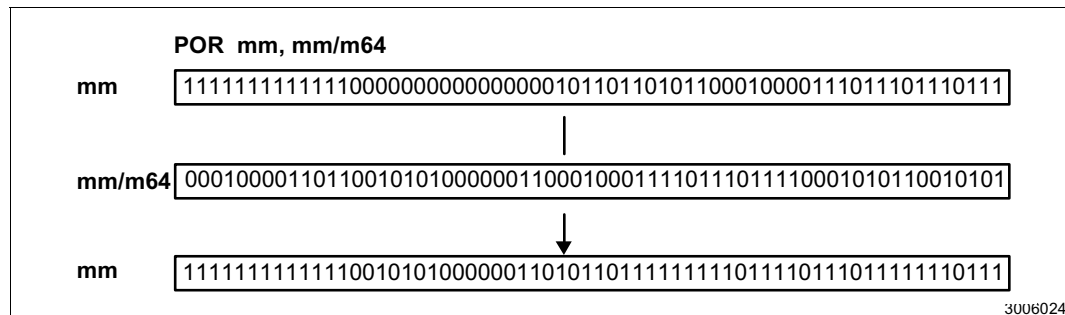

Operation

$DEST \leftarrow DEST \text{ OR } SRC;$

Flags Affected

None.

Additional Itanium® System Environment Exceptions

Itanium Reg Faults Disabled FP Register Fault if PSR.dfl is 1, NaT Register Consumption Abort.

Itanium Mem Faults VHPT Data Fault, Nested TLB Fault, Data TLB Fault, Alternate Data TLB Fault, Data Page Not Present Fault, Data NaT Page Consumption Abort, Data Key Miss Fault, Data Key Permission Fault, Data Access Rights Fault, Data Access Bit Fault, Data Dirty Bit Fault

POR—Bitwise Logical OR (Continued)

Protected Mode Exceptions

| | |
|-----------------|--|
| #GP(0) | If a memory operand effective address is outside the CS, DS, ES, FS or GS segment limit. |
| #SS(0) | If a memory operand effective address is outside the SS segment limit. |
| #UD | If EM in CR0 is set. |
| #NM | If TS in CR0 is set. |
| #MF | If there is a pending FPU exception. |
| #PF(fault-code) | If a page fault occurs. |
| #AC(0) | If alignment checking is enabled and an unaligned memory reference is made while the current privilege level is 3. |

Real-Address Mode Exceptions

| | |
|-----|---|
| #GP | If any part of the operand lies outside of the effective address space from 0 to FFFFH. |
| #UD | If EM in CR0 is set. |
| #NM | If TS in CR0 is set. |
| #MF | If there is a pending FPU exception. |

Virtual-8086 Mode Exceptions

| | |
|-----------------|---|
| #GP | If any part of the operand lies outside of the effective address space from 0 to FFFFH. |
| #UD | If EM in CR0 is set. |
| #NM | If TS in CR0 is set. |
| #MF | If there is a pending FPU exception. |
| #PF(fault-code) | If a page fault occurs. |
| #AC(0) | If alignment checking is enabled and an unaligned memory reference is made. |

PSLLW/PSLLD/PSLLQ—Packed Shift Left Logical

| Opcode | Instruction | Description |
|--------------|---------------------------------|---|
| 0F F1 /r | PSLLW <i>mm</i> , <i>mm/m64</i> | Shift words in <i>mm</i> left by amount specified in <i>mm/m64</i> , while shifting in zeros. |
| 0F 71 /6, ib | PSLLW <i>mm</i> , <i>imm8</i> | Shift words in <i>mm</i> left by <i>imm8</i> , while shifting in zeros. |
| 0F F2 /r | PSLLD <i>mm</i> , <i>mm/m64</i> | Shift doublewords in <i>mm</i> left by amount specified in <i>mm/m64</i> , while shifting in zeros. |
| 0F 72 /6 ib | PSLLD <i>mm</i> , <i>imm8</i> | Shift doublewords in <i>mm</i> by <i>imm8</i> , while shifting in zeros. |
| 0F F3 /r | PSLLQ <i>mm</i> , <i>mm/m64</i> | Shift <i>mm</i> left by amount specified in <i>mm/m64</i> , while shifting in zeros. |
| 0F 73 /6 ib | PSLLQ <i>mm</i> , <i>imm8</i> | Shift <i>mm</i> left by <i>imm8</i> , while shifting in zeros. |

Description

Shifts the bits in the data elements (words, doublewords, or quadword) in the destination operand (first operand) to the left by the number of bits specified in the unsigned count operand (second operand). (See [Figure 2-16](#).) The result of the shift operation is written to the destination operand. As the bits in the data elements are shifted left, the empty low-order bits are cleared (set to zero). If the value specified by the count operand is greater than 15 (for words), 31 (for doublewords), or 63 (for a quadword), then the destination operand is set to all zeros.

The destination operand must be an MMX technology register; the count operand can be either an MMX technology register, a 64-bit memory location, or an 8-bit immediate.

The PSLLW instruction shifts each of the four words of the destination operand to the left by the number of bits specified in the count operand; the PSLLD instruction shifts each of the two doublewords of the destination operand; and the PSLLQ instruction shifts the 64-bit quadword in the destination operand. As the individual data elements are shifted left, the empty low-order bit positions are filled with zeros.

Figure 2-16. Operation of the PSLLW Instruction

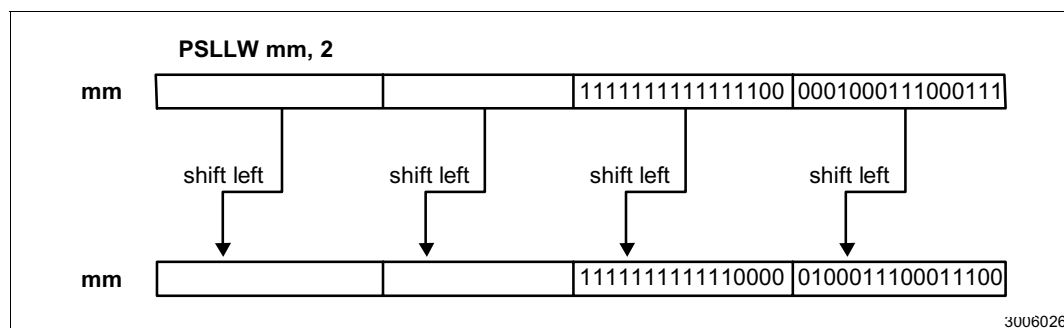

PSLLW/PSLLD/PSLLQ—Packed Shift Left Logical (Continued)

Operation

```

IF instruction is PSLLW
  THEN
    DEST(15..0) ← DEST(15..0) << COUNT;
    DEST(31..16) ← DEST(31..16) << COUNT;
    DEST(47..32) ← DEST(47..32) << COUNT;
    DEST(63..48) ← DEST(63..48) << COUNT;
  ELSE IF instruction is PSLLD
    THEN {
      DEST(31..0) ← DEST(31..0) << COUNT;
      DEST(63..32) ← DEST(63..32) << COUNT;
    }
  ELSE (* instruction is PSLLQ *)
    DEST ← DEST << COUNT;
FI;

```

Flags Affected

None.

Additional Itanium® System Environment Exceptions

Itanium Reg Faults Disabled FP Register Fault if PSR.dfl is 1, NaT Register Consumption Abort.

Itanium Mem Faults VHPT Data Fault, Nested TLB Fault, Data TLB Fault, Alternate Data TLB Fault, Data Page Not Present Fault, Data NaT Page Consumption Abort, Data Key Miss Fault, Data Key Permission Fault, Data Access Rights Fault, Data Access Bit Fault, Data Dirty Bit Fault

Protected Mode Exceptions

| | |
|-----------------|--|
| #GP(0) | If a memory operand effective address is outside the CS, DS, ES, FS or GS segment limit. |
| #SS(0) | If a memory operand effective address is outside the SS segment limit. |
| #UD | If EM in CR0 is set. |
| #NM | If TS in CR0 is set. |
| #MF | If there is a pending FPU exception. |
| #PF(fault-code) | If a page fault occurs. |
| #AC(0) | If alignment checking is enabled and an unaligned memory reference is made while the current privilege level is 3. |

Real-Address Mode Exceptions

| | |
|-----|---|
| #GP | If any part of the operand lies outside of the effective address space from 0 to FFFFH. |
| #UD | If EM in CR0 is set. |
| #NM | If TS in CR0 is set. |
| #MF | If there is a pending FPU exception. |



PSLLW/PSLLD/PSLLQ—Packed Shift Left Logical (Continued)

Virtual-8086 Mode Exceptions

| | |
|-----------------|---|
| #GP | If any part of the operand lies outside of the effective address space from 0 to FFFFH. |
| #UD | If EM in CR0 is set. |
| #NM | If TS in CR0 is set. |
| #MF | If there is a pending FPU exception. |
| #PF(fault-code) | If a page fault occurs. |
| #AC(0) | If alignment checking is enabled and an unaligned memory reference is made. |

PSRAW/PSRAD—Packed Shift Right Arithmetic

| Opcode | Instruction | Description |
|-------------|---------------------------------|--|
| 0F E1 /r | PSRAW <i>mm</i> , <i>mm/m64</i> | Shift words in <i>mm</i> right by amount specified in <i>mm/m64</i> while shifting in sign bits. |
| 0F 71 /4 ib | PSRAW <i>mm</i> , <i>imm8</i> | Shift words in <i>mm</i> right by <i>imm8</i> while shifting in sign bits |
| 0F E2 /r | PSRAD <i>mm</i> , <i>mm/m64</i> | Shift doublewords in <i>mm</i> right by amount specified in <i>mm/m64</i> while shifting in sign bits. |
| 0F 72 /4 ib | PSRAD <i>mm</i> , <i>imm8</i> | Shift doublewords in <i>mm</i> right by <i>imm8</i> while shifting in sign bits. |

Description

Shifts the bits in the data elements (words or doublewords) in the destination operand (first operand) to the right by the amount of bits specified in the unsigned count operand (second operand). (See [Figure 2-17](#).) The result of the shift operation is written to the destination operand. The empty high-order bits of each element are filled with the initial value of the sign bit of the data element. If the value specified by the count operand is greater than 15 (for words) or 31 (for doublewords), each destination data element is filled with the initial value of the sign bit of the element.

The destination operand must be an MMX technology register; the count operand (source operand) can be either an MMX technology register, a 64-bit memory location, or an 8-bit immediate.

The PSRAW instruction shifts each of the four words in the destination operand to the right by the number of bits specified in the count operand; the PSRAD instruction shifts each of the two doublewords in the destination operand. As the individual data elements are shifted right, the empty high-order bit positions are filled with the sign value.

Figure 2-17. Operation of the PSRAW Instruction

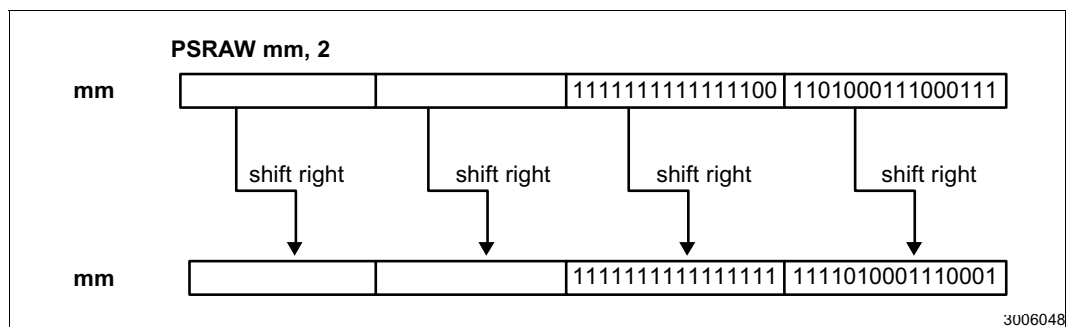

PSRAW/PSRAD—Packed Shift Right Arithmetic (Continued)

Operation

```

IF instruction is PSRAW
  THEN
    DEST(15..0) ← SignExtend (DEST(15..0) >> COUNT);
    DEST(31..16) ← SignExtend (DEST(31..16) >> COUNT);
    DEST(47..32) ← SignExtend (DEST(47..32) >> COUNT);
    DEST(63..48) ← SignExtend (DEST(63..48) >> COUNT);
  ELSE { (*instruction is PSRAD *)
    DEST(31..0) ← SignExtend (DEST(31..0) >> COUNT);
    DEST(63..32) ← SignExtend (DEST(63..32) >> COUNT);
  }
FI;

```

Flags Affected

None.

Additional Itanium® System Environment Exceptions

Itanium Reg Faults Disabled FP Register Fault if PSR.dfl is 1, NaT Register Consumption Abort.

Itanium Mem Faults VHPT Data Fault, Nested TLB Fault, Data TLB Fault, Alternate Data TLB Fault, Data Page Not Present Fault, Data NaT Page Consumption Abort, Data Key Miss Fault, Data Key Permission Fault, Data Access Rights Fault, Data Access Bit Fault, Data Dirty Bit Fault

Protected Mode Exceptions

| | |
|-----------------|--|
| #GP(0) | If a memory operand effective address is outside the CS, DS, ES, FS or GS segment limit. |
| #SS(0) | If a memory operand effective address is outside the SS segment limit. |
| #UD | If EM in CR0 is set. |
| #NM | If TS in CR0 is set. |
| #MF | If there is a pending FPU exception. |
| #PF(fault-code) | If a page fault occurs. |
| #AC(0) | If alignment checking is enabled and an unaligned memory reference is made while the current privilege level is 3. |

Real-Address Mode Exceptions

| | |
|-----|---|
| #GP | If any part of the operand lies outside of the effective address space from 0 to FFFFH. |
| #UD | If EM in CR0 is set. |
| #NM | If TS in CR0 is set. |
| #MF | If there is a pending FPU exception. |

PSRAW/PSRAD—Packed Shift Right Arithmetic (Continued)

Virtual-8086 Mode Exceptions

| | |
|-----------------|---|
| #GP | If any part of the operand lies outside of the effective address space from 0 to FFFFH. |
| #UD | If EM in CR0 is set. |
| #NM | If TS in CR0 is set. |
| #MF | If there is a pending FPU exception. |
| #PF(fault-code) | If a page fault occurs. |
| #AC(0) | If alignment checking is enabled and an unaligned memory reference is made. |

PSRLW/PSRLD/PSRLQ—Packed Shift Right Logical

| Opcode | Instruction | Description |
|-------------|---------------------------------|--|
| 0F D1 /r | PSRLW <i>mm</i> , <i>mm/m64</i> | Shift words in <i>mm</i> right by amount specified in <i>mm/m64</i> while shifting in zeros. |
| 0F 71 /2 ib | PSRLW <i>mm</i> , <i>imm8</i> | Shift words in <i>mm</i> right by <i>imm8</i> . |
| 0F D2 /r | PSRLD <i>mm</i> , <i>mm/m64</i> | Shift doublewords in <i>mm</i> right by amount specified in <i>mm/m64</i> while shifting in zeros. |
| 0F 72 /2 ib | PSRLD <i>mm</i> , <i>imm8</i> | Shift doublewords in <i>mm</i> right by <i>imm8</i> . |
| 0F D3 /r | PSRLQ <i>mm</i> , <i>mm/m64</i> | Shift <i>mm</i> right by amount specified in <i>mm/m64</i> while shifting in zeros. |
| 0F 73 /2 ib | PSRLQ <i>mm</i> , <i>imm8</i> | Shift <i>mm</i> right by <i>imm8</i> while shifting in zeros. |

Description

Shifts the bits in the data elements (words, doublewords, or quadword) in the destination operand (first operand) to the right by the number of bits specified in the unsigned count operand (second operand). (See [Figure 2-18](#).) The result of the shift operation is written to the destination operand. As the bits in the data elements are shifted right, the empty high-order bits are cleared (set to zero). If the value specified by the count operand is greater than 15 (for words), 31 (for doublewords), or 63 (for a quadword), then the destination operand is set to all zeros.

The destination operand must be an MMX technology register; the count operand can be either an MMX technology register, a 64-bit memory location, or an 8-bit immediate.

The PSRLW instruction shifts each of the four words of the destination operand to the right by the number of bits specified in the count operand; the PSRLD instruction shifts each of the two doublewords of the destination operand; and the PSRLQ instruction shifts the 64-bit quadword in the destination operand. As the individual data elements are shifted right, the empty high-order bit positions are filled with zeros.

Figure 2-18. Operation of the PSRLW Instruction

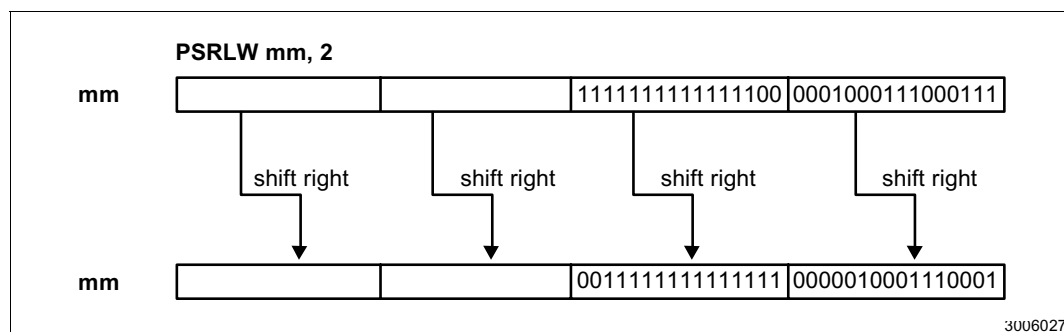

PSRLW/PSRLD/PSRLQ—Packed Shift Right Logical (Continued)

Operation

```

IF instruction is PSRLW
  THEN {
    DEST(15..0) ← DEST(15..0) >> COUNT;
    DEST(31..16) ← DEST(31..16) >> COUNT;
    DEST(47..32) ← DEST(47..32) >> COUNT;
    DEST(63..48) ← DEST(63..48) >> COUNT;
  }
ELSE IF instruction is PSRLD
  THEN {
    DEST(31..0) ← DEST(31..0) >> COUNT;
    DEST(63..32) ← DEST(63..32) >> COUNT;
  }
ELSE (* instruction is PSRLQ *)
  DEST ← DEST >> COUNT;
FI;

```

Flags Affected

None.

Additional Itanium® System Environment Exceptions

Itanium Reg Faults Disabled FP Register Fault if PSR.dfl is 1, NaT Register Consumption Abort.

Itanium Mem Faults VHPT Data Fault, Nested TLB Fault, Data TLB Fault, Alternate Data TLB Fault, Data Page Not Present Fault, Data NaT Page Consumption Abort, Data Key Miss Fault, Data Key Permission Fault, Data Access Rights Fault, Data Access Bit Fault, Data Dirty Bit Fault

Protected Mode Exceptions

| | |
|-----------------|--|
| #GP(0) | If a memory operand effective address is outside the CS, DS, ES, FS or GS segment limit. |
| #SS(0) | If a memory operand effective address is outside the SS segment limit. |
| #UD | If EM in CR0 is set. |
| #NM | If TS in CR0 is set. |
| #MF | If there is a pending FPU exception. |
| #PF(fault-code) | If a page fault occurs. |
| #AC(0) | If alignment checking is enabled and an unaligned memory reference is made while the current privilege level is 3. |

Real-Address Mode Exceptions

| | |
|-----|---|
| #GP | If any part of the operand lies outside of the effective address space from 0 to FFFFH. |
| #UD | If EM in CR0 is set. |
| #NM | If TS in CR0 is set. |
| #MF | If there is a pending FPU exception. |



PSRLW/PSRLD/PSRLQ—Packed Shift Right Logical (Continued)

Virtual-8086 Mode Exceptions

| | |
|-----------------|---|
| #GP | If any part of the operand lies outside of the effective address space from 0 to FFFFH. |
| #UD | If EM in CR0 is set. |
| #NM | If TS in CR0 is set. |
| #MF | If there is a pending FPU exception. |
| #PF(fault-code) | If a page fault occurs. |
| #AC(0) | If alignment checking is enabled and an unaligned memory reference is made. |

PSUBB/PSUBW/PSUBD—Packed Subtract

| Opcode | Instruction | Description |
|----------|-------------------------|---|
| 0F F8 /r | PSUBB <i>mm, mm/m64</i> | Subtract packed bytes in <i>mm/m64</i> from packed bytes in <i>mm</i> . |
| 0F F9 /r | PSUBW <i>mm, mm/m64</i> | Subtract packed words in <i>mm/m64</i> from packed words in <i>mm</i> . |
| 0F FA /r | PSUBD <i>mm, mm/m64</i> | Subtract packed doublewords in <i>mm/m64</i> from packed doublewords in <i>mm</i> . |

Description

Subtracts the individual data elements (bytes, words, or doublewords) of the source operand (second operand) from the individual data elements of the destination operand (first operand). (See [Figure 2-19](#).) If the result of a subtraction exceeds the range for the specified data type (overflows), the result is wrapped around, meaning that the result is truncated so that only the lower (least significant) bits of the result are returned (that is, the carry is ignored).

The destination operand must be an MMX technology register; the source operand can be either an MMX technology register or a quadword memory location.

Figure 2-19. Operation of the PSUBW Instruction

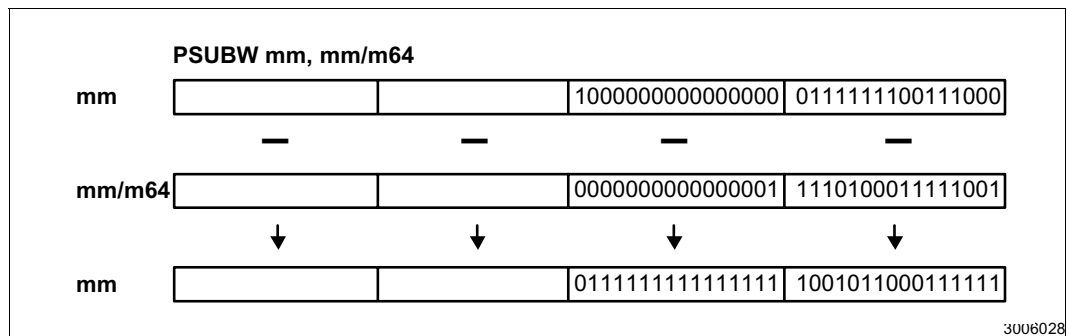

The PSUBB instruction subtracts the bytes of the source operand from the bytes of the destination operand and stores the results to the destination operand. When an individual result is too large to be represented in 8 bits, the lower 8 bits of the result are written to the destination operand and therefore the result wraps around.

The PSUBW instruction subtracts the words of the source operand from the words of the destination operand and stores the results to the destination operand. When an individual result is too large to be represented in 16 bits, the lower 16 bits of the result are written to the destination operand and therefore the result wraps around.

The PSUBD instruction subtracts the doublewords of the source operand from the doublewords of the destination operand and stores the results to the destination operand. When an individual result is too large to be represented in 32 bits, the lower 32 bits of the result are written to the destination operand and therefore the result wraps around.

PSUBB/PSUBW/PSUBD—Packed Subtract (Continued)

Note that like the integer SUB instruction, the PSUBB, PSUBW, and PSUBD instructions can operate on either unsigned or signed (two's complement notation) packed integers. Unlike the integer instructions, none of the MMX instructions affect the EFLAGS register. With MMX instructions, there are no carry or overflow flags to indicate when overflow has occurred, so the software must control the range of values or else use the “with saturation” MMX instructions.

Operation

IF instruction is PSUBB

THEN

```
DEST(7..0) ← DEST(7..0) – SRC(7..0);
DEST(15..8) ← DEST(15..8) – SRC(15..8);
DEST(23..16) ← DEST(23..16) – SRC(23..16);
DEST(31..24) ← DEST(31..24) – SRC(31..24);
DEST(39..32) ← DEST(39..32) – SRC(39..32);
DEST(47..40) ← DEST(47..40) – SRC(47..40);
DEST(55..48) ← DEST(55..48) – SRC(55..48);
DEST(63..56) ← DEST(63..56) – SRC(63..56);
```

ELSEIF instruction is PSUBW

THEN

```
DEST(15..0) ← DEST(15..0) – SRC(15..0);
DEST(31..16) ← DEST(31..16) – SRC(31..16);
DEST(47..32) ← DEST(47..32) – SRC(47..32);
DEST(63..48) ← DEST(63..48) – SRC(63..48);
```

ELSE { (* instruction is PSUBD *)

```
DEST(31..0) ← DEST(31..0) – SRC(31..0);
DEST(63..32) ← DEST(63..32) – SRC(63..32);
```

FI;

Flags Affected

None.

Additional Itanium® System Environment Exceptions

| | |
|--------------------|--|
| Itanium Reg Faults | Disabled FP Register Fault if PSR.dfl is 1, NaT Register Consumption Abort. |
| Itanium Mem Faults | VHPT Data Fault, Nested TLB Fault, Data TLB Fault, Alternate Data TLB Fault, Data Page Not Present Fault, Data NaT Page Consumption Abort, Data Key Miss Fault, Data Key Permission Fault, Data Access Rights Fault, Data Access Bit Fault, Data Dirty Bit Fault |

PSUBB/PSUBW/PSUBD—Packed Subtract (Continued)**Protected Mode Exceptions**

| | |
|-----------------|--|
| #GP(0) | If a memory operand effective address is outside the CS, DS, ES, FS or GS segment limit. |
| #SS(0) | If a memory operand effective address is outside the SS segment limit. |
| #UD | If EM in CR0 is set. |
| #NM | If TS in CR0 is set. |
| #MF | If there is a pending FPU exception. |
| #PF(fault-code) | If a page fault occurs. |
| #AC(0) | If alignment checking is enabled and an unaligned memory reference is made while the current privilege level is 3. |

Real-Address Mode Exceptions

| | |
|-----|---|
| #GP | If any part of the operand lies outside of the effective address space from 0 to FFFFH. |
| #UD | If EM in CR0 is set. |
| #NM | If TS in CR0 is set. |
| #MF | If there is a pending FPU exception. |

Virtual-8086 Mode Exceptions

| | |
|-----------------|---|
| #GP | If any part of the operand lies outside of the effective address space from 0 to FFFFH. |
| #UD | If EM in CR0 is set. |
| #NM | If TS in CR0 is set. |
| #MF | If there is a pending FPU exception. |
| #PF(fault-code) | If a page fault occurs. |
| #AC(0) | If alignment checking is enabled and an unaligned memory reference is made. |

PSUBSB/PSUBSW—Packed Subtract with Saturation

| Opcode | Instruction | Description |
|----------|--------------------------|---|
| 0F E8 /r | PSUBSB <i>mm, mm/m64</i> | Subtract signed packed bytes in <i>mm/m64</i> from signed packed bytes in <i>mm</i> and saturate. |
| 0F E9 /r | PSUBSW <i>mm, mm/m64</i> | Subtract signed packed words in <i>mm/m64</i> from signed packed words in <i>mm</i> and saturate. |

Description

Subtracts the individual signed data elements (bytes or words) of the source operand (second operand) from the individual signed data elements of the destination operand (first operand). (See [Figure 2-20](#).) If the result of a subtraction exceeds the range for the specified data type, the result is saturated. The destination operand must be an MMX technology register; the source operand can be either an MMX technology register or a quadword memory location.

Figure 2-20. Operation of the PSUBSW Instruction

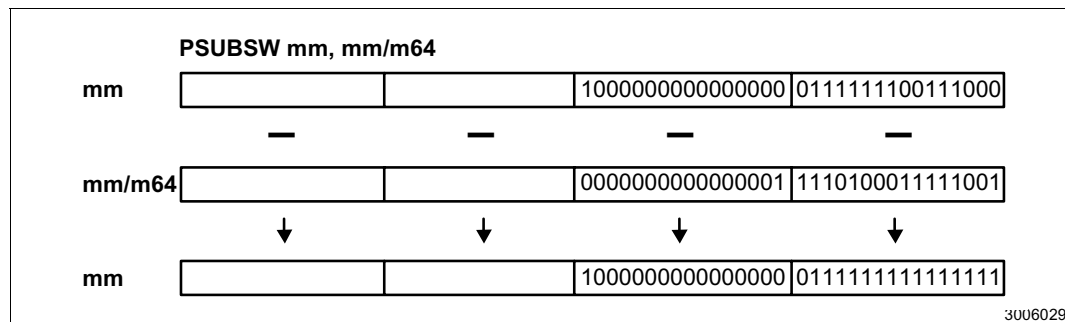

The PSUBSB instruction subtracts the signed bytes of the source operand from the signed bytes of the destination operand and stores the results to the destination operand. When an individual result is beyond the range of a signed byte (that is, greater than 7FH or less than 80H), the saturated byte value of 7FH or 80H, respectively, is written to the destination operand.

The PSUBSW instruction subtracts the signed words of the source operand from the signed words of the destination operand and stores the results to the destination operand. When an individual result is beyond the range of a signed word (that is, greater than 7FFFH or less than 8000H), the saturated word value of 7FFFH or 8000H, respectively, is written to the destination operand.

PSUBSB/PSUBSW—Packed Subtract with Saturation (Continued)

Operation

IF instruction is PSUBSB

THEN

```
DEST(7..0) ← SaturateToSignedByte(DEST(7..0) – SRC(7..0));
DEST(15..8) ← SaturateToSignedByte(DEST(15..8) – SRC(15..8));
DEST(23..16) ← SaturateToSignedByte(DEST(23..16) – SRC(23..16));
DEST(31..24) ← SaturateToSignedByte(DEST(31..24) – SRC(31..24));
DEST(39..32) ← SaturateToSignedByte(DEST(39..32) – SRC(39..32));
DEST(47..40) ← SaturateToSignedByte(DEST(47..40) – SRC(47..40));
DEST(55..48) ← SaturateToSignedByte(DEST(55..48) – SRC(55..48));
DEST(63..56) ← SaturateToSignedByte(DEST(63..56) – SRC(63..56))
```

ELSE (* instruction is PSUBSW *)

```
DEST(15..0) ← SaturateToSignedWord(DEST(15..0) – SRC(15..0));
DEST(31..16) ← SaturateToSignedWord(DEST(31..16) – SRC(31..16));
DEST(47..32) ← SaturateToSignedWord(DEST(47..32) – SRC(47..32));
DEST(63..48) ← SaturateToSignedWord(DEST(63..48) – SRC(63..48));
```

FI;

Flags Affected

None.

Additional Itanium® System Environment Exceptions

Itanium Reg Faults Disabled FP Register Fault if PSR.dfl is 1, NaT Register Consumption Abort.

Itanium Mem Faults VHPT Data Fault, Nested TLB Fault, Data TLB Fault, Alternate Data TLB Fault, Data Page Not Present Fault, Data NaT Page Consumption Abort, Data Key Miss Fault, Data Key Permission Fault, Data Access Rights Fault, Data Access Bit Fault, Data Dirty Bit Fault

Protected Mode Exceptions

| | |
|-----------------|--|
| #GP(0) | If a memory operand effective address is outside the CS, DS, ES, FS or GS segment limit. |
| #SS(0) | If a memory operand effective address is outside the SS segment limit. |
| #UD | If EM in CR0 is set. |
| #NM | If TS in CR0 is set. |
| #MF | If there is a pending FPU exception. |
| #PF(fault-code) | If a page fault occurs. |
| #AC(0) | If alignment checking is enabled and an unaligned memory reference is made while the current privilege level is 3. |

PSUBSB/PSUBSW—Packed Subtract with Saturation (Continued)

Real-Address Mode Exceptions

| | |
|-----|---|
| #GP | If any part of the operand lies outside of the effective address space from 0 to FFFFH. |
| #UD | If EM in CR0 is set. |
| #NM | If TS in CR0 is set. |
| #MF | If there is a pending FPU exception. |

Virtual-8086 Mode Exceptions

| | |
|-----------------|---|
| #GP | If any part of the operand lies outside of the effective address space from 0 to FFFFH. |
| #UD | If EM in CR0 is set. |
| #NM | If TS in CR0 is set. |
| #MF | If there is a pending FPU exception. |
| #PF(fault-code) | If a page fault occurs. |
| #AC(0) | If alignment checking is enabled and an unaligned memory reference is made. |

PSUBUSB/PSUBUSW—Packed Subtract Unsigned with Saturation

| Opcode | Instruction | Description |
|----------|---------------------------|---|
| 0F D8 /r | PSUBUSB <i>mm, mm/m64</i> | Subtract unsigned packed bytes in <i>mm/m64</i> from unsigned packed bytes in <i>mm</i> and saturate. |
| 0F D9 /r | PSUBUSW <i>mm, mm/m64</i> | Subtract unsigned packed words in <i>mm/m64</i> from unsigned packed words in <i>mm</i> and saturate. |

Description

Subtracts the individual unsigned data elements (bytes or words) of the source operand (second operand) from the individual unsigned data elements of the destination operand (first operand). (See [Figure 2-21](#).) If the result of an individual subtraction exceeds the range for the specified unsigned data type, the result is saturated. The destination operand must be an MMX technology register; the source operand can be either an MMX technology register or a quadword memory location.

Figure 2-21. Operation of the PSUBUSB Instruction

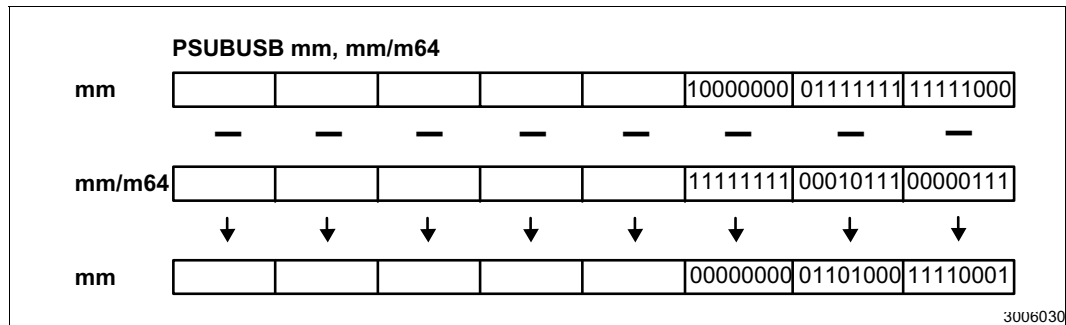

The PSUBUSB instruction subtracts the unsigned bytes of the source operand from the unsigned bytes of the destination operand and stores the results to the destination operand. When an individual result is less than zero (a negative value), the saturated unsigned byte value of 00H is written to the destination operand.

The PSUBUSW instruction subtracts the unsigned words of the source operand from the unsigned words of the destination operand and stores the results to the destination operand. When an individual result is less than zero (a negative value), the saturated unsigned word value of 0000H is written to the destination operand.

PSUBUSB/PSUBUSW—Packed Subtract Unsigned with Saturation (Continued)

Operation

IF instruction is PSUBUSB

THEN

```
DEST(7..0) ← SaturateToUnsignedByte (DEST(7..0) – SRC (7..0) );
DEST(15..8) ← SaturateToUnsignedByte ( DEST(15..8) – SRC(15..8) );
DEST(23..16) ← SaturateToUnsignedByte (DEST(23..16) – SRC(23..16) );
DEST(31..24) ← SaturateToUnsignedByte (DEST(31..24) – SRC(31..24) );
DEST(39..32) ← SaturateToUnsignedByte (DEST(39..32) – SRC(39..32) );
DEST(47..40) ← SaturateToUnsignedByte (DEST(47..40) – SRC(47..40) );
DEST(55..48) ← SaturateToUnsignedByte (DEST(55..48) – SRC(55..48) );
DEST(63..56) ← SaturateToUnsignedByte (DEST(63..56) – SRC(63..56) );
```

ELSE { (* instruction is PSUBUSW *)

```
DEST(15..0) ← SaturateToUnsignedWord (DEST(15..0) – SRC(15..0) );
DEST(31..16) ← SaturateToUnsignedWord (DEST(31..16) – SRC(31..16) );
DEST(47..32) ← SaturateToUnsignedWord (DEST(47..32) – SRC(47..32) );
DEST(63..48) ← SaturateToUnsignedWord (DEST(63..48) – SRC(63..48) );
```

FI;

Flags Affected

None.

Additional Itanium® System Environment Exceptions

Itanium Reg Faults Disabled FP Register Fault if PSR.dfl is 1, NaT Register Consumption Abort.

Itanium Mem Faults VHPT Data Fault, Nested TLB Fault, Data TLB Fault, Alternate Data TLB Fault, Data Page Not Present Fault, Data NaT Page Consumption Abort, Data Key Miss Fault, Data Key Permission Fault, Data Access Rights Fault, Data Access Bit Fault, Data Dirty Bit Fault

Protected Mode Exceptions

| | |
|-----------------|--|
| #GP(0) | If a memory operand effective address is outside the CS, DS, ES, FS or GS segment limit. |
| #SS(0) | If a memory operand effective address is outside the SS segment limit. |
| #UD | If EM in CR0 is set. |
| #NM | If TS in CR0 is set. |
| #MF | If there is a pending FPU exception. |
| #PF(fault-code) | If a page fault occurs. |
| #AC(0) | If alignment checking is enabled and an unaligned memory reference is made while the current privilege level is 3. |

PSUBUSB/PSUBUSW—Packed Subtract Unsigned with Saturation (Continued)

Real-Address Mode Exceptions

| | |
|-----|---|
| #GP | If any part of the operand lies outside of the effective address space from 0 to FFFFH. |
| #UD | If EM in CR0 is set. |
| #NM | If TS in CR0 is set. |
| #MF | If there is a pending FPU exception. |

Virtual-8086 Mode Exceptions

| | |
|-----------------|---|
| #GP | If any part of the operand lies outside of the effective address space from 0 to FFFFH. |
| #UD | If EM in CR0 is set. |
| #NM | If TS in CR0 is set. |
| #MF | If there is a pending FPU exception. |
| #PF(fault-code) | If a page fault occurs. |
| #AC(0) | If alignment checking is enabled and an unaligned memory reference is made. |

PUNPCKHBW/PUNPCKHWD/PUNPCKHDQ—Unpack High Packed Data

| Opcode | Instruction | Description |
|----------|-----------------------------|---|
| 0F 68 /r | PUNPCKHBW <i>mm, mm/m64</i> | Interleave high-order bytes from <i>mm</i> and <i>mm/m64</i> into <i>mm</i> . |
| 0F 69 /r | PUNPCKHWD <i>mm, mm/m64</i> | Interleave high-order words from <i>mm</i> and <i>mm/m64</i> into <i>mm</i> . |
| 0F 6A /r | PUNPCKHDQ <i>mm, mm/m64</i> | Interleave high-order doublewords from <i>mm</i> and <i>mm/m64</i> into <i>mm</i> . |

Description

Unpacks and interleaves the high-order data elements (bytes, words, or doublewords) of the destination operand (first operand) and source operand (second operand) into the destination operand (see Figure 2-22). The low-order data elements are ignored. The destination operand must be an MMX technology register; the source operand may be either an MMX technology register or a 64-bit memory location. When the source data comes from a memory operand, the full 64-bit operand is accessed from memory, but the instruction uses only the high-order 32 bits.

Figure 2-22. High-order Unpacking and Interleaving of Bytes with the PUNPCKHBW Instruction

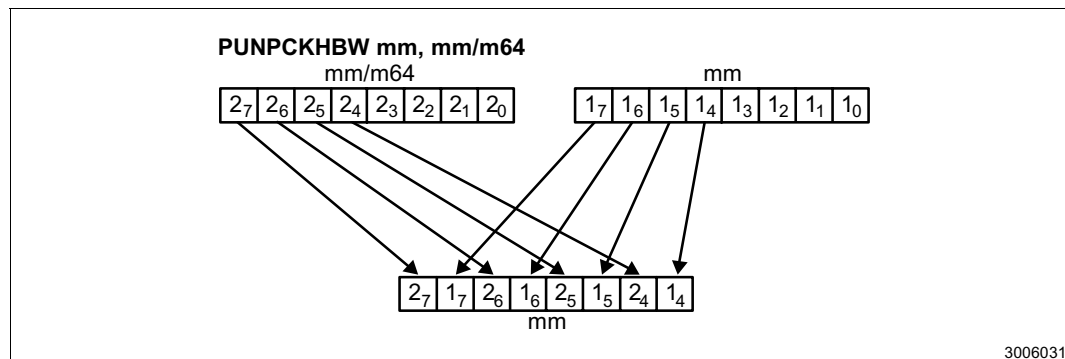

The PUNPCKHBW instruction interleaves the four high-order bytes of the source operand and the four high-order bytes of the destination operand and writes them to the destination operand.

The PUNPCKHWD instruction interleaves the two high-order words of the source operand and the two high-order words of the destination operand and writes them to the destination operand.

The PUNPCKHDQ instruction interleaves the high-order doubleword of the source operand and the high-order doubleword of the destination operand and writes them to the destination operand.

If the source operand is all zeros, the result (stored in the destination operand) contains zero extensions of the high-order data elements from the original value in the destination operand. With the PUNPCKHBW instruction the high-order bytes are zero extended (that is, unpacked into unsigned words), and with the PUNPCKHWD instruction, the high-order words are zero extended (unpacked into unsigned doublewords).

PUNPCKHBW/PUNPCKHWD/PUNPCKHDQ—Unpack High Packed Data (Continued)

Operation

```

IF instruction is PUNPCKHBW
  THEN
    DEST(7..0) ← DEST(39..32);
    DEST(15..8) ← SRC(39..32);
    DEST(23..16) ← DEST(47..40);
    DEST(31..24) ← SRC(47..40);
    DEST(39..32) ← DEST(55..48);
    DEST(47..40) ← SRC(55..48);
    DEST(55..48) ← DEST(63..56);
    DEST(63..56) ← SRC(63..56);
  ELSE IF instruction is PUNPCKHW
    THEN
      DEST(15..0) ← DEST(47..32);
      DEST(31..16) ← SRC(47..32);
      DEST(47..32) ← DEST(63..48);
      DEST(63..48) ← SRC(63..48);
    ELSE (* instruction is PUNPCKHDQ *)
      DEST(31..0) ← DEST(63..32)
      DEST(63..32) ← SRC(63..32);
  FI;

```

Flags Affected

None.

Additional Itanium® System Environment Exceptions

Itanium Reg Faults Disabled FP Register Fault if PSR.dfl is 1, NaT Register Consumption Abort.

Itanium Mem Faults VHPT Data Fault, Nested TLB Fault, Data TLB Fault, Alternate Data TLB Fault, Data Page Not Present Fault, Data NaT Page Consumption Abort, Data Key Miss Fault, Data Key Permission Fault, Data Access Rights Fault, Data Access Bit Fault, Data Dirty Bit Fault

Protected Mode Exceptions

| | |
|-----------------|--|
| #GP(0) | If a memory operand effective address is outside the CS, DS, ES, FS or GS segment limit. |
| #SS(0) | If a memory operand effective address is outside the SS segment limit. |
| #UD | If EM in CR0 is set. |
| #NM | If TS in CR0 is set. |
| #MF | If there is a pending FPU exception. |
| #PF(fault-code) | If a page fault occurs. |
| #AC(0) | If alignment checking is enabled and an unaligned memory reference is made while the current privilege level is 3. |



PUNPCKHBW/PUNPCKHWD/PUNPCKHDQ—Unpack High Packed Data (Continued)

Real-Address Mode Exceptions

| | |
|-----|---|
| #GP | If any part of the operand lies outside of the effective address space from 0 to FFFFH. |
| #UD | If EM in CR0 is set. |
| #NM | If TS in CR0 is set. |
| #MF | If there is a pending FPU exception. |

Virtual-8086 Mode Exceptions

| | |
|-----------------|---|
| #GP | If any part of the operand lies outside of the effective address space from 0 to FFFFH. |
| #UD | If EM in CR0 is set. |
| #NM | If TS in CR0 is set. |
| #MF | If there is a pending FPU exception. |
| #PF(fault-code) | If a page fault occurs. |
| #AC(0) | If alignment checking is enabled and an unaligned memory reference is made. |

PUNPCKLBW/PUNPCKLWD/PUNPCKLDQ—Unpack Low Packed Data

| Opcode | Instruction | Description |
|----------|-----------------------------|--|
| 0F 60 /r | PUNPCKLBW <i>mm, mm/m32</i> | Interleave low-order bytes from <i>mm</i> and <i>mm/m64</i> into <i>mm</i> . |
| 0F 61 /r | PUNPCKLWD <i>mm, mm/m32</i> | Interleave low-order words from <i>mm</i> and <i>mm/m64</i> into <i>mm</i> . |
| 0F 62 /r | PUNPCKLDQ <i>mm, mm/m32</i> | Interleave low-order doublewords from <i>mm</i> and <i>mm/m64</i> into <i>mm</i> . |

Description

Unpacks and interleaves the low-order data elements (bytes, words, or doublewords) of the destination and source operands into the destination operand (see Figure 2-23). The destination operand must be an MMX technology register; the source operand may be either an MMX technology register or a memory location. When source data comes from an MMX technology register, the upper 32 bits of the register are ignored. When the source data comes from a memory, only 32-bits are accessed from memory.

Figure 2-23. Low-order Unpacking and Interleaving of Bytes with the PUNPCKLBW Instruction

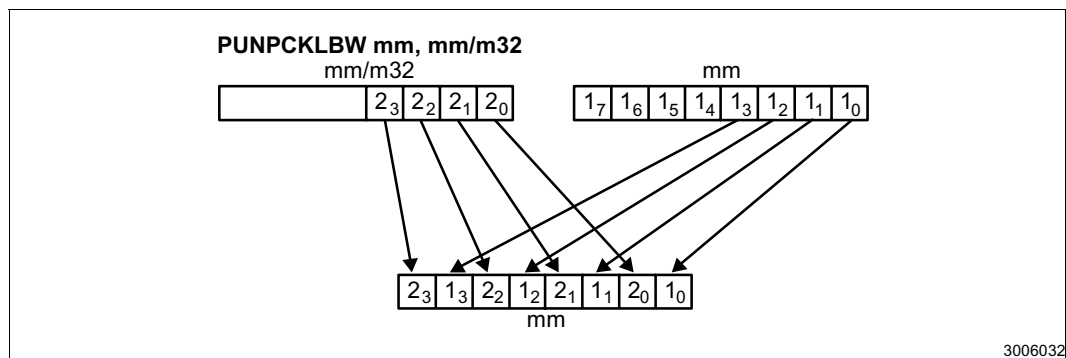

The PUNPCKLBW instruction interleaves the four low-order bytes of the source operand and the four low-order bytes of the destination operand and writes them to the destination operand.

The PUNPCKLWD instruction interleaves the two low-order words of the source operand and the two low-order words of the destination operand and writes them to the destination operand.

The PUNPCKLDQ instruction interleaves the low-order doubleword of the source operand and the low-order doubleword of the destination operand and writes them to the destination operand.

If the source operand is all zeros, the result (stored in the destination operand) contains zero extensions of the high-order data elements from the original value in the destination operand. With the PUNPCKLBW instruction the low-order bytes are zero extended (that is, unpacked into unsigned words), and with the PUNPCKLWD instruction, the low-order words are zero extended (unpacked into unsigned doublewords).

PUNPCKLBW/PUNPCKLWD/PUNPCKLDQ—Unpack Low Packed Data (Continued)

Operation

```

IF instruction is PUNPCKLBW
  THEN
    DEST(63..56) ← SRC(31..24);
    DEST(55..48) ← DEST(31..24);
    DEST(47..40) ← SRC(23..16);
    DEST(39..32) ← DEST(23..16);
    DEST(31..24) ← SRC(15..8);
    DEST(23..16) ← DEST(15..8);
    DEST(15..8) ← SRC(7..0);
    DEST(7..0) ← DEST(7..0);
ELSE IF instruction is PUNPCKLWD
  THEN
    DEST(63..48) ← SRC(31..16);
    DEST(47..32) ← DEST(31..16);
    DEST(31..16) ← SRC(15..0);
    DEST(15..0) ← DEST(15..0);
ELSE (* instruction is PUNPCKLDQ *)
  DEST(63..32) ← SRC(31..0);
  DEST(31..0) ← DEST(31..0);
FI;

```

Flags Affected

None.

Additional Itanium® System Environment Exceptions

Itanium Reg Faults Disabled FP Register Fault if PSR.dfl is 1, NaT Register Consumption Abort.

Itanium Mem Faults VHPT Data Fault, Nested TLB Fault, Data TLB Fault, Alternate Data TLB Fault, Data Page Not Present Fault, Data NaT Page Consumption Abort, Data Key Miss Fault, Data Key Permission Fault, Data Access Rights Fault, Data Access Bit Fault, Data Dirty Bit Fault

Protected Mode Exceptions

| | |
|-----------------|--|
| #GP(0) | If a memory operand effective address is outside the CS, DS, ES, FS or GS segment limit. |
| #SS(0) | If a memory operand effective address is outside the SS segment limit. |
| #UD | If EM in CR0 is set. |
| #NM | If TS in CR0 is set. |
| #MF | If there is a pending FPU exception. |
| #PF(fault-code) | If a page fault occurs. |
| #AC(0) | If alignment checking is enabled and an unaligned memory reference is made while the current privilege level is 3. |

PUNPCKLBW/PUNPCKLWD/PUNPCKLDQ—Unpack Low Packed Data (Continued)

Real-Address Mode Exceptions

| | |
|-----|---|
| #GP | If any part of the operand lies outside of the effective address space from 0 to FFFFH. |
| #UD | If EM in CR0 is set. |
| #NM | If TS in CR0 is set. |
| #MF | If there is a pending FPU exception. |

Virtual-8086 Mode Exceptions

| | |
|-----------------|---|
| #GP | If any part of the operand lies outside of the effective address space from 0 to FFFFH. |
| #UD | If EM in CR0 is set. |
| #NM | If TS in CR0 is set. |
| #MF | If there is a pending FPU exception. |
| #PF(fault-code) | If a page fault occurs. |
| #AC(0) | If alignment checking is enabled and an unaligned memory reference is made. |

PXOR—Logical Exclusive OR

| Opcode | Instruction | Description |
|----------|--------------------------------|--|
| 0F EF /r | PXOR <i>mm</i> , <i>mm/m64</i> | XOR quadword from <i>mm/m64</i> to quadword in <i>mm</i> . |

Description

Performs a bitwise logical exclusive-OR (XOR) operation on the quadword source (second) and destination (first) operands and stores the result in the destination operand location (see [Figure 2-24](#)). The source operand can be an MMX technology register or a quadword memory location; the destination operand must be an MMX technology register. Each bit of the result is 1 if the corresponding bits of the two operands are different; each bit is 0 if the corresponding bits of the operands are the same.

Figure 2-24. Operation of the PXOR Instruction

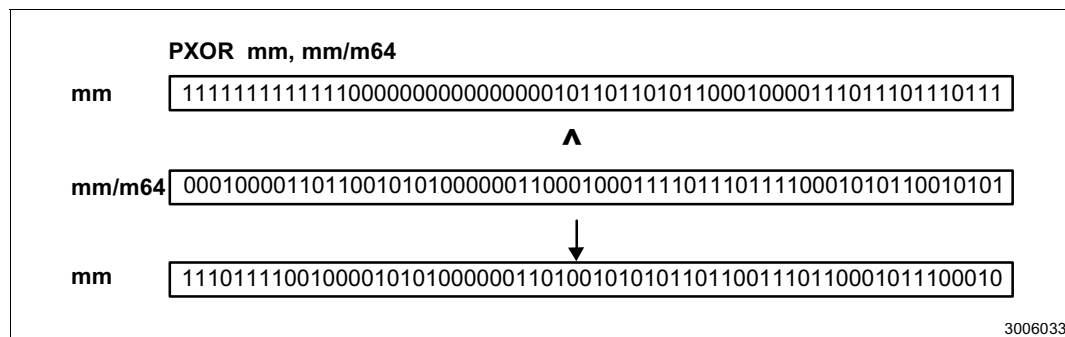

Operation

$DEST \leftarrow DEST \text{ XOR } SRC;$

Flags Affected

None.

Additional Itanium® System Environment Exceptions

Itanium Reg Faults Disabled FP Register Fault if PSR.dfl is 1, NaT Register Consumption Abort.

Itanium Mem Faults VHPT Data Fault, Nested TLB Fault, Data TLB Fault, Alternate Data TLB Fault, Data Page Not Present Fault, Data NaT Page Consumption Abort, Data Key Miss Fault, Data Key Permission Fault, Data Access Rights Fault, Data Access Bit Fault, Data Dirty Bit Fault

PXOR—Logical Exclusive OR (Continued)

Protected Mode Exceptions

| | |
|-----------------|--|
| #GP(0) | If a memory operand effective address is outside the CS, DS, ES, FS or GS segment limit. |
| #SS(0) | If a memory operand effective address is outside the SS segment limit. |
| #UD | If EM in CR0 is set. |
| #NM | If TS in CR0 is set. |
| #MF | If there is a pending FPU exception. |
| #PF(fault-code) | If a page fault occurs. |
| #AC(0) | If alignment checking is enabled and an unaligned memory reference is made while the current privilege level is 3. |

Real-Address Mode Exceptions

| | |
|-----|---|
| #GP | If any part of the operand lies outside of the effective address space from 0 to FFFFH. |
| #UD | If EM in CR0 is set. |
| #NM | If TS in CR0 is set. |
| #MF | If there is a pending FPU exception. |

Virtual-8086 Mode Exceptions

| | |
|-----------------|---|
| #GP | If any part of the operand lies outside of the effective address space from 0 to FFFFH. |
| #UD | If EM in CR0 is set. |
| #NM | If TS in CR0 is set. |
| #MF | If there is a pending FPU exception. |
| #PF(fault-code) | If a page fault occurs. |
| #AC(0) | If alignment checking is enabled and an unaligned memory reference is made. |

IA-32 Streaming SIMD Extension Instruction Reference

3.1 IA-32 Streaming SIMD Extension Instructions

This section lists the IA-32 Streaming SIMD Extension instructions designed to increase performance of IA-32 3D and floating-point intensive applications. For details on Streaming SIMD Extension please refer to the *IA-32 Intel[®] Architecture Software Developer's Manual*.

3.2 About the Intel[®] Architecture Streaming SIMD Extensions

The Streaming SIMD Extensions for the Intel Architecture (IA) accelerates performance of 3D graphics applications over the current P6 generation of the Pentium Pro, Pentium II and Pentium III processors. The programming model is similar to the MMX technology model except that instructions now operate on new packed floating-point data types which contain four single-precision floating-point numbers.

The Streaming SIMD Extensions introduces new general purpose floating-point instructions, which operate on a new set of eight 128-bit Streaming SIMD Extension registers. This gives the programmer the ability to develop algorithms that can finely mix packed single-precision floating-point and integer using both Streaming SIMD Extension and MMX instructions respectively. In addition to these instructions, Streaming SIMD Extensions also provides new instructions to control cacheability of all MMX technology data types. These include ability to stream data into and from the processor while minimizing pollution of the caches and the ability to prefetch data before it is actually used. The main focus of packed floating-point instructions is the acceleration of 3D geometry. The new definition also contains additional SIMD Integer instructions to accelerate 3D rendering and video encoding and decoding. Together with the cacheability control instruction, this combination enables the development of new algorithms that can significantly accelerate 3D graphics.

The new Streaming SIMD Extension state requires OS support for saving and restoring the new state during a context switch. A new set of extended FSAVE/FRSTOR instructions will permit saving/restoring new and existing state for applications and OS. To make use of these new instructions, an application must verify that the processor supports Streaming SIMD Extensions and the operating system supports this new extension. If both the extension and support is enabled, then the software application can use the new features.

The Streaming SIMD Extension instruction set is fully compatible with all software written for Intel architecture microprocessors. All existing software continues to run correctly, without modification, on microprocessors that incorporate the Streaming SIMD Extensions, as well as in the presence of existing and new applications that incorporate this technology.

3.3 Single Instruction Multiple Data

The Streaming SIMD Extensions uses the Single Instruction Multiple Data (SIMD) technique. This technique speeds up software performance by processing multiple data elements in parallel, using a single instruction. The Streaming SIMD Extensions supports operations on packed single-precision floating-point data types, and the additional SIMD Integer instructions support operations on packed quadrate data types (byte, word, or double-word). This approach was chosen because most 3D graphics and DSP applications have the following characteristics:

- Inherently parallel
- Wide dynamic range, hence floating-point based
- Regular and re-occurring memory access patterns
- Localized re-occurring operations performed on the data
- Data independent control flow

Streaming SIMD Extensions is 100% compatible with the IEEE Standard 754 for Binary Floating-point Arithmetic. The Streaming SIMD Extension instructions are accessible from all IA execution modes: Protected mode, Real address mode, and Virtual 8086 mode. **New Features**

Streaming SIMD Extensions provides the following new features, while maintaining backward compatibility with all existing Intel architecture microprocessors, IA applications and operating systems.

- New data type
- Eight Streaming SIMD Extension registers
- Enhanced instruction set

Streaming SIMD Extensions can enhance the performance of applications that use these features.

3.4 New Data Types

The principal data type of the Streaming SIMD Extensions is a packed single-precision floating-point operand, specifically:

- Four 32-bit single-precision (SP) floating-point numbers ([Figure 3-1](#)).

The SIMD Integer instructions will operate on the packed byte, word or doubleword data types. The prefetch instruction works on typeless data of size 32 bytes or greater.

Figure 3-1. Packed Single-FP Data Type

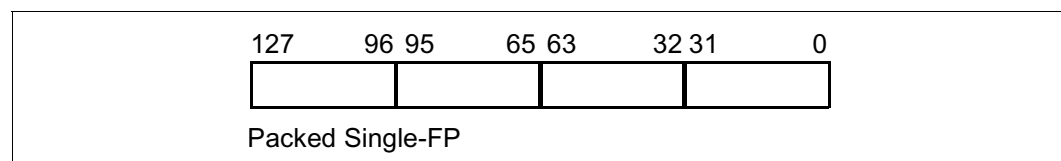

3.5 Streaming SIMD Extension Registers

The Streaming SIMD Extensions provides eight 128-bit general purpose registers, each of which can be directly addressed. These registers are new state, and require support from the operating system to use them.

The Streaming SIMD Extension registers can hold packed 128-bit data. The Streaming SIMD Extension instructions access the Streaming SIMD Extension registers directly using the registers names XMM0 to XMM7 (Figure 3-2).

Figure 3-2. Streaming SIMD Extension Register Set

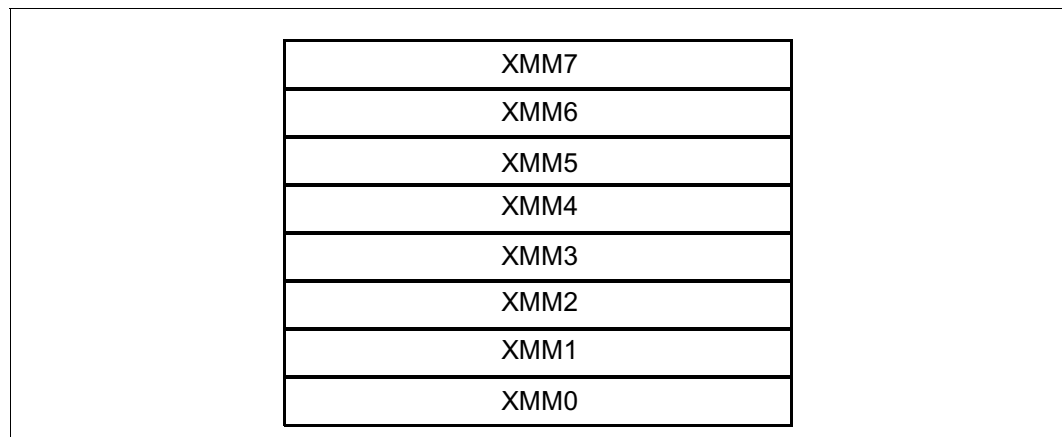

Streaming SIMD Extension registers can be used to perform calculation on data. They cannot be used to address memory; addressing is accomplished by using the integer registers and existing IA addressing modes.

The contents of Streaming SIMD Extension registers are cleared upon reset.

There is a new control/status register MXCSR which is used to mask/unmask numerical exception handling, to set rounding modes, to set flush-to-zero mode, and to view status flags.

3.6 Extended Instruction Set

The Streaming SIMD Extensions supplies a rich set of instructions that operate on either all or the least significant pairs of packed data operands, in parallel. The packed instructions operate on a pair of operands as shown in Figure 3-3 while scalar instructions always operate on the least significant pair of the two operands as shown in Figure 3-4; for scalar operations, the three upper components from the first operand are passed through to the destination. In general, the address of a memory operand has to be aligned on a 16-byte boundary for all instructions, except for unaligned loads and stores.

Figure 3-3. Packed Operation

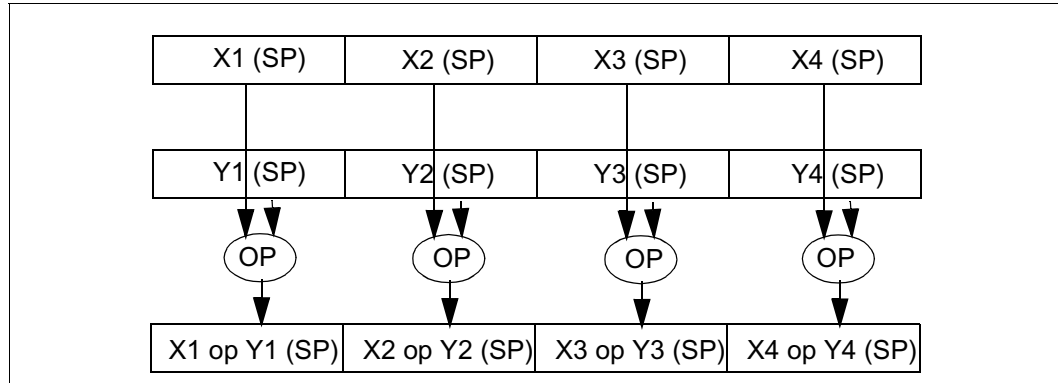
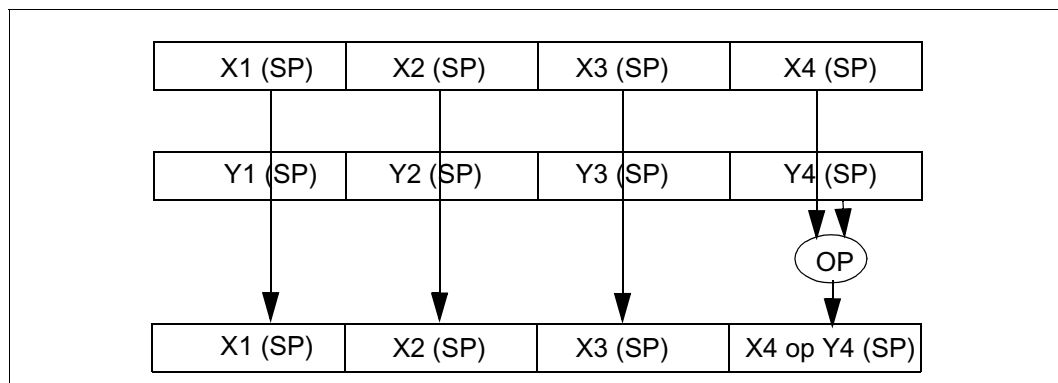

Figure 3-4. Scalar Operation



3.6.1 Instruction Group Review

3.6.1.1 Arithmetic Instructions

Packed/Scalar Addition and Subtraction

The ADDPS (Add packed single-precision floating-point) and SUBPS (Subtract packed single-precision floating-point) instructions add or subtract four pairs of packed single-precision floating-point operands.

The ADDSS (Add scalar single-precision floating-point) and SUBSS (Subtract scalar single-precision floating-point) instructions add or subtract the least significant pair of packed single-precision floating-point operands; the upper three fields are passed through from the source operand.

Packed/Scalar Multiplication and Division

The MULPS (Multiply packed single-precision floating-point) instruction multiplies four pairs of packed single-precision floating-point operands.

The MULSS (Multiply scalar single-precision floating-point) instruction multiplies the least significant pair of packed single-precision floating-point operands; the upper three fields are passed through from the source operand.

The DIVPS (Divide packed single-precision floating-point) instruction divides four pairs of packed single-precision floating-point operands.

The DIVSS (Divide scalar single-precision floating-point) instruction divides the least significant pair of packed single-precision floating-point operands; the upper three fields are passed through from the source operand.

Packed/Scalar Square Root

The SQRTPS (Square root packed single-precision floating-point) instruction returns the square root of the packed four single-precision floating-point numbers from the source to a destination register.

The SQRTSS (Square root scalar single-precision floating-point) instruction returns the square root of the least significant component of the packed single-precision floating-point numbers from source to a destination register; the upper three fields are passed through from the source operand.

Packed Maximum/Minimum

The MAXPS (Maximum packed single-precision floating-point) instruction returns the maximum of each pair of packed single-precision floating-point numbers into the destination register.

The MAXSS (Maximum scalar single-precision floating-point) instructions returns the maximum of the least significant pair of packed single-precision floating-point numbers into the destination register; the upper three fields are passed through from the source operand, to the destination register.

The MINPS (Minimum packed single-precision floating-point) instruction returns the minimum of each pair of packed single-precision floating-point numbers into the destination register.

The MINSS (Minimum scalar single-precision floating-point) instruction returns the minimum of the least significant pair of packed single-precision floating-point numbers into the destination register; the upper three fields are passed through from the source operand, to the destination register

3.6.1.2 Logical Instructions

The ANDPS (Bit-wise packed logical AND for single-precision floating-point) instruction returns a bitwise AND between the two operands.

The ANDNPS (Bit-wise packed logical AND NOT for single-precision floating-point) instruction returns a bitwise AND NOT between the two operands.

The ORPS (Bit-wise packed logical OR for single-precision floating-point) instruction returns a bitwise OR between the two operands.

The XORPS (Bit-wise packed logical XOR for single-precision floating-point) instruction returns a bitwise XOR between the two operands.

3.6.1.3 Compare Instructions

The CMPPS (Compare packed single-precision floating-point) instruction compares four pairs of packed single-precision floating-point numbers using the immediate operand as a predicate, returning per SP field an all “1” 32-bit mask or an all “0” 32-bit mask as a result. The instruction supports a full set of 12 conditions: equal, less than, less than equal, greater than, greater than or equal, unordered, not equal, not less than, not less than or equal, not greater than, not greater than or equal, ordered.

The CMPSS (Compare scalar single-precision floating-point) instruction compares the least significant pairs of packed single-precision floating-point numbers using the immediate operand as a predicate (same as CMPPS), returning per SP field an all “1” 32-bit mask or an all “0” 32-bit mask as a result.

The COMISS (Compare scalar single-precision floating-point ordered and set EFLAGS) instruction compares the least significant pairs of packed single-precision floating-point numbers and sets the ZF,PF,CF bits in the EFLAGS register (the OF, SF and AF bits are cleared).

The UCOMISS (Unordered compare scalar single-precision floating-point ordered and set EFLAGS) instruction compares the least significant pairs of packed single-precision floating-point numbers and sets the ZF,PF,CF bits in the EFLAGS register as described above (the OF, SF and AF bits are cleared).

3.6.1.4 Shuffle Instructions

The SHUFPS (Shuffle packed single-precision floating-point) instruction is able to shuffle any of the packed four single-precision floating-point numbers from one source operand to the lower two destination fields; the upper two destination fields are generated from a shuffle of any of the four SP FP numbers from the second source operand (Figure 3-5). By using the same register for both sources, SHUFPS can return any combination of the four SP FP numbers from this register.

Figure 3-5. Packed Shuffle Operation

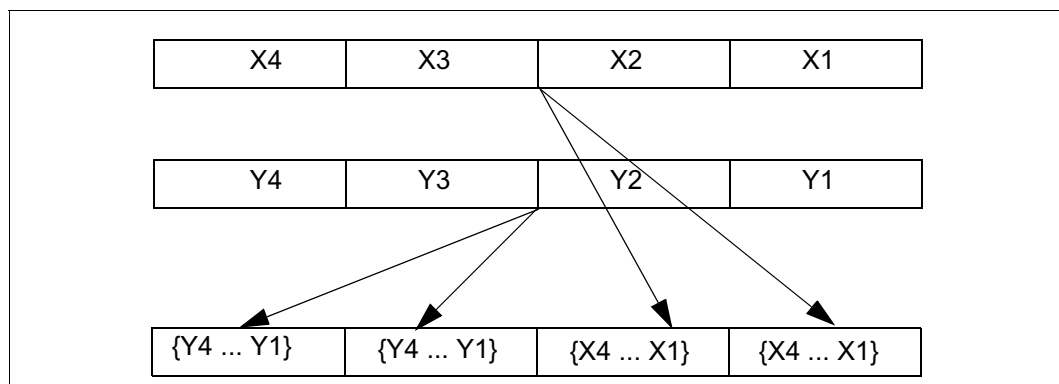

The UNPCKHPS (Unpacked high packed single-precision floating-point) instruction performs an interleaved unpack of the high-order data elements of first and second packed single-precision floating-point operands. It ignores the lower half part of the sources (Figure 3-6). When unpacking from a memory operand, the full 128-bit operand is accessed from memory but only the high order 64 bits are utilized by the instruction.

Figure 3-6. Unpack High Operation

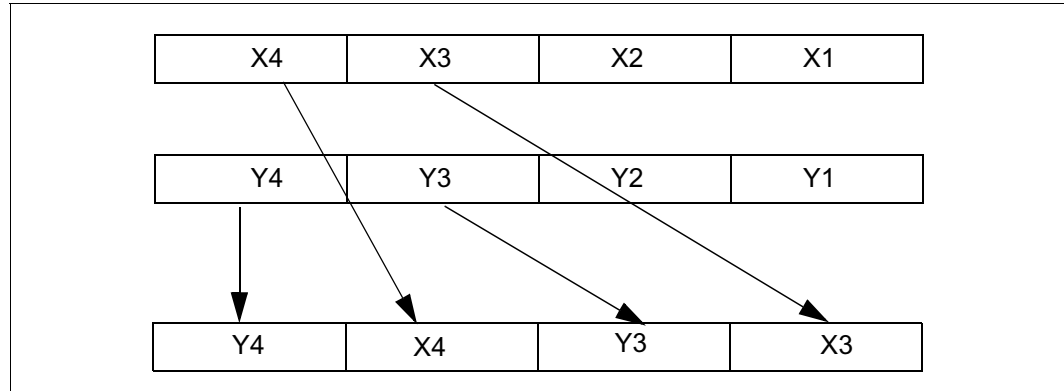

The UNPCKLPS (Unpacked low packed single-precision floating-point) instruction performs an interleaved unpack of the low-order data elements of first and second packed single-precision floating-point operands. It ignores the higher half part of the sources (Figure 3-7). When unpacking from a memory operand, the full 128-bit operand is accessed from memory but only the low order 64 bits are utilized by the instruction.

Figure 3-7. Unpack Low Operation

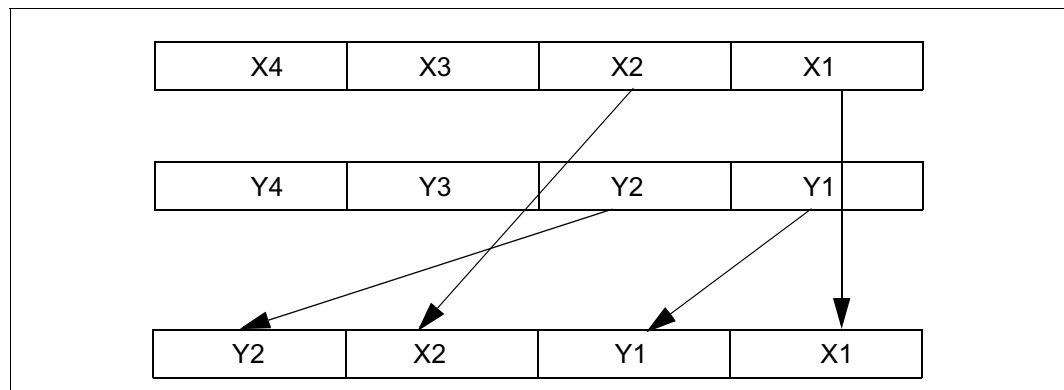

3.6.1.5 Conversion Instructions

These instructions support packed and scalar conversions between 128-bit Streaming SIMD Extension registers and either 64-bit integer MMX technology registers or 32-bit integer IA-32 registers. The packed versions behave identically to original MMX instructions, in the presence of x87-FP instructions, including:

- Transition from x87-FP to MMX technology (TOS=0, FP valid bits set to all valid).
- MMX instructions write ones (1's) to the exponent part of the corresponding x87-FP register.
- Use of EMMS for transition from MMX technology to x87-FP.

The CVTPI2PS (Convert packed 32-bit integer to packed single-precision floating-point) instruction converts two 32-bit signed integers in a MMX technology register to the two least significant single-precision floating-point numbers; when the conversion is inexact, the rounded value according to the rounding mode in MXCSR is returned. The upper two significant numbers in the destination register are retained.

The CVTSS2SI (Convert scalar single-precision floating-point to a 32-bit integer) instruction converts the least significant single-precision floating-point number to a 32-bit signed integer in an Intel architecture 32-bit integer register; when the conversion is inexact, the rounded value according to the rounding mode in MXCSR is returned. The CVTSS2SI instruction is similar to CVTSS2SI except if the conversion is inexact, the truncated result is returned.

The CVTSS2SI (Convert scalar single-precision floating-point to a 32-bit integer) instruction converts the least significant single-precision floating-point number to a 32-bit signed integer in an Intel architecture 32-bit integer register; when the conversion is inexact, the rounded value according to the rounding mode in MXCSR is returned. The CVTSS2SI instruction is similar to CVTSS2SI except if the conversion is inexact, the truncated result is returned.

The CVTSS2SI (Convert scalar single-precision floating-point to a 32-bit integer) instruction converts the least significant single-precision floating-point number to a 32-bit signed integer in an Intel architecture 32-bit integer register; when the conversion is inexact, the rounded value according to the rounding mode in MXCSR is returned. The CVTSS2SI instruction is similar to CVTSS2SI except if the conversion is inexact, the truncated result is returned.

3.6.1.6 Data Movement Instructions

The MOVAPS (Move aligned packed single-precision floating-point) instruction transfers 128-bits of packed data from memory to Streaming SIMD Extension registers and vice versa, or between Streaming SIMD Extension registers. The memory address is aligned to 16-byte boundary; if not then a general protection exception will occur.

The MOVUPS (Move unaligned packed single-precision floating-point) instruction transfers 128-bits of packed data from memory to Streaming SIMD Extension registers and vice versa, or between Streaming SIMD Extension registers. No assumption is made for alignment.

The MOVHPS (Move aligned high packed single-precision floating-point) instruction transfers 64-bits of packed data from memory to the upper two fields of a Streaming SIMD Extension register and vice versa. The lower field is left unchanged.

The MOVLPS (Move aligned low packed single-precision floating-point) instruction transfers 64-bits of packed data from memory to the lower two fields of a Streaming SIMD Extension register and vice versa. The upper field is left unchanged.

The MOVMSKPS (Move mask packed single-precision floating-point) instruction transfers the most significant bit of each of the four packed single-precision floating-point number to an IA integer register. This 4-bit value can then be used as a condition to perform branching.

The MOVSS (Move scalar single-precision floating-point) instruction transfers a single 32-bit floating-point number from memory to a Streaming SIMD Extension register or vice versa, and between registers.

3.6.1.7 State Management Instructions

The LDMXCSR (Load Streaming SIMD Extension Control and Status Register) instruction loads the Streaming SIMD Extension control and status register from memory. STMXCSR (Store Streaming SIMD Extension Control and Status Register) instruction stores the Streaming SIMD Extension control and status word to memory.

The FXSAVE instruction saves FP and MMX technology state and Streaming SIMD Extension state to memory. Unlike FSAVE, FXSAVE does not clear the x87-FP state. FXRSTOR loads FP and MMX technology state and Streaming SIMD Extension state from memory.

3.6.1.8 Additional SIMD Integer Instructions

Similar to the conversions instructions discussed in [Section 3.6.1.5](#), these SIMD Integer instructions also behave identically to original MMX instructions, in the presence of x87-FP instructions.

The PAVGB/PAVGW (Average unsigned source sub-operands, without incurring a loss in precision) instructions add the unsigned data elements of the source operand to the unsigned data elements of the destination register. The results of the add are then each independently right shifted right by one bit position. The high order bits of each element are filled with the carry bits of the sums. To prevent cumulative round-off errors, an averaging is performed. The low order bit of each final shifted result is set to 1 if at least one of the two least significant bits of the intermediate unshifted shifted sum is 1.

The PEXTRW (Extract 16-bit word from MMX technology register) instruction moves the word in a MMX technology register selected by the two least significant bits of the immediate operand to the lower half of a 32-bit integer register; the upper word in the integer register is cleared.

The PINSRW (Insert 16-bit word into MMX technology register) instruction moves the lower word in a 32-bit integer register or 16-bit word from memory into one of the four word locations in a MMX technology register, selected by the two least significant bits of the immediate operand.

The PMAXUB/PMAXSW (Maximum of packed unsigned integer bytes or signed integer words) instruction returns the maximum of each pair of packed elements into the destination register.

The PMINUB/PMINSW (Minimum of packed unsigned integer bytes or signed integer words) instructions returns the minimum of each pair of packed data elements into the destination register.

The PMOVMASKB (Move Byte Mask from MMX technology register) instruction returns an 8-bit mask formed of the most significant bits of each byte of its source operand in a MMX technology register to an IA integer register.

The PMULHUW (Unsigned high packed integer word multiply in MMX technology register) instruction performs an unsigned multiply on each word field of the two source MMX technology registers, returning the high word of each result to a MMX technology register.

The PSADBW (Sum of absolute differences) instruction computes the absolute difference for each pair of sub-operand byte sources and then accumulates the 8 differences into a single 16-bit result.

The PSHUFW (Shuffle packed integer word in MMX technology register) instruction performs a full shuffle of any source word field to any result word field, using an 8-bit immediate operand.

3.6.1.9 Cacheability Control Instructions

Data referenced by a programmer can have temporal (data will be used again) or spatial (data will be in adjacent locations, e.g. same cache line) locality. Some multimedia data types, such as the display list in a 3D graphics application, are referenced once and not reused in the immediate future. We will refer to this data type as non-temporal data. Thus the programmer does not want the application's cached code and data to be overwritten by this non-temporal data. The cacheability control instructions enable the programmer to control caching so that non-temporal accesses will minimize cache pollution.

In addition, the execution engine needs to be fed such that it does not become stalled waiting for data. Streaming SIMD Extension instructions allow the programmer to prefetch data long before it's final use. These instructions are not architectural since they do not update any architectural state, and are specific to each implementation. The programmer may have to tune his application for each implementation to take advantage of these instructions. These instructions merely provide a hint to the hardware, and they will not generate exceptions or faults. Excessive use of prefetch instructions may be throttled by the processor.

The following four instructions provide hints to the cache hierarchy which enables the data to be prefetched to different levels of the cache hierarchy and avoid polluting cache with non-temporal data.

The MASKMOVQ (Non-temporal byte mask store of packed integer in a MMX technology register) instruction stores data from a MMX technology register to the location specified by the EDI register. The most significant bit in each byte of the second MMX technology mask register is used to selectively write the data of the first register on a per-byte basis. The instruction is implicitly weakly-ordered, with all of the characteristics of the WC memory type; successive non-temporal stores may not write memory in program-order, do not write-allocate (i.e. the processor will not fetch the corresponding cache line into the cache hierarchy, prior to performing the store), write combine/collapse, and minimize cache pollution.

The MOVNTQ (Non-temporal store of packed integer in a MMX technology register) instruction stores data from a MMX technology register to memory. The instruction is implicitly weakly-ordered, does not write-allocate and minimizes cache pollution.

The MOVNTPS (Non-temporal store of packed single-precision floating-point) instruction stores data from a Streaming SIMD Extension register to memory. The memory address must be aligned to a 16-byte boundary; if it is not aligned, a general protection exception will occur. The instruction is implicitly weakly-ordered, does not write-allocate and minimizes cache pollution.

The main difference between a non-temporal store and a regular cacheable store is in the write-allocation policy. The memory type of the region being written to can override the non-temporal hint, leading to the following considerations:

- If the programmer specifies a non-temporal store to uncacheable memory, then the store behaves like an uncacheable store; the non-temporal hint is ignored and the memory type for the region is retained. Uncacheable as referred to here means that the region being written to has been mapped with either a UC or WP memory type. If the memory region has been mapped as WB, WT or WC, the non-temporal store will implement weakly-ordered (WC) semantic behavior.

- If the programmer specifies a non-temporal store to cacheable memory, two cases may result:
 - If the data is present in the cache hierarchy, the instruction will ensure consistency. A given processor may choose different ways to implement this; some examples include: updating data in-place in the cache hierarchy while preserving the memory type semantics assigned to that region, or evicting the data from the caches and writing the new non-temporal data to memory (with WC semantics).
 - If the data is not present in the cache hierarchy, and the destination region is mapped as WB, WT or WC, the transaction will be weakly ordered, and is subject to all WC memory semantics. The non-temporal store will not write allocate. Different implementations may choose to collapse and combine these stores.
- In general, WC semantics require software to ensure coherence, with respect to other processors and other system agents (such as graphics cards). Appropriate use of synchronization and a fencing operation (see SFENCE, below) must be performed for producer-consumer usage models. Fencing ensures that all system agents have global visibility of the stored data; for instance, failure to fence may result in a written cache line staying within a processor, and the line would not be visible to other agents. For processors which implement non-temporal stores by updating data in-place that already resides in the cache hierarchy, the destination region should also be mapped as WC. Otherwise if mapped as WB or WT, there is the potential for speculative processor reads to bring the data into the caches; in this case, non-temporal stores would then update in place, and data would not be flushed from the processor by a subsequent fencing operation.
- The memory type visible on the bus in the presence of memory type aliasing is implementation specific. As one possible example, the memory type written to the bus may reflect the memory type for the first store to this line, as seen in program order; other alternatives are possible. This behavior should be considered reserved, and dependency on the behavior of any particular implementation risks future incompatibility.

The PREFETCH (Load 32 or greater number of bytes) instructions load either non-temporal data or temporal data in the specified cache level. This access and the cache level are specified as a hint. The prefetch instructions do not affect functional behavior of the program and will be implementation specific.

The SFENCE (Store Fence) instruction guarantees that every store instruction that precedes the store fence instruction in program order is globally visible before any store instruction which follows the fence. The SFENCE instruction provides an efficient way of ensuring ordering between routines that produce weakly-ordered results and routines that consume this data.

3.7 IEEE Compliance

A Streaming SIMD Extension floating-point computation is IEEE-754 compliant except when the control word is set to flush to zero mode. IEEE-754 compliance includes support for single-precision signed infinities, QNaNs, SNaNs, integer indefinite, signed zeros, denormals, masked and unmasked exceptions. single-precision floating-point values are represented identically both internally and in memory, and are of the following form:

| Sign | Exponent | Significand |
|------|----------|-------------|
| 31 | 30...23 | 22...0 |

This is a change from x87 floating-point which internally represents all numbers in 80-bit extended format. This change implies that x87-FP libraries re-written to use Streaming SIMD Extension instructions may not produce results that are identical to the those of the x87-FP implementation. Real Numbers and Floating-point Formats.

This section describes how real numbers are represented in floating-point format in the processor. It also introduces terms such as normalized numbers, denormalized numbers, biased exponents, signed zeros, and NaNs. Readers who are already familiar with floating-point processing techniques and the IEEE standards may wish to skip this section.

3.7.1 Real Number System

As shown in Figure 3-8, the real-number system comprises the continuum of real numbers from minus infinity ($-\infty$) to plus infinity ($+\infty$).

Figure 3-8. Binary Real Number System

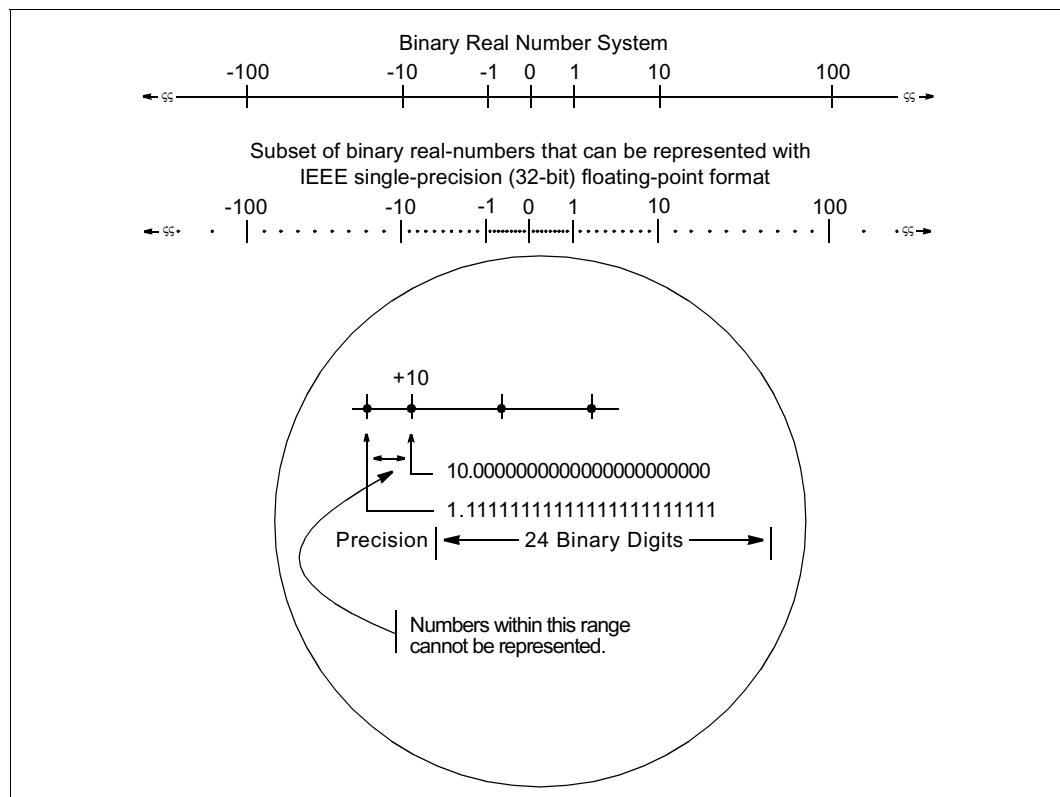

Because the size and number of registers that any computer can have is limited, only a subset of the real-number continuum can be used in real-number calculations. As shown at the bottom of Figure 3-1, the subset of real numbers that a particular processor supports represents an approximation of the real number system. The range and precision of this real-number subset is determined by the format that the processor uses to represent real numbers.

3.7.1.1 Floating-point Format

To increase the speed and efficiency of real-number computations, computers typically represent real numbers in a binary floating-point format. In this format, a real number has three parts: a sign, a significand, and an exponent. Figure 3-9 shows the binary floating-point format that Streaming SIMD Extension data uses. This format conforms to the IEEE standard.

Figure 3-9. Binary Floating-point Format

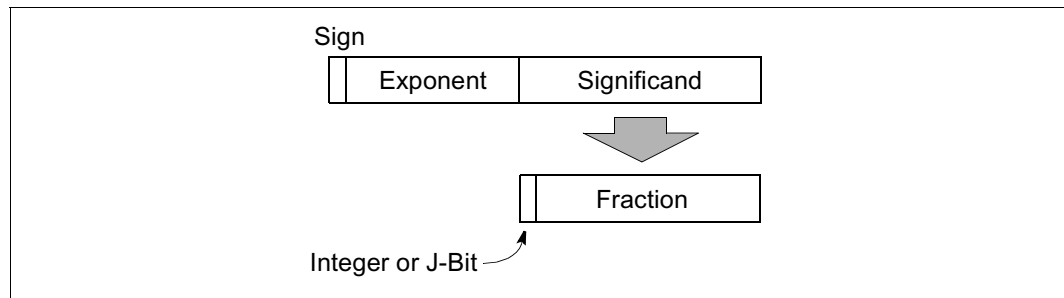

The sign is a binary value that indicates whether the number is positive (0) or negative (1). The significand has two parts: a 1-bit binary integer (also referred to as the J-bit) and a binary fraction. The J-bit is often not represented, but instead is an implied value. The exponent is a binary integer that represents the base-2 power that the significand is raised to.

Table 3-1 shows how the real number 178.125 (in ordinary decimal format) is stored in floating-point format. The table lists a progression of real number notations that leads to the format that the processor uses. In this format, the binary real number is normalized and the exponent is biased.

Table 3-1. Real Number Notation

| Notation | Value | | |
|-------------------------------------|------------------------------------|-----------------|---|
| Ordinary Decimal | 178.125 | | |
| Scientific Decimal | 1.78125E ₁₀₂ | | |
| Scientific Binary | 1.0110010001E ₂₁₁₁ | | |
| Scientific Binary (Biased Exponent) | 1.0110010001E ₂₁₀₀₀₀₁₁₀ | | |
| Single Format (Normalized) | Sign | Biased Exponent | Significand |
| | 0 | 10000110 | 011001000100000000000000 1 (Implied) |

3.7.1.2 Normalized Numbers

In most cases, the processor represents real numbers in normalized form. This means that except for zero, the significand is always made up of an integer of 1 and the following fraction:
1.fff...ff

For values less than 1, leading zeros are eliminated. (For each leading zero eliminated, the exponent is decremented by one.)

Representing numbers in normalized form maximizes the number of significant digits that can be accommodated in a significand of a given width. To summarize, a normalized real number consists of a normalized significand that represents a real number between 1 and 2 and an exponent that specifies the number's binary point.

3.7.1.3 Biased Exponent

The processor represents exponents in a biased form. This means that a constant is added to the actual exponent so that the biased exponent is always a positive number. The value of the biasing constant depends on the number of bits available for representing exponents in the floating-point format being used. The biasing constant is chosen so that the smallest normalized number can be reciprocated without overflow.

3.7.1.4 Real Number and Non-Number Encodings

A variety of real numbers and special values can be encoded in the processor's floating-point format. These numbers and values are generally divided into the following classes:

- Signed zeros
- Denormalized finite numbers
- Normalized finite numbers
- Signed infinities
- NaNs
- Indefinite numbers

(The term NaN stands for "Not a Number.")

Figure 3-10 shows how the encodings for these numbers and non-numbers fit into the real number continuum. The encodings shown here are for the IEEE single-precision (32-bit) format, where the term "S" indicates the sign bit, "E" the biased exponent, and "F" the fraction. (The exponent values are given in decimal.)

The processor can operate on and/or return any of these values, depending on the type of computation being performed. The following sections describe these number and non-number classes.

3.7.1.5 Signed Zeros

Zero can be represented as a +0 or a -0 depending on the sign bit. Both encodings are equal in value. The sign of a zero result depends on the operation being performed and the rounding mode being used. Signed zeros have been provided to aid in implementing interval arithmetic. The sign of a zero may indicate the direction from which underflow occurred, or it may indicate the sign of an ∞ that has been reciprocated.

3.7.1.6 Normalized and Denormalized Finite Numbers

Non-zero, finite numbers are divided into two classes: normalized and denormalized. The normalized finite numbers comprise all the non-zero finite values that can be encoded in a normalized real number format between zero and ∞ . In the format shown in Figure 3-10, this group of numbers includes all the numbers with biased exponents ranging from 1 to 254_{10} (unbiased, the exponent range is from -126_{10} to $+127_{10}$).

Figure 3-10. Real Numbers and NaNs

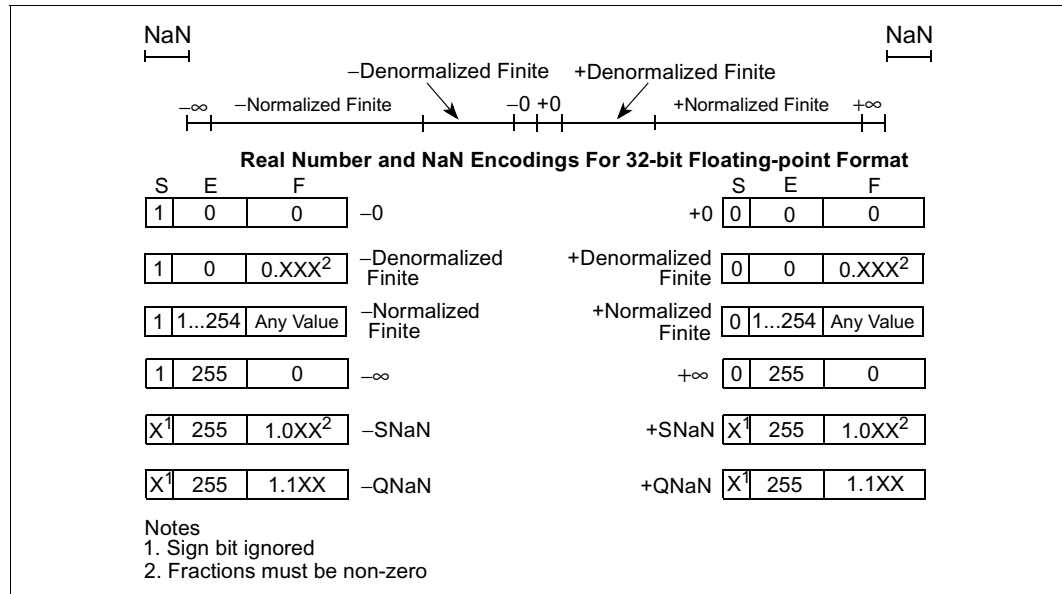

When real numbers become very close to zero, the normalized-number format can no longer be used to represent the numbers. This is because the range of the exponent is not large enough to compensate for shifting the binary point to the right to eliminate leading zeros.

When the biased exponent is zero, smaller numbers can only be represented by making the integer bit (and perhaps other leading bits) of the significand zero. The numbers in this range are called *denormalized* (or *tiny*) numbers. The use of leading zeros with denormalized numbers allows smaller numbers to be represented. However, this denormalization causes a loss of precision (the number of significant bits in the fraction is reduced by the leading zeros).

When performing normalized floating-point computations, a processor normally operates on normalized numbers and produces normalized numbers as results. Denormalized numbers represent an *underflow* condition.

A denormalized number is computed through a technique called gradual underflow. Table 3-2 gives an example of gradual underflow in the denormalization process. Here the single-real format is being used, so the minimum exponent (unbiased) is -126_{10} . The true result in this example requires an exponent of -129_{10} in order to have a normalized number. Since -129_{10} is beyond the allowable exponent range, the result is denormalized by inserting leading zeros until the minimum exponent of -126_{10} is reached.

Table 3-2. Denormalization Process

| Operation | Sign | Exponent ^a | Significand |
|-----------------|------|-----------------------|--------------------|
| True Result | 0 | -129 | 1.01011100000...00 |
| Denormalize | 0 | -128 | 0.10101110000...00 |
| Denormalize | 0 | -127 | 0.01010111000...00 |
| Denormalize | 0 | -126 | 0.00101011100...00 |
| Denormal Result | 0 | -126 | 0.00101011100...00 |

a. Expressed as an unbiased, decimal number.

In the extreme case, all the significant bits are shifted out to the right by leading zeros, creating a zero result.

The processor deals with denormal values in the following ways:

- It avoids creating denormals by normalizing numbers whenever possible.
- It provides the floating-point underflow exception to permit programmers to detect cases when denormals are created.
- It provides the floating-point denormal-operand exception to permit procedures or programs to detect when denormals are being used as source operands for computations.

3.7.1.7 Signed Infinities

The two infinities, $+\infty$ and $-\infty$, represent the maximum positive and negative real numbers, respectively, that can be represented in the floating-point format. Infinity is always represented by a zero significand (fraction and integer bit) and the maximum biased exponent allowed in the specified format (for example, 255_{10} for the single-real format).

The signs of infinities are observed, and comparisons are possible. Infinities are always interpreted in the affine sense; that is, $-\infty$ is less than any finite number and $+\infty$ is greater than any finite number. Arithmetic on infinities is always exact. Exceptions are generated only when the use of an infinity as a source operand constitutes an invalid operation.

Whereas denormalized numbers represent an underflow condition, the two infinity numbers represent the result of an overflow condition. Here, the normalized result of a computation has a biased exponent greater than the largest allowable exponent for the selected result format.

3.7.1.8 NaNs

Since NaNs are non-numbers, they are not part of the real number line. In [Figure 3-10](#), the encoding space for NaNs in the processor floating-point formats is shown above the ends of the real number line. This space includes any value with the maximum allowable biased exponent and a non-zero fraction. (The sign bit is ignored for NaNs.)

The IEEE standard defines two classes of NaN: quiet NaNs (QNaNs) and signaling NaNs (SNaNs). A QNaN is a NaN with the most significant fraction bit set; an SNaN is a NaN with the most significant fraction bit clear. QNaNs are allowed to propagate through most arithmetic operations without signaling an exception. SNaNs generally signal an invalid-operation exception whenever they appear as operands in arithmetic operations. Exceptions, as well as detailed information on how the processor handles NaNs, are discussed in [Section 3.7.2](#).

3.7.1.9 Indefinite

In response to a masked invalid-operation floating-point exceptions, the indefinite value QNaN is produced. The integer indefinite, which can be produced during conversion from single-precision floating-point to 32-bit integer, is defined to be 80000000H.

3.7.2 Operating on NaNs

As was described in [Section 3.7.1.8](#), Streaming SIMD Extension supports two types of NaNs: SNaNs and QNaNs. An SNaN is any NaN value with its most-significant fraction bit set to 0 and at least one other fraction bit set to 1. (If all the fraction bits are set to 0, the value is an ∞ .) A QNaN is any NaN value with the most-significant fraction bit set to 1. The sign bit of a NaN is not interpreted.

As a general rule, when a QNaN is used in one or more arithmetic floating-point instructions, it is allowed to propagate through a computation. An SNaN on the other hand causes a floating-point invalid-operation exception to be signaled. SNaNs are typically used to trap or invoke an exception handler.

The invalid operation exception has a flag and a mask bit associated with it in MXCSR. The mask bit determines how the an SNaN value is handled. If the invalid operation mask bit is set, the SNaN is converted to a QNaN by setting the most-significant fraction bit of the value to 1. The result is then stored in the destination operand and the invalid operation flag is set. If the invalid operation mask is clear, an invalid operation fault is signaled and no result is stored in the destination operand.

When a real operation or exception delivers a QNaN result, the value of the result depends on the source operands, as shown in [Table 3-3](#). The exceptions to the behavior described in [Table 3-3](#) are the MINPS and MAXPS instructions. If only one source is a NaN for these instructions, the Src2 operand (either NaN or real value) is written to the result; this differs from the behavior for other instructions as defined in [Table 3-3](#), which is to always write the NaN to the result, regardless of which source operand contains the NaN. This approach for MINPS/MAXPS allows NaN data to be screened out of the bounds-checking portion of an algorithm. If instead of this behavior, it is required that the NaN source operand be returned, the min/max functionality can be emulated using a sequence of instructions: comparison followed by AND, ANDN and OR.

In general Src1 and Src2 relate to a Streaming SIMD Extension instruction as follows:

```
ADDPS Src1, Src2/m128
```

Except for the rules given at the beginning of this section for encoding SNaNs and QNaNs, software is free to use the bits in the significand of a NaN for any purpose. Both SNaNs and QNaNs can be encoded to carry and store data, such as diagnostic information.

Table 3-3. Results of Operations with NaN Operands

| Source Operands | NaN Result (invalid operation exception is masked) |
|---|---|
| An SNaN and a QNaN. | Src1 NaN (converted to QNaN if Src1 is an SNaN). |
| Two SNaNs. | Src1 NaN (converted to QNaN) |
| Two QNaNs. | Src1 QNaN |
| An SNaN and a real value. | The SNaN converted into a QNaN. |
| A QNaN and a real value. | The QNaN source operand. |
| An SNaN/QNaN value (for instructions which take only one operand i.e. RCPPS, RCPSS, RSQRTPS, RSQRTSS) | The SNaN converted into a QNaN/the source QNaN. |
| Neither source operand is a NaN and a floating-point invalid-operation exception is signaled. | The default QNaN <i>real indefinite</i> . |

3.8 Data Formats

3.8.1 Memory Data Formats

The Intel architecture Streaming SIMD Extension introduces a new packed 128-bit data type which consists of 4 single-precision floating-point numbers. The 128 bits are numbered 0 through 127. Bit 0 is the least significant bit (LSB), and bit 127 is the most significant bit (MSB).

Bytes in the new data type format have consecutive memory addresses. The ordering is always little endian, that is, the bytes with the lower addresses are less significant than the bytes with the higher addresses.

Figure 3-11. Four Packed FP Data in Memory (at address 1000H)

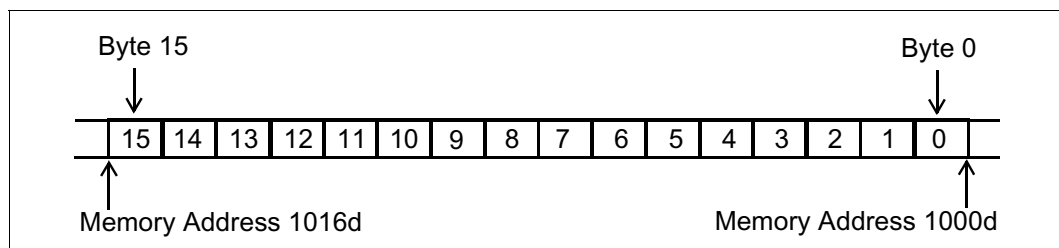

3.8.2 Streaming SIMD Extension Register Data Formats

Values in Streaming SIMD Extension registers have the same format as a 128-bit quantity in memory. They have two data access modes: 128-bit access mode and 32-bit access mode. The data type corresponds directly to the single-precision format in the IEEE standard. Table 3-4 gives the precision and range of this data type. Only the fraction part of the significand is encoded. The integer is assumed to be 1 for all numbers except 0 and denormalized finite numbers. The exponent of the single-precision data type is encoded in biased format. The biasing constant is 127 for the single-precision format.

Table 3-4. Precision and Range of Streaming SIMD Extension Datatype

| Data Type | Length | Precision (Bits) | Approximate Normalized Range | |
|------------------|--------|------------------|------------------------------|---|
| | | | Binary | Decimal |
| Single-precision | 32 | 24 | 2^{-126} to 2^{127} | 1.18×10^{-38} to 3.40×10^{38} |

Table 3-5 shows the encodings for all the classes of real numbers (that is, zero, denormalized-finite, normalized-finite, and ∞) and NaNs for the single-real data-type. It also gives the format for the real indefinite value, which is a QNaN encoding that is generated by several Streaming SIMD Extension instructions in response to a masked floating-point invalid-operation exception.

Table 3-5. Real Number and NaN Encodings

| Class | | Sign | Biased Exponent | Significand | |
|----------|------------------------|--------|-----------------|----------------------|---------------------|
| | | | | Integer ¹ | Fraction |
| Positive | +∞ | 0 | 11..11 | 1 | 00..00 |
| | +Normals | 0 | 11..10 | 1 | 11..11 |
| | | . | . | . | . |
| | | 0 | 00..01 | 1 | 00..00 |
| | +Denormals | 0 | 00..00 | 0 | 11.11 |
| | | . | . | . | . |
| 0 | | 00..00 | 0 | 00..01 | |
| +Zero | 0 | 00..00 | 0 | 00..00 | |
| Negative | -Zero | 1 | 00..00 | 0 | 00..00 |
| | -Denormals | 1 | 00..00 | 0 | 00..01 |
| | | . | . | . | . |
| | | 1 | 00..00 | 0 | 11..11 |
| | -Normals | 1 | 00..01 | 1 | 00..00 |
| | | . | . | . | . |
| 1 | | 11..10 | 1 | 11..11 | |
| -∞ | 1 | 11..11 | 1 | 00..00 | |
| NaNs | SNaN | X | 11..11 | 1 | 0X..XX ² |
| | QNaN | X | 11..11 | 1 | 1X..XX |
| | Real Indefinite (QNaN) | 1 | 11..11 | 1 | 10..00 |
| Single | | | ← 8 Bits → | | ← 23 Bits → |

When storing real values in memory, single-real values are stored in 4 consecutive bytes in memory. The 128-bit access mode is used for 128-bit memory accesses, 128-bit transfers between Streaming SIMD Extension registers, and all logical, unpack and arithmetic instructions. The 32-bit access mode is used for 32-bit memory access, 32-bit transfers between Streaming SIMD Extension registers, and all arithmetic instructions.

There are sixty-eight new instructions in a Streaming SIMD Extension instruction set. This chapter describes the packed and scalar floating-point instructions in alphabetical order, with a full description of each instruction. The last two sections of this chapter describe the SIMD Integer instructions and the cacheability control instructions.

3.9 Instruction Formats

The nature of Streaming SIMD Extension allows the use of existing instruction formats. Instructions use the ModR/M format and are preceded by the 0F prefix byte. In general, operations are not duplicated to provide two directions (i.e. separate load and store variants).

3.10 Instruction Prefixes

The Streaming SIMD Extension instruction uses prefixes as specified in [Table 3-6](#), [Table 3-7](#), and [Table 3-8](#). The effect of multiple prefixes (more than one prefix from a group) is unpredictable and may vary from processor to processor.

Applying a prefix, in a manner not defined in this document, is considered reserved behavior. For example, [Table 3-6](#) shows general behavior for most Streaming SIMD Extension instructions; however, the application of a prefix (Repeat, Repeat NE, Operand Size) is reserved for the following instructions:

ANDPS, ANDNPS, COMISS, FXRSTOR, FXSAVE, ORPS, LDMXCSR, MOVAPS, MOVHPS, MOVLPS, MOVMSKPS, MOVNTPS, MOVUPS, SHUFPS, STMXCSR, UCOMISS, UNPCKHPS, UNPCKLPS, XORPS.

Table 3-6. Streaming SIMD Extension Instruction Behavior with Prefixes

| Prefix Type | Effect on Streaming SIMD Extension Instructions |
|--|---|
| Address Size Prefix (67H) | Affects Streaming SIMD Extension instructions with memory operand Ignored by Streaming SIMD Extension instructions without memory operand. |
| Operand Size (66H) | Reserved and may result in unpredictable behavior. |
| Segment Override (2EH,36H,3EH,26H,64H,65H) | Affects Streaming SIMD Extension instructions with mem.operand Ignored by Streaming SIMD Extension instructions without mem operand |
| Repeat Prefix (F3H) | Affects Streaming SIMD Extension instructions |
| Repeat NE Prefix(F2H) | Reserved and may result in unpredictable behavior. |
| Lock Prefix (0F0H) | Generates invalid opcode exception. |

Table 3-7. SIMD Integer Instructions – Behavior with Prefixes

| Prefix Type | Effect on Intel® MMX™ Instructions |
|--|---|
| Address Size Prefix (67H) | Affects Intel® MMX™ instructions with mem. operand Ignored by Intel® MMX™ instructions without mem. operand. |
| Operand Size (66H) | Reserved and may result in unpredictable behavior. |
| Segment Override (2EH,36H,3EH,26H,64H,65H) | Affects Intel® MMX™ instructions with mem. operand Ignored by Intel® MMX™ instructions without mem operand |
| Repeat Prefix (F3H) | Reserved and may result in unpredictable behavior. |
| Repeat NE Prefix(F2H) | Reserved and may result in unpredictable behavior. |
| Lock Prefix (0F0H) | Generates invalid opcode exception. |

Table 3-8. Cacheability Control Instruction Behavior with Prefixes

| Prefix Type | Effect on Streaming SIMD Extension Instructions |
|---|---|
| Address Size Prefix (67H) | Affects cacheability control instruction with a mem. operand Ignored by cacheability control instruction w/o a mem. operand. |
| Operand Size (66H) | Reserved and may result in unpredictable behavior. |
| Segment Override (2EH,36H,3EH,26H,64H,65H) | Affects cacheability control instructions with mem. operand Ignored by cacheability control instruction without mem operand |
| Repeat Prefix(F3H) | Reserved and may result in unpredictable behavior. |
| Repeat NE Prefix(F2H) | Reserved and may result in unpredictable behavior. |
| Lock Prefix (0F0H) | Generates an invalid opcode exception for all cacheability instructions. |

3.11 Reserved Behavior and Software Compatibility

In many register and memory layout descriptions, certain bits are marked as *reserved*. When bits are marked as reserved, it is essential for compatibility with future processors that software treat these bits as having a future, though unknown, effect. The behavior of reserved bits should be regarded as not only reserved, but unpredictable. In general, reserved behavior may also be applied in other areas. Software should follow these guidelines in dealing with reserved behavior:

- Do not depend on the states of any reserved fields when testing the values of registers which contain such bits. Mask out the reserved fields before testing.
- Do not depend on the states of any reserved fields when storing to memory or to a register.
- Do not depend on the ability to retain information written into any reserved fields.
- When loading a register, always load the reserved fields with the values indicated in the documentation, if any, or reload them with values previously read from the same register.

Note: Avoid any software dependency upon the reserved state/behavior. Depending upon reserved behavior will make the software dependent upon the unspecified manner in which the processor handles this behavior and risks incompatibility with future processors.

3.12 Notations

Besides opcodes, two kinds of notations are found which both describe information found in the ModR/M byte:

1. **/digit:** (digit between 0 and 7) indicates that the instruction uses only the r/m (register and memory) operand. The reg field contains the digit that provides an extension to the instruction's opcode.
2. **/r:** indicates that the ModR/M byte of an instruction contains both a register operand and an r/m operand.

In addition, the following abbreviations are used:

- **r32:** Intel architecture 32-bit integer register.
- **xmm/m128:** Indicates a 128-bit multimedia register or a 128-bit memory location.
- **xmm/m64:** Indicates a 128-bit multimedia register or a 64-bit memory location.

- **xmm/m32:** Indicates a 128-bit multimedia register or a 32-bit memory location.
- **mm/m64:** Indicates a 64-bit multimedia register or a 64-bit memory location.
- **imm8:** Indicates an immediate 8-bit operand.
- **ib:** Indicates that an immediate byte operand follows the opcode, ModR/M byte or scaled-indexing byte.

When there is ambiguity, xmm1 indicates the first source operand and xmm2 the second source operand.

Table 3-9 describes the naming conventions used in the Streaming SIMD Extension instruction mnemonics.

Table 3-9. Key to Streaming SIMD Extension Naming Convention

| Mnemonic | Description |
|-----------------|---|
| PI | Packed integer qword (e.g. mm0) |
| PS | Packed single FP (e.g. xmm0) |
| SI | Scalar integer (e.g. eax) |
| SS | Scalar single-FP (e.g. low 32 bits of xmm0) |

ADDPS: Packed Single-FP Add

| Opcode | Instruction | Description |
|---------|-----------------------|---|
| 0F,58,r | ADDPS xmm1, xmm2/m128 | Add packed SP FP numbers from XMM2/Mem to XMM1. |

Operation:

$$\begin{aligned} \text{xmm1}[31-0] &= \text{xmm1}[31-0] + \text{xmm2/m128}[31-0]; \\ \text{xmm1}[63-32] &= \text{xmm1}[63-32] + \text{xmm2/m128}[63-32]; \\ \text{xmm1}[95-64] &= \text{xmm1}[95-64] + \text{xmm2/m128}[95-64]; \\ \text{xmm1}[127-96] &= \text{xmm1}[127-96] + \text{xmm2/m128}[127-96]; \end{aligned}$$

Description: The ADDPS instruction adds the packed SP FP numbers of both their operands.

Exceptions: General protection exception if not aligned on 16-byte boundary, regardless of segment.

Numeric Exceptions: Overflow, Underflow, Invalid, Precision, Denormal.

Protected Mode Exceptions:

#GP(0) for an illegal memory operand effective address in the CS, DS, ES, FS or GS segments; #SS(0) for an illegal address in the SS segment; #PF(fault-code) for a page fault; #UD if CR0.EM = 1; #NM if TS bit in CR0 is set. #XM for an unmasked Streaming SIMD Extension numeric exception (CR4.OSXMMEXCPT = 1); #UD for an unmasked Streaming SIMD Extension numeric exception (CR4.OSXMMEXCPT = 0); #UD if CR4.OSFXSR(bit 9) = 0; #UD if CPUID.XMM(EDX bit 25) = 0.

Real Address Mode Exceptions:

Interrupt 13 if any part of the operand would lie outside of the effective address space from 0 to 0FFFFH; #UD if CR0.EM = 1; #NM if TS bit in CR0 is set. #XM for an unmasked Streaming SIMD Extension numeric exception (CR4.OSXMMEXCPT = 1); #UD for an unmasked Streaming SIMD Extension numeric exception (CR4.OSXMMEXCPT = 0)

Virtual 8086 Mode Exceptions:

Same exceptions as in Real Address Mode; #PF(fault-code) for a page fault.

Additional Itanium® System Environment Exceptions

Itanium Reg Faults Disabled FP Register Fault if PSR.dfl is 1, NaT Register Consumption Fault
 Itanium Mem Faults VHPT Data Fault, Data TLB Fault, Alternate Data TLB Fault, Data Page Not Present Fault, Data NaT Page Consumption Abort, Data Key Miss Fault, Data Key Permission Fault, Data Access Rights Fault, Data Access Bit Fault

ADDSS: Scalar Single-FP Add

| Opcode | Instruction | Description |
|--------------|----------------------|---|
| F3,0F,58, /r | ADDSS xmm1, xmm2/m32 | Add the lower SP FP number from XMM2/Mem to XMM1. |

Operation:

$$\text{xmm1}[31-0] = \text{xmm1}[31-0] + \text{xmm2/m32}[31-0];$$

$$\text{xmm1}[63-32] = \text{xmm1}[63-32];$$

$$\text{xmm1}[95-64] = \text{xmm1}[95-64];$$

$$\text{xmm1}[127-96] = \text{xmm1}[127-96];$$

Description: The ADDSS instruction adds the lower SP FP numbers of both their operands; the upper 3 fields are passed through from xmm1.

FP Exceptions: None.

Numeric Exceptions: Overflow, Underflow, Invalid, Precision, Denormal.

Protected Mode Exceptions:

#GP(0) for an illegal memory operand effective address in the CS, DS, ES, FS or GS segments; #SS(0) for an illegal address in the SS segment; #PF(fault-code) for a page fault; #UD if CR0.EM = 1; #NM if TS bit in CR0 is set; #AC for unaligned memory reference. To enable #AC exceptions, three conditions must be true(CR0.AM is set; EFLAGS.AC is set; current CPL is 3); #XM for an unmasked Streaming SIMD Extension numeric exception (CR4.OSXMMEXCPT =1); #UD for an unmasked Streaming SIMD Extension numeric exception (CR4.OSXMMEXCPT =0); #UD if CR4.OSFXSR(bit 9) = 0; #UD if CPUID.XMM(EDX bit 25) = 0.

Real Address Mode Exceptions:

Interrupt 13 if any part of the operand would lie outside of the effective address space from 0 to 0FFFFH; #UD if CR0.EM = 1; #NM if TS bit in CR0 is set; #XM for an unmasked Streaming SIMD Extension numeric exception (CR4.OSXMMEXCPT =1); #UD for an unmasked Streaming SIMD Extension numeric exception (CR4.OSXMMEXCPT =0); #UD if CR4.OSFXSR(bit 9) = 0; #UD if CPUID.XMM(EDX bit 25) = 0.

Virtual 8086 Mode Exceptions:

Same exceptions as in Real Address Mode; #AC for unaligned memory reference if the current privilege level is 3; #PF (fault-code) for a page fault.

Additional Itanium® System Environment Exceptions

Itanium Reg Faults Disabled FP Register Fault if PSR.dfl is 1, NaT Register Consumption Fault
 Itanium Mem Faults VHPT Data Fault, Data TLB Fault, Alternate Data TLB Fault, Data Page Not Present Fault, Data NaT Page Consumption Abort, Data Key Miss Fault, Data Key Permission Fault, Data Access Rights Fault, Data Access Bit Fault

ANDNPS: Bit-wise Logical And Not for Single-FP

| Opcode | Instruction | Description |
|----------|------------------------|--|
| 0F,55,/r | ANDNPS xmm1, xmm2/m128 | Invert the 128 bits in XMM1 and then AND the result with 128 bits from XMM2/Mem. |

Operation: $xmm1[127-0] = \sim(xmm1[127-0]) \& xmm2/m128[127-0];$

Description: The ANDNPS instructions returns a bit-wise logical AND between the complement of XMM1 and XMM2/Mem.

FP Exceptions: General protection exception if not aligned on 16-byte boundary, regardless of segment.

Numeric Exceptions: None

Protected Mode Exceptions:

#GP(0) for an illegal memory operand effective address in the CS, DS, ES, FS or GS segments; #SS(0) for an illegal address in the SS segment; #PF(fault-code) for a page fault; #UD if CR0.EM = 1; #NM if TS bit in CR0 is set; #UD if CRCR4.OSFXSR(bit 9) = 0; #UD if CPUID.XMM(EDX bit 25) = 0.

Real Address Mode Exceptions:

Interrupt 13 if any part of the operand would lie outside of the effective address space from 0 to 0FFFFH; #UD if CR0.EM = 1; #NM if TS bit in CR0 is set.

Virtual 8086 Mode Exceptions:

Same exceptions as in Real Address Mode; #PF(fault-code) for a page fault; #UD if CRCR4.OSFXSR(bit 9) = 0; #UD if CPUID.XMM(EDX bit 25) = 0.

Additional Itanium® System Environment Exceptions

Itanium Reg Faults Disabled FP Register Fault if PSR.dfl is 1, NaT Register Consumption Fault
 Itanium Mem Faults VHPT Data Fault, Data TLB Fault, Alternate Data TLB Fault, Data Page Not Present Fault, Data NaT Page Consumption Abort, Data Key Miss Fault, Data Key Permission Fault, Data Access Rights Fault, Data Access Bit Fault

Comments: The usage of Repeat Prefixes (F2H, F3H) with ANDNPS is reserved. Different processor implementations may handle this prefix differently. Usage of this prefix with ANDNPS risks incompatibility with future processors.

ANDPS: Bit-wise Logical And for Single-FP

| Opcode | Instruction | Description |
|---------|-----------------------|---|
| 0F,54,r | ANDPS xmm1, xmm2/m128 | Logical AND of 128 bits from XMM2/Mem to XMM1 register. |

Operation: `xmm1[127-0] &= xmm2/m128[127-0];`

Description: The ANDPS instruction returns a bit-wise logical AND between XMM1 and XMM2/Mem.

FP Exceptions: General protection exception if not aligned on 16-byte boundary, regardless of segment.

Numeric Exceptions: None

Protected Mode Exceptions:

#GP(0) for an illegal memory operand effective address in the CS, DS, ES, FS or GS segments; #SS(0) for an illegal address in the SS segment; #PF(fault-code) for a page fault; #UD if CR0.EM = 1; #NM if TS bit in CR0 is set; #UD if CR4.OSFXSR(bit 9) = 0; #UD if CPUID.XMM(EDX bit 25) = 0.

Real Address Mode Exceptions:

Interrupt 13 if any part of the operand would lie outside of the effective address space from 0 to 0FFFFH; #UD if CR0.EM = 1; #NM if TS bit in CR0 is set; #UD if CR4.OSFXSR(bit 9) = 0; #UD if CPUID.XMM(EDX bit 25) = 0.

Virtual 8086 Mode Exceptions:

Same exceptions as in Real Address Mode; #PF(fault-code) for a page fault.

Additional Itanium® System Environment Exceptions

Itanium Reg Faults Disabled FP Register Fault if PSR.dfl is 1, NaT Register Consumption Fault
 Itanium Mem Faults VHPT Data Fault, Data TLB Fault, Alternate Data TLB Fault, Data Page Not Present Fault, Data NaT Page Consumption Abort, Data Key Miss Fault, Data Key Permission Fault, Data Access Rights Fault, Data Access Bit Fault

Comments: The usage of Repeat Prefixes (F2H, F3H) with ANDPS is reserved. Different processor implementations may handle this prefix differently. Usage of this prefix with ANDPS risks incompatibility with future processors.

CMPPS: Packed Single-FP Compare

| Opcode | Instruction | Description |
|------------|-----------------------------|--|
| 0F,C2,r,ib | CMPPS xmm1, xmm2/m128, imm8 | Compare packed SP FP numbers from XMM2/Mem to packed SP FP numbers in XMM1 register using imm8 as predicate. |

Operation:

```

switch (imm8) {
    case eq:      op = eq;
    case lt:      op = lt;
    case le:      op = le;
    case unord:   op = unord;
    case neq:     op = neq;
    case nlt:     op = nlt;
    case nle:     op = nle;
    case ord:     op = ord;
    default:      Reserved;
}

```

```

cmp0 = op(xmm1[31-0], xmm2/m128[31-0]);
cmp1 = op(xmm1[63-32], xmm2/m128[63-32]);
cmp2 = op(xmm1[95-64], xmm2/m128[95-64]);
cmp3 = op(xmm1[127-96], xmm2/m128[127-96]);

```

```

xmm1[31-0]   = (cmp0) ? 0xffffffff : 0x00000000;
xmm1[63-32]  = (cmp1) ? 0xffffffff : 0x00000000;
xmm1[95-64]  = (cmp2) ? 0xffffffff : 0x00000000;
xmm1[127-96] = (cmp3) ? 0xffffffff : 0x00000000;

```

Description: For each individual pairs of SP FP numbers, the CMPPS instruction returns an all “1” 32-bit mask or an all “0” 32-bit mask, using the comparison predicate specified by imm8; note that a subsequent computational instruction which uses this mask as an input operand will not generate a fault, since a mask of all “0’s” corresponds to a FP value of +0.0 and a mask of all “1’s” corresponds to a FP value of -qNaN. Some of the comparisons can be achieved only through software emulation. For these comparisons the programmer must swap the operands, copying registers when necessary to protect the data that will now be in the destination, and then perform the compare using a different predicate. The predicate to be used for these emulations is listed in under the heading “Emulation”. The following table shows the different comparison types:

| Predicate | Description ^a | Relation | Emulation | imm8 Encoding | Result if NaN Operand | QNaN Operand Signals Invalid |
|-----------|---------------------------|---------------------|--------------------|---------------|-----------------------|------------------------------|
| eq | equal | $xmm1 == xmm2$ | | 000B | False | No |
| lt | less-than | $xmm1 < xmm2$ | | 001B | False | Yes |
| le | less-than-or-equal | $xmm1 \leq xmm2$ | | 010B | False | Yes |
| | greater than | $xmm1 > xmm2$ | swap, protect, lt | | False | Yes |
| unord | greater-than-or-equal | $xmm1 \geq xmm2$ | swap protect, le | | False | Yes |
| | unordered | $xmm1 ? xmm2$ | | 011B | True | No |
| neq | not-equal | $!(xmm1 == xmm2)$ | | 100B | True | No |
| nlt | not-less-than | $!(xmm1 < xmm2)$ | | 101B | True | Yes |
| nle | not-less-than-or-equal | $!(xmm1 \leq xmm2)$ | | 110B | True | Yes |
| | not-greater-than | $!(xmm1 > xmm2)$ | swap, protect, nlt | | True | Yes |
| ord | not-greater-than-or-equal | $!(xmm1 \geq xmm2)$ | swap, protect, nle | | True | Yes |
| | ordered | $!(xmm1 ? xmm2)$ | | 111B | False | No |

a. The greater-than, greater-than-or-equal, not-greater-than, and not-greater-than-or-equal relations are not directly implemented in hardware.

FP Exceptions: General protection exception if not aligned on 16-byte boundary, regardless of segment.

Numeric Exceptions: Invalid if sNaN operand, invalid if qNaN and predicate as listed in above table, denormal.

Protected Mode Exceptions:

#GP(0) for an illegal memory operand effective address in the CS, DS, ES, FS or GS segments; #SS(0) for an illegal address in the SS segment; #PF (fault-code) for a page fault; #UD if CR0.EM = 1; #NM if TS bit in CR0 is set. #XM for an unmasked Streaming SIMD Extension numeric exception (CR4.OSXMMEXCPT =1); #UD for an unmasked Streaming SIMD Extension numeric exception (CR4.OSXMMEXCPT =0); #UD if CR4.OSFXSR(bit 9) = 0; #UD if CPUID.XMM(EDX bit 25) = 0.

Real Address Mode Exceptions:

Interrupt 13 if any part of the operand would lie outside of the effective address space from 0 to 0FFFFH; #UD if CR0.EM = 1; #NM if TS bit in CR0 is set; #XM for an unmasked Streaming SIMD Extension numeric exception (CR4.OSXMMEXCPT =1); #UD for an unmasked Streaming SIMD Extension numeric exception (CR4.OSXMMEXCPT =0); #UD if CR4.OSFXSR(bit 9) = 0; #UD if CPUID.XMM(EDX bit 25) = 0.

Virtual 8086 Mode Exceptions:

Same exceptions as in Real Address Mode; #PF(fault-code) for a page fault.

Additional Itanium® System Environment Exceptions

Itanium Reg Faults Disabled FP Register Fault if PSR.dfl is 1, NaT Register Consumption Fault
 Itanium Mem Faults VHPT Data Fault, Data TLB Fault, Alternate Data TLB Fault, Data Page Not Present Fault, Data NaT Page Consumption Abort, Data Key Miss Fault, Data Key Permission Fault, Data Access Rights Fault, Data Access Bit Fault



Comments: Compilers and assemblers should implement the following 2-operand pseudo-ops in addition to the 3-operand CMPPS instruction:

| Pseudo-Op | Implementation |
|-----------------------|--------------------|
| CMPEQPS xmm1, xmm2 | CMPPS xmm1,xmm2, 0 |
| CMPLTPS xmm1, xmm2 | CMPPS xmm1,xmm2, 1 |
| CMPLEPS xmm1, xmm2 | CMPPS xmm1,xmm2, 2 |
| CMPUNORDPS xmm1, xmm2 | CMPPS xmm1,xmm2, 3 |
| CMPNEQPS xmm1, xmm2 | CMPPS xmm1,xmm2, 4 |
| CMPNLTPS xmm1, xmm2 | CMPPS xmm1,xmm2, 5 |
| CMPNLEPS xmm1, xmm2 | CMPPS xmm1,xmm2, 6 |
| CMPORDPS xmm1, xmm2 | CMPPS xmm1,xmm2, 7 |

The greater-than relations not implemented in hardware require more than one instruction to emulate in software and therefore should not be implemented as pseudo-ops. (For these, the programmer should reverse the operands of the corresponding less than relations and use move instructions to ensure that the mask is moved to the correct destination register and that the source operand is left intact.)

Bits 7-4 of the immediate field are reserved. Different processors may handle them differently. Usage of these bits risks incompatibility with future processors.

CMPSS: Scalar Single-FP Compare

| Opcode | Instruction | Description |
|---------------|----------------------------|--|
| F3,0F,C2,r,ib | CMPSS xmm1, xmm2/m32, imm8 | Compare lowest SP FP number from XMM2/Mem to lowest SP FP number in XMM1 register using imm8 as predicate. |

Operation:

```

switch (imm8) {
    case eq:      op = eq;
    case lt:      op = lt;
    case le:      op = le;
    case unord:   op = unord;
    case neq:     op = neq;
    case nlt:     op = nlt;
    case nle:     op = nle;
    case ord:     op = ord;
    default:     Reserved;
}

```

```

cmp0 = op(xmm1[31-0], xmm2/m32[31-0]);

```

```

xmm1[31-0] = (cmp0) ? 0xffffffff : 0x00000000;

```

```

xmm1[63-32] = xmm1[63-32];

```

```

xmm1[95-64] = xmm1[95-64];

```

```

xmm1[127-96] = xmm1[127-96];

```

Description: For the lowest pair of SP FP numbers, the CMPSS instruction returns an all “1” 32-bit mask or an all “0” 32-bit mask, using the comparison predicate specified by imm8; the values for the upper three pairs of SP FP numbers are not compared. Note that a subsequent computational instruction which uses this mask as an input operand will not generate a fault, since a mask of all “0’s” corresponds to a FP value of +0.0 and a mask of all “1’s” corresponds to a FP value of -qNaN. Some of the comparisons can be achieved only through software emulation. For these comparisons the programmer must swap the operands, copying registers when necessary to protect the data that will now be in the destination, and then perform the compare using a different predicate. The predicate to be used for these emulations is listed in under the heading “Emulation”. The following table shows the different comparison types:

| Predicate | Description ^a | Relation | Emulation | imm8 Encoding | Result if NaN Operand | qNaN Operand Signals Invalid |
|-----------|---------------------------|-----------------|--------------------|---------------|-----------------------|------------------------------|
| eq | equal | xmm1 == xmm2 | | 000B | False | No |
| lt | less-than | xmm1 < xmm2 | | 001B | False | Yes |
| le | less-than-or-equal | xmm1 <= xmm2 | | 010B | False | Yes |
| | greater than | xmm1 > xmm2 | swap, protect, lt | | False | Yes |
| | greater-than-or-equal | xmm1 >= xmm2 | swap protect, le | | False | Yes |
| unord | unordered | xmm1 ? xmm2 | | 011B | True | No |
| neq | not-equal | !(xmm1 == xmm2) | | 100B | True | No |
| nl | not-less-than | !(xmm1 < xmm2) | | 101B | True | Yes |
| nle | not-less-than-or-equal | !(xmm1 <= xmm2) | | 110B | True | Yes |
| | not-greater-than | !(xmm1 > xmm2) | swap, protect, nl | | True | Yes |
| | not-greater-than-or-equal | !(xmm1 >= xmm2) | swap, protect, nle | | True | Yes |
| ord | ordered | !(xmm1 ? xmm2) | | 111B | False | No |

a. The greater-than, greater-than-or-equal, not-greater-than, and not-greater-than-or-equal relations are not directly implemented in hardware.

FP Exceptions: None.

Numeric Exceptions: Invalid if sNaN operand, invalid if qNaN and predicate as listed in above table, denormal.

Protected Mode Exceptions:

#GP(0) for an illegal memory operand effective address in the CS, DS, ES, FS or GS segments; #SS(0) for an illegal address in the SS segment; #PF (fault-code) for a page fault; #UD if CR0.EM = 1; #NM if TS bit in CR0 is set; #AC for unaligned memory reference. To enable #AC exceptions, three conditions must be true (CR0.AM is set; EFLAGS.AC is set; current CPL is 3); #XM for an unmasked Streaming SIMD Extension numeric exception (CR4.OSXMMEXCPT = 1); #UD for an unmasked Streaming SIMD Extension numeric exception (CR4.OSXMMEXCPT = 0); #UD if CR4.OSFXSR(bit 9) = 0; #UD if CPUID.XMM(EDX bit 25) = 0.

Real Address Mode Exceptions:

Interrupt 13 if any part of the operand would lie outside of the effective address space from 0 to 0FFFFH; #UD if CR0.EM = 1; #NM if TS bit in CR0 is set; #XM for an unmasked Streaming SIMD Extension numeric exception (CR4.OSXMMEXCPT = 1); #UD for an unmasked Streaming SIMD Extension numeric exception (CR4.OSXMMEXCPT = 0); #UD if CR4.OSFXSR(bit 9) = 0; #UD if CPUID.XMM(EDX bit 25) = 0.

Virtual 8086 Mode Exceptions:

Same exceptions as in Real Address Mode; #AC for unaligned memory reference if the current privilege level is 3; #PF (fault-code) for a page fault.

Additional Itanium® System Environment Exceptions

Itanium Reg Faults Disabled FP Register Fault if PSR.dfl is 1, NaT Register Consumption Fault

Itanium Mem Faults VHPT Data Fault, Data TLB Fault, Alternate Data TLB Fault, Data Page Not Present Fault, Data NaT Page Consumption Abort, Data Key Miss Fault, Data Key Permission Fault, Data Access Rights Fault, Data Access Bit Fault

Comments: Compilers and assemblers should implement the following 2-operand pseudo-ops in addition to the 3-operand CMPSS instruction:

| Pseudo-Op | Implementation |
|-----------------------|--------------------|
| CMPEQSS xmm1, xmm2 | CMPSS xmm1,xmm2, 0 |
| CMPLTSS xmm1, xmm2 | CMPSS xmm1,xmm2, 1 |
| CMPLESS xmm1, xmm2 | CMPSS xmm1,xmm2, 2 |
| CMPUNORDSS xmm1, xmm2 | CMPSS xmm1,xmm2, 3 |
| CMPNEQSS xmm1, xmm2 | CMPSS xmm1,xmm2, 4 |
| CMPNLTSS xmm1, xmm2 | CMPSS xmm1,xmm2, 5 |
| CMPNLESS xmm1, xmm2 | CMPSS xmm1,xmm2, 6 |
| CMPORDSS xmm1, xmm2 | CMPSS xmm1,xmm2, 7 |

The greater-than relations not implemented in hardware require more than one instruction to emulate in software and therefore should not be implemented as pseudo-ops. (For these, the programmer should reverse the operands of the corresponding less than relations and use move instructions to ensure that the mask is moved to the correct destination register and that the source operand is left intact.)

Bits 7-4 of the immediate field are reserved. Different processors may handle them differently. Usage of these bits risks incompatibility with future processors.

COMISS: Scalar Ordered Single-FP Compare and set EFLAGS

| Opcode | Instruction | Description |
|---------|-----------------------|--|
| 0F,2F,r | COMISS xmm1, xmm2/m32 | Compare lower SP FP number in XMM1 register with lower SP FP number in XMM2/Mem and set the status flags accordingly |

Operation:

```

switch (xmm1[31-0] <> xmm2/m32[31-0]) {
    OF,SF,AF = 000;

    case UNORDERED:    ZF,PF,CF = 111;

    case GREATER_THAN: ZF,PF,CF = 000;

    case LESS_THAN:    ZF,PF,CF = 001;

    case EQUAL:        ZF,PF,CF = 100;

}

```

Description: The COMISS instructions compare two SP FP numbers and sets the ZF,PF,CF bits in the EFLAGS register as described above. Although the data type is packed single-FP, only the lower SP numbers are compared. In addition, the OF, SF and AF bits in the EFLAGS register are zeroed out. The unordered predicate is returned if either source operand is a NaN (qNaN or sNaN).

FP Exceptions: None.

Numeric Exceptions: Invalid (if SNaN or QNaN operands), Denormal. Integer EFLAGS values will not be updated in the presence of unmasked numeric exceptions.

Protected Mode Exceptions:

#GP(0) for an illegal memory operand effective address in the CS, DS, ES, FS or GS segments; #SS(0) for an illegal address in the SS segment; #PF (fault-code) for a page fault; #UD if CR0.EM = 1; #NM if TS bit in CR0 is set; #AC for unaligned memory reference. To enable #AC exceptions, three conditions must be true (CR0.AM is set; EFLAGS.AC is set; current CPL is 3); #XM for an unmasked Streaming SIMD Extension numeric exception (CR4.OSXMMEXCPT = 1); #UD for an unmasked Streaming SIMD Extension numeric exception (CR4.OSXMMEXCPT = 0); #UD if CR4.OSFXSR(bit 9) = 0; #UD if CPUID.XMM(EDX bit 25) = 0.

Real Address Mode Exceptions:

Interrupt 13 if any part of the operand would lie outside of the effective address space from 0 to 0FFFFH; #UD if CR0.EM = 1; #NM if TS bit in CR0 is set; #XM for an unmasked Streaming SIMD Extension numeric exception (CR4.OSXMMEXCPT = 1); #UD for an unmasked Streaming SIMD Extension numeric exception (CR4.OSXMMEXCPT = 0); #UD if CR4.OSFXSR(bit 9) = 0; #UD if CPUID.XMM(EDX bit 25) = 0.

Virtual 8086 Mode Exceptions:

Same exceptions as in Real Address Mode; #AC for unaligned memory reference if the current privilege level is 3; #PF (fault-code) for a page fault.

COMISS: Scalar Ordered Single-FP Compare and set EFLAGS (Continued)

Additional Itanium® System Environment Exceptions

Itanium Reg Faults Disabled FP Register Fault if PSR.dfl is 1, NaT Register Consumption Fault

Itanium Mem Faults VHPT Data Fault, Data TLB Fault, Alternate Data TLB Fault, Data Page Not Present Fault, Data NaT Page Consumption Abort, Data Key Miss Fault, Data Key Permission Fault, Data Access Rights Fault, Data Access Bit Fault

Comments: COMISS differs from UCOMISS in that it signals an invalid numeric exception when a source operand is either a qNaN or sNaN; UCOMISS signals invalid only if a source operand is an sNaN.

The usage of Repeat (F2H, F3H) and Operand-Size (66H) prefixes with COMISS is reserved. Different processor implementations may handle this prefix differently. Usage of this prefix with COMISS risks incompatibility with future processors.

CVTPI2PS: Packed Signed INT32 to Packed Single-FP Conversion

| Opcode | Instruction | Description |
|---------|----------------------|--|
| 0F,2A,r | CVTPI2PS xmm, mm/m64 | Convert two 32-bit signed integers from MM/Mem to two SP FP. |

Operation:

```
xmm[31-0] = (float) (mm/m64[31-0]);
xmm[63-32] = (float) (mm/m64[63-32]);
xmm[95-64] = xmm[95-64];
xmm[127-96] = xmm[127-96];
```

Description: The CVTPI2PS instruction converts signed 32-bit integers to SP FP numbers; when the conversion is inexact, rounding is done according to MXCSR.

FP Exceptions: None.

Numeric Exceptions: Precision.

Protected Mode Exceptions:

#GP(0) for an illegal memory operand effective address in the CS, DS, ES, FS or GS segments; #SS(0) for an illegal address in the SS segment; #PF (fault-code) for a page fault; #UD if CR0.EM = 1; #NM if TS bit in CR0 is set; #MF if there is a pending FPU exception; #AC for unaligned memory reference; #AC for unaligned memory reference. To enable #AC exceptions, three conditions must be true(CR0.AM is set; EFLAGS.AC is set; current CPL is 3); #XM for an unmasked Streaming SIMD Extension numeric exception (CR4.OSXMMEXCPT =1); #UD for an unmasked Streaming SIMD Extension numeric exception (CR4.OSXMMEXCPT =0); #UD if CR4.OSFXSR(bit 9) = 0; #UD if CPUID.XMM(EDX bit 25) = 0.

Real Address Mode Exceptions:

Interrupt 13 if any part of the operand would lie outside of the effective address space from 0 to 0FFFFH; #UD if CR0.EM = 1; #NM if TS bit in CR0 is set; #MF if there is a pending FPU exception; #AC for unaligned memory reference; #XM for an unmasked Streaming SIMD Extension numeric exception (CR4.OSXMMEXCPT =1); #UD for an unmasked Streaming SIMD Extension numeric exception (CR4.OSXMMEXCPT =0); #UD if CR4.OSFXSR(bit 9) = 0; #UD if CPUID.XMM(EDX bit 25) = 0.

Virtual 8086 Mode Exceptions:

Same exceptions as in Real Address Mode; #AC for unaligned memory reference if the current privilege level is 3; #PF (fault-code) for a page fault.

Additional Itanium® System Environment Exceptions

Itanium Reg Faults Disabled FP Register Fault if PSR.dfl is 1, NaT Register Consumption Fault
 Itanium Mem Faults VHPT Data Fault, Data TLB Fault, Alternate Data TLB Fault, Data Page Not Present Fault, Data NaT Page Consumption Abort, Data Key Miss Fault, Data Key Permission Fault, Data Access Rights Fault, Data Access Bit Fault

CVTPI2PS: Packed Signed INT32 to Packed Single-FP Conversion (Continued)

- Comments:** This instruction behaves identically to original MMX instructions, in the presence of x87-FP instructions:
- Transition from x87-FP to MMX technology (TOS=0, FP valid bits set to all valid).
 - MMX instructions write ones (1's) to the exponent part of the corresponding x87-FP register.

However, the use of a memory source operand with this instruction will not result in the above transition from x87-FP to MMX technology.

Prioritization for fault and assist behavior for CVTPI2PS is as follows:

Memory source

1. Invalid opcode (CR0.EM=1)
2. DNA (CR0.TS=1)
3. #SS or #GP, for limit violation
4. #PF, page fault
5. Streaming SIMD Extension numeric fault (i.e. precision)

Register source

1. Invalid opcode (CR0.EM=1)
2. DNA (CR0.TS=1)
3. #MF, pending x87-FP fault signalled
4. After returning from #MF, x87-FP->MMX technology transition
5. Streaming SIMD Extension numeric fault (i.e. precision)

CVTPS2PI: Packed Single-FP to Packed INT32 Conversion

| Opcode | Instruction | Description |
|---------|----------------------|---|
| 0F,2D,r | CVTPS2PI mm, xmm/m64 | Convert lower 2 SP FP from XMM/Mem to 2 32-bit signed integers in MM using rounding specified by MXCSR. |

Operation: $mm[31-0] = (int)(xmm/m64[31-0]);$
 $mm[63-32] = (int)(xmm/m64[63-32]);$

Description: The CVTPS2PI instruction converts the lower 2 SP FP numbers in xmm/m64 to signed 32-bit integers in mm; when the conversion is inexact, the value rounded according to the MXCSR is returned. If the converted result(s) is/are larger than the maximum signed 32 bit value, the Integer Indefinite value (0x80000000) will be returned.

FP Exceptions: None.

Numeric Exceptions: Invalid, Precision.

Protected Mode Exceptions:

#GP(0) for an illegal memory operand effective address in the CS, DS, ES, FS or GS segments; #SS(0) for an illegal address in the SS segment; #PF (fault-code) for a page fault; #UD if CR0.EM = 1; #NM if TS bit in CR0 is set; #MF if there is a pending FPU exception; #AC for unaligned memory reference. To enable #AC exceptions, three conditions must be true(CR0.AM is set; EFLAGS.AC is set; current CPL is 3); #XM for an unmasked Streaming SIMD Extension numeric exception (CR4.OSXMMEXCPT =1); #UD for an unmasked Streaming SIMD Extension numeric exception (CR4.OSXMMEXCPT =0); #UD if CR4.OSFXSR(bit 9) = 0; #UD if CPUID.XMM(EDX bit 25) = 0.

Real Address Mode Exceptions:

Interrupt 13 if any part of the operand would lie outside of the effective address space from 0 to 0FFFFH; #UD if CR0.EM = 1; #NM if TS bit in CR0 is set; #MF if there is a pending FPU exception; #XM for an unmasked Streaming SIMD Extension numeric exception (CR4.OSXMMEXCPT =1); #UD for an unmasked Streaming SIMD Extension numeric exception (CR4.OSXMMEXCPT =0); #UD if CR4.OSFXSR(bit 9) = 0; #UD if CPUID.XMM(EDX bit 25) = 0.

Virtual 8086 Mode Exceptions:

Same exceptions as in Real Address Mode; #AC for unaligned memory reference if the current privilege level is 3; #PF (fault-code) for a page fault.

Additional Itanium® System Environment Exceptions

Itanium Reg Faults Disabled FP Register Fault if PSR.dfl is 1, NaT Register Consumption Fault
 Itanium Mem Faults VHPT Data Fault, Data TLB Fault, Alternate Data TLB Fault, Data Page Not Present Fault, Data NaT Page Consumption Abort, Data Key Miss Fault, Data Key Permission Fault, Data Access Rights Fault, Data Access Bit Fault

Comments: This instruction behaves identically to original MMX instructions, in the presence of x87-FP instructions, including:

CVTTPS2PI: Packed Single-FP to Packed INT32 Conversion (Continued)

- Transition from x87-FP to MMX technology (TOS=0, FP valid bits set to all valid).
- MMX instructions write ones (1's) to the exponent part of the corresponding x87-FP register.

Prioritization for fault and assist behavior for CVTTPS2PI is as follows:

Memory source

1. Invalid opcode (CR0.EM=1)
2. DNA (CR0.TS=1)
3. #MF, pending x87-FP fault signalled
4. After returning from #MF, x87-FP->MMX technology transition
5. #SS or #GP, for limit violation
6. #PF, page fault
7. Streaming SIMD Extension numeric fault (i.e. invalid, precision)

Register source

1. Invalid opcode (CR0.EM=1)
2. DNA (CR0.TS=1)
3. #MF, pending x87-FP fault signalled
4. After returning from #MF, x87-FP->MMX technology transition
5. Streaming SIMD Extension numeric fault (i.e. precision)

CVTSS2SS: Scalar signed INT32 to Single-FP Conversion

| Opcode | Instruction | Description |
|-------------|---------------------|--|
| F3,0F,2A,/r | CVTSS2SS xmm, r/m32 | Convert one 32-bit signed integer from Integer Reg/Mem to one SP FP. |

Operation: `xmm[31-0] = (float) (r/m32);`

`xmm[63-32] = xmm[63-32];`

`xmm[95-64] = xmm[95-64];`

`xmm[127-96] = xmm[127-96];`

Description: The CVTSS2SS instruction converts a signed 32-bit integer from memory or from a 32-bit integer register to a SP FP number; when the conversion is inexact, rounding is done according to the MXCSR.

FP Exceptions: None.

Numeric Exceptions: Precision.

Protected Mode Exceptions:

#GP(0) for an illegal memory operand effective address in the CS, DS, ES, FS or GS segments; #SS(0) for an illegal address in the SS segment; #PF (fault-code) for a page fault; #UD if CR0.EM = 1; #NM if TS bit in CR0 is set; #AC for unaligned memory reference. To enable #AC exceptions, three conditions must be true (CR0.AM is set; EFLAGS.AC is set; current CPL is 3); #XM for an unmasked Streaming SIMD Extension numeric exception (CR4.OSXMMEXCPT = 1); #UD for an unmasked Streaming SIMD Extension numeric exception (CR4.OSXMMEXCPT = 0); #UD if CR4.OSFXSR(bit 9) = 0; #UD if CPUID.XMM(EDX bit 25) = 0.

Real Address Mode Exceptions:

Interrupt 13 if any part of the operand would lie outside of the effective address space from 0 to 0FFFFH; #UD if CR0.EM = 1; #NM if TS bit in CR0 is set; #XM for an unmasked Streaming SIMD Extension numeric exception (CR4.OSXMMEXCPT = 1); #UD for an unmasked Streaming SIMD Extension numeric exception (CR4.OSXMMEXCPT = 0); #UD if CR4.OSFXSR(bit 9) = 0; #UD if CPUID.XMM(EDX bit 25) = 0.

Virtual 8086 Mode Exceptions:

Same exceptions as in Real Address Mode; #AC for unaligned memory reference if the current privilege level is 3; #PF (fault-code) for a page fault.

Additional Itanium® System Environment Exceptions

Itanium Reg Faults Disabled FP Register Fault if PSR.dfl is 1, NaT Register Consumption Fault

Itanium Mem Faults VHPT Data Fault, Data TLB Fault, Alternate Data TLB Fault, Data Page Not Present Fault, Data NaT Page Consumption Abort, Data Key Miss Fault, Data Key Permission Fault, Data Access Rights Fault, Data Access Bit Fault

CVTSS2SI: Scalar Single-FP to Signed INT32 Conversion

| Opcode | Instruction | Description |
|------------|-----------------------|---|
| F3,0F,2D,r | CVTSS2SI r32, xmm/m32 | Convert one SP FP from XMM/Mem to one 32 bit signed integer using rounding mode specified by MXCSR, and move the result to an integer register. |

Operation: `r32 = (int) (xmm/m32[31-0]);`

Description: The CVTSS2SI instruction converts a SP FP number to a signed 32-bit integer and returns it in the 32-bit integer register; when the conversion is inexact, the rounded value according to the MXCSR is returned. If the converted result is larger than the maximum signed 32 bit integer, the Integer Indefinite value (0x80000000) will be returned.

FP Exceptions: None.

Numeric Exceptions: Invalid, Precision.

Protected Mode Exceptions:

#GP(0) for an illegal memory operand effective address in the CS, DS, ES, FS or GS segments; #SS(0) for an illegal address in the SS segment; #PF (fault-code) for a page fault; #UD if CR0.EM = 1; #NM if TS bit in CR0 is set; #AC for unaligned memory reference. To enable #AC exceptions, three conditions must be true (CR0.AM is set; EFLAGS.AC is set; current CPL is 3); #XM for an unmasked Streaming SIMD Extension numeric exception (CR4.OSXMMEXCPT = 1); #UD for an unmasked Streaming SIMD Extension numeric exception (CR4.OSXMMEXCPT = 0); #UD if CR4.OSFXSR(bit 9) = 0; #UD if CPUID.XMM(EDX bit 25) = 0.

Real Address Mode Exceptions:

Interrupt 13 if any part of the operand would lie outside of the effective address space from 0 to 0FFFFH; #UD if CR0.EM = 1; #NM if TS bit in CR0 is set; #XM for an unmasked Streaming SIMD Extension numeric exception (CR4.OSXMMEXCPT = 1); #UD for an unmasked Streaming SIMD Extension numeric exception (CR4.OSXMMEXCPT = 0); #UD if CR4.OSFXSR(bit 9) = 0; #UD if CPUID.XMM(EDX bit 25) = 0.

Virtual 8086 Mode Exceptions:

Same exceptions as in Real Address Mode; #AC for unaligned memory reference if the current privilege level is 3; #PF (fault-code) for a page fault.

Additional Itanium® System Environment Exceptions

Itanium Reg Faults Disabled FP Register Fault if PSR.dfl is 1, NaT Register Consumption Fault

Itanium Mem Faults VHPT Data Fault, Data TLB Fault, Alternate Data TLB Fault, Data Page Not Present Fault, Data NaT Page Consumption Abort, Data Key Miss Fault, Data Key Permission Fault, Data Access Rights Fault, Data Access Bit Fault

CVTTPS2PI: Packed Single-FP to Packed INT32 Conversion (truncate)

| Opcode | Instruction | Description |
|---------|-----------------------|--|
| 0F,2C,r | CVTTPS2PI mm, xmm/m64 | Convert lower 2 SP FP from XMM/Mem to 2 32-bit signed integers in MM using truncate. |

Operation: $mm[31-0] = (int) (xmm/m64[31-0]);$
 $mm[63-32] = (int) (xmm/m64[63-32]);$

Description: The CVTTPS2PI instruction converts the lower 2 SP FP numbers in xmm/m64 to 2 32-bit signed integers in mm; if the conversion is inexact, the truncated result is returned. If the converted result(s) is/are larger than the maximum signed 32 bit value, the Integer Indefinite value (0x80000000) will be returned.

FP Exceptions: None.

Numeric Exceptions: Invalid, Precision.

Protected Mode Exceptions:

#GP(0) for an illegal memory operand effective address in the CS, DS, ES, FS or GS segments; #SS(0) for an illegal address in the SS segment; #PF (fault-code) for a page fault; #UD if CR0.EM = 1; #NM if TS bit in CR0 is set; #MF if there is a pending FPU exception; #AC for unaligned memory reference. To enable #AC exceptions, three conditions must be true (CR0.AM is set; EFLAGS.AC is set; current CPL is 3); #XM for an unmasked Streaming SIMD Extension numeric exception (CR4.OSXMMEXCPT = 1); #UD for an unmasked Streaming SIMD Extension numeric exception (CR4.OSXMMEXCPT = 0); #UD if CR4.OSFXSR(bit 9) = 0; #UD if CPUID.XMM(EDX bit 25) = 0.

Real Address Mode Exceptions:

Interrupt 13 if any part of the operand would lie outside of the effective address space from 0 to 0FFFFH; #UD if CR0.EM = 1; #NM if TS bit in CR0 is set; #MF if there is a pending FPU exception; #XM for an unmasked Streaming SIMD Extension numeric exception (CR4.OSXMMEXCPT = 1); #UD for an unmasked Streaming SIMD Extension numeric exception (CR4.OSXMMEXCPT = 0); #UD if CR4.OSFXSR(bit 9) = 0; #UD if CPUID.XMM(EDX bit 25) = 0.

Virtual 8086 Mode Exceptions:

Same exceptions as in Real Address Mode; #AC for unaligned memory reference if the current privilege level is 3; #PF (fault-code) for a page fault.

Additional Itanium® System Environment Exceptions

Itanium Reg Faults Disabled FP Register Fault if PSR.dfl is 1, NaT Register Consumption Fault
 Itanium Mem Faults VHPT Data Fault, Data TLB Fault, Alternate Data TLB Fault, Data Page Not Present Fault, Data NaT Page Consumption Abort, Data Key Miss Fault, Data Key Permission Fault, Data Access Rights Fault, Data Access Bit Fault

CVTTTPS2PI: Packed Single-FP to Packed INT32 Conversion (truncate) (Continued)

Comments: This instruction behaves identically to original MMX instructions, in the presence of x87-FP instructions, including:

- Transition from x87-FP to MMX technology (TOS=0, FP valid bits set to all valid).
- MMX instructions write ones (1's) to the exponent part of the corresponding x87-FP register.

Prioritization for fault and assist behavior for CVTTTPS2PI is as follows:

Memory source

1. Invalid opcode (CR0.EM=1)
2. DNA (CR0.TS=1)
3. #MF, pending x87-FP fault signalled
4. After returning from #MF, x87-FP->MMX technology transition
5. #SS or #GP, for limit violation
6. #PF, page fault
7. Streaming SIMD Extension numeric fault (i.e. invalid, precision)

Register source

1. Invalid opcode (CR0.EM=1)
2. DNA (CR0.TS=1)
3. #MF, pending x87-FP fault signalled
4. After returning from #MF, x87-FP->MMX technology transition
5. Streaming SIMD Extension numeric fault (i.e. precision)

CVTTSS2SI: Scalar Single-FP to signed INT32 Conversion (truncate)

| Opcode | Instruction | Description |
|-------------|------------------------|--|
| F3,0F,2C,/r | CVTTSS2SI r32, xmm/m32 | Convert lowest SP FP from XMM/Mem to one 32 bit signed integer using truncate, and move the result to an integer register. |

Operation: `r32 = (int) (xmm/m32[31-0]);`

Description: The CVTTSS2SI instruction converts a SP FP number to a signed 32-bit integer and returns it in the 32-bit integer register; if the conversion is inexact, the truncated result is returned. If the converted result is larger than the maximum signed 32 bit value, the Integer Indefinite value (0x80000000) will be returned.

FP Exceptions: None.

Numeric Exceptions: Invalid, Precision.

Protected Mode Exceptions:

#GP(0) for an illegal memory operand effective address in the CS, DS, ES, FS or GS segments; #SS(0) for an illegal address in the SS segment; #PF (fault-code) for a page fault; #UD if CR0.EM = 1; #NM if TS bit in CR0 is set; #AC for unaligned memory reference. To enable #AC exceptions, three conditions must be true (CR0.AM is set; EFLAGS.AC is set; current CPL is 3); #XM for an unmasked Streaming SIMD Extension numeric exception (CR4.OSXMMEXCPT = 1); #UD for an unmasked Streaming SIMD Extension numeric exception (CR4.OSXMMEXCPT = 0); #UD if CR4.OSFXSR(bit 9) = 0; #UD if CPUID.XMM(EDX bit 25) = 0.

Real Address Mode Exceptions:

Interrupt 13 if any part of the operand would lie outside of the effective address space from 0 to 0FFFFH; #UD if CR0.EM = 1; #NM if TS bit in CR0 is set; #XM for an unmasked Streaming SIMD Extension numeric exception (CR4.OSXMMEXCPT = 1); #UD for an unmasked Streaming SIMD Extension numeric exception (CR4.OSXMMEXCPT = 0); #UD if CR4.OSFXSR(bit 9) = 0; #UD if CPUID.XMM(EDX bit 25) = 0.

Virtual 8086 Mode Exceptions:

Same exceptions as in Real Address Mode; #AC for unaligned memory reference if the current privilege level is 3; #PF (fault-code) for a page fault.

Additional Itanium® System Environment Exceptions

Itanium Reg Faults Disabled FP Register Fault if PSR.dfl is 1, NaT Register Consumption Fault

Itanium Mem Faults VHPT Data Fault, Data TLB Fault, Alternate Data TLB Fault, Data Page Not Present Fault, Data NaT Page Consumption Abort, Data Key Miss Fault, Data Key Permission Fault, Data Access Rights Fault, Data Access Bit Fault

DIVPS: Packed Single-FP Divide

| Opcode | Instruction | Description |
|---------|-----------------------|---|
| 0F,5E,r | DIVPS xmm1, xmm2/m128 | Divide packed SP FP numbers in XMM1 by XMM2/Mem |

Operation:

$$\text{xmm1}[31-0] = \text{xmm1}[31-0] / (\text{xmm2}/\text{m128}[31-0]);$$

$$\text{xmm1}[63-32] = \text{xmm1}[63-32] / (\text{xmm2}/\text{m128}[63-32]);$$

$$\text{xmm1}[95-64] = \text{xmm1}[95-64] / (\text{xmm2}/\text{m128}[95-64]);$$

$$\text{xmm1}[127-96] = \text{xmm1}[127-96] / (\text{xmm2}/\text{m128}[127-96]);$$

Description: The DIVPS instruction divides the packed SP FP numbers of both their operands.

FP Exceptions: General protection exception if not aligned on 16-byte boundary, regardless of segment.

Numeric Exceptions: Overflow, Underflow, Invalid, Divide by Zero, Precision, Denormal.

Protected Mode Exceptions:

#GP(0) for an illegal memory operand effective address in the CS, DS, ES, FS or GS segments; #SS(0) for an illegal address in the SS segment; #PF(fault-code) for a page fault; #UD if CR0.EM = 1; #NM if TS bit in CR0 is set; #XM for an unmasked Streaming SIMD Extension numeric exception (CR4.OSXMMEXCPT = 1); #UD for an unmasked Streaming SIMD Extension numeric exception (CR4.OSXMMEXCPT = 0); #UD if CR4.OSFXSR(bit 9) = 0; #UD if CPUID.XMM(EDX bit 25) = 0.

Real Address Mode Exceptions:

Interrupt 13 if any part of the operand would lie outside of the effective address space from 0 to 0FFFFH; #UD if CR0.EM = 1; #NM if TS bit in CR0 is set; #XM for an unmasked Streaming SIMD Extension numeric exception (CR4.OSXMMEXCPT = 1); #UD for an unmasked Streaming SIMD Extension numeric exception (CR4.OSXMMEXCPT = 0); #UD if CR4.OSFXSR(bit 9) = 0; #UD if CPUID.XMM(EDX bit 25) = 0.

Virtual 8086 Mode Exceptions:

Same exceptions as in Real Address Mode; #PF(fault-code) for a page fault.

Additional Itanium[®] System Environment Exceptions

Itanium Reg Faults Disabled FP Register Fault if PSR.dfl is 1, NaT Register Consumption Fault
 Itanium Mem Faults VHPT Data Fault, Data TLB Fault, Alternate Data TLB Fault, Data Page Not Present Fault, Data NaT Page Consumption Abort, Data Key Miss Fault, Data Key Permission Fault, Data Access Rights Fault, Data Access Bit Fault

DIVSS: Scalar Single-FP Divide

| Opcode | Instruction | Description |
|-------------|----------------------|--|
| F3,0F,5E,/r | DIVSS xmm1, xmm2/m32 | Divide lower SP FP numbers in XMM1 by XMM2/Mem |

Operation:

$$\text{xmm1}[31-0] = \text{xmm1}[31-0] / (\text{xmm2}/\text{m32}[31-0]);$$

$$\text{xmm1}[63-32] = \text{xmm1}[63-32];$$

$$\text{xmm1}[95-64] = \text{xmm1}[95-64];$$

$$\text{xmm1}[127-96] = \text{xmm1}[127-96];$$

Description: The DIVSS instructions divide the lowest SP FP numbers of both operands; the upper 3 fields are passed through from xmm1.

FP Exceptions: None.

Numeric Exceptions: Overflow, Underflow, Invalid, Divide by Zero, Precision, Denormal.

Protected Mode Exceptions:

#GP(0) for an illegal memory operand effective address in the CS, DS, ES, FS or GS segments; #SS(0) for an illegal address in the SS segment; #PF (fault-code) for a page fault; #UD if CR0.EM = 1; #NM if TS bit in CR0 is set; #AC for unaligned memory reference. To enable #AC exceptions, three conditions must be true (CR0.AM is set; EFLAGS.AC is set; current CPL is 3); #XM for an unmasked Streaming SIMD Extension numeric exception (CR4.OSXMMEXCPT = 1); #UD for an unmasked Streaming SIMD Extension numeric exception (CR4.OSXMMEXCPT = 0); #UD if CR4.OSFXSR(bit 9) = 0; #UD if CPUID.XMM(EDX bit 25) = 0.

Real Address Mode Exceptions:

Interrupt 13 if any part of the operand would lie outside of the effective address space from 0 to 0FFFFH; #UD if CR0.EM = 1; #NM if TS bit in CR0 is set; #XM for an unmasked Streaming SIMD Extension numeric exception (CR4.OSXMMEXCPT = 1); #UD for an unmasked Streaming SIMD Extension numeric exception (CR4.OSXMMEXCPT = 0); #UD if CR4.OSFXSR(bit 9) = 0; #UD if CPUID.XMM(EDX bit 25) = 0.

Virtual 8086 Mode Exceptions:

Same exceptions as in Real Address Mode; #AC for unaligned memory reference if the current privilege level is 3; #PF (fault-code) for a page fault.

Additional Itanium® System Environment Exceptions

Itanium Reg Faults Disabled FP Register Fault if PSR.dfl is 1, NaT Register Consumption Fault
 Itanium Mem Faults VHPT Data Fault, Data TLB Fault, Alternate Data TLB Fault, Data Page Not Present Fault, Data NaT Page Consumption Abort, Data Key Miss Fault, Data Key Permission Fault, Data Access Rights Fault, Data Access Bit Fault

FXRSTOR: Restore FP and Intel® MMX™ State and Streaming SIMD Extension State

| Opcode | Instruction | Description |
|----------|---------------------|---|
| 0F,AE,/1 | FXRSTOR m512byte | Load FP/Intel® MMX™ and Streaming SIMD Extension state from m512byte. |

Operation: FP and MMX state and Streaming SIMD Extension state = m512byte;

Description: The FXRSTOR instruction reloads the FP and MMX technology state and Streaming SIMD Extension state (environment and registers) from the memory area defined by m512byte. This data should have been written by a previous FXSAVE.

The FP and MMX technology and Streaming SIMD Extension environment and registers consist of the following data structure (little-endian byte order as arranged in memory, with byte offset into row described by right column):

| 15 | 14 | 13 | 12 | 11 | 10 | 9 | 8 | 7 | 6 | 5 | 4 | 3 | 2 | 1 | 0 | |
|----------|----|-------|----|---------|-------|-----|-----|-----|---|---|---|---|---|---|-----|----|
| Rsrvd | CS | IP | | FOP | | FTW | FSW | FCW | | | | | | | | 0 |
| Reserved | | MXCSR | | | Rsrvd | DS | DP | | | | | | | | | 16 |
| Reserved | | | | ST0/MM0 | | | | | | | | | | | 32 | |
| Reserved | | | | ST1/MM1 | | | | | | | | | | | 48 | |
| Reserved | | | | ST2/MM2 | | | | | | | | | | | 64 | |
| Reserved | | | | ST3/MM3 | | | | | | | | | | | 80 | |
| Reserved | | | | ST4/MM4 | | | | | | | | | | | 96 | |
| Reserved | | | | ST5/MM5 | | | | | | | | | | | 112 | |
| Reserved | | | | ST6/MM6 | | | | | | | | | | | 128 | |
| Reserved | | | | ST7/MM7 | | | | | | | | | | | 144 | |
| XMM0 | | | | | | | | | | | | | | | 160 | |
| XMM1 | | | | | | | | | | | | | | | 176 | |
| XMM2 | | | | | | | | | | | | | | | 192 | |
| XMM3 | | | | | | | | | | | | | | | 208 | |
| XMM4 | | | | | | | | | | | | | | | 224 | |
| XMM5 | | | | | | | | | | | | | | | 240 | |
| XMM6 | | | | | | | | | | | | | | | 256 | |
| XMM7 | | | | | | | | | | | | | | | 272 | |
| Reserved | | | | | | | | | | | | | | | 288 | |
| Reserved | | | | | | | | | | | | | | | 304 | |
| Reserved | | | | | | | | | | | | | | | 320 | |
| Reserved | | | | | | | | | | | | | | | 336 | |
| Reserved | | | | | | | | | | | | | | | 352 | |
| Reserved | | | | | | | | | | | | | | | 368 | |
| Reserved | | | | | | | | | | | | | | | 384 | |
| Reserved | | | | | | | | | | | | | | | 400 | |
| Reserved | | | | | | | | | | | | | | | 416 | |
| Reserved | | | | | | | | | | | | | | | 432 | |
| Reserved | | | | | | | | | | | | | | | 448 | |

| 15 | 14 | 13 | 12 | 11 | 10 | 9 | 8 | 7 | 6 | 5 | 4 | 3 | 2 | 1 | 0 |
|----------|----|----|----|----|----|---|-----|---|-----|-----|-----|---|---|---|-----|
| Rsrvd | CS | | IP | | | | FOP | | FTW | FSW | FCW | | 0 | | |
| Reserved | | | | | | | | | | | | | | | 464 |
| Reserved | | | | | | | | | | | | | | | 480 |
| Reserved | | | | | | | | | | | | | | | 496 |

Three fields in the floating-point save area contain reserved bits that are not indicated in the table:

- FOP: The lower 11-bits contain the opcode, upper 5-bits are reserved.
- IP & DP:32-bit mode: 32-bit IP-offset.
- 16-bit mode: lower 16-bits are IP-offset and upper 16-bits are reserved.

If the MXCSR state contains an unmasked exception with corresponding status flag also set, loading it will not result in a floating-point error condition being asserted; only the next occurrence of this unmasked exception will result in the error condition being asserted.

Some bits of MXCSR (bits 31-16 and bit 6) are defined as reserved and cleared; attempting to write a non-zero value to these bits will result in a general protection exception.

FXRSTOR does not flush pending x87-FP exceptions, unlike FRSTOR. To check and raise exceptions when loading a new operating environment, use FWAIT after FXRSTOR.

The Streaming SIMD Extension fields in the save image (XMM0-XMM7 and MXCSR) may not be loaded into the processor if the CR4.OSFXSR bit is not set. This CR4 bit must be set in order to enable execution of Streaming SIMD Extension instructions.

FP Exceptions: If #AC exception detection is disabled, a general protection exception is signalled if the address is not aligned on 16-byte boundary. Note that if #AC is enabled (and CPL is 3), signalling of #AC is not guaranteed and may vary with implementation; in all implementations where #AC is not signalled, a general protection fault will instead be signalled. In addition, the width of the alignment check when #AC is enabled may also vary with implementation; for instance, for a given implementation #AC might be signalled for a 2-byte misalignment, whereas #GP might be signalled for all other misalignments (4/8/16-byte). Invalid opcode exception if instruction is preceded by a LOCK override prefix. General protection fault if reserved bits of MXCSR are loaded with non-zero values

Numeric Exceptions: None

Protected Mode Exceptions:

#GP(0) for an illegal memory operand effective address in the CS, DS, ES, FS or GS segments; #SS(0) for an illegal address in the SS segment; #PF (fault-code) for a page fault; #NM if CR0.EM = 1; #NM if TS bit in CR0 is set; #AC for unaligned memory reference. To enable #AC exceptions, three conditions must be true(CR0.AM is set; EFLAGS.AC is set; current CPL is 3).

Real Address Mode Exceptions:

Interrupt 13 if any part of the operand would lie outside of the effective address space from 0 to 0FFFFH; #NM if CR0.EM = 1; #NM if TS bit in CR0 is set.

FXRSTOR: Restore FP and Intel® MMX™ State and Streaming SIMD Extension State (Continued)

Virtual 8086 Mode Exceptions:

Same exceptions as in Real Address Mode; #AC for unaligned memory reference if the current privilege level is 3; #PF (fault-code) for a page fault.

Additional Itanium® System Environment Exceptions

Itanium Reg Faults Disabled FP Register Fault if PSR.dfl is 1, NaT Register Consumption Fault

Itanium Mem Faults VHPT Data Fault, Data TLB Fault, Alternate Data TLB Fault, Data Page Not Present Fault, Data NaT Page Consumption Abort, Data Key Miss Fault, Data Key Permission Fault, Data Access Rights Fault, Data Access Bit Fault

Notes:

State saved with FXSAVE and restored with FRSTOR (and vice versa) will result in incorrect restoration of state in the processor. The address size prefix will have the usual effect on address calculation but will have no effect on the format of the FXRSTOR image.

The use of Repeat (F2H, F3H) and Operand Size (66H) prefixes with FXRSTOR is reserved. Different processor implementations may handle this prefix differently. Use of this prefix with FXRSTOR risks incompatibility with future processors.



FXSAVE: Store FP and Intel® MMX™ State and Streaming SIMD Extension State

| Opcode | Instruction | Description |
|----------|--------------------|--|
| 0F,AE,/0 | FXSAVE m512byte | Store FP and Intel® MMX™ state and Streaming SIMD Extension state to m512byte. |

Operation: m512byte = FP and MMX state and Streaming SIMD Extension state;

Description: The FXSAVE instruction writes the current FP and MMX technology state and Streaming SIMD Extension state (environment and registers) to the specified destination defined by m512byte. It does this without checking for pending unmasked floating-point exceptions, similar to the operation of FNSAVE. Unlike the FSAVE/FNSAVE instructions, the processor retains the contents of the FP and MMX technology state and Streaming SIMD Extension state in the processor after the state has been saved. This instruction has been optimized to maximize floating-point save performance. The save data structure is as follows (little-endian byte order as arranged in memory, with byte offset into row described by right column):

| | | | | | | | 15 | 14 | 13 | 12 | 11 | 10 | 9 | 8 | 7 | 6 | 5 | 4 | 3 | 2 | 1 | 0 |
|----------|----|--|-------|--|--|---------|-----|----|-----|----|-----|----|---|---|-----|---|---|----|---|---|---|-----|
| Rsrvd | CS | | IP | | | FOP | FTW | | FSW | | FCW | | | | | | | | | 0 | | |
| Reserved | | | MXCSR | | | Rsrvd | DS | | DP | | | | | | | | | 16 | | | | |
| Reserved | | | | | | ST0/MM0 | | | | | | | | | 32 | | | | | | | |
| Reserved | | | | | | ST1/MM1 | | | | | | | | | 48 | | | | | | | |
| Reserved | | | | | | ST2/MM2 | | | | | | | | | 64 | | | | | | | |
| Reserved | | | | | | ST3/MM3 | | | | | | | | | 80 | | | | | | | |
| Reserved | | | | | | ST4/MM4 | | | | | | | | | 96 | | | | | | | |
| Reserved | | | | | | ST5/MM5 | | | | | | | | | 112 | | | | | | | |
| Reserved | | | | | | ST6/MM6 | | | | | | | | | 128 | | | | | | | |
| Reserved | | | | | | ST7/MM7 | | | | | | | | | 144 | | | | | | | |
| XMM0 | | | | | | | | | | | | | | | | | | | | | | 160 |
| XMM1 | | | | | | | | | | | | | | | | | | | | | | 176 |
| XMM2 | | | | | | | | | | | | | | | | | | | | | | 192 |
| XMM3 | | | | | | | | | | | | | | | | | | | | | | 208 |
| XMM4 | | | | | | | | | | | | | | | | | | | | | | 224 |
| XMM5 | | | | | | | | | | | | | | | | | | | | | | 240 |
| XMM6 | | | | | | | | | | | | | | | | | | | | | | 256 |
| XMM7 | | | | | | | | | | | | | | | | | | | | | | 272 |
| Reserved | | | | | | | | | | | | | | | | | | | | | | 288 |
| Reserved | | | | | | | | | | | | | | | | | | | | | | 304 |
| Reserved | | | | | | | | | | | | | | | | | | | | | | 320 |
| Reserved | | | | | | | | | | | | | | | | | | | | | | 336 |
| Reserved | | | | | | | | | | | | | | | | | | | | | | 352 |
| Reserved | | | | | | | | | | | | | | | | | | | | | | 368 |
| Reserved | | | | | | | | | | | | | | | | | | | | | | 384 |
| Reserved | | | | | | | | | | | | | | | | | | | | | | 400 |
| Reserved | | | | | | | | | | | | | | | | | | | | | | 416 |
| Reserved | | | | | | | | | | | | | | | | | | | | | | 432 |
| Reserved | | | | | | | | | | | | | | | | | | | | | | 448 |

| 15 | 14 | 13 | 12 | 11 | 10 | 9 | 8 | 7 | 6 | 5 | 4 | 3 | 2 | 1 | 0 | |
|----------|----|----|----|----|----|-----|---|-----|---|-----|---|-----|---|---|-----|---|
| Rsrvd | CS | | IP | | | FOP | | FTW | | FSW | | FCW | | | | 0 |
| Reserved | | | | | | | | | | | | | | | 464 | |
| Reserved | | | | | | | | | | | | | | | 480 | |
| Reserved | | | | | | | | | | | | | | | 496 | |

Three fields in the floating-point save area contain reserved bits that are not indicated in the table:

- FOP: The lower 11-bits contain the opcode, upper 5-bits are reserved.
- IP & DP: 32-bit mode: 32-bit IP-offset.
- 16-bit mode: lower 16-bits are IP-offset and upper 16-bits are reserved.

The FXSAVE instruction is used when an operating system needs to perform a context switch or when an exception handler needs to use the FP and MMX technology and Streaming SIMD Extension units. It cannot be used by an application program to pass a “clean” FP state to a procedure, since it retains the current state. An application must explicitly execute a FINIT instruction after FXSAVE to provide for this functionality.

All of the x87-FP fields retain the same internal format as in FSAVE except for FTW.

Unlike FSAVE, FXSAVE saves only the FTW valid bits rather than the entire x87-FP FTW field. The FTW bits are saved in a non-TOS relative order, which means that FR0 is always saved first, followed by FR1, FR2 and so forth. As an example, if TOS=4 and only ST0, ST1 and ST2 are valid, FSAVE saves the FTW field in the following format:

| | | | | | | | |
|-----|-----|-----|-----|-----|-----|-----|-------------|
| ST3 | ST2 | ST1 | ST0 | ST7 | ST6 | ST5 | ST4 (TOS=4) |
| FR7 | FR6 | FR5 | FR4 | FR3 | FR2 | FR1 | FR0 |
| 11 | xx | xx | xx | 11 | 11 | 11 | 11 |

where xx is one of (00, 01, 10). (11) indicates an empty stack elements, and the 00, 01, and 10 indicate Valid, Zero, and Special, respectively. In this example, FXSAVE would save the following vector:

| | | | | | | | |
|-----|-----|-----|-----|-----|-----|-----|-----|
| FR7 | FR6 | FR5 | FR4 | FR3 | FR2 | FR1 | FR0 |
| 0 | 1 | 1 | 1 | 0 | 0 | 0 | 0 |

The FSAVE format for FTW can be recreated from the FTW valid bits and the stored 80-bit FP data (assuming the stored data was not the contents of MMX technology registers) using the following table:

| Exponent all 1's | Exponent all 0's | Fraction all 0's | J and M bits | FTW valid bit | x87 FTW | |
|---------------------|---------------------|---------------------|-----------------|---------------|---------|----|
| 0 | 0 | 0 | 0x | 1 | Special | 10 |
| 0 | 0 | 0 | 1x | 1 | Valid | 00 |
| 0 | 0 | 1 | 00 | 1 | Special | 10 |
| 0 | 0 | 1 | 10 | 1 | Valid | 00 |
| 0 | 1 | 0 | 0x | 1 | Special | 10 |
| 0 | 1 | 0 | 1x | 1 | Special | 10 |
| 0 | 1 | 1 | 00 | 1 | Zero | 01 |
| 0 | 1 | 1 | 10 | 1 | Special | 10 |
| 1 | 0 | 0 | 1x | 1 | Special | 10 |
| 1 | 0 | 0 | 1x | 1 | Special | 10 |

| Exponent all 1's | Exponent all 0's | Fraction all 0's | J and M bits | FTW valid bit | x87 FTW |
|----------------------------------|---------------------|---------------------|-----------------|---------------|------------|
| 1 | 0 | 1 | 00 | 1 | Special 10 |
| 1 | 0 | 1 | 10 | 1 | Special 10 |
| For all legal combinations above | | | | 0 | Empty 11 |

The J-bit is defined to be the 1-bit binary integer to the left of the decimal place in the significand. The M-bit is defined to be the most significant bit of the fractional portion of the significand (i.e. the bit immediately to the right of the decimal place).

When the M-bit is the most significant bit of the fractional portion of the significand, it must be 0 if the fraction is all 0's.

If the FXSAVE instruction is immediately preceded by an FP instruction which does not use a memory operand, then the FXSAVE instruction does not write/update the DP field, in the FXSAVE image.

MXCSR holds the contents of the Streaming SIMD Extension Control/Status Register. See the LDMXCSR instruction for a full description of this field.

The fields XMM0-XMM7 contain the content of registers XMM0-XMM7 in exactly the same format as they exist in the registers.

The Streaming SIMD Extension fields in the save image (XMM0-XMM7 and MXCSR) may not be loaded into the processor if the CR4.OSFXSR bit is not set. This CR4 bit must be set in order to enable execution of Streaming SIMD Extension instructions.

The destination m512byte is assumed to be aligned on a 16-byte boundary. If m512byte is not aligned on a 16-byte boundary, FXSAVE generates a general protection exception.

FP Exceptions: If #AC exception detection is disabled, a general protection exception is signalled if the address is not aligned on 16-byte boundary. Note that if #AC is enabled (and CPL is 3), signalling of #AC is not guaranteed and may vary with implementation; in all implementations where #AC is not signalled, a general protection fault will instead be signalled. In addition, the width of the alignment check when #AC is enabled may also vary with implementation; for instance, for a given implementation #AC might be signalled for a 2-byte misalignment, whereas #GP might be signalled for all other misalignments (4/8/16-byte). Invalid opcode exception if instruction is preceded by a LOCK override prefix.

Numeric Exceptions: None

Protected Mode Exceptions:

#GP(0) for an illegal memory operand effective address in the CS, DS, ES, FS or GS segments; #SS(0) for an illegal address in the SS segment; #PF (fault-code) for a page fault; #NM if CR0.EM = 1; #NM if TS bit in CR0 is set; #AC for unaligned memory reference. To enable #AC exceptions, three conditions must be true (CR0.AM is set; EFLAGS.AC is set; current CPL is 3).

FXSAVE: Store FP and Intel® MMX™ State and Streaming SIMD Extension State (Continued)

Real Address Mode Exceptions:

Interrupt 13 if any part of the operand would lie outside of the effective address space from 0 to 0FFFFFFH; #NM if CR0.EM = 1; #NM if TS bit in CR0 is set.

Virtual 8086 Mode Exceptions:

Same exceptions as in Real Address Mode; #AC for unaligned memory reference if the current privilege level is 3; #PF (fault-code) for a page fault.

Additional Itanium® System Environment Exceptions

Itanium Reg Faults Disabled FP Register Fault if PSR.dfl is 1, NaT Register Consumption Fault

Itanium Mem Faults VHPT Data Fault, Data TLB Fault, Alternate Data TLB Fault, Data Page Not Present Fault, Data NaT Page Consumption Abort, Data Key Miss Fault, Data Key Permission Fault, Data Access Rights Fault, Data Access Bit Fault, Data Dirty Bit Fault

Notes:

State saved with FXSAVE and restored with FRSTOR (and vice versa) will result in incorrect restoration of state in the processor. The address size prefix will have the usual effect on address calculation but will have no effect on the format of the FXSAVE image.

If there is a pending unmasked FP exception at the time FXSAVE is executed, the sequence of FXSAVE-FWAIT-FXRSTOR will result in incorrect state in the processor. The FWAIT instruction causes the processor to check and handle pending unmasked FP exceptions. Since the processor does not clear the FP state with FXSAVE (unlike FSAVE), the exception is handled but that fact is not reflected in the saved image. When the image is reloaded using FXRSTOR, the exception bits in FSW will be incorrectly reloaded.

The use of Repeat (F2H, F3H) and Operand Size (66H) prefixes with FXSAVE is reserved. Different processor implementations may handle this prefix differently. Use of these prefixes with FXSAVE risks incompatibility with future processors.

LDMXCSR: Load Streaming SIMD Extension Control/Status

| Opcode | Instruction | Description |
|----------|-------------|---|
| 0F,AE,/2 | LDMXCSR m32 | Load Streaming SIMD Extension control/status word from m32. |

Operation: MXCSR = m32;

Description: The MXCSR control/status register is used to enable masked/unmasked exception handling, to set rounding modes, to set flush-to-zero mode, and to view exception status flags. The following figure shows the format and encoding of the fields in MXCSR.

| | | | | | | | | | | | | | | | | |
|----------|----|----|----|----|----|----|----|----|----|------|----|----|----|----|----|----|
| 31-16 | 15 | 10 | | | | | | 5 | | | | | 0 | | | |
| Reserved | FZ | RC | RC | PM | UM | OM | ZM | DM | IM | Rsvd | PE | UE | OE | ZE | DE | IE |

Bits 5-0 indicate whether a Streaming SIMD Extension numerical exception has been detected. They are “sticky” flags, and can be cleared by using the LDMXCSR instruction to write zeroes to these fields. If a LDMXCSR instruction clears a mask bit and sets the corresponding exception flag bit, an exception will not be immediately generated. The exception will occur only upon the next Streaming SIMD Extension to cause this type of exception. A Streaming SIMD Extension uses only one exception flag for each exception. There is no provision for individual exception reporting within a packed data type. In situations where multiple identical exceptions occur within the same instruction, the associated exception flag is updated and indicates that at least one of these conditions happened. These flags are cleared upon reset.

Bits 12-7 configure numerical exception masking; an exception type is masked if the corresponding bit is set and it is unmasked if the bit is clear. These enables are set upon reset, meaning that all numerical exceptions are masked.

Bits 14-13 encode the rounding-control, which provides for the common round-to-nearest mode, as well as directed rounding and true chop. Rounding control affects the arithmetic instructions and certain conversion instructions. The encoding for RC is as follows:

| Rounding Mode | RC Field | Description |
|-------------------------------------|----------|--|
| Round to nearest (even) | 00B | Rounded result is the closest to the infinitely precise result. If two values are equally close, the result is the even value (that is, the one with the least-significant bit of zero). |
| Round down (to minus infinity) | 01B | Rounded result is close to but no greater than the infinitely precise result |
| Round up (toward positive infinity) | 10B | Rounded result is close to but no less than the infinitely precise result. |
| Round toward zero (truncate) | 11B | Rounded result is close to but no greater in absolute value than the infinitely precise result. |

The rounding-control is set to round to nearest upon reset.

Bit 15 (FZ) is used to turn on the Flush To Zero mode (bit is set). Turning on the Flush To Zero mode has the following effects during underflow situations:

- Zero results are returned with the sign of the true result.
- Precision and underflow exception flags are set.

LDMXCSR: Load Streaming SIMD Extension Control/Status (Continued)

The IEEE mandated masked response to underflow is to deliver the denormalized result (i.e. gradual underflow); consequently, the flush to zero mode is not compatible with IEEE Std. 754. It is provided primarily for performance reasons. At the cost of a slight precision loss, faster execution can be achieved for applications where underflows are common. Unmasking the underflow exception takes precedence over Flush To Zero mode; this means that an exception handler will be invoked for a Streaming SIMD Extension instruction that generates an underflow condition while this exception is unmasked, regardless of whether flush to zero is enabled.

The other bits of MXCSR (bits 31-16 and bit 6) are defined as reserved and cleared; attempting to write a non-zero value to these bits, using either the FXRSTOR or LDMXCSR instructions, will result in a general protection exception.

The linear address corresponds to the address of the least-significant byte of the referenced memory data.

FP Exceptions: General protection fault if reserved bits are loaded with non-zero values.

Numeric Exceptions: None

Protected Mode Exceptions:

#GP(0) for an illegal memory operand effective address in the CS, DS, ES, FS or GS segments; #SS(0) for an illegal address in the SS segment; #PF(fault-code) for a page fault; #UD if CR0.EM = 1; #NM if TS bit in CR0 is set. #AC for unaligned memory reference. To enable #AC exceptions, three conditions must be true (CR0.AM is set; EFLAGS.AC is set; current CPL is 3); #UD if CRCR4.OSFXSR(bit 9) = 0; #UD if CPUID.XMM(EDX bit 25) = 0.

Real Address Mode Exceptions:

Interrupt 13 if any part of the operand would lie outside of the effective address space from 0 to 0FFFFH; #UD if CR0.EM = 1; #NM if TS bit in CR0 is set; #UD if CRCR4.OSFXSR(bit 9) = 0; #UD if CPUID.XMM(EDX bit 25) = 0.

Virtual 8086 Mode Exceptions:

Same exceptions as in Real Address Mode; #PF(fault-code) for a page fault. #AC for unaligned memory reference.

Additional Itanium® System Environment Exceptions

Itanium Reg Faults NaT Register Consumption Fault

Itanium Mem Faults VHPT Data Fault, Data TLB Fault, Alternate Data TLB Fault, Data Page Not Present Fault, Data NaT Page Consumption Abort, Data Key Miss Fault, Data Key Permission Fault, Data Access Rights Fault, Data Access Bit Fault

Comments: The usage of Repeat (F2H, F3H) and Operand Size (66H) prefixes with LDMXCSR is reserved. Different processor implementations may handle this prefix differently. Usage of this prefix with LDMXCSR risks incompatibility with future processors.

MAXPS: Packed Single-FP Maximum

| Opcode | Instruction | Description |
|---------|-----------------------|---|
| 0F,5F,r | MAXPS xmm1, xmm2/m128 | Return the maximum SP FP numbers between XMM2/Mem and XMM1. |

Operation:

$$\begin{aligned} \text{xmm1}[31-0] &= (\text{xmm1}[31-0] == \text{NaN}) ? \text{xmm2}[31-0] : \\ &(\text{xmm2}[31-0] == \text{NaN}) ? \text{xmm2}[31-0] : \\ &(\text{xmm1}[31-0] > \text{xmm2}/\text{m128}[31-0]) ? \text{xmm1}[31-0] ? \text{xmm2}/ \\ &\text{m128}[31-0]; \\ \text{xmm1}[63-32] &= (\text{xmm1}[63-32] == \text{NaN}) ? \text{xmm2}[63-32] : \\ &(\text{xmm2}[63-32] == \text{NaN}) ? \text{xmm2}[63-32] : \\ &(\text{xmm1}[63-32] > \text{xmm2}/\text{m128}[63-32]) ? \text{xmm1}[63-32] ? \text{xmm2}/ \\ &\text{m128}[63-32]; \\ \text{xmm1}[95-64] &= (\text{xmm1}[95-64] == \text{NaN}) ? \text{xmm2}[95-64] : \\ &(\text{xmm2}[95-64] == \text{NaN}) ? \text{xmm2}[95-64] : \\ &(\text{xmm1}[95-64] > \text{xmm2}/\text{m128}[95-64]) ? \text{xmm1}[95-64] ? \text{xmm2}/ \\ &\text{m128}[95-64]; \\ \text{xmm1}[127-96] &= (\text{xmm1}[127-96] == \text{NaN}) ? \text{xmm2}[127-96] : \\ &(\text{xmm2}[127-96] == \text{NaN}) ? \text{xmm2}[127-96] : \\ &(\text{xmm1}[127-96] > \text{xmm2}/\text{m128}[127-96]) ? \text{xmm1}[127-96] ? \\ &\text{xmm2}/\text{m128}[127-96]; \end{aligned}$$

Description: The MAXPS instruction returns the maximum SP FP numbers from XMM1 and XMM2/Mem. If the values being compared are both zeros, source2 (xmm2/m128) would be returned. If source2 (xmm2/m128) is an sNaN, this sNaN is forwarded unchanged to the destination (i.e. a quieted version of the sNaN is not returned).

FP Exceptions: General protection exception if not aligned on 16-byte boundary, regardless of segment.

Numeric Exceptions: Invalid (including qNaN source operand), Denormal.

Protected Mode Exceptions:

#GP(0) for an illegal memory operand effective address in the CS, DS, ES, FS or GS segments; #SS(0) for an illegal address in the SS segment; #PF(fault-code) for a page fault; #UD if CR0.EM = 1; #NM if TS bit in CR0 is set; #XM for an unmasked Streaming SIMD Extension numeric exception (CR4.OSXMMEXCPT = 1); #UD for an unmasked Streaming SIMD Extension numeric exception (CR4.OSXMMEXCPT = 0); #UD if CR4.OSFXSR(bit 9) = 0; #UD if CPUID.XMM(EDX bit 25) = 0.

MAXPS: Packed Single-FP Maximum (Continued)

Real Address Mode Exceptions:

Interrupt 13 if any part of the operand would lie outside of the effective address space from 0 to 0FFFFH; #UD if CR0.EM = 1; #NM if TS bit in CR0 is set; #XM for an unmasked Streaming SIMD Extension numeric exception (CR4.OSXMMEXCPT =1); #UD for an unmasked Streaming SIMD Extension numeric exception (CR4.OSXMMEXCPT =0); #UD if CR4.OSFXSR(bit 9) = 0; #UD if CPUID.XMM(EDX bit 25) = 0.

Virtual 8086 Mode Exceptions:

Same exceptions as in Real Address Mode; #PF(fault-code) for a page fault.

Additional Itanium® System Environment Exceptions

Itanium Reg Faults Disabled FP Register Fault if PSR.dfl is 1, NaT Register Consumption Fault

Itanium Mem Faults VHPT Data Fault, Data TLB Fault, Alternate Data TLB Fault, Data Page Not Present Fault, Data NaT Page Consumption Abort, Data Key Miss Fault, Data Key Permission Fault, Data Access Rights Fault, Data Access Bit Fault

Comments: Note that if only one source is a NaN for these instructions, the Src2 operand (either NaN or real value) is written to the result; this differs from the behavior for other instructions as defined in [Table 3-3](#), which is to always write the NaN to the result, regardless of which source operand contains the NaN. This approach for MAXPS allows compilers to use the MAXPS instruction for common C conditional constructs. If instead of this behavior, it is required that the NaN source operand be returned, the min/max functionality can be emulated using a sequence of instructions: comparison followed by AND, ANDN and OR.

MAXSS: Scalar Single-FP Maximum

| Opcode | Instruction | Description |
|------------|----------------------|---|
| F3,0F,5F,r | MAXSS xmm1, xmm2/m32 | Return the maximum SP FP number between the lower SP FP numbers from XMM2/Mem and XMM1. |

Operation:

$$\begin{aligned} \text{xmm1}[31-0] &= (\text{xmm1}[31-0] == \text{NaN}) ? \text{xmm2}[31-0] : \\ &(\text{xmm2}[31-0] == \text{NaN}) ? \text{xmm2}[31-0] : \\ &(\text{xmm1}[31-0] > \text{xmm2/m32}[31-0]) ? \text{xmm1}[31-0] : \text{xmm2/m32}[31-0]; \\ \text{xmm1}[63-32] &= \text{xmm1}[63-32]; \\ \text{xmm1}[95-64] &= \text{xmm1}[95-64]; \\ \text{xmm1}[127-96] &= \text{xmm1}[127-96]; \end{aligned}$$

Description: The MAXSS instruction returns the maximum SP FP number from the lower SP FP numbers of XMM1 and XMM2/Mem; the upper 3 fields are passed through from xmm1. If the values being compared are both zeros, source2 (xmm2/m128) would be returned. If source2 (xmm2/m128) is an sNaN, this sNaN is forwarded unchanged to the destination (i.e. a quieted version of the sNaN is not returned).

FP Exceptions: None

Numeric Exceptions: Invalid (including qNaN source operand), Denormal.

Protected Mode Exceptions:

#GP(0) for an illegal memory operand effective address in the CS, DS, ES, FS or GS segments; #SS(0) for an illegal address in the SS segment; #PF (fault-code) for a page fault; #UD if CR0.EM = 1; #NM if TS bit in CR0 is set; #AC for unaligned memory reference. To enable #AC exceptions, three conditions must be true (CR0.AM is set; EFLAGS.AC is set; current CPL is 3); #XM for an unmasked Streaming SIMD Extension numeric exception (CR4.OSXMMEXCPT = 1); #UD for an unmasked Streaming SIMD Extension numeric exception (CR4.OSXMMEXCPT = 0); #UD if CR4.OSFXSR(bit 9) = 0; #UD if CPUID.XMM(EDX bit 25) = 0.

Real Address Mode Exceptions:

Interrupt 13 if any part of the operand would lie outside of the effective address space from 0 to 0FFFFH; #UD if CR0.EM = 1; #NM if TS bit in CR0 is set; #XM for an unmasked Streaming SIMD Extension numeric exception (CR4.OSXMMEXCPT = 1); #UD for an unmasked Streaming SIMD Extension numeric exception (CR4.OSXMMEXCPT = 0); #UD if CR4.OSFXSR(bit 9) = 0; #UD if CPUID.XMM(EDX bit 25) = 0.

Virtual 8086 Mode Exceptions:

Same exceptions as in Real Address Mode; #AC for unaligned memory reference if the current privilege level is 3; #PF (fault-code) for a page fault.

MAXSS: Scalar Single-FP Maximum (Continued)

Additional Itanium® System Environment Exceptions

Itanium Reg Faults Disabled FP Register Fault if PSR.dfl is 1, NaT Register Consumption Fault

Itanium Mem Faults VHPT Data Fault, Data TLB Fault, Alternate Data TLB Fault, Data Page Not Present Fault, Data NaT Page Consumption Abort, Data Key Miss Fault, Data Key Permission Fault, Data Access Rights Fault, Data Access Bit Fault

Comments: Note that if only one source is a NaN for these instructions, the Src2 operand (either NaN or real value) is written to the result; this differs from the behavior for other instructions as defined in [Table 3-3](#), which is to always write the NaN to the result, regardless of which source operand contains the NaN. The upper three operands are still bypassed from the src1 operand, as in all other scalar operations. This approach for MAXSS allows compilers to use the MAXSS instruction for common C conditional constructs. If instead of this behavior, it is required that the NaN source operand be returned, the min/max functionality can be emulated using a sequence of instructions: comparison followed by AND, ANDN and OR.

MINPS: Packed Single-FP Minimum

| Opcode | Instruction | Description |
|---------|-----------------------|--|
| 0F,5D,r | MINPS xmm1, xmm2/m128 | Return the minimum SP numbers between XMM2/Mem and XMM1. |

Operation:

$$\begin{aligned} \text{xmm1}[31-0] &= (\text{xmm1}[31-0] == \text{NaN}) ? \text{xmm2}[31-0] : \\ &(\text{xmm2}[31-0] == \text{NaN}) ? \text{xmm2}[31-0] : \\ &(\text{xmm1}[31-0] < \text{xmm2}/\text{m128}[31-0]) : \text{xmm1}[31-0] ? \text{xmm2}/ \\ &\text{m128}[31-0]; \\ \text{xmm1}[63-32] &= (\text{xmm1}[63-32] == \text{NaN}) ? \text{xmm2}[63-32] : \\ &(\text{xmm2}[63-32] == \text{NaN}) ? \text{xmm2}[63-32] : \\ &(\text{xmm1}[63-32] < \text{xmm2}/\text{m128}[63-32]) : \text{xmm1}[63-32] ? \text{xmm2}/ \\ &\text{m128}[63-32]; \\ \text{xmm1}[95-64] &= (\text{xmm1}[95-64] == \text{NaN}) ? \text{xmm2}[95-64] : \\ &(\text{xmm2}[95-64] == \text{NaN}) ? \text{xmm2}[95-64] : \\ &(\text{xmm1}[95-64] < \text{xmm2}/\text{m128}[95-64]) : \text{xmm1}[95-64] ? \text{xmm2}/ \\ &\text{m128}[95-64]; \\ \text{xmm1}[127-96] &= (\text{xmm1}[127-96] == \text{NaN}) ? \text{xmm2}[127-96] : \\ &(\text{xmm2}[127-96] == \text{NaN}) ? \text{xmm2}[127-96] : \\ &(\text{xmm1}[127-96] < \text{xmm2}/\text{m128}[127-96]) : \text{xmm1}[127-96] ? \\ &\text{xmm2}/\text{m128}[127-96]; \end{aligned}$$

Description: The MINPS instruction returns the minimum SP FP numbers from XMM1 and XMM2/Mem. If the values being compared are both zeros, source2 (xmm2/m128) would be returned. If source2 (xmm2/m128) is an sNaN, this sNaN is forwarded unchanged to the destination (i.e. a quieted version of the sNaN is not returned).

FP Exceptions: General protection exception if not aligned on 16-byte boundary, regardless of segment.

Numeric Exceptions: Invalid (including qNaN source operand), Denormal.

Protected Mode Exceptions:

#GP(0) for an illegal memory operand effective address in the CS, DS, ES, FS or GS segments; #SS(0) for an illegal address in the SS segment; #PF(fault-code) for a page fault; #UD if CR0.EM = 1; #NM if TS bit in CR0 is set. #XM for an unmasked Streaming SIMD Extension numeric exception (CR4.OSXMMEXCPT = 1); #UD for an unmasked Streaming SIMD Extension numeric exception (CR4.OSXMMEXCPT = 0); #UD if CR4.OSFXSR(bit 9) = 0; #UD if CPUID.XMM(EDX bit 25) = 0.

MINPS: Packed Single-FP Minimum (Continued)

Real Address Mode Exceptions:

Interrupt 13 if any part of the operand would lie outside of the effective address space from 0 to 0FFFFH; #UD if CR0.EM = 1; #NM if TS bit in CR0 is set; #XM for an unmasked Streaming SIMD Extension numeric exception (CR4.OSXMMEXCPT =1); #UD for an unmasked Streaming SIMD Extension numeric exception (CR4.OSXMMEXCPT =0); #UD if CR4.OSFXSR(bit 9) = 0; #UD if CPUID.XMM(EDX bit 25) = 0.

Virtual 8086 Mode Exceptions:

Same exceptions as in Real Address Mode; #PF(fault-code) for a page fault.

Additional Itanium® System Environment Exceptions

Itanium Reg Faults Disabled FP Register Fault if PSR.dfl is 1, NaT Register Consumption Fault

Itanium Mem Faults VHPT Data Fault, Data TLB Fault, Alternate Data TLB Fault, Data Page Not Present Fault, Data NaT Page Consumption Abort, Data Key Miss Fault, Data Key Permission Fault, Data Access Rights Fault, Data Access Bit Fault

Comments: Note that if only one source is a NaN for these instructions, the Src2 operand (either NaN or real value) is written to the result; this differs from the behavior for other instructions as defined in [Table 3-3](#), which is to always write the NaN to the result, regardless of which source operand contains the NaN. This approach for MINPS allows compilers to use the MINPS instruction for common C conditional constructs. If instead of this behavior, it is required that the NaN source operand be returned, the min/max functionality can be emulated using a sequence of instructions: comparison followed by AND, ANDN and OR.

MINSS: Scalar Single-FP Minimum

| Opcode | Instruction | Description |
|------------|----------------------|--|
| F3,0F,5D,r | MINSS xmm1, xmm2/m32 | Return the minimum SP FP number between the lowest SP FP numbers from XMM2/Mem and XMM1. |

Operation:

$$\begin{aligned} \text{xmm1}[31-0] &= (\text{xmm1}[31-0] == \text{NaN}) ? \text{xmm2}[31-0] : \\ &\quad (\text{xmm2}[31-0] == \text{NaN}) ? \text{xmm2}[31-0] : \\ &\quad (\text{xmm1}[31-0] < \text{xmm2/m32}[31-0]) ? \text{xmm1}[31-0] : \text{xmm2/m32}[31-0]; \\ \text{xmm1}[63-32] &= \text{xmm1}[63-32]; \\ \text{xmm1}[95-64] &= \text{xmm1}[95-64]; \\ \text{xmm1}[127-96] &= \text{xmm1}[127-96]; \end{aligned}$$

Description: The MINSS instruction returns the minimum SP FP number from the lower SP FP numbers from XMM1 and XMM2/Mem; the upper 3 fields are passed through from xmm1. If the values being compared are both zeros, source2 (xmm2/m128) would be returned. If source2 (xmm2/m128) is an sNaN, this sNaN is forwarded unchanged to the destination (i.e. a quieted version of the sNaN is not returned).

FP Exceptions: None

Numeric Exceptions: Invalid (including qNaN source operand), Denormal.

Protected Mode Exceptions:

#GP(0) for an illegal memory operand effective address in the CS, DS, ES, FS or GS segments; #SS(0) for an illegal address in the SS segment; #PF (fault-code) for a page fault; #UD if CR0.EM = 1; #NM if TS bit in CR0 is set; #AC for unaligned memory reference. To enable #AC exceptions, three conditions must be true (CR0.AM is set; EFLAGS.AC is set; current CPL is 3); #XM for an unmasked Streaming SIMD Extension numeric exception (CR4.OSXMMEXCPT = 1); #UD for an unmasked Streaming SIMD Extension numeric exception (CR4.OSXMMEXCPT = 0); #UD if CR4.OSFXSR(bit 9) = 0; #UD if CPUID.XMM(EDX bit 25) = 0.

Real Address Mode Exceptions:

Interrupt 13 if any part of the operand would lie outside of the effective address space from 0 to 0FFFFH; #UD if CR0.EM = 1; #NM if TS bit in CR0 is set; #XM for an unmasked Streaming SIMD Extension numeric exception (CR4.OSXMMEXCPT = 1); #UD for an unmasked Streaming SIMD Extension numeric exception (CR4.OSXMMEXCPT = 0); #UD if CR4.OSFXSR(bit 9) = 0; #UD if CPUID.XMM(EDX bit 25) = 0.

Virtual 8086 Mode Exceptions:

Same exceptions as in Real Address Mode; #PF (fault-code) for a page fault; #AC for unaligned memory references.

MINSS: Scalar Single-FP Minimum (Continued)

Additional Itanium® System Environment Exceptions

Itanium Reg Faults Disabled FP Register Fault if PSR.dfl is 1, NaT Register Consumption Fault

Itanium Mem Faults VHPT Data Fault, Data TLB Fault, Alternate Data TLB Fault, Data Page Not Present Fault, Data NaT Page Consumption Abort, Data Key Miss Fault, Data Key Permission Fault, Data Access Rights Fault, Data Access Bit Fault

Comments: Note that if only one source is a NaN for these instructions, the Src2 operand (either NaN or real value) is written to the result; this differs from the behavior for other instructions as defined in [Table 3-3](#), which is to always write the NaN to the result, regardless of which source operand contains the NaN. The upper three operands are still bypassed from the src1 operand, as in all other scalar operations. This approach for MINSS allows compilers to use the MINSS instruction for common C conditional constructs. If instead of this behavior, it is required that the NaN source operand be returned, the min/max functionality can be emulated using a sequence of instructions: comparison followed by AND, ANDN and OR.

MOVAPS: Move Aligned Four Packed Single-FP

| Opcode | Instruction | Description |
|---------|------------------------|---|
| 0F,28,r | MOVAPS xmm1, xmm2/m128 | Move 128 bits representing 4 packed SP data from XMM2/Mem to XMM1 register. |
| 0F,29,r | MOVAPS xmm2/m128, xmm1 | Move 128 bits representing 4 packed SP from XMM1 register to XMM2/Mem. |

Operation:

```

if (destination == xmm1) {
    if (source == m128) {
        // load instruction
        xmm1[127-0] = m128;
    }
    else {
        // move instruction
        xmm1[127-0] = xmm2[127-0];
    }
}
else {
    if (destination == m128) {
        // store instruction
        m128 = xmm1[127-0];
    }
    else {
        // move instruction
        xmm2[127-0] = xmm1[127-0];
    }
}

```

Description: The linear address corresponds to the address of the least-significant byte of the referenced memory data. When a memory address is indicated, the 16 bytes of data at memory location m128 are loaded or stored. When the register-register form of this operation is used, the content of the 128-bit source register is copied into 128-bit destination register.

FP Exceptions: General protection exception if not aligned on 16-byte boundary, regardless of segment.

Numeric Exceptions: None

MOVAPS: Move Aligned Four Packed Single-FP (Continued)

Protected Mode Exceptions:

#GP(0) for an illegal memory operand effective address in the CS, DS, ES, FS or GS segments; #SS(0) for an illegal address in the SS segment; #PF(fault-code) for a page fault; #UD if CR0.EM = 1; #NM if TS bit in CR0 is set; #UD if CR4.OSFXSR(bit 9) = 0; #UD if CPUID.XMM(EDX bit 25) = 0.

Real Address Mode Exceptions:

Interrupt 13 if any part of the operand would lie outside of the effective address space from 0 to 0FFFFH; #UD if CR0.EM = 1; #NM if TS bit in CR0 is set; #UD if CR4.OSFXSR(bit 9) = 0; #UD if CPUID.XMM(EDX bit 25) = 0.

Virtual 8086 Mode Exceptions:

Same exceptions as in Real Address Mode; #PF(fault-code) for a page fault.

Additional Itanium® System Environment Exceptions

Itanium Reg Faults Disabled FP Register Fault if PSR.dfl is 1, NaT Register Consumption Fault
 Itanium Mem Faults VHPT Data Fault, Data TLB Fault, Alternate Data TLB Fault, Data Page Not Present Fault, Data NaT Page Consumption Abort, Data Key Miss Fault, Data Key Permission Fault, Data Access Rights Fault, Data Access Bit Fault

Comments: MOVAPS should be used when dealing with 16-byte aligned SP FP numbers. If the data is not known to be aligned, MOVUPS should be used instead of MOVAPS. The usage of this instruction should be limited to the cases where the aligned restriction is easy to meet. Processors that support Streaming SIMD Extension will provide optimal aligned performance for the MOVAPS instruction.

The usage of Repeat Prefixes (F2H, F3H) with MOVAPS is reserved. Different processor implementations may handle this prefix differently. Usage of this prefix with MOVAPS risks incompatibility with future processors.

MOVHLPS: Move High to Low Packed Single-FP

| Opcode | Instruction | Description |
|----------|--------------------|--|
| 0F,12,/r | MOVHLPS xmm1, xmm2 | Move 64 bits representing higher two SP operands from XMM2 to lower two fields of XMM1 register. |

Operation: // move instruction

```
xmm1[127-64] = xmm1[127-64];
xmm1[63-0] = xmm2[127-64];
```

Description: The upper 64-bits of the source register xmm2 are loaded into the lower 64-bits of the 128-bit register xmm1 and the upper 64-bits of xmm1 are left unchanged.

FP Exceptions: None

Numeric Exceptions: None

Protected Mode Exceptions:

#UD if CR0.EM = 1; #NM if TS bit in CR0 is set; #UD if CR4.OSFXSR(bit 9) = 0; #UD if CPUID.XMM(EDX bit 25) = 0.

Real Address Mode Exceptions:

#UD if CR0.EM = 1; #NM if TS bit in CR0 is set; #UD if CR4.OSFXSR(bit 9) = 0; #UD if CPUID.XMM(EDX bit 25) = 0.

Virtual 8086 Mode Exceptions:

Same exceptions as in Real Address Mode.

Additional Itanium® System Environment Exceptions

Itanium Reg Faults Disabled FP Register Fault if PSR.dfl is 1

Comments: The usage of Repeat (F2H, F3H) and Operand Size (66H) prefixes with MOVHLPS is reserved. Different processor implementations may handle these prefixes differently. Usage of these prefixes with MOVHLPS risks incompatibility with future processors.

MOVHPS: Move High Packed Single-FP

| Opcode | Instruction | Description |
|---------|-----------------|---|
| 0F,16,r | MOVHPS xmm, m64 | Move 64 bits representing two SP operands from Mem to upper two fields of XMM register. |
| 0F,17,r | MOVHPS m64, xmm | Move 64 bits representing two SP operands from upper two fields of XMM register to Mem. |

Operation:

```

if (destination == xmm) {
    // load instruction
    xmm[127-64] = m64;
    xmm[31-0] = xmm[31-0];
    xmm[63-32] = xmm[63-32];
}
else {
    // store instruction
    m64 = xmm[127-64];
}

```

Description: The linear address corresponds to the address of the least-significant byte of the referenced memory data. When the load form of this operation is used, m64 is loaded into the upper 64-bits of the 128-bit register xmm and the lower 64-bits are left unchanged.

FP Exceptions: None

Numeric Exceptions: None

Protected Mode Exceptions:

#GP(0) for an illegal memory operand effective address in the CS, DS, ES, FS or GS segments; #SS(0) for an illegal address in the SS segment; #PF (fault-code) for a page fault; #UD if CR0.EM = 1; #NM if TS bit in CR0 is set; #AC for unaligned memory reference. To enable #AC exceptions, three conditions must be true (CR0.AM is set; EFLAGS.AC is set; current CPL is 3); #UD if CRCR4.OSFXSR(bit 9) = 0; #UD if CPUID.XMM(EDX bit 25) = 0.

Real Address Mode Exceptions:

Interrupt 13 if any part of the operand would lie outside of the effective address space from 0 to 0FFFFH; #UD if CR0.EM = 1; #NM if TS bit in CR0 is set; #UD if CRCR4.OSFXSR(bit 9) = 0; #UD if CPUID.XMM(EDX bit 25) = 0.

Virtual 8086 Mode Exceptions:

Same exceptions as in Real Address Mode; #PF (fault-code) for a page fault; #AC for unaligned memory reference if the current privilege level is 3.



MOVHPS: Move High Packed Single-FP (Continued)

Additional Itanium® System Environment Exceptions

Itanium Reg Faults Disabled FP Register Fault if PSR.dfl is 1, NaT Register Consumption Fault

Itanium Mem Faults VHPT Data Fault, Data TLB Fault, Alternate Data TLB Fault, Data Page Not Present Fault, Data NaT Page Consumption Abort, Data Key Miss Fault, Data Key Permission Fault, Data Access Rights Fault, Data Access Bit Fault, Data Dirty Bit Fault

Comments: The usage of Repeat Prefixes (F2H, F3H) with MOVHPS is reserved. Different processor implementations may handle this prefix differently. Usage of this prefix with MOVHPS risks incompatibility with future processors.

MOVLHPS: Move Low to High Packed Single-FP

| Opcode | Instruction | Description |
|---------|--------------------|---|
| 0F,16,r | MOVLHPS xmm1, xmm2 | Move 64 bits representing lower two SP operands from XMM2 to upper two fields of XMM1 register. |

Operation: // move instruction

```
xmm1[127-64] = xmm2[63-0];
```

```
xmm1[63-0] = xmm1[63-0];
```

Description: The lower 64-bits of the source register xmm2 are loaded into the upper 64-bits of the 128-bit register xmm1 and the lower 64-bits of xmm1 are left unchanged.

FP Exceptions: None

Numeric Exceptions: None

Protected Mode Exceptions:

#UD if CR0.EM = 1; #NM if TS bit in CR0 is set; #UD if CR4.OSFXSR(bit 9) = 0; #UD if CPUID.XMM(EDX bit 25) = 0.

Real Address Mode Exceptions:

#UD if CR0.EM = 1; #NM if TS bit in CR0 is set; #UD if CR4.OSFXSR(bit 9) = 0; #UD if CPUID.XMM(EDX bit 25) = 0.

Virtual 8086 Mode Exceptions:

Same exceptions as in Real Address Mode.

Additional Itanium® System Environment Exceptions

Itanium Reg Faults Disabled FP Register Fault if PSR.dfl is 1

Comments:

Example: The usage of Repeat (F2H, F3H) and Operand Size (66H) prefixes with MOVLHPS is reserved. Different processor implementations may handle these prefixes differently. Usage of these prefixes with MOVLHPS risks incompatibility with future processors.

MOVLPS: Move Low Packed Single-FP

| Opcode | Instruction | Description |
|----------|-----------------|---|
| 0F,12,/r | MOVLPS xmm, m64 | Move 64 bits representing two SP operands from Mem to lower two fields of XMM register. |
| 0F,13,/r | MOVLPS m64, xmm | Move 64 bits representing two SP operands from lower two fields of XMM register to Mem. |

Operation:

```

if (destination == xmm) {
    // load instruction
    xmm[63-0] = m64;
    xmm[95-64] = xmm[95-64];
    xmm[127-96] = xmm[127-96];
}
else {
    // store instruction
    m64 = xmm[63-0];
}

```

Description: The linear address corresponds to the address of the least-significant byte of the referenced memory data. When the load form of this operation is used, m64 is loaded into the lower 64-bits of the 128-bit register xmm and the upper 64-bits are left unchanged.

FP Exceptions: None

Numeric Exceptions: None

Protected Mode Exceptions:

#GP(0) for an illegal memory operand effective address in the CS, DS, ES, FS or GS segments; #SS(0) for an illegal address in the SS segment; #PF (fault-code) for a page fault; #UD if CR0.EM = 1; #NM if TS bit in CR0 is set; #AC for unaligned memory reference. To enable #AC exceptions, three conditions must be true (CR0.AM is set; EFLAGS.AC is set; current CPL is 3); #UD if CRCR4.OSFXSR(bit 9) = 0; #UD if CPUID.XMM(EDX bit 25) = 0.

Real Address Mode Exceptions:

Interrupt 13 if any part of the operand would lie outside of the effective address space from 0 to 0FFFFH; #UD if CR0.EM = 1; #NM if TS bit in CR0 is set.; #UD if CRCR4.OSFXSR(bit 9) = 0; #UD if CPUID.XMM(EDX bit 25) = 0.

Virtual 8086 Mode Exceptions:

Same exceptions as in Real Address Mode; #PF (fault-code) for a page fault; #AC for unaligned memory reference if the current privilege level is 3.

MOVLPS: Move Low Packed Single-FP (Continued)

Additional Itanium® System Environment Exceptions

Itanium Reg Faults Disabled FP Register Fault if PSR.dfl is 1, NaT Register Consumption Fault

Itanium Mem Faults VHPT Data Fault, Data TLB Fault, Alternate Data TLB Fault, Data Page Not Present Fault, Data NaT Page Consumption Abort, Data Key Miss Fault, Data Key Permission Fault, Data Access Rights Fault, Data Access Bit Fault, Data Dirty Bit Fault

Comments: The usage of Repeat Prefixes (F2H, F3H) with MOVLPS is reserved. Different processor implementations may handle this prefix differently. Usage of this prefix with MOVLPS risks incompatibility with future processors.

MOVMSKPS: Move Mask to Integer

| Opcode | Instruction | Description |
|----------|-------------------|------------------------------|
| 0F,50,/r | MOVMSKPS r32, xmm | Move the single mask to r32. |

Operation: $r32[3] = xmm[127]; r32[2] = xmm[95];$
 $r32[1] = xmm[63]; r32[0] = xmm[31];$
 $r32[7-4] = 0x0; r32[15-8] = 0x00;$
 $r32[31-16] = 0x0000;$

Description: The MOVMSKPS instruction returns to the integer register r32 a 4-bit mask formed of the most significant bits of each SP FP number of its operand.

FP Exceptions: None

Numeric Exceptions: None.

Protected Mode Exceptions:

#UD if CR0.EM = 1; #NM if TS bit in CR0 is set; #MF if there is a pending FPU exception.;
 #UD if CR4.OSFXSR(bit 9) = 0; #UD if CPUID.XMM(EDX bit 25) = 0.

Real Address Mode Exceptions:

#UD if CR0.EM = 1; #NM if TS bit in CR0 is set.; #UD if CR4.OSFXSR(bit 9) = 0; #UD if CPUID.XMM(EDX bit 25) = 0.

Virtual 8086 Mode Exceptions:

Same exceptions as in Real Address Mode.

Additional Itanium® System Environment Exceptions

Itanium Reg Faults Disabled FP Register Fault if PSR.dfl is 1, NaT Register Consumption Fault

Comments: The usage of Repeat Prefixes (F2H, F3H) with MOVMSKPS is reserved. Different processor implementations may handle this prefix differently. Usage of this prefix with MOVMSKPS risks incompatibility with future processors.

MOVSS: Move Scalar Single-FP

| Opcode | Instruction | Description |
|-------------|----------------------|---|
| F3,0F,10,/r | MOVSS xmm1, xmm2/m32 | Move 32 bits representing one scalar SP operand from XMM2/Mem to XMM1 register. |
| F3,0F,11,/r | MOVSS xmm2/m32, xmm1 | Move 32 bits representing one scalar SP operand from XMM1 register to XMM2/Mem. |

```

Operation:  if (destination == xmm1) {
                if (source == m32) {
                    // load instruction
                    xmm1[31-0]   = m32;
                    xmm1[63-32]  = 0x00000000;
                    xmm1[95-64]  = 0x00000000;
                    xmm1[127-96] = 0x00000000;
                }
                else {
                    // move instruction
                    xmm1[31-0]   = xmm2[31-0];
                    xmm1[63-32]  = xmm1[63-32];
                    xmm1[95-64]  = xmm1[95-64];
                    xmm1[127-96] = xmm1[127-96];
                }
            }
            else {
                if (destination == m32) {
                    // store instruction
                    m32 = xmm1[31-0];
                }
                else {
                    // move instruction
                    xmm2[31-0]   = xmm1[31-0]
                    xmm2[63-32]  = xmm2[63-32];
                    xmm2[95-64]  = xmm2[95-64];
                }
            }

```

MOVSS: Move Scalar Single-FP (Continued)

```

        xmm2[127-96] = xmm2[127-96];
    }
}

```

Description: The linear address corresponds to the address of the least-significant byte of the referenced memory data. When a memory address is indicated, the 4 bytes of data at memory location m32 are loaded or stored. When the load form of this operation is used, the 32-bits from memory are copied into the lower 32 bits of the 128-bit register xmm, the 96 most significant bits being cleared.

FP Exceptions: None

Numeric Exceptions: None

Protected Mode Exceptions:

#GP(0) for an illegal memory operand effective address in the CS, DS, ES, FS or GS segments; #SS(0) for an illegal address in the SS segment; #PF (fault-code) for a page fault; #UD if CR0.EM = 1; #NM if TS bit in CR0 is set; #AC for unaligned memory reference. To enable #AC exceptions, three conditions must be true (CR0.AM is set; EFLAGS.AC is set; current CPL is 3); #UD if CRCR4.OSFXSR(bit 9) = 0; #UD if CPUID.XMM(EDX bit 25) = 0.

Real Address Mode Exceptions:

Interrupt 13 if any part of the operand would lie outside of the effective address space from 0 to 0FFFFH; #UD if CR0.EM = 1; #NM if TS bit in CR0 is set; #UD if CRCR4.OSFXSR(bit 9) = 0; #UD if CPUID.XMM(EDX bit 25) = 0.

Virtual 8086 Mode Exceptions:

Same exceptions as in Real Address Mode; #AC for unaligned memory reference if the current privilege level is 3; #PF (fault-code) for a page fault.

Additional Itanium® System Environment Exceptions

Itanium Reg Faults Disabled FP Register Fault if PSR.dfl is 1, NaT Register Consumption Fault
 Itanium Mem Faults VHPT Data Fault, Data TLB Fault, Alternate Data TLB Fault, Data Page Not Present Fault, Data NaT Page Consumption Abort, Data Key Miss Fault, Data Key Permission Fault, Data Access Rights Fault, Data Access Bit Fault, Data Dirty Bit Fault

MOVUPS: Move Unaligned Four Packed Single-FP

| Opcode | Instruction | Description |
|---------|------------------------|---|
| 0F,10,r | MOVUPS xmm1, xmm2/m128 | Move 128 bits representing four SP data from XMM2/Mem to XMM1 register. |
| 0F,11,r | MOVUPS xmm2/m128, xmm1 | Move 128 bits representing four SP data from XMM1 register to XMM2/Mem. |

Operation:

```

if (destination == xmm1) {
    if (source == m128) {
        // load instruction
        xmm1[127-0] = m128;
    }
    else {
        // move instruction
        xmm1[127-0] = xmm2[127-0];
    }
}
else {
    if (destination == m128) {
        // store instruction
        m128 = xmm1[127-0];
    }
    else {
        // move instruction
        xmm2[127-0] = xmm1[127-0];
    }
}

```

Description: The linear address corresponds to the address of the least-significant byte of the referenced memory data. When a memory address is indicated, the 16 bytes of data at memory location m128 are loaded to the 128-bit multimedia register xmm or stored from the 128-bit multimedia register xmm. When the register-register form of this operation is used, the content of the 128-bit source register is copied into 128-bit register xmm. No assumption is made about alignment.

FP Exceptions: None

Numeric Exceptions: None

MOVUPS: Move Unaligned Four Packed Single-FP (Continued)

Protected Mode Exceptions:

#GP(0) for an illegal memory operand effective address in the CS, DS, ES, FS or GS segments; #SS(0) for an illegal address in the SS segment; #PF (fault-code) for a page fault; #UD if CR0.EM = 1; #AC for unaligned memory reference if the current privilege level is 3; #NM if TS bit in CR0 is set.

Real Address Mode Exceptions:

Interrupt 13 if any part of the operand would lie outside of the effective address space from 0 to 0FFFFH; #UD if CR0.EM = 1; #NM if TS bit in CR0 is set.

Virtual 8086 Mode Exceptions:

Same exceptions as in Real Address Mode; #AC for unaligned memory reference if the current privilege level is 3; #PF (fault-code) for a page fault.

Additional Itanium® System Environment Exceptions

Itanium Reg Faults Disabled FP Register Fault if PSR.dfl is 1, NaT Register Consumption Fault

Itanium Mem Faults VHPT Data Fault, Data TLB Fault, Alternate Data TLB Fault, Data Page Not Present Fault, Data NaT Page Consumption Abort, Data Key Miss Fault, Data Key Permission Fault, Data Access Rights Fault, Data Access Bit Fault, Data Dirty Bit Fault

Comments: MOVUPS should be used with SP FP numbers when that data is known to be unaligned. The usage of this instruction should be limited to the cases where the aligned restriction is hard or impossible to meet. Streaming SIMD Extension implementations guarantee optimum unaligned support for MOVUPS. Efficient Streaming SIMD Extension applications should mainly rely on MOVAPS, not MOVUPS, when dealing with aligned data.

The usage of Repeat-NE Prefix (F2H) and Operand Size Prefix (66H) with MOVUPS is reserved. Different processor implementations may handle this prefix differently. Usage of this prefix with MOVUPS risks incompatibility with future processors.

A linear address of the 128 bit data access, while executing in 16-bit mode, that overlaps the end of a 16-bit segment is not allowed and is defined as reserved behavior. Different processor implementations may/may not raise a GP fault in this case if the segment limit has been exceeded; additionally, the address that spans the end of the segment may/may not wrap around to the beginning of the segment.

MULPS: Packed Single-FP Multiply

| Opcode | Instruction | Description |
|---------|-----------------------|--|
| 0F,59,r | MULPS xmm1, xmm2/m128 | Multiply packed SP FP numbers in XMM2/Mem to XMM1. |

Operation:

$$\text{xmm1}[31-0] = \text{xmm1}[31-0] * \text{xmm2/m128}[31-0];$$

$$\text{xmm1}[63-32] = \text{xmm1}[63-32] * \text{xmm2/m128}[63-32];$$

$$\text{xmm1}[95-64] = \text{xmm1}[95-64] * \text{xmm2/m128}[95-64];$$

$$\text{xmm1}[127-96] = \text{xmm1}[127-96] * \text{xmm2/m128}[127-96];$$

Description: The MULPS instructions multiply the packed SP FP numbers of both their operands.

FP Exceptions: General protection exception if not aligned on 16-byte boundary, regardless of segment.

Numeric Exceptions: Overflow, Underflow, Invalid, Precision, Denormal.

Protected Mode Exceptions:

#GP(0) for an illegal memory operand effective address in the CS, DS, ES, FS or GS segments; #SS(0) for an illegal address in the SS segment; #PF(fault-code) for a page fault; #UD if CR0.EM = 1; #NM if TS bit in CR0 is set; #XM for an unmasked Streaming SIMD Extension numeric exception (CR4.OSXMMEXCPT = 1); #UD for an unmasked Streaming SIMD Extension numeric exception (CR4.OSXMMEXCPT = 0).

Real Address Mode Exceptions:

Interrupt 13 if any part of the operand would lie outside of the effective address space from 0 to 0FFFFH; #UD if CR0.EM = 1; #NM if TS bit in CR0 is set; #XM for an unmasked Streaming SIMD Extension numeric exception (CR4.OSXMMEXCPT = 1); #UD for an unmasked Streaming SIMD Extension numeric exception (CR4.OSXMMEXCPT = 0).

Virtual 8086 Mode Exceptions:

Same exceptions as in Real Address Mode; #PF(fault-code) for a page fault.

Additional Itanium[®] System Environment Exceptions

Itanium Reg Faults Disabled FP Register Fault if PSR.dfl is 1, NaT Register Consumption Fault
 Itanium Mem Faults VHPT Data Fault, Data TLB Fault, Alternate Data TLB Fault, Data Page Not Present Fault, Data NaT Page Consumption Abort, Data Key Miss Fault, Data Key Permission Fault, Data Access Rights Fault, Data Access Bit Fault

MULSS: Scalar Single-FP Multiply

| Opcode | Instruction | Description |
|------------|---------------------|---|
| F3,0F,59,r | MULSS xmm1 xmm2/m32 | Multiply the lowest SP FP number in XMM2/Mem to XMM1. |

$xmm1[31-0] = xmm1[31-0] * xmm2/m32[31-0];$

$xmm1[63-32] = xmm1[63-32];$

$xmm1[95-64] = xmm1[95-64];$

$xmm1[127-96] = xmm1[127-96];$

Description: The MULSS instructions multiply the lowest SP FP numbers of both their operands; the upper 3 fields are passed through from xmm1.

FP Exceptions: None

Numeric Exceptions: Overflow, Underflow, Invalid, Precision, Denormal.

Protected Mode Exceptions:

#GP(0) for an illegal memory operand effective address in the CS, DS, ES, FS or GS segments; #SS(0) for an illegal address in the SS segment; #PF (fault-code) for a page fault; #UD if CR0.EM = 1; #NM if TS bit in CR0 is set; #AC for unaligned memory reference. To enable #AC exceptions, three conditions must be true (CR0.AM is set; EFLAGS.AC is set; current CPL is 3); #XM for an unmasked Streaming SIMD Extension numeric exception (CR4.OSXMMEXCPT = 1); #UD for an unmasked Streaming SIMD Extension numeric exception (CR4.OSXMMEXCPT = 0).

Real Address Mode Exceptions:

Interrupt 13 if any part of the operand would lie outside of the effective address space from 0 to 0FFFFH; #UD if CR0.EM = 1; #NM if TS bit in CR0 is set; #XM for an unmasked Streaming SIMD Extension numeric exception (CR4.OSXMMEXCPT = 1); #UD for an unmasked Streaming SIMD Extension numeric exception (CR4.OSXMMEXCPT = 0).

Virtual 8086 Mode Exceptions:

Same exceptions as in Real Address Mode; #AC for unaligned memory reference if the current privilege level is 3; #PF (fault-code) for a page fault.

Additional Itanium® System Environment Exceptions

Itanium Reg Faults Disabled FP Register Fault if PSR.dfl is 1, NaT Register Consumption Fault

Itanium Mem Faults VHPT Data Fault, Data TLB Fault, Alternate Data TLB Fault, Data Page Not Present Fault, Data NaT Page Consumption Abort, Data Key Miss Fault, Data Key Permission Fault, Data Access Rights Fault, Data Access Bit Fault

ORPS: Bit-wise Logical OR for Single-FP Data

| Opcode | Instruction | Description |
|---------|----------------------|---|
| 0F,56,r | ORPS xmm1, xmm2/m128 | OR 128 bits from XMM2/Mem to XMM1 register. |

Operation: $xmm1[127-0] \mid = xmm2/m128[127-0];$

Description: The ORPS instructions return a bit-wise logical OR between xmm1 and xmm2/mem.

FP Exceptions: General protection exception if not aligned on 16-byte boundary, regardless of segment.

Numeric Exceptions: None

Protected Mode Exceptions:

#GP(0) for an illegal memory operand effective address in the CS, DS, ES, FS or GS segments;
 #SS(0) for an illegal address in the SS segment; #PF(fault-code) for a page fault; #UD if CR0.EM = 1; #NM if TS bit in CR0 is set.

Real Address Mode Exceptions:

Interrupt 13 if any part of the operand would lie outside of the effective address space from 0 to 0FFFFH; #UD if CR0.EM = 1; #NM if TS bit in CR0 is set.

Virtual 8086 Mode Exceptions:

Same exceptions as in Real Address Mode; #PF(fault-code) for a page fault.

Additional Itanium® System Environment Exceptions

Itanium Reg Faults Disabled FP Register Fault if PSR.dfl is 1, NaT Register Consumption Fault

Itanium Mem Faults VHPT Data Fault, Data TLB Fault, Alternate Data TLB Fault, Data Page Not Present Fault, Data NaT Page Consumption Abort, Data Key Miss Fault, Data Key Permission Fault, Data Access Rights Fault, Data Access Bit Fault

Comments: The usage of Repeat Prefixes (F2H, F3H) with ORPS is reserved. Different processor implementations may handle this prefix differently. Usage of this prefix with ORPS risks incompatibility with future processors.

$$1.111111111010000000001_{\text{B}} \times 2^{125} \leq |x| \leq 1.000000000011000000000_{\text{B}} \times 2^{126}$$

flush-to-zero might or might not occur, depending on the implementation (this interval contains $6144 + 3072 = 9216$ single precision floating-point numbers).

Results are guaranteed to be tiny, and therefore flushed to zero, for input values x which satisfy

$$|x| \leq 1.000000000011000000000_{\text{B}} \times 2^{126}$$

The decimal approximations of the single precision numbers that delimit the three intervals specified above, are as follows:

$$1.111111111010000000000_{\text{B}} \times 2^{125} \approx 8.5039437 \times 10^{37}$$

$$1.111111111010000000001_{\text{B}} \times 2^{125} \approx 8.5039443 \times 10^{37}$$

$$1.000000000011000000000_{\text{B}} \times 2^{126} \approx 4.2550872 \times 10^{37}$$

$$1.000000000011000000001_{\text{B}} \times 2^{126} \approx 4.2550877 \times 10^{37}$$

The hexadecimal representations of the single precision numbers that delimit the three intervals specified above, are as follows:

$$1.111111111010000000000_{\text{B}} \times 2^{125} = 0x7e7fe800$$

$$1.111111111010000000001_{\text{B}} \times 2^{125} = 0x7e7fe801$$

$$1.000000000011000000000_{\text{B}} \times 2^{126} = 0x7e800c00$$

$$1.000000000011000000001_{\text{B}} \times 2^{126} = 0x7e800c01$$

$$1.111111111010000000001_{\text{B}} \times 2^{125} \leq |x| \leq 1.000000000011000000000_{\text{B}} \times 2^{126}$$

flush-to-zero might or might not occur, depending on the implementation (this interval contains $6144 + 3072 = 9216$ single precision floating-point numbers).

Results are guaranteed to be tiny, and therefore flushed to zero, for input values x which satisfy

$$|x| \leq 1.000000000011000000000_{\text{B}} \times 2^{126}$$

The decimal approximations of the single precision numbers that delimit the three intervals specified above, are as follows:

$$1.111111111010000000000_{\text{B}} \times 2^{125} \approx 8.5039437 \times 10^{37}$$

$$1.111111111010000000001_{\text{B}} \times 2^{125} \approx 8.5039443 \times 10^{37}$$

$$1.000000000011000000000_{\text{B}} \times 2^{126} \approx 4.2550872 \times 10^{37}$$

$$1.000000000011000000001_{\text{B}} \times 2^{126} \approx 4.2550877 \times 10^{37}$$

The hexadecimal representations of the single precision numbers that delimit the three intervals specified above, are as follows:

$$1.111111111010000000000_{\text{B}} \times 2^{125} = 0x7e7fe800$$

$$1.111111111010000000001_{\text{B}} \times 2^{125} = 0x7e7fe801$$

$$1.000000000011000000000_{\text{B}} \times 2^{126} = 0x7e800c00$$

$$1.000000000011000000001_{\text{B}} \times 2^{126} = 0x7e800c01$$

RSQRTPS: Packed Single-FP Square Root Reciprocal

| Opcode | Instruction | Description |
|----------|-------------------------|---|
| 0F,52,/r | RSQRTPS xmm1, xmm2/m128 | Return a packed approximation of the square root of the reciprocal of XMM2/Mem. |

Operation:

```
xmm1[31-0] = approx (1.0/sqrt(xmm2/m128[31-0]));
xmm1[63-32] = approx (1.0/sqrt(xmm2/m128[63-32]));
xmm1[95-64] = approx (1.0/sqrt(xmm2/m128[95-64]));
xmm1[127-96] = approx (1.0/sqrt(xmm2/m128[127-96]));
```

Description: RSQRTPS returns an approximation of the reciprocal of the square root of the SP FP numbers from xmm2/m128. The relative error for this approximation is Error, which satisfies:

$$|\text{Error}| \leq 1.5 \times 2^{-12}$$

FP Exceptions: General protection exception if not aligned on 16-byte boundary, regardless of segment.

Numeric Exceptions: None.

Protected Mode Exceptions:

#GP(0) for an illegal memory operand effective address in the CS, DS, ES, FS or GS segments;
 #SS(0) for an illegal address in the SS segment; #PF(fault-code) for a page fault; #UD if CR0.EM = 1; #NM if TS bit in CR0 is set; #UD if CR4.OSFXSR(bit 9) = 0; #UD if CPUID.XMM(EDX bit 25) = 0.

Real Address Mode Exceptions:

Interrupt 13 if any part of the operand would lie outside of the effective address space from 0 to 0FFFFH; #UD if CR0.EM = 1; #NM if TS bit in CR0 is set; #UD if CR4.OSFXSR(bit 9) = 0; #UD if CPUID.XMM(EDX bit 25) = 0.

Virtual 8086 Mode Exceptions:

Same exceptions as in Real Address Mode; #PF(fault-code) for a page fault.

Additional Itanium® System Environment Exceptions

Itanium Reg Faults Disabled FP Register Fault if PSR.dfl is 1, NaT Register Consumption Fault
 Itanium Mem Faults VHPT Data Fault, Data TLB Fault, Alternate Data TLB Fault, Data Page Not Present Fault, Data NaT Page Consumption Abort, Data Key Miss Fault, Data Key Permission Fault, Data Access Rights Fault, Data Access Bit Fault

Comments: RSQRTPS is not affected by the rounding control in MXCSR. Denormal inputs are treated as zeros (of the same sign).

RSQRTSS: Scalar Single-FP Square Root Reciprocal

| Opcode | Instruction | Description |
|------------|------------------------|--|
| F3,0F,52,r | RSQRTSS xmm1, xmm2/m32 | Return an approximation of the square root of the reciprocal of the lowest SP FP number in XMM2/Mem. |

Operation:

```
xmm1[31-0] = approx (1.0/sqrt(xmm2/m32[31-0]));
xmm1[63-32] = xmm1[63-32];
xmm1[95-64] = xmm1[95-64];
xmm1[127-96] = xmm1[127-96];
```

Description: RSQRTSS returns an approximation of the reciprocal of the square root of the lowest SP FP number from xmm2/m32; the upper 3 fields are passed through from xmm1. The relative error for this approximation is Error, which satisfies:

$$|\text{Error}| \leq 1.5 \times 2^{-12}$$

Numeric Exceptions: None.

Protected Mode Exceptions:

#GP(0) for an illegal memory operand effective address in the CS, DS, ES, FS or GS segments; #SS(0) for an illegal address in the SS segment; #PF (fault-code) for a page fault; #UD if CR0.EM = 1; #NM if TS bit in CR0 is set; #AC for unaligned memory reference. To enable #AC exceptions, three conditions must be true (CR0.AM is set; EFLAGS.AC is set; current CPL is 3).

Real Address Mode Exceptions:

Interrupt 13 if any part of the operand would lie outside of the effective address space from 0 to 0FFFFH; #UD if CR0.EM = 1; #NM if TS bit in CR0 is set.

Virtual 8086 Mode Exceptions:

Same exceptions as in Real Address Mode; #AC for unaligned memory reference if the current privilege level is 3; #PF (fault-code) for a page fault.

Additional Itanium® System Environment Exceptions

Itanium Reg Faults Disabled FP Register Fault if PSR.dfl is 1, NaT Register Consumption Fault
 Itanium Mem Faults VHPT Data Fault, Data TLB Fault, Alternate Data TLB Fault, Data Page Not Present Fault, Data NaT Page Consumption Abort, Data Key Miss Fault, Data Key Permission Fault, Data Access Rights Fault, Data Access Bit Fault

Comments:

Example: RSQRTSS is not affected by the rounding control in MXCSR. Denormal inputs are treated as zeros (of the same sign).

SHUFPS: Shuffle Single-FP

| Opcode | Instruction | Description |
|--------------|------------------------------|-----------------|
| 0F,C6,/r, ib | SHUFPS xmm1, xmm2/m128, imm8 | Shuffle Single. |

Operation:

```

fp_select = (imm8 >> 0) & 0x3;
xmm1[31-0] = (fp_select == 0) ? xmm1[31-0] :
              (fp_select == 1) ? xmm1[63-32] :
              (fp_select == 2) ? xmm1[95-64] :
              xmm1[127-96];

fp_select = (imm8 >> 2) & 0x3;
xmm1[63-32] = (fp_select == 0) ? xmm1[31-0] :
              (fp_select == 1) ? xmm1[63-32] :
              (fp_select == 2) ? xmm1[95-64] :
              xmm1[127-96];

fp_select = (imm8 >> 4) & 0x3;
xmm1[95-64] = (fp_select == 0) ? xmm2/m128[31-0] :
              (fp_select == 1) ? xmm2/m128[63-32] :
              (fp_select == 2) ? xmm2/m128[95-64] :
              xmm2/m128[127-96];

fp_select = (imm8 >> 6) & 0x3;
xmm1[127-96] = (fp_select == 0) ? xmm2/m128[31-0] :
              (fp_select == 1) ? xmm2/m128[63-32] :
              (fp_select == 2) ? xmm2/m128[95-64] :
              xmm2/m128[127-96];

```

Description: The SHUFPS instruction is able to shuffle any of the four SP FP numbers from xmm1 to the lower 2 destination fields; the upper 2 destination fields are generated from a shuffle of any of the four SP FP numbers from xmm2/m128. By using the same register for both sources, SHUFPS can return any combination of the four SP FP numbers from this register. Bits 0 and 1 of the immediate field are used to select which of the four input SP FP numbers will be put in the first SP FP number of the result; bits 3 and 2 of the immediate field are used to select which of the four input SP FP will be put in the second SP FP number of the result; etc.

SHUFPS: Shuffle Single-FP (Continued)

Example:

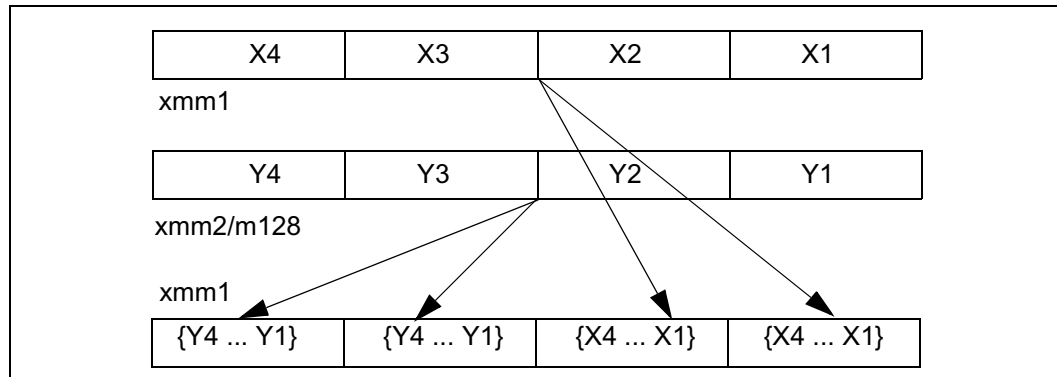

FP Exceptions: General protection exception if not aligned on 16-byte boundary, regardless of segment.

Numeric Exceptions: None

Protected Mode Exceptions:

#GP(0) for an illegal memory operand effective address in the CS, DS, ES, FS or GS segments; #SS(0) for an illegal address in the SS segment; #PF(fault-code) for a page fault; #UD if CR0.EM = 1; #NM if TS bit in CR0 is set; #UD if CR4.OSFXSR(bit 9) = 0; #UD if CPUID.XMM(EDX bit 25) = 0.

Real Address Mode Exceptions:

Interrupt 13 if any part of the operand would lie outside of the effective address space from 0 to 0FFFFH; #UD if CR0.EM = 1; #NM if TS bit in CR0 is set; #UD if CR4.OSFXSR(bit 9) = 0; #UD if CPUID.XMM(EDX bit 25) = 0.

Virtual 8086 Mode Exceptions:

Same exceptions as in Real Address Mode; #PF(fault-code) for a page fault.

Additional Itanium® System Environment Exceptions

Itanium Reg Faults Disabled FP Register Fault if PSR.dfl is 1, NaT Register Consumption Fault

Itanium Mem Faults VHPT Data Fault, Data TLB Fault, Alternate Data TLB Fault, Data Page Not Present Fault, Data NaT Page Consumption Abort, Data Key Miss Fault, Data Key Permission Fault, Data Access Rights Fault, Data Access Bit Fault

Comments: The usage of Repeat Prefixes (F2H, F3H) with SHUFPS is reserved. Different processor implementations may handle this prefix differently. Usage of this prefix with SHUFPS risks incompatibility with future processors.



SQRTPS: Packed Single-FP Square Root

| Opcode | Instruction | Description |
|---------|------------------------|--|
| 0F,51,r | SQRTPS xmm1, xmm2/m128 | Square Root of the packed SP FP numbers in XMM2/Mem. |

Operation:

```
xmm1[31-0] = sqrt (xmm2/m128[31-0]);  
xmm1[63-32] = sqrt (xmm2/m128[63-32]);  
xmm1[95-64] = sqrt (xmm2/m128[95-64]);  
xmm1[127-96] = sqrt (xmm2/m128[127-96]);
```

Description: The SQRTPS instruction returns the square root of the packed SP FP numbers from xmm2/m128.

FP Exceptions: General protection exception if not aligned on 16-byte boundary, regardless of segment.

Numeric Exceptions: Invalid, Precision, Denormal.

Protected Mode Exceptions:

#GP(0) for an illegal memory operand effective address in the CS, DS, ES, FS or GS segments; #SS(0) for an illegal address in the SS segment; #PF(fault-code) for a page fault; #UD if CR0.EM = 1; #NM if TS bit in CR0 is set; #XM for an unmasked Streaming SIMD Extension numeric exception (CR4.OSXMMEXCPT = 1); #UD for an unmasked Streaming SIMD Extension numeric exception (CR4.OSXMMEXCPT = 0); #UD if CR4.OSFXSR(bit 9) = 0; #UD if CPUID.XMM(EDX bit 25) = 0.

Real Address Mode Exceptions:

Interrupt 13 if any part of the operand would lie outside of the effective address space from 0 to 0FFFFH; #UD if CR0.EM = 1; #NM if TS bit in CR0 is set; #XM for an unmasked Streaming SIMD Extension numeric exception (CR4.OSXMMEXCPT = 1); #UD for an unmasked Streaming SIMD Extension numeric exception (CR4.OSXMMEXCPT = 0); #UD if CR4.OSFXSR(bit 9) = 0; #UD if CPUID.XMM(EDX bit 25) = 0.

Virtual 8086 Mode Exceptions:

Same exceptions as in Real Address Mode; #PF(fault-code) for a page fault.

Additional Itanium® System Environment Exceptions

Itanium Reg Faults Disabled FP Register Fault if PSR.dfl is 1, NaT Register Consumption Fault
Itanium Mem Faults VHPT Data Fault, Data TLB Fault, Alternate Data TLB Fault, Data Page Not Present Fault, Data NaT Page Consumption Abort, Data Key Miss Fault, Data Key Permission Fault, Data Access Rights Fault, Data Access Bit Fault

SQRTSS: Scalar Single-FP Square Root

| Opcode | Instruction | Description |
|------------|-----------------------|--|
| F3,0F,51,r | SQRTSS xmm1, xmm2/m32 | Square Root of the lower SP FP number in XMM2/Mem. |

Operation:

```

xmm1[31-0] = sqrt (xmm2/m32[31-0]);
xmm1[63-32] = xmm1[63-32];
xmm1[95-64] = xmm1[95-64];
xmm1[127-96] = xmm1[127-96];

```

Description: The SQRTSS instructions return the square root of the lowest SP FP numbers of their operand.

FP Exceptions: None

Numeric Exceptions: Invalid, Precision, Denormal.

Protected Mode Exceptions:

#GP(0) for an illegal memory operand effective address in the CS, DS, ES, FS or GS segments; #SS(0) for an illegal address in the SS segment; #PF (fault-code) for a page fault; #UD if CR0.EM = 1; #NM if TS bit in CR0 is set; #AC for unaligned memory reference. To enable #AC exceptions, three conditions must be true (CR0.AM is set; EFLAGS.AC is set; current CPL is 3); #XM for an unmasked Streaming SIMD Extension numeric exception (CR4.OSXMMEXCPT = 1); #UD for an unmasked Streaming SIMD Extension numeric exception (CR4.OSXMMEXCPT = 0); #UD if CR4.OSFXSR(bit 9) = 0; #UD if CPUID.XMM(EDX bit 25) = 0.

Real Address Mode Exceptions:

Interrupt 13 if any part of the operand would lie outside of the effective address space from 0 to 0FFFFH; #UD if CR0.EM = 1; #NM if TS bit in CR0 is set; #XM for an unmasked Streaming SIMD Extension numeric exception (CR4.OSXMMEXCPT = 1); #UD for an unmasked Streaming SIMD Extension numeric exception (CR4.OSXMMEXCPT = 0); #UD if CR4.OSFXSR(bit 9) = 0; #UD if CPUID.XMM(EDX bit 25) = 0.

Virtual 8086 Mode Exceptions:

Same exceptions as in Real Address Mode; #AC for unaligned memory reference if the current privilege level is 3; #PF (fault-code) for a page fault.

Additional Itanium® System Environment Exceptions

Itanium Reg Faults Disabled FP Register Fault if PSR.dfl is 1, NaT Register Consumption Fault
 Itanium Mem Faults VHPT Data Fault, Data TLB Fault, Alternate Data TLB Fault, Data Page Not Present Fault, Data NaT Page Consumption Abort, Data Key Miss Fault, Data Key Permission Fault, Data Access Rights Fault, Data Access Bit Fault

STMXCSR: Store Streaming SIMD Extension Control/Status

| Opcode | Instruction | Description |
|----------|-------------|--|
| 0F,AE,/3 | STMXCSR m32 | Store Streaming SIMD Extension control/status word to m32. |

Operation: m32 = MXCSR;

Description: The MXCSR control/status register is used to enable masked/unmasked exception handling, to set rounding modes, to set flush-to-zero mode, and to view exception status flags. Refer to LDMXCSR for a description of the format of MXCSR. The linear address corresponds to the address of the least-significant byte of the referenced memory data. The reserved bits in the MXCSR are stored as zeroes.

FP Exceptions: None.

Numeric Exceptions: None

Protected Mode Exceptions:

#GP(0) for an illegal memory operand effective address in the CS, DS, ES, FS or GS segments; #SS(0) for an illegal address in the SS segment; #PF(fault-code) for a page fault; #UD if CR0.EM = 1; #NM if TS bit in CR0 is set. #AC for unaligned memory reference. To enable #AC exceptions, three conditions must be true(CR0.AM is set; EFLAGS.AC is set; current CPL is 3); #UD if CRCR4.OSFXSR(bit 9) = 0; #UD if CPUID.XMM(EDX bit 25) = 0.

Real Address Mode Exceptions:

Interrupt 13 if any part of the operand would lie outside of the effective address space from 0 to 0FFFFH; #UD if CR0.EM = 1; #NM if TS bit in CR0 is set; #UD if CRCR4.OSFXSR(bit 9) = 0; #UD if CPUID.XMM(EDX bit 25) = 0.

Virtual 8086 Mode Exceptions:

Same exceptions as in Real Address Mode; #PF(fault-code) for a page fault. #AC for unaligned memory reference.

Additional Itanium® System Environment Exceptions

Itanium Reg Faults NaT Register Consumption Fault

Itanium Mem Faults VHPT Data Fault, Data TLB Fault, Alternate Data TLB Fault, Data Page Not Present Fault, Data NaT Page Consumption Abort, Data Key Miss Fault, Data Key Permission Fault, Data Access Rights Fault, Data Access Bit Fault, Data Dirty Bit Fault

Comments: The usage of Repeat (F2H, F3H) and Operand Size (66H) prefixes with STMXCSR is reserved. Different processor implementations may handle this prefix differently. Usage of this prefix with STMXCSR risks incompatibility with future processors.

SUBPS: Packed Single-FP Subtract

| Opcode | Instruction | Description |
|---------|----------------------|--|
| 0F,5C,r | SUBPS xmm1 xmm2/m128 | Subtract packed SP FP numbers in XMM2/Mem from XMM1. |

Operation:

$$\text{xmm1}[31-0] = \text{xmm1}[31-0] - \text{xmm2/m128}[31-0];$$

$$\text{xmm1}[63-32] = \text{xmm1}[63-32] - \text{xmm2/m128}[63-32];$$

$$\text{xmm1}[95-64] = \text{xmm1}[95-64] - \text{xmm2/m128}[95-64];$$

$$\text{xmm1}[127-96] = \text{xmm1}[127-96] - \text{xmm2/m128}[127-96];$$

Description: The SUBPS instruction subtracts the packed SP FP numbers of both their operands.

FP Exceptions: General protection exception if not aligned on 16-byte boundary, regardless of segment.

Numeric Exceptions: Overflow, Underflow, Invalid, Precision, Denormal.

Protected Mode Exceptions:

#GP(0) for an illegal memory operand effective address in the CS, DS, ES, FS or GS segments; #SS(0) for an illegal address in the SS segment; #PF(fault-code) for a page fault; #UD if CR0.EM = 1; #NM if TS bit in CR0 is set; #XM for an unmasked Streaming SIMD Extension numeric exception (CR4.OSXMMEXCPT = 1); #UD for an unmasked Streaming SIMD Extension numeric exception (CR4.OSXMMEXCPT = 0); #UD if CR4.OSFXSR(bit 9) = 0; #UD if CPUID.XMM(EDX bit 25) = 0.

Real Address Mode Exceptions:

Interrupt 13 if any part of the operand would lie outside of the effective address space from 0 to 0FFFFH; #UD if CR0.EM = 1; #NM if TS bit in CR0 is set; #XM for an unmasked Streaming SIMD Extension numeric exception (CR4.OSXMMEXCPT = 1); #UD for an unmasked Streaming SIMD Extension numeric exception (CR4.OSXMMEXCPT = 0); #UD if CR4.OSFXSR(bit 9) = 0; #UD if CPUID.XMM(EDX bit 25) = 0.

Virtual 8086 Mode Exceptions:

Same exceptions as in Real Address Mode; #PF(fault-code) for a page fault.

Additional Itanium® System Environment Exceptions

Itanium Reg Faults Disabled FP Register Fault if PSR.dfl is 1, NaT Register Consumption Fault
 Itanium Mem Faults VHPT Data Fault, Data TLB Fault, Alternate Data TLB Fault, Data Page Not Present Fault, Data NaT Page Consumption Abort, Data Key Miss Fault, Data Key Permission Fault, Data Access Rights Fault, Data Access Bit Fault

SUBSS: Scalar Single-FP Subtract

| Opcode | Instruction | Description |
|--------------|----------------------|---|
| F3,0F,5C, /r | SUBSS xmm1, xmm2/m32 | Subtract the lower SP FP numbers in XMM2/Mem from XMM1. |

Operation:

$$\text{xmm1}[31-0] = \text{xmm1}[31-0] - \text{xmm2/m32}[31-0];$$

$$\text{xmm1}[63-32] = \text{xmm1}[63-32];$$

$$\text{xmm1}[95-64] = \text{xmm1}[95-64];$$

$$\text{xmm1}[127-96] = \text{xmm1}[127-96];$$

Description: The SUBSS instruction subtracts the lower SP FP numbers of both their operands.

FP Exceptions: None.

Numeric Exceptions: Overflow, Underflow, Invalid, Precision, Denormal.

Protected Mode Exceptions:

#GP(0) for an illegal memory operand effective address in the CS, DS, ES, FS or GS segments; #SS(0) for an illegal address in the SS segment; #PF (fault-code) for a page fault; #UD if CR0.EM = 1; #NM if TS bit in CR0 is set; #AC for unaligned memory reference. To enable #AC exceptions, three conditions must be true (CR0.AM is set; EFLAGS.AC is set; current CPL is 3); #XM for an unmasked Streaming SIMD Extension numeric exception (CR4.OSXMMEXCPT = 1); #UD for an unmasked Streaming SIMD Extension numeric exception (CR4.OSXMMEXCPT = 0); #UD if CR4.OSFXSR(bit 9) = 0; #UD if CPUID.XMM(EDX bit 25) = 0.

Real Address Mode Exceptions:

Interrupt 13 if any part of the operand would lie outside of the effective address space from 0 to 0FFFFH; #UD if CR0.EM = 1; #NM if TS bit in CR0 is set; #XM for an unmasked Streaming SIMD Extension numeric exception (CR4.OSXMMEXCPT = 1); #UD for an unmasked Streaming SIMD Extension numeric exception (CR4.OSXMMEXCPT = 0); #UD if CR4.OSFXSR(bit 9) = 0; #UD if CPUID.XMM(EDX bit 25) = 0.

Virtual 8086 Mode Exceptions:

Same exceptions as in Real Address Mode; #AC for unaligned memory reference if the current privilege level is 3; #PF(fault-code) for a page fault.

Additional Itanium® System Environment Exceptions

Itanium Reg Faults Disabled FP Register Fault if PSR.dfl is 1, NaT Register Consumption Fault
 Itanium Mem Faults VHPT Data Fault, Data TLB Fault, Alternate Data TLB Fault, Data Page Not Present Fault, Data NaT Page Consumption Abort, Data Key Miss Fault, Data Key Permission Fault, Data Access Rights Fault, Data Access Bit Fault

UCOMISS: Unordered Scalar Single-FP Compare and Set EFLAGS

| Opcode | Instruction | Description |
|---------|------------------------|---|
| 0F,2E,r | UCOMISS xmm1, xmm2/m32 | Compare lower SP FP number in XMM1 register with lower SP FP number in XMM2/Mem and set the status flags accordingly. |

Operation:

```
switch (xmm1[31-0] <> xmm2/m32[31-0]) {
    OF, SF, AF = 000;

    case UNORDERED:      ZF, PF, CF = 111;
    case GREATER_THAN:  ZF, PF, CF = 000;
    case LESS_THAN:     ZF, PF, CF = 001;
    case EQUAL:         ZF, PF, CF = 100;
}
```

Description: The UCOMISS instructions compare the two lowest scalar SP FP numbers and sets the ZF,PF,CF bits in the EFLAGS register as described above. In addition, the OF, SF and AF bits in the EFLAGS register are zeroed out. The unordered predicate is returned if either source operand is a NaN (qNaN or sNaN).

FP Exceptions: None.

Numeric Exceptions: Invalid (if SNaN operands), Denormal. Integer EFLAGS values will not be updated in the presence of unmasked numeric exceptions.

Protected Mode Exceptions:

#GP(0) for an illegal memory operand effective address in the CS, DS, ES, FS or GS segments; #SS(0) for an illegal address in the SS segment; #PF (fault-code) for a page fault; #UD if CR0.EM = 1; #NM if TS bit in CR0 is set; #AC for unaligned memory reference. To enable #AC exceptions, three conditions must be true (CR0.AM is set; EFLAGS.AC is set; current CPL is 3); #XM for an unmasked Streaming SIMD Extension numeric exception (CR4.OSXMMEXCPT = 1); #UD for an unmasked Streaming SIMD Extension numeric exception (CR4.OSXMMEXCPT = 0); #UD if CR4.OSFXSR(bit 9) = 0; #UD if CPUID.XMM(EDX bit 25) = 0.

Real Address Mode Exceptions:

Interrupt 13 if any part of the operand would lie outside of the effective address space from 0 to 0FFFFH; #UD if CR0.EM = 1; #NM if TS bit in CR0 is set; #XM for an unmasked Streaming SIMD Extension numeric exception (CR4.OSXMMEXCPT = 1); #UD for an unmasked Streaming SIMD Extension numeric exception (CR4.OSXMMEXCPT = 0); #UD if CR4.OSFXSR(bit 9) = 0; #UD if CPUID.XMM(EDX bit 25) = 0.

Virtual 8086 Mode Exceptions:

Same exceptions as in Real Address Mode; #AC for unaligned memory reference if the current privilege level is 3; #PF (fault-code) for a page fault.



UCOMISS: Unordered Scalar Single-FP Compare and Set EFLAGS (Continued)

Additional Itanium® System Environment Exceptions

Itanium Reg Faults Disabled FP Register Fault if PSR.dfl is 1, NaT Register Consumption Fault

Itanium Mem Faults VHPT Data Fault, Data TLB Fault, Alternate Data TLB Fault, Data Page Not Present Fault, Data NaT Page Consumption Abort, Data Key Miss Fault, Data Key Permission Fault, Data Access Rights Fault, Data Access Bit Fault

Comments: UCOMISS differs from COMISS in that it signals an invalid numeric exception when a source operand is an sNaN; COMISS signals invalid if a source operand is either a qNaN or an sNaN.

The usage of Repeat (F2H, F3H) and Operand-Size prefixes with UCOMISS is reserved. Different processor implementations may handle this prefix differently. Usage of this prefix with UCOMISS risks incompatibility with future processors.

UNPCKHPS: Unpack High Packed Single-FP Data

| Opcode | Instruction | Description |
|---------|--------------------------|---|
| 0F,15,r | UNPCKHPS xmm1, xmm2/m128 | Interleaves SP FP numbers from the high halves of XMM1 and XMM2/Mem into XMM1 register. |

Operation:

$$\text{xmm1}[31-0] = \text{xmm1}[95-64];$$

$$\text{xmm1}[63-32] = \text{xmm2/m128}[95-64];$$

$$\text{xmm1}[95-64] = \text{xmm1}[127-96];$$

$$\text{xmm1}[127-96] = \text{xmm2/m128}[127-96];$$

Description: The UNPCKHPS instruction performs an interleaved unpack of the high-order data elements of XMM1 and XMM2/Mem. It ignores the lower half of the sources.

Example:

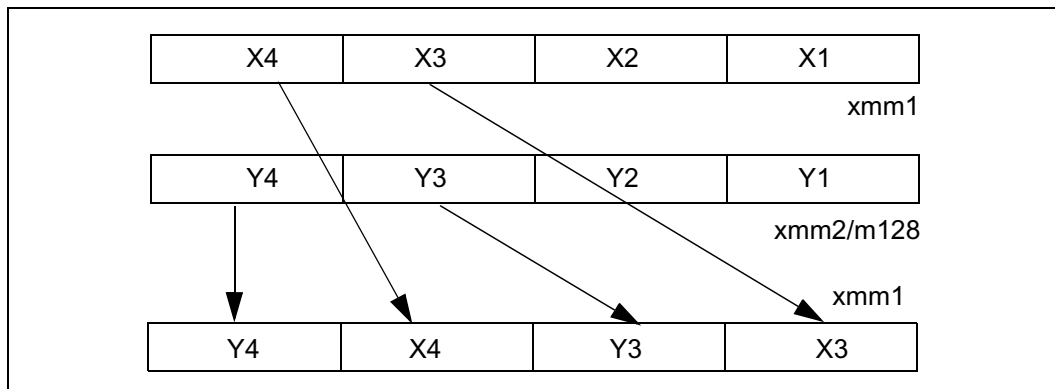

FP Exceptions: General protection exception if not aligned on 16-byte boundary, regardless of segment.

Numeric Exceptions: None

Protected Mode Exceptions:

#GP(0) for an illegal memory operand effective address in the CS, DS, ES, FS or GS segments; #SS(0) for an illegal address in the SS segment; #PF(fault-code) for a page fault; #UD if CR0.EM = 1; #NM if TS bit in CR0 is set; #UD if CR4.OSFXSR(bit 9) = 0; #UD if CPUID.XMM(EDX bit 25) = 0.

Real Address Mode Exceptions:

Interrupt 13 if any part of the operand would lie outside of the effective address space from 0 to 0FFFFH; #UD if CR0.EM = 1; #NM if TS bit in CR0 is set; #UD if CR4.OSFXSR(bit 9) = 0; #UD if CPUID.XMM(EDX bit 25) = 0.

Virtual 8086 Mode Exceptions:

Same exceptions as in Real Address Mode; #PF(fault-code) for a page fault.



UNPCKHPS: Unpack High Packed Single-FP Data (Continued)

Additional Itanium® System Environment Exceptions

Itanium Reg Faults Disabled FP Register Fault if PSR.dfl is 1, NaT Register Consumption Fault

Itanium Mem Faults VHPT Data Fault, Data TLB Fault, Alternate Data TLB Fault, Data Page Not Present Fault, Data NaT Page Consumption Abort, Data Key Miss Fault, Data Key Permission Fault, Data Access Rights Fault, Data Access Bit Fault

Comments: When unpacking from a memory operand, an implementation may decide to fetch only the appropriate 64 bits. Alignment to 16-byte boundary and normal segment checking will still be enforced.

The usage of Repeat Prefixes (F2H, F3H) with UNPCKHPS is reserved. Different processor implementations may handle this prefix differently. Usage of this prefix with UNPCKHPS risks incompatibility with future processors.

UNPCKLPS: Unpack Low Packed Single-FP Data

| Opcode | Instruction | Description |
|---------|--------------------------|--|
| 0F,14,r | UNPCKLPS xmm1, xmm2/m128 | Interleaves SP FP numbers from the low halves of XMM1 and XMM2/Mem into XMM1 register. |

Operation:

$$\text{xmm1}[31-0] = \text{xmm1}[31-0];$$

$$\text{xmm1}[63-32] = \text{xmm2/m128}[31-0];$$

$$\text{xmm1}[95-64] = \text{xmm1}[63-32];$$

$$\text{xmm1}[127-96] = \text{xmm2/m128}[63-32];$$

Description: The UNPCKLPS instruction performs an interleaved unpack of the low-order data elements of XMM1 and XMM2/Mem. It ignores the upper half part of the sources.

Example:

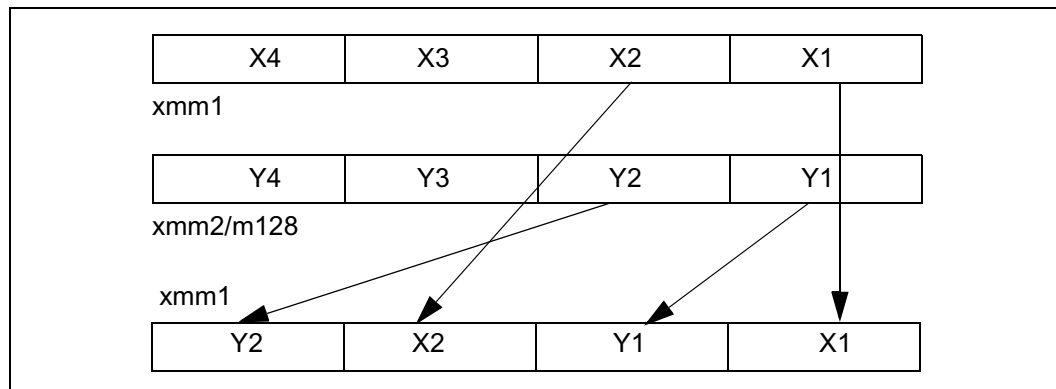

FP Exceptions: General protection exception if not aligned on 16-byte boundary, regardless of segment.

Numeric Exceptions: None.

Protected Mode Exceptions:

#GP(0) for an illegal memory operand effective address in the CS, DS, ES, FS or GS segments; #SS(0) for an illegal address in the SS segment; #PF(fault-code) for a page fault; #UD if CR0.EM = 1; #NM if TS bit in CR0 is set; #UD if CR4.OSFXSR(bit 9) = 0; #UD if CPUID.XMM(EDX bit 25) = 0.

Real Address Mode Exceptions:

Interrupt 13 if any part of the operand would lie outside of the effective address space from 0 to 0FFFFH; #UD if CR0.EM = 1; #NM if TS bit in CR0 is set; #UD if CR4.OSFXSR(bit 9) = 0; #UD if CPUID.XMM(EDX bit 25) = 0.

Virtual 8086 Mode Exceptions:

Same exceptions as in Real Address Mode; #PF(fault-code) for a page fault.



UNPCKLPS: Unpack Low Packed Single-FP Data (Continued)

Additional Itanium® System Environment Exceptions

Itanium Reg Faults Disabled FP Register Fault if PSR.dfl is 1, NaT Register Consumption Fault

Itanium Mem Faults VHPT Data Fault, Data TLB Fault, Alternate Data TLB Fault, Data Page Not Present Fault, Data NaT Page Consumption Abort, Data Key Miss Fault, Data Key Permission Fault, Data Access Rights Fault, Data Access Bit Fault

Comments: When unpacking from a memory operand, an implementation may decide to fetch only the appropriate 64 bits. Alignment to 16-byte boundary and normal segment checking will still be enforced.

The usage of Repeat Prefixes (F2H, F3H) with UNPCKLPS is reserved. Different processor implementations may handle this prefix differently. Usage of this prefix with UNPCKLPS risks incompatibility with future processors.

XORPS: Bit-wise Logical Xor for Single-FP Data

| Opcode | Instruction | Description |
|---------|-----------------------|--|
| 0F,57,r | XORPS xmm1, xmm2/m128 | XOR 128 bits from XMM2/Mem to XMM1 register. |

Operation: $\text{xmm}[127-0] \wedge= \text{xmm}/\text{m}128[127-0];$

Description: The XORPS instruction returns a bit-wise logical XOR between XMM1 and XMM2/Mem.

FP Exceptions: General protection exception if not aligned on 16-byte boundary, regardless of segment.

Numeric Exceptions: None

Protected Mode Exceptions:

#GP(0) for an illegal memory operand effective address in the CS, DS, ES, FS or GS segments; #SS(0) for an illegal address in the SS segment; #PF(fault-code) for a page fault; #UD if CR0.EM = 1; #NM if TS bit in CR0 is set; #UD if CR4.OSFXSR(bit 9) = 0; #UD if CPUID.XMM(EDX bit 25) = 0.

Real Address Mode Exceptions:

Interrupt 13 if any part of the operand would lie outside of the effective address space from 0 to 0FFFFH; #UD if CR0.EM = 1; #NM if TS bit in CR0 is set; #UD if CR4.OSFXSR(bit 9) = 0; #UD if CPUID.XMM(EDX bit 25) = 0.

Virtual 8086 Mode Exceptions:

Same exceptions as in Real Address Mode; #PF(fault-code) for a page fault.

Additional Itanium® System Environment Exceptions

Itanium Reg Faults Disabled FP Register Fault if PSR.dfl is 1, NaT Register Consumption Fault
 Itanium Mem Faults VHPT Data Fault, Data TLB Fault, Alternate Data TLB Fault, Data Page Not Present Fault, Data NaT Page Consumption Abort, Data Key Miss Fault, Data Key Permission Fault, Data Access Rights Fault, Data Access Bit Fault

Comments:

The usage of Repeat Prefixes (F2H, F3H) with XORPS is reserved. Different processor implementations may handle this prefix differently. Usage of this prefix with XORPS risks incompatibility with future processors.

3.13 SIMD Integer Instruction Set Extensions

Additional new SIMD Integer instructions have been added to accelerate the performance of 3D graphics, video decoding and encoding and other applications. These instructions operate on the MMX technology registers and on 64-bit memory operands.

PAVGB/PAVGW: Packed Average

| Opcode | Instruction | Description |
|-----------|--------------------|---|
| 0F,E0, /r | PAVGB mm1,mm2/m64 | Average with rounding packed unsigned bytes from MM2/Mem to packed bytes in MM1 register. |
| 0F,E3, /r | PAVGW mm1, mm2/m64 | Average with rounding packed unsigned words from MM2/Mem to packed words in MM1 register. |

Operation:

```

if (instruction == PAVGB) {
    x[0] = mm1[7-0]          y[0] = mm2/m64[7-0];
    x[1] = mm1[15-8]        y[1] = mm2/m64[15-8];
    x[2] = mm1[23-16]       y[2] = mm2/m64[23-16];
    x[3] = mm1[31-24]       y[3] = mm2/m64[31-24];
    x[4] = mm1[39-32]       y[4] = mm2/m64[39-32];
    x[5] = mm1[47-40]       y[5] = mm2/m64[47-40];
    x[6] = mm1[55-48]       y[6] = mm2/m64[55-48];
    x[7] = mm1[63-56]       y[7] = mm2/m64[63-56];

    for (i = 0; i < 8; i++) {
        temp[i] = zero_ext(x[i], 8) + zero_ext(y[i], 8);
        res[i] = (temp[i] + 1) >> 1;
    }
    mm1[7-0] = res[0];
    ...
    mm1[63-56] = res[7];
}

else if (instruction == PAVGW){
    x[0] = mm1[15-0]          y[0] = mm2/m64[15-0];
    x[1] = mm1[31-16]         y[1] = mm2/m64[31-16];
    x[2] = mm1[47-32]         y[2] = mm2/m64[47-32];
    x[3] = mm1[63-48]         y[3] = mm2/m64[63-48];

    for (i = 0; i < 4; i++) {

```

PAVGB/PAVGW: Packed Average (Continued)

```

        temp[i] = zero_ext(x[i], 16) + zero_ext(y[i], 16);

        res[i] = (temp[i] +1) >> 1;

    }

    mm1[15-0]    =  res[0];

    ...

    mm1[63-48]   =  res[3];

}

```

Description: The PAVG instructions add the unsigned data elements of the source operand to the unsigned data elements of the destination register, along with a carry-in. The results of the add are then each independently right shifted by one bit position. The high order bits of each element are filled with the carry bits of the corresponding sum.

The destination operand is a MMX technology register. The source operand can either be a MMX technology register or a 64-bit memory operand.

The PAVGB instruction operates on packed unsigned bytes and the PAVGW instruction operates on packed unsigned words.

Numeric Exceptions: None.

Protected Mode Exceptions:

#GP(0) for an illegal memory operand effective address in the CS, DS, ES, FS or GS segments; #SS(0) for an illegal address in the SS segment; #PF(fault-code) for a page fault; #UD if CR0.EM = 1; #NM if TS bit in CR0 is set. #MF if there is a pending FPU exception; #AC for unaligned memory reference. To enable #AC exceptions, three conditions must be true(CR0.AM is set; EFLAGS.AC is set; current CPL is 3).

Real Address Mode Exceptions:

Interrupt 13 if any part of the operand would lie outside of the effective address space from 0 to 0FFFFH; #UD if CR0.EM = 1; #NM if TS bit in CR0 is set; #MF if there is a pending FPU exception.

Virtual 8086 Mode Exceptions:

Same exceptions as in Real Address Mode; #PF(fault-code) for a page fault; #AC for unaligned memory references (if the current privilege level is 3).

Additional Itanium® System Environment Exceptions

Itanium Reg Faults Disabled FP Register Fault if PSR.dfl is 1, NaT Register Consumption Fault

Itanium Mem Faults VHPT Data Fault, Data TLB Fault, Alternate Data TLB Fault, Data Page Not Present Fault, Data NaT Page Consumption Abort, Data Key Miss Fault, Data Key Permission Fault, Data Access Rights Fault, Data Access Bit Fault



PEXTRW: Extract Word

| Opcode | Instruction | Description |
|---------------|----------------------|---|
| 0F,C5, /r, ib | PEXTRW r32, mm, imm8 | Extract the word pointed to by imm8 from MM and move it to a 32-bit integer register. |

Operation:

```
sel = imm8 & 0x3;  
mm_temp = (mm >> (sel * 16)) & 0xffff;  
r[15-0] = mm_temp[15-0];  
r[31-16] = 0x0000;
```

Description: The PEXTRW instruction moves the word in MM selected by the two least significant bits of imm8 to the lower half of a 32-bit integer register.

Numeric Exceptions: None.

Protected Mode Exceptions:

#GP(0) for an illegal memory operand effective address in the CS, DS, ES, FS or GS segments; #SS(0) for an illegal address in the SS segment; #PF(fault-code) for a page fault; #UD if CR0.EM = 1; #NM if TS bit in CR0 is set. #MF if there is a pending FPU exception.

Real Address Mode Exceptions:

Interrupt 13 if any part of the operand would lie outside of the effective address space from 0 to 0FFFFH; #UD if CR0.EM = 1; #NM if TS bit in CR0 is set. #MF if there is a pending FPU exception.

Virtual 8086 Mode Exceptions:

Same exceptions as in Real Address Mode; #PF(fault-code) for a page fault.

Additional Itanium® System Environment Exceptions

Itanium Reg Faults Disabled FP Register Fault if PSR.dfl is 1

PINSRW: Insert Word

| Opcode | Instruction | Description |
|------------|--------------------------|---|
| 0F,C4,r,ib | PINSRW mm, r32/m16, imm8 | Insert the word from the lower half of r32 or from Mem16 into the position in MM pointed to by imm8 without touching the other words. |

Operation:

```

sel = imm8 & 0x3;

mask = (sel == 0)? 0x000000000000ffff :
      (sel == 1)? 0x00000000ffff0000 :
      (sel == 2)? 0x0000ffff00000000 :
              0xffff000000000000;

mm = (mm & ~mask) | ((m16/r32[15-0] << (sel * 16)) & mask);

```

Description: The PINSRW instruction loads a word from the lower half of a 32-bit integer register (or from memory) and inserts it in the MM destination register at a position defined by the two least significant bits of the imm8 constant. The insertion is done in such a way that the three other words from the destination register are left untouched.

Numeric Exceptions: None.

Protected Mode Exceptions:

#GP(0) for an illegal memory operand effective address in the CS, DS, ES, FS or GS segments; #SS(0) for an illegal address in the SS segment; #PF (fault-code) for a page fault; #UD if CR0.EM = 1; #NM if TS bit in CR0 is set; #MF if there is a pending FPU exception; #AC for unaligned memory reference. To enable #AC exceptions, three conditions must be true(CR0.AM is set; EFLAGS.AC is set; current CPL is 3).

Real Address Mode Exceptions:

Interrupt 13 if any part of the operand would lie outside of the effective address space from 0 to 0FFFFH; #UD if CR0.EM = 1; #NM if TS bit in CR0 is set. #MF if there is a pending FPU exception.

Virtual 8086 Mode Exceptions:

Same exceptions as in Real Address Mode; #AC for unaligned memory reference if the current privilege level is 3; #PF (fault-code) for a page fault.

Additional Itanium[®] System Environment Exceptions

Itanium Reg Faults Disabled FP Register Fault if PSR.dfl is 1, NaT Register Consumption Fault
 Itanium Mem Faults VHPT Data Fault, Data TLB Fault, Alternate Data TLB Fault, Data Page Not Present Fault, Data NaT Page Consumption Abort, Data Key Miss Fault, Data Key Permission Fault, Data Access Rights Fault, Data Access Bit Fault

PMAXSW: Packed Signed Integer Word Maximum

| Opcode | Instruction | Description |
|-----------|---------------------|---|
| 0F,EE, /r | PMAXSW mm1, mm2/m64 | Return the maximum words between MM2/Mem and MM1. |

Operation:

$$\begin{aligned} \text{mm1}[15-0] &= (\text{mm1}[15-0] > \text{mm2/m64}[15-0]) ? \text{mm1}[15-0] : \text{mm2/m64}[15-0]; \\ \text{mm1}[31-16] &= (\text{mm1}[31-16] > \text{mm2/m64}[31-16]) ? \text{mm1}[31-16] : \text{mm2/m64}[31-16]; \\ \text{mm1}[47-32] &= (\text{mm1}[47-32] > \text{mm2/m64}[47-32]) ? \text{mm1}[47-32] : \text{mm2/m64}[47-32]; \\ \text{mm1}[63-48] &= (\text{mm1}[63-48] > \text{mm2/m64}[63-48]) ? \text{mm1}[63-48] : \text{mm2/m64}[63-48]; \end{aligned}$$

Description: The PMAXSW instruction returns the maximum between the four signed words in MM1 and MM2/Mem.

Numeric Exceptions: None.

Protected Mode Exceptions:

#GP(0) for an illegal memory operand effective address in the CS, DS, ES, FS or GS segments; #SS(0) for an illegal address in the SS segment; #PF (fault-code) for a page fault; #UD if CR0.EM = 1; #NM if TS bit in CR0 is set; #MF if there is a pending FPU exception #AC for unaligned memory reference. To enable #AC exceptions, three conditions must be true (CR0.AM is set; EFLAGS.AC is set; current CPL is 3).

Real Address Mode Exceptions:

Interrupt 13 if any part of the operand would lie outside of the effective address space from 0 to 0FFFFH; #UD if CR0.EM = 1; #NM if TS bit in CR0 is set. #MF if there is a pending FPU exception.

Virtual 8086 Mode Exceptions:

Same exceptions as in Real Address Mode; #PF(fault-code) for a page fault; #AC for unaligned memory reference if the current privilege level is 3.

Additional Itanium® System Environment Exceptions

Itanium Reg Faults Disabled FP Register Fault if PSR.dfl is 1, NaT Register Consumption Fault
 Itanium Mem Faults VHPT Data Fault, Data TLB Fault, Alternate Data TLB Fault, Data Page Not Present Fault, Data NaT Page Consumption Abort, Data Key Miss Fault, Data Key Permission Fault, Data Access Rights Fault, Data Access Bit Fault

PMAXUB: Packed Unsigned Integer Byte Maximum

| Opcode | Instruction | Description |
|------------|---------------------|---|
| 0F, DE, /r | PMAXUB mm1, mm2/m64 | Return the maximum bytes between MM2/Mem and MM1. |

Operation:

$$\begin{aligned} \text{mm1}[7-0] &= (\text{mm1}[7-0] > \text{mm2/m64}[7-0]) ? \text{mm1}[7-0] : \text{mm2/m64}[7-0]; \\ \text{mm1}[15-8] &= (\text{mm1}[15-8] > \text{mm2/m64}[15-8]) ? \text{mm1}[15-8] : \text{mm2/m64}[15-8]; \\ \text{mm1}[23-16] &= (\text{mm1}[23-16] > \text{mm2/m64}[23-16]) ? \text{mm1}[23-16] : \text{mm2/m64}[23-16]; \\ \text{mm1}[31-24] &= (\text{mm1}[31-24] > \text{mm2/m64}[31-24]) ? \text{mm1}[31-24] : \text{mm2/m64}[31-24]; \\ \text{mm1}[39-32] &= (\text{mm1}[39-32] > \text{mm2/m64}[39-32]) ? \text{mm1}[39-32] : \text{mm2/m64}[39-32]; \\ \text{mm1}[47-40] &= (\text{mm1}[47-40] > \text{mm2/m64}[47-40]) ? \text{mm1}[47-40] : \text{mm2/m64}[47-40]; \\ \text{mm1}[55-48] &= (\text{mm1}[55-48] > \text{mm2/m64}[55-48]) ? \text{mm1}[55-48] : \text{mm2/m64}[55-48]; \\ \text{mm1}[63-56] &= (\text{mm1}[63-56] > \text{mm2/m64}[63-56]) ? \text{mm1}[63-56] : \text{mm2/m64}[63-56]; \end{aligned}$$

Description: The PMAXUB instruction returns the maximum between the eight unsigned words in MM1 and MM2/Mem.

Numeric Exceptions: None.

Protected Mode Exceptions:

#GP(0) for an illegal memory operand effective address in the CS, DS, ES, FS or GS segments; #SS(0) for an illegal address in the SS segment; #PF (fault-code) for a page fault; #UD if CR0.EM = 1; #NM if TS bit in CR0 is set; #MF if there is a pending FPU exception #AC for unaligned memory reference. To enable #AC exceptions, three conditions must be true (CR0.AM is set; EFLAGS.AC is set; current CPL is 3).

Real Address Mode Exceptions:

Interrupt 13 if any part of the operand would lie outside of the effective address space from 0 to 0FFFFH; #UD if CR0.EM = 1; #NM if TS bit in CR0 is set. #MF if there is a pending FPU exception.

Virtual 8086 Mode Exceptions:

Same exceptions as in Real Address Mode; #PF(fault-code) for a page fault; #AC for unaligned memory reference if the current privilege level is 3.

Additional Itanium® System Environment Exceptions

Itanium Reg Faults Disabled FP Register Fault if PSR.dfl is 1, NaT Register Consumption Fault
 Itanium Mem Faults VHPT Data Fault, Data TLB Fault, Alternate Data TLB Fault, Data Page Not Present Fault, Data NaT Page Consumption Abort, Data Key Miss Fault, Data Key Permission Fault, Data Access Rights Fault, Data Access Bit Fault

PMINSW: Packed Signed Integer Word Minimum

| Opcode | Instruction | Description |
|-----------|---------------------|---|
| 0F,EA, /r | PMINSW mm1, mm2/m64 | Return the minimum words between MM2/Mem and MM1. |

Operation:

$$\begin{aligned} \text{mm1}[15-0] &= (\text{mm1}[15-0] < \text{mm2}/\text{m64}[15-0]) ? \text{mm1}[15-0] : \text{mm2}/\text{m64}[15-0]; \\ \text{mm1}[31-16] &= (\text{mm1}[31-16] < \text{mm2}/\text{m64}[31-16]) ? \text{mm1}[31-16] : \text{mm2}/\text{m64}[31-16]; \\ \text{mm1}[47-32] &= (\text{mm1}[47-32] < \text{mm2}/\text{m64}[47-32]) ? \text{mm1}[47-32] : \text{mm2}/\text{m64}[47-32]; \\ \text{mm1}[63-48] &= (\text{mm1}[63-48] < \text{mm2}/\text{m64}[63-48]) ? \text{mm1}[63-48] : \text{mm2}/\text{m64}[63-48]; \end{aligned}$$

Description: The PMINSW instruction returns the minimum between the four signed words in MM1 and MM2/Mem.

Numeric Exceptions: None.

Protected Mode Exceptions:

#GP(0) for an illegal memory operand effective address in the CS, DS, ES, FS or GS segments; #SS(0) for an illegal address in the SS segment; #PF (fault-code) for a page fault; #UD if CR0.EM = 1; #NM if TS bit in CR0 is set; #MF if there is a pending FPU exception; #AC for unaligned memory reference. To enable #AC exceptions, three conditions must be true (CR0.AM is set; EFLAGS.AC is set; current CPL is 3).

Real Address Mode Exceptions:

Interrupt 13 if any part of the operand would lie outside of the effective address space from 0 to 0FFFFH; #UD if CR0.EM = 1; #NM if TS bit in CR0 is set. #MF if there is a pending FPU exception.

Virtual 8086 Mode Exceptions:

Same exceptions as in Real Address Mode; #PF(fault-code) for a page fault; #AC for unaligned memory reference if the current privilege level is 3.

Additional Itanium® System Environment Exceptions

Itanium Reg Faults Disabled FP Register Fault if PSR.dfl is 1, NaT Register Consumption Fault
 Itanium Mem Faults VHPT Data Fault, Data TLB Fault, Alternate Data TLB Fault, Data Page Not Present Fault, Data NaT Page Consumption Abort, Data Key Miss Fault, Data Key Permission Fault, Data Access Rights Fault, Data Access Bit Fault

PMINUB: Packed Unsigned Integer Byte Minimum

| Opcode | Instruction | Description |
|------------|---------------------|---|
| 0F, DA, /r | PMINUB mm1, mm2/m64 | Return the minimum bytes between MM2/Mem and MM1. |

Operation:

$$\begin{aligned} \text{mm1}[7-0] &= (\text{mm1}[7-0] < \text{mm2/m64}[7-0]) ? \text{mm1}[7-0] : \text{mm2/m64}[7-0]; \\ \text{mm1}[15-8] &= (\text{mm1}[15-8] < \text{mm2/m64}[15-8]) ? \text{mm1}[15-8] : \text{mm2/m64}[15-8]; \\ \text{mm1}[23-16] &= (\text{mm1}[23-16] < \text{mm2/m64}[23-16]) ? \text{mm1}[23-16] : \text{mm2/m64}[23-16]; \\ \text{mm1}[31-24] &= (\text{mm1}[31-24] < \text{mm2/m64}[31-24]) ? \text{mm1}[31-24] : \text{mm2/m64}[31-24]; \\ \text{mm1}[39-32] &= (\text{mm1}[39-32] < \text{mm2/m64}[39-32]) ? \text{mm1}[39-32] : \text{mm2/m64}[39-32]; \\ \text{mm1}[47-40] &= (\text{mm1}[47-40] < \text{mm2/m64}[47-40]) ? \text{mm1}[47-40] : \text{mm2/m64}[47-40]; \\ \text{mm1}[55-48] &= (\text{mm1}[55-48] < \text{mm2/m64}[55-48]) ? \text{mm1}[55-48] : \text{mm2/m64}[55-48]; \\ \text{mm1}[63-56] &= (\text{mm1}[63-56] < \text{mm2/m64}[63-56]) ? \text{mm1}[63-56] : \text{mm2/m64}[63-56]; \end{aligned}$$

Description: The PMINUB instruction returns the minimum between the eight unsigned words in MM1 and MM2/Mem.

Numeric Exceptions: None.

Protected Mode Exceptions:

#GP(0) for an illegal memory operand effective address in the CS, DS, ES, FS or GS segments; #SS(0) for an illegal address in the SS segment; #PF (fault-code) for a page fault; #UD if CR0.EM = 1; #NM if TS bit in CR0 is set; #MF if there is a pending FPU exception; #AC for unaligned memory reference. To enable #AC exceptions, three conditions must be true (CR0.AM is set; EFLAGS.AC is set; current CPL is 3).

Real Address Mode Exceptions:

Interrupt 13 if any part of the operand would lie outside of the effective address space from 0 to 0FFFFH; #UD if CR0.EM = 1; #NM if TS bit in CR0 is set; #MF if there is a pending FPU exception.

Virtual 8086 Mode Exceptions:

Same exceptions as in Real Address Mode; #PF(fault-code) for a page fault; #AC for unaligned memory reference if the current privilege level is 3.

Additional Itanium® System Environment Exceptions

Itanium Reg Faults Disabled FP Register Fault if PSR.dfl is 1, NaT Register Consumption Fault

Itanium Mem Faults VHPT Data Fault, Data TLB Fault, Alternate Data TLB Fault, Data Page Not Present Fault, Data NaT Page Consumption Abort, Data Key Miss Fault, Data Key Permission Fault, Data Access Rights Fault, Data Access Bit Fault

PMOVMSKB: Move Byte Mask To Integer

| Opcode | Instruction | Description |
|---------|------------------|----------------------------------|
| 0F,D7,r | PMOVMSKB r32, mm | Move the byte mask of MM to r32. |

Operation:

```

r32[7] = mm[63]; r32[6] = mm[55];
r32[5] = mm[47]; r32[4] = mm[39];
r32[3] = mm[31]; r32[2] = mm[23];
r32[1] = mm[15]; r32[0] = mm[7];
r32[31-8] = 0x000000;
```

Description: The PMOVMSKB instruction returns a 8-bit mask formed of the most significant bits of each byte of its source operand.

Numeric Exceptions: None.

Protected Mode Exceptions:

#GP(0) for an illegal memory operand effective address in the CS, DS, ES, FS or GS segments; #SS(0) for an illegal address in the SS segment; #PF (fault-code) for a page fault; #UD if CR0.EM = 1; #NM if TS bit in CR0 is set; #MF if there is a pending FPU exception; #AC for unaligned memory reference. To enable #AC exceptions, three conditions must be true (CR0.AM is set; EFLAGS.AC is set; current CPL is 3).

Real Address Mode Exceptions:

Interrupt 13 if any part of the operand would lie outside of the effective address space from 0 to 0FFFFH; #UD if CR0.EM = 1; #NM if TS bit in CR0 is set; #MF if there is a pending FPU exception.

Virtual 8086 Mode Exceptions:

Same exceptions as in Real Address Mode; #PF (fault-code) for a page fault; #AC for unaligned memory reference if the current privilege level is 3.

Additional Itanium® System Environment Exceptions

Itanium Reg Faults Disabled FP Register Fault if PSR.dfl is 1

PMULHUW: Packed Multiply High Unsigned

| Opcode | Instruction | Description |
|------------|----------------------|--|
| 0F, E4, /r | PMULHUW mm1, mm2/m64 | Multiply the packed unsigned words in MM1 register with the packed unsigned words in MM2/Mem, then store the high-order 16 bits of the results in MM1. |

Operation:

$$\begin{aligned} \text{mm1}[15-0] &= (\text{mm1}[15-0] * \text{mm2/m64}[15-0])[31-16]; \\ \text{mm1}[31-16] &= (\text{mm1}[31-16] * \text{mm2/m64}[31-16])[31-16]; \\ \text{mm1}[47-32] &= (\text{mm1}[47-32] * \text{mm2/m64}[47-32])[31-16]; \\ \text{mm1}[63-48] &= (\text{mm1}[63-48] * \text{mm2/m64}[63-48])[31-16]; \end{aligned}$$

Description: The PMULHUW instruction multiplies the four unsigned words in the destination operand with the four unsigned words in the source operand. The high-order 16 bits of the 32-bit intermediate results are written to the destination operand.

Numeric Exceptions: None.

Protected Mode Exceptions

#GP(0) for an illegal memory operand effective address in the CS, DS, ES, FS or GS segments; #SS(0) for an illegal address in the SS segment; #PF (fault-code) for a page fault; #UD if CR0.EM = 1; #NM if TS bit in CR0 is set; #MF if there is a pending FPU exception; #AC for unaligned memory reference. To enable #AC exceptions, three conditions must be true (CR0.AM is set; EFLAGS.AC is set; current CPL is 3).

Real Address Mode Exceptions

Interrupt 13 if any part of the operand would lie outside of the effective address space from 0 to 0FFFFH; #UD if CR0.EM = 1; #NM if TS bit in CR0 is set; #MF if there is a pending FPU exception.

Virtual 8086 Mode Exceptions

Same exceptions as in Real Address Mode; #PF (fault-code) for a page fault; #AC for unaligned memory reference if the current privilege level is 3.

Additional Itanium[®] System Environment Exceptions

Itanium Reg Faults Disabled FP Register Fault if PSR.dfl is 1, NaT Register Consumption Fault
 Itanium Mem Faults VHPT Data Fault, Data TLB Fault, Alternate Data TLB Fault, Data Page Not Present Fault, Data NaT Page Consumption Abort, Data Key Miss Fault, Data Key Permission Fault, Data Access Rights Fault, Data Access Bit Fault

PSADBW: Packed Sum of Absolute Differences

| Opcode | Instruction | Description |
|------------|---------------------|--|
| 0F, F6, /r | PSADBW mm1, mm2/m64 | Absolute difference of packed unsigned bytes from MM2/Mem and MM1; these differences are then summed to produce a word result. |

Operation:

```
temp1 = ABS(mm1[7-0] - mm2/m64[7-0]);
temp2 = ABS(mm1[15-8] - mm2/m64[15-8]);
temp3 = ABS(mm1[23-16] - mm2/m64[23-16]);
temp4 = ABS(mm1[31-24] - mm2/m64[31-24]);
temp5 = ABS(mm1[39-32] - mm2/m64[39-32]);
temp6 = ABS(mm1[47-40] - mm2/m64[47-40]);
temp7 = ABS(mm1[55-48] - mm2/m64[55-48]);
temp8 = ABS(mm1[63-56] - mm2/m64[63-56]);
```

```
mm1[15:0] = temp1 + temp2 + temp3 + temp4 + temp5 + temp6 + temp7 + temp8;
```

```
mm1[31:16] = 0x00000000;
```

```
mm1[47:32] = 0x00000000;
```

```
mm1[63:48] = 0x00000000;
```

Description: The PSADBW instruction computes the absolute value of the difference of unsigned bytes for mm1 and mm2/m64. These differences are then summed to produce a word result in the lower 16-bit field; the upper 3 words are cleared.

The destination operand is a MMX technology register. The source operand can either be a MMX technology register or a 64-bit memory operand.

Numeric Exceptions: None

Protected Mode Exceptions

#GP(0) for an illegal memory operand effective address in the CS, DS, ES, FS or GS segments; #SS(0) for an illegal address in the SS segment; #PF (fault-code) for a page fault; #UD if CR0.EM = 1; #NM if TS bit in CR0 is set; #MF if there is a pending FPU exception; #AC for unaligned memory reference. To enable #AC exceptions, three conditions must be true (CR0.AM is set; EFLAGS.AC is set; current CPL is 3).

Real Address Mode Exceptions

Interrupt 13 if any part of the operand would lie outside of the effective address space from 0 to 0FFFFH; #UD if CR0.EM = 1; #NM if TS bit in CR0 is set; #MF if there is a pending FPU exception.

PSADBW: Packed Sum of Absolute Differences (Continued)

Virtual 8086 Mode Exceptions

Same exceptions as in Real Address Mode; #PF(fault-code) for a page fault.

Additional Itanium® System Environment Exceptions

Itanium Reg Faults Disabled FP Register Fault if PSR.dfl is 1, NaT Register Consumption Fault

Itanium Mem Faults VHPT Data Fault, Data TLB Fault, Alternate Data TLB Fault, Data Page Not Present Fault, Data NaT Page Consumption Abort, Data Key Miss Fault, Data Key Permission Fault, Data Access Rights Fault, Data Access Bit Fault

PSHUFW: Packed Shuffle Word

| Opcode | Instruction | Description |
|------------|---------------------------|--|
| 0F,70,r,ib | PSHUFW mm1, mm2/m64, imm8 | Shuffle the words in MM2/Mem based on the encoding in imm8 and store in MM1. |

Operation:

$$\text{mm1}[15-0] = (\text{mm2}/\text{m64} \gg (\text{imm8}[1-0] * 16)) [15-0]$$

$$\text{mm1}[31-16] = (\text{mm2}/\text{m64} \gg (\text{imm8}[3-2] * 16)) [15-0]$$

$$\text{mm1}[47-32] = (\text{mm2}/\text{m64} \gg (\text{imm8}[5-4] * 16)) [15-0]$$

$$\text{mm1}[63-48] = (\text{mm2}/\text{m64} \gg (\text{imm8}[7-6] * 16)) [15-0]$$

Description: The PSHUF instruction uses the imm8 operand to select which of the four words in MM2/Mem will be placed in each of the words in MM1. Bits 1 and 0 of imm8 encode the source for destination word 0 (MM1[15-0]), bits 3 and 2 encode for word 1, bits 5 and 4 encode for word 2, and bits 7 and 6 encode for word 3 (MM1[63-48]). Similarly, the two bit encoding represents which source word is to be used, e.g. an binary encoding of 10 indicates that source word 2 (MM2/Mem[47-32]) will be used.

Numeric Exceptions: None.

Protected Mode Exceptions:

#GP(0) for an illegal memory operand effective address in the CS, DS, ES, FS or GS segments; #SS(0) for an illegal address in the SS segment; #PF (fault-code) for a page fault; #UD if CR0.EM = 1; #NM if TS bit in CR0 is set; #MF if there is a pending FPU exception; #AC for unaligned memory reference. To enable #AC exceptions, three conditions must be true (CR0.AM is set; EFLAGS.AC is set; current CPL is 3).

Real Address Mode Exceptions:

Interrupt 13 if any part of the operand would lie outside of the effective address space from 0 to 0FFFFH; #UD if CR0.EM = 1; #NM if TS bit in CR0 is set; #MF if there is a pending FPU exception.

Virtual 8086 Mode Exceptions:

Same exceptions as in Real Address Mode; #PF(fault-code) for a page fault; #AC for unaligned memory reference if the current privilege level is 3.

Additional Itanium® System Environment Exceptions

Itanium Reg Faults Disabled FP Register Fault if PSR.dfl is 1, NaT Register Consumption Fault
 Itanium Mem Faults VHPT Data Fault, Data TLB Fault, Alternate Data TLB Fault, Data Page Not Present Fault, Data NaT Page Consumption Abort, Data Key Miss Fault, Data Key Permission Fault, Data Access Rights Fault, Data Access Bit Fault

3.14 Cacheability Control Instructions

This section describes the cacheability control instructions which enable an application writer to minimize data access latency and cache pollution.

MASKMOVQ: Byte Mask Write

| Opcode | Instruction | Description |
|---------|-------------------|---|
| 0F,F7,r | MASKMOVQ mm1, mm2 | Move 64-bits representing integer data from MM1 register to memory location specified by the edi register, using the byte mask in MM2 register. |

Operation:

```

if (mm2[7])    m64[edi]    = mm1[7-0];
if (mm2[15])   m64[edi+1] = mm1[15-8];
if (mm2[23])   m64[edi+2] = mm1[23-16];
if (mm2[31])   m64[edi+3] = mm1[31-24];
if (mm2[39])   m64[edi+4] = mm1[39-32];
if (mm2[47])   m64[edi+5] = mm1[47-40];
if (mm2[55])   m64[edi+6] = mm1[55-48];
if (mm2[63])   m64[edi+7] = mm1[63-56];

```

Description: Data is stored from the mm1 register to the location specified by the di/edi register (using DS segment). The size of the store address depends on the address-size attribute. The most significant bit in each byte of the mask register mm2 is used to selectively write the data (0 = no write, 1 = write), on a per-byte basis. Behavior with a mask of all zeroes is as follows:

- No data will be written to memory. However, transition from FP to MMX technology state (if necessary) will occur, irrespective of the value of the mask.
- For memory references, a zero byte mask does not prevent addressing faults (i.e. #GP, #SS) from being signalled.
- Signalling of page faults (#PF) is implementation-specific.
- #UD, #NM, #MF, and #AC faults are signalled irrespective of the value of the mask.
- Signalling of breakpoints (code or data) is not guaranteed; different processor implementations may signal or not signal these breakpoints.
- If the destination memory region is mapped as UC or WP, enforcement of associated semantics for these memory types is not guaranteed (i.e. is reserved) and is implementation-specific. Dependency on the behavior of a specific implementation in this case is not recommended, and may lead to future incompatibility.

The Mod field of the ModR/M byte must be 11, or an Invalid Opcode Exception will result.

Numeric Exceptions: None

Protected Mode Exceptions:

#GP(0) for an illegal memory operand effective address in the CS, DS, ES, FS or GS segments; #SS(0) for an illegal address in the SS segment; #PF (fault-code) for a page fault; #UD if CR0.EM = 1; #NM if TS bit in CR0 is set; #MF if there is a pending FPU exception; #AC for unaligned memory reference. To enable #AC exceptions, three conditions must be true(CR0.AM is set; EFLAGS.AC is set; current CPL is 3).

MASKMOVQ: Byte Mask Write (Continued)

Real Address Mode Exceptions:

Interrupt 13 if any part of the operand would lie outside of the effective address space from 0 to 0FFFFH; #UD if CR0.EM = 1; #NM if TS bit in CR0 is set; #MF if there is a pending FPU exception.

Virtual 8086 Mode Exceptions:

Same exceptions as in Real Address Mode; #AC for unaligned memory reference if the current privilege level is 3; #PF (fault-code) for a page fault.

Additional Itanium® System Environment Exceptions

Itanium Reg Faults Disabled FP Register Fault if PSR.dfl is 1

Comments: MASKMOVQ can be used to improve performance for algorithms which need to merge data on a byte granularity. MASKMOVQ should not cause a read for ownership; doing so generates unnecessary bandwidth since data is to be written directly using the byte-mask without allocating old data prior to the store. Similar to the Streaming SIMD Extension non-temporal store instructions, MASKMOVQ minimizes pollution of the cache hierarchy. MASKMOVQ implicitly uses weakly-ordered, write-combining stores (WC). See [Section 3.6.1.9](#) for further information about non-temporal stores.

As a consequence of the resulting weakly-ordered memory consistency model, a fencing operation such as SFENCE should be used if multiple processors may use different memory types to read/write the same memory location specified by edi.

This instruction behaves identically to MMX instructions, in the presence of x87-FP instructions: transition from x87-FP to MMX technology (TOS=0, FP valid bits set to all valid).

MASKMOVQ ignores the value of CR4.OSFXSR. Since it does not affect the new Streaming SIMD Extension state, they will not generate an invalid exception if CR4.OSFXSR = 0.

MOVNTPS: Move Aligned Four Packed Single-FP Non-temporal

| Opcode | Instruction | Description |
|-----------|-------------------|--|
| 0F,2B, /r | MOVNTPS m128, xmm | Move 128 bits representing four packed SP FP data from XMM register to Mem, minimizing pollution in the cache hierarchy. |

Operation: $m128 = xmm;$

Description: The linear address corresponds to the address of the least-significant byte of the referenced memory data. This store instruction minimizes cache pollution.

FP Exceptions: General protection exception if not aligned on 16-byte boundary, regardless of segment.

Numeric Exceptions: None

Protected Mode Exceptions:

#GP(0) for an illegal memory operand effective address in the CS, DS, ES, FS or GS segments; #SS(0) for an illegal address in the SS segment; #PF(fault-code) for a page fault; #UD if CR0.EM = 1; #NM if TS bit in CR0 is set; #UD if CR4.OSFXSR(bit 9) = 0; #UD if CPUID.XMM(EDX bit 25) = 0.

Real Address Mode Exceptions:

Interrupt 13 if any part of the operand would lie outside of the effective address space from 0 to 0FFFFH; #UD if CR0.EM = 1; #NM if TS bit in CR0 is set; #UD if CR4.OSFXSR(bit 9) = 0; #UD if CPUID.XMM(EDX bit 25) = 0.

Virtual 8086 Mode Exceptions:

Same exceptions as in Real Address Mode; #PF(fault-code) for a page fault.

Additional Itanium® System Environment Exceptions

Itanium Reg Faults Disabled FP Register Fault if PSR.dfl is 1, NaT Register Consumption Fault
 Itanium Mem Faults VHPT Data Fault, Data TLB Fault, Alternate Data TLB Fault, Data Page Not Present Fault, Data NaT Page Consumption Abort, Data Key Miss Fault, Data Key Permission Fault, Data Access Rights Fault, Data Access Bit Fault, Data Dirty Bit Fault

Comments: MOVNTPS should be used when dealing with 16-byte aligned single-precision FP numbers. MOVNTPS minimizes pollution in the cache hierarchy. As a consequence of the resulting weakly-ordered memory consistency model, a fencing operation should be used if multiple processors may use different memory types to read/write the memory location. See [Section 3.6.1.9](#) for further information about non-temporal stores.

The usage of Repeat Prefixes(F2H, F3H) with MOVNTPS is reserved. Different processor implementations may handle this prefix differently. Usage of this prefix with MOVNTPS risks incompatibility with future processors.

MOVNTQ: Move 64 Bits Non-temporal

| Opcode | Instruction | Description |
|---------|----------------|--|
| 0F,E7,r | MOVNTQ m64, mm | Move 64 bits representing integer operands (8b, 16b, 32b) from MM register to memory, minimizing pollution within cache hierarchy. |

Operation: m64 = mm;

Description: The linear address corresponds to the address of the least-significant byte of the referenced memory data. This store instruction minimizes cache pollution.

Numeric Exceptions: None

Protected Mode Exceptions:

#GP(0) for an illegal memory operand effective address in the CS, DS, ES, FS or GS segments; #SS(0) for an illegal address in the SS segment; #PF (fault-code) for a page fault; #UD if CR0.EM = 1; #NM if TS bit in CR0 is set; #MF if there is a pending FPU exception; #AC for unaligned memory reference. To enable #AC exceptions, three conditions must be true (CR0.AM is set; EFLAGS.AC is set; current CPL is 3).

Real Address Mode Exceptions:

Interrupt 13 if any part of the operand would lie outside of the effective address space from 0 to 0FFFFH; #UD if CR0.EM = 1; #NM if TS bit in CR0 is set; #MF if there is a pending FPU exception.

Virtual 8086 Mode Exceptions:

Same exceptions as in Real Address Mode; #AC for unaligned memory reference if the current privilege level is 3; #PF (fault-code) for a page fault.

Additional Itanium® System Environment Exceptions

Itanium Reg Faults Disabled FP Register Fault if PSR.dfl is 1, NaT Register Consumption Fault
 Itanium Mem Faults VHPT Data Fault, Data TLB Fault, Alternate Data TLB Fault, Data Page Not Present Fault, Data NaT Page Consumption Abort, Data Key Miss Fault, Data Key Permission Fault, Data Access Rights Fault, Data Access Bit Fault, Data Dirty Bit Fault

Comments: MOVNTQ minimizes pollution in the cache hierarchy. As a consequence of the resulting weakly-ordered memory consistency model, a fencing operation should be used if multiple processors may use different memory types to read/write the memory location. See [Section 3.6.1.9](#) for further information about non-temporal stores.

MOVNTQ ignores the value of CR4.OSFXSR. Since it does not affect the new Streaming SIMD Extension state, they will not generate an invalid exception if CR4.OSFXSR = 0.

PREFETCH: Prefetch

| Opcode | Instruction | Description |
|----------|----------------|--|
| 0F,18,/1 | PREFETCHT0 m8 | Move data specified by address closer to the processor using the t0 hint. |
| 0F,18,/2 | PREFETCHT1 m8 | Move data specified by address closer to the processor using the t1 hint. |
| 0F,18,/3 | PREFETCHT2 m8 | Move data specified by address closer to the processor using the t2 hint. |
| 0F,18,/0 | PREFETCHNTA m8 | Move data specified by address closer to the processor using the nta hint. |

Operation: `fetch (m8) ;`

Description: If there are no excepting conditions, the prefetch instruction fetches the line containing the addresses byte to a location in the cache hierarchy specified by a locality hint. If the line is already present in the cache hierarchy at a level closer to the processor, no data movement occurs. The bits 5:3 of the ModR/M byte specify locality hints as follows:

- Temporal data(t0) - prefetch data into all cache levels.
- Temporal with respect to first level cache (t1) – prefetch data in all cache levels except 0th cache level.
- Temporal with respect to second level cache (t2) – prefetch data in all cache levels, except 0th and 1st cache levels.
- Non-temporal with respect to all cache levels (nta) – prefetch data into non-temporal cache structure.

Locality hints do not affect the functional behavior of the program. They are implementation dependent, and can be overloaded or ignored by an implementation. The prefetch instruction does not cause any exceptions (except for code breakpoints), does not affect program behavior and may be ignored by the implementation. The amount of data prefetched is implementation dependent. It will however be a minimum of 32 bytes. Prefetches to uncacheable memory (UC or WC memory types) will be ignored. Additional ModRM encodings, besides those specified above, are defined to be reserved and the use of reserved encodings risks future incompatibility.

Numeric Exceptions: None

Protected Mode Exceptions: None

Real Address Mode Exceptions: None

Virtual 8086 Mode Exceptions: None

Additional Itanium® System Environment Exceptions: None

Comments: This instruction is merely a hint. If executed, this instruction moves data closer to the processor in anticipation of future use. The performance of these instructions in application code can be implementation specific. To achieve maximum speedup, code tuning might be necessary for each implementation. The non temporal hint also minimizes pollution of useful cache data.

PREFETCH instructions ignore the value of CR4.OSFXSR. Since they do not affect the new Streaming SIMD Extension state, they will not generate an invalid exception if CR4.OSFXSR = 0.

SFENCE: Store Fence

| Opcode | Instruction | Description |
|----------|-------------|--|
| 0F AE /7 | SFENCE | Guarantees that every store instruction that precedes in program order the store fence instruction is globally visible before any store instruction which follows the fence is globally visible. |

Operation: `while (!(preceding_stores_globally_visible)) wait();`

Description: Weakly ordered memory types can enable higher performance through such techniques as out-of-order issue, write-combining, and write-collapsing. Memory ordering issues can arise between a producer and a consumer of data and there are a number of common usage models which may be affected by weakly ordered stores: (1) library functions, which use weakly ordered memory to write results (2) compiler-generated code, which also benefit from writing weakly-ordered results, and (3) hand-written code. The degree to which a consumer of data knows that the data is weakly ordered can vary for these cases. As a result, the SFENCE instruction provides a performance-efficient way of ensuring ordering between routines that produce weakly-ordered results and routines that consume this data.

SFENCE uses the following ModRM encoding:

Mod (7:6) = 11B

Reg/Opcode (5:3) = 111B

R/M (2:0) = 000B

All other ModRM encodings are defined to be reserved, and use of these encodings risks incompatibility with future processors.

Numeric Exceptions: None

Protected Mode Exceptions: None

Real Address Mode Exceptions: None

Virtual 8086 Mode Exceptions: None

Additional Itanium® System Environment Exceptions: None

Comments: SFENCE ignores the value of CR4.OSFXSR. SFENCE will not generate an invalid exception if CR4.OSFXSR = 0



Part I: Intel® Itanium® Instruction Set Descriptions

| | | |
|----------|---|--------------|
| 1 | About this Manual | 3:1 |
| 1.1 | Overview of Volume 1: Application Architecture | 3:1 |
| 1.1.1 | Part 1: Application Architecture Guide..... | 3:1 |
| 1.1.2 | Part 2: Optimization Guide for the Intel® Itanium® Architecture | 3:2 |
| 1.2 | Overview of Volume 2: System Architecture..... | 3:2 |
| 1.2.1 | Part 1: System Architecture Guide | 3:2 |
| 1.2.2 | Part 2: System Programmer's Guide..... | 3:3 |
| 1.2.3 | Appendices..... | 3:4 |
| 1.3 | Overview of Volume 3: Instruction Set Reference | 3:4 |
| 1.3.1 | Part 1: Intel® Itanium® Instruction Set Descriptions | 3:4 |
| 1.3.2 | Part 2: IA-32 Instruction Set Descriptions..... | 3:4 |
| 1.4 | Terminology | 3:5 |
| 1.5 | Related Documents | 3:5 |
| 1.6 | Revision History..... | 3:6 |
| 2 | Instruction Reference | 3:9 |
| 2.1 | Instruction Page Conventions..... | 3:9 |
| 2.2 | Instruction Descriptions | 3:10 |
| 3 | Pseudo-Code Functions | 3:245 |
| 4 | Instruction Formats | 3:255 |
| 4.1 | Format Summary | 3:256 |
| 4.2 | A-Unit Instruction Encodings | 3:262 |
| 4.2.1 | Integer ALU | 3:262 |
| 4.2.2 | Integer Compare..... | 3:264 |
| 4.2.3 | Multimedia | 3:268 |
| 4.3 | I-Unit Instruction Encodings..... | 3:272 |
| 4.3.1 | Multimedia and Variable Shifts | 3:272 |
| 4.3.2 | Integer Shifts | 3:277 |
| 4.3.3 | Test Bit | 3:279 |
| 4.3.4 | Miscellaneous I-Unit Instructions..... | 3:280 |
| 4.3.5 | GR/BR Moves..... | 3:282 |
| 4.3.6 | GR/Predicate/IP Moves | 3:283 |
| 4.3.7 | GR/AR Moves (I-Unit)..... | 3:284 |
| 4.3.8 | Sign/Zero Extend/Compute Zero Index | 3:285 |
| 4.4 | M-Unit Instruction Encodings..... | 3:285 |
| 4.4.1 | Loads and Stores | 3:285 |
| 4.4.2 | Line Prefetch | 3:300 |
| 4.4.3 | Semaphores | 3:302 |
| 4.4.4 | Set/Get FR..... | 3:303 |
| 4.4.5 | Speculation and Advanced Load Checks..... | 3:303 |
| 4.4.6 | Cache/Synchronization/RSE/ALAT | 3:304 |
| 4.4.7 | GR/AR Moves (M-Unit)..... | 3:306 |
| 4.4.8 | GR/CR Moves | 3:307 |
| 4.4.9 | Miscellaneous M-Unit Instructions..... | 3:307 |
| 4.4.10 | System/Memory Management..... | 3:308 |
| 4.4.11 | Nop/Hint (M-Unit)..... | 3:313 |
| 4.5 | B-Unit Instruction Encodings | 3:313 |
| 4.5.1 | Branches | 3:314 |
| 4.5.2 | Branch Predict/Nop/Hint | 3:317 |

| | | |
|----------|---|--------------|
| 4.5.3 | Miscellaneous B-Unit Instructions | 3:319 |
| 4.6 | F-Unit Instruction Encodings | 3:320 |
| 4.6.1 | Arithmetic | 3:322 |
| 4.6.2 | Parallel Floating-point Select..... | 3:323 |
| 4.6.3 | Compare and Classify | 3:323 |
| 4.6.4 | Approximation | 3:325 |
| 4.6.5 | Minimum/Maximum and Parallel Compare..... | 3:326 |
| 4.6.6 | Merge and Logical..... | 3:327 |
| 4.6.7 | Conversion | 3:327 |
| 4.6.8 | Status Field Manipulation | 3:328 |
| 4.6.9 | Miscellaneous F-Unit Instructions..... | 3:329 |
| 4.7 | X-Unit Instruction Encodings | 3:329 |
| 4.7.1 | Miscellaneous X-Unit Instructions | 3:329 |
| 4.7.2 | Move Long Immediate ₆₄ | 3:330 |
| 4.7.3 | Long Branches | 3:331 |
| 4.7.4 | Nop/Hint (X-Unit)..... | 3:332 |
| 4.8 | Immediate Formation..... | 3:332 |
| 5 | Resource and Dependency Semantics | 3:335 |
| 5.1 | Reading and Writing Resources | 3:335 |
| 5.2 | Dependencies and Serialization | 3:335 |
| 5.3 | Resource and Dependency Table Format Notes | 3:336 |
| 5.3.1 | Special Case Instruction Rules | 3:338 |
| 5.3.2 | RAW Dependency Table..... | 3:338 |
| 5.3.3 | WAW Dependency Table | 3:346 |
| 5.3.4 | WAR Dependency Table..... | 3:350 |
| 5.3.5 | Listing of Rules Referenced in Dependency Tables..... | 3:350 |
| 5.4 | Support Tables | 3:352 |

Part II: IA-32 Instruction Set Descriptions

| | | |
|----------|---|--------------|
| 1 | Base IA-32 Instruction Reference | 3:361 |
| 1.1 | Additional Intel® Itanium® Faults | 3:361 |
| 1.2 | Interpreting the IA-32 Instruction Reference Pages | 3:362 |
| 1.2.1 | IA-32 Instruction Format..... | 3:362 |
| 1.2.2 | Operation..... | 3:365 |
| 1.2.3 | Flags Affected | 3:368 |
| 1.2.4 | FPU Flags Affected | 3:368 |
| 1.2.5 | Protected Mode Exceptions | 3:368 |
| 1.2.6 | Real-address Mode Exceptions | 3:369 |
| 1.2.7 | Virtual-8086 Mode Exceptions | 3:369 |
| 1.2.8 | Floating-point Exceptions | 3:369 |
| 1.3 | IA-32 Base Instruction Reference..... | 3:370 |
| 2 | IA-32 Intel® MMX™ Technology Instruction Reference | 3:747 |
| 3 | IA-32 Streaming SIMD Extension Instruction Reference | 3:811 |
| 3.1 | IA-32 Streaming SIMD Extension Instructions..... | 3:811 |
| 3.2 | About the Intel® Architecture Streaming SIMD Extensions | 3:811 |
| 3.3 | Single Instruction Multiple Data | 3:812 |
| 3.4 | New Data Types | 3:812 |
| 3.5 | Streaming SIMD Extension Registers | 3:813 |
| 3.6 | Extended Instruction Set | 3:813 |



| | | |
|-------|--|-------|
| 3.6.1 | Instruction Group Review | 3:814 |
| 3.7 | IEEE Compliance..... | 3:821 |
| 3.7.1 | Real Number System | 3:822 |
| 3.7.2 | Operating on NaNs..... | 3:827 |
| 3.8 | Data Formats | 3:828 |
| 3.8.1 | Memory Data Formats..... | 3:828 |
| 3.8.2 | Streaming SIMD Extension Register Data Formats | 3:828 |
| 3.9 | Instruction Formats | 3:830 |
| 3.10 | Instruction Prefixes | 3:830 |
| 3.11 | Reserved Behavior and Software Compatibility | 3:831 |
| 3.12 | Notations..... | 3:831 |
| 3.13 | SIMD Integer Instruction Set Extensions | 3:908 |
| 3.14 | Cacheability Control Instructions | 3:922 |

Part I: Intel® Itanium® Instruction Set Descriptions

| | | |
|------|---|-------|
| 2-1 | Add Pointer | 3:12 |
| 2-2 | Stack Frame | 3:13 |
| 2-3 | Operation of br.ctop and br.cexit | 3:20 |
| 2-4 | Operation of br.wtop and br.wexit | 3:20 |
| 2-5 | Deposit Example (merge_form) | 3:45 |
| 2-6 | Deposit Example (zero_form) | 3:45 |
| 2-7 | Extract Example | 3:48 |
| 2-8 | Floating-point Merge Negative Sign Operation | 3:72 |
| 2-9 | Floating-point Merge Sign Operation | 3:72 |
| 2-10 | Floating-point Merge Sign and Exponent Operation | 3:72 |
| 2-11 | Floating-point Mix Left | 3:75 |
| 2-12 | Floating-point Mix Right | 3:75 |
| 2-13 | Floating-point Mix Left-Right | 3:75 |
| 2-14 | Floating-point Pack | 3:86 |
| 2-15 | Floating-point Parallel Merge Negative Sign Operation | 3:96 |
| 2-16 | Floating-point Parallel Merge Sign Operation | 3:96 |
| 2-17 | Floating-point Parallel Merge Sign and Exponent Operation | 3:96 |
| 2-18 | Floating-point Swap | 3:118 |
| 2-19 | Floating-point Swap Negate Left | 3:118 |
| 2-20 | Floating-point Swap Negate Right | 3:118 |
| 2-21 | Floating-point Sign Extend Left | 3:120 |
| 2-22 | Floating-point Sign Extend Right | 3:120 |
| 2-23 | Function of getf.exp | 3:123 |
| 2-24 | Function of getf.sig | 3:123 |
| 2-25 | Mix Example | 3:147 |
| 2-26 | Mux1 Operation (8-bit elements) | 3:164 |
| 2-27 | Mux2 Examples (16-bit elements) | 3:165 |
| 2-28 | Pack Operation | 3:169 |
| 2-29 | Parallel Add Examples | 3:171 |
| 2-30 | Parallel Average Example | 3:174 |
| 2-31 | Parallel Average with Round Away from Zero Example | 3:175 |
| 2-32 | Parallel Average Subtract Example | 3:177 |
| 2-33 | Parallel Compare Example | 3:179 |
| 2-34 | Parallel Maximum Example | 3:181 |
| 2-35 | Parallel Minimum Example | 3:182 |
| 2-36 | Parallel Multiply Operation | 3:183 |
| 2-37 | Parallel Multiply and Shift Right Operation | 3:184 |
| 2-38 | Parallel Sum of Absolute Difference Example | 3:189 |
| 2-39 | Parallel Shift Left Example | 3:190 |
| 2-40 | Parallel Subtract Example | 3:195 |
| 2-41 | Function of setf.exp | 3:210 |
| 2-42 | Function of setf.sig | 3:210 |
| 2-43 | Shift Left and Add Pointer | 3:214 |
| 2-44 | Shift Right Pair | 3:216 |
| 2-45 | Unpack Operation | 3:236 |
| 4-1 | Bundle Format | 3:255 |

Part II: IA-32 Instruction Set Descriptions

| | | |
|-----|----------------------------------|-------|
| 1-1 | Bit Offset for BIT[EAX,21] | 3:367 |
| 1-2 | Memory Bit Indexing | 3:368 |



| | | |
|------|---|-------|
| 1-3 | Version Information in Registers EAX | 3:429 |
| 2-1 | Operation of the MOVD Instruction | 3:749 |
| 2-2 | Operation of the MOVQ Instruction | 3:751 |
| 2-3 | Operation of the PACKSSDW Instruction | 3:753 |
| 2-4 | Operation of the PACKUSWB Instruction | 3:756 |
| 2-5 | Operation of the PADDW Instruction..... | 3:758 |
| 2-6 | Operation of the PADDDW Instruction | 3:761 |
| 2-7 | Operation of the PADDUSB Instruction..... | 3:764 |
| 2-8 | Operation of the PAND Instruction | 3:767 |
| 2-9 | Operation of the PANDN Instruction | 3:769 |
| 2-10 | Operation of the PCMPEQW Instruction | 3:771 |
| 2-11 | Operation of the PCMPGTW Instruction | 3:774 |
| 2-12 | Operation of the PMADDWD Instruction | 3:777 |
| 2-13 | Operation of the PMULHW Instruction | 3:779 |
| 2-14 | Operation of the PMULLW Instruction..... | 3:781 |
| 2-15 | Operation of the POR Instruction. | 3:783 |
| 2-16 | Operation of the PSLLW Instruction | 3:785 |
| 2-17 | Operation of the PSRAW Instruction | 3:788 |
| 2-18 | Operation of the PSRLW Instruction | 3:791 |
| 2-19 | Operation of the PSUBW Instruction | 3:794 |
| 2-20 | Operation of the PSUBSW Instruction | 3:797 |
| 2-21 | Operation of the PSUBUSB Instruction..... | 3:800 |
| 2-22 | High-order Unpacking and Interleaving of Bytes with the PUNPCKHBW Instruction | 3:803 |
| 2-23 | Low-order Unpacking and Interleaving of Bytes with the PUNPCKLBW Instruction | 3:806 |
| 2-24 | Operation of the PXOR Instruction | 3:809 |
| 3-1 | Packed Single-FP Data Type | 3:812 |
| 3-2 | Streaming SIMD Extension Register Set | 3:813 |
| 3-3 | Packed Operation..... | 3:814 |
| 3-4 | Scalar Operation | 3:814 |
| 3-5 | Packed Shuffle Operation | 3:816 |
| 3-6 | Unpack High Operation | 3:817 |
| 3-7 | Unpack Low Operation..... | 3:817 |
| 3-8 | Binary Real Number System | 3:822 |
| 3-9 | Binary Floating-point Format | 3:823 |
| 3-10 | Real Numbers and NaNs | 3:825 |
| 3-11 | Four Packed FP Data in Memory (at address 1000H) | 3:828 |

Part I: Intel® Itanium® Instruction Set Descriptions

| | | |
|------|---|-------|
| 2-1 | Instruction Page Description | 3:9 |
| 2-2 | Instruction Page Font Conventions | 3:9 |
| 2-3 | Register File Notation..... | 3:10 |
| 2-4 | C Syntax Differences | 3:10 |
| 2-5 | Pervasive Conditions Not Included in Instruction Description Code | 3:10 |
| 2-6 | Branch Types | 3:17 |
| 2-7 | Branch Whether Hint..... | 3:21 |
| 2-8 | Sequential Prefetch Hint | 3:21 |
| 2-9 | Branch Cache Deallocation Hint | 3:21 |
| 2-10 | Long Branch Types | 3:26 |
| 2-11 | IP-relative Branch Predict Whether Hint..... | 3:28 |
| 2-12 | Indirect Branch Predict Whether Hint..... | 3:28 |
| 2-13 | Importance Hint..... | 3:28 |
| 2-14 | ALAT Clear Completer | 3:31 |
| 2-15 | Comparison Types | 3:34 |
| 2-16 | 64-bit Comparison Relations for Normal and unc Compares..... | 3:35 |
| 2-17 | 64-bit Comparison Relations for Parallel Compares | 3:35 |
| 2-18 | Immediate Range for 32-bit Compares | 3:37 |
| 2-19 | Memory Compare and Exchange Size | 3:40 |
| 2-20 | Compare and Exchange Semaphore Types | 3:40 |
| 2-21 | Result Ranges for <i>czx</i> | 3:43 |
| 2-22 | Specified <i>pc</i> Mnemonic Values | 3:50 |
| 2-23 | <i>sf</i> Mnemonic Values | 3:50 |
| 2-24 | Floating-point Class Relations | 3:57 |
| 2-25 | Floating-point Classes..... | 3:57 |
| 2-26 | Floating-point Comparison Types | 3:60 |
| 2-27 | Floating-point Comparison Relations | 3:60 |
| 2-28 | Fetch and Add Semaphore Types | 3:67 |
| 2-29 | Floating-point Parallel Comparison Results | 3:89 |
| 2-30 | Floating-point Parallel Comparison Relations | 3:89 |
| 2-31 | Hint Immediates | 3:125 |
| 2-32 | <i>sz</i> Completers | 3:131 |
| 2-33 | Load Types | 3:131 |
| 2-34 | Load Hints | 3:132 |
| 2-35 | <i>fsz</i> Completers | 3:135 |
| 2-36 | FP Load Types..... | 3:135 |
| 2-37 | <i>lftype</i> Mnemonic Values | 3:141 |
| 2-38 | <i>lfhint</i> Mnemonic Values | 3:142 |
| 2-39 | Move to BR Whether Hints..... | 3:151 |
| 2-40 | Indirect Register File Mnemonics..... | 3:156 |
| 2-41 | Mux Permutations for 8-bit Elements | 3:164 |
| 2-42 | Pack Saturation Limits | 3:169 |
| 2-43 | Parallel Add Saturation Completers | 3:171 |
| 2-44 | Parallel Add Saturation Limits | 3:171 |
| 2-45 | <i>Pcmp</i> Relations | 3:179 |
| 2-46 | <i>PMPYSHR</i> Shift Options..... | 3:184 |
| 2-47 | Parallel Subtract Saturation Completers | 3:195 |
| 2-48 | Parallel Subtract Saturation Limits | 3:195 |
| 2-49 | Store Types..... | 3:219 |
| 2-50 | Store Hints | 3:220 |



| | | |
|------|--|-------|
| 2-51 | xsx Mnemonic Values | 3:225 |
| 2-52 | Test Bit Relations for Normal and unc tbits | 3:228 |
| 2-53 | Test Bit Relations for Parallel tbits | 3:228 |
| 2-54 | Test NaT Relations for Normal and unc tnats | 3:231 |
| 2-55 | Test NaT Relations for Parallel tnats | 3:231 |
| 2-56 | Memory Exchange Size | 3:237 |
| 3-1 | Pseudo-Code Functions | 3:245 |
| 4-1 | Relationship between Instruction Type and Execution Unit Type | 3:255 |
| 4-2 | Template Field Encoding and Instruction Slot Mapping | 3:256 |
| 4-3 | Major Opcode Assignments | 3:257 |
| 4-4 | Instruction Format Summary | 3:258 |
| 4-5 | Instruction Field Color Key | 3:260 |
| 4-6 | Instruction Field Names..... | 3:260 |
| 4-7 | Special Instruction Notations..... | 3:261 |
| 4-8 | Integer ALU 2-bit+1-bit Opcode Extensions | 3:262 |
| 4-9 | Integer ALU 4-bit+2-bit Opcode Extensions | 3:263 |
| 4-10 | Integer Compare Opcode Extensions | 3:265 |
| 4-11 | Integer Compare Immediate Opcode Extensions | 3:265 |
| 4-12 | Multimedia ALU 2-bit+1-bit Opcode Extensions | 3:268 |
| 4-13 | Multimedia ALU Size 1 4-bit+2-bit Opcode Extensions | 3:269 |
| 4-14 | Multimedia ALU Size 2 4-bit+2-bit Opcode Extensions | 3:269 |
| 4-15 | Multimedia ALU Size 4 4-bit+2-bit Opcode Extensions | 3:270 |
| 4-16 | Multimedia and Variable Shift 1-bit Opcode Extensions | 3:272 |
| 4-17 | Multimedia Opcode 7 Size 1 2-bit Opcode Extensions | 3:272 |
| 4-18 | Multimedia Opcode 7 Size 2 2-bit Opcode Extensions | 3:273 |
| 4-19 | Multimedia Opcode 7 Size 4 2-bit Opcode Extensions | 3:273 |
| 4-20 | Variable Shift Opcode 7 2-bit Opcode Extensions | 3:274 |
| 4-21 | Integer Shift/Test Bit/Test NaT 2-bit Opcode Extensions | 3:277 |
| 4-22 | Deposit Opcode Extensions | 3:277 |
| 4-23 | Test Bit Opcode Extensions | 3:279 |
| 4-24 | Misc I-Unit 3-bit Opcode Extensions | 3:280 |
| 4-25 | Misc I-Unit 6-bit Opcode Extensions | 3:281 |
| 4-26 | Misc I-Unit 1-bit Opcode Extensions | 3:281 |
| 4-27 | Move to BR Whether Hint Completer | 3:282 |
| 4-28 | Integer Load/Store/Semaphore/Get FR 1-bit Opcode Extensions | 3:285 |
| 4-29 | Floating-point Load/Store/Load Pair/Set FR 1-bit Opcode Extensions | 3:285 |
| 4-30 | Integer Load/Store Opcode Extensions | 3:286 |
| 4-31 | Integer Load +Reg Opcode Extensions | 3:287 |
| 4-32 | Integer Load/Store +Imm Opcode Extensions | 3:287 |
| 4-33 | Semaphore/Get FR/16-Byte Opcode Extensions..... | 3:288 |
| 4-34 | Floating-point Load/Store/Lfetch Opcode Extensions | 3:288 |
| 4-35 | Floating-point Load/Lfetch +Reg Opcode Extensions | 3:289 |
| 4-36 | Floating-point Load/Store/Lfetch +Imm Opcode Extensions | 3:289 |
| 4-37 | Floating-point Load Pair/Set FR Opcode Extensions..... | 3:290 |
| 4-38 | Floating-point Load Pair +Imm Opcode Extensions..... | 3:290 |
| 4-39 | Load Hint Completer | 3:291 |
| 4-40 | Store Hint Completer..... | 3:291 |
| 4-41 | Line Prefetch Hint Completer | 3:300 |
| 4-42 | Opcode 0 System/Memory Management 3-bit Opcode Extensions..... | 3:309 |
| 4-43 | Opcode 0 System/Memory Management 4-bit+2-bit Opcode Extensions..... | 3:309 |
| 4-44 | Opcode 1 System/Memory Management 3-bit Opcode Extensions..... | 3:309 |

| | | |
|------|--|-------|
| 4-45 | Opcode 1 System/Memory Management 6-bit Opcode Extensions..... | 3:310 |
| 4-46 | Misc M-Unit 1-bit Opcode Extensions | 3:313 |
| 4-47 | IP-Relative Branch Types | 3:314 |
| 4-48 | Indirect/Miscellaneous Branch Opcode Extensions | 3:314 |
| 4-49 | Indirect Branch Types | 3:315 |
| 4-50 | Indirect Return Branch Types | 3:315 |
| 4-51 | Sequential Prefetch Hint Completer | 3:315 |
| 4-52 | Branch Whether Hint Completer | 3:315 |
| 4-53 | Indirect Call Whether Hint Completer..... | 3:316 |
| 4-54 | Branch Cache Deallocation Hint Completer..... | 3:316 |
| 4-55 | Indirect Predict/Nop/Hint Opcode Extensions | 3:318 |
| 4-56 | Branch Importance Hint Completer..... | 3:318 |
| 4-57 | IP-Relative Predict Whether Hint Completer..... | 3:318 |
| 4-58 | Indirect Predict Whether Hint Completer..... | 3:319 |
| 4-59 | Miscellaneous Floating-point 1-bit Opcode Extensions..... | 3:320 |
| 4-60 | Opcode 0 Miscellaneous Floating-point 6-bit Opcode Extensions..... | 3:321 |
| 4-61 | Opcode 1 Miscellaneous Floating-point 6-bit Opcode Extensions..... | 3:321 |
| 4-62 | Reciprocal Approximation 1-bit Opcode Extensions | 3:322 |
| 4-63 | Floating-point Status Field Completer | 3:322 |
| 4-64 | Floating-point Arithmetic 1-bit Opcode Extensions | 3:322 |
| 4-65 | Fixed-point Multiply Add and Select Opcode Extensions..... | 3:322 |
| 4-66 | Floating-point Compare Opcode Extensions | 3:324 |
| 4-67 | Floating-point Class 1-bit Opcode Extensions | 3:324 |
| 4-68 | Misc F-Unit 1-bit Opcode Extensions | 3:329 |
| 4-69 | Misc X-Unit 3-bit Opcode Extensions..... | 3:330 |
| 4-70 | Misc X-Unit 6-bit Opcode Extensions..... | 3:330 |
| 4-71 | Move Long 1-bit Opcode Extensions | 3:331 |
| 4-72 | Long Branch Types | 3:331 |
| 4-73 | Misc X-Unit 1-bit Opcode Extensions..... | 3:332 |
| 4-74 | Immediate Formation | 3:332 |
| 5-1 | Semantics of Dependency Codes..... | 3:337 |
| 5-2 | RAW Dependencies Organized by Resource | 3:339 |
| 5-3 | WAW Dependencies Organized by Resource | 3:346 |
| 5-4 | WAR Dependencies Organized by Resource | 3:350 |
| 5-5 | Instruction Classes | 3:352 |

Part II: IA-32 Instruction Set Descriptions

| | | |
|------|---|-------|
| 1-1 | Register Encodings Associated with the +rb, +rw, and +rd Nomenclature | 3:363 |
| 1-2 | Exception Mnemonics, Names, and Vector Numbers..... | 3:369 |
| 1-3 | Floating-point Exception Mnemonics and Names | 3:370 |
| 1-4 | Information Returned by CPUID Instruction..... | 3:428 |
| 1-5 | Feature Flags Returned in EDX Register..... | 3:429 |
| 1-6 | FPATAN Zeros and NaNs..... | 3:497 |
| 1-7 | FPREM Zeros and NaNs | 3:499 |
| 1-8 | FPREM1 Zeros and NaNs | 3:502 |
| 1-9 | FSUB Zeros and NaNs | 3:531 |
| 1-10 | FSUBR Zeros and NaNs | 3:534 |
| 1-11 | FYL2X Zeros and NaNs | 3:547 |
| 1-12 | FYL2XP1 Zeros and NaNs..... | 3:549 |
| 1-13 | IDIV Operands | 3:552 |
| 1-14 | INT Cases | 3:566 |



| | | |
|------|---|-------|
| 1-15 | LAR Descriptor Validity | 3:601 |
| 1-16 | LEA Address and Operand Sizes..... | 3:606 |
| 1-17 | Repeat Conditions..... | 3:686 |
| 3-1 | Real Number Notation..... | 3:823 |
| 3-2 | Denormalization Process | 3:826 |
| 3-3 | Results of Operations with NAN Operands | 3:828 |
| 3-4 | Precision and Range of Streaming SIMD Extension Datatype | 3:829 |
| 3-5 | Real Number and NaN Encodings | 3:829 |
| 3-6 | Streaming SIMD Extension Instruction Behavior with Prefixes | 3:830 |
| 3-7 | SIMD Integer Instructions – Behavior with Prefixes | 3:830 |
| 3-8 | Cacheability Control Instruction Behavior with Prefixes | 3:831 |
| 3-9 | Key to Streaming SIMD Extension Naming Convention | 3:832 |

