

\$5.00

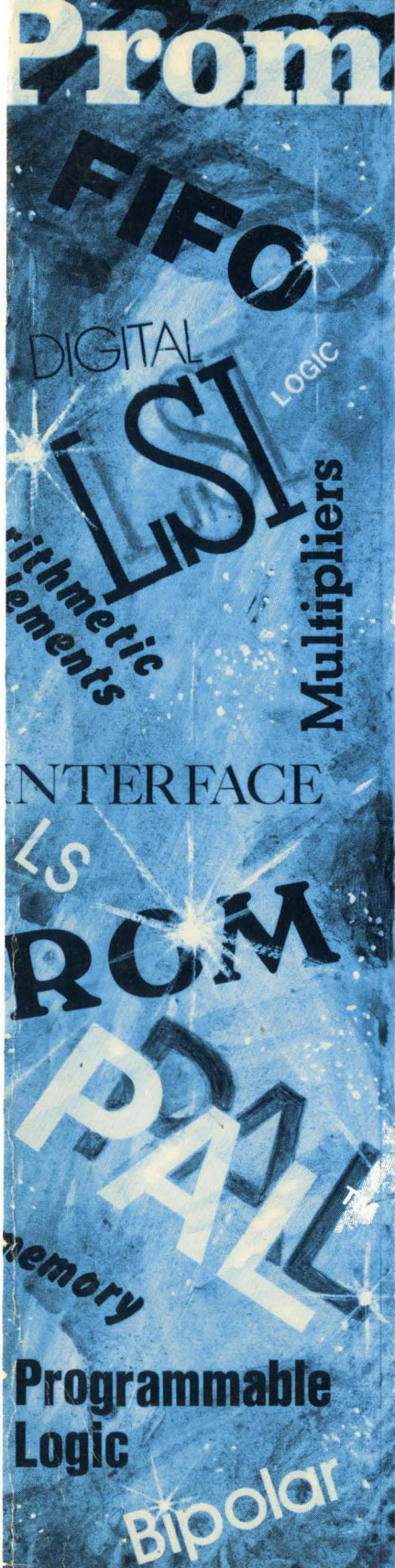

# *Bipolar LSI Data Book*

**Monolithic Memories** 

# Bipolar LSI Data Book



Second Edition

Introduction	<b>1</b>
HI REL	<b>2</b>
PROM	<b>3</b>
ROM	<b>4</b>
Character Generators	<b>5</b>
PAL™	<b>6</b>
FIFO	<b>7</b>
Arithmetic Elements	<b>8</b>
Interface	<b>9</b>
General Information	<b>10</b>
Representatives/Distributors	<b>11</b>

PAL™ is a trademark of Monolithic Memories

**Monolithic Memories** 

---

# 1. Introduction

The purpose of this document is to provide a comprehensive overview of the project's objectives, scope, and the methodology used to achieve them. This section will outline the key goals and the approach taken to address the challenges identified in the initial phase of the project.

The project is designed to explore the feasibility of implementing a new system that will streamline our current processes and improve overall efficiency. The primary focus is on understanding the requirements of the stakeholders and ensuring that the solution meets their needs while staying within the allocated budget and timeline.

The methodology adopted for this project is a combination of agile development and traditional project management practices. This hybrid approach allows for flexibility in responding to changes while maintaining a structured framework for project execution and reporting.

The project is organized into several key phases, each with specific deliverables and milestones. The initial phase involves a detailed analysis of the current state and the identification of key areas for improvement. This is followed by the design and development of the new system, which will be tested and deployed in a controlled environment.

The final phase of the project is the evaluation and reporting, where the results of the implementation will be measured against the initial objectives. This will provide valuable insights into the effectiveness of the new system and the overall success of the project.

The project team is committed to transparency and communication throughout the entire process. Regular updates and reports will be provided to all stakeholders to ensure they are kept informed of the project's progress and any potential risks or challenges that may arise.

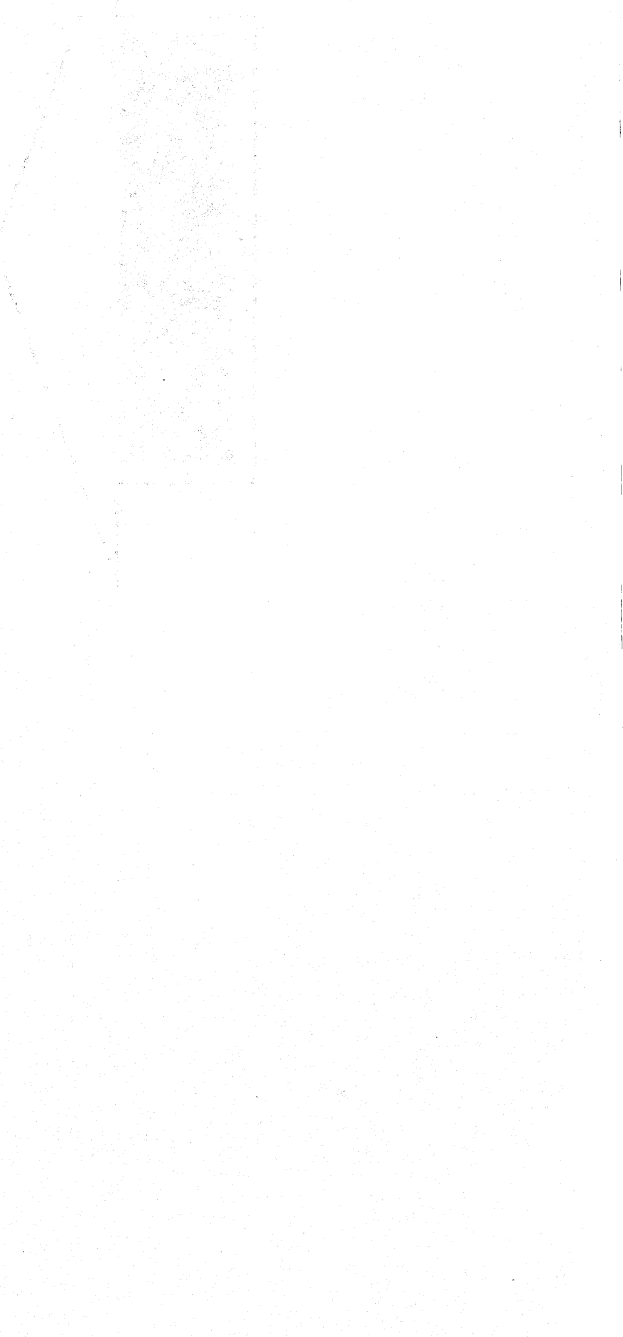

---

## Introduction

*This book has been prepared to give the user a concise list of all Bipolar LSI Products offered by Monolithic Memories. It is divided by products into sections on HI REL, PROMs, ROMs, Character Generators, PAL, FIFO, Arithmetic Elements and Interface. Each section has been designed to allow the user the most useable format for the products described. The PROM, ROM, and Character Generator sections give data in the "generic" form allowing a quick review of the trade-off between devices. Cross references and selection guides are given where applicable. Programming and available programmers are given in detail. FIFO, PAL™, Arithmetic Elements and Interface data sheets are shown in detail for each product. This LSI data book was formatted with you, the user, in mind. For more information, contact the local Monolithic Memories sales representative or franchised distributor.*

# Table of Contents

<b>INTRODUCTION</b> .....	1-3
Company Profile .....	1-6
Product Assurance Program .....	1-7

## HI-REL PRODUCTS .....

### PROMs

Bipolar PROM Selection Guide .....	3-2
Bipolar PROM Cross Reference .....	3-3
53/6300-1    256x4 Bit PROM, Standard .....	3-4
53/6301-1    256x4 Bit PROM, Standard .....	3-4
53/6305-1    512x4 Bit PROM, Standard .....	3-4
53/6306-1    512x4 Bit PROM, Standard .....	3-4
53/6350-1    1024 Bit PROM, Standard .....	3-4
53/6351-1    1024x4 Bit PROM, Standard .....	3-4
53/6352-1    1024x4 Bit PROM, Standard .....	3-4
53/6353-1    1024x4 Bit PROM, Standard .....	3-4
53/6330-1    32x8 Bit PROM, Standard .....	3-4
53/6331-1    32x8 Bit PROM, Standard .....	3-4
53/6308-1    256x8 Bit PROM, Standard .....	3-4
53/6309-1    256x8 Bit PROM, Standard .....	3-4
6335-1       256x8 Bit PROM, Standard .....	3-4
6336-1       256x8 Bit PROM, Standard .....	3-4
53/6340-1    512x8 Bit PROM, Standard .....	3-4
53/6341-1    512x8 Bit PROM, Standard .....	3-4
53/6348-1    512x8 Bit PROM, Standard .....	3-4
53/6349-1    512x8 Bit PROM, Standard .....	3-4
53/6380-1    1024x8 Bit PROM, Standard .....	3-4
53/6381-1    1024x8 Bit PROM, Standard .....	3-4
Standard PROM Programming Instruction .....	3-8

### ROMS

Generic ROM Selection Guide .....	4-2
52/6280-1    1024x8 Bit ROM, Standard .....	4-2
52/6281-1    1024x8 Bit ROM, Standard .....	4-2
52/6280-2    1024x8 Bit ROM, Standard .....	4-2
52/6281-2    1024x8 Bit ROM, Standard .....	4-2
52/6282-1    1024x8 Bit ROM, Standard .....	4-2
52/6283-1    1024x8 Bit ROM, Standard .....	4-2
52/6275-1    2048-8 Bit ROM, Standard .....	4-2
52/6276-1    2048x8 Bit ROM, Standard .....	4-2
52/6260-1    1024x9 Bit ROM, Standard .....	4-2
52/6261-1    1024x9 Bit ROM, Standard .....	4-2
52/6290       1152x9 Bit ROM, Standard .....	4-2
52/6291       1152x9 Bit ROM, Standard .....	4-2
52/6255-1    1024x10 Bit ROM, Standard .....	4-2
52/6256-1    1024x10 Bit ROM, Standard .....	4-2

### CHARACTER GENERATORS

Character Generator Selection Guide .....	5-3
50/6055       5x7 Character Generator RS64 .....	5-7
6056         5x7 Character Generator CS64 .....	5-8
6061         5x7 Character Generator RS128 .....	5-10, 5-11
6062         5x7 Character Generator RS128 .....	5-10, 5-11
51/6155       5x7 Character Generator RS64 .....	5-7
6156         5x7 Character Generator CS64 .....	5-8
6161         5x7 Character Generator RS128 .....	5-10, 5-11
6162         5x7 Character Generator RS128 .....	5-10, 5-11
6071         7x9 Character Generator RS64 .....	5-9
6072         7x9 Character Generator RS128 .....	5-12, 5-13
6171         7x9 Character Generator RS64 .....	5-9
6172         7x9 Character Generator RS128 .....	5-12, 5-13
52/6290       7x9 Custom Character ROM RS/128 .....	5-15
52/6291       7x9 Custom Character Generator RS128 .....	5-15
52/6292       9x9 Custom Character ROM CS/RS128 .....	5-15
52/6293       9x9 Custom Character CS/RS128 .....	5-15
Character Generator Characteristics .....	5-4, 5-16

### PAL

PAL Introduction .....	6-2
The PAL Concept .....	6-2

### PAL (continued)

PAL Series 20 Data Sheet .....	6-7
PAL10H8    Octal 10 Input And/Or Gate Array .....	6-8
PAL12H6    Hex 12 Input And/Or Gate Array .....	6-8
PAL14H4    Quad 14 Input And/Or Gate Array .....	6-8
PAL16H2    Dual 16 Input And/Or Gate Array .....	6-8
PAL16C1    16 Input And/Or Invert Gate Array .....	6-8
PAL10L8    Octal 10 Input And/Or Invert Gate Array .....	6-8
PAL12L6    Hex 12 Input And/Or Invert Gate Array .....	6-8
PAL14L4    Quad 14 Input And/Or Invert Gate Array .....	6-8
PAL16L2    Dual 16 Input And/Or Invert Gate Array .....	6-8
PAL16L8    Octal 16 Input And/Or Invert Gate Array .....	6-8
PAL16R8    Octal 16 Input Registered And/Or Gate Array .....	6-8
PAL16R6    Hex 16 Input Registered And/Or Gate Array .....	6-8
PAL16R4    Quad 16 Input Registered And/Or Gate Array .....	6-8

Approved Programmers .....	6-11
PAL Programming Instructions .....	6-13
PAL Logic Diagrams .....	6-14

PAL Programming .....	6-27
Selecting the Right PAL .....	6-28
Defining the Pinout .....	6-28
Specifying the Design .....	6-28
PAL Legend .....	6-29
Phantom Fuse .....	6-30

Documenting the PAL Design Specification .....	6-30
--	------

### PALASM

Sample PAL Design Specification .....	6-31
PALASM Flow Chart .....	6-32
PALASM Source Code .....	6-33
PROM Programmer Virgin Fuse Patterns .....	6-42

### MANUAL CODING

Logic Diagrams .....	6-47
Programming Formats .....	6-51
PAL10H8 .....	6-48
PAL12H6 .....	6-50
PAL14H4 .....	6-52
PAL16H2 .....	6-54
PAL16C1 .....	6-56
PAL10L8 .....	6-58
PAL12L6 .....	6-60
PAL14L4 .....	6-62
PAL16L2 .....	6-64
PAL16L8 .....	6-66
PAL16R8 .....	6-68
PAL16R6 .....	6-70
PAL16R4 .....	6-72
Paper Tape Inputs .....	6-74
BHLF Format .....	6-74
BPNF Format .....	6-74
Hexadecimal Format .....	6-74
Decimal to Hexadecimal Conversion Table .....	6-75

### Applications

Example 1 .....	6-78
Example 2 .....	6-86

### FIFO

57/67401       64x4 First-In First-Out .....	7-3
--	-----

### ARITHMETIC ELEMENTS

Arithmetic Elements Selection Guide .....	8-2
57/67558       8x8 Multiplier .....	8-3
57/67558-1     8x8 Multiplier .....	8-3
5/6086         10 Bit Sine Look Up Table .....	8-9
5/6087         10 Bit Sine Look Up Table .....	8-9
SN54/74S381    Arithmetic Logic Unit/Function Generator .....	8-11
SN54/74S182    Look-Ahead Carry Generators .....	8-15

# Table of Contents

## INTERFACE

Octal Interface Selection Guide .....	9-2
SN54/74LS240 Octal Buffer, Invert .....	9-3
SN54/74LS241 Octal Buffer .....	9-3
SN54/74LS244 Octal Buffer .....	9-3
SN54/74S240 Octal Buffer, Invert .....	9-3
SN54/74S241 Octal Buffer .....	9-3
SN54/74S244 Octal Buffer .....	9-3
57/67LS300 Octal Buffer, Invert .....	9-6
57/67LS301 Octal Buffer .....	9-6
57/67LS304 Octal Buffer .....	9-6
SN54/74LS645 Octal Transceiver .....	9-8
SN54/74LS373 Octal Latch, Standard .....	9-10
SN54/74LS374 Octal Register, Standard .....	9-10
SN54/74S373 Octal Latch, Standard .....	9-10
SN54/74S374 Octal Latch, Standard .....	9-10
57/67LS376 Octal Register, Invert .....	9-13
57/67LS380 Octal Latch, Invert .....	9-13

## INTERFACE (continued)

57/67S376 Octal Register, Invert .....	9-13
57/67S380 Octal Latch, Invert .....	9-13
67S373 Octal Latch, Hi-drive .....	9-16
67S374 Octal Register, Hi-drive .....	9-16
67S378 Octal Register, Invert .....	9-18
67S382 Octal Latch, Invert, Hi-drive .....	9-18
Interface Test Load/Waveforms .....	9-20

## GENERAL INFORMATION

Definition of Terms and Waveforms .....	10-2
PROM/ROM Programming Input Format .....	10-4
Technical Publications .....	10-6
Package Drawings .....	10-7

REPRESENTATIVES AND DISTRIBUTORS .....	11-2
--	------

## Numerical Index

<p><b>10H8</b> 6-10</p> <p><b>10L8</b> 6-10</p> <p><b>12H6</b> 6-10</p> <p><b>12L6</b> 6-10</p> <p><b>14H4</b> 6-10</p> <p><b>14L4</b> 6-10</p> <p><b>16C1</b> 6-10</p> <p><b>16H2</b> 6-10</p> <p><b>16L2</b> 6-10</p> <p><b>16L8</b> 6-10</p> <p><b>16R4</b> 6-10</p> <p><b>16R6</b> 6-10</p> <p><b>16R8</b> 6-10</p> <p><b>5055</b> 5-3</p> <p><b>5086</b> 8-9</p> <p><b>5087</b> 8-9</p> <p><b>5155</b> 5-3</p> <p><b>5255-1</b> 4-2</p> <p><b>5256-1</b> 4-2</p> <p><b>5260-1</b> 4-2</p> <p><b>5261-1</b> 4-2</p> <p><b>5275-1</b> 4-2</p> <p><b>5276-1</b> 4-2</p> <p><b>5280-1</b> 4-2</p> <p><b>5280-2</b> 4-2</p> <p><b>5281-1</b> 4-2</p> <p><b>5281-2</b> 3-2</p> <p><b>5282-1</b> 4-2</p> <p><b>5283-1</b> 4-2</p> <p><b>5290</b> 5-15</p> <p><b>5291</b> 5-15</p> <p><b>5292</b> 5-15</p> <p><b>5293</b> 5-15</p> <p><b>5300-1</b> 3-4</p> <p><b>5301-1</b> 3-4</p> <p><b>5305-1</b> 3-4</p> <p><b>5306-1</b> 3-4</p> <p><b>5308-1</b> 3-4</p> <p><b>5309-1</b> 3-4</p> <p><b>5330-1</b> 3-4</p> <p><b>5331-1</b> 3-4</p>	<p><b>5340-1</b> 3-4</p> <p><b>5341-1</b> 3-4</p> <p><b>5348-1</b> 3-4</p> <p><b>5349-1</b> 3-4</p> <p><b>5350-1</b> 3-4</p> <p><b>5351-1</b> 3-4</p> <p><b>5352-1</b> 3-4</p> <p><b>5353-1</b> 3-4</p> <p><b>5380-1</b> 3-4</p> <p><b>5381-1</b> 3-4</p> <p><b>54LS240</b> 9-3</p> <p><b>54LS241</b> 9-3</p> <p><b>54LS244</b> 9-3</p> <p><b>54LS645</b> 9-8</p> <p><b>54LS373</b> 9-10</p> <p><b>54LS374</b> 9-10</p> <p><b>54S182</b> 8-15</p> <p><b>54S240</b> 9-3</p> <p><b>54S241</b> 9-3</p> <p><b>54S244</b> 9-3</p> <p><b>54S373</b> 9-10</p> <p><b>54S374</b> 9-10</p> <p><b>54S381</b> 8-11</p> <p><b>57401</b> 7-3</p> <p><b>57558</b> 8-3</p> <p><b>57558-1</b> 8-3</p> <p><b>57LS300</b> 9-3</p> <p><b>57LS301</b> 9-3</p> <p><b>57LS304</b> 9-3</p> <p><b>57LS376</b> 9-13</p> <p><b>57LS380</b> 9-13</p> <p><b>57S376</b> 9-13</p> <p><b>57S380</b> 9-13</p> <p><b>6055</b> 5-3</p> <p><b>6056</b> 5-3</p> <p><b>6061</b> 5-3</p> <p><b>6062</b> 5-3</p>	<p><b>6071</b> 5-3</p> <p><b>6072</b> 5-3</p> <p><b>6086</b> 8-9</p> <p><b>6087</b> 8-9</p> <p><b>6155</b> 5-3</p> <p><b>6156</b> 5-3</p> <p><b>6161</b> 5-3</p> <p><b>6162</b> 5-3</p> <p><b>6171</b> 5-3</p> <p><b>6172</b> 5-3</p> <p><b>6255-1</b> 4-2</p> <p><b>6256-1</b> 4-2</p> <p><b>6260-1</b> 4-2</p> <p><b>6261-1</b> 4-2</p> <p><b>6275-1</b> 4-2</p> <p><b>6276-1</b> 4-2</p> <p><b>6280-1</b> 4-2</p> <p><b>6280-2</b> 4-2</p> <p><b>6281-1</b> 4-2</p> <p><b>6281-2</b> 4-2</p> <p><b>6282-1</b> 4-2</p> <p><b>6283-1</b> 4-2</p> <p><b>6290</b> 4-2</p> <p><b>6291</b> 4-2</p> <p><b>6292</b> 4-2</p> <p><b>6293</b> 4-2</p> <p><b>6300-1</b> 3-4</p> <p><b>6301-1</b> 3-4</p> <p><b>6305-1</b> 3-4</p> <p><b>6306-1</b> 3-4</p> <p><b>6308-1</b> 3-4</p> <p><b>6309-1</b> 3-4</p> <p><b>6330-1</b> 3-4</p> <p><b>6331-1</b> 3-4</p> <p><b>6335-1</b> 3-4</p> <p><b>6336-1</b> 3-4</p> <p><b>6340-1</b> 3-4</p> <p><b>6341-1</b> 3-4</p> <p><b>6348-1</b> 3-4</p> <p><b>6349-1</b> 3-4</p>	<p><b>6350-1</b> 3-4</p> <p><b>6351-1</b> 3-4</p> <p><b>6352-1</b> 3-4</p> <p><b>6353-1</b> 3-4</p> <p><b>6380-1</b> 3-4</p> <p><b>6381-1</b> 3-4</p> <p><b>67401</b> 7-3</p> <p><b>67558</b> 8-3</p> <p><b>67558-1</b> 8-3</p> <p><b>67LS300</b> 9-6</p> <p><b>67LS301</b> 9-6</p> <p><b>67LS304</b> 9-6</p> <p><b>67LS376</b> 9-13</p> <p><b>67LS380</b> 9-13</p> <p><b>67S373</b> 9-16</p> <p><b>67S374</b> 9-16</p> <p><b>67S376</b> 9-16</p> <p><b>67S378</b> 9-18</p> <p><b>67S380</b> 9-13</p> <p><b>67S382</b> 9-18</p> <p><b>74LS240</b> 9-3</p> <p><b>74LS241</b> 9-3</p> <p><b>74LS244</b> 9-3</p> <p><b>74LS645</b> 9-8</p> <p><b>74LS373</b> 9-10</p> <p><b>74LS374</b> 9-10</p> <p><b>74S182</b> 8-15</p> <p><b>74S240</b> 9-3</p> <p><b>74S241</b> 9-3</p> <p><b>74S244</b> 9-3</p> <p><b>74S373</b> 9-10</p> <p><b>74S374</b> 9-10</p> <p><b>74S381</b> 8-11</p>
--	---	---	--

# Monolithic Memories—Company Profile

Monolithic Memories, Inc. is a company whose entire energies and resources are devoted to the development and production of Bipolar Large Scale Integrated (LSI) Memory and Logic circuits.

Since the company started its operation in 1970 the objective has been to establish its leadership in high-technology bipolar devices. Starting in 1971 MMI introduced the 1K PROM. This was followed with the first 2K PROM in 1972, the first 4K PROM in 1975 and the first 8K PROM in 1976.

In 1974 MMI started its expansion into the bipolar logic market with the introduction of the world's first 4-bit Slice, FIFO's Multipliers and most recently the Programmable Array Logic — PAL™.



Monolithic Memories is the world's leader in shipments of bipolar memory devices. The design fabrication and testing of all of our products is accomplished in a modern facility in Sunnyvale, California. Assembly of all devices is performed in a company owned facility in Penang, Malaysia. Both facilities are in the process of expansion to provide the bipolar LSI devices in great demand by the electronics industry.

PAL™ is a trademark of Monolithic Memories

## Fast FIFOs from inventory

For years MMI has made the world's fastest FIFOs. Now they're even faster, and come in four-bit and five-bit versions.

For details and information on a wide variety of LSI devices, contact your nearest MMI distributor or write to: Monolithic Memories, Inc., Dept. 100, Sunnyvale, CA 95088.

MMI-STD FIFOs from inventory

**Monolithic Memories**

The company's products are used in a wide variety of products that range from electronic games to highly complex computer applications. There is a special emphasis placed on the manufacture of quality high-reliability devices for use in applications which include undersea and space programs.

## Pick the interface that really fits.

Why compromise? MMI's broad line of LS and S octal interface lets you pick the exact part you need every time.

With the industry's largest selection of octal devices, you can choose the exact part you need every time. MMI's broad line of LS and S octal interface lets you pick the exact part you need every time.

MMI has an excellent reputation for quality and reliability. Contact your nearest MMI distributor or write to: Monolithic Memories, Inc., Dept. 100, Sunnyvale, CA 95088.

**Monolithic Memories**

Monolithic Memories sells its products through a worldwide organization of sales representatives and distributors in the United States, Europe and Japan.

## Monolithic Memories announces: a revolution in logic design!

PAL will save you money, space and sweat.

Use PAL to change your implementation. PAL is a programmable logic device that can be programmed to perform any logic function. It is a single-chip solution for many logic designs.

**Monolithic Memories**

## Hire a veteran.

Employ Monolithic Memories' industry standard LSI to your advantage in your military system.

MMI-STD FIFOs from inventory

**Monolithic Memories**

**Quality System**

The quality system at Monolithic Memories is based on MIL-Q-9858, "Quality Program Requirements," MIL-I-45208, "Inspection System Requirements," and MIL-M-38510, Appendix A, "Product Assurance Program." MIL-M-38510 plays a significant role in structuring MMI's quality program.

MMI's facilities in Sunnyvale were certified in June of 1977 by DESC, Defense Electronics Supply Center, to manufacture and qualify to class B and class C Schottky Bipolar PROMs, ROMs and RAMs in accordance with the requirements of MIL-M-38510. This certification included a successful audit of our quality system to the stringent requirements of Appendix A of MIL-M-38510 which defines a Product Assurance Program tailored for integrated circuit manufacturers by DESC. This same quality system has also met the strict requirements of both "controlled" and "captive" line programs connected with our special Hi-Rel programs.

The quality accent at MMI is on process control as reflected in the use of many monitors and audits rather than gate inspections. This philosophy is consistent with building in quality and reliability rather than attempting to screen for it.

**Process Control**

MMI's advanced low-power Schottky TTL process uses such techniques as redundant masking to reduce random defects and self-aligning masking to reduce active chip area. Although more costly than the standard SSI or MSI Schottky TTL processes, these approaches yield better quality, increased reliability and lower overall cost due to higher net die per wafer. During the initial production stages of new designs and periodically thereafter, engineering characterizes the design-process compatibility by careful sample selection of lots reflecting process variable extremes.

**Screening**

Much of the assembly (packaging only) is performed offshore at our Penang, Malaysia facility. This facility has been qualified and is routinely monitored for conformance to MIL-STD-883 by MMI's military customers as well as by MMI's Quality Control Department. All standard military hermetic MMI products are 100% screened to MIL-STD-883 Class C. This includes:

- Pre-cap inspection.\*
- High-temperature storage at 150°C.
- Temperature cycling. -65°C to +150°C.
- Constant acceleration.
- Fine and gross leak.
- Final electrical test.
- Q.A. sample acceptance testing.

\*Modified for LSI.

Standard commercial hermetic product receives the following screens and monitors to insure the highest possible product quality.

- Pre-cap inspection\*
  - High temperature storage
  - Temperature cycle
  - Constant acceleration
  - Fine and gross leak
  - Final electrical test
- } Daily monitors in lieu of 100% screening which insure the AQL levels before are met or exceeded.

\*Modified MIL-STD-883 Pre cap.

The product assurance levels which MMI guarantees are listed in the table on this page.

Reliability Engineering maintains product surveillance through routine sampling and submission to MIL-STD-883, method 5005, qualification testing. Additional step-stress and extended (limit) testing conditions are used when warranted. In general, failure rates have been found to be two orders of magnitude better than MIL-HDBK-217 estimates.

The quality organization is defined into three departments:

- Quality control
- Quality assurance
- Reliability assurance

**Quality Assurance (AQL) Levels**

TEST	LEVEL I COMMERCIAL (%)	LEVEL II MILITARY (%)
Hermeticity (includes fine and gross)	0.65	0.4
Electrical		
DC at 25°C	.40	.25
Functional at 25°C	.40	.25
AC at 25°C	.65	.40
DC at Temperature Extremes	.65	.65
Functional at Temperature Extremes	.65	.65
AC at Temperature Extremes	1.5	1.5





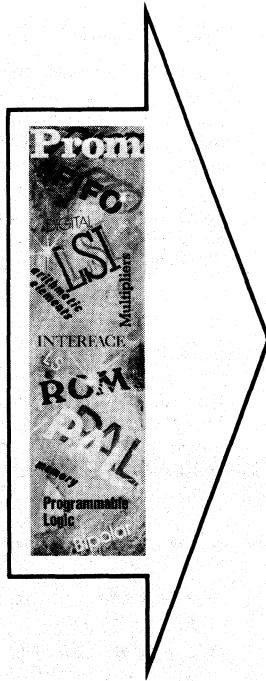

Introduction	<b>1</b>
HI REL	<b>2</b>
PROM	<b>3</b>
ROM	<b>4</b>
Character Generators	<b>5</b>
PAL	<b>6</b>
FIFO	<b>7</b>
Arithmetic Elements	<b>8</b>
Interface	<b>9</b>
General Information	<b>10</b>
Representatives/Distributors	<b>11</b>

# Hi-Rel Products

## Hi-Rel Products

MMI's Hi-Reliability Program offers a broad line of industry standard Bipolar LSI components processed and tested to Military standards. All Hi-Reliability products can be purchased screened to Classes B or C of MIL-STD-883B, Method 5004, each with two options or in full compliance with MIL-M-38510 where slash sheets exist as delineated herein.

The inherent quality and reliability of MMI's products have been successfully demonstrated in such aircraft programs as F14, F15, F16, F18, MRCA and Mirage to name the most significant. We have supplied bipolar LSI devices for the Block V and Pioneer Venus Satellite programs.

## Screening Options

The following process options are available:

MIL-M-38510 Class B

MIL-STD-883 Class B

MMI "B" Program (Includes Group A tests at 125°C; Group B requirements deleted)

MIL-M-38510 Class C

MIL-STD-883 Class C

MMI "C" Program (Includes Group A tests at 125°C, Group B requirements deleted)

## Package Options

The package options available are:

J: Cerdip 16, 18, 20, 24 and 40 lead varieties standard.

D: Ceramic Sidebrazed 16, 18, 24 and 40 lead upon request.

W: Ceramic Flatpack 16, 18 and 24 lead variety upon request.

F: Glass-metal Flatpack 16, 18 and 24 lead variety upon special request.

## MIL-STD-883 Processed Parts

Monolithic Memories offers a complete line of high reliability bipolar LSI devices. All of our products are designed to operate over the entire military performance specification of  $\pm 10\%$  VCC tolerance and  $-55^{\circ}\text{C}$  to  $+125^{\circ}\text{C}$  operating temperature ambient. As such, all standard military temperature range devices can be processed either to full compliance of Classes B and C of MIL-STD-883 or to only the 100% screening criteria of MIL-STD-883 (Method 5004) for both Classes B and C (MMI equivalent) as delineated in Table 1.

Many devices are available from stock. In addition to standard MIL-STD-883 high reliability devices, "Monolithic Memories has the ability to process parts to customers unique screening specifications. Some examples are:

- Selected electrical parameters
- 100% instant on (cold start) testing at  $-55^{\circ}\text{C}$
- Read and record data with  $\Delta$  drift parameters
- Complete data reduction including mean, average, and three sigma analysis of each parameter
- Extended burn-in screening
- 100% AC, DC and functional testing at temperature extremes -  $-55^{\circ}\text{C}$  and  $+125^{\circ}\text{C}$
- DPA (Destructive Physical Analysis)
- SEM (Scanning Electron Microscope) evaluation on a wafer lot basis.
- Special lot traceability to critical wafer fabrication processes, i.e., metalization
- Residual gas analysis on hermetic packages
- Custom lot qualification tests
- Special customer source inspection at pre-cap, SEM, process control monitoring points or at lot qualification testing

**Table 1 Hi Rel Screening  
MMI Available Standard Hi-Rel Screening Levels<sup>c</sup>**

FLOW	METHOD	883C METHOD 5004 <sup>a</sup>				MMI "C" <sup>b</sup>				883C METHOD 5004 <sup>a</sup>				MMI "B" <sup>b</sup>			
		PROM/PAL		ROM/ HAL	LSI*	PROM/PAL		ROM/ HAL	LSI*	PROM/PAL		ROM/ HAL	LSI*	PROM/PAL		ROM/ HAL	LSI*
		Unpro- grammed	Pro- grammed			Unpro- grammed	Pro- grammed			Unpro- grammed	Pro- grammed			Unpro- grammed	Pro- grammed		
Pre-cap visual (prior to seal)	2010 Cond B	Yes	Yes	Yes	Yes	Yes	Yes	Yes	Yes	Yes	Yes	Yes	Yes	Yes	Yes	Yes	Yes
Seal		Yes	Yes	Yes	Yes	Yes	Yes	Yes	Yes	Yes	Yes	Yes	Yes	Yes	Yes	Yes	Yes
High Temp storage 24 Hr. @ 150°C (after seal)	1008 Cond. C	Yes	Yes	Yes	Yes	Yes	Yes	Yes	Yes	Yes	Yes	Yes	Yes	Yes	Yes	Yes	Yes
Temp. cycling 10 cycles, -65°C to +150°C	1010 Cond. C	Yes	Yes	Yes	Yes	Yes	Yes	Yes	Yes	Yes	Yes	Yes	Yes	Yes	Yes	Yes	Yes
Constant acceleration: Y1 30 KG	2001 Cond. E	Yes	Yes	Yes	Yes	Yes	Yes	Yes	Yes	Yes	Yes	Yes	Yes	Yes	Yes	Yes	Yes
Leak: Fine-5 x 10 <sup>-8</sup> cc/sec Gross—	1014 Cond. A or B 1014 Cond. C	Yes	Yes	Yes	Yes	Yes	Yes	Yes	Yes	Yes	Yes	Yes	Yes	Yes	Yes	Yes	Yes
Interim electrical test. DC & functional 25°C (correlated)	MMI Data Sheet	Yes	Yes	Yes	Yes	Yes	Yes	Yes	Yes	Yes	Yes	Yes	Yes	Yes	Yes	Yes	Yes
Test fuse/verify (DC)	MMI Std.	Yes	Yes	—	—	Yes	Yes	—	—	Yes	Yes	—	—	Yes	Yes	—	—
Program/verify		—	Yes	—	—	—	Yes	—	—	—	Yes	—	—	—	Yes	—	—
Burn-in 160 hr. @ 125°C	1015 Cond. D (Dynamic)	—	—	—	—	—	—	—	—	—	Yes	Yes	Yes	—	Yes	Yes	Yes
Final Electrical Test Static Tests at 25°C	MMI Data Sheet	Yes	Yes	Yes	Yes	Yes	Yes	Yes	Yes	Yes	Yes	Yes	Yes	Yes	Yes	Yes	Yes
-55°C, +125°C		—	—	—	—	—	—	—	—	Yes	Yes	Yes	Yes	Yes	Yes	Yes	Yes
—Dynamic <sup>d</sup> & switching tests @ 25°C		—	—	—	—	—	—	—	—	—	Yes	Yes	Yes	—	Yes	Yes	Yes
—Functional Tests at 25°C		Yes	Yes	Yes	Yes	Yes	Yes	Yes	Yes	Yes	Yes	Yes	Yes	Yes	Yes	Yes	Yes
Lot Acceptance: Group A Subgroup 2		—	—	—	—	Yes	Yes	Yes	Yes	—	—	—	—	Yes	Yes	Yes	Yes
Sub 1, 2, 3, 7, 8, 9 except Sub 9 for unprogrammed devices		Yes	Yes	Yes	Yes	—	—	—	—	Yes	Yes	Yes	Yes	—	—	—	—
Group B tests		Yes	Yes	Yes	Yes	—	—	—	—	Yes	Yes	Yes	Yes	—	—	—	—

<sup>a</sup> Tested in full accordance with MIL-STD-883 requirements

<sup>b</sup> Tested only to 100% screening requirements of MIL-STD-883 Method 5004. Reduced Group A testing and Group B testing not performed.

<sup>c</sup> MMI will screen and test to the latest issue in effect or as dictated by the contract.

<sup>d</sup> Dynamic Testing at 25°C, +125°C, -55°C; Switching tests at 25°C only.

\* LSI Logic Products (include 54SXXX and 54LSXXX Interface circuits)

## MIL-M-38510

The MIL-M-38510 Program is designed to standardize the Hi Reliability portion of the microcircuit industry much the same as MIL-S-19500 standardized the transistor industry. Its purpose is to provide the customer the highest possible quality level for the required application along with reasonable prices and fastest delivery.

The device electrical and package requirements of MIL-M-38510 are detailed by a device specification referred to as a slash sheet. Each slash sheet defines the microcircuit electrical performances and mechanical requirements. Each device listed on a slash sheet is referred to as a dash number and the group of microcircuits contained on a slash sheet is defined as a family of devices.

A unique MIL-M-38510 part number completely defines the microcircuit being procured: Device type, electrical specification, mechanical outline, 100% screening requirement/quality level, and lead finish in the following format (Table 2).

**Table 2: MIL-M-38510 Part Numbering Format**

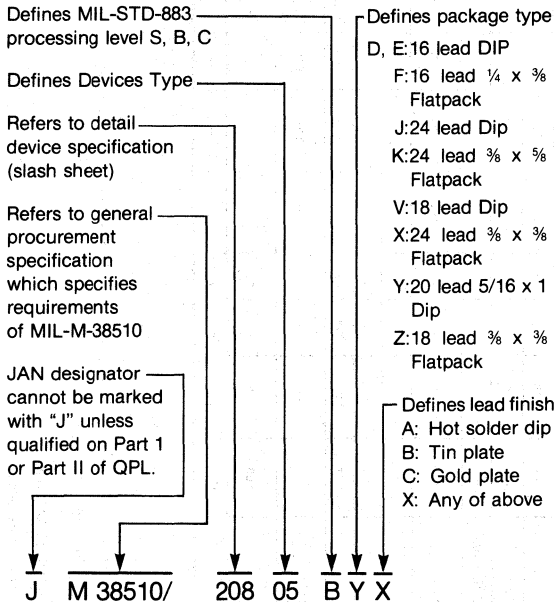

In addition, all MIL-M-38510 microcircuits must be completely manufactured and assembled in a domestic USA facility.

We have a strong commitment to the MIL-M-38510 program and participate in slash sheet development with DESC, RADC and our customers. We have or will qualify all of our products for which there is a released MIL-M-38510 detailed specification (slash sheet). If one requires a product for which a slash sheet does not exist—then we can provide "883 processed" product. "883 processed" parts are screened to the full requirements of MIL-STD-883 Methods 5004 and 5005 with full electrical tests (DC, switching, and functional) over the military temperature range per MMI data sheet limits in our DESC certified facility. Each lot of 883 processed devices shipped includes a Certificate of Conformance and Group A Summary Report.

Currently released "slash sheets" for MMI supplied product are as follows:

MIL-M38510/203 1K Schottky NiCR PROMS (256x4)	01 5300-1
	02 5301-1
MIL-M-38510/204 2K Schottky NiCR PROMS (512x4)	01 5305-1
	02 5306-1
MIL-M-38510/206 4K Schottky NiCR PROMS (1Kx4)	01 5352-1
	02 5353-1
MIL-M-38510/207 1/4K Schottky NiCR PROMS (32x8)	01 5330-1
	02 5331-1
MIL-M-38510/208 4K Schottky NiCR PROMS (512x8)	01 5340-1
	02 5341-1
	04 5348-1
	05 5349-1
MIL-M-38510/209 8K Schottky NiCR PROMS (1Kx8)	03 5380-1
	04 5381-1

For an up-to-date status on our QPL program, call your factory representative.

## Advanced Programs

MMI has participated in the Trident Missile program since 1975. This participation has involved two manufacturing concepts for the production of Extreme Reliability Components.

1. **Controlled Line**—This concept places MMI manufacturing documentation and equipment under customer control and concurrence with any change.
2. **Captive Line**—This concept defines the equipment to be used, controls and supplies wire and packages. MMI documents the systems and provides the semiconductor expertise.

The Military Programs Department is involved in TRIDENT, DISCUSS, MX, F-18, MK500 and various NASA/SPACE PROGRAMS. Our products have the capability of meeting full radiation requirements of neutron, gamma dot and ionizing environments.

Our facility has DOD clearance and we have the capability to participate in customer analysis of our designs. These analyses may lead to design changes which enhance the product capability in hostile environments. Products which have been qualified for these advanced programs are:

- 5301—1K NiCR PROM
- 5300—1K Gold PROM
- 5341—4K NiCR PROM
- 5206—2K ROM (5306 NiCR PROM Equivalent)

Contact us for further details should you require this facet of our Hi-Reliability capability.

## Flat/Pack Chip Carriers and Die

Most products are available in flat packs (see individual selection guides and the package appendix for details), and our manufacturing line can accommodate your chip carrier packaging requirements as well. If your needs are for the ultimate in density, we can also supply LSI chips for your hybrid applications. These can be furnished with special 100% testing and optical inspection screens geared for hybrid packaging.

## Ordering Information

Each of the screening options which MMI offers can be identified by a unique indicator for a given product. This part/screening identification system must be used when placing an order to ensure that the desired screening level is ordered. The product delivered is also marked with this indicator to verify compliance with purchase order requirements. Table 3 below provides the details of the screening identification system and includes an example.

## In-House Reliability Programs

In addition to the execution of specific customer requested Hi-Rel testing, the Reliability Assurance Group conducts the following activities to establish and maintain our complete line of Hi-Reliability Bipolar LSI devices.

- Device design qualification (new/revised)
- Package qualification
- Process qualification
- On-going device/package/process qualification program.
- Extended and accelerated life testing (step/stress).
- Periodic reliability reports for in-house/field consumption.
- Process monitors (SEM).

Table 3 Screening Level Identification/Part Marking

SCREENING LEVEL	PRODUCT IDENTIFICATION	EXAMPLE USING 512x8 N1CR PROM WITH TRI STATE OUTPUTS AND ENCASED IN 20 PIN Cerdip
MIL-M-38510 Class B	MIL-M-38510/XXXXX BXX or JM38510/XXXXX BXX	JM38510/20805 BYX
MIL-STD-883 Class B	5XXX-1X883B*	5349-1J883B
MMI "B" Program	5XXX-1XB	5349-1JB
MIL-M-38510 Class C	MIL-M-38510/XXXXX CXX or JM 38510/XXXXX CXX	JM38510/20805 CYX
MIL-STD-883 Class C	5XXX-1X 883C	5349-1J883C
MMI "C" Program	5XXX-1XC	5349-1JC

\*-1 identification for Schottky NiCR PROMS only.

# Hi-Rel Products

**Table 4 Group A Electrical Tests**

SUBGROUPS	LTPD		INITIAL SAMPLE SIZE*	
	B	C	B	C
Subgroup 1—Static Tests at +25°C	5	5	45	45
Subgroup 2—Static Tests at Maximum Rated Operating Temperature	7	10	32	22
Subgroup 3—Static Tests at Minimum Operating Temperature	7	10	32	22
Subgroup 4—Dynamic Tests at +25°C†	5	5	45	45
Subgroup 5—Dynamic Tests at Maximum Rated Operating Temperature†	7	10	32	22
Subgroup 6—Dynamic Tests at Minimum Rated Operating Temperature†	7	10	32	22
Subgroup 7—Functional Tests at +25°C	5	5	45	45
Subgroup 8—Functional Tests at Maximum and Minimum Operating Temperatures	0	15	22	15
Subgroup 9—Switching Tests at +25°C Except Unprogrammed PROM	7	10	32	22

\*Groups A, B, C, and D sampling plans are based on standard LTPD tables of MIL-M-38510 Appendix B. The smallest sample size based on zero rejects allowed, has been chosen unless otherwise indicated. If necessary, the sample size will be increased once to the quantity corresponding to the next acceptance number.

† Dynamic tests are not applicable to digital memory devices; switching subgroup tests are performed to a specified functional pattern and dynamically exercised.

**Table 5 Group B Tests**

TEST	METHOD	CONDITIONS	LTPD	INITIAL † SAMPLE SIZE
Subgroup 1 Physical Dimensions	2016	MMI Data Sheet	No failures	2
Subgroup 2 Resistance to Solvents	2015		No failures	4
Subgroup 3 Solderability	2003	Soldering temperature of +260°C ±10°C. 90% coverage, void concentration not to exceed 10% of area	15	15 Leads from 3 devices minimum
Subgroup 4 Internal Visual and Mechanical	2014	Failure criteria from design and construction	No failures	1
Subgroup 5 Bond strength	2011	Condition D: 3 gram force minimum for aluminum wire, ultrasonic bonding	15	15 wires from 4 devices minimum
Subgroup 6 Internal Water-Vapor Content* D-1-B	1018	100 ppm max. at +100°C	No failures 1 failure	3 5

\*For packages with desiccant only. MMI packages do not contain a desiccant. Thus subgroup 6 does not apply.

† All samples are devices unless otherwise stated.

# Hi-Rel Products

**Table 6 Group C Tests (Die Related Tests)**

TEST	METHOD	CONDITIONS	LTPD	INITIAL SAMPLE SIZE
Subgroup 1* Operating Life Test	1005	Steady state life: 1,000 Hr., +125°C, condition D, Dynamic	5	77 ACC = 1*
Subgroup 2* A. Temperature Cycling	1010	Test condition C: air to air, -65°C to +150°C, 10 cycles	15	15
B. Constant Acceleration (Centrifuge)	2001	Test condition E: 30kG centri- fugal acceleration -Y1 axis only		
C. Seal (Fine and Gross)	1014	Test Conditions A or B and C		
D. Visual Examination	1010			

**Table 7 Group D Test (Packages Related Tests)**

TEST	METHOD	CONDITIONS	LTPD	INITIAL SAMPLE SIZE
Subgroup 1 A. Physical Dimensions	2016	MMI Data Sheet	15	15
B. Internal Water Vapor Content	1018	5000 PPM max. @ 100°C	No failures 1 failure	3 5
Subgroup 2 A. Lead Fatigue	2004	Test condition: B2: 3 oz. for ribbon leads: 8 oz. for all others	15	15
B. Seal (Fine and Gross)	1014	Test conditions A or B and C		
Subgroup 3* A. Thermal Shock	1011	Test method B: liquid to liquid, -55°C to +125°C, 15 cycles	15	15
B. Temperature Cycling	1010	Test condition C: air to air, -65°C to +150°C, 100 cycles		
C. Moisture Resistance	1004	Omit initial conditioning and vibration		
D. Seal (Fine and Gross)	1014	Test conditions A or B and C		
E. Visual examination	1004			
Subgroup 4* A. Mechanical Shock	2002	Test condition B: 5 shock pulses, 6 directions: 1500 g	15	15
B. Vibration Variable Frequency	2007	Test condition A: 20 g		
C. Constant Acceleration (Centrifuge)	2001	Test condition E: 30 kg centri- fugal acceleration. Y1 axis only		
D. Seal (Fine and Gross)	1014	Test conditions A or B and C		
E. Visual Examination	1010			
Subgroup 5 A. Salt Atmosphere (Corrosion)	1009	Test condition A: 24 Hr.	15	15
B. Seal (Fine and Gross)	1014	Test conditions A or B and C		
C. Visual Examination	1010			

\* Electrical end points required for all subgroups (except in Group B and Subgroups 1, 2 and 5 of Group D), are room temperature. Subgroups 1, 2 and 3 of Group A DC tests, per MMI data sheet. Check factory for additional requirements.

2





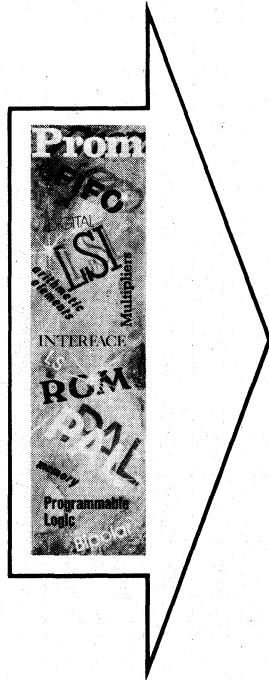

<b>Introduction</b>	<b>1</b>
<b>HI REL</b>	<b>2</b>
<b>PROM</b>	<b>3</b>
<b>ROM</b>	<b>4</b>
<b>Character Generators</b>	<b>5</b>
<b>PAL</b>	<b>6</b>
<b>FIFO</b>	<b>7</b>
<b>Arithmetic Elements</b>	<b>8</b>
<b>Interface</b>	<b>9</b>
<b>General Information</b>	<b>10</b>
<b>Representatives/Distributors</b>	<b>11</b>

## Bipolar PROM Cross-Reference Guide

MEMORY DESCRIPTION				MMI	AMD	FAIR-CHILD	HARRIS	INTEL	INTERSIL	MOTOROLA	NATIONAL	RAYTHEON	SIGNETICS	TI	
SIZE	ORGANIZATION	PINS	OUTPUT												
256	32x8	16	OC	6330-1	27S08/29750		7602		5600				N82S23	TBP18SA030 SN74S188	
			TS	6331-1	27S09/29751		7603		5610					N82S123	TBP18S030 SN74S288
1024	256x4	16	OC	6300-1	29S10/29760		7610	3601	5603			29660	N82S27/82S126	TBP14SA10 SN74S387	
			TS	6301-1	27S11/29761		7611	3621	5623			29661	N82S129	TBP14510 SN74S287	
2048	256x8	20	OC	6308-1							DM74S470	29600		TBP18SA22 SN74S470	
			TS	6309-1							DM74S471	29601		TBP18S22 SN74S471	
		24	OC	6335-1											
			TS	6336-1											
2048	512x4	16	OC	6305-1	27S12/29770		7620	3602A	5604	MCM 7620	DM74S570	29610	N82S130		
			TS	6306-1	27S13/29771		7621	3602A	5624	MCM 7621	DM74S571	29611	N82S131		
4096	512x8	20	OC	6348-1			7648				DM74S473	29620		TBP18SA42 SN74S473	
			TS	6349-1			7649				DM74S472	29621		TBP18S42 SN74S472	
4096	512x8	24	OC	6340-1			7640	3604A	5605	MCM 7640	DM87S295	29624	N82S140	TBP18SA46 SN74S475	
			TS	6341-1			7641	3624A	5625	MCM 7641	DM87S296	29625	N82S141	TBP18S46 SN74S474	
4096	1024x4	18	OC	6352-1		93452	7642	3605	5606	MCM 7642	DM74S572		N82S136		
			TS	6353-1		93453	7643	3625	5626	MCM 7643	DM74S573			N82S137	
8192	1024x8	24	OC	6380-1		93450	7680	3608	5608	MCM 7680	DM87S229	29630	N82S180	TBP28SA86 SN74S479	
			TS	6381-1		93451	7681	3628	5618	MCM 7681	DM87S228	29631	N82S181	TBP2S586 SN74S478	

Note: Only commercial specification part numbers are listed.

# Bipolar PROM Cross Reference Guide

**AMD**            **MMI**  
 27S08/29750    6330-1  
 27S09/29751    6331-1  
 27S10/29760    6300-1  
 27S11/29761    6301-1  
 27S12/29770    6305-1  
 27S13/29771    6306-1

**FAIRCHILD**    **MMI**  
 93450            6389-1  
 93451            6381-1  
 93452            6352-1  
 93453            6353-1

**HARRIS**        **MMI**  
 7602            6331-1  
 7603            6331-1  
 7610            6300-1  
 7611            6301-1  
 7620            6305-1  
 7621            6306-1  
 7648            6348-1  
 7649            6349-1  
 7640            6340-1  
 7641            6341-1  
 7642            6352-1  
 7643            6353-1  
 7680            6380-1  
 7681            6381-1

**INTEL**           **MMI**  
 3601            6300-1  
 3602A          6305-1  
 3602A          6306-1  
 3604A          6340-1  
 3605            6352-1  
 3608            6380-1  
 3621            6301-1  
 3624A          6341-1  
 3625            6353-1  
 3628            6381-1

**INTERSIL**       **MMI**  
 5600            6330-1  
 5603            6300-1  
 5604            6305-1  
 5605            6340-1  
 5606            6352-1  
 5608            6380-1  
 5610            6331-1  
 5618            6381-1  
 5623            6301-1  
 5624            6306-1  
 5625            6341-1  
 5626            6353-1

**MOTOROLA**    **MMI**  
 MCM 7620       6305-1  
 MCM 7621       6306-1  
 MCM 7640       6340-1  
 MCM 7641       6341-1  
 MCM 7642       6352-1  
 MCM 7643       6353-1  
 MCM 7680       6380-1  
 MCM 7681       6381-1

**NATIONAL**     **MMI**  
 DM74S470       6308-1  
 DM74S471       6309-1  
 DM74S472       6349-1  
 DM74S473       6348-1  
 DM74S580       6305-1  
 DM74S571       6306-1  
 DM74S572       6352-1  
 DM74S573       6353-1  
 DM87S228       6381-1  
 DM87S229       6380-1  
 DM87S295       6340-1  
 DM87S296       6341-1

**RAYTHEON**     **MMI**  
 29600           6308-1  
 29601           6309-1  
 29610           6305-1  
 29611           6306-1  
 29620           6348-1  
 29621           6349-1  
 29624           6340-1  
 29625           6341-1  
 29630           638C-1  
 29631           6381-1  
 29660           630F-1  
 29661           630:-1

**SIGNETICS**     **MMI**  
 N82S23          6330-1  
 N82S27/82S127 6300-1  
 N82S123        6331-1  
 N82S129        6301-1  
 N82S130        6305-1  
 N82S131        6306-1  
 N82S136        6352-1  
 N82S137        6353-1  
 N82S140        6340-1  
 N82S141        6341-1  
 N82S180        6380-1  
 N28S181        6381-1

**TI**                **MMI**  
**OLD NUMBERS**  
 SN74S188       6330-1  
 SN74S287       6301-1  
 SN74S288       6331-1  
 SN74S387       6300-1  
 SN74S470       6308-1  
 SN74S471       6309-1  
 SN74S472       6349-1  
 SN74S473       6348-1  
 SN74S474       6341-1  
 SN74S475       6340-1  
 SN74S478       6381-1  
 SN74S479       6380-1

**TI**                **MMI**  
**NEW NUMBERS**  
 TBP18SA030     6330-1  
 TBP14S10       6301-1  
 TBP18S030      6331-1  
 TBP14SA10      6300-1  
 TBP18SA22      6308-1  
 TBP18S22       6309-1  
 TBP18S42       6349-1  
 TBP18SA42      6348-1  
 TBP18S46       6341-1  
 TBP18SA42      6340-1  
 TBP28S86       6381-1  
 TBP28SA86      6380-1

3

# Generic PROM Family

## 53/63XX-1

### Features/Benefits

- Standard Schottky processing
- Reliability proven nichrome fusible links (qualified for MIL-M-38510)
- PNP inputs for low input current
- Compatible pin configurations for upward expansion
- 4-bit-wide and 8-bit-wide for byte oriented applications

### Application

- Microprogram store
- Microprocessor program store
- Look up table
- Character generator
- Random logic
- Code converter

### Description

The 53/63XX-1-series generic PROM family offers the widest selection of sizes and organizations available in the industry. The 4-bit wide PROMs range from 256x4 to 1024x4 and feature upward/downward pin out compatibility in the space saving 16 and 18 pin packages. The 8-bit-wide PROMs range from 32x8 to 1024x8 in a wide selection of package sizes. All PROMs have the same programming specifications allowing a single generic programmer.

The family features low input current PNP inputs, full Schottky clamping, three-state and open collector outputs. The nichrome fuses store a logical high and are programmed to the low state. Special on chip circuitry and extra fuses provide preprogramming tests which assure high programming yields and high reliability.

The 63 series is specified for operation over the commercial temperature and voltage range. The 53 series is specified for the military ranges.

### Generic PROM Selection Guide

MEMORY			PACKAGE	DEVICE TYPE		
SIZE	ORGANIZATION			COMMERCIAL	MILITARY	
1K	256x4	OC	J16	6300-1	5300-1	4-bit-wide
		TS		6301-1	5301-1	
2K	512x4	OC	J16	6305-1	5305-1	
		TS		6306-1	5306-1	
4K	1024x4	OC	J18	6350-1	5350-1	
		TS		6351-1	5351-1	
		OC		6352-1	5352-1	
		TS		6353-1	5353-1	
1/4K	32x8	OC	J16	6330-1	5330-1	8-bit-wide
		TS		6331-1	5331-1	
2K	256x8	OC	J20	6308-1	5308-1	
		TS		6309-1	5309-1	
		OC	J24	6335-1		
		TS		6336-1		
4K	512x8	OC	J24	6340-1	5340-1	
		TS		6341-1	5341-1	
		OC	J20	6348-1	5348-1	
		TS		6349-1	5349-1	
8K	1024x8	OC	J24	6380-1	5380-1	
		TS		6381-1	5381-1	

Pin Configurations

53/6300-1  
53/6301-1

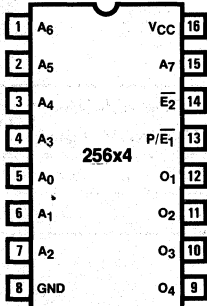

53/6305-1  
53/6306-1

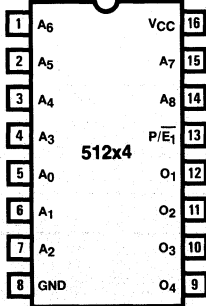

53/6330-1  
53/6331-1

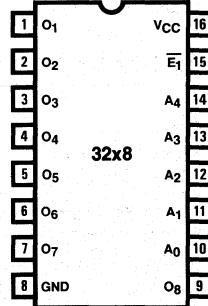

53/6350-1  
53/6351-1

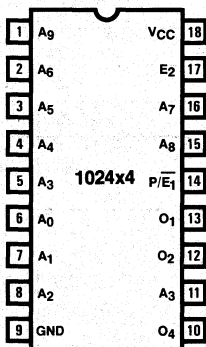

53/6352-1  
53/6353-1

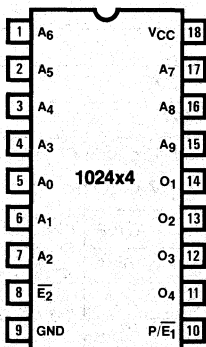

53/6308-1  
53/6309-1

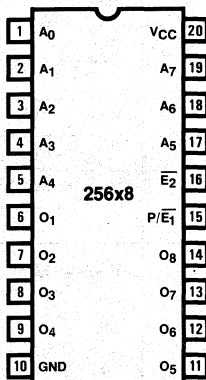

53/6348-1  
53/6349-1

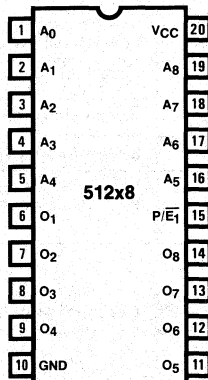

6335-1  
6336-1

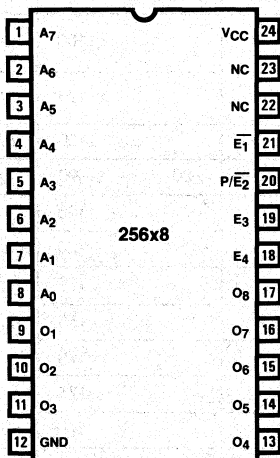

53/6340-1  
53/6341-1

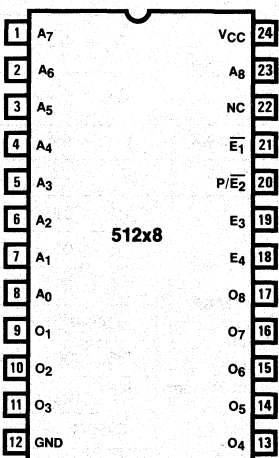

53/6380-1  
53/6381-1

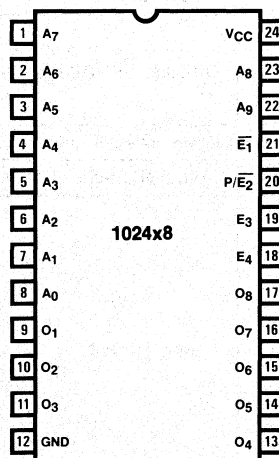

3

**Absolute Maximum Ratings**

Supply Voltage, $V_{CC}$	7V
Input Voltage	7V
Off-state output voltage	5.5V
Storage temperature	-65° to +150°C

**Operating Conditions**

SYMBOL	PARAMETER	MILITARY			COMMERCIAL			UNIT
		MIN	NOM	MAX	MIN	NOM	MAX	
$V_{CC}$	Supply voltage	4.5	5	5.5	4.75	5	5.25	V
$T_A$	Operating free-air temperature	-55		125	0		75	°C

**Electrical Characteristics Over Operating Conditions**

SYMBOL	PARAMETER	TEST CONDITIONS	MIN TYP MAX			UNIT	
$V_{IL}$	Low-level input voltage				0.8	V	
$V_{IH}$	High-level input voltage			2		V	
$V_{IC}$	Input clamp voltage	$V_{CC} = \text{MIN}$ $I_I = -18\text{mA}$			-1.5	V	
$I_{IL}$	Low-level input current	$V_{CC} = \text{MAX}$ $V_I = 0.45\text{V}$			-0.25	mA	
$I_{IH}$	High-level input current	$V_{CC} = \text{MAX}$ $V_I = 4.5\text{V}$ (Program Pin) $V_I = V_{CC} \text{MAX}$ (Other inputs)			40	$\mu\text{A}$	
$V_{OL}$	Low-level output voltage	$V_{CC} = \text{MIN}$ $V_{IL} = 0.8\text{V}$ $V_{IH} = 2\text{V}$	MIL $I_{OL} = 12\text{mA}$	All PROMs except '30, '31, '80, '81	0.5	V	
			COM $I_{OL} = 16\text{mA}$				
			MIL $I_{OL} = 8\text{mA}$				
			COM $I_{OL} = 12\text{mA}$				
$V_{OH}$	High-level output voltage	$V_{CC} = \text{MIN}$ $V_{IL} = 0.8\text{V}$ $V_{IH} = 2\text{V}$	MIL $I_{OH} = -2\text{mA}$	2.4		V	
			COM $I_{OH} = -3.2\text{mA}$				
$I_{OZL}$	Off-state output current	$V_{CC} = \text{MAX}$	$V_O = 0.5\text{V}$		-100	$\mu\text{A}$	
$I_{OZH}$			$V_O = 2.4\text{V}$		100	$\mu\text{A}$	
$I_{CEX}$	Open collector output current	$V_{CC} = \text{MAX}$	$V_O = 2.4\text{V}$		100	$\mu\text{A}$	
$I_{OS}$	Output short-circuit current*	$V_{CC} = 5\text{V}$	$V_O = 0\text{V}$		-20	-90	mA
$I_{CC}$	Supply current	$V_{CC} = \text{MAX}$ All inputs grounded All outputs open	'30, '31		125	mA	
			'00, '01, '05, '06		130		
			'08, '09, 6348/9		170		
			5348/9		155		
			'35, '36, '40, '41		170		
			'50, '51, '52, '53		175		
			6380/1		190		
5380/1		180					

\*Not more than one output should be shorted at a time and duration of the short-circuit should not exceed one second.

### Switching Characteristics

Over Commercial Operating Conditions

DEVICE TYPE	t <sub>AA</sub> (ns) ADDRESS ACCESS TIME	t <sub>EA</sub> & t <sub>ER</sub> (ns) ENABLE ACCESS & RECOVERY TIME	CONDITIONS (See standard test load)	
	MAX	MAX	R1(Ω)	R2(Ω)
6300-1, 6301-1	55	30	300	600
6305-1, 6306-1	60	30		
6308-1, 6309-1	70	30		
6335-1, 6336-1	70	30		
6340-1, 6341-1	70	30		
6348-1, 6349-1	70	30		
6350-1, 6351-1	60	30		
6352-1, 6353-1	60	30		
6330-1, 6331-1	50	30	375	750
6380-1, 6381-1	90	40		

Over Military Operating Conditions

DEVICE TYPE	t <sub>AA</sub> (ns) ADDRESS ACCESS TIME	t <sub>EA</sub> & t <sub>ER</sub> (ns) ENABLE ACCESS & RECOVERY TIME	CONDITIONS (See standard test load)	
	MAX	MAX	R1(Ω)	R2(Ω)
5300-1, 5301-1	75	40	300	600
5305-1, 5306-1	75	40		
5308-1, 5309-1	80	40		
5335-1, 5336-1	80	40		
5340-1, 5341-1	80	40		
5348-1, 5349-1	80	40		
5350-1, 5351-1	75	40		
5352-1, 5353-1	75	40		
5330-1, 5331-1	60	40	375	750
5380-1, 5381-1	125	40		

3

### Standard Test Load

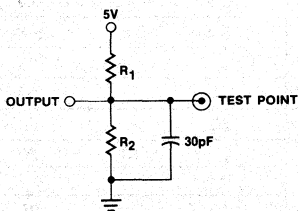

Input Pulse: 0V to 3V  
 Input Rise and Fall Times: 5ns from 1V to 2V  
 Measurements Made at 1.5V

### Definition of Waveforms

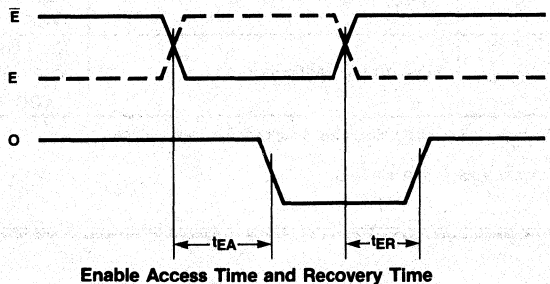
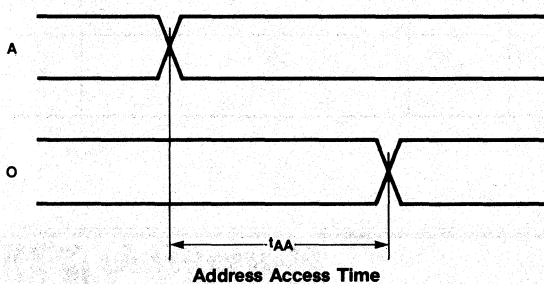



# PROM Programming Instructions

## 53/63XX-1

### Description

The 53/63XX-1 Generic PROM Family is manufactured with outputs high in all storage locations. To make an output low at

a particular word, a nichrome fusible link must be opened. This procedure is called programming.

### Programming Procedure (See Figure 1)

1. Apply the desired address to the inputs.
2. Enable Inputs may be left at any state.\*
3. Apply 5.5V to  $V_{CC}$ .
4. Apply  $V_{PP}$  to the program pin. (This step is not used on the 32x8 PROM)\*.
5. Apply  $V_{OUT}$  to the output to be programmed. (Program only one output at a time).
6. Remove  $V_{OUT}$ .
7. Remove  $V_{PP}$ .
8. Verification may be performed after each bit or word or after completing the programming of all memory locations.

### Verification Procedure (See Figure 2)

1. Enable the device.
2. To verify low-state:
  - 2A. Apply an address where the output should be low.
  - 2B. Apply 4.2V to  $V_{CC}$ .
  - 2C. Load the output with  $I_{OL} = 12$  mA.
  - 2D. Check that the output is less than 0.8V.
3. To verify High-state:
  - 3A. Apply an address where the output should be high.
  - 3B. Apply 6V to  $V_{CC}$ .
  - 3C. Load the output with  $I_{OH} = 0.3$  mA.
  - 3D. Check that the output is higher than 4.5V.

\*The 5330/1 and 6330/1 do not have a program pin. For these devices the output only is used in programming a particular selected bit and the device must be in the disabled state.

### Programming Parameters Do not test these parameters or you will program the device.

SYMBOL	PARAMETER	CONDITIONS $T_A = +25^\circ C$	FIGURE	LIMITS			UNIT
				MIN	TYP	MAX	
$t_R$	Slew rate of Programming Pulses †			0.3		0.5	V/ $\mu s$
$V_{CCP}$	VCC During Programming			5.4	5.5	5.6	V
	Maximum Duty Cycle					25	%
$V_{PP}$	Programming Voltage on Program Pin *		1	27		33	V
$V_{OUT}$	Programming Voltage on Output Pin *		1	20		26	V
$t_{D1}$	Delay between $V_{PP}$ and $V_{OUT}$		1	0	10	20	$\mu s$
$t_{D2}$				0	0.5	1	
$t_p$	Pulse width of $V_{OUT}$		1	10		25	$\mu s$
$V_{OLV}$	VOL during verification	Chip enabled $I_{OL} = 12$ mA $V_{CC} = 4.2V$	2			0.8	V
$V_{OHV}$	VOH during verification	Chip enabled $I_{OH} = 0.3$ mA $V_{CC} = 6V$	2	4.5			V

\*Voltage supply must be capable of supplying at least 240 mA.

† Leading edge of  $V_{PP}$  and  $V_{OUT}$

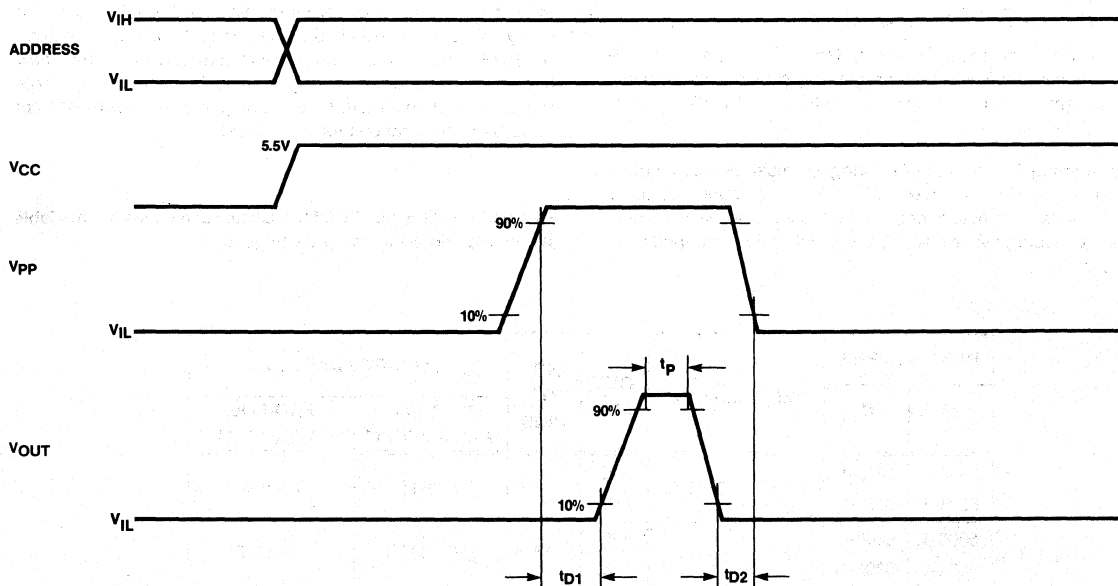

Figure 1. Programming Timing Diagram

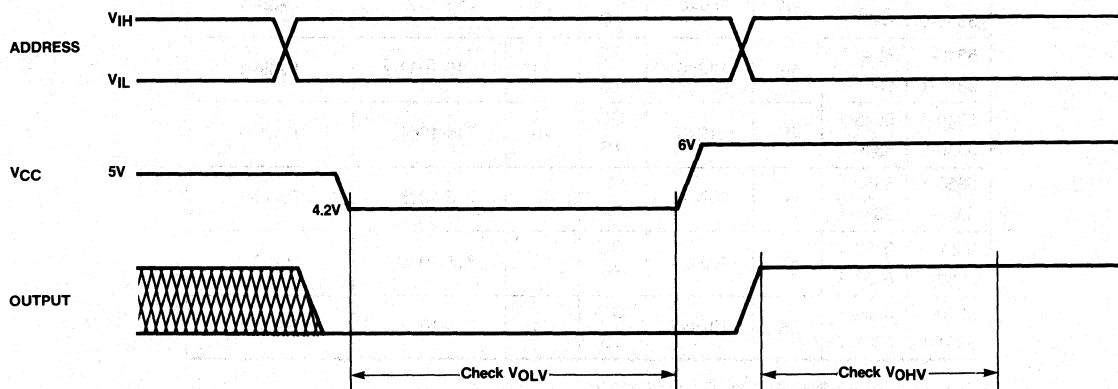

Figure 2. Verification Timing Diagram

### Optimized Programming Algorithm

1. Pulse all fuses to be programmed with single, minimum voltage programming pulses (line 1 in the table).
2. Verify all fuses at low VCC (4.2V). During this step, unprogrammed fuses are pulsed up to eight more times (see table).
3. Re-verify at low VCC (4.2V) and high VCC (6V).

PULSE NUMBER	PROGRAM PIN VOLTAGE	OUTPUT VOLTAGE
1 to 3	27V	20V
4 to 6	30V	23V
7 to 9	33V	26V

## Commercial Programmers

MMI PROMs are designed and tested to give a programming yield greater than 95%. If your programming yield is lower, check your programmer. It may not be properly calibrated. (See figures 1 and 2).

Programming is final manufacturing—it must be quality-controlled. Equipment must be calibrated as a regular routine, ideally under the actual conditions of use. The best method involves a storage scope, with DC current probes clamped over

the external wires to the program pin and the output pin. The current should not be limited at a value less than 240mA. This can be checked by using a 50-ohm resistor as a load. Each time a new board or a new programming module is inserted, the whole system should be checked. Both timing and voltages must meet published specifications for the device.

**Remember—The best PROMs available can be made unreliable by improper programming techniques.**

PART NUMBER		SIZE	CONFIG.	OUT PUT	NO. OF PINS	SOCKET ADAPTER	
M	C					DATA I/O (ALL SERIES) *	PRO-LOG (SERIES 90, 92)†
5330-1	6330-1	1/4K	32x8	OC	16	715-1046	PA16-2
5331-1	6331-1			TS			
5300-1	6300-1	1K	256x4	OC	16	715-1035-1	PA16-1
5301-1	6301-1			TS			
5305-1	6305-1	2K	512x4	OC	16	715-1035-2	PA16-1
5306-1	6306-1			TS			
5308-1	6308-1	2K	256x8	OC	20	715-1028-1	PA20-2
5309-1	6309-1			TS			
5335-1	6335-1	2K	256x8	OC	24	715-1033-1	PA24-1
5336-1	6336-1			TS			
5340-1	6340-1	4K	512x8	OC	24	715-1033-2	PA24-1
5341-1	6341-1			TS			
5348-1	6348-1	4K	512x8	OC	20	715-1064	PA20-2
5349-1	6349-1			TS			
5350-1	6350-1	4K	1024x4	OC	18	715-1036	PA18-1
5351-1	6351-1			TS			
5352-1	6352-1	4K	1024x4	OC	18	715-1039-3	PA18-2
5353-1	6353-1			TS			
5380-1	6380-1	8K	1024x8	OC	24	715-1033-3	PA24-1
5381-1	6381-1			TS			

\* Program card set is 909-1226-1 for all series DATA I/O

† Personality module is PM 9037 for all PRO-LOG (series 90, 92)

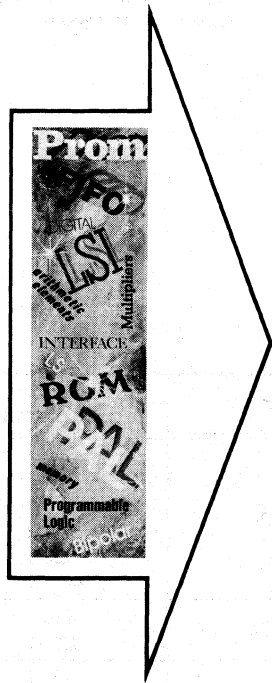

Introduction	<b>1</b>
HI REL	<b>2</b>
PROM	<b>3</b>
ROM	<b>4</b>
Character Generators	<b>5</b>
PAL	<b>6</b>
FIFO	<b>7</b>
Arithmetic Elements	<b>8</b>
Interface	<b>9</b>
General Information	<b>10</b>
Representatives/Distributors	<b>11</b>

# Generic ROM Family

## 52/62XX-1 52/62XX-2

### Features/Benefits

- High bit density up to 16K
- PNP inputs for low input current
- High speed Schottky technology
- Open collector or three state outputs

### Applications

- Character generator
- Look up table
- Microprocessor program store
- Microprogram store
- Random logic
- Code converter

### Description

The 52/6200 series generic ROM family is available in sizes from 8K through 16K bits. The 8-bit-wide ROMs are available as 1Kx8 and 2Kx8 organization. Additional 9-bit and 10-bit-wide output configurations are available for custom logic or character generator applications.

### Generic ROM Selection Guide

MEMORY		PACKAGE	DEVICE TYPE	
SIZE	ORGANIZATION		COMMERCIAL	MILITARY
8192	1024x8	J24	6280-1	5280-1
			6281-1	5281-1
			6280-2	5280-2
			6281-2	5281-2
			6282-1	5282-1
			6283-1	5283-1
9216	1024x9	J24	6260-1	5260-1
			6261-1	5261-1
10240	1024x10	J24	6255-1	5255-1
			6256-1	5256-1
10368	1152x9	J24	6290 *	5290 *
			6291 *	5291 *
16384	2048x8	J24	6275-1	5275-1
			6276-1	5276-1

\* Detailed information in section 5 (character generators)

Pin Configurations

52/6280-1 52/6280-2 \*52/6282-1  
 52/6281-1 52/6281-2 \*52/6283-1

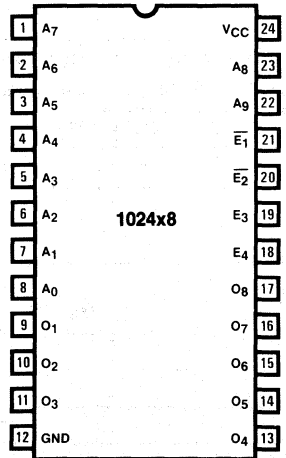

\*"OR" ENABLE =  $\bar{E}1 \bar{E}2 + E3 E4$

52/6260-1  
 52/6261-1

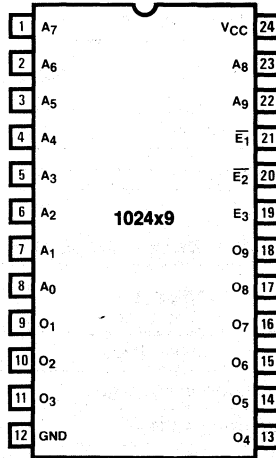

4

52/6275-1  
 52/6276-1

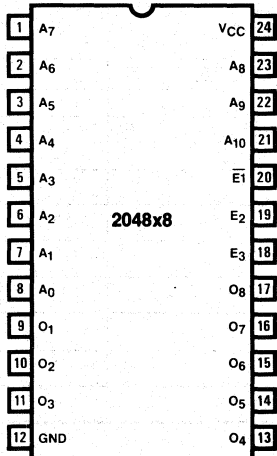

52/6255-1  
 52/6256-1

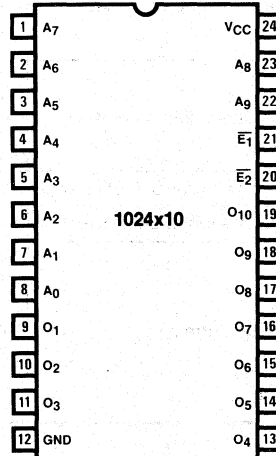

**Absolute Maximum Ratings**

Supply Voltage, $V_{CC}$ .....	7V
Input Voltage .....	7V
Off-state output voltage .....	5.5V
Storage temperature .....	-65° to +150°C

**Operating Conditions**

SYMBOL	PARAMETER	MILITARY			COMMERCIAL			UNIT
		MIN	NOM	MAX	MIN	NOM	MAX	
$V_{CC}$	Supply voltage	4.5	5	5.5	4.75	5	5.25	V
$T_A$	Operating free-air temperature	-55		125	0		75	°C

**Electrical Characteristics Over Operating Conditions**

SYMBOL	PARAMETER	TEST CONDITIONS	MIN TYP MAX			UNIT		
			MIN	TYP	MAX			
$V_{IL}$	Low-level input voltage				0.8	V		
$V_{IH}$	High-level input voltage				2	V		
$V_{IC}$	Input clamp voltage	$V_{CC} = \text{MIN}$ $I_I = -18\text{mA}$			-1.5	V		
$I_{IL}$	Low-level input current	$V_{CC} = \text{MAX}$ $V_I = 0.45\text{V}$			-0.25	mA		
$I_{IH}$	High-level input current	$V_{CC} = \text{MAX}$ $V_I = 2.4\text{V}$			40	$\mu\text{A}$		
$I_I$	Maximum input current	$V_{CC} = \text{MAX}$ $V_I = 5.5\text{V}$			1.0	mA		
$V_{OL}$	Low-level output voltage	$V_{CC} = \text{MIN}$ $V_{IL} = 0.8\text{V}$ $V_{IH} = 2\text{V}$	MIL	$I_{OL} = 8\text{mA}$	'75, '76, '80, '81, '82, '83	0.5	V	
			COM	$I_{OL} = 10\text{mA}$				
			MIL	$I_{OL} = 6\text{mA}$	'55, '56, '60, '61			
			COM					
$V_{OH}$	High-level output voltage	$V_{CC} = \text{MIN}$ $V_{IL} = 0.8\text{V}$ $V_{IH} = 2\text{V}$	MIL	$I_{OH} = -1\text{mA}$	2.4	V		
			COM	$I_{OH} = -2\text{mA}$				
$I_{OZL}$	Off-state output current	$V_{CC} = \text{MAX}$ $V_O = 0.5\text{V}$	'80, '81, '82, '83, '55, '56, '60, '61			-50	$\mu\text{A}$	
			'75, '76			-100		
$I_{OZH}$			$V_{CC} = \text{MAX}$ $V_O = 2.4\text{V}$	'80, '81, '82, '83, '55, '56, '60, '61			50	$\mu\text{A}$
				'75, '76			100	
$I_{CEX}$	Open collector output current	$V_{CC} = \text{MAX}$	$V_O = 2.4\text{V}$			100	$\mu\text{A}$	
$I_{OS}$	Output short-circuit current	$V_{CC} = 5.0\text{V}$	$V_O = 0\text{V}$			-20	-90	mA
$I_{CC}$	Supply current	$V_{CC} = \text{MAX}$ , All inputs grounded All outputs open	'55, '60			165	mA	
			'56, '61			175		
			'80, '82			170		
			'81, '83			180		
			'75, '76			190		

### Switching Characteristics

Over operating conditions

DEVICE TYPE	$t_{AA}(ns)$ ADDRESS ACCESS TIME	$t_{EA}(ns)$ ENABLE ACCESS TIME	$t_{ER}(ns)$ ENABLE RECOVERY TIME	CONDITIONS (See standard test load)	
	MAX	MAX	MAX	$R_1\Omega$	$R_2\Omega$
6255-1, 6256-1	100	70	40	750	1500
5255-1, 5256-1	150	80	45		
6260-1, 6261-1	100	70	40		
5260-1, 5261-1	150	80	45		
6275-1, 6276-1	110	40	40	560	1100
5275-1, 5276-1	120	50	50		
6280-1, 6281-1	100	70	45		
5280-1, 5281-1	175	90	50		
6280-2, 6281-2	55	30	30		
5280-2, 5281-2	75	35	35		
6282-1, 6283-1	100	70	45		
5282-1, 5283-1	175	90	50		

4

### Standard Test Load

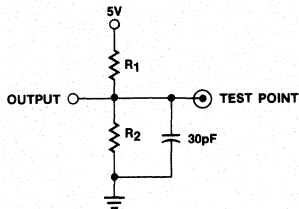

Input Pulse Amplitude 3.0V  
 Input Rise and Fall Times 5ns from 1.0V to 2.0V  
 Measurements Made at 1.5V

### Definition of Waveforms

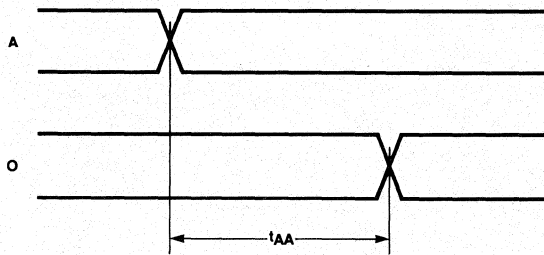

Address Access Time

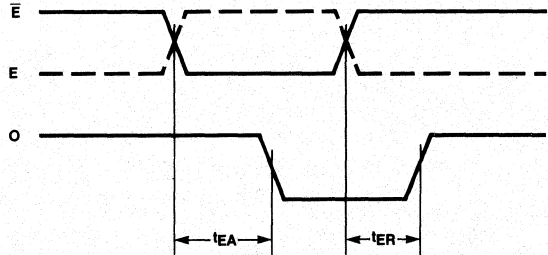

Enable Access Time and Recovery Time





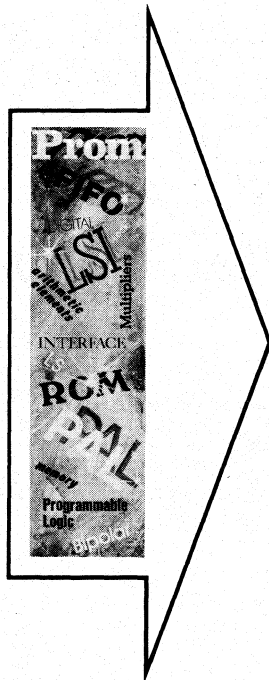

Introduction	<b>1</b>
HI REL	<b>2</b>
PROM	<b>3</b>
ROM	<b>4</b>
Character Generators	<b>5</b>
PAL	<b>6</b>
FIFO	<b>7</b>
Arithmetic Elements	<b>8</b>
Interface	<b>9</b>
General Information	<b>10</b>
Representatives/Distributors	<b>11</b>



# High Speed Character Generators

## Features/Benefits

- 100 ns max. access time
- Low power dissipation—500 mW
- Standard packaging—18 pin dip/24 pin dip
- Single 5 volt supply
- 64/128 characters in one package
- Open collector or three-state

## Applications

- CRT displays
- Printing calculators
- LED arrays
- Typesetting

## Description

The intended application for these devices is the generation of 64 or 128 ASCII alpha-numeric characters utilizing a read out system which generates the characters either horizontally or vertically, one word line at a time.

## Character Generator Selection Guide

GENERIC PART NO.	CHARACTERS		MATRIX	SCAN	COMMERCIAL		MILITARY		PKG
	NO.	TYPE			OC	TS	OC	TS	
6055	64	ASCII	5 x 7	Row	6055	6155	5055	5155	J18
6056 †			5 x 7	Column	6056	6156	*	*	J24
6071			7 x 9	Row	6071	6171	*	*	J24
6061 †	128	ASCII	5 x 7	Row	6061	6161	*	*	J24
6062 †			5 x 7	Column	6062	6162	*	*	
6072			7 x 9	Row	6072	6172	*	*	
6290	128	Custom	7 x 9	Row	6290	6291	5290	5291	J24
6292			9 x 9	Row/Column	6292	6293	5292	5293	

\* For military versions of these Character Generators contact the factory.

† "OR" enable = E1 E2 + E3 E4

## Pin Configurations

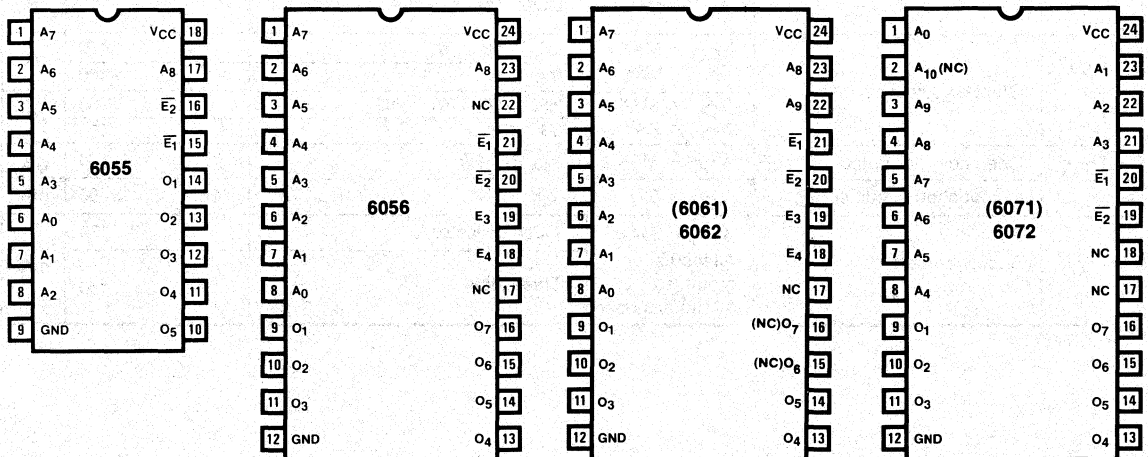

# High Speed Character Generators

## Absolute Maximum Ratings

Supply Voltage, $V_{CC}$ .....	7V
Input Voltage .....	7V
Off-state output voltage .....	5.5V
Storage temperature .....	-65° to +150°C

## Operating Conditions

SYMBOL	PARAMETER	MILITARY			COMMERCIAL			UNIT
		MIN	NOM	MAX	MIN	NOM	MAX	
$V_{CC}$	Supply voltage	4.5	5	5.5	4.75	5	5.25	V
$T_A$	Operating free-air temperature	-55		125	0		75	°C

## Electrical Characteristics Over Operating Conditions

SYMBOL	PARAMETER	TEST CONDITIONS	MIN TYP MAX			UNIT	
			MIN	TYP	MAX		
$V_{IL}$	Low-level input voltage				0.8	V	
$V_{IH}$	High-level input voltage		2				
$V_{IC}$	Input clamp voltage	$V_{CC} = \text{MIN}$ $I_I = -18\text{mA}$			-1.5	V	
$I_{IL}$	Low-level input current	$V_{CC} = \text{MAX}$ $V_I = 0.45\text{V}$			-0.25	mA	
$I_{IH}$	High-level input current	$V_{CC} = \text{MAX}$ $V_I = 2.4\text{V}$			40	$\mu\text{A}$	
$I_I$	Maximum input current	$V_{CC} = \text{MAX}$ $V_I = 5.5\text{V}$			1	mA	
$V_{OL}$	Low-level output voltage	$V_{CC} = \text{MIN}$ $V_{IL} = 0.8\text{V}$ $V_{IH} = 2\text{V}$	MIL $I_{OL} = 8\text{mA}$	'55, '56, '61, '62	0.5	V	
			COM $I_{OL} = 10\text{mA}$				
			$I_{OL} = 6\text{mA}$	'71, '72			
$V_{OH}$	High-level output voltage	$V_{CC} = \text{MIN}$ $V_{IL} = 0.8\text{V}$ $V_{IH} = 2\text{V}$	MIL $I_{OH} = -1\text{mA}$	2.4		V	
			COM $I_{OH} = -2\text{mA}$				
$I_{OZL}$	Off-state output current	$V_{CC} = \text{MAX}$ $V_O = 0.5\text{V}$	'55, '56, '61, '62		-50	$\mu\text{A}$	
			'71, '72				
$I_{OZH}$	Off-state output current	$V_{CC} = \text{MAX}$ $V_O = 2.4\text{V}$	'55, '56, '61, '62		50	$\mu\text{A}$	
			'71, '72				
$I_{CEX}$	Open collector output current	$V_{CC} = \text{MAX}$ $V_O = 2.4\text{V}$			100	$\mu\text{A}$	
$I_{OS}$	Output short-circuit current	$V_{CC} = 5\text{V}$ $V_O = 0\text{V}$			-20	-90	mA
$I_{CC}$	Supply current	$V_{CC} = \text{MAX}$ All inputs grounded All outputs open	Open collector		170	mA	
			Three state		180		

## Switching Characteristics

Over Operating Conditions

DEVICE TYPE	tAA(ns) ADDRESS ACCESS TIME	tEA(ns) ENABLE ACCESS TIME	tER(ns) ENABLE RECOVERY TIME	CONDITIONS (See standard test load)	
	MAX	MAX	MAX	R1Ω	R2Ω
6X55, 6X56, 6X61, 6X62	100	70	45	560	1100
5055, 5155	175	90	50		
6X71, 6X72	125	75	40	750	1500

## Standard Test Load

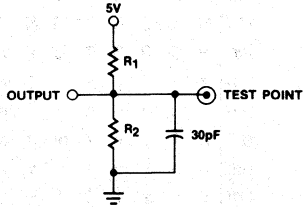

Input Pulse Amplitude 3.0V  
 Input Rise and Fall Times 5ns from 1.0V to 2.0V  
 Measurements Made at 1.5V

5

## Definition of Waveforms

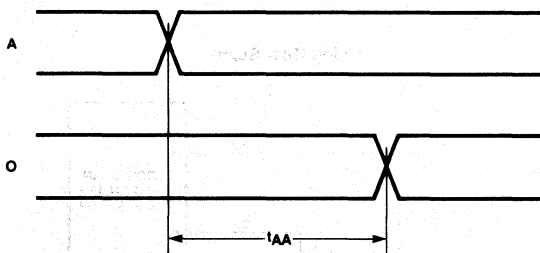

Address Access Time

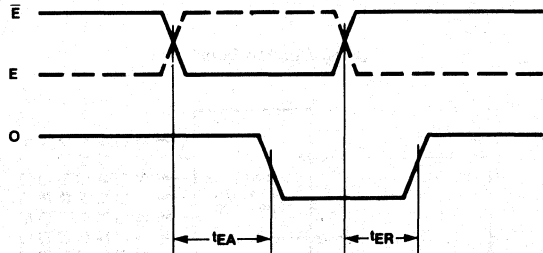

Enable Access Time and Recovery Time

# Character Generators

## Tabulation by Octal Select-Code

### 64 ASCII Characters

Row Scan 6055, 6071  
Column Scan 6056

	0	1	2	3	4	5	6	7
0	@	A	B	C	D	E	F	G
10	H	I	J	K	L	M	N	O
20	P	Q	R	S	T	U	V	W
30	X	Y	Z	[	\	]	↑	←
40	!	"	#	\$	%	&	'	
50	(	)	*	+	,	-	.	/
60	0	1	2	3	4	5	6	7
70	8	9	:	;	<	=	>	?

**Example:**

The Character \$ is addressed by the octal code 44.

### 128 ASCII Characters

Row Scan 6061, 6072  
Column Scan 6062

	0	1	2	3	4	5	6	7
0	△	△	△	△	△	△	△	△
10	△	△	△	△	△	△	△	△
20	△	△	△	△	△	△	△	△
30	△	△	△	△	△	△	△	△
40	!	"	#	\$	%	&	'	
50	(	)	*	+	,	-	.	/
60	0	1	2	3	4	5	6	7
70	8	9	:	;	<	=	>	?
100	@	A	B	C	D	E	F	G
110	H	I	J	K	L	M	N	O
120	P	Q	R	S	T	U	V	W
130	X	Y	Z	[	\	]	↑	←
140	'	a	b	c	d	e	f	g
150	h	i	j	k	l	m	n	o
160	p	q	r	s	t	u	v	w
170	x	y	z	{		}	~	△

△ This ASCII code represents a control character.  
For the corresponding display character see the detailed data sheet.

## Generation of the Letter "F"

### Using Column Scan

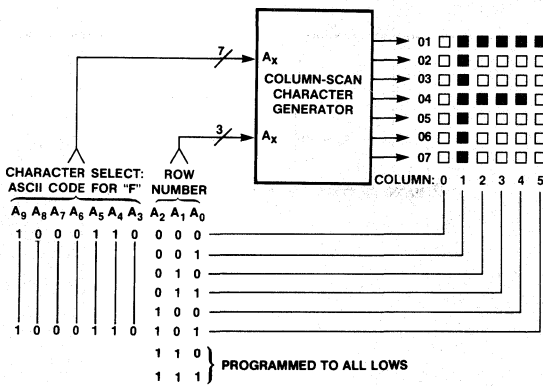

### Using Row Scan

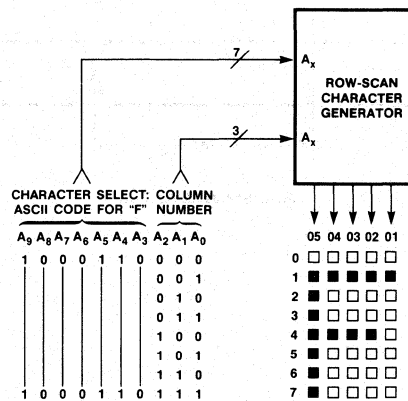









# 5 x 7 Character Font 6061 6161

A "Filled In" Square Represents a Low Memory Output

ASCII INPUT ADDRESS	A <sub>5</sub> A <sub>4</sub> A <sub>3</sub> 0 0 0	0 0 1	0 1 0	0 1 1	1 0 0	1 0 1	1 1 0	1 1 1
A <sub>9</sub> A <sub>8</sub> A <sub>7</sub> A <sub>6</sub> 0 0 0 0	O <sub>5</sub> O <sub>4</sub> O <sub>3</sub> O <sub>2</sub> O <sub>1</sub>  (NUL)*	O <sub>5</sub> O <sub>4</sub> O <sub>3</sub> O <sub>2</sub> O <sub>1</sub>  (SOH)*	O <sub>5</sub> O <sub>4</sub> O <sub>3</sub> O <sub>2</sub> O <sub>1</sub>  (STX)*	O <sub>5</sub> O <sub>4</sub> O <sub>3</sub> O <sub>2</sub> O <sub>1</sub>  (ETX)*	O <sub>5</sub> O <sub>4</sub> O <sub>3</sub> O <sub>2</sub> O <sub>1</sub>  (EOT)*	O <sub>5</sub> O <sub>4</sub> O <sub>3</sub> O <sub>2</sub> O <sub>1</sub>  (ENQ)*	O <sub>5</sub> O <sub>4</sub> O <sub>3</sub> O <sub>2</sub> O <sub>1</sub>  (ACK)*	O <sub>5</sub> O <sub>4</sub> O <sub>3</sub> O <sub>2</sub> O <sub>1</sub>  (BEL)*
0 0 0 1	 (BS)*	 (HT)*	 (LF)*	 (VT)*	 (FF)*	 (CR)*	 (SO)*	 (SI)*
0 0 1 0	 (DLE)*	 (DC1)*	 (DC2)*	 (DC3)*	 (DC4)*	 (NAK)*	 (SYN)*	 (ETB)*
0 0 1 1	 (CAN)*	 (EM)*	 (SUB)*	 (ESC)*	 (FS)*	 (GS)*	 (RS)*	 (US)*
0 1 0 0	 (space)	 (space)	 (space)	 (space)	 (space)	 (space)	 (space)	 (space)
0 1 0 1	 (space)	 (space)	 (space)	 (space)	 (space)	 (space)	 (space)	 (space)
0 1 1 0	 (space)	 (space)	 (space)	 (space)	 (space)	 (space)	 (space)	 (space)
0 1 1 1	 (space)	 (space)	 (space)	 (space)	 (space)	 (space)	 (space)	 (space)

\* The letters in parenthesis identify the control code corresponding to the appropriate pictorial representation. These representations were obtained from the USASI X 3.2 Code Practice Manual.









# High Speed Custom Character Generators

## 52/6290 52/6291 52/6292 52/6293

### Features/Benefits

- Schottky—high speed 10MHz
- Specifically designed for custom 7 x 9 row scan and 9 x 9 font character generators
- Up to 128 characters in one package
- Low power dissipation—500mW
- Standard packaging—24 pin dip
- Single 5 volt supply
- 125 ns max. access time

### Applications

- A single package high speed bipolar replacement for slow multiple package MOS character generators
- CRT displays
- Printing calculators
- LED arrays
- Typesetting
- Navigation systems

### Description

A 7 x 9 font row scan character has 7 outputs and 9 rows per character. The character is formed one row at a time. 9 words of a ROM with 7 outputs per word are required for each character. 128 characters required on 1152 x 7 ROM which is the size of the 5290/1, 6290/1. For custom column scan 7 x 9 characters consult the standard bipolar 7 x 9 character generator data sheet.

### Pin Configuration

5290/1, 6290/1 (7 x 9 Row Scan)

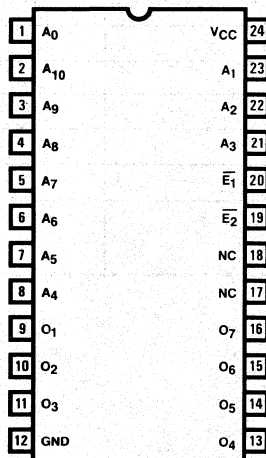

5292/3, 6292/3 (9 x 9 Row or Column Scan)

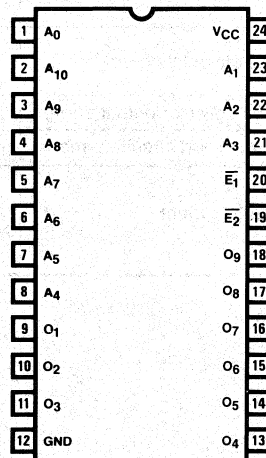

Note 1): A0, A1, A2, A3 are used for the character scan.  
2): Both enables must be low to advance the device.

A 9 x 9 font character has 9 outputs and 9 rows of columns per character depending upon whether we are forming a row or column scan. 9 words of a ROM with 9 outputs per row are required for each character. 128 characters require an 1152 x 9 ROM which is the 5292/3, 6292/3.

A3, A2, A1, and A0 pins are used to scan through the 9 ROM words per character. This is usually implemented by "short counting" a 4-bit binary counter so that it counts from 0000 to 1000 (9 counts) continuously (See applications section). A4 thru A10 are used to pick one of the 128 characters. A4 is the least significant binary digit and A10 is the most significant binary digit.

The enable E1, and E2 must both be low to activate the part. A disabled part (E1 or E2 high) has high memory outputs permitting wire ORing or blanking.

Unused scan locations generate low outputs.

### Custom Font

It's easy to go from custom font to the punched card or tape format preferred by Monolithic Memories Inc. Several examples are shown. We have arbitrarily assumed that a character is formed by a series of low memory outputs in a background of high memory outputs. The assumption, of course can be reversed.

5



**Absolute Maximum Ratings**

Supply Voltage, $V_{CC}$ .....	7V
Input Voltage .....	7V
Off-state output voltage .....	5.5V
Storage temperature .....	-65° to +150°C

**Operating Conditions**

SYMBOL	PARAMETER	MILITARY			COMMERCIAL			UNIT
		MIN	NOM	MAX	MIN	NOM	MAX	
$V_{CC}$	Supply voltage	4.5	5	5.5	4.75	5	5.25	V
$T_A$	Operating free-air temperature	-55		125	0		75	°C

**Electrical Characteristics Over Operating Conditions**

SYMBOL	PARAMETER	TEST CONDITIONS		MIN TYP MAX			UNIT	
$V_{IL}$	Low-level input voltage					0.8	V	
$V_{IH}$	High-level input voltage			2				
$V_{IC}$	Input clamp voltage	$V_{CC} = \text{MIN}$	$I_I = -18\text{mA}$			-1.5	V	
$I_{IL}$	Low-level input current	$V_{CC} = \text{MAX}$	$V_I = 0.45\text{V}$			-0.25	mA	
$I_{IH}$	High-level input current	$V_{CC} = \text{MAX}$	$V_I = 2.4\text{V}$			40	$\mu\text{A}$	
$I_I$	Maximum input current	$V_{CC} = \text{MAX}$	$V_I = 5.5\text{V}$			1	mA	
$V_{OL}$	Low-level output voltage	$V_{CC} = \text{MIN}$ $V_{IL} = 0.8\text{V}$ $V_{IH} = 2\text{V}$	$I_{OL} = 6\text{mA}$			0.5	V	
$V_{OH}$	High-level output voltage	$V_{CC} = \text{MIN}$ $V_{IL} = 0.8\text{V}$ $V_{IH} = 2\text{V}$	MIL $I_{OH} = -1\text{mA}$	2.4			V	
			COM $I_{OH} = -2\text{mA}$					
$I_{OZL}$	Off-state output current	$V_{CC} = \text{MAX}$	$V_O = 0.5\text{V}$			-100	$\mu\text{A}$	
$I_{OZH}$		$V_{CC} = \text{MAX}$	$V_O = 2.4\text{V}$			100	$\mu\text{A}$	
$I_{CEX}$	Open collector output current	$V_{CC} = \text{MAX}$	$V_O = 2.4\text{V}$			100	$\mu\text{A}$	
$I_{OS}$	Output short-circuit current	$V_{CC} = 5\text{V}$	$V_O = 0\text{V}$			-20	-90	mA
$I_{CC}$	Supply current	$V_{CC} = \text{MAX}$ All inputs grounded All outputs open	Open collector			170	mA	
			Three state			180		

### Switching Characteristics

Over Operating Conditions

DEVICE TYPE	tAA(ns) ADDRESS ACCESS TIME	tEA(ns) ENABLE ACCESS TIME	tER(ns) ENABLE RECOVERY TIME
	MAX	MAX	MAX
6290/1, 6292/3	125	75	40
5290/1, 5292/3	150	85	50

### Standard Test Load

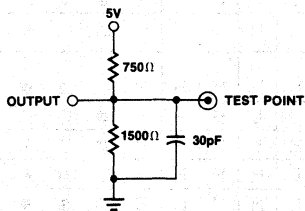

Input Pulse Amplitude 3.0V  
 Input Rise and Fall Times 5ns from 1.0V to 2.0V  
 Measurements Made at 1.5V

5

### Definition of Waveforms

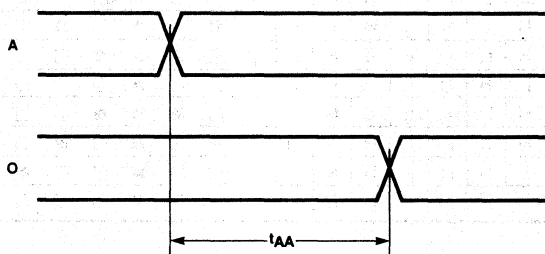

Address Access Time

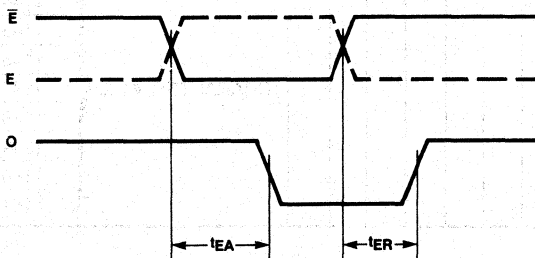

Enable Access Time and Recovery Time

**Custom Truth Table Coding—5290/1, 6290/1**

**7 x 9 ROW SCAN**

The characters \$, &, \*, are shown below along with the ROM coding. A "filled in" dot is arbitrarily coded with a low (L)

CHARACTER SELECT							ROM WORD (DECIMAL)	OUTPUTS							FONT											
A <sub>10</sub>	A <sub>9</sub>	A <sub>8</sub>	A <sub>7</sub>	A <sub>6</sub>	A <sub>5</sub>	A <sub>4</sub>		A <sub>3</sub>	A <sub>2</sub>	A <sub>1</sub>	A <sub>0</sub>	O <sub>7</sub>	O <sub>6</sub>	O <sub>5</sub>	O <sub>4</sub>	O <sub>3</sub>	O <sub>2</sub>	O <sub>1</sub>	F <sub>7</sub>	F <sub>6</sub>	F <sub>5</sub>	F <sub>4</sub>	F <sub>3</sub>	F <sub>2</sub>	F <sub>1</sub>	
L	L	L	L	L	L	L	CHARACTER #1	0	0	0	0	0	H	H	L	H	L	H	H	□	□	■	□	■	□	□
								0	0	0	1	1	H	L	L	L	L	L	L	□	■	■	■	■	■	■
								0	0	1	0	2	L	H	L	H	L	H	H	■	□	■	□	■	□	□
								0	0	1	1	3	L	H	L	H	L	H	H	■	□	■	□	■	□	□
								0	1	0	0	4	H	L	L	L	L	L	H	□	■	■	■	■	■	□
								0	1	0	1	5	H	H	L	H	L	H	L	□	□	■	□	■	□	■
								0	1	1	0	6	H	H	L	H	L	H	L	□	□	■	□	■	□	■
								0	1	1	1	7	L	L	L	L	L	L	H	■	■	■	■	■	■	□
							1	0	0	0	8	H	H	L	H	L	H	H	□	□	■	□	■	□	□	
L	L	L	L	L	L	H	CHARACTER #2	9	H	L	L	H	H	H	H	□	■	■	□	□	□	□				
								10	L	H	H	L	H	H	H	■	□	□	■	□	□	□				
								11	L	H	H	L	H	H	H	■	□	□	■	□	□	□				
								12	H	L	L	H	H	H	H	□	■	■	□	□	□	□				
								13	H	L	L	H	H	H	H	□	■	■	□	□	□	□				
								14	L	H	H	L	H	L	H	■	□	□	■	□	■	□				
								15	L	H	H	H	L	L	H	■	□	□	□	■	■	□				
								16	L	H	H	H	H	L	H	■	□	□	□	□	■	□				
							17	H	L	L	L	L	H	L	□	■	■	■	■	□	■					
H	H	H	H	H	H	H	CHARACTER #128	1143	H	H	H	L	H	H	H	□	□	□	■	□	□	□				
								1144	L	H	H	L	H	H	L	■	□	□	■	□	□	■				
								1145	H	L	H	L	H	L	H	□	■	□	■	□	■	□				
								1146	H	H	L	L	L	H	H	□	□	■	■	■	□	□				
								1147	H	H	H	L	H	H	H	□	□	□	■	□	□	□				
								1148	H	H	L	L	L	H	H	□	□	■	■	■	□	□				
								1149	H	L	H	L	H	L	H	□	■	□	■	□	■	□				
								1150	L	H	H	L	H	H	L	■	□	□	■	□	□	■				
							1151	H	H	H	L	H	H	H	□	□	□	■	□	□	□					

**Use of Custom Truth Table Form—5290/1, 6290/1**

Truth table forms are available from Monolithic Memories upon request. For customers desiring to make their own forms an example is shown below coded to the 7 x 9 Row Scan example:

WORD NUMBER	OUTPUTS							
	PIN	16 O <sub>7</sub>	15 O <sub>6</sub>	14 O <sub>5</sub>	13 O <sub>4</sub>	11 O <sub>3</sub>	10 O <sub>2</sub>	9 O <sub>1</sub>
0		H	H	L	H	L	H	H
1		H	L	L	L	L	L	L
•		•	•	•	•	•	•	•
•		•	•	•	•	•	•	•
•		•	•	•	•	•	•	•
1151		H	H	H	L	H	H	H

NOTE:  
A high voltage on the data out lines is signified by an "H". A low voltage on the data out lines is signified by an "L". The word number assumes positive logic on the address pin so for example word 511 = HHHHHHHH.

**Custom Truth Table Coding—5292/3, 6292/3**

**9 x 9 COLUMN SCAN**

The characters \$, &, \*, can be seen in the font if this page is rotated 90° clockwise. A "filled in" dot is arbitrarily coded with a low (L).

**9 x 9 ROW SCAN**

The 9 x 9 row scan translation would be similar to the 7 x 9 row scan previously shown except that there would be a 9 x 9 font for each character and outputs 8 and 9 in the ROM would be used and coded.

CHARACTER SELECT								ROM WORD (DECIMAL)	OUTPUTS									FONT									
A <sub>10</sub>	A <sub>9</sub>	A <sub>8</sub>	A <sub>7</sub>	A <sub>6</sub>	A <sub>5</sub>	A <sub>4</sub>			O <sub>9</sub>	O <sub>8</sub>	O <sub>7</sub>	O <sub>6</sub>	O <sub>5</sub>	O <sub>4</sub>	O <sub>3</sub>	O <sub>2</sub>	O <sub>1</sub>	O <sub>9</sub>	O <sub>8</sub>	O <sub>7</sub>	O <sub>6</sub>	O <sub>5</sub>	O <sub>4</sub>	O <sub>3</sub>	O <sub>2</sub>	O <sub>1</sub>	
L	L	L	L	L	L	L	L	CHARACTER #1	8	H	L	H	H	H	L	L	H	H	□	■	□	□	□	■	■	□	□
									7	H	L	H	H	L	H	H	L	H	□	■	□	□	■	□	□	■	□
									6	H	L	H	H	L	H	H	L	H	□	■	□	□	■	□	□	■	□
									5	L	L	L	L	L	L	L	L	L	■	■	■	■	■	■	■	■	■
									4	H	L	H	H	L	H	H	L	H	□	■	□	□	■	□	□	■	□
									3	L	L	L	L	L	L	L	L	L	■	■	■	■	■	■	■	■	■
									2	H	L	H	H	L	H	H	L	H	□	■	□	□	■	□	□	■	□
									1	H	L	H	H	L	H	H	L	H	□	■	□	□	■	□	□	■	□
									0	H	H	L	L	H	H	H	L	H	□	□	■	■	□	□	□	■	□
L	L	L	L	L	L	L	H	CHARACTER #2	17	H	H	H	H	H	H	H	H	H	□	□	□	□	□	□	□	□	□
									16	H	H	H	H	H	L	H	L	□	□	□	□	□	□	■	□	■	
									15	H	H	H	H	H	L	L	H	□	□	□	□	□	□	■	■	□	
									14	H	H	H	H	H	L	L	H	□	□	□	□	□	□	■	■	□	
									13	H	L	L	L	L	L	H	H	L	□	■	■	■	■	■	□	□	■
									12	L	H	H	L	L	H	H	H	L	■	□	□	■	■	□	□	□	■
									11	L	H	H	L	L	H	H	H	L	■	□	□	■	■	□	□	□	■
									10	L	H	H	L	L	H	H	L	H	■	□	□	■	■	□	□	□	■
									9	H	L	L	H	H	L	L	H	H	□	■	■	□	□	■	■	□	□
H	H	H	H	H	H	H	H	CHARACTER #128	1151	H	H	H	H	H	H	H	H	H	□	□	□	□	□	□	□	□	□
									1150	H	L	H	H	H	H	L	H	□	■	□	□	□	□	□	■	□	
									1149	H	H	L	H	H	L	H	H	□	□	■	□	□	□	■	□	□	
									1148	H	H	H	L	H	L	H	H	H	□	□	□	■	□	■	□	□	□
									1147	L	L	L	L	L	L	L	L	L	■	■	■	■	■	■	■	■	■
									1146	H	H	H	L	H	L	H	H	H	□	□	□	■	□	■	□	□	□
									1145	H	H	L	H	H	H	L	H	H	□	□	■	□	□	□	■	□	□
									1144	H	L	H	H	H	H	L	H	H	□	■	□	□	□	□	□	■	□
									1143	H	H	H	H	H	H	H	H	H	□	□	□	□	□	□	□	□	□

5

**Use of Custom Truth Table Form—5292/3, 6292/3**

Truth table forms are available from Monolithic Memories upon request. For customers desiring to make their own forms an example is shown below coded to the 9 x 9 column scan example:

WORD NUMBER	OUTPUTS									
	PIN	18	17	16	15	14	13	11	10	9
		O <sub>9</sub>	O <sub>8</sub>	O <sub>7</sub>	O <sub>6</sub>	O <sub>5</sub>	O <sub>4</sub>	O <sub>3</sub>	O <sub>2</sub>	O <sub>1</sub>
0		H	H	L	L	H	H	H	L	H
1		H	L	H	H	L	H	H	L	H
•		•	•	•	•	•	•	•	•	•
•		•	•	•	•	•	•	•	•	•
•		•	•	•	•	•	•	•	•	•
1151		H	H	H	H	H	H	H	H	H

NOTE:  
A high voltage on the data out lines is signified by an "H". A low voltage on the data out lines is signified by an "L". The word number assumes positive logic on the address pin so for example word 511 = HHHHHHHH.

CONFIDENTIAL - SECURITY INFORMATION

1. The following information is being provided to you for your information only. It is not intended to be used for any other purpose. The information is confidential and should be protected accordingly.

Serial Number	Manufacturer	Model	Part Number	Description
1	...	...	...	...
2	...	...	...	...
3	...	...	...	...
4	...	...	...	...
5	...	...	...	...
6	...	...	...	...
7	...	...	...	...
8	...	...	...	...
9	...	...	...	...
10	...	...	...	...
11	...	...	...	...
12	...	...	...	...
13	...	...	...	...
14	...	...	...	...
15	...	...	...	...
16	...	...	...	...
17	...	...	...	...
18	...	...	...	...
19	...	...	...	...
20	...	...	...	...
21	...	...	...	...
22	...	...	...	...
23	...	...	...	...
24	...	...	...	...
25	...	...	...	...
26	...	...	...	...
27	...	...	...	...
28	...	...	...	...
29	...	...	...	...
30	...	...	...	...
31	...	...	...	...
32	...	...	...	...
33	...	...	...	...
34	...	...	...	...
35	...	...	...	...
36	...	...	...	...
37	...	...	...	...
38	...	...	...	...
39	...	...	...	...
40	...	...	...	...
41	...	...	...	...
42	...	...	...	...
43	...	...	...	...
44	...	...	...	...
45	...	...	...	...
46	...	...	...	...
47	...	...	...	...
48	...	...	...	...
49	...	...	...	...
50	...	...	...	...

CONFIDENTIAL - SECURITY INFORMATION

The following information is being provided to you for your information only. It is not intended to be used for any other purpose. The information is confidential and should be protected accordingly.

Serial Number	Manufacturer	Model	Part Number	Description
1	...	...	...	...
2	...	...	...	...
3	...	...	...	...
4	...	...	...	...
5	...	...	...	...
6	...	...	...	...
7	...	...	...	...
8	...	...	...	...
9	...	...	...	...
10	...	...	...	...
11	...	...	...	...
12	...	...	...	...
13	...	...	...	...
14	...	...	...	...
15	...	...	...	...
16	...	...	...	...
17	...	...	...	...
18	...	...	...	...
19	...	...	...	...
20	...	...	...	...
21	...	...	...	...
22	...	...	...	...
23	...	...	...	...
24	...	...	...	...
25	...	...	...	...
26	...	...	...	...
27	...	...	...	...
28	...	...	...	...
29	...	...	...	...
30	...	...	...	...
31	...	...	...	...
32	...	...	...	...
33	...	...	...	...
34	...	...	...	...
35	...	...	...	...
36	...	...	...	...
37	...	...	...	...
38	...	...	...	...
39	...	...	...	...
40	...	...	...	...
41	...	...	...	...
42	...	...	...	...
43	...	...	...	...
44	...	...	...	...
45	...	...	...	...
46	...	...	...	...
47	...	...	...	...
48	...	...	...	...
49	...	...	...	...
50	...	...	...	...

The following information is being provided to you for your information only. It is not intended to be used for any other purpose. The information is confidential and should be protected accordingly.

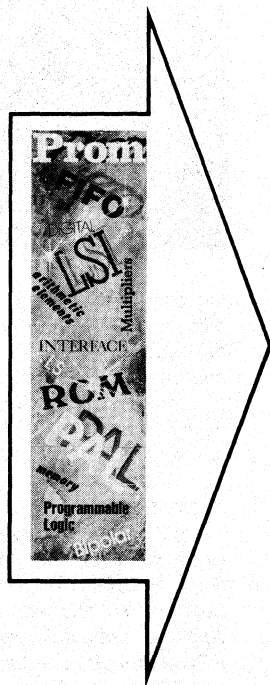

<b>Introduction</b>	<b>1</b>
<b>HI REL</b>	<b>2</b>
<b>PROM</b>	<b>3</b>
<b>ROM</b>	<b>4</b>
<b>Character Generators</b>	<b>5</b>
<b>PAL</b>	<b>6</b>
<b>FIFO</b>	<b>7</b>
<b>Arithmetic Elements</b>	<b>8</b>
<b>Interface</b>	<b>9</b>
<b>General Information</b>	<b>10</b>
<b>Representatives/Distributors</b>	<b>11</b>

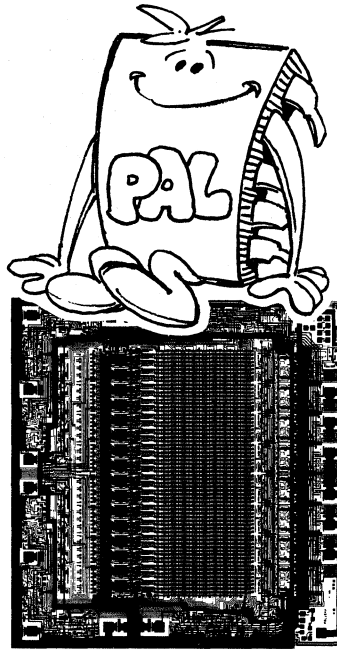

### The PAL™ Concept

Monolithic Memories' family of PAL devices gives designers a powerful tool with unique capabilities for use in new and existing logic designs. The PAL saves time and money by solving many of the system partitioning and interface problems brought about by increases in semiconductor device technology.

Rapid advances in large scale integration technology have led to larger and larger standard logic functions; single I.C.s now perform functions that formerly required complete circuit cards. While LSI offers many advantages, advances have been made at the expense of device flexibility. Most LSI devices still require large numbers of SSI/MSI devices for interfacing with user systems. Designers are still forced to turn to random logic for many applications.

The "complexity gap" between TTL and LSI devices has led to ineffective use of both. The TTL provides the speed and flexibility, but it is ineffective in terms of package count, power consumption, and P.C. board space. LSI offers high functional density and low power consumption, but it is slow and rigidly partitioned. Even the microprocessor, widely acclaimed for its flexibility, is slow and expensive when the costs of programming and support interfaces are considered.

The designer is confronted with another problem when a low to medium complexity product is designed. Often the

function is well defined and could derive significant benefits from fabrication as an integrated circuit. However, the design cycle for a custom circuit is long and the costs can be very high. This makes the risk significant enough to deter most users. The technology to support maximum flexibility combined with fast turn around on custom logic has simply not been available.

Attempts to solve these problems have led to increasing interest in fuse programmable logic devices. These devices can all be user configured to provide custom functions. PROMs, FPLAs, FPGAs, and PMUXs have all been used in this way. These approaches have met with some success, but all are deficient in one or more areas. PROMs require careful design to avoid undesirable data transitions; FPLAs are expensive, difficult to program and complex to understand; FPGAs and PMUXs are not widely available and lack flexibility. All of these devices still require extensive interface logic for use in systems.

The PAL family offers a fresh approach to using fuse programmable logic. PALs are a conceptually unified group of devices which combine programmable flexibility with high speed and an extensive selection of interface options. PALs can lower inventory, cut design cycles and provide high complexity with maximum flexibility. These features, combined with lower package count and high reliability, truly make the PAL a circuit designer's best friend.

The PAL—Teaching Old PROMs New Tricks



MMI developed the modern PROM and introduced many of the architectures and techniques now regarded as industry standards. As the world's largest PROM manufacturer, MMI has the proven technology and high volume production capability required to manufacture and support the PAL.

The PAL is an extension of the fusible link technology pioneered by Monolithic Memories for use in bi-polar PROMs. The fusible link PROM first gave the digital systems designer the power to "write on silicon." In a few seconds he was able to transform a blank PROM from a general purpose device into one containing a custom algorithm, microprogram, or Boolean transfer function. This opened up new horizons for the use of PROMs in computer control stores, character generators, data storage tables and many other applications. The wide acceptance of this technology is clearly demonstrated by today's multi-million dollar PROM market.

The key to the PROM's success is that it allows the designer to quickly and easily customize the chip to fit his unique requirements. The PAL extends this programmable flexibility by utilizing proven fusible link technology to implement logic functions. Using PALs the designer can quickly and effectively implement custom logic varying in complexity from random gates to complex arithmetic functions.

ANDs and ORs

The PAL implements the familiar sum of products logic by using a programmable AND array whose output terms feed a fixed OR

array. Since the sum of products form can express any Boolean transfer function, the PAL's uses are only limited by the number of terms available in the AND - OR arrays. PAL's come in different sizes to allow for effective logic optimization.

Figure 1 shows the basic PAL structure for a two input, one output logic segment. The general logic equation for this segment is

$$\text{Output} = (I_1 + \bar{f}_1)(\bar{I}_1 + \bar{f}_2)(I_2 + \bar{f}_3)(\bar{I}_2 + \bar{f}_4) + (I_1 + \bar{f}_5)(\bar{I}_1 + \bar{f}_6)(I_2 + \bar{f}_7)(\bar{I}_2 + \bar{f}_8)$$

where the "f" terms represent the state of the fusible links in the PAL's AND array. An unblown link represents a logic 1. Thus,

fuse blown, f = 0

fuse intact, f = 1

An unprogrammed PAL has all fuses intact.

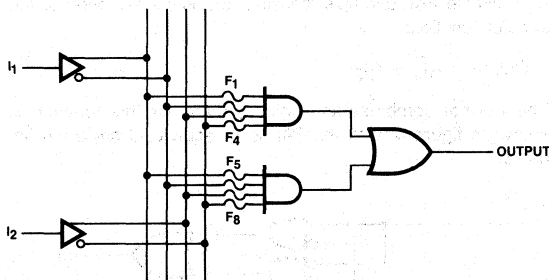

Figure 1

New Device, New Notation

Logic equations, while convenient for small functions, rapidly become cumbersome in large systems. To reduce possible confusion, complex logic networks are generally defined by logic diagrams and truth tables. Figure 2 shows the logic convention adopted to keep PAL logic easy to understand and use. In the figure, an "x" represents an intact fuse used to perform the logic AND function. (Note: the input terms on the common line with the x's are not connected together.) The logic symbology shown in Figure 2 has been informally adopted by integrated circuit manufacturers because it clearly establishes a one-to-one correspondence between the chip layout and the logic diagram. It also allows the logic diagram and truth table to be combined into a compact and easy to read form, thereby serving as a convenient shorthand for PALs. The two input - one output example from Figure 1 redrawn using the new logic convention is shown in Figure 3.



# PAL Introduction

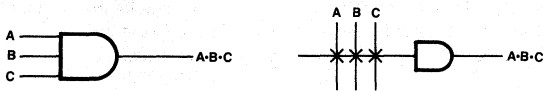

Figure 2

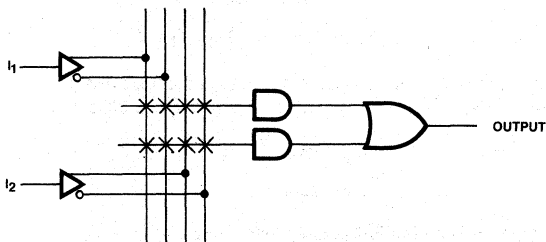

Figure 3

As a simple PAL example, consider the implementation of the transfer function:

$$\text{Output} = I_1 \bar{I}_2 + \bar{I}_1 I_2$$

The normal combinatorial logic diagram for this function is shown in figure 4, with the PAL logic equivalent shown in figure 5.

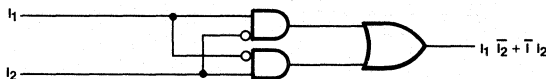

Figure 4

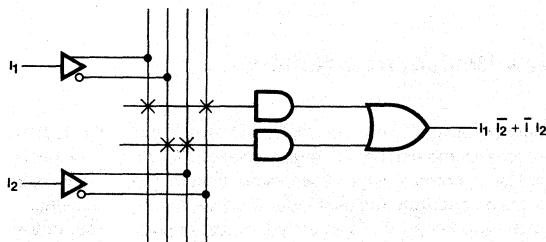

Figure 5

Using this logic convention it is now possible to compare the PAL structure to the structure of the more familiar PROM and PLA. The basic logic structure of a PROM consists of a fixed AND array whose outputs feed a programmable OR array (figure 6). PROMs are low-cost, easy to program, and available in a variety of sizes and organizations. They are most commonly

used to store computer programs and data. In these applications the fixed input is a computer memory address; the output is the contents of that memory location.

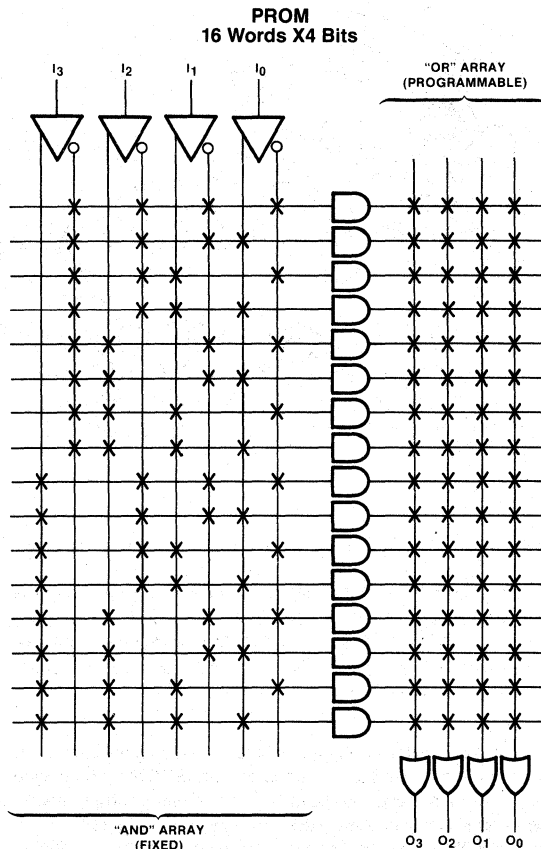

Figure 6

The basic logic structure of the PLA consists of a programmable AND array whose outputs feed a programmable OR array (Figure 7). Since the designer has complete control over all inputs and outputs, the PLA provides the ultimate flexibility for implementing logic functions. They are used in a wide variety of applications. However, this generality makes PLA's expensive, quite formidable to understand, and are costly to program (they require special programmers).

The basic logic structure of the PAL, as mentioned earlier, consists of a programmable AND array whose outputs feed a fixed OR array (Figure 8). The PAL combines much of the flexibility of the PLA with the low cost and easy programmability of the PROM. Table 1 summarizes the characteristics of the PROM, PLA, and PAL logic families.

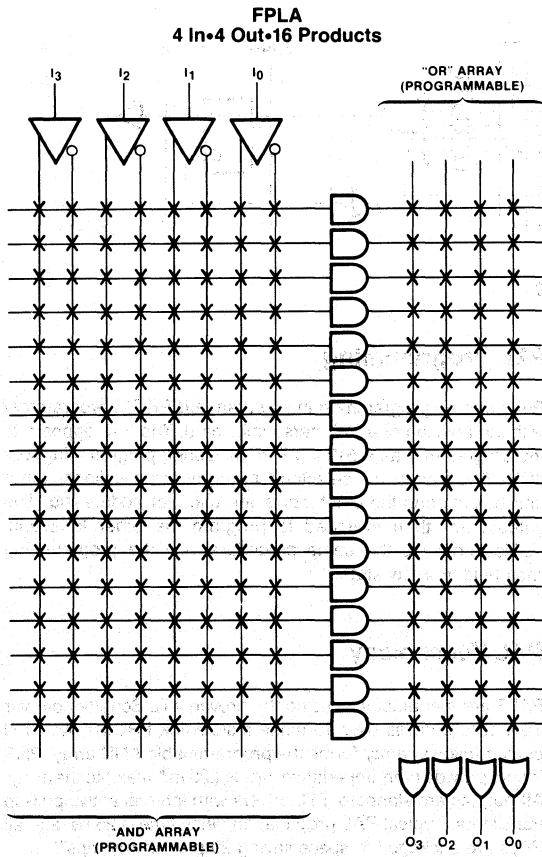

Figure 7

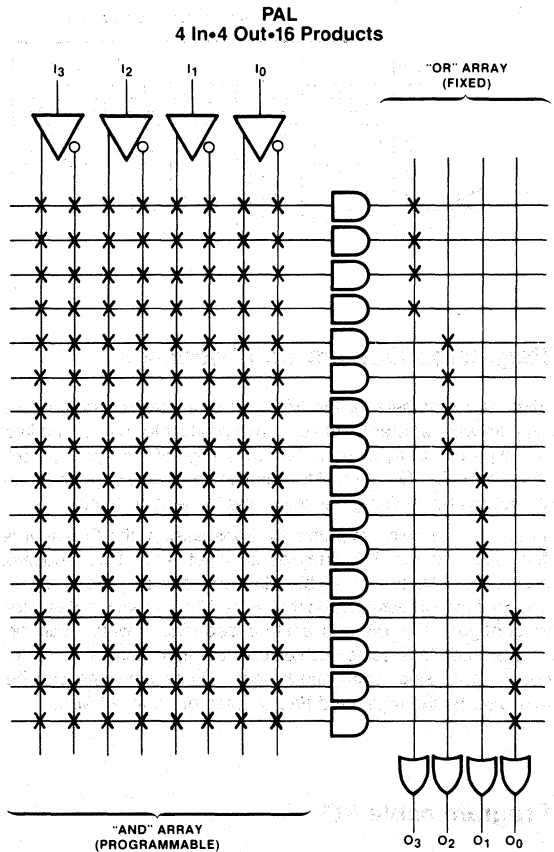

Figure 8

	AND	OR	OUTPUT OPTIONS
PROM	Fixed	Prog	TS, OC
FPLA	Prog	Prog	TS, OC, Fusible Polarity
FPGA	Prog	None	TS, OC, Fusible Polarity
PMUX	Fix/Prog	Fixed	TS
PAL	Prog	Fixed	TS, Registered, Feedback, I/O

Table 1

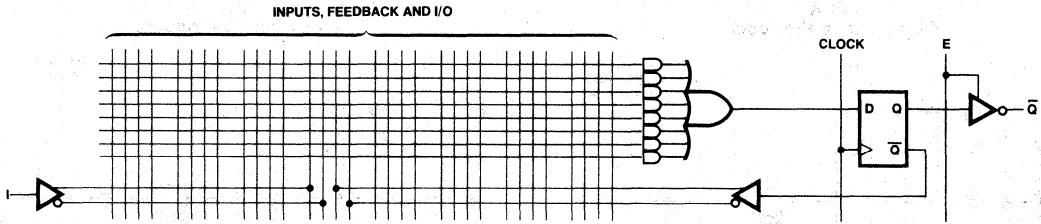

Figure 9

## Registered Outputs with Feedback

High end members of the PAL family feature registered data outputs with register feedback. Each product term is stored into a D-type output flip-flop on the rising edge of the system clock (Figure 9). The Q output of the flip-flop can then be gated to the output pin by enabling the active low three-state buffer.

In addition to being available for transmission, the Q output is fed back into the PAL array as an input term. This feedback allows the PAL to "remember" the previous state, and it can alter its function based upon that state. This allows the designer to configure the PAL as a state sequencer which can be programmed to execute such elementary functions as count up, count down, skip, shift, and branch. These functions can be executed by the registered PAL at rates of up to 20 MHz.

## Programmable I/O

Another feature of the high-end members of the PAL family is programmable input/output. This allows the product terms to directly control the outputs of the PAL (Figure 10). One product term is used to enable the three-state buffer, which in turn gates the summation term to the output pin. The output is also fed back into the PAL array as an input. Thus the PAL drives the I/O pin when the three-state gate is enabled; the I/O pin is an input to the PAL array when the three-state gate is disabled. This feature can be used to allocate available pins for I/O functions or to provide bi-directional output pins for operations such as shifting and rotating serial data.

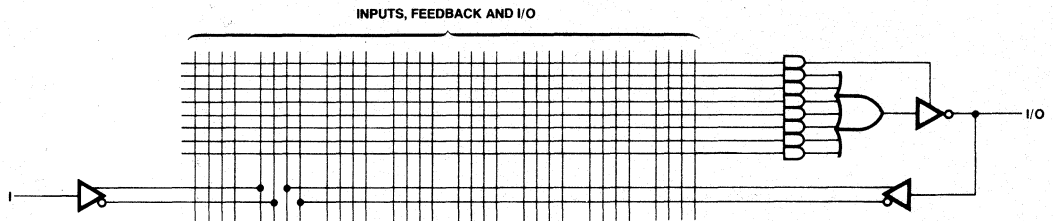

Figure 10

## PAL Programming

PALs can be programmed in any standard PROM programmer with the addition of a PAL personality card. The PAL appears to the programmer as a 512 x 4 PROM. During programming four of the PAL outputs are selected for programming while the other four outputs and the eight inputs are used for addressing. The outputs are then switched to program the other locations. Verification uses the same procedure with the programming lines held in a low state.

## PAL Technology

PALs are manufactured using the proven TTL Schottky bipolar Ti-W fuse process used to make fusible-link PROMs. An NPN emitter follower array forms the programmable AND array. PNP inputs provide high-impedance inputs (.25 mA max.) to the array. All outputs are standard TTL drivers with internal active pull-up transistors. Typical PAL propagation delay time is 25 ns, and all PALs are packaged in space saving 20-pin "skinny-dips".

## PAL Data Security

The circuitry used for programming and logic verification can be used at any time to determine the logic pattern stored in the PAL array. For security, the PAL has a "last fuse" which can be blown to disable the verification logic. This provides a significant deterrent to potential copiers, and it can be used to effectively protect proprietary designs.

# PAL Series 20 Data Sheet

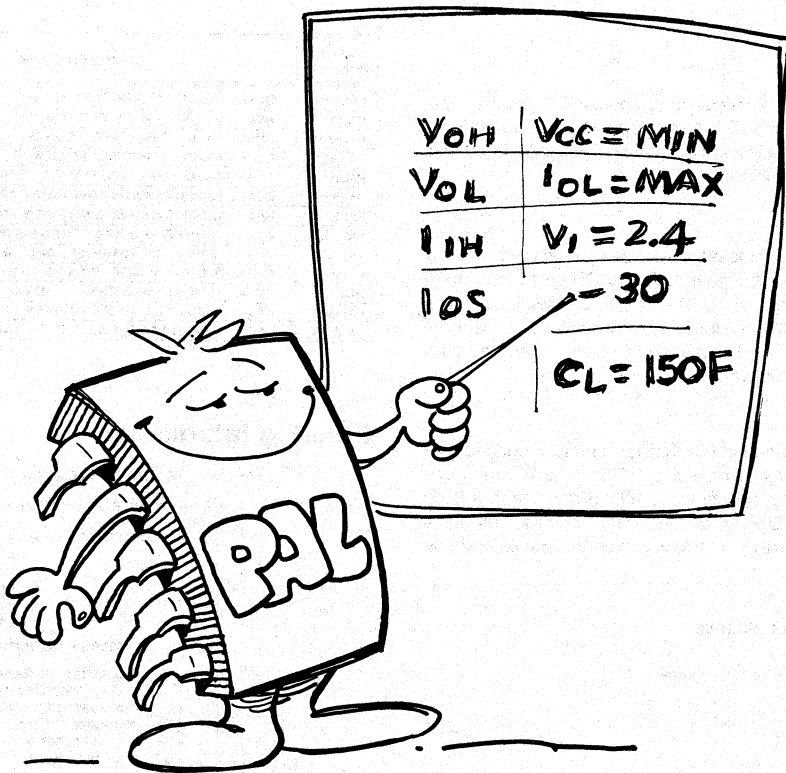

6

# Programmable Array Logic Family

## PAL™ Series 20 Data Sheet

U.S. Patent 4124899

### Features/Benefits

- Programmable replacement for conventional TTL logic.
- Reduces IC inventories substantially and simplifies their control.
- Reduces chip count by 4 to 1.
- Expedites and simplifies prototyping and board layout.
- Saves space with 20-pin Skinny DIP packages.
- High speed: 25ns typical propagation delay.
- Programmed on standard PROM programmers.
- Programmable three-state outputs.
- Special feature reduces possibility of copying by competitors.

### Description

The PAL family utilizes an advanced Schottky TTL process and the Bipolar PROM fusible link technology to provide user programmable logic for replacing conventional SSI/MSI gates and flip-flops at reduced chip count.

The family lets the systems engineer "design his own chip" by blowing fusible links to configure AND and OR gates to perform his desired logic function. Complex interconnections which previously required time-consuming layout are thus "lifted" from PC board etch and placed on silicon where they can be easily modified during prototype check-out or production.

The PAL transfer function is the familiar sum of products. Like the PROM, the PAL has a single array of fusible links. Unlike the PROM, the PAL is a programmable AND array driving a fixed OR array (the PROM is a fixed AND array driving a programmable OR array). In addition the PAL provides these options:

- Variable input/output pin ratio
- Programmable three-state outputs
- Registers with feedback
- Arithmetic capability

Unused inputs are tied directly to  $V_{CC}$  or GND. Product terms with all fuses blown assume the logical high state, and product terms connected to both true and complement of any single input assume the logical low state. Registers consist of D type flip-flops which are loaded on the low to high transition of the clock. PAL Logic Diagrams are shown with all fuses blown, enabling the designer use of the diagrams as coding sheets.

The entire PAL family is programmed on inexpensive conventional PROM programmers with appropriate personality and socket adapter cards. Once the PAL is programmed and verified, two additional fuses may be blown to defeat verification. This feature gives the user a proprietary circuit which is very difficult to copy.

PART NUMBER	DESCRIPTION
PAL10H8	OCTAL 10 INPUT AND-OR GATE ARRAY
PAL12H6	HEX 12 INPUT AND-OR GATE ARRAY
PAL14H4	QUAD 14 INPUT AND-OR GATE ARRAY
PAL16H2	DUAL 16 INPUT AND-OR GATE ARRAY
PAL16C1	16 INPUT AND-OR/AND-OR-INVERT GATE ARRAY
PAL10L8	OCTAL 10 INPUT AND-OR-INVERT GATE ARRAY
PAL12L6	HEX 12 INPUT AND-OR-INVERT GATE ARRAY
PAL14L4	QUAD 14 INPUT AND-OR-INVERT GATE ARRAY
PAL16L2	DUAL 16 INPUT AND-OR-INVERT GATE ARRAY
PAL16L8	OCTAL 16 INPUT AND-OR-INVERT GATE ARRAY
PAL16R8	OCTAL 16 INPUT REGISTERED AND-OR GATE ARRAY
PAL16R6	HEX 16 INPUT REGISTERED AND-OR GATE ARRAY
PAL16R4	QUAD 16 INPUT REGISTERED AND-OR GATE ARRAY

### Ordering Information

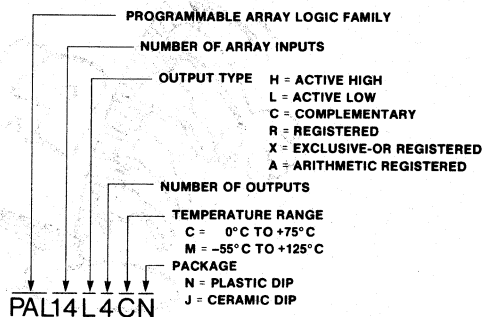

PAL Logic Symbols

PAL10H8

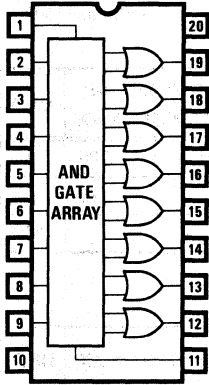

PAL12H6

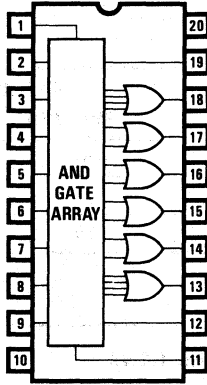

PAL14H4

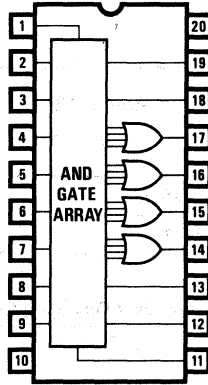

PAL16H2

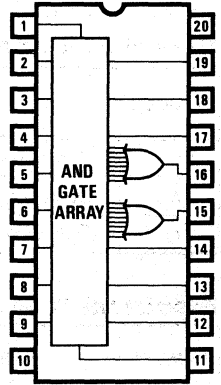

PAL16C1

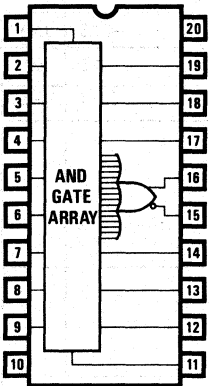

PAL10L8

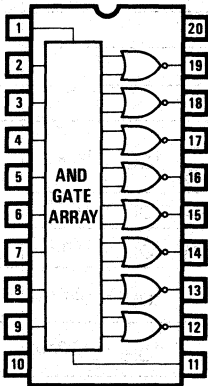

PAL12L6

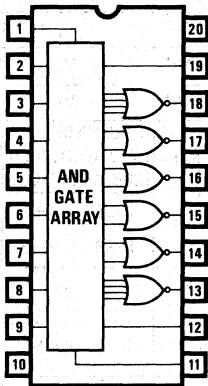

PAL14L4

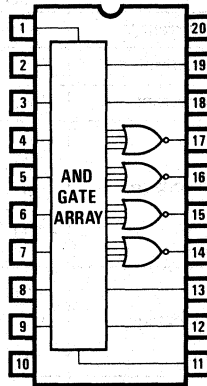

PAL16L2

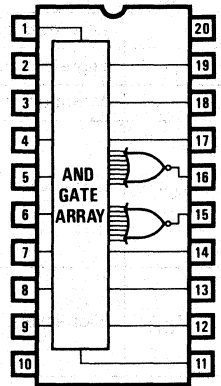

6

PAL16L8

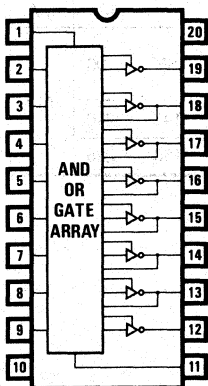

PAL16R8

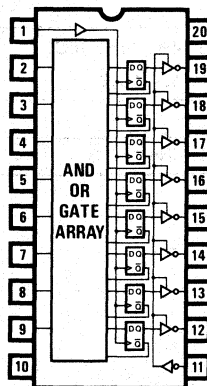

PAL16R6

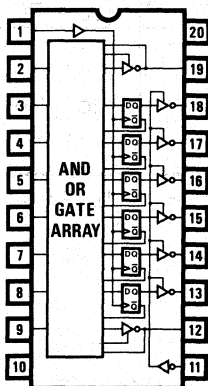

PAL16R4

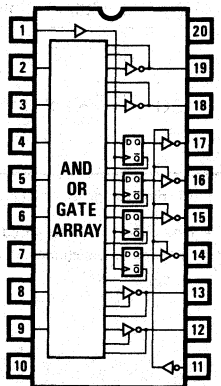

**Absolute Maximum Ratings**

Supply Voltage, V <sub>CC</sub> .....	7	Operating	12V
Input Voltage .....	5.5V	Programming	12V*
Off-state output Voltage .....	5.5V		12V
Storage temperature .....	-65° to +150°C		

**Operating Conditions**

SYMBOL	PARAMETER	MILITARY			COMMERCIAL			UNIT
		MIN	NOM	MAX	MIN	NOM	MAX	
V <sub>CC</sub>	Supply voltage	4.5	5	5.5	4.75	5	5.25	V
T <sub>A</sub>	Operating free-air temperature				0		75	°C
T <sub>C</sub>	Operating case temperature	-55		125				°C

**Electrical Characteristics Over Operating Conditions**

SYMBOL	PARAMETER	TEST CONDITIONS		MIN	TYP	MAX	UNIT	
V <sub>IL</sub>	Low-level input voltage					0.8	V	
V <sub>IH</sub>	High-level input voltage			2			V	
V <sub>IC</sub>	Input clamp voltage	V <sub>CC</sub> = MIN	I <sub>I</sub> = -18mA			-1.5	V	
I <sub>IL</sub>	Low-level input current †	V <sub>CC</sub> = MAX	V <sub>I</sub> = 0.4V			-0.25	mA	
I <sub>IH</sub>	High-level input current †	V <sub>CC</sub> = MAX	V <sub>I</sub> = 2.4V			25	μA	
I <sub>I</sub>	Maximum input current	V <sub>CC</sub> = MAX	V <sub>I</sub> = 5.5V			1	mA	
V <sub>OL</sub>	Low-level output voltage	V <sub>CC</sub> = MIN V <sub>IL</sub> = 0.8V V <sub>IH</sub> = 2V	10H8, 12H6, 14H4 16H2, 16C1, 10L8 12L6, 14L4, 16L2	MIL	I <sub>OL</sub> = 8mA	0.5	V	
			16L8 16R4	MIL				I <sub>OL</sub> = 12mA
			16R6 16R8	COM				I <sub>OL</sub> = 24mA
V <sub>OH</sub>	High-level output voltage	V <sub>CC</sub> = MIN V <sub>IL</sub> = 0.8V V <sub>IH</sub> = 2V	MIL	I <sub>OH</sub> = -2mA	2.4	V		
			COM	I <sub>OH</sub> = -3.2mA				
I <sub>OZL</sub>	Off-state output current †	V <sub>CC</sub> = MAX V <sub>IL</sub> = 0.8V V <sub>IH</sub> = 2V	Three-state only	V <sub>O</sub> = 0.4V		-100	μA	
I <sub>OZH</sub>				V <sub>O</sub> = 2.4V		100	μA	
I <sub>OS</sub>	Output short-circuit current**	V <sub>CC</sub> = 5V		V <sub>O</sub> = 0V		-30	-130	mA
I <sub>CC</sub>	Supply current	V <sub>CC</sub> = MAX	10H8, 12H6, 14H4, 16H2, 16C1 10L8, 12L6, 14L4, 16L2		55	90	mA	
			16L8		140	210		
			16R4, 16R6, 16R8		150	225		

† I/O pin leakage is the worst case of I<sub>OZX</sub> or I<sub>IX</sub> e.g. I<sub>IL</sub> and I<sub>OZH</sub>

\* Pins 1 and 11 may be raised to 22V max.

\*\* Only one output shorted at a time.

### Switching Characteristics

Over Operating Conditions

SYMBOL	PARAMETER	TEST CONDITIONS	MILITARY			COMMERCIAL			UNIT
			MIN	TYP	MAX	MIN	TYP	MAX	
$t_{PD}$	Input to output	10H8 12H6 14H4 16H2 16C1 10L8 12L6 14L4 16L2 $R_1 = 560\Omega$ $R_2 = 1.1k\Omega$		25	45		25	40	ns
$t_{PD}$	Input or feedback to output	16R8 16R6 16R4 16L8  $R_1 = 200\Omega$ $R_2 = 390\Omega$		25	45		25	40	ns
$t_{CLK}$	Clock to output or feedback			15	25		15	25	ns
$t_{PZX}$	Pin 11 to output enable			15	25		15	25	ns
$t_{PXZ}$	Pin 11 to output disable			15	25		15	25	ns
$t_{PZX}$	Input to output enable			25	45		25	40	ns
$t_{PXZ}$	Input to output disable			25	45		25	40	ns
$t_W$	Width of clock		Low	25			25		ns
			High	25			25		
$t_{SU}$	Setup time from input or feedback	16R8 16R6 16R4	45			40		ns	
$t_H$	Hold time		0	-15		0	-15	ns	
$f_{MAX}$	Maximum frequency	16R8 16R6 16R4	14			16		MHz	

### Test Load

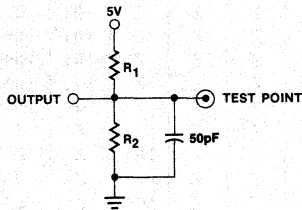

### Schematic of Inputs and Outputs

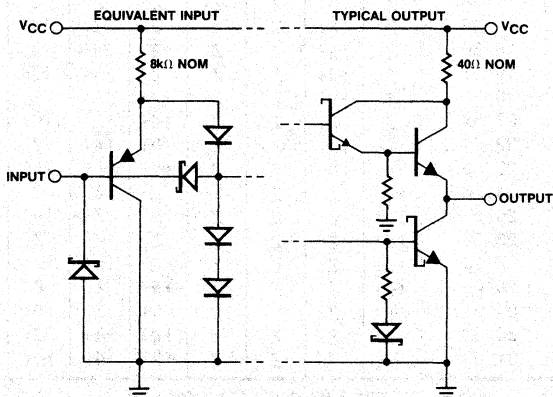

### Approved Programmers

MANUFACTURER	PERSONALITY CARD SET	SOCKET ADAPTER CONFIGURATION
Cybernetic Programming Systems, Inc.	CYMPC-1	
Data I/O Corporation	909-1427	715 1428-1 715 1428-2 715 1428-3
Pro-Log Corporation	PM9068	
Stag Systems	PM202	AM10H8 AM10L8 AM12H6 AM12L6 AM14H4 AM14L4 AM16H2 AM16L2 AM16C1
Structured Design	SD-20	

6



## Programming

PAL fuses are programmed using a low-voltage linear-select procedure which is common to all 15 PAL types. The array is divided into two groups, products 0 thru 31 and products 32 thru 63, for which pin identifications are shown in Pin Configurations below. To program a particular fuse, both an input line and a product line are selected according to the following procedure:

- Step 1 Raise Output Disable, OD, to  $V_{IH}$
- Step 2 Select an input line by specifying  $I_0, I_1, I_2, I_3, I_4, I_5, I_6, I_7$  and L/R as shown in Table 1.
- Step 3 Select a product line by specifying  $A_0, A_1$  and  $A_2$  one-of-eight select as shown in Table 2.
- Step 4 Raise  $V_{CC}$  (pin 20) to  $V_{IH}$

Step 5 Program the fuse by pulsing the output pins,  $O_i$ , of the selected product group to  $V_{IH}$  as shown in Programming Waveform.

- Step 6 Lower  $V_{CC}$  (pin 20) to 6.0 V
- Step 7 Pulse the CLOCK pin and verify the output pin,  $O_i$ , to be Low for active Low PAL types or High for active High PAL types.
- Step 8 Lower  $V_{CC}$  (pin 20) to 4.5 V and repeat step 7.
- Step 9 Should the output not verify, repeat steps 1 thru 8 up to five (5) times.

This procedure is repeated for all fuses to be blown (see Programming Waveforms).

To prevent further verification, two last fuses may be blown by raising pin 1 and pin 11 to  $V_p$ .  $V_{CC}$  is not required during this operation.

## Voltage Legend

L = Low-level input voltage,  $V_{IL}$   
 H = High-level input voltage,  $V_{IH}$   
 HH = High-level program voltage,  $V_{IHH}$   
 Z = High impedance (e.g., 10k $\Omega$  to 5.0V)

INPUT LINE NUMBER	PIN IDENTIFICATION								
	I7	I6	I5	I4	I3	I2	I1	I0	L/R
0	HH	HH	HH	HH	HH	HH	HH	L	Z
1	HH	HH	HH	HH	HH	HH	HH	H	Z
2	HH	HH	HH	HH	HH	HH	HH	L	HH
3	HH	HH	HH	HH	HH	HH	HH	H	HH
4	HH	HH	HH	HH	HH	HH	L	HH	Z
5	HH	HH	HH	HH	HH	HH	H	HH	Z
6	HH	HH	HH	HH	HH	HH	L	HH	HH
7	HH	HH	HH	HH	HH	HH	H	HH	HH
8	HH	HH	HH	HH	HH	L	HH	HH	Z
9	HH	HH	HH	HH	HH	H	HH	HH	Z
10	HH	HH	HH	HH	HH	L	HH	HH	HH
11	HH	HH	HH	HH	HH	H	HH	HH	HH
12	HH	HH	HH	HH	L	HH	HH	HH	Z
13	HH	HH	HH	HH	H	HH	HH	HH	Z
14	HH	HH	HH	HH	L	HH	HH	HH	HH
15	HH	HH	HH	HH	H	HH	HH	HH	HH
16	HH	HH	HH	L	HH	HH	HH	HH	Z
17	HH	HH	HH	H	HH	HH	HH	HH	Z
18	HH	HH	HH	L	HH	HH	HH	HH	HH
19	HH	HH	HH	H	HH	HH	HH	HH	HH
20	HH	HH	L	HH	HH	HH	HH	HH	Z
21	HH	HH	H	HH	HH	HH	HH	HH	Z
22	HH	HH	L	HH	HH	HH	HH	HH	HH
23	HH	HH	H	HH	HH	HH	HH	HH	HH
24	HH	L	HH	HH	HH	HH	HH	HH	Z
25	HH	H	HH	HH	HH	HH	HH	HH	Z
26	HH	L	HH	HH	HH	HH	HH	HH	HH
27	HH	H	HH	HH	HH	HH	HH	HH	HH
28	L	HH	HH	HH	HH	HH	HH	HH	Z
29	H	HH	HH	HH	HH	HH	HH	HH	Z
30	L	HH	HH	HH	HH	HH	HH	HH	HH
31	H	HH	HH	HH	HH	HH	HH	HH	HH

Table 1 Input Line Select

PRODUCT LINE NUMBER	PIN IDENTIFICATION						
	O3	O2	O1	O0	A2	A1	A0
0, 32	Z	Z	Z	HH	Z	Z	Z
1, 33	Z	Z	Z	HH	Z	Z	HH
2, 34	Z	Z	Z	HH	Z	HH	Z
3, 35	Z	Z	Z	HH	Z	HH	HH
4, 36	Z	Z	Z	HH	HH	Z	Z
5, 37	Z	Z	Z	HH	HH	Z	HH
6, 38	Z	Z	Z	HH	HH	HH	Z
7, 39	Z	Z	Z	HH	HH	HH	HH
8, 40	Z	Z	HH	Z	Z	Z	Z
9, 41	Z	Z	HH	Z	Z	Z	HH
10, 42	Z	Z	HH	Z	Z	HH	Z
11, 43	Z	Z	HH	Z	Z	HH	HH
12, 44	Z	Z	HH	Z	HH	Z	Z
13, 45	Z	Z	HH	Z	HH	Z	HH
14, 46	Z	Z	HH	Z	HH	HH	Z
15, 47	Z	Z	HH	Z	HH	HH	HH
16, 48	Z	HH	Z	Z	Z	Z	Z
17, 49	Z	HH	Z	Z	Z	Z	HH
18, 50	Z	HH	Z	Z	Z	HH	Z
19, 51	Z	HH	Z	Z	Z	HH	HH
20, 52	Z	HH	Z	Z	HH	Z	Z
21, 53	Z	HH	Z	Z	HH	Z	HH
22, 54	Z	HH	Z	Z	HH	HH	Z
23, 55	Z	HH	Z	Z	HH	HH	HH
24, 56	HH	Z	Z	Z	Z	Z	Z
25, 57	HH	Z	Z	Z	Z	Z	HH
26, 58	HH	Z	Z	Z	Z	HH	Z
27, 59	HH	Z	Z	Z	Z	HH	HH
28, 60	HH	Z	Z	Z	HH	Z	Z
29, 61	HH	Z	Z	Z	HH	Z	HH
30, 62	HH	Z	Z	Z	HH	HH	Z
31, 63	HH	Z	Z	Z	HH	HH	HH

Table 2 Product Line Select

Pin Configurations

PRODUCTS 0 THRU 31

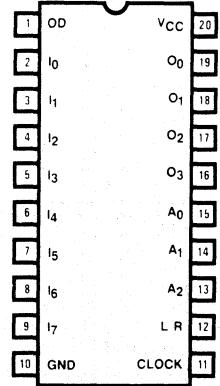

PRODUCTS 32 THRU 63

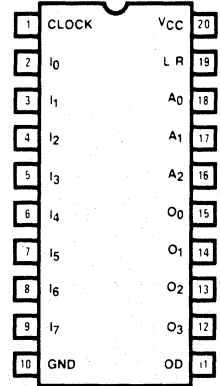

Programming Parameters  $T_A = 25^\circ C$

SYMBOL	PARAMETER	LIMITS			UNIT	
		MIN	TYP	MAX		
$V_{IH}$	Program-level input voltage	11	11.5	12	V	
$I_{IH}$	Program-level input current	Output Program Pulse			50	mA
		OD, L/R			25	
		All Other Inputs			5	
$I_{CCH}$	Program Supply Current				400	mA
$T_P$	Program Pulse Width	10			50	$\mu s$
$t_D$	Delay time	100				ns
$t_{DV}$	Delay Time to Verify	100				$\mu s$
	Program Pulse duty cycle				25	%
$V_P$	Verify-Protect-input voltage	20	21	22	V	
$I_P$	Verify-Protect-input current				400	mA
$T_{PP}$	Verify-Protect Pulse Width	20			50	msec

6

Programming Waveforms

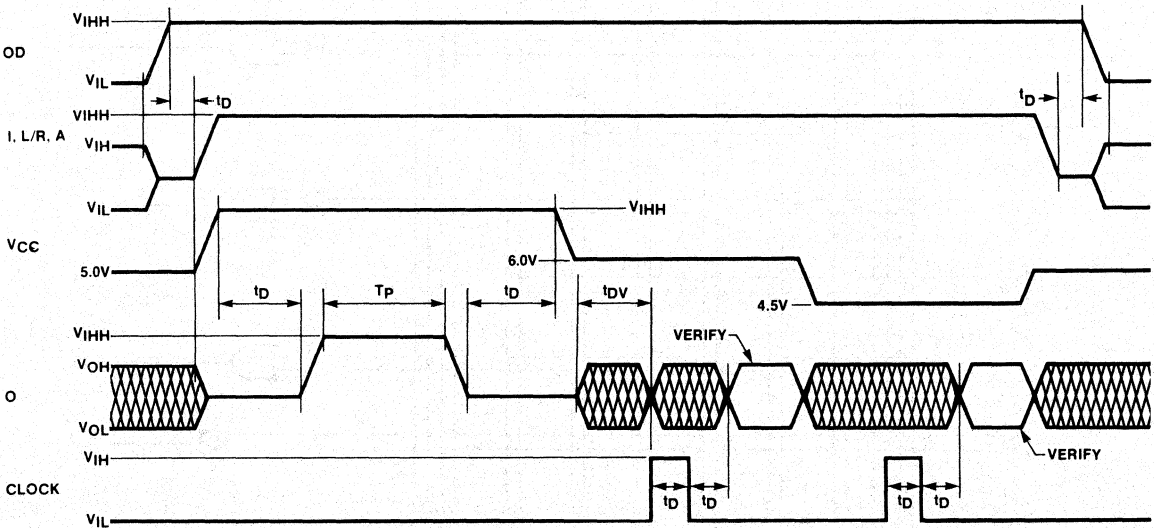

Logic Diagram PAL10H8

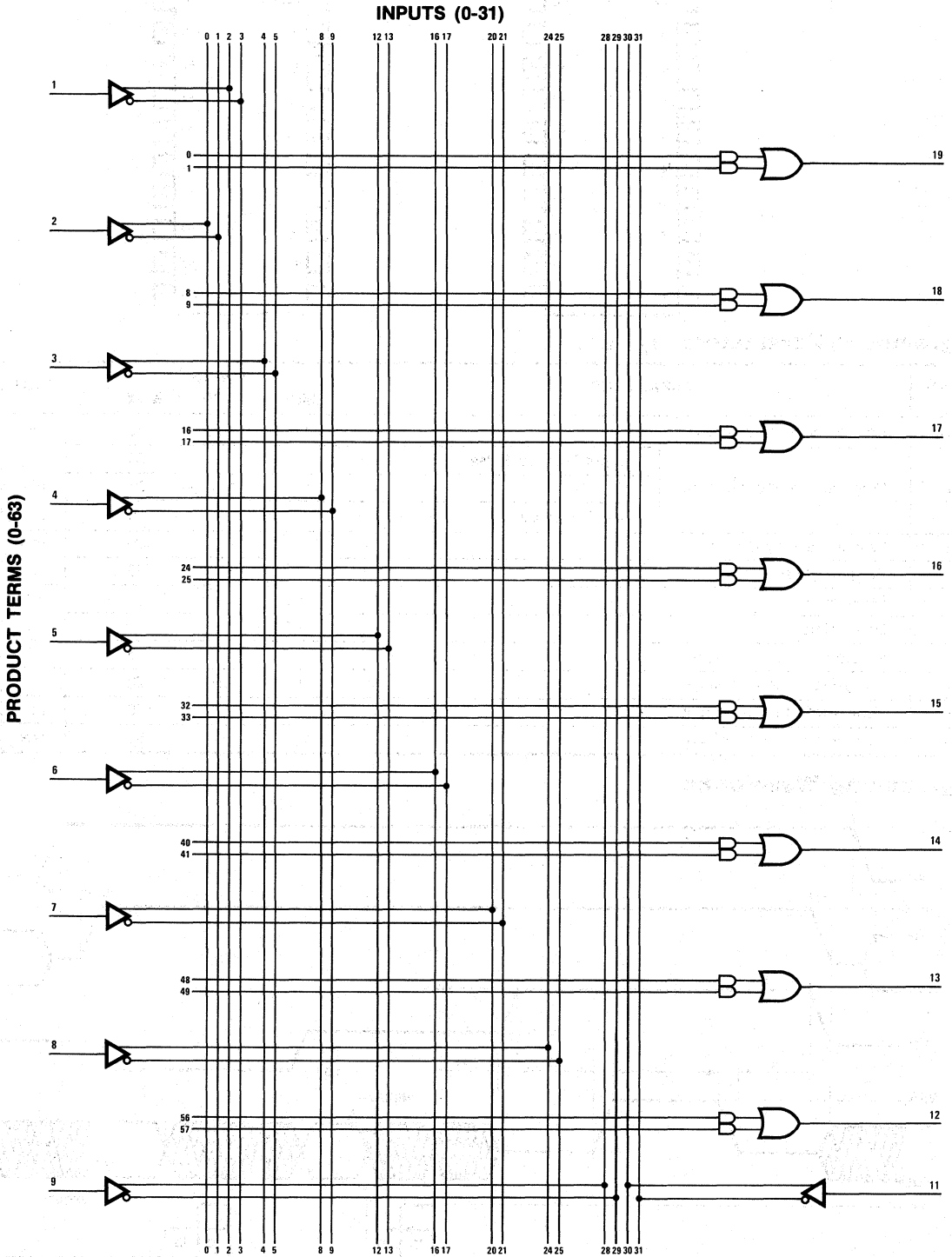

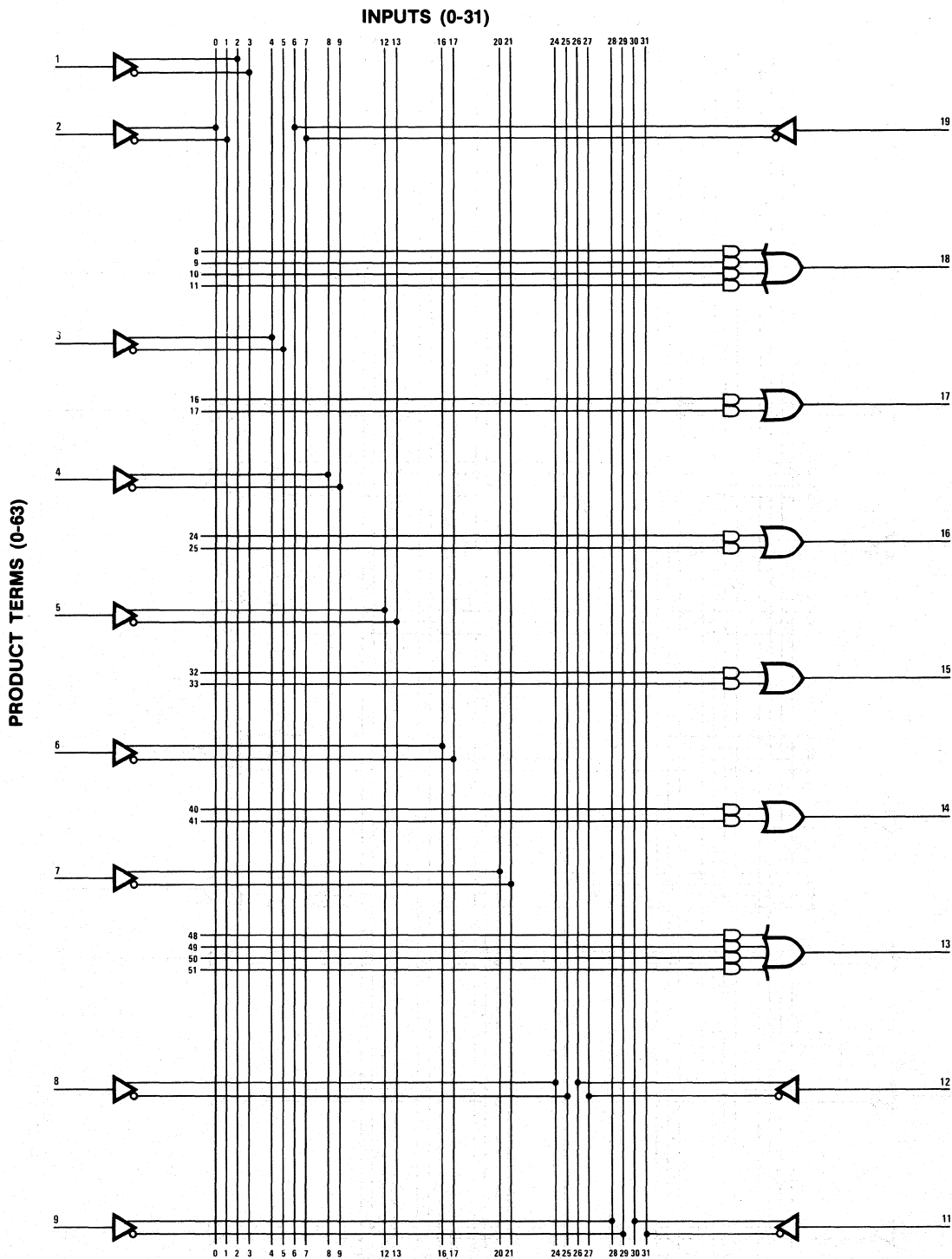

6

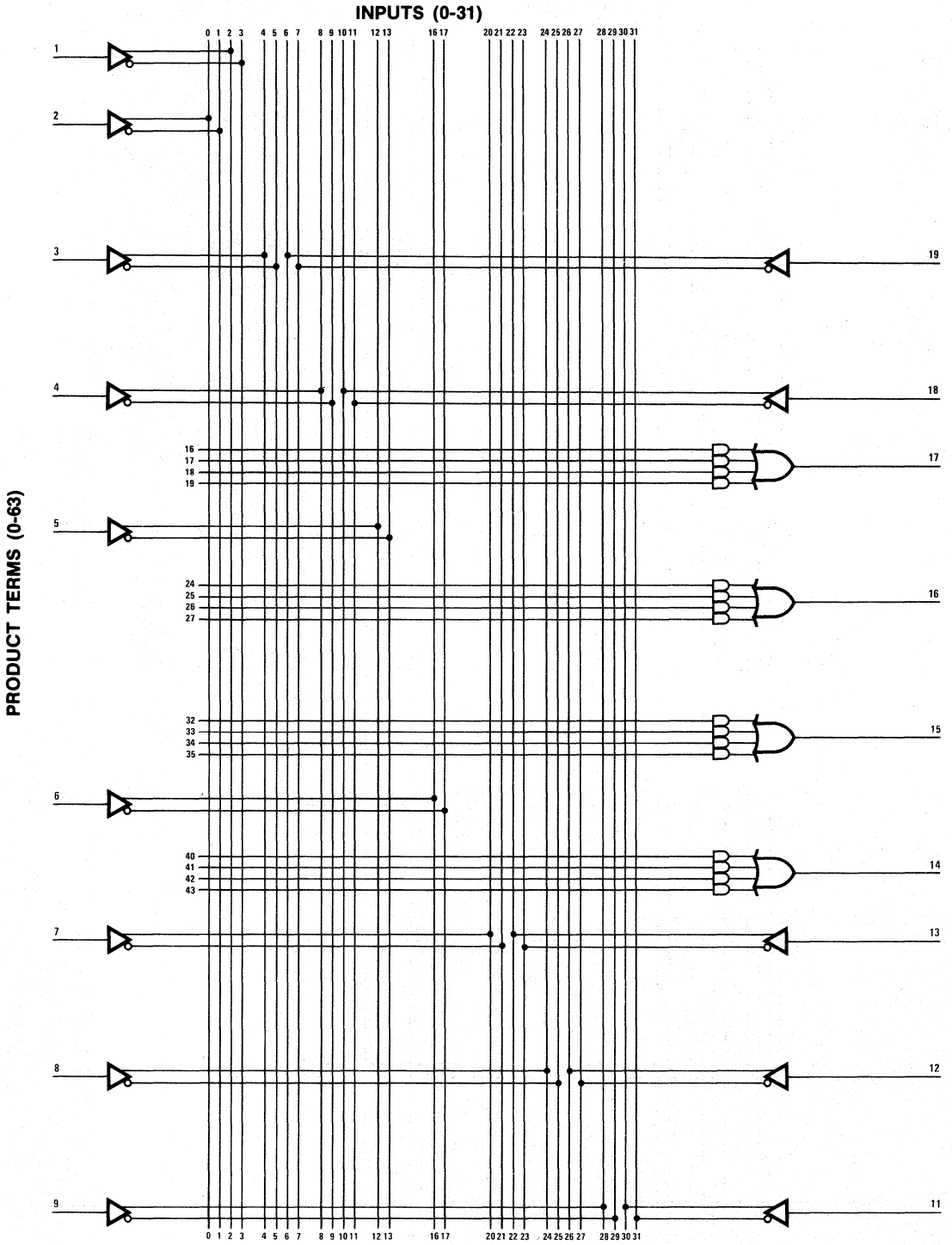

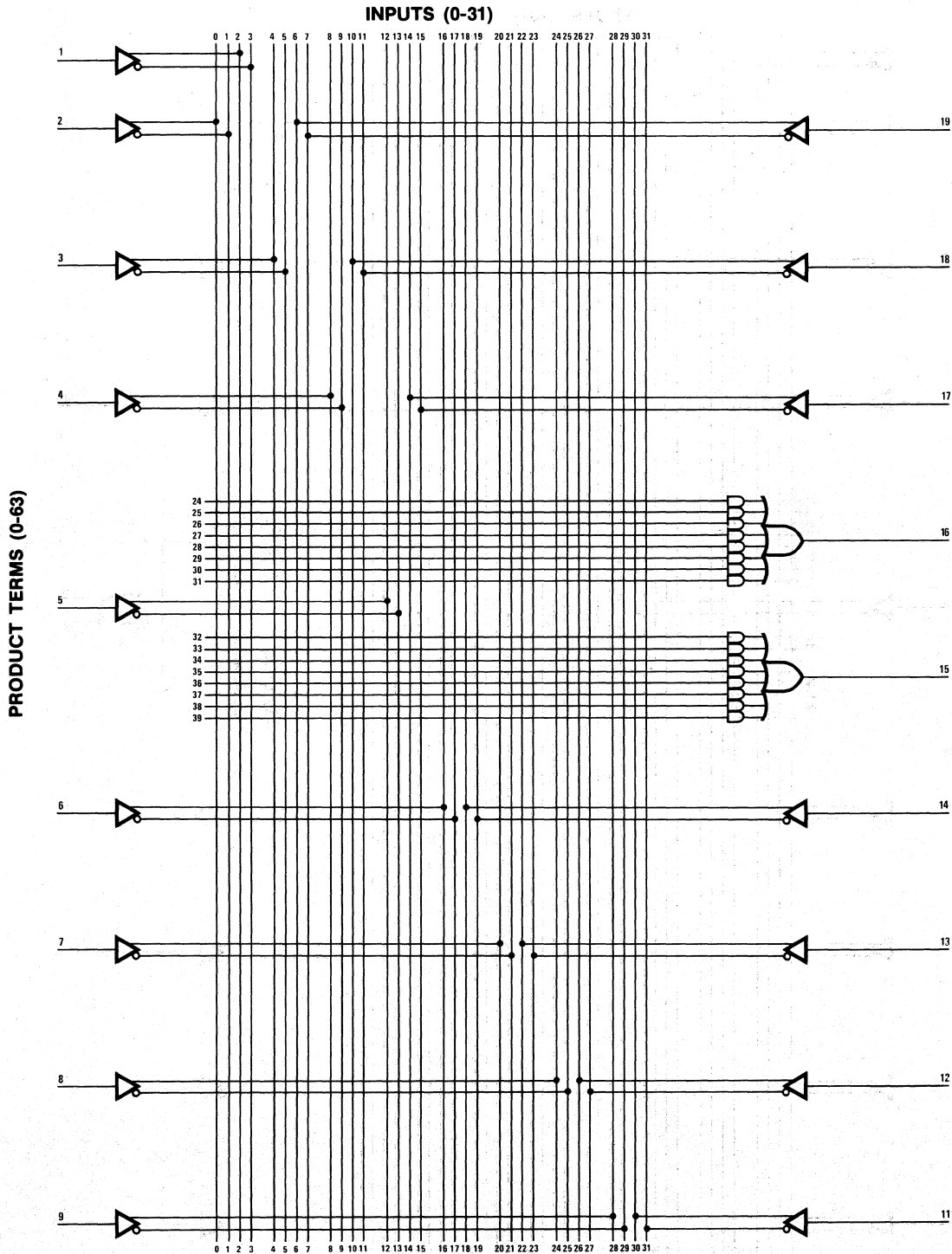

Logic Diagram PAL16C1

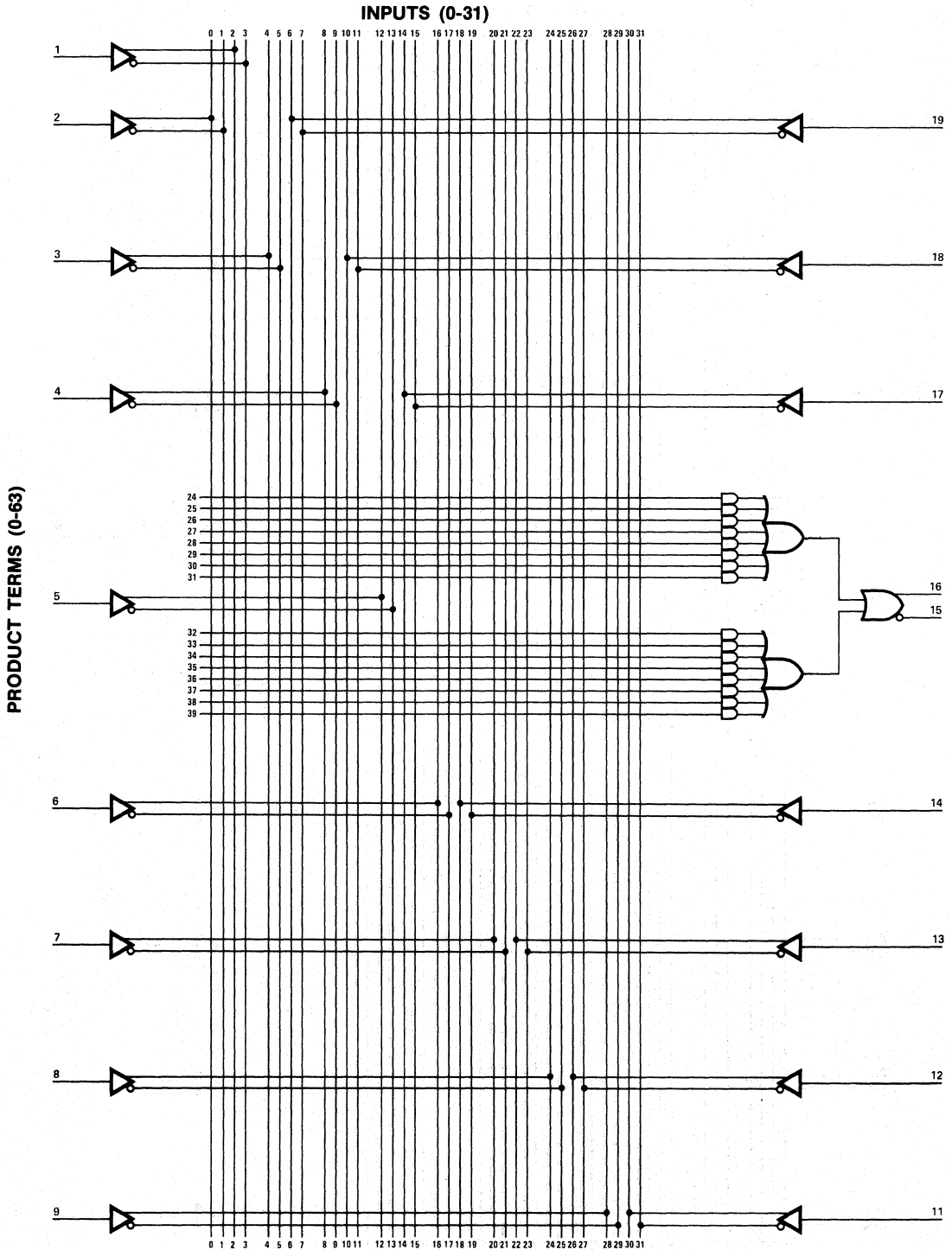

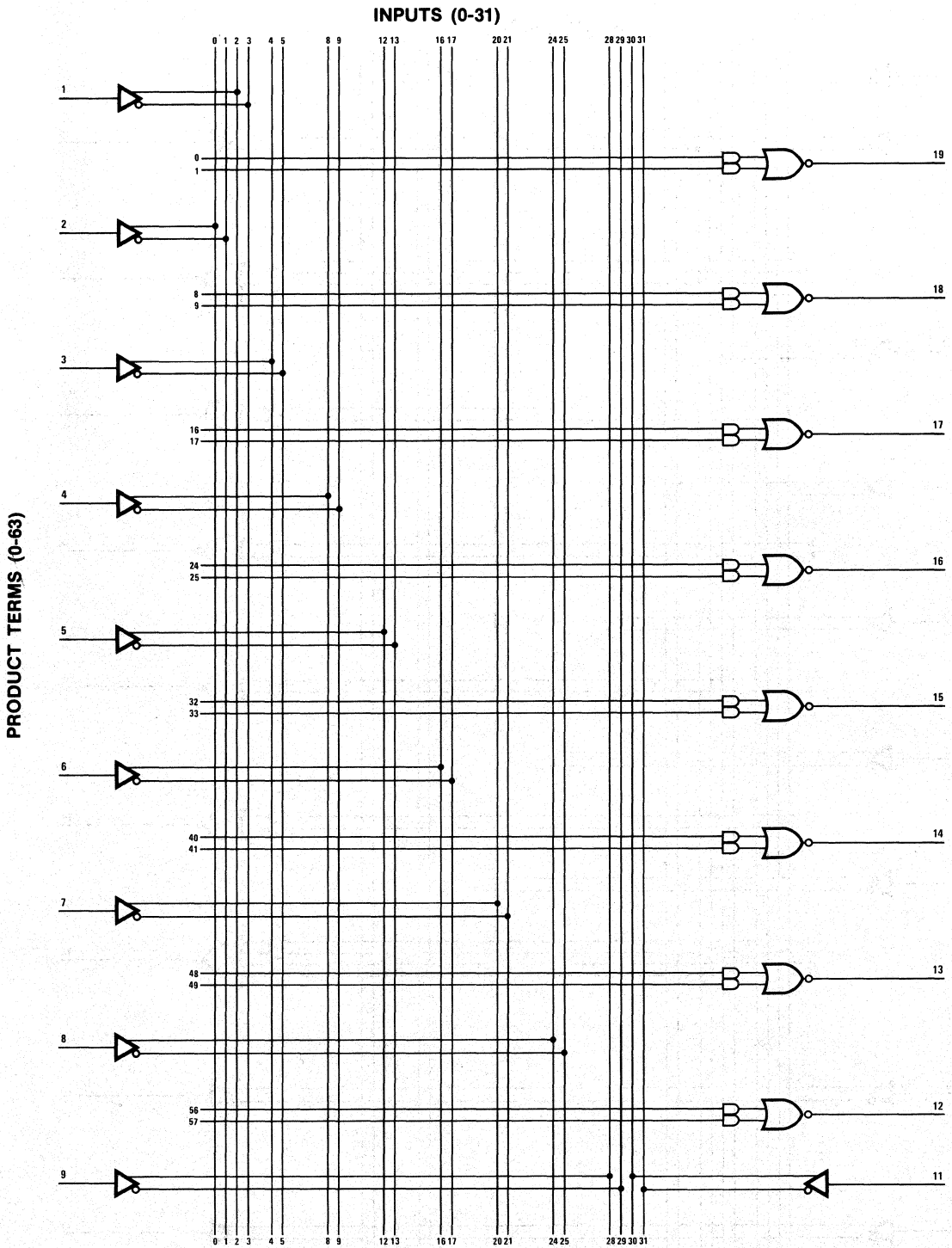

6



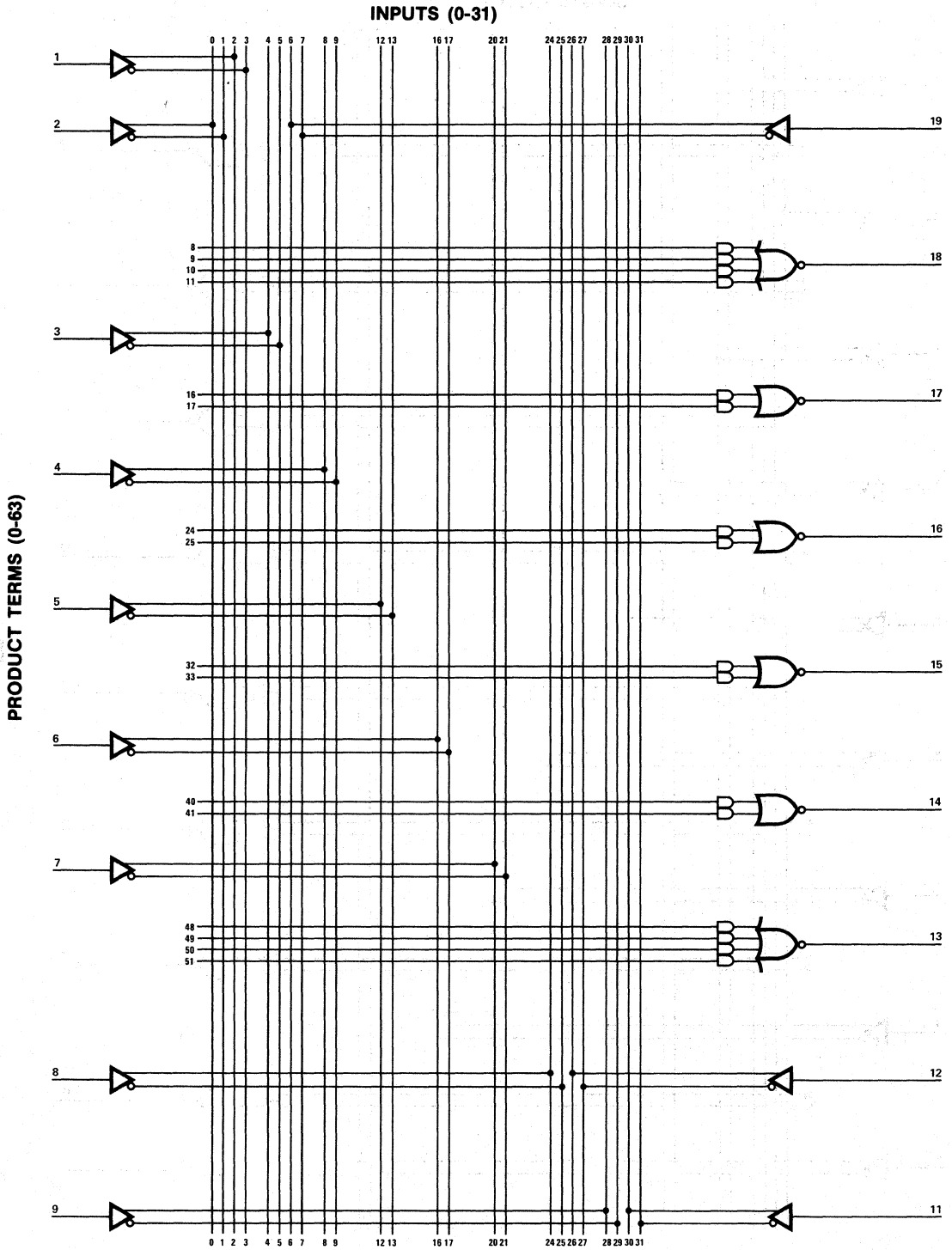

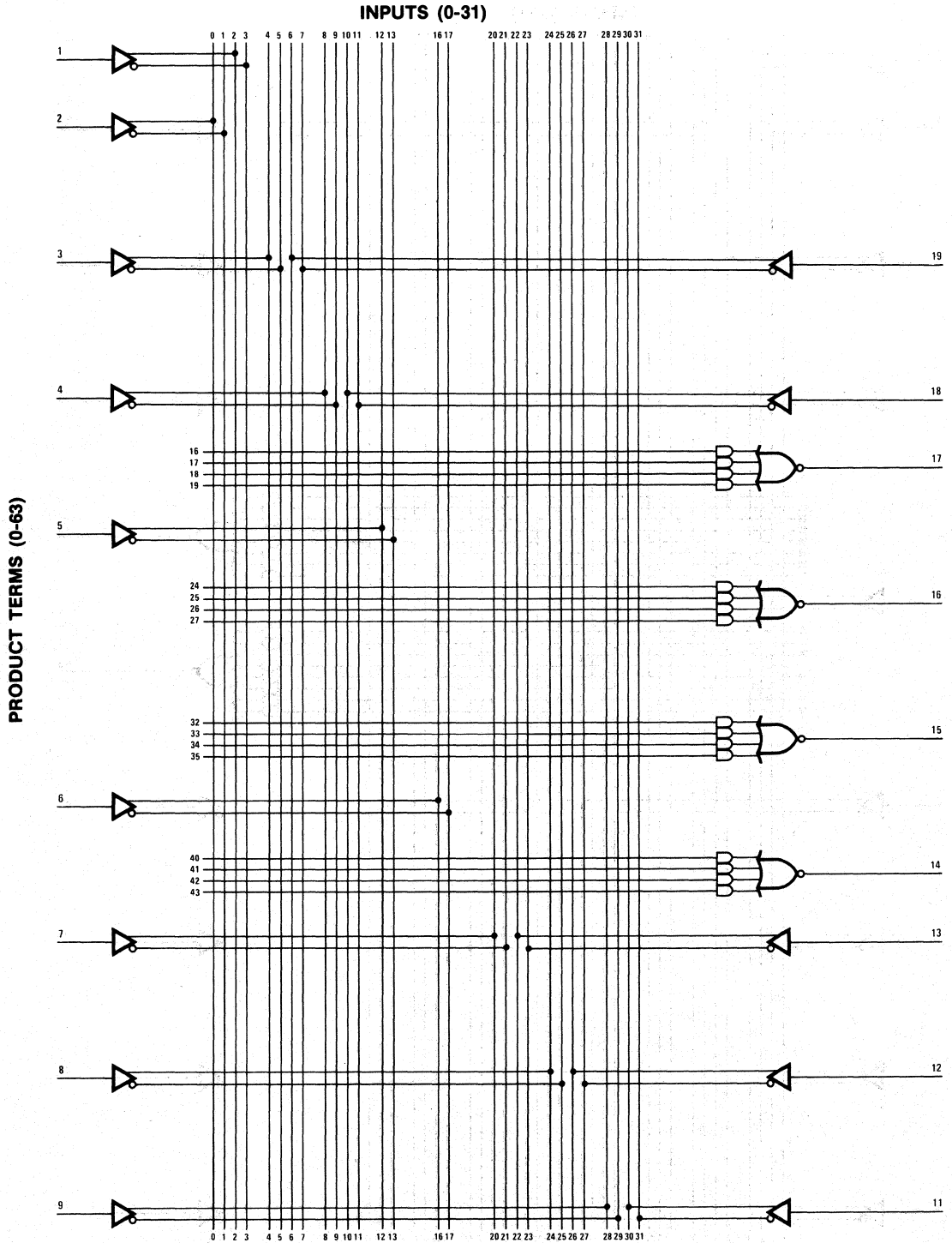

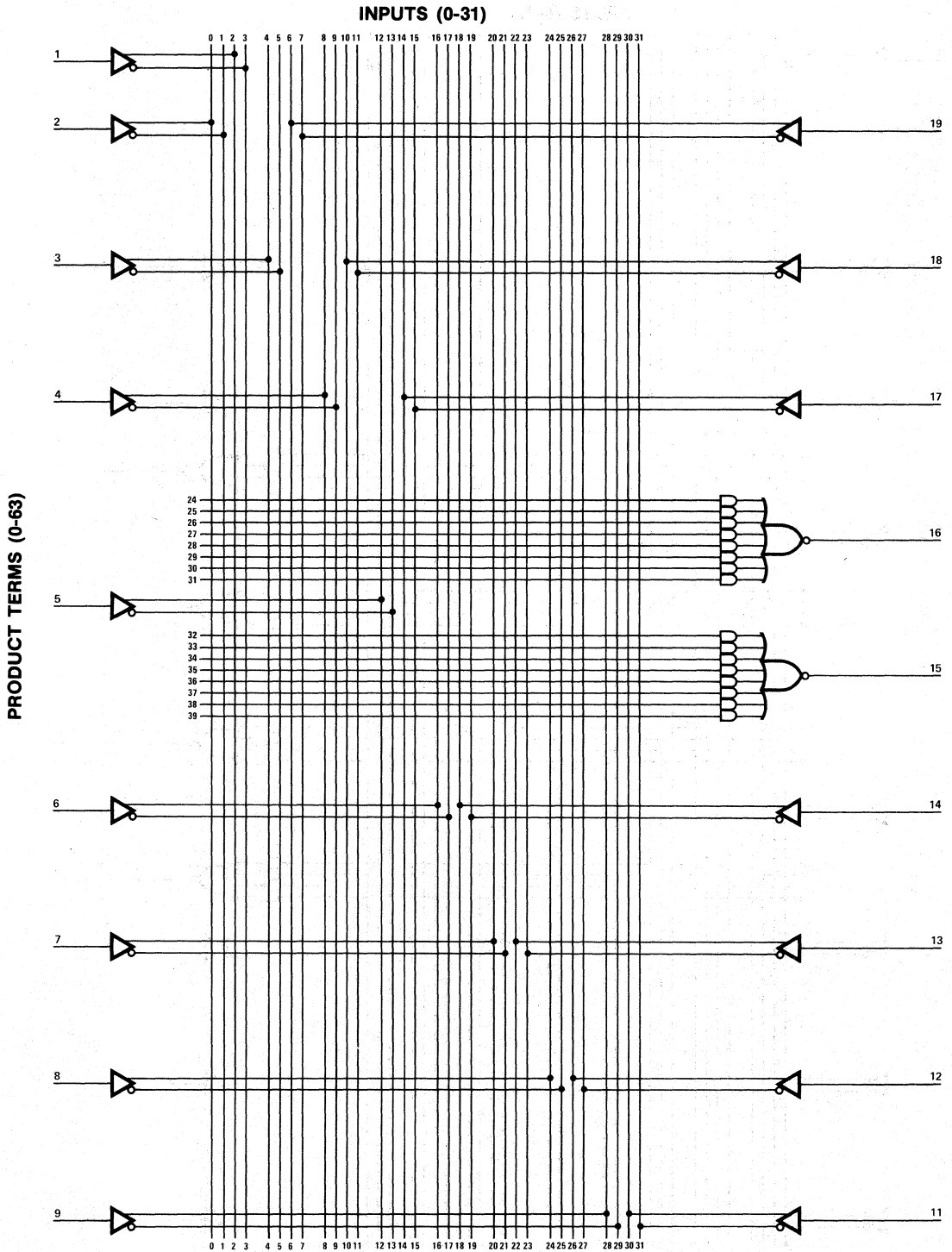

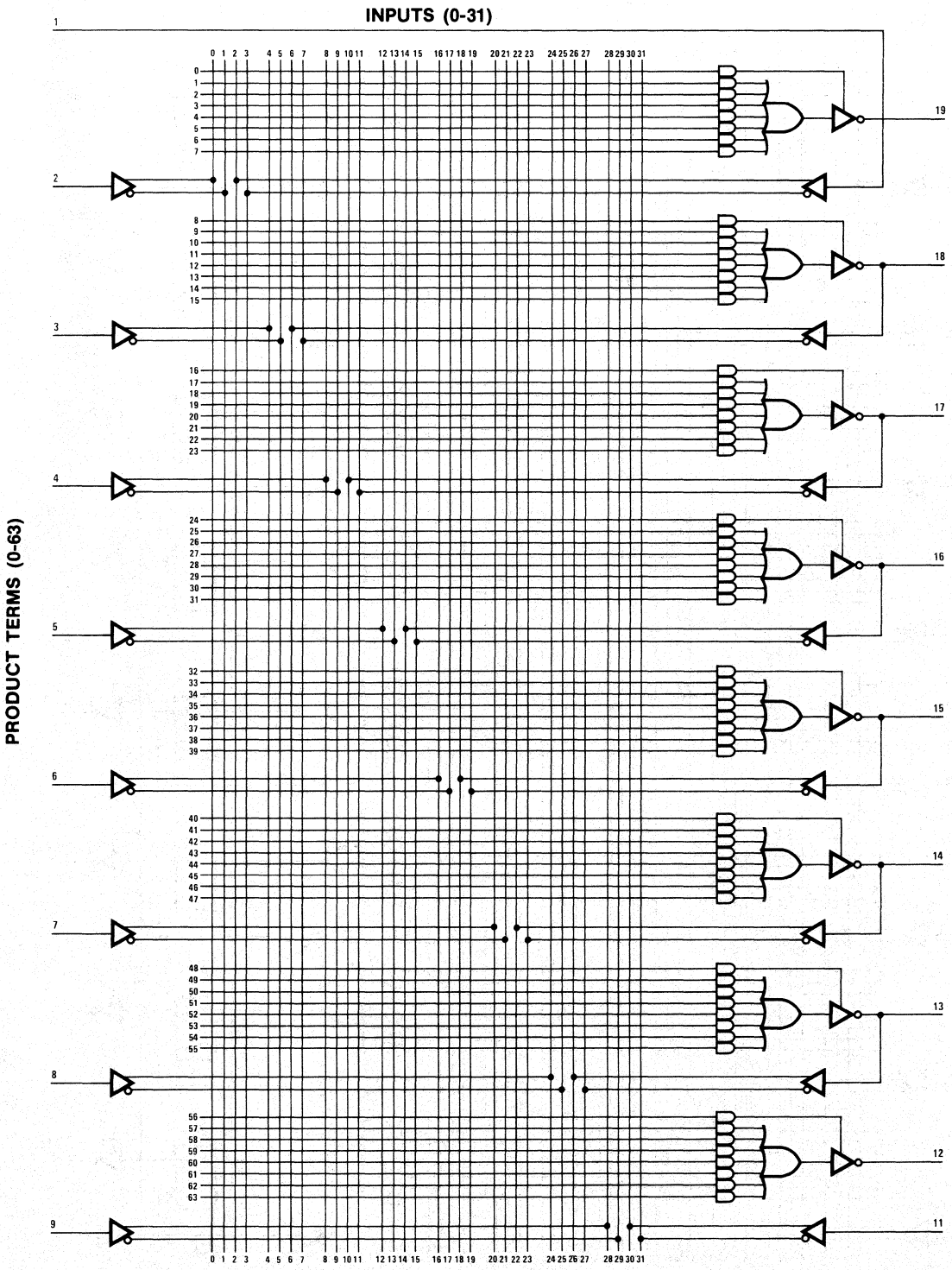

6

Logic Diagram PAL16R8

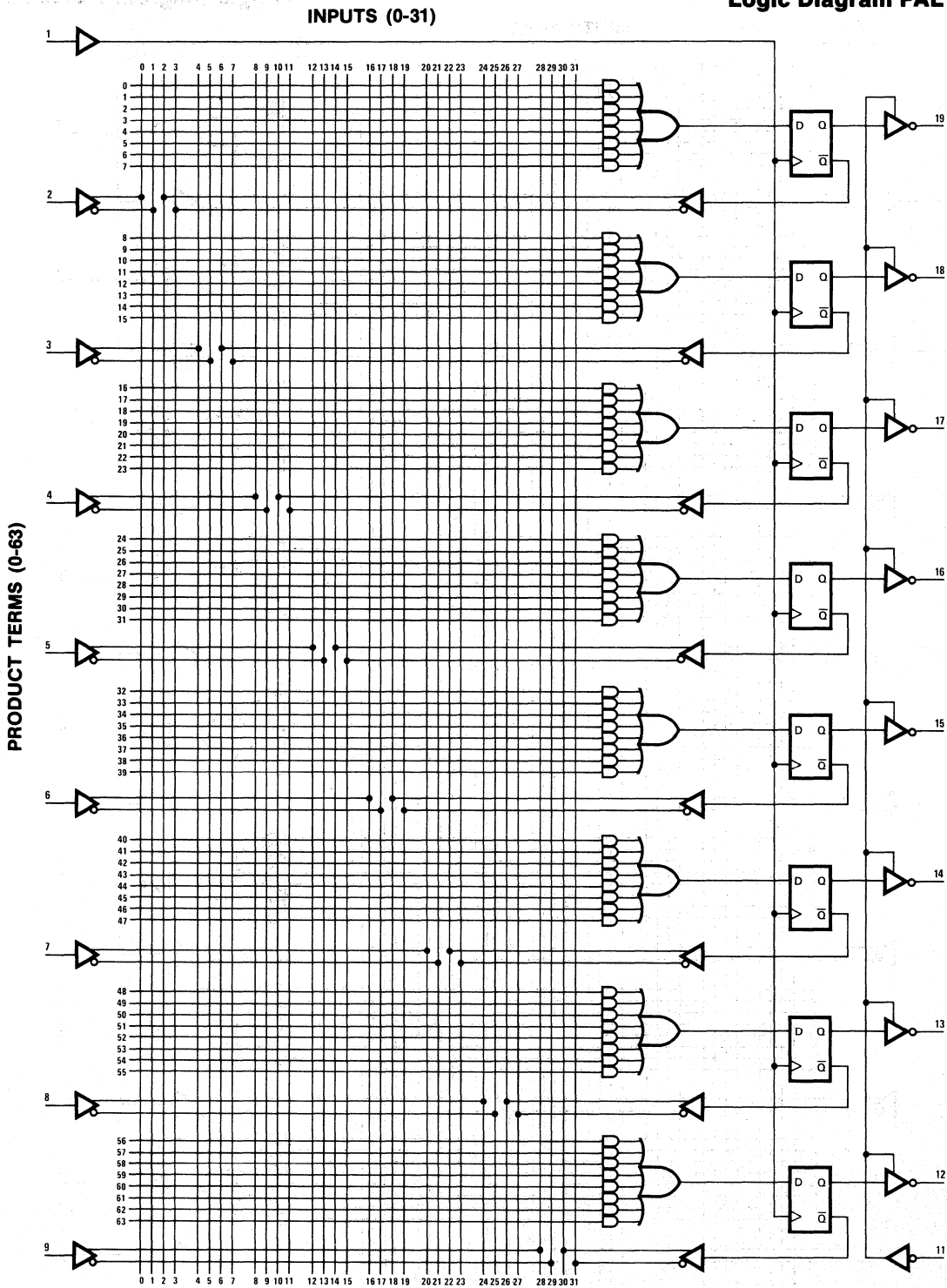

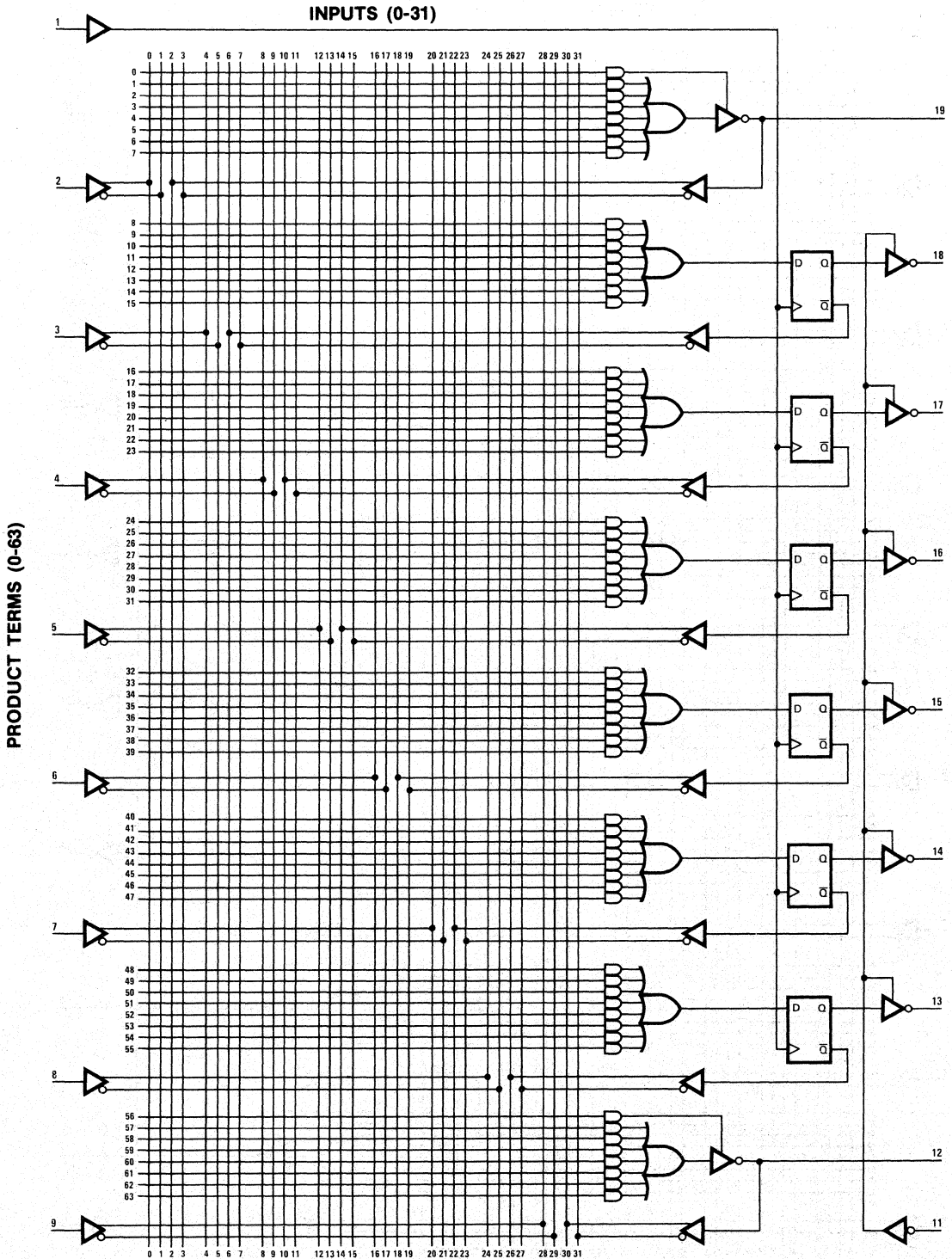

6

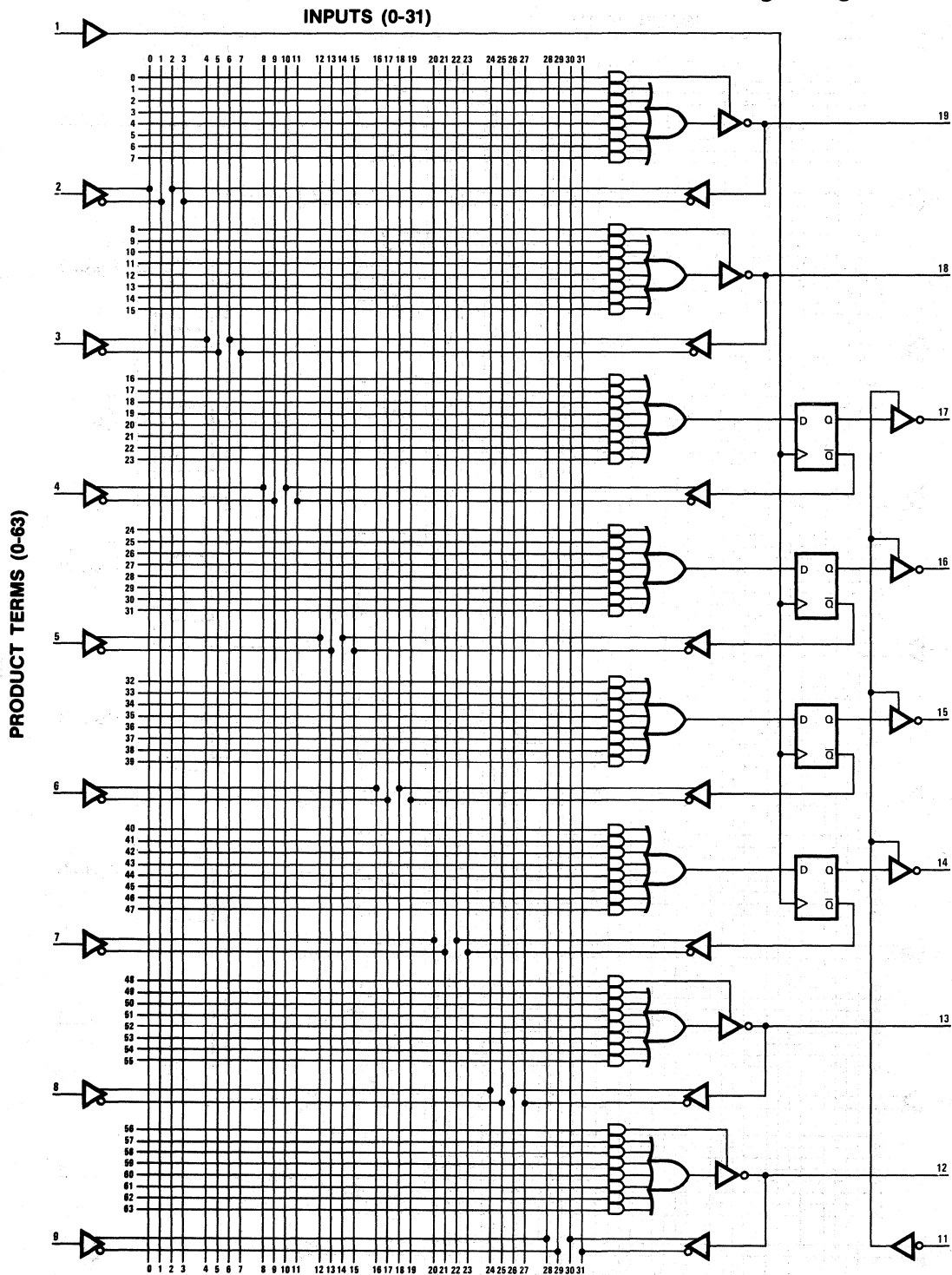

# PAL Programming

6

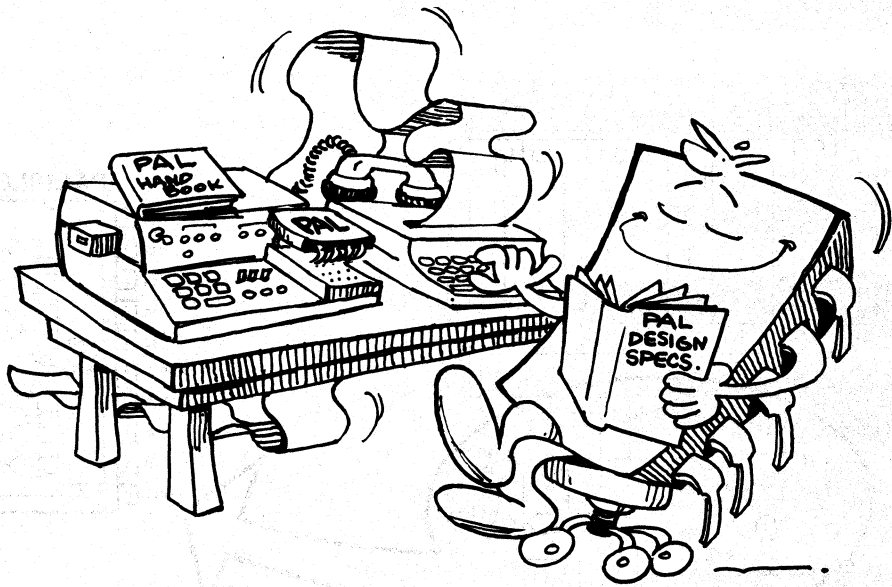



## Selecting the Right PAL

The 15 PAL part types offer a wide range of complexity to choose from. Starting with the PAL10H8 (10 inputs, 8 active high outputs), the first 9 PAL types can replace random SSI gate functions at about a 4 to 1 chip count reduction. With a variety of input/output pin ratios and Active High or Active Low outputs, this group, described as combinatorial, is designed to provide the Low Power Schottky (LS) fan-out and fan-in characteristics of 8 mA output sink (IOL) for totem-pole outputs and 250  $\mu$ A input loading (IIL).

The next 6 PALS provide the additional features of three-state outputs, state sequencing, arithmetic, and programmable input/output pin ratios. The three-state outputs drive the standard LS output sink of 24 mA (IOL), providing bus driving capability. These sequential PALS are ideal for replacing existing MSI and/or defining LSI functions not presently available.

Unused inputs should be tied to either VCC or GND. The series resistor required for unused inputs on standard TTL is NOT required for PALS, thus using less parts.

## Defining the Pinout

The first step in designing a PAL is selecting the Pinout. The example shown below shows a method for circling a section of conventionally drawn logic to define a boundary for a PAL

function. This boundary will dictate a specific number of input pins and output pins. For the following example, 8 inputs and 6 outputs are required, well within the capability of the PAL10L8. Assignment of inputs and outputs to specific pins can be done using the PAL Logic Symbol as shown below.

## Specifying the Design

The next step is to generate a fuse pattern in order to program a PAL. The following two methods are commonly used for generating a fuse pattern.

### PALASM:

Logic equations are entered as specified on page 6-31 and the fuse pattern is generated.

### MANUAL CODING:

In this case logic equations or conventional logic diagram is translated into PAL logic diagram. This is accomplished by marking PAL logic diagrams with appropriate fuse interconnections for the desired logic transfer function. The PAL logic diagram is then transformed into PAL programming format. The programming format can be used to either enter data into the PAL Programmer manually, or to generate a tape using BHLF, BPNP or HEX format.

The two methods described above are explained in detail on the following pages. Page 6-29 gives the necessary information required to convert the conventional logic into PAL logic.

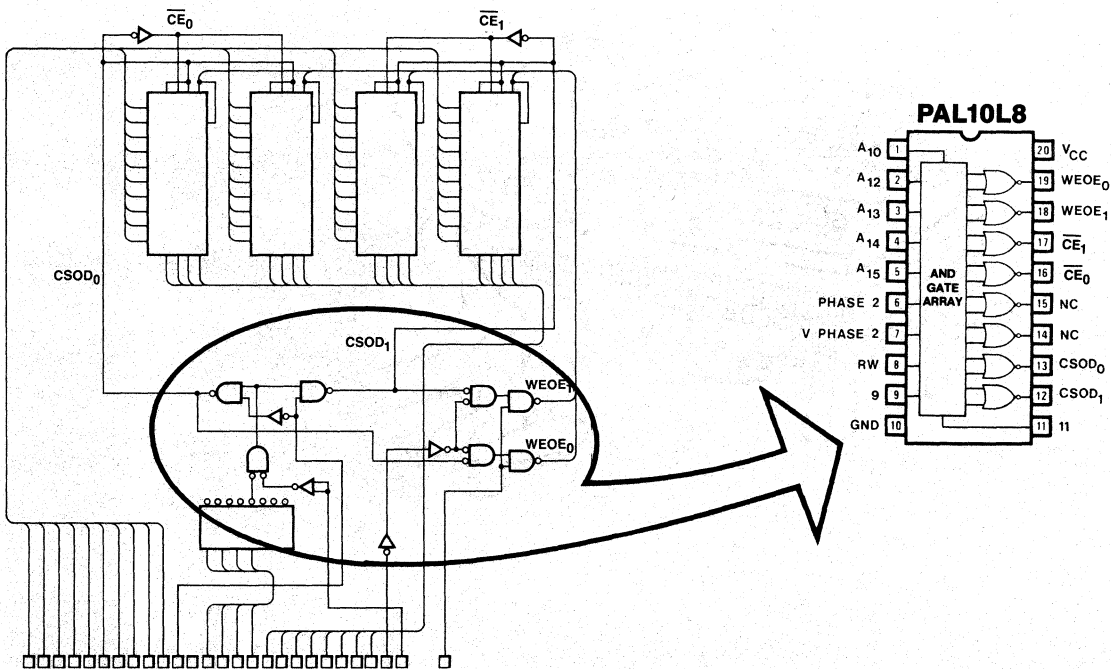

## PAL Legend

### Constants

LOW (L)	NEGATIVE (N)	ZERO (0)	GND	FALSE	x		FUSE NOT BLOWN
HIGH (H)	POSITIVE (P)	ONE (1)	V <sub>CC</sub>	TRUE	-		FUSE BLOWN

### Operators

- = EQUAL
- := REPLACED BY FOLLOWING CLOCK
- / COMPLEMENT
- \* AND, PRODUCT
- + OR, SUM
- +: XOR
- \*: XNOR
- ( ) CONDITIONAL THREE STATE, IF STATEMENT, ARITHMETIC

### Equations

Standard  $Q_1 = I_1 \bar{I}_2 + \bar{I}_1 I_2$   
 PALASM  $01 = I1*/I2 + /I1*I2$

### Conventional Symbology

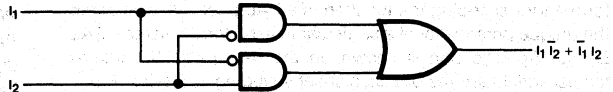

### PAL Symbology

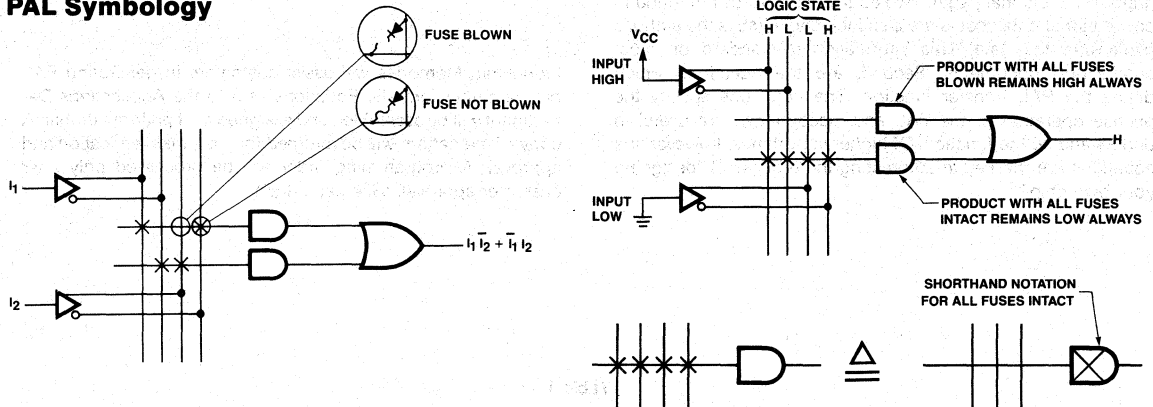

6

### PAL Logic Diagram

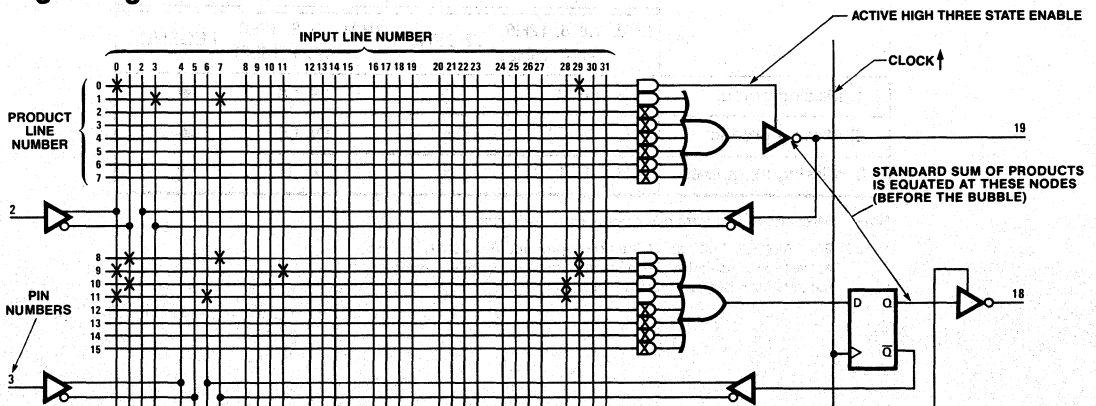

## Phantom Fuse

Phantom fuse locations are those locations where a fuse does not exist. These are shown by the missing outputs, product terms or input lines in the Logic Diagrams on pages 6-14 thru 6-22. The PALs with phantom fuse locations appear to the PROM programmer as a partially programmed 512x4 PROM. As the programmer will expect to verify all 2048 locations, the PAL programming format must provide the expected pattern for verifying non-existent fuse nodes. When filling out the programming format, Table 1 should be used for phantom fuse locations. The following PALs have phantom fuses:

PAL10H8	PAL10L8
PAL12H6	PAL12L6
PAL14H4	PAL14L4
PAL16H2	PAL16L2
PAL16C1	

## Documenting the PAL Design Specification

The PAL Design Specification is a recommended *data sheet* format for describing the function of a PAL once it has acquired the unique personality of a particular fuse pattern. A sample PAL Design Specification is shown on the next page. It contains the essential features of a data sheet including 1) Device Name, 2) Pin List, 3) Description, 4) Function Table and 5) Logic Diagram (on additional page). Two additional features not found in conventional data sheets are also included. First, is the author's name and the date. This information is standard on most engineering documents. Second, are the equations which define the PAL transfer function. The equations specify the precise operation of the PAL and, accordingly, are useful in understanding the function. Of higher importance, however, the equations are the key to automating the process of "designing your own chip."

## PALASM

The equations in the PAL Design Specification, along with the PIN List and part number, contain the exact information necessary to generate PAL fuse patterns. Any computer can transform the spec into programming instructions in the form of paper tape or, preferably, RS232C voltage waveforms for direct input to PROM programmers. With a little help from your computer, your PALs can be designed, documented and programmed within minutes.

PALASM, for PAL Assembler, is a Fortran IV program which translates a PAL Design Specification into a PAL Fuse Pattern and PAL Programming Format (BHLF, BPNP or HEX). The flow chart on page 6-32 outlines the PALASM operation. PALASM source code is available to users on the following pages. Other source code media is available on request.

PROM programmer fuse patterns for VIRGIN PALs, using PALASM, are shown on pages 6-44 thru 6-46. Note that the unprogrammed locations are shown by an 'X' and phantom fuse locations are shown by '□' or '○', representing 'H' or 'L', respectively.

Monolithic Memories will assist customers in generating PAL programming formats. Equations sent to the Applications Department will be assembled and assigned a bit pattern number. A copy of the pattern will be returned for customer verification and approval. A programming order will be processed only after customer approval. (See page 6-80)

Table 1

	ACTIVE HIGH LOGIC		ACTIVE LOW LOGIC	
	(PAL 10H8, 12H6, 14H4, 16H2)	LEGEND	(PAL 10L8, 12L6, 14L4, 16L2)	LEGEND
1) Missing output	H (P, 1)	⊕	L (N, O)	⊖
2) Missing product	L (N, O)	⊖	L (N, O)	⊖
3) Missing input lines	H (P, 1)	⊕	H (P, 1)	⊕

Note 1: Missing product term overrides missing input line.

Note 2: For PAL16C1, first half of the array (product terms 0-31) acts as active high logic and the second half of the array (product terms 32-63) acts as active low logic device.

## Sample PAL Design Specification

PAL PART NO. (MUST START AT LINE 1, COLUMN 1)  
 PATTERN NO.  
 NAME OF DEVICE (MUST START ON LINE 3)

PALXXXX  
 PATXXXX  
 NAME OF DEVICE (EG. CLOCK GENERATOR, PORT ADDRESS DECODER, ETC)

PAL DESIGN SPECIFICATION  
 AUTHOR'S NAME, .DATE

PIN1 PIN2 3 /4 5 6 7 8 9 GND 11 12 13 /14 15 16 /17  
 18 19 VCC

19 = PIN1\*4 + /PIN2  
 18 = 5 + 6 + 7 + /8 + 9\*11  
 /17 := 8\*9  
 16 = 9\*8  
 IF (PIN1\*PIN2) 15 = 3 + 6  
 /14 = 3 + 6  
 IF (VCC) 13 = 8\*7 + PIN2

} EQUATIONS

PIN LIST (MUST START ON LINE 5)  
 CONSISTS OF 20 SYMBOLIC NAMES WHICH  
 ARE CONSECUTIVELY ASSIGNED TO  
 PINS 1 THRU 20.

CONDITIONAL THREE STATE

PALASM STOPS COMPILING AT FIRST UNDEFINED SYMBOL

DESCRIPTION:

THIS PROGRAM DESCRIBES THE OPERATION OF THE DEVICE. APPLICATIONS INFORMATION MAY ALSO BE PROVIDED.

INPUTS		OUTPUTS										OPERATION	
PIN1	PIN2	7	8	9	12	13	14	15	16	17	18	19	
H	L	X	L	L	H	H	L	H	L	H	H	L	CLEAR
.	.	.	.	.	.	.	.	.	.	.	.	.	.
.	.	.	.	.	.	.	.	.	.	.	.	.	.
.	.	.	.	.	.	.	.	.	.	.	.	.	.
.	.	.	.	.	.	.	.	.	.	.	.	.	.

SEE DEFINITION OF TERMS FOR FUNCTION TABLE DEFINITIONS

## PALASM Flow Chart

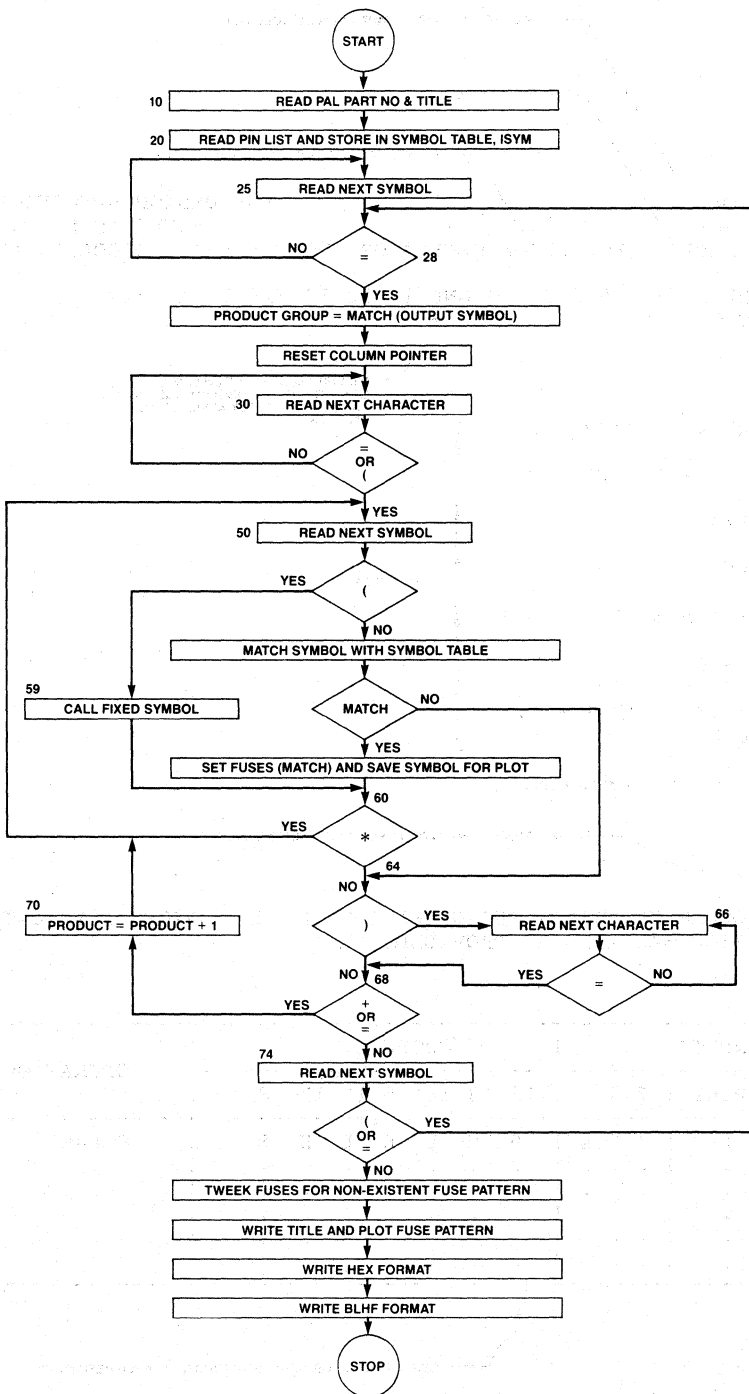

## PALASM Source Code

```

C   P A L A S M   -   TRANSLATES SYMBOLIC EQUATIONS INTO PAL OBJECT
C   CODE . FORMATTED FOR DIRECT INPUT TO STANDARD
C   PROM PROGRAMMERS.
C
C   INPUT:           PAL DESIGN SPECIFICATION ASSIGNED
C                   TO DATA SET REFERENCE NUMBER 1
C
C   OUTPUT:         FUSE PATTERN, HEX FORMAT, AND BHLF
C                   FORMAT ON DATA SET REFERENCE
C                   NUMBER 6.  COMMENTS ON DSRN 7 & 8
C
C   PART NUMBER:    THE PAL PART NUMBER MUST
C                   APPEAR IN COLUMN ONE OF LINE ONE
C
C   PIN LIST:       20 SYMBOLIC PIN NAMES MUST APPEAR
C                   STARTING ON LINE 5
C
C   EQUATIONS:      STARTING FIRST LINE AFTER THE
C                   PIN LIST IN THE FOLLOWING FORMS:
C
C                   A = B*C + D
C
C                   A := B*C + D
C
C                   IF( A*B ) C = D + E
C
C                   A2 := (A1:*:B1) + /C
C
C                   BLANKS ARE IGNORED
C
C   OPERATORS:      =      EQUALITY
C                   :=     REPLACED BY (AFTER CLOCK)
C                   /      COMPLEMENT
C                   *      AND, PRODUCT
C                   +      OR, SUM
C                   :+     EXCLUSIVE OR
C                   :*     EXCLUSIVE NOR
C                   ( )    CONDITIONAL THREE-STATE
C                   OR FIXED SYMBOL
C
C   FIXED SYMBOLS
C   FOR PAL16X4
C   AND PAL16A4
C   ONLY:           (AN+/BN)      WHERE N = 0,1,2,3
C                   (AN+BN)      FOR OUTPUT PINS
C                   (AN)         17,16,15,14, RESP
C                   (/AN+/BN)    A IS OUTPUT
C                   (/BN)       B IS INPUT
C                   (AN+:BN)
C                   (AN*/BN)
C                   (/AN+BN)
C                   (AN*:BN)
C                   (BN)
C                   (AN*BN)
C                   (/AN)
C                   (/AN*/BN)
C                   (/AN*BN)
C
C   SUBROUTINES:    INITLZ,GETSYM,INCR,MATCH,FIXSYM,
C                   TWEAK,PLOT,HEX,BHLF,MAP,SLIP
C
C   FUNCTIONS:      IXLATE
C
C   REV LEVEL:      J 1/16/80  JB,SK
C
C   FINE PRINT:     MONOLITHIC MEMORIES TAKES NO
C                   RESPONSIBILITY FOR THE OPERATION
C                   OR MAINTENANCE OF THIS PROGRAM.
C                   THE SOURCE CODE AS PRINTED HERE
C                   PRODUCED THE OBJECT CODE OF THE
C                   EXAMPLES IN THE APPLICATIONS
C                   SECTION ON A NATIONAL CSS IBM
C                   SYSTEM/370 FORTRAN IV(G).
C*****

```

PALASM Source Code

```

C   MAIN PROGRAM
C
COMMON  LBLANK, LLEFT, LAND, LOR, LSLASH, LEQUAL, LRIGHT
LOGICAL LBLANK, LLEFT, LAND, LOR, LSLASH, LEQUAL, LRIGHT, LFIRST, LFIX
LOGICAL LFUSES(32,64), LPHASE(20), LBUF(20), LMATCH
INTEGER  TITLE(80), ILINE(20), ICOLUM, ISYM(8,20), IBUF(2,20), C,H,R,P,
C       S,M,Q,IBLOW
DATA  LFUSES/2048*.FALSE./, ICOLUM/0/,L/'L'/,H/'H'/,N/'N'/,P/'P'/,
C     C/'C'/,R/'R'/,M/'M'/,Q/'Q'/,IBLOW/0/,S/'S'/
C
READ(1,10) INOAI, IOT, INOO, TITLE, ILINE
10  FORMAT(3X,I2,A1,I1,///,80A1,///,80A1)
CALL INITLZ(INOAI, IOT, INOO, ITYPE, LFUSES, ILINE, ICOLUM)
DO 20 J=1,20
20  CALL GETSYM(LPHASE, ISYM, J, ILINE, ICOLUM, LFIX)
     IF(.NOT.(LEQUAL.OR.LLEFT.OR.LAND.OR.LOR.OR.LRIGHT)) GO TO 25
     WRITE(7,23)
23  FORMAT(' PIN LIST ERROR, LESS THAN 20 SYMBOLS')
25  CALL GETSYM(LBUF, IBUF, 1, ILINE, ICOLUM, LFIX)
28  IF(.NOT.LEQUAL) GO TO 25
     CALL MATCH(IMATCH, IBUF, ISYM)
     IF( (IMATCH.LT.12) .OR. (IMATCH.GT.19) ) GO TO 100
     I88PRO=(19-IMATCH)*8 + 1
     IF( IOT.EQ.C ) I88PRO=25
     ICOLUM=0
30  CALL INCR(ILINE, ICOLUM, LFIX)
     IF( .NOT. ( LEQUAL.OR.LLEFT ) ) GO TO 30
     IF(.NOT.LLEFT) CALL SLIP(LFUSES, I88PRO, INOAI, IOT, INOO, IBLOW)
DO 70 I8PRO=1,16
     IPROD = I88PRO + I8PRO - 1
     LFIRST=.TRUE.
50  CALL GETSYM(LBUF, IBUF, 1, ILINE, ICOLUM, LFIX)
     IF(LFIX) GO TO 59
     CALL MATCH(IMATCH, IBUF, ISYM)
     IF(IMATCH.EQ.0) GO TO 100
     IF(IMATCH.EQ.99) GO TO 64
     IF(.NOT.LFIRST) GO TO 58
     LFIRST=.FALSE.
     DO 56 I=1,32
         IBLOW = IBLOW + 1
         LFUSES(I, IPROD)=.TRUE.
56
58  IBUBL=0
     IF((( LPHASE(IMATCH)).AND.(.NOT.LBUF(1))).OR.
C     ((.NOT.LPHASE(IMATCH)).AND.( LBUF(1)))) IBUBL=1
     IINPUT=IXLATE(IMATCH, ITYPE)+IBUBL
     IF(IINPUT.LE.0) GO TO 60
     IBLOW = IBLOW - 1
     LFUSES(IINPUT, IPROD)=.FALSE.
     CALL PLOT(LBUF, IBUF, LFUSES, IPROD, TITLE, .FALSE., ITYPE)
     GO TO 60
59  CALL FIXSYM(LBUF, IBUF, ILINE, ICOLUM, LFIRST, LFUSES, IPROD,
C     LFIX)
60  IF(LAND) GO TO 50
64  IF(.NOT.LRIGHT) GO TO 68
66  CALL INCR(ILINE, ICOLUM, LFIX)
     IF( .NOT.LEQUAL ) GO TO 66
68  IF(.NOT.(LOR.OR.LEQUAL) ) GO TO 74
70  CONTINUE
74  CALL GETSYM(LBUF, IBUF, 1, ILINE, ICOLUM, LFIX)
     IF(LLEFT.OR.LEQUAL) GO TO 28

```

PALASM Source Code

```

100 IF((IBUF(1,1).EQ.C).AND.(IBUF(2,1).EQ.R).AND.(IBUF(4,1).EQ.P)
C .AND.(IBUF(8,1).EQ.N)) GO TO 102
WRITE(7,101) (IBUF(I,1),I=1,8),ILINE
101 FORMAT(' ERROR SYMBOL = ',8A1,/,80A1,/)
102 IF(ITYPE.LE.4) CALL TWECK(ITYPE,IOT,LFUSES)
WRITE(7,104) IBLW
104 FORMAT(' NUMBER OF FUSES BLOWN = ',I4)
WRITE(8,106)
106 FORMAT(' OPERATION CODES: ',
C 'P=PLOT H=HEX S=SHORT L=BHLF N=BPNF M=MAP Q=QUIT')
108 WRITE(8,110)
110 FORMAT(' ENTER OPERATION CODE')
READ(5,120) IOP
120 FORMAT(1A1)
CALL IODC2
IF(IOP.EQ.P) CALL PLOT(LBUF,IBUF,LFUSES,IPROD,TITLE,.TRUE.,ITYPE)
IF(IOP.EQ.H) CALL HEX(LFUSES,H)
IF(IOP.EQ.S) CALL HEX(LFUSES,S)
IF(IOP.EQ.L) CALL BHLF(LFUSES,H,L)
IF(IOP.EQ.N) CALL BHLF(LFUSES,P,N)
IF(IOP.EQ.M) CALL MAP(LFUSES)
CALL IODC4
IF(IOP.NE.Q) GO TO 108
STOP
END

C
C*****
C
SUBROUTINE INITLZ(INOAI,IOT,INOO,ITYPE,LFUSES,ILINE,ICOLUM,LFIX)
INTEGER L,R,X,A
LOGICAL LFIX
DATA L/'L'/,R/'R'/,X/'X'/,A/'A'/
IF( INOAI .LT. 16 ) ITYPE = (INOAI/2) - 4
IF( (INOAI .EQ. 16) ) ITYPE = 4
IF( (INOAI .EQ. 16) .AND. (INOO .EQ. 8) ) ITYPE = 5
IF( (IOT .EQ. R) .OR. (IOT .EQ. A) .OR. (IOT .EQ. X) ) ITYPE = 6
CALL INCR(ILINE,ICOLUM,LFIX)
RETURN
END

C
C*****
C
SUBROUTINE GETSYM(LPHASE,ISYM,J,ILINE,ICOLUM,LFIX)
COMMON LBLANK,LLEFT,LAND,LOR,LSLASH,LEQUAL,LRIGHT
LOGICAL LBLANK,LLEFT,LAND,LOR,LSLASH,LEQUAL,LRIGHT,LPHASE(20),LFIX
INTEGER ILINE(80),ISYM(8,20),IBLANK
DATA IBLANK/' '/
LFIX=.FALSE.
IF( .NOT.(LLEFT.OR.LAND.OR.LOR.OR.LEQUAL.OR.LRIGHT) ) GO TO 10
CALL INCR(ILINE,ICOLUM,LFIX)
IF(LLEFT) GO TO 60
10 LPHASE(J)=(.NOT.LSLASH)
IF(LPHASE(J)) GO TO 15
CALL INCR(ILINE,ICOLUM,LFIX)
15 DO 20 I=1,8
20 ISYM(I,J)=IBLANK
25 DO 30 I=1,7
30 ISYM(I,J)=ISYM(I+1,J)
ISYM(8,J)=ILINE(ICOLUM)
CALL INCR(ILINE,ICOLUM,LFIX)
IF( LLEFT.OR.LBLANK.OR.LAND.OR.LOR.OR.LRIGHT.OR.LEQUAL ) GO TO 40
GO TO 25
40 CONTINUE
C WRITE(7,50) (ISYM(I,J), I=1,8)
C 50 FORMAT(' ',8A1)
RETURN
60 LFIX=.TRUE.
RETURN
END

C
C*****
C

```



PALASM Source Code

```

SUBROUTINE INCR(ILINE, ICOLUM, LFIX)
COMMON LBLANK, LLEFT, LAND, LOR, LSLASH, LEQUAL, LRIGHT
LOGICAL LBLANK, LLEFT, LAND, LOR, LSLASH, LEQUAL, LRIGHT, LFIX
INTEGER ILINE(80), IBLANK, ILEFT, IAND, IOR, ISLASH, IEQUAL, IRIGHT,
C ICOLON
DATA IBLANK/' ', ILEFT/'(', IAND/'*', IOR/'+'/,
C ISLASH/'/', IEQUAL/'=', IRIGHT/')', ICOLON/':'/
LBLANK=.FALSE.
10 ICOLUM=ICOLUM+1
IF(ICOLUM.LE.79) GO TO 30
READ(1,20,ERR=70,END=70) ILINE
ICOLUM=1
20 FORMAT(80A1)
30 IF( ILINE(ICOLUM) .EQ. IBLANK ) LBLANK=.TRUE.
C WRITE(7,50) ILINE(ICOLUM)
C 50 FORMAT(' ',1A1)
IF( ( ILINE(ICOLUM) .EQ. IBLANK ) .OR.
C ((ILINE(ICOLUM) .EQ. ICOLON) .AND. (.NOT. LFIX))) GO TO 10
LLEFT =( ILINE(ICOLUM) .EQ. ILEFT )
LAND =( ILINE(ICOLUM) .EQ. IAND )
LOR =( ILINE(ICOLUM) .EQ. IOR )
LSLASH=( ILINE(ICOLUM) .EQ. ISLASH)
LEQUAL=( ILINE(ICOLUM) .EQ. IEQUAL)
LRIGHT=( ILINE(ICOLUM) .EQ. IRIGHT)
60 RETURN
70 LBLANK=.TRUE.
RETURN
END
C
C*****
C
SUBROUTINE MATCH(IMATCH, IBUF, ISYM)
INTEGER IBUF(8,20), ISYM(8,20), C,A,R,Y
LOGICAL LMATCH
DATA C/'C'/, A/'A'/, R/'R'/, Y/'Y'/
IMATCH=0
DO 20 J=1,20
LMATCH=.TRUE.
DO 10 I=1,8
10 LMATCH=LMATCH.AND. (IBUF(I,J) .EQ. ISYM(I,J))
IF(LMATCH) IMATCH=J
CONTINUE
IF( (IBUF(3,1) .EQ. C) .AND.
C (IBUF(4,1) .EQ. A) .AND.
C (IBUF(5,1) .EQ. R) .AND.
C (IBUF(6,1) .EQ. Y) .AND.
C (IBUF(7,1) .EQ. Y) ) IMATCH=99
RETURN
END
C
C*****
C
FUNCTION IXLATE(IMATCH, ITYPE)
INTEGER ITABLE(20,6)
DATA ITABLE/
C 3, 1, 5, 9,13,17,21,25,29,-1,31,-1,-1,-1,-1,-1,-1,-1,-1,-1,-1,
C 3, 1, 5, 9,13,17,21,25,29,-1,31,27,-1,-1,-1,-1,-1,-1, 7,-1,
C 3, 1, 5, 9,13,17,21,25,29,-1,31,27,23,-1,-1,-1,-1,11, 7,-1,
C 3, 1, 5, 9,13,17,21,25,29,-1,31,27,23,19,-1,-1,15,11, 7,-1,
C 3, 1, 5, 9,13,17,21,25,29,-1,31,-1,27,23,19,15,11, 7,-1,-1,
C -1, 1, 5, 9,13,17,21,25,29,-1,-1,31,27,23,19,15,11, 7, 3,-1/
IXLATE=ITABLE(IMATCH, ITYPE)
RETURN
END
C
C*****
C

```

PALASM Source Code

```

SUBROUTINE FIXSYM(LBUF,IBUF,ILINE,ICOLUM,LFIRST,LFUSES,IPROD,LFIX)
LOGICAL LBUF(20),LFUSES(32,64),LFIRST,LMATCH,LFIX
INTEGER IBUF(8,20),ILINE(80),FIXBUF(8),A,B,ISLASH,IOR,IAND,N,Q,
C      NO,N1,N2,N3,IBLANK,IRIGHT,TABLE(5,14)
DATA A/'A'//,B/'B'//,ISLASH/'/'//,IOR/'+'//,IBLANK/' ' //,IRIGHT/' ' //,
C      IAND/'*'//,N/'N'//,Q/'Q'//,NO/'0'//,N1/'1'//,N2/'2'//,N3/'3'//,
C      ICOLON/':'//,
C      TABLE
C      /
C      'A'/'/'/'A'/'+'/'B'/' ' /'A'/'+'/'B'/' ' /
C      'A'/'+'/'B'/' ' /'A'/'+'/'B'/' ' /
C      'A'/'*'/'B'/' ' /'A'/'*'/'B'/' ' /
C      'A'/' ' /'A'/' ' /'A'/'*'/'B'/' ' /'A'/'*'/'B'/' ' /
IINPUT=0
DO 20 I=1,8
    IBUF(I,1)=IBLANK
20    FIXBUF(I)=IBLANK
21    CALL INCR(ILINE,ICOLUM,LFIX)
    I=ILINE(ICOLUM)
    IF(I.EQ.IRIGHT) GO TO 40
    IF(I.EQ.NO) IINPUT=8
    IF(I.EQ.N1) IINPUT=12
    IF(I.EQ.N2) IINPUT=16
    IF(I.EQ.N3) IINPUT=20
    DO 24 J=1,7
24      IBUF(J,1)=IBUF(J+1,1)
        IBUF(8,1)=I
        IF(.NOT. ( (I.EQ.A).OR.(I.EQ.B).OR.(I.EQ.ISLASH).OR.(I.EQ.IOR)
C          .OR.(I.EQ.IAND).OR.(I.EQ.ICOLON) ) ) GO TO 21
        DO 30 I=1,4
30          FIXBUF(I)=FIXBUF(I+1)
            FIXBUF(5)=ILINE(ICOLUM)
            GO TO 21
40    IMATCH=0
        DO 60 J=1,14
        DO 50 I=1,5
50          LMATCH=LMATCH .AND. ( FIXBUF(I).EQ.TABLE(I,J) )
60          IF(LMATCH) IMATCH=J
            IF(IMATCH.EQ.0) GO TO 100
            IF(.NOT.LFIRST) GO TO 85
            LFIRST=.FALSE.
            DO 80 I=1,32
80            LFUSES(I,IPROD)=.TRUE.
85    DO 90 I=1,4
            IF( (IMATCH-7).GT.0 ) LFUSES(IINPUT+I,IPROD)=.FALSE.
            IF( (IMATCH-7).GT.0 ) IMATCH=IMATCH-8
90    IMATCH=IMATCH+IMATCH
        LBUF(1)=.TRUE.
        CALL PLOT(LBUF,IBUF,LFUSES,IPROD,TITLE,.FALSE.,ITYPE)
100    LFIX=.FALSE.
        CALL INCR(ILINE,ICOLUM,LFIX)
        RETURN
    END
C
C*****
C
SUBROUTINE IODC2
C*** THIS ROUTINE IS OPTIONAL. IT MAY BE USED TO TURN PERIPHERALS ON.
INTEGER DC2,BEL
DATA DC2/Z12000000/,BEL/Z2F000000/
WRITE(6,10) DC2,BEL
10  FORMAT(' ',2A1)
RETURN
END
C
C*****
C

```

PALASM Source Code

```

SUBROUTINE PLOT(LBUF,IBUF,LFUSES,IPROD,TITLE,LDUMP,ITYPE)
INTEGER IBUF(8,20),IOUT(64),IBLANK,IAND,IOR,ISLASH,IDASH,X,
C      ISAVE(64,32),TITLE(80)
DATA IBLANK/' ',IAND/'*',ISAVE/2048*' ',
C      IOR/'+',ISLASH/'/',X/'X',IDASH/'-'//
LOGICAL LBUF(20),LFUSES(32,64),LDUMP
IF(LDUMP) GO TO 60
IF(ISAVE(IPROD,1).NE.IBLANK) RETURN
IF( LBUF(1) ) GO TO 5
DO 30 J=1,31
30  ISAVE(IPROD,J)=ISAVE(IPROD,J+1)
   ISAVE(IPROD,32)=ISLASH
5  DO 20 I=1,8
   IF( ISAVE(IPROD,1).NE.IBLANK ) RETURN
   IF( IBUF(I,1) .EQ. IBLANK ) GO TO 20
   DO 10 J=1,31
10  ISAVE(IPROD,J)=ISAVE(IPROD,J+1)
   ISAVE(IPROD,32)=IBUF(I,1)
20  CONTINUE
   IF(ISAVE(IPROD,1).NE.IBLANK) RETURN
40  DO 50 J=1,31
50  ISAVE(IPROD,J)=ISAVE(IPROD,J+1)
   ISAVE(IPROD,32)=IAND
   RETURN
60  WRITE(6,62) TITLE
62  FORMAT(////,' ',80A1,/,/,
C '      11 1111 1111 2222 2222 2233',/,
C '      0123 4567 8901 2345 6789 0123 4567 8901',/)
DO 100 I88PRO=1,57,8
DO 94 I8PRO=1,8
   IPROD=I88PRO+I8PRO-1
   ISAVE(IPROD,32)=IBLANK
DO 70 I=1,32
   IF( ISAVE(IPROD,1) .NE. IBLANK ) GO TO 70
DO 65 J=1,31
   ISAVE(IPROD,J)=ISAVE(IPROD,J+1)
   ISAVE(IPROD,32)=IBLANK
70  CONTINUE
DO 80 I=1,32
   IOUT(I)=X
   IF( LFUSES(I,IPROD) ) IOUT(I)=IDASH
   IOUT(I+32)=ISAVE(IPROD,I)
80  CONTINUE
   IF( ITYPE .LE. 4 ) CALL FANTOM(ITYPE,IOUT,IPROD,I8PRO)
   IPROD=IPROD-1
   WRITE(6,90) IPROD,IOUT
90  FORMAT(' ',I2,8(' ',4A1),' ',32A1)
94  CONTINUE
   WRITE(6,96)
96  FORMAT(1X)
100 CONTINUE
   WRITE(6,110)
110 FORMAT(/,
C ' LEGEND: X : FUSE NOT BLOWN (L,N,0) - : FUSE BLOWN (H,P,1)')
   IF( ITYPE.LE.4) WRITE(6,111)
111 FORMAT(
C '      0 : PHANTOM FUSE (L,N,0) O : PHANTOM FUSE (H,P,1)')
   WRITE(6,112)
112 FORMAT(////)
   RETURN
   END
C
C*****
C

```

PALASM Source Code

```

SUBROUTINE HEX(LFUSES,IOP)
LOGICAL LFUSES(32,64)
INTEGER ITEMP(64),S,H,IOP
DATA STX/Z02000000/,BEL/Z2F000000/,SOH/Z01000000/,
C H/'H'/,S/'S'/
IF(IOP.EQ.H) WRITE(6,10)
10 FORMAT(//,'
C***** NOTE: SOME PROM PROGRAMMERS NEED A START CHARACTER.
C***** THIS PROGRAM OUTPUTS AN STX FOR THE DATA I/O MODEL 9
C***** (USE SOH FOR MODEL 5)
WRITE(6,5) BEL,BEL,BEL,BEL,BEL,BEL,BEL,BEL,STX,SOH
5 FORMAT(9A1)
DO 40 I=1,33,32
INC=I-1
DO 40 IPROD=1,7,2
DO 20 J=1,2
DO 20 IINPUT=1,32
IHEX=0
IF(LFUSES(IINPUT,IPROD+J-1+0+INC)) IHEX=IHEX+1
IF(LFUSES(IINPUT,IPROD+J-1+8+INC)) IHEX=IHEX+2
IF(LFUSES(IINPUT,IPROD+J-1+16+INC)) IHEX=IHEX+4
IF(LFUSES(IINPUT,IPROD+J-1+24+INC)) IHEX=IHEX+8
20 ITEMP(IINPUT+32*(J-1))=IHEX
IF(IOP.EQ.H) WRITE(6,60) ITEMP
40 IF(IOP.EQ.S) WRITE(6,61) ITEMP
60 FORMAT(' ',32(Z1,' '),'.',/,', ',32(Z1,' '),'.')
61 FORMAT(' ',64Z1)
IF(IOP.EQ.H) WRITE(6,70)
70 FORMAT(' ',/,',
RETURN
END

C
C*****
C
SUBROUTINE BHLF(LFUSES,H,L)
LOGICAL LFUSES(32,64)
INTEGER ITEMP(4,8),L,H
WRITE(6,10)
10 FORMAT(//,'
DO 20 I=1,33,32
INC=I-1
DO 20 IPROD=1,8
DO 20 J=1,25,8
DO 15 K=1,8
IINPUT=J+K-1
ITEMP(1,K)=L
ITEMP(2,K)=L
ITEMP(3,K)=L
ITEMP(4,K)=L
IF(LFUSES(IINPUT,IPROD+0+INC)) ITEMP(4,K)=H
IF(LFUSES(IINPUT,IPROD+8+INC)) ITEMP(3,K)=H
IF(LFUSES(IINPUT,IPROD+16+INC)) ITEMP(2,K)=H
IF(LFUSES(IINPUT,IPROD+24+INC)) ITEMP(1,K)=H
15 CONTINUE
20 WRITE(6,30) ITEMP
30 FORMAT(' ',8('B',4A1,'F '))
WRITE(6,10)
RETURN
END

C
C*****
C
SUBROUTINE IODC4
C*** THIS ROUTINE IS OPTIONAL. IT MAY BE USED TO TURN PERIPHERALS OFF.
INTEGER DC3,DC4,BEL
DATA DC3/Z37000000/,DC4/Z3C000000/,PEL/Z2F000000/
WRITE(6,10) BEL,DC3,DC4
10 FORMAT(' ',3A1)
RETURN
END

C
C*****
C

```

PALASM Source Code

```

SUBROUTINE TWEAK(ITYPE,IOT,LFUSES)
INTEGER L,C
LOGICAL LFUSES(32,64)
DATA L/'L'/,C/'C'/
IF(ITYPE.GE.4) GO TO 20
DO 10 IPROD=1,64
    LFUSES(15,IPROD)=.TRUE.
    LFUSES(16,IPROD)=.TRUE.
    LFUSES(19,IPROD)=.TRUE.
    LFUSES(20,IPROD)=.TRUE.
    IF(ITYPE.GE.3) GO TO 10
    LFUSES(11,IPROD)=.TRUE.
    LFUSES(12,IPROD)=.TRUE.
    LFUSES(23,IPROD)=.TRUE.
    LFUSES(24,IPROD)=.TRUE.
    IF(ITYPE.GE.2) GO TO 10
    LFUSES( 7,IPROD)=.TRUE.
    LFUSES( 8,IPROD)=.TRUE.
    LFUSES(27,IPROD)=.TRUE.
    LFUSES(28,IPROD)=.TRUE.
10 CONTINUE
DO 18 IINPUT=7,28
    DO 12 IPROD=1,57,8
        LFUSES(IINPUT,IPROD+4)=.FALSE.
        LFUSES(IINPUT,IPROD+5)=.FALSE.
        LFUSES(IINPUT,IPROD+6)=.FALSE.
12 LFUSES(IINPUT,IPROD+7)=.FALSE.
        IF(ITYPE.GE.3) GO TO 18
        DO 14 IPROD=17,41,8
            LFUSES(IINPUT,IPROD+2)=.FALSE.
14 LFUSES(IINPUT,IPROD+3)=.FALSE.
            IF(ITYPE.GE.2) GO TO 18
            DO 16 IPROD=1,57,8
                LFUSES(IINPUT,IPROD+2)=.FALSE.
16 LFUSES(IINPUT,IPROD+3)=.FALSE.
18 CONTINUE
20 IF( (ITYPE.EQ.1) .OR. ((ITYPE.EQ.4).AND.(IOT.EQ.L)) ) GO TO 100
DO 99 IINPUT=1,32
    DO 30 IPROD=1,8
        LFUSES(IINPUT,IPROD+ 0) = (IOT.NE.L)
30 IF(IOT.NE.C) LFUSES(IINPUT,IPROD+56) = (IOT.NE.L)
        IF(ITYPE.LE.2) GO TO 99
        DO 40 IPROD=1,8
            LFUSES(IINPUT,IPROD+ 8) = (IOT.NE.L)
40 IF(IOT.NE.C) LFUSES(IINPUT,IPROD+48) = (IOT.NE.L)
        IF(ITYPE.LE.3) GO TO 99
        DO 50 IPROD=1,8
            LFUSES(IINPUT,IPROD+16) = (IOT.NE.L)
50 IF(IOT.NE.C) LFUSES(IINPUT,IPROD+40) = (IOT.NE.L)
99 CONTINUE
100 RETURN
END
C
C*****
C
SUBROUTINE SLIP(LFUSES,I88PRO,INOAI,IOT,INOO,IBLOW)
LOGICAL LFUSES(32,64)
INTEGER R
DATA R/'R'/
IF( (INOAI.LT.16) .OR. (INOO.LT.4) .OR.
C ( (IOT.EQ.R).AND.(INOO.EQ.8) ) .OR.
C ( (I88PRO.GE. 9).AND.(I88PRO.LE.49).AND.(INOO.EQ.6) ) .OR.
C ( (I88PRO.GE.17).AND.(I88PRO.LE.41).AND.(INOO.EQ.4) ) ) RETURN
DO 10 I=1,32
    IBLOW = IBLOW + 1
10 LFUSES(I,I88PRO) = .TRUE.
    I88PRO = I88PRO + 1
RETURN
END
C
C*****
C

```

PALASM Source Code

```

SUBROUTINE MAP(LFUSES)
LOGICAL LFUSES(32,64)
INTEGER X,D,ILINE(16),ITABLE(32)
DATA X/'X'/,D/'-'/,
C ITABLE/17,16,19,18,21,20,23,22,25,24,27,26,29,28,31,30,
C 13,12,15,14, 9, 8,11,10, 5, 4, 7, 6, 1, 0, 3, 2/
WRITE(6,10)
10 FORMAT(
      '          INPUT',/,/,
      '          11 11 22 22 22 22 22 33',/,/,
      '          76 98 10 32 54 76 98 10',/,/,
      '          11 11 11 11',/,/,
      ' PRODUCT 32 54 98 10 54 76 10 32',/,/)
IPROD=7
IDELTA = -1
DO 50 I=1,2
  DO 40 J=1,4
    DO 30 K=1,4
      DO 20 L=1,16
        ILINE(L)=X
        IF( LFUSES(ITABLE(L)+1 ,IPROD+1 ) ) ILINE(L)=D
20      WRITE(6,21) IPROD,ILINE
21      FORMAT(' ',I2,' ',8(2A1,' '))
        DO 22 L=1,16
          ILINE(L)=X
          IF( LFUSES(ITABLE(L+16)+1 ,IPROD+1 ) ) ILINE(L)=D
22      WRITE(6,21) IPROD,ILINE
          IPROD = IPROD + IDELTA
          DO 23 L=1,16
            ILINE(L)=X
            IF( LFUSES(ITABLE(L+16)+1 ,IPROD+1 ) ) ILINE(L)=D
23      WRITE(6,21) IPROD,ILINE
          DO 24 L=1,16
            ILINE(L)=X
            IF( LFUSES(ITABLE(L)+1 ,IPROD+1 ) ) ILINE(L)=D
24      WRITE(6,21) IPROD,ILINE
          IPROD = IPROD + IDELTA
30      WRITE(6,29)
29      FORMAT(' ')
40      IPROD = IPROD + 8*(1-IDELTA)
50      IPROD = 32
        IDELTA = +1
        WRITE(6,29)
        WRITE(6,29)
        RETURN
        END
C
C*****
C
SUBROUTINE FANTOM(ITYPE,IOUT,IPROD,I8PRO)
INTEGER ITYPE,IOUT(64),IPROD,I8PRO,X,IDASH,FX,FIDASH
DATA X/'X'/,IDASH/'-'/,FX/'0'/,FIDASH/'O'/'
DO 10 I=1,32
  IF( IOUT(I).EQ.X ) IOUT(I)=FX
10  IF( IOUT(I).EQ.IDASH ) IOUT(I)=FIDASH
  IF((ITYPE.EQ.4).AND.((IPROD.LE.24).OR.(IPROD.GE.41))) GO TO 100
  IF((ITYPE.EQ.3).AND.((IPROD.LE.16).OR.(IPROD.GE.45))) GO TO 100
  IF((ITYPE.EQ.2).AND.((IPROD.LE. 8).OR.(IPROD.GE.53))) GO TO 100
  IF((ITYPE.LE.3).AND.(I8PRO.GE.5)) GO TO 100
  IF((ITYPE.LE.2).AND.(IPROD.GE.19).AND.(IPROD.LE.48).AND.
C (I8PRO.GE.3)) GO TO 100
  IF((ITYPE.EQ.1).AND.(I8PRO.GE.3)) GO TO 100
  DO 50 I=1,32
    IF(((I.EQ.15).OR.(I.EQ.16).OR.(I.EQ.19).OR.(I.EQ.20)).AND.
C (ITYPE.LE.3)) GO TO 50
    IF(((I.EQ.11).OR.(I.EQ.12).OR.(I.EQ.23).OR.(I.EQ.24)).AND.
C (ITYPE.LE.2)) GO TO 50
    IF(((I.EQ. 7).OR.(I.EQ. 8).OR.(I.EQ.27).OR.(I.EQ.28)).AND.
C (ITYPE.LE.1)) GO TO 50
    IF(IOUT(I).EQ.FX ) IOUT(I)=X
    IF(IOUT(I).EQ.FIDASH) IOUT(I)=IDASH
50 CONTINUE
100 RETURN
END
C
C*****
C

```















## MANUAL CODING

### Logic Diagrams

The phantom fuse locations are shown on pages 6-48 thru 6-65. Note that the input and product terms that were missing in the logic diagrams of previous section on pages 6-14 thru 6-22 are now being shown as phantom fuse locations. These locations are filled in according to the Table 1 on page 6-30.

The remaining locations are the nodes where fuses are intact. Fuses left intact are indicated by an "X" at the intersection of the input line and the product term. A blown fuse is not marked. The PAL logic diagrams are provided with no fuses marked, allowing a designer to put an "X" on the nodes where a fuse is to remain intact and leave the other nodes blank.

Once the logic diagram is completed, this information must be transferred to the programming format. Each fuse node is identified by a product line number and an input line number which are used to locate the corresponding square in the PAL programming format.

The following legend is being used:

Logic Diagram	Programming format
✱	L, N, O
+	H, P, 1
⊕	Phantom Fuse Location (H, P, 1)
●	Phantom Fuse Location (L, N, O)

### Programming Format:

The programming format is designed such that it is compatible with standard PROM programmer format for 512x4 (2048-bit) PROM. Words addresses are in HEX since most of the PROM programmers use HEX addresses. A table which contains HEX to decimal conversion is also provided on page 6-75. Referring to page 6-49 note that the input lines go from left to right and are in sequence. The product terms go from top to bottom and are not in sequence and are scrambled. This is because, to form one 4-bit word, we need four different product terms on the same input line. A word is read from top to bottom and consists of four product terms on one input line. The top bit is most significant (MSB) and the bottom bit is least significant (LSB).

### EXAMPLE

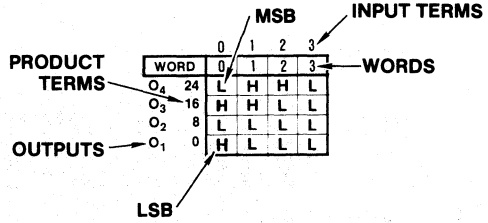

WORD	0	:	LHLH
WORD	1	:	HHLL
WORD	2	:	HLLL
WORD	3	:	LLLL

As in the case of logic diagrams, the programming format for the first nine PALs are filled with an 'H' or an 'L' representing the phantom fuse locations. The remaining blank squares are to be filled by the designer. If one decides to use a programming format other than BHLF, then 'H' and 'L' will have to be converted into the equivalent format. (e.g., if one decides to use BPNF format, then 'H' has to be replaced by 'P' and 'L' has to be replaced by 'N' on the programming format). Logic diagrams and the programming formats for all different options are shown on pages 6-48 thru 6-73.

The most common PROM programmer input medium is paper tape, with BHLF, BPNF or HEXADECIMAL format. Information regarding generation of paper tape and different formats are described on page 6-74.

INPUTS (0-31)

PRODUCT TERMS (0-63)

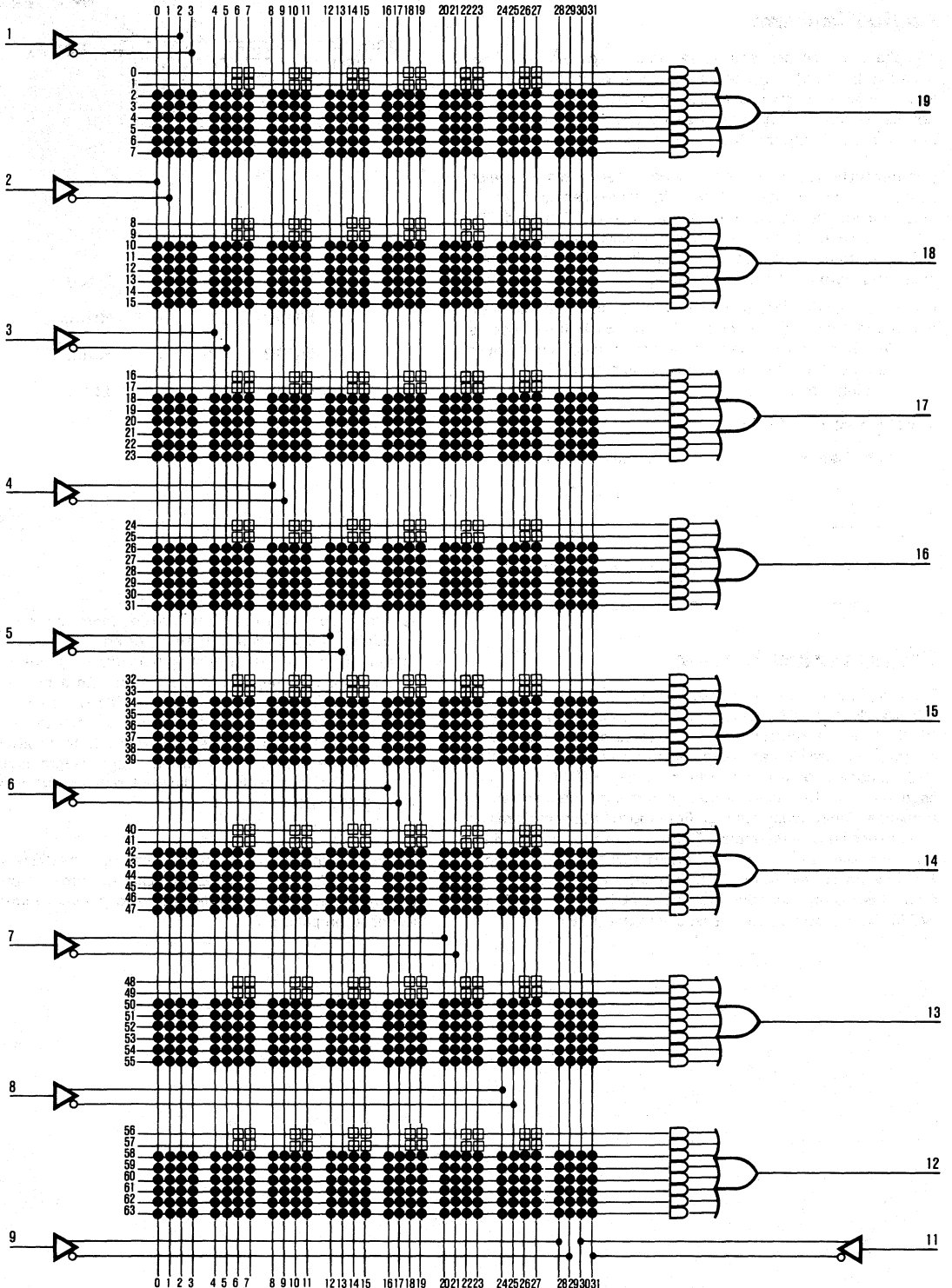

LEGEND:

● : Phantom Fuse (L, N, 0)

□ : Phantom Fuse (H, P, 1)

n.u. — not used





**INPUTS (0-31)**

	0	1	2	3	4	5	6	7	8	9	10	11	12	13	14	15	16	17	18	19	20	21	22	23	24	25	26	27	28	29	30	31						
<b>WORD</b>	0	1	2	3	4	5	6	7	8	9	A	B	C	D	E	F	10	11	12	13	14	15	16	17	18	19	1A	1B	1C	1D	1E	1F						
O <sub>4</sub>	24										H	H			H	H			H	H			H	H														
O <sub>3</sub>	16										H	H			H	H			H	H			H	H														
O <sub>2</sub>	8										H	H			H	H			H	H			H	H														
O <sub>1</sub>	0	H	H	H	H	H	H	H	H	H	H	H	H	H	H	H	H	H	H	H	H	H	H	H	H	H	H	H	H	H	H	H						
<b>WORD</b>	20	21	22	23	24	25	26	27	28	29	2A	2B	2C	2D	2E	2F	30	31	32	33	34	35	36	37	38	39	3A	3B	3C	3D	3E	3F						
O <sub>4</sub>	25										H	H			H	H			H	H			H	H														
O <sub>3</sub>	17										H	H			H	H			H	H			H	H														
O <sub>2</sub>	9										H	H			H	H			H	H			H	H														
O <sub>1</sub>	1	H	H	H	H	H	H	H	H	H	H	H	H	H	H	H	H	H	H	H	H	H	H	H	H	H	H	H	H	H	H	H						
<b>WORD</b>	40	41	42	43	44	45	46	47	48	49	4A	4B	4C	4D	4E	4F	50	51	52	53	54	55	56	57	58	59	5A	5B	5C	5D	5E	5F						
O <sub>4</sub>	26	L	L	L	L	L	L	L	L	L	L	L	L	L	L	L	L	L	L	L	L	L	L	L	L	L	L	L	L	L	L	L						
O <sub>3</sub>	18	L	L	L	L	L	L	L	L	L	L	L	L	L	L	L	L	L	L	L	L	L	L	L	L	L	L	L	L	L	L	L						
O <sub>2</sub>	10	L	L	L	L	L	L	L	L	L	L	L	L	L	L	L	L	L	L	L	L	L	L	L	L	L	L	L	L	L	L	L						
O <sub>1</sub>	2	H	H	H	H	H	H	H	H	H	H	H	H	H	H	H	H	H	H	H	H	H	H	H	H	H	H	H	H	H	H	H						
<b>WORD</b>	60	61	62	63	64	65	66	67	68	69	6A	6B	6C	6D	6E	6F	70	71	72	73	74	75	76	77	78	79	7A	7B	7C	7D	7E	7F						
O <sub>4</sub>	27	L	L	L	L	L	L	L	L	L	L	L	L	L	L	L	L	L	L	L	L	L	L	L	L	L	L	L	L	L	L	L						
O <sub>3</sub>	19	L	L	L	L	L	L	L	L	L	L	L	L	L	L	L	L	L	L	L	L	L	L	L	L	L	L	L	L	L	L	L	L					
O <sub>2</sub>	11	L	L	L	L	L	L	L	L	L	L	L	L	L	L	L	L	L	L	L	L	L	L	L	L	L	L	L	L	L	L	L	L					
O <sub>1</sub>	3	H	H	H	H	H	H	H	H	H	H	H	H	H	H	H	H	H	H	H	H	H	H	H	H	H	H	H	H	H	H	H	H					
<b>WORD</b>	80	81	82	83	84	85	86	87	88	89	8A	8B	8C	8D	8E	8F	90	91	92	93	94	95	96	97	98	99	9A	9B	9C	9D	9E	9F						
O <sub>4</sub>	28	L	L	L	L	L	L	L	L	L	L	L	L	L	L	L	L	L	L	L	L	L	L	L	L	L	L	L	L	L	L	L	L					
O <sub>3</sub>	20	L	L	L	L	L	L	L	L	L	L	L	L	L	L	L	L	L	L	L	L	L	L	L	L	L	L	L	L	L	L	L	L	L				
O <sub>2</sub>	12	L	L	L	L	L	L	L	L	L	L	L	L	L	L	L	L	L	L	L	L	L	L	L	L	L	L	L	L	L	L	L	L	L				
O <sub>1</sub>	4	H	H	H	H	H	H	H	H	H	H	H	H	H	H	H	H	H	H	H	H	H	H	H	H	H	H	H	H	H	H	H	H	H				
<b>WORD</b>	AD	A1	A2	A3	A4	A5	A6	A7	A8	A9	AA	AB	AC	AD	AE	AF	80	81	82	83	84	85	86	87	88	89	8A	8B	8C	8D	8E	8F						
O <sub>4</sub>	29	L	L	L	L	L	L	L	L	L	L	L	L	L	L	L	L	L	L	L	L	L	L	L	L	L	L	L	L	L	L	L	L	L				
O <sub>3</sub>	21	L	L	L	L	L	L	L	L	L	L	L	L	L	L	L	L	L	L	L	L	L	L	L	L	L	L	L	L	L	L	L	L	L	L			
O <sub>2</sub>	13	L	L	L	L	L	L	L	L	L	L	L	L	L	L	L	L	L	L	L	L	L	L	L	L	L	L	L	L	L	L	L	L	L	L			
O <sub>1</sub>	5	H	H	H	H	H	H	H	H	H	H	H	H	H	H	H	H	H	H	H	H	H	H	H	H	H	H	H	H	H	H	H	H	H	H			
<b>WORD</b>	CD	C1	C2	C3	C4	C5	C6	C7	C8	C9	CA	CB	CC	CD	CE	CF	DD	D1	D2	D3	D4	D5	D6	D7	D8	D9	DA	DB	DC	DD	DE	DF						
O <sub>4</sub>	30	L	L	L	L	L	L	L	L	L	L	L	L	L	L	L	L	L	L	L	L	L	L	L	L	L	L	L	L	L	L	L	L	L	L			
O <sub>3</sub>	22	L	L	L	L	L	L	L	L	L	L	L	L	L	L	L	L	L	L	L	L	L	L	L	L	L	L	L	L	L	L	L	L	L	L	L		
O <sub>2</sub>	14	L	L	L	L	L	L	L	L	L	L	L	L	L	L	L	L	L	L	L	L	L	L	L	L	L	L	L	L	L	L	L	L	L	L	L		
O <sub>1</sub>	6	H	H	H	H	H	H	H	H	H	H	H	H	H	H	H	H	H	H	H	H	H	H	H	H	H	H	H	H	H	H	H	H	H	H	H		
<b>WORD</b>	ED	E1	E2	E3	E4	E5	E6	E7	E8	E9	EA	EB	EC	ED	EE	EF	FO	F1	F2	F3	F4	F5	F6	F7	F8	F9	FA	FB	FC	FD	FE	FF						
O <sub>4</sub>	31	L	L	L	L	L	L	L	L	L	L	L	L	L	L	L	L	L	L	L	L	L	L	L	L	L	L	L	L	L	L	L	L	L	L	L		
O <sub>3</sub>	23	L	L	L	L	L	L	L	L	L	L	L	L	L	L	L	L	L	L	L	L	L	L	L	L	L	L	L	L	L	L	L	L	L	L	L	L	
O <sub>2</sub>	15	L	L	L	L	L	L	L	L	L	L	L	L	L	L	L	L	L	L	L	L	L	L	L	L	L	L	L	L	L	L	L	L	L	L	L	L	
O <sub>1</sub>	7	H	H	H	H	H	H	H	H	H	H	H	H	H	H	H	H	H	H	H	H	H	H	H	H	H	H	H	H	H	H	H	H	H	H	H	H	
<b>WORD</b>	100	101	102	103	104	105	106	107	108	109	10A	10B	10C	10D	10E	10F	110	111	112	113	114	115	116	117	118	119	11A	11B	11C	11D	11E	11F						
O <sub>4</sub>	56	H	H	H	H	H	H	H	H	H	H	H	H	H	H	H	H	H	H	H	H	H	H	H	H	H	H	H	H	H	H	H	H	H	H	H	H	
O <sub>3</sub>	48																																					
O <sub>2</sub>	40																																					
O <sub>1</sub>	32																																					
<b>WORD</b>	120	121	122	123	124	125	126	127	128	129	12A	12B	12C	12D	12E	12F	130	131	132	133	134	135	136	137	138	139	13A	13B	13C	13D	13E	13F						
O <sub>4</sub>	57	H	H	H	H	H	H	H	H	H	H	H	H	H	H	H	H	H	H	H	H	H	H	H	H	H	H	H	H	H	H	H	H	H	H	H	H	
O <sub>3</sub>	49																																					
O <sub>2</sub>	41																																					
O <sub>1</sub>	33																																					
<b>WORD</b>	140	141	142	143	144	145	146	147	148	149	14A	14B	14C	14D	14E	14F	150	151	152	153	154	155	156	157	158	159	15A	15B	15C	15D	15E	15F						
O <sub>4</sub>	58	H	H	H	H	H	H	H	H	H	H	H	H	H	H	H	H	H	H	H	H	H	H	H	H	H	H	H	H	H	H	H	H	H	H	H	H	
O <sub>3</sub>	50																																					
O <sub>2</sub>	42	L	L	L	L	L	L	L	L	L	L	L	L	L	L	L	L	L	L	L	L	L	L	L	L	L	L	L	L	L	L	L	L	L	L	L	L	
O <sub>1</sub>	34	L	L	L	L	L	L	L	L	L	L	L	L	L	L	L	L	L	L	L	L	L	L	L	L	L	L	L	L	L	L	L	L	L	L	L	L	L
<b>WORD</b>	160	161	162	163	164	165	166	167	168	169	16A	16B	16C	16D	16E	16F	170	171	172	173	174	175	176	177	178	179	17A	17B	17C	17D	17E	17F						
O <sub>4</sub>	59	H	H	H	H	H	H	H	H	H	H	H	H	H	H	H	H	H	H	H	H	H	H	H	H	H	H	H	H	H	H	H	H	H	H	H	H	H
O <sub>3</sub>	51																																					
O <sub>2</sub>	43	L	L	L	L	L	L	L	L	L	L	L	L	L	L	L	L	L	L	L	L	L	L	L	L	L	L	L	L	L	L	L	L	L	L	L	L	
O <sub>1</sub>	35	L	L	L	L	L	L	L	L	L	L	L	L	L	L	L	L	L	L	L	L	L	L	L	L	L	L	L	L	L	L	L	L	L	L	L	L	L
<b>WORD</b>	180	181	18																																			



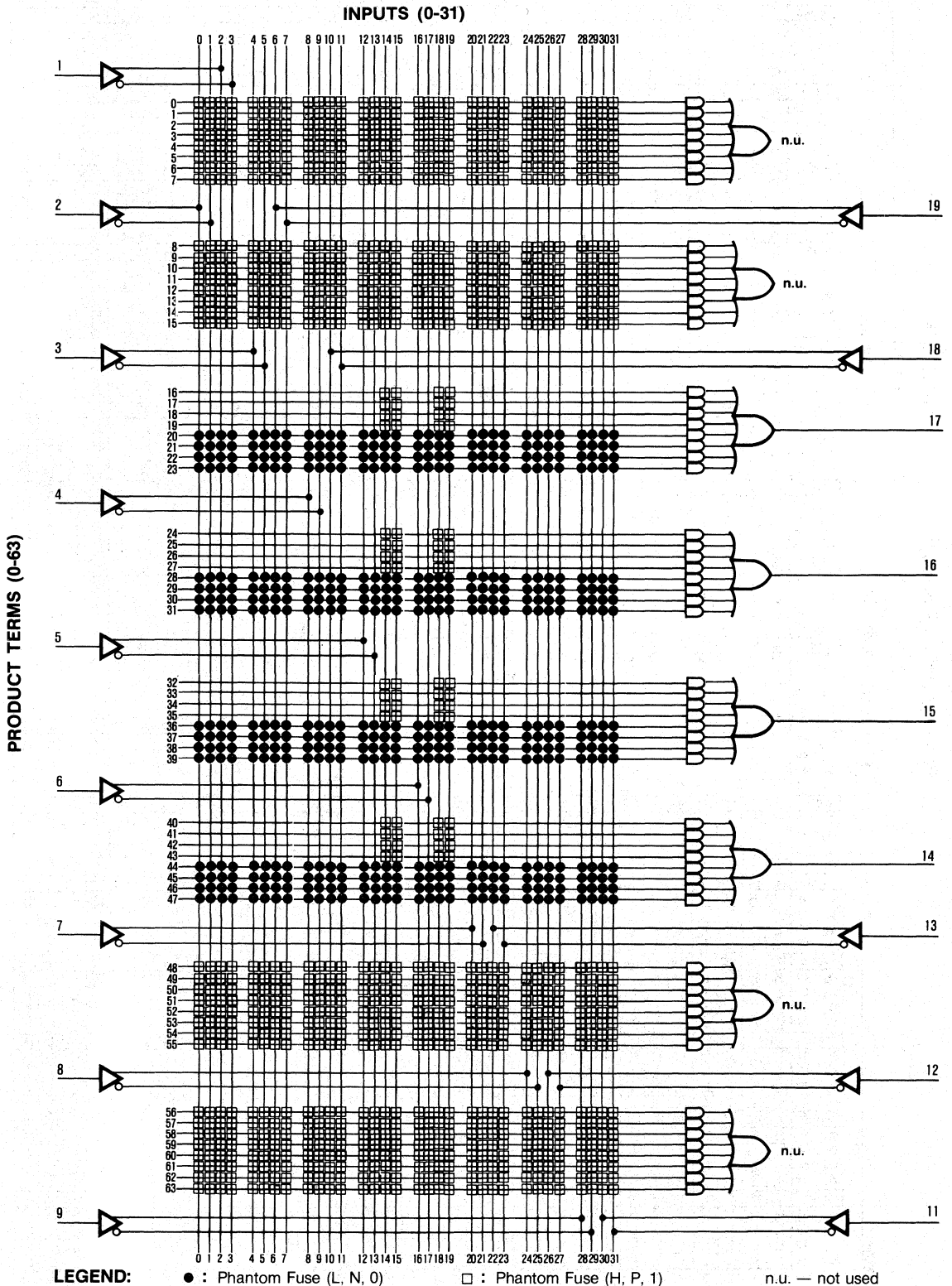



INPUTS (0-31)

PRODUCT TERMS (0-63)

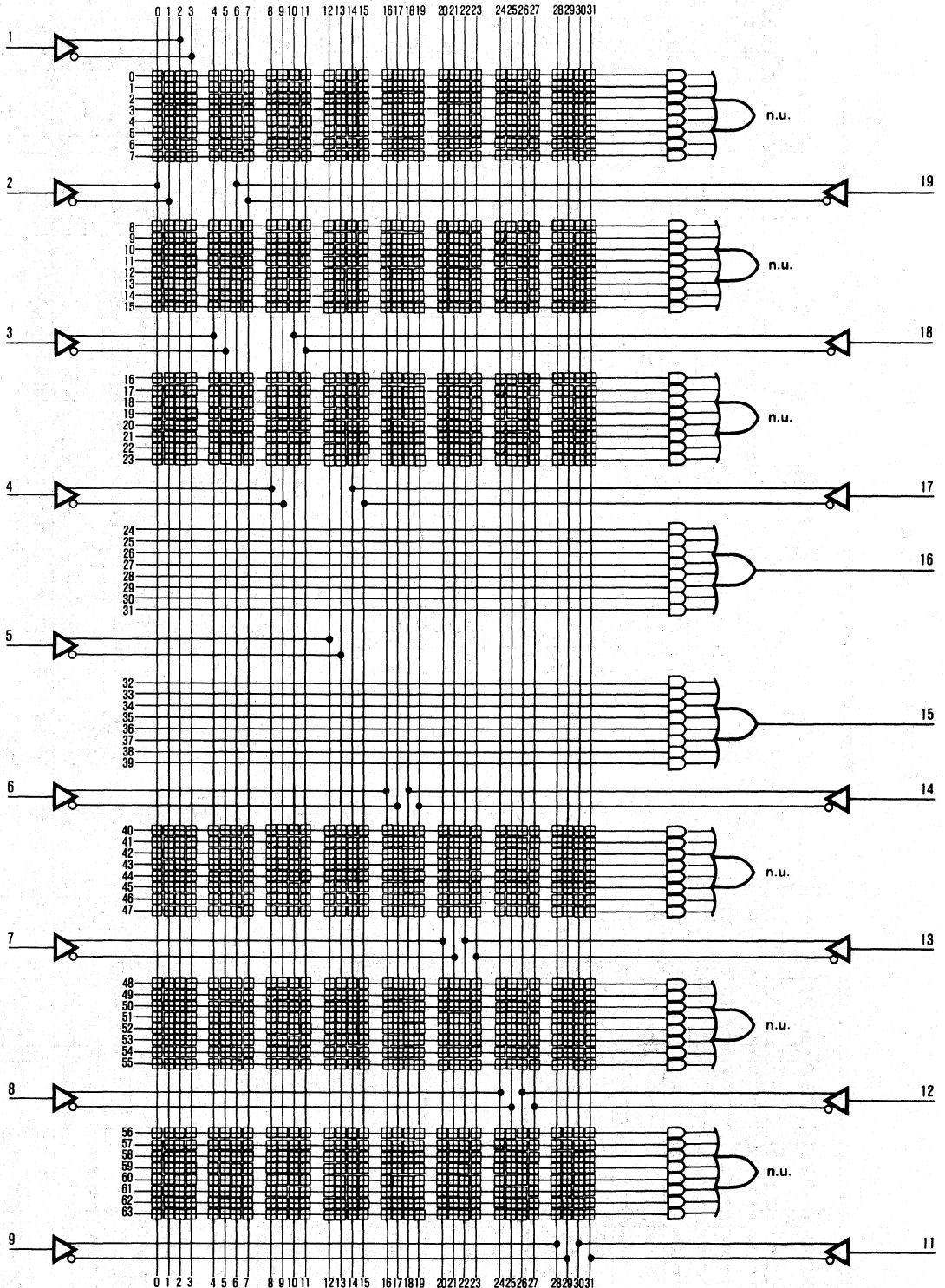

LEGEND:

● : Phantom Fuse (L, N, 0)

□ : Phantom Fuse (H, P, 1)

n.u. — not used

Programming Format

PAL16H2

PATTERN:

NAME:

PRODUCT TERMS (0-63)

DATE:

INPUTS (0-31)

	0	1	2	3	4	5	6	7	8	9	10	11	12	13	14	15	16	17	18	19	20	21	22	23	24	25	26	27	28	29	30	31			
WORD	0	1	2	3	4	5	6	7	8	9	A	B	C	D	E	F	10	11	12	13	14	15	16	17	18	19	1A	1B	1C	1D	1E	1F			
O <sub>4</sub>	24																																		
O <sub>3</sub>	16	H	H	H	H	H	H	H	H	H	H	H	H	H	H	H	H	H	H	H	H	H	H	H	H	H	H	H	H	H	H	H	H	H	
O <sub>2</sub>	8	H	H	H	H	H	H	H	H	H	H	H	H	H	H	H	H	H	H	H	H	H	H	H	H	H	H	H	H	H	H	H	H	H	
O <sub>1</sub>	0	H	H	H	H	H	H	H	H	H	H	H	H	H	H	H	H	H	H	H	H	H	H	H	H	H	H	H	H	H	H	H	H	H	
WORD	20	21	22	23	24	25	26	27	28	29	2A	2B	2C	2D	2E	2F	30	31	32	33	34	35	36	37	38	39	3A	3B	3C	3D	3E	3F			
O <sub>4</sub>	25																																		
O <sub>3</sub>	17	H	H	H	H	H	H	H	H	H	H	H	H	H	H	H	H	H	H	H	H	H	H	H	H	H	H	H	H	H	H	H	H	H	
O <sub>2</sub>	9	H	H	H	H	H	H	H	H	H	H	H	H	H	H	H	H	H	H	H	H	H	H	H	H	H	H	H	H	H	H	H	H	H	
O <sub>1</sub>	1	H	H	H	H	H	H	H	H	H	H	H	H	H	H	H	H	H	H	H	H	H	H	H	H	H	H	H	H	H	H	H	H	H	
WORD	40	41	42	43	44	45	46	47	48	49	4A	4B	4C	4D	4E	4F	50	51	52	53	54	55	56	57	58	59	5A	5B	5C	5D	5E	5F			
O <sub>4</sub>	26																																		
O <sub>3</sub>	18	H	H	H	H	H	H	H	H	H	H	H	H	H	H	H	H	H	H	H	H	H	H	H	H	H	H	H	H	H	H	H	H	H	
O <sub>2</sub>	10	H	H	H	H	H	H	H	H	H	H	H	H	H	H	H	H	H	H	H	H	H	H	H	H	H	H	H	H	H	H	H	H	H	
O <sub>1</sub>	2	H	H	H	H	H	H	H	H	H	H	H	H	H	H	H	H	H	H	H	H	H	H	H	H	H	H	H	H	H	H	H	H	H	
WORD	60	61	62	63	64	65	66	67	68	69	6A	6B	6C	6D	6E	6F	70	71	72	73	74	75	76	77	78	79	7A	7B	7C	7D	7E	7F			
O <sub>4</sub>	27																																		
O <sub>3</sub>	19	H	H	H	H	H	H	H	H	H	H	H	H	H	H	H	H	H	H	H	H	H	H	H	H	H	H	H	H	H	H	H	H	H	
O <sub>2</sub>	11	H	H	H	H	H	H	H	H	H	H	H	H	H	H	H	H	H	H	H	H	H	H	H	H	H	H	H	H	H	H	H	H	H	
O <sub>1</sub>	3	H	H	H	H	H	H	H	H	H	H	H	H	H	H	H	H	H	H	H	H	H	H	H	H	H	H	H	H	H	H	H	H	H	
WORD	80	81	82	83	84	85	86	87	88	89	8A	8B	8C	8D	8E	8F	90	91	92	93	94	95	96	97	98	99	9A	9B	9C	9D	9E	9F			
O <sub>4</sub>	28																																		
O <sub>3</sub>	20	H	H	H	H	H	H	H	H	H	H	H	H	H	H	H	H	H	H	H	H	H	H	H	H	H	H	H	H	H	H	H	H	H	
O <sub>2</sub>	12	H	H	H	H	H	H	H	H	H	H	H	H	H	H	H	H	H	H	H	H	H	H	H	H	H	H	H	H	H	H	H	H	H	
O <sub>1</sub>	4	H	H	H	H	H	H	H	H	H	H	H	H	H	H	H	H	H	H	H	H	H	H	H	H	H	H	H	H	H	H	H	H	H	
WORD	A0	A1	A2	A3	A4	A5	A6	A7	A8	A9	AA	AB	AC	AD	AE	AF	B0	B1	B2	B3	B4	B5	B6	B7	B8	B9	BA	BB	BC	BD	BE	BF			
O <sub>4</sub>	29																																		
O <sub>3</sub>	21	H	H	H	H	H	H	H	H	H	H	H	H	H	H	H	H	H	H	H	H	H	H	H	H	H	H	H	H	H	H	H	H	H	
O <sub>2</sub>	13	H	H	H	H	H	H	H	H	H	H	H	H	H	H	H	H	H	H	H	H	H	H	H	H	H	H	H	H	H	H	H	H	H	
O <sub>1</sub>	5	H	H	H	H	H	H	H	H	H	H	H	H	H	H	H	H	H	H	H	H	H	H	H	H	H	H	H	H	H	H	H	H	H	
WORD	C0	C1	C2	C3	C4	C5	C6	C7	C8	C9	CA	CB	CC	CD	CE	CF	D0	D1	D2	D3	D4	D5	D6	D7	D8	D9	DA	DB	DC	DD	DE	DF			
O <sub>4</sub>	30																																		
O <sub>3</sub>	22	H	H	H	H	H	H	H	H	H	H	H	H	H	H	H	H	H	H	H	H	H	H	H	H	H	H	H	H	H	H	H	H	H	
O <sub>2</sub>	14	H	H	H	H	H	H	H	H	H	H	H	H	H	H	H	H	H	H	H	H	H	H	H	H	H	H	H	H	H	H	H	H	H	
O <sub>1</sub>	6	H	H	H	H	H	H	H	H	H	H	H	H	H	H	H	H	H	H	H	H	H	H	H	H	H	H	H	H	H	H	H	H	H	
WORD	E0	E1	E2	E3	E4	E5	E6	E7	E8	E9	EA	EB	EC	ED	EE	EF	F0	F1	F2	F3	F4	F5	F6	F7	F8	F9	FA	FB	FC	FD	FE	FF			
O <sub>4</sub>	31																																		
O <sub>3</sub>	23	H	H	H	H	H	H	H	H	H	H	H	H	H	H	H	H	H	H	H	H	H	H	H	H	H	H	H	H	H	H	H	H	H	
O <sub>2</sub>	15	H	H	H	H	H	H	H	H	H	H	H	H	H	H	H	H	H	H	H	H	H	H	H	H	H	H	H	H	H	H	H	H	H	
O <sub>1</sub>	7	H	H	H	H	H	H	H	H	H	H	H	H	H	H	H	H	H	H	H	H	H	H	H	H	H	H	H	H	H	H	H	H	H	
WORD	100	101	102	103	104	105	106	107	108	109	10A	10B	10C	10D	10E	10F	110	111	112	113	114	115	116	117	118	119	11A	11B	11C	11D	11E	11F			
O <sub>4</sub>	56	H	H	H	H	H	H	H	H	H	H	H	H	H	H	H	H	H	H	H	H	H	H	H	H	H	H	H	H	H	H	H	H	H	
O <sub>3</sub>	48	H	H	H	H	H	H	H	H	H	H	H	H	H	H	H	H	H	H	H	H	H	H	H	H	H	H	H	H	H	H	H	H	H	
O <sub>2</sub>	40	H	H	H	H	H	H	H	H	H	H	H	H	H	H	H	H	H	H	H	H	H	H	H	H	H	H	H	H	H	H	H	H	H	
O <sub>1</sub>	32	H	H	H	H	H	H	H	H	H	H	H	H	H	H	H	H	H	H	H	H	H	H	H	H	H	H	H	H	H	H	H	H	H	
WORD	120	121	122	123	124	125	126	127	128	129	12A	12B	12C	12D	12E	12F	130	131	132	133	134	135	136	137	138	139	13A	13B	13C	13D	13E	13F			
O <sub>4</sub>	57	H	H	H	H	H	H	H	H	H	H	H	H	H	H	H	H	H	H	H	H	H	H	H	H	H	H	H	H	H	H	H	H	H	
O <sub>3</sub>	49	H	H	H	H	H	H	H	H	H	H	H	H	H	H	H	H	H	H	H	H	H	H	H	H	H	H	H	H	H	H	H	H	H	
O <sub>2</sub>	41	H	H	H	H	H	H	H	H	H	H	H	H	H	H	H	H	H	H	H	H	H	H	H	H	H	H	H	H	H	H	H	H	H	
O <sub>1</sub>	33	H	H	H	H	H	H	H	H	H	H	H	H	H	H	H	H	H	H	H	H	H	H	H	H	H	H	H	H	H	H	H	H	H	
WORD	140	141	142	143	144	145	146	147	148	149	14A	14B	14C	14D	14E	14F	150	151	152	153	154	155	156	157	158	159	15A	15B	15C	15D	15E	15F			
O <sub>4</sub>	58	H	H	H	H	H	H	H	H	H	H	H	H	H	H	H	H	H	H	H	H	H	H	H	H	H	H	H	H	H	H	H	H	H	
O <sub>3</sub>	50	H	H	H	H	H	H	H	H	H	H	H	H	H	H	H	H	H	H	H	H	H	H	H	H	H	H	H	H	H	H	H	H	H	
O <sub>2</sub>	42	H	H	H	H	H	H	H	H	H	H	H	H	H	H	H	H	H	H	H	H	H	H	H	H	H	H	H	H	H	H	H	H	H	
O <sub>1</sub>	34	H	H	H	H	H	H	H	H	H	H	H	H	H	H	H	H	H	H	H	H	H	H	H	H	H	H	H	H	H	H	H	H	H	
WORD	160	161	162	163	164	165	166	167	168	169	16A	16B	16C	16D	16E	16F	170	171	172	173	174	175	176	177	178	179	17A	17B	17C	17D	17E	17F			
O <sub>4</sub>	59	H	H	H	H	H	H	H	H	H	H	H	H	H	H	H	H	H	H	H	H	H	H	H	H	H	H	H	H	H	H	H	H	H	
O <sub>3</sub>	51	H	H	H	H	H	H	H	H	H	H	H	H	H	H	H	H	H	H	H	H	H	H	H	H	H	H	H	H	H	H	H	H	H	
O <sub>2</sub>	43	H	H	H	H	H	H	H	H	H	H	H	H	H	H	H	H	H	H	H	H	H	H	H	H	H	H	H	H	H	H	H	H	H	
O <sub>1</sub>	35	H	H	H	H	H	H	H	H	H	H	H	H	H	H	H	H	H	H	H	H	H	H	H	H	H	H	H	H	H	H	H	H	H	
WORD	180	181	182	183	184	185	186	187	188	189	18A	18B	18C	18D	18E	18F	190	191	192	193	194	195	196	197	198	199	19A	19B	19C						

INPUTS (0-31)

PRODUCT TERMS (0-63)

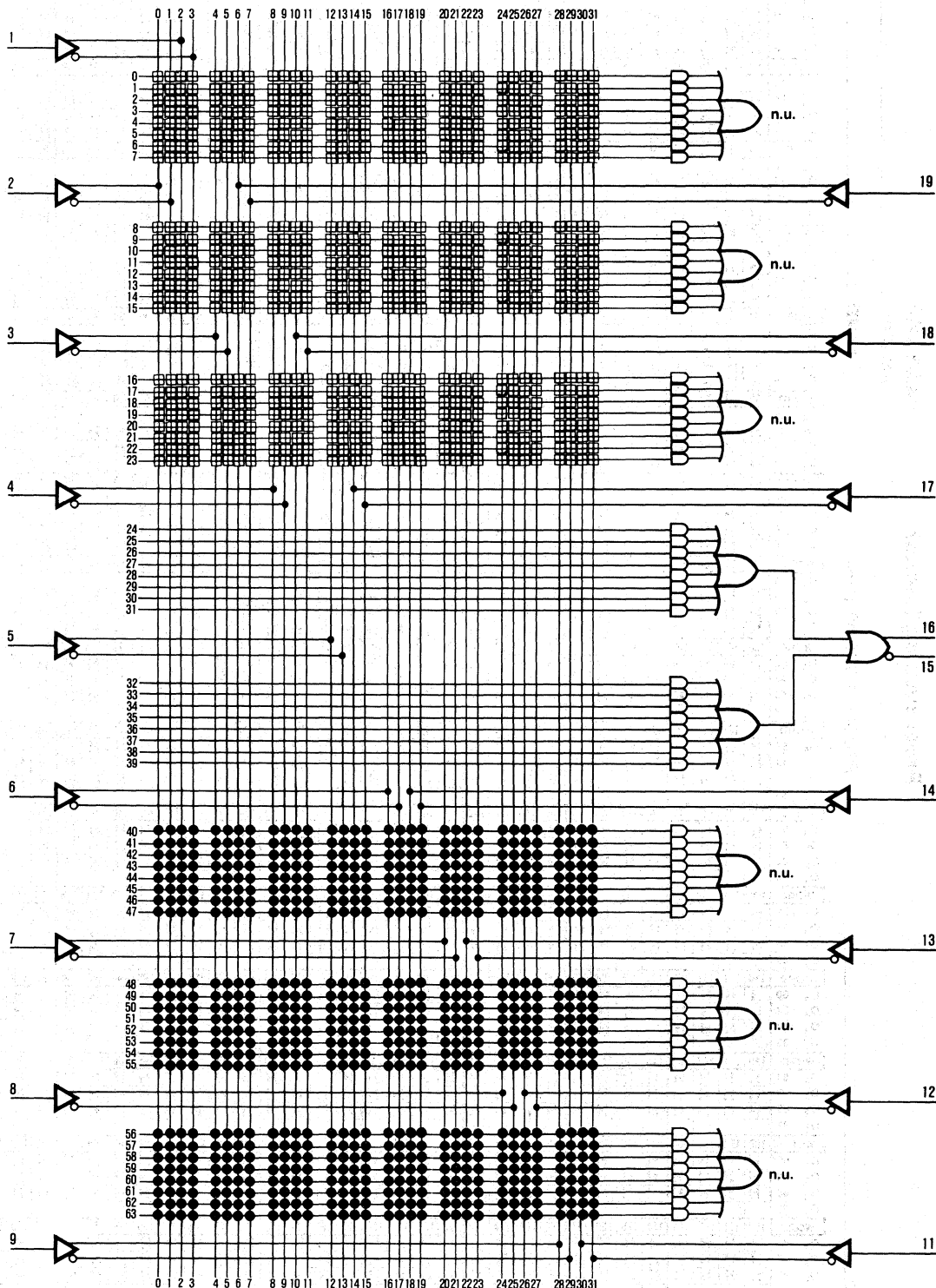

LEGEND:

● : Phantom Fuse (L, N, 0)

□ : Phantom Fuse (H, P, 1)

n.u. — not used

PAL16C1

Programming Format

PATTERN:

NAME:

PRODUCT TERMS (0-63)

DATE:

INPUTS (0-31)

	0	1	2	3	4	5	6	7	8	9	10	11	12	13	14	15	16	17	18	19	20	21	22	23	24	25	26	27	28	29	30	31			
WORD	0	1	2	3	4	5	6	7	8	9	A	B	C	D	E	F	10	11	12	13	14	15	16	17	18	19	1A	1B	1C	1D	1E	1F			
O <sub>4</sub>	24																																		
O <sub>3</sub>	16	H	H	H	H	H	H	H	H	H	H	H	H	H	H	H	H	H	H	H	H	H	H	H	H	H	H	H	H	H	H	H	H		
O <sub>2</sub>	8	H	H	H	H	H	H	H	H	H	H	H	H	H	H	H	H	H	H	H	H	H	H	H	H	H	H	H	H	H	H	H	H		
O <sub>1</sub>	0	H	H	H	H	H	H	H	H	H	H	H	H	H	H	H	H	H	H	H	H	H	H	H	H	H	H	H	H	H	H	H	H		
WORD	20	21	22	23	24	25	26	27	28	29	2A	2B	2C	2D	2E	2F	30	31	32	33	34	35	36	37	38	39	3A	3B	3C	3D	3E	3F			
O <sub>4</sub>	25																																		
O <sub>3</sub>	17	H	H	H	H	H	H	H	H	H	H	H	H	H	H	H	H	H	H	H	H	H	H	H	H	H	H	H	H	H	H	H	H		
O <sub>2</sub>	9	H	H	H	H	H	H	H	H	H	H	H	H	H	H	H	H	H	H	H	H	H	H	H	H	H	H	H	H	H	H	H	H		
O <sub>1</sub>	1	H	H	H	H	H	H	H	H	H	H	H	H	H	H	H	H	H	H	H	H	H	H	H	H	H	H	H	H	H	H	H	H	H	
WORD	40	41	42	43	44	45	46	47	48	49	4A	4B	4C	4D	4E	4F	50	51	52	53	54	55	56	57	58	59	5A	5B	5C	5D	5E	5F			
O <sub>4</sub>	26																																		
O <sub>3</sub>	18	H	H	H	H	H	H	H	H	H	H	H	H	H	H	H	H	H	H	H	H	H	H	H	H	H	H	H	H	H	H	H	H		
O <sub>2</sub>	10	H	H	H	H	H	H	H	H	H	H	H	H	H	H	H	H	H	H	H	H	H	H	H	H	H	H	H	H	H	H	H	H	H	
O <sub>1</sub>	2	H	H	H	H	H	H	H	H	H	H	H	H	H	H	H	H	H	H	H	H	H	H	H	H	H	H	H	H	H	H	H	H	H	
WORD	60	61	62	63	64	65	66	67	68	69	6A	6B	6C	6D	6E	6F	70	71	72	73	74	75	76	77	78	79	7A	7B	7C	7D	7E	7F			
O <sub>4</sub>	27																																		
O <sub>3</sub>	19	H	H	H	H	H	H	H	H	H	H	H	H	H	H	H	H	H	H	H	H	H	H	H	H	H	H	H	H	H	H	H	H	H	
O <sub>2</sub>	11	H	H	H	H	H	H	H	H	H	H	H	H	H	H	H	H	H	H	H	H	H	H	H	H	H	H	H	H	H	H	H	H	H	
O <sub>1</sub>	3	H	H	H	H	H	H	H	H	H	H	H	H	H	H	H	H	H	H	H	H	H	H	H	H	H	H	H	H	H	H	H	H	H	H
WORD	80	81	82	83	84	85	86	87	88	89	8A	8B	8C	8D	8E	8F	90	91	92	93	94	95	96	97	98	99	9A	9B	9C	9D	9E	9F			
O <sub>4</sub>	28																																		
O <sub>3</sub>	20	H	H	H	H	H	H	H	H	H	H	H	H	H	H	H	H	H	H	H	H	H	H	H	H	H	H	H	H	H	H	H	H	H	
O <sub>2</sub>	12	H	H	H	H	H	H	H	H	H	H	H	H	H	H	H	H	H	H	H	H	H	H	H	H	H	H	H	H	H	H	H	H	H	H
O <sub>1</sub>	4	H	H	H	H	H	H	H	H	H	H	H	H	H	H	H	H	H	H	H	H	H	H	H	H	H	H	H	H	H	H	H	H	H	H
WORD	A0	A1	A2	A3	A4	A5	A6	A7	A8	A9	AA	AB	AC	AD	AE	AF	B0	B1	B2	B3	B4	B5	B6	B7	B8	B9	BA	BB	BC	BD	BE	BF			
O <sub>4</sub>	29																																		
O <sub>3</sub>	21	H	H	H	H	H	H	H	H	H	H	H	H	H	H	H	H	H	H	H	H	H	H	H	H	H	H	H	H	H	H	H	H	H	
O <sub>2</sub>	13	H	H	H	H	H	H	H	H	H	H	H	H	H	H	H	H	H	H	H	H	H	H	H	H	H	H	H	H	H	H	H	H	H	H
O <sub>1</sub>	5	H	H	H	H	H	H	H	H	H	H	H	H	H	H	H	H	H	H	H	H	H	H	H	H	H	H	H	H	H	H	H	H	H	H
WORD	C0	C1	C2	C3	C4	C5	C6	C7	C8	C9	CA	CB	CC	CD	CE	CF	D0	D1	D2	D3	D4	D5	D6	D7	D8	D9	DA	DB	DC	DD	DE	DF			
O <sub>4</sub>	30																																		
O <sub>3</sub>	22	H	H	H	H	H	H	H	H	H	H	H	H	H	H	H	H	H	H	H	H	H	H	H	H	H	H	H	H	H	H	H	H	H	
O <sub>2</sub>	14	H	H	H	H	H	H	H	H	H	H	H	H	H	H	H	H	H	H	H	H	H	H	H	H	H	H	H	H	H	H	H	H	H	H
O <sub>1</sub>	6	H	H	H	H	H	H	H	H	H	H	H	H	H	H	H	H	H	H	H	H	H	H	H	H	H	H	H	H	H	H	H	H	H	H
WORD	E0	E1	E2	E3	E4	E5	E6	E7	E8	E9	EA	EB	EC	ED	EE	EF	F0	F1	F2	F3	F4	F5	F6	F7	F8	F9	FA	FB	FC	FD	FE	FF			
O <sub>4</sub>	31																																		
O <sub>3</sub>	23	H	H	H	H	H	H	H	H	H	H	H	H	H	H	H	H	H	H	H	H	H	H	H	H	H	H	H	H	H	H	H	H	H	H
O <sub>2</sub>	15	H	H	H	H	H	H	H	H	H	H	H	H	H	H	H	H	H	H	H	H	H	H	H	H	H	H	H	H	H	H	H	H	H	H
O <sub>1</sub>	7	H	H	H	H	H	H	H	H	H	H	H	H	H	H	H	H	H	H	H	H	H	H	H	H	H	H	H	H	H	H	H	H	H	H
WORD	100	101	102	103	104	105	106	107	108	109	10A	10B	10C	10D	10E	10F	110	111	112	113	114	115	116	117	118	119	11A	11B	11C	11D	11E	11F			
O <sub>4</sub>	56	L	L	L	L	L	L	L	L	L	L	L	L	L	L	L	L	L	L	L	L	L	L	L	L	L	L	L	L	L	L	L	L	L	
O <sub>3</sub>	48	L	L	L	L	L	L	L	L	L	L	L	L	L	L	L	L	L	L	L	L	L	L	L	L	L	L	L	L	L	L	L	L	L	L
O <sub>2</sub>	40	L	L	L	L	L	L	L	L	L	L	L	L	L	L	L	L	L	L	L	L	L	L	L	L	L	L	L	L	L	L	L	L	L	L
O <sub>1</sub>	32	L	L	L	L	L	L	L	L	L	L	L	L	L	L	L	L	L	L	L	L	L	L	L	L	L	L	L	L	L	L	L	L	L	L
WORD	120	121	122	123	124	125	126	127	128	129	12A	12B	12C	12D	12E	12F	130	131	132	133	134	135	136	137	138	139	13A	13B	13C	13D	13E	13F			
O <sub>4</sub>	57	L	L	L	L	L	L	L	L	L	L	L	L	L	L	L	L	L	L	L	L	L	L	L	L	L	L	L	L	L	L	L	L	L	L
O <sub>3</sub>	49	L	L	L	L	L	L	L	L	L	L	L	L	L	L	L	L	L	L	L	L	L	L	L	L	L	L	L	L	L	L	L	L	L	L
O <sub>2</sub>	41	L	L	L	L	L	L	L	L	L	L	L	L	L	L	L	L	L	L	L	L	L	L	L	L	L	L	L	L	L	L	L	L	L	L
O <sub>1</sub>	33	L	L	L	L	L	L	L	L	L	L	L	L	L	L	L	L	L	L	L	L	L	L	L	L	L	L	L	L	L	L	L	L	L	L
WORD	140	141	142	143	144	145	146	147	148	149	14A	14B	14C	14D	14E	14F	150	151	152	153	154	155	156	157	158	159	15A	15B	15C	15D	15E	15F			
O <sub>4</sub>	58	L	L	L	L	L	L	L	L	L	L	L	L	L	L	L	L	L	L	L	L	L	L	L	L	L	L	L	L	L	L	L	L	L	L
O <sub>3</sub>	50	L	L	L	L	L	L	L	L	L	L	L	L	L	L	L	L	L	L	L	L	L	L	L	L	L	L	L	L	L	L	L	L	L	L
O <sub>2</sub>	42	L	L	L	L	L	L	L	L	L	L	L	L	L	L	L	L	L	L	L	L	L	L	L	L	L	L	L	L	L	L	L	L	L	L
O <sub>1</sub>	34	L	L	L	L	L	L	L	L	L	L	L	L	L	L	L	L	L	L	L	L	L	L	L	L	L	L	L	L	L	L	L	L	L	L
WORD	160	161	162	163	164	165	166	167	168	169	16A	16B	16C	16D	16E	16F	170	171	172	173	174	175	176	177	178	179	17A	17B	17C	17D	17E	17F			
O <sub>4</sub>	59	L	L	L	L	L	L	L	L	L	L	L	L	L	L	L	L	L	L	L	L	L	L	L	L	L	L	L	L	L	L	L	L	L	L
O <sub>3</sub>	51	L	L	L	L	L	L	L	L	L	L	L	L	L	L	L	L	L	L	L	L	L	L	L	L	L	L	L	L	L	L	L	L	L	L
O <sub>2</sub>	43	L	L	L	L	L	L	L	L	L	L	L	L	L	L	L	L	L	L	L	L	L	L	L	L	L	L	L	L	L	L	L	L	L	L
O <sub>1</sub>	35	L	L	L	L	L	L	L	L	L	L	L	L	L	L	L	L	L	L	L	L	L	L	L	L	L	L	L	L	L	L	L	L	L	L
WORD	180	181	182	183	184	185	186	187	188	189	18A	18B	18C	18D	18E	18F	190	191	192	193															

INPUTS (0-31)

PRODUCT TERMS (0-63)

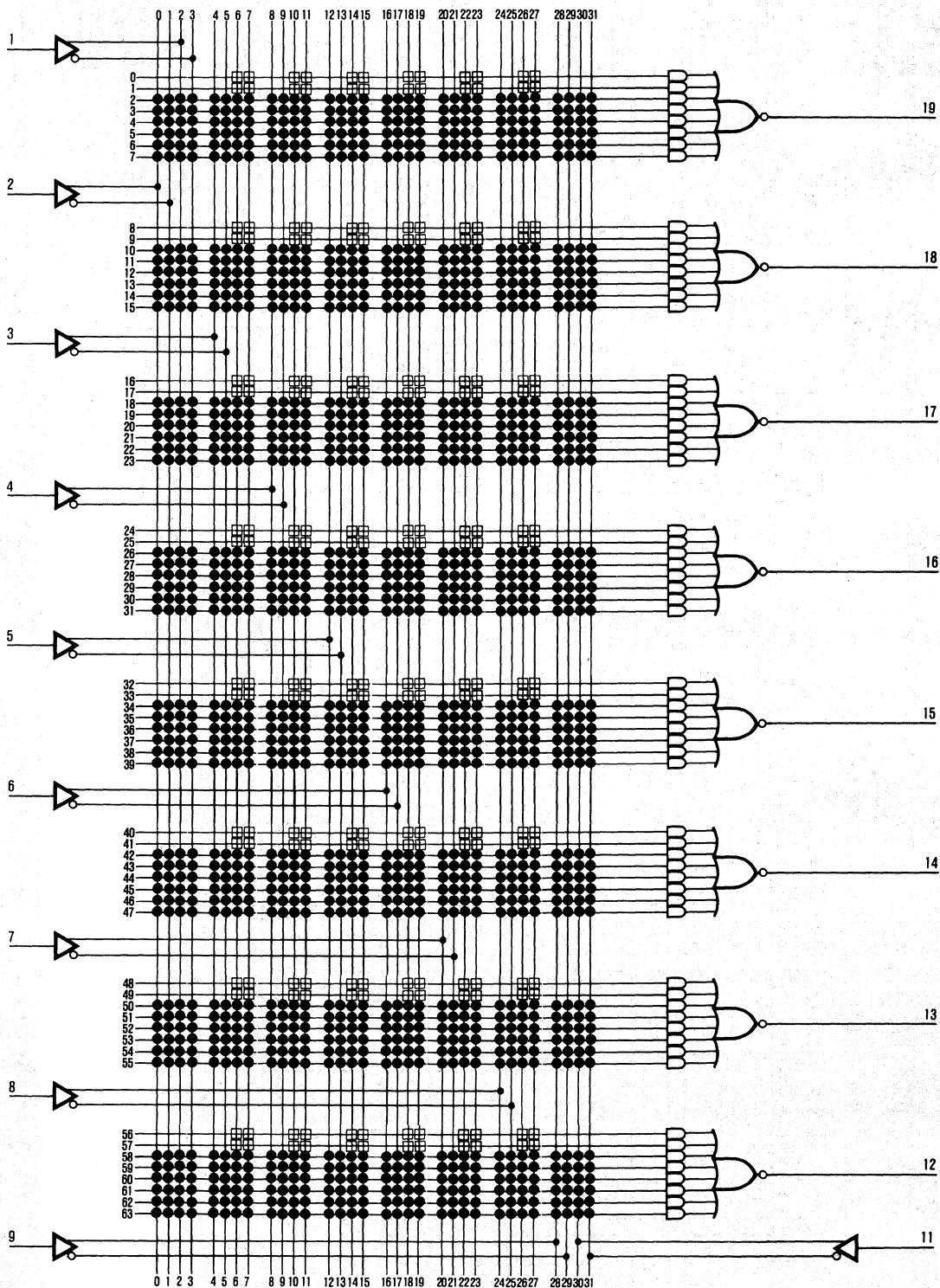

LEGEND:

● : Phantom Fuse (L, N, 0)

□ : Phantom Fuse (H, P, 1)

n.u. — not used





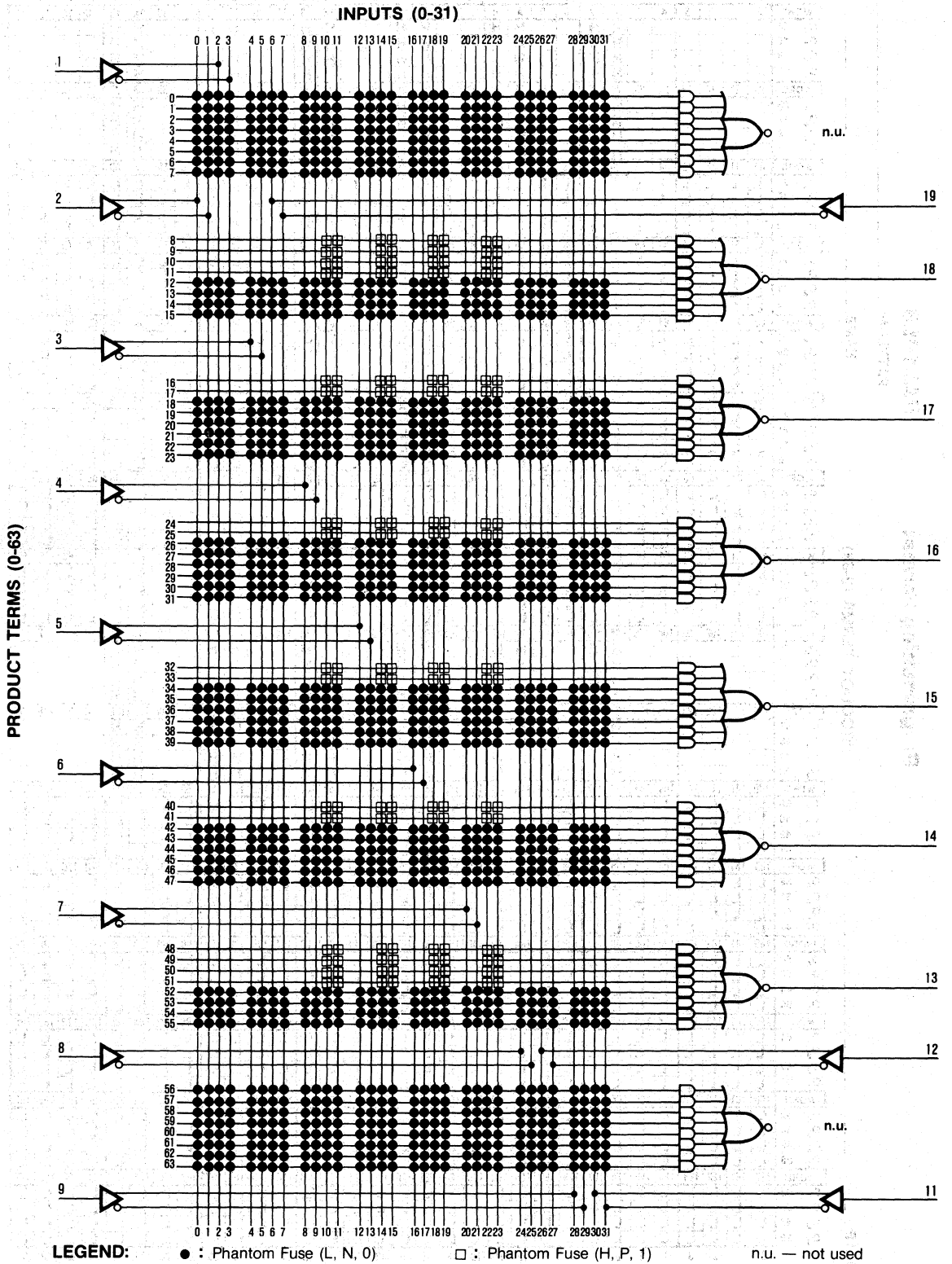

INPUTS (0-31)

	0	1	2	3	4	5	6	7	8	9	10	11	12	13	14	15	16	17	18	19	20	21	22	23	24	25	26	27	28	29	30	31	
WORD	0	1	2	3	4	5	6	7	8	9	A	B	C	D	E	F	10	11	12	13	14	15	16	17	18	19	1A	1B	1C	1D	1E	1F	
O <sub>4</sub>	24										H	H			H	H			H	H			H	H									
O <sub>3</sub>	16										H	H			H	H			H	H			H	H									
O <sub>2</sub>	8										H	H			H	H			H	H			H	H									
O <sub>1</sub>	0										H	H			H	H			H	H			H	H									
WORD	20	21	22	23	24	25	26	27	28	29	2A	2B	2C	2D	2E	2F	30	31	32	33	34	35	36	37	38	39	3A	3B	3C	3D	3E	3F	
O <sub>4</sub>	25										H	H			H	H			H	H			H	H									
O <sub>3</sub>	17										H	H			H	H			H	H			H	H									
O <sub>2</sub>	9										H	H			H	H			H	H			H	H									
O <sub>1</sub>	1										H	H			H	H			H	H			H	H									
WORD	40	41	42	43	44	45	46	47	48	49	4A	4B	4C	4D	4E	4F	50	51	52	53	54	55	56	57	58	59	5A	5B	5C	5D	5E	5F	
O <sub>4</sub>	26	L	L	L	L	L	L	L	L	L	L	L	L	L	L	L	L	L	L	L	L	L	L	L	L	L	L	L	L	L	L	L	L
O <sub>3</sub>	18	L	L	L	L	L	L	L	L	L	L	L	L	L	L	L	L	L	L	L	L	L	L	L	L	L	L	L	L	L	L	L	L
O <sub>2</sub>	10	L	L	L	L	L	L	L	L	L	L	L	L	L	L	L	L	L	L	L	L	L	L	L	L	L	L	L	L	L	L	L	L
O <sub>1</sub>	2	L	L	L	L	L	L	L	L	L	L	L	L	L	L	L	L	L	L	L	L	L	L	L	L	L	L	L	L	L	L	L	L
WORD	60	61	62	63	64	65	66	67	68	69	6A	6B	6C	6D	6E	6F	70	71	72	73	74	75	76	77	78	79	7A	7B	7C	7D	7E	7F	
O <sub>4</sub>	27	L	L	L	L	L	L	L	L	L	L	L	L	L	L	L	L	L	L	L	L	L	L	L	L	L	L	L	L	L	L	L	L
O <sub>3</sub>	19	L	L	L	L	L	L	L	L	L	L	L	L	L	L	L	L	L	L	L	L	L	L	L	L	L	L	L	L	L	L	L	L
O <sub>2</sub>	11	L	L	L	L	L	L	L	L	L	L	L	L	L	L	L	L	L	L	L	L	L	L	L	L	L	L	L	L	L	L	L	L
O <sub>1</sub>	3	L	L	L	L	L	L	L	L	L	L	L	L	L	L	L	L	L	L	L	L	L	L	L	L	L	L	L	L	L	L	L	L
WORD	80	81	82	83	84	85	86	87	88	89	8A	8B	8C	8D	8E	8F	90	91	92	93	94	95	96	97	98	99	9A	9B	9C	9D	9E	9F	
O <sub>4</sub>	28	L	L	L	L	L	L	L	L	L	L	L	L	L	L	L	L	L	L	L	L	L	L	L	L	L	L	L	L	L	L	L	L
O <sub>3</sub>	20	L	L	L	L	L	L	L	L	L	L	L	L	L	L	L	L	L	L	L	L	L	L	L	L	L	L	L	L	L	L	L	L
O <sub>2</sub>	12	L	L	L	L	L	L	L	L	L	L	L	L	L	L	L	L	L	L	L	L	L	L	L	L	L	L	L	L	L	L	L	L
O <sub>1</sub>	4	L	L	L	L	L	L	L	L	L	L	L	L	L	L	L	L	L	L	L	L	L	L	L	L	L	L	L	L	L	L	L	L
WORD	A0	A1	A2	A3	A4	A5	A6	A7	A8	A9	AA	AB	AC	AD	AE	AF	B0	B1	B2	B3	B4	B5	B6	B7	B8	B9	BA	BB	BC	BD	BE	BF	
O <sub>4</sub>	29	L	L	L	L	L	L	L	L	L	L	L	L	L	L	L	L	L	L	L	L	L	L	L	L	L	L	L	L	L	L	L	L
O <sub>3</sub>	21	L	L	L	L	L	L	L	L	L	L	L	L	L	L	L	L	L	L	L	L	L	L	L	L	L	L	L	L	L	L	L	L
O <sub>2</sub>	13	L	L	L	L	L	L	L	L	L	L	L	L	L	L	L	L	L	L	L	L	L	L	L	L	L	L	L	L	L	L	L	L
O <sub>1</sub>	5	L	L	L	L	L	L	L	L	L	L	L	L	L	L	L	L	L	L	L	L	L	L	L	L	L	L	L	L	L	L	L	L
WORD	C0	C1	C2	C3	C4	C5	C6	C7	C8	C9	CA	CB	CC	CD	CE	CF	00	01	02	03	04	05	06	07	08	09	0A	0B	0C	0D	0E	0F	
O <sub>4</sub>	30	L	L	L	L	L	L	L	L	L	L	L	L	L	L	L	L	L	L	L	L	L	L	L	L	L	L	L	L	L	L	L	L
O <sub>3</sub>	22	L	L	L	L	L	L	L	L	L	L	L	L	L	L	L	L	L	L	L	L	L	L	L	L	L	L	L	L	L	L	L	L
O <sub>2</sub>	14	L	L	L	L	L	L	L	L	L	L	L	L	L	L	L	L	L	L	L	L	L	L	L	L	L	L	L	L	L	L	L	L
O <sub>1</sub>	6	L	L	L	L	L	L	L	L	L	L	L	L	L	L	L	L	L	L	L	L	L	L	L	L	L	L	L	L	L	L	L	L
WORD	E0	E1	E2	E3	E4	E5	E6	E7	E8	E9	EA	EB	EC	ED	EE	EF	F0	F1	F2	F3	F4	F5	F6	F7	F8	F9	FA	FB	FC	FD	FE	FF	
O <sub>4</sub>	31	L	L	L	L	L	L	L	L	L	L	L	L	L	L	L	L	L	L	L	L	L	L	L	L	L	L	L	L	L	L	L	L
O <sub>3</sub>	23	L	L	L	L	L	L	L	L	L	L	L	L	L	L	L	L	L	L	L	L	L	L	L	L	L	L	L	L	L	L	L	L
O <sub>2</sub>	15	L	L	L	L	L	L	L	L	L	L	L	L	L	L	L	L	L	L	L	L	L	L	L	L	L	L	L	L	L	L	L	L
O <sub>1</sub>	7	L	L	L	L	L	L	L	L	L	L	L	L	L	L	L	L	L	L	L	L	L	L	L	L	L	L	L	L	L	L	L	L
WORD	100	101	102	103	104	105	106	107	108	109	10A	10B	10C	10D	10E	10F	110	111	112	113	114	115	116	117	118	119	11A	11B	11C	11D	11E	11F	
O <sub>4</sub>	56	L	L	L	L	L	L	L	L	L	L	L	L	L	L	L	L	L	L	L	L	L	L	L	L	L	L	L	L	L	L	L	L
O <sub>3</sub>	48										H	H			H	H			H	H			H	H									
O <sub>2</sub>	40										H	H			H	H			H	H			H	H									
O <sub>1</sub>	32										H	H			H	H			H	H			H	H									
WORD	120	121	122	123	124	125	126	127	128	129	12A	12B	12C	12D	12E	12F	130	131	132	133	134	135	136	137	138	139	13A	13B	13C	13D	13E	13F	
O <sub>4</sub>	57	L	L	L	L	L	L	L	L	L	L	L	L	L	L	L	L	L	L	L	L	L	L	L	L	L	L	L	L	L	L	L	L
O <sub>3</sub>	49										H	H			H	H			H	H			H	H									
O <sub>2</sub>	41										H	H			H	H			H	H			H	H									
O <sub>1</sub>	33										H	H			H	H			H	H			H	H									
WORD	140	141	142	143	144	145	146	147	148	149	14A	14B	14C	14D	14E	14F	150	151	152	153	154	155	156	157	158	159	15A	15B	15C	15D	15E	15F	
O <sub>4</sub>	58	L	L	L	L	L	L	L	L	L	L	L	L	L	L	L	L	L	L	L	L	L	L	L	L	L	L	L	L	L	L	L	L
O <sub>3</sub>	50										H	H			H	H			H	H			H	H									
O <sub>2</sub>	42										H	H			H	H			H	H			H	H									
O <sub>1</sub>	34										H	H			H	H			H	H			H	H									
WORD	160	161	162	163	164	165	166	167	168	169	16A	16B	16C	16D	16E	16F	170	171	172	173	174	175	176	177	178	179	17A	17B	17C	17D	17E	17F	
O <sub>4</sub>	59	L	L	L	L	L	L	L	L	L	L	L	L	L	L	L	L	L	L	L	L	L	L	L	L	L	L	L	L	L	L	L	L
O <sub>3</sub>	51										H	H			H	H			H	H			H	H									
O <sub>2</sub>	43										H	H			H	H			H	H			H	H									
O <sub>1</sub>	35										H	H			H	H			H	H			H	H									
WORD	180	181	182	183	184	185	186	187	188	189	18A	18B	18C	18D	18E	18F	190	191	192	193	194	195	196	197	198	199	19A	19B	19C	19D	19E	19F	
O <sub>4</sub>	60	L	L	L	L	L	L	L	L	L	L	L	L	L	L	L	L	L	L	L	L	L	L	L	L	L	L	L	L	L	L	L	L
O <sub>3</sub>	52	L	L	L	L	L	L	L	L	L	L	L	L	L	L	L	L	L	L	L	L	L	L	L	L	L	L	L	L	L	L	L	L
O <sub>2</sub>	44	L	L	L	L																												

INPUTS (0-31)

PRODUCT TERMS (0-63)

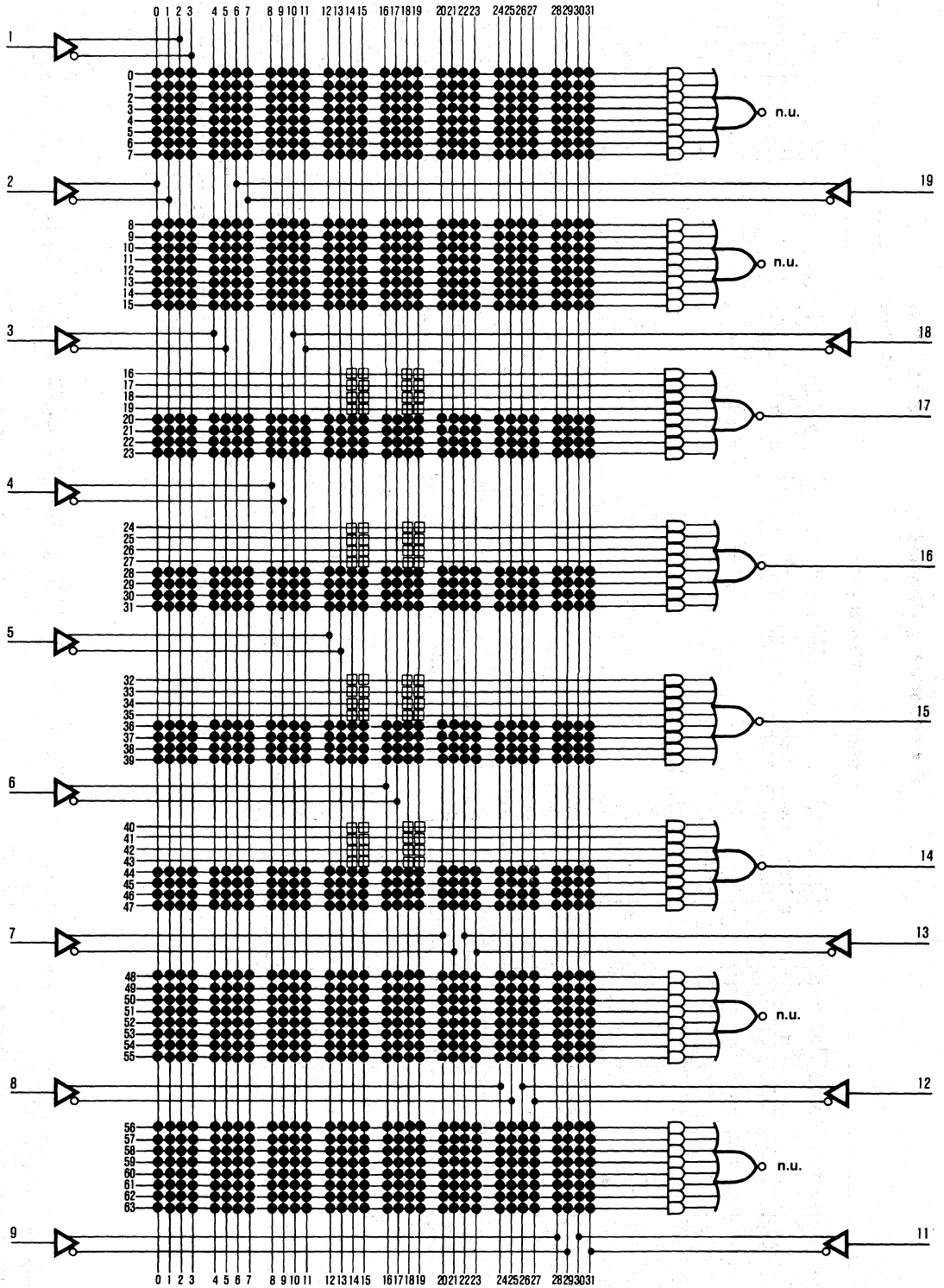

LEGEND:

● : Phantom Fuse (L, N, 0)

□ : Phantom Fuse (H, P, 1)

n.u. — not used

INPUTS (0-31)

Table with 32 columns (0-31) and 4 rows per block (O4, O3, O2, O1). Blocks are labeled 'WORD' and contain alphanumeric characters (A-Z, 0-9) and 'L' characters. The table is organized into 15 blocks, each containing 32 words. The characters are arranged in a grid pattern, with some 'H' characters appearing in specific positions.

PATTERN:

NAME:

PRODUCT TERMS (0-63)

DATE:

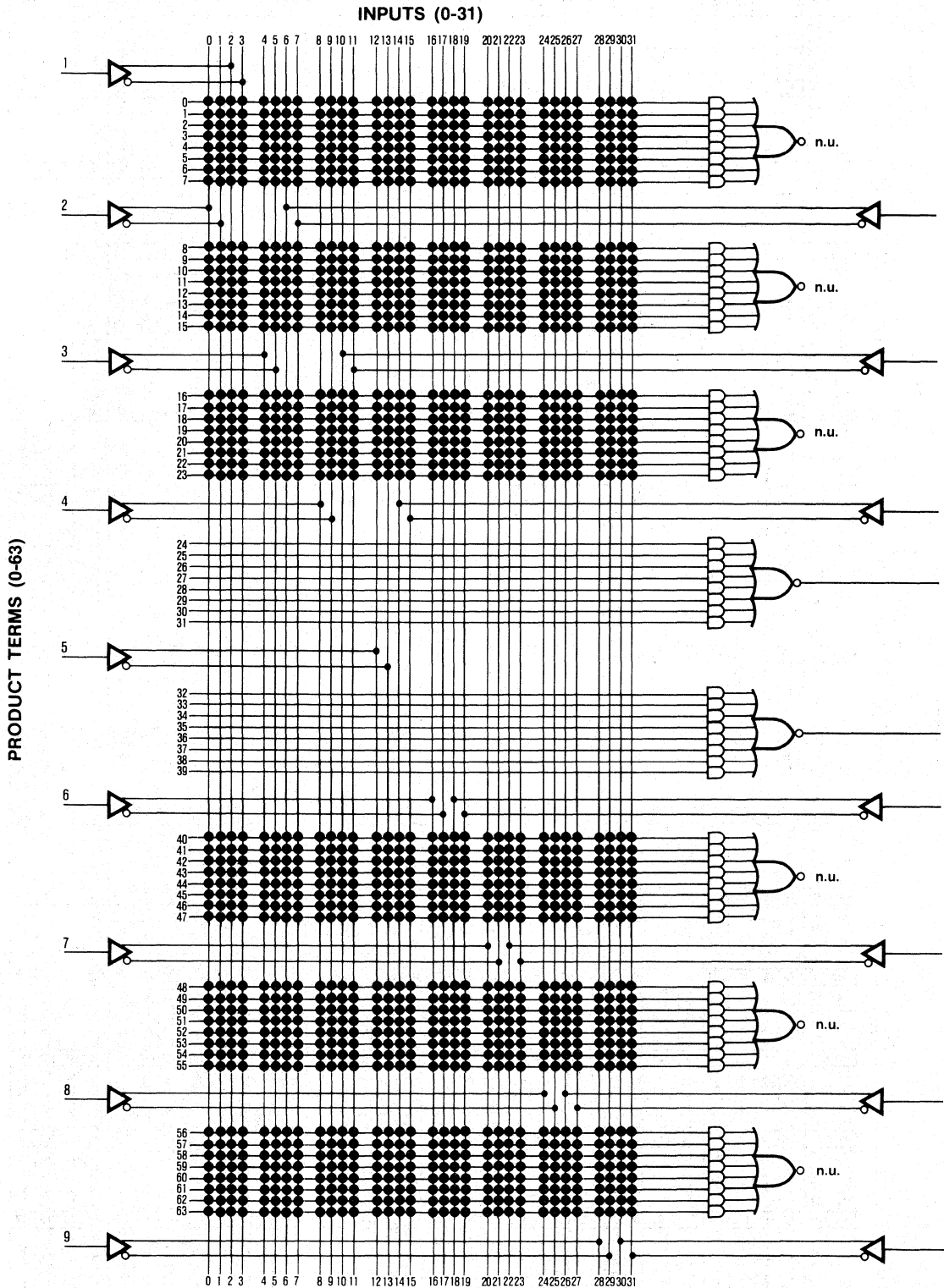

LEGEND:

● : Phantom Fuse (L, N, 0)

□ : Phantom Fuse (H, P, 1)

n.u. — not used

INPUTS (0-31)

Programming Format  
PAL16L2

PATTERN:

NAME:

DATE:

	0	1	2	3	4	5	6	7	8	9	10	11	12	13	14	15	16	17	18	19	20	21	22	23	24	25	26	27	28	29	30	31
WORD 24	0	1	2	3	4	5	6	7	8	9	A	B	C	D	E	F	10	11	12	13	14	15	16	17	18	19	1A	1B	1C	1D	1E	1F
O <sub>4</sub>	L	L	L	L	L	L	L	L	L	L	L	L	L	L	L	L	L	L	L	L	L	L	L	L	L	L	L	L	L	L	L	L
O <sub>3</sub>	L	L	L	L	L	L	L	L	L	L	L	L	L	L	L	L	L	L	L	L	L	L	L	L	L	L	L	L	L	L	L	L
O <sub>2</sub>	L	L	L	L	L	L	L	L	L	L	L	L	L	L	L	L	L	L	L	L	L	L	L	L	L	L	L	L	L	L	L	L
O <sub>1</sub>	L	L	L	L	L	L	L	L	L	L	L	L	L	L	L	L	L	L	L	L	L	L	L	L	L	L	L	L	L	L	L	L
WORD 25	20	21	22	23	24	25	26	27	28	29	2A	2B	2C	2D	2E	2F	30	31	32	33	34	35	36	37	38	39	3A	3B	3C	3D	3E	3F
O <sub>4</sub>	L	L	L	L	L	L	L	L	L	L	L	L	L	L	L	L	L	L	L	L	L	L	L	L	L	L	L	L	L	L	L	L
O <sub>3</sub>	L	L	L	L	L	L	L	L	L	L	L	L	L	L	L	L	L	L	L	L	L	L	L	L	L	L	L	L	L	L	L	L
O <sub>2</sub>	L	L	L	L	L	L	L	L	L	L	L	L	L	L	L	L	L	L	L	L	L	L	L	L	L	L	L	L	L	L	L	L
O <sub>1</sub>	L	L	L	L	L	L	L	L	L	L	L	L	L	L	L	L	L	L	L	L	L	L	L	L	L	L	L	L	L	L	L	L
WORD 26	40	41	42	43	44	45	46	47	48	49	4A	4B	4C	4D	4E	4F	50	51	52	53	54	55	56	57	58	59	5A	5B	5C	5D	5E	5F
O <sub>4</sub>	L	L	L	L	L	L	L	L	L	L	L	L	L	L	L	L	L	L	L	L	L	L	L	L	L	L	L	L	L	L	L	L
O <sub>3</sub>	L	L	L	L	L	L	L	L	L	L	L	L	L	L	L	L	L	L	L	L	L	L	L	L	L	L	L	L	L	L	L	L
O <sub>2</sub>	L	L	L	L	L	L	L	L	L	L	L	L	L	L	L	L	L	L	L	L	L	L	L	L	L	L	L	L	L	L	L	L
O <sub>1</sub>	L	L	L	L	L	L	L	L	L	L	L	L	L	L	L	L	L	L	L	L	L	L	L	L	L	L	L	L	L	L	L	L
WORD 27	60	61	62	63	64	65	66	67	68	69	6A	6B	6C	6D	6E	6F	70	71	72	73	74	75	76	77	78	79	7A	7B	7C	7D	7E	7F
O <sub>4</sub>	L	L	L	L	L	L	L	L	L	L	L	L	L	L	L	L	L	L	L	L	L	L	L	L	L	L	L	L	L	L	L	L
O <sub>3</sub>	L	L	L	L	L	L	L	L	L	L	L	L	L	L	L	L	L	L	L	L	L	L	L	L	L	L	L	L	L	L	L	L
O <sub>2</sub>	L	L	L	L	L	L	L	L	L	L	L	L	L	L	L	L	L	L	L	L	L	L	L	L	L	L	L	L	L	L	L	L
O <sub>1</sub>	L	L	L	L	L	L	L	L	L	L	L	L	L	L	L	L	L	L	L	L	L	L	L	L	L	L	L	L	L	L	L	L
WORD 28	80	81	82	83	84	85	86	87	88	89	8A	8B	8C	8D	8E	8F	90	91	92	93	94	95	96	97	98	99	9A	9B	9C	9D	9E	9F
O <sub>4</sub>	L	L	L	L	L	L	L	L	L	L	L	L	L	L	L	L	L	L	L	L	L	L	L	L	L	L	L	L	L	L	L	L
O <sub>3</sub>	L	L	L	L	L	L	L	L	L	L	L	L	L	L	L	L	L	L	L	L	L	L	L	L	L	L	L	L	L	L	L	L
O <sub>2</sub>	L	L	L	L	L	L	L	L	L	L	L	L	L	L	L	L	L	L	L	L	L	L	L	L	L	L	L	L	L	L	L	L
O <sub>1</sub>	L	L	L	L	L	L	L	L	L	L	L	L	L	L	L	L	L	L	L	L	L	L	L	L	L	L	L	L	L	L	L	L
WORD 29	A0	A1	A2	A3	A4	A5	A6	A7	A8	A9	AA	AB	AC	AD	AE	AF	B0	B1	B2	B3	B4	B5	B6	B7	B8	B9	BA	BB	BC	BD	BE	BF
O <sub>4</sub>	L	L	L	L	L	L	L	L	L	L	L	L	L	L	L	L	L	L	L	L	L	L	L	L	L	L	L	L	L	L	L	L
O <sub>3</sub>	L	L	L	L	L	L	L	L	L	L	L	L	L	L	L	L	L	L	L	L	L	L	L	L	L	L	L	L	L	L	L	L
O <sub>2</sub>	L	L	L	L	L	L	L	L	L	L	L	L	L	L	L	L	L	L	L	L	L	L	L	L	L	L	L	L	L	L	L	L
O <sub>1</sub>	L	L	L	L	L	L	L	L	L	L	L	L	L	L	L	L	L	L	L	L	L	L	L	L	L	L	L	L	L	L	L	L
WORD 30	C0	C1	C2	C3	C4	C5	C6	C7	C8	C9	CA	CB	CC	CD	CE	CF	DD	DD	DD	DD	DD	DD	DD	DD	DD	DD	DD	DD	DD	DD	DD	DD
O <sub>4</sub>	L	L	L	L	L	L	L	L	L	L	L	L	L	L	L	L	L	L	L	L	L	L	L	L	L	L	L	L	L	L	L	L
O <sub>3</sub>	L	L	L	L	L	L	L	L	L	L	L	L	L	L	L	L	L	L	L	L	L	L	L	L	L	L	L	L	L	L	L	L
O <sub>2</sub>	L	L	L	L	L	L	L	L	L	L	L	L	L	L	L	L	L	L	L	L	L	L	L	L	L	L	L	L	L	L	L	L
O <sub>1</sub>	L	L	L	L	L	L	L	L	L	L	L	L	L	L	L	L	L	L	L	L	L	L	L	L	L	L	L	L	L	L	L	L
WORD 31	E0	E1	E2	E3	E4	E5	E6	E7	E8	E9	EA	EB	EC	ED	EE	EF	FO	F1	F2	F3	F4	F5	F6	F7	F8	F9	FA	FB	FC	FD	FE	FF
O <sub>4</sub>	L	L	L	L	L	L	L	L	L	L	L	L	L	L	L	L	L	L	L	L	L	L	L	L	L	L	L	L	L	L	L	L
O <sub>3</sub>	L	L	L	L	L	L	L	L	L	L	L	L	L	L	L	L	L	L	L	L	L	L	L	L	L	L	L	L	L	L	L	L
O <sub>2</sub>	L	L	L	L	L	L	L	L	L	L	L	L	L	L	L	L	L	L	L	L	L	L	L	L	L	L	L	L	L	L	L	L
O <sub>1</sub>	L	L	L	L	L	L	L	L	L	L	L	L	L	L	L	L	L	L	L	L	L	L	L	L	L	L	L	L	L	L	L	L
WORD 100	100	101	102	103	104	105	106	107	108	109	10A	10B	10C	10D	10E	10F	110	111	112	113	114	115	116	117	118	119	11A	11B	11C	11D	11E	11F
O <sub>4</sub>	L	L	L	L	L	L	L	L	L	L	L	L	L	L	L	L	L	L	L	L	L	L	L	L	L	L	L	L	L	L	L	L
O <sub>3</sub>	L	L	L	L	L	L	L	L	L	L	L	L	L	L	L	L	L	L	L	L	L	L	L	L	L	L	L	L	L	L	L	L
O <sub>2</sub>	L	L	L	L	L	L	L	L	L	L	L	L	L	L	L	L	L	L	L	L	L	L	L	L	L	L	L	L	L	L	L	L
O <sub>1</sub>	L	L	L	L	L	L	L	L	L	L	L	L	L	L	L	L	L	L	L	L	L	L	L	L	L	L	L	L	L	L	L	L
WORD 120	120	121	122	123	124	125	126	127	128	129	12A	12B	12C	12D	12E	12F	130	131	132	133	134	135	136	137	138	139	13A	13B	13C	13D	13E	13F
O <sub>4</sub>	L	L	L	L	L	L	L	L	L	L	L	L	L	L	L	L	L	L	L	L	L	L	L	L	L	L	L	L	L	L	L	L
O <sub>3</sub>	L	L	L	L	L	L	L	L	L	L	L	L	L	L	L	L	L	L	L	L	L	L	L	L	L	L	L	L	L	L	L	L
O <sub>2</sub>	L	L	L	L	L	L	L	L	L	L	L	L	L	L	L	L	L	L	L	L	L	L	L	L	L	L	L	L	L	L	L	L
O <sub>1</sub>	L	L	L	L	L	L	L	L	L	L	L	L	L	L	L	L	L	L	L	L	L	L	L	L	L	L	L	L	L	L	L	L
WORD 140	140	141	142	143	144	145	146	147	148	149	14A	14B	14C	14D	14E	14F	150	151	152	153	154	155	156	157	158	159	15A	15B	15C	15D	15E	15F
O <sub>4</sub>	L	L	L	L	L	L	L	L	L	L	L	L	L	L	L	L	L	L	L	L	L	L	L	L	L	L	L	L	L	L	L	L
O <sub>3</sub>	L	L	L	L	L	L	L	L	L	L	L	L	L	L	L	L	L	L	L	L	L	L	L	L	L	L	L	L	L	L	L	L
O <sub>2</sub>	L	L	L	L	L	L	L	L	L	L	L	L	L	L	L	L	L	L	L	L	L	L	L	L	L	L	L	L	L	L	L	L
O <sub>1</sub>	L	L	L	L	L	L	L	L	L	L	L	L	L	L	L	L	L	L	L	L	L	L	L	L	L	L	L	L	L	L	L	L
WORD 160	160	161	162	163	164	165	166	167	168	169	16A	16B	16C	16D	16E	16F	170	171	172	173	174	175	176	177	178	179	17A	17B	17C	17D	17E	17F
O <sub>4</sub>	L	L	L	L	L	L	L	L	L	L	L	L	L	L	L	L	L	L	L	L	L	L	L	L	L	L	L	L	L	L	L	L
O <sub>3</sub>	L	L	L	L	L	L	L	L	L	L	L	L	L	L	L	L	L	L	L	L	L	L	L	L	L	L	L	L	L	L	L	L
O <sub>2</sub>	L	L	L	L	L	L	L	L	L	L	L	L	L	L	L	L	L	L	L	L	L	L	L	L	L	L	L	L	L	L	L	L
O <sub>1</sub>	L	L	L	L	L	L	L	L	L	L	L	L	L	L	L	L	L	L	L	L	L	L	L	L	L	L	L	L	L	L	L	L
WORD 180	180	181	182	183	184	185	186	187	188	189	18A	18B	18C	18D	18E	18F	190	191	192	193	194	195	196	197	198	199	19A	19B	19C	19D		

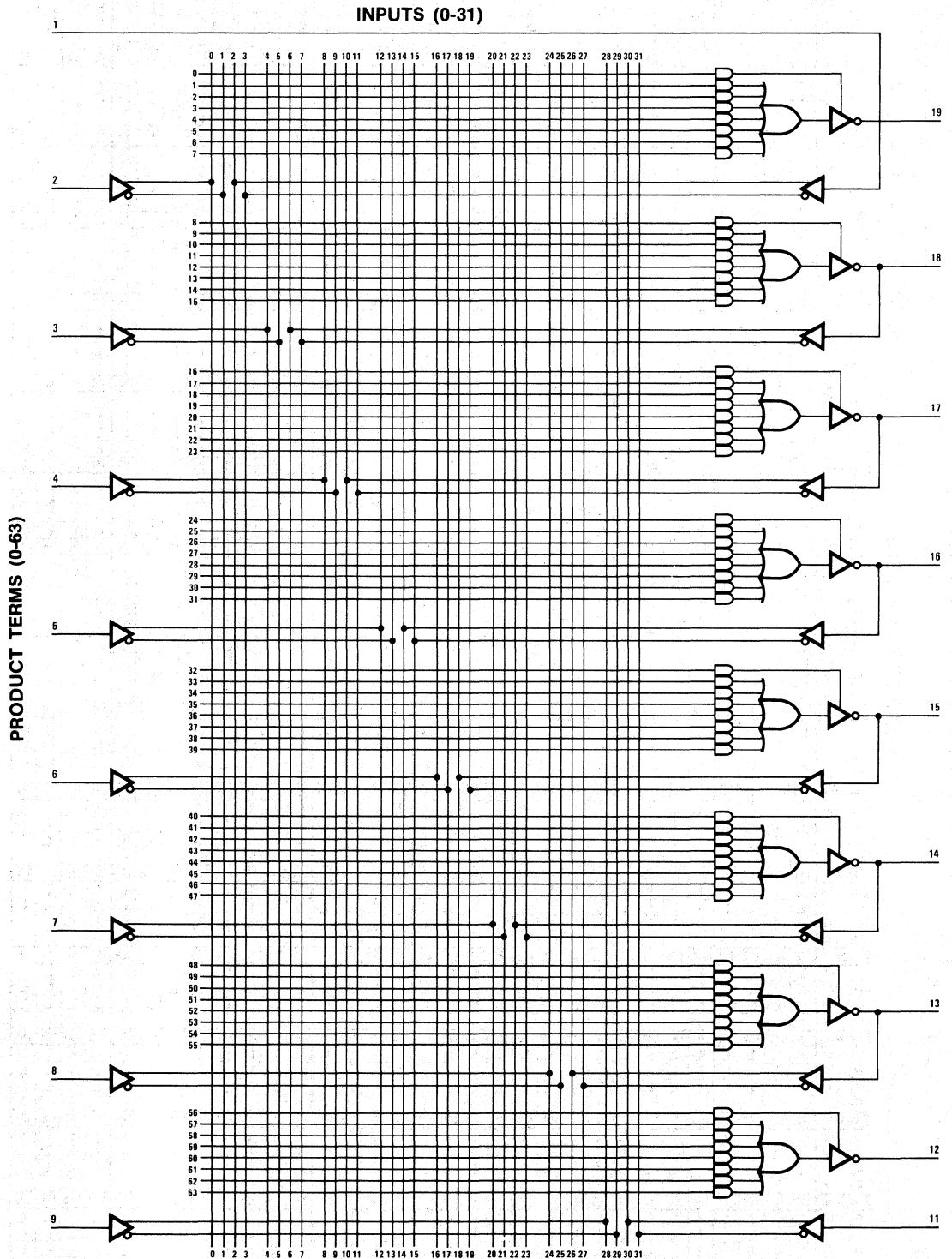

INPUTS (0-31)

	0	1	2	3	4	5	6	7	8	9	10	11	12	13	14	15	16	17	18	19	20	21	22	23	24	25	26	27	28	29	30	31
WORD	0	1	2	3	4	5	6	7	8	9	A	B	C	D	E	F	10	11	12	13	14	15	16	17	18	19	1A	1B	1C	1D	1E	1F
O <sub>4</sub>	24																															
O <sub>3</sub>	16																															
O <sub>2</sub>	8																															
O <sub>1</sub>	0																															
WORD	20	21	22	23	24	25	26	27	28	29	2A	2B	2C	2D	2E	2F	30	31	32	33	34	35	36	37	38	39	3A	3B	3C	3D	3E	3F
O <sub>4</sub>	25																															
O <sub>3</sub>	17																															
O <sub>2</sub>	9																															
O <sub>1</sub>	1																															
WORD	40	41	42	43	44	45	46	47	48	49	4A	4B	4C	4D	4E	4F	50	51	52	53	54	55	56	57	58	59	5A	5B	5C	5D	5E	5F
O <sub>4</sub>	26																															
O <sub>3</sub>	18																															
O <sub>2</sub>	10																															
O <sub>1</sub>	2																															
WORD	60	61	62	63	64	65	66	67	68	69	6A	6B	6C	6D	6E	6F	70	71	72	73	74	75	76	77	78	79	7A	7B	7C	7D	7E	7F
O <sub>4</sub>	27																															
O <sub>3</sub>	19																															
O <sub>2</sub>	11																															
O <sub>1</sub>	3																															
WORD	80	81	82	83	84	85	86	87	88	89	8A	8B	8C	8D	8E	8F	90	91	92	93	94	95	96	97	98	99	9A	9B	9C	9D	9E	9F
O <sub>4</sub>	28																															
O <sub>3</sub>	20																															
O <sub>2</sub>	12																															
O <sub>1</sub>	4																															
WORD	A0	A1	A2	A3	A4	A5	A6	A7	A8	A9	AA	AB	AC	AD	AE	AF	B0	B1	B2	B3	B4	B5	B6	B7	B8	B9	BA	BB	BC	BD	BE	BF
O <sub>4</sub>	29																															
O <sub>3</sub>	21																															
O <sub>2</sub>	13																															
O <sub>1</sub>	5																															
WORD	C0	C1	C2	C3	C4	C5	C6	C7	C8	C9	CA	CB	CC	CD	CE	CF	D0	D1	D2	D3	D4	D5	D6	D7	D8	D9	DA	DB	DC	DD	DE	DF
O <sub>4</sub>	30																															
O <sub>3</sub>	22																															
O <sub>2</sub>	14																															
O <sub>1</sub>	6																															
WORD	E0	E1	E2	E3	E4	E5	E6	E7	E8	E9	EA	EB	EC	ED	EE	EF	F0	F1	F2	F3	F4	F5	F6	F7	F8	F9	FA	FB	FC	FD	FE	FF
O <sub>4</sub>	31																															
O <sub>3</sub>	23																															
O <sub>2</sub>	15																															
O <sub>1</sub>	7																															
WORD	100	101	102	103	104	105	106	107	108	109	10A	10B	10C	10D	10E	10F	110	111	112	113	114	115	116	117	118	119	11A	11B	11C	11D	11E	11F
O <sub>4</sub>	56																															
O <sub>3</sub>	48																															
O <sub>2</sub>	40																															
O <sub>1</sub>	32																															
WORD	120	121	122	123	124	125	126	127	128	129	12A	12B	12C	12D	12E	12F	130	131	132	133	134	135	136	137	138	139	13A	13B	13C	13D	13E	13F
O <sub>4</sub>	57																															
O <sub>3</sub>	49																															
O <sub>2</sub>	41																															
O <sub>1</sub>	33																															
WORD	140	141	142	143	144	145	146	147	148	149	14A	14B	14C	14D	14E	14F	150	151	152	153	154	155	156	157	158	159	15A	15B	15C	15D	15E	15F
O <sub>4</sub>	58																															
O <sub>3</sub>	50																															
O <sub>2</sub>	42																															
O <sub>1</sub>	34																															
WORD	160	161	162	163	164	165	166	167	168	169	16A	16B	16C	16D	16E	16F	170	171	172	173	174	175	176	177	178	179	17A	17B	17C	17D	17E	17F
O <sub>4</sub>	59																															
O <sub>3</sub>	51																															
O <sub>2</sub>	43																															
O <sub>1</sub>	35																															
WORD	180	181	182	183	184	185	186	187	188	189	18A	18B	18C	18D	18E	18F	190	191	192	193	194	195	196	197	198	199	19A	19B	19C	19D	19E	19F
O <sub>4</sub>	60																															
O <sub>3</sub>	52																															
O <sub>2</sub>	44																															
O <sub>1</sub>	36																															
WORD	1A0	1A1	1A2	1A3	1A4	1A5	1A6	1A7	1A8	1A9	1AA	1AB	1AC	1AD	1AE	1AF	1B0	1B1	1B2	1B3	1B4	1B5	1B6	1B7	1B8	1B9	1BA	1BB	1BC	1BD	1BE	1BF
O <sub>4</sub>	61																															
O <sub>3</sub>	53																															
O <sub>2</sub>	45																															
O <sub>1</sub>	37																															
WORD	1C0	1C1	1C2	1C3	1C4	1C5	1C6	1C7	1C8	1C9	1CA	1CB	1CC	1CD	1CE	1CF	1D0	1D1	1D2	1D3	1D4	1D5	1D6	1D7	1D8	1D9	1DA	1DB				



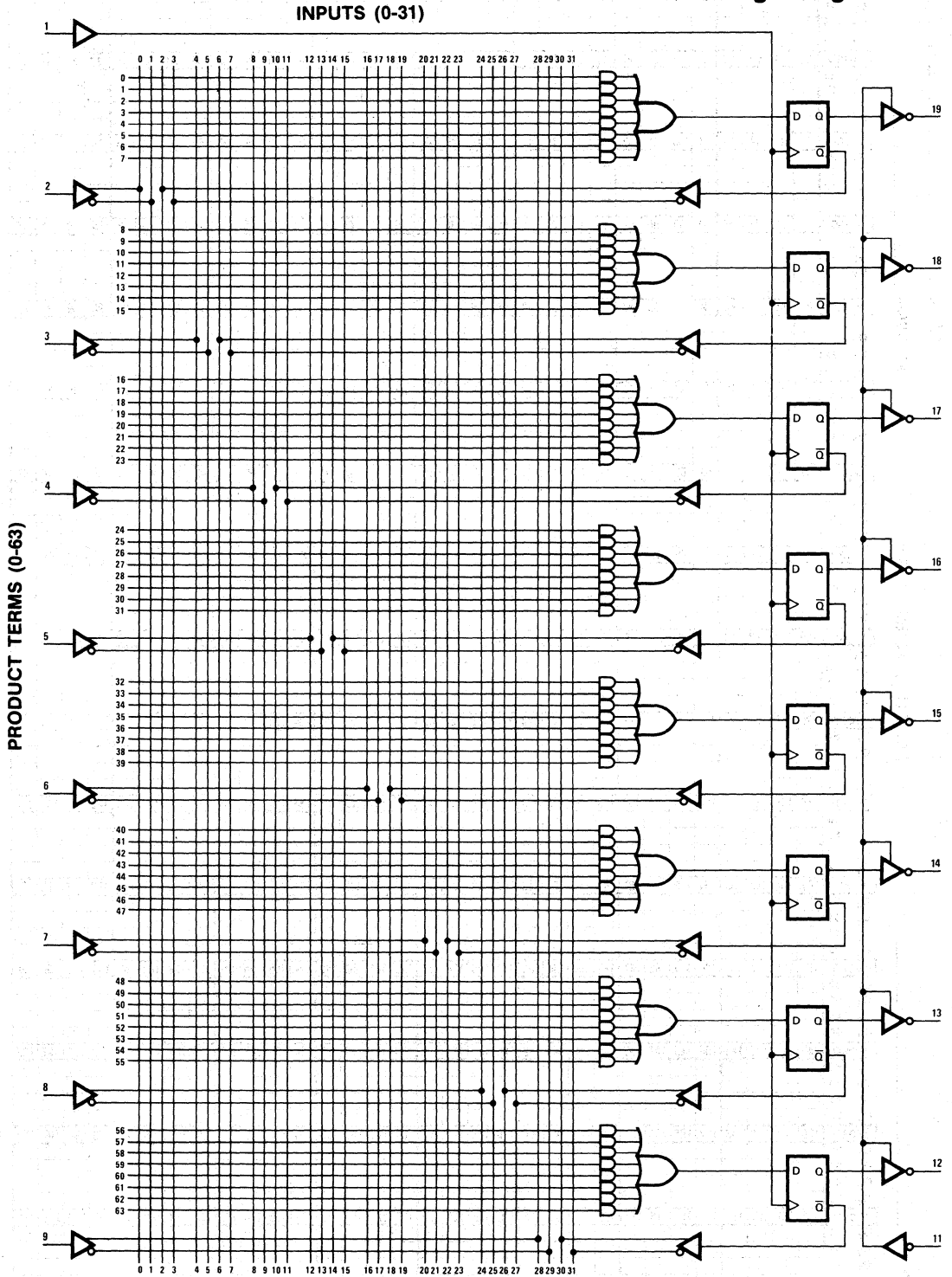



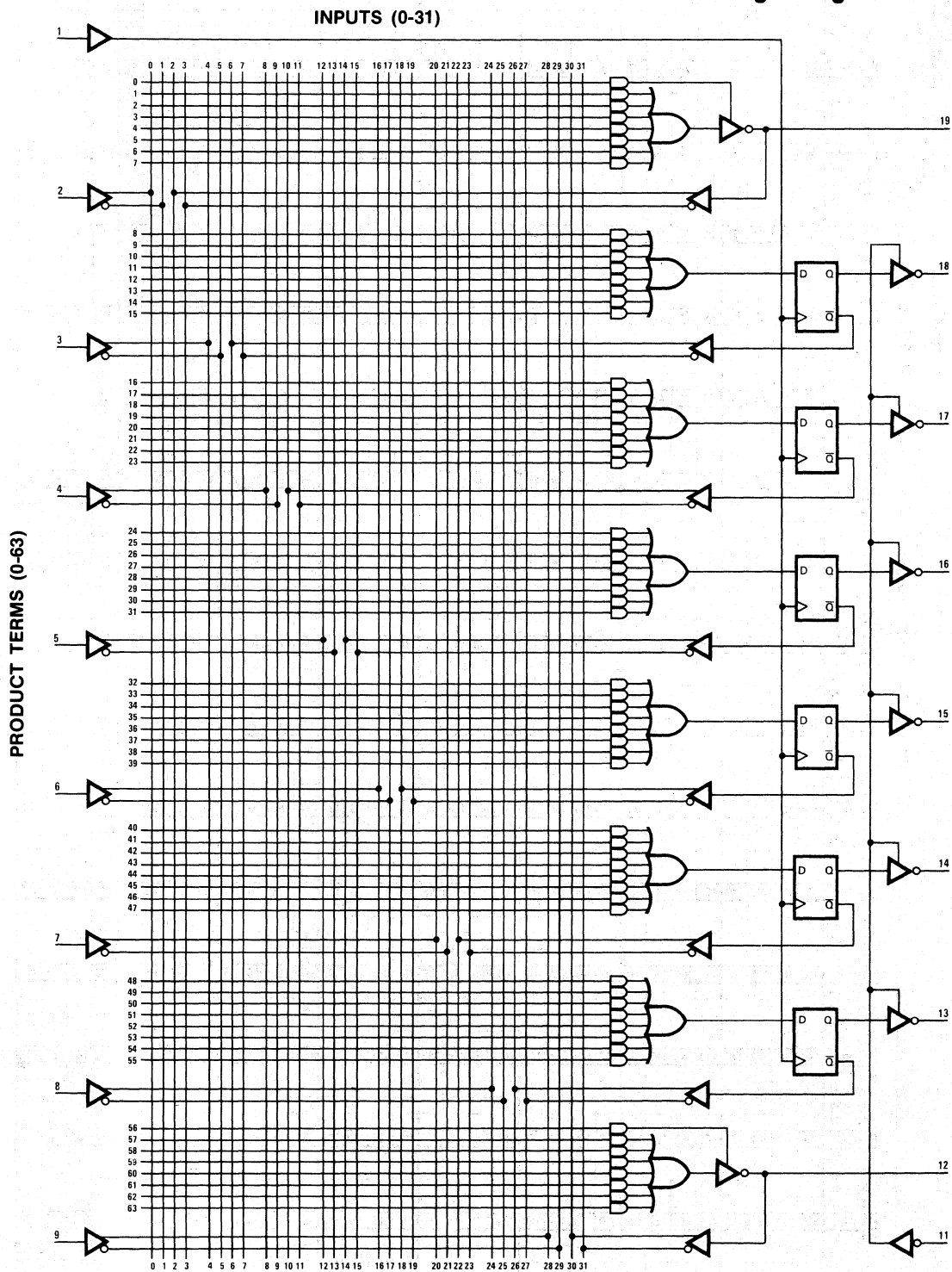

INPUTS (0-31)

PAL16R6

Programming Format

NAME:

PATTERN:

PRODUCT TERMS (0-63)

DATE:

	0	1	2	3	4	5	6	7	8	9	10	11	12	13	14	15	16	17	18	19	20	21	22	23	24	25	26	27	28	29	30	31	
WORD	0	1	2	3	4	5	6	7	8	9	A	B	C	D	E	F	10	11	12	13	14	15	16	17	18	19	1A	1B	1C	1D	1E	1F	
O <sub>4</sub>	24																																
O <sub>3</sub>	16																																
O <sub>2</sub>	8																																
O <sub>1</sub>	0																																
WORD	20	21	22	23	24	25	26	27	28	29	2A	2B	2C	2D	2E	2F	30	31	32	33	34	35	36	37	38	39	3A	3B	3C	3D	3E	3F	
O <sub>4</sub>	25																																
O <sub>3</sub>	17																																
O <sub>2</sub>	9																																
O <sub>1</sub>	1																																
WORD	40	41	42	43	44	45	46	47	48	49	4A	4B	4C	4D	4E	4F	50	51	52	53	54	55	56	57	58	59	5A	5B	5C	5D	5E	5F	
O <sub>4</sub>	26																																
O <sub>3</sub>	18																																
O <sub>2</sub>	10																																
O <sub>1</sub>	2																																
WORD	60	61	62	63	64	65	66	67	68	69	6A	6B	6C	6D	6E	6F	70	71	72	73	74	75	76	77	78	79	7A	7B	7C	7D	7E	7F	
O <sub>4</sub>	27																																
O <sub>3</sub>	19																																
O <sub>2</sub>	11																																
O <sub>1</sub>	3																																
WORD	80	81	82	83	84	85	86	87	88	89	8A	8B	8C	8D	8E	8F	90	91	92	93	94	95	96	97	98	99	9A	9B	9C	9D	9E	9F	
O <sub>4</sub>	28																																
O <sub>3</sub>	20																																
O <sub>2</sub>	12																																
O <sub>1</sub>	4																																
WORD	A0	A1	A2	A3	A4	A5	A6	A7	A8	A9	AA	AB	AC	AD	AE	AF	B0	B1	B2	B3	B4	B5	B6	B7	B8	B9	BA	BB	BC	BD	BE	BF	
O <sub>4</sub>	29																																
O <sub>3</sub>	21																																
O <sub>2</sub>	13																																
O <sub>1</sub>	5																																
WORD	C0	C1	C2	C3	C4	C5	C6	C7	C8	C9	CA	CB	CC	CD	CE	CF	D0	D1	D2	D3	D4	D5	D6	D7	D8	D9	DA	DB	DC	DD	DE	DF	
O <sub>4</sub>	30																																
O <sub>3</sub>	22																																
O <sub>2</sub>	14																																
O <sub>1</sub>	6																																
WORD	E0	E1	E2	E3	E4	E5	E6	E7	E8	E9	EA	EB	EC	ED	EE	EF	F0	F1	F2	F3	F4	F5	F6	F7	F8	F9	FA	FB	FC	FD	FE	FF	
O <sub>4</sub>	31																																
O <sub>3</sub>	23																																
O <sub>2</sub>	15																																
O <sub>1</sub>	7																																
WORD	100	101	102	103	104	105	106	107	108	109	10A	10B	10C	10D	10E	10F	110	111	112	113	114	115	116	117	118	119	11A	11B	11C	11D	11E	11F	
O <sub>4</sub>	56																																
O <sub>3</sub>	48																																
O <sub>2</sub>	40																																
O <sub>1</sub>	32																																
WORD	120	121	122	123	124	125	126	127	128	129	12A	12B	12C	12D	12E	12F	130	131	132	133	134	135	136	137	138	139	13A	13B	13C	13D	13E	13F	
O <sub>4</sub>	57																																
O <sub>3</sub>	49																																
O <sub>2</sub>	41																																
O <sub>1</sub>	33																																
WORD	140	141	142	143	144	145	146	147	148	149	14A	14B	14C	14D	14E	14F	150	151	152	153	154	155	156	157	158	159	15A	15B	15C	15D	15E	15F	
O <sub>4</sub>	58																																
O <sub>3</sub>	50																																
O <sub>2</sub>	42																																
O <sub>1</sub>	34																																
WORD	160	161	162	163	164	165	166	167	168	169	16A	16B	16C	16D	16E	16F	170	171	172	173	174	175	176	177	178	179	17A	17B	17C	17D	17E	17F	
O <sub>4</sub>	59																																
O <sub>3</sub>	51																																
O <sub>2</sub>	43																																
O <sub>1</sub>	35																																
WORD	180	181	182	183	184	185	186	187	188	189	18A	18B	18C	18D	18E	18F	190	191	192	193	194	195	196	197	198	199	19A	19B	19C	19D	19E	19F	
O <sub>4</sub>	60																																
O <sub>3</sub>	52																																
O <sub>2</sub>	44																																
O <sub>1</sub>	36																																
WORD	1A0	1A1	1A2	1A3	1A4	1A5	1A6	1A7	1A8	1A9	1AA	1AB	1AC	1AD	1AE	1AF	1B0	1B1	1B2	1B3	1B4	1B5	1B6	1B7	1B8	1B9	1BA	1BB	1BC	1BD	1BE	1BF	
O <sub>4</sub>	61																																
O <sub>3</sub>	53																																
O <sub>2</sub>	45																																
O <sub>1</sub>	37																																
WORD	1C0	1C1	1C2																														

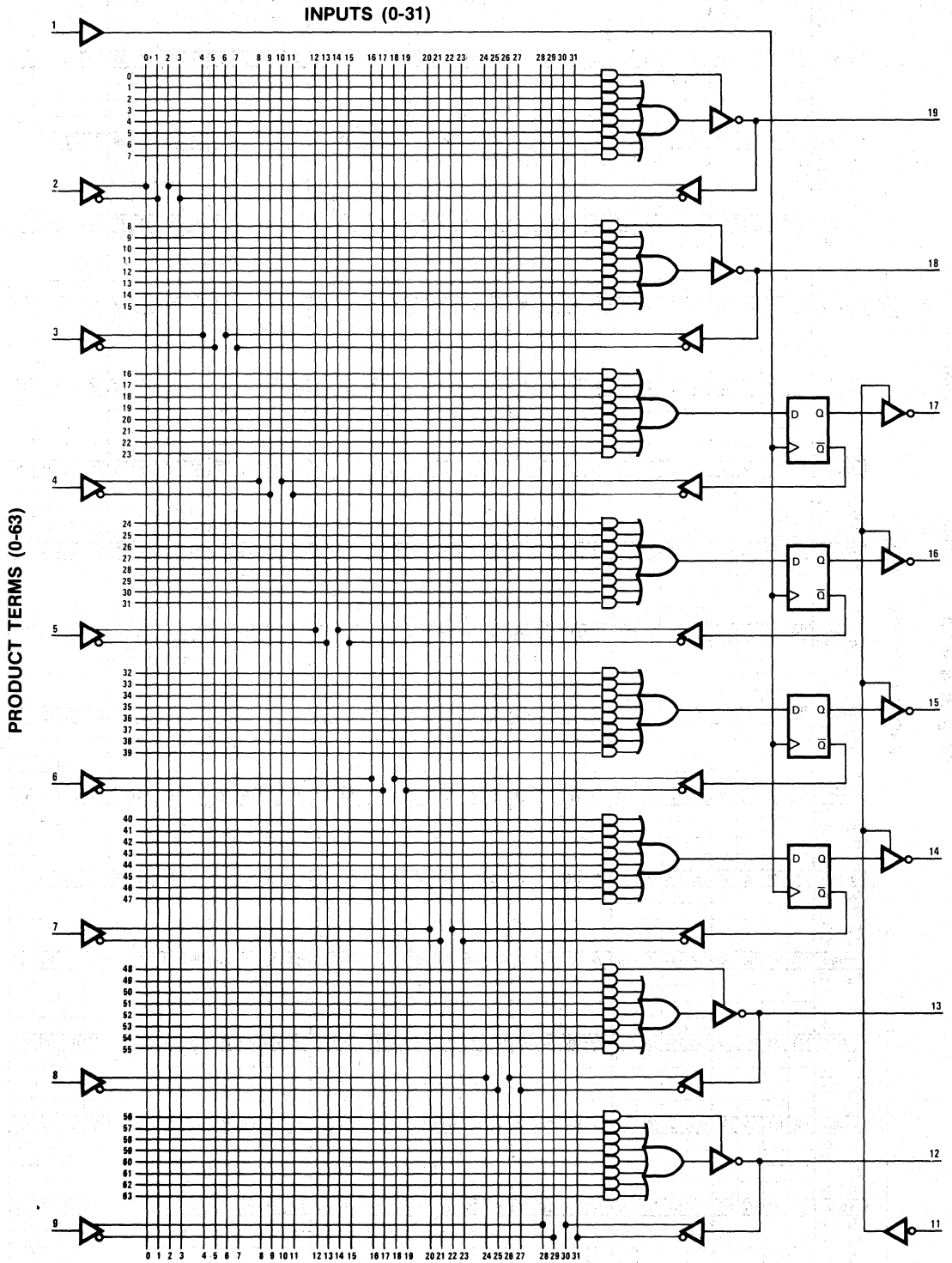



# PAL Programming

## Paper Tape Inputs

Truth tables can be sent to MMI in an ASCII tape format. Information can be sent by mail or TWX. (MMI's TWX number is 910-339-9229.) Although MMI can program PALs with the tape in any format, the following formats have been the most popular.

## 8 Level TWX

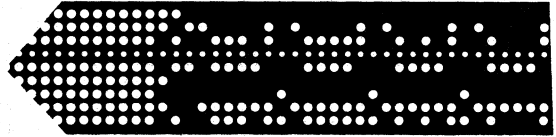

## BHLF Format

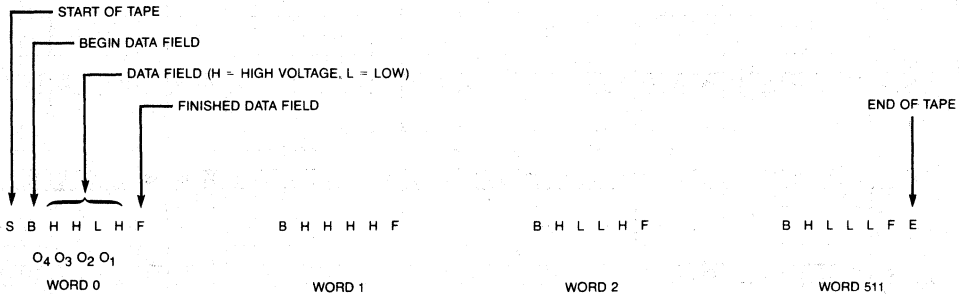

The required heading information at the beginning of the tape is as follows:

CUSTOMER'S NAME AND PHONE _____	CUSTOMER SYMBOLIZED PART NUMBER _____
CUSTOMER'S TWX NUMBER (IF ANY) _____	TRUTH TABLE NUMBER (IF ANY) _____
PURCHASE ORDER NUMBER _____	TYPE OF FORMAT (IF ASCII, HEX, BHLF, ETC.) _____
MMI PART NUMBER _____	25 BELL OR RUBOUT CHARACTERS _____

An example is shown below:

```
BLARNEY ELECTRONICS 408-735-8104
TWX911-338-9225
POL42
PAL16R8
0431
PAT0001
BHLF
```

(25 Bell or Rubout Characters)

```
S
BLLLHF BLLLLF BLHLHF BLHHHF BLLHHF BHHHFF BLLLHF BLHLHF
.      .      .      .      .      .      .      .
.      .      .      .      .      .      .      .
.      .      .      .      .      .      .      .
.      .      .      .      .      .      .      .
BLLLLF BLHLHF BLHHHF BLLHHF BHHHFF BLLLHF BLHLHF BLLLLF
E
```

## BNPF Format

This format is identical to the BHLF format with the exception that a "P" designates a positive bit, and hence a "high" level, and an "N" represents a negative bit, and hence a "low" level.

## Hexadecimal Format

In this format the heading required is identical to the BHLF format but the data is different. Instead of an "S," the hexadecimal

data begins with the SOH or STX character (control A). The data is then represented by the hexadecimal character (0-9 and A-F) which represents the output data of address 0, followed by a space.

Next comes the output data of address 1 followed by a space, etc. The character ETX (control C) is used to end the data. Carriage return and line feed may be included to format the data when the tape is printed.







# Applications

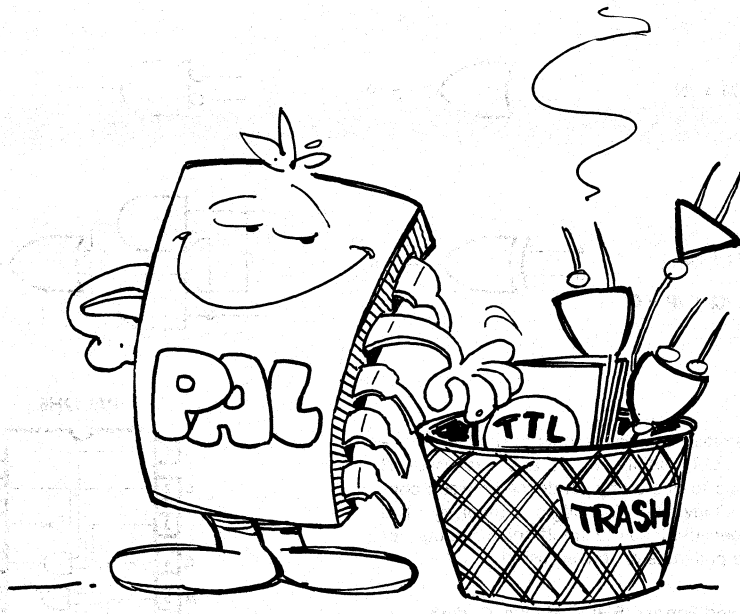

6

## Example 1: Basic Gates

$$B = \neg A$$



$$E = C \cdot D$$



$$H = F + G$$

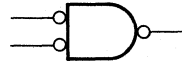

$$L = \neg I + \neg J + \neg K$$



$$O = \neg M \cdot \neg N$$

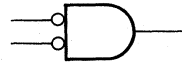

$$R = P \oplus Q$$

$$= P \cdot \neg Q + \neg P \cdot Q$$

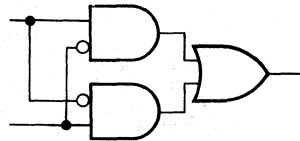

This example demonstrates how fusible logic can implement the basic inverter, AND, OR, NAND, NOR, and exclusive-OR functions. Note the one to one correspondence between conventional logic symbology and PAL logic symbology. The PAL12H6 is selected because it has 12 inputs and 6 outputs. For this example, the fuse pattern is generated using

- a) PALASM
- b) Manual Programming Format (BHLF) Manual Coding

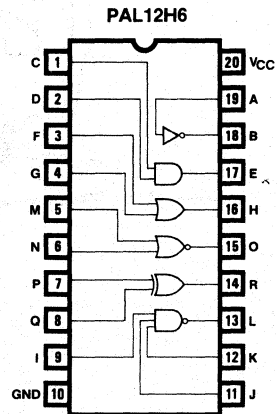

## Basic Gates

## Logic Diagram PAL12H6

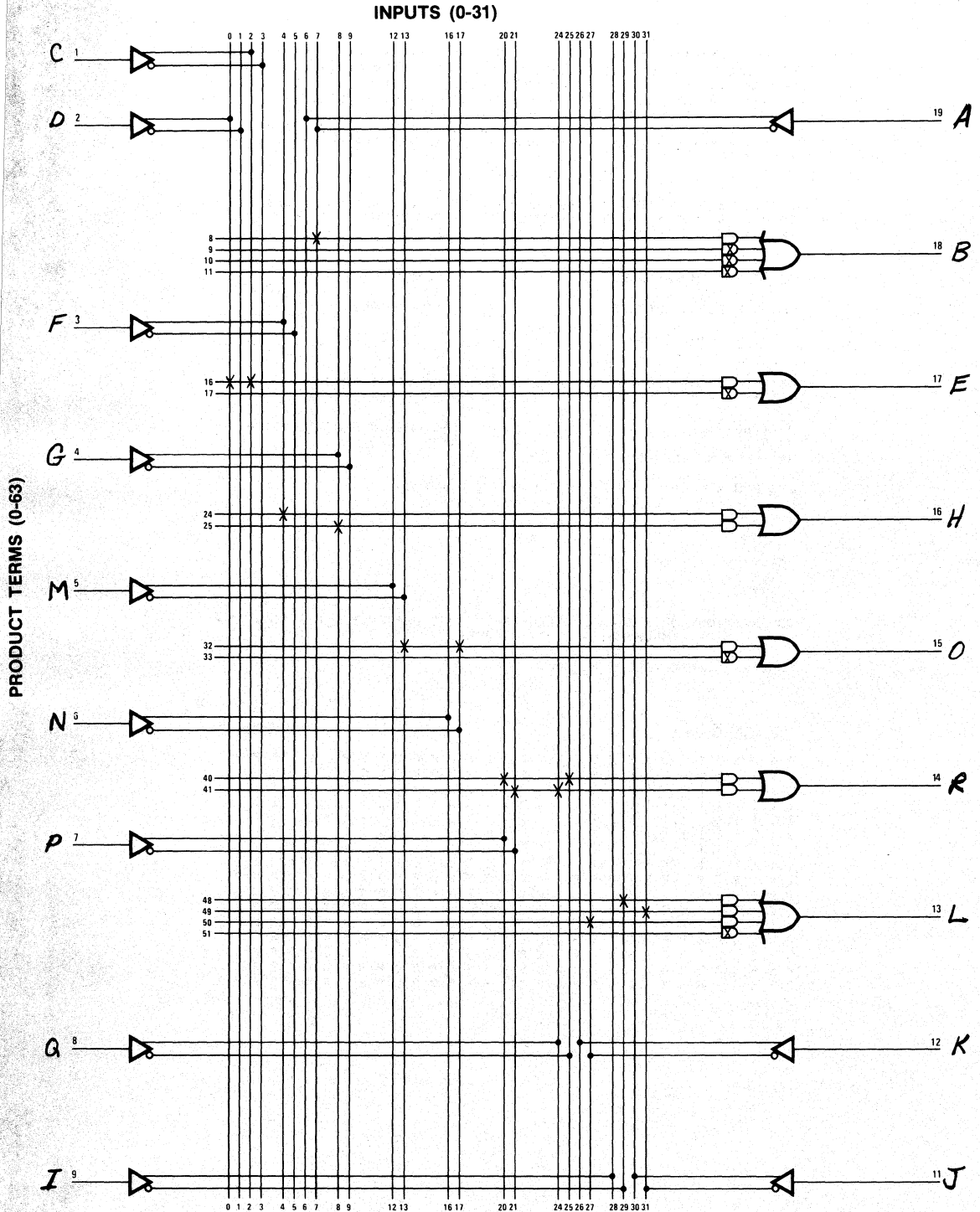



# PAL Applications

## PALASM Output: Basic Gates

## Fuse Plot PAL12H6

```

                11 1111 1111 2222 2222 2233
          0123 4567 8901 2345 6789 0123 4567 8901

0 0000 0000 0000 0000 0000 0000 0000 0000
1 0000 0000 0000 0000 0000 0000 0000 0000
2 0000 0000 0000 0000 0000 0000 0000 0000
3 0000 0000 0000 0000 0000 0000 0000 0000
4 0000 0000 0000 0000 0000 0000 0000 0000
5 0000 0000 0000 0000 0000 0000 0000 0000
6 0000 0000 0000 0000 0000 0000 0000 0000
7 0000 0000 0000 0000 0000 0000 0000 0000

8 ---- -X- --00 --00 --00 --00 ---- ---- /A
9 XXXX XXXX XX00 XX00 XX00 XX00 XXXX XXXX
10 XXXX XXXX XX00 XX00 XX00 XX00 XXXX XXXX
11 XXXX XXXX XX00 XX00 XX00 XX00 XXXX XXXX
12 0000 0000 0000 0000 0000 0000 0000 0000
13 0000 0000 0000 0000 0000 0000 0000 0000
14 0000 0000 0000 0000 0000 0000 0000 0000
15 0000 0000 0000 0000 0000 0000 0000 0000

16 X-X- ---- --00 --00 --00 --00 ---- ---- C*D
17 XXXX XXXX XX00 XX00 XX00 XX00 XXXX XXXX
18 0000 0000 0000 0000 0000 0000 0000 0000
19 0000 0000 0000 0000 0000 0000 0000 0000
20 0000 0000 0000 0000 0000 0000 0000 0000
21 0000 0000 0000 0000 0000 0000 0000 0000
22 0000 0000 0000 0000 0000 0000 0000 0000
23 0000 0000 0000 0000 0000 0000 0000 0000

24 ---- X--- --00 --00 --00 --00 ---- ---- F
25 ---- ---- X-00 --00 --00 --00 ---- ---- G
26 0000 0000 0000 0000 0000 0000 0000 0000
27 0000 0000 0000 0000 0000 0000 0000 0000
28 0000 0000 0000 0000 0000 0000 0000 0000
29 0000 0000 0000 0000 0000 0000 0000 0000
30 0000 0000 0000 0000 0000 0000 0000 0000
31 0000 0000 0000 0000 0000 0000 0000 0000

32 ---- ---- --00 -X00 -X00 --00 ---- ---- /M*/N
33 XXXX XXXX XX00 XX00 XX00 XX00 XXXX XXXX
34 0000 0000 0000 0000 0000 0000 0000 0000
35 0000 0000 0000 0000 0000 0000 0000 0000
36 0000 0000 0000 0000 0000 0000 0000 0000
37 0000 0000 0000 0000 0000 0000 0000 0000
38 0000 0000 0000 0000 0000 0000 0000 0000
39 0000 0000 0000 0000 0000 0000 0000 0000

40 ---- ---- --00 --00 --00 X-00 -X-- ---- P*/Q
41 ---- ---- --00 --00 --00 -X00 X--- ---- /P*Q
42 0000 0000 0000 0000 0000 0000 0000 0000
43 0000 0000 0000 0000 0000 0000 0000 0000
44 0000 0000 0000 0000 0000 0000 0000 0000
45 0000 0000 0000 0000 0000 0000 0000 0000
46 0000 0000 0000 0000 0000 0000 0000 0000
47 0000 0000 0000 0000 0000 0000 0000 0000

48 ---- ---- --00 --00 --00 --00 ---- -X-- /I
49 ---- ---- --00 --00 --00 --00 ---- ---X /J
50 ---- ---- --00 --00 --00 --00 ---- -X-- /K
51 XXXX XXXX XX00 XX00 XX00 XX00 XXXX XXXX
52 0000 0000 0000 0000 0000 0000 0000 0000
53 0000 0000 0000 0000 0000 0000 0000 0000
54 0000 0000 0000 0000 0000 0000 0000 0000
55 0000 0000 0000 0000 0000 0000 0000 0000

56 0000 0000 0000 0000 0000 0000 0000 0000
57 0000 0000 0000 0000 0000 0000 0000 0000
58 0000 0000 0000 0000 0000 0000 0000 0000
59 0000 0000 0000 0000 0000 0000 0000 0000
60 0000 0000 0000 0000 0000 0000 0000 0000
61 0000 0000 0000 0000 0000 0000 0000 0000
62 0000 0000 0000 0000 0000 0000 0000 0000
63 0000 0000 0000 0000 0000 0000 0000 0000

```

6

LEGEND: X : FUSE NOT BLOWN (L,N,0)    - : FUSE BLOWN (H,P,1)  
 0 : PHANTOM FUSE (L,N,0)        O : PHANTOM FUSE (H,P,1)







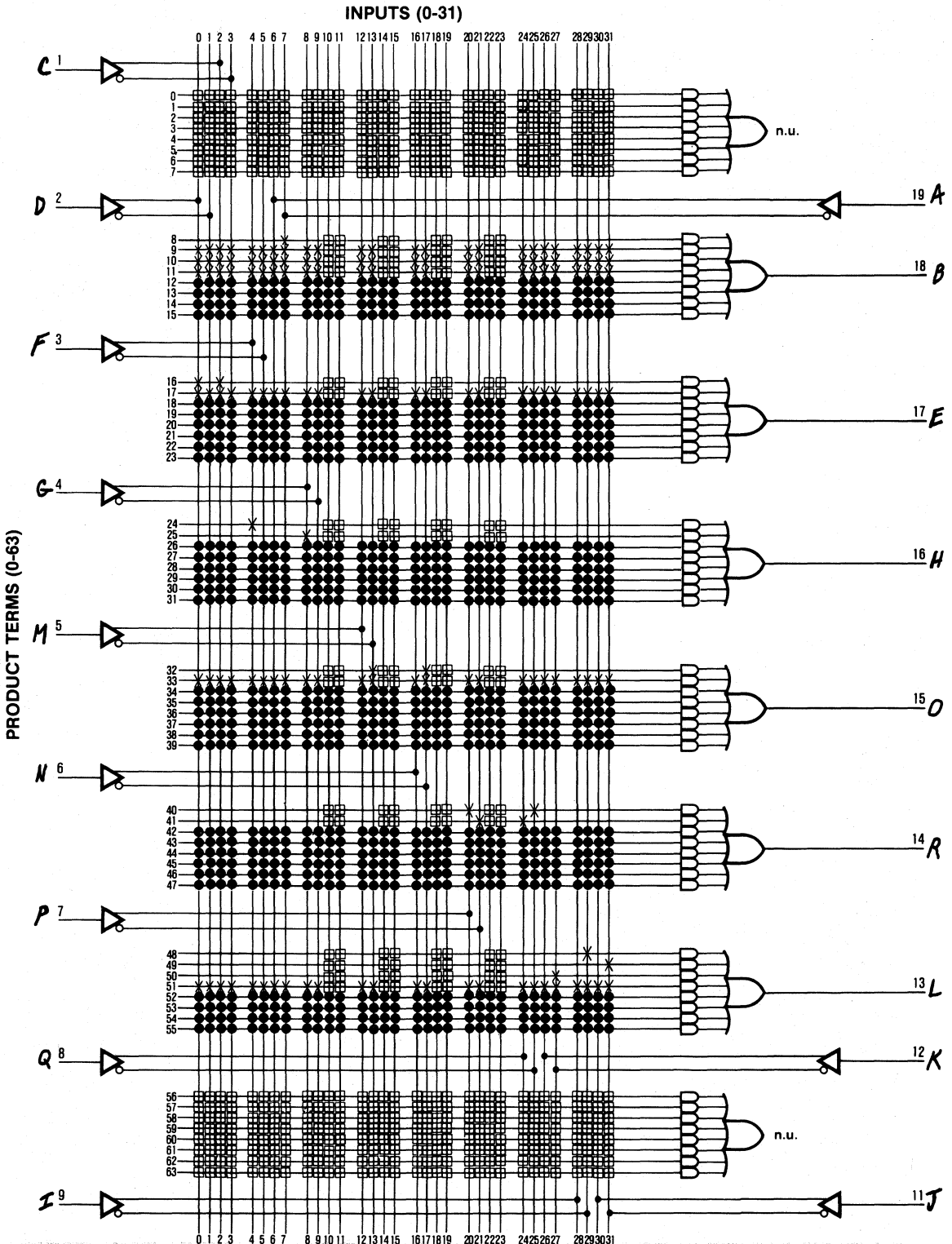

PRODUCT TERMS (0-63)

LEGEND:

- : Phantom Fuse (L, N, O)
- : Phantom Fuse (H, P, 1)
- n.u. — not used



**Example 2:  
6-Bit Shift Register with Three-State Outputs**

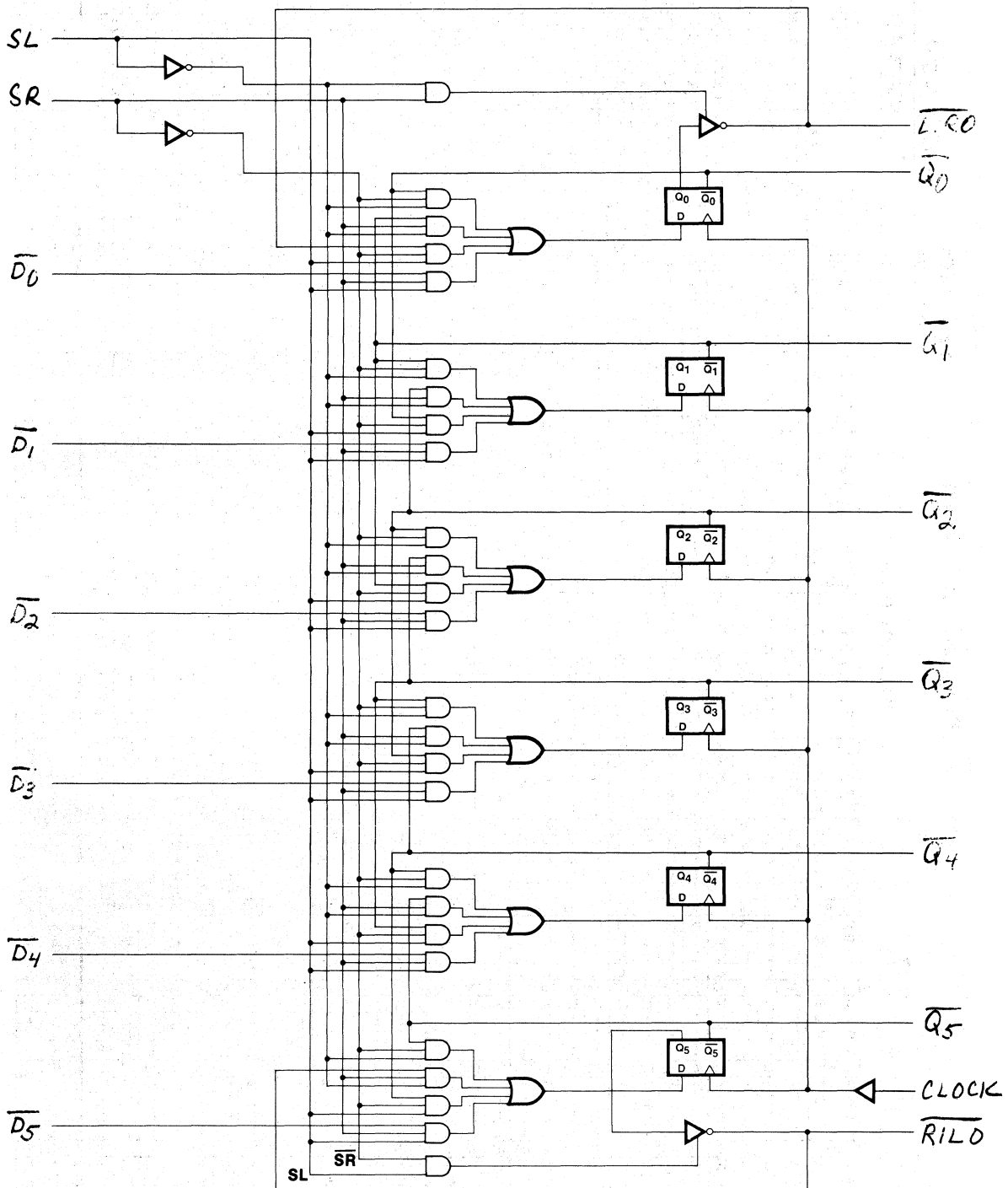

**PALASM Output: 6-Bit Shift Register with Three-State Outputs**

**Design Specification PAL16R6**

\*\*\*\*\* P00206 \*\*\*\*\*  
 YOUR PAL DESIGN SPEC IS ACCEPTED AS MONOLITHIC MEMORIES BIT  
 PATTERN NUMBER P00206 . YOUR PASSWORD IS PAT0005 .  
 PLEASE CONFIRM THAT THESE EQUATIONS ARE CORRECT. MONOLITHIC  
 MEMORIES WILL NOT PROCESS A PRODUCTION ORDER WITHOUT PROPER  
 APPROVAL. USE BP NO. P00206 WHEN PLACING A PROGRAMMING ORDER.  
 \*\*\*\*\*

CUSTOMER CONFIRMATION

I HAVE REVIEWED THIS PAL DESIGN SPECIFICATION AND UNDERSTAND  
 THAT PALS ORDERED BY BIT PATTERN NUMBER P00206 WILL BE  
 PROGRAMMED AS SPECIFIED BELOW.

CUSTOMER COMPANY NAME \_\_\_\_\_ CITY, STATE \_\_\_\_\_  
 AUTHORISED SIGNATURE \_\_\_\_\_ DATE \_\_\_\_\_  
 NAME (PRINT) \_\_\_\_\_ TITLE \_\_\_\_\_

RETURN TO MMI 1165 E. ARQUES SUNNYVALE, CA 94086 ATTN:  
 \*\*\*\*\*

PAL16R6 PAL DESIGN SPECIFICATION  
 PAT0005 JOHN BIRKNER 11/20/77  
 6-BIT SHIFT REGISTER WITH THREE-STATE OUTPUTS  
 MMI,SV  
 CK SR D0 D1 D2 D3 D4 D5 SL GND /E RILO Q5 Q4 Q3 Q2 Q1 Q0 LIRO VCC

IF(SR\*/SL) /LIRO=/Q0  
 /Q0 := /SR\*/SL\*/Q0 + SR\*/SL\*/Q1 + /SR\*SL\*/LIRO + SR\*SL\*/D0  
 /Q1 := /SR\*/SL\*/Q1 + SR\*/SL\*/Q2 + /SR\*SL\*/Q0 + SR\*SL\*/D1  
 /Q2 := /SR\*/SL\*/Q2 + SR\*/SL\*/Q3 + /SR\*SL\*/Q1 + SR\*SL\*/D2  
 /Q3 := /SR\*/SL\*/Q3 + SR\*/SL\*/Q4 + /SR\*SL\*/Q2 + SR\*SL\*/D3  
 /Q4 := /SR\*/SL\*/Q4 + SR\*/SL\*/Q5 + /SR\*SL\*/Q3 + SR\*SL\*/D4  
 /Q5 := /SR\*/SL\*/Q5 + SR\*/SL\*/RILO + /SR\*SL\*/Q4 + SR\*SL\*/D5  
 IF(/SR\*SL) /RILO=/Q5

DESCRIPTION:  
 THE 6-BIT SHIFT REGISTER WILL HOLD , SHIFT RIGHT, SHIFT LEFT, OR LOAD  
 ON THE RISING EDGE OF THE CLOCK (CK).  
 THE THREE STATE OUTPUTS ARE HIGH-Z WHEN THE ENABLE LINE (/E) IS HIGH AND  
 ENABLED WHEN ENABLE LINE (/E) IS LOW.

FUNCTION TABLE:

-----											-----										
! INPUTS !											! OUTPUTS !										
! SL	! SR	! RILO	! LIRO	! CLOCK	! RILO	! Q5	! Q4	! Q3	! Q2	! Q1	! Q0	! LIRO	! OPERATION	!							
! L	! L	! X	! X	! L-H	! Z	! Q5	! Q4	! Q3	! Q2	! Q1	! Q0	! Z	! HOLD	!							
! L	! H	! RI	! X	! L-H	! Z	! R1	! Q5	! Q4	! Q3	! Q2	! Q1	! Q1	! RIGHT SHFT!	!							
! H	! L	! X	! LI	! L-H	! Q4	! Q4	! Q3	! Q2	! Q1	! Q0	! LI	! Z	! LEFT SHFT!	!							
! H	! H	! X	! X	! L-H	! Z	! D5	! D4	! D3	! D2	! D1	! D0	! Z	! LOAD D	!							

NUMBER OF FUSES BLOWN = 818

PALASM Output

HEX FORMAT

```

E 1 F F F F F D F F F B F F F 7 F F F F F F F F F F F F F F F F F .
1 F F F F F F F F F D F F F B F F F 7 F F F F F F F F F F F F F F F .
0 E C E E E A E E E 6 E E E E E E E E E E E E E E E E E E E E E .
0 E E E E C E E E A E E E 6 E E E E E E E E E E E E E E E E E E E .
0 0 0 0 0 0 0 0 0 0 0 0 0 0 0 0 0 0 0 0 0 0 0 0 0 0 0 0 0 0 .
0 0 0 0 0 0 0 0 0 0 0 0 0 0 0 0 0 0 0 0 0 0 0 0 0 0 0 0 0 0 .
0 0 0 0 0 0 0 0 0 0 0 0 0 0 0 0 0 0 0 0 0 0 0 0 0 0 0 0 0 0 .
0 0 0 0 0 0 0 0 0 0 0 0 0 0 0 0 0 0 0 0 0 0 0 0 0 0 0 0 0 0 .
0 0 0 0 0 0 0 0 0 0 0 0 0 0 0 0 0 0 0 0 0 0 0 0 0 0 0 0 0 0 .
0 0 0 0 0 0 0 0 0 0 0 0 0 0 0 0 0 0 0 0 0 0 0 0 0 0 0 0 0 0 .
0 0 0 0 0 0 0 0 0 0 0 0 0 0 0 0 0 0 0 0 0 0 0 0 0 0 0 0 0 0 .
0 0 0 0 0 0 0 0 0 0 0 0 0 0 0 0 0 0 0 0 0 0 0 0 0 0 0 0 0 0 .
0 0 0 0 0 0 0 0 0 0 0 0 0 0 0 0 0 0 0 0 0 0 0 0 0 0 0 0 0 0 .
0 0 0 0 0 0 0 0 0 0 0 0 0 0 0 0 0 0 0 0 0 0 0 0 0 0 0 0 0 0 .
0 0 0 0 0 0 0 0 0 0 0 0 0 0 0 0 0 0 0 0 0 0 0 0 0 0 0 0 0 0 .
    
```



**PALASM Output: 6-Bit Shift Register  
with Three-State Outputs**

**Fuse Plot PAL16R6**

	0123	4567	8901	11	1111	1111	2222	2222	2233	
	0123	4567	8901	2345	6789	0123	4567	8901		
0	X---	----	----	----	----	----	----	----	-X--	SR*/SL
1	----	---X	----	----	----	----	----	----	----	/Q0
2	XXXX	XXXX	XXXX	XXXX	XXXX	XXXX	XXXX	XXXX	XXXX	XXXX
3	XXXX	XXXX	XXXX	XXXX	XXXX	XXXX	XXXX	XXXX	XXXX	XXXX
4	XXXX	XXXX	XXXX	XXXX	XXXX	XXXX	XXXX	XXXX	XXXX	XXXX
5	XXXX	XXXX	XXXX	XXXX	XXXX	XXXX	XXXX	XXXX	XXXX	XXXX
6	XXXX	XXXX	XXXX	XXXX	XXXX	XXXX	XXXX	XXXX	XXXX	XXXX
7	XXXX	XXXX	XXXX	XXXX	XXXX	XXXX	XXXX	XXXX	XXXX	XXXX
8	-X--	---X	----	----	----	----	----	----	-X--	/SR*/SL*/Q0
9	X---	----	---X	----	----	----	----	----	-X--	SR*/SL*/Q1
10	-X-X	----	----	----	----	----	----	----	X---	/SR*/SL*/LIRO
11	X---	-X--	----	----	----	----	----	----	X---	SR*SL*/D0
12	XXXX	XXXX	XXXX	XXXX	XXXX	XXXX	XXXX	XXXX	XXXX	XXXX
13	XXXX	XXXX	XXXX	XXXX	XXXX	XXXX	XXXX	XXXX	XXXX	XXXX
14	XXXX	XXXX	XXXX	XXXX	XXXX	XXXX	XXXX	XXXX	XXXX	XXXX
15	XXXX	XXXX	XXXX	XXXX	XXXX	XXXX	XXXX	XXXX	XXXX	XXXX
16	-X--	----	---X	----	----	----	----	----	-X--	/SR*/SL*/Q1
17	X---	----	----	---X	----	----	----	----	-X--	SR*/SL*/Q2
18	-X--	---X	----	----	----	----	----	----	X---	/SR*/SL*/Q0
19	X---	----	-X--	----	----	----	----	----	X---	SR*SL*/D1
20	XXXX	XXXX	XXXX	XXXX	XXXX	XXXX	XXXX	XXXX	XXXX	XXXX
21	XXXX	XXXX	XXXX	XXXX	XXXX	XXXX	XXXX	XXXX	XXXX	XXXX
22	XXXX	XXXX	XXXX	XXXX	XXXX	XXXX	XXXX	XXXX	XXXX	XXXX
23	XXXX	XXXX	XXXX	XXXX	XXXX	XXXX	XXXX	XXXX	XXXX	XXXX
24	-X--	----	----	---X	----	----	----	----	-X--	/SR*/SL*/Q2
25	X---	----	----	----	---X	----	----	----	-X--	SR*/SL*/Q3
26	-X--	----	---X	----	----	----	----	----	X---	/SR*/SL*/Q1
27	X---	----	----	-X--	----	----	----	----	X---	SR*SL*/D2
28	XXXX	XXXX	XXXX	XXXX	XXXX	XXXX	XXXX	XXXX	XXXX	XXXX
29	XXXX	XXXX	XXXX	XXXX	XXXX	XXXX	XXXX	XXXX	XXXX	XXXX
30	XXXX	XXXX	XXXX	XXXX	XXXX	XXXX	XXXX	XXXX	XXXX	XXXX
31	XXXX	XXXX	XXXX	XXXX	XXXX	XXXX	XXXX	XXXX	XXXX	XXXX
32	-X--	----	----	----	---X	----	----	----	-X--	/SR*/SL*/Q3
33	X---	----	----	----	----	---X	----	----	-X--	SR*/SL*/Q4
34	-X--	----	----	---X	----	----	----	----	X---	/SR*/SL*/Q2
35	X---	----	----	----	-X--	----	----	----	X---	SR*SL*/D3
36	XXXX	XXXX	XXXX	XXXX	XXXX	XXXX	XXXX	XXXX	XXXX	XXXX
37	XXXX	XXXX	XXXX	XXXX	XXXX	XXXX	XXXX	XXXX	XXXX	XXXX
38	XXXX	XXXX	XXXX	XXXX	XXXX	XXXX	XXXX	XXXX	XXXX	XXXX
39	XXXX	XXXX	XXXX	XXXX	XXXX	XXXX	XXXX	XXXX	XXXX	XXXX
40	-X--	----	----	----	----	---X	----	----	-X--	/SR*/SL*/Q4
41	X---	----	----	----	----	----	---X	----	-X--	SR*/SL*/Q5
42	-X--	----	----	----	----	---X	----	----	X---	/SR*/SL*/Q3
43	X---	----	----	----	----	-X--	----	----	X---	SR*SL*/D4
44	XXXX	XXXX	XXXX	XXXX	XXXX	XXXX	XXXX	XXXX	XXXX	XXXX
45	XXXX	XXXX	XXXX	XXXX	XXXX	XXXX	XXXX	XXXX	XXXX	XXXX
46	XXXX	XXXX	XXXX	XXXX	XXXX	XXXX	XXXX	XXXX	XXXX	XXXX
47	XXXX	XXXX	XXXX	XXXX	XXXX	XXXX	XXXX	XXXX	XXXX	XXXX
48	-X--	----	----	----	----	----	---X	----	-X--	/SR*/SL*/Q5
49	X---	----	----	----	----	----	----	---X	-X--	SR*/SL*/RILO
50	-X--	----	----	----	----	----	---X	----	X---	/SR*/SL*/Q4
51	X---	----	----	----	----	----	-X--	----	X---	SR*SL*/D5
52	XXXX	XXXX	XXXX	XXXX	XXXX	XXXX	XXXX	XXXX	XXXX	XXXX
53	XXXX	XXXX	XXXX	XXXX	XXXX	XXXX	XXXX	XXXX	XXXX	XXXX
54	XXXX	XXXX	XXXX	XXXX	XXXX	XXXX	XXXX	XXXX	XXXX	XXXX
55	XXXX	XXXX	XXXX	XXXX	XXXX	XXXX	XXXX	XXXX	XXXX	XXXX
56	-X--	----	----	----	----	----	----	----	X---	/SR*SL
57	----	----	----	----	----	----	----	---X	----	/Q5
58	XXXX	XXXX	XXXX	XXXX	XXXX	XXXX	XXXX	XXXX	XXXX	XXXX
59	XXXX	XXXX	XXXX	XXXX	XXXX	XXXX	XXXX	XXXX	XXXX	XXXX
60	XXXX	XXXX	XXXX	XXXX	XXXX	XXXX	XXXX	XXXX	XXXX	XXXX
61	XXXX	XXXX	XXXX	XXXX	XXXX	XXXX	XXXX	XXXX	XXXX	XXXX
62	XXXX	XXXX	XXXX	XXXX	XXXX	XXXX	XXXX	XXXX	XXXX	XXXX
63	XXXX	XXXX	XXXX	XXXX	XXXX	XXXX	XXXX	XXXX	XXXX	XXXX

LEGEND: X : FUSE NOT BLOWN (L,N,0) - : FUSE BLOWN (H,P,1)



Manual Coding: 6-Bit Shift Register with Three-State Outputs

Logic Diagram PAL16R6

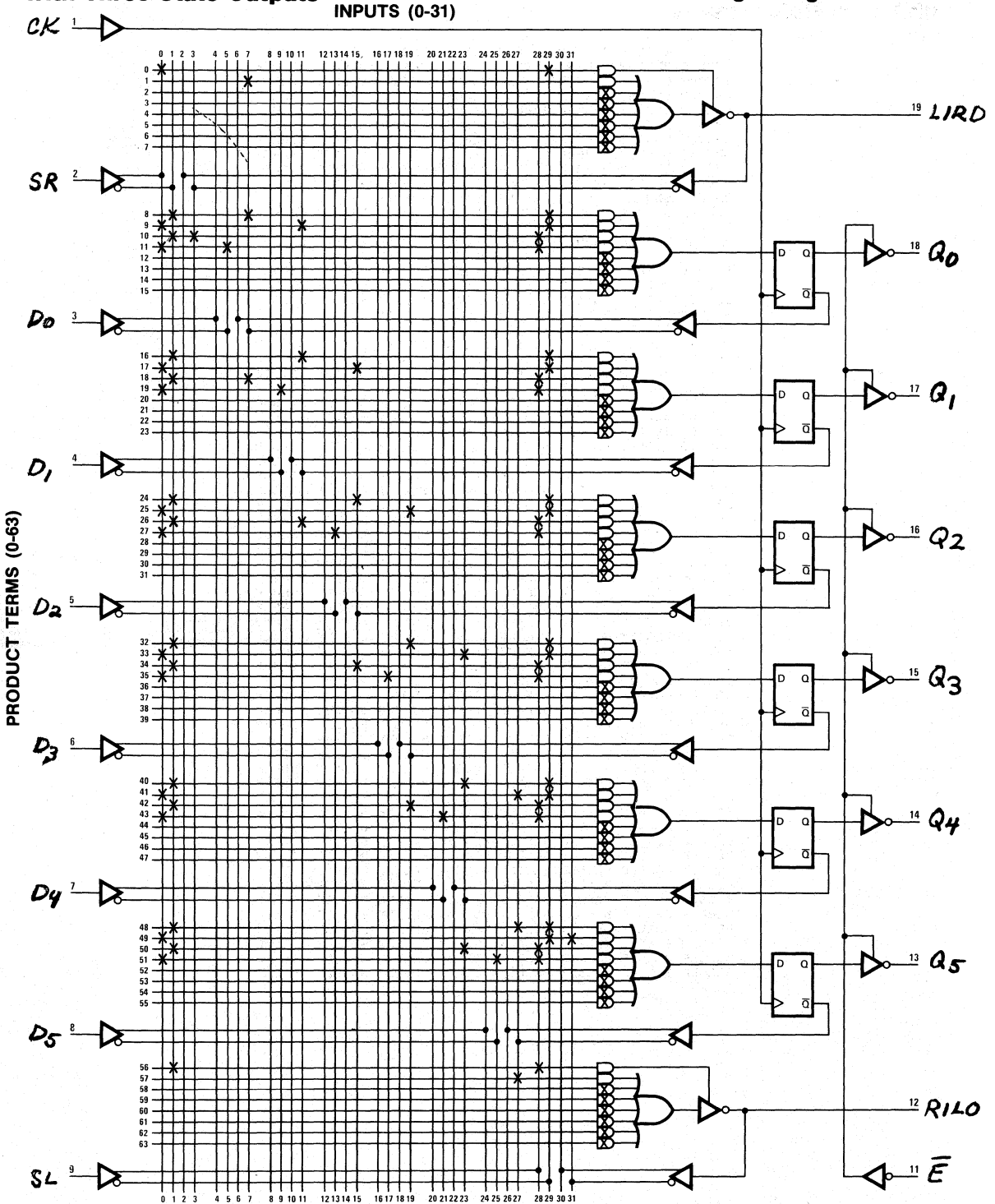

# Manual Coding: 6-Bit Shift Register with Three-State Outputs

INPUTS (0-31)

PAL 16R6  
PATTERN: P0005  
NAME: John Birkner

Programming Format  
PRODUCT TERMS (0-63)

DATE: 11-20-77

	0	1	2	3	4	5	6	7	8	9	10	11	12	13	14	15	16	17	18	19	20	21	22	23	24	25	26	27	28	29	30	31	
WORD	0	1	2	3	4	5	6	7	8	9	A	B	C	D	E	F	10	11	12	13	14	15	16	17	18	19	1A	1B	1C	1D	1E	1F	
O <sub>4</sub>	H	L	H	H	H	H	H	H	H	H	H	H	H	H	H	L	H	H	H	H	H	H	H	H	H	H	H	H	H	H	L	H	H
O <sub>3</sub>	24	H	L	H	H	H	H	H	H	H	H	H	H	H	H	H	H	H	H	H	H	H	H	H	H	H	H	H	H	H	L	H	H
O <sub>2</sub>	8	H	L	H	H	H	H	H	H	H	H	H	H	H	H	H	H	H	H	H	H	H	H	H	H	H	H	H	H	H	L	H	H
O <sub>1</sub>	0	L	H	H	H	H	H	H	H	H	H	H	H	H	H	H	H	H	H	H	H	H	H	H	H	H	H	H	H	H	H	H	H
WORD	20	21	22	23	24	25	26	27	28	29	2A	2B	2C	2D	2E	2F	30	31	32	33	34	35	36	37	38	39	3A	3B	3C	3D	3E	3F	
O <sub>4</sub>	25	L	H	H	H	H	H	H	H	H	H	H	H	H	H	H	H	H	H	H	L	H	H	H	H	H	H	H	H	H	L	H	H
O <sub>3</sub>	17	L	H	H	H	H	H	H	H	H	H	H	H	H	H	H	H	H	H	H	H	H	H	H	H	H	H	H	H	H	L	H	H
O <sub>2</sub>	9	L	H	H	H	H	H	H	H	H	H	H	H	H	H	H	H	H	H	H	H	H	H	H	H	H	H	H	H	H	L	H	H
O <sub>1</sub>	1	L	H	H	H	H	H	H	H	H	H	H	H	H	H	H	H	H	H	H	H	H	H	H	H	H	H	H	H	H	H	H	H
WORD	40	41	42	43	44	45	46	47	48	49	4A	4B	4C	4D	4E	4F	50	51	52	53	54	55	56	57	58	59	5A	5B	5C	5D	5E	5F	
O <sub>4</sub>	26	H	L	H	H	H	H	H	H	H	H	H	H	H	H	H	H	H	H	H	H	H	H	H	H	H	H	H	H	H	L	H	H
O <sub>3</sub>	18	H	L	H	H	H	H	H	H	H	H	H	H	H	H	H	H	H	H	H	H	H	H	H	H	H	H	H	H	H	L	H	H
O <sub>2</sub>	10	H	L	H	H	H	H	H	H	H	H	H	H	H	H	H	H	H	H	H	H	H	H	H	H	H	H	H	H	H	L	H	H
O <sub>1</sub>	2	L	H	H	H	H	H	H	H	H	H	H	H	H	H	H	H	H	H	H	H	H	H	H	H	H	H	H	H	H	H	H	H
WORD	60	61	62	63	64	65	66	67	68	69	6A	6B	6C	6D	6E	6F	70	71	72	73	74	75	76	77	78	79	7A	7B	7C	7D	7E	7F	
O <sub>4</sub>	27	L	H	H	H	H	H	H	H	H	H	H	H	H	H	H	H	H	H	H	H	H	H	H	H	H	H	H	H	L	H	H	
O <sub>3</sub>	19	L	H	H	H	H	H	H	H	H	H	H	H	H	H	H	H	H	H	H	H	H	H	H	H	H	H	H	H	L	H	H	
O <sub>2</sub>	11	L	H	H	H	H	H	H	H	H	H	H	H	H	H	H	H	H	H	H	H	H	H	H	H	H	H	H	H	L	H	H	
O <sub>1</sub>	3	L	H	H	H	H	H	H	H	H	H	H	H	H	H	H	H	H	H	H	H	H	H	H	H	H	H	H	H	H	H	H	H
WORD	80	81	82	83	84	85	86	87	88	89	8A	8B	8C	8D	8E	8F	90	91	92	93	94	95	96	97	98	99	9A	9B	9C	9D	9E	9F	
O <sub>4</sub>	28	L	L	L	L	L	L	L	L	L	L	L	L	L	L	L	L	L	L	L	L	L	L	L	L	L	L	L	L	L	L	L	
O <sub>3</sub>	20	L	L	L	L	L	L	L	L	L	L	L	L	L	L	L	L	L	L	L	L	L	L	L	L	L	L	L	L	L	L	L	
O <sub>2</sub>	12	L	L	L	L	L	L	L	L	L	L	L	L	L	L	L	L	L	L	L	L	L	L	L	L	L	L	L	L	L	L	L	
O <sub>1</sub>	4	L	L	L	L	L	L	L	L	L	L	L	L	L	L	L	L	L	L	L	L	L	L	L	L	L	L	L	L	L	L	L	
WORD	A0	A1	A2	A3	A4	A5	A6	A7	A8	A9	AA	AB	AC	AD	AE	AF	B0	B1	B2	B3	B4	B5	B6	B7	B8	B9	BA	BB	BC	BD	BE	BF	
O <sub>4</sub>	29	L	L	L	L	L	L	L	L	L	L	L	L	L	L	L	L	L	L	L	L	L	L	L	L	L	L	L	L	L	L	L	
O <sub>3</sub>	21	L	L	L	L	L	L	L	L	L	L	L	L	L	L	L	L	L	L	L	L	L	L	L	L	L	L	L	L	L	L	L	
O <sub>2</sub>	13	L	L	L	L	L	L	L	L	L	L	L	L	L	L	L	L	L	L	L	L	L	L	L	L	L	L	L	L	L	L	L	
O <sub>1</sub>	5	L	L	L	L	L	L	L	L	L	L	L	L	L	L	L	L	L	L	L	L	L	L	L	L	L	L	L	L	L	L	L	
WORD	C0	C1	C2	C3	C4	C5	C6	C7	C8	C9	CA	CB	CC	CD	CE	CF	D0	D1	D2	D3	D4	D5	D6	D7	D8	DA	DB	DC	DD	DE	DF		
O <sub>4</sub>	30	L	L	L	L	L	L	L	L	L	L	L	L	L	L	L	L	L	L	L	L	L	L	L	L	L	L	L	L	L	L	L	
O <sub>3</sub>	22	L	L	L	L	L	L	L	L	L	L	L	L	L	L	L	L	L	L	L	L	L	L	L	L	L	L	L	L	L	L	L	
O <sub>2</sub>	14	L	L	L	L	L	L	L	L	L	L	L	L	L	L	L	L	L	L	L	L	L	L	L	L	L	L	L	L	L	L	L	
O <sub>1</sub>	6	L	L	L	L	L	L	L	L	L	L	L	L	L	L	L	L	L	L	L	L	L	L	L	L	L	L	L	L	L	L	L	
WORD	E0	E1	E2	E3	E4	E5	E6	E7	E8	E9	EA	EB	EC	ED	EE	EF	F0	F1	F2	F3	F4	F5	F6	F7	F8	FA	FB	FC	FD	FE	FF		
O <sub>4</sub>	31	L	L	L	L	L	L	L	L	L	L	L	L	L	L	L	L	L	L	L	L	L	L	L	L	L	L	L	L	L	L	L	
O <sub>3</sub>	23	L	L	L	L	L	L	L	L	L	L	L	L	L	L	L	L	L	L	L	L	L	L	L	L	L	L	L	L	L	L	L	
O <sub>2</sub>	15	L	L	L	L	L	L	L	L	L	L	L	L	L	L	L	L	L	L	L	L	L	L	L	L	L	L	L	L	L	L	L	
O <sub>1</sub>	7	L	L	L	L	L	L	L	L	L	L	L	L	L	L	L	L	L	L	L	L	L	L	L	L	L	L	L	L	L	L	L	
WORD	100	101	102	103	104	105	106	107	108	109	10A	10B	10C	10D	10E	10F	110	111	112	113	114	115	116	117	118	119	11A	11B	11C	11D	11E	11F	
O <sub>4</sub>	56	H	L	H	H	H	H	H	H	H	H	H	H	H	H	H	H	H	H	H	H	H	H	H	H	H	H	H	H	L	H	H	
O <sub>3</sub>	48	H	L	H	H	H	H	H	H	H	H	H	H	H	H	H	H	H	H	H	H	H	H	H	H	H	H	H	H	L	H	H	
O <sub>2</sub>	40	H	L	H	H	H	H	H	H	H	H	H	H	H	H	H	H	H	H	H	H	H	H	H	H	H	H	H	H	L	H	H	
O <sub>1</sub>	32	H	L	H	H	H	H	H	H	H	H	H	H	H	H	H	H	H	H	H	H	H	H	H	H	H	H	H	H	H	L	H	H
WORD	120	121	122	123	124	125	126	127	128	129	12A	12B	12C	12D	12E	12F	130	131	132	133	134	135	136	137	138	139	13A	13B	13C	13D	13E	13F	
O <sub>4</sub>	57	H	L	H	H	H	H	H	H	H	H	H	H	H	H	H	H	H	H	H	H	H	H	H	H	H	H	H	H	L	H	H	
O <sub>3</sub>	49	H	L	H	H	H	H	H	H	H	H	H	H	H	H	H	H	H	H	H	H	H	H	H	H	H	H	H	H	L	H	H	
O <sub>2</sub>	41	H	L	H	H	H	H	H	H	H	H	H	H	H	H	H	H	H	H	H	H	H	H	H	H	H	H	H	H	L	H	H	
O <sub>1</sub>	33	L	H	H	H	H	H	H	H	H	H	H	H	H	H	H	H	H	H	H	H	H	H	H	H	H	H	H	H	H	H	H	H
WORD	140	141	142	143	144	145	146	147	148	149	14A	14B	14C	14D	14E	14F	150	151	152	153	154	155	156	157	158	159	15A	15B	15C	15D	15E	15F	
O <sub>4</sub>	58	L	L	L	L	L	L	L	L	L	L	L	L	L	L	L	L	L	L	L	L	L	L	L	L	L	L	L	L	L	L	L	
O <sub>3</sub>	50	H	L	H	H	H	H	H	H	H	H	H	H	H	H	H	H	H	H	H	H	H	H	H	H	H	H	H	H	L	H	H	
O <sub>2</sub>	42	H	L	H	H	H	H	H	H	H	H	H	H	H	H	H	H	H	H	H	H	H	H	H	H	H	H	H	H	L	H	H	
O <sub>1</sub>	34	L	H	H	H	H	H	H	H	H	H	H	H	H	H	H	H	H	H	H	H	H	H	H	H	H	H	H	H	H	H	H	H
WORD	160	161	162	163	164	165	166	167	168	169	16A	16B	16C	16D	16E	16F	170	171	172	173	174	175	176	177	178	179	17A	17B	17C	17D	17E	17F	
O <sub>4</sub>	59	L	L	L	L	L	L	L	L	L	L	L	L	L	L	L	L	L	L	L	L	L	L	L	L	L	L	L	L	L	L	L	
O <sub>3</sub>	51	L	H	H	H	H	H	H	H	H	H	H	H	H	H	H	H	H	H	H	H	H	H	H	H	H	H	H	H	L	H	H	
O <sub>2</sub>	43	L	H	H	H	H	H	H	H	H	H	H	H	H	H	H	H	H	H	H	H	H	H	H	H	H	H	H	H	L	H	H	
O <sub>1</sub>	35	L	H	H	H	H	H	H	H	H	H	H	H	H	H	H	H	H	H	H	H	H	H	H	H	H	H	H	H	H	H	H	H
WORD	180	181	182	183	184	185	186	187	188	189	18A	18B	18C	18D	18E	18F	190	191	192	193	194	195											







<b>Introduction</b>	<b>1</b>
<b>HI REL</b>	<b>2</b>
<b>PROM</b>	<b>3</b>
<b>ROM</b>	<b>4</b>
<b>Character Generators</b>	<b>5</b>
<b>PAL</b>	<b>6</b>
<b>FIFO</b>	<b>7</b>
<b>Arithmetic Elements</b>	<b>8</b>
<b>Interface</b>	<b>9</b>
<b>General Information</b>	<b>10</b>
<b>Representatives/Distributors</b>	<b>11</b>



# First-In First-Out (FIFO) 64x4 Serial Memory

## 57/67401

U.S. Patent 4151609

### Features/Benefits

- 10 MHz shift in, shift out guaranteed rates
- TTL inputs and outputs
- Readily expandable in word and bit dimensions
- Output pins directly opposite corresponding input pins
- Asynchronous or synchronous operation
- Pin compatible with Fairchild's F3341 MOS FIFO and ten times as fast

### Ordering Information

PART NUMBER	PACKAGE	TEMPERATURE RANGE
57401	J16	Military
67401	J16	Commercial

### Description

The 67401 is an expandable "fall-through" high speed First-In First-Out (FIFO) memory organized 64 words by 4-bit. A 10 MHz data rate allows usage in high speed tape or disc controllers and communication buffer applications.

### Block Diagram

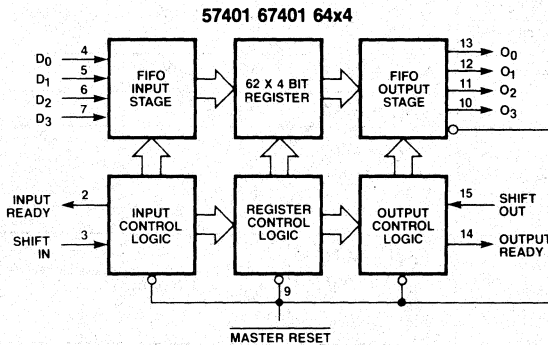

### Pin Configuration

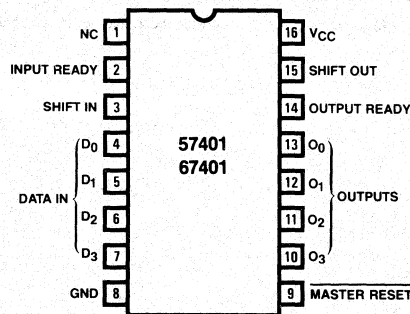

**Absolute Maximum Ratings**

Supply Voltage, $V_{CC}$	7V
Input Voltage	7V
Off-state output voltage	5.5V
Storage temperature	-65° to +150°C

**Operating Conditions**

SYMBOL	PARAMETER	MILITARY			COMMERCIAL			UNIT
		MIN	NOM	MAX	MIN	NOM	MAX	
$V_{CC}$	Supply voltage	4.5	5	5.5	4.75	5	5.25	V
$T_A$	Operating free-air temperature	-55		125	0		75	°C

**Electrical Characteristics Over Operating Conditions**

SYMBOL	PARAMETER		TEST CONDITIONS		MIN TYP MAX			UNIT
					MIN	TYP	MAX	
$V_{IL}$	Low-level input voltage				0.8			V
$V_{IH}$	High-level input voltage				2			V
$V_{IC}$	Input clamp voltage		$V_{CC} = \text{MIN}$	$I_I = -18\text{mA}$	-1.5			V
$I_{IL1}$	Low-level input current	$D_0-D_3, MR$	$V_{CC} = \text{MAX}$	$V_I = 0.45\text{V}$	-0.8			mA
$I_{IL2}$		$SI, SO$			-1.6			mA
$I_{IH}$	High-level input current		$V_{CC} = \text{MAX}$	$V_I = 2.4\text{V}$	50			$\mu\text{A}$
$I_I$	Maximum input current		$V_{CC} = \text{MAX}$	$V_I = 5.5\text{V}$	1			mA
$V_{OL}$	Low-level output voltage		$V_{CC} = \text{MIN}$ $V_{IL} = 0.8\text{V}$ $V_{IH} = 2\text{V}$	$I_{OL} = 8\text{mA}$	0.5			V
$V_{OH}$	High-level output voltage		$V_{CC} = \text{MIN}$ $V_{IL} = 0.8\text{V}$ $V_{IH} = 2\text{V}$	$I_{OH} = -0.9\text{mA}$	2.4			V
$I_{OS}$	Output short-circuit current *		$V_{CC} = 6\text{V}$	$V_O = 0.5\text{V}$	-20		-90	mA
$I_{CC}$	Supply current		$V_{CC} = \text{MAX}$	57401	150			mA
				67401	160			

\* Not more than one output should be shorted at a time and duration of the short-circuit should not exceed one second.

## Switching Characteristics

Over Operating Conditions

SYMBOL	PARAMETER	FIGURE	MILITARY		COMMERCIAL		UNIT
			MIN	MAX	MIN	MAX	
$f_{IN}$	Shift In rate	1	7		10		MHz
$t_{SIH}$	Shift In HIGH time	1	45		35		ns
$t_{SIL}$	Shift In LOW time	1	45		35		ns
$t_{IRL}$	Shift In to input ready LOW	1		60		45	ns
$t_{IRH}$	Shift In to input ready HIGH	1		60		45	ns
$t_{IDS}$	Input data set up	1	10		5		ns
$t_{IDH}$	Input data hold time	1	55		45		ns
$f_{OUT}$	Shift Out rate	6	7		10		MHz
$t_{SOH}$	Shift Out HIGH time	6	45		35		ns
$t_{SOL}$	Shift Out LOW time	6	45		35		ns
$t_{ORL}$	Shift Out to Output Ready LOW	6		65		55	ns
$t_{ORH}$	Shift Out to Output Ready HIGH	6		65		55	ns
$t_{OD}$	Output data delay	6	10	65	10	55	ns
$t_{PT}$	Data throughput time	4, 9		4		3	$\mu$ s
$t_{MRW}$	Master Reset pulse*	11	30		35		ns
$t_{MRORL}$	Master Reset to OR LOW	11		65		60	ns
$t_{MRIRH}$	Master Reset to IR HIGH	11		65		60	ns
$t_{MRS}$	Master Reset to SI	11	45		35		ns
$t_{IPH}$	Input Ready pulse HIGH	4	20		20		ns
$t_{OPH}$	Output Ready pulse HIGH	9	20		20		ns

\*Master reset clears all the cells to the empty state, and the data-outputs to a LOW-state.

## Standard Test Load

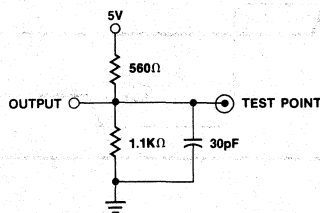

## Functional Description

### Data Input

Data is entered into the FIFO on D0-D3 inputs. To enter data the Input Ready (IR) should be HIGH, indicating that the first location is ready to accept data. Data then present at the four data inputs is entered into the first location when the Shift In (SI) is brought HIGH. A SI HIGH signal causes the IR to go LOW. Data remains at the first location until SI is brought LOW. When SI is brought LOW and the FIFO is not full, IR will go HIGH, indicating that more room is available. Simultaneously, data will propagate to the second location and continue shifting until it reaches the output stage or a full location. If the memory is full, IR will remain LOW.

### Data Transfer

Once data is entered into the second cell, the transfer of any full cell to the adjacent (downstream) empty cell is automatic, activated by an on-chip control. Thus data will stack up at the end of the device while empty locations will "bubble" to the front.  $t_{PT}$  defines the time required for the first data to travel from input to the output of a previously empty device.

### Data Output

Data is read from the O0-O3 outputs. When data is shifted to the output stage, Output Ready (OR) goes HIGH, indicating the presence of valid data. When the OR is HIGH, data may be shifted out by bringing the Shift Out (SO) HIGH. A HIGH signal at SO causes the OR to go LOW. Valid data is maintained while the SO is HIGH. When SO is brought LOW the upstream data, provided that stage has valid data, is shifted to the output stage. When new valid data is shifted to the output stage, OR goes HIGH. If the FIFO is emptied, OR stays LOW, and O0-3 remains as before, (i.e. data does not change if FIFO is empty).

Input Ready and Output Ready may also be used as status signals indicating that the FIFO is completely full (Input Ready stays LOW for at least  $t_{PT}$ ) or completely empty (Output Ready stays LOW for at least  $t_{PT}$ ).

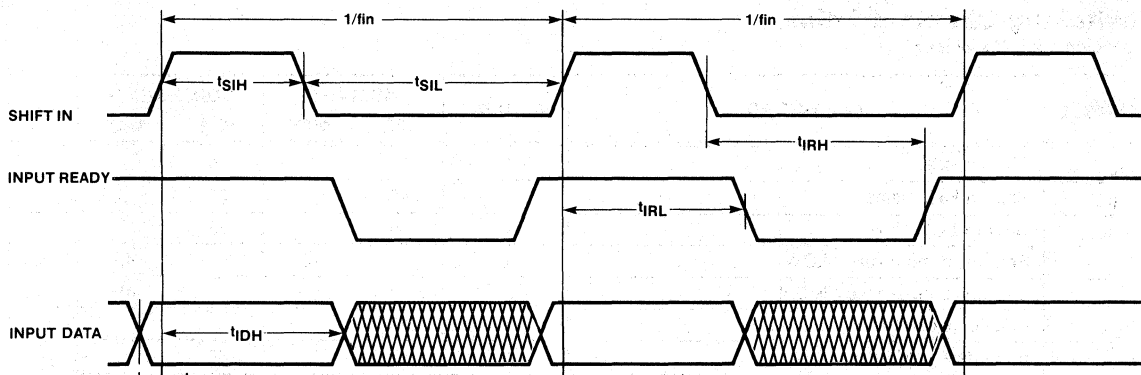

Figure 1. Input Timing

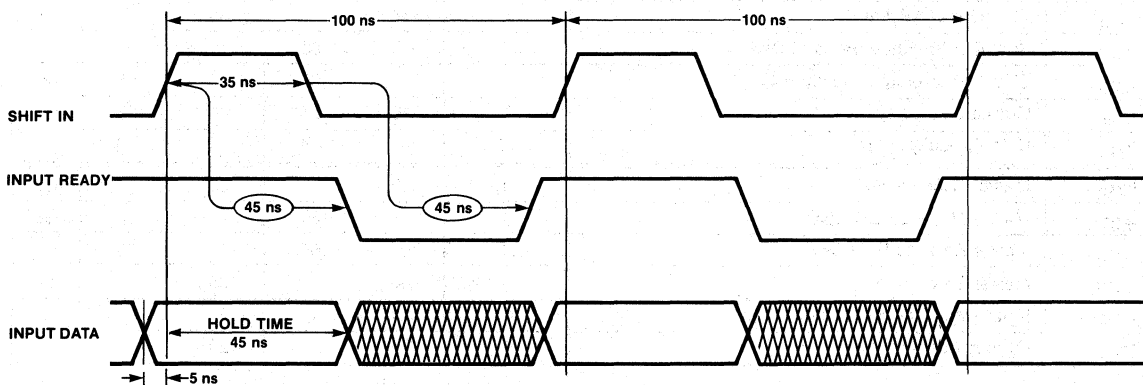

Figure 2. Typical Waveforms for 10 MHz Shift In Data Rate

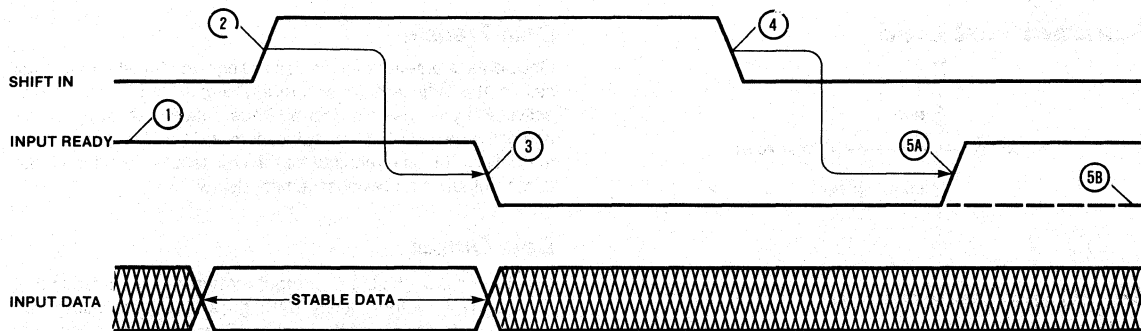

Figure 3. The Mechanism of Shifting Data into the FIFO

- ① Input Ready HIGH indicates space is available and a Shift In pulse may be applied.
- ② Input Data is loaded into the first word.
- ③ Input Ready goes LOW indicating the first word is full.
- ④ The Data from the first word is released for "fall-through" to second word.
- ⑤A The Data from the first word is transferred to second word. The first word is now empty as indicated by Input Ready HIGH.
- ⑤B If the second word is already full then the data remains at the first word. Since the FIFO is now full Input Ready remains low.

NOTE: Shift In pulses applied while Input Ready is LOW will be ignored (See Figure 5).

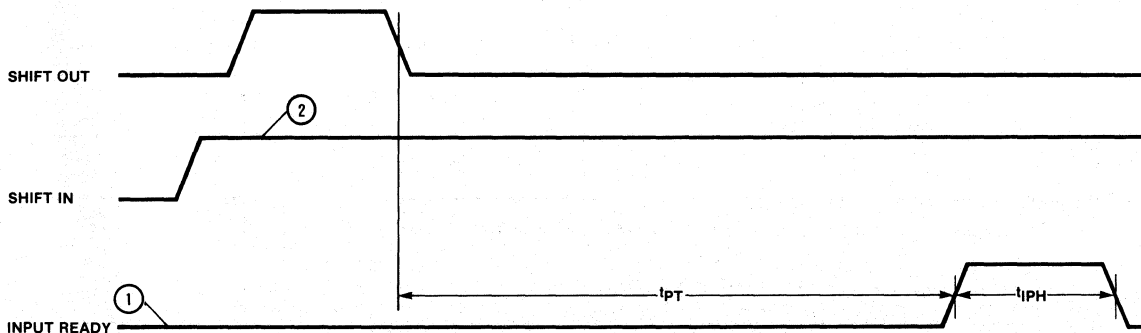

Figure 4.  $t_{IPH}$  Specification

- ① FIFO is initially full.
- ② Shift In held HIGH.

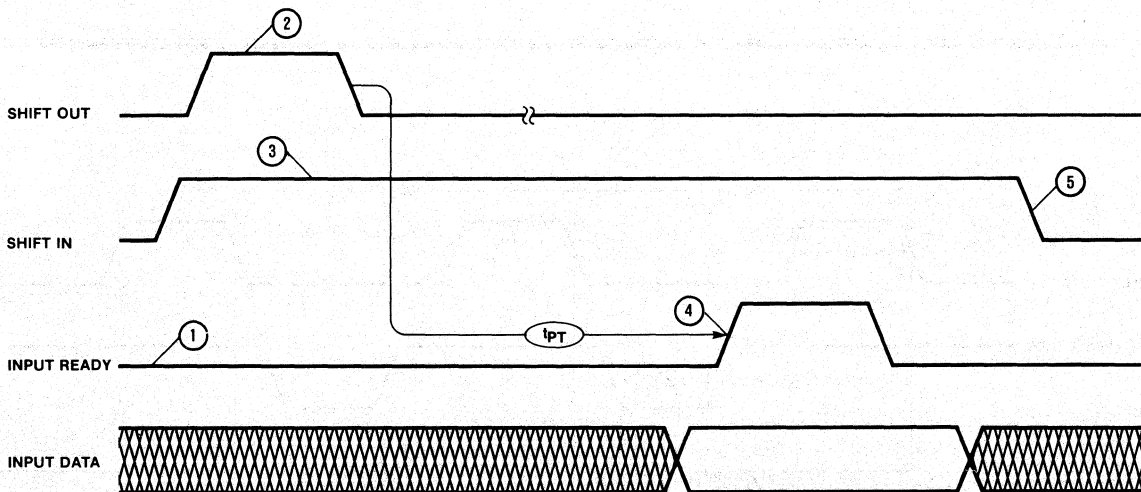

Figure 5. Data is Shifted in Whenever Shift In and Input Ready are Both HIGH

- ① FIFO is initially full.
- ② Shift Out pulse is applied. An empty location start "bubbling" to the front.
- ③ Shift In is held HIGH.
- ④ As soon as Input Ready becomes HIGH the Input Data is loaded into the first word.
- ⑤ The Data from the first word is released for "fall through" to second word.

7



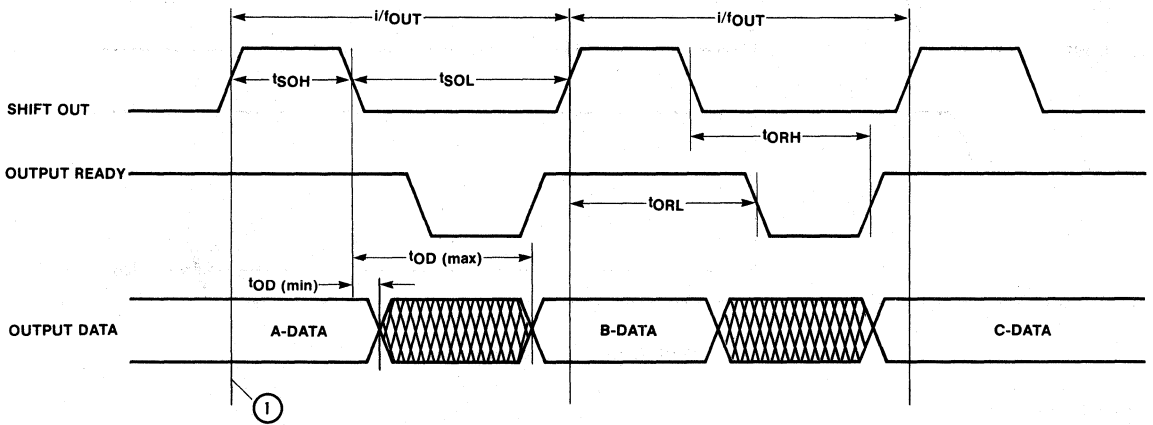

Figure 6. Output Timing

① The diagram assumes, that at this time, words 63, 62, 61 are loaded with A, B, C Data, respectively.

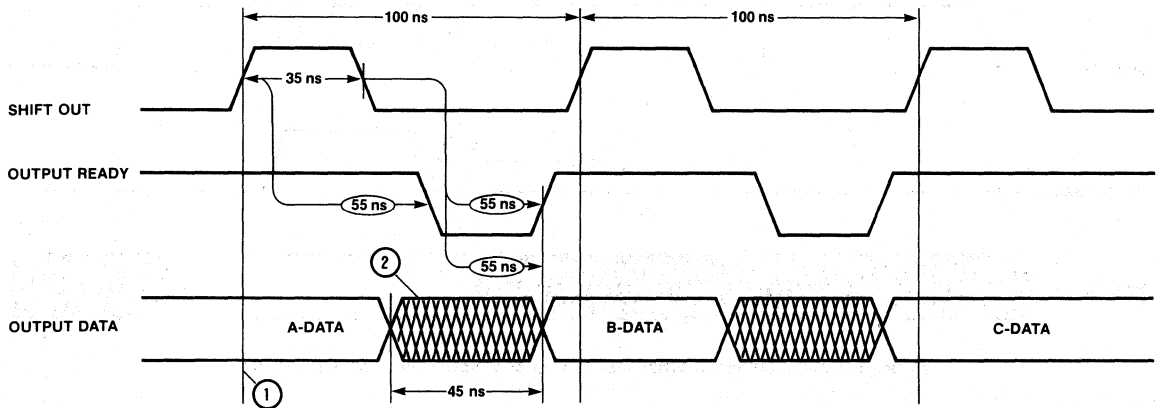

Figure 7. Typical Waveforms for 10 MHz Shift Out Data Rate

① The diagram assumes, that at this time, words 63, 62, 61 are loaded with A, B, C Data, respectively.

② Data in the crosshatched region may be A or B Data.

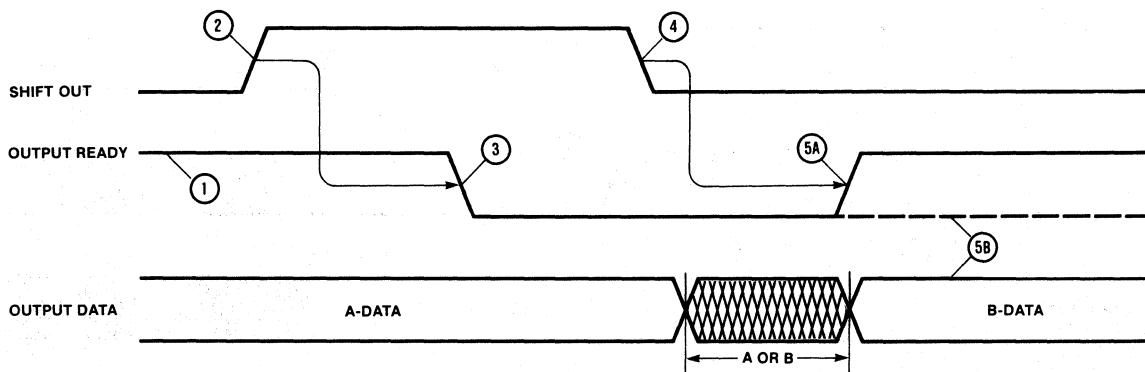

Figure 8. The Mechanism of Shifting Data Out of the FIFO.

- ① Output Ready HIGH indicates that data is available and a Shift Out pulse may be applied.
- ② Shift Out goes HIGH causing the next step.
- ③ Output Ready goes LOW.
- ④ Contents of word 62 (B-DATA) is released for "fall through" to word 63.
- ⑤A Output Ready goes HIGH indicating that new data (B) is now available at the FIFO outputs.
- ⑤B If the FIFO has only one word loaded (A-DATA) then Input Ready stays LOW and the A-DATA remains unchanged at the outputs.

7

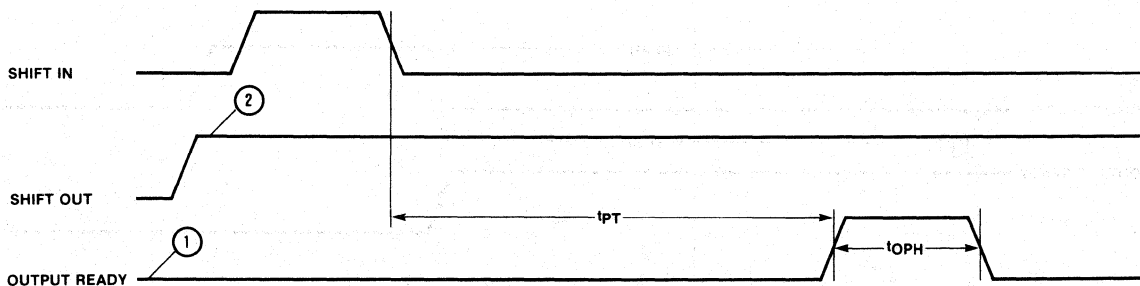

Figure 9.  $t_{PT}$  and  $t_{OPH}$  Specification

- ① FIFO initially empty.
- ② Shift Out held HIGH.

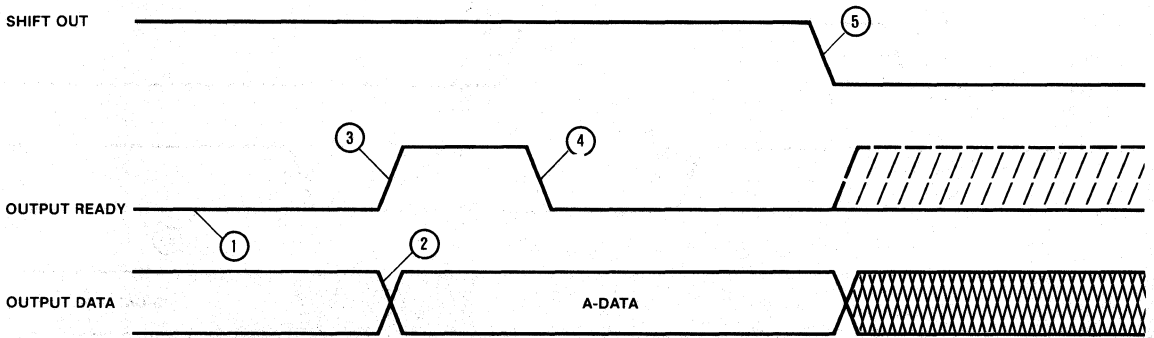

Figure 10. Data is Shifted Out Whenever Shift Out and Output Ready are Both HIGH.

- ① Word 63 is empty.
- ② New data (A) arrives at the outputs (word 63).
- ③ Output Ready goes HIGH indicating the arrival of the new data.
- ④ Since Shift Out is held HIGH, Output Ready goes immediately LOW.
- ⑤ As soon as Shift Out goes LOW the Output Data is subject to change as shown by the dashed line on Output Ready.

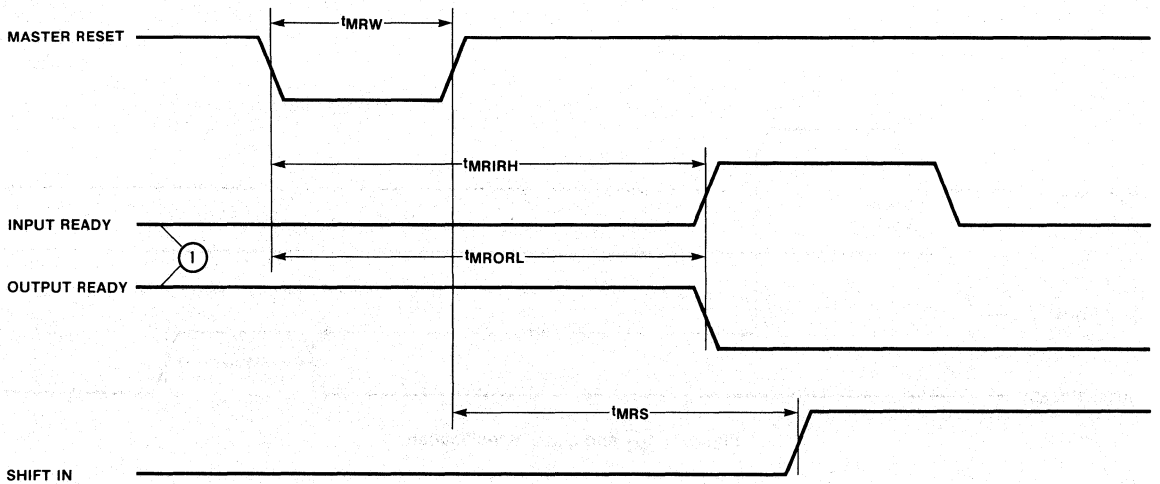

Figure 11. Master Reset Timing

- ① FIFO initially full.

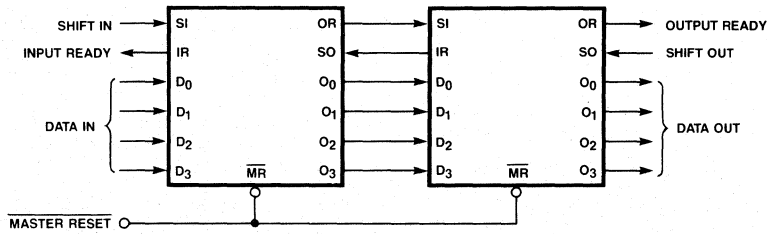

Figure 12. Cascading FIFOs to Form 128x4 FIFO.

FIFOs can be easily cascaded to any desired depth. The handshaking and associated timing between the FIFOs are handled by the FIFOs themselves.

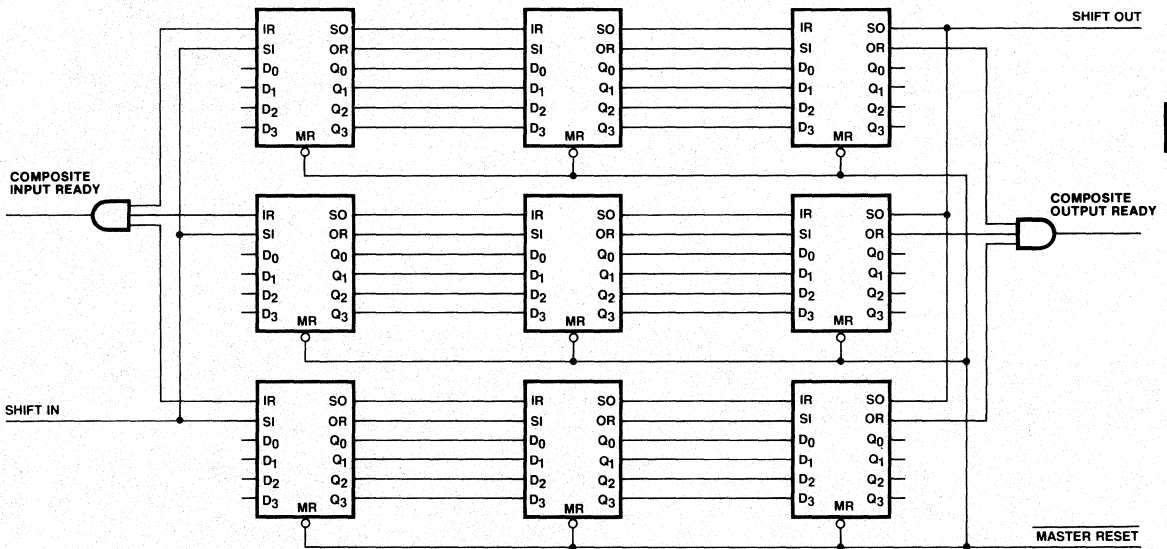

Figure 13. 192x12 FIFO.

FIFOs are expandable in depth and width. However, in forming wider words two external gates are required to generate composite Input and Output Ready flags. This need is due to the different fall through times of the FIFOs.

7

The first part of the document discusses the importance of maintaining accurate records of all transactions. It emphasizes that proper record-keeping is essential for the integrity of the financial system and for the ability to detect and prevent fraud. The text also mentions the need for regular audits and the role of independent auditors in ensuring the reliability of financial statements.

In addition, the document highlights the significance of transparency and accountability in financial reporting. It states that stakeholders, including investors and the public, have a right to know how their money is being managed. This requires the provision of clear, concise, and timely information about the organization's financial performance and the risks it faces.

The document also addresses the issue of financial stability and the role of financial institutions in maintaining it. It notes that sound financial practices, such as prudent risk management and adequate capitalization, are crucial for the long-term survival and success of these institutions. Furthermore, it discusses the importance of regulatory oversight in ensuring that financial institutions operate in a safe and sound manner.

Item	Description	Amount	Date
1	Office Supplies	150.00	2023-10-01
2	Travel Expenses	500.00	2023-10-05
3	Utilities	200.00	2023-10-10
4	Salaries	1000.00	2023-10-15
5	Equipment	300.00	2023-10-20
6	Insurance	100.00	2023-10-25
7	Marketing	250.00	2023-10-30
8	Research & Development	750.00	2023-11-01
9	Legal Fees	100.00	2023-11-05
10	Interest	50.00	2023-11-10

The final part of the document provides a summary of the key findings and recommendations. It reiterates the importance of strong financial governance and the need for continuous improvement in financial reporting practices. The document concludes by stating that the information provided is intended to assist stakeholders in making informed decisions and to promote the overall health and stability of the financial system.

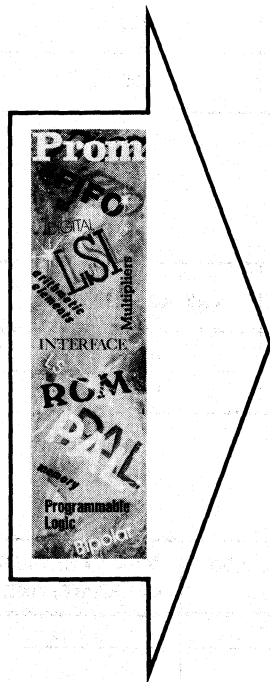

<b>Introduction</b>	<b>1</b>
<b>HI REL</b>	<b>2</b>
<b>PROM</b>	<b>3</b>
<b>ROM</b>	<b>4</b>
<b>Character Generators</b>	<b>5</b>
<b>PAL</b>	<b>6</b>
<b>FIFO</b>	<b>7</b>
<b>Arithmetic Elements</b>	<b>8</b>
<b>Interface</b>	<b>9</b>
<b>General Information</b>	<b>10</b>
<b>Representatives/Distributors</b>	<b>11</b>

## Arithmetic Elements Selection Guide

The following selection guides are designed to simplify the choice of the particular function to fit the specific application.

### High Speed Parallel Multipliers

DESCRIPTION	PART NO.	MAX DELAY	PINS	PAGE
8x8 Multiplier	67558-1	125 ns	40	8-3
	57558-1	135 ns	40	
	67558	150 ns	40	
	57558	155 ns	40	
8x8 Pipelined multiplier	67559 † 57559 †	65 ns	40	†
16x16 Pipelined multiplier	MPY-16 †	140 ns	64	†

### Sequential Multipliers/Accumulators/Dividers

DESCRIPTION	PART NO.	MULTIPLICATION TIME	PINS	PAGE
8 Bits	67508 † 57508 †	400 ns	24	†
16 Bits	67516 † 57516 †	800 ns	24	†

### Look-Up Tables

DESCRIPTION	PART NO.	MAX ACCESS TIME	PINS	PAGE
Sine (0°-90°) Look-Up Table	6086/7	100 ns	24	8-9
	5086/7	150 ns	24	8-9

### MSI Arithmetic Elements

DESCRIPTION	PART NO.	MAX. ADD TIME	MAX. CARRY (OR GENERATE) TIME	PINS	PAGE
4 Bit ALU	5/74S381	27 ns	20 ns	20	8-11
4 Bit fast ALU (pin compatible to 74S381)	5/67S581/2 †	17 ns	15 ns	20	†
4 Group carry- look-ahead generator	5/74S182		7 ns	16	8-15

† Data Sheet will appear in a future edition of the LSI Data Book. The performance shown is a design goal. Contact Application Department for additional information.

# 8 x 8 Multiplier

## 57/67558 57/67558-1

U.S. Patent 4153938

### Features/Benefits

- Industry Standard
- Easy to Use; Combinatorial
- Unsigned, Signed, or Mixed Multiplication
- Rounding Inputs for Signed or Unsigned Operation
- Three-State Outputs for Bus Operation
- High Speed — 125 ns Max

### Description

The 57558/67558 is a high speed 8 x 8 combinatorial Multiplier which can multiply two eight-bit unsigned or signed 2s complement numbers and generate the sixteen-bit unsigned or signed product. Each input operand X and Y has an associated Mode control line,  $X_M$  and  $Y_M$  respectively. When a Mode control line is at a Low logic level the operand is treated as an unsigned eight-bit number while if the Mode control is at a High logic level the operand is treated as an eight-bit signed 2s complement number. Two additional inputs  $R_S$  and  $R_U$  allow the addition of a bit in the multiplier array at the appropriate bit positions for rounding signed or unsigned fractional numbers. The most significant product bit is available in both True and Complement form to assist in expansion to larger signed multipliers. The product outputs are three-state, controlled by an active Low Output Enable which allows several Multipliers to be connected to a parallel bus or be used in a pipelined system. The device uses a single +5V power supply and is packaged in a standard 40-pin DIP.

### Logic Symbol

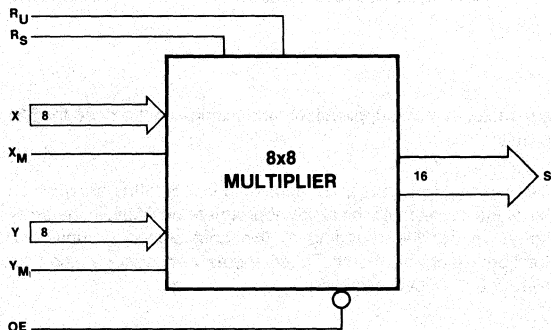

### Ordering Information

PART NUMBER	PACKAGE	TEMPERATURE
57558, 57558-1	J40	Military
67558, 67558-1	J40	Commercial

### Pin Configuration

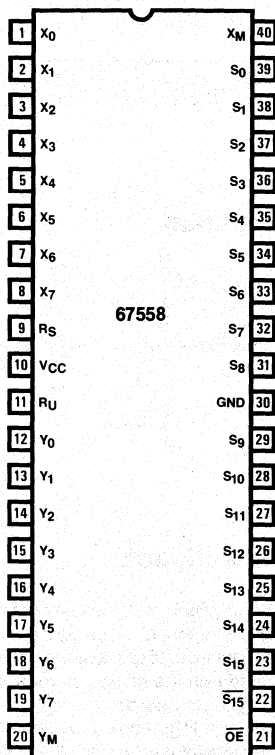

8



## Switching Characteristics

Over operating conditions

SYMBOL	PARAMETER	DEVICE	TYP	MAX	UNIT
$t_{PXZ}$	Delay from OE to S High Impedance State	67558	30	40	ns
		57558	30	50	
		67558-1	30	40	
		57558-1	30	50	
$t_{PZX}$	Delay from OE to S Active State	67558	30	40	ns
		57558	30	50	
		67558-1	30	40	
		57558-1	30	50	
$t_{PD1}$	Delay from Y, X to $S_{0-4}$	67558	80	135	ns
		57558	80	140	
		67558-1	80	115	
		57558-1	80	125	
$t_{PD2}$	Delay from Y, X to $S_{5-15}, S_{15}$	67558	100	150	ns
		57558	100	155	
		67558-1	100	125	
		57558-1	100	135	

### Standard Test Load

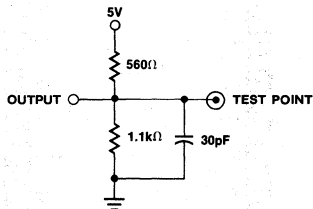

### Timing Waveform

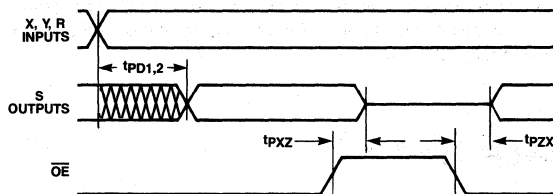

### Functional Description

The 57558/67558 Multiplier is an  $8 \times 8$  combinatorial logic array capable of multiplying numbers in unsigned, signed 2s complement, or mixed notation. Each eight-bit input operand X and Y has associated with it a mode control which determines whether the array treats the number as signed or unsigned. If the mode control is at a High Logic level then the operand is treated as a 2s complement number with the most significant bit having a negative weight, while if the mode control is at a Low Logic level then the operand is treated as an unsigned number.

The multiplier provides all 16 product bits generated by the multiplication. For expansion during signed or mixed multiplication the most significant product bit has both true and complement available. This allows an adder to be used as a

subtractor in many applications and eliminates the need for SSI circuits.

Two inputs,  $R_S$  and  $R_U$ , are additional inputs to the array which allow the addition of a bit at the appropriate positions in the array so as to provide rounding to the best signed or unsigned fractional eight-bit result. These inputs can also be used for rounding in larger multipliers.

The product outputs of the multiplier are controlled by an active Low Output Enable control. When this control is at a Low Logic level the multiplier outputs are active, while if the control is at a High Logic level then the outputs are placed in a high-impedance state. This three-state capability allows multipliers to be placed on a common bus and also allows pipelining of multiplications for higher speed systems.

**Absolute Maximum Ratings**

Supply Voltage, $V_{CC}$ .....	7V
Input Voltage .....	7V
Off-state output voltage .....	5.5V
Storage temperature .....	-65° to +150°C

**Operating Conditions**

SYMBOL	PARAMETER	MILITARY			COMMERCIAL			UNIT
		MIN	NOM	MAX	MIN	NOM	MAX	
$V_{CC}$	Supply voltage	4.5	5	5.5	4.75	5	5.25	V
$T_A$	Operating free-air temperature				0		75	°C
$T_C$	Operating case temperature	-55		125				°C

**Electrical Characteristics Over Operating Conditions**

SYMBOL	PARAMETER	TEST CONDITIONS	MIN	TYP	MAX	UNIT	
$V_{IL}$	Low-level input voltage				0.8	V	
$V_{IH}$	High-level input voltage		2			V	
$V_{IC}$	Input clamp voltage	$V_{CC} = \text{MIN}$ $I_I = -18\text{mA}$			-1.5	V	
$I_{IL}$	Low-level input current	$V_{CC} = \text{MAX}$ $V_I = 0.5\text{V}$			-1	mA	
$I_{IH}$	High-level input current	$V_{CC} = \text{MAX}$ $V_I = 2.4\text{V}$			100	$\mu\text{A}$	
$I_I$	Maximum input current	$V_{CC} = \text{MAX}$ $V_I = 5.5\text{V}$			1	mA	
$V_{OL}$	Low-level output voltage	$V_{CC} = \text{MIN}$ $I_{OL} = 8\text{mA}$			0.5	V	
$V_{OH}$	High-level output voltage	$V_{CC} = \text{MIN}$ $I_{OH} = -2\text{mA}$	2.4			V	
$I_{OZL}$	Off-state output current	$V_{CC} = \text{MAX}$				-100	$\mu\text{A}$
$I_{OZH}$						$V_O = 2.4\text{V}$	100
$I_{OS}$	Output short-circuit current*	$V_{CC} = \text{MAX}$ $V_O = 0\text{V}$	-10		-90	mA	
$I_{CC}$	Supply current	$V_{CC} = \text{MAX}$		180	280	mA	

\* Not more than one output should be shorted at a time and duration of the short-circuit should not exceed one second.

### Rounding

Multiplication of two n-bit operands results in 2n-bit product<sup>†</sup>. Therefore, in n-bit system it is necessary to convert the double-length product into a single-length product. This can be accomplished by truncating or rounding. The following examples, illustrate the difference between the two conversion techniques in decimal arithmetic.

$$\begin{array}{l}
 39.2 \rightarrow 39 \\
 39.6 \rightarrow 39 \\
 \left. \vphantom{\begin{array}{l} 39.2 \\ 39.6 \end{array}} \right\} \text{Truncating} \\
 \\
 39.2 + 0.5 = 39.7 \rightarrow 39 \\
 39.6 + 0.5 = 40.1 \rightarrow 40 \\
 \left. \vphantom{\begin{array}{l} 39.2 + 0.5 \\ 39.6 + 0.5 \end{array}} \right\} \text{Rounding}
 \end{array}$$

Obviously, rounding maintains more precision than truncating, but it may take one more step to implement. The additional step involves adding one-half of the weight of the single length LSB to the MSB of the discarded part e.g. in decimal arithmetic round-

ing 39.28 to one decimal point is accomplished by adding 0.05 to the number and truncating the LSB.

$$39.28 + 0.05 = 39.33 \rightarrow 39.3$$

The situation in binary arithmetic is quite similar, but two cases need to be considered; signed and unsigned data representation. In signed multiplication, the two MSBs are identical (except when both operands are -1) therefore, the best single length product is shifted one position to the right with respect to the unsigned multiplications. Figure 1 illustrates these two cases for the 8x8 multiplier. In the signed case, adding one-half of the S<sub>7</sub> weight is accomplished by adding 1 in bit position 6, and in the unsigned case 1 is added to bit position 7. Therefore, the 67558 multiplier has two rounding inputs, R<sub>S</sub> and R<sub>U</sub>. Thus, to get a rounded single length result the appropriate R input is tied to V<sub>CC</sub> (logic one) and the other R input is grounded. If double length result is desired both R inputs are grounded.

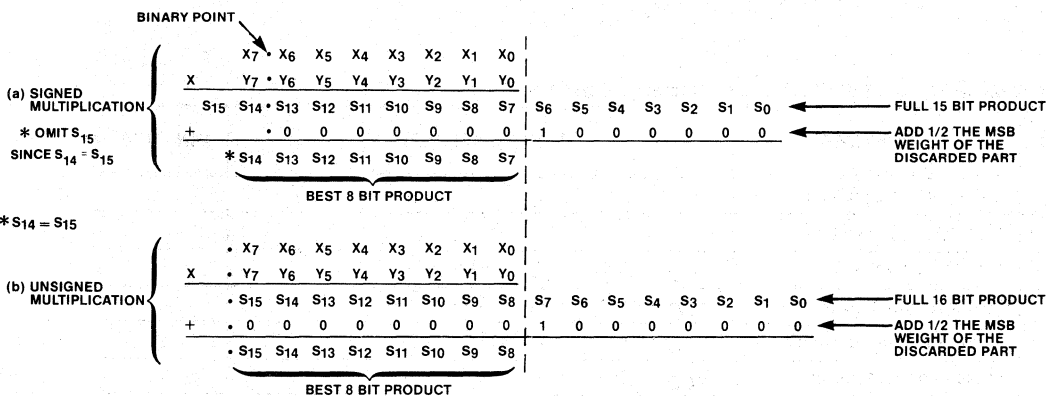

Figure 1. Rounding the Result of Binary Fractional Multiplication.

- (a) In signed (2's complement) notation, the MSB of each operand is the sign bit, and the binary point is to the right of the MSB. The resulting product has a redundant sign bit and the binary point is to the right of the second MSB of the product. The best eight-bit product is from S<sub>14</sub> through S<sub>7</sub>, and rounding is performed by adding "1" to bit position S<sub>6</sub>.
- (b) In unsigned notation the best 8-bit product, is the most significant half of the product, corrected by adding "1" to bit position S<sub>7</sub>.

<sup>†</sup> In general: multiplication of M-bit operand by N-bit operand results in M + N bit product.

### Signed Expansion

The most significant product bit has both true and complement outputs available. When building larger signed multipliers the partial products except at the lower stages are signed numbers. These unsigned and signed partial products must be added together to give the correct signed product. Having both the true and complement of the most significant product bit available assists in this addition. For example, say that two signed partial products must be added and MSI adders are used; we then have the situation of adding together the Carry from the previous adder stage plus the addition of the two negative most significant partial product bits. The result of adding these variables must be a positive sum and a negative carry (borrow). The equations for this are:

$$S = A \oplus B \oplus C$$

$$C_0 = AB + BC + CA$$

where C is the Carry In and A and B the sign bits of the two partial products.

Now an adder produces the equations:

$$S = A \oplus B \oplus C$$

$$C_0 = AB + BC + CA$$

Examining these equations it can be seen that if the inversion of A and B are used then the adder produces the inversion of the negative carry since

$$AB + \overline{B}\overline{C} + \overline{C}A = \overline{\overline{A}B + BC + C\overline{A}}$$

and the sum remains the same.

### 16 x 16 Two's Complement Multiplication

The 16-bit X operand is broken into two 8-bit operands (X<sub>0</sub>-X<sub>7</sub> and X<sub>8</sub>-X<sub>15</sub>), and so is the Y operand. Since the situation is that of a cross product, four partial products are generated as follows:

$$A = X_L * Y_L$$

$$B = X_L * Y_H$$

$$C = X_H * Y_L$$

$$D = X_H * Y_H$$

where the subscript L stands for bits 0-7, and the subscript H stands for bits 8-15.

Expanding in two's complement multiplication requires a sign extension of the B and C partial products. Thus, B<sub>15</sub> and C<sub>15</sub> need to be extended eight positions to the left (to align with D<sub>15</sub>). In this approach two more adders are required. But the complement of the MSB (S<sub>15</sub>) on the 67558 can be used to save these two adders. The Figure shows the implementation of such a 16x16 signed two's complement multiplication.

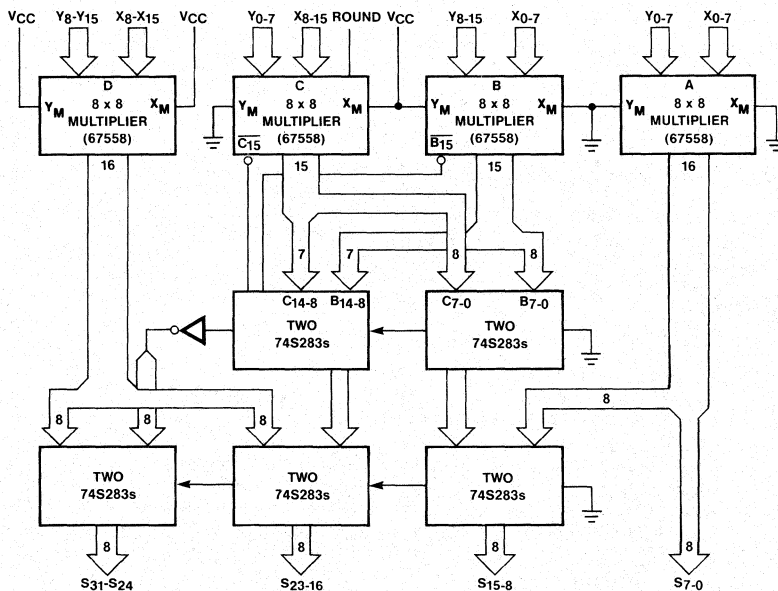

Figure 2. 16 x 16 Two's Complement Signed Multiplication.

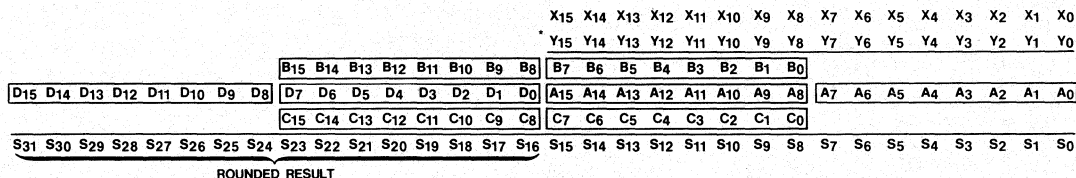

Figure 3. Unsigned Expansions of the 8x8 Multiplier to 16x16 Multiplication.



# Sine (0° to 90°) Look Up Table

## Using a 1024 X 10 ROM (5/6255 5/6256)

### 5/6086 5/6087

#### Features/Benefits

- Input angle increments of  $90^\circ/1024 = .0879^\circ$
- 10 bit binary outputs
- Low power dissipation. Typically 500 mw
- Fast access time 100 ns max.
- TTL compatible

#### Description

The 5255/6255, 1024 words by 10 bits Read Only Memory has been customized to make a sine  $\theta$  look up table (5086/6086) for  $0^\circ \leq \theta < 90^\circ$ . The address inputs are used to divide the first  $90^\circ$  quadrant into angles increments of  $90^\circ/1024$  words or  $.0879^\circ$ /word. The memory outputs should be interpreted as binary weighted fractions where output 1 has a weight of  $1/2$  or  $.500$ ,

#### Ordering Information

PART NUMBER	PACKAGE	TEMPERATURE
5086/87	J24	Military
6086/87	J24	Commercial

output 2 has a weight of  $1/4$  or  $.250$ , and so on until output 10 which has a weight of  $1/1024$  or  $.000976$ . The 10 bit output code has not been rounded off so that output error will always be positive and less than  $1/1024$  or  $.0009765$ . Round off error, in approximating the ROM input word, must be added or subtracted to the output error. For electrical characteristics and pin out refer to 6255 specifications (pages 4-3 through 4-5).

#### Example 1:

Find the sine  $45^\circ$   
Let X = the ROM word where sine  $45^\circ$  is stored

$$\frac{X}{1024 \text{ words}} = \frac{45^\circ}{90^\circ}$$

X = word 512

Word 511 has the following stored data and interpretation:

Output #	O <sub>1</sub>	O <sub>2</sub>	O <sub>3</sub>	O <sub>4</sub>	O <sub>5</sub>	O <sub>6</sub>	O <sub>7</sub>	O <sub>8</sub>	O <sub>9</sub>	O <sub>10</sub>	
Stored Data	H	L	H	H	L	H	L	H	L	L	(H = TTL HIGH)
Binary Weight	$\frac{1}{2}$	$\frac{1}{4}$	$\frac{1}{8}$	$\frac{1}{16}$	$\frac{1}{32}$	$\frac{1}{64}$	$\frac{1}{128}$	$\frac{1}{256}$	$\frac{1}{512}$	$\frac{1}{1024}$	

Adding the fractions wherever an "H" appears given.

$$\frac{1}{2} + \frac{1}{8} + \frac{1}{16} + \frac{1}{64} + \frac{1}{256} = .50000 + .12500 + .06250 + .01562 + .00391 = .70507$$

Handbook Value =  $.70711$

Our Error =  $.70711 - .70703 = .00008$

#### Example 2:

Find the sine  $210^\circ$   
This value is in quadrant three, therefore,  $\theta' = 210^\circ - 180^\circ$  or  $30^\circ$

Let X = the ROM word where sine  $30^\circ$  is stored  $\frac{X}{1024 \text{ words}} = \frac{30^\circ}{90^\circ}$

X = word 341.33 (round off to word 341)

Word 341 has the following stored data and interpretation:

Output #	O <sub>1</sub>	O <sub>2</sub>	O <sub>3</sub>	O <sub>4</sub>	O <sub>5</sub>	O <sub>6</sub>	O <sub>7</sub>	O <sub>8</sub>	O <sub>9</sub>	O <sub>10</sub>
Stored Data	L	H	H	H	H	H	H	H	H	H
Binary Weight	$\frac{1}{2}$	$\frac{1}{4}$	$\frac{1}{8}$	$\frac{1}{16}$	$\frac{1}{32}$	$\frac{1}{64}$	$\frac{1}{128}$	$\frac{1}{256}$	$\frac{1}{512}$	$\frac{1}{1024}$

Adding the fractions wherever an "H" appears gives  $0.49902$

The sine  $210^\circ$ , therefore, =  $-.49902$  with the sign generated by external logic. Note that the address 341 to which we rounded off is actually the sine  $29.97^\circ$ .

8



# Arithmetic Logic Unit/ Function Generator

## SN54S381 SN74S381

### Features/Benefits

- A Fully Parallel 4-Bit ALU in 20-Pin Package for 0.300-inch Row Spacing
- Ideally Suited for High-Density Economical Processors
- Parallel Inputs and Outputs and Full Look-Ahead Provide System Flexibility
- Arithmetic and Logic Operations Selected Specifically to Simplify System Implementation:

A Minus B  
B Minus A  
A Plus B  
and Five Other Functions

### Description

The 'S381 is a Schottky TTL arithmetic logic unit (ALU)/function generator that performs eight binary arithmetic/logic operations on two 4-bit words as shown in the function table. These operations are selected by the three function-select lines (S0, S1, S2). A fully carry look-ahead circuit is provided for fast, simultaneous carry generation by means of two cascade outputs ( $\bar{P}$  and  $\bar{G}$ ) for the four bits in the package.

### Logic Symbol

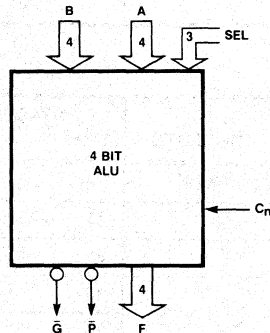

### Ordering Information

PART NUMBER	PACKAGE	TEMPERATURE
SN54S381	J20	Military
SN74S381	J20	Commercial

### Pin Configuration

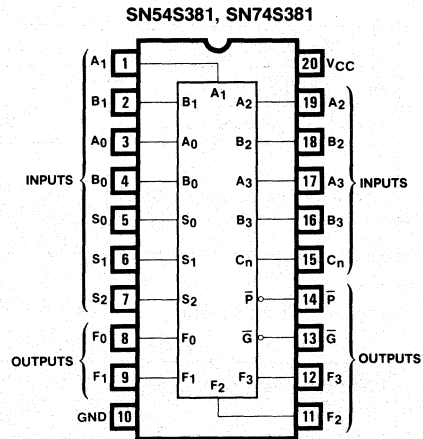

### Function Table

SELECTION			ARITHMETIC/LOGIC OPERATION
S2	S1	S0	
L	L	L	Clear †
L	L	H	B minus A
L	H	L	A minus B
L	H	H	A plus B
H	L	L	A ⊕ B
H	L	H	A + B
H	H	L	AB
H	H	H	Preset ††

† Force all F outputs to be Lows.  
†† Force all F outputs to be Highs.



**Absolute Maximum Ratings**

Supply Voltage, $V_{CC}$ .....	7V
Input Voltage .....	5.5V
Storage Temperature Range .....	-65°C to +150°C

**Operating Conditions**

SYMBOL	PARAMETER	MILITARY			COMMERCIAL			UNIT
		MIN	NOM	MAX	MIN	NOM	MAX	
$V_{CC}$	Supply voltage	4.5	5	5.5	4.75	5	5.25	V
$T_A$	Operating free-air temperature	-55		125	0		70	°C

**Electrical Characteristics** Over operating conditions

SYMBOL	PARAMETER	TEST CONDITIONS	MIN TYP MAX			UNIT
$V_{IL}$	Low-level input voltage				0.8	V
$V_{IH}$	High-level input voltage		2			V
$V_{IC}$	Input clamp voltage	$V_{CC} = \text{MIN}$ $I_I = -18\text{mA}$			-1.2	V
$I_{IL}$	Low-level input current	$V_{CC} = \text{MAX}$ $V_I = 0.5\text{V}$	Any S input		-2	mA
			Cn		-8	
			All others		-6	
$I_{IH}$	High-level input current	$V_{CC} = \text{MAX}$ $V_I = 2.7\text{V}$	Any S input		50	$\mu\text{A}$
			Cn		250	
			All others		200	
$I_I$	Maximum input current	$V_{CC} = \text{MAX}$ $V_I = 5.5\text{V}$			1	mA
$V_{OL}$	Low-level output voltage	$V_{CC} = \text{MIN}$ $V_{IH} = 2\text{V}$ $V_{IL} = 0.8\text{V}$ $I_{OL} = 20\text{mA}$			0.5	V
$V_{OH}$	High-level output voltage	$V_{CC} = \text{MIN}$ $V_{IH} = 2\text{V}$ $V_{IL} = 0.8\text{V}$ $I_{OH} = -1\text{mA}$	SN54S381	2.4	3.4	V
			SN74S381	2.7	3.4	
$I_{OS}$	Output short-circuit current*	$V_{CC} = \text{MAX}$	-40		-100	mA
$I_{CC}$	Supply current	$V_{CC} = \text{MAX}$		105	160	mA

\* Not more than one output should be shorted at a time.

**Switching Characteristics**  $V_{CC} = 5\text{V}$ ,  $T_A = 25^\circ\text{C}$

SYMBOL	PARAMETER	FROM (INPUT)	TO (OUTPUT)	5/74S381		UNIT
				TYP	MAX	
$t_P$	Propagation delay time	Cn	Any F	10	17	ns
$t_P$	Propagation delay time	Any A or B	$\bar{G}$	12	20	ns
$t_P$	Propagation delay time	Any A or B	$\bar{P}$	11	18	ns
$t_{PLH}$	Propagation delay, low-to-high	Ai or Bi	Fi	18	27	ns
$t_{PHL}$	Propagation delay, high-to-low			16	25	ns
$t_P$	Propagation delay time	Any S	Fi, $\bar{G}$ , $\bar{P}$	18	30	ns

Standard Test Load

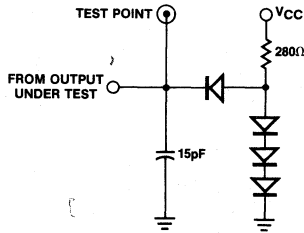

16-BIT ALU (USING 74S381)

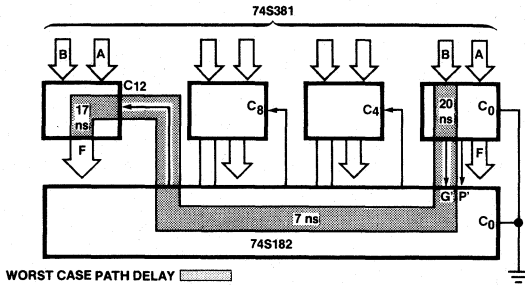

16-BIT ALU (USING 67S581/2)

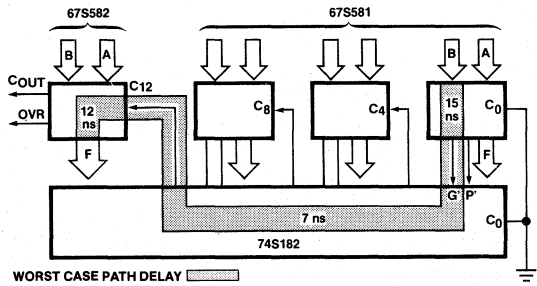

MAXIMUM DELAY OF ADDITION/SUBTRACTION.

	74S381	67S581
1-4 bits	27ns	22ns
5-16 bits	44ns	34ns
17-64 bits	64ns	54ns



# Look-Ahead Carry Generators

## SN54S182 SN74S182

### Description

The SN54S182, and SN74S182 are high-speed, look-ahead carry generators capable of anticipating a carry across four binary adders or group of adders. They are cascadable to perform full look-ahead across n-bit adders. Carry, generate-carry, and propagate-carry functions are provided as enumerated in the pin designation table below.

When used in conjunction with 74S381, 67S581, 74S181, 2901, 6701 arithmetic logic units (ALU), these generators provide high-speed carry lookahead capability for any word length. Each 'S182 generates the look-ahead (anticipated carry) across a group of four ALU's and, in addition, other carry look-ahead circuits may be employed to anticipate carry across sections of four look-ahead packages up to n-bits.

The carry functions (inputs, outputs, generate, and propagate) of the look-ahead generators are implemented in the compatible forms for direct connection to the ALU. Logic equations for the 'S182 are:

$$C_{n+x} = G_0 + P_0 C_n$$

$$C_{n+y} = G_1 + P_1 G_0 + P_1 P_0 C_n$$

$$C_{n+z} = G_2 + P_2 G_1 + P_2 P_1 G_0 + P_2 P_1 P_0 C_n$$

$$\bar{G} = \bar{G}_3 + P_3 G_2 + P_3 P_2 G_1 + P_3 P_2 P_1 G_0$$

$$\bar{P} = \bar{P}_3 P_2 P_1 P_0$$

or

$$\bar{C}_{n+x} = \bar{Y}_0 (X_0 + C_n)$$

$$\bar{C}_{n+y} = \bar{Y}_1 [X_1 + Y_0 (X_0 + C_n)]$$

$$\bar{C}_{n+z} = \bar{Y}_2 \{X_2 + Y_1 [X_1 + Y_0 (X_0 + C_n)]\}$$

$$Y = Y_3 (X_3 + Y_2) (X_3 + X_2 + Y_1) (X_3 + X_2 + X_1 + Y_0)$$

$$X = X_3 + X_2 + X_1 + X_0$$

### Pin Configuration

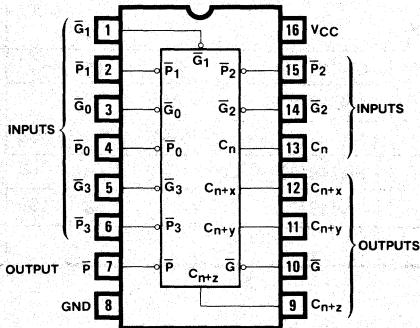

### Ordering Information

PART NUMBER	PACKAGE	TEMPERATURE
SN54S182	J16	Military
SN74S182	J16	Commercial

### Summarizing Tables

FUNCTION TABLE FOR  $C_{n+y}$  OUTPUT

INPUTS					OUTPUT
$\bar{G}_1$	$\bar{G}_0$	$\bar{P}_1$	$\bar{P}_0$	$C_n$	$C_{n+y}$
L	X	X	X	X	H
X	L	L	X	X	H
X	X	L	L	H	H
All other combinations					L

FUNCTION TABLE FOR  $\bar{P}$  OUTPUT

INPUTS				OUTPUT
$\bar{P}_3$	$\bar{P}_2$	$\bar{P}_1$	$\bar{P}_0$	$\bar{P}$
L	L	L	L	L
All other combinations				H

FUNCTION TABLE FOR  $C_{n+x}$  OUTPUT

INPUTS				OUTPUT
$\bar{G}_0$	$\bar{P}_0$	$C_n$	$C_{n+x}$	
L	X	X	H	
X	L	H	H	
All other combinations				L

FUNCTION TABLE FOR  $\bar{G}$  OUTPUT

INPUTS						OUTPUT
$\bar{G}_3$	$\bar{G}_2$	$\bar{G}_1$	$\bar{G}_0$	$\bar{P}_3$	$\bar{P}_1$	$\bar{G}$
L	X	X	X	X	X	L
X	L	X	X	L	X	L
X	X	L	X	L	L	L
X	X	X	L	L	L	L
All other combinations						H

FUNCTION TABLE FOR  $C_{n+z}$  OUTPUT

INPUTS						OUTPUT	
$\bar{G}_2$	$\bar{G}_1$	$\bar{G}_0$	$\bar{P}_2$	$\bar{P}_1$	$\bar{P}_0$	$C_n$	$C_{n+z}$
L	X	X	X	X	X	X	H
X	L	X	L	X	X	X	H
X	X	L	L	L	X	X	H
X	X	X	L	L	L	H	H
All other combinations						L	

H = High Level, L = Low Level, X = Irrelevant. Any inputs not shown in a given table are irrelevant with respect to that output.

**Absolute Maximum Ratings**

Supply Voltage,  $V_{CC}$  ..... 7V  
 Input Voltage ..... 5.5V  
 Storage Temperature Range ..... -65°C to +150°C

**Operating Conditions**

SYMBOL	PARAMETER	MILITARY			COMMERCIAL			UNIT
		MIN	NOM	MAX	MIN	NOM	MAX	
$V_{CC}$	Supply voltage	4.5	5	5.5	4.75	5	5.25	V
$T_A$	Operating free-air temperature	-55		125	0		70	°C

**Electrical Characteristics** Over operating conditions

SYMBOL	PARAMETER	TEST CONDITIONS		MIN	TYP	MAX	UNIT
$V_{IL}$	Low-level input voltage					0.8	V
$V_{IH}$	High-level input voltage			2			V
$V_{IC}$	Input clamp voltage	$V_{CC} = \text{MIN}$	$I_I = -18\text{mA}$			-1.2	V
$I_{IL}$	Low-level input current	$V_{CC} = \text{MAX}$	$V_I = 0.5\text{V}$	$C_n$ input		-2	mA
				$\overline{P}_3$ input		-4	
				$\overline{P}_2$ input		-6	
				$\overline{P}_0, \overline{P}_1,$ or $\overline{G}_3$ input		-8	
				$\overline{G}_0$ or $\overline{G}_2$		-14	
				$\overline{G}_1$ input		-16	
$I_{IH}$	High-level input current	$V_{CC} = \text{MAX}$	$V_I = 2.7\text{V}$	$C_n$ input		50	$\mu\text{A}$
				$\overline{P}_3$ input		100	
				$\overline{P}_2$ input		150	
				$\overline{P}_0, \overline{P}_1,$ or $\overline{G}_3$ input		200	
				$\overline{G}_0$ or $\overline{G}_2$		350	
				$\overline{G}_1$ input		400	
$I_I$	Maximum input current	$V_{CC} = \text{MAX}$	$V_I = 5.5\text{V}$			1	mA
$V_{OL}$	Low-level output voltage	$V_{CC} = \text{MIN}$ $V_{IL} = 0.8\text{V}$	$V_{IH} = 2\text{V}$ $I_{OH} = -1\text{mA}$			0.5	V
$V_{OH}$	High-level output voltage	$V_{CC} = \text{MIN}$ $V_{IL} = 0.8\text{V}$	$V_{IH} = 2\text{V}$ $I_{OL} = 20\text{mA}$	SN74S182	2.7	3.4	V
				SN54S182	2.5	3.4	
$I_{OS}$	Output short-circuit current *	$V_{CC} = \text{MAX}$		-40		-100	mA
$I_{CCL}$	Supply current, all outputs low	$V_{CC} = \text{MAX}$	See Note 1	SN74S182	69	109	mA
				SN54S182	69	99	
$I_{CCH}$	Supply current, all outputs high	$V_{CC} = 5\text{V}$	See Note 2		35		mA

\*Not more than one output should be shorted at a time and duration of the short-circuit test should not exceed one second.

NOTES: 1.  $I_{CCL}$  is measured with all outputs open; inputs  $\overline{G}_0, \overline{G}_1,$  and  $\overline{G}_2$  at 4.5 V; and all other inputs grounded.

2.  $I_{CCH}$  is measured with all outputs open, inputs  $\overline{P}_3$  and  $\overline{G}_3$  at 4.5 V, and all other inputs grounded.

**Switching Characteristics**  $V_{CC} = 5\text{ V}$ ,  $T_A = 25^\circ\text{C}$

SYMBOL	PARAMETER	FROM (INPUT)	TO (OUTPUT)	TYP	MAX	UNIT
t <sub>PLH</sub>	Propagation delay, low-to-high	$\overline{G}0, \overline{G}1, \overline{G}2, \overline{G}3,$	$C_{n+x}, C_{n+y},$	4.5	7	ns
t <sub>PHL</sub>	Propagation delay, high-to-low	$\overline{P}0, \overline{P}1, \overline{P}2, \text{ or } \overline{P}3$	or $C_{n+z}$	4.5	7	ns
t <sub>PLH</sub>	Propagation delay, low-to-high	$\overline{G}0, \overline{G}1, \overline{G}2, \overline{G}3,$	$\overline{G}$	5	7.5	ns
t <sub>PHL</sub>	Propagation delay, high-to-low	$\overline{P}1, \overline{P}2, \text{ or } \overline{P}3$		7	10.5	ns
t <sub>PLH</sub>	Propagation delay, low-to-high	$\overline{P}0, \overline{P}1, \overline{P}2, \text{ or } \overline{P}3$	$\overline{P}$	4.5	6.5	ns
t <sub>PHL</sub>	Propagation delay, high-to-low			6.5	10	ns
t <sub>PLH</sub>	Propagation delay, low-to-high	$C_n$	$C_{n+x}, C_{n+y},$ or $C_{n+z}$	6.5	10	ns
t <sub>PHL</sub>	Propagation delay, high-to-low			7	10.5	ns

**Standard Test Load**

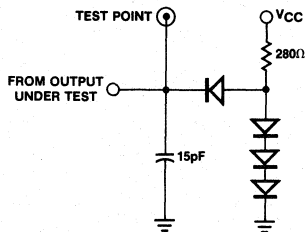

---

Category	Sub-category	Description
1	A	[Illegible]
2	B	[Illegible]
3	C	[Illegible]
4	D	[Illegible]
5	E	[Illegible]
6	F	[Illegible]
7	G	[Illegible]
8	H	[Illegible]
9	I	[Illegible]
10	J	[Illegible]
11	K	[Illegible]
12	L	[Illegible]
13	M	[Illegible]
14	N	[Illegible]
15	O	[Illegible]
16	P	[Illegible]
17	Q	[Illegible]
18	R	[Illegible]
19	S	[Illegible]
20	T	[Illegible]
21	U	[Illegible]
22	V	[Illegible]
23	W	[Illegible]
24	X	[Illegible]
25	Y	[Illegible]
26	Z	[Illegible]
27	AA	[Illegible]
28	AB	[Illegible]
29	AC	[Illegible]
30	AD	[Illegible]
31	AE	[Illegible]
32	AF	[Illegible]
33	AG	[Illegible]
34	AH	[Illegible]
35	AI	[Illegible]
36	AJ	[Illegible]
37	AK	[Illegible]
38	AL	[Illegible]
39	AM	[Illegible]
40	AN	[Illegible]
41	AO	[Illegible]
42	AP	[Illegible]
43	AQ	[Illegible]
44	AR	[Illegible]
45	AS	[Illegible]
46	AT	[Illegible]
47	AU	[Illegible]
48	AV	[Illegible]
49	AW	[Illegible]
50	AX	[Illegible]
51	AY	[Illegible]
52	AZ	[Illegible]
53	BA	[Illegible]
54	BB	[Illegible]
55	BC	[Illegible]
56	BD	[Illegible]
57	BE	[Illegible]
58	BF	[Illegible]
59	BG	[Illegible]
60	BH	[Illegible]
61	BI	[Illegible]
62	BJ	[Illegible]
63	BK	[Illegible]
64	BL	[Illegible]
65	BM	[Illegible]
66	BN	[Illegible]
67	BO	[Illegible]
68	BP	[Illegible]
69	BQ	[Illegible]
70	BR	[Illegible]
71	BS	[Illegible]
72	BT	[Illegible]
73	BU	[Illegible]
74	BV	[Illegible]
75	BW	[Illegible]
76	BX	[Illegible]
77	BY	[Illegible]
78	BZ	[Illegible]
79	CA	[Illegible]
80	CB	[Illegible]
81	CC	[Illegible]
82	CD	[Illegible]
83	CE	[Illegible]
84	CF	[Illegible]
85	CG	[Illegible]
86	CH	[Illegible]
87	CI	[Illegible]
88	CJ	[Illegible]
89	CK	[Illegible]
90	CL	[Illegible]
91	CM	[Illegible]
92	CN	[Illegible]
93	CO	[Illegible]
94	CP	[Illegible]
95	CQ	[Illegible]
96	CR	[Illegible]
97	CS	[Illegible]
98	CT	[Illegible]
99	CU	[Illegible]
100	CV	[Illegible]
101	CW	[Illegible]
102	CX	[Illegible]
103	CY	[Illegible]
104	CZ	[Illegible]
105	DA	[Illegible]
106	DB	[Illegible]
107	DC	[Illegible]
108	DD	[Illegible]
109	DE	[Illegible]
110	DF	[Illegible]
111	DG	[Illegible]
112	DH	[Illegible]
113	DI	[Illegible]
114	DJ	[Illegible]
115	DK	[Illegible]
116	DL	[Illegible]
117	DM	[Illegible]
118	DN	[Illegible]
119	DO	[Illegible]
120	DP	[Illegible]
121	DQ	[Illegible]
122	DR	[Illegible]
123	DS	[Illegible]
124	DT	[Illegible]
125	DU	[Illegible]
126	DV	[Illegible]
127	DW	[Illegible]
128	DX	[Illegible]
129	DY	[Illegible]
130	DZ	[Illegible]
131	EA	[Illegible]
132	EB	[Illegible]
133	EC	[Illegible]
134	ED	[Illegible]
135	EE	[Illegible]
136	EF	[Illegible]
137	EG	[Illegible]
138	EH	[Illegible]
139	EI	[Illegible]
140	EJ	[Illegible]
141	EK	[Illegible]
142		

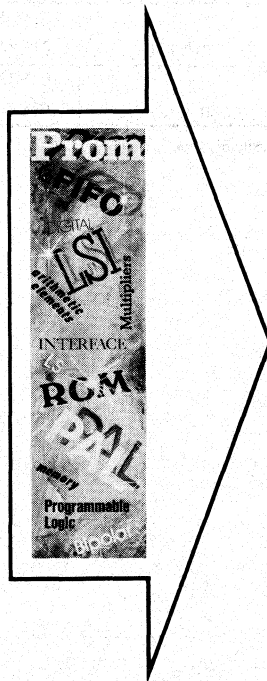

<b>Introduction</b>	<b>1</b>
<b>HI REL</b>	<b>2</b>
<b>PROM</b>	<b>3</b>
<b>ROM</b>	<b>4</b>
<b>Character Generators</b>	<b>5</b>
<b>PAL</b>	<b>6</b>
<b>FIFO</b>	<b>7</b>
<b>Arithmetic Elements</b>	<b>8</b>
<b>Interface</b>	<b>9</b>
<b>General Information</b>	<b>10</b>
<b>Representatives/Distributors</b>	<b>11</b>



## Octal Interface Selection Guide

FUNCTION	POWER	POLARITY	FEATURE	PART NUMBER		PAGE
				COMMERCIAL	MILITARY	
Buffer	LS	Non-invert	—	SN74LS244	SN54LS244	3
			—	SN74LS241	SN54LS241	3
		Schmitt Trigger	67LS304	57LS304	6	
			67LS301	57LS301	6	
	Invert	—	SN74LS240	SN54LS240	3	
		Schmitt Trigger	67LS300	57LS300	6	
S	Non-invert	—	SN74S244	SN54S244	3	
		—	SN74S241	SN54S241	3	
Invert	—	SN74S240	SN54S240	3		
	Transceiver	LS	Non-invert	—	SN74LS645	SN54LS645
Latch	LS	Non-invert	—	SN74LS373	SN54LS373	10
		Invert	—	67LS380	57LS380	13
	S	Non-invert	—	SN74S373	SN54S373	10
			32mA IOL	67S373	—	16
		Invert	—	67S380	57S380	13
			32mA IOL	67S382	—	18
Register	LS	Non-invert	—	SN74LS374	SN54LS374	10
		Invert	—	67LS376	57LS376	13
	S	Non-invert	—	SN74S374	SN54S374	10
			32mA IOL	67S374	—	16
		Invert	—	67S376	57S376	13
			32mA IOL	67S378	—	18

Package Types — All octal interface are in the 20 pin dual-in-line ceramic or plastic package.

# Octal Buffers

**SN54/74LS240    SN54/74S240**  
**SN54/74LS241    SN54/74S241**  
**SN54/74LS244    SN54/74S244**

## Features/Benefits

- Three-state outputs drive bus lines
- Low current PNP inputs reduce loading
- 20-pin Skinny DIP™ saves space
- 8-bits matches byte boundaries
- Ideal for microprocessor interface

## Description

The Octal Buffers provide high speed and high current interface capability for bus organized Digital Systems. The three-state drivers will source a termination to ground (up to 133Ω) or sink a pull-up to VCC as in the popular 220Ω/330Ω computer peripheral termination. The PNP inputs provide improved fan-in with 0.2 mA I<sub>IL</sub> on the Low Power Schottky buffers and 0.4mA I<sub>IL</sub> on the Schottky buffers.

The 240 and 244 provide inverting and non-inverting outputs with active low enables. The 241 provides non-inverting outputs with both active low and active high enables allowing transceiver operation.

## Ordering Information

PART NUMBER	PKG	TEMP.	ENABLE	POLARITY	POWER
SN54LS240 SN74LS240	J N,J	mil com	LOW	Invert	LS
SN54LS244 SN74LS244	J N,J	mil com	LOW	Non- invert	
SN54LS241 SN74LS241	J N,J	mil com	HIGH- LOW	Non- Invert	S
SN54S240 SN74S240	J N,J	mil com	LOW		
SN54S244 SN74S244	J N,J	mil com	LOW		
SN54S241 SN74S241	J N,J	mil com	HIGH- LOW		

## Logic Symbols

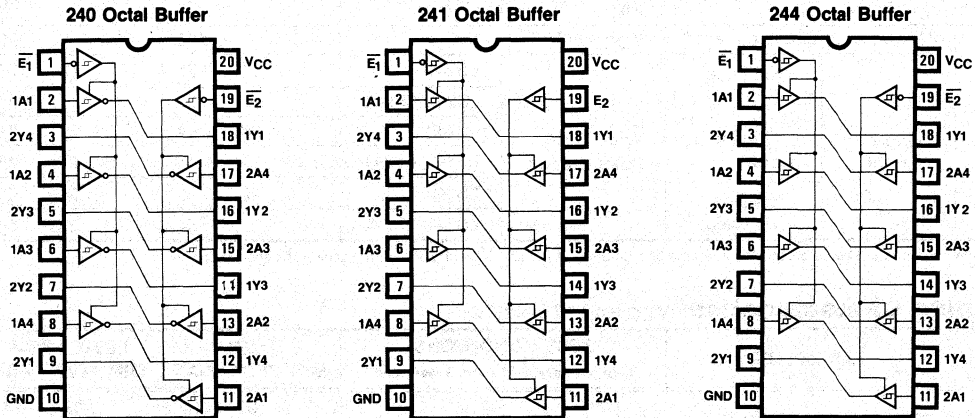

™Skinny DIP is a trademark of Monolithic Memories

**Absolute Maximum Ratings**

Supply Voltage V <sub>CC</sub> .....	7V
Input Voltage .....	7V
Off-state output voltage .....	5.5V
Storage temperature .....	-65° to +150°C

**Operating Conditions**

SYMBOL	PARAMETER	MILITARY			COMMERCIAL			UNIT				
		MIN	TYP	MAX	MIN	TYP	MAX					
V <sub>CC</sub>	Supply voltage	4.5	5	5.5	4.75	5	5.25	V				
T <sub>A</sub>	Operating free-air temperature	-55			125			0		75		°C

**Electrical Characteristics Over Operating Conditions**

SYMBOL	PARAMETER	TEST CONDITIONS	MILITARY			COMMERCIAL			UNIT						
			MIN	TYP	MAX	MIN	TYP	MAX							
V <sub>IL</sub>	Low-level input voltage				0.7			0.8			V				
V <sub>IH</sub>	High-level input voltage		2			2				V					
V <sub>IC</sub>	Input clamp voltage	V <sub>CC</sub> = MIN, I <sub>I</sub> = -18mA			-1.5			-1.5			V				
ΔV <sub>T</sub>	Hysteresis (V <sub>T+</sub> - V <sub>T-</sub> )	V <sub>CC</sub> = MIN	0.2	0.4		0.2	0.4		V						
I <sub>IL</sub>	Low-level input current	V <sub>CC</sub> = MAX, V <sub>I</sub> = 0.4V			-0.2			-0.2			mA				
I <sub>IH</sub>	High-level input current	V <sub>CC</sub> = MAX, V <sub>I</sub> = 2.7V			20			20			μA				
I <sub>I</sub>	Maximum input current	V <sub>CC</sub> = MAX, V <sub>I</sub> = 7V			0.1			0.1			mA				
V <sub>OL</sub>	Low-level output voltage	V <sub>CC</sub> = MIN, I <sub>OL</sub> = 12mA			0.4			0.4			V				
		V <sub>IL</sub> = MAX, V <sub>IH</sub> = 2V, I <sub>OL</sub> = 24mA						0.5							
V <sub>OH</sub>	High-level output voltage	V <sub>CC</sub> = MIN, I <sub>OH</sub> = -3mA	2.4	3.4		2.4	3.4		V						
		V <sub>IL</sub> = 0.5V, I <sub>OH</sub> = -12mA	2												
		V <sub>IH</sub> = 2V, I <sub>OH</sub> = -15mA				2									
I <sub>OZL</sub>	Off-state output current	V <sub>CC</sub> = MAX, V <sub>O</sub> = 0.4V			-20			-20			μA				
I <sub>OZH</sub>		V <sub>IL</sub> = MAX, V <sub>IH</sub> = 2V, V <sub>O</sub> = 2.7V			20			20			μA				
I <sub>OS</sub>	Output short-circuit current *	V <sub>CC</sub> = MAX	-40			-225			-40			-225			mA
I <sub>CC</sub>	Supply Current	Outputs High	V <sub>CC</sub> = MAX, Outputs open	LS240	17		27		17		27		mA		
				LS241, LS244	17		27		17		27				
				LS240	26		44		26		44				
				LS241, LS244	27		46		27		46				
				LS240	29		50		29		50				
				LS241, LS244	32		54		32		54				

\* Not more than one output should be shorted at a time and duration of the short-circuit should not exceed one second.

**Switching Characteristics V<sub>CC</sub> = 5 V, T<sub>A</sub> = 25° C**

SYMBOL	PARAMETER	TEST CONDITIONS (See Interface Test Load/Waveforms)	LS240			LS241, LS244			UNIT			
			MIN	TYP	MAX	MIN	TYP	MAX				
t <sub>PLH</sub>	Data to Output delay	C <sub>L</sub> = 45pF    R <sub>L</sub> = 667Ω	9			12			18			ns
t <sub>PHL</sub>			12			12			18			ns
t <sub>PZL</sub>	Output Enable delay		20			20			30			ns
t <sub>PZH</sub>			15			15			23			ns
t <sub>PLZ</sub>	Output Disable delay	C <sub>L</sub> = 5pF    R <sub>L</sub> = 667Ω	15			15			25			ns
t <sub>PHZ</sub>			10			10			18			ns

**Absolute Maximum Ratings**

Supply Voltage V <sub>CC</sub> .....	7V
Input Voltage .....	5.5V
Off-state output voltage .....	5.5V
Storage temperature .....	-65° to +150°C

**Operating Conditions**

SYMBOL	PARAMETER	MILITARY			COMMERCIAL			UNIT
		MIN	TYP	MAX	MIN	TYP	MAX	
V <sub>CC</sub>	Supply voltage	4.5	5	5.5	4.75	5	5.25	V
T <sub>A</sub>	Operating free-air temperature	-55		125*	0		75	°C

\*The SN54S241/244J operating at free air temperature above 116°C requires a heat sink such that R<sub>θCA</sub> is not more than 40°C/W.

**Electrical Characteristics Over Operating Conditions**

SYMBOL	PARAMETER		TEST CONDITIONS	MILITARY			COMMERCIAL			UNIT
				MIN	TYP	MAX	MIN	TYP	MAX	
V <sub>IL</sub>	Low-level input voltage					0.8			0.8	V
V <sub>IH</sub>	High-level input voltage			2			2			V
V <sub>IC</sub>	Input clamp voltage		V <sub>CC</sub> = MIN    I <sub>I</sub> = -18mA			-1.2			-1.2	V
ΔV <sub>T</sub>	Hysteresis (V <sub>T+</sub> - V <sub>T-</sub> )		V <sub>CC</sub> = MIN	0.2	0.4		0.2	0.4		V
I <sub>IL</sub>	Low-level input current	Any A	V <sub>CC</sub> = MAX    V <sub>I</sub> = 0.5V			-0.4			-0.4	mA
		Any E				-2		-2		
I <sub>IH</sub>	High-level input current		V <sub>CC</sub> = MAX    V <sub>I</sub> = 2.7V			50			50	μA
I <sub>I</sub>	Maximum input current		V <sub>CC</sub> = MAX    V <sub>I</sub> = 5.5V			1			1	mA
V <sub>OL</sub>	Low-level output voltage		V <sub>CC</sub> = MIN	I <sub>OL</sub> = 48mA		0.55		0.55		V
			V <sub>IL</sub> = 0.8V							
			V <sub>IH</sub> = 2V							
V <sub>OH</sub>	High-level output voltage		V <sub>CC</sub> = MIN	I <sub>OH</sub> = -1mA I <sub>OH</sub> = -3mA I <sub>OH</sub> = -12mA I <sub>OH</sub> = -15mA		2.4    3.4		2.4    3.4		V
			V <sub>IL</sub> = 0.8V							
			V <sub>IH</sub> = 2V							
I <sub>OZL</sub>	Off-state output current		V <sub>CC</sub> = MAX	V <sub>O</sub> = 0.5V		-50		-50	μA	
I <sub>OZH</sub>			V <sub>IL</sub> = 0.8V		V <sub>O</sub> = 2.4V		50			50
I <sub>OS</sub>	Output short-circuit current †		V <sub>CC</sub> = MAX		-50	-225	-50	-225	mA	
I <sub>CC</sub>	Supply Current	Outputs High	V <sub>CC</sub> = MAX Outputs open	S240	80	123	80	135	mA	
				S241, S244	95	147	95	160		
		Outputs Low		S240	100	145	100	150		
				S241, S244	120	170	120	180		
		Outputs Disabled		S240	100	145	100	150		
				S241, S244	120	170	120	180		

† Not more than one output should be shorted at a time and duration of the short-circuit should not exceed one second.

**Switching Characteristics    V<sub>CC</sub> = 5 V, T<sub>A</sub> = 25° C**

SYMBOL	PARAMETER	TEST CONDITIONS (See Interface Test Load/Waveforms)	S240			S241, S244			UNIT
			MIN	TYP	MAX	MIN	TYP	MAX	
t <sub>PLH</sub>	Data to Output delay	C <sub>L</sub> = 50pF    R <sub>L</sub> = 90Ω	4.5	7		6	9	ns	
t <sub>PHL</sub>			4.5	7		6	9	ns	
t <sub>PZL</sub>	Output Enable delay		10	15		10	15	ns	
t <sub>PZH</sub>			6.5	10		8	12	ns	
t <sub>PLZ</sub>	Output Disable delay	C <sub>L</sub> = 5pF    R <sub>L</sub> = 90Ω	10	15		10	15	ns	
t <sub>PHZ</sub>			6	9		6	9	ns	



# Octal Buffers with Schmitt Triggers

## 57/67LS300 57LS301 57/67LS304

### Features/Benefits

- Schmitt trigger guarantees high noise margin
- Three-state outputs drive bus lines
- Low current PNP inputs reduce loading
- 20-pin Skinny DIP™ saves space
- 8-bits matches byte boundaries
- Ideal for microprocessor interface

### Ordering Information

PART NUMBER	PKG	TEMP.	ENABLE	POLARITY	POWER
57LS300 67LS300	J N,J	mil com	LOW	Invert	LS
57LS304 67LS304	J N,J	mil com	LOW	Non-invert	
57LS301 67LS301	J N,J	mil com	HIGH- LOW		

### Description

In addition to the standard Schottky and Low Power Schottky Octal Buffers, Monolithic Memories provides a full hysteresis with "a true" Schmitt trigger circuit. The improved performance characteristics are designed to be consistent with the SN54/74LS14 Hex Schmitt trigger and guarantee a full 400 mV noise immunity. The Schmitt trigger operation makes the LS buffers ideal for bus receivers in a noisy environment.

The Octal Buffers provide high speed and high current interface capability for bus organized Digital Systems. The PNP inputs provide improved fan-in with 0.2 mA  $I_{IL}$ . The 300 and 304 provide inverting and non-inverting outputs with active low enables. The 301 provides non-inverting outputs with both active low and active high enables allowing transceiver operation.

### Logic Symbols

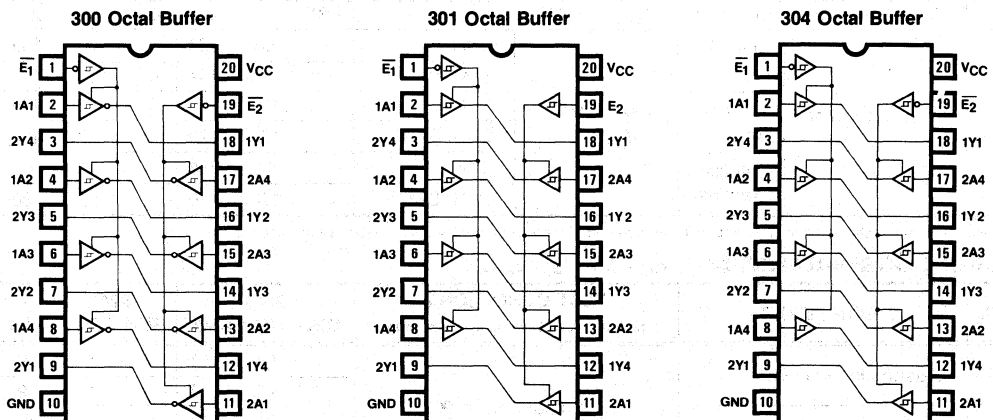

### Absolute Maximum Ratings

Supply Voltage VCC .....	7V
Input Voltage .....	7V
Off-state output voltage .....	5.5V
Storage temperature .....	-65° to +150°C

### Operating Conditions

SYMBOL	PARAMETER	MILITARY			COMMERCIAL			UNIT
		MIN	TYP	MAX	MIN	TYP	MAX	
V <sub>CC</sub>	Supply voltage	4.5	5	5.5	4.75	5	5.25	V
T <sub>A</sub>	Operating free-air temperature	-55		125	0		75	°C

### Electrical Characteristics Over Operating Conditions

SYMBOL	PARAMETER	TEST CONDITIONS	MILITARY			COMMERCIAL			UNIT
			MIN	TYP	MAX	MIN	TYP	MAX	
V <sub>T+</sub>	Positive threshold voltage	V <sub>CC</sub> = 5V	1.5	1.7	2.0	1.5	1.7	2.0	V
V <sub>T-</sub>	Negative threshold voltage	V <sub>CC</sub> = 5V	0.6	0.9	1.1	0.6	0.9	1.1	V
V <sub>IC</sub>	Input clamp voltage	V <sub>CC</sub> = MIN, I <sub>I</sub> = -18mA			-1.5			-1.5	V
ΔV <sub>T</sub>	Hysteresis (V <sub>T+</sub> - V <sub>T-</sub> )	V <sub>CC</sub> = 5V	0.4	0.8		0.4	0.8		V
I <sub>IL</sub>	Low-level input current	V <sub>CC</sub> = MAX, V <sub>I</sub> = 0.4V			-0.2			-0.2	mA
I <sub>IH</sub>	High-level input current	V <sub>CC</sub> = MAX, V <sub>I</sub> = 2.7V			20			20	μA
I <sub>I</sub>	Maximum input current	V <sub>CC</sub> = MAX, V <sub>I</sub> = 7V			0.1			0.1	mA
V <sub>OL</sub>	Low-level output voltage	V <sub>CC</sub> = MIN, V <sub>T+</sub> = 2V, V <sub>T-</sub> = 0.6V	I <sub>OL</sub> = 12mA					0.4	V
			I <sub>OL</sub> = 24mA					0.5	
V <sub>OH</sub>	High-level output voltage	V <sub>CC</sub> = MIN, V <sub>T+</sub> = 2V, V <sub>T-</sub> = 0.6V	I <sub>OH</sub> = -3mA		2.4	3.4	2.4	3.4	V
			I <sub>OH</sub> = -12mA		2				
			I <sub>OH</sub> = -15mA				2		
I <sub>OZL</sub>	Off-state output current	V <sub>CC</sub> = MAX, V <sub>T+</sub> = 2V, V <sub>T-</sub> = 0.6V	V <sub>O</sub> = 0.4V				-20	-20	μA
I <sub>OZH</sub>			V <sub>O</sub> = 2.7V				20	20	μA
I <sub>OS</sub>	Output short-circuit current *	V <sub>CC</sub> = MAX			-40	-225	-40	-225	mA
I <sub>CC</sub>	Supply Current	Outputs open V <sub>CC</sub> = MAX, Outputs open	LS300		17	27	17	27	mA
			LS301, LS304		18	31	18	31	
			LS300		26	44	26	44	
			LS301, LS304		32	46	32	46	
			LS300		29	50	29	50	
			LS301, LS304		34	54	34	54	

\* Not more than one output should be shorted at a time and duration of the short-circuit should not exceed one second.

### Switching Characteristics V<sub>CC</sub> = 5 V, T<sub>A</sub> = 25° C

SYMBOL	PARAMETER	TEST CONDITIONS (See Interface Test Load/Waveforms)	LS300			LS301, LS304			UNIT
			MIN	TYP	MAX	MIN	TYP	MAX	
t <sub>PLH</sub>	Data to Output delay	C <sub>L</sub> = 45pF R <sub>L</sub> = 667Ω	19			19			ns
t <sub>PHL</sub>			19			19			ns
t <sub>PZL</sub>	Output Enable delay		37			26			ns
t <sub>PZH</sub>			26			26			ns
t <sub>PLZ</sub>	Output Disable delay	C <sub>L</sub> = 5pF R <sub>L</sub> = 667Ω	19			22			ns
t <sub>PHZ</sub>			19			22			ns

# Octal Transceiver

## SN54/74LS645

### Features/Benefits

- 3-state outputs drive bus lines
- Low current PNP inputs reduce loading
- 20 pin Skinny DIP™ saves space
- 8-bits matches byte boundaries
- Ideal for microprocessor interface

### Description

These Octal Bus transceivers are designed for asynchronous two-way communication between data buses. The control function implementation minimizes external timing requirements.

The device allows data transmission from the A bus to the B bus or from the B bus to the A bus depending upon the logic level at the direction control (DIR) input. The enable input (E) can be used to disable the device so that the buses are effectively isolated.

### Ordering Information

PART NUMBER	TYPE	TEMP	POLARITY	POWER
SN54LS645	J	mil	Non-invert	LS
SN74LS645	N,J	com		

### Function Table

ENABLE $\bar{E}$	DIRECTION CONTROL DIR	OPERATION
L	L	B data to A bus
L	H	A data to B bus
H	X	Isolated

### Logic Symbol

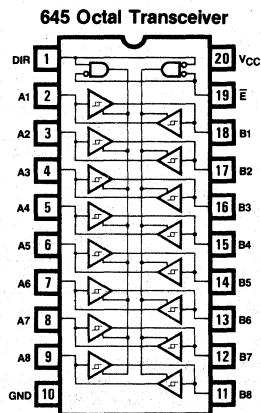

**Absolute Maximum Ratings**

Supply Voltage V <sub>CC</sub> .....	7V
Input Voltage .....	7V
Off-state output voltage .....	5.5V
Storage temperature .....	-65° to +150°C

**Operating Conditions**

SYMBOL	PARAMETER	MILITARY			COMMERCIAL			UNIT
		MIN	TYP	MAX	MIN	TYP	MAX	
V <sub>CC</sub>	Supply voltage	4.5	5	5.5	4.75	5	5.25	V
T <sub>A</sub>	Operating free-air temperature	-55		125	0		75	°C

**Electrical Characteristics** Over Operating Conditions

SYMBOL	PARAMETER	TEST CONDITIONS	MILITARY			COMMERCIAL			UNIT
			MIN	TYP	MAX	MIN	TYP	MAX	
V <sub>IL</sub>	Low-level input voltage				0.5		0.6	V	
V <sub>IH</sub>	High-level input voltage		2			2		V	
V <sub>IC</sub>	Input clamp voltage	V <sub>CC</sub> = MIN, I <sub>I</sub> = -18mA			-1.5		-1.5	V	
ΔV <sub>T</sub>	Hysteresis (V <sub>T+</sub> - V <sub>T-</sub> ) A or B	V <sub>CC</sub> = MIN	0.1	0.4		0.2	0.4	V	
I <sub>IL</sub>	Low-level input current	V <sub>CC</sub> = MAX, V <sub>I</sub> = 0.4V			-0.4		-0.4	mA	
I <sub>IH</sub>	High-level input current	V <sub>CC</sub> = MAX, V <sub>I</sub> = 2.7V			20		20	μA	
I <sub>I</sub>	Maximum input current	V <sub>CC</sub> = MAX, V <sub>I</sub> = 5.5V			0.1		0.1	mA	
V <sub>OL</sub>	Low-level output voltage	V <sub>CC</sub> = MIN, V <sub>IL</sub> = MAX, V <sub>IH</sub> = 2V	I <sub>OL</sub> = 12mA		0.25	0.4	0.25	0.4	V
			I <sub>OL</sub> = 24mA				0.35	0.5	
V <sub>OH</sub>	High-level output voltage	V <sub>CC</sub> = MIN, V <sub>IL</sub> = MAX, V <sub>IH</sub> = 2V	I <sub>OH</sub> = -3mA		2.4	3.4	2.4	3.4	V
			I <sub>OH</sub> = -12mA		2				
			I <sub>OH</sub> = -15mA				2		
I <sub>OZL</sub>	Off-state output current	V <sub>CC</sub> = MAX, V <sub>IL</sub> = MAX, V <sub>IH</sub> = 2V	V <sub>O</sub> = 0.4V				-400	μA	
I <sub>OZH</sub>			V <sub>O</sub> = 2.7V				20	μA	
I <sub>OS</sub>	Output short-circuit current *	V <sub>CC</sub> = MAX	-40		-225	-40	-225	mA	
I <sub>CC</sub>	Supply Current	Outputs High	V <sub>CC</sub> = MAX, Outputs open		48	70	48	70	mA
		Outputs Low			62	90	62	90	
		Outputs Disabled			64	95	64	95	

\* Not more than one output should be shorted at a time and duration of the short-circuit should not exceed one second.

**Switching Characteristics** V<sub>CC</sub> = 5 V, T<sub>A</sub> = 25° C

SYMBOL	PARAMETER	TEST CONDITIONS (See Interface Test Load/Waveforms)	A to B			B to A			UNIT
			MIN	TYP	MAX	MIN	TYP	MAX	
t <sub>PLH</sub>	Data to Output delay	C <sub>L</sub> = 45pF R <sub>L</sub> = 667Ω	8	15		8	15	ns	
t <sub>PHL</sub>			11	15		11	15	ns	
t <sub>PZL</sub>	Output Enable delay		31	40		31	40	ns	
t <sub>PZH</sub>			26	40		26	40	ns	
t <sub>PLZ</sub>	Output Disable delay		15	25		15	25	ns	
t <sub>PHZ</sub>			15	25		15	25	ns	





# Octal Latches, Octal Registers

**SN54/74LS373 SN54/74S373**  
**SN54/74LS374 SN54/74S374**

## Features/Benefits

- 3-State Outputs Drive Bus Lines
- 20 Pin Skinny DIP™ Saves Space
- 8 Bits Matches Byte Boundaries
- Hysteresis Improves Noise Margin
- Low Current PNP Inputs Reduce Loading
- Ideal for Microprocessor Interface

## Ordering Information

PART NUMBER	PKG	TEMP	POLARITY	TYPE	POWER
SN54LS373 SN74LS373	J N,J	mil com	Non-invert	Latch	LS
SN54LS374 SN74LS374	J N,J	mil com		Register	
SN54S373 SN74S373	J N,J	mil com		Latch	S
SN54S374 SN74S374	J N,J	mil com		Register	

## Description

The latch passes eight (octal) bits of data from the inputs (D) to the outputs (Q) when the gate (G) is high. The data is "latched" when the gate (G) goes low. The register loads eight (octal) bits of input data and passes it to the output on the "rising edge" of the clock.

The three state outputs are active when  $\overline{OE}$  is low, and high

impedance when  $\overline{OE}$  is high. Schmitt-trigger buffers at the gate/clock inputs improve system noise margin by providing typically 400 mV of hysteresis.

All of the octal devices are packaged in the popular 20 Pin Skinny DIP™.

## Function Tables

373 Octal Latch

$\overline{OE}$	G	D	Q
L	H	H	H
L	H	L	L
L	L	X	$Q_0$
H	X	X	Z

374 Octal Register

$\overline{OE}$	CK	D	Q
L	↑	H	H
L	↑	L	L
L	L	X	$Q_0$
H	X	X	Z

## Logic Symbols

373 Octal Latch

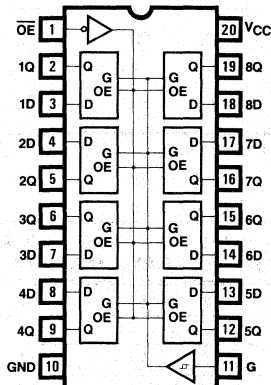

374 Octal Register

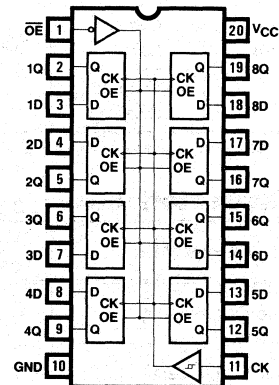

**Absolute Maximum Ratings**

Supply Voltage, V <sub>CC</sub> .....	7V
Input Voltage .....	7V
Off-state output voltage .....	5.5V
Storage temperature .....	-65° to +150°C

**Operating Conditions**

SYMBOL	PARAMETER	MILITARY			COMMERCIAL			UNIT
		MIN	TYP	MAX	MIN	TYP	MAX	
V <sub>CC</sub>	Supply voltage	4.5	5	5.5	4.75	5	5.25	V
T <sub>A</sub>	Operating free air temperature	-55		125	0		75	°C

**Electrical Characteristics Over Operating Conditions**

SYMBOL	PARAMETER	TEST CONDITIONS	MILITARY		COMMERCIAL		UNIT		
			MIN	TYP	MAX	MIN		TYP	MAX
V <sub>IL</sub>	Low-level input voltage				0.7		0.8	V	
V <sub>IH</sub>	High-level input voltage		2			2		V	
V <sub>IC</sub>	Input clamp voltage	V <sub>CC</sub> = MIN    I <sub>I</sub> = -18mA			-1.5		-1.5	V	
I <sub>IL</sub>	Low-level input current	V <sub>CC</sub> = MAX    V <sub>I</sub> = 0.4V			-0.4		-0.4	mA	
I <sub>IH</sub>	High-level input current	V <sub>CC</sub> = MAX    V <sub>I</sub> = 2.7V			20		20	µA	
I <sub>I</sub>	Maximum input current	V <sub>CC</sub> = MAX    V <sub>I</sub> = 7V			0.1		0.1	mA	
V <sub>OL</sub>	Low-level output voltage	V <sub>CC</sub> = MIN    I <sub>OL</sub> = 12mA		0.25	0.4		0.25	0.4	V
		V <sub>IL</sub> = MAX    I <sub>OL</sub> = 24mA					0.35	0.5	
V <sub>OH</sub>	High-level output voltage	V <sub>CC</sub> = MIN    I <sub>OH</sub> = -1mA	2.4	3.4					V
		V <sub>IL</sub> = MAX    I <sub>OH</sub> = -2.6mA				2.4	3.1		
I <sub>OZL</sub>	Off-state output current	V <sub>CC</sub> = MAX    V <sub>O</sub> = 0.4V			-20		-20	µA	
I <sub>OZH</sub>		V <sub>IL</sub> = MAX    V <sub>O</sub> = 2.7V			20		20	µA	
I <sub>OS</sub>	Output short-circuit current *	V <sub>CC</sub> = MAX	-30		-130		-30	-130	mA
I <sub>CC</sub>	Supply current	V <sub>CC</sub> = MAX		24	40		24	40	mA
		Outputs open	LS373						
				27	40		27	40	

\*Not more than one output should be shorted at a time and duration of the short-circuit should not exceed one second.

**Switching Characteristics V<sub>CC</sub> = 5 V, T<sub>A</sub> = 25°C**

SYMBOL	PARAMETER	TEST CONDITIONS (See Interface Test Load/Waveforms)	LS373			LS374			UNIT
			MIN	TYP	MAX	MIN	TYP	MAX	
t <sub>MAX</sub>	Maximum Clock frequency	C <sub>L</sub> = 45pF    R <sub>L</sub> = 667Ω				35	50		MHz
t <sub>PLH</sub>	Data to Output delay			12	18				ns
t <sub>PHL</sub>				12	18				ns
t <sub>PLH</sub>	Clock/Enable to output delay			20	30		15	28	ns
t <sub>PHL</sub>				18	30		19	28	ns
t <sub>PZL</sub>				25	36		21	28	ns
t <sub>PZH</sub>	Output Enable delay		15	28		20	28	ns	
t <sub>PLZ</sub>	Output Disable delay	C <sub>L</sub> = 5pF    R <sub>L</sub> = 667Ω		15	25		14	25	ns
t <sub>PHZ</sub>				12	20		12	20	ns
t <sub>w</sub>	Width of Clock/Gate	High	15			15		ns	
		Low	15			15			
t <sub>su</sub>	Setup time		0			20†		ns	
t <sub>h</sub>	Hold time		10†			0†			



**Absolute Maximum Ratings**

Supply Voltage, V <sub>CC</sub> .....	7V
Input Voltage .....	5.5V
Off-state output voltage .....	5.5V
Storage temperature .....	-65° to +150°C

**Operating Conditions**

SYMBOL	PARAMETER	MILITARY			COMMERCIAL			UNIT
		MIN	TYP	MAX	MIN	TYP	MAX	
V <sub>CC</sub>	Supply voltage	4.5	5	5.5	4.75	5	5.25	V
T <sub>A</sub>	Operating free air temperature	-55		125	0		75	°C

**Electrical Characteristics Over Operating Conditions**

SYMBOL	PARAMETER	TEST CONDITIONS	MILITARY			COMMERCIAL			UNIT
			MIN	TYP	MAX	MIN	TYP	MAX	
V <sub>IL</sub>	Low-level input voltage				0.8		0.8	V	
V <sub>IH</sub>	High-level input voltage		2			2		V	
V <sub>IC</sub>	Input clamp voltage	V <sub>CC</sub> = MIN I <sub>I</sub> = -18mA			-1.2		-1.2	V	
I <sub>IL</sub>	Low-level input current	V <sub>CC</sub> = MAX V <sub>I</sub> = 0.5V			-0.25		-0.25	mA	
I <sub>IH</sub>	High-level input current	V <sub>CC</sub> = MAX V <sub>I</sub> = 2.7V			50		50	μA	
I <sub>I</sub>	Maximum input current	V <sub>CC</sub> = MAX V <sub>I</sub> = 5.5V			1		1	mA	
V <sub>OL</sub>	Low-level output voltage	V <sub>CC</sub> = MIN V <sub>IL</sub> = 0.8V V <sub>IH</sub> = 2V I <sub>OL</sub> = 20mA			0.5		0.5	V	
V <sub>OH</sub>	High-level output voltage	V <sub>CC</sub> = MIN V <sub>IL</sub> = 0.8V V <sub>IH</sub> = 2V I <sub>OH</sub> = -2mA	2.4	3.4				V	
		I <sub>OH</sub> = -6.5mA				2.4	3.1		
I <sub>OZL</sub>	Off-state output current	V <sub>CC</sub> = MAX V <sub>IL</sub> = 0.8V V <sub>IH</sub> = 2V V <sub>O</sub> = 0.5V			-50		-50	μA	
I <sub>OZH</sub>		V <sub>O</sub> = 2.4V			50		50	μA	
I <sub>OS</sub>	Output short-circuit current*	V <sub>CC</sub> = MAX	-40		-100	-40	-100	mA	
I <sub>CC</sub>	Supply current	V <sub>CC</sub> = MAX Outputs open						mA	
		S373	105	160		105	160		
		S374	90	140		90	140		

\* Not more than one output should be shorted at a time and duration of the short-circuit should not exceed one second.

**Switching Characteristics V<sub>CC</sub> = 5 V, T<sub>A</sub> = 25° C**

SYMBOL	PARAMETER	TEST CONDITIONS (See Interface Test Load/Waveforms)	S373			S374			UNIT
			MIN	TYP	MAX	MIN	TYP	MAX	
f <sub>MAX</sub>	Maximum Clock frequency	C <sub>L</sub> = 15pF R <sub>L</sub> = 280Ω				75	100		MHz
t <sub>PLH</sub>	Data to Output delay			5	9				ns
t <sub>PHL</sub>				9	13				ns
t <sub>PLH</sub>	Clock/Enable to output delay			7	14		8	15	ns
t <sub>PHL</sub>				12	18		11	17	ns
t <sub>PZL</sub>	Output Enable delay			11	18		11	18	ns
t <sub>PZH</sub>			8	15		8	15	ns	
t <sub>PLZ</sub>	Output Disable delay	C <sub>L</sub> = 5pF R <sub>L</sub> = 280Ω		8	12		7	12	ns
t <sub>PHZ</sub>				6	9		5	9	ns
t <sub>w</sub>	Width of Clock/Gate	High	6			6		ns	
		Low	7.3			7.3			
t <sub>SU</sub>	Setup time		0			5		ns	
t <sub>H</sub>	Hold time		10			2			

# Octal Latches, Octal Registers With Inverting Outputs

**57/67LS376 57/67S376**  
**57/67LS380 57/67S380**

## Features/Benefits

- Inverting Outputs
- 3-State Outputs Drive Bus Lines
- 20 Pin Skinny DIP™ Saves Space
- 8 Bits Matches Byte Boundaries
- Hysteresis Improves Noise Margin
- Low Current PNP Inputs Reduce Loading
- Ideal for Microprocessor Interface

## Description

In addition to the standard S and LS latches and Registers, Monolithic Memories provides inverting outputs instead of non-inverting outputs. The inverting outputs are intended for bus applications that require inversion as in interfacing the Am2901A 4-Bit Slice to an active low bus.

The latch passes eight (octal) bits of data from the inputs (D) to the outputs (Q) when the gate (G) is high. The data is "latched"

## Function Tables

380 Octal Latch (Inverting)

$\overline{OE}$	G	D	$\overline{Q}$
L	H	H	L
L	H	L	H
L	L	X	$Q_0$
H	X	X	Z

376 Octal Latch (Inverting)

$\overline{OE}$	CK	D	$\overline{Q}$
L	↑	H	L
L	↑	L	H
L	L	X	$Q_0$
H	X	X	Z

## Logic Symbols

380 Octal Latch (Inverting)

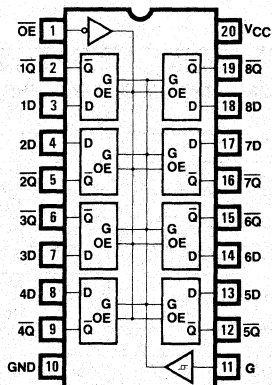

376 Octal Register (Inverting)

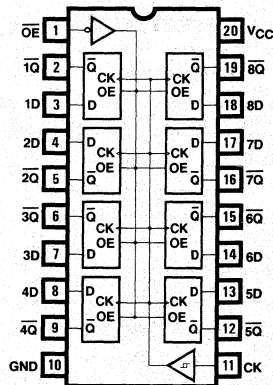

## Ordering Information

PART NUMBER	PKG	TEMP	POLARITY	TYPE	POWER
57LS380 67LS380	J N,J	mil com	Invert	Latch	LS
57LS376 67LS376	J N,J	mil com		Register	
57S380 67S380	J N,J	mil com		Latch	S
57S376 67S376	J N,J	mil com		Register	

when the gate (G) goes low. The register loads eight (octal) bits of input data and passes it to the output on the "rising edge" of the clock.

The three state outputs are active when  $\overline{OE}$  is low, and high impedance when  $\overline{OE}$  is high. Schmitt-trigger buffers at the gate/clock inputs improve system noise margin by providing typically 400 mV of hysteresis.

All of the octal devices are packaged in the popular 20 Pin Skinny DIP™.



**Absolute Maximum Ratings**

Supply Voltage, V <sub>CC</sub> .....	7V
Input Voltage .....	7V
Off-state output voltage .....	5.5V
Storage temperature .....	-65° to +150°C

**Operating Conditions**

SYMBOL	PARAMETER	MILITARY			COMMERCIAL			UNIT
		MIN	TYP	MAX	MIN	TYP	MAX	
V <sub>CC</sub>	Supply voltage	4.5	5	5.5	4.75	5	5.25	V
T <sub>A</sub>	Operating free air temperature	-55		125	0		75	°C

**Electrical Characteristics Over Operating Conditions**

SYMBOL	PARAMETER	TEST CONDITIONS	MILITARY			COMMERCIAL			UNIT
			MIN	TYP	MAX	MIN	TYP	MAX	
V <sub>IL</sub>	Low-level input voltage				0.7		0.8	V	
V <sub>IH</sub>	High-level input voltage		2			2		V	
V <sub>IC</sub>	Input clamp voltage	V <sub>CC</sub> = MIN I <sub>I</sub> = -18mA			-1.5		-1.5	V	
I <sub>IL</sub>	Low-level input current	V <sub>CC</sub> = MAX V <sub>I</sub> = 0.4V			-0.4		-0.4	mA	
I <sub>IH</sub>	High-level input current	V <sub>CC</sub> = MAX V <sub>I</sub> = 2.7V			20		20	µA	
I <sub>I</sub>	Maximum input current	V <sub>CC</sub> = MAX V <sub>I</sub> = 7V			0.1		0.1	mA	
V <sub>OL</sub>	Low-level output voltage	V <sub>CC</sub> = MIN V <sub>IL</sub> = MAX V <sub>IH</sub> = 2V	I <sub>OL</sub> = 12mA	0.25	0.4	0.25	0.4	V	
			I <sub>OL</sub> = 24mA	35	50	0.35	0.5		
V <sub>OH</sub>	High-level output voltage	V <sub>CC</sub> = MIN V <sub>IL</sub> = MAX V <sub>IH</sub> = 2V	I <sub>OH</sub> = -1mA	2.4	3.4			V	
			I <sub>OH</sub> = -2.6mA			2.4	3.1		
I <sub>OZL</sub>	Off-state output current	V <sub>CC</sub> = MAX V <sub>IL</sub> = MAX V <sub>IH</sub> = 2V	V <sub>O</sub> = 0.4V				-20	µA	
I <sub>OZH</sub>			V <sub>O</sub> = 2.7V		20		20	µA	
I <sub>OS</sub>	Output short-circuit current *	V <sub>CC</sub> = MAX	-30		-130	-30		-130	mA
I <sub>CC</sub>	Supply current	V <sub>CC</sub> = MAX Outputs open	LS 380	36	48	36	48	mA	
			LS376	27	48	27	48		

\* Not more than one output should be shorted at a time and duration of the short-circuit should not exceed one second.

**Switching Characteristics V<sub>CC</sub> = 5 V, T<sub>A</sub> = 25°C**

SYMBOL	PARAMETER	TEST CONDITIONS (See Interface Test Load/Waveforms)	LS380			LS376			UNIT
			MIN	TYP	MAX	MIN	TYP	MAX	
f <sub>MAX</sub>	Maximum Clock frequency							MHz	
t <sub>PLH</sub>	Data to Output delay	C <sub>L</sub> = 45pF R <sub>L</sub> = 667Ω		17	25			ns	
t <sub>PHL</sub>				12	25			ns	
t <sub>PLH</sub>	Clock/Enable to output delay			20	35	19	30	ns	
t <sub>PHL</sub>				18	35	15	30	ns	
t <sub>PZL</sub>	Output Enable delay			25	36	21	30	ns	
t <sub>PZH</sub>				17	30	20	30	ns	
t <sub>PLZ</sub>	Output Disable delay	C <sub>L</sub> = 5pF R <sub>L</sub> = 667Ω		18	29	18	29	ns	
t <sub>PHZ</sub>				16	24	16	24	ns	
t <sub>w</sub>	Width of Clock/Gate	High	15		15		ns		
		Low	15						
t <sub>su</sub>	Setup Time		0		20		ns		
t <sub>h</sub>	Hold Time		10		0				

### Absolute Maximum Ratings

Supply Voltage, V <sub>CC</sub> .....	7V
Input Voltage .....	5.5V
Off-state output voltage .....	5.5V
Storage temperature .....	-65° to +150°C

### Operating Conditions

SYMBOL	PARAMETER	MILITARY			COMMERCIAL			UNIT
		MIN	TYP	MAX	MIN	TYP	MAX	
V <sub>CC</sub>	Supply voltage	4.5	5	5.5	4.75	5	5.25	V
T <sub>A</sub>	Operating free air temperature	-55		125	0		75	°C

### Electrical Characteristics Over Operating Conditions

SYMBOL	PARAMETER	TEST CONDITIONS	MILITARY		COMMERCIAL		UNIT		
			MIN	TYP	MAX	MIN		TYP	MAX
V <sub>IL</sub>	Low-level input voltage				0.8		0.8	V	
V <sub>IH</sub>	High-level input voltage		2			2		V	
V <sub>IC</sub>	Input clamp voltage	V <sub>CC</sub> = MIN, I <sub>I</sub> = -18mA			-1.2		-1.2	V	
I <sub>IL</sub>	Low-level input current	V <sub>CC</sub> = MAX, V <sub>I</sub> = 0.5V			-0.25		-0.25	mA	
I <sub>IH</sub>	High-level input current	V <sub>CC</sub> = MAX, V <sub>I</sub> = 2.7V			50		50	µA	
I <sub>I</sub>	Maximum input current	V <sub>CC</sub> = MAX, V <sub>I</sub> = 5.5V			1		1	mA	
V <sub>OL</sub>	Low-level output voltage	V <sub>CC</sub> = MIN, V <sub>IL</sub> = 0.8V, V <sub>IH</sub> = 2V, I <sub>OL</sub> = 20mA			0.5		0.5	V	
V <sub>OH</sub>	High-level output voltage	V <sub>CC</sub> = MIN, V <sub>IL</sub> = 0.8V, V <sub>IH</sub> = 2V, I <sub>OH</sub> = -2mA	2.4	3.4				V	
		I <sub>OH</sub> = -6.5mA			2.4	3.1			
I <sub>OZL</sub>	Off-state output current	V <sub>CC</sub> = MAX, V <sub>IL</sub> = 0.8V, V <sub>IH</sub> = 2V, V <sub>O</sub> = 0.5V			-50		-50	µA	
I <sub>OZH</sub>		V <sub>O</sub> = 2.4V			50		50	µA	
I <sub>OS</sub>	Output short-circuit current *	V <sub>CC</sub> = MAX	-40		-100		-100	mA	
I <sub>CC</sub>	Supply current	V <sub>CC</sub> = MAX, Outputs open	S380	105	160		105	160	mA
			S376	90	140		90	140	

\*Not more than one output should be shorted at a time and duration of the short-circuit should not exceed one second.

### Switching Characteristics V<sub>CC</sub> = 5 V, T<sub>A</sub> = 25°C

SYMBOL	PARAMETER	TEST CONDITIONS (See Interface Test Load/Waveforms)	S380			S376			UNIT
			MIN	TYP	MAX	MIN	TYP	MAX	
f <sub>MAX</sub>	Maximum Clock frequency	C <sub>L</sub> = 15pF R <sub>L</sub> = 280Ω				75	100		MHz
t <sub>PLH</sub>	Data to Output delay		9	18					ns
t <sub>PHL</sub>			5	16					ns
t <sub>PLH</sub>	Clock/Enable to output delay		12	22		11	20		ns
t <sub>PHL</sub>			7	20		8	18		ns
t <sub>PZL</sub>	Output Enable delay		11	20		11	20		ns
t <sub>PZH</sub>		8	17		8	17		ns	
t <sub>PLZ</sub>	Output Disable delay	C <sub>L</sub> = 5pF R <sub>L</sub> = 280Ω	8	16		7	16		ns
t <sub>PHZ</sub>		6	13		5	13		ns	
t <sub>w</sub>	Width of Clock/Gate	High	6			6			ns
		Low	7.3			7.3			
t <sub>SU</sub>	Setup time		0			5		ns	
t <sub>H</sub>	Hold time		10			2			



# Octal Latches, Octal Registers With 32mA Outputs

## 67S373 67S374

### Features/Benefits

- 32mA  $I_{OL}$
- 3-State Outputs Drive Bus Lines
- 20 Pin Skinny DIP™ Saves Space
- 8 Bits Matches Byte Boundaries
- Hysteresis Improves Noise Margin
- Low Current PNP Inputs Reduce Loading
- Ideal for Microprocessor Interface

### Description

In addition to the standard S and LS latches and registers, Monolithic Memories provides increased output sink current ( $I_{OL}$ ) from the standard Schottky  $I_{OL}$  of 20 mA to an improved 32 mA.

The higher  $I_{OL}$  is intended for upgrading systems which presently satisfy 32 mA requirements with SN54/74365, 366, 367, 368, Hex Buffers.

### Function Tables

373 Octal Latch

$\overline{OE}$	G	D	Q
L	H	H	H
L	H	L	L
L	L	X	$Q_0$
H	X	X	Z

374 Octal Register

$\overline{OE}$	CK	D	Q
L	↑	H	H
L	↑	L	L
L	L	X	$Q_0$
H	X	X	Z

### Logic Symbols

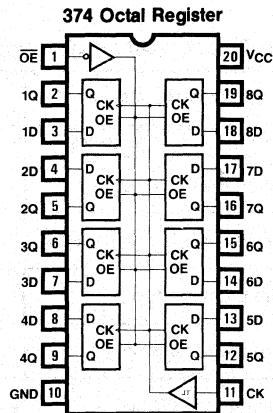
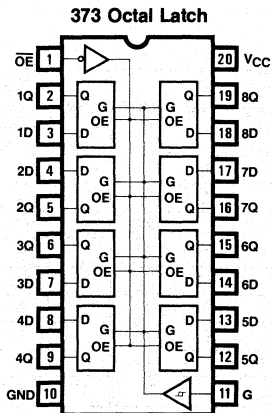

### Ordering Information

PART NUMBER	PKG	TEMP	POLARITY	TYPE	POWER
67S373	N,J	com	Non-invert	Latch	S
67S374	N,J	com		Register	

The latch passes eight (octal) bits of data from the inputs (D) to the outputs (Q) when the gate (G) is high. The data is "latched" when the gate (G) goes low. The register loads eight (octal) bits of input data and passes it to the output on the "rising edge" of the clock.

The three state outputs are active when  $\overline{OE}$  is low, and high impedance when  $\overline{OE}$  is high. Schmitt-trigger buffers at the gate/clock inputs improve system noise margin by providing typically 400 mV of hysteresis.

All of the octal devices are packaged in the popular 20 Pin Skinny DIP™.

**Absolute Maximum Ratings**

Supply Voltage, V <sub>CC</sub> .....	7V
Input Voltage .....	5.5V
Off-state output voltage .....	5.5V
Storage temperature .....	-65° to +150°C

**Operating Conditions**

SYMBOL	PARAMETER	COMMERCIAL			UNIT
		MIN	TYP	MAX	
V <sub>CC</sub>	Supply voltage	4.75	5	5.25	V
T <sub>A</sub>	Operating free air temperature	0		75	°C

**Electrical Characteristics Over Operating Conditions**

SYMBOL	PARAMETER	TEST CONDITIONS	COMMERCIAL			UNIT
			MIN	TYP	MAX	
V <sub>IL</sub>	Low-level input voltage				0.8	V
V <sub>IH</sub>	High-level input voltage		2			V
V <sub>IC</sub>	Input clamp voltage	V <sub>CC</sub> = MIN, I <sub>I</sub> = -18mA			-1.2	V
I <sub>IL</sub>	Low-level input current	V <sub>CC</sub> = MAX, V <sub>I</sub> = 0.5V			-0.25	mA
I <sub>IH</sub>	High-level input current	V <sub>CC</sub> = MAX, V <sub>I</sub> = 2.7V			50	μA
I <sub>I</sub>	Maximum input current	V <sub>CC</sub> = MAX, V <sub>I</sub> = 5.5V			1	mA
V <sub>OL</sub>	Low-level output voltage	V <sub>CC</sub> = MIN, V <sub>IL</sub> = 0.8V, V <sub>IH</sub> = 2V, I <sub>OL</sub> = 32mA			0.5	V
V <sub>OH</sub>	High-level output voltage	V <sub>CC</sub> = MIN, V <sub>IL</sub> = 0.8V, V <sub>IH</sub> = 2V, I <sub>OH</sub> = -6.5mA	2.4	3.1		V
I <sub>OZL</sub>	Off-state output current	V <sub>CC</sub> = MAX, V <sub>IL</sub> = 0.8V, V <sub>IH</sub> = 2V, V <sub>O</sub> = 0.5V			-50	μA
I <sub>OZH</sub>		V <sub>O</sub> = 2.4V			50	μA
I <sub>OS</sub>	Output short-circuit current *	V <sub>CC</sub> = MAX,	-40		-100	mA
I <sub>CC</sub>	Supply current	V <sub>CC</sub> = MAX, Outputs open		S373 105 S374 90	160 140	mA

\*Not more than one output should be shorted at a time and duration of the short-circuit should not exceed one second.

**Switching Characteristics V<sub>CC</sub> = 5 V, T<sub>A</sub> = 25° C**

SYMBOL	PARAMETER	TEST CONDITIONS (See Interface Test Load/Waveforms)	S373			S374			UNIT
			MIN	TYP	MAX	MIN	TYP	MAX	
t <sub>MAX</sub>	Maximum Clock frequency	C <sub>L</sub> = 15pF R <sub>L</sub> = 280Ω				75	100		MHz
t <sub>PLH</sub>	Data to Output delay			5	9				ns
t <sub>PHL</sub>				9	13				ns
t <sub>PLH</sub>	Clock/Enable to output delay			7	14	8	15		ns
t <sub>PHL</sub>				12	18	11	17		ns
t <sub>PZL</sub>				11	18	11	18		ns
t <sub>PZH</sub>	Output Enable delay		8	15	8	15		ns	
t <sub>PLZ</sub>	Output Disable delay	C <sub>L</sub> = 5pF R <sub>L</sub> = 280Ω		8	12	7	12		ns
t <sub>PHZ</sub>				6	9	5	9		ns
t <sub>w</sub>	Width of Clock/Enable	High	6		6			ns	
		Low	7.3		7.3				
t <sub>su</sub>	Setup Time		0l		5l			ns	
t <sub>h</sub>	Hold Time		10l		2l				





# Octal Latches, Octal Registers With Inverting, 32 mA Outputs

## 67S378 67S382

### Features/Benefits

- Inverting Outputs
- 32 mA IOL
- 3-State Outputs Drive Bus Lines
- 20 Pin Skinny DIP™ Saves Space
- 8 Bits Matches Byte Boundaries
- Hysteresis Improves Noise Margin
- Low Current PNP Inputs Reduce Loading
- Ideal for Microprocessor Interface

### Description

In addition to the standard S and LS latches and registers, Monolithic Memories provides increased output sink current (IOL) from the standard Schottky IOL of 20 mA to an improved 32 mA, also inverting outputs instead of the standard non-inverting outputs.

The higher IOL is intended for upgrading systems which presently satisfy 32 mA requirements with SN54/74365, 366, 367, 368, Hex Buffers. The inverting outputs are intended for bus

### Ordering Information

PART NUMBER	PKG	TEMP	POLARITY	TYPE	POWER
67S382	N,J	com	Invert	Latch	S
67S378	N,J	com		Register	

applications that require inversion as in interfacing the Am2901A 4-Bit Slice to an active low bus.

The latch passes eight (octal) bits of data from the inputs (D) to the outputs (Q) when the gate (G) is high. The data is "latched" when the gate (G) goes low. The register loads eight (octal) bits of input data and passes it to the output on the "rising edge" of the clock.

The three state outputs are active when  $\overline{OE}$  is low, and high impedance when  $\overline{OE}$  is high. Schmitt-trigger buffers at the gate/clock inputs improve system noise margin by providing typically 400 mV of hysteresis.

All of the octal devices are packaged in the popular 20 Pin Skinny DIP™.

### Function Tables

382 Octal Latch (Inverting)

$\overline{OE}$	G	D	$\overline{Q}$
L	H	H	L
L	H	L	H
L	L	X	$Q_0$
H	X	X	Z

378 Octal Register (Inverting)

$\overline{OE}$	CK	D	$\overline{Q}$
L	↑	H	L
L	↑	L	H
L	L	X	$Q_0$
H	X	X	Z

### Logic Symbols

382 Octal Latch (Inverting)

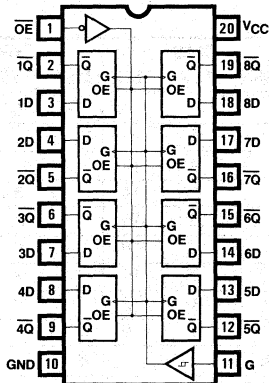

378 Octal Register (Inverting)

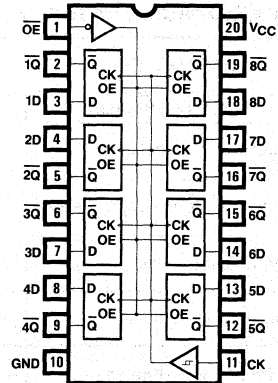

**Absolute Maximum Ratings**

Supply Voltage, V <sub>CC</sub> .....	7V
Input Voltage .....	5.5V
Off-state output voltage .....	5.5V
Storage temperature .....	-65° to +150°C

**Operating Conditions**

SYMBOL	PARAMETER	COMMERCIAL			UNIT
		MIN	TYP	MAX	
V <sub>CC</sub>	Supply voltage	4.75	5	5.25	V
T <sub>A</sub>	Operating free air temperature	0		75	°C

**Electrical Characteristics Over Operating Conditions**

SYMBOL	PARAMETER	TEST CONDITIONS	COMMERCIAL			UNIT
			MIN	TYP	MAX	
V <sub>IL</sub>	Low-level input voltage				0.8	V
V <sub>IH</sub>	High-level input voltage		2			V
V <sub>IC</sub>	Input clamp voltage	V <sub>CC</sub> = MIN, I <sub>I</sub> = -18mA			-1.2	V
I <sub>IL</sub>	Low-level input current	V <sub>CC</sub> = MAX, V <sub>I</sub> = 0.5V			-0.25	mA
I <sub>IH</sub>	High-level input current	V <sub>CC</sub> = MAX, V <sub>I</sub> = 2.7V			50	μA
I <sub>I</sub>	Maximum input current	V <sub>CC</sub> = MAX, V <sub>I</sub> = 5.5V			1	mA
V <sub>OL</sub>	Low-level output voltage	V <sub>CC</sub> = MIN, V <sub>IL</sub> = 0.8V, V <sub>IH</sub> = 2V, I <sub>OL</sub> = 32mA			0.5	V
V <sub>OH</sub>	High-level output voltage	V <sub>CC</sub> = MAX, V <sub>IL</sub> = 0.8V, V <sub>IH</sub> = 2V, I <sub>OH</sub> = -6.5mA	2.4	3.1		V
I <sub>OZL</sub>	Off-state output current	V <sub>CC</sub> = MIN, V <sub>O</sub> = 0.5V			-50	μA
I <sub>OZH</sub>		V <sub>CC</sub> = MAX, V <sub>O</sub> = 2.4V			50	μA
I <sub>OS</sub>	Output short-circuit current *	V <sub>CC</sub>	-40		-100	mA
I <sub>CC</sub>	Supply current	V <sub>CC</sub> = MAX, Outputs open		105	160	mA
		S382		90	140	

\*Not more than one output should be shorted at a time and duration of the short-circuit should not exceed one second.

**Switching Characteristics V<sub>CC</sub> = 5 V, T<sub>A</sub> = 25° C**

SYMBOL	PARAMETER	TEST CONDITIONS (See Interface Test Load/Waveforms)	S382			S378			UNIT
			MIN	TYP	MAX	MIN	TYP	MAX	
f <sub>MAX</sub>	Maximum Clock frequency	C <sub>L</sub> = 15pF R <sub>L</sub> = 280Ω				75	100		MHz
t <sub>PLH</sub>	Data to Output delay		9	18					ns
t <sub>PHL</sub>			5	16					ns
t <sub>PLH</sub>	Clock/Enable to output delay		12	22		11	20		ns
t <sub>PHL</sub>			7	20		8	18		ns
t <sub>PZL</sub>			11	20		11	20		ns
t <sub>PZH</sub>	Output Enable delay	8	17		8	17		ns	
t <sub>PLZ</sub>	Output Disable delay	C <sub>L</sub> = 5pF R <sub>L</sub> = 280Ω	8	16		7	16		ns
t <sub>PHZ</sub>			6	13		5	13		ns
t <sub>w</sub>	Width of Clock/Enable	High	6		6			ns	
		Low	7.3		7.3				
t <sub>SU</sub>	Setup Time		0†		5†			ns	
t <sub>H</sub>	Hold Time		10†		2†				



# Interface Test Load/Waveforms

## Test Load

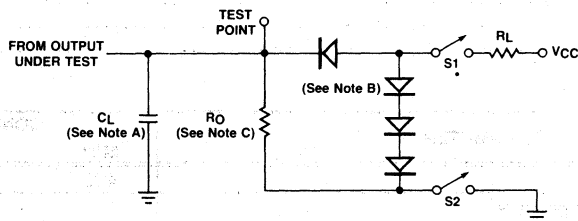

## Test Waveforms

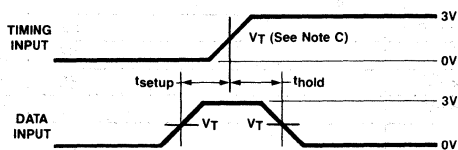

Setup and Hold

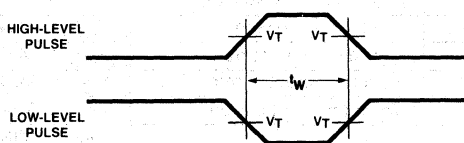

Pulse Width

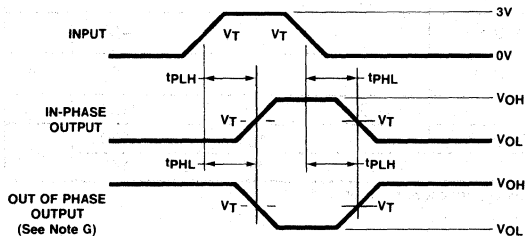

Propagation Delay

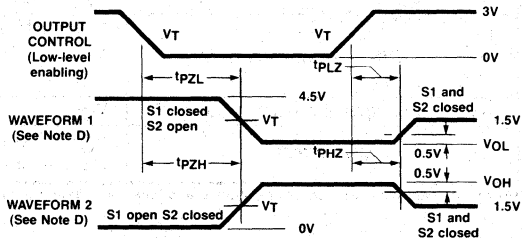

Enable and Disable

NOTES: A.  $C_L$  includes probe and jig capacitance.

B. All diodes are 1N916 or 1N3064.

C. For Series 54/74S, 57/67S,  $R_O = 1K$ ,  $V_T = 1.5V$

For Series 54/74LS and 57/67LS,  $R_O = 5K$ ,  $V_T = 1.2V$  excepting 57/67LS300, 301, 304

For Series 54/74LS300, 301, 304  $R_O = 5K$ ,  $V_T = V_{T+} = 1.7V$  for low to high input transition

For Series 54/74LS300, 301, 304  $R_O = 5K$ ,  $V_T = V_{T-} = 0.9V$  for high to low input transition

D. Waveform 1 is for an output with internal conditions such that the output is low except when disabled by the output control.

Waveform 2 is for an output with internal conditions such that the output is high except when disabled by the output control.

E. In the examples above, the phase relationships between inputs and outputs have been chosen arbitrarily.

F. All input pulses are supplied by generators having the following characteristics:  $PRR \leq 1$  MHz,  $Z_{out} = 50\Omega$  and:

For Series 54/74S and 57/67S,  $t_R \leq 2.5$  ns  $t_F \leq 2.5$  ns

For Series 54/74LS and 57/67LS, and PALS,  $t_R \leq 15$  ns  $t_F \leq 6$  ns

G. When measuring propagation delay times of 3-state outputs, switches S1 and S2 are closed.

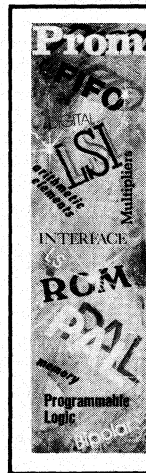

Introduction	<b>1</b>
HI REL	<b>2</b>
PROM	<b>3</b>
ROM	<b>4</b>
Character Generators	<b>5</b>
PAL	<b>6</b>
FIFO	<b>7</b>
Arithmetic Elements	<b>8</b>
Interface	<b>9</b>
General Information	<b>10</b>
Representatives/Distributors	<b>11</b>

## Setup Time

### Setup time, $t_{su}$

The time interval between the application of a signal that is maintained at a specified input terminal and a consecutive active transition at another specified input terminal.

- NOTES: 1. The setup time is the actual time between two events and may be insufficient to accomplish the setup. A minimum value is specified that is the shortest interval for which correct operation of the logic element is guaranteed.
2. The setup time may have a negative value in which case the minimum limit defines the longest interval (between the active transition and the application of the other signal) for which correct operation of the logic element is guaranteed.

## Voltage

### High-level input voltage, $V_{IH}$

An input voltage within the more positive (less negative) of the two ranges of values used to represent the binary variables.

NOTE: A minimum is specified that is the least positive value of high-level voltage for which operation of the logic element within specification limits is guaranteed.

### High-level output voltage, $V_{OH}$

The voltage at an output terminal with input conditions applied that according to the product specification will establish a high level at the output.

### Input clamp voltage, $V_{IC}$

An input voltage in a region of relatively low differential resistance that serves to limit the input voltage swing.

### Low-level input voltage, $V_{IL}$

An input voltage level within the less positive (more negative) of the two ranges of values used to represent the binary variables.

NOTE: A maximum is specified that is the most positive value of low-level input voltage for which operation of the logic element within specification limits is guaranteed.

### Low-level output voltage, $V_{OL}$

The voltage at an output terminal with input conditions applied that according to the product specification will establish a low level at the output.

### Negative-going threshold voltage, $V_T$

The voltage level at a transition-operated input that causes operation of the logic element according to specification as the input voltage falls from a level above the positive-going threshold voltage,  $V_{T+}$ .

### Positive-going threshold voltage, $V_{T+}$

The voltage level at a transition-operated input that causes operation of the logic element according to specification as the input voltage rises from a level below the negative-going threshold voltage,  $V_{T-}$ .

## Truth Table Explanations

H	= high level (steady-state)
L	= low level (steady-state)
↑	= transition from low to high level
↓	= transition from high to low level
X	= irrelevant (any input, including transitions)
Z	= off (high-impedance) state of a 3-state output
a..h	= the level of steady-state inputs at inputs A through H respectively
$Q_0$	= level of Q before the indicated steady-state input conditions were established
$\overline{Q}_0$	= complement of $Q_0$ or level of $\overline{Q}$ before the indicated steady-state input conditions were established
$Q_n$	= level of Q before the most recent active transition indicated by ↓ or ↑

If, in the input columns, a row contains only the symbols H, L, and/or X, this means the indicated output is valid whenever the input configuration is achieved and regardless of the sequence in which it is achieved. The output persists so long as the input configuration is maintained.

If, in the input columns, a row contains H, L, and/or X together with ↑ and/or ↓, this means the output is valid whenever the input configuration is achieved but the transition(s) must occur following the achievement of the steady-state levels. If the output is shown as a level (H, L,  $Q_0$ , or  $\overline{Q}_0$ ), it persists so long as the steady-state input levels and the levels that terminate indicated transitions are maintained. Unless otherwise indicated, input transitions in the opposite direction to those shown have no effect at the output.

## Clock Frequency

### Maximum clock frequency, $f_{max}$

The highest rate at which the clock input of a bistable circuit can be driven through its required sequence while maintaining stable transitions of logic level at the output with input conditions established that should cause changes of output logic level in accordance with the specification.

## Current

### High-level input current, $I_{IH}$

The current into \* an input when a high-level voltage is applied to that input.

### High-level output current, $I_{OH}$

The current into \* an output with input conditions applied that according to the product specification will establish a high level at the output.

### High-level output current, $I_{CEX}$

The high-level leakage current of an open collector output.

### Low-level input current, $I_{IL}$

The current into \* an input when a low-level voltage is applied to that input.

### Low-level output current, $I_{OL}$

The current into \* an output with input conditions applied that according to the product specification will establish a low level at the output.

### Off-state (high-impedance-state) output current (of a three-state output), $I_{OZ}$

The current into \* an output having three-state capability with input conditions applied that according to the product specification will establish the high-impedance state at the output.

### Short-circuit output current, $I_{OS}$

The current into \* an output when that output is short-circuited to ground (or other specified potential) with input conditions applied to establish the output logic level farthest from ground potential (or other specified potential).

### Supply current, $I_{CC}$

The current into \* the  $V_{CC}$  supply terminal of an integrated circuit.

\*Current out of a terminal is given as a negative value.

## Hold Time

### Hold time, $t_H$

The interval during which a signal is retained at a specified input terminal after an active transition occurs at another specified input terminal.

- NOTES:
1. The hold time is the actual time between two events and may be insufficient to accomplish the intended result. A minimum value is specified that is the shortest interval for which correct operation of the logic element is guaranteed.
  2. The hold time may have a negative value in which case the minimum limit defines the longest interval (between the release of data and the active transition) for which correct operation of the logic element is guaranteed.

## Output Enable and Disable Time

### Output enable time (of a three-state output) to high level, $tpZH$ (or low level, $tpZL$ )

The propagation delay time between the specified reference points on the input and output voltage waveforms with the three-state output changing from a high-impedance (off) state to the defined high (or low) level.

### Output enable time (of a three-state output) to high or low level, $tpZX$

The propagation delay time between the specified reference points on the input and output voltage waveforms with the three-state output changing from a high-impedance (off) state to either of the defined active levels (high or low).

### Output disable time (of a three-state output) from high level, $tpHZ$ (or low level, $tpLZ$ )

The propagation delay time between the specified reference points on the input and output voltage waveforms with the three-state output changing from the defined high (or low) level to a high-impedance (off) state.

### Output disable time (of a three-state output) from high or low level, $tpXZ$

The propagation delay time between the specified reference points on the input and output voltage waveforms with the three-state output changing from either of the defined active levels (high or low) to a high-impedance (off) state.

$t_{EA}$  is the output enable access time of memory devices.

$t_{ER}$  is the output disable (enable recovery) time of memory devices.

## Propagation Time

### Propagation delay time, $t_{PD}$

The time between the specified reference points on the input and output voltage waveforms with the output changing from one defined level (high or low) to the other defined level.

### Propagation delay time, low-to-high-level output, $t_{PLH}$

The time between the specified reference points on the input and output voltage waveforms with the output changing from the defined low level to the defined high level.

### Propagation delay time, high-to-low-level output, $t_{PHL}$

The time between the specified reference points on the input and output voltage waveforms with the output changing from the defined high level to the defined low level.

$t_{AA}$  is the address (to output) access time of memory devices.

10

## Pulse Width

### Pulse width, $t_w$

The time interval between specified reference points on the leading and trailing edges of the pulse waveform.

## Programming Input Formats

MMI can program your ROM or PROM from input data in any of several types: truth table, punched cards, paper tape or pre-programmed ROM or PROM. However, the preferred input data for PROMs is paper tape and for ROMs punched cards.

### Truth Table Inputs

Devices are programmed at our facility from MMI truth table forms (available on request). For customers desiring to make their own forms, examples are shown below:

4-BIT OUTPUT		WORD NUMBER	PIN	OUTPUTS			
				10 O <sub>4</sub>	11 O <sub>3</sub>	12 O <sub>2</sub>	13 O <sub>1</sub>
	0			H	H	H	L
	1			L	H	L	H
	.			.	.	.	.
	.			.	.	.	.
	255			L	H	H	H

8-BIT OUTPUT		WORD NUMBER	PIN	OUTPUTS							
				17 O <sub>8</sub>	16 O <sub>7</sub>	15 O <sub>6</sub>	14 O <sub>5</sub>	13 O <sub>4</sub>	11 O <sub>3</sub>	10 O <sub>2</sub>	9 O <sub>1</sub>
	0			H	H	H	L	H	L	H	H
	1			L	H	L	H	L	H	L	H
	.			.	.	.	.	.	.	.	.
	.			.	.	.	.	.	.	.	.
	511			L	H	H	H	H	H	H	L

NOTE: A high voltage on the data out lines is signified by an "H." A low voltage on the data out lines is signified by an "L." The word number assumes positive logic on the address pins, so for example, word 1023 = HHHHHHHHHH'.

### Paper Tape Format Inputs

Truth tables can also be sent to MMI in an ASCII tape in either a 7 or 8 level format. Send information air mail or TWX 910-339-9224. The tape reading equipment at MMI only recognizes ASCII characters S, B, H, L, F and E and interprets them respectively

as Start, Begin a word, High data, Low data, Finish a word, and End of tape. All other characters such as carriage returns, line feeds, etc. are ignored so that comments and spaces may be sent in the data field to improve readability. Comments, however, should not use the characters S, B, H, L, F, E. Word addresses must begin with zero and count sequentially to word 31, 255, 511 or 1023 respectively.

In order to assist the machine operator in determining where the heading information stops and the data field begins, 25 bell characters or rubout characters should precede the start of the truth table. Any type of 8 level paper tape (mylar, fanfold, etc.) is acceptable. Channel 1 is the most significant bit and channel 8 (parity) is ignored. Sprocket holes are located between channels 3 and 4. Note that the order of the outputs between characters B and F is O<sub>4</sub>, O<sub>3</sub>, O<sub>2</sub>, O<sub>1</sub>, not O<sub>1</sub>, O<sub>2</sub>, O<sub>3</sub>, O<sub>4</sub>.

A typical list of characters and their machine interpretations is shown below:

#### 4-BIT OUTPUT

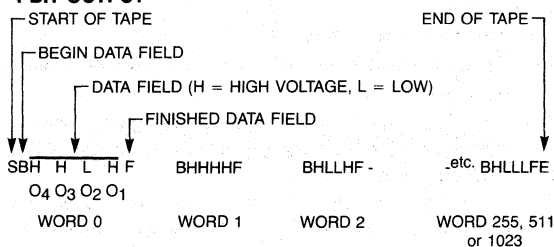

#### 8-BIT OUTPUT

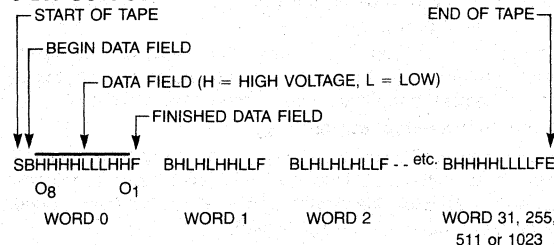

The required heading information at the beginning of the tape is as follows:

CUSTOMER'S NAME AND PHONE _____	TRUTH TABLE NUMBER _____
CUSTOMER'S TWX NUMBER _____	NUMBER OF TRUTH TABLES _____
PURCHASE ORDER NUMBER _____	TOTAL NUMBER OF PARTS _____
MMI PART NUMBER _____	NUMBER OF PARTS OF EACH TRUTH TABLE _____
CUSTOMER SYMBOLIZED PART NUMBER _____	25 BELL OR RUBOUT CHARACTERS _____

An example is shown below for a 256 x 4 PROM (6300)

SCOTT ELECTRONICS 408 426-6134

TWX 911-338-9225

PO142

6300

0431

12

1

3

3

SBLLHF BLLLLF BLHLHF BLHHHF BLLHFF BHHHFF BLLLHF BLHLHF BLLLLF  
BLLLLF BLHLHF BLLHFF BHHHFF BHHLLF BLLHFF BHHLLF BLLLHF BLHLHF

8 level  
TWX

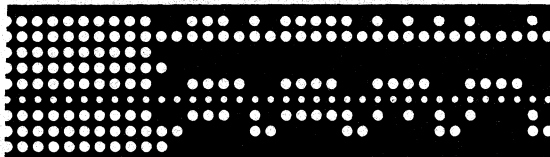

## ROM Programming Punched Card

ROMs can be programmed using several input methods. These are truth table, punched cards in the format shown below, paper tape in the same format as cards, and paper tape in the ASCII BHLF format of the equivalent PROM.

### Punched Card or Tape Input

First card or line (80 columns max.): enter Company Name, Part Number, Data, Number of "L's" in Pattern.

(Free Form Entry: no commas; Paper Tape Format: terminate each line with carriage return and linefeed).

CARD 1

**COMPANY NAME CX 1816—2052 7—12—70 L = 796**

2nd Card Or Line thru Last (80 Columns Max.)

ENTER WORD ADDRESS OF FIRST DATA FIELD IN COLUMNS 1 THRU 5

Enter First Data Field (O<sub>10</sub>—O<sub>1</sub>) in Columns 8 thru 17

Enter Second Data Field (O<sub>10</sub>—O<sub>1</sub>) in Columns 19 thru 28

Enter Third Data Field (O<sub>10</sub>—O<sub>1</sub>) in Columns 30 thru 39

Enter Fourth Data Field (O<sub>10</sub>—O<sub>1</sub>) in Columns 41 thru 50

Enter Fifth Data Field (O<sub>10</sub>—O<sub>1</sub>) in Columns 52 thru 61

Enter Sixth Data Field (O<sub>10</sub>—O<sub>1</sub>) in Columns 63 thru 72

## Hexadecimal Format

In this format the heading required is identical to the BHLF format but the data is different. Instead of an "S," the hexadecimal data begins with the SOH character (control A). The data is then represented by the hexadecimal character (0-9 and A-F) which represents the output data of address 0, followed by a space. Next comes the output data of address 1 followed by a space, etc. The character ETX (control C) is used to end the data. Carriage return and the line feed may be included to format the data when the tape is printed.

CARD 2

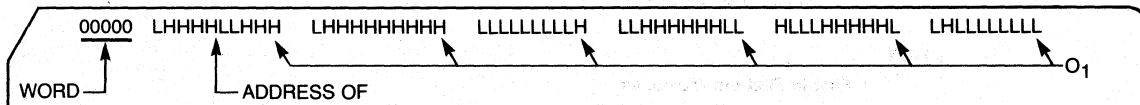

NOTE: Output 1 (O<sub>1</sub>) is always in cols. 17,28,39,50,61,72

CARD 3

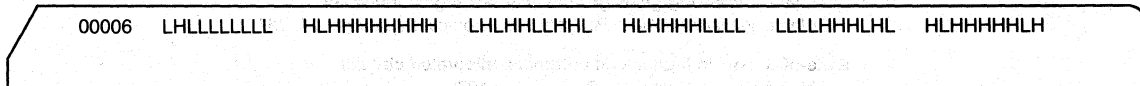

LAST CARD

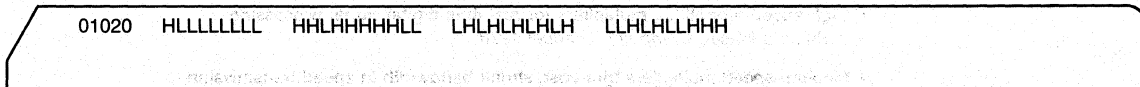

### NOTES:

1. Leading edge zeroes in the word number may be eliminated. Columns 73 thru 80 are for comments.

2. Regardless of the number of outputs which a particular ROM has, the data for a specific output always goes in a specific column.

Output 1 (O <sub>1</sub> )	Columns 17, 28, 39, 50, 61, 72
Output 2 (O <sub>2</sub> )	Columns 16, 27, 38, 49, 60, 71
Output 3 (O <sub>3</sub> )	Columns 15, 26, 37, 48, 59, 70
Output 4 (O <sub>4</sub> )	Columns 14, 25, 36, 47, 58, 69

Output 5 (O <sub>5</sub> )	Columns 13, 24, 35, 46, 57, 68
Output 6 (O <sub>6</sub> )	Columns 12, 23, 34, 45, 56, 67
Output 7 (O <sub>7</sub> )	Columns 11, 22, 33, 44, 55, 66
Output 8 (O <sub>8</sub> )	Columns 10, 21, 32, 43, 54, 65
Output 9 (O <sub>9</sub> )	Columns 9, 20, 31, 42, 53, 64
Output 10 (O <sub>10</sub> )	Columns 8, 19, 30, 41, 52, 63

3. 0 and 1 may replace L and H, but the customer must define for MMI whether 0 = L or 0 = H.

10



## Application Notes

### PROMS

- **PROM card simplifies computer diagnosis**  
*Shlomo Waser, Computer Design, January 1977*
- **Registered PROMs Impact Computer Architecture**  
*John Birkner*

### PAL

- **Reduce random-logic complexity by using arrays of fuse-programmable circuits**  
*John Birkner, Electronic Design, August 16, 1978*
- **High speed/low cost fuse link arrays compete with TTL 74S/LS**  
*John Birkner, WESCON 78*
- **Synthesis of stable output state sequencers**  
*Bill Black, WESCON 78*
- **PALs: Programmable logic functions help minimize hardware**  
*John Birkner, WESCON 79*

### FIFO

- **First-in First-out Memories**  
*Operations and Applications*

### MULTIPLIERS

- **Real-time processing gains ground with fast digital multiplier**  
*Shlomo Waser and Allen Peterson, Electronics, September 29, 1977*
- **State-of-the-art in high speed arithmetic integrated circuits**  
*Shlomo Waser, Computer Design, July 1978*
- **Dedicated multiplier ICs speed up processing in fast computer systems**  
*Shlomo Waser, Electronic Design, September 1978*
- **High-speed monolithic multipliers for real-time digital signal processing**  
*Shlomo Waser, Computer, October 1978*
- **Medium-speed multipliers trim cost, shrink bandwidth in speed transmission**  
*Shlomo Waser and Dr. Allen Peterson, Electronic Design, February 1, 1979*

**J16 Ceramic DIP**

$\theta_{JA} = 75^\circ \text{ C/W}$

$\theta_{JC} = 35^\circ \text{ C/W}$

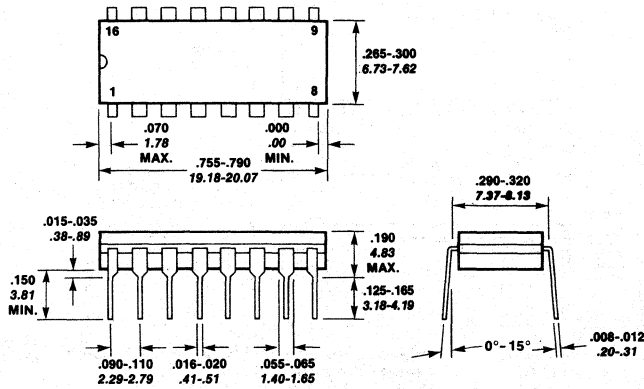

UNLESS OTHERWISE SPECIFIED:  
ALL DIMENSIONS MIN.-MAX. IN INCHES.  
ALL DIMENSIONS MIN.-MAX. IN MILLIMETERS.

**J18 Ceramic DIP**

$\theta_{JA} = 75^\circ \text{ C/W}$

$\theta_{JC} = 35^\circ \text{ C/W}$

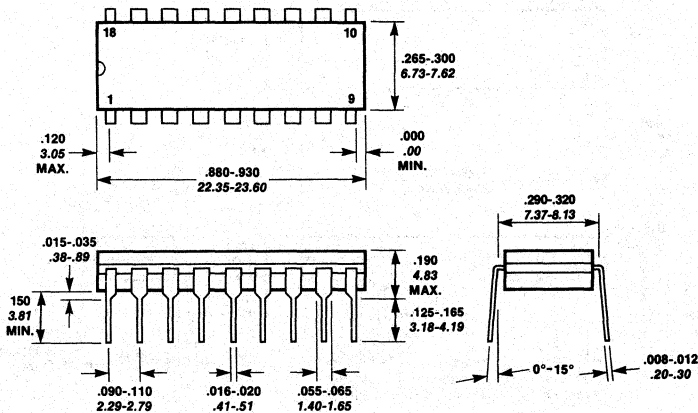

UNLESS OTHERWISE SPECIFIED:  
ALL DIMENSIONS MIN.-MAX. IN INCHES.  
ALL DIMENSIONS MIN.-MAX. IN MILLIMETERS.

**10**

**J20 Ceramic DIP**

$\theta_{JA} = 75^\circ \text{C/W}$

$\theta_{JC} = 35^\circ \text{C/W}$

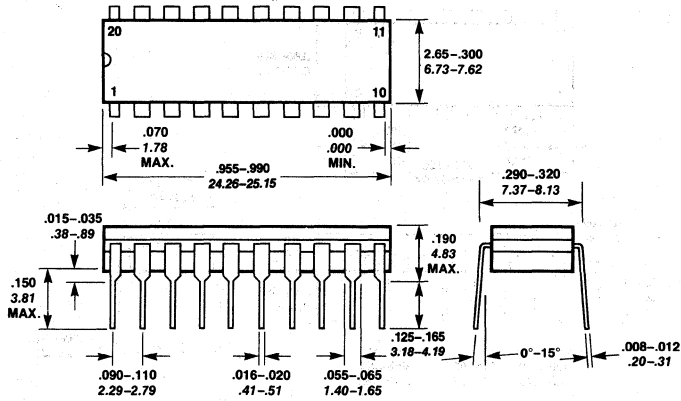

UNLESS OTHERWISE SPECIFIED:  
ALL DIMENSIONS MIN.-MAX. IN INCHES.  
ALL DIMENSIONS MIN.-MAX. IN MILLIMETERS.

**N20 Plastic Kool DIP™**

$\theta_{JA} = 75^\circ \text{C/W}$

$\theta_{JC} = 35^\circ \text{C/W}$

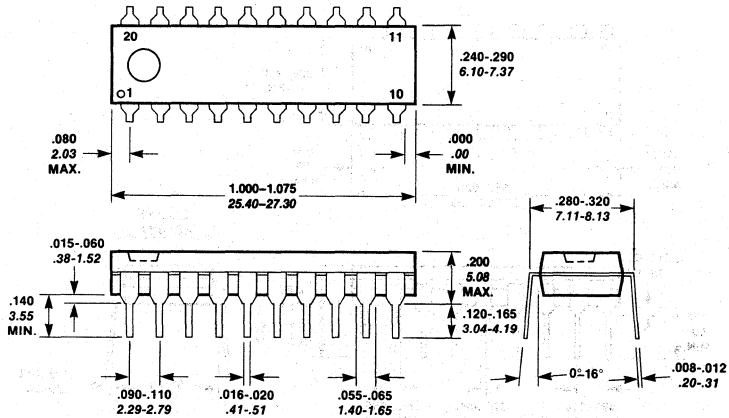

UNLESS OTHERWISE SPECIFIED:  
ALL DIMENSIONS MIN.-MAX. IN INCHES.  
ALL DIMENSIONS MIN.-MAX. IN MILLIMETERS.

**J24 Ceramic DIP**

$\theta_{JA} = 65^{\circ}\text{C/W}$

$\theta_{JC} = 30^{\circ}\text{C/W}$

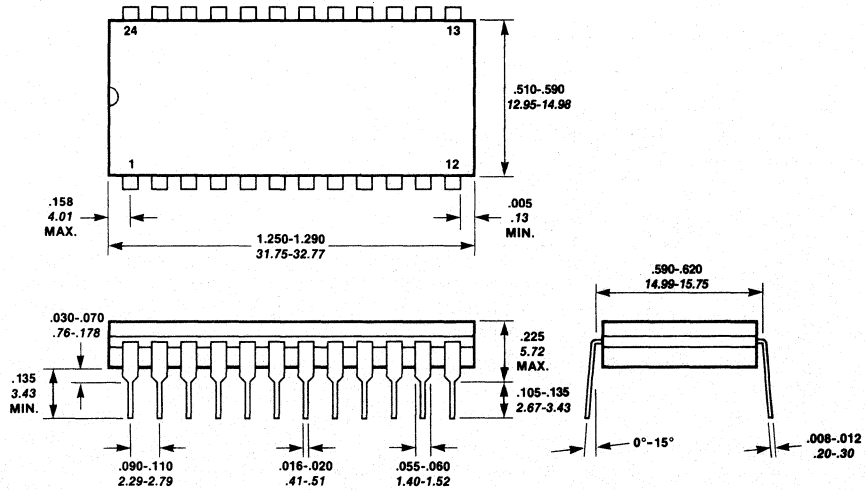

UNLESS OTHERWISE SPECIFIED:  
ALL DIMENSIONS MIN.-MAX. IN INCHES.  
ALL DIMENSIONS MIN.-MAX. IN MILLIMETERS

**D40 Side Brazed Ceramic DIP**

$\theta_{JA} = 55^{\circ}\text{C/W}$

$\theta_{JC} = 20^{\circ}\text{C/W}$

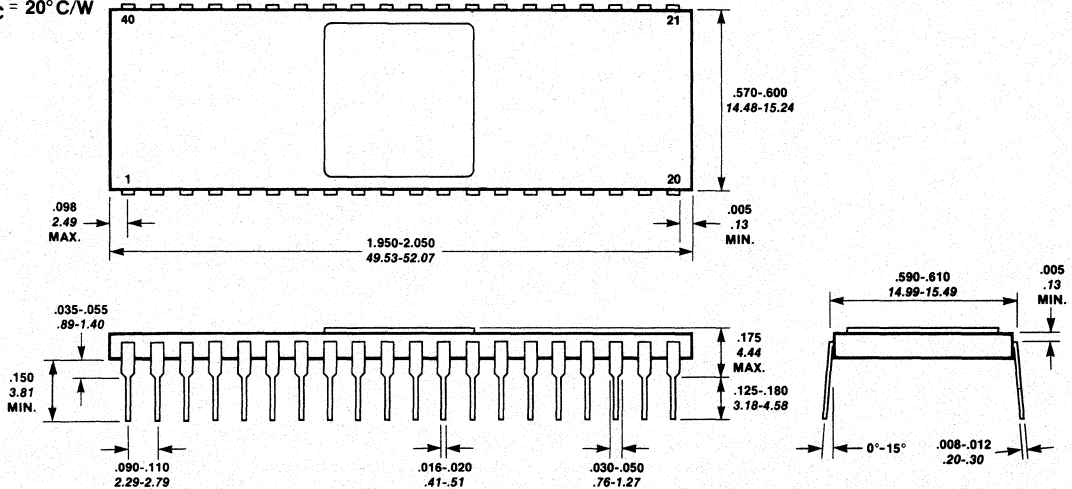

UNLESS OTHERWISE SPECIFIED:  
ALL DIMENSIONS MIN.-MAX. IN INCHES.  
ALL DIMENSIONS MIN.-MAX. IN MILLIMETERS.

**10**



<b>Introduction</b>	<b>1</b>
<b>HI REL</b>	<b>2</b>
<b>PROM</b>	<b>3</b>
<b>ROM</b>	<b>4</b>
<b>Character Generators</b>	<b>5</b>
<b>PAL</b>	<b>6</b>
<b>FIFO</b>	<b>7</b>
<b>Arithmetic Elements</b>	<b>8</b>
<b>Interface</b>	<b>9</b>
<b>General Information</b>	<b>10</b>
<b>Representatives/Distributors</b>	<b>11</b>

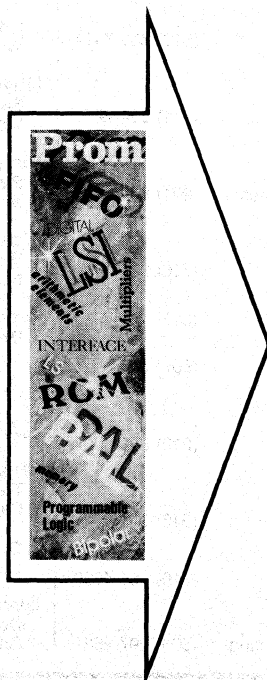

## MMI Area and Regional Sales Managers and FAEs

<b>California</b>		<b>Illinois</b>		<b>Reading</b>	
<b>Huntington Beach</b>		<b>Lombard</b>		Stan Karandanis	(617) 944-5535
Dick Siemiakowski	(714) 556-1216	Dick Jones, FAE	(312) 932-1940	<b>New Jersey</b>	
<b>Pasadena</b>		<b>Naperville</b>		<b>Sussex</b>	
Wayne Caraway	(714) 556-1216	Sal Graziano	(312) 961-9200	Bill Bartley	(201) 875-9430
<b>Florida</b>		<b>Massachusetts</b>		<b>Texas</b>	
<b>Longwood</b>		<b>Framingham</b>		<b>Garland</b>	
Jim McGrath	(305) 831-4096	Russ French	(617) 655-7070	Bob Rainwater	(214) 233-5833

## MMI Representatives

### U.S.A.

<b>Alabama</b>		<b>Iowa</b>		<b>Pennsylvania</b>	
<b>Huntsville</b>		<b>Cedar Rapids</b>		<b>Oreland</b>	
REP, Inc.	(205) 881-9270	S & O Sales	(319) 393-1845	CMS Marketing	(215) 885-5106
<b>Arizona</b>		<b>Kansas</b>		<b>South Carolina</b>	
<b>Scottsdale</b>		<b>Olathe</b>		<b>Greenville</b>	
Summit Sales	(602) 994-4587	Rush and West	(913) 764-2700	REP, Inc.	(803) 233-8595
<b>California</b>		<b>Maryland</b>		<b>Tennessee</b>	
<b>Culver City</b>		<b>Baltimore</b>		<b>Jefferson City</b>	
Bestronics	(213) 870-9191	Monolithic Sales	(301) 296-2444	REP, Inc.	(615) 475-4105
<b>Irvine</b>		<b>Massachusetts</b>		<b>Texas</b>	
Bestronics	(714) 979-9910	<b>Needham Heights</b>		<b>Austin</b>	
<b>Mountain View</b>		Comp Rep Associates	(617) 444-2484	West and Associates	(512) 451-2456
Thresum Associates	(415) 965-9180	<b>Michigan</b>		<b>Dallas</b>	
<b>San Diego</b>		<b>Grosse Pointe</b>		West and Associates	(214) 661-9400
Littlefield & Smith	(714) 455-0055	Greiner Associates	(313) 499-0188	<b>Houston</b>	
<b>Colorado</b>		<b>Minnesota</b>		West and Associates	(713) 777-4108
<b>Wheatridge</b>		<b>Minneapolis</b>		<b>Utah</b>	
Waugaman Associates	(303) 423-1020	Nortec Sales	(612) 835-7414	<b>Salt Lake City</b>	
<b>Connecticut</b>		<b>Missouri</b>		Waugaman Associates	(801) 467-4263
<b>North Haven</b>		<b>Ballwin</b>		<b>Virginia</b>	
Comp Rep Associates	(203) 239-9762	Rush and West	(314) 394-7271	<b>Reston</b>	
<b>Florida</b>		<b>New Jersey</b>		Monolithic Sales	(703) 620-9558
<b>Altamonte Springs</b>		<b>Teaneck</b>		<b>Washington</b>	
Dyne-A-Mark	(305) 831-2097	R.T. Reid Associates	(201) 692-0200	<b>Bellevue</b>	
<b>Clearwater</b>		<b>New York</b>		Northwest Marketing	(206) 455-5846
Dyne-A-Mark	(813) 441-4702	<b>Rochester</b>		<b>Wisconsin</b>	
<b>Fort Lauderdale</b>		L-Mar Associates	(716) 328-5240	<b>Brookfield</b>	
Dyne-A-Mark	(305) 771-6501	<b>Syracuse</b>		Sumer	(414) 784-6641
<b>Palm Bay</b>		L-Mar Associates	(315) 437-7779	<b>Canada</b>	
Dyne-A-Mark	(305) 831-2097	<b>Endicott</b>		<b>Ontario</b>	
<b>Georgia</b>		L-Mar Associates	(607) 748-1482	<b>Toronto</b>	
<b>Tucker</b>		<b>North Carolina</b>		Cantec	(416) 675-2460
REP, Inc.	(404) 938-4358	<b>Raleigh</b>		<b>Ottawa</b>	
<b>Illinois</b>		REP, Inc.	(919) 851-3007	Cantec	(613) 725-3704
<b>Rolling Meadows</b>		<b>Ohio</b>		<b>Quebec</b>	
Sumer	(312) 991-8500	<b>Cincinnati</b>		<b>Dollard Des Ormeaux</b>	
<b>Indiana</b>		Makin Associates	(513) 871-2424	Cantec	(514) 620-6313
<b>Indianapolis</b>		<b>Mentor</b>			
Leslie M. DeVoe Co.	(317) 842-3245	Makin Associates	(216) 464-4330		
		<b>Oregon</b>			
		<b>Portland</b>			
		North West Marketing	(503) 297-2581		

**U.S.A.**

**Alabama**  
**Huntsville**  
 Hall-Mark Electronics (205) 837-8700

**Arizona**  
**Phoenix**  
 Kierulff Electronics (602) 243-4101  
 Sterling Electronics (602) 258-4531

**California**  
**Los Angeles**  
 Kierulff Electronics (213) 725-0325  
**Palo Alto**  
 Kierulff Electronics (415) 968-6292  
**San Diego**  
 Anthem Electronics (714) 279-5200  
 Kierulff Electronics (714) 278-2112  
**Santa Ana**  
 Anthem Electronics (714) 540-1322  
**Sunnyvale**  
 Diplomat/Westland (408) 734-1900  
 Anthem Electronics (408) 738-1111  
**Tustin**  
 Kierulff Electronics (714) 731-5711

**Colorado**  
**Denver**  
 Kierulff Electronics (303) 371-6500  
**Wheatridge**  
 Century/Bell Electronics (303) 424-1985

**Connecticut**  
**Hamden**  
 Arrow Electronics (203) 265-7741  
**E. Norwalk**  
 Connecticut Components  
 for Industries (203) 852-1001

**Florida**  
**Clearwater**  
 Diplomat/Southland (813) 443-4514  
**Fort Lauderdale**  
 Arrow Electronics (305) 776-7790  
 Hall-Mark Electronics (305) 971-9280  
**Orlando**  
 Hall-Mark Electronics (305) 855-4020  
**Palm Bay**  
 Arrow Electronics (305) 725-1480  
**St. Petersburg**  
 Kierulff Electronics (813) 576-1966

**Georgia**  
**Atlanta**  
 Arrow Electronics (404) 449-8252

**Illinois**  
**Bensenville**  
 Hall-Mark Electronics (312) 860-3800  
**Eik Grove Village**  
 Kierulff Electronics (312) 640-0200  
**Schaumburg**  
 Arrow Electronics (312) 893-9420

**Indiana**  
**Indianapolis**  
 Advent Electronics (317) 297-4910  
 RM Electronics Co. (317) 247-9701

**Iowa**  
**Cedar Rapids**  
 Advent Electronics (319) 363-0221

**Kansas**  
**Shawnee Mission**  
 Hall-Mark Electronics (913) 888-4747

**Maryland**  
**Baltimore**  
 Arrow Electronics (202) 737-1700  
 Hallmark (301) 796-9300  
**Gaithersburg**  
 Pioneer Washington (301) 948-0710

**Massachusetts**  
**Billerica**  
 Kierulff Electronics (617) 667-8331  
**Burlington**  
 Lionex (617) 272-9400  
**Woburn**  
 Arrow Electronics (617) 933-8130

**Michigan**  
**Ann Arbor**  
 Arrow Electronics (313) 971-8220  
**Farmington**  
 Diplomat/Northland (313) 477-3200  
**Grand Rapids**  
 RM Electronics Co. (616) 531-9300

**Minnesota**  
**Bloomington**  
 Hall-Mark Electronics (612) 884-9056  
**Edina**  
 Arrow Electronics (612) 887-6400  
 Kierulff Electronics Co. (612) 835-4388

**Missouri**  
**Earth City**  
 Hall-Mark Electronics (314) 291-5350

**New Hampshire**  
**Manchester**  
 Arrow Electronics (603) 668-6968

**New Jersey**  
**Fairfield**  
 Kierulff Electronics (201) 575-6750  
 Lionex (201) 227-7960  
**Totowa**  
 Diplomat/IPC (201) 785-1830  
**Moorestown**  
 Arrow Electronics (609) 235-1900  
**Saddlebrook**  
 Arrow Electronics (201) 797-5800

**New Mexico**  
**Albuquerque**  
 Century Electronics (505) 292-2700  
 Arrow Electronics (505) 243-4556

**New York**  
**Buffalo**  
 Summit Distributors (716) 884-3450  
**Ronkonkoma**  
 Arrow Electronics (516) 694-6800  
**Rochester**  
 Summit Distributors (716) 334-8110  
**Hauppauge**  
 Current Components (516) 273-2600  
**Woodbury**  
 Lionex (516) 921-4414  
**Melville**  
 Diplomat Electronics (516) 454-6400

**North Carolina**  
**Raleigh**  
 Hall-Mark Electronics (919) 832-4465  
**Winston/Salem**  
 Arrow Electronics (919) 996-2039

**Ohio**  
**Cincinnati**  
 Arrow Electronics (513) 761-5432

**Ohio (continued)**  
**Cleveland**  
 Arrow Electronics (216) 248-3990  
**Dayton**  
 Arrow Electronics (513) 253-9176

**Oklahoma**  
**Tulsa**  
 Hall-Mark Electronics (918) 835-8458  
 Radio, Inc. (918) 587-9123

**Oregon**  
**Portland**  
 Almac/Strom  
 Electronics (503) 292-3534  
 Kierulff Electronics (503) 641-9150

**Pennsylvania**  
**Horsham**  
 Pioneer/Delaware Valley (215) 674-4000  
**Pittsburgh**  
 Arrow Electronics (412) 351-4000

**Texas**  
**Austin**  
 Hall-Mark Electronics (512) 837-2814  
 Quality Components (512) 835-0220  
**Dallas**  
 Hall-Mark Electronics (214) 234-1340  
 Quality Components (214) 387-4949  
**Houston**  
 Hall-Mark Electronics (713) 781-6100  
 Quality Components (713) 772-7100  
 Sterling Electronics (713) 627-9800

**Utah**  
**Salt Lake City**  
 Century/Bell Electronics (801) 972-6969  
 Kierulff Electronics (801) 973-6913

**Washington**  
**Seattle**  
 Almac/Strom  
 Electronics (206) 763-2300  
**Tukwila**  
 Kierulff Electronics (206) 575-4420  
 Arrow Electronics (206) 575-0907

**Wisconsin**  
**Oak Creek**  
 Arrow Electronics (414) 764-6600  
 Hall-Mark Electronics (414) 761-3000  
**Waukesha**  
 Kierulff Electronics (414) 784-8160

**CANADA**

**Ontario**  
**Ottawa**  
 Future Electronics (613) 820-8313  
 Zentronics Limited (613) 238-6411  
**Toronto**  
 Future Electronics (416) 663-5563  
 Zentronics Limited (416) 676-9000

**British Columbia**  
**Vancouver**  
 RAE Electronics (604) 291-8866  
 Future Electronics (604) 438-5545

**Manitoba**  
**Winnipeg**  
 Zentronics (204) 775-8661

**Quebec**  
**Montreal**  
 Future Electronics (514) 731-7441  
 Zentronics Limited (514) 735-5361



## EUROPE

### Headquarters

**Monolithic Memories, GmbH**  
Mauerkircherstr 4  
D 8000 Munich 80  
West Germany  
Phone: 89-984961  
Telex: 524385  
Fax: 89-983162

### AUSTRIA

**Ing. Ernst Steiner**  
Geylinggasse 16  
A 1130 Wien  
Phone: 22-822674  
Telex: 77086

### BELGIUM

**Ritro Electronics, B.V.**  
Plantin & Moretuslei 172  
B 2000 Antwerp  
Phone: 31-353272  
Telex: 33637

### DENMARK

**C-88**  
Uldvejen 10  
DK 2970 Horsholm  
Phone: 2-570888  
Telex: 37578

### ENGLAND

**Memory Devices Ltd.**  
Central Avenue  
East Molesey  
KT8 0SN  
Phone: 1-9411066  
Telex: 929962

**Macro Marketing Ltd.**  
396 Bath Road  
South, Berkshire  
Phone: 062864422  
Telex: 847083

**Monolithic Memories Ltd.**  
Lynwood House  
1 Camp Road  
Farnborough  
Hampshire  
GU14 6EN  
Phone: (0252) 517431  
Telex: 858893 FLETET G

### FINLAND

**Telercas O.Y.**  
P.O. Box 2  
01511 Vantaa 51  
Phone: 0-821655  
Telex: 12111

### FRANCE

**Monolithic Memories France S.A.R.L.**  
Siilic 463  
F 94613 Rungis Cedex  
Phone: 1-6874500  
Telex: 202146

**Alfatronic S.A.R.L.**  
La Tour d'Asnieres 4  
Avenue Laurent Cely  
F 92606 Asnieres  
Phone: 1-7914444  
Telex: 612790

### FRANCE (continued)

**Generim S.A.R.L.,  
Zone d'Activites de Courtaboeuf**  
Avenue de la Baltique  
P.O. Box 88  
91403 Orsay  
Phone: 1-9077878  
Telex: 691700

### GERMANY

**Monolithic Memories, GmbH**  
Mauerkircherstr 4  
D 8000 Munich 80  
Phone: 89-984961  
Telex: 524385  
Fax: 89-983162

**Astronic GmbH**  
Winzerstrasse 47D  
D 8000 Munich 40  
Phone: 89-304061  
Telex: 5216187

**Electronic 2000 Vertriebs GmbH**  
Neumarkter Strasse 75  
D 8000 Munich 80  
Phone: 89-434061  
Telex: 522561

**Positron Bauelemente  
Vertriebs GmbH**  
Benzstrasse 1  
Postfach 1140  
D 7016 Gerlingen-Stuttgart  
Phone: 07 156-23051  
Telex: 7245266

### ISRAEL

**TELSYS LTD.**  
54, Jabotinsky Rd.  
Ramat-Gan 52462  
Phone: 07156-23051  
Telex: 032392

### ITALY

**Comprel S.R.L.**  
20092 Cinisello Balsamo/Milano  
Viale Romagna 1  
Phone: 2-6180809  
Telex: 43332484

### NETHERLANDS

**Ritro Electronics B.V.**  
Gelreweg 22  
Postbus 123  
B 2930 Barneveld  
Phone: 03420-5041  
Telex: 40554

**Ritro Electronics B.V.**  
P.O. Box 7035  
5605 JA  
Eindhoven  
Netherlands  
Phone: 040-525355  
Telex: 59527 RIENV ML

**Famatra Benelux**  
P.O. Box 721  
NL 4803 AS Breda  
Phone: 76-133457  
Telex: 54521

### NORWAY

**Henaco A/S**  
P.O. Box 248  
Okern Torgvei 13  
Oslo 5  
Phone: 2-157550  
Telex: 16716

### SOUTH AFRICA

**Ortal Engineering**  
P.O. Box 4362  
Johannesburg 2000  
Phone: 23-5845  
Telex: 8-9865SA

### SPAIN

**Comisa Ingenieros S.A.**  
Reina Mercedes, 20  
Madrid 20  
Phone: 1-2542901  
Telex: 23723

### SWEDEN

**NAXAB**  
Box 4115  
S 17104 Solna  
Phone: 8-985140  
Telex: 17912

### SWITZERLAND

**Baerlocher A.G.**  
Forrliibuckstrasse 110  
CH 8005 Zurich  
Phone: 1-429900  
Telex: 53118

### FAR EAST

#### Headquarters

**Monolithic Memories Japan KK**  
4-5-15, Sendagaya  
Shibuya-Ku  
Tokyo 151  
Phone: 3-4039061  
Telex: 781-26364

### AUSTRALIA

**R & D Electronics Pty Ltd.**  
257 Burwood Hwy.  
Burwood, Vic. 3125  
Phone: 3-288-8232  
Telex: AA33288

**R & D Electronics Pty Ltd.**  
133 Alexander St.  
Crows Nest—2065  
Phone: 2-439-5488  
Telex: AA25468

### INDIA

**Chawla Sales**  
3481, Najaji Subhash Marg.  
Daryaganj, New Delhi—110002  
Phone: 277388

### TAIWAN

**Multitech American Co.**  
2nd Floor  
977 Minshene Road  
Taipei, Taiwan R.O.C.

**Monolithic Memories** 

Monolithic Memories  
1165 East Arques Avenue  
Sunnyvale • CA 94086  
Phone (408) 739-3535  
TWX (910) 339-9229

MMI reserves the right to make changes in order to improve circuitry and supply the best product possible.

MMI cannot assume responsibility for the use of any circuitry described other than circuitry entirely embodied in their product. No other circuit patent licenses are implied.

Printed in U.S.A./A-201/3-80

