



MOTOROLA

MOTOROLA FACT DATA



FACT DATA

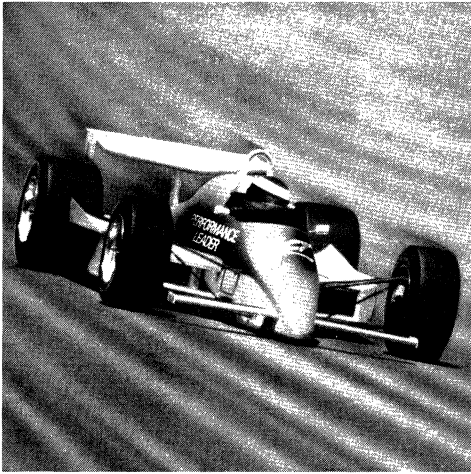

Selection Information

1

**Fact Description and
Family Characteristics**

2

**Ratings, Specifications
and Waveforms**

3

Design Considerations

4

Data Sheets

5

**Package Outlines and
Ordering Information**

6

DATA CLASSIFICATION

Product Preview

This heading on a data sheet indicates that the device is in the formative stages or in design (under development). The disclaimer at the bottom of the first page reads: "This document contains information on a product under development. Motorola reserves the right to change or discontinue this product without notice."

Advance Information

This heading on a data sheet indicates that the device is in sampling, preproduction, or first production stages. The disclaimer at the bottom of the first page reads: "This document contains information on a new product. Specifications and information herein are subject to change without notice."

Fully Released

A fully released data sheet contains neither a classification heading nor a disclaimer at the bottom of the first page. This document contains information on a product in full production. Guaranteed limits will not be changed without written notice to your local Motorola Semiconductor Sales Office.



MOTOROLA

FACT DATA

Prepared by
Technical Information Center

This data book presents advanced information on Motorola's very high-speed, low-power advanced CMOS logic family.

FACT utilizes a sub 2 micron silicon gate CMOS process to attain speeds similar to that of Advanced Low Power Schottky while retaining the advantages of CMOS logic, namely, ultra low power and high noise immunity. As an added benefit, FACT offers the system designer superior line driving characteristics and excellent ESD and latchup immunity.

The FACT family consists of devices in two categories:

1. **AC**, standard logic functions with CMOS compatible inputs and TTL and MOS compatible outputs;
2. **ACT**, standard logic functions with TTL compatible inputs and TTL and MOS compatible outputs.

Motorola reserves the right to make changes without further notice to any products herein to improve reliability, function or design. Motorola does not assume any liability arising out of the application or use of any product or circuit described herein; neither does it convey any license under its patent rights nor the rights of others. Motorola products are not authorized for use as components in life support devices or systems intended for surgical implant into the body or intended to support or sustain life. Buyer agrees to notify Motorola of any such intended end use whereupon Motorola shall determine availability and suitability of its product or products for the use intended. Motorola and  are registered trademarks of Motorola, Inc. Motorola, Inc. is an Equal Employment Opportunity/Affirmative Action Employer.

Series A
©Motorola Inc., 1988
"All Rights Reserved"

CONTENTS

| | Page |
|---|------|
| Alphanumeric Index of Devices | ii |
| CHAPTER 1. Selection Information | |
| Inverters | 1-2 |
| Gates | 1-2 |
| Schmitt Triggers | 1-2 |
| Flip-Flops | 1-2 |
| Multiplexers | 1-2 |
| Decoders/Demultiplexers | 1-2 |
| Latches | 1-2 |
| Shift Registers | 1-3 |
| Counters | 1-3 |
| Buffers/Line Drivers | 1-3 |
| Transceivers | 1-3 |
| MSI Flip-Flops/Registers | 1-3 |
| Comparators | 1-3 |
| CHAPTER 2. FACT Description and Family Characteristics | |
| Family Characteristics | 2-2 |
| Circuit Characteristics | 2-6 |
| CHAPTER 3. Ratings, Specifications and Waveforms | |
| 3-2 | |
| CHAPTER 4. Design Considerations | |
| Interfacing | 4-2 |
| Line Driving | 4-4 |
| Termination Schemes | 4-5 |
| Thevenin Termination | 4-5 |
| CMOS Bus Loading | 4-6 |
| Noise Effects | 4-6 |
| Crosstalk | 4-6 |
| Ground Bounce | 4-8 |
| Design Rules | 4-9 |
| Decoupling Requirements | 4-9 |
| Capacitor Types | 4-11 |
| TTL Compatible CMOS Design Require Delta I _{CC} Consideration | 4-12 |
| Testing Advanced CMOS Devices with I/O Pins | 4-13 |
| Testing Disable Times of 3-State Outputs in a Transmission Line Environment | 4-15 |
| CHAPTER 5. Data Sheets | |
| 5-2 | |
| CHAPTER 6. Package Outlines and Ordering Information | |
| Ordering Information | 6-2 |
| Package Outlines | |
| SOIC Packages | 6-3 |
| Plastic Dual-In-Line Packages | 6-5 |

Alphanumeric Index of Devices

MC74ACXX Devices — CMOS Input Levels

| Device | Description | Page |
|-----------|---|-------|
| MC74AC00 | Quad 2-Input NAND Gate | 5-2 |
| MC74AC02 | Quad 2-Input NOR Gate | 5-4 |
| MC74AC04 | Hex Inverter | 5-5 |
| MC74AC08 | Quad 2-Input AND Gate | 5-7 |
| MC74AC10 | Triple 3-Input NAND Gate | 5-9 |
| MC74AC11 | Triple 3-Input AND Gate | 5-10 |
| MC74AC14 | Hex Inverter Schmitt Trigger | 5-11 |
| MC74AC20 | Dual 4-Input NAND Gate | 5-13 |
| MC74AC32 | Quad 2-Input OR Gate | 5-14 |
| MC74AC74 | Dual D Flip-Flop | 5-16 |
| MC74AC86 | Quad 2-Input Exclusive-OR Gate | 5-19 |
| MC74AC109 | Dual JK Positive Edge-Triggered Flip-Flop | 5-20 |
| MC74AC138 | 1-of-8 Decoder/Demultiplexer | 5-23 |
| MC74AC139 | Dual 1-of-4 Decoder/Demultiplexer | 5-27 |
| MC74AC151 | 8-Input Multiplexer | 5-30 |
| MC74AC153 | Dual 4-Input Multiplexer | 5-34 |
| MC74AC157 | Quad 2-Input Multiplexer | 5-37 |
| MC74AC158 | Quad 2-Input Multiplexer | 5-40 |
| MC74AC160 | BCD Decade Counter, Asynchronous Reset | 5-43 |
| MC74AC161 | 4-Bit Binary Counter, Asynchronous Reset | 5-50 |
| MC74AC162 | BCD Decade Counter, Synchronous Reset | 5-43 |
| MC74AC163 | 4-Bit Binary Counter, Synchronous Reset | 5-50 |
| MC74AC168 | 4-Bit Bidirectional Binary Counter | 5-59 |
| MC74AC169 | 4-Bit Bidirectional Binary Counter | 5-59 |
| MC74AC174 | Hex D Flip-Flop with Master Reset | 5-65 |
| MC74AC175 | Quad D Flip-Flop with Master Reset | 5-69 |
| MC74AC190 | Up/Down Decade Counter | 5-74 |
| MC74AC191 | Up/Down Binary Counter | 5-74 |
| MC74AC192 | Up/Down Decade Counter | 5-82 |
| MC74AC193 | Up/Down Binary Counter | 5-82 |
| MC74AC240 | Octal Buffer/Line Driver | 5-88 |
| MC74AC241 | Octal Buffer/Line Driver | 5-90 |
| MC74AC244 | Octal Buffer/Line Driver | 5-92 |
| MC74AC245 | Octal Bidirectional Transceiver | 5-94 |
| MC74AC251 | 8-Input Multiplexer | 5-96 |
| MC74AC253 | Dual 4-Input Multiplexer | 5-100 |
| MC74AC257 | Quad 2-Input Multiplexer | 5-104 |
| MC74AC258 | Quad 2-Input Multiplexer | 5-108 |
| MC74AC273 | Octal D Flip-Flop | 5-112 |
| MC74AC299 | Octal Shift/Storage Register | 5-116 |

| Device | Description | Page |
|---------------|--|-------------|
| MC74AC323 | Octal Shift/Storage Register | 5-121 |
| MC74AC352 | Dual 4-Input Multiplexer | 5-126 |
| MC74AC353 | Dual 4-Input Multiplexer | 5-129 |
| MC74AC373 | Octal D Latch | 5-132 |
| MC74AC374 | Octal D Flip-Flop | 5-136 |
| MC74AC377 | Octal D Flip-Flop with Clock Enable | 5-140 |
| MC74AC378 | Parallel D Register with Enable | 5-143 |
| MC74AC379 | Quad D Flip-Flop with Enable | 5-147 |
| MC74AC398 | Quad 2-Port Register | 5-151 |
| MC74AC399 | Quad 2-Port Register | 5-151 |
| MC74AC520 | 8-Bit Identity Comparator with Pull-Up Resistors | 5-155 |
| MC74AC521 | 8-Bit Identity Comparator | 5-155 |
| MC74AC533 | Octal Transparent Latch | 5-160 |
| MC74AC534 | Octal D Flip-Flop | 5-164 |
| MC74AC540 | Octal Buffer/Line Driver | 5-168 |
| MC74AC541 | Octal Buffer/Line Driver | 5-168 |
| MC74AC563 | Octal D Latch | 5-171 |
| MC74AC564 | Octal D Flip-Flop | 5-175 |
| MC74AC568 | 4-Bit Bidirectional Decade Counter | 5-179 |
| MC74AC569 | 4-Bit Bidirectional Binary Counter | 5-179 |
| MC74AC573 | Octal D Latch | 5-187 |
| MC74AC574 | Octal D Flip-Flop | 5-191 |
| MC74AC640 | Octal Transceiver | 5-195 |
| MC74AC643 | Octal Transceiver | 5-197 |
| MC74AC646 | Octal Bus Transceiver and Register | 5-199 |
| MC74AC648 | Octal Bus Transceiver and Register | 5-203 |
| MC74AC825 | 8-Bit D Flip-Flop, Noninverting | 5-207 |
| MC74AC826 | 8-Bit D Flip-Flop, Inverting | 5-207 |
| MC74AC843 | 9-Bit Transparent Latch | 5-211 |
| MC74AC844 | 9-Bit Transparent Latch | 5-211 |
| MC74AC845 | 8-Bit Transparent Latch | 5-216 |
| MC74AC846 | 8-Bit Transparent Latch | 5-216 |
| MC74AC4020 | 14-Stage Binary Counter | 5-221 |
| MC74AC4040 | 12-Stage Binary Counter | 5-222 |

MC74ACTXX Devices — TTL Input Levels

| Device | Description | Page |
|------------|---|-------|
| MC74ACT00 | Quad 2-Input NAND Gate | 5-2 |
| MC74ACT02 | Quad 2-Input NOR Gate | 5-4 |
| MC74ACT04 | Hex Inverter | 5-5 |
| MC74ACT08 | Quad 2-Input AND Gate | 5-7 |
| MC74ACT10 | Triple 3-Input NAND Gate | 5-9 |
| MC74ACT11 | Triple 3-Input AND Gate | 5-10 |
| MC74ACT14 | Hex Inverter Schmitt Trigger | 5-11 |
| MC74ACT32 | Quad 2-Input OR Gate | 5-14 |
| MC74ACT74 | Dual D Flip-Flop | 5-16 |
| MC74ACT109 | Dual JK Positive Edge-Triggered Flip-Flop | 5-20 |
| MC74ACT138 | 1-of-8 Decoder/Demultiplexer | 5-23 |
| MC74ACT139 | Dual 1-of-4 Decoder/Demultiplexer | 5-27 |
| MC74ACT151 | 8-Input Multiplexer | 5-30 |
| MC74ACT153 | Dual 4-Input Multiplexer | 5-34 |
| MC74ACT157 | Quad 2-Input Multiplexer | 5-37 |
| MC74ACT158 | Quad 2-Input Multiplexer | 5-40 |
| MC74ACT160 | BCD Decade Counter, Asynchronous Reset | 5-43 |
| MC74ACT161 | 4-Bit Binary Counter, Asynchronous Reset | 5-50 |
| MC74ACT162 | BCD Decade Counter, Synchronous Reset | 5-43 |
| MC74ACT163 | 4-Bit Binary Counter, Synchronous Reset | 5-50 |
| MC74ACT174 | Hex D Flip-Flop with Master Reset | 5-65 |
| MC74ACT175 | Quad D Flip-Flop | 5-69 |
| MC74ACT240 | Octal Buffer/Line Driver | 5-88 |
| MC74ACT241 | Octal Buffer/Line Driver | 5-90 |
| MC74ACT244 | Octal Buffer/Line Driver | 5-92 |
| MC74ACT245 | Octal Bidirectional Transceiver | 5-94 |
| MC74ACT251 | 8-Input Multiplexer | 5-96 |
| MC74ACT253 | Dual 4-Bit Multiplexer | 5-100 |
| MC74ACT257 | Quad 2-Input Multiplexer | 5-104 |
| MC74ACT258 | Quad 2-Input Multiplexer | 5-108 |
| MC74ACT273 | Octal D Flip-Flop | 5-112 |
| MC74ACT299 | Octal Shift/Storage Register | 5-116 |
| MC74ACT323 | Octal Shift/Storage Register | 5-121 |
| MC74ACT352 | Dual 4-Input Multiplexer | 5-126 |
| MC74ACT353 | Dual 4-Input Multiplexer | 5-129 |
| MC74ACT373 | Octal D Latch | 5-132 |
| MC74ACT374 | Octal D Flip-Flop | 5-136 |
| MC74ACT377 | Octal D Flip-Flop with Clock Enable | 5-140 |
| MC74ACT378 | Parallel D Register with Enable | 5-143 |
| MC74ACT379 | Quad D Flip-Flop with Enable | 5-147 |

| Device | Description | Page |
|---------------|--|-------------|
| MC74ACT398 | Quad 2-Port Register | 5-151 |
| MC74ACT399 | Quad 2-Port Register | 5-151 |
| MC74ACT520 | 8-Bit Identity Comparator with Pull-Up Resistors | 5-155 |
| MC74ACT521 | 8-Bit Transparent Comparator | 5-155 |
| MC74ACT533 | Octal Transparent Latch | 5-160 |
| MC74ACT534 | Octal D Flip-Flop | 5-164 |
| MC74ACT540 | Octal Buffer/Line Driver | 5-168 |
| MC74ACT541 | Octal Buffer/Line Driver | 5-168 |
| MC74ACT563 | Octal D Latch | 5-171 |
| MC74ACT564 | Octal D Flip-Flop | 5-175 |
| MC74ACT573 | Octal D Latch | 5-187 |
| MC74ACT574 | Octal D Flip-Flop | 5-191 |
| MC74ACT640 | Octal Transceiver | 5-195 |
| MC74ACT643 | Octal Transceiver | 5-197 |
| MC74ACT825 | 8-Bit D Flip-Flop | 5-207 |
| MC74ACT826 | 8-Bit D Flip-Flop | 5-207 |
| MC74ACT843 | 9-Bit Transparent Latch | 5-211 |
| MC74ACT844 | 9-Bit Transparent Latch | 5-211 |
| MC74ACT845 | 8-Bit Transparent Latch | 5-216 |
| MC74ACT846 | 8-Bit Transparent Latch | 5-216 |

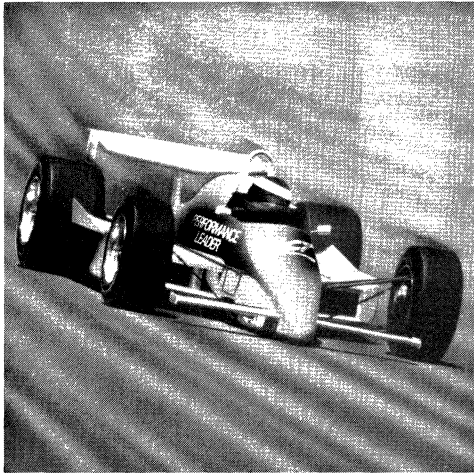

Selection Information

Functional Selection

Abbreviations

S = Synchronous
 A = Asynchronous
 B = Both Synchronous and Asynchronous

2S = 2-State Output
 3S = 3-State Output

P = Planned (See FACT Selector Guide, SG-122 for latest availability status)

Inverters

| Description | Type of Output | No. | AC | ACT |
|-------------|----------------|-----|----|-----|
| Hex | 2S | 04 | P | P |

AND Gates

| Description | Type of Output | No. | AC | ACT |
|----------------|----------------|-----|----|-----|
| Quad 2-Input | 2S | 08 | P | P |
| Triple 3-Input | 2S | 11 | P | P |

NAND Gates

| Description | Type of Output | No. | AC | ACT |
|----------------|----------------|-----|----|-----|
| Quad 2-Input | 2S | 00 | P | P |
| Triple 3-Input | 2S | 10 | P | P |
| Dual 4-Input | 2S | 20 | P | |

OR Gates

| Description | Type of Output | No. | AC | ACT |
|--------------|----------------|-----|----|-----|
| Quad 2-Input | 2S | 32 | P | P |

NOR Gates

| Description | Type of Output | No. | AC | ACT |
|--------------|----------------|-----|----|-----|
| Quad 2-Input | 2S | 02 | P | P |

Exclusive OR Gates

| Description | Type of Output | No. | AC | ACT |
|--------------|----------------|-----|----|-----|
| Quad 2-Input | 2S | 86 | P | |

Schmitt Triggers

| Description | Type of Output | No. | AC | ACT |
|----------------|----------------|-----|----|-----|
| Hex, Inverting | 2S | 14 | P | P |

Flip-Flops

| Description | Clock Edge | No. | AC | ACT |
|------------------------|------------|-----|----|-----|
| Dual D w/Set & Clear | Pos | 74 | P | P |
| Dual JK w/Set & Clear | Pos | 109 | P | P |
| 8-Bit D, Non-Inverting | Pos | 825 | P | P |
| 8-Bit D, Inverting | Pos | 826 | P | P |

Multiplexers

| Description | Type of Output | No. | AC | ACT |
|--|----------------|-----|----|-----|
| Quad 2-to-1, Non-Inverting | 2S | 157 | P | P |
| | 3S | 257 | P | P |
| Quad 2-to-1, Inverting | 2S | 158 | P | P |
| | 3S | 258 | P | P |
| Dual 4-to-1, Non-Inverting | 2S | 153 | P | P |
| | 3S | 253 | P | P |
| Dual 4-to-1, Inverting | 2S | 352 | P | P |
| | 3S | 353 | P | P |
| 8-to-1 | 2S | 151 | P | P |
| | 3S | 251 | P | P |
| Quad 2-to-1 with Output Register 398 — Positive edge triggered, Q/ \bar{Q} Outputs | 2S | 398 | P | P |
| | 2S | 399 | P | P |
| Quad 2-to-1 with Output Register 399 — Positive edge triggered, Q Output Only | 2S | 398 | P | P |
| | 2S | 399 | P | P |

Decoders/Demultiplexers

| Description | Type of Output | No. | AC | ACT |
|-------------|----------------|-----|----|-----|
| Dual 1-of-4 | 2S | 139 | P | P |
| 1-of-8 | 2S | 138 | P | P |

Latches

| Description | No. of Bits | Type of Output | No. | AC | ACT |
|----------------------------|-------------|----------------|-----|----|-----|
| Transparent, Non-Inverting | 8 | 3S | 373 | P | P |
| | 9 | 3S | 843 | P | P |
| | 9 | 3S | 845 | P | P |
| Octal, Non-Inverting | 8 | 3S | 573 | P | P |
| | 8 | 3S | 533 | P | P |
| | 8 | 3S | 563 | P | P |
| Transparent, Inverting | 9 | 3S | 844 | P | P |
| | 9 | 3S | 846 | P | P |
| | 9 | 3S | 846 | P | P |

Shift Registers

| Description | No. of Bits | Type of Output | Mode* | | | | No. | AC | ACT |
|---|-------------|----------------|-------|----|------|-------|-----|----|-----|
| | | | SR | SL | Hold | Reset | | | |
| Parallel In-Parallel Out, Bidirectional | 8 | 3S | X | X | X | A | 299 | P | P |
| | 8 | 3S | X | X | X | S | 323 | P | P |

* SR = Shift Right
SL = Shift Left

Asynchronous Counters — Negative Edge-Triggered

| Description | Load | Set | Reset | No. | AC | ACT |
|-----------------|------|-----|-------|------|----|-----|
| 14-Stage Binary | | | X | 4020 | P | |
| 12-Stage Binary | | | X | 4040 | P | |

Buffers/Line Drivers

| Description | Type of Output | No. | AC | ACT |
|----------------------|----------------|-----|----|-----|
| Octal, Non-Inverting | 3S | 241 | P | P |
| | 3S | 244 | P | P |
| Bus Pinout | 3S | 541 | P | P |
| Octal, Inverting | 3S | 240 | P | P |
| Bus Pinout | 3S | 540 | P | P |

Transceivers

| Description | Type of Output | No. | AC | ACT |
|--|----------------|-----|----|-----|
| Octal, Non-Inverting | 3S | 245 | P | P |
| | 3S | 640 | P | P |
| | 3S | 643 | P | P |
| Octal, Non-Inverting with Register Mux Latch | 3S | 646 | P | |
| | OC | 647 | | P |
| | 3S | 648 | P | |

MSI Flip-Flops/Registers

| Description | No. of Bits | Type of Output | Set or Reset | Clock Enable | No. | AC | ACT |
|---------------------------------|-------------|----------------|--------------|--------------|-----|----|-----|
| D-Type, Non-Inverting | 4 | 2S | | X | 377 | P | P |
| | 6 | 2S | A | | 174 | P | P |
| | 6 | 2S | | X | 378 | P | P |
| | 8 | 2S | A | | 273 | P | P |
| | 8 | 3S | | | 374 | P | P |
| | 8 | 3S | | | 574 | P | P |
| D-Type, Inverting | 8 | 3S | | | 534 | P | P |
| | 8 | 3S | | | 564 | P | P |
| D-Type, Q and \bar{Q} Outputs | 4 | 2S | A | | 175 | P | P |
| | 4 | 2S | | X | 379 | P | P |

Cascadable Synchronous Counters — Positive Edge-Triggered

| Description | Type of Output | Load | Reset | No. | AC | ACT |
|-----------------------|----------------|------|-------|------|----|-----|
| Decade | 2S | S | A | 160 | P | P |
| | 2S | S | S | 162 | P | P |
| Decade, Up/Down | 2S | S | | 168 | P | |
| | 2S | A | | 190 | P | |
| | 2S | A | A | 192* | P | |
| | 3S | S | B | 568 | P | |
| 4-Bit Binary | 2S | S | A | 161 | P | P |
| | 2S | S | S | 163 | P | P |
| 4-Bit Binary, Up/Down | 2S | S | | 169 | P | |
| | 2S | A | | 191 | P | |
| | 2S | A | A | 193* | P | |
| | 3S | S | B | 569 | P | |

*The 192 and 193 do not provide a clock enable for synchronous cascading.

Comparators

| Description | Type of Output | P=Q | P>Q | P<Q | No. | AC | ACT |
|----------------|----------------|-----|-----|-----|-----|----|-----|
| 4-Bit Identity | 2S | X | | | 520 | P | P |
| | 2S | X | | | 521 | P | P |

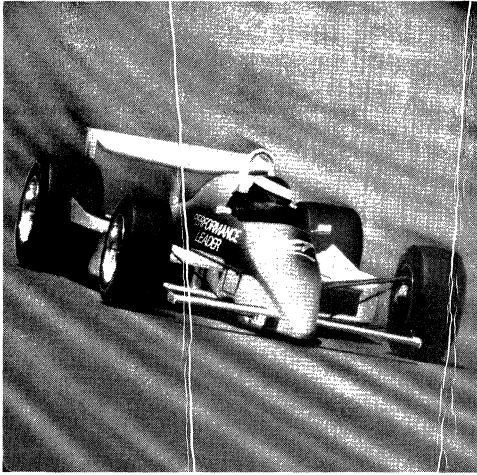

Fact Description and Family Characteristics

2

FACT Descriptions and Family Characteristics

FACT — Logic

Motorola FACT logic offers a unique combination of high speed, low power dissipation, high noise immunity, wide fan-out capability, extended power supply range and high reliability.

This data book describes the product line with device specifications as well as material discussing design considerations and comparing the FACT family to predecessor technologies.

The sub two-micron silicon gate CMOS process utilized in this family has been proven in the field. It has been further enhanced to meet and exceed the JEDEC standards for 74ACXX logic.

For direct replacement of LS, ALS and other TTL devices, the FACT circuits with TTL-type input thresholds are included in the FACT family. These include the more popular bus drivers/transceivers as well as many other 74ACTXXX devices.

Characteristics

- Full Logic Product Line
- Industry Standard Functions and Pinouts for SSI, MSI and LSI
- Meets or Exceeds JEDEC Standards for 74ACXX Family
- TTL Inputs on Selected Circuits
- High Performance Outputs
 - Common Output Structure for Standard and Buffer Drivers
 - Output Sink/Source Current of 24 mA
 - Transmission Line Driving 50 ohm (Commercial) Guaranteed
- Operation from 2–6 Volts Guaranteed
- Temperature Range -40°C to $+85^{\circ}\text{C}$ (Commercial)
- Improved ESD Protection Network
- High Current Latch-Up Immunity

Interfacing

FACT devices have a wide operating voltage range (V_{CC} = 2 to 6 Vdc) and sufficient current drive to interface with most other logic families available today.

Device designators are as follows:

'AC — This is a high-speed CMOS device with CMOS input switching levels and buffered CMOS outputs that can drive ± 24 mA of I_{OH} and I_{OL} current. Industry standard 'AC nomenclature and pinouts are used.

'ACT — This is a high-speed CMOS device with a TTL-to-CMOS input buffer stage. These device inputs are designed to interface with TTL outputs operating with a $V_{CC} = 5\text{ V} \pm 0.5\text{ V}$ with $V_{OH} = 2.4\text{ V}$ and $V_{OL} = 0.4\text{ V}$, but are functional over the entire FACT operating voltage range of 2 to 5.5 Vdc. These devices have buffered outputs that will drive CMOS or TTL devices with no additional interface circuitry. 'ACT devices have the same output structures as 'AC devices.

Low Power CMOS Operation

If there is one single characteristic that justifies the existence of CMOS, it is low power dissipation. In the quiescent state, FACT draws three orders of magnitude less power than the equivalent LS or ALS TTL device. This enhances system

reliability; because costly regulated high current power supplies, heat sinks and fans are eliminated, FACT logic devices are ideal for portable systems such as laptop computers and backpack communications systems. Operating power is also very low for FACT logic. Power consumption of various technologies with a clock frequency of 1 MHz is shown below.

| | |
|------|---------------|
| FACT | = 0.1 mW/Gate |
| ALS | = 1.2 mW/Gate |
| LS | = 2.0 mW/Gate |
| HC | = 0.1 mW/Gate |

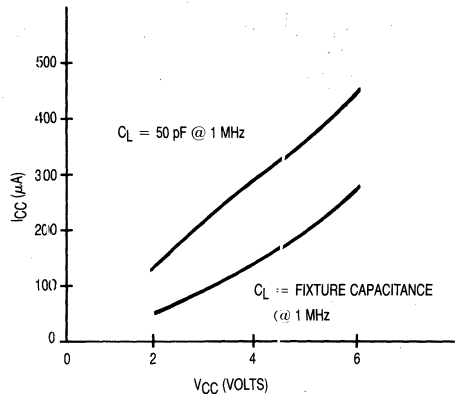

Figure 2-1. I_{CC} versus V_{CC}

Figure 2-1 illustrates the effects of I_{CC} versus power supply voltage (V_{CC}) for two load capacitance values: 50 pF and stray capacitance. The clock frequency was 1 MHz for the measurements.

AC Performance

In comparison to LS, ALS and HC families, FACT devices have faster internal gate delays. Additionally, as the level of integration increases, FACT logic leads the way to very high-speed systems.

The example below describes typical values for a 74XX138, 3-to-8 line decoder.

| | |
|------|----------------------------------|
| FACT | = 6.0 ns @ $C_L = 50\text{ pF}$ |
| ALS | = 12.0 ns @ $C_L = 50\text{ pF}$ |
| LS | = 22.0 ns @ $C_L = 15\text{ pF}$ |
| HC | = 17.5 ns @ $C_L = 50\text{ pF}$ |

AC performance specifications are guaranteed at $5\text{ V} \pm 0.5\text{ V}$ and $3.3\text{ V} \pm 0.3\text{ V}$. For worst case design at 2 V V_{CC} on all device types, the formula below can be used to determine AC performance.

AC performance at 2 V $V_{CC} = 1.9 \times$ AC specification at 3.3 V.

Multiple Output Switching

Propagation delay is affected by the number of outputs switching simultaneously. Typically, devices with more than one output will follow the rule: for each output switching, derate the databook specification by 250 ps. This effect typically is not significant on an octal device unless more than four outputs are switching simultaneously. This derating is valid for the entire temperature range and $5\text{ V} \pm 10\% V_{CC}$.

Noise Immunity

The noise immunity of a logic family is also an important equipment cost factor in terms of decoupling components, power supply dynamic resistance and regulation as well as layout rules for PC boards and signal cables.

The comparisons shown describe the difference between the input threshold of a device and the output voltage, $|V_{IL} - V_{OL}| / |V_{IH} - V_{OH}|$ at $4.5\text{ V } V_{CC}$.

| | |
|------|-------------------------------|
| FACT | = 1.25/1.25 V |
| ALS | = 0.4/0.7 V |
| LS | = 0.3/0.7 V @ 4.75 V V_{CC} |
| HC | = 0.8/1.25 V |

Output Characteristics

All FACT outputs are buffered to ensure consistent output voltage and current specifications across the family. Both 'AC' and 'ACT' device types have the same output structures. Two clamp diodes are internally connected to the output pin to suppress voltage overshoot and undershoot in noisy system applications which can result from impedance mismatching. The balanced output design allows for controlled edge rates and equal rise and fall times.

All devices ('AC' or 'ACT') are guaranteed to source and sink 24 mA. Commercial devices, 74AC/ACTXXX, are capable of driving 50 ohm transmission lines.

I_{OL}/I_{OH} Characteristics

| | |
|------|--------------------------------|
| FACT | = 24/- 24 mA |
| ALS | = 24/- 15 mA |
| LS | = 8/- 0.4 mA @ 4.75 V V_{CC} |
| HC | = 4/- 4 mA |

Dynamic Output Drive

Traditionally, in order to predict what incident wave voltages would occur in a system, the designer was required to do an output analysis using a Bergeron diagram. Not only is this a long and time consuming operation, but the designer needed to depend upon the accuracy and reliability of the manufacturer-supplied 'typical' output I/V curve. Additionally, there was no way to guarantee that any supplied device would meet these 'typical' performance values across the operating voltage and temperature limits. Fortunately for the system designers, Motorola has taken the necessary steps to guarantee incident wave switching on transmission lines with impedances as low as 50 ohms for the commercial temperature range.

Figure 2-2 shows a Bergeron diagram for switching both HIGH-to-LOW and LOW-to-HIGH. On the right side of the graph ($I_{out} > 0$), are the V_{OH} and I_{IH} curves for FACT logic while on the left side ($I_{out} < 0$), are the curves for V_{OL} and I_{IL} . Although we will only discuss here the LOW-to-HIGH transition, the information presented may be applied to a HIGH-to-LOW transition.

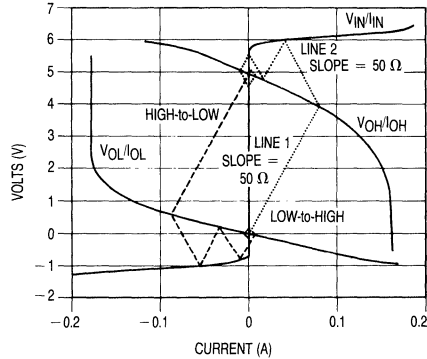

Figure 2-2. Gate Driving 50 Ohm Line Reflection Diagram

Begin analysis at the V_{OL} (quiescent) point. This is the intersection of the V_{OL}/I_{OL} curve for the output and the V_{IN}/I_{IN} curve for the input. For CMOS inputs and outputs, this point will be approximately 100 mV. Then draw a 50 ohm load line from this intersection to the V_{OH}/I_{OH} curve as shown by Line 1. This intersection is the voltage that the incident wave will have. Here it occurs at approximately 3.95 V. Then draw a line with a slope of -50 ohms from this first intersection point to the V_{IN}/I_{IN} curve as shown by Line 2. This second intersection will be the first reflection back from the input gate. Continue this process of drawing the load lines from each intersection to the next. Lines terminating on the V_{OH}/I_{OH} curve should have positive slopes while lines terminating on the V_{IN}/I_{IN} curve should have negative slopes.

Each intersection point predicts the voltage of each reflected wave on the transmission line. Intersection points on the V_{OH}/I_{OH} curve will be waves travelling from the driver to the receiver while intersection points on the V_{IN}/I_{IN} curve will be waves travelling from the receiver to the driver.

Figures 2-3a, 2-3b, 2-3c and 2-3d show the resultant waveforms. Each division on the time scale represents the propagation delay of the transmission line.

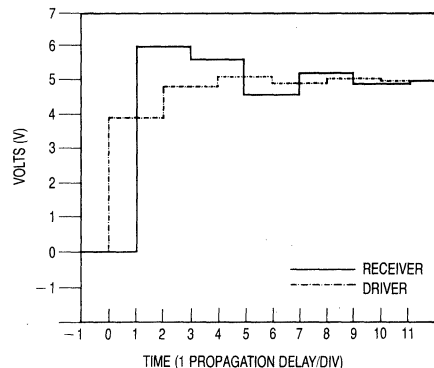

Figure 2-3a. Resultant Waveforms Driving 50 Ohm Line — Theoretical

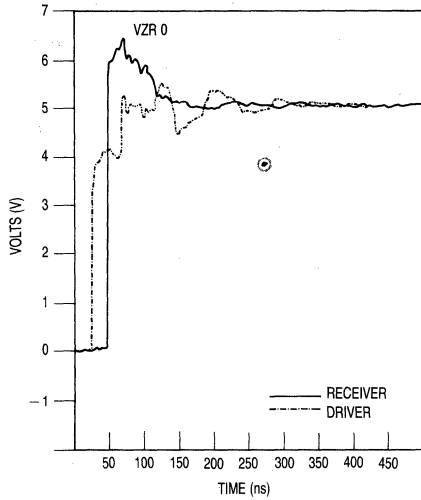

Figure 2-3b. Resultant Waveforms Driving 50 Ohm Line — Actual

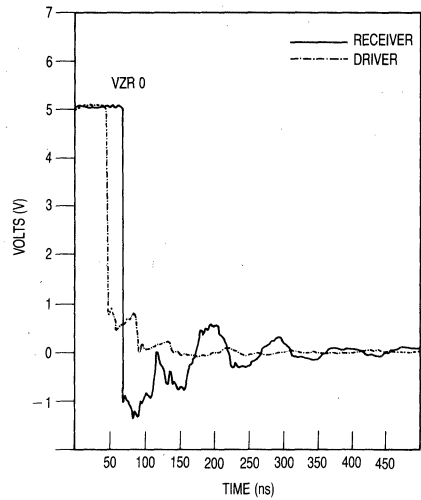

Figure 2-3d. Resultant Waveforms Driving 50 Ohm Line — Actual

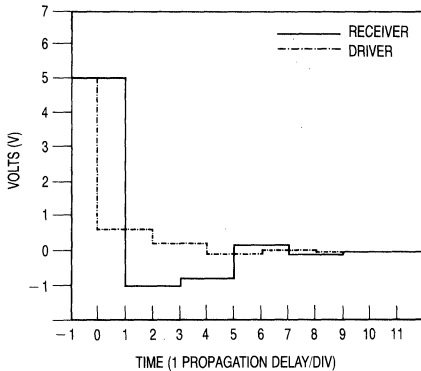

Figure 2-3c. Resultant Waveforms Driving 50 Ohm Line — Theoretical

While this exercise can be done for FACT, it is no longer necessary. FACT is guaranteed to drive an incident wave of enough voltage to switch another FACT input.

We can calculate what current is required by looking at the Bergeron diagram. The quiescent voltage on the line will be within 100 mV of either rail. We know what voltage is required to guarantee a valid voltage at the receiver. This is either 70% or 30% of V_{CC} . The formula for calculating the current and voltage required is $|(V_{OQ} - V_I)/Z_0|$ at V_I . For $V_{OQ} = 100$ mV, $V_{IH} = 3.85$ V, $V_{CC} = 5.5$ V and $Z_0 = 50$ ohms, the required I_{OH} at 3.85 V is 75 mA. For the HIGH-to-LOW transition, $V_{OQ} = 5.4$ V, $V_{IL} = 1.35$ V and $Z_0 = 50$ ohms,

I_{OL} is 75 mA at 1.65 V. FACT's I/O specifications include these limits. For transmission lines with impedances greater than 50 ohms, the current requirements are less and switching is still guaranteed.

It is important to note that the typical 24 mA drive specification is not adequate to guarantee incident wave switching. The only way to guarantee this is to guarantee the current required to switch a transmission line from the output quiescent point to the valid V_{IN} level.

The following performance charts are provided in order to aid the designer in determining dynamic output current drive of FACT devices with various power supply voltages.

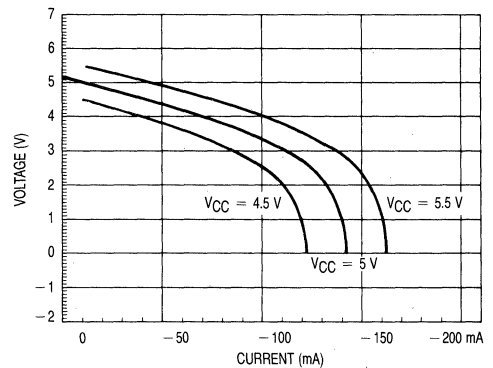

Figure 2-4. Output Characteristics V_{OH}/I_{OH} , 'AC00

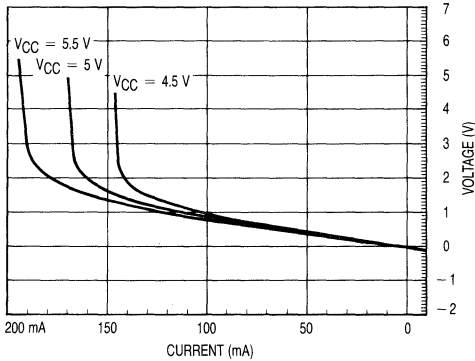

Figure 2-5. Output Characteristics V_{OL}/I_{OL} , 'AC00

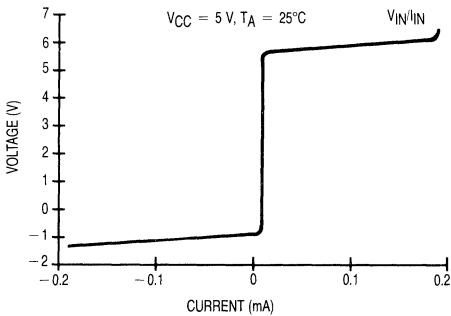

Figure 2-6. Input Characteristics V_{IN}/I_{IN}

Choice of Voltage Specifications

To obtain better performance and higher density, semiconductor technologies are reducing the vertical and horizontal dimensions of integrated device structures. Due to a number of electrical limitations in the manufacture of VLSI devices and the need for low voltage operation in memory cards, it was decided by the JEDEC committee to establish interface standards for devices operating at $3.3 \text{ V} \pm 0.3 \text{ V}$. To this end, Motorola guarantees all of its devices operational at $3.3 \text{ V} \pm 0.3 \text{ V}$. Note also that AC and DC specifications are guaranteed between 3 and 5.5 V. Operation of FACT logic is also guaranteed from 2 to 6 V on V_{CC} .

Operating Voltage Ranges

| | |
|------|--------------------------|
| FACT | = 2 to 6 V |
| ALS | = $5 \text{ V} \pm 10\%$ |
| LS | = $5 \text{ V} \pm 5\%$ |
| HC | = 2 to 6 V |

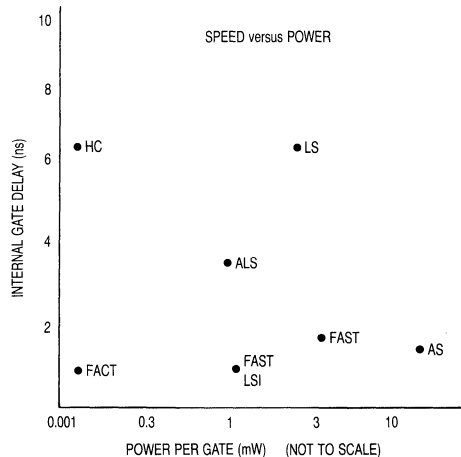

Figure 2-7. Internal Gate Delays

Figure 2-8. Logic Family Comparisons

GENERAL CHARACTERISTICS (All Max Ratings)

| Symbol | Parameter | LS | ALS | HCMOS | FACT | | Unit |
|-----------------|---------------------------------|-------------|--------------|---------------------|----------------------|----------------------|---------------|
| | | | | | 'AC | 'ACT | |
| $V_{CC}/EE/DD$ | Operating Voltage Range | $5 \pm 5\%$ | $5 \pm 10\%$ | 2 to 6 | 2 to 6 | 2 to 6 | V |
| T_A 74 Series | Operating Temperature Range | 0 to +70 | 0 to +70 | -40 to +85 | -40 to +85 | -40 to +85 | °C |
| V_{IH} (min) | Input Voltage (limits) | 2 | 2 | 3.15 | 3.15 | 2 | V |
| V_{IL} (max) | | 0.8 | 0.8 | 0.9 | 1.35 | 0.8 | V |
| V_{OH} (min) | Output Voltage (limits) | 2.7 | 2.7 | $V_{CC} - 0.1$ | $V_{CC} - 0.1$ | $V_{CC} - 0.1$ | V |
| V_{OL} (max) | | 0.5 | 0.5 | 0.1 | 0.1 | 0.1 | V |
| I_{IH} | Input Current | 20 | 20 | +1 | +1 | +1 | μA |
| I_{IL} | | -400 | -200 | -1 | -1 | -1 | μA |
| I_{OH} | Output Current at V_O (limit) | -0.4 | -0.4 | -4 @ $V_{CC} - 0.8$ | -24 @ $V_{CC} - 0.8$ | -24 @ $V_{CC} - 0.8$ | mA |
| I_{OL} | | 8 | 8 | 4 @ 0.4 V | 24 @ 0.4 V | 24 @ 0.4 V | mA |
| DCM | DC Noise Margin LOW/HIGH | 0.3/0.7 | 0.4/0.7 | 0.8/1.25 | 1.25/1.25 | 0.7/2.4 | V |

Note: All DC parameters are specified over the commercial temperature range.

FACT Replaces LS, ALS, HCMOS

Motorola's Advanced CMOS family is specifically designed to outperform the LS, ALS and HCMOS families. Figure 2-7 shows the relative position of various logic families in speed/power performance. FACT exhibits 1 ns internal propagation

delays while consuming 1 μ W of power.

The Logic Family Comparisons table below summarizes the key performance specifications for various competitive technology logic families.

Figure 2-8. Logic Family Comparisons, cont'd.

SPEED/POWER CHARACTERISTICS (All Typical Ratings)

| Symbol | Parameter | LS | ALS | HCMOS | FACT | Unit |
|-----------|-------------------------------|-----|-----|--------|--------|---------|
| I_G | Quiescent Supply Current/Gate | 0.4 | 0.2 | 0.0005 | 0.0005 | mA |
| P_G | Power/Gate (Quiescent) | 2 | 1.2 | 0.0025 | 0.0025 | mW |
| t_p | Propagation Delay | 7 | 5 | 8 | 5 | ns |
| — | Speed Power Product | 14 | 6 | 0.02 | 0.01 | μ J |
| f_{max} | Clock Frequency D/FF | 33 | 50 | 50 | 160 | MHz |

PROPAGATION DELAY (Commercial Temperature Range)

| | Product | | LS | ALS | HCMOS | FACT | Unit |
|-----------------------------------|---------|-----|----|-----|-------|------|------|
| t_{PLH}/t_{PHL} | 74XX00 | Typ | 10 | 5 | 8 | 5 | ns |
| | | Max | 15 | 11 | 23 | 8.5 | ns |
| t_{PLH}/t_{PHL} (Clock to Q) | 74XX74 | Typ | 25 | 12 | 23 | 8 | ns |
| | | Max | 40 | 18 | 44 | 10.5 | ns |
| t_{PLH}/t_{PHL} (Clock to Q) | 74XX163 | Typ | 18 | 10 | 20 | 5 | ns |
| | | Max | 27 | 17 | 52 | 10 | ns |

Conditions: (LS) $V_{CC} = 5$ V, $C_L = 15$ pF, 25°C;
(ALS/HC/FACT) $V_{CC} = 5$ V, $\pm 10\%$, $C_L = 50$ pF, Typ values at 25°C, Max values at 0 to 70°C for ALS, -40 to +85°C for HC/FACT.

Circuit Characteristics

Power Dissipation

One advantage to using CMOS logic is its extremely low power consumption. During quiescent conditions, FACT will consume several orders of magnitude less current than its bipolar counterparts. But DC power consumption is not the whole picture. Any circuit will have AC power consumption, whether it is built with CMOS or bipolar technologies.

Power consumption of a circuit can be calculated using the formula:

$$P_D = [(C_L + C_{PD}) \cdot V_{CC} \cdot V_S \cdot f] + [I_Q \cdot V_{CC}]$$

where

- P_D = power dissipation
- C_L = load capacitance
- C_{PD} = device power capacitance
- V_{CC} = power supply
- V_S = output voltage swing
- f = frequency of operation
- I_Q = quiescent current

Power consumption for FACT is dependent on the supply voltage, frequency of operation, internal capacitance and load. V_S will be V_{CC} and I_Q can be considered negligible for CMOS. Therefore, the simplified formula for CMOS is:

$$P_D = (C_L + C_{PD}) V_{CC}^2 f$$

C_{PD} values for CMOS devices are calculated by measuring the power consumption of a device at two different frequencies. C_{PD} is calculated in the following manner:

1. The power supply voltage is set to $V_{CC} = 5$ Vdc.
2. Signal inputs are set up so that as many outputs as possible are switching, giving a worst-case situation per JEDEC C_{PD} conditions (see Section 3).
3. The power supply current is measured and recorded at input frequencies of 200 kHz and 1 MHz.
4. The power dissipation capacitance is calculated by solving the two simultaneous equations

$$P_1 = (C_{PD} \cdot V_{CC}^2 \cdot f_1) + (I_{CC} \cdot V_{CC})$$

$$P_2 = (C_{PD} \cdot V_{CC}^2 \cdot f_2) + (I_{CC} \cdot V_{CC})$$

giving

$$C_{PD} = (P_1 - P_2) / V_{CC}^2 (f_1 - f_2)$$

or

$$C_{PD} = (I_1 - I_2) / V_{CC} (f_1 - f_2)$$

where

$$I_1 = \text{supply current at } f_1 = 200 \text{ kHz.}$$

$$I_2 = \text{supply current at } f_2 = 1 \text{ MHz.}$$

On FACT device data sheets, C_{PD} is a typical value and is given either for the package or for the individual device (i.e., gates, flip-flops, etc.) within the package.

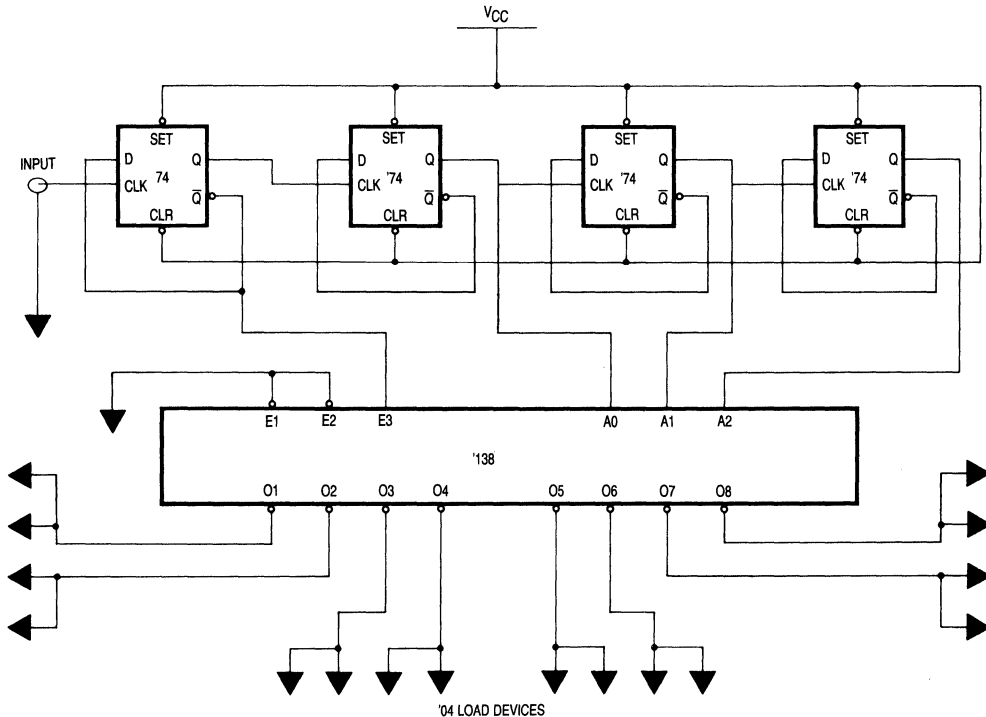

Figure 2-9. Power Demonstration Circuit Schematic

The circuit shown in Figure 2-9 was used to compare the power consumption of FACT versus ALS devices.

Two identical circuits were built on the same board and driven from the same input. In the circuit, the input signal was driven into four D-type flip-flops which act as divide-by-2 frequency dividers. The outputs from the flip-flops were connected to the inputs of a '138 decoder. This generated eight

non-overlapping clock pulses on the outputs of the '138, which were then connected to an '04 inverter. The input frequency was then varied and the power consumption was measured. Figure 2-10 illustrates the results of these measurements.

Below 40 MHz, the FACT circuit dissipates much less power than the ALS version. It is interesting to note that when the frequency went to zero, the FACT circuit's power consumption also went to near zero; the ALS circuit continued to dissipate almost 100 mW. Another advantage of FACT is its capabilities above 40 MHz. At this frequency, the first 74ALS74 D-type flip-flop ceased to operate. Once this occurred, the entire circuit stopped working and the power consumption fell to its quiescent value. The FACT device, however, continued functioning beyond the limit of the frequency generator, which was 100 MHz.

This graph shows two advantages of FACT circuits (power and speed). FACT logic delivers increased performance in addition to offering the power savings of CMOS.

Refer to Section 3 for test philosophies regarding power dissipation.

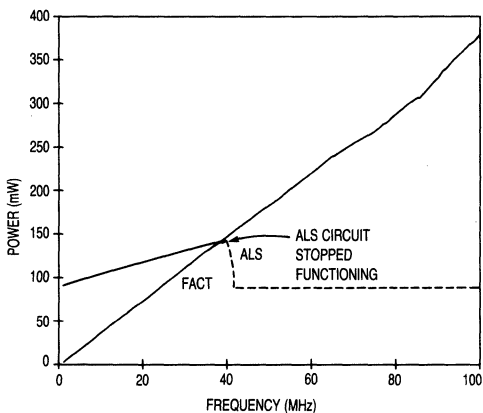

Figure 2-10. FACT versus ALS Circuit Power

Specification Derivation

At first glance, the specifications for FACT logic might appear to be widely spread, possibly indicating wide design margins are required. However, several effects are reflected in each specification.

Figures 2-11a through 2-11e illustrate how the data from

the characterization of actual devices is transformed into the specifications that appear on the data sheet. This data is taken from the 'AC245.

Figure 2-11a shows the data taken (from one part) on a typical, single path, t_{PHL} from An to Bn, over temperature at 5 V; there is negligible variation in the value of t_{PHL} . The next graph, Figure 2-11b, depicts data taken on the same device; this set of curves represents the data on all paths A to B and B to A. The data on this plot indicates only a small variation for t_{PHL} .

The graphs in Figures 2-11a and 2-11b include data at 5 V; Figure 2-11c shows the variation of delay times over the standard 5 ± 0.5 V voltage range. Note there is only a $\pm 6\%$ variation in delay time due to voltage effects.

Now refer to Figure 2-11d which illustrates the process effects on delay time. This graph indicates that the process effects contribute to the spread in specifications more than any other factor in that the effects of the theoretical process spread can increase or decrease specification times by 30%. Because this 30% spread represents considerably more than ± 3 standard deviations, this guarantees an increase in the manufacturability and the quality level of FACT product. To further ensure parts within specification will pass on testers at the limits of calibration, tester guardbands are incorporated.

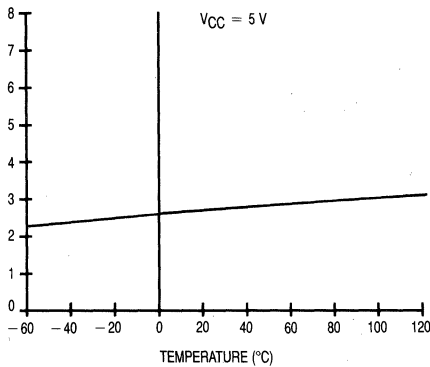

Figure 2-11a. t_{PHL} , An to Bn, Single Path

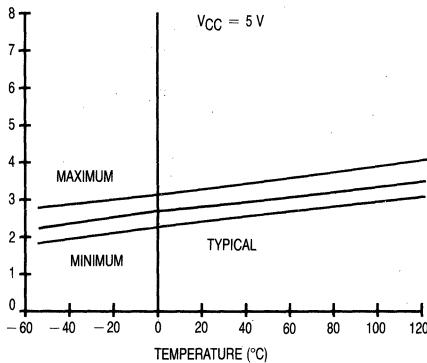

Figure 2-11b. t_{PHL} , A to B, All Paths

With voltage and process effects added (Figure 2-11e), the full range of the specification can be seen. For reference, the data sheet values are shown on the graph.

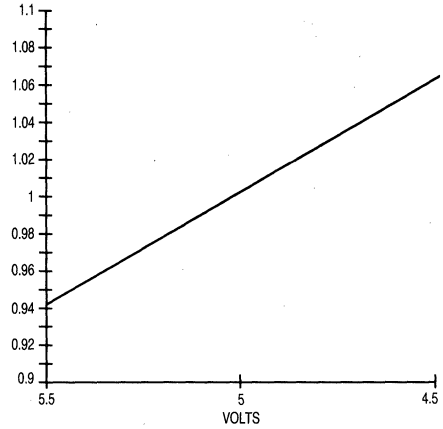

Figure 2-11c. Voltage Effects on Delay Times

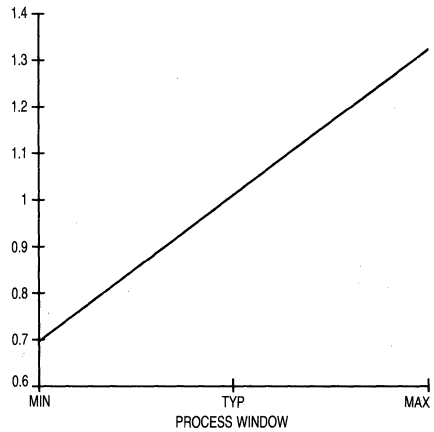

Figure 2-11d. FACT Process Effects on Delay Times

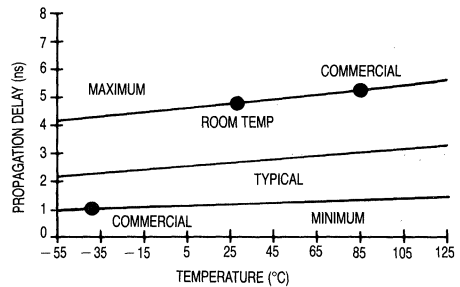

Figure 2-11e. t_{PHL} , A to B, with Voltage and Process Variation

This linear behavior with temperature and voltage is typical of CMOS. Although the graphs are drawn for a specific device, other part types have very similar graphical representations. Therefore, for performance-critical applications, where not all variables need to be taken into account at once, the user can narrow the specifications. For example, all parts in a critically timed subcircuit are together on a board, so it may be assumed the devices are at the same supply and temperature.

The same reasoning can be applied to setup and hold times. Consider the 'AC74. The setup time is 3 ns while the hold time is 0 ns. Theoretically, if these numbers were violated, the device would malfunction; however, in actuality, the device probably will not malfunction. Looking at the typical setup and hold times gives a better understanding of the device operation.

At 25°C and 5 V, the setup time is 1.5 ns while the hold time is -1.5 ns. They are the same; a positive setup time means the control signal to be valid before the clock edge, a positive hold time indicates the control signal will be held valid after the clock edge for the specified time, and a negative hold time means the control signal can transition before the clock edge. FACT devices were designed to be as immune to metastability as possible. This is reflected in the typical specifications. The true 'critical' time where the input is actually sampled is extremely short: less than 50 ps.

By applying the same reasoning as we did to the propagation delays to the setup and hold times, it becomes obvious that the spread from setup to hold time (3 ns worst-case) really covers devices across the entire process/temperature/voltage spread. The real difference between the setup and hold times for any single device, at a specified temperature and voltage, is negligible.

Capacitive Loading Effects

In addition to temperature and power supply effects, capacitive loading effects for loads greater than 50 pF should be taken into account for propagation delays of FACT devices. Minimum delay numbers may be determined from the table below. Propagation delays are measured to the 50% point of the output waveform.

| Parameter | Voltage (V) | | | Units |
|------------|-------------|-----|------|-------|
| | 3 | 4.5 | 5.5 | |
| t_{rise} | 31 | 22 | 19 | ps/pF |
| t_{fall} | 18 | 13 | 12.5 | ps/pF |

$T_A = 25^\circ\text{C}$

The two graphs following, Figures 2-12 and 2-13, describe propagation delays on FACT devices as affected by variations in power supply voltage (V_{CC}) and lumped load capacitance (C_L). Figures 2-14 and 2-15 show the effects of lumped load capacitance on rise and fall times for FACT devices.

Latch-up

A major problem with CMOS has been its sensitivity to latch-up, usually attributed to high parasitic gains and high input impedance. FACT logic is guaranteed not to latch-up with dynamic currents of 100 mA forced into or out of the inputs or the outputs under worst case conditions ($T_A = 125^\circ\text{C}$ and $V_{CC} = 5.5\text{ Vdc}$). At room temperature the parts can typically withstand dynamic currents of over 450 mA. For most designs, latch-up will not be a problem, but the designer should be aware of its causes and how to prevent it.

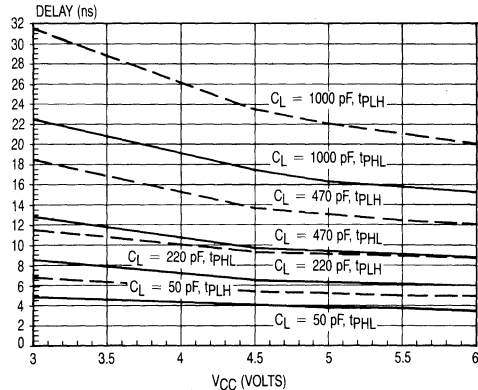

Figure 2-12. Propagation Delay versus V_{CC} ('AC00)

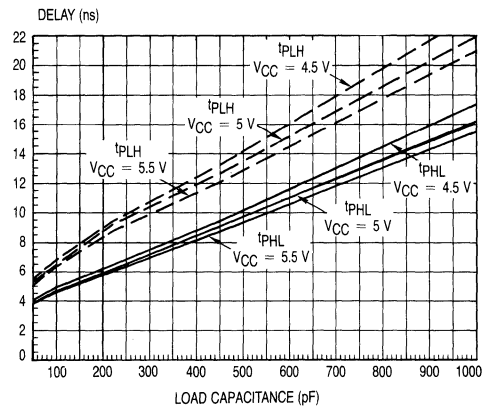

Figure 2-13. Propagation Delay versus C_L ('AC00)

FACT devices have been specifically designed to reduce the possibility of latch-up occurring; Motorola accomplished this by lowering the gain of the parasitic transistors, reducing substrate and p-well resistivity to increase external drive current required to cause a parasitic to turn ON, and careful design and layout to minimize the substrate-injected current coupling to other circuit areas.

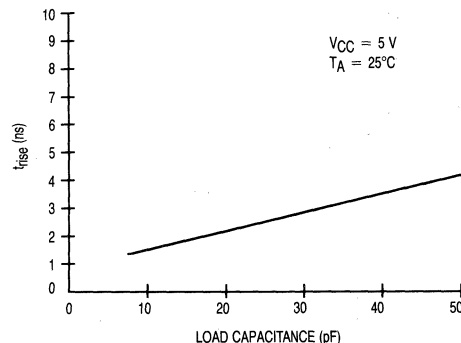

Figure 2.14. t_{rise} versus Capacitance

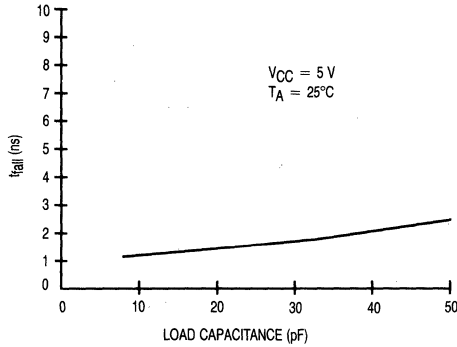

Figure 2-15. t_{fall} versus Capacitance

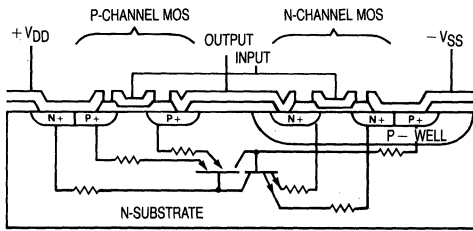

Figure 2-16. CMOS Inverter Cross Section with Latch-up Circuit Schematic

Electrostatic Discharge (ESD) Sensitivity

FACT circuits show excellent resistance to ESD-type damage. FACT logic is guaranteed to have 2000 V ESD immunity on all inputs and outputs using Human Body Model (1500 ohms, 100 pF). FACT parts do not require any special handling procedures. However, normal handling precautions should be observed as in the case of any semiconductor device.

Figure 2-17 shows the ESD test circuit used in the sensitivity analysis for this specification. Figure 2-18 is the pulse waveform required to perform the sensitivity test.

The test procedure is as follows: five pulses, each of 2000 V, are applied to every combination of pins with a five second cool-down period between each pulse. The polarity is then reversed and the same procedure, pulse and pin combination used for an additional five discharges. Continue until all pins have been tested. The voltage is increased and the testing procedure is again performed; this entire process is repeated until failure is detected. This is done to thoroughly evaluate all pins.

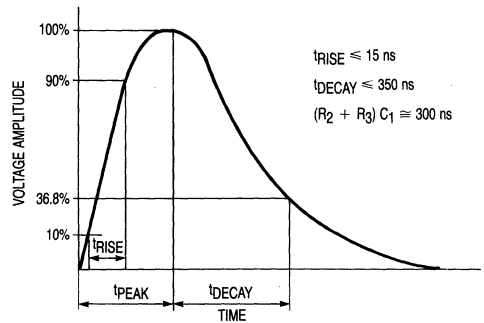

Figure 2-18. ESD Pulse Waveform

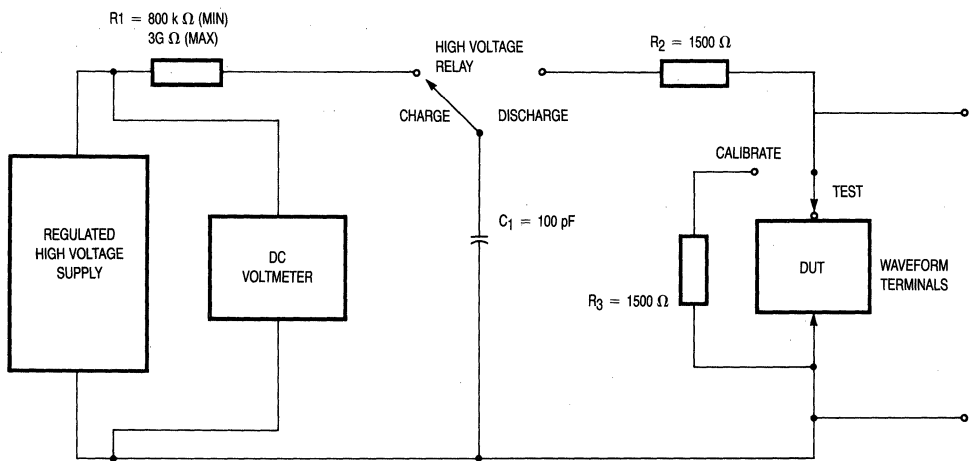
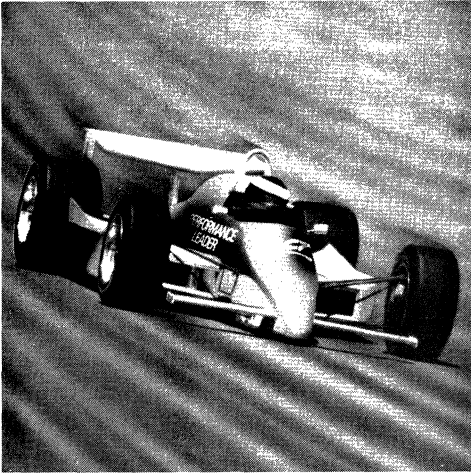

Figure 2-17. ESD Test Circuit

2



Ratings, Specifications and Waveforms

Ratings, Specifications and Waveforms

Specifying FACT Devices

Traditionally, when a semiconductor manufacturer completed a new device for introduction, specifications were based on the characterization of just a few parts. While these specifications were appealing to the designer, they were often too tight and, over time, the IC manufacturers had difficulty producing devices to the original specs. This forced the manufacturer to relax circuit specifications to reflect the actual performance of the device.

As a result, designers were required to review system designs to ensure the system would remain reliable with the new specifications. Motorola realized and understood the problems associated with characterizing devices too aggressively.

To provide more realistic and manufacturable specs, Motorola devised a systematic and thorough process to generate specifications. Devices are selected from multiple wafer lots to ensure process variations are taken into account. In addition, the process parameters are measured and compared to the known process limits.

This method of characterizing parts more accurately represents the product across time, voltage, temperature and process rather than portraying the fastest possible device. FACT circuits are therefore guaranteed to be manufacturable over time without the need to respecify timing.

These specification guidelines allow designers to design systems more efficiently since the devices used will behave as documented. Unspecified guardbands no longer need to be added by the designer to ensure system reliability.

Power Dissipation — Test Philosophy

In an effort to reduce confusion about measuring C_{PD} , a JEDEC standard test procedure (Appendix E) has been adopted which specifies the test setup for each type of device. This allows a device to be exercised in a consistent manner for the purpose of specification comparison. All device measurements are made with $V_{CC} = 5\text{ V}$ at 25°C , with 3-state outputs both enabled and disabled.

Gates — Switch one input. Bias the remaining inputs such that the output switches.

Latches — Switch the Enable and D inputs such that the latch toggles.

Flip-Flops — Switch the clock pin while changing D (or bias J and K) such that the output(s) change each clock cycle. For parts with a common clock, exercise only one flip-flop.

Decoders — Switch one address pin which changes two outputs.

Multiplexers — Switch one address pin with the corresponding data inputs at opposite logic levels so that the output switches.

Counters — Switch the clock pin with other inputs biased such that the device counts.

Shift Registers — Switch the clock pin with other inputs biased such that the device counts.

Transceivers — Switch one data input. For bidirectional devices enable only one direction.

Parity Generator — Switch one input.

Priority Encoders — Switch the lowest priority input.

Load Capacitance — Each output which is switching should be loaded with the standard 50 pF.

If the device is tested at a high enough frequency, the static supply current can be ignored. Thus at 1 MHz, the following formula can be used to calculate C_{PD} :

$$C_{PD} = I_{CC}/(V_{CC}) (1 \times 10^6) - \text{Equivalent Load Capacitance}$$

Ratings and Specifications

Figure 3-1. Absolute Maximum Ratings¹

| Parameter | Symbol | Conditions | Limits | Units |
|--|-----------------------|--------------------------------------|-------------------------------------|------------------|
| Supply Voltage | V_{CC} | | -0.5 to 7 | V |
| DC Input Diode Current or DC Input Voltage | I_{IK} V_I | $V_I = -0.5$ $V_I = V_{CC} + 0.5$ | -20 20 -0.5 to $V_{CC} + 0.5$ | mA mA V |
| DC Output Diode Current or DC Output Voltage | I_{OK} V_O | $V_O = -0.5$ $V_O = V_{CC} + 0.5$ | -20 20 -0.5 to $V_{CC} + 0.5$ | mA mA V |
| DC Output Source or Sink Current | I_O | | ± 50 | mA |
| DC V_{CC} or Ground Current Per Output Pin | I_{CC} or I_{GND} | | ± 50 | mA |
| Storage Temperature | T_{stg} | | -65 to 150 | $^\circ\text{C}$ |

¹Absolute maximum ratings are those values beyond which damage to the device may occur. Obviously the databook specifications should be met, without exception, to ensure that the system design is reliable over its power supply, temperature, output/input loading variables. Motorola does not recommend operation of FACT circuits outside databook specifications.

Figure 3-2. Recommended Operating Conditions

| Parameter | Symbol | Conditions | Limits | Units | |
|---|---------------------------------|--------------|---|-----------------|----------------------|
| Supply Voltage (unless otherwise specified) | V _{CC} | | 2.0 to 6.0 | V | |
| Input Voltage | V _I | | 0 to V _{CC} | V | |
| Output Voltage | V _O | | 0 to V _{CC} | V | |
| Operating Temperature | T _A | 74AC/ACT | -40 to +85 | °C | |
| Junction Temperature | T _J | PDIP | 140 | °C | |
| Input Rise and Fall Time ² (typical) (except Schmitt inputs) V _{IN} from 30% to 70% of V _{CC} | t _r , t _f | 'AC devices | V _{CC} @ 3 V V _{CC} @ 4.5 V V _{CC} @ 5.5 V | 150 40 25 | ns/V ns/V ns/V |
| Input Rise and Fall Time ² (typical) (except Schmitt inputs) V _{IN} from 0.8 to 2 V, V _{meas} from 0.8 to 2 V | t _r , t _f | 'ACT devices | V _{CC} @ 4.5 V V _{CC} @ 5.5 V | 10 8 | ns/V ns/V |

²See individual data sheets for those devices which differ from the typical input rise and fall times noted here.

DC Characteristics for 'AC Family Devices

| Symbol | Parameter | Conditions | V _{CC} (V) | 74AC | | | Units |
|------------------------|-----------------------------------|--|------------------------|-----------------------|-------------------|-----------------------------------|-------|
| | | | | T _A = 25°C | | T _A = -40° to +85°C | |
| | | | | Typ | Guaranteed Limits | | |
| V _{IH} | Minimum High Level Input Voltage | V _O = 0.1 V or V _{CC} - 0.1 V | 3.0 | 1.5 | 2.1 | 2.1 | V |
| | | | 4.5 | 2.25 | 3.15 | 3.15 | |
| | | | 5.5 | 2.75 | 3.85 | 3.85 | |
| V _{IL} | Maximum Low Level Input Voltage | V _O = 0.1 V or V _{CC} - 0.1 V | 3.0 | 1.5 | 0.9 | 0.9 | V |
| | | | 4.5 | 2.25 | 1.35 | 1.35 | |
| | | | 5.5 | 2.75 | 1.65 | 1.65 | |
| V _{OH} | Minimum High Level Output Voltage | I _O = -50 μA | 3.0 | 2.99 | 2.9 | 2.9 | V |
| | | | 4.5 | 4.49 | 4.4 | 4.4 | |
| | | | 5.5 | 5.49 | 5.4 | 5.4 | |
| | | *V _{IN} = V _{IL} or V _{IH} -12 mA | 3.0 | | 2.56 | 2.46 | V |
| I _{OH} -24 mA | 4.5 | | 3.86 | 3.76 | | | |
| 5.5 | | | 4.86 | 4.76 | | | |
| V _{OL} | Maximum Low Level Output Voltage | I _O = 50 μA | 3.0 | 0.002 | 0.1 | 0.1 | V |
| | | | 4.5 | 0.001 | 0.1 | 0.1 | |
| | | | 5.5 | 0.001 | 0.1 | 0.1 | |
| | | *V _{IN} = V _{IL} or V _{IH} 12 mA | 3.0 | | 0.32 | 0.37 | V |
| I _{OL} 24 mA | 4.5 | | 0.32 | 0.37 | | | |
| 5.5 | | | 0.32 | 0.37 | | | |
| I _{IN} | Maximum Input Leakage Current | V _I = V _{CC} , GND | 5.5 | | ±0.1 | ±1.0 | μA |
| I _{OZ} | Maximum 3-State Current | V _I (OE) = V _{IL} , V _{IH} V _I = V _{CC} , V _{GND} V _O = V _{CC} , GND | 5.5 | | ±0.5 | ±5.0 | μA |
| I _{OLD} | †Minimum Dynamic Output Current | V _O = 1.1 V | 5.5 | | | 86 | mA |
| I _{OHD} | Output Current | V _O = 3.85 V | 5.5 | | | -75 | mA |

*All outputs loaded; threshold on input associated with output under test.

†Maximum test duration 20 ms, one output loaded at a time.

3

DC Characteristics for 'ACT Family Devices

| Symbol | Parameter | Conditions | V _{CC} (V) | 74AC | | 74ACT | Units |
|------------------|----------------------------------|---|---------------------|-----------------------|-------------------|--------------------------------|-------|
| | | | | T _A = 25°C | | T _A = -40° to +85°C | |
| | | | | Typ | Guaranteed Limits | | |
| V _{IH} | Minimum High Level Input Voltage | V _{OUT} = 0.1 V or V _{CC} - 0.1 V | 4.5 5.5 | 1.5 1.5 | 2.0 2.0 | 2.0 2.0 | V |
| V _{IL} | Maximum Low Level Input Voltage | V _{OUT} = 0.1 V or V _{CC} - 0.1 V | 4.5 5.5 | 1.5 1.5 | 0.8 0.8 | 0.8 0.8 | V |
| V _{OH} | Minimum High Level | I _{OUT} = -50 μA | 4.5 5.5 | 4.49 5.49 | 4.4 5.4 | 4.4 5.4 | V |
| | | *V _{IN} = V _{IL} or V _{IH} I _{OH} = -24 mA I _{OL} = -24 mA | 4.5 5.5 | 0.0001 | 3.86 4.86 | 3.76 4.76 | V |
| V _{OL} | Maximum Low Level Output Voltage | I _{OUT} = 50 μA | 4.5 5.5 | 0.001 0.001 | 0.1 0.1 | 0.1 0.1 | V |
| | | *V _{IN} = V _{IL} or V _{IH} I _{OL} = 24 mA I _{OL} = 24 mA | 4.5 5.5 | | 0.32 0.32 | 0.37 0.37 | V |
| I _{IN} | Maximum Input | V _I = V _{CC} , GND | 5.5 | | ±0.1 | ±1.0 | μA |
| I _{OZ} | Maximum 3-State Current | V _I = V _{IL} , V _{IH} V _O = V _{CC} , GND | 5.5 | | ±0.5 | ±5.0 | μA |
| I _{CCT} | Maximum I _{CC} /Input | V _I = V _{CC} - 2.1 V | 5.5 | 0.6 | | 1.5 | mA |
| I _{OLD} | †Minimum Dynamic Output Current | V _{OLD} = 1.1 V | 5.5 | | | 86 | mA |
| I _{OHD} | | V _{OHD} = 3.85 V | 5.5 | | | -75 | mA |

*All outputs loaded; thresholds on input associated with output under test.
†Maximum test duration 2 ms, one output loaded at a time.

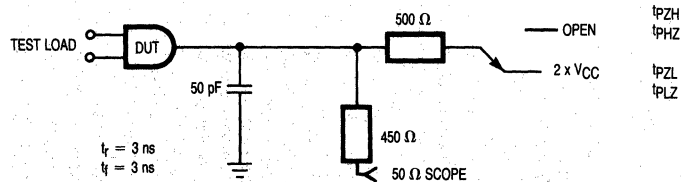

Figure 3-3. AC Tri-State Loading Circuit

AC Loading and Waveforms

Loading Circuit

Figure 3-3 shows the AC loading circuit used in characterizing and specifying propagation delays of all FACT devices ('AC and 'ACT) unless otherwise specified in the data sheet of a specific device.

The use of this load, differs somewhat from previous (HCMOS) practice, provides more meaningful information and minimizes problems of instrumentation and customer correlation. In the past, +25°C propagation delays for TTL devices were specified with a load of 15 pF to ground; this required great care in building test jigs to minimize stray

capacitance and implied the use of high impedance, high frequency scope probes. FAST circuits changed to 50 pF of capacitance allowing more leeway in stray capacitance and also loading the device during rising or falling output transitions. This more closely resembles the inloading to be expected in average applications and thus gives the designer more useful delay figures. We have incorporated this scheme into the FACT product line. The net effect of the change in AC load is to increase the average observed propagation delay by about 1 ns.

The 500 ohm resistor to ground can be a high frequency passive probe for a sampling oscilloscope, which costs much less than the equivalent high impedance probe. Alternately, the 500 ohm resistor to ground can simply be a 450 ohm resistor feeding into a 50 ohm coaxial cable leading to a sampling scope input connector, with the internal 50 ohm termination of the scope completing the path to ground. This is the preferred scheme for correlation. (See Figure 3-3.) With this scheme there should be a matching cable from the device input pin to the other input of the sampling scope; this also

serves as a 50 ohm termination for the pulse generator that supplies the input signal.

Shown in Figure 3-3 is a second 500 ohm resistor from the device output to a switch. For most measurements this switch is open; it is closed for measuring one set of the Enable/Disable parameters (LOW-to-OFF and OFF-to-LOW) of a 3-state output. With the switch closed, the pair of 500 ohm resistors and the $2 \times V_{CC}$ supply voltage establish a quiescent HIGH level.

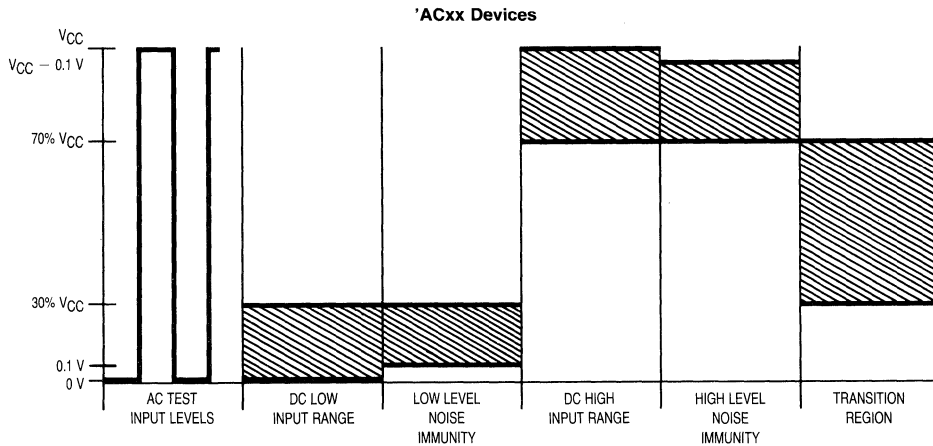

Figure 3-4a. Test Input Signal Levels

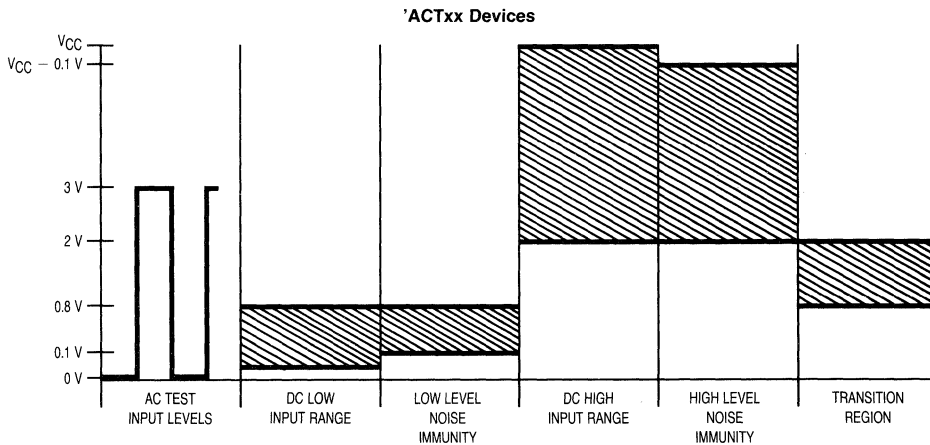

Figure 3-4b. Test Input Signal Levels

Test Conditions

Figures 3-4a and 3-4b describe the input signal voltage levels to be used when testing FACT circuits. The AC test conditions follow industry convention requiring V_{IN} to range from 0 V for a logic LOW to 3 V for a logic HIGH for 'ACT devices and 0 V to V_{CC} for 'AC devices. The DC parameters are normally tested with V_{IN} at guaranteed input levels, that is V_{IH} to V_{IL} (see data tables for details). Care must be taken to adequately decouple these high performance parts and to protect the test signals from electrical noise. In an electrically noisy environment, (e.g., a tester and handler not specifically designed for high speed work), DC input levels may need to be adjusted to increase the noise margin to allow for the extra noise in the tester which would not be seen in a system.

Noise immunity testing is performed by raising V_{IN} to the nominal supply voltage of 5 V then dropping to a level corresponding to V_{IH} characteristics, and then raising again to the 5 V level. Noise tests can also be performed on the V_{IL} characteristics by raising V_{IN} from 0 V to V_{IL} , then returning to 0 V. Both V_{IH} and V_{IL} noise immunity tests should not induce a switch condition on the appropriate outputs of the FACT device.

Good high frequency wiring practices should be used in constructing test jigs. Leads on the load capacitor should be as short as possible to minimize ripples on the output waveform transitions and to minimize undershoot. Generous ground metal (preferably a ground plane) should be used for the same reasons. A V_{CC} bypass capacitor should be provided at the test socket, also with minimum lead lengths.

Rise and Fall Times

Input signals should have rise and fall times of 3 ns and signal swing of 0 V to 3.0 V V_{CC} for 'ACT devices or 0 V to V_{CC} for 'AC devices. Rise and fall times less than or equal to 1 ns should be used for testing f_{max} or pulse widths.

CMOS devices, including 4000 Series CMOS, HC, HCT and FACT families, tend to oscillate when the input rise and fall times become lengthy. As a direct result of its increased performance, FACT devices can be more sensitive to slow input rise and fall times than other lower performance technologies.

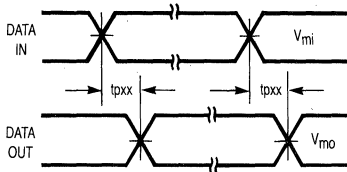

Figure 3-5. Waveform for Inverting and Non-Inverting Functions

V_{mi} = 50% V_{CC} for 'AC devices; 1.5 V for 'ACT devices
 V_{mo} = 50% for 'AC/'ACT devices

It is important to understand why this oscillation occurs. Consider the outputs, where the problem is initiated. Usually, CMOS outputs drive capacitive loads with low DC leakage. When the output changes from a HIGH level to a LOW level, or from a LOW level to a HIGH level, this capacitance has to be charged or discharged. With the present high performance technologies, this charging or discharging takes place in a very short time, typically 2–3 ns. The requirement to charge or discharge the capacitive loads quickly creates a condition where the instantaneous current change through the output structure is quite high. A voltage is generated across the V_{CC} or ground leads inside the package due to the inductance of these leads. The internal ground of the chip will change in reference to the outside world because of this induced voltage.

Consider the input. If the internal ground changes, the input voltage level appears to change to the DUT. If the input rise time is slow enough, its level might still be in the device threshold region, or very close to it, when the output switches. If the internally-induced voltage is large enough, it is possible to shift the threshold region enough so that it re-crosses the input level. If the gain of the device is sufficient and the input rise or fall time is slow enough, then the device may go into oscillation. As device propagation delays become shorter, the inputs will have less time to rise or fall through the threshold region. As device gains increase, the outputs will swing more, creating more induced voltage. Instantaneous current change will be greater as outputs become quicker, generating more induced voltage.

Package-related causes of output oscillation are not entirely to blame for problems with input rise and fall time measurements. All testers have V_{CC} and ground leads with a finite inductance. This inductance needs to be added to the inductance in the package to determine the overall voltage which will be induced when the outputs change. As the reference for the input signals moves further away from the pin under test, the test will be more susceptible to problems caused by the inductance of the leads and stray noise. Any noise on the input signal will also cause problems. With FACT logic having gains as high as 100, it merely takes a 50 mV change in the input to generate a full 5 V swing on the output.

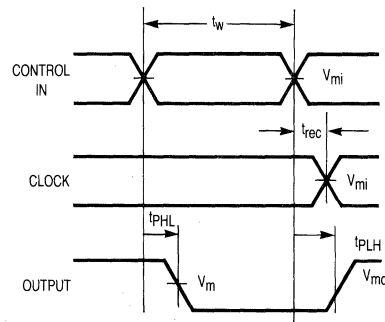

Figure 3-6. Propagation Delay, Pulse Width and t_{rec} Waveforms

Propagation Delay, f_{max} , Set and Hold Times

A 1 MHz square wave is recommended for most propagation delay tests. The repetition rate must necessarily be increased for testing f_{max} . A 50% duty cycle should always be used when testing f_{max} . Two pulse generators are usually required for testing such parameters as setup time, hold time, recovery time, etc.

Enable and Disable Times

Figures 3-7 and 3-8 show that the disable times are measured at the point where the output voltage has risen or fallen by 10% from the voltage rail level (i.e., ground for t_{PLZ} or V_{CC} for t_{PHZ}). This change enhances the repeatability of measurements, reduces test times, and gives the system designer more realistic delay times to use in calculating minimum cycle times. Since the high impedance state rising or falling waveform is RC-controlled, the first 10% of change is more linear and is less susceptible to external influences. More importantly, perhaps from the system designer's point of view, a change in voltage of 10% is adequate to ensure that a device output has turned OFF. Measuring to a larger change in voltage merely exaggerates the apparent Disable time and thus penalizes system performance since the designer must use the Enable and Disable times to devise worst case timing signals to ensure that the output of one device is disabled before that of another device is enabled.

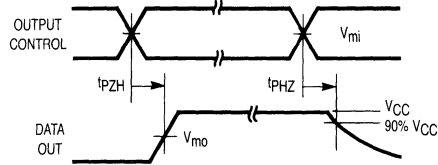

Figure 3-7. 3-State Output High Enable and Disable Times

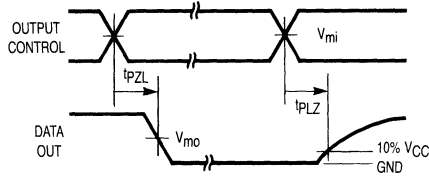

Figure 3-8. 3-State Output Low Enable and Disable Times

Electrostatic Discharge

Precautions should be taken to prevent damage to devices by electrostatic discharge. Static charge tends to accumulate on insulated surfaces such as synthetic fabrics or carpeting, plastic sheets, trays, foam, tubes or bags, and on ungrounded electrical tools or appliances. The problem is much worse in a dry atmosphere. In general, it is recommended that individuals take the precaution of touching a known ground before handling devices. To effectively avoid electrostatic damage to FACT devices, it is recommended that individuals wear a grounded wrist strap when handling devices. More often, handling equipment, which is not properly grounded, causes damage to parts. Ensure that all plastic parts of the tester, which are near the device, are conductive and connected to ground.

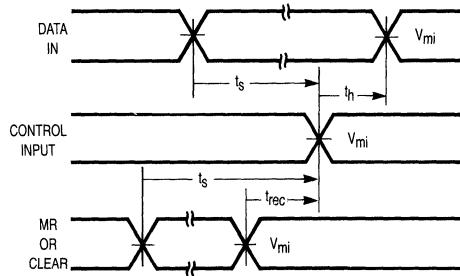

Figure 3-9. Setup Time, Hold Time and Recovery Time

$V_{mi} = 50\% V_{CC}$ for 'AC' devices; 1.5 V for 'ACT' devices
 $V_{mo} = 50\% V_{CC}$ for 'AC'/'ACT' devices



Design Considerations

Design Considerations

Today's system designer is faced with the problem of keeping ahead when addressing system performance and reliability. Motorola's Advanced CMOS helps designers achieve these goals.

FACT logic was designed to alleviate many of the drawbacks that are common to current technology logic circuits. FACT logic combines the low static power consumption and the high noise margins of CMOS with a high fan-out, low input loading and a 50 ohm transmission line drive capability (comparable to Motorola's FAST bipolar technology family) to offer a complete family of sub 2-micron SSI and MSI devices.

Performance features such as advanced Schottky speeds at CMOS power levels, advanced Schottky drive, excellent noise, ESD and latch-up immunity are characteristics that designers of state-of-the-art systems require. FACT logic answers all of these concerns in one family of products. To fully utilize the advantages provided by FACT, the system designer should have an understanding of the flexibility as well as the trade-offs of CMOS design. The following section discusses common design concerns relative to the performance and requirements of FACT.

There are five items of interest which need to be evaluated when implementing FACT devices in new designs:

- **Interfacing** — interboard and technology interfaces, battery backup and power down or live insert/extract systems require some special thought.
- **Transmission Line Driving** — FACT has line driving capabilities superior to all CMOS families and most TTL families.
- **Noise effects** — As edge rates increase, the probability of crosstalk and ground bounce problems increases. The enhanced noise immunity and high threshold levels improve FACT's resistance to crosstalk problems.

- **Board Layout** — Prudent board layout will ensure that most noise effects are minimized.
- **Power Supplies and Decoupling** — Maximize ground and Vcc traces to keep Vcc/ground impedance as low as possible; full ground/Vcc planes are best. Decouple any device driving a transmission line; otherwise add one capacitor for every package.

Interfacing

FACT devices have outputs which combine balanced CMOS outputs with high current line driving capability. Each standard output is guaranteed to source or sink 24 mA of current at worst case conditions. This allows FACT circuits to drive more loads than standard advanced Schottky parts; FACT can directly drive ALS, AS, LS, HC and HCT devices.

Figure 4-1. Interfacing FACT to NMOS, CMOS and TTL

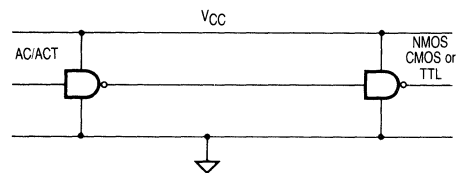

FACT devices can be directly driven by both NMOS and CMOS families, as shown in Figure 4-1, operating at the same rail potential without special considerations. This is possible due to the low input loading of FACT product, guaranteed to be less than 1 μ A per input.

Some older technologies, including all existing TTL families, will not be able to drive FACT circuits directly; this is due to inadequate high level capability, which is guaranteed to 2.4 V. There are two simple approaches to the TTL-to-FACT interface problem. A TTL-to-CMOS converter can be

constructed employing a resistor pull-up to V_{CC} of approximately 4.7k ohms, which is depicted in Figure 4-2. The correct HIGH level is seen by the CMOS device while not loading down the TTL driver.

Figure 4-2. V_{IH} Pull-Up on TTL Outputs

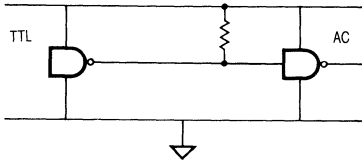

Unfortunately, there will be designs where including a pull-up resistor will not be acceptable. In these cases, such as a terminated TTL bus, Motorola has designed devices which offer thresholds that are TTL-compatible (Figure 4-3). These interfaces tend to be slightly slower than their CMOS-level counterparts due to an extra buffer stage required for level conversion.

Figure 4-3. TTL Interfacing to 'ACT

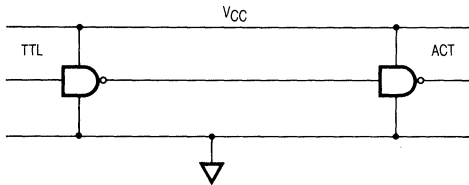

ECL devices cannot directly drive FACT devices. Interfacing FACT-to-ECL can be accomplished by using TTL-to-ECL translators and 10125 ECL-to-TTL translators in addition to following the same rules on the TTL outputs to CMOS inputs (i.e., a resistor pull-up to V_{CC} of approximately 4.7k ohms). The translation can also be accomplished by a resistive network. A three-resistor interface between FACT and ECL logic is illustrated in Figure 4-4a. Figures 4-4b and 4-4c show the translation from ECL-to-FACT, which is somewhat more complicated. These two examples offer some possible interfaces between ECL and FACT logic.

Figure 4-4a. Resistive FACT-to-ECL Translation

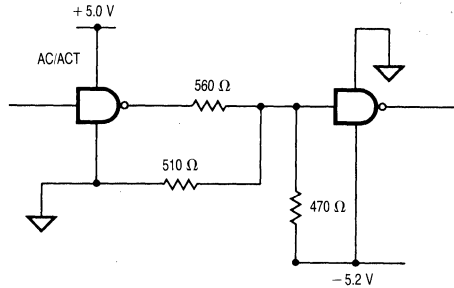

Figure 4-4b. Single-Ended ECL-to-'ACT Circuit

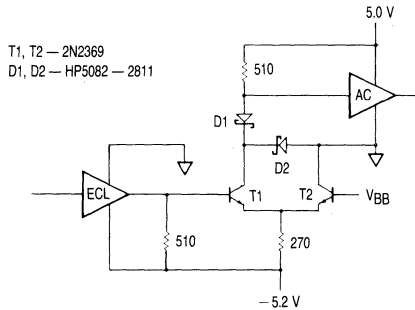
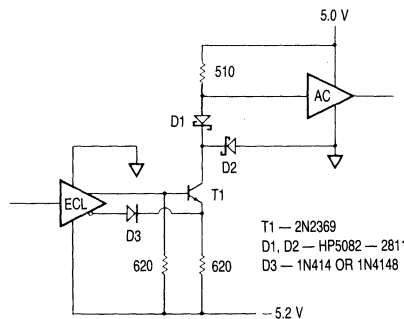
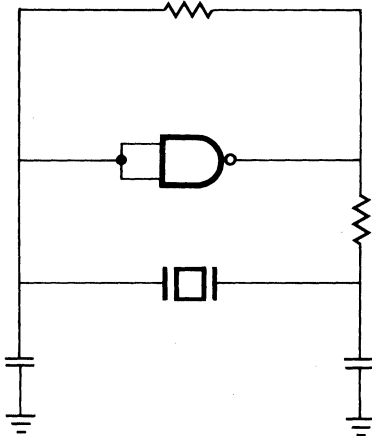

Figure 4-4c. Differential Output ECL-to-'ACT Circuit



It should be understood that for FACT, as with other CMOS technologies, input levels that are between specified input values will cause both transistors in the CMOS structure to be conducting. This will cause a low resistive path from the supply rail to ground, increasing the power consumption by several orders of magnitude. It is important that CMOS inputs are always driven as close as possible to the rail.

Figure 4-5. Crystal Oscillator Circuit Implemented with FACT 'AC00



Line Driving

With the available high-speed logic families, designers can reach new heights in system performance. Yet, these faster devices require a closer look at transmission line effects.

Although all circuit conductors have transmission line properties, these characteristics become significant when the edge rates of the drivers are equal to or less than three times the propagation delay of the line. Significant transmission line

properties may be exhibited in an example where devices have edge rates of 3 ns and lines of 8 inches or greater, assuming propagation delays of 1.7 ns/ft for an unloaded printed circuit trace.

Of the many properties of transmission lines, two are of major interest to the system designer: Z_{oe} , the effective equivalent impedance of the line, and t_{pde} , the effective propagation delay down the line. It should be noted that the intrinsic values of line impedance and propagation delay, Z_o and t_{pd} , are geometry-dependent. Once the intrinsic values are known, the effects of gate loading can be calculated. The loaded values for Z_{oe} and t_{pde} can be calculated with:

$$Z_{oe} = \frac{Z_o}{\sqrt{1 + C_t/C_i}}$$

$$t_{pde} = t_{pd} \sqrt{1 + C_t/C_i}$$

where C_i = intrinsic line capacitance and C_t = additional capacitance due to gate loading.

The formulas indicate that the loading of lines decreases the effective impedance of the line and increases the propagation delay. Lines that have a propagation delay greater than one third the rise time of the signal driver should be evaluated for transmission line effects. When performing transmission line analysis on a bus, only the longest, most heavily loaded and the shortest, least loaded lines need to be analyzed. All lines in a bus should be terminated equally; if one line requires termination, all lines in the bus should be terminated. This will ensure similar signals on all of the lines.

There are several termination schemes which may be used. Included are series, parallel, AC parallel and Thevenin terminations. AC parallel and series terminations are the most useful for low power applications since they do not consume any DC power. Parallel and Thevenin terminations experience high DC power consumption.

Termination Schemes

Figure 4-6. Termination Schemes

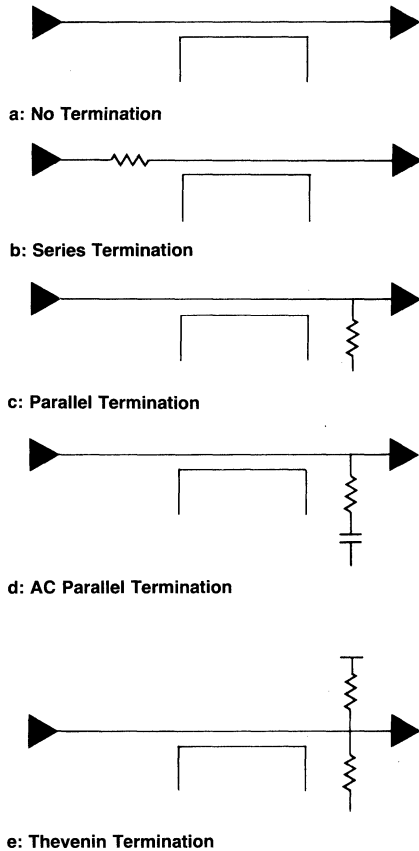

Series Terminations

Series terminations are most useful in high-speed applications where most of the loads are at the far end of the line. Loads that are between the driver and the end of the line will receive a two-step waveform. The first wave will be the incident wave. The amplitude is dependent upon the output impedance of the driver, the value of the series resistor and the impedance of the line according to the formula

$$V_w = V_{CC} \cdot Z_{oe} / (Z_{oe} + R_s + Z_s)$$

The amplitude will be one-half the voltage swing if R_s (the series resistor) plus the output impedance (Z_s) of the driver is equal to the line impedance. The second step of the waveform is the reflection from the end of the line and will have an amplitude equal to that of the first step. All devices on the line will receive a valid level only after the wave has propagated down the line and returned to the driver. Therefore, all inputs will see the full voltage swing within two times the delay of the line.

Parallel Termination

Parallel terminations are not generally recommended for CMOS circuits due to their power consumption, which can exceed the power consumption of the logic itself. The power consumption of parallel terminations is a function of the resistor value and the duty cycle of the signal. In addition, parallel termination tends to bias the output levels of the driver towards either V_{CC} or ground. While this feature is not desirable for driving CMOS inputs, it can be useful for driving TTL inputs.

AC Parallel Termination

AC parallel terminations work well for applications where the delays caused by series terminations are unacceptable. The effects of AC parallel terminations are similar to the effects of standard parallel terminations. The major difference is that the capacitor blocks any DC current path and helps to reduce power consumption.

Thevenin Termination

Thevenin terminations are also not generally recommended due to their power consumption. Like parallel termination, a DC path to ground is created by the terminating resistors. The power consumption of a Thevenin termination, though, will generally not be a function of the signal duty cycle. Thevenin terminations are more applicable for driving CMOS inputs because they do not bias the output levels as paralleled terminations do. It should be noted that lines with Thevenin terminations should not be left floating since this will cause the input levels to float between V_{CC} or ground, increasing power consumption.

FACT circuits have been designed to drive 50 ohm transmission lines over the full commercial temperature range. This is guaranteed by the FACT family's specified dynamic drive capability of 86 mA sink and 75 mA source current. This ensures incident wave switching on

50 ohm transmission lines and is consistent with the 3 ns rated edge transition time.

FACT devices also feature balanced output totem pole structures to allow equal source and sink current capability. This gives rise to balanced edge rates and equal rise and fall times. Balanced drive capability and transition times eliminate both the need to calculate two different delay times for each signal path and the requirement to correct signal polarity for the shortest delay time.

FACT product inputs have been created to take full advantage of high output levels to deliver the maximum noise immunity to the system designer. V_{IH} and V_{IL} are specified at 70% and 30% of V_{CC} respectively. The corresponding output levels, V_{OH} and V_{OL} , are specified to be within 0.1 V of the rails, of which the output is sourcing or sinking 20 μ A or less. These noise margins are outlined in Figure 4-7.

Figure 4-7. Input Threshold

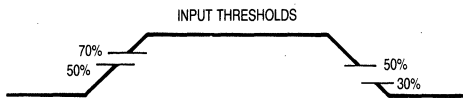

CMOS Bus Loading

CMOS logic devices have clamp diodes from all inputs and outputs to V_{CC} and ground. While these diodes increase system reliability by damping out undershoot and overshoot noise, they can cause problems if power is lost.

Figure 4-8 exemplifies the situation when power is removed. Any input driven above the V_{CC} pin will forward-bias the clamp diode. Current can then flow into the device, and out V_{CC} or any output that is HIGH. Depending upon the system, this current, I_{IN} , can be quite high, and may not allow the bus voltage to reach a valid HIGH state. One possible solution to eliminate this problem is to place a series resistor in the line.

Figure 4-8. Noise Effects

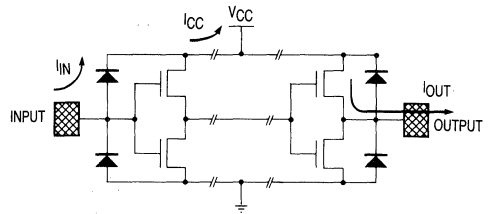

Noise Effects

FACT offers the best noise immunity of any competing technology available today. With input thresholds specified at 30% and 70% of V_{CC} and outputs that drive to within 100 mV of the rails, FACT devices offer noise margins approaching 30% of V_{CC} . At 5 V V_{CC} , FACT's specified input and output levels give almost 1.5 V of noise margin for both ground- and V_{CC} -born noise. With realistic input thresholds closer to 50% of V_{CC} , the actual margins approach 2.5 V.

However, even the most advanced technology cannot alone eliminate noise problems. Good circuit board layout techniques are essential to take full advantage of the superior performance of FACT circuits.

Well-designed circuit boards also help eliminate manufacturing and testing problems.

Another recommended practice is to segment the board into a high-speed area, a medium-speed area and a low-speed area. The circuit areas with high current requirements (i.e., buffer circuits and high-speed logic) should be as close to the power supplies as possible; low-speed circuit areas can be furthest away.

Decoupling capacitors should be adjacent to all buffer chips; they should be distributed throughout the logic: one capacitor per chip. Transmission lines need to be terminated to keep reflections minimal. To minimize crosstalk, long signal lines should not be close together.

Crosstalk

The problem of crosstalk and how to deal with it is becoming more important as system performance and board densities increase. Crosstalk is the capacitive coupling of signals from one line to

another. The amplitude of the noise generated on the inactive line is directly related to the edge rates of the signal on the active line, the proximity of the two lines and the distance that the two lines are adjacent.

Crosstalk has two basic causes. Forward crosstalk, Figure 4-9a, is caused by the wavefront propagating down the printed circuit trace at two different velocities. This difference in velocities is due to the difference in the dielectric constants of air ($\epsilon_r=1.0$) and epoxy glass ($\epsilon_r=4.7$). As the wave propagates down the trace, this difference in velocities will cause one edge to reach the end before the other. This delay is the cause of forward crosstalk; it increases with longer trace length, so consequently the magnitude of forward crosstalk will increase with distance.

Reverse crosstalk, Figure 4-9b, is caused by the mutual inductance and capacitance between the lines which is a transformer action. Reverse crosstalk increases linearly with distance up to a critical length. This critical length is the distance that the signal can travel during its rise or fall time.

Although crosstalk cannot be totally eliminated, there are some design techniques that can reduce system problems resulting from crosstalk. FACT's industry-leading noise margins make systems immune to crosstalk-related problems easier to design. FACT's AC noise margins, shown in Figures 4-10a and 4-10b, exemplify the outstanding immunity to everyday noise which can effect system reliability.

Figure 4-9a. Forward Crosstalk on PCB Traces

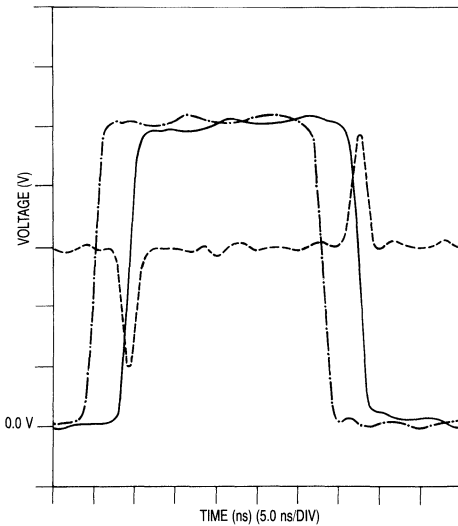

| Key | Vertical Scale | Horizontal Scale |
|-------------------------|----------------|------------------|
| ----- Active Driver | 1.0 V/Div | 50 ns/Div |
| Forward Crosstalk | 0.2 V/Div | 5.0 ns/Div |
| ———— Active Receiver | 1.0 V/Div | 5.0 ns/Div |

This figure shows traces taken on a test fixture designed to exaggerate the amplitude of crosstalk pulses.

Figure 4-9b. Reverse Crosstalk on PCB Traces

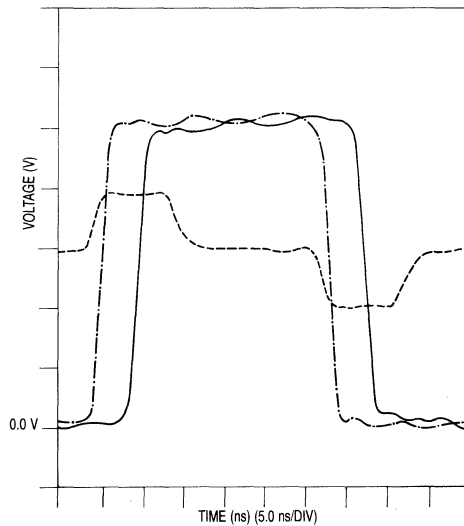

| Key | Vertical Scale | Horizontal Scale |
|-------------------------|----------------|------------------|
| ----- Active Driver | 1.0 V/Div | 50 ns/Div |
| Reverse Crosstalk | 0.2 V/Div | 5.0 ns/Div |
| ———— Active Receiver | 1.0 V/Div | 5.0 ns/Div |

This figure shows traces taken on a test fixture designed to exaggerate the amplitude of crosstalk pulses.

Figure 4-10a. High Noise Margin

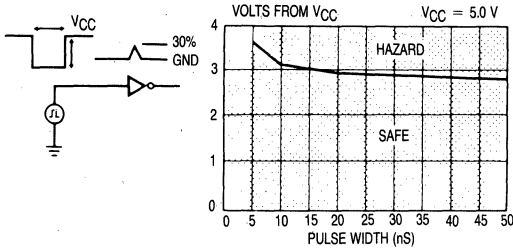
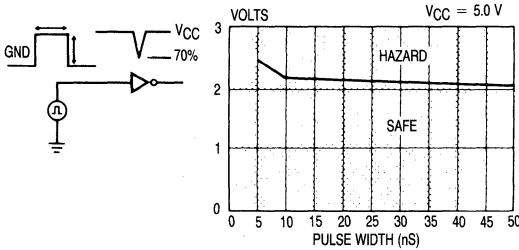

Figure 4-10b. Low Noise Margin



With over 2.0 V of noise margins, the FACT family offers better noise rejection than any other comparable technology.

In any design, the distance that lines run adjacent to each other should be kept as short as possible. The best situation is when the lines are perpendicular to each other. For those situations where lines must run parallel, the effects of crosstalk can be minimized by line termination. Terminating a line in its characteristic impedance reduces the amplitude of an initial crosstalk pulse by 50%. Terminating the line will also reduce the amount of ringing. Crosstalk problems can also be reduced by moving lines further apart or by inserting ground lines or planes between them.

Figure 4-11. Effects of Termination on Crosstalk

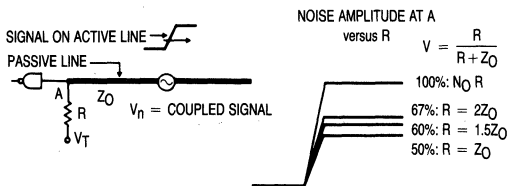

Ground Bounce

Ground bounce occurs as a result of the intrinsic characteristics of the leadframes and bondwires of the packages used to house CMOS devices. As edge rates and drive capability increase in advanced logic families, the effects of these intrinsic electrical characteristics become more pronounced.

Figure 4-12a shows a simple circuit model for a device in a leadframe driving a standard test load. The inductor L1 represents the parasitic inductance in the ground lead of the package; inductor L2 represents the parasitic inductance in the power lead of the package; inductor L3 represents the parasitic inductance in the output lead of the package; the resistor R1 represents the output impedance of the device output, and the capacitor and resistor CL and RL represent the standard test load on the output of the device.

Figure 4-12a. Output Model

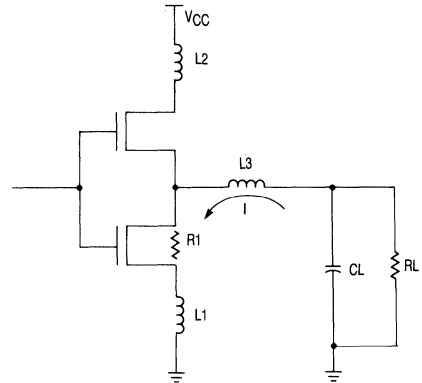

Figure 4-12b. Output Voltage



Figure 4-12c. Output Current

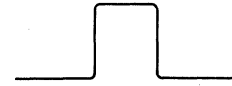
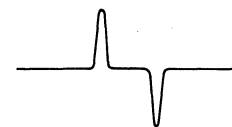

Figure 4-12d. Inductor Voltage



The three waveforms shown in Figures 4-12b, c and d, depict how ground bounce is generated. The first waveform shows the voltage (V) across the load as it is switched from a logic HIGH to a logic LOW. The output slew rate is dependent upon the characteristics of the output transistor, the inductors L1 and L3, and C_L, the load capacitance. The second waveform shows the current that is generated as the capacitor discharges [$I = C_L \cdot dV/dt$]. The third waveform shows the voltage that is induced across the inductance in the ground lead due to the changing currents [$V_{gb} = -L \cdot (dI/dt)$].

There are many factors which affect the amplitude of the ground bounce. Included are:

- Number of outputs switching simultaneously: more outputs results in more ground bounce.
- Type of output load: capacitive loads generate two to three times more ground bounce than typical system traces. Increasing the capacitive load to approximately 60-70 pF increases ground bounce. Beyond 70 pF, ground bounce drops off due to the filtering effect of the load. Moving the load away from the output reduces the ground bounce.
- Location of the output pin: outputs closer to the ground pin exhibit less ground bounce than those further away.
- Voltage: lowering V_{cc} reduces ground bounce.
- Test fixtures: standard test fixtures generate 30 to 50% more ground bounce than a typical system since they use capacitive loads which both increase the AC load and form LCR tank circuits that oscillate.

Ground bounce produces several symptoms:

- Altered device states. FACT logic does not exhibit this symptom.
- Propagation delay degradation. FACT devices are characterized not to degrade more than 250 ps per additional output switching.
- Undershoot on active outputs. The worst-case undershoot will be approximately equal to the worst-case quiet output noise.
- Quiet output noise. FACT logic's worst-case quiet output noise has been measured to be approximately 500-1100 mV in actual system applications.

Observing either one of the following rules is sufficient to avoid running into any of the problems associated with ground bounce:

First, use caution when driving asynchronous TTL-level inputs from CMOS octal outputs, or Second, use caution when running control lines (set, reset, load, clock, chip select) which are glitch-sensitive through the same devices that drive data or address lines.

When it is not possible to avoid the above conditions, there are simple precautions available which can minimize ground bounce noise. These are:

- Locate these outputs as close to the ground pin as possible.
- Use the lowest V_{cc} possible or separate the power supplies.
- Use board design practices which reduce any additive noise sources, such as crosstalk, reflections, etc.

Design Rules

The set of design rules listed below are recommended to ensure reliable system operation by providing the optimum power supply connection to the devices. Most designers will recognize these guidelines as those they have employed with advanced bipolar logic families.

- Use multi-layer boards with V_{cc} and ground planes, with the device power pins soldered directly to the planes to insure the lowest power line impedances possible.
- Use decoupling capacitors for every device, usually 0.10 μF should be adequate. These capacitors should be located as close to the ground pin as possible.
- Do not use sockets or wirewrap boards whenever possible.
- Do not connect capacitors from the outputs directly to ground.

Decoupling Requirements

Motorola Advanced CMOS, as with other high-performance, high-drive logic families, has special decoupling and printed circuit board layout requirements. Adhering to these requirements will ensure the maximum advantages are gained with FACT products.

Figure 4-13. Power Distribution Impedances

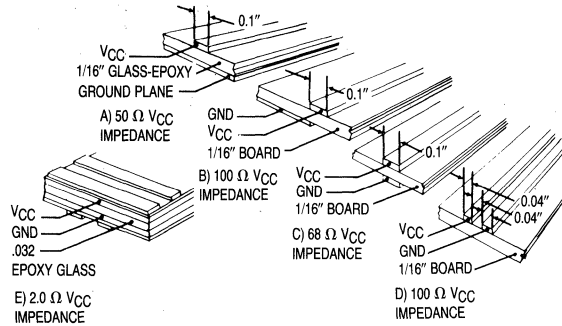

Local high frequency decoupling is required to supply power to the chip when it is transitioning from a LOW to a HIGH value. This power is necessary to charge the load capacitance or drive a line impedance. Figure 4-13 displays various Vcc and ground layout schemes along with associated impedances.

For most power distribution networks, the typical impedance is between 50 and 100 ohms. This impedance appears in series with the load

impedance and will cause a droop in the Vcc at the part. This limits the available voltage swing at the local node, unless some form of decoupling is used. This drooping of rails will cause the rise and fall times to become elongated. Consider the example described in Figure 4-14 to calculate the amount of decoupling necessary. This circuit utilizes an 'AC240 driving a 100 ohm bus from a point somewhere in the middle.

Figure 4-14. Octal Buffer Driving a 100 Ohm Bus

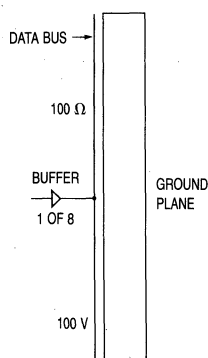

Buffer Output Sees Net 50 Ω Load.
50 Ω Load Line on I_{OH}-V_{OH} Characteristic Shows Low-to-High Step of Approx. 4.8 V

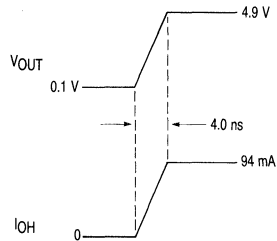

Worst-Case Octal Drain = 8 x 94 mA = 0.75 Amp.

Being in the middle of the bus, the driver will see two 100 ohm loads in parallel, or an effective impedance of 50 ohms. To switch the line from rail to rail, a drive of 94 mA is needed; more than 750 mA will be required if all eight lines switch at once. This instantaneous current requirement will generate a voltage across the impedance of the power lines, causing the actual Vcc at the chip to droop. This droop limits the voltage swing available to the driver. The net effect of the voltage droop will lengthen device rise and fall times and slow system operation. A local decoupling capacitor is required to act as a low impedance supply for the driver chip during high current conditions. It will maintain the voltage within acceptable limits and keep rise and fall times to a minimum. The necessary values for decoupling capacitors can be calculated with the formula given in Figure 4-15.

In this example, if the Vcc droop is to be kept below 0.1 V and the edge rate equals 4 ns, a 0.030 μf capacitor is needed.

It is good practice to distribute decoupling capacitors evenly through the logic, placing one capacitor for every package.

Capacitor Types

Decoupling capacitors need to be of the high K ceramic type with low equivalent series resistance (ESR), consisting primarily of series inductance and series resistance. Capacitors using 5ZU dielectric have suitable properties and make a good choice for decoupling capacitors; they offer minimum cost and effective performance.

Figure 4-15. Formula for Calculating Decoupling Capacitors

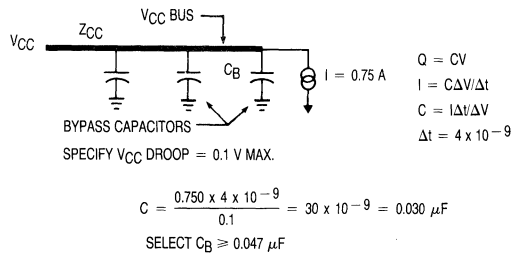

Place one decoupling capacitor adjacent to each package driving any transmission line and distribute others evenly throughout the logic. One capacitor per three packages.

TTL-Compatible CMOS Designs Require Delta I_{CC} Consideration

The FACT product line is comprised of two types of advanced CMOS circuits: 'AC and 'ACT devices. 'ACT indicates an advanced CMOS device with TTL-type input thresholds for direct replacement of LS and ALS circuits. As this 'ACT series is used to replace TTL, the Delta I_{CC} specification must be considered; this spec may be confusing and misleading to the engineer unfamiliar with CMOS.

It is important to understand the concept of Delta I_{CC} and how to use it within a design. First, consider where Delta I_{CC} initiates. Most CMOS input structures are of the totem pole type with an n-channel transistor in a series with a p-channel transistor as illustrated below.

Figure 4-16. CMOS Input Structure

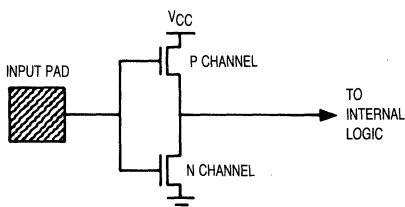

These two transistors can be modeled as variable resistors with resistances varying according to the input voltage. The resistance of an ON transistor is approximately 50 ohms while the resistance of an OFF transistor is generally greater than 5 Mohm. When the input to this structure is at either ground or V_{CC}, one transistor will be ON and one will be OFF. The total series resistance of this pair will be the combination of the two individual resistances, greater than 5 Mohm. The leakage current will then be less than 1 μ A. When the input is between ground and V_{CC}, the resistance of the ON transistor will increase while the resistance of the OFF transistor will decrease. The net resistance will drop due to the much larger value of the OFF resistance. The total series resistance can be as low as 600 ohms. This reduction in series resistance of the input structure will cause a corresponding increase in I_{CC} as current flows through the input structure. The following graph depicts typical I_{CC} variance with input voltage for an 'ACT device.

Figure 4-17. I_{CC} versus Input Voltage for 'ACT Devices

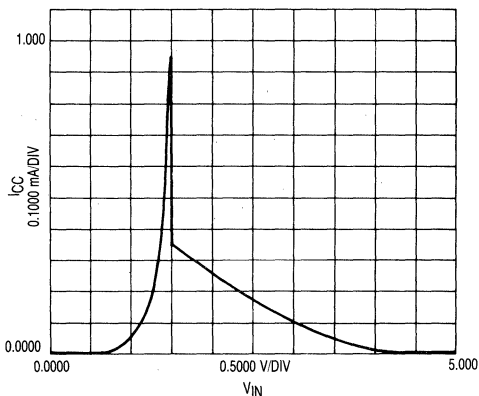

The Delta I_{CC} specification is the increase in I_{CC}. For each input at V_{CC}-2.1 V, the Delta I_{CC} value should be added to the quiescent supply current to arrive at the circuit's worst-case static I_{CC} value.

Fortunately, there are several factors which tend to reduce the increase in I_{CC} per input. Most TTL devices will be able to drive FACT inputs well beyond the TTL output specification due to FACT's low input loading in a typical system. FAST logic outputs can drive 'ACT-type inputs down to 200 mV and up to 3.5 V. Additionally, the typical I_{CC} increase per input will be less than the specified limit. As shown in the graph above, the I_{CC} increase at V_{CC}-2.1 V is less than 200 μ A in the typical system. Experiments have shown that the I_{CC} of an 'ACT240 series device typically increases only 200 μ A when all of the inputs are connected to a FAST device instead of ground or V_{CC}.

It is important when designing with FACT, as with any TTL-compatible CMOS technology, that the Delta I_{CC} specification be considered. Designers should be aware of the spec's significance and that the data book specification is a worst-case value; most systems will see values that are much less.

Testing Advanced CMOS Devices with I/O Pins

There are more and more CMOS families becoming available which can replace TTL circuits. Although testing these new CMOS units with programs and fixtures which were developed for bipolar devices will yield acceptable results most of the time, there are some cases where this approach will cause the test engineer problems.

Such is the case with parts that have a bidirectional pin, exemplified by the '245 Octal Transceiver. If the proper testing methods are not followed, these types of parts may not pass those tests for I_{CC} and input leakage currents, even when there is no fault with the devices.

CMOS circuits, unlike their bipolar counterparts, have static I_{CC} specification orders of magnitude less than standard load currents. Most CMOS I_{CC} specifications are usually less than $100 \mu A$. When conducting an I_{CC} test, greater care must be taken so that other currents will not mask the actual I_{CC} of the device. These currents are usually sourced from the inputs and outputs.

Since the static I_{CC} requirements of CMOS devices are so low, output load currents must be prevented from masking the current load of the device during an I_{CC} test. Even a standard 500 ohm load resistor will sink 10 mA at 5 V, which is more than twice the I_{CC} level being tested. Thus, most manufacturers will specify that all outputs must be unloaded during I_{CC} tests.

Another area of concern is identified when considering the inputs of the device. When the input is in the transition region, I_{CC} can be several orders of magnitude greater than the specification. When the input voltage is in the transition region, both the n-channel and the p-channel transistors in the input totem-pole structure will be slightly ON, and a conduction is created from V_{CC} to ground. This conduction path leads to the increased I_{CC} current seen in the I_{CC} vs. V_{IN} curve. When the input is at either rail, the input structure no longer

conducts. Most I_{CC} testing is done with all of the inputs tied to either V_{CC} or ground. If the inputs are allowed to float, they will typically float to the middle of the transition region, and the input structure will conduct an order of magnitude more current than the actual I_{CC} of the device under test which is being measured by the tester.

Figure 4-18. I_{CC} versus I_{IN}

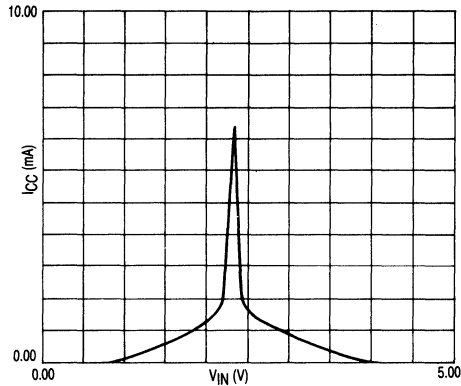

When testing the I_{CC} of a CMOS '245, problems can arise depending upon how the test is conducted. Note the structure of the '245's I/O pins illustrated below.

Figure 4-19. '245 I/O Structure

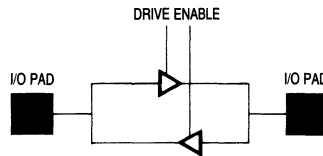

Each I/O pin is connected to both an input device and an output device. The pin can be viewed as having three states: input, output and output disabled. However, only two states actually exist.

The pin is either an input or an output. When testing the I_{CC} of the device, the pins selected as outputs by the T/R signal must either be enabled and left open or be disabled and tied to either rail. If the output device is disabled and allowed to float, the input

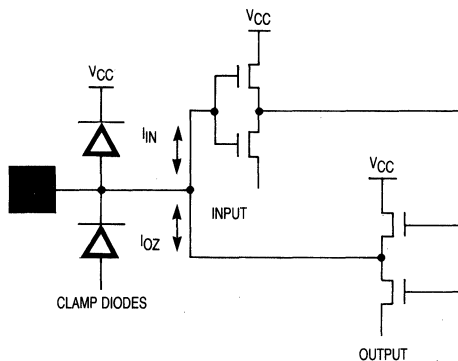

Figure 4-20. I/O Pin Internal Structure

device will also float, and an excessive amount of current will flow from V_{CC} to ground. A simple rule to follow is to treat any output which is disabled as an input. This will help insure the integrity of an I_{CC} test.

Another area which might precipitate problems is the measurement of the leakages on I/O pins. The I/O pin internal structure is depicted below.

The pin is internally connected to both an input device and an output device; the limit for a leakage test must be the combined I_{IN} specification of the input and the I_{OZ} specification of the output. For FACT devices, I_{IN} is specified at $\pm 1 \mu A$ while I_{OZ} is specified at $\pm 5 \mu A$. Combining these gives a limit of $\pm 6 \mu A$ for I/O pins. Usually, I/O pins will show leakages that are less than the I_{OZ} specification of the output alone.

Testing CMOS circuits is no more difficult than testing their bipolar counterparts. However, there are some areas of concern that will be new to many test engineers beginning to work with CMOS. Becoming familiar with and understanding these areas of concern prior to creating a test philosophy will avert many problems that might otherwise arise later.

Testing Disable Times of 3-State Outputs in a Transmission Line Environment

Traditionally, the disable time of a 3-state buffer has been measured from the 50% point on the disable input, to the 10% or 90% point on the output. On a bench test site, the output waveform is generated by a load capacitor and a pull-up/pull-down resistor. This circuit gives an RC charge/discharge curve as shown below.

Figure 4-21. Typical Bench 3-State Waveform

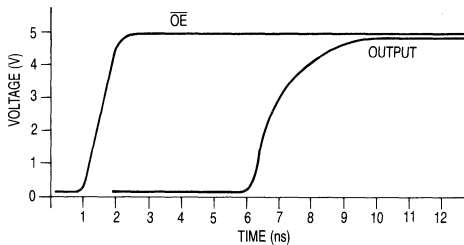

ATE test sites generally are unable to duplicate the bench test structure. ATE test loads differ because they are usually programmable and are situated away from the actual device. A commonly used test load is a Wheatstone bridge. The following figure illustrates the Wheatstone bridge test structure when used on the MCT 2000 test-system to duplicate the bench load.

Figure 4-22. MCT Wheatstone Bridge Test Load

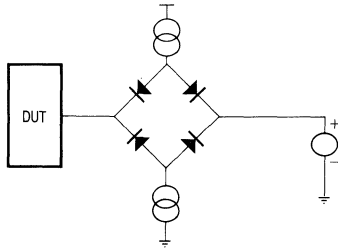

The voltage source provides a pull-up/pull-down voltage while the current sources provide I_{OH} and I_{OL} . When devices with slow output slew rates are tested with the ATE load, the resultant waveforms closely approximate the bench waveform, and a

high degree of correlation can be achieved. However, when devices with high output slew rates are tested, different results are observed that make correlating tester results with bench results more difficult. This difference is due to the transmission line properties of the test equipment. Most disable tests are preceded by establishing a current flow through the output structure. Typically, these currents will be between 5 mA and 20 mA. The device is then disabled, and a comparator detects when the output has risen to the 10% or 90% level.

Consider the situation where the connection between the device under test (DUT) and the comparator is a transmission line. Visualize the device output as a switch; the effect is easier to see. There is current flowing through the line, and then the switch is opened. At the device end, the reflection coefficient changes from 0 to 1. This generates a current edge flowing back down the line equal to the current flowing in the line prior to the opening of the switch. This current wave will propagate down the line where it will encounter the high impedance tester load. This will cause the wave to be reflected back down the line toward the DUT. The current wave will continue to reflect in the transmission line until it reaches the voltage applied to the tester load. At this point, the current source impedance decreases and it will dissipate the current. A typical waveshape on a modern ATE is depicted in Figure 4-23.

Figure 4-23. Typical ATE 3-State Waveform

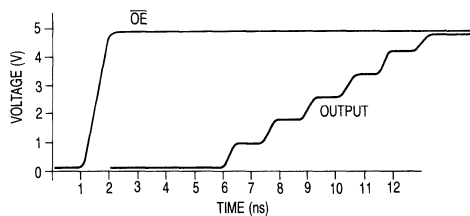

Transmission line theory states the voltage level of this current wave is equal to the current in the line times the impedance of the line. With typical currents as low as 5 mA and impedances of 50 to 60 ohms, this voltage step can be as minimal as 250 mV. If the comparator was programmed to the 10% point, it would be looking for a step of 550 mV at 5.5 V Vcc. Three reflections of the current pulse

would be required before the comparator would detect the level. It is this added delay time caused by the transmission line environment of the ATE that may cause parts to fail customers' incoming tests, even though the device meets specifications. The figure below graphically shows this stepout.

Figure 4-24. Measurement Stepout

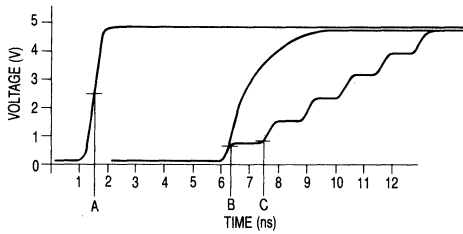

Point A represents the typical 50% measurement point on tester driven waveforms. Point B represents the point at which the delay time would be measured on a bench test fixture. Point C represents where the delay time could be measured on ATE fixtures. The delay time measured on the ATE fixture can vary from the bench measured delay time to some greater value, depending upon the voltage level that the tester is set. If the voltage level of the tester is close to voltage levels of the plateaus, the results may become non-repeatable.



Data Sheets

5



MOTOROLA

**MC74AC00
MC74ACT00**

Product Preview

Quad 2-Input NAND Gate

- Outputs Source/Sink 24 mA
- 'ACT00 Has TTL Compatible Inputs

**QUAD 2-INPUT
NAND GATE**

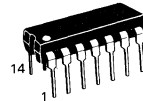
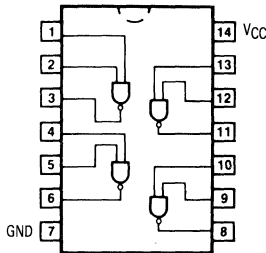

**N SUFFIX
CASE 646-06
PLASTIC**

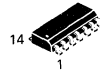

**D SUFFIX
CASE 751A-02
PLASTIC**

DC CHARACTERISTICS (unless otherwise specified)

| Symbol | Parameter | Value | Units | Test Conditions |
|-----------|---|-------|---------|---|
| I_{CC} | Maximum Quiescent Supply Current | 40 | μA | $V_{IN} = V_{CC}$ or Ground, $V_{CC} = 5.5 V$, $T_A = \text{Worst Case}$ |
| I_{CC} | Maximum Quiescent Supply Current | 4.0 | μA | $V_{IN} = V_{CC}$ or Ground, $V_{CC} = 5.5 V$, $T_A = 25^\circ C$ |
| I_{CCT} | Maximum Additional I_{CC} /Input ('ACT00) | 1.5 | mA | $V_{IN} = V_{CC} - 2.1 V$, $V_{CC} = 5.5 V$, $T_A = \text{Worst Case}$ |

AC CHARACTERISTICS (For Figures and Waveforms — See Section 3)

| Symbol | Parameter | V_{CC}^* (V) | 74AC | | | 74AC | | Units | Fig. No. |
|-----------|-------------------|-------------------|--------------------------------------|------------|------------|--|------------|-------|----------|
| | | | $T_A = +25^\circ C$ $C_L = 50 pF$ | | | $T_A = -40^\circ C$ to $+85^\circ C$ $C_L = 50 pF$ | | | |
| | | | Min | Typ | Max | Min | Max | | |
| t_{PLH} | Propagation Delay | 3.3 5.0 | 1.0 1.0 | 7.0 6.0 | 9.5 8.0 | 1.0 1.0 | 10 8.5 | ns | 3-5 |
| t_{PHL} | Propagation Delay | 3.3 5.0 | 1.0 1.0 | 5.5 4.5 | 8.0 6.5 | 1.0 1.0 | 8.5 7.0 | ns | 3-5 |

*Voltage Range 3.3 is $3.3 V \pm 0.3 V$
Voltage Range 5.0 is $5.0 V \pm 0.5 V$

This document contains information on a product under development. Motorola reserves the right to change or discontinue this product without notice.

5

MC74AC00 • MC74ACT00

AC CHARACTERISTICS (For Figures and Waveforms — See Section 3)

| Symbol | Parameter | V _{CC} * (V) | 74ACT | | | 74ACT | | Units | Fig. No. |
|------------------|-------------------|--------------------------|--|-----|-----|--|-----|-------|----------|
| | | | T _A = +25°C C _L = 50 pF | | | T _A = -40°C to +85°C C _L = 50 pF | | | |
| | | | Min | Typ | Max | Min | Max | | |
| t _{PLH} | Propagation Delay | 5.0 | 1.0 | 5.5 | 9.0 | 1.0 | 9.5 | ns | 3-5 |
| t _{PHL} | Propagation Delay | 5.0 | 1.0 | 4.0 | 7.0 | 1.0 | 8.0 | ns | 3-5 |

*Voltage Range 5.0 is 5.0 V ± 0.5 V

CAPACITANCE

| Symbol | Parameter | Value Typ | Units | Test Conditions |
|-----------------|-------------------------------|--------------|-------|-------------------------|
| C _{IN} | Input Capacitance | 4.5 | pF | V _{CC} = 5.0 V |
| C _{PD} | Power Dissipation Capacitance | 30 | pF | V _{CC} = 5.0 V |



MOTOROLA

**MC74AC02
MC74ACT02**

Product Preview

Quad 2-Input NOR Gate

- Outputs Source/Sink 24 mA
- 'ACT02 Has TTL Compatible Inputs

**QUAD 2-INPUT
NOR GATE**

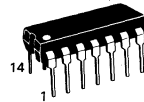
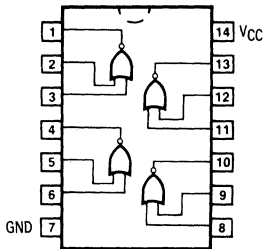

**N SUFFIX
CASE 646-06
PLASTIC**



**D SUFFIX
CASE 751A-02
PLASTIC**

DC CHARACTERISTICS (unless otherwise specified)

| Symbol | Parameter | Value | Units | Test Conditions |
|----------|----------------------------------|-------|---------|---|
| I_{CC} | Maximum Quiescent Supply Current | 40 | μA | $V_{IN} = V_{CC}$ or Ground, $V_{CC} = 5.5 V$, $T_A = \text{Worst Case}$ |
| I_{CC} | Maximum Quiescent Supply Current | 4.0 | μA | $V_{IN} = V_{CC}$ or Ground, $V_{CC} = 5.5 V$, $T_A = 25^\circ C$ |

AC CHARACTERISTICS (For Figures and Waveforms — See Section 3)

| Symbol | Parameter | V_{CC}^* (V) | 74AC | | | 74AC | | Units | Fig. No. |
|-----------|-------------------|-------------------|--------------------------------------|------------|------------|--|------------|-------|----------|
| | | | $T_A = +25^\circ C$ $C_L = 50 pF$ | | | $T_A = -40^\circ C$ to $+85^\circ C$ $C_L = 50 pF$ | | | |
| | | | Min | Typ | Max | Min | Max | | |
| t_{PLH} | Propagation Delay | 3.3 5.0 | 1.0 1.0 | 5.0 4.0 | 7.5 6.0 | 1.0 1.0 | 8.0 6.5 | ns | 3-5 |
| t_{PHL} | Propagation Delay | 3.3 5.0 | 1.0 1.0 | 5.0 4.5 | 7.5 6.5 | 1.0 1.0 | 8.0 7.0 | ns | 3-5 |

*Voltage Range 3.3 is $3.3 V \pm 0.3 V$
Voltage Range 5.0 is $5.0 V \pm 0.5 V$

AC CHARACTERISTICS — MC74ACT02
(Contact Local Motorola Sales Office)

CAPACITANCE

| Symbol | Parameter | Value Typ | Units | Test Conditions |
|----------|-------------------------------|--------------|-------|------------------|
| C_{iN} | Input Capacitance | 4.5 | pF | $V_{CC} = 5.0 V$ |
| C_{PD} | Power Dissipation Capacitance | 30 | pF | $V_{CC} = 5.0 V$ |

This document contains information on a product under development. Motorola reserves the right to change or discontinue this product without notice.

5



MOTOROLA

MC74AC04 MC74ACT04

Product Preview Hex Inverter

- Outputs Source/Sink 24 mA
- 'ACT04 Has TTL Compatible Inputs

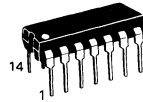
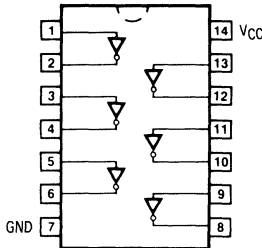

N SUFFIX
CASE 646-06
PLASTIC

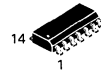

D SUFFIX
CASE 751A-02
PLASTIC

DC CHARACTERISTICS (unless otherwise specified)

| Symbol | Parameter | Value | Units | Test Conditions |
|-----------|---|-------|---------|--|
| I_{CC} | Maximum Quiescent Supply Current | 40 | μA | $V_{IN} = V_{CC}$ or Ground, $V_{CC} = 5.5 V, T_A = \text{Worst Case}$ |
| I_{CC} | Maximum Quiescent Supply Current | 4.0 | μA | $V_{IN} = V_{CC}$ or Ground, $V_{CC} = 5.5 V, T_A = 25^\circ C$ |
| I_{CCT} | Maximum Additional I_{CC}/Input ('ACT04) | 1.5 | mA | $V_{IN} = V_{CC} - 2.1 V$, $V_{CC} = 5.5 V, T_A = \text{Worst Case}$ |

AC CHARACTERISTICS (For Figures and Waveforms — See Section 3)

| Symbol | Parameter | V_{CC}^* (V) | 74AC | | | 74AC | | Units | Fig. No. |
|-----------|-------------------|-------------------|--------------------------------------|------------|------------|--|------------|-------|----------|
| | | | $T_A = +25^\circ C$ $C_L = 50 pF$ | | | $T_A = -40^\circ C$ to $+85^\circ C$ $C_L = 50 pF$ | | | |
| | | | Min | Typ | Max | Min | Max | | |
| t_{PLH} | Propagation Delay | 3.3 5.0 | 1.0 1.0 | 4.5 4.0 | 9.0 7.0 | 1.0 1.0 | 10 7.5 | ns | 3-5 |
| t_{PHL} | Propagation Delay | 3.3 5.0 | 1.0 1.0 | 4.5 3.5 | 8.5 6.5 | 1.0 1.0 | 9.5 7.0 | ns | 3-5 |

*Voltage Range 3.3 is $3.3 V \pm 0.3 V$
 Voltage Range 5.0 is $5.0 V \pm 0.5 V$

This document contains information on a product under development. Motorola reserves the right to change or discontinue this product without notice.

5

MC74AC04 • MC74ACT04

AC CHARACTERISTICS (For Figures and Waveforms — See Section 3)

| Symbol | Parameter | V _{CC} * (V) | 74ACT | | | 74ACT | | Units | Fig. No. |
|------------------|-------------------|--------------------------|--|-----|-----|--|-----|-------|----------|
| | | | T _A = +25°C C _L = 50 pF | | | T _A = -40°C to +85°C C _L = 50 pF | | | |
| | | | Min | Typ | Max | Min | Max | | |
| t _{PLH} | Propagation Delay | 5.0 | | 4.5 | | | ns | 3-6 | |
| t _{PHL} | Propagation Delay | 5.0 | | 3.9 | | | ns | 3-6 | |

*Voltage Range 5.0 is 5.0 V ± 0.5 V

CAPACITANCE

| Symbol | Parameter | Value Typ | Units | Test Conditions |
|-----------------|-------------------------------|--------------|-------|-------------------------|
| C _{IN} | Input Capacitance | 4.5 | pF | V _{CC} = 5.0 V |
| C _{PD} | Power Dissipation Capacitance | 30 | pF | V _{CC} = 5.0 V |



MOTOROLA

**MC74AC08
MC74ACT08**

Product Preview

Quad 2-Input AND Gate

- Outputs Source/Sink 24 mA
- *ACT08 Has TTL Compatible Inputs

QUAD 2-INPUT
AND GATE

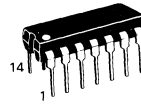
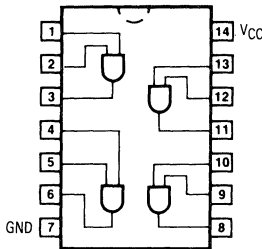

N SUFFIX
CASE 646-06
PLASTIC



D SUFFIX
CASE 751A-02
PLASTIC

DC CHARACTERISTICS (unless otherwise specified)

| Symbol | Parameter | Value | Units | Test Conditions |
|-----------|---|-------|---------|---|
| I_{CC} | Maximum Quiescent Supply Current | 40 | μA | $V_{IN} = V_{CC}$ or Ground, $V_{CC} = 5.5 V$, $T_A = \text{Worst Case}$ |
| I_{CC} | Maximum Quiescent Supply Current | 4.0 | μA | $V_{IN} = V_{CC}$ or Ground, $V_{CC} = 5.5 V$, $T_A = 25^\circ C$ |
| I_{CCT} | Maximum Additional I_{CC} /Input (*ACT08) | 1.5 | mA | $V_{IN} = V_{CC} - 2.1 V$, $V_{CC} = 5.5 V$, $T_A = \text{Worst Case}$ |

AC CHARACTERISTICS (For Figures and Waveforms — See Section 3)

| Symbol | Parameter | V_{CC}^* (V) | 74AC | | | 74AC | | Units | Fig. No. |
|-----------|-------------------|-------------------|--------------------------------------|------------|------------|--|------------|-------|----------|
| | | | $T_A = +25^\circ C$ $C_L = 50 pF$ | | | $T_A = -40^\circ C$ to $+85^\circ C$ $C_L = 50 pF$ | | | |
| | | | Min | Typ | Max | Min | Max | | |
| t_{PLH} | Propagation Delay | 3.3 5.0 | 1.0 1.0 | 7.5 5.5 | 9.5 7.5 | 1.0 1.0 | 10 8.5 | ns | 3-5 |
| t_{PHL} | Propagation Delay | 3.3 5.0 | 1.0 1.0 | 7.0 5.5 | 8.5 7.0 | 1.0 1.0 | 9.0 7.5 | ns | 3-5 |

*Voltage Range 3.3 is $3.3 V \pm 0.3 V$
Voltage Range 5.0 is $5.0 V \pm 0.5 V$

This document contains information on a product under development. Motorola reserves the right to change or discontinue this product without notice.

5

MC74AC08 • MC74ACT08

AC CHARACTERISTICS (For Figures and Waveforms — See Section 3)

| Symbol | Parameter | V _{CC} * (V) | 74ACT | | | 74ACT | | Units | Fig. No. |
|------------------|-------------------|--------------------------|--|-----|-----|--|-----|-------|----------|
| | | | T _A = +25°C C _L = 50 pF | | | T _A = -40°C to +85°C C _L = 50 pF | | | |
| | | | Min | Typ | Max | Min | Max | | |
| t _{PLH} | Propagation Delay | 5.0 | | 6.5 | | | ns | 3-5 | |
| t _{PHL} | Propagation Delay | 5.0 | | 6.7 | | | ns | 3-5 | |

*Voltage Range 5.0 is 5.0 V ± 0.5 V

CAPACITANCE

| Symbol | Parameter | Value Typ | Units | Test Conditions |
|-----------------|-------------------------------|--------------|-------|-------------------------|
| C _{IN} | Input Capacitance | 4.5 | pF | V _{CC} = 5.0 V |
| C _{PD} | Power Dissipation Capacitance | 20 | pF | V _{CC} = 5.0 V |

5



MOTOROLA

**MC74AC10
MC74ACT10**

Product Preview

Triple 3-Input NAND Gate

- Outputs Source/Sink 24 mA
- *ACT10 Has TTL Compatible Inputs

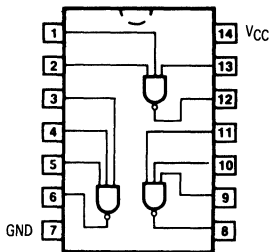

**TRIPLE 3-INPUT
NAND GATE**

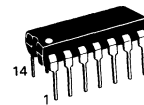

**N SUFFIX
CASE 646-06
PLASTIC**

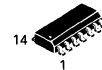

**D SUFFIX
CASE 751A-02
PLASTIC**

DC CHARACTERISTICS (unless otherwise specified)

| Symbol | Parameter | Value | Units | Test Conditions |
|----------|----------------------------------|-------|---------|--|
| I_{CC} | Maximum Quiescent Supply Current | 40 | μA | $V_{IN} = V_{CC}$ or Ground, $V_{CC} = 5.5 V$, $T_A =$ Worst Case |
| I_{CC} | Maximum Quiescent Supply Current | 4.0 | μA | $V_{IN} = V_{CC}$ or Ground, $V_{CC} = 5.5 V$, $T_A = 25^\circ C$ |

AC CHARACTERISTICS (For Figures and Waveforms — See Section 3)

| Symbol | Parameter | V_{CC}^* (V) | 74AC | | | 74AC | | Units | Fig. No. |
|------------------|-------------------|-------------------|--------------------------------------|------------|------------|--|-------------|-------|----------|
| | | | $T_A = +25^\circ C$ $C_L = 50 pF$ | | | $T_A = -40^\circ C$ to $+85^\circ C$ $C_L = 50 pF$ | | | |
| | | | Min | Typ | Max | Min | Max | | |
| t _{PLH} | Propagation Delay | 3.3 5.0 | 1.0 1.0 | 6.0 4.5 | 9.5 7.0 | 1.0 1.0 | 10.5 8.0 | ns | 3-5 |
| t _{PHL} | Propagation Delay | 3.3 5.0 | 1.0 1.0 | 5.5 4.0 | 8.5 6.0 | 1.0 1.0 | 10 6.5 | ns | 3-5 |

*Voltage Range 3.3 is $3.3 V \pm 0.3 V$
 Voltage Range 5.0 is $5.0 V \pm 0.5 V$

AC CHARACTERISTICS — MC74ACT10
(Contact Local Motorola Sales Office)

CAPACITANCE

| Symbol | Parameter | Value Typ | Units | Test Conditions |
|----------|-------------------------------|--------------|-------|------------------|
| C_{IN} | Input Capacitance | 4.5 | pF | $V_{CC} = 5.0 V$ |
| C_{PD} | Power Dissipation Capacitance | 25 | pF | $V_{CC} = 5.0 V$ |

This document contains information on a product under development. Motorola reserves the right to change or discontinue this product without notice.



MOTOROLA

**MC74AC11
MC74ACT11**

Product Preview

Triple 3-Input AND Gate

- Outputs Source/Sink 24 mA
- 'ACT11 Has TTL Compatible Inputs

**TRIPLE 3-INPUT
AND GATE**

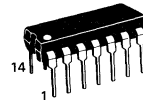
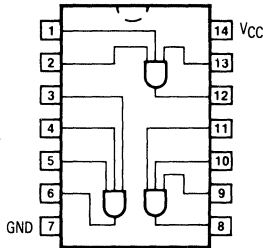

**N SUFFIX
CASE 646-06
PLASTIC**

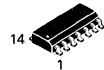

**D SUFFIX
CASE 751A-02
PLASTIC**

DC CHARACTERISTICS (unless otherwise specified)

| Symbol | Parameter | Value | Units | Test Conditions |
|----------|----------------------------------|-------|---------|--|
| I_{CC} | Maximum Quiescent Supply Current | 40 | μA | $V_{IN} = V_{CC}$ or Ground, $V_{CC} = 5.5 V, T_A = \text{Worst Case}$ |
| I_{CC} | Maximum Quiescent Supply Current | 4.0 | μA | $V_{IN} = V_{CC}$ or Ground, $V_{CC} = 5.5 V, T_A = 25^\circ C$ |

AC CHARACTERISTICS (For Figures and Waveforms — See Section 3)

| Symbol | Parameter | V_{CC}^* (V) | 74AC | | | 74AC | | Units | Fig. No. |
|-----------|-------------------|-------------------|--------------------------------------|------------|------------|--|------------|-------|----------|
| | | | $T_A = +25^\circ C$ $C_L = 50 pF$ | | | $T_A = -40^\circ C$ to $+85^\circ C$ $C_L = 50 pF$ | | | |
| | | | Min | Typ | Max | Min | Max | | |
| t_{PLH} | Propagation Delay | 3.3 5.0 | 1.0 1.0 | 5.5 4.0 | 9.5 8.0 | 1.0 1.0 | 10 8.5 | ns | 3-5 |
| t_{PHL} | Propagation Delay | 3.3 5.0 | 1.0 1.0 | 5.5 4.0 | 8.5 7.0 | 1.0 1.0 | 9.5 7.5 | ns | 3-5 |

*Voltage Range 3.3 is $3.3 V \pm 0.3 V$
Voltage Range 5.0 is $5.0 V \pm 0.5 V$

AC CHARACTERISTICS — MC74ACT11
(Contact Local Motorola Sales Office)

CAPACITANCE

| Symbol | Parameter | Value Typ | Units | Test Conditions |
|----------|-------------------------------|--------------|-------|------------------|
| C_{IN} | Input Capacitance | 4.5 | pF | $V_{CC} = 5.0 V$ |
| C_{PD} | Power Dissipation Capacitance | 20 | pF | $V_{CC} = 5.0 V$ |

This document contains information on a product under development. Motorola reserves the right to change or discontinue this product without notice.

5



MOTOROLA

Product Preview

Hex Inverter Schmitt Trigger

The MC74AC14/74ACT14 contains six logic inverters which accept standard CMOS input signals (TTL levels for MC74ACT14) and provide standard CMOS output levels. They are capable of transforming slowly changing input signals into sharply defined, jitter-free output signals. In addition, they have a greater noise margin than conventional inverters.

The MC74AC14/74ACT14 has hysteresis between the positive-going and negative-going input thresholds (typically 1.0 V) which is determined internally by transistor ratios and is essentially insensitive to temperature and supply voltage variations.

- Outputs Source/Sink 24 mA
- 'ACT14 Has TTL Compatible Inputs

FUNCTION TABLE

| Input | Output |
|-------|--------|
| A | O |
| L | H |
| H | L |

**MC74AC14
MC74ACT14**

**HEX INVERTER
SCHMITT TRIGGER**

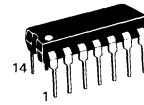

**N SUFFIX
CASE 646-06
PLASTIC**



**D SUFFIX
CASE 751A-02
PLASTIC**

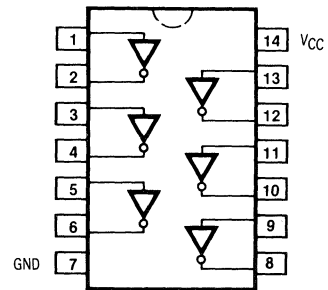

MC74AC14 • MC74ACT14

DC CHARACTERISTICS (unless otherwise specified)

| Symbol | Parameter | V _{CC} (V) | 74AC | 74ACT | Units | Test Conditions |
|---------------------|---|---------------------|-------------------|-------|-------|---|
| I _{CC} | Maximum Quiescent Supply Current | | 40 | 40 | μA | V _{IN} = V _{CC} or Ground, V _{CC} = 5.5 V, T _A = Worst Case |
| I _{CC} | Maximum Quiescent Supply Current | | 4.0 | 4.0 | μA | V _{IN} = V _{CC} or Ground, V _{CC} = 5.5 V, T _A = 25°C |
| I _{CCT} | Maximum Additional I _{CC} /Input (ACT14) | | | 1.5 | mA | V _{IN} = V _{CC} - 2.1 V, V _{CC} = 5.5 V, T _A = Worst Case |
| V _{t+} | Maximum Positive Threshold | 3.0 4.5 5.5 | 2.2 3.2 3.9 | 2.0 | V | T _A = Worst Case |
| V _{t-} | Minimum Negative Threshold | 3.0 4.5 5.5 | 0.5 0.9 1.1 | 0.8 | V | T _A = Worst Case |
| V _{h(max)} | Maximum Hysteresis | 3.0 4.5 5.5 | 1.2 1.4 1.6 | 1.2 | V | T _A = Worst Case |
| V _{h(min)} | Minimum Hysteresis | 3.0 4.5 5.5 | 0.3 0.4 0.5 | 0.4 | V | T _A = Worst Case |

AC CHARACTERISTICS (Figures and Waveforms — See Section 3)

| Symbol | Parameter | V _{CC} * (V) | 74AC | | | 74AC | | Units | Fig. No. |
|------------------|-------------------|-----------------------|--|------------|-------------|--|-----------|-------|----------|
| | | | T _A = +25°C C _L = 50 pF | | | T _A = -40°C to +85°C C _L = 50 pF | | | |
| | | | Min | Typ | Max | Min | Max | | |
| t _{PLH} | Propagation Delay | 3.3 5.0 | 1.0 1.0 | 9.5 7.0 | 13.5 10 | 1.0 1.0 | 15 11 | ns | 3-5 |
| t _{PHL} | Propagation Delay | 3.3 5.0 | 1.0 1.0 | 7.5 6.0 | 11.5 8.5 | 1.0 1.0 | 13 9.5 | ns | 3-5 |

*Voltage Range 3.3 is 3.3 V ± 0.3 V
Voltage Range 5.0 is 5.0 V ± 0.5 V

AC CHARACTERISTICS (Figures and Waveforms — See Section 3)

| Symbol | Parameter | V _{CC} * (V) | 74ACT | | | 74ACT | | Units | Fig. No. |
|------------------|-------------------|-----------------------|--|-----|-----|--|-----|-------|----------|
| | | | T _A = +25°C C _L = 50 pF | | | T _A = -40°C to +85°C C _L = 50 pF | | | |
| | | | Min | Typ | Max | Min | Max | | |
| t _{PLH} | Propagation Delay | 5.0 | | 7.4 | | | | ns | 3-5 |
| t _{PHL} | Propagation Delay | 5.0 | | 8.6 | | | | ns | 3-5 |

*Voltage Range 5.0 is 5.0 V ± 0.5 V

CAPACITANCE

| Symbol | Parameter | Value Typ | Units | Test Conditions |
|-----------------|-------------------------------|-----------|-------|-------------------------|
| C _{IN} | Input Capacitance | 4.5 | pF | V _{CC} = 5.0 V |
| C _{PD} | Power Dissipation Capacitance | 25 | pF | V _{CC} = 5.0 V |

5



MOTOROLA

MC74AC20 MC74ACT20

Product Preview

Dual 4-Input NAND Gate

- Outputs Source/Sink 24 mA
- 'ACT20 Has TTL Compatible Inputs

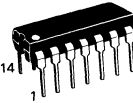
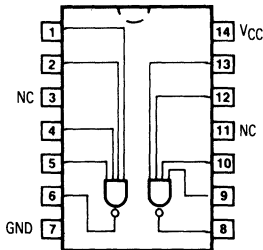

N SUFFIX
CASE 646-06
PLASTIC

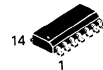

D SUFFIX
CASE 751A-02
PLASTIC

DC CHARACTERISTICS (unless otherwise specified)

| Symbol | Parameter | Value | Units | Test Conditions |
|----------|----------------------------------|-------|---------|---|
| I_{CC} | Maximum Quiescent Supply Current | 40 | μA | $V_{IN} = V_{CC}$ or Ground, $V_{CC} = 5.5 V, T_A = \text{Worst Case}$ |
| I_{CC} | Maximum Quiescent Supply Current | 4.0 | μA | $V_{IN} = V_{CC}$ or Ground, $V_{CC} = 5.5 V, T_A = 25^\circ C$ |

AC CHARACTERISTICS (For Figures and Waveforms — See Section 3)

| Symbol | Parameter | V_{CC}^* (V) | 74AC | | | 74AC | | Units | Fig. No. |
|-----------|-------------------|-------------------|--------------------------------------|------------|------------|--|------------|-------|----------|
| | | | $T_A = +25^\circ C$ $C_L = 50 pF$ | | | $T_A = -40^\circ C$ to $+85^\circ C$ $C_L = 50 pF$ | | | |
| | | | Min | Typ | Max | Min | Max | | |
| t_{PLH} | Propagation Delay | 3.3 5.0 | 1.0 1.0 | 6.0 5.0 | 8.5 7.0 | 1.0 1.0 | 10 8.0 | ns | 3-5 |
| t_{PHL} | Propagation Delay | 3.3 5.0 | 1.0 1.0 | 5.0 4.0 | 7.0 6.0 | 1.0 1.0 | 9.0 7.0 | ns | 3-5 |

*Voltage Range 3.3 is $3.3 V \pm 0.3 V$
Voltage Range 5.0 is $5.0 V \pm 0.5 V$

AC CHARACTERISTICS — MC74ACT20

(Contact Local Motorola Sales Office)

CAPACITANCE

| Symbol | Parameter | Value Typ | Units | Test Conditions |
|----------|-------------------------------|-----------|-------|------------------|
| C_{IN} | Input Capacitance | 4.5 | pF | $V_{CC} = 5.0 V$ |
| C_{PD} | Power Dissipation Capacitance | 40 | pF | $V_{CC} = 5.0 V$ |

This document contains information on a product under development. Motorola reserves the right to change or discontinue this product without notice.



MOTOROLA

Product Preview

Quad 2-Input OR Gate

- Outputs Source/Sink 24 mA
- 'ACT32 Has TTL Compatible Inputs

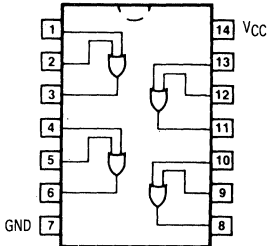

**MC74AC32
MC74ACT32**

**QUAD 2-INPUT
OR GATE**

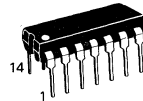

**N SUFFIX
CASE 646-06
PLASTIC**

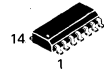

**D SUFFIX
CASE 751A-02
PLASTIC**

DC CHARACTERISTICS (unless otherwise specified)

| Symbol | Parameter | Value | Units | Test Conditions |
|-----------|---|-------|---------|--|
| I_{CC} | Maximum Quiescent Supply Current | 40 | μA | $V_{IN} = V_{CC}$ or Ground, $V_{CC} = 5.5 V$, $T_A =$ Worst Case |
| I_{CC} | Maximum Quiescent Supply Current | 4.0 | μA | $V_{IN} = V_{CC}$ or Ground, $V_{CC} = 5.5 V$, $T_A = 25^\circ C$ |
| I_{CCT} | Maximum Additional I_{CC} /Input ('ACT32) | 1.5 | mA | $V_{IN} = V_{CC} - 2.1 V$, $V_{CC} = 5.5 V$, $T_A =$ Worst Case |

AC CHARACTERISTICS (For Figures and Waveforms — See Section 3)

| Symbol | Parameter | V_{CC}^* (V) | 74AC | | | 74AC | | Units | Fig. No. |
|-----------|-------------------|-------------------|--------------------------------------|------------|------------|--|------------|-------|----------|
| | | | $T_A = +25^\circ C$ $C_L = 50 pF$ | | | $T_A = -40^\circ C$ to $+85^\circ C$ $C_L = 50 pF$ | | | |
| | | | Min | Typ | Max | Min | Max | | |
| t_{PLH} | Propagation Delay | 3.3 5.0 | 1.0 1.0 | 7.0 5.5 | 9.0 7.5 | 1.0 1.0 | 10 8.5 | ns | 3-5 |
| t_{PHL} | Propagation Delay | 3.3 5.0 | 1.0 1.0 | 7.0 5.0 | 8.5 7.0 | 1.0 1.0 | 9.0 7.5 | ns | 3-5 |

*Voltage Range 3.3 is $3.3 V \pm 0.3 V$
Voltage Range 5.0 is $5.0 V \pm 0.5 V$

This document contains information on a product under development. Motorola reserves the right to change or discontinue this product without notice.

5

MC74AC32 • MC74ACT32

AC CHARACTERISTICS (For Figures and Waveforms — See Section 3)

| Symbol | Parameter | V _{CC} * (V) | 74ACT | | | 74ACT | | Units | Fig. No. |
|------------------|-------------------|--------------------------|--|-----|-----|--|-----|-------|----------|
| | | | T _A = +25°C C _L = 50 pF | | | T _A = -40°C to +85°C C _L = 50 pF | | | |
| | | | Min | Typ | Max | Min | Max | | |
| t _{PLH} | Propagation Delay | 5.0 | | 7.2 | | | ns | 3-5 | |
| t _{PHL} | Propagation Delay | 5.0 | | 6.6 | | | ns | 3-5 | |

*Voltage Range 5.0 is 5.0 V ± 0.5 V

CAPACITANCE

| Symbol | Parameter | Value Typ | Units | Test Conditions |
|-----------------|-------------------------------|--------------|-------|-------------------------|
| C _{IN} | Input Capacitance | 4.5 | pF | V _{CC} = 5.0 V |
| C _{PD} | Power Dissipation Capacitance | 20 | pF | V _{CC} = 5.0 V |



MOTOROLA

Product Preview

Dual D-Type Positive Edge-Triggered Flip-Flop

The MC74AC74/74ACT74 is a dual D-type flip-flop with Asynchronous Clear and Set inputs and complementary (Q , \bar{Q}) outputs. Information at the input is transferred to the outputs on the positive edge of the clock pulse. Clock triggering occurs at a voltage level of the clock pulse and is not directly related to the transition time of the positive-going pulse. After the Clock Pulse input threshold voltage has been passed, the Data input is locked out and information present will not be transferred to the outputs until the next rising edge of the Clock Pulse input.

Asynchronous Inputs:

- LOW input to \bar{S}_D (Set) sets Q to HIGH level
- LOW input to \bar{C}_D (Clear) sets Q to LOW level
- Clear and Set are independent of clock
- Simultaneous LOW on \bar{C}_D and \bar{S}_D makes both Q and \bar{Q} HIGH

- Outputs Source/Sink 24 mA
- 'ACT74 Has TTL Compatible Inputs

LOGIC SYMBOL

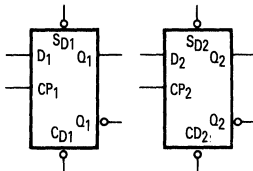

PIN NAMES

- D_1, D_2 Data Inputs
- CP_1, CP_2 Clock Pulse Inputs
- \bar{C}_D1, \bar{C}_D2 Direct Clear Inputs
- \bar{S}_D1, \bar{S}_D2 Direct Set Inputs
- $Q_1, \bar{Q}_1, Q_2, \bar{Q}_2$ Outputs

TRUTH TABLE (Each Half)

| Inputs | | | Outputs | | |
|-------------|-------------|----|---------|-------|-------------|
| \bar{S}_D | \bar{C}_D | CP | D | Q | \bar{Q} |
| L | H | X | X | H | L |
| H | L | X | X | L | H |
| L | L | X | X | H | H |
| H | H | ┘ | H | H | L |
| H | H | ┘ | L | L | H |
| H | H | L | X | Q_0 | \bar{Q}_0 |

H = HIGH Voltage Level
 L = LOW Voltage Level
 X = Immaterial
 ┘ = LOW-to-HIGH Clock Transition
 $Q_0(\bar{Q}_0)$ = Previous $Q(\bar{Q})$ before LOW-to-HIGH Transition of Clock

**MC74AC74
MC74ACT74**

**DUAL D-TYPE POSITIVE
EDGE-TRIGGERED
FLIP-FLOP**

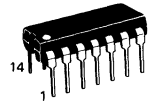

**N SUFFIX
CASE 646-06
PLASTIC**

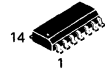

**D SUFFIX
CASE 751A-02
PLASTIC**

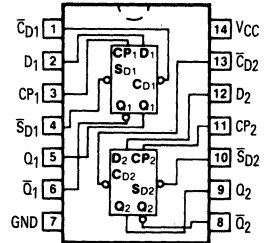

5

This document contains information on a product under development. Motorola reserves the right to change or discontinue this product without notice.

MC74AC74 • MC74ACT74

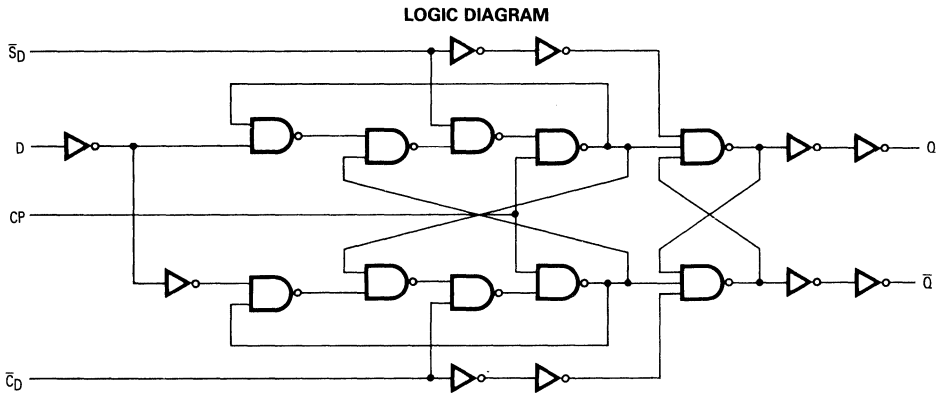

Please note that this diagram is provided only for the understanding of logic operations and should not be used to estimate propagation delays.

DC CHARACTERISTICS (unless otherwise specified)

| Symbol | Parameter | Value | Units | Test Conditions |
|-----------|---|-------|---------|--|
| I_{CC} | Maximum Quiescent Supply Current | 40 | μA | $V_{IN} = V_{CC}$ or Ground, $V_{CC} = 5.5 V, T_A = \text{Worst Case}$ |
| I_{CC} | Maximum Quiescent Supply Current | 4.0 | μA | $V_{IN} = V_{CC}$ or Ground, $V_{CC} = 5.5 V, T_A = 25^\circ C$ |
| I_{CCT} | Maximum Additional I_{CC} /Input ('ACT74) | 1.5 | mA | $V_{IN} = V_{CC} - 2.1 V, V_{CC} = 5.5 V, T_A = \text{Worst Case}$ |

AC CHARACTERISTICS (Figures and Waveforms — See Section 3)

| Symbol | Parameter | V_{CC}^* (V) | 74AC | | | 74AC | | Units | Fig. No. |
|-----------|--|----------------|----------------------------------|-------------|------------|--|--------------|-------|----------|
| | | | $T_A = +25^\circ C, C_L = 50 pF$ | | | $T_A = -40^\circ C \text{ to } +85^\circ C, C_L = 50 pF$ | | | |
| | | | Min | Typ | Max | Min | Max | | |
| f_{max} | Maximum Clock Frequency | 3.3 5.0 | 100 140 | 125 160 | | 95 125 | | MHz | 3-3 |
| t_{PLH} | Propagation Delay \bar{C}_{Dn} or \bar{S}_{Dn} to Q_n or \bar{Q}_n | 3.3 5.0 | 1.0 1.0 | 8.0 6.0 | 12 9.0 | 1.0 1.0 | 13 10 | ns | 3-6 |
| t_{PHL} | Propagation Delay \bar{C}_{Dn} or \bar{S}_{Dn} to Q_n or \bar{Q}_n | 3.3 5.0 | 1.0 1.0 | 10.5 8.0 | 12 9.5 | 1.0 1.0 | 13.5 10.5 | ns | 3-6 |
| t_{PLH} | Propagation Delay CP_n to Q_n or \bar{Q}_n | 3.3 5.0 | 1.0 1.0 | 8.0 6.0 | 13.5 10 | 1.0 1.0 | 16 10.5 | ns | 3-6 |
| t_{PHL} | Propagation Delay CP_n to Q_n or \bar{Q}_n | 3.3 5.0 | 1.0 1.0 | 8.0 6.0 | 14 10 | 1.0 1.0 | 14.5 10.5 | ns | 3-6 |

*Voltage Range 3.3 is $3.3 V \pm 0.3 V$
 Voltage Range 5.0 is $5.0 V \pm 0.5 V$



MC74AC74 • MC74ACT74

AC OPERATING REQUIREMENTS

| Symbol | Parameter | V _{CC} * (V) | 74AC | | 74ACT | | Units | Fig. No. |
|------------------|--|--------------------------|--|--------------------|--|----|-------|----------|
| | | | T _A = +25°C C _L = 50 pF | | T _A = -40°C to +85°C C _L = 50 pF | | | |
| | | | Typ | Guaranteed Minimum | | | | |
| t _s | Set-up Time, HIGH or LOW D _n to CP _n | 3.3 5.0 | 1.5 | 4.0 | 4.5 | ns | 3-9 | |
| | | | 1.0 | 3.0 | 3.0 | | | |
| t _h | Hold Time, HIGH or LOW D _n to CP _n | 3.3 5.0 | -2.0 -1.5 | 0 0 | 0 0 | ns | 3-9 | |
| | | | | | | | | |
| t _w | CP _n or C _{Dn} or S _{Dn} Pulse Width | 3.3 5.0 | 3.0 2.5 | 5.5 4.5 | 7.0 5.0 | ns | 3-6 | |
| | | | | | | | | |
| t _{rec} | Recovery Time C _{Dn} or S _{Dn} to CP | 3.3 5.0 | -2.5 -2.0 | 0 0 | 0 0 | ns | 3-9 | |
| | | | | | | | | |

*Voltage Range 3.3 is 3.3 V ± 0.3 V
Voltage Range 5.0 is 5.0 V ± 0.5 V

AC CHARACTERISTICS (Figures and Waveforms — See Section 3)

| Symbol | Parameter | V _{CC} * (V) | 74ACT | | | 74ACT | | Units | Fig. No. |
|------------------|--|--------------------------|--|-----|-----|--|------|-------|----------|
| | | | T _A = +25°C C _L = 50 pF | | | T _A = -40°C to +85°C C _L = 50 pF | | | |
| | | | Min | Typ | Max | Min | Max | | |
| f _{max} | Maximum Clock Frequency | 5.0 | 145 | 210 | | 125 | | MHz | 3-3 |
| t _{PLH} | Propagation Delay C _{Dn} or S _{Dn} to Q _n or Q̄ _n | 5.0 | 1.0 | 5.5 | 9.5 | 1.0 | 10.5 | ns | 3-6 |
| t _{PHL} | Propagation Delay C _{Dn} or S _{Dn} to Q _n or Q̄ _n | 5.0 | 1.0 | 6.0 | 10 | 1.0 | 11.5 | ns | 3-6 |
| t _{PLH} | Propagation Delay CP _n to Q _n or Q̄ _n | 5.0 | 1.0 | 7.5 | 11 | 1.0 | 13 | ns | 3-6 |
| t _{PHL} | Propagation Delay CP _n to Q _n or Q̄ _n | 5.0 | 1.0 | 6.0 | 10 | 1.0 | 11.5 | ns | 3-6 |

*Voltage Range 5.0 is 5.0 V ± 0.5 V

AC OPERATING REQUIREMENTS

| Symbol | Parameter | V _{CC} * (V) | 74ACT | | 74ACT | | Units | Fig. No. |
|------------------|--|--------------------------|--|--------------------|--|----|-------|----------|
| | | | T _A = +25°C C _L = 50 pF | | T _A = -40°C to +85°C C _L = 50 pF | | | |
| | | | Typ | Guaranteed Minimum | | | | |
| t _s | Set-up Time, HIGH or LOW D _n to CP _n | 5.0 | 1.0 | 3.0 | 3.5 | ns | 3-9 | |
| t _h | Hold Time, HIGH or LOW D _n to CP _n | 5.0 | -0.5 | 1.0 | 1.0 | ns | 3-9 | |
| t _w | CP _n or C _{Dn} or S _{Dn} Pulse Width | 5.0 | 3.0 | 5.0 | 6.0 | ns | 3-6 | |
| t _{rec} | Recovery Time C _{Dn} or S _{Dn} to CP | 5.0 | -2.5 | 0 | 0 | ns | 3-9 | |

*Voltage Range 5.0 is 5.0 V ± 0.5 V

CAPACITANCE

| Symbol | Parameter | Value Typ | Units | Test Conditions |
|-----------------|-------------------------------|--------------|-------|-------------------------|
| C _{IN} | Input Capacitance | 4.5 | pF | V _{CC} = 5.0 V |
| C _{PD} | Power Dissipation Capacitance | 35 | pF | V _{CC} = 5.0 V |

FACT DATA



MOTOROLA

MC74AC86

Product Preview

Quad 2-Input Exclusive-OR Gate

- Outputs Source/Sink 24 mA

QUAD 2-INPUT
EXCLUSIVE-OR GATE

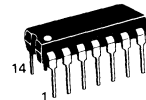
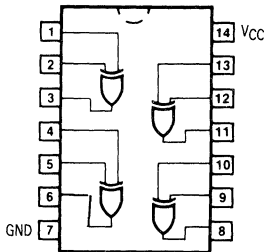

N SUFFIX
CASE 646-06
PLASTIC

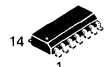

D SUFFIX
CASE 751A-02
PLASTIC

DC CHARACTERISTICS OVER OPERATING TEMPERATURE RANGE (unless otherwise specified)

| Symbol | Parameter | Value | Units | Test Conditions |
|----------|----------------------------------|-------|---------|---|
| I_{CC} | Maximum Quiescent Supply Current | 40 | μA | $V_{IN} = V_{CC}$ or Ground, $V_{CC} = 5.5 V, T_A = \text{Worst Case}$ |
| I_{CC} | Maximum Quiescent Supply Current | 4.0 | μA | $V_{IN} = V_{CC}$ or Ground, $V_{CC} = 5.5 V, T_A = 25^\circ C$ |

AC CHARACTERISTICS (For Figures and Waveforms — See Section 3)

| Symbol | Parameter | V_{CC}^* (V) | 74AC | | | 74AC | | Units | Fig. No. |
|-----------|--|-------------------|--------------------------------------|------------|-----|--|-----|-------|----------|
| | | | $T_A = +25^\circ C$ $C_L = 50 pF$ | | | $T_A = -40^\circ C$ to $+85^\circ C$ $C_L = 50 pF$ | | | |
| | | | Min | Typ | Max | Min | Max | | |
| t_{PLH} | Propagation Delay Inputs to Outputs | 3.3 5.0 | | 6.0 4.5 | | | ns | 3-5 | |
| t_{PHL} | Propagation Delay Inputs to Outputs | 3.3 5.0 | | 6.5 4.5 | | | ns | 3-5 | |

*Voltage Range 3.3 is $3.3 V \pm 0.3 V$
 Voltage Range 5.0 is $5.0 V \pm 0.5 V$

CAPACITANCE

| Symbol | Parameter | Value Typ | Units | Test Conditions |
|----------|-------------------------------|--------------|-------|------------------|
| C_{IN} | Input Capacitance | 4.5 | pF | $V_{CC} = 5.0 V$ |
| C_{PD} | Power Dissipation Capacitance | | pF | $V_{CC} = 5.0 V$ |

This document contains information on a product under development. Motorola reserves the right to change or discontinue this product without notice.



Product Preview

Dual JK Positive Edge-Triggered Flip-Flop

The MC74AC109/74ACT109 consists of two high-speed completely independent transition clocked JK flip-flops. The clocking operation is independent of rise and fall times of the clock waveform. The JK design allows operation as a D flip-flop (refer to MC74AC74/74ACT74 data sheet) by connecting the J and K inputs together.

Asynchronous Inputs:

- LOW input to \bar{S}_D (Set) sets Q to HIGH level
- LOW input to \bar{C}_D (Clear) sets Q to LOW level
- Clear and Set are independent of clock
- Simultaneous LOW on \bar{C}_D and \bar{S}_D makes both Q and \bar{Q} HIGH

- Outputs Source/Sink 24 mA
- 'ACT109 Has TTL Compatible Inputs

LOGIC SYMBOL

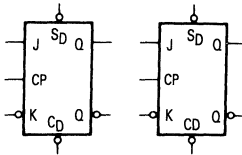

PIN NAMES

- J₁, J₂, K₁, K₂ Data Inputs
- CP₁, CP₂ Clock Pulse Inputs
- \bar{C}_D1 , \bar{C}_D2 Direct Clear Inputs
- \bar{S}_D1 , \bar{S}_D2 Direct Set Inputs
- Q₁, Q₂, \bar{Q}_1 , \bar{Q}_2 Outputs

TRUTH TABLE

| Inputs | | | | | Outputs | |
|-------------|-------------|--------------|---|-----------|----------------|-------------|
| \bar{S}_D | \bar{C}_D | CP | J | \bar{K} | Q | \bar{Q} |
| L | H | X | X | X | H | L |
| H | L | X | X | X | L | H |
| L | L | X | X | X | H | H |
| H | H | \downarrow | L | L | L | H |
| H | H | \downarrow | H | L | Toggle | |
| H | H | \downarrow | L | H | Q ₀ | \bar{Q}_0 |
| H | H | \downarrow | H | H | H | L |
| H | H | L | X | X | Q ₀ | \bar{Q}_0 |

- H = HIGH Voltage Level
- L = LOW Voltage Level
- \downarrow = LOW-to-HIGH Clock Transition
- X = Immaterial
- Q₀(\bar{Q}_0) = Previous Q₀(\bar{Q}_0) before LOW-to-HIGH Transition of Clock

MC74AC109
MC74ACT109

DUAL JK POSITIVE
EDGE-TRIGGERED
FLIP-FLOP

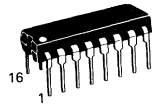

N SUFFIX
CASE 648-08
PLASTIC

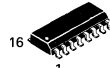

D SUFFIX
CASE 751B-03
PLASTIC

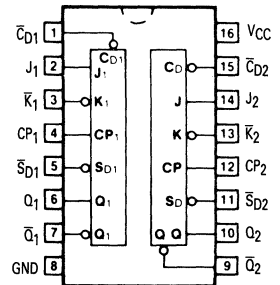

This document contains information on a product under development. Motorola reserves the right to change or discontinue this product without notice.

MC74AC109 • MC74ACT109

LOGIC DIAGRAM (one half shown)

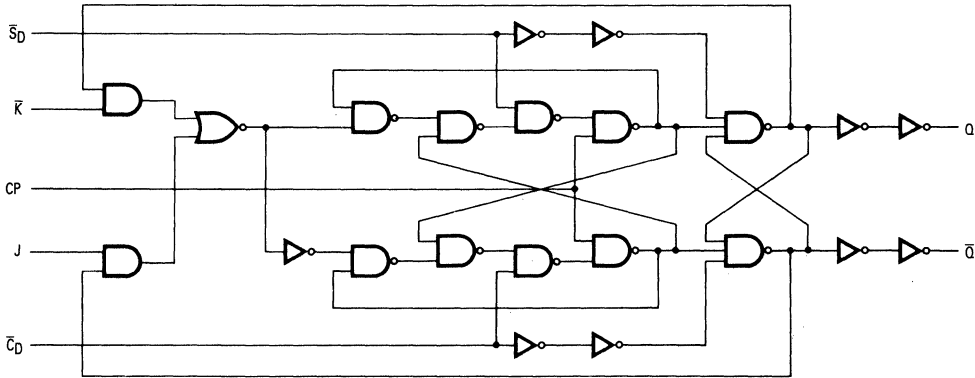

Please note that this diagram is provided only for the understanding of logic operations and should not be used to estimate propagation delays.

DC CHARACTERISTICS (unless otherwise specified)

| Symbol | Parameter | Value | Units | Test Conditions |
|-----------|--|-------|---------|---|
| I_{CC} | Maximum Quiescent Supply Current | 40 | μA | $V_{IN} = V_{CC}$ or Ground, $V_{CC} = 5.5 V$, $T_A = \text{Worst Case}$ |
| I_{CC} | Maximum Quiescent Supply Current | 4.0 | μA | $V_{IN} = V_{CC}$ or Ground, $V_{CC} = 5.5 V$, $T_A = 25^\circ C$ |
| I_{CCT} | Maximum Additional I_{CC} /Input ('ACT109) | 1.5 | mA | $V_{IN} = V_{CC} - 2.1 V$, $V_{CC} = 5.5 V$, $T_A = \text{Worst Case}$ |

AC CHARACTERISTICS (Figures and Waveforms — See Section 3)

| Symbol | Parameter | V_{CC}^* (V) | 74AC | | | 74AC | | Units | Fig. No. |
|-----------|---|-------------------|--------------------------------------|------------|------------|--|--------------|-------|----------|
| | | | $T_A = +25^\circ C$ $C_L = 50 pF$ | | | $T_A = -40^\circ C$ to $+85^\circ C$ $C_L = 50 pF$ | | | |
| | | | Min | Typ | Max | Min | Max | | |
| f_{max} | Maximum Clock Frequency | 3.3 5.0 | 125 150 | 150 175 | | 100 125 | | MHz | 3-3 |
| t_{PLH} | Propagation Delay CP_n to Q_n or \bar{Q}_n | 3.3 5.0 | 1.0 1.0 | 8.0 6.0 | 13.5 10 | 1.0 1.0 | 16 10.5 | ns | 3-6 |
| t_{PHL} | Propagation Delay CP_n to Q_n or \bar{Q}_n | 3.3 5.0 | 1.0 1.0 | 8.0 6.0 | 14 10 | 1.0 1.0 | 14.5 10.5 | ns | 3-6 |
| t_{PLH} | Propagation Delay \bar{C}_{Dn} or \bar{S}_{Dn} to Q_n or \bar{Q}_n | 3.3 5.0 | 1.0 1.0 | 8.0 6.0 | 12 9.0 | 1.0 1.0 | 13 10 | ns | 3-6 |
| t_{PHL} | Propagation Delay \bar{C}_{Dn} or \bar{S}_{Dn} to Q_n or \bar{Q}_n | 3.3 5.0 | 1.0 1.0 | 10 7.5 | 12 9.5 | 1.0 1.0 | 13.5 10.5 | ns | 3-6 |

*Voltage Range 3.3 is $3.3 V \pm 0.3 V$
Voltage Range 5.0 is $5.0 V \pm 0.5 V$

MC74AC109 • MC74ACT109

AC OPERATING REQUIREMENTS

| Symbol | Parameter | V _{CC} * (V) | 74AC | | 74ACT | | Units | Fig. No. |
|------------------|--|--------------------------|--|--------------------|--|----|-------|----------|
| | | | T _A = +25°C C _L = 50 pF | | T _A = -40°C to +85°C C _L = 50 pF | | | |
| | | | Typ | Guaranteed Minimum | | | | |
| t _s | Set-up Time, HIGH or LOW J _N or \bar{K}_N to CP _N | 3.3 | 3.5 | 6.5 | 7.5 | ns | 3-9 | |
| | | 5.0 | 2.0 | 4.5 | 5.0 | | | |
| t _h | Hold Time, HIGH or LOW J _N or \bar{K}_N to CP _N | 3.3 | -1.5 | 0 | 0 | ns | 3-9 | |
| | | 5.0 | -0.5 | 0.5 | 0.5 | | | |
| t _w | Pulse Width CP _N or \bar{C}_{DN} or \bar{S}_{DN} | 3.3 | 2.0 | 4.0 | 4.5 | ns | 3-6 | |
| | | 5.0 | 2.0 | 3.5 | 3.5 | | | |
| t _{rec} | Recovery Time \bar{C}_{DN} or \bar{S}_{DN} to CP | 3.3 | -2.5 | 0 | 0 | ns | 3-9 | |
| | | 5.0 | -1.5 | 0 | 0 | | | |

*Voltage Range 3.3 is 3.3 V ± 0.3 V
Voltage Range 5.0 is 5.0 V ± 0.5 V

AC CHARACTERISTICS (Figures and Waveforms — See Section 3)

| Symbol | Parameter | V _{CC} * (V) | 74ACT | | | 74ACT | | Units | Fig. No. |
|------------------|--|--------------------------|--|-----|-----|--|------|-------|----------|
| | | | T _A = +25°C C _L = 50 pF | | | T _A = -40°C to +85°C C _L = 50 pF | | | |
| | | | Min | Typ | Max | Min | Max | | |
| f _{max} | Maximum Clock Frequency | 5.0 | 145 | 210 | | 125 | | MHz | 3-3 |
| t _{PLH} | Propagation Delay CP _N to Q _N or \bar{Q}_N | 5.0 | 1.0 | 7.0 | 11 | 1.0 | 13 | ns | 3-6 |
| t _{PHL} | Propagation Delay CP _N to Q _N or \bar{Q}_N | 5.0 | 1.0 | 6.0 | 10 | 1.0 | 11.5 | ns | 3-6 |
| t _{PLH} | Propagation Delay \bar{C}_{DN} or \bar{S}_{DN} to Q _N or \bar{Q}_N | 5.0 | 1.0 | 5.5 | 9.5 | 1.0 | 10.5 | ns | 3-6 |
| t _{PHL} | Propagation Delay \bar{C}_{DN} or \bar{S}_{DN} to Q _N or \bar{Q}_N | 5.0 | 1.0 | 6.0 | 10 | 1.0 | 11.5 | ns | 3-6 |

*Voltage Range 5.0 is 5.0 V ± 0.5 V

AC OPERATING REQUIREMENTS

| Symbol | Parameter | V _{CC} * (V) | 74ACT | | 74ACT | | Units | Fig. No. |
|------------------|--|--------------------------|--|--------------------|--|----|-------|----------|
| | | | T _A = +25°C C _L = 50 pF | | T _A = -40°C to +85°C C _L = 50 pF | | | |
| | | | Typ | Guaranteed Minimum | | | | |
| t _s | Set-up Time, HIGH or LOW J _N or \bar{K}_N to CP _N | 5.0 | 0.5 | 2.0 | 2.5 | ns | 3-9 | |
| | | | | | | | | |
| t _h | Hold Time, HIGH or LOW J _N or \bar{K}_N to CP _N | 5.0 | 0 | 2.0 | 2.0 | ns | 3-9 | |
| | | | | | | | | |
| t _w | Pulse Width CP _N or \bar{C}_{DN} or \bar{S}_{DN} | 5.0 | 3.0 | 5.0 | 6.0 | ns | 3-6 | |
| | | | | | | | | |
| t _{rec} | Recovery Time \bar{C}_{DN} or \bar{S}_{DN} to CP | 5.0 | -2.5 | 0 | 0 | ns | 3-9 | |
| | | | | | | | | |

*Voltage Range 5.0 is 5.0 V ± 0.5 V

CAPACITANCE

| Symbol | Parameter | Value Typ | Units | Test Conditions |
|-----------------|-------------------------------|--------------|-------|-------------------------|
| C _{IN} | Input Capacitance | 4.5 | pF | V _{CC} = 5.0 V |
| CPD | Power Dissipation Capacitance | 35 | pF | V _{CC} = 5.0 V |

FACT DATA

5



MOTOROLA

Product Preview

1-of-8 Decoder/Demultiplexer

The MC74AC138/74ACT138 is a high-speed 1-of-8 decoder/demultiplexer. This device is ideally suited for high-speed bipolar memory chip select address decoding. The multiple input enables allow parallel expansion to a 1-of-24 decoder using just three MC74AC138/74ACT138 devices or a 1-of-32 decoder using four MC74AC138/74ACT138 devices and one inverter.

- Demultiplexing Capability
- Multiple Input Enable for Easy Expansion
- Active LOW Mutually Exclusive Outputs
- Outputs Source/Sink 24 mA
- 'ACT138 Has TTL Compatible Inputs

LOGIC SYMBOL

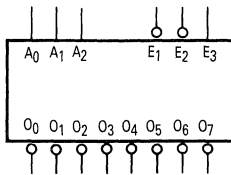

PIN NAMES

A_0 – A_2 Address Inputs
 \bar{E}_1 – \bar{E}_2 Enable Inputs
 E_3 Enable Input
 \bar{O}_0 – \bar{O}_7 Outputs

MC74AC138
MC74ACT138

1-OF-8 DECODER/
DEMULTIPLEXER

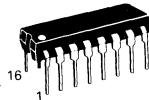

N SUFFIX
CASE 648-08
PLASTIC

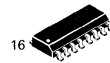

D SUFFIX
CASE 751B-03
PLASTIC

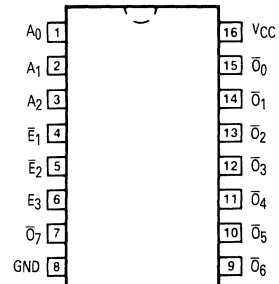

MC74AC138 • MC74ACT138

FUNCTIONAL DESCRIPTION

The MC74AC138/74ACT138 high-speed 1-of-8 decoder/demultiplexer accepts three binary weighted inputs (A_0 , A_1 , A_2) and, when enabled, provides eight mutually exclusive active-LOW outputs (\bar{O}_0 – \bar{O}_7). The MC74AC138/74ACT138 features three Enable inputs, two active-LOW (\bar{E}_1 , \bar{E}_2) and one active-HIGH (E_3). All outputs will be HIGH unless \bar{E}_1 and \bar{E}_2 are LOW and E_3 is HIGH. This multiple enabled function allows easy parallel expansion of the

device to a 1-of-32 (5 lines to 32 lines) decoder with just four MC74AC138/74ACT138 devices and one inverter (See Figure a). The MC74AC138/74ACT138 can be used as an 8-output demultiplexer by using one of the active LOW Enable inputs as the data input and the other Enable inputs as strobes. The Enable inputs which are not used must be permanently tied to their appropriate active-HIGH or active-LOW state.

TRUTH TABLE

| Inputs | | | | | | Outputs | | | | | | | |
|-------------|-------------|-------|-------|-------|-------|-------------|-------------|-------------|-------------|-------------|-------------|-------------|-------------|
| \bar{E}_1 | \bar{E}_2 | E_3 | A_0 | A_1 | A_2 | \bar{O}_0 | \bar{O}_1 | \bar{O}_2 | \bar{O}_3 | \bar{O}_4 | \bar{O}_5 | \bar{O}_6 | \bar{O}_7 |
| H | X | X | X | X | X | H | H | H | H | H | H | H | H |
| X | H | X | X | X | X | H | H | H | H | H | H | H | H |
| X | X | L | X | X | X | H | H | H | H | H | H | H | H |
| L | L | H | L | L | L | L | H | H | H | H | H | H | H |
| L | L | H | H | L | L | H | L | H | H | H | H | H | H |
| L | L | H | L | H | L | H | H | L | H | H | H | H | H |
| L | L | H | H | H | L | H | H | H | L | H | H | H | H |
| L | L | H | L | L | H | H | H | H | H | L | H | H | H |
| L | L | H | H | L | H | H | H | H | H | H | L | H | H |
| L | L | H | L | H | H | H | H | H | H | H | H | L | H |
| L | L | H | H | H | H | H | H | H | H | H | H | H | L |

H = HIGH Voltage Level
L = LOW Voltage Level
X = Immaterial

LOGIC DIAGRAM

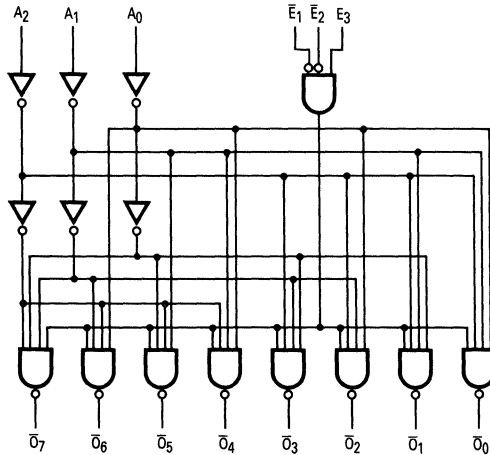

Please note that this diagram is provided only for the understanding of logic operations and should not be used to estimate propagation delays.

5

MC74AC138 • MC74ACT138

Figure a: Expansion to 1-of-32 Decoding

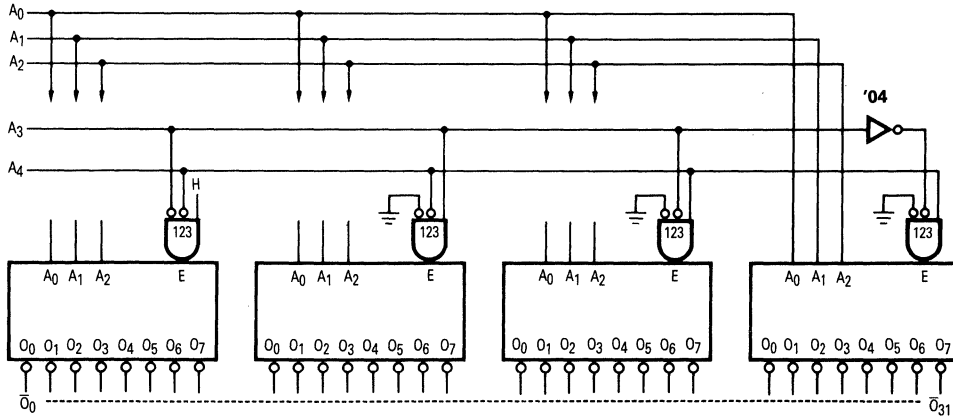

DC CHARACTERISTICS (unless otherwise specified)

| Symbol | Parameter | Value | Units | Test Conditions |
|-----------|--|-------|---------|---|
| I_{CC} | Maximum Quiescent Supply Current | 80 | μA | $V_{IN} = V_{CC}$ or Ground, $V_{CC} = 5.5 V, T_A = \text{Worst Case}$ |
| I_{CC} | Maximum Quiescent Supply Current | 8.0 | μA | $V_{IN} = V_{CC}$ or Ground, $V_{CC} = 5.5 V, T_A = 25^\circ C$ |
| I_{CCT} | Maximum Additional I_{CC}/Input ('ACT138) | 1.5 | mA | $V_{IN} = V_{CC} - 2.1 V$ $V_{CC} = 5.5 V, T_A = \text{Worst Case}$ |

MC74AC138 \rightarrow **MC74ACT138**

AC CHARACTERISTICS (Figures and Waveforms — See Section 3)

| Symbol | Parameter | V _{CC} * (V) | 74AC | | | 74AC | | Units | Fig. No. |
|------------------|--|-----------------------|--|------------|-------------|--|--------------|-------|----------|
| | | | T _A = +25°C C _L = 50 pF | | | T _A = -40°C to +85°C C _L = 50 pF | | | |
| | | | Min | Typ | Max | Min | Max | | |
| t _{PLH} | Propagation Delay A _n to \bar{O}_n | 3.3 5.0 | 1.0 1.0 | 8.5 6.5 | 13 9.5 | 1.0 1.0 | 15 10.5 | ns | 3-6 |
| t _{PHL} | Propagation Delay A _n to \bar{O}_n | 3.3 5.0 | 1.0 1.0 | 8.0 6.0 | 12.5 9.0 | 1.0 1.0 | 14 10.5 | ns | 3-6 |
| t _{PLH} | Propagation Delay \bar{E}_1 or \bar{E}_2 to \bar{O}_n | 3.3 5.0 | 1.0 1.0 | 11 8.0 | 15 11 | 1.0 1.0 | 16 12 | ns | 3-6 |
| t _{PHL} | Propagation Delay \bar{E}_1 or \bar{E}_2 to \bar{O}_n | 3.3 5.0 | 1.0 1.0 | 9.5 7.0 | 13.5 9.5 | 1.0 1.0 | 15 10.5 | ns | 3-6 |
| t _{PLH} | Propagation Delay E ₃ to \bar{O}_n | 3.3 5.0 | 1.0 1.0 | 11 8.0 | 15.5 11 | 1.0 1.0 | 16.5 12.5 | ns | 3-6 |
| t _{PHL} | Propagation Delay E ₃ to \bar{O}_n | 3.3 5.0 | 1.0 1.0 | 8.5 6.0 | 13 8.0 | 1.0 1.0 | 14 9.5 | ns | 3-6 |

*Voltage Range 3.3 is 3.3 V \pm 0.3 V
 *Voltage Range 5.0 is 5.0 V \pm 0.5 V

AC CHARACTERISTICS (Figures and Waveforms — See Section 3)

| Symbol | Parameter | V _{CC} * (V) | 74ACT | | | 74ACT | | Units | Fig. No. |
|------------------|--|-----------------------|--|-----|------|--|------|-------|----------|
| | | | T _A = +25°C C _L = 50 pF | | | T _A = -40°C to +85°C C _L = 50 pF | | | |
| | | | Min | Typ | Max | Min | Max | | |
| t _{PLH} | Propagation Delay A _n to \bar{O}_n | 5.0 | 1.0 | 7.0 | 10.5 | 1.0 | 11.5 | ns | 3-6 |
| t _{PHL} | Propagation Delay A _n to \bar{O}_n | 5.0 | 1.0 | 6.5 | 10.5 | 1.0 | 11.5 | ns | 3-6 |
| t _{PLH} | Propagation Delay \bar{E}_1 or \bar{E}_2 to \bar{O}_n | 5.0 | 1.0 | 8.0 | 11.5 | 1.0 | 12.5 | ns | 3-6 |
| t _{PHL} | Propagation Delay \bar{E}_1 or \bar{E}_2 to \bar{O}_n | 5.0 | 1.0 | 7.5 | 11.5 | 1.0 | 12.5 | ns | 3-6 |
| t _{PLH} | Propagation Delay E ₃ to \bar{O}_n | 5.0 | 1.0 | 8.0 | 12 | 1.0 | 13 | ns | 3-6 |
| t _{PHL} | Propagation Delay E ₃ to \bar{O}_n | 5.0 | 1.0 | 6.5 | 10.5 | 1.0 | 11.5 | ns | 3-6 |

*Voltage Range 5.0 is 5.0 V \pm 0.5 V

CAPACITANCE

| Symbol | Parameter | Value Typ | Units | Test Conditions |
|-----------------|-------------------------------|--------------|-------|-------------------------|
| C _{IN} | Input Capacitance | 4.5 | pF | V _{CC} = 5.0 V |
| C _{PD} | Power Dissipation Capacitance | 60 | pF | V _{CC} = 5.0 V |

5



MOTOROLA

Product Preview

Dual 1-of-4 Decoder/Demultiplexer

The MC74AC139/74ACT139 is a high-speed, dual 1-of-4 decoder/demultiplexer. The device has two independent decoders, each accepting two inputs and providing four mutually-exclusive active-LOW outputs. Each decoder has an active-LOW Enable input which can be used as a data input for a 4-output demultiplexer. Each half of the MC74AC139/74ACT139 can be used as a function generator providing all four minterms of two variables.

- Multifunction Capability
- Two Completely Independent 1-of-4 Decoders
- Active LOW Mutually Exclusive Outputs
- Outputs Source/Sink 24 mA
- 'ACT139 Has TTL Compatible Inputs

LOGIC SYMBOL

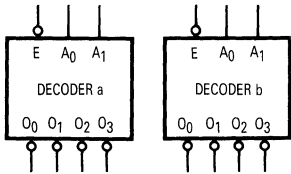

PIN NAMES

- A₀, A₁ Address Inputs
- \bar{E} Enable Inputs
- \bar{O}_0 - \bar{O}_3 Outputs

TRUTH TABLE

| Inputs | | | Outputs | | | |
|-----------|----------------|----------------|-------------|-------------|-------------|-------------|
| \bar{E} | A ₀ | A ₁ | \bar{O}_0 | \bar{O}_1 | \bar{O}_2 | \bar{O}_3 |
| H | X | X | H | H | H | H |
| L | L | L | L | H | H | H |
| L | H | L | H | L | H | H |
| L | L | H | H | H | L | H |
| L | H | H | H | H | H | L |

H = HIGH Voltage Level
 L = LOW Voltage Level
 X = Immaterial

**MC74AC139
 MC74ACT139**

**DUAL 1-OF-4
 DECODER/DEMULTIPLER**

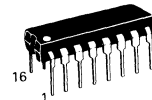

**N SUFFIX
 CASE 648-08
 PLASTIC**

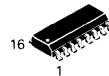

**D SUFFIX
 CASE 751B-03
 PLASTIC**

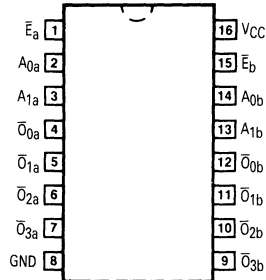

LOGIC DIAGRAM

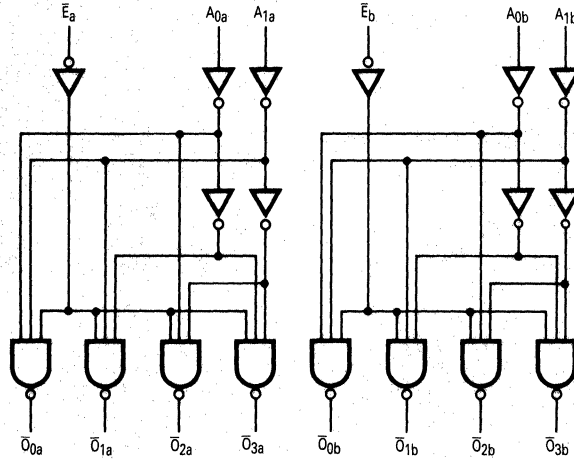

Please note that this diagram is provided only for the understanding of logic operations and should not be used to estimate propagation delays.

FUNCTIONAL DESCRIPTION

The MC74AC139/74ACT139 is a high-speed dual 1-of-4 decoder/demultiplexer. The device has two independent decoders, each of which accepts two binary weighted inputs (A_0 – A_1) and provides four mutually exclusive active-LOW outputs (\bar{O}_0 – \bar{O}_3). Each decoder has an active-LOW enable (\bar{E}). When \bar{E} is HIGH all outputs are forced HIGH. The enable can be used as the data input for a 4-output demultiplexer application. Each half of the MC74AC139/74ACT139 generates all four minterms of two variables. These four minterms are useful in some applications, replacing multiple gate functions as shown in Figure a, and thereby reducing the number of packages required in a logic network.

Figure a: Gate Functions (each half)

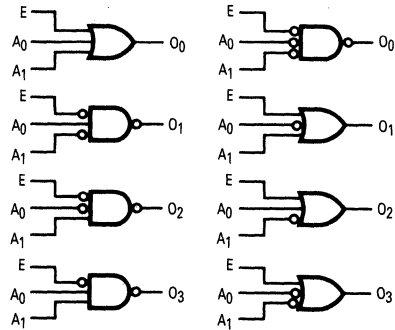

MC74AC139 • MC74ACT139

DC CHARACTERISTICS (unless otherwise specified)

| Symbol | Parameter | Value | Units | Test Conditions |
|-----------------|----------------------------------|-------|-------|---|
| I _{CC} | Maximum Quiescent Supply Current | 80 | μA | V _{IN} = V _{CC} or Ground, V _{CC} = 5.5 V, T _A = Worst Case |
| I _{CC} | Maximum Quiescent Supply Current | 8.0 | μA | V _{IN} = V _{CC} or Ground, V _{CC} = 5.5 V, T _A = 25°C |

AC CHARACTERISTICS (Figures and Waveforms — See Section 3)

| Symbol | Parameter | V _{CC} * (V) | 74AC | | | 74AC | | Units | Fig. No. |
|------------------|--|-----------------------|--|------------|-------------|--|-----------|-------|----------|
| | | | T _A = +25°C C _L = 50 pF | | | T _A = -40°C to +85°C C _L = 50 pF | | | |
| | | | Min | Typ | Max | Min | Max | | |
| t _{PLH} | Propagation Delay A _n to \bar{O}_n | 3.3 5.0 | 1.0 1.0 | 8.0 6.5 | 11.5 8.5 | 1.0 1.0 | 13 9.5 | ns | 3-6 |
| t _{PHL} | Propagation Delay A _n to \bar{O}_n | 3.3 5.0 | 1.0 1.0 | 7.0 5.5 | 10 7.5 | 1.0 1.0 | 11 8.5 | ns | 3-6 |
| t _{PLH} | Propagation Delay \bar{E}_n to \bar{O}_n | 3.3 5.0 | 1.0 1.0 | 9.5 7.0 | 12 8.5 | 1.0 1.0 | 13 10 | ns | 3-6 |
| t _{PHL} | Propagation Delay \bar{E}_n to \bar{O}_n | 3.3 5.0 | 1.0 1.0 | 8.0 6.0 | 10 7.5 | 1.0 1.0 | 11 8.5 | ns | 3-6 |

*Voltage Range 3.3 is 3.3 V ± 0.3 V
Voltage Range 5.0 is 5.0 V ± 0.5 V

AC CHARACTERISTICS (Figures and Waveforms — See Section 3)

| Symbol | Parameter | V _{CC} * (V) | 74ACT | | | 74ACT | | Units | Fig. No. |
|------------------|--|-----------------------|--|-----|-----|--|------|-------|----------|
| | | | T _A = +25°C C _L = 50 pF | | | T _A = -40°C to +85°C C _L = 50 pF | | | |
| | | | Min | Typ | Max | Min | Max | | |
| t _{PLH} | Propagation Delay A _n to \bar{O}_n | 5.0 | 1.0 | 6.0 | 8.5 | 1.0 | 9.5 | ns | 3-6 |
| t _{PHL} | Propagation Delay A _n to \bar{O}_n | 5.0 | 1.0 | 6.0 | 9.5 | 1.0 | 10.5 | ns | 3-6 |
| t _{PLH} | Propagation Delay \bar{E}_n to \bar{O}_n | 5.0 | 1.0 | 7.0 | 10 | 1.0 | 11 | ns | 3-6 |
| t _{PHL} | Propagation Delay \bar{E}_n to \bar{O}_n | 5.0 | 1.0 | 7.0 | 9.5 | 1.0 | 10.5 | ns | 3-6 |

*Voltage Range 5.0 is 5.0 V ± 0.5 V

CAPACITANCE

| Symbol | Parameter | Value Typ | Units | Test Conditions |
|-----------------|-------------------------------|--------------|-------|-------------------------|
| C _{IN} | Input Capacitance | 4.5 | pF | V _{CC} = 5.0 V |
| C _{PD} | Power Dissipation Capacitance | 40 | pF | V _{CC} = 5.0 V |

5



MOTOROLA

Product Preview

1-of-8 Decoder/Demultiplexer

The MC74AC151/74ACT151 is a high-speed 8-input digital multiplexer. It provides, in one package, the ability to select one line of data from up to eight sources. The MC74AC151/74ACT151 can be used as a universal function generator to generate any logic function of four variables. Both true and complementary outputs are provided.

- Outputs Source/Sink 24 mA
- 'ACT151 Has TTL Compatible Inputs

LOGIC SYMBOL

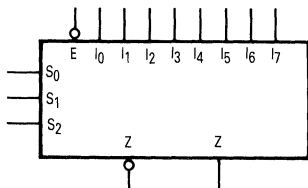

PIN NAMES

- I_0 - I_7 Data Inputs
- S_0 - S_2 Select Inputs
- E Enable Input
- Z Data Output
- \bar{Z} Inverted Data Output

TRUTH TABLE

| Inputs | | | | Outputs | |
|-----------|-------|-------|-------|---------|-----------|
| \bar{E} | S_2 | S_1 | S_0 | Z | \bar{Z} |
| H | X | X | X | H | L |
| L | L | L | L | I_0 | I_0 |
| L | L | L | H | I_1 | I_1 |
| L | L | H | L | I_2 | I_2 |
| L | L | H | H | I_3 | I_3 |
| L | H | L | L | I_4 | I_4 |
| L | H | L | H | I_5 | I_5 |
| L | H | H | L | I_6 | I_6 |
| L | H | H | H | I_7 | I_7 |

H = HIGH Voltage Level
 L = LOW Voltage Level
 X = Immaterial

MC74AC151
MC74ACT151

1-OF-8
DECODER/DEMULTIPLXER

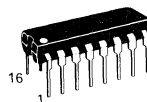

N SUFFIX
CASE 648-08
PLASTIC

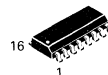

D SUFFIX
CASE 751B-03
PLASTIC

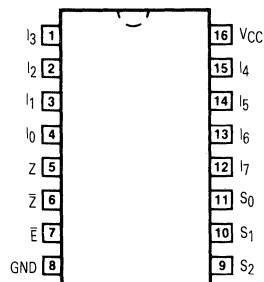

MC74AC151 • MC74ACT151

FUNCTIONAL DESCRIPTION

The MC74AC151/74ACT151 is a logic implementation of a single pole, 8-position switch with the switch position controlled by the state of three Select inputs, S_0 , S_1 , S_2 . Both true and complementary outputs are provided. The Enable input (\bar{E}) is active LOW. When it is not activated, the complementary output is HIGH and the true output is LOW regardless of all other inputs. The logic function provided at the output is:

$$Z = \bar{E} \cdot (I_0 \cdot \bar{S}_0 \cdot \bar{S}_1 \cdot \bar{S}_2 + I_1 \cdot S_0 \cdot \bar{S}_1 \cdot \bar{S}_2 + I_2 \cdot \bar{S}_0 \cdot S_1 \cdot \bar{S}_2 + I_3 \cdot S_0 \cdot S_1 \cdot \bar{S}_2 + I_4 \cdot \bar{S}_0 \cdot \bar{S}_1 \cdot S_2 + I_5 \cdot S_0 \cdot \bar{S}_1 \cdot S_2 + I_6 \cdot \bar{S}_0 \cdot S_1 \cdot S_2 + I_7 \cdot S_0 \cdot S_1 \cdot S_2)$$

The MC74AC151/74ACT151 provides the ability, in one package, to select from eight sources of data or control information. By proper manipulation of the inputs, the MC74AC151/74ACT151 can provide any logic function of four variables and its complement.

LOGIC DIAGRAM

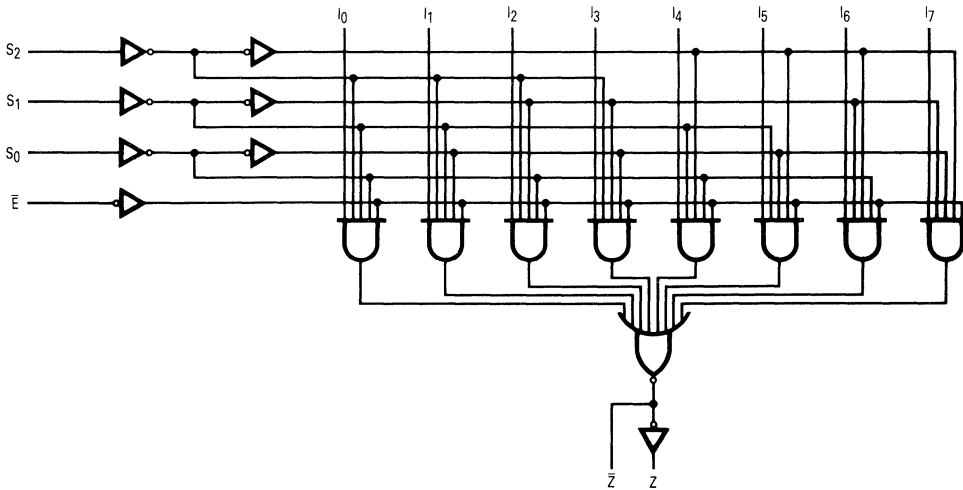

Please note that this diagram is provided only for the understanding of logic operations and should not be used to estimate propagation delays.

MC74AC151 • MC74ACT151

DC CHARACTERISTICS (unless otherwise specified)

| Symbol | Parameter | Value | Units | Test Conditions |
|-------------------|---|-------|-------|---|
| I _{CC} | Maximum Quiescent Supply Current | 80 | μA | V _{IN} = V _{CC} or Ground, V _{CC} = 5.5 V, T _A = Worst Case |
| I _{CC} | Maximum Quiescent Supply Current | 8.0 | μA | V _{IN} = V _{CC} or Ground, V _{CC} = 5.5 V, T _A = 25°C |
| I _{CC} T | Maximum Additional I _{CC} /Input ('ACT151) | 1.5 | mA | V _{IN} = V _{CC} - 2.1 V, V _{CC} = 5.5 V, T _A = Worst Case |

AC CHARACTERISTICS (Figures and Waveforms — See Section 3)

| Symbol | Parameter | V _{CC} * (V) | 74AC | | | 74AC | | Units | Fig. No. |
|------------------|---|-----------------------|--|-------------|------------|--|------------|-------|----------|
| | | | T _A = +25°C C _L = 50 pF | | | T _A = -40°C to +85°C C _L = 50 pF | | | |
| | | | Min | Typ | Max | Min | Max | | |
| t _{PLH} | Propagation Delay S _n to Z or \bar{Z} | 3.3 5.0 | 1.0 1.0 | 11.5 8.5 | 18 13 | 1.0 1.0 | 20 15 | ns | 3-6 |
| t _{PHL} | Propagation Delay S _n to Z or \bar{Z} | 3.3 5.0 | 1.0 1.0 | 12 8.5 | 18 13 | 1.0 1.0 | 20 15 | ns | 3-6 |
| t _{PLH} | Propagation Delay \bar{E} to Z or \bar{Z} | 3.3 5.0 | 1.0 1.0 | 8.0 6.0 | 13 10 | 1.0 1.0 | 14 11 | ns | 3-6 |
| t _{PHL} | Propagation Delay \bar{E} to Z or \bar{Z} | 3.3 5.0 | 1.0 1.0 | 8.5 6.5 | 13 10 | 1.0 1.0 | 14 11 | ns | 3-6 |
| t _{PLH} | Propagation Delay I _n to Z or \bar{Z} | 3.3 5.0 | 1.0 1.0 | 9.5 7.0 | 14 10.5 | 1.0 1.0 | 15.5 11 | ns | 3-5 |
| t _{PHL} | Propagation Delay I _n to Z or \bar{Z} | 3.3 5.0 | 1.0 1.0 | 9.5 7.0 | 15 11 | 1.0 1.0 | 16 12 | ns | 3-5 |

*Voltage Range 3.3 is 3.3 V ± 0.3 V
Voltage Range 5.0 is 5.0 V ± 0.5 V

MC74AC151 • MC74ACT151

AC CHARACTERISTICS (Figures and Waveforms — See Section 3)

| Symbol | Parameter | V _{CC} * (V) | 74ACT | | | 74ACT | | Units | Fig. No. |
|------------------|---|--------------------------|--|------|------|--|------|-------|----------|
| | | | T _A = +25°C C _L = 50 pF | | | T _A = -40°C to +85°C C _L = 50 pF | | | |
| | | | Min | Typ | Max | Min | Max | | |
| t _{PLH} | Propagation Delay S _n to Z | 5.0 | 1.0 | 12.5 | 15.5 | 1.0 | 17 | ns | 3-6 |
| t _{PHL} | Propagation Delay S _n to Z | 5.0 | 1.0 | 12.5 | 15.5 | 1.0 | 16.5 | ns | 3-6 |
| t _{PLH} | Propagation Delay S _n to Z̄ | 5.0 | 1.0 | 12.5 | 15 | 1.0 | 16.5 | ns | 3-6 |
| t _{PHL} | Propagation Delay S _n to Z̄ | 5.0 | 1.0 | 12.5 | 16.5 | 1.0 | 18.5 | ns | 3-6 |
| t _{PLH} | Propagation Delay Ē to Z | 5.0 | 1.0 | 10 | 9.5 | 1.0 | 10 | ns | 3-6 |
| t _{PHL} | Propagation Delay Ē to Z | 5.0 | 1.0 | 10.5 | 9.0 | 1.0 | 10 | ns | 3-6 |
| t _{PLH} | Propagation Delay Ē to Z̄ | 5.0 | 1.0 | 10 | 8.5 | 1.0 | 9.5 | ns | 3-6 |
| t _{PHL} | Propagation Delay Ē to Z̄ | 5.0 | 1.0 | 10.5 | 10 | 1.0 | 10.5 | ns | 3-6 |
| t _{PLH} | Propagation Delay I _n to Z | 5.0 | 1.0 | 11 | 11.5 | 1.0 | 12.5 | ns | 3-6 |
| t _{PHL} | Propagation Delay I _n to Z | 5.0 | 1.0 | 11 | 12 | 1.0 | 13.5 | ns | 3-6 |
| t _{PLH} | Propagation Delay I _n to Z̄ | 5.0 | 1.0 | 11 | 12 | 1.0 | 13 | ns | 3-6 |
| t _{PHL} | Propagation Delay I _n to Z̄ | 5.0 | 1.0 | 11 | 12.5 | 1.0 | 14 | ns | 3-6 |

*Voltage Range 5.0 is 5.0 V ± 0.5 V

CAPACITANCE

| Symbol | Parameter | Value Typ | Units | Test Conditions |
|-----------------|-------------------------------|--------------|-------|-------------------------|
| C _{IN} | Input Capacitance | 4.5 | pF | V _{CC} = 5.0 V |
| C _{PD} | Power Dissipation Capacitance | 70 | pF | V _{CC} = 5.0 V |

5



MOTOROLA

Product Preview

Dual 4-Input Multiplexer

The MC74AC153/74ACT153 is a high-speed dual 4-input multiplexer with common select inputs and individual enable inputs for each section. It can select two lines of data from four sources. The two buffered outputs present data in the true (non-inverted) form. In addition to multiplexer operation, the MC74AC153/74ACT153 can act as a function generator and generate any two functions of three variables.

- Outputs Source/Sink 24 mA
- 'ACT153 Has TTL Compatible Inputs

LOGIC SYMBOL

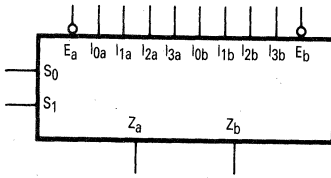

PIN NAMES

- I_{0a}-I_{3a} Side A Data Inputs
- I_{0b}-I_{3b} Side B Data Inputs
- S₀, S₁ Common Select Inputs
- E_a Side A Enable Input
- E_b Side B Enable Input
- Z_a Side A Output
- Z_b Side B Output

TRUTH TABLE

| Select Inputs | | Inputs (a or b) | | | | | Output |
|----------------|----------------|-----------------|----------------|----------------|----------------|----------------|--------|
| S ₀ | S ₁ | Ē | I ₀ | I ₁ | I ₂ | I ₃ | Z |
| X | X | H | X | X | X | X | L |
| L | L | L | L | X | X | X | L |
| L | L | L | H | X | X | X | H |
| H | L | L | X | L | X | X | L |
| H | L | L | X | H | X | X | H |
| L | H | L | X | X | L | X | L |
| L | H | L | X | X | H | X | H |
| H | H | L | X | X | X | L | L |
| H | H | L | X | X | X | H | H |

H = HIGH Voltage Level
 L = LOW Voltage Level
 X = Immaterial

MC74AC153
MC74ACT153

DUAL 4-INPUT
MULTIPLEXER

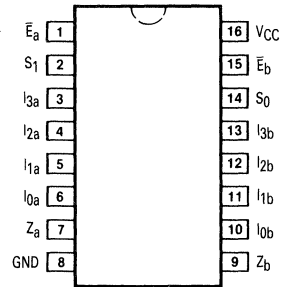
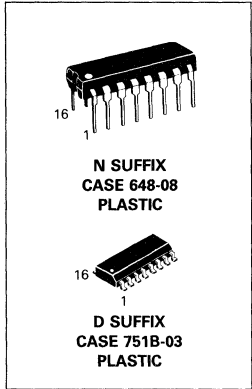

5

This document contains information on a product under development. Motorola reserves the right to change or discontinue this product without notice.

FUNCTIONAL DESCRIPTION

The MC74AC153/74ACT153 is a dual 4-input multiplexer. It can select two bits of data from up to four sources under the control of the common Select inputs (S_0, S_1). The two 4-input multiplexer circuits have individual active-LOW Enables (\bar{E}_a, \bar{E}_b) which can be used to strobe the outputs independently. When the Enables (\bar{E}_a, \bar{E}_b) are HIGH, the corresponding outputs (Z_a, Z_b) are forced LOW. The MC74AC153/74ACT153 is the logic

implementation of a 2-pole, 4-position switch, where the position of the switch is determined by the logic levels supplied to the two Select inputs. The logic equations for the outputs are shown below.

$$Z_a = \bar{E}_a \cdot (I_{0a} \cdot \bar{S}_1 \cdot \bar{S}_0 + I_{1a} \cdot \bar{S}_1 \cdot S_0 + I_{2a} \cdot S_1 \cdot \bar{S}_0 + I_{3a} \cdot S_1 \cdot S_0)$$

$$Z_b = \bar{E}_b \cdot (I_{0b} \cdot \bar{S}_1 \cdot \bar{S}_0 + I_{1b} \cdot \bar{S}_1 \cdot S_0 + I_{2b} \cdot S_1 \cdot \bar{S}_0 + I_{3b} \cdot S_1 \cdot S_0)$$

LOGIC DIAGRAM

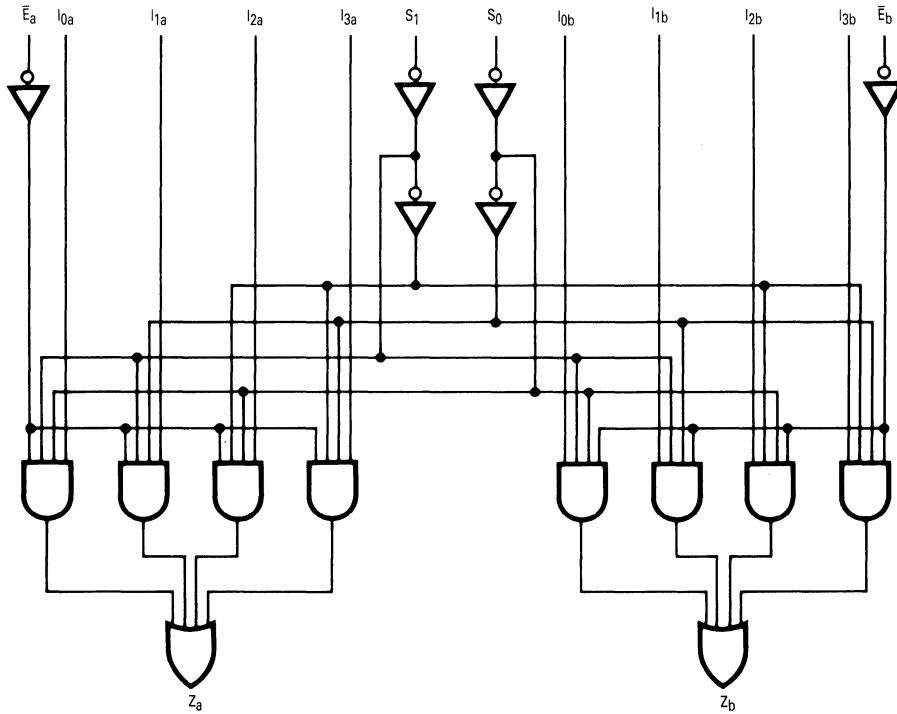

Please note that this diagram is provided only for the understanding of logic operations and should not be used to estimate propagation delays.

MC74AC153 • MC74ACT153

DC CHARACTERISTICS (unless otherwise specified)

| Symbol | Parameter | Value | Units | Test Conditions |
|----------|----------------------------------|-------|---------|---|
| I_{CC} | Maximum Quiescent Supply Current | 80 | μA | $V_{IN} = V_{CC}$ or Ground, $V_{CC} = 5.5 V, T_A = \text{Worst Case}$ |
| I_{CC} | Maximum Quiescent Supply Current | 8.0 | μA | $V_{IN} = V_{CC}$ or Ground, $V_{CC} = 5.5 V, T_A = 25^\circ C$ |

AC CHARACTERISTICS (Figures and Waveforms — See Section 3)

| Symbol | Parameter | V_{CC}^* (V) | 74AC | | | 74AC | | Units | Fig. No. |
|-----------|---|-------------------|--------------------------------------|------------|-------------|--|--------------|-------|----------|
| | | | $T_A = +25^\circ C$ $C_L = 50 pF$ | | | $T_A = -40^\circ C$ to $+85^\circ C$ $C_L = 50 pF$ | | | |
| | | | Min | Typ | Max | Min | Max | | |
| t_{PLH} | Propagation Delay S_n to Z_n | 3.3 5.0 | 1.0 1.0 | 9.5 6.5 | 15 11 | 1.0 1.0 | 17.5 12.5 | ns | 3-6 |
| t_{PHL} | Propagation Delay S_n to Z_n | 3.3 5.0 | 1.0 1.0 | 8.5 6.5 | 14.5 11 | 1.0 1.0 | 16.5 12 | ns | 3-6 |
| t_{PLH} | Propagation Delay \bar{E}_n to Z_n | 3.3 5.0 | 1.0 1.0 | 8.0 5.5 | 13.5 9.5 | 1.0 1.0 | 16 11 | ns | 3-6 |
| t_{PHL} | Propagation Delay \bar{E}_n to Z_n | 3.3 5.0 | 1.0 1.0 | 7.0 5.0 | 11 8.0 | 1.0 1.0 | 12.5 9.0 | ns | 3-6 |
| t_{PLH} | Propagation Delay I_n to Z_n | 3.3 5.0 | 1.0 1.0 | 7.5 5.5 | 12.5 9.0 | 1.0 1.0 | 14.5 10.5 | ns | 3-5 |
| t_{PHL} | Propagation Delay I_n to Z_n | 3.3 5.0 | 1.0 1.0 | 7.0 5.0 | 11.5 8.5 | 1.0 1.0 | 13 10 | ns | 3-5 |

*Voltage Range 3.3 is $3.3 V \pm 0.3 V$

Voltage Range 5.0 is $5.0 V \pm 0.5 V$

AC CHARACTERISTICS (Figures and Waveforms — See Section 3)

| Symbol | Parameter | V_{CC}^* (V) | 74ACT | | | 74ACT | | Units | Fig. No. |
|-----------|---|-------------------|--------------------------------------|-----|------|--|------|-------|----------|
| | | | $T_A = +25^\circ C$ $C_L = 50 pF$ | | | $T_A = -40^\circ C$ to $+85^\circ C$ $C_L = 50 pF$ | | | |
| | | | Min | Typ | Max | Min | Max | | |
| t_{PLH} | Propagation Delay S_n to Z_n | 5.0 | 1.0 | 7.0 | 11.5 | 1.0 | 13.5 | ns | 3-6 |
| t_{PHL} | Propagation Delay S_n to Z_n | 5.0 | 1.0 | 7.0 | 11.5 | 1.0 | 13.5 | ns | 3-6 |
| t_{PLH} | Propagation Delay \bar{E}_n to Z_n | 5.0 | 1.0 | 6.5 | 10.5 | 1.0 | 12.5 | ns | 3-6 |
| t_{PHL} | Propagation Delay \bar{E}_n to Z_n | 5.0 | 1.0 | 6.0 | 9.5 | 1.0 | 11 | ns | 3-6 |
| t_{PLH} | Propagation Delay I_n to Z_n | 5.0 | 1.0 | 5.5 | 9.5 | 1.0 | 11 | ns | 3-5 |
| t_{PHL} | Propagation Delay I_n to Z_n | 5.0 | 1.0 | 5.5 | 9.5 | 1.0 | 11 | ns | 3-5 |

*Voltage Range 5.0 is $5.0 V \pm 0.5 V$

CAPACITANCE

| Symbol | Parameter | Value Typ | Units | Test Conditions |
|----------|-------------------------------|--------------|-------|------------------|
| C_{IN} | Input Capacitance | 4.5 | pF | $V_{CC} = 5.0 V$ |
| C_{PD} | Power Dissipation Capacitance | 65 | pF | $V_{CC} = 5.0 V$ |



MOTOROLA

Product Preview

Quad 2-Input Multiplexer

The MC74AC157/74ACT157 is a high-speed quad 2-input multiplexer. Four bits of data from two sources can be selected using the common Select and Enable inputs. The four outputs present the selected data in the true (noninverted) form. The MC74AC157/74ACT157 can also be used as a function generator.

- Outputs Source/Sink 24 mA
- 'ACT157 Has TTL Compatible Inputs

LOGIC SYMBOL

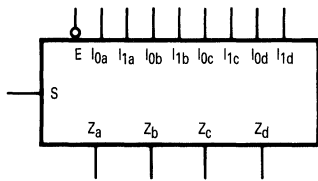

PIN NAMES

- I_{0a}-I_{0d} Source 0 Data Inputs
- I_{1a}-I_{1d} Source 1 Data Inputs
- \bar{E} Enable Input
- S Select Input
- Z_a-Z_d Outputs

TRUTH TABLE

| Inputs | | | | Outputs |
|-----------|---|----------------|----------------|---------|
| \bar{E} | S | I ₀ | I ₁ | Z |
| H | X | X | X | L |
| L | H | X | L | L |
| L | L | X | H | H |
| L | L | L | X | L |
| L | L | L | H | H |

H = HIGH Voltage Level
 L = LOW Voltage Level
 X = Immaterial

**MC74AC157
 MC74ACT157**

**QUAD 2-INPUT
 MULTIPLEXER**

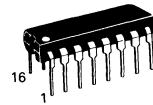

**N SUFFIX
 CASE 648-08
 PLASTIC**

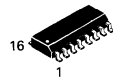

**D SUFFIX
 CASE 751B-03
 PLASTIC**

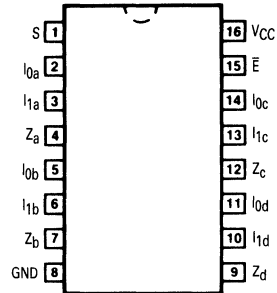

MC74AC157 • MC74ACT157

FUNCTIONAL DESCRIPTION

The MC74AC157/74ACT157 is a quad 2-input multiplexer. It selects four bits of data from two sources under the control of a common Select input (S). The Enable input (\bar{E}) is active-LOW. When \bar{E} is HIGH, all of the outputs (Z) are forced LOW regardless of all other inputs. The MC74AC157/74ACT157 is the logic implementation of a 4-pole, 2-position switch where the position of the switch is determined by the logic levels supplied to the Select input. The logic equations for the outputs are shown below:

$$Z_a = \bar{E} \cdot (I_{1a} \cdot S + I_{0a} \cdot \bar{S})$$

$$Z_b = \bar{E} \cdot (I_{1b} \cdot S + I_{0b} \cdot \bar{S})$$

$$Z_c = \bar{E} \cdot (I_{1c} \cdot S + I_{0c} \cdot \bar{S})$$

$$Z_d = \bar{E} \cdot (I_{1d} \cdot S + I_{0d} \cdot \bar{S})$$

A common use of the MC74AC157/74ACT157 is the moving of data from two groups of registers to four common output busses. The particular register from which the data comes is determined by the state of the Select input. A less obvious use is as a function generator. The MC74AC157/74ACT157 can generate any four of the sixteen different functions of two variables with one variable common. This is useful for implementing gating functions.

LOGIC DIAGRAM

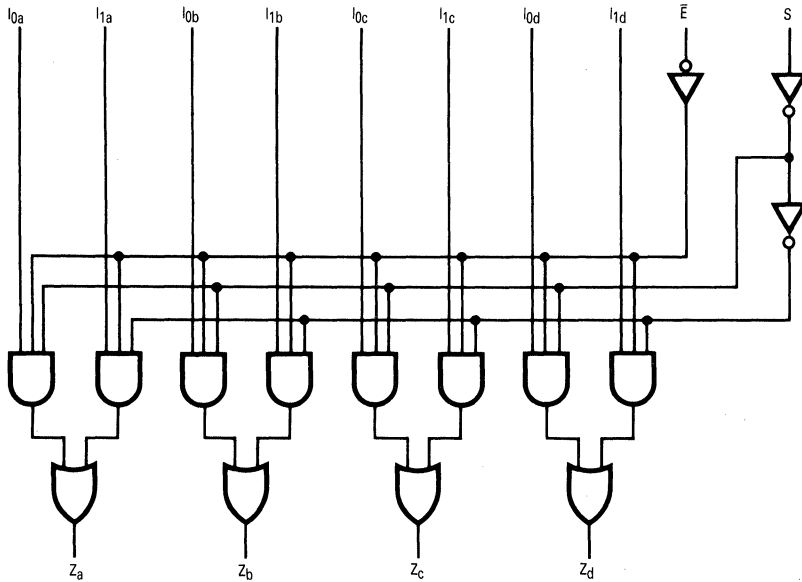

Please note that this diagram is provided only for the understanding of logic operations and should not be used to estimate propagation delays.

5

MC74AC157 • MC74ACT157

DC CHARACTERISTICS (unless otherwise specified)

| Symbol | Parameter | Value | Units | Test Conditions |
|-----------------|----------------------------------|-------|-------|---|
| I _{CC} | Maximum Quiescent Supply Current | 80 | μA | V _{IN} = V _{CC} or Ground, V _{CC} = 5.5 V, T _A = Worst Case |
| I _{CC} | Maximum Quiescent Supply Current | 8.0 | μA | V _{IN} = V _{CC} or Ground, V _{CC} = 5.5 V, T _A = 25°C |

AC CHARACTERISTICS (Figures and Waveforms — See Section 3)

| Symbol | Parameter | V _{CC} * (V) | 74AC | | | 74AC | | Units | Fig. No. |
|------------------|---|-----------------------|--|------------|-------------|--|------------|-------|----------|
| | | | T _A = +25°C C _L = 50 pF | | | T _A = -40°C to +85°C C _L = 50 pF | | | |
| | | | Min | Typ | Max | Min | Max | | |
| t _{PLH} | Propagation Delay S to Z _N | 3.3 5.0 | 1.0 1.0 | 7.0 5.5 | 11.5 9.0 | 1.0 1.0 | 13 10 | ns | 3-6 |
| t _{PHL} | Propagation Delay S to Z _N | 3.3 5.0 | 1.0 1.0 | 6.5 5.0 | 11 8.5 | 1.0 1.0 | 12 9.5 | ns | 3-6 |
| t _{PLH} | Propagation Delay E to Z _N | 3.3 5.0 | 1.0 1.0 | 7.0 5.5 | 11.5 9.0 | 1.0 1.0 | 13 10 | ns | 3-6 |
| t _{PHL} | Propagation Delay E _N to Z _N | 3.3 5.0 | 1.0 1.0 | 6.5 5.5 | 11 9.0 | 1.0 1.0 | 12 9.5 | ns | 3-6 |
| t _{PLH} | Propagation Delay I _N to Z _N | 3.3 5.0 | 1.0 1.0 | 5.0 4.0 | 8.5 6.5 | 1.0 1.0 | 9.0 7.0 | ns | 3-5 |
| t _{PHL} | Propagation Delay I _N to Z _N | 3.3 5.0 | 1.0 1.0 | 5.0 4.0 | 8.0 6.5 | 1.0 1.0 | 9.0 7.0 | ns | 3-5 |

*Voltage Range 3.3 is 3.3 V ± 0.3 V
Voltage Range 5.0 is 5.0 V ± 0.5 V

AC CHARACTERISTICS (Figures and Waveforms — See Section 3)

| Symbol | Parameter | V _{CC} * (V) | 74ACT | | | 74ACT | | Units | Fig. No. |
|------------------|---|-----------------------|--|-----|-----|--|------|-------|----------|
| | | | T _A = +25°C C _L = 50 pF | | | T _A = -40°C to +85°C C _L = 50 pF | | | |
| | | | Min | Typ | Max | Min | Max | | |
| t _{PLH} | Propagation Delay S to Z _N | 5.0 | 1.0 | 5.5 | 9.0 | 1.0 | 10 | ns | 3-6 |
| t _{PHL} | Propagation Delay S to Z _N | 5.0 | 1.0 | 5.5 | 9.5 | 1.0 | 10.5 | ns | 3-6 |
| t _{PLH} | Propagation Delay E _N to Z _N | 5.0 | 1.0 | 6.0 | 10 | 1.0 | 11.5 | ns | 3-6 |
| t _{PHL} | Propagation Delay E _N to Z _N | 5.0 | 1.0 | 5.0 | 8.5 | 1.0 | 9.0 | n | 3-6 |
| t _{PLH} | Propagation Delay I _N to Z _N | 5.0 | 1.0 | 4.0 | 7.0 | 1.0 | 8.5 | ns | 3-5 |
| t _{PHL} | Propagation Delay I _N to Z _N | 5.0 | 1.0 | 4.5 | 7.5 | 1.0 | 8.5 | ns | 3-5 |

*Voltage Range 5.0 is 5.0 V ± 0.5 V

CAPACITANCE

| Symbol | Parameter | Value Typ | Units | Test Conditions |
|-----------------|-------------------------------|--------------|-------|-------------------------|
| C _{IN} | Input Capacitance | 4.5 | pF | V _{CC} = 5.0 V |
| C _{PD} | Power Dissipation Capacitance | 50 | pF | V _{CC} = 5.0 V |



MOTOROLA

Product Preview

Quad 2-Input Multiplexer

The MC74AC158/74ACT158 is a high-speed quad 2-input multiplexer. It selects four bits of data from two sources using the common Select and Enable inputs. The four buffered outputs present the selected data in the inverted form. The MC74AC158/74ACT158 can also be used as a function generator.

- Outputs Source/Sink 24 mA
- 'ACT158 Has TTL Compatible Inputs

LOGIC SYMBOL

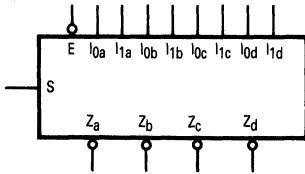

PIN NAMES

I_{0a} - I_{0d} Source 0 Data Inputs
 I_{1a} - I_{1d} Source 1 Data Inputs
 \bar{E} Enable Input
 S Select Input
 \bar{Z}_a - \bar{Z}_d Inverted Outputs

TRUTH TABLE

| Inputs | | | | Outputs |
|-----------|-----|-------|-------|-----------|
| \bar{E} | S | I_0 | I_1 | \bar{Z} |
| H | X | X | X | H |
| L | L | L | X | H |
| L | L | L | X | L |
| L | H | X | L | H |
| L | H | X | H | L |

H = HIGH Voltage Level
 L = LOW Voltage Level
 X = Immaterial

**MC74AC158
MC74ACT158**

**QUAD 2-INPUT
MULTIPLEXER**

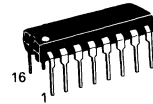

**N SUFFIX
CASE 648-08
PLASTIC**

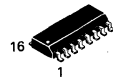

**D SUFFIX
CASE 751B-03
PLASTIC**

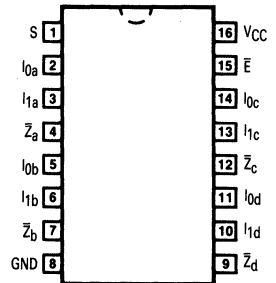

FUNCTIONAL DESCRIPTION

The MC74AC158/74ACT158 quad 2-input multiplexer selects four bits of data from two sources under the control of a common Select input (S) and presents the data in inverted form at the four outputs. The Enable input (\bar{E}) is active-LOW. When \bar{E} is HIGH, all of the outputs (\bar{Z}) are forced HIGH regardless of all other inputs. The MC74AC158/74ACT158 is the logic implementation of a 4-pole, 2-position switch where the position of the switch is determined by the logic levels supplied to the Select input.

A common use of the MC74AC158/74ACT158 is the moving of data from two groups of registers to four common output busses. The particular register from which the data comes is determined by the state of the Select input. A less obvious use is as a function generator. The MC74AC158/74ACT158 can generate four functions of two variables with one variable common. This is useful for implementing gating functions.

LOGIC DIAGRAM

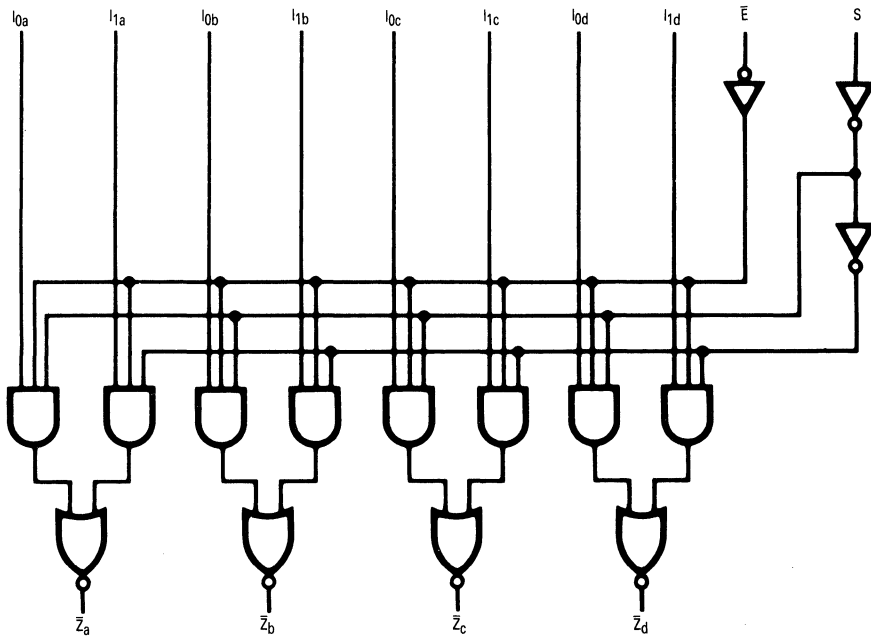

Please note that this diagram is provided only for the understanding of logic operations and should not be used to estimate propagation delays.

MC74AC158 • MC74ACT158

DC CHARACTERISTICS (unless otherwise specified)

| Symbol | Parameter | Value | Units | Test Conditions |
|--------------------|---|-------|-------|---|
| I _{CC} | Maximum Quiescent Supply Current | 80 | μA | V _{IN} = V _{CC} or Ground, V _{CC} = 5.5 V, T _A = Worst Case |
| I _{CC} | Maximum Quiescent Supply Current | 8.0 | μA | V _{IN} = V _{CC} or Ground, V _{CC} = 5.5 V, T _A = 25°C |
| I _{CC(T)} | Maximum Additional I _{CC} /Input (*ACT158) | 1.5 | mA | V _{IN} = V _{CC} - 2.1 V, V _{CC} = 5.5 V, T _A = Worst Case |

AC CHARACTERISTICS (Figures and Waveforms — See Section 3)

| Symbol | Parameter | V _{CC} * (V) | 74AC | | | 74AC | | Units | Fig. No. |
|------------------|---|-----------------------|--|------------|-------------|--|-------------|-------|----------|
| | | | T _A = +25°C C _L = 50 pF | | | T _A = -40°C to +85°C C _L = 50 pF | | | |
| | | | Min | Typ | Max | Min | Max | | |
| t _{PLH} | Propagation Delay S to \bar{Z}_n | 3.3 5.0 | 1.0 1.0 | 7.0 5.5 | 11.5 9.0 | 1.0 1.0 | 12.5 9.5 | ns | 3-6 |
| t _{PHL} | Propagation Delay S to \bar{Z}_n | 3.3 5.0 | 1.0 1.0 | 7.0 5.5 | 11.5 9.0 | 1.0 1.0 | 12.5 10 | ns | 3-6 |
| t _{PLH} | Propagation Delay \bar{E} to \bar{Z}_n | 3.3 5.0 | 1.0 1.0 | 7.5 6.0 | 12 9.5 | 1.0 1.0 | 13 10.5 | ns | 3-6 |
| t _{PHL} | Propagation Delay \bar{E}_n to \bar{Z}_n | 3.3 5.0 | 1.0 1.0 | 7.0 5.5 | 11 8.5 | 1.0 1.0 | 12 9.5 | ns | 3-6 |
| t _{PLH} | Propagation Delay I _n to \bar{Z}_n | 3.3 5.0 | 1.0 1.0 | 5.5 4.0 | 9.0 7.0 | 1.0 1.0 | 10 7.5 | ns | 3-5 |
| t _{PHL} | Propagation Delay I _n to \bar{Z}_n | 3.3 5.0 | 1.0 1.0 | 5.0 4.0 | 8.0 6.5 | 1.0 1.0 | 8.5 6.5 | ns | 3-5 |

*Voltage Range 3.3 is 3.3 V ± 0.3 V
Voltage Range 5.0 is 5.0 V ± 0.5 V

AC CHARACTERISTICS (Figures and Waveforms — See Section 3)

| Symbol | Parameter | V _{CC} * (V) | 74ACT | | | 74ACT | | Units | Fig. No. |
|------------------|---|-----------------------|--|-----|-----|--|------|-------|----------|
| | | | T _A = +25°C C _L = 50 pF | | | T _A = -40°C to +85°C C _L = 50 pF | | | |
| | | | Min | Typ | Max | Min | Max | | |
| t _{PLH} | Propagation Delay S to \bar{Z}_n | 5.0 | 1.0 | 6.0 | 9.5 | 1.0 | 11 | ns | 3-6 |
| t _{PHL} | Propagation Delay S to \bar{Z}_n | 5.0 | 1.0 | 5.5 | 9.0 | 1.0 | 10 | ns | 3-6 |
| t _{PLH} | Propagation Delay \bar{E}_n to \bar{Z}_n | 5.0 | 1.0 | 5.5 | 9.5 | 1.0 | 10.5 | ns | 3-6 |
| t _{PHL} | Propagation Delay \bar{E}_n to \bar{Z}_n | 5.0 | 1.0 | 5.5 | 9.5 | 1.0 | 10.5 | ns | 3-6 |
| t _{PLH} | Propagation Delay I _n to \bar{Z}_n | 5.0 | 1.0 | 4.5 | 8.0 | 1.0 | 8.5 | ns | 3-6 |
| t _{PHL} | Propagation Delay I _n to \bar{Z}_n | 5.0 | 1.0 | 4.0 | 6.5 | 1.0 | 7.5 | ns | 3-6 |

*Voltage Range 5.0 is 5.0 V ± 0.5 V

CAPACITANCE

| Symbol | Parameter | Value Typ | Units | Test Conditions |
|-----------------|-------------------------------|-----------|-------|-------------------------|
| C _{IN} | Input Capacitance | 4.5 | pF | V _{CC} = 5.0 V |
| C _{PD} | Power Dissipation Capacitance | 45 | pF | V _{CC} = 5.0 V |



MOTOROLA

Product Preview

Synchronous Presettable BCD Decade Counter

The MC74AC160/74ACT160 and MC74AC162/74ACT162 are high-speed synchronous decade counters operating in the BCD (8421) sequence. They are synchronously presettable for application in programmable dividers and have two types of Count Enable inputs plus a Terminal Count output for versatility in forming synchronous multistage counters. The MC74AC160/74ACT160 has an asynchronous Master Reset input that overrides all other inputs and forces the outputs LOW. The MC74AC162/74ACT162 has a Synchronous Reset input that overrides counting and parallel loading and allows all outputs to be simultaneously reset on the rising edge of the clock.

- Synchronous Counting and Loading
- High-Speed Synchronous Expansion
- Typical Count Rate of 120 MHz
- Outputs Source/Sink 24 mA
- *ACT160 and *ACT162 Have TTL Compatible Inputs

LOGIC SYMBOL

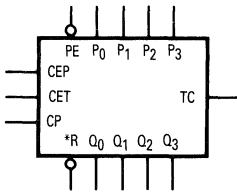

*MR for '160
*SR for '162

PIN NAMES

- CEP Count Enable Parallel Input
- CET Count Enable Trickle Input
- CP Clock Pulse Input
- MR ('160) Asynchronous Master Reset Input
- SR ('162) Synchronous Reset Input
- P₀-P₃ Parallel Data Inputs
- PE Parallel Enable Input
- Q₀-Q₃ Flip-Flop Outputs
- TC Terminal Count Output

**MC74AC160
MC74ACT160
MC74AC162
MC74ACT162**

**SYNCHRONOUS
PRESETTABLE
BCD DECADE COUNTER**

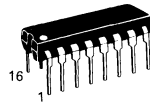

**N SUFFIX
CASE 648-08
PLASTIC**

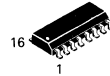

**D SUFFIX
CASE 751B-03
PLASTIC**

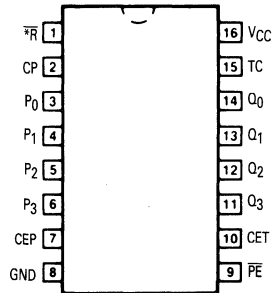

5

This document contains information on a product under development. Motorola reserves the right to change or discontinue this product without notice.

FUNCTIONAL DESCRIPTION

The MC74AC160/74ACT160 and MC74AC162/74ACT162 count modulo-10 in the BCD (8421) sequence. From state 9 (HLLH) they increment to state 0 (LLLL). The clock inputs of all flip-flops are driven in parallel through a clock buffer. Thus all changes of the Q outputs (except due to Master Reset of the '160) occur as a result of, and synchronous with, the LOW-to-HIGH transition of the CP input signal. The circuits have four fundamental modes of operation, in order of precedence: asynchronous reset ('160), synchronous reset ('162), parallel load, count-up and hold. Five control inputs — Master Reset (\overline{MR} , '160), Synchronous Reset (\overline{SR} , '162), Parallel Enable (\overline{PE}), Count Enable Parallel (CEP) and Count Enable Trickle (CET) — determine the mode of operation, as shown in the Mode Select Table. A LOW signal on \overline{MR} overrides all other inputs and asynchronously forces all outputs LOW. A LOW signal on \overline{SR} overrides counting and parallel loading and allows all outputs to go LOW on the next rising edge of CP. A LOW signal on \overline{PE} overrides counting and allows information on the Parallel Data (P_n) inputs to be loaded into the flip-flops on the next rising edge of CP. With \overline{PE} and \overline{MR} ('160) or \overline{SR} ('162) HIGH, CEP and CET permit counting when both are HIGH. Conversely, a LOW signal on either CEP or CET inhibits counting.

The MC74AC160/74ACT160 and MC74AC162/74ACT162 use D-type edge-triggered flip-flops and changing the \overline{SR} , \overline{PE} , CEP and CET inputs when the CP is in either state does not cause errors, provided that the recommended setup and hold times, with respect to the rising edge of CP, are observed.

The Terminal Count (TC) output is HIGH when CET is HIGH and counter is in state 9. To implement synchronous multistage counters, the TC outputs can be used with the CEP and CET inputs in two different ways. Please refer to the MC74AC568 data sheet. The TC output is subject to decoding spikes due to internal race conditions and is therefore not recommended for use as a clock or asynchronous reset for flip-flops, counters or registers. In the MC74AC160/74ACT160 and MC74AC162/74ACT162 decade counters, the TC output is fully decoded and can only be HIGH in state 9. If a decade counter is preset to an illegal state, or assumes an illegal state when power is applied, it will return to the normal sequence within two counts, as shown in the State Diagram.

Logic Equations: Count Enable = CEP·CET· \overline{PE}
 TC = $Q_0 \cdot \overline{Q_1} \cdot \overline{Q_2} \cdot Q_3 \cdot CET$

MODE SELECT TABLE

| * \overline{SR} | \overline{PE} | CET | CEP | Action on the Rising Clock Edge (\uparrow) |
|-------------------|-----------------|-----|-----|--|
| L | X | X | X | Reset (Clear) |
| H | L | X | X | Load ($P_n \rightarrow Q_n$) |
| H | H | H | H | Count (Increment) |
| H | H | L | X | No Change (Hold) |
| H | H | X | L | No Change (Hold) |

*For '162 only
 H = HIGH Voltage Level
 L = LOW Voltage Level
 X = Immaterial

STATE DIAGRAM

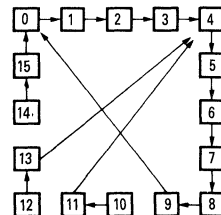

5

MC74AC160 • MC74ACT160 • MC74AC162 • MC74ACT162

LOGIC DIAGRAM

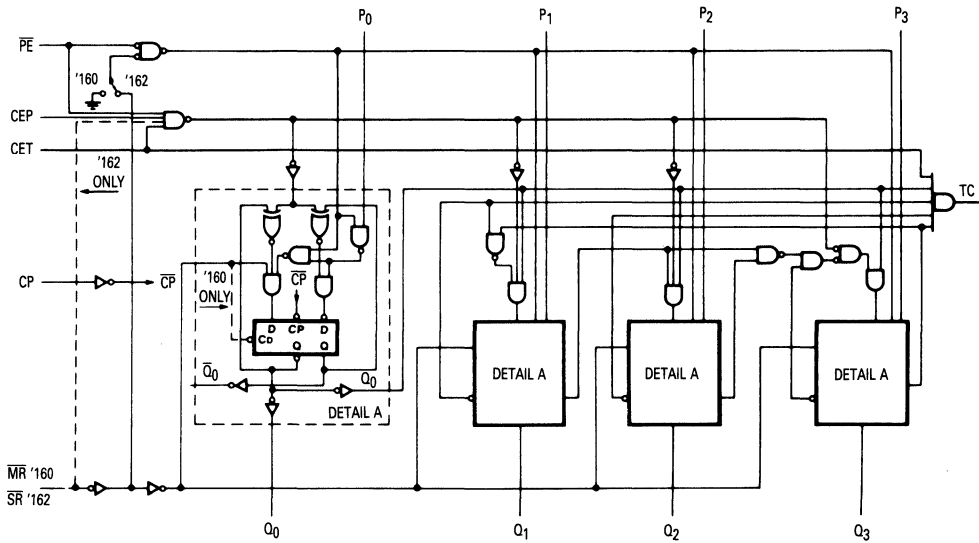

Please note that this diagram is provided only for the understanding of logic operations and should not be used to estimate propagation delays.

DC CHARACTERISTICS (unless otherwise specified)

| Symbol | Parameter | Value | Units | Test Conditions |
|-----------|--|-------|---------|---|
| I_{CC} | Maximum Quiescent Supply Current | 80 | μA | $V_{IN} = V_{CC}$ or Ground, $V_{CC} = 5.5 V, T_A = \text{Worst Case}$ |
| I_{CC} | Maximum Quiescent Supply Current | 8.0 | μA | $V_{IN} = V_{CC}$ or Ground, $V_{CC} = 5.5 V, T_A = 25^\circ C$ |
| I_{CCT} | Maximum Additional I_{CC} /Input ('ACT160/162) | 1.5 | mA | $V_{IN} = V_{CC} - 2.1 V$ $V_{CC} = 5.5 V, T_A = \text{Worst Case}$ |

MC74AC160 • MC74ACT160 • MC74AC162 • MC74ACT162

AC CHARACTERISTICS (For Figures and Waveforms — See Section 3)

| Symbol | Parameter | VCC* (V) | 74AC | | | 74AC | | Units | Fig. No. |
|--------|---|-------------|--------------------------|------------|-----|--------------------------------------|-----|-------|-------------|
| | | | TA = +25°C CL = 50 pF | | | TA = -40°C to +85°C CL = 50 pF | | | |
| | | | Min | Typ | Max | Min | Max | | |
| fmax | Maximum Count Frequency | 3.3 5.0 | | 87 118 | | | MHz | 3-3 | |
| tPLH | Propagation Delay CP to Qn (PE Input HIGH) | 3.3 5.0 | | 7.5 5.5 | | | ns | 3-6 | |
| tPHL | Propagation Delay CP to Qn (PE Input HIGH) | 3.3 5.0 | | 8.5 6.0 | | | ns | 3-6 | |
| tPLH | Propagation Delay CP to Qn (PE Input LOW) | 3.3 5.0 | | 9.5 7.0 | | | ns | 3-6 | |
| tPHL | Propagation Delay CP to Qn (PE Input LOW) | 3.3 5.0 | | 9.5 7.0 | | | ns | 3-6 | |
| tPLH | Propagation Delay CP to TC | 3.3 5.0 | | 9.5 7.0 | | | ns | 3-6 | |
| tPHL | Propagation Delay CP to TC | 3.3 5.0 | | 11 8.0 | | | ns | 3-6 | |
| tPLH | Propagation Delay CET to TC | 3.3 5.0 | | 7.5 5.5 | | | ns | 3-6 | |
| tPHL | Propagation Delay CET to TC | 3.3 5.0 | | 8.5 6.0 | | | ns | 3-6 | |
| tPLH | Propagation Delay MR to Qn (AC160) | 3.3 5.0 | | 8.5 6.0 | | | ns | 3-6 | |
| tPHL | Propagation Delay MR to Qn (AC160) | 3.3 5.0 | | 8.5 6.0 | | | ns | 3-6 | |

*Voltage Range 3.3 is 3.0 V ± 0.3 V
Voltage Range 5.0 is 5.0 V ± 0.5 V

MC74AC160 • MC74ACT160 • MC74AC162 • MC74ACT162

AC OPERATING REQUIREMENTS

| Symbol | Parameter | V _{CC} * (V) | 74AC | | 74AC | | Units | Fig. No. |
|------------------|---|--------------------------|--|--------------------|--|--|-------|----------|
| | | | T _A = +25°C C _L = 50 pF | | T _A = -40°C to +85°C C _L = 50 pF | | | |
| | | | Typ | Guaranteed Minimum | | | | |
| t _s | Setup Time, HIGH or LOW P _n to CP | 3.3 5.0 | 5.5 4.0 | | | | ns | 3-9 |
| t _h | Hold Time, HIGH or LOW P _n to CP | 3.3 5.0 | -7.0 -5.0 | | | | ns | 3-9 |
| t _s | Setup Time, HIGH or LOW PE or SR to CP | 3.3 3.3 | 5.5 4.0 | | | | ns | 3-9 |
| t _h | Hold Time, HIGH or LOW PE or SR to CP | 3.3 5.0 | -7.5 -5.5 | | | | ns | 3-9 |
| t _s | Setup Time, HIGH or LOW CEP or CET to CP | 3.3 5.0 | 3.5 2.5 | | | | ns | 3-9 |
| t _h | Hold Time, HIGH or LOW CEP or CET to CP | 3.3 5.0 | -4.5 -3.0 | | | | ns | 3-9 |
| t _w | Clock Pulse Width (Load) HIGH or LOW | 3.3 5.0 | 3.0 2.0 | | | | ns | 3-6 |
| t _w | Clock Pulse Width (Count) HIGH or LOW | 3.3 5.0 | 3.0 2.0 | | | | ns | 3-6 |
| t _w | \overline{MR} Pulse Width, LOW (AC160) | 3.3 5.0 | 4.5 3.0 | | | | ns | 3-6 |
| t _{rec} | Recovery Time MR to CP (AC160) | 3.3 5.0 | 0 0 | | | | ns | 3-9 |

*Voltage Range 3.3 is 3.3 V ± 0.3 V
Voltage Range 5.0 is 5.0 V ± 0.5 V

MC74AC160 • MC74ACT160 • MC74AC162 • MC74ACT162

AC CHARACTERISTICS (For Figures and Waveforms — See Section 3)

| Symbol | Parameter | V _{CC} * (V) | 74ACT | | | 74ACT | | Units | Fig. No. |
|------------------|---|--------------------------|--|-----|-----|--|-----|-------|----------|
| | | | T _A = +25°C C _L = 50 pF | | | T _A = -40°C to +85°C C _L = 50 pF | | | |
| | | | Min | Typ | Max | Min | Max | | |
| f _{max} | Maximum Count Frequency | 5.0 | | 118 | | | | MHz | 3-3 |
| t _{PLH} | Propagation Delay CP to Q _n (PE Input HIGH) | 5.0 | | 5.5 | | | | ns | 3-6 |
| t _{PHL} | Propagation Delay CP to Q _n (PE Input HIGH) | 5.0 | | 6.0 | | | | ns | 3-6 |
| t _{PLH} | Propagation Delay CP to Q _n (PE Input LOW) | 5.0 | | 7.0 | | | | ns | 3-6 |
| t _{PHL} | Propagation Delay CP to Q _n (PE Input LOW) | 5.0 | | 7.0 | | | | ns | 3-6 |
| t _{PLH} | Propagation Delay CP to TC | 5.0 | | 7.0 | | | | ns | 3-6 |
| t _{PHL} | Propagation Delay CP to TC | 5.0 | | 8.0 | | | | ns | 3-6 |
| t _{PLH} | Propagation Delay CET to TC | 5.0 | | 5.5 | | | | ns | 3-6 |
| t _{PHL} | Propagation Delay CET to TC | 5.0 | | 6.0 | | | | ns | 3-6 |
| t _{PLH} | Propagation Delay MR to Q _n (*ACT160) | 5.0 | | 6.0 | | | | ns | 3-6 |
| t _{PHL} | Propagation Delay MR to Q _n (*ACT160) | 5.0 | | 6.0 | | | | ns | 3-6 |

*Voltage Range 5.0 is 5.0 V ± 0.5 V

MC74AC160 • MC74ACT160 • MC74AC162 • MC74ACT162

AC OPERATING REQUIREMENTS

| Symbol | Parameter | VCC* (V) | 74ACT | | 74ACT | | Units | Fig. No. |
|------------------|---|-------------|--------------------------|--------------------|--------------------------------------|--|-------|----------|
| | | | TA = +25°C CL = 50 pF | | TA = -40°C to +85°C CL = 50 pF | | | |
| | | | Typ | Guaranteed Minimum | | | | |
| t _s | Setup Time, HIGH or LOW P _n to CP | 5.0 | 4.0 | | | | ns | 3-9 |
| t _h | Hold Time, HIGH or LOW P _n to CP | 5.0 | -5.0 | | | | ns | 3-9 |
| t _s | Setup Time, HIGH or LOW PE or SR to CP ('ACT162) | 5.0 | 4.0 | | | | ns | 3-9 |
| t _h | Hold Time, HIGH or LOW PE or SR to CP ('ACT162) | 5.0 | -5.5 | | | | ns | 3-9 |
| t _s | Setup Time, HIGH or LOW PE or MR to CP ('ACT160) | 5.0 | 4.0 | | | | ns | 3-9 |
| t _h | Hold Time, HIGH or LOW PE or MR to CP ('ACT160) | 5.0 | -5.5 | | | | ns | 3-9 |
| t _s | Setup Time, HIGH or LOW CEP or CET to CP | 5.0 | 2.5 | | | | ns | 3-9 |
| t _h | Hold Time, HIGH or LOW CEP or CET to CP | 5.0 | -3.0 | | | | ns | 3-9 |
| t _w | Clock Pulse Width (Load) HIGH or LOW | 5.0 | 2.0 | | | | ns | 3-6 |
| t _w | Clock Pulse Width (Count) HIGH or LOW | 5.0 | 2.0 | | | | ns | 3-6 |
| t _w | MR Pulse Width, LOW ('ACT160) | 5.0 | 3.0 | | | | ns | 3-6 |
| t _{rec} | Recovery Time MR to CP ('ACT160) | 5.0 | 0 | | | | ns | 3-9 |

*Voltage Range 5.0 is 5.0 V ± 0.5 V

CAPACITANCE

| Symbol | Parameter | Value Typ | Units | Conditions |
|-----------------|-------------------------------|--------------|-------|-------------|
| C _{IN} | Input Capacitance | 4.5 | pF | VCC = 5.0 V |
| CPD | Power Dissipation Capacitance | | pF | VCC = 5.0 V |

5



MOTOROLA

Product Preview

Synchronous Presetable Binary Counter

The MC74AC161/74ACT161 and MC74AC163/74ACT163 are high-speed synchronous modulo-16 binary counters. They are synchronously presetable for application in programmable dividers and have two types of Count Enable inputs plus a Terminal Count output for versatility in forming synchronous multistage counters. The MC74AC161/74ACT161 has an asynchronous Master Reset input that overrides all other inputs and forces the outputs LOW. The MC74AC163/74ACT163 has a Synchronous Reset input that overrides counting and parallel loading and allows the outputs to be simultaneously reset on the rising edge of the clock.

- Synchronous Counting and Loading
- High-Speed Synchronous Expansion
- Typical Count Rate of 125 MHz
- Outputs Source/Sink 24 mA
- 'ACT161 and 'ACT163 Have TTL Compatible Inputs

LOGIC SYMBOL

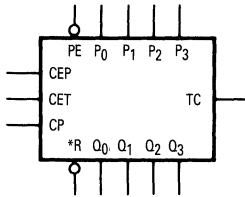

*MR for '161
 *SR for '163

PIN NAMES

- | | |
|--------------------------------|---------------------------------|
| CEP | Count Enable Parallel Input |
| CET | Count Enable Trickle Input |
| CP | Clock Pulse Input |
| MR ('161) | Asynchronous Master Reset Input |
| SR ('163) | Synchronous Reset Input |
| P ₀ -P ₃ | Parallel Data Inputs |
| PE | Parallel Enable Input |
| Q ₀ -Q ₃ | Flip-Flop Outputs |
| TC | Terminal Count Output |

**MC74AC161
 MC74ACT161
 MC74AC163
 MC74ACT163**

**SYNCHRONOUS
 PRESETTABLE
 BINARY COUNTER**

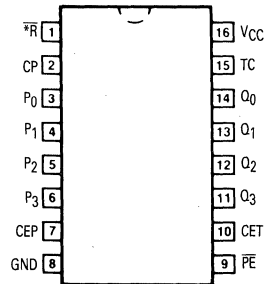
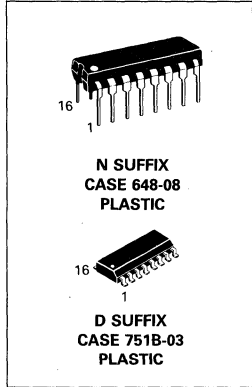

5

This document contains information on a product under development. Motorola reserves the right to change or discontinue this product without notice.

MC74AC161 • MC74ACT161 • MC74AC163 • MC74ACT163

FUNCTIONAL DESCRIPTION

The MC74AC161/74ACT161 and MC74AC163/74ACT163 count modulo-16 binary sequence. From state 15 (HHHH) they increment to state 0 (LLLL). The clock inputs of all flip-flops are driven in parallel through a clock buffer. Thus all changes of the Q outputs (except due to Master Reset of the '161) occur as a result of, and synchronous with, the LOW-to-HIGH transition of the CP input signal. The circuits have four fundamental modes of operation, in order of precedence: asynchronous reset ('161), synchronous reset ('163), parallel load, count-up and hold. Five control inputs — Master Reset (\overline{MR} , '161), Synchronous Reset (\overline{SR} , '163), Parallel Enable (\overline{PE}), Count Enable Parallel (CEP) and Count Enable Trickle (CET) — determine the mode of operation, as shown in the Mode Select Table. A LOW signal on \overline{MR} overrides all other inputs and asynchronously forces all outputs LOW. A LOW signal on \overline{SR} overrides counting and parallel loading and allows all outputs to go LOW on the next rising edge of CP. A LOW signal on \overline{PE} overrides counting and allows information on the Parallel Data (P_n) inputs to be loaded

into the flip-flops on the next rising edge of CP. With \overline{PE} and \overline{MR} ('161) or \overline{SR} ('163) HIGH, CEP and CET permit counting when both are HIGH. Conversely, a LOW signal on either CEP or CET inhibits counting.

The MC74AC161/74ACT161 and MC74AC163/74ACT163 use D-type edge-triggered flip-flops and changing the \overline{SR} , \overline{PE} , CEP and CET inputs when the CP is in either state does not cause errors, provided that the recommended setup and hold times, with respect to the rising edge of CP, are observed.

The Terminal Count (TC) output is HIGH when CET is HIGH and counter is in state 15. To implement synchronous multistage counters, the TC outputs can be used with the CEP and CET inputs in two different ways. Please refer to the MC74AC568 data sheet. The TC output is subject to decoding spikes due to internal race conditions and is therefore not recommended for use as a clock or asynchronous reset for flip-flops, counters or registers.

Logic Equations: Count Enable = $CEP \cdot CET \cdot \overline{PE}$
 $TC = Q_0 \cdot Q_1 \cdot Q_2 \cdot Q_3 \cdot CET$

MODE SELECT TABLE

| *SR | \overline{PE} | CET | CEP | Action on the Rising Clock Edge () |
|-----|-----------------|-----|-----|-------------------------------------|
| L | X | X | X | Reset (Clear) |
| H | L | X | X | Load ($P_n \rightarrow Q_n$) |
| H | H | H | H | Count (Increment) |
| H | H | L | X | No Change (Hold) |
| H | H | X | L | No Change (Hold) |

*For '163 only
 H = HIGH Voltage Level
 L = LOW Voltage Level
 X = Immaterial

STATE DIAGRAM

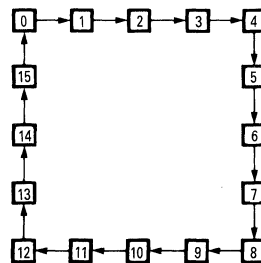

BLOCK DIAGRAM

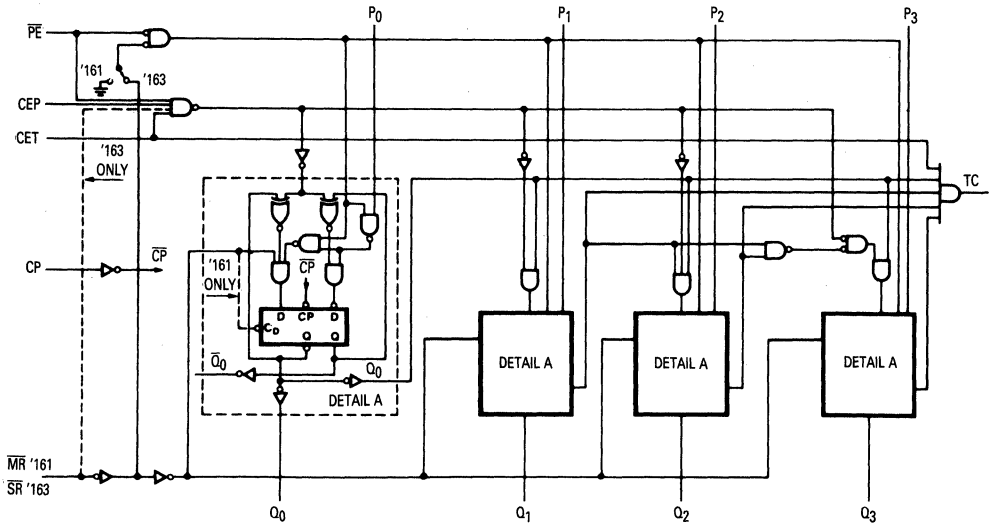

Please note that this diagram is provided only for the understanding of logic operations and should not be used to estimate propagation delays.

DC CHARACTERISTICS (unless otherwise specified)

| Symbol | Parameter | Value | Units | Test Conditions |
|-----------|---|-------|---------|--|
| I_{CC} | Maximum Quiescent Supply Current | 80 | μA | $V_{IN} = V_{CC}$ or Ground, $V_{CC} = 5.5 V, T_A = \text{Worst Case}$ |
| I_{CC} | Maximum Quiescent Supply Current | 8.0 | μA | $V_{IN} = V_{CC}$ or Ground, $V_{CC} = 5.5 V, T_A = 25^\circ C$ |
| I_{CCT} | Maximum Additional I_{CC} /Input (ACT161/163) | 1.5 | mA | $V_{IN} = V_{CC} - 2.1 V$, $V_{CC} = 5.5 V, T_A = \text{Worst Case}$ |

5

MC74AC161 • MC74ACT161 • MC74AC163 • MC74ACT163

AC CHARACTERISTICS (For Figures and Waveforms — See Section 3)

| Symbol | Parameter | V _{CC} * (V) | 74AC161 | | | 74ACT161 | | Units | Fig. No. |
|------------------|--|--------------------------|--|------------|-----|--|-----|-------|----------|
| | | | T _A = +25°C C _L = 50 pF | | | T _A = -40°C to +85°C C _L = 50 pF | | | |
| | | | Min | Typ | Max | Min | Max | | |
| f _{max} | Maximum Count Frequency | 3.3 5.0 | | 87 118 | | | | MHz | 3-3 |
| t _{PLH} | Propagation Delay CP to Q _n (PE Input HIGH or LOW) | 3.3 5.0 | | 7.5 5.5 | | | | ns | 3-6 |
| t _{PHL} | Propagation Delay CP to Q _n (PE Input HIGH or LOW) | 3.3 5.0 | | 8.5 6.0 | | | | ns | 3-6 |
| t _{PLH} | Propagation Delay CP to TC | 3.3 5.0 | | 9.5 7.0 | | | | ns | 3-6 |
| t _{PHL} | Propagation Delay CP to TC | 3.3 5.0 | | 11 8.0 | | | | ns | 3-6 |
| t _{PLH} | Propagation Delay CET to TC | 3.3 5.0 | | 7.5 5.5 | | | | ns | 3-6 |
| t _{PHL} | Propagation Delay CET to TC | 3.3 5.0 | | 8.5 6.0 | | | | ns | 3-6 |
| t _{PLH} | Propagation Delay MR to Q _n | 3.3 5.0 | | 8.5 6.0 | | | | ns | 3-6 |
| t _{PHL} | Propagation Delay MR to TC | 3.3 5.0 | | 11 8.0 | | | | ns | 3-6 |

*Voltage Range 3.3 is 3.0 V ± 0.3 V
Voltage Range 5.0 is 5.0 V ± 0.5 V

MC74AC161 • MC74ACT161 • MC74AC163 • MC74ACT163

AC OPERATING REQUIREMENTS

| Symbol | Parameter | V _{CC} * (V) | 74AC161 | | 74ACT161 | | Units | Fig. No. |
|------------------|---|--------------------------|--|--------------------|--|----|-------|----------|
| | | | T _A = +25°C C _L = 50 pF | | T _A = -40°C to +85°C C _L = 50 pF | | | |
| | | | Typ | Guaranteed Minimum | | | | |
| t _s | Setup Time, HIGH or LOW P _n to CP | 3.3 | 5.5 | | | ns | 3-9 | |
| | | 5.0 | 4.0 | | | | | |
| t _h | Hold Time, HIGH or LOW P _n to CP | 3.3 | -7.0 | | | ns | 3-9 | |
| | | 5.0 | -5.0 | | | | | |
| t _s | Setup Time, HIGH or LOW SR to CP | 3.3 | 5.5 | | | ns | 3-9 | |
| | | 3.3 | 4.0 | | | | | |
| t _h | Hold Time, HIGH or LOW SR to CP | 3.3 | -7.5 | | | ns | 3-9 | |
| | | 5.0 | -5.5 | | | | | |
| t _s | Setup Time, HIGH or LOW PE to CP | 3.3 | 5.5 | | | ns | 3-9 | |
| | | 5.0 | 4.0 | | | | | |
| t _h | Hold Time, HIGH or LOW PE to CP | 3.3 | -7.5 | | | ns | 3-9 | |
| | | 5.0 | -5.5 | | | | | |
| t _s | Setup Time, HIGH or LOW CEP or CET to CP | 3.3 | 3.5 | | | ns | 3-9 | |
| | | 5.0 | 2.5 | | | | | |
| t _h | Hold Time, HIGH or LOW CEP or CET to CP | 3.3 | -4.5 | | | ns | 3-9 | |
| | | 5.0 | -3.0 | | | | | |
| t _w | Clock Pulse Width (Load) HIGH or LOW | 3.3 | 3.0 | | | ns | 3-6 | |
| | | 5.0 | 2.0 | | | | | |
| t _w | Clock Pulse Width (Count) HIGH or LOW | 3.3 | 3.0 | | | ns | 3-6 | |
| | | 5.0 | 2.0 | | | | | |
| t _w | MR Pulse Width, LOW | 3.3 | 4.5 | | | ns | 3-6 | |
| | | 5.0 | 3.0 | | | | | |
| t _{rec} | Recovery Time MR to CP | 3.3 | 0 | | | ns | 3-9 | |
| | | 5.0 | 0 | | | | | |

*Voltage Range 3.3 is 3.3 V ± 0.3 V
Voltage Range 5.0 is 5.0 V ± 0.5 V

MC74AC161 • MC74ACT161 • MC74AC163 • MC74ACT163

AC CHARACTERISTICS (For Figures and Waveforms — See Section 3)

| Symbol | Parameter | V _{CC} * (V) | 74ACT161 | | | 74ACT161 | | Units | Fig. No. |
|------------------|--|--------------------------|--|-----|------|--|------|-------|----------|
| | | | T _A = +25°C C _L = 50 pF | | | T _A = -40°C to +85°C C _L = 50 pF | | | |
| | | | Min | Typ | Max | Min | Max | | |
| f _{max} | Maximum Count Frequency | 5.0 | 115 | 125 | | 100 | | MHz | 3-3 |
| t _{PLH} | Propagation Delay CP to Q _n (\overline{PE} Input HIGH or LOW) | 5.0 | 1.0 | 5.5 | 9.5 | 1.0 | 10.5 | ns | 3-6 |
| t _{PHL} | Propagation Delay CP to Q _n (\overline{PE} Input HIGH or LOW) | 5.0 | 1.0 | 6.0 | 10.5 | 1.0 | 11.5 | ns | 3-6 |
| t _{PLH} | Propagation Delay CP to TC | 5.0 | 1.0 | 7.0 | 11 | 1.0 | 12.5 | ns | 3-6 |
| t _{PHL} | Propagation Delay CP to TC | 5.0 | 1.0 | 8.0 | 12.5 | 1.0 | 13.5 | ns | 3-6 |
| t _{PLH} | Propagation Delay CET to TC | 5.0 | 1.0 | 5.5 | 8.5 | 1.0 | 10 | ns | 3-6 |
| t _{PHL} | Propagation Delay CET to TC | 5.0 | 1.0 | 6.0 | 9.5 | 1.0 | 10.5 | ns | 3-6 |
| t _{PHL} | Propagation Delay MR to Q _n | 5.0 | 1.0 | 6.0 | 10 | 1.0 | 11 | ns | 3-6 |
| t _{PHL} | Propagation Delay MR to TC | 5.0 | 1.0 | 8.0 | 13.5 | 1.0 | 14.5 | ns | 3-6 |

*Voltage Range 5.0 is 5.0 V ± 0.5 V

AC OPERATING REQUIREMENTS

| Symbol | Parameter | V _{CC} * (V) | 74ACT161 | | 74ACT161 | | Units | Fig. No. |
|------------------|---|--------------------------|--|--------------------|--|----|-------|----------|
| | | | T _A = +25°C C _L = 50 pF | | T _A = -40°C to +85°C C _L = 50 pF | | | |
| | | | Typ | Guaranteed Minimum | | | | |
| t _s | Setup Time, HIGH or LOW P _n to CP | 5.0 | 4.0 | 9.5 | 11.5 | ns | 3-9 | |
| t _h | Hold Time, HIGH or LOW P _n to CP | 5.0 | -5.0 | 0 | 0 | ns | 3-9 | |
| t _s | Setup Time, HIGH or LOW MR to CP | 5.0 | 4.0 | 8.5 | 9.5 | ns | 3-9 | |
| t _h | Hold Time, HIGH or LOW MR to CP | 5.0 | -5.5 | -0.5 | -0.5 | ns | 3-9 | |
| t _s | Setup Time, HIGH or LOW PE to CP | 5.0 | 4.0 | 8.5 | 9.5 | ns | 3-9 | |
| t _h | Hold Time, HIGH or LOW PE to CP | 5.0 | -5.5 | -0.5 | -0.5 | ns | 3-9 | |
| t _s | Setup Time, HIGH or LOW CEP or CET to CP | 5.0 | 2.5 | 5.5 | 6.5 | ns | 3-9 | |
| t _h | Hold Time, HIGH or LOW CEP or CET to CP | 5.0 | -3.0 | 0 | 0 | ns | 3-9 | |
| t _w | Clock Pulse Width (Load) HIGH or LOW | 5.0 | 2.0 | 3.0 | 3.5 | ns | 3-6 | |
| t _w | Clock Pulse Width (Count) HIGH or LOW | 5.0 | 2.0 | 3.0 | 3.5 | ns | 3-6 | |
| t _w | MR Pulse Width, LOW | 5.0 | 3.0 | 3.0 | 7.5 | ns | 3-6 | |
| t _{rec} | Recovery Time MR to CP | 5.0 | 0 | 0 | 0.5 | ns | 3-9 | |

*Voltage Range 5.0 is 5.0 V ± 0.5 V

CAPACITANCE

| Symbol | Parameter | Value Typ | Units | Conditions |
|-----------------|-------------------------------|--------------|-------|-------------------------|
| C _{IN} | Input Capacitance | 4.5 | pF | V _{CC} = 5.0 V |
| C _{PD} | Power Dissipation Capacitance | 45 | pF | V _{CC} = 5.0 V |

MC74AC161 • MC74ACT161 • MC74AC163 • MC74ACT163

AC CHARACTERISTICS (For Figures and Waveforms — See Section 3)

| Symbol | Parameter | V _{CC} * (V) | 74AC163 | | | 74AC163 | | Units | Fig. No. |
|------------------|--|-----------------------|--|------------|-------------|--|--------------|-------|----------|
| | | | T _A = +25°C C _L = 50 pF | | | T _A = -40°C to +85°C C _L = 50 pF | | | |
| | | | Min | Typ | Max | Min | Max | | |
| f _{max} | Maximum Count Frequency | 3.3 5.0 | 70 110 | 87 118 | | 60 95 | | MHz | 3-3 |
| t _{PLH} | Propagation Delay CP to Q _n (PE Input HIGH or LOW) | 3.3 5.0 | 1.0 1.0 | 7.5 5.5 | 12.5 9.0 | 1.0 1.0 | 13.5 9.5 | ns | 3-6 |
| t _{PHL} | Propagation Delay CP to Q _n (PE Input HIGH or LOW) | 3.3 5.0 | 1.0 1.0 | 8.5 6.0 | 12 9.5 | 1.0 1.0 | 13 10 | ns | 3-6 |
| t _{PLH} | Propagation Delay CP to TC | 3.3 5.0 | 1.0 1.0 | 9.5 7.0 | 15 10.5 | 1.0 1.0 | 16.5 11.5 | ns | 3-6 |
| t _{PHL} | Propagation Delay CP to TC | 3.3 5.0 | 1.0 1.0 | 11 8.0 | 14 11 | 1.0 1.0 | 15.5 11.5 | ns | 3-6 |
| t _{PLH} | Propagation Delay CET to TC | 3.3 5.0 | 1.0 1.0 | 7.5 5.5 | 9.5 6.5 | 1.0 1.0 | 11 7.5 | ns | 3-6 |
| t _{PHL} | Propagation Delay CET to TC | 3.3 5.0 | 1.0 1.0 | 8.5 6.0 | 11 8.5 | 1.0 1.0 | 12.5 9.5 | ns | 3-6 |

*Voltage Range 3.3 is 3.0 V ± 0.3 V
Voltage Range 5.0 is 5.0 V ± 0.5 V

AC OPERATING REQUIREMENTS

| Symbol | Parameter | V _{CC} * (V) | 74AC163 | | 74AC163 | | Units | Fig. No. |
|----------------|---|-----------------------|--|--------------------|--|--|-------|----------|
| | | | T _A = +25°C C _L = 50 pF | | T _A = -40°C to +85°C C _L = 50 pF | | | |
| | | | Typ | Guaranteed Minimum | | | | |
| t _s | Setup Time, HIGH or LOW P _n to CP | 3.3 5.0 | 5.5 4.0 | 13.5 8.5 | 16 10.5 | | ns | 3-9 |
| t _h | Hold Time, HIGH or LOW P _n to CP | 3.3 5.0 | -7.0 -5.0 | -1.0 0 | -0.5 0 | | ns | 3-9 |
| t _s | Setup Time, HIGH or LOW SR to CP | 3.3 5.0 | 5.5 4.0 | 14 9.5 | 16.5 11 | | ns | 3-9 |
| t _h | Hold Time, HIGH or LOW SR to CP | 3.3 5.0 | -7.5 -5.5 | -1.0 -0.5 | -0.5 0 | | ns | 3-9 |
| t _s | Setup Time, HIGH or LOW PE to CP | 3.3 5.0 | 5.5 4.0 | 11.5 7.5 | 14 8.5 | | ns | 3-9 |
| t _h | Hold Time, HIGH or LOW PE to CP | 3.3 5.0 | -7.5 -5.0 | -1.0 -0.5 | -0.5 0 | | ns | 3-9 |
| t _s | Setup Time, HIGH or LOW CEP or CET to CP | 3.3 5.0 | 3.5 2.5 | 6.0 4.5 | 7.0 5.0 | | ns | 3-9 |
| t _h | Hold Time, HIGH or LOW CEP or CET to CP | 3.3 5.0 | -4.5 -3.0 | 0 0 | 0 0.5 | | ns | 3-9 |
| t _w | Clock Pulse Width (Load) HIGH or LOW | 3.3 5.0 | 3.0 2.0 | 3.5 2.5 | 4.0 3.0 | | ns | 3-6 |
| t _w | Clock Pulse Width (Count) HIGH or LOW | 3.3 5.0 | 3.0 2.0 | 4.0 3.0 | 4.5 3.5 | | ns | 3-6 |

*Voltage Range 3.3 is 3.3 V ± 0.3 V
Voltage Range 5.0 is 5.0 V ± 0.5 V



MC74AC161 • MC74ACT161 • MC74AC163 • MC74ACT163

AC CHARACTERISTICS (For Figures and Waveforms — See Section 3)

| Symbol | Parameter | V _{CC} * (V) | 74ACT163 | | | 74ACT163 | | Units | Fig. No. |
|------------------|--|--------------------------|--|-----|------|--|------|-------|----------|
| | | | T _A = +25°C C _L = 50 pF | | | T _A = -40°C to +85°C C _L = 50 pF | | | |
| | | | Min | Typ | Max | Min | Max | | |
| f _{max} | Maximum Count Frequency | 5.0 | 120 | 128 | | 105 | | MHz | 3-3 |
| t _{PLH} | Propagation Delay CP to Q _n (\overline{PE} Input HIGH or LOW) | 5.0 | 1.0 | 5.5 | 10 | 1.0 | 11 | ns | 3-6 |
| t _{PHL} | Propagation Delay CP to Q _n (\overline{PE} Input HIGH or LOW) | 5.0 | 1.0 | 6.0 | 11 | 1.0 | 12 | ns | 3-6 |
| t _{PLH} | Propagation Delay CP to TC | 5.0 | 1.0 | 7.0 | 11.5 | 1.0 | 13.5 | ns | 3-6 |
| t _{PHL} | Propagation Delay CP to TC | 5.0 | 1.0 | 8.0 | 13.5 | 1.0 | 15 | ns | 3-6 |
| t _{PLH} | Propagation Delay CET to TC | 5.0 | 1.0 | 5.5 | 9.0 | 1.0 | 10.5 | ns | 3-6 |
| t _{PHL} | Propagation Delay CET to TC | 5.0 | 1.0 | 6.0 | 10 | 1.0 | 11 | ns | 3-6 |

*Voltage Range 5.0 is 5.0 V ± 0.5 V

AC OPERATING REQUIREMENTS

| Symbol | Parameter | V _{CC} * (V) | 74ACT163 | | 74ACT163 | | Units | Fig. No. |
|----------------|--|--------------------------|--|--------------------|--|----|-------|----------|
| | | | T _A = +25°C C _L = 50 pF | | T _A = -40°C to +85°C C _L = 50 pF | | | |
| | | | Typ | Guaranteed Minimum | | | | |
| t _s | Setup Time, HIGH or LOW P _n to CP | 5.0 | 4.0 | 10 | 12 | ns | 3-9 | |
| t _h | Hold Time, HIGH or LOW P _n to CP | 5.0 | -5.0 | 0.5 | 0.5 | ns | 3-9 | |
| t _s | Setup Time, HIGH or LOW \overline{SR} to CP | 5.0 | 4.0 | 10 | 11.5 | ns | 3-9 | |
| t _h | Hold Time, HIGH or LOW \overline{SR} to CP | 5.0 | -5.5 | -0.5 | -0.5 | ns | 3-9 | |
| t _s | Setup Time, HIGH or LOW \overline{PE} to CP | 5.0 | 4.0 | 8.5 | 10.5 | ns | 3-9 | |
| t _h | Hold Time, HIGH or LOW \overline{PE} to CP | 5.0 | -5.5 | -0.5 | 0 | ns | 3-9 | |
| t _s | Setup Time, HIGH or LOW CEP or CET to CP | 5.0 | 2.5 | 5.5 | 6.5 | ns | 3-9 | |
| t _h | Hold Time, HIGH or LOW CEP or CET to CP | 5.0 | -3.0 | 0 | 0.5 | ns | 3-9 | |
| t _w | Clock Pulse Width HIGH or LOW | 5.0 | 2.0 | 3.5 | 3.5 | ns | 3-6 | |
| t _w | Clock Pulse Width (Count) HIGH or LOW | 5.0 | 2.0 | 3.5 | 3.5 | ns | 3-6 | |

*Voltage Range 5.0 is 5.0 V ± 0.5 V

CAPACITANCE

| Symbol | Parameter | Value Type | Units | Conditions |
|-----------------|-------------------------------|---------------|-------|-------------------------|
| C _{IN} | Input Capacitance | 4.5 | pF | V _{CC} = 5.0 V |
| C _{PD} | Power Dissipation Capacitance | 45 | pF | V _{CC} = 5.0 V |

FACT DATA

5



MOTOROLA

Product Preview

4-Stage Synchronous Bidirectional Counters

The MC74AC168 and MC74AC169 are fully synchronous 4-stage up/down counters. The MC74AC168 is a BCD decade counter; the MC74AC169 is a modulo-16 binary counter. Both feature a preset capability for programmable operation, carry lookahead for easy cascading and a U/D input to control the direction of counting. All state changes, whether in counting or parallel loading, are initiated by the LOW-to-HIGH transition of the Clock.

- Synchronous Counting and Loading
- Built-in Lookahead Carry Capability
- Presettable for Programmable Operation
- Outputs Source/Sink 24 mA

LOGIC SYMBOL

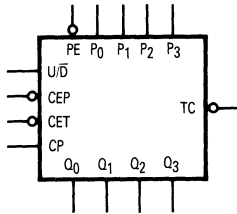

PIN NAMES

- CEP Count Enable Parallel Input
- CET Count Enable Trickle Input
- CP Clock Pulse Input
- P₀-P₃ Parallel Data Inputs
- PE Parallel Enable Input
- U/D Up-Down Count Control Input
- Q₀-Q₃ Flip-Flop Outputs
- TC Terminal Count Output

**MC74AC168
MC74AC169**

**4-STAGE
SYNCHRONOUS
BIDIRECTIONAL
COUNTERS**

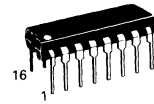

**N SUFFIX
CASE 648-08
PLASTIC**

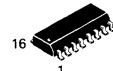

**D SUFFIX
CASE 751B-03
PLASTIC**

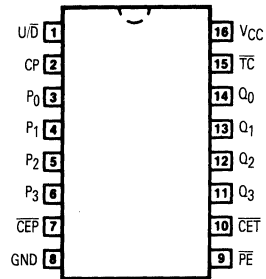

This document contains information on a product under development. Motorola reserves the right to change or discontinue this product without notice.

MC74AC168 • MC74AC169

LOGIC DIAGRAMS

MC74AC168

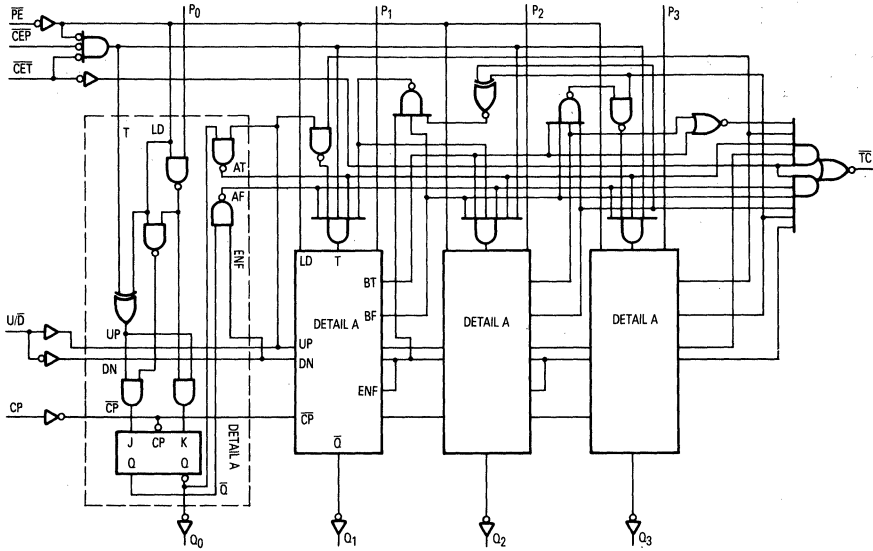

Please note that this diagram is provided only for the understanding of logic operations and should not be used to estimate propagation delays.

MC74AC169

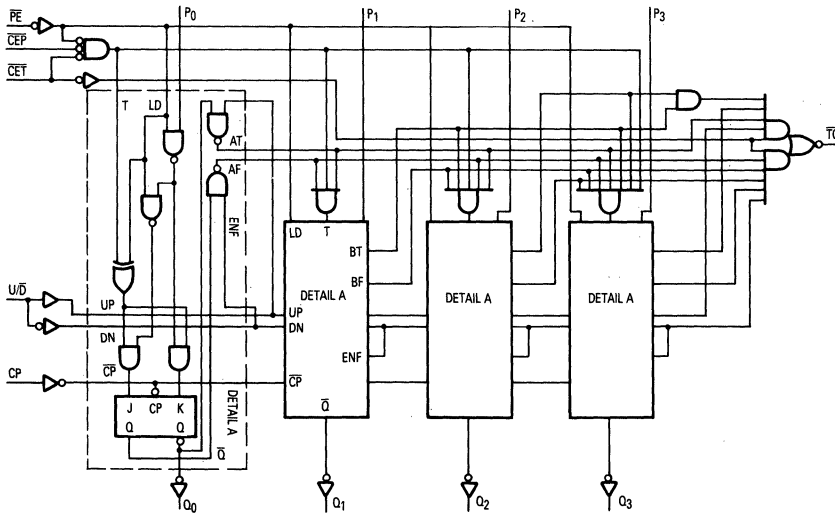

Please note that this diagram is provided only for the understanding of logic operations and should not be used to estimate propagation delays.

5

MC74AC168 • MC74AC169

FUNCTIONAL DESCRIPTION

The MC74AC168 and MC74AC169 use edge-triggered J-K-type flip-flops and have no constraints on changing the control or data input signals in either state of the Clock. The only requirement is that the various inputs attain the desired state at least a setup time before the rising edge of the clock and remain valid for the recommended hold time thereafter. The parallel load operation takes precedence over the other operations, as indicated in the Mode Select Table. When PE is LOW, the data on the P0-P3 inputs enters the flip-flops on the next rising edge of the Clock. In order for counting to occur, both CEP and CET must be LOW and PE must be HIGH; the U/D input then determines the direction of counting. The Terminal Count (TC) output is normally HIGH and goes LOW, provided that CET is LOW, when a counter reaches zero in the Count Down mode or reaches 9 (15 for the MC74AC169) in the Count Up mode. The TC output state is not a function of the Count Enable Parallel (CEP) input level. The TC output of the MC74AC168 decade counter can also be LOW in the illegal states 11, 13 and 15, which can occur when power is turned on or via parallel loading. If an illegal state occurs, the MC74AC169 will return to the legitimate sequence within two counts. Since the TC signal is derived by decoding the flip-flop states, there exists the possibility of decoding spikes on TC. For this reason the use of TC as a clock signal is not recommended (see logic equations below).

- 1) Count Enable = $\overline{CEP} \cdot \overline{CET} \cdot \overline{PE}$
- 2) Up: ('AC168): $TC = Q_0 \cdot \overline{Q_1} \cdot \overline{Q_2} \cdot \overline{Q_3} \cdot (Up) \cdot \overline{CET}$
('AC169): $TC = Q_0 \cdot \overline{Q_1} \cdot \overline{Q_2} \cdot \overline{Q_3} \cdot (Up) \cdot \overline{CET}$
- 3) Down (both): $TC = \overline{Q_0} \cdot \overline{Q_1} \cdot \overline{Q_2} \cdot \overline{Q_3} \cdot (Down) \cdot \overline{CET}$

MODE SELECT TABLE

| PE | CEP | CET | U/D | Action on Rising Clock Edge |
|----|-----|-----|-----|--|
| L | X | X | X | Load (P _n to Q _n) |
| H | L | L | H | Count Up (Increment) |
| H | L | L | L | Count Down (Decrement) |
| H | H | X | X | No Change (Hold) |
| H | X | H | X | No Change (Hold) |

H = HIGH Voltage Level
L = LOW Voltage Level
X = Immaterial

STATE DIAGRAM

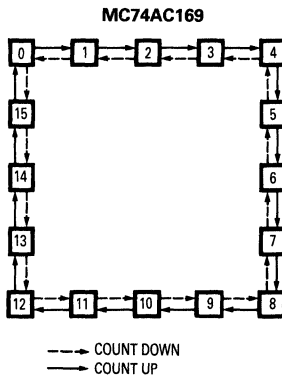
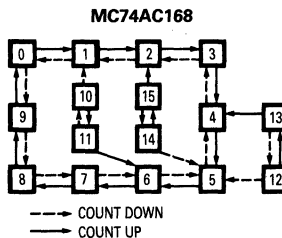

MC74AC168 • MC74AC169

DC CHARACTERISTICS (unless otherwise specified)

| Symbol | Parameter | Value | Units | Test Conditions |
|-----------------|----------------------------------|-------|-------|---|
| I _{CC} | Maximum Quiescent Supply Current | 80 | μA | V _{IN} = V _{CC} or Ground, V _{CC} = 5.5 V, T _A = Worst Case |
| I _{CC} | Maximum Quiescent Supply Current | 8.0 | μA | V _{IN} = V _{CC} or Ground, V _{CC} = 5.5 V, T _A = 25°C |

AC CHARACTERISTICS (For Figures and Waveforms — See Section 3)

| Symbol | Parameter | V _{CC} * (V) | 74AC168 | | | 74AC168 | | Units | Fig. No. |
|------------------|--|-----------------------|--|-------------|-----|--|-----|-------|----------|
| | | | T _A = +25°C C _L = 50 pF | | | T _A = -40°C to +85°C C _L = 50 pF | | | |
| | | | Min | Typ | Max | Min | Max | | |
| f _{max} | Maximum Count Frequency | 3.3 5.0 | | 118 154 | | | | MHz | 3-3 |
| t _{PLH} | Propagation Delay CP to Q _n (PE HIGH or LOW) | 3.3 5.0 | | 9.5 7.0 | | | | ns | 3-6 |
| t _{PHL} | Propagation Delay CP to Q _n (PE HIGH or LOW) | 3.3 5.0 | | 10.5 7.5 | | | | ns | 3-6 |
| t _{PLH} | Propagation Delay CP to TC | 3.3 5.0 | | 13.5 9.5 | | | | ns | 3-6 |
| t _{PHL} | Propagation Delay CP to TC | 3.3 5.0 | | 13.5 9.5 | | | | ns | 3-6 |
| t _{PLH} | Propagation Delay CET to TC | 3.3 5.0 | | 11 8.0 | | | | ns | 3-6 |
| t _{PHL} | Propagation Delay CET to TC | 3.3 5.0 | | 9.5 7.0 | | | | ns | 3-6 |
| t _{PLH} | Propagation Delay U/D to TC | 3.3 5.0 | | 10.5 7.5 | | | | ns | 3-6 |
| t _{PHL} | Propagation Delay U/D to TC | 3.3 5.0 | | 9.0 6.5 | | | | ns | 3-6 |

*Voltage Range 3.3 is 3.0 V ± 0.3 V
Voltage Range 5.0 is 5.0 V ± 0.5 V

MC74AC168 • MC74AC169

AC OPERATING REQUIREMENTS

| Symbol | Parameter | V _{CC} * (V) | 74AC168 | | 74AC169 | | Units | Fig. No. |
|----------------|---|--------------------------|--|--------------------|--|-----|-------|----------|
| | | | T _A = +25°C C _L = 50 pF | | T _A = -40°C to +85°C C _L = 50 pF | | | |
| | | | Typ | Guaranteed Minimum | Min | Max | | |
| t _s | Setup Time, HIGH or LOW P _n to CP | 3.3 5.0 | 3.0 1.5 | | | | ns | 3-9 |
| t _h | Hold Time, HIGH or LOW P _n to CP | 3.3 5.0 | 1.5 0.5 | | | | ns | 3-9 |
| t _s | Setup Time, HIGH or LOW CEP to CP | 3.3 3.3 | 7.5 4.5 | | | | ns | 3-9 |
| t _h | Hold Time, HIGH or LOW CEP to CP | 3.3 5.0 | 4.5 2.0 | | | | ns | 3-9 |
| t _s | Setup Time, HIGH or LOW CET to CP | 3.3 5.0 | 7.0 4.0 | | | | ns | 3-9 |
| t _h | Hold Time, HIGH or LOW CET to CP | 3.3 5.0 | 6.0 4.0 | | | | ns | 3-9 |
| t _s | Setup Time, HIGH or LOW PE to CP | 3.3 5.0 | 3.5 2.0 | | | | ns | 3-9 |
| t _h | Hold Time, HIGH or LOW PE to CP | 3.3 5.0 | 3.5 1.5 | | | | ns | 3-9 |
| t _s | Setup Time, HIGH or LOW U/D to CP | 3.3 5.0 | 12.5 9.0 | | | | ns | 3-9 |
| t _h | Hold Time, HIGH or LOW U/D to CP | 3.3 5.0 | 7.0 4.0 | | | | ns | 3-9 |
| t _w | CP Pulse Width, HIGH or LOW | 3.3 5.0 | 2.0 2.0 | | | | ns | 3-6 |

*Voltage Range 3.3 is 3.3 V ± 0.3 V
Voltage Range 5.0 is 5.0 V ± 0.5 V

AC CHARACTERISTICS (For Figures and Waveforms — See Section 3)

| Symbol | Parameter | V _{CC} * (V) | 74AC169 | | | 74AC169 | | Units | Fig. No. |
|------------------|--|--------------------------|--|-------------|-------------|--|-----|-------|----------|
| | | | T _A = +25°C C _L = 50 pF | | | T _A = -40°C to +85°C C _L = 50 pF | | | |
| | | | Min | Typ | Max | Min | Max | | |
| f _{max} | Maximum Count Frequency | 3.3 5.0 | 75 100 | 118 154 | | 65 90 | | MHz | 3-3 |
| t _{PLH} | Propagation Delay CP to Q _n (PE HIGH or LOW) | 3.3 5.0 | 1.0 1.0 | 9.5 7.0 | 13 10 | 14.5 11 | | ns | 3-6 |
| t _{PHL} | Propagation Delay CP to Q _n (PE HIGH or LOW) | 3.3 5.0 | 1.0 1.0 | 10.5 7.5 | 14.5 11 | 16 12 | | ns | 3-6 |
| t _{PLH} | Propagation Delay CP to TC | 3.3 5.0 | 1.0 1.0 | 13.5 9.5 | 18 13 | 22 14 | | ns | 3-6 |
| t _{PHL} | Propagation Delay CP to TC | 3.3 5.0 | 1.0 1.0 | 13.5 9.5 | 18 13 | 20.5 14.5 | | ns | 3-6 |
| t _{PLH} | Propagation Delay CET to TC | 3.3 5.0 | 1.0 1.0 | 11 8.0 | 15 10.5 | 16.5 12 | | ns | 3-6 |
| t _{PHL} | Propagation Delay CET to TC | 3.3 5.0 | 1.0 1.0 | 9.5 7.0 | 12.5 9.0 | 14.5 10 | | ns | 3-6 |
| t _{PLH} | Propagation Delay U/D to TC | 3.3 5.0 | 1.0 1.0 | 11 8.0 | 15 10.5 | 17 12 | | ns | 3-6 |
| t _{PHL} | Propagation Delay U/D to TC | 3.3 5.0 | 1.0 1.0 | 10 7.0 | 13.5 9.5 | 15.5 10.5 | | ns | 3-6 |

*Voltage Range 3.3 is 3.3 V ± 0.3 V
Voltage Range 5.0 is 5.0 V ± 0.5 V



AC OPERATING REQUIREMENTS

| Symbol | Parameter | V _{CC} * (V) | 74AC169 | | 74AC169 | | Units | Fig. No. |
|----------------|--|--------------------------|--|--------------------|--|----|-------|----------|
| | | | T _A = +25°C C _L = 50 pF | | T _A = -40°C to +85°C C _L = 50 pF | | | |
| | | | Typ | Guaranteed Minimum | | | | |
| t _s | Setup Time, HIGH or LOW P _n to CP | 3.3 5.0 | 3.0 1.5 | 4.5 2.5 | 5.0 2.5 | ns | 3-9 | |
| t _h | Hold Time, HIGH or LOW P _n to CP | 3.3 5.0 | 1.5 0.5 | 0.5 1.5 | 0.5 1.5 | ns | 3-9 | |
| t _s | Setup Time, HIGH or LOW C _{EP} to CP | 3.3 5.0 | 7.5 4.5 | 10.5 7.0 | 12.5 8.0 | ns | 3-9 | |
| t _h | Hold Time, HIGH or LOW C _{EP} to CP | 3.3 5.0 | 4.5 2.0 | 0 0.5 | 0 1.0 | ns | 3-9 | |
| t _s | Setup Time, HIGH or LOW C _{ET} to CP | 3.3 5.0 | 7.0 4.0 | 10 6.5 | 12 8.0 | ns | 3-9 | |
| t _h | Hold Time, HIGH or LOW C _{ET} to CP | 3.3 5.0 | 6.0 4.0 | 0 0.5 | 0 1.0 | ns | 3-9 | |
| t _s | Setup Time, HIGH or LOW P _E to CP | 3.3 5.0 | 3.5 2.0 | 5.5 3.5 | 6.5 4.0 | ns | 3-9 | |
| t _h | Hold Time, HIGH or LOW P _E to CP | 3.3 5.0 | 3.5 1.5 | 0 0.5 | 0 0.5 | ns | 3-9 | |
| t _s | Setup Time, HIGH or LOW U/ \bar{D} to CP | 3.3 5.0 | 7.0 4.5 | 10 6.5 | 11.5 7.5 | ns | 3-9 | |
| t _h | Hold Time, HIGH or LOW U/ \bar{D} to $\bar{C}P$ | 3.3 5.0 | 7.0 4.0 | 0 0.5 | 0 0.5 | ns | 3-9 | |
| t _w | CP Pulse Width, HIGH or LOW | 3.3 5.0 | 2.0 2.0 | 3.0 3.0 | 4.0 3.0 | ns | 3-6 | |

*Voltage Range 3.3 is 3.3 V ± 0.3 V
Voltage Range 5.0 is 5.0 V ± 0.5 V

CAPACITANCE

| Symbol | Parameter | Value Typ | Units | Test Conditions |
|-----------------|-------------------------------|--------------|-------|-------------------------|
| C _{IN} | Input Capacitance | 4.5 | pF | V _{CC} = 5.0 V |
| C _{PD} | Power Dissipation Capacitance | 60 | pF | V _{CC} = 5.0 V |



MOTOROLA

Product Preview

Hex D Flip-Flop with Master Reset

The MC74AC174/74ACT174 is a high-speed hex D flip-flop. The device is used primarily as a 6-bit edge-triggered storage register. The information on the D inputs is transferred to storage during the LOW-to-HIGH clock transition. The device has a Master Reset to simultaneously clear all flip-flops.

- Outputs Source/Sink 24 mA
- 'ACT174 Has TTL Compatible Inputs

LOGIC SYMBOL

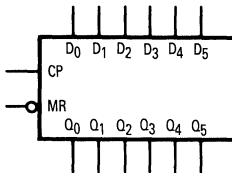

PIN NAMES

- D₀-D₅ Data Inputs
- CP Clock Pulse Input
- MR Master Reset Input
- Q₀-Q₅ Outputs

TRUTH TABLE

| Inputs | | | Output |
|--------|----|---|--------|
| MR | CP | D | Q |
| L | X | X | L |
| H | J | H | H |
| H | J | L | L |
| H | L | X | Q |

- H = HIGH Voltage Level
- L = LOW Voltage Level
- X = Immaterial
- J = LOW-to-HIGH Transition of Clock

**MC74AC174
MC74ACT174**

**HEX D FLIP-FLOP
WITH MASTER RESET**

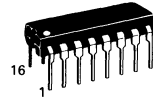

**N SUFFIX
CASE 648-08
PLASTIC**

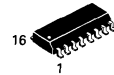

**D SUFFIX
CASE 751B-03
PLASTIC**

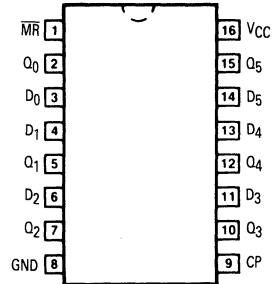

5

This document contains information on a product under development. Motorola reserves the right to change or discontinue this product without notice.

MC74AC174 • MC74ACT174

FUNCTIONAL DESCRIPTION

The MC74AC174/74ACT174 consists of six edge-triggered D flip-flops with individual D inputs and Q outputs. The Clock (CP) and Master Reset (\overline{MR}) are common to all flip-flops. Each D input's state is transferred to the corresponding flip-flop's output following the LOW-to-HIGH Clock (CP) transition. A LOW input to the

Master Reset (\overline{MR}) will force all outputs LOW independent of Clock or Data inputs. The MC74AC174/74ACT174 is useful for applications where the true output only is required and the Clock and Master Reset are common to all storage elements.

LOGIC DIAGRAM

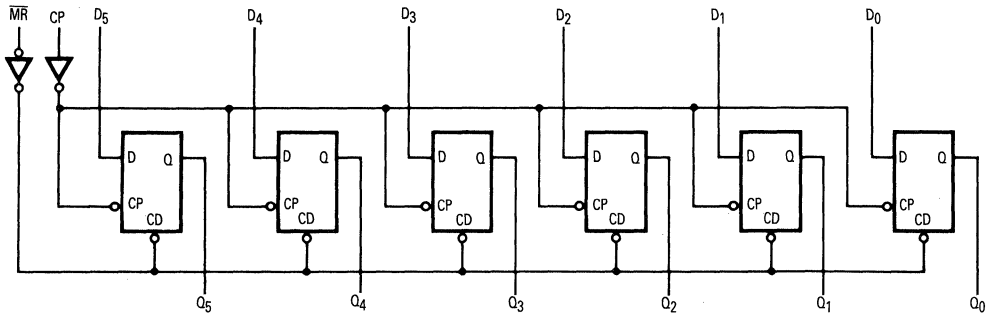

Please note that this diagram is provided only for the understanding of logic operations and should not be used to estimate propagation delays.

DC CHARACTERISTICS (unless otherwise specified)

| Symbol | Parameter | Value | Units | Test Conditions |
|-----------|--|-------|---------|--|
| I_{CC} | Maximum Quiescent Supply Current | 80 | μA | $V_{IN} = V_{CC}$ or Ground, $V_{CC} = 5.5 V$, $T_A = \text{Worst Case}$ |
| I_{CC} | Maximum Quiescent Supply Current | 8.0 | μA | $V_{IN} = V_{CC}$ or Ground, $V_{CC} = 5.5 V$, $T_A = 25^\circ C$ |
| I_{CCT} | Maximum Additional I_{CC}/Input ('ACT174) | 1.5 | mA | $V_{IN} = V_{CC} - 2.1 V$ $V_{CC} = 5.5 V$, $T_A = \text{Worst Case}$ |

MC74AC174 • MC74ACT174

AC CHARACTERISTICS (For Figures and Waveforms — See Section 3)

| Symbol | Parameter | V _{CC} * (V) | 74AC | | | 74AC | | Units | Fig. No. |
|------------------|---|--------------------------|--|------------|-------------|--|--------------|-------|----------|
| | | | T _A = +25°C C _L = 50 pF | | | T _A = -40°C to +85°C C _L = 50 pF | | | |
| | | | Min | Typ | Max | Min | Max | | |
| f _{max} | Maximum Clock Frequency | 3.3 5.0 | 90 100 | 100 125 | | 70 100 | | MHz | 3-3 |
| t _{PLH} | Propagation Delay CP to Q _N | 3.3 5.0 | 1.0 1.0 | 9.0 6.0 | 11.5 8.5 | 1.0 1.0 | 12.5 9.5 | ns | 3-6 |
| t _{PHL} | Propagation Delay CP to Q _N | 3.3 5.0 | 1.0 1.0 | 8.5 6.0 | 11 8.0 | 1.0 1.0 | 12 9.0 | ns | 3-6 |
| t _{PHL} | Propagation Delay MR to Q _N | 3.3 5.0 | 1.0 1.0 | 9.0 7.0 | 11.5 9.0 | 1.0 1.0 | 12.5 10.5 | ns | 3-6 |

*Voltage Range 3.3 is 3.3 V ± 0.3 V

Voltage Range 5.0 is 5.0 V ± 0.5 V

AC OPERATING REQUIREMENTS

| Symbol | Parameter | V _{CC} * (V) | 74AC | | 74AC | | Units | Fig. No. |
|------------------|---|--------------------------|--|--------------------|--|----|-------|----------|
| | | | T _A = +25°C C _L = 50 pF | | T _A = -40°C to +85°C C _L = 50 pF | | | |
| | | | Typ | Guaranteed Minimum | | | | |
| t _s | Setup Time, HIGH or LOW D _N to CP | 3.3 5.0 | 2.5 2.0 | 6.5 5.0 | 7.0 5.5 | ns | 3-9 | |
| t _h | Hold Time, HIGH or LOW D _N to CP | 3.3 5.0 | 1.0 0.5 | 3.0 3.0 | 3.0 3.0 | ns | 3-9 | |
| t _w | MR Pulse Width, LOW | 3.3 5.0 | 1.0 1.0 | 5.5 5.0 | 7.0 5.0 | ns | 3-6 | |
| t _w | CP Pulse Width | 3.3 5.0 | 1.0 1.0 | 5.5 5.0 | 7.0 5.0 | ns | 3-6 | |
| t _{rec} | Recovery Time MR to CP | 3.3 5.0 | 0 0 | 2.5 2.0 | 2.5 2.0 | ns | 3-6 | |

*Voltage Range 3.3 is 3.3 V ± 0.3 V

Voltage Range 5.0 is 5.0 V ± 0.5 V

MC74AC174 • MC74ACT174

AC CHARACTERISTICS (For Figures and Waveforms — See Section 3)

| Symbol | Parameter | V _{CC} * (V) | 74ACT | | | 74ACT | | Units | Fig. No. |
|------------------|--|--------------------------|--|-----|------|--|------|-------|----------|
| | | | T _A = +25°C C _L = 50 pF | | | T _A = -40°C to +85°C C _L = 50 pF | | | |
| | | | Min | Typ | Max | Min | Max | | |
| f _{max} | Maximum Clock Frequency | 5.0 | 165 | 200 | | 140 | | MHz | 3-3 |
| t _{PLH} | Propagation Delay CP to Q _n | 5.0 | 1.0 | 7.0 | 10.5 | 1.0 | 11.5 | ns | 3-6 |
| t _{PHL} | Propagation Delay CP to Q _n | 5.0 | 1.0 | 7.0 | 10.5 | 1.0 | 11.5 | ns | 3-6 |
| t _{PHL} | Propagation Delay MR to Q _n | 5.0 | 1.0 | 6.5 | 9.5 | 1.0 | 11 | ns | 3-6 |

*Voltage Range 5.0 is 5.0 V ± 0.5 V

AC OPERATING REQUIREMENTS

| Symbol | Parameter | V _{CC} * (V) | 74ACT | | 74ACT | | Units | Fig. No. |
|------------------|--|--------------------------|--|--------------------|--|--|-------|----------|
| | | | T _A = +25°C C _L = 50 pF | | T _A = -40°C to +85°C C _L = 50 pF | | | |
| | | | Typ | Guaranteed Minimum | | | | |
| t _s | Setup Time, HIGH or LOW D _n to CP | 5.0 | 0.5 | 1.5 | 1.5 | | ns | 3-9 |
| t _h | Hold Time, HIGH or LOW D _n to CP | 5.0 | 1.0 | 2.0 | 2.0 | | ns | 3-9 |
| t _w | MR Pulse Width, LOW | 5.0 | 1.5 | 3.0 | 3.5 | | ns | 3-6 |
| t _w | CP Pulse Width HIGH or LOW | 5.0 | 1.5 | 3.0 | 3.5 | | ns | 3-6 |
| t _{rec} | Recovery Time MR to CP | 5.0 | -1.0 | 0.5 | 0.5 | | ns | 3-6 |

*Voltage Range 5.0 is 5.0 V ± 0.5 V

CAPACITANCE

| Symbol | Parameter | Value Typ | Units | Test Conditions |
|-----------------|-------------------------------|-----------|-------|-------------------------|
| C _{IN} | Input Capacitance | 4.5 | pF | V _{CC} = 5.0 V |
| C _{PD} | Power Dissipation Capacitance | 85 | pF | V _{CC} = 5.0 V |



MOTOROLA

Product Preview Quad D Flip-Flop

The MC74AC175/74ACT175 is a high-speed quad D flip-flop. The device is useful for general flip-flop requirements where clock and clear inputs are common. The information on the D inputs is stored during the LOW-to-HIGH clock transition. Both true and complemented outputs of each flip-flop are provided. A Master Reset input resets all flip-flops, independent of the Clock or D inputs, when LOW.

- Edge-Triggered D-Type Inputs
- Buffered Positive Edge-Triggered Clock
- Asynchronous Common Reset
- True and Complement Output
- Outputs Source/Sink 24 mA
- ACT175 Has TTL Compatible Inputs

LOGIC SYMBOL

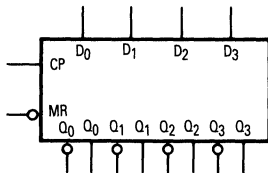

PIN NAMES

D₀-D₃ Data Inputs
 CP Clock Pulse Input
 MR Master Reset Input
 Q₀-Q₃ True Outputs
 Q₀-Q₃ Complement Outputs

TRUTH TABLE

| Inputs | Outputs | |
|---------------------------|--------------------|------------------|
| @ t _n , MR = H | @ t _{n+1} | |
| D _n | Q _n | Q _n - |
| L | L | H |
| H | H | L |

H = HIGH Voltage Level
 L = LOW Voltage Level
 t_n = Bit Time before Clock Pulse
 t_{n+1} = Bit Time after Clock Pulse

MC74AC175
MC74ACT175

QUAD D FLIP-FLOP

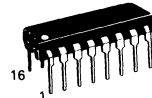

N SUFFIX
CASE 648-08
PLASTIC



D SUFFIX
CASE 751B-03
PLASTIC

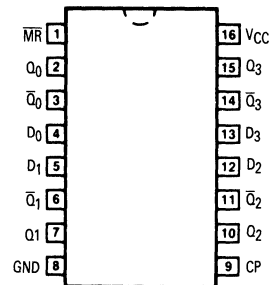

MC74AC175 • MC74ACT175

FUNCTIONAL DESCRIPTION

The MC74AC175/74ACT175 consists of four edge-triggered D flip-flops with individual D inputs and Q and \bar{Q} outputs. The Clock and Master Reset are common. The four flip-flops will store the state of their individual D inputs on the LOW-to-HIGH clock (CP) transition, causing individual Q and \bar{Q} outputs to follow. A

LOW input on the Master Reset (\overline{MR}) will force all Q outputs LOW and \bar{Q} outputs HIGH independent of Clock or Data inputs. The MC74AC175/74ACT175 is useful for general logic applications where a common Master Reset and Clock are acceptable.

LOGIC DIAGRAM

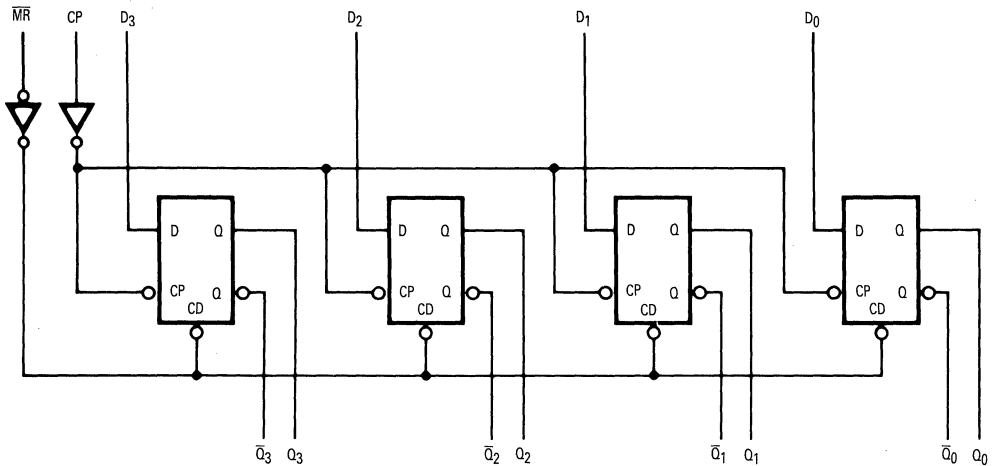

Please note that this diagram is provided only for the understanding of logic operations and should not be used to estimate propagation delays.

MC74AC175 • MC74ACT175

DC CHARACTERISTICS (unless otherwise specified)

| Symbol | Parameter | Value | Units | Test Conditions |
|-------------------|---|-------|-------|---|
| I _{CC} | Maximum Quiescent Supply Current | 80 | μA | V _{IN} = V _{CC} or Ground, V _{CC} = 5.5 V, T _A = Worst Case |
| I _{CC} | Maximum Quiescent Supply Current | 8.0 | μA | V _{IN} = V _{CC} or Ground, V _{CC} = 5.5 V, T _A = 25°C |
| I _{CC} T | Maximum Additional I _{CC} /Input ('ACT175) | 1.5 | mA | V _{IN} = V _{CC} - 2.1 V, V _{CC} = 5.5 V, T _A = Worst Case |

AC CHARACTERISTICS (For Figures and Waveforms — See Section 3)

| Symbol | Parameter | V _{CC} * (V) | 74AC | | | 74AC | | Units | Fig. No. |
|------------------|---|--------------------------|--|------------|-----|--|-----|-------|----------|
| | | | T _A = +25°C C _L = 50 pF | | | T _A = -40°C to +85°C C _L = 50 pF | | | |
| | | | Min | Typ | Max | Min | Max | | |
| f _{max} | Maximum Clock Frequency | 3.3 5.0 | | 118 160 | | | | MHz | 3-3 |
| t _{PLH} | Propagation Delay CP to Q _n or \overline{Q}_n | 3.3 5.0 | | 9.5 7.0 | | | | ns | 3-6 |
| t _{PHL} | Propagation Delay CP to Q _n or \overline{Q}_n | 3.3 5.0 | | 8.5 6.0 | | | | ns | 3-6 |
| t _{PHL} | Propagation Delay \overline{MR} to Q _n | 3.3 5.0 | | 7.5 5.5 | | | | ns | 3-6 |
| t _{PLH} | Propagation Delay \overline{MR} to \overline{Q}_n | 3.3 5.0 | | 8.5 6.0 | | | | ns | 3-6 |

*Voltage Range 3.3 is 3.3 V ± 0.3 V
Voltage Range 5.0 is 5.0 V ± 0.5 V

MC74AC175 • MC74ACT175

AC OPERATING REQUIREMENTS

| Symbol | Parameter | V _{CC} * (V) | 74AC | | 74ACT | | Units | Fig. No. |
|------------------|---|--------------------------|--|--------------------|--|-----|-------|----------|
| | | | T _A = +25°C C _L = 50 pF | | T _A = -40°C to +85°C C _L = 50 pF | | | |
| | | | Typ | Guaranteed Minimum | Min | Max | | |
| t _s | Setup Time, HIGH or LOW D _n to CP | 3.3 5.0 | 4.5 3.0 | | | | ns | 3-9 |
| t _h | Hold Time, HIGH or LOW D _n to CP | 3.3 5.0 | 0 0 | | | | ns | 3-9 |
| t _w | CP Pulse Width HIGH or LOW | 3.3 5.0 | 5.5 4.0 | | | | ns | 3-6 |
| t _w | \overline{MR} Pulse Width, LOW | 3.3 5.0 | 5.5 4.0 | | | | ns | 3-6 |
| t _{rec} | Recovery Time \overline{MR} to CP | 3.3 5.0 | 0 0 | | | | ns | 3-9 |

*Voltage Range 3.3 is 3.3 V ± 0.3 V
Voltage Range 5.0 is 5.0 V ± 0.5 V

AC CHARACTERISTICS (For Figures and Waveforms — See Section 3)

| Symbol | Parameter | V _{CC} * (V) | 74ACT | | | 74ACT | | Units | Fig. No. |
|------------------|---|--------------------------|--|-----|-----|--|------|-------|----------|
| | | | T _A = +25°C C _L = 50 pF | | | T _A = -40°C to +85°C C _L = 50 pF | | | |
| | | | Min | Typ | Max | Min | Max | | |
| f _{max} | Maximum Clock Frequency | 5.0 | 175 | 160 | | 145 | | MHz | 3-3 |
| t _{PLH} | Propagation Delay CP to Q _n or \overline{Q}_n | 5.0 | 1.0 | 6.0 | 10 | 1.0 | 11 | ns | 3-6 |
| t _{PHL} | Propagation Delay CP to Q _n or \overline{Q}_n | 5.0 | 1.0 | 7.0 | 11 | 1.0 | 12 | ns | 3-6 |
| t _{PLH} | Propagation Delay \overline{MR} to Q _n | 5.0 | 1.0 | 6.0 | 9.5 | 1.0 | 10.5 | ns | 3-6 |
| t _{PHL} | Propagation Delay \overline{MR} to Q _n | 5.0 | 1.0 | 5.5 | 9.5 | 1.0 | 10.5 | ns | 3-6 |

*Voltage Range 5.0 is 5.0 V ± 0.5 V

MC74AC175 • MC74ACT175

AC OPERATING REQUIREMENTS

| Symbol | Parameter | V _{CC} * (V) | 74ACT | | 74ACT | Units | Fig. No. |
|------------------------------|--|--------------------------|--|--------------------|--|-------|----------|
| | | | T _A = +25°C C _L = 50 pF | | T _A = -40°C to +85°C C _L = 50 pF | | |
| | | | Typ | Guaranteed Minimum | | | |
| t _s (H) (L) | Setup Time D _n to CP | 5.0 | 3.0 | 2.0 | 2.0 | ns | 3-9 |
| | | | 3.0 | 2.5 | 2.5 | | |
| t _h | Hold-Time, HIGH or LOW D _n to CP | 5.0 | 0 | 1.0 | 1.0 | ns | 3-9 |
| t _w | CP Pulse Width HIGH or LOW | 5.0 | 4.0 | 3.0 | 3.5 | ns | 3-6 |
| t _w | MR Pulse Width, LOW | 5.0 | 4.0 | 3.5 | 4.0 | ns | 3-6 |
| t _{rec} | Recovery Time MR to CP | 5.0 | 0 | 0 | 0 | ns | 3-9 |

*Voltage Range 5.0 is 5.0 V ± 0.5 V

CAPACITANCE

| Symbol | Parameter | Value Typ | Units | Test Conditions |
|-----------------|-------------------------------|--------------|-------|-------------------------|
| C _{IN} | Input Capacitance | 4.5 | pF | V _{CC} = 5.0 V |
| CPD | Power Dissipation Capacitance | 45 | pF | V _{CC} = 5.0 V |



MOTOROLA

Product Preview

Up/Down Counters with Preset and Ripple Clock

The MC74AC190 is a reversible BCD (8421) decade counter. The MC74AC191 is a reversible modulo 16 binary counter. Both feature synchronous counting and asynchronous presetting. The preset feature allows the MC74AC190 and MC74AC191 to be used in programmable dividers. The Count Enable input, the Terminal Count output and the Ripple Clock output make possible a variety of methods of implementing multistage counters. In the counting modes, state changes are initiated by the rising edge of the clock.

- High-Speed — 120 MHz Typical Count Frequency
- Synchronous Counting
- Asynchronous Parallel Load
- Cascadable
- Outputs Source/Sink 24 mA

LOGIC SYMBOL

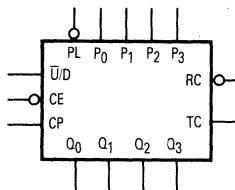

PIN NAMES

- CE Count Enable Input
- CP Clock Pulse Input
- P₀-P₃ Parallel Data Inputs
- PL Asynchronous Parallel Load Input
- U/D Up/Down Count Control Input
- Q₀-Q₃ Flip-Flop Outputs
- RC Ripple Clock Output
- TC Terminal Count Output

MC74AC190 MC74AC191

UP/DOWN COUNTERS WITH PRESET AND RIPPLE CLOCK

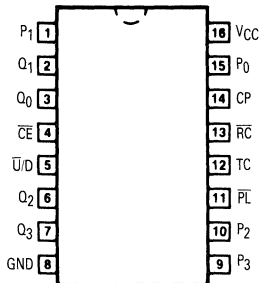
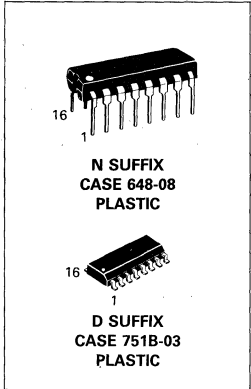

5

This document contains information on a product under development. Motorola reserves the right to change or discontinue this product without notice.

FUNCTIONAL DESCRIPTION

The MC74AC190/74C191 are synchronous up/down counters. The MC74AC190 is a BCD decade counter while the MC74AC191 is organized as a 4-bit binary counter. Both contain four edge-triggered flip-flops with internal gating and steering logic to provide individual preset, count-up and count-down operations.

Each circuit has an asynchronous parallel load capability permitting the counter to be preset to any desired number. When the Parallel Load (PL) input is LOW, information present on the Parallel Load inputs (P₀-P₃) is loaded into the counter and appears on the Q outputs. This operation overrides the counting functions, as indicated in the Mode Select Table.

A HIGH signal on the \overline{CE} input inhibits counting. When \overline{CE} is LOW, internal state changes are initiated synchronously by the LOW-to-HIGH transition of the clock input. The direction of counting is determined by the $\overline{U/D}$ input signal, as indicated in the Mode Select Table. \overline{CE} and $\overline{U/D}$ can be changed with the clock in either state, provided only that the recommended setup and hold times are observed.

Two types of outputs are provided as overflow/underflow indicators. The terminal count (TC) output is normally LOW. It goes HIGH when the circuits reach zero in the count down mode or 9 (MC74AC190) or 15 (MC74AC191) in the count up mode. The TC output will then remain HIGH until a state change occurs, whether by counting or presetting or until $\overline{U/D}$ is changed. The TC output should not be used as a clock signal because it is subject to decoding spikes.

The TC signal is also used internally to enable the Ripple Clock (RC) output. The RC output is normally HIGH. When \overline{CE} is LOW and TC is HIGH, RC output will go LOW when the clock next goes LOW and will stay LOW until the clock goes HIGH again. This feature simplifies the design of multistage counters, as indicated in Figures a and b. In Figure a, each RC output is used as the clock input for the next higher stage. This configuration is particularly advantageous when the clock source has a limited drive capability, since it drives only the first stage. To prevent counting in all stages it is only necessary to inhibit the first stage, since a HIGH signal on \overline{CE} inhibits the RC output pulse, as indicated in the RC Truth Table. A disadvantage of this configuration, in some applications, is the timing skew between state changes in the first and last stages. This represents the cumulative delay of the clock as it ripples through the preceding stages.

A method of causing state changes to occur simultaneously in all stages is shown in Figure b. All clock inputs are driven in parallel and the RC outputs propagate the carry/borrow signals in ripple fashion. In this configuration the LOW state duration of the clock must be long enough to allow the negative-going edge of the carry/borrow signal to ripple through to the last stage before the clock goes HIGH. There is no such restriction on the HIGH state duration of the clock, since the RC output of any device goes HIGH shortly after its CP input goes HIGH.

The configuration shown in Figure c avoids ripple delays and their associated restrictions. The \overline{CE} input for a given stage is formed by combining the TC signals from all the preceding stages. Note that in order to inhibit counting an enable signal must be included in each carry gate. The simple inhibit scheme of Figures a and b doesn't apply, because the TC output of a given stage is not affected by its own \overline{CE} .

MODE SELECT TABLE

| Inputs | | | | Mode |
|--------|-----------------|------------------|----|------------------|
| PL | \overline{CE} | $\overline{U/D}$ | CP | |
| H | L | L | ↕ | Count Up |
| H | L | H | ↕ | Count Down |
| L | X | X | X | Preset (Asyn.) |
| H | H | X | X | No Change (Hold) |

RC TRUTH TABLE

| Inputs | | | Outputs |
|-----------------|-----|----|---------|
| \overline{CE} | TC* | CP | RC |
| L | H | ↕ | ↕ |
| H | X | X | H |
| X | L | X | H |

*TC is generated internally
 H = HIGH Voltage Level
 L = LOW Voltage Level
 X = Immaterial
 ↕ = LOW-to-HIGH Transition

STATE DIAGRAM

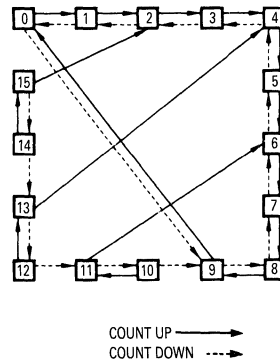

Figure a: N-Stage Counter Using Ripple Clock

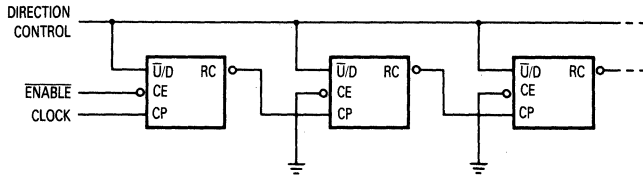

Figure b: Synchronous N-Stage Counter Using Ripple Carry/Borrow

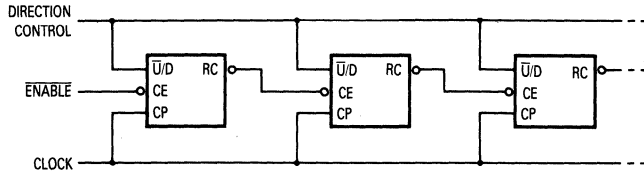
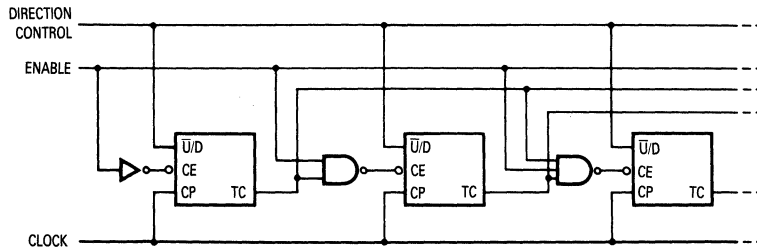
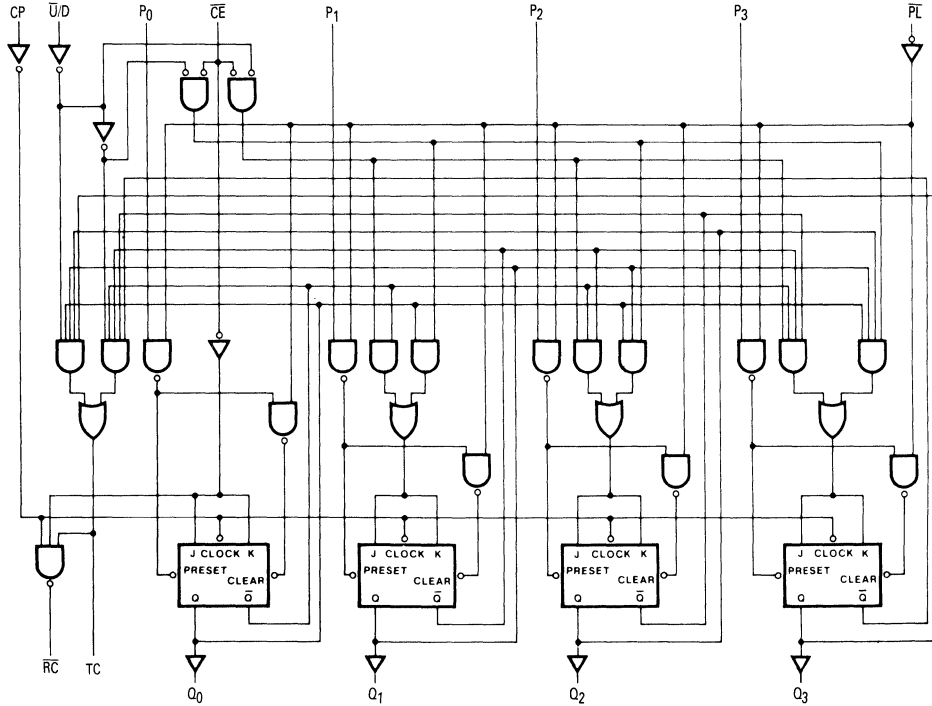

Figure c: Synchronous N-Stage Counter With Parallel Gated Carry/Borrow



5

LOGIC DIAGRAM



Please note that this diagram is provided only for the understanding of the logic operations and should not be used to estimate propagation delays.

DC CHARACTERISTICS (unless otherwise specified)

| Symbol | Parameter | Value | Units | Test Conditions |
|----------|----------------------------------|-------|---------|---|
| I_{CC} | Maximum Quiescent Supply Current | 80 | μA | $V_{IN} = V_{CC}$ or Ground, $V_{CC} = 5.5 V, T_A = \text{Worst Case}$ |
| I_{CC} | Maximum Quiescent Supply Current | 8.0 | μA | $V_{IN} = V_{CC}$ or Ground, $V_{CC} = 5.5 V, T_A = 25^\circ C$ |

MC74AC190 • MC74AC191

AC CHARACTERISTICS (For Figures and Waveforms — See Section 3)

| Symbol | Parameter | V _{CC} * (V) | 74AC190 | | | 74AC190 | | Units | Fig. No. |
|------------------|---|--------------------------|--|-------------|-----|--|-----|-------|----------|
| | | | T _A = +25°C C _L = 50 pF | | | T _A = -40°C to +85°C C _L = 50 pF | | | |
| | | | Min | Typ | Max | Min | Max | | |
| f _{max} | Maximum Count Frequency | 3.3 5.0 | | 88 120 | | | | MHz | 3-3 |
| t _{PLH} | Propagation Delay CP to Q _n | 3.3 5.0 | | 9.5 7.0 | | | | ns | 3-6 |
| t _{PHL} | Propagation Delay CP to Q _n | 3.3 5.0 | | 10.5 7.5 | | | | ns | 3-6 |
| t _{PLH} | Propagation Delay CP to TC | 3.3 5.0 | | 15 11 | | | | ns | 3-6 |
| t _{PHL} | Propagation Delay CP to TC | 3.3 5.0 | | 13 9.5 | | | | ns | 3-6 |
| t _{PLH} | Propagation Delay CP to RC | 3.3 5.0 | | 9.0 6.5 | | | | ns | 3-6 |
| t _{PHL} | Propagation Delay CP to RC | 3.3 5.0 | | 9.5 7.0 | | | | ns | 3-6 |
| t _{PLH} | Propagation Delay CE to RC | 3.3 5.0 | | 9.5 7.0 | | | | ns | 3-6 |
| t _{PHL} | Propagation Delay CE to RC | 3.3 5.0 | | 8.5 6.0 | | | | ns | 3-6 |
| t _{PLH} | Propagation Delay U/D to RC | 3.3 5.0 | | 11 8.0 | | | | ns | 3-6 |
| t _{PHL} | Propagation Delay U/D to RC | 3.3 5.0 | | 10.5 7.5 | | | | ns | 3-6 |
| t _{PLH} | Propagation Delay U/D to TC | 3.3 5.0 | | 9.5 7.0 | | | | ns | 3-6 |
| t _{PHL} | Propagation Delay U/D to TC | 3.3 5.0 | | 9.5 7.0 | | | | ns | 3-6 |
| t _{PLH} | Propagation Delay P _n to Q _n | 3.3 5.5 | | 10.5 7.5 | | | | ns | 3-6 |
| t _{PHL} | Propagation Delay P _n to Q _n | 3.3 5.0 | | 9.5 7.0 | | | | ns | 3-6 |
| t _{PLH} | Propagation Delay PL to Q _n | 3.3 5.0 | | 11.5 8.5 | | | | ns | 3-6 |
| t _{PHL} | Propagation Delay PL to Q _n | 3.3 5.0 | | 11.5 8.5 | | | | ns | 3-6 |

*Voltage Range 3.3 is 3.3 V ± 0.3 V
Voltage Range 5.0 is 5.0 V ± 0.5 V

5

MC74AC190 • MC74AC191

AC OPERATING REQUIREMENTS

| Symbol | Parameter | V _{CC} * (V) | 74AC190 | | 74AC190 | | Units | Fig. No. |
|------------------|--|--------------------------|--|--------------------|--|----|-------|----------|
| | | | T _A = +25°C C _L = 50 pF | | T _A = -40°C to +85°C C _L = 50 pF | | | |
| | | | Typ | Guaranteed Minimum | | | | |
| t _s | Setup Time, HIGH or LOW P _n to \overline{PL} | 3.3 | 4.5 | | | ns | 3-9 | |
| | | 5.0 | 3.0 | | | | | |
| t _h | Hold Time, HIGH or LOW P _n to \overline{PL} | 3.3 | -0.5 | | | ns | 3-9 | |
| | | 5.0 | -0.5 | | | | | |
| t _s | Setup Time, LOW \overline{CE} to CP | 3.3 | 7.0 | | | ns | 3-9 | |
| | | 5.0 | 5.0 | | | | | |
| t _h | Hold Time, LOW \overline{CE} to CP | 3.3 | -1.5 | | | ns | 3-9 | |
| | | 5.0 | -1.0 | | | | | |
| t _s | Setup Time, HIGH or LOW $\overline{U/D}$ to CP | 3.3 | 7.0 | | | ns | 3-9 | |
| | | 5.0 | 5.0 | | | | | |
| t _h | Hold Time, HIGH or LOW $\overline{U/D}$ to CP | 3.3 | -1.5 | | | ns | 3-9 | |
| | | 5.0 | -1.0 | | | | | |
| t _w | \overline{PL} Pulse Width, LOW | 3.3 | 5.5 | | | ns | 3-6 | |
| | | 5.0 | 6.0 | | | | | |
| t _w | CP Pulse Width, LOW | 3.3 | 5.5 | | | ns | 3-6 | |
| | | 5.0 | 6.0 | | | | | |
| t _{rec} | Recovery Time \overline{PL} to CP | 3.3 | 4.5 | | | ns | 3-9 | |
| | | 5.0 | 3.0 | | | | | |

*Voltage Range 3.3 is 3.3 V ± 0.3 V
Voltage Range 5.0 is 5.0 V ± 0.5 V

MC74AC190 • MC74AC191

AC CHARACTERISTICS (For Figures and Waveforms — See Section 3)

| Symbol | Parameter | V _{CC} * (V) | 74AC191 | | | 74AC191 | | Units | Fig. No. |
|------------------|--|--------------------------|--|-------------|--------------|--|--------------|-------|----------|
| | | | T _A = +25°C C _L = 50 pF | | | T _A = -40°C to +85°C C _L = 50 pF | | | |
| | | | Min | Typ | Max | Min | Max | | |
| f _{max} | Maximum Count Frequency | 3.3 5.0 | 70 90 | 105 133 | | 65 85 | | MHz | 3-3 |
| t _{PLH} | Propagation Delay CP to Q _n | 3.3 5.0 | 3.0 2.0 | 8.5 6.0 | 15 11 | 1.0 1.0 | 16 12 | ns | 3-6 |
| t _{PHL} | Propagation Delay CP to Q _n | 3.3 5.0 | 3.0 2.0 | 8.5 6.0 | 14.5 10.5 | 1.0 1.0 | 16 11.5 | ns | 3-6 |
| t _{PLH} | Propagation Delay CP to TC | 3.3 5.0 | 4.0 3.0 | 10.5 7.5 | 18 12 | 1.0 1.0 | 20 14 | ns | 3-6 |
| t _{PHL} | Propagation Delay CP to TC | 3.3 5.0 | 4.5 3.0 | 10.5 7.5 | 17.5 12.5 | 1.0 1.0 | 19 13.5 | ns | 3-6 |
| t _{PLH} | Propagation Delay CP to \overline{RC} | 3.3 5.0 | 3.0 2.5 | 7.5 5.5 | 12 9.5 | 1.0 1.0 | 13.5 10.5 | ns | 3-6 |
| t _{PHL} | Propagation Delay CP to \overline{RC} | 3.3 5.0 | 2.5 2.0 | 7.0 5.0 | 11.5 8.5 | 1.0 1.0 | 12.5 9.5 | ns | 3-6 |
| t _{PLH} | Propagation Delay \overline{CE} to \overline{RC} | 3.3 5.0 | 2.5 1.5 | 7.0 5.0 | 12 8.5 | 1.0 1.0 | 13.5 9.5 | ns | 3-6 |
| t _{PHL} | Propagation Delay \overline{CE} to \overline{RC} | 3.3 5.0 | 2.5 1.5 | 6.5 5.0 | 11 8.0 | 1.0 1.0 | 12.5 9.0 | ns | 3-6 |
| t _{PLH} | Propagation Delay $\overline{U/D}$ to \overline{RC} | 3.3 5.0 | 2.5 1.5 | 6.5 5.0 | 12.5 9.0 | 1.0 1.0 | 14.5 10 | ns | 3-6 |
| t _{PHL} | Propagation Delay $\overline{U/D}$ to \overline{RC} | 3.3 5.0 | 2.5 1.5 | 7.0 5.0 | 12 8.5 | 1.0 1.0 | 13.5 10 | ns | 3-6 |
| t _{PLH} | Propagation Delay $\overline{U/D}$ to TC | 3.3 5.0 | 2.5 2.0 | 7.0 5.0 | 11.5 8.5 | 1.0 1.0 | 13.5 9.5 | ns | 3-6 |
| t _{PHL} | Propagation Delay $\overline{U/D}$ to TC | 3.3 5.0 | 2.5 1.5 | 6.5 5.0 | 11 8.5 | 1.0 1.0 | 12.5 9.5 | ns | 3-6 |
| t _{PLH} | Propagation Delay P _n to Q _n | 3.3 5.0 | 3.0 2.0 | 8.0 5.5 | 13.5 9.5 | 1.0 1.0 | 15.5 10.5 | ns | 3-6 |
| t _{PHL} | Propagation Delay P _n to Q _n | 3.3 5.0 | 3.0 2.0 | 7.5 5.5 | 13 9.5 | 1.0 1.0 | 14.5 10.5 | ns | 3-6 |
| t _{PLH} | Propagation Delay \overline{PL} to Q _n | 3.3 5.0 | 3.5 2.0 | 9.5 5.5 | 14.5 9.5 | 1.0 1.0 | 17.5 10.5 | ns | 3-6 |
| t _{PHL} | Propagation Delay \overline{PL} to Q _n | 3.3 5.0 | 3.0 2.0 | 8.0 6.0 | 13.5 10 | 1.0 1.0 | 15.5 11 | ns | 3-6 |

*Voltage Range 3.3 is 3.3 V ± 0.3 V
Voltage Range 5.0 is 5.0 V ± 0.5 V

MC74AC190 • MC74AC191

AC OPERATING REQUIREMENTS

| Symbol | Parameter | V _{CC} * (V) | 74AC191 | | 74AC191 | | Units | Fig. No. |
|------------------|---|--------------------------|--|--------------------|--|----|-------|----------|
| | | | T _A = +25°C C _L = 50 pF | | T _A = -40°C to +85°C C _L = 50 pF | | | |
| | | | Typ | Guaranteed Minimum | | | | |
| t _s | Setup Time, HIGH or LOW P _n to $\overline{P_L}$ | 3.3 | 1.0 | 3.0 | 3.0 | ns | 3-9 | |
| | | 5.0 | 0.5 | 2.0 | 2.5 | | | |
| t _h | Hold Time, HIGH or LOW P _n to $\overline{P_L}$ | 3.3 | -1.5 | 0.5 | 1.0 | ns | 3-9 | |
| | | 5.0 | -0.5 | 1.0 | 1.0 | | | |
| t _s | Setup Time, LOW CE to CP | 3.3 | 3.0 | 6.0 | 7.0 | ns | 3-9 | |
| | | 5.0 | 1.5 | 4.0 | 4.5 | | | |
| t _h | Hold Time, LOW CE to CP | 3.3 | -4.0 | -0.5 | -0.5 | ns | 3-9 | |
| | | 5.0 | -2.5 | 0 | 0 | | | |
| t _s | Setup Time, HIGH or LOW $\overline{U/D}$ to CP | 3.3 | 4.0 | 8.0 | 9.0 | ns | 3-9 | |
| | | 5.0 | 2.5 | 5.5 | 6.5 | | | |
| t _h | Hold Time, HIGH or LOW $\overline{U/D}$ to CP | 3.3 | -5.0 | 0 | 0 | ns | 3-9 | |
| | | 5.0 | -3.0 | 0.5 | 0.5 | | | |
| t _w | $\overline{P_L}$ Pulse Width, LOW | 3.3 | 2.0 | 3.5 | 4.0 | ns | 3-6 | |
| | | 5.0 | 1.0 | 1.0 | 1.0 | | | |
| t _w | CP Pulse Width, LOW | 3.3 | 2.0 | 3.5 | 4.0 | ns | 3-6 | |
| | | 5.0 | 2.0 | 3.0 | 4.0 | | | |
| t _{rec} | Recovery Time $\overline{P_L}$ to CP | 3.3 | -0.5 | 0 | 0 | ns | 3-9 | |
| | | 5.0 | -1.0 | 0 | 0 | | | |

*Voltage Range 3.3 is 3.3 V ± 0.3 V
Voltage Range 5.0 is 5.0 V ± 0.5 V

CAPACITANCE

| Symbol | Parameter | Value Typ | Units | Test Conditions |
|-----------------|-------------------------------|--------------|-------|-------------------------|
| C _{IN} | Input Capacitance | 4.5 | pF | V _{CC} = 5.0 V |
| C _{PD} | Power Dissipation Capacitance | 75 | pF | V _{CC} = 5.0 V |



MOTOROLA

Product Preview

Up/Down Counters with Separate Up/Down Clocks

The MC74AC192 is an up/down BCD decade (8421) counter. The MC74AC193 is an up/down modulo-16 binary counter. Separate Count Up and Count Down Clocks are used, and in either counting mode the outputs change state synchronously with the LOW-to-HIGH transitions on the clock inputs.

Separate Terminal Count Up and Terminal Count Down outputs are provided that are used as the clocks for a subsequent stage without extra logic, thus simplifying multistage counter designs. Individual preset inputs allow the circuit to be used as a programmable counter. Both the Parallel Load (\overline{PL}) and the Master Reset (MR) inputs asynchronously override the clocks.

- High-Speed — 120 MHz Typical Count Frequency
- Synchronous Counting
- Asynchronous Parallel Load and Master Reset
- Outputs Source/Sink 24 mA

LOGIC SYMBOL

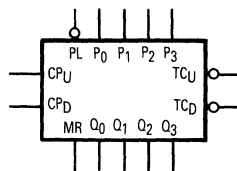

PIN NAMES

- CP_U Count Up Clock Input
- CP_D Count Down Clock Input
- MR Asynchronous Master Reset Input
- \overline{PL} Asynchronous Parallel Load Input
- P₀-P₃ Parallel Data Inputs
- Q₀-Q₃ Flip-Flop Outputs
- \overline{TC}_D Terminal Count Down (Borrow) Output
- \overline{TC}_U Terminal Count Up (Carry) Output

**MC74AC192
MC74AC193**

**UP/DOWN COUNTERS
WITH SEPARATE
UP/DOWN CLOCKS**

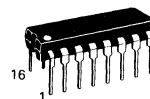

**N SUFFIX
CASE 648-08
PLASTIC**

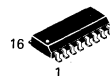

**D SUFFIX
CASE 751B-03
PLASTIC**

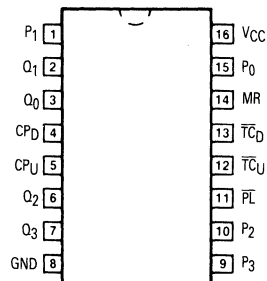

MC74AC192 • MC74AC193

LOGIC DIAGRAM

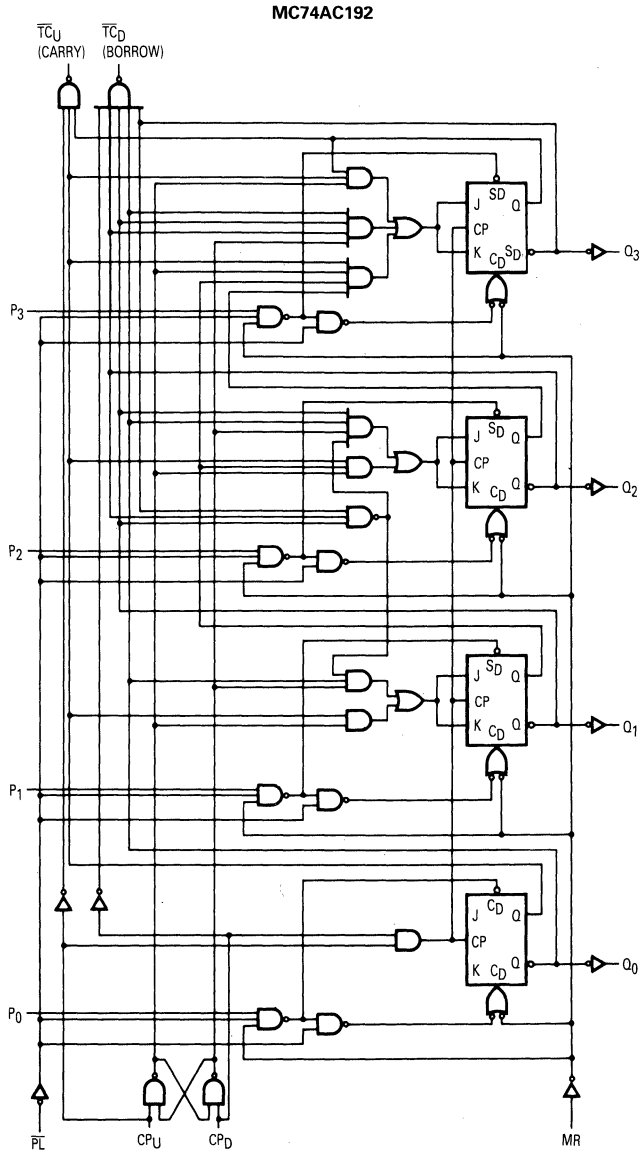

Please note that this diagram is provided only for the understanding of logic operations and should not be used to estimate propagation delays.

MC74AC192 • MC74AC193

LOGIC DIAGRAM

MC74AC193

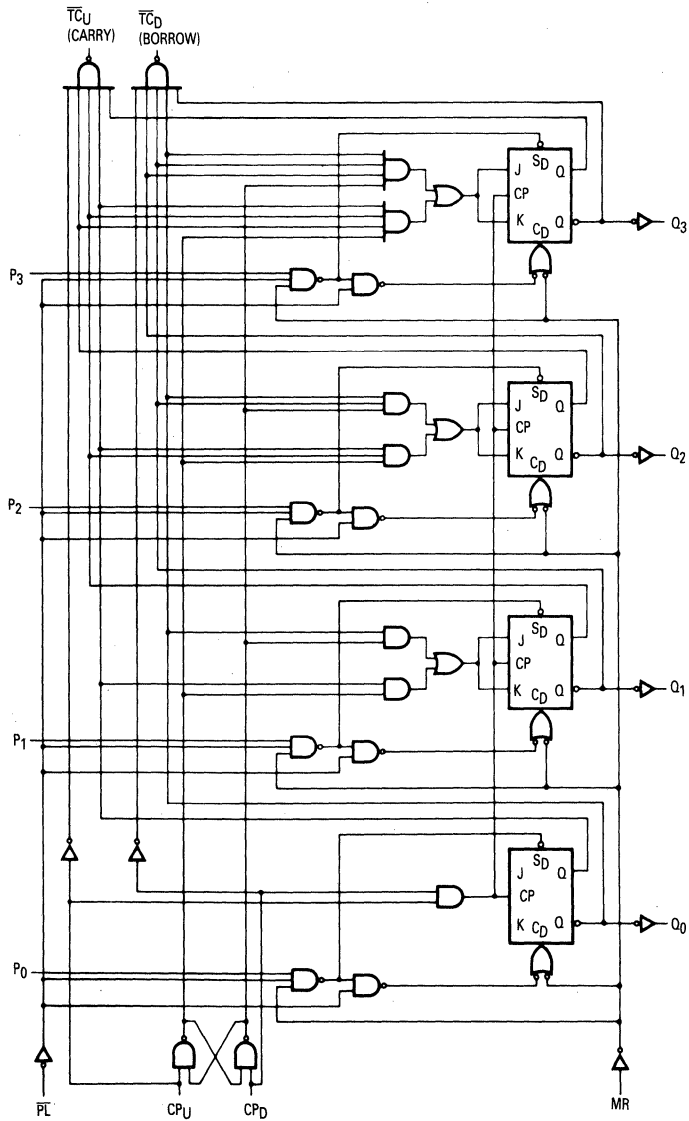

Please note that this diagram is provided only for the understanding of logic operations and should not be used to estimate propagation delays.

MC74AC192 • MC74AC193

FUNCTIONAL DESCRIPTION

The MC74AC192/74AC193 are asynchronously presett-able counters. The MC74AC192 is a decade counter while the MC74AC193 is organized for 4-bit binary operation. They both contain four edge-triggered flip-flops, with internal gating and steering logic to provide master reset, individual preset, count up and count down operations.

A LOW-to-HIGH transition on the CP input to each flip-flop causes the output to change state. Synchronous switching, as opposed to ripple counting, is achieved by driving the steering gates of all stages from a common Count Up line and a common Count Down line, thereby causing all state changes to be initiated simultaneously. A LOW-to-HIGH transition on the Count Up input will advance the count by one; a similar transition on the Count Down input will decrease the count by one. While counting with one clock input, the other should be held HIGH, as indicated in the Function Table. Otherwise, the circuit will either count by twos or not at all, depending on the state of the first flip-flop, which cannot toggle as long as either clock input is LOW.

The Terminal Count Up (\overline{TC}_U) and Terminal Count Down (\overline{TC}_D) outputs are normally HIGH. When the circuit has reached the maximum count state, 9 (MC74AC192) or 15 (MC74AC193), the reset HIGH-to-LOW transition of the Count Up Clock will cause \overline{TC}_U to go LOW. \overline{TC}_U will stay LOW until CP_U goes HIGH again, thus effectively repeating the Count Up Clock, but delayed by two gate delays. Similarly, the \overline{TC}_D output will go LOW when the circuit is in the zero state and the Count Down Clock goes LOW. Since the \overline{TC} outputs repeat the clock waveforms, they can be used as the clock input signals to the next higher order circuit in a multistage counter.

$$\overline{TC}_U = Q_0 \cdot \overline{Q}_1 \cdot \overline{Q}_2 \cdot Q_3 \cdot \overline{CP}_U \text{ ('AC192)}$$

$$\overline{TC}_U = Q_0 \cdot Q_1 \cdot Q_2 \cdot Q_3 \cdot \overline{CP}_U \text{ ('AC193)}$$

$$\overline{TC}_D = \overline{Q}_0 \cdot \overline{Q}_1 \cdot \overline{Q}_2 \cdot \overline{Q}_3 \cdot \overline{CP}_D$$

Both the MC74AC192 and the MC74AC193 have an asynchronous parallel load capability permitting the counter to be preset. When the Parallel Load (\overline{PL}) and the Master Reset (MR) inputs are LOW, information present on the Parallel Data input (P_0 - P_3) is loaded into the counter and appears on the outputs regardless of the conditions of the clock inputs. A HIGH signal on the Master Reset input will disable the preset gates, override both clock inputs, and latch each Q output in the LOW state. If one of the clock inputs is LOW during and after a reset or load operation, the next LOW-to-HIGH transition of that clock will be interpreted as a legitimate signal and will be counted.

FUNCTION TABLE

| MR | \overline{PL} | CP_U | CP_D | Mode |
|----|-----------------|--------|--------|----------------|
| H | X | X | X | Reset (Asyn.) |
| L | L | X | X | Preset (Asyn.) |
| L | H | H | H | No Change |
| L | H | H | H | Count Up |
| L | H | H | H | Count Down |

H = HIGH Voltage Level
L = LOW Voltage Level

X = Immaterial
= LOW-to-HIGH Transition

STATE DIAGRAMS

MC74AC192

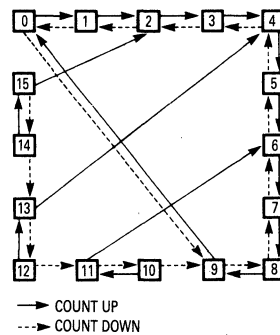

MC74AC193

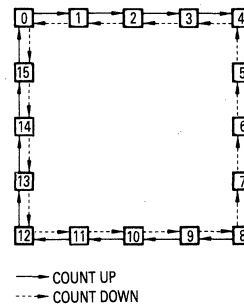

MC74AC192 • MC74AC193

DC CHARACTERISTICS (unless otherwise specified)

| Symbol | Parameter | Value | Units | Test Conditions |
|-----------------|----------------------------------|-------|-------|---|
| I _{CC} | Maximum Quiescent Supply Current | 80 | μA | V _{IN} = V _{CC} or Ground, V _{CC} = 5.5 V, T _A = Worst Case |
| I _{CC} | Maximum Quiescent Supply Current | 8.0 | μA | V _{IN} = V _{CC} or Ground, V _{CC} = 5.5 V, T _A = 25°C |

AC CHARACTERISTICS (For Figures and Waveforms — See Section 3)

| Symbol | Parameter | V _{CC} * (V) | 74AC | | | 74AC | | Units | Fig. No. |
|------------------|---|-----------------------|--|-------------|-----|--|-----|-------|----------|
| | | | T _A = +25°C C _L = 50 pF | | | T _A = -40°C to +85°C C _L = 50 pF | | | |
| | | | Min | Typ | Max | Min | Max | | |
| f _{max} | Maximum Count Frequency | 3.3 5.0 | | 88 120 | | | MHz | 3-3 | |
| t _{PLH} | Propagation Delay C _{PJ} or C _{PD} to $\overline{T_C}_U$ or $\overline{T_C}_D$ | 3.3 5.0 | | 15 11 | | | ns | 3-6 | |
| t _{PHL} | Propagation Delay C _{PJ} or C _{PD} to $\overline{T_C}_U$ or $\overline{T_C}_D$ | 3.3 5.0 | | 13 9.5 | | | ns | 3-6 | |
| t _{PLH} | Propagation Delay C _{PJ} or C _{PD} to Q _n | 3.3 5.0 | | 9.5 7.0 | | | ns | 3-6 | |
| t _{PHL} | Propagation Delay C _{PJ} or C _{PD} to Q _n | 3.3 5.0 | | 10.5 7.5 | | | ns | 3-6 | |
| t _{PLH} | Propagation Delay P _n to Q _n | 3.3 5.0 | | 9.5 7.0 | | | ns | 3-6 | |
| t _{PHL} | Propagation Delay P _n to Q _n | 3.3 5.0 | | 9.5 7.0 | | | ns | 3-6 | |
| t _{PLH} | Propagation Delay $\overline{P_L}$ to Q _n | 3.3 5.0 | | 12.5 9.0 | | | ns | 3-6 | |
| t _{PHL} | Propagation Delay $\overline{P_L}$ to Q _n | 3.3 5.0 | | 11 8.0 | | | ns | 3-6 | |
| t _{PLH} | Propagation Delay MR to Q _n | 3.3 5.0 | | 12.5 9.0 | | | ns | 3-6 | |
| t _{PLH} | Propagation Delay MR to $\overline{T_C}_U$ | 3.3 5.0 | | 12.5 9.0 | | | ns | 3-6 | |
| t _{PHL} | Propagation Delay MR to $\overline{T_C}_D$ | 3.3 5.0 | | 11 8.0 | | | ns | 3-6 | |
| t _{PLH} | Propagation Delay $\overline{P_L}$ to $\overline{T_C}_U$ or $\overline{T_C}_D$ | 3.3 5.0 | | 11.5 8.5 | | | ns | 3-6 | |
| t _{PHL} | Propagation Delay $\overline{P_L}$ to $\overline{T_C}_U$ or $\overline{T_C}_D$ | 3.3 5.0 | | 9.5 7.0 | | | ns | 3-6 | |
| t _{PLH} | Propagation Delay P _n to $\overline{T_C}_U$ or $\overline{T_C}_D$ | 3.3 5.0 | | 11.5 8.5 | | | ns | 3-6 | |
| t _{PHL} | Propagation Delay P _n to $\overline{T_C}_U$ or $\overline{T_C}_D$ | 3.3 5.0 | | 11.5 8.5 | | | ns | 3-6 | |

*Voltage Range 3.3 is 3.3 V ± 0.3 V
Voltage Range 5.0 is 5.0 V ± 0.5 V

5

MC74AC192 • MC74AC193

AC OPERATING REQUIREMENTS

| Symbol | Parameter | V _{CC} * (V) | 74AC | | 74AC | | Units | Fig. No. |
|------------------|--|--------------------------|--|--------------------|--|----|-------|----------|
| | | | T _A = +25°C C _L = 50 pF | | T _A = -40°C to +85°C C _L = 50 pF | | | |
| | | | Typ | Guaranteed Minimum | | | | |
| t _s | Setup Time, HIGH or LOW P _n to PL | 3.3 5.0 | 4.5 3.0 | | | ns | 3-9 | |
| t _h | Hold Time, HIGH or LOW P _n to PL | 3.3 5.0 | -0.5 -0.5 | | | ns | 3-9 | |
| t _w | PL Pulse Width, LOW | 3.3 5.0 | 8.5 6.0 | | | ns | 3-6 | |
| t _w | CP _U or CP _D Pulse Width, LOW | 3.3 5.0 | 5.5 4.0 | | | ns | 3-6 | |
| t _w | CP _U or CP _D Pulse Width, LOW (Change of Direction) | 3.3 5.0 | 9.0 6.5 | | | ns | 3-6 | |
| t _w | MR Pulse Width, HIGH | 3.3 5.0 | 7.0 5.0 | | | ns | 3-6 | |
| t _{rec} | Recovery Time PL to CP _U or CP _D | 3.3 5.0 | 4.5 3.0 | | | ns | 3-9 | |
| t _{rec} | Recovery Time MR to CP _U or CP _D | 3.3 5.0 | 8.5 6.0 | | | ns | 3-9 | |

*Voltage Range 3.3 is 3.3 V ± 0.3 V
Voltage Range 5.0 is 5.0 V ± 0.5 V

CAPACITANCE

| Symbol | Parameter | Value Typ | Units | Test Conditions |
|-----------------|-------------------------------|--------------|-------|-------------------------|
| C _{IN} | Input Capacitance | 4.5 | pF | V _{CC} = 5.0 V |
| C _{PD} | Power Dissipation Capacitance | | pF | V _{CC} = 5.0 V |



MOTOROLA

Product Preview

Octal Buffer/Line Driver with 3-State Outputs

The MC74AC240/74ACT240 is an octal buffer and line driver designed to be employed as a memory address driver, clock driver and bus oriented transmitter or receiver which provides improved PC board density.

- 3-State Outputs Drive Bus Lines or Buffer Memory Address Registers
- Outputs Source/Sink 24 mA
- 'ACT240 Has TTL Compatible Inputs

TRUTH TABLES

| Inputs | | Outputs |
|-------------------|---|-----------------------|
| \overline{OE}_1 | D | (Pins 12, 14, 16, 18) |
| L | L | H |
| L | H | L |
| H | X | Z |

| Inputs | | Outputs |
|-------------------|---|-------------------|
| \overline{OE}_2 | D | (Pins 3, 5, 7, 9) |
| L | L | H |
| L | H | L |
| H | X | Z |

H = HIGH Voltage Level
 L = LOW Voltage Level
 X = Immaterial
 Z = High Impedance

**MC74AC240
MC74ACT240**

OCTAL BUFFER/LINE DRIVER WITH 3-STATE OUTPUTS

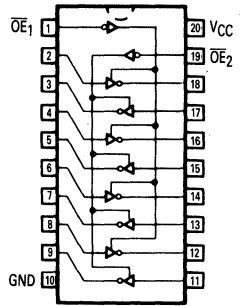
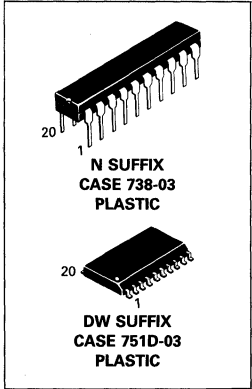

5

This document contains information on a product under development. Motorola reserves the right to change or discontinue this product without notice.

MC74AC240 • MC74ACT240

DC CHARACTERISTICS (unless otherwise specified)

| Symbol | Parameter | Value | Units | Test Conditions |
|--------------------|--|-------|-------|---|
| I _{CC} | Maximum Quiescent Supply Current | 80 | μA | V _{IN} = V _{CC} or Ground, V _{CC} = 5.5 V, T _A = Worst Case |
| I _{CC} | Maximum Quiescent Supply Current | 8.0 | μA | V _{IN} = V _{CC} or Ground, V _{CC} = 5.5 V, T _A = 25°C |
| I _{CC(T)} | Maximum Additional I _{CC} /Input (ACT240) | 1.5 | mA | V _{IN} = V _{CC} - 2.1 V, V _{CC} = 5.5 V, T _A = Worst Case |

AC CHARACTERISTICS (For Figures and Waveforms — See Section 3)

| Symbol | Parameter | V _{CC} * (V) | 74AC | | | 74AC | | Units | Fig. No. |
|------------------|----------------------------------|-----------------------|--|------------|-------------|--|-------------|-------|----------|
| | | | T _A = +25°C C _L = 50 pF | | | T _A = -40°C to +85°C C _L = 50 pF | | | |
| | | | Min | Typ | Max | Min | Max | | |
| t _{PLH} | Propagation Delay Data to Output | 3.3 5.0 | 1.0 1.0 | 6.0 4.5 | 8.0 6.5 | 1.0 1.0 | 9.0 7.0 | ns | 3-5 |
| t _{PHL} | Propagation Delay Data to Output | 3.3 5.0 | 1.0 1.0 | 5.5 4.5 | 8.0 6.0 | 1.0 1.0 | 8.5 6.5 | ns | 3-5 |
| t _{PZH} | Output Enable Time | 3.3 5.0 | 1.0 1.0 | 6.0 5.0 | 10.5 7.0 | 1.0 1.0 | 11 8.0 | ns | 3-7 |
| t _{PZL} | Output Enable Time | 3.3 5.0 | 1.0 1.0 | 7.0 5.5 | 10 8.0 | 1.0 1.0 | 11 8.5 | ns | 3-8 |
| t _{PHZ} | Output Disable Time | 3.3 5.0 | 1.0 1.0 | 7.0 6.5 | 10 9.0 | 1.0 1.0 | 10.5 9.5 | ns | 3-7 |
| t _{PLZ} | Output Disable Time | 3.3 5.0 | 1.0 1.0 | 7.5 6.5 | 10.5 9.0 | 1.0 1.0 | 11.5 9.5 | ns | 3-8 |

*Voltage Range 3.3 is 3.3 V ± 0.3 V
Voltage Range 5.0 is 5.0 V ± 0.5 V

AC CHARACTERISTICS (For Figures and Waveforms — See Section 3)

| Symbol | Parameter | V _{CC} * (V) | 74ACT | | | 74ACT | | Units | Fig. No. |
|------------------|----------------------------------|-----------------------|--|-----|-----|--|------|-------|----------|
| | | | T _A = +25°C C _L = 50 pF | | | T _A = -40°C to +85°C C _L = 50 pF | | | |
| | | | Min | Typ | Max | Min | Max | | |
| t _{PLH} | Propagation Delay Data to Output | 5.0 | 1.0 | 6.0 | 8.5 | 1.0 | 9.5 | ns | 3-5 |
| t _{PHL} | Propagation Delay Data to Output | 5.0 | 1.0 | 5.5 | 7.5 | 1.0 | 8.5 | ns | 3-5 |
| t _{PZH} | Output Enable Time | 5.0 | 1.0 | 7.0 | 8.5 | 1.0 | 9.5 | ns | 3-7 |
| t _{PZL} | Output Enable Time | 5.0 | 1.0 | 7.0 | 9.5 | 1.0 | 10.5 | ns | 3-8 |
| t _{PHZ} | Output Disable Time | 5.0 | 1.0 | 8.0 | 9.5 | 1.0 | 10.5 | ns | 3-7 |
| t _{PLZ} | Output Disable Time | 5.0 | 1.0 | 6.5 | 10 | 1.0 | 10.5 | ns | 3-8 |

*Voltage Range 5.0 is 5.0 V ± 0.5 V

CAPACITANCE

| Symbol | Parameter | Value Typ | Units | Test Conditions |
|-----------------|-------------------------------|-----------|-------|-------------------------|
| C _{IN} | Input Capacitance | 4.5 | pF | V _{CC} = 5.0 V |
| C _{PD} | Power Dissipation Capacitance | 45 | pF | V _{CC} = 5.0 V |



MOTOROLA

Product Preview

Octal Buffer/Line Driver with 3-State Outputs

The MC74AC241/74ACT241 is an octal buffer and line driver designed to be employed as a memory address driver, clock driver and bus oriented transmitter or receiver which provides improved PC board density.

- 3-State Outputs Drive Bus Lines or Buffer Memory Address Registers
- Outputs Source/Sink 24 mA
- 'ACT241 Has TTL Compatible Inputs

TRUTH TABLES

| Inputs | | Outputs |
|-----------------|---|-----------------------|
| OE ₁ | D | (Pins 12, 14, 16, 18) |
| L | L | L |
| L | H | H |
| H | X | Z |

| Inputs | | Outputs |
|-----------------|---|-------------------|
| OE ₂ | D | (Pins 3, 5, 7, 9) |
| H | L | L |
| H | H | H |
| L | X | Z |

H = HIGH Voltage Level
 L = LOW Voltage Level
 X = Immaterial
 Z = High Impedance

**MC74AC241
MC74ACT241**

OCTAL BUFFER/LINE DRIVER WITH 3-STATE OUTPUTS

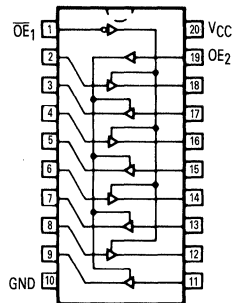
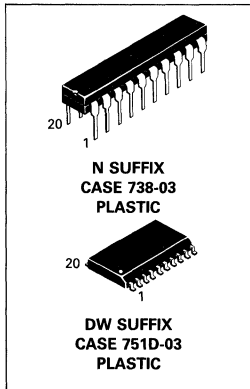

5

This document contains information on a product under development. Motorola reserves the right to change or discontinue this product without notice.

MC74AC241 • MC74ACT241

DC CHARACTERISTICS (unless otherwise specified)

| Symbol | Parameter | Value | Units | Test Conditions |
|-------------------|---|-------|-------|---|
| I _{CC} | Maximum Quiescent Supply Current | 80 | μA | V _{IN} = V _{CC} or Ground, V _{CC} = 5.5 V, T _A = Worst Case |
| I _{CC} | Maximum Quiescent Supply Current | 8.0 | μA | V _{IN} = V _{CC} or Ground, V _{CC} = 5.5 V, T _A = 25°C |
| I _{CC} T | Maximum Additional I _{CC} /Input ('ACT241) | 1.5 | mA | V _{IN} = V _{CC} - 2.1 V, V _{CC} = 5.5 V, T _A = Worst Case |

AC CHARACTERISTICS (For Figures and Waveforms — See Section 3)

| Symbol | Parameter | V _{CC} * (V) | 74AC | | | 74AC | | Units | Fig. No. |
|------------------|----------------------------------|-----------------------|--|------------|-------------|--|--------------|-------|----------|
| | | | T _A = +25°C C _L = 50 pF | | | T _A = -40°C to +85°C C _L = 50 pF | | | |
| | | | Min | Typ | Max | Min | Max | | |
| t _{PLH} | Propagation Delay Data to Output | 3.3 5.0 | 1.0 1.0 | 6.0 5.0 | 9.0 7.0 | 1.0 1.0 | 10 7.5 | ns | 3-5 |
| t _{PHL} | Propagation Delay Data to Output | 3.3 5.0 | 1.0 1.0 | 6.0 4.5 | 9.0 7.0 | 1.0 1.0 | 10.5 7.5 | ns | 3-5 |
| t _{PZH} | Output Enable Time | 3.3 5.0 | 1.0 1.0 | 6.5 5.5 | 12.5 9.0 | 1.0 1.0 | 13 9.5 | ns | 3-7 |
| t _{PZL} | Output Enable Time | 3.3 5.0 | 1.0 1.0 | 7.0 5.5 | 12 9.0 | 1.0 1.0 | 13 9.5 | ns | 3-8 |
| t _{PHZ} | Output Disable Time | 3.3 5.0 | 1.0 1.0 | 8.0 6.5 | 12 10 | 1.0 1.0 | 12.5 10.5 | ns | 3-7 |
| t _{PLZ} | Output Disable Time | 3.3 5.0 | 1.0 1.0 | 7.0 6.0 | 12.5 10 | 1.0 1.0 | 13.5 10.5 | ns | 3-8 |

*Voltage Range 3.3 is 3.3 V ± 0.3 V
Voltage Range 5.0 is 5.0 V ± 0.5 V

AC CHARACTERISTICS (For Figures and Waveforms — See Section 3)

| Symbol | Parameter | V _{CC} * (V) | 74ACT | | | 74ACT | | Units | Fig. No. |
|------------------|----------------------------------|-----------------------|--|-----|------|--|------|-------|----------|
| | | | T _A = +25°C C _L = 50 pF | | | T _A = -40°C to +85°C C _L = 50 pF | | | |
| | | | Min | Typ | Max | Min | Max | | |
| t _{PLH} | Propagation Delay Data to Output | 5.0 | 1.0 | 6.5 | 9.0 | 1.0 | 10 | ns | 3-5 |
| t _{PHL} | Propagation Delay Data to Output | 5.0 | 1.0 | 7.0 | 9.0 | 1.0 | 10 | ns | 3-5 |
| t _{PZH} | Output Enable Time | 5.0 | 1.0 | 6.0 | 9.0 | 1.0 | 10 | ns | 3-7 |
| t _{PZL} | Output Enable Time | 5.0 | 1.0 | 7.0 | 10 | 1.0 | 11 | ns | 3-8 |
| t _{PHZ} | Output Disable Time | 5.0 | 1.0 | 8.0 | 10.5 | 1.0 | 11.5 | ns | 3-7 |
| t _{PLZ} | Output Disable Time | 5.0 | 1.0 | 7.0 | 10.5 | 1.0 | 11.5 | ns | 3-8 |

*Voltage Range 5.0 is 5.0 V ± 0.5 V

CAPACITANCE

| Symbol | Parameter | Value Typ | Units | Test Conditions |
|-----------------|-------------------------------|-----------|-------|-------------------------|
| C _{IN} | Input Capacitance | 4.5 | pF | V _{CC} = 5.0 V |
| CPD | Power Dissipation Capacitance | 45 | pF | V _{CC} = 5.0 V |





MOTOROLA

Product Preview

Octal Buffer/Line Driver with 3-State Outputs

The MC74AC244/74ACT244 is an octal buffer and line driver designed to be employed as a memory address driver, clock driver and bus oriented transmitter/receiver which provides improved PC board density.

- 3-State Outputs Drive Bus Lines or Buffer Memory Address Registers
- Outputs Source/Sink 24 mA
- 'ACT244 Has TTL Compatible Inputs

TRUTH TABLES

| Inputs | | Outputs |
|-------------------|---|-----------------------|
| \overline{OE}_1 | D | (Pins 12, 14, 16, 18) |
| L | L | L |
| L | H | H |
| H | X | Z |

| Inputs | | Outputs |
|-------------------|---|-------------------|
| \overline{OE}_2 | D | (Pins 3, 5, 7, 9) |
| L | L | L |
| L | H | H |
| H | X | Z |

H = HIGH Voltage Level
 L = LOW Voltage Level
 X = Immaterial
 Z = High Impedance

**MC74AC244
MC74ACT244**

OCTAL BUFFER/LINE DRIVER WITH 3-STATE OUTPUTS

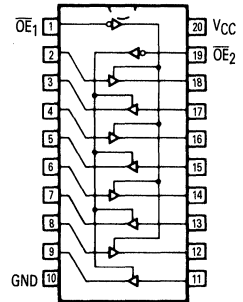
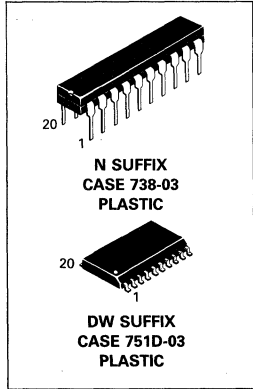

5

This document contains information on a product under development. Motorola reserves the right to change or discontinue this product without notice.

MC74AC244 • MC74ACT244

DC CHARACTERISTICS (unless otherwise specified)

| Symbol | Parameter | Value | Units | Test Conditions |
|------------------|--|-------|-------|---|
| I _{CC} | Maximum Quiescent Supply Current | 80 | μA | V _{IN} = V _{CC} or Ground, V _{CC} = 5.5 V, T _A = Worst Case |
| I _{CC} | Maximum Quiescent Supply Current | 8.0 | μA | V _{IN} = V _{CC} or Ground, V _{CC} = 5.5 V, T _A = 25°C |
| I _{CCT} | Maximum Additional I _{CC} /Input (ACT244) | 1.5 | mA | V _{IN} = V _{CC} - 2.1 V, V _{CC} = 5.5 V, T _A = Worst Case |

AC CHARACTERISTICS (For Figures and Waveforms — See Section 3)

| Symbol | Parameter | V _{CC} * (V) | 74AC | | | 74AC | | Units | Fig. No. |
|------------------|-------------------------------------|-----------------------|--|------------|-------------|--|-------------|-------|----------|
| | | | T _A = +25°C C _L = 50 pF | | | T _A = -40°C to +85°C C _L = 50 pF | | | |
| | | | Min | Typ | Max | Min | Max | | |
| t _{PLH} | Propagation Delay Data to Output | 3.3 5.0 | 1.0 1.0 | 6.5 5.0 | 9.0 7.0 | 1.0 1.0 | 10 7.5 | ns | 3-5 |
| t _{PHL} | Propagation Delay Data to Output | 3.3 5.0 | 1.0 1.0 | 6.5 5.0 | 9.0 7.0 | 1.0 1.0 | 10 7.5 | ns | 3-5 |
| t _{PZH} | Output Enable Time | 3.3 5.0 | 1.0 1.0 | 6.0 5.0 | 10.5 7.0 | 1.0 1.0 | 11 8.0 | ns | 3-7 |
| t _{PZL} | Output Enable Time | 3.3 5.0 | 1.0 1.0 | 7.5 5.5 | 10 8.0 | 1.0 1.0 | 11 8.5 | ns | 3-8 |
| t _{PHZ} | Output Disable Time | 3.3 5.0 | 1.0 1.0 | 7.0 6.5 | 10 9 | 1.0 1.0 | 10.5 9.5 | ns | 3-7 |
| t _{PLZ} | Output Disable Time | 3.3 5.0 | 1.0 1.0 | 7.5 6.5 | 10.5 9.0 | 1.0 1.0 | 11.5 9.5 | ns | 3-8 |

*Voltage Range 3.3 is 3.3 V ± 0.3 V
Voltage Range 5.0 is 5.0 V ± 0.5 V

AC CHARACTERISTICS (For Figures and Waveforms — See Section 3)

| Symbol | Parameter | V _{CC} * (V) | 74ACT | | | 74ACT | | Units | Fig. No. |
|------------------|-------------------------------------|-----------------------|--|-----|-----|--|------|-------|----------|
| | | | T _A = +25°C C _L = 50 pF | | | T _A = -40°C to +85°C C _L = 50 pF | | | |
| | | | Min | Typ | Max | Min | Max | | |
| t _{PLH} | Propagation Delay Data to Output | 5.0 | 1.0 | 6.5 | 9.0 | 1.0 | 10 | ns | 3-5 |
| t _{PHL} | Propagation Delay Data to Output | 5.0 | 1.0 | 7.0 | 9.0 | 1.0 | 10 | ns | 3-5 |
| t _{PZH} | Output Enable Time | 5.0 | 1.0 | 6.0 | 8.5 | 1.0 | 9.5 | ns | 3-7 |
| t _{PZL} | Output Enable Time | 5.0 | 1.0 | 7.0 | 9.5 | 1.0 | 10.5 | ns | 3-8 |
| t _{PHZ} | Output Disable Time | 5.0 | 1.0 | 7.0 | 9.5 | 1.0 | 10.5 | ns | 3-7 |
| t _{PLZ} | Output Disable Time | 5.0 | 1.0 | 7.5 | 10 | 1.0 | 10.5 | ns | 3-8 |

*Voltage Range 5.0 is 5.0 V ± 0.5 V

CAPACITANCE

| Symbol | Parameter | Value Typ | Units | Test Conditions |
|-----------------|-------------------------------|--------------|-------|-------------------------|
| C _{IN} | Input Capacitance | 4.5 | pF | V _{CC} = 5.0 V |
| CPD | Power Dissipation Capacitance | 45 | pF | V _{CC} = 5.0 V |



MOTOROLA

Product Preview

Octal Bidirectional Transceiver with 3-State Inputs/Outputs

The MC74AC245/74ACT245 contains eight non-inverting bidirectional buffers with 3-state outputs and is intended for bus-oriented applications. Current sinking capability is 24 mA at both the A and B ports. The Transmit/Receive (T/R) input determines the direction of data flow through the bidirectional transceiver. Transmit (active-HIGH) enables data from A ports to B ports; Receive (active-LOW) enables data from B ports to A ports. The Output Enable input, when HIGH, disables both A and B ports by placing them in a High Z condition.

- Noninverting Buffers
- Bidirectional Data Path
- A and B Outputs Source/Sink 24 mA
- 'ACT245 Has TTL Compatible Inputs

PIN NAMES

- OE Output Enable Input
- T/R Transmit/Receive Input
- A₀-A₇ Side A 3-State Inputs or 3-State Outputs
- B₀-B₇ Side B 3-State Inputs or 3-State Outputs

TRUTH TABLES

| Inputs | | Outputs |
|--------|-----|---------------------|
| OE | T/R | |
| L | L | Bus B Data to Bus A |
| L | H | Bus A Data to Bus B |
| H | X | High Z State |

H = HIGH Voltage Level
 L = LOW Voltage Level
 X = Immaterial

**MC74AC245
MC74ACT245**

**OCTAL BIDIRECTIONAL
TRANSCIVER
WITH 3-STATE
INPUTS/OUTPUTS**

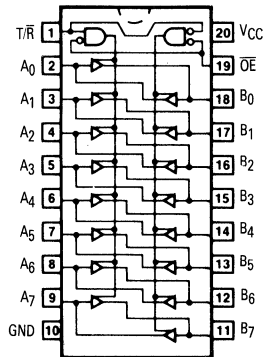
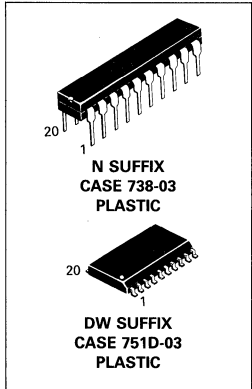

5

This document contains information on a product under development. Motorola reserves the right to change or discontinue this product without notice.

MC74AC245 • MC74ACT245

DC CHARACTERISTICS (unless otherwise specified)

| Symbol | Parameter | Value | Units | Test Conditions |
|--------------------|--|-------|-------|---|
| I _{CC} | Maximum Quiescent Supply Current | 80 | μA | V _{IN} = V _{CC} or Ground, V _{CC} = 5.5 V, T _A = Worst Case |
| I _{CC} | Maximum Quiescent Supply Current | 8.0 | μA | V _{IN} = V _{CC} or Ground, V _{CC} = 5.5 V, T _A = 25°C |
| I _{CC(T)} | Maximum Additional I _{CC} /Input (ACT245) | 1.5 | mA | V _{IN} = V _{CC} - 2.1 V, V _{CC} = 5.5 V, T _A = Worst Case |

AC CHARACTERISTICS (For Figures and Waveforms — See Section 3)

| Symbol | Parameter | V _{CC} * (V) | 74AC | | | 74AC | | Units | Fig. No. |
|------------------|---|-----------------------|--|------------|-------------|--|-------------|-------|----------|
| | | | T _A = +25°C C _L = 50 pF | | | T _A = -40°C to +85°C C _L = 50 pF | | | |
| | | | Min | Typ | Max | Min | Max | | |
| t _{PLH} | Propagation Delay A _n to B _n or B _n to A _n | 3.3 5.0 | 1.0 1.0 | 5.0 3.5 | 8.5 6.5 | 1.0 1.0 | 9.0 7.0 | ns | 3-5 |
| t _{PHL} | Propagation Delay A _n to B _n or B _n to A _n | 3.3 5.0 | 1.0 1.0 | 5.0 3.5 | 8.5 6.0 | 1.0 1.0 | 9.0 7.0 | ns | 3-5 |
| t _{PZH} | Output Enable Time | 3.3 5.0 | 1.0 1.0 | 7.0 5.0 | 11.5 8.5 | 1.0 1.0 | 12.5 9.0 | ns | 3-7 |
| t _{PZL} | Output Enable Time | 3.3 5.0 | 1.0 1.0 | 7.5 5.5 | 12 9.0 | 1.0 1.0 | 13.5 9.5 | ns | 3-8 |
| t _{PHZ} | Output Disable Time | 3.3 5.0 | 1.0 1.0 | 6.5 5.5 | 12 9.0 | 1.0 1.0 | 12.5 10 | ns | 3-7 |
| t _{PLZ} | Output Disable Time | 3.3 5.0 | 1.0 1.0 | 7.0 5.5 | 11.5 9.0 | 1.0 1.0 | 13 10 | ns | 3-8 |

*Voltage Range 3.3 is 3.3 V ± 0.3 V
Voltage Range 5.0 is 5.0 V ± 0.5 V

AC CHARACTERISTICS (For Figures and Waveforms — See Section 3)

| Symbol | Parameter | V _{CC} * (V) | 74ACT | | | 74ACT | | Units | Fig. No. |
|------------------|---|-----------------------|--|-----|-----|--|-----|-------|----------|
| | | | T _A = +25°C C _L = 50 pF | | | T _A = -40°C to +85°C C _L = 50 pF | | | |
| | | | Min | Typ | Max | Min | Max | | |
| t _{PLH} | Propagation Delay A _n to B _n or B _n to A _n | 5.0 | 1.0 | 4.0 | 7.5 | 1.0 | 8.0 | ns | 3-5 |
| t _{PHL} | Propagation Delay A _n to B _n or B _n to A _n | 5.0 | 1.0 | 4.0 | 8.0 | 1.0 | 9.0 | ns | 3-5 |
| t _{PZH} | Output Enable Time | 5.0 | 1.0 | 5.0 | 10 | 1.0 | 11 | ns | 3-7 |
| t _{PZL} | Output Enable Time | 5.0 | 1.0 | 5.5 | 10 | 1.0 | 12 | ns | 3-8 |
| t _{PHZ} | Output Disable Time | 5.0 | 1.0 | 5.5 | 10 | 1.0 | 11 | ns | 3-7 |
| t _{PLZ} | Output Disable Time | 5.0 | 1.0 | 5.0 | 10 | 1.0 | 11 | ns | 3-8 |

*Voltage Range 5.0 is 5.0 V ± 0.5 V

CAPACITANCE

| Symbol | Parameter | Value Typ | Units | Test Conditions |
|------------------|-------------------------------|--------------|-------|-------------------------|
| C _{IN} | Input Capacitance | 4.5 | pF | V _{CC} = 5.0 V |
| C _{I/O} | Input/Output Capacitance | 15 | pF | V _{CC} = 5.0 V |
| C _{PD} | Power Dissipation Capacitance | 45 | pF | V _{CC} = 5.0 V |



MOTOROLA

Product Preview

8-Input Multiplexer with 3-State Outputs

The MC74AC251/74ACT251 is a high-speed 8-input digital multiplexer. It provides, in one package, the ability to select one bit of data from up to eight sources. It can be used as a universal function generator to generate any logic function of four variables. Both true and complementary outputs are provided.

- Multifunctional Capability
- On-Chip Select Logic Decoding
- Inverting and Noninverting 3-State Outputs
- Outputs Source/Sink 24 mA
- 'ACT251 Has TTL Compatible Inputs

LOGIC SYMBOL

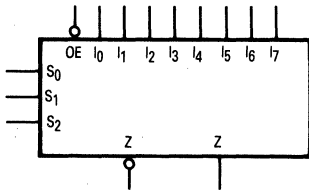

PIN NAMES

- S₀-S₂ Select Inputs
- OE 3-State Output Enable Input
- I₀-I₇ Multiplexer Inputs
- Z 3-State Multiplexer Output
- Z̄ Complementary 3-State Multiplexer Output

TRUTH TABLE

| OE | Inputs | | | Outputs | |
|----|----------------|----------------|----------------|----------------|----------------|
| | S ₂ | S ₁ | S ₀ | Z̄ | Z |
| H | X | X | X | Z | Z |
| L | L | L | L | I ₀ | I ₀ |
| L | L | L | H | I ₁ | I ₁ |
| L | L | H | L | I ₂ | I ₂ |
| L | L | H | H | I ₃ | I ₃ |
| L | H | L | L | I ₄ | I ₄ |
| L | H | L | H | I ₅ | I ₅ |
| L | H | H | L | I ₆ | I ₆ |
| L | H | H | H | I ₇ | I ₇ |

H = HIGH Voltage Level
 L = LOW Voltage Level
 X = Immaterial
 Z = High Impedance

MC74AC251
MC74ACT251

8-INPUT
MULTIPLEXER WITH
3-STATE OUTPUTS

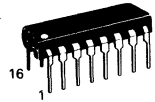

N SUFFIX
CASE 648-08
PLASTIC

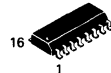

D SUFFIX
CASE 751B-03
PLASTIC

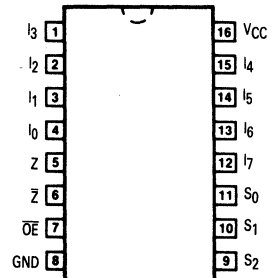

FUNCTIONAL DESCRIPTION

This device is a logical implementation of a single-pole, 8-position switch with the switch position controlled by the state of three Select inputs, S₀, S₁, S₂. Both true and complementary outputs are provided. The Output Enable input (\overline{OE}) is active LOW. When it is activated, the logic function provided at the output is:

$$Z = \overline{OE} \cdot (I_0 \cdot \overline{S_0} \cdot \overline{S_1} \cdot \overline{S_2} + I_1 \cdot S_0 \cdot \overline{S_1} \cdot \overline{S_2} + I_2 \cdot \overline{S_0} \cdot S_1 \cdot \overline{S_2} + I_3 \cdot S_0 \cdot S_1 \cdot \overline{S_2} + I_4 \cdot \overline{S_0} \cdot \overline{S_1} \cdot S_2 + I_5 \cdot S_0 \cdot \overline{S_1} \cdot S_2 + I_6 \cdot \overline{S_0} \cdot S_1 \cdot S_2 + I_7 \cdot S_0 \cdot S_1 \cdot S_2)$$

When the Output Enable is HIGH, both outputs are in the high impedance (High Z) state. This feature allows multiplexer expansion by tying the outputs of up to 128 devices together. When the outputs of the 3-state devices are tied together, all but one device must be in the high impedance state to avoid high currents that would exceed the maximum ratings. The Output Enable signals should be designed to ensure there is no overlap in the active-LOW portion of the enable voltages.

LOGIC DIAGRAM

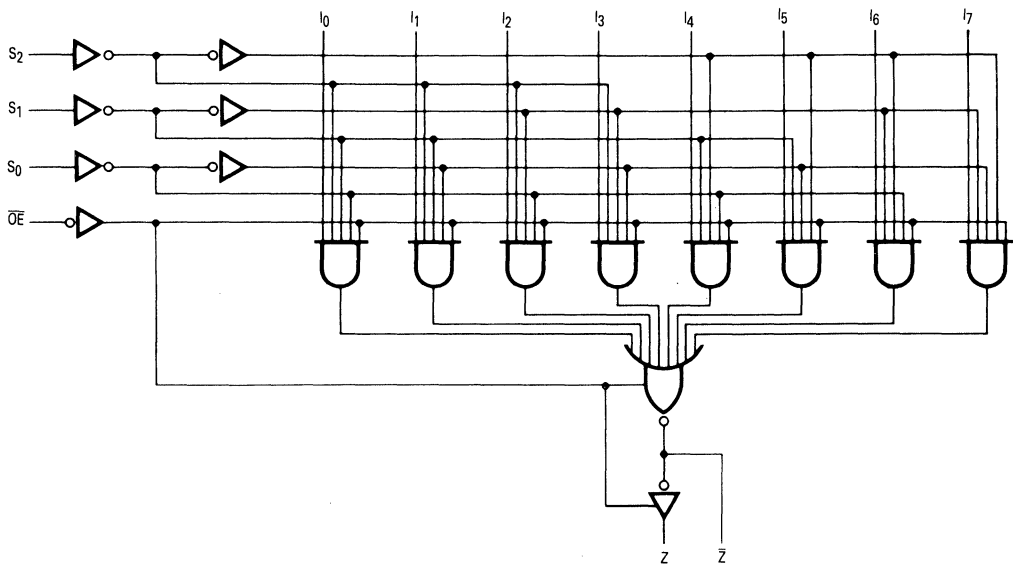

Please note that this diagram is provided only for the understanding of logic operations and should not be used to estimate propagation delays.

MC74AC251 • MC74ACT251
DC CHARACTERISTICS (unless otherwise specified)

| Symbol | Parameter | Value | Units | Test Conditions |
|--------------------|---|-------|-------|---|
| I _{CC} | Maximum Quiescent Supply Current | 80 | μA | V _{IN} = V _{CC} or Ground, V _{CC} = 5.5 V, T _A = Worst Case |
| I _{CC} | Maximum Quiescent Supply Current | 8.0 | μA | V _{IN} = V _{CC} or Ground, V _{CC} = 5.5 V, T _A = 25°C |
| I _{CC(T)} | Maximum Additional I _{CC} /Input ('ACT251) | 1.5 | mA | V _{IN} = V _{CC} - 2.1 V, V _{CC} = 5.5 V, T _A = Worst Case |

AC CHARACTERISTICS (For Figures and Waveforms — See Section 3)

| Symbol | Parameter | V _{CC} * (V) | 74AC | | | 74AC | | Units | Fig. No. |
|------------------|--|-----------------------|--|------|------|--|------|-------|----------|
| | | | T _A = +25°C C _L = 50 pF | | | T _A = -40°C to +85°C C _L = 50 pF | | | |
| | | | Min | Typ | Max | Min | Max | | |
| t _{PLH} | Propagation Delay S _n to Z or \bar{Z} | 3.3 | 1.0 | 11.5 | 17.5 | 1.0 | 19 | ns | 3-6 |
| | | 5.0 | 1.0 | 8.5 | 12.5 | 1.0 | 13.5 | | |
| t _{PHL} | Propagation Delay S _n to Z or \bar{Z} | 3.3 | 1.0 | 11 | 17.5 | 1.0 | 19 | ns | 3-6 |
| | | 5.0 | 1.0 | 8.0 | 12.5 | 1.0 | 13.5 | | |
| t _{PLH} | Propagation Delay I _n to Z or \bar{Z} | 3.3 | 1.0 | 10 | 14 | 1.0 | 15.5 | ns | 3-5 |
| | | 5.0 | 1.0 | 7.0 | 10 | 1.0 | 11 | | |
| t _{PHL} | Propagation Delay I _n to Z or \bar{Z} | 3.3 | 1.0 | 9.0 | 14 | 1.0 | 15.5 | ns | 3-5 |
| | | 5.0 | 1.0 | 6.5 | 10 | 1.0 | 11 | | |
| t _{PZH} | Output Enable Time \overline{OE} to Z or \bar{Z} | 3.3 | 1.0 | 7.5 | 11 | 1.0 | 12 | ns | 3-7 |
| | | 5.0 | 1.0 | 5.5 | 8.0 | 1.0 | 9.0 | | |
| t _{PZL} | Output Enable Time \overline{OE} to Z or \bar{Z} | 3.3 | 1.0 | 7.5 | 11 | 1.0 | 12 | ns | 3-8 |
| | | 5.0 | 1.0 | 5.5 | 8.0 | 1.0 | 9.0 | | |
| t _{PHZ} | Output Disable Time \overline{OE} to Z or \bar{Z} | 3.3 | 3.5 | 8.5 | 11.5 | 3.5 | 13 | ns | 3-7 |
| | | 5.0 | 2.5 | 7.0 | 9.5 | 2.5 | 10 | | |
| t _{PLZ} | Output Disable Time \overline{OE} to Z or \bar{Z} | 3.3 | 4.0 | 7.0 | 11 | 4.0 | 12 | ns | 3-8 |
| | | 5.0 | 3.0 | 5.5 | 8.0 | 3.0 | 8.5 | | |

*Voltage Range 3.3 is 3.3 V ± 0.3 V
Voltage Range 5.0 is 5.0 V ± 0.5 V

MC74AC251 • MC74ACT251

AC CHARACTERISTICS (For Figures and Waveforms — See Section 3)

| Symbol | Parameter | V _{CC} * (V) | 74ACT | | | 74ACT | | Units | Fig. No. |
|------------------|---|--------------------------|--|-----|------|--|------|-------|----------|
| | | | T _A = +25°C C _L = 50 pF | | | T _A = -40°C to +85°C C _L = 50 pF | | | |
| | | | Min | Typ | Max | Min | Max | | |
| t _{PLH} | Propagation Delay S _n to Z or \bar{Z} | 5.0 | 1.0 | 7.0 | 13.5 | 1.0 | 13 | ns | 3-6 |
| t _{PHL} | Propagation Delay S _n to Z or \bar{Z} | 5.0 | 1.0 | 7.5 | 13 | 1.0 | 14.5 | ns | 3-6 |
| t _{PLH} | Propagation Delay I _n to Z or \bar{Z} | 5.0 | 1.0 | 5.5 | 10 | 1.0 | 10.5 | ns | 3-5 |
| t _{PHL} | Propagation Delay I _n to Z or \bar{Z} | 5.0 | 1.0 | 6.5 | 10.5 | 1.0 | 12 | ns | 3-5 |
| t _{PZH} | Output Enable Time $\bar{O}\bar{E}$ to Z or \bar{Z} | 5.0 | 1.0 | 5.0 | 9.0 | 1.0 | 9.0 | ns | 3-7 |
| t _{PZL} | Output Enable Time $\bar{O}\bar{E}$ to Z or \bar{Z} | 5.0 | 1.0 | 4.5 | 9.0 | 1.0 | 8.5 | ns | 3-8 |
| t _{PHZ} | Output Disable Time $\bar{O}\bar{E}$ to Z or \bar{Z} | 5.0 | 1.0 | 6.0 | 10.5 | 1.0 | 10 | ns | 3-7 |
| t _{PLZ} | Output Disable Time $\bar{O}\bar{E}$ to Z or \bar{Z} | 5.0 | 1.0 | 4.5 | 9.0 | 1.0 | 8.5 | ns | 3-8 |

*Voltage Range 5.0 is 5.0 V ± 0.5 V

CAPACITANCE

| Symbol | Parameter | Value Typ | Units | Test Conditions |
|-----------------|-------------------------------|--------------|-------|-------------------------|
| C _{IN} | Input Capacitance | 4.5 | pF | V _{CC} = 5.0 V |
| C _{PD} | Power Dissipation Capacitance | 70 | pF | V _{CC} = 5.0 V |



MOTOROLA

Product Preview

Dual 4-Input Multiplexer with 3-State Outputs

The MC74AC253/74ACT253 is a dual 4-input multiplexer with 3-state outputs. It can select two bits of data from four sources using common select inputs. The outputs may be individually switched to a high impedance state with a HIGH on the respective Output Enable (\overline{OE}) inputs, allowing the outputs to interface directly with bus oriented systems.

- Multifunctional Capability
- Noninverting 3-State Outputs
- Outputs Source/Sink 24 mA
- 'ACT253 Has TTL Compatible Inputs

LOGIC SYMBOL

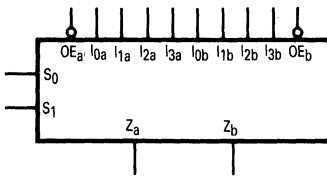

PIN NAMES

- I_{0a} - I_{3a} Side A Data Inputs
- I_{0b} - I_{3b} Side B Data Inputs
- S_0, S_1 Common Select Inputs
- \overline{OE}_a Side A Output Enable Input
- \overline{OE}_b Side B Output Enable Input
- Z_a, Z_b 3-State Outputs

TRUTH TABLE

| Select Inputs | | Data Inputs | | | | Output Enable | Outputs |
|---------------|-------|-------------|-------|-------|-------|-----------------|---------|
| S_0 | S_1 | I_0 | I_1 | I_2 | I_3 | \overline{OE} | Z |
| X | X | X | X | X | X | H | Z |
| L | L | L | X | X | X | L | L |
| L | L | H | X | X | X | L | H |
| H | L | X | L | X | X | L | L |
| H | L | X | H | X | X | L | H |
| L | H | X | X | L | X | L | L |
| L | H | X | X | H | X | L | H |
| H | H | X | X | X | L | L | L |
| H | H | X | X | X | H | L | H |

Address inputs S_0 and S_1 are common to both sections.

- H = HIGH Voltage Level
- L = LOW Voltage Level
- X = Immaterial
- Z = High Impedance

This document contains information on a product under development. Motorola reserves the right to change or discontinue this product without notice.

MC74AC253 MC74ACT253

DUAL 4-INPUT MULTIPLEXER WITH 3-STATE OUTPUTS

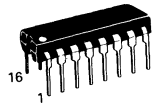

N SUFFIX
CASE 648-08
PLASTIC

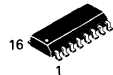

D SUFFIX
CASE 751B-03
PLASTIC

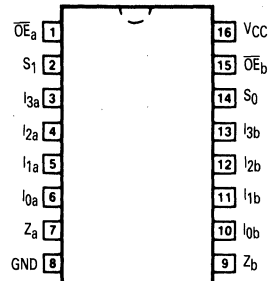

MC74AC253 • MC74ACT253

FUNCTIONAL DESCRIPTION

The MC74AC253/74ACT253 contains two identical 4-input multiplexers with 3-state outputs. They select two bits from four sources selected by common Select inputs (S_0, S_1). The 4-input multiplexers have individual Output Enable ($\overline{OE}_a, \overline{OE}_b$) inputs which, when HIGH, force the outputs to a high impedance (High Z) state. This device is the logic implementation of a 2-pole, 4-position switch, where the position of the switch is determined by the logic levels supplied to the two select inputs. The logic

equations for the outputs are shown:

$$Z_a = \overline{OE}_a \cdot (I_{0a} \cdot \overline{S_1} \cdot \overline{S_0} + I_{1a} \cdot \overline{S_1} \cdot S_0 + I_{2a} \cdot S_1 \cdot \overline{S_0} + I_{3a} \cdot S_1 \cdot S_0)$$

$$Z_b = \overline{OE}_b \cdot (I_{0b} \cdot \overline{S_1} \cdot \overline{S_0} + I_{1b} \cdot \overline{S_1} \cdot S_0 + I_{2b} \cdot S_1 \cdot \overline{S_0} + I_{3b} \cdot S_1 \cdot S_0)$$

If the outputs of 3-state devices are tied together, all but one device must be in the high impedance state to avoid high currents that would exceed the maximum ratings. Designers should ensure that Output Enable signals to 3-state devices whose outputs are tied together are designed so that there is no overlap.

LOGIC DIAGRAM

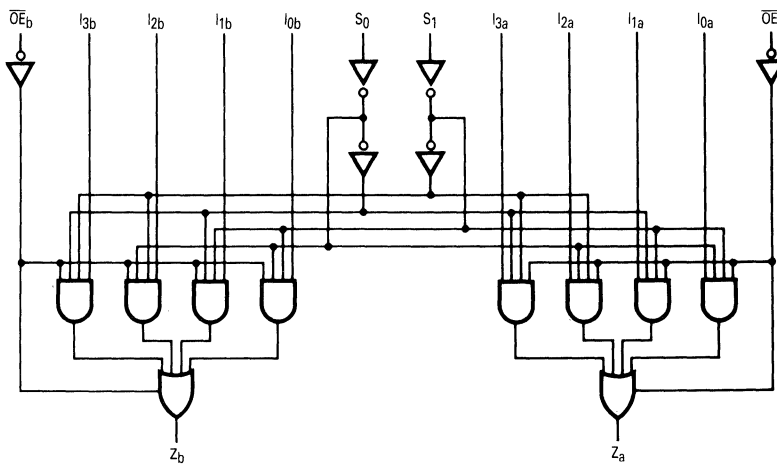

Please note that this diagram is provided only for the understanding of logic operations and should not be used to estimate propagation delays.

MC74AC253 • MC74ACT253

DC CHARACTERISTICS (unless otherwise specified)

| Symbol | Parameter | Value | Units | Test Conditions |
|------------------|--|-------|-------|---|
| I _{CC} | Maximum Quiescent Supply Current | 80 | μA | V _{IN} = V _{CC} or Ground, V _{CC} = 5.5 V, T _A = Worst Case |
| I _{CC} | Maximum Quiescent Supply Current | 8.0 | μA | V _{IN} = V _{CC} or Ground, V _{CC} = 5.5 V, T _A = 25°C |
| I _{CCT} | Maximum Additional I _{CC} /Input (ACT253) | 1.5 | mA | V _{IN} = V _{CC} - 2.1 V, V _{CC} = 5.5 V, T _A = Worst Case |

AC CHARACTERISTICS (For Figures and Waveforms — See Section 3)

| Symbol | Parameter | V _{CC} * (V) | 74AC | | | 74AC | | Units | Fig. No. |
|------------------|---|-----------------------|--|------------|------------|--|--------------|-------|----------|
| | | | T _A = +25°C C _L = 50 pF | | | T _A = -40°C to +85°C C _L = 50 pF | | | |
| | | | Min | Typ | Max | Min | Max | | |
| t _{PLH} | Propagation Delay S _n to Z _n | 3.3 5.0 | 1.0 1.0 | 8.5 6.5 | 15.5 11 | 1.0 1.0 | 17.5 12.5 | ns | 3-6 |
| t _{PHL} | Propagation Delay S _n to Z _n | 3.3 5.0 | 1.0 1.0 | 9.5 7.0 | 16 11.5 | 1.0 1.0 | 18 13 | ns | 3-6 |
| t _{PLH} | Propagation Delay I _n to Z _n | 3.3 5.0 | 1.0 1.0 | 7.0 5.5 | 14.5 10 | 1.0 1.0 | 17 11.5 | ns | 3-5 |
| t _{PHL} | Propagation Delay I _n to Z _n | 3.3 5.0 | 1.0 1.0 | 7.5 5.5 | 13 9.5 | 1.0 1.0 | 15 11 | ns | 3-5 |
| t _{PZH} | Output Enable Time | 3.3 5.0 | 1.0 1.0 | 4.5 3.5 | 8.0 6.0 | 1.0 1.0 | 8.5 6.5 | ns | 3-7 |
| t _{PZL} | Output Enable Time | 3.3 5.0 | 1.0 1.0 | 5.0 3.5 | 8.0 6.0 | 1.0 1.0 | 9.0 7.0 | ns | 3-8 |
| t _{PHZ} | Output Disable Time | 3.3 5.0 | 1.0 1.0 | 5.5 5.0 | 9.5 8.0 | 1.0 1.0 | 10 8.5 | ns | 3-7 |
| t _{PLZ} | Output Disable Time | 3.3 5.0 | 1.0 1.0 | 5.0 4.0 | 8.0 7.0 | 1.0 1.0 | 9.0 7.5 | ns | 3-8 |

*Voltage Range 3.3 is 3.3 V ± 0.3 V
Voltage Range 5.0 is 5.0 V ± 0.5 V

MC74AC253 • MC74ACT253

AC CHARACTERISTICS (For Figures and Waveforms — See Section 3)

| Symbol | Parameter | V _{CC} * (V) | 74ACT | | | 74ACT | | Units | Fig. No. |
|------------------|---|--------------------------|--|-----|------|--|------|-------|----------|
| | | | T _A = +25°C C _L = 50 pF | | | T _A = -40°C to +85°C C _L = 50 pF | | | |
| | | | Min | Typ | Max | Min | Max | | |
| t _{PLH} | Propagation Delay S _n to Z _n | 5.0 | 1.0 | 7.0 | 11.5 | 1.0 | 13 | ns | 3-6 |
| t _{PHL} | Propagation Delay S _n to Z _n | 5.0 | 1.0 | 7.5 | 13 | 1.0 | 14.5 | ns | 3-6 |
| t _{PLH} | Propagation Delay I _n to Z _n | 5.0 | 1.0 | 5.5 | 10 | 1.0 | 11 | ns | 3-5 |
| t _{PHL} | Propagation Delay I _n to Z _n | 5.0 | 1.0 | 6.5 | 11 | 1.0 | 12.5 | ns | 3-5 |
| t _{PZH} | Output Enable Time | 5.0 | 1.0 | 4.5 | 7.5 | 1.0 | 8.5 | ns | 3-7 |
| t _{PZL} | Output Enable Time | 5.0 | 1.0 | 5.0 | 8.0 | 1.0 | 9.0 | ns | 3-8 |
| t _{PHZ} | Output Disable Time | 5.0 | 1.0 | 6.0 | 9.5 | 1.0 | 10 | ns | 3-7 |
| t _{PLZ} | Output Disable Time | 5.0 | 1.0 | 4.5 | 7.5 | 1.0 | 8.5 | ns | 3-8 |

*Voltage Range 5.0 is 5.0 V ± 0.5 V

CAPACITANCE

| Symbol | Parameter | Value Typ | Units | Test Conditions |
|-----------------|-------------------------------|--------------|-------|-------------------------|
| C _{IN} | Input Capacitance | 4.5 | pF | V _{CC} = 5.0 V |
| C _{PD} | Power Dissipation Capacitance | 50 | pF | V _{CC} = 5.0 V |



MOTOROLA

Product Preview

Quad 2-Input Multiplexer with 3-State Outputs

The MC74AC257/74ACT257 is a quad 2-input multiplexer with 3-state outputs. Four bits of data from two sources can be selected using a Common Data Select input. The four outputs present the selected data in true (noninverted) form. The outputs may be switched to a high impedance state by placing a logic HIGH on the common Output Enable (\overline{OE}) input, allowing the outputs to interface directly with bus-oriented systems.

- Multiplexer Expansion by Tying Outputs Together
- Noninverting 3-State Outputs
- Outputs Source/Sink 24 mA
- 'ACT257 Has TTL Compatible Inputs

LOGIC SYMBOL

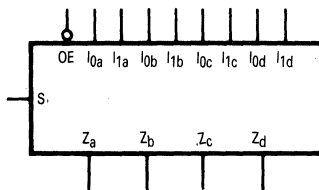

PIN NAMES

- S Common Data Select Input
- \overline{OE} 3-State Output Enable Input
- $I_{0a}-I_{0d}$ Data Inputs from Source 0
- $I_{1a}-I_{1d}$ Data Inputs from Source 1
- Z_a-Z_d 3-State Multiplexer Outputs

TRUTH TABLE

| Output Enable | Select Input | Data Inputs | | Outputs |
|-----------------|--------------|-------------|-------|---------|
| \overline{OE} | S | I_0 | I_1 | Z |
| H | X | X | X | Z |
| L | H | X | L | L |
| L | H | X | H | H |
| L | L | L | X | L |
| L | L | H | X | H |

- H = HIGH Voltage Level
- L = LOW Voltage Level
- X = Immaterial
- Z = High Impedance

MC74AC257
MC74ACT257

QUAD 2-INPUT
MULTIPLEXER WITH
3-STATE OUTPUTS

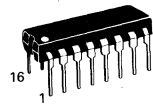

N SUFFIX
CASE 648-08
PLASTIC

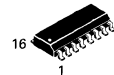

D SUFFIX
CASE 751B-03
PLASTIC

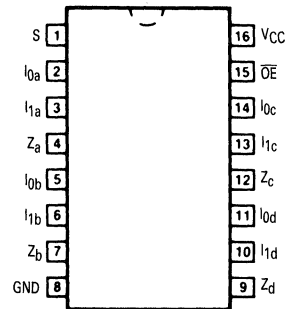

This document contains information on a product under development. Motorola reserves the right to change or discontinue this product without notice.

FACT DATA

FUNCTIONAL DESCRIPTION

The MC74AC257/74ACT257 is a quad 2-input multiplexer with 3-state outputs. It selects four bits of data from two sources under control of a Common Data Select input. When the Select input is LOW, the I_{0X} inputs are selected and when Select is HIGH, the I_{1X} inputs are selected. The data on the selected inputs appears at the outputs in true (noninverted) form. The device is the logic implementation of a 4-pole, 2-position switch where the position of the switch is determined by the logic levels supplied to the Select input. The logic equations for the

outputs are shown below:

$$Z_a = \overline{OE} \cdot (I_{1a} \cdot S + I_{0a} \cdot \overline{S})$$

$$Z_b = \overline{OE} \cdot (I_{1b} \cdot S + I_{0b} \cdot \overline{S})$$

$$Z_c = \overline{OE} \cdot (I_{1c} \cdot S + I_{0c} \cdot \overline{S})$$

$$Z_d = \overline{OE} \cdot (I_{1d} \cdot S + I_{0d} \cdot \overline{S})$$

When the Output Enable input (\overline{OE}) is HIGH, the outputs are forced to a high impedance state. If the outputs are tied together, all but one device must be in the high impedance state to avoid high currents that would exceed the maximum ratings. Designers should ensure the Output Enable signals to 3-state devices whose outputs are tied together are designed so there is no overlap.

LOGIC DIAGRAM

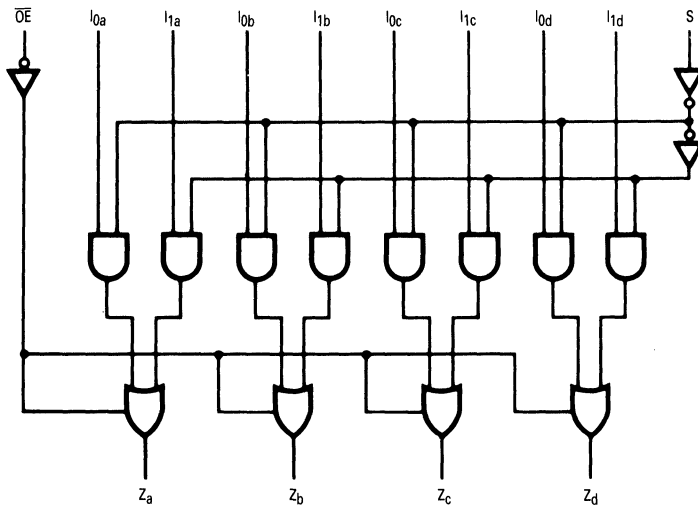

Please note that this diagram is provided only for the understanding of logic operations and should not be used to estimate propagation delays.

MC74AC257 • MC74ACT257

DC CHARACTERISTICS (unless otherwise specified)

| Symbol | Parameter | Value | Units | Test Conditions |
|--------------------|---|-------|-------|---|
| I _{CC} | Maximum Quiescent Supply Current | 80 | μA | V _{IN} = V _{CC} or Ground, V _{CC} = 5.5 V, T _A = Worst Case |
| I _{CC} | Maximum Quiescent Supply Current | 8.0 | μA | V _{IN} = V _{CC} or Ground, V _{CC} = 5.5 V, T _A = 25°C |
| I _{CC(T)} | Maximum Additional I _{CC} /Input ('ACT257) | 1.5 | mA | V _{IN} = V _{CC} - 2.1 V, V _{CC} = 5.5 V, T _A = Worst Case |

AC CHARACTERISTICS (For Figures and Waveforms — See Section 3)

| Symbol | Parameter | V _{CC} * (V) | 74AC | | | 74AC | | Units | Fig. No. |
|------------------|---|--------------------------|--|------------|-----|--|-----|-------|----------|
| | | | T _A = +25°C C _L = 50 pF | | | T _A = -40°C to +85°C C _L = 50 pF | | | |
| | | | Min | Typ | Max | Min | Max | | |
| t _{PLH} | Propagation Delay I _n to Z _n | 3.3 5.0 | | 5.0 4.0 | | | ns | 3-5 | |
| t _{PHL} | Propagation Delay I _n to Z _n | 3.3 5.0 | | 6.0 4.5 | | | ns | 3-5 | |
| t _{PLH} | Propagation Delay S to Z _n | 3.3 5.0 | | 7.0 5.0 | | | ns | 3-6 | |
| t _{PHL} | Propagation Delay S to Z _n | 3.3 5.0 | | 7.5 5.5 | | | ns | 3-6 | |
| t _{PZH} | Output Enable Time | 3.3 5.0 | | 6.5 5.0 | | | ns | 3-7 | |
| t _{PZL} | Output Enable Time | 3.3 5.0 | | 5.5 5.0 | | | ns | 3-8 | |
| t _{PHZ} | Output Disable Time | 3.3 5.0 | | 5.5 5.0 | | | ns | 3-7 | |
| t _{PLZ} | Output Disable Time | 3.3 5.0 | | 5.5 5.0 | | | ns | 3-8 | |

*Voltage Range 3.3 is 3.3 V ± 0.3 V
Voltage Range 5.0 is 5.0 V ± 0.5 V

MC74AC257 • MC74ACT257

AC CHARACTERISTICS (For Figures and Waveforms — See Section 3)

| Symbol | Parameter | V _{CC} * (V) | 74ACT | | | 74ACT | | Units | Fig. No. |
|------------------|---|--------------------------|--|-----|------|--|------|-------|----------|
| | | | T _A = +25°C C _L = 50 pF | | | T _A = -40°C to +85°C C _L = 50 pF | | | |
| | | | Min | Typ | Max | Min | Max | | |
| t _{PLH} | Propagation Delay I _N to Z _N | 5.0 | 1.0 | 5.0 | 7.0 | 1.0 | 7.5 | ns | 3-6 |
| t _{PHL} | Propagation Delay I _N to Z _N | 5.0 | 1.0 | 6.0 | 7.5 | 1.0 | 8.5 | ns | 3-6 |
| t _{PLH} | Propagation Delay S to Z _N | 5.0 | 1.0 | 7.0 | 9.5 | 1.0 | 10.5 | ns | 3-6 |
| t _{PHL} | Propagation Delay S to Z _N | 5.0 | 1.0 | 7.0 | 10.5 | 1.0 | 11.5 | ns | 3-6 |
| t _{PZH} | Output Enable Time | 5.0 | 1.0 | 6.0 | 8.0 | 1.0 | 9.0 | ns | 3-7 |
| t _{PZL} | Output Enable Time | 5.0 | 1.0 | 6.0 | 8.0 | 1.0 | 9.0 | ns | 3-8 |
| t _{PHZ} | Output Disable Time | 5.0 | 1.0 | 6.5 | 9.0 | 1.0 | 10 | ns | 3-7 |
| t _{PLZ} | Output Disable Time | 5.0 | 1.0 | 6.0 | 7.5 | 1.0 | 8.5 | ns | 3-8 |

*Voltage Range 5.0 is 5.0 V ± 0.5 V

CAPACITANCE

| Symbol | Parameter | Value Typ | Units | Test Conditions |
|------------------|-------------------------------|--------------|-------|-------------------------|
| C _{I/N} | Input Capacitance | 4.5 | pF | V _{CC} = 5.0 V |
| C _{PD} | Power Dissipation Capacitance | 50 | pF | V _{CC} = 5.0 V |



MOTOROLA

Product Preview

Quad 2-Input Multiplexer with 3-State Outputs

The MC74AC258/74ACT258 is a quad 2-input multiplexer with 3-state outputs. Four bits of data from two sources can be selected using a common data select input. The four outputs present the selected data in the complement (inverted) form. The outputs may be switched to a high impedance state with a HIGH on the common Output Enable (OE) input, allowing the outputs to interface directly with bus-oriented systems.

- Multiplexer Expansion by Tying Outputs Together
- Inverting 3-State Outputs
- Outputs Source/Sink 24 mA
- 'ACT258 Has TTL Compatible Inputs

LOGIC SYMBOL

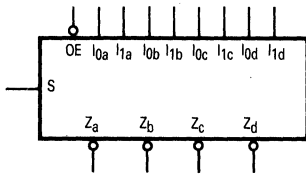

PIN NAMES

- S Common Data Select Input
- OE 3-State Output Enable Input
- I0a-I0d Data Inputs from Source 0
- I1a-I1d Data Inputs from Source 1
- Za-Zd 3-State Multiplexer Outputs

TRUTH TABLE

| Output Enable | Select Input | Data Inputs | | Outputs |
|---------------|--------------|-------------|----|---------|
| OE | S | I0 | I1 | Z |
| H | X | X | X | Z |
| L | H | X | L | H |
| L | H | X | H | L |
| L | L | L | X | H |
| L | L | H | X | L |

H = HIGH Voltage Level
 L = LOW Voltage Level
 X = Immaterial
 Z = High Impedance

**MC74AC258
MC74ACT258**

**QUAD 2-INPUT
MULTIPLEXER WITH
3-STATE OUTPUTS**

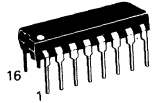

**N SUFFIX
CASE 648-08
PLASTIC**

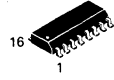

**D SUFFIX
CASE 751B-03
PLASTIC**

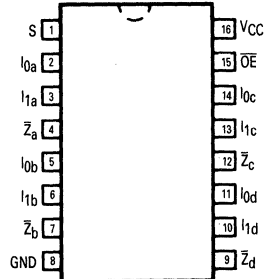

5

This document contains information on a product under development. Motorola reserves the right to change or discontinue this product without notice.

FACT DATA

MC74AC258 • MC74ACT258

FUNCTIONAL DESCRIPTION

The MC74AC258/74ACT258 is a quad 2-input multiplexer with 3-state outputs. It selects four bits of data from two sources under control of a common Select input (S). When the Select input is LOW, the I_{0x} inputs are selected and when Select is HIGH, the I_{1x} inputs are selected. The data on the selected inputs appears at the outputs in inverted form. The MC74AC258/74ACT258 is the logic implementation of a 4-pole, 2-position switch where the position of the switch is determined by the logic levels supplied to the Select input. The logic equa-

tions for the outputs are shown below:

$$\bar{Z}_a = \overline{OE} \cdot (I_{1a} \cdot S + I_{0a} \cdot \bar{S})$$

$$\bar{Z}_b = \overline{OE} \cdot (I_{1b} \cdot S + I_{0b} \cdot \bar{S})$$

$$\bar{Z}_c = \overline{OE} \cdot (I_{1c} \cdot S + I_{0c} \cdot \bar{S})$$

$$\bar{Z}_d = \overline{OE} \cdot (I_{1d} \cdot S + I_{0d} \cdot \bar{S})$$

When the Output Enable input (\overline{OE}) is HIGH, the outputs are forced to a high impedance state. If the outputs of the 3-state devices are tied together, all but one device must be in the high impedance state to avoid high currents that would exceed the maximum ratings. Designers should ensure the Output Enable signals to 3-state devices whose outputs are tied together are designed so there is no overlap.

LOGIC DIAGRAM

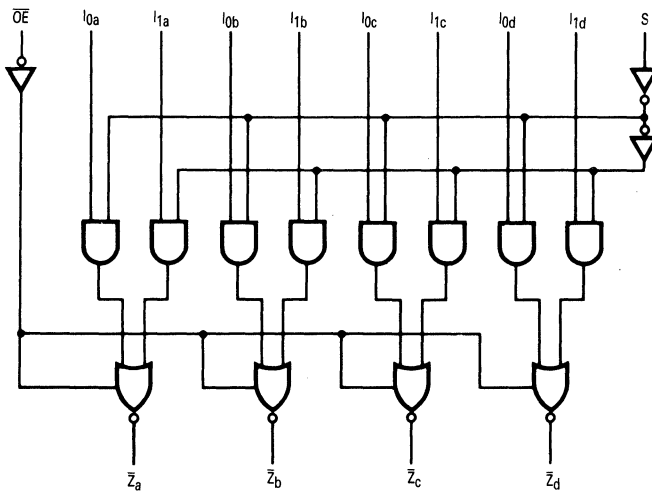

Please note that this diagram is provided only for the understanding of logic operations and should not be used to estimate propagation delays.

MC74AC258 • MC74ACT258

DC CHARACTERISTICS (unless otherwise specified)

| Symbol | Parameter | Value | Units | Test Conditions |
|--------------------|--|-------|-------|---|
| I _{CC} | Maximum Quiescent Supply Current | 80 | μA | V _{IN} = V _{CC} or Ground, V _{CC} = 5.5 V, T _A = Worst Case |
| I _{CC} | Maximum Quiescent Supply Current | 8.0 | μA | V _{IN} = V _{CC} or Ground, V _{CC} = 5.5 V, T _A = 25°C |
| I _{CC(T)} | Maximum Additional I _{CC} /Input (ACT258) | 1.5 | mA | V _{IN} = V _{CC} - 2.1 V, V _{CC} = 5.5 V, T _A = Worst Case |

AC CHARACTERISTICS (For Figures and Waveforms — See Section 3)

| Symbol | Parameter | V _{CC} * (V) | 74AC | | | 74AC | | Units | Fig. No. |
|------------------|---|-----------------------|--|------------|-------------|--|-------------|-------|----------|
| | | | T _A = +25°C C _L = 50 pF | | | T _A = -40°C to +85°C C _L = 50 pF | | | |
| | | | Min | Typ | Max | Min | Max | | |
| t _{PLH} | Propagation Delay I _n to Z _n | 3.3 5.0 | 1.0 1.0 | 6.0 4.5 | 9.5 7.5 | 1.0 1.0 | 11 8.5 | ns | 3-5 |
| t _{PHL} | Propagation Delay I _n to Z _n | 3.3 5.0 | 1.0 1.0 | 5.0 4.0 | 8.5 6.5 | 1.0 1.0 | 9.5 7.0 | ns | 3-5 |
| t _{PLH} | Propagation Delay S to Z _n | 3.3 5.0 | 1.0 1.0 | 7.5 6.0 | 12 9.5 | 1.0 1.0 | 14 10.5 | ns | 3-6 |
| t _{PHL} | Propagation Delay S to Z _n | 3.3 5.0 | 1.0 1.0 | 7.5 5.5 | 11.5 9.0 | 1.0 1.0 | 13 10 | ns | 3-6 |
| t _{PZH} | Output Enable Time | 3.3 5.0 | 1.0 1.0 | 6.0 4.5 | 9.5 7.5 | 1.0 1.0 | 10.5 8.5 | ns | 3-7 |
| t _{PZL} | Output Enable Time | 3.3 5.0 | 1.0 1.0 | 5.5 5.5 | 9.0 7.0 | 1.0 1.0 | 10 8.0 | ns | 3-8 |
| t _{PHZ} | Output Disable Time | 3.3 5.0 | 1.0 1.0 | 5.5 5.5 | 10 8.5 | 1.0 1.0 | 11.5 9.0 | ns | 3-7 |
| t _{PLZ} | Output Disable Time | 3.3 5.0 | 1.0 1.0 | 5.5 5.0 | 9.0 7.0 | 1.0 1.0 | 10 8.0 | ns | 3-8 |

*Voltage Range 3.3 is 3.3 V ± 0.3 V
Voltage Range 5.0 is 5.0 V ± 0.5 V

MC74AC258 • MC74ACT258

AC CHARACTERISTICS (For Figures and Waveforms — See Section 3)

| Symbol | Parameter | V _{CC} * (V) | 74ACT | | | 74ACT | | Units | Fig. No. |
|------------------|--|--------------------------|--|-----|------|--|------|-------|----------|
| | | | T _A = +25°C C _L = 50 pF | | | T _A = -40°C to +85°C C _L = 50 pF | | | |
| | | | Min | Typ | Max | Min | Max | | |
| t _{PLH} | Propagation Delay I _n to \bar{Z}_n | 5.0 | 1.0 | 6.5 | 8.5 | 1.0 | 9.5 | ns | 3-5 |
| t _{PHL} | Propagation Delay I _n to \bar{Z}_n | 5.0 | 1.0 | 5.5 | 7.5 | 1.0 | 8.0 | ns | 3-5 |
| t _{PLH} | Propagation Delay S to \bar{Z}_n | 5.0 | 1.0 | 7.5 | 10.5 | 1.0 | 11.5 | ns | 3-6 |
| t _{PHL} | Propagation Delay S to \bar{Z}_n | 5.0 | 1.0 | 7.0 | 9.5 | 1.0 | 11 | ns | 3-6 |
| t _{PZH} | Output Enable Time | 5.0 | 1.0 | 6.5 | 8.5 | 1.0 | 9.5 | ns | 3-7 |
| t _{PZL} | Output Enable Time | 5.0 | 1.0 | 6.5 | 8.5 | 1.0 | 9.5 | ns | 3-8 |
| t _{PHZ} | Output Disable Time | 5.0 | 1.0 | 7.0 | 9.0 | 1.0 | 10 | ns | 3-7 |
| t _{PLZ} | Output Disable Time | 5.0 | 1.0 | 6.0 | 8.0 | 1.0 | 9.0 | ns | 3-8 |

*Voltage Range 5.0 is 5.0 V ± 0.5 V

CAPACITANCE

| Symbol | Parameter | Value Typ | Units | Test Conditions |
|-----------------|-------------------------------|--------------|-------|-------------------------|
| C _{IN} | Input Capacitance | 4.5 | pF | V _{CC} = 5.0 V |
| C _{PD} | Power Dissipation Capacitance | 55 | pF | V _{CC} = 5.0 V |



MOTOROLA

Product Preview Octal D Flip-Flop

The MC74AC273/74ACT273 has eight edge-triggered D-type flip-flops with individual D inputs and Q outputs. The common buffered Clock (CP) and Master Reset (\overline{MR}) inputs load and reset (clear) all flip-flops simultaneously.

The register is fully edge-triggered. The state of each D input, one setup time before the LOW-to-HIGH clock transition, is transferred to the corresponding flip-flop's Q output.

All outputs will be forced LOW independently of Clock or Data inputs by a LOW voltage level on the \overline{MR} input. The device is useful for applications where the true output only is required and the Clock and Master Reset are common to all storage elements.

- Ideal Buffer for MOS Microprocessor or Memory
- Eight Edge-Triggered D Flip-Flops
- Buffered Common Clock
- Buffered, Asynchronous Master Reset
- See MC74AC377 for Clock Enable Version
- See MC74AC373 for Transparent Latch Version
- See MC74AC374 for 3-State Version
- Outputs Source/Sink 24 mA
- 'ACT273 Has TTL Compatible Inputs

LOGIC SYMBOL

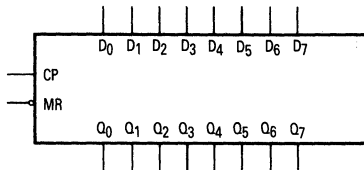

PIN NAMES

D₀-D₇ Data Inputs
 \overline{MR} Master Reset
 CP Clock Pulse Input
 Q₀-Q₇ Data Outputs

MC74AC273 MC74ACT273

OCTAL D FLIP-FLOP

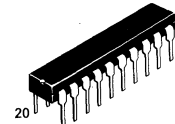

N SUFFIX
CASE 738-03
PLASTIC



DW SUFFIX
CASE 751D-03
PLASTIC

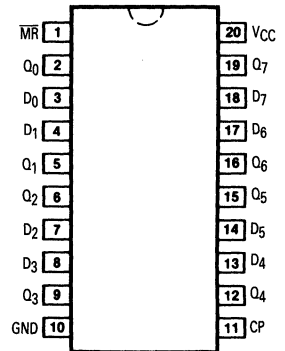

MC74AC273 • MC74ACT273

LOGIC DIAGRAM

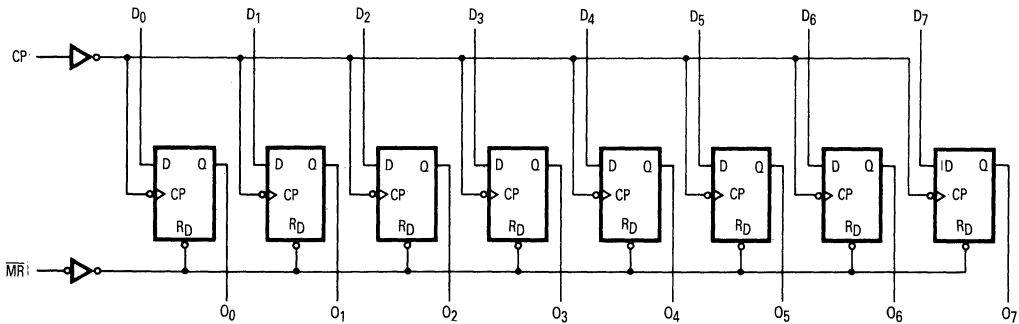

Please note that this diagram is provided only for the understanding of logic operations and should not be used to estimate propagation delays.

MODE SELECT-FUNCTION TABLE

| Operating Mode | Inputs | | | Outputs |
|----------------|-----------------|-------------|-------|---------|
| | \overline{MR} | CP | D_n | Q_n |
| Reset (Clear) | L | X | X | L |
| Load '1' | H | \lrcorner | H | H |
| Load '0' | H | \lrcorner | L | L |

H = HIGH Voltage Level
 L = LOW Voltage Level
 X = Immaterial
 \lrcorner = LOW-to-HIGH Clock Transition

DC CHARACTERISTICS (unless otherwise specified)

| Symbol | Parameter | Value | Units | Test Conditions |
|-----------|--|-------|---------|--|
| I_{CC} | Maximum Quiescent Supply Current | 80 | μA | $V_{IN} = V_{CC}$ or Ground, $V_{CC} = 5.5 V, T_A = \text{Worst Case}$ |
| I_{CC} | Maximum Quiescent Supply Current | 8.0 | μA | $V_{IN} = V_{CC}$ or Ground, $V_{CC} = 5.5 V, T_A = 25^\circ C$ |
| I_{CCT} | Maximum Additional I_{CC} /Input ('ACT273) | 1.5 | mA | $V_{IN} = V_{CC} - 2.1 V$, $V_{CC} = 5.5 V, T_A = \text{Worst Case}$ |

MC74AC273 • MC74ACT273

AC CHARACTERISTICS (For Figures and Waveforms — See Section 3)

| Symbol | Parameter | V _{CC} * (V) | 74AC | | | 74AC | | Units | Fig. No. |
|------------------|--------------------------------------|--------------------------|--|------------|-------------|--|------------|-------|----------|
| | | | T _A = +25°C C _L = 50 pF | | | T _A = -40°C to +85°C C _L = 50 pF | | | |
| | | | Min | Typ | Max | Min | Max | | |
| f _{max} | Maximum Clock Frequency | 3.3 5.0 | 90 140 | 125 175 | | 75 125 | | MHz | 3-3 |
| t _{PLH} | Propagation Delay Clock to Output | 3.3 5.0 | 1.0 1.0 | 7.0 5.5 | 12.5 9.0 | 1.0 1.0 | 14 10 | ns | 3-6 |
| t _{PHL} | Propagation Delay Clock to Output | 3.3 5.0 | 1.0 1.0 | 7.0 5.0 | 13 10 | 1.0 1.0 | 14.5 11 | ns | 3-6 |
| t _{PHL} | Propagation Delay MR to Output | 3.3 5.0 | 1.0 1.0 | 7.0 5.0 | 13 10 | 1.0 1.0 | 14 10.5 | ns | 3-6 |

*Voltage Range 3.3 is 3.3 V ± 0.3 V
Voltage Range 5.0 is 5.0 V ± 0.5 V

AC OPERATING REQUIREMENTS

| Symbol | Parameter | V _{CC} * (V) | 74AC | | 74AC | | Units | Fig. No. |
|------------------|---------------------------------------|--------------------------|--|--------------------|--|--|-------|----------|
| | | | T _A = +25°C C _L = 50 pF | | T _A = -40°C to +85°C C _L = 50 pF | | | |
| | | | Typ | Guaranteed Minimum | | | | |
| t _s | Setup Time, HIGH or LOW Data to CP | 3.3 5.0 | 3.5 2.5 | 5.5 4.0 | 6.0 4.5 | | ns | 3-9 |
| t _h | Hold Time, HIGH or LOW Data to CP | 3.3 5.0 | -2.0 -1.0 | 0 1.0 | 0 1.0 | | ns | 3-9 |
| t _w | Clock Pulse Width HIGH or LOW | 3.3 5.0 | 3.5 2.5 | 5.5 4.0 | 6.0 4.5 | | ns | 3-6 |
| t _w | MR Pulse Width HIGH or LOW | 3.3 5.0 | 2.0 1.5 | 5.5 4.0 | 6.0 4.5 | | ns | 3-6 |
| t _{rec} | Recovery Time MR to CP | 3.3 5.0 | 1.5 1.0 | 3.5 2.0 | 4.5 3.0 | | ns | 3-9 |

*Voltage Range 3.3 is 3.3 V ± 0.3 V
Voltage Range 5.0 is 5.0 V ± 0.5 V

MC74AC273 • MC74ACT273

AC CHARACTERISTICS (For Figures and Waveforms — See Section 3)

| Symbol | Parameter | V _{CC} * (V) | 74ACT | | | 74ACT | | Units | Fig. No. |
|------------------|--------------------------------------|--------------------------|--|-----|-----|--|-----|-------|----------|
| | | | T _A = +25°C C _L = 50 pF | | | T _A = -40°C to +85°C C _L = 50 pF | | | |
| | | | Min | Typ | Max | Min | Max | | |
| f _{max} | Maximum Clock Frequency | 5.0 | | 200 | | | MHz | 3-3 | |
| t _{PLH} | Propagation Delay Clock to Output | 5.0 | | 6.0 | | | ns | 3-6 | |
| t _{PHL} | Propagation Delay Clock to Output | 5.0 | | 6.5 | | | ns | 3-6 | |
| t _{PHL} | Propagation Delay MR to Output | 5.0 | | 7.0 | | | ns | 3-6 | |

*Voltage Range 5.0 is 5.0 V ± 0.5 V

AC OPERATING REQUIREMENTS

| Symbol | Parameter | V _{CC} * (V) | 74ACT | | 74ACT | | Units | Fig. No. |
|------------------|---------------------------------------|--------------------------|--|--------------------|--|--|-------|----------|
| | | | T _A = +25°C C _L = 50 pF | | T _A = -40°C to +85°C C _L = 50 pF | | | |
| | | | Typ | Guaranteed Minimum | | | | |
| t _s | Setup Time, HIGH or LOW Data to CP | 5.0 | 3.0 | | | | ns | 3-9 |
| t _h | Hold Time, HIGH or LOW Data to CP | 5.0 | -2.5 | | | | ns | 3-9 |
| t _w | Clock Pulse Width HIGH or LOW | 5.0 | 2.5 | | | | ns | 3-6 |
| t _w | MR Pulse Width HIGH or LOW | 5.0 | 2.5 | | | | ns | 3-6 |
| t _{rec} | Recovery Time MR to CP | 5.0 | -1.0 | | | | ns | 3-6 |

*Voltage Range 5.0 is 5.0 V ± 0.5 V

CAPACITANCE

| Symbol | Parameter | Value Typ | Units | Test Conditions |
|-----------------|-------------------------------|--------------|-------|-------------------------|
| C _{IN} | Input Capacitance | 4.5 | pF | V _{CC} = 5.0 V |
| C _{PD} | Power Dissipation Capacitance | 50 | pF | V _{CC} = 5.0 V |





MOTOROLA

Product Preview

8-Input Universal Shift/Storage Register with Common Parallel I/O Pins

The MC74AC299/74ACT299 is an 8-bit universal shift/storage register with 3-state outputs. Four modes of operation are possible: hold (store), shift left, shift right and load data. The parallel load inputs and flip-flop outputs are multiplexed to reduce the total number of package pins. Additional outputs are provided for flip-flops Q₀, Q₇ to allow easy serial cascading. A separate active LOW Master Reset is used to reset the register.

- Common Parallel I/O for Reduced Pin Count
- Additional Serial Inputs and Outputs for Expansion
- Four Operating Modes: Shift Left, Shift Right, Load and Store
- 3-State Outputs for Bus-Oriented Applications
- Outputs Source/Sink 24 mA
- 'ACT299 Has TTL Compatible Inputs

LOGIC SYMBOL

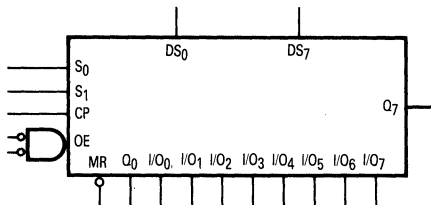

PIN NAMES

- CP Clock Pulse Input
- DS₀ Serial Data Input for Right Shift
- DS₇ Serial Data Input for Left Shift
- S₀, S₁ Mode Select Inputs
- MR Asynchronous Master Reset
- OE₁, OE₂ 3-State Output Enable Inputs
- I/O₀–I/O₇ Parallel Data Inputs or 3-State Parallel Outputs
- Q₀, Q₇ Serial Outputs

MC74AC299 MC74ACT299

8-INPUT UNIVERSAL
SHIFT/STORAGE
REGISTER WITH
COMMON
PARALLEL I/O PINS

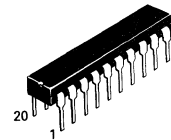

N SUFFIX
CASE 738-03
PLASTIC

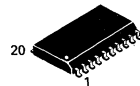

DW SUFFIX
CASE 751D-03
PLASTIC

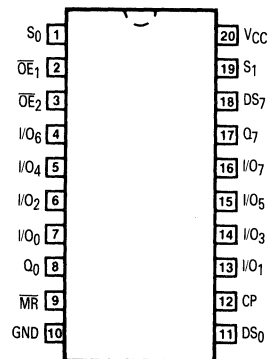

This document contains information on a product under development. Motorola reserves the right to change or discontinue this product without notice.

FACT DATA

5-116

MC74AC299 • MC74ACT299

LOGIC DIAGRAM

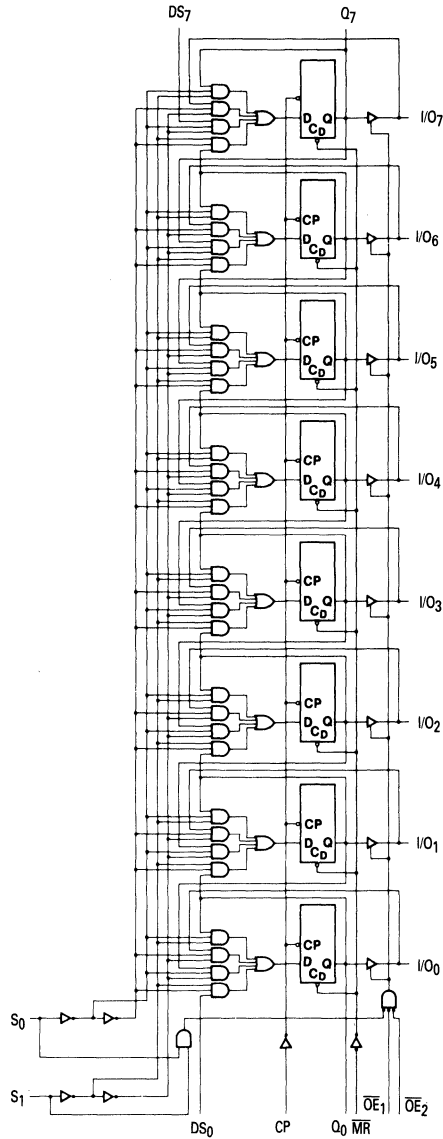

Please note that this diagram is provided only for the understanding of logic operations and should not be used to estimate propagation delays.

FUNCTIONAL DESCRIPTION

The MC74AC299/74ACT299 contains eight edge-triggered D-type flip-flops and the interstage logic necessary to perform synchronous shift left, shift right, parallel load and hold operations. The type of operation is determined by S_0 and S_1 , as shown in the Truth Table. All flip-flop outputs are brought out through 3-state buffers to separate I/O pins that also serve as data inputs in the parallel load mode. Q_0 and Q_7 are also brought out on other pins for expansion in serial shifting of longer words.

A LOW signal on \overline{MR} overrides the Select and CP inputs and resets the flip-flops. All other state changes are initiated by the rising edge of the clock. Inputs can change when the clock is in either state provided only that the recommended setup and hold times, relative to the rising edge of CP, are observed.

A HIGH signal on either \overline{OE}_1 or \overline{OE}_2 disables the 3-state buffers and puts the I/O pins in the high impedance state. In this condition the shift, hold, load and reset operations can still occur. The 3-state buffers are also disabled by HIGH signals on both S_0 and S_1 in preparation for a parallel load operation.

TRUTH TABLE

| Inputs | | | | Response |
|-----------------|-------|-------|------------|--|
| \overline{MR} | S_1 | S_0 | CP | |
| L | X | X | X | Asynchronous Reset; $Q_0 - Q_7 = \text{LOW}$ |
| H | H | H | \uparrow | Parallel Load; $I/O_n \rightarrow Q_n$ |
| H | L | H | \uparrow | Shift Rights; $DS_0 \rightarrow Q_0$, $Q_0 \rightarrow Q_1$, etc. |
| H | H | L | \uparrow | Shift Left; $DS_7 \rightarrow Q_7$, $Q_7 \rightarrow Q_6$, etc. |
| H | L | L | X | Hold |

H = HIGH Voltage Level
 L = LOW Voltage Level
 X = Immaterial
 \uparrow = LOW-to-HIGH Transition

DC CHARACTERISTICS (unless otherwise specified)

| Symbol | Parameter | Value | Units | Test Conditions |
|-----------|--|-------|---------------|---|
| I_{CC} | Maximum Quiescent Supply Current | 80 | μA | $V_{IN} = V_{CC}$ or Ground, $V_{CC} = 5.5 \text{ V}$, $T_A = \text{Worst Case}$ |
| I_{CC} | Maximum Quiescent Supply Current | 8.0 | μA | $V_{IN} = V_{CC}$ or Ground, $V_{CC} = 5.5 \text{ V}$, $T_A = 25^\circ\text{C}$ |
| I_{CCT} | Maximum Additional I_{CC}/Input ('ACT299) | 1.5 | mA | $V_{IN} = V_{CC} - 2.1 \text{ V}$ $V_{CC} = 5.5 \text{ V}$, $T_A = \text{Worst Case}$ |

5

MC74AC299 • MC74ACT299

AC CHARACTERISTICS (For Figures and Waveforms — See Section 3)

| Symbol | Parameter | V _{CC} * (V) | 74AC | | | 74AC | | Units | Fig. No. |
|------------------|---|--------------------------|--|-----------|-----|--|-----|-------|----------|
| | | | T _A = +25°C C _L = 50 pF | | | T _A = -40°C to +85°C C _L = 50 pF | | | |
| | | | Min | Typ | Max | Min | Max | | |
| f _{max} | Maximum Input Frequency | 3.3 5.0 | | 55 130 | | | | MHz | 3-3 |
| t _{PLH} | Propagation Delay CP to Q ₀ or Q ₇ | 3.3 5.0 | | 31 12 | | | | ns | 3-6 |
| t _{PHL} | Propagation Delay CP to Q ₀ or Q ₇ | 3.3 5.0 | | 30 13 | | | | ns | 3-6 |
| t _{PLH} | Propagation Delay CP to I/O _n | 3.3 5.0 | | 28 11 | | | | ns | 3-6 |
| t _{PHL} | Propagation Delay CP to I/O _n | 3.3 5.0 | | 28 12 | | | | ns | 3-6 |
| t _{PLH} | Propagation Delay MR to I/O _n | 3.3 5.0 | | 33 14 | | | | ns | 3-6 |
| t _{PHL} | Propagation Delay MR to I/O _n | 3.3 5.0 | | 31 13 | | | | ns | 3-6 |
| t _{PZH} | Output Enable Time OE to I/O _n | 3.3 5.0 | | 24 10 | | | | ns | 3-7 |
| t _{PZL} | Output Enable Time OE to I/O _n | 3.3 5.0 | | 24 10 | | | | ns | 3-8 |
| t _{PHZ} | Output Disable Time OE to I/O _n | 3.3 5.0 | | 25 13 | | | | ns | 3-7 |
| t _{PLZ} | Output Disable Time OE to I/O _n | 3.3 5.0 | | 24 12 | | | | ns | 3-8 |

*Voltage Range 3.3 is 3.3 V ± 0.3 V
Voltage Range 5.0 is 5.0 V ± 0.5 V

AC OPERATING REQUIREMENTS

| Symbol | Parameter | V _{CC} * (V) | 74AC | | 74AC | | Units | Fig. No. |
|------------------|--|--------------------------|--|--------------------|--|--|-------|----------|
| | | | T _A = +25°C C _L = 50 pF | | T _A = -40°C to +85°C C _L = 50 pF | | | |
| | | | Typ | Guaranteed Minimum | | | | |
| t _s | Setup Time, HIGH or LOW S ₀ or S ₁ to CP | 3.3 5.0 | 12 5.0 | | | | ns | 3-9 |
| t _h | Hold Time, HIGH or LOW S ₀ or S ₁ to CP | 3.3 5.0 | 0 0 | | | | ns | 3-9 |
| t _s | Setup Time, HIGH or LOW I/O _n , DS ₀ or DS ₇ to CP | 3.3 5.0 | 6.0 3.0 | | | | ns | 3-9 |
| t _h | Hold Time, HIGH or LOW I/O _n , DS ₀ or DS ₇ to CP | 3.3 5.0 | 0 0 | | | | ns | 3-9 |
| t _w | CP Pulse Width HIGH or LOW | 3.3 5.0 | 9.0 4.0 | | | | ns | 3-6 |
| t _w | MR Pulse Width, LOW | 3.3 5.0 | 7.0 4.0 | | | | ns | 3-6 |
| t _{rec} | Recovery Time MR to CP | 3.3 5.0 | 0 0 | | | | ns | 3-9 |

*Voltage Range 3.3 is 3.3 V ± 0.3 V
Voltage Range 5.0 is 5.0 V ± 0.5 V



MC74AC299 • MC74ACT299

AC CHARACTERISTICS (For Figures and Waveforms — See Section 3)

| Symbol | Parameter | V _{CC} * (V) | 74ACT | | | 74ACT | | Units | Fig. No. |
|------------------|--|-----------------------|--|-----|-----|--|-----|-------|----------|
| | | | T _A = +25°C C _L = 50 pF | | | T _A = -40°C to +85°C C _L = 50 pF | | | |
| | | | Min | Typ | Max | Min | Max | | |
| f _{max} | Maximum Input Frequency | 5.0 | | 125 | | | | MHz | 3-3 |
| t _{PLH} | Propagation Delay CP to Q ₀ or Q ₇ | 5.0 | | 11 | | | | ns | 3-6 |
| t _{PHL} | Propagation Delay CP to Q ₀ or Q ₇ | 5.0 | | 12 | | | | ns | 3-6 |
| t _{PLH} | Propagation Delay CP to I/O _n | 5.0 | | 10 | | | | ns | 3-6 |
| t _{PHL} | Propagation Delay CP to I/O _n | 5.0 | | 12 | | | | ns | 3-6 |
| t _{PLH} | Propagation Delay MR to Q ₀ or Q ₇ | 5.0 | | 14 | | | | ns | 3-6 |
| t _{PHL} | Propagation Delay MR to Q ₀ or Q ₇ | 5.0 | | 13 | | | | ns | 3-6 |
| t _{PZH} | Output Enable Time OE to I/O _n | 5.0 | | 10 | | | | ns | 3-7 |
| t _{PZL} | Output Enable Time OE to I/O _n | 5.0 | | 10 | | | | ns | 3-8 |
| t _{PHZ} | Output Disable Time OE to I/O _n | 5.0 | | 12 | | | | ns | 3-7 |
| t _{PLZ} | Output Disable Time OE to I/O _n | 5.0 | | 11 | | | | ns | 3-8 |

*Voltage Range 5.0 is 5.0 V ± 0.5 V

AC OPERATING REQUIREMENTS

| Symbol | Parameter | V _{CC} * (V) | 74ACT | | 74ACT | | Units | Fig. No. |
|------------------|---|-----------------------|--|--------------------|--|--|-------|----------|
| | | | T _A = +25°C C _L = 50 pF | | T _A = -40°C to +85°C C _L = 50 pF | | | |
| | | | Typ | Guaranteed Minimum | | | | |
| t _s | Setup Time, HIGH or LOW S ₀ or S ₁ to CP | 5.0 | 5.0 | | | | ns | 3-9 |
| t _h | Hold Time, HIGH or LOW S ₀ or S ₁ to CP | 5.0 | 0 | | | | ns | 3-9 |
| t _s | Setup Time, HIGH or LOW I/O _n , DS ₀ or DS ₇ to CP | 5.0 | 3.0 | | | | ns | 3-9 |
| t _h | Hold Time, HIGH or LOW I/O _n , DS ₀ or DS ₇ to CP | 5.0 | 0 | | | | ns | 3-9 |
| t _w | CP Pulse Width HIGH or LOW | 5.0 | 4.0 | | | | ns | 3-6 |
| t _w | MR Pulse Width, LOW | 5.0 | 4.0 | | | | ns | 3-6 |
| t _{rec} | Recovery Time MR to CP | 5.0 | 0 | | | | ns | 3-9 |

*Voltage Range 5.0 is 5.0 V ± 0.5 V

CAPACITANCE

| Symbol | Parameter | Value Typ | Units | Test Conditions |
|------------------|-------------------------------|-----------|-------|-------------------------|
| C _I N | Input Capacitance | 4.5 | pF | V _{CC} = 5.0 V |
| C _p D | Power Dissipation Capacitance | | pF | V _{CC} = 5.0 V |

5



MOTOROLA

Product Preview

8-Input Universal Shift/Storage Register with Synchronous Reset and Common I/O Pins

The MC74AC323/74ACT323 is an 8-bit universal shift/storage register with 3-state outputs. Its function is similar to the MC74AC299/74ACT299 with the exception of Synchronous Reset. Parallel load inputs and flip-flop outputs are multiplexed to minimize pin count. Separate serial inputs and outputs are provided for Q₀ and Q₇ to allow easy cascading. Four operation modes are possible: hold (store), shift left, shift right and parallel load.

- Common Parallel I/O for Reduced Pin Count
- Additional Serial Inputs and Outputs for Expansion
- Four Operating Modes: Shift Left, Shift Right, Load and Store
- 3-State Outputs for Bus-Oriented Applications
- Outputs Source/Sink 24 mA
- 'ACT323 Has TTL Compatible Inputs

LOGIC SYMBOL

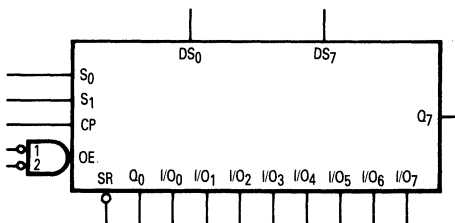

PIN NAMES

- CP Clock Pulse Input
- DS₀ Serial Data Input for Right Shift
- DS₇ Serial Data Input for Left Shift
- S₀, S₁ Mode Select Inputs
- SR Synchronous Master Reset
- OE₁, OE₂ 3-State Output Enable Inputs
- I/O₀-I/O₇ Multiplexed Parallel Data Inputs or 3-State Parallel Data Outputs
- Q₀, Q₇ Serial Outputs

**MC74AC323
MC74ACT323**

**8-INPUT UNIVERSAL
SHIFT/STORAGE
REGISTER WITH
SYNCHRONOUS RESET
AND COMMON
I/O PINS**

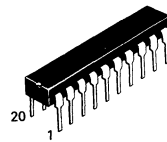

**N SUFFIX
CASE 738-03
PLASTIC**

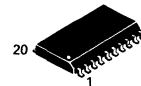

**DW SUFFIX
CASE 751D-03
PLASTIC**

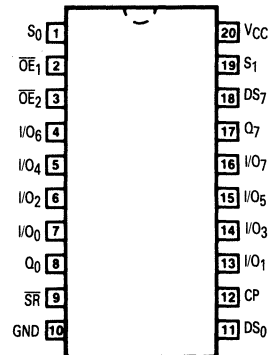

5

This document contains information on a product under development. Motorola reserves the right to change or discontinue this product without notice.

MC74AC323 • MC74ACT323

LOGIC DIAGRAM

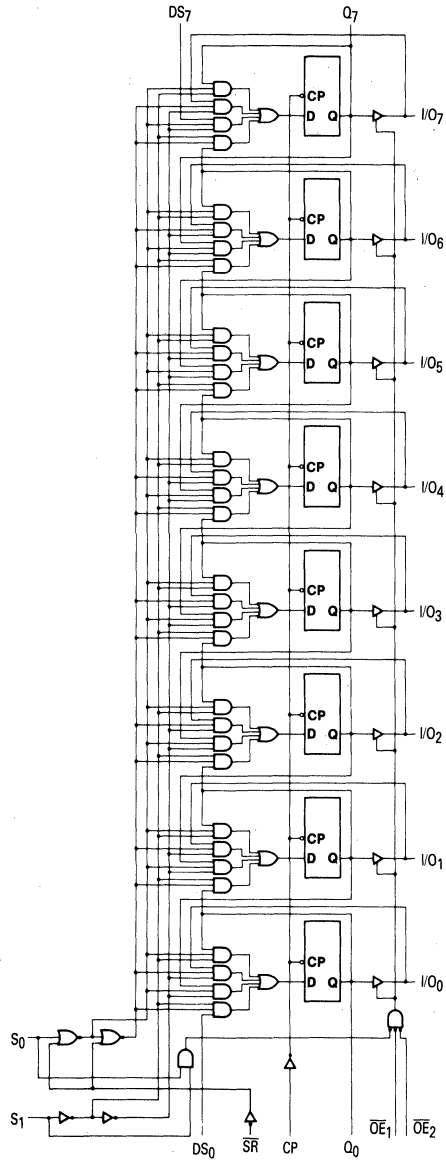

Please note that this diagram is provided only for the understanding of logic operations and should not be used to estimate propagation delays.

FUNCTIONAL DESCRIPTION

The MC74AC323/74ACT323 contains eight edge-triggered D-type flip-flops and the interstage logic necessary to perform synchronous reset, shift left, shift right, parallel load and hold operations. The type of operation is determined by S_0 and S_1 as shown in the Mode Select Table. All flip-flop outputs are brought out through 3-state buffers to separate I/O pins that also serve as data inputs in the parallel load mode. Q_0 and Q_7 are also brought out on other pins for expansion in serial shifting of longer words.

A LOW signal on \overline{SR} overrides the Select inputs and allows the flip-flops to be reset by the next rising edge

of CP. All other state changes are also initiated by the LOW-to-HIGH CP transition. Inputs can change when the clock is in either state provided only that the recommended setup and hold times, relative to the rising edge of CP, are observed.

A HIGH signal on either \overline{OE}_1 or \overline{OE}_2 disables the 3-state buffers and puts the I/O pins in the high impedance state. In this condition the shift, hold, load and reset operations can still occur. The 3-state buffers are also disabled by HIGH signals on both S_0 and S_1 in preparation for a parallel load operation.

TRUTH TABLE

| Inputs | | | | Response |
|-----------------|-------|-------|----|---|
| \overline{SR} | S_1 | S_0 | CP | |
| L | X | X | ┐ | Synchronous Reset; Q_0 - Q_7 = LOW |
| H | H | H | ┐ | Parallel Load; $I/O_n \rightarrow Q_n$ |
| H | L | H | ┐ | Shift Right; $DS_0 \rightarrow Q_0, Q_0 \rightarrow Q_1$, etc. |
| H | H | L | ┐ | Shift Left; $DS_7 \rightarrow Q_7, Q_7 \rightarrow Q_6$, etc. |
| H | L | L | X | Hold |

H = HIGH Voltage Level
 L = LOW Voltage Level
 X = Immaterial
 ┐ = LOW-to-HIGH Clock Transition

DC CHARACTERISTICS (unless otherwise specified)

| Symbol | Parameter | Value | Units | Test Conditions |
|-----------|---|-------|---------|--|
| I_{CC} | Maximum Quiescent Supply Current | 80 | μA | $V_{IN} = V_{CC}$ or Ground, $V_{CC} = 5.5 V, T_A = \text{Worst Case}$ |
| I_{CC} | Maximum Quiescent Supply Current | 8.0 | μA | $V_{IN} = V_{CC}$ or Ground, $V_{CC} = 5.5 V, T_A = 25^\circ C$ |
| I_{CCT} | Maximum Additional I_{CC}/Input (ACT323) | 1.5 | mA | $V_{IN} = V_{CC} - 2.1 V$, $V_{CC} = 5.5 V, T_A = \text{Worst Case}$ |

MC74AC323 • MC74ACT323

AC CHARACTERISTICS (For Figures and Waveforms — See Section 3)

| Symbol | Parameter | V _{CC} * (V) | 74AC | | | 74AC | | Units | Fig. No. |
|------------------|---|-----------------------|--|-----------|-----|--|-----|-------|----------|
| | | | T _A = +25°C C _L = 50 pF | | | T _A = -40°C to +85°C C _L = 50 pF | | | |
| | | | Min | Typ | Max | Min | Max | | |
| f _{max} | Maximum Input Frequency | 3.3 5.0 | | 55 130 | | | | MHz | 3-3 |
| t _{PLH} | Propagation Delay CP to Q ₀ or Q ₇ | 3.3 5.0 | | 31 12 | | | | ns | 3-6 |
| t _{PHL} | Propagation Delay CP to Q ₀ or Q ₇ | 3.3 5.0 | | 30 13 | | | | ns | 3-6 |
| t _{PLH} | Propagation Delay CP to I/O _n | 3.3 5.0 | | 28 11 | | | | ns | 3-6 |
| t _{PHL} | Propagation Delay CP to I/O _n | 3.3 5.0 | | 28 12 | | | | ns | 3-6 |
| t _{PZH} | Output Enable Time | 3.3 5.0 | | 24 10 | | | | ns | 3-7 |
| t _{PZL} | Output Enable Time | 3.3 5.0 | | 24 10 | | | | ns | 3-8 |
| t _{PHZ} | Output Disable Time | 3.3 5.0 | | 25 13 | | | | ns | 3-7 |
| t _{PLZ} | Output Disable Time | 3.3 5.0 | | 24 12 | | | | ns | 3-8 |

*Voltage Range 3.3 is 3.3 V ± 0.3 V
Voltage Range 5.0 is 5.0 V ± 0.5 V

AC OPERATING REQUIREMENTS

| Symbol | Parameter | V _{CC} * (V) | 74AC | | 74AC | | Units | Fig. No. |
|----------------|---|-----------------------|--|--------------------|--|--|-------|----------|
| | | | T _A = +25°C C _L = 50 pF | | T _A = -40°C to +85°C C _L = 50 pF | | | |
| | | | Typ | Guaranteed Minimum | | | | |
| t _s | Setup Time, HIGH or LOW S ₀ or S ₁ to CP | 3.3 5.0 | 12 5.0 | | | | ns | 3-9 |
| t _h | Hold Time, HIGH or LOW S ₀ or S ₁ to CP | 3.3 5.0 | 0 0 | | | | ns | 3-9 |
| t _s | Setup Time, HIGH or LOW I/O _n , DS ₀ , DS ₇ to CP | 3.3 5.0 | 5.0 5.0 | | | | ns | 3-9 |
| t _h | Hold Time, HIGH or LOW I/O _n , DS ₀ , DS ₇ to CP | 3.3 5.0 | 0 0 | | | | ns | 3-9 |
| t _s | Setup Time, HIGH or LOW S _R to CP | 3.3 5.0 | 4.0 2.0 | | | | ns | 3-9 |
| t _h | Hold Time, HIGH or LOW S _R to CP | 3.3 5.0 | 0 0 | | | | ns | 3-9 |
| t _w | CP Pulse Width HIGH or LOW | 3.3 5.0 | 9.0 4.0 | | | | ns | 3-6 |

*Voltage Range 3.3 is 3.3 V ± 0.3 V
Voltage Range 5.0 is 5.0 V ± 0.5 V

5

MC74AC323 • MC74ACT323

AC CHARACTERISTICS (For Figures and Waveforms — See Section 3)

| Symbol | Parameter | V _{CC} * (V) | 74ACT | | | 74ACT | | Units | Fig. No. |
|------------------|---|--------------------------|--|-----|-----|--|-----|-------|----------|
| | | | T _A = +25°C C _L = 50 pF | | | T _A = -40°C to +85°C C _L = 50 pF | | | |
| | | | Min | Typ | Max | Min | Max | | |
| f _{max} | Maximum Input Frequency | 5.0 | | 125 | | | MHz | 3-3 | |
| t _{PLH} | Propagation Delay CP to Q ₀ or Q ₇ | 5.0 | | 12 | | | ns | 3-6 | |
| t _{PHL} | Propagation Delay CP to Q ₀ or Q ₇ | 5.0 | | 13 | | | ns | 3-6 | |
| t _{PLH} | Propagation Delay CP to I/O _n | 5.0 | | 10 | | | ns | 3-6 | |
| t _{PHL} | Propagation Delay CP to I/O _n | 5.0 | | 12 | | | ns | 3-6 | |
| t _{PZH} | Output Enable Time | 5.0 | | 10 | | | ns | 3-7 | |
| t _{PZL} | Output Enable Time | 5.0 | | 10 | | | ns | 3-8 | |
| t _{PHZ} | Output Disable Time | 5.0 | | 12 | | | ns | 3-7 | |
| t _{PLZ} | Output Disable Time | 5.0 | | 11 | | | ns | 3-8 | |

*Voltage Range 5.0 is 5.0 V ± 0.5 V

AC OPERATING REQUIREMENTS

| Symbol | Parameter | V _{CC} * (V) | 74ACT | | 74ACT | | Units | Fig. No. |
|----------------|---|--------------------------|--|--------------------|--|--|-------|----------|
| | | | T _A = +25°C C _L = 50 pF | | T _A = -40°C to +85°C C _L = 50 pF | | | |
| | | | Typ | Guaranteed Minimum | | | | |
| t _s | Setup Time, HIGH or LOW S ₀ or S ₁ to CP | 5.0 | 5.0 | | | | ns | 3-9 |
| t _h | Hold Time, HIGH or LOW S ₀ or S ₁ to CP | 5.0 | 0 | | | | ns | 3-9 |
| t _s | Setup Time, HIGH or LOW I/O _n , DS ₀ , DS ₇ to CP | 5.0 | 3.0 | | | | ns | 3-9 |
| t _h | Hold Time, HIGH or LOW I/O _n , DS ₀ , DS ₇ to CP | 5.0 | 0 | | | | ns | 3-9 |
| t _s | Setup Time, HIGH or LOW SR to CP | 5.0 | 2.0 | | | | ns | 3-9 |
| t _h | Hold Time, HIGH or LOW SR to CP | 5.0 | 0 | | | | ns | 3-9 |
| t _w | CP Pulse Width HIGH or LOW | 5.0 | 4.0 | | | | ns | 3-6 |

*Voltage Range 5.0 is 5.0 V ± 0.5 V

CAPACITANCE

| Symbol | Parameter | Value Typ | Units | Test Conditions |
|-----------------|-------------------------------|--------------|-------|-------------------------|
| C _{IN} | Input Capacitance | 4.5 | pF | V _{CC} = 5.0 V |
| C _{PD} | Power Dissipation Capacitance | | pF | V _{CC} = 5.0 V |



MOTOROLA

Product Preview

Dual 4-Input Multiplexer

The MC74AC352/74ACT352 is a very high-speed dual 4-input multiplexer with common Select inputs and individual Enable inputs for each section. It can select two bits of data from four sources. The two buffered outputs present data in the inverted (complementary) form. The MC74AC352/74ACT352 is the functional equivalent of the MC74AC353/74ACT353 except with inverted outputs.

- Inverted Version of the MC74AC353/74ACT353
- Separate Enables for Each Multiplexer
- Outputs Source/Sink 24 mA
- 'ACT352 Has TTL Compatible Inputs

LOGIC SYMBOL

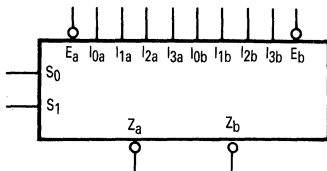

PIN NAMES

- I0a-I3a Side A Data Inputs
- I0b-I3b Side B Data Inputs
- S0, S1 Common Select Inputs
- Ea Side A Enable Input
- Eb Side B Enable Input
- Za, Zb Multiplexer Outputs

TRUTH TABLE

| Select Inputs | | Inputs (a or b) | | | | Outputs | |
|---------------|----|-----------------|----|----|----|---------|-----------|
| S0 | S1 | \bar{E} | I0 | I1 | I2 | I3 | \bar{Z} |
| X | X | H | X | X | X | X | H |
| L | L | L | L | X | X | X | H |
| L | L | L | H | X | X | X | L |
| H | L | L | X | L | X | X | H |
| H | L | L | X | H | X | X | L |
| L | H | L | X | X | L | X | H |
| L | H | L | X | X | H | X | L |
| H | H | L | X | X | X | L | H |
| H | H | L | X | X | X | H | L |

H = HIGH Voltage Level
 L = LOW Voltage Level
 X = Immaterial

**MC74AC352
 MC74ACT352**

**DUAL 4-INPUT
 MULTIPLEXER**

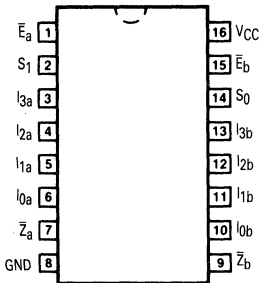
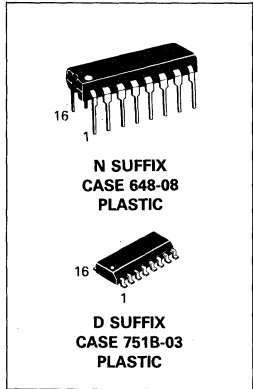

5

This document contains information on a product under development. Motorola reserves the right to change or discontinue this product without notice.

MC74AC352 • MC74ACT352

FUNCTIONAL DESCRIPTION

The MC74AC352/74ACT352 is a dual 4-input multiplexer. It selects two bits of data from up to four sources under the control of the common Select inputs (S_0, S_1). The two 4-input multiplexer circuits have individual active LOW Enables (\bar{E}_a, \bar{E}_b) which can be used to strobe the outputs independently. When the Enables (\bar{E}_a, \bar{E}_b) are HIGH, the corresponding outputs (\bar{Z}_a, \bar{Z}_b) are forced HIGH.

The logic equations for the outputs are shown below:

$$\bar{Z}_a = \bar{E}_a \cdot (I_{0a} \cdot \bar{S}_1 \cdot \bar{S}_0 + I_{1a} \cdot \bar{S}_1 \cdot S_0 + I_{2a} \cdot S_1 \cdot \bar{S}_0 + I_{3a} \cdot S_1 \cdot S_0)$$

$$\bar{Z}_b = \bar{E}_b \cdot (I_{0b} \cdot \bar{S}_1 \cdot \bar{S}_0 + I_{1b} \cdot \bar{S}_1 \cdot S_0 + I_{2b} \cdot S_1 \cdot \bar{S}_0 + I_{3b} \cdot S_1 \cdot S_0)$$

The MC74AC352/74ACT352 can be used to move data from a group of registers to a common output bus. The particular register from which the data came would be determined by the state of the Select inputs. A less obvious application is as a function generator. The MC74AC352/74ACT352 can generate two functions of three variables. This is useful for implementing highly irregular random logic.

LOGIC DIAGRAM

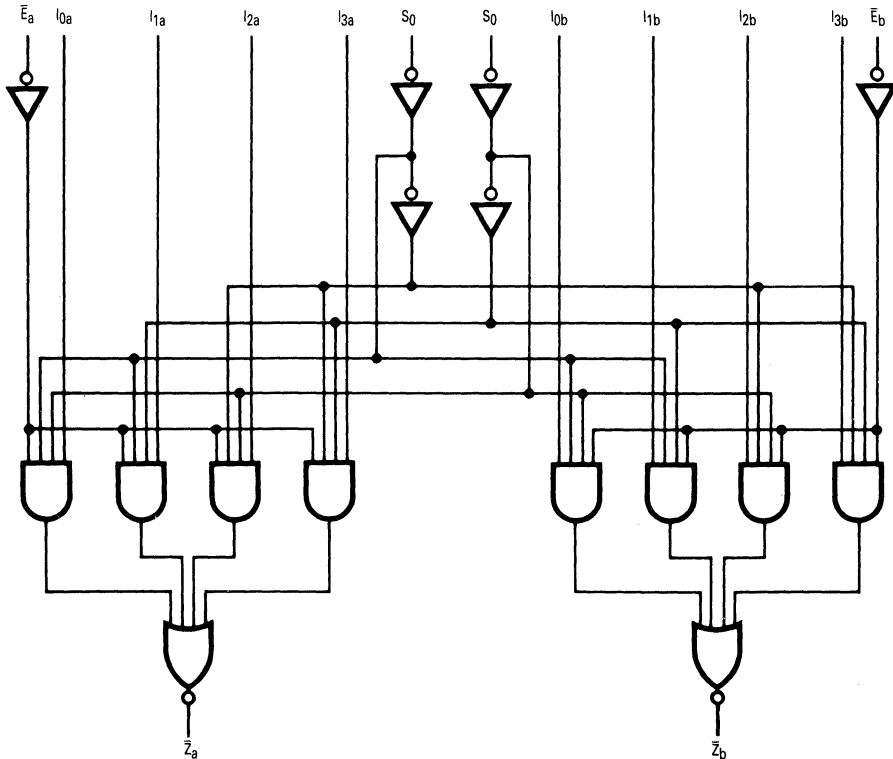

Please note that this diagram is provided only for the understanding of logic operations and should not be used to estimate propagation delays.

MC74AC352 • MC74ACT352

DC CHARACTERISTICS (unless otherwise specified)

| Symbol | Parameter | Value | Units | Test Conditions |
|--------------------|--|-------|-------|---|
| I _{CC} | Maximum Quiescent Supply Current | 80 | μA | V _{IN} = V _{CC} or Ground, V _{CC} = 5.5 V, T _A = Worst Case |
| I _{CC} | Maximum Quiescent Supply Current | 8.0 | μA | V _{IN} = V _{CC} or Ground, V _{CC} = 5.5 V, T _A = 25°C |
| I _{CC(T)} | Maximum Additional I _{CC} /Input (ACT352) | 1.5 | mA | V _{IN} = V _{CC} - 2.1 V, V _{CC} = 5.5 V, T _A = Worst Case |

AC CHARACTERISTICS (For Figures and Waveforms — See Section 3)

| Symbol | Parameter | V _{CC} * (V) | 74AC | | | 74AC | | Units | Fig. No. |
|------------------|---|-----------------------|--|------------|-----|--|-----|-------|----------|
| | | | T _A = +25°C C _L = 50 pF | | | T _A = -40°C to +85°C C _L = 50 pF | | | |
| | | | Min | Typ | Max | Min | Max | | |
| t _{PLH} | Propagation Delay S _n to Z _n | 3.3 5.0 | | 9.0 6.5 | | | ns | 3-6 | |
| t _{PHL} | Propagation Delay S _n to Z _n | 3.3 5.0 | | 9.0 6.5 | | | ns | 3-6 | |
| t _{PLH} | Propagation Delay E _n to Z _n | 3.3 5.0 | | 6.5 5.0 | | | ns | 3-6 | |
| t _{PHL} | Propagation Delay E _n to Z _n | 3.3 5.0 | | 6.5 5.0 | | | ns | 3-6 | |
| t _{PLH} | Propagation Delay I _n to Z _n | 3.3 5.0 | | 8.5 6.0 | | | ns | 3-5 | |
| t _{PHL} | Propagation Delay I _n to Z _n | 3.3 5.0 | | 8.5 6.0 | | | ns | 3-5 | |

*Voltage Range 3.3 is 3.3 V ± 0.3 V
Voltage Range 5.0 is 5.0 V ± 0.5 V

AC CHARACTERISTICS (For Figures and Waveforms — See Section 3)

| Symbol | Parameter | V _{CC} * (V) | 74ACT | | | 74ACT | | Units | Fig. No. |
|------------------|---|-----------------------|--|-----|-----|--|-----|-------|----------|
| | | | T _A = +25°C C _L = 50 pF | | | T _A = -40°C to +85°C C _L = 50 pF | | | |
| | | | Min | Typ | Max | Min | Max | | |
| t _{PLH} | Propagation Delay S _n to Z _n | 5.0 | | 7.0 | | | ns | 3-6 | |
| t _{PHL} | Propagation Delay S _n to Z _n | 5.0 | | 7.0 | | | ns | 3-6 | |
| t _{PLH} | Propagation Delay E _n to Z _n | 5.0 | | 5.5 | | | ns | 3-6 | |
| t _{PHL} | Propagation Delay E _n to Z _n | 5.0 | | 5.5 | | | ns | 3-6 | |
| t _{PLH} | Propagation Delay I _n to Z _n | 5.0 | | 6.5 | | | ns | 3-5 | |
| t _{PHL} | Propagation Delay I _n to Z _n | 5.0 | | 6.5 | | | ns | 3-5 | |

*Voltage Range 5.0 is 5.0 V ± 0.5 V

CAPACITANCE

| Symbol | Parameter | Value Typ | Units | Test Conditions |
|-----------------|-------------------------------|--------------|-------|-------------------------|
| C _{IN} | Input Capacitance | 4.5 | pF | V _{CC} = 5.0 V |
| C _{PD} | Power Dissipation Capacitance | | pF | V _{CC} = 5.0 V |



MOTOROLA

Product Preview

Dual 4-Input Multiplexer with 3-State Outputs

The MC74AC353/74ACT353 is a dual 4-input multiplexer with 3-state outputs. It can select two bits of data from four sources using common Select inputs. The outputs may be individually switched to a high impedance state with a HIGH on the respective Output Enable (\overline{OE}) inputs, allowing the outputs to interface directly with bus-oriented systems.

- Inverted Version of the MC74AC253/74ACT253
- Multifunction Capability
- Separate Enables for Each Multiplexer
- Outputs Source/Sink 24 mA
- 'ACT353 Has TTL Compatible Inputs

LOGIC SYMBOL

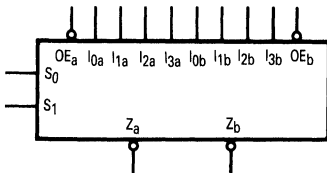

PIN NAMES

- I_{0a} - I_{3a} Side A Data Inputs
- I_{0b} - I_{3b} Side B Data Inputs
- S_0, S_1 Common Select Inputs
- \overline{OE}_a Side A Enable Input
- \overline{OE}_b Side B Enable Input
- Z_a, Z_b Multiplexer Outputs

TRUTH TABLE

| Select Inputs | | Data Inputs | | | | Output Enable | Outputs |
|---------------|-------|-------------|-------|-------|-------|-----------------|-----------|
| S_0 | S_1 | I_0 | I_1 | I_2 | I_3 | \overline{OE} | \bar{Z} |
| X | X | X | X | X | X | H | Z |
| L | L | L | X | X | X | L | H |
| L | L | H | X | X | X | L | L |
| H | L | X | L | X | X | L | H |
| H | L | X | H | X | X | L | L |
| L | H | X | X | L | X | L | H |
| L | H | X | X | H | X | L | L |
| H | H | X | X | X | L | L | H |
| H | H | X | X | X | H | L | L |

Address inputs S_0 and S_1 are common to both sections.

- H = HIGH Voltage Level
- L = LOW Voltage Level
- X = Immaterial
- Z = High Impedance

This document contains information on a product under development. Motorola reserves the right to change or discontinue this product without notice.

**MC74AC353
MC74ACT353**

**DUAL 4-INPUT
MULTIPLEXER
WITH 3-STATE OUTPUTS**

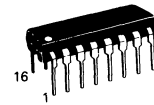

**N SUFFIX
CASE 648-08
PLASTIC**



**D SUFFIX
CASE 751B-03
PLASTIC**

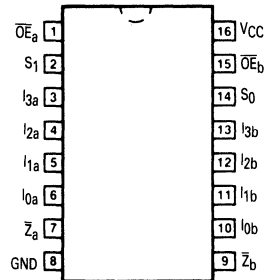

FUNCTIONAL DESCRIPTION

The MC74AC353/74ACT353 contains two identical 4-input multiplexers with 3-state outputs. They select two bits from four sources selected by common Select inputs (S₀, S₁). The 4-input multiplexers have individual Output Enable (OE_a, OE_b) inputs which, when HIGH, force the outputs to a high impedance (High Z) state. The logic equations for the outputs are shown below:

$$\bar{Z}_a = \bar{OE}_a \cdot (I_{0a} \cdot \bar{S}_1 \cdot \bar{S}_0 + I_{1a} \cdot \bar{S}_1 \cdot S_0 + I_{2a} \cdot S_1 \cdot \bar{S}_0 + I_{3a} \cdot S_1 \cdot S_0)$$

$$\bar{Z}_b = \bar{OE}_b \cdot (I_{0b} \cdot \bar{S}_1 \cdot \bar{S}_0 + I_{1b} \cdot \bar{S}_1 \cdot S_0 + I_{2b} \cdot S_1 \cdot \bar{S}_0 + I_{3b} \cdot S_1 \cdot S_0)$$

If the outputs of 3-state devices are tied together, all but one device must be in the high impedance state to avoid high currents that would exceed the maximum ratings. Designers should ensure that Output Enable signals to 3-state devices whose outputs are tied together are designed so that there is no overlap.

LOGIC DIAGRAM

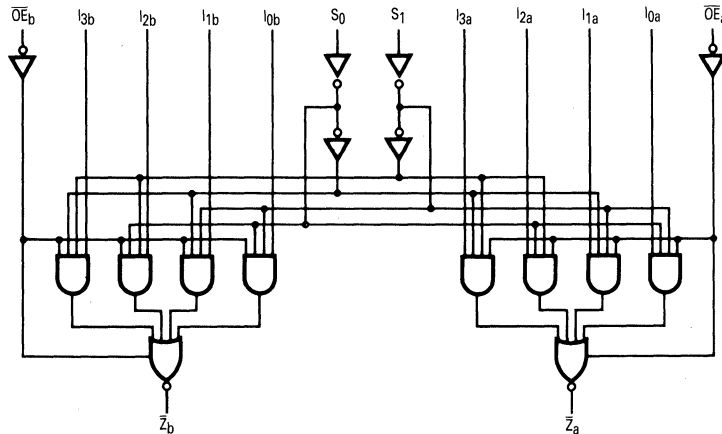

Please note that this diagram is provided only for the understanding of logic operations and should not be used to estimate propagation delays.

DC CHARACTERISTICS (unless otherwise specified)

| Symbol | Parameter | Value | Units | Test Conditions |
|--------------------|---|-------|-------|---|
| I _{CC} | Maximum Quiescent Supply Current | 80 | μA | V _{IN} = V _{CC} or Ground, V _{CC} = 5.5 V, T _A = Worst Case |
| I _{CC} | Maximum Quiescent Supply Current | 8.0 | μA | V _{IN} = V _{CC} or Ground, V _{CC} = 5.5 V, T _A = 25°C |
| I _{CC(T)} | Maximum Additional I _{CC} /Input ('ACT353) | 1.5 | mA | V _{IN} = V _{CC} - 2.1 V, V _{CC} = 5.5 V, T _A = Worst Case |

MC74AC353 • MC74ACT353

AC CHARACTERISTICS (For Figures and Waveforms — See Section 3)

| Symbol | Parameter | V _{CC} * (V) | 74AC | | | 74AC | | Units | Fig. No. |
|------------------|---|-----------------------|--|------------|-----|--|-----|-------|----------|
| | | | T _A = +25°C C _L = 50 pF | | | T _A = -40°C to +85°C C _L = 50 pF | | | |
| | | | Min | Typ | Max | Min | Max | | |
| t _{PLH} | Propagation Delay S _n to Z _n | 3.3 5.0 | | 9.0 6.5 | | | | ns | 3-6 |
| t _{PHL} | Propagation Delay S _n to Z _n | 3.3 5.0 | | 9.0 6.5 | | | | ns | 3-6 |
| t _{PLH} | Propagation Delay I _n to Z _n | 3.3 5.0 | | 6.5 5.0 | | | | ns | 3-6 |
| t _{PHL} | Propagation Delay I _n to Z _n | 3.3 5.0 | | 6.5 5.0 | | | | ns | 3-6 |
| t _{PZH} | Output Enable Time | 3.3 5.0 | | 5.5 4.0 | | | | ns | 3-7 |
| t _{PZL} | Output Enable Time | 3.3 5.0 | | 6.0 4.5 | | | | ns | 3-8 |
| t _{PHZ} | Output Disable Time | 3.3 5.0 | | 7.0 5.5 | | | | ns | 3-7 |
| t _{PLZ} | Output Disable Time | 3.3 5.0 | | 5.5 4.0 | | | | ns | 3-8 |

*Voltage Range 3.3 is 3.3 V ± 0.3 V
Voltage Range 5.0 is 5.0 V ± 0.5 V

AC CHARACTERISTICS (For Figures and Waveforms — See Section 3)

| Symbol | Parameter | V _{CC} * (V) | 74ACT | | | 74ACT | | Units | Fig. No. |
|------------------|---|-----------------------|--|-----|-----|--|-----|-------|----------|
| | | | T _A = +25°C C _L = 50 pF | | | T _A = -40°C to +85°C C _L = 50 pF | | | |
| | | | Min | Typ | Max | Min | Max | | |
| t _{PLH} | Propagation Delay S _n to Z _n | 5.0 | | 7.0 | | | | ns | 3-6 |
| t _{PHL} | Propagation Delay S _n to Z _n | 5.0 | | 7.0 | | | | ns | 3-6 |
| t _{PLH} | Propagation Delay I _n to Z _n | 5.0 | | 5.5 | | | | ns | 3-6 |
| t _{PHL} | Propagation Delay I _n to Z _n | 5.0 | | 5.5 | | | | ns | 3-6 |
| t _{PZH} | Output Enable Time | 5.0 | | 4.5 | | | | ns | 3-7 |
| t _{PZL} | Output Enable Time | 5.0 | | 5.0 | | | | ns | 3-8 |
| t _{PHZ} | Output Disable Time | 5.0 | | 6.0 | | | | ns | 3-7 |
| t _{PLZ} | Output Disable Time | 5.0 | | 4.5 | | | | ns | 3-8 |

*Voltage Range 5.0 is 5.0 V ± 0.5 V

CAPACITANCE

| Symbol | Parameter | Value Typ | Units | Test Conditions |
|-----------------|-------------------------------|-----------|-------|-------------------------|
| C _{IN} | Input Capacitance | 4.5 | pF | V _{CC} = 5.0 V |
| C _{PD} | Power Dissipation Capacitance | | pF | V _{CC} = 5.0 V |

5



MOTOROLA

Product Preview

Octal Transparent Latch with 3-State Outputs

The MC74AC373/74ACT373 consists of eight latches with 3-state outputs for bus organized system applications. The flip-flops appear transparent to the data when Latch Enable (LE) is HIGH. When LE is LOW, the data that meets the setup time is latched. Data appears on the bus when the Output Enable (\overline{OE}) is LOW. When \overline{OE} is HIGH, the bus output is in the high impedance state.

- Eight Latches in a Single Package
- 3-State Outputs for Bus Interfacing
- Outputs Source/Sink 24 mA
- 'ACT373 Has TTL Compatible Inputs

LOGIC SYMBOL

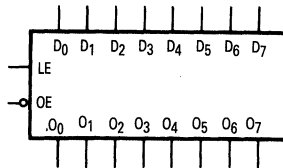

PIN NAMES

- D₀-D₇ Data Inputs
- LE Latch Enable Input
- OE Output Enable Input
- O₀-O₇ 3-State Latch Outputs

TRUTH TABLE

| \overline{OE} | Inputs | | Outputs |
|-----------------|--------|----------------|----------------|
| | LE | D _n | O _n |
| H | X | X | Z |
| L | H | L | L |
| L | H | H | H |
| L | L | X | O ₀ |

H = HIGH Voltage Level
 L = LOW Voltage Level
 Z = High Impedance
 X = Immaterial
 O₀ = Previous O₀ before LOW-to-HIGH Transition of Clock

**MC74AC373
MC74ACT373**

**OCTAL TRANSPARENT
LATCH WITH
3-STATE OUTPUTS**

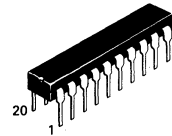

**N SUFFIX
CASE 738-03
PLASTIC**

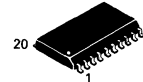

**DW SUFFIX
CASE 751D-03
PLASTIC**

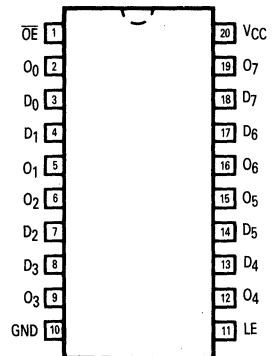

MC74AC373 • MC74ACT373

FUNCTIONAL DESCRIPTION

The MC74AC373/74ACT373 contains eight D-type latches with 3-state standard outputs. When the Latch Enable (LE) input is HIGH, data on the D_n inputs enters the latches. In this condition the latches are transparent, i.e., a latch output will change state each time its D input changes. When LE is LOW, the latches store the information that was present on the D inputs a setup time

preceding the HIGH-to-LOW transition of LE. The 3-state standard outputs are controlled by the Output Enable (\overline{OE}) input. When \overline{OE} is LOW, the standard outputs are in the 2-state mode. When \overline{OE} is HIGH, the standard outputs are in the high impedance mode but this does not interfere with entering new data into the latches.

LOGIC DIAGRAM

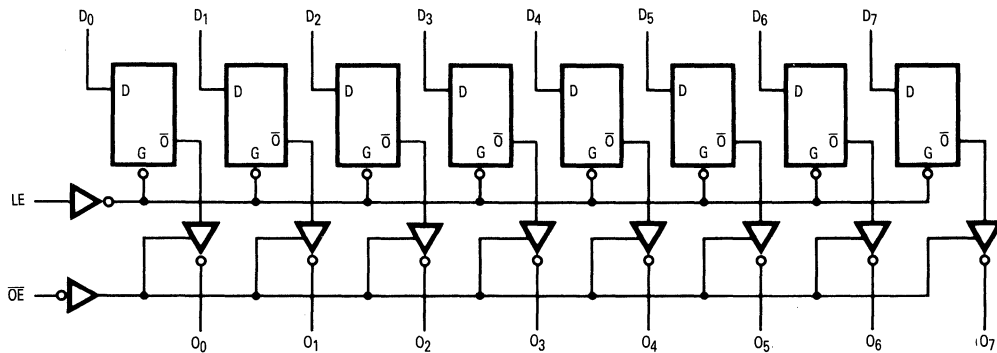

Please note that this diagram is provided only for the understanding of logic operations and should not be used to estimate propagation delays.

DC CHARACTERISTICS (unless otherwise specified)

| Symbol | Parameter | Value | Units | Test Conditions |
|-----------|---|-------|---------|---|
| I_{CC} | Maximum Quiescent Supply Current | 80 | μA | $V_{IN} = V_{CC}$ or Ground, $V_{CC} = 5.5 V$, $T_A = \text{Worst Case}$ |
| I_{CC} | Maximum Quiescent Supply Current | 8.0 | μA | $V_{IN} = V_{CC}$ or Ground, $V_{CC} = 5.5 V$, $T_A = 25^\circ C$ |
| I_{CCT} | Maximum Additional I_{CC}/Input (ACT373) | 1.5 | mA | $V_{IN} = V_{CC} - 2.1 V$, $V_{CC} = 5.5 V$, $T_A = \text{Worst Case}$ |

MC74AC373 • MC74ACT373

AC CHARACTERISTICS (For Figures and Waveforms — See Section 3)

| Symbol | Parameter | V _{CC} * (V) | 74AC | | | 74AC | | Units | Fig. No. |
|------------------|---|--------------------------|--|------------|-------------|--|--------------|-------|----------|
| | | | T _A = +25°C C _L = 50 pF | | | T _A = -40°C to +85°C C _L = 50 pF | | | |
| | | | Min | Typ | Max | Min | Max | | |
| t _{PLH} | Propagation Delay D _n to O _n | 3.3 5.0 | 1.0 1.0 | 10 7.0 | 13.5 9.5 | 1.0 1.0 | 15 10.5 | ns | 3-5 |
| t _{PHL} | Propagation Delay D _n to O _n | 3.3 5.0 | 1.0 1.0 | 9.5 7.0 | 13 9.5 | 1.0 1.0 | 14.5 10.5 | ns | 3-5 |
| t _{PLH} | Propagation Delay LE to O _n | 3.3 5.0 | 1.0 1.0 | 10 7.5 | 13.5 9.5 | 1.0 1.0 | 15 10.5 | ns | 3-6 |
| t _{PHL} | Propagation Delay LE to O _n | 3.3 5.0 | 1.0 1.0 | 9.5 7.0 | 12.5 9.5 | 1.0 1.0 | 14 10.5 | ns | 3-6 |
| t _{PZH} | Output Enable Time | 3.3 5.0 | 1.0 1.0 | 9.0 7.0 | 11.5 8.5 | 1.0 1.0 | 13 9.5 | ns | 3-7 |
| t _{PZL} | Output Enable Time | 3.3 5.0 | 1.0 1.0 | 8.5 6.5 | 11.5 8.5 | 1.0 1.0 | 13 9.5 | ns | 3-8 |
| t _{PHZ} | Output Disable Time | 3.3 5.0 | 1.0 1.0 | 10 8.0 | 12.5 11 | 1.0 1.0 | 14.5 12.5 | ns | 3-7 |
| t _{PLZ} | Output Disable Time | 3.3 5.0 | 1.0 1.0 | 8.0 6.5 | 11.5 8.5 | 1.0 1.0 | 12.5 10 | ns | 3-8 |

*Voltage Range 3.3 is 3.3 V ± 0.3 V
Voltage Range 5.0 is 5.0 V ± 0.5 V

AC OPERATING REQUIREMENTS

| Symbol | Parameter | V _{CC} * (V) | 74AC | | 74AC | | Units | Fig. No. |
|----------------|---|--------------------------|--|--------------------|--|--|-------|----------|
| | | | T _A = +25°C C _L = 50 pF | | T _A = -40°C to +85°C C _L = 50 pF | | | |
| | | | Typ | Guaranteed Minimum | | | | |
| t _s | Setup Time, HIGH or LOW D _n to LE | 3.3 5.0 | 3.5 2.0 | 5.5 4.0 | 6.0 4.5 | | ns | 3-9 |
| t _h | Hold Time, HIGH or LOW D _n to LE | 3.3 5.0 | -3.0 -1.5 | 0 0 | 0 0 | | ns | 3-9 |
| t _w | LE Pulse Width, HIGH | 3.3 5.0 | 4.0 2.0 | 5.5 4.0 | 6.0 4.5 | | ns | 3-6 |

*Voltage Range 3.3 is 3.3 V ± 0.3 V
Voltage Range 5.0 is 5.0 V ± 0.5 V

MC74AC373 • MC74ACT373

AC CHARACTERISTICS (For Figures and Waveforms — See Section 3)

| Symbol | Parameter | VCC* (V) | 74ACT | | | 74ACT | | Units | Fig. No. |
|--------|-------------------------------|----------|--------------------------|-----|-----|--------------------------------------|------|-------|----------|
| | | | TA = +25°C CL = 50 pF | | | TA = -40°C to +85°C CL = 50 pF | | | |
| | | | Min | Typ | Max | Min | Max | | |
| tPLH | Propagation Delay Dn to On | 5.0 | 1.0 | 8.5 | 10 | 1.0 | 11.5 | ns | 3-5 |
| tPHL | Propagation Delay Dn to On | 5.0 | 1.0 | 8.0 | 10 | 1.0 | 11.5 | ns | 3-5 |
| tPLH | Propagation Delay LE to On | 5.0 | 1.0 | 8.5 | 11 | 1.0 | 11.5 | ns | 3-6 |
| tPHL | Propagation Delay LE to On | 5.0 | 1.0 | 8.0 | 10 | 1.0 | 11.5 | ns | 3-6 |
| tpZH | Output Enable Time | 5.0 | 1.0 | 8.0 | 9.5 | 1.0 | 10.5 | ns | 3-7 |
| tpZL | Output Enable Time | 5.0 | 1.0 | 7.5 | 9.0 | 1.0 | 10.5 | ns | 3-8 |
| tpHZ | Output Disable Time | 5.0 | 1.0 | 9.0 | 11 | 1.0 | 12.5 | ns | 3-7 |
| tpLZ | Output Disable Time | 5.0 | 1.0 | 7.5 | 8.5 | 1.0 | 10 | ns | 3-8 |

*Voltage Range 5.0 is 5.0 V ± 0.5 V

AC OPERATING REQUIREMENTS

| Symbol | Parameter | VCC* (V) | 74ACT | | 74ACT | | Units | Fig. No. |
|--------|-------------------------------------|----------|--------------------------|--------------------|--------------------------------------|----|-------|----------|
| | | | TA = +25°C CL = 50 pF | | TA = -40°C to +85°C CL = 50 pF | | | |
| | | | Typ | Guaranteed Minimum | | | | |
| ts | Setup Time, HIGH or LOW Dn to LE | 5.0 | 3.0 | 7.0 | 8.0 | ns | 3-9 | |
| th | Hold Time, HIGH or LOW Dn to LE | 5.0 | 0 | 0 | 1.0 | ns | 3-9 | |
| tw | LE Pulse Width, HIGH | 5.0 | 2.0 | 7.0 | 8.0 | ns | 3-6 | |

*Voltage Range 5.0 is 5.0 V ± 0.5 V

CAPACITANCE

| Symbol | Parameter | Value Typ | Units | Test Conditions |
|--------|-------------------------------|--------------|-------|-----------------|
| CIN | Input Capacitance | 4.5 | pF | VCC = 5.0 V |
| CPD | Power Dissipation Capacitance | 40 | pF | VCC = 5.0 V |



MOTOROLA

Product Preview

**Octal D-Type Flip-Flop
with 3-State Outputs**

The MC74AC374/74ACT374 is a high-speed, low-power octal D-type flip-flop featuring separate D-type inputs for each flip-flop and 3-state outputs for bus-oriented applications. A buffered Clock (CP) and Output Enable (\overline{OE}) are common to all flip-flops.

- Buffered Positive Edge-Triggered Clock
- 3-State Outputs for Bus-Oriented Applications
- Outputs Source/Sink 24 mA
- See MC74AC273 for Reset Version
- See MC74AC377 for Clock Enable Version
- See MC74AC373 for Transparent Latch Version
- See MC74AC574 for Broadside Pinout Version
- See MC74AC564 for Broadside Pinout Version with Inverted Outputs
- 'ACT374 Has TTL Compatible Inputs

LOGIC SYMBOL

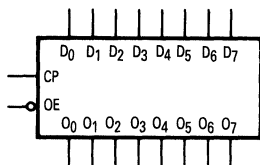

PIN NAMES

- D₀-D₇ Data Inputs
- CP Clock Pulse Input
- \overline{OE} 3-State Output Enable Input
- O₀-O₇ 3-State Outputs

TRUTH TABLE

| Inputs | | | Outputs |
|----------------|----|-----------------|----------------|
| D _n | CP | \overline{OE} | O _n |
| H | ┌ | L | H |
| L | ┌ | L | L |
| X | X | H | Z |

- H = HIGH Voltage Level
- L = LOW Voltage Level
- X = Immaterial
- Z = High Impedance
- ┌ = LOW-to-HIGH Transition

**MC74AC374
MC74ACT374**

**OCTAL D-TYPE
FLIP-FLOP WITH
3-STATE OUTPUTS**

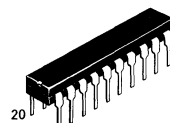

**N SUFFIX
CASE 738-03
PLASTIC**



**DW SUFFIX
CASE 751D-03
PLASTIC**

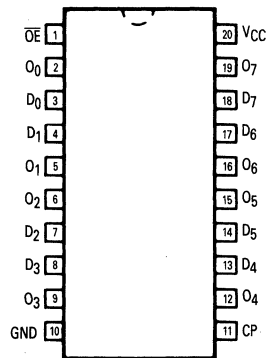

5

This document contains information on a product under development. Motorola reserves the right to change or discontinue this product without notice.

MC74AC374 • MC74ACT374

FUNCTIONAL DESCRIPTION

The MC74AC374/74ACT374 consists of eight edge-triggered flip-flops with individual D-type inputs and 3-state true outputs. The buffered clock and buffered Output Enable are common to all flip-flops. The eight flip-flops will store the state of their individual D inputs that meet the setup and hold time requirements on the

LOW-to-HIGH Clock (CP) transition. With the Output Enable (\overline{OE}) LOW, the contents of the eight flip-flops are available at the outputs. When the \overline{OE} is HIGH, the outputs go to the high impedance state. Operation of the \overline{OE} input does not affect the state of the flip-flops.

LOGIC DIAGRAM

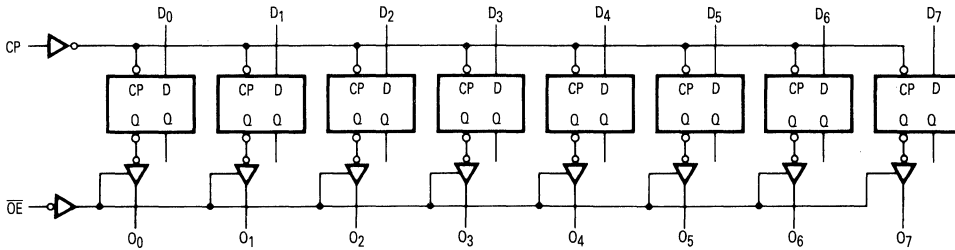

Please note that this diagram is provided only for the understanding of logic operations and should not be used to estimate propagation delays.

DC CHARACTERISTICS (unless otherwise specified)

| Symbol | Parameter | Value | Units | Test Conditions |
|-----------|--|-------|---------|--|
| I_{CC} | Maximum Quiescent Supply Current | 80 | μA | $V_{IN} = V_{CC}$ or Ground, $V_{CC} = 5.5 V, T_A = \text{Worst Case}$ |
| I_{CC} | Maximum Quiescent Supply Current | 8.0 | μA | $V_{IN} = V_{CC}$ or Ground, $V_{CC} = 5.5 V, T_A = 25^\circ C$ |
| I_{CCT} | Maximum Additional I_{CC}/Input ('ACT374) | 1.5 | mA | $V_{IN} = V_{CC} - 2.1 V$, $V_{CC} = 5.5 V, T_A = \text{Worst Case}$ |

MC74AC374 • MC74ACT374

AC CHARACTERISTICS (For Figures and Waveforms — See Section 3)

| Symbol | Parameter | V _{CC} * (V) | 74AC | | | 74AC | | Units | Fig. No. |
|------------------|---|--------------------------|--|-------------|-------------|--|--------------|-------|----------|
| | | | T _A = +25°C C _L = 50 pF | | | T _A = -40°C to +85°C C _L = 50 pF | | | |
| | | | Min | Typ | Max | Min | Max | | |
| f _{max} | Maximum Clock Frequency | 3.3 5.0 | 60 100 | 110 155 | | 60 100 | | MHz | 3-3 |
| t _{PLH} | Propagation Delay CP to O _n | 3.3 5.0 | 1.0 1.0 | 11 8.0 | 13.5 9.5 | 1.0 1.0 | 15.5 10.5 | ns | 3-6 |
| t _{PHL} | Propagation Delay CP to O _n | 3.3 5.0 | 1.0 1.0 | 10 7.0 | 12.5 9.0 | 1.0 1.0 | 14 10 | ns | 3-6 |
| t _{PZH} | Output Enable Time | 3.3 5.0 | 1.0 1.0 | 9.5 7.0 | 11.5 8.5 | 1.0 1.0 | 13 9.5 | ns | 3-7 |
| t _{PZL} | Output Enable Time | 3.3 5.0 | 1.0 1.0 | 9.0 6.5 | 11.5 8.5 | 1.0 1.0 | 13 9.5 | ns | 3-8 |
| t _{PHZ} | Output Disable Time | 3.3 5.0 | 1.0 1.0 | 10.5 8.0 | 12.5 11 | 1.0 1.0 | 14.5 12.5 | ns | 3-7 |
| t _{PLZ} | Output Disable Time | 3.3 5.0 | 1.0 1.0 | 8.0 6.5 | 11.5 8.5 | 1.0 1.0 | 12.5 10 | ns | 3-8 |

*Voltage Range 3.3 is 3.3 V ± 0.3 V
Voltage Range 5.0 is 5.0 V ± 0.5 V

AC OPERATING REQUIREMENTS

| Symbol | Parameter | V _{CC} * (V) | 74AC | | 74AC | | Units | Fig. No. |
|----------------|---|--------------------------|--|--------------------|--|--|-------|----------|
| | | | T _A = +25°C C _L = 50 pF | | T _A = -40°C to +85°C C _L = 50 pF | | | |
| | | | Typ | Guaranteed Minimum | | | | |
| t _s | Setup Time, HIGH or LOW D _n to CP | 3.3 5.0 | 2.0 1.0 | 5.5 4.0 | 6.0 4.5 | | ns | 3-9 |
| t _h | Hold Time, HIGH or LOW D _n to CP | 3.3 5.0 | -1.0 0 | 1.0 1.5 | 1.0 1.5 | | ns | 3-9 |
| t _w | CP Pulse Width HIGH or LOW | 3.3 5.0 | 4.0 2.5 | 5.5 4.0 | 6.0 4.5 | | ns | 3-6 |

*Voltage Range 3.3 is 3.3 V ± 0.3 V
Voltage Range 5.0 is 5.0 V ± 0.5 V

MC74AC374 • MC74ACT374

AC CHARACTERISTICS (For Figures and Waveforms — See Section 3)

| Symbol | Parameter | V _{CC} * (V) | 74ACT | | | 74ACT | | Units | Fig. No. |
|------------------|---|--------------------------|--|-----|------|--|------|-------|----------|
| | | | T _A = +25°C C _L = 50 pF | | | T _A = -40°C to +85°C C _L = 50 pF | | | |
| | | | Min | Typ | Max | Min | Max | | |
| f _{max} | Maximum Clock Frequency | 5.0 | 100 | 160 | | 90 | | MHz | 3-3 |
| t _{PLH} | Propagation Delay CP to O _n | 5.0 | 1.0 | 8.5 | 10 | 1.0 | 11.5 | ns | 3-6 |
| t _{PHL} | Propagation Delay CP to O _n | 5.0 | 1.0 | 8.0 | 9.5 | 1.0 | 11 | ns | 3-6 |
| t _{PZH} | Output Enable Time | 5.0 | 1.0 | 8.0 | 9.5 | 1.0 | 10.5 | ns | 3-7 |
| t _{PZL} | Output Enable Time | 5.0 | 1.0 | 8.0 | 9.0 | 1.0 | 10.5 | ns | 3-8 |
| t _{PHZ} | Output Disable Time | 5.0 | 1.0 | 8.5 | 11.5 | 1.0 | 12.5 | ns | 3-7 |
| t _{PLZ} | Output Disable Time | 5.0 | 1.0 | 7.0 | 8.5 | 1.0 | 10 | ns | 3-8 |

*Voltage Range 5.0 is 5.0 V ± 0.5 V

AC OPERATING REQUIREMENTS

| Symbol | Parameter | V _{CC} * (V) | 74ACT | | 74ACT | | Units | Fig. No. |
|----------------|---|--------------------------|--|--------------------|--|--|-------|----------|
| | | | T _A = +25°C C _L = 50 pF | | T _A = -40°C to +85°C C _L = 50 pF | | | |
| | | | Typ | Guaranteed Minimum | | | | |
| t _s | Setup Time, HIGH or LOW D _n to CP | 5.0 | 1.0 | 7.0 | 8.0 | | ns | 3-9 |
| t _h | Hold Time, HIGH or LOW D _n to CP | 5.0 | 0 | 1.5 | 1.5 | | ns | 3-9 |
| t _w | CP Pulse Width HIGH or LOW | 5.0 | 2.0 | 7.0 | 8.0 | | ns | 3-6 |

*Voltage Range 5.0 is 5.0 V ± 0.5 V

CAPACITANCE

| Symbol | Parameter | Value Typ | Units | Test Conditions |
|-----------------|-------------------------------|--------------|-------|-------------------------|
| C _{IN} | Input Capacitance | 4.5 | pF | V _{CC} = 5.0 V |
| C _{PD} | Power Dissipation Capacitance | 80 | pF | V _{CC} = 5.0 V |





MOTOROLA

Product Preview

Octal D Flip-Flop with Clock Enable

The MC74AC377/74ACT377 has eight edge-triggered, D-type flip-flops with individual D inputs and Q outputs. The common buffered Clock (CP) input loads all flip-flops simultaneously, when the Clock Enable (CE) is LOW.

The register is fully edge-triggered. The state of each D input, one setup time before the LOW-to-HIGH clock transition, is transferred to the corresponding flip-flop's Q output. The CE input must be stable only one setup time prior to the LOW-to-HIGH clock transition for predictable operation.

- Ideal for Addressable Register Applications
- Clock Enable for Address and Data Synchronization Applications
- Eight Edge-Triggered D Flip-Flops
- Buffered Common Clock
- Outputs Source/Sink 24 mA
- See MC74AC273 for Master Reset Version
- See MC74AC373 for Transparent Latch Version
- See MC74AC374 for 3-State Version
- 'ACT377 Has TTL Compatible Inputs

LOGIC SYMBOL

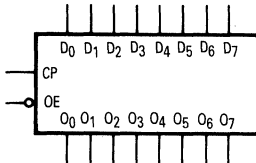

PIN NAMES

D₀-D₇ Data Inputs
 CE Clock Enable (Active LOW)
 Q₀-Q₇ Data Outputs
 CP Clock Pulse Input

MODE SELECT-FUNCTION TABLE

| Operating Mode | Inputs | | | Outputs |
|-------------------|--------|-----------------|----------------|----------------|
| | CP | \overline{CE} | D _n | Q _n |
| Load '1' | ⌄ | L | H | H |
| Load '0' | ⌄ | L | L | L |
| Hold (Do Nothing) | ⌄ | H | X | No Change |
| | X | H | X | No Change |

H = HIGH Voltage Level
 L = LOW Voltage Level
 X = Immaterial
 ⌄ = LOW-to-HIGH Clock Transition

**MC74AC377
MC74ACT377**

**OCTAL D
FLIP-FLOP WITH
CLOCK ENABLE**

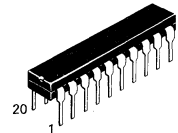

**N SUFFIX
CASE 738-03
PLASTIC**

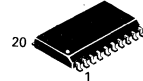

**DW SUFFIX
CASE 751D-03
PLASTIC**

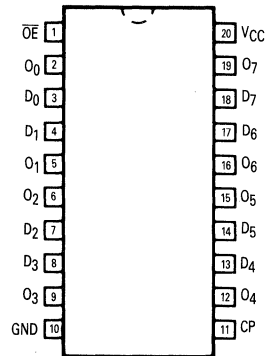

LOGIC DIAGRAM

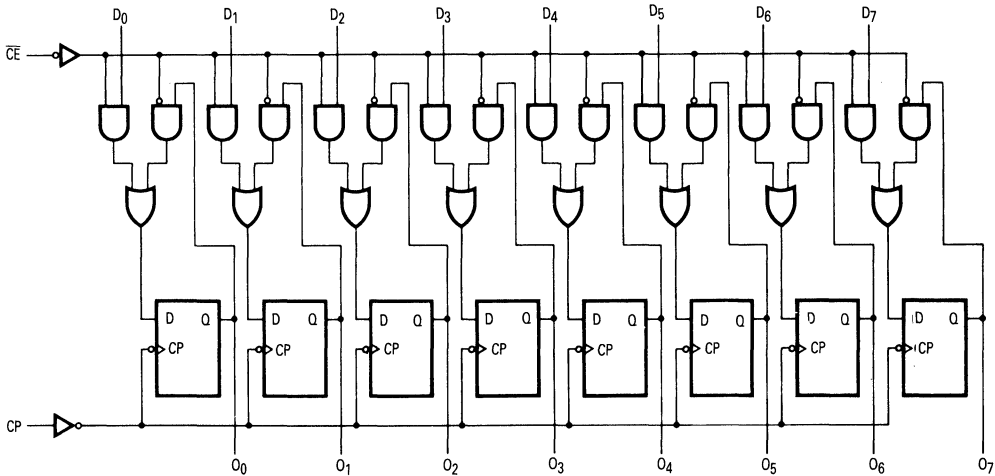

Please note that this diagram is provided only for the understanding of logic operations and should not be used to estimate propagation delays.

DC CHARACTERISTICS (unless otherwise specified)

| Symbol | Parameter | Value | Units | Test Conditions |
|-----------|--|-------|---------|---|
| I_{CC} | Maximum Quiescent Supply Current | 80 | μA | $V_{IN} = V_{CC}$ or Ground, $V_{CC} = 5.5 V$, $T_A = \text{Worst Case}$ |
| I_{CC} | Maximum Quiescent Supply Current | 8.0 | μA | $V_{IN} = V_{CC}$ or Ground, $V_{CC} = 5.5 V$, $T_A = 25^\circ C$ |
| I_{CCT} | Maximum Additional I_{CC} /Input ('ACT377) | 1.5 | mA | $V_{IN} = V_{CC} - 2.1 V$, $V_{CC} = 5.5 V$, $T_A = \text{Worst Case}$ |



AC CHARACTERISTICS (For Figures and Waveforms — See Section 3)

| Symbol | Parameter | V_{CC}^* (V) | 74AC | | | 74AC | | Units | Fig. No. |
|-----------|----------------------------------|-------------------|--------------------------------------|------------|-----------|--|------------|-------|----------|
| | | | $T_A = +25^\circ C$ $C_L = 50 pF$ | | | $T_A = -40^\circ C$ to $+85^\circ C$ $C_L = 50 pF$ | | | |
| | | | Min | Typ | Max | Min | Max | | |
| f_{max} | Maximum Clock Frequency | 3.3 5.0 | 90 140 | 125 175 | | 75 125 | | MHz | 3-3 |
| t_{PLH} | Propagation Delay CP to Q_n | 3.3 5.0 | 1.0 1.0 | 8.0 6.0 | 13 9.0 | 1.0 1.0 | 14 10 | ns | 3-6 |
| t_{PHL} | Propagation Delay CP to Q_n | 3.3 5.0 | 1.0 1.0 | 8.5 6.5 | 13 10 | 1.0 1.0 | 14.5 11 | ns | 3-6 |

*Voltage Range 3.3 is $3.3 V \pm 0.3 V$
Voltage Range 5.0 is $5.0 V \pm 0.5 V$

MC74AC377 • MC74ACT377

AC OPERATING REQUIREMENTS

| Symbol | Parameter | V _{CC} * (V) | 74AC | | 74AC | | Units | Fig. No. |
|----------------|---|-----------------------|--|--------------------|--|----|-------|----------|
| | | | T _A = +25°C C _L = 50 pF | | T _A = -40°C to +85°C C _L = 50 pF | | | |
| | | | Typ | Guaranteed Minimum | | | | |
| t _s | Setup Time, HIGH or LOW D _n to CP | 3.3 5.0 | 3.5 2.5 | 5.5 4.0 | 6.0 4.5 | ns | 3-9 | |
| t _h | Hold Time, HIGH or LOW D _n to CP | 3.3 5.0 | -2.0 -1.0 | 0 1.0 | 0 1.0 | ns | 3-9 | |
| t _s | Setup Time, HIGH or LOW CE to CP | 3.3 5.0 | 4.0 2.5 | 6.0 4.0 | 7.5 4.5 | ns | 3-9 | |
| t _h | Hold Time, HIGH or LOW CE to CP | 3.3 5.0 | -3.5 -2.0 | 0 1.0 | 0 1.0 | ns | 3-9 | |
| t _w | CP Pulse Width HIGH or LOW | 3.3 5.0 | 3.5 2.5 | 5.5 4.0 | 6.0 4.5 | ns | 3-6 | |

*Voltage Range 3.3 is 3.3 V ± 0.3 V
 *Voltage Range 5.0 is 5.0 V ± 0.5 V

AC CHARACTERISTICS (For Figures and Waveforms — See Section 3)

| Symbol | Parameter | V _{CC} * (V) | 74ACT | | | 74ACT | | Units | Fig. No. |
|------------------|---|-----------------------|--|-----|-----|--|-----|-------|----------|
| | | | T _A = +25°C C _L = 50 pF | | | T _A = -40°C to +85°C C _L = 50 pF | | | |
| | | | Min | Typ | Max | Min | Max | | |
| f _{max} | Maximum Clock Frequency | 5.0 | 140 | 175 | | 125 | | MHz | 3-3 |
| t _{PLH} | Propagation Delay CP to Q _n | 5.0 | 1.0 | 6.5 | 9.0 | 1.0 | 10 | ns | 3-6 |
| t _{PHL} | Propagation Delay CP to Q _n | 5.0 | 1.0 | 7.0 | 10 | 1.0 | 11 | ns | 3-6 |

*Voltage Range 5.0 is 5.0 V ± 0.5 V

AC OPERATING REQUIREMENTS

| Symbol | Parameter | V _{CC} * (V) | 74ACT | | 74ACT | | Units | Fig. No. |
|----------------|---|-----------------------|--|--------------------|--|----|-------|----------|
| | | | T _A = +25°C C _L = 50 pF | | T _A = -40°C to +85°C C _L = 50 pF | | | |
| | | | Typ | Guaranteed Minimum | | | | |
| t _s | Setup Time, HIGH or LOW D _n to CP | 5.0 | 2.5 | 4.5 | 5.5 | ns | 3-9 | |
| t _h | Hold Time, HIGH or LOW D _n to CP | 5.0 | -1.0 | 1.0 | 1.0 | ns | 3-9 | |
| t _s | Setup Time, HIGH or LOW CE to CP | 5.0 | 2.5 | 4.5 | 5.5 | ns | 3-9 | |
| t _h | Hold Time, HIGH or LOW CE to CP | 5.0 | -1.0 | 1.0 | 1.0 | ns | 3-9 | |
| t _w | CP Pulse Width HIGH or LOW | 5.0 | 2.0 | 4.0 | 4.5 | ns | 3-6 | |

*Voltage Range 5.0 is 5.0 V ± 0.5 V

CAPACITANCE

| Symbol | Parameter | Value Typ | Units | Test Conditions |
|-------------------|-------------------------------|--------------|-------|-------------------------|
| C _{I(N)} | Input Capacitance | 4.5 | pF | V _{CC} = 5.0 V |
| C _{PD} | Power Dissipation Capacitance | 90 | pF | V _{CC} = 5.0 V |



MOTOROLA

Product Preview

Parallel D Register with Enable

The MC74AC378/74ACT378 is a 6-bit register with a buffered common Enable. This device is similar to the MC74AC174/74ACT174, but with common Enable rather than common Master Reset.

- 6-Bit High-Speed Parallel Register
- Positive Edge-Triggered D-Type Inputs
- Fully Buffered Common Clock and Enable Inputs
- Outputs Source/Sink 24 mA
- 'ACT378 Has TTL Compatible Inputs

LOGIC SYMBOL

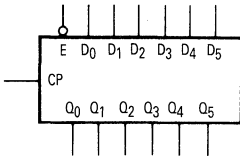

PIN NAMES

- \bar{E} Enable Input
- D_0 - D_5 Data Inputs
- CP Clock Pulse Input
- Q_0 - Q_5 Outputs

TRUTH TABLE

| Inputs | | | Outputs |
|-----------|-------------|-------|-----------|
| \bar{E} | CP | D_n | Q_n |
| H | \lrcorner | X | No Change |
| L | \lrcorner | H | H |
| L | \lrcorner | L | L |

- H = HIGH Voltage Level
- L = LOW Voltage Level
- X = Immaterial
- \lrcorner = LOW-to-HIGH Transition

MC74AC378
MC74ACT378

PARALLEL
D REGISTER
WITH ENABLE

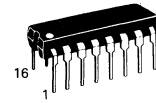

N SUFFIX
CASE 648-08
PLASTIC

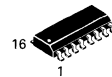

D SUFFIX
CASE 751B-03
PLASTIC

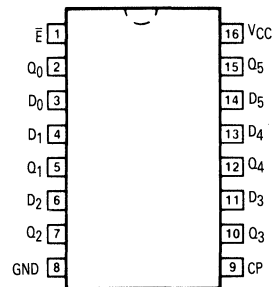

MC74AC378 • MC74ACT378

FUNCTIONAL DESCRIPTION

The MC74AC378/74ACT378 consists of six edge-triggered D-type flip-flops with individual D inputs and Q outputs. The Clock (CP) and Enable (\bar{E}) inputs are common to all flip-flops.

When the \bar{E} input is LOW, new data is entered into the register on the LOW-to-HIGH transition of the CP input. When the \bar{E} input is HIGH, the register will retain the present data independent of the CP input.

LOGIC DIAGRAM

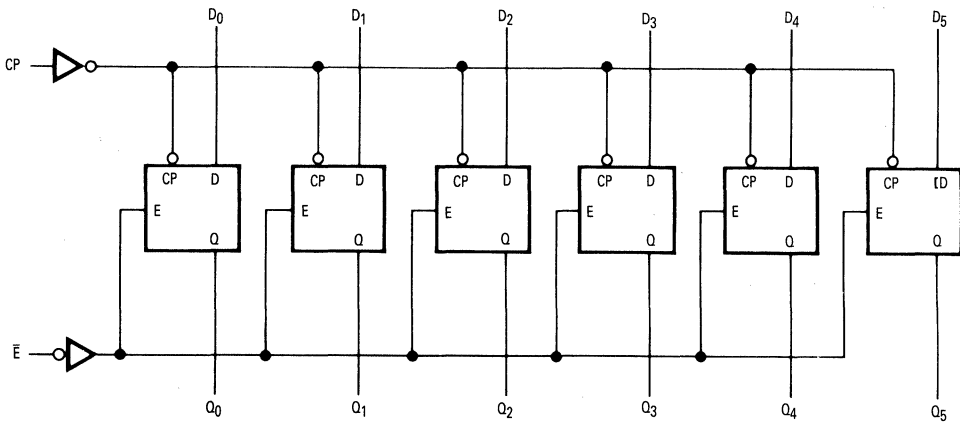

Please note that this diagram is provided only for the understanding of logic operations and should not be used to estimate propagation delays.

5

DC CHARACTERISTICS (unless otherwise specified)

| Symbol | Parameter | Value | Units | Test Conditions |
|-----------|--|-------|---------|---|
| I_{CC} | Maximum Quiescent Supply Current | 80 | μA | $V_{IN} = V_{CC}$ or Ground, $V_{CC} = 5.5 V$, $T_A = \text{Worst Case}$ |
| I_{CC} | Maximum Quiescent Supply Current | 8.0 | μA | $V_{IN} = V_{CC}$ or Ground, $V_{CC} = 5.5 V$, $T_A = 25^\circ C$ |
| I_{CCT} | Maximum Additional I_{CC} /Input ('ACT378) | 1.5 | mA | $V_{IN} = V_{CC} - 2.1 V$, $V_{CC} = 5.5 V$, $T_A = \text{Worst Case}$ |

MC74AC378 • MC74ACT378

AC CHARACTERISTICS (For Figures and Waveforms — See Section 3)

| Symbol | Parameter | VCC* (V) | 74AC | | | 74AC | | Units | Fig. No. |
|------------------|---|-------------|--------------------------|------------|-----|--------------------------------------|-----|-------|----------|
| | | | TA = +25°C CL = 50 pF | | | TA = -40°C to +85°C CL = 50 pF | | | |
| | | | Min | Typ | Max | Min | Max | | |
| f _{max} | Maximum Clock Frequency | 3.3 5.0 | | 74 100 | | | MHz | 3-3 | |
| t _{PLH} | Propagation Delay CP to Q _n | 3.3 5.0 | | 8.5 6.0 | | | ns | 3-6 | |
| t _{PHL} | Propagation Delay CP to Q _n | 3.3 5.0 | | 7.5 5.5 | | | ns | 3-6 | |

*Voltage Range 3.3 is 3.3 V ± 0.3 V
Voltage Range 5.0 is 5.0 V ± 0.5 V

AC OPERATING REQUIREMENTS

| Symbol | Parameter | VCC* (V) | 74AC | | 74AC | | Units | Fig. No. |
|----------------|---|-------------|--------------------------|--------------------|--------------------------------------|----|-------|----------|
| | | | TA = +25°C CL = 50 pF | | TA = -40°C to +85°C CL = 50 pF | | | |
| | | | Typ | Guaranteed Minimum | | | | |
| t _s | Setup Time, HIGH or LOW D _n to CP | 3.3 5.0 | 4.5 3.0 | | | ns | 3-9 | |
| t _h | Hold Time, HIGH or LOW D _n to CP | 3.3 5.0 | 1.5 1.0 | | | ns | 3-9 | |
| t _s | Setup Time, HIGH or LOW Ē to CP | 3.3 5.0 | -1.5 -1.0 | | | ns | 3-9 | |
| t _h | Hold Time, HIGH or LOW Ē to CP | 3.3 5.0 | 0 0 | | | ns | 3-9 | |
| t _w | CP Pulse Width HIGH or LOW | 3.3 5.0 | 8.5 6.0 | | | ns | 3-6 | |

*Voltage Range 3.3 is 3.3 V ± 0.3 V
Voltage Range 5.0 is 5.0 V ± 0.5 V

MC74AC378 • MC74ACT378

AC CHARACTERISTICS (For Figures and Waveforms — See Section 3)

| Symbol | Parameter | V _{CC} * (V) | 74ACT | | | 74ACT | | Units | Fig. No. |
|------------------|---|-----------------------|--|-----|-----|--|-----|-------|----------|
| | | | T _A = +25°C C _L = 50 pF | | | T _A = -40°C to +85°C C _L = 50 pF | | | |
| | | | Min | Typ | Max | Min | Max | | |
| f _{max} | Maximum Clock Frequency | 5.0 | | 100 | | | | MHz | 3-3 |
| t _{PLH} | Propagation Delay CP to Q _n | 5.0 | | 6.0 | | | | ns | 3-6 |
| t _{PHL} | Propagation Delay CP to Q _n | 5.0 | | 5.5 | | | | ns | 3-6 |

*Voltage Range 5.0 is 5.0 V ± 0.5 V

AC OPERATING REQUIREMENTS

| Symbol | Parameter | V _{CC} * (V) | 74ACT | | 74ACT | | Units | Fig. No. |
|----------------|---|-----------------------|--|--------------------|--|--|-------|----------|
| | | | T _A = +25°C C _L = 50 pF | | T _A = -40°C to +85°C C _L = 50 pF | | | |
| | | | Typ | Guaranteed Minimum | | | | |
| t _s | Setup Time, HIGH or LOW D _n to CP | 5.0 | 3.0 | | | | ns | 3-9 |
| t _h | Hold Time, HIGH or LOW D _n to CP | 5.0 | 1.0 | | | | ns | 3-9 |
| t _s | Setup Time, HIGH or LOW Ē to CP | 5.0 | -1.0 | | | | ns | 3-9 |
| t _h | Hold Time, HIGH or LOW Ē to CP | 5.0 | 0 | | | | ns | 3-9 |
| t _w | CP Pulse Width HIGH or LOW | 5.0 | 6.0 | | | | ns | 3-6 |

*Voltage Range 5.0 is 5.0 V ± 0.5 V

CAPACITANCE

| Symbol | Parameter | Value Typ | Units | Test Conditions |
|-----------------|-------------------------------|--------------|-------|-------------------------|
| C _{IN} | Input Capacitance | 4.5 | pF | V _{CC} = 5.0 V |
| C _{PD} | Power Dissipation Capacitance | | pF | V _{CC} = 5.0 V |

5



MOTOROLA

Product Preview

Quad Parallel Register with Enable

The MC74AC379/74ACT379 is a 4-bit register with a buffered common Enable. This device is similar to the MC74AC175/74ACT175 but features the common Enable rather than common Master Reset.

- Edge-Triggered D-Type Inputs
- Buffered Positive Edge-Triggered Clock
- Buffered Common Enable Input
- True and Complement Outputs
- Outputs Source/Sink 24 mA
- 'ACT379 Has TTL Compatible Inputs

LOGIC SYMBOL

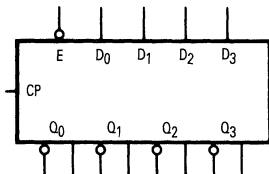

PIN NAMES

- E Enable Input
- D₀-D₃ Data Inputs
- CP Clock Pulse Input
- Q₀-Q₃ Flip-Flop Outputs
- Q₀-Q₃ Complement Outputs

TRUTH TABLE

| Inputs | | | Outputs | |
|--------|----|----------------|----------------|----------------|
| E | CP | D _n | Q _n | Q _n |
| H | ┐ | X | NC | NC |
| L | ┐ | H | H | L |
| L | ┐ | L | L | H |

- H = HIGH Voltage Level
- L = LOW Voltage Level
- X = Immaterial
- ┐ = LOW-to-HIGH Transition
- NC = No Change

**MC74AC379
MC74ACT379**

QUAD PARALLEL REGISTER WITH ENABLE

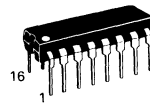

**N SUFFIX
CASE 648-08
PLASTIC**

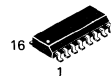

**D SUFFIX
CASE 751B-03
PLASTIC**

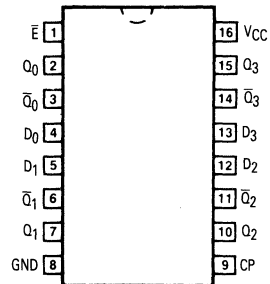

MC74AC379 • MC74ACT379

FUNCTIONAL DESCRIPTION

The MC74AC379/74ACT379 consists of four edge-triggered D-type flip-flops with individual D inputs and Q and \bar{Q} outputs. The Clock (CP) and Enable (\bar{E}) inputs are common to all flip-flops. When the \bar{E} input is HIGH,

the register will retain the present data independent of the CP input. When the \bar{E} is LOW, new data is entered into the register on the LOW-to-HIGH transition of the CP input.

LOGIC DIAGRAM

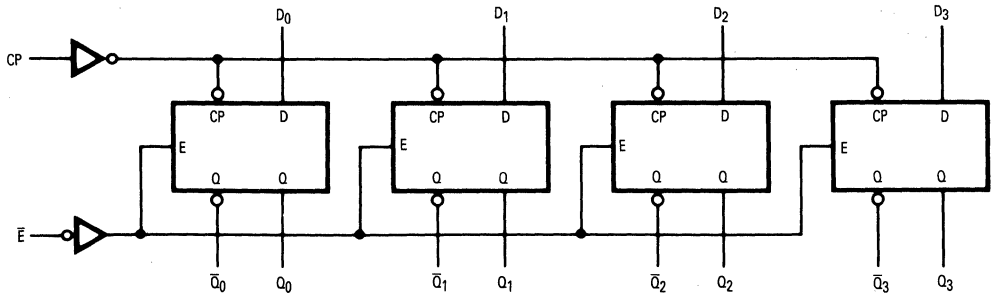

Please note that this diagram is provided only for the understanding of logic operations and should not be used to estimate propagation delays.

DC CHARACTERISTICS (unless otherwise specified)

| Symbol | Parameter | Value | Units | Test Conditions |
|-----------|--|-------|---------|---|
| I_{CC} | Maximum Quiescent Supply Current | 80 | μA | $V_{IN} = V_{CC}$ or Ground, $V_{CC} = 5.5 V$, $T_A = \text{Worst Case}$ |
| I_{CC} | Maximum Quiescent Supply Current | 8.0 | μA | $V_{IN} = V_{CC}$ or Ground, $V_{CC} = 5.5 V$, $T_A = 25^\circ C$ |
| I_{CCT} | Maximum Additional I_{CC} /Input ('ACT379) | 1.5 | mA | $V_{IN} = V_{CC} - 2.1 V$, $V_{CC} = 5.5 V$, $T_A = \text{Worst Case}$ |

5

MC74AC379 • MC74ACT379

AC CHARACTERISTICS (For Figures and Waveforms — See Section 3)

| Symbol | Parameter | V _{CC} * (V) | 74AC | | | 74AC | | Units | Fig. No. |
|------------------|--|--------------------------|--|------------|-----|--|-----|-------|----------|
| | | | T _A = +25°C C _L = 50 pF | | | T _A = -40°C to +85°C C _L = 50 pF | | | |
| | | | Min | Typ | Max | Min | Max | | |
| f _{max} | Maximum Clock Frequency | 3.3 5.0 | | 118 160 | | | MHz | 3-3 | |
| t _{PLH} | Propagation Delay CP to Q _n , \overline{Q}_n | 3.3 5.0 | | 8.5 7.0 | | | ns | 3-6 | |
| t _{PHL} | Propagation Delay CP to Q _n , \overline{Q}_n | 3.3 5.0 | | 8.5 6.0 | | | ns | 3-6 | |

*Voltage Range 3.3 is 3.3 V ± 0.3 V
Voltage Range 5.0 is 5.0 V ± 0.5 V

AC OPERATING REQUIREMENTS

| Symbol | Parameter | V _{CC} * (V) | 74AC | | 74AC | | Units | Fig. No. |
|----------------|---|--------------------------|--|--------------------|--|--|-------|----------|
| | | | T _A = +25°C C _L = 50 pF | | T _A = -40°C to +85°C C _L = 50 pF | | | |
| | | | Typ | Guaranteed Minimum | | | | |
| t _s | Setup Time, HIGH or LOW D _n to CP | 3.3 5.0 | 4.5 3.0 | | | | ns | 3-9 |
| t _h | Hold Time, HIGH or LOW D _n to CP | 3.3 5.0 | 0 0 | | | | ns | 3-9 |
| t _s | Setup Time, HIGH or LOW E to CP | 3.3 5.0 | 4.5 3.0 | | | | ns | 3-9 |
| t _h | Hold Time, HIGH or LOW E to CP | 3.3 5.0 | 3.0 2.0 | | | | ns | 3-9 |
| t _w | CP Pulse Width HIGH or LOW | 3.3 5.0 | 5.5 4.0 | | | | ns | 3-6 |

*Voltage Range 3.3 is 3.3 V ± 0.3 V
Voltage Range 5.0 is 5.0 V ± 0.5 V

MC74AC379 • MC74ACT379

AC CHARACTERISTICS (For Figures and Waveforms — See Section 3)

| Symbol | Parameter | V _{CC} * (V) | 74ACT | | | 74ACT | | Units | Fig. No. |
|------------------|---|--------------------------|--|-----|-----|--|-----|-------|----------|
| | | | T _A = +25°C C _L = 50 pF | | | T _A = -40°C to +85°C C _L = 50 pF | | | |
| | | | Min | Typ | Max | Min | Max | | |
| f _{max} | Maximum Clock Frequency | 5.0 | | 160 | | | MHz | 3-3 | |
| t _{PLH} | Propagation Delay CP to Q _n , \bar{Q}_n | 5.0 | | 7.0 | | | ns | 3-6 | |
| t _{PHL} | Propagation Delay CP to Q _n , \bar{Q}_n | 5.0 | | 6.0 | | | ns | 3-6 | |

*Voltage Range 5.0 is 5.0 V ± 0.5 V

AC OPERATING REQUIREMENTS

| Symbol | Parameter | V _{CC} * (V) | 74ACT | | 74ACT | | Units | Fig. No. |
|----------------|---|--------------------------|--|--------------------|--|--|-------|----------|
| | | | T _A = +25°C C _L = 50 pF | | T _A = -40°C to +85°C C _L = 50 pF | | | |
| | | | Typ | Guaranteed Minimum | | | | |
| t _s | Setup Time, HIGH or LOW D _n to CP | 5.0 | 3.0 | | | | ns | 3-9 |
| t _h | Hold Time, HIGH or LOW D _n to CP | 5.0 | 0 | | | | ns | 3-9 |
| t _s | Setup Time, HIGH or LOW \bar{E} to CP | 5.0 | 3.0 | | | | ns | 3-9 |
| t _h | Hold Time, HIGH or LOW \bar{E} to CP | 5.0 | 2.0 | | | | ns | 3-9 |
| t _w | CP Pulse Width HIGH or LOW | 5.0 | 4.0 | | | | ns | 3-6 |

*Voltage Range 5.0 is 5.0 V ± 0.5 V

CAPACITANCE

| Symbol | Parameter | Value Typ | Units | Test Conditions |
|-----------------|-------------------------------|--------------|-------|-------------------------|
| C _{IN} | Input Capacitance | 4.5 | pF | V _{CC} = 5.0 V |
| C _{PD} | Power Dissipation Capacitance | | pF | V _{CC} = 5.0 V |

5



MOTOROLA

Product Preview Quad 2-Port Register

The MC74AC398/74ACT398 and MC74AC399/74ACT399 are the logical equivalents of a quad 2-input multiplexer feeding into four edge-triggered flip-flops. A common Select input determines which of the two 4-bit words is accepted. The selected data enters the flip-flop on the rising edge of the clock. The MC74AC399/74ACT399 is the 16-pin version of the MC74AC398/74ACT398, with only the Q outputs of the flip-flops available.

- Select Inputs from Two Data Sources
- Fully Positive Edge-Triggered Operation
- Both True and Complement Outputs — MC74AC398/74ACT398
- Outputs Source/Sink 24 mA
- 'ACT398 and 'ACT399 Have TTL Compatible Inputs

LOGIC SYMBOL

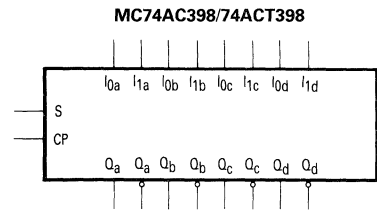

MC74AC398/74ACT398

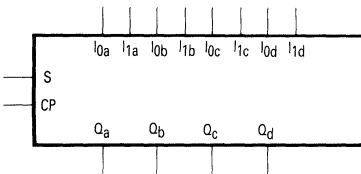

PIN NAMES

- S Common Select Input
- CP Clock Pulse
- I_{0a}-I_{0d} Data Inputs from Source 0
- I_{1a}-I_{1d} Data Inputs from Source 1
- Q_a-Q_d Register True Outputs
- Q_a-Q_d Register Complementary Outputs (MC74AC398/74ACT398)

MC74AC398/74ACT398

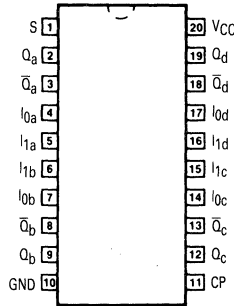

MC74AC399/74ACT399

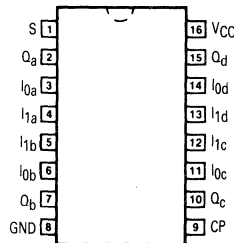

**MC74AC398
MC74ACT398
MC74AC399
MC74ACT399**

**QUAD
2-PORT REGISTER**

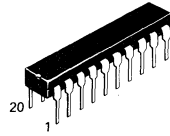

**N SUFFIX
CASE 738-03
PLASTIC**

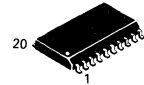

**N SUFFIX
CASE 648-08
PLASTIC**

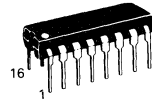

**N SUFFIX
CASE 648-06
PLASTIC**

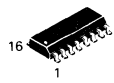

**D SUFFIX
CASE 751B-03
PLASTIC**

5

FUNCTIONAL DESCRIPTION

The MC74AC398/74ACT398 and MC74AC399/74ACT399 are high-speed quad 2-port registers. They select four bits of data from either of two sources (Ports) under control of a common Select input (S). The selected data is transferred to a 4-bit output register synchronous with the LOW-to-HIGH transition of the Clock input (CP). The 4-bit D-type output register is fully edge-triggered. The Data inputs (I_{0x} , I_{1x}) and Select input (S) must be stable only a setup time prior to and hold time after the LOW-to-HIGH transition of the Clock input for predictable operation. The MC74AC398/74ACT398 has both Q and \bar{Q} outputs.

FUNCTION TABLE

| Inputs | | | | Outputs | |
|--------|-------|-------|----|---------|-------------|
| S | I_0 | I_1 | CP | Q | \bar{Q}^* |
| L | L | X | ┐ | L | H |
| L | H | X | ┐ | H | L |
| H | X | L | ┐ | L | H |
| H | X | H | ┐ | H | L |

H = HIGH Voltage Level
 L = LOW Voltage Level
 X = Immaterial
 ┐ = LOW-to-HIGH Clock Transition
 * = MC74AC398/74ACT398 only

LOGIC DIAGRAM

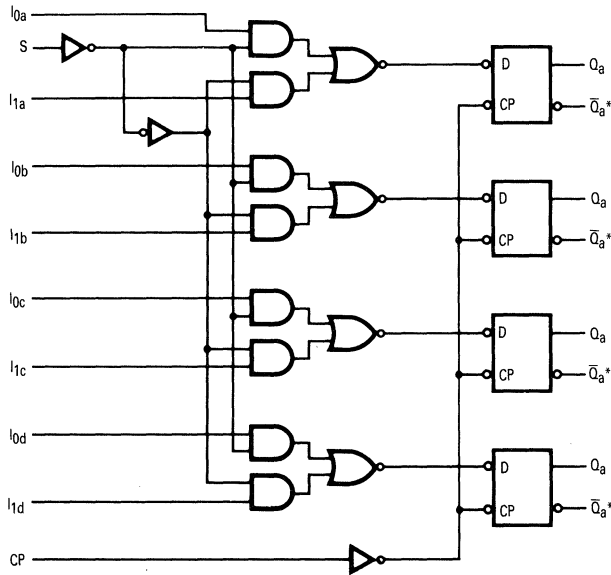

*MC74AC398/74ACT398

Please note that this diagram is provided only for the understanding of logic operations and should not be used to estimate propagation delays.

5

MC74AC398 • MC74ACT398 • MC74AC399 • MC74ACT399

DC CHARACTERISTICS (unless otherwise specified)

| Symbol | Parameter | Value | Units | Test Conditions |
|--------------------|---|-------|-------|---|
| I _{CC} | Maximum Quiescent Supply Current | 80 | μA | V _{IN} = V _{CC} or Ground, V _{CC} = 5.5 V, T _A = Worst Case |
| I _{CC} | Maximum Quiescent Supply Current | 8.0 | μA | V _{IN} = V _{CC} or Ground, V _{CC} = 5.5 V, T _A = 25°C |
| I _{CC(T)} | Maximum Additional I _{CC} /Input (*ACT398/399) | 1.5 | mA | V _{IN} = V _{CC} - 2.1 V, V _{CC} = 5.5 V, T _A = Worst Case |

AC CHARACTERISTICS (For Figures and Waveforms — See Section 3)

| Symbol | Parameter | V _{CC} * (V) | 74AC | | | 74AC | | Units | Fig. No. |
|------------------|--|-----------------------|--|------------|-----|--|-----|-------|----------|
| | | | T _A = +25°C C _L = 50 pF | | | T _A = -40°C to +85°C C _L = 50 pF | | | |
| | | | Min | Typ | Max | Min | Max | | |
| f _{max} | Maximum Clock Frequency | 3.3 5.0 | | 180 160 | | | | MHz | 3-3 |
| t _{PLH} | Propagation Delay CP to Q ₀ or \bar{Q} | 3.3 5.0 | | 9.5 7.0 | | | | ns | 3-6 |
| t _{PHL} | Propagation Delay CP to Q ₀ or \bar{Q} | 3.3 5.0 | | 8.5 6.0 | | | | ns | 3-6 |

*Voltage Range 3.3 is 3.3 V ± 0.3 V
Voltage Range 5.0 is 5.0 V ± 0.5 V

| Symbol | Parameter | V _{CC} * (V) | 74AC | | 74AC | | Units | Fig. No. |
|----------------|---|-----------------------|--|--------------------|--|--|-------|----------|
| | | | T _A = +25°C C _L = 50 pF | | T _A = -40°C to +85°C C _L = 50 pF | | | |
| | | | Typ | Guaranteed Minimum | | | | |
| t _s | Setup Time, HIGH or LOW I _n to CP | 3.3 5.0 | 4.5 3.0 | | | | ns | 3-9 |
| t _h | Hold Time, HIGH or LOW I _n to CP | 3.3 5.0 | 0 0 | | | | ns | 3-9 |
| t _s | Setup Time, HIGH or LOW S to CP (*398) | 3.3 5.0 | 4.5 3.0 | | | | ns | 3-9 |
| t _s | Setup Time, HIGH or LOW S to CP (*399) | 3.3 5.0 | 4.5 3.0 | | | | ns | 3-9 |
| t _h | Hold Time, HIGH or LOW S to CP | 3.3 5.0 | -1.5 -1.0 | | | | ns | 3-9 |
| t _w | CP Pulse Width HIGH or LOW | 3.3 5.0 | 5.5 4.0 | | | | ns | 3-6 |

*Voltage Range 3.3 is 3.3 V ± 0.3 V
Voltage Range 5.0 is 5.0 V ± 0.5 V



AC CHARACTERISTICS (For Figures and Waveforms — See Section 3)

| Symbol | Parameter | V _{CC} * (V) | 74ACT | | | 74ACT | | Units | Fig. No. |
|------------------|--|--------------------------|--|-----|-----|--|-----|-------|----------|
| | | | T _A = +25°C C _L = 50 pF | | | T _A = -40°C to +85°C C _L = 50 pF | | | |
| | | | Min | Typ | Max | Min | Max | | |
| f _{max} | Input Clock Frequency | 5.0 | | 160 | | | | MHz | 3-3 |
| t _{PLH} | Propagation Delay CP to Q _n or \bar{Q} | 5.0 | | 7.0 | | | | ns | 3-6 |
| t _{PHL} | Propagation Delay CP to Q _n or \bar{Q} | 5.0 | | 6.0 | | | | ns | 3-6 |

*Voltage Range 5.0 is 5.0 V ± 0.5 V

AC OPERATING REQUIREMENTS

| Symbol | Parameter | V _{CC} * (V) | 74ACT | | 74ACT | | Units | Fig. No. |
|----------------|---|--------------------------|--|--------------------|--|--|-------|----------|
| | | | T _A = +25°C C _L = 50 pF | | T _A = -40°C to +85°C C _L = 50 pF | | | |
| | | | Typ | Guaranteed Minimum | | | | |
| t _s | Setup Time, HIGH or LOW I _n to CP | 5.0 | 3.0 | | | | ns | 3-9 |
| t _h | Hold Time, HIGH or LOW I _n to CP | 5.0 | 0 | | | | ns | 3-9 |
| t _s | Setup Time, HIGH or LOW S to CP ('398) | 5.0 | 3.0 | | | | ns | 3-9 |
| t _s | Setup Time, HIGH or LOW S to CP ('399) | 5.0 | 3.0 | | | | ns | 3-9 |
| t _h | Hold Time, HIGH or LOW S to CP | 5.0 | -1.0 | | | | ns | 3-9 |
| t _w | CP Pulse Width HIGH or LOW | 5.0 | 5.5 | | | | ns | 3-6 |

*Voltage Range 5.0 is 5.0 V ± 0.5 V

CAPACITANCE

| Symbol | Parameter | Value Typ | Units | Test Conditions |
|-----------------|-------------------------------|--------------|-------|-------------------------|
| C _{IN} | Input Capacitance | 4.5 | pF | V _{CC} = 5.0 V |
| C _{PD} | Power Dissipation Capacitance | | pF | V _{CC} = 5.0 V |

5



MOTOROLA

Product Preview

8-Bit Identity Comparator

The MC74AC534/74ACT534 is a high-speed, low-power octal D-type flip-flop featuring separate D-type inputs for each flip-flop and 3-state outputs for bus-oriented applications. A buffered Clock (CP) and Output Enable (\overline{OE}) are common to all flip-flops. The MC74AC534/74ACT534 is the same as the MC74AC374/74ACT374 except that the outputs are inverted.

- Edge-Triggered D-Type Inputs
- Buffered Positive Edge-Triggered Clock
- 3-State Outputs for Bus-Oriented Applications
- Outputs Source/Sink 24 mA
- 'ACT534 Has TTL Compatible Inputs
- Inverted Output Version of MC74AC374/74ACT374

LOGIC SYMBOL

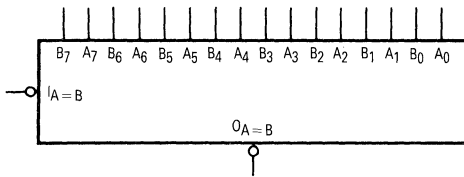

PIN NAMES

- A₀–A₇ Word A Inputs
- B₀–B₇ Word B Inputs
- $\overline{I}_A=B$ Expansion or Enable Input
- $\overline{O}_A=B$ Identity Output

TRUTH TABLE

| Inputs | | Outputs |
|--------------------|------|--------------------|
| $\overline{I}_A=B$ | A, B | $\overline{O}_A=B$ |
| L | A=B* | L |
| L | A≠B | H |
| H | A=B* | H |
| H | A≠B | H |

H = HIGH Voltage Level
 L = LOW Voltage Level
 *A₀=B₀, A₁=B₁, A₂=B₂, etc.

MC74AC520
MC74ACT520
MC74AC521
MC74ACT521

**8-BIT IDENTITY
 COMPARATOR**

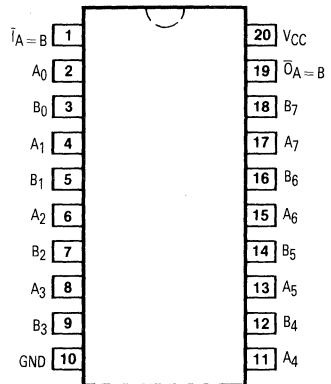
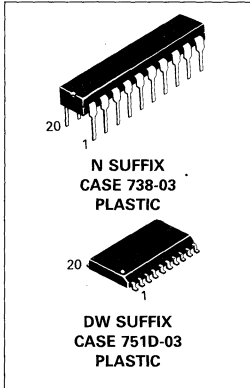

5

This document contains information on a product under development. Motorola reserves the right to change or discontinue this product without notice.

LOGIC DIAGRAM (MC74AC521/74ACT521)

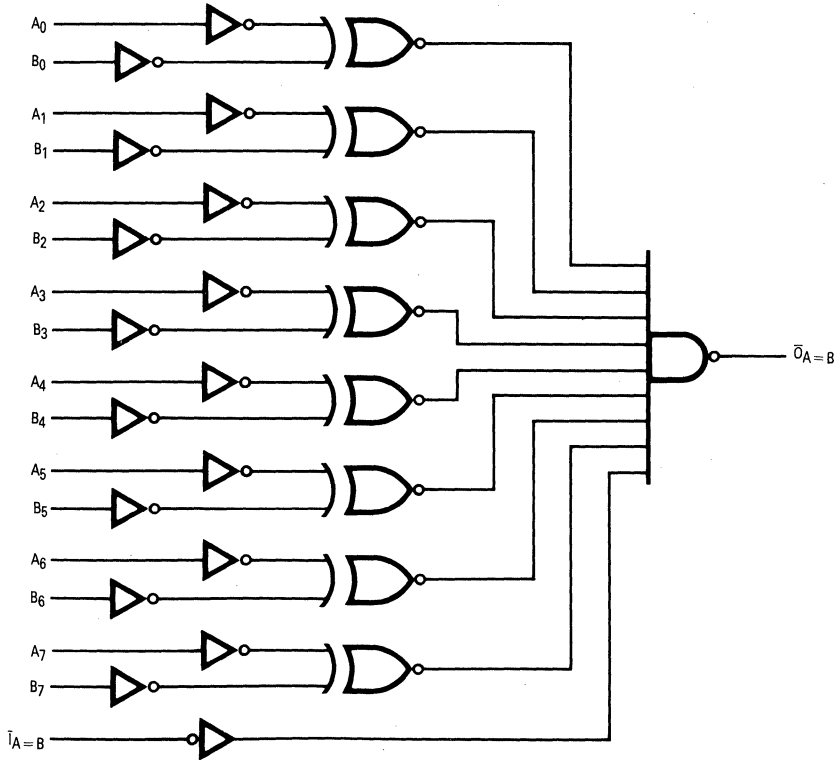

Please note that this diagram is provided only for the understanding of logic operations and should not be used to estimate propagation delays.

5

MC74AC520 • MC74ACT520 • MC74AC521 • MC74ACT521

LOGIC DIAGRAM (MC74AC520/74ACT520)

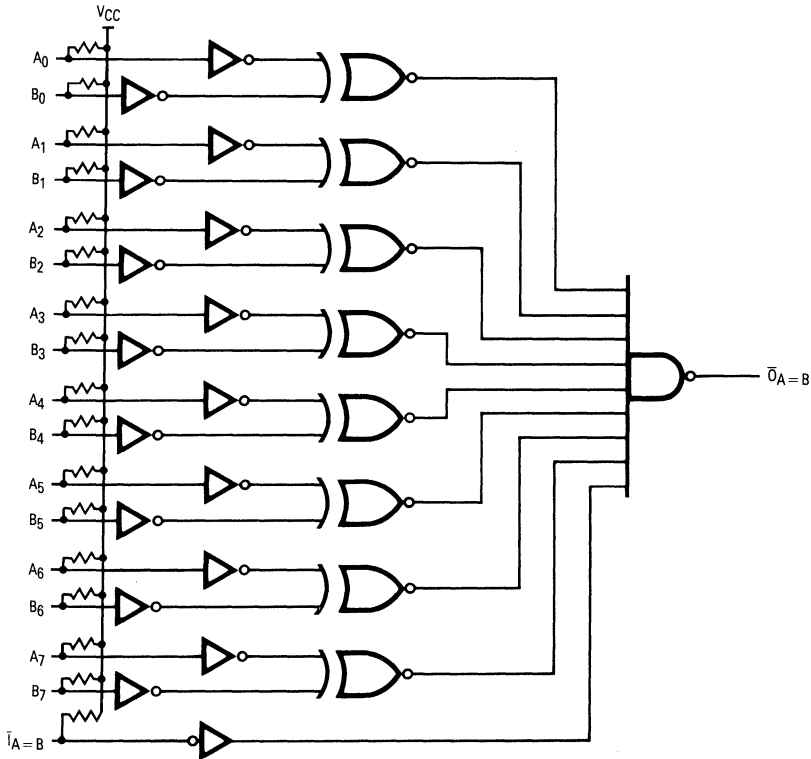

Please note that this diagram is provided only for the understanding of logic operations and should not be used to estimate propagation delays.

DC CHARACTERISTICS (unless otherwise specified)

| Symbol | Parameter | Value | Units | Test Conditions |
|-----------|--|-------|---------|---|
| I_{CC} | Maximum Quiescent Supply Current | 80 | μA | $V_{IN} = V_{CC}$ or Ground, $V_{CC} = 5.5 V, T_A = \text{Worst Case}$ |
| I_{CC} | Maximum Quiescent Supply Current | 8.0 | μA | $V_{IN} = V_{CC}$ or Ground, $V_{CC} = 5.5 V, T_A = 25^\circ C$ |
| I_{CCT} | Maximum Additional I_{CC} /Input ('ACT520/521) | 1.5 | mA | $V_{IN} = V_{CC} - 2.1 V$ $V_{CC} = 5.5 V, T_A = \text{Worst Case}$ |

MC74AC520 • MC74ACT520 • MC74AC521 • MC74ACT521

AC CHARACTERISTICS (For Figures and Waveforms — See Section 3)

| Symbol | Parameter | V _{CC} * (V) | 74AC | | | 74AC | | Units | Fig. No. |
|------------------|---|--------------------------|--|------------|-----|--|-----|-------|----------|
| | | | T _A = +25°C C _L = 50 pF | | | T _A = -40°C to +85°C C _L = 50 pF | | | |
| | | | Min | Typ | Max | Min | Max | | |
| t _{PLH} | Propagation Delay A _n or B _n to $\overline{O}_{A=B}$ | 3.3 5.0 | | 13 9.5 | | | ns | 3-6 | |
| t _{PHL} | Propagation Delay A _n or B _n to $\overline{O}_{A=B}$ | 3.3 5.0 | | 13 9.5 | | | ns | 3-6 | |
| t _{PLH} | Propagation Delay $\overline{I}_{A=B}$ to $\overline{O}_{A=B}$ | 3.3 5.0 | | 9.0 6.5 | | | ns | 3-6 | |
| t _{PHL} | Propagation Delay $\overline{I}_{A=B}$ to $\overline{O}_{A=B}$ | 3.3 5.0 | | 9.5 7.0 | | | ns | 3-6 | |

*Voltage Range 3.3 is 3.3 V ± 0.3 V
Voltage Range 5.0 is 5.0 V ± 0.5 V

AC CHARACTERISTICS (For Figures and Waveforms — See Section 3)

| Symbol | Parameter | V _{CC} * (V) | 74ACT | | | 74ACT | | Units | Fig. No. |
|------------------|---|--------------------------|--|-----|-----|--|-----|-------|----------|
| | | | T _A = +25°C C _L = 50 pF | | | T _A = -40°C to +85°C C _L = 50 pF | | | |
| | | | Min | Typ | Max | Min | Max | | |
| t _{PLH} | Propagation Delay A _n or B _n to $\overline{O}_{A=B}$ | 5.0 | | 9.5 | | | ns | 3-6 | |
| t _{PHL} | Propagation Delay A _n or B _n to $\overline{O}_{A=B}$ | 5.0 | | 9.5 | | | ns | 3-6 | |
| t _{PLH} | Propagation Delay $\overline{I}_{A=B}$ to $\overline{O}_{A=B}$ | 5.0 | | 6.5 | | | ns | 3-6 | |
| t _{PHL} | Propagation Delay $\overline{I}_{A=B}$ to $\overline{O}_{A=B}$ | 5.0 | | 7.0 | | | ns | 3-6 | |

*Voltage Range 5.0 is 5.0 V ± 0.5 V

CAPACITANCE

| Symbol | Parameter | Value Typ | Units | Test Conditions |
|-----------------|-------------------------------|--------------|-------|-------------------------|
| C _{IN} | Input Capacitance | 4.5 | pF | V _{CC} = 5.0 V |
| C _{PD} | Power Dissipation Capacitance | | pF | V _{CC} = 5.0 V |

5

APPLICATIONS

RIPPLE EXPANSION

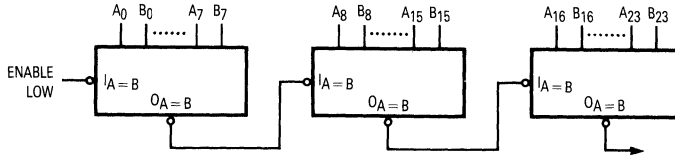

PARALLEL EXPANSION

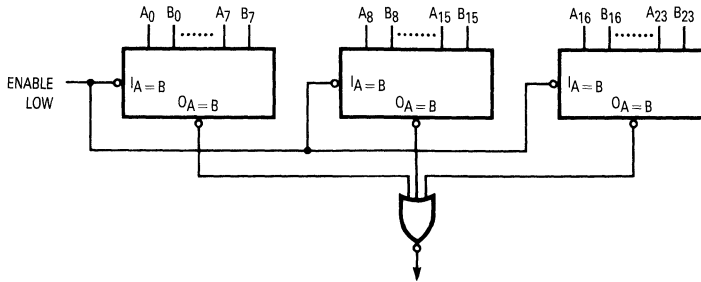



MOTOROLA

Product Preview

Octal Transparent Latch with 3-State Outputs

The MC74AC533/74ACT533 consists of eight latches with 3-state outputs for bus organized system applications. The flip-flops appear transparent to the data when Latch Enable (LE) is HIGH. When LE is LOW, the data that meets the setup times is latched. Data appears on the bus when the Output Enable (\overline{OE}) is LOW. When \overline{OE} is HIGH the bus output is in the high impedance state. The MC74AC533/74ACT533 is the same as the MC74AC373/74ACT373, except that the outputs are inverted on the MC74AC533/74ACT533. For functional description please refer to the MC74AC373/74ACT373 data sheet.

- Eight Latches in a Single Package
- 3-State Outputs for Bus Interfacing
- Outputs Source/Sink 24 mA
- 'ACT533 Has TTL Compatible Inputs
- Inverted Output Version of MC74ACT373

LOGIC SYMBOL

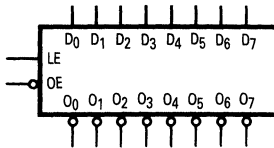

PIN NAMES

- D_0 - D_7 Data Inputs
- LE Latch Enable Input
- \overline{OE} Output Enable Input
- \overline{O}_0 - \overline{O}_7 Complementary 3-State Outputs

**MC74AC533
MC74ACT533**

**OCTAL TRANSPARENT
LATCH WITH
3-STATE OUTPUTS**

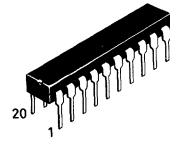

**N SUFFIX
CASE 738-03
PLASTIC**

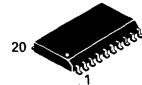

**DW SUFFIX
CASE 751D-03
PLASTIC**

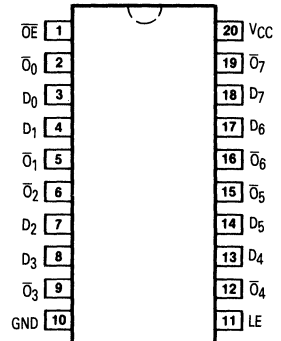

5

This document contains information on a product under development. Motorola reserves the right to change or discontinue this product without notice.

MC74AC533 • MC74ACT533

LOGIC DIAGRAM

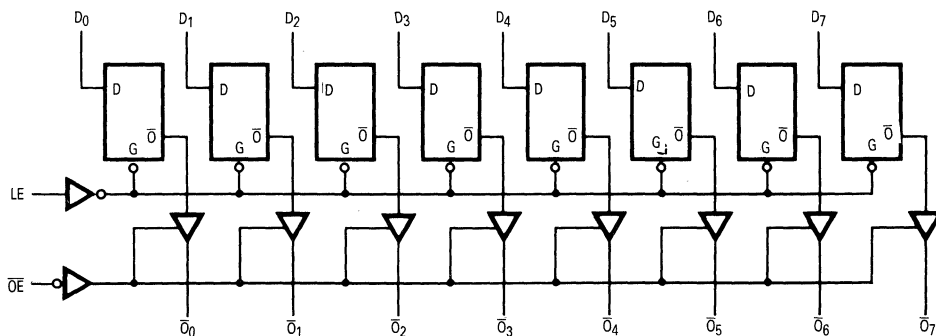

Please note that this diagram is provided only for the understanding of logic operations and should not be used to estimate propagation delays.

DC CHARACTERISTICS (unless otherwise specified)

| Symbol | Parameter | Value | Units | Test Conditions |
|-----------|---|-------|---------|--|
| I_{CC} | Maximum Quiescent Supply Current | 80 | μA | $V_{IN} = V_{CC}$ or Ground, $V_{CC} = 5.5 V, T_A = \text{Worst Case}$ |
| I_{CC} | Maximum Quiescent Supply Current | 8.0 | μA | $V_{IN} = V_{CC}$ or Ground, $V_{CC} = 5.5 V, T_A = 25^\circ C$ |
| I_{CCT} | Maximum Additional I_{CC}/Input (ACT533) | 1.5 | mA | $V_{IN} = V_{CC} - 2.1 V$, $V_{CC} = 5.5 V, T_A = \text{Worst Case}$ |

MC74AC533 • MC74ACT533

AC CHARACTERISTICS (For Figures and Waveforms — See Section 3)

| Symbol | Parameter | V _{CC} * (V) | 74AC | | | 74AC | | Units | Fig. No. |
|------------------|--|-----------------------|--|------------|-----|--|-----|-------|----------|
| | | | T _A = +25°C C _L = 50 pF | | | T _A = -40°C to +85°C C _L = 50 pF | | | |
| | | | Min | Typ | Max | Min | Max | | |
| t _{PLH} | Propagation Delay D _n to \bar{O}_n | 3.3 5.0 | | 8.0 5.0 | | | | ns | 3-5 |
| t _{PHL} | Propagation Delay D _n to \bar{O}_n | 3.3 5.0 | | 7.0 5.0 | | | | ns | 3-5 |
| t _{PLH} | Propagation Delay LE to \bar{O}_n | 3.3 5.0 | | 8.0 5.0 | | | | ns | 3-6 |
| t _{PHL} | Propagation Delay LE to \bar{O}_n | 3.3 5.0 | | 7.0 5.0 | | | | ns | 3-6 |
| t _{PZH} | Output Enable Time | 3.3 5.0 | | 6.5 4.5 | | | | ns | 3-7 |
| t _{PZL} | Output Enable Time | 3.3 5.0 | | 6.0 4.5 | | | | ns | 3-8 |
| t _{PHZ} | Output Disable Time | 3.3 5.0 | | 7.0 5.0 | | | | ns | 3-7 |
| t _{PLZ} | Output Disable Time | 3.3 5.0 | | 5.0 3.5 | | | | ns | 3-8 |

*Voltage Range 3.3 is 3.3 V ± 0.3 V
Voltage Range 5.0 is 5.0 V ± 0.5 V

AC OPERATING REQUIREMENTS

| Symbol | Parameter | V _{CC} * (V) | 74AC | | 74AC | | Units | Fig. No. |
|----------------|---|-----------------------|--|--------------------|--|--|-------|----------|
| | | | T _A = +25°C C _L = 50 pF | | T _A = -40°C to +85°C C _L = 50 pF | | | |
| | | | Typ | Guaranteed Minimum | | | | |
| t _s | Setup Time, HIGH or LOW D _n to LE | 3.3 5.0 | 3.5 2.0 | | | | ns | 3-9 |
| t _h | Hold Time, HIGH or LOW D _n to LE | 3.3 5.0 | -2.5 -1.5 | | | | ns | 3-9 |
| t _w | LE Pulse Width, HIGH | 3.3 5.0 | 3.0 2.5 | | | | ns | 3-6 |

*Voltage Range 3.3 is 3.3 V ± 0.3 V
Voltage Range 5.0 is 5.0 V ± 0.5 V

5

MC74AC533 • MC74ACT533

AC CHARACTERISTICS (For Figures and Waveforms — See Section 3)

| Symbol | Parameter | V _{CC} * (V) | 74ACT | | | 74ACT | | Units | Fig. No. |
|------------------|--|--------------------------|--|-----|-----|--|-----|-------|----------|
| | | | T _A = +25°C C _L = 50 pF | | | T _A = -40°C to +85°C C _L = 50 pF | | | |
| | | | Min | Typ | Max | Min | Max | | |
| t _{PLH} | Propagation Delay D _n to \bar{O}_n | 5.0 | | 7.0 | | | ns | 3-5 | |
| t _{PHL} | Propagation Delay D _n to \bar{O}_n | 5.0 | | 6.5 | | | ns | 3-5 | |
| t _{PLH} | Propagation Delay LE to \bar{O}_n | 5.0 | | 6.5 | | | ns | 3-6 | |
| t _{PHL} | Propagation Delay LE to \bar{O}_n | 5.0 | | 6.0 | | | ns | 3-6 | |
| t _{PZH} | Output Enable Time | 5.0 | | 6.0 | | | ns | 3-7 | |
| t _{PZL} | Output Enable Time | 5.0 | | 5.5 | | | ns | 3-8 | |
| t _{PHZ} | Output Disable Time | 5.0 | | 7.5 | | | ns | 3-7 | |
| t _{PLZ} | Output Disable Time | 5.0 | | 5.0 | | | ns | 3-8 | |

*Voltage Range 5.0 is 5.0 V ± 0.5 V

AC OPERATING REQUIREMENTS

| Symbol | Parameter | V _{CC} * (V) | 74ACT | | 74ACT | | Units | Fig. No. |
|----------------|---|--------------------------|--|--------------------|--|--|-------|----------|
| | | | T _A = +25°C C _L = 50 pF | | T _A = -40°C to +85°C C _L = 50 pF | | | |
| | | | Typ | Guaranteed Minimum | | | | |
| t _s | Setup Time, HIGH or LOW D _n to LE | 5.0 | 2.0 | | | | ns | 3-9 |
| t _h | Hold Time, HIGH or LOW D _n to LE | 5.0 | -1.5 | | | | ns | 3-9 |
| t _w | LE Pulse Width, HIGH | 5.0 | 2.0 | | | | ns | 3-6 |

*Voltage Range 5.0 is 5.0 V ± 0.5 V

CAPACITANCE

| Symbol | Parameter | Value Typ | Units | Test Conditions |
|-----------------|-------------------------------|--------------|-------|-------------------------|
| C _{IN} | Input Capacitance | 4.5 | pF | V _{CC} = 5.0 V |
| C _{PD} | Power Dissipation Capacitance | | pF | V _{CC} = 5.0 V |

5



MOTOROLA

Product Preview

Octal D-Type Flip-Flop with 3-State Outputs

The MC74AC534/74ACT534 is a high-speed, low-power octal D-type flip-flop featuring separate D-type inputs for each flip-flop and 3-state outputs for bus-oriented applications. A buffered Clock (CP) and Output Enable (\overline{OE}) are common to all flip-flops. The MC74AC534/74ACT534 is the same as the MC74AC374/74ACT374 except that the outputs are inverted.

- Edge-Triggered D-Type Inputs
- Buffered Positive Edge-Triggered Clock
- 3-State Outputs for Bus-Oriented Applications
- Outputs Source/Sink 24 mA
- 'ACT534 Has TTL Compatible Inputs
- Inverted Output Version of MC74AC374/74ACT374

LOGIC SYMBOL

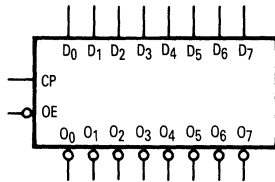

PIN NAMES

- D_0 - D_7 Data Inputs
- CP Clock Pulse Input
- \overline{OE} 3-State Output Enable Input
- \overline{O}_0 - \overline{O}_7 Complementary 3-State Outputs

**MC74AC534
MC74ACT534**

**OCTAL D-TYPE
FLIP-FLOP WITH
3-STATE OUTPUTS**

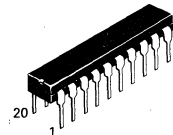

**N SUFFIX
CASE 738-03
PLASTIC**

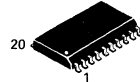

**DW SUFFIX
CASE 751D-03
PLASTIC**

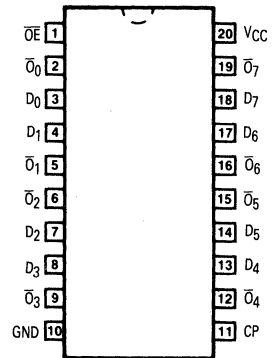

MC74AC534 • MC74ACT534

FUNCTIONAL DESCRIPTION

The MC74AC534/74ACT534 consists of eight edge-triggered flip-flops with individual D-type inputs and 3-state complementary outputs. The buffered clock and buffered Output Enable are common to all flip-flops. The eight flip-flops will store the state of their individual D inputs that meet the setup and hold time requirements

on the LOW-to-HIGH Clock (CP) transition. With the Output Enable (\overline{OE}) LOW, the contents of the eight flip-flops are available at the outputs. When the \overline{OE} is HIGH, the outputs go to the high impedance state. Operation of the \overline{OE} input does not affect the state of the flip-flops.

LOGIC DIAGRAM

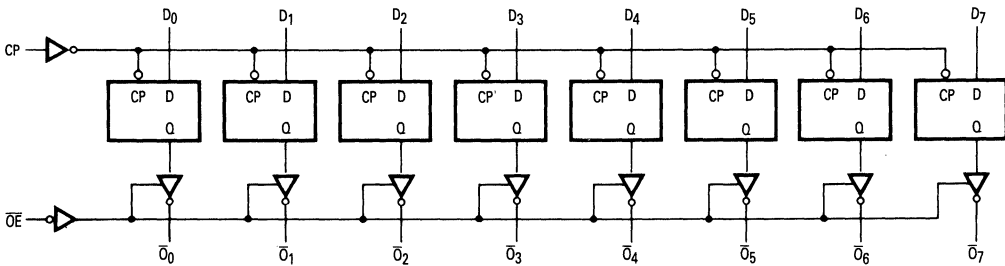

Please note that this diagram is provided only for the understanding of logic operations and should not be used to estimate propagation delays.

DC CHARACTERISTICS (unless otherwise specified)

| Symbol | Parameter | Value | Units | Test Conditions |
|-----------|--|-------|---------|--|
| I_{CC} | Maximum Quiescent Supply Current | 80 | μA | $V_{IN} = V_{CC}$ or Ground, $V_{CC} = 5.5 V, T_A = \text{Worst Case}$ |
| I_{CC} | Maximum Quiescent Supply Current | 8.0 | μA | $V_{IN} = V_{CC}$ or Ground, $V_{CC} = 5.5 V, T_A = 25^\circ C$ |
| I_{CCT} | Maximum Additional I_{CC} /Input ('ACT534) | 1.5 | mA | $V_{IN} = V_{CC} - 2.1 V$, $V_{CC} = 5.5 V, T_A = \text{Worst Case}$ |

MC74AC534 • MC74ACT534

AC CHARACTERISTICS (For Figures and Waveforms — See Section 3)

| Symbol | Parameter | VCC* (V) | 74AC | | | 74AC | | Units | Fig. No. |
|--------|--|-------------|--------------------------|------------|-----|--------------------------------------|-----|-------|-------------|
| | | | TA = +25°C CL = 50 pF | | | TA = -40°C to +85°C CL = 50 pF | | | |
| | | | Min | Typ | Max | Min | Max | | |
| fmax | Maximum Clock Frequency | 3.3 5.0 | | 125 150 | | | MHz | 3-3 | |
| tPLH | Propagation Delay CP to \bar{O}_n | 3.3 5.0 | | 10 7.0 | | | ns | 3-6 | |
| tPHL | Propagation Delay CP to \bar{O}_n | 3.3 5.0 | | 9.5 6.5 | | | ns | 3-6 | |
| tpZH | Output Enable Time | 3.3 5.0 | | 8.5 6.5 | | | ns | 3-7 | |
| tpZL | Output Enable Time | 3.3 5.0 | | 8.5 6.0 | | | ns | 3-8 | |
| tpHZ | Output Disable Time | 3.3 5.0 | | 9.0 7.0 | | | ns | 3-7 | |
| tpLZ | Output Disable Time | 3.3 5.0 | | 7.5 6.0 | | | ns | 3-8 | |

*Voltage Range 3.3 is 3.3 V ± 0.3 V
Voltage Range 5.0 is 5.0 V ± 0.5 V

AC OPERATING REQUIREMENTS

| Symbol | Parameter | VCC* (V) | 74AC | | 74AC | | Units | Fig. No. |
|--------|-------------------------------------|-------------|--------------------------|--------------------|--------------------------------------|--|-------|-------------|
| | | | TA = +25°C CL = 50 pF | | TA = -40°C to +85°C CL = 50 pF | | | |
| | | | Typ | Guaranteed Minimum | | | | |
| ts | Setup Time, HIGH or LOW Dn to CP | 3.3 5.0 | 2.0 1.0 | | | | ns | 3-9 |
| th | Hold Time, HIGH or LOW Dn to CP | 3.3 5.0 | -1.0 -0.5 | | | | ns | 3-9 |
| tw | CP Pulse Width HIGH or LOW | 3.3 5.0 | 3.5 2.5 | | | | ns | 3-6 |

*Voltage Range 3.3 is 3.3 V ± 0.3 V
Voltage Range 5.0 is 5.0 V ± 0.5 V

5

MC74AC534 • MC74ACT534

AC CHARACTERISTICS (For Figures and Waveforms — See Section 3)

| Symbol | Parameter | V _{CC} * (V) | 74ACT | | | 74ACT | | Units | Fig. No. |
|------------------|--|--------------------------|--|-----|-----|--|-----|-------|----------|
| | | | T _A = +25°C C _L = 50 pF | | | T _A = -40°C to +85°C C _L = 50 pF | | | |
| | | | Min | Typ | Max | Min | Max | | |
| f _{max} | Maximum Clock Frequency | 5.0 | | 100 | | | MHz | 3-3 | |
| t _{PLH} | Propagation Delay CP to \bar{O}_n | 5.0 | | 6.5 | | | ns | 3-6 | |
| t _{PHL} | Propagation Delay CP to \bar{O}_n | 5.0 | | 6.0 | | | ns | 3-6 | |
| t _{PZH} | Output Enable Time | 5.0 | | 5.5 | | | ns | 3-7 | |
| t _{PZL} | Output Enable Time | 5.0 | | 5.5 | | | ns | 3-8 | |
| t _{PHZ} | Output Disable Time | 5.0 | | 7.0 | | | ns | 3-7 | |
| t _{PLZ} | Output Disable Time | 5.0 | | 5.0 | | | ns | 3-8 | |

*Voltage Range 5.0 is 5.0 V ± 0.5 V

AC OPERATING REQUIREMENTS

| Symbol | Parameter | V _{CC} * (V) | 74ACT | | 74ACT | | Units | Fig. No. |
|----------------|---|--------------------------|--|--------------------|--|--|-------|----------|
| | | | T _A = +25°C C _L = 50 pF | | T _A = -40°C to +85°C C _L = 50 pF | | | |
| | | | Typ | Guaranteed Minimum | | | | |
| t _s | Setup Time, HIGH or LOW D _n to CP | 5.0 | 1.0 | | | | ns | 3-9 |
| t _h | Hold Time, HIGH or LOW D _n to CP | 5.0 | -0.5 | | | | ns | 3-9 |
| t _w | CP Pulse Width HIGH or LOW | 5.0 | 2.5 | | | | ns | 3-6 |

*Voltage Range 5.0 is 5.0 V ± 0.5 V

CAPACITANCE

| Symbol | Parameter | Value Typ | Units | Test Conditions |
|-----------------|-------------------------------|--------------|-------|-------------------------|
| C _{IN} | Input Capacitance | 4.5 | pF | V _{CC} = 5.0 V |
| CPD | Power Dissipation Capacitance | | pF | V _{CC} = 5.0 V |





MOTOROLA

Product Preview

Octal Buffer/Line Driver with 3-State Outputs

The MC74AC540/74ACT540 and MC74AC541/74ACT541 are octal buffer/line drivers designed to be employed as memory and address drivers, clock drivers and bus oriented transmitter/receivers. The MC74AC541/74ACT541 is a noninverting option of the MC74AC540/74ACT540.

These devices are similar in function to the MC74AC240/74ACT240 and MC74AC244/74ACT244 while providing flow-through architecture (inputs on opposite side from outputs). This pinout arrangement makes these devices especially useful as output ports for microprocessors, allowing ease of layout and greater PC board density.

- 3-State Outputs
- Inputs and Outputs Opposite Side of Package, Allowing Easier Interface to Microprocessors
- Outputs Source/Sink 24 mA
- MC74AC540/74ACT540 Provides Inverted Outputs
- MC74AC541/74ACT541 Provides Noninverted Outputs
- 'ACT540 and 'ACT541 Have TTL Compatible Inputs

**MC74AC540
MC74ACT540
MC74AC541
MC74ACT541**

**OCTAL
BUFFER/LINE DRIVER
WITH 3-STATE
OUTPUTS**

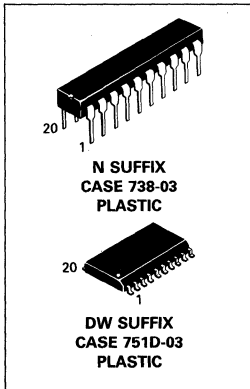

MC74AC540/74ACT540

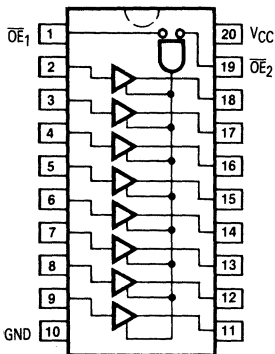

MC74AC541/74ACT541

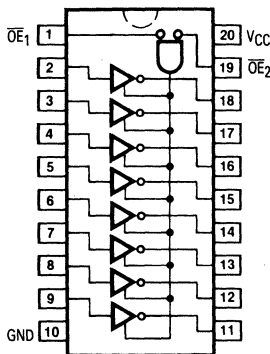

TRUTH TABLE

| Inputs | | | Outputs | |
|-----------------|-----------------|---|---------|------|
| OE ₁ | OE ₂ | D | '540 | '541 |
| L | L | H | L | L |
| H | X | X | Z | Z |
| X | H | X | Z | Z |
| L | L | L | H | L |

H = HIGH Voltage Level
 L = LOW Voltage Level
 X = Immaterial
 Z = High Impedance

This document contains information on a product under development. Motorola reserves the right to change or discontinue this product without notice.

5

MC74AC540 • MC74ACT540 • MC74AC541 • MC74ACT541

DC CHARACTERISTICS (unless otherwise specified)

| Symbol | Parameter | Value | Units | Test Conditions |
|--------------------|---|-------|-------|---|
| I _{CC} | Maximum Quiescent Supply Current | 80 | μA | V _{IN} = V _{CC} or Ground, V _{CC} = 5.5 V, T _A = Worst Case |
| I _{CC} | Maximum Quiescent Supply Current | 8.0 | μA | V _{IN} = V _{CC} or Ground, V _{CC} = 5.5 V, T _A = 25°C |
| I _{CC(T)} | Maximum Additional I _{CC} /Input ('ACT540/541) | 1.5 | mA | V _{IN} = V _{CC} - 2.1 V, V _{CC} = 5.5 V, T _A = Worst Case |

AC CHARACTERISTICS (For Figures and Waveforms — See Section 3)

| Symbol | Parameter | V _{CC} * (V) | 74AC | | | 74AC | | Units | Fig. No. |
|------------------|---|-----------------------|--|------------|-------------|--|-------------|-------|----------|
| | | | T _A = +25°C C _L = 50 pF | | | T _A = -40°C to +85°C C _L = 50 pF | | | |
| | | | Min | Typ | Max | Min | Max | | |
| t _{PLH} | Propagation Delay Data to Output ('AC540) | 3.3 5.0 | 1.0 1.0 | 5.5 4.0 | 7.5 6.0 | 1.0 1.0 | 8.0 6.5 | ns | 3-5 |
| t _{PHL} | Propagation Delay Data to Output ('AC540) | 3.3 5.0 | 1.0 1.0 | 5.0 4.0 | 7.0 5.5 | 1.0 1.0 | 7.5 6.0 | ns | 3-5 |
| t _{PZH} | Output Enable Time ('AC540) | 3.3 5.0 | 1.0 1.0 | 8.5 6.5 | 11 8.5 | 1.0 1.0 | 12 9.5 | ns | 3-7 |
| t _{PZL} | Output Enable Time ('AC540) | 3.3 5.0 | 1.0 1.0 | 7.5 6.0 | 10 7.5 | 1.0 1.0 | 11 8.5 | ns | 3-8 |
| t _{PHZ} | Output Disable Time ('AC540) | 3.3 5.0 | 1.0 1.0 | 8.5 7.5 | 13 10.5 | 1.0 1.0 | 14 11 | ns | 3-7 |
| t _{PLZ} | Output Disable Time ('AC540) | 3.3 5.0 | 1.0 1.0 | 7.0 6.0 | 10 8.0 | 1.0 1.0 | 11 9.0 | ns | 3-8 |
| t _{PLH} | Propagation Delay Data to Output ('AC541) | 3.3 5.0 | 1.0 1.0 | 5.5 4.0 | 8.0 6.0 | 1.0 1.0 | 9.0 6.5 | ns | 3-5 |
| t _{PHL} | Propagation Delay Data to Output ('AC541) | 3.3 5.0 | 1.0 1.0 | 5.5 4.0 | 8.0 6.0 | 1.0 1.0 | 8.5 6.5 | ns | 3-5 |
| t _{PZH} | Output Enable Time ('AC541) | 3.3 5.0 | 1.0 1.0 | 8.0 6.0 | 11.5 8.5 | 1.0 1.0 | 12.5 9.5 | ns | 3-7 |
| t _{PZL} | Output Enable Time ('AC541) | 3.3 5.0 | 1.0 1.0 | 7.0 5.5 | 10 7.5 | 1.0 1.0 | 11.5 8.5 | ns | 3-8 |
| t _{PHZ} | Output Disable Time ('AC541) | 3.3 5.0 | 1.0 1.0 | 9.0 7.0 | 12.5 9.5 | 1.0 1.0 | 14 10.5 | ns | 3-7 |
| t _{PLZ} | Output Disable Time ('AC541) | 3.3 5.0 | 1.0 1.0 | 6.5 5.5 | 9.5 7.5 | 1.0 1.0 | 10.5 8.5 | ns | 3-8 |

*Voltage Range 3.3 is 3.3 V ± 0.3 V
Voltage Range 5.0 is 5.0 V ± 0.5 V



MC74AC540 • MC74ACT540 • MC74AC541 • MC74ACT541

AC CHARACTERISTICS (For Figures and Waveforms — See Section 3)

| Symbol | Parameter | V _{CC} * (V) | 74ACT | | | 74ACT | | Units | Fig. No. |
|------------------|---|--------------------------|--|-----|-----|--|-----|-------|----------|
| | | | T _A = +25°C C _L = 50 pF | | | T _A = -40°C to +85°C C _L = 50 pF | | | |
| | | | Min | Typ | Max | Min | Max | | |
| t _{PLH} | Propagation Delay Data to Output ('ACT540) | 5.0 | | 6.0 | | | ns | 3-5 | |
| t _{PHL} | Propagation Delay Data to Output ('ACT540) | 5.0 | | 5.5 | | | ns | 3-5 | |
| t _{PZH} | Output Enable Time ('ACT540) | 5.0 | | 8.0 | | | ns | 3-7 | |
| t _{PZL} | Output Enable Time ('ACT540) | 5.0 | | 6.5 | | | ns | 3-8 | |
| t _{PHZ} | Output Disable Time ('ACT540) | 5.0 | | 10 | | | ns | 3-7 | |
| t _{PLZ} | Output Disable Time ('ACT540) | 5.0 | | 7.0 | | | ns | 3-8 | |
| t _{PLH} | Propagation Delay Data to Output ('ACT541) | 5.0 | | 6.0 | | | ns | 3-5 | |
| t _{PHL} | Propagation Delay Data to Output ('ACT541) | 5.0 | | 6.0 | | | ns | 3-5 | |
| t _{PZH} | Output Enable Time ('ACT541) | 5.0 | | 8.0 | | | ns | 3-7 | |
| t _{PZL} | Output Enable Time ('ACT541) | 5.0 | | 6.5 | | | ns | 3-8 | |
| t _{PHZ} | Output Disable Time ('ACT541) | 5.0 | | 10 | | | ns | 3-7 | |
| t _{PLZ} | Output Disable Time ('ACT541) | 5.0 | | 7.0 | | | ns | 3-8 | |

*Voltage Range 5.0 is 5.0 V ± 0.5 V

CAPACITANCE

| Symbol | Parameter | Value Typ | Units | Test Conditions |
|-----------------|-------------------------------|--------------|-------|-------------------------|
| C _{IN} | Input Capacitance | 4.5 | pF | V _{CC} = 5.0 V |
| C _{PD} | Power Dissipation Capacitance | 30 | pF | V _{CC} = 5.0 V |

5



MOTOROLA

Product Preview

Octal D-Type Latch with 3-State Outputs

The MC74AC563/74ACT563 is a high-speed octal latch with buffered common Latch Enable (LE) and buffered common Output Enable (\overline{OE}) inputs.

The MC74AC563/74ACT563 device is functionally identical to the MC74AC573/74ACT573, but with inverted outputs.

- Inputs and Outputs on Opposite Sides of Package Allowing Easy Interface with Microprocessors
- Useful as Input or Output Port for Microprocessors
- Functionally Identical to MC74AC573/74ACT573 but with Inverted Outputs
- Outputs Source/Sink 24 mA
- 'ACT563 Has TTL Compatible Inputs

LOGIC SYMBOL

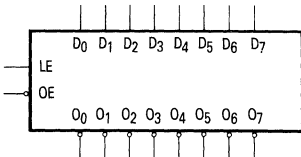

PIN NAMES

- D_0 - D_7 Data Inputs
- LE Latch Enable Input
- \overline{OE} 3-State Output Enable Input
- \overline{O}_0 - \overline{O}_7 3-State Latch Outputs

**MC74AC563
MC74ACT563**

**OCTAL D-TYPE
LATCH WITH
3-STATE OUTPUTS**

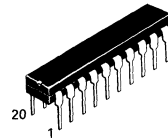

**N SUFFIX
CASE 738-03
PLASTIC**

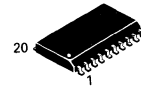

**DW SUFFIX
CASE 751D-03
PLASTIC**

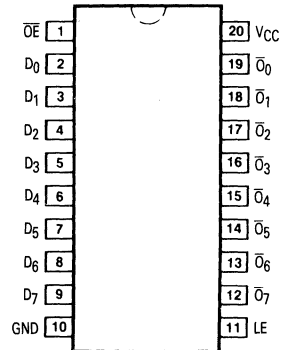

5

FUNCTIONAL DESCRIPTION

The MC74AC563/74ACT563 contains eight D-type latches with 3-state complementary outputs. When the Latch Enable (LE) input is HIGH, data on the D_n inputs enters the latches. In this condition the latches are transparent, i.e., a latch output will change state each time its D input changes. When LE is LOW the latches store the information that was present on the D inputs a setup time preceding the HIGH-to-LOW transition of LE. The 3-state buffers are controlled by the Output Enable (OE) input. When OE is LOW, the buffers are in the bi-state mode. When OE is HIGH the buffers are in the high impedance mode but that does not interfere with entering new data into the latches.

FUNCTION TABLE

| Inputs | | Internal | Outputs | | Function |
|--------|----|----------|---------|----|-------------|
| OE | LE | Q | O | | |
| H | X | X | Z | Z | High Z |
| H | H | L | H | Z | High Z |
| H | H | H | L | Z | High Z |
| H | L | X | NC | Z | Latched |
| L | H | L | H | H | Transparent |
| L | H | H | L | L | Transparent |
| L | L | X | NC | NC | Latched |

H = HIGH Voltage Level
 L = LOW Voltage Level
 X = Immaterial
 Z = High Impedance
 NC = No Change

LOGIC DIAGRAM

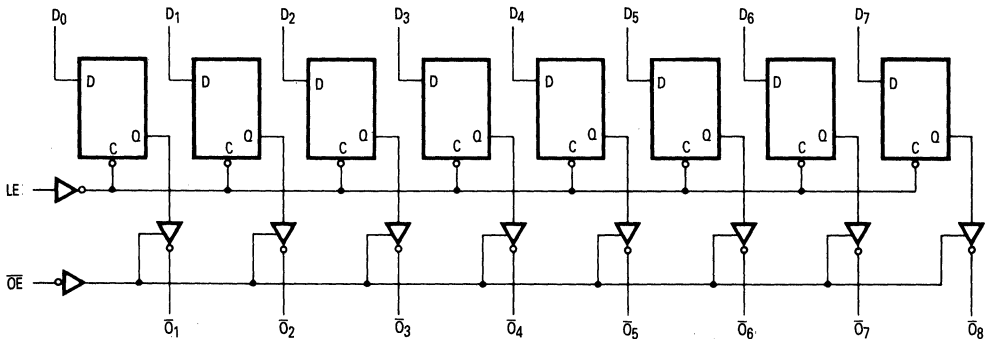

Please note that this diagram is provided only for the understanding of logic operations and should not be used to estimate propagation delays.

DC CHARACTERISTICS (unless otherwise specified)

| Symbol | Parameter | Value | Units | Test Conditions |
|--------------------|---|-------|-------|---|
| I _{CC} | Maximum Quiescent Supply Current | 80 | μA | V _{IN} = V _{CC} or Ground, V _{CC} = 5.5 V, T _A = Worst Case |
| I _{CC} | Maximum Quiescent Supply Current | 8.0 | μA | V _{IN} = V _{CC} or Ground, V _{CC} = 5.5 V, T _A = 25°C |
| I _{CC(T)} | Maximum Additional I _{CC} /Input (*ACT563) | 1.5 | mA | V _{IN} = V _{CC} - 2.1 V, V _{CC} = 5.5 V, T _A = Worst Case |

5

MC74AC563 • MC74ACT563

AC CHARACTERISTICS (For Figures and Waveforms — See Section 3)

| Symbol | Parameter | V _{CC} * (V) | 74AC | | | 74AC | | Units | Fig. No. |
|------------------|--|--------------------------|--|------------|-----|--|-----|-------|----------|
| | | | T _A = +25°C C _L = 50 pF | | | T _A = -40°C to +85°C C _L = 50 pF | | | |
| | | | Min | Typ | Max | Min | Max | | |
| t _{PLH} | Propagation Delay D _n to \bar{O}_n | 3.3 5.0 | | 7.5 5.0 | | | | ns | 3-5 |
| t _{PHL} | Propagation Delay D _n to \bar{O}_n | 3.3 5.0 | | 7.0 4.5 | | | | ns | 3-5 |
| t _{PLH} | Propagation Delay LE to \bar{O}_n | 3.3 5.0 | | 7.5 5.0 | | | | ns | 3-6 |
| t _{PHL} | Propagation Delay LE to \bar{O}_n | 3.3 5.0 | | 8.0 5.5 | | | | ns | 3-6 |
| t _{PZH} | Output Enable Time | 3.3 5.0 | | 6.0 4.0 | | | | ns | 3-7 |
| t _{PZL} | Output Enable Time | 3.3 5.0 | | 6.0 4.0 | | | | ns | 3-8 |
| t _{PHZ} | Output Disable Time | 3.3 5.0 | | 7.0 5.0 | | | | ns | 3-7 |
| t _{PLZ} | Output Disable Time | 3.3 5.0 | | 5.0 3.5 | | | | ns | 3-8 |

*Voltage Range 3.3 is 3.3 V ± 0.3 V
Voltage Range 5.0 is 5.0 V ± 0.5 V

AC OPERATING REQUIREMENTS

| Symbol | Parameter | V _{CC} * (V) | 74AC | | 74AC | | Units | Fig. No. |
|----------------|---|--------------------------|--|--------------------|--|--|-------|----------|
| | | | T _A = +25°C C _L = 50 pF | | T _A = -40°C to +85°C C _L = 50 pF | | | |
| | | | Typ | Guaranteed Minimum | | | | |
| t _s | Setup Time, HIGH or LOW D _n to LE | 3.3 5.0 | 2.0 1.5 | | | | ns | 3-9 |
| t _h | Hold Time, HIGH or LOW D _n to LE | 3.3 5.0 | -2.5 -1.5 | | | | ns | 3-9 |
| t _w | LE Pulse Width, HIGH | 3.3 5.0 | 3.0 2.5 | | | | ns | 3-6 |

*Voltage Range 3.3 is 3.3 V ± 0.3 V
Voltage Range 5.0 is 5.0 V ± 0.5 V



MC74AC563 • MC74ACT563

AC CHARACTERISTICS (For Figures and Waveforms — See Section 3)

| Symbol | Parameter | V _{CC} * (V) | 74ACT | | | 74ACT | | Units | Fig. No. |
|------------------|--|--------------------------|--|-----|------|--|------|-------|----------|
| | | | T _A = +25°C C _L = 50 pF | | | T _A = -40°C to +85°C C _L = 50 pF | | | |
| | | | Min | Typ | Max | Min | Max | | |
| t _{PLH} | Propagation Delay D _n to \bar{O}_n | 5.0 | 1.0 | 7.0 | 11.5 | 1.0 | 12.5 | ns | 3-5 |
| t _{PHL} | Propagation Delay D _n to \bar{O}_n | 5.0 | 1.0 | 6.0 | 10 | 1.0 | 11 | ns | 3-5 |
| t _{PLH} | Propagation Delay LE to \bar{O}_n | 5.0 | 1.0 | 6.5 | 10.5 | 1.0 | 11.5 | ns | 3-6 |
| t _{PHL} | Propagation Delay LE to \bar{O}_n | 5.0 | 1.0 | 5.5 | 9.5 | 1.0 | 10.5 | ns | 3-6 |
| t _{PZH} | Output Enable Time | 5.0 | 1.0 | 5.5 | 9.0 | 1.0 | 10 | ns | 3-7 |
| t _{PZL} | Output Enable Time | 5.0 | 1.0 | 5.5 | 8.5 | 1.0 | 9.5 | ns | 3-8 |
| t _{PHZ} | Output Disable Time | 5.0 | 1.0 | 6.5 | 10.5 | 1.0 | 11.5 | ns | 3-7 |
| t _{PLZ} | Output Disable Time | 5.0 | 1.0 | 4.5 | 8.0 | 1.0 | 8.5 | ns | 3-8 |

*Voltage Range 5.0 is 5.0 V ± 0.5 V

AC OPERATING REQUIREMENTS

| Symbol | Parameter | V _{CC} * (V) | 74ACT | | 74ACT | | Units | Fig. No. |
|----------------|---|--------------------------|--|--------------------|--|----|-------|----------|
| | | | T _A = +25°C C _L = 50 pF | | T _A = -40°C to +85°C C _L = 50 pF | | | |
| | | | Typ | Guaranteed Minimum | | | | |
| t _s | Setup Time, HIGH or LOW D _n to LE | 5.0 | 1.5 | 4.0 | 4.5 | ns | 3-9 | |
| t _h | Hold Time, HIGH or LOW D _n to LE | 5.0 | -2.0 | 0 | 0 | ns | 3-9 | |
| t _w | LE Pulse Width, HIGH | 5.0 | 2.0 | 3.0 | 3.0 | ns | 3-6 | |

*Voltage Range 5.0 is 5.0 V ± 0.5 V

CAPACITANCE

| Symbol | Parameter | Value Typ | Units | Test Conditions |
|-----------------|-------------------------------|--------------|-------|-------------------------|
| C _{IN} | Input Capacitance | 4.5 | pF | V _{CC} = 5.0 V |
| CPD | Power Dissipation Capacitance | 50 | pF | V _{CC} = 5.0 V |



MOTOROLA

Product Preview

Octal D-Type Latch with 3-State Outputs

The MC74AC564/74ACT564 is a high-speed, low power octal flip-flop with a buffered common Clock (CP) and a buffered common Output Enable (\overline{OE}). The information presented to the D inputs is stored in the flip-flops on the LOW-to-HIGH Clock (CP) transition.

The MC74AC564/74ACT564 device is functionally identical to the MC74AC574/74ACT574, but with inverted outputs.

- Inputs and Outputs on Opposite Sides of Package Allowing Easy Interface with Microprocessors
- Useful as Input or Output Port for Microprocessors
- Functionally Identical to MC74AC574/74ACT574 but with Inverted Outputs
- 3-State Outputs for Bus-Oriented Applications
- Outputs Source/Sink 24 mA
- 'ACT564 Has TTL Compatible Inputs

LOGIC SYMBOL

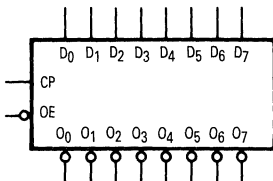

PIN NAMES

- D₀-D₇ Data Inputs
- CP Clock Pulse Input
- \overline{OE} 3-State Output Enable Input
- $\overline{O_0}$ - $\overline{O_7}$ 3-State Outputs

**MC74AC564
MC74ACT564**

**OCTAL D-TYPE
LATCH WITH
3-STATE OUTPUTS**

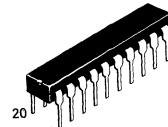

**N SUFFIX
CASE 738-03
PLASTIC**

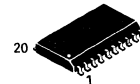

**DW SUFFIX
CASE 751D-03
PLASTIC**

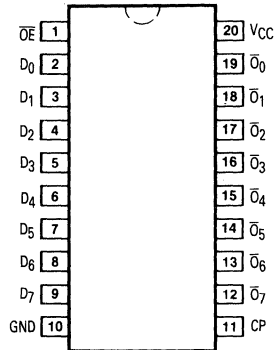

MC74AC564 • MC74ACT564

FUNCTIONAL DESCRIPTION

The MC74AC564/74ACT564 consists of eight edge-triggered flip-flops with individual D-type inputs and 3-state complementary outputs. The buffered clock and buffered Output Enable are common to all flip-flops. The eight flip-flops will store the state of their individual D inputs that meet the setup and hold times requirements on the LOW-to-HIGH Clock (CP) transition. With the Output Enable (\overline{OE}) LOW, the contents of the eight flip-flops are available at the outputs. When \overline{OE} is HIGH, the outputs go to the high impedance state. Operation of the \overline{OE} input does not affect the state of the flip-flops.

FUNCTION TABLE

| Inputs | | | Internal | Outputs | | Function |
|-----------------|----|---|----------|---------|----|-------------------|
| \overline{OE} | CP | D | Q | O | | |
| H | H | L | NC | Z | Z | Hold |
| H | H | H | NC | Z | Z | Hold |
| H | J | L | H | Z | Z | Load |
| H | J | H | L | Z | Z | Load |
| L | J | L | H | H | H | Data Available |
| L | J | H | L | L | L | Data Available |
| L | H | L | NC | NC | NC | No Change in Data |
| L | H | H | NC | NC | NC | No Change in Data |

H = HIGH Voltage Level
 L = LOW Voltage Level
 X = Immaterial
 Z = High Impedance
 J = LOW-to-HIGH Transition
 NC = No Change

LOGIC DIAGRAM

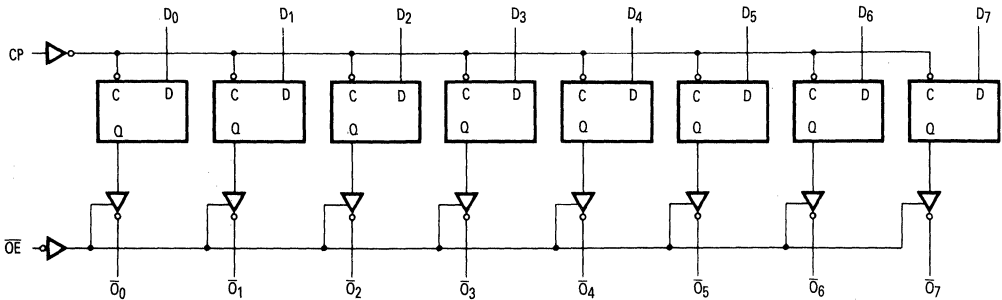

Please note that this diagram is provided only for the understanding of logic operations and should not be used to estimate propagation delays.

DC CHARACTERISTICS (unless otherwise specified)

| Symbol | Parameter | Value | Units | Test Conditions |
|-----------|---|-------|---------|--|
| I_{CC} | Maximum Quiescent Supply Current | 80 | μA | $V_{IN} = V_{CC}$ or Ground, $V_{CC} = 5.5 V, T_A = \text{Worst Case}$ |
| I_{CC} | Maximum Quiescent Supply Current | 8.0 | μA | $V_{IN} = V_{CC}$ or Ground, $V_{CC} = 5.5 V, T_A = 25^\circ C$ |
| I_{CCT} | Maximum Additional I_{CC} /Input (ACT564) | 1.5 | mA | $V_{IN} = V_{CC} - 2.1 V, V_{CC} = 5.5 V, T_A = \text{Worst Case}$ |

5

MC74AC564 • MC74ACT564

AC CHARACTERISTICS (For Figures and Waveforms — See Section 3)

| Symbol | Parameter | V _{CC} * (V) | 74AC | | | 74AC | | Units | Fig. No. |
|------------------|--|--------------------------|--|-------------|-----|--|-----|-------|----------|
| | | | T _A = +25°C C _L = 50 pF | | | T _A = -40°C to +85°C C _L = 50 pF | | | |
| | | | Min | Typ | Max | Min | Max | | |
| f _{max} | Maximum Clock Frequency | 3.3 5.0 | | 110 150 | | | MHz | 3-3 | |
| t _{PLH} | Propagation Delay CP to \bar{O}_n | 3.3 5.0 | | 10.5 7.0 | | | ns | 3-6 | |
| t _{PHL} | Propagation Delay CP to \bar{O}_n | 3.3 5.0 | | 9.5 6.0 | | | ns | 3-6 | |
| t _{PZH} | Output Enable Time | 3.3 5.0 | | 8.5 6.5 | | | ns | 3-7 | |
| t _{PZL} | Output Enable Time | 3.3 5.0 | | 8.0 5.5 | | | ns | 3-8 | |
| t _{PHZ} | Output Disable Time | 3.3 5.0 | | 9.5 7.0 | | | ns | 3-7 | |
| t _{PLZ} | Output Disable Time | 3.3 5.0 | | 7.5 5.5 | | | ns | 3-8 | |

*Voltage Range 3.3 is 3.3 V ± 0.3 V
Voltage Range 5.0 is 5.0 V ± 0.5 V

AC OPERATING REQUIREMENTS

| Symbol | Parameter | V _{CC} * (V) | 74AC | | 74AC | | Units | Fig. No. |
|----------------|---|--------------------------|--|--------------------|--|--|-------|----------|
| | | | T _A = +25°C C _L = 50 pF | | T _A = -40°C to +85°C C _L = 50 pF | | | |
| | | | Typ | Guaranteed Minimum | | | | |
| t _s | Setup Time, HIGH or LOW D _n to CP | 3.3 5.0 | 2.0 1.0 | | | | ns | 3-9 |
| t _h | Hold Time, HIGH or LOW D _n to CP | 3.3 5.0 | -1.0 -0.5 | | | | ns | 3-9 |
| t _w | CP Pulse Width HIGH or LOW | 3.3 5.0 | 3.5 2.5 | | | | ns | 3-6 |

*Voltage Range 3.3 is 3.3 V ± 0.3 V
Voltage Range 5.0 is 5.0 V ± 0.5 V



MC74AC564 • MC74ACT564

AC CHARACTERISTICS (For Figures and Waveforms — See Section 3)

| Symbol | Parameter | V _{CC} * (V) | 74ACT | | | 74ACT | | Units | Fig. No. |
|------------------|-------------------------------------|-----------------------|--|-----|------|--|------|-------|----------|
| | | | T _A = +25°C C _L = 50 pF | | | T _A = -40°C to +85°C C _L = 50 pF | | | |
| | | | Min | Typ | Max | Min | Max | | |
| f _{max} | Maximum Clock Frequency | 5.0 | 85 | 90 | | 75 | | MHz | 3-3 |
| t _{PLH} | Propagation Delay CP to \bar{O}_N | 5.0 | 1.0 | 6.5 | 10.5 | 1.0 | 11.5 | ns | 3-6 |
| t _{PHL} | Propagation Delay CP to \bar{O}_N | 5.0 | 1.0 | 6.0 | 9.5 | 1.0 | 10.5 | ns | 3-6 |
| t _{PZH} | Output Enable Time | 5.0 | 1.0 | 5.5 | 9.0 | 1.0 | 9.5 | ns | 3-7 |
| t _{PZL} | Output Enable Time | 5.0 | 1.0 | 5.5 | 8.5 | 1.0 | 9.5 | ns | 3-8 |
| t _{PHZ} | Output Disable Time | 5.0 | 1.0 | 7.0 | 10.5 | 1.0 | 11.5 | ns | 3-7 |
| t _{PLZ} | Output Disable Time | 5.0 | 1.0 | 5.0 | 8.0 | 1.0 | 8.5 | ns | 3-8 |

*Voltage Range 5.0 is 5.0 V ± 0.5 V

AC OPERATING REQUIREMENTS

| Symbol | Parameter | V _{CC} * (V) | 74ACT | | 74ACT | | Units | Fig. No. |
|----------------|--|-----------------------|--|--------------------|--|----|-------|----------|
| | | | T _A = +25°C C _L = 50 pF | | T _A = -40°C to +85°C C _L = 50 pF | | | |
| | | | Typ | Guaranteed Minimum | | | | |
| t _s | Setup Time, HIGH or LOW D _N to CP | 5.0 | 1.0 | 2.5 | 3.0 | ns | 3-9 | |
| t _h | Hold Time, HIGH or LOW D _N to CP | 5.0 | -0.5 | 1.0 | 1.0 | ns | 3-9 | |
| t _w | LE Pulse Width HIGH or LOW | 5.0 | 2.5 | 3.0 | 3.5 | ns | 3-6 | |

*Voltage Range 5.0 is 5.0 V ± 0.5 V

CAPACITANCE

| Symbol | Parameter | Value Typ | Units | Test Conditions |
|-----------------|-------------------------------|-----------|-------|-------------------------|
| C _{IN} | Input Capacitance | 4.5 | pF | V _{CC} = 5.0 V |
| C _{PD} | Power Dissipation Capacitance | 50 | pF | V _{CC} = 5.0 V |

5



MOTOROLA

Product Preview

4-Bit Bidirectional Counters with 3-State Outputs

The MC74AC568 and MC74AC569 are fully synchronous, bidirectional counters with 3-state outputs. The MC74AC568 is a BCD decade counter; the MC74AC569 is a modulo 16 binary counter. They feature preset capability for programmable operation, carry lookahead for easy cascading, and a U/D input to control the direction of counting. For maximum flexibility there are both synchronous and master asynchronous reset inputs as well as both Clocked Carry (CC) and Terminal Count (TC) outputs. All state changes except Master Reset are initiated by the rising edge of the clock. A HIGH signal on the Output Enable (OE) input forces the output buffers into the high-impedance state but does not prevent counting, resetting or parallel loading.

- Synchronous Counting and Loading
- Lookahead Carry Capability for Easy Cascading
- Preset Capability for Programmable Operation
- 3-State Outputs for Bus Organized Systems
- Outputs Source/Sink 24 mA
- Synchronous and Asynchronous Resets

**MC74AC568
MC74AC569**

**4-BIT BIDIRECTIONAL
COUNTERS WITH
3-STATE OUTPUTS**

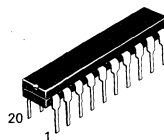

**N SUFFIX
CASE 738-03
PLASTIC**

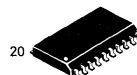

**DW SUFFIX
CASE 751D-03
PLASTIC**

LOGIC SYMBOL

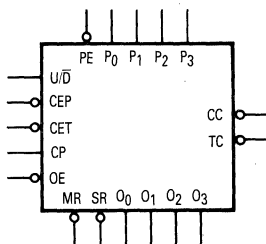

PIN NAMES

- P_0 – P_3 Parallel Data Inputs
- CEP Count Enable Parallel Input
- CET Count Enable Trickle Input
- CP Clock Pulse Input
- PE Parallel Enable Input
- U/D Up/Down Count Control Input
- OE Output Enable Input
- MR Master Reset Input
- SR Synchronous Reset Input
- O_0 – O_3 3-State Parallel Data Outputs
- TC Terminal Count Output
- CC Clocked Carry Output

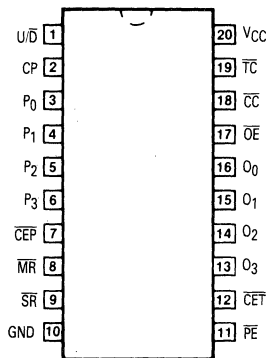

MC74AC568 • MC74AC569

LOGIC DIAGRAM (MC74AC568)

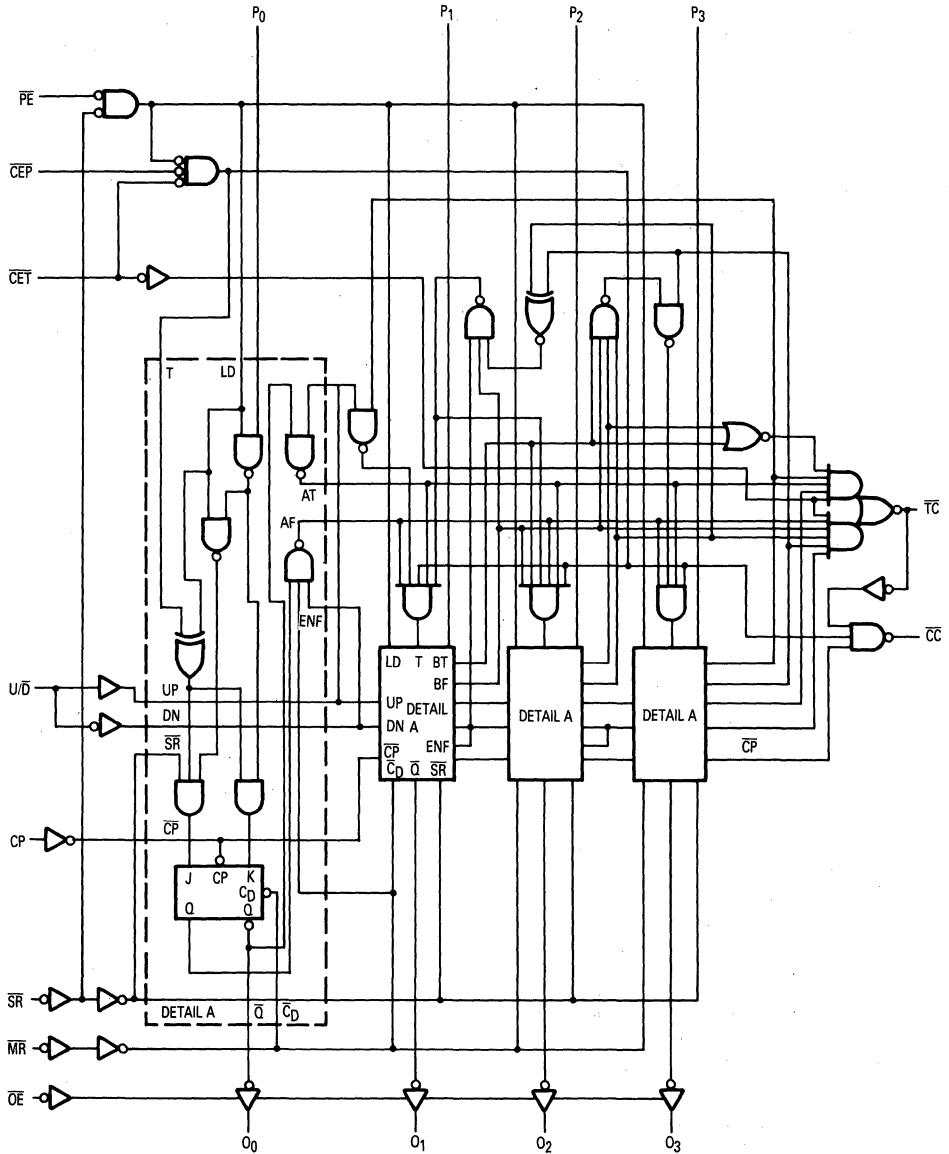

Please note that this diagram is provided only for the understanding of logic operations and should not be used to estimate propagation delays.

5

MC74AC568 • MC74AC569

LOGIC DIAGRAM (MC74AC569)

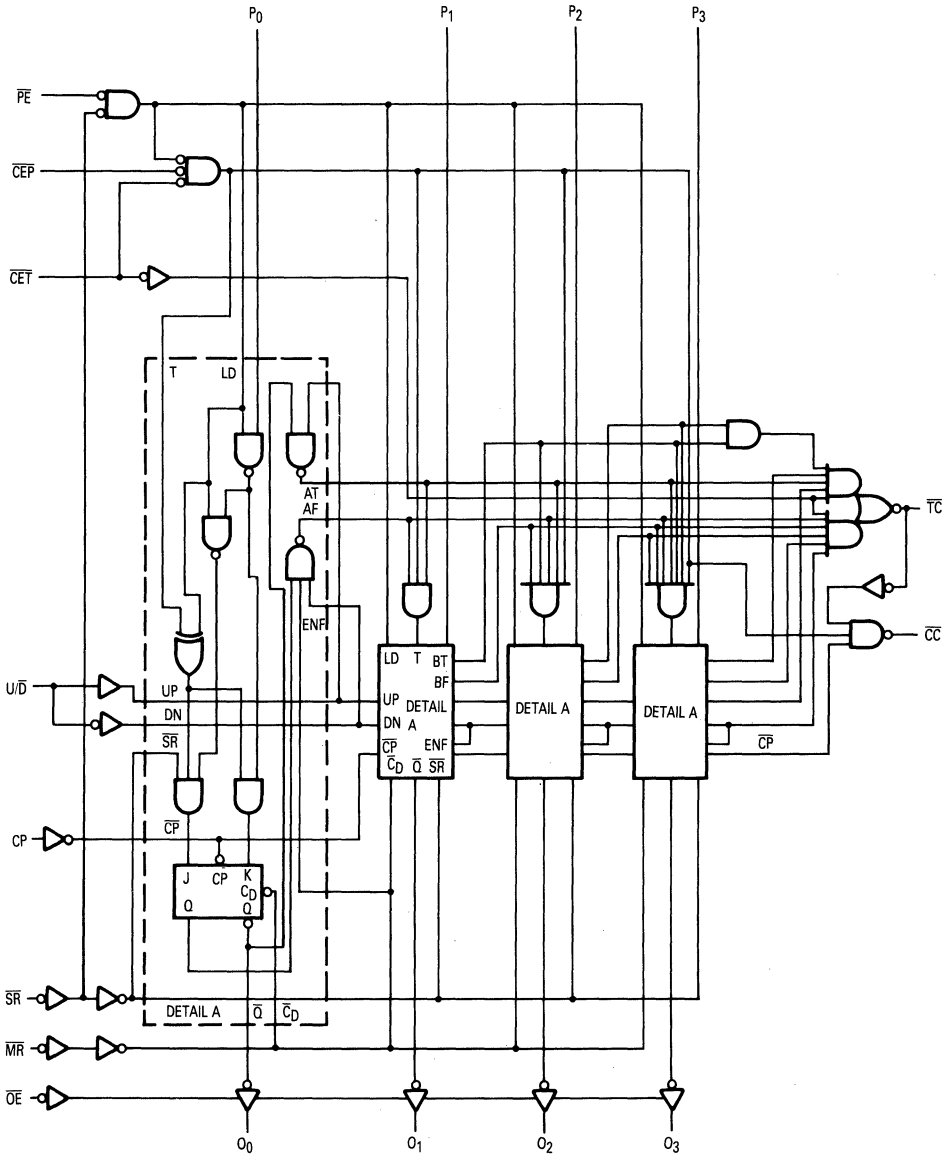

Please note that these diagrams are provided only for the understanding of logic operations and should not be used to estimate propagation delays.

STATE DIAGRAMS

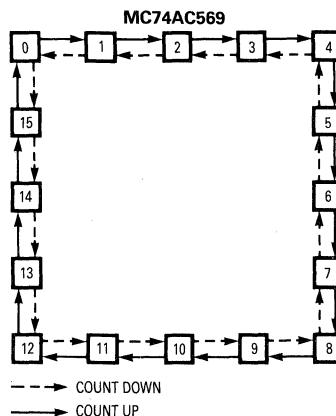
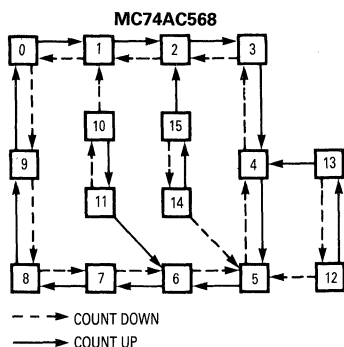

LOGIC EQUATIONS:

Count Enable = $\overline{CEP} \cdot \overline{CET} \cdot PE$
 Up ('AC568): $\overline{TC} = Q_0 \cdot \overline{Q_1} \cdot \overline{Q_2} \cdot Q_3 \cdot (Up) \cdot \overline{CET}$
 ('AC569): $\overline{TC} = Q_0 \cdot \overline{Q_1} \cdot \overline{Q_2} \cdot \overline{Q_3} \cdot (Up) \cdot \overline{CET}$
 Down (Both): $\overline{TC} = Q_0 \cdot \overline{Q_1} \cdot \overline{Q_2} \cdot \overline{Q_3} \cdot (Down) \cdot \overline{CET}$

FUNCTIONAL DESCRIPTION

The MC74AC568 counts modulo-10 in the BCD (8421) sequence. From state 9 (HLLH) it will increment to 0 (LLLL) in the Up mode; in Down mode it will decrement from 0 to 9. The MC74AC569 counts in the modulo-16 binary sequence. From state 15 it will increment to state 0 in the Up mode; in the Down mode it will decrement from 0 to 15. The clock inputs of all flip-flops are driven in parallel through a clock buffer. All state changes (except due to Master Reset) occur synchronously with the LOW-to-HIGH transition of the Clock Pulse (CP) input signal.

The circuits have five fundamental modes of operation, in order of precedence: asynchronous reset, synchronous reset, parallel load, count and hold. Five control inputs — Master Reset (\overline{MR}), Synchronous Reset (\overline{SR}), Parallel Enable (\overline{PE}), Count Enable Parallel (\overline{CEP}) and Count Enable Trickle (\overline{CET}) — plus the Up/Down (U/D) input determine the mode of operation, as shown in the Mode Select Table. A LOW signal on \overline{MR} overrides all other inputs and asynchronously forces the flip-flop Q outputs LOW. A LOW signal on \overline{SR} overrides counting and parallel loading and allows the Q outputs to go LOW on the next rising edge of CP. A LOW signal on \overline{PE} overrides counting and allows information on the Parallel Data (P_n) inputs to be loaded into the flip-flops on the next rising edge of CP. With \overline{MR} , \overline{SR} and \overline{PE} HIGH, \overline{CEP} and \overline{CET} permit counting when both are LOW. Conversely, a HIGH signal on either \overline{CEP} or \overline{CET} inhibits counting.

the MC74AC568 and MC74AC569 use edge-triggered flip-flops and changing the \overline{SR} , \overline{PE} , \overline{CEP} , \overline{CET} or U/D inputs when the CP is in either state does not cause errors, provided that the recommended setup and hold times, with respect to the rising edge of CP, are observed.

Two types of outputs are provided as overflow/underflow indicators. The Terminal Count (\overline{TC}) output is normally HIGH and goes LOW providing \overline{CET} is LOW, when the counter reaches zero in the Down mode, or reaches maximum (9 for the MC74AC568, 15 for the MC74AC569) in the Up mode. \overline{TC} will then remain LOW until a state change occurs, whether by counting or presetting, or until U/D or \overline{CET} is changed. To implement synchronous multistage counters, the connections between the \overline{TC} output and the \overline{CEP} and \overline{CET} inputs can provide either slow or fast carry propagation. Figure a shows the connections for simple ripple carry, in which the clock period must be longer than the CP to \overline{TC} delay of the first stage, plus the cumulative \overline{CET} to \overline{TC} delays of the intermediate stages, plus the \overline{CET} to CP setup time of the last stage. This total delay plus setup time sets the upper limit on clock frequency. For faster clock rates, the carry lookahead connections shown in Figure b are recommended. In this scheme the ripple delay through the intermediate stages commences with the same clock that causes the first stage to tick over from max to min in the Up mode, or min to max in the Down mode, to start its final cycle. Since this final cycle takes 10 (MC74AC568) or 16

(MC74AC569) clocks to complete, there is plenty of time for the ripple to progress through the intermediate stages. The critical timing that limits the clock period is the CP to TC delay of the first stage plus the CEP to CP setup time of the last stage. The TC output is subject to decoding spikes due to internal race conditions and is therefore not recommended for use as a clock or asynchronous reset for flip-flops, registers or counters. For such applications, the Clocked Carry (CC) output is pro-

vided. The CC output is normally HIGH. When SR and PE are HIGH, and CEP, CET and TC are LOW, the CC output will go LOW when the clock next goes LOW and will stay LOW until the clock goes HIGH again, as shown in the CC Truth Table. When the Output Enable (OE) is LOW, the parallel data outputs O₀–O₃ are active and follow the flip-flop Q outputs. A HIGH signal on OE forces O₀–O₃ to the high-Z state but does not prevent counting, loading or resetting.

MODE SELECT TABLE

| Inputs | | | | | | Operating Mode |
|--------|----|----|-----|-----|-----|--------------------|
| MR | SR | PE | CEP | CET | U/D | |
| L | X | X | X | X | X | Asynchronous Reset |
| H | L | X | X | X | X | Synchronous Reset |
| H | H | L | X | X | X | Parallel Load |
| H | H | H | H | X | X | Hold |
| H | H | H | X | H | X | Hold |
| H | H | H | L | L | H | Count Up |
| H | H | H | L | L | L | Count Down |

H = HIGH Voltage Level
 L = LOW Voltage Level
 X = Immaterial

CC TRUTH TABLE

| Inputs | | | | | | Output | |
|--------|----|-----|-----|-----|----|--------|----|
| SR | PE | CEP | CET | TC* | CP | CC | CC |
| L | X | X | X | X | X | H | H |
| X | L | X | X | X | X | H | H |
| X | X | H | X | X | X | H | H |
| X | X | X | H | X | X | H | H |
| X | X | X | X | H | X | H | H |
| H | H | L | L | L | ⌊ | ⌊ | ⌊ |

* = TC is generated internally
 H = HIGH Voltage Level
 L = LOW Voltage Level
 X = Immaterial

Figure a. Multistage Counter with Ripple Carry

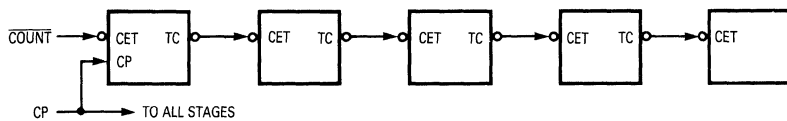
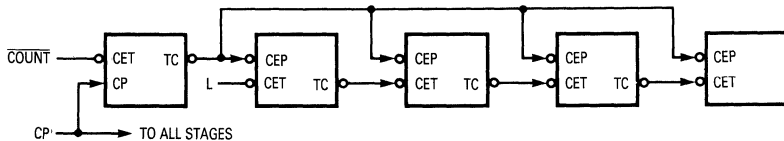

Figure b. Multistage Counter with Lookahead Carry



MC74AC568 • MC74AC569

DC CHARACTERISTICS (unless otherwise specified)

| Symbol | Parameter | Value | Units | Test Conditions |
|-----------------|----------------------------------|-------|-------|---|
| I _{CC} | Maximum Quiescent Supply Current | 80 | μA | V _{IN} = V _{CC} or Ground, V _{CC} = 5.5 V, T _A = Worst Case |
| I _{CC} | Maximum Quiescent Supply Current | 8.0 | μA | V _{IN} = V _{CC} or Ground, V _{CC} = 5.5 V, T _A = 25°C |

AC CHARACTERISTICS (For Figures and Waveforms — See Section 3)

| Symbol | Parameter | V _{CC} * (V) | 74AC | | | 74AC | | Units | Fig. No. |
|------------------|---|-----------------------|--|-------------|-----|--|-----|-------|----------|
| | | | T _A = +25°C C _L = 50 pF | | | T _A = -40°C to +85°C C _L = 50 pF | | | |
| | | | Min | Typ | Max | Min | Max | | |
| f _{max} | Maximum Clock Frequency | 3.3 5.0 | | 87 117 | | | | MHz | 3-3 |
| t _{PLH} | Propagation Delay CP to O _n (PE HIGH or LOW) | 3.3 5.0 | | 10 7.5 | | | | ns | 3-6 |
| t _{PHL} | Propagation Delay CP to O _n (PE HIGH or LOW) | 3.3 5.0 | | 11 8.0 | | | | ns | 3-6 |
| t _{PLH} | Propagation Delay CP to T _C | 3.3 5.0 | | 16.5 12 | | | | ns | 3-6 |
| t _{PHL} | Propagation Delay CP to T _C | 3.3 5.0 | | 16.5 12 | | | | ns | 3-6 |
| t _{PLH} | Propagation Delay C _{ET} to T _C | 3.3 5.0 | | 10.5 7.5 | | | | ns | 3-6 |
| t _{PHL} | Propagation Delay C _{ET} to T _C | 3.3 5.0 | | 10 7.0 | | | | ns | 3-6 |
| t _{PLH} | Propagation Delay U/D to T _C ('568) | 3.3 5.0 | | 10.5 7.5 | | | | ns | 3-6 |
| t _{PHL} | Propagation Delay U/D to T _C ('568) | 3.3 5.0 | | 9.0 6.5 | | | | ns | 3-6 |

*Voltage Range 3.3 is 3.3 V ± 0.3 V
Voltage Range 5.0 is 5.0 V ± 0.5 V

MC74AC568 • MC74AC569

AC CHARACTERISTICS — continued (For Figures and Waveforms — See Section 3)

| Symbol | Parameter | V _{CC} * (V) | 74AC | | | 74AC | | Units | Fig. No. |
|------------------|--|--------------------------|--|-------------|-----|--|-----|-------|----------|
| | | | T _A = +25°C C _L = 50 pF | | | T _A = -40°C to +85°C C _L = 50 pF | | | |
| | | | Min | Typ | Max | Min | Max | | |
| t _{PLH} | Propagation Delay U/D to \overline{TC} ('569) | 3.3 5.0 | | 10.5 7.5 | | | | ns | 3-6 |
| t _{PHL} | Propagation Delay U/D to \overline{TC} ('569) | 3.3 5.0 | | 9.0 6.5 | | | | ns | 3-6 |
| t _{PLH} | Propagation Delay CP to \overline{CC} | 3.3 5.0 | | 11 8.0 | | | | ns | 3-6 |
| t _{PHL} | Propagation Delay CP to \overline{CC} | 3.3 5.0 | | 9.5 7.0 | | | | ns | 3-6 |
| t _{PLH} | Propagation Delay \overline{CEP} or \overline{CET} to \overline{CC} | 3.3 5.0 | | 9.5 7.0 | | | | ns | 3-6 |
| t _{PHL} | Propagation Delay \overline{CEP} or \overline{CET} to \overline{CC} | 3.3 5.0 | | 9.5 7.0 | | | | ns | 3-6 |
| t _{PHL} | Propagation Delay \overline{MR} to O_N | 3.3 5.0 | | 12.5 9.0 | | | | ns | 3-6 |
| t _{PZH} | Output Enable Time \overline{OE} to O_N | 3.3 5.0 | | 7.5 5.5 | | | | ns | 3-7 |
| t _{PZL} | Output Enable Time \overline{OE} to O_N | 3.3 5.0 | | 7.5 5.5 | | | | ns | 3-8 |
| t _{PHZ} | Output Disable Time \overline{OE} to O_N | 3.3 5.0 | | 9.5 7.0 | | | | ns | 3-7 |
| t _{PZL} | Output Disable Time \overline{OE} to O_N | 3.3 5.0 | | 11 8.0 | | | | ns | 3-8 |

*Voltage Range 3.3 is 3.3 V ± 0.3 V
Voltage Range 5.0 is 5.0 V ± 0.5 V

AC OPERATING REQUIREMENTS

| Symbol | Parameter | V _{CC} * (V) | 74AC | | 74AC | | Units | Fig. No. |
|----------------|---|--------------------------|--|--------------------|--|--|-------|----------|
| | | | T _A = +25°C C _L = 50 pF | | T _A = -40°C to +85°C C _L = 50 pF | | | |
| | | | Typ | Guaranteed Minimum | | | | |
| t _s | Setup Time, HIGH or LOW P _n to CP | 3.3 5.0 | 8.0 6.0 | | | | ns | 3-9 |
| t _h | Hold Time, HIGH or LOW P _n to CP | 3.3 5.0 | 0 0 | | | | ns | 3-9 |
| t _s | Setup Time, HIGH or LOW CEP or CET to CP | 3.3 5.0 | 8.0 12.5 | | | | ns | 3-9 |
| t _h | Hold Time, HIGH or LOW CEP or CET to CP | 3.3 5.0 | 0 0 | | | | ns | 3-9 |
| t _s | Setup Time, HIGH or LOW PE to CP | 3.3 5.0 | 12.5 9.0 | | | | ns | 3-9 |
| t _h | Hold Time, HIGH or LOW PE to CP | 3.3 5.0 | 0 0 | | | | ns | 3-9 |
| t _s | Setup Time, HIGH or LOW U/D to CP ('568) | 3.3 5.0 | 12.5 9.0 | | | | ns | 3-9 |
| t _s | Setup Time, HIGH or LOW U/D to CP ('569) | 3.3 5.0 | 12.5 9.0 | | | | ns | 3-9 |
| t _h | Hold Time, HIGH or LOW U/D to CP | 3.3 5.0 | 0 0 | | | | ns | 3-9 |
| t _s | Setup Time, HIGH or LOW SR to CP | 3.3 5.0 | 4.0 3.0 | | | | ns | 3-9 |
| t _h | Hold Time, HIGH or LOW SR to CP | 3.3 5.0 | -1.5 -1.0 | | | | ns | 3-9 |

*Voltage Range 3.3 is 3.3 V ± 0.3 V
Voltage Range 5.0 is 5.0 V ± 0.5 V

AC OPERATING REQUIREMENTS — continued

| Symbol | Parameter | V _{CC} * (V) | 74AC | | 74AC | | Units | Fig. No. |
|------------------|-------------------------------|--------------------------|--|--------------------|--|--|-------|----------|
| | | | T _A = +25°C C _L = 50 pF | | T _A = -40°C to +85°C C _L = 50 pF | | | |
| | | | Typ | Guaranteed Minimum | | | | |
| t _w | CP Pulse Width HIGH or LOW | 3.3 5.0 | 4.0 3.0 | | | | ns | 3-6 |
| t _w | MR Pulse Width, LOW | 3.3 5.0 | 4.0 3.0 | | | | ns | 3-6 |
| t _{rec} | MR Recovery Time | 3.3 5.0 | 4.0 3.0 | | | | ns | 3-9 |

*Voltage Range 3.3 is 3.3 V ± 0.3 V
Voltage Range 5.0 is 5.0 V ± 0.5 V

CAPACITANCE

| Symbol | Parameter | Value Typ | Units | Test Conditions |
|-----------------|-------------------------------|--------------|-------|-------------------------|
| C _{IN} | Input Capacitance | 4.5 | pF | V _{CC} = 5.0 V |
| C _{PD} | Power Dissipation Capacitance | | pF | V _{CC} = 5.0 V |



MOTOROLA

Product Preview

Octal D-Type Latch with 3-State Outputs

The MC74AC573/74ACT573 is a high-speed octal latch with buffered common Latch Enable (LE) and buffered common Output Enable (\overline{OE}) inputs.

The MC74AC573/74ACT573 is functionally identical to the MC74AC373/74ACT373 but has inputs and outputs on opposite sides.

- Inputs and Outputs on Opposite Sides of Package Allowing Easy Interface with Microprocessors
- Useful as Input or Output Port for Microprocessors
- Functionally Identical to MC74AC373/74ACT373
- 3-State Outputs for Bus Interfacing
- Outputs Source/Sink 24 mA
- *ACT573 Has TTL Compatible Inputs

LOGIC SYMBOL

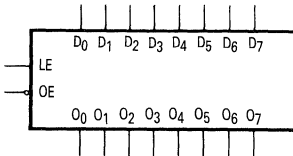

PIN NAMES

- D_0 - D_7 Data Inputs
- LE Latch Enable Input
- \overline{OE} 3-State Output Enable Input
- O_0 - O_7 3-State Latch Outputs

TRUTH TABLE

| Inputs | | | Outputs |
|-----------------|----|---|---------|
| \overline{OE} | LE | D | O_n |
| L | H | H | H |
| L | H | L | H |
| L | L | X | O_0 |
| H | X | X | Z |

- H = HIGH Voltage Level
- L = LOW Voltage Level
- Z = High Impedance
- X = Immaterial
- O_0 = Previous O_0 before LOW-to-HIGH Transition of Clock

**MC74AC573
MC74ACT573**

OCTAL D-TYPE
LATCH WITH
3-STATE OUTPUTS

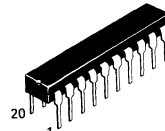

N SUFFIX
CASE 738-03
PLASTIC

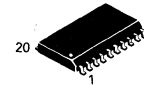

DW SUFFIX
CASE 751D-03
PLASTIC

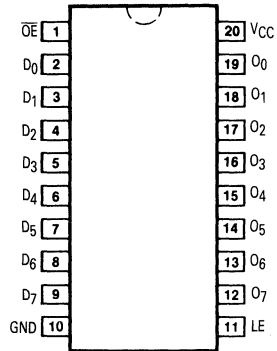

This document contains information on a product under development. Motorola reserves the right to change or discontinue this product without notice.

MC74AC573 • MC74ACT573

FUNCTIONAL DESCRIPTION

The MC74AC573/74ACT573 contains eight D-type latches with 3-state output buffers. When the Latch Enable (LE) input is HIGH, data on the D_n inputs enters the latches. In this condition the latches are transparent, i.e., a latch output will change state each time its D input changes. When LE is LOW the latches store the information that was present on the D inputs a setup time

preceding the HIGH-to-LOW transition of LE. The 3-state buffers are controlled by the Output Enable (\overline{OE}) input. When \overline{OE} is LOW, the buffers are enabled. When \overline{OE} is HIGH the buffers are in the high impedance mode but this does not interfere with entering new data into the latches.

LOGIC DIAGRAM

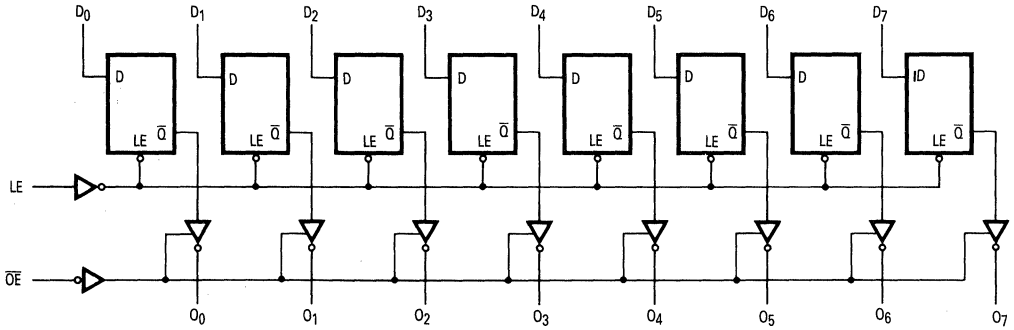

Please note that this diagram is provided only for the understanding of logic operations and should not be used to estimate propagation delays.

DC CHARACTERISTICS (unless otherwise specified)

| Symbol | Parameter | Value | Units | Test Conditions |
|--------------------|---|-------|---------|---|
| I _{CC} | Maximum Supply Current | 80 | μ A | V _{IN} = V _{CC} or Ground, V _{CC} = 5.5 V, T _A = Worst Case |
| I _{CC} | Maximum Quiescent Supply Current | 8.0 | μ A | V _{IN} = V _{CC} or Ground, V _{CC} = 5.5 V, T _A = 25°C |
| I _{CC(T)} | Maximum Additional I _{CC} /Input ('ACT573) | 1.5 | mA | V _{IN} = V _{CC} - 2.1 V, V _{CC} = 5.5 V, T _A = Worst Case |

5

MC74AC573 • MC74ACT573

AC CHARACTERISTICS (For Figures and Waveforms — See Section 3)

| Symbol | Parameter | V _{CC} * (V) | 74AC | | | 74AC | | Units | Fig. No. |
|------------------|---|--------------------------|--|------------|-----|--|-----|-------|----------|
| | | | T _A = +25°C C _L = 50 pF | | | T _A = -40°C to +85°C C _L = 50 pF | | | |
| | | | Min | Typ | Max | Min | Max | | |
| t _{PLH} | Propagation Delay D _n to O _n | 3.3 5.0 | | 9.0 6.0 | | | ns | 3-5 | |
| t _{PHL} | Propagation Delay D _n to O _n | 3.3 5.0 | | 9.0 6.0 | | | ns | 3-5 | |
| t _{PLH} | Propagation Delay LE to O _n | 3.3 5.0 | | 9.0 6.0 | | | ns | 3-6 | |
| t _{PHL} | Propagation Delay LE to O _n | 3.3 5.0 | | 8.0 5.5 | | | ns | 3-6 | |
| t _{PZH} | Output Enable Time | 3.3 5.0 | | 7.0 5.5 | | | ns | 3-7 | |
| t _{PZL} | Output Enable Time | 3.3 5.0 | | 7.5 5.5 | | | ns | 3-8 | |
| t _{PHZ} | Output Disable Time | 3.3 5.0 | | 8.5 6.5 | | | ns | 3-7 | |
| t _{PLZ} | Output Disable Time | 3.3 5.0 | | 6.5 5.0 | | | ns | 3-8 | |

*Voltage Range 3.3 is 3.3 V ± 0.3 V
Voltage Range 5.0 is 5.0 V ± 0.5 V

AC OPERATING REQUIREMENTS

| Symbol | Parameter | V _{CC} * (V) | 74AC | | 74AC | | Units | Fig. No. |
|----------------|---|--------------------------|--|--------------------|--|--|-------|----------|
| | | | T _A = +25°C C _L = 50 pF | | T _A = -40°C to +85°C C _L = 50 pF | | | |
| | | | Typ | Guaranteed Minimum | | | | |
| t _s | Setup Time, HIGH or LOW D _n to LE | 3.3 5.0 | 2.0 1.0 | | | | ns | 3-9 |
| t _h | Hold Time, HIGH or LOW D _n to LE | 3.3 5.0 | 0 0 | | | | ns | 3-9 |
| t _w | LE Pulse Width, HIGH | 3.3 5.0 | 4.0 2.5 | | | | ns | 3-6 |

*Voltage Range 3.3 is 3.3 V ± 0.3 V
Voltage Range 5.0 is 5.0 V ± 0.5 V

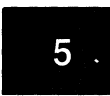

AC CHARACTERISTICS (For Figures and Waveforms — See Section 3)

| Symbol | Parameter | V _{CC} * (V) | 74ACT | | | 74ACT | | Units | Fig. No. |
|------------------|---|--------------------------|--|-----|------|--|------|-------|----------|
| | | | T _A = +25°C C _L = 50 pF | | | T _A = -40°C to +85°C C _L = 50 pF | | | |
| | | | Min | Typ | Max | Min | Max | | |
| t _{PLH} | Propagation Delay D _n to O _n | 5.0 | 1.0 | 6.0 | 10.5 | 1.0 | 12 | ns | 3-5 |
| t _{PHL} | Propagation Delay D _n to O _n | 5.0 | 1.0 | 6.0 | 10.5 | 1.0 | 12 | ns | 3-5 |
| t _{PLH} | Propagation Delay LE to O _n | 5.0 | 1.0 | 6.0 | 10.5 | 1.0 | 12 | ns | 3-6 |
| t _{PHL} | Propagation Delay LE to O _n | 5.0 | 1.0 | 5.5 | 9.5 | 1.0 | 10.5 | ns | 3-6 |
| t _{PZH} | Output Enable Time | 5.0 | 1.0 | 5.5 | 10 | 1.0 | 11 | ns | 3-7 |
| t _{PZL} | Output Enable Time | 5.0 | 1.0 | 5.5 | 9.5 | 1.0 | 10.5 | ns | 3-8 |
| t _{PHZ} | Output Disable Time | 5.0 | 1.0 | 6.5 | 11 | 1.0 | 12.5 | ns | 3-7 |
| t _{PLZ} | Output Disable Time | 5.0 | 1.0 | 5.0 | 8.5 | 1.0 | 9.5 | ns | 3-8 |

*Voltage Range 5.0 is 5.0 V ± 0.5 V

AC OPERATING REQUIREMENTS

| Symbol | Parameter | V _{CC} * (V) | 74ACT | | 74ACT | | Units | Fig. No. |
|----------------|---|--------------------------|--|--------------------|--|----|-------|----------|
| | | | T _A = +25°C C _L = 50 pF | | T _A = -40°C to +85°C C _L = 50 pF | | | |
| | | | Typ | Guaranteed Minimum | | | | |
| t _s | Setup Time, HIGH or LOW D _n to LE | 5.0 | 1.5 | 3.0 | 3.5 | ns | 3-9 | |
| t _h | Hold Time, HIGH or LOW D _n to LE | 5.0 | -1.5 | 0 | 0 | ns | 3-9 | |
| t _w | LE Pulse Width, HIGH | 5.0 | 2.0 | 3.5 | 4.0 | ns | 3-6 | |

*Voltage Range 5.0 is 5.0 V ± 0.5 V

CAPACITANCE

| Symbol | Parameter | Value Typ | Units | Test Conditions |
|-----------------|-------------------------------|--------------|-------|-------------------------|
| C _{IN} | Input Capacitance | 5.0 | pF | V _{CC} = 5.0 V |
| C _{PD} | Power Dissipation Capacitance | 25 | pF | V _{CC} = 5.0 V |

5



MOTOROLA

Product Preview

Octal D-Type Flip-Flop with 3-State Outputs

The MC74AC574/74ACT574 is a high-speed, low power octal flip-flop with a buffered common Clock (CP) and a buffered common Output Enable (\overline{OE}). The information presented to the D inputs is stored in the flip-flops on the LOW-to-HIGH Clock (CP) transition.

The MC74AC574/74ACT574 is functionally identical to the MC74AC374/74ACT374 except for the pinouts.

- Inputs and Outputs on Opposite Sides of Package Allowing Easy Interface with Microprocessors
- Useful as Input or Output Port for Microprocessors
- Functionally Identical to MC74AC374/74ACT374
- 3-State Outputs for Bus-Oriented Applications
- Outputs Source/Sink 24 mA
- 'ACT574 Has TTL Compatible Inputs

LOGIC SYMBOL

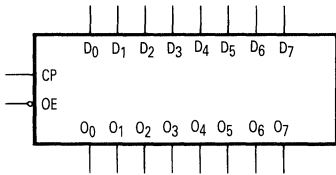

PIN NAMES

- D₀-D₇ Data Inputs
- CP Clock Pulse Input
- \overline{OE} 3-State Output Enable Input
- O₀-O₇ 3-State Outputs

**MC74AC574
MC74ACT574**

**OCTAL D-TYPE
FLIP-FLOP WITH
3-STATE OUTPUTS**

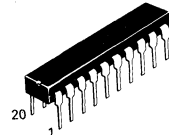

**N SUFFIX
CASE 738-03
PLASTIC**

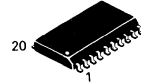

**DW SUFFIX
CASE 751D-03
PLASTIC**

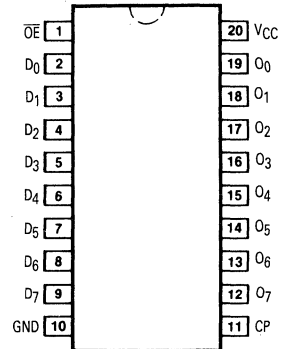

5

MC74AC574 • MC74ACT574

FUNCTIONAL DESCRIPTION

The MC74AC574/74ACT574 consists of eight edge-triggered flip-flops with individual D-type inputs and 3-state true outputs. The buffered clock and buffered Output Enable are common to all flip-flops. The eight flip-flops will store the state of their individual D inputs that meet the setup and hold time requirements on the LOW-to-HIGH Clock (CP) transition. With the Output Enable (\overline{OE}) LOW, the contents of the eight flip-flops are available at the outputs. When \overline{OE} is HIGH, the outputs go to the high impedance state. Operation of the \overline{OE} input does not affect the state of the flip-flops.

FUNCTION TABLE

| Inputs | | | Internal | Outputs | Function |
|-----------------|--------------|---|----------|----------------|-------------------|
| \overline{OE} | CP | D | Q | O _n | |
| H | H | L | NC | Z | Hold |
| H | H | H | NC | Z | Hold |
| H | \downarrow | L | L | Z | Load |
| H | \downarrow | H | H | Z | Load |
| L | \downarrow | L | L | L | Data Available |
| L | \downarrow | H | H | H | Data Available |
| L | H | L | NC | NC | No Change in Data |
| L | H | H | NC | NC | No Change in Data |

H = HIGH Voltage Level
 L = LOW Voltage Level
 X = Immaterial
 Z = High Impedance
 \downarrow = LOW-to-HIGH Clock Transition
 NC = No Change

LOGIC DIAGRAM

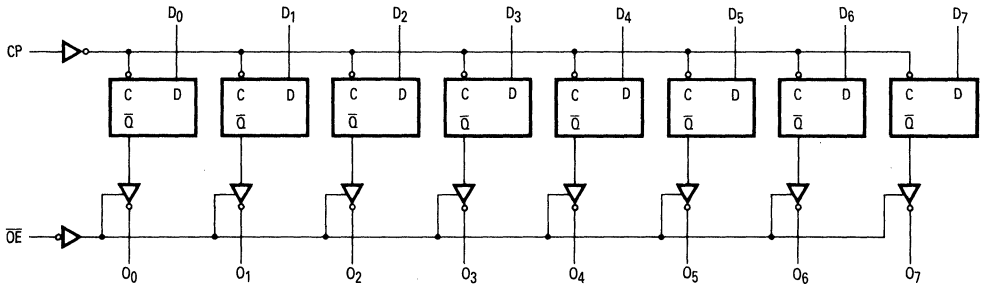

Please note that this diagram is provided only for the understanding of logic operations and should not be used to estimate propagation delays.

DC CHARACTERISTICS (unless otherwise specified)

| Symbol | Parameter | Value | Units | Test Conditions |
|------------------|---|-------|-------|---|
| I _{CC} | Maximum Quiescent Supply Current | 80 | μA | V _{IN} = V _{CC} or Ground, V _{CC} = 5.5 V, T _A = Worst Case |
| I _{CC} | Maximum Quiescent Supply Current | 8.0 | μA | V _{IN} = V _{CC} or Ground, V _{CC} = 5.5 V, T _A = 25°C |
| I _{CCT} | Maximum Additional I _{CC} /Input ('ACT574) | 1.5 | mA | V _{IN} = V _{CC} - 2.1 V, V _{CC} = 5.5 V, T _A = Worst Case |

5

MC74AC574 • MC74ACT574

AC CHARACTERISTICS (For Figures and Waveforms — See Section 3)

| Symbol | Parameter | V _{CC} * (V) | 74AC | | | 74AC | | Units | Fig. No. |
|------------------|---|--------------------------|--|------------|-----|--|-----|-------|----------|
| | | | T _A = +25°C C _L = 50 pF | | | T _A = -40°C to +85°C C _L = 50 pF | | | |
| | | | Min | Typ | Max | Min | Max | | |
| f _{max} | Maximum Clock Frequency | 3.3 5.0 | | 110 160 | | | MHz | 3-3 | |
| t _{PLH} | Propagation Delay CP to O _n | 3.3 5.0 | | 10 7.0 | | | ns | 3-6 | |
| t _{PHL} | Propagation Delay CP to O _n | 3.3 5.0 | | 10 6.5 | | | ns | 3-6 | |
| t _{PZH} | Output Enable Time | 3.3 5.0 | | 6.5 5.0 | | | ns | 3-7 | |
| t _{PZL} | Output Enable Time | 3.3 5.0 | | 6.0 4.0 | | | ns | 3-8 | |
| t _{PHZ} | Output Disable Time | 3.3 5.0 | | 7.0 5.0 | | | ns | 3-7 | |
| t _{PLZ} | Output Disable Time | 3.3 5.0 | | 5.0 3.5 | | | ns | 3-8 | |

*Voltage Range 3.3 is 3.3 V ± 0.3 V
Voltage Range 5.0 is 5.0 V ± 0.5 V

AC OPERATING REQUIREMENTS

| Symbol | Parameter | V _{CC} * (V) | 74AC | | 74AC | | Units | Fig. No. |
|----------------|---|--------------------------|--|--------------------|--|--|-------|----------|
| | | | T _A = +25°C C _L = 50 pF | | T _A = -40°C to +85°C C _L = 50 pF | | | |
| | | | Typ | Guaranteed Minimum | | | | |
| t _s | Setup Time, HIGH or LOW D _n to CP | 3.3 5.0 | 2.0 1.0 | | | | ns | 3-9 |
| t _h | Hold Time, HIGH or LOW D _n to CP | 3.3 5.0 | 0 0 | | | | ns | 3-9 |
| t _w | CP Pulse Width HIGH or LOW | 3.3 5.0 | 4.0 2.5 | | | | ns | 3-6 |

*Voltage Range 3.3 is 3.3 V ± 0.3 V
Voltage Range 5.0 is 5.0 V ± 0.5 V

MC74AC574 • MC74ACT574

AC CHARACTERISTICS (For Figures and Waveforms — See Section 3)

| Symbol | Parameter | V _{CC} * (V) | 74ACT | | | 74ACT | | Units | Fig. No. |
|------------------|---|-----------------------|--|-----|------|--|------|-------|----------|
| | | | T _A = +25°C C _L = 50 pF | | | T _A = -40°C to +85°C C _L = 50 pF | | | |
| | | | Min | Typ | Max | Min | Max | | |
| f _{max} | Maximum Clock Frequency | 5.0 | 100 | 110 | | 85 | | ns | 3-3 |
| t _{PLH} | Propagation Delay CP to O _n | 5.0 | 1.0 | 7.0 | 11 | 1.0 | 12 | ns | 3-6 |
| t _{PHL} | Propagation Delay CP to O _n | 5.0 | 1.0 | 6.5 | 10 | 1.0 | 11 | ns | 3-6 |
| t _{PZH} | Output Enable Time | 5.0 | 1.0 | 6.4 | 9.5 | 1.0 | 10 | ns | 3-7 |
| t _{PZL} | Output Enable Time | 5.0 | 1.0 | 6.0 | 9.0 | 1.0 | 10 | ns | 3-8 |
| t _{PHZ} | Output Disable Time | 5.0 | 1.0 | 7.0 | 10.5 | 1.0 | 11.5 | ns | 3-7 |
| t _{PLZ} | Output Disable Time | 5.0 | 1.0 | 5.5 | 8.5 | 1.0 | 9.0 | ns | 3-8 |

*Voltage Range 5.0 is 5.0 V ± 0.5 V

AC OPERATING REQUIREMENTS

| Symbol | Parameter | V _{CC} * (V) | 74ACT | | 74ACT | | Units | Fig. No. |
|----------------|---|-----------------------|--|--------------------|--|--|-------|----------|
| | | | T _A = +25°C C _L = 50 pF | | T _A = -40°C to +85°C C _L = 50 pF | | | |
| | | | Typ | Guaranteed Minimum | | | | |
| t _s | Setup Time, HIGH or LOW D _n to CP | 5.0 | 1.5 | 2.5 | 2.5 | | ns | 3-9 |
| t _h | Hold Time, HIGH or LOW D _n to CP | 5.0 | -0.5 | 1.0 | 1.0 | | ns | 3-9 |
| t _w | CP Pulse Width HIGH or LOW | 5.0 | 2.5 | 3.0 | 4.0 | | ns | 3-6 |

*Voltage Range 3.3 is 3.3 V ± 0.3 V
Voltage Range 5.0 is 5.0 V ± 0.5 V

CAPACITANCE

| Symbol | Parameter | Value Typ | Units | Test Conditions |
|-----------------|-------------------------------|--------------|-------|-------------------------|
| C _{IN} | Input Capacitance | 4.5 | pF | V _{CC} = 5.0 V |
| C _{PD} | Power Dissipation Capacitance | 40 | pF | V _{CC} = 5.0 V |



MOTOROLA

Product Preview

Octal Bidirectional Transceiver with 3-State Outputs

The MC74AC640/74ACT640 octal bus transceiver is designed for asynchronous two-way communication between data buses. The device transmits data from bus A to bus B when $T/\bar{R} = \text{HIGH}$, or from bus B to bus A when $T/\bar{R} = \text{LOW}$. The enable input can be used to disable the device so the buses are effectively isolated.

- Bidirectional Data Path
- A and B Outputs Sink 24 mA/Source - 24 mA
- 'ACT640 Has TTL Compatible Inputs

PIN NAMES

- A₀-A₇ Side A Inputs or 3-State Outputs
- $\bar{O}E$ Output Enable Input
- T/ \bar{R} Transmit/Receive Input
- B₀-B₇ Side B Inputs or 3-State Outputs

TRUTH TABLE

| $\bar{O}E$ | T/ \bar{R} | Applied Inputs | Valid Direction I/P→O/P | Output |
|------------|--------------|----------------|-------------------------|--------|
| H | X | X | X | X |
| L | H | H | A to B | L |
| L | H | L | A to B | H |
| L | L | H | B to A | L |
| L | L | L | B to A | H |

H = HIGH Voltage Level
 L = LOW Voltage Level
 X = Immaterial

**MC74AC640
MC74ACT640**

**OCTAL BIDIRECTIONAL
TRANSCIVER WITH
3-STATE OUTPUTS**

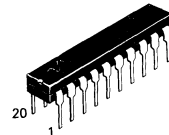

**N SUFFIX
CASE 738-03
PLASTIC**

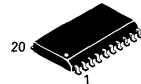

**DW SUFFIX
CASE 751D-03
PLASTIC**

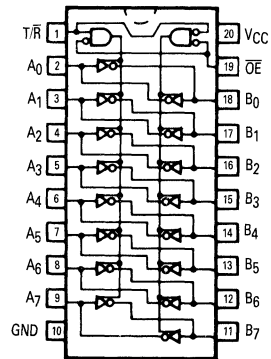

5

This document contains information on a product under development. Motorola reserves the right to change or discontinue this product without notice.

MC74AC640 • MC74ACT640

DC CHARACTERISTICS (unless otherwise specified)

| Symbol | Parameter | Value | Units | Test Conditions |
|--------------------|---|-------|-------|---|
| I _{CC} | Maximum Quiescent Supply Current | 80 | μA | V _{IN} = V _{CC} or Ground, V _{CC} = 5.5 V, T _A = Worst Case |
| I _{CC} | Maximum Quiescent Supply Current | 8.0 | μA | V _{IN} = V _{CC} or Ground, V _{CC} = 5.5 V, T _A = 25°C |
| I _{CC(T)} | Maximum Additional I _{CC} /Input (*ACT640) | 1.5 | mA | V _{IN} = V _{CC} - 2.1 V, V _{CC} = 5.5 V, T _A = Worst Case |

AC CHARACTERISTICS (For Figures and Waveforms — See Section 3)

| Symbol | Parameter | V _{CC} * (V) | 74AC | | | 74AC | | Units | Fig. No. |
|------------------|---|-----------------------|--|------------|-----|--|-----|-------|----------|
| | | | T _A = +25°C C _L = 50 pF | | | T _A = -40°C to +85°C C _L = 50 pF | | | |
| | | | Min | Typ | Max | Min | Max | | |
| t _{PLH} | Propagation Delay A _n to B _n or B _n to A _n | 3.3 5.0 | | 5.5 4.0 | | | ns | 3-5 | |
| t _{PHL} | Propagation Delay A _n to B _n or B _n to A _n | 3.3 5.0 | | 5.5 4.0 | | | ns | 3-5 | |
| t _{PZH} | Output Enable Time | 3.3 5.0 | | 8.0 6.0 | | | ns | 3-7 | |
| t _{PZL} | Output Enable Time | 3.3 5.0 | | 7.5 5.5 | | | ns | 3-8 | |
| t _{PHZ} | Output Disable Time | 3.3 5.0 | | 7.0 6.0 | | | ns | 3-7 | |
| t _{PLZ} | Output Disable Time | 3.3 5.0 | | 7.5 6.0 | | | ns | 3-8 | |

*Voltage Range 3.3 is 3.3 V ± 0.3 V
Voltage Range 5.0 is 5.0 V ± 0.5 V

AC CHARACTERISTICS (For Figures and Waveforms — See Section 3)

| Symbol | Parameter | V _{CC} * (V) | 74ACT | | | 74ACT | | Units | Fig. No. |
|------------------|---|-----------------------|--|-----|-----|--|-----|-------|----------|
| | | | T _A = +25°C C _L = 50 pF | | | T _A = -40°C to +85°C C _L = 50 pF | | | |
| | | | Min | Typ | Max | Min | Max | | |
| t _{PLH} | Propagation Delay A _n to B _n or B _n to A _n | 5.0 | | 5.0 | | | ns | 3-5 | |
| t _{PHL} | Propagation Delay A _n to B _n or B _n to A _n | 5.0 | | 5.0 | | | ns | 3-5 | |
| t _{PZH} | Output Enable Time | 5.0 | | 7.0 | | | ns | 3-7 | |
| t _{PZL} | Output Enable Time | 5.0 | | 6.0 | | | ns | 3-8 | |
| t _{PHZ} | Output Disable Time | 5.0 | | 6.5 | | | ns | 3-7 | |
| t _{PLZ} | Output Disable Time | 5.0 | | 6.0 | | | ns | 3-8 | |

*Voltage Range 5.0 is 5.0 V ± 0.5 V

CAPACITANCE

| Symbol | Parameter | Value Typ | Units | Test Conditions |
|------------------|-------------------------------|--------------|-------|-------------------------|
| C _{IN} | Input Capacitance | 4.5 | pF | V _{CC} = 5.0 V |
| C _{I/O} | Input/Output Capacitance | 15 | pF | V _{CC} = 5.0 V |
| C _{PD} | Power Dissipation Capacitance | | pF | V _{CC} = 5.0 V |



MOTOROLA

Product Preview

Octal Bidirectional Transceiver with 3-State Outputs

The MC74AC643/74ACT643 octal bus transceiver is designed for asynchronous two-way communication between data buses. The device transmits data from bus A to bus B when $T/\bar{R} = \text{HIGH}$, or from bus B to bus A when $T/\bar{R} = \text{LOW}$. The enable input can be used to disable the device so the buses are effectively isolated.

- Noninverting Buffers
- Bidirectional Data Path
- A and B Outputs Sink 24 mA/Source - 24 mA
- 'ACT643 Has TTL Compatible Inputs

PIN NAMES

- A_0 - A_7 Side A Inputs or 3-State Outputs
- $\bar{O}E$ Output Enable Input
- T/\bar{R} Transmit/Receive Input
- B_0 - B_7 Side B Inputs or 3-State Outputs

TRUTH TABLE

| $\bar{O}E$ | T/\bar{R} | Applied Inputs | Valid Direction I/P→O/P | Output |
|------------|-------------|----------------|-------------------------|--------|
| H | X | X | X | X |
| L | H | H | A to B | L |
| L | H | L | A to B | H |
| L | L | H | B to A | H |
| L | L | L | B to A | L |

H = HIGH Voltage Level
 L = LOW Voltage Level
 X = Immaterial

**MC74AC643
 MC74ACT643**

**OCTAL BIDIRECTIONAL
 TRANSCIVER WITH
 3-STATE OUTPUTS**

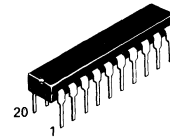

**N SUFFIX
 CASE 738-03
 PLASTIC**

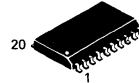

**DW SUFFIX
 CASE 751D-03
 PLASTIC**

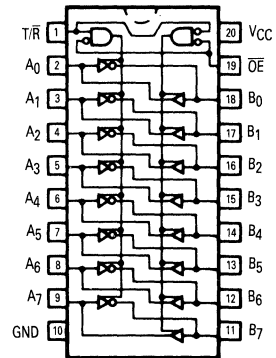

5

This document contains information on a product under development. Motorola reserves the right to change or discontinue this product without notice.

MC74AC643 • MC74ACT643

DC CHARACTERISTICS (unless otherwise specified)

| Symbol | Parameter | Value | Units | Test Conditions |
|-------------------|--|-------|-------|---|
| I _{CC} | Maximum Quiescent Supply Current | 80 | μA | V _{IN} = V _{CC} or Ground, V _{CC} = 5.5 V, T _A = Worst Case |
| I _{CC} | Maximum Quiescent Supply Current | 8.0 | μA | V _{IN} = V _{CC} or Ground, V _{CC} = 5.5 V, T _A = 25°C |
| I _{CC} T | Maximum Additional I _{CC} /Input (ACT643) | 1.5 | mA | V _{IN} = V _{CC} - 2.1 V, V _{CC} = 5.5 V, T _A = Worst Case |

AC CHARACTERISTICS (For Figures and Waveforms — See Section 3)

| Symbol | Parameter | V _{CC} * (V) | 74ACT | | | 74ACT | | Units | Fig. No. |
|------------------|---|-----------------------|--|------------|-----|--|-----|-------|----------|
| | | | T _A = +25°C C _L = 50 pF | | | T _A = -40°C to +85°C C _L = 50 pF | | | |
| | | | Min | Typ | Max | Min | Max | | |
| t _{PLH} | Propagation Delay A _n to B _n or B _n to A _n | 3.3 5.0 | | 5.5 4.0 | | | ns | 3-5 | |
| t _{PHL} | Propagation Delay A _n to B _n or B _n to A _n | 3.3 5.0 | | 5.5 4.0 | | | ns | 3-5 | |
| t _{PZH} | Output Enable Time | 3.3 5.0 | | 8.0 6.0 | | | ns | 3-7 | |
| t _{PZL} | Output Enable Time | 3.3 5.0 | | 7.5 5.5 | | | ns | 3-8 | |
| t _{PHZ} | Output Disable Time | 3.3 5.0 | | 7.0 6.0 | | | ns | 3-7 | |
| t _{PLZ} | Output Disable Time | 3.3 5.0 | | 7.5 6.0 | | | ns | 3-8 | |

*Voltage Range 3.3 is 3.3 V ± 0.3 V
Voltage Range 5.0 is 5.0 V ± 0.5 V

AC CHARACTERISTICS (For Figures and Waveforms — See Section 3)

| Symbol | Parameter | V _{CC} * (V) | 74ACT | | | 74ACT | | Units | Fig. No. |
|------------------|---|-----------------------|--|-----|-----|--|-----|-------|----------|
| | | | T _A = +25°C C _L = 50 pF | | | T _A = -40°C to +85°C C _L = 50 pF | | | |
| | | | Min | Typ | Max | Min | Max | | |
| t _{PLH} | Propagation Delay A _n to B _n or B _n to A _n | 5.0 | | 5.0 | | | ns | 3-5 | |
| t _{PHL} | Propagation Delay A _n to B _n or B _n to A _n | 5.0 | | 5.0 | | | ns | 3-5 | |
| t _{PZH} | Output Enable Time | 5.0 | | 7.0 | | | ns | 3-7 | |
| t _{PZL} | Output Enable Time | 5.0 | | 6.0 | | | ns | 3-8 | |
| t _{PHZ} | Output Disable Time | 5.0 | | 6.5 | | | ns | 3-7 | |
| t _{PLZ} | Output Disable Time | 5.0 | | 6.0 | | | ns | 3-8 | |

*Voltage Range 5.0 is 5.0 V ± 0.5 V

CAPACITANCE

| Symbol | Parameter | Value Typ | Units | Test Conditions |
|------------------|-------------------------------|--------------|-------|-------------------------|
| C _{IN} | Input Capacitance | 4.5 | pF | V _{CC} = 5.0 V |
| C _{I/O} | Input/Output Capacitance | 15 | pF | V _{CC} = 5.0 V |
| C _{PD} | Power Dissipation Capacitance | | pF | V _{CC} = 5.0 V |



MOTOROLA

Product Preview

Octal Transceiver/Register with 3-State Outputs (Non-Inverting)

The MC74AC646 consists of registered bus transceiver circuits, with outputs, D-type flip-flops and control circuitry providing multiplexed transmission of data directly from the input bus or from the internal storage registers. Data on the A or B bus will be loaded into the respective registers on the LOW-to-HIGH transition of the appropriate clock pin (CAB or CBA). The four fundamental data handling functions available are illustrated in the following figures.

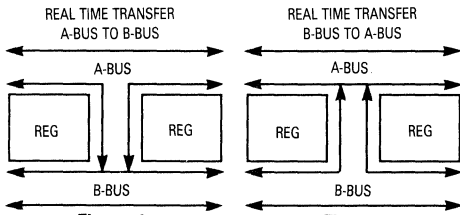

Figure 1

Figure 2

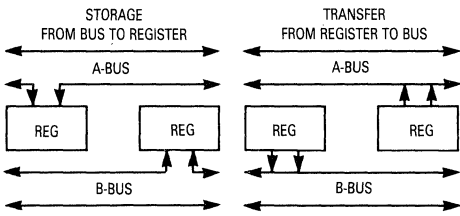
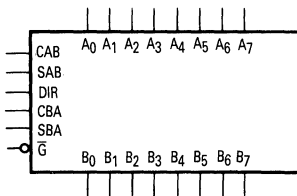

Figure 3

Figure 4

- Independent Registers for A and B Buses
- Multiplexed Real-Time and Stored Data Transfers
- Choice of True and Inverting Data Paths
- 3-State Outputs
- 300 mil Slim Dual In-Line Package
- Outputs Source/Sink 24 mA

LOGIC SYMBOL



PIN NAMES

- A₀-A₇ Data Register Inputs
- B₀-B₇ Data Register A Outputs
- Data Register B Outputs
- Data Register B Outputs
- CAB, CBA Clock Pulse Inputs
- SAB, SBA Transmit/Receive Inputs
- DIR, G-bar Output Enable Inputs

MC74AC646

OCTAL
TRANSCIVER/REGISTER
WITH 3-STATE OUTPUTS
(NON-INVERTING)

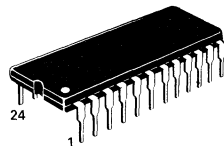

N SUFFIX
CASE 649-03
PLASTIC

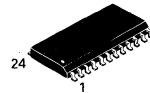

DW SUFFIX
CASE 751E-02
PLASTIC

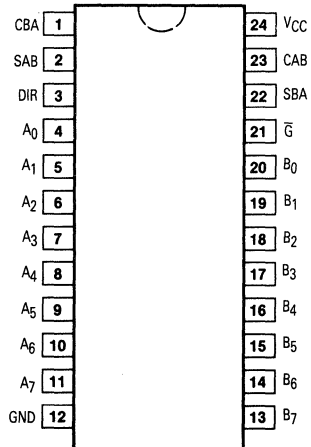

5

This document contains information on a product under development. Motorola reserves the right to change or discontinue this product without notice.

MC74AC646

FUNCTION TABLE

| Inputs | | | | | | Data I/O* | | Operation or Function |
|-----------|-----|--------------|--------------|-----|-----|--------------------------------|--------------------------------|---|
| \bar{G} | DIR | CAB | CBA | SAB | SBA | A ₀ -A ₇ | B ₀ -B ₇ | |
| H | X | H or L | H or L | X | X | Input | Input | Isolation Store A and B Data |
| H | X | \downarrow | \downarrow | X | X | | | |
| L | L | X | X | X | L | Output | Input | Real Time B Data to A Bus Stored B Data to A Bus |
| L | L | X | X | X | H | | | |
| L | H | X | X | L | X | Input | Output | Real Time A Data to B Bus Stored A Data to B Bus |
| L | H | H or L | X | H | X | | | |

*The data output functions may be enabled or disabled by various signals at the \bar{G} and DIR inputs. Data input functions are always enabled; i.e., data at the bus pins will be stored on every LOW-to-HIGH transition of the appropriate clock inputs.

H = HIGH Voltage Level
 L = LOW Voltage Level
 X = Immaterial
 \downarrow = LOW-to-HIGH Transition

LOGIC DIAGRAM

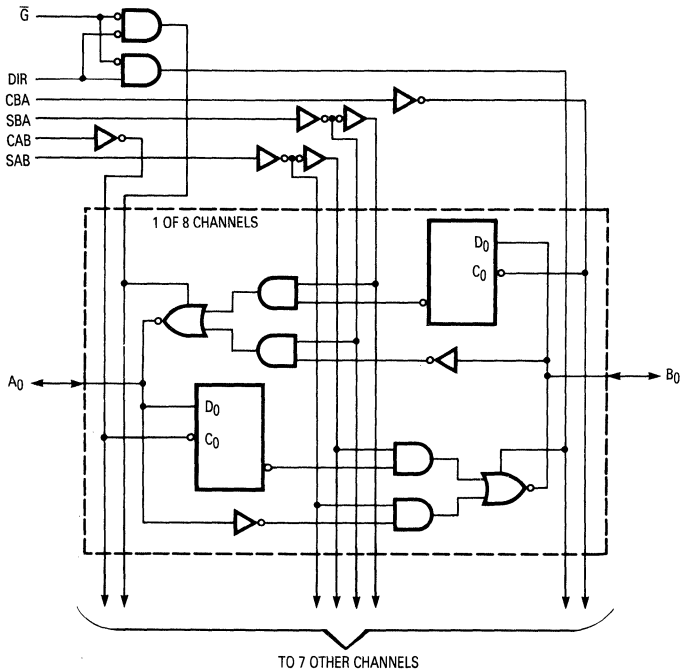

Please note that this diagram is provided only for the understanding of logic operations and should not be used to estimate propagation delays.

5

MC74AC646

DC CHARACTERISTICS (unless otherwise specified)

| Symbol | Parameter | Value | Units | Test Conditions |
|----------|----------------------------------|-------|---------|--|
| I_{CC} | Maximum Quiescent Supply Current | 80 | μA | $V_{IN} = V_{CC}$ or Ground, $V_{CC} = 5.5 V$, $T_A = \text{Worst Case}$ |
| I_{CC} | Maximum Quiescent Supply Current | 8.0 | μA | $V_{IN} = V_{CC}$ or Ground, $V_{CC} = 5.5 V$, $T_A = 25^\circ C$ |

AC CHARACTERISTICS (For Figures and Waveforms — See Section 3)

| Symbol | Parameter | V_{CC}^* (V) | 74AC | | | 74AC | | Units | Fig. No. |
|-----------|--|-------------------|--------------------------------------|-------------|--------------|--|--------------|-------|----------|
| | | | $T_A = +25^\circ C$ $C_L = 50 pF$ | | | $T_A = -40^\circ C$ to $+85^\circ C$ $C_L = 50 pF$ | | | |
| | | | Min | Typ | Max | Min | Max | | |
| t_{PLH} | Propagation Delay Clock to Bus | 3.3 5.0 | 1.0 1.0 | 10.5 7.5 | 16.5 12 | 1.0 1.0 | 18.5 13 | ns | 3-6 |
| t_{PHL} | Propagation Delay Clock to Bus | 3.3 5.0 | 1.0 1.0 | 9.5 6.5 | 14.5 10.5 | 1.0 1.0 | 16 11.5 | ns | 3-6 |
| t_{PLH} | Propagation Delay Bus to Bus | 3.3 5.0 | 1.0 1.0 | 7.5 5.0 | 12 8.0 | 1.0 1.0 | 13.5 9.0 | ns | 3-5 |
| t_{PHL} | Propagation Delay Bus to Bus | 3.3 5.0 | 1.0 1.0 | 7.5 5.0 | 12.5 9.0 | 1.0 1.0 | 13.5 9.5 | ns | 3-5 |
| t_{PLH} | Propagation Delay SBA or SAB to A_N or B_N (w/ A_N or B_N HIGH or LOW) | 3.3 5.0 | 1.0 1.0 | 8.5 6.0 | 13.5 10 | 1.0 1.0 | 15.5 11 | ns | 3-6 |
| t_{PHL} | Propagation Delay SBA or SAB to A_N or B_N (w/ A_N or B_N HIGH or LOW) | 3.3 5.0 | 1.0 1.0 | 8.5 6.0 | 13.5 10 | 1.0 1.0 | 15 11 | ns | 3-6 |
| t_{PZH} | Enable Time \bar{G} to A_N or B_N | 3.3 5.0 | 1.0 1.0 | 7.0 5.0 | 11.5 8.5 | 1.0 1.0 | 12.5 9.0 | ns | 3-7 |
| t_{PZL} | Enable Time \bar{G} to A_N or B_N | 3.3 5.0 | 1.0 1.0 | 7.5 5.5 | 12.5 9.0 | 1.0 1.0 | 14 10 | ns | 3-8 |
| t_{PHZ} | Disable Time \bar{G} to A_N or B_N | 3.3 5.0 | 1.0 1.0 | 8.0 6.5 | 12.5 10 | 1.0 1.0 | 13.5 11 | ns | 3-7 |
| t_{PLZ} | Disable Time \bar{G} to A_N or B_N | 3.3 5.0 | 1.0 1.0 | 7.5 6.0 | 12 9.5 | 1.0 1.0 | 13.5 10.5 | ns | 3-8 |

*Voltage Range 3.3 is $3.3 V \pm 0.3 V$
Voltage Range 5.0 is $5.0 V \pm 0.5 V$

MC74AC646

AC CHARACTERISTICS — continued (For Figures and Waveforms — See Section 3)

| Symbol | Parameter | V _{CC} * (V) | 74AC | | | 74AC | | Units | Fig. No. |
|------------------|---|-----------------------|--|------------|-------------|--|--------------|-------|----------|
| | | | T _A = +25°C C _L = 50 pF | | | T _A = -40°C to +85°C C _L = 50 pF | | | |
| | | | Min | Typ | Max | Min | Max | | |
| t _{PZH} | Enable Time DIR to A _n or B _n | 3.3 5.0 | 1.0 1.0 | 6.5 5.0 | 11 7.5 | 1.0 1.0 | 12 8.5 | ns | 3-7 |
| t _{PZL} | Enable Time DIR to A _n or B _n | 3.3 5.0 | 1.0 1.0 | 7.0 5.0 | 11.5 8.0 | 1.0 1.0 | 13 9.0 | ns | 3-8 |
| t _{PHZ} | Disable Time DIR to A _n or B _n | 3.3 5.0 | 1.0 1.0 | 7.5 5.5 | 11.5 9.5 | 1.0 1.0 | 12.5 10 | ns | 3-7 |
| t _{PLZ} | Disable Time DIR to A _n or B _n | 3.3 5.0 | 1.0 1.0 | 7.5 5.5 | 12 9.5 | 1.0 1.0 | 13.5 10.5 | ns | 3-8 |

*Voltage Range 3.3 is 3.3 V ± 0.3 V
Voltage Range 5.0 is 5.0 V ± 0.5 V

AC OPERATING REQUIREMENTS

| Symbol | Parameter | V _{CC} * (V) | 74AC | | 74AC | | Units | Fig. No. |
|----------------|---|-----------------------|--|--------------------|--|----|-------|----------|
| | | | T _A = +25°C C _L = 50 pF | | T _A = -40°C to +85°C C _L = 50 pF | | | |
| | | | Typ | Guaranteed Minimum | | | | |
| t _s | Setup time, HIGH or LOW Bus to Clock | 3.3 5.0 | 2.0 1.5 | 5.0 4.0 | 5.5 4.5 | ns | 3-9 | |
| t _h | Hold Time, HIGH or LOW Bus to Clock | 3.3 5.0 | -1.5 -0.5 | 0 0.5 | 0 1.0 | ns | 3-9 | |
| t _w | Clock Pulse Width HIGH or LOW | 3.3 5.0 | 2.0 2.0 | 3.5 3.5 | 4.5 3.5 | ns | 3-6 | |

*Voltage Range 3.3 is 3.3 V ± 0.3 V
Voltage Range 5.0 is 5.0 V ± 0.5 V

CAPACITANCE

| Symbol | Parameter | Value Typ | Units | Test Conditions |
|------------------|-------------------------------|--------------|-------|-------------------------|
| C _{IN} | Input Capacitance | 4.5 | pF | V _{CC} = 5.0 V |
| C _{I/O} | Input/Output Capacitance | 15 | pF | V _{CC} = 5.0 V |
| C _{PD} | Power Dissipation Capacitance | 60 | pF | V _{CC} = 5.0 V |



MOTOROLA

Product Preview

Octal Transceiver/Register with 3-State Outputs (Inverting)

The MC74AC648 consists of registered bus transceiver circuits, with outputs, D-type flip-flops and control circuitry providing multiplexed transmission of data directly from the input bus or from the internal storage registers. Data on the A or B bus will be loaded into the respective registers on the LOW-to-HIGH transition of the appropriate clock pin (CAB or CBA). The four fundamental data handling functions available are illustrated in the following figures.

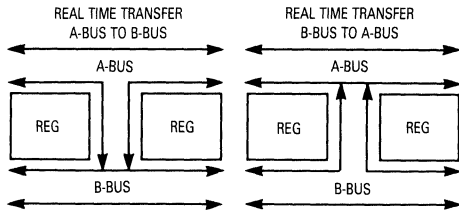

Figure 1

Figure 2

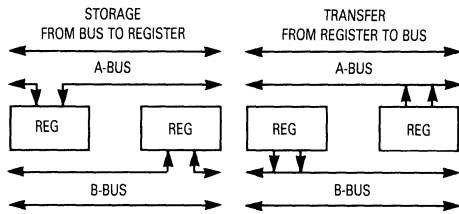
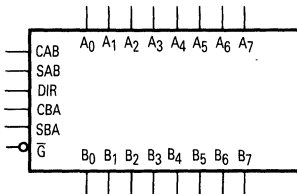

Figure 3

Figure 4

- Independent Registers for A and B Buses
- Multiplexed Real-Time and Stored Data Transfers
- Choice of True and Inverting Data Paths
- 3-State Outputs
- 300 mil Slim Dual In-Line Package
- Outputs Source/Sink 24 mA

LOGIC SYMBOL



MC74AC648

OCTAL
TRANSCIVER/REGISTER
WITH 3-STATE OUTPUTS
(INVERTING)

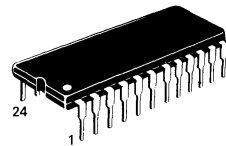

N SUFFIX
CASE 649-03
PLASTIC

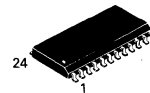

DW SUFFIX
CASE 751E-02
PLASTIC

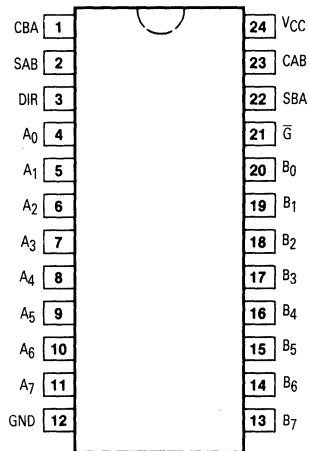

PIN NAMES

- A₀-A₇ Data Register Inputs
- A₀-A₇ Data Register A Outputs
- B₀-B₇ Data Register B Inputs
- B₀-B₇ Data Register B Outputs
- CAB, CBA Clock Pulse Inputs
- SAB, SBA Transmit/Receive Inputs
- DIR, G-bar Output Enable Inputs

This document contains information on a product under development. Motorola reserves the right to change or discontinue this product without notice.

MC74AC648

FUNCTION TABLE

| Inputs | | | | | | Data I/O* | | Operation or Function |
|-----------|-----|----------|----------|-----|-----|--------------------------------|--------------------------------|---|
| \bar{G} | DIR | CAB | CBA | SAB | SBA | A ₀ -A ₇ | B ₀ -B ₇ | |
| H | X | H or L | H or L | X | X | Input | Input | Isolation Store A and B Data |
| H | X | \lceil | \lceil | X | X | | | |
| L | L | X | X | X | L | Output | Input | Real Time \bar{B} Data to A Bus Stored \bar{B} Data to A Bus |
| L | L | X | X | X | H | | | |
| L | H | X | X | L | X | Input | Output | Real Time \bar{A} Data to B Bus Stored \bar{A} Data to B Bus |
| L | H | H or L | X | H | X | | | |

*The data output functions may be enabled or disabled by various signals at the G and DIR inputs. Data input functions are always enabled; i.e., data at the bus pins will be stored on every LOW-to-HIGH transition of the appropriate clock inputs.

H = HIGH Voltage Level
 L = LOW Voltage Level
 X = Immaterial
 \lceil = LOW-to-HIGH Transition

LOGIC DIAGRAM

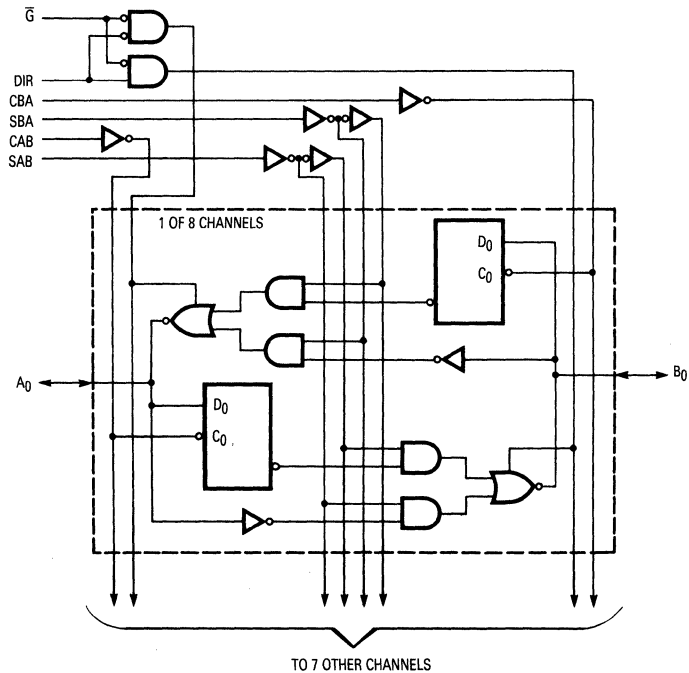

Please note that this diagram is provided only for the understanding of logic operations and should not be used to estimate propagation delays.

5

MC74AC648

DC CHARACTERISTICS (unless otherwise specified)

| Symbol | Parameter | Value | Units | Test Conditions |
|----------|----------------------------------|-------|---------|---|
| I_{CC} | Maximum Quiescent Supply Current | 80 | μA | $V_{IN} = V_{CC}$ or Ground, $V_{CC} = 5.5 V, T_A = \text{Worst Case}$ |
| I_{CC} | Maximum Quiescent Supply Current | 8.0 | μA | $V_{IN} = V_{CC}$ or Ground, $V_{CC} = 5.5 V, T_A = 25^\circ C$ |

AC CHARACTERISTICS (For Figures and Waveforms — See Section 3)

| Symbol | Parameter | V_{CC}^* (V) | 74AC | | | 74AC | | Units | Fig. No. |
|-----------|--|-------------------|--------------------------------------|-----|------|--|------|-------|----------|
| | | | $T_A = +25^\circ C$ $C_L = 50 pF$ | | | $T_A = -40^\circ C$ to $+85^\circ C$ $C_L = 50 pF$ | | | |
| | | | Min | Typ | Max | Min | Max | | |
| t_{PLH} | Propagation Delay Clock to Bus | 3.3 | 1.0 | 10 | 15.5 | 1.0 | 17 | ns | 3-6 |
| | | 5.0 | 1.0 | 7.0 | 11 | 1.0 | 12 | | |
| t_{PHL} | Propagation Delay Clock to Bus | 3.3 | 1.0 | 8.5 | 13.5 | 1.0 | 14.5 | ns | 3-6 |
| | | 5.0 | 1.0 | 6.0 | 10.5 | 1.0 | 11.5 | | |
| t_{PLH} | Propagation Delay Bus to Bus | 3.3 | 1.0 | 6.0 | 10 | 1.0 | 11 | ns | 3-5 |
| | | 5.0 | 1.0 | 4.0 | 7.0 | 1.0 | 7.5 | | |
| t_{PHL} | Propagation Delay Bus to Bus | 3.3 | 1.0 | 5.5 | 9.0 | 1.0 | 10 | ns | 3-5 |
| | | 5.0 | 1.0 | 3.5 | 7.5 | 1.0 | 8.0 | | |
| t_{PLH} | Propagation Delay SBA or SAB to A_n or B_n (w/ A_n or B_n HIGH or LOW) | 3.3 | 1.0 | 7.5 | 12.5 | 1.0 | 14 | ns | 3-6 |
| | | 5.0 | 1.0 | 5.5 | 9.0 | 1.0 | 10 | | |
| t_{PHL} | Propagation Delay SBA or SAB to A_n or B_n (w/ A_n or B_n HIGH or LOW) | 3.3 | 1.0 | 7.5 | 12.5 | 1.0 | 14 | ns | 3-6 |
| | | 5.0 | 1.0 | 5.5 | 9.5 | 1.0 | 10.5 | | |
| t_{PZH} | Enable Time \bar{G} to A_n or B_n | 3.3 | 1.0 | 6.5 | 11 | 1.0 | 11.5 | ns | 3-7 |
| | | 5.0 | 1.0 | 5.0 | 8.0 | 1.0 | 9.0 | | |
| t_{PZL} | Enable Time \bar{G} to A_n or B_n | 3.3 | 1.0 | 7.0 | 11 | 1.0 | 12.5 | ns | 3-8 |
| | | 5.0 | 1.0 | 5.0 | 8.0 | 1.0 | 9.0 | | |
| t_{PHZ} | Disable Time \bar{G} to A_n or B_n | 3.3 | 1.0 | 7.5 | 12 | 1.0 | 13 | ns | 3-7 |
| | | 5.0 | 1.0 | 6.0 | 10 | 1.0 | 11 | | |
| t_{PLZ} | Disable Time \bar{G} to A_n or B_n | 3.3 | 1.0 | 7.0 | 11.5 | 1.0 | 12.5 | ns | 3-8 |
| | | 5.0 | 1.0 | 5.5 | 9.0 | 1.0 | 10 | | |

*Voltage Range 3.3 is $3.3 V \pm 0.3 V$
Voltage Range 5.0 is $5.0 V \pm 0.5 V$

MC74AC648

AC CHARACTERISTICS — continued (For Figures and Waveforms — See Section 3)

| Symbol | Parameter | V _{CC} * (V) | 74AC | | | 74AC | | Units | Fig. No. |
|------------------|---|--------------------------|--|------------|-------------|--|--------------|-------|----------|
| | | | T _A = +25°C C _L = 50 pF | | | T _A = -40°C to +85°C C _L = 50 pF | | | |
| | | | Min | Typ | Max | Min | Max | | |
| t _{PZH} | Enable Time DIR to A _n or B _n | 3.3 5.0 | 1.0 1.0 | 6.0 4.5 | 12.5 9.5 | 1.0 1.0 | 14 10.5 | ns | 3-7 |
| t _{PZL} | Enable Time DIR to A _n or B _n | 3.3 5.0 | 1.0 1.0 | 6.5 4.5 | 13 9.0 | 1.0 1.0 | 14.5 10.5 | ns | 3-8 |
| t _{PHZ} | Disable Time DIR to A _n or B _n | 3.3 5.0 | 1.0 1.0 | 7.0 5.5 | 11.5 9.0 | 1.0 1.0 | 13.5 10 | ns | 3-7 |
| t _{PLZ} | Disable Time DIR to A _n or B _n | 3.3 5.0 | 1.0 1.0 | 7.0 5.0 | 13.5 9.5 | 1.0 1.0 | 15 10 | ns | 3-8 |

*Voltage Range 3.3 is 3.3 V ± 0.3 V
Voltage Range 5.0 is 5.0 V ± 0.5 V

AC OPERATING REQUIREMENTS

| Symbol | Parameter | V _{CC} * (V) | 74AC | | 74AC | | Units | Fig. No. |
|----------------|---|--------------------------|--|--------------------|--|----|-------|----------|
| | | | T _A = +25°C C _L = 50 pF | | T _A = -40°C to +85°C C _L = 50 pF | | | |
| | | | Typ | Guaranteed Minimum | | | | |
| t _s | Setup time, HIGH or LOW Bus to Clock | 3.3 5.0 | 2.0 1.5 | 3.0 2.0 | 3.5 2.0 | ns | 3-9 | |
| t _h | Hold Time, HIGH or LOW Bus to Clock | 3.3 5.0 | -1.5 -0.5 | 0 1.0 | 0 1.0 | ns | 3-9 | |
| t _w | Clock Pulse Width HIGH or LOW | 3.3 5.0 | 2.0 2.0 | 3.5 3.0 | 4.0 3.0 | ns | 3-6 | |

*Voltage Range 3.3 is 3.3 V ± 0.3 V
Voltage Range 5.0 is 5.0 V ± 0.5 V

CAPACITANCE

| Symbol | Parameter | Value Typ | Units | Test Conditions |
|------------------|-------------------------------|--------------|-------|-------------------------|
| C _{I/N} | Input Capacitance | 4.5 | pF | V _{CC} = 5.0 V |
| C _{I/O} | Input/Output Capacitance | 15 | pF | V _{CC} = 5.0 V |
| C _{PD} | Power Dissipation Capacitance | 65 | pF | V _{CC} = 5.0 V |



MOTOROLA

Product Preview

8-Bit D-Type Flip-Flop

The MC74AC825/74ACT825 and MC74AC826/74ACT826 are 8-bit buffered registers. They have Clock Enable and Clear features which are ideal for parity bus interfacing in high performance microprogramming systems. Also included are multiple enables that allow multi-use control of the interface. The MC74AC825/74ACT825 has noninverting outputs; the MC74AC826/74ACT826 has inverting outputs.

The MC74AC825/74ACT825 is fully compatible with AMD's AM29825.

- Outputs Source/Sink 24 mA
- Inputs and Outputs are on Opposite Sides
- 'ACT825 and 'ACT826 Have TTL Compatible Inputs

LOGIC SYMBOL (MC74AC825/74ACT825)*

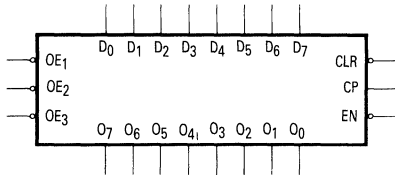

*The MC74AC826/74ACT826 has inverting outputs.

PIN NAMES

- | | |
|---|-----------------------------------|
| D ₀ -D ₇ | Data Inputs |
| Q ₀ -Q ₇ | Data Outputs (MC74AC825/74ACT825) |
| $\overline{Q_0}$ - $\overline{Q_7}$ | Data Outputs (MC74AC826/74ACT826) |
| $\overline{OE_1}$, $\overline{OE_2}$, $\overline{OE_3}$ | Output Enables |
| \overline{EN} | Clock Enable |
| \overline{CLR} | Clear |
| CP | Clock Input |

MC74AC825
MC74ACT825
MC74AC826
MC74ACT826

8-BIT D-TYPE
FLIP-FLOP

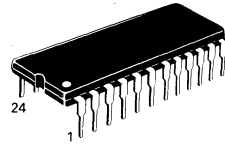

N SUFFIX
CASE 649-03
PLASTIC

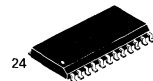

DW SUFFIX
CASE 751E-02
PLASTIC

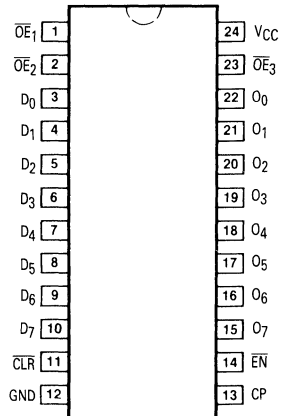

5

This document contains information on a product under development. Motorola reserves the right to change or discontinue this product without notice.

MC74AC825 • MC74ACT825 • MC74AC826 • MC74ACT826

FUNCTIONAL DESCRIPTION

The MC74AC825/74ACT825 and MC74AC826/74ACT826 consist of eight D-type edge-triggered flip-flops. These devices have 3-state outputs for bus systems, organized in a broadside pinning. In addition to the clock and output enable pins, the buffered clock (CP) and buffered Output Enable (\overline{OE}) are common to all flip-flops. The flip-flops will store the state of their individual D inputs that meet the setup and hold time requirements on the LOW-to-HIGH CP transition. With \overline{OE}_1 , \overline{OE}_2 and \overline{OE}_3 LOW, the contents of the flip-flops are available at the outputs. When one of \overline{OE}_1 , \overline{OE}_2 or \overline{OE}_3 is HIGH, the outputs go to the high impedance state.

Operation of the \overline{OE} input does not affect the state of the flip-flops. The MC74AC825/74ACT825 and MC74AC826/74ACT826 have Clear (\overline{CLR}) and Clock Enable (\overline{EN}) pins. These pins are ideal for parity bus interfacing in high performance systems.

When \overline{CLR} is LOW and \overline{OE} is LOW, the outputs are LOW. When \overline{CLR} is HIGH, data can be entered into the flip-flops. When \overline{EN} is LOW, data on the inputs is transferred to the outputs on the LOW-to-HIGH clock transition. When \overline{EN} is HIGH, the outputs do not change state, regardless of the data or clock input transitions.

FUNCTION TABLE

| Inputs | | | | | Internal | Outputs | | Function |
|-----------------|------------------|-----------------|--------------|----------------|----------|----------|-----------------------|----------|
| \overline{OE} | \overline{CLR} | \overline{EN} | CP | D _n | Q | O ('825) | \overline{O} ('826) | |
| H | X | L | \downarrow | L | L | Z | Z | High Z |
| H | X | L | \downarrow | H | H | Z | Z | High Z |
| H | L | X | X | X | L | Z | Z | Clear |
| L | L | X | X | X | L | L | L | Clear |
| H | H | H | X | X | NC | Z | Z | Hold |
| L | H | H | X | X | NC | NC | NC | Hold |
| H | H | L | \downarrow | L | L | Z | Z | Load |
| H | H | L | \downarrow | H | H | Z | Z | Load |
| L | H | L | \downarrow | L | L | L | H | Load |
| L | H | L | \downarrow | H | H | H | L | Load |

H = HIGH Voltage Level
 L = LOW Voltage Level
 X = Immaterial
 Z = High Impedance
 \downarrow = LOW-to-HIGH Transition
 NC = No Change

LOGIC DIAGRAM (MC74AC825/74ACT825)

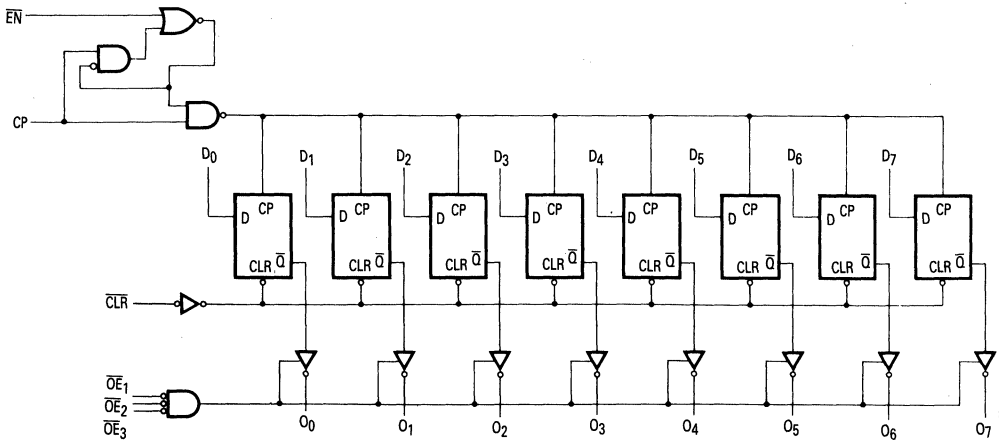

Please note that this diagram is provided only for the understanding of logic operations and should not be used to estimate propagation delays. The MC74AC826/74ACT826 also has the same logic diagram with inverting outputs.

5

MC74AC825 • MC74ACT825 • MC74AC826 • MC74ACT826

DC CHARACTERISTICS (unless otherwise specified)

| Symbol | Parameter | Value | Units | Test Conditions |
|--------------------|---|-------|-------|---|
| I _{CC} | Maximum Quiescent Supply Current | 80 | μA | V _{IN} = V _{CC} or Ground, V _{CC} = 5.5 V, T _A = Worst Case |
| I _{CC} | Maximum Quiescent Supply Current | 8.0 | μA | V _{IN} = V _{CC} or Ground, V _{CC} = 5.5 V, T _A = 25°C |
| I _{CC(T)} | Maximum Additional I _{CC} /Input (†ACT825/826) | 1.5 | mA | V _{IN} = V _{CC} - 2.1 V, V _{CC} = 5.5 V, T _A = Worst Case |

AC CHARACTERISTICS (For Figures and Waveforms — See Section 3)

| Symbol | Parameter | V _{CC} * (V) | 74AC | | | 74AC | | Units | Fig. No. |
|------------------|--|-----------------------|--|--------------|-----|--|-----|-------|----------|
| | | | T _A = +25°C C _L = 50 pF | | | T _A = -40°C to +85°C C _L = 50 pF | | | |
| | | | Min | Typ | Max | Min | Max | | |
| f _{max} | Maximum Clock Frequency | 3.3 5.0 | | 100 125 | | | MHz | 3-3 | |
| t _{PLH} | Propagation Delay CP to O _n | 3.3 5.0 | | 9.0 6.5 | | | ns | 3-6 | |
| t _{PHL} | Propagation Delay CP to O _n | 3.3 5.0 | | 9.0 6.5 | | | ns | 3-6 | |
| t _{PHL} | Propagation Delay CLR to O _n | 3.3 5.0 | | 14.5 10.5 | | | ns | 3-6 | |
| t _{PZH} | Output Enable Time OE to O _n | 3.3 5.0 | | 9.0 6.0 | | | ns | 3-7 | |
| t _{PZL} | Output Enable Time OE to O _n | 3.3 5.0 | | 9.5 6.5 | | | ns | 3-8 | |
| t _{PHZ} | Output Disable Time OE to O _n | 3.3 5.0 | | 12.5 8.5 | | | ns | 3-7 | |
| t _{PLZ} | Output Disable Time OE to O _n | 3.3 5.0 | | 12 7.5 | | | ns | 3-8 | |

*Voltage Range 3.3 is 3.3 V ± 0.3 V
Voltage Range 5.0 is 5.0 V ± 0.5 V

AC OPERATING REQUIREMENTS

| Symbol | Parameter | V _{CC} * (V) | 74AC | | 74AC | | Units | Fig. No. |
|------------------|--|-----------------------|--|--------------------|--|--|-------|----------|
| | | | T _A = +25°C C _L = 50 pF | | T _A = -40°C to +85°C C _L = 50 pF | | | |
| | | | Typ | Guaranteed Minimum | | | | |
| t _s | Setup Time, HIGH or LOW D _n to CP | 3.3 5.0 | 3.0 2.0 | | | | ns | 3-9 |
| t _h | Hold Time, HIGH or LOW D _n to CP | 3.3 5.0 | 2.0 1.5 | | | | ns | 3-9 |
| t _s | Setup Time, HIGH or LOW EN to CP | 3.3 5.0 | 3.0 2.0 | | | | ns | 3-9 |
| t _h | Hold Time, HIGH or LOW EN to CP | 3.3 5.0 | 2.0 1.5 | | | | ns | 3-9 |
| t _w | CP Pulse Width HIGH or LOW | 3.3 5.0 | 3.5 2.5 | | | | ns | 3-6 |
| t _w | CLR Pulse Width, LOW | 3.3 5.0 | 5.0 3.5 | | | | ns | 3-6 |
| t _{rec} | CLR to CP Recovery Time | 3.3 5.0 | 2.0 1.5 | | | | ns | 3-9 |

*Voltage Range 3.3 is 3.3 V ± 0.3 V
Voltage Range 5.0 is 5.0 V ± 0.5 V

MC74AC825 • MC74ACT825 • MC74AC826 • MC74ACT826

AC CHARACTERISTICS (For Figures and Waveforms — See Section 3)

| Symbol | Parameter | V _{CC} * (V) | 74ACT | | | 74ACT | | Units | Fig. No. |
|------------------|--|-----------------------|--|-----|-----|--|-----|-------|----------|
| | | | T _A = +25°C C _L = 50 pF | | | T _A = -40°C to +85°C C _L = 50 pF | | | |
| | | | Min | Typ | Max | Min | Max | | |
| f _{max} | Maximum Clock Frequency | 5.0 | | 110 | | | | MHz | 3-3 |
| t _{PLH} | Propagation Delay CP to O _n | 5.0 | | 8.0 | | | | ns | 3-6 |
| t _{PHL} | Propagation Delay CP to O _n | 5.0 | | 8.0 | | | | ns | 3-6 |
| t _{PHL} | Propagation Delay CLR to O _n | 5.0 | | 12 | | | | ns | 3-6 |
| t _{PZH} | Output Enable Time OE to O _n | 5.0 | | 7.5 | | | | ns | 3-7 |
| t _{PZL} | Output Enable Time OE to O _n | 5.0 | | 8.0 | | | | ns | 3-8 |
| t _{PHZ} | Output Disable Time OE to O _n | 5.0 | | 11 | | | | ns | 3-7 |
| t _{PLZ} | Output Disable Time OE to O _n | 5.0 | | 9.5 | | | | ns | 3-8 |

*Voltage Range 5.0 is 5.0 V ± 0.5 V

AC OPERATING REQUIREMENTS

| Symbol | Parameter | V _{CC} * (V) | 74ACT | | 74ACT | | Units | Fig. No. |
|------------------|--|-----------------------|--|--------------------|--|--|-------|----------|
| | | | T _A = +25°C C _L = 50 pF | | T _A = -40°C to +85°C C _L = 50 pF | | | |
| | | | Typ | Guaranteed Minimum | | | | |
| t _s | Setup Time, HIGH or LOW D _n to CP | 5.0 | 2.0 | | | | ns | 3-9 |
| t _h | Hold Time, HIGH or LOW D _n to CP | 5.0 | 1.0 | | | | ns | 3-9 |
| t _s | Setup Time, HIGH or LOW EN to CP | 5.0 | 2.0 | | | | ns | 3-9 |
| t _h | Hold Time, HIGH or LOW EN to CP | 5.0 | 1.5 | | | | ns | 3-9 |
| t _w | CP Pulse Width HIGH or LOW | 5.0 | 3.0 | | | | ns | 3-6 |
| t _w | CLR Pulse Width, LOW | 5.0 | 3.5 | | | | ns | 3-6 |
| t _{rec} | CLR to CP Recovery Time | 5.0 | 1.5 | | | | ns | 3-9 |

*Voltage Range 5.0 is 5.0 V ± 0.5 V

CAPACITANCE

| Symbol | Parameter | Value Typ | Units | Test Conditions |
|-----------------|-------------------------------|-----------|-------|-------------------------|
| C _{IN} | Input Capacitance | 4.5 | pF | V _{CC} = 5.0 V |
| C _{PD} | Power Dissipation Capacitance | | pF | V _{CC} = 5.0 V |



MOTOROLA

Product Preview

9-Bit Transparent Latch

The MC74AC843/74ACT843 and MC74AC844/74ACT844 bus interface latch is designed to eliminate the extra packages required to buffer existing latches and provide extra data width for wider address/data paths or buses carrying parity.

The MC74AC843/74ACT843 is functionally and pin compatible with AMD's AM29843.

- 'ACT843 and 'ACT844 Have TTL Compatible Inputs

LOGIC SYMBOL (MC74AC843/74ACT843)*

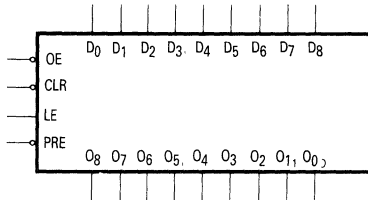

*The MC74AC844/74ACT844 has inverting outputs.

PIN NAMES

| | |
|--------------------------------|-----------------------------------|
| D ₀ -D ₈ | Data Inputs |
| O ₀ -O ₈ | Data Outputs (MC74AC843/74ACT843) |
| O ₀ -O ₈ | Data Outputs (MC74AC844/74ACT844) |
| OE | Output Enable |
| LE | Latch Enable |
| CLR | Clear |
| PRE | Preset |

MC74AC843
MC74ACT843
MC74AC844
MC74ACT844

**9-BIT
 TRANSPARENT
 LATCH**

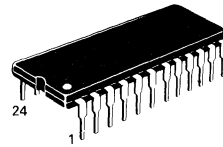

**N SUFFIX
 CASE 649-03
 PLASTIC**

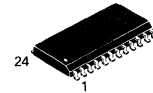

**DW SUFFIX
 CASE 751E-02
 PLASTIC**

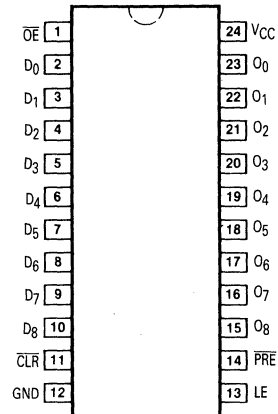

MC74AC843 • MC74ACT843 • MC74AC844 • MC74ACT844

FUNCTIONAL DESCRIPTION

The MC74AC843/74ACT843 and MC74AC844/74ACT844 consist of nine D-type latches with 3-state outputs. The flip-flops appear transparent to the data when Latch Enable (LE) is HIGH. This allows asynchronous operation, as the output transition follows the data in transition. On the LE HIGH-to-LOW transition, the data that meets the setup times is latched. Data appears on the bus when the Output Enable (OE) is LOW. When OE is HIGH, the bus output is in the high impedance state.

In addition to the LE and OE pins, the MC74AC843/74ACT843 and MC74AC844/74ACT844 have a Clear (CLR) pin and a Preset (PRE) pin. These pins are ideal for parity bus interfacing in high performance systems. When CLR is LOW, the outputs are LOW if OE is LOW. When CLR is HIGH, data can be entered into the latch. When PRE is LOW, the outputs are HIGH if OE is LOW. Preset overrides CLR.

FUNCTION TABLE

| Inputs | | | | | Internal | Outputs | | Function |
|--------|-----|----|----|---|----------|----------|-----------|---------------|
| CLR | PRE | OE | LE | D | Q | O ('843) | Ō ('844) | |
| H | H | H | H | L | L | Z | Z | High Z |
| H | H | H | H | H | H | Z | Z | High Z |
| H | H | H | L | X | NC | Z | Z | Latched |
| H | H | L | H | L | L | L | H | Transparent |
| H | H | L | H | H | H | H | L | Transparent |
| H | H | L | L | X | NC | NC | NC | Latched |
| H | L | L | X | X | H | H | L | Preset |
| L | H | L | X | X | L | L | H | Clear |
| L | L | L | X | X | H | H | L | Preset |
| L | H | H | L | X | L | Z | Z | Clear/High Z |
| H | L | H | L | X | H | Z | Z | Preset/High Z |

H = HIGH Voltage Level
 L = LOW Voltage Level
 X = Immaterial
 Z = High Impedance
 NC = No Change

LOGIC DIAGRAM (MC74AC843/74ACT843)

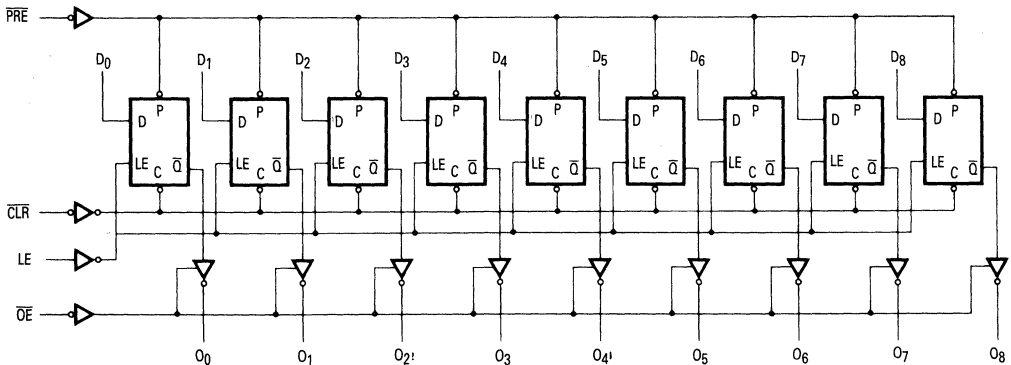

Please note that this diagram is provided only for the understanding of logic operations and should not be used to estimate propagation delays. The MC74AC844/74ACT844 also has the same logic diagram with inverting outputs.

5

MC74AC843 • MC74ACT843 • MC74AC844 • MC74ACT844

DC CHARACTERISTICS (unless otherwise specified)

| Symbol | Parameter | Value | Units | Test Conditions |
|--------------------|---|-------|-------|---|
| I _{CC} | Maximum Quiescent Supply Current | 80 | μA | V _{IN} = V _{CC} or Ground, V _{CC} = 5.5 V, T _A = Worst Case |
| I _{CC} | Maximum Quiescent Supply Current | 8.0 | μA | V _{IN} = V _{CC} or Ground, V _{CC} = 5.5 V, T _A = 25°C |
| I _{CC(T)} | Maximum Additional I _{CC} /Input (*ACT843/844) | 1.5 | mA | V _{IN} = V _{CC} - 2.1 V, V _{CC} = 5.5 V, T _A = Worst Case |

AC CHARACTERISTICS (For Figures and Waveforms — See Section 3)

| Symbol | Parameter | V _{CC} * (V) | 74AC | | | 74AC | | Units | Fig. No. |
|------------------|---|--------------------------|--|-------------|-----|--|-----|-------|----------|
| | | | T _A = +25°C C _L = 50 pF | | | T _A = -40°C to +85°C C _L = 50 pF | | | |
| | | | Min | Typ | Max | Min | Max | | |
| t _{PLH} | Propagation Delay D _n to O _n | 3.3 5.0 | | 17 12 | | | | ns | 3-5 |
| t _{PHL} | Propagation Delay D _n to O _n | 3.3 5.0 | | 16.5 11 | | | | ns | 3-5 |
| t _{PLH} | Propagation Delay LE to O _n | 3.3 5.0 | | 18.5 13 | | | | ns | 3-6 |
| t _{PHL} | Propagation Delay LE to O _n | 3.3 5.0 | | 17 12 | | | | ns | 3-6 |
| t _{PLH} | Propagation Delay PRE to O _n | 3.3 5.0 | | 17 12 | | | | ns | 3-6 |
| t _{PHL} | Propagation Delay CLR to O _n | 3.3 5.0 | | 17 12 | | | | ns | 3-6 |
| t _{PZH} | Output Enable Time OE to O _n | 3.3 5.0 | | 14.5 10 | | | | ns | 3-7 |
| t _{PZL} | Output Enable Time OE to O _n | 3.3 5.0 | | 11.5 8.0 | | | | ns | 3-8 |
| t _{PHZ} | Output Disable Time OE to O _n | 3.3 5.0 | | 13 9.0 | | | | ns | 3-7 |
| t _{PLZ} | Output Disable Time OE to O _n | 3.3 5.0 | | 13 9.0 | | | | ns | 3-8 |

*Voltage Range 3.3 is 3.3 V ± 0.3 V
Voltage Range 5.0 is 5.0 V ± 0.5 V

AC OPERATING REQUIREMENTS

| Symbol | Parameter | V _{CC} * (V) | 74AC | | 74AC | | Units | Fig. No. |
|------------------|---|-----------------------|--|--------------------|--|----|-------|----------|
| | | | T _A = +25°C C _L = 50 pF | | T _A = -40°C to +85°C C _L = 50 pF | | | |
| | | | Typ | Guaranteed Minimum | | | | |
| t _s | Setup Time, HIGH or LOW D _n to LE | 3.3 | 4.0 | | | ns | 3-9 | |
| | | 5.0 | 2.5 | | | | | |
| t _h | Hold Time, HIGH or LOW D _n to LE | 3.3 | 0 | | | ns | 3-9 | |
| | | 5.0 | 0 | | | | | |
| t _w | LE Pulse Width, HIGH | 3.3 | 4.0 | | | ns | 3-6 | |
| | | 5.0 | 2.5 | | | | | |
| t _w | PRE Pulse Width, LOW | 3.3 | 4.0 | | | ns | 3-6 | |
| | | 5.0 | 2.5 | | | | | |
| t _w | CLR Pulse Width, LOW | 3.3 | 4.0 | | | ns | 3-6 | |
| | | 5.0 | 2.5 | | | | | |
| t _{rec} | PRE Recovery Time | 3.3 | 5.0 | | | ns | 3-9 | |
| | | 5.0 | 4.0 | | | | | |
| t _{rec} | CLR Recovery Time | 3.3 | 5.0 | | | ns | 3-9 | |
| | | 5.0 | 4.0 | | | | | |

*Voltage Range 3.3 is 3.3 V ± 0.3 V
Voltage Range 5.0 is 5.0 V ± 0.5 V

AC CHARACTERISTICS (For Figures and Waveforms — See Section 3)

| Symbol | Parameter | V _{CC} * (V) | 74ACT | | | 74ACT | | Units | Fig. No. |
|------------------|---|-----------------------|--|-----|-----|--|-----|-------|----------|
| | | | T _A = +25°C C _L = 50 pF | | | T _A = -40°C to +85°C C _L = 50 pF | | | |
| | | | Min | Typ | Max | Min | Max | | |
| t _{PLH} | Propagation Delay D _n to O _n | 5.0 | | 12 | | | ns | 3-5 | |
| t _{PHL} | Propagation Delay D _n to O _n | 5.0 | | 11 | | | ns | 3-5 | |
| t _{PLH} | Propagation Delay LE to O _n | 5.0 | | 13 | | | ns | 3-6 | |
| t _{PHL} | Propagation Delay LE to O _n | 5.0 | | 12 | | | ns | 3-6 | |
| t _{PLH} | Propagation Delay PRE to O _n | 5.0 | | 12 | | | ns | 3-6 | |
| t _{PHL} | Propagation Delay CLR to O _n | 5.0 | | 12 | | | ns | 3-6 | |
| t _{PZH} | Output Enable Time OE to O _n | 5.0 | | 10 | | | ns | 3-7 | |
| t _{PZL} | Output Enable Time OE to O _n | 5.0 | | 8.0 | | | ns | 3-8 | |
| t _{PHZ} | Output Disable Time OE to O _n | 5.0 | | 9.0 | | | ns | 3-7 | |
| t _{PLZ} | Output Disable Time OE to O _n | 5.0 | | 9.0 | | | ns | 3-8 | |

*Voltage Range 5.0 is 5.0 V ± 0.5 V

5

AC OPERATING REQUIREMENTS

| Symbol | Parameter | V _{CC} * (V) | 74ACT | | Units | Fig. No. |
|------------------|---|--------------------------|--|--------------------|-------|----------|
| | | | T _A = +25°C C _L = 50 pF | | | |
| | | | Typ | Guaranteed Minimum | | |
| t _s | Setup Time, HIGH or LOW D _n to LE | 5.0 | 2.5 | | ns | 3-9 |
| t _h | Hold Time, HIGH or LOW D _n to LE | 5.0 | 0 | | ns | 3-9 |
| t _w | LE Pulse Width, HIGH | 5.0 | 2.5 | | ns | 3-6 |
| t _w | $\overline{\text{PRE}}$ Pulse Width, LOW | 5.0 | 2.5 | | ns | 3-6 |
| t _w | $\overline{\text{CLR}}$ Pulse Width, LOW | 5.0 | 2.5 | | ns | 3-6 |
| t _{rec} | $\overline{\text{PRE}}$ Recovery Time | 5.0 | 5.0 | | ns | 3-9 |
| t _{rec} | $\overline{\text{CLR}}$ Recovery Time | 5.0 | 5.0 | | ns | 3-9 |

*Voltage Range 5.0 is 5.0 V ± 0.5 V

CAPACITANCE

| Symbol | Parameter | Value Typ | Units | Test Conditions |
|-----------------|-------------------------------|--------------|-------|-------------------------|
| C _{IN} | Input Capacitance | 4.5 | pF | V _{CC} = 5.0 V |
| CPD | Power Dissipation Capacitance | | pF | V _{CC} = 5.0 V |



Product Preview

8-Bit Transparent Latch

The MC74AC845/74ACT845 and MC74AC846/74ACT846 bus interface latches are designed to eliminate the extra packages required to buffer existing latches and provide easy expansion through multiple OE controls.

The MC74AC845/74ACT845 is functionally and pin compatible with AMD's AM29845.

- 'ACT845 and 'ACT846 Have TTL Compatible Inputs

LOGIC SYMBOL (MC74AC845/74ACT845)*

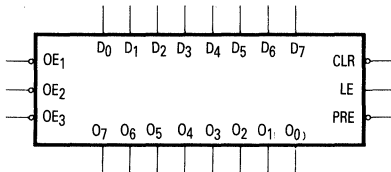

*The MC74AC846/74ACT846 has inverting outputs.

PIN NAMES

| | |
|----------------------------------|-----------------------------------|
| D ₀ -D ₇ | Data Inputs |
| O ₀ -O ₇ | Data Outputs (MC74AC845/74ACT845) |
| \bar{O}_0 - \bar{O}_7 | Data Outputs (MC74AC846/74ACT846) |
| OE ₁ -OE ₃ | Output Enables |
| LE | Latch Enable |
| CLR | Clear |
| PRE | Preset |

**MC74AC845
MC74ACT845
MC74AC846
MC74ACT846**

**8-BIT
TRANSPARENT
LATCH**

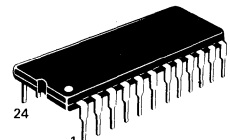

**N SUFFIX
CASE 649-03
PLASTIC**

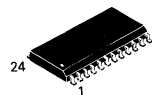

**DW SUFFIX
CASE 751E-02
PLASTIC**

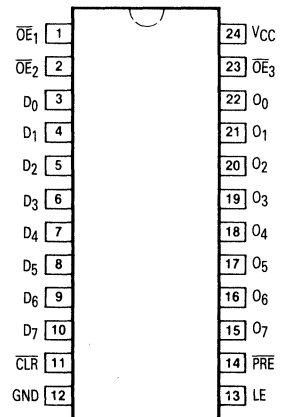

MC74AC845 • MC74ACT845 • MC74AC846 • MC74ACT846

FUNCTIONAL DESCRIPTION

The MC74AC845/74ACT845 and MC74AC846/74ACT846 consist of eight D-type latches with 3-state outputs. The flip-flops appear transparent to the data when Latch Enable (LE) is HIGH. This allows asynchronous operation as the output transition follows the data in tran-

sition. On the LE HIGH-to-LOW transition, the data that meets the setup times is latched. Data appears on the bus when the Output Enables ($\overline{OE}_1, \overline{OE}_2, \overline{OE}_3$) are LOW. When any one of $\overline{OE}_1, \overline{OE}_2$ or \overline{OE}_3 is HIGH, the bus output is in the high impedance state.

FUNCTION TABLE

| Inputs | | | | | Internal | Outputs | | Function |
|--------|-----|---|----|---|----------|----------|-----------------------|---------------|
| CLR | PRE | $\overline{OE}_1\text{--}\overline{OE}_3$ | LE | D | Q | O ('845) | \overline{O} ('846) | |
| H | H | H | H | L | L | Z | Z | High Z |
| H | H | H | H | H | H | Z | Z | High Z |
| H | H | H | L | X | NC | Z | Z | Latched |
| H | H | L | H | L | L | L | H | Transparent |
| H | H | L | H | H | H | H | L | Transparent |
| H | H | L | L | X | NC | NC | NC | Latched |
| H | L | L | X | X | H | H | L | Preset |
| L | H | L | X | X | L | L | H | Clear |
| L | L | L | X | X | H | H | L | Preset |
| L | H | H | L | X | L | Z | Z | Clear/High Z |
| H | L | H | L | X | H | Z | Z | Preset/High Z |

H = HIGH Voltage Level
 L = LOW Voltage Level
 X = Immaterial
 Z = High Impedance
 NC = No Change

LOGIC DIAGRAM (MC74AC845/74ACT845)

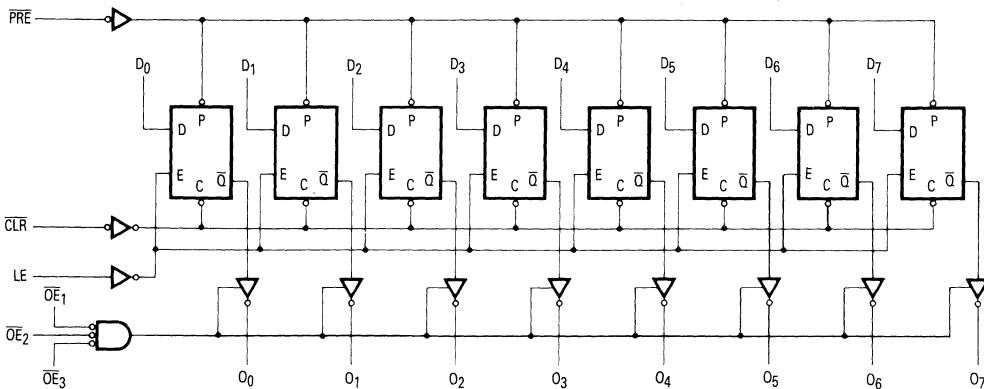

Please note that this diagram is provided only for the understanding of logic operations and should not be used to estimate propagation delays. The MC74AC846/74ACT846 also has the same logic diagram with inverting outputs.

MC74AC845 • MC74ACT845 • MC74AC846 • MC74ACT846

DC CHARACTERISTICS (unless otherwise specified)

| Symbol | Parameter | Value | Units | Test Conditions |
|--------------------|--|-------|-------|---|
| I _{CC} | Maximum Quiescent Supply Current | 80 | μA | V _{IN} = V _{CC} or Ground, V _{CC} = 5.5 V, T _A = Worst Case |
| I _{CC} | Maximum Quiescent Supply Current | 8.0 | μA | V _{IN} = V _{CC} or Ground, V _{CC} = 5.5 V, T _A = 25°C |
| I _{CC(T)} | Maximum Additional I _{CC} /Input (ACT845/846) | 1.5 | mA | V _{IN} = V _{CC} - 2.1 V, V _{CC} = 5.5 V, T _A = Worst Case |

AC CHARACTERISTICS (For Figures and Waveforms — See Section 3)

| Symbol | Parameter | V _{CC} * (V) | 74AC | | | 74AC | | Units | Fig. No. |
|------------------|---|-----------------------|--|-------------|-----|--|-----|-------|----------|
| | | | T _A = +25°C C _L = 50 pF | | | T _A = -40°C to +85°C C _L = 50 pF | | | |
| | | | Min | Typ | Max | Min | Max | | |
| t _{PLH} | Propagation Delay D _n to O _n | 3.3 5.0 | | 17 12 | | | | ns | 3-5 |
| t _{PHL} | Propagation Delay D _n to O _n | 3.3 5.0 | | 16.5 11 | | | | ns | 3-5 |
| t _{PLH} | Propagation Delay LE to O _n | 3.3 5.0 | | 18.5 13 | | | | ns | 3-6 |
| t _{PHL} | Propagation Delay LE to O _n | 3.3 5.0 | | 17 12 | | | | ns | 3-6 |
| t _{PLH} | Propagation Delay PRE to O _n | 3.3 5.0 | | 17 12 | | | | ns | 3-6 |
| t _{PHL} | Propagation Delay CLR to O _n | 3.3 5.0 | | 17 12 | | | | ns | 3-6 |
| t _{PZH} | Output Enable Time OE to O _n | 3.3 5.0 | | 14.5 10 | | | | ns | 3-7 |
| t _{PZL} | Output Enable Time OE to O _n | 3.3 5.0 | | 11.5 8.0 | | | | ns | 3-8 |
| t _{PHZ} | Output Disable Time OE to O _n | 3.3 5.0 | | 13 9.0 | | | | ns | 3-7 |
| t _{PLZ} | Output Disable Time OE to O _n | 3.3 5.0 | | 13 9.0 | | | | ns | 3-8 |

*Voltage Range 3.3 is 3.3 V ± 0.3 V
Voltage Range 5.0 is 5.0 V ± 0.5 V

5

AC OPERATING REQUIREMENTS

| Symbol | Parameter | V _{CC} * (V) | 74AC | | 74AC | | Units | Fig. No. |
|------------------|---|-----------------------|--|--------------------|--|--|-------|----------|
| | | | T _A = +25°C C _L = 50 pF | | T _A = -40°C to +85°C C _L = 50 pF | | | |
| | | | Typ | Guaranteed Minimum | | | | |
| t _s | Setup Time, HIGH or LOW D _n to LE | 3.3 5.0 | 4.0 2.5 | | | | ns | 3-9 |
| t _h | Hold Time, HIGH or LOW D _n to LE | 3.3 5.0 | 0 0 | | | | ns | 3-9 |
| t _w | LE Pulse Width, HIGH | 3.3 5.0 | 4.0 2.5 | | | | ns | 3-6 |
| t _w | PRE Pulse Width, LOW | 3.3 5.0 | 4.0 2.5 | | | | ns | 3-6 |
| t _w | CLR Pulse Width, LOW | 3.3 5.0 | 4.0 2.5 | | | | ns | 3-6 |
| t _{rec} | PRE Recovery Time | 3.3 5.0 | 5.0 4.0 | | | | ns | 3-9 |
| t _{rec} | CLR Recovery Time | 3.3 5.0 | 5.0 4.0 | | | | ns | 3-9 |

*Voltage Range 3.3 is 3.3 V ± 0.3 V
Voltage Range 5.0 is 5.0 V ± 0.5 V

AC CHARACTERISTICS (For Figures and Waveforms — See Section 3)

| Symbol | Parameter | V _{CC} * (V) | 74ACT | | | 74ACT | | Units | Fig. No. |
|------------------|---|-----------------------|--|------|-----|--|-----|-------|----------|
| | | | T _A = +25°C C _L = 50 pF | | | T _A = -40°C to +85°C C _L = 50 pF | | | |
| | | | Min | Typ | Max | Min | Max | | |
| t _{PLH} | Propagation Delay D _n to O _n | 5.0 | | 12 | | | | ns | 3-5 |
| t _{PHL} | Propagation Delay D _n to O _n | 5.0 | | 11 | | | | ns | 3-5 |
| t _{PLH} | Propagation Delay LE to O _n | 5.0 | | 13.5 | | | | ns | 3-6 |
| t _{PHL} | Propagation Delay LE to O _n | 5.0 | | 12 | | | | ns | 3-6 |
| t _{PLH} | Propagation Delay PRE to O _n | 5.0 | | 12 | | | | ns | 3-6 |
| t _{PHL} | Propagation Delay CLR to O _n | 5.0 | | 12 | | | | ns | 3-6 |
| t _{PZH} | Output Enable Time O _E to O _n | 5.0 | | 10 | | | | ns | 3-7 |
| t _{PZL} | Output Enable Time O _E to O _n | 5.0 | | 18 | | | | ns | 3-8 |
| t _{PHZ} | Output Disable Time O _E to O _n | 5.0 | | 9.0 | | | | ns | 3-7 |
| t _{PLZ} | Output Disable Time O _E to O _n | 5.0 | | 9.0 | | | | ns | 3-8 |

*Voltage Range 5.0 is 5.0 V ± 0.5 V



AC OPERATING REQUIREMENTS

| Symbol | Parameter | V _{CC} * (V) | 74ACT | | 74ACT | | Units | Fig. No. |
|------------------|---|--------------------------|--|--------------------|--|--|-------|----------|
| | | | T _A = +25°C C _L = 50 pF | | T _A = -40°C to +85°C C _L = 50 pF | | | |
| | | | Typ | Guaranteed Minimum | | | | |
| t _s | Setup Time, HIGH or LOW D _n to LE | 5.0 | 2.5 | | | | ns | 3-9 |
| t _h | Hold Time, HIGH or LOW D _n to LE | 5.0 | 0 | | | | ns | 3-9 |
| t _w | LE Pulse Width, HIGH | 5.0 | 2.5 | | | | ns | 3-6 |
| t _w | $\overline{\text{PRE}}$ Pulse Width, LOW | 5.0 | 2.5 | | | | ns | 3-6 |
| t _w | $\overline{\text{CLR}}$ Pulse Width, LOW | 5.0 | 2.5 | | | | ns | 3-6 |
| t _{rec} | $\overline{\text{PRE}}$ Recovery Time | 5.0 | 5.0 | | | | ns | 3-9 |
| t _{rec} | $\overline{\text{CLR}}$ Recovery Time | 5.0 | 5.0 | | | | ns | 3-9 |

*Voltage Range 5.0 is 5.0 V ± 0.5 V

CAPACITANCE

| Symbol | Parameter | Value Typ | Units | Test Conditions |
|-----------------|-------------------------------|--------------|-------|-------------------------|
| C _{IN} | Input Capacitance | 4.5 | pF | V _{CC} = 5.0 V |
| C _{PD} | Power Dissipation Capacitance | | pF | V _{CC} = 5.0 V |



Product Preview

14-Stage Binary Ripple Counter

The MC74AC4020 consists of 14 master-slave flip-flops with 12 stages brought out to pins. The output of each flip-flop feeds the next and the frequency at each output is half that of the preceding one. The state of the counter advances on the negative-going edge of the Clock input. Reset is asynchronous and active-high.

State changes of the Q outputs do not occur simultaneously because of internal ripple delays. Therefore, decoded output signals are subject to decoding spikes and may have to be gated with the Clock of the MC74AC4020 for some designs.

- Outputs Source/Sink 24 mA
- Operating Voltage Range: 2.0 to 6.0 V
- High Noise Immunity

LOGIC DIAGRAM

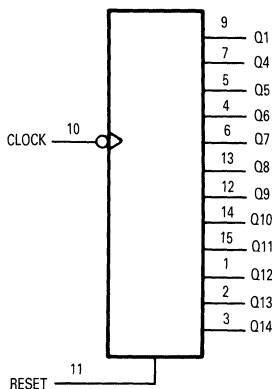

PIN 16 = V_{CC}
PIN 8 = GND

FUNCTION TABLE

| Clock | Reset | Output State |
|-------|-------|-----------------------|
| | L | No Change |
| | L | Advance to next state |
| X | H | All Outputs are low |

MC74AC4020

**14-STAGE
BINARY RIPPLE
COUNTER**

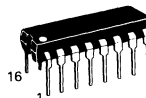

**N SUFFIX
CASE 648-08
PLASTIC**

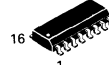

**D SUFFIX
CASE 751B-03
PLASTIC**

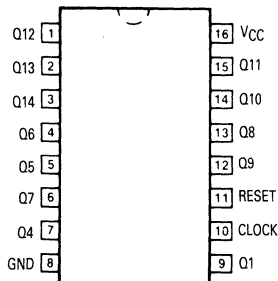



MOTOROLA

Product Preview

12-Stage Binary Ripple Counter

The MC74AC4040 consists of 12 master-slave flip-flops. The output of each flip-flop feeds the next and the frequency at each output is half that of the preceding one. The state of the counter advances on the negative-going edge of the Clock input. Reset is asynchronous and active-high.

State changes of the Q outputs do not occur simultaneously because of internal ripple delays. Therefore, decoded output signals are subject to decoding spikes and may have to be gated with the Clock of the MC74AC4040 for some designs.

- Outputs Source/Sink 24 mA
- Operating Voltage Range: 2.0 to 6.0 V
- High Noise Immunity

LOGIC DIAGRAM

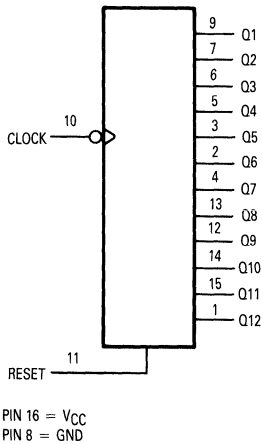

FUNCTION TABLE

| Clock | Reset | Output State |
|-------|-------|-----------------------|
| | L | No Change |
| | L | Advance to next state |
| X | H | All Outputs are low |

MC74AC4040

**12-STAGE
BINARY RIPPLE
COUNTER**

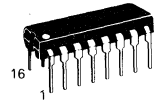

**N SUFFIX
CASE 648-08
PLASTIC**

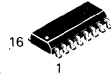

**D SUFFIX
CASE 751B-03
PLASTIC**

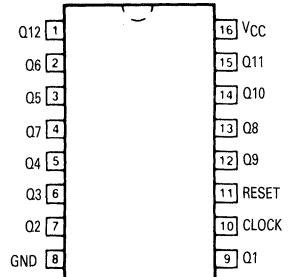

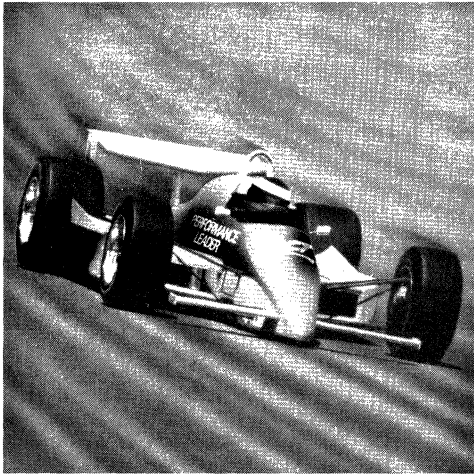

Package Outlines and Ordering Information

Package Outlines and Ordering Information

Ordering Information

The Product Index and Selection Guide in Section 1 lists only the basic device numbers. This basic number is used to form part of a simplified purchasing code where the package type and temperature range are defined as follows:

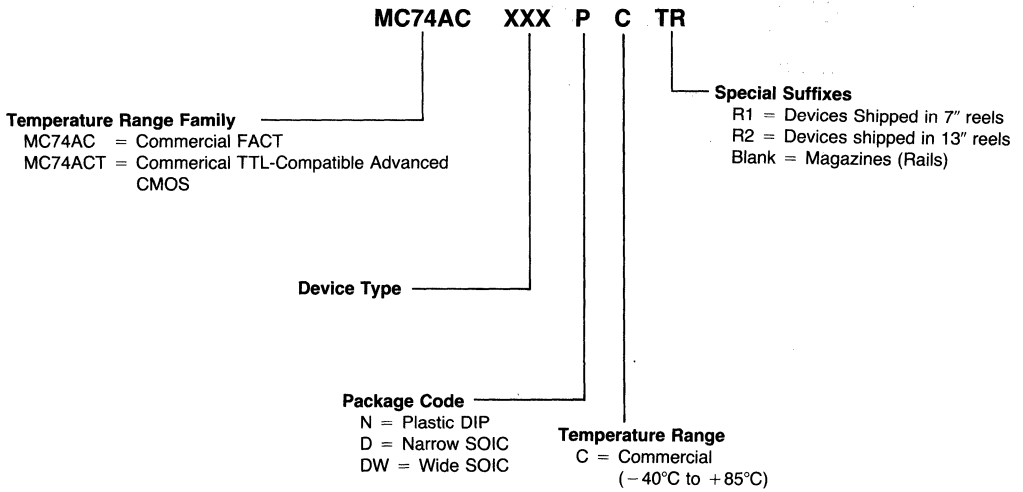

Package Outlines

The package outlines indicated above are shown in the detailed outline drawings in this section.

6

PACKAGE OUTLINES

SOIC

Case 751A-02 D Suffix 14-Pin Plastic SO-14

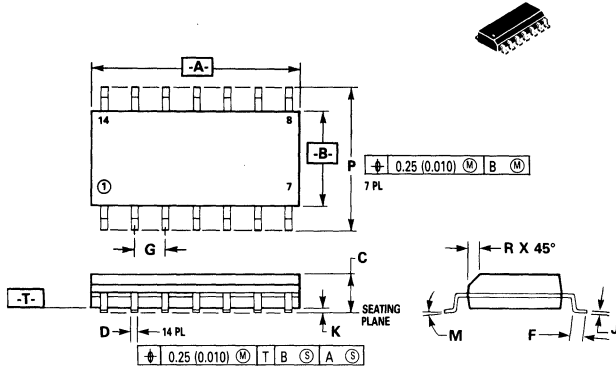

NOTES:

1. DIMENSIONS A AND B ARE DATUMS AND T IS A DATUM SURFACE.
2. DIMENSIONING AND TOLERANCING PER ANSI Y14.5M, 1982.
3. CONTROLLING DIMENSION: MILLIMETER.
4. DIMENSION A AND B DO NOT INCLUDE MOLD PROTRUSION.
5. MAXIMUM MOLD PROTRUSION 0.15 (0.006) PER SIDE.

| DIM | MILLIMETERS | | INCHES | |
|-----|-------------|------|-----------|-------|
| | MIN | MAX | MIN | MAX |
| A | 8.55 | 8.75 | 0.337 | 0.344 |
| B | 3.80 | 4.00 | 0.150 | 0.157 |
| C | 1.35 | 1.75 | 0.054 | 0.068 |
| D | 0.35 | 0.49 | 0.014 | 0.019 |
| F | 0.40 | 1.25 | 0.016 | 0.049 |
| G | 1.27 BSC | | 0.050 BSC | |
| J | 0.19 | 0.25 | 0.008 | 0.009 |
| K | 0.10 | 0.25 | 0.004 | 0.009 |
| M | 0° 7° | | 0° 7° | |
| P | 5.80 | 6.20 | 0.229 | 0.244 |
| R | 0.25 | 0.50 | 0.010 | 0.019 |

Case 751B-03 D Suffix 16-Pin Plastic SO-16

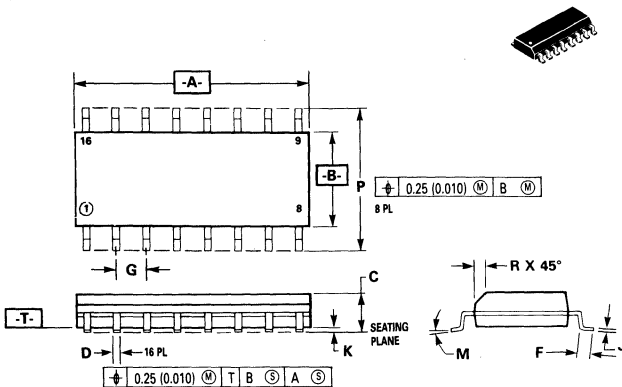

NOTES:

1. DIMENSIONS A AND B ARE DATUMS AND T IS A DATUM SURFACE.
2. DIMENSIONING AND TOLERANCING PER ANSI Y14.5M, 1982.
3. CONTROLLING DIMENSION: MILLIMETER.
4. DIMENSION A AND B DO NOT INCLUDE MOLD PROTRUSION.
5. MAXIMUM MOLD PROTRUSION 0.15 (0.006) PER SIDE.

| DIM | MILLIMETERS | | INCHES | |
|-----|-------------|-------|-----------|-------|
| | MIN | MAX | MIN | MAX |
| A | 9.80 | 10.00 | 0.386 | 0.393 |
| B | 3.80 | 4.00 | 0.150 | 0.157 |
| C | 1.35 | 1.75 | 0.054 | 0.068 |
| D | 0.35 | 0.49 | 0.014 | 0.019 |
| F | 0.40 | 1.25 | 0.016 | 0.049 |
| G | 1.27 BSC | | 0.050 BSC | |
| J | 0.19 | 0.25 | 0.008 | 0.009 |
| K | 0.10 | 0.25 | 0.004 | 0.009 |
| M | 0° 7° | | 0° 7° | |
| P | 5.80 | 6.20 | 0.229 | 0.244 |
| R | 0.25 | 0.50 | 0.010 | 0.019 |

6

SOIC (continued)

Case 751D-03 DW Suffix 20-Pin Plastic SO-20

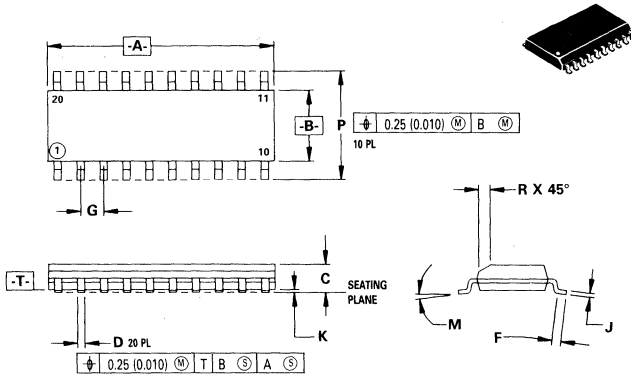

- NOTES:
1. DIMENSIONS A AND B ARE DATUMS AND T IS A DATUM SURFACE.
 2. DIMENSIONING AND TOLERANCING PER ANSI Y14.5M, 1982.
 3. CONTROLLING DIMENSION: MILLIMETER.
 4. DIMENSION A AND B DO NOT INCLUDE MOLD PROTRUSION.
 5. MAXIMUM MOLD PROTRUSION 0.15 (0.006) PER SIDE.

| DIM | MILLIMETERS | | INCHES | |
|-----|-------------|-------|-----------|-------|
| | MIN | MAX | MIN | MAX |
| A | 12.65 | 12.95 | 0.499 | 0.510 |
| B | 7.40 | 7.60 | 0.292 | 0.299 |
| C | 2.35 | 2.65 | 0.093 | 0.104 |
| D | 0.35 | 0.49 | 0.014 | 0.019 |
| F | 0.50 | 0.90 | 0.020 | 0.035 |
| G | 1.27 BSC | | 0.050 BSC | |
| J | 0.25 | 0.32 | 0.010 | 0.012 |
| K | 0.10 | 0.25 | 0.004 | 0.009 |
| M | 0° | 7° | 0° | 7° |
| P | 10.05 | 10.55 | 0.395 | 0.415 |
| R | 0.25 | 0.75 | 0.010 | 0.029 |

Case 751E-02 DW Suffix 24-Pin Plastic SO-24

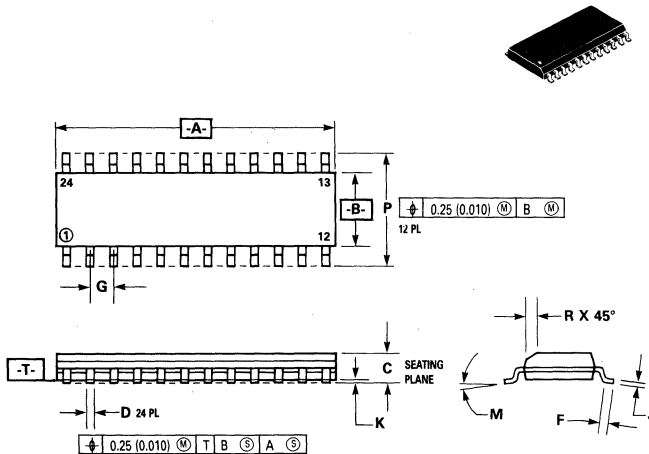

- NOTES:
1. DIMENSIONS A AND B ARE DATUMS AND T IS A DATUM SURFACE.
 2. DIMENSIONING AND TOLERANCING PER ANSI Y14.5M, 1982.
 3. CONTROLLING DIMENSION: MILLIMETER.
 4. DIMENSION A AND B DO NOT INCLUDE MOLD PROTRUSION.
 5. MAXIMUM MOLD PROTRUSION 0.15 (0.006) PER SIDE.

| DIM | MILLIMETERS | | INCHES | |
|-----|-------------|-------|-----------|-------|
| | MIN | MAX | MIN | MAX |
| A | 15.25 | 15.50 | 0.601 | 0.610 |
| B | 7.40 | 7.60 | 0.292 | 0.299 |
| C | 2.35 | 2.65 | 0.093 | 0.104 |
| D | 0.35 | 0.49 | 0.014 | 0.019 |
| F | 0.50 | 0.90 | 0.020 | 0.035 |
| G | 1.27 BSC | | 0.050 BSC | |
| J | 0.25 | 0.32 | 0.010 | 0.012 |
| K | 0.10 | 0.25 | 0.004 | 0.009 |
| M | 0° | 7° | 0° | 7° |
| P | 10.05 | 10.55 | 0.395 | 0.415 |
| R | 0.25 | 0.75 | 0.010 | 0.029 |

FACT DATA

PLASTIC DUAL-IN-LINE

Case 646-06 N Suffix 14-Pin Plastic

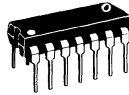
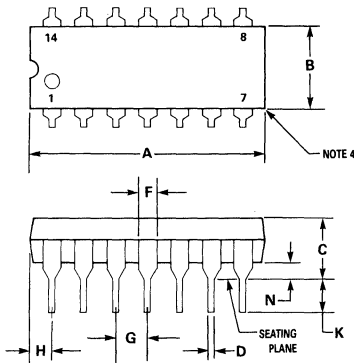

NOTES:

- LEADS WITHIN 0.13 mm (0.005) RADIUS OF TRUE POSITION AT SEATING PLANE AT MAXIMUM MATERIAL CONDITION.
- DIMENSION "L" TO CENTER OF LEADS WHEN FORMED PARALLEL.
- DIMENSION "B" DOES NOT INCLUDE MOLD FLASH.
- ROUNDED CORNERS OPTIONAL.

| DIM | MILLIMETERS | | INCHES | |
|-----|-------------|-------|-----------|-------|
| | MIN | MAX | MIN | MAX |
| A | 18.16 | 19.56 | 0.715 | 0.770 |
| B | 6.10 | 6.60 | 0.240 | 0.260 |
| C | 3.69 | 4.69 | 0.145 | 0.185 |
| D | 0.38 | 0.53 | 0.015 | 0.021 |
| F | 1.02 | 1.78 | 0.040 | 0.070 |
| G | 2.54 BSC | | 0.100 BSC | |
| H | 1.32 | 2.41 | 0.052 | 0.095 |
| J | 0.20 | 0.38 | 0.008 | 0.015 |
| K | 2.92 | 3.43 | 0.115 | 0.135 |
| L | 7.62 BSC | | 0.300 BSC | |
| M | 0° | 10° | 0° | 10° |
| N | 0.39 | 1.01 | 0.015 | 0.039 |

Case 648-08 N Suffix 16-Pin Plastic

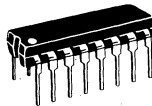
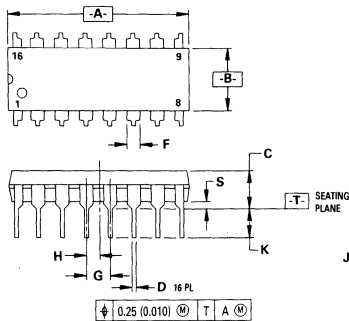

NOTES:

- DIMENSIONING AND TOLERANCING PER ANSI Y14.5M, 1982.
- CONTROLLING DIMENSION: INCH.
- DIMENSION "L" TO CENTER OF LEADS WHEN FORMED PARALLEL.
- DIMENSION "B" DOES NOT INCLUDE MOLD FLASH.
- ROUNDED CORNERS OPTIONAL.

| DIM | MILLIMETERS | | INCHES | |
|-----|-------------|-------|-----------|-------|
| | MIN | MAX | MIN | MAX |
| A | 18.80 | 19.55 | 0.740 | 0.770 |
| B | 6.35 | 6.85 | 0.250 | 0.270 |
| C | 3.69 | 4.44 | 0.145 | 0.175 |
| D | 0.39 | 0.53 | 0.015 | 0.021 |
| F | 1.02 | 1.77 | 0.040 | 0.070 |
| G | 2.54 BSC | | 0.100 BSC | |
| H | 1.27 BSC | | 0.050 BSC | |
| J | 0.21 | 0.38 | 0.008 | 0.015 |
| K | 2.80 | 3.30 | 0.110 | 0.130 |
| L | 7.50 | 7.74 | 0.295 | 0.305 |
| M | 0° | 10° | 0° | 10° |
| S | 0.51 | 1.01 | 0.020 | 0.040 |

PLASTIC DUAL-IN-LINE (continued)

Case 738-03 N Suffix 20-Pin Plastic

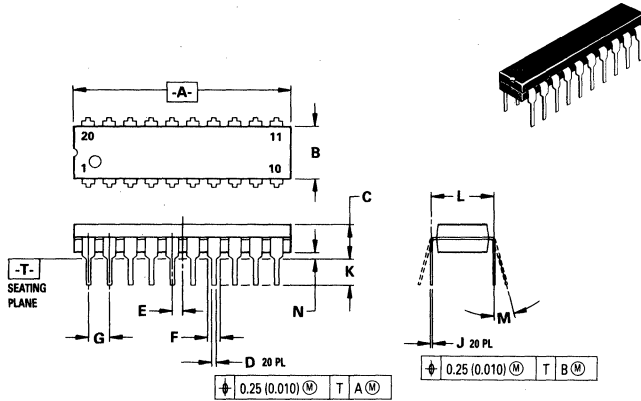

NOTES:

1. DIMENSIONING AND TOLERANCING PER ANSI Y14.5M, 1982.
2. CONTROLLING DIMENSION: INCH.
3. DIMENSION "L" TO CENTER OF LEAD WHEN FORMED PARALLEL.
4. DIMENSION "B" DOES NOT INCLUDE MOLD FLASH.

| DIM | MILLIMETERS | | INCHES | |
|-----|-------------|-------|-----------|-------|
| | MIN | MAX | MIN | MAX |
| A | 25.66 | 27.17 | 1.010 | 1.070 |
| B | 6.10 | 6.60 | 0.240 | 0.260 |
| C | 3.81 | 4.57 | 0.150 | 0.180 |
| D | 0.39 | 0.55 | 0.015 | 0.022 |
| E | 1.27 BSC | | 0.050 BSC | |
| F | 1.27 | 1.77 | 0.050 | 0.070 |
| G | 2.54 BSC | | 0.100 BSC | |
| J | 0.21 | 0.38 | 0.008 | 0.015 |
| K | 2.80 | 3.55 | 0.110 | 0.140 |
| L | 7.62 BSC | | 0.300 BSC | |
| M | 0° | 15° | 0° | 15° |
| N | 0.51 | 1.01 | 0.020 | 0.040 |

Case 649-03 N Suffix 24-Pin Plastic

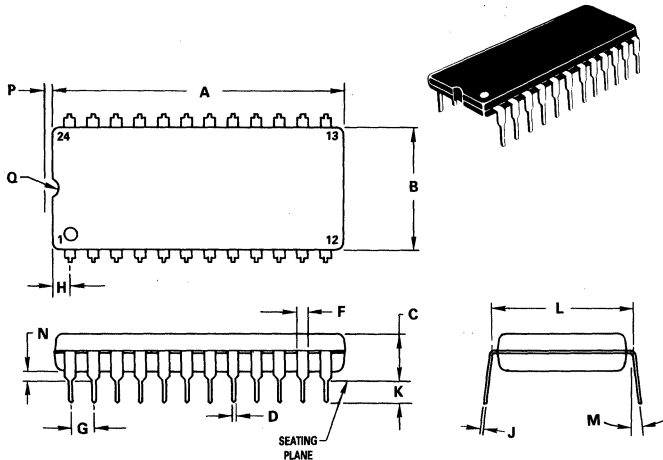

NOTES:

1. LEADS WITHIN 0.13 mm (0.005) RADIUS OF TRUE POSITION AT SEATING PLANE AT MAXIMUM MATERIAL CONDITION.
2. DIMENSION "L" TO CENTER OF LEADS WHEN FORMED PARALLEL.

| DIM | MILLIMETERS | | INCHES | |
|-----|-------------|-------|-----------|-------|
| | MIN | MAX | MIN | MAX |
| A | 31.50 | 32.13 | 1.240 | 1.265 |
| B | 13.21 | 13.72 | 0.520 | 0.540 |
| C | 4.70 | 5.21 | 0.185 | 0.205 |
| D | 0.38 | 0.51 | 0.015 | 0.020 |
| F | 1.02 | 1.52 | 0.040 | 0.060 |
| G | 2.54 BSC | | 0.100 BSC | |
| H | 1.65 | 2.16 | 0.065 | 0.085 |
| J | 0.20 | 0.30 | 0.008 | 0.012 |
| K | 2.92 | 3.43 | 0.115 | 0.135 |
| L | 14.99 | 15.49 | 0.590 | 0.610 |
| M | | 10° | | 10° |
| N | 0.51 | 1.02 | 0.020 | 0.040 |
| P | 0.13 | 0.38 | 0.005 | 0.015 |
| Q | 0.51 | 0.76 | 0.020 | 0.030 |

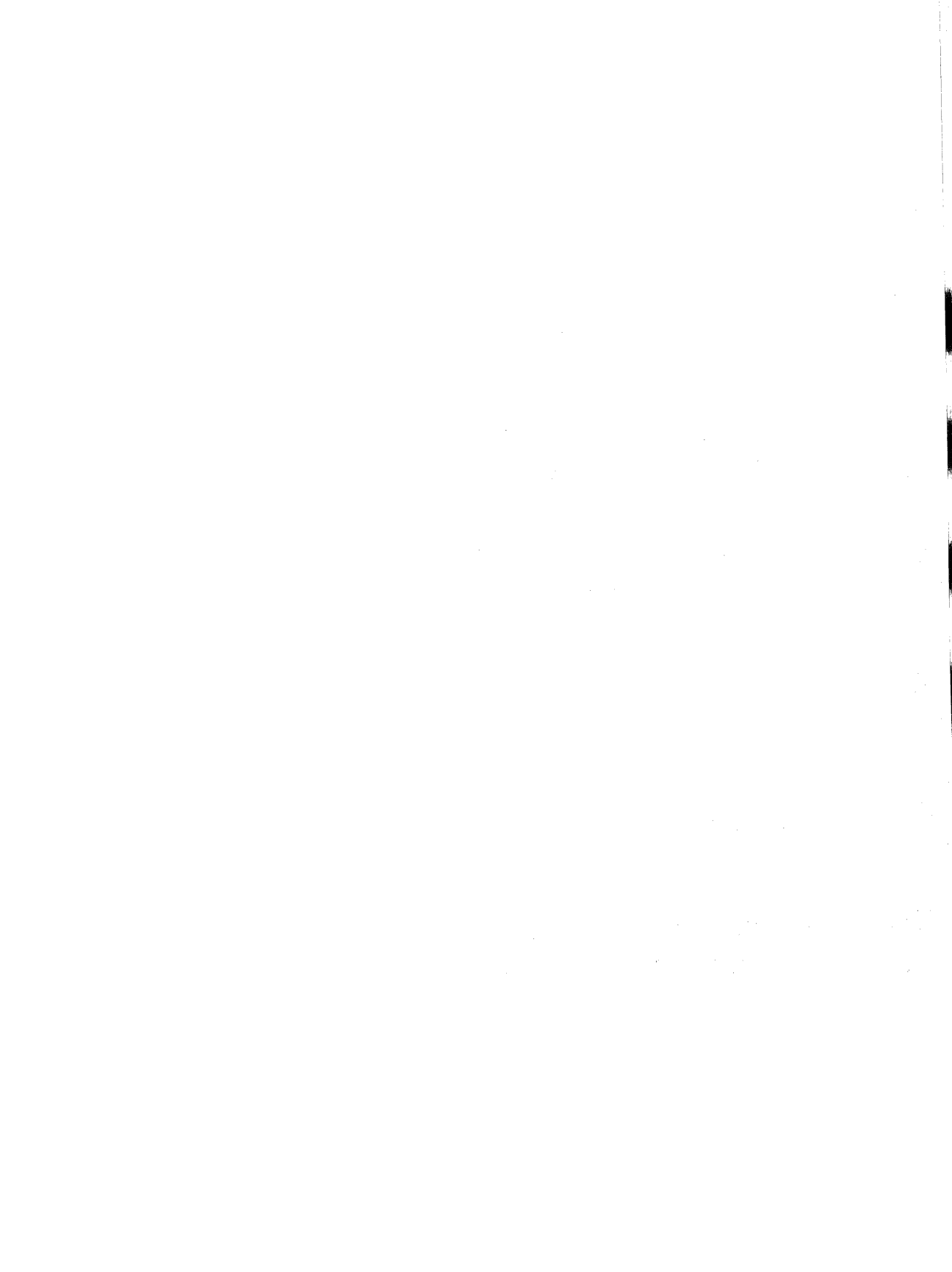

1 Selection Information

**2 Fact Description and
Family Characteristics**

**3 Ratings, Specifications
and Waveforms**

4 Design Considerations

5 Data Sheets

**6 Package Outlines and
Ordering Information**



Literature Distribution Centers:

USA: Motorola Literature Distribution; P.O. Box 20912; Phoenix, Arizona 85036.

EUROPE: Motorola Ltd.; European Literature Center; 88 Tanners Drive, Blakelands Milton Keynes, MK145BP, England.

ASIA PACIFIC: Motorola Semiconductors H.K. Ltd.; P.O. Box 80300; Cheung Sha Wan Post Office; Kowloon Hong Kong.