

PHILIPS

Devices for optoelectronics

S8

09-83

PHILIPS

Data handbook



Electronic
components
and materials

Semiconductors

Part 8 September 1983

Photosensitive diodes and transistors

Light emitting diodes

Displays

Photocouplers

Infrared sensitive devices

Photoconductive devices

SEMICONDUCTORS

PART 8 — SEPTEMBER 1983

DEVICES FOR OPTOELECTRONICS

INDEX AND TYPE NUMBER SURVEY

GENERAL

PHOTOSENSITIVE DIODES AND TRANSISTORS

LIGHT EMITTING DIODES
AND SELECTION GUIDE

DISPLAYS

PHOTOCOUPLEDERS

INFRARED SENSITIVE DEVICES

PHOTOCONDUCTIVE DEVICES



DATA HANDBOOK SYSTEM

Our Data Handbook System is a comprehensive source of information on electronic components, sub-assemblies and materials; it is made up of four series of handbooks each comprising several parts.

ELECTRON TUBES	BLUE
SEMICONDUCTORS	RED
INTEGRATED CIRCUITS	PURPLE
COMPONENTS AND MATERIALS	GREEN

The several parts contain all pertinent data available at the time of publication, and each is revised and reissued periodically.

Where ratings or specifications differ from those published in the preceding edition they are pointed out by arrows. Where application information is given it is advisory and does not form part of the product specification.

If you need confirmation that the published data about any of our products are the latest available, please contact our representative. He is at your service and will be glad to answer your inquiries.

This information is furnished for guidance, and with no guarantee as to its accuracy or completeness; its publication conveys no licence under any patent or other right, nor does the publisher assume liability for any consequence of its use; specifications and availability of goods mentioned in it are subject to change without notice; it is not to be reproduced in any way, in whole or in part without the written consent of the publisher.

ELECTRON TUBES (BLUE SERIES)

The blue series of data handbooks is comprised of the following parts:

- T1 Tubes for r.f. heating**
- T2 Transmitting tubes for communications**
- T3 Klystrons, travelling-wave tubes, microwave diodes**
- ET3 Special Quality tubes, miscellaneous devices (will not be reprinted)**
- T4 Magnetrons**
- T5 Cathode-ray tubes**
Instrument tubes, monitor and display tubes, C.R. tubes for special applications
- T6 Geiger-Muller tubes**
- T7 Gas-filled tubes**
Segment indicator tubes, indicator tubes, dry reed contact units, thyratrons, industrial rectifying tubes, ignitrons, high-voltage rectifying tubes, associated accessories
- T8 Picture tubes and components**
Colour TV picture tubes, black and white TV picture tubes, colour monitor tubes for data graphic display, monochrome monitor tubes for data graphic display, components for colour television, components for black and white television and monochrome data graphic display
- T9 Photo and electron multipliers**
Photomultiplier tubes, phototubes, single channel electron multipliers, channel electron multiplier plates
- T10 Camera tubes and accessories, image intensifiers**
- T11 Microwave semiconductors and components**

SEMICONDUCTORS (RED SERIES)

The red series of data handbooks is comprised of the following parts:

- S1 Diodes**
Small-signal germanium diodes, small-signal silicon diodes, voltage regulator diodes(< 1,5 W), voltage reference diodes, tuner diodes, rectifier diodes
- S2 Power diodes, thyristors, triacs**
Rectifier diodes, voltage regulator diodes (> 1,5 W), rectifier stacks, thyristors, triacs
- S3 Small-signal transistors**
- S4 Low-frequency power transistors and hybrid IC modules**
- S5 Field-effect transistors**
- S6 R.F. power transistors and modules**
- S7 Microminiature semiconductors for hybrid circuits**
- S8 Devices for optoelectronics**
Photosensitive diodes and transistors, light-emitting diodes, displays, photocouplers, infrared sensitive devices, photoconductive devices.
- S9 Taken into handbook T11 of the blue series**
- S10 Wideband transistors and wideband hybrid IC modules**

INTEGRATED CIRCUITS (PURPLE SERIES)

The purple series of data handbooks is comprised of the following parts:

- IC1 **Bipolar ICs for radio and audio equipment**
- IC2 **Bipolar ICs for video equipment**
- IC3 **ICs for digital systems in radio, audio and video equipment**
- IC4 **Digital integrated circuits**
 CMOS HE4000B family
- IC5 **Digital integrated circuits – ECL**
 ECL10 000 (GX family), ECL100 000 (HX family), dedicated designs
- IC6 **Professional analogue integrated circuits**
- IC7 **Signetics bipolar memories**
- IC8 **Signetics analogue circuits**
- IC9 **Signetics TTL logic**
- IC10 **Signetics Integrated Fuse Logic (IFL)**
- IC11 **Microprocessors, microcomputers and peripheral circuitry**

COMPONENTS AND MATERIALS (GREEN SERIES)

The green series of data handbooks is comprised of the following parts:

- C1 Assemblies for industrial use**
PLC modules, PC20 modules, HNIL FZ/30 series, NORbits 60-, 61-, 90-series, input devices, hybrid ICs
- C2 Television tuners, video modulators, surface acoustic wave filters**
- C3 Loudspeakers**
- C4 Ferroxcube potcores, square cores and cross cores**
- C5 Ferroxcube for power, audio/video and accelerators**
- C6 Electric motors and accessories**
Permanent magnet synchronous motors, stepping motors, direct current motors
- C7 Variable capacitors**
- C8 Variable mains transformers**
- C9 Piezoelectric quartz devices**
Quartz crystal units, temperature compensated crystal oscillators, compact integrated oscillators, quartz crystal cuts for temperature measurements
- C10 Connectors**
- C11 Non-linear resistors**
Voltage dependent resistors (VDR), light dependent resistors (LDR), negative temperature coefficient thermistors (NTC), positive temperature coefficient thermistors (PTC)
- C12 Variable resistors and test switches**
- C13 Fixed resistors**
- C14 Electrolytic and solid capacitors**
- C15 Film capacitors, ceramic capacitors**
- C16 Piezoelectric ceramics, permanent magnet materials**

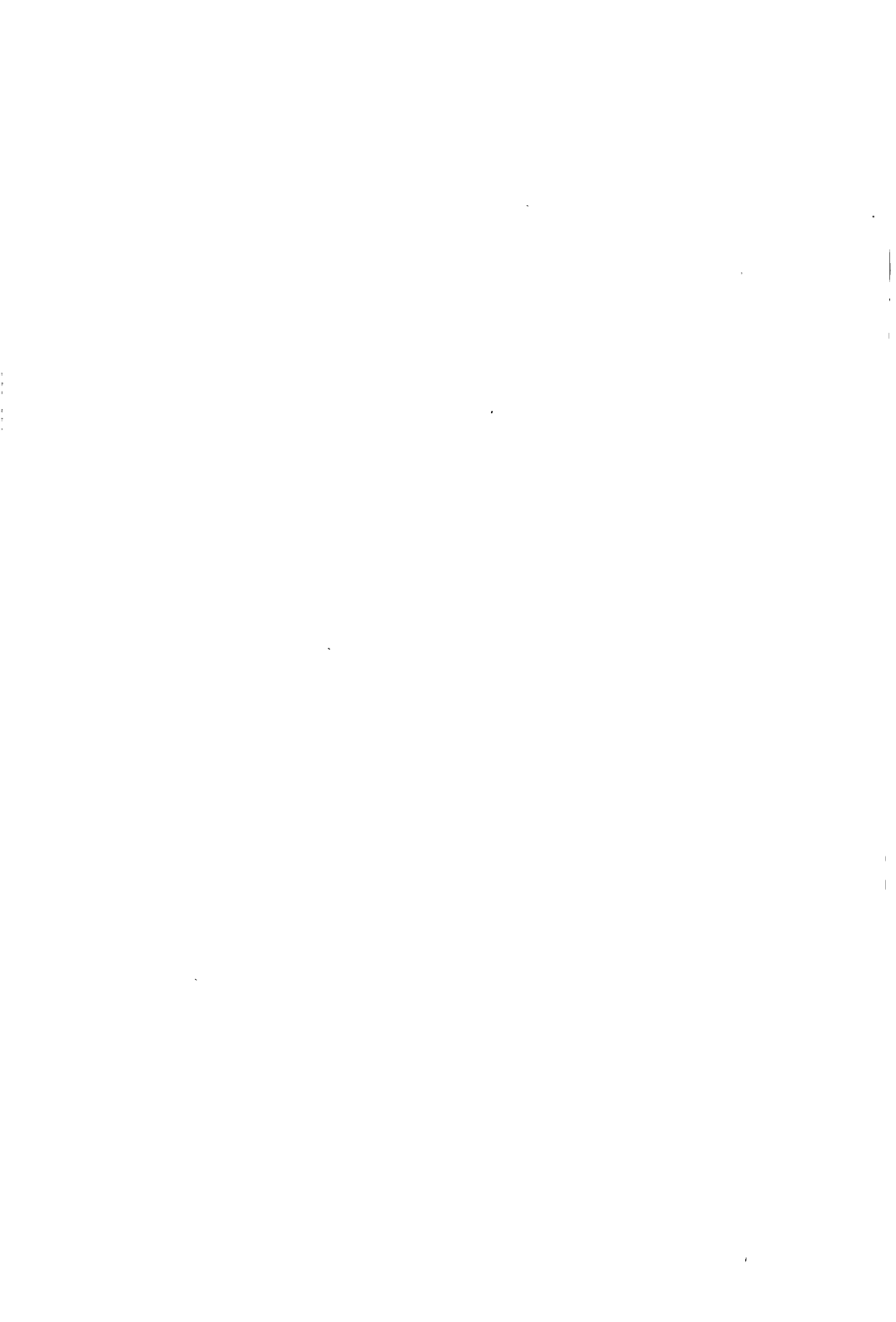

INDEX OF TYPE NUMBERS

Data Handbooks S1 to S10

The inclusion of a type number in this publication does not necessarily imply its availability.

type no.	book	section	type no.	book	section	type no.	book	section
AA119	S1	GD	BAS19	S7/S1	Mm/SD	BB109G	S1	T
AAZ15	S1	GD	BAS20	S7/S1	Mm/SD	BB112	S1	T
AAZ17	S1	GD	BAS21	S7/S1	Mm/SD	BB119	S1	T
AAZ18	S1	GD	BAT17	S7/S1	Mm/T	BB130	S1	T
BA220	S1	SD	BAT18	S7/S1	Mm/T	BB204B	S1	T
BA221	S1	SD	BAT81	S1	T	BB204G	S1	T
BA223	S1	T	BAT82	S1	T	BB212	S1	T
BA243	S1	T	BAT83	S1	T	BB405B	S1	T
BA244	S1	T	BAT85	S1	T	BB405G	S1	T
BA280	S1	T	BAV10	S1	SD	BB417	S1	T
BA314	S1	Vrg	BAV18	S1	SD	BB809	S1	T
BA315	S1	Vrg	BAV19	S1	SD	BB909A	S1	T
BA316	S1	SD	BAV20	S1	SD	BB909B	S1	T
BA317	S1	SD	BAV21	S1	SD	BBY31	S7/S1	Mm/T
BA318	S1	SD	BAV45	S1	Sp	BBY40	S7/S1	Mm/T
BA379	S1	T	BAV70	S7/S1	Mm/SD	BC107	S3	Sm
BA423	S1	T	BAV99	S7/S1	Mm/SD	BC108	S3	Sm
BA481	S1	T	BAW56	S7/S1	Mm/SD	BC109	S3	Sm
BA482	S1	T	BAW62	S1	SD	BC146	S3	Sm
BA483	S1	T	BAX12	S1	SD	BC177	S3	Sm
BA484	S1	T	BAX12A	S1	SD	BC178	S3	Sm
BAS11	S1	SD	BAX14	S1	SD	BC179	S3	Sm
BAS16	S7/S1	Mm/SD	BAX18	S1	SD	BC200	S3	Sm
BAS17	S7/S1	Mm/Vrg	BB105B	S1	T	BC264A	S5	FET
BAS18	S1	SD	BB105G	S1	T	BC264B	S5	FET

FET = Field-effect transistors

GD = Germanium diodes

Mm = Microminiature semiconductors
for hybrid circuits

SD = Small-signal diodes

Sm = Small-signal transistors

Sp = Special diodes

T = Tuner diodes

Vrg = Voltage regulator diodes

INDEX

type no.	book	section	type no.	book	section	type no.	book	section
BC264C	S5	FET	BC868	S7	Mm	BCY71	S3	Sm
BC264D	S5	FET	BC869	S7	Mm	BCY72	S3	Sm
BC327;A	S3	Sm	BCF29;R	S7	Mm	BCY78	S3	Sm
BC328	S3	Sm	BCF30;R	S7	Mm	BCY79	S3	Sm
BC337;A	S3	Sm	BCF32;R	S7	Mm	BCY87	S3	Sm
BC338	S3	Sm	BCF33;R	S7	Mm	BCY88	S3	Sm
BC368	S3	Sm	BCF70;R	S7	Mm	BCY89	S3	Sm
BC369	S3	Sm	BCF81;R	S7	Mm	BD131	S4	P
BC375	S3	Sm	BCV71;R	S7	Mm	BD132	S4	P
BC376	S3	Sm	BCV72;R	S7	Mm	BD135	S4	P
BC546	S3	Sm	BCW29;R	S7	Mm	BD136	S4	P
BC547	S3	Sm	BCW30;R	S7	Mm	BD137	S4	P
BC548	S3	Sm	BCW31;R	S7	Mm	BD138	S4	P
BC549	S3	Sm	BCW32;R	S7	Mm	BD139	S4	P
BC550	S3	Sm	BCW33;R	S7	Mm	BD140	S4	P
BC556	S3	Sm	BCW60*	S7	Mm	BD201	S4	P
BC557	S3	Sm	BCW61*	S7	Mm	BD202	S4	P
BC558	S3	Sm	BCW69;R	S7	Mm	BD203	S4	P
BC559	S3	Sm	BCW70;R	S7	Mm	BD204	S4	P
BC560	S3	Sm	BCW71;R	S7	Mm	BD226	S4	P
BC635	S3	Sm	BCW72;R	S7	Mm	BD227	S4	P
BC636	S3	Sm	BCW81;R	S7	Mm	BD228	S4	P
BC637	S3	Sm	BCW89;R	S7	Mm	BD229	S4	P
BC638	S3	Sm	BCX17;R	S7	Mm	BD230	S4	P
BC639	S3	Sm	BCX18;R	S7	Mm	BD231	S4	P
BC640	S3	Sm	BCX19;R	S7	Mm	BD233	S4	P
BC807	S7	Mm	BCX20;R	S7	Mm	BD234	S4	P
BC808	S7	Mm	BCX51	S7	Mm	BD235	S4	P
BC817	S7	Mm	BCX52	S7	Mm	BD236	S4	P
BC818	S7	Mm	BCX53	S7	Mm	BD237	S4	P
BC846	S7	Mm	BCX54	S7	Mm	BD238	S4	P
BC847	S7	Mm	BCX55	S7	Mm	BD291	S4	P
BC848	S7	Mm	BCX56	S7	Mm	BD292	S4	P
BC849	S7	Mm	BCX70*	S7	Mm	BD293	S4	P
BC850	S7	Mm	BCX71*	S7	Mm	BD294	S4	P
BC856	S7	Mm	BCY56	S3	Sm	BD295	S4	P
BC857	S7	Mm	BCY57	S3	Sm	BD296	S4	P
BC858	S7	Mm	BCY58	S3	Sm	BD329	S4	P
BC859	S7	Mm	BCY59	S3	Sm	BD330	S4	P
BC860	S7	Mm	BCY70	S3	Sm	BD331	S4	P

* = series

FET = Field-effect transistors

Mm = Microminiature semiconductors
for hybrid circuits

P = Low-frequency power transistors

Sm = Small-signal transistors

type no.	book	section	type no.	book	section	type no.	book	section
BD332	S4	P	BD828	S4	P	BDT30C	S4	P
BD333	S4	P	BD829	S4	P	BDT31	S4	P
BD334	S4	P	BD830	S4	P	BDT31A	S4	P
BD335	S4	P	BD839	S4	P	BDT31B	S4	P
BD336	S4	P	BD840	S4	P	BDT31C	S4	P
BD337	S4	P	BD841	S4	P	BDT32	S4	P
BD338	S4	P	BD842	S4	P	BDT32A	S4	P
BD433	S4	P	BD843	S4	P	BDT32B	S4	P
BD434	S4	P	BD844	S4	P	BDT32C	S4	P
BD435	S4	P	BD933	S4	P	BDT41	S4	P
BD436	S4	P	BD934	S4	P	BDT41A	S4	P
BD437	S4	P	BD935	S4	P	BDT41B	S4	P
BD438	S4	P	BD936	S4	P	BDT41C	S4	P
BD645	S4	P	BD937	S4	P	BDT42	S4	P
BD646	S4	P	BD938	S4	P	BDT42A	S4	P
BD647	S4	P	BD939	S4	P	BDT42B	S4	P
BD648	S4	P	BD940	S4	P	BDT42C	S4	P
BD649	S4	P	BD941	S4	P	BDT60	S4	P
BD650	S4	P	BD942	S4	P	BDT60A	S4	P
BD651	S4	P	BD943	S4	P	BDT60B	S4	P
BD652	S4	P	BD944	S4	P	BDT60C	S4	P
BD675	S4	P	BD945	S4	P	BDT61	S4	P
BD676	S4	P	BD946	S4	P	BDT61A	S4	P
BD677	S4	P	BD947	S4	P	BDT61B	S4	P
BD678	S4	P	BD948	S4	P	BDT61C	S4	P
BD679	S4	P	BD949	S4	P	BDT62	S4	P
BD680	S4	P	BD950	S4	P	BDT62A	S4	P
BD681	S4	P	BD951	S4	P	BDT62B	S4	P
BD682	S4	P	BD952	S4	P	BDT62C	S4	P
BD683	S4	P	BD953	S4	P	BDT63	S4	P
BD684	S4	P	BD954	S4	P	BDT63A	S4	P
BD813	S4	P	BD955	S4	P	BDT63B	S4	P
BD814	S4	P	BD956	S4	P	BDT63C	S4	P
BD815	S4	P	BDT29	S4	P	BDT64	S4	P
BD816	S4	P	BDT29A	S4	P	BDT64A	S4	P
BD817	S4	P	BDT29B	S4	P	BDT64B	S4	P
BD818	S4	P	BDT29C	S4	P	BDT64C	S4	P
BD825	S4	P	BDT30	S4	P	BDT65	S4	P
BD826	S4	P	BDT30A	S4	P	BDT65A	S4	P
BD827	S4	P	BDT30B	S4	P	BDT65B	S4	P

P = Low-frequency power transistors

INDEX

type no.	book	section	type no.	book	section	type no.	book	section
BDT65C	S4	P	BDX63	S4	P	BF241	S3	Sm
BDT91	S4	P	BDX63A	S4	P	BF245A	S5	FET
BDT92	S4	P	BDX63B	S4	P	BF245B	S5	FET
BDT93	S4	P	BDX63C	S4	P	BF245C	S5	FET
BDT94	S4	P	BDX64	S4	P	BF246A	S5	FET
BDT95	S4	P	BDX64A	S4	P	BF246B	S5	FET
BDT96	S4	P	BDX64B	S4	P	BF246C	S5	FET
BDV64	S4	P	BDX64C	S4	P	BF256A	S5	FET
BDV64A	S4	P	BDX65	S4	P	BF256B	S5	FET
BDV64B	S4	P	BDX65A	S4	P	BF256C	S5	FET
BDV64C	S4	P	BDX65B	S4	P	BF324	S3	Sm
BDV65	S4	P	BDX65C	S4	P	BF370	S3	Sm
BDV65A	S4	P	BDX66	S4	P	BF410A	S5	FET
BDV65B	S4	P	BDX66A	S4	P	BF410B	S5	FET
BDV65C	S4	P	BDX66B	S4	P	BF410C	S5	FET
BDV91	S4	P	BDX66C	S4	P	BF410D	S5	FET
BDV92	S4	P	BDX67	S4	P	BF419	S4	P
BDV93	S4	P	BDX67A	S4	P	BF422	S3	Sm
BDV94	S4	P	BDX67B	S4	P	BF423	S3	Sm
BDV95	S4	P	BDX67C	S4	P	BF450	S3	Sm
BDV96	S4	P	BDX77	S4	P	BF451	S3	Sm
BDW55	S4	P	BDX78	S4	P	BF457	S4	P
BDW56	S4	P	BDX91	S4	P	BF458	S4	P
BDW57	S4	P	BDX92	S4	P	BF459	S4	P
BDW58	S4	P	BDX93	S4	P	BF469	S4	P
BDW59	S4	P	BDX94	S4	P	BF470	S4	P
BDW60	S4	P	BDX95	S4	P	BF471	S4	P
BDX35	S4	P	BDX96	S4	P	BF472	S4	P
BDX36	S4	P	BDY90	S4	P	BF480	S3	Sm
BDX37	S4	P	BDY90A	S4	P	BF494	S3	Sm
BDX42	S4	P	BDY91	S4	P	BF495	S3	Sm
BDX43	S4	P	BDY92	S4	P	BF496	S3	Sm
BDX44	S4	P	BF180	S3	Sm	BF510	S7	Mm
BDX45	S4	P	BF181	S3	Sm	BF511	S7	Mm
BDX46	S4	P	BF182	S3	Sm	BF512	S7	Mm
BDX47	S4	P	BF183	S3	Sm	BF513	S7	Mm
BDX62	S4	P	BF198	S3	Sm	BF536	S7	Mm
BDX62A	S4	P	BF199	S3	Sm	BF550;R	S7	Mm
BDX62B	S4	P	BF200	S3	Sm	BF569	S7	Mm
BDX62C	S4	P	BF240	S3	Sm	BF579	S7	Mm

FET = Field-effect transistors
Mm = Microminiature semiconductors
for hybrid circuits

P = Low-frequency power transistors
Sm = Small-signal transistors

type no.	book	section	type no.	book	section	type no.	book	section
BF620	S7	Mm	BFP90A	S10	WBT	BFR90A	S10	WBT
BF621	S7	Mm	BFP91A	S10	WBT	BFR91	S10	WBT
BF622	S7	Mm	BFP96	S10	WBT	BFR91A	S10	WBT
BF623	S7	Mm	BFQ10	S5	FET	BFR92;R	S7	Mm
BF660;R	S7	Mm	BFQ11	S5	FET	BFR92A;R	S7	Mm
BF689K	S10	WBT	BFQ12	S5	FET	BFR93;R	S7	Mm
BF767	S7	Mm	BFQ13	S5	FET	BFR93A;R	S7	Mm
BF819	S4	P	BFQ14	S5	FET	BFR94	S10	WBT
BF820	S7	Mm	BFQ15	S5	FET	BFR95	S10	WBT
BF821	S7	Mm	BFQ16	S5	FET	BFR96	S10	WBT
BF822	S7	Mm	BFQ17	S7	Mm	BFR96S	S10	WBT
BF823	S7	Mm	BFQ18A	S7	Mm	BFR101A;B	S7	Mm
BF857	S4	P	BFQ19	S7	Mm	BFS17;R	S7	Mm
BF858	S4	P	BFQ22	S10	WBT	BFS18;R	S7	Mm
BF859	S4	P	BFQ22S	S10	WBT	BFS19;R	S7	Mm
BF869	S4	P	BFQ23	S10	WBT	BFS20;R	S7	Mm
BF870	S4	P	BFQ24	S10	WBT	BFS21	S5	FET
BF871	S4	P	BFQ32	S10	WBT	BFS21A	S5	FET
BF872	S4	P	BFQ33	S10	WBT	BFS22A	S6	RFP
BF926	S3	Sm	BFQ34	S10	WBT	BFS23A	S6	RFP
BF936	S3	Sm	BFQ34T	S10	WBT	BFT24	S10	WBT
BF939	S3	Sm	BFQ42	S6	RFP	BFT25;R	S7	Mm
BF960	S5	FET	BFQ43	S6	RFP	BFT44	S3	Sm
BF964	S5	FET	BFQ51	S10	WBT	BFT45	S3	Sm
BF966	S5	FET	BFQ52	S10	WBT	BFT46	S7	Mm
BF967	S3	Sm	BFQ53	S10	WBT	BFT92;R	S7	Mm
BF970	S3	Sm	BFQ63	S10	WBT	BFT93;R	S7	Mm
BF979	S3	Sm	BFQ65	S10	WBT	BFW10	S5	FET
BF980	S5	FET	BFQ66	S10	WBT	BFW11	S5	FET
BF981	S5	FET	BFQ68	S10	WBT	BFW12	S5	FET
BF982	S5	FET	BFR29	S5	FET	BFW13	S5	FET
BF989	S7	Mm	BFR30	S7	Mm	BFW16A	S10	WBT
BF990	S7	Mm	BFR31	S7	Mm	BFW17A	S10	WBT
BF991	S7	Mm	BFR49	S10	WBT	BFW30	S10	WBT
BF992	S7	Mm	BFR53;R	S7	Mm	BFW61	S5	FET
BF994	S7	Mm	BFR54	S3	Sm	BFW92	S10	WBT
BF996	S7	Mm	BFR64	S10	WBT	BFW92A	S10	WBT
BFG90A	S10	WBT	BFR65	S10	WBT	BFW93	S10	WBT
BFG91A	S10	WBT	BFR84	S5	FET	BFX29	S3	Sm
BFG96	S10	WBT	BFR90	S10	WBT	BFX30	S3	Sm

FET = Field-effect transistors
Mm = Microminiature semiconductors
for hybrid circuits
P = Low-frequency power transistors

RFP = R.F. power transistors and modules
Sm = Small-signal transistors
WBT = Wideband hybrid IC transistors

INDEX

type no.	book	section	type no.	book	section	type no.	book	section
BFX34	S3	Sm	BGY57	S10	WBM	BLW82	S6	RFP
BFX84	S3	Sm	BGY58	S10	WBM	BLW83	S6	RFP
BFX85	S3	Sm	BGY58A	S10	WBT	BLW84	S6	RFP
BFX86	S3	Sm	BGY59	S10	WBM	BLW85	S6	RFP
BFX87	S3	Sm	BGY60	S10	WBM	BLW86	S6	RFP
BFX88	S3	Sm	BGY61	S10	WBT	BLW87	S6	RFP
BFX89	S10	WBT	BGY65	S10	WBT	BLW89	S6	RFP
BFY50	S3	Sm	BGY67	S10	WBT	BLW90	S6	RFP
BFY51	S3	Sm	BGY70	S10	WBT	BLW91	S6	RFP
BFY52	S3	Sm	BGY71	S10	WBT	BLW95	S6	RFP
BFY55	S3	Sm	BGY74	S10	WBM	BLW96	S6	RFP
BFY90	S10	WBT	BGY75	S10	WBM	BLW98	S6	RFP
BG2000	S1	RT	BLV10	S6	RFP	BLX13	S6	RFP
BG2097	S1	RT	BLV11	S6	RFP	BLX13C	S6	RFP
BGX11*	S2	ThM	BLV20	S6	RFP	BLX14	S6	RFP
BGX12*	S2	ThM	BLV21	S6	RFP	BLX15	S6	RFP
BGX13*	S2	ThM	BLV25	S6	RFP	BLX39	S6	RFP
BGX14*	S2	ThM	BLV30	S6	RFP	BLX65	S6	RFP
BGX15*	S2	ThM	BLV31	S6	RFP	BLX66	S6	RFP
BGX17*	S2	ThM	BLV32F	S6	RFP	BLX67	S6	RFP
BGY22	S6	RFP	BLV33	S6	RFP	BLX68	S6	RFP
BGY22A	S6	RFP	BLV33F	S6	RFP	BLX69A	S6	RFP
BGY23	S6	RFP	BLV36	S6	RFP	BLX91A	S6	RFP
BGY23A	S6	RFP	BLV57	S6	RFP	BLX92A	S6	RFP
BGY32	S6	RFP	BLW29	S6	RFP	BLX93A	S6	RFP
BGY33	S6	RFP	BLW31	S6	RFP	BLX94A	S6	RFP
BGY35	S6	RFP	BLW32	S6	RFP	BLX94C	S6	RFP
BGY36	S6	RFP	BLW33	S6	RFP	BLX95	S6	RFP
BGY40A	S6	RFP	BLW34	S6	RFP	BLX96	S6	RFP
BGY40B	S6	RFP	BLW50F	S6	RFP	BLX97	S6	RFP
BGY41A	S6	RFP	BLW60	S6	RFP	BLX98	S6	RFP
BGY41B	S6	RFP	BLW60C	S6	RFP	BLY33	S6	RFP
BGY43	S6	RFP	BLW64	S6	RFP	BLY34	S6	RFP
BGY50	S10	WBM	BLW75	S6	RFP	BLY35	S6	RFP
BGY51	S10	WBM	BLW76	S6	RFP	BLY36	S6	RFP
BGY52	S10	WBM	BLW77	S6	RFP	BLY83	S6	RFP
BGY53	S10	WBM	BLW78	S6	RFP	BLY84	S6	RFP
BGY54	S10	WBM	BLW79	S6	RFP	BLY85	S6	RFP
BGY55	S10	WBM	BLW80	S6	RFP	BLY87A	S6	RFP
BGY56	S10	WBM	BLW81	S6	RFP	BLY87C	S6	RFP

RFP = R.F. power transistors and modules

RT = Tripler

Sm = Small-signal transistors

ThM = Thyristor Modules

WBM = Wideband hybrid IC modules

WBT = Wideband hybrid IC transistors

type no.	book	section	type no.	book	section	type no.	book	section
BLY88A	S6	RFP	BSR30	S7	Mm	BSV78	S5	FET
BLY88C	S6	RFP	BSR31	S7	Mm	BSV79	S5	FET
BLY89A	S6	RFP	BSR32	S7	Mm	BSV80	S5	FET
BLY89C	S6	RFP	BSR33	S7	Mm	BSV81	S5	FET
BLY90	S6	RFP	BSR40	S7	Mm	BSW66A	S3	Sm
BLY91A	S6	RFP	BSR41	S7	Mm	BSW67A	S3	Sm
BLY91C	S6	RFP	BSR42	S7	Mm	BSW68A	S3	Sm
BLY92A	S6	RFP	BSR43	S7	Mm	BSX19	S3	Sm
BLY92C	S6	RFP	BSR50	S3	Sm	BSX20	S3	Sm
BLY93A	S6	RFP	BSR51	S3	Sm	BSX45	S3	Sm
BLY93C	S6	RFP	BSR52	S3	Sm	BSX46	S3	Sm
BLY94	S6	RFP	BSR56	S7	Mm	BSX47	S3	Sm
BLY97	S6	RFP	BSR57	S7	Mm	BSX59	S3	Sm
BPF10	S8	PDT	BSR58	S7	Mm	BSX60	S3	Sm
BPF24	S8	PDT	BSR60	S3	Sm	BSX61	S3	Sm
BPW22A	S8	PDT	BSR61	S3	Sm	BSY95A	S3	Sm
BPW50	S8	PDT	BSR62	S3	Sm	BT136*	S2	Tri
BPX25	S8	PDT	BSS38	S3	Sm	BT137*	S2	Tri
BPX29	S8	PDT	BSS50	S3	Sm	BT138*	S2	Tri
BPX40	S8	PDT	BSS51	S3	Sm	BT139*	S2	Tri
BPX41	S8	PDT	BSS52	S3	Sm	BT149*	S2	Th
BPX42	S8	PDT	BSS60	S3	Sm	BT151*	S2	Th
BPX71	S8	PDT	BSS61	S3	Sm	BT152*	S2	Th
BPX72	S8	PDT	BSS62	S3	Sm	BT153	S2	Th
BPX95C	S8	PDT	BSS63;R	S7	Mm	BT154	S2	Th
BR100/03	S2	Th	BSS64;R	S7	Mm	BT155*	S2	Th
BR101	S3	Sm	BSS68	S3	Sm	BTV24*	S2	Th
BRY39	S3	Sm	BST15	S7	Mm	BTV34*	S2	Tri
BRY56	S3	Sm	BST16	S7	Mm	BTV58*	S2	Th
BRY61	S7	Mm	BST50	S7	Mm	BTW23*	S2	Th
BRY62	S7	Mm	BST51	S7	Mm	BTW30S*	S2	Th
BSR12;R	S7	Mm	BST52	S7	Mm	BTW31W*	S2	Th
BSR13;R	S7	Mm	BST60	S7	Mm	BTW38*	S2	Th
BSR14;R	S7	Mm	BST61	S7	Mm	BTW40*	S2	Th
BSR15;R	S7	Mm	BST62	S7	Mm	BTW42*	S2	Th
BSR16;R	S7	Mm	BSV15	S3	Sm	BTW43*	S2	Tri
BSR17;R	S7	Mm	BSV16	S3	Sm	BTW45*	S2	Th
BSR17A;R	S7	Mm	BSV17	S3	Sm	BTW47*	S2	Th
BSR18;R	S7	Mm	BSV52;R	S7	Mm	BTW58*	S2	Th
BSR18A;R	S7	Mm	BSV64	S3	Sm	BTW63*	S2	Th

* = series

FET = Field-effect transistors

Mm = Microminiature semiconductors
for hybrid circuits

PDT = Photodiodes or transistors

RFP = R.F. power transistors and modules

Sm = Small-signal transistors

Th = Thyristors

Tri = Triacs

INDEX

type no.	book	section	type no.	book	section	type no.	book	section
BTW92*	S2	Th	BY249	S2	R	BYW93*	S2	R
BTX18*	S2	Th	BY260*	S2	R	BYW94*	S2	R
BTX94*	S2	Tri	BY261*	S2	R	BYW95A	S1	R
BTY79*	S2	Th	BY277*	S2	R	BYW95B	S1	R
BTY87*	S2	Th	BY438	S1	R	BYW95C	S1	R
BTY91*	S2	Th	BY448	S1	R	BYW96D	S1	R
BU208A	S4	P	BY458	S1	R	BYW96E	S1	R
BU326	S4	P	BY476	S1	R	BYX10	S1	R
BU326A	S4	P	BY477	S1	R	BYX22*	S2	R
BU426	S4	P	BY478	S1	R	BYX25*	S2	R
BU426A	sS	P	BY505	S1	R	BYX30*	S2	R
BU433	S4	P	BY509	S1	R	BYX32*	S2	R
BUS11;A	S4	P	BY527	S1	R	BYX38*	S2	R
BUS12;A	S4	P	BY584	S1	R	BYX39*	S2	R
BUS13;A	S4	P	BY609	S1	R	BYX42*	S2	R
BUS14;A	S4	P	BY610	S1	R	BYX45*	S2	R
BUV82	S4	P	BYV20	S2	R	BYX46*	S2	R
BUV83	S4	P	BYV21*	S2	R	BYX49*	S2	R
BUW84	S4	P	BYV22	S2	R	BYX50*	S2	R
BUW85	S4	P	BYV23	S2	R	BYX52*	S2	R
BUX46;A	S4	P	BYV24	S2	R	BYX56*	S2	R
BUX47;A	S4	P	BYV27	S1	R	BYX71*	S2	R
BUX48;A	S4	P	BYV28	S1	R	BYX90	S1	R
BUX80	S4	P	BYV30*	S2	R	BYX91*	S1	R
BUX81	S4	P	BYV32*	S2	R	BYX94	S1	R
BUX82	S4	P	BYV92*	S2	R	BYX96*	S2	R
BUX83	S4	P	BYV95A	S1	R	BYX97*	S2	R
BUX84	S4	P	BYV95B	S1	R	BYX98*	S2	R
BUX85	S4	P	BYV95C	S1	R	BYX99*	S2	R
BUX86	S4	P	BYV96D	S1	R	BZT03	S1	Vrg
BUX87	S4	P	BYV96E	S1	R	BZV10	S1	Vrf
BUX98	S4	P	BYW19*	S2	R	BZV11	S1	Vrf
BUY89	S4	P	BYW25	S2	R	BZV12	S1	Vrf
BY184	S1	R	BYW29*	S2	R	BZV13	S1	Vrf
BY188G	S1	R	BYW30*	S2	R	BZV14	S1	Vrf
BY223	S2	R	BYW31*	S2	R	BZV15*	S2	Vrf
BY224*	S2	R	BYW54	S1	R	BZV37	S1	Vrf
BY225*	S2	R	BYW55	S1	R	BZV46	S1	Vrg
BY228	S1	R	BYW56	S1	R	BZV49*	S1/S7	Vrg
BY229*	S2	R	BYW92*	S2	R	BZV85	S1	Vrg

* = series

Th = Thyristors

Tri = Triacs

P = Low-frequency power transistors

R = Rectifier diodes

Vrg = Voltage regulator diodes

Vrf = Voltage reference diodes

type no.	book	section	type no.	book	section	type no.	book	section
BZW70*	S2	TS	CQ332;R	S8	D	CQX10	S8	LED
BZW86*	S2	TS	CQ427;R	S8	D	CQX11	S8	LED
BZW91*	S2	TS	CQ430;R	S8	D	CQX12	S8	LED
BZX55	S1	Vrg	CQ431;R	S8	D	CQX24(L)	S8	LED
BZX70*	S2	Vrg	CQ432;R	S8	D	CQX51	S8	LED
BZX75	S1	Vrg	CQF24	S8	Ph	CQX54(L)	S8	LED
BZX79*	S1	Vrg	CQL10A	S8	Ph	CQX64(L)	S8	LED
BZX84*	S7/S1	Mm/Vrg	CQL13	S8	Ph	CQX74(L)	S8	LED
BZX87*	S1	Vrg	CQL13A	S8	Ph	CQX74Y	S8	LED
BZX90	S1	Vrf	CQL14A	S8	Ph	CQY11B	S8	LED
BZX91	S1	Vrf	CQL14B	S8	Ph	CQY11C	S8	LED
BZX92	S1	Vrf	CQN10	S8	LED	CQY24B(L)	S8	LED
BZX93	S1	Vrf	CQN11	S8	LED	CQY49B	S8	LED
BZX94	S1	Vrf	CQT10	S8	LED	CQY49C	S8	LED
BZY91*	S2	Vrg	CQT11	S8	LED	CQY50	S8	LED
BZY93+	S2	Vrg	CQT12	S8	LED	CQY52	S8	LED
BZY95*	S2	Vrg	CQV60(L)	S8	LED	CQY54A	S8	LED
BZY96*	S2	Vrg	CQV60A(L)	S8	LED	CQY58A	S8	LED
CNX21	S8	PhC	CQV61A(L)	S8	LED	CQY89A	S8	LED
CNX35	S8	PhC	CQV62(L)	S8	LED	CQY94	S8	LED
CNX36	S8	PhC	CQV70(L)	S8	LED	CQY94B(L)	S8	LED
CNX37	S8	PhC	CQV70A(L)	S8	LED	CQY95B	S8	LED
CNX38	S8	PhC	CQV71A(L)	S8	LED	CQY96(L)	S8	LED
CNX44	S8	PhC	CQV72(L)	S8	LED	CQY97A	S8	LED
CNX48	S8	PhC	CQV80L	S8	LED	OA90	S1	GD
CNX62	S8	PhC	CQV80AL	S8	LED	OA91	S1	GD
CNY50	S8	PhC	CQV81L	S8	LED	OA95	S1	GD
CNY52	S8	PhC	CQV82L	S8	LED	OM320	S10	WBM
CNY53	S8	PhC	CQW10(L)	S8	LED	OM321	S10	WBM
CNY57	S8	PhC	CQW10A(L)	S8	LED	OM322	S10	WBM
CNY57A	S8	PhC	CQW10B(L)	S8	LED	OM323	S10	WBM
CNY62	S8	PhC	CQW11A(L)	S8	LED	OM323A	S10	WBM
CNY63	S8	PhC	CQW11B(L)	S8	LED	OM335	S10	WBM
CQ209S	S8	D	CQW12(L)	S8	LED	OM336	S10	WBM
CQ216X	S8	D	CQW12B(L)	S8	LED	OM337	S10	WBM
CQ216Y	S8	D	CQW20A	S8	LED	OM337A	S10	WBM
CQ327;R	S8	D	CQW21	S8	LED	OM339	S10	WBM
CQ330;R	S8	D	CQW22	S8	LED	OM345	S10	WBM
CQ331;R	S8	D	CQW24(L)	S8	LED	OM350	S10	WBM
			CQW54	S8	LED	OM360	S10	WBM

* = series

D = Displays

GD = Germanium diodes

LED = Light emitting diodes

Mm = Microminiature semiconductors for hybrid circuits

Ph = Photoconductive devices

PhC = Photocouplers

WBM = Wideband hybrid IC modules

TS = Transient suppressor diodes

Vrf = Voltage reference diodes

Vrg = Voltage regulator diodes

INDEX

type no.	book	section	type no.	book	section	type no.	book	section
OM361	S10	WBM	1N821;A	S1	Vrf	1N5059	S1	R
OM370	S10	WBM	1N823;A	S1	Vrf	1N5060	S1	R
OM931	S4	P	1N825;A	S1	Vrf	1N5061	S1	R
OM961	S4	P	1N827;A	S1	Vrf	1N5062	S1	R
OSB9110	S2	St	1N829;A	S1	Vrf	2N918	S10	WBT
OSB9210	S2	St	1N914	S1	SD	2N929	S3	Sm
OSB9410	S2	St	1N916	S1	SD	2N930	S3	Sm
OSM9110	S2	St	1N3879	S2	R	2N1613	S3	Sm
OSM9210	S2	St	1N3880	S2	R	2N1711	S3	Sm
OSM9410	S2	St	1N3881	S2	R	2N1893	S3	Sm
OSM9510	S2	St	1N3882	S2	R	2N2218	S3	Sm
OSM9511	S2	St	1N3889	S2	R	2N2218A	S3	Sm
OSM9512	S2	St	1N3890	S2	R	2N2219	S3	Sm
OSS9110	S2	St	1N3891	S2	R	2N2219A	S3	Sm
OSS9210	S2	St	1N3892	S2	R	2N2221	S3	Sm
OSS9410	S2	St	1N3899	S2	R	2N2221A	S3	Sm
PH2222;R	S3	Sm	1N3900	S2	R	2N2222	S3	Sm
PH2222A;RS3	S3	Sm	1N3901	S2	R	2N2222A	S3	Sm
PH2369	S3	Sm	1N3902	S2	R	2N2297	S3	Sm
PH2907;R	S3	Sm	1N3903	S2	R	2N2368	S3	Sm
PH2907A;RS3	S3	Sm	1N3909	S2	R	2N2369	S3	Sm
PH40*	S2	R	1N3910	S2	R	2N2369A	S3	Sm
PH70*	S2	R	1N3911	S2	R	2N2483	S3	Sm
RPY58A	S8	Ph	1N3912	S2	R	2N2484	S3	Sm
RPY76B	S8	Ph	1N3913	S2	R	2N2904	S3	Sm
RPY86	S8	I	1N4001G	S1	R	2N2904A	S3	Sm
RPY87	S8	I	1N4002G	S1	R	2N2905	S3	Sm
RPY88	S8	I	1N4003G	S1	R	2N2905A	S3	Sm
RPY89	S8	I	1N4004G	S1	R	2N2906	S3	Sm
RPY90*	S8	I	1N4005G	S1	R	2N2906A	S3	Sm
RPY91*	S8	I	1N4006G	S1	R	2N2907	S3	Sm
RPY93	S8	I	1N4007G	S1	R	2N2907A	S3	Sm
RPY94	S8	I	1N4148	S1	SD	2N3019	S3	Sm
RPY95	S8	I	1N4150	S1	SD	2N3020	S3	Sm
RPY96	S8	I	1N4151	S1	SD	2N3053	S3	Sm
RPY97	S8	I	1N4154	S1	SD	2N3375	S6	RFP
RTC901	S8	Ar	1N4446	S1	SD	2N3553	S6	RFP
RTC902	S8	Ar	1N4448	S1	SD	2N3632	S6	RFP
RTC903	S8	Ar	1N4531	S1	SD	2N3822	S5	FET
RTC904	S8	Ar	1N4532	S1	SD	2N3823	S5	FET

Ar = Arrays

FET = Field-effect transistors

I = Infrared devices

P = Low-frequency power transistors

R = Rectifier diodes

RFP = R.F. power transistors and modules

SD = Small-signal diodes

Sm = Small-signal transistors

St = Rectifier stacks

Vrf = Voltage reference diodes

WBT = Wideband hybrid IC transistors

WBM = Wideband hybrid IC modules

type no.	book	section	type no.	book	section	type no.	book	section
2N3866	S6	RFP	2N5415	S3	Sm	56353	S4	A
2N3903	S3	Sm	2N5416	S3	Sm	56354	S4	A
2N3904	S3	Sm	61SV	S8	I	56359b	S4	A
2N3905	S3	Sm	375CQY/B	S8	Ph	56359c	S4	A
2N3906	S3	Sm	497CQF/A	S8	Ph	56359d	S4	A
2N3924	S6	RFP	498CQL	S8	Ph	56360a	S4	A
2N3926	S6	RFP	56201d	S4	A	56363	S2,S4	A
2N3927	S6	RFP	56201j	S4	A	56364	S2,S4	A
2N3966	S5	FET	56230	S2	HE	56366	S2	A
2N4030	S3	Sm	56231	S2	HE	56367	S2	A
2N4031	S3	Sm	56245	S3,6,10A		56368a	S4	A
2N4032	S3	Sm	56246	S3,5,10A		56368b	S4	A
2N4033	S3	Sm	56253	S2	DH	56369	S2,S4	A
2N4091	S5	FET	56256	S2	DH	56378	S4	A
2N4092	S5	FET	56261a	S4	A			
2N4093	S5	FET	56262A	S2	A	56379	S4	A
2N4123	S3	Sm	56264A	S2	A	56387a,b	S4	A
2N4124	S3	Sm	56268	S2	DH			
2N4125	S3	Sm	56290	S2	HE			
2N4126	S3	Sm	56295	S2	A			
2N4391	S5	FET	56312	S2	DH			
2N4392	S5	FET	56313	S2	DH			
2N4393	S5	FET	56316	S2	A			
2N4427	S6	RFP	56317	S2	A			
2N4856	S5	FET	56326	S4	A			
2N4857	S5	FET	56333	S4	A			
2N4858	S5	FET	56339	S4	A			
2N4859	S5	FET	56348	S2	DH			
2N4860	S5	FET	56350	S2	DH			
2N4861	S5	FET	56352	S4	A			

A = Accessories
 DH = Diecast heatsinks
 FET = Field-effect transistors
 HE = Heatsink extrusions

I = Infrared devices
 RFP = R.F. power transistors and modules
 Sm = Small-signal transistors
 Ph = Photoconductive devices

TYPE NUMBER SURVEY

		page
BPF10	Photodiode for fibre-optic transmissions, modified TO-18	21
BPF24	Photodiode for fibre-optic transmissions, TO-46	27
BPW22A	Phototransistor for optical coupling and decoding, SOD-53D	31
BPW50	Photodiode for optical coupling and decoding, plastic SOD-67	37
BPX25	Phototransistor with lens, IR remote control, TO-18	43
BPX29	Phototransistor with plane window, IR remote control, TO-18	43
BPX40	Photodiode unencapsulated	49
BPX41		55
BPX42		61
BPX71	Phototransistor with glass lens, SOT-71A (DO-31)	67
BPX72	Phototransistor with plastic lens, SOT-70A	73
BPX95C	Phototransistor with clear plastic encapsulation, SOD-63A	79
CNX21	Photocoupler, IR, 10 kV, $I_C/I_F > 0,2$, 4-lead DIL	361
CNX35	Photocoupler, IR, 1,5 kV, $I_C/I_F > 0,4$, 6-lead DIL	369
CNX36		383
CNX37	Photocoupler, IR, 2,5 kV, $I_C/I_F > 0,4$, 6-lead DIL	383
CNX38	Photocoupler, IR, 1,5 kV, $I_C/I_F > 0,7$, 6-lead DIL	395
CNX44	Photocoupler, IR, 1 kV, $I_C/I_F > 0,3$, metal SOT-104C	409
CNX48	Photocoupler, IR, 1,5 kV, Darlington, $I_C/I_F > 5$, 6-lead DIL	421
CNX62	Photocoupler, IR, 2,5 kV, $I_C/I_F > 0,4$, 6-lead DIL	431
CNY50	Photocoupler, IR, metal SOT-104B	443
CNY52	Photocoupler, IR, 1,5 kV, 4-lead plastic (SOT-91A)	455
CNY53		469
CNY57	Photocoupler, IR, 1,5 kV, 6-lead DIL (SOT-90)	469
CNY57A		483
CNY62	Photocoupler, IR, 1,5 kV, 4-lead plastic (SOT-91B)	483
CNY63		343
CQ209S	Display, red, 1,5-digit, 9-segment	343
CQ216X	Display, super-red, 2-digit	347
CQ216Y		351
CQ327(R)	Display, red, 4-digit 2-point, clock	351
to CQ332(R)		355
CQ427(R)	Display, red, 4-digit 2 point, clock	355
to CQ432(R)		91
CQF24	LED, IR, for fibre-optic transmissions, TO-46	91
QQL10A	Diode laser, SOT-148	97
QQL13	Collimator pen, 2 mW, 790 nm	101
QQL13A	Collimator pen, 2 mW, 820 nm	105
QQL13C	Collimator pen, 2 mW, 870 nm	109
QQL14A	Collimator pen, 20 mW, 820 nm	113
QQL14B	Collimator pen, 20 mW, 850 nm	117
QQN10	LED, WIB, hyper-red, 2 diodes, SOD-73	121
QQN11	LED, WIB, super-green, 2 diodes, SOD-73	125
QQT10	LED, bi-colour, hyper-red or super-green (polarity-dependent), SOD-77A2	129
QQT11	LED, bi-colour, hyper-red or super-green (polarity dependent), SOD-78	133
QQT12	LED, bi-colour, hyper-red or super-green (polarity dependent), SOD-75A2	137
QQV60(L)	LED, super-red, 1 x 5 mm, SOD-75A1 and SOD-75L	141
QQV60A(L)	LED, hyper-red, 1 x 5 mm, SOD-75A2 and SOD-75L	145
QQV61A(L)	LED, super-green, 1 x 5 mm, SOD-75A1 and SOD-75L	149
QQV62(L)	LED, yellow, 1 x 5 mm, SOD-75A1 and SOD-75L	153

	page
CQV70(L)	157
CQV70A(L)	161
CQV71A(L)	165
CQV72(L)	169
CQV80L	173
CQV80AL	177
CQV81L	181
CQV82L	185
CQW10(L)	189
CQW10A(L)	193
CQW10B(L)	189
CQW11A(L)	197
CQW11B(L)	197
CQW12(L)	201
CQW12B(L)	201
CQW20A	205
CQW21	209
CQW22	213
CQW24(L)	217
CQW54	221
CQX10	225
CQX11	229
CQX12	233
CQX24(L)	237
CQX51	243
CQX54(L)	249
CQX64(L)	253
CQX74(L)	257
CQX74Y	257
CQY11B	261
CQY11C	267
CQY24B(L)	273
CQY49B	279
CQY49C	279
CQY50 } CQY52 }	285
CQY54A	291
CQY58A	295
CQY89A	301
CQY94	307
CQY94B(L)	311
CQY95B	315
CQY96(L)	319
CQY97A	323

TYPE NUMBER SURVEY

		page
RPY58A	Photoconductive device, 5 x 5 mm, plastic	603
RPY76B	Photoconductive cell for wavelengths over 1,5 μm , SOT-49/1	607
RPY86	Pyroelectric IR detector with preamplifier, SOT-49E	497
RPY87		497
RPY88		509
RPY89		509
RPY90A		Pyroelectric IR detector, 2,0 x 0,5 mm sensitive area
RPY90C		
RPY90D		
RPY90E		
RPY91A		
RPY91C	Pyroelectric IR detector, 2,75 x 1,25 mm sensitive area	535
RPY91D		
RPY91E		
RPY93		
RPY93	Dual element pyroelectric IR detector, SOT-49E	549
RPY94	Dual element pyroelectric IR detector, SOT-49E	557
RPY95	Single element pyroelectric IR detector, SOT-49F	565
RPY96	Single element pyroelectric IR detector, SOT-49F	573
RPY97	Dual element pyroelectric IR detector, SOT-49H	581
RTC901	12 segment array with 12 x CQV60 (super-red)	327
RTC902	12 segment array with 12 x CQV61A (super-green)	327
RTC903	12 segment array with 12 x CQV62 (yellow)	327
RTC904	12 segment array with colour mix upon request	327
375CQY/B	Diode laser with fibre pigtail, 850 nm	329
497CQF/A	Diode laser with fibre pigtail, 835 nm	333
498CQL	Diode laser, 840 nm, SOT-148	337

GENERAL

Rating systems

Letter symbols

Definitions for optoelectronic devices

General safety recommendations optoelectronic devices



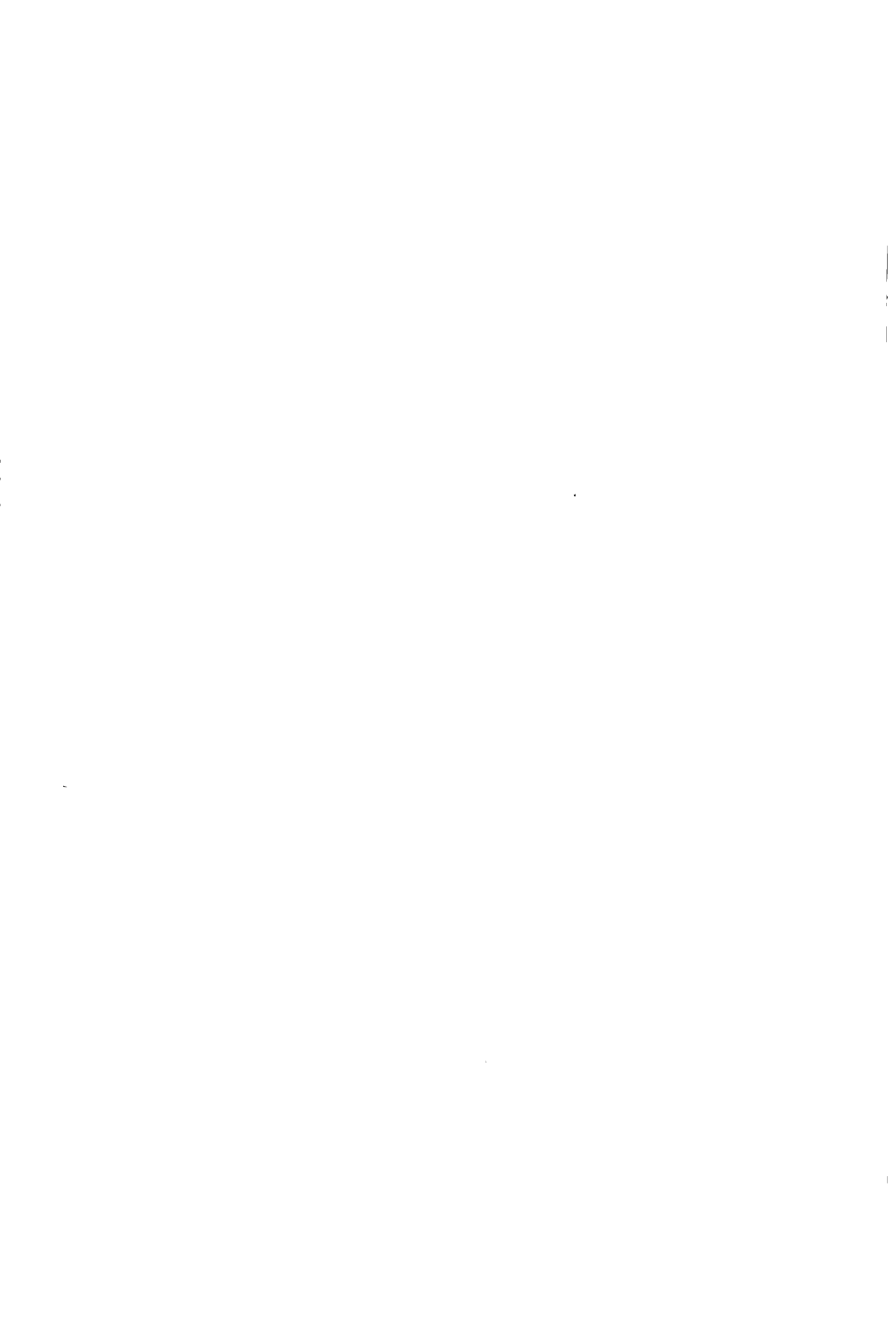

RATING SYSTEMS

The rating systems described are those recommended by the International Electrotechnical Commission (IEC) in its Publication 134.

DEFINITIONS OF TERMS USED

Electronic device. An electronic tube or valve, transistor or other semiconductor device.

Note

This definition excludes inductors, capacitors, resistors and similar components.

Characteristic. A characteristic is an inherent and measurable property of a device. Such a property may be electrical, mechanical, thermal, hydraulic, electro-magnetic, or nuclear, and can be expressed as a value for stated or recognized conditions. A characteristic may also be a set of related values, usually shown in graphical form.

Bogey electronic device. An electronic device whose characteristics have the published nominal values for the type. A bogey electronic device for any particular application can be obtained by considering only those characteristics which are directly related to the application.

Rating. A value which establishes either a limiting capability or a limiting condition for an electronic device. It is determined for specified values of environment and operation, and may be stated in any suitable terms.

Note

Limiting conditions may be either maxima or minima.

Rating system. The set of principles upon which ratings are established and which determine their interpretation.

Note

The rating system indicates the division of responsibility between the device manufacturer and the circuit designer, with the object of ensuring that the working conditions do not exceed the ratings.

ABSOLUTE MAXIMUM RATING SYSTEM

Absolute maximum ratings are limiting values of operating and environmental conditions applicable to any electronic device of a specified type as defined by its published data, which should not be exceeded under the worst probable conditions.

These values are chosen by the device manufacturer to provide acceptable serviceability of the device, taking no responsibility for equipment variations, environmental variations, and the effects of changes in operating conditions due to variations in the characteristics of the device under consideration and of all other electronic devices in the equipment.

The equipment manufacturer should design so that, initially and throughout life, no absolute maximum value for the intended service is exceeded with any device under the worst probable operating conditions with respect to supply voltage variation, equipment component variation, equipment control adjustment, load variations, signal variation, environmental conditions, and variations in characteristics of the device under consideration and of all other electronic devices in the equipment.

DESIGN MAXIMUM RATING SYSTEM

Design maximum ratings are limiting values of operating and environmental conditions applicable to a bogey electronic device of a specified type as defined by its published data, and should not be exceeded under the worst probable conditions.

These values are chosen by the device manufacturer to provide acceptable serviceability of the device, taking responsibility for the effects of changes in operating conditions due to variations in the characteristics of the electronic device under consideration.

The equipment manufacturer should design so that, initially and throughout life, no design maximum value for the intended service is exceeded with a bogey device under the worst probable operating conditions with respect to supply voltage variation, equipment component variation, variation in characteristics of all other devices in the equipment, equipment control adjustment, load variation, signal variation and environmental conditions.

DESIGN CENTRE RATING SYSTEM

Design centre ratings are limiting values of operating and environmental conditions applicable to a bogey electronic device of a specified type as defined by its published data, and should not be exceeded under normal conditions.

These values are chosen by the device manufacturer to provide acceptable serviceability of the device in average applications, taking responsibility for normal changes in operating conditions due to rated supply voltage variation, equipment component variation, equipment control adjustment, load variation, signal variation, environmental conditions, and variations in the characteristics of all electronic devices.

The equipment manufacturer should design so that, initially, no design centre value for the intended service is exceeded with a bogey electronic device in equipment operating at the stated normal supply voltage.

LETTER SYMBOLS FOR TRANSISTORS AND SIGNAL DIODES

based on IEC Publication 148

LETTER SYMBOLS FOR CURRENTS, VOLTAGES AND POWERS

Basic letters

The basic letters to be used are :

I, i = current
V, v = voltage
P, p = power.

Lower-case basic letters shall be used for the representation of instantaneous values which vary with time.

In all other instances upper-case basic letters shall be used.

Subscripts

A, a	Anode terminal
(AV), (av)	Average value
B, b	Base terminal, for MOS devices: Substrate
(BR)	Breakdown
C, c	Collector terminal
D, d	Drain terminal
E, e	Emitter terminal
F, f	Forward
G, g	Gate terminal
K, k	Cathode terminal
M, m	Peak value
O, o	As third subscript: The terminal not mentioned is open circuited
R, r	As first subscript: Reverse. As second subscript: Repetitive. As third subscript: With a specified resistance between the terminal not mentioned and the reference terminal.
(RMS), (rms)	R. M. S. value
S, s	{ As first or second subscript: Source terminal (for FETS only) As second subscript: Non-repetitive (not for FETS) As third subscript: Short circuit between the terminal not mentioned and the reference terminal
X, x	Specified circuit
Z, z	Replaces R to indicate the actual working voltage, current or power of voltage reference and voltage regulator diodes.

Note: No additional subscript is used for d. c. values.

Upper-case subscripts shall be used for the indication of:

- a) continuous (d. c.) values (without signal)
Example I_B
- b) instantaneous total values
Example i_B
- c) average total values
Example $I_{B(AV)}$
- d) peak total values
Example I_{BM}
- e) root-mean-square total values
Example $I_{B(RMS)}$

Lower-case subscripts shall be used for the indication of values applying to the varying component alone:

- a) instantaneous values
Example i_b
- b) root-mean-square values
Example $I_b(rms)$
- c) peak values
Example I_{bm}
- d) average values
Example $I_{b(av)}$

Note: If more than one subscript is used, subscript for which both styles exist shall either be all upper-case or all lower-case.

Additional rules for subscripts

Subscripts for currents

Transistors: If it is necessary to indicate the terminal carrying the current, this should be done by the first subscript (conventional current flow from the external circuit into the terminal is positive).

Examples: I_B, i_B, i_b, I_{bm}

Diodes: To indicate a forward current (conventional current flow into the anode terminal) the subscript F or f should be used; for a reverse current (conventional current flow out of the anode terminal) the subscript R or r should be used.

Examples: $I_F, I_R, i_F, I_f(rms)$

Subscripts for voltages

Transistors: If it is necessary to indicate the points between which a voltage is measured, this should be done by the first two subscripts. The first subscript indicates the terminal at which the voltage is measured and the second the reference terminal or the circuit node. Where there is no possibility of confusion, the second subscript may be omitted.

Examples: V_{BE} , v_{BE} , v_{be} , V_{bem}

Diodes: To indicate a forward voltage (anode positive with respect to cathode), the subscript F or f should be used; for a reverse voltage (anode negative with respect to cathode) the subscript R or r should be used.

Examples: V_F , V_R , v_F , V_{rm}

Subscripts for supply voltages or supply currents

Supply voltages or supply currents shall be indicated by repeating the appropriate terminal subscript.

Examples: V_{CC} , I_{EE}

Note: If it is necessary to indicate a reference terminal, this should be done by a third subscript

Example: V_{CCE}

Subscripts for devices having more than one terminal of the same kind

If a device has more than one terminal of the same kind, the subscript is formed by the appropriate letter for the terminal followed by a number; in the case of multiple subscripts, hyphens may be necessary to avoid misunderstanding.

Examples: I_{B2} = continuous (d.c.) current flowing into the second base terminal

V_{B2-E} = continuous (d.c.) voltage between the terminals of second base and emitter

Subscripts for multiple devices

For multiple unit devices, the subscripts are modified by a number preceding the letter subscript; in the case of multiple subscripts, hyphens may be necessary to avoid misunderstanding.

Examples: I_{2C} = continuous (d.c.) current flowing into the collector terminal of the second unit

V_{1C-2C} = continuous (d.c.) voltage between the collector terminals of the first and the second unit.

Application of the rules

The figure below represents a transistor collector current as a function of time. It consists of a continuous (d. c.) current and a varying component.

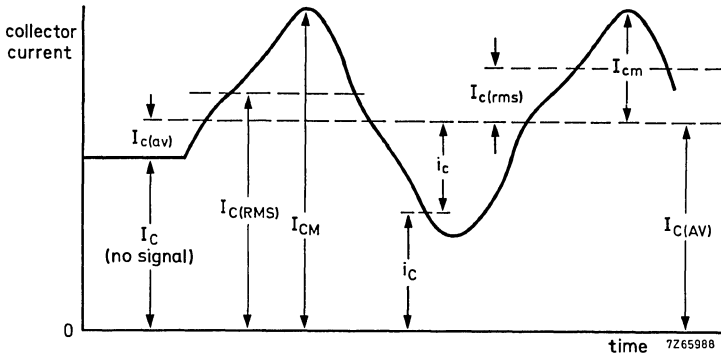

LETTER SYMBOLS FOR ELECTRICAL PARAMETERS

Definition

For the purpose of this Publication, the term "electrical parameter" applies to four-pole matrix parameters, elements of electrical equivalent circuits, electrical impedances and admittances, inductances and capacitances.

Basic letters

The following is a list of the most important basic letters used for electrical parameters of semiconductor devices.

- B, b = susceptance; imaginary part of an admittance
- C = capacitance
- G, g = conductance; real part of an admittance
- H, h = hybrid parameter
- L = inductance
- R, r = resistance; real part of an impedance
- X, x = reactance; imaginary part of an impedance
- Y, y = admittance;
- Z, z = impedance;

Upper-case letters shall be used for the representation of:

- a) electrical parameters of external circuits and of circuits in which the device forms only a part;
- b) all inductances and capacitances.

Lower-case letters shall be used for the representation of electrical parameters inherent in the device (with the exception of inductances and capacitances).

Subscripts

General subscripts

The following is a list of the most important general subscripts used for electrical parameters of semiconductor devices:

F, f	= forward: forward transfer
I, i (or 1)	= input
L, l	= load
O, o (or 2)	= output
R, r	= reverse; reverse transfer
S, s	= source

Examples: Z_S , h_I , h_F

The upper-case variant of a subscript shall be used for the designation of static (d.c.) values.

Examples : h_{FE} = static value of forward current transfer ratio in common-emitter configuration (d.c. current gain)

R_E = d.c. value of the external emitter resistance.

Note: The static value is the slope of the line from the origin to the operating point on the appropriate characteristic curve, i.e. the quotient of the appropriate electrical quantities at the operating point.

The lower-case variant of a subscript shall be used for the designation of small-signal values.

Examples: h_{fe} = small-signal value of the short-circuit forward current transfer ratio in common-emitter configuration

Z_e = $R_e + jX_e$ = small-signal value of the external impedance

Note: If more than one subscript is used, subscripts for which both styles exist shall either be all upper-case or all lower-case

Examples: h_{FE} , y_{RE} , h_{fe}

Subscripts for four-pole matrix parameters

The first letter subscript (or double numeric subscript) indicates input, output, forward transfer or reverse transfer

Examples: h_i (or h_{11})
 h_o (or h_{22})
 h_f (or h_{21})
 h_r (or h_{12})

A further subscript is used for the identification of the circuit configuration. When no confusion is possible, this further subscript may be omitted.

Examples: h_{fc} (or h_{21c}), h_{fE} (or h_{21E})

Distinction between real and imaginary parts

If it is necessary to distinguish between real and imaginary parts of electrical parameters, no additional subscripts should be used. If basic symbols for the real and imaginary parts exist, these may be used.

Examples: $Z_i = R_i + jX_i$
 $y_{fc} = g_{fc} + jb_{fc}$

If such symbols do not exist or if they are not suitable, the following notation shall be used:

Examples: $\text{Re}(h_{ib})$ etc. for the real part of h_{ib}
 $\text{Im}(h_{ib})$ etc. for the imaginary part of h_{ib}

DEFINITIONS FOR OPTOELECTRONIC DEVICES ACCORDING TO IEC 306

DEFINITIONS AND UNITS OF RADIATION AND LIGHT QUANTITIES

Radiant flux, radiant power ϕ , P , (ϕ_e)

This is the power emitted, transferred or received as radiation, i.e. the radiant energy (dQ_e) emitted per second.

$$\phi_e = \frac{dQ_e}{dt} \quad \text{unit: watt, W}$$

Radiant intensity I_e , I

For a source of given direction, the radiant intensity is the radiant power leaving the source, or an element of the source, in an element of solid angle (Ω) containing the given direction, divided by that element of solid angle.

$$I_e = \frac{d\phi_e}{d\Omega} \quad \text{unit: watt per steradian, W/sr}$$

Irradiance E , (E_e)

At a point on a surface, the irradiance is the radiant power incident on an element of the surface containing the point divided by the area (A) of that element.

$$E = \frac{d\phi_e}{dA} \quad \text{unit: watt per square metre, W/m}^2$$

Light

This is radiation capable of stimulating the eye. Exceptions to this definition are made where necessary in the data sheets, e.g. dark and light currents of a phototransistor and light rise time of a near-infrared light emitting diode.

Luminous flux ϕ_v , (ϕ_V)

The luminous flux $d\phi_v$ of a source of luminous intensity I_v in an element of solid angle of $d\Omega$, is given by:

$$d\phi_v = I_v \cdot d\Omega \quad \text{unit: lumen, lm}$$

Lumen

This is the luminous flux radiating from a point source of uniform luminous intensity of 1 candela, contained within a solid angle of 1 steradian.

$$1 \text{ lm} = 1 \text{ cd} \cdot \text{sr}$$

Luminous intensity I_v , (I)

For a source of given direction, the luminous intensity is the luminous flux leaving the source, or an element of the source, in an element of solid angle (Ω) containing the given direction, divided by that element of solid angle.

$$I_v = \frac{d\phi_v}{d\Omega} \quad \text{unit: candela, cd}$$

Candela

This is the luminous intensity, in the perpendicular direction, of a surface of 1/600 000 square metre of a black body at the temperature of freezing platinum under a pressure of 101 325 pascal.

Illuminance E_v , (E)

At a point on a surface, the illuminance is the luminous flux incident on an element of the surface containing the point, divided by the area (A) of that element.

$$E_v = \frac{d\phi_v}{dA} \quad \text{unit: lux, lx}$$

Lux lx

This is the illumination produced when 1 lumen of flux falls on a surface of area 1 square metre. It will be seen that an illumination of 1 lx is produced on a area of 1 square metre at a distance of 1 metre from a point source of 1 candela.

Distribution temperature T_d

This is the temperature of a black body at which the spectral radiation distribution of the radiator under consideration, in a given wavelength range, is proportional or approximately proportional to the spectral radiation distribution of the black body. If the wavelength range given includes visible radiation, then the distribution temperature corresponds to the colour temperature.

Colour temperature T_c

The colour temperature of a radiator is the temperature of a black body which has the same, or approximately the same, spectral radiation distribution in the visible range as the radiator under consideration.

DEFINITIONS OF ELECTRICAL QUANTITIES

Photocurrent I_{ph}

This is the change in output current from the photocathode due to incident radiation.

Dark current I_d

This is the current flowing in a photoelectric device in the absence of illumination.

Dark current equivalent radiation E_d

This is the incident radiation required to give a d.c. signal output current equal to the dark current.

Quantum efficiency

This is the ratio of the number of emitted photoelectrons to the number of incident photons. Quantum efficiency (Q.E.) at a given wavelength of incident radiation may be calculated as follows:

$$Q.E. = \frac{\text{constant} \times S_k}{\lambda}$$

where S_k = spectral sensitivity (A/W) at wavelength λ
 λ = wavelength of incident radiation (nm)

$$\text{constant} = \frac{hc}{e} = 1,24 \times 10^3 \text{ W.nm/A}$$

h = Planck's constant (6,6256 x 10⁻³⁴ js)

c = velocity of electromagnetic waves in vacuo = 2,997925 x 10⁸ m/s

e = elementary charge = 1,60210 x 10⁻¹⁹ coulomb or 4,80298 x 10⁻¹⁹ e.s.u.

Saturation voltage V_{CEsat}

This is the lowest operating voltage which causes no change in photocurrent when this voltage is increased with constant radiation.

Saturation current I_{CEsat}

This is the output current of a photosensitive device which is not changed by an increase of either:

- a. the irradiance under constant operating conditions, or,
- b. the operating voltage under constant irradiance.

Thermal resistance

This is the ratio of temperature rise to power dissipation or

$$R_{th\ j-a} = \frac{T_j - T_{amb}}{P_{tot}}$$

The thermal resistance is also the reciprocal of the derating factor.

Pulsed operation

Under these conditions higher peak power dissipation is possible. In general, the shorter the pulse and lower the frequency, the lower is the temperature that the junction reaches.

By analogy with thermal resistance:

$$Z_{th\ j-a} = \frac{T_j - T_{amb}}{P_{tot}}$$

DEFINITIONS OF SENSITIVITY

These definitions apply more directly to photocathode sensitivity. For devices in which it is necessary to define the anode (overall) sensitivity, the signal output current should be considered instead of the photocurrent.

Activity of radiation Z

This is the ratio of the sensitivity to a given radiation to the sensitivity to a reference radiation.

Radiant sensitivity S_R

This may be expressed as either:

- a. the ratio of the photocurrent of the device to the incident radiant power, expressed in amperes per watt (A/W), or,
- b. the ratio of the photocurrent of the device to the incident irradiance, expressed in amperes per watt per square metre (A/W/m²).

Absolute spectral sensitivity $s(\lambda)$

This is the radiant sensitivity for monochromatic radiation of a stated wavelength.

Relative spectral sensitivity $s(\lambda)_{rel}$

This is the ratio of the radiant sensitivity at a particular wavelength to the radiant sensitivity at a reference wavelength, usually the wavelength of maximum response.

Note

For non-linear detectors, it is necessary to refer to constant photocurrent at all wavelengths.

Luminous sensitivity S_L

This may be expressed as either:

- a. the ratio of the photocurrent of the device to the incident luminous flux, expressed in amperes per lumen (A/lm), or,
- b. the ratio of the photocurrent of the device to the incident illuminance, expressed in amperes per lux (A/lx).

Dynamic sensitivity S_D

Under stated operating conditions, this is the ratio of the variation of the photocurrent of the device to the initiating small variation in the incident radiant or luminous power.

Note

Distinction is made between luminous dynamic sensitivity and radiant sensitivity.

Spectral sensitivity characteristics

This is the relationship, usually shown in graphical form, between the wavelength and the absolute or relative spectral sensitivity.

Absolute spectral sensitivity characteristics

This is the relationship, usually shown in graphical form, between the wavelength and the absolute spectral sensitivity.

Relative spectral sensitivity characteristics

This is the relationship between wavelength and the relative spectral sensitivity.

Quantum efficiency characteristic

This is the relationship, usually shown in graphical form, between the wavelength and the quantum efficiency.

DEFINITIONS OF TIME QUANTITIES

Rise time t_r

This is the time required for the photocurrent to rise from a stated low percentage to a stated higher percentage of the maximum value when a steady state of radiation is instantaneously applied. It is usual to consider the 10% and 90% levels (see Figs 1 and 2).

Fall time t_f

This is the time required for the photocurrent to fall from a stated high percentage to a stated lower percentage of the maximum value when the steady state of radiation is instantaneously removed.

It is usual to consider the 90% and 10% levels (see Figs 1 and 2).

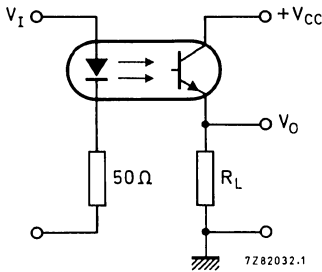

Fig. 1 Switching circuit.

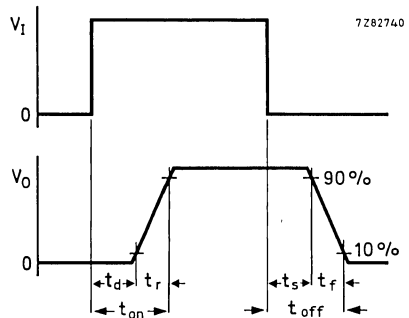

Fig. 2 Waveforms.

DEFINITIONS AND UNITS OF INFRARED SENSITIVE DEVICES

Emissivity

This is the ratio of the radiant exitance of a thermal radiator to that of a black body radiator at the same temperature.

Absolute refractive index n

This is the ratio of the velocity of light in vacuo to that in a particular medium. For most practical purposes the velocity of light in vacuo can be replaced by that in air.

Detectivity

This is the signal-to-noise ratio per unit radiant power. Thus it is the reciprocal of the N.E.P. Care must be exercised when considering detectivity as this term has also been used in the definitions of D*.

unit: 1/watts (1/W)

D*

This is an independent figure of merit which is defined as the r.m.s. signal-to-noise ratio in a 1 Hz bandwidth per unit r.m.s. incident radiant power per square root of detector area. Unless otherwise stated, it is assumed that the detector field of view is hemispherical (2 π steradian).

unit: cm√Hz/W

Wave number

This is the reciprocal of the wavelength in centimetres. ($\frac{1}{\lambda}$)

N.E.P. (Noise Equivalent Power)

This is the r.m.s. value of the incident, chopped, radiant power necessary to produce an r.m.s. signal to r.m.s. noise ratio of unity. The r.m.s. noise refers to the value calculated for unit square root bandwidth $V/\sqrt{\text{Hz}}$.

unit: $W/\sqrt{\text{Hz}}$

Responsivity

This is the ratio of the r.m.s. signal in volts to the r.m.s. value of the incident, chopped, radiant power.

unit: V/W

Noise equivalent irradiation

This is the value of incident radiation which, when modulated in a stated manner, produces a signal output power equal to the noise power, both of which are in a stated bandwidth.

Radiance L_e

This is the radiant intensity (I_e) at a point on a surface and in a given direction, of an element of that surface, divided by the area of the orthogonal projection of the element on a plane perpendicular to the given direction.

unit: watt per steradian square metre, $W/sr.m^2$

Radiant exitance (radiant emittance) M_e

At a point on a surface, this is the radiant power leaving an element of that surface, divided by the area of the element.

$$M_e = \frac{d\phi_e}{dA} \quad \text{unit: watt per square metre, } W/m^2$$

Luminous exitance (luminous emittance) M_v

At a point on a surface, this is the luminous flux leaving an element of that surface, divided by the area of that element.

$$M_v = \frac{d\phi_v}{dA} \quad \text{unit: lumen per square metre, } lm/m^2$$

Luminance L_v

This is the luminous intensity (I_v) at a point on a surface and in a given direction, of an element of that surface divided by the area of the orthogonal projection of the element on a plane perpendicular to the given direction.

unit: candela per square metre, cd/m^2

Steradian sr (see Fig. 3)

This is the solid angle subtended at the centre of a sphere by an element of the surface area equal to the square of the radius of the sphere. There are, therefore, 4π steradians in a complete sphere.

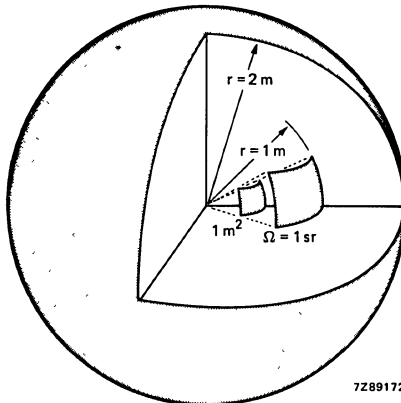
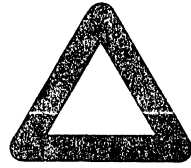

Fig. 3.

7289172

GENERAL SAFETY RECOMMENDATIONS OPTOELECTRONIC DEVICES



1. GENERAL

When properly used and handled, optoelectronic devices do not constitute a risk to health or environment. Modern high technology materials have been used in the manufacture of these devices to ensure optimum performance. Some of these materials are toxic in certain circumstances. Mechanical or electrical damage is unlikely to give rise to any hazard, but toxic vapours may be generated if the devices are heated to destruction and it is important that the following recommendations are observed.

Care should be taken to ensure that all personnel who may handle, use or dispose of these products are aware of the necessary precautions.

Individual product data sheets will indicate whether any specific hazards are likely to be present.

2. DISPOSAL

These devices should be disposed of in accordance with the relevant legislation; in the United Kingdom disposal should therefore be carried out in accordance with the Deposit of Poisonous Waste Act 1972 and the Control of Pollution Act 1974, or with the latest legislation.

3. FIRE

Optoelectronic devices themselves, when used within the specified limits, do not present a fire hazard.

Devices can contain arsenic, beryllium, cadmium, lead, mercury, selenium, tellurium or similar hazardous materials or compounds, which, if exposed to high temperatures may emit toxic or noxious fumes.

Most packaging materials are flammable and care should be taken in the disposal of such materials, some of which will emit toxic fumes if burned.

4. HANDLING

Care must be exercised with those devices incorporating glass or plastic. If these devices are broken, precautions must be taken against the following hazards that may arise:

Broken glass or ceramic. Protective clothing such as gloves should be worn.

Contamination from toxic materials and vapours. In particular, skin contact and inhalation must be avoided.

Access to live contacts which may be at high potential. Devices must be isolated from the mains supply prior to their removal.

5. BERYLLIUM COMPOUNDS

Beryllium oxide dust is toxic if inhaled or if particles enter a cut or an abrasion. At all times avoid handling beryllium oxide ceramics; if they are touched, the hands must be washed thoroughly with soap and water. Do nothing to beryllium oxide ceramics that may produce dust or fumes.

Care should be taken upon eventual disposal that they are not thrown out with general industrial waste. Users seeking disposal of devices incorporating beryllium oxide ceramics should first take advice from the manufacturer's service department.

This potential hazard is present at all times from receipt to disposal of devices.

6. CADMIUM COMPOUNDS

Cadmium compounds are toxic. In the event of accidental breakage, cadmium dust may be released. Gloves should be worn and the dust should be mopped up with a damp cloth. Upon disposal, the cloth should be sealed in a plastic bag and the hands washed thoroughly with soap and water.

Controlled disposal of devices containing cadmium compounds should be conducted in the open air or in a well ventilated area.

Inhalation of cadmium dust must be avoided.

This potential hazard is present, if breakage occurs, at all times from receipt to disposal of devices.

7. OTHER COMPOUNDS

Other compounds, such as those containing arsenic, indium, lead, lithium, selenium, tantalum, tellurium etc., may be toxic by ingestion or inhalation.

The above information and recommendations are given in good faith and are in accordance with the best knowledge and opinion available at the date of the compilation of the data sheets.

PHOTOSENSITIVE DIODES AND TRANSISTORS





SILICON AVALANCHE PHOTODIODE FOR FIBRE-OPTIC COMMUNICATIONS

Type 1 Silicon avalanche photodiode in a hermetically sealed modified TO-18 envelope coupled directly to a graded-index optical quartz glass fibre.

The device features high coupling and quantum efficiency, extremely fast response time and very low noise characteristics. The characteristics of this photodiode make it useful in a wide variety of applications in fibre-optic communications as well as in laser detection, ranging, high-sensitivity measurements, high-speed switching and transit-time measurements.

Type 2 A separate silicon avalanche (photo) diode in a hermetically "dark sealed" TO-18 envelope, to be used as a reference diode, with corresponding "dark electrical" behaviour.

QUICK REFERENCE DATA

Reverse dark avalanche breakdown voltage $I_{R(D)} = 1 \mu A$	$V_{(BR)R}$	typ.	200 V
Reach-through voltage	$V_{(RT)R}$	typ.	140 V
Dark reverse current $V_{R(D)} = 0,8 V_{(BR)R}$	$I_{R(D)}$	typ.	5 nA
Wavelength at peak response	λ_{pk}	typ.	800 nm
Quantum efficiency $V_R > V_{(RT)R}; \lambda = 800 \text{ nm}$	η_λ	typ.	90 %
Responsivity $V_R > V_{(RT)R}; \lambda = 800 \text{ nm}; M = 100$	R	typ.	60 A/W
Diode capacitance $V_{R(D)} > V_{(RT)R}$	C_d	typ.	1,3 pF
Pulse response FWHM M = 50 to 100	σ	typ.	0,44 ns
Effective noise factor (see page 26)	k_{eff}	typ.	0,02
Diameter active area	ϕ		350 μm

MECHANICAL DATA

Dimensions in mm

Fig. 1 TO-18 (modified).

Anode connected to case.

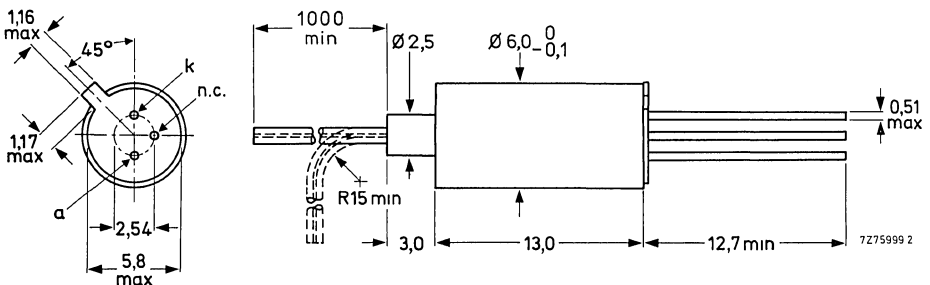

BPF10 (368BPY)

RATINGS

Limiting values in accordance with the Absolute Maximum System (IEC 134)

Forward current (d.c.)	I_F	max.	10 mA
Total power dissipation up to $T_{amb} = 90\text{ }^\circ\text{C}$	P_{tot}	max.	100 mW
Storage temperature	T_{stg}		0 to $+90\text{ }^\circ\text{C}$
Avalanche photodiode with fibre	T_{stg}		-25 to $+125\text{ }^\circ\text{C}$
Reference diode	T_j	max.	$125\text{ }^\circ\text{C}$

THERMAL RESISTANCE

From junction to ambient in free air	$R_{th\ j-a}$	=	$350\text{ }^\circ\text{C/W}$
From junction to case	$R_{th\ j-c}$	=	$100\text{ }^\circ\text{C/W}$

CHARACTERISTICS (measured on crystal)

$T_j = 25\text{ }^\circ\text{C}$

Dark reverse currents

$V_{R(D)} = 0,8 V_{(BR)R}$; surface

$I_{R(D)}$	typ.	5 nA
	<	30 nA

$V_{R(D)} = 0,8 V_{(BR)R}$; bulk (unmultiplied)

$I_{R(D)b}$	typ.	20 pA
-------------	------	-------

Reverse dark avalanche breakdown voltage

$I_{R(D)} = 1\text{ }\mu\text{A}$

$V_{(BR)R}$	typ.	200 V
		165 to 245 V

Reach-through voltage

$V_{(RT)R}$	typ.	140 V
-------------	------	-------

Forward voltage

$I_F = 1\text{ mA}$

V_F	typ.	600 mV
-------	------	--------

Temperature coefficient of reverse voltage at $M = 100$

$\frac{\Delta V_R}{T_{amb}}$	typ.	$0,6\text{ V}/^\circ\text{C}$
------------------------------	------	-------------------------------

Wavelength at peak response

λ_{pk}	typ.	800 nm
----------------	------	--------

Multiplication operating range

M		20 to 120
-----	--	-----------

Responsivity

$V_R > V_{(RT)R}$; $\lambda = 800\text{ nm}$; $M = 100$

R	typ.	60 A/W
-----	------	--------

Quantum efficiency

$V_R > V_{(RT)R}$; $\lambda = 800\text{ nm}$

η_λ	typ.	90 %
----------------	------	------

Effective noise factor (see page 26)

Excess noise factor $F \approx 2 + k_{eff} M - 1/M$
up to $M = 120$

k_{eff}	typ.	0,020
	<	0,025

Noise equivalent power

$M = 50$; $\eta = 0,90$; $\lambda = 800\text{ nm}$

$I_{R(D)d} = 20\text{ pA}$; $k_{eff} = 0,02$

N.E.P.	typ.	$7,6 \times 10^{-15}\text{ W}/\sqrt{\text{Hz}}$
--------	------	---

Diode capacitance ($\approx 0,7\text{ pF}$ TO-18 envelope included)

$V_{R(D)} > V_{(RT)R}$

C_d	typ.	1,3 pF
-------	------	--------

Pulse response FWHM*

$M = 50$ to 100 ; $\lambda = 850\text{ nm}$; $R_L = 50\text{ }\Omega$

$\sigma_{opt} \approx 100\text{ ps}$ FWHM

σ	typ.	0,44 ns
----------	------	---------

* FWHM means full width half maximum.

OPTICAL DATA

Graded-index optical quartz glass fibre

Numerical aperture on-axis	NA	typ. 0,21 0,20 to 0,22
Core diameter	ϕ_{core}	typ. 50 μm 48 to 52 μm
Cladding diameter	ϕ_{cladding}	typ. 125 μm 123 to 127 μm
Primary coating thickness		typ. 5 μm
Secondary coating diameter	ϕ_{coating}	typ. 0,9 mm
Coupling efficiency	η_{coupling}	> 85 %

Note 1

$$\eta_{\text{a.p.d.}} = \eta_{\lambda} \times \eta_{\text{coupling}}$$

$$\eta_{\lambda} = \text{quantum efficiency}$$

η_{coupling} = optical coupling efficiency for the assembled envelope, from the free end of the avalanche photodiode fibre to the active area of the crystal.

Note 2

On special request the same crystals on TO-18 headers can be delivered with flat or lens windows. Also optical glass-fibres of deviating specifications can be mounted (e.g. $\phi_{\text{core}} = 50 \mu\text{m}$; $\phi_{\text{cladding}} = 100 \mu\text{m}$).

BPF10
(368BPY)

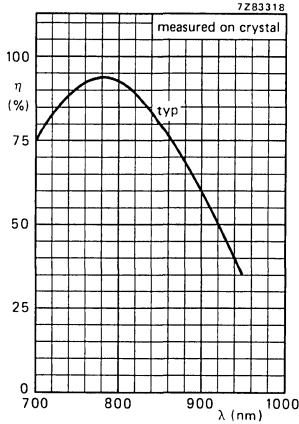

Fig. 2 Quantum efficiency versus wavelength; $V_R > V(RT)R$.

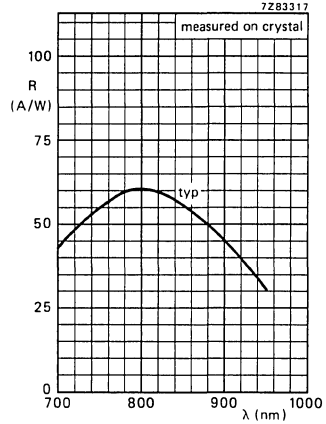

Fig. 3 Responsivity ($M = 100$) versus wavelength; $V_R > V(RT)R$.

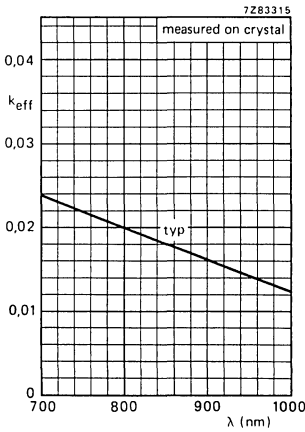

Fig. 4 Effective noise factor versus wavelength.

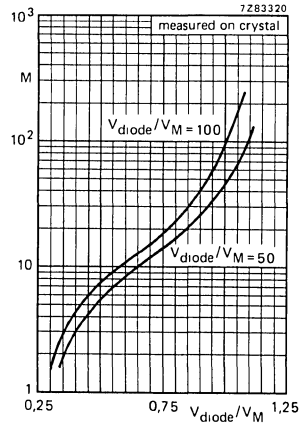

Fig. 5 Multiplication versus normalized voltage.

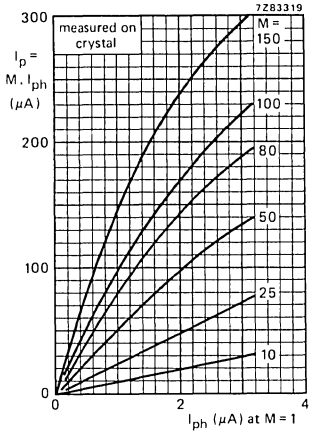

Fig. 6 Multiplied photocurrent versus primary photocurrent; typical values.

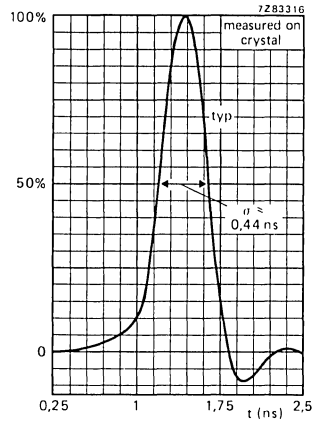

Fig. 7 Pulse response on a lightpulse $\sigma_{opt} \approx 100$ ps FWHM versus time; $\lambda = 850$ nm; $M = 50$ to 100.

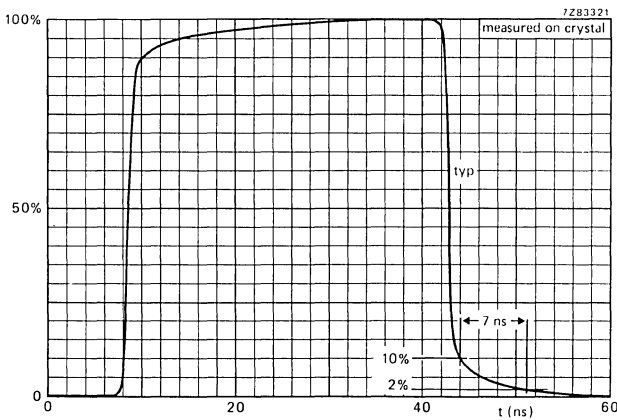

Fig. 8 Step response versus time; $\lambda = 850$ nm; $M = 50$.

BPF10 (368BPY)

Explanation of the effective noise factor (k_{eff}), noise equivalent power (N.E.P.) and signal to noise ratio (S/N).

The excess noise factor F is expressed by $F = \frac{\langle M^2 \rangle}{\langle M \rangle^2}$ in which:

$\langle M^2 \rangle$ = the mean square gain

$\langle M \rangle^2$ = the average gain squared

$\langle M^2 \rangle > \langle M \rangle^2$.

F is the ratio of the actual noise to that which would exist when all generated pairs are multiplied by exactly M.

$F \approx 2 + k_{\text{eff}} M - \frac{1}{M}$ in which:

k_{eff} , the effective noise factor, is a weighted ionization rate ratio of holes and electrons.

The mean square noise current for the avalanche photodiode is given by

$\langle i_n^2 \rangle = 2 qB \left\{ M^2 F (I_b + I_{ph}) + I_s \right\} \approx 2 qBM^2 F I_{ph}$ in which:

q = electronic charge 1.602×10^{-19} (C)

B = bandwidth (Hz)

$I_b = I_{R(D)b}$ bulk dark reverse current; $M = 1$ (unmultiplied); (A)

I_{ph} = photocurrent; $M = 1$ (unmultiplied); (A)

I_s = surface dark reverse current; (A).

N.E.P. ($W/\sqrt{\text{Hz}}$) = $\frac{\text{noise current without signal, } I_{ph} = 0 \text{ (A}/\sqrt{\text{Hz}})}{\text{responsivity (A/W)}}$

N.E.P. ($W/\sqrt{\text{Hz}}$) = $\frac{i_n \sqrt{B} \text{ (without signal, } I_{ph} = 0); \text{ (A}/\sqrt{\text{Hz}})}{R_m \text{ (A/W)}}$

$S/N = \frac{\text{responsivity (A/W)} \times \text{N.E.P. (W}/\sqrt{\text{Hz}})}{\text{noise current without signal, } I_{ph} = 0 \text{ (A}/\sqrt{\text{Hz}})} = 1$

$S/N = \frac{R_m \text{ (A/W)} \times \text{N.E.P. (W}/\sqrt{\text{Hz}})}{i_n \sqrt{B} \text{ (without signal, } I_{ph} = 0); \text{ (A}/\sqrt{\text{Hz}})} = 1$

$R_m = \frac{m}{100} \times R_M = 100$

SILICON PHOTODIODE FOR FIBRE-OPTIC COMMUNICATIONS

Photo p-i-n diode in hermetic TO-46 encapsulation, designed for fibre-optic transmissions over short and medium distances, mainly for military and industrial applications.

It is optimized to be coupled with a 200 μm core diameter fibre and to be used in combination with the CQF24 emitter.

The crystal is electrically isolated from the case.

QUICK REFERENCE DATA

Continuous reverse voltage	V_R	max.	50 V
Dark reverse current at $V_R = 10\text{ V}$	$I_{R(D)}$	max.	0,8 nA
Total power dissipation up to $T_{\text{amb}} = 25\text{ }^\circ\text{C}$	P_{tot}	max.	300 mW
Diode capacitance at $V_R = 10\text{ V}$	C_d	max.	3 pF
Spectral sensitivity at $V_R = 10\text{ V}$; $\lambda = 830\text{ nm}$	s_λ	min.	0,3 A/W

MECHANICAL DATA

Dimensions in mm

Fig. 1.

Pinning:

- 1 = anode
- 2 = cathode
- 3 = case

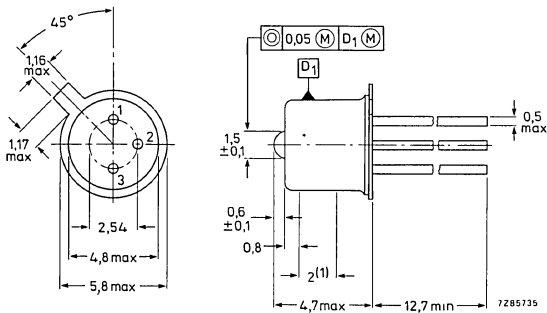

(1) Case diameter over this length is 4,7 (+ 0,05; -0,1) mm.

RATINGS

Limiting values in accordance with the Absolute Maximum System (IEC 134)

Continuous reverse voltage	V_R	max.	50 V
Total power dissipation up to $T_{amb} = 25\text{ }^\circ\text{C}$	P_{tot}	max.	300 mW
Junction temperature	T_j	max.	150 $^\circ\text{C}$
Operating temperature	T_{op}	-55 to +125	$^\circ\text{C}$
Storage temperature	T_{stg}	-65 to +150	$^\circ\text{C}$

THERMAL RESISTANCE

From junction to ambient when the device is mounted on a printed circuit	$R_{th\ j-a}$	typ.	400 K/W	max.	500 K/W
From junction to case	$R_{th\ j-c}$	typ.	100 K/W	max.	150 K/W

CHARACTERISTICS

$T_{amb} = 25\text{ }^\circ\text{C}$ unless otherwise specified

Dark reverse current at $V_R = 10\text{ V}$	$I_{R(D)}$	max.	0,8 nA			
Spectral sensitivity at $V_R = 10\text{ V}; \lambda = 830\text{ nm}$	s_λ	min.	0,3 A/W	typ.	0,4 A/W	
Wavelength at peak response	λ_{pk}	typ.	750 nm			
Diode capacitance at $V_R = 10\text{ V}$	C_d	typ.	2 pF	max.	3 pF	
Switching times at $V_R = 10\text{ V}; R_L = 50\ \Omega$ (10%-90%)	t_r	max.	1 ns	t_f	max.	1 ns
Light photocurrent, when coupled to a fibre-glass rod with NA = 0,2 and $\phi_{core} = 200\ \mu\text{m}$ and at a distance $d = 0,7\text{ mm}$ (see Fig. 2) at $V_R = 10\text{ V}; \lambda = 830\text{ nm};$ $P_{opt} = 100\ \mu\text{W}$	I_R	typ.	25 μA			

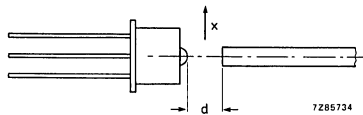

Fig. 2 Distance d and lateral displacement x.

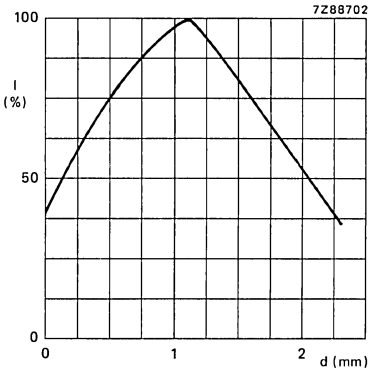

Fig. 3.

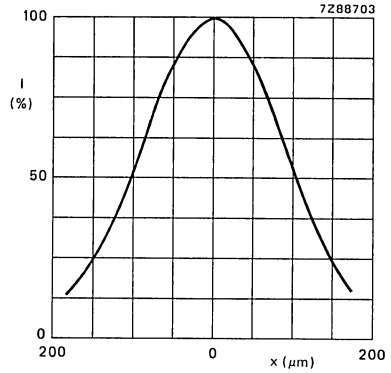

Fig. 4.

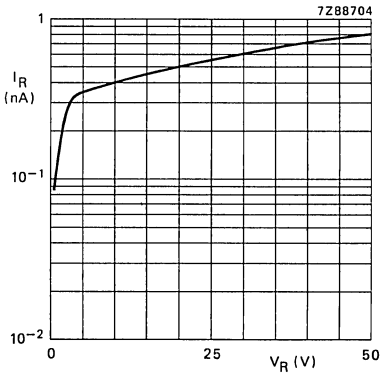

Fig. 5 $T_{amb} = 25 \text{ }^\circ\text{C}$.

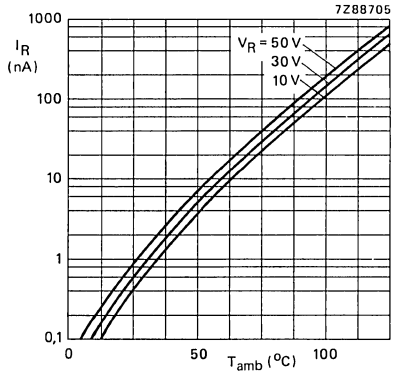

Fig. 6.

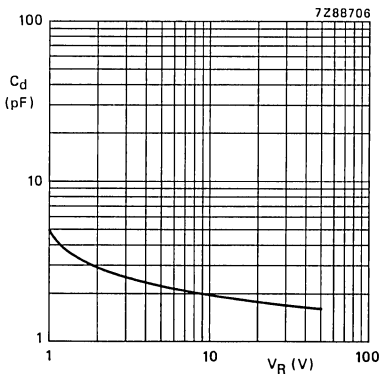

Fig. 7 $f = 1 \text{ MHz}$; $T_{amb} = 25 \text{ }^\circ\text{C}$.

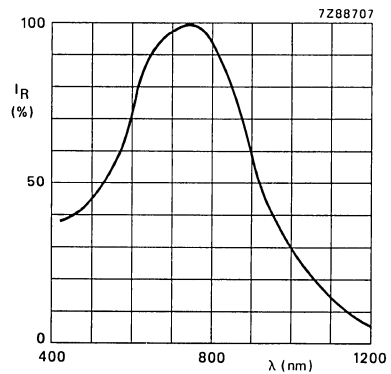

Fig. 8 $V_R = 10 \text{ V}$; $T_{amb} = 25 \text{ }^\circ\text{C}$.

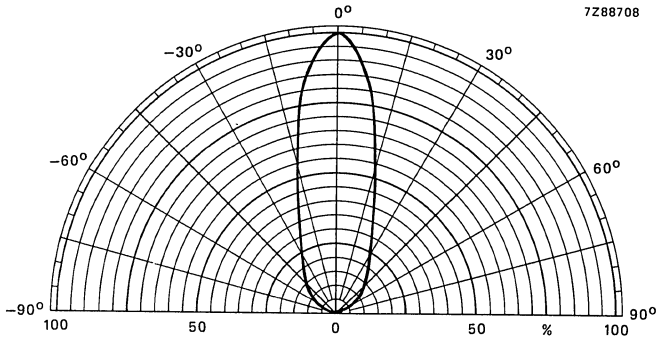

Fig. 9.



SILICON PHOTOTRANSISTÖR

N-P-N silicon phototransistor in epoxy resin encapsulation intended for optical coupling and encoding. The base is inaccessible. Combination with LED CQY58A is recommended.

QUICK REFERENCE DATA

Collector-emitter voltage	V_{CEO}	max.	50 V	
Collector current (d.c.)	I_C	max.	25 mA	
Total power dissipation up to $T_{amb} = 25\text{ }^\circ\text{C}$	P_{tot}	max.	100 mW	
Collector dark current $V_{CE} = 30\text{ V}; E = 0$	$I_{CEO(D)}$	<	100 nA	
Collector light current $V_{CE} = 5\text{ V}; E_e = 1\text{ mW/cm}^2; \lambda_{pk} = 930\text{ nm}$	BPW22A-I BPW22A-II	$I_{CEO(L)}$ $I_{CEO(L)}$	> >	1,5 mA 5 mA
Wavelength at peak response	λ_{pk}	typ.	800 nm	

MECHANICAL DATA

Dimensions in mm

Fig. 1 SOD-53D.

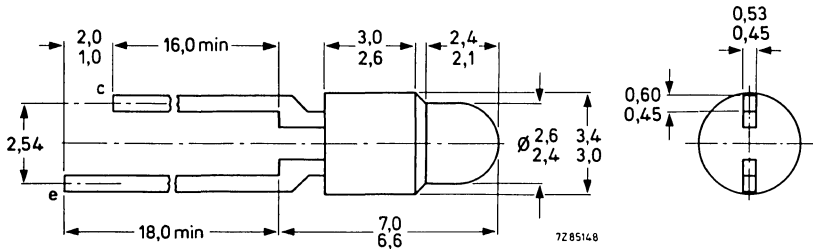

RATINGS

Limiting values in accordance with the Absolute Maximum System (IEC 134)

Collector-emitter voltage	V_{CEO}	max.	50 V
Emitter-collector voltage	V_{ECO}	max.	7 V
Collector current			
d.c.	I_C	max.	25 mA
peak value	I_{CM}	max.	50 mA
Total power dissipation up to $T_{amb} = 25\text{ }^\circ\text{C}$	P_{tot}	max.	100 mW
Storage temperature	T_{stg}		-55 to +100 $^\circ\text{C}$
Junction temperature	T_j	max.	100 $^\circ\text{C}$
Lead soldering temperature > 3,5 mm from the body; $t_{sld} < 7\text{ s}$	T_{sld}	max.	240 $^\circ\text{C}$

THERMAL RESISTANCE

From junction to ambient,
device mounted on printed-circuit board

$R_{th\ j-a} = 750\text{ }^\circ\text{C/W}$

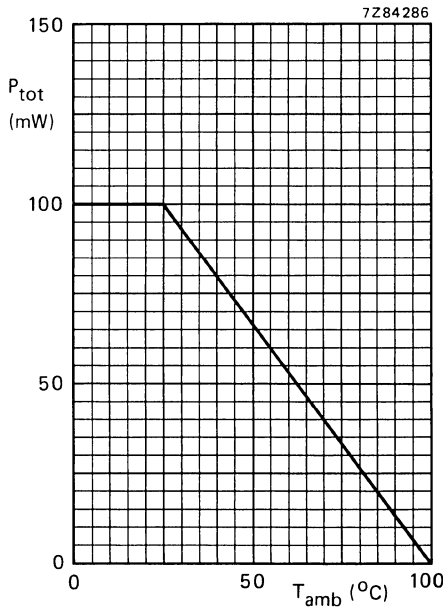

Fig. 2 Power derating curve versus ambient temperature.

CHARACTERISTICS

$T_j = 25\text{ }^\circ\text{C}$ unless otherwise specified

Collector dark current

$V_{CE} = 30\text{ V}; E = 0$

$I_{CEO(D)} < 100\text{ nA}$

Collector light current

$V_{CE} = 5\text{ V}; E_e = 1\text{ mW/cm}^2; \lambda_{pk} = 930\text{ nm}$

BPW22A-I $I_{CEO(L)} 1,5\text{ to }8\text{ mA}$
BPW22A-II $I_{CEO(L)} 5\text{ to }25\text{ mA}$

Collector-emitter saturation voltage

$I_C = 1\text{ mA}; E_e = 1\text{ mW/cm}^2; \lambda_{pk} = 930\text{ nm}$

$V_{CEsat} < 0,4\text{ V}$

Wavelength at peak response

λ_{pk} typ. 800 nm

Bandwidth at half height

$B_{50\%}$ typ. 400 nm

Beamwidth between half sensitivity directions

$\alpha_{50\%}$ typ. $\pm 20^\circ$

Switching times (see Figs 3, 4, 9 and 10)

$I_{Con} = 2\text{ mA}; V_{CC} = 5\text{ V}; R_E = 100\ \Omega; T_{amb} = 25\text{ }^\circ\text{C}$

turn-on time

t_{on} typ. $3\ \mu\text{s}$

turn-off time

t_{off} typ. $3\ \mu\text{s}$

$I_{Con} = 2\text{ mA}; V_{CC} = 5\text{ V}; R_E = 1\text{ k}\Omega; T_{amb} = 25\text{ }^\circ\text{C}$

turn-on time

t_{on} typ. $12,0\ \mu\text{s}$

turn-off time

t_{off} typ. $12,5\ \mu\text{s}$

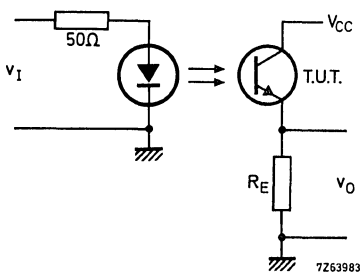

Fig. 3 Switching circuit with light emitting diode CQY58A. T.U.T. = BPW22A.

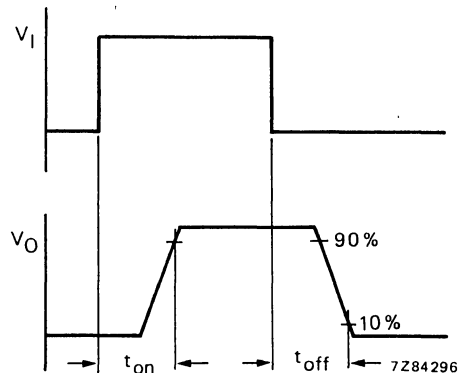

Fig. 4 Input and output switching waveforms.

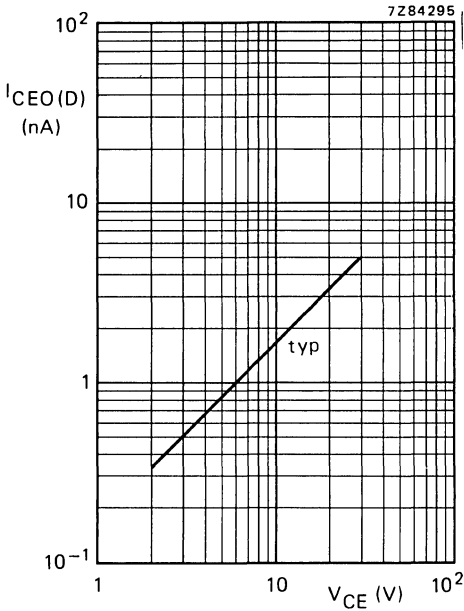

Fig. 5 $E = 0$; $T_j = 25^\circ\text{C}$.

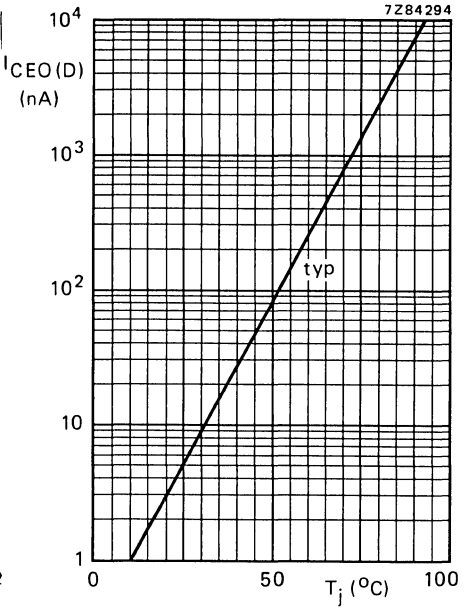

Fig. 6 $E = 0$; $V_{CE} = 30\text{ V}$.

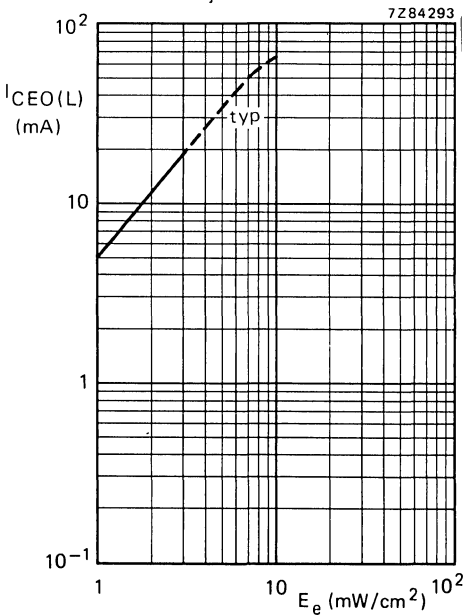

Fig. 7 GaAs source; $\lambda_{pk} = 930\text{ nm}$; $V_{CE} = 5\text{ V}$; $T_j = 25^\circ\text{C}$.

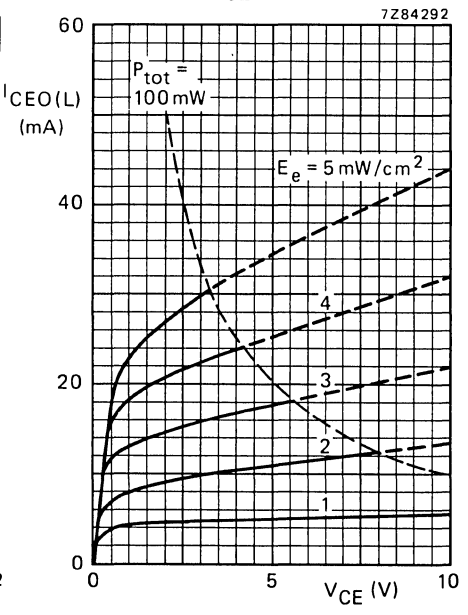

Fig. 8 $\lambda_{pk} = 930\text{ nm}$; $T_j = 25^\circ\text{C}$; typical values.

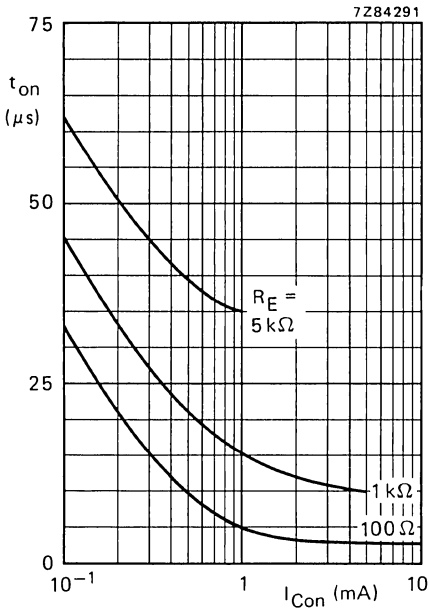

Fig. 9 $V_{CC} = 5 V$; $T_{amb} = 25^\circ C$; typical values; see also Figs 3 and 4.

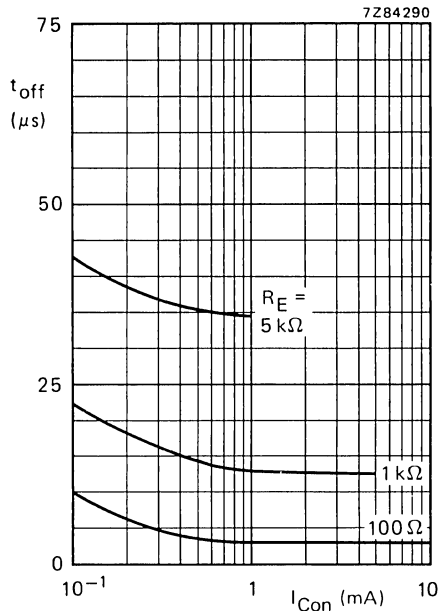

Fig. 10 $V_{CC} = 5 V$; $T_{amb} = 25^\circ C$; typical values; see also Figs 3 and 4.

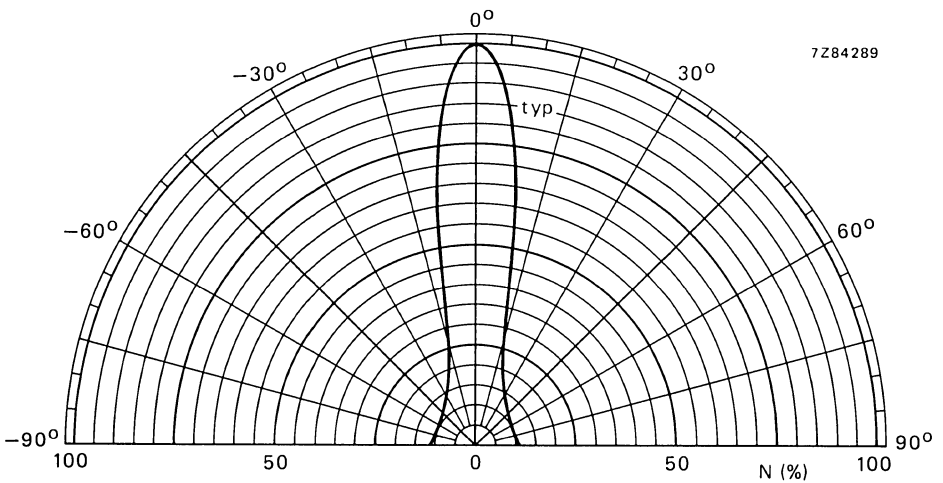

Fig. 11.

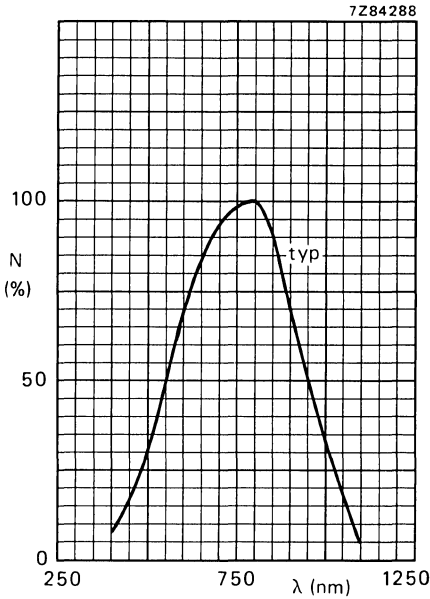

Fig. 12 Spectral response.

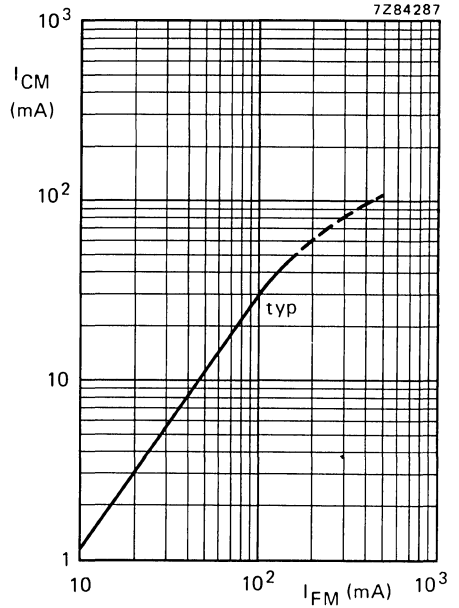

Fig. 13 $V_{CE} = 5 \text{ V}$; $t_p(I_{FM}) = 10 \mu\text{s}$; $T = 1 \text{ ms}$; $d^* = 10 \text{ mm}$; $T_{amb} = 25 \text{ }^\circ\text{C}$.

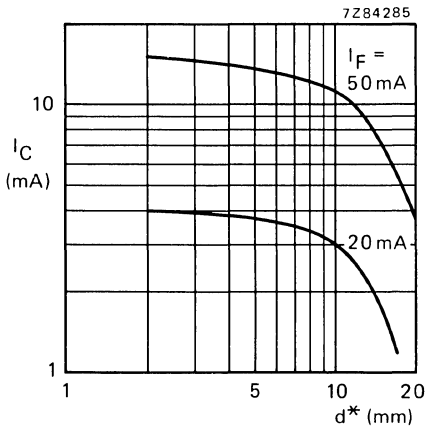

Fig. 14 $V_{CE} = 5 \text{ V}$; $T_{amb} = 25 \text{ }^\circ\text{C}$; typical values.

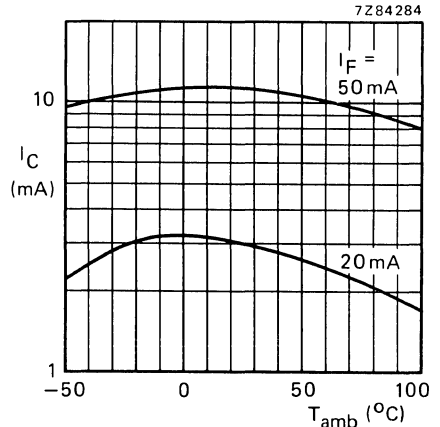

Fig. 15 $V_{CE} = 5 \text{ V}$; $d^* = 10 \text{ mm}$; typical values.

* d = shortest free distance of mechanical on-axis when BPW22A is coupled with CQY58A.

SILICON PHOTO P-I-N DIODE

Silicon photo p-i-n diode in a plastic envelope with an infrared filter.

QUICK REFERENCE DATA

Continuous reverse voltage	V_R	max.	32 V
Total power dissipation up to $T_{amb} = 47,5\text{ }^\circ\text{C}$	P_{tot}	max.	150 mW
Junction temperature	T_j	max.	100 $^\circ\text{C}$
Dark reverse current $V_R = 10\text{ V}; E_e = 0$	$I_{R(D)}$	<	30 nA
Light reverse current $V_R = 5\text{ V}; E_e = 1\text{ mW/cm}^2; \lambda = 930\text{ nm}$	$I_{R(L)}$	>	30 μA
Wavelength at peak response $V_R = 5\text{ V}$	λ_{pk}	typ.	930 nm
Sensitive area	A	typ.	5 mm ²

MECHANICAL DATA

Dimensions in mm

Fig. 1 SOD-67.

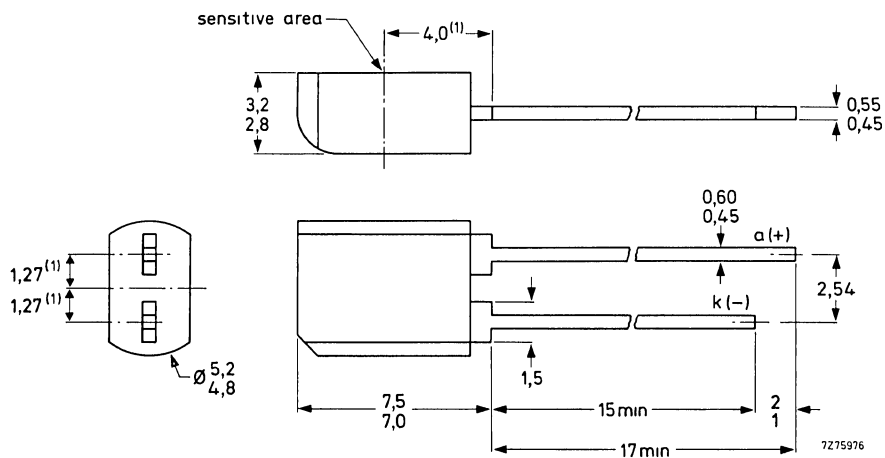

(1) Reference for the positional tolerance of the sensitive area.

RATINGS

Limiting values in accordance with the Absolute Maximum System (IEC 134)

Continuous reverse voltage	V_R	max.	32 V
Total power dissipation up to $T_{amb} = 47,5\text{ }^\circ\text{C}$	P_{tot}	max.	150 mW
Storage temperature	T_{stg}	-30 to + 100	$^\circ\text{C}$
Junction temperature	T_j	max.	100 $^\circ\text{C}$
Lead soldering temperature up to the seating plane; $t_{sld} < 10\text{ s}$	T_{sld}	max.	260 $^\circ\text{C}$

THERMAL RESISTANCE

From junction to ambient in free air	$R_{th\ j-a}$	=	350 $^\circ\text{C/W}$
--------------------------------------	---------------	---	------------------------

CHARACTERISTICS

$T_j = 25\text{ }^\circ\text{C}$

Dark reverse current
 $V_R = 10\text{ V}; E_e = 0$

$I_{R(D)}$	typ.	2 nA
	<	30 nA

Light reverse current
 $V_R = 5\text{ V}; E_e = 1\text{ mW/cm}^2; \lambda = 930\text{ nm}$

$I_{R(L)}$	>	30 μA
	typ.	45 μA

Reverse voltage
 $I_R = 0,1\text{ mA}; E_e = 0$

V_R	>	32 V
-------	---	------

Wavelength at peak response
 $V_R = 5\text{ V}$

λ_{pk}	typ.	930 nm
----------------	------	--------

Diode capacitance
 $V_R = 3\text{ V}$

C_d	typ.	17 pF
	<	30 pF

$V_R = 0$

C_d	typ.	50 pF
-------	------	-------

Light switching times (see Figs 2 and 3)

Rise time and fall time

$V_{KK} = 10\text{ V}; R_A = 1\text{ k}\Omega$

t_r, t_f	typ.	50 ns
------------	------	-------

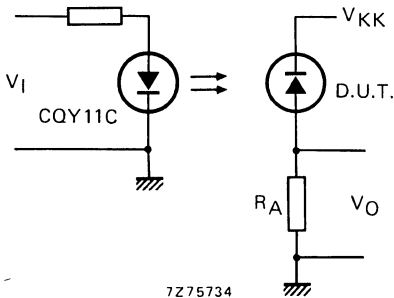

Fig. 2 Switching circuit.

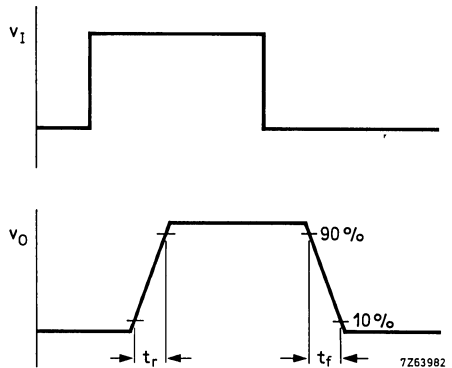

Fig. 3 Input and output switching waveforms.

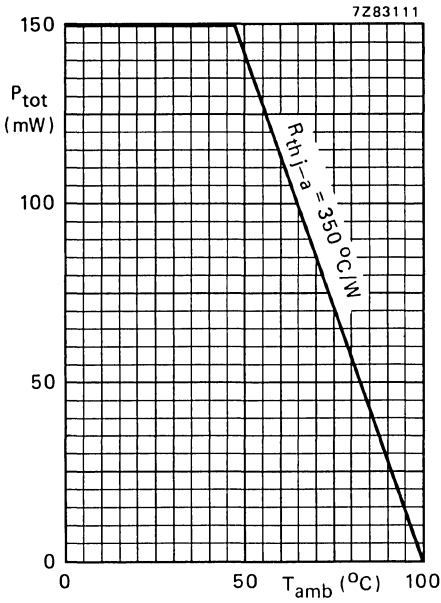

Fig. 4 Maximum permissible power dissipation as a function of temperature.

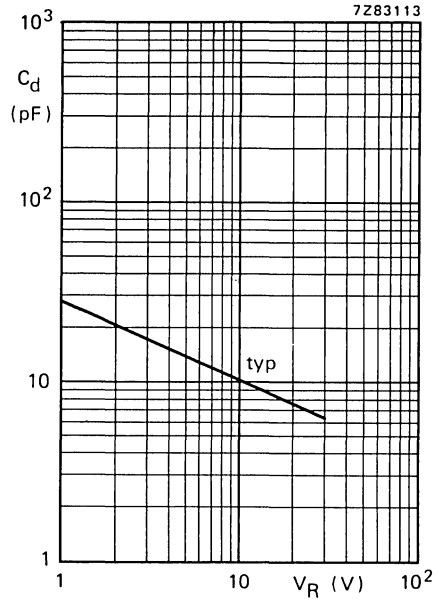

Fig. 5 $T_{amb} = 25^\circ\text{C}$.

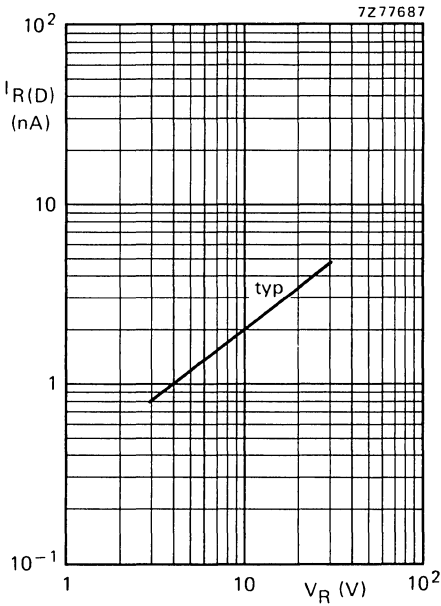

Fig. 6 $E = 0$; $T_{amb} = 25^\circ C$.

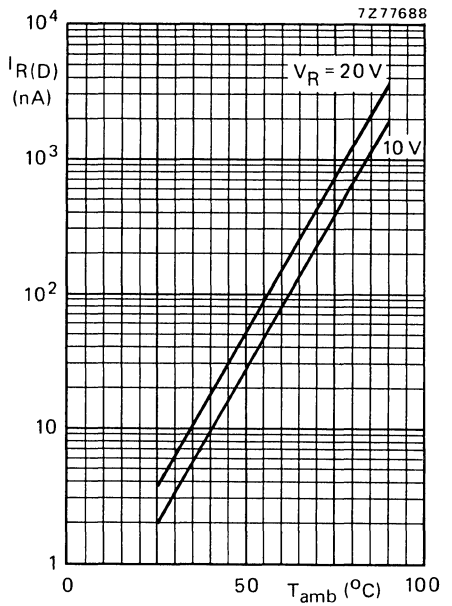

Fig. 7 $E = 0$; typical values.

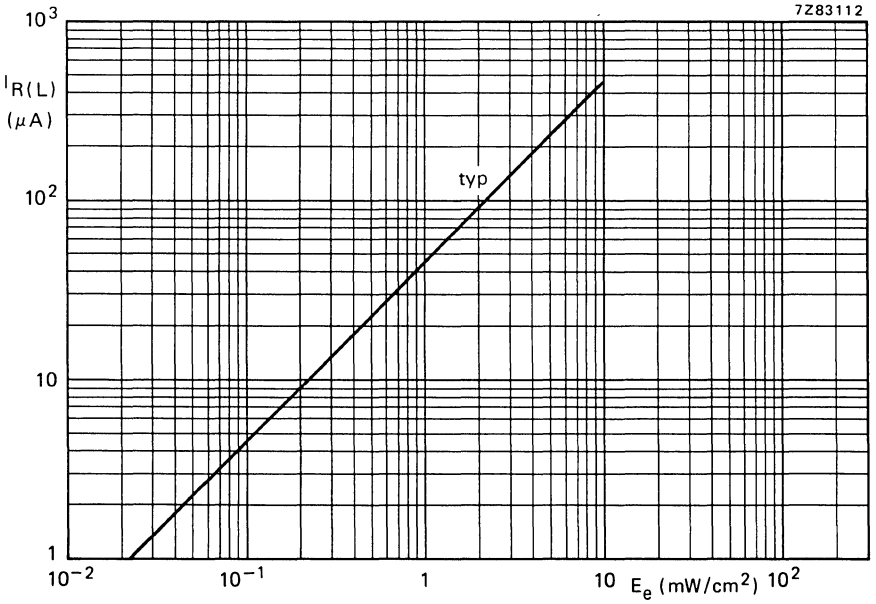

Fig. 8 $V_R = 5 V$; $\lambda = 930 nm$; $T_{amb} = 25^\circ C$.

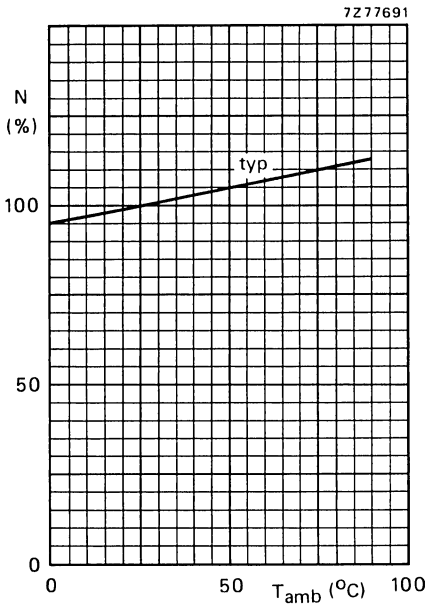

Fig. 9 $E_e = 1 \text{ mW/cm}^2$; $\lambda = 930 \text{ nm}$.

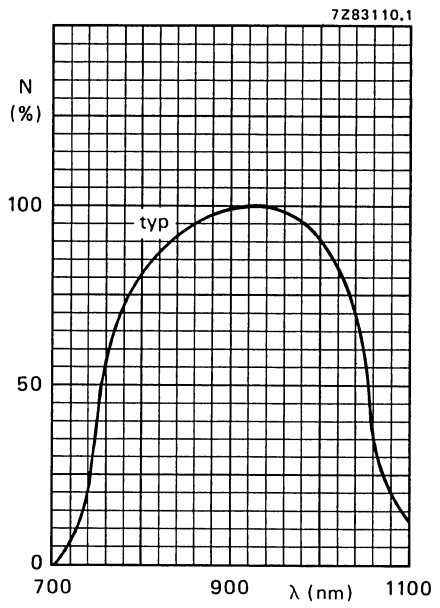

Fig. 10 $V_R = 5 \text{ V}$; $T_{\text{amb}} = 25 \text{ }^\circ\text{C}$.

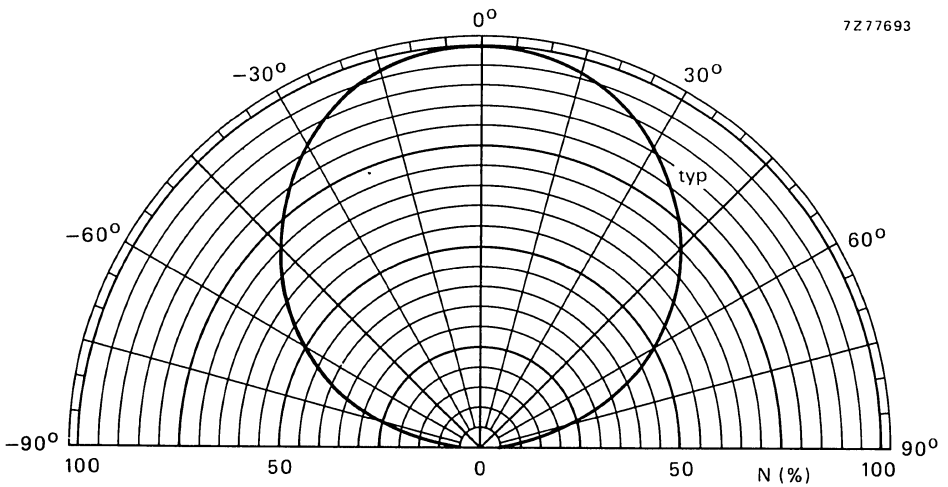

Fig. 11.

SILICON PLANAR EPITAXIAL PHOTOTRANSISTORS

General purpose n-p-n silicon phototransistors in TO-18.
The BPX25 has a lens, the BPX29 has a plane window.

QUICK REFERENCE DATA								
Collector-emitter voltage (open base)	V_{CEO}	max.	32	V				
Collector current (peak value)	I_{CM}	max.	200	mA				
Junction temperature	T_j	max.	150	°C				
Collector dark current $I_B = 0; V_{CE} = 24$ V	$I_{CEO(D)}$	<	500	nA				
Collector light current $I_B = 0; V_{CE} = 6$ V; at 1000 lx	$I_{CEO(L)}$	typ.	<table border="1" style="display: inline-table; vertical-align: middle;"> <thead> <tr> <th>BPX25</th> <th>BPX29</th> </tr> </thead> <tbody> <tr> <td>13</td> <td>0,8</td> </tr> </tbody> </table>	BPX25	BPX29	13	0,8	mA
BPX25	BPX29							
13	0,8							
Wavelength at peak response	λ_{pk}	typ.	800	nm				

MECHANICAL DATA

Dimensions in mm

BPX25

TO-18, except for lens
Collector connected to case

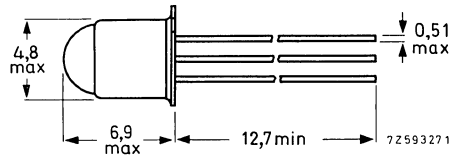
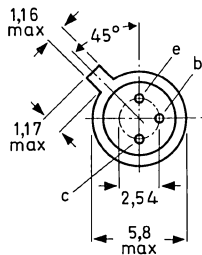

BPX29

TO-18, except for window
Collector connected to case

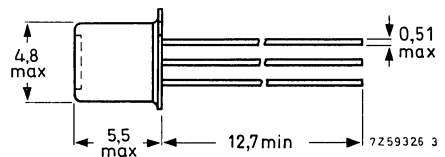
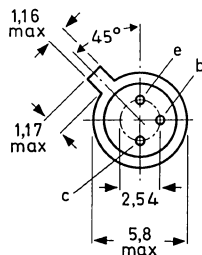

RATINGS Limiting values in accordance with the Absolute Maximum System (IEC 134)

Voltages

Collector-base voltage (open emitter)	V_{CBO}	max.	32	V
Collector-emitter voltage (open base)	V_{CEO}	max.	32	V
Emitter-base voltage (open collector)	V_{EBO}	max.	5	V

Current

Collector current (d. c.)	I_C	max.	100	mA
Collector current (peak value)	I_{CM}	max.	200	mA

Power dissipation

Total power dissipation up to $T_{amb} = 25\text{ }^\circ\text{C}$	P_{tot}	max.	300	mW
--	-----------	------	-----	----

Temperatures

Storage temperature	T_{stg}	-65 to +150	$^\circ\text{C}$
Junction temperature	T_j	max. 150	$^\circ\text{C}$

THERMAL RESISTANCE

From junction to ambient in free air	$R_{th\ j-a}$	=	0,4	$^\circ\text{C}/\text{mW}$
From junction to case	$R_{th\ j-c}$	=	0,15	$^\circ\text{C}/\text{mW}$

.CHARACTERISTICS

$T_{amb} = 25\text{ }^\circ\text{C}$ unless otherwise specified

Collector dark current

$I_B = 0; V_{CE} = 24\text{ V}$	$I_{CEO(D)}$	typ.	100	nA
		<	500	nA
$I_B = 0; V_{CE} = 24\text{ V}; T_{amb} = 100\text{ }^\circ\text{C}$	$I_{CEO(D)}$	typ.	15	μA
		<	100	μA

Collector light current

$I_B = 0; V_{CE} = 6\text{ V};$ tungsten filament lamp source with $T_C = 2700\text{ K};$ $E_V = 1000\text{ lx (7,7 mW/cm}^2)$	$I_{CEO(L)}$		BPX25	BPX29
		>	5	0,25 mA
		typ.	13	0,8 mA

D. C. current gain

$I_C = 2\text{ mA}; V_{CE} = 6\text{ V}$	h_{FE}	typ.	500	500
--	----------	------	-----	-----

Cut-off frequency

Source : modulated GaAs; 0,4 mW/cm ²	f_{co}	typ.	200	150 kHz
Load : optimum (50 Ω); $V_{CE} = 24\text{ V}$				

CHARACTERISTICS (continued)

		BPX25	BPX29
<u>Switching times</u> ¹⁾			
Delay time	t_d	typ. 1,0 < 3,0	2,5 μs 5,0 μs
Rise time	t_r	typ. 1,5 < 3,0	2,5 μs 5,0 μs
Storage time	t_s	typ. 0,2 < 0,4	0,2 μs 0,4 μs
Fall time	t_f	typ. 1,5 < 4,0	3,5 μs 8,0 μs
<u>Wavelength at peak response</u>	λ_{pk}	typ. 800	800 nm

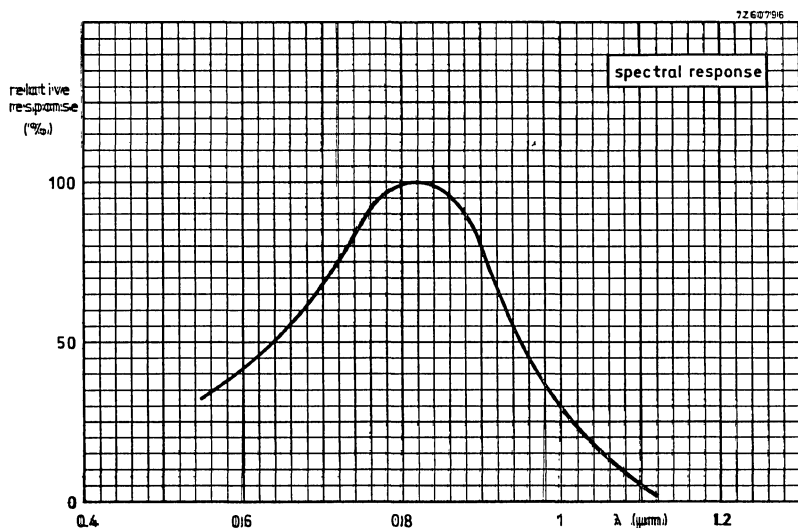

¹⁾ Source: modulated GaAs: 0,4 mW/cm²

Load: optimum (50 Ω)

V_{CE} = 24 V

Improved switching times can be obtained by a quiescent bias current.

I. e. I_B = 2 μA : t_d < 0,2 μs .

**BPX25
BPX29**

7267709

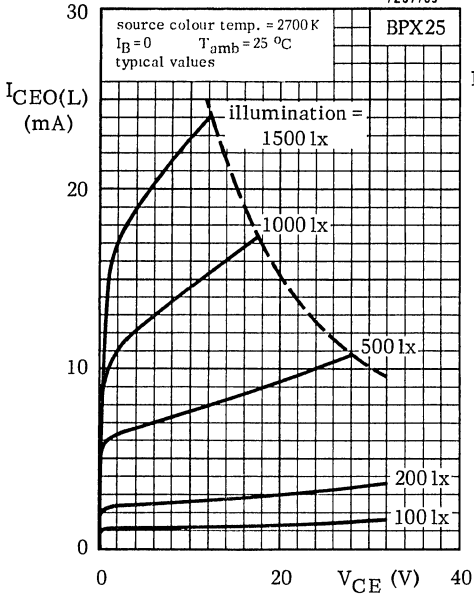

7267859

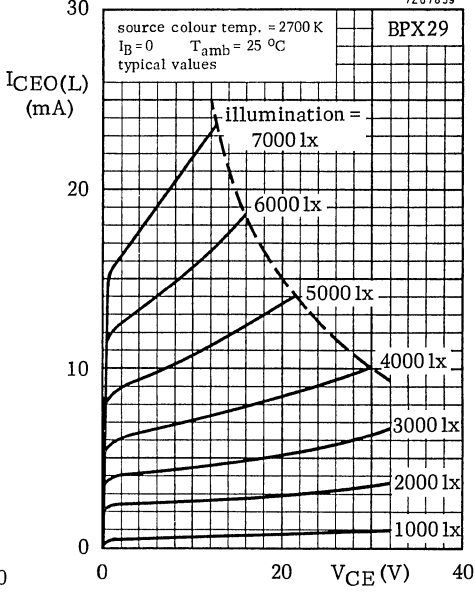

7267711

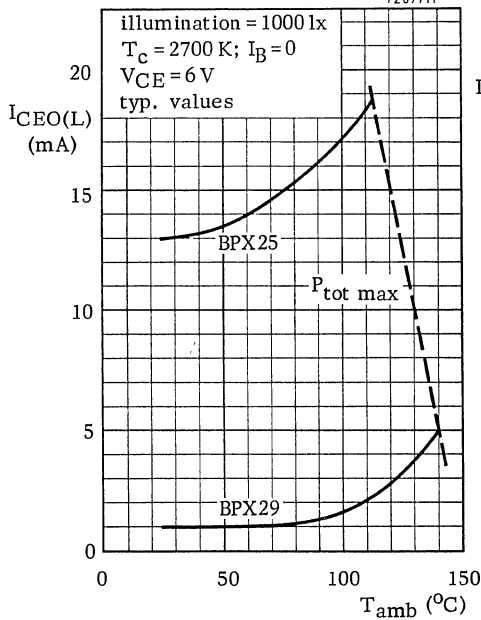

7267710

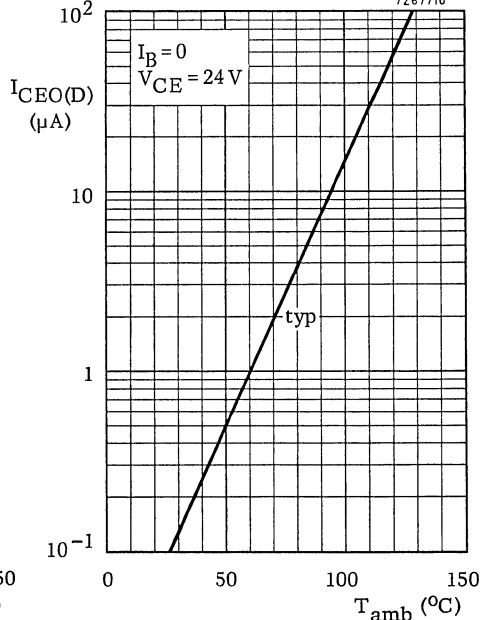

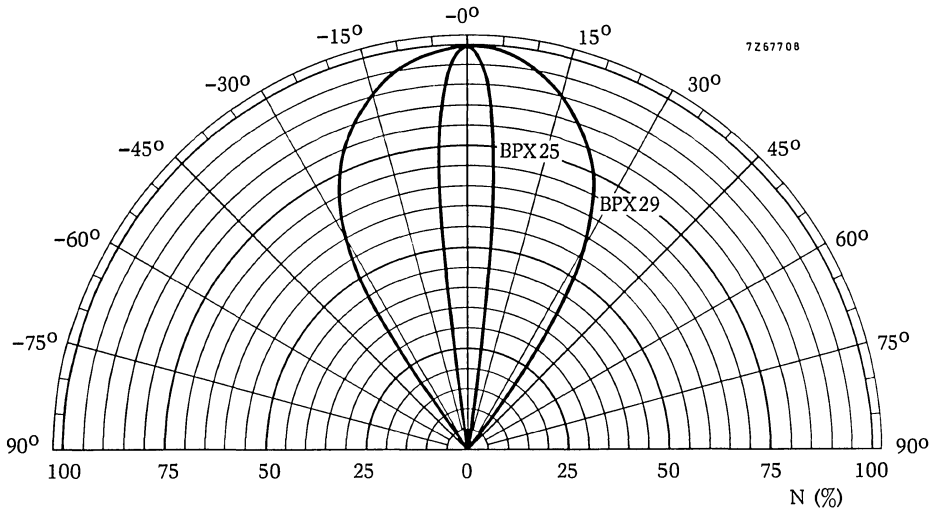

SILICON PLANAR PHOTODIODE

Unencapsulated photodiode for general purpose applications.

QUICK REFERENCE DATA			
Reverse voltage	V_R	max.	18 V
Luminous sensitivity $V_R = 15 \text{ V}; E = 1000 \text{ lx}$	N	typ.	14 nA/lx
Dark reverse current at $V_R = 15 \text{ V}$	I_d	<	0,5 μA
Wavelength at peak response	λ_{pk}	typ.	800 nm

MECHANICAL DATA

Dimensions in mm

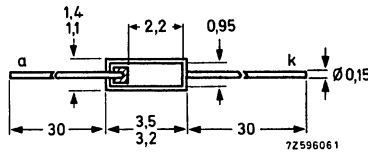

Slice thickness 0,27 mm

RATINGS Limiting values in accordance with the Absolute Maximum System (IEC 134)

Voltage

Reverse voltage V_R max. 18 V

Currents

Forward current I_F max. 5 mA

Dark reverse current I_R max. 2 mA

Temperatures

Storage temperature T_{stg} -65 to +125 °C

Junction temperature T_j max. 125 °C

THERMAL RESISTANCE

From junction to ambient in free air $R_{th\ j-a}$ = 0,5 °C/mW

CHARACTERISTICS

$T_{amb} = 25\text{ °C}$ unless otherwise specified

Dark reverse current

$V_R = 15\text{ V}$ I_d typ. 0,01 μA
 $<$ 0,5 μA

$V_R = 15\text{ V}; T_{amb} = 100\text{ °C}$ I_d typ. 0,6 μA
 $<$ 4,0 μA

Photovoltaic mode

$E = 1000\text{ lx}; T_c = 2700\text{ K}$ (equivalent to 7,7 mW/cm²)

Light reverse current; $V = 0$ I_l $>$ 10 μA
typ. 13 μA

Forward voltage; $I = 0$ V_F $>$ 330 mV
typ. 350 mV

Luminous sensitivity with external voltage ¹⁾

$V_R = 15\text{ V}; E = 1000\text{ lx}; T_c = 2700\text{ K}$
(equivalent to 7,7 mW/cm²) N $>$ 10,5 nA/lx
typ. 14 nA/lx

Wavelength at peak response

λ_{pk} typ. 800 nm

Diode capacitance; $f = 500\text{ kHz}$

$V_R = 15\text{ V}$ C_d typ. 90 pF

$V_R = 0$ C_d typ. 300 pF

Cut-off frequency (modulated GaAs source)

f_{co} typ. 500 kHz

¹⁾ The value of light current increases with temperature by an amount approximately equal to the increase in dark current.

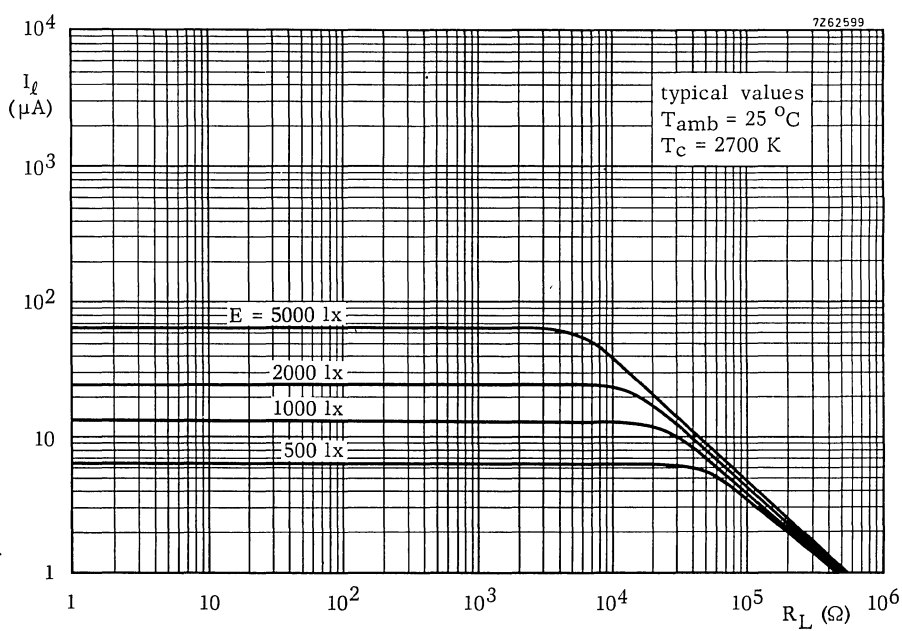
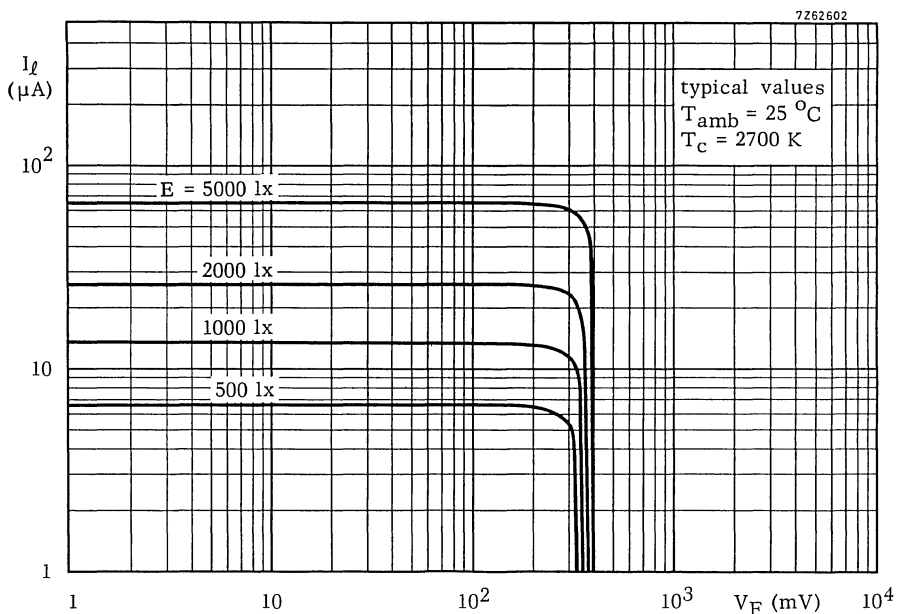

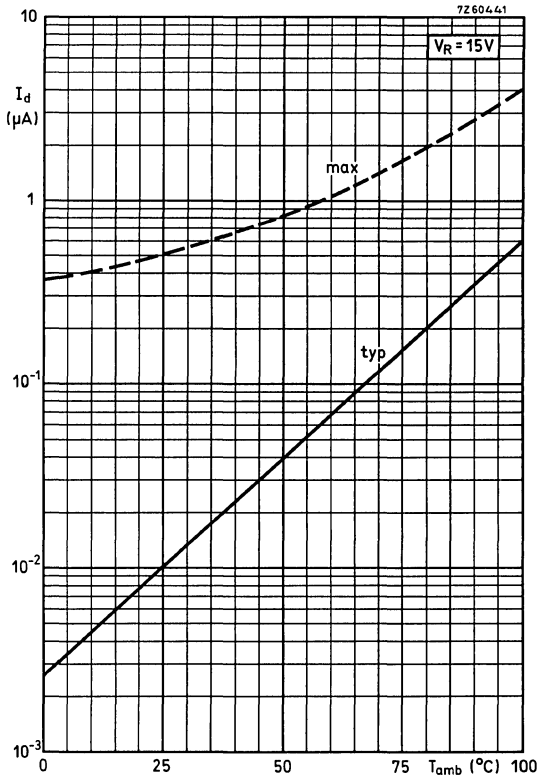

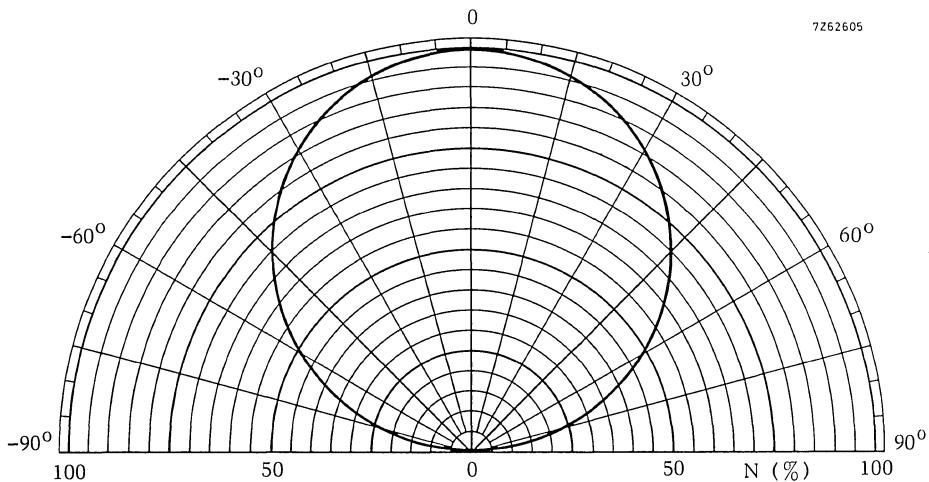
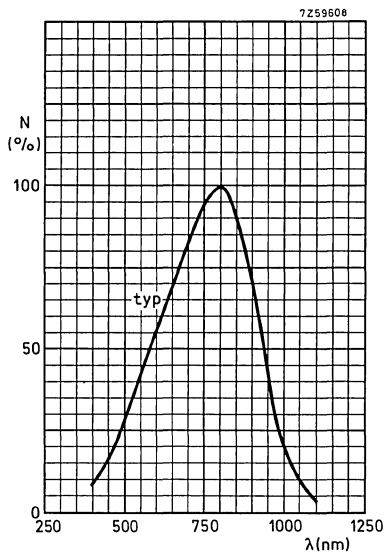

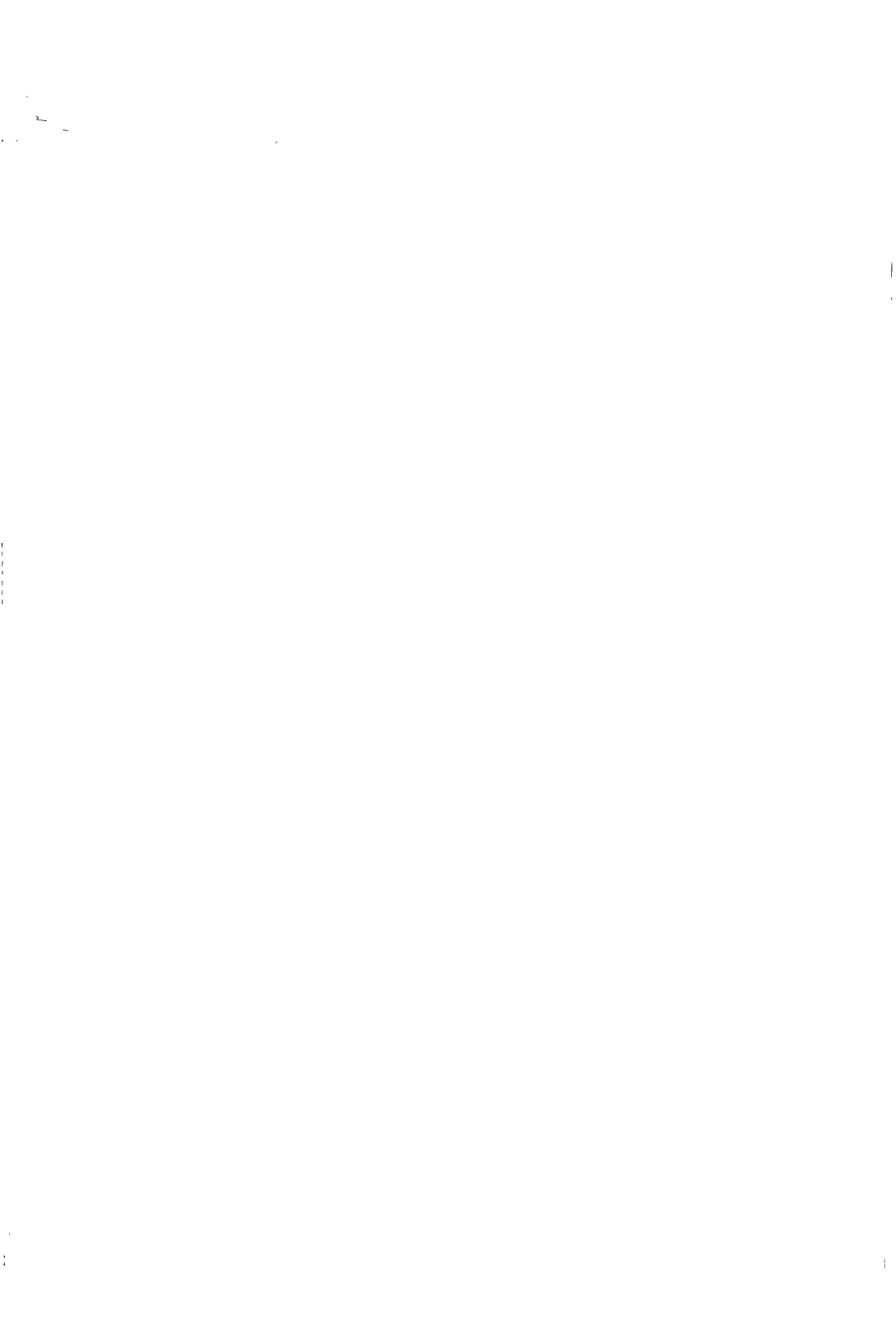

SILICON PLANAR PHOTODIODE

Unencapsulated photodiode for general purpose applications.

QUICK REFERENCE DATA			
Reverse voltage	V_R	max.	18 V
Luminous sensitivity			
$V_R = 15 \text{ V}; E = 1000 \text{ lx}$	N	typ.	40 nA/lx
Dark reverse current at $V_R = 15 \text{ V}$	I_d	<	1 μA
Wavelength at peak response	λ_{pk}	typ.	800 nm

MECHANICAL DATA

Dimensions in mm

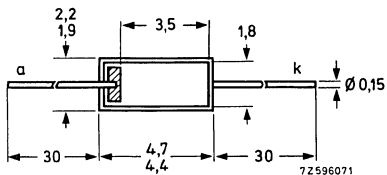

Slice thickness 0,27 mm

RATINGS Limiting values in accordance with the Absolute Maximum System (IEC 134)

Voltage

Reverse voltage V_R max. 18 V

Currents

Forward current I_F max. 10 mA

Dark reverse current I_R max. 5 mA

Temperatures

Storage temperature T_{stg} -65 to +125 °C

Junction temperature T_j max. 125 °C

THERMAL RESISTANCE

From junction to ambient in free air $R_{th\ j-a} = 0,5$ °C/mW

CHARACTERISTICS

$T_{amb} = 25$ °C unless otherwise specified

Dark reverse current

$V_R = 15$ V I_d typ. 0,02 μ A
< 1,0 μ A

$V_R = 15$ V; $T_{amb} = 100$ °C I_d typ. 1,2 μ A
< 8,0 μ A

Photovoltaic mode

$E = 1000$ lx; $T_c = 2700$ K (equivalent to 7,7 mW/cm²)

Light reverse current; $V = 0$ I_I > 30 μ A
typ. 38 μ A

Forward voltage; $I = 0$ V_F > 330 mV
typ. 350 mV

Luminous sensitivity with external voltage ¹⁾

$V_R = 15$ V; $E = 1000$ lx; $T_c = 2700$ K
(equivalent to 7,7 mW/cm²) N > 31 nA/lx
typ. 40 nA/lx

Wavelength at peak response

λ_{pk} typ. 800 nm

Diode capacitance; $f = 500$ kHz

$V_R = 15$ V C_d typ. 250 pF

$V_R = 0$ C_d typ. 800 pF

Cut-off frequency (modulated GaAs source)

f_{co} typ. 500 kHz

¹⁾ The value of light current increases with temperature by an amount approximately equal to the increase in dark current.

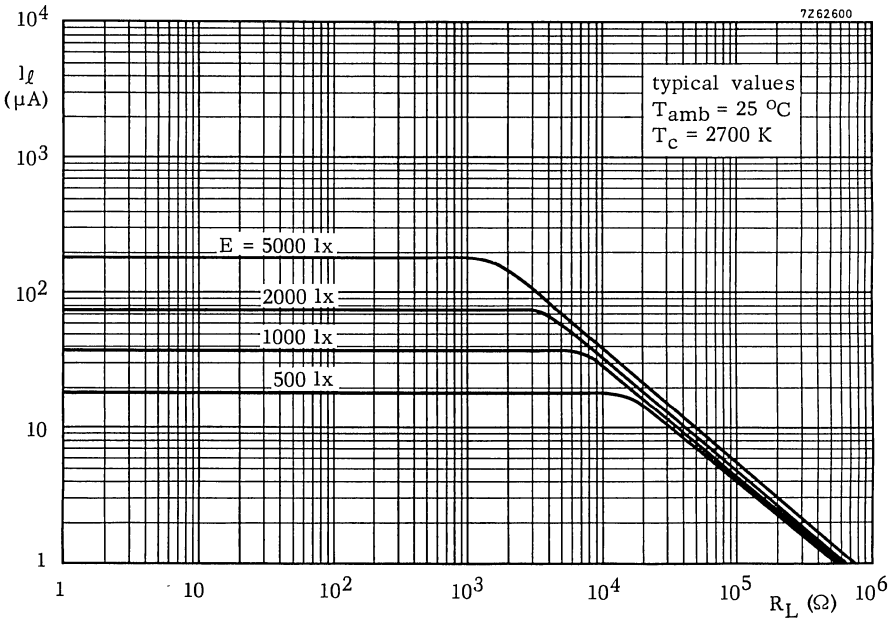
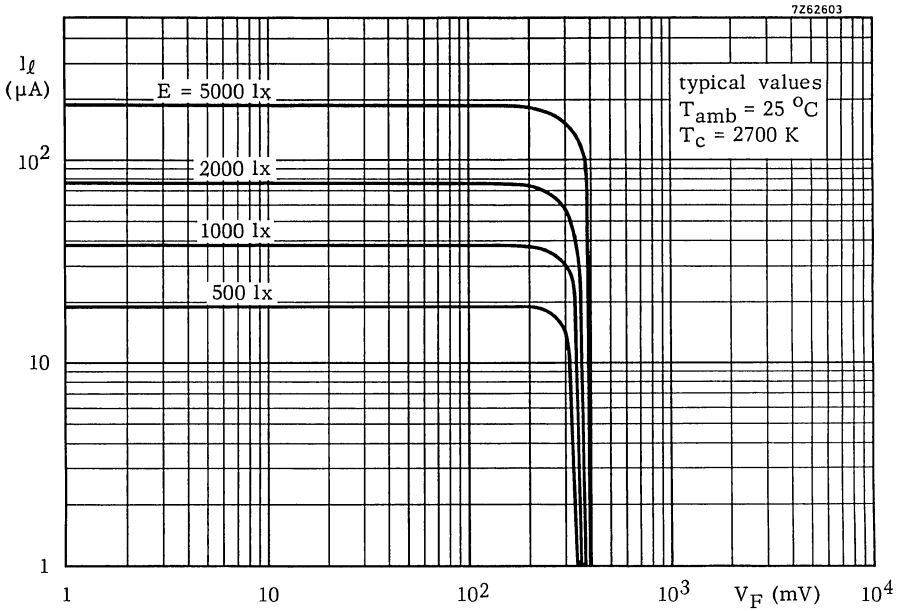

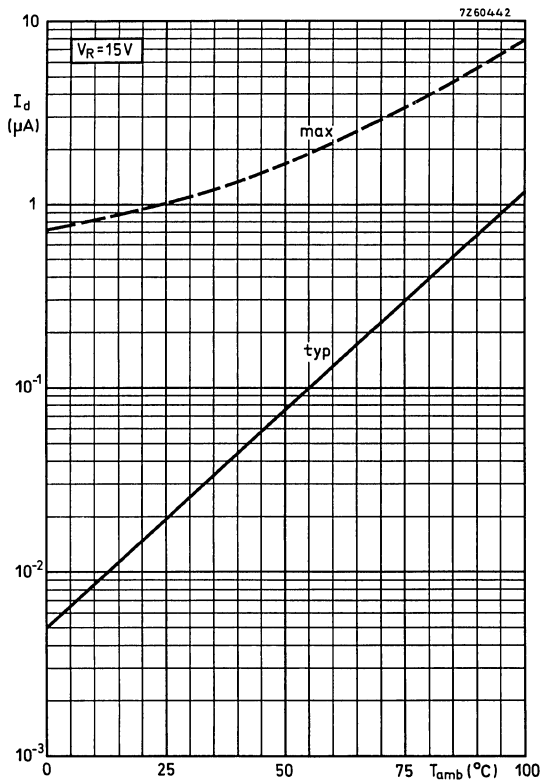

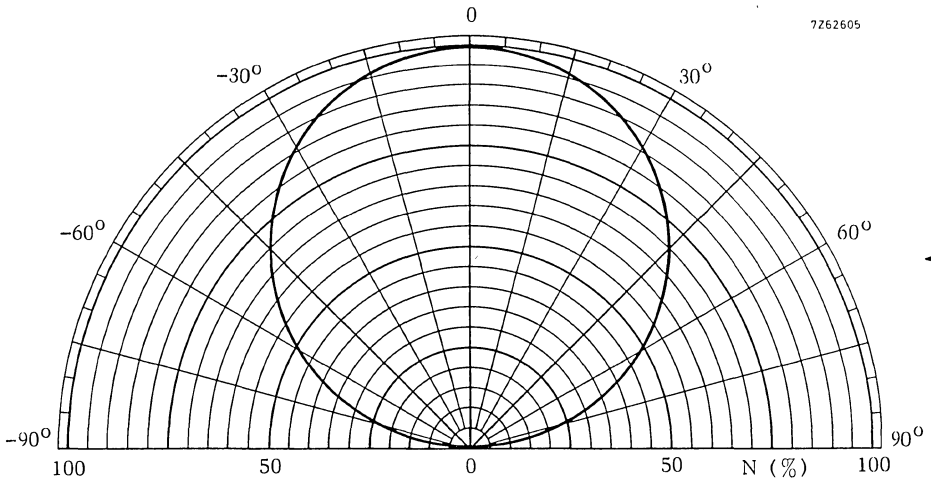
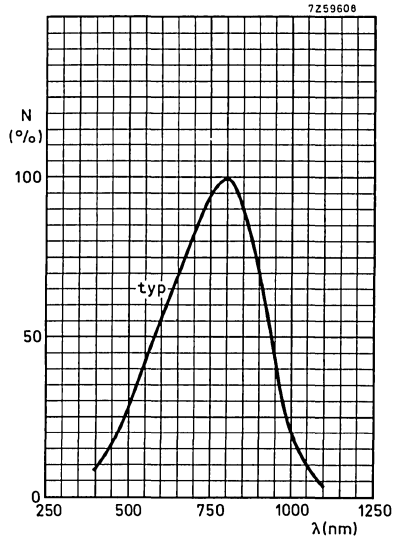

SILICON PLANAR PHOTODIODE

Unencapsulated photodiode for general purpose applications.

QUICK REFERENCE DATA		
Reverse voltage	V_R	max. 12 V
Luminous sensitivity $V_R = 10 \text{ V}; E = 1000 \text{ lx}$	N	typ. 150 nA/lx
Dark reverse current at $V_R = 10 \text{ V}$	I_d	< 5 μA
Wavelength at peak response	λ_{pk}	typ. 800 nm

MECHANICAL DATA

Dimensions in mm

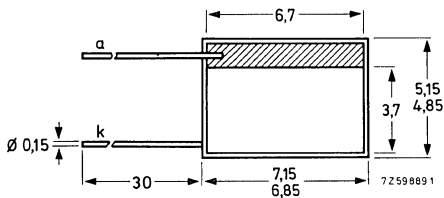

Slice thickness 0,27 mm

RATINGS Limiting values in accordance with the Absolute Maximum System (IEC 134)

Voltage

Reverse voltage V_R max. 12 V

Currents

Forward current I_F max. 50 mA

Dark reverse current I_R max. 20 mA

Temperatures

Storage temperature T_{stg} -65 to +125 °C

Junction temperature T_j max. 125 °C

THERMAL RESISTANCE

From junction to ambient in free air $R_{th\ j-a}$ = 0,3 °C/mW

CHARACTERISTICS

$T_{amb} = 25\text{ °C}$ unless otherwise specified

Dark reverse current

$V_R = 10\text{ V}$ I_d typ. 0,1 μA
 $<$ 5,0 μA

$V_R = 10\text{ V}; T_{amb} = 100\text{ °C}$ I_d typ. 6,0 μA
 $<$ 40 μA

Photovoltaic mode

$E = 1000\text{ lx}; T_c = 2700\text{ K}$ (equivalent to 7,7 mW/cm²)

Light reverse current; $V = 0$ I_l $>$ 110 μA
typ. 140 μA

Forward voltage; $I = 0$ V_F $>$ 330 mV
typ. 350 mV

Luminous sensitivity with external voltage ¹⁾

$V_R = 10\text{ V}; E = 1000\text{ lx}; T_c = 2700\text{ K}$
(equivalent to 7,7 mW/cm²) N $>$ 120 nA/lx
typ. 150 nA/lx

Wavelength at peak response

λ_{pk} typ. 800 nm

Diode capacitance; $f = 500\text{ kHz}$

$V_R = 10\text{ V}$ C_d typ. 1000 pF

$V_R = 0$ C_d typ. 3000 pF

Cut-off frequency (modulated GaAs source)

f_{co} typ. 500 kHz

¹⁾ The value of light current increases with temperature by an amount approximately equal to the increase in dark current.

7262604

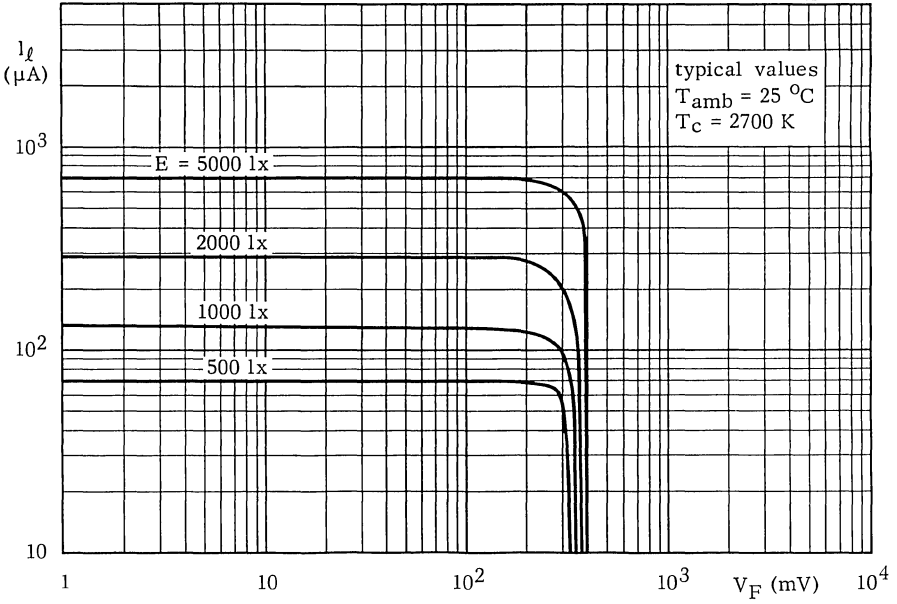

7262601

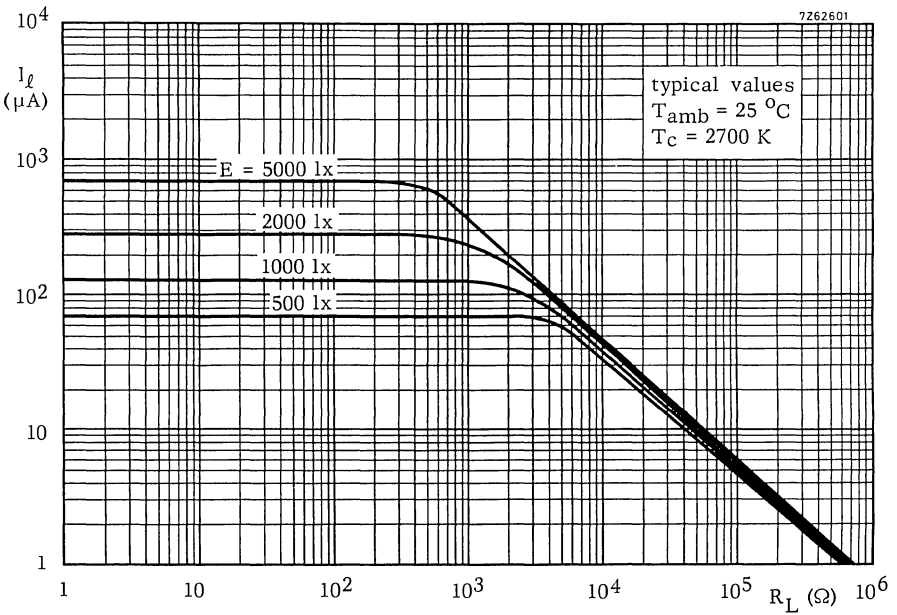

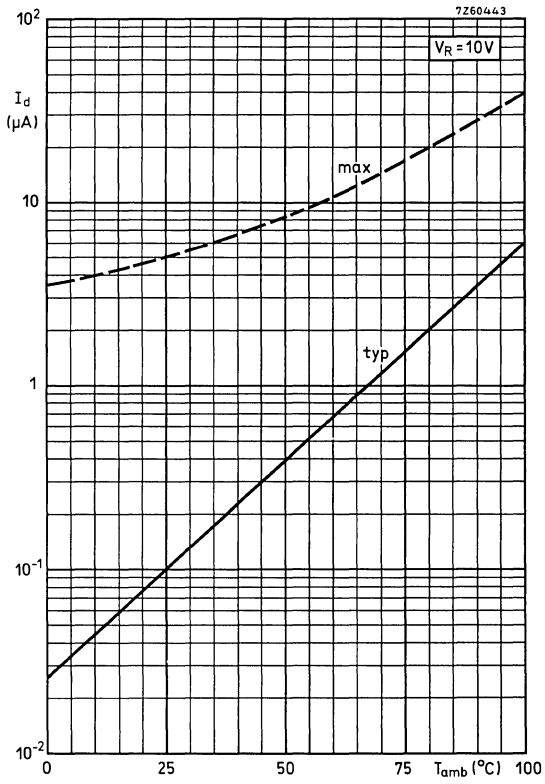

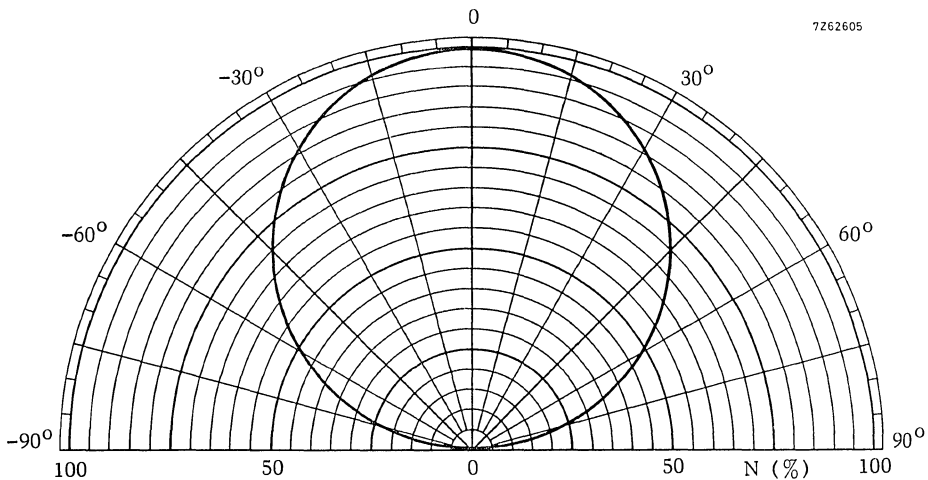
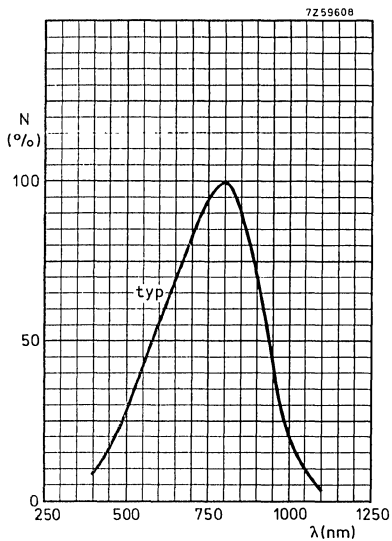

PHOTOTRANSISTOR

General purpose n-p-n silicon phototransistor with a glass lens. Inaccessible base.

QUICK REFERENCE DATA

Collector-emitter voltage	V_{CE0} max.	50 V
Collector current (d.c.)	I_C max.	20 mA
Junction temperature	T_j max.	150 °C
Collector dark (cut-off) current $V_{CE} = 30$ V	I_d	< 25 nA
Collector light (cut-off) current $V_{CE} = 5$ V; $E_e = 20$ mW/cm ²	BPX71 BPX71-203 BPX71-204	I_{ℓ} 0,5 to 15 mA I_{ℓ} 4 to 8 mA I_{ℓ} 7 to 15 mA
Wavelength at peak response	λ_{pk} typ.	800 nm
Angle between half-sensitivity directions	$\alpha_{50\%}$ typ.	40°

MECHANICAL DATA

Dimensions in mm

Fig. 1 SOT-71A (DO-31).

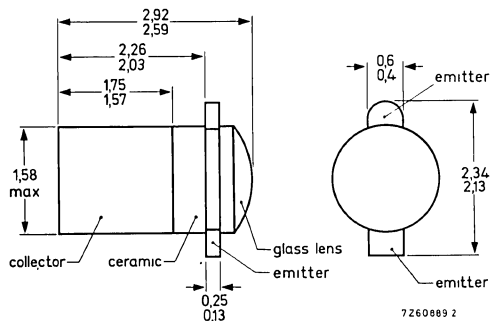

RATINGS

Limiting values in accordance with the Absolute Maximum System (IEC 134)

Collector-emitter voltage	V_{CEO}	max.	50 V
Emitter-collector voltage	V_{ECO}	max.	7 V
Collector current			
d.c.	I_C	max.	20 mA
(peak value); $t_p \leq 50 \mu s$; $\delta \leq 0,1$	I_{CM}	max.	50 mA
Total power dissipation			
up to $T_{amb} = 50 \text{ }^\circ\text{C}$	P_{tot}	max.	50 mW
up to $T_{mb} = 55 \text{ }^\circ\text{C}$	P_{tot}	max.	100 mW
Storage temperature	T_{stg}		-65 to +150 $^\circ\text{C}$
Junction temperature	T_j	max.	150 $^\circ\text{C}$

THERMAL RESISTANCE

From junction to ambient in free air	$R_{th j-a}$	=	2000 $^\circ\text{C/W}$
From junction to mounting base	$R_{th j-mb}$	=	950 $^\circ\text{C/W}$

CHARACTERISTICS

$T_{amb} = 25 \text{ }^\circ\text{C}$ unless otherwise specified

Collector dark (cut-off) current			
$V_{CE} = 30 \text{ V}$	I_d	<	25 nA
$V_{CE} = 30 \text{ V}$; $T_{amb} = 100 \text{ }^\circ\text{C}$	I_d	<	100 μA
Collector light (cut-off) current			
$V_{CE} = 5$; tungsten filament lamp			
source with colour temperature 2856 K			
$E_e = 4,75 \text{ mW/cm}^2$	I_l	typ.	1 mA
$E_e = 20 \text{ mW/cm}^2$	BPX71	I_l	0,5 to 15 mA
	BPX71-203	I_l	4 to 8 mA
	BPX71-204	I_l	7 to 15 mA

CHARACTERISTICS (continued)

Breakdown voltages

Collector-emitter voltage

$E = 0; I_C = 0,5 \text{ mA}$

$V_{(BR)CEO} > 50 \text{ V}$

Emitter-collector voltage

$E = 0; I_C = 0,1 \text{ mA}$

$V_{(BR)ECO} > 7 \text{ V}$

Collector-emitter light saturation voltage

$I_C = 0,4 \text{ mA}; E_e = 20 \text{ mW/cm}^2; T_C = 2856 \text{ K}$

$V_{CEsat} \begin{matrix} \text{typ.} & 150 \text{ mV} \\ < & 400 \text{ mV} \end{matrix}$

Wavelength at peak response

$\lambda_{pk} \text{ typ. } 800 \text{ nm}$

Bandwidth at half height

$B_{50\%} \text{ typ. } 400 \text{ nm}$

Switching times

$I_{Con} = 0,8 \text{ mA}; V_{CC} = 35 \text{ V}; R_L = 1 \text{ k}\Omega$

Delay time

$t_d \begin{matrix} \text{typ.} & 2,0 \text{ }\mu\text{s} \\ < & 20 \text{ }\mu\text{s} \end{matrix}$

Rise time

$t_r \begin{matrix} \text{typ.} & 3,0 \text{ }\mu\text{s} \\ < & 30 \text{ }\mu\text{s} \end{matrix}$

Storage time

$t_s \begin{matrix} \text{typ.} & 0,1 \text{ }\mu\text{s} \\ < & 2,0 \text{ }\mu\text{s} \end{matrix}$

Fall time

$t_f \begin{matrix} \text{typ.} & 2,5 \text{ }\mu\text{s} \\ < & 20 \text{ }\mu\text{s} \end{matrix}$

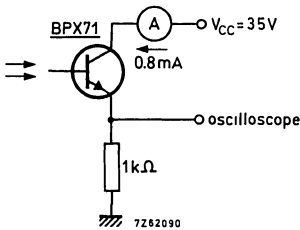

Light input pulse:

$t_r = t_f = 20 \text{ ns}$

$t_p = 20 \text{ }\mu\text{s}$

$f = 500 \text{ Hz}$

$\lambda = 800 \text{ nm}$

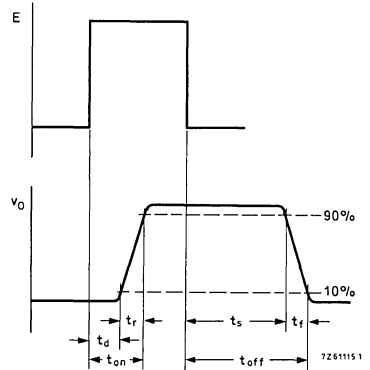

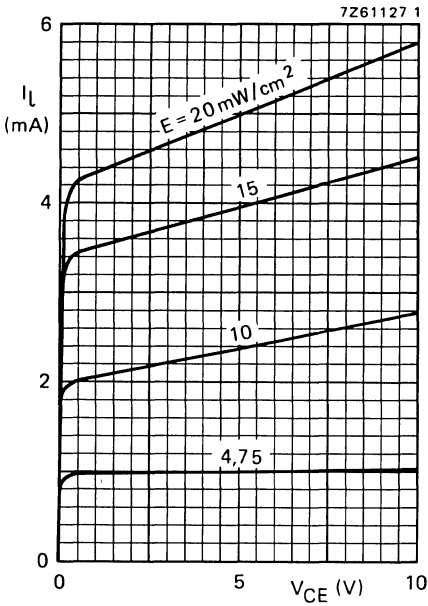

Typical values; $T_{amb} = 25 \text{ }^\circ\text{C}$.

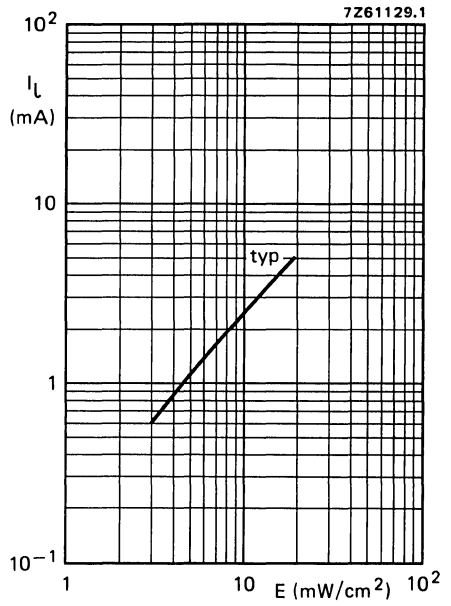

$V_{CE} = 5 \text{ V}$; $T_{amb} = 25 \text{ }^\circ\text{C}$.

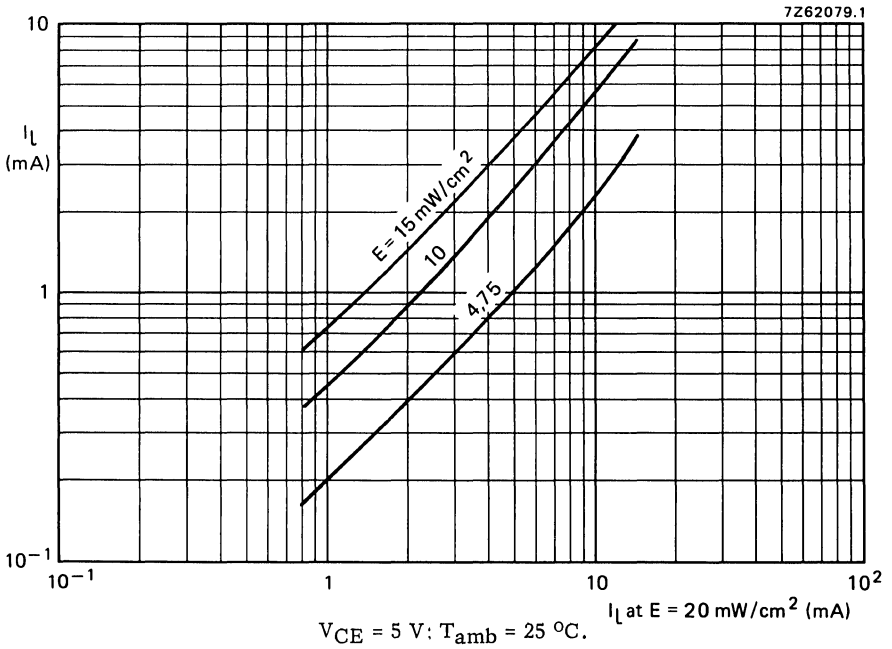

$V_{CE} = 5 \text{ V}$; $T_{amb} = 25 \text{ }^\circ\text{C}$.

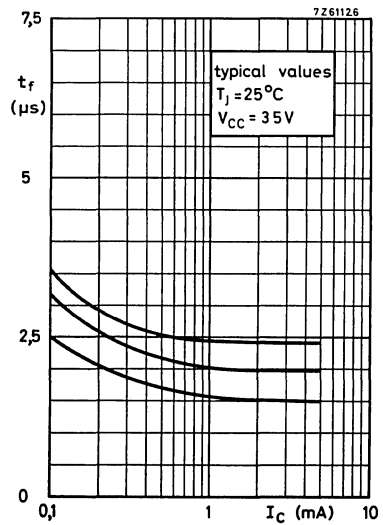
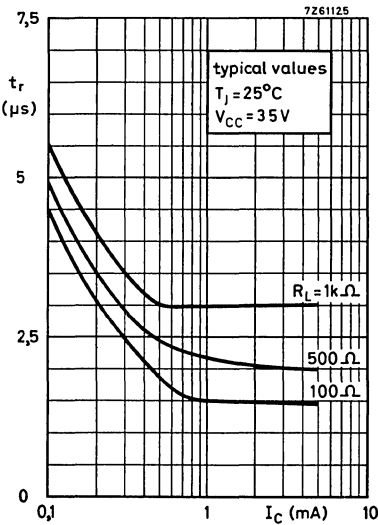
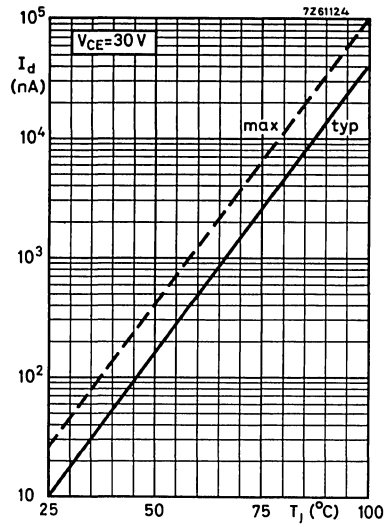
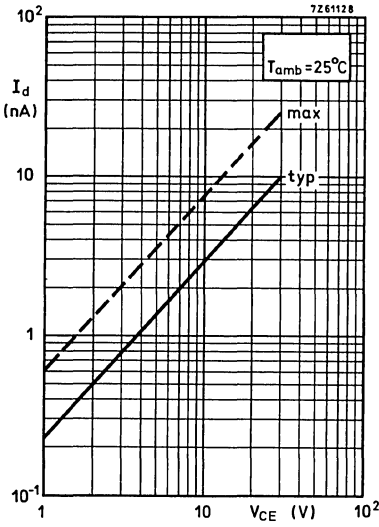

polar response of relative sensitivity

T_{amb} = 25°C

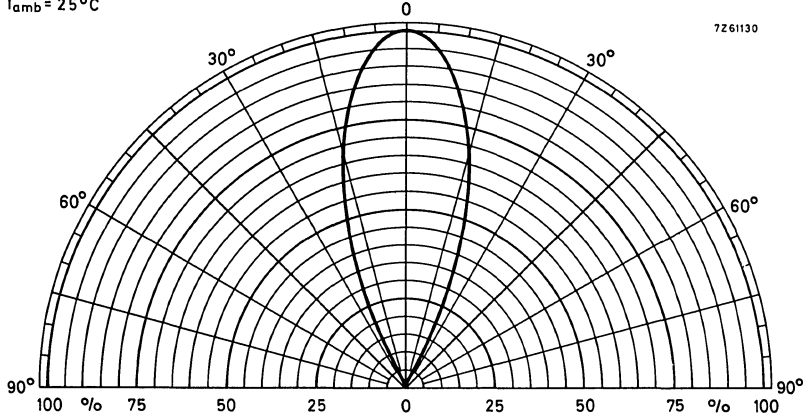

7261120.1

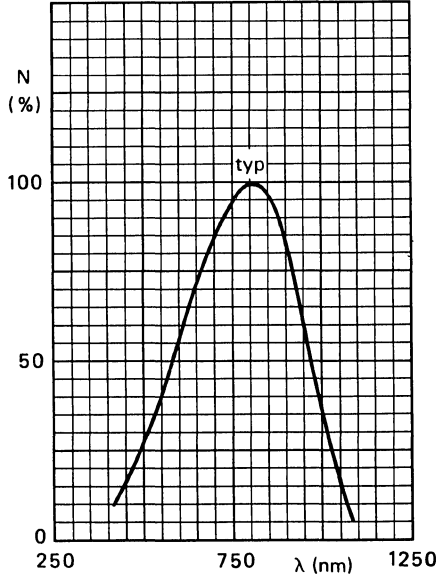

PHOTOTRANSISTOR

General purpose n-p-n silicon phototransistor with a plastic lens.

QUICK REFERENCE DATA

Collector-emitter voltage (open base)	V_{CEO}	max.	30 V
Collector current (d.c.)	I_C	max.	25 mA
Junction temperature	T_j	max.	125 °C
Collector dark (cut-off) current $V_{CE} = 20$ V	I_d	<	100 nA
Collector light (cut-off) current $V_{CE} = 5$ V; $E_v = 1000$ lx ($E_e = 4,75$ mW/cm ²)	BPX72 BPX72D BPX72E BPX72F	I_{ℓ}	500 to 3000 μ A 850 to 2000 μ A 1400 to 3000 μ A 2400 to 5000 μ A
Wavelength at peak response	λ_{pk}	typ.	800 nm
Angle between half-sensitivity directions	$\alpha_{50\%}$	typ.	120°

MECHANICAL DATA

Dimensions in mm

Fig. 1 SOT-70A.

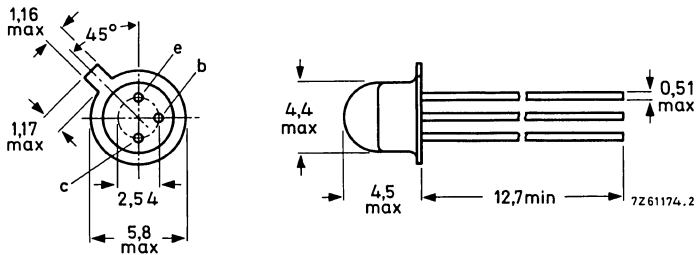

Maximum lead diameter is guaranteed only for 12,7 mm.

RATINGS

Limiting values in accordance with the Absolute Maximum System (IEC 134)

Collector-base voltage (open emitter)	V_{CBO}	max.	40 V
Collector-emitter voltage (open base)	V_{CEO}	max.	30 V
Emitter-collector voltage (open base)	V_{ECO}	max.	6 V
Collector current d.c.	I_C	max.	25 mA
(peak value); $t_p \leq 50 \mu s$; $\delta \leq 0,1$	I_{CM}	max.	50 mA
Total power dissipation up to $T_{amb} = 25 \text{ }^\circ\text{C}$	P_{tot}	max.	180 mW
Storage temperature	T_{stg}		-40 to +125 $^\circ\text{C}$
Junction temperature	T_j	max.	125 $^\circ\text{C}$

THERMAL RESISTANCE

From junction to ambient in free air	$R_{th\ j-a}$	=	550 $^\circ\text{C/W}$
--------------------------------------	---------------	---	------------------------

CHARACTERISTICS

$I_B = 0$; $T_{amb} = 25 \text{ }^\circ\text{C}$ unless otherwise specified

Collector dark (cut-off) current

$$V_{CE} = 20 \text{ V}$$

I_d	typ.	10 nA
	<	100 nA

$$V_{CE} = 20 \text{ V}; T_j = 100 \text{ }^\circ\text{C}$$

I_d	typ.	10 μA
	<	100 μA

Collector light (cut-off) current

$V_{CE} = 5 \text{ V}$; tungsten filament lamp
source with colour temperature 2856 K
 $E_v = 1000 \text{ lx}$ ($E_e = 4,75 \text{ mW/cm}^2$)

BPX72	I_{ℓ}	500 to 3000 μA
BPX72D	I_{ℓ}	850 to 2000 μA
BPX72E	I_{ℓ}	1400 to 3000 μA
BPX72F	I_{ℓ}	2400 to 5000 μA
	I_{ℓ}	typ. 3000 μA

$$E_v = 2500 \text{ lx} \text{ (} E_e = 12 \text{ mW/cm}^2 \text{)}$$

CHARACTERISTICS (continued)

Breakdown voltages

Collector-base voltage

$E = 0; I_C = 0, 1 \text{ mA}$

$V_{(BR)CBO} > 40 \text{ V}$

Collector-emitter voltage

$E = 0; I_C = 1 \text{ mA}$

$V_{(BR)CEO} > 30 \text{ V}$

Emitter-collector voltage

$E = 0; I_C = 0, 1 \text{ mA}$

$V_{(BR)ECO} > 6 \text{ V}$

Collector capacitance

$I_E = I_e = 0; V_{CB} = 20 \text{ V}$

$C_c \text{ typ. } 3,5 \text{ pF}$

Wavelength at peak response

$\lambda_{pk} \text{ typ. } 800 \text{ nm}$

Bandwidth at half height

$B_{50\%} \text{ typ. } 300 \text{ nm}$

Switching times

$I_{Con} = 1 \text{ mA}; V_{CC} = 5 \text{ V}; R_L = 100 \Omega$

Delay time

$t_d \text{ typ. } 3,0 \mu\text{s}$
 $< 6,0 \mu\text{s}$

Rise time

$t_r \text{ typ. } 6,0 \mu\text{s}$
 $< 20 \mu\text{s}$

Storage time

$t_s \text{ typ. } 1,5 \mu\text{s}$
 $< 3,0 \mu\text{s}$

Fall time

$t_f \text{ typ. } 4,0 \mu\text{s}$
 $< 20 \mu\text{s}$

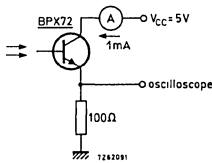

Light input pulse:

$t_r = t_f = 20 \text{ ns}$
 $t_p = 20 \mu\text{s}$
 $f = 500 \text{ Hz}$
 $\lambda = 800 \text{ nm}$

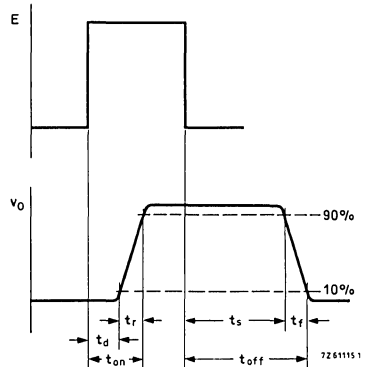

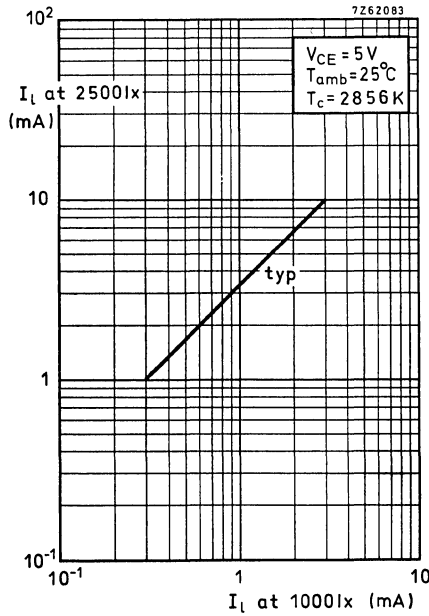
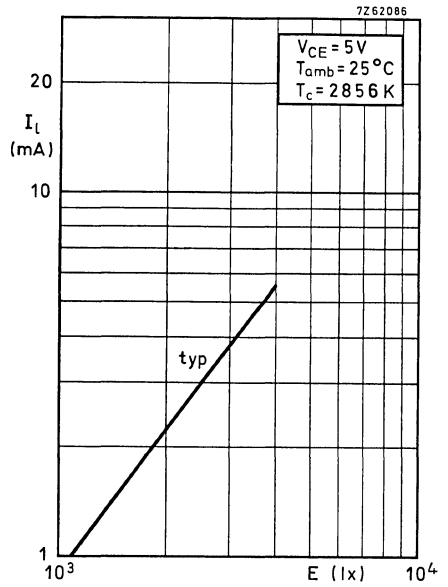
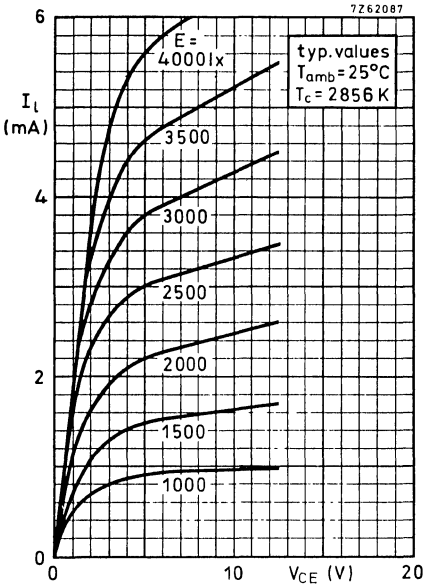

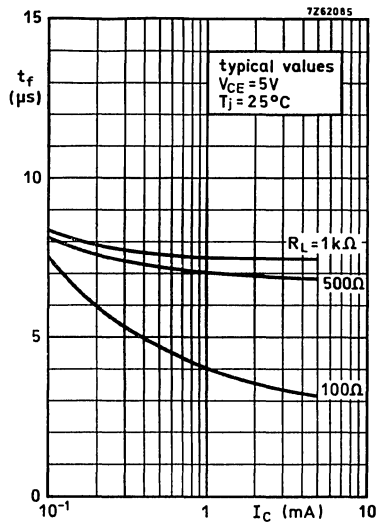
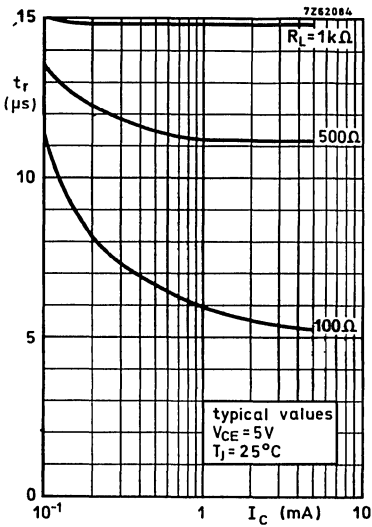
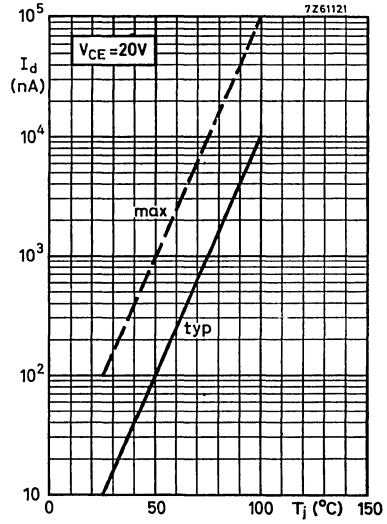
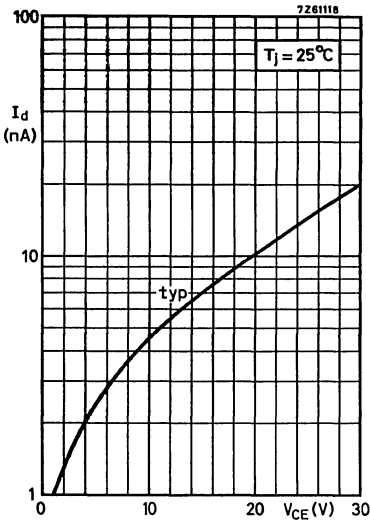

polar response of relative sensitivity

$T_{amb} = 25^{\circ}C$

7261122

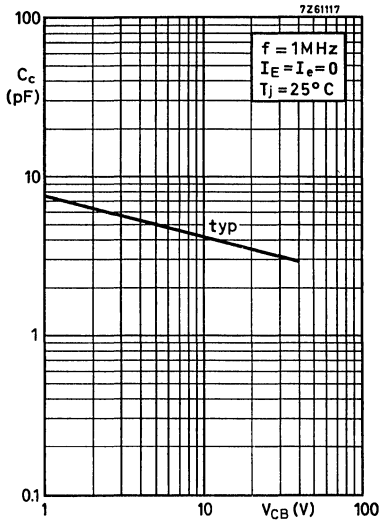
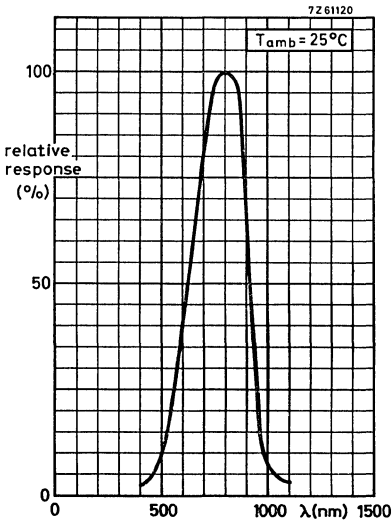
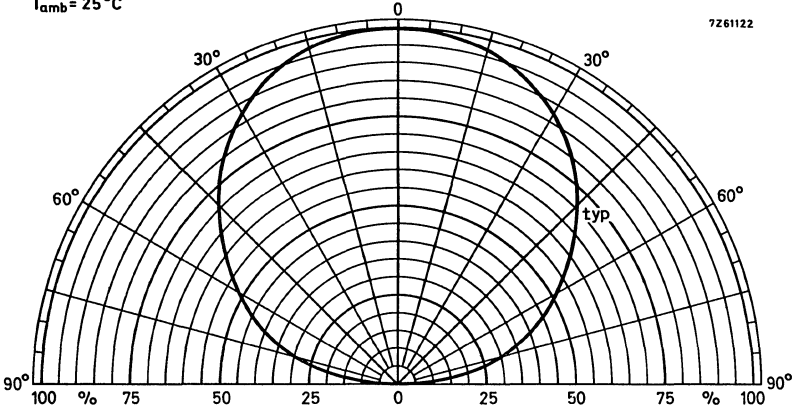

SILICON PLANAR EPITAXIAL PHOTOTRANSISTOR

N-P-N phototransistor designed for use as detector. Clear epoxy encapsulation.

QUICK REFERENCE DATA

Collector-emitter voltage (open base)	V_{CE0}	max.	30 V
Collector current (d.c.)	I_C	max.	25 mA
Total power dissipation up to $T_{amb} = 25\text{ }^\circ\text{C}$	P_{tot}	max.	100 mW
Collector light (cut-off) current $V_{CE} = 5\text{ V}; E = 1\text{ mW/cm}^2; \lambda = 930\text{ nm}$	$I_{CE0(L)}$	>	3 mA
Wavelength at peak response	λ_{pk}	typ.	800 nm

MECHANICAL DATA

Dimensions in mm

Fig. 1 SOD-63A.

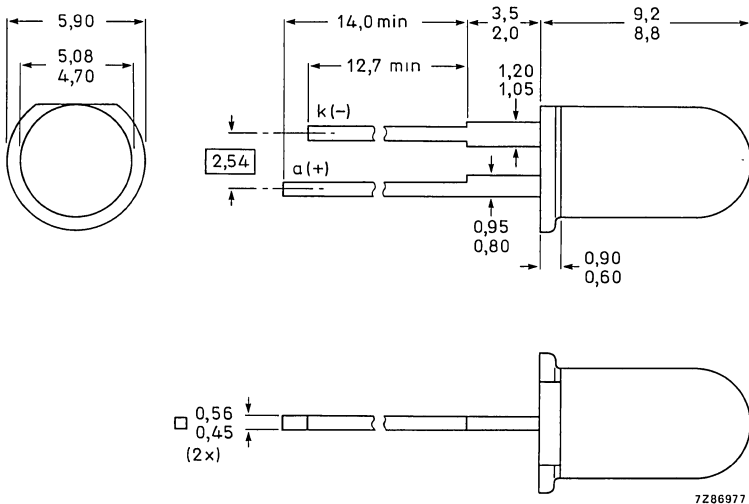

RATINGS

Limiting values in accordance with the Absolute Maximum System (IEC 134)

Collector-emitter voltage (open base)	V_{CE0}	max.	30 V
Emitter-collector voltage (open base)	V_{ECO}	max.	5 V
Collector current (d.c.)	I_C	max.	25 mA
Collector current (peak value) $t_p = 50 \mu s; \delta = 0,1$	I_{CM}	max.	50 mA
Total power dissipation up to $T_{amb} = 25 \text{ }^\circ\text{C}$	P_{tot}	max.	100 mW
Storage temperature	T_{stg}		-40 to +100 $^\circ\text{C}$
Junction temperature	T_j	max.	100 $^\circ\text{C}$
Lead soldering temperature up to the seating plane; $t_{slid} < 10 \text{ s}$	T_{slid}	max.	240 $^\circ\text{C}$

THERMAL RESISTANCE

From junction to ambient	$R_{th j-a}$	=	750 $^\circ\text{C/W}$
From junction to ambient, device mounted on a printed-circuit board	$R_{th j-a}$	=	500 $^\circ\text{C/W}$

CHARACTERISTICS

$T_j = 25 \text{ }^\circ\text{C}$ unless otherwise specified

Collector dark (cut-off) current $V_{CE} = 20 \text{ V}$	$I_{CEO(D)}$	<	100 nA
Collector light (cut-off) current* $V_{CE} = 5 \text{ V}; E = 1 \text{ mW/cm}^2; \lambda = 930 \text{ nm}$	BPX95C-1 BPX95C-2 $I_{CEO(L)}$ $I_{CEO(L)}$	>	3 to 15 mA 10 mA
Collector-emitter saturation voltage* $I_C = 2 \text{ mA}; E = 1 \text{ mW/cm}^2; \lambda = 930 \text{ nm}$	V_{CEsat}	<	0,4 V
Wavelength at peak response	λ_{pk}	typ.	800 nm
Bandwidth at half height	$B_{50\%}$	typ.	400 nm
Angle between half-sensitivity directions	$\alpha_{50\%}$	typ.	20 $^\circ$
Receiving area		typ.	1 mm ²

* Measured with a tungsten linear filament lamp and an interference filter at $\lambda = 930 \text{ nm}$.

Switching times (see Figs 2, 3, 4 and 5)

$I_{Con} = 2 \text{ mA}$; $V_{CC} = 5 \text{ V}$; $R_E = 100 \Omega$; $T_{amb} = 25 \text{ }^\circ\text{C}$

Light current turn-on time

Light current turn-off time

t_{on} typ. $3 \mu\text{s}$
 t_{off} typ. $3 \mu\text{s}$

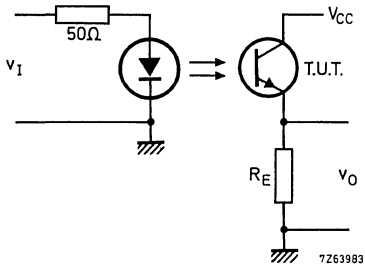

Fig. 2 Switching circuit.

Pulse generator:

$f = 500 \text{ Hz}$

$t_p = 20 \mu\text{s}$

$t_r = t_f = 20 \text{ ns}$

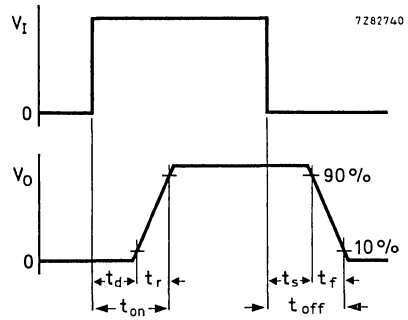

Fig. 3 Input and output switching waveforms.

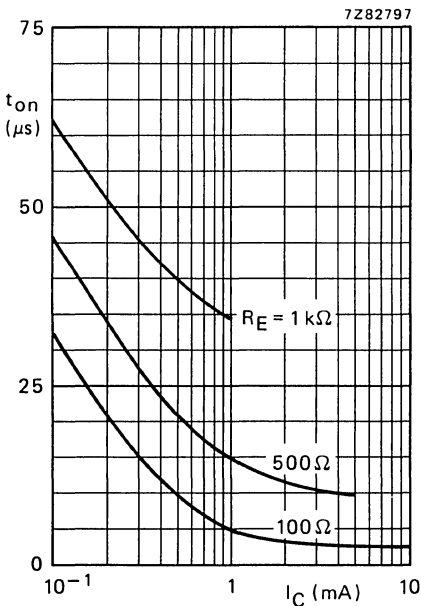

Fig. 4 $V_{CC} = 5 \text{ V}$; $T_{amb} = 25 \text{ }^\circ\text{C}$; typ. values.

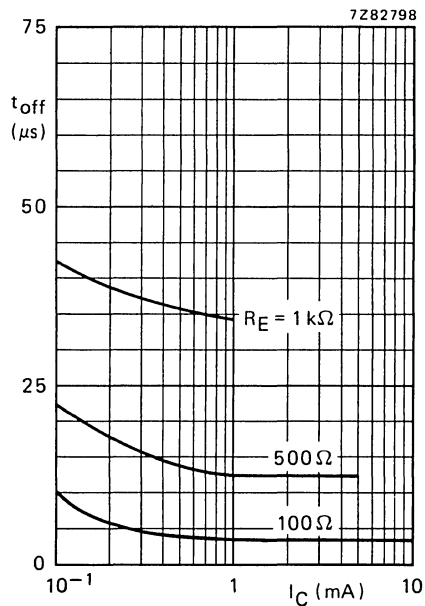

Fig. 5 $V_{CC} = 5 \text{ V}$; $T_{amb} = 25 \text{ }^\circ\text{C}$; typ. values.

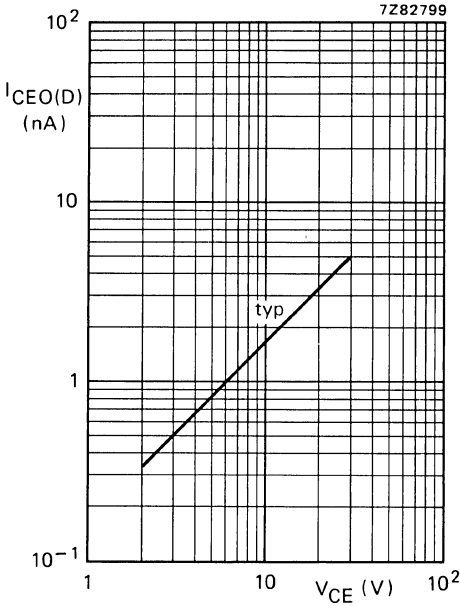

Fig. 6 $T_j = 25\text{ }^\circ\text{C}$.

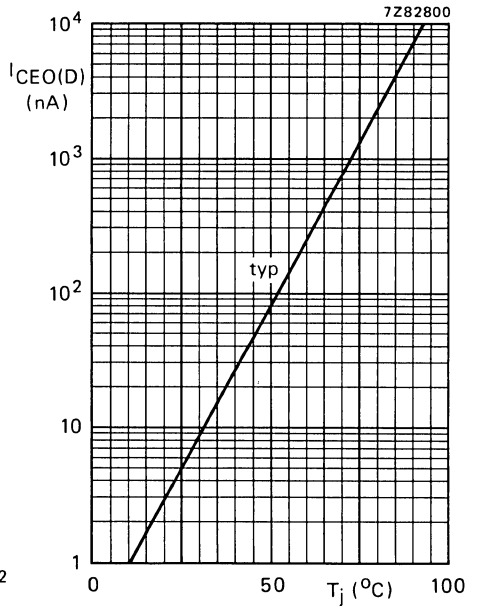

Fig. 7 $V_{CE} = 30\text{ V}$.

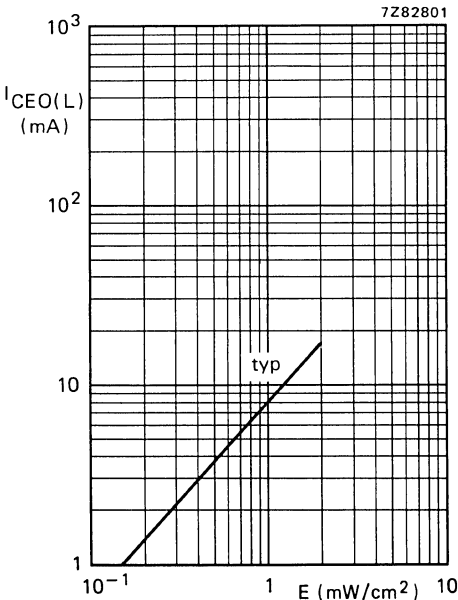

Fig. 8 $V_{CE} = 5\text{ V}$; $\lambda = 930\text{ nm}$; $T_j = 25\text{ }^\circ\text{C}$.

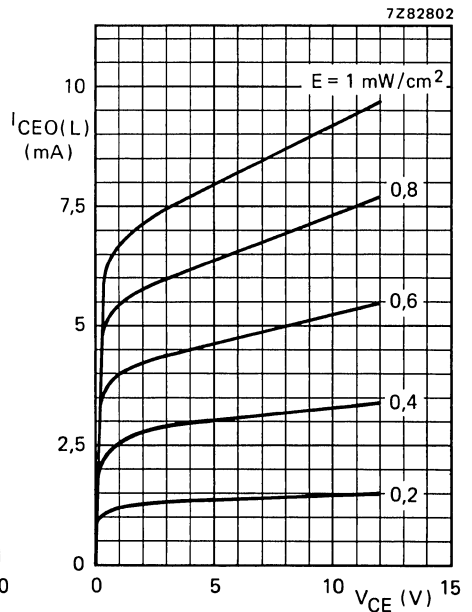

Fig. 9 $\lambda = 930\text{ nm}$; $T_j = 25\text{ }^\circ\text{C}$; typ. values.

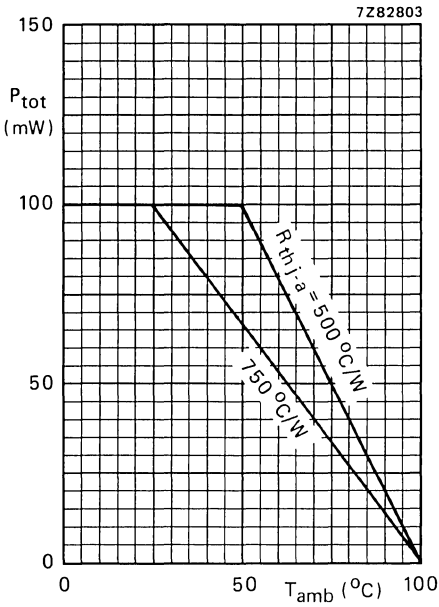

Fig. 10 Total power dissipation as a function of ambient temperature.

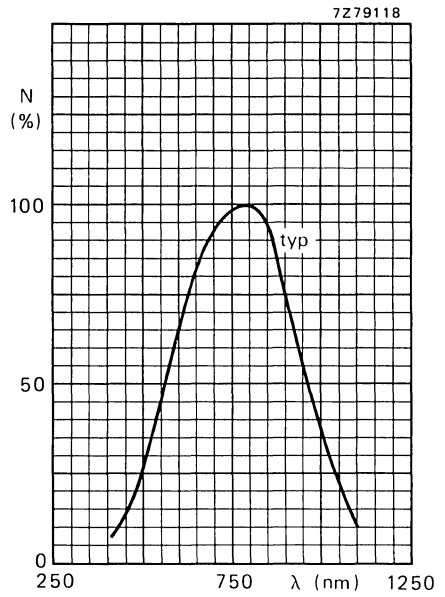

Fig. 11 Spectral response.

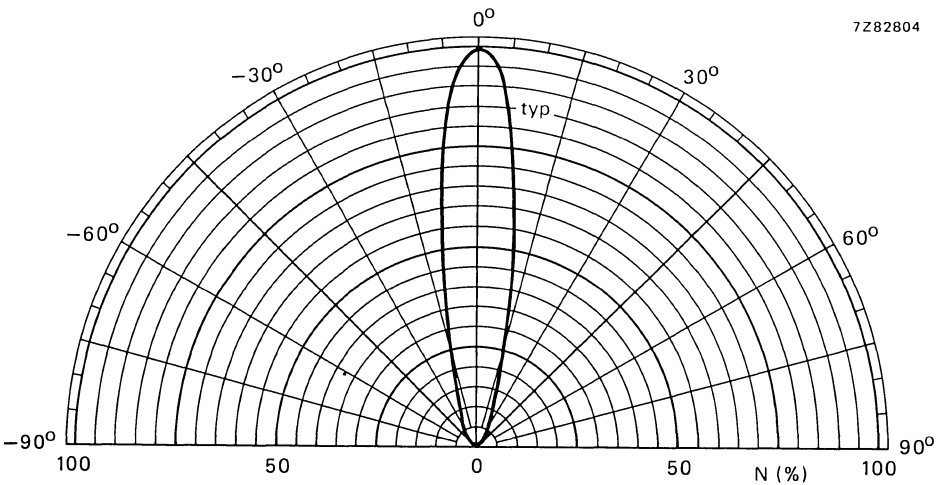

Fig. 12.

LIGHT EMITTING DIODES
AND SELECTION GUIDE



SELECTION GUIDE

Selection guide for LEDs (visible light) grouped according to light families

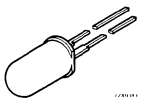
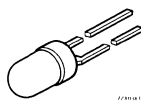
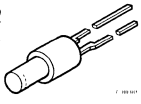
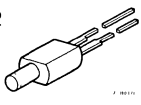
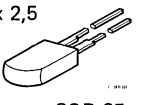
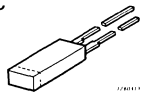
OUTLINE INDICATION dimensions in mm item no.	type number	light colour	λ_{peak} nm	$\alpha_{50\%}$	V_F at $I_F = 10 \text{ mA}$ V	I_F max. mA	package: colour/ diffuser	
 SOD-63	1▲	CQX24	hyper-red	650	25°	1,75	100	transparent
	2▲	CQX54	super-red	630	25°	2,1	30	transparent
	3▲	CQX64	super-green	565	25°	2,1	60	transparent
	4▲	CQX74	yellow	590	25°	2,1	30	transparent
	5▲	CQW24	hyper-red	650	60°	1,75	100	red/diff
	6	CQX51	super-red	630	60°	2,1	30	red/diff
	7▲	CQY24B	standard-red	650	60°	1,6	50	red/diff
	8	CQY94	green	560	60°	2,1	30	green/diff
	9▲	CQY94B	super-green	565	60°	2,1	60	green/diff
	10▲	CQY96	yellow	590	60°	2,1	30	yellow/diff
 SOD-53E	11	CQW54	hyper-red	650	60°	1,75	60	red/diff
	12	CQW51	super-red	630	60°	2,1	30	red/diff
	13	CQY54A	standard-red	650	60°	1,6	50	red/diff
	14	CQY95B	super-green	565	60°	2,1	60	green/diff
	15	CQY97A	yellow	590	60°	2,1	30	yellow/diff
 SOD-79	16	CQW20A	hyper-red	650	100°	1,75	60	red DC
	17	CQW21	super-green	565	100°	2,1	60	green DC
	18	CQW22	yellow	590	100°	2,1	30	yellow DC
 SOD-78	19	CQT11	bi-colour	see item 46				
 SOD-65	20	CQX10	super-red	630	50°	2,1	30	red/diff
	21	CQX11	super-green	565	50°	2,1	60	green/diff
	22	CQX12	yellow	590	50°	2,1	30	yellow/diff
 SOD-76	23▲	CQW10A	hyper-red	650	100°	1,75	100	dark red
	24▲	CQW10	super-red	630	100°	2,1	30	red
	25▲	CQW11A	super-green	565	100°	2,1	60	green
	26▲	CQW12	yellow	590	100°	2,1	30	yellow
	27▲	CQW10B	super-red	630	100°	2,1	30	dark red
	28▲	CQW11B	super-green	565	100°	2,1	60	dark green
	29▲	CQW12B	yellow	590	100°	2,1	30	dark yellow

▲ indicates availability of a long lead (25 mm) version; in that case letter L is added to the type number e.g. CQX24L.

DC double cast product (with diffusing zone), flat top.

existing I_V classes in mcd at $I_F = 10$ mA										
0,5	0,7-1,6	1,0-2,2	1,6-3,5	3,0-7,0	5-12	10-22	16-35	30-70	50-120	
	I*	II	I*	I* > 4,0 II	II* > 7,5 III	X* > 12 X* > 12 X* > 12	I* > 20	II* > 50	III* > 100	
	I*	II	III	IV*	For these classes $I_F = 20$ mA					
	I*		III	IV*						
	I*		III	IV	V*					
	I*		III	IV	V*					
	X*			X* > 4,0	V	VI	VII*			
	X*	II	III*	For these classes $I_F = 20$ mA						
	X*		III	IV	V*					
	X*		III	IV	V*					
X*	X*									
X*										
	I*	II	III	IV*						
	I*	II	III	IV*						
	I*	II	III	IV*						
X*		X*	III	IV						
X*		II	III							
X*		II	III							
X*		II	III							
X*		II	III							
X*		II	III							

X class without classification number; basic type number used only, e.g. CQX54.
 * class without maximum I_V value; minimum I_V level specified only.

SELECTION GUIDE

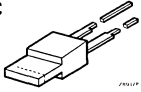
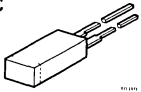
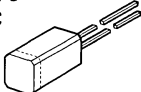
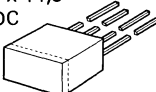
OUTLINE INDICATION dimensions in mm item no.	type number	light colour	λ_{peak} nm	$\alpha_{50\%}$	V_F at $I_F = 10 \text{ mA}$ V	I_F max. mA	package: colour/ diffusor		
5 x 1 DC  SOD-75	30▲	CQV60A	hyper-red	650	110°	1,75	100	red	
	31▲	CQV60	super-red	630	110°	2,1	30	red	
	32▲	CQV61A	super-green	565	110°	2,1	60	green	
	33▲	CQV62	yellow	590	110°	2,1	30	yellow	
5 x 3 DC  SOD-77	34▲	CQV70A	hyper-red	650	100°	1,75	100	red	
	35▲	CQV70	super-red	630	100°	2,1	30	red	
	36▲	CQV71A	super-green	565	100°	2,1	60	green	
	37▲	CQV72	yellow	590	100°	2,1	30	yellow	
5 x 5 DC  SOD-74	38	CQV80AL	hyper-red	650	100°	1,75	100	red	
	39	CQV80L	super-red	630	100°	2,1	30	red	
	40	CQV81L	super-green	565	100°	2,1	60	green	
	41	CQV82L	yellow	590	100°	2,1	30	yellow	
7 x 14,5 DC  SOD-73	42	CQN10	hyper-red	650	100°	1,75	100	red	
	43	CQN11	super-green	565	100°	2,1	60	green	
5 x 3	SOD-77	45	CQT10	hyper-red super-green	650 565	110°	1,75 2,1	100 60	transp. DC
ϕ 2	SOD-78	46	CQT11	hyper-red super-green	650 565	110°	1,75 2,1	100 60	transp. DC
5 x 1	SOD-75	47	CQT12	hyper-red super-green	650 565	110°	1,75 2,1	100 60	transp. DC

▲ indicates availability of long lead (25 mm) version; in that case letter L is added to the type number e.g. CQX24L.

DC double cast product (with diffusing zone), flat top.

existing I_V classes in mcd at $I_F = 10$ mA									
0,5	0,7-1,6	1,0-2,2	1,6-3,5	3,0-7,0	5-12	10-22	16-35	30-70	50-120
X*		X*	III	IV					
X*		II	III						
X*		II	III						
X*		II	III						
X*		X*	III	IV					
X*		II	III						
X*		II	III	IV					
X*		II	III						
X*		II	III						
			X* > 2 X* > 2	For this class $I_F = 20$ mA					
		X*	For this class $I_F = 20$ mA						
		X*	For this class $I_F = 20$ mA						
		X*	For this class $I_F = 20$ mA						
		X*	For this class $I_F = 20$ mA						

X class without classification number; basic type number used only, e.g. CQX54.
 * class without maximum I_V value; minimum I_V level specified only.

GaAlAs LIGHT EMITTING DIODE

Infrared light emitting diode in hermetic TO-46 encapsulation, designed for fibre-optic transmissions over short and medium distances, mainly for military and industrial applications.

It is optimized to be coupled with a 200 μm core diameter fibre and to be used in combination with the BPF24 receiver.

The crystal is electrically isolated from the case.

QUICK REFERENCE DATA

Continuous reverse voltage	V_R	max.	3 V
Forward current (d.c.)	I_F	max.	100 mA
Total power dissipation up to $T_{amb} = 25\text{ }^\circ\text{C}$	P_{tot}	max.	250 mW
Optical power coupled into fibre (ϕ core = 200 μm and $NA = 0,2$) at $I_F = 100\text{ mA}$	ϕ_e	min.	200 μW
Switching times at $I_F = 100\text{ mA}$	t_r	typ.	10 ns
	t_f	typ.	10 ns
Wavelength at peak emission	λ_{pk}	typ.	830 nm

MECHANICAL DATA

Dimensions in mm

Fig. 1.

Pinning:
1 = anode
2 = cathode
3 = case

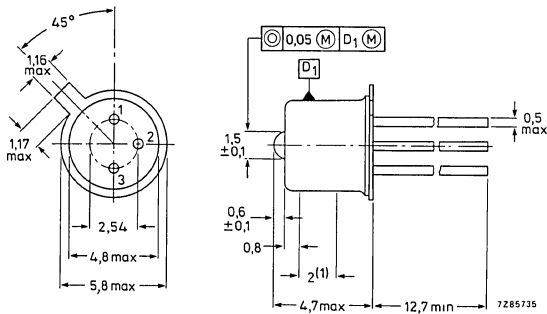

(1) Case diameter over this length is 4,7 (+ 0,05; -0,1) mm.

RATINGS

Limiting values in accordance with the Absolute Maximum System (IEC 134)

Continuous reverse voltage	V_R	max.	3 V
Forward current	I_F	max.	100 mA
Forward current (peak) $t = 10 \mu\text{s}; \delta = 0,1$	I_{FM}	max.	300 mA
Total power dissipation up to $T_{amb} = 25 \text{ }^\circ\text{C}$ device mounted on a printed circuit	P_{tot}	max.	250 mW
Junction temperature	T_j	max.	150 $^\circ\text{C}$
Operating temperature	T_{op}		-55 to +125 $^\circ\text{C}$
Storage temperature	T_{stg}		-65 to +150 $^\circ\text{C}$

THERMAL RESISTANCE

From junction to ambient when the device
is mounted on a printed circuit

$R_{th\ j-a}$	typ.	400 K/W
	max.	500 K/W

From junction to case

$R_{th\ j-c}$	typ.	100 K/W
	max.	150 K/W

CHARACTERISTICS

 $T_{amb} = 25 \text{ }^\circ\text{C}$ unless otherwise specifiedForward voltage
at $I_F = 100 \text{ mA}$

V_F	typ.	2,2 V
	max.	2,5 V

Reverse current
at $V_R = 3 \text{ V}$

I_R	max.	100 μA
-------	------	-------------------

Radiant power coupled into fibre

at $I_F = 100 \text{ mA}$
 $\phi \text{ core} = 200 \mu\text{m},$
 $NA = 0,2$ } see notes 1 and 2

ϕ_e	min.	200 μW
	typ.	400 μW

Radiant intensity
at $I_F = 100 \text{ mA}$

I_e	min.	5 mW/sr
	min.	800 nm

Wavelength at peak emission

λ_{pk}	typ.	830 nm
	max.	880 nm

Bandwidth at half height

$B_{50\%}$	typ.	40 nm
------------	------	-------

Switching times

at $I_{Fon} = 100 \text{ mA}$

t_r	typ.	10 ns
	max.	15 ns
t_f	typ.	10 ns
	max.	15 ns

NOTES

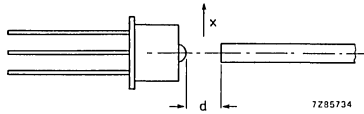
Fig. 2 Distance d and lateral displacement x .

1. For this measurement the device is shifted along its 3 axes, so that the maximum power is coupled into the fibre.

If the device is adjusted in front of the geometrical axis of the same fibre with distance $d = 0,7 \text{ mm}$, $P_{\min} = 100 \mu\text{W}$.

2. For a different core diameter $\phi_x \leq 200 \mu\text{m}$: $\frac{P_{\text{inj}}(x)}{P_{\text{inj}}(200)} = \left(\frac{\phi_x}{200}\right)^2$

For a different numerical aperture $NA_x \leq 0,2$: $\frac{P_{\text{inj}}(x)}{P_{\text{inj}}(0,2)} = \left(\frac{NA_x}{0,2}\right)^2$

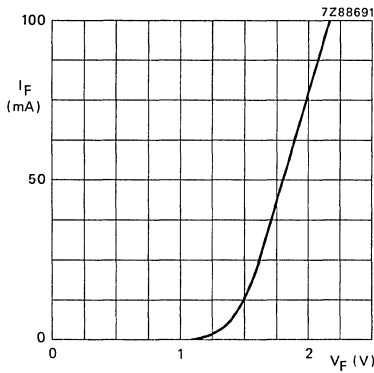

Fig. 3 $T_{amb} = 25\text{ }^{\circ}\text{C}$.

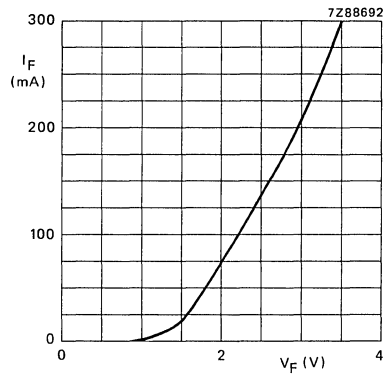

Fig. 4 $T_{amb} = 25\text{ }^{\circ}\text{C}$; $T_{on} = 10\text{ }\mu\text{s}$; $\delta = 0,1$.

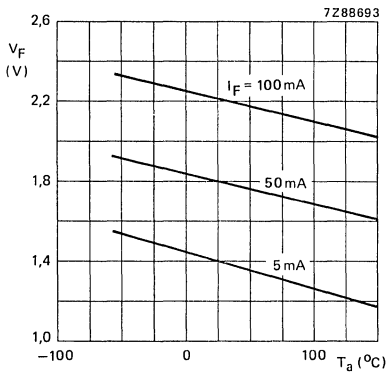

Fig. 5.

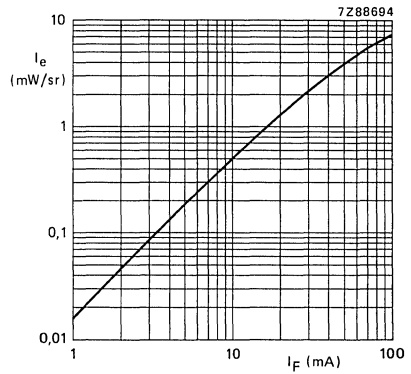

Fig. 6 $T_{amb} = 25\text{ }^{\circ}\text{C}$.

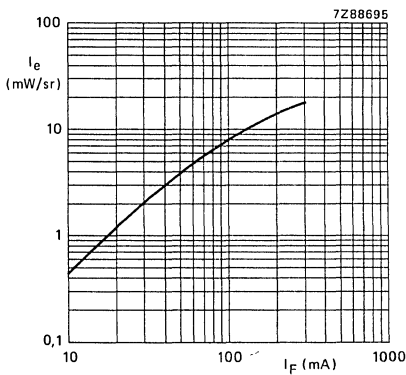

Fig. 7 $T_{amb} = 25\text{ }^{\circ}\text{C}$; $T_{on} = 10\text{ }\mu\text{s}$; $\delta = 0,01$.

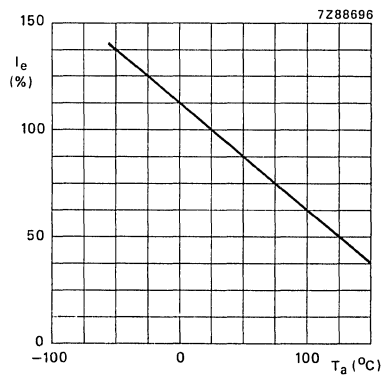

Fig. 8.

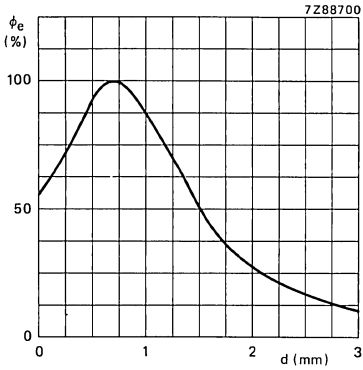

Fig. 9 See notes 1 and 2.

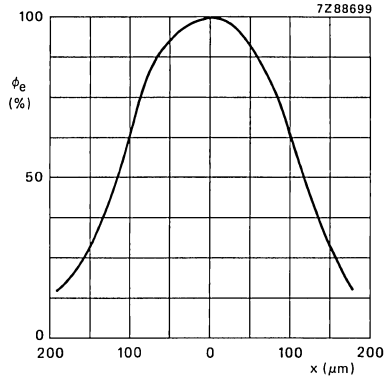

Fig. 10 Distance $d = 700 \mu\text{m}$.
See notes 1 and 2.

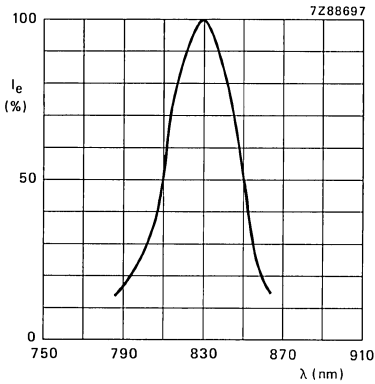

Fig. 11 $I_F = 100 \text{ mA}$; $T_{\text{amb}} = 25 \text{ }^\circ\text{C}$.

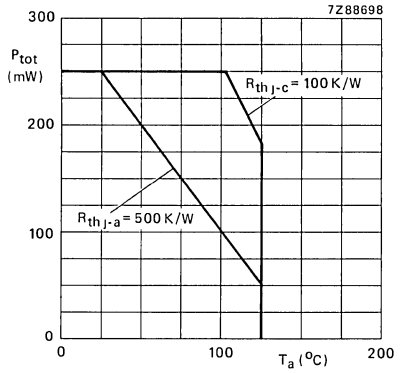

Fig. 12.

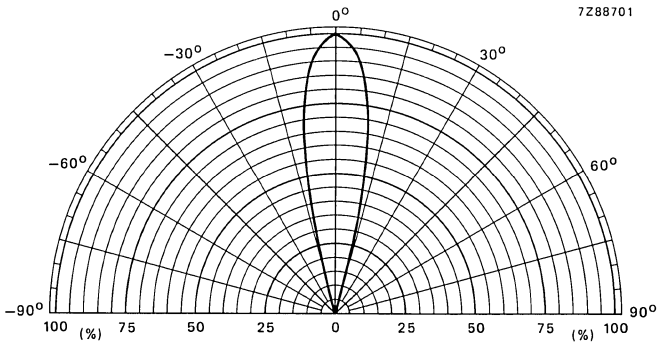

Fig. 13.

DOUBLE HETEROSTRUCTURE AlGaAs LASER

The CQL10A is designed for reading applications such as: video-audio disc applications, optical memories, security systems, etc.

This device is mounted in an hermetic SOT-148 encapsulation specifically designed for easy alignment in an optical read or write system. The copper heatsink is circular and precision engineered with a diameter accuracy of $+0, -9 \mu\text{m}$. Laser-stripe and mechanical axis coincide within $50 \mu\text{m}$.

The CQL10A is standard equipped with a photo p-i-n diode, optically coupled to the rear emitting facet of the laser. This fast responding (less than 20 ns) photodiode can be used as a sensor to control the laser radiant output level. The ultra-flat top window (flat within two fringes) guarantees an unperturbed beam wavefront.

QUICK REFERENCE DATA

Threshold current at $T_c = 30 \text{ }^\circ\text{C}$	I_{th}	typ.	65 mA
C.W. radiant output power up to $T_c = 60 \text{ }^\circ\text{C}$	ϕ_e	typ.	5 mW
Wavelength at peak emission	λ_{pk}	typ.	820 nm

MECHANICAL DATA

Fig. 1 SOT-148.

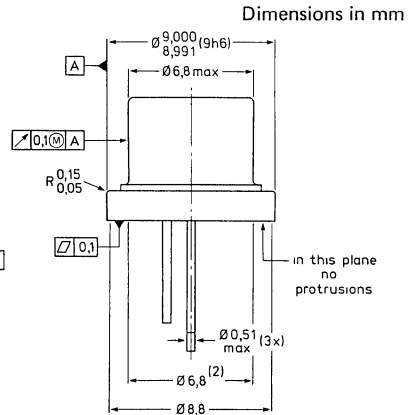
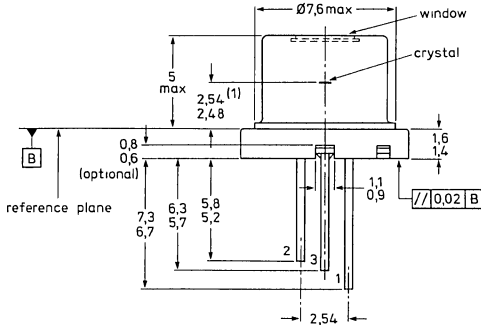

(1) Position of the laser crystal from the reference plane.

(2) Within the plane of $\phi 6,8$ protrusions and irregularities are permitted.

(3) The positional accuracy of the laser stripe with respect to the flange diameter.

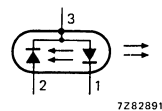
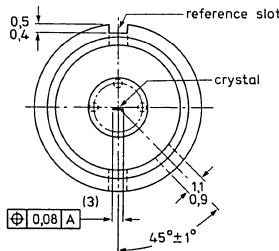

LASER

The double heterostructure stripe laser operates in single transverse, multiple longitudinal mode (TE_{00}) over the full power range. The structure is designed to operate C.W. 5 mW up to relatively high temperatures (60 °C case temperature) and a wavelength of 820 nm which makes reading standard Video Long Play records and compact discs (DAD) a possible application.

RATINGS

Limiting values in accordance with the Absolute Maximum System (IEC 134)

Radiant output power	ϕ_e	max.	10 mW
Reverse voltage	V_R	max.	1 V
Temperatures (<i>both laser and photodiode</i>)			
C.W. operation	T_C	-20 to +60 °C	
storage	T_{stg}	-55 to +100 °C	

CHARACTERISTICS

Threshold current			
at $T_C = 30\text{ °C}$	I_{th}	typ.	65 mA
at $T_C = 60\text{ °C}$			90 mA
Operating current			
$\phi_e = 5\text{ mW}; T_C = 30\text{ °C}$	I_{op}	typ.	85 mA
		max.	120 mA
$\phi_e = 5\text{ mW}; T_C = 60\text{ °C}$	I_{op}	typ.	120 mA
		max.	160 mA
Recommended operating radiant output power up to $T_C = 60\text{ °C}$	ϕ_e	typ.	5 mW
Forward voltage drop up to $T_C = 60\text{ °C}$ $\phi_e = 5\text{ mW}$	V_F	typ.	2,5 V
Wavelength at peak emission $\phi_e = 5\text{ mW}; T_C = 30\text{ °C}$	λ_{pk}	typ.	820 nm
Spectral width at half height $\phi_e = 5\text{ mW}$	$\Delta\lambda$	typ.	4 nm
Far-field angle at half-intensity directions (FWHM)			
perpendicular to the junction plane	$\alpha_{50\%(\perp)}$	typ.	50 °
parallel to the junction plane	$\alpha_{50\%()}$	typ.	35 °
Near-field width at half-intensity directions (FWHM)	$\delta_{50\%}$	typ.	6-7 μm
Astigmatism (distance between focal lines)	A_D	typ.	15 μm
Series resistance	R_S	typ.	5 Ω
Differential efficiency at $\phi_e = 2\text{ mW}$	ϵ	typ.	0,15 W/A
Spontaneous emission at I_{th}	ϕ_{spon}	typ.	0,5 mW
Turn-on/turn-off time (above threshold)	t_{on}/t_{off}	typ.	1 ns
Degradation rate $T_C = 60\text{ °C}; \phi_e = 5\text{ mW}$	$\frac{1}{I_{op}} \cdot \frac{dI_{op}}{dT}$	typ.	5 %/Kh
Temperature coefficient of wavelength	$\frac{d\lambda_{pk}}{dT}$	typ.	0,25 nm/K
Temperature coefficient of I_{th}	$\frac{I}{I_{th}} \cdot \frac{dI_{th}}{dT}$	typ.	1 %/K
Thermal resistance from junction to case	R_{th-j-c}	typ.	50 K/W

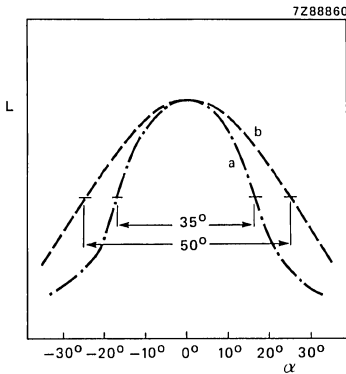

Fig. 2 Far-field pattern.
 a. parallel to the junction plane.
 b. perpendicular to the junction plane.

PHOTODIODE

RATINGS

Limiting values in accordance with the Absolute Maximum System (IEC 134)

Reverse voltage V_R max. 30 V

CHARACTERISTICS

Luminous sensitivity at $V_R = 15$ V

N typ. 0,5 A/W

Dark reverse current at $V_R = 15$ V

$I_{R(D)}$ max. 10 nA

Capacitance at $V_R = 0$

C_d max. 5 pF

Monitor diode current at $V_R = 15$ V

$I_{R(L)}$ 150-400 μ A/mW

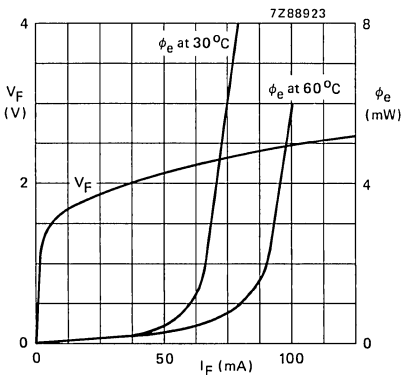

Fig. 3 Forward voltage drop (V_F) and radiant output power (ϕ_e) of laser diode as a function of forward current; typ. values.

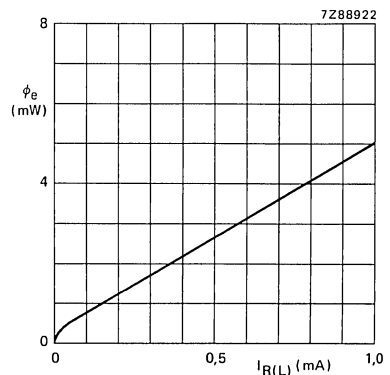
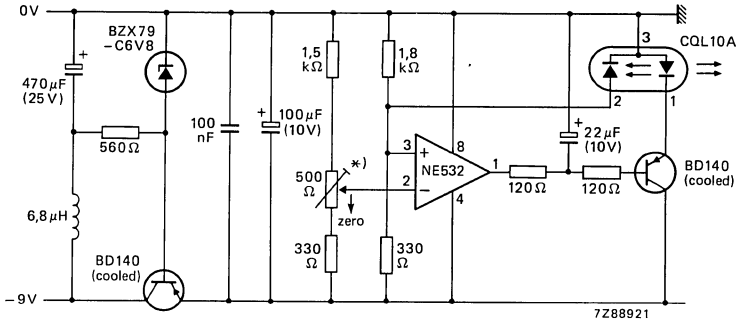

Fig. 4 Radiant output power (ϕ_e) as a function of monitor current of photodiode; V_R (photodiode) = 15 V; typ. values.



* Ten-turn. Zero position is at 0,58 revolution. Each revolution is equivalent to 500 μA monitor diode current. Adjust from zero position.

Fig. 5 Recommended control circuit for continuous operation.

OPERATING PRECAUTIONS

Semiconductor lasers in general are easily damaged by overdriving and electrical transients. Electrically, the laser diode is a very reliable device and can easily withstand current surges of several amperes. Optically, however, the laser diode is more susceptible to damage because of the extremely high optical flux density passing through both facets, while in operation. By overdriving or transients to the laser, even for pulses in the nanosecond region, the optical flux density can rise to unacceptable values (10 to 100 MW/cm²), causing gradual or catastrophic degradation of the laser facets. Current transients should therefore be carefully avoided; they can substantially decrease the laser life time.

CAUTION

Aluminium gallium arsenide lasers emit radiation which is invisible to the human eye. When in use, do not look directly into the device. Direct viewing of laser light at close ranges, especially in conjunction with collimating lenses, may cause eye damage.

The device falls within safety class 3B of the international standard code.

COLLIMATOR PEN

The collimator pen CQL13 is used for reading applications such as: data retrieval, video-audio disc applications, optical memories, security systems etc.

The pen is mounted in a non-hermetic encapsulation, specifically designed for easy alignment in an optical read or write system, and consists of a lens system and a laser device. The lens system collimates the diverging laser light. The wavefront quality is diffraction limited. A cylindrical lens is used for correction of the astigmatism of the laser.

The housing is circular and precision manufactured with a diameter accuracy between +0 and -11 μm .

QUICK REFERENCE DATA

Output power ϕ_e	2 mW
Current at output power $\phi_e = 2 \text{ mW}$ and temperature of 60 °C	< 175 mA
Wavelength at peak emission λ_{pk}	typ. 790 nm
Wavefront form of bundle (non-convergent) divergence	< 0,3 mrad

MECHANICAL DATA

Dimensions in mm

Fig. 1.

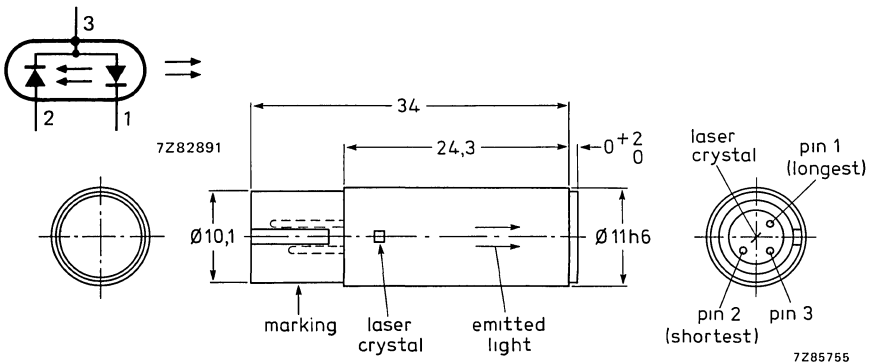

Mass	max. 8 g
Concentricity	angle between the mechanical and optical axis $\leq 10 \text{ mrad}$
Marking	type number CQL13 and serial number
Mounting	on a p.c. board by means of a specifically designed connector
Accessories	the pen is supplied with a connector
WARNING	THE LASER AND CONSEQUENTLY THE COLLIMATOR PEN HAS POSITIVE POLARITY ON THE CASE.

CHARACTERISTICS

Measuring conditions

Climatological	relative humidity 5–90%, atmospheric pressure. Housing temperature of the pen 5–60 °C
Electrical	d.c. operation, optical feedback drive and protection against transients
Optical	only the radiation in a bundle with a diameter of 5,4 mm is relevant

Optical data

Output power	ϕ_e	max. 2 mW (see Fig. 4)
Spectral	wavelength	λ 790 ± 10 nm
	bandwidth	$\Delta\lambda$ < 4 nm (see note)
	wavelength	$\Delta\lambda/\Delta T$ approx. 0,25 nm/K
Bundle properties	dimension	ϕ 5,4 mm
	wavefront form	plane, non-convergent divergence < 0,3 mrad
	aberrations	variance of wavefront with respect to the Gaussian reference sphere is less than $\lambda^2/300$
polarization	polarization	plane
	polarization ratio	typ. 35 : 1
Intensity distribution	transversal mode	TE ₀₀ -fundamental
	longitudinal mode	see note
	symmetry	variation of optical power in the four quadrants (see Fig. 2) typ. 20%
	ripple	local value of the intensity < 15% of the smooth value
filling ratio	I_{rim}/I_{max}	> 0,17

Note: the number of longitudinal modes is related to the spectral width.

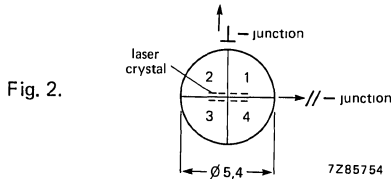

Electrical data

Current		
at $\phi_e = 2$ mW and $T_h = 60$ °C		≤ 175 mA
Drive voltage V_d		≤ 5 V
Resistance between collimator pen and connector at 10 mA, max. 20 mV _{pp} and 1 kHz		≤ 12 m Ω

PHOTODIODE (see Fig. 5)

RATINGS

Reverse voltage $V_R \leq 30 \text{ V}$

CHARACTERISTICS

Monitor diode sensitivity (ratio of photodiode current to optical power emitted by collimator pen) at $\phi_e = 2 \text{ mW}$

0,1 A/W

Dark reverse current at $V_R = 15 \text{ V}$

$I_{R(D)} < 10 \text{ nA}$

Capacitance at $V_R = 0$

$C_d < 5 \text{ pF}$

ENVIRONMENTAL TESTS

The device meets all specifications mentioned below 2 hours after each test. During these tests the collimator pen is not operating.

test	in accordance with	conditions
Rapid change of temperature	IEC 68-2-14, test Na	-25 °C to 25 °C to 70 °C to 25 °C; duration of each exposure 30 min and 10 cycles in total
Dry heat	IEC 68-2-2, test Bc	Temperature: 70 °C Duration: 7 days
Cold	IEC 68-2-1 test Aa	Temperature: -25 °C Duration: 7 days
Damp heat, steady state	IEC 68-2-3 test Ca	Temperature: 40 °C Relative humidity (R.H.): 90–95% Duration: 42 days
Damp heat, cyclic	IEC 68-2-30 test Db	Temperature/R.H. 45 °C/100% (12 h) to 25 °C/ 85% (12 h) Duration of one cycle: 24 hours Number of cycles: 42
Vibration	IEC 68-2-6 test Db	Frequency range: 10–55 Hz Amplitude: 0,75 mm Duration: 6 hours (2 h in each of directions)
Shock	IEC 68-2-27 test Ea	Pulse shape: half-sine Pulse duration: 11 ms Peak acceleration: 981 m/s ² Number of shocks: 10 in each of 3 directions
Bump	IEC 68-2-29 test Eb	Pulse duration: 6 ms Peak acceleration: 390 m/s ² Number of bumps: 1000 Axes of direction: 6

Cleaning test

The cylinder lens at the side of the long conjugate is cleaned 100x with a small piece of cotton wool, soaked in a 45–95% solution of ethyl-alcohol in water, attached to the end of a small stick.

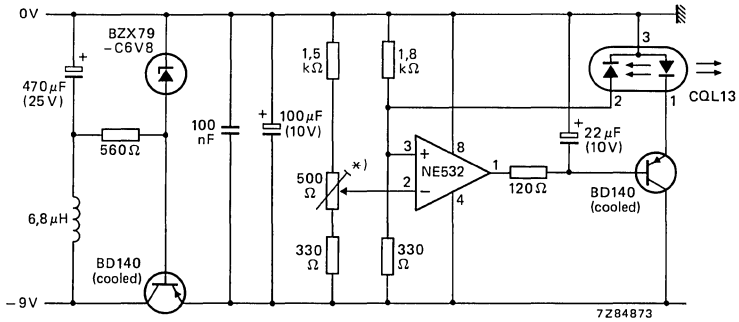

* Ten-turn. Zero position is at 0,58 revolution. Each revolution is equivalent to 500 μA monitor diode current.

Fig. 3 Recommended control circuit.

OPERATING PRECAUTIONS

Semiconductor lasers in general are easily damaged by overdriving and transients. Electrically, the laser diode is a very reliable device and can easily withstand current surges of several amperes. Optically, however, the diode laser is more susceptible to damage because of the extremely high optical flux density passing through both facets, while in operation. By overdriving or transients to the laser, even for pulses in the nanosecond region, the optical flux density can rise to unacceptable values (10 to 100 MW/cm²), causing gradual or catastrophic degradation of the laser facets. Current transients should therefore be carefully avoided; they decrease the laser life time.

CAUTION

Aluminium gallium arsenide lasers emit radiation which is invisible to the human eye. When in use, do not look directly into the device. Direct viewing of laser light at close ranges, especially in conjunction with collimating lenses, may cause eye damage.

The device meets the requirements of safety class 3B of the international standard code.

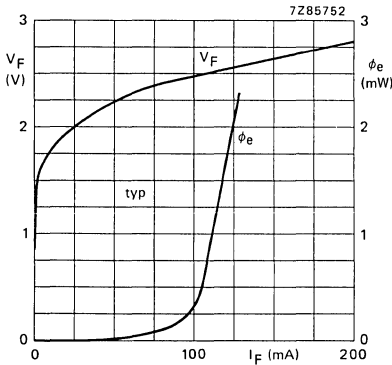

Fig. 4 $T_h = 60^\circ\text{C}$.

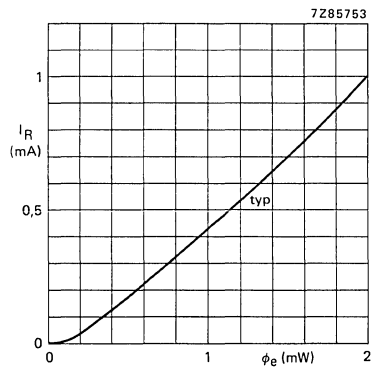

Fig. 5 $V_R = 15\text{ V}$.

COLLIMATOR PEN

The collimator pen CQL13A is used for reading applications such as: data retrieval, video-audio disc applications, optical memories, security systems etc.

The pen is mounted in a non-hermetic encapsulation, specifically designed for easy alignment in an optical read or write system, and consists of a lens system and a laser device. The lens system collimates the diverging laser light. The wavefront quality is diffraction limited. A cylindrical lens is used for correction of the astigmatism of the laser.

The housing is circular and precision manufactured with a diameter accuracy between +0 and -11 μm.

QUICK REFERENCE DATA

Output power ϕ_e	2 mW
Current at output power $\phi_e = 2$ mW and temperature of 60 °C	< 175 mA
Wavelength at peak emission λ_{pk}	typ. 820 nm
Wavefront form of bundle (non-convergent) divergence	< 0,3 mrad

MECHANICAL DATA

Dimensions in mm

Fig. 1.

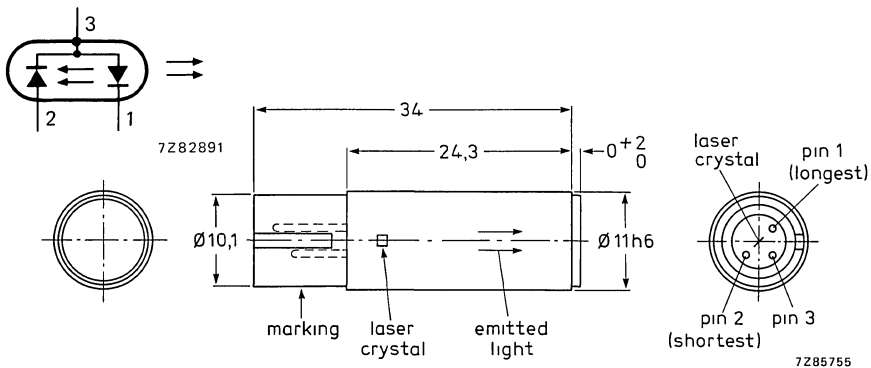

Mass	max. 8 g
Concentricity	angle between the mechanical and optical axis ≤ 10 mrad
Marking	type number CQL13A and serial number
Mounting	on a p.c. board by means of a specifically designed connector
Accessories	the pen is supplied with a connector

WARNING THE LASER AND CONSEQUENTLY THE COLLIMATOR PEN HAS POSITIVE POLARITY ON THE CASE.

CHARACTERISTICS

Measuring conditions

Climatological	relative humidity 5–90%, atmospheric pressure. Housing temperature of the pen 5–60 °C
Electrical	d.c. operation, optical feedback drive and protection against transients
Optical	only the radiation in a bundle with a diameter of 5,4 mm is relevant

Optical data

Output power	ϕ_e	max. 2 mW (see Fig. 4)
Spectral	wavelength	λ 820 ± 10 nm
	bandwidth	$\Delta\lambda$ < 4 nm (see note)
	wavelength drift	$\Delta\lambda/\Delta T$ approx. 0,25 nm/K
Bundle properties	dimension	ϕ 5,4 mm
	wavefront form aberrations	plane, non-convergent divergence < 0,3 mrad variance of wavefront with respect to the Gaussian reference sphere is less than $\lambda^2/300$
polarization	polarization ratio	plane typ. 35 : 1
	intensity distribution	TE ₀₀ -fundamental see note variation of optical power in the four quadrants (see Fig. 2) typ. 20% local value of the intensity < 15% of the smooth value
ripple		local value of the intensity < 15% of the smooth value
filling ratio	I_{rim}/I_{max}	> 0,17

Note: the number of longitudinal modes is related to the spectral width.

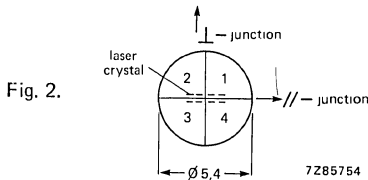

Fig. 2.

Electrical data

Current	at $\phi_e = 2$ mW and $T_h = 60$ °C	≤ 175 mA
Drive voltage	V_d	≤ 5 V
Resistance between collimator pen and connector at 10 mA, max. 20 mV _{pp} and 1 kHz		≤ 12 mΩ

PHOTODIODE (see Fig. 5)

RATINGS

Reverse voltage $V_R \leq 30 \text{ V}$

CHARACTERISTICS

Monitor diode sensitivity (ratio of photodiode current to optical power emitted by collimator pen) at $\phi_e = 2 \text{ mW}$ 0,1 A/W

Dark reverse current at $V_R = 15 \text{ V}$ $I_{R(D)} < 10 \text{ nA}$

Capacitance at $V_R = 0$ $C_d < 5 \text{ pF}$

ENVIRONMENTAL TESTS

The device meets all specifications mentioned below 2 hours after each test. During these tests the collimator pen is not operating.

test	in accordance with	conditions
Rapid change of temperature	IEC 68-2-14, test Na	-25 °C to 25 °C to 70 °C to 25 °C; duration of each exposure 30 min and 10 cycles in total
Dry heat	IEC 68-2-2, test Bc	Temperature: 70 °C Duration: 7 days
Cold	IEC 68-2-1 test Aa	Temperature: -25 °C Duration: 7 days
Damp heat, steady state	IEC 68-2-3 test Ca	Temperature: 40 °C Relative humidity (R.H.): 90-95% Duration: 42 days
Damp heat, cyclic	IEC 68-2-30 test Db	Temperature/R.H. 45 °C/100% (12 h) to 25 °C/ 85% (12 h) Duration of one cycle: 24 hours Number of cycles: 42
Vibration	IEC 68-2-6 test Db	Frequency range: 10-55 Hz Amplitude: 0,75 mm Duration: 6 hours (2 h in each of directions)
Shock	IEC 68-2-27 test Ea	Pulse shape: half-sine Pulse duration: 11 ms Peak acceleration: 981 m/s ² Number of shocks: 10 in each of 3 directions
Bump	IEC 68-2-29 test Eb	Pulse duration: 6 ms Peak acceleration: 390 m/s ² Number of bumps: 1000 Axes of direction: 6

Cleaning test The cylinder lens at the side of the long conjugate is cleaned 100x with a small piece of cotton wool, soaked in a 45-95% solution of ethyl-alcohol in water, attached to the end of a small stick.

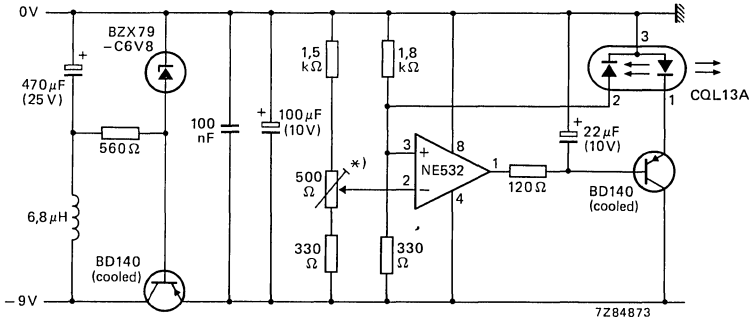

* Ten-turn. Zero position is at 0,58 revolution. Each revolution is equivalent to 500 μA monitor diode current.

Fig. 3 Recommended control circuit.

OPERATING PRECAUTIONS

Semiconductor lasers in general are easily damaged by overdriving and transients. Electrically, the laser diode is a very reliable device and can easily withstand current surges of several amperes. Optically, however, the diode laser is more susceptible to damage because of the extremely high optical flux density passing through both facets, while in operation. By overdriving or transients to the laser, even for pulses in the nanosecond region, the optical flux density can rise to unacceptable values (10 to 100 MW/cm²), causing gradual or catastrophic degradation of the laser facets. Current transients should therefore be carefully avoided; they decrease the laser life time.

CAUTION

Aluminium gallium arsenide lasers emit radiation which is invisible to the human eye. When in use, do not look directly into the device. Direct viewing of laser light at close ranges, especially in conjunction with collimating lenses, may cause eye damage.

The device meets the requirements of safety class 3B of the international standard code.

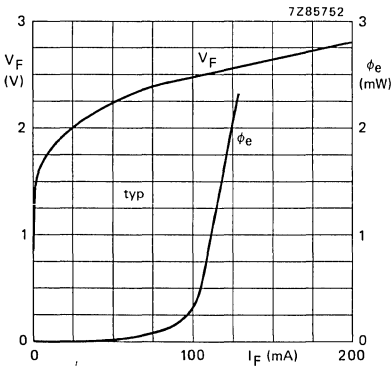

Fig. 4 T_h = 60 °C.

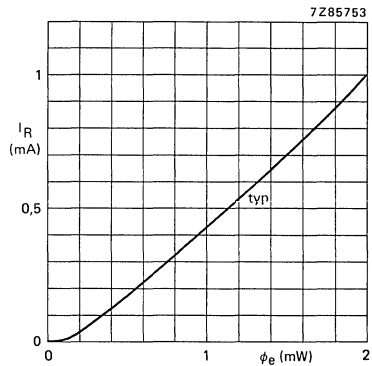

Fig. 5 V_R = 15 V.

COLLIMATOR PEN

The collimator pen CQL13C is used for reading applications such as: data retrieval, video-audio disc applications, optical memories, security systems etc.

The pen is mounted in a non-hermetic encapsulation, specifically designed for easy alignment in an optical read or write system, and consists of a lens system and a laser device. The lens system collimates the diverging laser light. The wavefront quality is diffraction limited. A cylindrical lens is used for correction of the astigmatism of the laser.

The housing is circular and precision manufactured with a diameter accuracy between +0 and $-11 \mu\text{m}$.

QUICK REFERENCE DATA

Output power	ϕ_e	2 mW
Current at output power $\phi_e = 2 \text{ mW}$ and temperature of $60 \text{ }^\circ\text{C}$	<	175 mA
Wavelength at peak emission	λ_{pk} typ.	870 nm
Wavefront form of bundle (non-convergent) divergence	<	0,3 mrad

MECHANICAL DATA

Dimensions in mm

Fig. 1.

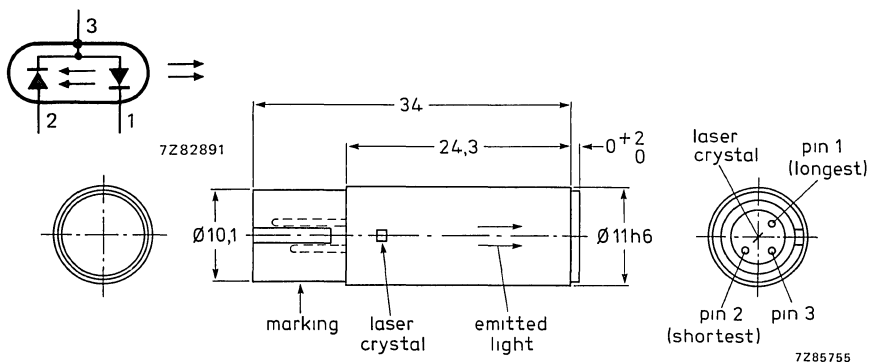

Mass	max. 8 g
Concentricity	angle between the mechanical and optical axis $\leq 10 \text{ mrad}$
Marking	type number CQL13C and serial number
Mounting	on a p.c. board by means of a specifically designed connector
Accessories	the pen is supplied with a connector
WARNING	THE LASER AND CONSEQUENTLY THE COLLIMATOR PEN HAS POSITIVE POLARITY ON THE CASE.

CHARACTERISTICS

Measuring conditions

- Climatological relative humidity 5–90%, atmospheric pressure. Housing temperature of the pen 5–60 °C
- Electrical d.c. operation, optical feedback drive and protection against transients
- Optical only the radiation in a bundle with a diameter of 5,4 mm is relevant

Optical data

Output power	ϕ_e	max. 2 mW (see Fig. 4)
Spectral		
wavelength	λ	870 ± 10 nm
bandwidth	$\Delta\lambda$	< 4 nm (see note)
wavelength drift	$\Delta\lambda/\Delta T$	approx. 0,25 nm/K
Bundle properties		
dimension		ϕ 5,4 mm
wavefront form		plane, non-convergent divergence < 0,3 mrad
aberrations		variance of wavefront with respect to the Gaussian reference sphere is less than $\lambda^2/300$
polarization		plane
polarization ratio		typ. 35 : 1
Intensity distribution		
transversal mode		TE ₀₀ -fundamental
longitudinal mode		see note
symmetry		variation of optical power in the four quadrants (see Fig. 2) typ. 20%
ripple		local value of the intensity < 15% of the smooth value
filling ratio I_{rim}/I_{max}		> 0,17

Note: the number of longitudinal modes is related to the spectral width.

Fig. 2.

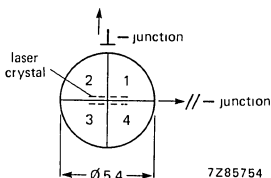

Electrical data

- Current
 - at $\phi_e = 2$ mW and $T_h = 60$ °C ≤ 175 mA
- Drive voltage V_d ≤ 5 V
- Resistance between collimator pen and connector at 10 mA, max. 20 mV_{pp} and 1 kHz ≤ 12 m Ω

PHOTODIODE (see Fig. 5)

RATINGS

Reverse voltage $V_R \leq 30 \text{ V}$

CHARACTERISTICS

Monitor diode sensitivity (ratio of photodiode current to optical power emitted by collimator pen) at $\phi_e = 2 \text{ mW}$ 0,1 A/W

Dark reverse current at $V_R = 15 \text{ V}$ $I_{R(D)} < 10 \text{ nA}$

Capacitance at $V_R = 0$ $C_d < 5 \text{ pF}$

ENVIRONMENTAL TESTS

The device meets all specifications mentioned below 2 hours after each test. During these tests the collimator pen is not operating.

test	in accordance with	conditions
Rapid change of temperature	IEC 68-2-14, test Na	-25 °C to 25 °C to 70 °C to 25 °C; duration of each exposure 30 min and 10 cycles in total
Dry heat	IEC 68-2-2, test Bc	Temperature: 70 °C Duration: 7 days
Cold	IEC 68-2-1 test Aa	Temperature: -25 °C Duration: 7 days
Damp heat, steady state	IEC 68-2-3 test Ca	Temperature: 40 °C Relative humidity (R.H.): 90-95% Duration: 42 days
Damp heat, cyclic	IEC 68-2-30 test Db	Temperature/R.H. 45 °C/100% (12 h) to 25 °C/ 85% (12 h) Duration of one cycle: 24 hours Number of cycles: 42
Vibration	IEC 68-2-6 test Db	Frequency range: 10-55 Hz Amplitude: 0,75 mm Duration: 6 hours (2 h in each of directions)
Shock	IEC 68-2-27 test Ea	Pulse shape: half-sine Pulse duration: 11 ms Peak acceleration: 981 m/s ² Number of shocks: 10 in each of 3 directions
Bump	IEC 68-2-29 test Eb	Pulse duration: 6 ms Peak acceleration: 390 m/s ² Number of bumps: 1000 Axes of direction: 6

Cleaning test The cylinder lens at the side of the long conjugate is cleaned 100x with a small piece of cotton wool, soaked in a 45-90% solution of ethyl-alcohol in water, attached to the end of a small stick.

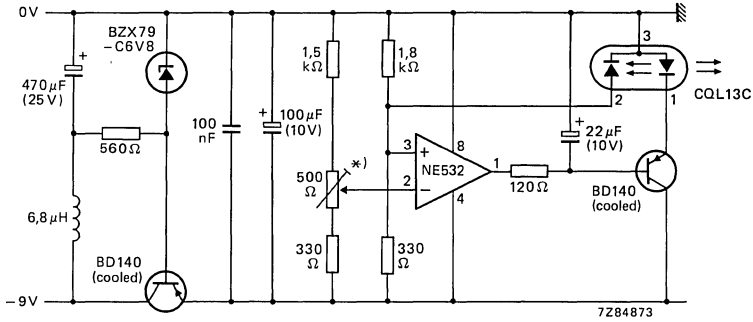

* Ten-turn. Zero position is at 0,58 revolution. Each revolution is equivalent to 500 µA monitor diode current.

Fig. 3 Recommended control circuit.

OPERATING PRECAUTIONS

Semiconductor lasers in general are easily damaged by overdriving and transients. Electrically, the laser diode is a very reliable device and can easily withstand current surges of several amperes. Optically, however, the diode laser is more susceptible to damage because of the extremely high optical flux density passing through both facets, while in operation. By overdriving or transients to the laser, even for pulses in the nanosecond region, the optical flux density can rise to unacceptable values (10 to 100 MW/cm²), causing gradual or catastrophic degradation of the laser facets. Current transients should therefore be carefully avoided; they decrease the laser life time.

CAUTION

Aluminium gallium arsenide lasers emit radiation which is invisible to the human eye. When in use, do not look directly into the device. Direct viewing of laser light at close ranges, especially in conjunction with collimating lenses, may cause eye damage.

The device meets the requirements of safety class 3B of the international standard code.

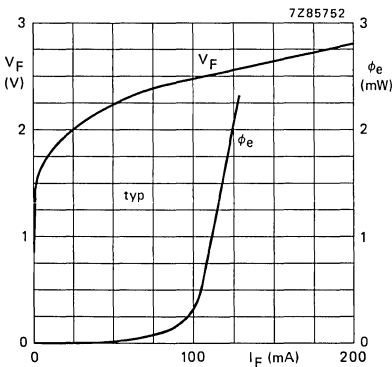

Fig. 4 $T_h = 60\text{ }^\circ\text{C}$.

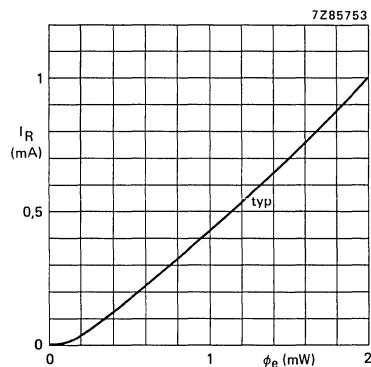

Fig. 5 $V_R = 15\text{ V}$.

COLLIMATOR PEN

The collimator pen CQL14A is used for writing applications such as: data retrieval (as used in optical memories), video disc applications, laser printers etc.

The pen is mounted in a non-hermetic encapsulation, specifically designed for easy alignment in an optical read or write system, and consists of a lens system and a laser device. The lens system collimates the diverging laser light. The wavefront quality is diffraction limited. A cylindrical lens is used for correction of the astigmatism of the laser.

The housing is circular and precision manufactured with a diameter accuracy between +0 and -11 μm.

QUICK REFERENCE DATA

Output peak power at $t_p = 60$ ns and $\delta = 0,1$	ϕ_e	20 mW
Current at output power $\phi_e = 20$ mW and temperature of 60 °C		≤ 500 mA
Wavelength at peak emission	λ_{pk}	typ. 820 nm
Wavefront form of bundle (non-convergent) divergence		$< 0,3$ mrad

MECHANICAL DATA

Dimensions in mm

Fig. 1.

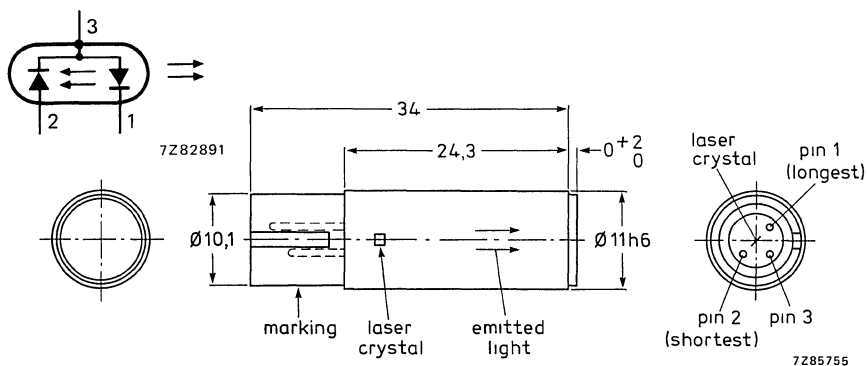

Mass	max. 8 g
Concentricity	angle between the mechanical and optical axis ≤ 10 mrad
Marking	type number CQL14A and serial number
Mounting	on a p.c. board by means of a specifically designed connector
Accessories	the pen is supplied with a connector

WARNING THE LASER AND CONSEQUENTLY THE COLLIMATOR PEN HAS POSITIVE POLARITY ON THE CASE.

CHARACTERISTICS

Measuring conditions

- Climatological relative humidity 5–90%, atmospheric pressure. Housing temperature of the pen 5–60 °C
- Electrical current modulation; repetition frequency 1,3 MHz; pulse length 60 ns at FWHM; rise and fall time < 20 ns at 500 mA
- Optical only the radiation in a bundle with a diameter of 5,4 mm is relevant

Optical data

Output peak power	ϕ_e	max. 20 mW ($t_p = 60$ ns; $\delta = 0,1$)
Spectral		
wavelength	λ	820 ± 10 nm
bandwidth	$\Delta\lambda$	< 3 nm
wavelength drift	$\Delta\lambda/\Delta T$	approx. 0,25 nm/K
Bundle properties		
dimension		ϕ 5,4 mm
wavefront form		plane, non-convergent, divergence < 0,3 mrad
aberrations		variance of wavefront with respect to the Gaussian reference sphere is less than $\lambda^2/300$
polarization		plane
polarization ratio		typ. 35 : 1
Intensity distribution		
transversal mode		TE ₀₀ -fundamental
longitudinal mode		see note
symmetry		variation of optical power in the four quadrants (see Fig. 2) typ. 20%
ripple		local value of the intensity < 15% of the smooth value

Note: the number of longitudinal modes is related to the spectral width.

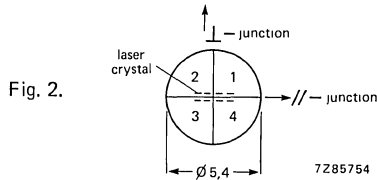

Electrical data

- Current
 - at $\phi_e = 20$ mW and $T_h = 60$ °C ≤ 500 mA
- Drive voltage V_d ≤ 5 V
- Capacitance < 10 pF
- Resistance between collimator pen and connector at 10 mA, max. 20 mV_{pp} and 1 kHz ≤ 12 m Ω

*PHOTODIODE***RATINGS**

Reverse voltage $V_R \leq 30 \text{ V}$

CHARACTERISTICS

Monitor diode sensitivity (ratio of photodiode current to optical power emitted by collimator pen) at $\phi_e = 20 \text{ mW}$ 0,1 A/W

Dark reverse current at $V_R = 15 \text{ V}$ $I_{R(D)} < 10 \text{ nA}$

Capacitance at $V_R = 0$ $C_d < 5 \text{ pF}$

ENVIRONMENTAL TESTS

The device meets all specifications mentioned below 2 hours after each test. During these tests the collimator pen is not operating.

test	in accordance with	conditions
Rapid change of temperature	IEC 68-2-14, test Na	-25 °C to 25 °C to 70 °C to 25 °C; duration of each exposure 30 min and 10 cycles in total
Dry heat	IEC 68-2-2, test Bc	Temperature: 70 °C Duration: 7 days
Cold	IEC 68-2-1 test Aa	Temperature: -25 °C Duration: 7 days
Damp heat, steady state	IEC 68-2-3 test Ca	Temperature: 40 °C Relative humidity (R.H.): 90-95% Duration: 42 days
Damp heat, cyclic	IEC 68-2-30 test Db	Temperature/R.H. 45 °C/100% (12 h) to 25 °C/ 85% (12 h) Duration of one cycle: 24 hours Number of cycles: 42
Vibration	IEC 68-2-6 test Db	Frequency range: 10-55 Hz Amplitude: 0,75 mm Duration: 6 hours (2 h in each of directions)
Shock	IEC 68-2-27 test Ea	Pulse shape: half-sine Pulse duration: 11 ms Peak acceleration: 981 m/s ² Number of shocks: 10 in each of 3 directions
Bump	IEC 68-2-29 test Eb	Pulse duration: 6 ms Peak acceleration: 390 m/s ² Number of bumps: 1000 Axes of direction: 6

Cleaning test The cylinder lens at the side of the long conjugate is cleaned 100x with a small piece of cotton wool, soaked in a 45-95% solution of ethyl-alcohol in water, attached to the end of a small stick.

OPERATING PRECAUTIONS

Semiconductor lasers in general are easily damaged by overdriving and transients. Electrically, the laser diode is a very reliable device and can easily withstand current surges of several amperes. Optically, however, the diode laser is more susceptible to damage because of the extremely high optical flux density passing through both facets, while in operation. By overdriving or transients to the laser, even for pulses in the nanosecond region, the optical flux density can rise to unacceptable values (10 to 100 MW/cm²), causing gradual or catastrophic degradation of the laser facets. Current transients should therefore be carefully avoided; they decrease the laser life time.

CAUTION

Aluminium gallium arsenide lasers emit radiation which is invisible to the human eye. When in use, do not look directly into the device. Direct viewing of laser light at close ranges, especially in conjunction with collimating lenses, may cause eye damage.

The device meets the requirements of safety class 3B of the international standard code.

COLLIMATOR PEN

The collimator pen CQL14B is used for writing applications such as: data retrieval (as used in optical memories), video disc applications, laser printers etc.

The pen is mounted in a non-hermetic encapsulation, specifically designed for easy alignment in an optical read or write system, and consists of a lens system and a laser device. The lens system collimates the diverging laser light. The wavefront quality is diffraction limited. A cylindrical lens is used for correction of the astigmatism of the laser.

The housing is circular and precision manufactured with a diameter accuracy between +0 and -11 μm.

QUICK REFERENCE DATA

Output peak power at $t_p = 60$ ns and $\delta = 0,1$	ϕ_e	20 mW
Current at output power $\phi_e = 20$ mW and temperature of 60 °C	\leq	500 mA
Wavelength at peak emission	λ_{pk} typ.	850 nm
Wavefront form of bundle (non-convergent) divergence	$<$	0,3 mrad

MECHANICAL DATA

Dimensions in mm

Fig. 1.

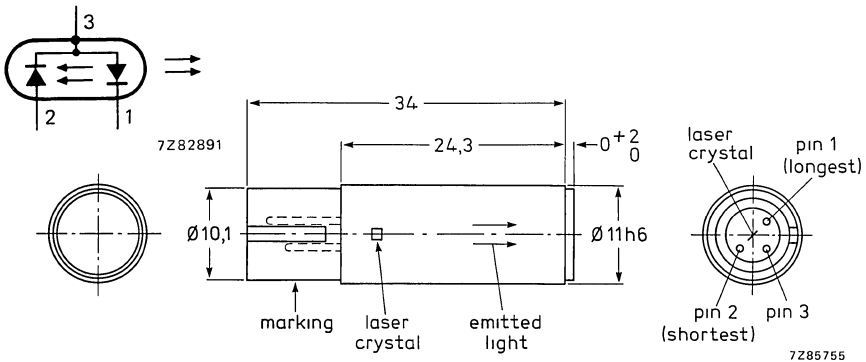

Mass	max. 8 g
Concentricity	angle between the mechanical and optical axis ≤ 10 mrad
Marking	type number CQL14B and serial number
Mounting	on a p.c. board by means of a specifically designed connector
Accessories	the pen is supplied with a connector
WARNING	THE LASER AND CONSEQUENTLY THE COLLIMATOR PEN HAS POSITIVE POLARITY ON THE CASE.

CHARACTERISTICS

Measuring conditions

- Climatological relative humidity 5–90%, atmospheric pressure. Housing temperature of the pen 5–60 °C
- Electrical current modulation; repetition frequency 1,3 MHz; pulse length 60 ns at FWHM; rise and fall time < 20 ns at 500 mA
- Optical only the radiation in a bundle with a diameter of 5,4 mm is relevant

Optical data

Output peak power	ϕ_e	max. 20 mW ($t_p = 60$ ns; $\delta = 0,1$)
Spectral		
wavelength	λ	850 ± 10 nm
bandwidth	$\Delta\lambda$	< 3 nm
wavelength drift	$\Delta\lambda/\Delta T$	approx. 0,25 nm/K
Bundle properties		
dimension		ϕ 5,4 mm
wavefront form		plane, non-convergent, divergence < 0,3 mrad
aberrations		variance of wavefront with respect to the Gaussian reference sphere is less than $\lambda^2/300$
polarization		plane
polarization ratio		typ. 35 : 1
Intensity distribution		
transversal mode		TE ₀₀ -fundamental
longitudinal mode		see note
symmetry		variation of optical power in the four quadrants (see Fig. 2) typ. 20%
ripple		local value of the intensity < 15% of the smooth value

Note: the number of longitudinal modes is related to the spectral width.

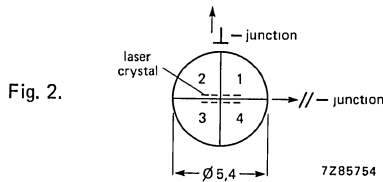

Electrical data

- Current
 - at $\phi_e = 20$ mW and $T_h = 60$ °C ≤ 500 mA
- Drive voltage V_d ≤ 5 V
- Capacitance < 10 pF
- Resistance between collimator pen and connector at 10 mA, max. 20 mV_{pp} and 1 kHz ≤ 12 m Ω

*PHOTODIODE***RATINGS**

Reverse voltage $V_R \leq 30 \text{ V}$

CHARACTERISTICS

Monitor diode sensitivity (ratio of photodiode current to optical power emitted by collimator pen) at $\phi_e = 20 \text{ mW}$ 0,1 A/W

Dark reverse current at $V_R = 15 \text{ V}$ $I_{R(D)} < 10 \text{ nA}$

Capacitance at $V_R = 0$ $C_d < 5 \text{ pF}$

ENVIRONMENTAL TESTS

The device meets all specifications mentioned below 2 hours after each test. During these tests the collimator pen is not operating.

test	in accordance with	conditions
Rapid change of temperature	IEC 68-2-14, test Na	-25 °C to 25 °C to 70 °C to 25 °C; duration of each exposure 30 min and 10 cycles in total
Dry heat	IEC 68-2-2, test Bc	Temperature: 70 °C Duration: 7 days
Cold	IEC 68-2-1 test Aa	Temperature: -25 °C Duration: 7 days
Damp heat, steady state	IEC 68-2-3 test Ca	Temperature: 40 °C Relative humidity (R.H.): 90-95% Duration: 42 days
Damp heat, cyclic	IEC 68-2-30 test Db	Temperature/R.H. 45 °C/100% (12 h) to 25 °C/ 85% (12 h) Duration of one cycle: 24 hours Number of cycles: 42
Vibration	IEC 68-2-6 test Db	Frequency range: 10-55 Hz Amplitude: 0,75 mm Duration: 6 hours (2 h in each of directions)
Shock	IEC 68-2-27 test Ea	Pulse shape: half-sine Pulse duration: 11 ms Peak acceleration: 981 m/s ² Number of shocks: 10 in each of 3 directions
Bump	IEC 68-2-29 test Eb	Pulse duration: 6 ms Peak acceleration: 390 m/s ² Number of bumps: 1000 Axes of direction: 6

Cleaning test The cylinder lens at the side of the long conjugate is cleaned 100x with a small piece of cotton wool, soaked in a 45-95% solution of ethyl-alcohol in water, attached to the end of a small stick.

OPERATING PRECAUTIONS

Semiconductor lasers in general are easily damaged by overdriving and transients. Electrically, the laser diode is a very reliable device and can easily withstand current surges of several amperes. Optically, however, the diode laser is more susceptible to damage because of the extremely high optical flux density passing through both facets, while in operation. By overdriving or transients to the laser, even for pulses in the nanosecond region, the optical flux density can rise to unacceptable values (10 to 100 MW/cm²), causing gradual or catastrophic degradation of the laser facets. Current transients should therefore be carefully avoided; they decrease the laser life time.

CAUTION

Aluminium gallium arsenide lasers emit radiation which is invisible to the human eye. When in use, do not look directly in to the device. Direct viewing of laser light at close ranges, especially in conjunction with collimating lenses, may cause eye damage.

The device meets the requirements of safety class 3B of the international standard code.

DEVELOPMENT SAMPLE DATA

This information is derived from development samples made available for evaluation. It does not necessarily imply that the device will go into regular production.

CQN10

LIGHT EMITTING DIODE

The CQN10 is a hyper-red light emitting block. The SOD-73 envelope is a block (7 mm x 14,5 mm) containing 2 GaAlAs diodes and has long leads. The diodes are encapsulated in a transparent resin with a medium-red coloured diffusing zone cast on the top.

This so-called Word Illumination Block (WIB) is designed to illuminate small texts in equipment. Because of its high light intensity and large (7 x 14,5) light diffusing surface it is very suitable for special indicator purposes, for example, in cars, white goods, power switches etc., and in applications where only low currents are available.

QUICK REFERENCE DATA

Continuous reverse voltage	V_R	max.	5 V
Forward current (d.c.)	I_F	max.	60 mA
Total power dissipation up to $T_{amb} = 25\text{ }^\circ\text{C}$	P_{tot}	max.	360 mW
Junction temperature	T_j	max.	100 $^\circ\text{C}$
Luminous intensity $I_F = 10\text{ mA}$	I_v	min.	2 mCd
Wavelength at peak emission	λ_{pk}	typ.	650 nm
Beamwidth between half-intensity directions	$\alpha_{50\%}$	typ.	110 $^\circ$

MECHANICAL DATA

SOD-73 (see page 122)

MECHANICAL DATA

Fig. 1 SOD-73.

Dimensions in mm

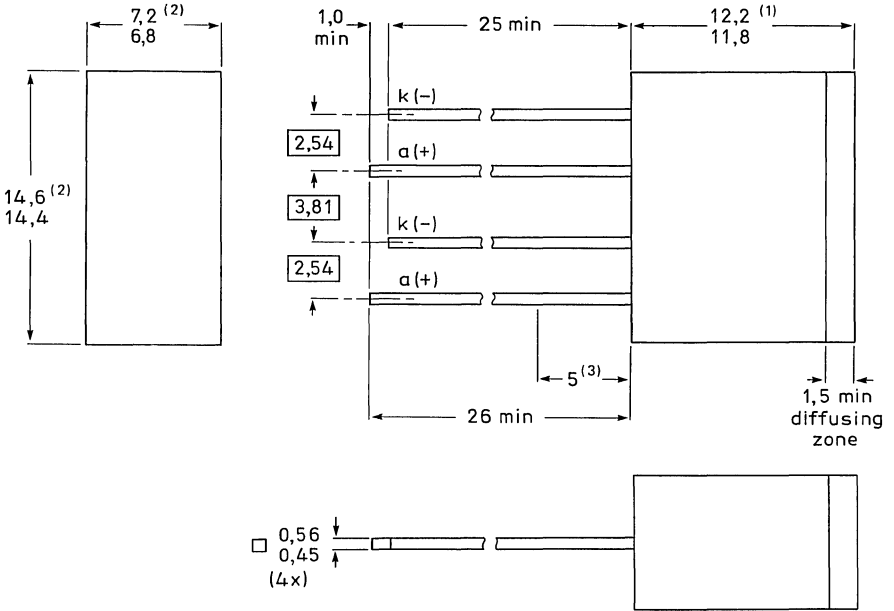

7Z86929 1

Notes

1. The seating plane is defined when the device is mounted over an aperture of 12,6 mm x 5,2 mm
2. Max. value including plastic burrs
3. Solderability not guaranteed within this zone due to tie-bar cropping.

RATINGS

Limiting values in accordance with the Absolute Maximum System (IEC 134)

Continuous reverse voltage	V_R	max.	5 V
Forward current	I_F	max.	60 mA
d.c.	I_{FM}	max.	1 A
peak value; $t_p = 1 \mu s$; $f = 300$ Hz	I_{FM}	max.	500 mA
peak value; $t_{on} = 20 \mu s$; $\delta = 0,01$	P_{tot}	max.	360 mW
Total power dissipation up to $T_{amb} = 25 \text{ }^\circ\text{C}$	T_{stg}	-55 to	+85 $^\circ\text{C}$
Storage temperature	T_j	max.	100 $^\circ\text{C}$
Junction temperature	T_{slid}	max.	260 $^\circ$
Lead soldering temperature			
> 5 mm from the plastic body; $t_{slid} < 7$ s			

THERMAL RESISTANCE

From junction to ambient when the device is mounted on a p.c. board

$R_{th j-a}$	max.	210 K/W
--------------	------	---------

CHARACTERISTICS

$T_j = 25\text{ }^\circ\text{C}$ unless otherwise specified

Forward voltage (per diode)

$I_F = 10\text{ mA}$

Reverse current (per diode)

$V_R = 5\text{ V}$

Beamwidth between half-intensity directions

Bandwidth at half height

Wavelength at peak emission

Luminous intensity

$I_F = 10\text{ mA}$

Capacitance (per diode)

V_F	typ.	1,75 V
	max.	2,2 V
I_R	max.	100 μA
$\alpha_{50\%}$	typ.	110 $^\circ$
$B_{50\%}$	typ.	20 nm
λ_{pk}	typ.	650 nm
I_V	min.	2 mCd
C_d	typ.	60 pF

DEVELOPMENT SAMPLE DATA

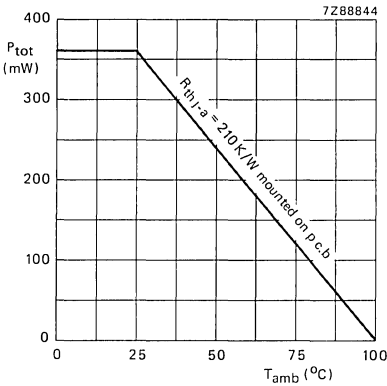

Fig. 2.

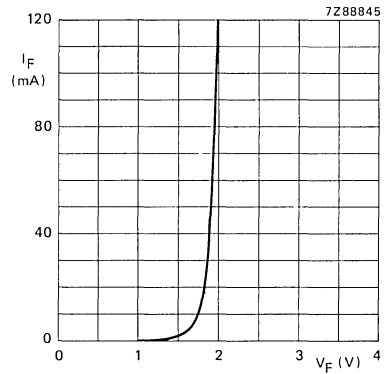

Fig. 3 $T_{amb} = 25\text{ }^\circ\text{C}$; typ. values.

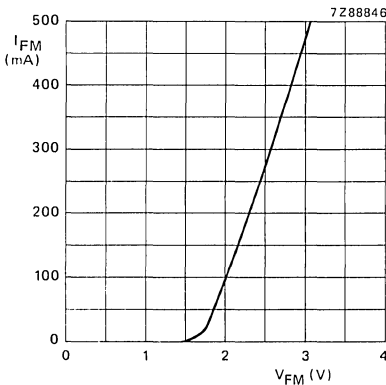

Fig. 4 $t_{on} = 20\text{ }\mu\text{s}$; $\delta = 0,01$;
 $T_{amb} = 25\text{ }^\circ\text{C}$; typ. values.

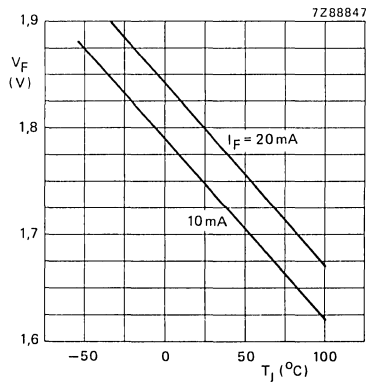

Fig. 5 Value per diode; typ. values.

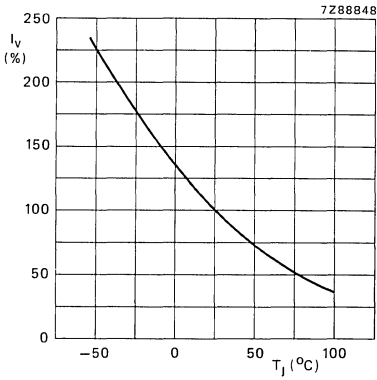

Fig. 6 $I_F = 10$ mA; typ. values.

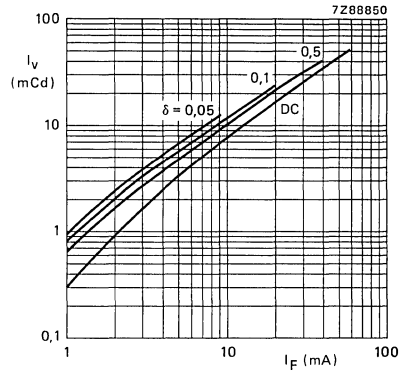

Fig. 7 $t_p = 50 \mu s$; typ. values.

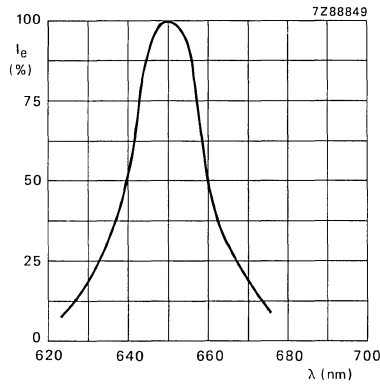

Fig. 8 $I_F = 10$ mA; $T_{amb} = 25$ °C; typ. values.

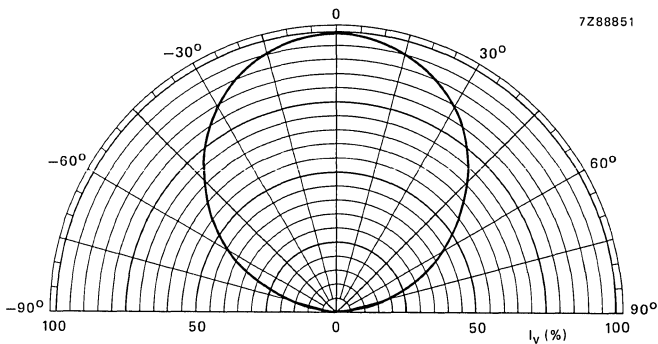

Fig. 9 Typical values.

DEVELOPMENT SAMPLE DATA

This information is derived from development samples made available for evaluation. It does not necessarily imply that the device will go into regular production.

CQN11

LIGHT EMITTING DIODE

The CQN11 is a super-green light emitting block. The SOD-73 envelope is a block (7 mm x 14,5 mm) containing 2 GaP diodes and has long leads. The diodes are encapsulated in a transparent resin with an extra medium-green coloured diffusing zone cast on the top.

This so-called Word Illumination Block (WIB) is designed to illuminate small texts in equipment. Because of its high light intensity and large (7 x 14,5) light diffusing surface it is very suitable for special indicator purposes, for example, in cars, white goods, power switches etc. and in applications where only low currents are available.

QUICK REFERENCE DATA

Continuous reverse voltage	V_R	max.	5 V
Forward current (d.c.)	I_F	max.	60 mA
Total power dissipation up to $T_{amb} = 25\text{ }^\circ\text{C}$	P_{tot}	max.	360 mW
Junction temperature	T_j	max.	100 $^\circ\text{C}$
Luminous intensity $I_F = 20\text{ mA}$	I_v	min.	2 mCd
Wavelength at peak emission	λ_{pk}	typ.	565 nm
Beamwidth between half-intensity directions	$\alpha_{50\%}$	typ.	110 $^\circ$

MECHANICAL DATA

SOD-73 (see page 126)

MECHANICAL DATA

Fig. 1 SOD-73.

Dimensions in mm

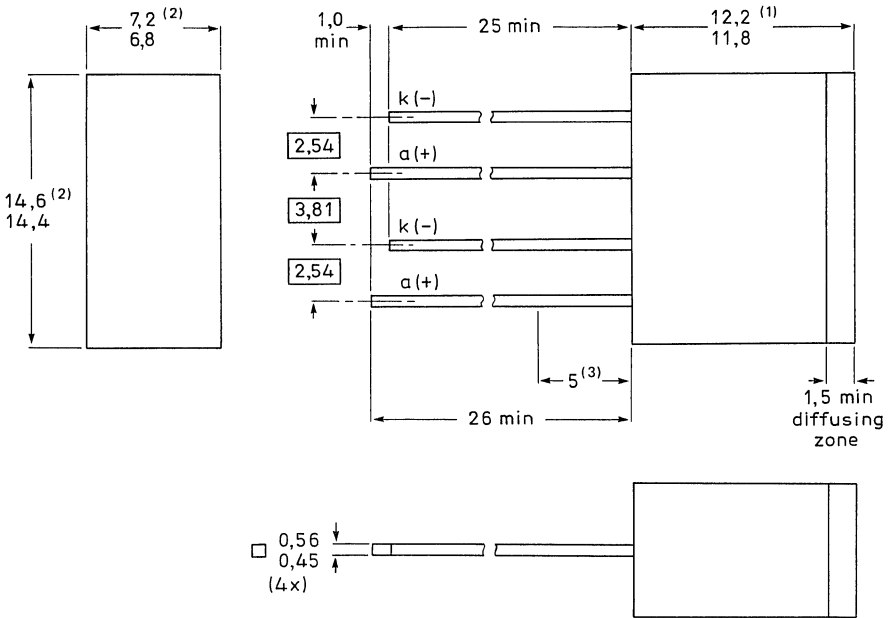

7Z86929 1

Notes

1. The seating plane is defined when the device is mounted over an aperture of 12,6 mm x 5,2 mm
2. Max. value including plastic burrs
3. Solderability not guaranteed within this zone due to tie-bar cropping.

RATINGS

Limiting values in accordance with the Absolute Maximum System (IEC 134)

Continuous reverse voltage	V_R	max.	5 V
Forward current			
d.c.	I_F	max.	60 mA
peak value; $t_p = 1 \mu s$; $f = 300 \text{ Hz}$	I_{FM}	max.	1 A
peak value; $t_{on} = 1 \text{ ms}$; $\delta = 0,33$	I_{FM}	max.	150 mA
Total power dissipation up to $T_{amb} = 25 \text{ }^\circ\text{C}$	P_{tot}	max.	360 mW
Storage temperature	T_{stg}	-55 to +85	$^\circ\text{C}$
Junction temperature	T_j	max.	100 $^\circ\text{C}$
Lead soldering temperature			
> 5 mm from the plastic body; $t_{sld} < 7 \text{ s}$	T_{sld}	max.	260 $^\circ$

THERMAL RESISTANCE

From junction to ambient when the device is mounted on a p.c. board

$R_{th j-a}$	max.	210 K/W
--------------	------	---------

CHARACTERISTICS

$T_j = 25\text{ }^\circ\text{C}$ unless otherwise specified

Forward voltage (per diode)

$I_F = 20\text{ mA}$

Reverse current (per diode)

$V_R = 5\text{ V}$

Beamwidth between half-intensity directions

Bandwidth at half height

Wavelength at peak emission

Luminous intensity

$I_F = 20\text{ mA}$

Capacitance (per diode)

V_F typ. 2,1 V
max. 3,0 V

I_R max. 100 μA

$\alpha_{50\%}$ typ. 110 $^\circ$

$B_{50\%}$ typ. 30 nm

λ_{pk} typ. 565 nm

I_V min. 2 mCd

C_D typ. 35 pF

DEVELOPMENT SAMPLE DATA

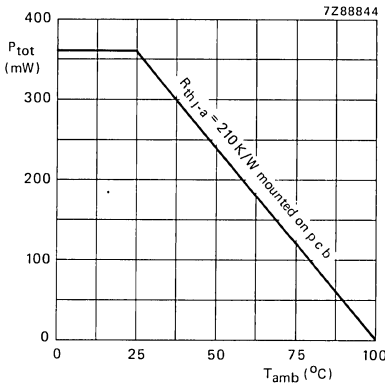

Fig. 2.

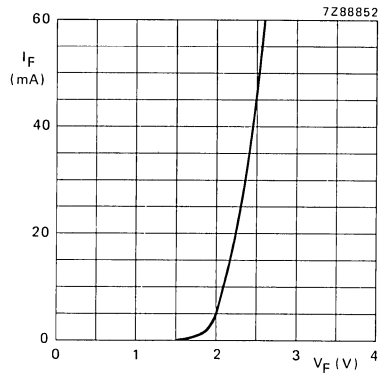

Fig. 3 $T_{amb} = 25\text{ }^\circ\text{C}$; typ. values.

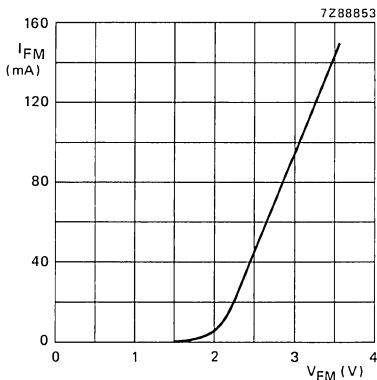

Fig. 4 $t_{on} = 20\text{ }\mu\text{s}$; $\delta = 0,01$; $T_{amb} = 25\text{ }^\circ\text{C}$.
 $T_{amb} = 25\text{ }^\circ\text{C}$; typ. values.

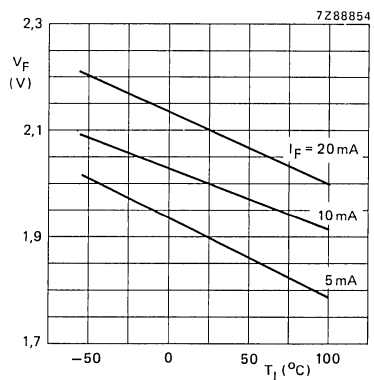

Fig. 5 Value per diode; typ. values.

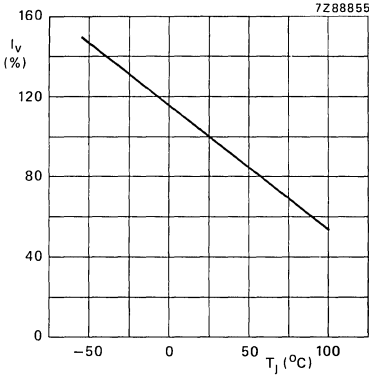

Fig. 6 $I_F = 20 \text{ mA}$; typ. values.

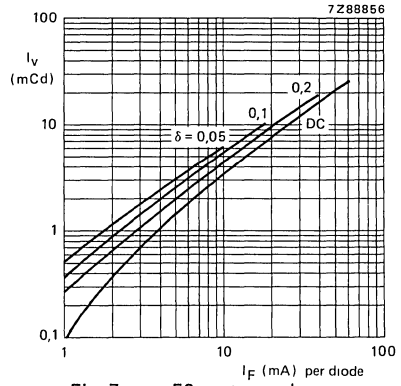

Fig. 7 $t_p = 50 \mu\text{s}$; typ. values.

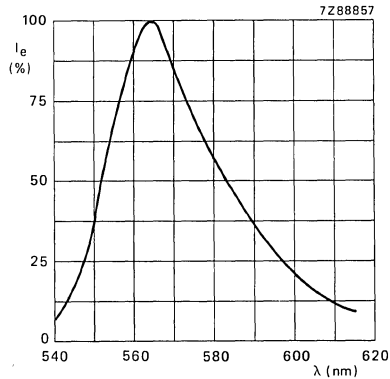

Fig. 8 $I_F = 20 \text{ mA}$; $T_{\text{amb}} = 25 \text{ }^\circ\text{C}$; typ. values.

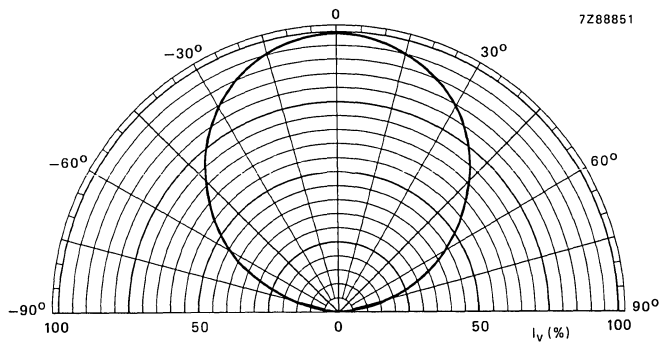

Fig. 9 Typical values.

DEVELOPMENT SAMPLE DATA

This information is derived from development samples made available for evaluation. It does not necessarily imply that the device will go into regular production.

CQT10

LIGHT EMITTING DIODE

Solid-state rectangular lamp of 3 mm x 5 mm which emits hyper-red light (GaAlAs) or super-green light (GaP) depending on the polarity of the current.

The CQT10 has a SOD-77A outline and is encapsulated in a transparent resin with a diffusing zone cast on the top. Because of its SOD-77 envelope it can be used in configurations together with the CQV70 LED family. The bicolour function gives this light emitting device special application possibilities e.g.

- as level sensor overdrive indicator
- as zero point indicator
- as tuning indicator

QUICK REFERENCE DATA

Forward current (d.c.)			
red	I_F	max.	100 mA
green			60 mA
Total power dissipation up to $T_{amb} = 35\text{ }^\circ\text{C}$	P_{tot}	max.	180 mW
Junction temperature	T_j	max.	100 $^\circ\text{C}$
Luminous intensity			
red at $I_F = 10\text{ mA}$	I_v	min.	1 mcd
green at $I_F = 20\text{ mA}$			
Wavelength at peak emission			
red	λ_{pk}	typ.	650 nm
green			565 nm
Beamwidth between half-intensity directions in the plane of the leads	$\alpha_{50\%}$	typ.	110 $^\circ$

MECHANICAL DATA

Dimensions in mm

SOT-77A (see page 130)

MECHANICAL DATA

Fig. 1 SOD-77A.

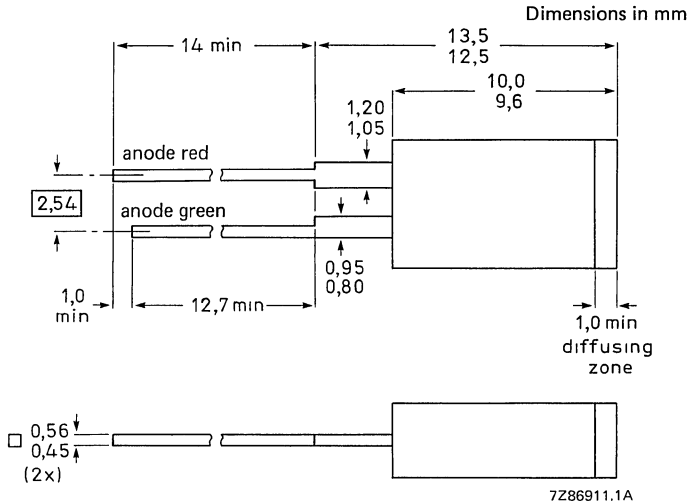
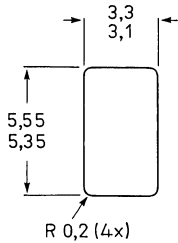

7Z86911.1A

RATINGS

Limiting values in accordance with the Absolute Maximum System (IEC 134)

Forward current (d.c.)

red	I_F	max.	100 mA
green			60 mA

Forward current

peak value; $t_p = 1 \mu s$; $f = 300 \text{ Hz}$	I_{FM}	max.	1 A
--	----------	------	-----

peak value; $t_{on} = 1 \text{ ns}$; $\delta = 0,33$	I_{FM}	max.	150 mA
---	----------	------	--------

Total power dissipation up to $T_{amb} = 35 \text{ }^\circ\text{C}$

P_{tot}	max.	180 mW
-----------	------	--------

Junction temperature

T_j	max.	100 $^\circ\text{C}$
-------	------	----------------------

Storage temperature

T_{stg}		-55 to +100 $^\circ\text{C}$
-----------	--	------------------------------

Lead soldering temperature

> 1,5 mm from the seating plane; $t_{sld} < 7 \text{ s}$

T_{sld}	max.	260 $^\circ\text{C}$
-----------	------	----------------------

THERMAL RESISTANCE

From junction to ambient when the device is mounted on a p.c. board

$R_{th \text{ j-a}}$	max.	350 K/W
----------------------	------	---------

CHARACTERISTICS

$T_{amb} = 25 \text{ }^\circ\text{C}$ unless otherwise specified

Forward voltage

red at $I_F = 10 \text{ mA}$	V_F	typ.	1,75 V
		max.	2,2 V

green at $I_F = 20 \text{ mA}$	V_F	typ.	2,1 V
		max.	3,0 V

Beamwidth between half-intensity directions

at $I_F = 10 \text{ mA}$ (in the plane of the leads)	$\alpha_{50\%}$	typ.	110 $^\circ$
---	-----------------	------	--------------

CHARACTERISTICS (continued)

Wavelength at peak emission

at $I_F = 10 \text{ mA}$

red

green

λ_{pk}

typ.

650 nm

565 nm

Capacitance

at $V = 0; f = 1 \text{ MHz}$

C_d

typ.

90 pF

Luminous intensity

red at $I_F = 10 \text{ mA}$

green at $I_F = 20 \text{ mA}$

I_v

min.

1,0 mcd

typ.

1,5 mcd

DEVELOPMENT SAMPLE DATA

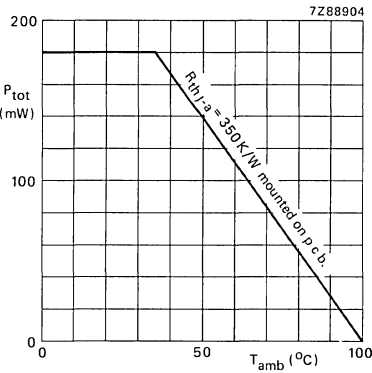

Fig. 2.

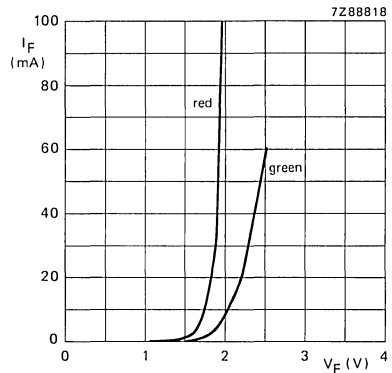

Fig. 3 $T_{amb} = 25 \text{ }^\circ\text{C}$; typ. values.

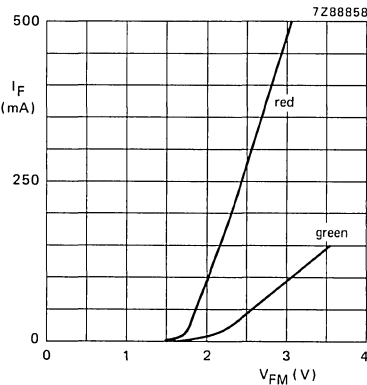

Fig. 4 $t_{on} = 20 \text{ } \mu\text{s}$; $\delta = 0,01$;
 $T_{amb} = 25 \text{ }^\circ\text{C}$; typ. values.

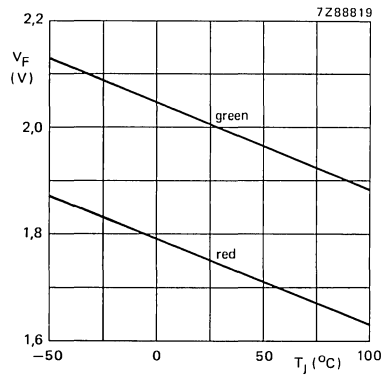

Fig. 5 $I_F = 10 \text{ mA}$; typ. values.

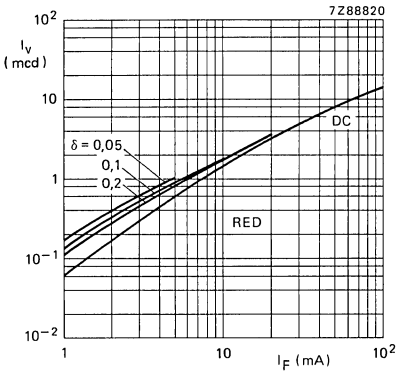

Fig. 6 $t_p = 50 \mu s$; typ. values.

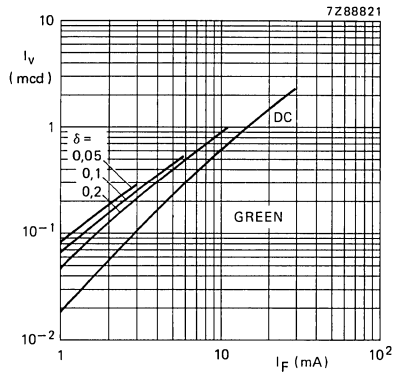

Fig. 7 $t_p = 50 \mu s$; typ. values.

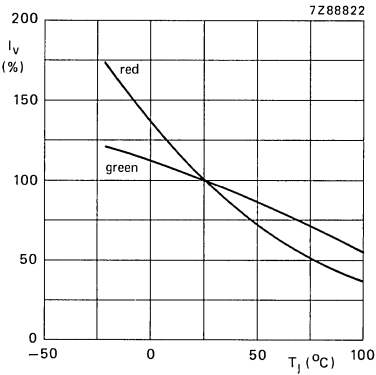

Fig. 8 Typical values.

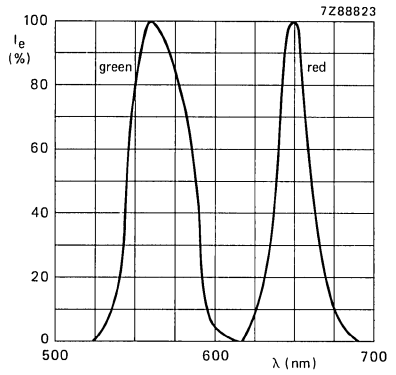

Fig. 9 $I_F = 10 \text{ mA}$; typ. values.

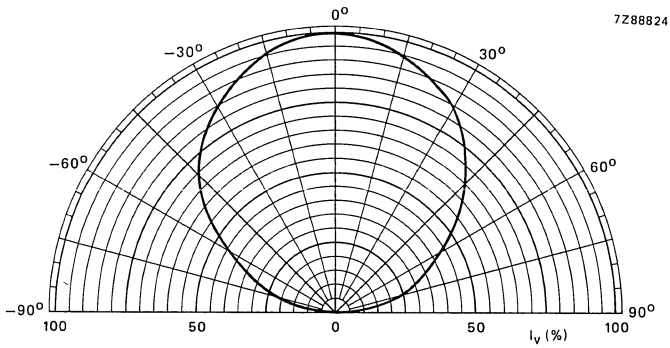

Fig. 10 $I_F = 10 \text{ mA}$; typ. values.

DEVELOPMENT SAMPLE DATA

This information is derived from development samples made available for evaluation. It does not necessarily imply that the device will go into regular production

CQT11

LIGHT EMITTING DIODE

Solid-state lamp with diameter of 2 mm, which emits either hyper-red light (GaAlAs) or super-green light (GaP) depending on the polarity of the current.

The CQT11 has a SOD-78 outline and is encapsulated in a transparent resin with a diffusing zone cast on the top. Because of its 2 mm diameter it can be used in configurations together with the CQW20 LED family. The bicolour function gives this light emitting device special application possibilities such as:

- level sensor overdrive indicator
- zero point indicator
- tuning indicator

QUICK REFERENCE DATA

Forward current (d.c.)			
red	I_F	max.	100 mA
green			60 mA
Total power dissipation up to $T_{amb} = 35\text{ }^\circ\text{C}$	P_{tot}	max.	180 mW
Junction temperature	T_j	max.	100 $^\circ\text{C}$
Luminous intensity			
red at $I_F = 10\text{ mA}$	I_v	min.	1 mcd
green at $I_F = 20\text{ mA}$			
Wave length at peak emission			
red	λ_{pk}	typ.	650 nm
green			565 nm
Beamwidth between half-intensity directions	$\alpha_{50\%}$	typ.	110 $^\circ$

MECHANICAL DATA

SOD-78 (see page 134)

Dimensions in mm

MECHANICAL DATA

Fig. 1 SOD-78.

Dimensions in mm

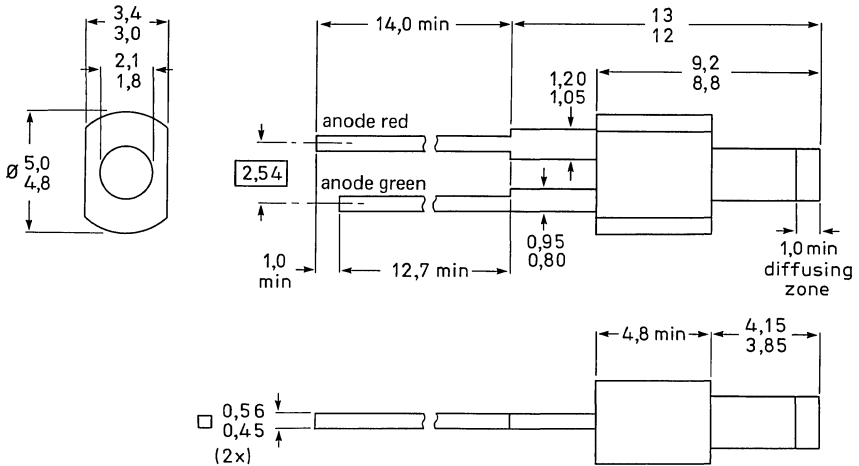

7Z86910 1

RATINGS

Limiting values in accordance with the Absolute Maximum System (IEC 134)

Forward current (d.c.)

red	I_F	max.	100 mA
green			60 mA

Forward current

peak value; $t_p = 1 \mu s$; $f = 300 \text{ Hz}$	I_{FM}	max.	1 A
peak value; $t_{ON} = 1 \text{ ms}$; $\delta = 0,33$	I_{FM}	max.	150 mA

Total power dissipation up to $T_{amb} = 35 \text{ }^\circ\text{C}$

P_{tot}	max.	180 mW
-----------	------	--------

Junction temperature

T_j	max.	100 $^\circ\text{C}$
-------	------	----------------------

Storage temperature

T_{stg}	-55 to +100	$^\circ\text{C}$
-----------	-------------	------------------

Lead soldering temperature

> 1,5 mm from the seating plane; $t_{sld} < 7 \text{ s}$	T_{sld}	max.	260 $^\circ\text{C}$
--	-----------	------	----------------------

THERMAL RESISTANCE

From junction to ambient when the device is mounted on a p.c. board

$R_{th \text{ j-a}}$	max.	350 K/W
----------------------	------	---------

CHARACTERISTICS

$T_{amb} = 25 \text{ }^\circ\text{C}$ unless otherwise specified

Forward voltage

red at $I_F = 10 \text{ mA}$	V_F	typ.	1,75 V
		max.	2,2 V
green at $I_F = 20 \text{ mA}$	V_F	typ.	2,1 V
		max.	3,0 V

CHARACTERISTICS (continued)

Beamwidth between half-intensity directions
at $I_F = 10 \text{ mA}$

$\alpha_{50\%}$ typ. 110°

Wavelength at peak emission
at $I_F = 10 \text{ mA}$

λ_{pk} typ. 650 nm
typ. 565 nm

Capacitance
at $V = 0$; $f = 1 \text{ MHz}$

C_d typ. 90 pF

Luminous intensity
red at $I_F = 10 \text{ mA}$
green at $I_F = 20 \text{ mA}$ }

I_v min. $1,0 \text{ mcd}$
typ. $1,5 \text{ mcd}$

DEVELOPMENT SAMPLE DATA

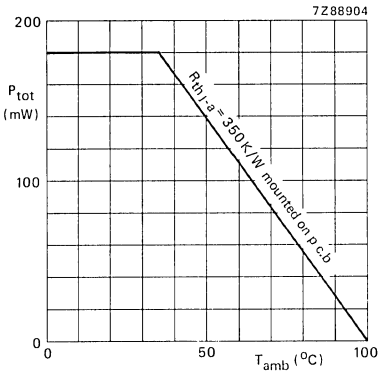

Fig. 2.

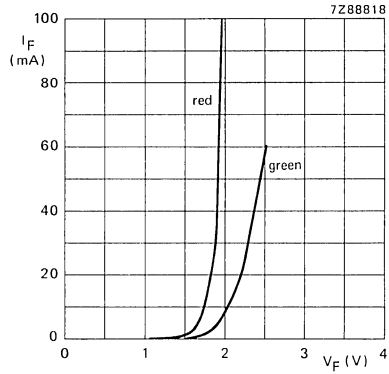

Fig. 3 $T_{amb} = 25^\circ\text{C}$; typ. values.

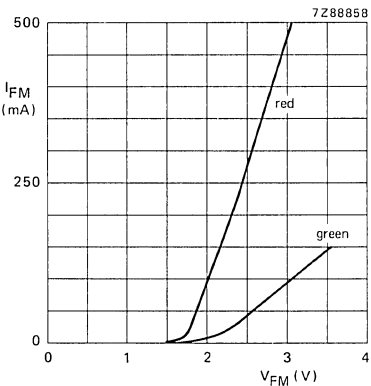

Fig. 4 $t_{on} = 20 \mu\text{s}$; $\delta = 0,01$;
 $T_{amb} = 25^\circ\text{C}$; typ. values.

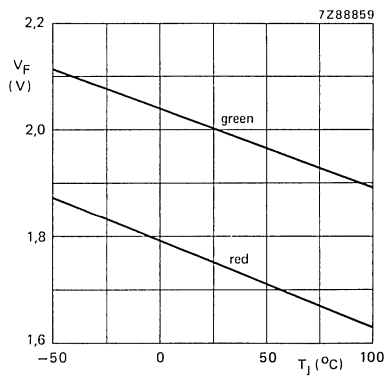

Fig. 5 $I_F = 10 \text{ mA}$; typ. values.

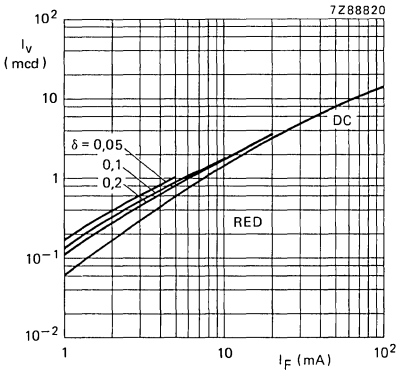

Fig. 6 $t_p = 50 \mu s$; typ. values.

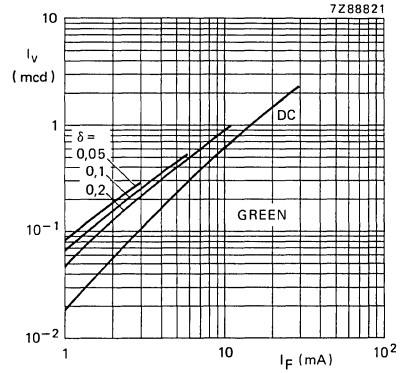

Fig. 7 $t_p = 50 \mu s$; typ. values.

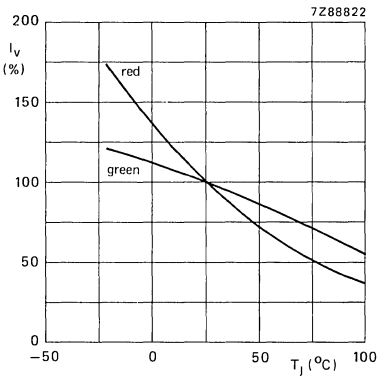

Fig. 8 Typical values.

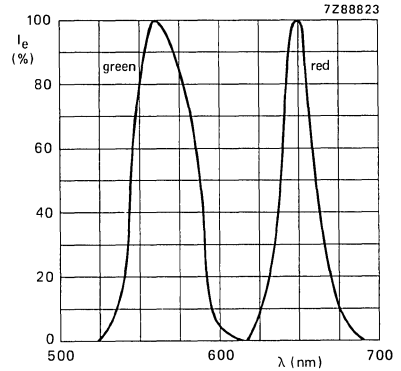

Fig. 9 $I_F = 10 \text{ mA}$; typ. values.

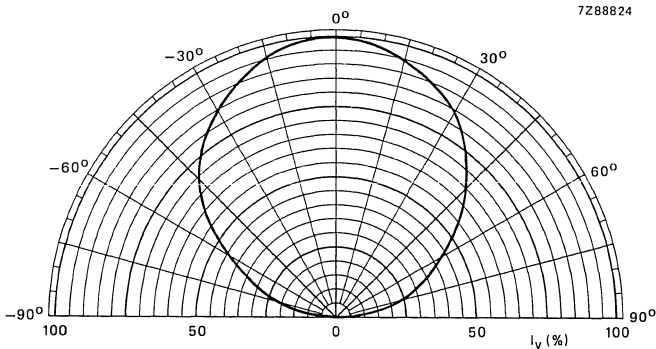

Fig. 10 $I_F = 10 \text{ mA}$; typ. values.

DEVELOPMENT SAMPLE DATA

This information is derived from development samples made available for evaluation. It does not necessarily imply that the device will go into regular production.

CQT12

LIGHT EMITTING DIODE

Solid-state rectangular lamp of 1 mm x 5 mm which emits either hyper-red light (GaAlAs) or super-green light (GaP) depending on the polarity of the current.

The CQT12 has a SOD-75A2 outline and is encapsulated in a transparent resin with a diffusing zone cast on the top. Because of its SOD-75 envelope it can be used in configurations together with the CQV60 LED family e.g. the LED array RTC 907. The bicolour function gives this light emitting device special application possibilities e.g.

- as level sensor overdrive indicator
- as zero point indicator
- as tuning indicator

QUICK REFERENCE DATA

Forward current (d.c.)			
red	I_F	max.	100 mA
green			60 mA
Total power dissipation up to $T_{amb} = 35^\circ\text{C}$	P_{tot}	max.	180 mW
Junction temperature	T_j	max.	100 $^\circ\text{C}$
Luminous intensity			
red at $I_F = 10\text{ mA}$	I_v	min.	1 mcd
green at $I_F = 20\text{ mA}$			
Wavelength at peak emission			
red	λ_{pk}	typ.	650 nm
green			565 nm
Beamwidth between half-intensity directions in the plane of the leads	$\alpha_{50\%}$	typ.	110 $^\circ$

MECHANICAL DATA

Fig. 1 SOD-75A2

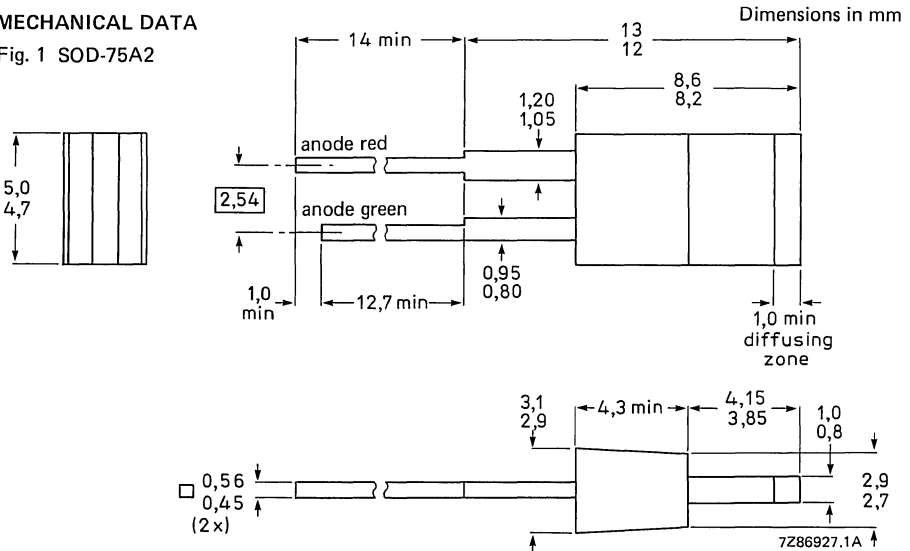

RATINGS

Limiting values in accordance with the Absolute Maximum System (IEC 134)

Forward current (d.c.)

red	I_F	max.	100 mA
green			60 mA

Forward current

peak value; $t_p = 1 \mu\text{s}$; $f = 300 \text{ Hz}$	I_{FM}	max.	1 A
peak value; $t_{on} = 1 \text{ ms}$; $\delta = 0,33$	I_{FM}	max.	150 mA

Total power dissipation up to $T_{amb} = 35 \text{ }^\circ\text{C}$

P_{tot}	max.	180 mW
-----------	------	--------

Junction temperature

T_j	max.	100 $^\circ\text{C}$
-------	------	----------------------

Storage temperature

T_{stg}	-55 to +100 $^\circ\text{C}$	
-----------	------------------------------	--

Lead soldering temperature

> 1,5 mm from the seating plane; $t_{sld} < 7 \text{ s}$	T_{sld}	max.	260 $^\circ\text{C}$
--	-----------	------	----------------------

THERMAL RESISTANCE

From junction to ambient when the device is mounted on a p.c. board

$R_{th \text{ j-a}}$	max.	350 K/W
----------------------	------	---------

CHARACTERISTICS

 $T_{amb} = 25 \text{ }^\circ\text{C}$ unless otherwise specified

Forward voltage

red at $I_F = 10 \text{ mA}$	V_F	typ.	1,75 V
		max.	2,2 V
green at $I_F = 20 \text{ mA}$	V_F	typ.	2,1 V
		max.	3,0 V

Beamwidth between half-intensity directions

at $I_F = 10 \text{ mA}$ (in the plane of the leads)	$\alpha_{50\%}$	typ.	110 $^\circ$
---	-----------------	------	--------------

Wavelength at peak emission

at $I_F = 10 \text{ mA}$	λ_{pk}	typ.	650 nm
red		typ.	565 nm
green			

Capacitance

at $V = 0$; $f = 1 \text{ MHz}$	C_d	typ.	90 pF
----------------------------------	-------	------	-------

Luminous intensity

red at $I_F = 10 \text{ mA}$	I_v	min.	1,0 mcd
green at $I_F = 20 \text{ mA}$			

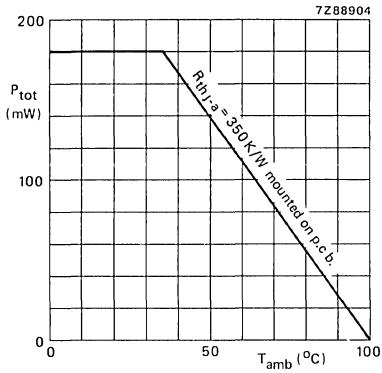

Fig. 2.

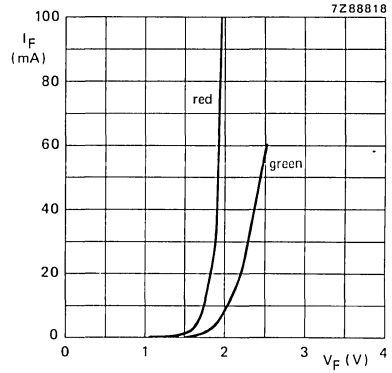

Fig. 3 $T_{amb} = 25^\circ\text{C}$; typical values.

DEVELOPMENT SAMPLE DATA

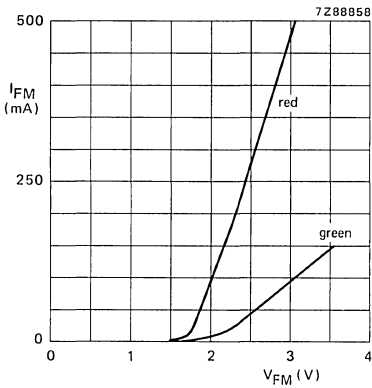

Fig. 4 $t_{on} = 20 \mu\text{s}$; $\delta = 0,01$;
 $T_{amb} = 25^\circ\text{C}$; typical values.

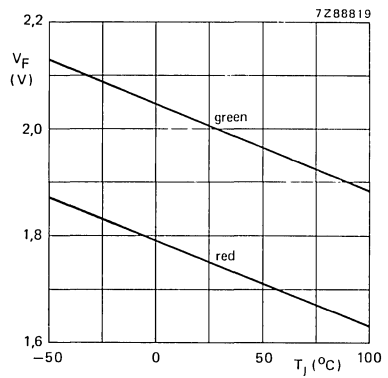

Fig. 5 $I_F = 10 \text{ mA}$; typical values.

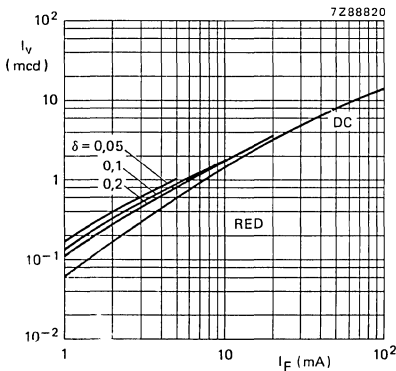

Fig. 6 $t_p = 50 \mu\text{s}$; typical values.

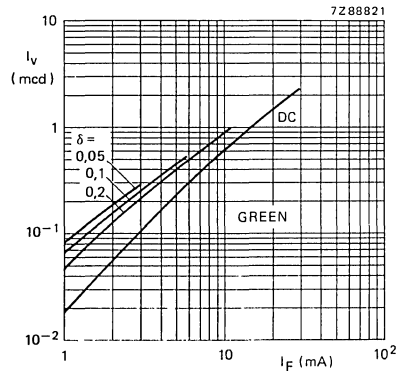

Fig. 7 $t_p = 50 \mu\text{s}$; typical values.

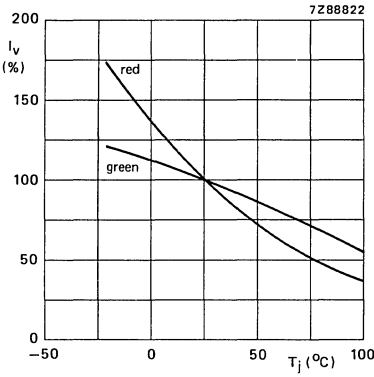

Fig. 8 Typical values.

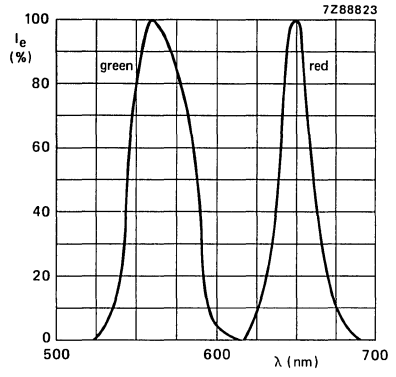

Fig. 9 $I_F = 10$ mA; typical values.

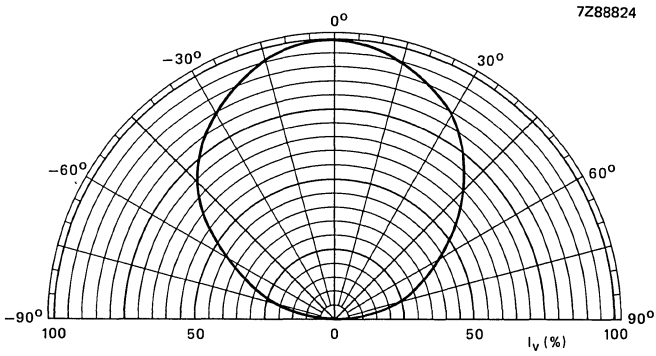

Fig. 10 $I_F = 10$ mA; typical values.

DEVELOPMENT SAMPLE DATA

This information is derived from development samples made available for evaluation. It does not necessarily imply that the device will go into regular production.

CQV60
CQV60L

LIGHT EMITTING DIODES

Rectangular light emitting diode of 1 mm x 5 mm which emits super-red light (GaPAs) when forward biased. The CQV60 and CQV60L have a SOD-75 outline and are encapsulated in a medium-red coloured resin with a diffusing zone cast on the top. These LEDs when stacked in the array RTC901 (or in combination with other SOD-75 LEDs) can be used e.g. as a level indicator.

The CQV60L is equal to the CQV60A but has long leads and no seating plane.

QUICK REFERENCE DATA

Continuous reverse voltage	V_R	max.	5 V
Forward current (d.c.)	I_F	max.	30 mA
Total power dissipation up to $T_{amb} = 65\text{ }^\circ\text{C}$	P_{tot}	max.	90 mW
Junction temperature	T_j	max.	100 $^\circ\text{C}$
Luminous intensity			
$I_F = 10\text{ mA}$	CQV60(L)	I_V	min. 0,5 mcd
	CQV60(L)-II	I_V	1,0 to 2,2 mcd
	CQV60(L)-III	I_V	1,6 to 3,5 mcd
Wavelength at peak emission			
$I_F = 10\text{ mA}$		λ_{pk}	typ. 630 nm
Beamwidth between half-intensity directions in the plane of the leads		$\alpha_{50\%}$	typ. 110 $^\circ$

MECHANICAL DATA

Fig. 1a SOD-75A2.
CQV60

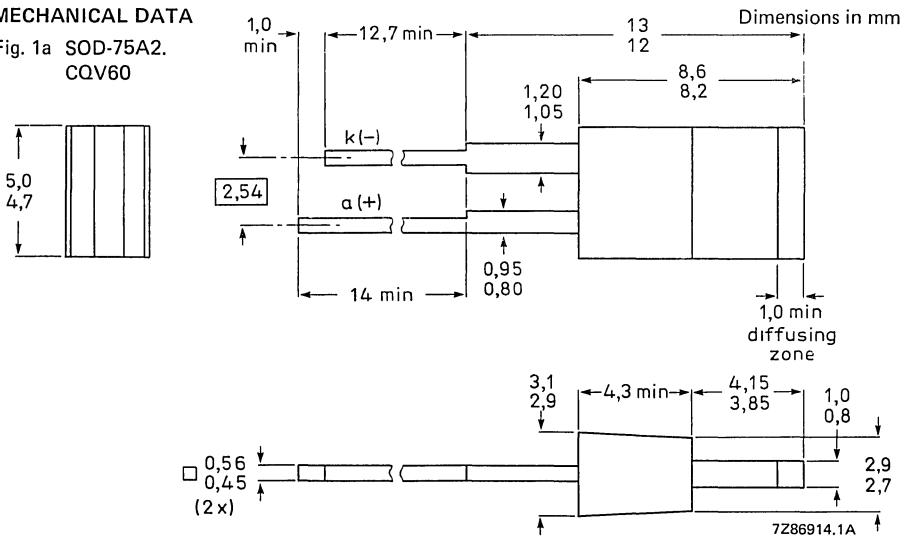

CQV60 CQV60L

Fig. 1b SOD-75L
CQV60L

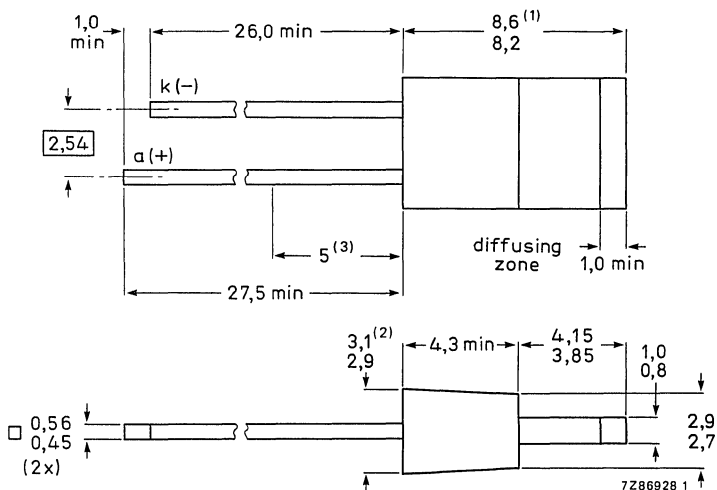
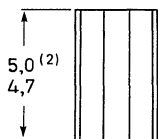

Notes

1. Dimension measured when the device is seated in a gauge with 2 holes of 0,80 mm diameter and 2,54 mm apart.
2. For the maximum value including plastic burrs.
3. Solderability is not guaranteed within this zone due to tie-bar cropping.

RATINGS

Limiting values in accordance with the Absolute Maximum System (IEC 134)

Reverse voltage	V_R	max.	5 V
Forward current d.c.	I_F	max.	30 mA
peak value; $t_p = 1 \mu s$; $f = 300$ Hz	I_{FM}	max.	1 A
peak value; $t_{ON} = 1$ ms; $\delta = 0,33$	I_{FM}	max.	60 mA
Total power dissipation up to $T_{amb} = 65$ °C	P_{tot}	max.	90 mW
Storage temperature	T_{stg}		-55 to +100 °C
Junction temperature	T_j	max.	100 °C
Lead soldering temperature at $t_{sld} < 7$ s > 1,5 mm from the seating plane for CQV60 > 5 mm from the plastic body for CQV60L	T_{sld}	max.	260 °C

THERMAL RESISTANCE

From junction to ambient when the device is mounted on a p.c. board	$R_{th j-a}$	max.	350 K/W
--	--------------	------	---------

CHARACTERISTICS

$T_j = 25$ °C unless otherwise specified

Forward voltage $I_F = 10$ mA	V_F	typ. max.	2,1 V 3,0 V
----------------------------------	-------	--------------	----------------

Reverse current

$$V_R = 5 \text{ V}$$

I_R max. 100 μA

Beamwidth between half-intensity directions
in the plane of the leads

$\alpha_{50\%}$ typ. 110 $^\circ$

Bandwidth at half height

$B_{50\%}$ typ. 45 nm

Wavelength at peak emission

$$I_F = 10 \text{ mA}$$

λ_{pk} typ. 630 nm

Luminous intensity

$$I_f = 10 \text{ mA}$$

CQV60(L) I_V min. 0,5 mcd

CQV60(L)-II I_V 1,0 to 2,2 mcd

CQV60(L)-III I_V 1,6 to 3,5 mcd

Diode capacitance

$$V_R = 0; f = 1 \text{ MHz}$$

C_d typ. 35 pF

DEVELOPMENT SAMPLE DATA

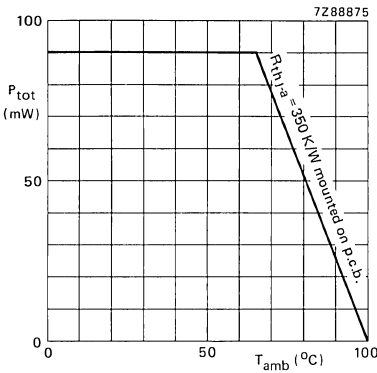

Fig. 2.

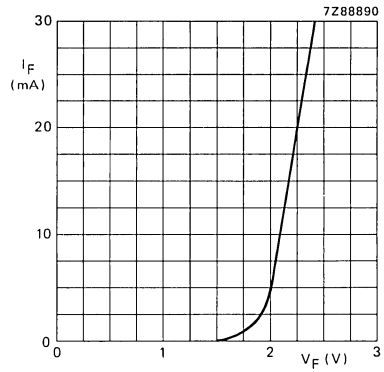

Fig. 3 $T_{amb} = 25 \text{ }^\circ\text{C}$; typ. values.

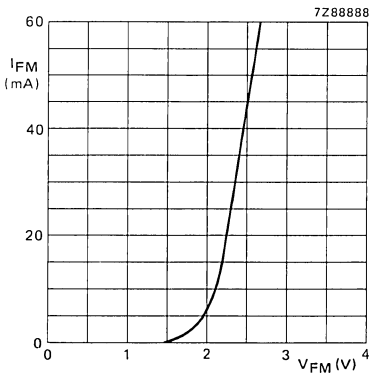

Fig. 4 $t_{on} = 50 \mu\text{s}$; $\delta = 0,0,1$;
 $T_{amb} = 25 \text{ }^\circ\text{C}$; typ. values.

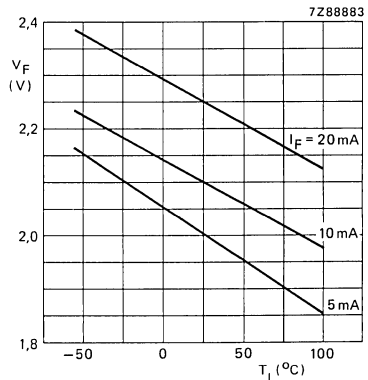

Fig. 5 Typical values.

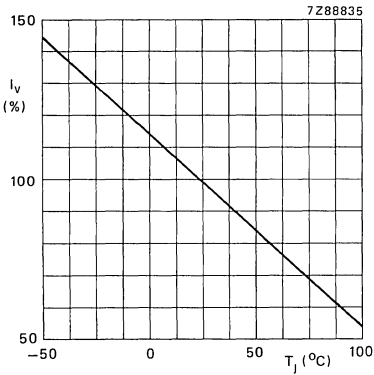

Fig. 6 $I_F = 10 \text{ mA}$; typ. values.

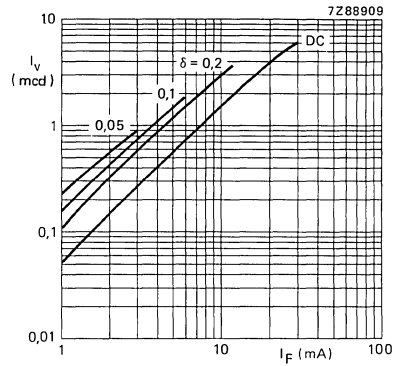

Fig. 7 $t_p = 50 \mu\text{s}$; typ. values.

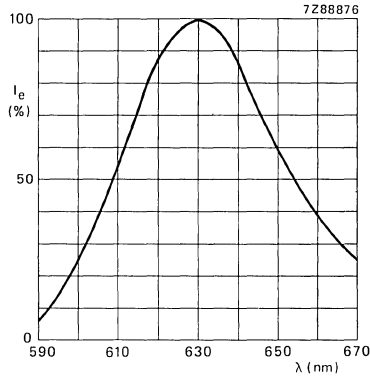

Fig. 8 Typical values.

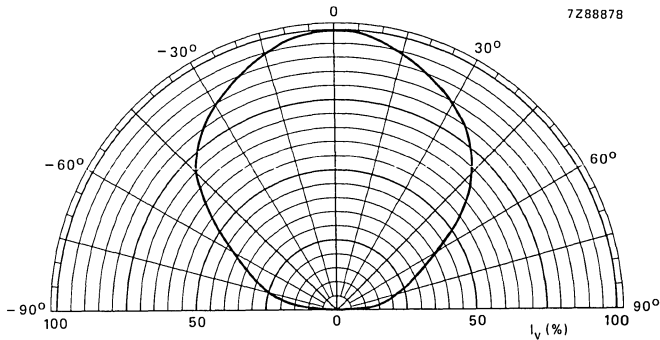

Fig. 9 Typical values.

DEVELOPMENT SAMPLE DATA

This information is derived from development samples made available for evaluation. It does not necessarily imply that the device will go into regular production.

CQV60A
CQV60AL

LIGHT EMITTING DIODES

Rectangular light emitting diode of 1 mm x 5 mm which emits hyper-red light (GaAlAs) when forward biased.

The CQV60A and CQV60AL have a SOD-75 outline and are encapsulated in a medium-red coloured resin with a diffusing zone cast on the top. These LEDs when stacked in the array RTC907 (in combination with other SOD-75 LEDs) can be used e.g. as a level indicator.

Because of the high light intensity the CQV60A(L) is very suitable in those applications where only very low currents are available and because of its high I_F max it can be used for high I_V applications. The CQV60AL is equal to the CQV60A but has long leads and no seating plane.

QUICK REFERENCE DATA

Continuous reverse voltage		V_R	max.	5 V
Forward current (d.c.)		I_F	max.	100 mA
Total power dissipation up to $T_{amb} = 25\text{ }^\circ\text{C}$		P_{tot}	max.	250 mW
Junction temperature		T_j	max.	100 $^\circ\text{C}$
Luminous intensity				
$I_F = 10\text{ mA}$	CQV60A(L)	I_V	min.	1,0 mcd
	CQV60A(L)-III	I_V		1,6 to 3,5 mcd
	CQV60A(L)-IV	I_V		3,0 to 7,0 mcd
Wavelength at peak emission				
$I_F = 10\text{ mA}$		λ_{pk}	typ.	650 nm
Beamwidth between half-intensity directions		$\alpha_{50\%}$	typ.	110 $^\circ$

MECHANICAL DATA

Fig. 1a SOD-75A2
CQV60A

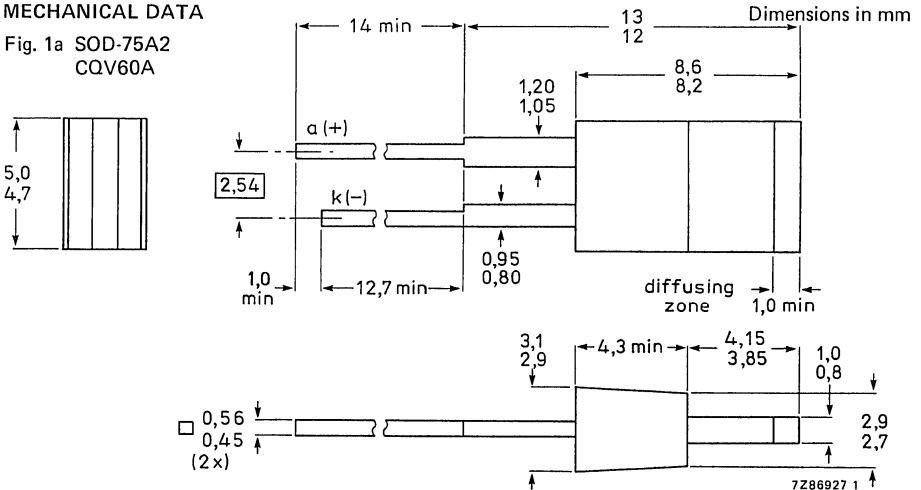

CQV60A CQV60AL

Fig. 1b SOD-75L
CQV60AL

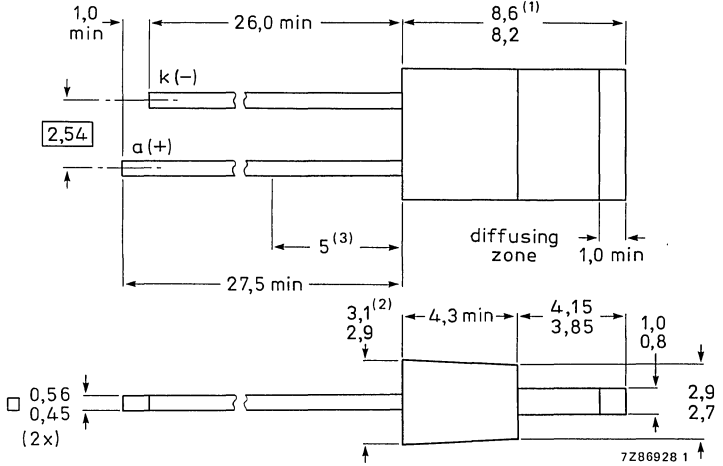
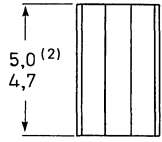

Notes

1. Dimension measured when the device is seated in a gauge with 2 holes of 0,80 mm diameter 2,54 mm apart.
2. For the maximum value: including plastic burrs.
3. Solderability is not guaranteed within this zone due to tie-bar cropping.

RATINGS

Limiting values in accordance with the Absolute Maximum System (IEC 134)

Reverse voltage	V_R	max.	5 V
Forward current d.c.	I_F	max.	100 mA
peak value; $t_p = 1 \mu s$; $f = 300 \text{ Hz}$	I_{FM}	max.	1 A
peak value; $t_{ON} = 20 \mu s$; $\delta = 0,01$	I_{FM}	max.	500 mA
Total power dissipation up to $T_{amb} = 25 \text{ }^\circ\text{C}$	P_{tot}	max.	250 mW
Storage temperature	T_{stg}		-55 to +100 $^\circ\text{C}$
Junction temperature	T_j	max.	100 $^\circ\text{C}$
Lead soldering temperature at $t_{sld} < 7 \text{ s}$ > 1,5 mm from the seating plane for CQV60A > 5 mm from the plastic body for CQV60AL	T_{sld}	max.	260 $^\circ\text{C}$

THERMAL RESISTANCE

From junction to ambient when the device
is mounted on a p.c. board

$R_{th \text{ j-a}}$	max.	350 K/W
----------------------	------	---------

CHARACTERISTICS

$T_j = 25 \text{ }^\circ\text{C}$ unless otherwise specified

Forward voltage

$$I_F = 10 \text{ mA}$$

V_F	typ.	1,75 V
	max.	2,20 V

Reverse current

$$V_R = 5 \text{ V}$$

I_R	max.	100 μA
-------	------	-------------------

Beamwidth between half-intensity directions
in the plane of the leads

Bandwidth at half height

Wavelength at peak emission

$I_F = 10 \text{ mA}$

Luminous intensity

$I_F = 10 \text{ mA}$

Diode capacitance

$V_R = 0; f = 1 \text{ MHz}$

$\alpha_{50\%}$ typ. 110 °

$B_{50\%}$ typ. 20 nm

λ_{pk} typ. 650 nm

CQV60A(L) I_V min. 1,0 mcd

CQV60A(L)-III I_V 1,6 to 3,5 mcd

CQV60A(L)-IV I_V 3,0 to 7,0 mcd

C_d typ. 60 pF

DEVELOPMENT SAMPLE DATA

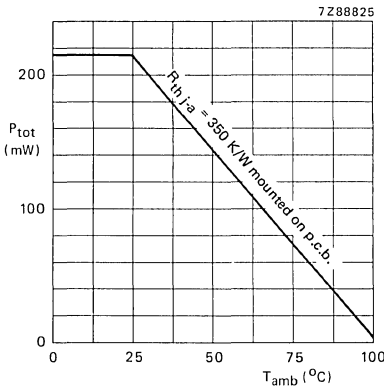

Fig. 2.

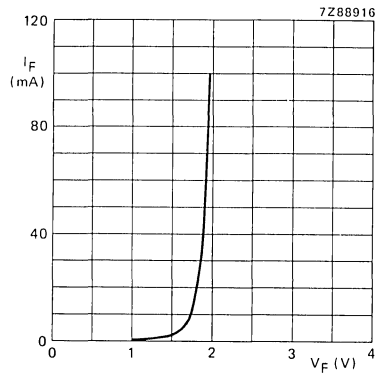

Fig. 3 $T_{amb} = 25 \text{ °C}$; typ. values.

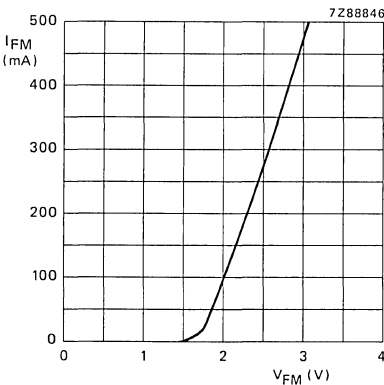

Fig. 4 $t_{on} = 20 \mu\text{s}$; $\delta = 0,01$;
 $T_{amb} = 25 \text{ °C}$; typ. values.

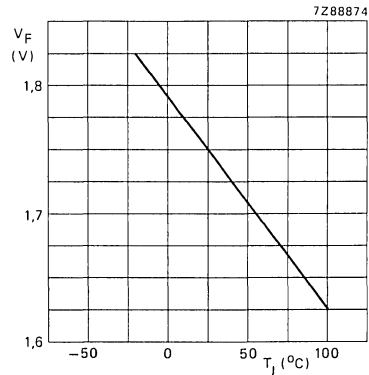

Fig. 5 $I_F = 10 \text{ mA}$; typ. values.

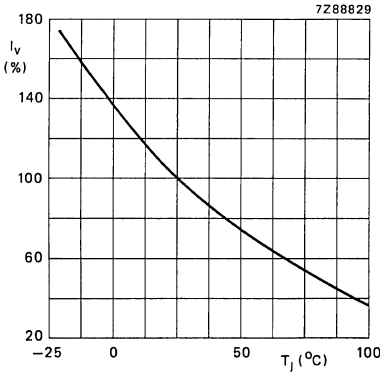

Fig. 6 Typical values.

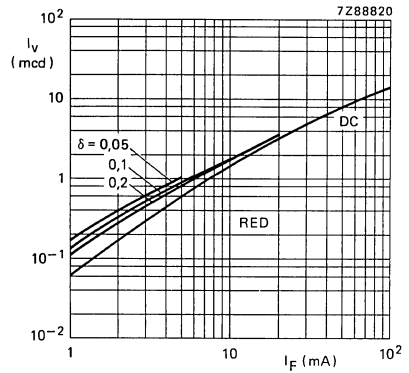

Fig. 7 $t_p = 50 \mu s$; typ. values.

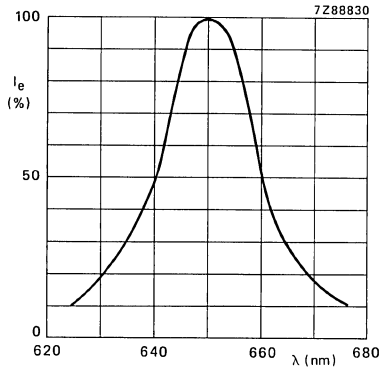

Fig. 8 $I_F = 10 \text{ mA}$; $T_{amb} = 25 \text{ }^\circ\text{C}$; typ. values.

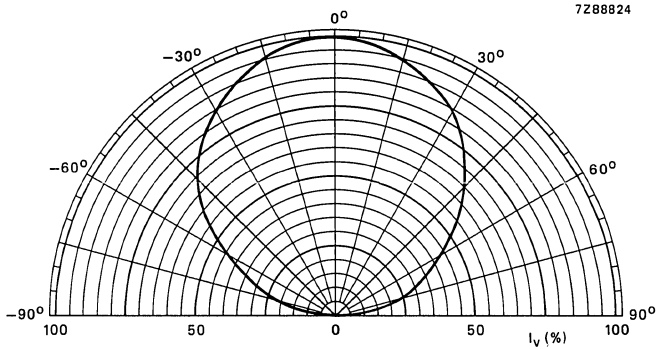

Fig. 9 Typical values.

DEVELOPMENT SAMPLE DATA

This information is derived from development samples made available for evaluation. It does not necessarily imply that the device will go into regular production

CQV61A
CQV61AL

LIGHT EMITTING DIODES

Rectangular light emitting diodes of 1 mm x 5 mm which emit super-green light (GaP) when forward biased.

The CQV61A and CQV61AL have a SOD-75 outline and are encapsulated in a medium-green coloured resin with a diffusing zone cast on the top. These LEDs, when stacked in the array RTC902, or in combination with other SOD-75 LEDs in the array RTC907, can be used e.g. as a level indicator.

The CQV61AL is equal to the CQV61A but has long leads and no seating plane.

QUICK REFERENCE DATA

Continuous reverse voltage	V_R	max.	5 V
Forward current (d.c.)	I_F	max.	60 mA
Total power dissipation up to $T_{amb} = 35\text{ }^\circ\text{C}$	P_{tot}	max.	180 mW
Junction temperature	T_j	max.	100 $^\circ\text{C}$
Luminous intensity			
$I_F = 10\text{ mA}$	CQV61A(L)	I_v	min. 0,5 mcd
	CQV61A(L)-II	I_v	1,0 to 2,2 mcd
	CQV61A(L)-III	I_v	1,6 to 3,5 mcd
Wavelength at peak emission			
$I_F = 10\text{ mA}$		λ_{pk}	typ. 565 nm
Beamwidth between half-intensity directions in the plane of the leads		$\alpha_{50\%}$	typ. 110 $^\circ$

MECHANICAL DATA

Fig. 1a SOD-75A1.
CQV61A

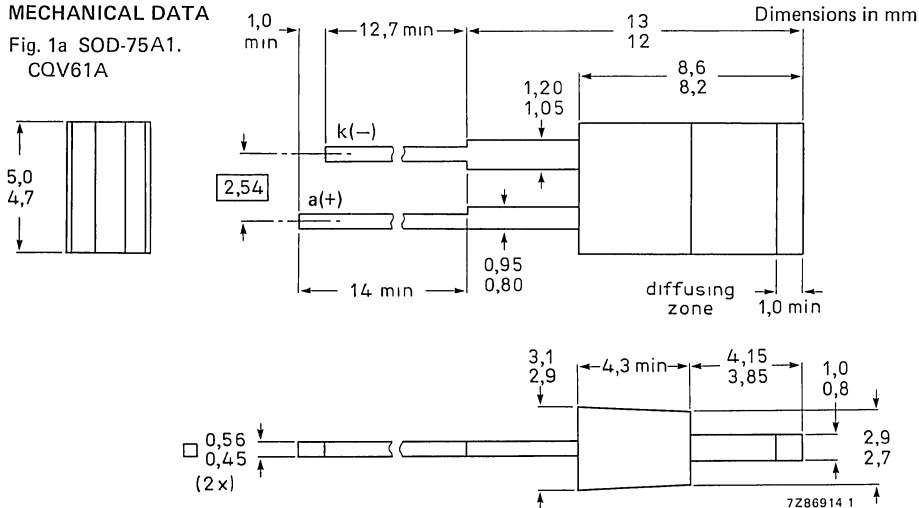

CQV61A CQV61AL

Fig. 1b SOD-75L.
CQV61AL

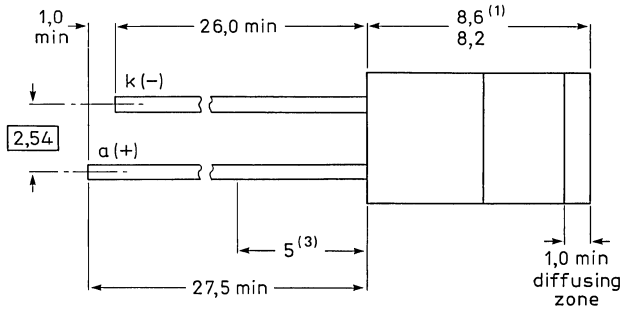
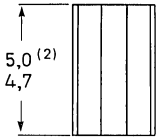

CQV61AL

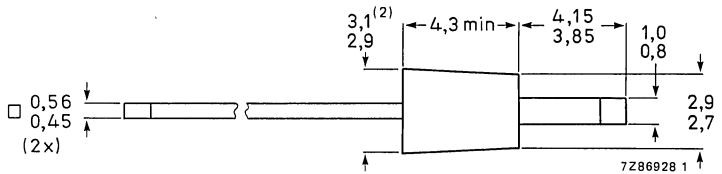

Notes

1. Measured when the device is seated in a gauge with 2 holes 0,80 mm diameter and 2,54 mm apart.
2. Maximum value including burrs.
3. Solderability not guaranteed within this zone due to tie-bar cropping.

RATINGS

Limiting values in accordance with the Absolute Maximum System (IEC 134)

Reverse voltage	V_R	max.	5 V
Forward current	I_F	max.	60 mA
d.c.	I_{FM}	max.	1 A
peak value; $t_p = 1 \mu s$; $f = 300 \text{ Hz}$		max.	150 mA
peak value; $t_{on} = 1 \text{ ms}$; $\delta = 0,33$	P_{tot}	max.	180 mW
Total power dissipation up to $T_{amb} = 35 \text{ }^\circ\text{C}$	T_{stg}		$-55 \text{ to } +100 \text{ }^\circ\text{C}$
Storage temperature	T_j	max.	100 $^\circ\text{C}$
Junction temperature	T_{slid}	max.	260 $^\circ\text{C}$
Lead soldering temperature at $t_{slid} < 7 \text{ s}$			
> 1,5 mm from the seating plane for CQV61A			
> 5 mm from the plastic body for CQV61AL			

THERMAL RESISTANCE

From junction to ambient when the device is mounted on a p.c. board

$R_{th \text{ j-a}}$	max.	350 K/W
----------------------	------	---------

CHARACTERISTICS

$T_j = 25 \text{ }^\circ\text{C}$ unless otherwise specified

Forward voltage
 $I_F = 10 \text{ mA}$

V_F	typ.	2,1 V
	max.	3,0 V

Reverse current

$V_R = 5 \text{ V}$

Beamwidth between half-intensity directions
in the plane of the leads; $I_F = 10 \text{ mA}$

Bandwidth at half height

Wavelength at peak emission

$I_F = 10 \text{ mA}$

Luminous intensity

$I_F = 10 \text{ mA}$

Diode capacitance

$V_R = 0; f = 1 \text{ MHz}$

I_R max. 100 μA

$\alpha_{50\%}$ typ. 110 $^\circ$

$B_{50\%}$ typ. 30 nm

λ_{pk} typ. 565 nm

CQV61A(L) I_V min. 0,5 mcd

CQV61A(L)-II I_V 1,0 to 2,2 mcd

CQV61A(L)-III I_V 1,6 to 3,5 mcd

C_d typ. 35 pF

DEVELOPMENT SAMPLE DATA

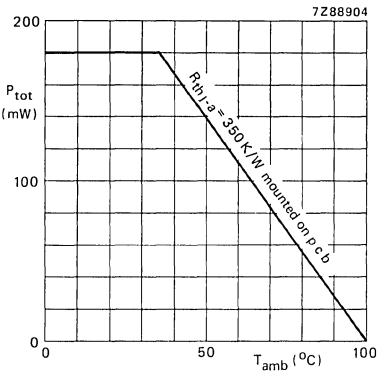

Fig. 2.

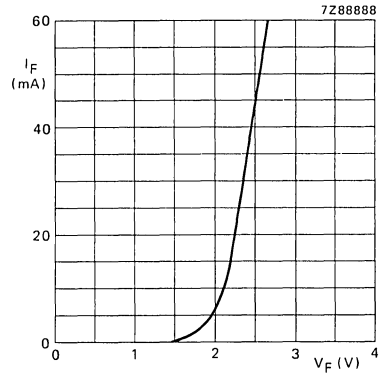

Fig. 3 $T_{amb} = 25 \text{ }^\circ\text{C}$; typical values.

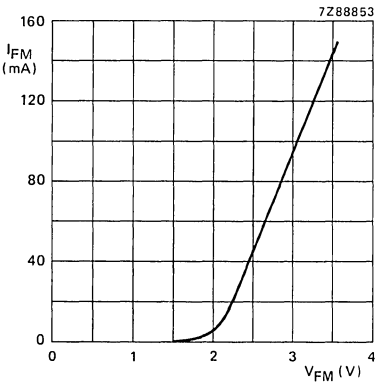

Fig. 4 $t_{ON} = 50 \mu\text{s}$; $\delta = 0,01$;
 $T_{amb} = 25 \text{ }^\circ\text{C}$; typical values.

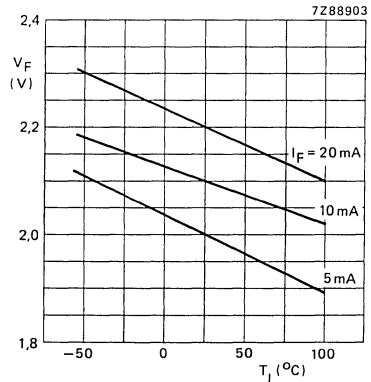

Fig. 5 Typical values.

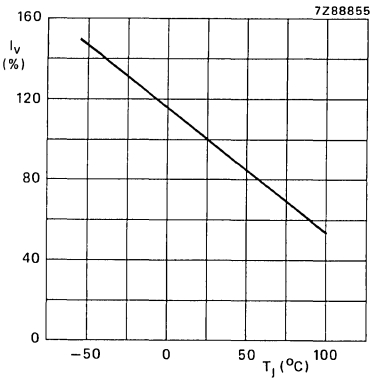

Fig. 6 Typical values.

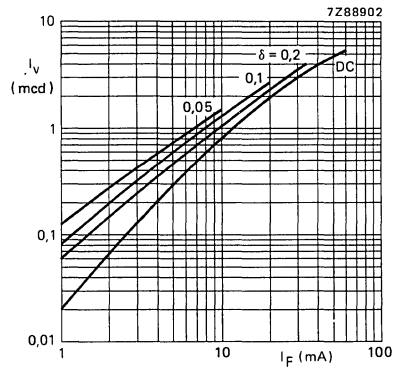

Fig. 7 $t_p = 50 \mu s$; typical values.

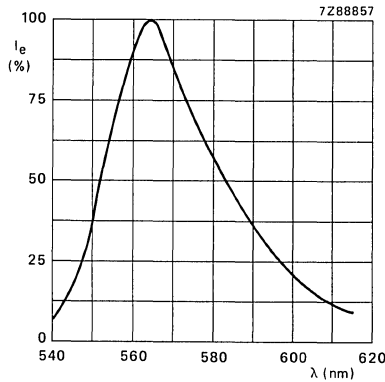

Fig. 8 $I_F = 10 \text{ mA}$; typical values.

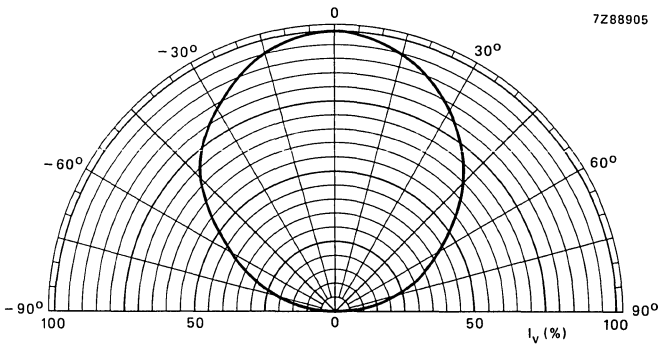

Fig. 9 Typical values.

DEVELOPMENT SAMPLE DATA

This information is derived from development samples made available for evaluation. It does not necessarily imply that the device will go into regular production.

CQV62
CQV62L

LIGHT EMITTING DIODES

Rectangular light emitting diodes of 1 mm x 5 mm which emits yellow light (GaPAs) when forward biased.

The CQV62 and CQV62L have a SOD-75 outline and are encapsulated in a medium-yellow coloured resin with a diffusing zone cast on the top. When stacked in the array RTC903 or in combination with other SOD-75 LEDs in the array RTC907 these LEDs can be used, for instance, as a level indicator. The CQV62L is equal to the CQV62 but has long leads and no seating plane.

QUICK REFERENCE DATA

Continuous reverse voltage	V_R	max.	5 V
Forward current (d.c.)	I_F	max.	30 mA
Total power dissipation up to $T_{amb} = 65\text{ }^\circ\text{C}$	P_{tot}	max.	90 mW
Junction temperature	T_j	max.	100 $^\circ\text{C}$
Luminous intensity			
$I_F = 10\text{ mA}$	CQV62(L)	I_V	min. 0,5 mcd
	CQV62-II(L)	I_V	1,0 to 2,2 mcd
	CQV62-III(L)	I_V	1,6 to 3,5 mcd
Wavelength at peak emission			
$I_F = 10\text{ mA}$		λ_{pk}	typ. 590 nm
Beamwidth between half-intensity directions in the plane of the leads		$\alpha_{50\%}$	typ. 110 $^\circ$

MECHANICAL DATA

Fig. 1a SOD-75A1.
CQV62

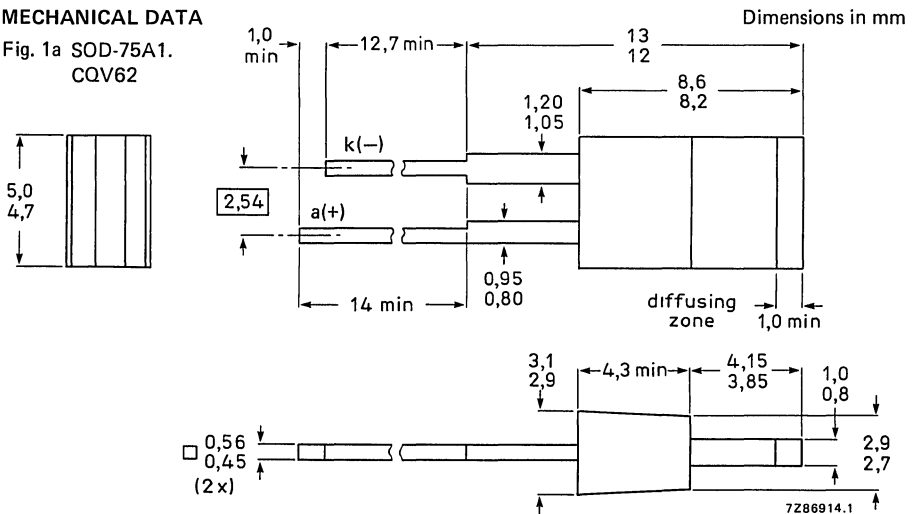

CQV62 |
CQV62L |

Fig. 1b SOD-75L
CQV62L

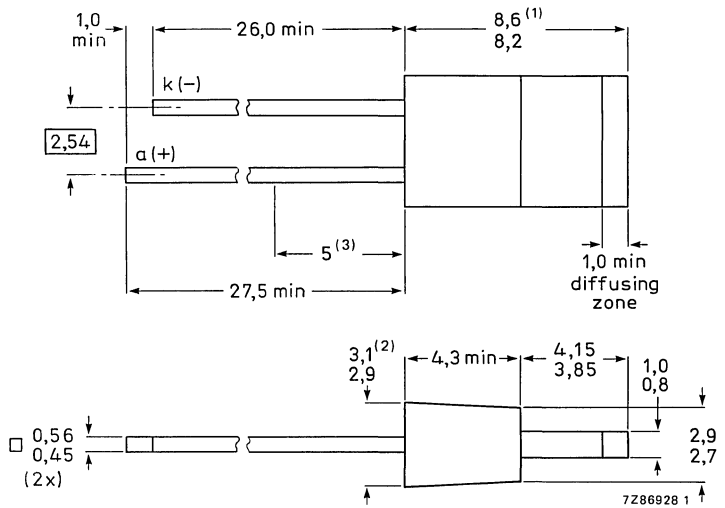
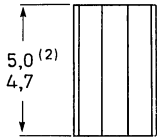

Note 1: Dimension measured when the device is seated in a gauge with 2 holes of 0,80 mm diameter 2,54 mm apart.

Note 2: For the maximum value: including plastic burrs.

Note 3: Solderability is not guaranteed within this zone due to tie-bar cropping.

RATINGS

Limiting values in accordance with the Absolute Maximum System (IEC 134)

Reverse voltage	V_R	max.	5 V
Forward current	I_F	max.	30 mA
d.c.	I_{FM}	max.	1 A
peak value; $t_p = 1 \mu s$; $f = 300 \text{ Hz}$	I_{FM}	max.	60 mA
peak value; $t_p = 1 \text{ ms}$; $\delta = 0,33$	P_{tot}	max.	90 mW
Total power dissipation up to $T_{amb} = 65 \text{ }^\circ\text{C}$	T_{stg}		-55 to + 100 $^\circ\text{C}$
Storage temperature	T_j	max.	100 $^\circ\text{C}$
Junction temperature	T_{sld}	max.	260 $^\circ\text{C}$
Lead soldering temperature at $t_{sld} < 7 \text{ s}$			
> 1,5 mm from the seating plane for CQV62			
> 5 mm from the plastic body for CQV62L			

THERMAL RESISTANCE:

From junction to ambient when the device is mounted on a p.c. board	$R_{th \text{ j-a}}$	max.	350 K/W
---	----------------------	------	---------

CHARACTERISTICS

$T_j = 25 \text{ }^\circ\text{C}$ unless otherwise specified

Forward voltage	V_F	typ.	2,1 V
$I_F = 10 \text{ mA}$		max.	3,0 V

Reverse current

$V_R = 5 \text{ V}$

I_R max. 100 μA

Beamwidth between half-intensity directions
in the plane of the leads; $I_F = 10 \text{ mA}$

$\alpha_{50\%}$ typ. 110 $^\circ$

Bandwidth at half height

$B_{50\%}$ typ. 40 nm

Wavelength at peak emission

$I_F = 10 \text{ mA}$

λ_{pk} typ. 590 nm

Luminous intensity

$I_F = 10 \text{ mA}$

CQV62(L) I_V min. 0,5 mcd

CQV62-II(L) I_V 1,0 to 2,2 mcd

CQV62-III(L) I_V 1,6 to 3,5 mcd

Diode capacitance

$V_R = 0; f = 1 \text{ MHz}$

C_d typ. 35 pF

DEVELOPMENT SAMPLE DATA

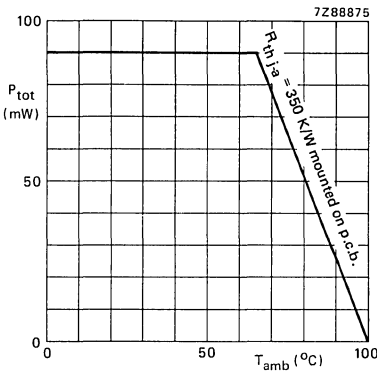

Fig. 2.

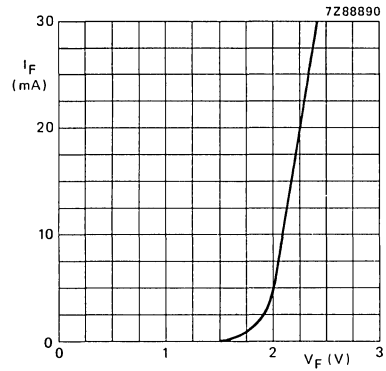

Fig. 3 $T_{amb} = 25 \text{ }^\circ\text{C}$; typical values.

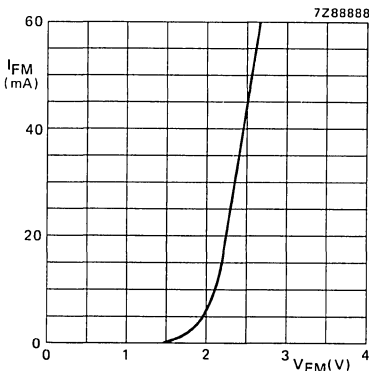

Fig. 4 $t_{on} = 50 \mu\text{s}$; $\delta = 0,01$;
 $T_{amb} = 25 \text{ }^\circ\text{C}$; typical values.

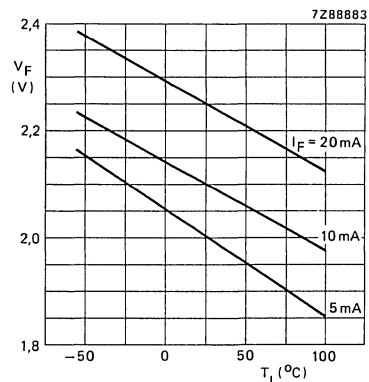

Fig. 5 Typical values.

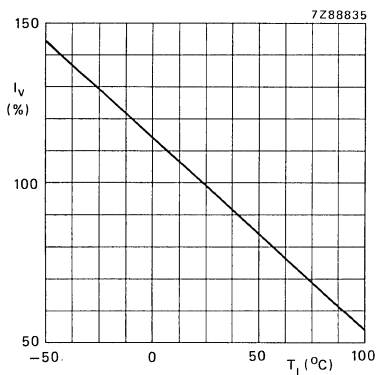

Fig. 6 $I_F = 10 \text{ mA}$; typical values.

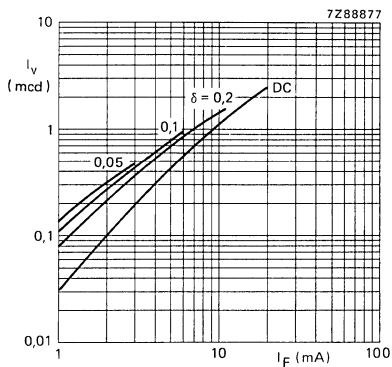

Fig. 7 $t_p = 50 \mu\text{s}$; typical values.

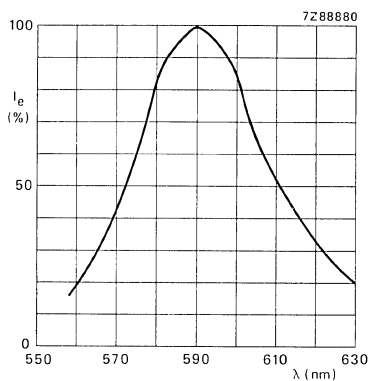

Fig. 8 Typical values.

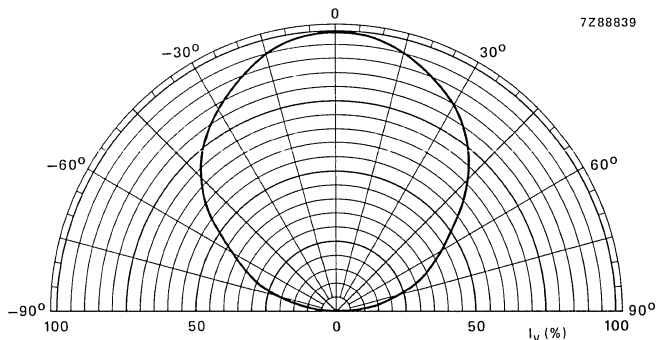

Fig. 9 Typical values.

DEVELOPMENT SAMPLE DATA

This information is derived from development samples made available for evaluation. It does not necessarily imply that the device will go into regular production.

CQV70
CQV70L

LIGHT EMITTING DIODES

Rectangular light emitting diodes of 3 mm x 5 mm which emit super-red light (GaPAs) when forward biased. The CQV70 (and CQV70L) has a SOD-77 envelope and is encapsulated in a medium-red coloured resin with a diffusing zone cast on the top.

When stacked in an array these SOD-77 LEDs can be used e.g. as a level indicator. The CQV70L is similar to the CQV70 but has long leads and has no seating plane.

QUICK REFERENCE DATA

Continuous reverse voltage	V_R	max.	5 V
Forward current (d.c.)	I_F	max.	30 mA
Total power dissipation up to $T_{amb} = 65\text{ }^\circ\text{C}$	P_{tot}	max.	90 mW
Junction temperature	T_j	max.	100 $^\circ\text{C}$
Luminous intensity $I_F = 10\text{ mA}$	CQV70(L) I_v	min.	0,5 mcd
	CQV70(L)-II I_v	1,6 to	2,2 mcd
	CQV70(L)-III I_v	1,6 to	3,5 mcd
Wavelength at peak emission $I_F = 10\text{ mA}$	λ_{pk}	typ.	630 nm
Beamwidth between half-intensity directions in the plane of the leads; $I_F = 10\text{ mA}$	$\alpha_{50\%}$	typ.	100 $^\circ$

MECHANICAL DATA

Dimensions in mm

Fig. 1a SOD-77A1.
CQV70

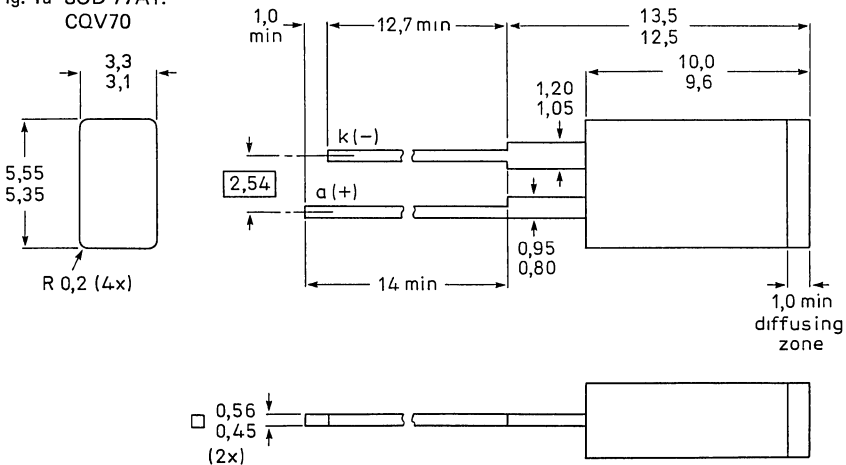

7286981

Fig. 1b SOD-77L.
CQV70L

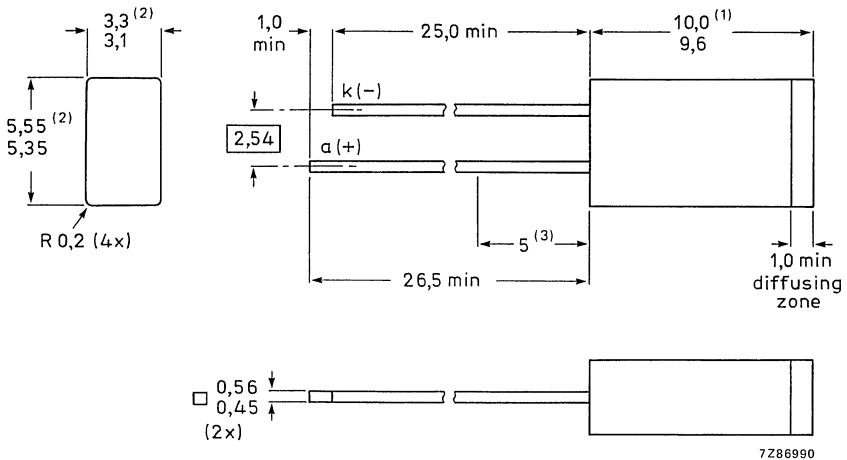

Notes

1. Measured when the device is seated in a gauge with 2 holes 0,80 mm in diameter and 2,54 mm apart.
2. Maximum value including plastic burrs.
3. Solderability not guaranteed within this zone due to tie-bar cropping.

RATINGS

Limiting values in accordance with the Absolute Maximum System (IEC 134)

Reverse voltage	V_R	max.	5 V
Forward current			
d.c.	I_F	max.	30 mA
peak value; $t_p = 1 \mu s$; $f = 300 \text{ Hz}$		max.	1 A
peak value; $t_{on} = 1 \text{ ms}$; $\delta = 0,33$	I_{FM}	max.	60 mA
Total power dissipation up to $T_{amb} = 65 \text{ }^\circ\text{C}$	P_{tot}	max.	90 mW
Storage temperature	T_{stg}		-55 to +100 $^\circ\text{C}$
Junction temperature	T_j	max.	100 $^\circ\text{C}$
Lead soldering temperature at $t_{sld} < 7 \text{ s}$			
> 1,5 mm from the seating plane for CQV70	T_{sld}	max.	260 $^\circ\text{C}$
> 5 mm from the plastic body for CQV70L			

THERMAL RESISTANCE

From junction to ambient when the device is mounted on a p.c. board	$R_{th j-a}$	max.	350 K/W
---	--------------	------	---------

CHARACTERISTICS

$T_j = 25 \text{ }^\circ\text{C}$ unless otherwise specified

Forward voltage			
$I_F = 10 \text{ mA}$	V_F	typ.	2,1 V
		max.	3,0 V

Reverse current

$V_R = 5 \text{ V}$

Beamwidth between half-intensity directions
in the plane of the leads; $I_F = 10 \text{ mA}$

Bandwidth at half height

Wavelength at peak emission

$I_F = 10 \text{ mA}$

Luminous intensity

$I_F = 10 \text{ mA}$

Diode capacitance

$V_R = 0; f = 1 \text{ MHz}$

I_R max. 100 μA

$\alpha_{50\%}$ typ. 100 $^\circ$

$B_{50\%}$ typ. 30 nm

λ_{pk} typ. 630 nm

CQV70(L) I_V min. 0,5 mCd

CQV70(L)-II I_V 1,0 to 2,2 mCd

CQV70(L)-III I_V 1,6 to 3,5 mCd

C_d typ. 35 pF

DEVELOPMENT SAMPLE DATA

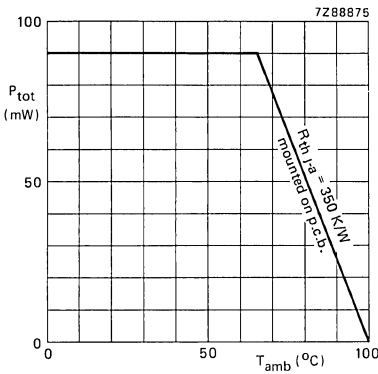

Fig. 2.

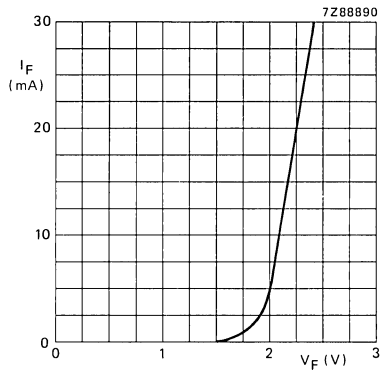

Fig. 3 $T_{amb} = 25 \text{ }^\circ\text{C}$; typical values.

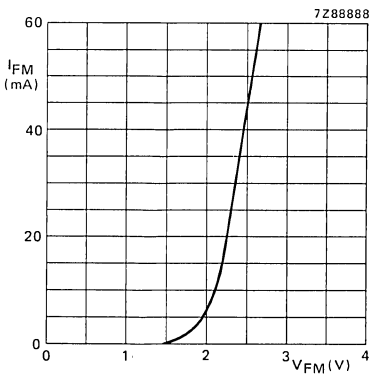

Fig. 4 $t_{on} = 50 \mu\text{s}; \delta = 0,01;$
 $T_{amb} = 25 \text{ }^\circ\text{C}$; typical values.

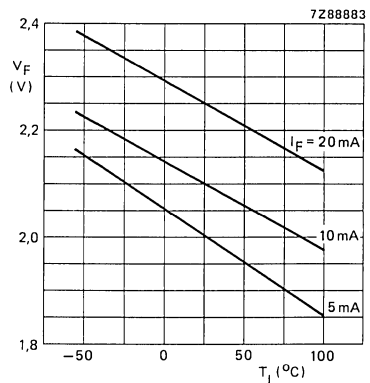

Fig. 5 Typical values.

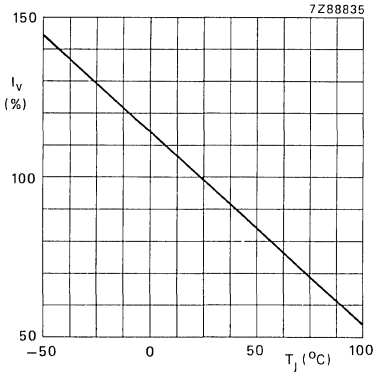

Fig. 6 $I_F = 10 \text{ mA}$; typical values.

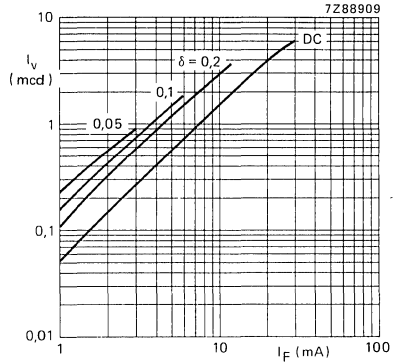

Fig. 7 $t_p = 50 \mu\text{s}$; typical values.

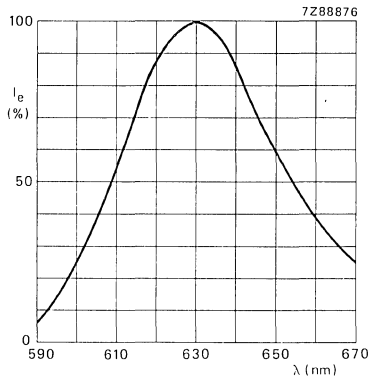

Fig. 8 $I_F = 10 \text{ mA}$; $T_{\text{amb}} = 25 \text{ }^\circ\text{C}$; typical values.

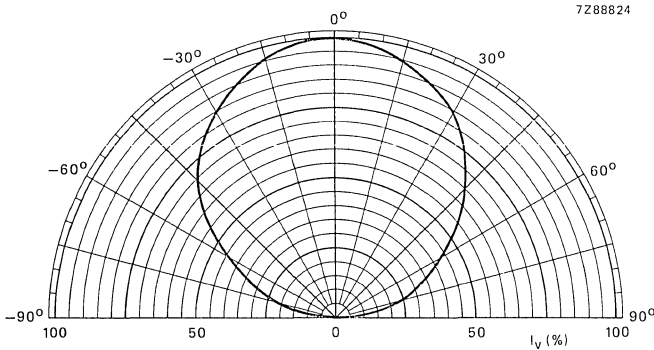

Fig. 9 Typical values.

DEVELOPMENT SAMPLE DATA

This information is derived from development samples made available for evaluation. It does not necessarily imply that the device will go into regular production

CQV70A
CQV70AL

LIGHT EMITTING DIODES

Rectangular light emitting diode of 3 mm x 5 mm which emits hyper-red light (GaAlAs) when forward biased. The CQV70A has a SOD-77 envelope and is encapsulated in a medium-red coloured resin with a diffusing zone cast on the top. Because of its high luminous intensity the CQV70A is very suitable in applications where only low currents are available and because of its high I_{Fmax} it can be used in high I_V applications.

These SOD-77 LEDs when stacked in an array can be used e.g. as a level indicator. The CQV70 AL is similar to the CQV70A but has long leads and has no seating plane.

QUICK REFERENCE DATA

Continuous reverse voltage	V_R	max.	5 V
Forward current (d.c.)	I_F	max.	100 mA
Total power dissipation up to $T_{amb} = 25\text{ }^\circ\text{C}$	P_{tot}	max.	215 mW
Junction temperature	T_j	max.	100 $^\circ\text{C}$
Luminous intensity			
$I_F = 10\text{ mA}$	CQV70A(L)	I_V	min. 1,0 mcd
	CQV70A(L)-III	I_V	1,6 to 3,5 mcd
	CQV70A(L)-IV	I_V	3,0 to 7,0 mcd
Wavelength at peak emission			
$I_F = 10\text{ mA}$		λ_{pk}	typ. 650 nm
Beamwidth between half-intensity directions in the plane of the leads; $I_F = 10\text{ mA}$		$\alpha_{50\%}$	typ. 100 $^\circ$

MECHANICAL DATA

Fig. 1a SOD-77A2.

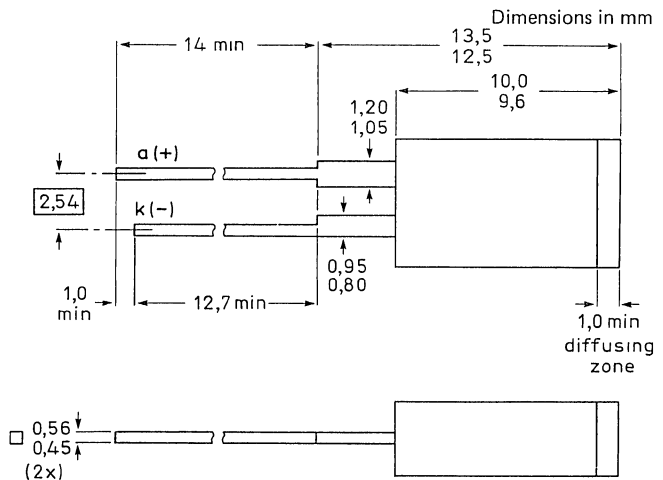
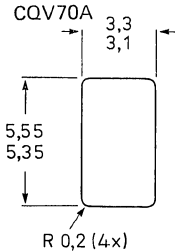

7Z86911.1A

CQV70A
CQV70AL

Fig. 1b SOT-77L.
CQV70AL

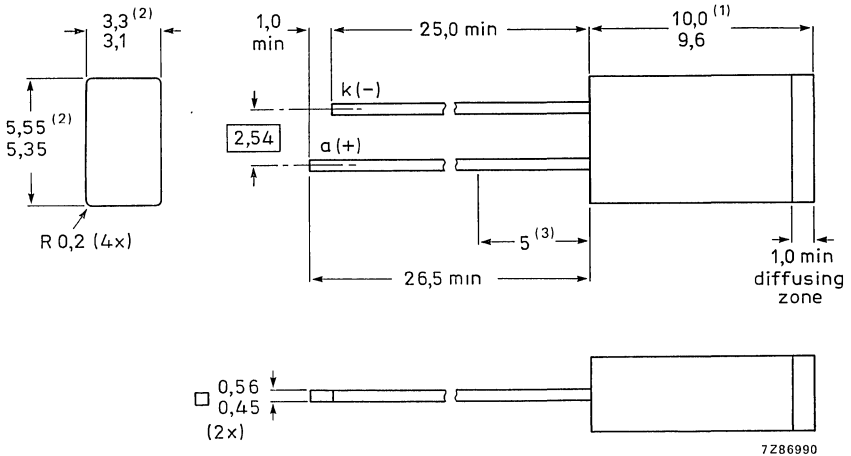

Notes

1. Measured when the device is seated in a gauge with 2 holes of 0,80 mm diameter and 2,54 mm apart.
2. Maximum value including plastic burrs.
3. Solderability not guaranteed within this zone due to tie-bar cropping.

RATINGS

Limiting values in accordance with the Absolute Maximum System (IEC 134)

Reverse voltage	V_R	max.	5 V
Forward current	I_F	max.	100 mA
d.c.	I_{FM}	max.	1 A
peak value; $t_p = 1 \mu s$; $f = 300 \text{ Hz}$		max.	500 mA
peak value; $t_{ON} = 20 \mu s$; $\delta = 0,01$	P_{tot}	max.	215 mW
Total power dissipation up to $T_{amb} = 25 \text{ }^\circ\text{C}$	T_{stg}		$-55 \text{ to } +100 \text{ }^\circ\text{C}$
Storage temperature	T_j	max.	100 $^\circ\text{C}$
Junction temperature	T_{sld}	max.	260 $^\circ\text{C}$
Lead soldering temperature at $t_{sld} < 7 \text{ s}$			
> 1,5 mm from the seating plane for CQV70A			
> 5 mm from the plastic body for CQV70AL			

THERMAL RESISTANCE

From junction to ambient when the device
is mounted on a p.c. board

$R_{th \text{ j-a}}$	max.	350 K/W
----------------------	------	---------

CHARACTERISTICS

$T_j = 25 \text{ }^\circ\text{C}$ unless otherwise specified

Forward voltage
 $I_F = 10 \text{ mA}$

V_f	typ.	1,75 V
	max.	2,2 V

Reverse current

$V_R = 5 \text{ V}$

Beamwidth between half-intensity directions

$I_F = 10 \text{ mA}$

Bandwidth at half height

Wavelength at peak emission

$I_F = 10 \text{ mA}$

Luminous intensity

$I_F = 10 \text{ mA}$

I_R max. 100 μA

$\alpha_{50\%}$ typ. 100 $^\circ$

$B_{50\%}$ typ. 20 nm

λ_{pk} typ. 650 nm

CQV70A(L) I_V min. 1,0 mcd

CQV70A(L)-III I_V 1,6 to 3,5 mcd

CQV70A(L)-IV I_V 3,0 to 7,0 mcd

C_d typ. 60 pF

Diode capacitance

$V_R = 0; f = 1 \text{ MHz}$

DEVELOPMENT SAMPLE DATA

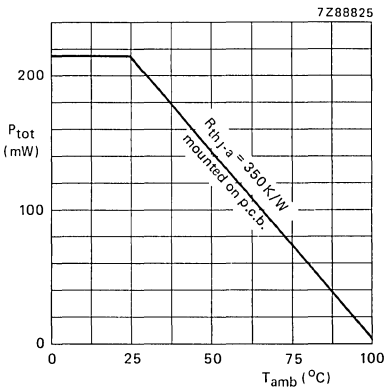

Fig. 2.

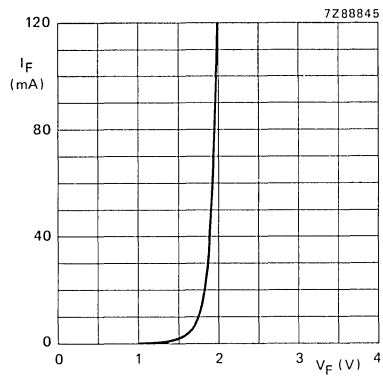

Fig. 3 $T_{amb} = 25 \text{ }^\circ\text{C}$; typ. values.

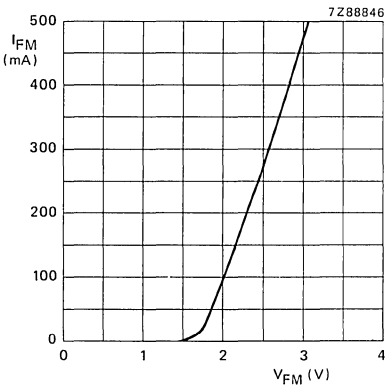

Fig. 4 $t_{on} = 20 \mu\text{s}; \delta = 0,01$; typ. values.

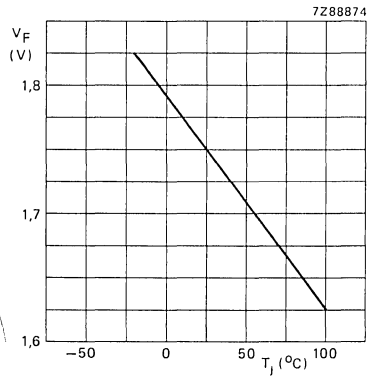

Fig. 5 $I_F = 10 \text{ mA}$; typ. values.

CQV70A
CQV70AL

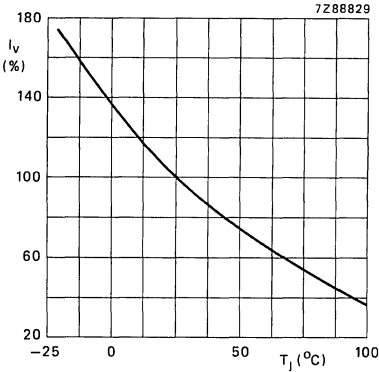

Fig. 6 Typical values.

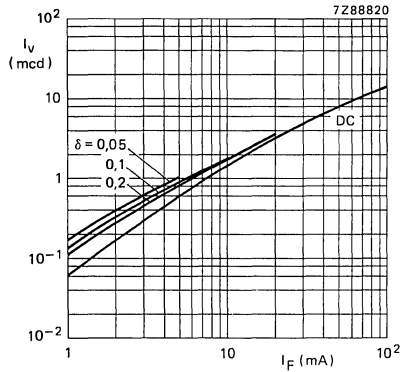

Fig. 7 $t_p = 50 \mu s$; typ. values.

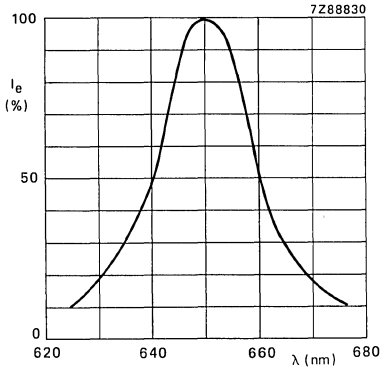

Fig. 8 $I_F = 10 \text{ mA}$; $T_{amb} = 25 \text{ }^\circ\text{C}$; typ. values.

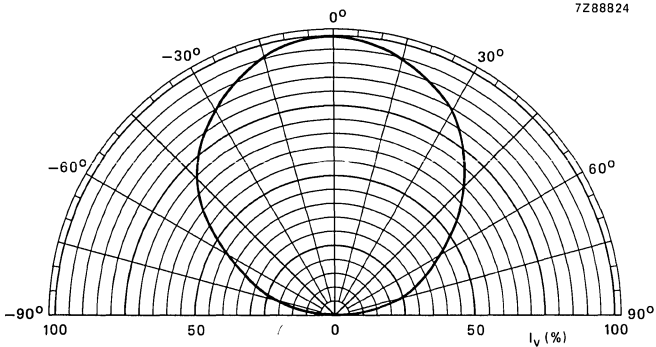

Fig. 9 Typical values.

DEVELOPMENT SAMPLE DATA

This information is derived from development samples made available for evaluation. It does not necessarily imply that the device will go into regular production.

CQV71A
CQV71AL

LIGHT EMITTING DIODES

Rectangular light emitting diodes of 3 mm x 5 mm which emit super-green light when forward biased. The CQV71A(L) has a SOD-77 envelope and is encapsulated in a medium-green coloured resin with a diffusing zone cast on the top.

When stacked in an array these LEDs with other SOD-77 LEDs can be used e.g. as a level indicator. The CQV71AL is similar to the CQV71A but has long leads and has no seating plane.

QUICK REFERENCE DATA

Continuous reverse voltage	V_R	max.	5 V
Forward current (d.c.)	I_F	max.	60 mA
Total power dissipation up to $T_{amb} = 35\text{ }^\circ\text{C}$	P_{tot}	max.	180 mW
Junction temperature	T_j	max.	100 $^\circ\text{C}$
Luminous intensity			
$I_F = 10\text{ mA}$	CQV71A(L)	I_v	min. 0,5 mcd
	CQV71A(L)-II	I_v	1,0 to 2,2 mcd
	CQV71A(L)-III	I_v	1,6 to 3,5 mcd
	CQV71A(L)-IV	I_v	3 to 7 mcd
Wavelength at peak emission			
$I_F = 10\text{ mA}$	λ_{pk}	typ.	565 nm
Beamwidth between half-intensity directions in the plane of the leads; $I_F = 10\text{ mA}$	$\alpha_{50\%}$	typ.	100 $^\circ$

MECHANICAL DATA

Fig. 1a SOD-77A1.
CQV71A

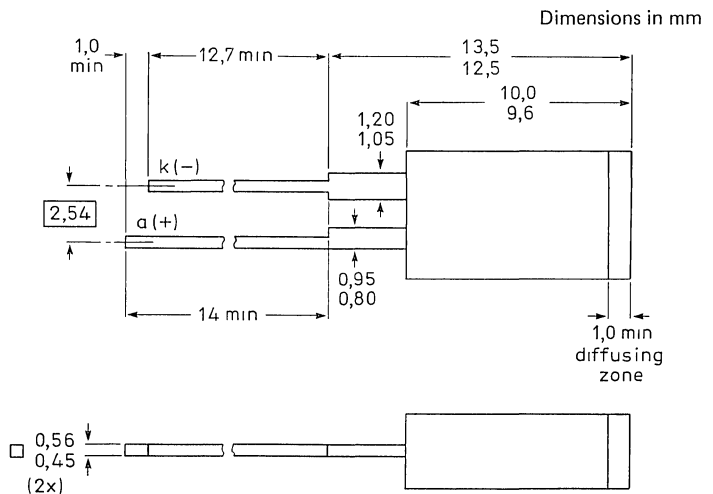
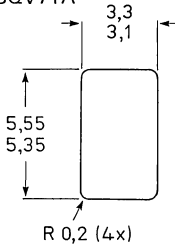

7Z86981

CQV71A
CQV71AL

Fig. 1b SOD-77L.
CQV71AL

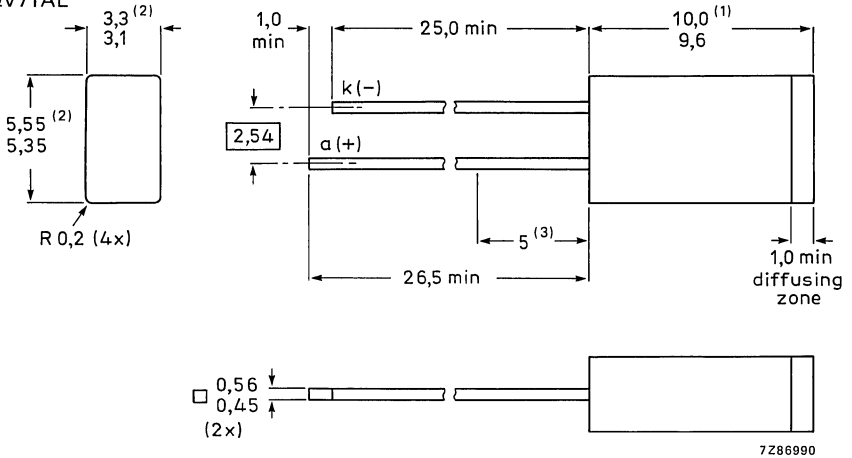

Notes

1. Measured when the device is seated in a gauge with 2 holes 0,80 mm diameter and 2,54 mm apart.
2. Maximum value including burrs.
3. Solderability not guaranteed within this zone due to tie-bar cropping.

RATINGS

Limiting values in accordance with the Absolute Maximum System (IEC 134)

Reverse voltage	V_R	max.	5 V
Forward current			
d.c.	I_F	max.	60 mA
peak value; $t_p = 1 \mu s$; $f = 300 \text{ Hz}$	I_{FM}	max.	1 A
peak value; $t_{on} = 1 \text{ ms}$; $\delta = 0,01$		max.	150 mA
Total power dissipation up to $T_{amb} = 35 \text{ }^\circ\text{C}$	P_{tot}	max.	180 mW
Storage temperature	T_{stg}		-55 to +100 $^\circ\text{C}$
Junction temperature	T_j	max.	100 $^\circ\text{C}$
Lead soldering temperature at $t_{sld} < 7 \text{ s}$			
> 1,5 mm from the seating plane for CQV71A	T_{sld}	max.	260 $^\circ\text{C}$
> 5 mm from the plastic body for CQV71AL			

THERMAL RESISTANCE

From junction to ambient when the device is mounted on a p.c. board	$R_{th \text{ j-a}}$	max.	350 K/W
---	----------------------	------	---------

CHARACTERISTICS

$T_j = 25 \text{ }^\circ\text{C}$ unless otherwise specified

Forward voltage			
$I_F = 10 \text{ mA}$	V_F	typ.	2,1 V
		max.	3,0 V

Reverse current

$V_R = 5 \text{ V}$

I_R max. 100 μA

Beamwidth between half-intensity directions
in the plane of the leads; $I_F = 10 \text{ mA}$

$\alpha_{50\%}$ typ. 100 $^\circ$

Bandwidth at half height

$B_{50\%}$ typ. 30 nm

Wavelength at peak emission

$I_F = 10 \text{ mA}$

λ_{pk} typ. 565 nm

Luminous intensity

$I_F = 10 \text{ mA}$

CQV71A(L) I_V min. 0,5 mcd

CQV71A(L)-II I_V 1,0 to 2,2 mcd

CQV71A(L)-III I_V 1,6 to 3,5 mcd

CQV71A(L)-IV I_V 3 to 7 mcd

Diode capacitance

$V_R = 0$; $f = 1 \text{ MHz}$

C_d typ. 35 pF

DEVELOPMENT SAMPLE DATA

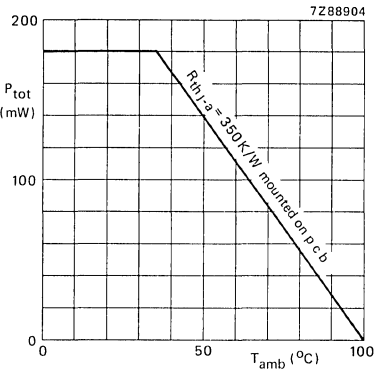

Fig. 2.

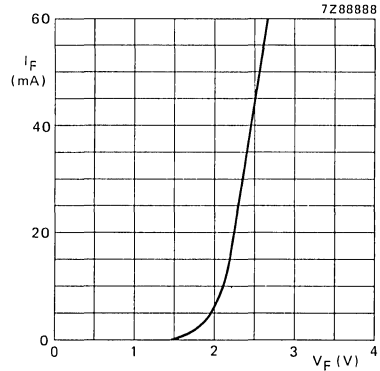

Fig. 3 $T_{amb} = 25^\circ\text{C}$; typical values.

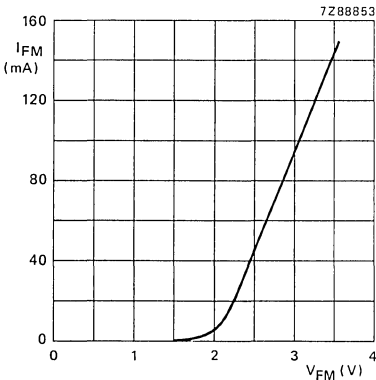

Fig. 4 $t_{on} = 1 \text{ ms}$; $\delta = 0,01$;
 $T_j = 25^\circ\text{C}$; typical values.

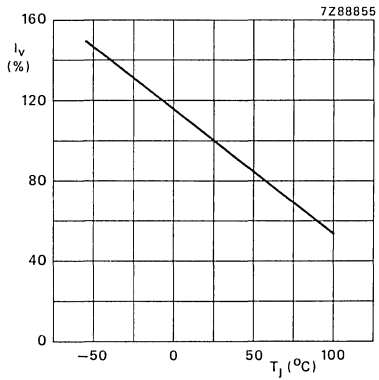

Fig. 5 Typical values.

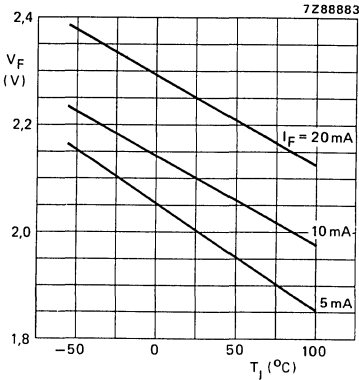

Fig. 6 $I_F = 10 \text{ mA}$; typical values.

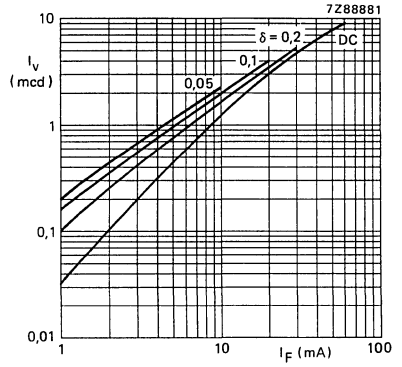

Fig. 7 $t_p = 50 \mu\text{s}$; typical values.

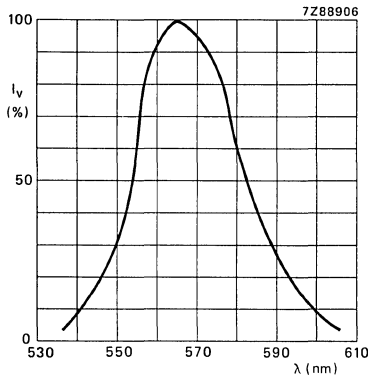

Fig. 8 Typical values.

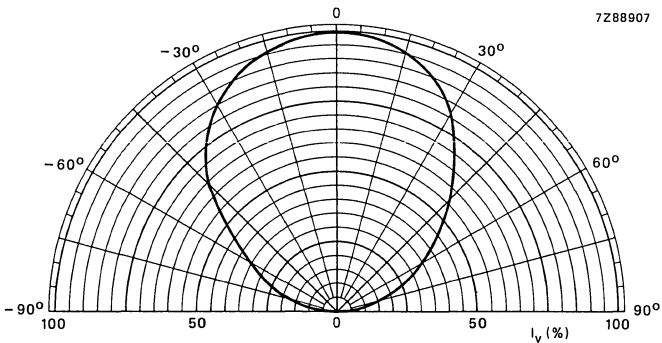

Fig. 9 Typical values.

DEVELOPMENT SAMPLE DATA

This information is derived from development samples made available for evaluation. It does not necessarily imply that the device will go into regular production

CQV72
CQV72L

LIGHT EMITTING DIODES

Rectangular light emitting diodes of 3 mm x 5 mm which emit yellow light when forward biased. The CQV72 (and CQV72L) has a SOD-77 envelope and is encapsulated in a medium-yellow coloured resin with a diffusing zone cast on the top.

When stacked in an array these SOD-77 LEDs can be used e.g. as a level indicator. The CQV72L is similar to the CQV72 but has long leads and has no seating plane.

QUICK REFERENCE DATA

Continuous reverse voltage	V_R	max.	5 V
Forward current (d.c.)	I_F	max.	30 mA
Total power dissipation up to $T_{amb} = 65\text{ }^\circ\text{C}$	P_{tot}	max.	90 mW
Junction temperature	T_j	max.	100 $^\circ\text{C}$
Luminous intensity			
$I_F = 10\text{ mA}$	CQV72(L)	I_v	min. 0,5 mcd
	CQV72(L)-II	I_v	1,0 to 2,2 mcd
	CQV72(L)-III	I_v	1,6 to 3,5 mcd
Wavelength at peak emission			
$I_F = 10\text{ mA}$	λ_{pk}	typ.	590 nm
Beamwidth between half-intensity directions in the plane of the leads; $I_F = 10\text{ mA}$	$\alpha_{50\%}$	typ.	100 $^\circ$

MECHANICAL DATA

Dimensions in mm

Fig. 1a SOD-77A1.
CQV72

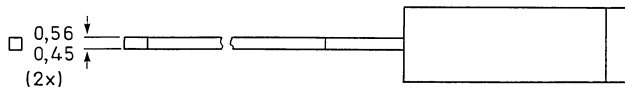
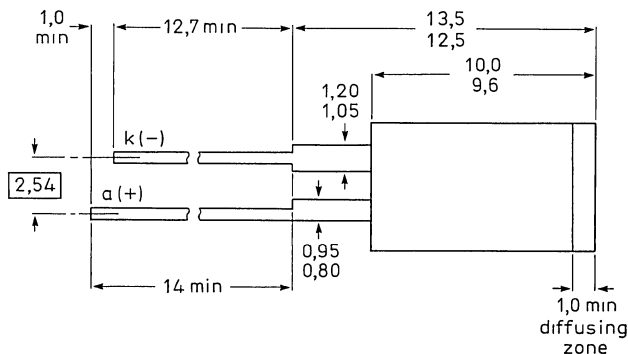
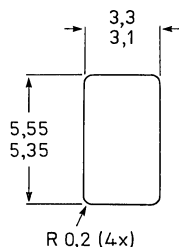

7Z86981

CQV72
CQV72L

Fig. 1b SOD-77L.
CQV72L

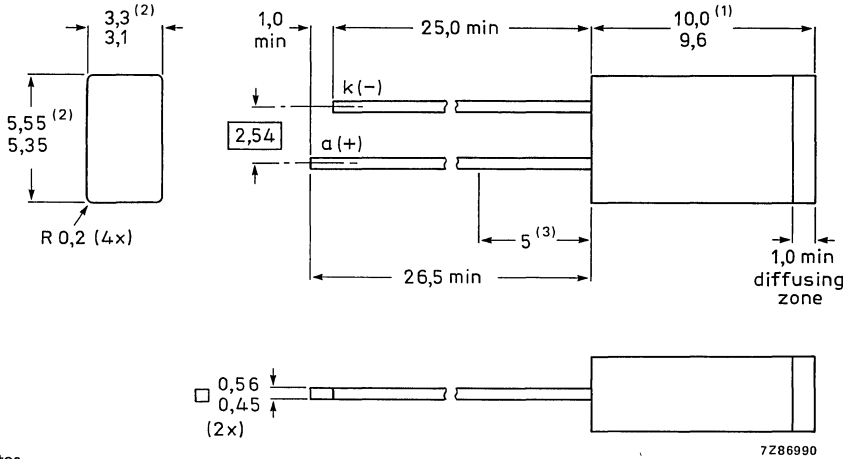

Notes

1. Measured when the device is seated in a gauge with 2 holes 0,80 mm in diameter and 2,54 mm apart.
2. Maximum value including plastic burrs.
3. Solderability not guaranteed within this zone due to tie-bar cropping.

RATINGS

Limiting values in accordance with the Absolute Maximum System (IEC 134)

Reverse voltage	V_R	max.	5 V
Forward current	I_F	max.	30 mA
d.c.	I_{FM}	max.	1 A
peak value; $t_p = 1 \mu s$; $f = 300 \text{ Hz}$	I_{FM}	max.	60 mA
peak value; $t_{ON} = 1 \text{ ms}$; $\delta = 0,33$	P_{tot}	max.	90 mW
Total power dissipation up to $T_{amb} = 65 \text{ }^\circ\text{C}$	T_{stg}		-55 to +100 $^\circ\text{C}$
Storage temperature	T_j	max.	100 $^\circ\text{C}$
Junction temperature	T_{sld}	max.	260 $^\circ\text{C}$
Lead soldering temperature at $t_{sld} < 7 \text{ s}$			
> 1,5 mm from the seating plane for CQV72			
> 5 mm from the plastic body for CQV72L			

THERMAL RESISTANCE

From junction to ambient when the device is mounted on a p.c. board	$R_{th \text{ j-a}}$	max.	350 K/W
---	----------------------	------	---------

CHARACTERISTICS

$T_j = 25 \text{ }^\circ\text{C}$ unless otherwise specified

Forward voltage	V_F	typ.	2,1 V
$I_F = 10 \text{ mA}$		max.	3,0 V

Reverse current

$V_R = 5 \text{ V}$

I_R max. 100 μA

Beamwidth between half-intensity directions
in the plane of the leads; $I_F = 10 \text{ mA}$

$\alpha_{50\%}$ typ. 100 $^\circ$

Bandwidth at half height

$B_{50\%}$ typ. 30 nm

Wavelength at peak emission

$I_F = 10 \text{ mA}$

λ_{pk} typ. 590 nm

Luminous intensity

$I_F = 10 \text{ mA}$

CQV72(L) I_V min. 0,5 mCd

CQV72(L)-II I_V 1,0 to 2,2 mCd

CQV72(L)-III I_V 1,6 to 3,5 mCd

Diode capacitance

$V_R = 0; f = 1 \text{ MHz}$

C_d typ. 35 pF

DEVELOPMENT SAMPLE DATA

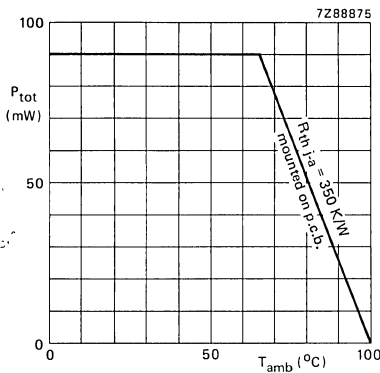

Fig. 2.

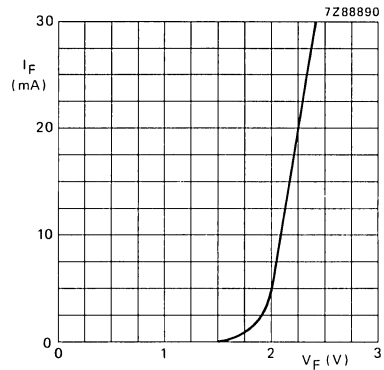

Fig. 3 $T_{amb} = 25 \text{ }^\circ\text{C}$; typ. values.

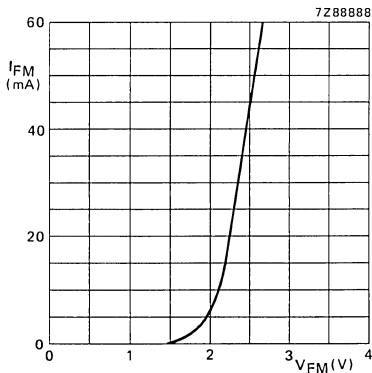

Fig. 4 $t_{on} = 50 \mu\text{s}$; $\delta = 0,01$;
 $T_{amb} = 25 \text{ }^\circ\text{C}$; typ. values.

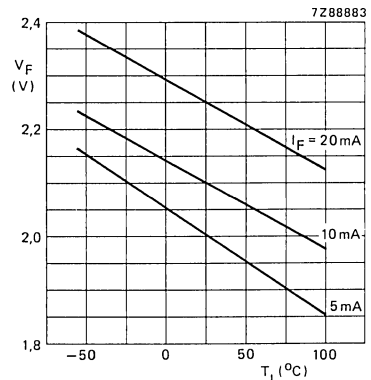

Fig. 5 Typical values.

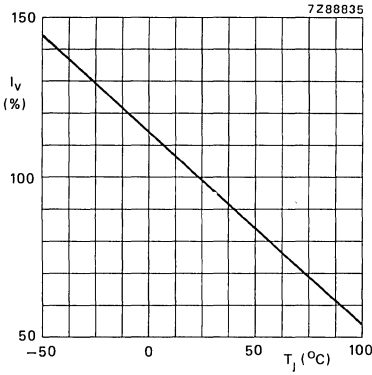

Fig. 6 $I_F = 10 \text{ mA}$; typ. values.

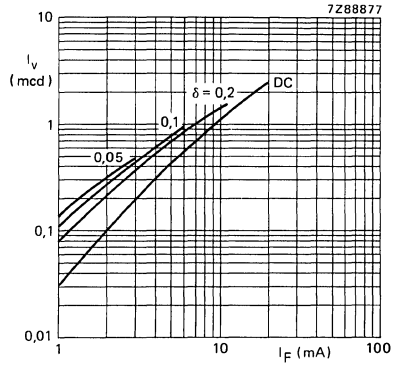

Fig. 7 $t_P = 50 \mu\text{s}$; typ. values.

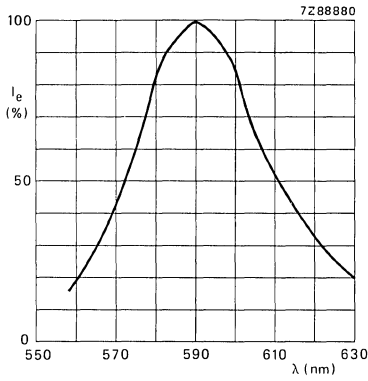

Fig. 8 Typical values.

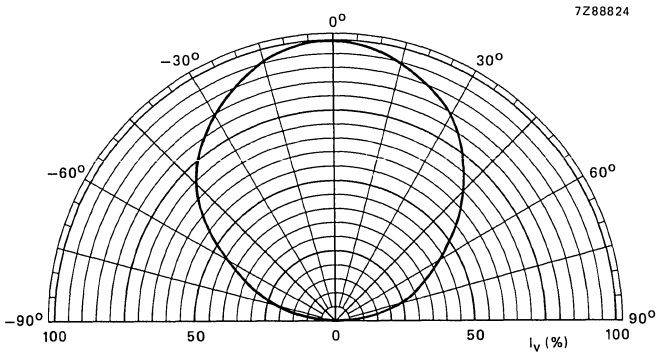

Fig. 9 Typical values.

DEVELOPMENT SAMPLE DATA

This information is derived from development samples made available for evaluation. It does not necessarily imply that the device will go into regular production.

CQV80L

LIGHT EMITTING DIODE

Rectangular light emitting diode of 5 mm x 5 mm which emits super-red light when forward biased. The CQV80L has a SOD-74L envelope and is encapsulated in a transparent resin with a medium-red coloured diffusing zone cast on the top.

These SOD-74 LEDs are very suitable for surface illumination, for example in information boards, score boards, moving advertisement and electronic game applications.

The CQV80L has long leads and has no seating plane.

QUICK REFERENCE DATA

Continuous reverse voltage	V_R	max.	5 V
Forward current (d.c.)	I_F	max.	30 mA
Total power dissipation up to $T_{amb} = 65\text{ }^\circ\text{C}$	P_{tot}	max.	90 mW
Junction temperature	T_j	max.	100 $^\circ\text{C}$
Luminous intensity			
$I_F = 10\text{ mA}$	CQV80L	I_v	min. 0,5 mcd
	CQV80L-II	I_v	1,0 to 2,2 mcd
	CQV80L-III	I_v	1,6 to 3,5 mcd
Wavelength at peak emission			
$I_F = 10\text{ mA}$		λ_{pk}	typ. 630 nm
Beamwidth between half-intensity directions			
$I_F = 10\text{ mA}$		$\alpha_{50\%}$	typ. 100 $^\circ$

MECHANICAL DATA

Fig. 1 SOD-74L

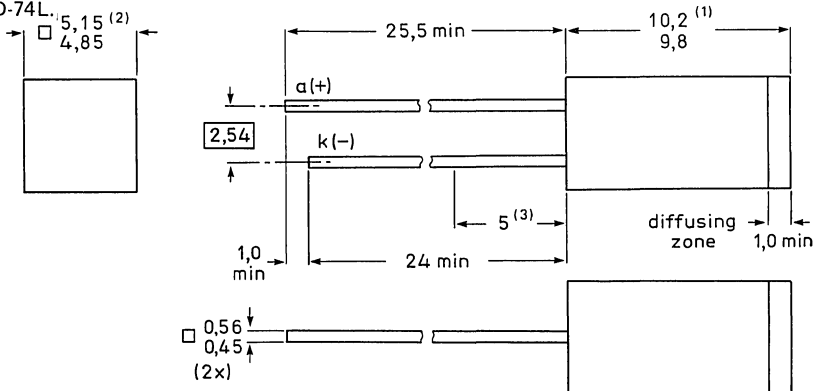

Notes

1. Measured when the device is seated in a gauge with 2 holes 0,80 mm in diameter and 2,54 mm apart.
2. Maximum value including plastic burrs.
3. Solderability not guaranteed within this zone due to tie-bar cropping.

RATINGS

Limiting values in accordance with the Absolute Maximum System (IEC 134)

Reverse voltage	V_R	max.	5 V
Forward current			
d.c.	I_F	max.	30 mA
peak value; $t_p = 1 \mu s$; $f = 300 \text{ Hz}$		max.	1 A
peak value; $t_{on} = 1 \text{ ms}$; $\delta = 0,33$	I_{FM}	max.	60 mA
Total power dissipation up to $T_{amb} = 65 \text{ }^\circ\text{C}$	P_{tot}	max.	90 mW
Storage temperature	T_{stg}		-55 to +100 $^\circ\text{C}$
Junction temperature	T_j	max.	100 $^\circ\text{C}$
Lead soldering temperature			
> 5,0 mm from the plastic body; $t_{std} < 7 \text{ s}$	T_{sld}	max.	260 $^\circ\text{C}$

THERMAL RESISTANCE

From junction to ambient when the device is mounted on a p.c. board

$R_{th \text{ j-a}}$	max.	350 K/W
----------------------	------	---------

CHARACTERISTICS

$T_j = 25 \text{ }^\circ\text{C}$ unless otherwise specified

Forward voltage				
$I_F = 10 \text{ mA}$	V_F	typ.	2,1 V	
		max.	3,0 V	
Reverse current				
$V_R = 5 \text{ V}$	I_R	max.	100 μA	
Beamwidth between half-intensity directions				
$I_F = 10 \text{ mA}$	$\alpha_{50\%}$	typ.	100 $^\circ$	
Bandwidth at half height	$B_{50\%}$	typ.	45 nm	
Wavelength at peak emission				
$I_F = 10 \text{ mA}$	λ_{pk}	typ.	630 nm	
Luminous intensity				
$I_F = 10 \text{ mA}$	CQV80L	I_v	min. 0,5 mcd	
	CQV80L-II	I_v	1,0 to 2,2 mcd	
	CQV80L-III	I_v	1,6 to 3,5 mcd	
Diode capacitance				
$V_R = 0$; $f = 1 \text{ MHz}$	C_d	typ.	35 pF	

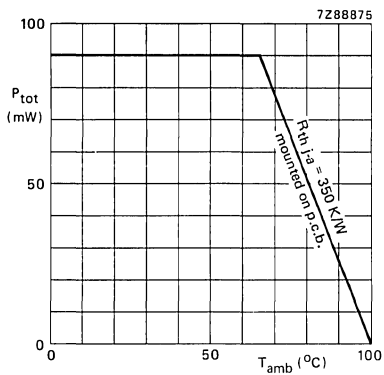

Fig. 2.

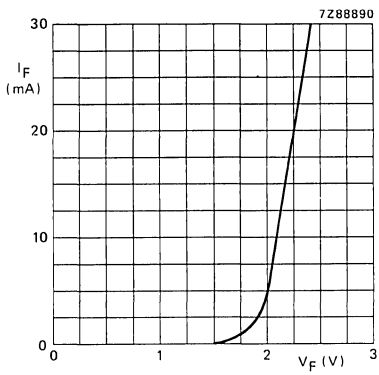

Fig. 3 $T_{amb} = 25^{\circ}C$; typ. values.

DEVELOPMENT SAMPLE DATA

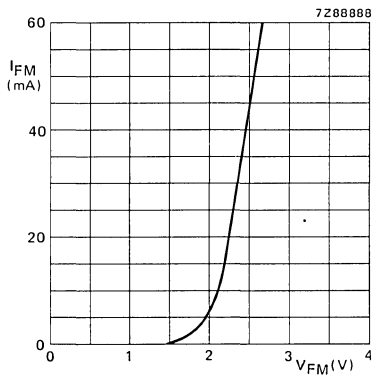

Fig. 4 $t_{on} = 50 \mu s$; $\delta = 0,01$;
 $T_{amb} = 25^{\circ}C$; typ. values.

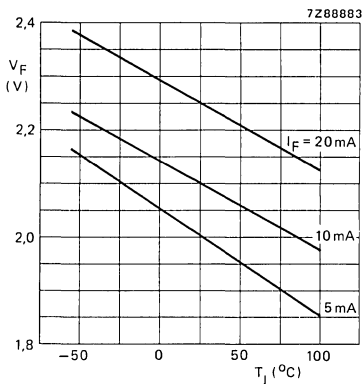

Fig. 5 Typical values.

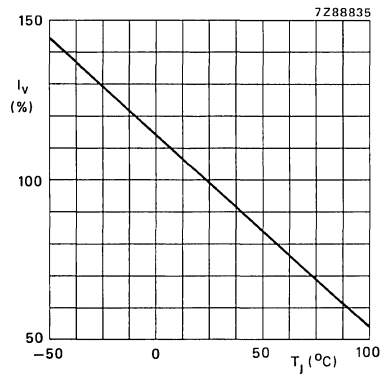

Fig. 6 $I_F = 10 \text{ mA}$; typ. values.

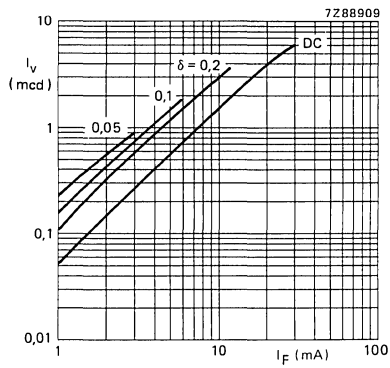

Fig. 7 $t_p = 50 \mu s$; typ. values.

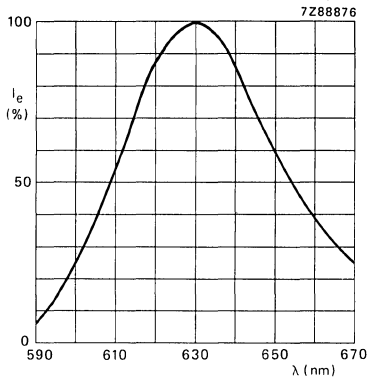

Fig. 8 Typical values.

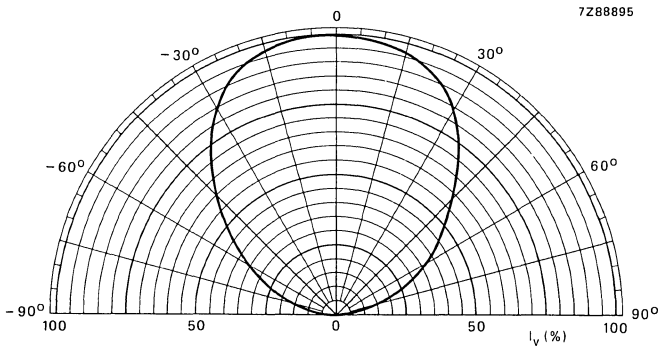

Fig. 9 Typical values.

DEVELOPMENT SAMPLE DATA

This information is derived from development samples made available for evaluation. It does not necessarily imply that the device will go into regular production.

CQV80AL

LIGHT EMITTING DIODE

Rectangular light emitting diode of 5 mm x 5 mm which emits hyper-red light (GaAlAs) when forward biased. The CQV80AL has a SOD-74L envelope and is encapsulated in a transparent resin with a medium-red coloured diffusing zone cast on the top. The CQV80AL has long leads but has no seating plane.

This LED is very suitable for surface illumination, for example in information boards, score boards, moving advertisements and electronic games applications. Because of its high light intensity the CQV80AL is also very suitable in applications where only very low currents are available and because of its high I_{Fmax} it can be used in high I_V applications.

QUICK REFERENCE DATA

Continuous reverse voltage	V_R	max.	5 V
Forward current (d.c.)	I_F	max.	100 mA
Total power dissipation up to $T_{amb} = 25\text{ }^\circ\text{C}$	P_{tot}	max.	215 mW
Junction temperature	T_j	max.	100 $^\circ\text{C}$
Luminous intensity			
$I_F = 10\text{ mA}$	CQV80AL	I_V	min. 1,0 mcd
	CQV80AL-III	I_V	1,6 to 3,5 mcd
	CQV80AL-IV	I_V	3,0 to 7,0 mcd
Wavelength at peak emission			
$I_F = 10\text{ mA}$		λ_{pk}	typ. 650 nm
Beamwidth between half-intensity directions			
$I_F = 10\text{ mA}$		$\alpha_{50\%}$	typ. 100 $^\circ$

MECHANICAL DATA

Dimensions in mm

Fig. 1 SOD-74L.

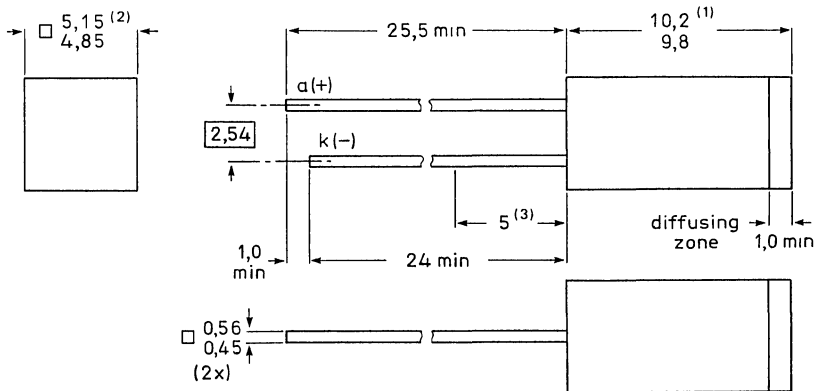

Notes

1. Measured when the device is seated in a gauge with 2 holes 0,80 mm diameter and 2,54 mm apart.
2. Maximum value including plastic burrs.
3. Solderability not guaranteed within this zone due to tie-bar cropping.

RATINGS

Limiting values in accordance with the Absolute Maximum System (IEC 134)

Reverse voltage	V_R	max.	5 V
Forward current			
d.c.	I_F	max.	100 mA
peak value; $t_p = 1 \mu s$; $f = 300 \text{ Hz}$		max.	1 A
peak value; $t_{on} = 20 \mu s$; $\delta = 0,01$	I_{FM}	max.	500 mA
Total power dissipation up to $T_{amb} = 25 \text{ }^\circ\text{C}$	P_{tot}	max.	215 mW
Storage temperature	T_{stg}		-55 to +100 $^\circ\text{C}$
Junction temperature	T_j	max.	100 $^\circ\text{C}$
Lead soldering temperature			
> 5,0 mm from the plastic body; $t_{sld} < 7 \text{ s}$	T_{sld}	max.	260 $^\circ\text{C}$

THERMAL RESISTANCE

From junction to ambient when the device is mounted on a p.c. board	$R_{th j-a}$	max.	350 K/W
---	--------------	------	---------

CHARACTERISTICS

$T_j = 25 \text{ }^\circ\text{C}$ unless otherwise specified

Forward voltage				
$I_F = 10 \text{ mA}$	V_F	typ.	1,75 V	
		max.	2,2 V	
Reverse current				
$V_R = 5 \text{ V}$	I_R	max.	100 μA	
Beamwidth between half-intensity directions				
$I_F = 10 \text{ mA}$	$\alpha_{50\%}$	typ.	100 $^\circ$	
Bandwidth at half height	$B_{50\%}$	typ.	20 nm	
Wavelength at peak emission				
$I_F = 10 \text{ mA}$	λ_{pk}	typ.	650 nm	
Luminous intensity				
$I_F = 10 \text{ mA}$	CQV80AL I_v	min.	1,0 mcd	
	CQV80AL-III I_v	1,6 to	3,5 mcd	
	CQV80AL-IV I_v	3,0 to	7,0 mcd	
Diode capacitance				
$V_R = 0$; $f = 1 \text{ MHz}$	C_d	typ.	60 pF	

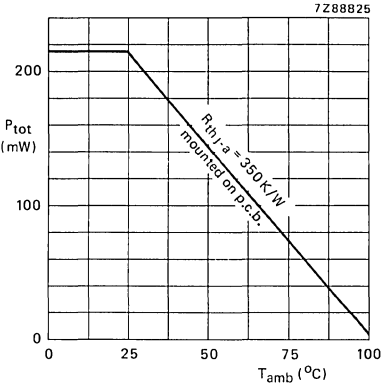

Fig. 2.

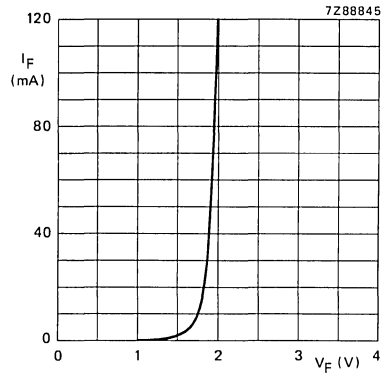

Fig. 3 $T_{amb} = 25 \text{ }^\circ\text{C}$; typ. values.

DEVELOPMENT SAMPLE DATA

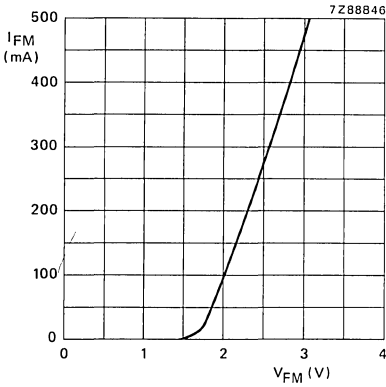

Fig. 4 $t_{ON} = 20 \text{ } \mu\text{s}$; $\delta = 0,01$;
 $T_{amb} = 25 \text{ }^\circ\text{C}$; typ. values.

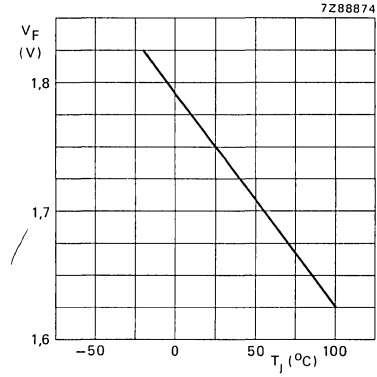

Fig. 5 $I_F = 10 \text{ mA}$; typ. values.

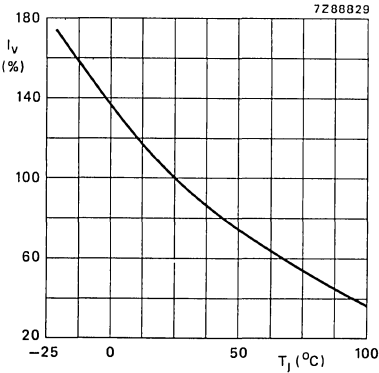

Fig. 6 Typical values.

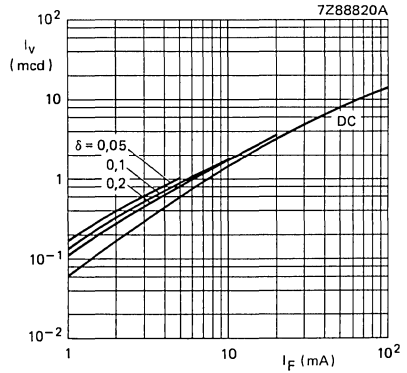

Fig. 7 $t_p = 50 \text{ } \mu\text{s}$; typ. values.

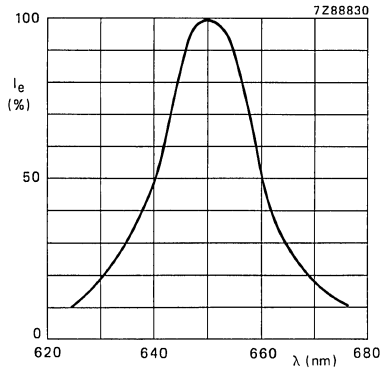

Fig. 8 $I_F = 10 \text{ mA}$; $T_{amb} = 25 \text{ }^\circ\text{C}$; typ. values.

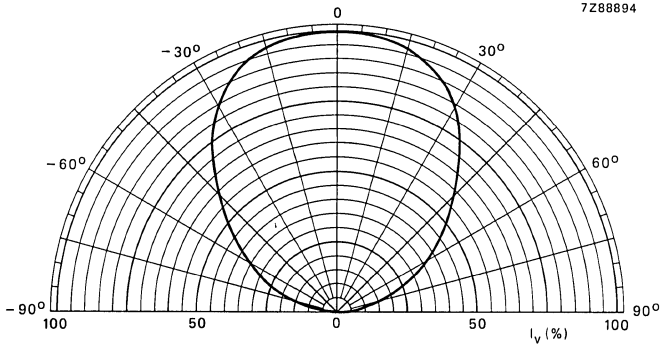

Fig. 9 Typical values.

DEVELOPMENT SAMPLE DATA

This information is derived from development samples made available for evaluation. It does not necessarily imply that the device will go into regular production.

CQV81L

LIGHT EMITTING DIODE

Rectangular light emitting diode of 5 mm x 5 mm which emits super-green light (GaP) when forward biased. The CQV81L has a SOD-74L envelope and is encapsulated in a transparent resin with a medium-green coloured diffusing zone cast on the top. This LED has long leads and no seating plane.

These SOD-74 LEDs are very suitable for surface illumination, for example in information boards, score boards, moving advertisement and electronic game applications.

QUICK REFERENCE DATA

Continuous reverse voltage	V_R	max.	5 V
Forward current (d.c.)	I_F	max.	60 mA
Total power dissipation up to $T_{amb} = 35\text{ }^\circ\text{C}$	P_{tot}	max.	180 mW
Junction temperature	T_j	max.	100 $^\circ\text{C}$
Luminous intensity			
$I_F = 10\text{ mA}$	CQV81L	I_v	min. 0,5 mcd
	CQV81L-II	I_v	1,0 to 2,2 mcd
	CQV81L-III	I_v	1,6 to 3,5 mcd
Wavelength at peak emission			
$I_F = 10\text{ mA}$		λ_{pk}	typ. 565 nm
Beamwidth between half-intensity directions			
$I_F = 10\text{ mA}$		$\alpha_{50\%}$	typ. 100 $^\circ$

MECHANICAL DATA

Dimensions in mm

Fig. 1 SOD-74L.

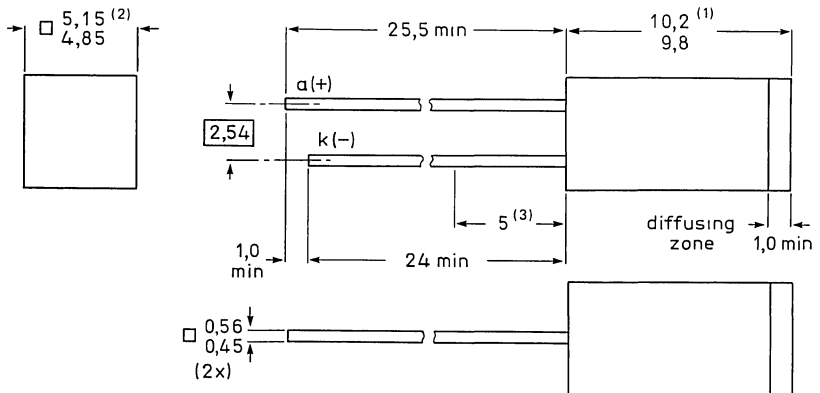

Notes

7Z86913 1

1. Measured when the device is seated in a gauge with 2 holes 0,80 mm diameter 2,54 mm apart.
2. Maximum value including plastic burrs.
3. Solderability not guaranteed within this zone due to tie-bar cropping.

RATINGS

Limiting values in accordance with the Absolute Maximum System (IEC 134)

Reverse voltage	V_R	max.	5 V
Forward current			
d.c.	I_F	max.	60 mA
peak value; $t_p = 1 \mu s$; $f = 300 \text{ Hz}$		max.	1 A
peak value; $t_{on} = 1 \text{ ms}$; $\delta = 0,33$	I_{FM}	max.	150 mA
Total power dissipation up to $T_{amb} = 35 \text{ }^\circ\text{C}$	P_{tot}	max.	180 mW
Storage temperature	T_{stg}		-55 to +100 $^\circ\text{C}$
Junction temperature	T_j	max.	100 $^\circ\text{C}$
Lead soldering temperature			
> 5,0 mm from the plastic body; $t_{sld} < 7 \text{ s}$	T_{sld}	max.	260 $^\circ\text{C}$

THERMAL RESISTANCE

From junction to ambient when the device is mounted on a p.c. board

$R_{th j-a}$	max.	350 K/W
--------------	------	---------

CHARACTERISTICS

$T_j = 25 \text{ }^\circ\text{C}$ unless otherwise specified

Forward voltage				
$I_F = 10 \text{ mA}$	V_F	typ.	2,1 V	
		max.	3,0 V	
Reverse current				
$V_R = 5 \text{ V}$	I_R	max.	100 μA	
Beamwidth between half-intensity directions				
$I_F = 10 \text{ mA}$	$\alpha_{50\%}$	typ.	100 $^\circ$	
Bandwidth at half height	$B_{50\%}$	typ.	30 nm	
Wavelength at peak emission				
$I_F = 10 \text{ mA}$	λ_{pk}	typ.	565 nm	
Luminous intensity				
$I_F = 10 \text{ mA}$				
	CQV81L	I_v	min.	0,5 mcd
	CQV81L-II	I_v	1,0 to	2,2 mcd
	CQV81L-III	I_v	1,6 to	3,5 mcd
Diode capacitance				
$V_R = 0$; $f = 1 \text{ MHz}$	C_d	typ.	35 pF	

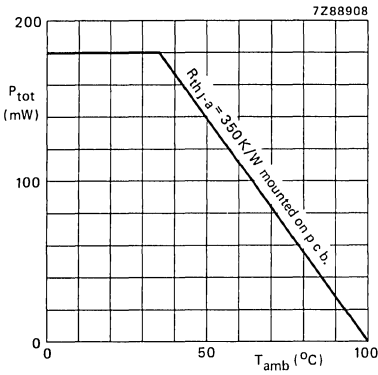

Fig. 2.

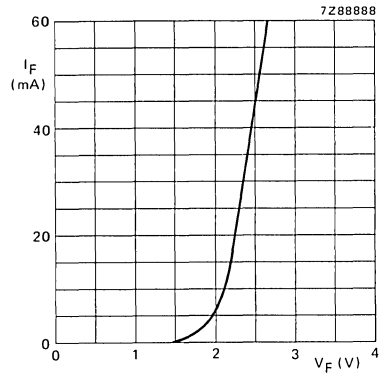

Fig. 3 $T_{amb} = 25^\circ\text{C}$; typical values.

DEVELOPMENT SAMPLE DATA

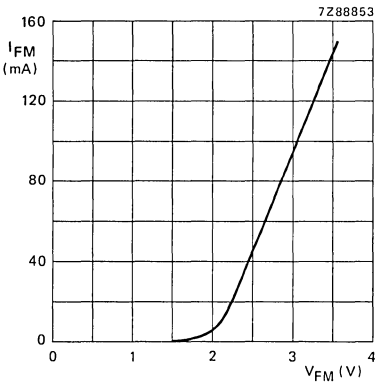

Fig. 4 $t_{on} = 50 \mu\text{s}$; $\delta = 0,01$;
 $T_{amb} = 25^\circ\text{C}$; typical values.

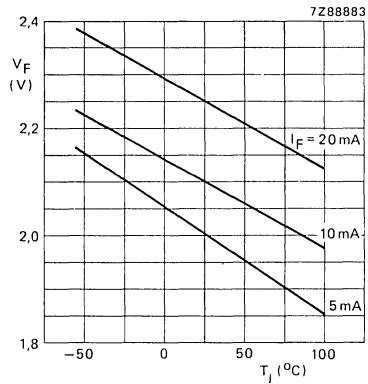

Fig. 5 Typical values.

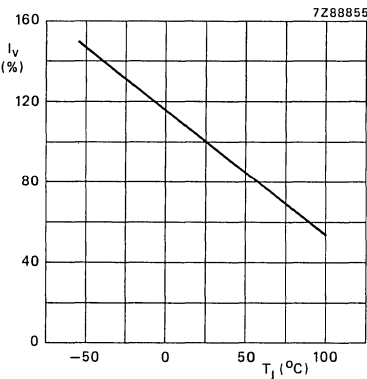

Fig. 6 $I_F = 10 \text{ mA}$; typical values.

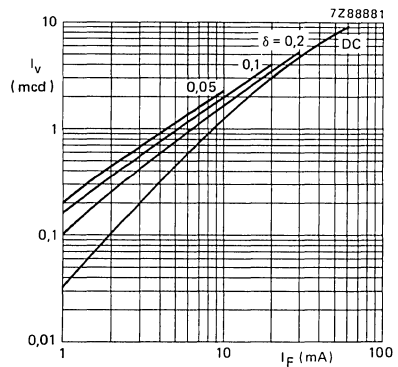

Fig. 7 $t_p = 50 \mu\text{s}$; typical values.

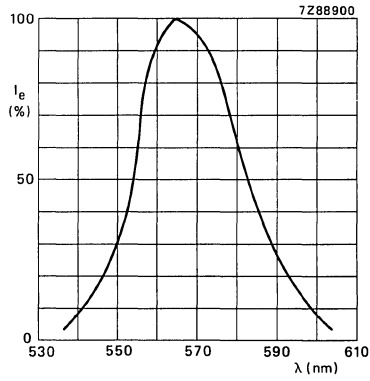

Fig. 8 Typical values.

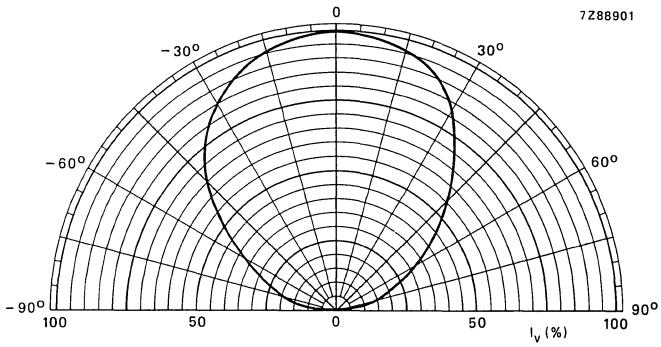

Fig. 9 Typical values.

DEVELOPMENT SAMPLE DATA

This information is derived from development samples made available for evaluation. It does not necessarily imply that the device will go into regular production.

CQV82L

LIGHT EMITTING DIODE

Rectangular light emitting diode of 5 mm x 5 mm which emits yellow light (GaPAs) when forward biased. The CQV82L has a SOD-74L envelope and is encapsulated in a transparent resin with a medium-yellow coloured diffusing zone cast on the top. These SOD-74 LEDs are very suitable for surface illumination, for example in information boards, score boards, moving advertisement and electronic game applications.

The CQV82L has long leads and has no seating plane.

QUICK REFERENCE DATA

Continuous reverse voltage	V_R	max.	5 V
Forward current (d.c.)	I_F	max.	30 mA
Total power dissipation up to $T_{amb} = 65\text{ }^\circ\text{C}$	P_{tot}	max.	90 mW
Junction temperature	T_j	max.	100 $^\circ\text{C}$
Luminous intensity			
$I_F = 10\text{ mA}$	CQV82L	I_v	min. 0,5 mcd
	CQV82L-II	I_v	1,0 to 2,2 mcd
	CQV82L-III	I_v	1,6 to 3,5 mcd
Wavelength at peak emission			
$I_F = 10\text{ mA}$		λ_{pk}	typ. 590 nm
Beamwidth between half-intensity directions		$\alpha_{50\%}$	typ. 100 $^\circ$

MECHANICAL DATA

Fig. 1 SOD-74L

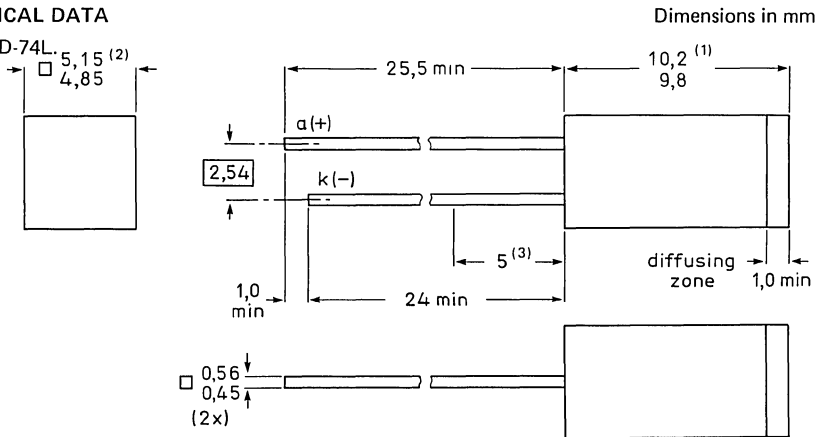

Notes

1. Measured when the device is seated in a gauge with 2 holes 0,80 mm diameter and 2,54 mm apart.
2. Maximum value including plastic burrs.
3. Solderability not guaranteed within this zone due to tie-bar cropping.

7286913 1

RATINGS

Limiting values in accordance with the Absolute Maximum System (IEC 134)

Reverse voltage	V_R	max.	5 V
Forward current			
d.c.	I_F	max.	30 mA
peak value; $t_p = 1 \mu s$; $f = 300 \text{ Hz}$		max.	1 A
peak value; $t_{on} = 1 \text{ ms}$; $\delta = 0,33$	I_{FM}	max.	60 mA
Total power dissipation up to $T_{amb} = 65 \text{ }^\circ\text{C}$	P_{tot}	max.	90 mW
Storage temperature	T_{stg}		-55 to +100 $^\circ\text{C}$
Junction temperature	T_j	max.	100 $^\circ\text{C}$
Lead soldering temperature			
> 5,0 mm from the plastic body; $t_{sld} < 7 \text{ s}$	T_{sld}	max.	260 $^\circ\text{C}$

THERMAL RESISTANCE

From junction to ambient when the device is mounted on a p.c. board

$R_{th \text{ j-a}}$	max.	350 K/W
----------------------	------	---------

CHARACTERISTICS

$T_j = 25 \text{ }^\circ\text{C}$ unless otherwise specified

Forward voltage	V_F	typ.	2,1 V
		max.	3,0 V
Reverse current			
$V_R = 5 \text{ V}$	I_R	max.	100 μA
Beamwidth between half-intensity directions			
$I_F = 10 \text{ mA}$	$\alpha_{50\%}$	typ.	100 $^\circ$
Bandwidth at half height	$B_{50\%}$	typ.	40 nm
Wavelength at peak emission			
$I_F = 10 \text{ mA}$	λ_{pk}	typ.	590 nm
Luminous intensity			
$I_F = 10 \text{ mA}$	CQV82L	I_v	min. 0,5 mcd
	CQV82L-II	I_v	1,0 to 2,2 mcd
	CQV82L-III	I_v	1,6 to 3,5 mcd
Diode capacitance			
$V_R = 0$; $f = 1 \text{ MHz}$	C_d	typ.	35 pF

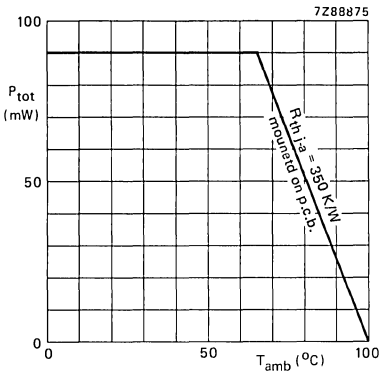

Fig. 2.

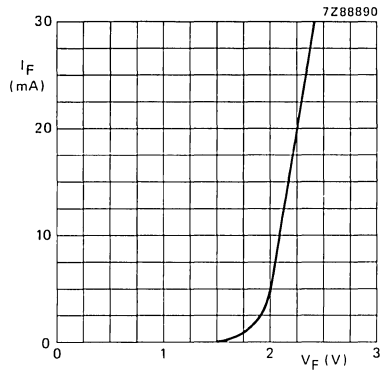

Fig. 3 Typical values.

DEVELOPMENT SAMPLE DATA

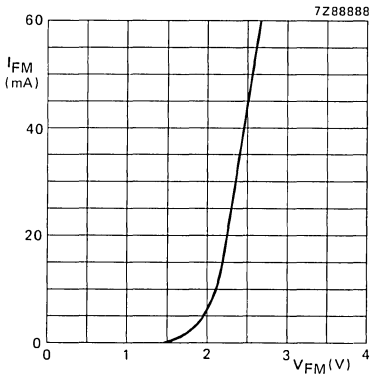

Fig. 4 $t_{ON} = 50 \mu s$; $\delta = 0,01$;
 $T_{amb} = 25 \text{ }^\circ\text{C}$; typ. values.

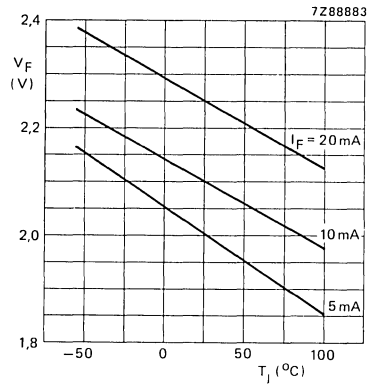

Fig. 5 Typical values.

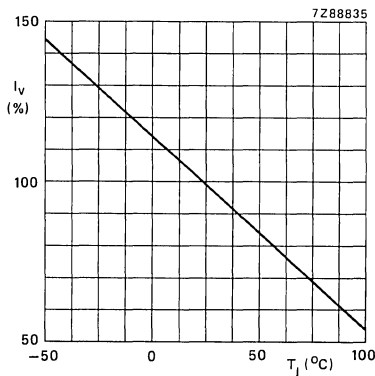

Fig. 6 $I_F = 10 \text{ mA}$; typ. values.

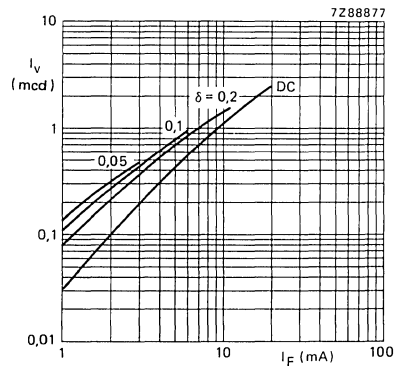

Fig. 7 $t_p = 50 \mu s$; typ. values.

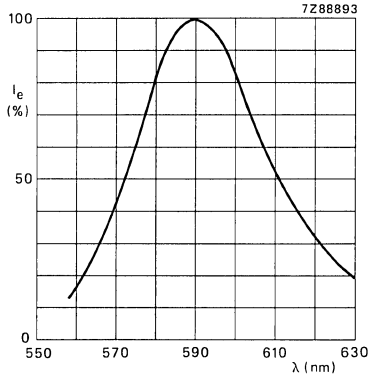

Fig. 8 Typical values.

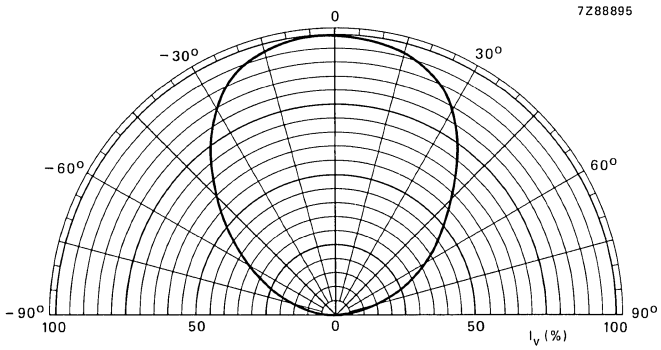

Fig. 9 Typical values.

DEVELOPMENT SAMPLE DATA

This information is derived from development samples made available for evaluation. It does not necessarily imply that the device will go into regular production.

CQW10 CQW10L
CQW10B CQW10BL

LIGHT EMITTING DIODES

The CQW10 and CQW10B are 2,5 mm x 5 mm rectangular light emitting diodes which emit super-red light (GaPAs) when forward biased.

These LEDs have a SOD-76 envelope and are encapsulated in a medium-red resin (CQW10 and CQW10L) and a dark-red coloured resin for the CQW10B and CQW10BL. An extra diffusing zone has been cast on the top, with a stronger diffusor for the B-types.

The CQW10L and CQW10BL (SOD-76L envelope) have no seating plane but have long leads and are in all other respects similar to the CQW10 and CQW10B.

When stacked in an array these SOD-76 LEDs can be used, for example, as level indicators.

QUICK REFERENCE DATA

Continuous reverse voltage	V_R	max.	5 V
Forward current (d.c.)	I_F	max.	30 mA
Total power dissipation up to $T_{amb} = 65\text{ }^\circ\text{C}$	P_{tot}	max.	90 mW
Junction temperature	T_j	max.	100 $^\circ\text{C}$
Luminous intensity			
$I_F = 10\text{ mA}$	CQW10(L)/CQW10B(L)	I_v	min. 0,5 mCd
	CQW10(L)/CQW10B(L)-II	I_v	1,0 to 2,2 mCd
	CQW10(L)/CQW10B(L)-III	I_v	1,6 to 3,5 mCd
Wavelength at peak emission			
$I_F = 10\text{ mA}$	λ_{pk}	typ.	630 nm
Beamwidth between half-intensity directions			
$I_F = 10\text{ mA}$	$\alpha_{50\%}$	typ.	100 $^\circ$

MECHANICAL DATA

Fig. 1a SOD-76A.

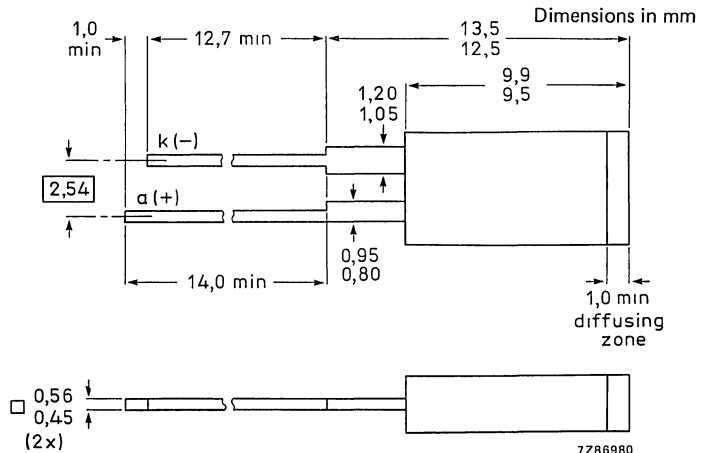
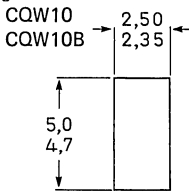
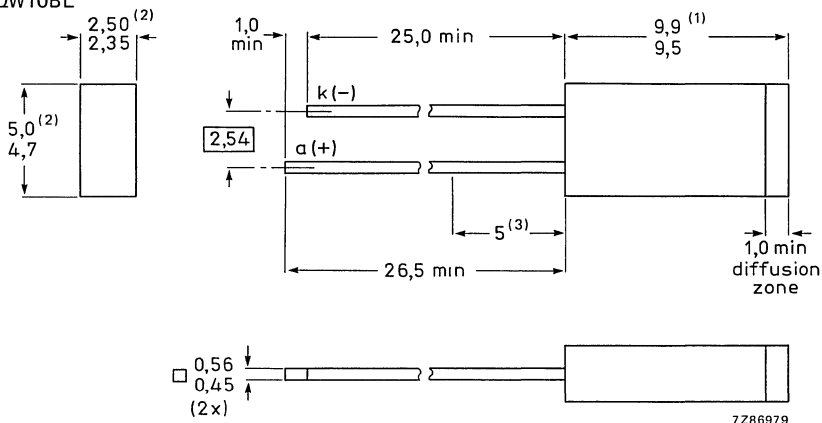

Fig. 1b SOD-76L.
CQW10L
CQW10BL



Notes

1. Measured when the device is seated in a gauge with 2 holes 0,80 mm diameter and 2,54 mm apart.
2. Maximum value including burrs.
3. Solderability not guaranteed within this zone due to tie-bar cropping.

RATINGS

Limiting values in accordance with the Absolute Maximum System (IEC 134)

Continuous reverse voltage	V_R	max.	5 V
Forward current			
d.c.	I_F	max.	30 mA
peak value; $t_p = 1 \mu s$; $f = 300 \text{ Hz}$	I_{FM}	max.	1 A
peak value; $t_{ON} = 1 \text{ ms}$; $\delta = 0,33$	I_{FM}	max.	60 mA
Total power dissipation up to $T_{amb} = 65 \text{ }^\circ\text{C}$	P_{tot}	max.	90 mW
Storage temperature	T_{stg}		-55 to +100 $^\circ\text{C}$
Junction temperature	T_j	max.	100 $^\circ\text{C}$
Lead soldering temperature; $t_{sld} < 7 \text{ s}$			
> 1,5 mm from the seating plane for CQW10/10B	T_{sld}	max.	260 $^\circ\text{C}$
> 5 mm from the plastic body for CQW10L/10BL			

THERMAL RESISTANCE

From junction to ambient when the device
is mounted on a p.c. board

$R_{th \text{ j-a}}$	max.	350 K/W
----------------------	------	---------

CHARACTERISTICS

$T_j = 25 \text{ }^\circ\text{C}$ unless otherwise specified

Forward voltage
 $I_F = 10 \text{ mA}$

V_F	typ.	2,1 V
	max.	3,0 V

Light emitting diodes

CQW10 CQW10L
CQW10B CQW10BL

Reverse current

$V_R = 5 \text{ V}$

I_R max. 100 μA

Beamwidth between half-intensity directions

$I_F = 10 \text{ mA}$

$\alpha_{50\%}$ typ. 100 $^\circ$

Bandwidth at half height

$B_{50\%}$ typ. 45 nm

Wavelength at peak emission

$I_F = 10 \text{ mA}$

λ_{pk} typ. 630 nm

Luminous intensity

$I_F = 10 \text{ mA}$

CQW10(L)/CQW10B(L) I_V min. 0,5 mCd
CQW10(L)/CQW10B(L)-II I_V 1,0 to 2,2 mCd
CQW10(L)/CQW10B(L)-III I_V 1,6 to 3,5 mCd

Diode capacitance

$V_R = 0; f = 1 \text{ MHz}$

C_d typ. 35 pF

DEVELOPMENT SAMPLE DATA

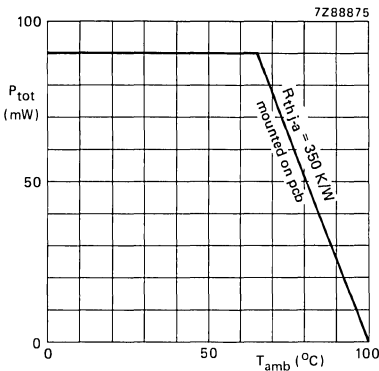

Fig. 2.

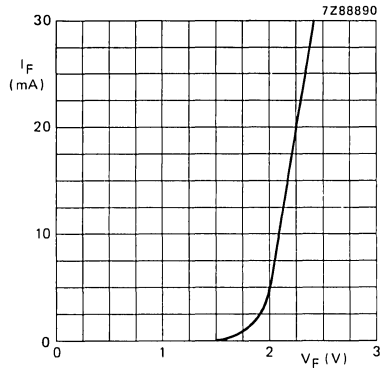

Fig. 3 $T_j = 25 \text{ }^\circ\text{C}$; typ. values.

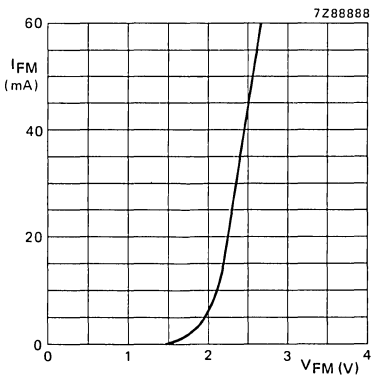

Fig. 4 $t_{ON} = 50 \mu\text{s}$; $\delta = 0,01$;
 $T_j = 25 \text{ }^\circ\text{C}$; typ. values.

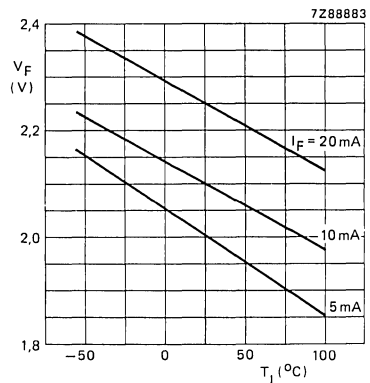

Fig. 5 Typical values.

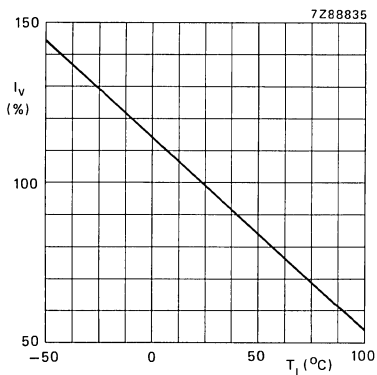

Fig. 6 $I_F = 10 \text{ mA}$; typ. values.

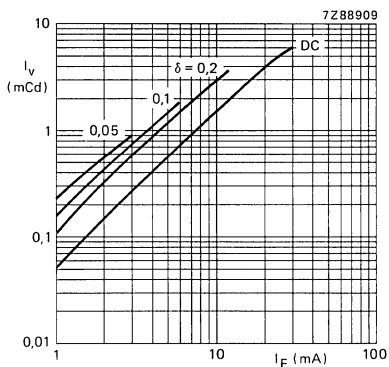

Fig. 7 $t_p = 50 \mu\text{s}$; typ. values.

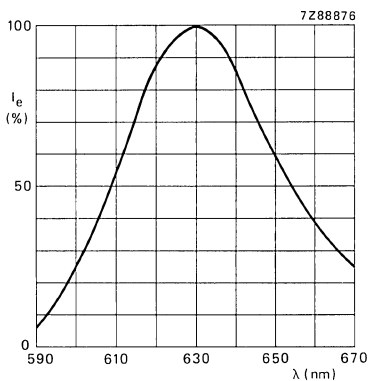

Fig. 8 $I_F = 10 \text{ mA}$; typ. values.

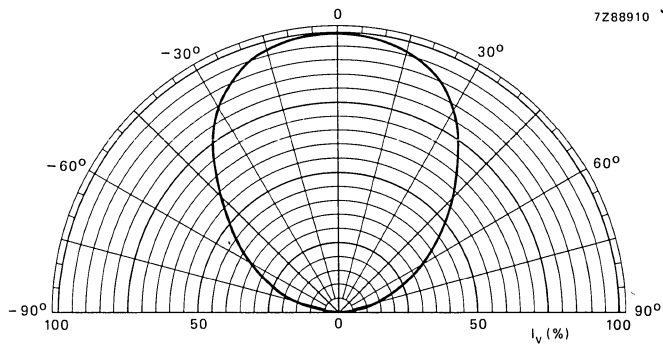
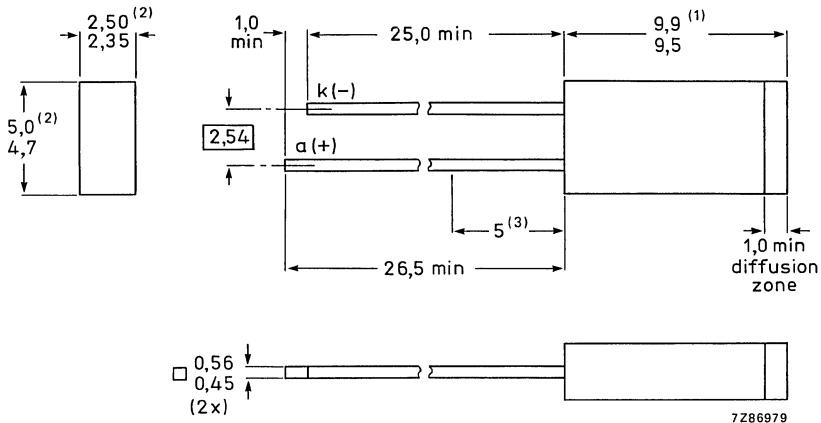

Fig. 9 Typical values.

CQW10A
CQW10AL

Fig. 1b SOD-76L.
CQW10AL



Notes

1. Measured when the device is seated in a gauge with 2 holes 0,80 mm diameter and 2,54 mm apart.
2. Maximum value including burrs.
3. Solderability not guaranteed within this zone due to tie-bar cropping.

RATINGS

Limiting values in accordance with the Absolute Maximum System (IEC 134)

Continuous reverse voltage	V_R	max.	5 V
d.c.	I_F	max.	100 mA
peak value; $t_p = 1 \mu s$; $f = 300$ Hz		max.	1 A
peak value; $t_{on} = 20 \mu s$; $\delta = 0,01$	I_{FM}	max.	500 mA
Total power dissipation up to $T_{amb} = 25 \text{ }^\circ\text{C}$	P_{tot}	max.	215 mW
Storage temperature	T_{stg}		-55 to +100 $^\circ\text{C}$
Junction temperature	T_j	max.	100 $^\circ\text{C}$
Lead soldering temperature; $t_{slid} < 7$ s			
> 1,5 mm from the seating plane for CQW10A	T_{slid}	max.	260 $^\circ\text{C}$
> 5 mm from the seating plane for CQW10AL			

THERMAL RESISTANCE

From junction to ambient when the device is mounted on a p.c. board

$R_{th\ j-a}$	max.	350 K/W
---------------	------	---------

CHARACTERISTICS

$T_j = 25 \text{ }^\circ\text{C}$ unless otherwise specified

Forward voltage			
$I_F = 10$ mA	V_F	typ.	1,75 V
		max.	2,2 V
Reverse current			
$V_R = 5$ V	I_R	max.	100 μA

Beamwidth between half-intensity directions

$I_F = 10 \text{ mA}$

$\alpha_{50\%}$ typ. 100°

Bandwidth at half height

$B_{50\%}$ typ. 20 nm

Wavelength at peak emission

$I_F = 10 \text{ mA}$

λ_{pk} typ. 650 nm

Luminous intensity

$I_F = 10 \text{ mA}$

CQW10A(L) min. $1,0 \text{ mcd}$
 CQW10A(L)-III $1,6 \text{ to } 3,5 \text{ mcd}$
 CQW10A(L)-IV $3,0 \text{ to } 7,0 \text{ mcd}$

Diode capacitance

$V_R = 0; f = 1 \text{ MHz}$

C_d typ. 60 pF

DEVELOPMENT SAMPLE DATA

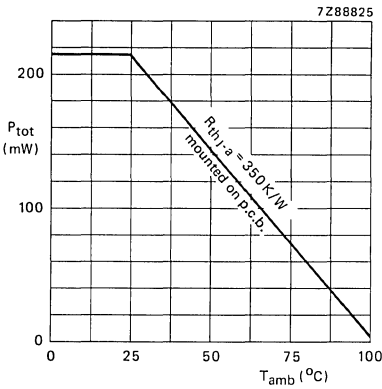

Fig. 2 Typical values.

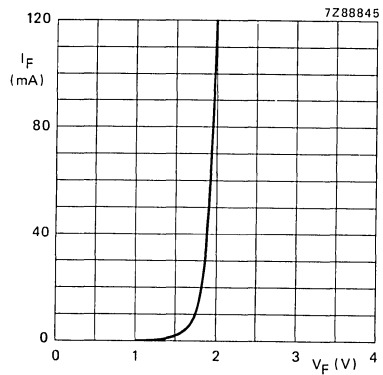

Fig. 3 $T_{amb} = 25^\circ\text{C}$; typ. values.

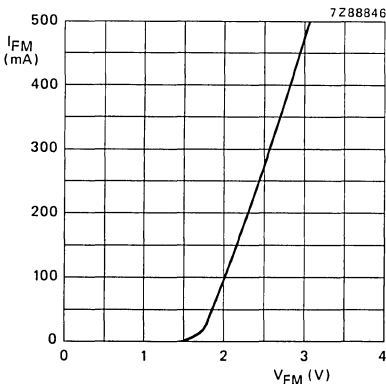

Fig. 4 $t_{on} = 20 \mu\text{s}; \delta = 0,01$; typ. values.

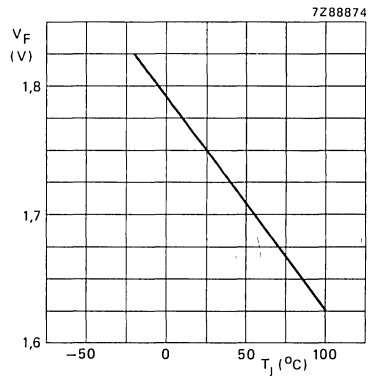

Fig. 5 $I_F = 10 \text{ mA}$; typ. values.

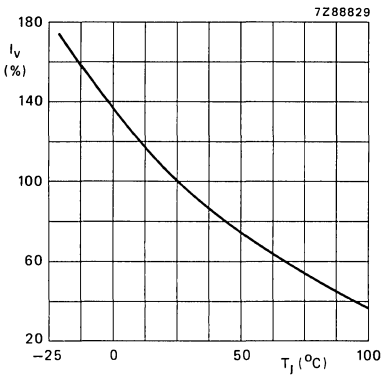

Fig. 6 Typical values.

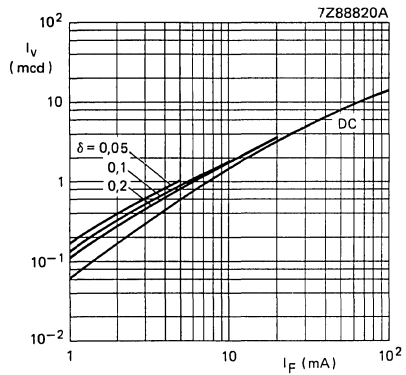

Fig. 7 $t_p = 50 \mu s$; typ. values.

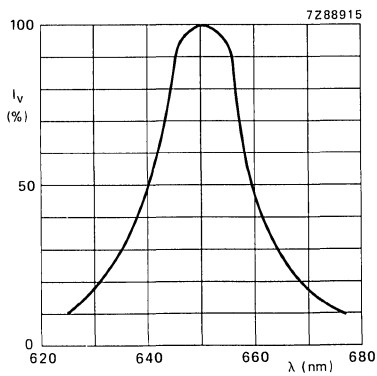

Fig. 8 $I_F = 10 \text{ mA}$; $T_{amb} = 25 \text{ }^\circ\text{C}$; typ. values.

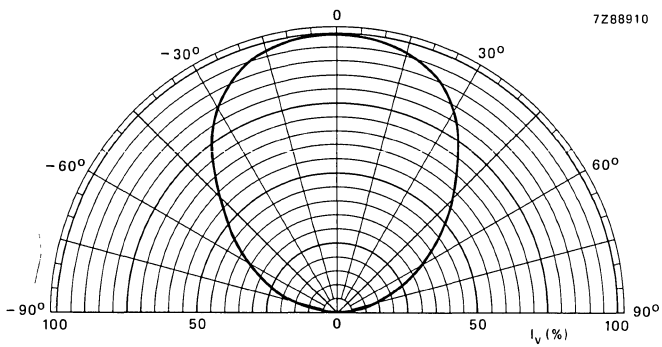

Fig. 9 Typical values.

DEVELOPMENT SAMPLE DATA

This information is derived from development samples made available for evaluation. It does not necessarily imply that the device will go into regular production.

CQW11A CQW11AL
CQW11B CQW11BL

LIGHT EMITTING DIODES

The CQW11A and CQW11B are 2,5 mm x 5 mm rectangular light emitting diodes which emit super-green light (GaP) when forward biased.

These LEDs have a SOD-76 envelope and are encapsulated in a medium-green resin for the CQW11A(L) and a dark-green coloured resin for the CQW11B(L). An extra diffusing zone has been cast on the top, with a stronger diffusor for the B-types.

The CQW11AL and CQW11BL (SOD-76L envelope) have no seating plane but have long leads and are in all other respects similar to the CQW11A and CQW11B.

When stacked in an array these SOD-76 LEDs can be used, for example, as level indicators. They can resist higher forward currents when a higher luminous intensity is wanted and because the CQW11A/11B is easily deliverable in high I_F classes this LED is very suitable in those applications where only low currents are available.

QUICK REFERENCE DATA

Continuous reverse voltage		V_R	max.	5 V
Forward current (d.c.)		I_F	max.	60 mA
Total power dissipation up to $T_{amb} = 35\text{ }^\circ\text{C}$		P_{tot}	max.	180 mW
Junction temperature		T_j	max.	100 $^\circ\text{C}$
Luminous intensity				
$I_F = 10\text{ mA}$	CQW11A(L)/CQW11B(L)	I_v	min.	0,5 mCd
	CQW11A(L)/CQW11B(L)-II	I_v	1,0 to	2,2 mCd
	CQW11A(L)/CQW11B(L)-III	I_v	1,6 to	3,5 mCd
Wavelength at peak emission				
$I_F = 10\text{ mA}$		λ_{pk}	typ.	565 nm
Beamwidth between half-intensity directions				
$I_F = 10\text{ mA}$		$\alpha_{50\%}$	typ.	100 $^\circ$

MECHANICAL DATA

Fig. 1a SOD-76A.

CQW11A
CQW11B

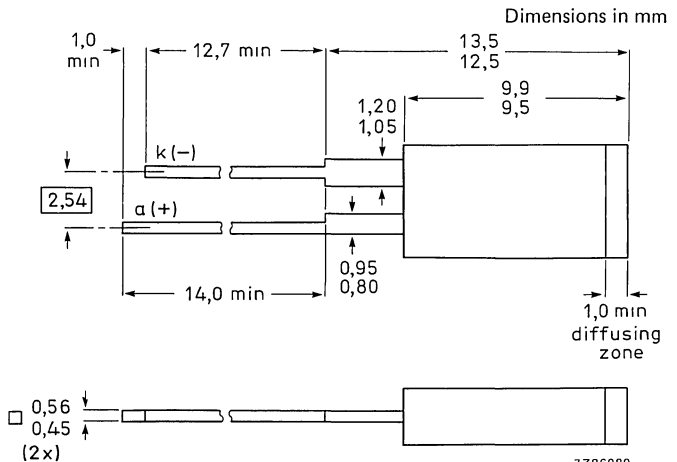
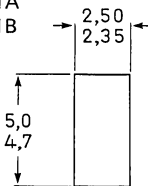
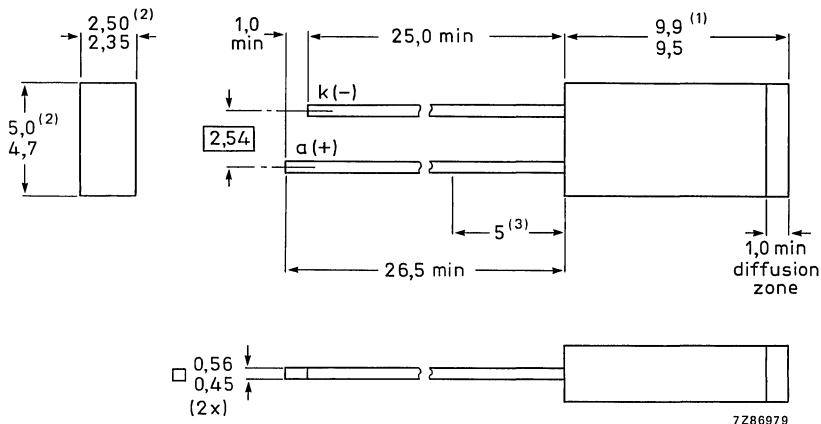

Fig. 1b SOD-76L.
CQW11AL
CQW11BL



Notes

1. Measured when the device is seated in a gauge with 2 holes 0,80 mm diameter and 2,54 mm apart.
2. Maximum value including burrs.
3. Solderability not guaranteed with this zone due to tie-bar cropping.

RATINGS

Limiting values in accordance with the Absolute Maximum System (IEC 134)

Continuous reverse voltage	V_R	max.	5 V
Forward current			
d.c.	I_F	max.	60 mA
peak value; $t_p = 1 \mu s$; $f = 300$ Hz	I_{FM}	max.	1 A
peak value; $t_{on} = 1$ ms; $\delta = 0,33$	I_{FM}	max.	150 mA
Total power dissipation up to $T_{amb} = 35^\circ C$	P_{tot}	max.	180 mW
Storage temperature	T_{stg}		-55 to $+100^\circ C$
Junction temperature	T_j	max.	$100^\circ C$
Lead soldering temperature; $t_{sld} < 7$ s			
$> 1,5$ mm from the seating plane (CQW11A/11B)	T_{sld}	max.	$260^\circ C$
> 5 mm from the plastic body (CQW11AL/11BL)			

THERMAL RESISTANCE

From junction to ambient when the device is mounted on a p.c. board	$R_{th\ j-a}$	max.	350 K/W
---	---------------	------	---------

CHARACTERISTICS

$T_j = 25^\circ C$ unless otherwise specified

Forward voltage			
$I_F = 10$ mA	V_F	typ.	2,1 V
		max.	3,0 V

Light emitting diodes

CQW11A CQW11AL
CQW11B CQW11BL

Reverse current

$V_R = 5 \text{ V}$

I_R max. 100 μA

Beamwidth between half-intensity directions

$I_F = 10 \text{ mA}$

$\alpha_{50\%}$ typ. 100 $^\circ$

Bandwidth at half height

$B_{50\%}$ typ. 30 nm

Wavelength at peak emission

$I_F = 10 \text{ mA}$

λ_{pk} typ. 565 nm

Luminous intensity

$I_F = 10 \text{ mA}$

CQW11A(L)/CQW11B(L)	I_V	min.	0,5 mCd
CQW11A(L)/CQW11B(L)-II	I_V	1,0 to	2,2 mCd
CQW11A(L)/CQW11B(L)-III	I_V	1,6 to	3,5 mCd

Diode capacitance

$V_R = 0; f = 1 \text{ MHz}$

C_D typ. 35 pF

DEVELOPMENT SAMPLE DATA

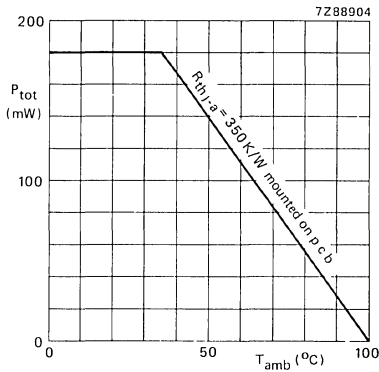

Fig. 2.

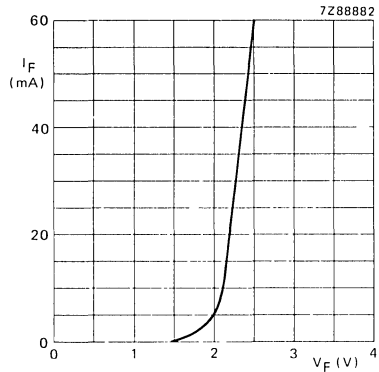

Fig. 3 $T_j = 25 \text{ }^\circ\text{C}$; typ. values.

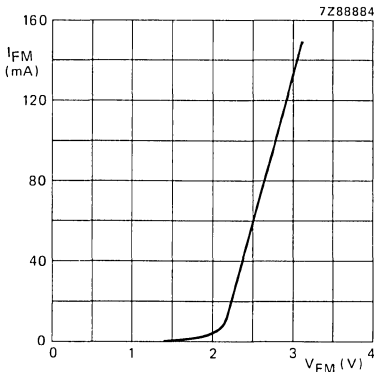

Fig. 4 $t_{on} = 1 \text{ ms}$; $\delta = 0,33$;
 $T_{amb} = 25 \text{ }^\circ\text{C}$; typ. values.

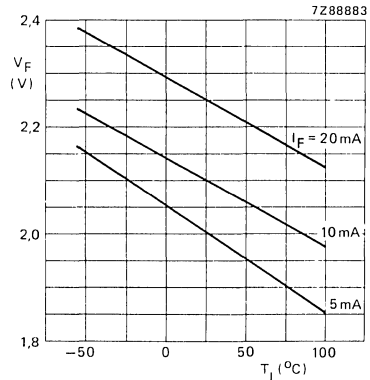

Fig. 5 Typical values.

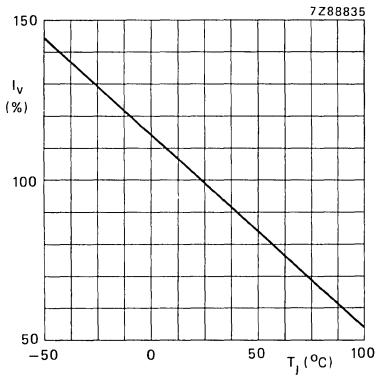

Fig. 6 $I_F = 10 \text{ mA}$; typ. values.

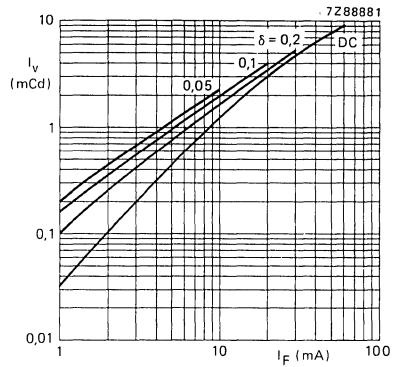

Fig. 7 $t_p = 50 \mu\text{s}$; typ. values.

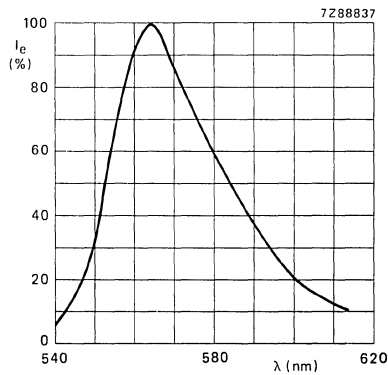

Fig. 8 $I_F = 10 \text{ mA}$; $T_{\text{amb}} = 25 \text{ }^\circ\text{C}$; typ. values.

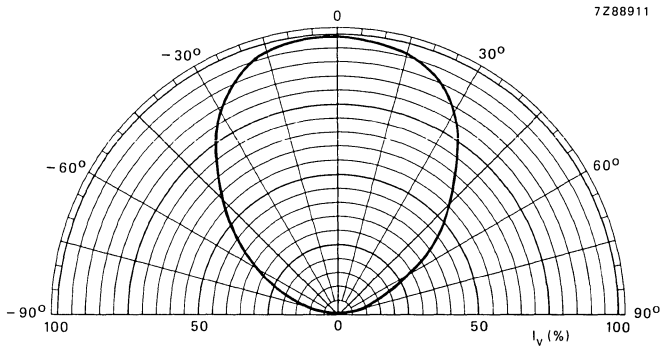

Fig. 9 Typical values.

DEVELOPMENT SAMPLE DATA

This information is derived from development samples made available for evaluation. It does not necessarily imply that the device will go into regular production.

CQW12 CQW12L
CQW12B CQW12BL

LIGHT EMITTING DIODES

The CQW12 and CQW12B are 2,5 mm x 5 mm rectangular light emitting diodes which emit yellow light when forward biased.

The CQW12 and CQW12B have a SOD-76A envelope and the CQW12L and CQW12BL have a SOD-76L envelope. The CQW12 and CQW12L are encapsulated in a medium-yellow resin and the CQW12B and CQW12BL in a slightly dark-yellow resin. Both have a diffusing zone cast on the top, with a stronger diffuser for the B-types.

The CQW12L and CQW12BL (SOD-76L envelope) have no seating plane but have long leads and are in all other respects similar to the CQW12 and CQW12B respectively.

When stacked in an array these SOD-76 LEDs can be used, for example, as level indicators.

QUICK REFERENCE DATA

Continuous reverse voltage	V_R	max.	5 V
Forward current (d.c.)	I_F	max.	30 mA
Total power dissipation up to $T_{amb} = 65\text{ }^\circ\text{C}$	P_{tot}	max.	90 mW
Junction temperature	T_j	max.	100 $^\circ\text{C}$
Luminous intensity			
$I_F = 10\text{ mA}$	CQW12(L)/CQW12B(L)	I_v	min. 0,5 mCd
	CQW12(L)/CQW12B(L)-II	I_v	1,0 to 2,2 mCd
	CQW12(L)/CQW12B(L)-III	I_v	1,6 to 3,5 mCd
Wavelength at peak emission			
$I_F = 10\text{ mA}$	λ_{pk}	typ.	590 nm
Beamwidth between half-intensity directions			
$I_F = 10\text{ mA}$; in the plane of the leads	$\alpha_{50\%}$	typ.	100 $^\circ$

MECHANICAL DATA

Dimensions in mm

Fig. 1a SOD-76A.

CQW12
CQW12B

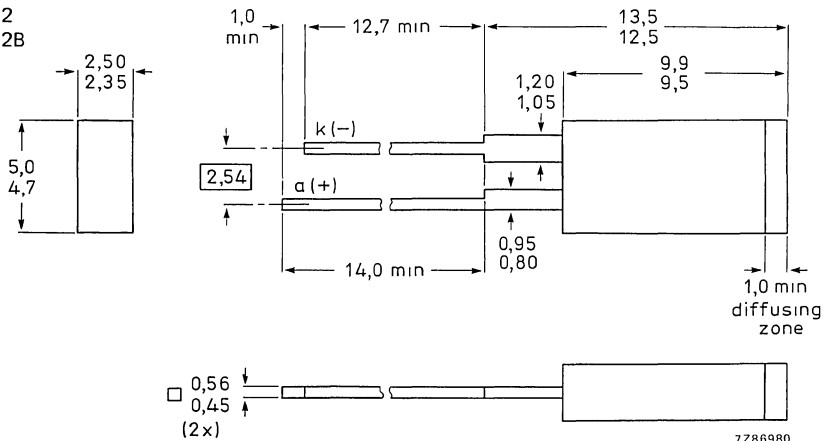

7286980

Fig. 1b SOD-76L.
CQW12L
CQW12BL

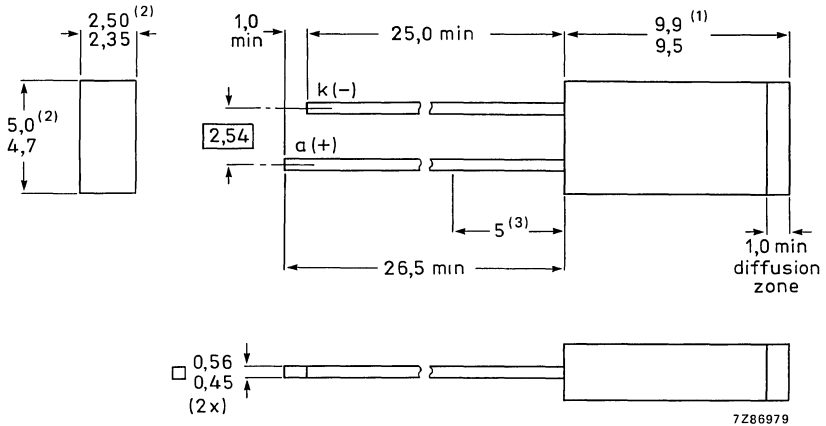

Notes

1. Measured when the device is seated in a gauge with 2 holes 0,80 mm diameter and 2,54 mm apart.
2. Maximum value including burrs.
3. Solderability not guaranteed within this zone due to tie-bar cropping.

RATINGS

Limiting values in accordance with the Absolute Maximum System (IEC 134)

Continuous reverse voltage	V_R	max.	5 V
Forward current			
d.c.	I_F	max.	30 mA
peak value; $t_p = 1 \mu s$; $f = 300 \text{ Hz}$	I_{FM}	max.	1 A
peak value; $t_{ON} = 1 \text{ ms}$; $\delta = 0,33$	I_{FM}	max.	60 mA
Total power dissipation up to $T_{amb} = 65 \text{ }^\circ\text{C}$	P_{tot}	max.	90 mW
Storage temperature	T_{stg}		-55 to +100 $^\circ\text{C}$
Junction temperature	T_j	max.	100 $^\circ\text{C}$
Lead soldering temperature; $t_{sld} < 7 \text{ s}$			
> 1,5 mm from the seating plane for CQW12/12B	T_{sld}	max.	260 $^\circ\text{C}$
> 5 mm from the plastic body for CQW12L/12BL			

THERMAL RESISTANCE

From junction to ambient when the device is mounted on a p.c. board	$R_{th \text{ j-a}}$	max.	350 K/W
---	----------------------	------	---------

CHARACTERISTICS

$T_j = 25 \text{ }^\circ\text{C}$ unless otherwise specified

Forward voltage			
$I_F = 10 \text{ mA}$	V_F	typ.	2,1 V
		max.	3,0 V

Light emitting diodes

CQW12 CQW12L
CQW12B CQW12BL

Reverse current $V_R = 5\text{ V}$	I_R	max.	100 μA
Beamwidth between half-intensity directions $I_F = 10\text{ mA}$	$\alpha_{50\%}$	typ.	100 $^\circ$
Bandwidth at half height $I_F = 10\text{ mA}$	$B_{50\%}$	typ.	40 nm
Wavelength at peak emission $I_F = 10\text{ mA}$	λ_{pk}	typ.	630 nm
Luminous intensity $I_F = 10\text{ mA}$	CQW12(L)/CQW12B(L) CQW12(L)/CQW12B(L)-II CQW12(L)/CQW12B(L)-III	I_V	min. 0,5 mCd 1,0 to 2,2 mCd 1,6 to 3,5 mCd
Diode capacitance $V_R = 0; f = 1\text{ MHz}$	C_d	typ.	35 pF

DEVELOPMENT SAMPLE DATA

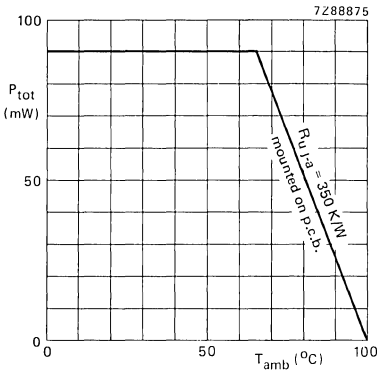

Fig. 2.

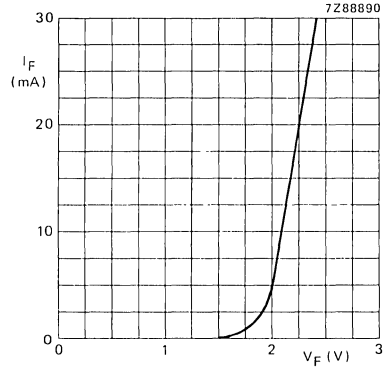

Fig. 3 $T_j = 25\text{ }^\circ\text{C}$; typ. values.

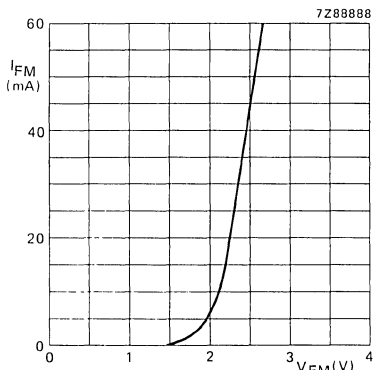

Fig. 4 $t_{on} = 50\text{ }\mu\text{s}$; $\delta = 0,01$;
 $T_j = 25\text{ }^\circ\text{C}$.; typ. values.

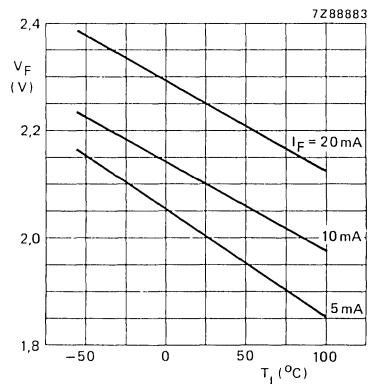

Fig. 5 Typical values.

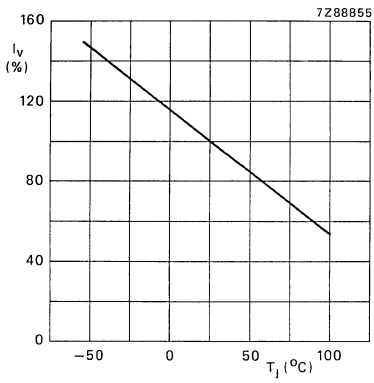

Fig. 6 $I_F = 10$ mA; typ. values.

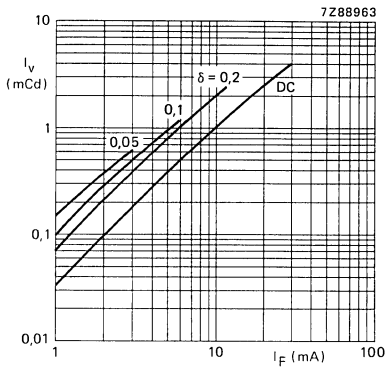

Fig. 7 $t_p = 50$ μ s; typ. values.

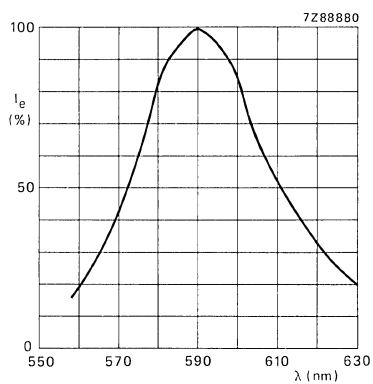

Fig. 8 Typical values.

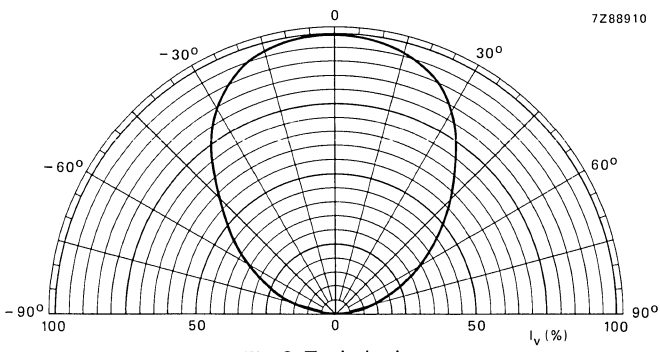

Fig. 9 Typical values.

DEVELOPMENT SAMPLE DATA

This information is derived from development samples made available for evaluation. It does not necessarily imply that the device will go into regular production

CQW20A

LIGHT EMITTING DIODE

Circular light emitting diode with diameter of 2 mm which emits hyper-red light (GaAlAs) when forward biased.

The CQW20A has a SOD-79 outline and is encapsulated in a medium-red coloured resin with an extra diffusing zone cast on the top. This LED is very suitable for small indicator functions and in applications where only low currents are available.

QUICK REFERENCE DATA

Continuous reverse voltage	V_R	max.	5 V
Forward current (d.c.)	I_F	max.	60 mA
Total power dissipation up to $T_{amb} = 25\text{ }^\circ\text{C}$	P_{tot}	max.	150 mW
Junction temperature	T_j	max.	100 $^\circ\text{C}$
Luminous intensity $I_F = 10\text{ mA}$	I_v	min. typ.	1,0 mCd 1,5 mCd
Wavelength at peak emission	λ_{pk}	typ.	650 nm
Beamwidth between half-intensity directions	$\alpha 50\%$	typ.	110 $^\circ$

MECHANICAL DATA

Dimensions in mm

Fig. 1 SOD-79.

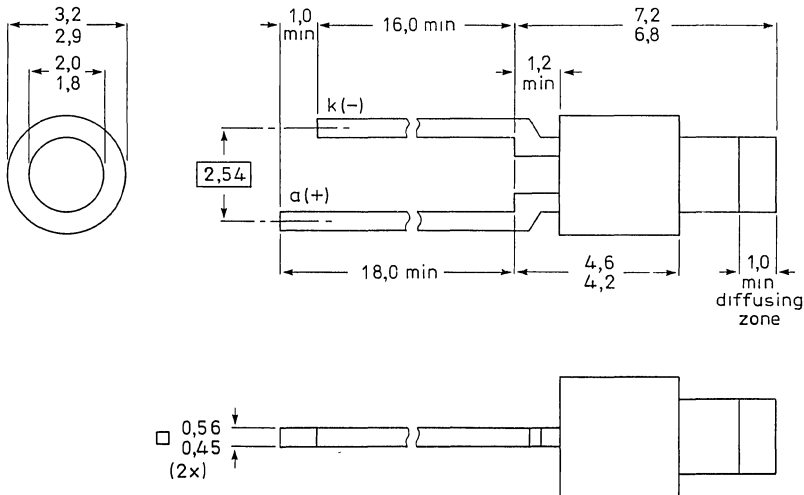

7Z86912 1

RATINGS

Limiting values in accordance with the Absolute Maximum System (IEC 134)

Reverse voltage	V_R	max.	5 V
Forward current			
d.c.	I_F	max.	60 mA
peak value; $t_p = 1 \mu s$; $f = 300 \text{ Hz}$	I_{FM}	max.	1 A
peak value; $t_{on} = 20 \mu s$; $\delta = 0,01$	I_{FM}	max.	500 mA
Total power dissipation up to $T_{amb} = 25 \text{ }^\circ\text{C}$	P_{tot}	max.	150 mW
Storage temperature	T_{stg}		-55 to +100 $^\circ\text{C}$
Junction temperature	T_j	max.	100 $^\circ\text{C}$
Lead soldering temperature			
> 1,5 mm from the seating plane; $t_{sld} < 7 \text{ s}$	T_{sld}	max.	260 $^\circ\text{C}$

THERMAL RESISTANCE

From junction to ambient when the device is mounted on a p.c. board	$R_{th \text{ j-a}}$	max.	500 K/W
--	----------------------	------	---------

CHARACTERISTICS

$T_j = 25 \text{ }^\circ\text{C}$ unless otherwise specified

Forward voltage			
$I_F = 4 \text{ mA}$	V_F	typ.	1,65 V
$I_F = 10 \text{ mA}$	V_F	typ. max.	1,75 V 2,20 V
Reverse current			
$V_R = 5 \text{ V}$	I_R	max.	100 μA
Beamwidth between half-intensity directions			
$I_F = 10 \text{ mA}$	$\alpha_{50\%}$	typ.	110 $^\circ$
Bandwidth at half height	$B_{50\%}$	typ.	20 nm
Wavelength at peak emission	λ_{pk}	typ.	650 nm
Luminous intensity			
$I_F = 10 \text{ mA}$	I_v	min. typ.	1,0 mCd 1,5 mCd
Diode capacitance			
$V_R = 0$; $f = 1 \text{ MHz}$	C_d	typ.	60 pF

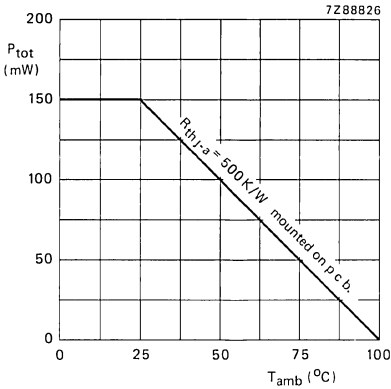

Fig. 2.

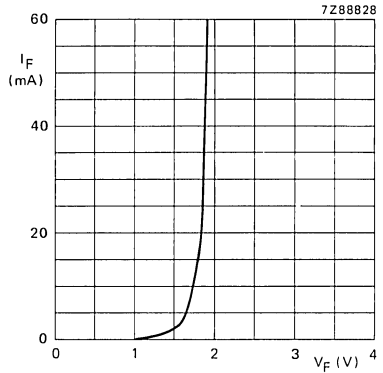

Fig. 3 $T_{amb} = 25^\circ\text{C}$; typ. values.

DEVELOPMENT SAMPLE DATA

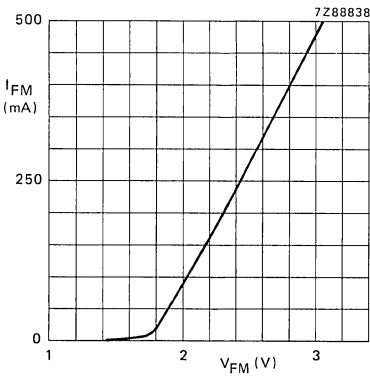

Fig. 4 $t_{on} = 20 \mu\text{s}$; $\delta = 0,01$;
 $T_{amb} = 25^\circ\text{C}$; typ. values.

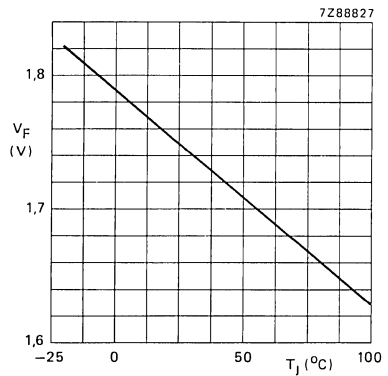

Fig. 5 $I_F = 10 \text{ mA}$; typ. values.

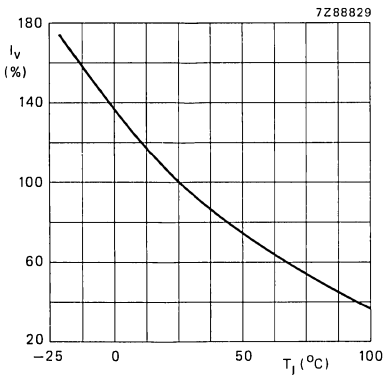

Fig. 6 Typical values.

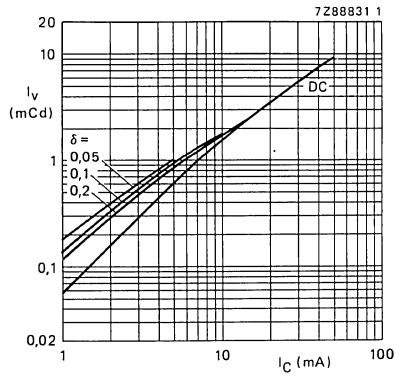

Fig. 7 $t_p = 50 \mu\text{s}$; typ. values.

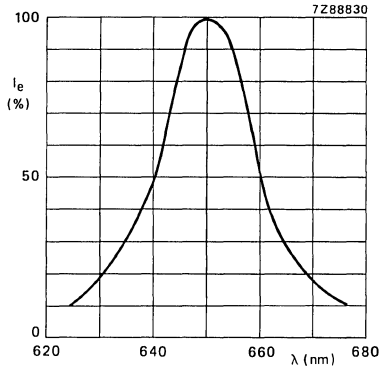

Fig. 8 $I_F = 10 \text{ mA}$; $T_{\text{amb}} = 25 \text{ }^\circ\text{C}$; typ. values.

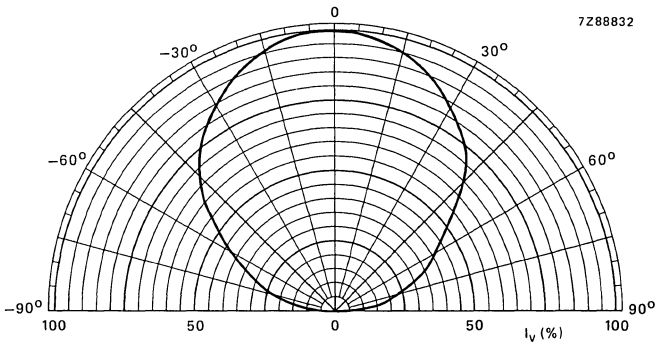

Fig. 9 $I_F = 10 \text{ mA}$; typ. values.

DEVELOPMENT SAMPLE DATA

This information is derived from development samples made available for evaluation. It does not necessarily imply that the device will go into regular production.

CQW21

LIGHT EMITTING DIODE

Circular light emitting diode with diameter of 2 mm which emits super-green light (GaP) when forward biased.

The CQW21 has a SOD-79 outline and is encapsulated in a medium-green coloured resin with a diffusing zone cast on the top. This LED is very suitable for very small indicator functions and can resist higher forward currents when a higher luminous intensity is wanted. In the near future the CQW21 is easily deliverable in high I_V classes and is therefore very suitable in those applications where only low currents are available.

QUICK REFERENCE DATA

Continuous reverse voltage	V_R	max.	5 V
Forward current (d.c.)	I_F	max.	60 mA
Total power dissipation up to $T_{amb} = 25\text{ }^\circ\text{C}$	P_{tot}	max.	150 mW
Junction temperature	T_j	max.	100 $^\circ\text{C}$
Luminous intensity $I_F = 10\text{ mA}$	I_V	min.	0,5 mcd
Wavelength at peak emission	λ_{pk}	typ.	565 nm
Beamwidth between half-intensity directions	$\alpha_{50\%}$	typ.	100 $^\circ$

MECHANICAL DATA

Dimensions in mm

Fig. 1 SOD-79

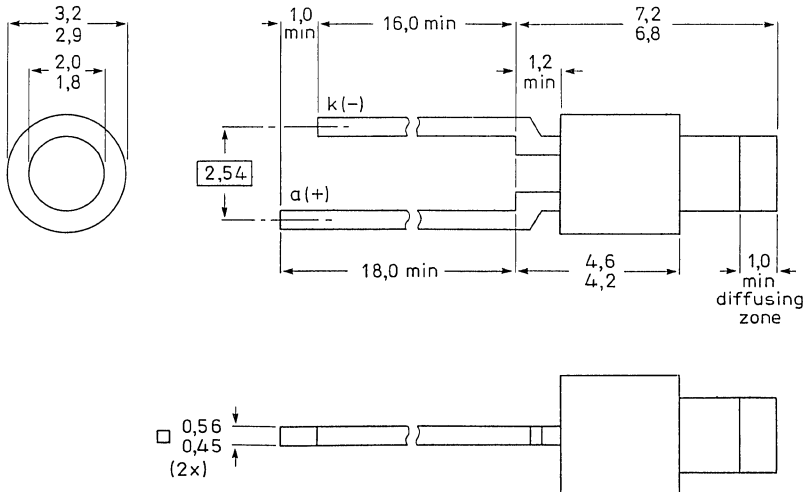

7Z86912 1

RATINGS

Limiting values in accordance with the Absolute Maximum System (IEC 134)

Reverse voltage	V_R	max.	5 V
Forward current	I_F	max.	60 mA
d.c.	I_{FM}	max.	1 A
peak value; $t_p = 1 \mu s$; $f = 300$ Hz	I_{FM}	max.	150 mA
peak value; $t_{on} = 1$ ms; $\delta = 0,33$	P_{tot}	max.	150 mW
Total power dissipation up to $T_{amb} = 25$ °C	T_{stg}	-55 to +100	°C
Storage temperature	T_j	max.	100 °C
Junction temperature	T_{sld}	max.	260 °C
Lead soldering temperature			
> 1,5 mm from the seating plane; $t_{sld} < 7$ s			

THERMAL RESISTANCE

From junction to ambient when the device is mounted on a p.c. board

$R_{th\ j-a}$	max.	500 K/W
---------------	------	---------

CHARACTERISTICS

 $T_j = 25$ °C unless otherwise specified

Forward voltage	V_F	typ.	2,1 V
$I_F = 10$ mA		max.	3,0 V
Reverse current	I_R	max.	100 μA
$V_R = 5$ V			
Beamwidth between half-intensity directions	$\alpha_{50\%}$	typ.	100 °
Bandwidth at half height	$B_{50\%}$	typ.	30 nm
Wavelength at peak emission	λ_{pk}	typ.	565 nm
Luminous intensity	I_v	min.	0,5 mcd
$I_F = 10$ mA		typ.	1,5 mcd

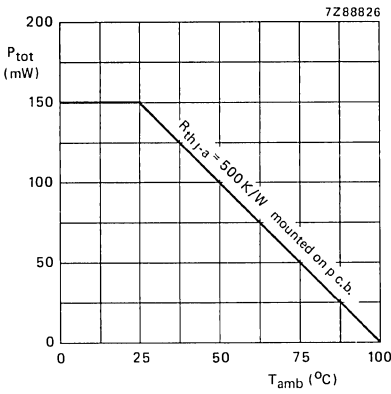

Fig. 2.

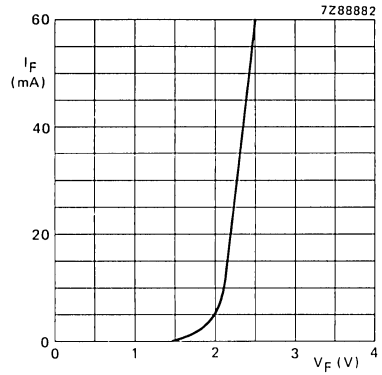

Fig. 3 $T_{amb} = 25^{\circ}C$; typ. values.

DEVELOPMENT SAMPLE DATA

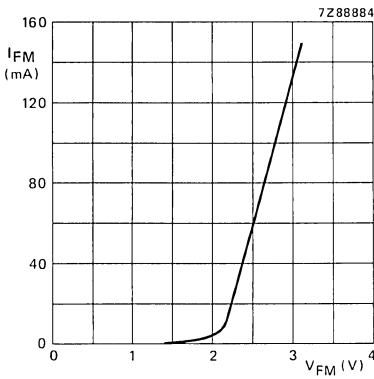

Fig. 4 $t_{on} = 1$ ms; $\delta = 0,33$;
 $T_{amb} = 25^{\circ}C$; typ. values.

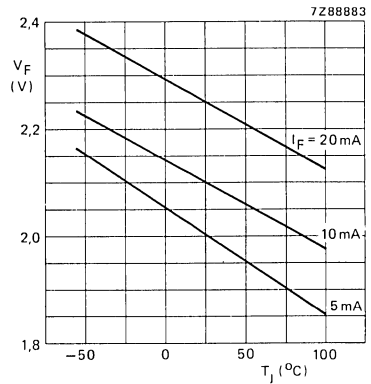

Fig. 5 Typical values.

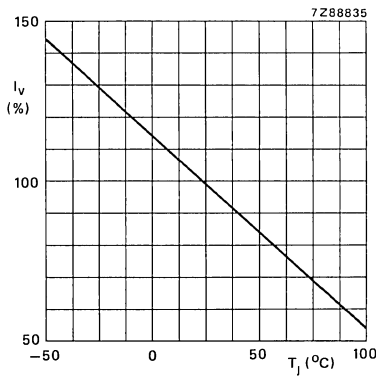

Fig. 6 Typical values.

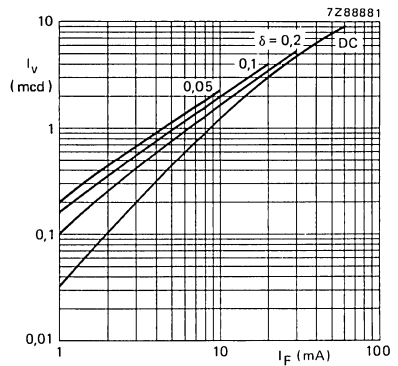

Fig. 7 $t_p = 50$ μs ; typ. values.

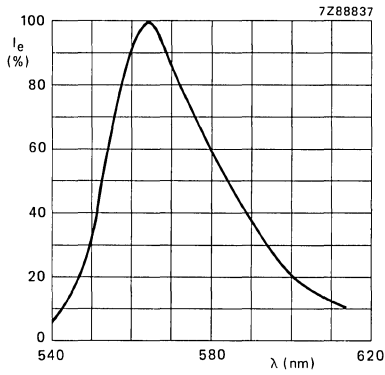

Fig. 8 $I_F = 10$ mA; typ. values.

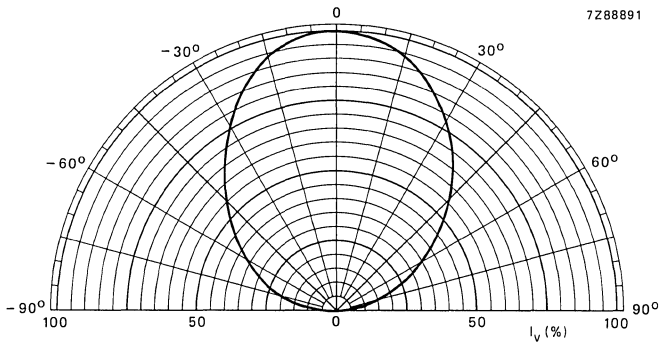

Fig. 9 Typical values.

DEVELOPMENT SAMPLE DATA

This information is derived from development samples made available for evaluation. It does not necessarily imply that the device will go into regular production.

CQW22

LIGHT EMITTING DIODE

Circular light emitting diode with diameter of 2 mm which emits yellow light (GaAsP) when forward biased.

The CQW22 has a SOD-79 outline and is encapsulated in a medium-yellow coloured resin with a diffusing zone cast on the top.

This LED is very suitable for very small indicator functions.

QUICK REFERENCE DATA

Continuous reverse voltage	V_R	max.	5 V
Forward current (d.c.)	I_F	max.	30 mA
Total power dissipation up to $T_{amb} = 55\text{ }^\circ\text{C}$	P_{tot}	max.	90 mW
Junction temperature	T_j	max.	100 $^\circ\text{C}$
Luminous intensity	I_v	min.	0,5 mCd
$I_F = 20\text{ mA}$		typ.	1,5 mCd
Wavelength at peak emission	λ_{pk}	typ.	590 nm
Beamwidth between half-intensity directions	$\alpha_{50\%}$	typ.	110 $^\circ$

MECHANICAL DATA

Dimensions in mm

Fig. 1 SOD-79.

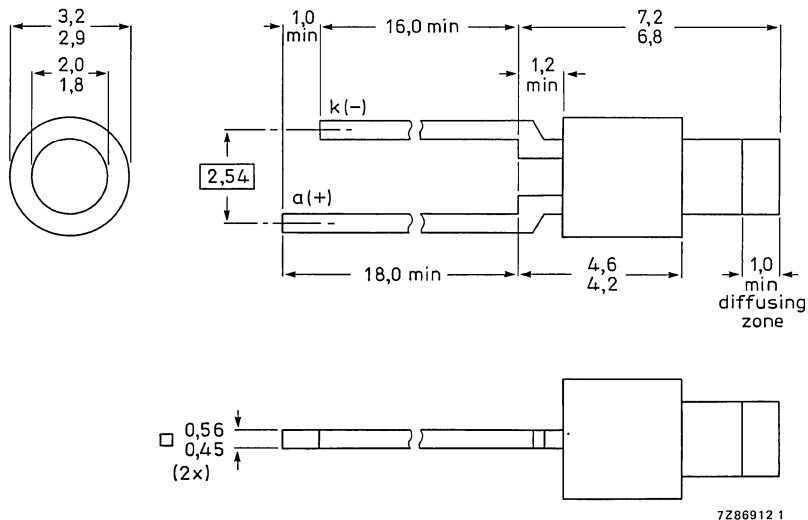

RATINGS

Limiting values in accordance with the Absolute Maximum System (IEC 134)

Reverse voltage	V_R	max.	5 V
Forward current			
d.c.	I_F	max.	30 mA
peak value; $t_p = 1 \mu s$; $f = 300 \text{ Hz}$	I_{FM}	max.	1 A
peak value; $t_{on} = 1 \text{ ms}$; $\delta = 0,33$	I_{FM}	max.	60 mA
Total power dissipation up to $T_{amb} = 55 \text{ }^\circ\text{C}$	P_{tot}	max.	90 mW
Storage temperature	T_{stg}		-55 to + 100 $^\circ\text{C}$
Junction temperature	T_j	max.	100 $^\circ\text{C}$
Lead soldering temperature			
> 1,5 mm from the seating plane; $t_{sld} < 7 \text{ s}$	T_{sld}	max.	260 $^\circ\text{C}$

THERMAL RESISTANCE

From junction to ambient when the device is mounted on a p.c. board

$R_{th \text{ j-a}}$	max.	500 K/W
----------------------	------	---------

CHARACTERISTICS

$T_j = 25 \text{ }^\circ\text{C}$ unless otherwise specified

Forward voltage			
$I_F = 20 \text{ mA}$	V_F	typ.	2,1 V
		max.	3,0 V
Reverse current			
$V_R = 5 \text{ V}$	I_R	max.	100 μA
Diode capacitance	C_d	typ.	35 pF
Beamwidth between half-intensity directions			
$I_F = 20 \text{ mA}$	$\alpha_{50\%}$	typ.	110 $^\circ$
Bandwidth at half height	$B_{50\%}$	typ.	40 nm
Wavelength at peak emission	λ_{pk}	typ.	590 nm
Luminous intensity			
$I_F = 20 \text{ mA}$	I_v	typ.	0,5 mCd
		typ.	1,5 mCd

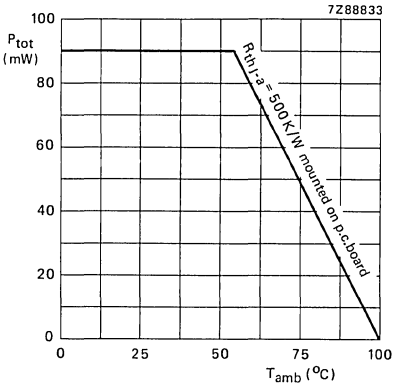

Fig. 2.

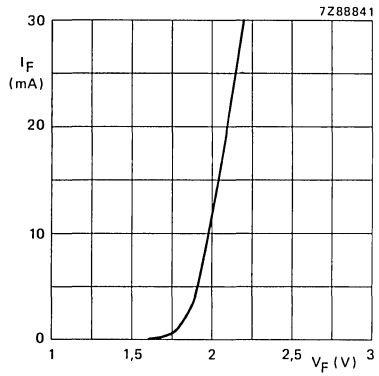

Fig. 3 $T_{amb} = 25$ °C; typical values.

DEVELOPMENT SAMPLE DATA

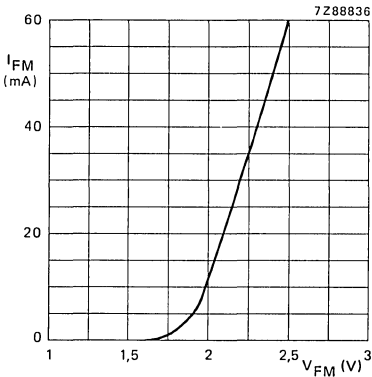

Fig. 4 $t_{on} = 1$ ms; $\delta = 0,33$; $T_{amb} = 25$ °C; typical values.

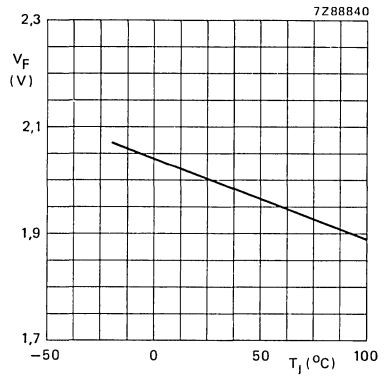

Fig. 5 $I_F = 10$ mA; typical values.

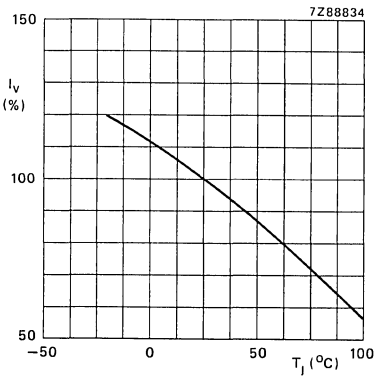

Fig. 6 Typical values.

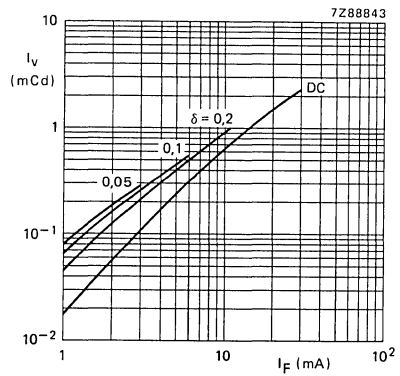

Fig. 7 $t_p = 50$ μ s; typical values.

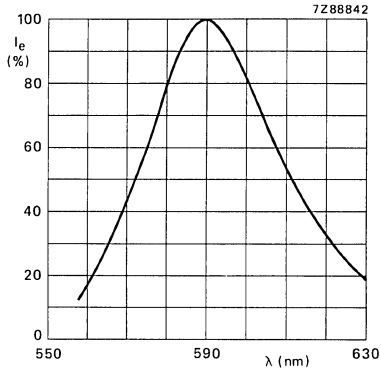

Fig. 8 Typical values.

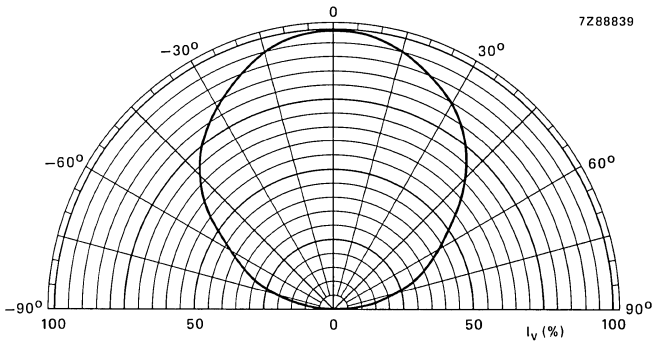

Fig. 9 Typical values.

DEVELOPMENT SAMPLE DATA

This information is derived from development samples made available for evaluation. It does not necessarily imply that the device will go into regular production.

CQW24
CQW24L

LIGHT EMITTING DIODES

Circular light emitting diodes with diameter of 5 mm which emit hyper-red (GaAlAs) light when forward biased. The CQW24 and CQW24L have a SOD-63 outline and are encapsulated in a medium-red coloured diffusing resin.

Because of its high light intensity the CQW24 (and CQW24L) is also very suitable in applications where only low currents are available.

The CQW24L is the long-lead version of the CQW24 and has no seating plane but is in all other respects equal to the CQW24.

QUICK REFERENCE DATA

Continuous reverse voltage	V_R	max.	5 V
Forward current (d.c.)	I_F	max.	100 mA
Total power dissipation up to $T_{amb} = 25\text{ }^\circ\text{C}$	P_{tot}	max.	215 mW
Junction temperature	T_j	max.	100 $^\circ\text{C}$
Luminous intensity $I_F = 10\text{ mA}$	CQW24(L)-I CQW24(L)-II	I_v	min. 4 mCd min. 7,5 mCd
Wavelength at peak emission		λ_{pk}	typ. 650 nm
Beamwidth between half-intensity directions		$\alpha_{50\%}$	typ. 60 $^\circ$

MECHANICAL DATA

Dimensions in mm

Fig. 1a SOD-63A.

CQW24

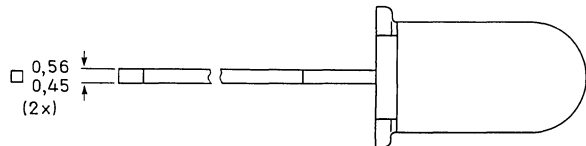
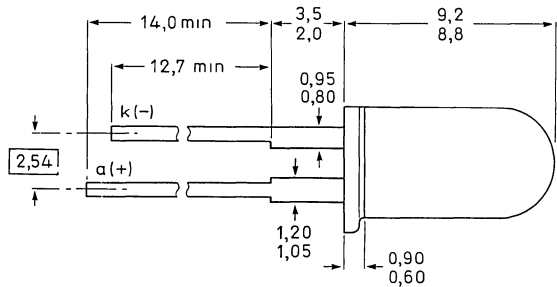
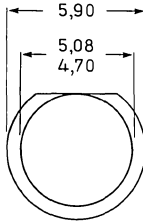

7286999

CQW24
CQW24L

Fig. 1b SOD-63L.
CQW24L

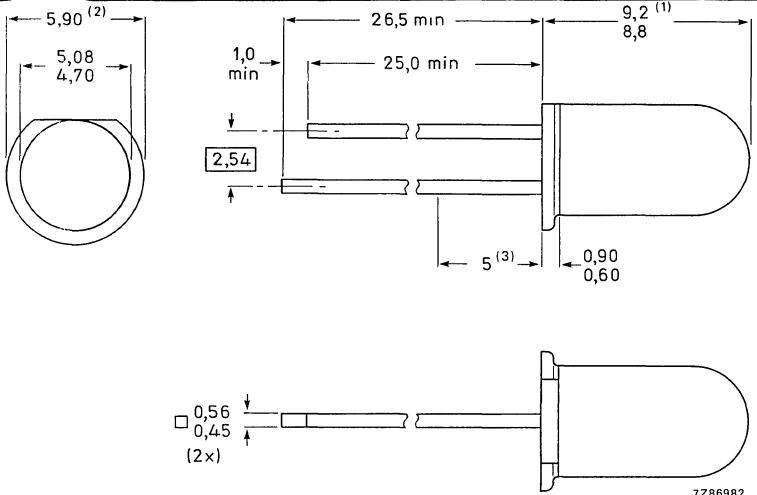

- (1) Measured when the device is seated in a gauge with 2 holes 0,80 mm diameter 2,54 mm apart.
- (2) Maximum value including burrs.
- (3) Solderability not guaranteed within this zone due to tie-bar cropping.

RATINGS

Limiting values in accordance with the Absolute Maximum System (IEC 134)

Reverse voltage	V_R	max.	5 V
Forward current d.c.	I_F	max.	100 mA
Forward current peak value; $t_p = 1 \mu s$; $f = 300 \text{ Hz}$	I_{FM}	max.	1 A
peak value; $t_{on} = 20 \mu s$; $\delta = 0,01$		max.	500 mA
Total power dissipation up to $T_{amb} = 25 \text{ }^\circ\text{C}$	P_{tot}	max.	215 mW
Storage temperature	T_{stg}		-55 to +100 $^\circ\text{C}$
Junction temperature	T_j	max.	100 $^\circ\text{C}$
Lead soldering temperature: $t_{sld} < 7 \text{ s}$	T_{sld}	max.	260 $^\circ\text{C}$
> 1,5 mm from the seating plane for CQW24			
> 5 mm from the plastic body for CQW24L			

THERMAL RESISTANCE

From junction to ambient when the device is mounted on a p.c. board	$R_{th \text{ j-a}}$	max.	350 K/W
--	----------------------	------	---------

CHARACTERISTICS

$T_j = 25 \text{ }^\circ\text{C}$ unless otherwise specified

Forward voltage $I_F = 4 \text{ mA}$	V_F	typ.	1,65 V
$I_F = 10 \text{ mA}$	V_F	typ.	1,75 V
$I_F = 50 \text{ mA}$	V_F	max.	2,2 V
	V_F	typ.	1,9 V

Reverse current

$V_R = 5 \text{ V}$

Bandwidth between half-intensity directions

$I_F = 10 \text{ mA}$

Bandwidth at half height

Wavelength at peak emission

$I_F = 10 \text{ mA}; T_{amb} = 25 \text{ }^\circ\text{C}$

Luminous intensity

$I_F = 4 \text{ mA}$

$I_F = 10 \text{ mA}$

$I_F = 50 \text{ mA}$

Diode capacitance

$V_R = 0; f = 1 \text{ MHz}$

I_R max. 100 μA

$\alpha_{50\%}$ typ. 60 $^\circ$

$B_{50\%}$ typ. 20 nm

λ_{pk} typ. 650 nm

CQW24(L)-I I_V typ. 3 mCd

CQW24(L)-II I_V typ. 6 mCd

CQW24(L)-I I_V min. 4 mCd

CQW24(L)-II I_V min. 10 mCd

CQW24(L)-II I_V min. 7,5 mCd

CQW24(L)-II I_V typ. 15 mCd

CQW24(L)-I I_V typ. 55 mCd

CQW24(L)-II I_V typ. 75 mCd

C_d typ. 60 pF

DEVELOPMENT SAMPLE DATA

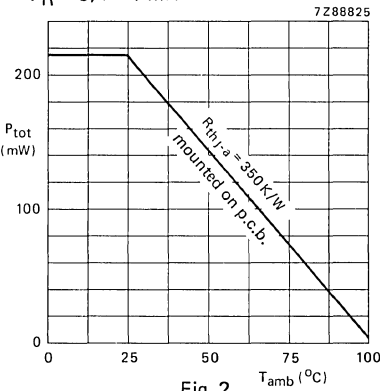

Fig. 2.

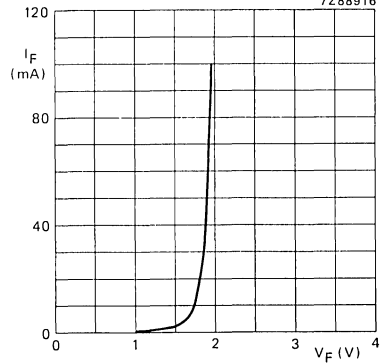

Fig. 3 $T_{amb} = 25 \text{ }^\circ\text{C}$; typ. values.

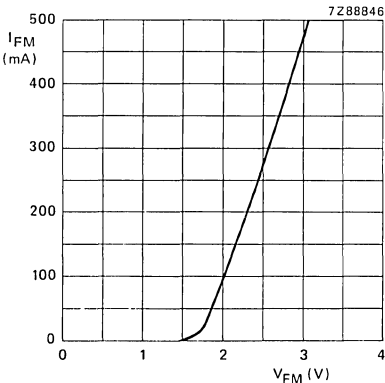

Fig. 4 $t_{ON} = 20 \mu\text{s}$; $\delta = 0,01$;
 $T_{amb} = 25 \text{ }^\circ\text{C}$; typ. values.

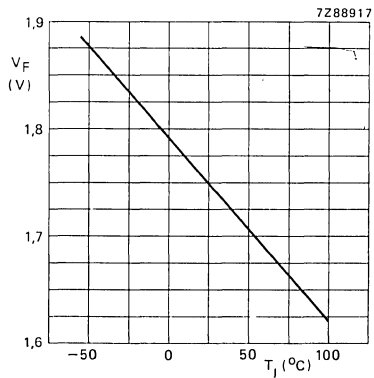

Fig. 5 $I_F = 10 \text{ mA}$; typ. values.

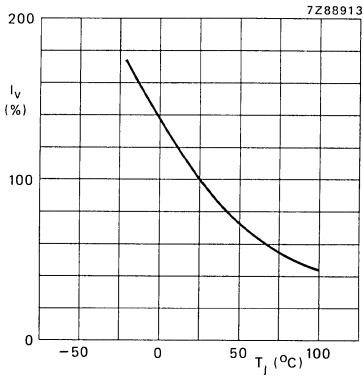

Fig. 6 Typ. values.

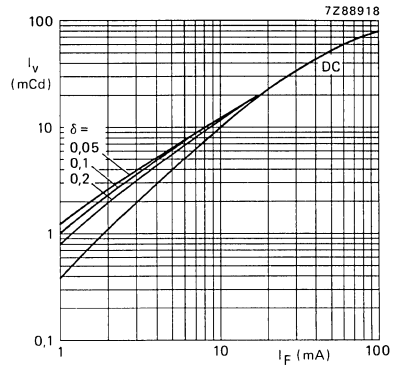

Fig. 7 $t_p = 50 \mu s$; typ. values.

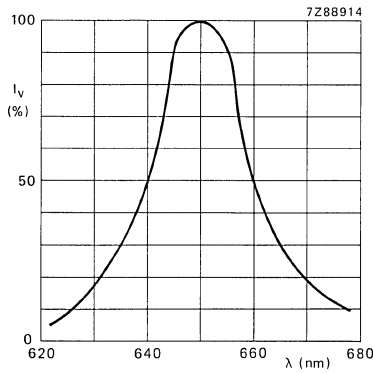

Fig. 8 $I_F = 10 \text{ mA}$; $T_{amb} = 25 \text{ }^\circ\text{C}$; typ. values.

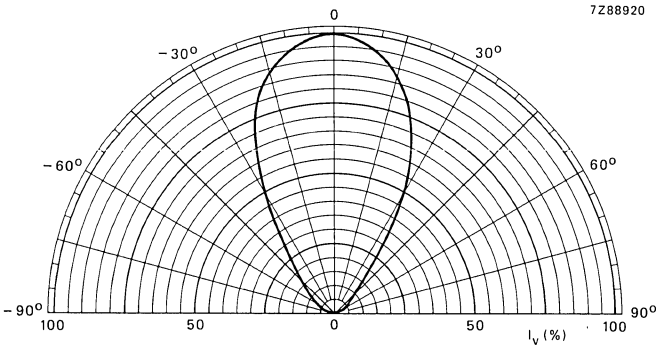

Fig. 9 Typ. values.

DEVELOPMENT SAMPLE DATA

This information is derived from development samples made available for evaluation. It does not necessarily imply that the device will go into regular production.

CQW54

LIGHT EMITTING DIODE

Circular light emitting diode with diameter of 3 mm which emits hyper-red light (GaAlAs) when forward biased.

The CQW54 has a SOD-53E outline and is encapsulated in a medium-red coloured diffusing resin.

Because of its high light intensity this LED is also very suitable in applications where only low currents are available.

QUICK REFERENCE DATA

Continuous reverse voltage	V_R	max.	5 V
Forward current (d.c.)	I_F	max.	60 mA
Total power dissipation up to $T_{amb} = 25\text{ }^\circ\text{C}$	P_{tot}	max.	150 mW
Junction temperature	T_j	max.	100 $^\circ\text{C}$
Luminous intensity			
$I_F = 10\text{ mA}$	CQW54	I_v	min. 4 mcd
	CQW54-V	I_v	5 to 12 mcd
	CQW54-VI	I_v	10 to 22 mcd
	CQW54-VII	I_v	min. 16 mcd
Wavelength at peak emission			
$I_F = 10\text{ mA}$	λ_{pk}	typ.	650 nm
Beamwidth at half-intensity directions	$\alpha_{50\%}$	typ.	60 $^\circ$

MECHANICAL DATA

Dimensions in mm

Fig. 1 SOD-53E.

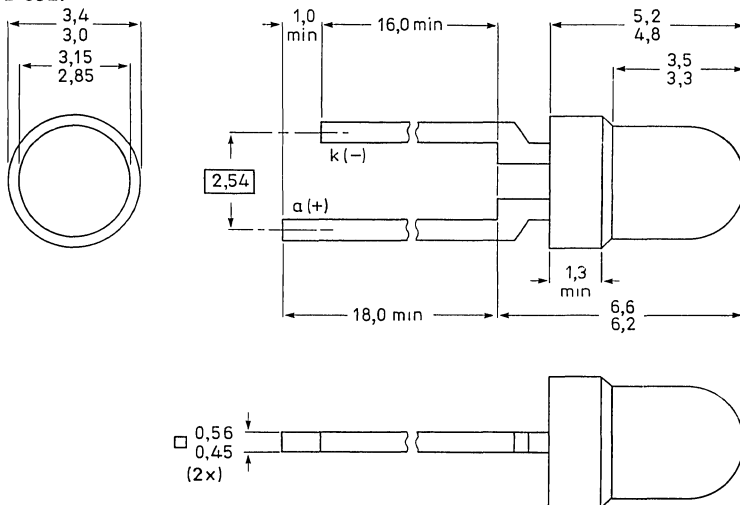

7Z86930 1

RATINGS

Limiting values in accordance with the Absolute Maximum System (IEC 134)

Reverse voltage	V_R	max.	5 V
Forward current			
d.c.	I_F	max.	60 mA
peak value; $t_p = 1 \mu s$; $f = 300 \text{ Hz}$	I_{FM}	max.	1 A
peak value; $t_{on} = 20 \mu s$; $\delta = 0,01$		max.	500 mA
Total power dissipation up to $T_{amb} = 25 \text{ }^\circ\text{C}$	P_{tot}	max.	150 mW
Storage temperature	T_{stg}	-55 to +100	$^\circ\text{C}$
Junction temperature	T_j	max.	100 $^\circ\text{C}$
Lead soldering temperature			
> 1,5 mm from the seating plane; $t_{sld} < 7 \text{ s}$	T_{sld}	max.	260 $^\circ\text{C}$

THERMAL RESISTANCE

From junction to ambient when the device is mounted on a p.c. board	$R_{th \text{ j-a}}$	max.	500 K/W
--	----------------------	------	---------

CHARACTERISTICS

$T_j = 25 \text{ }^\circ\text{C}$ unless otherwise specified

Forward voltage				
$I_F = 4 \text{ mA}$	V_F	typ.	1,65 V	
$I_F = 10 \text{ mA}$	V_F	typ.	2,1 V	
		max.	3,0 V	
Reverse current				
$V_R = 5 \text{ V}$	I_R	max.	100 μA	
Beamwidth between half-intensity directions				
$I_F = 10 \text{ mA}$	$\alpha_{50\%}$	typ.	60 $^\circ$	
Bandwidth at half height	$B_{50\%}$	typ.	20 nm	
Wavelength at peak emission				
$I_F = 10 \text{ mA}$	λ_{pk}	typ.	650 nm	
Luminous intensity				
$I_F = 4 \text{ mA}$	CQW54	I_v	typ.	2 mcd
	CQW54-V	I_v	typ.	3 mcd
	CQW54-VI	I_v	typ.	6 mcd
	CQW54-VII	I_v	typ.	7 mcd
$I_F = 10 \text{ mA}$	CQW54	I_v	min.	4 mcd
			typ.	5 mcd
	CQW54-V	I_v	5 to 12	mcd
			typ.	8 mcd
	CQW54-VI	I_v	10 to 22	mcd
			typ.	15 mcd
	CQW54-VII	I_v	min.	16 mcd
			typ.	18 mcd
$I_F = 50 \text{ mA}$	CQW54	I_v	typ.	25 mcd
	CQW54-V	I_v	typ.	40 mcd
	CQW54-VI	I_v	typ.	75 mcd
	CQW54-VII	I_v	typ.	90 mcd

Diode capacitance
 $V_R = 0; f = 1 \text{ MHz}$

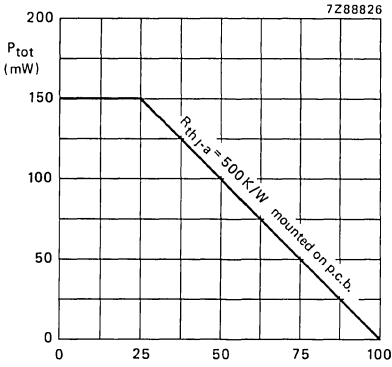

Fig. 2. $T_{amb} \text{ (}^\circ\text{C)}$

C_d typ. 60 pF

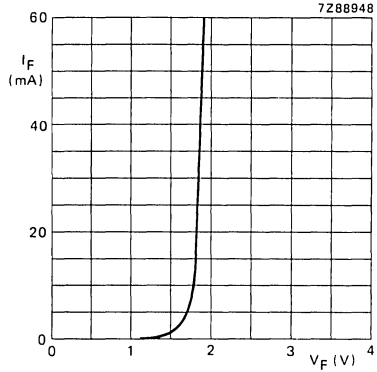

Fig. 3. $T_{amb} = 25 \text{ }^\circ\text{C}$; typ. values.

DEVELOPMENT SAMPLE DATA

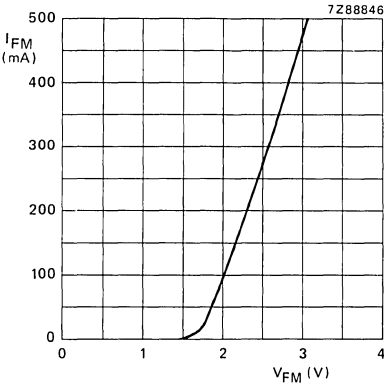

Fig. 4. $t_{on} = 20 \mu\text{s}$; $\delta = 0,01$;
 $T_{amb} = 25 \text{ }^\circ\text{C}$; typ. values.

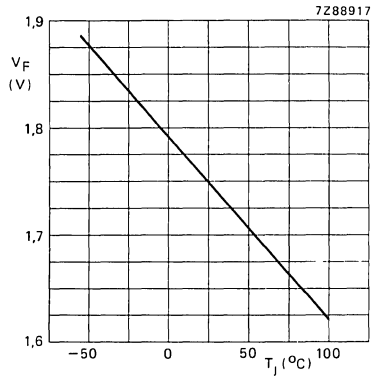

Fig. 5. $I_F = 10 \text{ mA}$; typ. values.

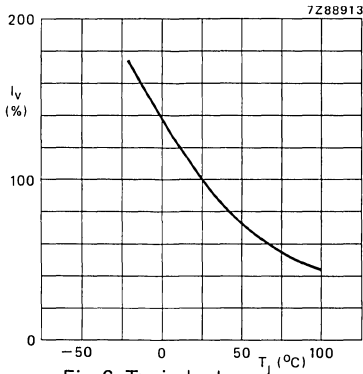

Fig. 6. Typical values.

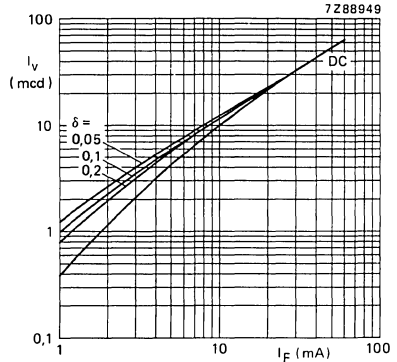

Fig. 7. $t_p = 50 \mu\text{s}$; typ. values.

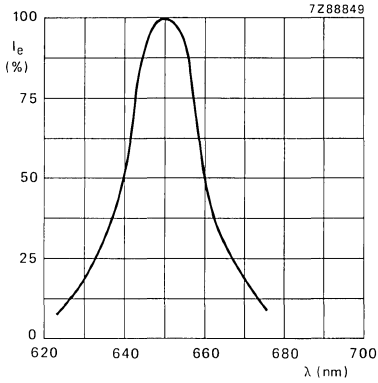

Fig. 8 $I_F = 10 \text{ mA}$; $T_{\text{amb}} = 25 \text{ }^\circ\text{C}$; typ. values.

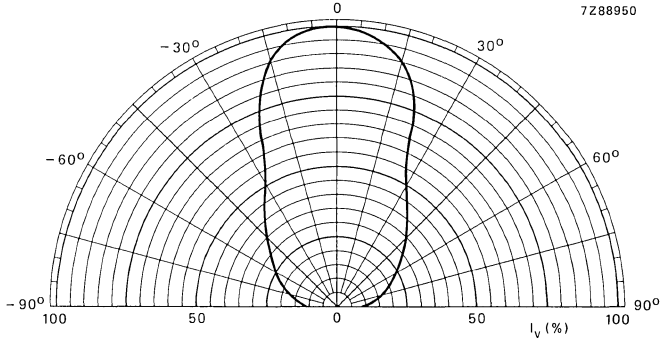

Fig. 9 Typical values.

LIGHT EMITTING DIODE

Light emitting diode in a flat plastic stackable envelope with rectangular lens (2,5 mm x 5 mm). The CQX10 emits visible super-red light (GaAsP), when forward biased.

QUICK REFERENCE DATA

Continuous reverse voltage	V_R	max.	5 V
Forward current (d.c.)	I_F	max.	30 mA
Total power dissipation up to $T_{amb} = 65\text{ }^\circ\text{C}$	P_{tot}	max.	90 mW
Luminous intensity (on-axis) $I_F = 10\text{ mA}$	CQX10-I	I_V	min. 0,7 mcd
	CQX10-II	I_V	1,0 to 2,2 mcd
	CQX10-III	I_V	1,6 to 3,5 mcd
	CQX10-IV	I_V	min. 3,0 mcd
Wavelength at peak emission	λ_{pk}	typ.	630 nm
Beamwidth between half-intensity directions in the plane of the connections	$\alpha_{50\%}$	typ.	50°

MECHANICAL DATA

Dimensions in mm

Fig. 1 SOD-65.

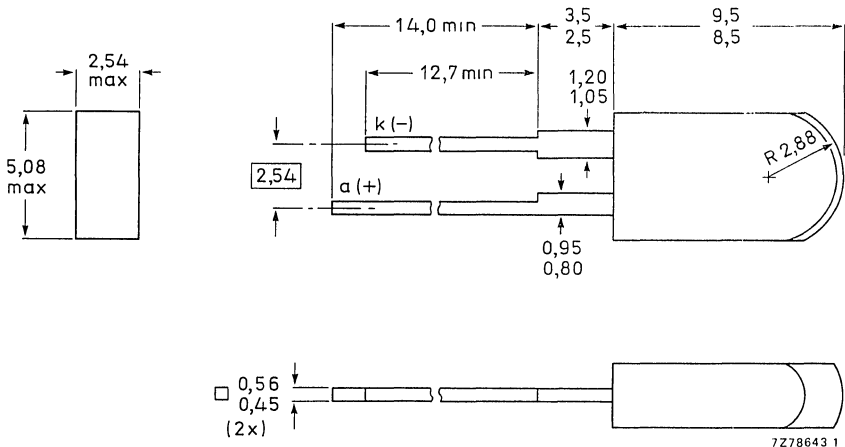

RATINGS

Limiting values in accordance with the Absolute Maximum System (IEC 134)

Continuous reverse voltage	V_R	max.	5 V
Forward current (d.c.)	I_F	max.	30 mA
Forward current			
peak value; $t_p = 1 \mu s$; $f = 300$ Hz	I_{FM}	max.	1000 mA
peak value; $t_{on} = 1$ ms; $\delta = 0,33$	I_{FM}	max.	60 mA
Total power dissipation up to $T_{amb} = 65$ °C	P_{tot}	max.	90 mW
Storage temperature	T_{stg}		-55 to + 100 °C
Junction temperature	T_j	max.	100 °C
Lead soldering temperature			
up to the seating plane; $t_{sld} < 7$ s	T_{sld}	max.	260 °C

THERMAL RESISTANCE

From junction to ambient when the device is mounted on a printed-circuit board

R_{thj-a}	=	350 K/W
-------------	---	---------

CHARACTERISTICS

$T_j = 25$ °C unless otherwise specified

Forward voltage				
$I_F = 10$ mA	V_F	typ.	2,1 V	
		<	3 V	
Reverse current				
$V_R = 5$ V	I_R	<	100 μA	
Beamwidth between half-intensity directions				
in the plane of the connections	$\alpha_{50\%}$	typ.	50 °	
in the plane perpendicular to the connections	$\alpha_{50\%}$	typ.	40 °	
Bandwidth at half height	$B_{50\%}$	typ.	45 nm	
Wavelength at peak emission	λ_{pk}	typ.	630 nm	
Luminous intensity (on-axis)				
$I_F = 10$ mA				
	CQX10-I	I_v	min.	0,7 mcd
	CQX10-II	I_v		1,0 to 2,2 mcd
	CQX10-III	I_v		1,6 to 3,5 mcd
	CQX10-IV	I_v	min.	3,0 mcd
Diode capacitance				
$V_R = 0$; $f = 1$ MHz	C_d	typ.	35 pF	

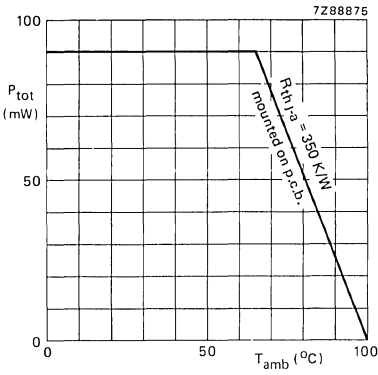

Fig. 2.

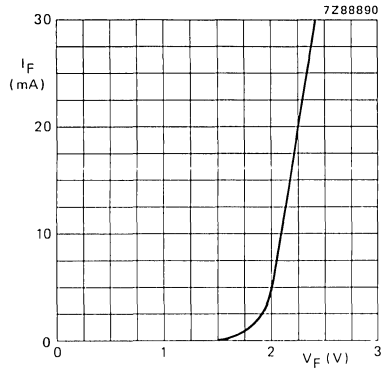

Fig. 3 $T_{amb} = 25^{\circ}\text{C}$; typ. values.

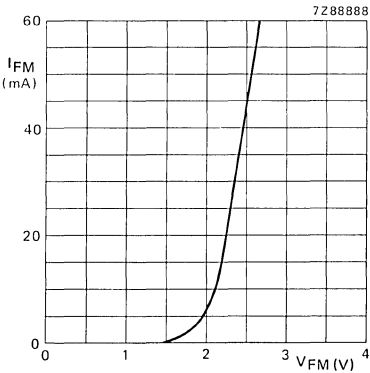

Fig. 4 $t_{on} = 50 \mu\text{s}$; $\delta = 0,01$;
 $T_{amb} = 25^{\circ}\text{C}$; typ. values.

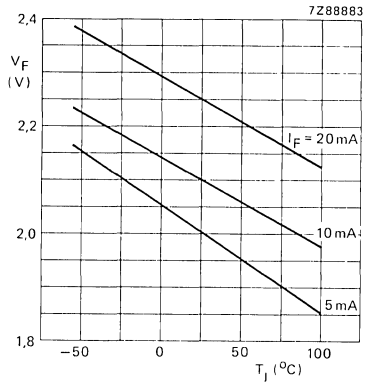

Fig. 5 Typical values.

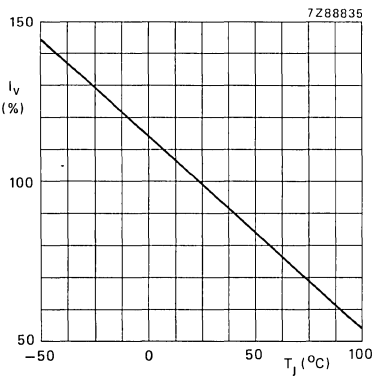

Fig. 6 $I_F = 10 \text{ mA}$; typ. values.

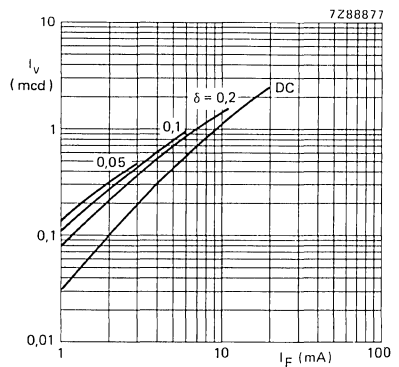

Fig. 7 $t_p = 50 \mu\text{s}$; typ. values.

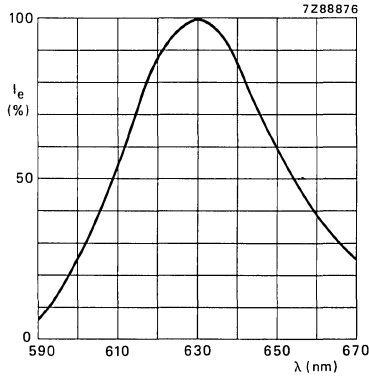

Fig. 8 Typical values.

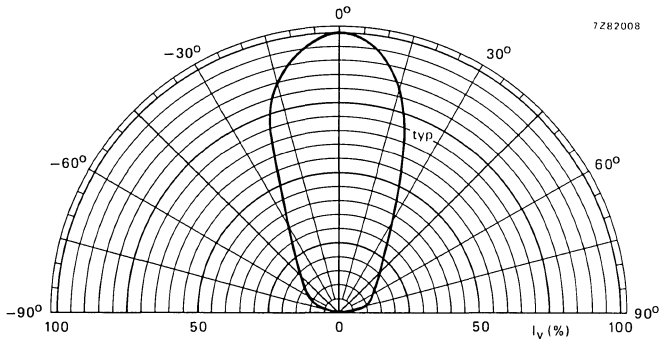

Fig. 9 Spatial distribution in the plane of the connections; typ. values.

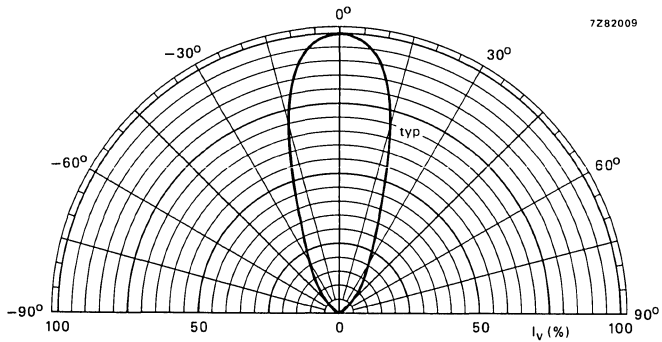

Fig. 10 Spatial distribution in the plane perpendicular to the connections; typ. values.

LIGHT EMITTING DIODE

Light emitting diodes in flat plastic stackable envelopes with rectangular lens (2,5 mm x 5 mm).
 The CQX11 emits visible super-green light (GaP) when forward biased.

QUICK REFERENCE DATA

Continuous reverse voltage	V_R	max.	5 V
Forward current (d.c.)	I_F	max.	60 mA
Total power dissipation up to $T_{amb} = 35\text{ }^\circ\text{C}$	P_{tot}	max.	180 mW
Luminous intensity (on-axis) $I_F = 10\text{ mA}$	CQX11-I CQX11-II CQX11-III CQX11-IV	I_V	min. 0,7 mCd 1,0 to 2,2 mCd 1,6 to 3,5 mCd min. 3,0 mCd
Wavelength at peak emission		λ_{pk}	typ. 565 nm
Beamwidth between half-intensity directions in the plane of the connections		$\alpha_{50\%}$	typ. 50 °

MECHANICAL DATA

Dimensions in mm

Fig. 1 SOD-65.

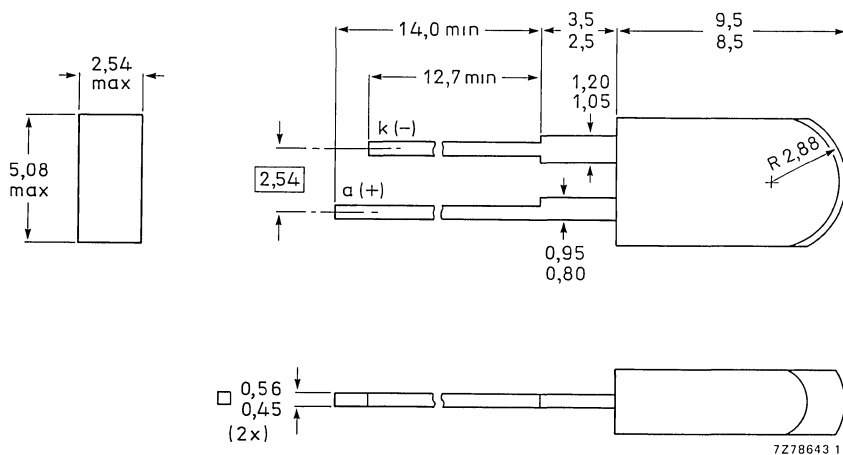

RATINGS

Limiting values in accordance with the Absolute Maximum System (IEC 134)

Reverse voltage	V_R	max.	5 V
Forward current			
d.c.	I_F	max.	60 mA
peak value; $t_p = 1 \mu s$; $f = 300 \text{ Hz}$	I_{FM}	max.	1 A
peak value; $t_{ON} = 1 \text{ ms}$; $\delta = 0,33$	I_{FM}	max.	150 mA
Total power dissipation up to $T_{amb} = 35 \text{ }^\circ\text{C}$	P_{tot}	max.	180 mW
Storage temperature	T_{stg}		$-55 \text{ to } + 100 \text{ }^\circ\text{C}$
Junction temperature	T_j	max.	100 $^\circ\text{C}$
Lead soldering temperature			
up to the seating plane; $t_{sld} < 7 \text{ s}$	T_{sld}	max.	260 $^\circ\text{C}$

THERMAL RESISTANCE

From junction to ambient when the device is mounted on a p.c. board

$R_{th \text{ j-a}}$	max.	350 K/W
----------------------	------	---------

CHARACTERISTICS

$T_j = 25 \text{ }^\circ\text{C}$ unless otherwise specified

Forward voltage				
$I_F = 10 \text{ mA}$	V_F	typ.	2,1 V	
		max.	3,0 V	
Reverse current				
$V_R = 5 \text{ V}$	I_R	max.	100 μA	
Beamwidth between half-intensity directions				
in the plane of the connections	$\alpha_{50\%}$	typ.	50 $^\circ$	
in the plane perpendicular to the connections	$\alpha_{50\%}$	typ.	40 $^\circ$	
Bandwidth at half height	$B_{50\%}$	typ.	30 nm	
Wavelength at peak emission				
$I_F = 10 \text{ mA}$	λ_{pk}	typ.	565 nm	
Luminous intensity (on-axis)				
$I_F = 10 \text{ mA}$				
	CQX11-I	I_v	min. 0,7 mCd	
	CQX11-II	I_v	1,0 to 2,2 mCd	
	CQX11-III	I_v	1,6 to 3,5 mCd	
	CQX11-IV	I_v	min. 3,0 mCd	
Diode capacitance				
$V_R = 0$; $f = 1 \text{ MHz}$	C_d	typ.	35 pF	

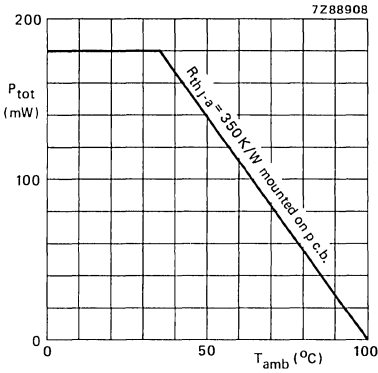

Fig. 2.

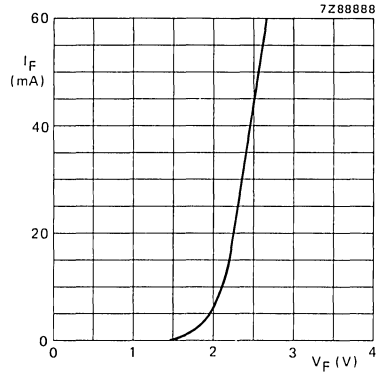

Fig. 3 $T_{amb} = 25^\circ C$; typical values.

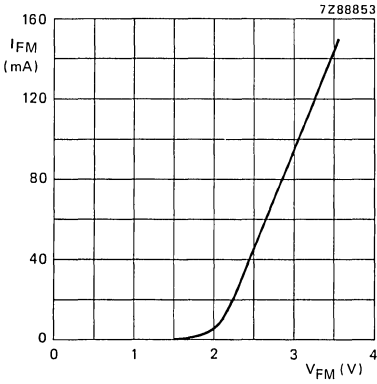

Fig. 4 $t_{on} = 50 \mu s$; $\delta = 0,01$;
 $T_{amb} = 25^\circ C$; typical values.

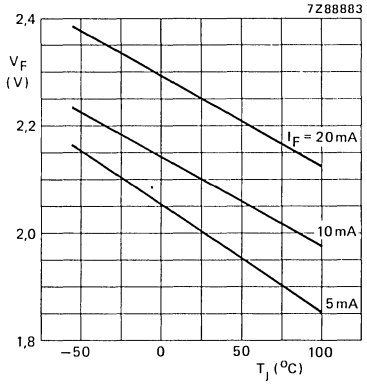

Fig. 5 Typical values.

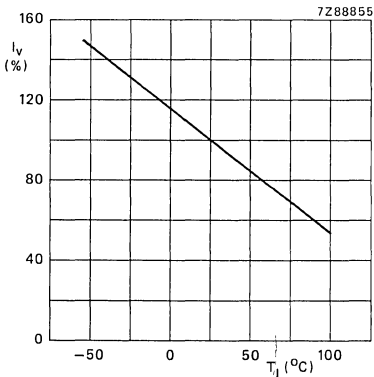

Fig. 6 $I_F = 10 mA$; typical values.

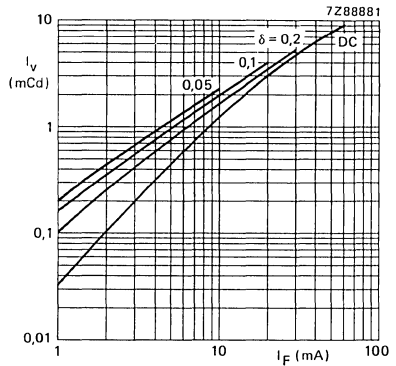

Fig. 7 $t_p = 50 \mu s$; typical values.

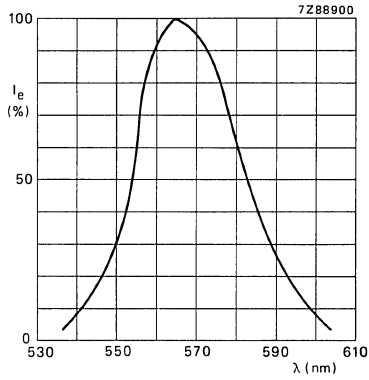

Fig. 8 Typical values.

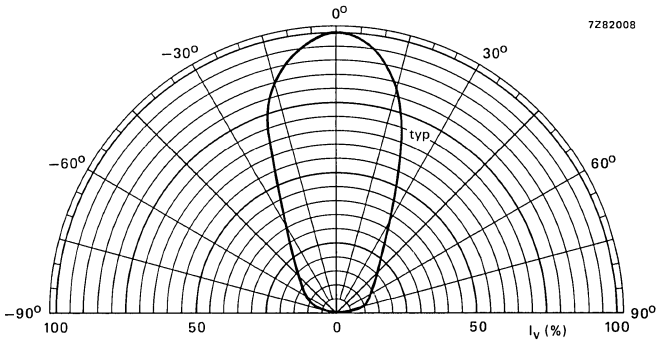

Fig. 9 Spatial distribution in the plane of the connections; typical values.

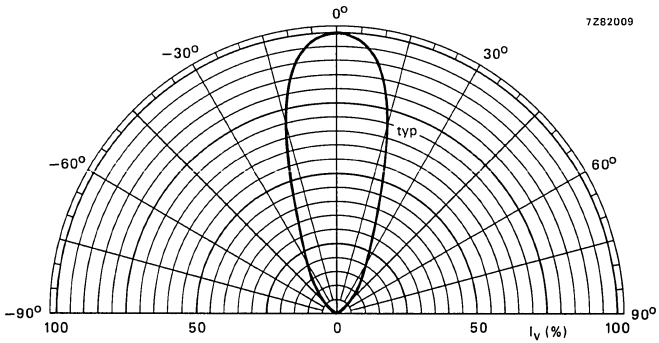

Fig. 10 Spatial distribution in the plane perpendicular to the connections; typical values.

LIGHT EMITTING DIODE

Light emitting diodes in flat plastic stackable envelopes with rectangular lens (2,5 mm x 5 mm).
The CQX12 emits visible yellow light (GaAsP) when forward biased.

QUICK REFERENCE DATA

Continuous reverse voltage	V_R	max.	5 V
Forward current (d.c.)	I_F	max.	30 mA
Total power dissipation up to $T_{amb} = 65\text{ }^\circ\text{C}$	P_{tot}	max.	90 mW
Luminous intensity (on-axis) $I_F = 10\text{ mA}$	CQX12-I CQX12-II CQX12-III CQX12-IV	I_v	min. 0,7 mcd 1,0 to 2,2 mcd 1,6 to 3,5 mcd min. 3,0 mcd
Wavelength at peak emission		λ_{pk}	typ. 590 nm
Beamwidth between half-intensity directions in the plane of the connections		$\alpha_{50\%}$	typ. 50 °

MECHANICAL DATA

Dimensions in mm

Fig. 1 SOD-65.

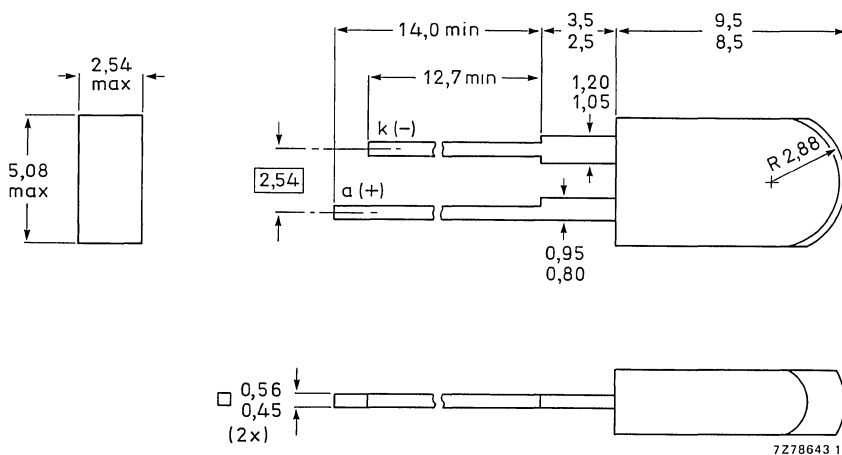

RATINGS

Limiting values in accordance with the Absolute Maximum System (IEC 134)

Reverse voltage	V_R	max.	5 V
Forward current			
d.c.	I_F	max.	30 mA
peak value; $t_p = 1 \mu s$; $f = 300 \text{ Hz}$	I_{FM}	max.	1 A
peak value; $t_{on} = 1 \text{ ms}$; $\delta = 0,33$	I_{FM}	max.	60 mA
Total power dissipation up to $T_{amb} = 65 \text{ }^\circ\text{C}$	P_{tot}	max.	90 mW
Storage temperature	T_{stg}		-55 to + 100 $^\circ\text{C}$
Junction temperature	T_j	max.	100 $^\circ\text{C}$
Lead soldering temperature			
up to the seating plane; $t_{sld} < 7 \text{ s}$	T_{sld}	max.	260 $^\circ\text{C}$

THERMAL RESISTANCE

From junction to ambient when the device is mounted on a p.c. board

$R_{th \text{ j-a}}$	max.	350 K/W
----------------------	------	---------

CHARACTERISTICS

$T_j = 25 \text{ }^\circ\text{C}$ unless otherwise specified

Forward voltage			
$I_F = 10 \text{ mA}$	V_F	typ.	2,1 V
		max.	3,0 V
Reverse current			
$V_R = 5 \text{ V}$	I_R	max.	100 μA
Beamwidth between half-intensity directions			
in the plane of the connections	$\alpha_{50\%}$	typ.	50 $^\circ$
in the plane perpendicular to the connections	$\alpha_{50\%}$	typ.	40 $^\circ$
Bandwidth at half height	$B_{50\%}$	typ.	40 nm
Wavelength at peak emission			
$I_F = 10 \text{ mA}$	λ_{pk}	typ.	590 nm
Luminous intensity (on-axis)			
$I_F = 10 \text{ mA}$	CQX12-I	I_v	min. 0,7 mcd
	CQX12-II	I_v	1,0 to 2,2 mcd
	CQX12-III	I_v	1,6 to 3,5 mcd
	CQX12-IV	I_v	min. 3,0 mcd
Diode capacitance			
$V_R = 0$; $f = 1 \text{ MHz}$	C_d	typ.	35 pF

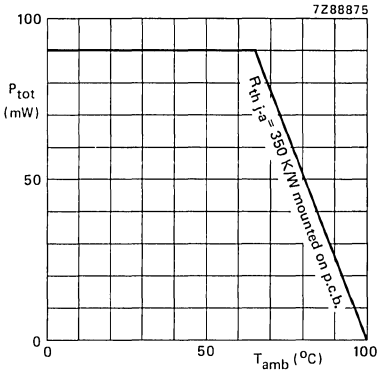

Fig. 2.

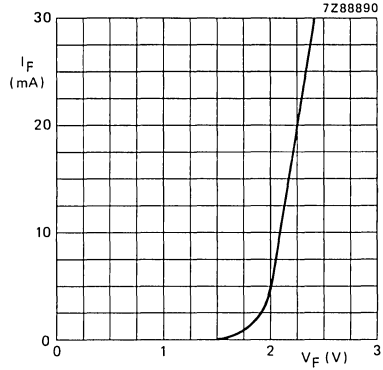

Fig. 3 Typical values.

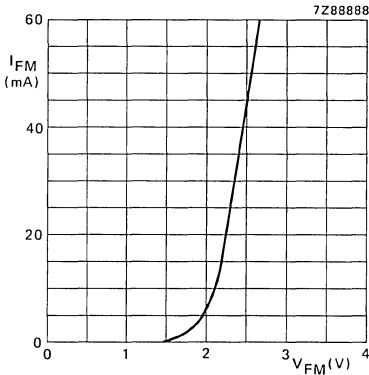

Fig. 4 $t_{on} = 50 \mu s$; $\delta = 0,01$;
 $T_{amb} = 25 \text{ }^\circ\text{C}$; typical values.

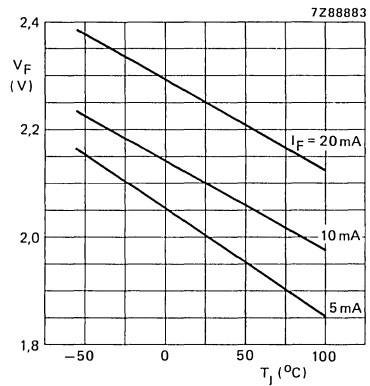

Fig. 5 Typical values.

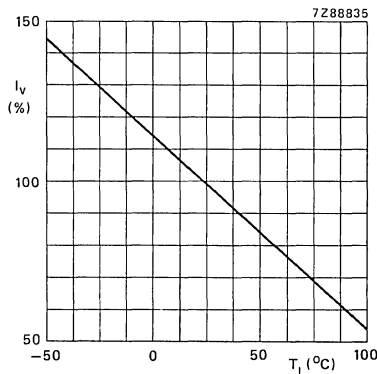

Fig. 6 $I_F = 10 \text{ mA}$; typical values.

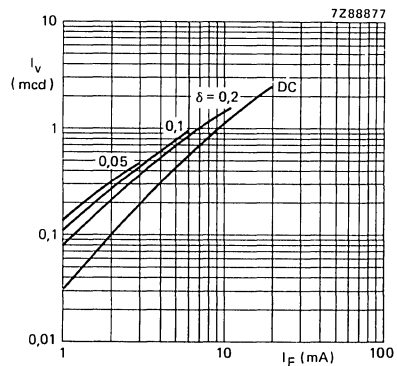

Fig. 7 $t_p = 50 \mu s$; typical values.

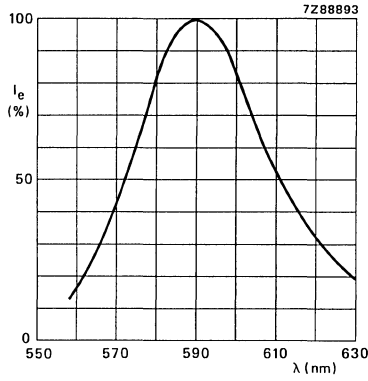

Fig. 8 Typical values.

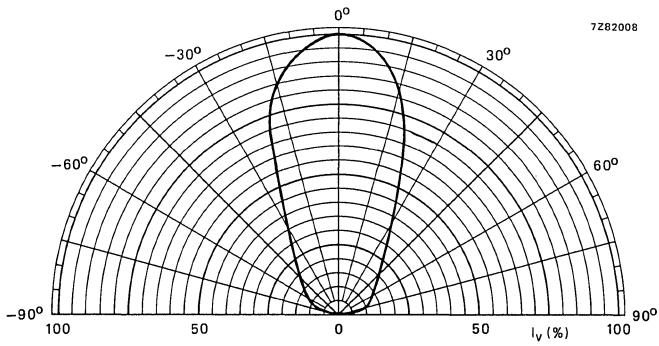

Fig. 9 Spatial distribution in the plane of the connections; typical values.

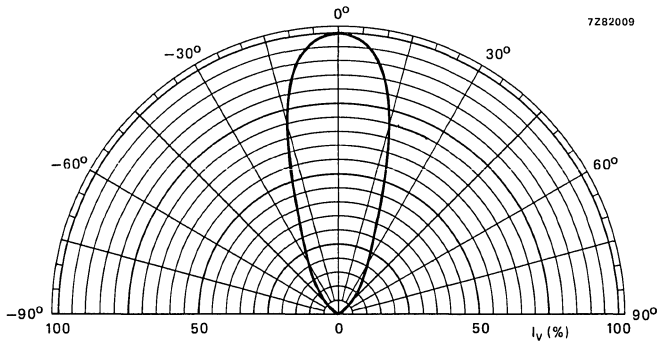

Fig. 10 Spatial distribution in the plane perpendicular to the connections; typical values.

DEVELOPMENT SAMPLE DATA

This information is derived from development samples made available for evaluation. It does not necessarily imply that the device will go into regular production.

CQX24
CQX24L

LIGHT EMITTING DIODES

Circular light emitting diodes with diameter of 5 mm which emit a narrow beam hyper-red (GaAlAs) light when forward biased. The CQX24 and CQX24L have a SOD-63 outline and are encapsulated in a transparent non-diffusing resin.

Because of its very high light intensity the CQX24 (and CQX24L) is very suitable in applications where only low currents are available and because this type can withstand high forward currents it is extremely suitable for very high luminous intensity applications.

The CQX24L is the long-lead version of the CQX24 and has no seating plane but is in all other respects equal to the CQX24.

QUICK REFERENCE DATA

Continuous reverse voltage	V_R	max.	5 V	
Forward current (d.c.)	I_F	max.	100 mA	
Total power dissipation up to $T_{amb} = 25\text{ }^\circ\text{C}$	P_{tot}	max.	215 mW	
Junction temperature	T_j	max.	100 $^\circ\text{C}$	
Luminous intensity $I_F = 10\text{ mA}$	CQX24(L)-I CQX24(L)-II CQX24(L)-III	I_v I_v I_v	min. min. min.	20 mCd 50 mCd 100 mCd
Wavelength at peak emission		λ_{pk}	typ.	650 nm
Beamwidth between half-intensity directions		$\alpha_{50\%}$	typ.	24 $^\circ$

MECHANICAL DATA

Dimensions in mm

Fig. 1a SOD-63B.

CQX24

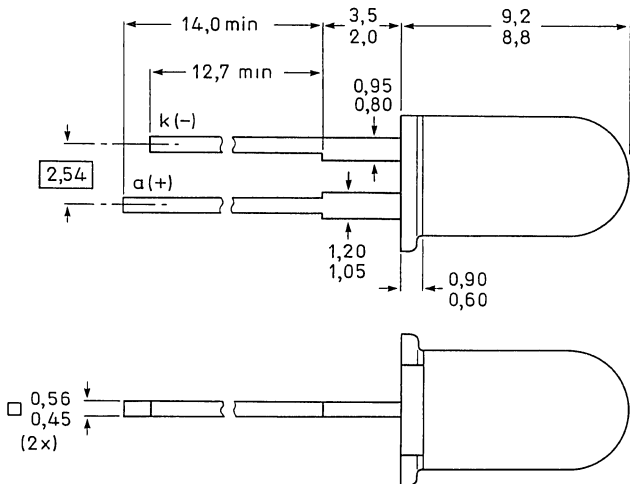
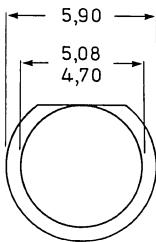

7286999

CQX24 CQX24L

Fig. 1b SOD-63L.
CQX24L

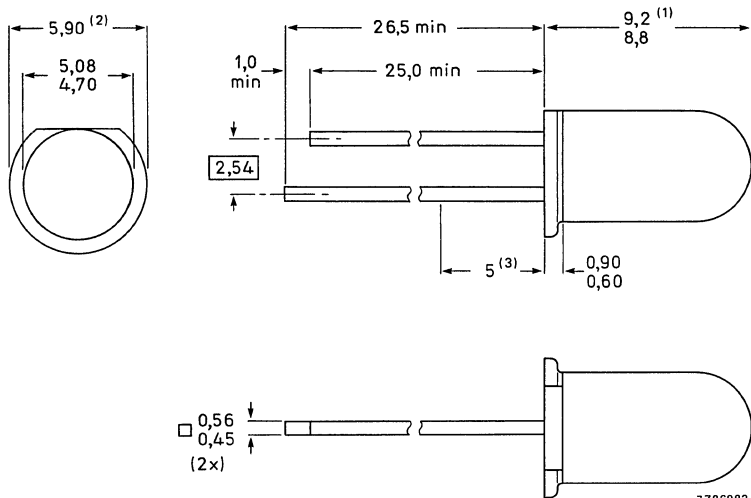

- (1) Measured when the device is seated in a gauge with 2 holes 0,80 mm diameter and 2,54 mm apart.
 (2) Maximum value including burrs.
 (3) Solderability not guaranteed within this zone due to tie-bar cropping.

RATINGS

Limiting values in accordance with the Absolute Maximum System (IEC 134)

Reverse voltage	V_R	max.	5 V
Forward current d.c.	I_F	max.	100 mA
Forward current peak value; $t_p = 1 \mu s$; $f = 300 \text{ Hz}$	I_{FM}	max.	1 A
peak value; $t_{ON} = 20 \mu s$; $\delta = 0,01$		max.	500 mA
Total power dissipation up to $T_{amb} = 25 \text{ }^\circ\text{C}$	P_{tot}	max.	215 mW
Storage temperature	T_{stg}		-55 to +100 $^\circ\text{C}$
Junction temperature	T_j	max.	100 $^\circ\text{C}$
Lead soldering temperature; $t_{sld} < 7 \text{ s}$	T_{sld}	max.	260 $^\circ\text{C}$
> 1,5 mm from the seating plane for CQX24			
> 5 mm from the plastic body for CQX24L			

THERMAL RESISTANCE

From junction to ambient when the device is mounted on a p.c. board	$R_{th \text{ j-a}}$	max.	350 K/W
--	----------------------	------	---------

CHARACTERISTICS

$T_j = 25 \text{ }^\circ\text{C}$ unless otherwise specified.

Forward voltage $I_F = 10 \text{ mA}$	V_F	typ.	1,75 V
$I_F = 50 \text{ mA}$	V_F	typ.	1,9 V
		max.	2,5 V

Reverse current

$V_R = 5 \text{ V}$

I_R max. 100 μA

Beamwidth between half-intensity directions

$I_F = 10 \text{ mA}$

$\alpha_{50\%}$ typ. 24 $^\circ$

Bandwidth at half height

$B_{50\%}$ typ. 20 nm

Wavelength at peak emission

$I_F = 10 \text{ mA}; T_{\text{amb}} = 25 \text{ }^\circ\text{C}$

λ_{pk} typ. 650 nm

Luminous intensity

$I_F = 4 \text{ mA}$

CQX24(L)-I I_V typ. 16 mCd

CQX24(L)-II I_V typ. 35 mCd

CQX24(L)-III I_V typ. 50 mCd

$I_F = 10 \text{ mA}$

CQX24(L)-I I_V min. 20 mCd

typ. 40 mCd

CQX24(L)-II I_V min. 50 mCd

typ. 80 mCd

CQX24(L)-III I_V min. 100 mCd

typ. 120 mCd

$I_F = 50 \text{ mA}$

CQX24(L)-I I_V typ. 200 mCd

CQX24(L)-II I_V typ. 400 mCd

CQX24(L)-III I_V typ. 600 mCd

Diode capacitance

$V_R = 0; f = 1 \text{ MHz}$

C_d typ. 35 pF

DEVELOPMENT SAMPLE DATA

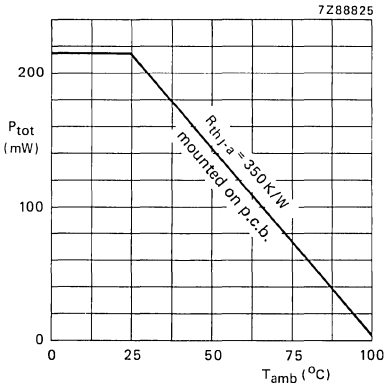

Fig. 2.

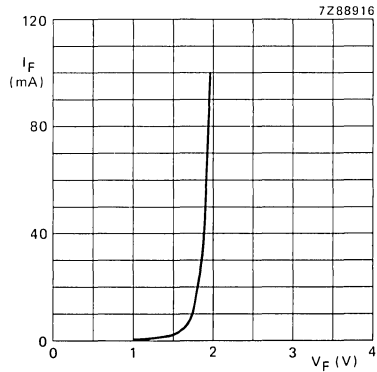

Fig. 3 $T_{\text{amb}} = 25 \text{ }^\circ\text{C}$; typ. values.

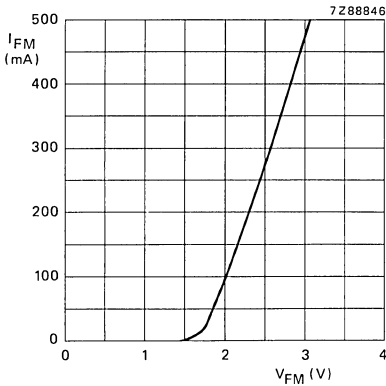

Fig. 4 $t_{ON} = 20 \mu s$; $\delta = 0,01$;
 $T_{amb} = 25 \text{ }^\circ\text{C}$; typ. values.

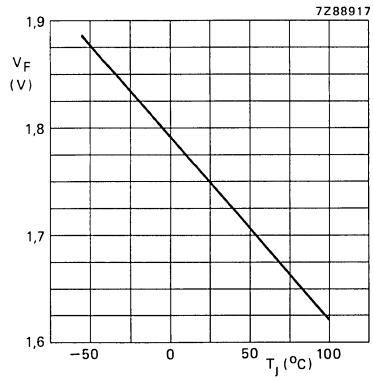

Fig. 5 $I_F = 10 \text{ mA}$; typ. values.

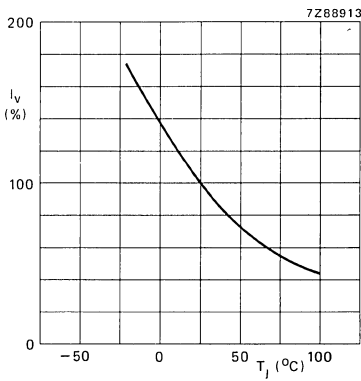

Fig. 6 Typ. values.

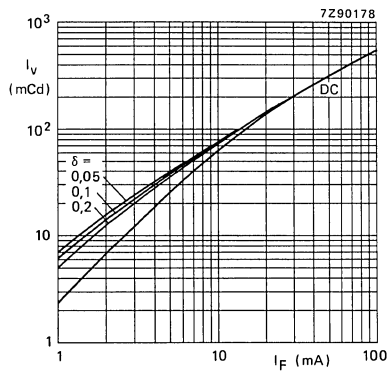

Fig. 7 $t_p = 50 \mu s$; typ. values.

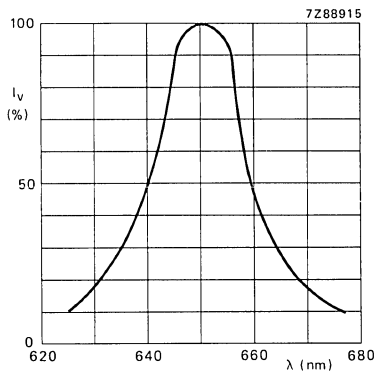

Fig. 8 $I_F = 10 \text{ mA}$; $T_{amb} = 25 \text{ }^\circ\text{C}$; typ. values.

7288919

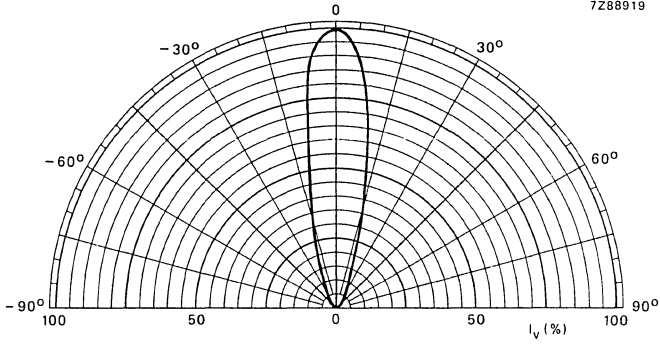

Fig. 9.

DEVELOPMENT SAMPLE DATA

Accessories for panel mounting (panel thickness < 4 mm)

Plastic clip and ring
black type RTC757
colourless type RTC758

Hole diameter
6,4 mm for panel thickness < 3 mm
6,5 mm for panel thickness > 3 mm

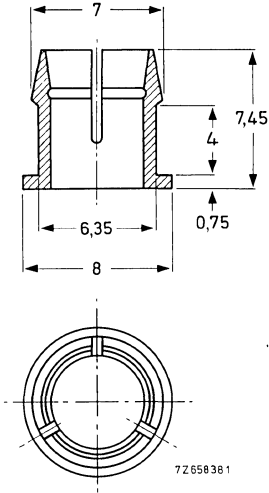

Fig. 2.

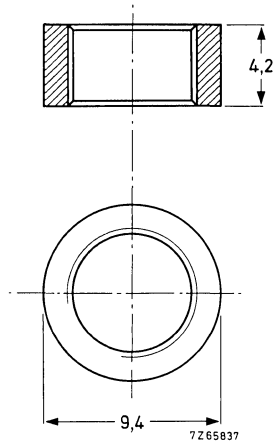

Fig. 3.

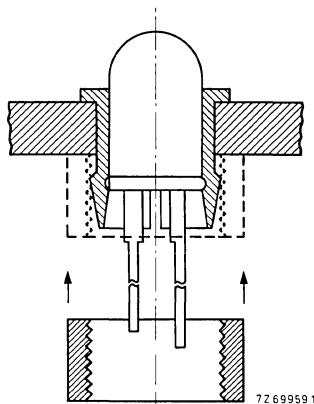

Fig. 4.

RATINGS

Limiting values in accordance with the Absolute Maximum System (IEC 134)

Continuous reverse voltage	V_R	max.	3 V
Forward current (d.c.)	I_F	max.	20 mA
Forward current (peak value)			
$t_p = 1 \text{ ms}; \delta = 0,33$	I_{FM}	max.	60 mA
$t_p = 1 \mu\text{s}; f = 300 \text{ Hz}$	I_{FM}	max.	1000 mA
Total power dissipation up to $T_{amb} = 55 \text{ }^\circ\text{C}$	P_{tot}	max.	60 mW
Storage temperature	T_{stg}		-55 to + 100 $^\circ\text{C}$
Junction temperature	T_j	max.	100 $^\circ\text{C}$
Lead soldering temperature			
> 1,5 mm from the seating plane; $t_{sld} < 7 \text{ s}$	T_{sld}	max.	230 $^\circ\text{C}$

THERMAL RESISTANCE

From junction to ambient			
in free air	$R_{th \text{ j-a}}$	=	750 K/W
mounted on a printed-circuit board	$R_{th \text{ j-a}}$	=	500 K/W

CHARACTERISTICS

$T_j = 25 \text{ }^\circ\text{C}$ unless otherwise specified

Forward voltage			
$I_F = 10 \text{ mA}$	V_F	typ.	2,1 V
		<	3 V
Reverse current			
$V_R = 3 \text{ V}$	I_R	<	100 μA
Diode capacitance			
$V_R = 0; f = 1 \text{ MHz}$	C_d	typ.	35 pF
Luminous intensity (on-axis)			
$I_F = 10 \text{ mA}$	CQX51-I	I_v	min. 1,6 mCd
	CQX51-II	I_v	3 to 7 mCd
	CQX51-III	I_v	5 to 11 mCd
Wavelength at peak emission	λ_{pk}	typ.	630 nm
Beamwidth between half-intensity directions	$\alpha_{50\%}$	typ.	55 $^\circ$

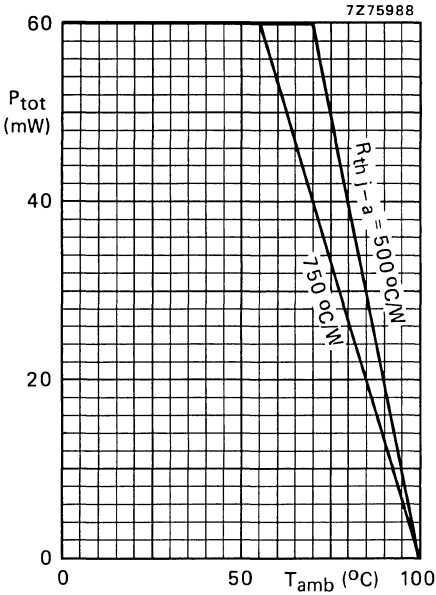

Fig. 5 Maximum permissible power dissipation as a function of ambient temperature.

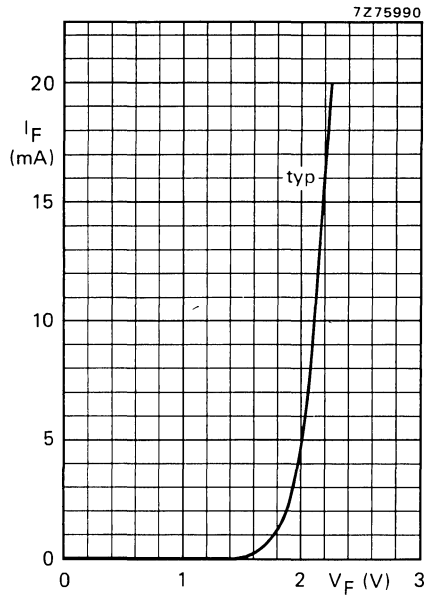

Fig. 6 $T_j = 25\text{ }^\circ\text{C}$.

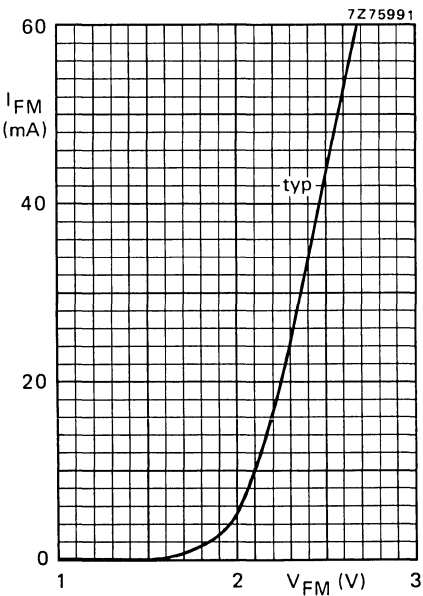

Fig. 7 $t_p = 50\text{ }\mu\text{s}$; $T = 5\text{ ms}$; $T_j = 25\text{ }^\circ\text{C}$.

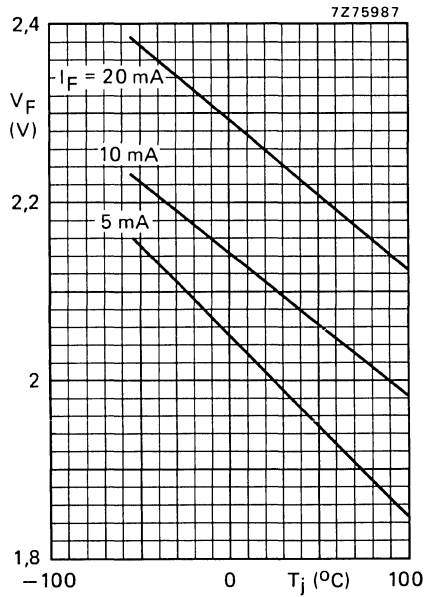

Fig. 8 Typical values.

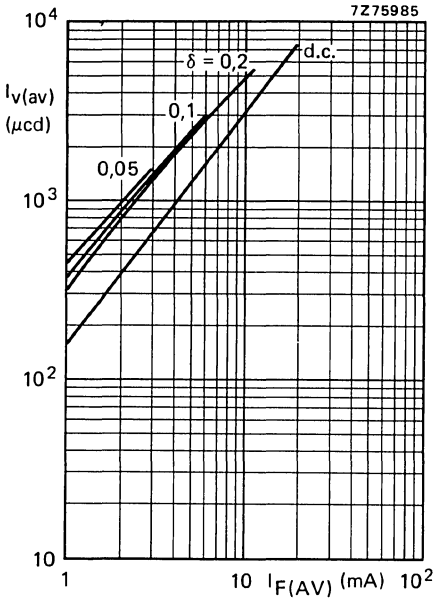

Fig. 9 Typical values; $T_j = 25^\circ C$.

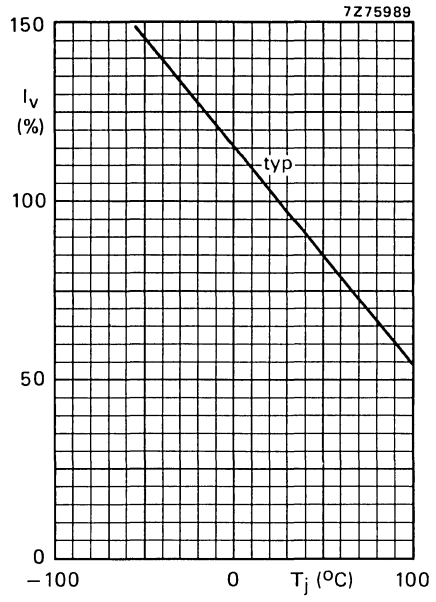

Fig. 10 $I_F = 10$ mA.

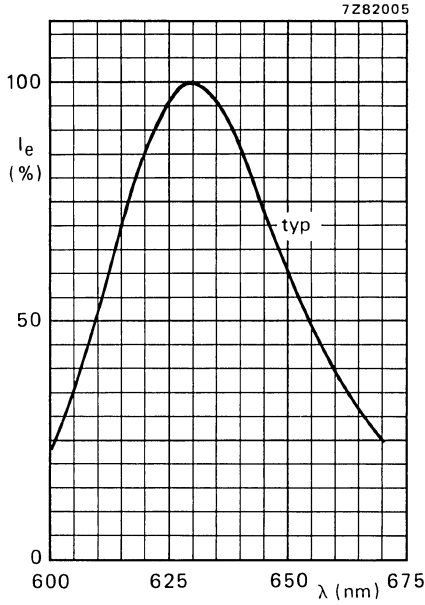

Fig. 11.

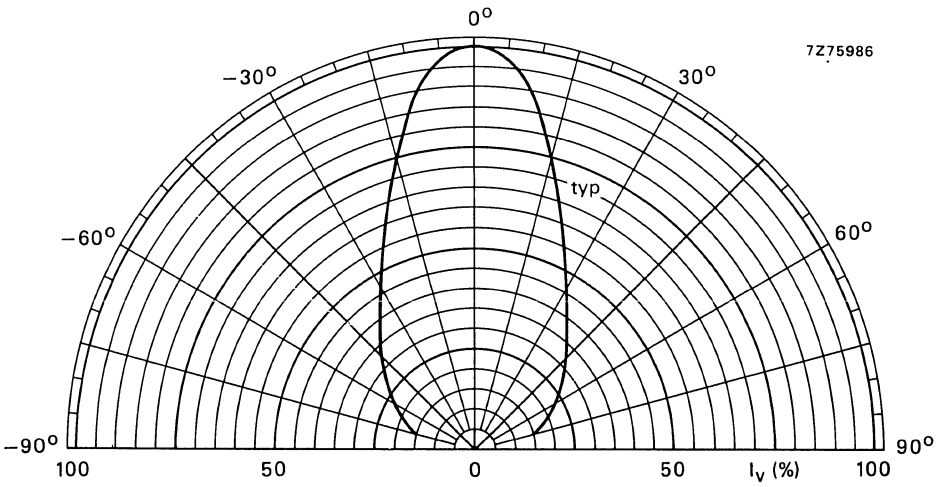

Fig. 12.

DEVELOPMENT SAMPLE DATA

This information is derived from development samples made available for evaluation. It does not necessarily imply that the device will go into regular production.

CQX54
CQX54L

LIGHT EMITTING DIODES

Circular light emitting diodes with diameter of 5 mm which emit a narrow-beam super-red (GaAsP) light when forward biased.

The CQX54 and CQX54L have a SOD-63 outline and are encapsulated in a transparent non-diffusing resin.

The CQX54L is the long-lead version of the CQX54 and has no seating plane but is in all other respects equal to the CQX54.

QUICK REFERENCE DATA

Continuous reverse voltage	V_R	max.	5 V
Forward current (d.c.)	I_F	max.	30 mA
Total power dissipation up to $T_{amb} = 65^\circ\text{C}$	P_{tot}	max.	90 mW
Junction temperature	T_j	max.	100 $^\circ\text{C}$
Luminous intensity $I_F = 10\text{ mA}$	I_v	min. typ.	15 mCd 20 mCd
Wavelength at peak emission	λ_{pk}	typ.	630 nm
Beamwidth between half-intensity directions	$\alpha_{50\%}$	typ.	20 $^\circ$

MECHANICAL DATA

Dimensions in mm

Fig. 1a SOD-63A.
CQX54

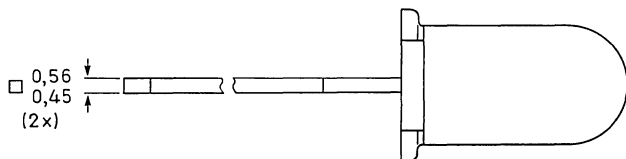
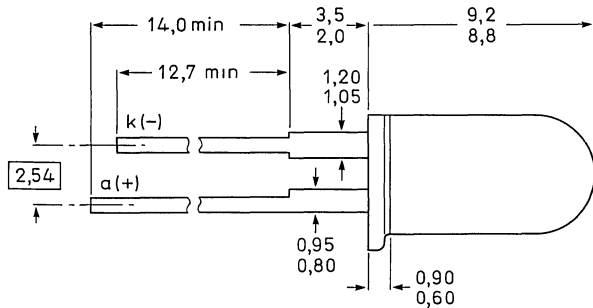
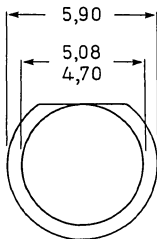

7286977

CQX54
CQX54L

Fig. 1b SOD-63L.
CQX54L

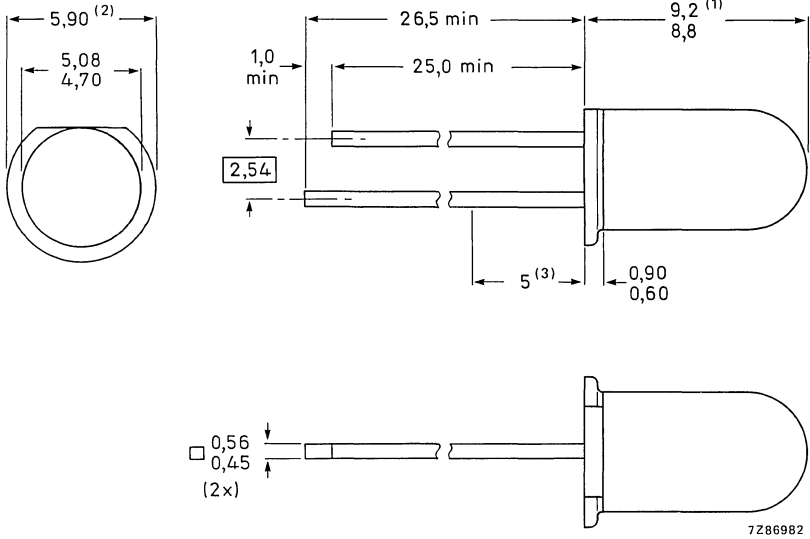

Notes

1. Dimension measured when the device is seated in a gauge with 2 holes of 0,80 mm diameter and 2,54 mm apart.
2. For the maximum value including plastic burrs.
3. Solderability is not guaranteed within this zone due to tie-bar cropping.

RATINGS

Limiting values in accordance with the Absolute Maximum System (IEC 134)

Reverse voltage	V_R	max.	5 V
Forward current d.c.	I_F	max.	30 mA
Forward current peak value; $t_p = 1 \mu s$; $f = 300 \text{ Hz}$ peak value; $t_p = 1 \text{ ms}$; $\delta = 0,33$	I_{FM}	max.	1 A 60 mA
Total power dissipation up to $T_{amb} = 65 \text{ }^\circ\text{C}$	P_{tot}	max.	90 mW
Storage temperature	T_{stg}		-55 to + 100 $^\circ\text{C}$
Junction temperature	T_j	max.	100 $^\circ\text{C}$
Lead soldering temperature > 1,5 mm from the seating plane; $t_{sld} < 7 \text{ s}$	T_{sld}	max.	260 $^\circ\text{C}$

THERMAL RESISTANCE

From junction to ambient when the device is mounted on a p.c. board	$R_{th j-a}$	max.	350 K/W
--	--------------	------	---------

CHARACTERISTICS

$T_j = 25\text{ }^\circ\text{C}$ unless otherwise specified

Forward voltage

$I_F = 10\text{ mA}$

Reverse current

$V_R = 5\text{ V}$

Beamwidth between half-intensity directions

Bandwidth at half height

Wavelength at peak emission

Luminous intensity

$I_F = 10\text{ mA}$

Diode capacitance

$V_R = 0; f = 1\text{ MHz}$

V_F	typ.	2,1 V
	max.	3,0 V
I_R	max.	100 μA
$\alpha_{50\%}$	typ.	20 $^\circ$
$B_{50\%}$	typ.	30 nm
λ_{pk}	typ.	565 nm
I_v	min.	15 mCd
	typ.	20 mCd
C_d	typ.	35 pF

DEVELOPMENT SAMPLE DATA

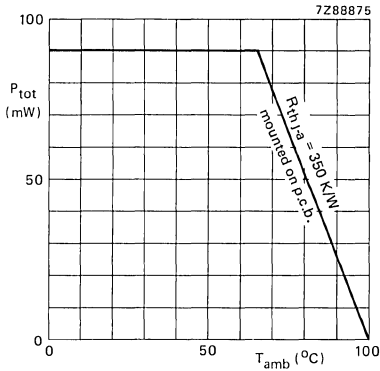

Fig. 2.

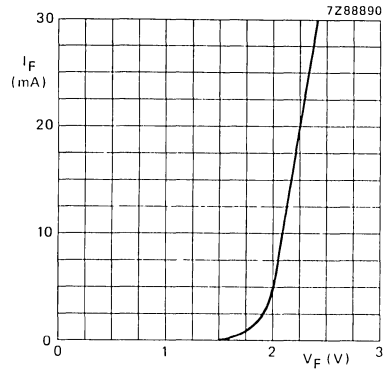

Fig. 3 $T_{amb} = 25\text{ }^\circ\text{C}$; typ. values.

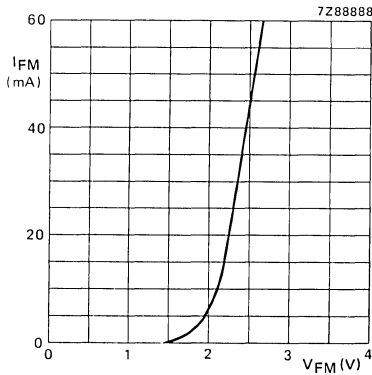

Fig. 4 $t_{on} = 50\text{ }\mu\text{s}$; $\delta = 0,01$;
 $T_{amb} = 25\text{ }^\circ\text{C}$; typ. values.

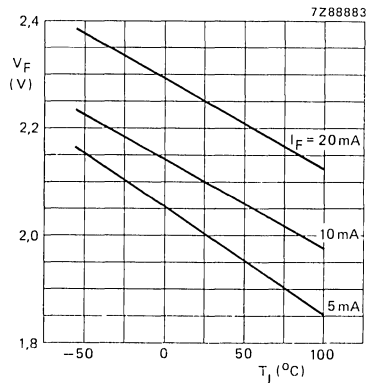

Fig. 5 Typical values.

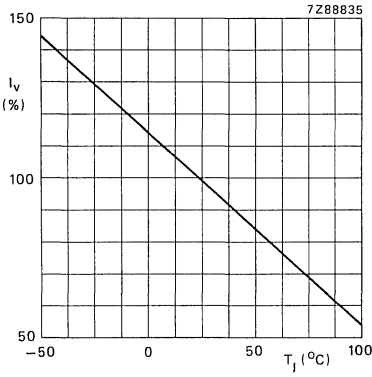

Fig. 6 Typical values.

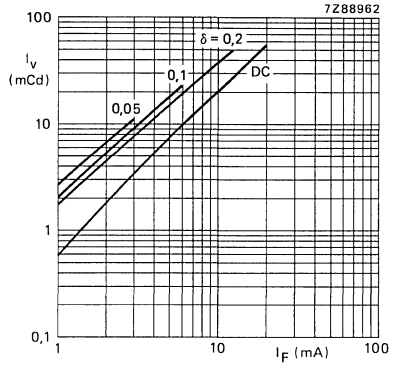

Fig. 7 $t_p = 50 \mu s$; typ. values.

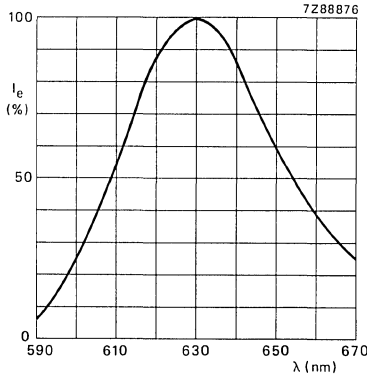

Fig. 8 Typical values.

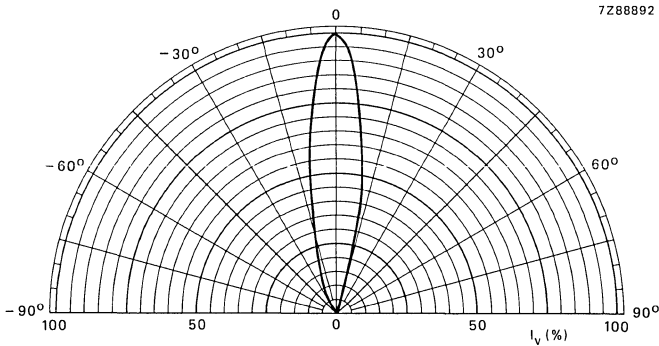

Fig. 9 $I_F = 10 \text{ mA}$; typ. values.

DEVELOPMENT SAMPLE DATA

This information is derived from development samples made available for evaluation. It does not necessarily imply that the device will go into regular production.

CQX64
CQX64L

LIGHT EMITTING DIODES

Circular light emitting diodes with diameter of 5 mm which emit a super-green (GaP) narrow light beam when forward biased.

The CQX64 and CQX64L have a SOD-63 outline and are encapsulated in a transparent non-diffusing resin. Because of its resistance to high forward currents the CQX64 (and CQX64L) is very suitable in applications where a high luminous intensity is wanted, but also very suitable in those applications where only low currents are available.

The CQX64L is the long-lead version of the CQX64 and has no seating plane but is in all other respects equal to the CQX64.

QUICK REFERENCE DATA

Continuous reverse voltage	V_R	max.	5 V
Forward current (d.c.)	I_F	max.	60 mA
Total power dissipation up to $T_{amb} = 35\text{ }^\circ\text{C}$	P_{tot}	max.	180 mW
Junction temperature	T_j	max.	100 $^\circ\text{C}$
Luminous intensity $I_F = 10\text{ mA}$	I_v	min.	15 mCd
Wavelength at peak emission	λ_{pk}	typ.	565 nm
Beamwidth between half-intensity directions	$\alpha_{50\%}$	typ.	20 $^\circ$

MECHANICAL DATA

Dimensions in mm

Fig. 1a SOD-63A.

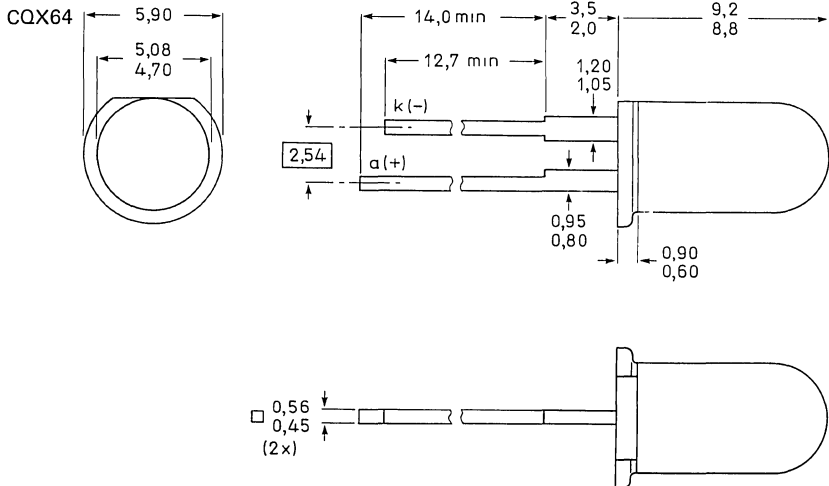

7Z86977

CQX64
CQX64L

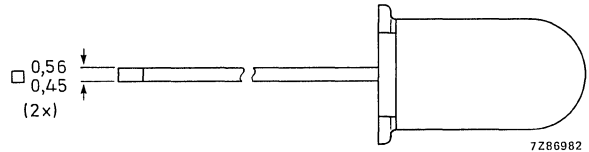
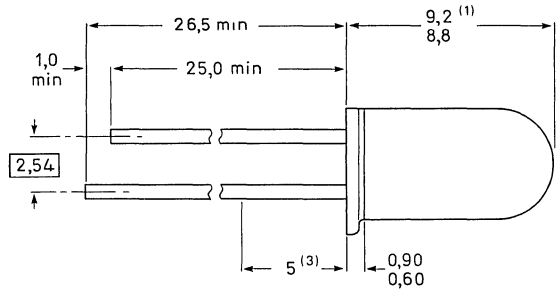
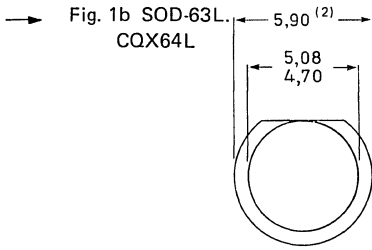

Notes

1. Measured when the device is seated in a gauge with holes 0,80 mm diameter and 2,54 mm apart.
2. Maximum value including plastic burrs.
3. Solderability not guaranteed within this zone due to tie-bar cropping.

RATINGS

Limiting values in accordance with the Absolute Maximum System (IEC 134)

Reverse voltage	V_R	max.	5 V
Forward current d.c.	I_F	max.	60 mA
Forward current peak value; $t_p = 1 \mu s$; $f = 300 \text{ Hz}$	I_{FM}	max.	1 A
peak value; $t_p = 1 \text{ ms}$; $\delta = 0,33$			150 mA
Total power dissipation up to $T_{amb} = 35 \text{ }^\circ\text{C}$	P_{tot}	max.	180 mW
Storage temperature	T_{stg}		-55 to +100 $^\circ\text{C}$
Junction temperature	T_j	max.	100 $^\circ\text{C}$
Lead soldering temperature; $t_{sld} < 7 \text{ s}$	T_{sld}	max.	260 $^\circ\text{C}$
> 1,5 mm from the seating plane for CQX64			
> 5 mm from the plastic body for CQX64L			

THERMAL RESISTANCE

From junction to ambient when the device is mounted on a p.c. board	$R_{th \text{ j-a}}$	max.	350 K/W
--	----------------------	------	---------

CHARACTERISTICS

$T_j = 25 \text{ }^\circ\text{C}$ unless otherwise specified

Forward voltage $I_F = 10 \text{ mA}$	V_F	typ.	2,1 V
		max.	3,0 V
Reverse current $V_R = 5 \text{ V}$	I_R	max.	100 μA

Beamwidth between half-intensity directions
 Bandwidth at half height
 Wavelength at peak emission
 Luminous intensity
 $I_F = 10 \text{ mA}$
 Diode capacitance
 $V_R = 0; f = 1 \text{ MHz}$

$\alpha_{50\%}$	typ.	20 °
$B_{50\%}$	typ.	30 nm
λ_{pk}	typ.	565 nm
I_V	min.	15 mCd
	typ.	20 mCd
C_d	typ.	35 pF

DEVELOPMENT SAMPLE DATA

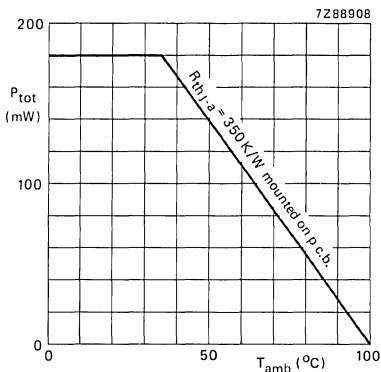

Fig. 2.

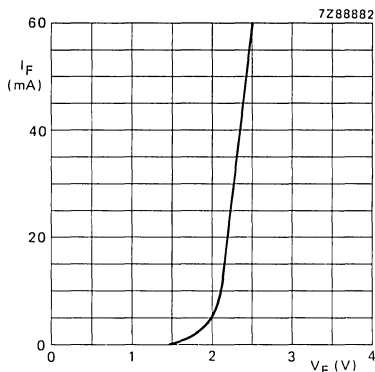

Fig. 3 $T_{amb} = 25 \text{ °C}$; typ. values.

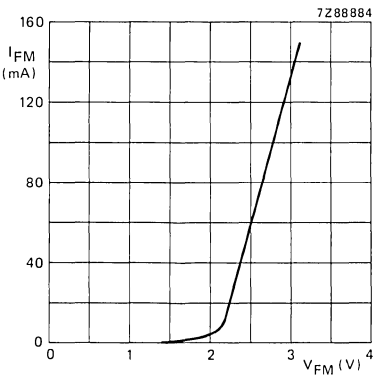

Fig. 4 $t_{on} = 1 \text{ ms}$; $\delta = 0,33$;
 $T_{amb} = 25 \text{ °C}$; typ. values.

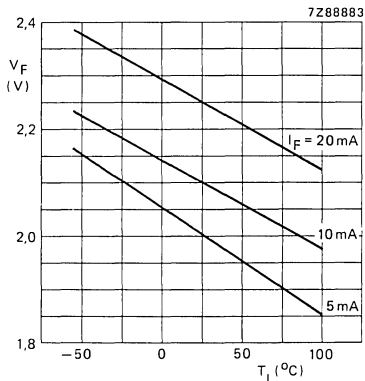

Fig. 5 Typical values.

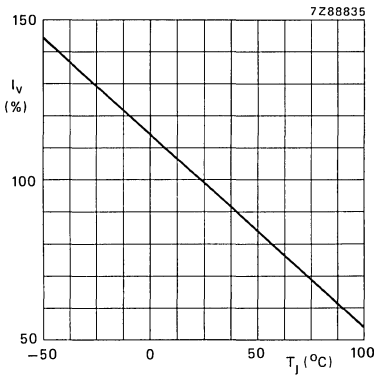

Fig. 6 Typical values.

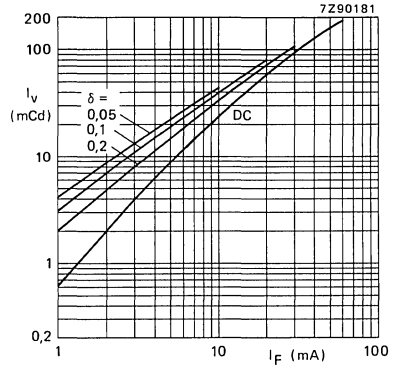

Fig. 7 $t_p = 50 \mu s$; typ. values.

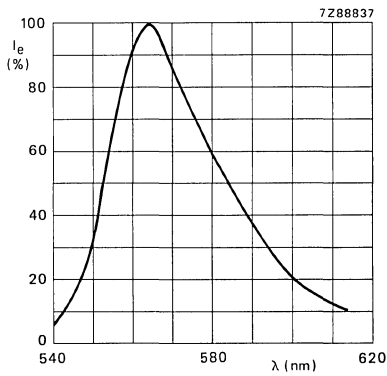

Fig. 8 $I_F = 10 \text{ mA}$; typ. values.

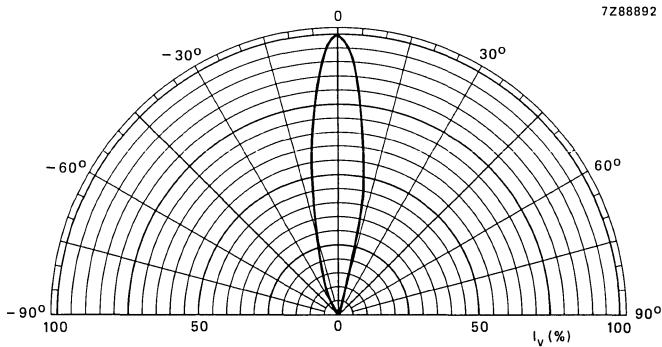

Fig. 9 $I_F = 10 \text{ mA}$; typ. values.

DEVELOPMENT SAMPLE DATA

This information is derived from development samples made available for evaluation. It does not necessarily imply that the device will go into regular production.

CQX74
CQX74Y
CQX74L

LIGHT EMITTING DIODES

Circular light emitting diodes with diameter of 5 mm which emit a narrow-beam yellow (GaPAs) light when forward biased.

The CQX74 and CQX74L have a SOD-63 outline and are encapsulated in a transparent non-diffusing resin. The CQX74Y is equal but has a yellow-coloured non-diffusing resin.

The CQX74L is the long-lead version of the CQX74 and has no seating plane but is in all other respects equal to the CQX74.

QUICK REFERENCE DATA

Continuous reverse voltage	V_R	max.	5 V
Forward current (d.c.)	I_F	max.	30 mA
Total power dissipation up to $T_{amb} = 65\text{ }^\circ\text{C}$	P_{tot}	max.	90 mW
Junction temperature	T_j	max.	100 $^\circ\text{C}$
Luminous intensity $I_F = 10\text{ mA}$	I_v	min. typ.	15 mcd 20 mcd
Wavelength at peak emission	λ_{pk}	typ.	590 nm
Beamwidth between half-intensity directions	$\alpha_{50\%}$	typ.	20 $^\circ$

MECHANICAL DATA

Dimensions in mm

Fig. 1a SOD-63A.

CQX74/74Y

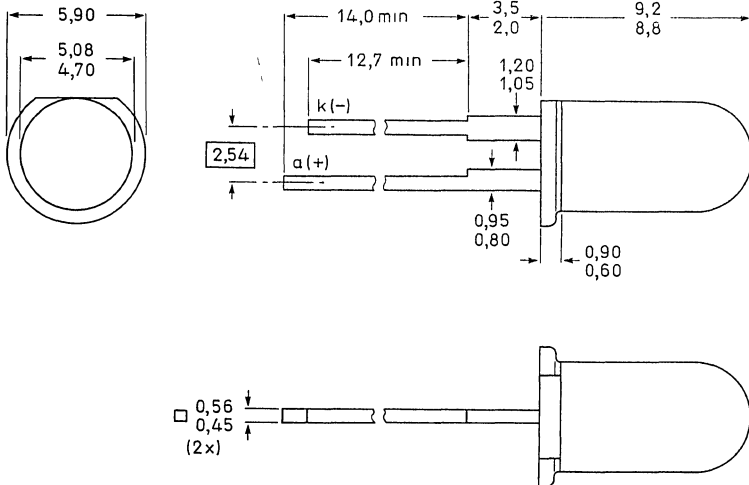

CQX74
 CQX74Y
 CQX74L

Fig. 1b SOD-63L.
 CQX74L

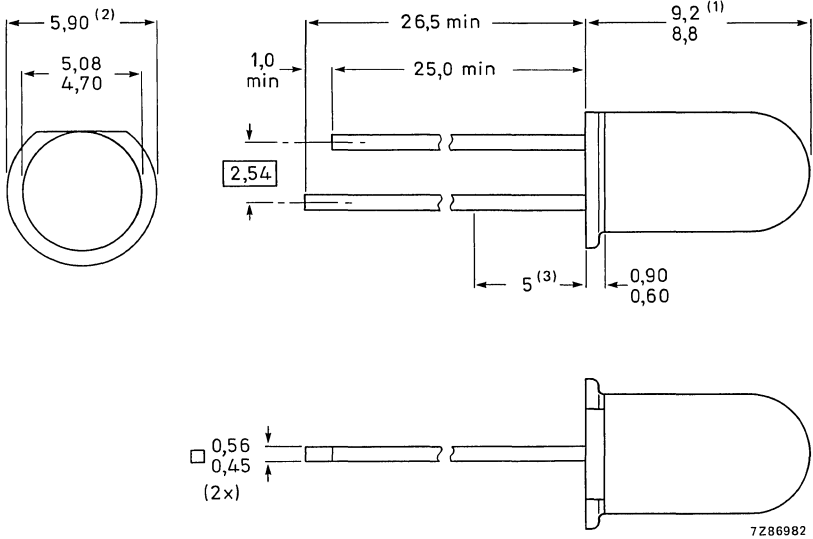

- (1) Measured when the device is seated in a gauge with 2 holes 0,80 mm diameter and 2,54 mm apart.
 (2) Maximum value including burrs.
 (3) Solderability not guaranteed within this zone due to tie-bar cropping.

RATINGS

Limiting values in accordance with the Absolute Maximum System (IEC 134)

Reverse voltage	V_R	max.	5 V
Forward current d.c.	I_F	max.	30 mA
Forward current peak value; $t_p = 1 \mu s$; $f = 300 \text{ Hz}$	I_{FM}	max.	1 A
peak value; $t_{ON} = 1 \text{ ms}$; $\delta = 0,33$		max.	60 mA
Total power dissipation up to $T_{amb} = 65 \text{ }^\circ\text{C}$	P_{tot}	max.	90 mW
Storage temperature	T_{stg}		-55 to +100 $^\circ\text{C}$
Junction temperature	T_j	max.	100 $^\circ\text{C}$
Lead soldering temperature; $t_{sld} < 7 \text{ s}$	T_{sld}	max.	260 $^\circ\text{C}$
> 1,5 mm from the seating plane for CQX74/74Y			
> 5 mm from the plastic body for CQX74L			

THERMAL RESISTANCE

From junction to ambient	$R_{th \text{ j-a}}$	max.	350 K/W
--------------------------	----------------------	------	---------

CHARACTERISTICS

$T_j = 25\text{ }^\circ\text{C}$ unless otherwise specified

Forward voltage

$I_F = 10\text{ mA}$

V_F typ. 2,1 V
max. 3,0 V

Reverse current

$V_R = 5\text{ V}$

I_R max. 100 μA

Beamwidth between half-intensity directions

$I_F = 10\text{ mA}$

$\alpha_{50\%}$ typ. 20 $^\circ$

Bandwidth at half height

$B_{50\%}$ typ. 40 nm

Wavelength at peak emission

$I_F = 10\text{ mA}$

λ_{pk} typ. 590 nm

Luminous intensity

$I_F = 10\text{ mA}$

I_v min. 15 mCd
typ. 20 mCd

Diode capacitance

$V_R = 0$; $f = 1\text{ MHz}$

C_d typ. 35 pF

DEVELOPMENT SAMPLE DATA

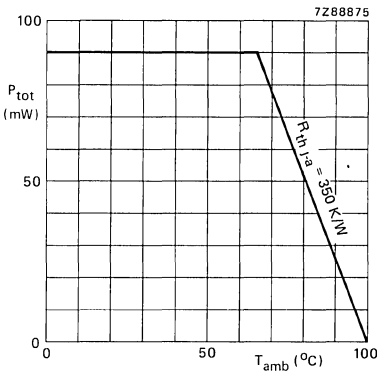

Fig. 2.

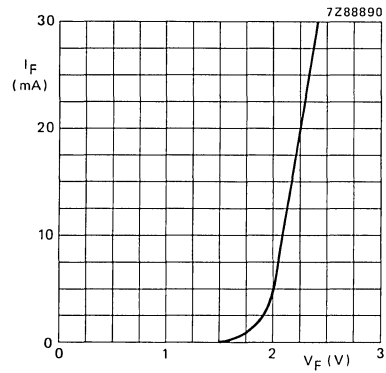

Fig. 3 $T_j = 25\text{ }^\circ\text{C}$; typ. values.

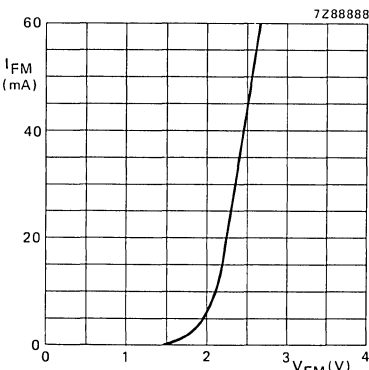

Fig. 4 $t_{ON} = 50\text{ }\mu\text{s}$; $\delta = 0,01$;
 $T_{amb} = 25\text{ }^\circ\text{C}$; typ. values.

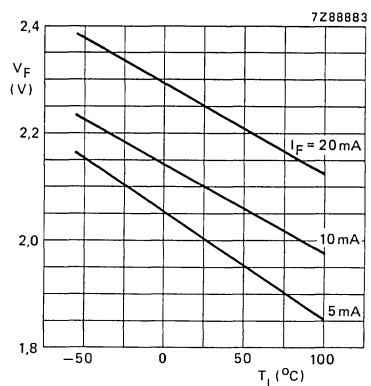

Fig. 5 Typical values.

CQX74
 CQX74Y
 CQX74L

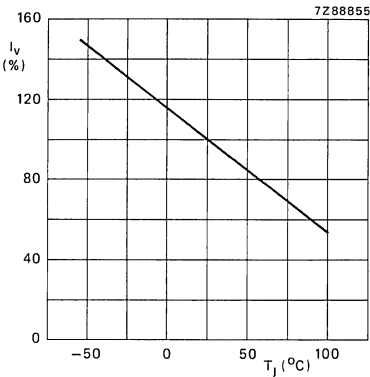

Fig. 6 $I_F = 10$ mA; typ. values.

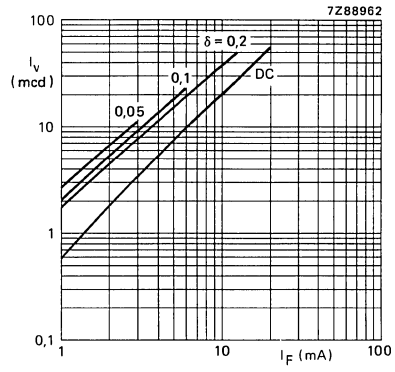

Fig. 7 $t_p = 50 \mu s$; typ. values.

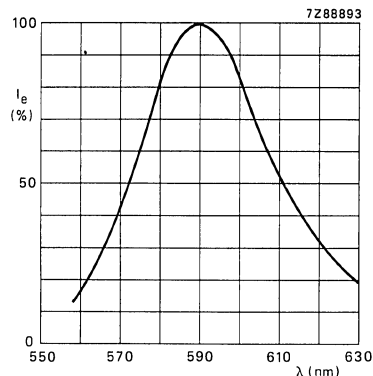

Fig. 8 Typical values.

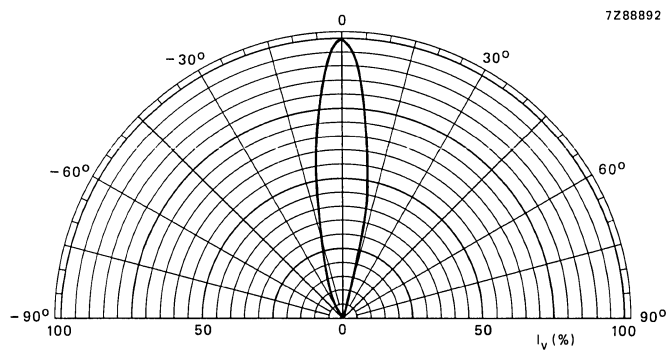

Fig. 9 Typical values.

GaAs LIGHT EMITTING DIODE

Gallium arsenide light emitting diode intended for optical coupling and encoding. It emits radiation in the near infrared when forward biased. The diode is provided with a flat glass window.

QUICK REFERENCE DATA			
Continuous reverse voltage	V_R	max.	2 V
Forward current (d. c.)	I_F	max.	30 mA
Forward current (peak value) $t_p = 100 \mu\text{s}; \delta = 0,1$	I_{FM}	max.	200 mA
Total power dissipation up to $T_{amb} = 95 \text{ }^\circ\text{C}$	P_{tot}	max.	50 mW
Total radiant power at $I_F = 20 \text{ mA}$	ϕ_e	> typ.	60 100 μW
Radiant intensity (on-axis) at $I_F = 20 \text{ mA}$	I_e	typ.	64 $\mu\text{W}/\text{sr}$
Light rise time at $I_{F on} = 20 \text{ mA}$	t_r	<	100 ns
Light fall time at $I_{F on} = 20 \text{ mA}$	t_f	<	100 ns
Wavelength at peak emission	λ_{pk}	typ.	880 nm
Thermal resistance from junction to ambient	$R_{th j-a}$	=	0,6 $^\circ\text{C}/\text{mW}$

MECHANICAL DATA

Dimensions in mm

TO-18, except for window

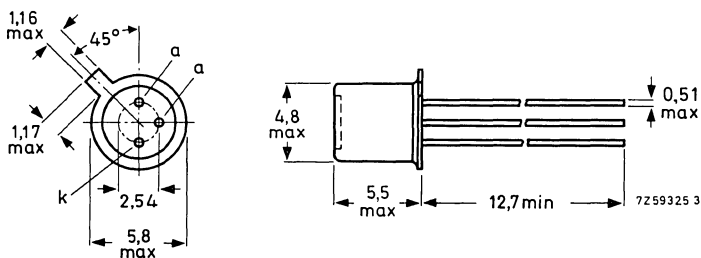

Max. lead diameter is guaranteed only for 12,7 mm

RATINGS Limiting values in accordance with the Absolute Maximum System (IEC 134)

Voltage

Continuous reverse voltage V_R max. 2 V

Current

Forward current (d. c.) I_F max. 30 mA

Forward current (peak value)

$t_p = 100 \mu s; \delta = 0, 1$ I_{FM} max. 200 mA

Power dissipation

Total power dissipation up to $T_{amb} = 95 \text{ }^\circ\text{C}$ P_{tot} max. 50 mW

Temperature

Storage temperature T_{stg} -55 to +150 $^\circ\text{C}$

Operating junction temperature T_j max. 125 $^\circ\text{C}$

THERMAL RESISTANCE

From junction to ambient in free air $R_{th j-a} = 0,6 \text{ }^\circ\text{C/mW}$

From junction to case $R_{th j-c} = 0,22 \text{ }^\circ\text{C/mW}$

CHARACTERISTICS

$T_{amb} = 25 \text{ }^\circ\text{C}$ unless otherwise specified

Forward voltage at $I_F = 30 \text{ mA}$ V_F typ. 1,3 V

< 1,6 V

$I_{FM} = 0,2 \text{ A}$ V_F typ. 1,5 V

Reverse current at $V_R = 2 \text{ V}$ I_R < 0,5 mA

Diode capacitance at $f = 1 \text{ MHz};$

$V_R = 0$ C_d typ. 65 pF

CHARACTERISTICS (continued)

 $T_{amb} = 25\text{ }^{\circ}\text{C}$ unless otherwise specified

Radiant output power at $I_F = 20\text{ mA}$	ϕ_e	>	60	μW
		typ.	100	μW
$I_F = 20\text{ mA}; T_j = 100\text{ }^{\circ}\text{C}$	ϕ_e	typ.	50	μW
	$I_F = 200\text{ mA}$ ¹⁾	ϕ_e	typ.	1, 16
Radiant intensity (on-axis) at $I_F = 20\text{ mA}$	I_e	typ.	64	$\mu\text{W}/\text{sr}$
	Radiance at $I_F = 20\text{ mA}$	L_e	typ.	1, 6
$I_F = 200\text{ mA}$ ¹⁾	L_e	typ.	15	$\text{mW}/\text{mm}^2\text{sr}$
Emissive area	A_e	typ.	0, 04	mm^2
Wavelength at peak emission	λ_{pk}	typ.	880	nm
Bandwidth at half height	$\Delta\lambda$	typ.	40	nm
Light rise time at $I_{Fon} = 20\text{ mA}$	t_r	typ.	30	ns
		<	100	ns
Light fall time at $I_{Fon} = 20\text{ mA}$	t_f	typ.	30	ns
		<	100	ns

¹⁾ $t_p = 100\text{ }\mu\text{s}; \delta = 0, 1.$

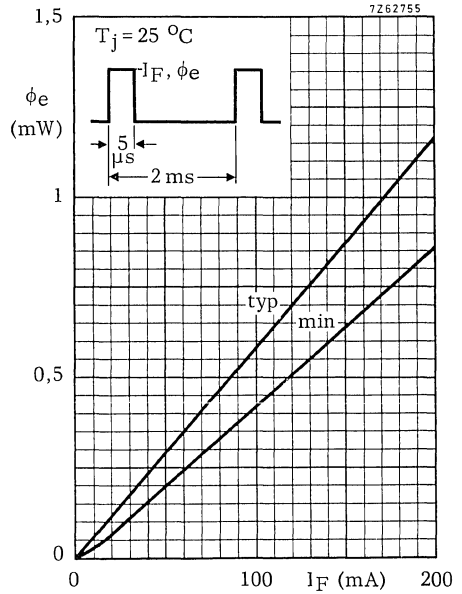
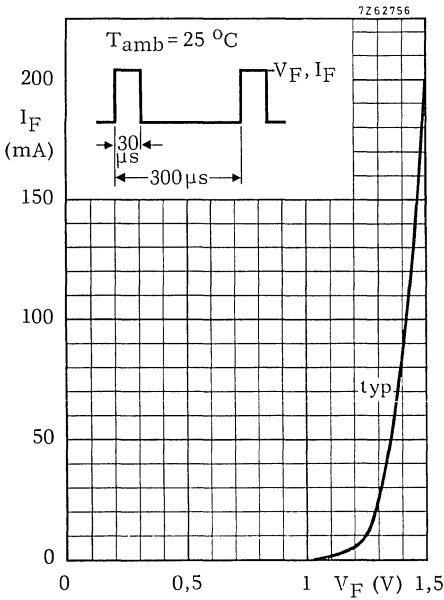
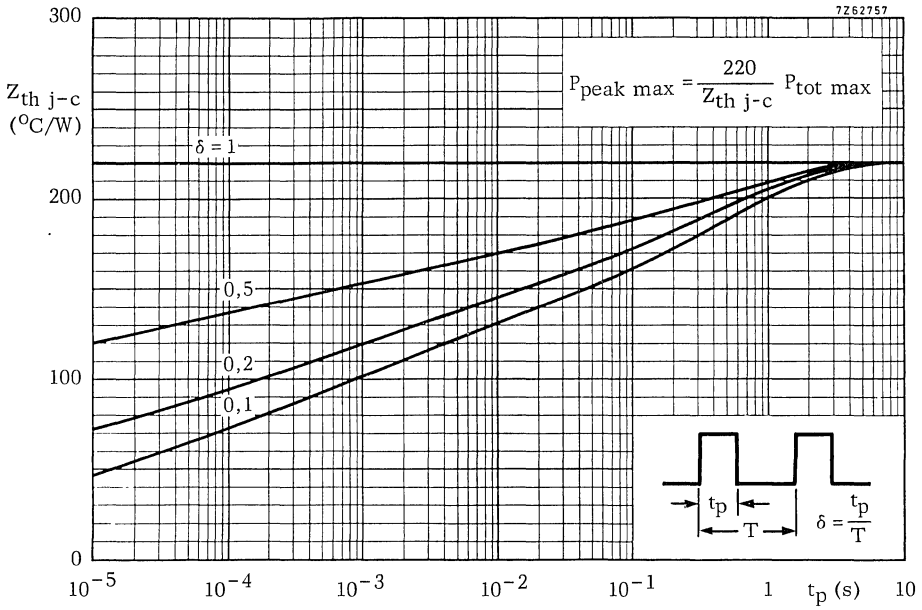

7Z62759

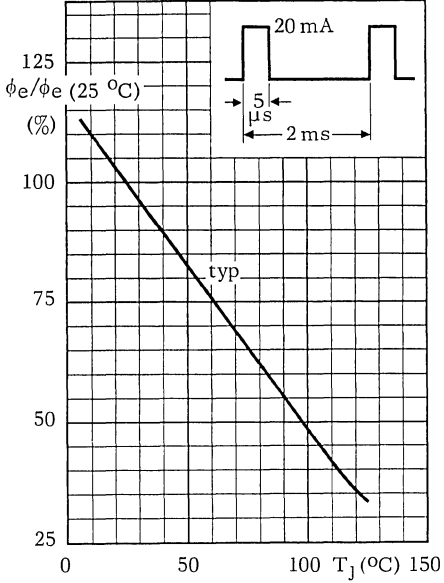

7Z62754

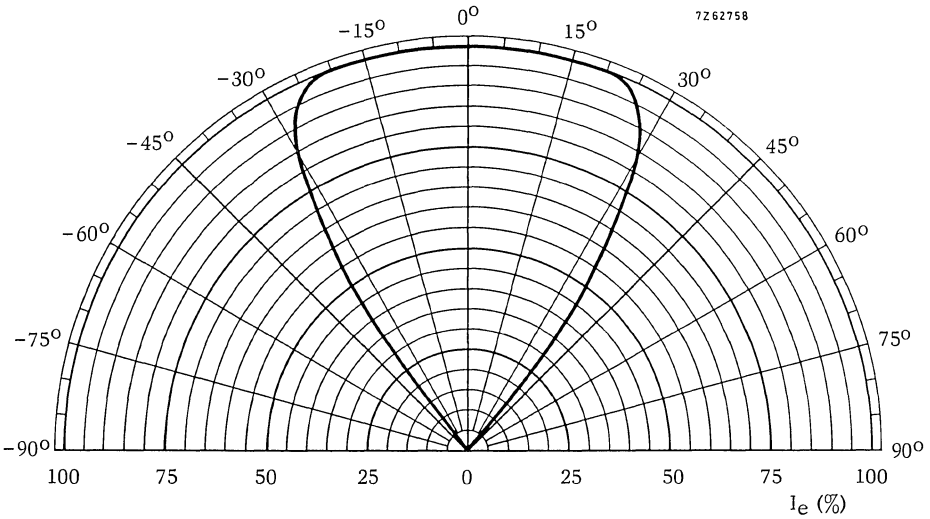
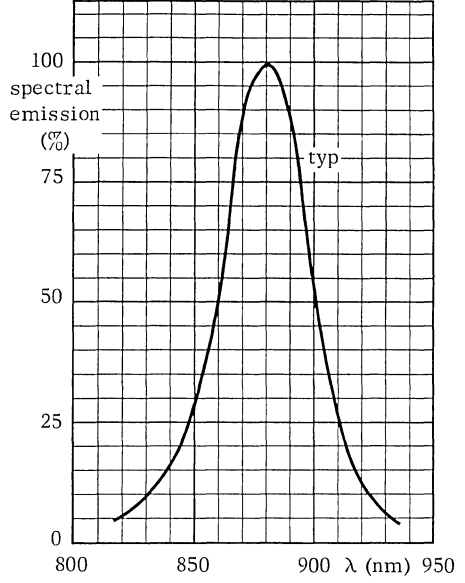

GALLIUM ARSENIDE LIGHT EMITTING DIODE

Gallium arsenide light emitting diode intended for optical coupling and encoding. It emits radiation in the near infrared when forward biased. Suitable for combination with photo-transistor BPX25 or BPX72.

QUICK REFERENCE DATA

Continuous reverse voltage	V_R	max.	2 V
Forward current (d. c.)	I_F	max.	30 mA
Forward current (peak value)	I_{FM}	max.	200 mA
Total power dissipation up to $T_{amb} = 95\text{ }^\circ\text{C}$	P_{tot}	max.	50 mW
Total radiant power at $I_F = 20\text{ mA}$	ϕ_e	typ.	50 μW
Radiant intensity (on-axis) at $I_F = 20\text{ mA}$	I_e	typ.	1,25 mW/sr
Light rise time at $I_{Fon} = 20\text{ mA}$	t_r	<	100 ns
Light fall time at $I_{Fon} = 20\text{ mA}$	t_f	<	100 ns
Wavelength at peak emission	λ_{pk}	typ.	880 nm
Thermal resistance from junction to ambient	$R_{th\ j-a}$	=	0,6 $^\circ\text{C}/\text{mW}$

MECHANICAL DATA

Dimensions in mm

TO-18, except for lens

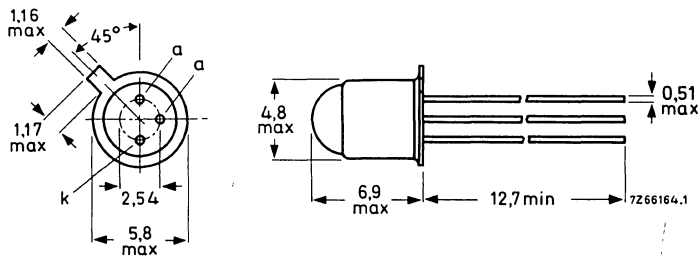

RATINGS Limiting values in accordance with the Absolute Maximum System (IEC 134)

Voltage

Continuous reverse voltage V_R max. 2 V

Current

Forward current (d. c.) I_F max. 30 mA

Forward current (peak value)
 $t_p = 100 \mu s; \delta = 0, 1$ I_{FM} max. 200 mA

Power dissipation

Total power dissipation up to
 $T_{amb} = 95 \text{ }^\circ C$ P_{tot} max. 50 mW

Temperature

Storage temperature T_{stg} -55 to + 150 $^\circ C$

Junction temperature T_j max. 125 $^\circ C$

THERMAL RESISTANCE

From junction to ambient in free air $R_{th j-a} = 0,6 \text{ }^\circ C/mW$

From junction to case $R_{th j-c} = 0,22 \text{ }^\circ C/mW$

CHARACTERISTICS

$T_{amb} = 25 \text{ }^\circ C$ unless otherwise specified

Forward voltage

$I_F = 30 \text{ mA}$ V_F typ. 1,3 V
 < 1,6 V

$I_{FM} = 200 \text{ mA}$ V_F typ. 1,5 V

Reverse current

$V_R = 2 \text{ V}$ I_R < 0,5 mA

Diode capacitance

$V_R = 0; f = 20 \text{ MHz}$ C_d typ. 25 pF

Total radiant power

$I_F = 20 \text{ mA}$ ϕ_e typ. 50 μW

Radiant intensity (on-axis)

$I_F = 20 \text{ mA}$ I_e typ. 1,25 mW/sr

CHARACTERISTICS (continued)

Mean irradiance

on a receiving area with $D = 2 \text{ mm}$ at a distance $a = 10 \text{ mm}$ and at $I_F = 20 \text{ mA}$, measured as below

E_e	>	0,28	mW/cm^2
	typ.	0,50	mW/cm^2 ¹⁾

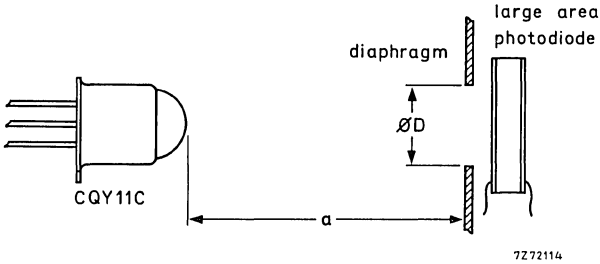
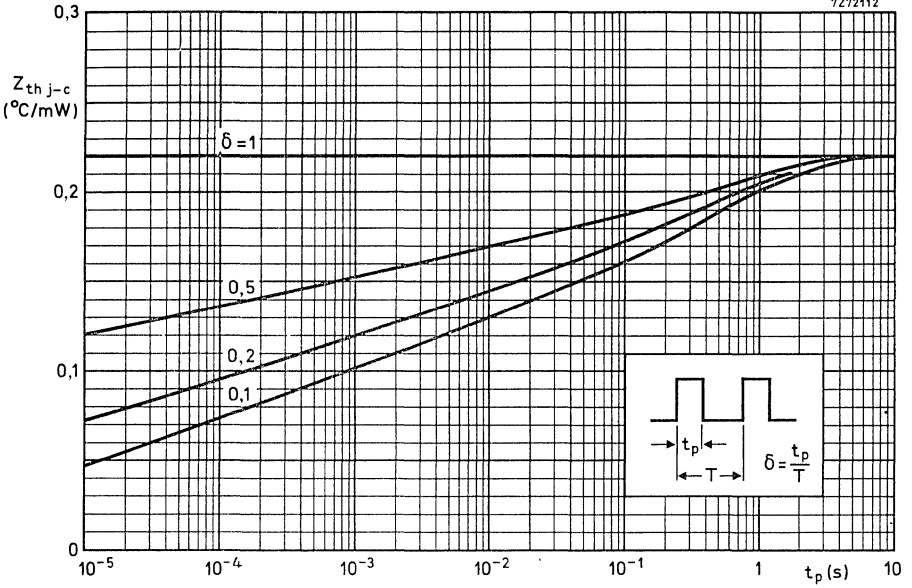

Fig. 1

<u>Decrease of radiant power with temperature</u>	$\frac{\Delta\phi_e}{\Delta T_j}$	typ.	0,7	$\%/^{\circ}\text{C}$
<u>Cross section of the radiant beam</u> between 0 to 10 mm from the lens	A_{beam}	typ.	7	mm^2
<u>Angle between optical and mechanical axis</u>			6°	
<u>Wavelength at peak emission</u>	λ_{pk}	typ.	880	nm
<u>Bandwidth at half height</u>	$B_{50\%}$	typ.	40	nm
<u>Light rise time at $I_{F\text{on}} = 20 \text{ mA}$</u>	t_r	typ. <	30 100	ns
<u>Light fall time at $I_{F\text{on}} = 20 \text{ mA}$</u>	t_f	typ. <	30 100	ns

¹⁾ This corresponds typically with $I_{\text{CEO(L)}} = 0,4 \text{ mA}$ in a phototransistor BPX25 and with $200 \mu\text{A}$ in a phototransistor BPX72.

7272112



7272106

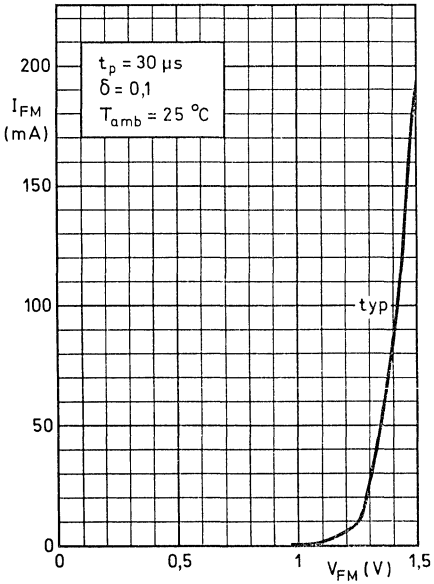

7272110

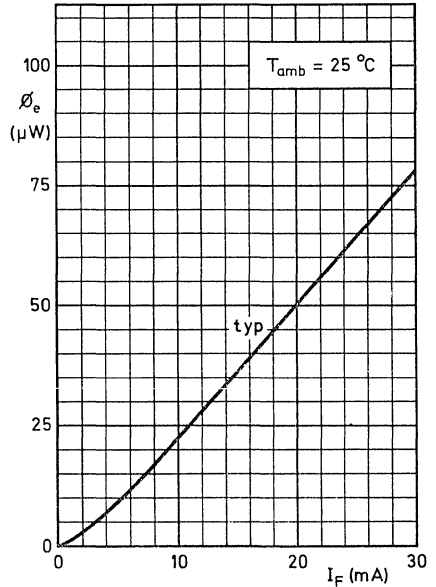

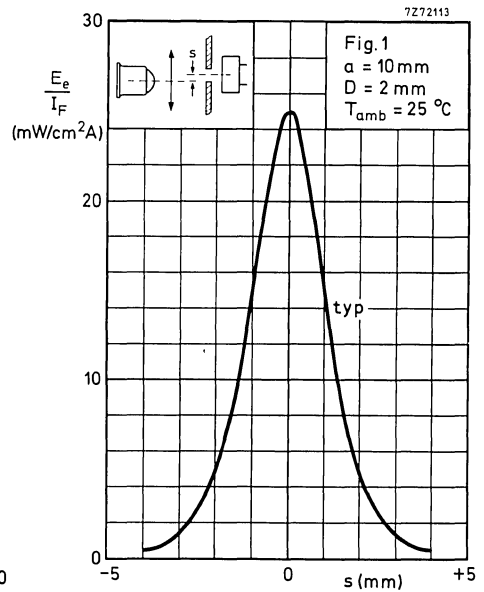
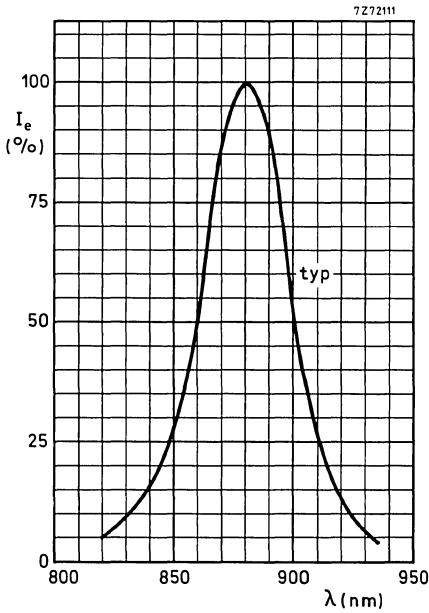
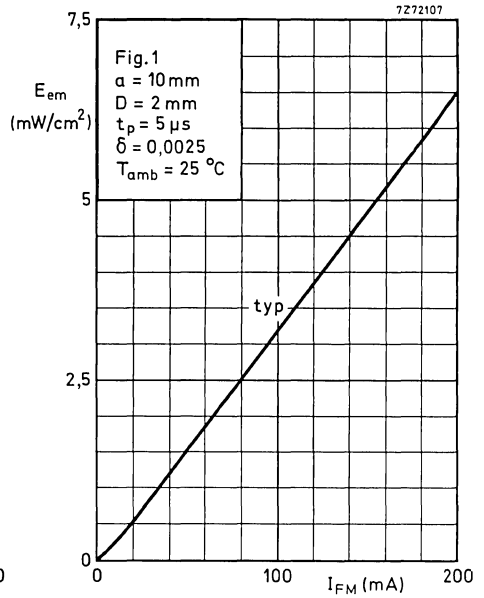
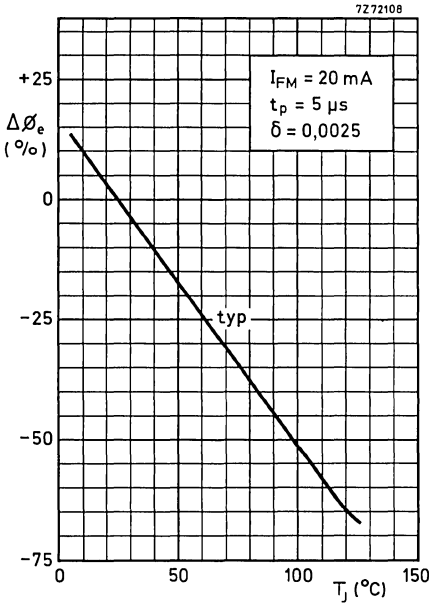

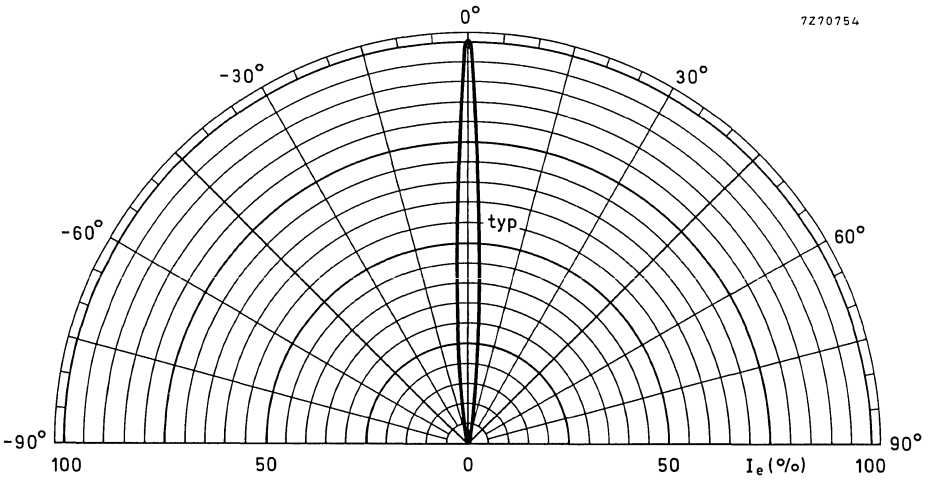
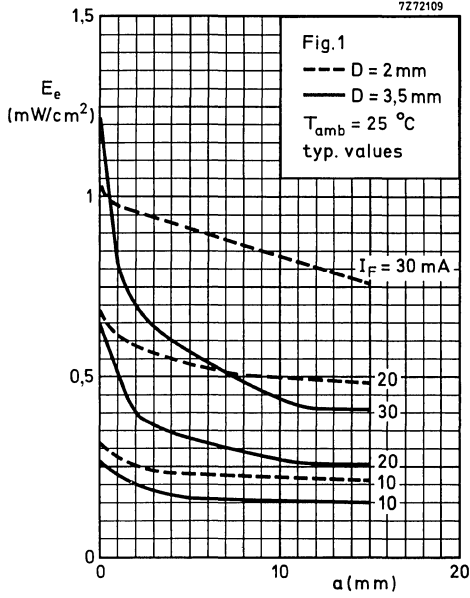

LIGHT EMITTING DIODES

Circular light emitting diodes with diameter of 5 mm which emit standard red light when forward biased.

The CQY24B and CQY24BL have a SOD-63 outline and are encapsulated in a medium-red diffusing resin. Together with the types CQY94B(L) and CQY96(L) they form one family.

The CQY24BL is the long-lead version of the CQY24B and has no seating plane but is in all other respects equal to the CQY24B.

QUICK REFERENCE DATA

Continuous reverse voltage	V_R	max.	5 V
Forward current (d.c.)	I_F	max.	50 mA
Total power dissipation up to $T_{amb} = 65\text{ }^\circ\text{C}$	P_{tot}	max.	100 mW
Junction temperature	T_j	max.	100 $^\circ\text{C}$
Luminous intensity $I_F = 20\text{ mA}$			
	CQY24B(L)-I	I_v	min. 0,7 mCd
	CQY24B(L)-II	I_v	1,0 to 2,2 mCd
	CQY24B(L)-III	I_v	1,6 to 3,5 mCd
	CQY24B(L)-IV	I_v	min. 3,0 mCd
Wavelength at peak emission	λ_{pk}	typ.	650 nm
Beamwidth between half-intensity directions	$\alpha_{50\%}$	typ.	60 $^\circ$

MECHANICAL DATA

Fig. 1a SOD-63A.

CQY24B

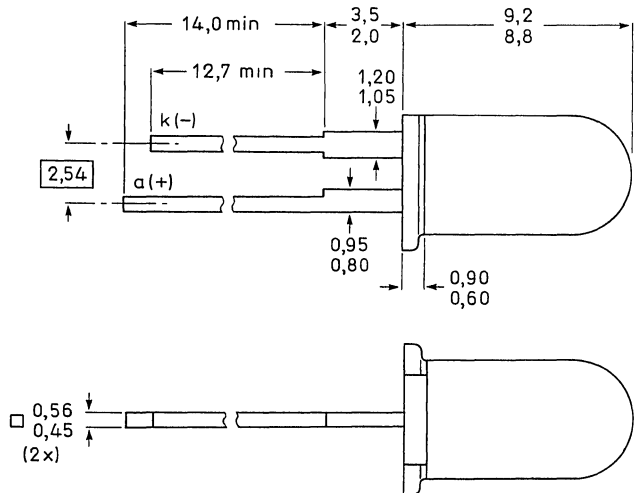
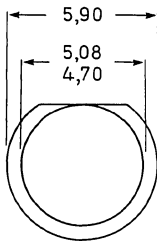

7286977

CQY24B
CQY24BL

Fig. 1b SOD-63L.

CQY24BL

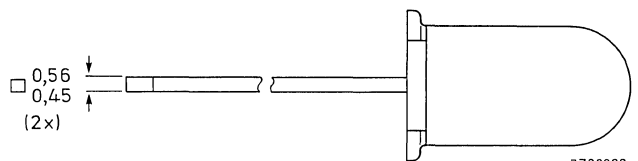
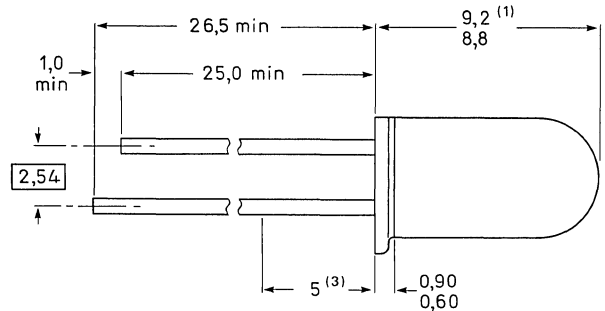
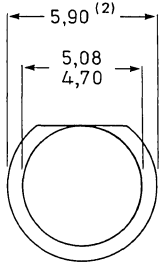

7286982

- (1) Measured when the device is seated in a gauge with 2 holes 0,80 mm in diameter and 2,54 mm between the holes.
- (2) Maximum value including burrs.
- (3) Solderability not guaranteed within this zone due to tie-bar cropping.

RATINGS

Limiting values in accordance with the Absolute Maximum System (IEC 134)

Continuous reverse voltage	V_R	max.	5 V
Forward current d.c.	I_F	max.	50 mA
Forward current peak value; $t_p = 1 \mu s$; $f = 300$ Hz	I_{FM}	max.	1 A
peak value; $t_p = 10 \mu s$; $f = 1000$ Hz	I_{FM}	max.	100 mA
Total power dissipation up to $T_{amb} = 65 \text{ }^\circ\text{C}$	P_{tot}	max.	100 mW
Storage temperature	T_{stg}		-55 to +100 $^\circ\text{C}$
Junction temperature	T_j	max.	100 $^\circ\text{C}$
Lead soldering temperature; $t_{sld} < 7$ s > 1,5 mm from the seating plane for CQY24B > 5 mm from the plastic body for CQY24BL	T_{sld}	max.	260 $^\circ\text{C}$

THERMAL RESISTANCE

From junction to ambient in free air	$R_{th j-a}$	max.	500 K/W
mounted on a p.c.b.	$R_{th j-a}$	max.	350 K/W

CHARACTERISTICS

$T_j = 25\text{ }^\circ\text{C}$ unless otherwise specified

Forward voltage

$I_F = 20\text{ mA}$

V_F	typ.	1,7 V
	max.	2,0 V

Negative temperature coefficient of V_F

$I_F = 20\text{ mA}$

$\frac{-\Delta V_F}{\Delta T_j}$	typ.	1,6 mV/ $^\circ\text{C}$
----------------------------------	------	--------------------------

$I_F = 2\text{ mA}$

$\frac{-\Delta V_F}{\Delta T_j}$	typ.	2,0 mV/ $^\circ\text{C}$
----------------------------------	------	--------------------------

Reverse current

$V_R = 5\text{ V}$

I_R	max.	100 μA
-------	------	-------------------

Beamwidth between half-intensity directions

$I_F = 10\text{ mA}$

$\alpha_{50\%}$	typ.	60 $^\circ$
-----------------	------	-------------

Bandwidth at half height

$B_{50\%}$	typ.	20 nm
------------	------	-------

Wavelength at peak emission

$I_F = 10\text{ mA}$

λ_{pk}	typ.	650 nm
----------------	------	--------

Luminous intensity (on axis)

CQY24B(L)-I

I_v	min.	0,7 mCd
-------	------	---------

CQY24B(L)-II

I_v	1,0 to	2,2 mCd
-------	--------	---------

CQY24B(L)-III

I_v	1,6 to	3,5 mCd
-------	--------	---------

CQY24B(L)-IV

I_v	min.	3,0 mCd
-------	------	---------

Diode capacitance

$V_R = 0; f = 1\text{ MHz}$

C_d	typ.	60 pF
-------	------	-------

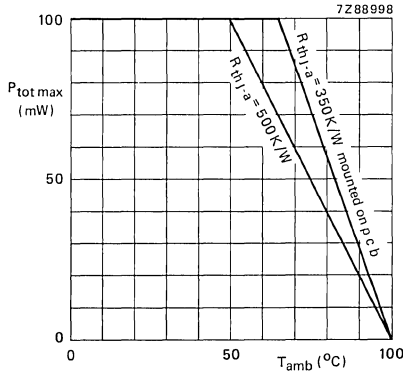

Fig. 2.

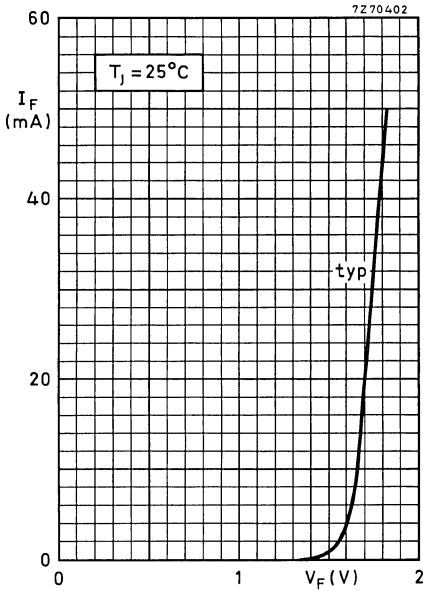

Fig. 3.

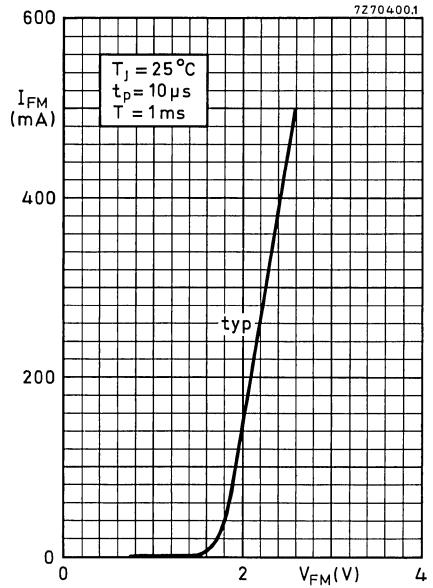

Fig. 4.

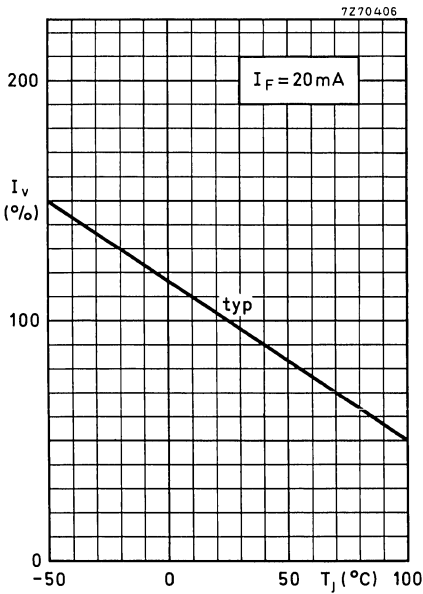

Fig. 5.

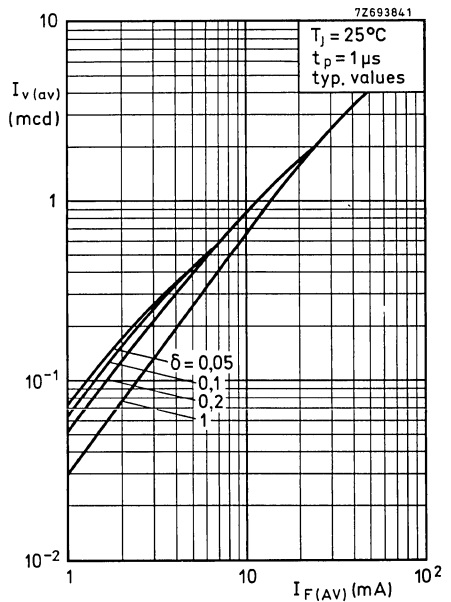

Fig. 6.

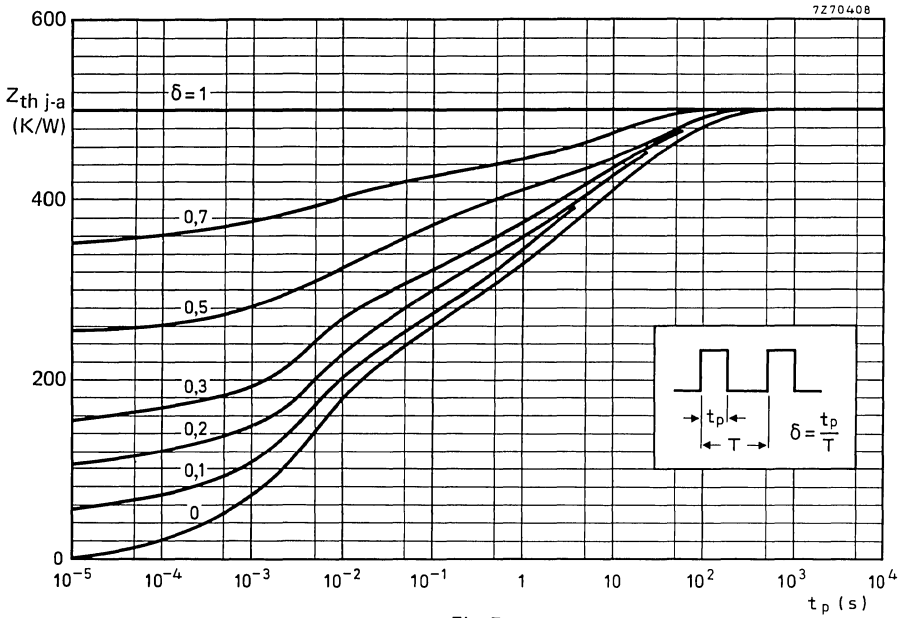

Fig. 7.

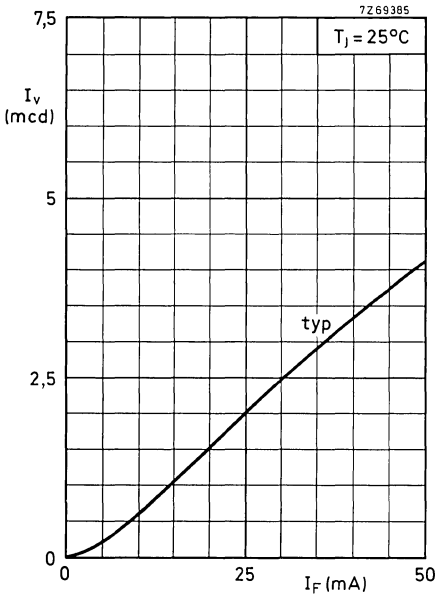

Fig. 8.

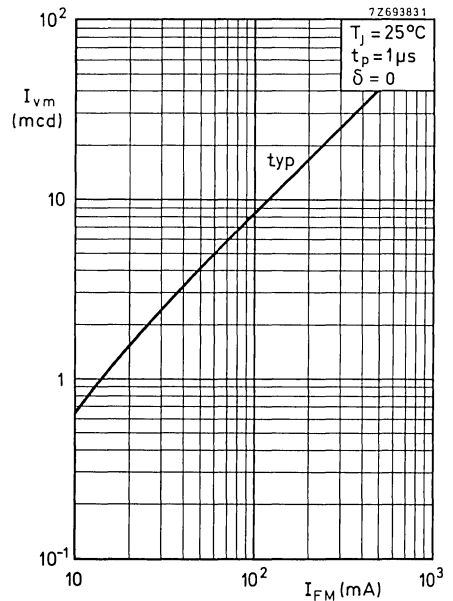

Fig. 9.

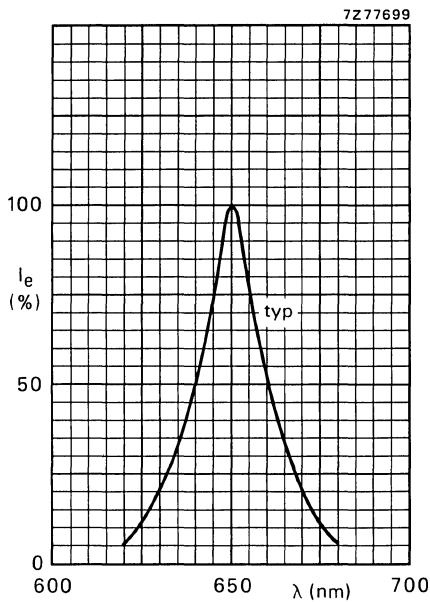

Fig. 10.

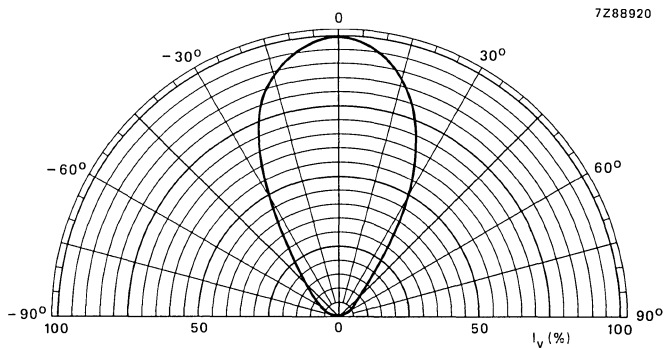

Fig. 11.

GaAs LIGHT EMITTING DIODES

Epitaxial gallium arsenide light emitting diodes intended for optical coupling and encoding. They emit radiation in the near infrared when forward biased. Envelopes like TO-18. Suitable for combination with phototransistors BPX25 and BPX72.

QUICK REFERENCE DATA

Continuous reverse voltage	V_R	max.	2	V
Forward current (d. c.)	I_F	max.	100	mA
Total power dissipation up to $T_{amb} = 25^\circ C$	P_{tot}	max.	150	mW
Radiant intensity (on-axis) at $I_F = 50$ mA	CQY49B	I_e	>	0,3 mW/sr
	CQY49C	I_e	>	3 mW/sr
Wavelength at peak emission	λ_{pk}	typ.	930	nm
Thermal resistance from junction to ambient	$R_{th\ j-a}$	=	0,665	$^\circ C/mW$

MECHANICAL DATA

Dimensions in mm

CQY49B : TO-18 except for window

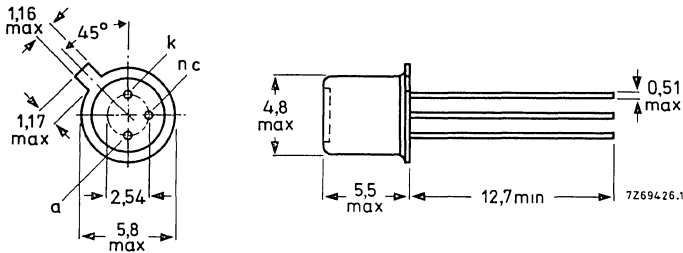

CQY49C : TO-18 except for lens

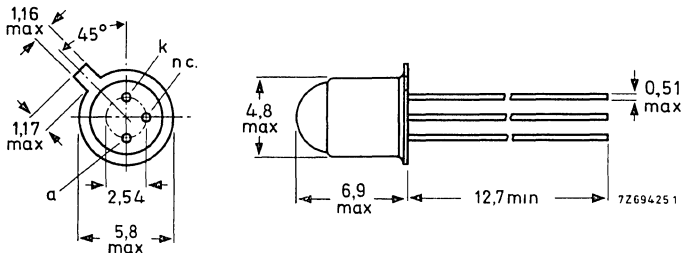

RATINGS Limiting values in accordance with the Absolute Maximum System (IEC 134)

Voltage

Continuous reverse voltage V_R max. 2 V

Current

Forward current (d. c.) I_F max. 100 mA

Forward current (peak value)
 $t_p < 10 \mu s; \delta < 0,01$ I_{FM} max. 1 A

Power dissipation

Total power dissipation up to $T_{amb} = 25 \text{ }^\circ\text{C}$ P_{tot} max. 150 mW

Temperature

Storage temperature T_{stg} -40 to +100 $^\circ\text{C}$

Operating junction temperature T_j max. 125 $^\circ\text{C}$

Lead soldering temperature
> 1,5 mm from the body; $t_{sld} < 10 \text{ s}$ T_{sld} max. 260 $^\circ\text{C}$

THERMAL RESISTANCE

From junction to ambient in free air $R_{th \text{ j-a}}$ = 0,665 $^\circ\text{C/mW}$

From junction to case $R_{th \text{ j-c}}$ = 0,3 $^\circ\text{C/mW}$

CHARACTERISTICS

$T_j = 25\text{ }^\circ\text{C}$ unless otherwise specified

		CQY49B CQY49C		
<u>Forward voltage</u> at $I_F = 50\text{ mA}$	V_F	typ. <	1,3 1,5	V V
<u>Reverse current</u> at $V_R = 2\text{ V}$	I_R	<	100	μA
<u>Diode capacitance</u> $V_R = 0; f = 1\text{ MHz}$	C_d	typ.	55	pF
<u>Radiant intensity</u> (on-axis) at $I_F = 50\text{ mA}$	I_e	> typ.	0,3 0,5	3 5 mW/sr mW/sr
<u>Wavelength</u> at peak emission	λ_{pk}	typ.	930	nm
<u>Bandwidth</u> at half height	$B_{50\%}$	typ.	50	nm
<u>Beamwidth</u> between half-intensity directions	$\alpha_{50\%}$	typ.	80°	15°
<u>Angle</u> between optical and mechanical axis		typ.	-	6°
<u>Switching times</u>				
$I_{Fon} = 50\text{ mA}; t_p = 2\text{ }\mu\text{s}; f = 45\text{ kHz}$				
Light rise time	t_r	typ.	600	ns
Light fall time	t_f	typ.	350	ns

CQY49B
CQY49C

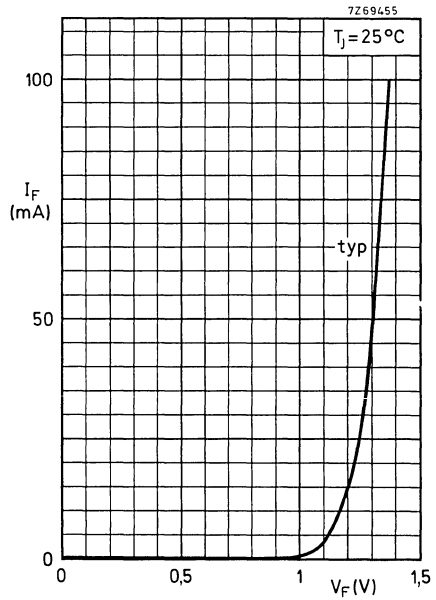
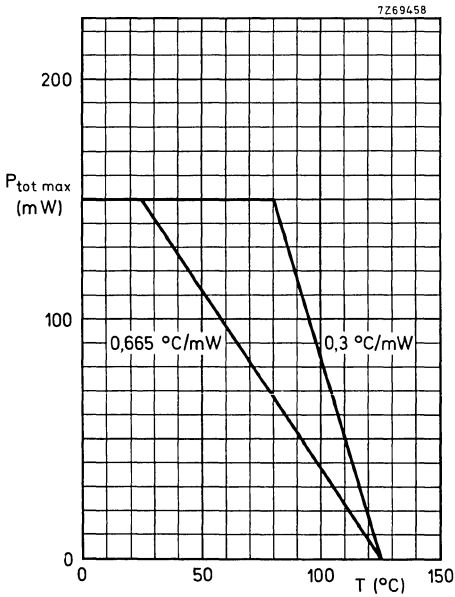
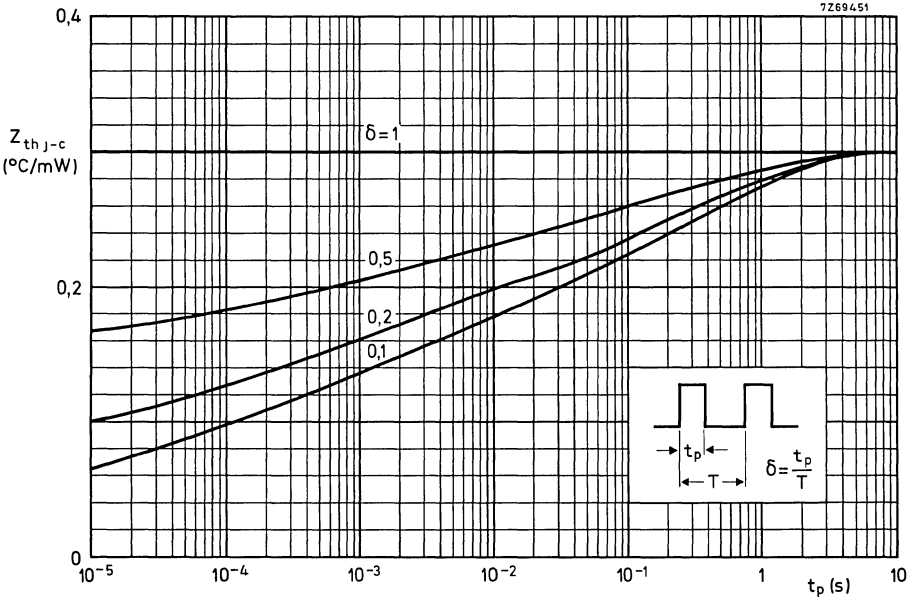

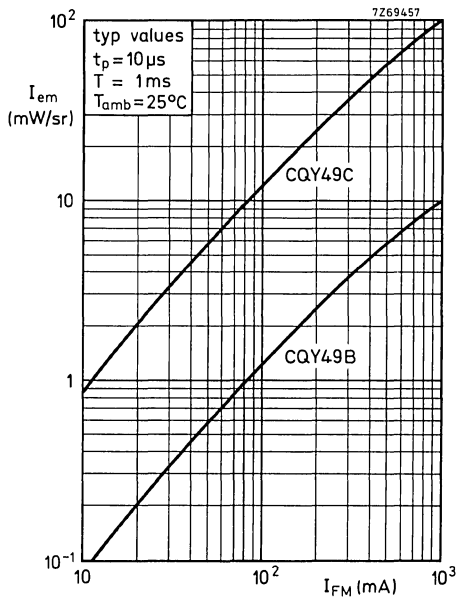
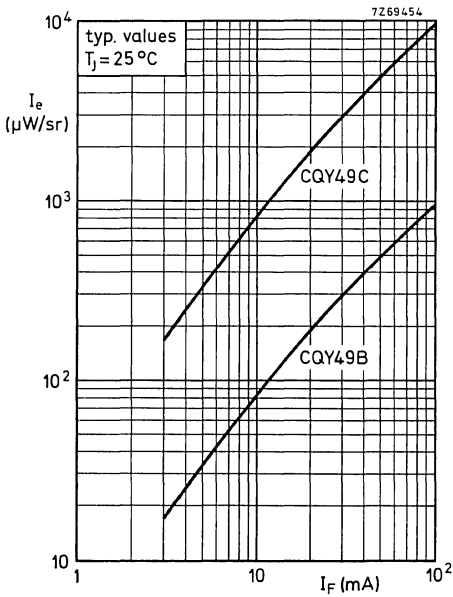
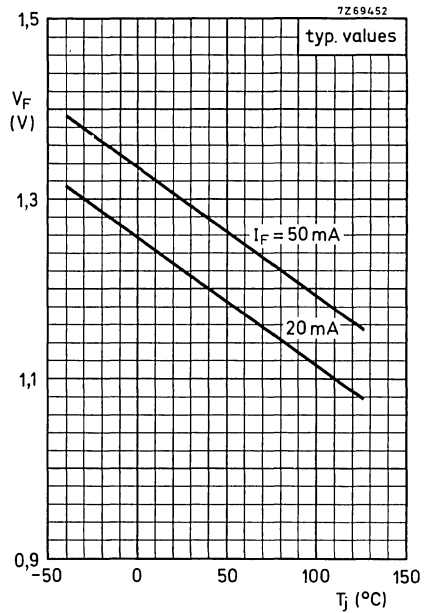
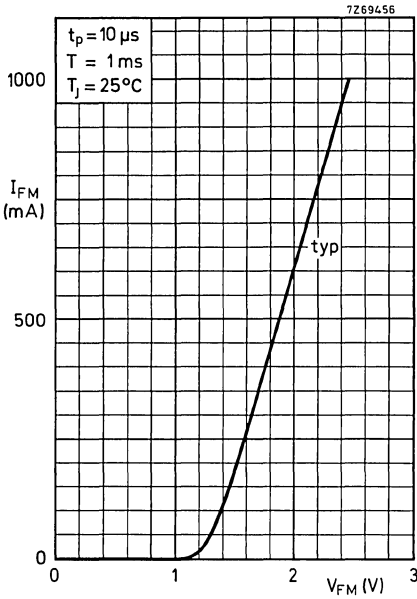

CQY49B
CQY49C

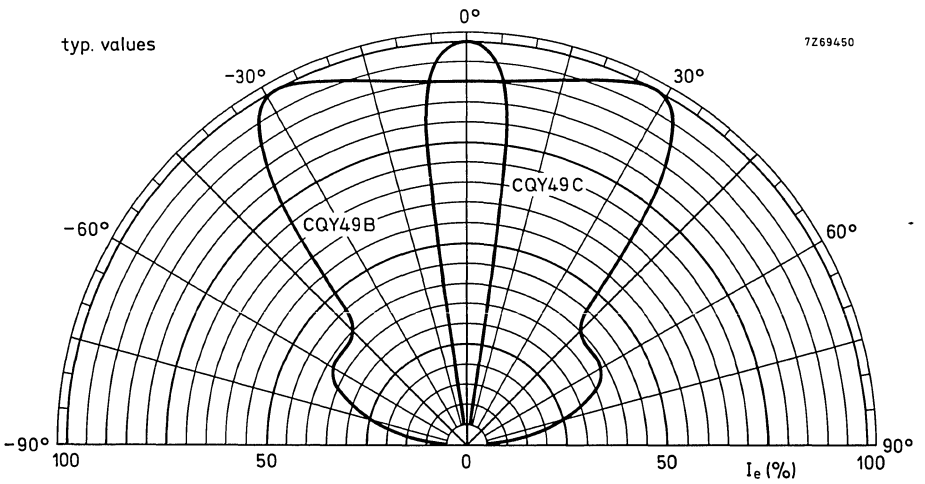
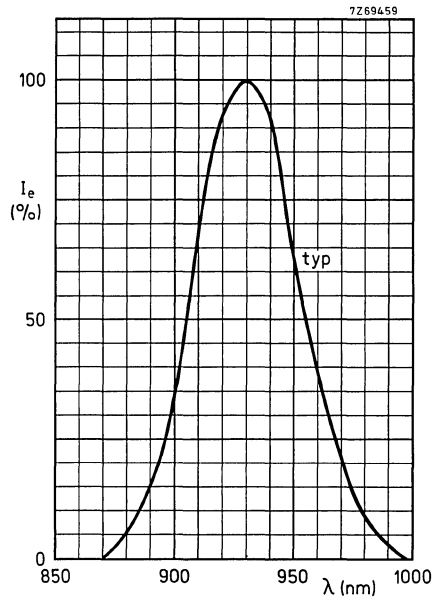
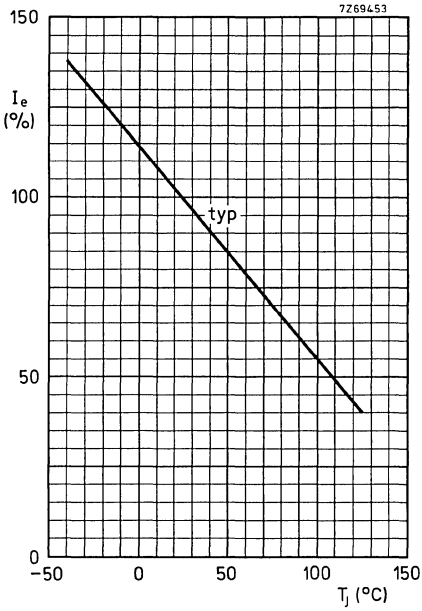

GaAs LIGHT EMITTING DIODES

Gallium arsenide light emitting diodes which emit near-infrared light when forward biased. Ceramic-metal envelope with glass lens like BPX71, suitable for matrix layout on printed circuit boards. In conjunction with BPX71 also suitable for punched card reading.

QUICK REFERENCE DATA				
Continuous reverse voltage	V_R	max.	2	V
Forward current (d. c.)	I_F	max.	100	mA
Total power dissipation up to $T_{amb} = 25\text{ }^\circ\text{C}$ mounted on printed circuit board	P_{tot}	max.	150	mW
Total radiant power at $I_F = 20\text{ mA}$	ϕ_e	>	CQY50	CQY52
			160	400
Radiant intensity (on-axis) at $I_F = 20\text{ mA}$	I_e	>	180	450
				$\mu\text{W}/\text{sr}$
Wavelength at peak emission	λ_{pk}	typ.	930	nm

MECHANICAL DATA

Dimensions in mm

DO-31 except for length

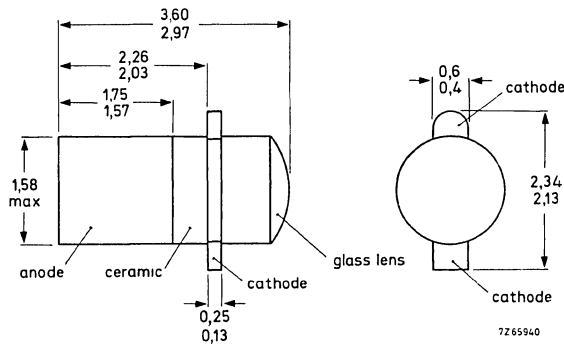

RATINGS Limiting values in accordance with the Absolute Maximum System (IEC 134)

Voltage

Continuous reverse voltage V_R max. 2 V

Current

Forward current (d.c.) I_F max. 100 mA

Forward current (peak value)
 $t_p = 10 \mu s; \delta = 0,01$ I_{FM} max. 500 mA

Temperature

Storage temperature T_{stg} -65 to +150 °C

Operating junction temperature T_J max. 125 °C

Power dissipation

Total power dissipation up to $T_{amb} = 25 \text{ }^\circ\text{C}$
device mounted on p.c. board ¹⁾ P_{tot} max. 150 mW

THERMAL RESISTANCE

From junction to ambient,
device mounted on p.c. board ¹⁾ $R_{th j-a} = 0,66 \text{ }^\circ\text{C/mW}$

¹⁾ With copper islands of 6 x 2 mm on both sides of 1,6 mm glass-epoxy printed circuit board; thickness of copper 35 μm .

CHARACTERISTICS

$T_{amb} = 25\text{ }^{\circ}\text{C}$ unless otherwise specified

		CQY50	CQY52	
<u>Forward voltage</u>				
$I_F = 50\text{ mA}$	V_F typ.	1, 3	1, 3	V
	V_F <	1, 5	1, 5	V
$I_F = 500\text{ mA}; t_p = 10\text{ }\mu\text{s}; \delta = 0.01$	V_F typ.	2.3	2.3	V
<u>Reverse current</u>				
$V_R = 2\text{ V}$	I_R <	100	100	μA
<u>Diode capacitance</u>				
$V_R = 0; f = 1\text{ MHz}$	C_d typ.	45	45	pF
<u>Total radiant power</u>				
$I_F = 20\text{ mA}$	ϕ_e >	160	400	μW
$I_F = 50\text{ mA}$	ϕ_e typ.	700	1500	μW
<u>Radiant intensity (on-axis)</u>				
$I_F = 20\text{ mA}$	I_e >	180	450	$\mu\text{W/sr}$
<u>Wavelength at peak emission</u>				
	λ_{pk} typ.	930	930	nm
<u>Bandwidth at half height</u>				
	$B_{50\%}$ typ.	40	40	nm
<u>Beamwidth between half-intensity directions</u>				
	$\alpha_{50\%}$ typ.	35°	35°	
<u>Switching times</u>				
$I_{Fon} = 20\text{ mA}; t_p = 2\text{ }\mu\text{s}; f = 45\text{ kHz}$				
Light rise time	t_r typ.	600	600	ns
Light fall time	t_f typ.	350	350	ns

**CQY50
CQY52**

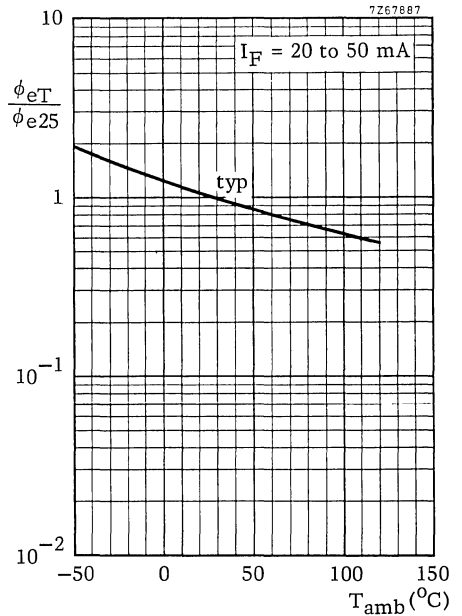
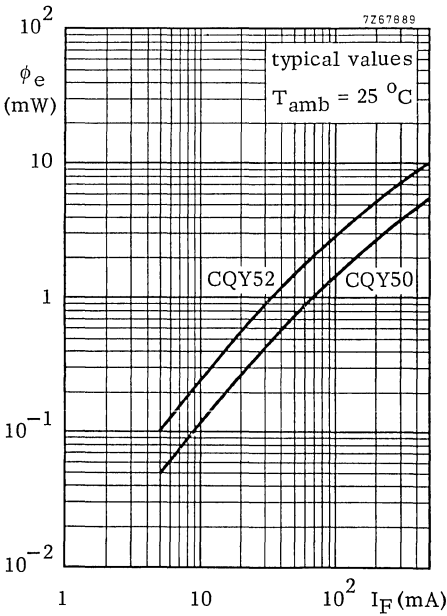
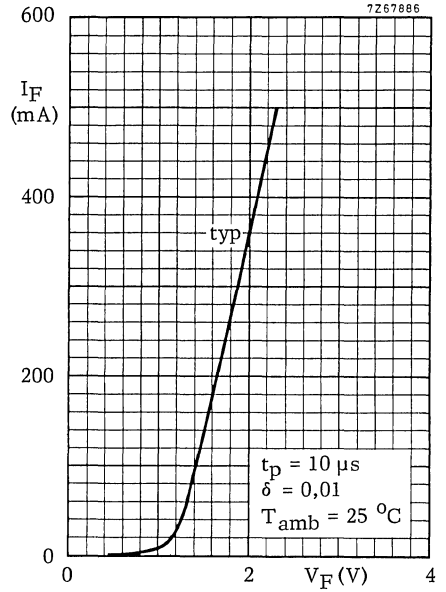
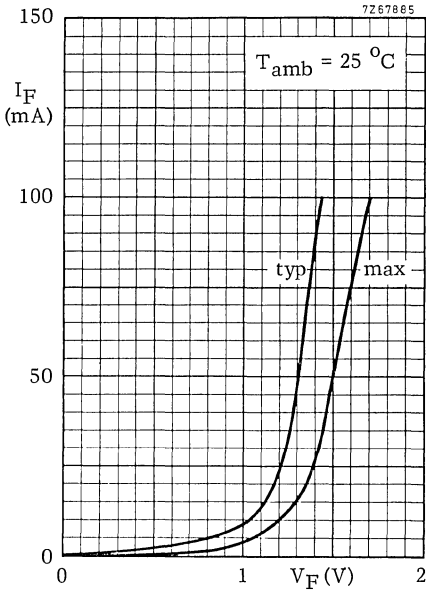

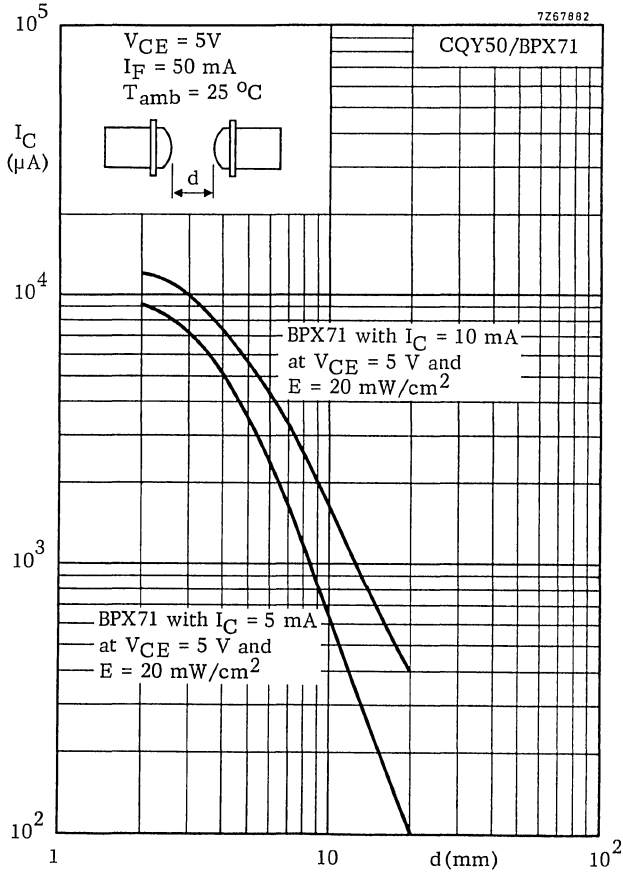

CQY50
CQY52

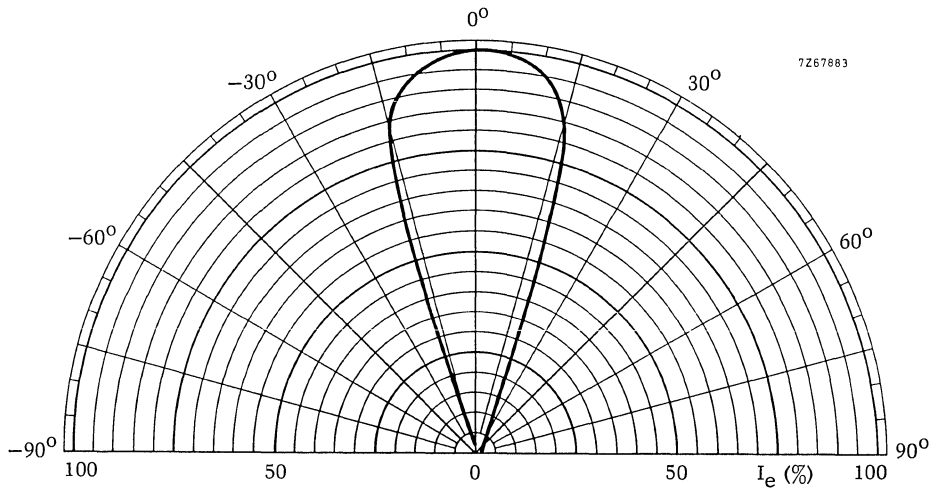
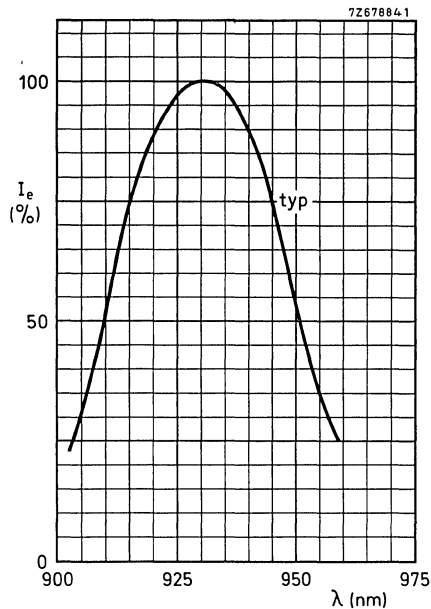
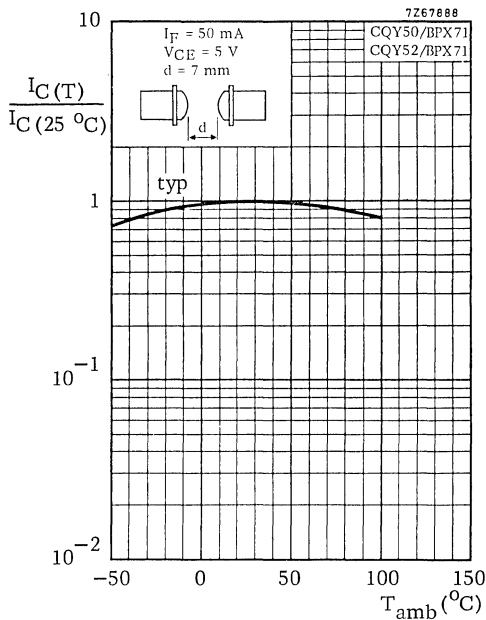

DEVELOPMENT SAMPLE DATA

This information is derived from development samples made available for evaluation. It does not necessarily imply that the device will go into regular production.

CQY54A

LIGHT EMITTING DIODE

Circular light emitting diode with diameter of 3 mm which emits standard red light (GaAsP) when forward biased.

The CQY54A has a SOD-53E outline and is encapsulated in a medium-red coloured diffusing resin.

Together with the CQY95B and the CQY97A the CQY54A forms one light-intensity family.

QUICK REFERENCE DATA

Continuous reverse voltage	V_R	max.	5 V
Forward current (d.c.)	I_F	max.	50 mA
Total power dissipation up to $T_{amb} = 55\text{ }^\circ\text{C}$	P_{tot}	max.	90 mW
Junction temperature	T_j	max.	100 $^\circ\text{C}$
Luminous intensity $I_F = 20\text{ mA}$	CQY54A CQY54A-I CQY54A-II CQY54A-III	I_v	min. 0,5 mCd 0,7 to 1,6 mCd 1,0 to 2,2 mCd min. 1,6 mCd
Wavelength at peak emission $I_F = 20\text{ mA}$		λ_{pk}	typ. 650 nm
Beamwidth at half-intensity directions $I_F = 20\text{ mA}$		$\alpha_{50\%}$	typ. 60 $^\circ$

MECHANICAL DATA

Dimensions in mm

Fig. 1 SOD-53E.

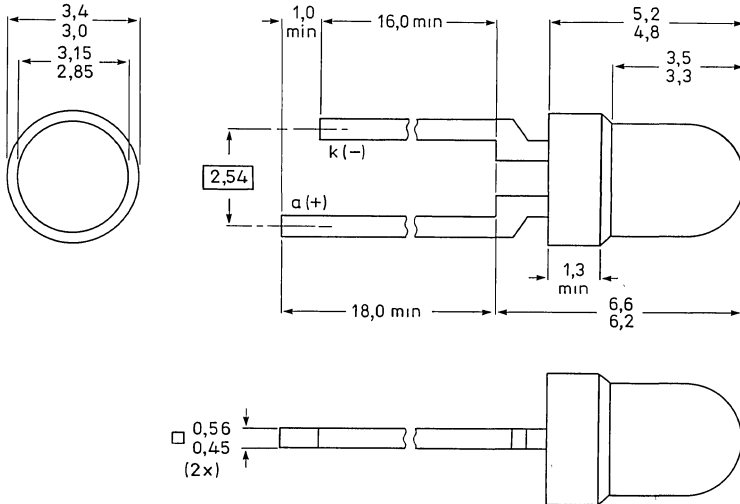

7Z86930 1

RATINGS

Limiting values in accordance with the Absolute Maximum System (IEC 134)

Reverse voltage	V_R	max.	5 V
Forward current			
d.c.	I_F	max.	50 mA
peak value; $t_p = 1 \mu s$; $f = 300 \text{ Hz}$	I_{FM}	max.	1 A
Total power dissipation up to $T_{amb} = 55 \text{ }^\circ\text{C}$	P_{tot}	max.	90 mW
Storage temperature	T_{stg}		-55 to +100 $^\circ\text{C}$
Junction temperature	T_j	max.	100 $^\circ\text{C}$
Lead soldering temperature			
> 1,5 mm from the seating plane; $t_{sld} < 7 \text{ s}$	T_{sld}	max;	260 $^\circ\text{C}$

THERMAL RESISTANCE

From junction to ambient when the device is mounted on a p.c. board	$R_{th \text{ j-a}}$	max.	500 K/W
--	----------------------	------	---------

CHARACTERISTICS

$T_j = 25 \text{ }^\circ\text{C}$ unless otherwise specified

$I_F = 20 \text{ mA}$	V_F	typ.	1,7 V
		max.	2,0 V
Reverse current			
$V_R = 3 \text{ V}$	I_R	max.	100 μA
Beamwidth between half-intensity directions			
$I_F = 20 \text{ mA}$	$\alpha_{50\%}$	typ.	60 $^\circ$
Bandwidth at half height	$B_{50\%}$	typ.	20 nm
Wavelength at peak emission			
$I_F = 20 \text{ mA}$	λ_{pk}	typ.	650 nm
Luminous intensity			
$I_F = 20 \text{ mA}$			
	CQY54A	min.	0,5 mCd
	CQY54A-I	0,2 to	1,6 mCd
	CQY54A-II	1,0 to	2,2 mCd
	CQY54A-III	min.	1,6 mCd
Diode capacitance			
$V_R = 0$; $f = 1 \text{ MHz}$	C_d	typ.	60 pF

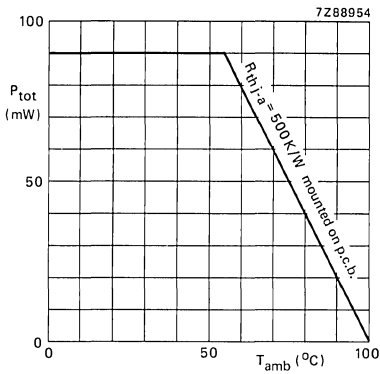

Fig. 2.

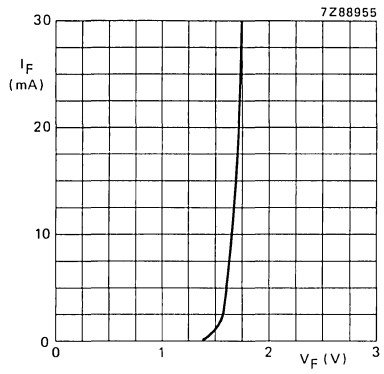

Fig. 3 $T_j = 25\text{ }^\circ\text{C}$; typ. values.

DEVELOPMENT SAMPLE DATA

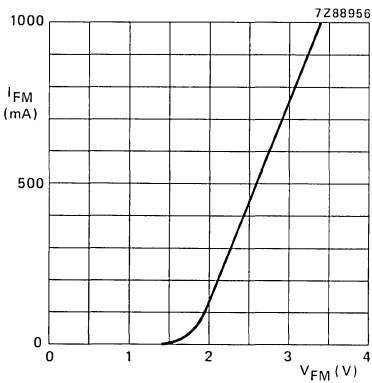

Fig. 4 Typical values.

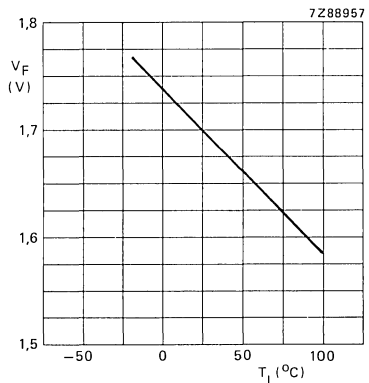

Fig. 5 $I_F = 20\text{ mA}$; typ. values.

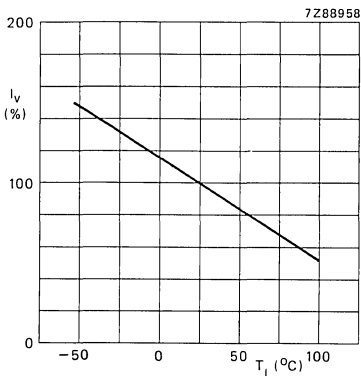

Fig. 6 $I_F = 20\text{ mA}$; typ. values.

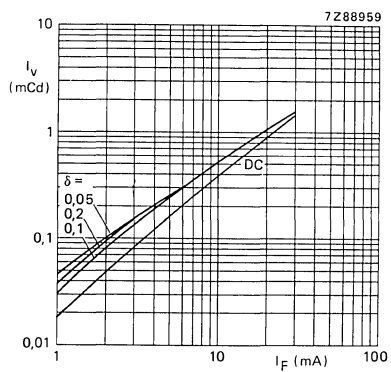

Fig. 7 $t_p = 50\text{ }\mu\text{s}$; $T_j = 25$; typ. values.

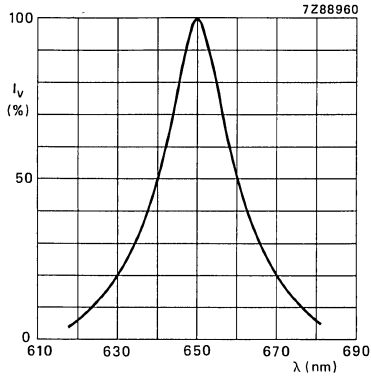

Fig. 8 Typical values.

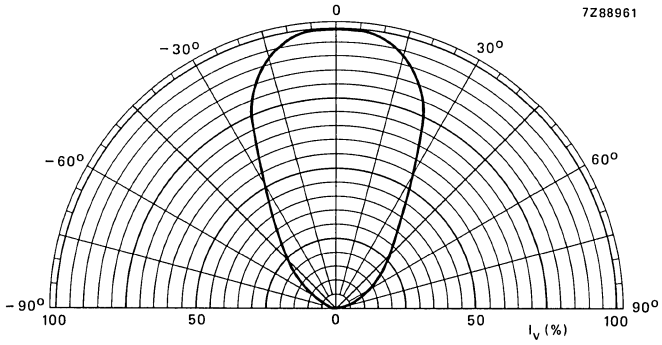

Fig. 9 Typical values.

GaAs LIGHT EMITTING DIODE

Diffused planar light emitting diode intended for optical coupling and encoding. It emits radiation in the near infrared when forward biased. Infrared translucent epoxy encapsulation (dark blue). Combination with phototransistor BPW22A is recommended.

QUICK REFERENCE DATA

Continuous reverse voltage	V_R	max.	5 V
Forward current (d.c.)	I_F	max.	50 mA
Total power dissipation up to $T_{amb} = 25\text{ }^\circ\text{C}$	P_{tot}	max.	100 mW
Radiant intensity (on-axis) at $I_F = 20\text{ mA}$	I_e	>	1 mW/sr
Wavelength at peak emission	λ_{pk}	typ.	930 nm

MECHANICAL DATA

Dimensions in mm

Fig. 1 SOD-53D.

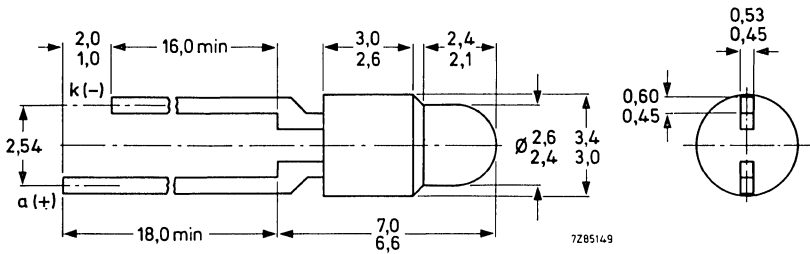

RATINGS

Limiting values in accordance with the Absolute Maximum System (IEC 134)

Continuous reverse voltage	V_R	max.	5 V
Forward current	I_F	max.	50 mA
d.c.	I_{FM}	max.	200 mA
(peak value); $t_p = 10 \mu s$; $\delta = 0,01$	P_{tot}	max.	100 mW
Total power dissipation up to $T_{amb} = 25 \text{ }^\circ\text{C}$ (see Fig. 2)	T_{stg}	-55 to +100 $^\circ\text{C}$	
Storage temperature	T_j	max.	100 $^\circ\text{C}$
Junction temperature	T_{sld}	max.	260 $^\circ\text{C}$
Lead soldering temperature > 3,5 mm from the body; $t_{sld} < 7 \text{ s}$			

THERMAL RESISTANCE

From junction to ambient,
device mounted on a printed-circuit board

$R_{th\ j-a} = 750 \text{ }^\circ\text{C/W}$

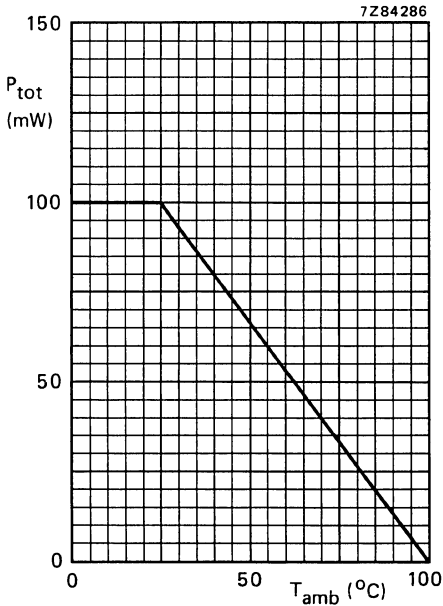

Fig. 2 Power derating curve versus ambient temperature.

CHARACTERISTICS

 $T_j = 25\text{ }^\circ\text{C}$

Forward voltage

 $I_F = 20\text{ mA}$

V_F	typ.	1,2 V
	<	1,5 V

Reverse current

 $V_R = 5\text{ V}$

I_R	<	100 μA
-------	---	-------------------

Diode capacitance

 $V_R = 0; f = 1\text{ MHz}$

C_d	typ.	40 pF
-------	------	-------

Total radiant power

 $I_F = 20\text{ mA}$

ϕ_e	typ.	1 mW
----------	------	------

Radiant intensity (on-axis)

 $I_F = 20\text{ mA}$

CQY58A-I*	I_e	>	1 mW/sr
		<	5 mW/sr
CQY58A-II*	I_e	>	3 mW/sr

Wavelength at peak emission

λ_{pk}	typ.	930 nm
----------------	------	--------

Bandwidth at half height

$B_{50\%}$	typ.	50 nm
------------	------	-------

Beamwidth between half-intensity directions

 $I_F = 20\text{ mA}$

$\alpha_{50\%}$	typ.	$\pm 10^\circ$
-----------------	------	----------------

Switching times

 $I_{Fon} = 20\text{ mA}$

Light rise time

t_r	typ.	3 μs
-------	------	-----------------

Light fall time

t_f	typ.	3 μs
-------	------	-----------------

* CQY58A (without class indication) has a radiant intensity (I_e) of 2,2 to 3,45 mW/sr.

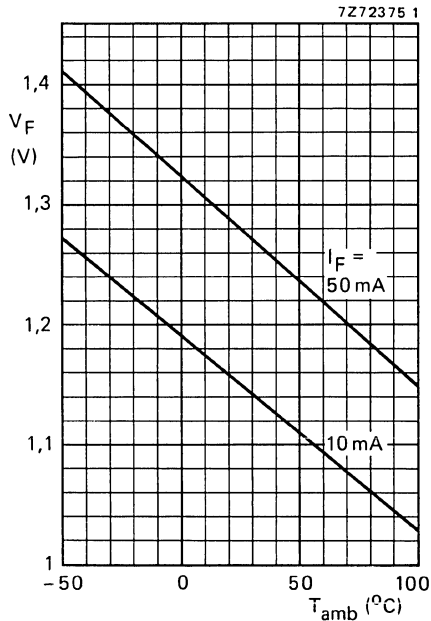
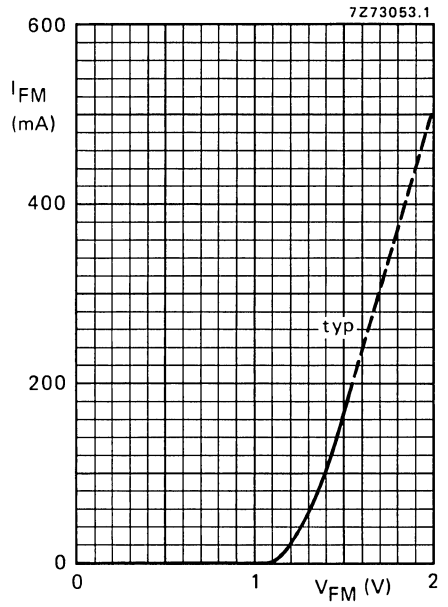
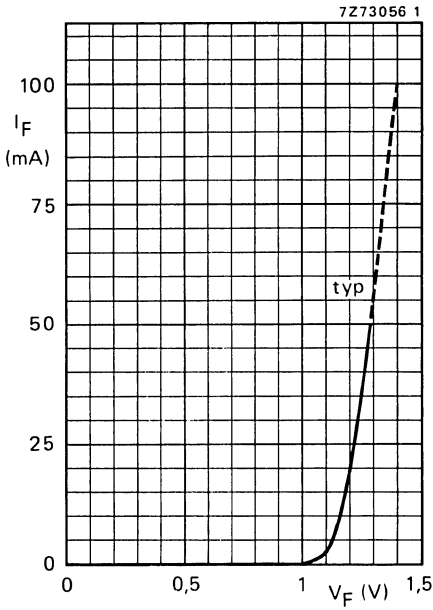

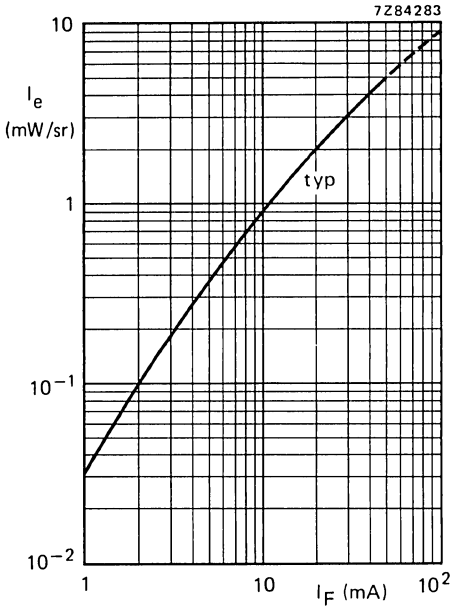

Fig. 6 $T_{amb} = 25\text{ }^\circ\text{C}$.

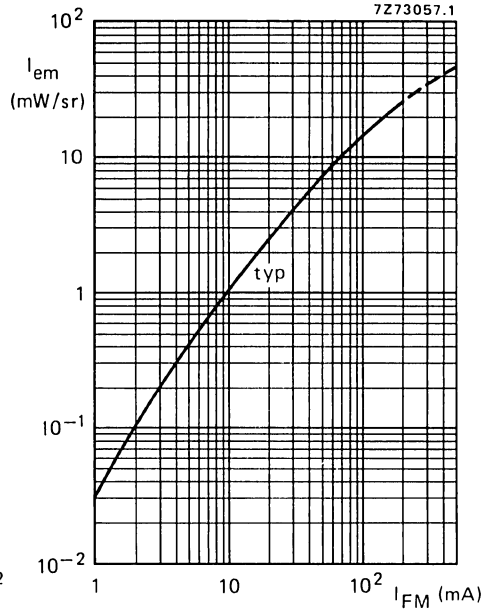

Fig. 7 $t_p = 10\text{ }\mu\text{s}$; $T = 1\text{ ms}$; $T_{amb} = 25\text{ }^\circ\text{C}$.

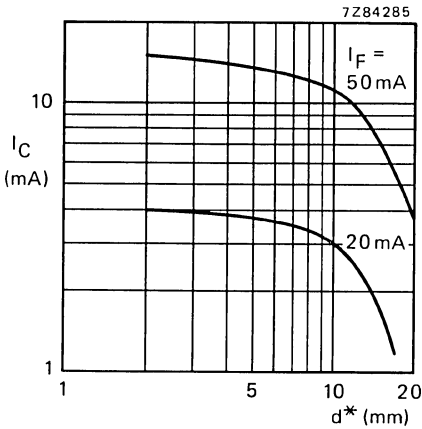

Fig. 8 $V_{CE} = 5\text{ V}$; $T_{amb} = 25\text{ }^\circ\text{C}$; typical values.

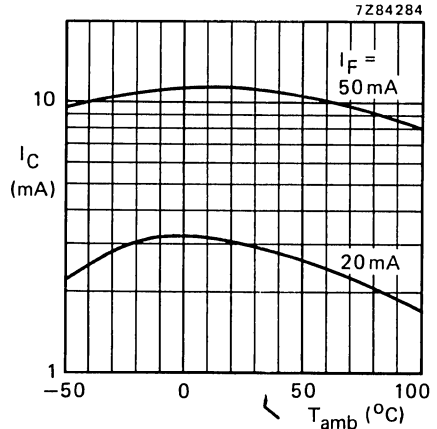

Fig. 9 $V_{CE} = 5\text{ V}$; $d^* = 10\text{ mm}$; typical values.

* d = shortest free distance of mechanical on-axis when BPW22A is coupled with CQY58A.

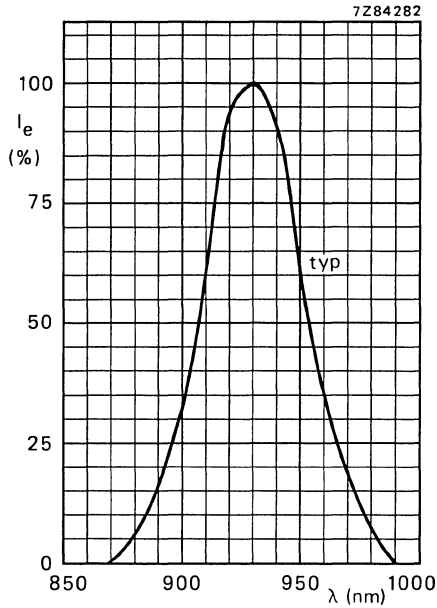

Fig. 10 Spectral response.

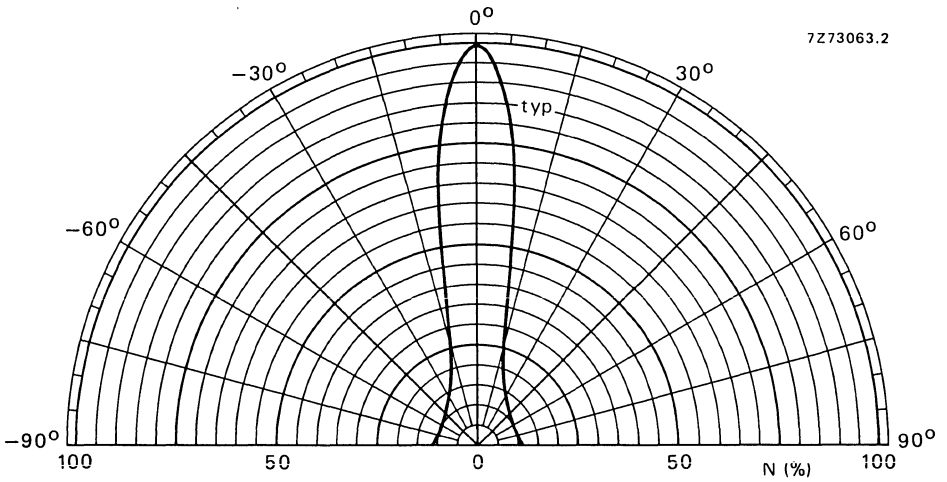

Fig. 11.

GaAs LIGHT EMITTING DIODE

Epitaxial gallium arsenide light emitting diode intended for remote-control applications. It emits radiation in the near infrared when forward biased. Infrared translucent epoxy encapsulation (dark blue).

QUICK REFERENCE DATA

Continuous reverse voltage	V_R	max.	5 V
Forward current (d.c.)	I_F	max.	130 mA
Total power dissipation up to $T_{amb} = 25\text{ }^\circ\text{C}$	P_{tot}	max.	215 mW
Junction temperature	T_j	max.	100 $^\circ\text{C}$
Radiant intensity (on-axis) at $I_F = 100\text{ mA}$	CQY89A	I_e	> 9 mW/sr
	CQY89A-I	I_e	9 to 20 mW/sr ←
	CQY89A-II	I_e	> 15 mW/sr ←
Wavelength at peak emission	λ_{pk}	typ.	930 nm

MECHANICAL DATA

Dimensions in mm

Fig. 1 SOD-63A.

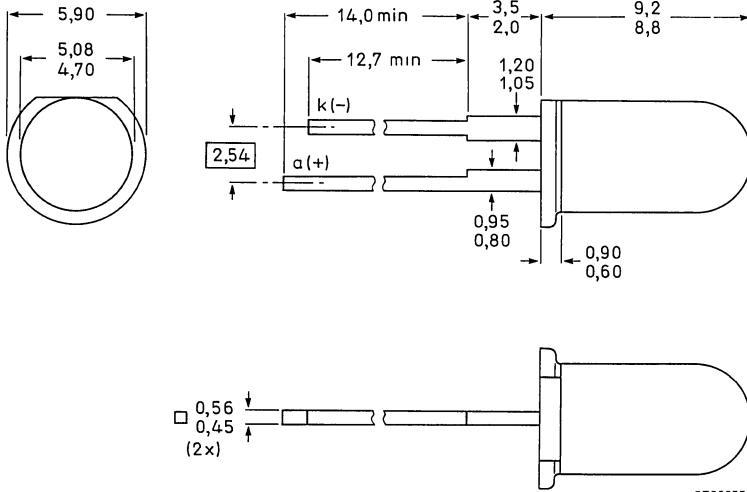

RATINGS

Limiting values in accordance with the Absolute Maximum System (IEC 134)

Continuous reverse voltage	V_R	max.	5 V
Forward current (d.c.)	I_F	max.	130 mA
Forward current (peak value) $t_p \leq 50 \mu\text{s}; \delta = 0,05$	I_{FM}	max.	1000 mA
Non-repetitive peak forward current ($t_p \leq 10 \mu\text{s}$)	I_{FSM}	max.	2500 mA
Total power dissipation up to $T_{amb} = 25 \text{ }^\circ\text{C}$	P_{tot}	max.	215 mW
Storage temperature	T_{stg}		-55 to +100 $^\circ\text{C}$
Junction temperature	T_j	max.	100 $^\circ\text{C}$
Lead soldering temperature up to the seating plane; $t_{slid} < 10 \text{ s}$	T_{slid}	max.	260 $^\circ\text{C}$

THERMAL RESISTANCE

From junction to ambient mounted on a printed-circuit board	$R_{th j-a}$	=	350 K/W
--	--------------	---	---------

CHARACTERISTICS

$T_j = 25 \text{ }^\circ\text{C}$ unless otherwise specified

Forward voltage $I_F = 100 \text{ mA}$	V_F	typ. <	1,4 V 1,6 V
$I_{FM} = 1500 \text{ mA}; t_p = 20 \mu\text{s}; \delta = 0,033$	V_{FM}	typ.	2,4 V
Reverse current $V_R = 5 \text{ V}$	I_R	<	100 μA
Diode capacitance $V_R = 0; f = 1 \text{ MHz}$	C_d	typ.	40 pF
Total radiant power $I_F = 100 \text{ mA}$	ϕ_e	> typ.	7 mW 12 mW
Decrease of radiant power with temperature $I_F = 100 \text{ mA}$	$\frac{\Delta\phi_e}{\Delta T_j}$	typ.	1 %/K
Radiant intensity (on-axis) $I_F = 100 \text{ mA}$	I_e	> typ.	9 mW/sr 15 mW/sr
	CQY89A-I		9 to 20 mW/sr
	CQY89A-II	>	15 mW/sr
Wavelength at peak emission $I_F = 100 \text{ mA}$	λ_{pk}	typ.	930 nm
Bandwidth at half height $I_F = 100 \text{ mA}$	$B_{50\%}$	typ.	50 nm
Beamwidth between half-intensity directions $I_F = 100 \text{ mA}$	$\alpha_{50\%}$	typ.	40 $^\circ$

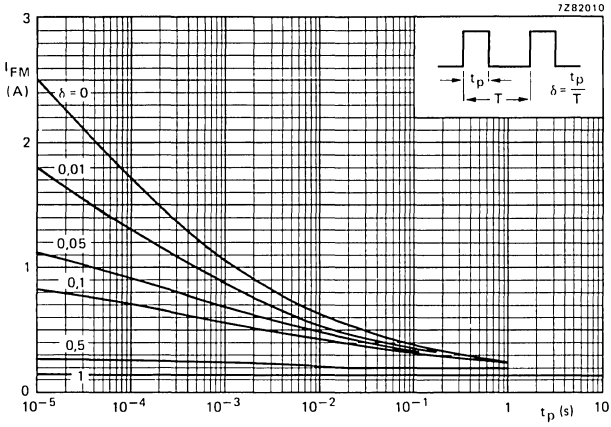

Fig. 2 $T_{amb} = 25\text{ }^\circ\text{C}$; $T_{j\text{ peak}} = 100\text{ }^\circ\text{C}$.

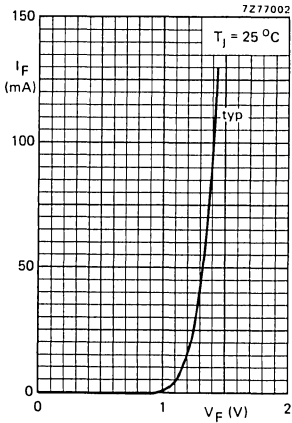

Fig. 3.

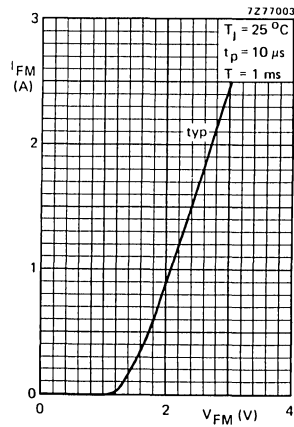

Fig. 4.

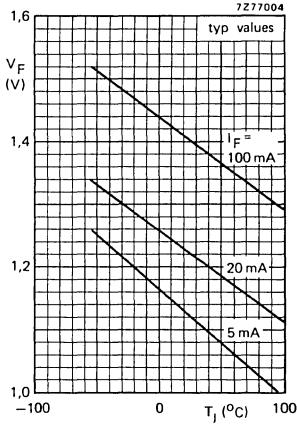

Fig. 5.

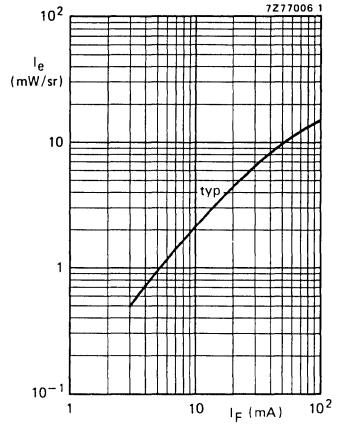

Fig. 6 $T_J = 25$ °C.

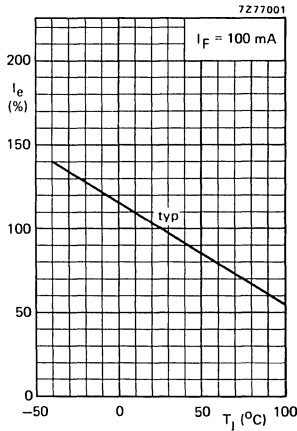

Fig. 7.

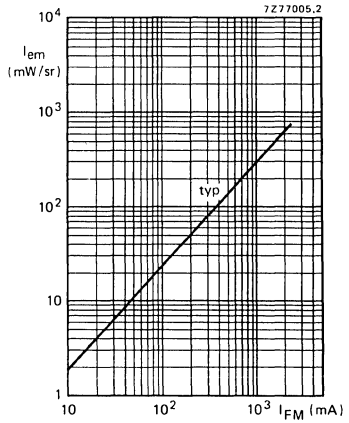

Fig. 8 $T_{amb} = 25$ °C; $t_p = 10$ μ s; $T = 1$ ms.

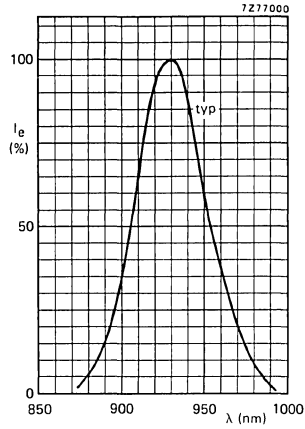

Fig. 9.

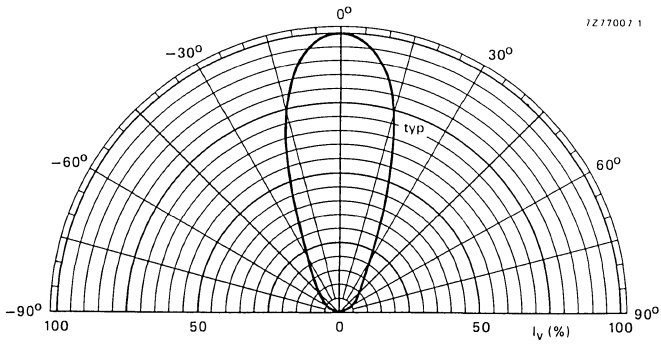

Fig. 10.

DEVELOPMENT SAMPLE DATA

This information is derived from development samples made available for evaluation. It does not necessarily imply that the device will go into regular production.

CQY94

LIGHT EMITTING DIODE

Circular light emitting diode with diameter of 5 mm which emits green light (GaP) when forward biased.

The CQY94 has a SOD-63A outline and is encapsulated in a medium-green diffusing resin. This device will eventually be replaced by the CQY94B which has a super-green crystal, which has a better yield in the higher I_V classes.

The CQY94 forms one family with the CQY24B and the CQY96.

QUICK REFERENCE DATA

Continuous reverse voltage	V_R	max.	5 V
Forward current (d.c.)	I_F	max.	30 mA
Total power dissipation up to $T_{amb} = 65^\circ\text{C}$	P_{tot}	max.	90 mW
Junction temperature	T_j	max.	100 $^\circ\text{C}$
Luminous intensity $I_F = 10\text{ mA}$	CQY94-I CQY94-II CQY94-III CQY94-IV	I_V	min. 0,7 mcd 1,0 to 2,2 mcd 1,6 to 3,5 mcd min. 3,0 mcd
Wavelength at peak emission		λ_{pk}	typ. 560 nm
Beamwidth between half-intensity directions		$\alpha_{50\%}$	typ. 60 $^\circ$

MECHANICAL DATA

Dimensions in mm

Fig. 1 SOD-63A.

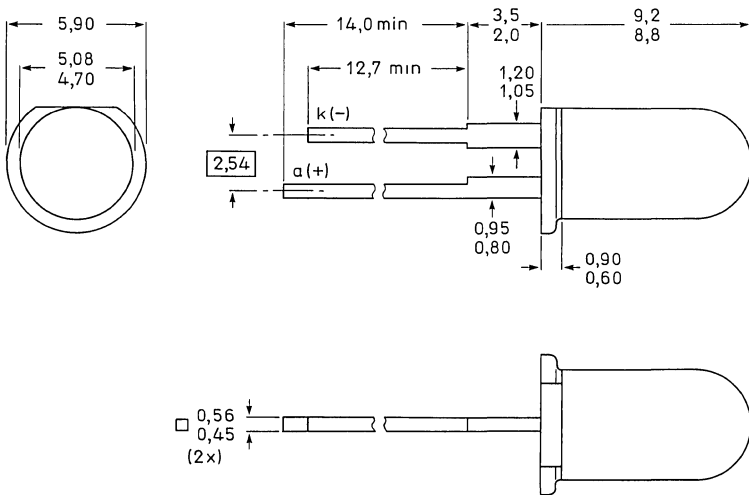

RATINGS

Limiting values in accordance with the Absolute Maximum System (IEC 134)

Reverse voltage	V_R	max.	5 V
Forward current d.c.	I_F	max.	30 mA
Forward current peak value; $t_p = 1 \mu s$; $f = 300 \text{ Hz}$	I_{FM}	max.	1 A
peak value; $t_{ON} = 1 \text{ ms}$; $\delta = 0,33$		max.	60 mA
Total power dissipation up to $T_{amb} = 65 \text{ }^\circ\text{C}$	P_{tot}	max.	90 mW
Storage temperature	T_{stg}		-55 to +100 $^\circ\text{C}$
Junction temperature	T_j	max.	100 $^\circ\text{C}$
Lead soldering temperature > 1,5 mm from the seating plane; $t_{sld} < 7 \text{ s}$	T_{sld}	max.	260 $^\circ\text{C}$

THERMAL RESISTANCE

From junction to ambient when the device is mounted on a p.c.b.

$R_{th j-a}$	max.	350 K/W
--------------	------	---------

CHARACTERISTICS

$T_j = 25 \text{ }^\circ\text{C}$ unless otherwise specified

Forward voltage $I_F = 10 \text{ mA}$	V_F	typ.	2,1 V
		max.	3,0 V
Reverse current $V_R = 5 \text{ V}$	I_R	max.	100 μA
Beamwidth between half-intensity directions $I_F = 10 \text{ mA}$	$\alpha_{50\%}$	typ.	60 $^\circ$
Bandwidth at half height	$B_{50\%}$	typ.	30 nm
Wavelength at peak emission $I_F = 10 \text{ mA}$	λ_{pk}	typ.	560 nm
Luminous intensity $I_F = 10 \text{ mA}$	I_v	min.	0,7 mcd
		1,0 to	2,2 mcd
		1,6 to	3,5 mcd
		min.	3,0 mcd
Diode capacitance $V_R = 0$; $f = 1 \text{ MHz}$	C_d	typ.	35 pF

CQY94-I	min.	0,7 mcd
CQY94-II	1,0 to	2,2 mcd
CQY94-III	1,6 to	3,5 mcd
CQY94-IV	min.	3,0 mcd

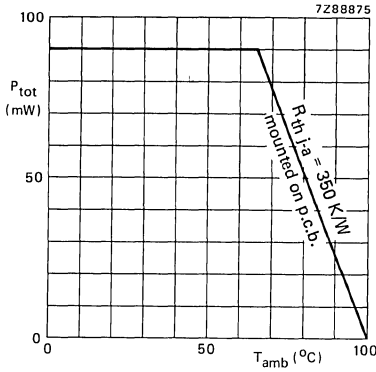

Fig. 2.

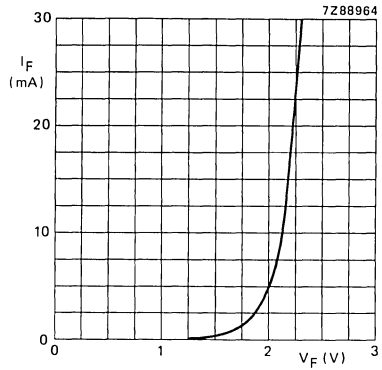

Fig. 3 $T_{amb} = 25^\circ\text{C}$; typ. values.

DEVELOPMENT SAMPLE DATA

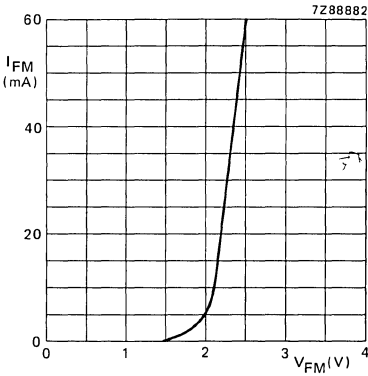

Fig. 4 $T_{amb} = 25^\circ\text{C}$; $t_{on} = 1\text{ ms}$; $\delta = 0,33$; typ. values.

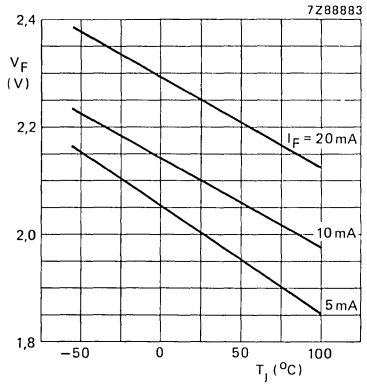

Fig. 5 Typical values.

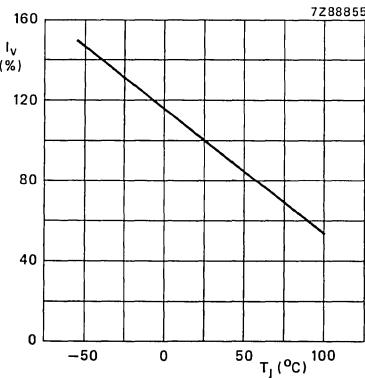

Fig. 6 $I_F = 10\text{ mA}$; typ. values.

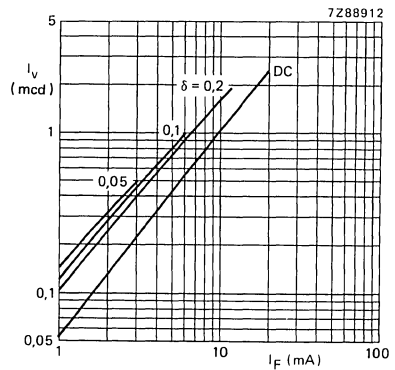

Fig. 7 $t_p = 50\ \mu\text{s}$; typ. values.

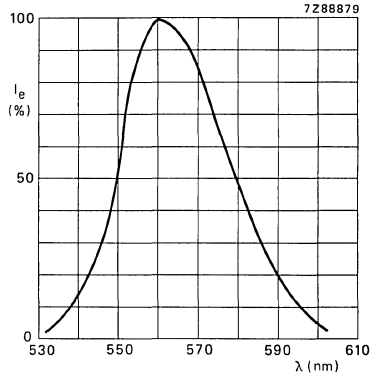

Fig. 8 Typical values.

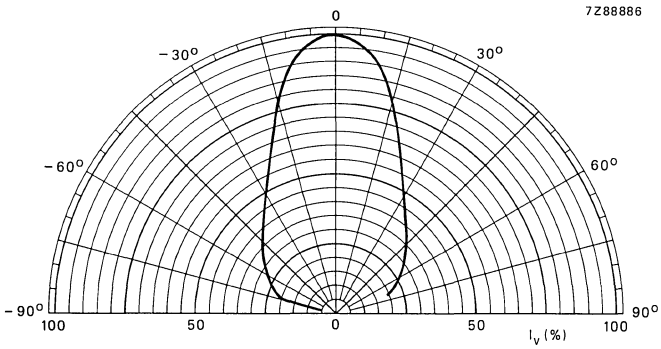

Fig. 9 Typical values.

DEVELOPMENT SAMPLE DATA

This information is derived from development samples made available for evaluation. It does not necessarily imply that the device will go into regular production.

CQY94B
CQY94BL

LIGHT EMITTING DIODES

Circular light emitting diodes with diameter of 5 mm which emit super-green (GaP) light when forward biased.

The CQY94B and CQY94BL have a SOD-63 outline and are encapsulated in a medium-green diffusing resin. Because of its resistance to high forward currents the CQY94B (and CQY94BL) is very suitable in applications where a high luminous intensity is wanted. This type is easily deliverable in high I_V classes and therefore very suitable in those applications where only low currents are available.

The CQY94BL is the long-lead version of the CQY94B and has no seating plane but is in all other respects equal to the CQY94B.

QUICK REFERENCE DATA

Continuous reverse voltage	V_R	max.	5 V
Forward current (d.c.)	I_F	max.	60 mA
Total power dissipation up to $T_{amb} = 35\text{ }^\circ\text{C}$	P_{tot}	max.	180 mW
Junction temperature	T_j	max.	100 $^\circ\text{C}$
Luminous intensity			
$I_F = 10\text{ mA}$	CQY94B(L)	I_V	min. 0,7 mCd
	CQY94B(L)-III	I_V	1,6 to 3,5 mCd
	CQY94B(L)-IV	I_V	3,0 to 7,0 mCd
	CQY94B(L)-V	I_V	min. 5,0 mCd
Wavelength at peak emission	λ_{pk}	typ.	565 nm
Beamwidth between half-intensity directions	$\alpha_{50\%}$	typ.	60 $^\circ$

MECHANICAL DATA

Dimensions in mm

Fig. 1a SOD-63A.

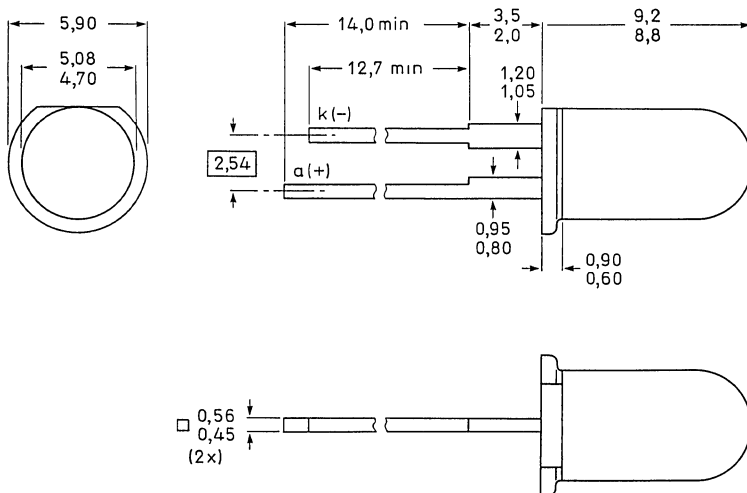

7286977

CQY94B
CQY94BL

Fig. 1b SOD-63L.

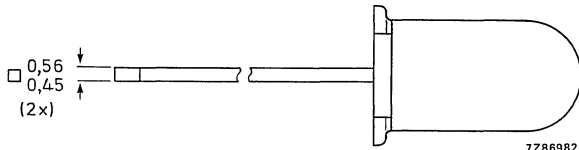
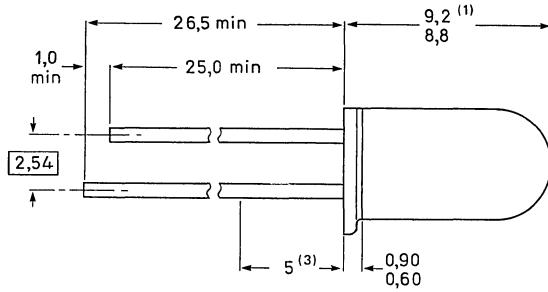
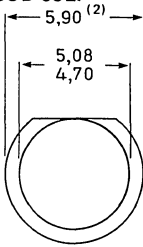

- (1) Measured when the device is seated in a gauge with 2 holes 0,80 mm diameter 2,54 mm apart.
 (2) Maximum value including burrs.
 (3) Solderability not guaranteed within this zone due to tie-bar cropping.

RATINGS

Limiting values in accordance with the Absolute Maximum System (IEC 134)

Reverse voltage	V_R	max.	5 V
Forward current d.c.	I_F	max.	60 mA
Forward current peak value; $t_p = 1 \mu s$; $f = 300$ Hz	I_{FM}	max.	1 A
peak value; $t_p = 1$ ms; $\delta = 0,33$			150 mA
Total power dissipation up to $T_{amb} = 35$ °C	P_{tot}	max.	180 mW
Storage temperature	T_{stg}		-55 to +100 °C
Junction temperature	T_j	max.	100 °C
Lead soldering temperature at $t_{sld} < 7$ s	T_{sld}	max.	260 °C
> 1,5 mm from the seating plane for CQY94B			
> 5 mm from the plastic body for CQY94BL			

THERMAL RESISTANCE

From junction to ambient when the device is mounted on a p.c. board	$R_{th j-a}$	max.	350 K/W
--	--------------	------	---------

CHARACTERISTICS

$T_j = 25$ °C unless otherwise specified

Forward voltage $I_F = 10$ mA	V_F	typ. max.	2,1 V 3,0 V
Reverse current $V_R = 5$ V	I_R	max.	100 μA

Beamwidth between half-intensity directions

$I_F = 10 \text{ mA}$

$\alpha_{50\%}$ typ. 60°

Bandwidth at half height

$B_{50\%}$ typ. 30 nm

Wavelength at peak emission

$I_F = 10 \text{ mA}$

λ_{pk} typ. 565 nm

Luminous intensity

$I_F = 10 \text{ mA}$

CQY94B(L)	I_V	min.	0,7 mCd
CQY94B(L)-III	I_V	1,6 to	3,5 mCd
CQY94B(L)-IV	I_V	3,0 to	7,0 mCd
CQY94B(L)-V	I_V	min.	5,0 mCd

Diode capacitance

$V_R = 0; f = 1 \text{ MHz}$

C_d typ. 35 pF

DEVELOPMENT SAMPLE DATA

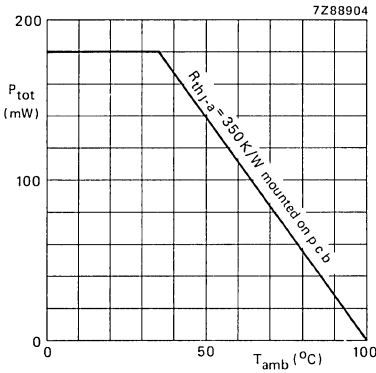

Fig. 2.

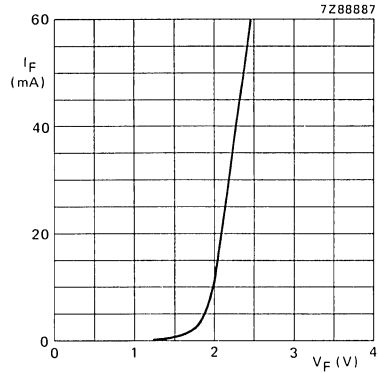

Fig. 3 $T_{amb} = 25^\circ\text{C}$; typ. values.

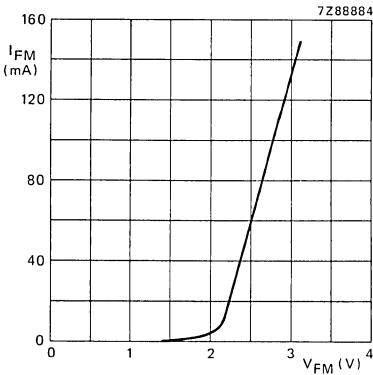

Fig. 4 $t_{on} = 1 \text{ ms}; \delta = 0,33;$
 $T_{amb} = 25^\circ\text{C}$; typ. values.

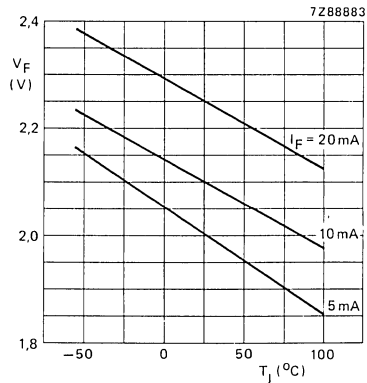

Fig. 5 Typical values.

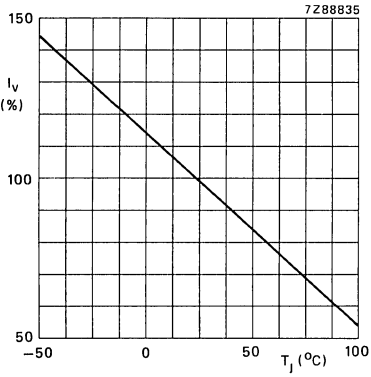

Fig. 6 Typical values.

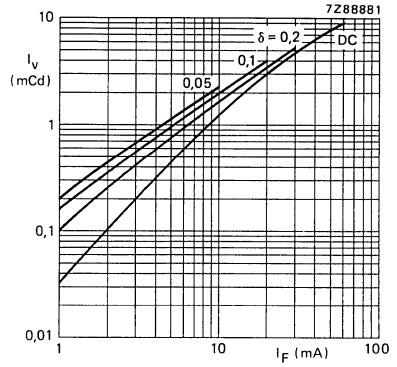

Fig. 7 $t_p = 50 \mu s$; typ. values.

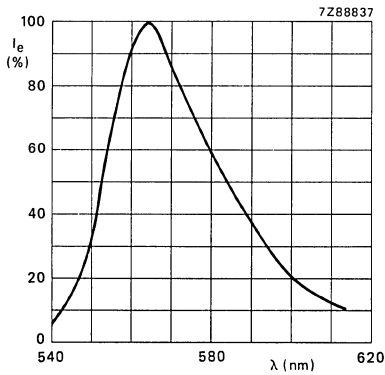

Fig. 8 $I_F = 10 \text{ mA}$; typ. values.

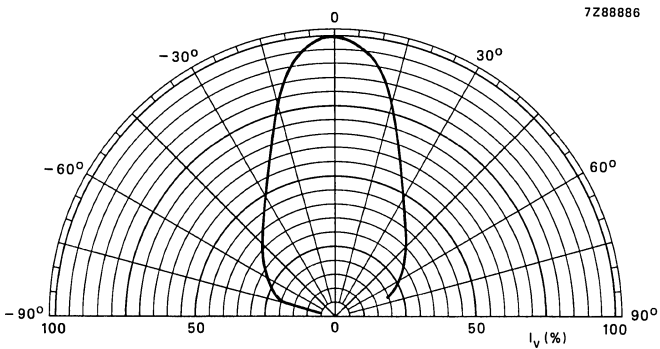

Fig. 9 $I_F = 10 \text{ mA}$; typ. values.

DEVELOPMENT SAMPLE DATA

This information is derived from development samples made available for evaluation. It does not necessarily imply that the device will go into regular production.

CQY95B

LIGHT EMITTING DIODE

Circular light emitting diode with diameter of 3 mm which emits super-green light (GaP) when forward biased.

The CQY95B has a SOD-53 outline and is encapsulated in a medium-green coloured resin.

This LED can resist higher forward currents when a higher luminous intensity is wanted. Because the CQY95B is easily deliverable in high I_V classes it is very suitable in those applications where only low currents are available.

QUICK REFERENCE DATA

Continuous reverse voltage	V_R	max.	5 V
Forward current (d.c.)	I_F	max.	60 mA
Total power dissipation up to $T_{amb} = 25\text{ }^\circ\text{C}$	P_{tot}	max.	150 mW
Junction temperature	T_j	max.	100 $^\circ\text{C}$
Luminous intensity $I_F = 10\text{ mA}$	CQY95B	I_V	min. 0,7 mCd
	CQY95B-III	I_V	1,6 to 3,5 mCd
	CQY95B-IV	I_V	3,0 to 7,0 mCd
	CQY95B-V	I_V	min. 5,0 mCd
Wavelength at peak emission	λ_{pk}	typ.	565 nm
Beamwidth between half-intensity directions	$\alpha_{50\%}$	typ.	60 $^\circ$

MECHANICAL DATA

Fig. 1 SOD-53E.1

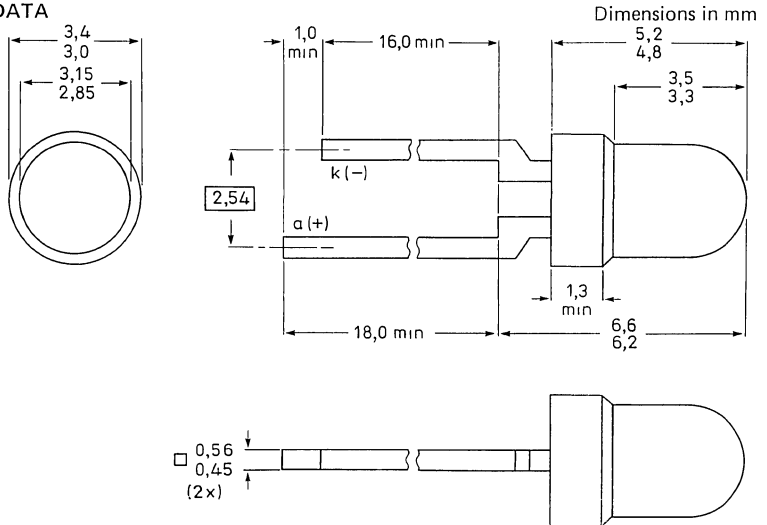

7Z86930 1

CQY95B

RATINGS

Limiting values in accordance with the Absolute Maximum System (IEC 134)

Reverse voltage	V_R	max.	5 V
Forward current			
d.c.	I_F	max.	60 mA
peak value; $t_p = 1 \mu s$; $f = 300 \text{ Hz}$	I_{FM}	max.	1 A
peak value; $t_{on} = 1 \text{ ms}$; $\delta = 0,33$	I_{FM}	max.	150 mA
Total power dissipation up to $T_{amb} = 25 \text{ }^\circ\text{C}$	P_{tot}	max.	150 mW
Storage temperature	T_{stg}		-55 to $+100 \text{ }^\circ\text{C}$
Junction temperature	T_j	max.	100 $^\circ\text{C}$
Lead soldering temperature			
$> 1,5 \text{ mm}$ from the seating plane; $t_{sld} < 7 \text{ s}$	T_{sld}	max.	260 $^\circ\text{C}$

THERMAL RESISTANCE

From junction to ambient when the device is mounted on a p.c. board

$R_{th \text{ j-a}}$	max.	500 K/W
----------------------	------	---------

CHARACTERISTICS

$T_j = 25 \text{ }^\circ\text{C}$ unless otherwise specified

Forward voltage				
$I_F = 10 \text{ mA}$	V_F	typ.	2,1 V	
		max.	3,0 V	
Reverse current				
$V_R = 5 \text{ V}$	I_R	max.	100 μA	
Beamwidth between half-intensity directions	$\alpha_{50\%}$	typ.	60 $^\circ$	
Bandwidth at half height	$B_{50\%}$	typ.	30 nm	
Wavelength at peak emission	λ_{pk}	typ.	565 nm	
Luminous intensity				
$I_F = 10 \text{ mA}$	CQY95B	I_v	min.	0,7 mCd
	CQY95B-III	I_v	1,6 to	3,5 mCd
	CQY95B-IV	I_v	3,0 to	7,0 mCd
	CQY95B-V	I_v	min.	5,0 mCd
Diode capacitance				
$V = 0$; $f = 1 \text{ MHz}$	C_d	typ.	35 pF	

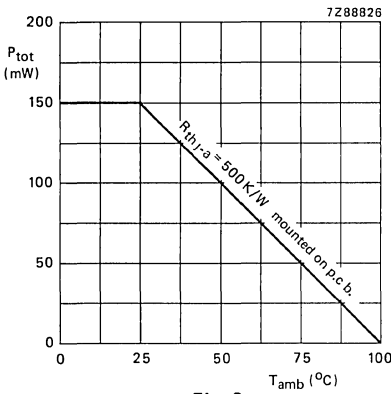

Fig. 2.

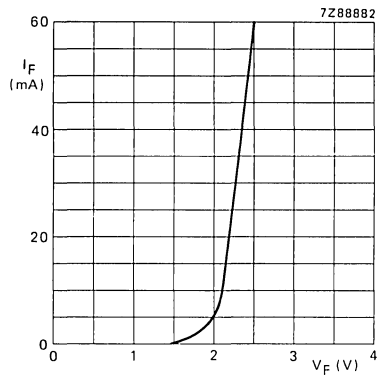

Fig. 3 $T_{amb} = 25^{\circ}C$; typ. values.

DEVELOPMENT SAMPLE DATA

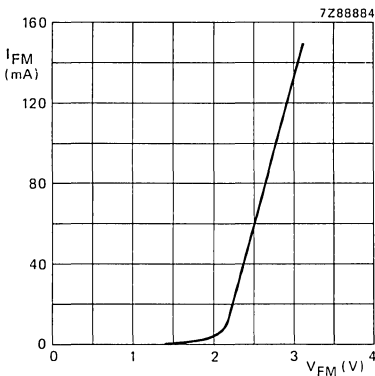

Fig. 4 $t_{on} = 1$ ms; $\delta = 0,33$;
 $T_{amb} = 25^{\circ}C$; typ. values.

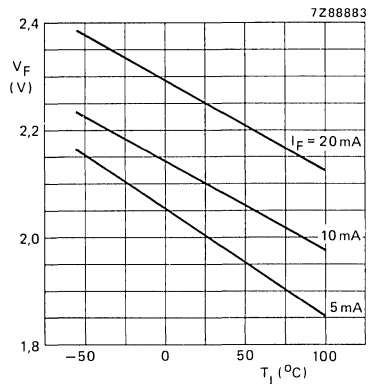

Fig. 5 Typical values.

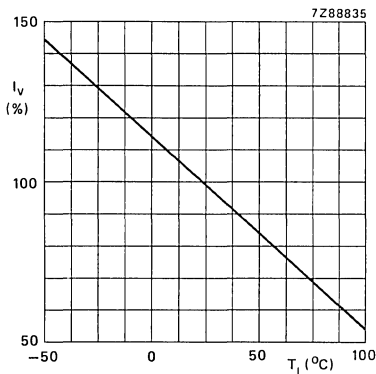

Fig. 6 Typical values.

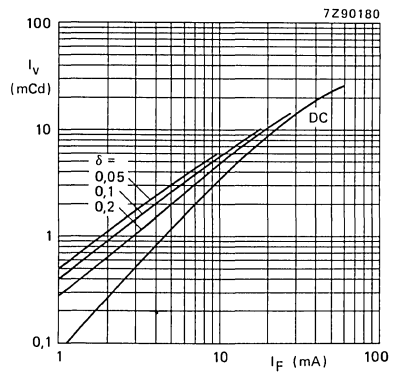

Fig. 7 $t_p = 50 \mu s$; typ. values.

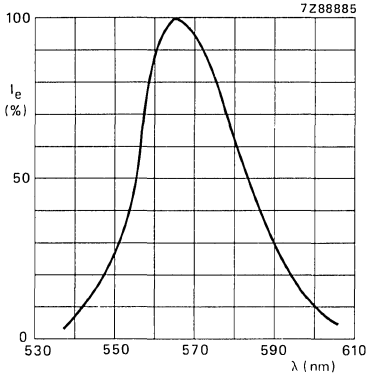

Fig. 8 $I_F = 10 \text{ mA}$; typ. values.

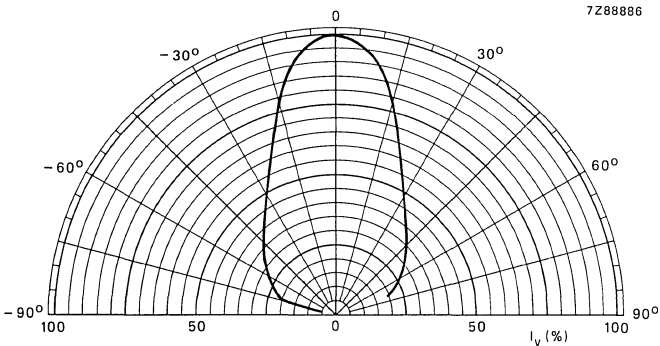

Fig. 9 Typical values.

LIGHT EMITTING DIODES

Circular light emitting diodes with diameter of 5 mm which emit yellow (GaAsP) light when forward biased.

The CQY96 and CQY96L have a SOD-63 outline and are encapsulated in a yellow diffusing resin.

The CQY96L is the long-lead version of the CQY96 and has no seating plane but is in all other respects equal to the CQY96.

QUICK REFERENCE DATA

Continuous reverse voltage	V_R	max.	5 V
Forward current (d.c.)	I_F	max.	30 mA
Total power dissipation up to $T_{amb} = 65\text{ }^\circ\text{C}$	P_{tot}	max.	90 mW
Junction temperature	T_j	max.	100 $^\circ\text{C}$
Luminous intensity (on-axis) $I_F = 10\text{ mA}$	CQY96(L)-I CQY96(L)-III CQY96(L)-IV CQY96(L)-V	I_v	min. 0,7 mCd 1,6 to 3,5 mCd 3,0 to 7,0 mCd min. 5,0 mCd
Wavelength at peak emission		λ_{pk}	typ. 590 nm
Beamwidth between half-intensity directions		$\alpha_{50\%}$	typ. 60 $^\circ$

MECHANICAL DATA

Dimensions in mm

Fig. 1a SOD-63A.
CQY96

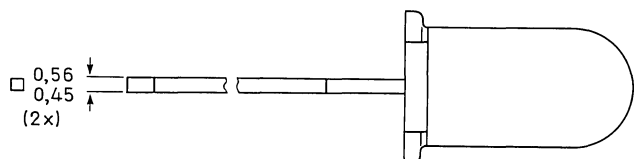
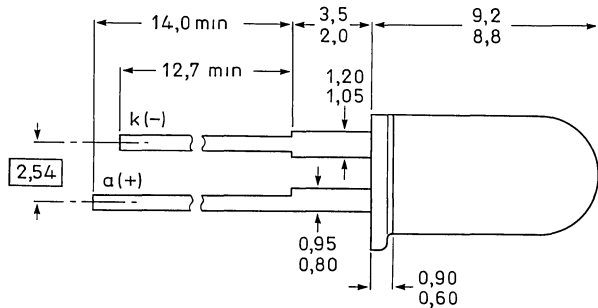
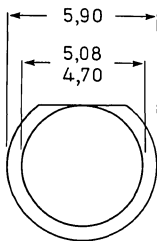

7286977

CQY96
CQY96L

Fig. 1b SOD-63L.
CQY96L

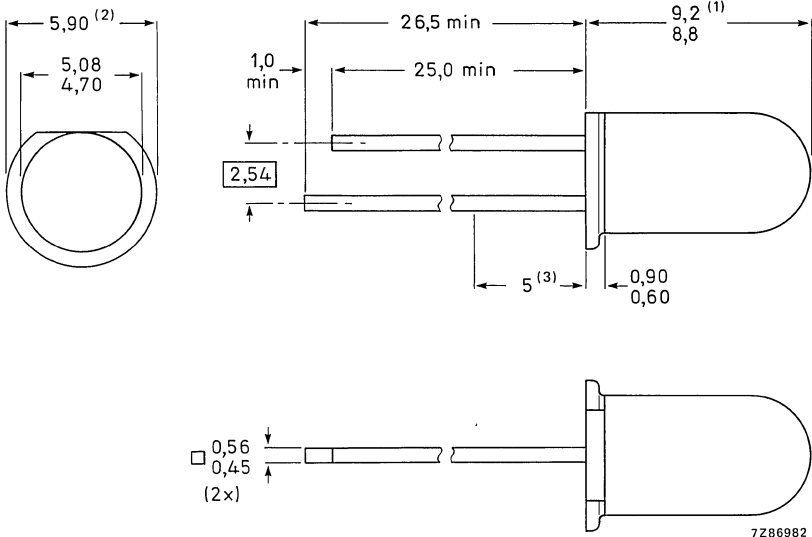

Notes

1. Measured when the device is seated in a gauge with 2 holes 0,80 mm diameter 2,54 mm apart.
2. Maximum value including burrs.
3. Solderability not guaranteed within this zone due to tie-bar cropping.

RATINGS

Limiting values in accordance with the Absolute Maximum System (IEC 134)

Continuous reverse voltage	V_R	max.	5 V
Forward current (d.c.)	I_F	max.	30 mA
Forward current (peak value)	I_{FM}	max.	1 A
$t_p < 1 \mu s; f < 300 \text{ Hz}$	I_{FM}	max.	60 mA
$t_p < 1 \text{ ms}; \delta = 0,33$	P_{tot}	max.	90 mW
Total power dissipation up to $T_{amb} = 65 \text{ }^\circ\text{C}$	T_{stg}		$-55 \text{ to } +100 \text{ }^\circ\text{C}$
Storage temperature	T_j	max.	100 $^\circ\text{C}$
Junction temperature	T_{slid}	max.	260 $^\circ\text{C}$
Lead soldering temperature at $t_{slid} < 7 \text{ s}$			
> 1,5 mm from the seating plane for CQY96			
> 5 mm from the plastic body for CQY96L			

THERMAL RESISTANCE

From junction to ambient in free air	$R_{th \text{ j-a}}$	=	500 K/W
mounted on a printed board	$R_{th \text{ j-a}}$	=	350 K/W

CHARACTERISTICS

$T_j = 25\text{ }^\circ\text{C}$ unless otherwise specified

Forward voltage

$I_F = 10\text{ mA}$

V_F	typ.	2,1 V
	max.	3 V

Reverse current

$V_R = 3\text{ V}$

I_R	max.	100 μA
-------	------	-------------------

Diode capacitance

$V_R = 0; f = 1\text{ MHz}$

C_d	typ.	35 pF
-------	------	-------

Luminous intensity (on-axis)

$I_F = 10\text{ mA}$

CQY96(L)-I	I_v	min.	0,7 mCd
CQY96(L)-III	I_v	1,6 to	3,5 mCd
CQY96(L)-IV	I_v	3,0 to	7,0 mCd
CQY96(L)-V	I_v	min.	5,0 mCd
	λ_{pk}	typ.	590 nm
	$B_{50\%}$	typ.	40 nm
	$\alpha_{50\%}$	typ.	60 $^\circ$

Wavelength at peak emission

Bandwidth at half height

Beamwidth between half-intensity directions

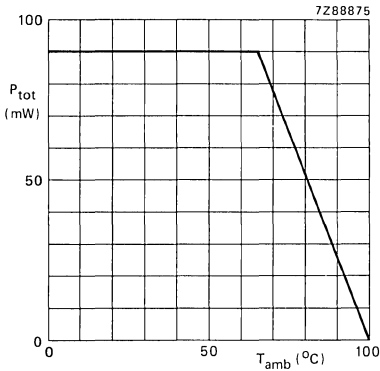

Fig. 2.

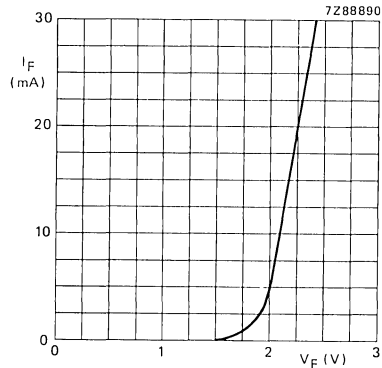

Fig. 3 $T_{amb} = 25\text{ }^\circ\text{C}$; typ. values.

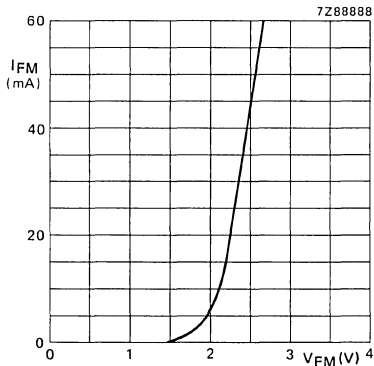

Fig. 4 $t_{on} = 1\text{ ms}$; $\delta = 0,33$;
 $T_{amb} = 25\text{ }^\circ\text{C}$; typ. values.

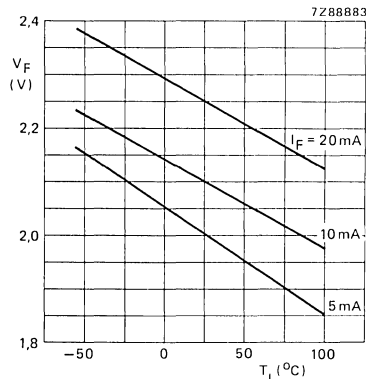

Fig. 5 Typical values.

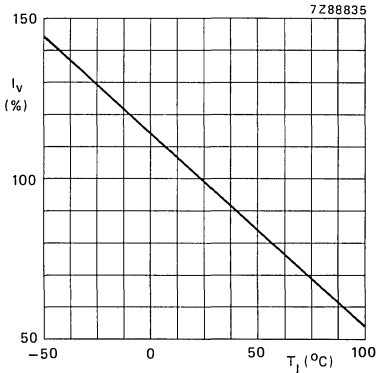

Fig. 6 Typical values.

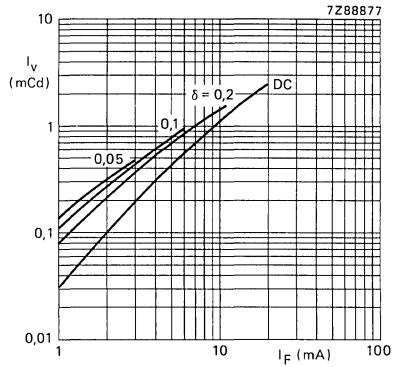

Fig. 7 $t_p = 50 \mu s$; typ. values.

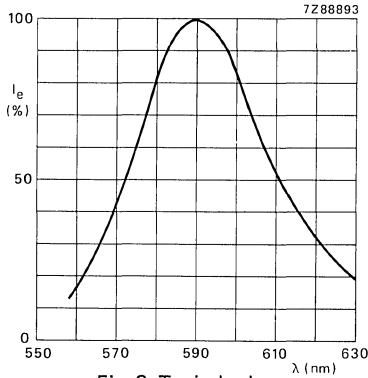

Fig. 8 Typical values.

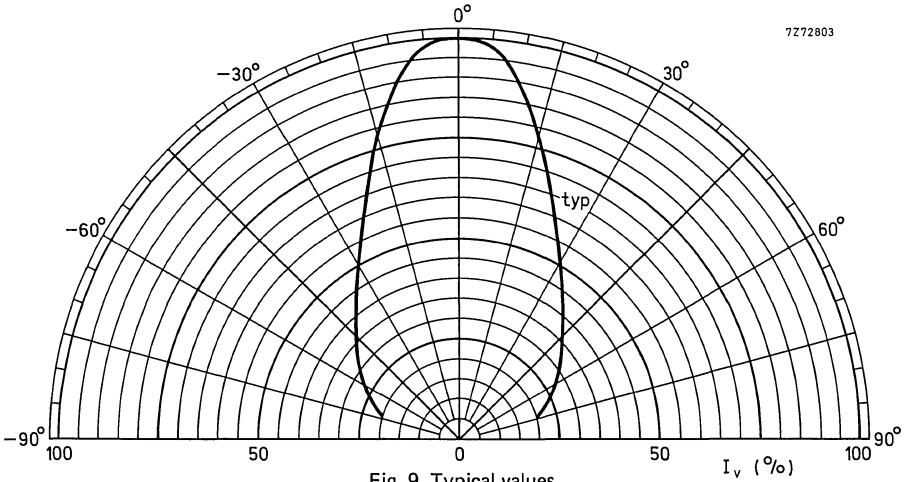

Fig. 9 Typical values.

DEVELOPMENT SAMPLE DATA

This information is derived from development samples made available for evaluation. It does not necessarily imply that the device will go into regular production

CQY97A

LIGHT EMITTING DIODE

Circular light emitting diode with diameter of 3 mm which emits yellow light (GaPAs) when forward biased.

The CQY97A has a SOD-53E envelope and is encapsulated in a medium-yellow coloured diffusing resin.

QUICK REFERENCE DATA

Continuous reverse voltage		V_R	max.	5 V
Forward current (d.c.)		I_F	max.	30 mA
Total power dissipation up to $T_{amb} = 55\text{ }^\circ\text{C}$		P_{tot}	max.	90 mW
Junction temperature		T_j	max.	100 $^\circ\text{C}$
Luminous intensity		I_v	min.	0,7 mCd
$I_F = 10\text{ mA}$	CQY97A	I_v	1,6 to	3,5 mCd
	CQY97A-III	I_v	3,0 to	7,0 mCd
	CQY97A-IV	I_v	min.	5,0 mCd
	CQY97A-V	I_v		
Wavelength at peak emission		λ_{pk}	typ.	590 nm
$I_F = 10\text{ mA}$		$\alpha_{50\%}$	typ.	60 $^\circ$
Beamwidth at half-intensity directions				

MECHANICAL DATA

Dimensions in mm

Fig. 1 SOD-53E.

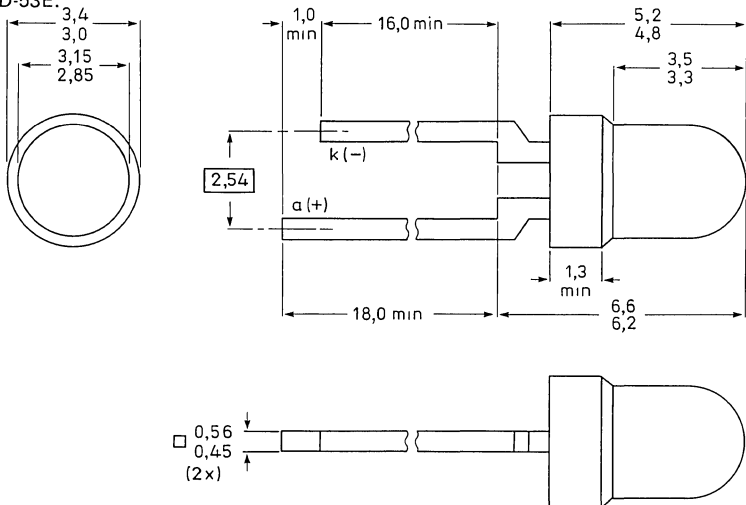

7286930 1

RATINGS

Limiting values in accordance with the Absolute Maximum System (IEC 134)

Reverse voltage	V_R	max.	5 V
Forward current d.c.	I_F	max.	30 mA
peak value; $t_p = 1 \mu s$; $f = 300$ Hz	I_{FM}	max.	1 A
peak value; $t_p = 1$ ms; $\delta = 0,33$			60 mA
Total power dissipation up to $T_{amb} = 55$ °C	P_{tot}	max.	90 mW
Storage temperature	T_{stg}	-55 to +100	°C
Junction temperature	T_j	max.	100 °C
Lead soldering temperature > 1,5 mm from the seating plane; $t_{sld} < 7$ s	T_{sld}	max.	260 °C

THERMAL RESISTANCE

From junction to ambient when the device is mounted on a p.c. board	$R_{th\ j-a}$	max.	500 K/W
--	---------------	------	---------

CHARACTERISTICS

$T_j = 25$ °C unless otherwise specified

Forward voltage $I_F = 10$ mA	V_F	typ. max.	2,1 V 3,0 V
Reverse current $V_R = 5$ V	I_R	max.	100 μA
Beamwidth between half-intensity directions $I_F = 10$ mA	$\alpha_{50\%}$	typ.	60 °
Bandwidth at half height	$B_{50\%}$	typ.	40 nm
Wavelength at peak emission $I_F = 10$ mA	λ_{pk}	typ.	590 nm
Luminous intensity (class division) $I_F = 10$ mA	I_v	min.	0,7 mCd
		1,6 to	3,5 mCd
		3,0 to	7,0 mCd
		min.	5,0 mCd
Diode capacitance $V_R = 0$; $f = 1$ MHz	C_d	typ.	35 pF

CQY97A
CQY97A-III
CQY97A-IV
CQY97A-V

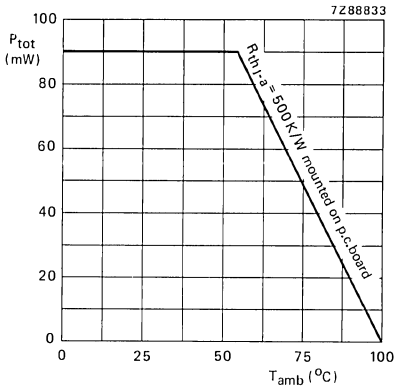

Fig. 2.

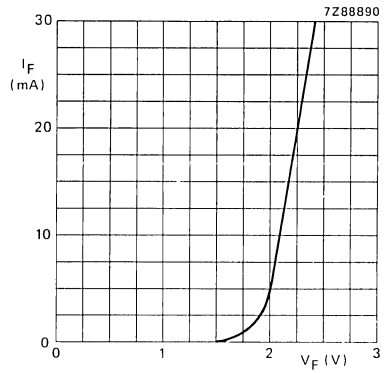

Fig. 3 $T_j = 25^{\circ}C$; typ. values.

DEVELOPMENT SAMPLE DATA

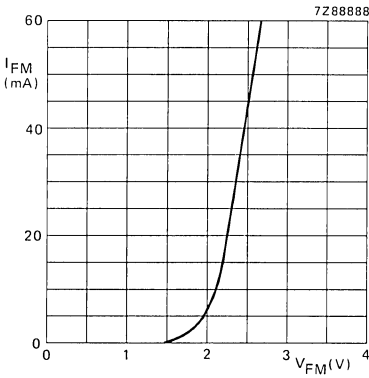

Fig. 4 $t_p = 50 \mu s$; $\delta = 0,01$;
 $T_{amb} = 25^{\circ}C$; typ. values.

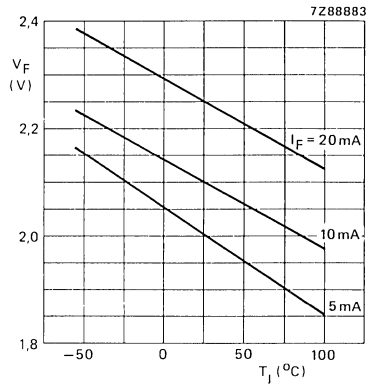

Fig. 5 Typical values.

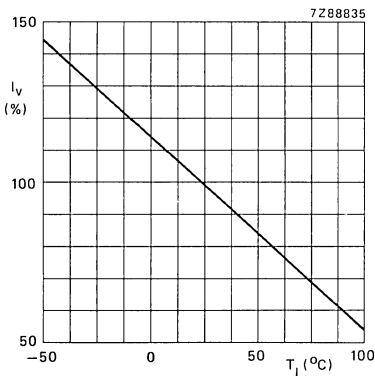

Fig. 6 Typical values.

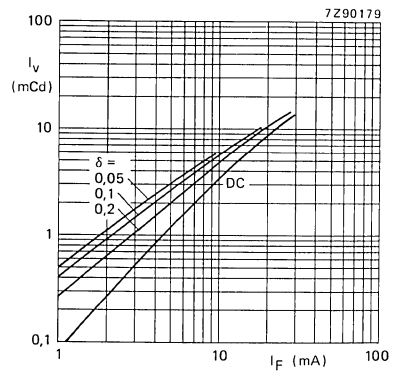

Fig. 7 $T_j = 25^{\circ}C$; typ. values.

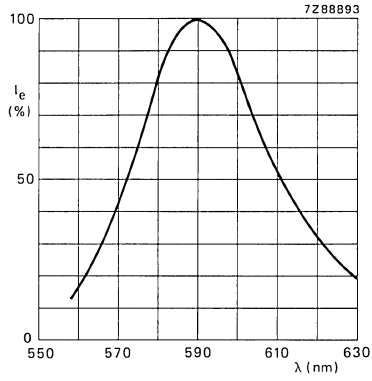

Fig. 8 Typical values.

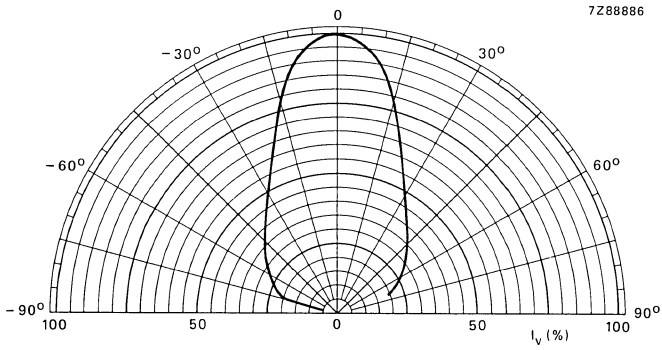

Fig. 9 Typical values.

DEVELOPMENT SAMPLE DATA

This information is derived from development samples made available for evaluation. It does not necessarily imply that the device will go into regular production.

RTC901 RTC903
RTC902 RTC904

TWELVE SEGMENTS BAR GRAPH DISPLAY

The RTC901 to 904 series are 12 segments bar graph LED displays with separate anode and cathodes for each light segment. The bar graph array consists of 12 pieces of rectangular LED of the family CQV60 assembled in a plastic bar (holder).

RTC901 = 12 CQV60 (super-red)

RTC902 = 12 CQV61A (super-green)

RTC903 = 12 CQV62 (yellow)

RTC904 = mix in any colour upon request (RTC907 = empty array)

Intensity matching in the array $< 2 : 1$.

Ratings and characteristics see CQV60..

MECHANICAL DATA

Dimensions in mm

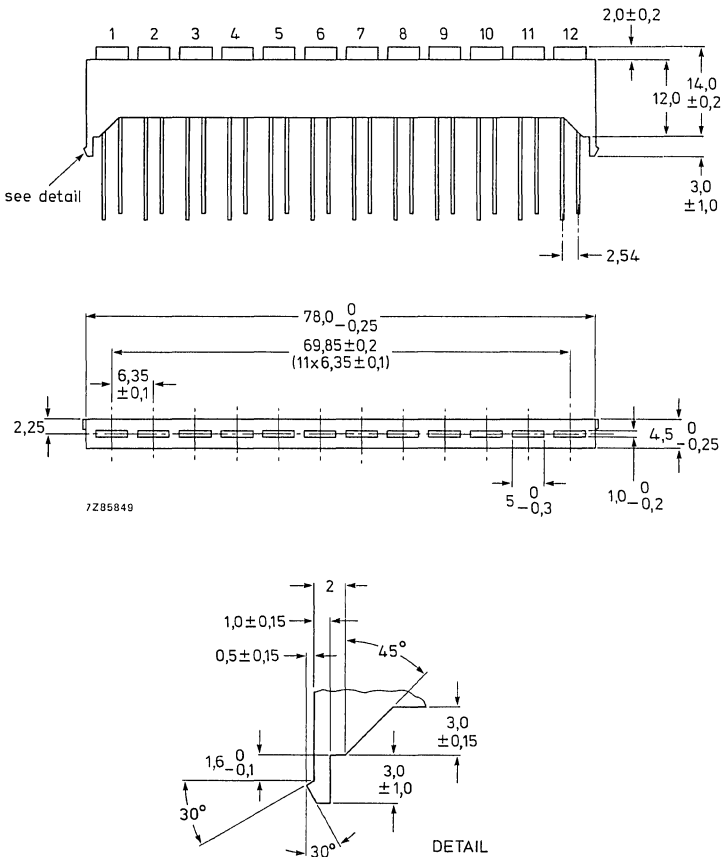

DOUBLE HETEROSTRUCTURE AlGaAs DIODE LASER WITH FIBRE PIGTAIL

The 375CQY/B is an AlGaAs double heterostructure semiconductor laser designed for high speed (560 Mbits/s), long distance, optical communications and CATV systems.

The diode laser, emitting in the 850 nm transmission window of silica optical fibres, is mounted in a specifically designed hermetic encapsulation (modified TO-5). The 375CQY/B is standard equipped with a fast-responding photodiode optically coupled to the rear facet of the laser for monitoring the laser radiant output power. A silica graded index optical fibre pigtail is coupled to the front facet of the laser.

For application in long-distance optical telecommunication, the silicon avalanche photodiode BPF10 (368BPY) is recommended as the photo-detector at the receiving end of the optical transmission section.

MECHANICAL DATA

Dimensions in mm

Fig. 1.

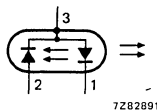
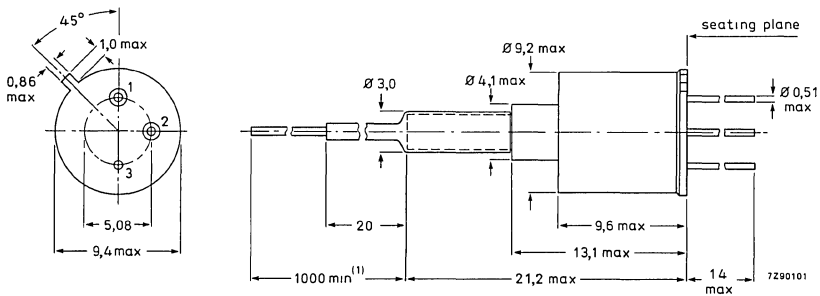

LASER

The double heterostructure laser, with very narrow stripe, operates in a stable single transverse mode (TE_{00}) over the full power range and in several longitudinal modes. This results in a rather short coherence length, which is advantageous in suppressing modal noise and optical feedback effects.

The structure is designed to operate at a radiant output level of up to 3 mW in the fibre, up to relatively high case temperatures (60 °C) and at an emission wavelength of 850 nm (at which wavelength the absorption of high-quality silica fibres is low).

All lasers have been subjected to a burn-in test at a radiant output level from the laser facet of 5 mW at a case temperature of 60 °C.

RATINGS

Limiting values in accordance with the Absolute Maximum System (IEC 134)

Radiant output power from fibre pigtail	ϕ_e	max.	5 mW
Reverse voltage	V_R	max.	1 V

CHARACTERISTICS

Threshold current			
$T_c = 30\text{ °C}$	I_{th}	typ.	90 mA
$T_c = 60\text{ °C}$	I_{th}	typ.	120 mA
		max.	150 mA
Radiant output power from fibre pigtail			
$T_c = 60\text{ °C}$	ϕ_e	typ.	3 mW
Forward voltage drop			
$\phi_e = 3\text{ mW}$	V_F	typ.	2,5 V
Wavelength at peak emission	λ_{pk}	typ.	850 nm
Spectral width at half intensity	$\Delta\lambda$	typ.	3 nm
Rise time, fall time			
laser biased near I_{th}	t_r, t_f	typ.	0,5 ns
Degradation rate			
$T_c = 60\text{ °C}; \phi_e = 3\text{ mW}$	$\frac{1}{I_{th}} \cdot \frac{dI_{th}}{dt}$	typ.	5 %/Kh
Spectrum at $\phi_e = 1\text{ mW}$ (FWHM)		typ.	6 longitudinal modes
Extinction ratio at $\phi_e = 3\text{ mW}$			1:10
Temperature coefficient of wavelength	$\frac{d\lambda_{pk}}{dT}$	typ.	0,25 nm/K
Temperature coefficient of I_{th}	$\frac{1}{I_{th}} \cdot \frac{dI_{th}}{dT}$	typ.	1 %/K
Differential efficiency (stimulated emission)	ϵ	typ.	0,1 mW/mA

PHOTODIODE

Reverse voltage	V_R	max.	30 V
Luminous sensitivity $V_R = 15$ V	N	typ.	0,5 A/W
Dark reverse current $V_R = 15$ V	I_{RD}	max.	10 nA
Capacitance $V_R = 0$	C_d	max.	5 pF
Monitor diode current	I_R	100 to	300 μ A/mW

FIBRE PIGTAIL

Graded index silica rubber numerical aperture on axis	NA	min.	typ.	max.
core diameter	ϕ_{core}	0,20	0,21	0,22
cladding diameter	ϕ_{clad}	48	50	52 μ m
primary coating thickness	ϕ_{pc}	123	125	127 μ m
secondary coating diameter	ϕ_{sc}		5	μ m
			500	μ m

Options: Other fibre for pigtail may be made available.

Other wavelengths are available and are specified by adding a suffix to the type number:

no suffix	=	780-810 nm
suffix A	=	810-840 nm
suffix B	=	840-860 nm
suffix C	=	860-880 nm

Options may be subject to surcharge.

TEMPERATURES (total assembly)

C.W. operation	T_{op}	0 to	60 °C
Storage	T_{stg}	-40 to	+125 °C
Thermal resistance junction to case	$R_{th j-c}$	typ.	45 K/W

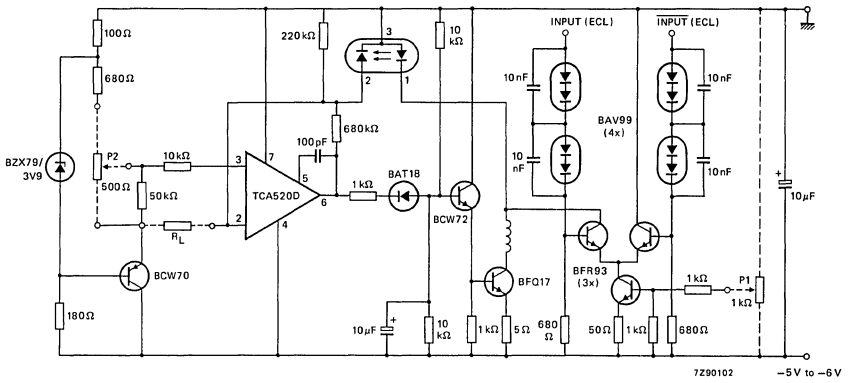

Fig. 2 Typical modulation circuit with ECL logic input and control of average optical power output. Data rate > 200 Mbits/s.

- P₁ sets the peak-peak modulation current.
- P₂ sets the laser bias current.
- R_L determines maximum mean value of optical output power.
- 1-2-3 laser connections.

Note: If single ECL drive is applied, the other input shall be connected to the ECL threshold level (-1,35 V).

OPERATING PRECAUTIONS

Semiconductor lasers in general are easily damaged by overdriving and electrical transients. Electrically, the laser diode is a very reliable device and can easily withstand current surges of several amperes. Optically, however, the laser diode is more susceptible to damage because of the extremely high optical flux density passing through both facets while in operation. By overdriving or transients to the laser, even for pulses to the nanosecond region, the optical flux density can rise to unacceptable values (10 to 100 MW/cm²), causing gradual or catastrophic degradation of the laser facets. Current transients should therefore be carefully avoided; they decrease the life time of the laser.

CAUTION

Aluminium gallium arsenide lasers emit radiation which is invisible to the human eye. When in use, do not look directly into the device. Direct viewing of laser light at close range to the fibre pigtail end, may cause eye damage.

The device falls within the safety class 3B the international standard code.

Note: Each laser is accompanied with an individual test sheet, showing the P_{opt}-I_{op} characteristic and the monitor current for a given optical output power.

DEVELOPMENT SAMPLE DATA

This information is derived from development samples made available for evaluation. It does not necessarily imply that the device will go into regular production.

497CQF/A

DOUBLE HETEROSTRUCTURE AlGaAs LASER DIODE WITH FIBRE PIGTAIL

The 497CQF/A is an AlGaAs double heterostructure semiconductor laser made in index guiding structure. The device is designed for high-speed long distance, optical communications and data transmissions.

The diode laser, emitting in the 835 nm transmission window of silica optical fibres, is mounted in a specifically designed hermetic encapsulation (modified TO-5). The 497CQF/A is standard equipped with a fast-responding photodiode optically coupled to the rear facet of the laser for monitoring the laser radiant output power. A silica graded index optical fibre pigtail is coupled to the front facet of the laser.

For application in long-distance optical telecommunication, the silicon avalanche photodiode BPF10 (368BPY) is recommended as the photo-detector at the receiving end of the optical transmission section.

MECHANICAL DATA

Dimensions in mm

Fig. 1.

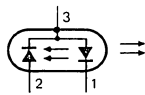
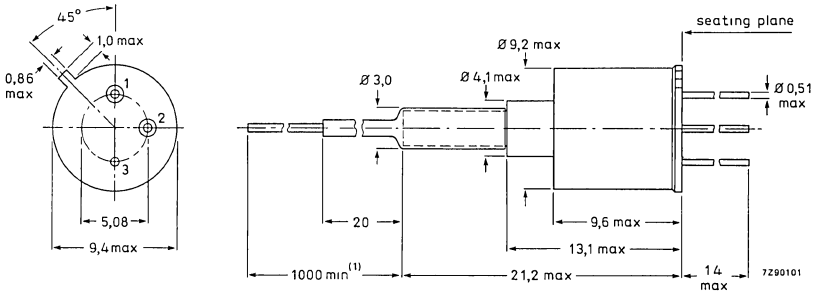

LASER

The double heterostructure laser AlGaAs laser is made by index guiding technology and provides single transverse mode as well as single longitudinal mode operation. This technology gives rise to a large spectral purity, large extinction ratio and is free of self-pulsations.

The structure is designed to operate at a radiant output level of up to 2 mW in the fibre, up to relatively high case temperatures (60 °C) and at an emission wavelength of 835 nm (at which wavelength the absorption of high-quality silica fibres is low).

All lasers have been subjected to a burn-in test at a radiant output level from the laser facet of 4 mW at a case temperature of 60 °C.

RATINGS

Limiting values in accordance with the Absolute Maximum System (IEC 134)

Radiant output power from fibre pigtail	ϕ_e	max.	4 mW
Reverse voltage	V_R	max.	1 V

CHARACTERISTICS

Threshold current

$T_c = 30\text{ °C}$	I_{th}	typ.	70 mA
$T_c = 60\text{ °C}$	I_{th}	typ.	100 mA
		max.	130 mA

Radiant output power from fibre pigtail

$T_c = 60\text{ °C}$	ϕ_e	typ.	2 mW
----------------------	----------	------	------

Forward voltage drop

$\phi_e = 2\text{ mW}$	V_F	typ.	2,0 V
------------------------	-------	------	-------

Wavelength at peak emission

λ_{pk}	typ.	835 nm
----------------	------	--------

Spectral width at half intensity

$\Delta\lambda$	typ.	0,5 nm
-----------------	------	--------

Rise time, fall time

laser biased near I_{th}	t_r, t_f	typ.	0,5 ns
----------------------------	------------	------	--------

Degradation rate

$T_c = 60\text{ °C}; \phi_e = 3\text{ mW}$	$\frac{1}{I_{th}} \cdot \frac{dI_{th}}{dt}$	typ.	3 %/Kh
--	---	------	--------

Temperature coefficient of wavelength

$\frac{d\lambda_{pk}}{dT}$	typ.	0,25 nm/K
----------------------------	------	-----------

Temperature coefficient of threshold current

$\frac{1}{I_{th}} \cdot \frac{dI_{th}}{dT}$	typ.	1 %/K
---	------	-------

Differential efficiency (stimulated emission)

ϵ	typ.	0,2 mW/mA
------------	------	-----------

Extinction ratio

$\phi_e = 4\text{ mW}$	typ.	1:25
------------------------	------	------

Spectral purity

(90% of output radiant power)			single longitudinal mode
-------------------------------	--	--	--------------------------

PHOTODIODE

Reverse voltage	V_R	max.	30 V
Luminous sensitivity $V_R = 15 V$	N	typ.	0,5 A/W
Dark reverse current $V_R = 15 V$	I_{RD}	max.	10 nA
Capacitance $V_R = 0$	C_d	max.	5 pF
Monitor diode current	I_R	100 to 300	$\mu A/mW$

FIBRE PIGTAIL

		min.	typ.	max.
Graded index silica rubber	NA	0,20	0,21	0,22
numerical aperture on axis	ϕ_{core}	48	50	52 μm
core diameter	ϕ_{clad}	123	125	127 μm
cladding diameter	ϕ_{pc}		5	μm
primary coating thickness	ϕ_{sc}		500	μm
secondary coating diameter				

Options: Other fibre for pigtail may be accommodated.

Other wavelengths are available and are specified by adding a suffix to the type number:

no suffix	=	780-810 nm
suffix A	=	810-840 nm
suffix B	=	840-860 nm
suffix C	=	860-880 nm

Options may be subject to surcharge.

TEMPERATURES (total assembly)

C.W. operation	T_{op}	0 to 60 °C
Storage	T_{stg}	-40 to + 125 °C
Thermal resistance from junction to case	$R_{th j-c}$	typ. 45 K/W

DEVELOPMENT SAMPLE DATA



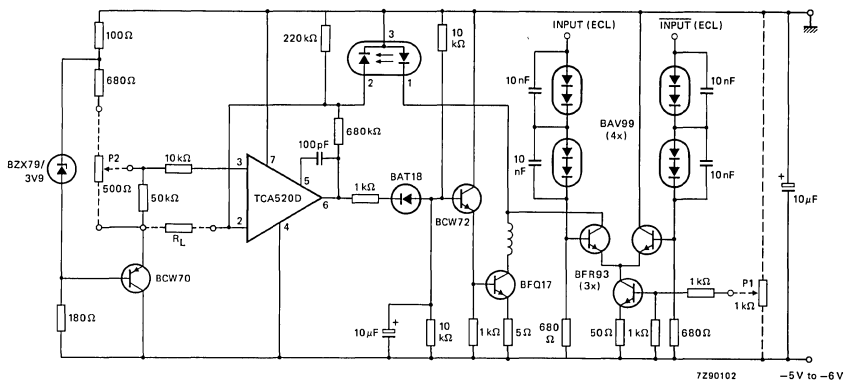

Fig. 2 Typical modulation circuit with ECL logic input and control of average optical power output. Data rate > 200 Mbits/s.

- P₁ sets the peak-peak modulation current.
- P₂ sets the laser bias current.
- R_L determines maximum mean value of optical output power.
- 1-2-3 laser connections.

Note: If single ECL drive is applied, the other input shall be connected to the ECL threshold level (-1,35 V).

OPERATING PRECAUTIONS

Semiconductor lasers in general are easily damaged by overdriving and electrical transients. Electrically, the laser diode is a very reliable device and can easily withstand current surges of several amperes. Optically, however, the laser diode is more susceptible to damage because of the extremely high optical flux density passing through both facets while in operation. By overdriving or transients to the laser, even for pulses in the nanosecond region, the optical flux density can rise to unacceptable values (10 to 100 MW/cm²), causing gradual or catastrophic degradation of the laser facets. Current transients should therefore be carefully avoided; they decrease the life time of the laser.

CAUTION

Aluminium gallium arsenide lasers emit radiation which is invisible to the human eye. When in use, do not look directly into the device. Direct viewing of laser light at close range to the fibre pigtail end, may cause eye damage.

The device falls within the safety class 3B of the international standard code.

Note: Laser is accompanied with an individual test sheet, showing the P_{opt}-I_{op} characteristic and the monitor current for a given optical output power.

DEVELOPMENT SAMPLE DATA

This information is derived from development samples made available for evaluation. It does not necessarily imply that the device will go into regular production.

498CQL

DOUBLE HETEROSTRUCTURE AlGaAs LASER

The 498CQL is an AlGaAs double heterostructure diode laser made in index guiding technology and is designed for reading applications such as: video-audio disc applications, optical memories, security systems, etc.

This device is mounted in an hermetic SOT-148 encapsulation specifically designed for easy alignment in an optical read or write system. The copper heatsink is circular and precision engineered with a diameter accuracy of $+0, -9 \mu\text{s}$. Laser stripe and mechanical axis coincide within $50 \mu\text{m}$.

The 498CQL is standard equipped with a photo p-i-n diode, optically coupled to the rear emitting facet of the laser. This fast responding (less than 20 ns) photodiode can be used as a sensor to control the laser radiant output level. The ultra-flat top window (flat within two fringes) guarantees an unperturbed beam wavefront.

QUICK REFERENCE DATA

Threshold current at $T_c = 30 \text{ }^\circ\text{C}$	I_{th}	typ.	50 mA
C.W. radiant output power up to $T_c = 60 \text{ }^\circ\text{C}$	ϕ_e	typ.	5 mW
Wavelength at peak emission	λ_{pk}	typ.	840 nm

MECHANICAL DATA

Fig. 1 SOT-148.

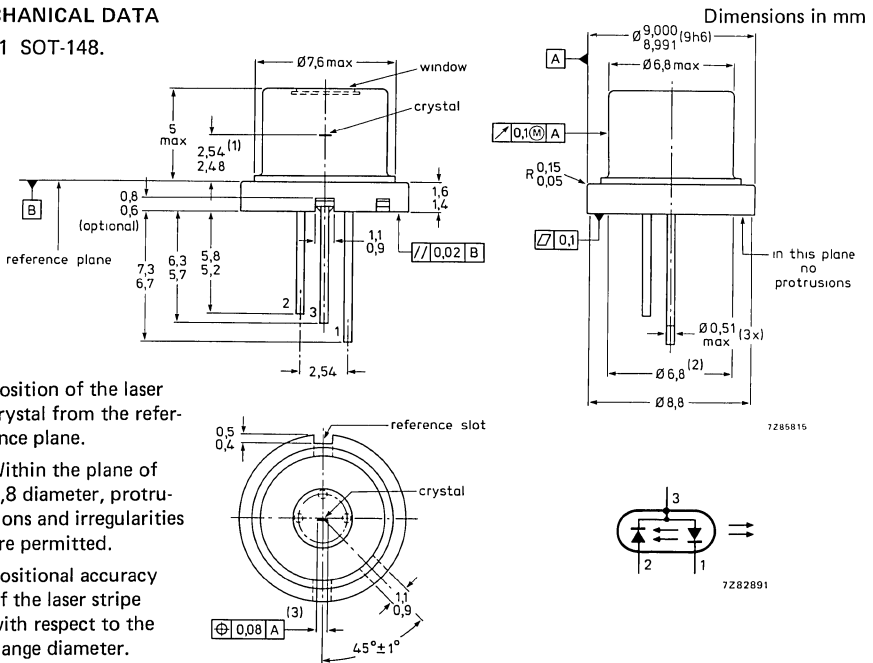

- (1) Position of the laser crystal from the reference plane.
- (2) Within the plane of 6,8 diameter, protrusions and irregularities are permitted.
- (3) Positional accuracy of the laser stripe with respect to the flange diameter.

LASER

The double heterostructure stripe laser is made by index guiding technology and operates in single transverse as well in single longitudinal mode over the full power range. This structure gives rise to large spectral purity, large coherence length and is free of self-pulsations.

The structure is designed to operate C.W. 5 mW up to relatively high temperatures (60 °C case temperature) with a wavelength of 840 nm which makes reading standard Video Long Play records and compact discs (DAD) a possible application.

RATINGS

Limiting values in accordance with the Absolute Maximum System (IEC 134)

Radiant output power	ϕ_e	max.	10 mW
Reverse voltage	V_R	max.	1 V
Temperatures			
C.W. operation	T_C		-20 to +60 °C
storage	T_{stg}		-55 to +100 °C

CHARACTERISTICS

Threshold current			
at $T_C = 30\text{ °C}$	I_{th}	typ.	50 mA
at $T_C = 60\text{ °C}$	I_{th}	typ.	75 mA
Operating current			
$\phi_e = 5\text{ mW}; T_C = 30\text{ °C}$	I_{op}	typ. max.	80 mA 110 mA
$\phi_e = 5\text{ mW}; T_C = 60\text{ °C}$	I_{op}	typ. max.	110 mA 145 mA
Recommended operating radiant output power up to $T_C = 60\text{ °C}$	ϕ_e	typ.	5 mW
Forward voltage drop up to $T_C = 60\text{ °C}$ $\phi_e = 5\text{ mW}$	V_F	typ.	2,0 V
Wavelength at peak emission $\phi_e = 5\text{ mW}; T_C = 30\text{ °C}$	λ_{pk}	typ.	840 nm
Spectral width at half height $\phi_e = 5\text{ mW}$	$\Delta\lambda$	typ.	0,5 nm
Far-field angle at half-intensity directions (FWHM)			
perpendicular to the junction plane	$\alpha_{50\%}(I)$	typ.	35 °
parallel to the junction plane	$\alpha_{50\%}(II)$	typ.	15 °
Series resistance	R_S	typ.	3 Ω
Differential efficiency at $\phi_e = 2\text{ mW}$	ϵ	typ.	0,20 W/A
Spontaneous emission at I_{th}	ϕ_{spon}	typ.	0,2 mW
Turn-on/turn-off time (above threshold)	t_{on}/t_{off}	typ.	1 ns
Degradation rate $T_C = 60\text{ °C}; \phi_e = 5\text{ mW}$	$\frac{1}{I_{op}} \cdot \frac{dI_{op}}{dT}$	typ.	3 %/Kh
Temperature coefficient of wavelength	$\frac{d\lambda_{pk}}{dT}$	typ.	0,25 nm/K
Temperature coefficient of I_{th}	$\frac{1}{I_{th}} \cdot \frac{dI_{th}}{dT}$	typ.	1 %/K
Thermal resistance from junction to case	$R_{th\ j-c}$	typ.	50 K/W

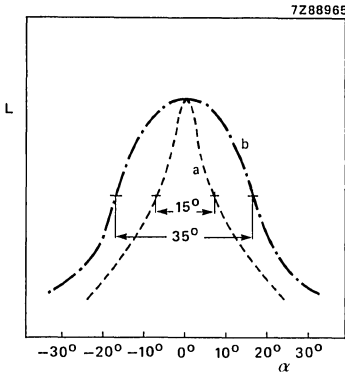

Fig. 2 Far-field pattern.
 a. parallel to the junction plane.
 b. perpendicular to the junction plane.

DEVELOPMENT SAMPLE DATA

PHOTODIODE

RATINGS

Limiting values in accordance with the Absolute Maximum System (IEC 134)

Reverse voltage V_R max. 30 V

CHARACTERISTICS

Luminous sensitivity at $V_R = 15$ V	N	typ.	0,5 A/W
Dark reverse current at $V_R = 15$ V	$I_{R(D)}$	max.	10 nA
Capacitance at $V_R = 0$	C_d	max.	5 pF
Monitor diode current at $V_R = 15$ V	$I_{R(L)}$		150-400 μ A/mW

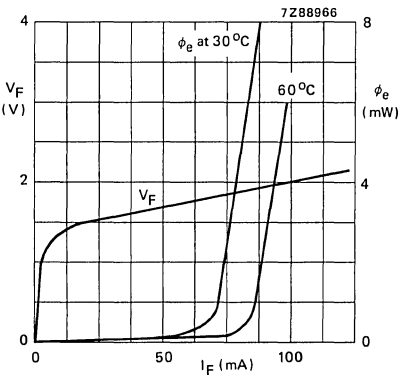

Fig. 3 Forward voltage drop (V_F) and radiant output power (ϕ_e) of laser diode as a function of forward current; typ. values.

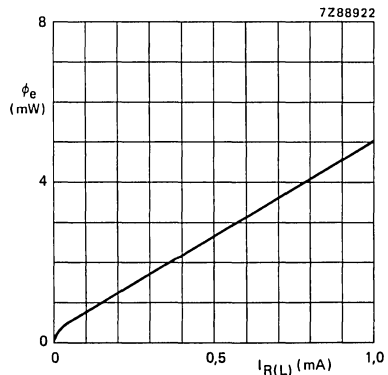
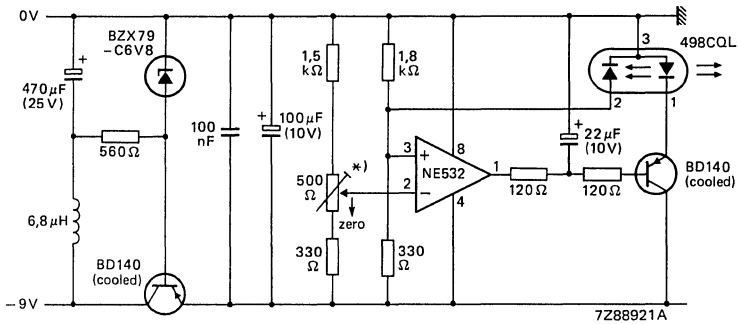

Fig. 4 Radiant output power (ϕ_e) as a function of monitor current of photodiode; V_R (photodiode) = 15 V; typ. values.



* Ten turn. Zero position is at 0,58 revolution. Each revolution is equivalent to 500 μ A monitor diode current. Adjust from zero position.

Fig. 5 Recommended control circuit for continuous operation.

OPERATING PRECAUTIONS

Semiconductor lasers in general are easily damaged by over-driving and electrical transients. Electrically, the laser diode is a very reliable device and can easily withstand current surges of several amperes. Optically, however, the diode laser is more susceptible to damage because of the extremely high optical flux density passing through both facets, while in operation. By over-driving or transients to the laser, even for pulses in the nanosecond region, the optical flux density can rise to unacceptable values (10 to 100 MW/cm²), causing gradual or catastrophic degradation of the laser facets. Current transients should therefore be carefully avoided; they can substantially decrease the laser life time.

CAUTION

Aluminium gallium arsenide lasers emit radiation which is invisible to the human eye. When in use, do not look directly into the device. Direct viewing of laser light at close ranges, especially in conjunction with collimating lenses, may cause eye damage.

The device falls within safety class 3B of the international standard code.

DISPLAYS

DEVELOPMENT SAMPLE DATA

This information is derived from development samples made available for evaluation. It does not necessarily imply that the device will go into regular production.

CQ209S

1½-DIGIT RED LED DISPLAY

The display has the following features:

- One and a half 12,7 mm (½") high red colour digits readout display.
- GaP type red light emitting crystal with low power consumption.
- Series connection for low current consumption.
- Wide operating segment current (d.c.) range from 1 mA to 20 mA.
- Each segment performs a diffused and uniform display with high contrast through filtering function of lens cap.
- Highly legible arabic numerals with wide viewing angle.
- Solid state reliability and long operational life.
- The SAB3064 is recommended as driver circuit.

QUICK REFERENCE DATA

Continuous reverse voltage	V_R	max.	3 V
Forward current (d.c.) per segment	I_F	max.	20 mA
Luminous intensity (of segment, normal to surface) $I_F = 5 \text{ mA}$	I_V	typ.	100 μcd
Wavelength at peak emission	λ_{pk}	typ.	700 nm

MECHANICAL DATA

Dimensions in mm

Fig. 1.

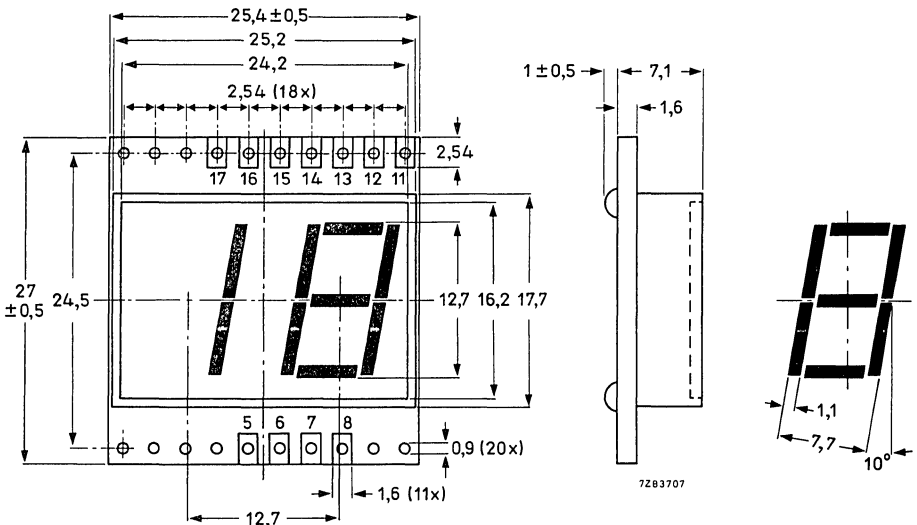

NOTE

Tolerance $\pm 0,25$ mm unless otherwise specified.

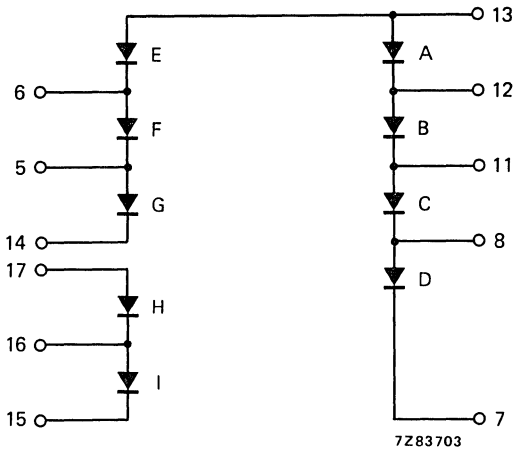

Fig. 2 Circuit diagram.

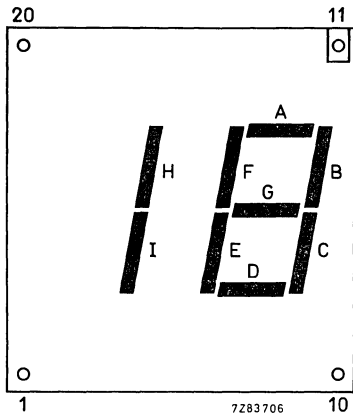

Fig. 3 Indication of segments per digit.
(See also terminal connection table below).

TERMINAL CONNECTION TABLE (see Figs 1, 2 and 3)

address	segment	cathode terminal number	anode terminal number
unit digit	A	12	13
	B	11	12
	C	8	11
	D	7	8
	E	6	13
	F	5	6
	G	14	5
10 s digit	H	16	17
	I	15	16

RATINGS

Limiting values in accordance with the Absolute Maximum System (IEC 134)

Continuous reverse voltage	V_R	max.	3 V
Forward current (d.c.) per segment	I_F	max.	20 mA
Storage temperature	T_{stg}		-40 to +75 °C
Operating junction temperature	T_j		-20 to +60 °C
Soldering temperature at 3 mm from reflector edge; $t_{sld} \leq 3$ s	T_{sld}	max.	260 °C

CHARACTERISTICS (single segment)

 $T_{amb} = 25$ °C

Forward voltage

 $I_F = 10$ mA

V_F	typ.	2,0 V
		1,7 to 2,3 V

Reverse current

 $V_R = 3$ V

I_R	<	5 μ A
-------	---	-----------

Luminous intensity (normal to surface)

 $I_F = 5$ mA

I_v	typ.	100 μ cd
-------	------	--------------

 $I_F = 10$ mA

I_v	>	100 μ cd
	typ.	160 μ cd

Intensity matching ratio

 $I_F = 5$ mA

	<	2,5
--	---	-----

Wavelength at peak emission

 $I_F = 5$ mA

λ_{pk}	typ.	700 nm
----------------	------	--------

Bandwidth at half height

 $I_F = 5$ mA

$B_{50\%}$	typ.	100 nm
------------	------	--------

DEVELOPMENT SAMPLE DATA

NOTES

Avoid immersing the whole display in liquid.

Avoid contact with chlorinated solvents. Recommended cleaning solvents for flux and stain contamination, Freon TE or TF and methyl alcohol.

Except for the printed-wiring board, avoid heating the display above 75 °C.

DEVELOPMENT SAMPLE DATA

This information is derived from development samples made available for evaluation. It does not necessarily imply that the device will go into regular production.

CQ216X
CQ216Y

2-DIGIT SUPER-RED LED DISPLAYS

The displays have the following features:

- Two 12,7 mm (½") high super-red colour digits readout display.
- Configuration in dynamic multiplex drive connections.
- Wide operating segment current (d.c.) range from 1 mA to 20 mA.
- Each segment performs a diffused and uniform display with high contrast through filtering function of lens cap.
- Highly legible arabic numerals with wide viewing angle.
- Solid state reliability and long operational life.

QUICK REFERENCE DATA

Continuous reverse voltage	V_R	max.	3 V
Forward current (d.c.) per segment	I_F	max.	20 mA
Luminous intensity (of segment, normal to surface) $I_F = 5 \text{ mA}$	I_v	typ.	50 μcd
Wavelength at peak emission	λ_{pk}	typ.	630 nm

MECHANICAL DATA

Dimensions in mm

Fig. 1.

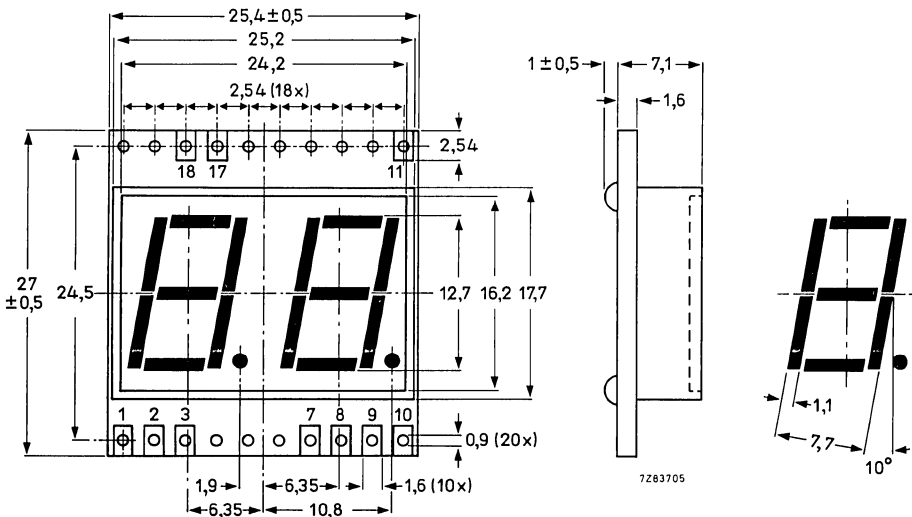

NOTE

Tolerance $\pm 0,25 \text{ mm}$ unless otherwise specified.

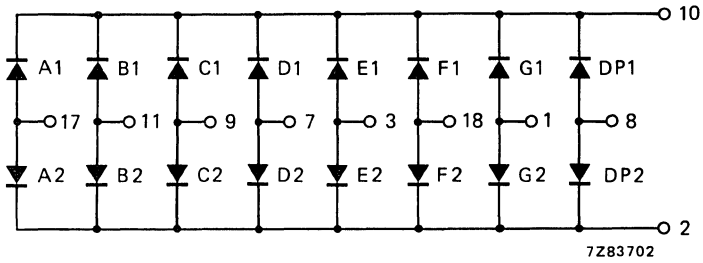

Fig. 2a Circuit diagram CQ216X (common cathode).

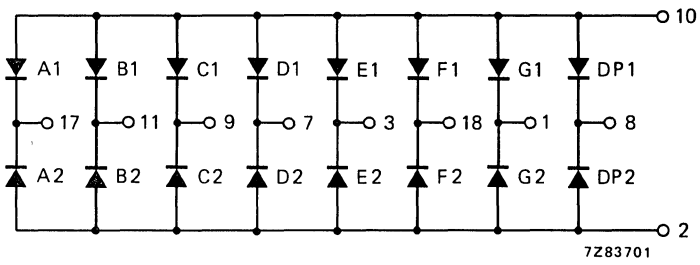

Fig. 2b Circuit diagram CQ216Y (common anode).

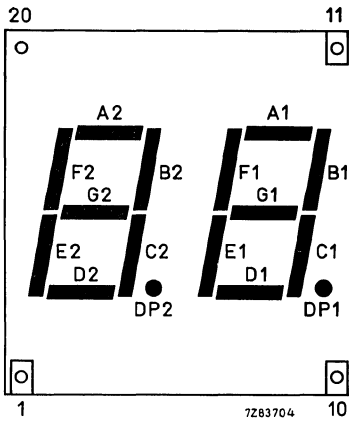

Fig. 3 Indication of segments per digit. (See also connection table on next page.)

TERMINAL CONNECTION TABLE (see Figs 1, 2a, 2b and 3)

address	segment	terminal number	address	segment	terminal number
10s digit	A2	17	unit digit	A1	17
	B2	11		B1	11
	C2	9		C1	9
	D2	7		D1	7
	E2	3		E1	3
	F2	18		F1	18
	G2	1		G1	1
	DP2	8		DP1	8
	common	2		common	10

RATINGS

Limiting values in accordance with the Absolute Maximum System (IEC 134)

Continuous reverse voltage	V_R	max.	3 V
Forward current (d.c.) per segment	I_F	max.	20 mA
Storage temperature	T_{stg}		-40 to + 75 °C
Operating junction temperature	T_j		-20 to + 60 °C
Soldering temperature at 3 mm from reflector edge; $t_{sld} \leq 3$ s	T_{sld}	max.	260 °C

CHARACTERISTICS (single segment)

$T_{amb} = 25$ °C

Forward voltage

$I_F = 10$ mA

V_F typ. 1,9 V
1,6 to 2,2 V

Reverse current

$V_R = 3$ V

$I_R < 5$ μ A

Luminous intensity (normal to surface)

$I_F = 5$ mA

I_v typ. 50 μ cd

$I_F = 10$ mA

$I_v > 70$ μ cd
typ. 100 μ cd

Intensity matching ratio

$I_F = 5$ mA

$< 2,5$

Wavelength at peak emission

$I_F = 5$ mA

λ_{pk} typ. 630 nm

Bandwidth at half height

$I_F = 5$ mA

$B_{50\%}$ typ. 100 nm

NOTES

Avoid immersing the whole display in liquid.

Avoid contact with chlorinated solvents. Recommended cleaning solvents for flux and stain contamination, Freon TE or TF and methyl alcohol.

Except for the printed-wiring board, avoid heating the display above 75 °C.

DEVELOPMENT SAMPLE DATA



DEVELOPMENT SAMPLE DATA

This information is derived from development samples made available for evaluation. It does not necessarily imply that the device will go into regular production.

CQ327 ; CQ327R
 CQ330 ; CQ330R
 CQ331 ; CQ331R
 CQ332 ; CQ332R

4-DIGIT LED CLOCK DISPLAYS

The displays, primarily designed for applications where compactness is of prime importance, have the following features:

- Four 15 mm high red colour digit readout clock display.
- Common anode or cathode configuration for use in static drive connections.
- Wide operating segment current (d.c.) range from 5 mA to 20 mA.
- Each segment performs a diffused and uniform display with high contrast.
- Display with dull surface free from undesirable glare or reflections.
- Highly legible arabic numerals with wide viewing angle.
- Display format available for 12 or 24 hours.
- Solid state reliability and long operational life.

QUICK REFERENCE DATA

Continuous reverse voltage	V_R	max.	3 V
Forward current (d.c.) per segment	I_F	max.	20 mA
Luminous intensity (of segment, normal to surface) $I_F = 5 \text{ mA}$	I_v	typ.	200 μcd
Wavelength at peak emission	λ_{pk}	typ.	700 nm

7Z85306

TYPE NUMBER		FULLY DISPLAYED FONT
common cathode	common anode	
CQ327	CQ327R	: 18:00
CQ330	CQ330R	00:00
CQ331	CQ331R	: 28:00
CQ332	CQ332R	: 00:00

Fig. 1.

CQ327 ; CQ327R
 CQ330 ; CQ330R
 CQ331 ; CQ331R
 CQ332 ; CQ332R

MECHANICAL DATA

Dimensions in mm

Fig. 2.

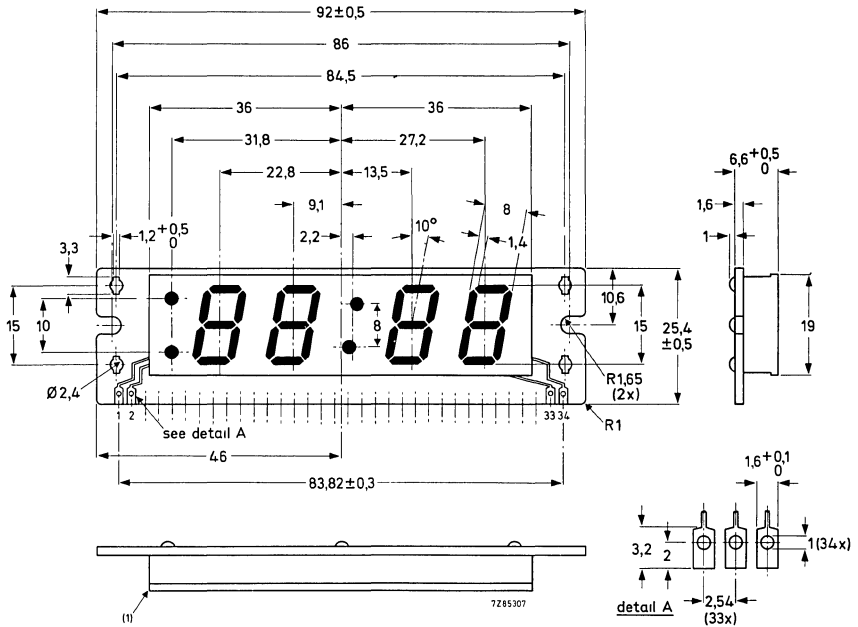

(1) Slip-out tolerance with light diffusing film and reflector is + 0,5 mm at each side.

NOTE

Tolerance $\pm 0,25$ mm unless otherwise specified.

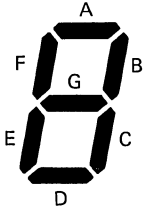

Fig. 3 Indication of segments per digit. (See also Fig. 2 and terminal connection table.)

TERMINAL CONNECTION TABLE (see Figs 2 and 3)

DEVELOPMENT SAMPLE DATA

terminal number	address	CQ327 CQ327R	CQ330 CQ330R	CQ331 CQ331R	CQ332 CQ332R
1	common	common for all segments, colon and dots			
2	p.m. dot	c	n.c.	c	c
3	a.m. dot	c	n.c.	c	c
4	A	n.c.	c	c	c
5	F	n.c.	c	n.c.	c
6	G	n.c.	c	c	c
7	E	n.c.	c	c	c
8	D	n.c.	c	c	c
9	C	c	c	c	c
10	B	c	c	c	c
} 10s hour digit					
11	F	c	c	c	c
12	G	c	c	c	c
13	A	c	c	c	c
14	B	c	c	c	c
15	E	c	c	c	c
16	D	c	c	c	c
17	C	c	c	c	c
} unit hour digit					
18	upper dot of colon	c	c	c	c
19	lower dot of colon	c	c	c	c
20	F	c	c	c	c
21	G	c	c	c	c
22	A	c	c	c	c
23	B	c	c	c	c
24	D	c	c	c	c
25	E	c	c	c	c
26	C	c	c	c	c
} 10s minute digit					
27	F	c	c	c	c
28	G	c	c	c	c
29	A	c	c	c	c
30	B	c	c	c	c
31	E	c	c	c	c
32	D	c	c	c	c
33	C	c	c	c	c
} unit minute digit					
34	common	common for all segments, colon and dots			

CQ327; CQ327R
 CQ330; CQ330R
 CQ331; CQ331R
 CQ332; CQ332R

RATINGS

Limiting values in accordance with the Absolute Maximum System (IEC 134)

Continuous reverse voltage	V_R	max.	3 V
Forward current (d.c.) per segment	I_F	max.	20 mA
Storage temperature	T_{stg}		-40 to + 75 °C
Operating junction temperature	T_j		-20 to + 60 °C
Soldering temperature at 3 mm from reflector edge; $t_{sld} \leq 3$ s	T_{sld}	max.	260 °C

CHARACTERISTICS (single segment)

$T_{amb} = 25$ °C

Forward voltage $I_F = 10$ mA	V_F	typ.	2,0 V
			1,7 to 2,3 V
Reverse current $V_R = 3$ V	I_R	<	5 μ A
Luminous intensity (normal to surface) $I_F = 5$ mA	I_v	typ.	200 μ cd
		>	200 μ cd
	I_v	typ.	400 μ cd
Intensity matching ratio $I_F = 5$ mA		<	2,5
Wavelength at peak emission $I_F = 5$ mA	λ_{pk}	typ.	700 nm
Bandwidth at half height $I_F = 5$ mA	$B_{50\%}$	typ.	100 nm

NOTES

Avoid immersing the whole display in liquid.

Avoid contact with chlorinated solvents. Recommended cleaning solvents for flux and stain contamination, Freon TE or TF and methyl alcohol.

Except for the printed-wiring board, avoid heating the display above 75 °C.

DEVELOPMENT SAMPLE DATA

This information is derived from development samples made available for evaluation. It does not necessarily imply that the device will go into regular production.

CQ427; CQ427R
 CQ430; CQ430R
 CQ431; CQ431R
 CQ432; CQ432R

4-DIGIT LED CLOCK DISPLAYS

The displays, with the overall dimensions 33,5 mm x 90 mm, have the following features:

- Four 15 mm high red colour digit readout clock display.
- Common anode or cathode configuration for use in static drive connections.
- Wide operating segment current (d.c.) range from 5 mA to 20 mA.
- Each segment performs a diffused and uniform display with high contrast through filtering function of lens cap.
- Highly legible arabic numerals with wide viewing angle.
- Display format available for 12 or 24 hours.
- Solid state reliability and long operational life.

QUICK REFERENCE DATA

Continuous reverse voltage	V_R	max.	3 V
Forward current (d.c.) per segment	I_F	max.	20 mA
Luminous intensity (of segment, normal to surface) $I_F = 5$ mA	I_v	typ.	100 μ cd
Wavelength at peak emission	λ_{pk}	typ.	700 nm

7Z75887.1

TYPE NUMBER		FULLY DISPLAYED FONT
common cathode	common anode	
CQ427	CQ427R	: 18 : 88
CQ430	CQ430R	88 : 88
CQ431	CQ431R	: 28 : 88
CQ432	CQ432R	: 88 : 88

Fig. 1.

CQ427; CQ427R
 CQ430; CQ430R
 CQ431; CQ431R
 CQ432; CQ432R

MECHANICAL DATA

Dimensions in mm

Fig. 2.

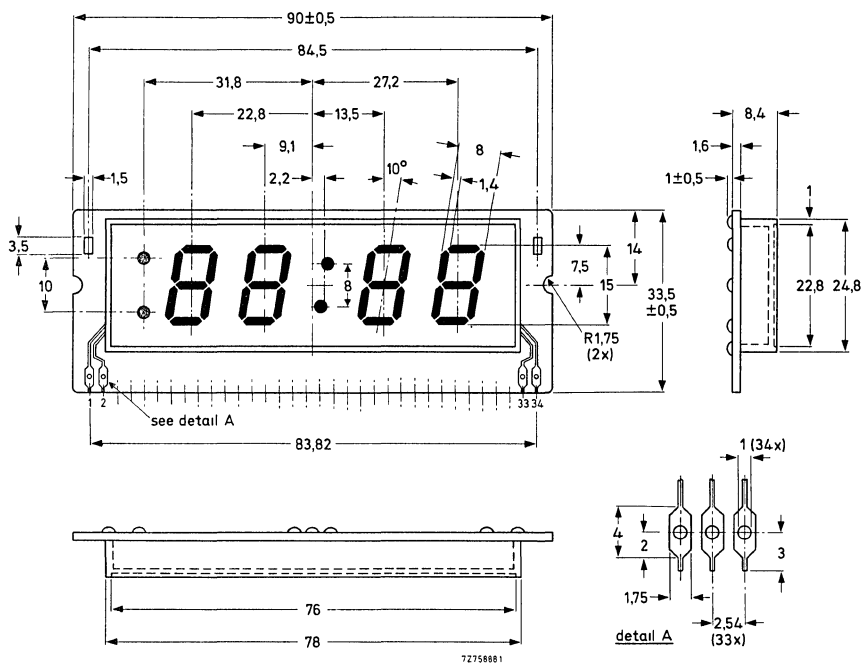

NOTE

Tolerance $\pm 0,25$ mm unless otherwise specified.

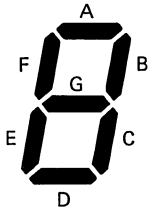

Fig. 3 Indication of segments per digit. (See also Fig. 2 and terminal connection table.)

TERMINAL CONNECTION TABLE (see Figs 2 and 3)

DEVELOPMENT SAMPLE DATA

terminal number	address	CQ427 CQ427R	CQ430 CQ430R	CQ431 CQ431R	CQ432 CQ432R
1	common	common for all segments, colon and dots			
2	p.m. dot	c	n.c.	c	c
3	a.m. dot	c	n.c.	c	c
4	A	n.c.	c	c	c
5	F	n.c.	c	n.c.	c
6	G	n.c.	c	c	c
7	E	n.c.	c	c	c
8	D	n.c.	c	c	c
9	C	c	c	c	c
10	B	c	c	c	c
} 10s hour digit					
11	F	c	c	c	c
12	G	c	c	c	c
13	A	c	c	c	c
14	B	c	c	c	c
15	E	c	c	c	c
16	D	c	c	c	c
17	C	c	c	c	c
} unit hour digit					
18	upper dot of colon	c	c	c	c
19	lower dot of colon	c	c	c	c
20	F	c	c	c	c
21	G	c	c	c	c
22	A	c	c	c	c
23	B	c	c	c	c
24	D	c	c	c	c
25	E	c	c	c	c
26	C	c	c	c	c
} 10s minute digit					
27	F	c	c	c	c
28	G	c	c	c	c
29	A	c	c	c	c
30	B	c	c	c	c
31	E	c	c	c	c
32	D	c	c	c	c
33	C	c	c	c	c
} unit minute digit					
34	common	common for all segments, colon and dots			

CQ427; CQ427R
 CQ430; CQ430R
 CQ431; CQ431R
 CQ432; CQ432R

RATINGS

Limiting values in accordance with the Absolute Maximum System (IEC 134)

Continuous reverse voltage	V_R	max.	3 V
Forward current (d.c.) per segment	I_F	max.	20 mA
Storage temperature	T_{stg}		-40 to + 75 °C
Operating junction temperature	T_j		-20 to + 60 °C
Soldering temperature at 3 mm from reflector edge; $t_{sld} \leq 3$ s	T_{sld}	max.	260 °C

CHARACTERISTICS (single segment)

$T_{amb} = 25$ °C

Forward voltage $I_F = 10$ mA	V_F	typ.	2,0 V
			1,7 to 2,3 V

Reverse current $V_R = 3$ V	I_R	<	5 μ A
--------------------------------	-------	---	-----------

Luminous intensity (normal to surface) $I_F = 5$ mA	I_v	typ.	100 μ cd
		>	100 μ cd
$I_F = 10$ mA	I_v	typ.	160 μ cd

Intensity matching ratio $I_F = 5$ mA		<	2,5
--	--	---	-----

Wavelength at peak emission $I_F = 5$ mA	λ_{pk}	typ.	700 nm
---	----------------	------	--------

Bandwidth at half height $I_F = 5$ mA	$B_{50\%}$	typ.	100 nm
--	------------	------	--------

NOTES

Avoid immersing the whole display in liquid.
 Avoid contact with chlorinated solvents. Recommended cleaning solvents for flux and stain contamination, Freon TE or TF and methyl alcohol.
 Except for the printed-wiring board, avoid heating the display above 75 °C.

PHOTOCOUPLERS





DEVELOPMENT SAMPLE DATA

This information is derived from development samples made available for evaluation. It does not necessarily imply that the device will go into regular production.

CNX21

HIGH-VOLTAGE PHOTOCOUPLER

Optically coupled isolator consisting of an infrared emitting GaAs diode and a silicon n-p-n photo-transistor without accessible base.

Features of this product:

- very high isolation voltage of 10 kV (d.c.).
- working voltage of 10 kV (d.c.).

QUICK REFERENCE DATA

Diode

Continuous reverse voltage	V_R	max.	5 V
Forward current			
d.c.	I_F	max.	100 mA
(peak value); $t_p = 10 \mu\text{s}$; $\delta = 0,1$	I_{FM}	max.	1000 mA
Total power dissipation up to $T_{amb} = 25 \text{ }^\circ\text{C}$	P_{tot}	max.	100 mW

Transistor

Collector-emitter voltage (open base)	V_{CEO}	max.	30 V
Total power dissipation up to $T_{amb} = 25 \text{ }^\circ\text{C}$	P_{tot}	max.	100 mW

Photocoupler

Output/input d.c. current transfer ratio $I_F = 10 \text{ mA}$; $V_{CE} = 0,4 \text{ V}$; ($I_B = 0$)	I_C/I_F	>	0,2
Collector cut-off current (dark) $V_{CC} = 10 \text{ V}$; working voltage (d.c.) = 10 kV diode: $I_F = 0$ (see also Fig. 4)	I_{CEW}	<	200 nA
Isolation voltage (d.c.)	V_{IO}	>	10 kV

MECHANICAL DATA

See Fig. 1.

MECHANICAL DATA

Fig. 1.

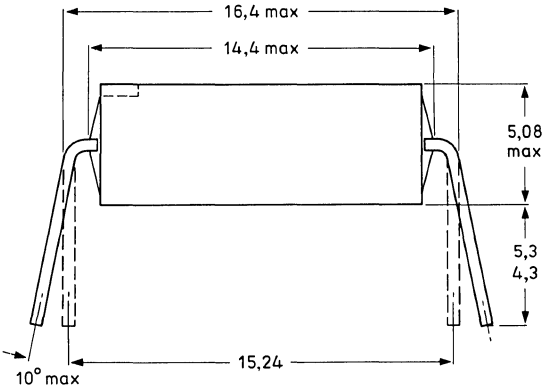

Dimensions in mm

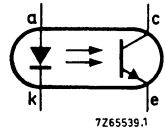
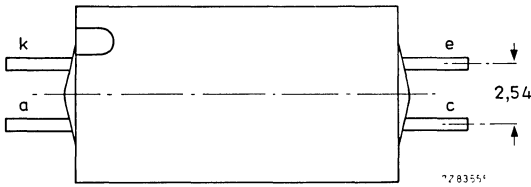
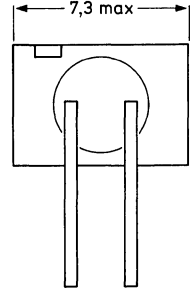

RATINGS

Limiting values in accordance with the Absolute Maximum System (IEC 134)

Diode

Continuous reverse voltage	V_R	max.	5 V
Forward current	I_F	max.	100 mA
d.c.	I_{FM}	max.	1000 mA
(peak value); $t_p = 10 \mu s$; $\delta = 0,1$	P_{tot}	max.	100 mW
Total power dissipation up to $T_{amb} = 25 \text{ }^\circ C$			

Transistor

Collector-emitter voltage (open base)	V_{CEO}	max.	30 V
Emitter-collector voltage (open base)	V_{ECO}	max.	7 V
Collector current	I_C	max.	25 mA
d.c.	I_{CM}	max.	50 mA
peak value	P_{tot}	max.	100 mW
Total power dissipation up to $T_{amb} = 25 \text{ }^\circ C$			

Photocoupler

Storage temperature	T_{stg}	-55 to + 100 °C
Junction temperature	T_j	max. 100 °C
Lead soldering temperature up to the seating plane; $t_{sld} < 10$ s	T_{sld}	max. 260 °C

THERMAL RESISTANCE

From junction to ambient in free air diode	$R_{th\ j-a}$	=	750 °C/W
transistor	$R_{th\ j-a}$	=	750 °C/W

CHARACTERISTICS

$T_j = 25$ °C unless otherwise specified

Diode

Forward voltage $I_F = 10$ mA	V_F	typ. <	1,2 V 1,5 V
Reverse current $V_R = 5$ V	I_R	<	100 μ A

Transistor

Collector cut-off current (dark) $V_{CE} = 10$ V	I_{CEO}	typ. <	5 nA 50 nA
---	-----------	-----------	---------------

Photocoupler ($I_B = 0$)*

Output/input d.c. current transfer ratio $I_F = 10$ mA; $V_{CE} = 0,4$ V	I_C/I_F	>	0,2
Collector-emitter saturation voltage $I_F = 10$ mA; $I_C = 2$ mA	V_{CEsat}	typ.	0,4 V
Isolation voltage, d.c. value	V_{IO}	>	10 kV
Capacitance between input and output $I_F = 0$; $V = 0$; $f = 1$ MHz	C_{io}	typ.	1 pF
Insulation resistance between input and output $\pm V_{IO} = 1$ kV	r_{IO}	> typ.	10^{11} Ω 10^{12} Ω

DEVELOPMENT SAMPLE DATA

* Where the phototransistor receives light from the diode the O (for open base) has been omitted from the symbols.

Switching times (see Figs 2 and 3)

$I_{Con} = 2 \text{ mA}$; $V_{CC} = 20 \text{ V}$; $R_L = 100 \Omega$

Rise time

Fall time

t_r typ. $3 \mu\text{s}$
 t_f typ. $2,5 \mu\text{s}$

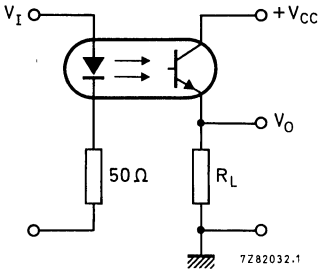

Fig. 2 Switching circuit.

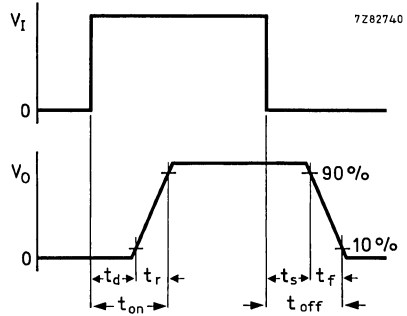

Fig. 3 Waveforms.

Collector cut-off current (dark) see Fig. 4

$V_{CC} = 10 \text{ V}$; working voltage (d.c.) = 10 kV

$I_{CEW} < 200 \text{ nA}^*$

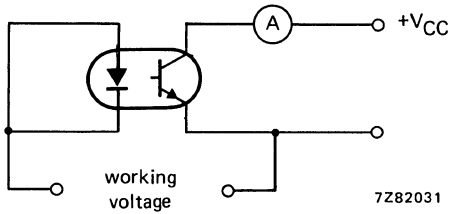

Fig. 4.

* As quality assurance (on a sample basis), these parameters are covered by a 1000 h reliability test.

DEVELOPMENT SAMPLE DATA

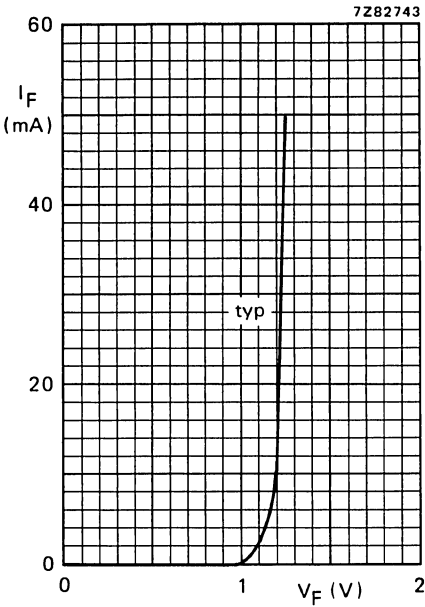

Fig. 5 $T_j = 25^\circ\text{C}$.

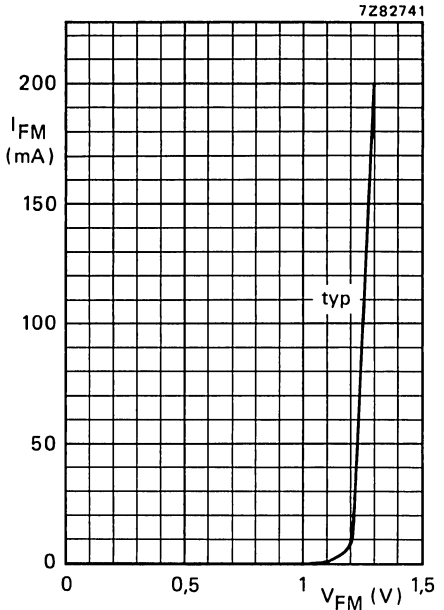

Fig. 6 $T_{\text{amb}} = 25^\circ\text{C}$; $t_p = 10 \mu\text{s}$; $T = 1 \text{ ms}$.

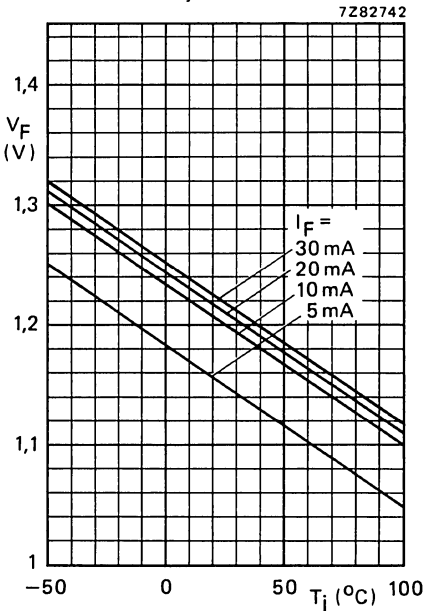

Fig. 7 Typical values.

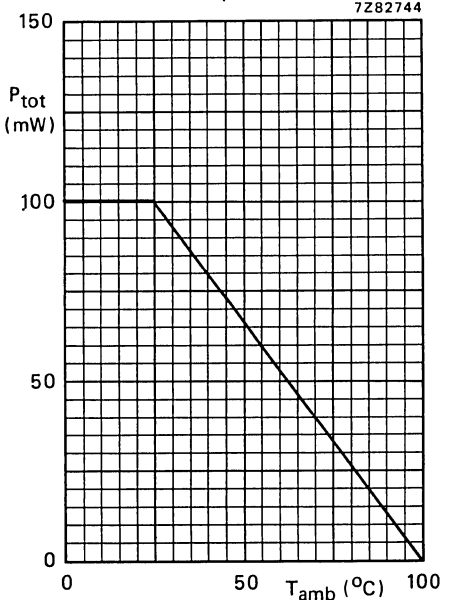

Fig. 8 Power derating curve for diode and transistor versus ambient temperature.

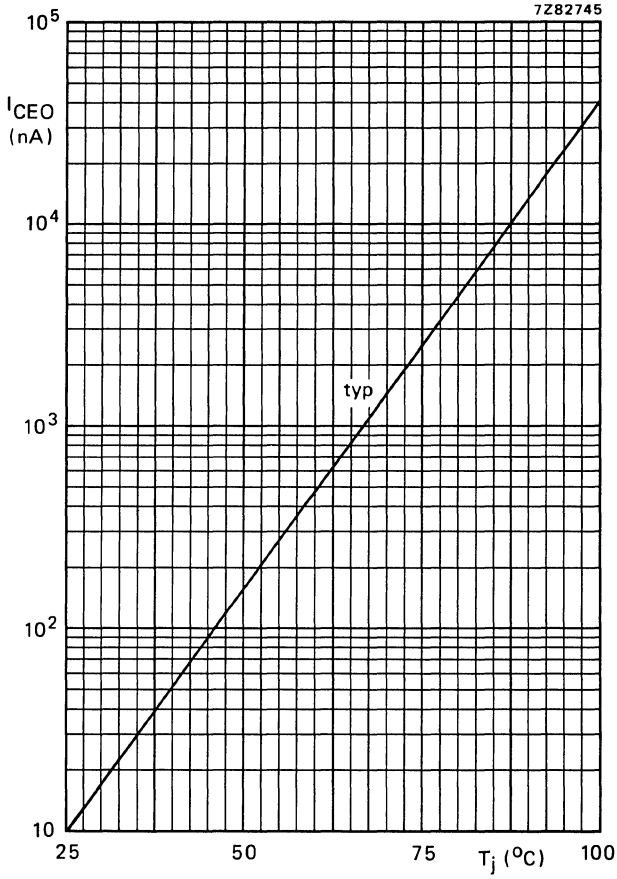

Fig. 9 $I_F = 0$; $V_{CE} = 20$ V.

DEVELOPMENT SAMPLE DATA

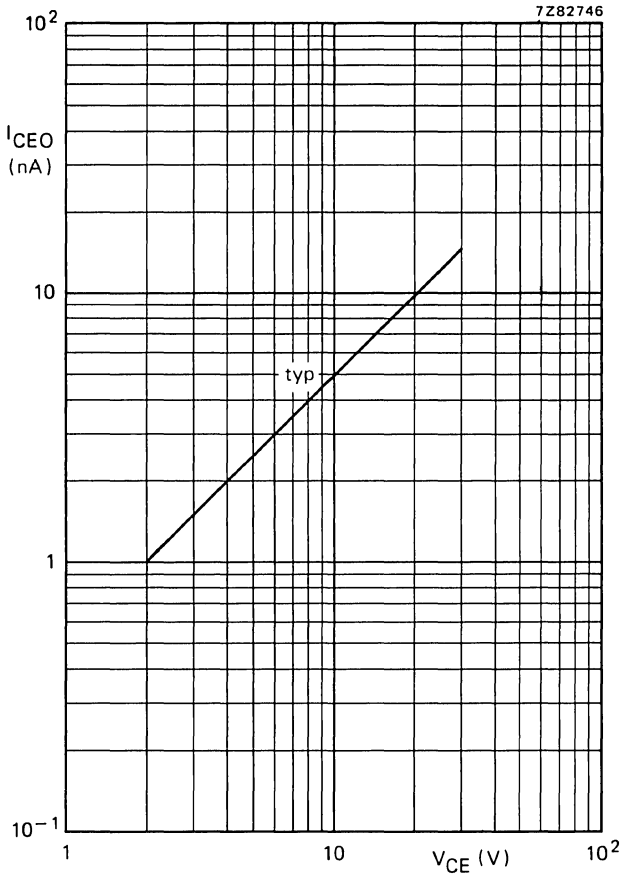

Fig. 10 $I_F = 0$; $T_j = 25$ °C.

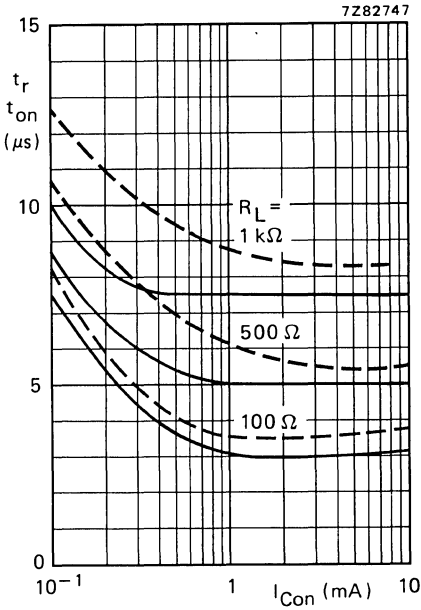

Fig. 11 — t_r ; --- t_{on} ; $I_B = 0$; $V_{CC} = 20\text{ V}$; $T_{amb} = 25\text{ }^\circ\text{C}$; typical values. See also Fig. 13.

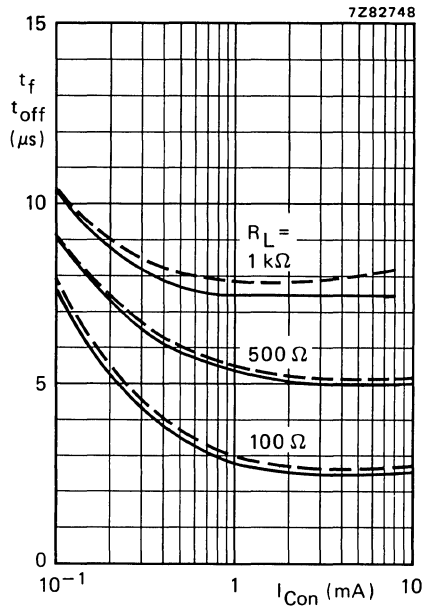

Fig. 12 — t_f ; --- t_{off} ; $I_B = 0$; $V_{CC} = 20\text{ V}$; $T_{amb} = 25\text{ }^\circ\text{C}$; typical values. See also Fig. 13.

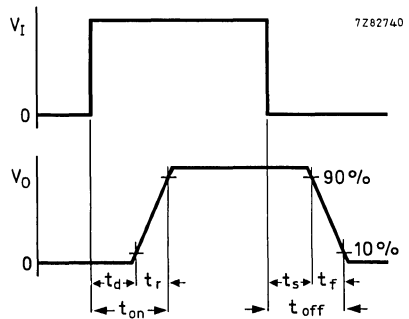
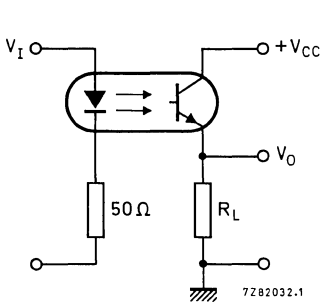

Fig. 13 Switching circuit and waveforms.

PHOTOCOUPLERS

Optically coupled isolators consisting of an infrared emitting GaAs diode and a silicon n-p-n photo-transistor with accessible base. Plastic envelopes. Suitable for TTL integrated circuits.

Features of these products:

- high output/input d.c. current transfer ratio;
- low saturation voltage;
- high isolation voltage of 3 kV (r.m.s.) and 4,4 kV (d.c.);
- working voltage 1,5 kV.

QUICK REFERENCE DATA

Diode

Continuous reverse voltage	V_R	max.	3 V
Forward current d.c. (peak value); $t_p = 10 \mu s$; $\delta = 0,1$	I_F I_{FM}	max. max.	100 mA 3000 mA
Total power dissipation up to $T_{amb} = 25^\circ C$	P_{tot}	max.	200 mW

Transistor

Collector-emitter voltage (open base)	V_{CEO}	max.	30 V
Total power dissipation up to $T_{amb} = 25^\circ C$	P_{tot}	max.	200 mW

Photocoupler

Output/input d.c. current transfer ratio $I_F = 10 \text{ mA}$; $V_{CE} = 0,4 \text{ V}$; ($I_B = 0$)	CNX35 CNX36	I_C/I_F I_C/I_F	> >	0,4 0,8
Collector cut-off current (dark) $V_{CC} = 10 \text{ V}$; working voltage (d.c.) = 1,5 kV diode: $I_F = 0$ (see also Fig. 2)		I_{CEW}	<	200 nA
Isolation voltage (d.c.) $t = 1 \text{ min}$		V_{IO}	>	4,4 kV

MECHANICAL DATA

SOT-90 (see Fig. 1)

MECHANICAL DATA

Fig. 1 SOT-90.

Dimensions in mm

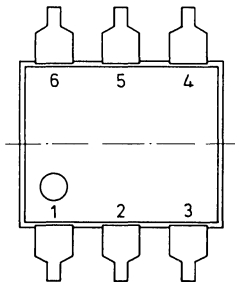
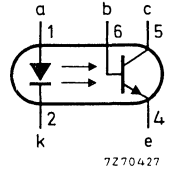
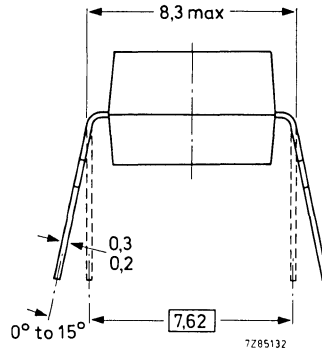
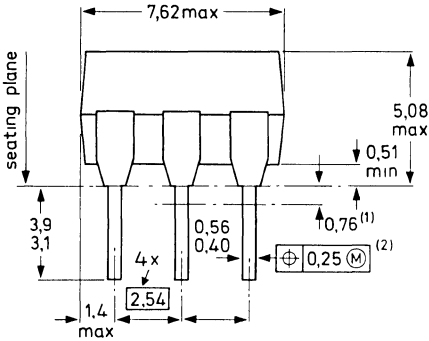

- ⊕ Positional accuracy.
- Ⓜ Maximum Material Condition.

- (1) Lead spacing tolerances apply from seating plane to the line indicated.
- (2) Centre-lines of all leads are within $\pm 0,125$ mm of the nominal position shown; in the worst case, the spacing between any two leads may deviate from nominal by $\pm 0,25$ mm.

RATINGS

Limiting values in accordance with the Absolute Maximum System (IEC 134)

Diode

Continuous reverse voltage	V_R	max.	3 V
Forward current			
d.c.	I_F	max.	100 mA
(peak value); $t_p = 10 \mu s$; $\delta = 0,1$	I_{FM}	max.	3000 mA
Total power dissipation up to $T_{amb} = 25 \text{ }^\circ\text{C}$	P_{tot}	max.	200 mW

Transistor

Collector-emitter voltage (open base)	V_{CEO}	max.	30 V
Collector-base voltage (open emitter)	V_{CBO}	max.	70 V
Emitter-collector voltage (open base)	V_{ECO}	max.	7 V
Collector current (d.c.)	I_C	max.	100 mA
Total power dissipation up to $T_{amb} = 25 \text{ }^\circ\text{C}$	P_{tot}	max.	200 mW

Photocoupler

Storage temperature	T_{stg}	-55 to + 150 °C
Operating junction temperature	T_j	max. 125 °C
Lead soldering temperature up to the seating plane; $t_{sld} < 10$ s	T_{sld}	max. 260 °C

THERMAL RESISTANCE

From junction to ambient in free air diode transistor	$R_{th\ j-a}$	=	500 °C/W
	$R_{th\ j-a}$	=	500 °C/W
From junction to ambient, device mounted on a printed-circuit board diode transistor	$R_{th\ j-a}$	=	400 °C/W
	$R_{th\ j-a}$	=	400 °C/W

CHARACTERISTICS

$T_j = 25$ °C unless otherwise specified

Diode

Forward voltage $I_F = 10$ mA	V_F	typ. <	1,15 V 1,5 V
Reverse current $V_R = 3$ V	I_R	<	10 μ A

Transistor (diode: $I_F = 0$)

Collector cut-off current (dark) $V_{CE} = 10$ V	I_{CEO}	typ. <	2 nA 50 nA
$V_{CE} = 10$ V; $T_{amb} = 70$ °C	I_{CEO}	<	10 μ A
$V_{CB} = 10$ V	I_{CBO}	<	20 nA

Photocoupler ($I_B = 0$)*

Output/input d.c. current transfer ratio $I_F = 10$ mA; $V_{CE} = 5$ V	I_C/I_F	typ.	1,5
$I_F = 10$ mA; $V_{CE} = 0,4$ V	CNX35 CNX36 I_C/I_F	>	0,4 to 1,6 0,8
Collector-emitter saturation voltage $I_F = 10$ mA; $I_C = 2$ mA	V_{CEsat}	typ.	0,15 V
$I_F = 10$ mA; $I_C = 4$ mA	V_{CEsat}	typ.	0,19 V
Isolation voltage, d.c. value **	V_{IO}	>	4,4 kV

* Where the phototransistor receives light from the diode the O (for open base) has been omitted from the symbols.

** Tested with a d.c. voltage for 1 minute between shorted input leads and shorted output leads.

Collector cut-off current (light) at $T_{amb} = 0\text{ }^{\circ}\text{C}$ to $70\text{ }^{\circ}\text{C}$

$V_F = 0,8\text{ V}$; $V_{CE} = 15\text{ V}$

$I_F = 2\text{ mA}$; $V_{CE} = 0,4\text{ V}$

Collector capacitance at $f = 1\text{ MHz}$

$I_E = I_e = 0$; $V_{CB} = 10\text{ V}$

Capacitance between input and output

$I_F = 0$; $V = 0$; $f = 1\text{ MHz}$

Insulation resistance between input and output

$\pm V_{IO} = 1\text{ kV}$

$I_{CE(L)} < 15\text{ }\mu\text{A}$

$I_{CE(L)} > 150\text{ }\mu\text{A}$

C_c typ. $4,5\text{ pF}$

C_{io} typ. $0,6\text{ pF}$

$r_{IO} > 10^{10}\text{ }\Omega$

r_{IO} typ. $10^{12}\text{ }\Omega$

Switching times (see Figs 2 and 3)

$I_{Con} = 2\text{ mA}$; $V_{CC} = 5\text{ V}$; $R_L = 100\text{ }\Omega$

Turn-on time

t_{on} typ. $3\text{ }\mu\text{s}$

Turn-off time

t_{off} typ. $3\text{ }\mu\text{s}$

$I_{Con} = 2\text{ mA}$; $V_{CC} = 5\text{ V}$; $R_L = 1\text{ k}\Omega$

Turn-on time

t_{on} typ. $12\text{ }\mu\text{s}$

Turn-off time

t_{off} typ. $12,5\text{ }\mu\text{s}$

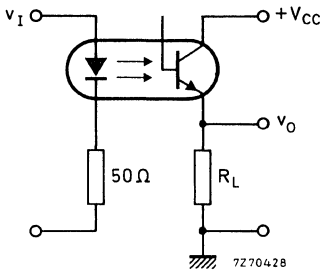

Fig. 2 Switching circuit.

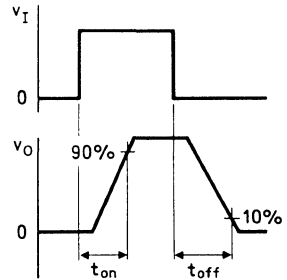

Fig. 3 Waveforms.

Collector cut-off current (dark) see Fig. 4

$V_{CC} = 10\text{ V}$; working voltage (d.c.) = $1,5\text{ kV}$

$V_{CC} = 10\text{ V}$; working voltage (d.c.) = $1,5\text{ kV}$; $T_j = 70\text{ }^{\circ}\text{C}$

$I_{CEW} < 200\text{ nA}^*$

$I_{CEW} < 100\text{ }\mu\text{A}^*$

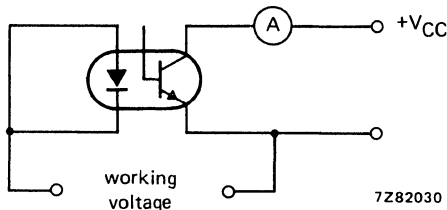

Fig. 4.

*As quality assurance (on a sample basis), these parameters are covered by a 1000 h reliability test.

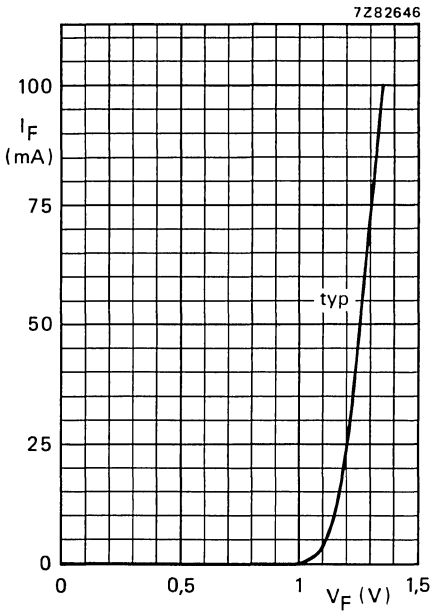

Fig. 5 $T_{amb} = 25\text{ }^{\circ}\text{C}$.

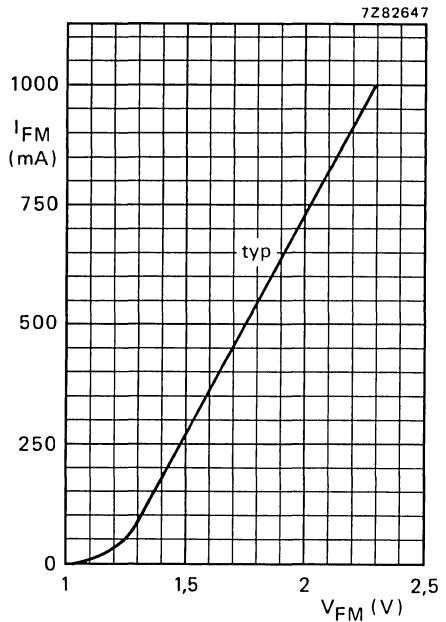

Fig. 6 $T_{amb} = 25\text{ }^{\circ}\text{C}$; $t_p = 10\text{ }\mu\text{s}$; $T = 1\text{ ms}$.

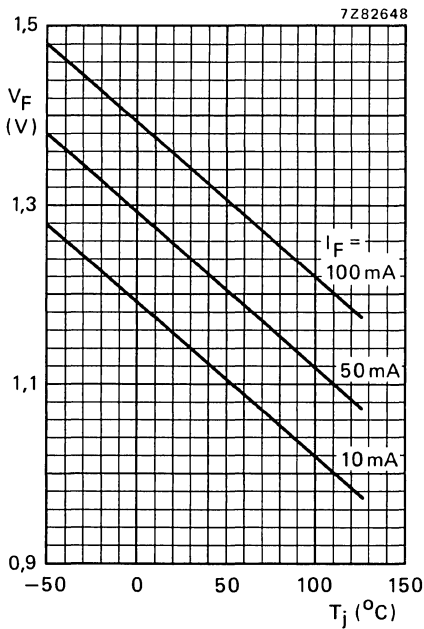

Fig. 7 Typical values.

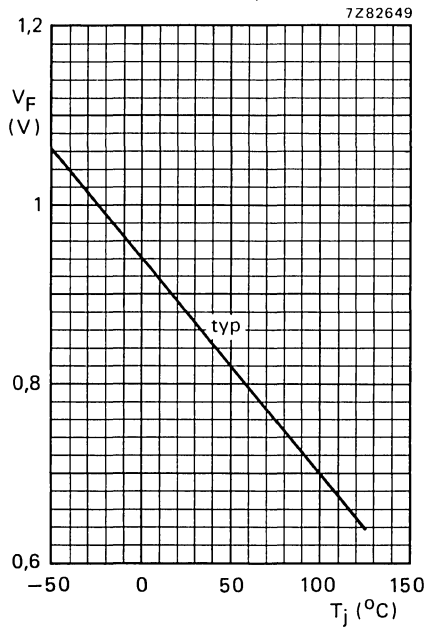

Fig. 8 $I_F = 50\text{ }\mu\text{A}$.

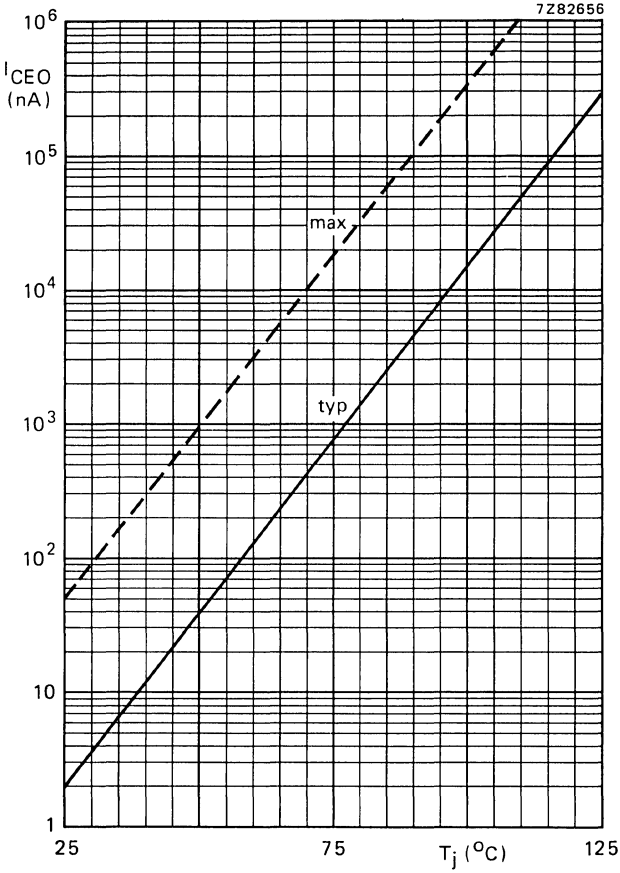

Fig. 9 $I_F = 0$; $V_{CE} = 10$ V.

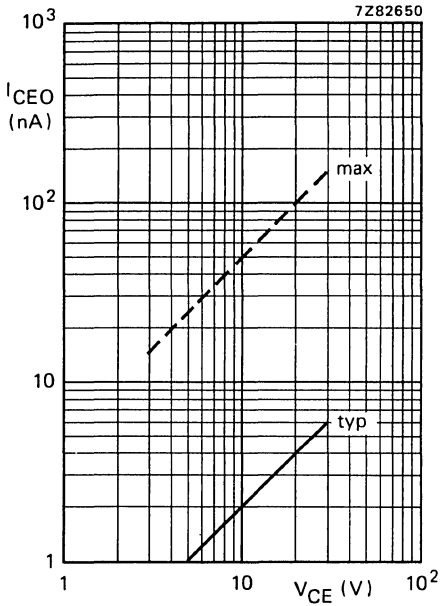

Fig. 10 $I_F = 0$; $T_j = 25^\circ\text{C}$.

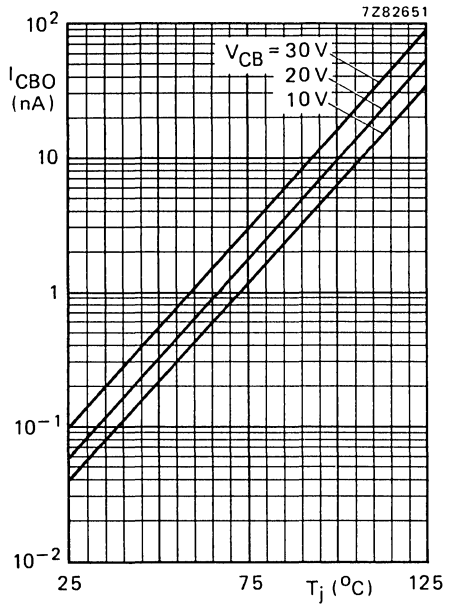

Fig. 11 Typical values.

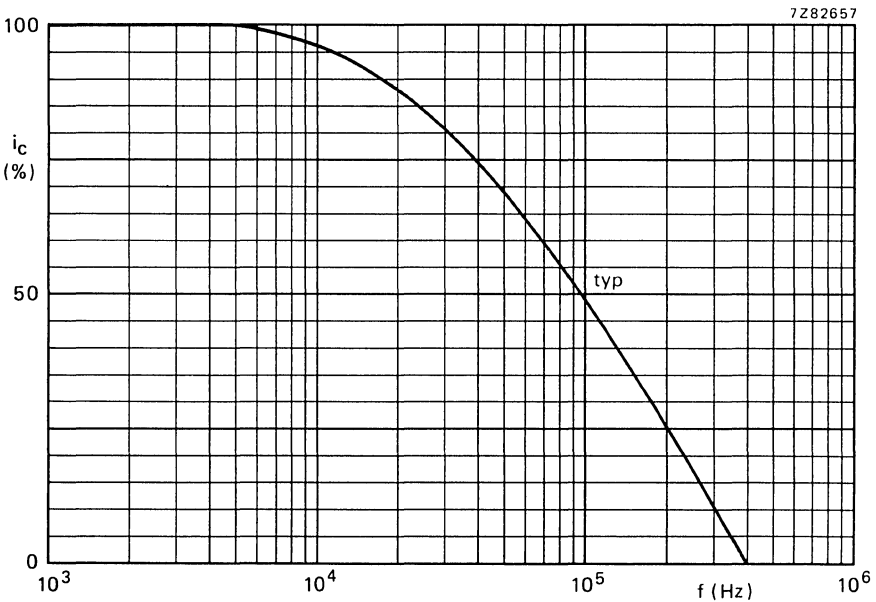

Fig. 12 $I_B = 0$; $I_C = 2\text{ mA}$; $V_{CC} = 5\text{ V}$; $R_L = 1\text{ k}\Omega$; $T_{\text{amb}} = 25^\circ\text{C}$.

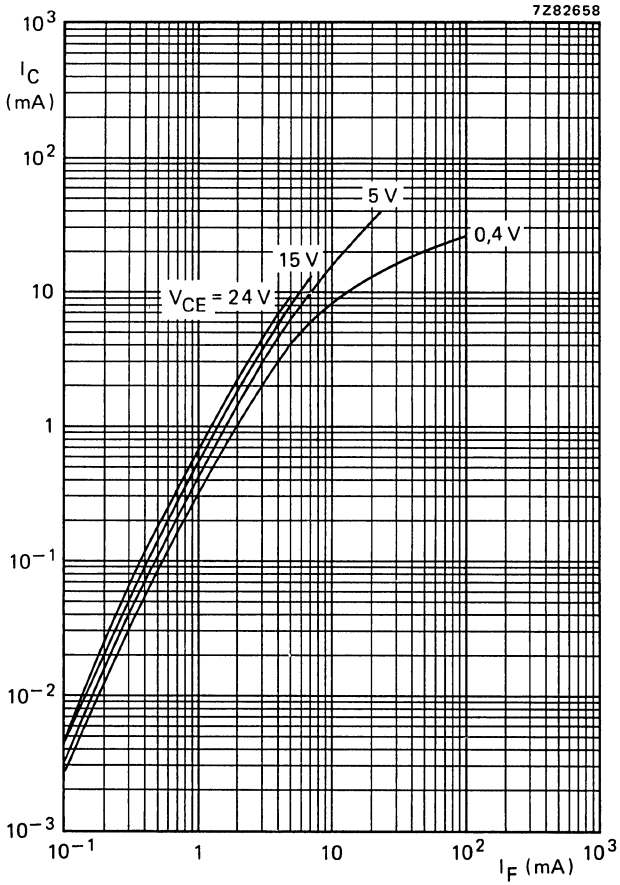

Fig. 13 $T_{amb} = 25$ °C, typical values.

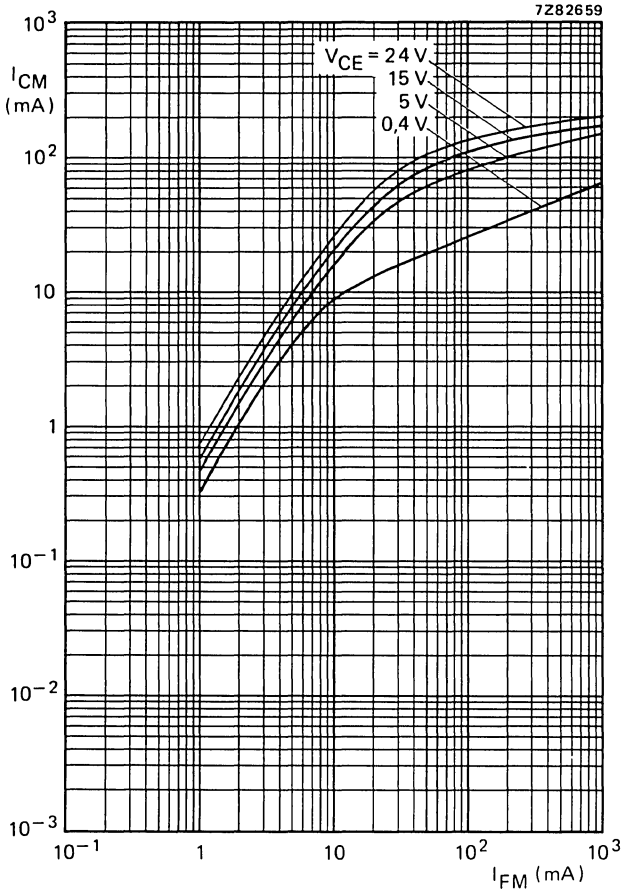

Fig. 14 $T_{amb} = 25\text{ }^{\circ}\text{C}$; $t_p = 10\text{ }\mu\text{s}$; $T = 1\text{ ms}$; typical values.

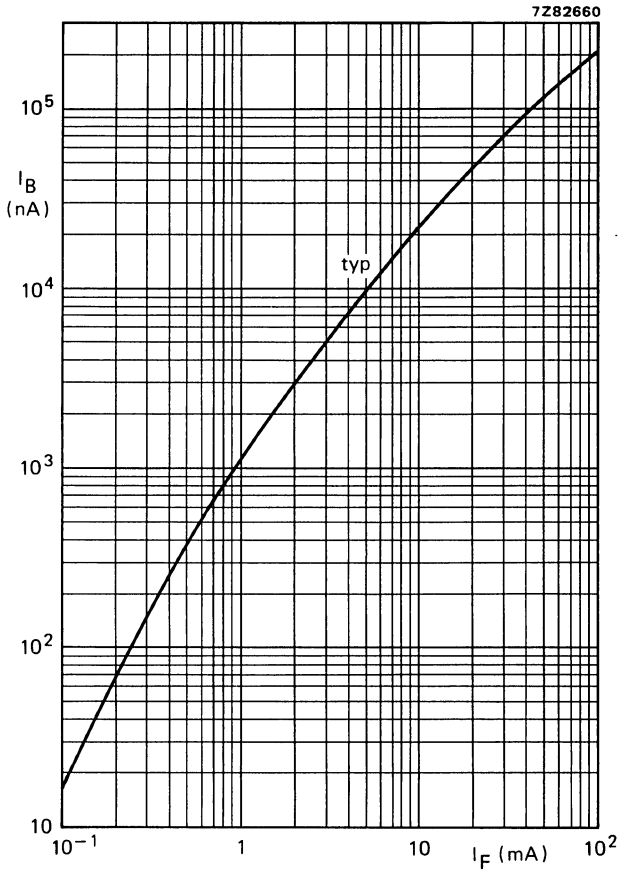

Fig. 15 $V_{CB} = 5$ V; $T_{amb} = 25$ °C.

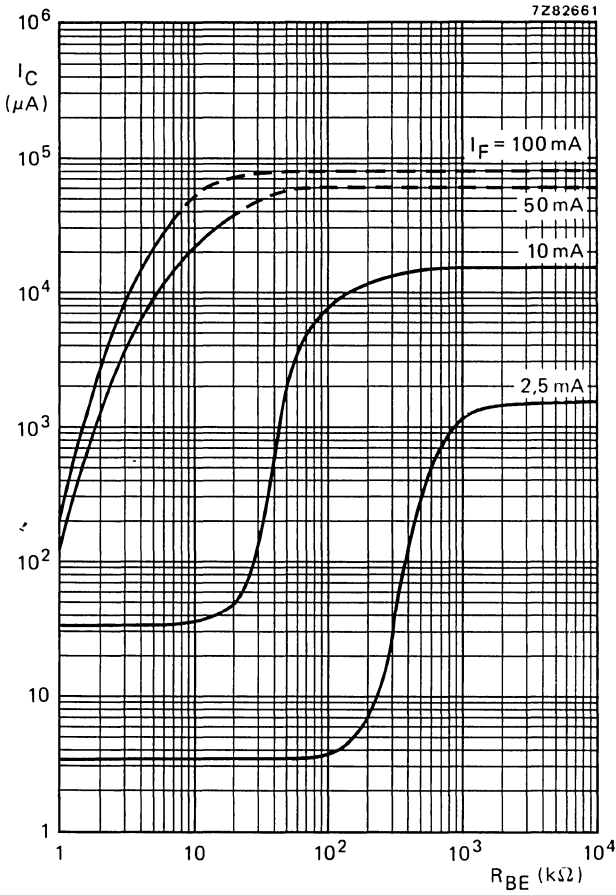

Fig. 16 $I_B = 0$; $V_{CE} = 5$ V; $T_{amb} = 25$ °C; typical values.

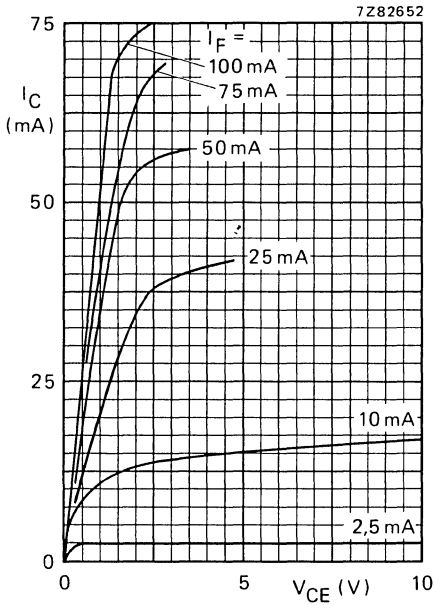

Fig. 17 $T_{amb} = 25^\circ C$; typical values.

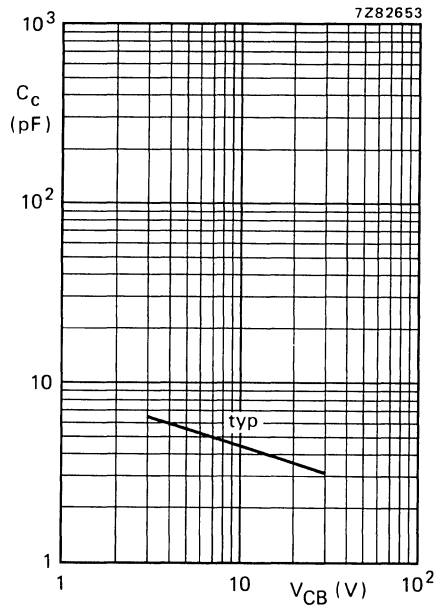

Fig. 18 $f = 1$ MHz; $T_{amb} = 25^\circ C$.

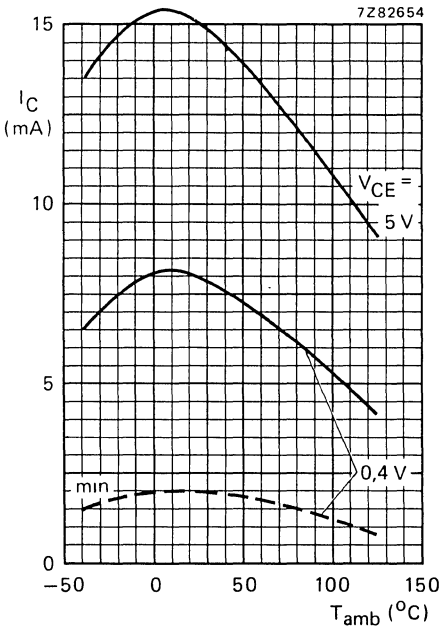

Fig. 19 $I_B = 0$; $I_F = 10$ mA; — typ. values.

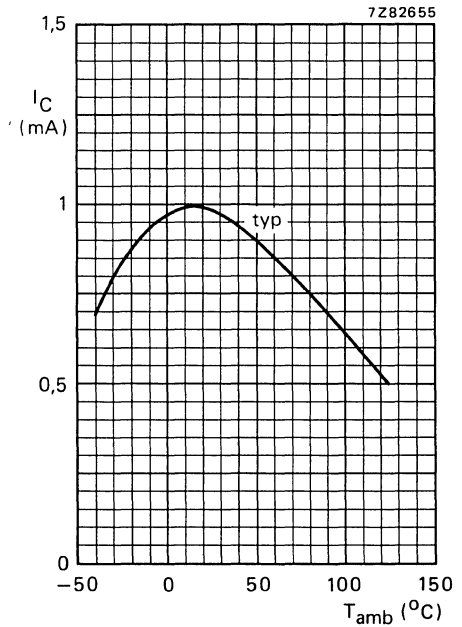

Fig. 20 $I_F = 2$ mA; $V_{CE} = 0,4$ V.

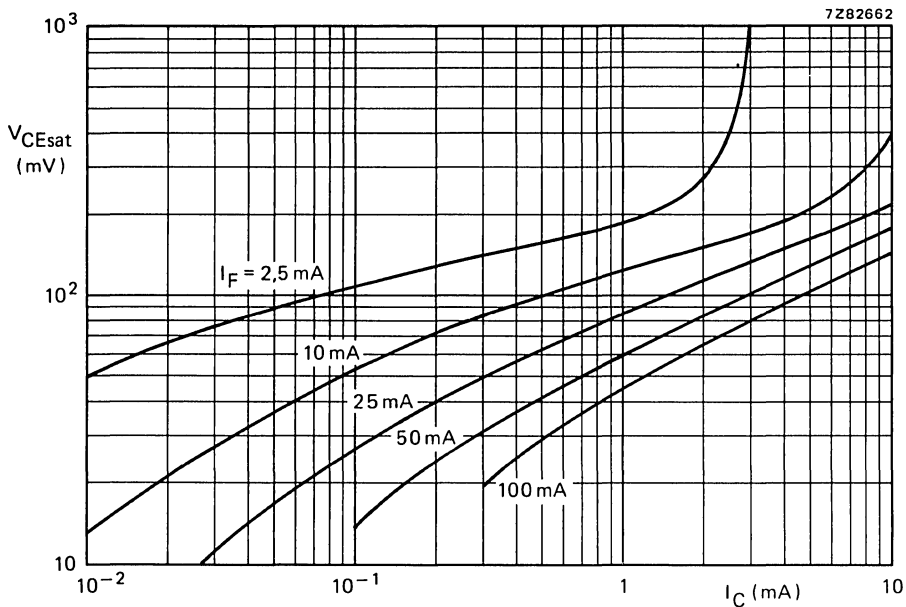

Fig. 21 $I_B = 0$; $T_{amb} = 25^\circ C$; typical values.

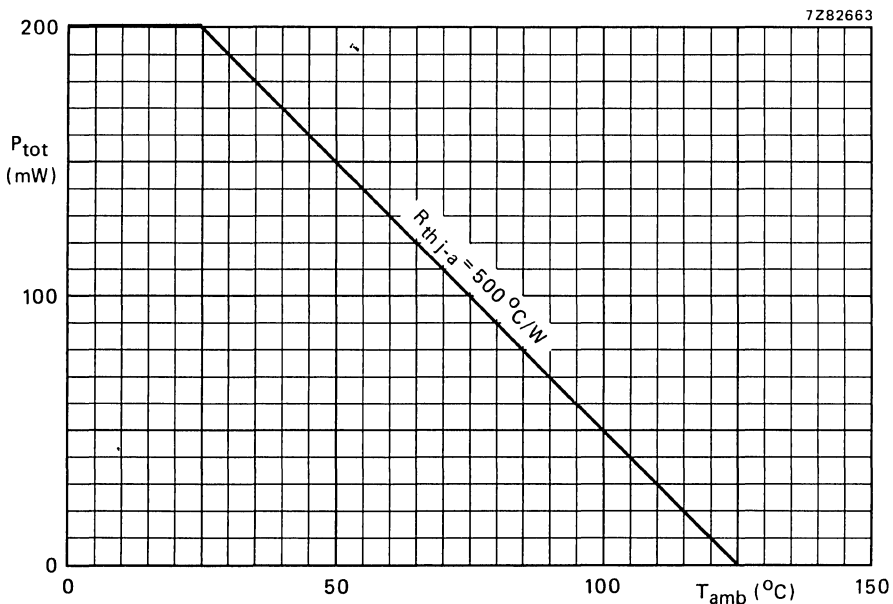

Fig. 22 Max. permissible power dissipation for diode and transistor versus ambient temperature.

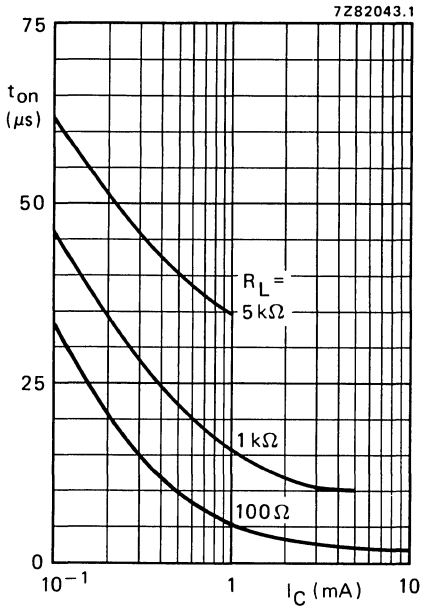

Fig. 23 $I_B = 0$; $V_{CC} = 5 V$; $T_{amb} = 25^\circ C$; typical values. (See also Fig. 25.)

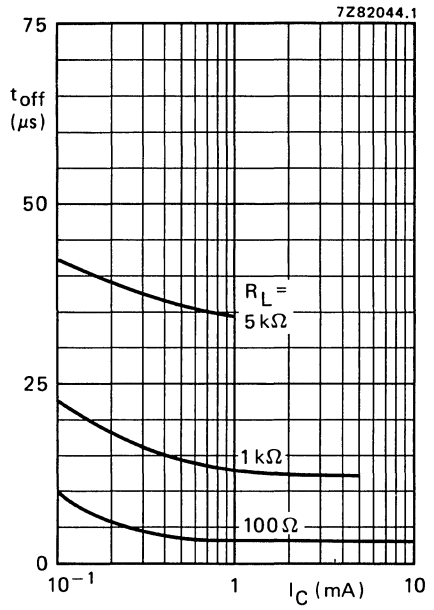

Fig. 24 $I_B = 0$; $V_{CC} = 5 V$; $T_{amb} = 25^\circ C$; typical values. (See also Fig. 25.)

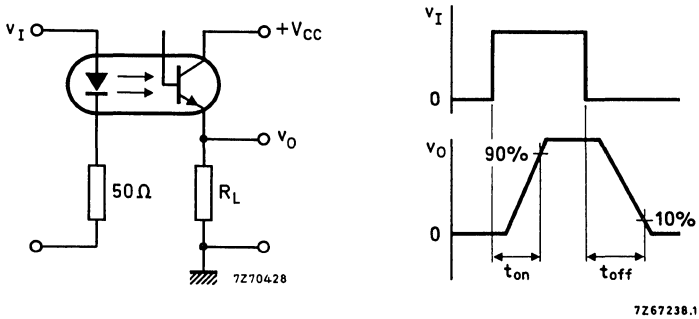

Fig. 25 Switching circuit and waveforms.

DEVELOPMENT SAMPLE DATA

This information is derived from development samples made available for evaluation. It does not necessarily imply that the device will go into regular production.

CNX37

HIGH-VOLTAGE PHOTOCOUPLER

The CNX37 is a photocoupler consisting of an infrared emitting GaAs diode and a silicon n-p-n phototransistor in a dual-in-line (DIL) envelope.

Features

- high current transfer ratio and a low saturation voltage suitable for use with TTL integrated circuits
- high degree of a.c. and d.c. insulation (3,9 kV r.m.s. and 5,3 kV d.c.)
- working voltage of 2,5 kV (d.c.)

QUICK REFERENCE DATA

Diode

Continuous reverse voltage	V_R	max.	3 V
Forward current			
d.c.	I_F	max.	100 mA
peak value; $t_{ON} = 10 \mu s$; $\delta = 0,01$	I_{FM}	max.	3 A
Total power dissipation up to $T_{amb} = 45 \text{ }^\circ\text{C}$ when mounted on a p.c.b.	P_{tot}	max.	200 mW

Transistor

Collector-emitter voltage (open base)	V_{CEO}	max.	30 V
Total power dissipation up to $T_{amb} = 45 \text{ }^\circ\text{C}$ when mounted on a p.c.b.	P_{tot}	max.	200 mW

Photocoupler

Output/input d.c. current transfer ratio $I_F = 10 \text{ mA}$; $V_{CE} = 5 \text{ V}$	I_C/I_F	min.	1,5
Collector cut-off current (dark) $V_{CC} = 10 \text{ V}$; working voltage (d.c.) = 2,5 kV I_F (diode) = 0 (see note 1)	I_{CEW}	max.	200 nA
Test isolation voltage (d.c.) $t = 1 \text{ min}$ (see note 2)	V_{IO}	max.	5,3 kV

MECHANICAL DATA

See Fig. 1.

MECHANICAL DATA

Fig. 1 SOT-90B.

Dimensions in mm

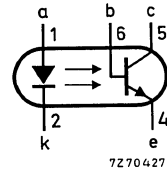
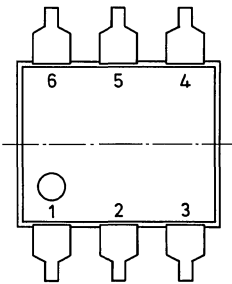
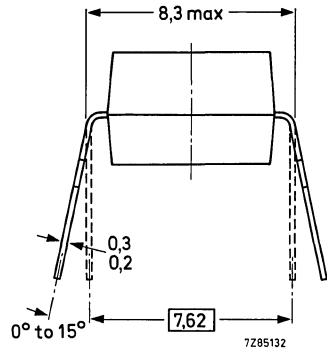
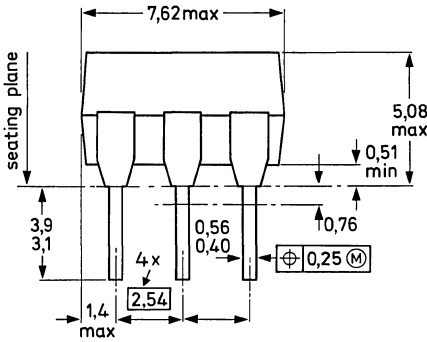

RATINGS

Limiting values in accordance with the Absolute Maximum System (IEC 134)

Diode

Continuous reverse voltage

V_R max. 3 V

Forward current

I_F max. 100 mA

d.c.

I_{FM} max. 3 A

peak value; $t_{ON} = 10 \mu s$; $\delta = 0,01$

Total power dissipation up to $T_{amb} = 45^\circ C$

P_{tot} max. 200 mW

when mounted on a p.c.b.

Transistor

Collector-emitter voltage (open base)

V_{CEO} max. 30 V

Collector-base voltage (open emitter)

V_{CBO} max. 70 V

Emitter-collector voltage

V_{ECO} max. 7 V

Collector current (d.c.)

I_C max. 100 mA

Total power dissipation up to $T_{amb} = 45^\circ C$

P_{tot} max. 200 mW

when mounted on a p.c.b.

Photocoupler

Storage temperature	T_{stg}	-55 to + 150 °C
Junction temperature	T_j	max. 125 °C
Soldering temperature up to the seating plane; $t_{sld} < 10$ s	T_{sld}	max. 260 °C

THERMAL RESISTANCE

From junction to ambient in free air			
diode	$R_{th\ j-a}$	max.	500 K/W
transistor	$R_{th\ j-a}$	max.	500 K/W
From junction to ambient when mounted on p.c.b.			
diode	$R_{th\ j-a}$	max.	400 K/W
transistor	$R_{th\ j-a}$	max.	400 K/W

CHARACTERISTICS

$T_j = 25$ °C unless otherwise specified

Diode

Forward voltage $I_F = 10$ mA	V_F	typ.	1,15 V
		max.	1,50 V
Reverse current	I_R	max.	10 μ A

Transistor

Collector-emitter breakdown voltage $I_C = 1$ mA	$V_{(BR)CEO}$	min.	30 V
Collector-base breakdown voltage $I_C = 0,1$ mA	$V_{(BR)CBO}$	min.	70 V
Emitter-collector breakdown voltage $I_E = 0,1$ mA	$V_{(BR)ECO}$	min.	7 V
Collector cut-off current (dark); diode $I_F = 0$ $V_{CE} = 10$ V	I_{CEO}	typ.	2 nA
		max.	50 nA
$V_{CE} = 10$ V; $T_{amb} = 70$ °C	I_{CEO}	max.	10 μ A
$V_{CB} = 10$ V	I_{CBO}	max.	20 nA

Photocoupler

Output/input d.c. current transfer ratio

$I_F = 10 \text{ mA}; V_{CE} = 0,4 \text{ V}$

$I_F = 10 \text{ mA}; V_{CE} = 5 \text{ V}$

I_C/I_F	min.	0,4
I_C/I_F	typ.	1,5

Collector cut-off current (light)

$T_{amb} = 0 \text{ to } 70 \text{ }^\circ\text{C}; V_F = 0,8 \text{ V}; V_{CE} = 15 \text{ V}$

$I_F = 2 \text{ mA}; V_{CE} = 0,4 \text{ V}$

$I_{CE(L)}$	max.	15 μA
$I_{CE(L)}$	min.	150 μA

Collector-emitter saturation voltage

$I_F = 10 \text{ mA}; I_C = 2 \text{ mA}$

V_{CEsat}	typ.	0,15 V
V_{CEsat}	max.	0,40 V

$I_F = 10 \text{ mA}; I_C = 4 \text{ mA}$

V_{CEsat}	typ.	0,19 V
V_{CEsat}	max.	0,40 V

Test isolation voltage, d.c. value

$t = 1 \text{ min}$ (see note 2)

V_{IO}	max.	5,3 kV
----------	------	--------

Output capacitance

$V_{CB} = 10 \text{ V}; f = 1 \text{ MHz}$

C_C	typ.	4,5 pF
-------	------	--------

Capacitance between input and output

$V = 0; f = 1 \text{ MHz}$

C_{io}	typ.	0,6 pF
----------	------	--------

Insulation resistance between input and output

$V_{IO} = \pm 1000 \text{ V}$

R_{IO}	min.	$10^{10} \Omega$
R_{IO}	typ.	$10^{12} \Omega$

Switching times (see Figs 2 and 3)

Turn-on time

$I_C = 2 \text{ mA}; V_{CC} = 5 \text{ V}; R_L = 100 \Omega$

$I_C = 2 \text{ mA}; V_{CC} = 5 \text{ V}; R_L = 1 \text{ k}\Omega$

t_{on}	typ.	3 μs
t_{on}	typ.	12 μs

Turn-off time

$I_C = 2 \text{ mA}; V_{CC} = 5 \text{ V}; R_L = 100 \Omega$

$I_C = 2 \text{ mA}; V_{CC} = 5 \text{ V}; R_L = 1 \text{ k}\Omega$

t_{off}	typ.	3 μs
t_{off}	typ.	12,5 μs

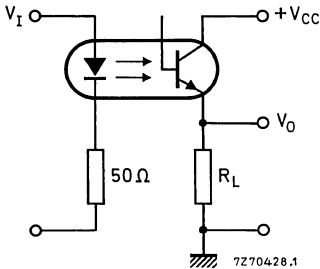

Fig. 2 Switching circuit.

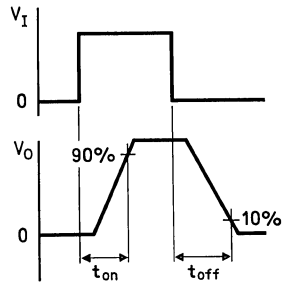

Fig. 3 Waveforms.

Note 1:

Collector cut-off current (dark) at
 working voltage $V_W = 2,5 \text{ kV}$ (d.c. value);
 $V_{CC} = 10 \text{ V}; T_j = 25 \text{ }^\circ\text{C}$
 $V_{CC} = 10 \text{ V}; T_j = 70 \text{ }^\circ\text{C}$

I_{CEW}	max.	200 nA*
	max.	100 μA^*

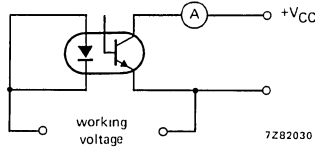

Fig. 4.

* The two parameters are tested on a sample basis for 1000 h.

Note 2:

A test voltage of 5,3 kV (d.c.) is applied between the shorted diode leads and the shorted transistor leads for 1 min.

DEVELOPMENT SAMPLE DATA

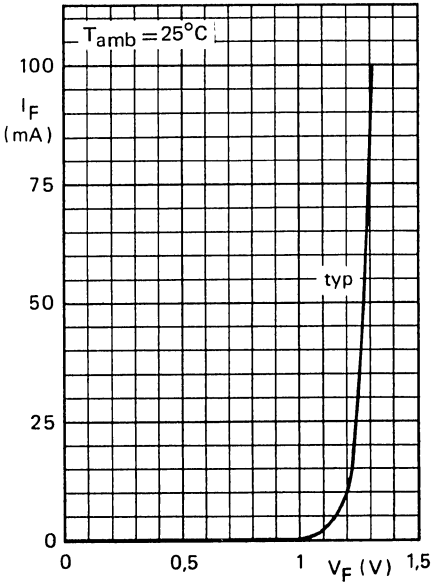

Fig. 5.

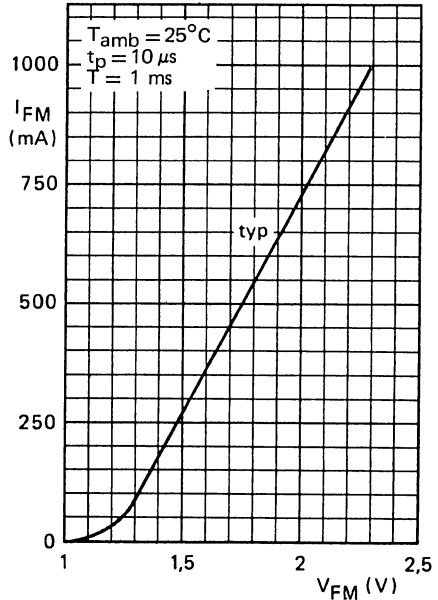

Fig. 6.

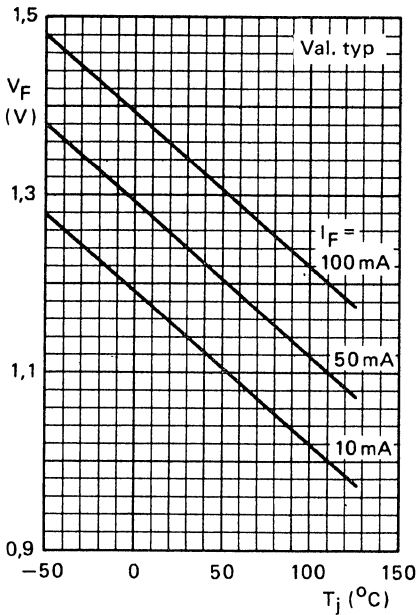

Fig. 7.

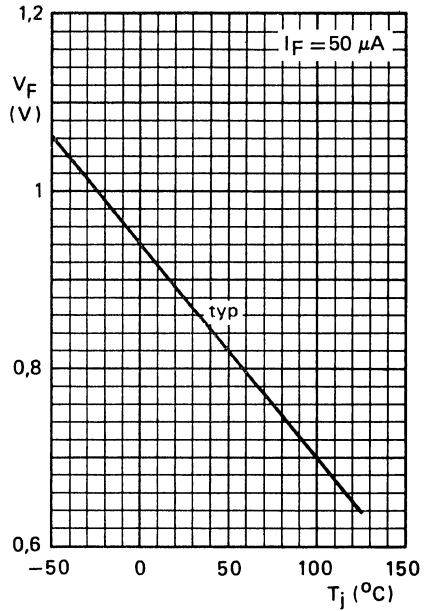

Fig. 8.

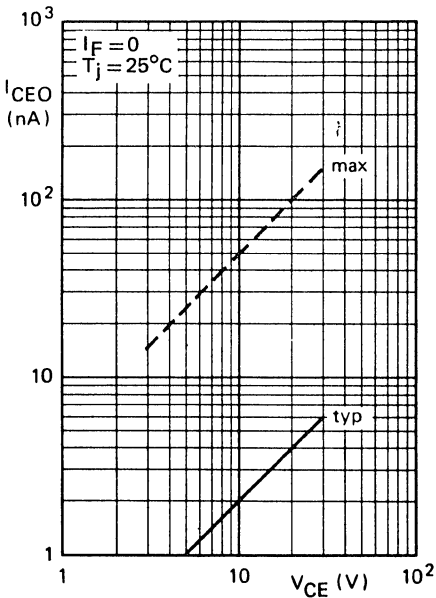

Fig. 9.

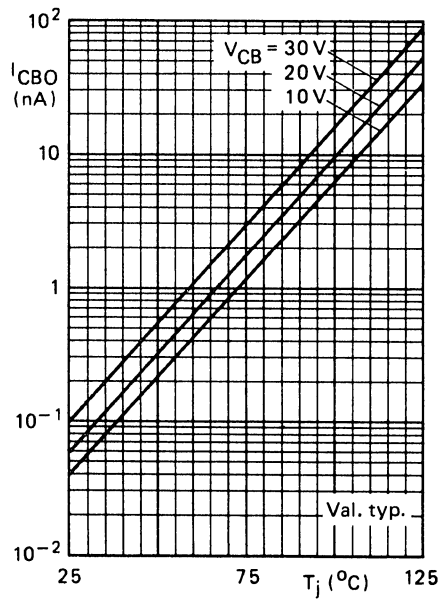

Fig. 10.

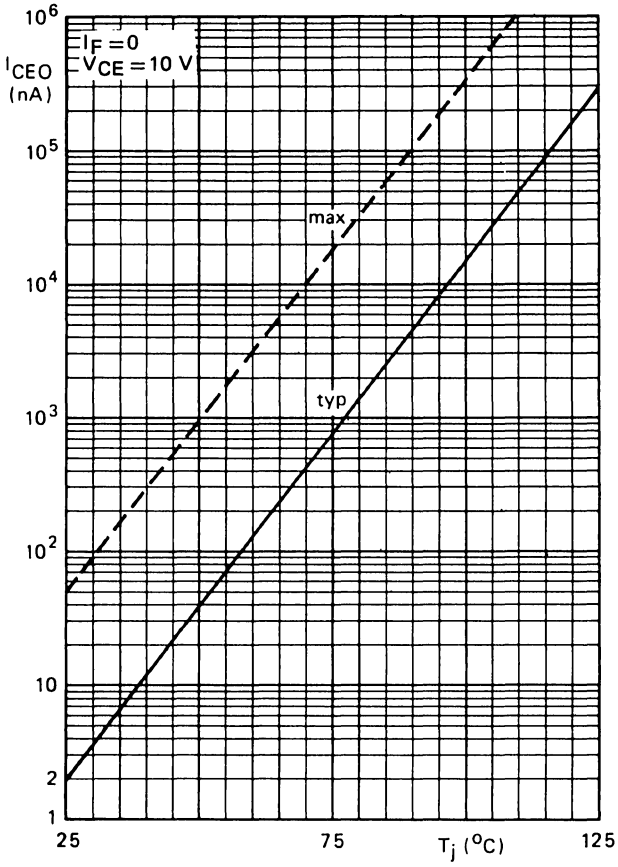

Fig. 11.

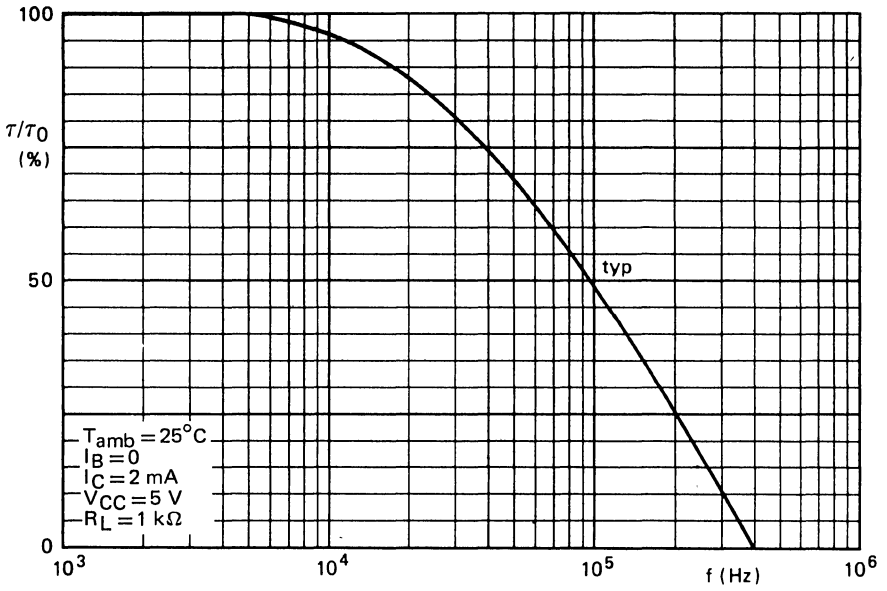

Fig. 12.

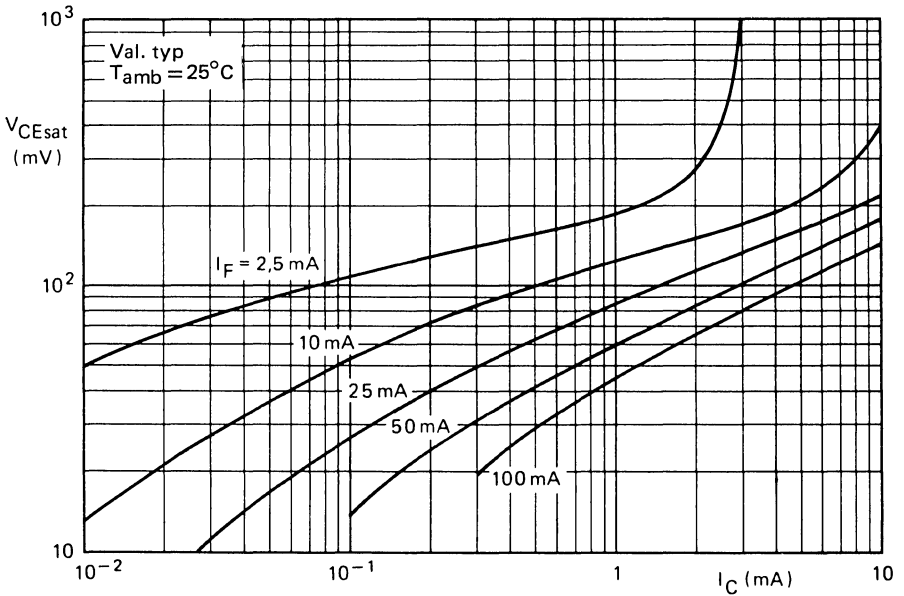

Fig. 13.

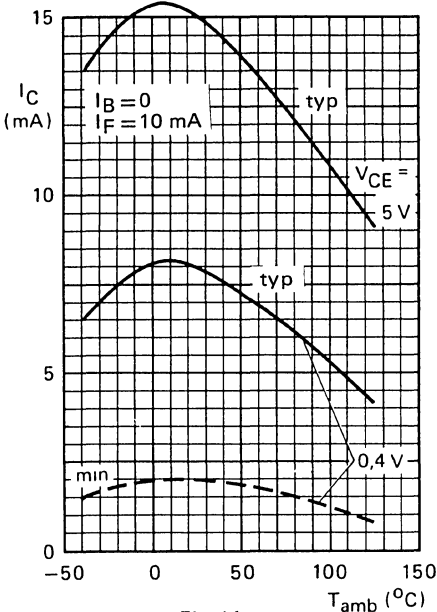

Fig. 14.

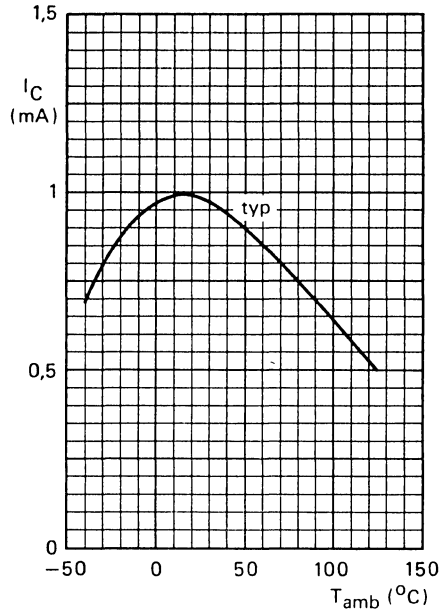

Fig. 15.

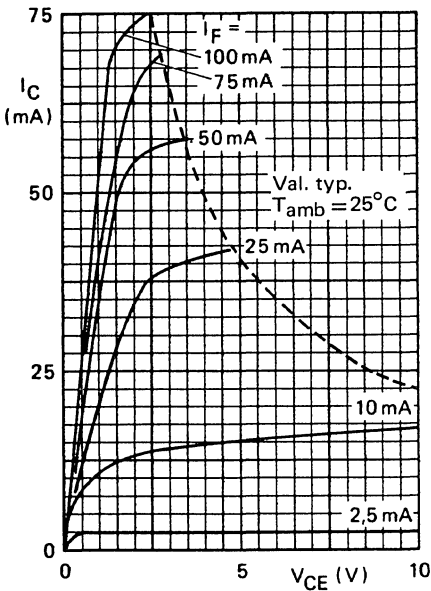

Fig. 16.

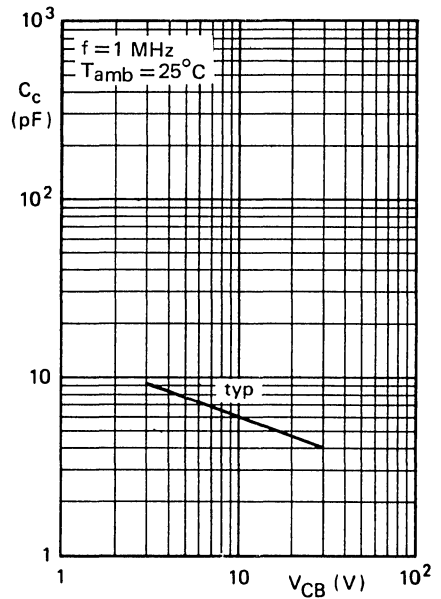

Fig. 17.

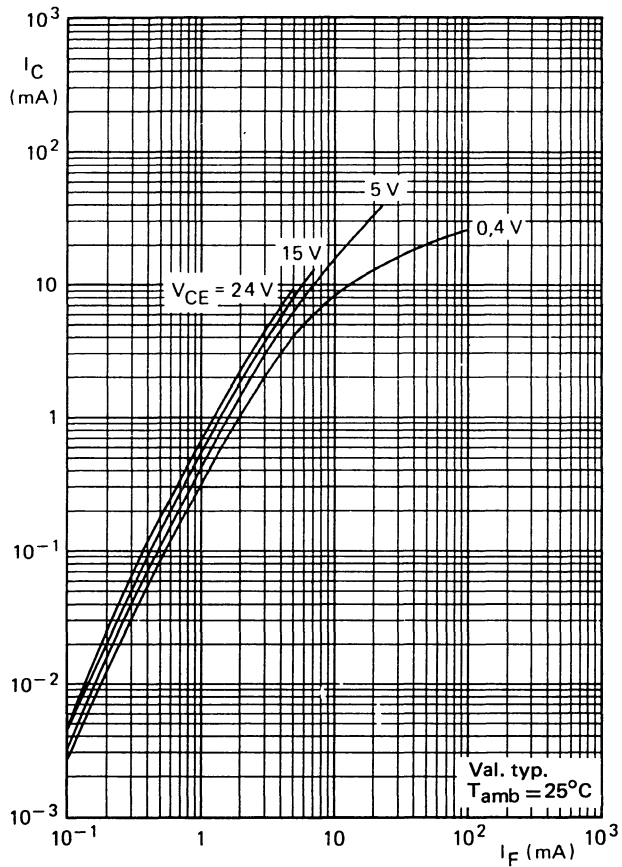

Fig. 18.

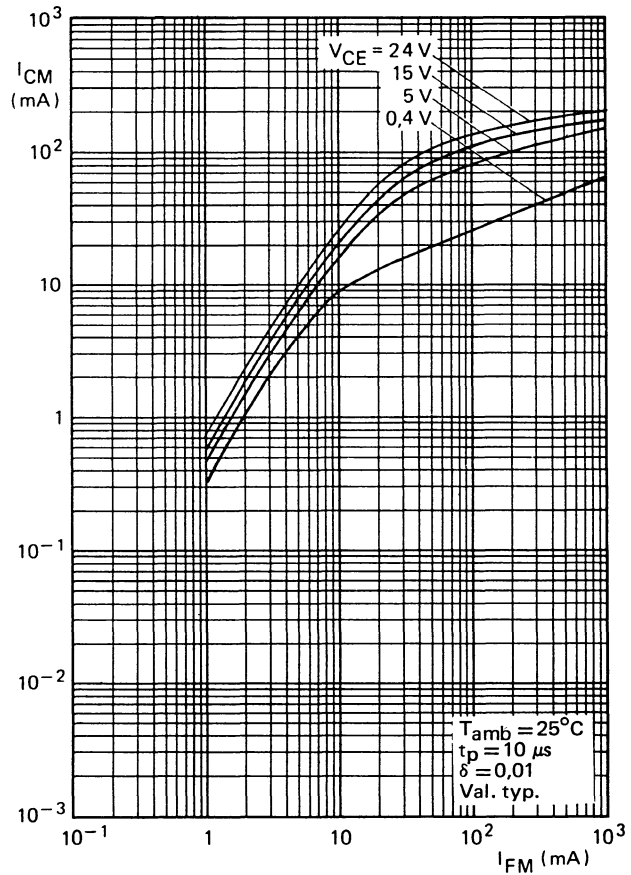

Fig. 19.

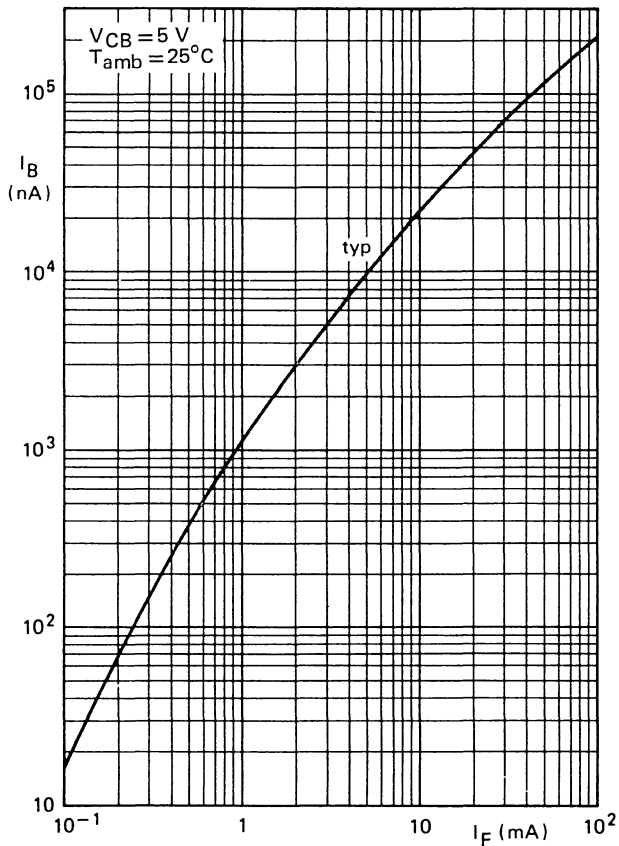

Fig. 20.

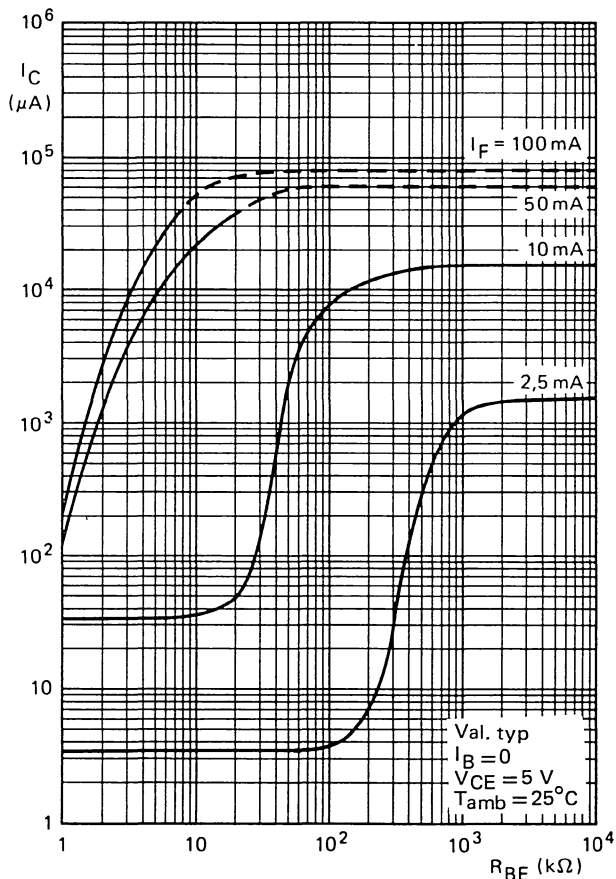

Fig. 21.



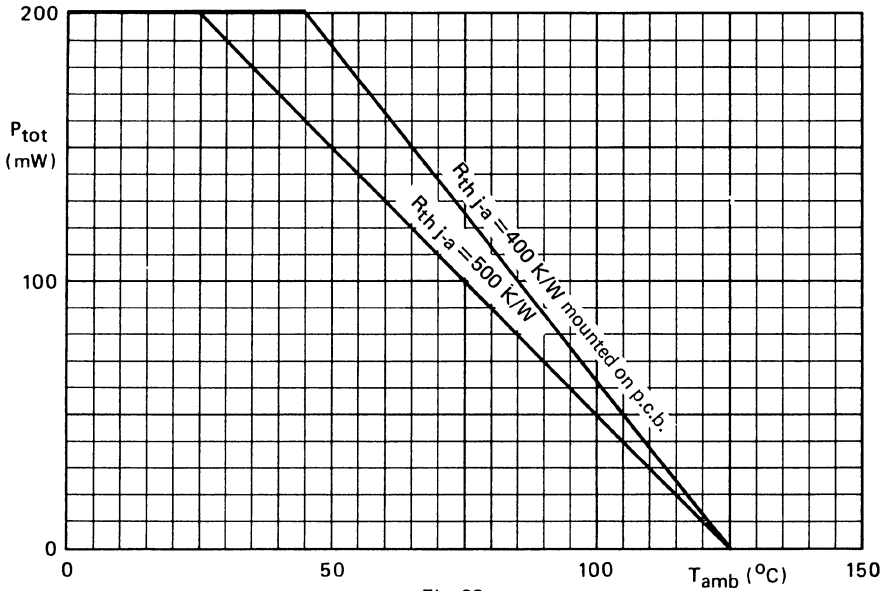

Fig. 22.

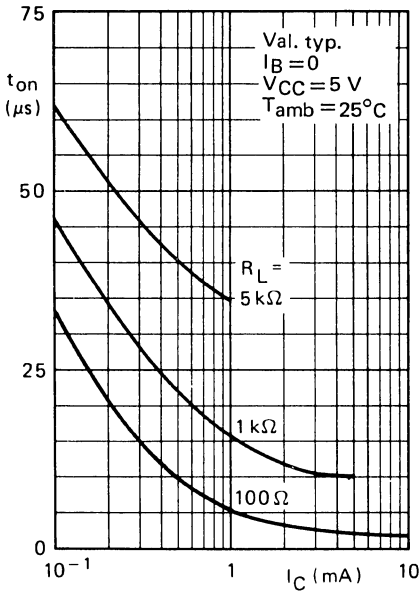

Fig. 23.

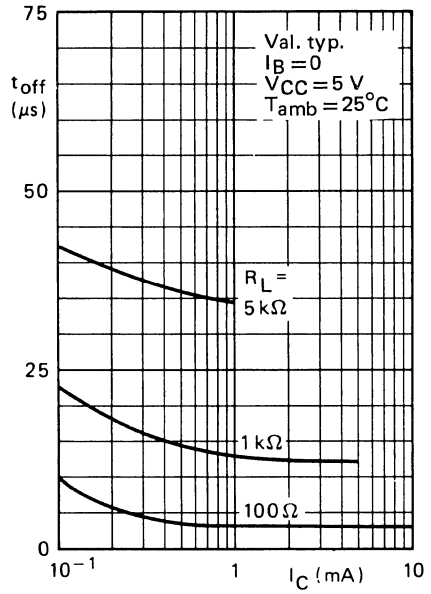

Fig. 24.

See Figs 2 and 3 in connection with Figs 23 and 24.

PHOTOCOUPLER

Optically coupled isolator consisting of an infrared emitting GaAs diode and a silicon n-p-n photo-transistor with accessible base. Plastic envelope. Suitable for TTL integrated circuits.

Features of these products:

- high output/input d.c. current transfer ratio;
- low saturation voltage;
- high isolation voltage of 3 kV (r.m.s.) and 4,3 kV (d.c.);
- working voltage 1,5 kV.

QUICK REFERENCE DATA

Diode

Continuous reverse voltage	V_R	max.	3 V
Forward current d.c. (peak value); $t_p = 10 \mu s$; $\delta = 0,1$	I_F I_{FM}	max. max.	100 mA 1000 mA
Total power dissipation up to $T_{amb} = 25 \text{ }^\circ\text{C}$	P_{tot}	max.	150 mW

Transistor

Collector-emitter voltage (open base)	V_{CEO}	max.	80 V
Total power dissipation up to $T_{amb} = 25 \text{ }^\circ\text{C}$	P_{tot}	max.	200 mW

Photocoupler

Output/input d.c. current transfer ratio $I_F = 10 \text{ mA}$; $V_{CE} = 10 \text{ V}$; ($I_B = 0$)	I_C/I_F		0,7 to 2,1
Collector cut-off current (dark) $V_{CC} = 10 \text{ V}$; working voltage (d.c.) = 1,5 kV diode; $I_F = 0$ (see also Fig. 4)	I_{CEW}	<	200 nA
Isolation voltage (d.c.) $t = 1 \text{ min}$	V_{IO}	>	4,3 kV

MECHANICAL DATA

SOT-90 (see Fig. 1).

MECHANICAL DATA

Dimensions in mm

Fig. 1 SOT-90.

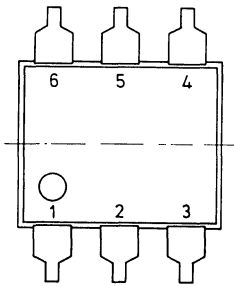
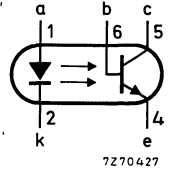
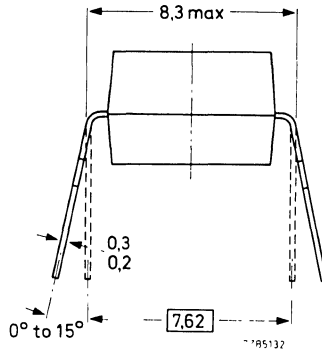
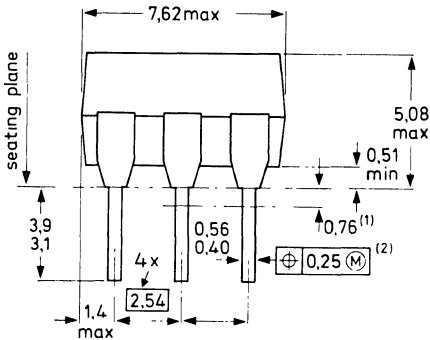

⊕ Positional accuracy.

Ⓜ Maximum Material Condition.

- (1) Lead spacing tolerances apply from seating plane to the line indicated.
- (2) Centre-lines of all leads are within $\pm 0,125$ mm of the nominal position shown; in the worst case, the spacing between any two leads may deviate from nominal by $\pm 0,25$ mm.

RATINGS

Limiting values in accordance with the Absolute Maximum System (IEC 134)

Diode

Continuous reverse voltage	V_R	max.	3 V
Forward current	I_F	max.	100 mA
d.c.	I_{FM}	max.	1000 mA
(peak value); $t_p = 10 \mu s$; $\delta = 0,1$	P_{tot}	max.	150 mW
Total power dissipation up to $T_{amb} = 25 \text{ }^\circ\text{C}$			

Transistor

Collector-base voltage (open emitter)	V_{CBO}	max.	120 V
Collector-emitter voltage (open base)	V_{CEO}	max.	80 V
Emitter-collector voltage (open base)	V_{ECO}	max.	7 V
Collector current (d.c.)	I_C	max.	100 mA
Total power dissipation up to $T_{amb} = 25 \text{ }^\circ\text{C}$	P_{tot}	max.	200 mW

Photocoupler

Storage temperature	T_{stg}	-55 to +150 °C
Operating junction temperature	T_j	max. 125 °C
Lead soldering temperature up to the seating plane; $t_{sld} < 10$ s	T_{sld}	max. 260 °C

THERMAL RESISTANCE

From junction to ambient in free air diode	$R_{th\ j-a}$	=	650 °C/W
transistor	$R_{th\ j-a}$	=	500 °C/W
From junction to ambient, device mounted on a printed-circuit board diode	$R_{th\ j-a}$	=	600 °C/W
transistor	$R_{th\ j-a}$	=	400 °C/W

CHARACTERISTICS

$T_j = 25$ °C unless otherwise specified

Diode

Forward voltage $I_F = 10$ mA	V_F	typ. <	1,2 V 1,5 V
Reverse current $V_R = 3$ V	I_R	<	10 μ A

Transistor (diode: $I_F = 0$)

Collector cut-off current (dark) $V_{CE} = 10$ V	I_{CEO}	typ. <	5 nA 50 nA
$V_{CE} = 10$ V; $T_{amb} = 70$ °C	I_{CEO}	<	10 μ A
$V_{CB} = 10$ V; $T_{amb} = 25$ °C	I_{CBO}	<	20 nA

Photocoupler ($I_B = 0$) *

Output/input d.c. current transfer ratio $I_F = 10$ mA; $V_{CE} = 10$ V	I_C/I_F		0,7 to 2,1
$I_F = 16$ mA; $V_{CE} = 0,4$ V	I_C/I_F	>	0,5
Collector-emitter saturation voltage $I_F = 16$ mA; $I_C = 2$ mA	V_{CEsat}	typ. <	0,2 V 0,4 V
Isolation voltage, d.c. value **	V_{IO}	>	4,3 kV

* Where the phototransistor receives light from the diode the O (for open base) has been omitted from the symbols.

** Tested with a d.c. voltage for 1 minute between shorted input leads and shorted output leads.

Collector capacitance at $f = 1 \text{ MHz}$

$I_E = I_e = 0; V_{CB} = 10 \text{ V}$

C_c typ. 6 pF

Capacitance between input and output

$I_F = 0; V = 0; f = 1 \text{ MHz}$

C_{io} typ. 0,6 pF

Insulation resistance between input and output

$\pm V_{IO} = 1 \text{ kV}$

$r_{IO} > 10^{10} \Omega$
typ. $10^{12} \Omega$

Switching times (see Figs 2 and 3)

$I_{Con} = 4 \text{ mA}; V_{CC} = 5 \text{ V}; R_L = 100 \Omega$

Turn-on time

t_{on} typ. 5 μs

Turn-off time

t_{off} typ. 5 μs

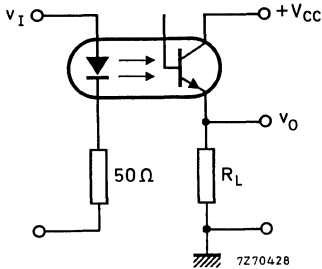

Fig. 2 Switching circuit.

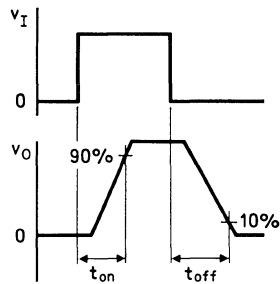

Fig. 3 Waveforms.

Collector cut-off current (dark) see Fig. 4

$V_{CC} = 10 \text{ V};$ working voltage (d.c.) = 1,5 kV

$I_{CEW} < 200 \text{ nA}^*$

$V_{CC} = 10 \text{ V};$ working voltage (d.c.) = 1,5 kV; $T_j = 70 \text{ }^\circ\text{C}$

$I_{CEW} < 100 \text{ } \mu\text{A}^*$

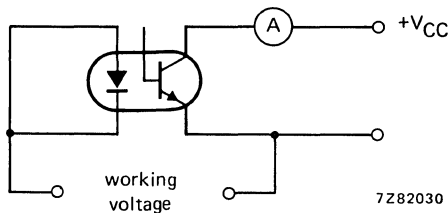

Fig. 4.

* As quality assurance (on a sample basis), these parameters are covered by a 1000 h reliability test.

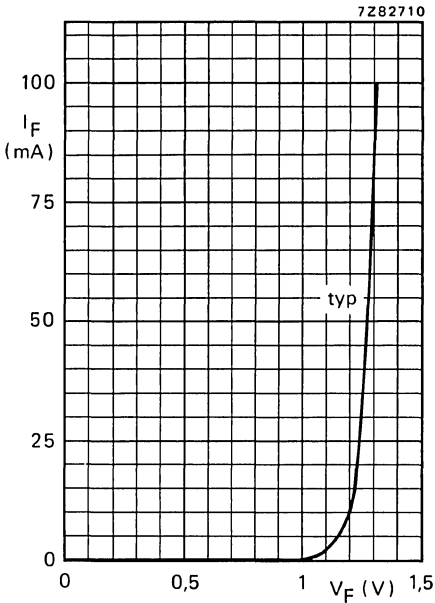

Fig. 5 $T_{amb} = 25^{\circ}C$.

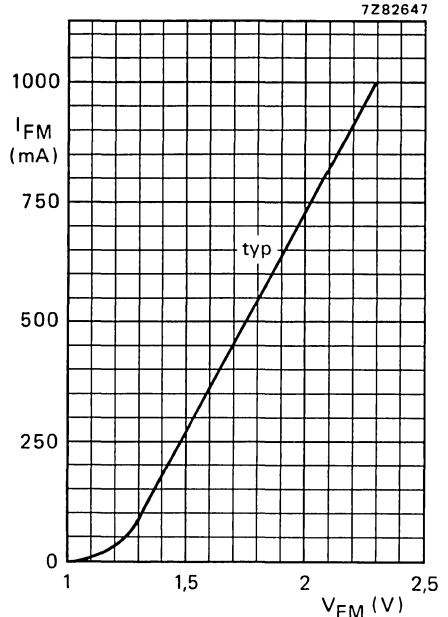

Fig. 6 $T_{amb} = 25^{\circ}C$; $t_p = 10 \mu s$; $T = 1 ms$.

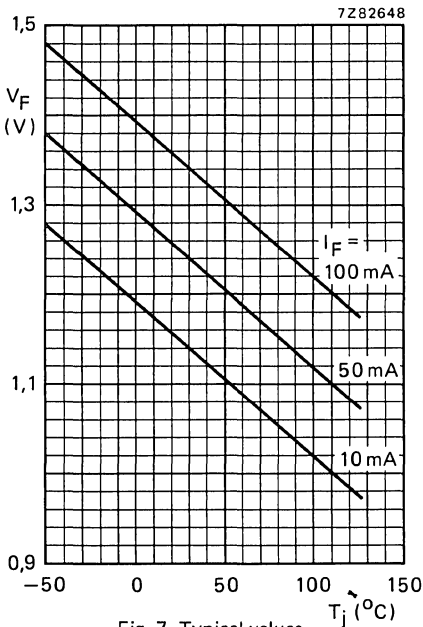

Fig. 7 Typical values.

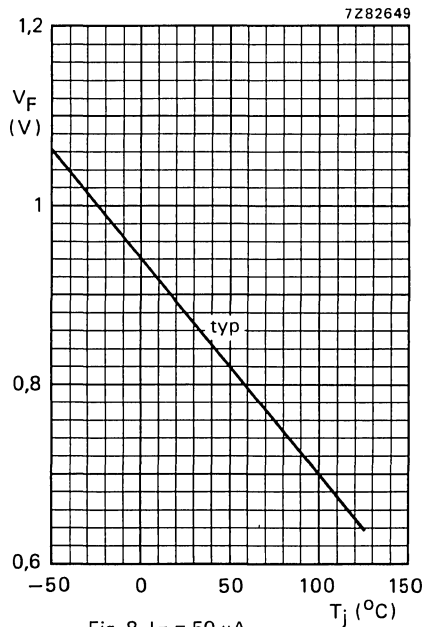

Fig. 8 $I_F = 50 \mu A$.

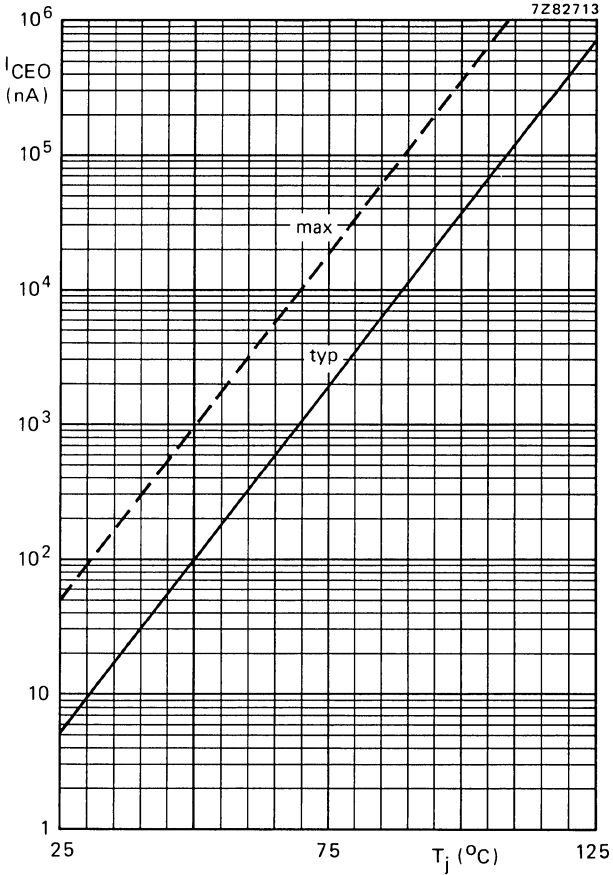

Fig. 9 $I_F = 0$; $V_{\text{CE}} = 10 \text{ V}$.

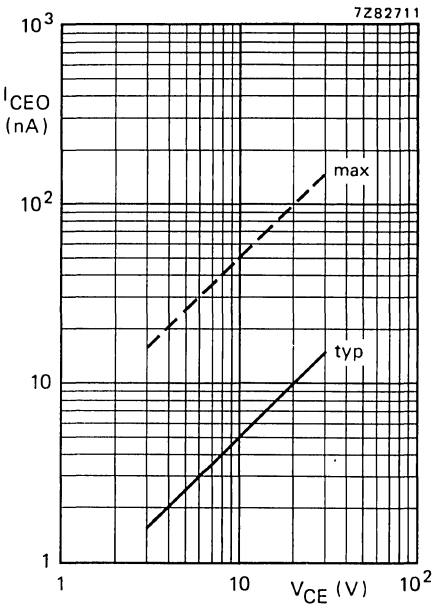

Fig. 10 $I_F = 0$; $T_j = 25$ °C.

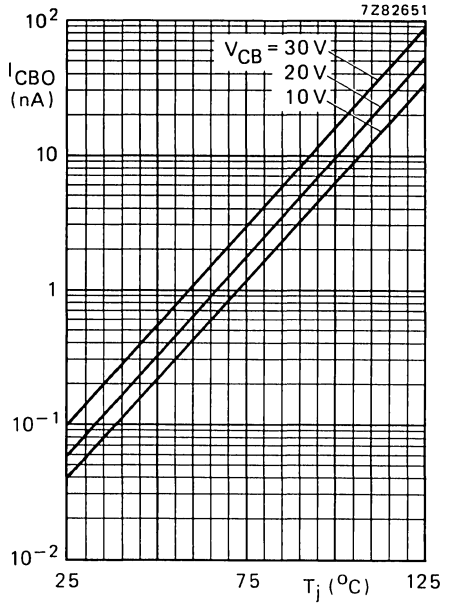

Fig. 11 Typical values.

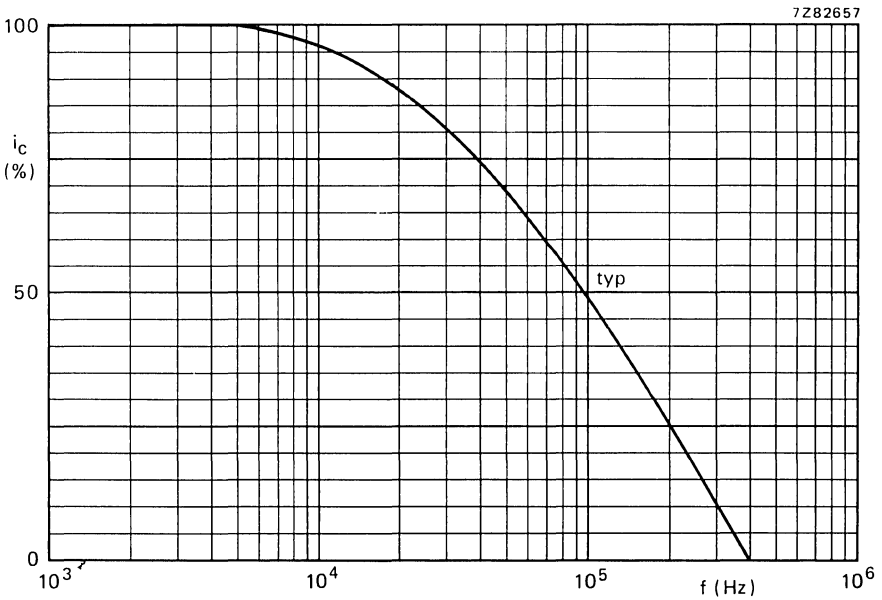

Fig. 12 $I_B = 0$; $I_C = 2$ mA; $V_{CC} = 5$ V; $R_L = 1$ k Ω ; $T_{amb} = 25$ °C.

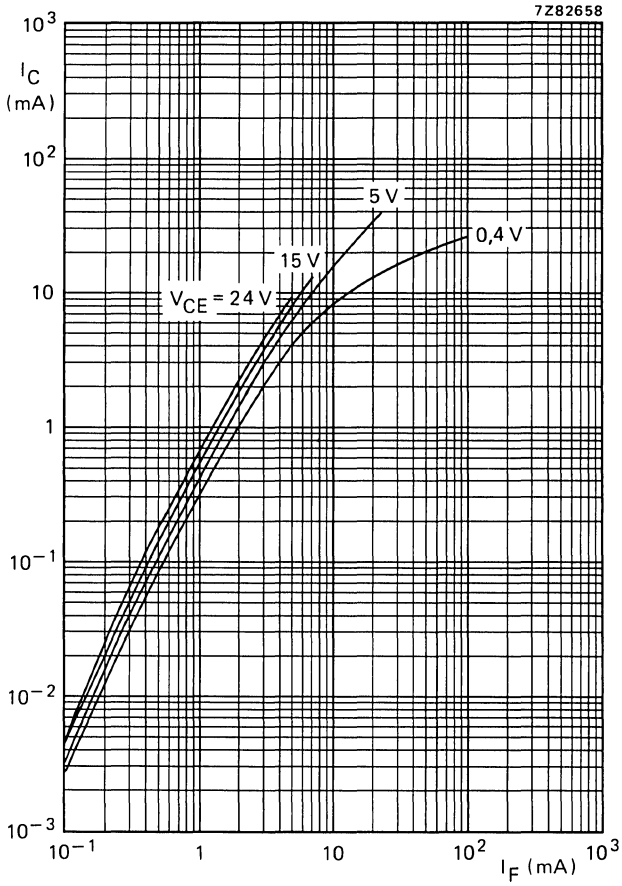

Fig. 13 $T_{amb} = 25 \text{ }^\circ\text{C}$, typical values.

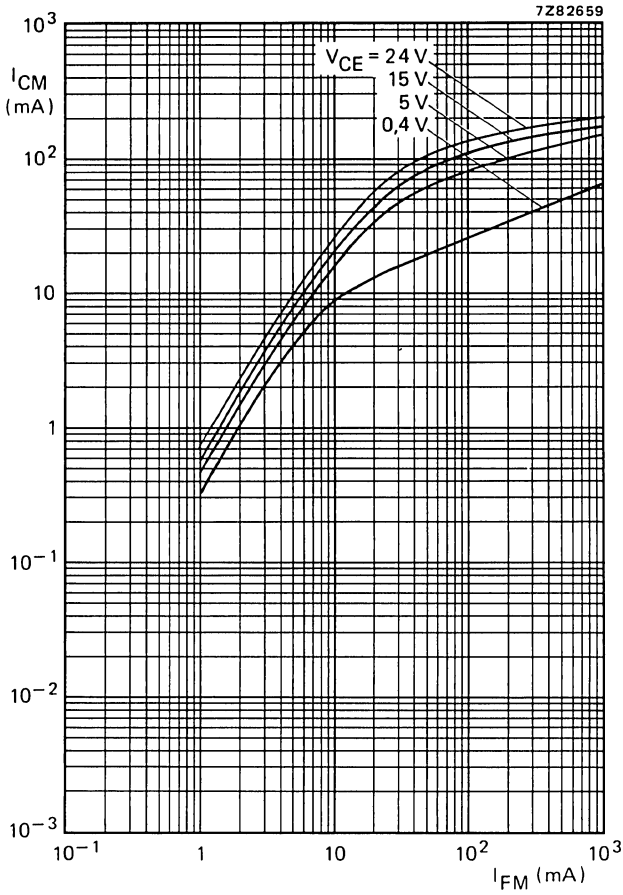

Fig. 14 $T_{amb} = 25\text{ }^{\circ}\text{C}$; $t_p = 10\text{ }\mu\text{s}$; $T = 1\text{ ms}$; typical values.

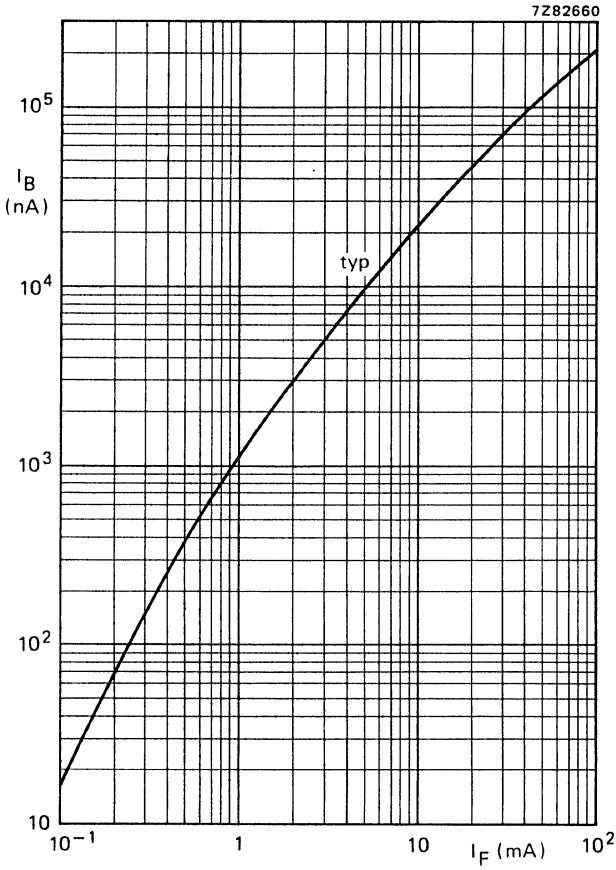

Fig. 15 $V_{CB} = 5 \text{ V}; T_{amb} = 25 \text{ }^\circ\text{C}.$

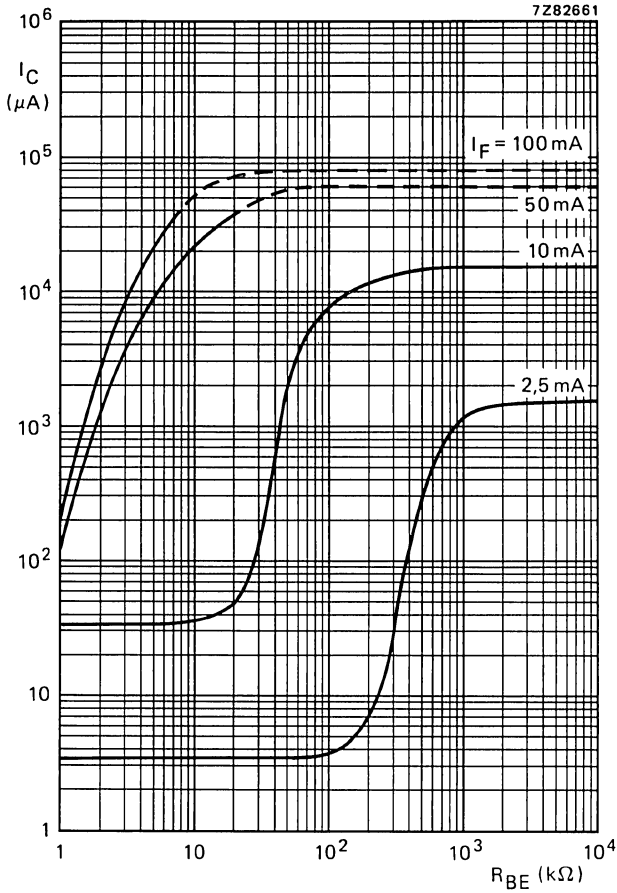

Fig. 16 $I_B = 0$; $V_{CE} = 5 \text{ V}$; $T_{amb} = 25 \text{ }^\circ\text{C}$; typical values.

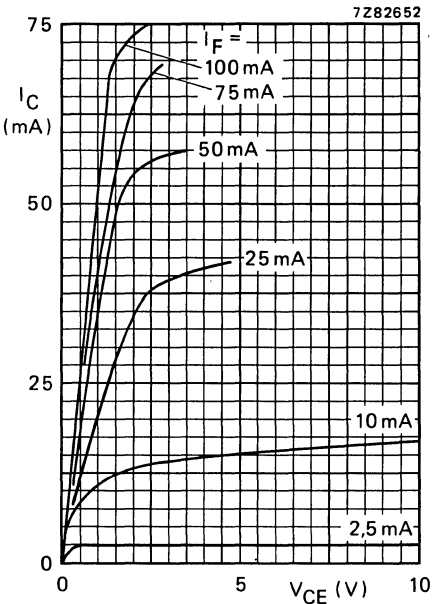

Fig. 17 $T_{amb} = 25^\circ C$; typical values.

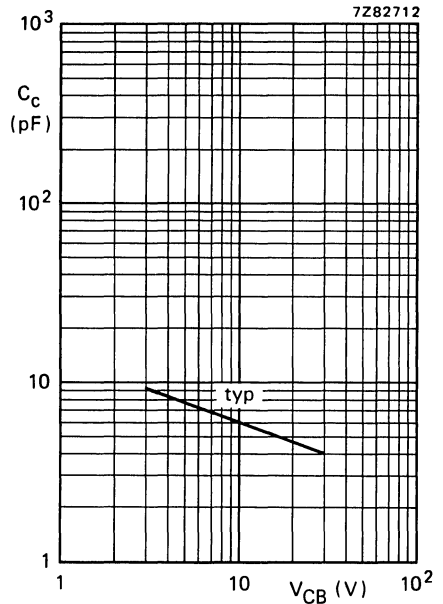

Fig. 18 $f = 1$ MHz; $T_{amb} = 25^\circ C$.

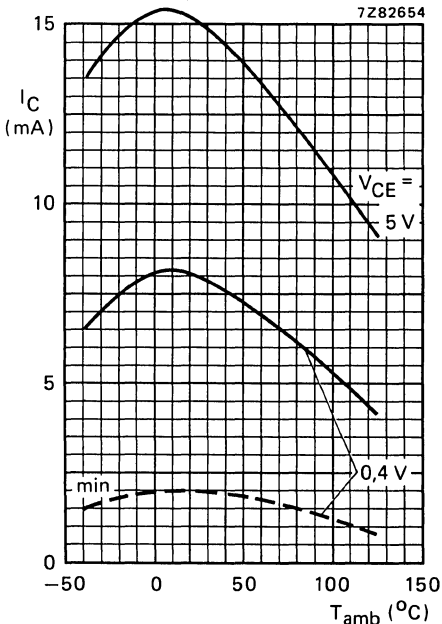

Fig. 19 $I_B = 0$; $I_F = 10$ mA; — typ. values.

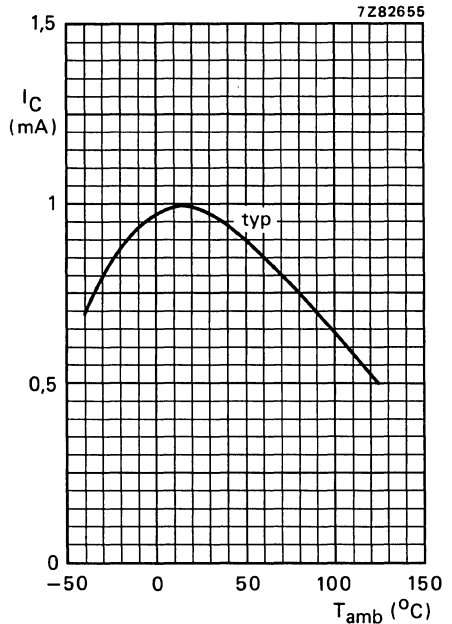

Fig. 20 $I_F = 2$ mA; $V_{CE} = 0.4$ V.

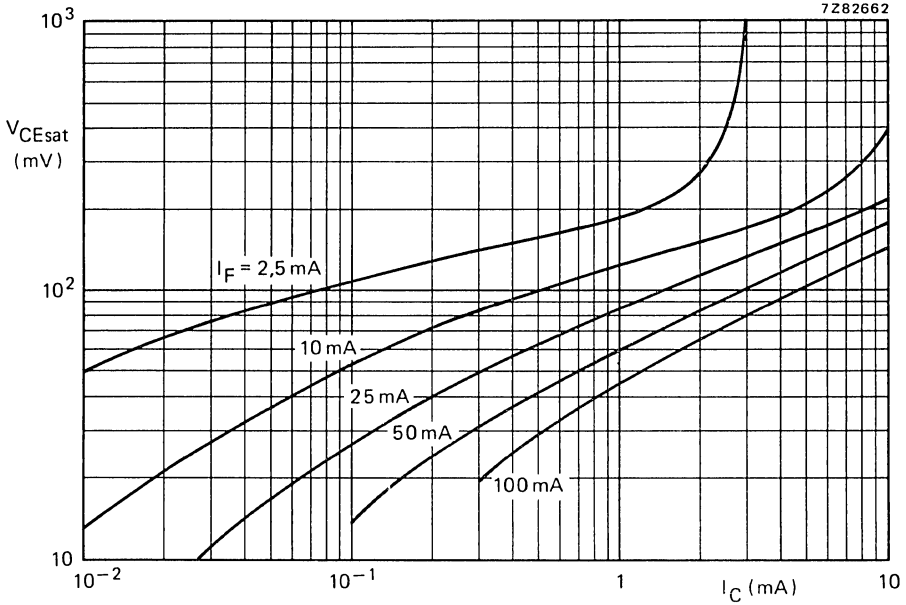

Fig. 21 $I_B = 0$; $T_{amb} = 25^\circ C$; typical values.

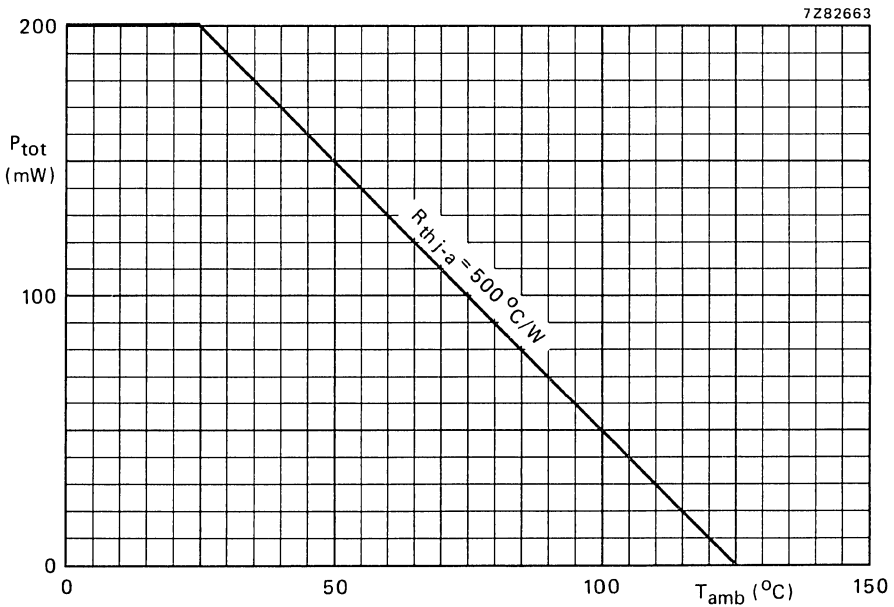

Fig. 22 Max. permissible power dissipation for total device versus ambient temperature.

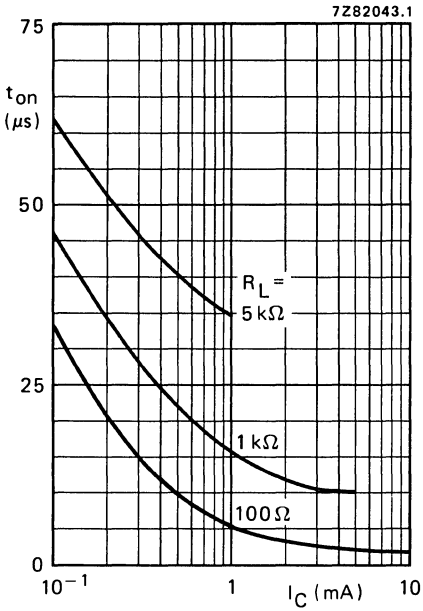

Fig. 23 $I_B = 0$; $V_{CC} = 5 V$; $T_{amb} = 25^\circ C$; typical values. (See also Fig. 25)

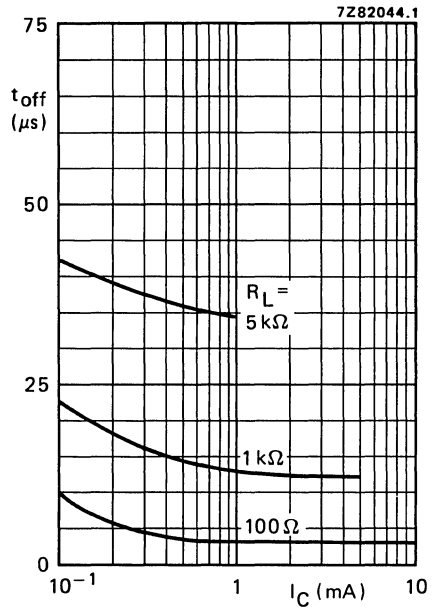

Fig. 24 $I_B = 0$; $V_{CC} = 5 V$; $T_{amb} = 25^\circ C$; typical values. (See also Fig. 25.)

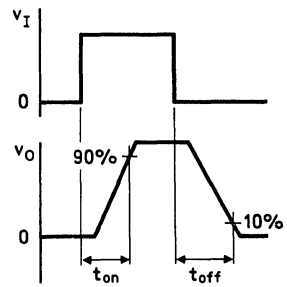
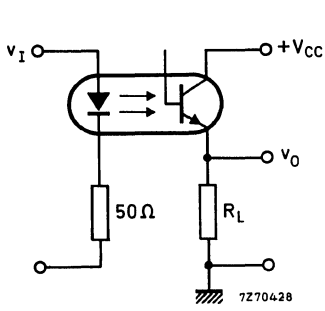

Fig. 25 Switching circuit and waveforms.

DEVELOPMENT SAMPLE DATA

This information is derived from development samples made available for evaluation. It does not necessarily imply that the device will go into regular production.

CNX44

HIGH-VOLTAGE OPTOCOUPLER

The CNX44 is an optocoupler hermetically sealed in a metal envelope. It has a high reliability and can be used under severe conditions such as in military or industrial applications.

An outstanding characteristic is the high common-mode rejection ratio.

QUICK REFERENCE DATA

Diode

Continuous reverse voltage	V_R	max.	3 V
Forward current			
d.c.	I_F	max.	100 mA
peak value; $t_{ON} = 10 \mu s$; $\delta = 0,01$	I_{FM}	max.	3 A
Total power dissipation up to $T_{amb} = 75 \text{ }^\circ\text{C}$ mounted on a p.c.b.	P_{tot}	max.	150 mW

Transistor

Collector-emitter voltage (open base)	V_{CEO}	max.	50 V
Total power dissipation up to $T_{amb} = 75 \text{ }^\circ\text{C}$ mounted on a p.c.b.	P_{tot}	max.	150 mW

Photocoupler

Output/input d.c. current transfer ratio $I_F = 10 \text{ mA}$; $V_{CE} = 0,4 \text{ V}$	I_C/I_F	min.	0,3
Collector cut-off current (dark) $V_{CE} = 15 \text{ V}$; working voltage (d.c.) = 1,0 kV I_F (diode) = 0 (see note)	I_{CEW}	max.	200 nA
Test isolation voltage (d.c.)	V_{IO}	max.	1 kV
Common-mode rejection ratio $I_C = 2 \text{ mA}$; $f = 10 \text{ kHz}$ (see Fig. 2)	CM_{RR}	typ.	-85 dB

MECHANICAL DATA

See Fig. 1.

4

MECHANICAL DATA

Fig. 1 SOT-104C.

Dimensions in mm

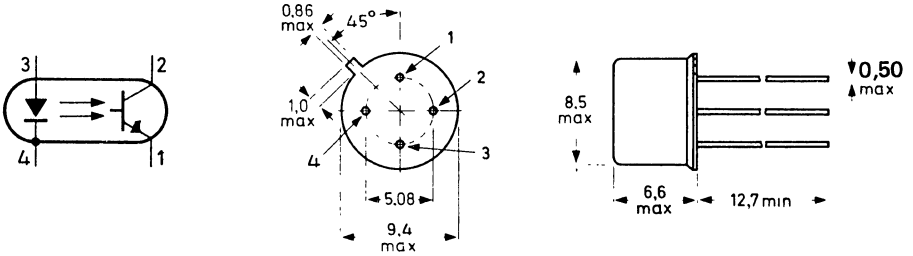

Fig. 1.

RATINGS

Limiting values in accordance with the Absolute Maximum System (IEC 134)

Diode

Continuous reverse voltage	V_R	max.	3 V
Forward current d.c.	I_F	max.	100 mA
peak value; $t_{on} = 10 \mu s$; $\delta = 0,01$	I_{FM}	max.	3 A

Transistor

Collector-emitter voltage (open base)	V_{CEO}	max.	50 V
Emitter-collector voltage	V_{ECO}	max.	7 V
Collector current (d.c.)	I_C	max.	100 mA

Photocoupler

Storage temperature	T_{stg}	-65 to + 150 °C
Operating ambient temperature	T_{amb}	-55 to + 125 °C
Total power dissipation of diode and transistor up to $T_{amb} = 75 \text{ °C}$	P_{tot}	max. 300 mW

THERMAL RESISTANCE

From junction to ambient when mounted on p.c.b.

diode	$R_{th\ j-a}$	max.	330 K/W
transistor	$R_{th\ j-a}$	max.	330 K/W

CHARACTERISTICS

 $T_j = 25\text{ }^\circ\text{C}$ unless otherwise specified

Diode

Forward voltage

 $I_F = 10\text{ mA}$

V_F	typ.	1,15 V
	max.	1,30 V

 $I_F = 2\text{ mA}; T_{\text{amb}} = 0\text{ to }70\text{ }^\circ\text{C}$

V_F	max.	1,20 V
-------	------	--------

Reverse current

 $V_R = 3\text{ V}$

I_R	typ.	1 μA
	max.	100 μA

Transistor

Collector-emitter breakdown voltage

 $I_C = 1\text{ mA}$

$V_{(\text{BR})\text{CEO}}$	min.	50 V
-----------------------------	------	------

Emitter-collector breakdown voltage

 $I_E = 0,1\text{ mA}$

$V_{(\text{BR})\text{ECO}}$	min.	7 V
-----------------------------	------	-----

Collector cut-off current (dark); diode $I_F = 0$ $V_{\text{CE}} = 20\text{ V}$

I_{CEO}	typ.	5 nA
	max.	100 nA

 $V_{\text{CE}} = 20\text{ V}; T_{\text{amb}} = 70\text{ }^\circ\text{C}$

I_{CEO}	max.	10 μA
------------------	------	------------------

D.C. current gain

 $I_C = 10\text{ mA}; V_{\text{CE}} = 5\text{ V}$

h_{FE}	typ.	600
-----------------	------	-----

Photocoupler

Collector current

 $I_F = 10\text{ mA}; V_{\text{CE}} = 0,4\text{ V}$

I_C	min.	3 mA
	typ.	6 mA

 $I_F = 10\text{ mA}; V_{\text{CE}} = 5\text{ V}$

I_C	typ.	10 mA
-------	------	-------

Switching times (see Figs 4 and 5)

 $I_C = 2\text{ mA}; V_{\text{CC}} = 5\text{ V}; R_L = 100\ \Omega$

t_{on}	typ.	5 μs
t_{off}	typ.	5 μs

Collector cut-off current (dark) at working voltage $V_W = 1\text{ kV}$ (d.c. value); $V_{\text{CC}} = 15\text{ V}; T_j = 25\text{ }^\circ\text{C}$ (see note) $V_{\text{CC}} = 15\text{ V}; T_j = 70\text{ }^\circ\text{C}$ (see note)

I_{CEW}	max.	200 nA
	max.	50 μA

Test isolation voltage (d.c. value) between shorted input and shorted output terminals

V_{IO}	max.	1 kV
-----------------	------	------

Capacitance between input and output

 $V = 0; f = 1\text{ MHz}$

C_{IO}	typ.	1 pF
-----------------	------	------

Insulation resistance between input and output

 $V_{\text{IO}} = 500\text{ V}$

R_{IO}	min.	100 G Ω
	typ.	1000 G Ω

Common-mode rejection ratio (see Fig. 2)

 $I_C = 2\text{ mA}; f = 10\text{ kHz}$

CMRR	typ.	-85 dB
---------------	------	--------

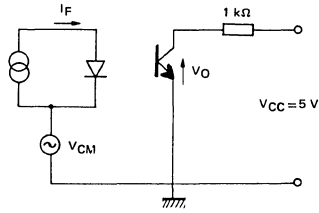

Fig. 2.

Note (see Fig. 3):

Collector cut-off current (dark) at
 working voltage $V_W = 1$ kV (d.c. value);
 $V_{CC} = 10$ V; $T_j = 25$ °C
 $V_{CC} = 10$ V; $T_j = 70$ °C

I_{CEW}	max.	200 nA*
	max.	50 μ A*

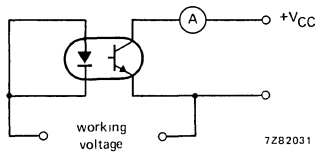

Fig. 3 $V_W = 1$ kV (d.c.); $V_{CC} = 10$ V.

* The two parameters are tested on a sample basis for 1000 h.

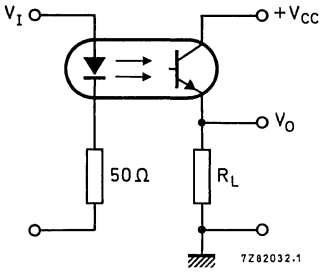

Fig. 4.

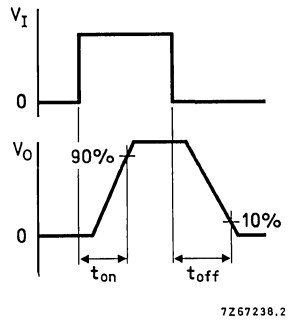

Fig. 5.

DEVELOPMENT SAMPLE DATA

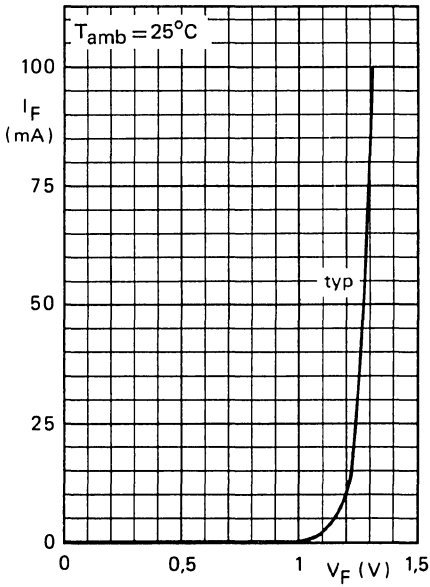

Fig. 6.

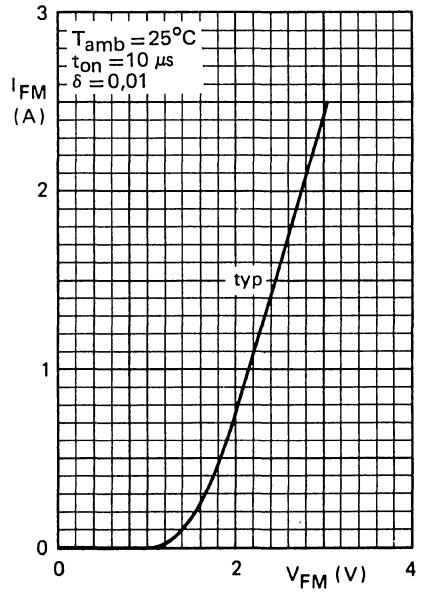

Fig. 7.

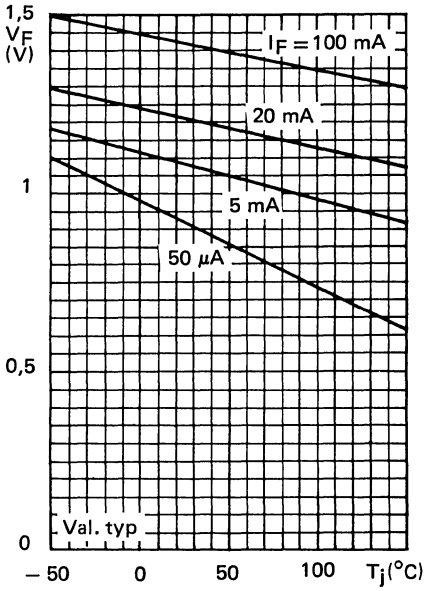

Fig. 8.

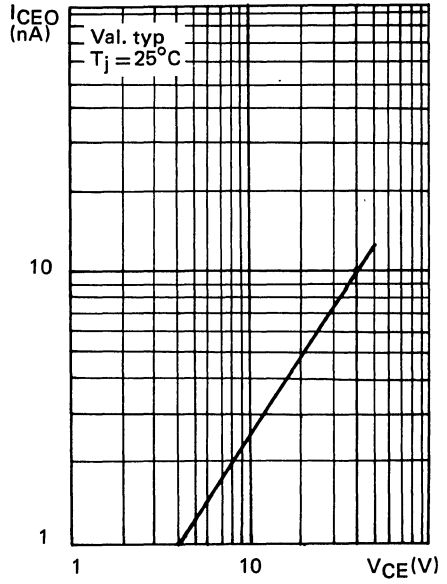

Fig. 9.

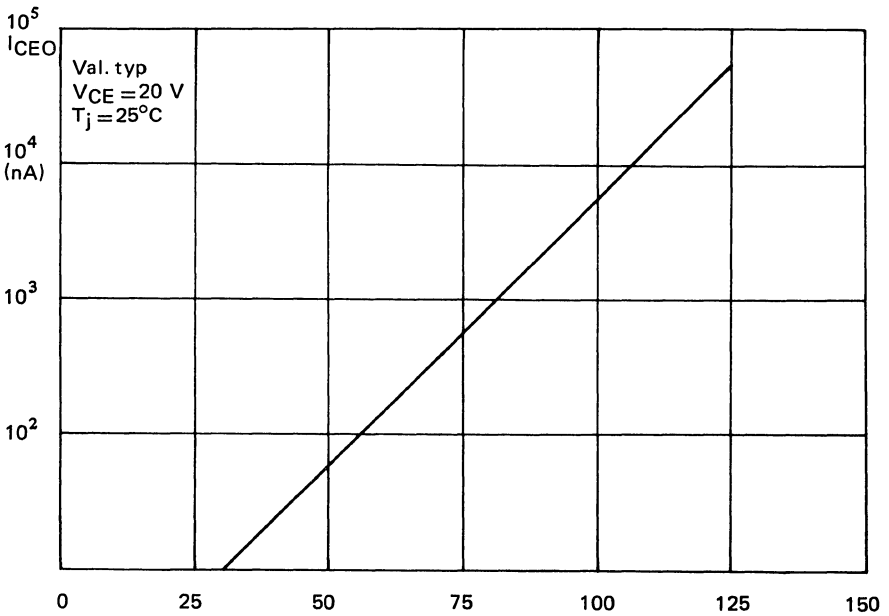

Fig. 10.

DEVELOPMENT SAMPLE DATA

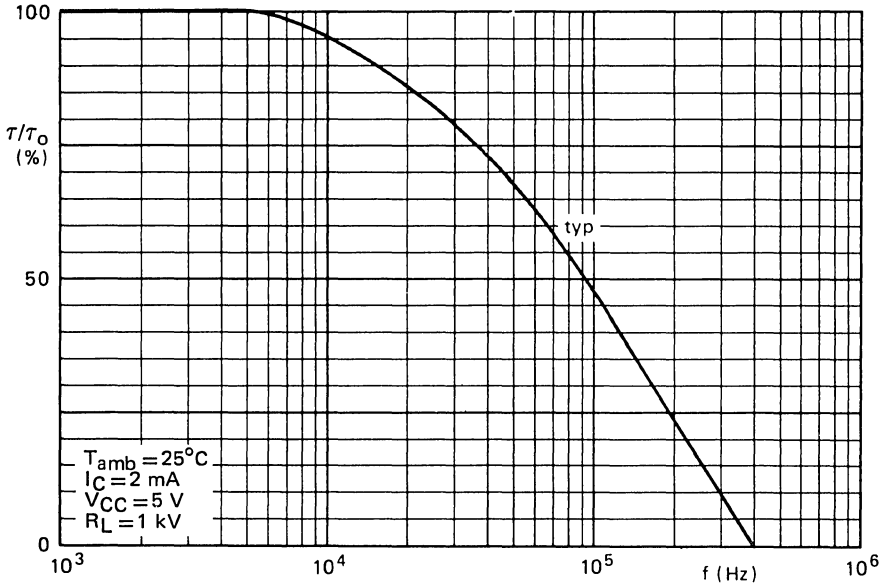

Fig. 11.

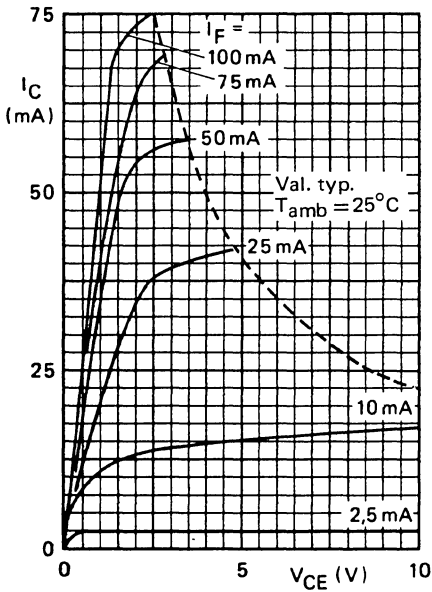

Fig. 12.

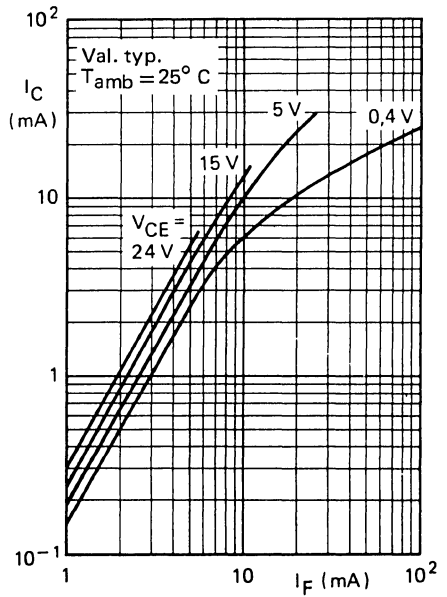

Fig. 13.

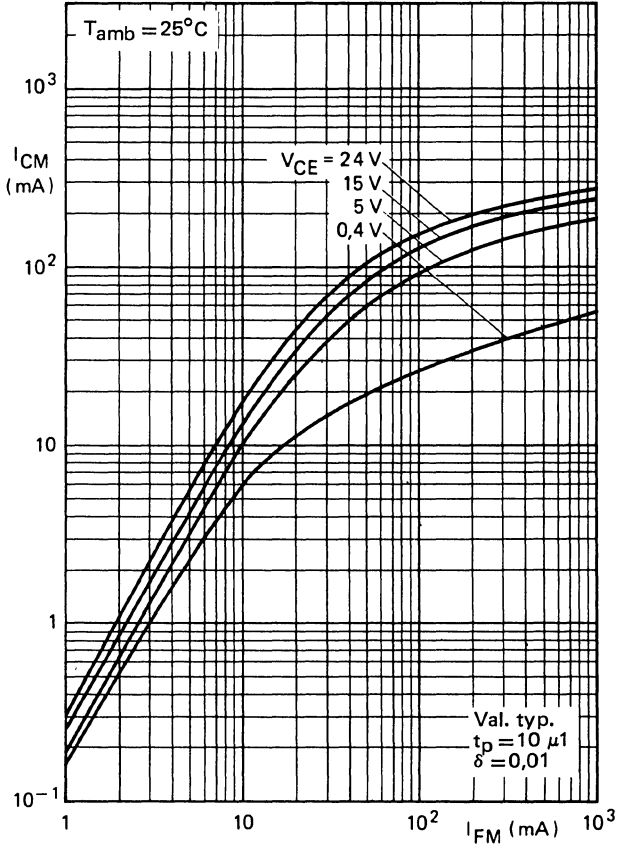

Fig. 14.

DEVELOPMENT SAMPLE DATA

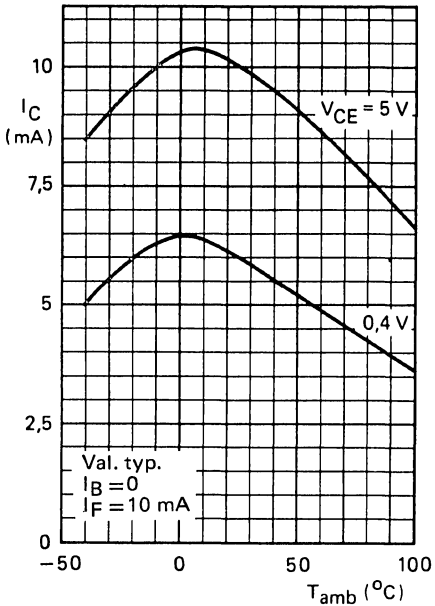

Fig. 15.

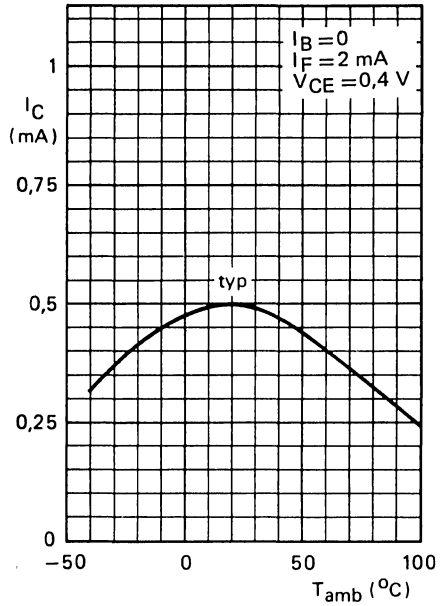

Fig. 16.

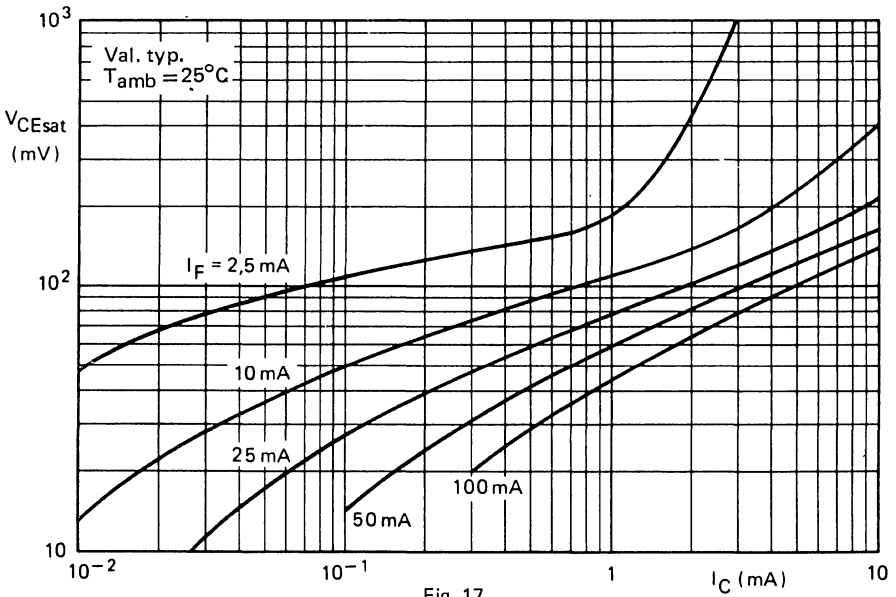

Fig. 17.

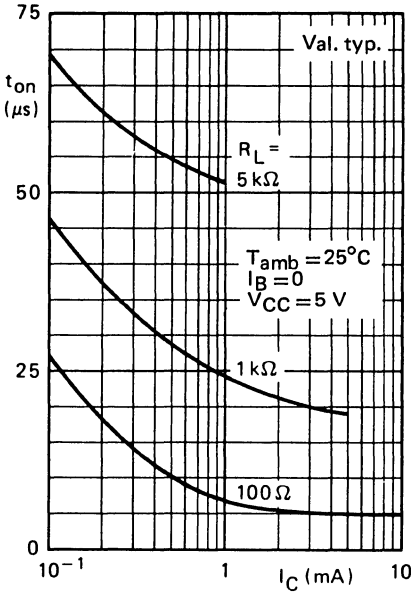

Fig. 18.

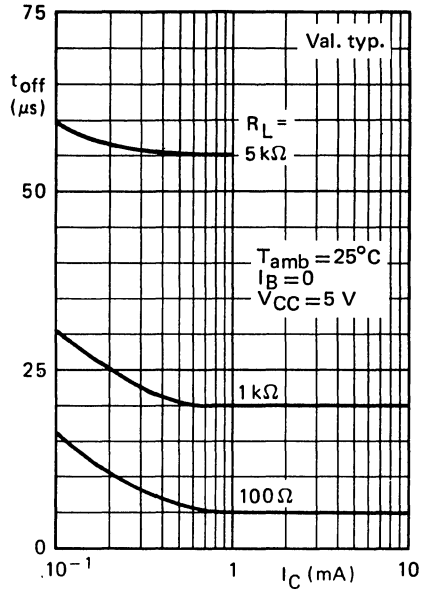

Fig. 19.

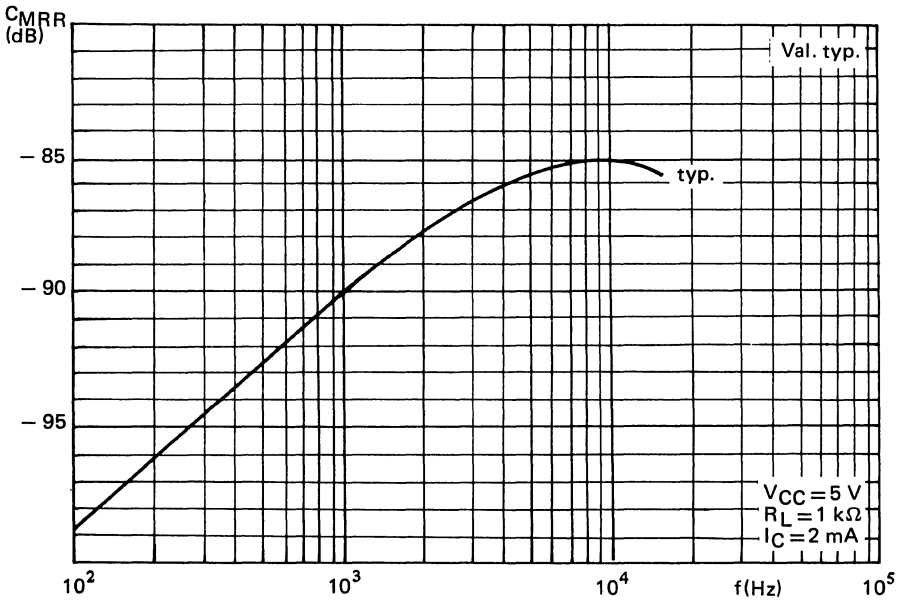

Fig. 20.

DEVELOPMENT SAMPLE DATA

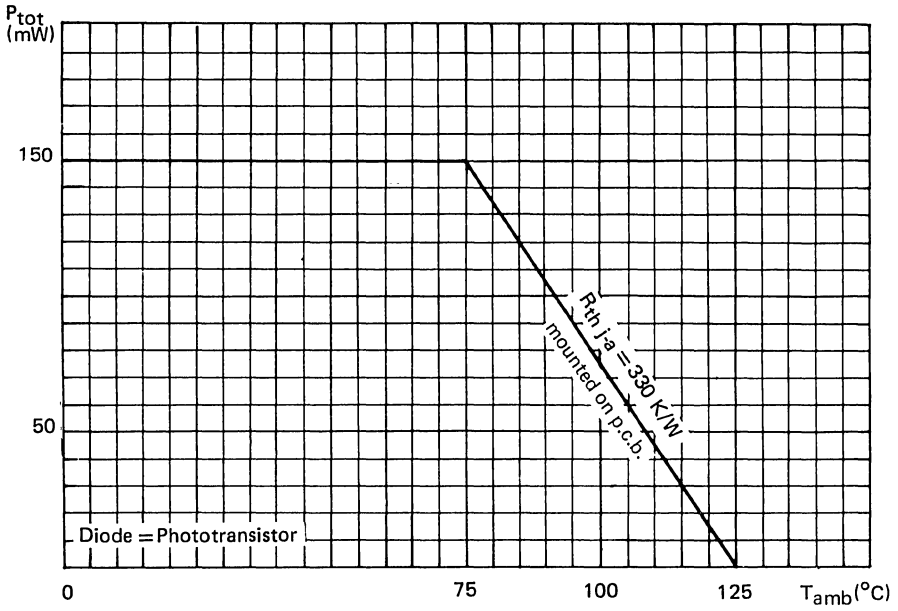

Fig. 21.

PHOTOCOUPLER

Opto-isolator comprising an infrared emitting GaAs diode and a silicon n-p-n Darlington phototransistor with accessible base. Plastic 6-lead dual-in line (DIL) envelope.

Features:

- very high output/input d.c. current transfer ratio;
- high isolation voltage of 3 kV (r.m.s.) and 4,4 kV (d.c.);
- working voltage 1,5 kV.

QUICK REFERENCE DATA

Diode

Continuous reverse voltage	V_R	max.	3 V
Forward current d.c. (peak value); $t_p = 10 \mu\text{s}$; $\delta = 0,1$	I_F I_{FM}	max. max.	100 mA 3 A
Total power dissipation up to $T_{amb} = 25^\circ\text{C}$	P_{tot}	max.	200 mW

Transistor

Collector-emitter voltage (open base)	V_{CEO}	max.	30 V
Total power dissipation up to $T_{amb} = 25^\circ\text{C}$	P_{tot}	max.	200 mW

Photocoupler

Output/input d.c. current transfer ratio $I_F = 1 \text{ mA}$; $V_{CE} = 1 \text{ V}$; ($I_B = 0$)	I_C/I_F	min.	5
Collector cut-off current (dark) $V_{CC} = 10 \text{ V}$; working voltage (d.c.) = 1,5 kV diode: $I_F = 0$ (see also Fig. 2)	I_{CEW}	max.	1 μA
Isolation voltage (d.c.) $t = 1 \text{ min}$	V_{IO}	max.	4,4 kV

MECHANICAL DATA

SOT-90B (see Fig. 1).

MECHANICAL DATA

Dimensions in mm

Fig. 1 SOT-90B.

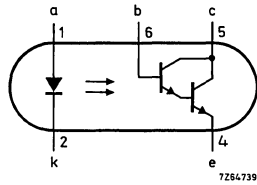

3 = n.c.

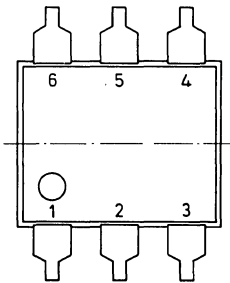
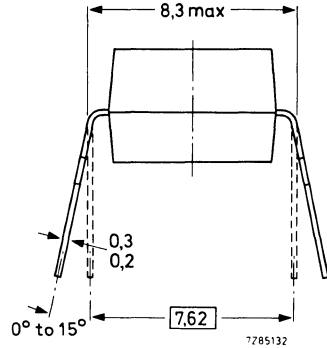
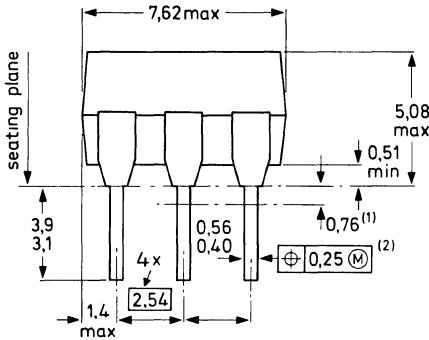

⊕ Positional accuracy.

Ⓜ Maximum material condition.

- (1) Lead spacing tolerances apply from seating plane to the line indicated.
- (2) Centre-lines of all leads are within $\pm 0,125$ mm of the nominal position shown; in the worst case, the spacing between any two leads may deviate from nominal by $\pm 0,25$ mm.

RATINGS

Limiting values in accordance with the Absolute Maximum System (IEC 134)

Diode

Continuous reverse voltage	V_R	max.	3 V
Forward current	I_F	max.	100 mA
d.c.	I_{FM}	max.	3 A
(peak value); $t_p = 10 \mu s$; $\delta = 0,1$	P_{tot}	max.	200 mW
Total power dissipation up to $T_{amb} = 25 \text{ }^\circ\text{C}$	T_j	max.	125 $^\circ\text{C}$
Junction temperature			

Transistor

Collector-emitter voltage (open base)	V_{CEO}	max.	30 V
Collector-base voltage (open emitter)	V_{CBO}	max.	30 V
Emitter-collector voltage (open base)	V_{ECO}	max.	6 V
Collector current (d.c.)	I_C	max.	100 mA
Total power dissipation up to $T_{amb} = 25\text{ }^\circ\text{C}$	P_{tot}	max.	200 mW
Junction temperature	T_j	max.	125 $^\circ\text{C}$

Photocoupler

Storage temperature	T_{stg}	-55 to +125 $^\circ\text{C}$	
Lead soldering temperature up to the seating plane; $t_{sld} < 10\text{ s}$	T_{sld}	max.	260 $^\circ\text{C}$

THERMAL RESISTANCE

From junction to ambient in free air diode and transistor	$R_{th\ j-a}$	=	500 K/W
From junction to ambient, device mounted on a printed-circuit board diode and transistor	$R_{th\ j-a}$	=	400 K/W

CHARACTERISTICS

$T_j = 25\text{ }^\circ\text{C}$ unless otherwise specified

Diode

Forward voltage $I_F = 10\text{ mA}$	V_F	typ.	1,15 V
		max.	1,3 V
Reverse current $V_R = 3\text{ V}$	I_R	max.	10 μA

Transistor (diode; $I_F = 0$)

Collector cut-off current (dark) $V_{CE} = 10\text{ V}$	I_{CEO}	typ.	20 nA
		max.	100 nA
$V_{CB} = 10\text{ V}$	I_{CEO}	max.	20 nA

Photocoupler ($I_B = 0$)*

Output/input d.c. current transfer ratio $I_F = 0,5\text{ mA}$; $V_{CE} = 1\text{ V}$	I_C/I_F	min.	3,5
$I_F = 1,0\text{ mA}$; $V_{CE} = 1\text{ V}$	I_C/I_F	min.	5
$I_F = 10\text{ mA}$; $V_{CE} = 1\text{ V}$	I_C/I_F	min.	6

* Where the phototransistor receives light from the diode the O (for open base) has been omitted from the symbols.

Collector cut-off current (dark) see Fig. 2

$V_{CC} = 10\text{ V}$; working voltage (d.c.) = 1,5 kV

$V_{CC} = 10\text{ V}$; working voltage (d.c.) = 1,5 kV; $T_j = 70\text{ }^\circ\text{C}$

Collector-emitter saturation voltage

$I_F = 5\text{ mA}$; $I_C = 10\text{ mA}$

Isolation voltage, d.c. value*

Collector capacitance at $f = 1\text{ MHz}$

$I_E = I_e = 0$; $V_{CB} = 10\text{ V}$

Capacitance between input and output

$I_F = 0$; $V = 0$; $f = 1\text{ MHz}$

Insulation resistance between input and output

$\pm V_{IO} = 1\text{ kV}$

Switching times (see Figs 3 and 4)

$I_{Fon} = 1\text{ mA}$; $V_{CC} = 5\text{ V}$; $R_E = 100\text{ }\Omega$; $R_{BE} = 1\text{ M}\Omega$

$I_{Fon} = 10\text{ mA}$; $V_{CC} = 5\text{ V}$; $R_E = 1\text{ k}\Omega$; $R_{BE} = 10\text{ M}\Omega$

I_{CEW} max. 1 μA^*

I_{CEW} max. 1000 μA^*

V_{CEsat} max. 1 V

V_{IO} max. 4,4 kV**

C_c typ. 4,5 pF

C_{io} typ. 0,6 pF

r_{IO} min. $10^{10}\text{ }\Omega$

typ. $10^{12}\text{ }\Omega$

t_{on} typ. 5 μs

t_{off} typ. 30 μs

t_{on} typ. 50 μs

t_{off} typ. 250 μs

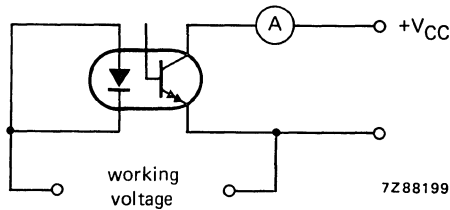

Fig. 2.

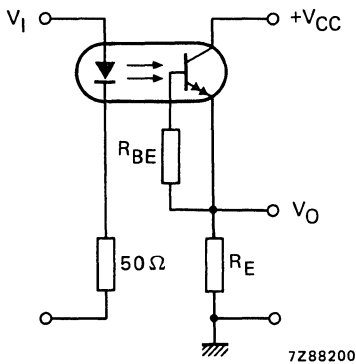

Fig. 3 Switching circuit.

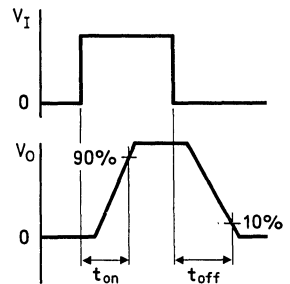

Fig. 4 Waveforms.

* As quality assurance (on a sample basis), these parameters are covered by a 1000 h reliability test.

** Tested with a d.c. voltage for 1 minute between shorted input leads and shorted output leads.

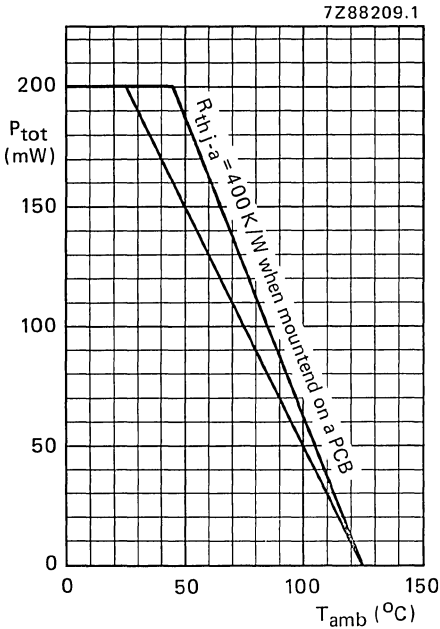

Fig. 5 Power derating curve for diode and transistor as a function of temperature.

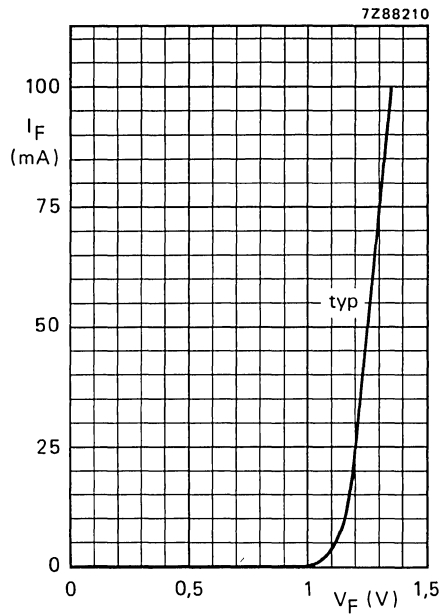

Fig. 6 $T_{amb} = 25^{\circ}C$.

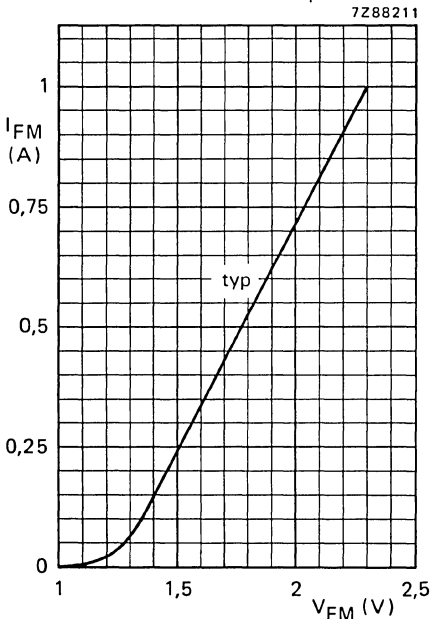

Fig. 7 $T_{amb} = 25^{\circ}C$; $t_p = 10 \mu s$; $\delta = 0,01$.

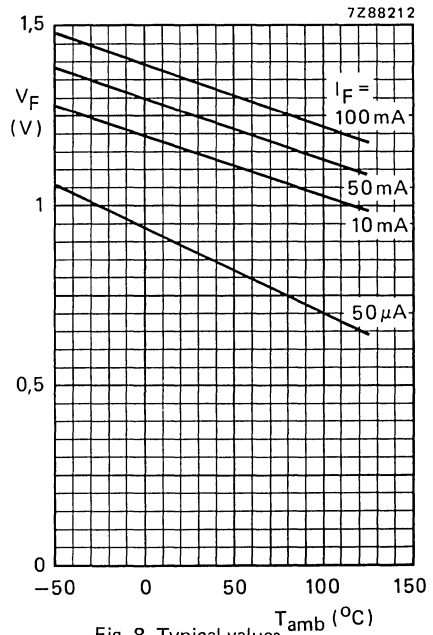

Fig. 8 Typical values.

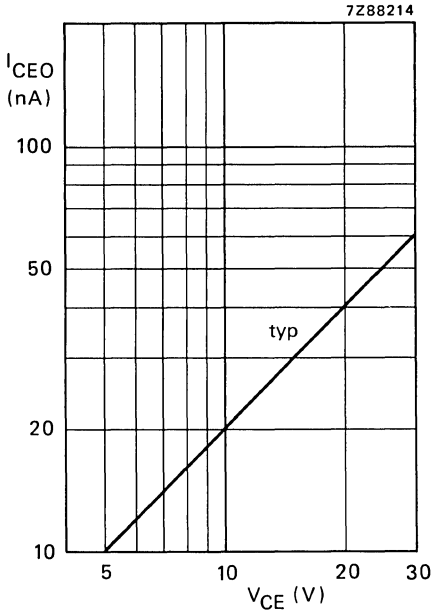

Fig. 9 $I_F = 0$; $T_j = 25^\circ\text{C}$.

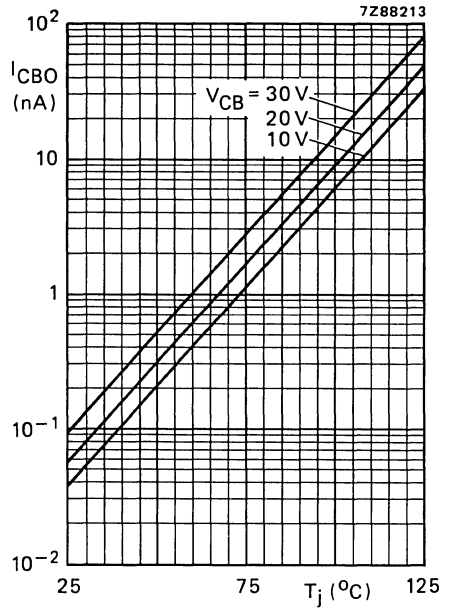

Fig. 10 Typical values.

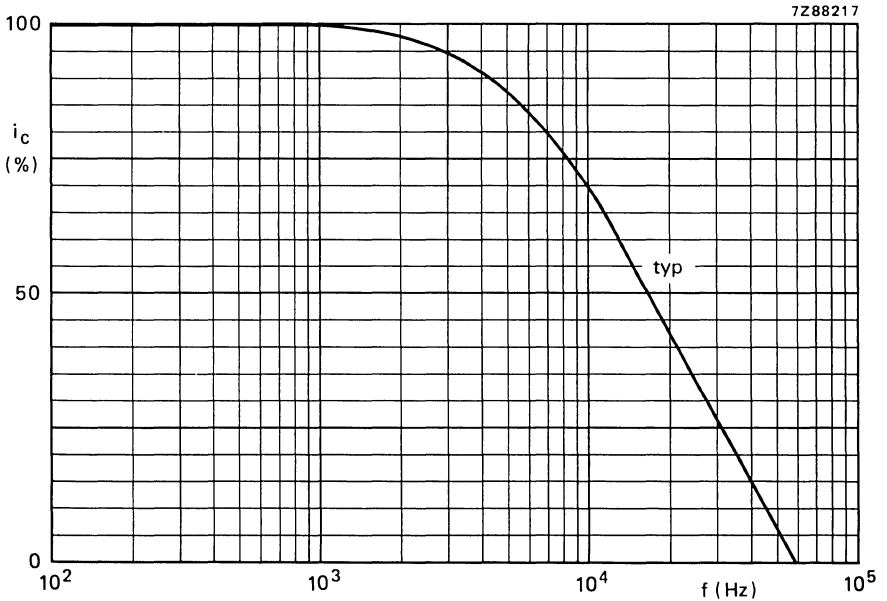

Fig. 11 $I_C = 10\text{ mA}$; $V_{CC} = 5\text{ V}$; $R_E = 100\ \Omega$; $R_{BE} = 1\text{ M}\Omega$; see also Fig. 4.

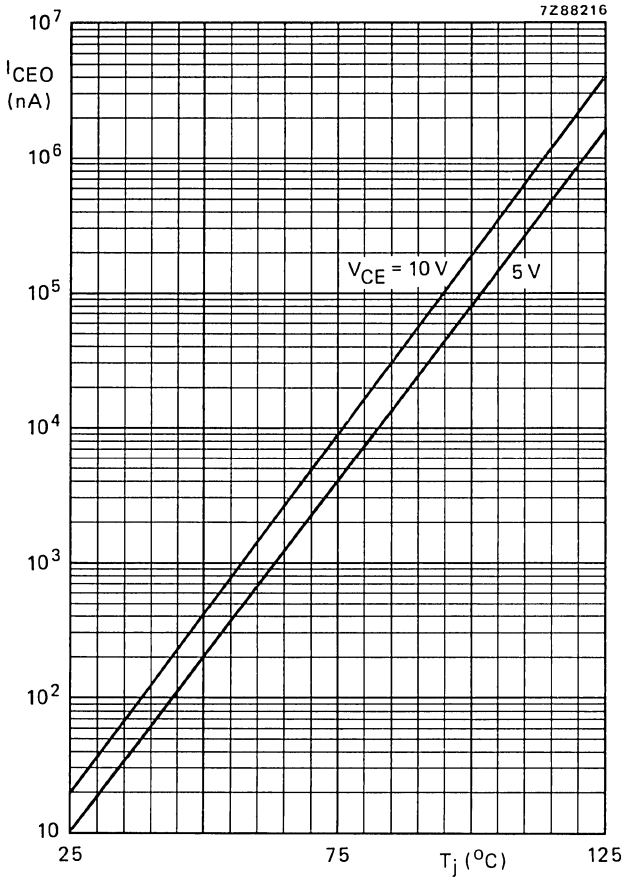

Fig. 12 $I_F = 0$; typical values.

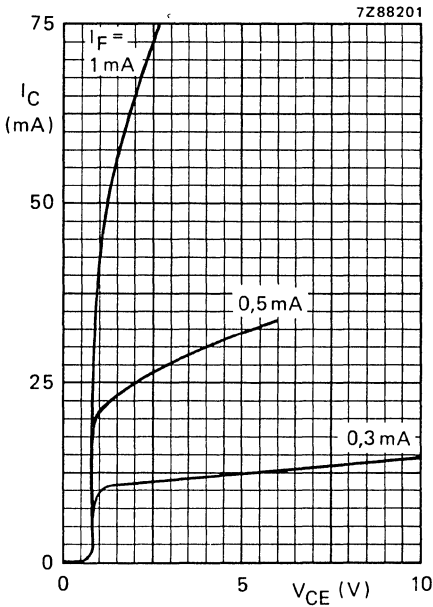

Fig. 13 Typical values; $I_B = 0$; $T_j = 25^\circ\text{C}$.

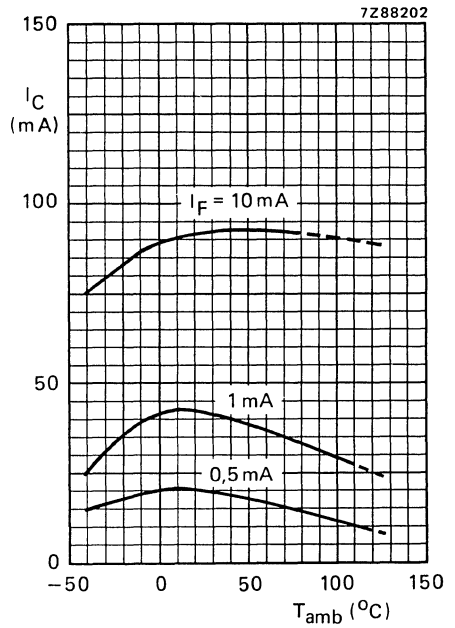

Fig. 14 Typical values; $I_B = 0$; $V_{CE} = 1\text{ V}$.

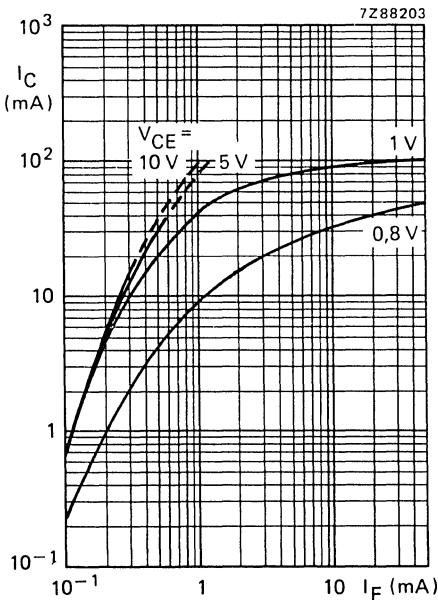

Fig. 15 Typical values; $I_B = 0$; $T_{amb} = 25^\circ\text{C}$.

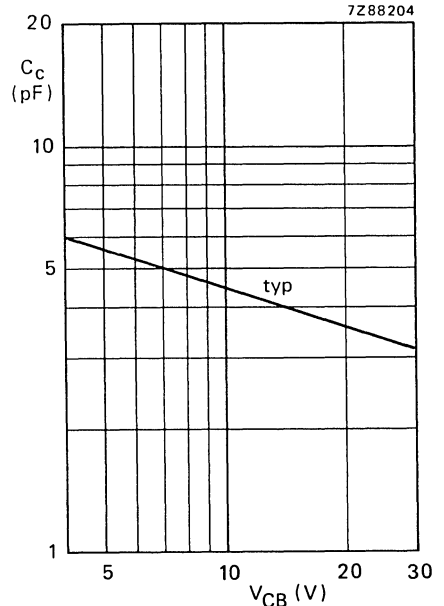

Fig. 16 $I_E = I_e = 0$; $f = 1\text{ MHz}$; $T_{amb} = 25^\circ\text{C}$.

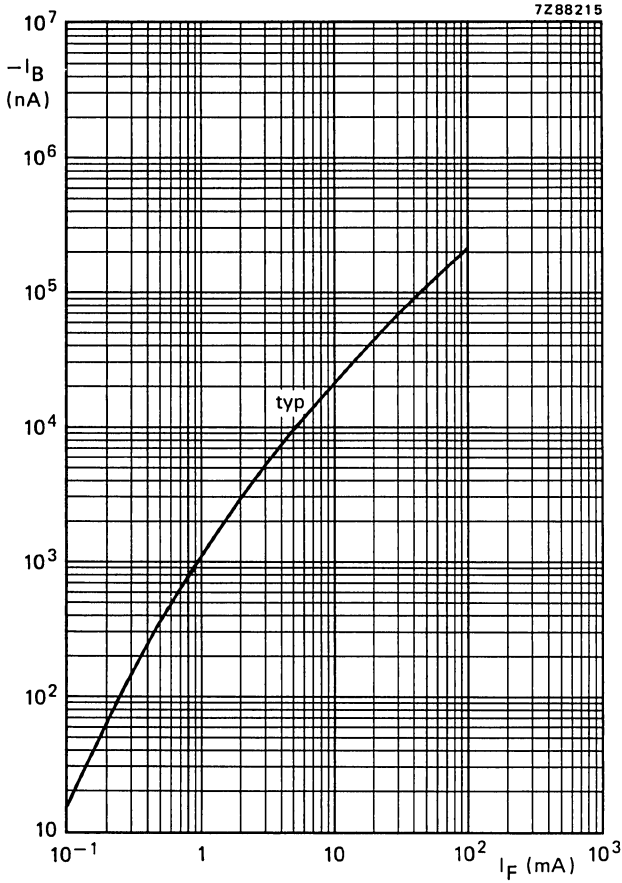

Fig. 17 $I_E = 0$; $V_{CB} = 5 \text{ V}$; $T_{amb} = 25 \text{ }^\circ\text{C}$.

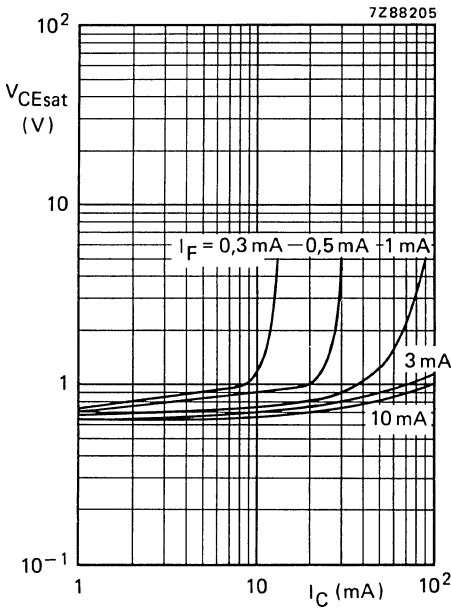

Fig. 18 Typical values; $I_B = 0$; $T_{amb} = 25^\circ C$.

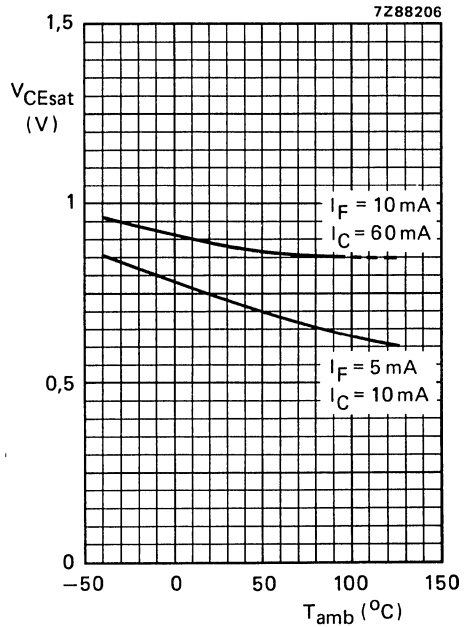

Fig. 19 Typical values; $I_B = 0$.

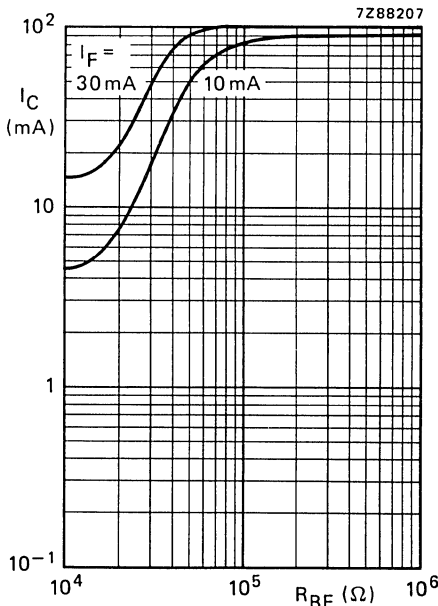

Fig. 20 Typ. values; $V_{CE} = 1$ V; $T_{amb} = 25^\circ C$.

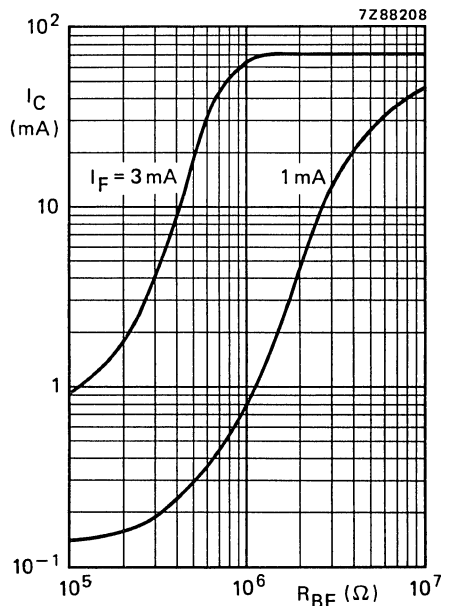

Fig. 21 Typ. values; $V_{CE} = 1$ V; $T_{amb} = 25^\circ C$.

DEVELOPMENT SAMPLE DATA

This information is derived from development samples made available for evaluation. It does not necessarily imply that the device will go into regular production.

CNX62

HIGH-VOLTAGE PHOTOCOUPLER

The CNX62 is a photocopler consisting of an infrared emitting GaAs diode and a silicon n-p-n photo-transistor in a dual-in-line (DIL) plastic envelope.

Features

- high current transfer ratio and a low saturation voltage suitable for use with TTL integrated circuits
- high degree of a.c. and d.c. insulation (3750 V r.m.s. and 5300 V d.c.)
- working voltage of 2,5 kV (d.c.)

QUICK REFERENCE DATA

Diode

Continuous reverse voltage	V_R	max.	3 V
Forward current d.c.	I_F	max.	100 mA
peak value; $t_{ON} = 10 \mu s$; $\delta = 0,01$	I_{FM}	max.	3 A
Total power dissipation up to $T_{amb} = 45^\circ C$ when mounted on a p.c.b.	P_{tot}	max.	200 mW

Transistor

Collector-emitter voltage (open base)	V_{CEO}	max.	50 V
Total power dissipation up to $T_{amb} = 45^\circ C$ when mounted on a p.c.b.	P_{tot}	max.	200 mW

Photocopler

Output/input d.c. current transfer ratio $I_F = 10 \text{ mA}$; $V_{CE} = 4 \text{ V}$	I_C/I_F	min.	0,4
Collector cut-off current (dark) $V_{CC} = 10 \text{ V}$; working voltage (d.c.) = 2,5 kV I_F (diode) = 0 (see note 1)	I_{CEW}	max.	200 nA
Collector-emitter saturation voltage $I_F = 10 \text{ mA}$; $I_C = 4 \text{ mA}$	V_{CEsat}	max.	0,4 V
Test isolation voltage (d.c.) $t = 1 \text{ min}$ (see note 2)	V_{IO}	max.	5,3 kV

MECHANICAL DATA

See Fig. 1.

MECHANICAL DATA

Dimensions in mm

Fig. 1 SOT-174.

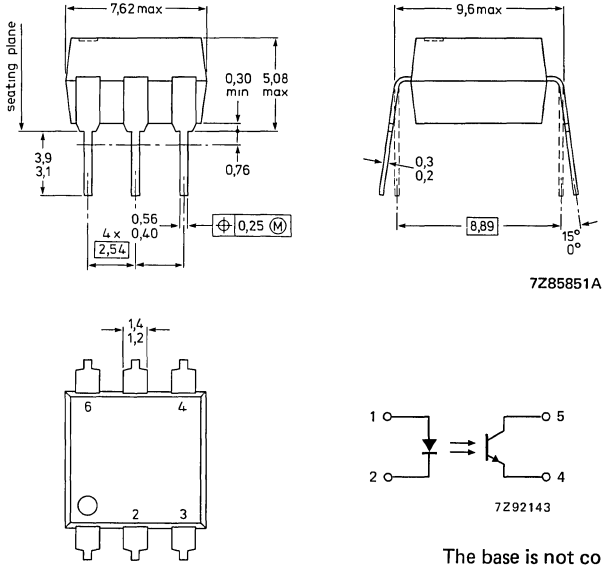

The base is not connected.

Fig. 1.

RATINGS

Limiting values in accordance with the Absolute Maximum System (IEC 134)

Diode

Continuous reverse voltage	V_R	max.	3 V
Forward current	I_F	max.	100 mA
d.c.	I_{FM}	max.	3 A
peak value; $t_{on} = 10 \mu s$; $\delta = 0,01$			
Total power dissipation up to $T_{amb} = 45 \text{ }^\circ\text{C}$ when mounted on a p.c.b.	P_{tot}	max.	200 mW

Transistor

Collector-emitter voltage (open base)	V_{CEO}	max.	50 V
Emitter-collector voltage	V_{ECO}	max.	7 V
Collector current (d.c.)	I_C	max.	100 mA
Total power dissipation up to $T_{amb} = 45 \text{ }^\circ\text{C}$ when mounted on a p.c.b.	P_{tot}	max.	200 mW

Photocoupler

Storage temperature	T_{stg}	−55 to +150 °C
Junction temperature	T_j	max. 125 °C
Soldering temperature up to the seating plane; $t_{sld} < 10$ s	T_{sld}	max. 260 °C

THERMAL RESISTANCE

From junction to ambient in free air diode	$R_{th\ j-a}$	max. 500 K/W
transistor	$R_{th\ j-a}$	max. 500 K/W
From junction to ambient when mounted on p.c.b. diode	$R_{th\ j-a}$	max. 400 K/W
transistor	$R_{th\ j-a}$	max. 400 K/W

CHARACTERISTICS

$T_j = 25$ °C unless otherwise specified

Diode

Forward voltage $I_F = 10$ mA	V_F	typ. 1,15 V max. 1,50 V
Reverse current $V_R = 3$ V	I_R	max. 10 μ A

Transistor

Collector-emitter breakdown voltage $I_C = 1$ mA	$V_{(BR)CEO}$	min. 50 V
Emitter-collector breakdown voltage $I_E = 0,1$ mA	$V_{(BR)ECO}$	min. 7 V
Collector cut-off current (dark); diode $I_F = 0$ $V_{CE} = 10$ V	I_{CEO}	typ. 2 nA max. 50 nA
$V_{CE} = 10$ V; $T_{amb} = 70$ °C	I_{CEO}	max. 10 μ A

Photocoupler

Output/input d.c. current transfer ratio $I_F = 10$ mA; $V_{CE} = 0,4$ V	I_C/I_F	min. 0,4 typ. 0,8
$I_F = 10$ mA; $V_{CE} = 5$ V	I_C/I_F	typ. 1,5
Collector cut-off current (light) $T_{amb} \leq 70$ °C; $V_F = 0,8$ V; $V_{CE} = 15$ V	$I_{CE(L)}$	max. 15 μ A
$T_{amb} \leq 70$ °C; $I_F = 2$ mA; $V_{CE} = 0,4$ V	$I_{CE(L)}$	min. 150 μ A
Collector-emitter saturation voltage $I_F = 10$ mA; $I_C = 2$ mA	V_{CEsat}	typ. 0,15 V max. 0,40 V
$I_F = 10$ mA; $I_C = 4$ mA	V_{CEsat}	typ. 0,19 V max. 0,40 V



Photocoupler (continued)

Collector cut-off current (dark) at working voltage $V_W = 2,5$ kV (d.c. value);

$V_{CC} = 10$ V; $T_j = 25$ °C (see note 1)

$V_{CC} = 10$ V; $T_j = 70$ °C (see note 1)

I_{CEW}	max.	200 nA
	max.	100 μ A

Test isolation voltage, d.c. value
 $t = 1$ min (see note 2)

V_{IO}	max.	5,3 kV
----------	------	--------

Capacitance between input and output
 $V = 0$; $f = 1$ MHz

C_{io}	typ.	0,6 pF
----------	------	--------

Insulation resistance between input and output
 $V_{IO} = \pm 1000$ V

R_{IO}	min.	10^{10} Ω
	typ.	10^{12} Ω

Switching times (see Figs 2 and 3)

Turn-on time

$I_C = 2$ mA; $V_{CC} = 5$ V; $R_L = 100$ Ω

$I_C = 2$ mA; $V_{CC} = 5$ V; $R_L = 1$ k Ω

t_{on}	typ.	3 μ s
	typ.	12 μ s

Turn-off time

$I_C = 2$ mA; $V_{CC} = 5$ V; $R_L = 100$ Ω

$I_C = 2$ mA; $V_{CC} = 5$ V; $R_L = 1$ k Ω

t_{off}	typ.	3 μ s
	typ.	12,5 μ s

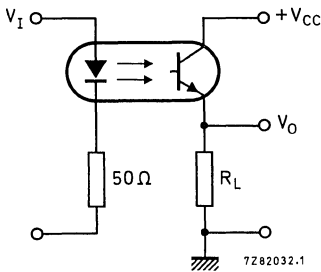

Fig. 2 Switching circuit.

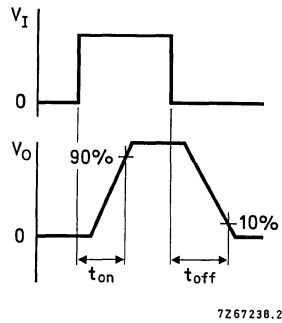

Fig. 3 Waveforms.

Note 1 (see Fig. 4):

Collector cut-off current (dark) at working voltage $V_W = 2,5$ kV (d.c. value);

$V_{CC} = 10$ V; $T_j = 25$ °C

$V_{CC} = 10$ V; $T_j = 70$ °C

I_{CEW}	max.	200 nA*
	max.	100 μ A*

* The two parameters are tested on a sample basis for 1000 h.

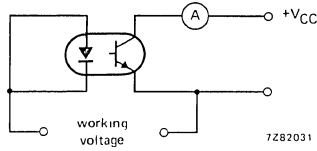

Fig. 4.

Note 2:

A test voltage of 5,3 kV (d.c.) is applied between the shorted diode leads and the shorted transistor leads for 1 min.

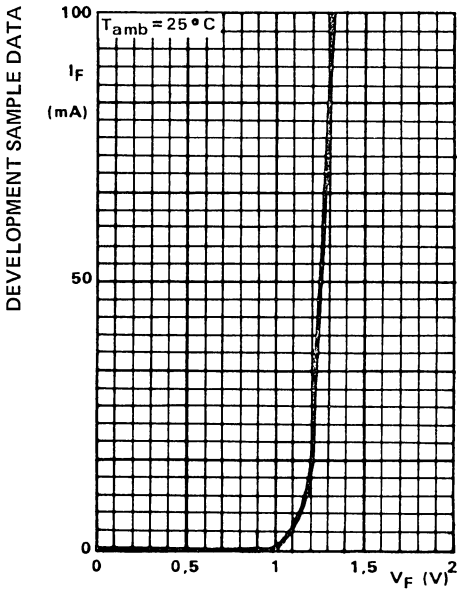

Fig. 5.

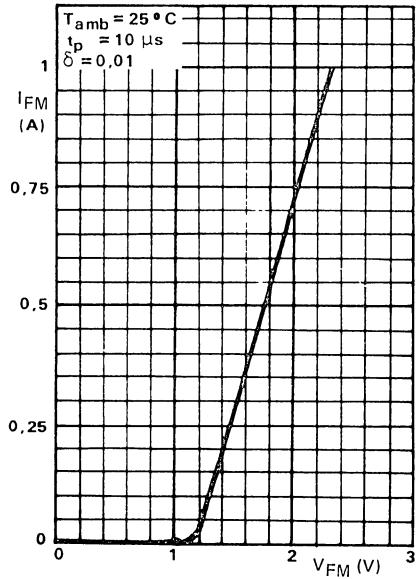

Fig. 6.

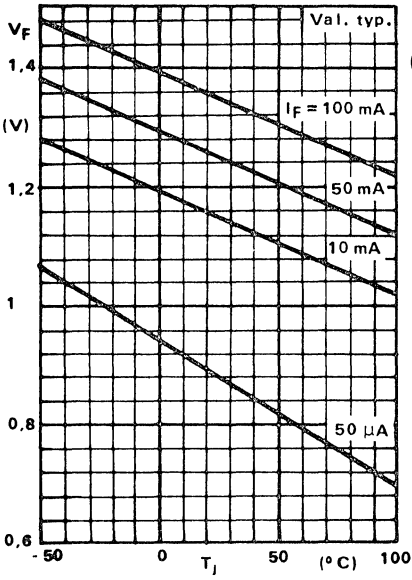

Fig. 7.

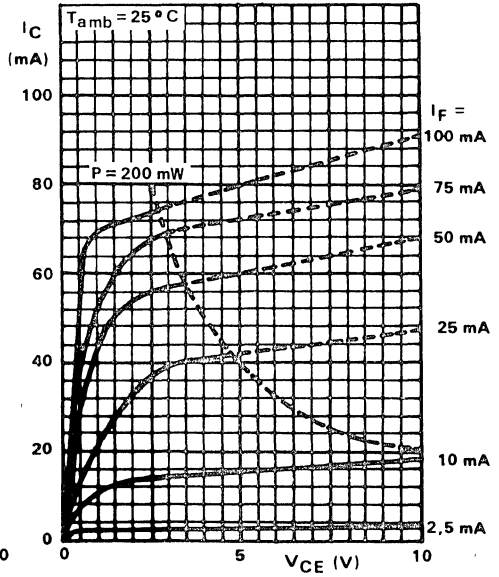

Fig. 8.

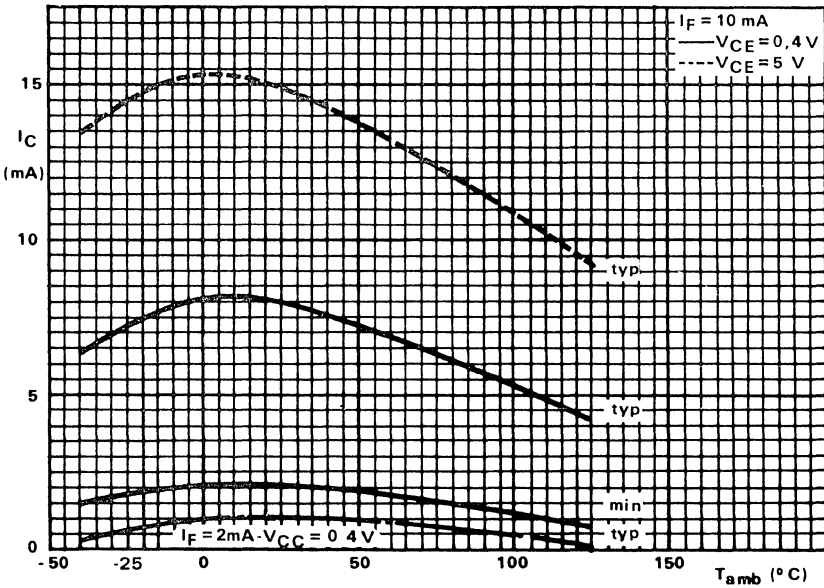

Fig. 9.

DEVELOPMENT SAMPLE DATA

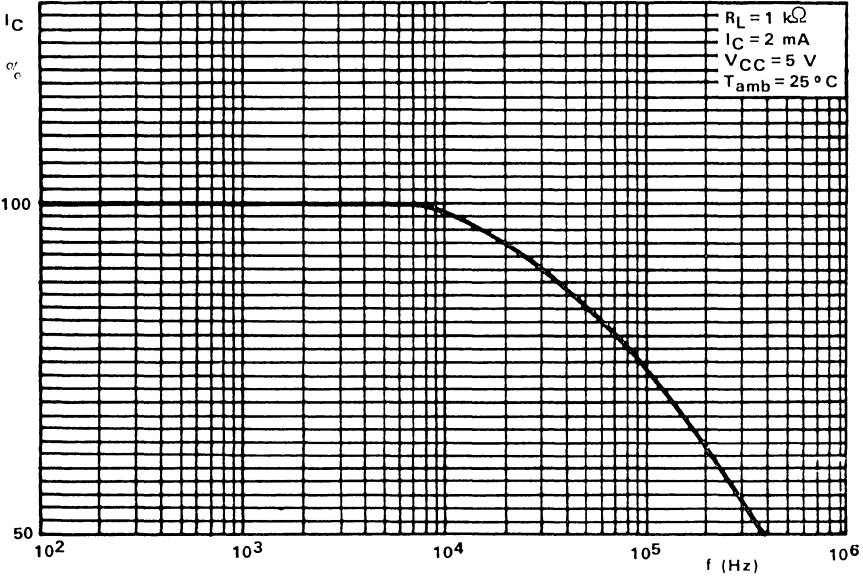

Fig. 10.

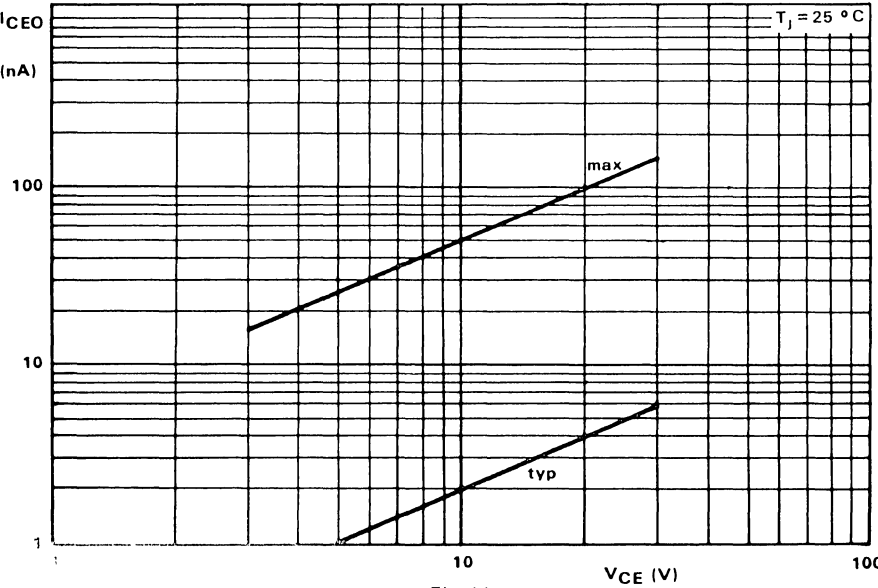

Fig. 11.

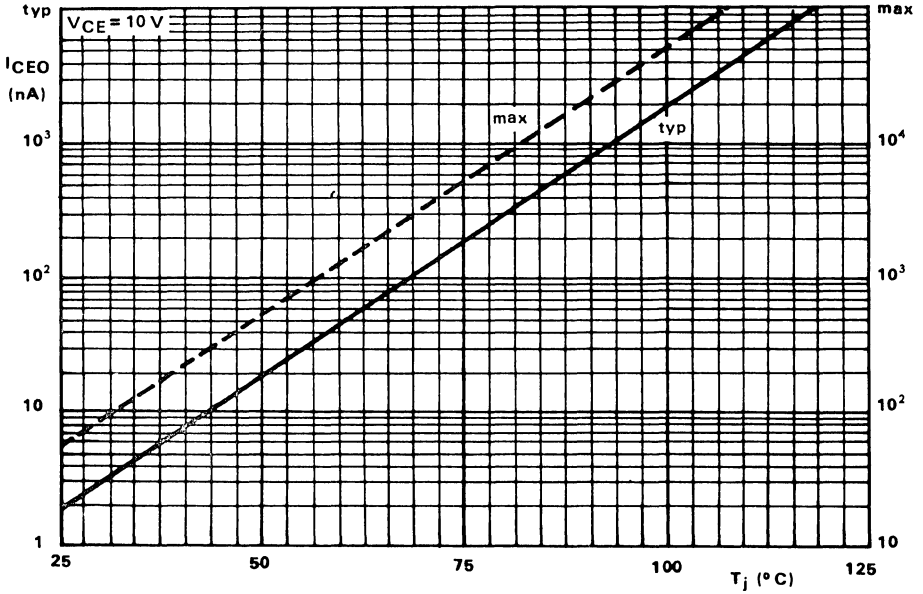

Fig. 12.

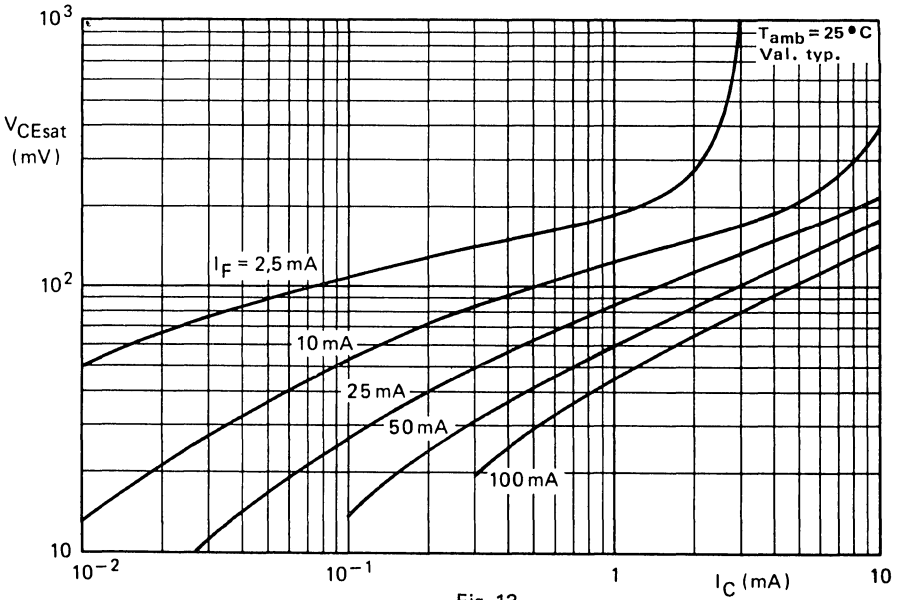

Fig. 13.

DEVELOPMENT SAMPLE DATA

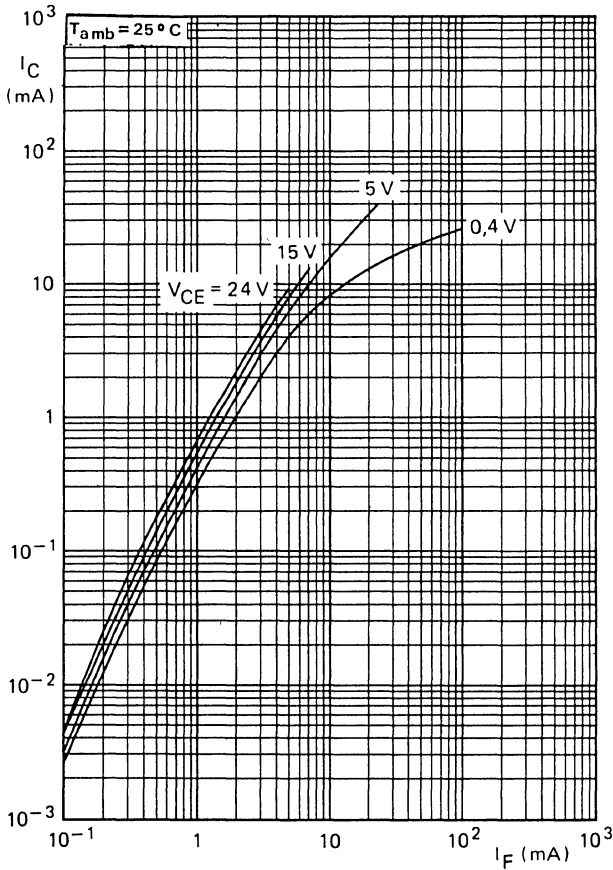

Fig. 14.

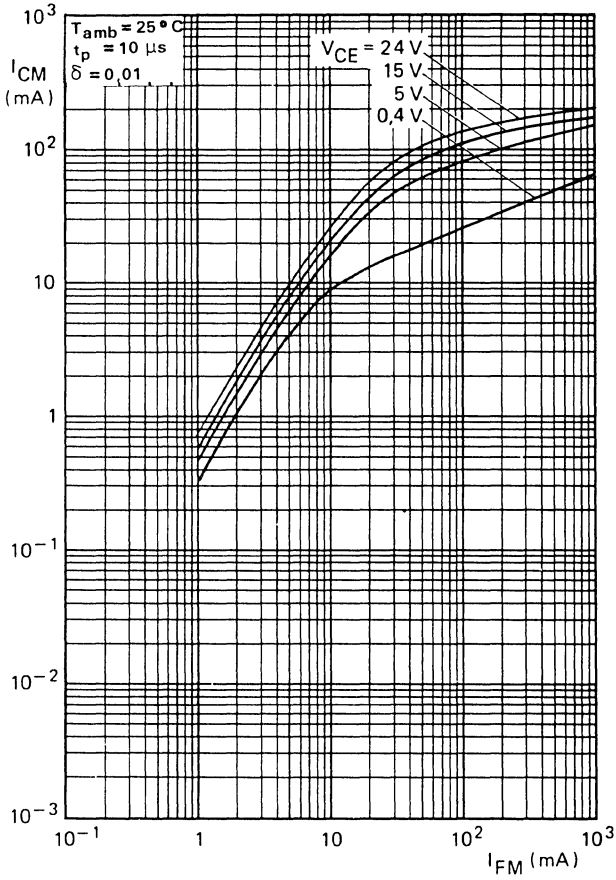

Fig. 15.

DEVELOPMENT SAMPLE DATA

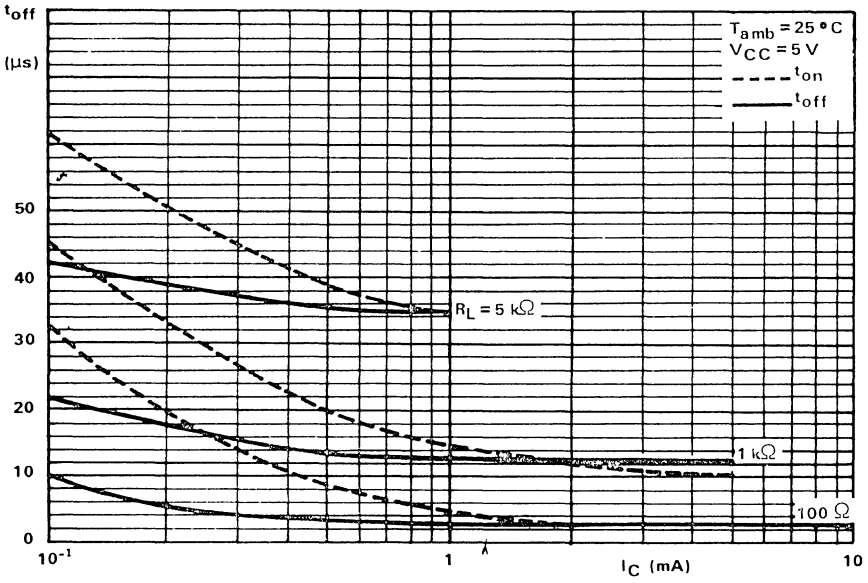

Fig. 16.

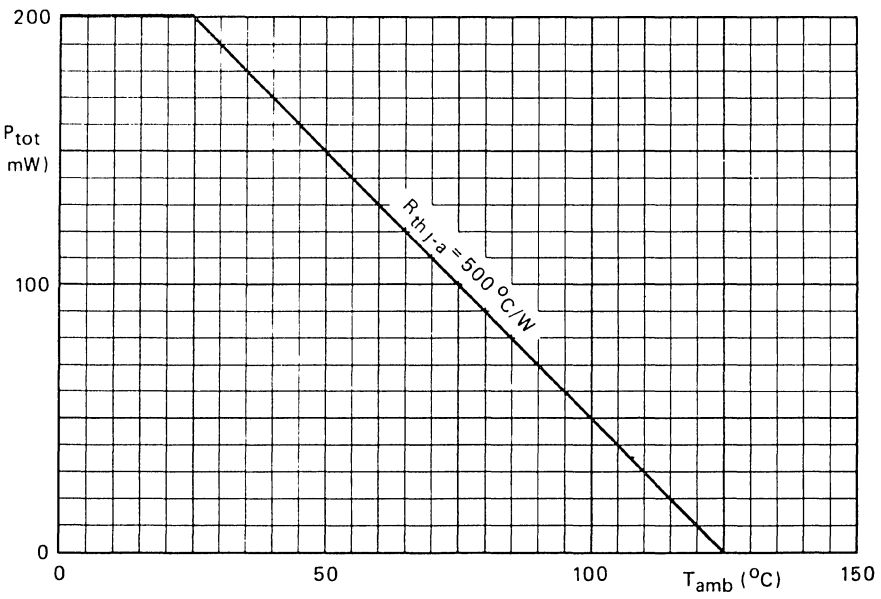

Fig. 17.



PHOTOCOUPLER

Optically coupled isolator consisting of an infrared emitting GaAs diode and a silicon n-p-n photo-transistor with accessible base. Hermetically encapsulated in a metal envelope. The CNY50 is intended for professional applications.

QUICK REFERENCE DATA

Diode

Continuous reverse voltage	V_R	max.	3 V
Forward current	I_F	max.	100 mA
d.c.	I_{FM}	max.	3000 mA
(peak value); $t_P = 300 \mu s$; $\delta = 0,02$			
Total power dissipation up to $T_{amb} = 75 \text{ }^\circ\text{C}$	P_{tot}	max.	150 mW

Transistor

Collector-emitter voltage (open base)	V_{CEO}	max.	35 V
Total power dissipation up to $T_{amb} = 75 \text{ }^\circ\text{C}$	P_{tot}	max.	150 mW

Photocoupler

Output/input d.c. current transfer ratio				
$I_F = 10 \text{ mA}$; $V_{CE} = 0,4 \text{ V}$; ($I_B = 0$)	CNY50-1	I_C/I_F	>	0,25
	CNY50-2	I_C/I_F	>	0,40
Collector cut-off current (dark)				
$V_{CC} = 15 \text{ V}$; working voltage (d.c.) = 1 kV				
diode: $I_F = 0$ (see also Fig. 2)		I_{CEW}	<	200 nA
Isolation voltage(d.c.)		V_{IO}	>	1 kV

MECHANICAL DATA

Dimensions in mm

Fig. 1 SOT-104B.

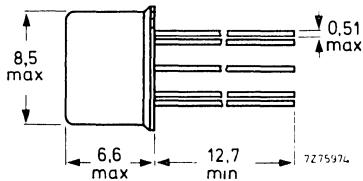
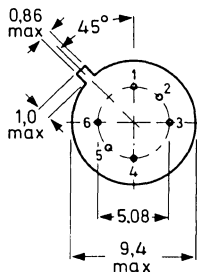

Pinning

- 1 emitter
- 2 base
- 3 collector
- 4 anode
- 5 internal connection
- 6 cathode

Maximum lead diameter guaranteed only for 12,7 mm.

RATINGS

Limiting values in accordance with the Absolute Maximum System (IEC 134)

Diode

Continuous reverse voltage	V_R	max.	3 V
Forward current			
d.c.	I_F	max.	100 mA
(peak value); $t_p = 300 \mu s$; $\delta = 0,02$	I_{FM}	max.	3000 mA
Total power dissipation up to $T_{amb} = 75 \text{ }^\circ\text{C}$ (see Fig. 2)	P_{tot}	max.	150 mW
Operating junction temperature	T_j	max.	125 $^\circ\text{C}$

Transistor

Collector-base voltage (open emitter)	V_{CBO}	max.	70 V
Collector-emitter voltage (open base)	V_{CEO}	max.	35 V
Emitter-collector voltage (open base)	V_{ECO}	max.	7 V
Collector current (d.c.)	I_C	max.	100 mA
Total power dissipation up to $T_{amb} = 75 \text{ }^\circ\text{C}$	P_{tot}	max.	150 mW
Operating junction temperature	T_j	max.	125 $^\circ\text{C}$

Photocoupler

Total power dissipation up to $T_{amb} = 75 \text{ }^\circ\text{C}$	P_{tot}	max.	300 mW
Storage temperature	T_{stg}		-65 to + 150 $^\circ\text{C}$
Operating ambient temperature	T_{amb}		-40 to + 85 $^\circ\text{C}$

THERMAL RESISTANCE

From junction to ambient in free air

diode	$R_{th j-a}$	=	330 $^\circ\text{C/W}$
transistor	$R_{th j-a}$	=	330 $^\circ\text{C/W}$

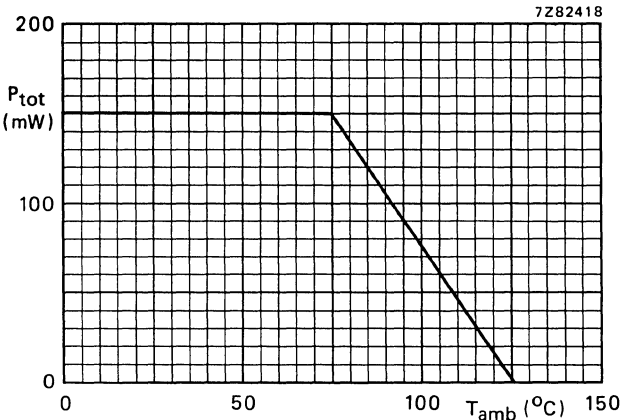

Fig. 2 Power/temperature derating curve for diode and transistor.

CHARACTERISTICS

$T_j = 25\text{ }^\circ\text{C}$ unless otherwise specified

Diode

Forward voltage

$I_F = 2\text{ mA}; T_{\text{amb}} = 0\text{ }^\circ\text{C to } 70\text{ }^\circ\text{C}$

$V_F < 1,2\text{ V}$

typ. 1,15 V

$I_F = 10\text{ mA}$

$V_F < 1,50\text{ V}$

Reverse current

$V_R = 3\text{ V}$

$I_R < 1\text{ }\mu\text{A}$
typ. 100 μA

Diode capacitance

$V_R = 0; f = 1\text{ MHz}$

C_d typ. 75 pF

Transistor (diode: $I_F = 0$)

Collector-base breakdown voltage

open emitter; $I_C = 0,1\text{ mA}$

$V_{(\text{BR})\text{CBO}} > 70\text{ V}$

Collector-emitter breakdown voltage

open base; $I_C = 1\text{ mA}$

$V_{(\text{BR})\text{CEO}} > 35\text{ V}$

Emitter-collector breakdown voltage

open base; $I_E = 0,1\text{ mA}$

$V_{(\text{BR})\text{ECO}} > 7\text{ V}$

Collector cut-off current (dark)

$I_E = 0; V_{\text{CB}} = 10\text{ V}$

$I_{\text{CBO}} < 20\text{ nA}$

$I_B = 0; V_{\text{CE}} = 20\text{ V}$

$I_{\text{CEO}} < 5\text{ nA}$
typ. 100 nA

$I_B = 0; V_{\text{CE}} = 20\text{ V}; T_{\text{amb}} = 70\text{ }^\circ\text{C}$

$I_{\text{CEO}} < 10\text{ }\mu\text{A}$

D.C. current gain

$I_C = 10\text{ mA}; V_{\text{CE}} = 5\text{ V}$

h_{FE} typ. 600

Photocoupler ($I_B = 0$)*

Collector cut-off current (light)

$V_F = 0,8\text{ V}; V_{\text{CE}} = 15\text{ V}; T_{\text{amb}} = 0\text{ }^\circ\text{C to } 70\text{ }^\circ\text{C}$

CNY50-1 $I_C < 15\text{ }\mu\text{A}$

$I_F = 2\text{ mA}; V_{\text{CE}} = 0,4\text{ V}; T_{\text{amb}} = 0\text{ }^\circ\text{C to } 70\text{ }^\circ\text{C}$

CNY50-2 $I_C < 150\text{ }\mu\text{A}$

Output/input d.c. current transfer ratio

$I_F = 10\text{ mA}; V_{\text{CE}} = 0,4\text{ V}$

CNY50-1 I_C/I_F typ. 0,4
0,25 to 1,0

CNY50-2 I_C/I_F typ. 0,8
0,40 to 1,6

Collector cut-off current (dark) see Fig. 3

$V_{\text{CC}} = 15\text{ V};$ working voltage (d.c.) = 1 kV

$T_j = 25\text{ }^\circ\text{C}$

$I_{\text{CEW}} < 200\text{ nA}$

$T_j = 70\text{ }^\circ\text{C}$

$I_{\text{CEW}} < 100\text{ }\mu\text{A}$

* Where the phototransistor receives light from the diode the O (for open base) has been omitted from the symbols.

CNY50

Isolation voltage, d.c. value
measured between shorted input leads
and shorted output leads

$V_{IO} > 1 \text{ kV}$

Capacitance between input and output
 $I_F = 0; V = 0; f = 1 \text{ MHz}$

$C_{io} \text{ typ. } 1 \text{ pF}$

Insulation resistance between input and output
 $\pm V_{IO} = 500 \text{ V}$

$r_{IO} > 100 \text{ G}\Omega$
typ. 1000 $\text{G}\Omega$

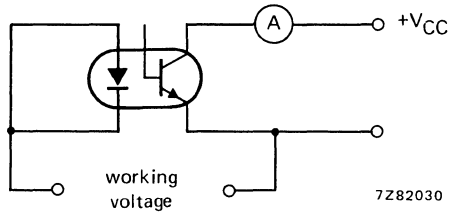

Fig. 3.

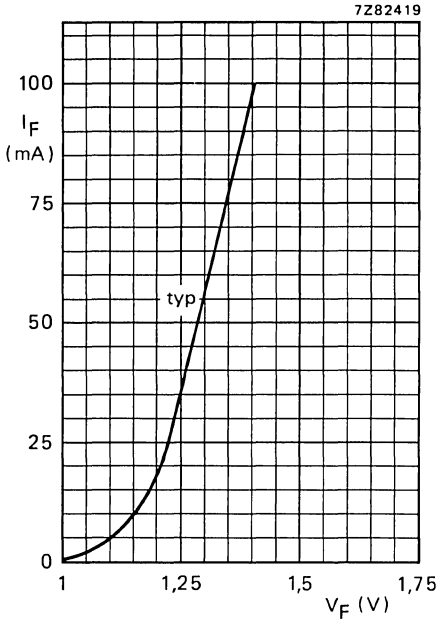

Fig. 4 $T_{amb} = 25^\circ C$.

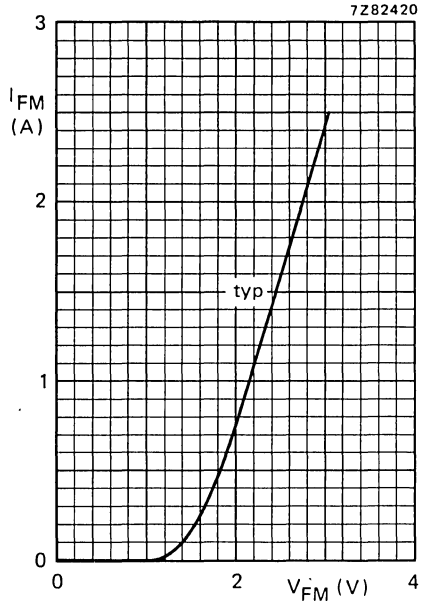

Fig. 5 $T_{amb} = 25^\circ C$; $t_p = 10 \mu s$; $\delta = 0,01$.

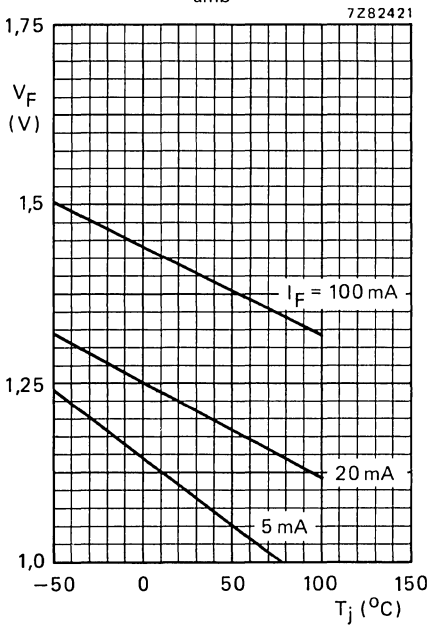

Fig. 6 Typical values.

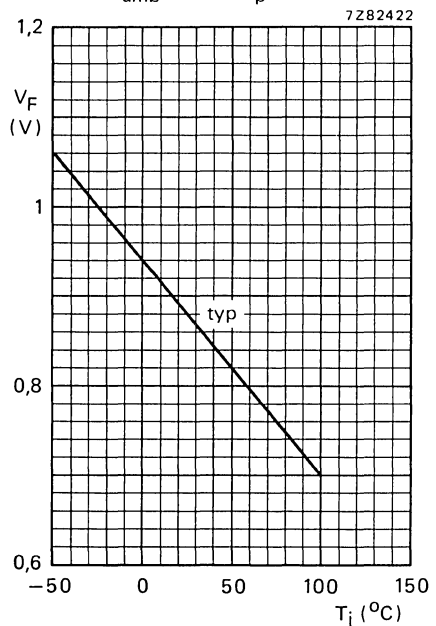

Fig. 7 $I_F = 50 \mu A$.

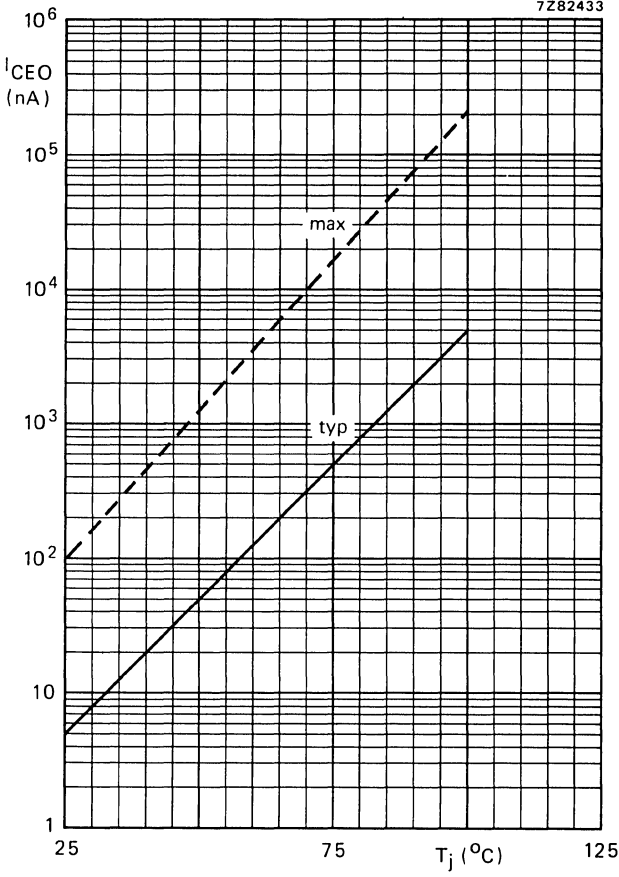

Fig. 8 $I_F = 0$; $V_{CE} = 20$ V.

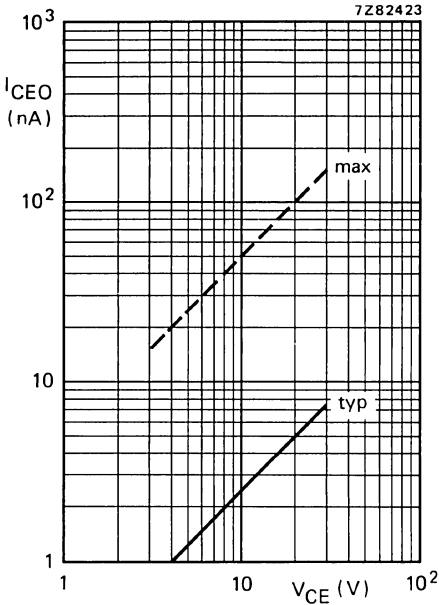

Fig. 9 $I_F = 0$; $T_j = 25^\circ\text{C}$.

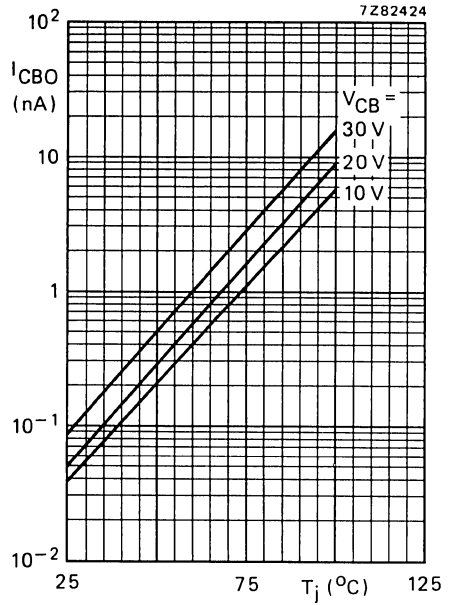

Fig. 10 $I_F = 0$; typical values.

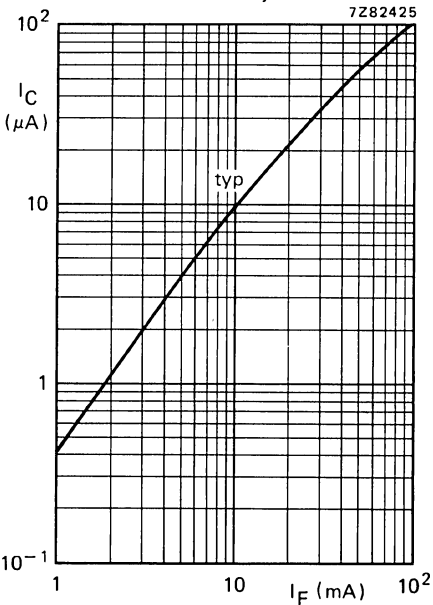

Fig. 11 $I_E = 0$; $V_{CB} = 5\text{ V}$; $T_{\text{amb}} = 25^\circ\text{C}$.

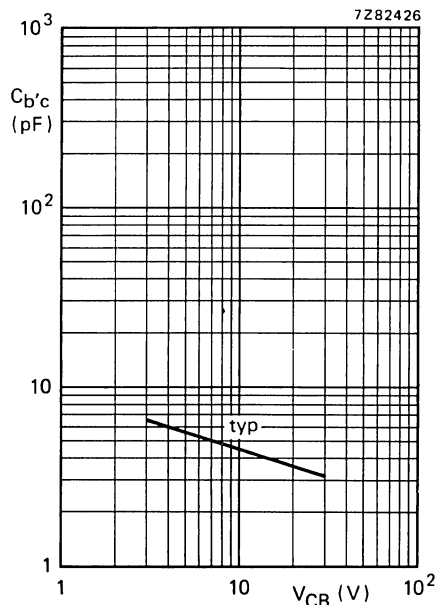

Fig. 12 $f = 1\text{ MHz}$; $T_{\text{amb}} = 25^\circ\text{C}$.

7Z82434

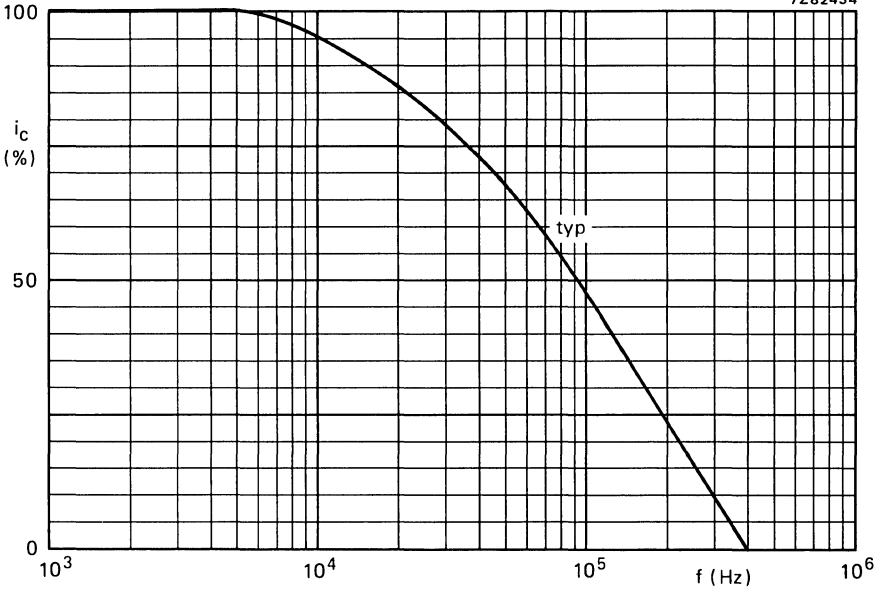

Fig. 13 $I_B = 0$; $I_C = 2 \text{ mA}$; $V_{CC} = 5 \text{ V}$; $R_L = 1 \text{ k}\Omega$; $T_{amb} = 25 \text{ }^\circ\text{C}$.

7Z82427

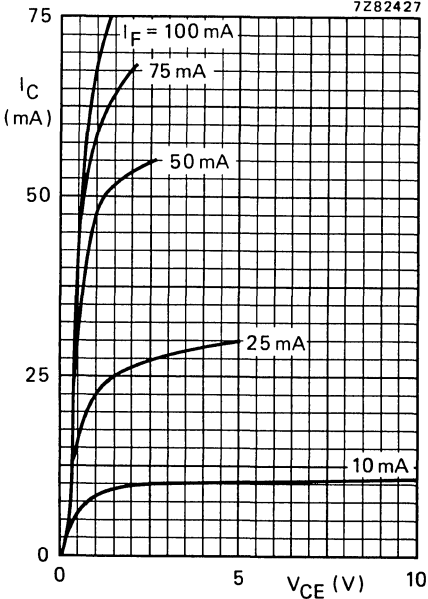

Fig. 14 $T_{amb} = 25 \text{ }^\circ\text{C}$; typical values.

7Z82428

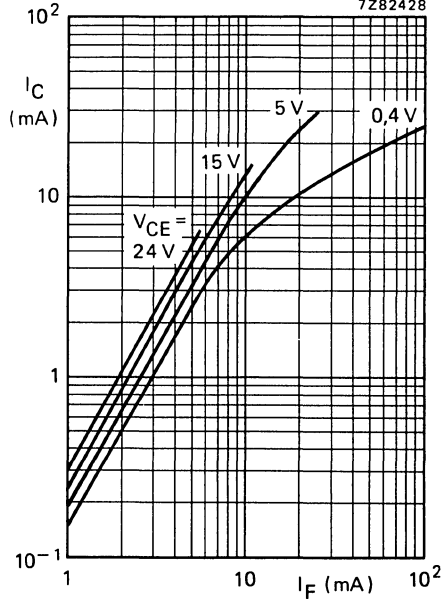

Fig. 15 $T_{amb} = 25 \text{ }^\circ\text{C}$; typical values.

7282435

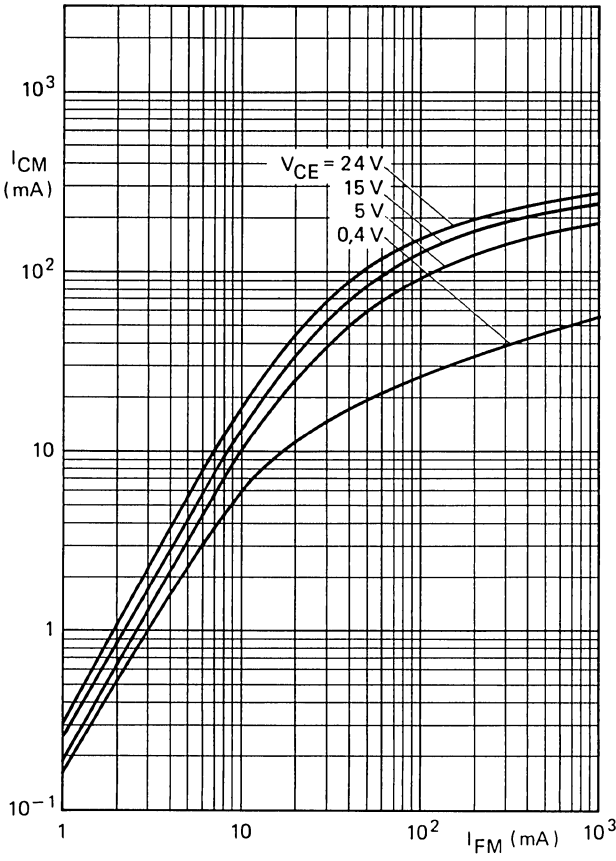

Fig. 16 $T_{amb} = 25\text{ }^{\circ}\text{C}$; $t_p = 10\text{ }\mu\text{s}$; $\delta = 0,01$; typical values.

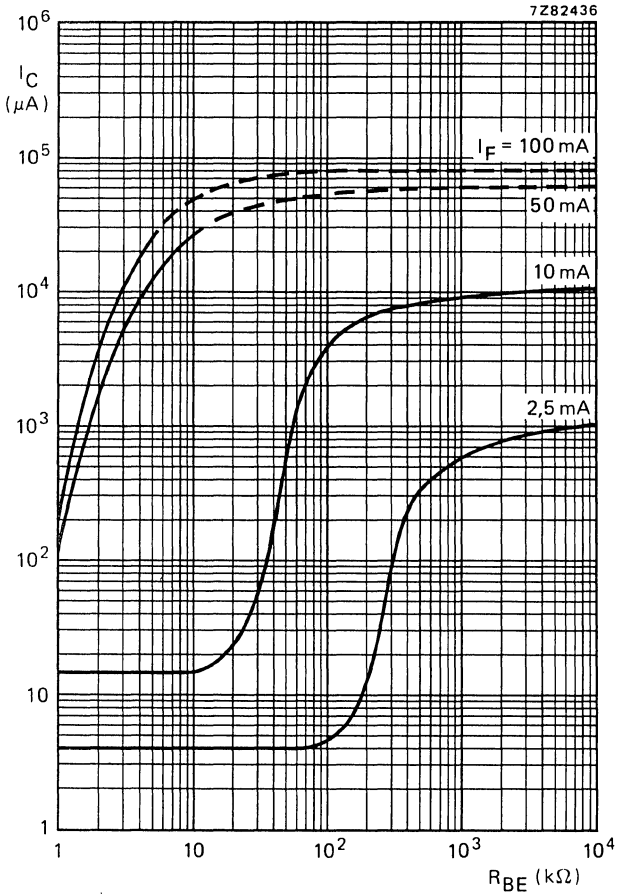

Fig. 17 $I_B = 0$; $V_{CE} = 5 \text{ V}$; $T_{amb} = 25 \text{ }^\circ\text{C}$; typical values.

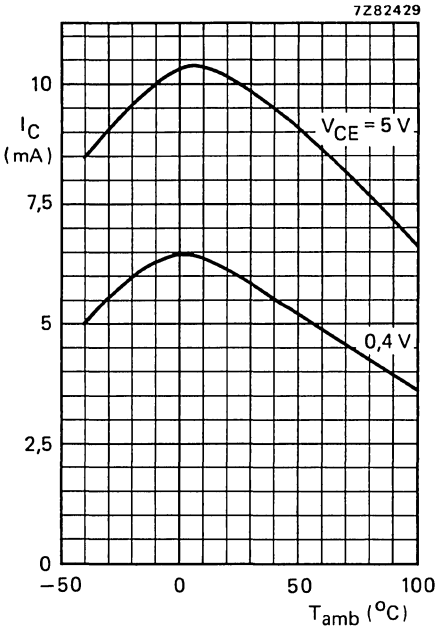

Fig. 18 $I_B = 0$; $I_F = 10$ mA; typical values.

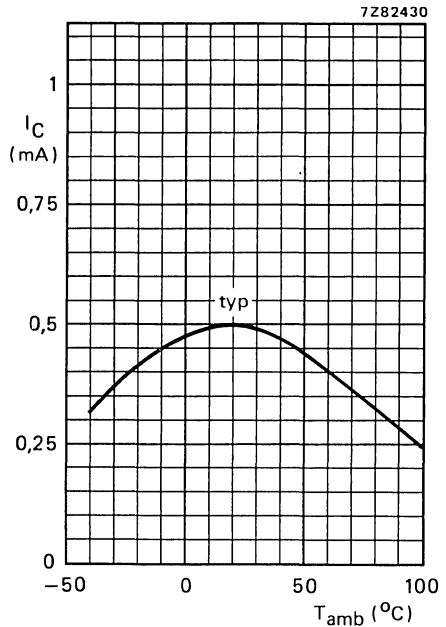

Fig. 19 $I_B = 0$; $I_F = 2$ mA; $V_{CE} = 0.4$ V.

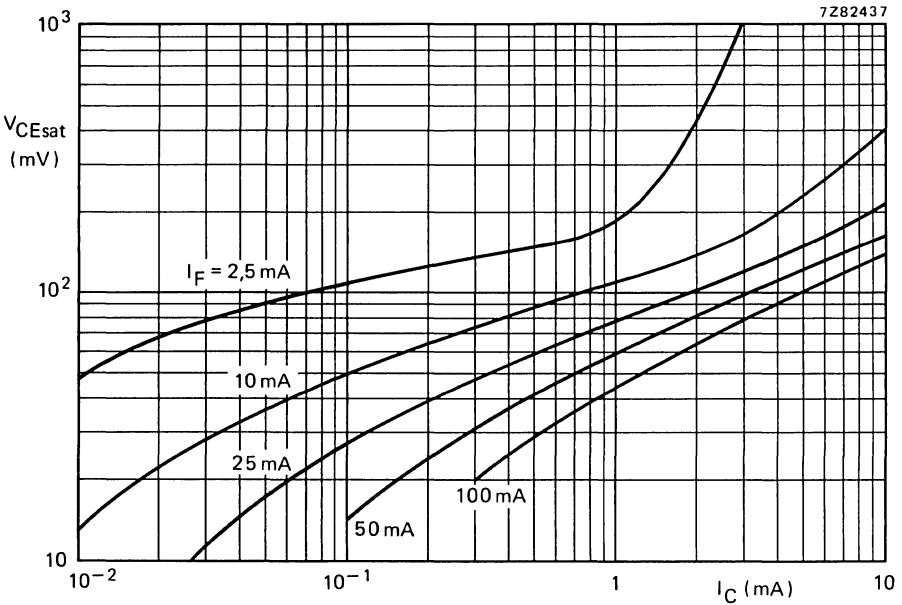

Fig. 20 $I_B = 0$; $T_{amb} = 25$ °C; typical values.

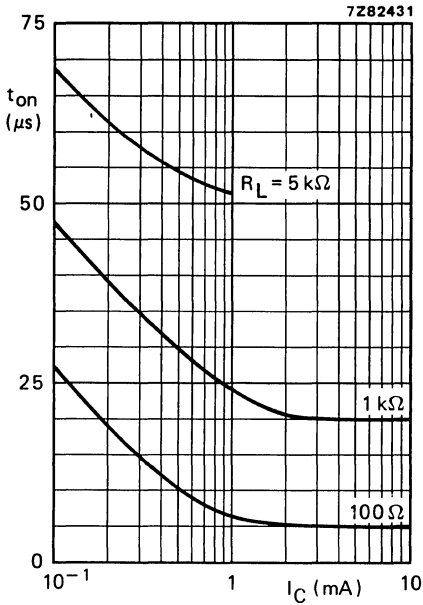

Fig. 21 $I_B = 0$; $V_{CC} = 5 V$; $T_{amb} = 25^\circ C$; typical values. (See Fig. 23).

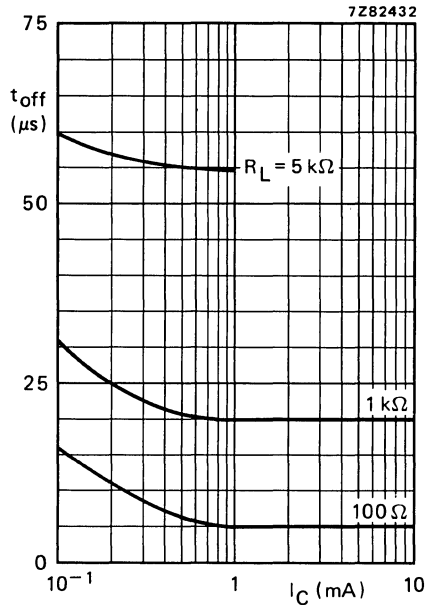
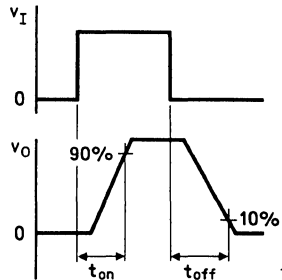
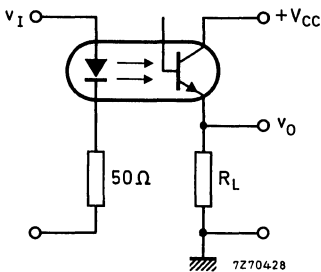

Fig. 22 $I_B = 0$; $V_{CC} = 5 V$; $T_{amb} = 25^\circ C$; typical values. (See Fig. 23).



7Z67238.1

Fig. 23 Switching circuit and waveforms.

PHOTOCOUPLERS

Optically coupled isolators consisting of an infrared emitting GaAs diode and a silicon n-p-n photo-transistor with accessible base. Plastic envelopes. Suitable for TTL integrated circuits.

Features of these products:

- high output/input d.c. current transfer ratio;
- low saturation voltage;
- high isolation voltage
 CNY52 3,75 kV (r.m.s.) and 5,3 kV (d.c.);
 CNY53 3 kV (r.m.s.) and 4,3 kV (d.c.);
- working voltage 1,5 kV.

QUICK REFERENCE DATA

Diode		CNY52	CNY53
Continuous reverse voltage	V_R max.	3	3 V
Forward current			
d.c.	I_F max.	100	100 mA
(peak value); $t_p = 10 \mu s$; $\delta = 0,1$	I_{FM} max.	1000	1000 mA
Total power dissipation up to $T_{amb} = 25 \text{ }^\circ\text{C}$	P_{tot} max.	150	150 mW
Transistor			
Collector-emitter voltage (open base)	V_{CEO} max.	50	30 V
Total power dissipation up to $T_{amb} = 25 \text{ }^\circ\text{C}$	P_{tot} max.	200	200 mW
Photocoupler			
Output/input d.c. current transfer ratio			
$I_F = 10 \text{ mA}$; $V_{CE} = 0,4 \text{ V}$; ($I_B = 0$)	$I_C/I_F >$	0,25	0,50
Collector cut-off current (dark)			
$V_{CC} = 10 \text{ V}$; working voltage (d.c.) = 1,5 kV diode: $I_F = 0$ (see also Fig. 2)	$I_{CEW} <$	200	200 nA
Isolation voltage (d.c.)			
$t = 1 \text{ min}$	$V_{IO} >$	5,3	4,3 kV

MECHANICAL DATA

SOT-91A (see Fig. 1)

MECHANICAL DATA

Dimensions in mm

Fig. 1 SOT-91A.

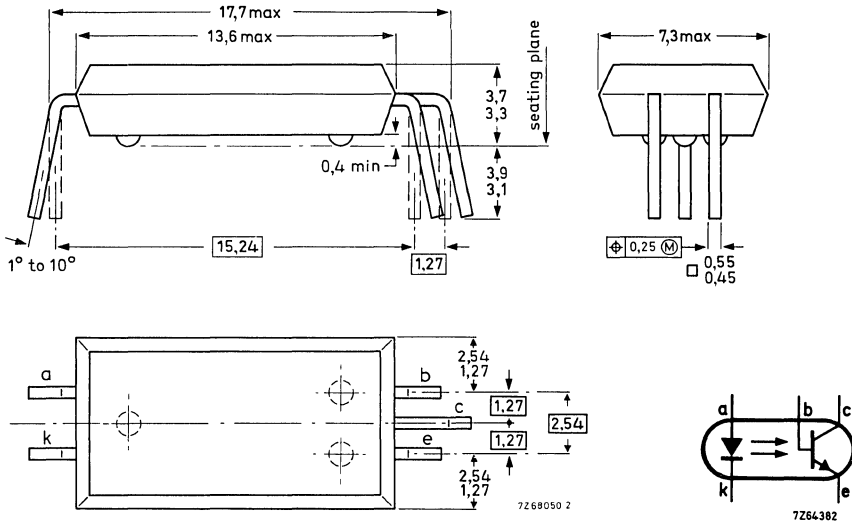

- \oplus Positional accuracy.
- \textcircled{M} Maximum material condition.

RATINGS

Limiting values in accordance with the Absolute Maximum System (IEC 134)

Diode

Continuous reverse voltage	V_R	max.	3 V
Forward current	I_F	max.	100 mA
d.c.	I_{FM}	max.	1000 mA
(peak value); $t_p = 10 \mu s$; $\delta = 0,1$	P_{tot}	max.	150 mW
Total power dissipation up to $T_{amb} = 25^\circ C$	T_j	max.,	125 $^\circ C$
Operating junction temperature			

Transistor

Collector-emitter voltage (open base)	CNY52	V_{CEO}	max.	50 V
	CNY53	V_{CEO}	max.	30 V
Collector-base voltage (open emitter)		V_{CBO}	max.	50 V
Emitter-collector voltage (open base)		V_{ECO}	max.	7 V

Collector current (d.c.)	I_C	max.	100 mA
Total power dissipation up to $T_{amb} = 25\text{ }^\circ\text{C}$	P_{tot}	max.	200 mW
Operating junction temperature	T_j	max.	125 $^\circ\text{C}$

Photocoupler

Storage temperature	T_{stg}	-55 to +150 $^\circ\text{C}$
Lead soldering temperature up to the seating plane; $t_{sld} < 10\text{ s}$	T_{sld}	max. 260 $^\circ\text{C}$

THERMAL RESISTANCE

From junction to ambient in free air diode	$R_{th\ j-a}$	=	0,65 $^\circ\text{C}/\text{mW}$
transistor	$R_{th\ j-a}$	=	0,5 $^\circ\text{C}/\text{mW}$
From junction to ambient, device mounted on a printed-circuit board diode	$R_{th\ j-a}$	=	0,6 $^\circ\text{C}/\text{mW}$
transistor	$R_{th\ j-a}$	=	0,4 $^\circ\text{C}/\text{mW}$

CHARACTERISTICS

$T_j = 25\text{ }^\circ\text{C}$ unless otherwise specified

Diode

Forward voltage $I_F = 10\text{ mA}$	V_F	typ. <	1,2 V 1,5 V
Reverse current $V_R = 3\text{ V}$	I_R	<	10 μA

Transistor (diode: $I_F = 0$)

Collector cut-off current (dark) $V_{CE} = 10\text{ V}$	I_{CEO}	typ. <	5 nA 100 nA
$V_{CE} = 10\text{ V}; T_{amb} = 70\text{ }^\circ\text{C}$	I_{CEO}	<	10 μA
$V_{CB} = 10\text{ V}$	I_{CBO}	<	20 nA

Photocoupler ($I_B = 0$)*

Output/input d.c. current transfer ratio $I_F = 10\text{ mA}; V_{CE} = 0,4\text{ V}$	CNY52	I_C/I_F	> typ.	0,25 0,50
	CNY53	I_C/I_F	> typ.	0,5 1,0

Collector cut-off current (dark) see Fig. 2

$V_{CC} = 10\text{ V};$ working voltage (d.c.) = 1,5 kV	I_{CEW}	<	200 nA
$V_{CC} = 10\text{ V};$ working voltage (d.c.) = 1,5 kV; $T_j = 70\text{ }^\circ\text{C}$	I_{CEW}	<	100 μA

* Where the phototransistor receives light from the diode the O (for open base) has been omitted from the symbols.

CNY52
CNY53

Collector-emitter saturation voltage

$I_F = 10 \text{ mA}; I_C = 2 \text{ mA}$

$I_F = 10 \text{ mA}; I_C = 4 \text{ mA}$

Isolation voltage, d.c. value*

Capacitance between input and output

$I_F = 0; V = 0; f = 1 \text{ MHz}$

Insulation resistance between input and output

$\pm V_{IO} = 1 \text{ kV}$

Switching times (see Figs 3 and 4)

$I_{Con} = 2 \text{ mA}; V_{CC} = 5 \text{ V}; R_L = 100 \Omega$

Turn-on time

Turn-off time

$I_{Con} = 4 \text{ mA}; V_{CC} = 5 \text{ V}; R_L = 100 \Omega$

Turn-on time

Turn-off time

	CNY52	CNY53
V_{CEsat}	typ. 0,17	— V
	< 0,40	— V
V_{CEsat}	typ. —	0,17 V
	< —	0,40 V
V_{IO}	> 5,3	4,3 kV
C_{io}	typ. 0,6	0,6 pF
r_{IO}	> 10^{10}	$10^{10} \Omega$
	typ. 10^{12}	$10^{12} \Omega$
t_{on}	typ. 3	— μs
	typ. 3	— μs
t_{off}	typ. —	5 μs
	typ. —	5 μs

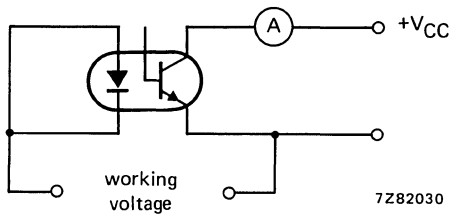

Fig. 2.

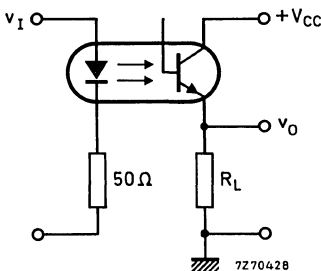

Fig. 3 Switching circuit.

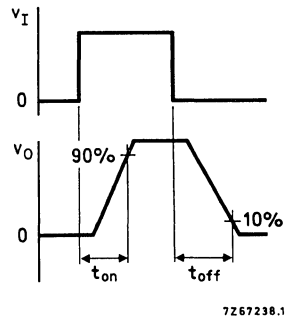

Fig. 4 Waveforms.

* Tested with a d.c. voltage for 1 minute between shorted input leads and shorted output leads.

7Z82033

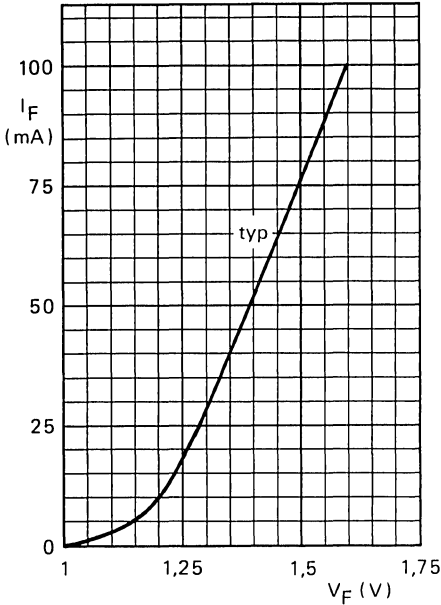

Fig. 5 $T_{amb} = 25\text{ }^\circ\text{C}$.

7Z82034

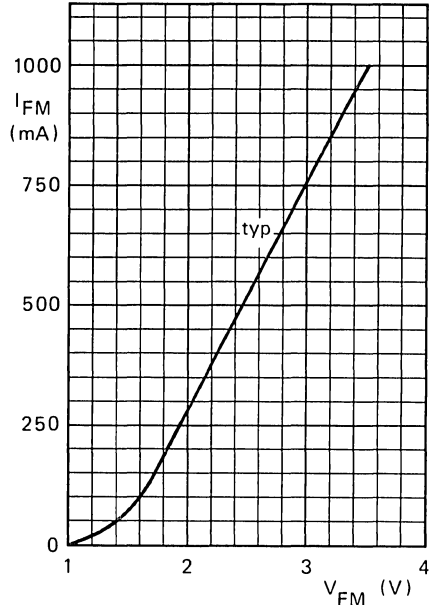

Fig. 6 $T_{amb} = 25\text{ }^\circ\text{C}$; $t_p = 10\text{ }\mu\text{s}$; $T = 1\text{ ms}$.

7Z82035

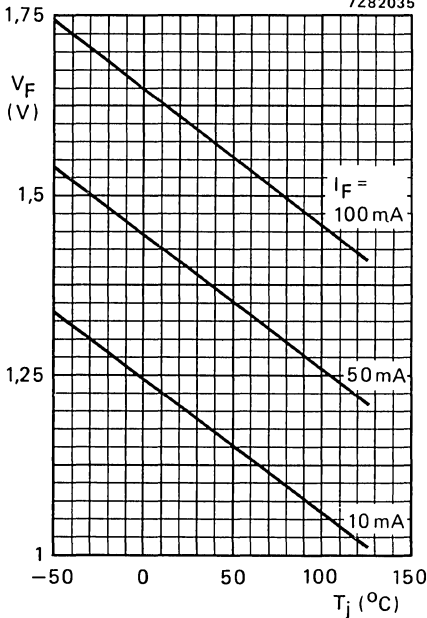

Fig. 7 Typical values.

7Z82036

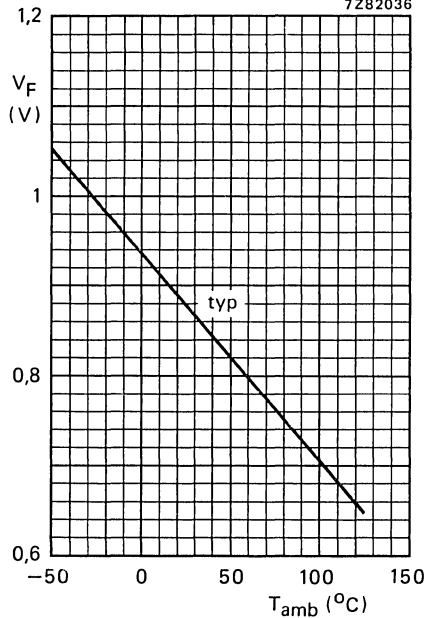

Fig. 8 $I_F = 50\text{ }\mu\text{A}$.

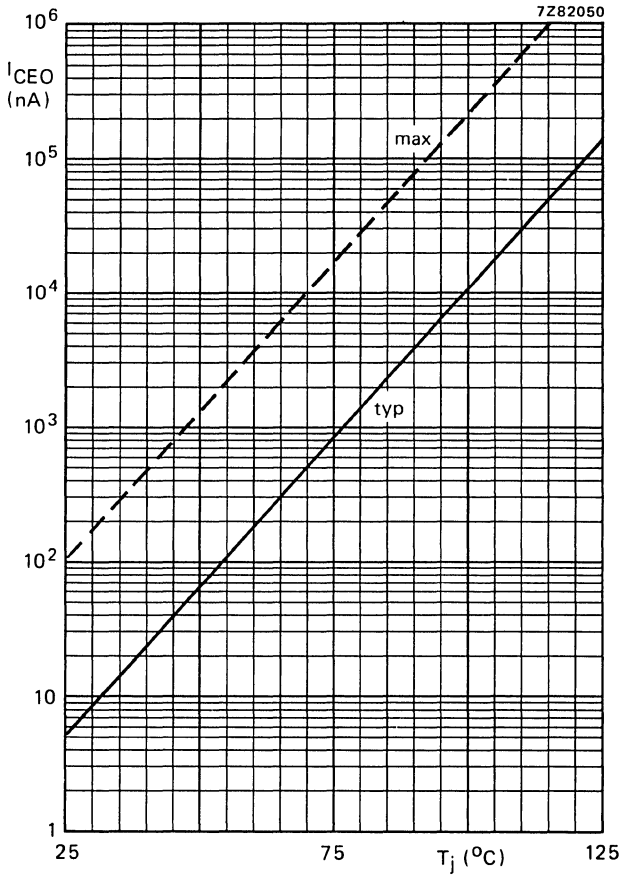

Fig. 9 $I_F = 0$; $V_{CE} = 10$ V.

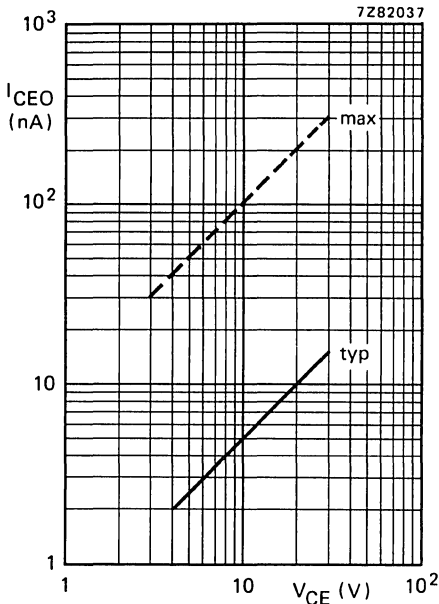

Fig. 10 $I_F = 0$; $T_j = 25^\circ\text{C}$.

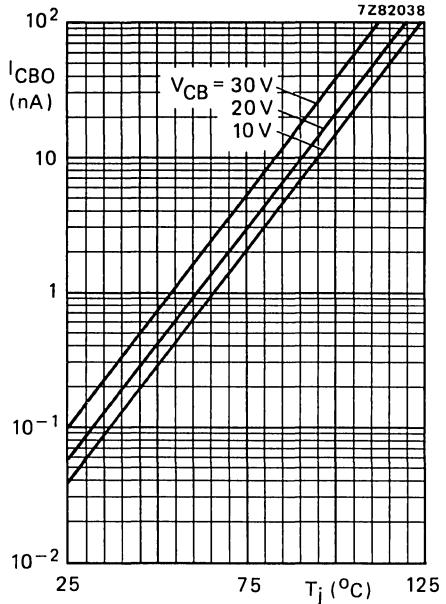

Fig. 11 $I_F = 0$; Typical values.

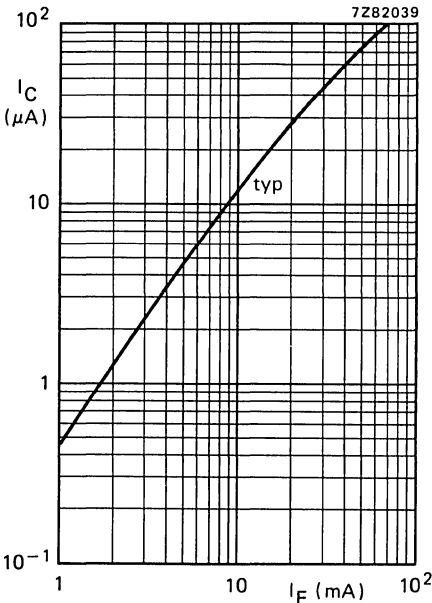

Fig. 12 $I_E = 0$; $V_{CB} = 5\text{ V}$; $T_{amb} = 25^\circ\text{C}$.

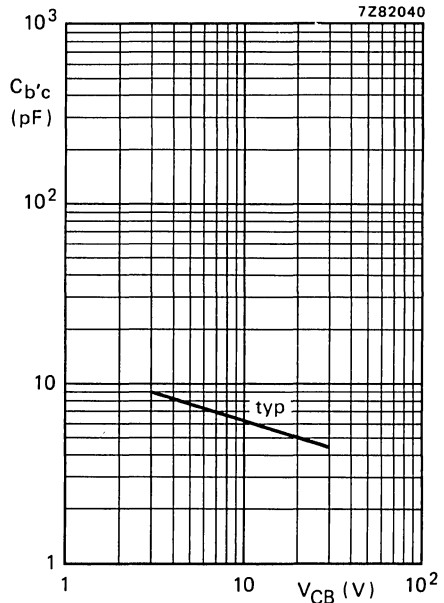

Fig. 13 $f = 1\text{ MHz}$; $T_j = 25^\circ\text{C}$.

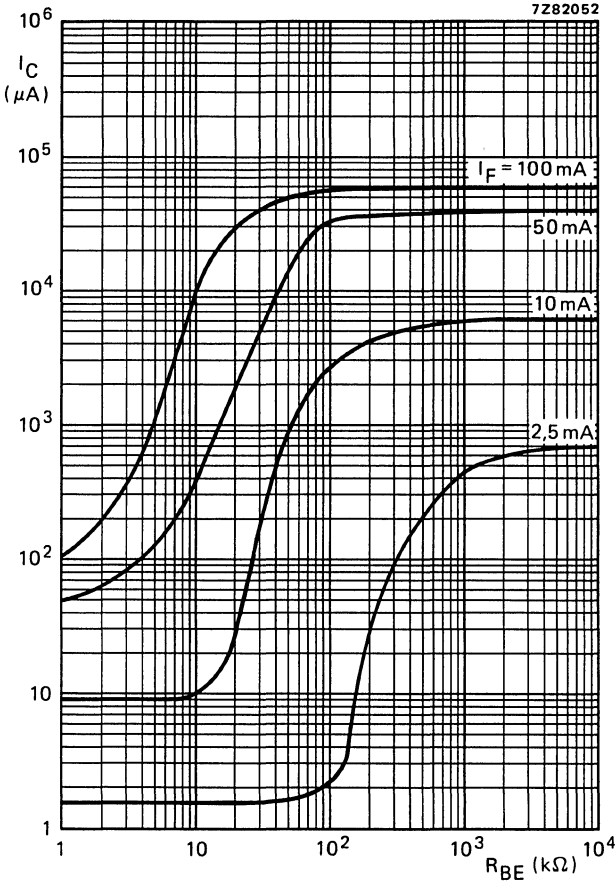

Fig. 14 CNY52; $I_B = 0$; $V_{CE} = 5 \text{ V}$; $T_{amb} = 25 \text{ }^\circ\text{C}$; typical values.

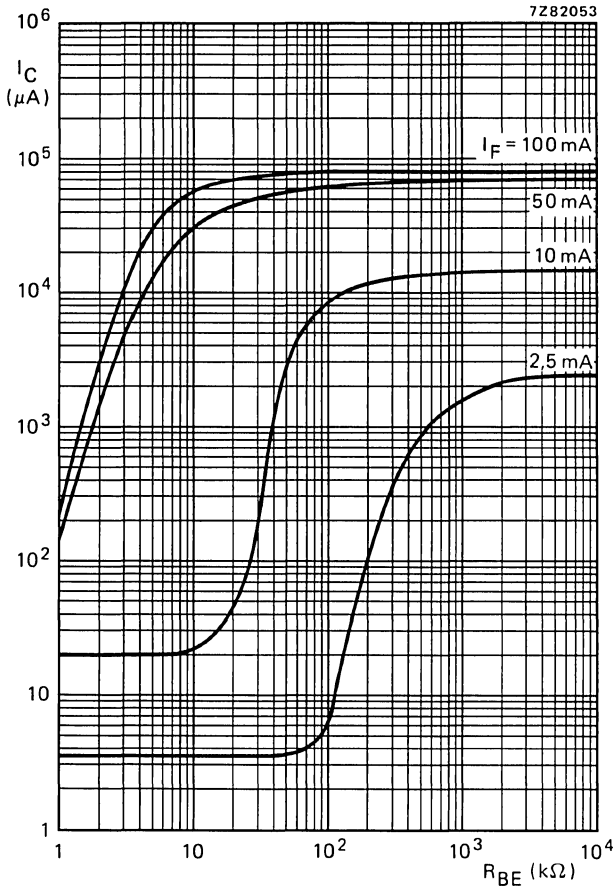

Fig. 15 CNY53; $I_B = 0$; $V_{CE} = 5$ V; $T_{amb} = 25$ °C; typical values.

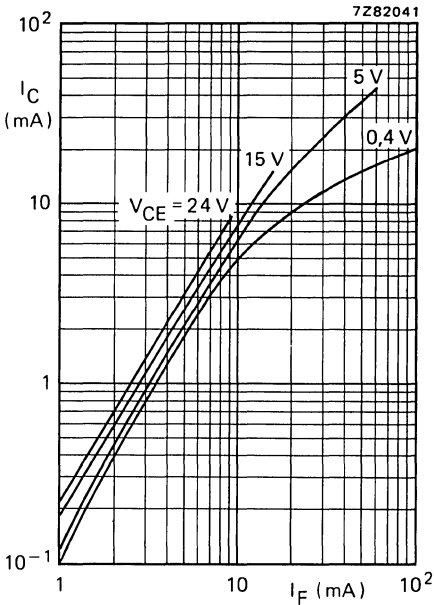

Fig. 16 CNY52; $T_{amb} = 25^\circ\text{C}$; typical values.

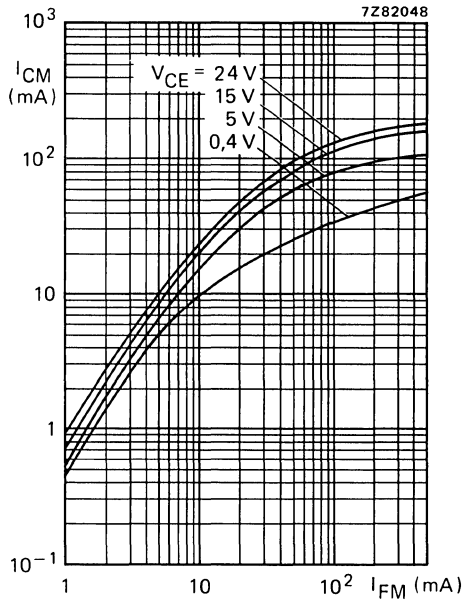

Fig. 17 CNY53; $T_{amb} = 25^\circ\text{C}$; $t_p = 10 \mu\text{s}$; $T = 1 \text{ ms}$; typical values.

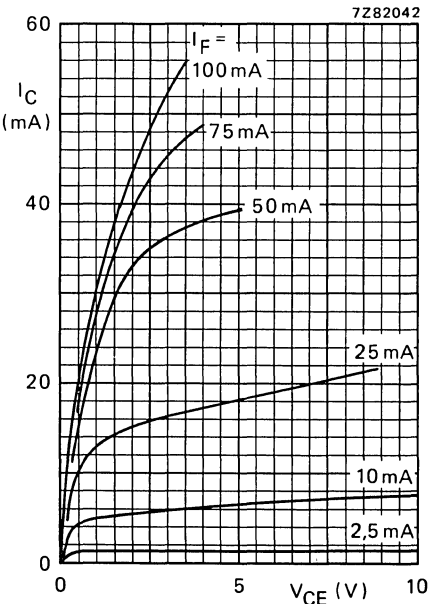

Fig. 18 CNY52; $T_{amb} = 25^\circ\text{C}$; typical values.

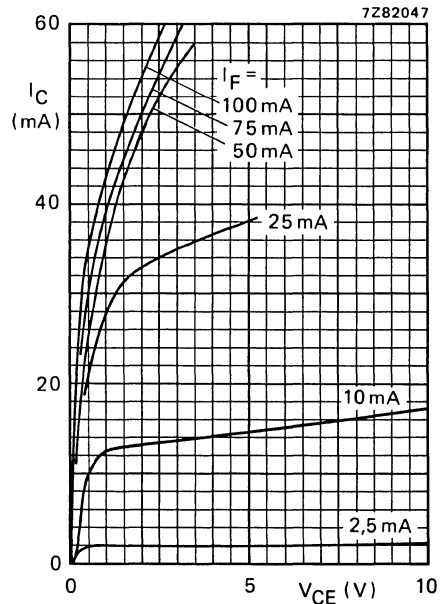

Fig. 19 CNY53; $T_{amb} = 25^\circ\text{C}$; Typical values.

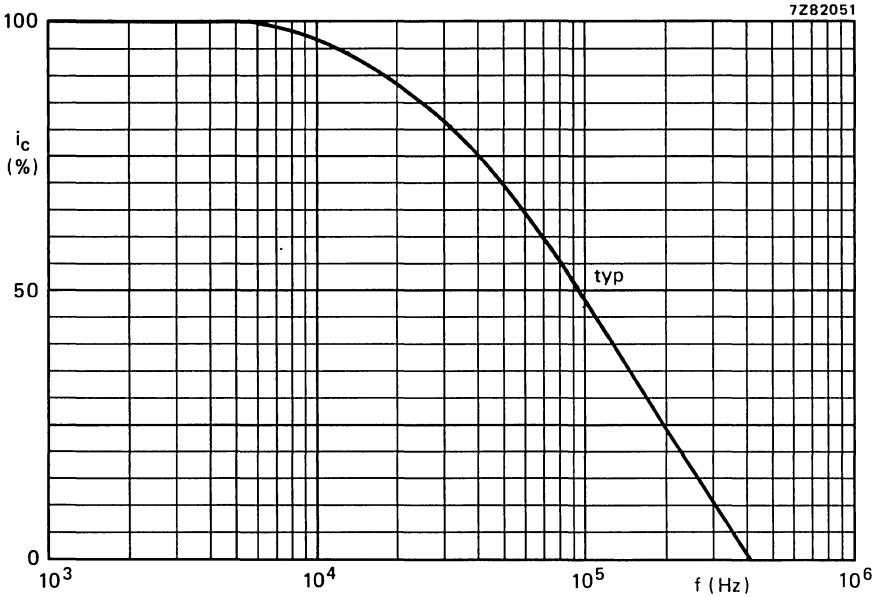

Fig. 20 $I_B = 0$; $I_C = 2$ mA; $V_{CC} = 5$ V; $R_L = 1$ k Ω ; $T_{amb} = 25$ $^{\circ}$ C.

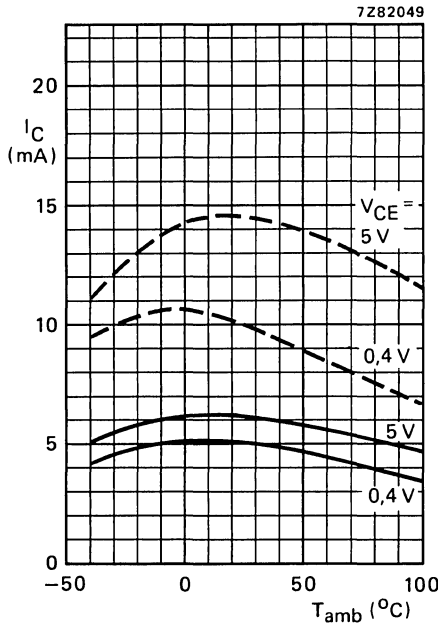

Fig. 21 — CNY52; --- CNY53; $I_B = 0$; $I_F = 10$ mA; typical values.

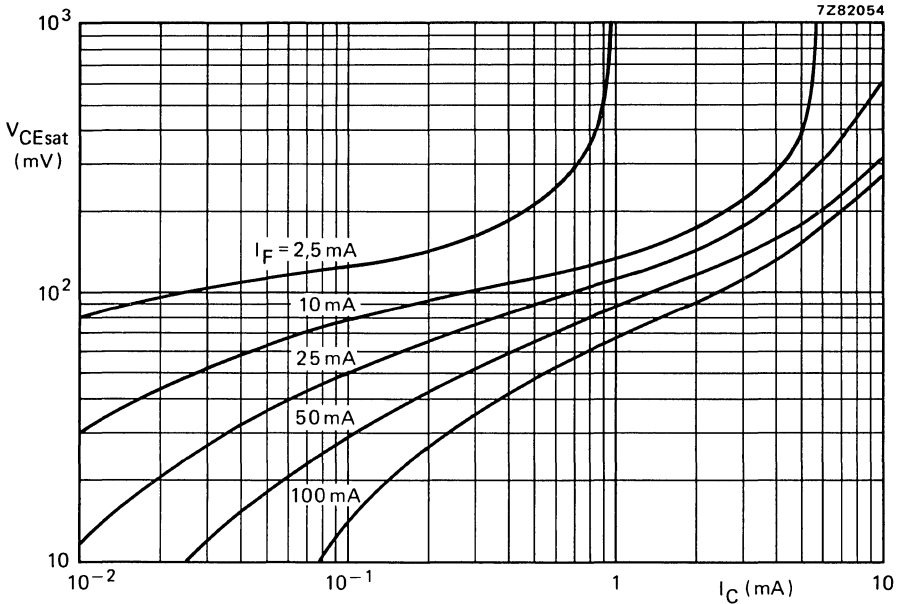

Fig. 22 CNY52; $I_B = 0$; $T_{amb} = 25^\circ C$; typical values.

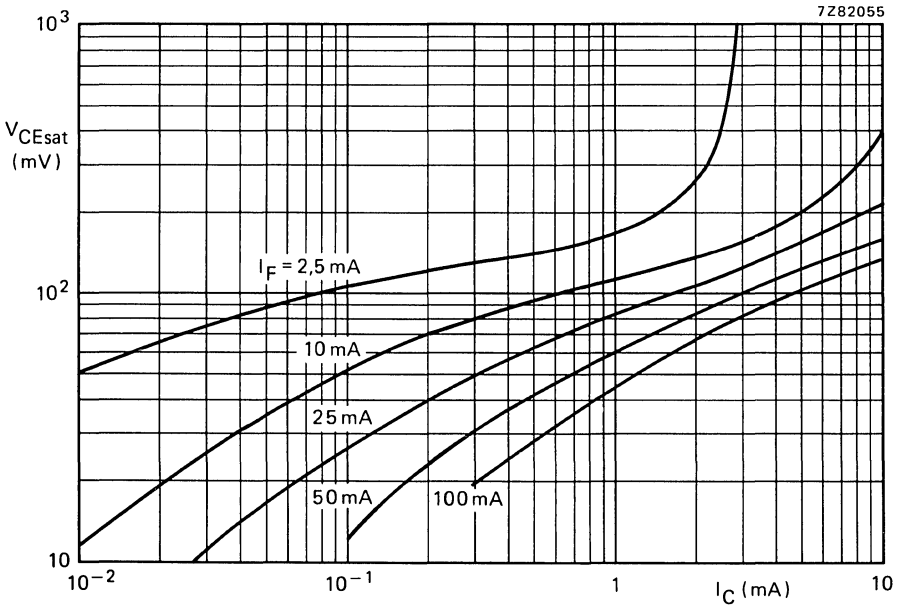

Fig. 23 CNY53; $I_B = 0$; $T_{amb} = 25^\circ C$; typical values.

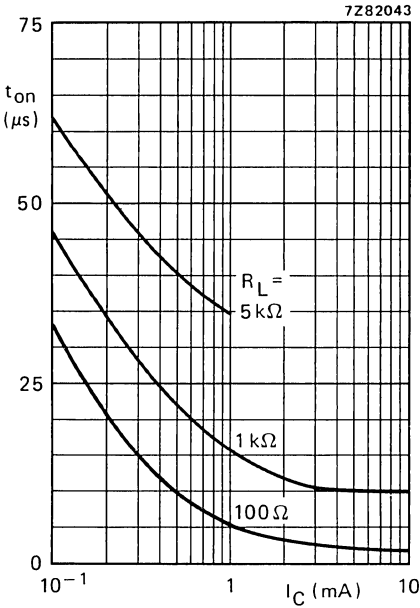

Fig. 24 CNY52; $I_B = 0$; $V_{CC} = 5$ V;
 $T_{amb} = 25$ °C; typical values.
(See also Fig. 26.)

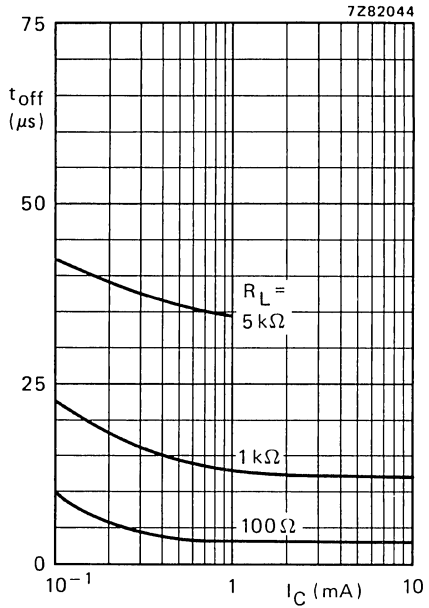

Fig. 25 CNY52; $I_B = 0$; $V_{CC} = 5$ V;
 $T_{amb} = 25$ °C; typical values.
(See also Fig. 26.)

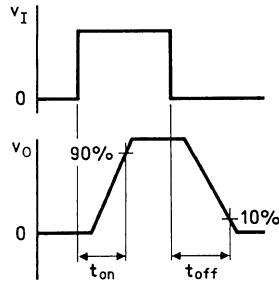
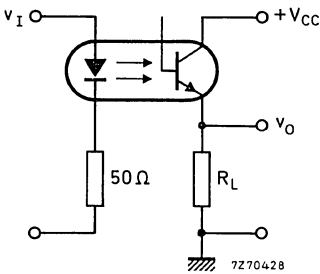

Fig. 26 Switching circuit and waveforms.

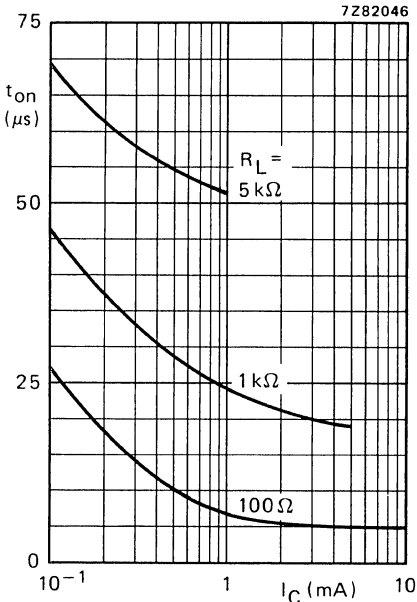

Fig. 27 CNY53; $I_B = 0$; $V_{CC} = 5 V$; $T_{amb} = 25^\circ C$; typical values. (See also Fig. 29.)

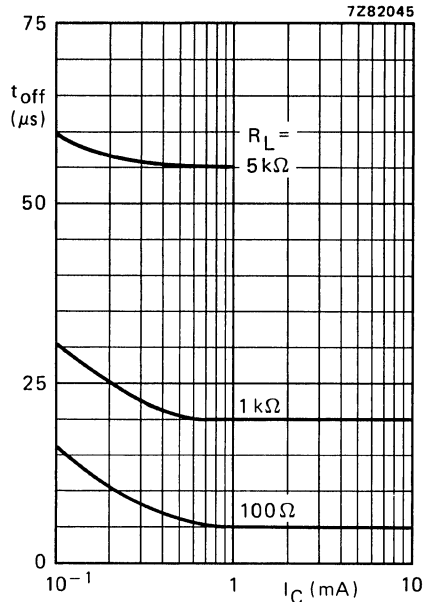

Fig. 28 CNY53; $I_B = 0$; $V_{CC} = 5 V$; $T_{amb} = 25^\circ C$; typical values. (See also Fig. 29.)

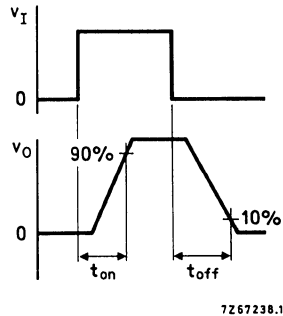
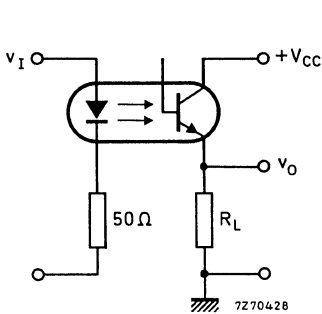

Fig. 29 Switching circuit and waveforms.

PHOTOCOUPLERS

Optically coupled isolators consisting of an infrared emitting GaAs diode and a silicon n-p-n photo-transistor with accessible base. Plastic envelopes. Suitable for TTL integrated circuits.

Features of these products:

- high output/input d.c. current transfer ratio;
- low saturation voltage;
- high isolation voltage of 3 kV (r.m.s.) and 4,3 kV (d.c.);
- working voltage 1,5 kV.

QUICK REFERENCE DATA

Diode

Continuous reverse voltage	V_R	max.	3 V
Forward current d.c. (peak value); $t_p = 10 \mu s$; $\delta = 0,1$	I_F I_{FM}	max.	100 mA 1000 mA
Total power dissipation up to $T_{amb} = 25 \text{ }^\circ\text{C}$	P_{tot}	max.	150 mW

Transistor

Collector-emitter voltage (open base)	V_{CEO}	max.	30 V
Total power dissipation up to $T_{amb} = 25 \text{ }^\circ\text{C}$	P_{tot}	max.	200 mW

Photocoupler

Output/input d.c. current transfer ratio $I_F = 10 \text{ mA}$; $V_{CE} = 0,4 \text{ V}$; ($I_B = 0$)	CNY57 CNY57A	I_C/I_F I_C/I_F	> >	0,2 0,4
Collector cut-off current (dark) $V_{CC} = 10 \text{ V}$; working voltage (d.c.) = 1,5 kV diode: $I_F = 0$ (see also Fig. 2)		I_{CEW}	<	200 nA
Isolation voltage (d.c.) $t = 1 \text{ min}$		V_{IO}	>	4,3 kV

MECHANICAL DATA

SOT-90 (see Fig. 1)

CNY57 CNY57A

MECHANICAL DATA

Fig. 1 SOT-90.

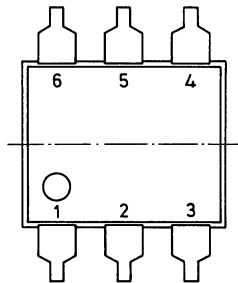
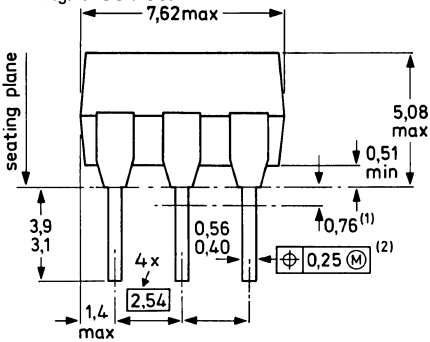

Dimensions in mm

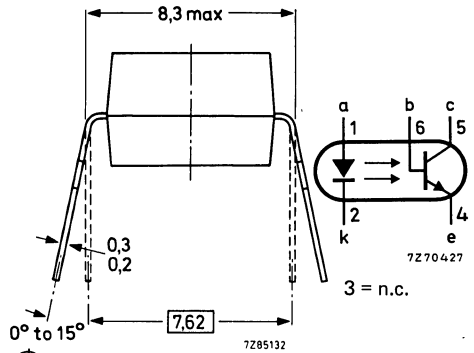

Positional accuracy.



Maximum material condition.

- (1) Lead spacing tolerances apply from seating plane to the line indicated.
- (2) Centre-lines of all leads are within $\pm 0,125$ mm of the nominal position shown; in the worst case, the spacing between any two leads may deviate from nominal by $\pm 0,25$ mm.

RATINGS

Limiting values in accordance with the Absolute Maximum System (IEC 134)

Diode

Continuous reverse voltage	V_R	max.	3 V
Forward current	I_F	max.	100 mA
d.c.	I_{FM}	max.	1000 mA
(peak value); $t_p = 10 \mu s$; $\delta = 0,1$	P_{tot}	max.	150 mW
Total power dissipation up to $T_{amb} = 25 \text{ }^\circ\text{C}$	T_j	max.	125 $^\circ\text{C}$
Operating junction temperature			

Transistor

Collector-emitter voltage (open base)	V_{CEO}	max.	30 V
Collector-base voltage (open emitter)	V_{CBO}	max.	50 V
Emitter-collector voltage (open base)	V_{ECO}	max.	7 V

Collector current (d.c.)	I_C	max.	100 mA
Total power dissipation up to $T_{amb} = 25\text{ }^\circ\text{C}$	P_{tot}	max.	200 mW
Operating junction temperature	T_j	max.	125 $^\circ\text{C}$

Photocoupler

Storage temperature	T_{stg}		-55 to + 150 $^\circ\text{C}$
Lead soldering temperature up to the seating plane; $t_{sld} < 10\text{ s}$	T_{sld}	max.	260 $^\circ\text{C}$

THERMAL RESISTANCE

From junction to ambient in free air diode	$R_{th\ j-a}$	=	0,65 $^\circ\text{C}/\text{mW}$
transistor	$R_{th\ j-a}$	=	0,5 $^\circ\text{C}/\text{mW}$
From junction to ambient, device mounted on a printed-circuit board diode	$R_{th\ j-a}$	=	0,6 $^\circ\text{C}/\text{mW}$
transistor	$R_{th\ j-a}$	=	0,4 $^\circ\text{C}/\text{mW}$

CHARACTERISTICS

$T_j = 25\text{ }^\circ\text{C}$ unless otherwise specified

Diode

Forward voltage $I_F = 10\text{ mA}$	V_F	typ. <	1,2 V 1,5 V
Reverse current $V_R = 3\text{ V}$	I_R	<	10 μA

Transistor (diode: $I_F = 0$)

Collector cut-off current (dark) $V_{CE} = 10\text{ V}$	I_{CEO}	typ. <	5 nA 100 nA
$V_{CE} = 10\text{ V}; T_{amb} = 70\text{ }^\circ\text{C}$	I_{CEO}	<	10 μA
$V_{CB} = 10\text{ V}$	I_{CBO}	<	20 nA

Photocoupler ($I_B = 0$)*

Output/input d.c. current transfer ratio $I_F = 10\text{ mA}; V_{CE} = 0,4\text{ V}$	CNY57 I_C/I_F	typ. 0,2 to 0,8	0,5
	CNY57A I_C/I_F	> typ.	0,4 1,0

Collector cut-off current (dark) see Fig. 2

$V_{CC} = 10\text{ V};$ working voltage (d.c.) = 1,5 kV	I_{CEW}	<	200 nA
$V_{CC} = 10\text{ V};$ working voltage (d.c.) = 1,5 kV; $T_j = 70\text{ }^\circ\text{C}$	I_{CEW}	<	100 μA

* Where the phototransistor receives light from the diode the O (for open base) has been omitted from the symbols.

CNY57
CNY57A

Collector-emitter saturation voltage

$I_F = 10 \text{ mA}; I_C = 2 \text{ mA}$

$I_F = 10 \text{ mA}; I_C = 4 \text{ mA}$

Isolation voltage, d.c. value*

Capacitance between input and output

$I_F = 0; V = 0; f = 1 \text{ MHz}$

Insulation resistance between input and output

$\pm V_{IO} = 1 \text{ kV}$

Switching times (see Figs 3 and 4)

$I_{Con} = 2 \text{ mA}; V_{CC} = 5 \text{ V}; R_L = 100 \Omega$

Turn-on time

Turn-off time

$I_{Con} = 4 \text{ mA}; V_{CC} = 5 \text{ V}; R_L = 100 \Omega$

Turn-on time

Turn-off time

		CNY57	CNY57A
V_{CEsat}	typ.	0,17	— V
	<	0,40	— V
V_{CEsat}	typ.	—	0,17 V
	<	—	0,40 V
V_{IO}	>	4,3	4,3 kV
C_{io}	typ.	0,6	0,6 pF
	>	10^{10}	$10^{10} \Omega$
r_{IO}	typ.	10^{12}	$10^{12} \Omega$
	typ.	3	— μs
t_{off}	typ.	3	— μs
t_{on}	typ.	—	5 μs
	typ.	—	5 μs

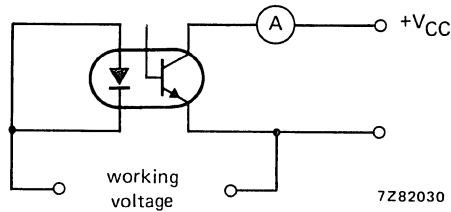

Fig. 2.

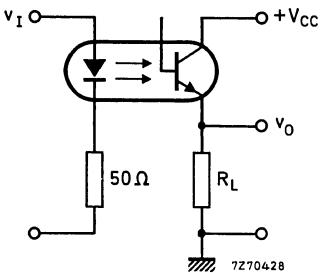

Fig. 3 Switching circuit.

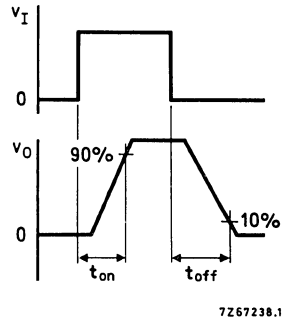

Fig. 4 Waveforms.

* Tested with a d.c. voltage for 1 minute between shorted input leads and shorted output leads.

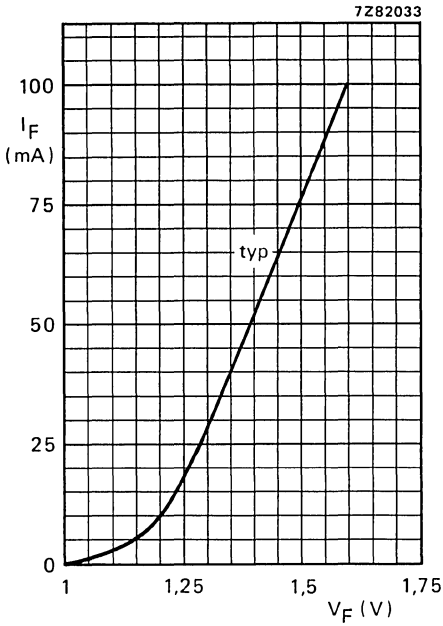

Fig. 5 $T_{amb} = 25^{\circ}C$.

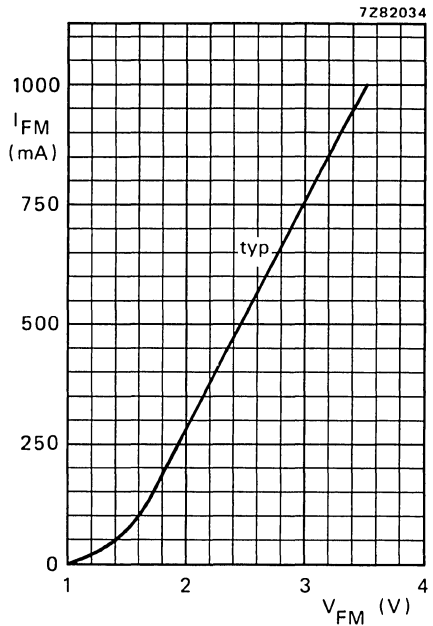

Fig. 6 $T_{amb} = 25^{\circ}C$; $t_p = 10 \mu s$; $T = 1 ms$.

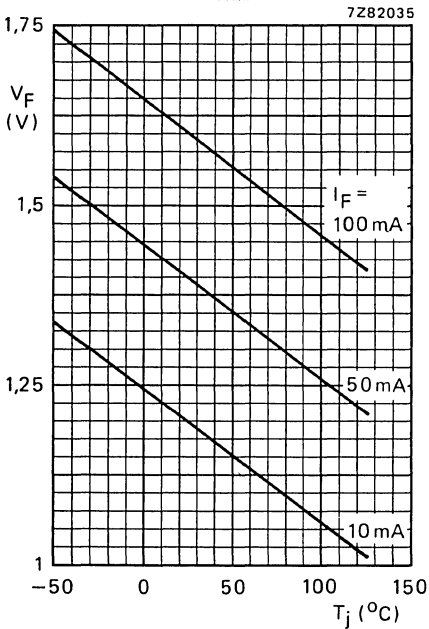

Fig. 7 Typical values.

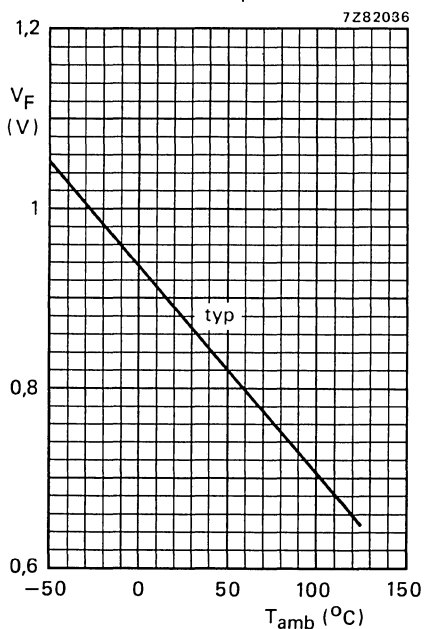

Fig. 8 $I_F = 50 \mu A$.

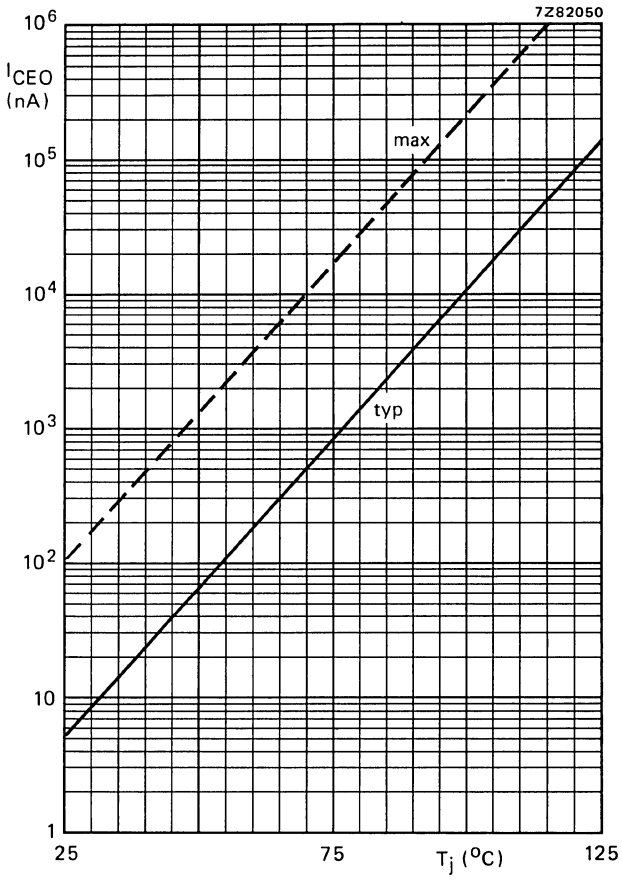

Fig. 9 $I_F = 0$; $V_{CE} = 10$ V.

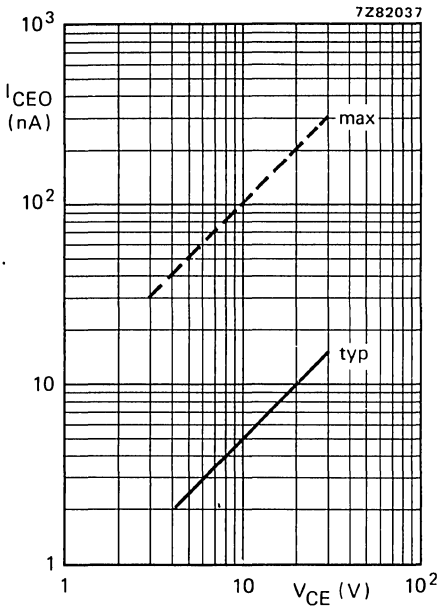

Fig. 10 $I_F = 0$; $T_j = 25^\circ\text{C}$.

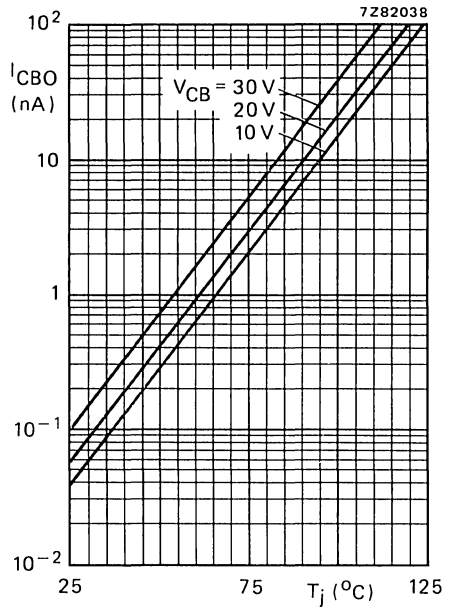

Fig. 11 $I_F = 0$; typical values.

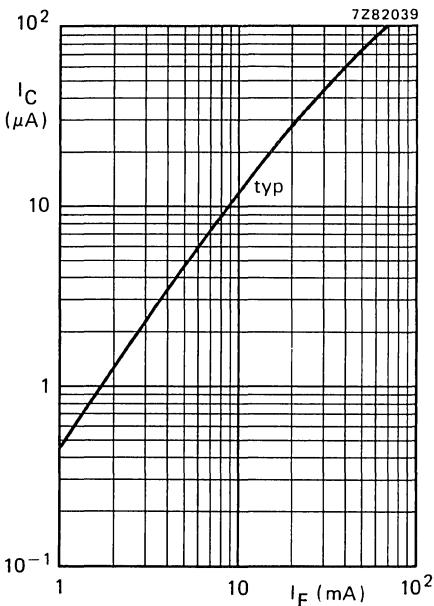

Fig. 12 $I_E = 0$; $V_{CB} = 5\text{ V}$; $T_{\text{amb}} = 25^\circ\text{C}$.

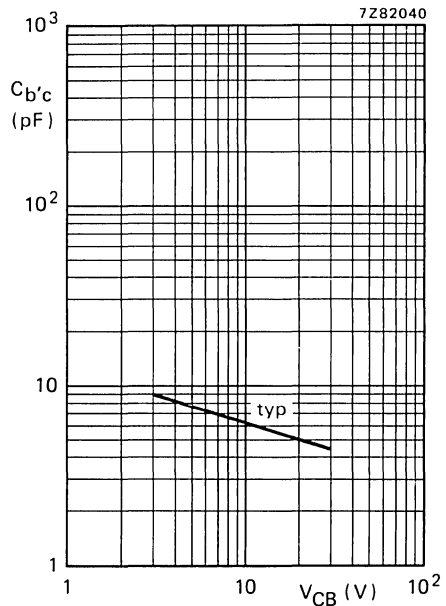

Fig. 13 $f = 1\text{ MHz}$; $T_j = 25^\circ\text{C}$.

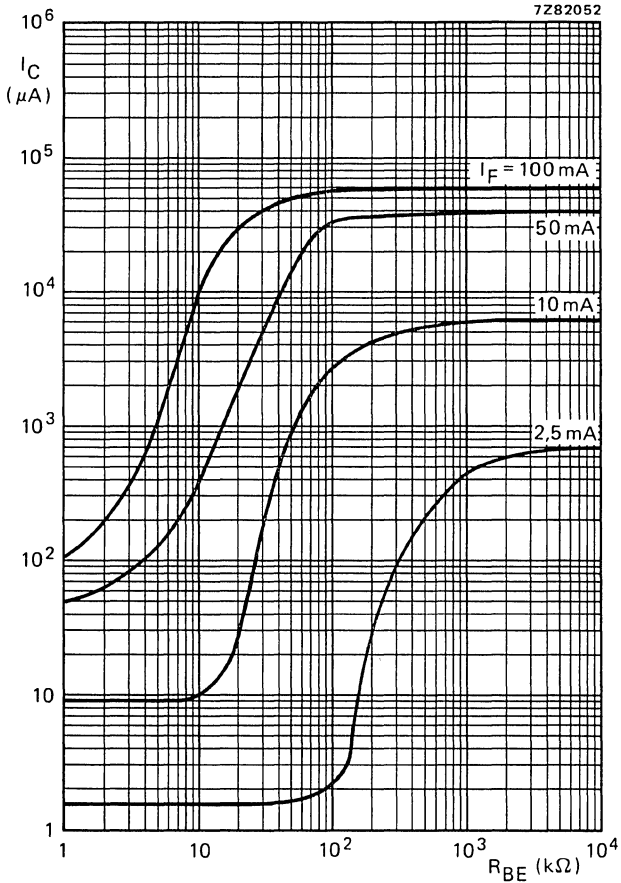

Fig. 14 CNY57; $I_B = 0$; $V_{CE} = 5$ V; $T_{amb} = 25$ °C; typical values.

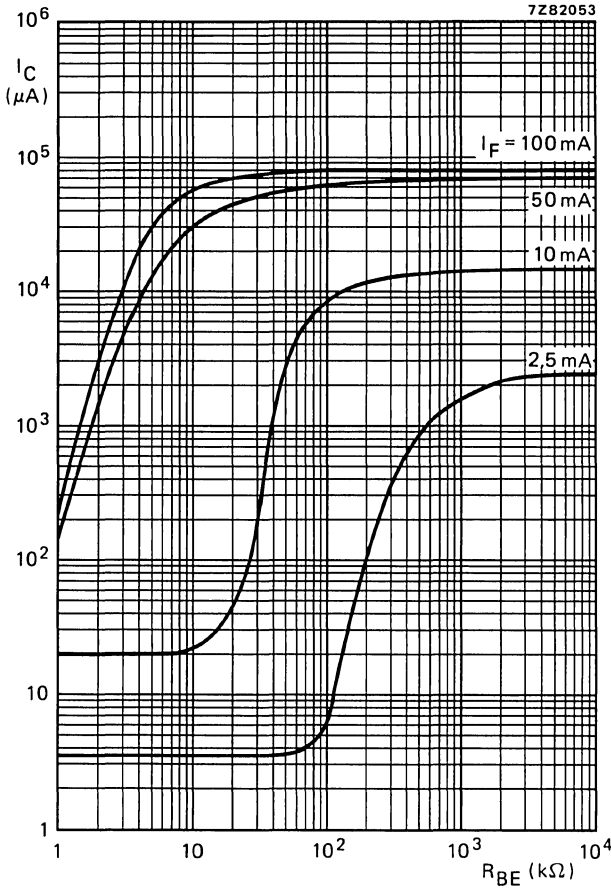

Fig. 15 CNY57A; $I_B = 0$; $V_{CE} = 5 \text{ V}$; $T_{\text{amb}} = 25 \text{ }^\circ\text{C}$; typical values.

CNY57
CNY57A

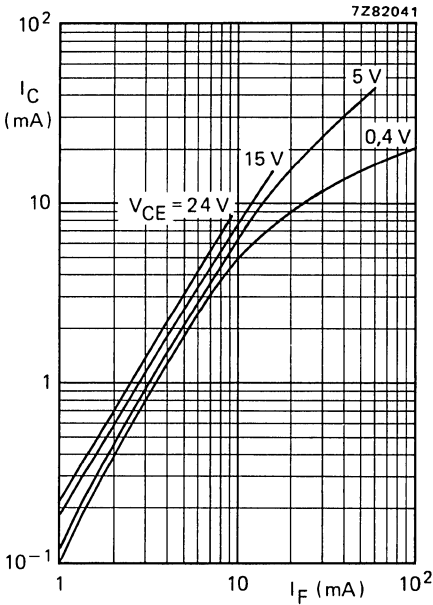

Fig. 16 CNY57; $T_{amb} = 25^\circ\text{C}$; typical values.

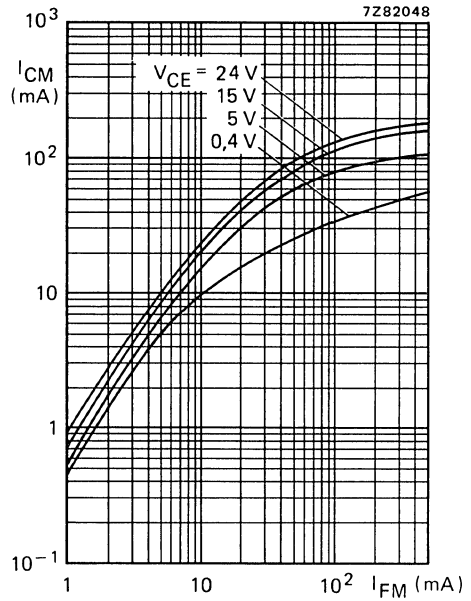

Fig. 17 CNY57A; $T_{amb} = 25^\circ\text{C}$; $t_p = 10 \mu\text{s}$; $T = 1$ ms; typical values.

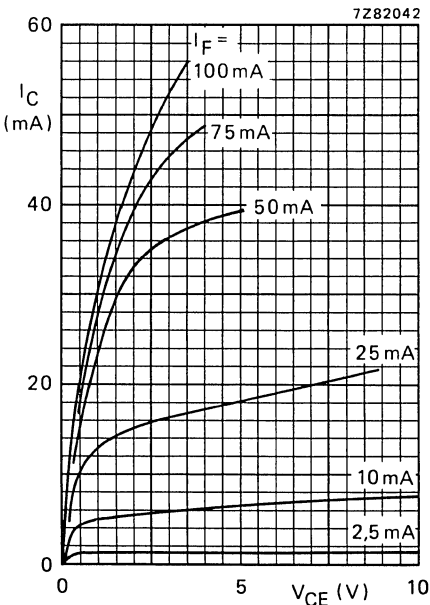

Fig. 18 CNY57; $T_{amb} = 25^\circ\text{C}$; typical values.

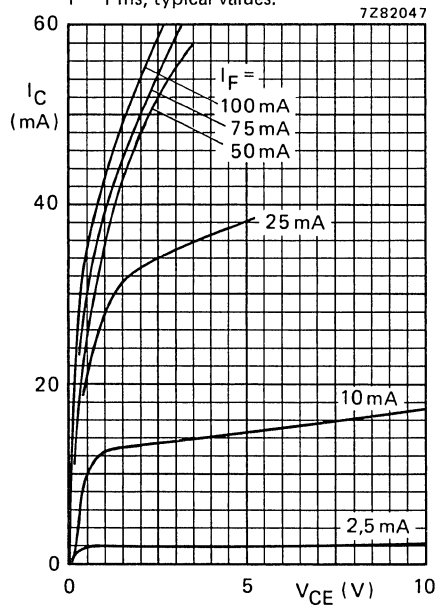

Fig. 19 CNY57A; $T_{amb} = 25^\circ\text{C}$; typical values.

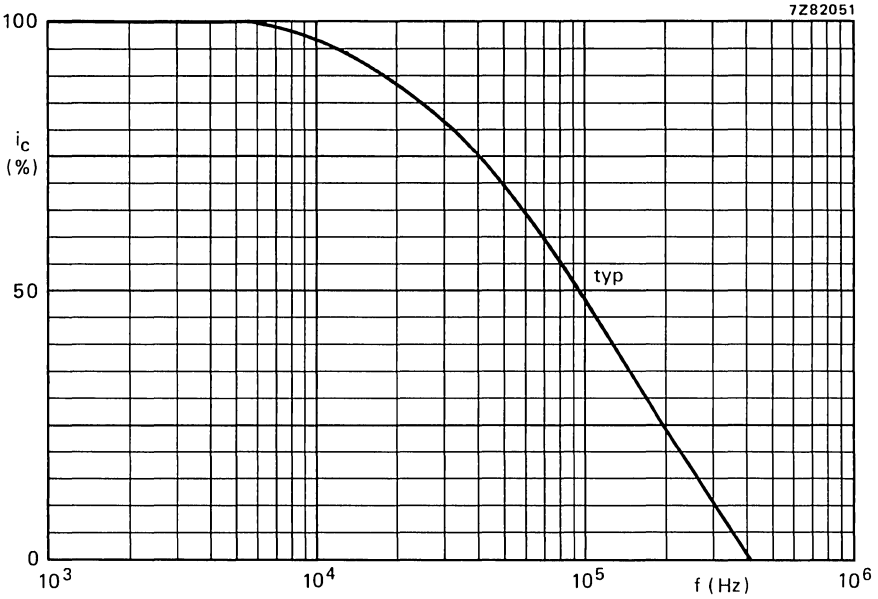

Fig. 20 $I_B = 0$; $I_C = 2 \text{ mA}$; $V_{CC} = 5 \text{ V}$; $R_L = 1 \text{ k}\Omega$; $T_{amb} = 25 \text{ }^\circ\text{C}$.

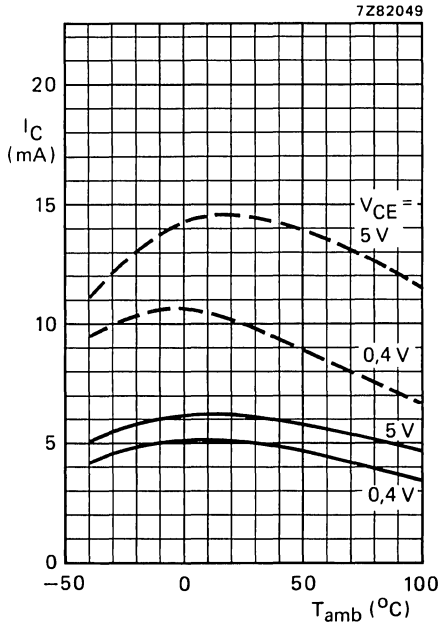

Fig. 21 ——— CNY57; - - - CNY57A; $I_B = 0$; $I_F = 10 \text{ mA}$; typical values.

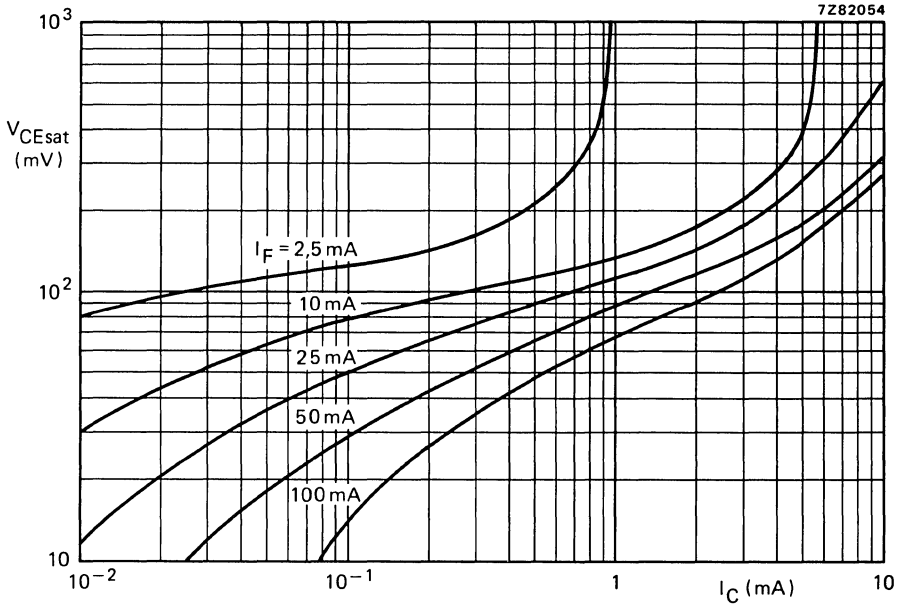

Fig. 22 CNY57; $I_B = 0$; $T_{amb} = 25 \text{ }^\circ\text{C}$; typical values.

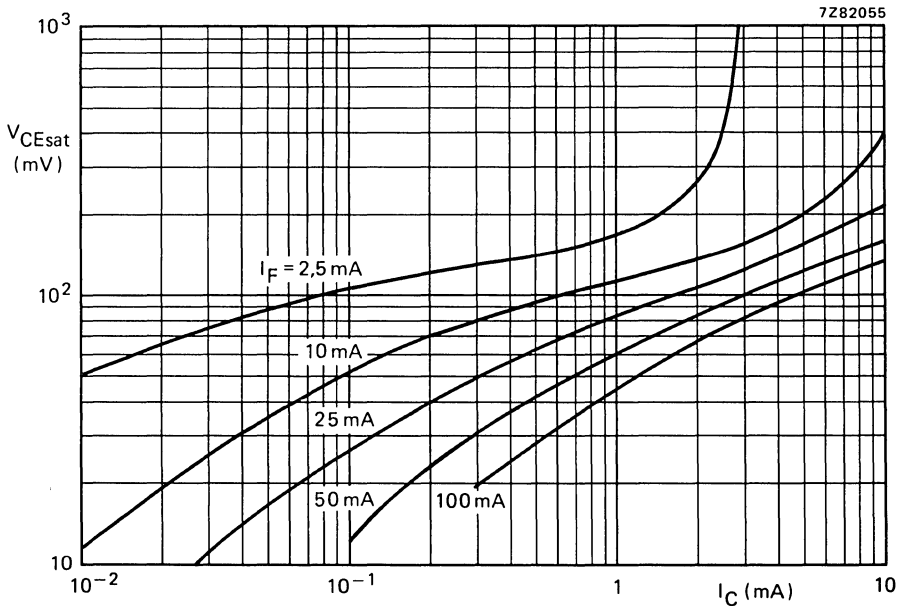

Fig. 23 CNY57A; $I_B = 0$; $T_{amb} = 25 \text{ }^\circ\text{C}$; typical values.

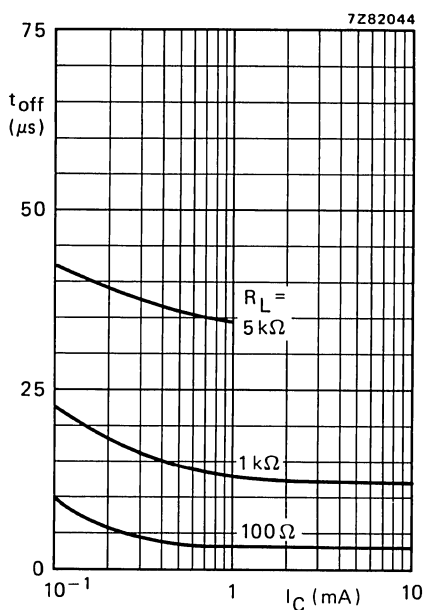
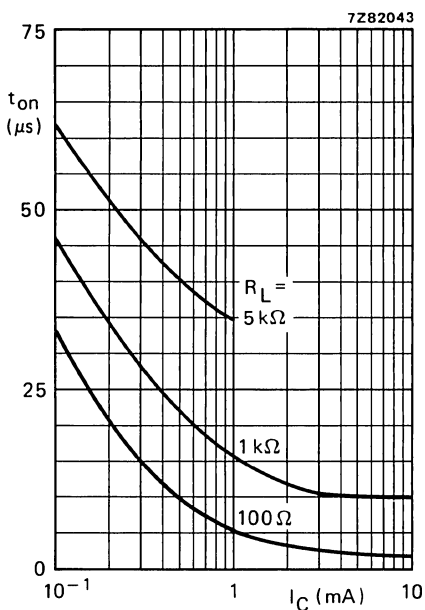

Fig. 24 CNY57; $I_B = 0$; $V_{CC} = 5\text{ V}$; $T_{amb} = 25\text{ }^\circ\text{C}$; typical values. (See also Fig. 26.)

Fig. 25 CNY57; $I_B = 0$; $V_{CC} = 5\text{ V}$; $T_{amb} = 25\text{ }^\circ\text{C}$; typical values. (See also Fig. 26.)

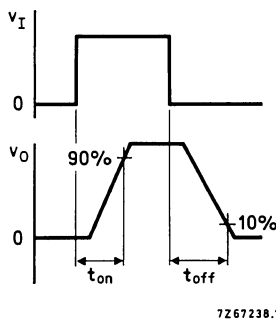
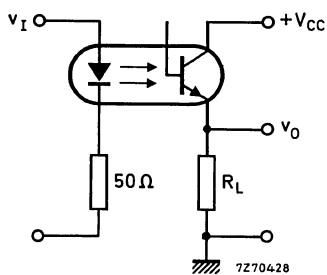

Fig. 26 Switching circuit and waveforms.

CNY57¹
CNY57A

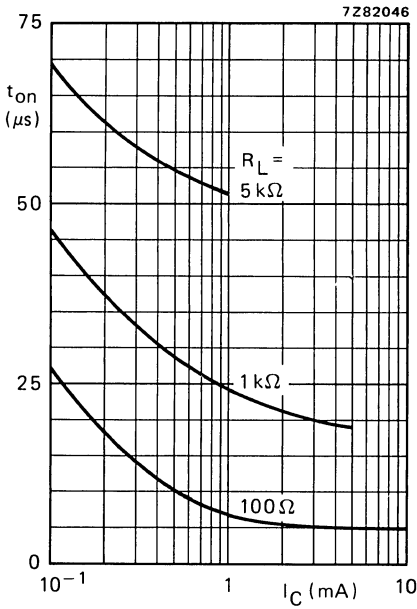

Fig. 27 CNY57A; $I_B = 0$; $V_{CC} = 5V$; $T_{amb} = 25^\circ C$; typical values. (See also Fig. 29.)

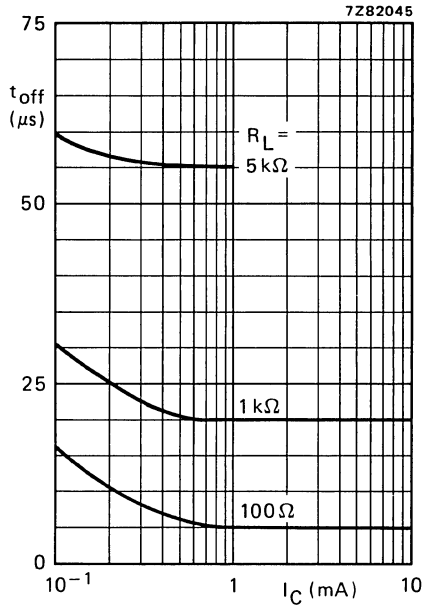
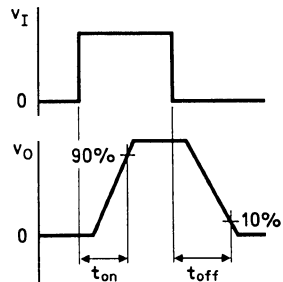
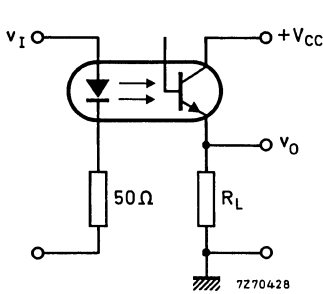

Fig. 28 CNY57A; $I_B = 0$; $V_{CC} = 5V$; $T_{amb} = 25^\circ C$; typical values. (See also Fig. 29.)



7Z67238.1

Fig. 29 Switching circuit and waveforms.

PHOTOCOUPLERS

Optically coupled isolators consisting of an infrared emitting GaAs diode and a silicon n-p-n photo-transistor without accessible base. Plastic envelopes. Suitable for TTL integrated circuits.

Features of these products:

- high output/input d.c. current transfer ratio;
- low saturation voltage;
- a high isolation voltage
CNY62 3,75 kV (r.m.s.) and 5,3 kV (d.c.);
CNY63 3 kV (r.m.s.) and 4,3 kV (d.c.);
- working voltage 1,5 kV.

QUICK REFERENCE DATA

Diode		CNY62	CNY63
Continuous reverse voltage	V_R	max. 3	3 V
Forward current			
d.c.	I_F	max. 100	100 mA
(peak value); $t_p = 10 \mu s$; $\delta = 0,1$	I_{FM}	max. 1000	1000 mA
Total power dissipation up to $T_{amb} = 25 \text{ }^\circ\text{C}$	P_{tot}	max. 150	150 mW
Transistor			
Collector-emitter voltage (open base)	V_{CEO}	max. 50	30 V
Total power dissipation up to $T_{amb} = 25 \text{ }^\circ\text{C}$	P_{tot}	max. 200	200 mW
Photocoupler			
Output/input d.c. current transfer ratio			
$I_F = 10 \text{ mA}$; $V_{CE} = 0,4 \text{ V}$; ($I_B = 0$)	I_C/I_F	> 0,25	0,50
Collector cut-off current (dark)			
$V_{CC} = 10 \text{ V}$; working voltage (d.c.) = 1,5 kV diode: $I_F = 0$ (see also Fig. 2)	I_{CEW}	< 200	200 nA
Isolation voltage (d.c.)			
$t = 1 \text{ min}$	V_{IO}	> 5,3	4,3 kV

MECHANICAL DATA

SOT-91B (see Fig. 1)

Total power dissipation up to $T_{amb} = 25\text{ }^{\circ}\text{C}$	P_{tot}	max.	200 mW
Operating junction temperature	T_j	max.	125 $^{\circ}\text{C}$

Photocoupler

Storage temperature	T_{stg}		-55 to +150 $^{\circ}\text{C}$
Lead soldering temperature up to the seating plane; $t_{sld} < 10\text{ s}$	T_{sld}	max.	260 $^{\circ}\text{C}$

THERMAL RESISTANCE

From junction to ambient in free air diode	$R_{th\ j-a}$	=	0,65 $^{\circ}\text{C}/\text{mW}$
transistor	$R_{th\ j-a}$	=	0,5 $^{\circ}\text{C}/\text{mW}$
From junction to ambient, device mounted on a printed-circuit board diode	$R_{th\ j-a}$	=	0,6 $^{\circ}\text{C}/\text{mW}$
transistor	$R_{th\ j-a}$	=	0,4 $^{\circ}\text{C}/\text{mW}$

CHARACTERISTICS

$T_j = 25\text{ }^{\circ}\text{C}$ unless otherwise specified

Diode

Forward voltage $I_F = 10\text{ mA}$	V_F	typ. <	1,2 V 1,5 V
Reverse current $V_R = 3\text{ V}$	I_R	<	10 μA

Transistor (diode: $I_F = 0$)

Collector cut-off current (dark) $V_{CE} = 10\text{ V}$	I_{CEO}	typ. <	5 nA 100 nA
$V_{CE} = 10\text{ V}; T_{amb} = 70\text{ }^{\circ}\text{C}$	I_{CEO}	<	10 μA

Photocoupler ($I_B = 0$)*

Output/input d.c. current transfer ratio $I_F = 10\text{ mA}; V_{CE} = 0,4\text{ V}$	CNY62	I_C/I_F	> typ.	0,25 0,50
	CNY63	I_C/I_F	> typ.	0,5 1,0
Collector cut-off current (dark) see Fig. 2 $V_{CC} = 10\text{ V};$ working voltage (d.c.) = 1,5 kV		I_{CEW}	<	200 nA
$V_{CC} = 10\text{ V};$ working voltage (d.c.) = 1,5 kV; $T_j = 70\text{ }^{\circ}\text{C}$		I_{CEW}	<	100 μA

* Where the phototransistor receives light from the diode the O (for open base) has been omitted from the symbols.

CNY62
CNY63

Collector-emitter saturation voltage

$I_F = 10 \text{ mA}; I_C = 2 \text{ mA}$

$I_F = 10 \text{ mA}; I_C = 4 \text{ mA}$

/ Isolation voltage, d.c. value*

Capacitance between input and output

$I_F = 0; V = 0; f = 1 \text{ MHz}$

Insulation resistance between input and output

$\pm V_{IO} = 1 \text{ kV}$

Switching times (see Figs 3 and 4)

$I_{Con} = 2 \text{ mA}; V_{CC} = 5 \text{ V}; R_L = 100 \Omega$

Turn-on time

Turn-off time

$I_{Con} = 4 \text{ mA}; V_{CC} = 5 \text{ V}; R_L = 100 \Omega$

Turn-on time

Turn-off time

		CNY62	CNY63
V_{CEsat}	typ.	0,17	— V
	<	0,40	— V
V_{CEsat}	typ.	—	0,17 V
	<	—	0,40 V
V_{IO}	>	5,3	4,3 kV
C_{io}	typ.	0,6	0,6 pF
r_{IO}	>	10^{10}	$10^{10} \Omega$
	typ.	10^{12}	$10^{12} \Omega$
t_{on}	typ.	3	— μs
t_{off}	typ.	3	— μs
t_{on}	typ.	—	5 μs
t_{off}	typ.	—	5 μs

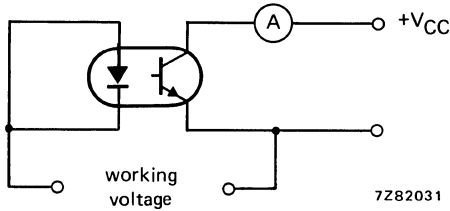

Fig. 2.

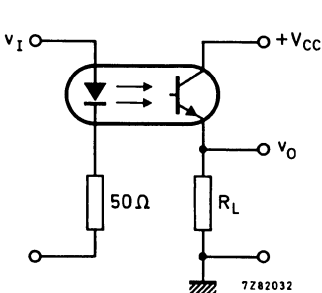

Fig. 3 Switching circuit.

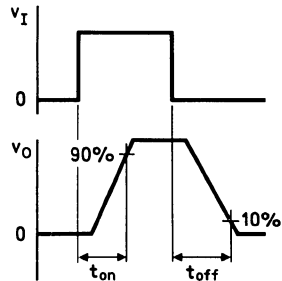

Fig. 4 Waveforms.

* Tested with a d.c. voltage for 1 minute between shorted input leads and shorted output leads.

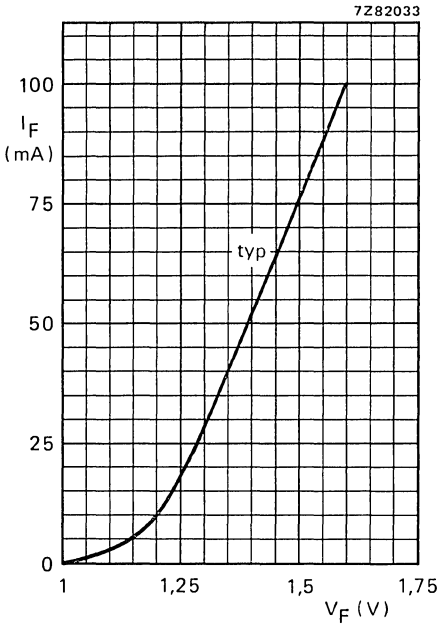

Fig. 5 $T_{amb} = 25^\circ C$.

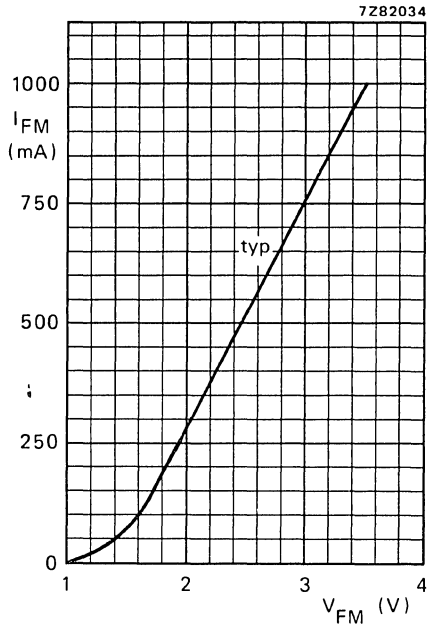

Fig. 6 $T_{amb} = 25^\circ C$; $t_p = 10 \mu s$; $T = 1 ms$.

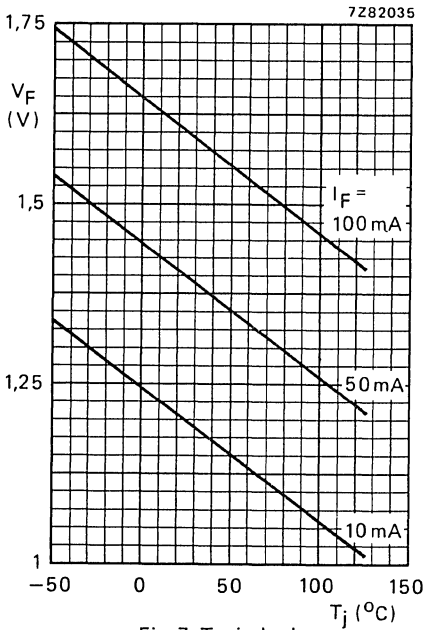

Fig. 7 Typical values.

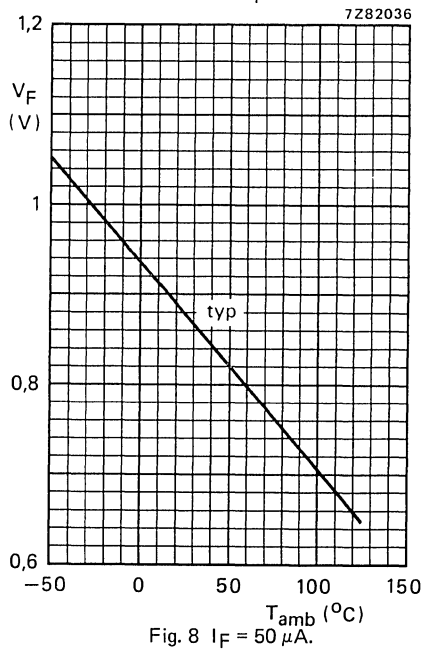

Fig. 8 $I_F = 50 \mu A$.

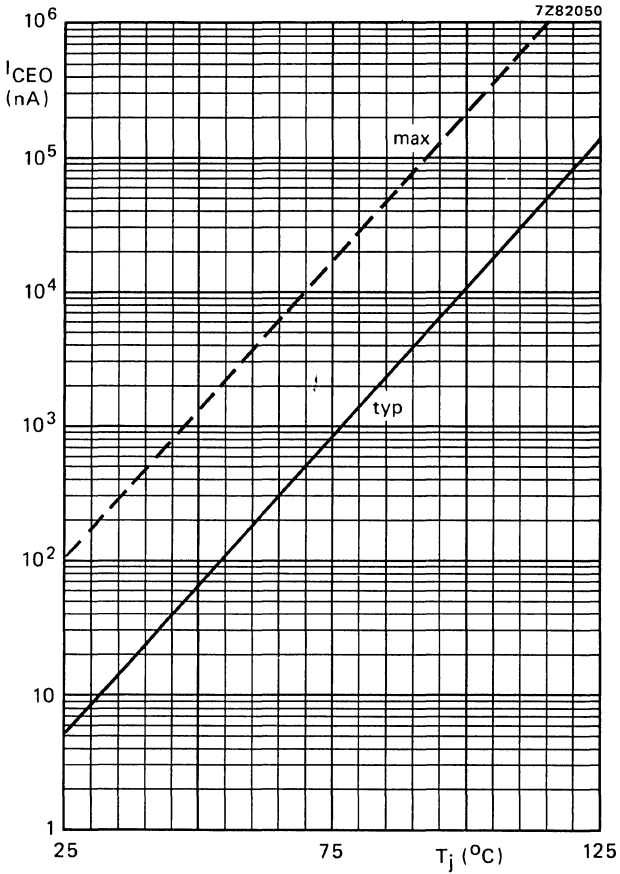

Fig. 9 $I_F = 0$; $V_{CE} = 10$ V.

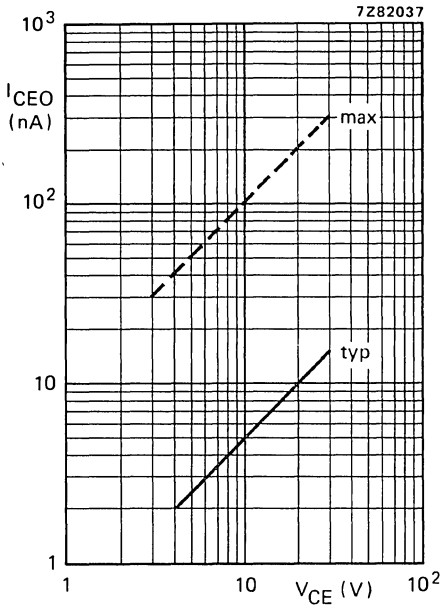

Fig. 10 $I_F = 0$; $T_j = 25^\circ\text{C}$.

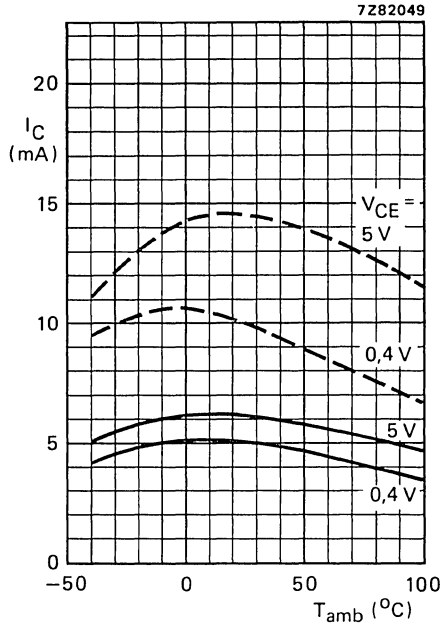

Fig. 11 $I_B = 0$; $I_F = 10\text{ mA}$;
— CNY62; --- CNY63; typical values.

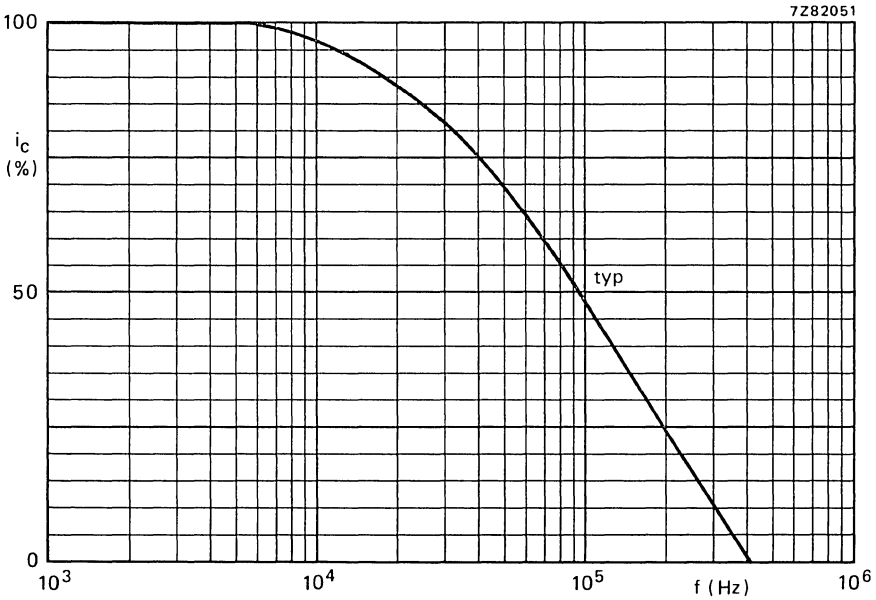

Fig. 12 $I_B = 0$; $I_C = 2\text{ mA}$; $V_{CC} = 5\text{ V}$; $R_L = 1\text{ k}\Omega$; $T_{\text{amb}} = 25^\circ\text{C}$.

CNY62
CNY63

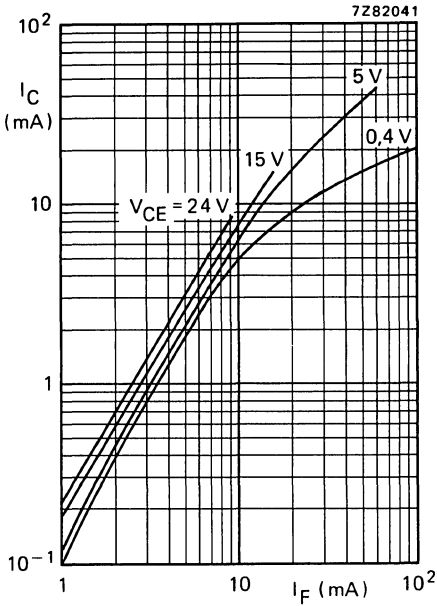

Fig. 13 CNY62; $T_{amb} = 25\text{ }^\circ\text{C}$; typical values.

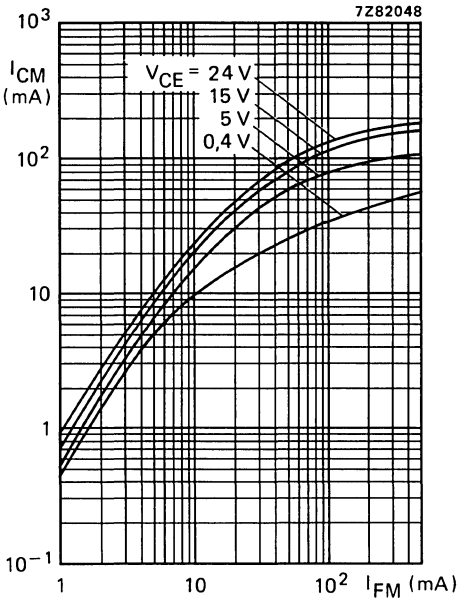

Fig. 14 CNY63; $T_{amb} = 25\text{ }^\circ\text{C}$; $t_p = 10\text{ }\mu\text{s}$; $T = 1\text{ ms}$; typical values.

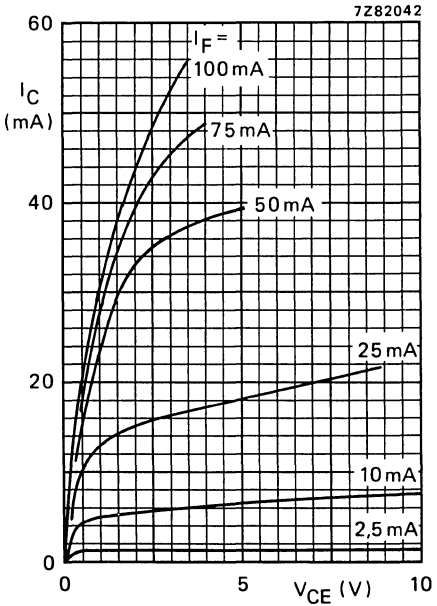

Fig. 15 CNY62; $T_{amb} = 25\text{ }^\circ\text{C}$; typical values.

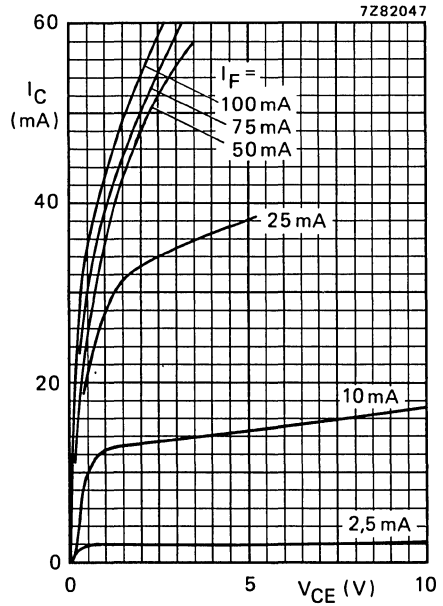

Fig. 16 CNY63; $T_{amb} = 25\text{ }^\circ\text{C}$; typical values.

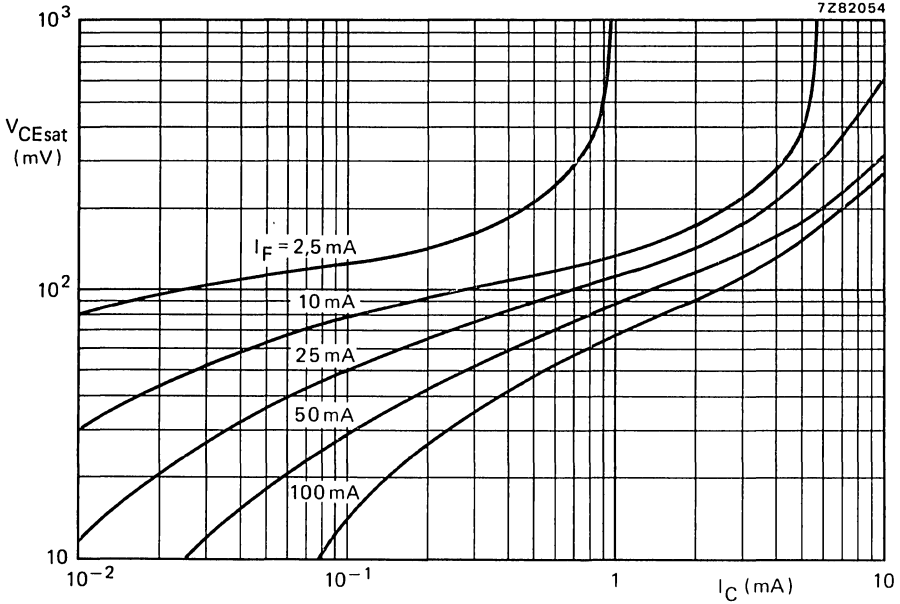

Fig. 17 CNY62; $I_B = 0$; $T_{amb} = 25$ °C; typical values.

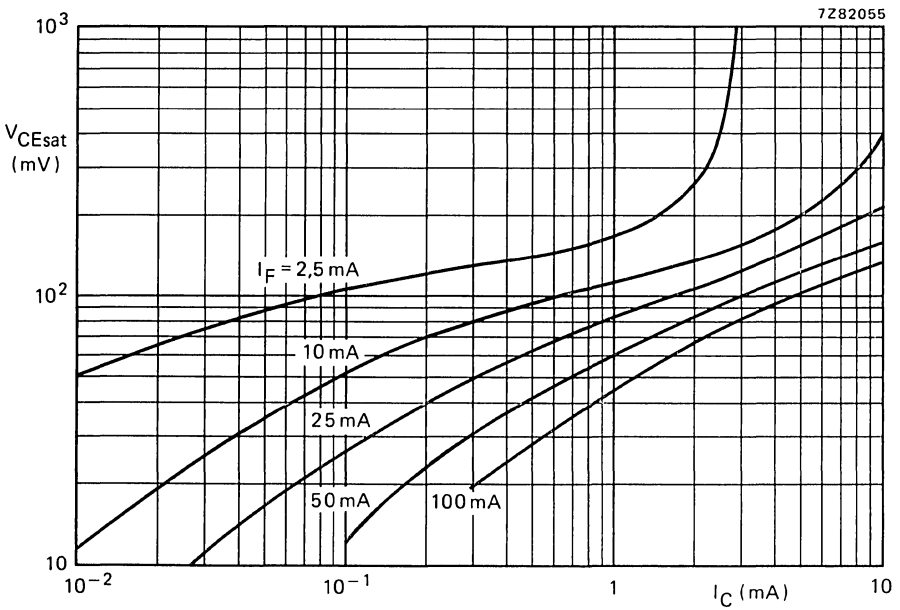

Fig. 18 CNY63; $I_B = 0$; $T_{amb} = 25$ °C; typical values.

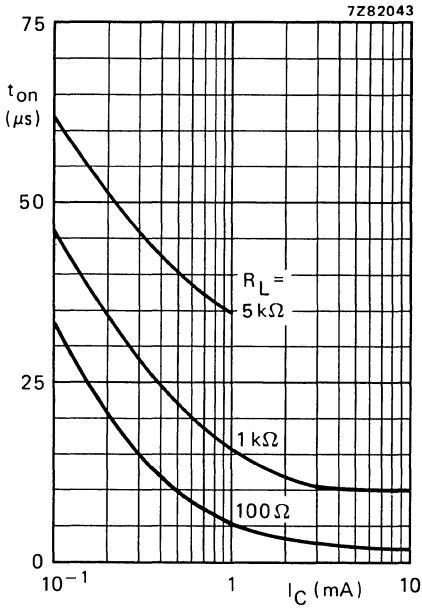

Fig. 19 CNY62; $I_B = 0$; $V_{CC} = 5$ V;
 $T_{amb} = 25$ °C; typical values.
(See also Fig. 21.)

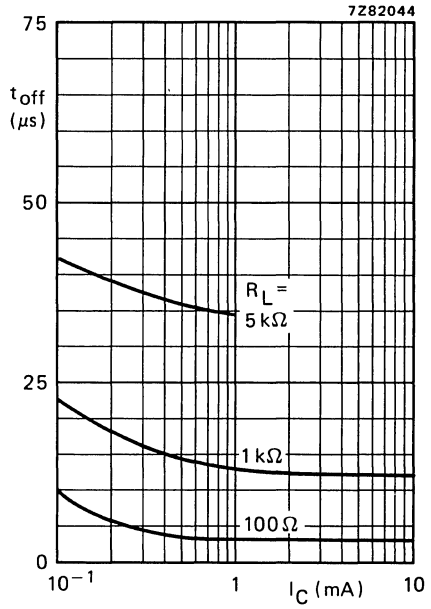

Fig. 20 CNY62; $I_B = 0$; $V_{CC} = 5$ V;
 $T_{amb} = 25$ °C; typical values.
(See also Fig. 21.)

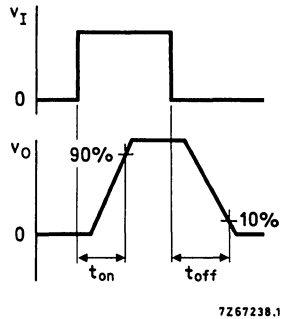
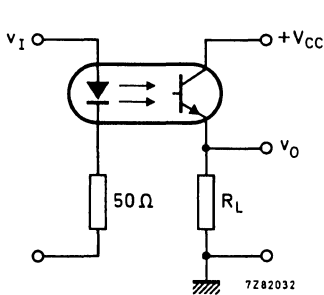

Fig. 21 Switching circuit and waveforms.

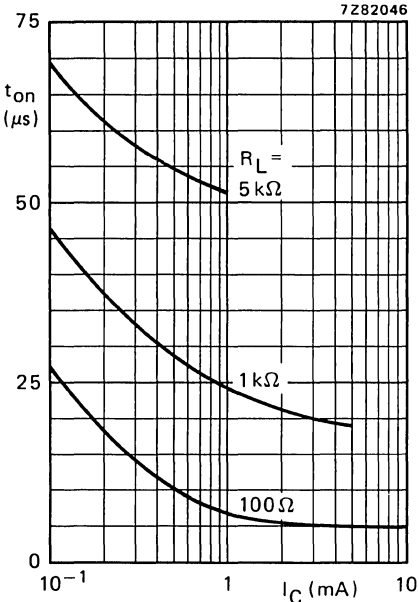

Fig. 22 CNY63; $I_B = 0$; $V_{CC} = 5 V$; $T_{amb} = 25^\circ C$; typical values. (See also Fig. 24.)

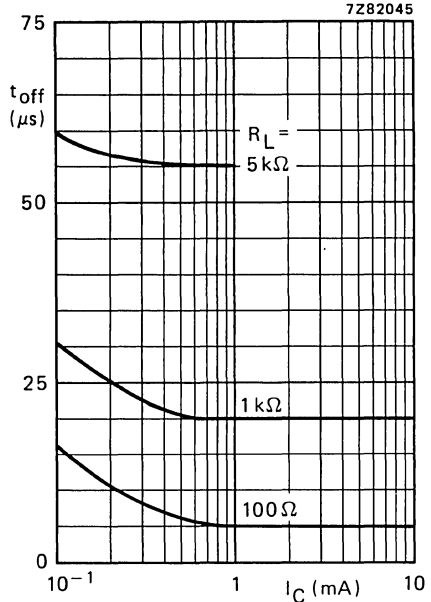

Fig. 23 CNY63; $I_B = 0$; $V_{CC} = 5 V$; $T_{amb} = 25^\circ C$; typical values. (See also Fig. 24.)

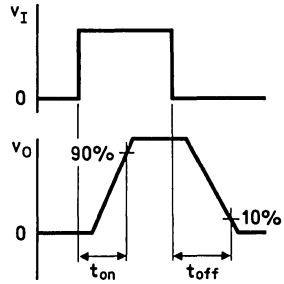
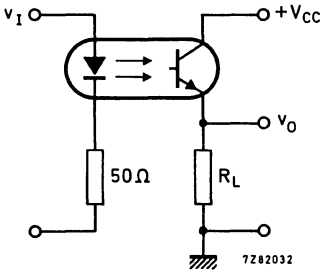

Fig. 24 Switching circuit and waveforms.

INFRARED SENSITIVE DEVICES



SINGLE ELEMENT PYROELECTRIC INFRARED DETECTORS

This is an infrared sensitive device, combined with a pre-amplifier which is stabilized to overcome d.c. saturation due to thermal changes. It is sealed in a low-profile TO-5 can.

QUICK REFERENCE DATA

	RPY86	RPY87	
Spectral Response	6.5 ± 0.5 to > 14	1.0 to > 15	μm
Responsivity	(10 μm, 10) typ. 600	(6 μm, 10) 500	VW ⁻¹
Noise Equivalent Power (N.E.P.),	(10 μm, 10, 1) typ. 0.9 × 10 ⁻⁹	(6 μm, 10, 1) 1.05 × 10 ⁻⁹	WHZ ^{-1/2}
Element dimensions		2 × 1	mm
Field of View	typ. 110		degrees
Operating voltage		9	V
Optimum operating frequency range		0.1 to 1000	Hz

This data must be read in conjunction with GENERAL SAFETY RECOMMENDATIONS – OPTOELECTRONIC DEVICES

MECHANICAL DATA

SOT-49E (low profile TO-5)

Dimensions in mm

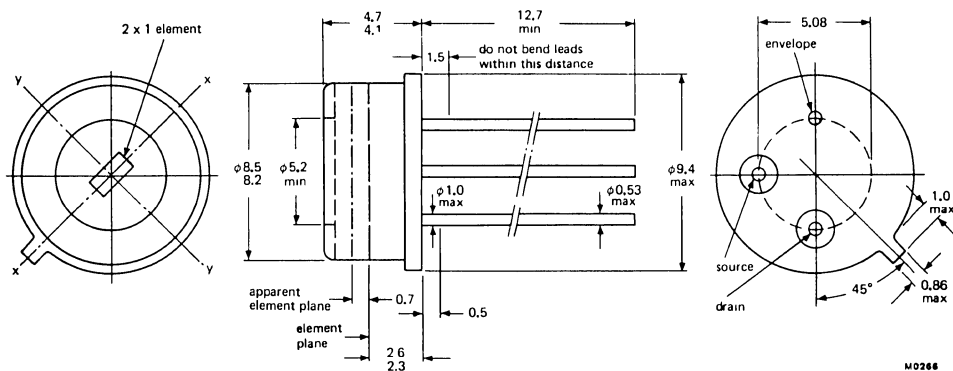

PRODUCT SAFETY

Modern high technology materials have been used in the manufacture of this device to ensure high performance. Some of these materials are toxic in certain circumstances. Mechanical or electrical damage is unlikely to give rise to any hazard, but toxic vapours may be generated if the device is heated to destruction. Disposal of large quantities should therefore be carried out in accordance with the latest local legislation.

SOLDERING

1. When making soldered connections to the leads, a thermal shunt should be used.
2. It is essential that any mains operated soldering iron should be both screened and earthed. Failure to observe these precautions could lead to the introduction of line voltage and possible damage to the device.

RATINGS

Limiting values in accordance with the Absolute Maximum System (IEC134)

Supply voltage	max.	30	V
Temperature, operating	max.	+100	°C
	min.	-40	°C
Temperature, storage	max.	+100	°C
	min.	-40	°C
Lead soldering temperature, ≥ 6 mm from header, $t_{sld} \leq 3$ s	max.	+350	°C

CHARACTERISTICS (at 25 ± 3 °C and with recommended circuit)

RPY86		min.	typ.	max.	
Spectral Response		6.5 ± 0.5	—	> 14	μm
Responsivity (10 μm , 10)	notes 1 and 4	450	600	—	VW^{-1}
N.E.P. (10 μm , 10, 1)	notes 1 and 4	—	0.9×10^{-9}	3×10^{-9}	$\text{WHz}^{-1/2}$
Field of view	note 2	—	110	—	degrees
Operating voltage	note 3	8	9	10	V

RPY87

Spectral Response		1	—	> 15	μm
Responsivity (500 K, 10) or (6 μm , 10)	notes 1 and 4	400	500	—	VW^{-1}
N.E.P. (500 K, 10, 1) or (6 μm , 10, 1)	notes 1 and 4	—	1.05×10^{-9}	3×10^{-9}	$\text{WHz}^{-1/2}$
Field of View	note 2	—	110	—	degrees
Operating voltage	note 3	8	9	10	V

Notes

1. These characteristics apply throughout the spectral response range.
2. Field of view to 50% of the maximum responsivity level.
3. The detector will operate outside the quoted range but may have a degraded performance.
4. For performance as a function of frequency and temperature, see pages 6 to 9.

RECOMMENDED CIRCUIT

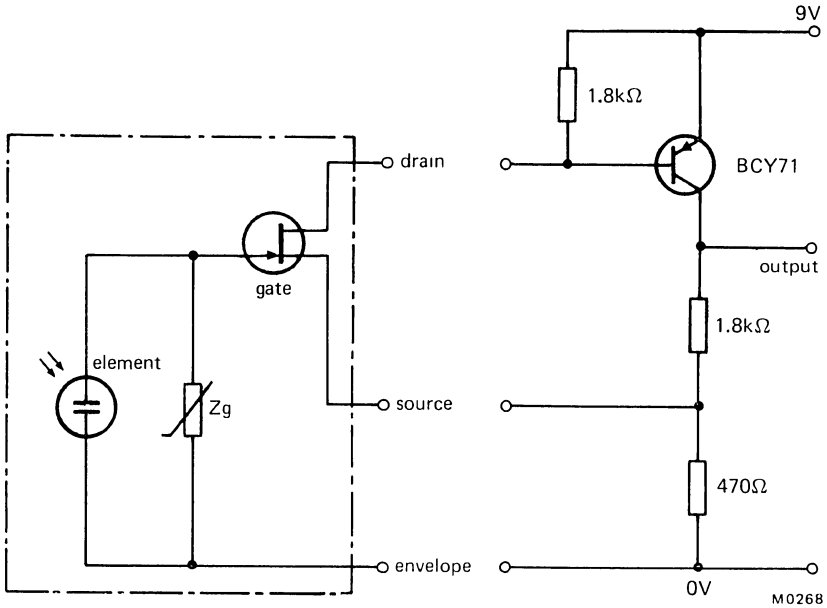

OPERATING NOTES

1. The case potential must not be allowed to become positive with respect to the other two terminals.
2. It is inadvisable to operate the detector at mains related frequencies.
3. To avoid the possibility of optical microphony, the detector must be firmly mounted
4. An increase in temperature of the element will produce a negative going signal at the output.
5. Use recommended circuit for low noise operation.
6. For simplicity of operation, a source follower may be used where noise is not a problem. This may be achieved with a 22 kΩ resistor between source and envelope with the positive supply taken to the drain terminal. This will give a voltage gain of approximately 0.9.

DEFINITIONS

1. Responsivity VW^{-1}

This is the ratio of the r.m.s. signal in volts to the r.m.s. value of the incident, chopped radiant power.

2. N.E.P. (Noise Equivalent Power), $WHz^{-\frac{1}{2}}$

This is the r.m.s. value of the incident, chopped radiant power necessary to produce an r.m.s. signal to r.m.s. noise ratio of unity. The r.m.s. noise refers to the value calculated for unit square root bandwidth $VHz^{-\frac{1}{2}}$

RECOMMENDED CIRCUIT

1. Optional additional stage for extra gain

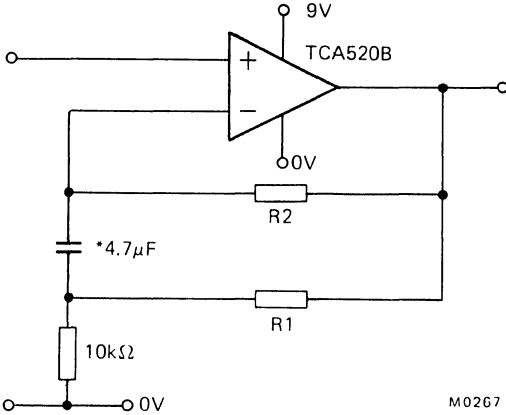

Recommended component value for various gains

Gain x	R ₁ kΩ	R ₂ MΩ
50	560	5.6
20	220	2.2
10	100	1.0

*this capacitor must be a low leakage type e.g. our 344 series.

2. Temperature slew

The FET used with a pyroelectric detector requires a gate leakage resistor to earth in parallel with the element. This stabilizes its working point. The pyroelectric voltage appearing across this resistor is proportional to the rate of change of temperature.

To ensure a low level of noise current from this resistor, its value should be of the order of $3 \times 10^{10} \Omega$. When the temperature slew rate is $1 \text{ }^\circ\text{C}/\text{minute}$, the pyroelectric voltage produce 1 volt. In a system which is designed to sense microvolts, this is almost certain to cause over any a.c. signal superimposed on this d.c. shift will be lost.

Our detectors incorporate a bleed system which acts progressively on the d.c. shift caused temperature slew. The law is logarithmic.

Thus a slew rate of $0.1 \text{ }^\circ\text{C}/\text{minute}$ may produce an offset across the sensing element of 200 millivolts, $1 \text{ }^\circ\text{C}/\text{minute}$ 280 millivolts and $10 \text{ }^\circ\text{C}/\text{minute}$ 360 millivolts.

MECHANICAL AND ENVIRONMENTAL STANDARDS

As part of the Quality Assurance programme, the detectors are assessed at regular intervals against the requirements of the following IEC standards. The frequency of testing and the limits and conditions for the pre- and post-test measurements are based on those stipulated for the CECC 50 000 series of approved transistors.

	Test		Severity	Duration	Note
IEC 68-2-3	Ca	Damp Heat, steady state	+40 °C, 95% RH	168 hours	1
68-2-20	Ta	Solderability	+235 °C, 1.5 mm from header	5 seconds	1
68-2-21	Ub	Lead Fatigue	4 cycles	—	1
68-2-1	A	Low Temperature Storage	-40 °C	2000 hours	2
68-2-2	Ba	High Temperature Storage	+100 °C	2000 hours	2
68-2-14	Nb	Change of Temperature	-40 °C to +100 °C	10 cycles	2
68-2-6	Fc (B4)	Vibration, swept frequency	125 Hz to 2kHz 196 ms ⁻²	2 h in each orientation	2
68-2-7	Ga	Acceleration, steady state	196000 m ⁻²	60 seconds	2
68-2-27	Ea	Shock	14700 ms ⁻²	3 pulses 6 orientations	2
68-2-20	Tb	Resistance to Solder Heat	+350 °C, 6 mm from header	3 seconds	3

Notes

1. The detectors are checked on a production batch release principle at approximately weekly intervals. This is equivalent to Group B.
2. The detectors are checked at quarterly intervals. This is equivalent to Group C.
3. This is an annual check.

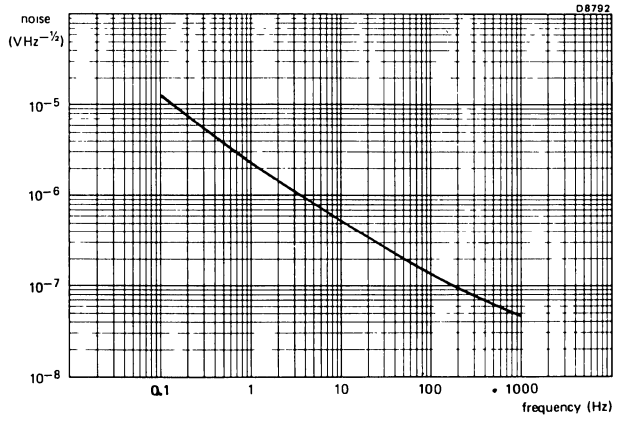
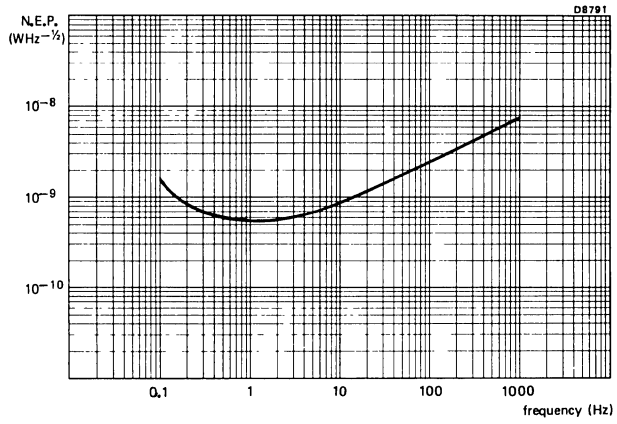
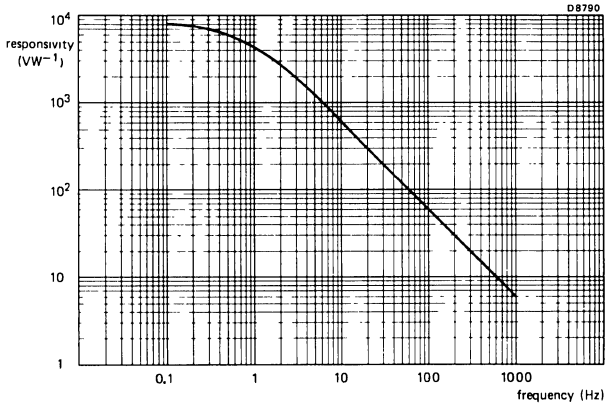

RPY86, typical Responsivity, N.E.P., and Noise as functions of Frequency

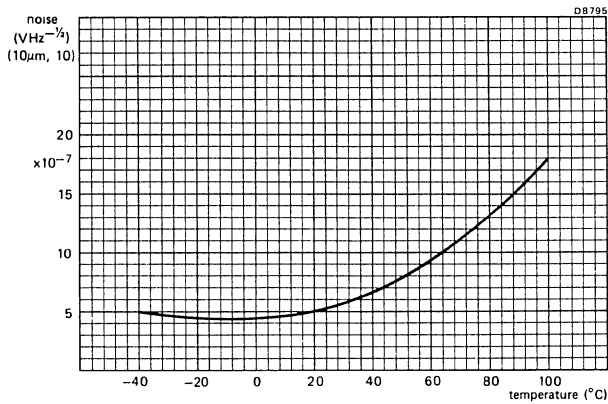
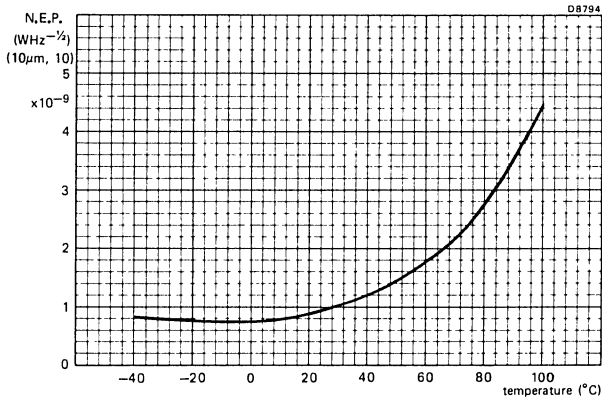
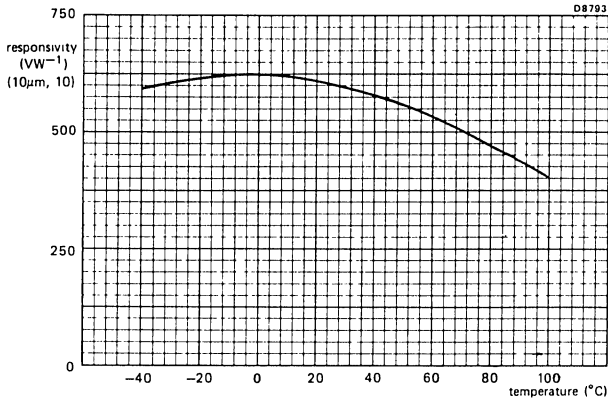

RPY86, typical Responsivity, N.E.P., and Noise as functions of Temperature

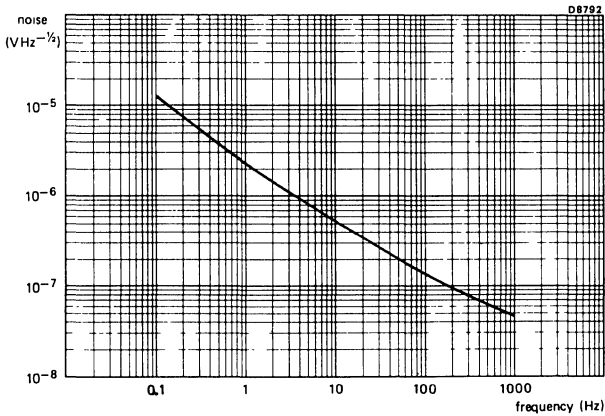
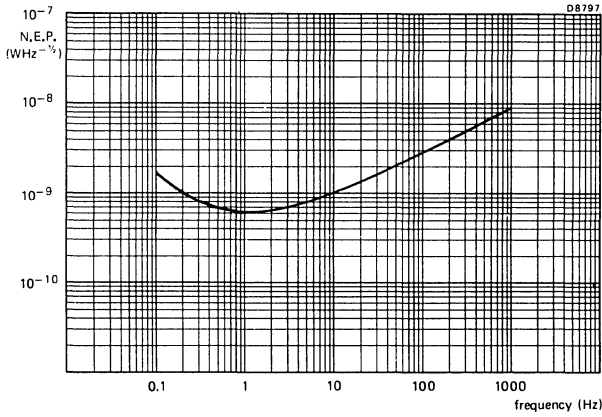
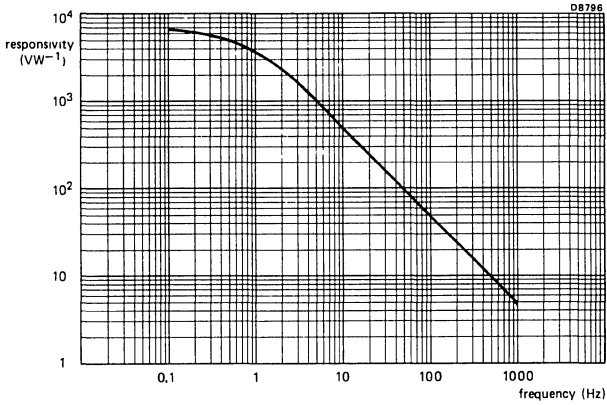

RPY87, typical Responsivity, N.E.P., and Noise as functions of Frequency

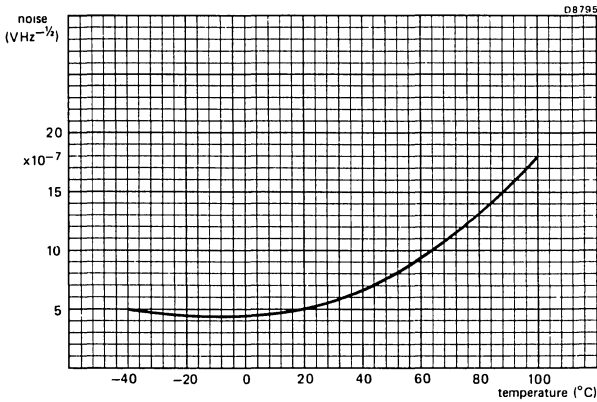
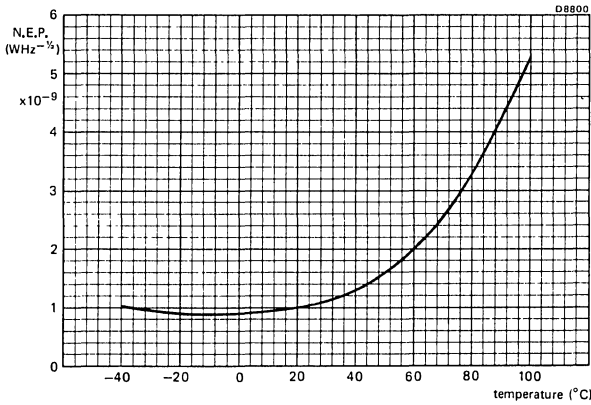
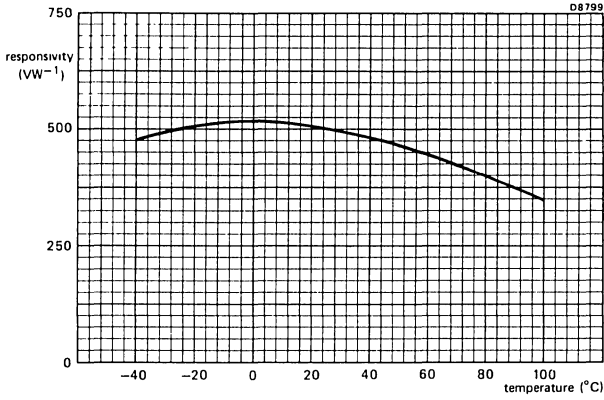

RPY87, typical Responsivity, N.E.P., and Noise as functions of Temperature

POLAR DIAGRAMS

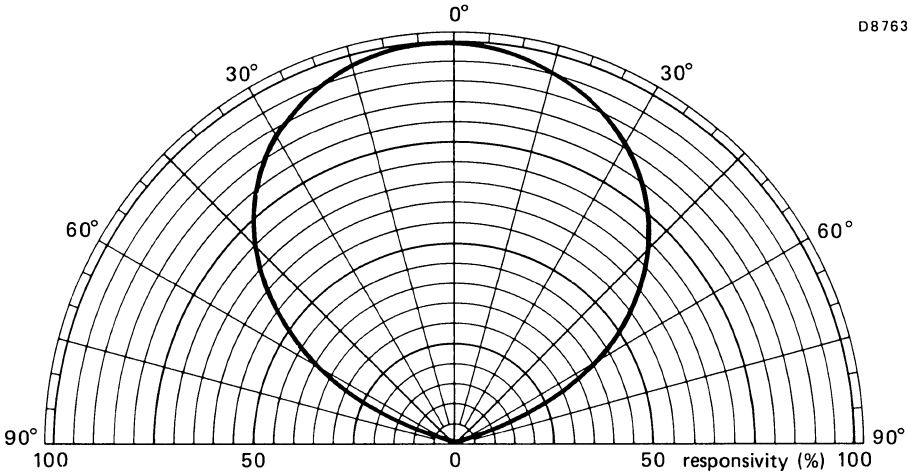

Typical Field of View in x-x plane (see Mechanical Data)

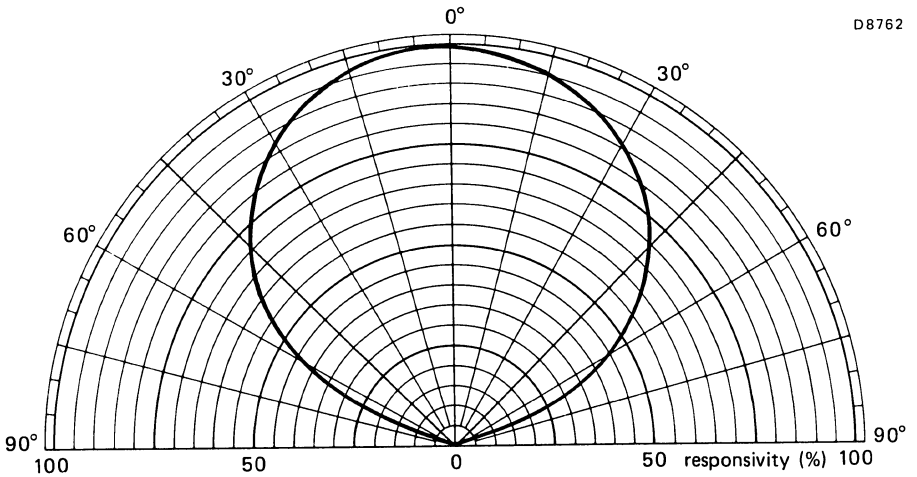

Typical Field of View in y-y plane (see Mechanical Data)

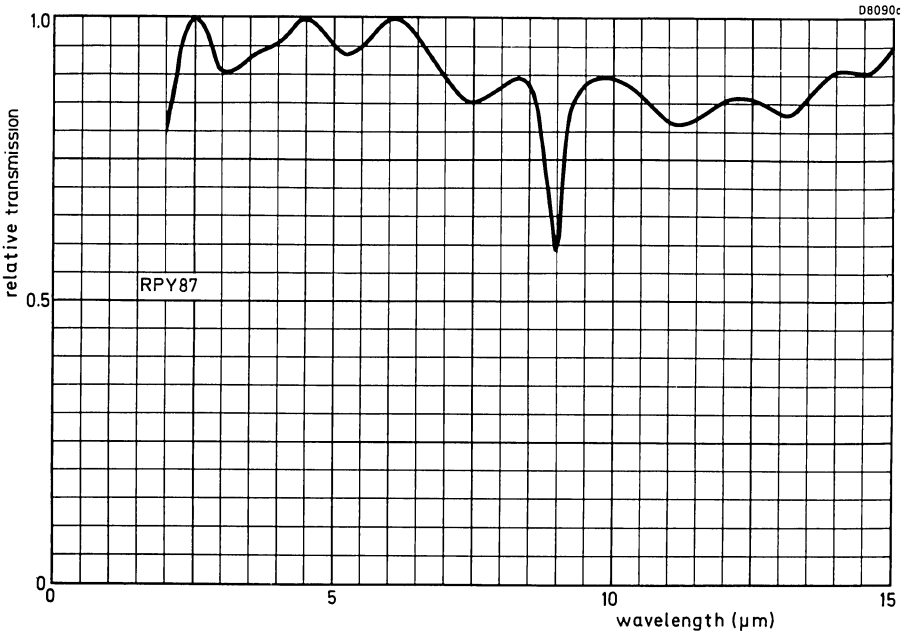
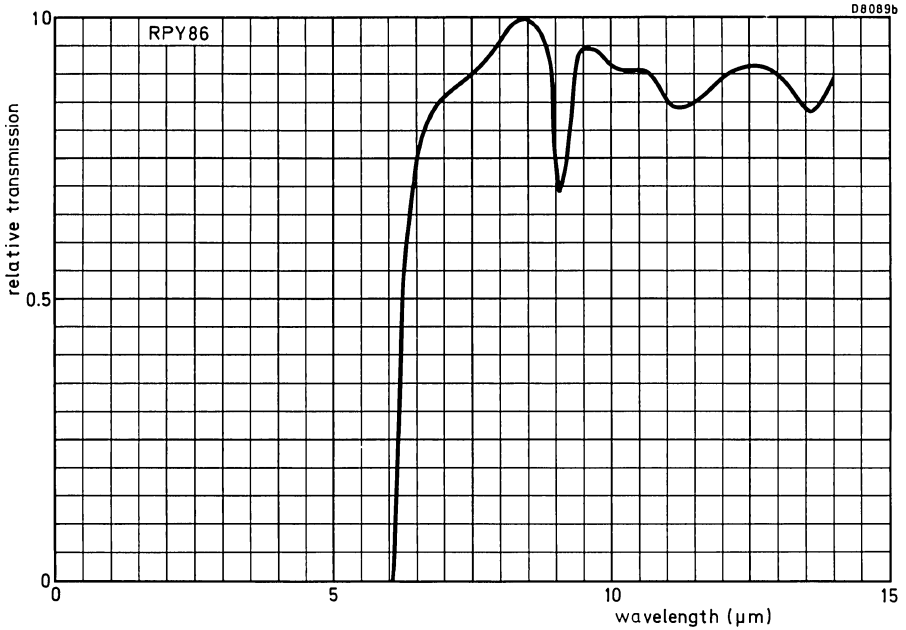

Typical normalized window transmission characteristics

SINGLE ELEMENT PYROELECTRIC INFRARED DETECTORS

This is an infrared sensitive device, combined with a pre-amplifier which is stabilized to overcome d.c. saturation due to thermal changes. It is sealed in a low-profile TO-5 can.

QUICK REFERENCE DATA

	RPY88	RPY89	
Spectral Response	6.5 ± 0.5 to > 14	1.0 to > 15	μm
Responsivity	(10 μm, 10)	(6 μm, 10)	
	typ. 300	250	VW ⁻¹
Noise Equivalent Power (N.E.P.),	(10 μm, 10, 1)	(6 μm, 10, 1)	
	typ. 1.65 x 10 ⁻⁹	2.0 x 10 ⁻⁹	WHz ^{-1/2}
Element dimensions		2 x 2	mm
Field of View	typ.	110	degrees
Operating voltage		9	V
Optimum operating frequency range		0.1 to 1000	Hz

This data must be read in conjunction with GENERAL SAFETY RECOMMENDATIONS – OPTOELECTRONIC DEVICES

MECHANICAL DATA

SOT-49E (low profile TO-5)

Dimensions in mm

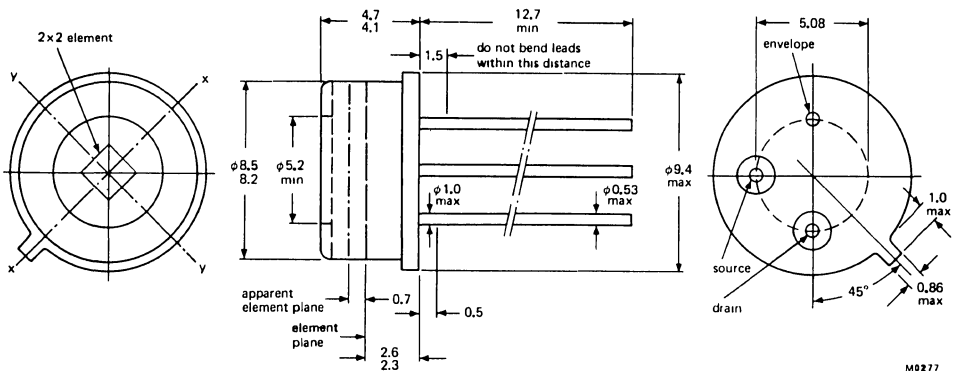

PRODUCT SAFETY

Modern high technology materials have been used in the manufacture of this device to ensure high performance. Some of these materials are toxic in certain circumstances. Mechanical or electrical damage is unlikely to give rise to any hazard, but toxic vapours may be generated if the device is heated to destruction. Disposal of large quantities should therefore be carried out in accordance with the latest local legislation.

SOLDERING

1. When making soldered connections to the leads, a thermal shunt should be used.
2. It is essential that any mains operated soldering iron should be both screened and earthed. Failure to observe these precautions could lead to the introduction of line voltage and possible damage to the device.

RATINGS

Limiting values in accordance with the Absolute Maximum System (IEC134)

Supply voltage	max.	30	V
Temperature, operating	max.	+100	°C
	min.	-40	°C
Temperature, storage	max.	+100	°C
	min.	-40	°C
Lead soldering temperature, ≥ 6 mm from header, $t_{sld} \leq 3$ s	max.	+350	°C

CHARACTERISTICS (at 25 ± 3 °C and with recommended circuit)

RPY88		min.	typ.	max.	
Spectral Response		6.5 ± 0.5	—	> 14	μm
Responsivity (10 μm , 10)	notes 1 and 4	225	300	—	VW^{-1}
N.E.P. (10 μm , 10, 1)	notes 1 and 4	—	1.65×10^{-9}	3×10^{-9}	$\text{WHz}^{-1/2}$
Field of View	note 2	—	110	—	degrees
Operating voltage	note 3	8	9	10	V

RPY89

Spectral Response		1	—	> 15	μm
Responsivity (500 K, 10) or (6 μm , 10)	notes 1 and 4	200	250	—	VW^{-1}
N.E.P. (500 K, 10, 1) or (6 μm , 10, 1)	notes 1 and 4	—	2.0×10^{-9}	3×10^{-9}	$\text{WHz}^{-1/2}$
Field of View	note 2	—	110	—	degrees
Operating voltage	note 3	8	9	10	V

Notes

1. These characteristics apply throughout the spectral response range.
2. Field of view to 50% of the maximum responsivity level.
3. The detector will operate outside the quoted range but may have a degraded performance.
4. For performance as a function of frequency and temperature, see pages 6 to 9.

RECOMMENDED CIRCUIT

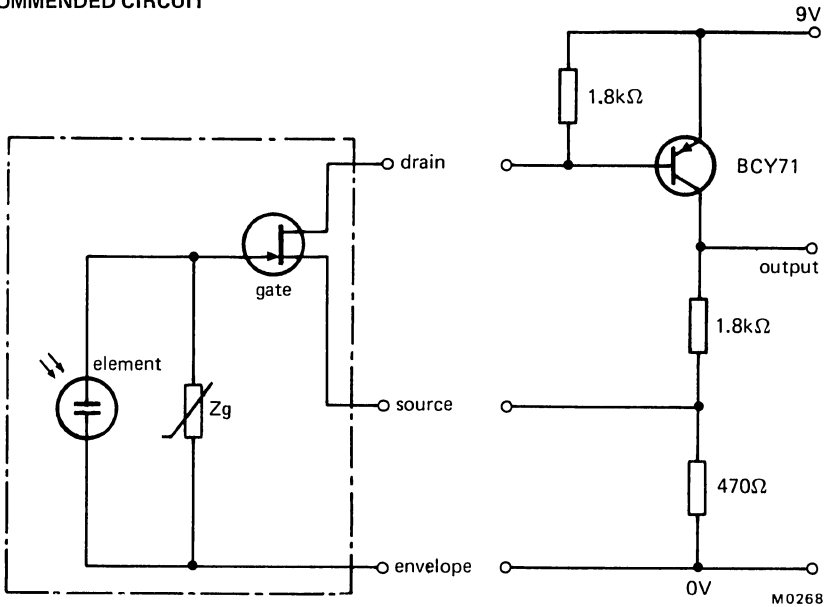

OPERATING NOTES

1. The case potential must not be allowed to become positive with respect to the other two terminals.
2. It is inadvisable to operate the detector at mains related frequencies.
3. To avoid the possibility of optical microphony, the detector must be firmly mounted
4. An increase in temperature of the element will produce a negative going signal at the output.
5. Use recommended circuit for low noise operation.
6. For simplicity of operation, a source follower may be used where noise is not a problem. This may be achieved with a 22 k Ω resistor between source and envelope with the positive supply taken to the drain terminal. This will give a voltage gain of approximately 0.9.

DEFINITIONS

1. Responsivity VW^{-1}

This is the ratio of the r.m.s. signal in volts to the r.m.s. value of the incident, chopped radiant power.

2. N.E.P. (Noise Equivalent Power), $WHz^{-\frac{1}{2}}$

This is the r.m.s. value of the incident, chopped radiant power necessary to produce an r.m.s. signal to r.m.s. noise ratio of unity. The r.m.s. noise refers to the value calculated for unit square root bandwidth $VHz^{-\frac{1}{2}}$.

APPLICATION INFORMATION

1. Optional additional stage for extra gain

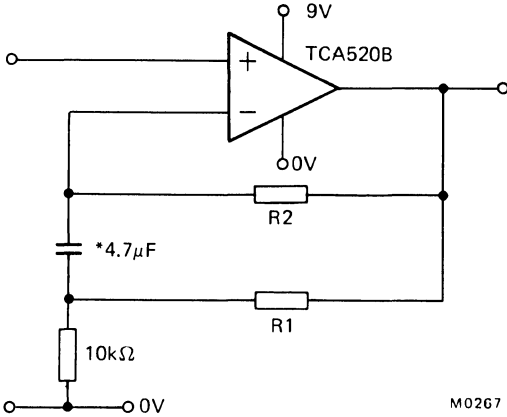

Recommended component values for various gains

Gain x	R ₁ kΩ	R ₂ MΩ
50	560	5.6
20	220	2.2
10	100	1.0

M0267

*this capacitor must be a low leakage type e.g. our 344 series.

2. Temperature slew

The FET used with a pyroelectric detector requires a gate leakage resistor to earth in parallel with the element. This stabilizes its working point. The pyroelectric voltage appearing across this resistor is proportional to the rate of change of temperature.

To ensure a low level of noise current from this resistor, its value should be of the order of $3 \times 10^{10} \Omega$. When the temperature slew rate is 1 °C/minute, the pyroelectric voltage produced is 1 volt. In a system which is designed to sense microvolts, this is almost certain to cause overload and any a.c. signal superimposed on this d.c. shift will be lost.

Our detectors incorporate a bleed system which acts progressively on the d.c. shift caused by temperature slew. The law is logarithmic.

Thus a slew rate of 0.1 °C/minute may produce an offset across the sensing element of 200 millivolts, 1 °C/minute 280 millivolts and 10 °C/minute 360 millivolts.

MECHANICAL AND ENVIRONMENTAL STANDARDS

As part of the Quality Assurance programme, the detectors are assessed at regular intervals against the requirements of the following IEC standards. The frequency of testing and the limits and conditions for the pre- and post-test measurements are based on those stipulated for the CECC 50 000 series of approved transistors.

	Test		Severity	Duration	Note
IEC 68-2-3	Ca	Damp Heat, steady state	+40 °C, 95% RH	168 hours	1
68-2-20	Ta	Solderability	+235 °C, 1.5 mm from header	5 seconds	1
68-2-21	Ub	Lead Fatigue	4 cycles	—	1
68-2-1	A	Low Temperature Storage	−40 °C	2000 hours	2
68-2-2	Ba	High Temperature Storage	+100 °C	2000 hours	2
68-2-14	Nb	Change of Temperature	−40 °C to +100 °C	10 cycles	2
68-2-6	Fc (B4)	Vibration, swept frequency	125 Hz to 2 kHz 196 ms ⁻²	2 h in each orientation	2
68-2-7	Ga	Acceleration, steady state	196000 ms ⁻²	60 seconds	2
68-2-27	Ea	Shock	14700 ms ⁻²	3 pulses 6 orientations	2
68-2-20	Tb	Resistance to Solder Heat	+350 °C, 6 mm from header	3 seconds	3

Notes

1. The detectors are checked on a production batch release principle at approximately weekly intervals. This is equivalent to Group B.
2. The detectors are checked at quarterly intervals. This is equivalent to Group C.
3. This is an annual check.

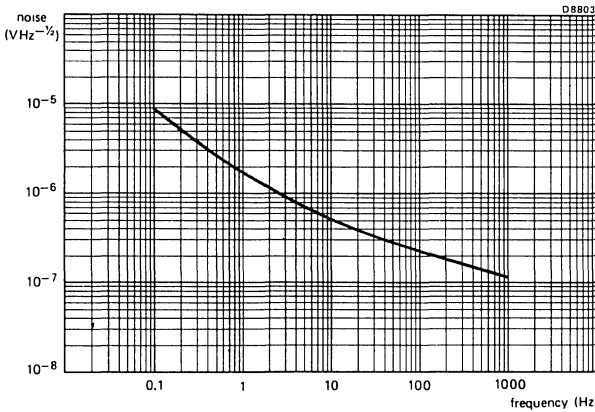
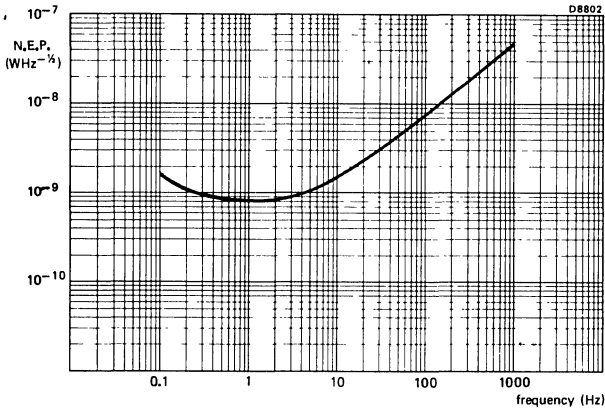
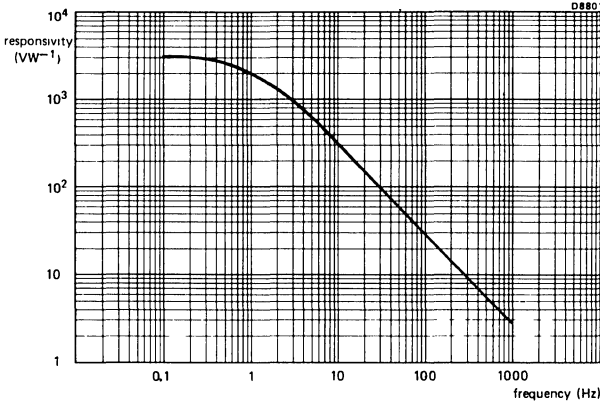

RPY88, typical Responsivity, N.E.P., and Noise as functions of Frequency

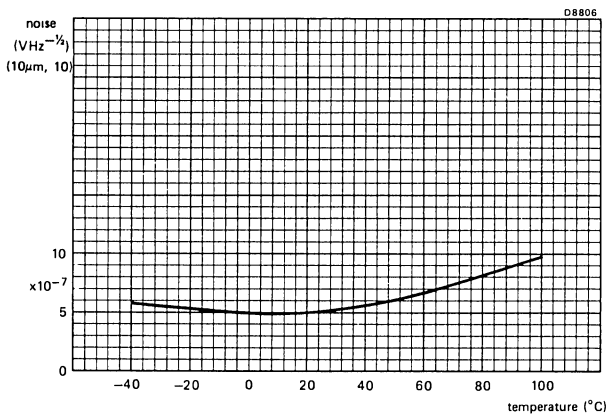
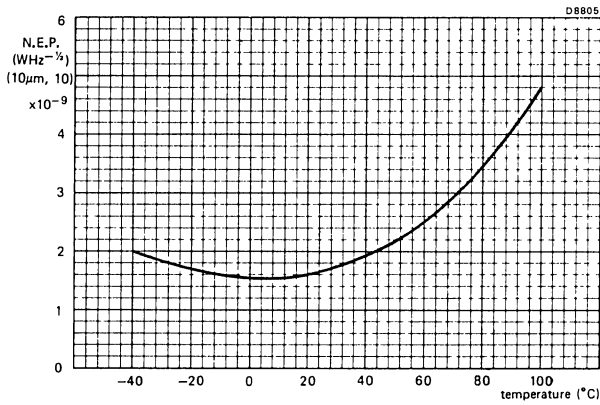
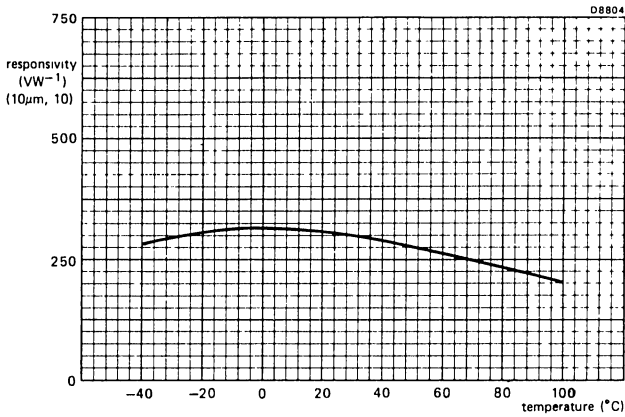

RPY88, typical Responsivity, N.E.P., and Noise as functions of Temperature

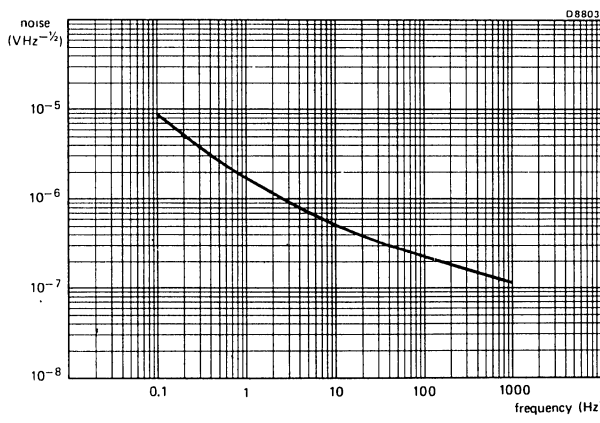
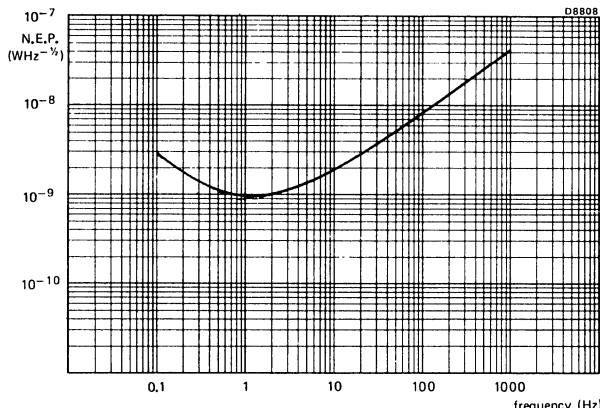
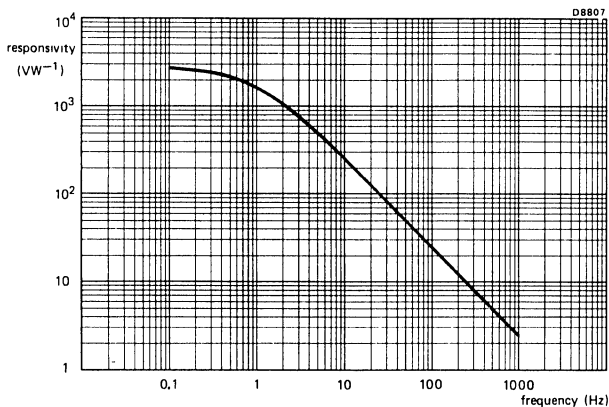

RPY89. typical Responsivity, N.E.P., and Noise as functions of Frequency

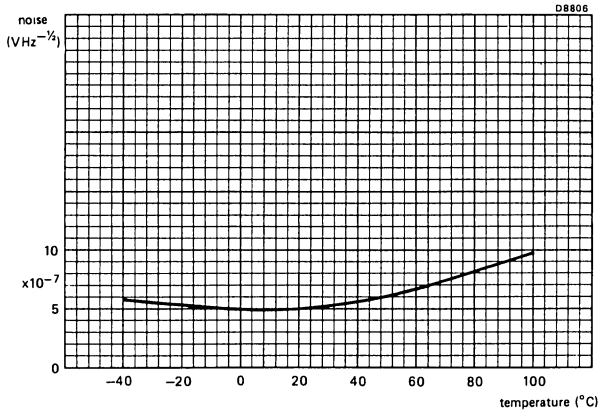
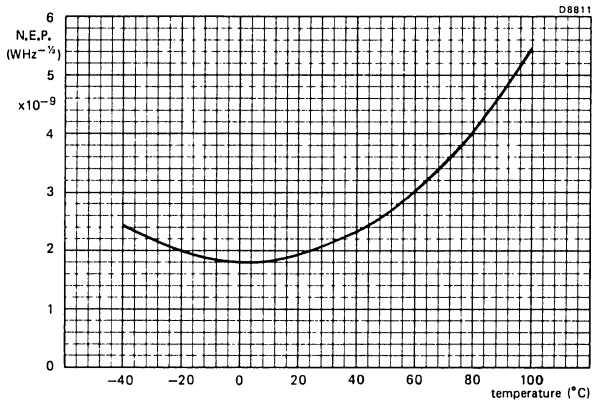
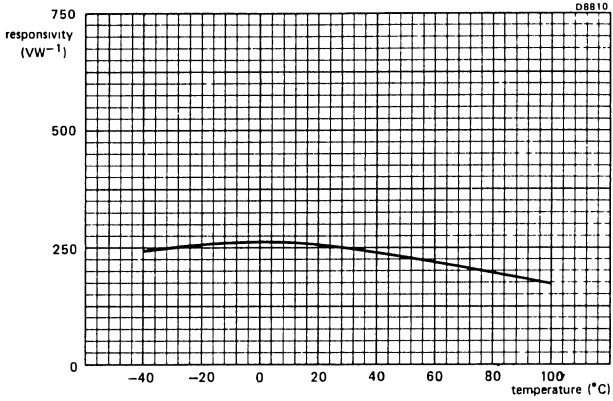

RPY89, typical Responsivity, N.E.P., and Noise as functions of Temperature

POLAR DIAGRAMS

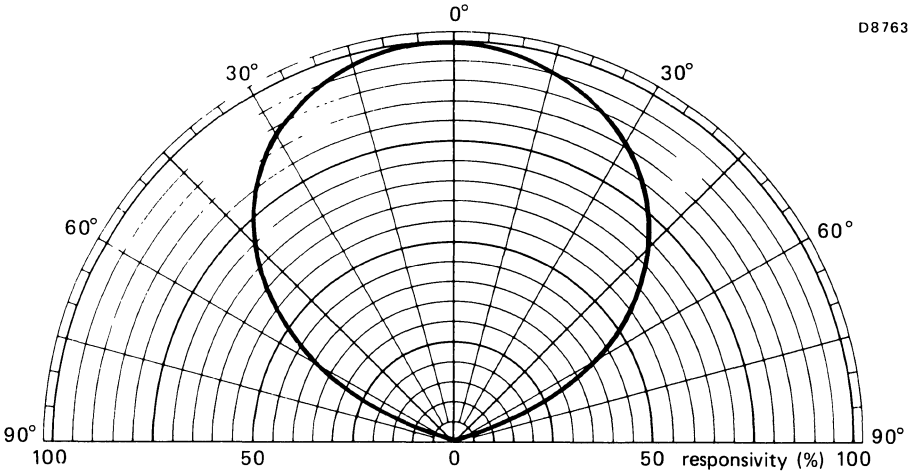

Typical Field of View in x-x plane (see Mechanical Data)

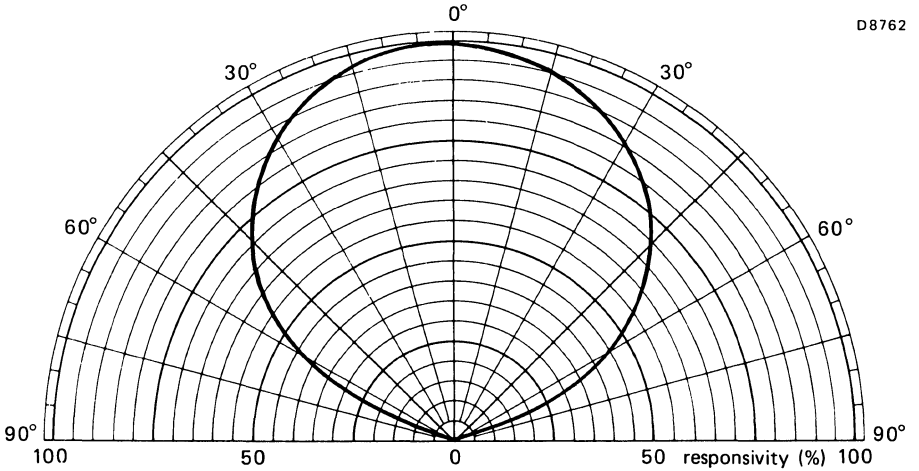

Typical Field of View in y-y plane (see Mechanical Data)

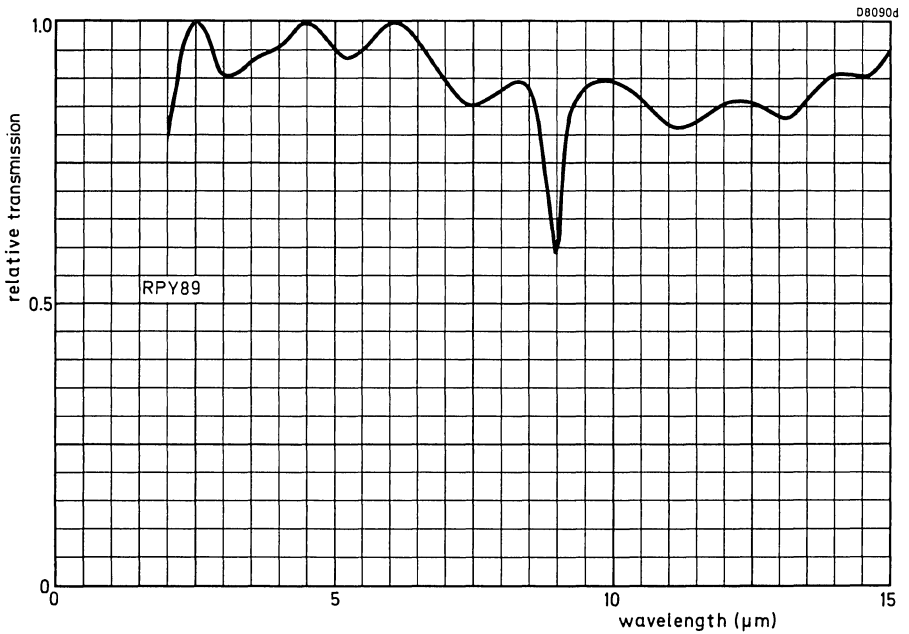
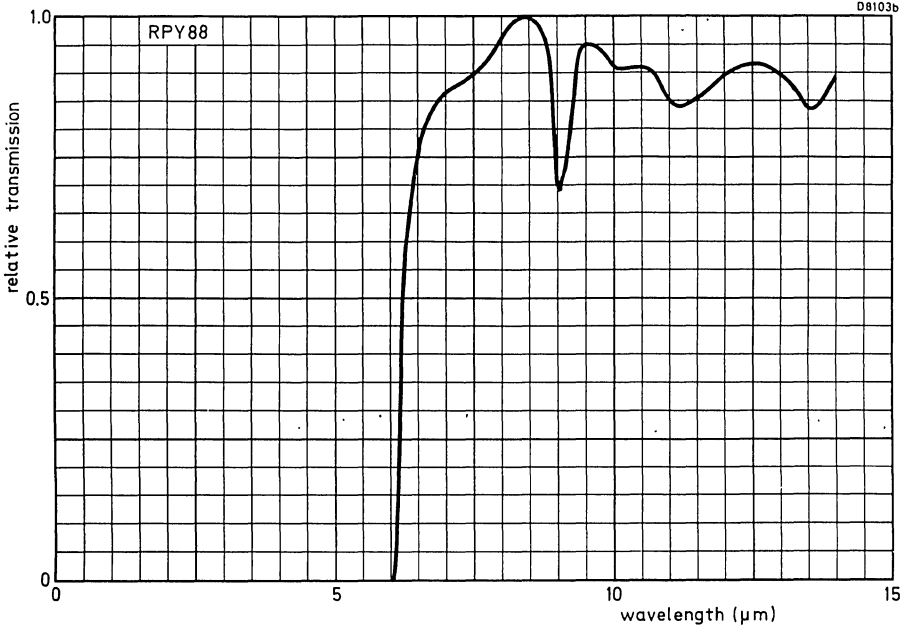

Typical normalized window transmission characteristics

LATGS PYROELECTRIC INFRARED DETECTORS

This series of pyroelectric infrared detectors is designed to replace conventional bolometers. The sensitive material is L-alanine doped triglycine sulphate* (LATGS) which operates at room temperature and has a good broadband performance. Each device has a 2.0 x 0.5 mm sensitive area and is available with a selection of window materials giving a range of spectral performance. A pre-amplifier with short circuit protection is incorporated.

QUICK REFERENCE DATA

	Window material	Spectral response μm	Window description
RPY90A	caesium iodide	1 to 70	transparent, hygroscopic, soft
RPY90C	KRS-5	1 to 40	non-hygroscopic, toxic
RPY90D	silicon (AR coated – optimized for 8 to 14 μm use).	1.2 to 15	non-hygroscopic
RPY90E	sapphire	1 to 6.5	transparent, non-hygroscopic
N.E.P.** (500K, 10, 1)	RPY90A	typ. 1.0×10^{-10}	WHZ ^{-1/2}
Responsivity (500K, 10)		typ. 8.0×10^3	VW ⁻¹
Recommended operating voltage		9	V
Operating frequency range		10 to 1000	Hz
Optimum operating temperature range		-20 to +45	°C
Field of view		> 60	degrees

This data must be read in conjunction with GENERAL SAFETY RECOMMENDATIONS – OPTOELECTRONIC DEVICES

PRODUCT SAFETY

Modern high technology materials have been used in the manufacture of this device to ensure high performance. Some of these materials are toxic in certain circumstances. Mechanical or electrical damage is unlikely to give rise to any hazard, but toxic vapours may be generated if the device is heated to destruction. Disposal of large quantities should therefore be carried out in accordance with the Deposit of Poisonous Waste Act 1972 and the Control of Pollution Act 1974, or with the latest legislation.

* LATGS cuts off below $\lambda = 1 \mu\text{m}$, where incident energy is no longer absorbed.

** Noise Equivalent Power

MECHANICAL DATA

Dimensions in mm

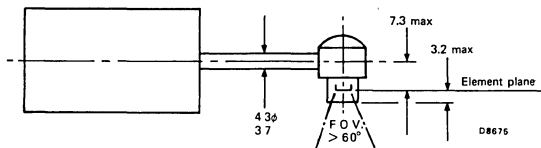
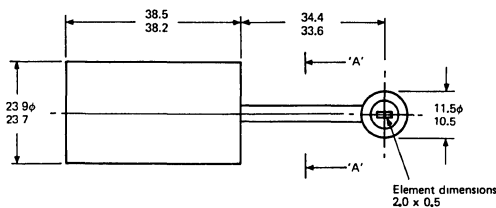
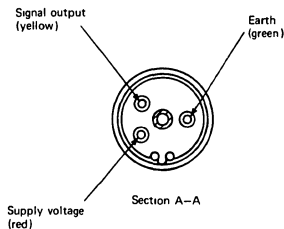

Three female connectors are supplied with each device to fit Seaelectro feed throughs type no. FT SM 14.

RATINGS

Limiting values in accordance with the Absolute Maximum System (IEC134)

Supply voltage	max.	+18	V
Supply current	max.	10	mA
Ambient operating temperature		-20 to +45	°C
Storage temperature		-20 to +55	°C

CHARACTERISTICS at $T_{amb} = 20\text{ }^{\circ}\text{C}$, using a 500 K black body source

		RPY90A	C	D	E	
N.E.P. (500 K, 10, 1)	typ.	1.0	1.3	1.6	3.0	$\times 10^{-10}$ $\text{WHz}^{-\frac{1}{2}}$
	<	1.5	2.0	2.4	4.5	$\times 10^{-10}$ $\text{WHz}^{-\frac{1}{2}}$
Responsivity (500 K, 10)*	typ.	8.0	6.2	5.0	2.7	$\times 10^3$ VW^{-1}
Noise per unit bandwidth at 10 Hz	typ.	0.8	0.8	0.8	0.8	$\mu\text{VHz}^{-\frac{1}{2}}$
Output voltage (d.c.level)	>	2	2	2	2	V
	typ.	3	3	3	3	V
	<	8	8	8	8	V
Output impedance	<	4	4	4	4	k Ω
Element dimensions		all types: 2.0 x 0.5				mm
Field of view		all types: > 60				degrees
Operating voltage range		all types: 8 to 10				V
Supply current		all types: up to 10				mA

*These detectors can also be supplied with an integral frequency compensated amplifier similar to that described under Application Information. This would, for example, increase the responsivity by up to x 100 with an amplifier designed to give a flat response to 20 Hz.

OPERATING NOTES

1. The detector is supplied with a black plastic cap to protect the window. This cap must be removed before operation.
2. The shape of the electrical output waveform is the integral of the incident radiation waveform.
3. It is inadvisable to operate the detector at mains related frequencies.
4. To avoid the possibility of optical microphony, the detector must be firmly mounted.
5. An increase in temperature of the element will produce a negative going signal at the output.
6. Provided that the operating voltage does not exceed 10 V, the maximum time for the output to be short-circuited (to the supply or common rail) is unlimited.

DEFINITIONS

1. N.E.P. (Noise Equivalent Power), $\text{WHz}^{-1/2}$
This is the r.m.s. value of the incident, chopped, radiant power necessary to produce an r.m.s. signal to r.m.s. noise ratio of unity. The r.m.s. noise refers to the value calculated for unit square root bandwidth $\text{VHz}^{-1/2}$.
2. Responsivity VW^{-1}
This is the ratio of the r.m.s. signal in volts to the r.m.s. value of the incident, chopped, radiant power.

APPLICATION INFORMATION

1. The pyroelectric element may be considered as a capacitor whose charge state changes with temperature. It also behaves as a normal capacitor, i.e. its voltage changes with charge. Thus a change of temperature results in a change of voltage. It can be seen that, for a given change in amplitude of incident radiation, the resulting change in temperature will decrease as the chopping frequency increases. Thus the voltage change will also decrease with frequency. In addition, there is a 90° phase lag between the thermal and electrical signals. The voltage signal therefore becomes the integral of the radiation signal.

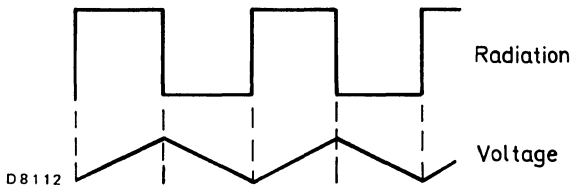

2. Frequency compensating amplifier
The following circuit is designed to be connected directly to the detector output and may be used to compensate for the falling responsivity characteristic with frequency. It is a simple 'virtual earth' amplifier which uses a series input capacitor to provide increasing current through the feedback resistor R_2 with increasing frequency. The time constants $R_2 C_2$ and $R_3 C_3$ are chosen to coincide with $R_1 C_1$, where R_1 is the output impedance of the detector ($< 4.0 \text{ k}\Omega$).

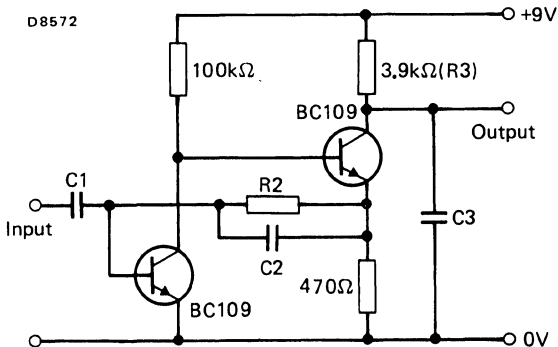

The table below gives recommended component values for various roll-off frequencies (approx. -3 dB point).

Frequency Hz	$C_1 C_3$ nF	R_2 kΩ	C_2 nF
30	680	330	10
300	68	220	1.5
600	33	330	0.47
1500	15	68	1.0
3000	15	82	0.47
4500	4.7	68	0.33

With this circuit the original shape of the radiation waveform is restored at the output for chopping frequencies sensibly lower than the roll-off frequency.

3. Additional stage for extra gain which may be connected directly to the detector output or to the output of the frequency compensating amplifier.

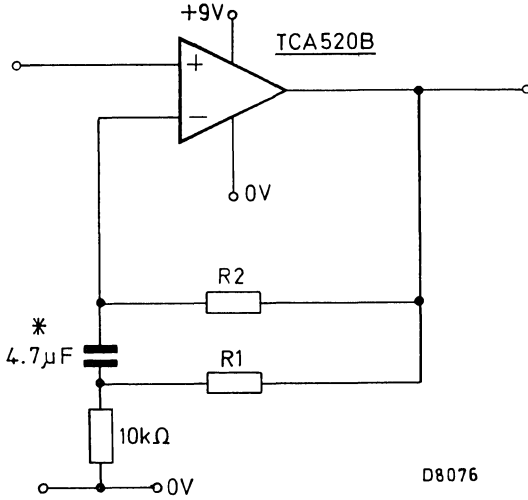

Recommended component values for various gains

Gain x	R ₁ kΩ	R ₂ MΩ
50	560	5.6
20	220	2.2
10	100	1.0

*this capacitor must be a low leakage type, e.g. our 344 series

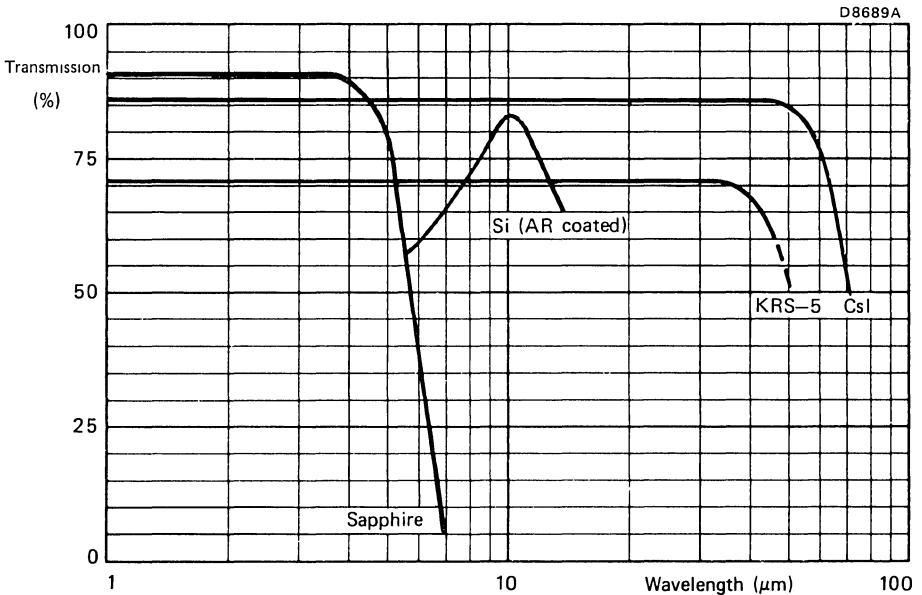

Typical window transmission characteristics.

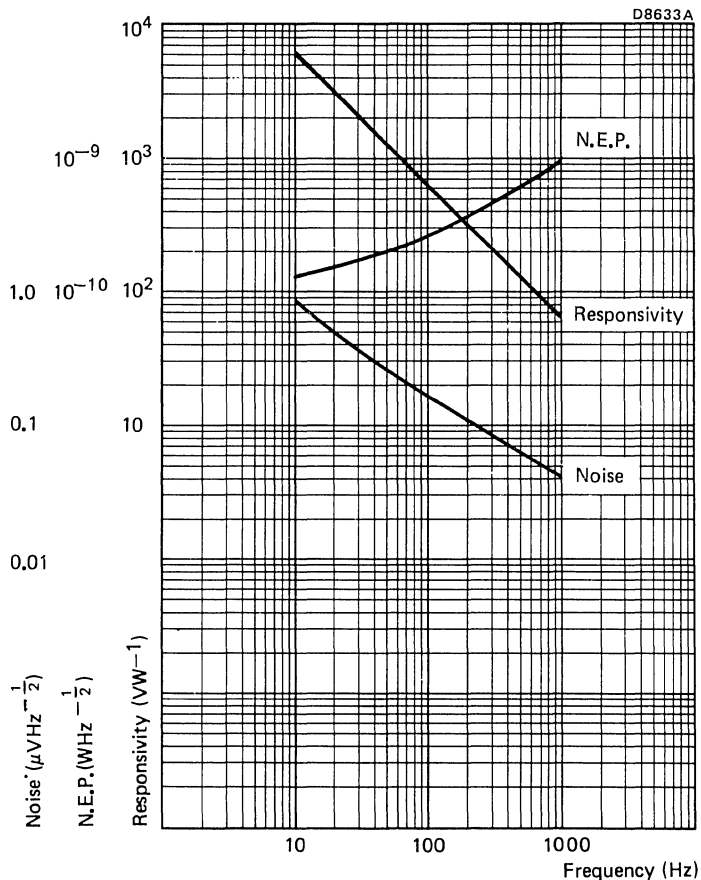

RPY90A

Typical 500 K black body performance as a function of frequency

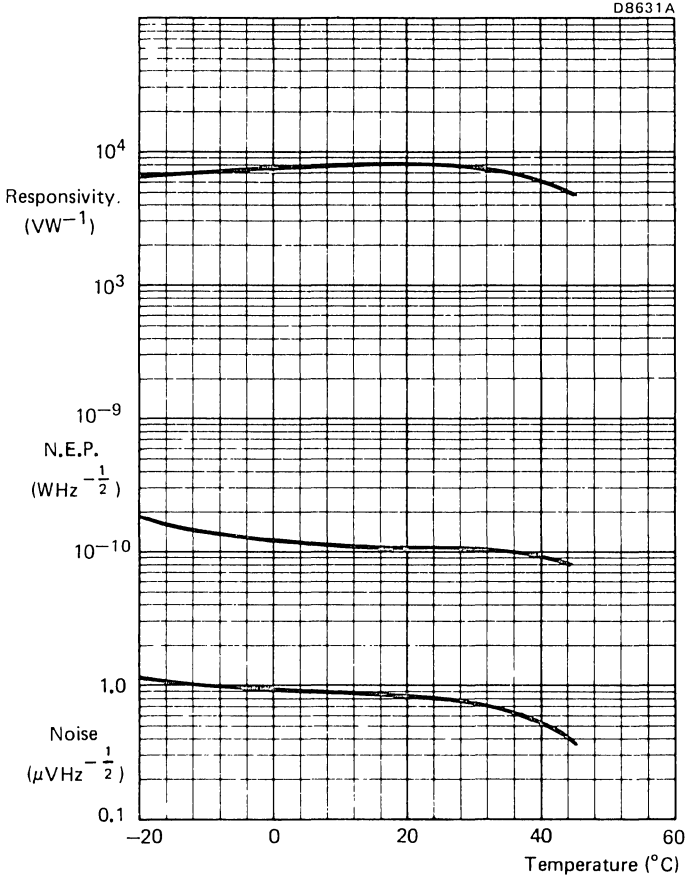

RPY90A

Typical 500 K black body performance as a function of temperature

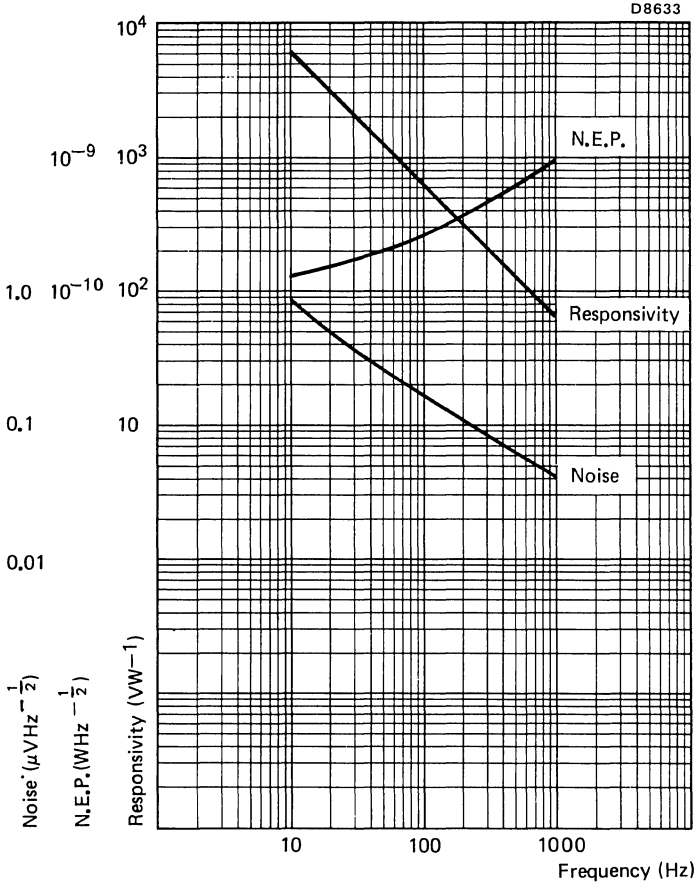

RPY90C

Typical 500 K black body performance as a function of frequency

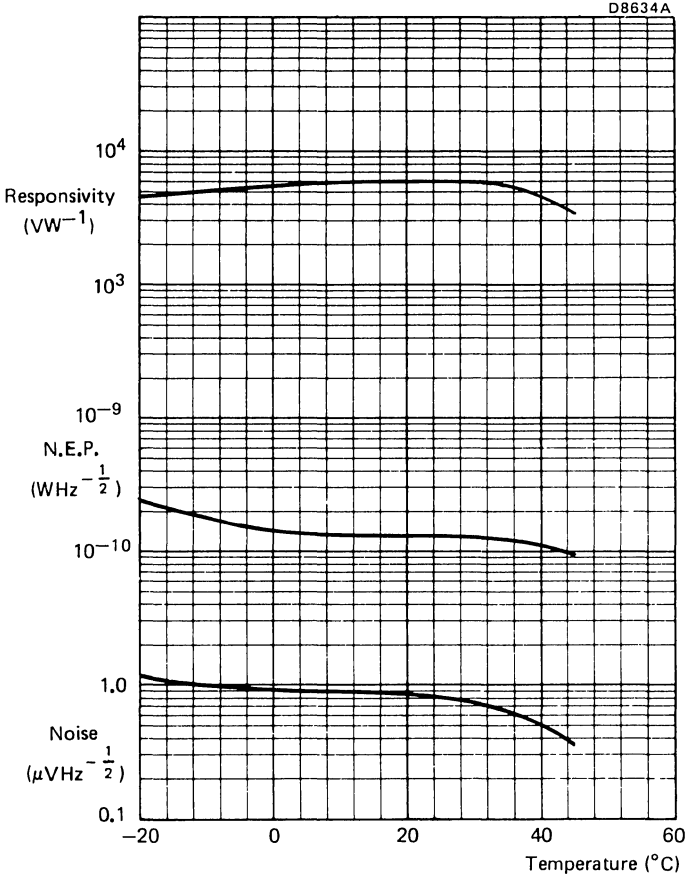

RPY90C

Typical 500 K black body performance as a function of temperature

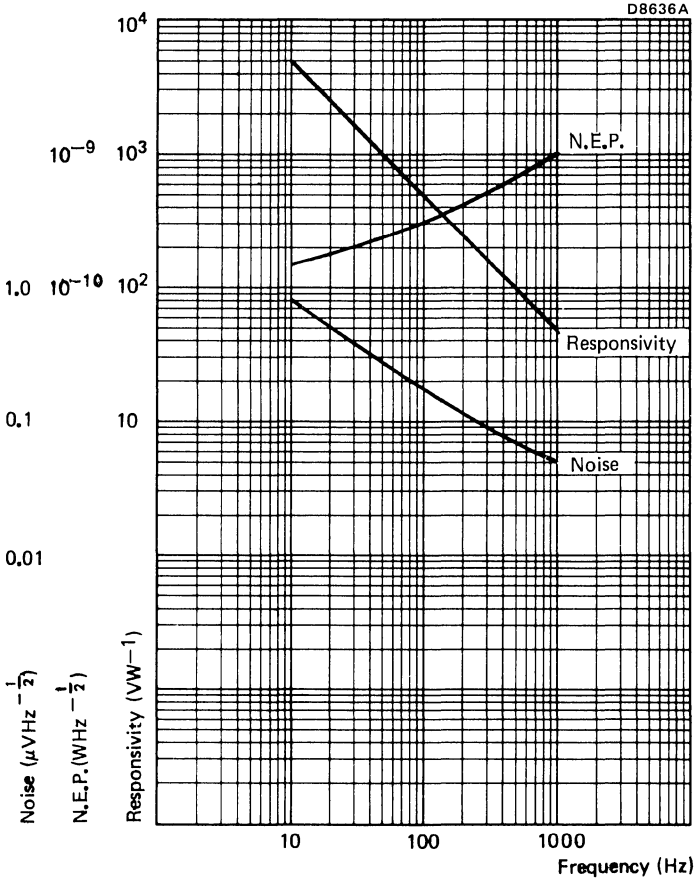

RPY90D

Typical 500 K black body performance as a function of frequency

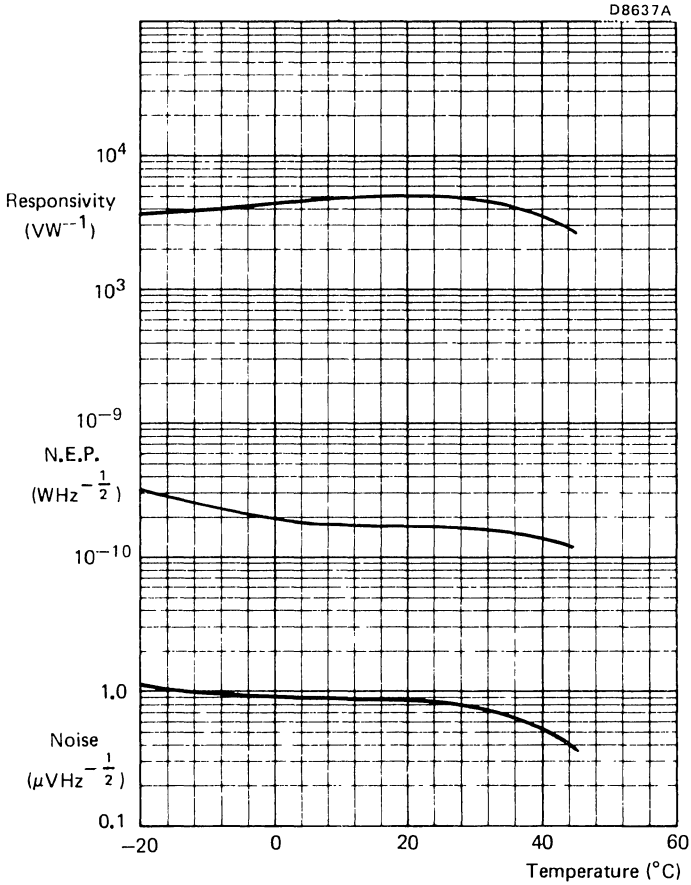

RPY90D

Typical 500 K black body performance as a function of temperature

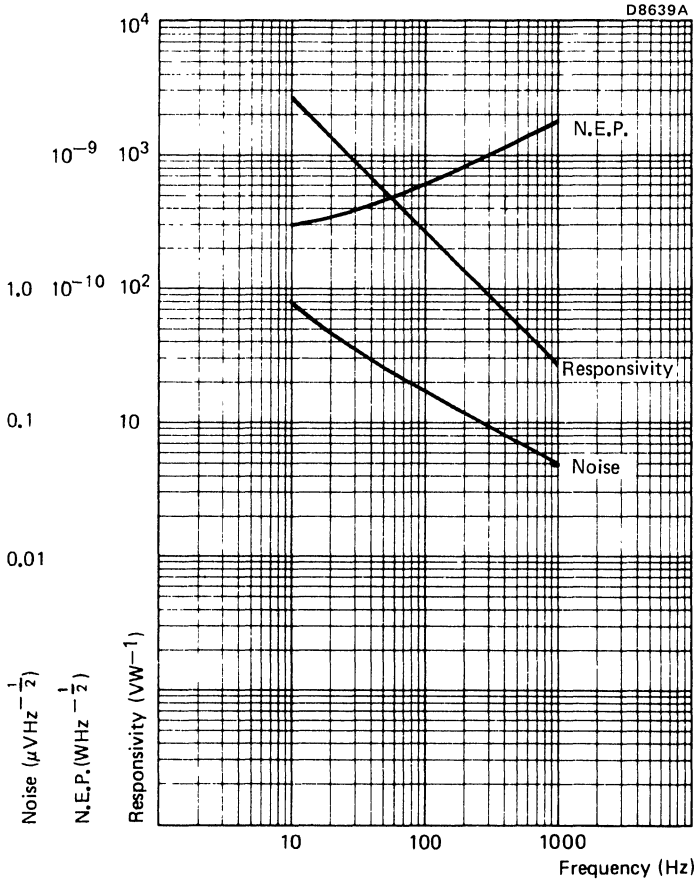

RPY90E

Typical 500 K black body performance as a function of frequency

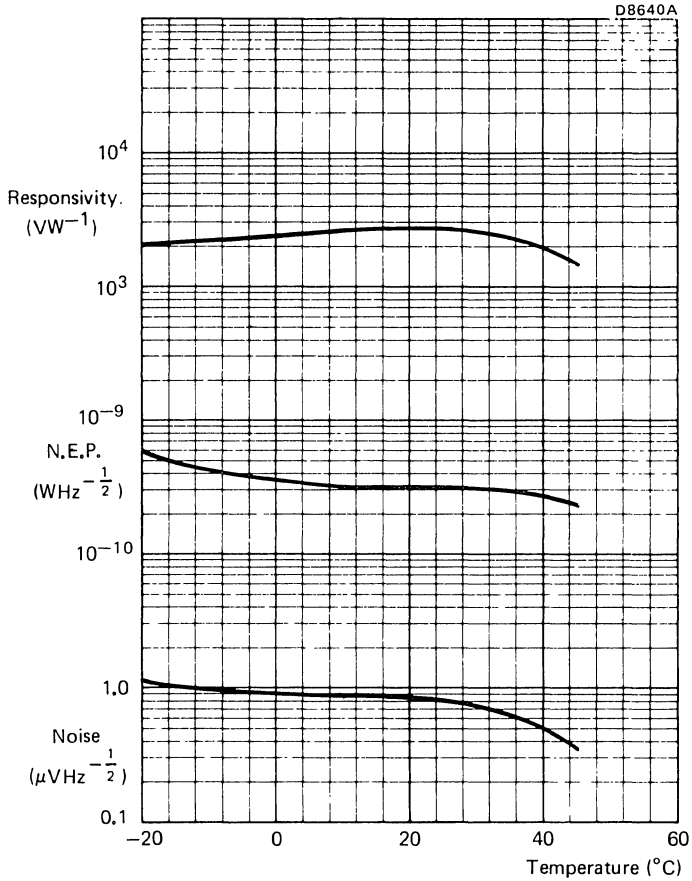

RPY90E

Typical 500K black body performance as a function of temperature

LATGS PYROELECTRIC INFRARED DETECTORS

This series of pyroelectric infrared detectors is designed to replace conventional bolometers. The sensitive material is L-alanine doped triglycine sulphate* (LATGS) which operates at room temperature and has a good broadband performance. Each device has a 2.75×1.25 mm sensitive area and is available with a selection of window materials giving a range of spectral performance. A pre-amplifier with short circuit protection is incorporated.

QUICK REFERENCE DATA

	Window material	Spectral response μm	Window description
RPY91A	caesium iodide	1 to 70	transparent, hygroscopic, soft
RPY91C	KRS-5	1 to 40	non-hygroscopic, toxic
RPY91D	silicon (AR coated— optimized for 8 to 14 μm use).	1.2 to 15	non-hygroscopic
RPY91E	sapphire	1 to 6.5	transparent, non-hygroscopic
N.E.P.** (500K, 10, 1)	RPY91A	typ. 1.5×10^{-10}	$\text{WHz}^{-\frac{1}{2}}$
Responsivity (500K, 10)		typ. 6.5×10^3	VW^{-1}
Recommended operating voltage		9	V
Operating frequency range		10 to 1000	Hz
Optimum operating temperature range		-20 to +45	$^{\circ}\text{C}$
Field of view		> 60	degrees

This data must be read in conjunction with GENERAL SAFETY RECOMMENDATIONS – OPTOELECTRONIC DEVICES

PRODUCT SAFETY

Modern high technology materials have been used in the manufacture of this device to ensure high performance. Some of these materials are toxic in certain circumstances. Mechanical or electrical damage is unlikely to give rise to any hazard, but toxic vapours may be generated if the device is heated to destruction. Disposal of large quantities should therefore be carried out in accordance with the Deposit of Poisonous Waste Act 1972 and the Control of Pollution Act 1974, or with the latest legislation.

* LATGS cuts off below $\lambda = 1 \mu\text{m}$, where incident energy is no longer absorbed.

** Noise Equivalent Power

MECHANICAL DATA

Dimensions in mm

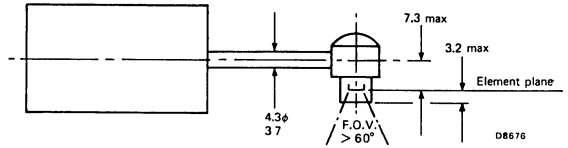
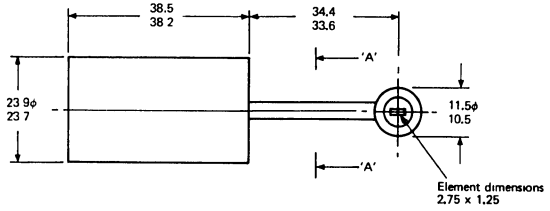
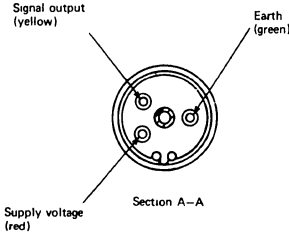

Three female connectors are supplied with each device to fit Sealectro feed throughs type no. FT SM 14.

RATINGS

Limiting values in accordance with the Absolute Maximum System (IEC134)

Supply voltage	max.	+18	V
Supply current	max.	10	mA
Ambient operating temperature		-20 to +45	°C
Storage temperature		-20 to +55	°C

CHARACTERISTICS at $T_{amb} = 20\text{ }^{\circ}\text{C}$, using a 500 K black body source

		RPY91A	C	D	E	
N.E.P. (500 K, 10, 1)	typ.	1.5	2.0	2.5	4.5	$\times 10^{-10}$ $\text{WHz}^{-\frac{1}{2}}$
	<	3.0	4.0	5.0	9.0	$\times 10^{-10}$ $\text{WHz}^{-\frac{1}{2}}$
Responsivity (500 K, 10)*	typ.	6.5	5.0	4.0	2.3	$\times 10^3$ VW^{-1}
Noise per unit bandwidth at 10 Hz	typ.	1.0	1.0	1.0	1.0	$\mu\text{VHz}^{-\frac{1}{2}}$
Output voltage (d.c. level)	>	4	4	4	4	V
	typ.	6	6	6	6	V
	<	8	8	8	8	V
Output impedance	<	4	4	4	4	k Ω
Element dimensions		all types: 2.75 x 1.25				mm
Field of view		all types: > 60				degrees
Operating voltage range		all types: 8 to 10				V
Supply current		all types: up to 10				mA

*These detectors can also be supplied with an integral frequency compensated amplifier similar to that described under Application Information. This would, for example, increase the responsivity by up to x 100 with an amplifier designed to give a flat response to 20 Hz.

OPERATING NOTES

1. The detector is supplied with a black plastic cap to protect the window. This cap must be removed before operation
2. The shape of the electrical output waveform is the integral of the incident radiation waveform.
3. It is inadvisable to operate the detector at mains related frequencies.
4. To avoid the possibility of optical microphony, the detector must be firmly mounted.
5. An increase in temperature of the element will produce a negative going signal at the output.
6. Provided that the operating voltage does not exceed 10 V, the maximum time for the output to be short-circuited (to the supply or common rail) is unlimited.

DEFINITIONS

1. N.E.P. (Noise Equivalent Power) $\text{WHz}^{-1/2}$
This is the r.m.s. value of the incident, chopped, radiant power necessary to produce an r.m.s. signal to r.m.s. noise ratio of unity. The r.m.s. noise refers to the value calculated for unit square root bandwidth $\text{VHz}^{-1/2}$.
2. Responsivity VW^{-1}
This is the ratio of the r.m.s. signal in volts to the r.m.s. value of the incident, chopped, radiant power.



APPLICATION INFORMATION

1. The pyroelectric element may be considered as a capacitor whose charge state changes with temperature. It also behaves as a normal capacitor, i.e. its voltage changes with charge. Thus a change of temperature results in a change of voltage. It can be seen that, for a given change in amplitude of incident radiation, the resulting change in temperature will decrease as the chopping frequency increases. Thus the voltage change will also decrease with frequency. In addition, there is a 90° phase lag between the thermal and electrical signals. The voltage signal therefore becomes the integral of the radiation signal.

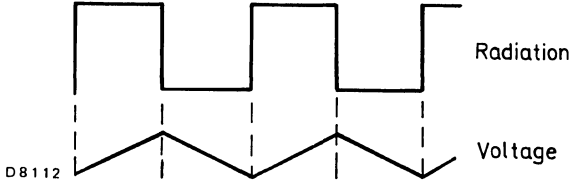

2. Frequency compensating amplifier

The following circuit is designed to be connected directly to the detector output and may be used to compensate for the falling responsivity characteristic with frequency. It is a simple 'virtual earth' amplifier which uses a series input capacitor to provide increasing current through the feedback resistor R_2 with increasing frequency. The time constants $R_2 C_2$ and $R_3 C_3$ are chosen to coincide with $R_1 C_1$, where R_1 is the output impedance of the detector ($< 4.0 \text{ k}\Omega$).

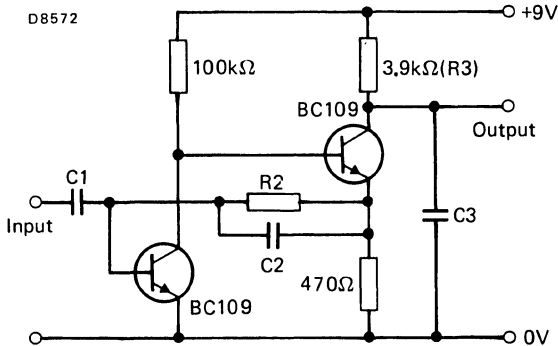

The table below gives recommended component values for various roll-off frequencies (approx. -3 dB point).

Frequency Hz	$C_1 C_3$ nF	R_2 kΩ	C_2 nF
30	680	330	10
300	68	220	1.5
600	33	330	0.47
1500	15	68	1.0
3000	15	82	0.47
4500	4.7	68	0.33

With this circuit the original shape of the radiation waveform is restored at the output for chopping frequencies sensibly lower than the roll-off frequency.

3. Additional stage for extra gain which may be connected directly to the detector output or to the output of the frequency compensating amplifier.

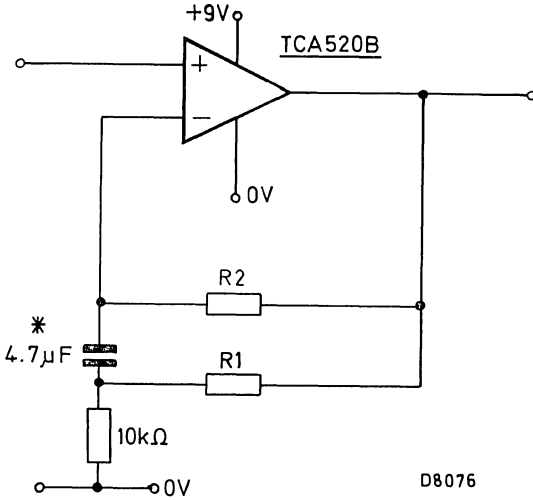

D8076

Recommended component values for various gains

Gain x	R ₁ kΩ	R ₂ MΩ
50	560	5.6
20	220	2.2
10	100	1.0

*this capacitor must be a low leakage type, e.g. our 344 series

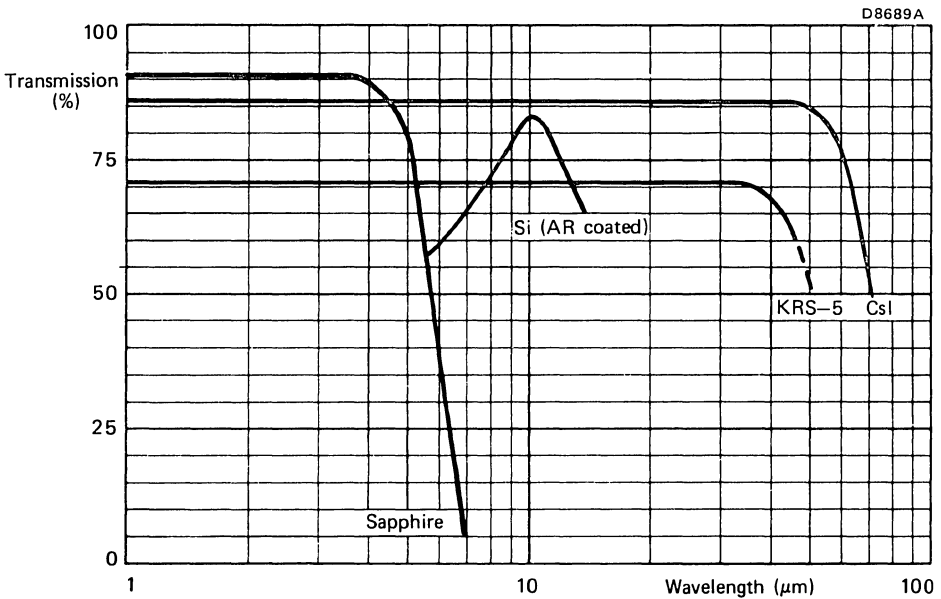

D8689A

Typical window transmission characteristics.

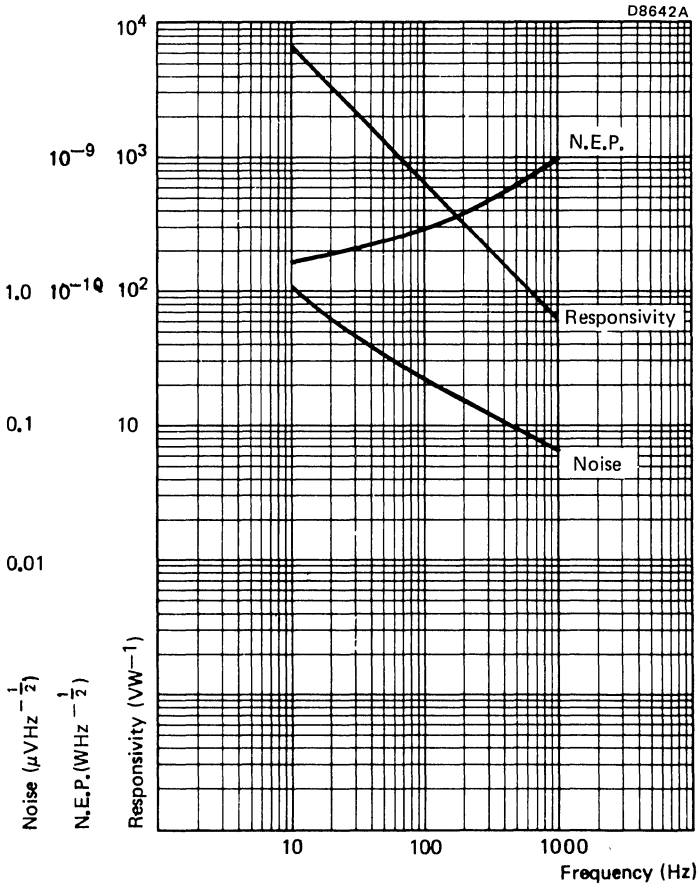

RPY91A

Typical 500K black body performance as a function of frequency

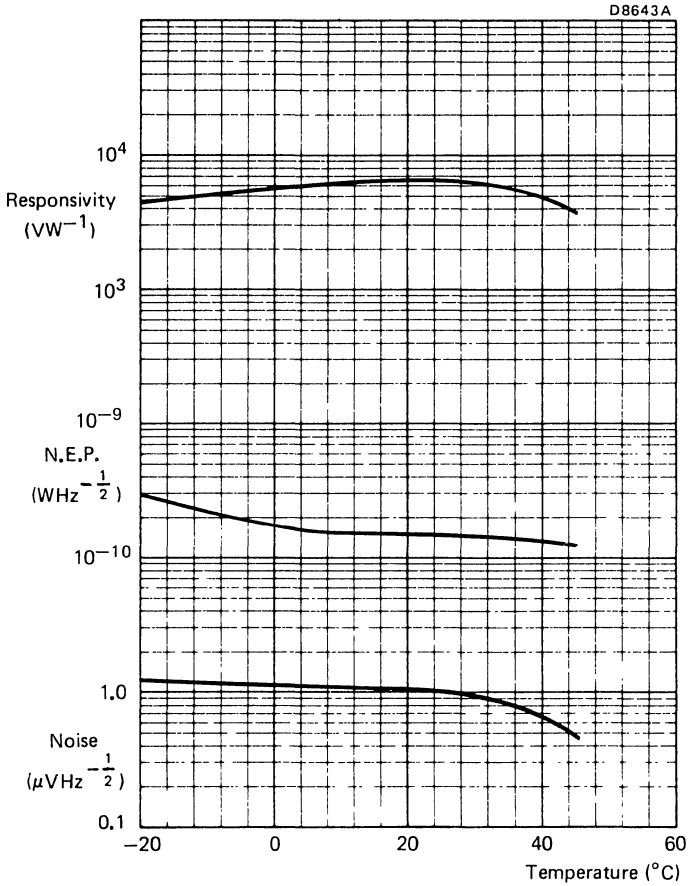

RPY91A

Typical 500K black body performance as a function of temperature

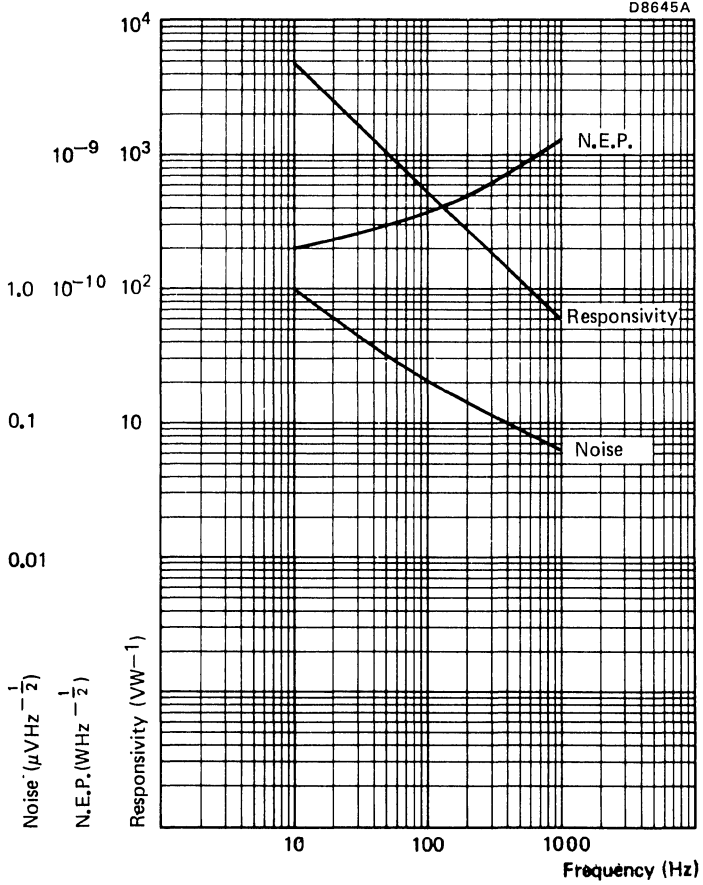

RPY91C

Typical 500K black body performance as a function of frequency

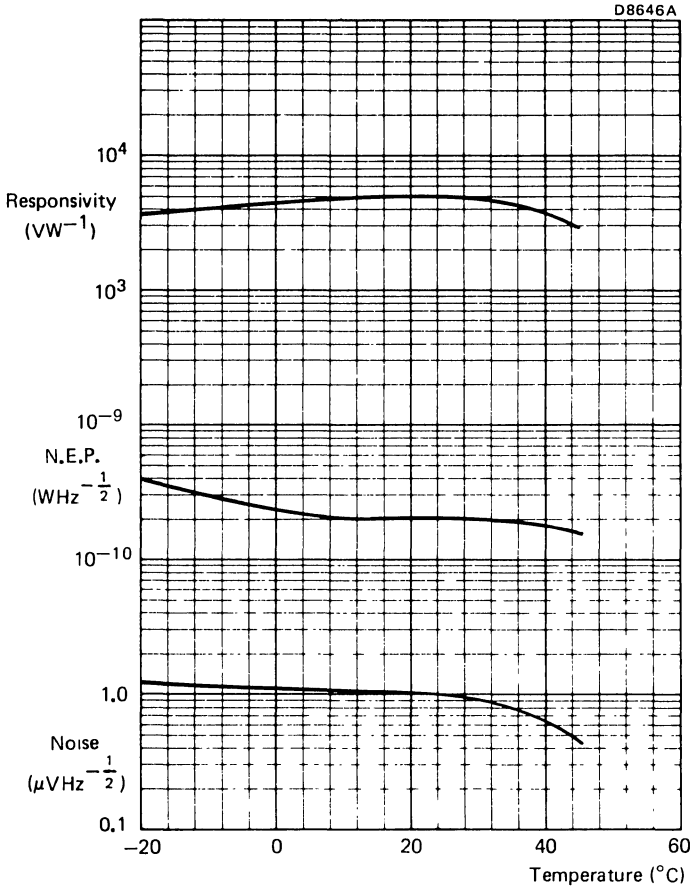

RPY91C

Typical 500K black body performance as a function of temperature

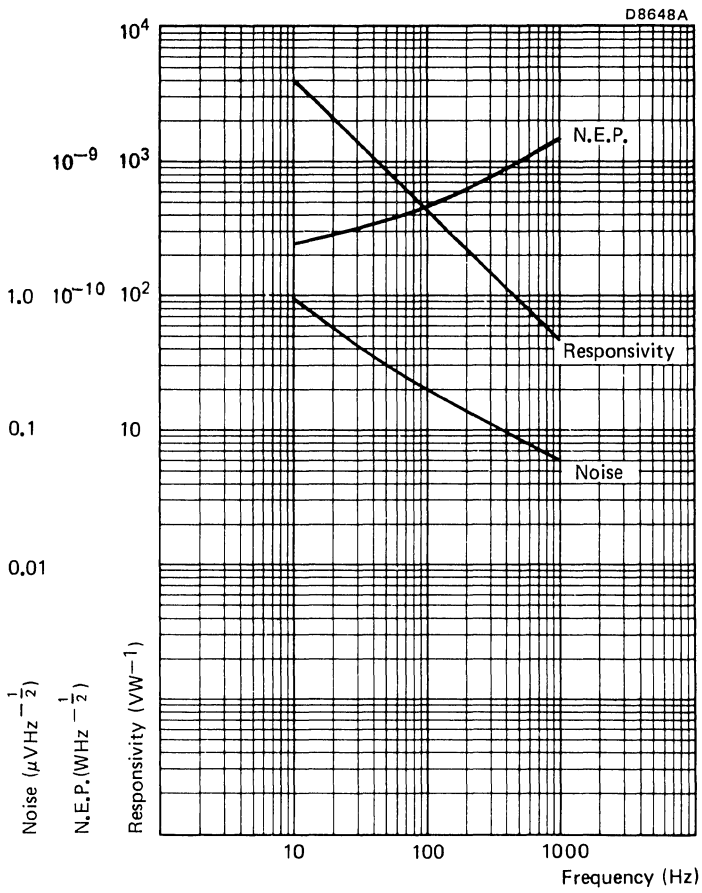

RPY91D

Typical 500K black body performance as a function of frequency

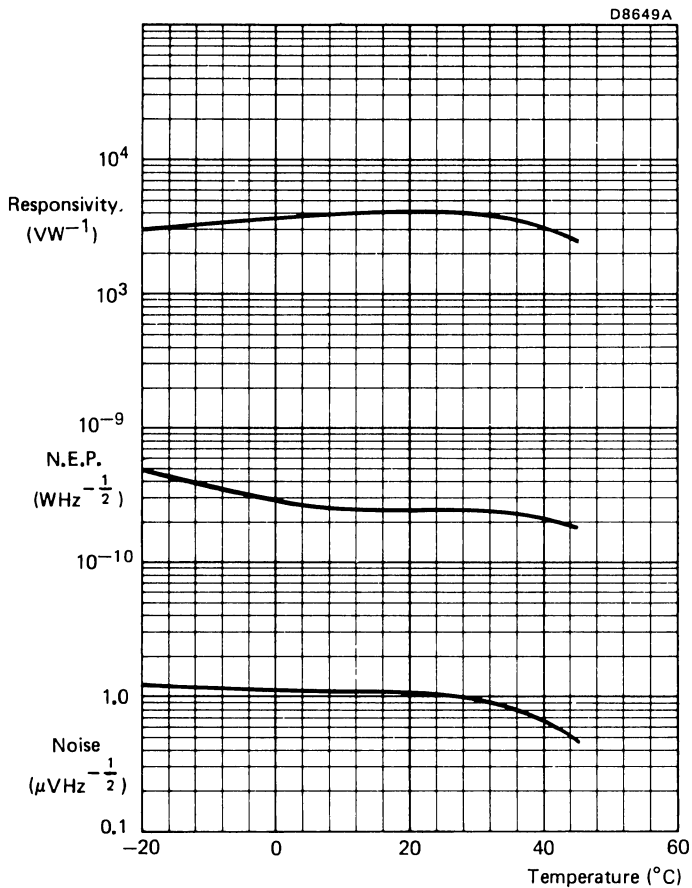

Typical 500K black body performance as a function of temperature

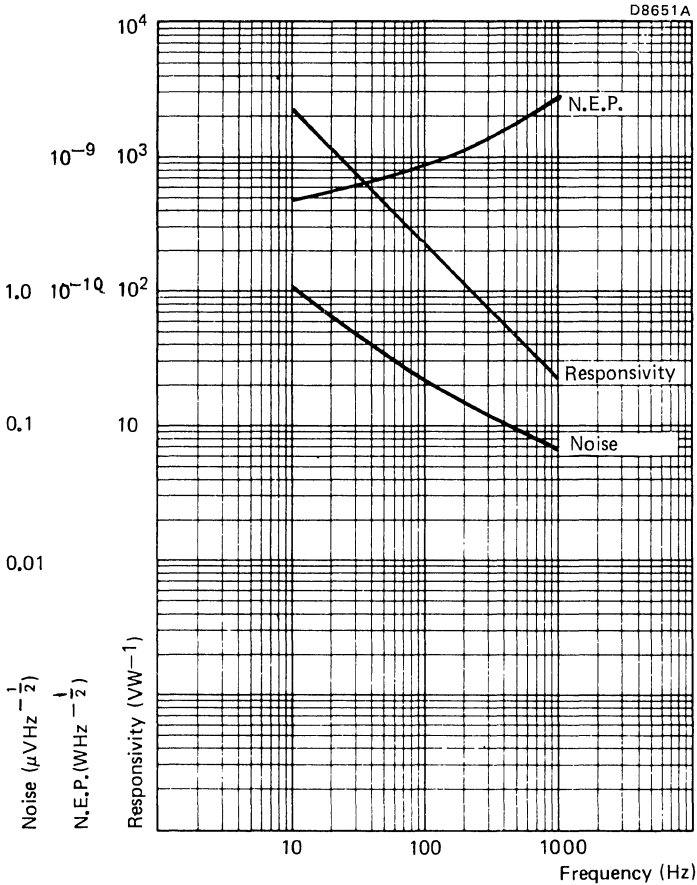

RPY91E

Typical 500K black body performance as a function of frequency

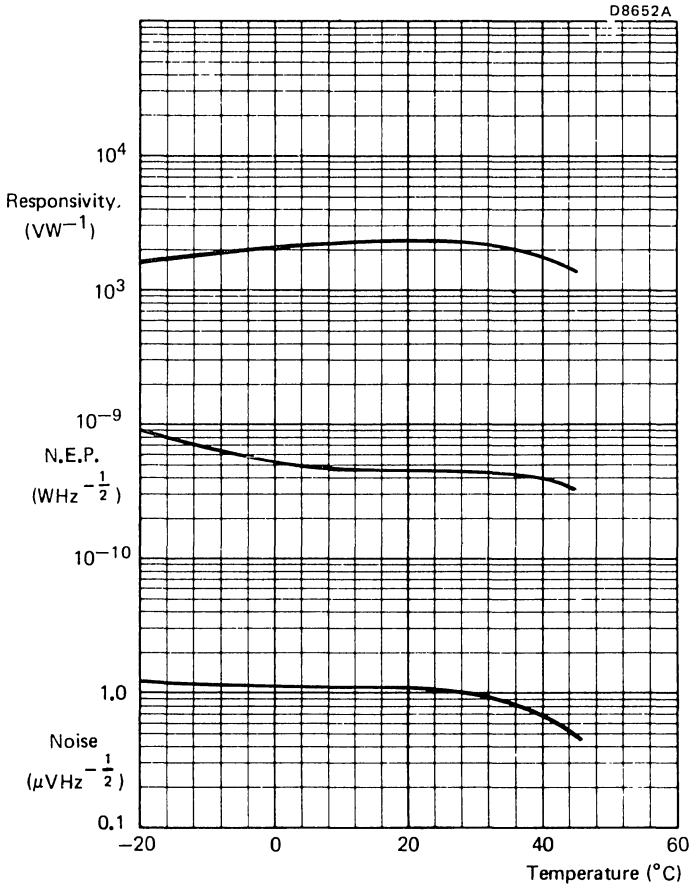

RPY91E

Typical 500K black body performance as a function of temperature

DUAL ELEMENT PYROELECTRIC INFRARED DETECTOR

This is an infrared sensitive device specifically designed for passive IR intruder alarms. It has differentially connected dual elements, combined with a single impedance converting amplifier to provide immunity from common mode signals such as those generated by variations in ambient temperature, background radiation and acoustic noise.

The detector will give an output signal only when radiation falling on the elements is unbalanced as in a focused system.

It is sealed in a low profile TO-5 can with a window optically coated to restrict the response to wavelengths greater than 6.5 μm .

QUICK REFERENCE DATA

Spectral Response		6.5 ± 0.5 to > 14	μm
Responsivity (10 μm , 10), each element	typ.	800	VW^{-1}
Noise Equivalent Power (N.E.P.), (10 μm , 10, 1), each element	typ.	1.4×10^{-9}	$\text{WHz}^{-1/2}$
Element dimensions, each element		2×0.75	mm
Element separation		0.5	mm
Field of View in horizontal plane (x-x)	typ.	120	degrees
Operating voltage		9	V
Optimum operating frequency range		0.1 to 1000	Hz

This data must be read in conjunction with GENERAL SAFETY RECOMMENDATIONS – OPTOELECTRONIC DEVICES

MECHANICAL DATA

SOT-49E (low profile TO-5)

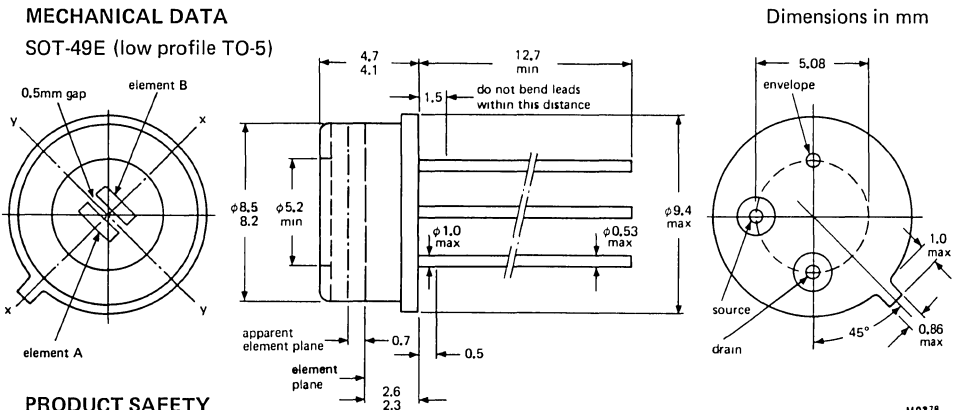

PRODUCT SAFETY

Modern high technology materials have been used in the manufacture of this device to ensure high performance. Some of these materials are toxic in certain circumstances. Mechanical or electrical damage is unlikely to give rise to any hazard, but toxic vapours may be generated if the device is heated to destruction. Disposal of large quantities should therefore be carried out in accordance with the latest local legislation.

SOLDERING

1. When making soldered connections to the leads, a thermal shunt should be used.
2. It is essential that any mains operated soldering iron should be both screened and earthed. Failure to observe these precautions could lead to the introduction of line voltage and possible damage to the device.

RATINGS

Limiting values in accordance with the Absolute Maximum System (IEC134)

Supply voltage	max.	30	V
Temperature, operating	max.	+50	°C
	min.	-40	°C
Temperature, storage	max.	+70	°C
	min.	-40	°C
Lead soldering temperature, ≥ 6 mm header, $t_{sld} \leq 3s$	max.	+350	°C

CHARACTERISTICS (at $T_{amb} = 25 \pm 3$ °C and with recommended circuit)

		min.	typ.	max.	
Spectral Response		6.5 ± 0.5	—	> 14	μm
Responsivity (10 μm , 10)	notes 1 and 5	605	800	—	VW^{-1}
N.E.P. (10 μm , 10, 1)	notes 1 and 5	—	1.4×10^{-9}	3×10^{-9}	$WHz^{-1/2}$
Element matching	note 2	—	± 4	± 20	%
Field of View (x-x plane)	note 3	—	120	—	degrees
Operating voltage	note 4	8	9	10	V

Notes

1. Each element. These characteristics apply throughout the spectral response range.
2. With both elements equally irradiated, the matching of the element signals is derived from:—

$$\frac{\Delta S}{\frac{1}{2}(S_A + S_B)} \times 100$$
 where S_A and S_B are the signals of the two elements and ΔS is the signal with both elements irradiated.
3. Field of view to 50% of the maximum responsivity level.
4. The detector will operate outside the quoted range but may have a degraded performance.
5. For performance as a function of frequency and temperature see pages 6 and 7.

RECOMMENDED CIRCUIT

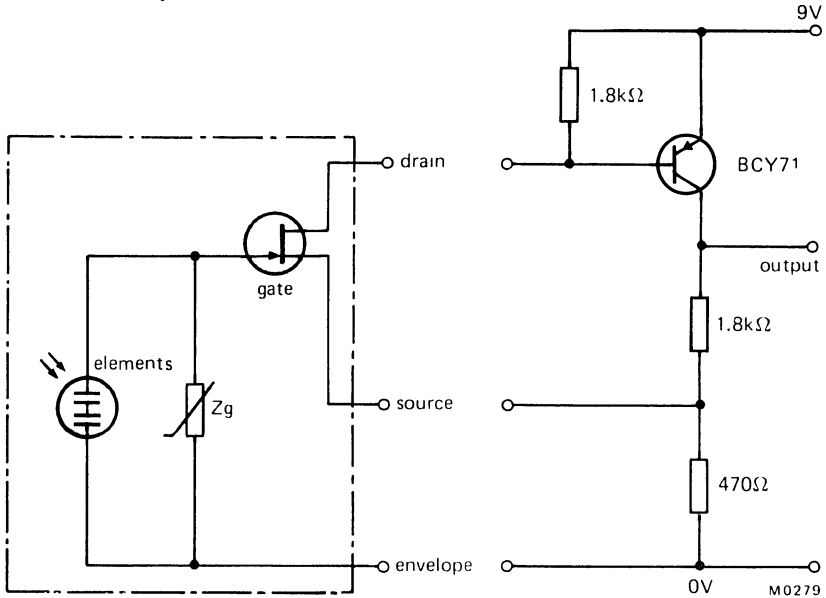

OPERATING NOTES

1. The case potential must not be allowed to become positive with respect to the other two terminals.
2. It is inadvisable to operate the detector at mains related frequencies.
3. To avoid the possibility of optical microphony, the detector must be firmly mounted.
4. An increase in temperature of element A will produce a negative going signal at the output. For element B, the corresponding output will be positive going.
5. Use recommended circuit for low noise operation.
6. For simplicity of operation, a source follower may be used where noise is not a problem. This may be achieved with a 22 kΩ resistor between source and envelope with the positive supply taken to the drain terminal. This will give a voltage gain of approximately 0.9.

DEFINITIONS

1. Responsivity VW^{-1}

This is the ratio of the r.m.s. signal in volts to the r.m.s. value of the incident, chopped radiant power.

2. N.E.P. (Noise Equivalent Power), $WHz^{-\frac{1}{2}}$

This is the r.m.s. value of the incident, chopped radiant power necessary to produce an r.m.s. signal to r.m.s. noise ratio of unity. The r.m.s. noise refers to the value calculated for unit square root bandwidth $VHz^{-\frac{1}{2}}$.

APPLICATION INFORMATION

Optional additional stage for extra gain

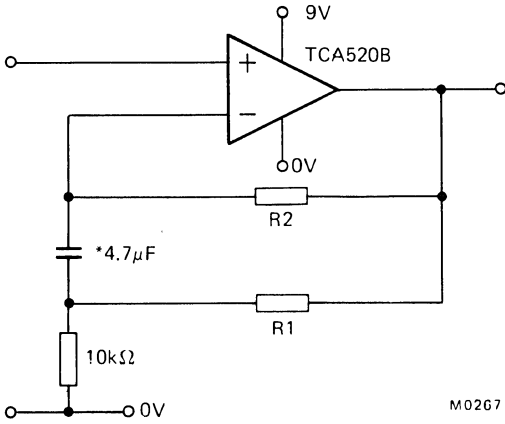

Recommended component values for various gains

Gain x	R ₁ kΩ	R ₂ MΩ
50	560	5.6
20	220	2.2
10	100	1.0

*this capacitor must be a low leakage type e.g. our 344 series.

MECHANICAL AND ENVIRONMENTAL STANDARDS

As part of the Quality Assurance programme, the detectors are assessed at regular intervals against the requirements of the following IEC standards. The frequency of testing and the limits and conditions for the pre- and post-test measurements are based on those stipulated for the CECC 50 000 series of approved transistors.

	Test		Severity	Duration	Note
IEC 68-2-3	Ca	Damp Heat, steady state	+40 °C, 95% RH	168 hours	1
68-2-20	Ta	Solderability	+235 °C, 1.5 mm from header	5 seconds	1
68-2-21	Ub	Lead Fatigue	4 cycles	—	1
68-2-1	A	Low Temperature Storage	-40 °C	2000 hours	2
68-2-2	Ba	High Temperature Storage	+70 °C	2000 hours	2
68-2-14	Nb	Change of Temperature	-40 °C to +70 °C	10 cycles	2
68-2-6	Fc (B4)	Vibration, swept frequency	125 Hz to 2 kHz 196 ms ⁻²	2 h in each orientation	2
68-2-7	Ga	Acceleration, steady state	196000 ms ⁻²	60 seconds	2
68-2-27	Ea	Shock	14700 ms ⁻²	3 pulses 6 orientations	2
68-2-20	Tb	Resistance to Solder Heat	+350 °C, 6 mm from header	3 seconds	3

Notes

1. The detectors are checked on a production batch release principle at approximately weekly intervals. This is equivalent to Group B.
2. The detectors are checked at quarterly intervals. This is equivalent to Group C.
3. This is an annual check.

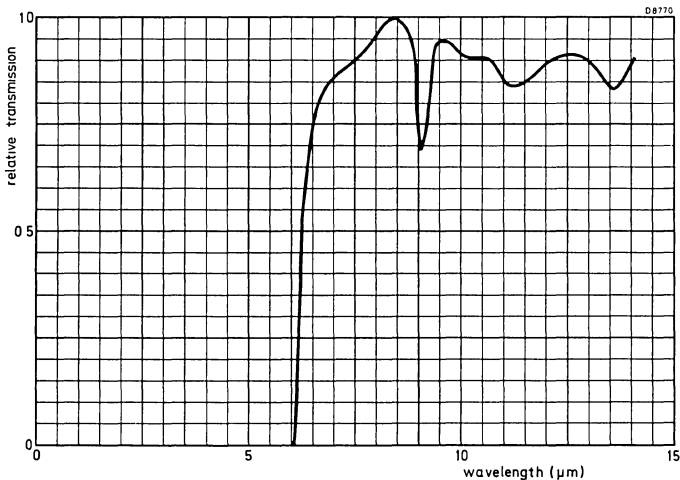

Typical normalized window transmission characteristic

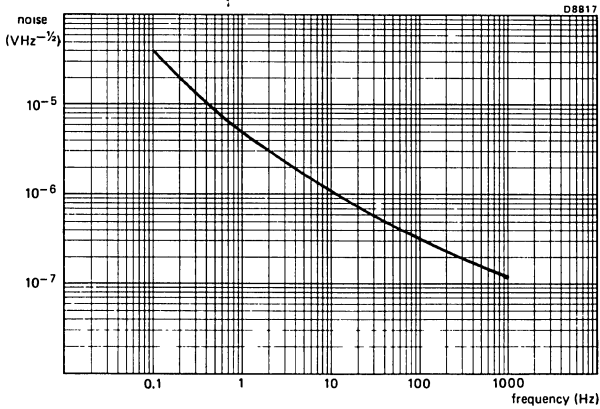
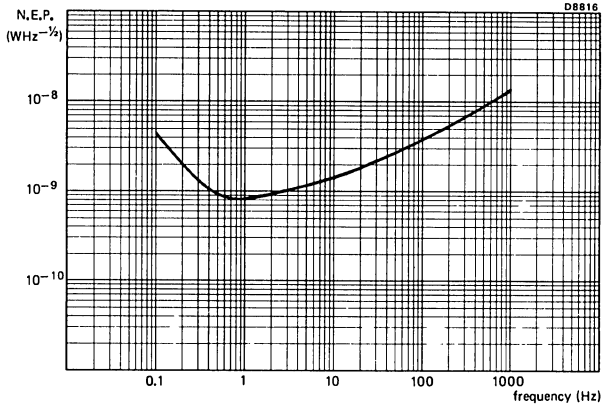
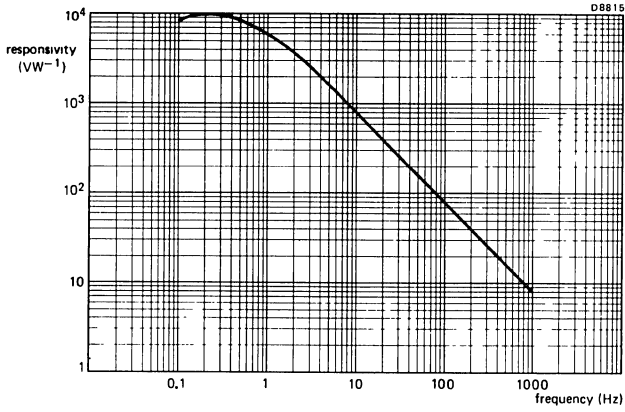

Typical Responsivity, N.E.P., and Noise as functions of Frequency
(one element screened)

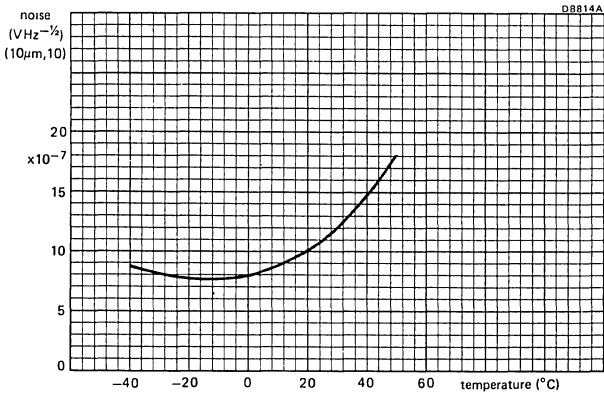
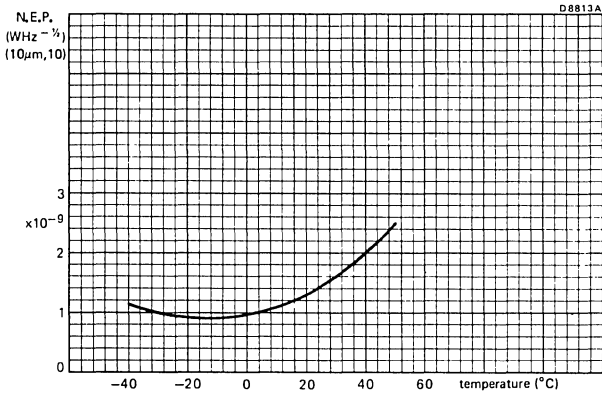
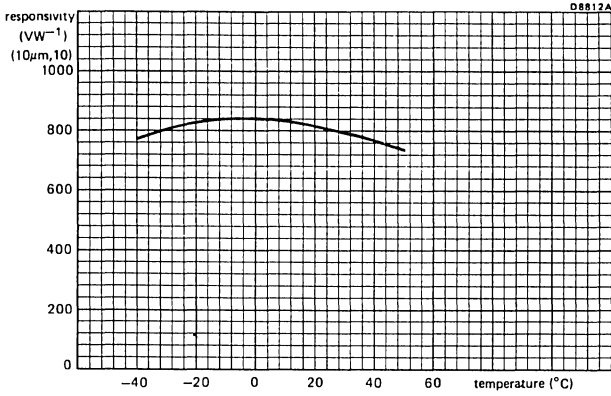

Typical Responsivity, N.E.P., and Noise as functions of Temperature
(one element screened)

POLAR DIAGRAMS

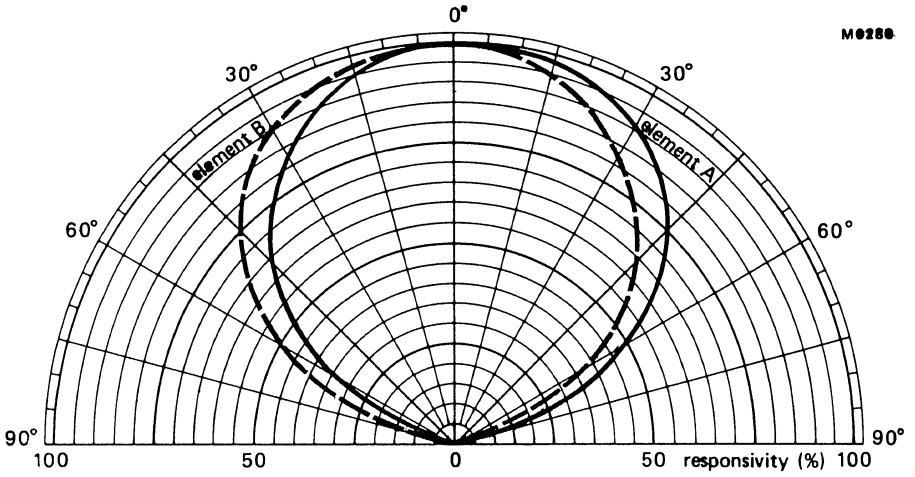

Typical Field of View in x-x plane (see Mechanical Data)

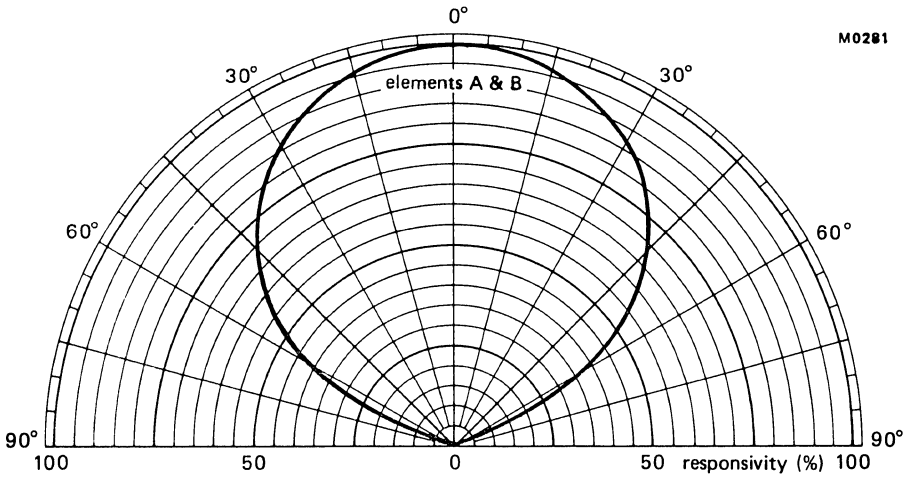

Typical Field of View in y-y plane (see Mechanical Data)

DUAL ELEMENT PYROELECTRIC INFRARED DETECTOR

This is an infrared sensitive device specifically designed for passive IR intruder alarms. It has differentially connected dual elements, with wide separation, combined with a single impedance converting amplifier to provide immunity from common mode signals such as those generated by variations in ambient temperature, background radiation and acoustic noise.

The detector will give an output signal only when the radiation falling on the elements is unbalanced as in a focused system.

It is sealed in a low profile TO-5 can with a window optically coated to restrict the response to wavelengths greater than 6.5 μm .

QUICK REFERENCE DATA

Spectral Response		6.5 \pm 0.5 to > 14	μm
Responsivity (10 μm , 10), each element	typ.	650	VW^{-1}
Noise Equivalent Power (N.E.P.) (10 μm , 10, 1), each element	typ.	1.5×10^{-9}	$\text{WHz}^{-1/2}$
Element dimensions, each element		2 x 1	mm
Element separation		1.0	mm
Field of View in horizontal plane (x-x)	typ.	130	degrees
Operating voltage		9	V
Optimum operating frequency range		0.1 to 1000	Hz

This data must be read in conjunction with GENERAL SAFETY RECOMMENDATIONS – OPTOELECTRONIC DEVICES

MECHANICAL DATA

SOT-49E (low profile TO-5)

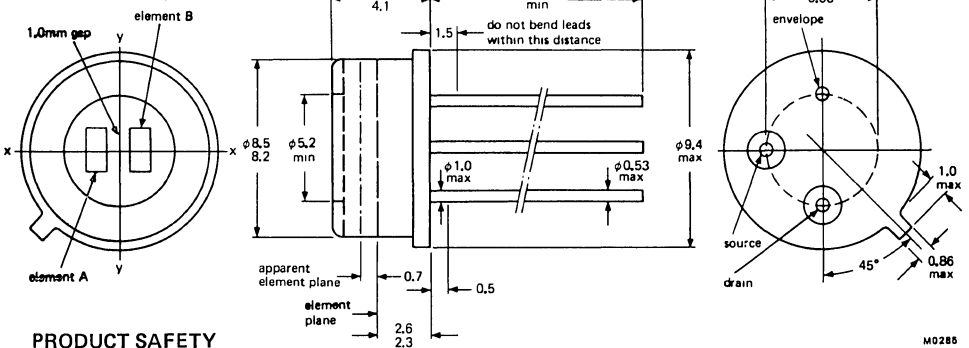

PRODUCT SAFETY

Modern high technology materials have been used in the manufacture of this device to ensure high performance. Some of these materials are toxic in certain circumstances. Mechanical or electrical damage is unlikely to give rise to any hazard, but toxic vapours may be generated if the device is heated to destruction. Disposal of large quantities should therefore be carried out in accordance with the latest local legislation.

SOLDERING

1. When making soldered connections to the leads, a thermal shunt should be used.
2. It is essential that any mains operated soldering iron should be both screened and earthed.
Failure to observe these precautions could lead to the introduction of line voltage and possible damage to the device.

RATINGS

Limiting values in accordance with the Absolute Maximum System (IEC134)

Supply voltage		max.	30	V
Temperature, operating		max.	+50	°C
		min.	-20	°C
Temperature, storage		max.	+50	°C
		min.	-20	°C
Lead soldering temperature, ≥ 6 mm from header, $t_{sld} \leq 3$ s		max.	+350	°C

CHARACTERISTICS (at $T_{amb} = 25 \text{ }^\circ\text{C} \pm 3 \text{ }^\circ\text{C}$ and with recommended circuit).

		min.	typ.	max.	
Spectral Response		6.5 ± 0.5	—	> 14	μm
Responsivity ($10 \mu\text{m}, 10$)	note 1	450	650	—	VW^{-1}
N.E.P. ($10 \mu\text{m}, 10, 1$)	note 1	—	1.5×10^{-9}	6×10^{-9}	$\text{WHz}^{-\frac{1}{2}}$
Element matching	note 2	—	—	± 20	%
Field of View (x-x plane)	note 3	—	130	—	degrees
Operating voltage	note 4	8	9	10	V

Notes

1. Each element. These characteristics apply throughout the spectral response range.
2. With both elements irradiated, the matching of the element signals is derived from:—

$$\frac{\Delta S}{\frac{1}{2}(S_A + S_B)} \times 100, \text{ where } S_A \text{ and } S_B \text{ are the signals of the two elements and } \Delta S \text{ is the signal with}$$

both elements irradiated.

3. Field of view to 50% of the maximum responsivity level.
4. The detector will operate outside the quoted range but may have a degraded performance.
5. For performance as a function of frequency and temperature see pages 6 and 7.

RECOMMENDED CIRCUIT

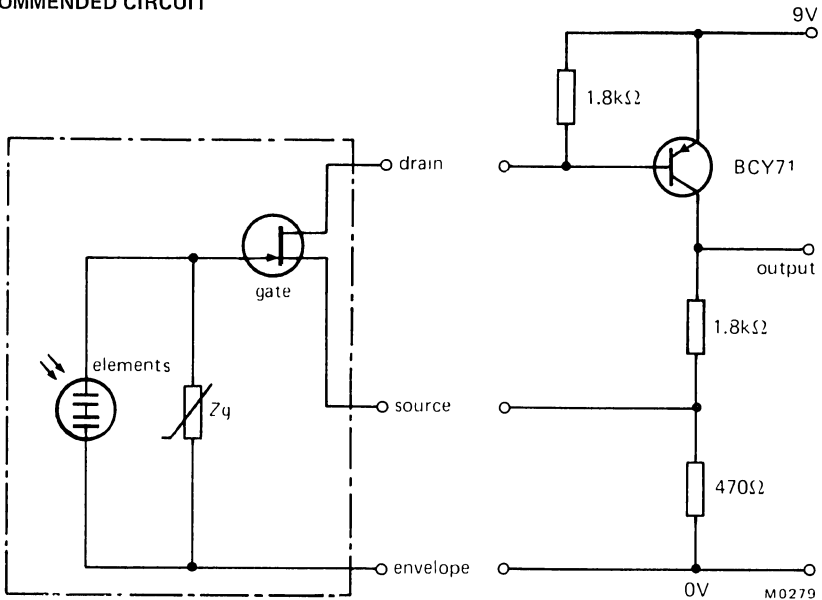

OPERATING NOTES

1. The case potential must not be allowed to become positive with respect to the other two terminals.
2. It is inadvisable to operate the detector at mains related frequencies.
3. To avoid the possibility of optical microphony, the detector must be firmly mounted.
4. An increase in temperature of element A will produce a positive going signal at the output. For element B, the corresponding output will be negative going.
5. Use recommended circuit for low noise operation.
6. For simplicity of operation, a source follower may be used where noise is not a problem. This may be achieved with a 22 kΩ resistor between source and envelope with the positive supply taken to the drain terminal. This will give a voltage gain of approximately 0.9.

DEFINITIONS

1. Responsivity VW^{-1}
This is the ratio of the r.m.s. signal in volts to the r.m.s. value of the incident, chopped radiant power.
2. N.E.P. (Noise Equivalent Power), $WHz^{-1/2}$
This is the r.m.s. value of the incident, chopped radiant power necessary to produce an r.m.s. signal to r.m.s. noise ratio of unity. The r.m.s. noise refers to the value calculated for unit square root bandwidth $VHz^{-1/2}$.

APPLICATION INFORMATION

Optional additional stage for extra gain

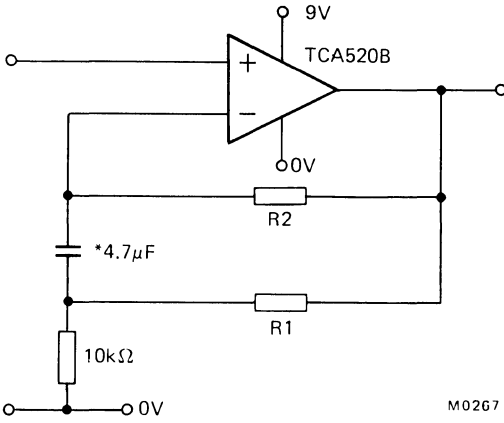

Recommended component value for various gains

Gain x	R ₁ kΩ	R ₂ MΩ
50	560	5.6
20	220	2.2
10	100	1.0

*this capacitor must be a low leakage type e.g. our 344 series.

.MECHANICAL AND ENVIRONMENTAL STANDARDS

As part of the Quality Assurance programme, the detectors are assessed at regular intervals against the requirements of the following IEC standards. The frequency of testing and the limits and conditions for the pre- and post-test measurements are based on those stipulated for the CECC 50 000 series of approved transistors.

	Test		Severity	Duration	Note
IEC 68-2-3	Ca	Damp Heat, steady state	+40 °C, 95% RH	168 hours	1
68-2-20	Ta	Solderability	+235 °C, 1.5 mm from header	5 seconds	1
68-2-21	Ub	Lead Fatigue	4 cycles	—	1
68-2-1	A	Low Temperature Storage	-20 °C	2000 hours	2
68-2-2	Ba	High Temperature Storage	+50 °C	2000 hours	2
68-2-14	Nb	Change of Temperature	-20 °C to +50 °C	10 cycles	2
68-2-6	Fc (B4)	Vibration, swept frequency	125 Hz to 2 kHz 196 ms ⁻²	2 h in each orientation	2
68-2-7	Ga	Acceleration, steady state	196000 ms ⁻²	60 seconds	2
68-2-27	Ea	Shock	14700 ms ⁻²	3 pulses 6 orientations	2
68-2-20	Tb	Resistance to Solder Heat	+350 °C, 6 mm from header	3 seconds	3

Notes

1. The detectors are checked on a production batch release principle at approximately weekly intervals. This is equivalent to Group B.
2. The detectors are checked at quarterly intervals. This is equivalent to Group C.
3. This is an annual check.

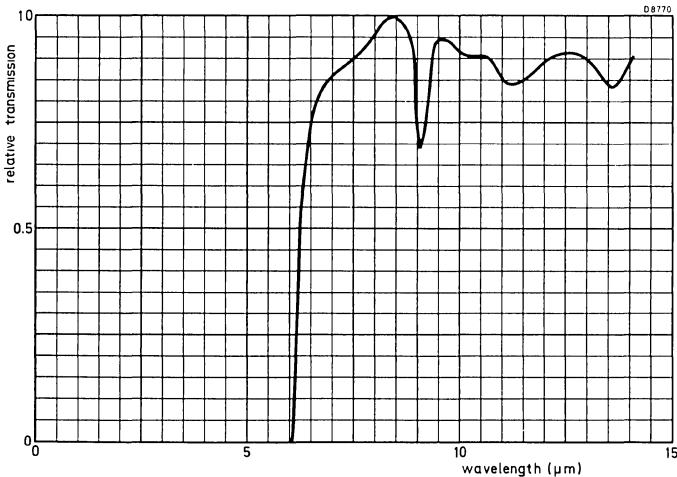

Typical normalized window transmission characteristic

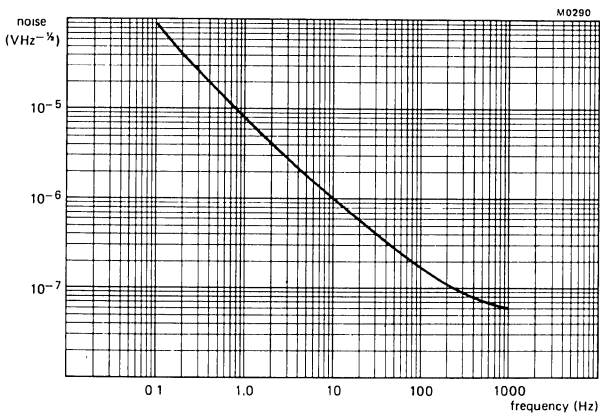
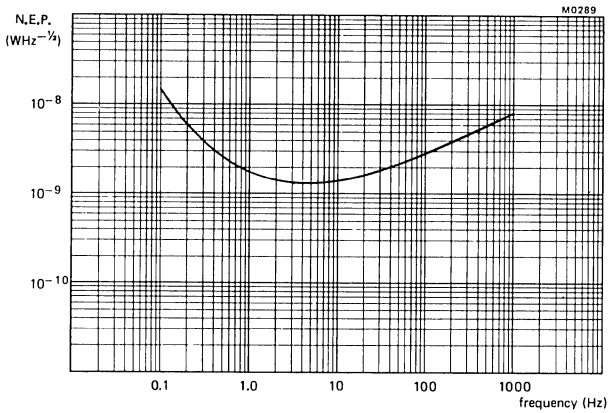
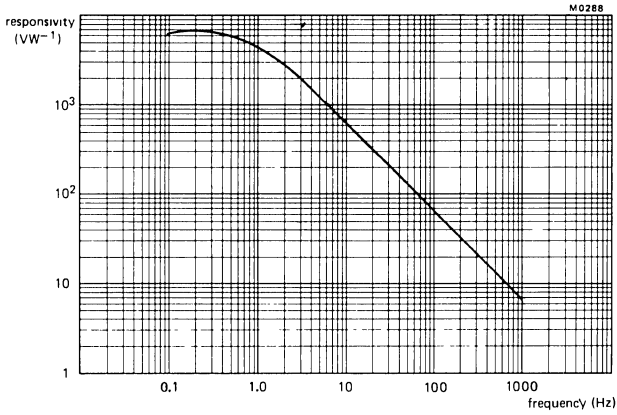

Typical Responsivity, N.E.P., and Noise as functions of Frequency
(one element screened)

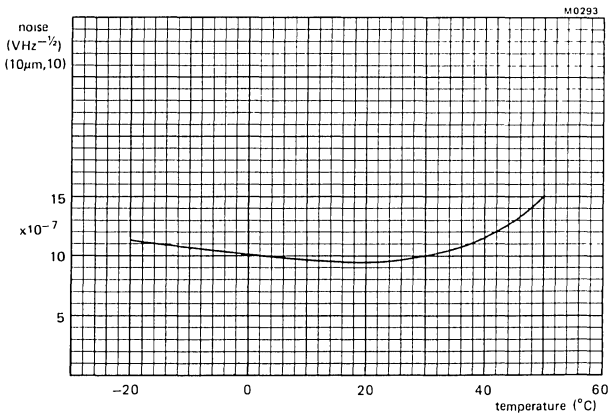
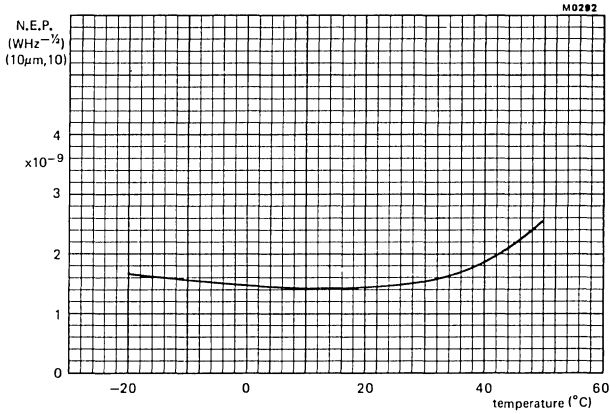
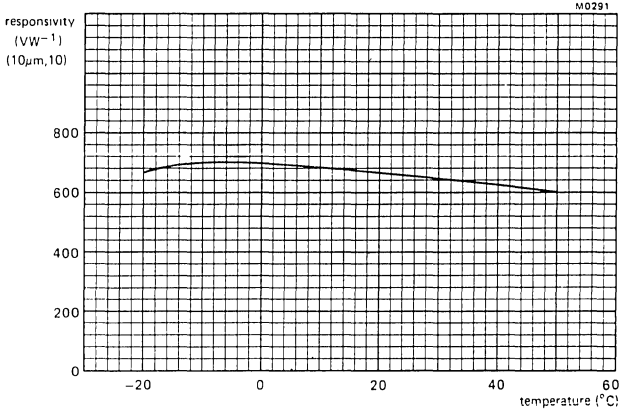

Typical Responsivity, N.E.P., and Noise as functions of Temperature
(one element screened)

POLAR DIAGRAMS

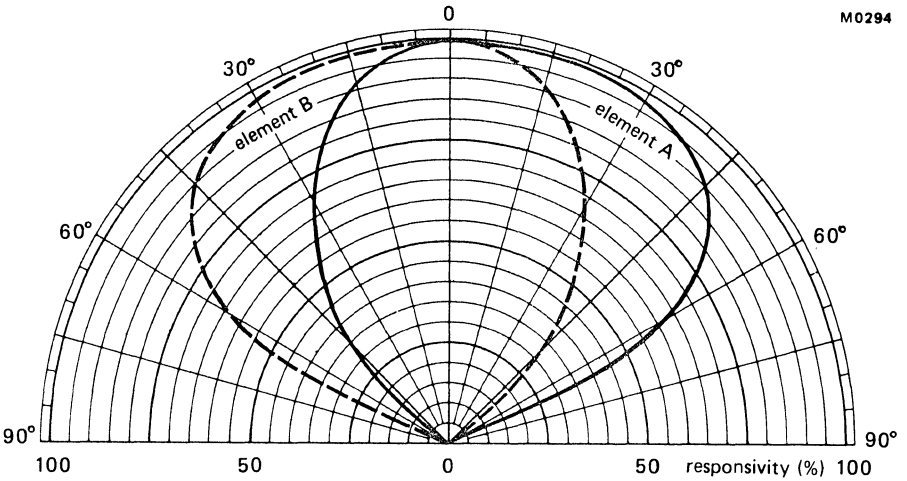

Typical Field of View in x-x plane (see Mechanical Data)

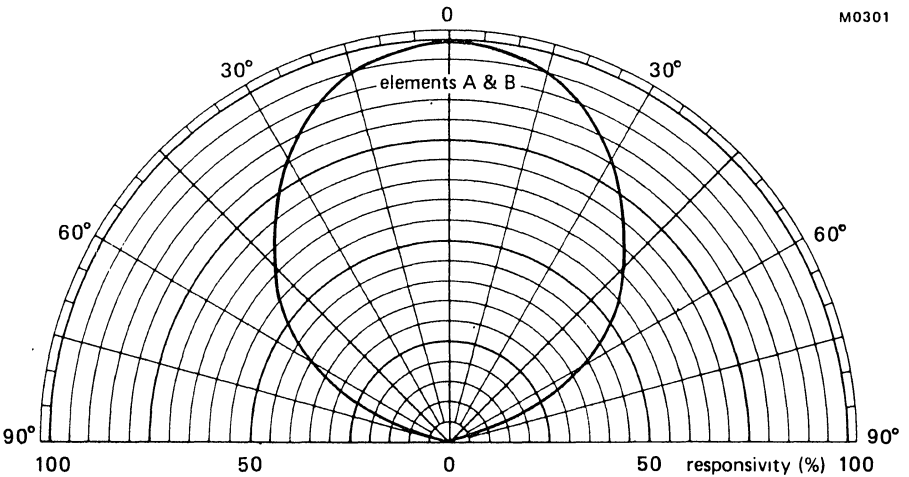

Typical Field of View in y-y plane (see Mechanical Data)

DUAL ELEMENT PYROELECTRIC INFRARED DETECTOR

This is an infrared sensitive device specifically designed for passive IR intruder alarms. It has differentially connected dual elements, with wide separation, combined with a single impedance converting amplifier to provide immunity from common mode signals such as those generated by variations in ambient temperature, background radiation and acoustic noise.

The detector will give an output signal only when the radiation falling on the elements is unbalanced as in a focused system.

It is sealed in a low profile TO-5 can with a window optically coated to restrict the response to wavelengths greater than 6.5 μm .

QUICK REFERENCE DATA

Spectral Response		6.5 ± 0.5 to > 14	μm
Responsivity (10 μm , 10), each element	typ.	450	VW^{-1}
Noise Equivalent Power (N.E.P.) (10 μm , 10, 1), each element	typ.	2.1×10^{-9}	$\text{WHz}^{-1/2}$
Element dimensions, each element		2×1	mm
Element separation		1.0	mm
Field of View in horizontal plane (x-x)	typ.	110	degrees
Operating voltage		9	V
Optimum operating frequency range		0.1 to 1000	Hz

This data must be read in conjunction with GENERAL SAFETY RECOMMENDATIONS – OPTOELECTRONIC DEVICES

MECHANICAL DATA

SOT-49F (low profile TO-5)

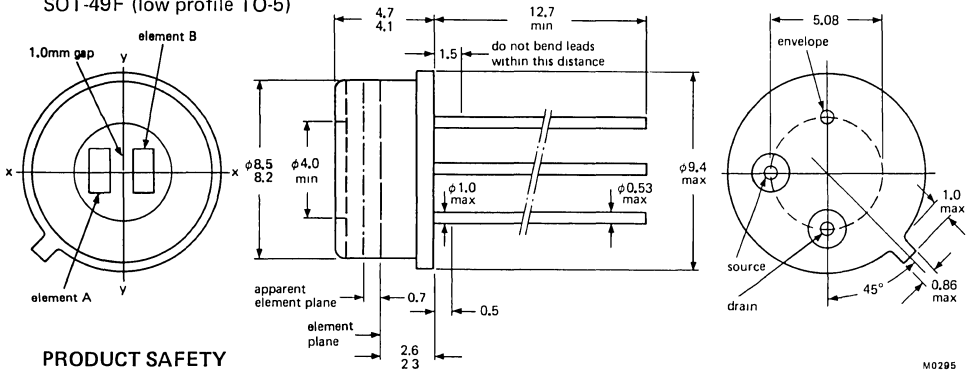

PRODUCT SAFETY

Modern high technology materials have been used in the manufacture of this device to ensure high performance. Some of these materials are toxic in certain circumstances. Mechanical or electrical damage is unlikely to give rise to any hazard, but toxic vapours may be generated if the device is heated to destruction. Disposal of large quantities should therefore be carried out in accordance with the latest local legislation.

SOLDERING

1. When making soldered connections to the leads, a thermal shunt should be used.
2. It is essential that any mains operated soldering iron should be both screened and earthed.
Failure to observe these precautions could lead to the introduction of line voltage and possible damage to the device.

RATINGS

Limiting values in accordance with the Absolute Maximum System (IEC134)

Supply voltage	max.	30	V
Temperature, operating	max.	+50	°C
	min.	-20	°C
Temperature, storage	max.	+50	°C
	min.	-20	°C
Lead soldering temperature ≥ 6 mm from header, $t_{sld} \leq 3$ s	max.	+350	°C

CHARACTERISTICS (at $T_{amb} = 25 \text{ }^\circ\text{C} \pm 3 \text{ }^\circ\text{C}$ and with recommended circuit)

		min.	typ.	max.	
Spectral Response		6.5 ± 0.5	—	> 14	μm
Responsivity ($10 \mu\text{m}$, 10)	note 1	265	450	—	VW^{-1}
N.E.P. ($10 \mu\text{m}$, 10, 1)	note 2	—	2.1×10^{-9}	6×10^{-9}	$\text{WHz}^{-\frac{1}{2}}$
Element matching	note 2	—	—	± 20	%
Field of View (x-x plane)	note 3	—	110	—	degrees
Operating voltage	note 4	8	9	10	V

Notes

1. Each element. These characteristics apply throughout the spectral response range.
2. With both elements irradiated, the matching of the element signals is derived from:—

$$\frac{\Delta S}{\frac{1}{2}(S_A + S_B)} \times 100, \text{ where } S_A \text{ and } S_B \text{ are the signals of the two elements and } \Delta S \text{ is the signal with both elements irradiated.}$$

3. Field of view to 50% of the maximum responsivity level.
4. The detector will operate outside the quoted range but may have a degraded performance.
5. For performance as a function frequency and temperature see pages 6 and 7.

RECOMMENDED CIRCUIT

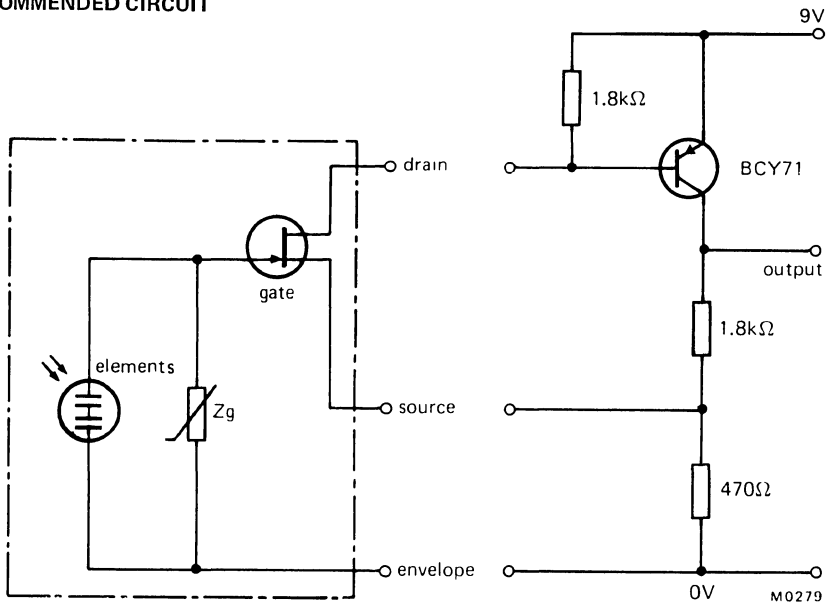

OPERATING NOTES

1. The case potential must not be allowed to become positive with respect to the other two terminals.
2. It is inadvisable to operate the detector at mains related frequencies.
3. To avoid the possibility of optical microphony, the detector must be firmly mounted.
4. An increase in temperature of element A will produce a positive going signal at the output. For element B, the corresponding output will be negative going.
5. Use recommended circuit for low noise operation.
6. For simplicity of operation, a source follower may be used where noise is not a problem. This may be achieved with a $22\text{ k}\Omega$ resistor between source and envelope with the positive supply taken to the drain terminal. This will give a voltage gain of approximately 0.9.

DEFINITIONS

1. Responsivity VW^{-1}
This is the ratio of the r.m.s. signal in volts to the r.m.s. value of the incident, chopped radiant power.
2. N,E.P. (Noise Equivalent Power), $\text{WHz}^{-\frac{1}{2}}$
This is the r.m.s. value of the incident, chopped radiant power necessary to produce an r.m.s. signal to r.m.s. noise ratio of unity. The r.m.s. noise refers to the value calculated for unit square root bandwidth $\text{VHz}^{-\frac{1}{2}}$.

APPLICATION INFORMATION

Optional additional stage for extra gain

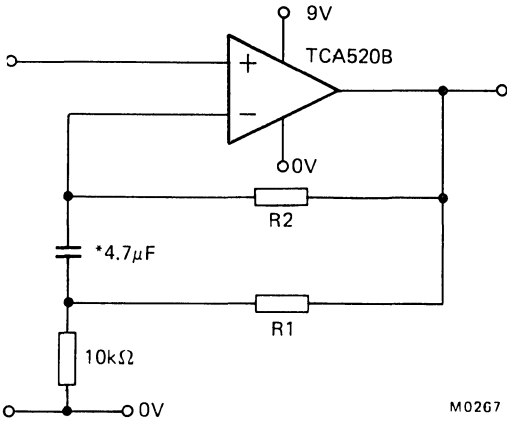

M0267

Recommended component values for various gains

Gain x	R ₁ kΩ	R ₂ MΩ
50	560	5.6
20	220	2.2
10	100	1.0

*this capacitor must be a low leakage type e.g. our 344 series

MECHANICAL AND ENVIRONMENTAL STANDARDS

As part of the Quality Assurance programme, the detectors are assessed at regular intervals against the requirements of the following IEC standards. The frequency of testing and the limits and conditions for the pre- and post-test measurements are based on those stipulated for the CECC 50 000 series of approved transistors.

	Test		Severity	Duration	Note
IEC 68-2-3	Ca	Damp Heat, steady state	+40 °C, 95% RH	168 hours	1
68-2-20	Ta	Solderability	+235 °C, 1.5 mm from header	5 seconds	1
68-2-21	Ub	Lead Fatigue	4 cycles	—	1
68-2-1	A	Low Temperature Storage	-20 °C	2000 hours	2
68-2-2	Ba	High Temperature Storage	+50 °C	2000 hours	2
68-2-14	Nb	Change of Temperature	-20 °C to +50 °C	10 cycles	2
68-2-6	Fc (B4)	Vibration, swept frequency	125 Hz to 2 kHz 196 ms ⁻²	2 h in each orientation	2
68-2-7	Ga	Acceleration, steady state	196000 ms ⁻²	60 seconds	2
68-2-27	Ea	Shock	14700 ms ⁻²	3 pulses 6 orientations	2
68-2-20	Tb	Resistance to Solder Heat	+350 °C, 6 mm from header	3 seconds	3

Notes

1. The detectors are checked on a production batch release principle at approximately weekly intervals. This is equivalent to Group B.
2. The detectors are checked at quarterly intervals. This is equivalent to Group C.
3. This is an annual check.

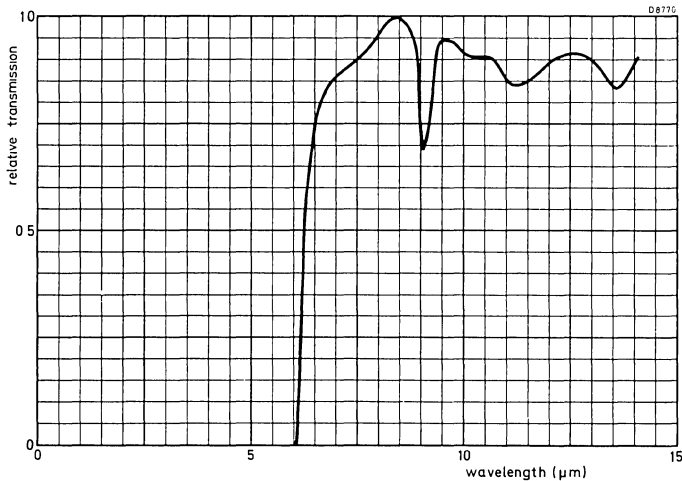

Typical normalized window transmission characteristic

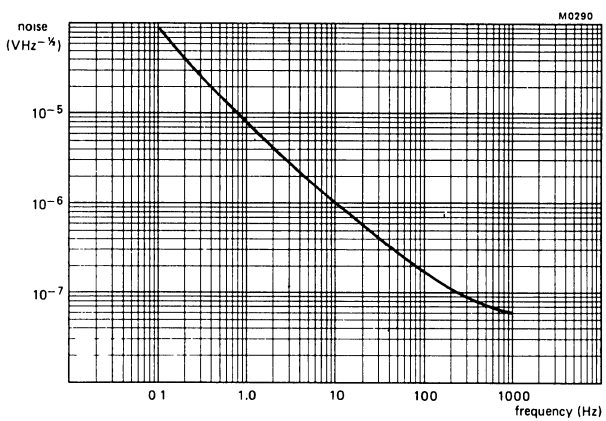
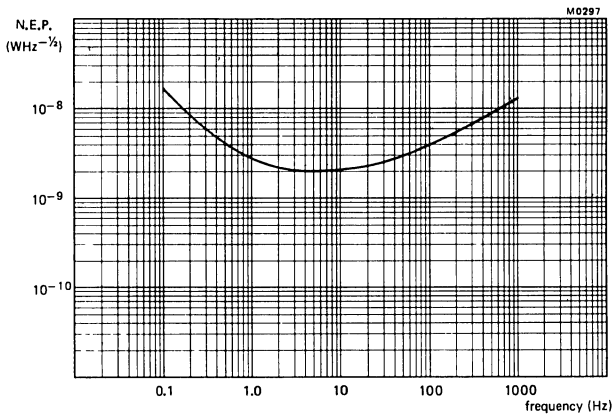
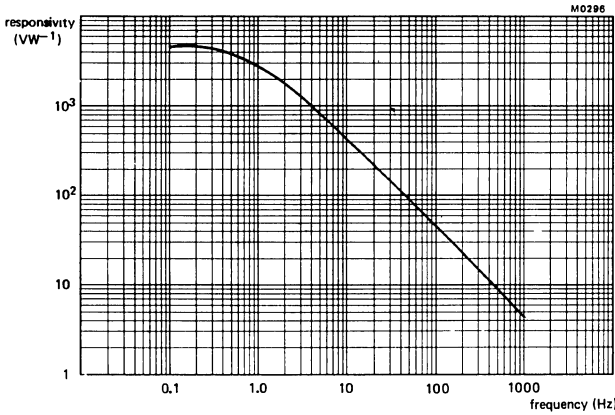

Typical Responsivity, N.E.P., and Noise as functions of Frequency
(one element screened)

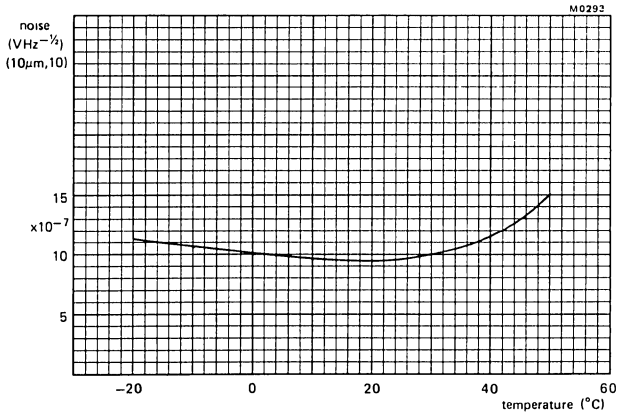
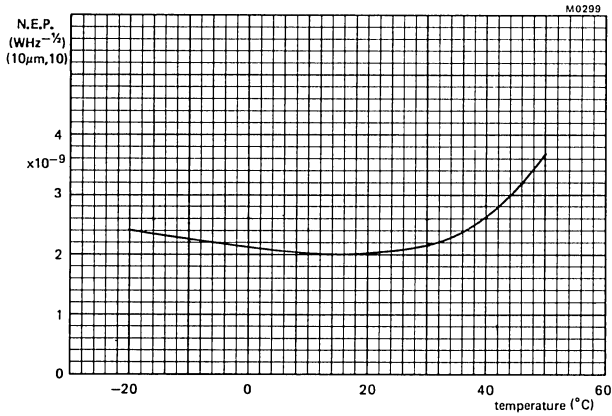
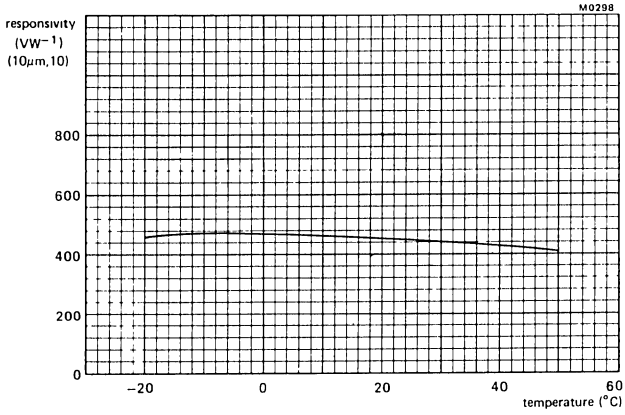

Typical Responsivity, N.E.P., and Noise as functions of Temperature
(one element screened)

POLAR DIAGRAMS

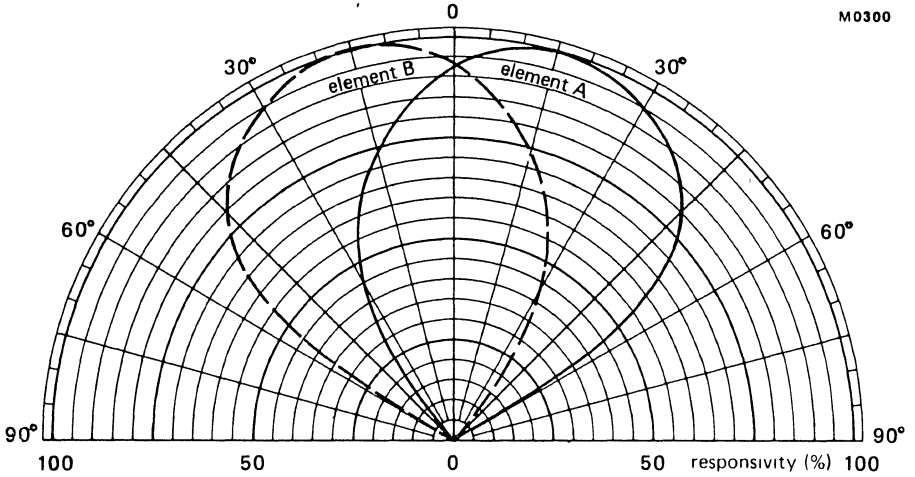

Typical Field of View in x-x plane (see Mechanical Data)

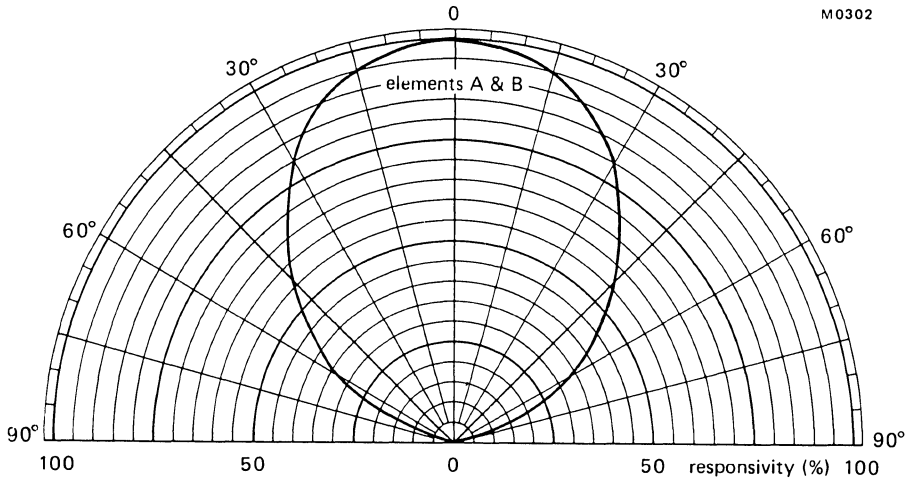

Typical Field of View in y-y plane (see Mechanical Data)

SINGLE ELEMENT PYROELECTRIC INFRARED DETECTOR

This is an infrared sensitive device, combined with a pre-amplifier which is stabilized to overcome d.c. saturation due to thermal changes. It is sealed in a low-profile TO-5 can.

QUICK REFERENCE DATA

Spectral Response		6.5 ± 0.5 to > 14	μm
Responsivity, (10 μm , 10)	typ.	130	VW^{-1}
Noise Equivalent Power (N.E.P.), (10 μm , 10, 1)	typ.	3.5×10^{-9}	$\text{WHz}^{-1/2}$
Element dimensions		2 x 1	mm
Field of view	typ.	105	degrees
Operating voltage		9	V
Optimum operating frequency range		0.1 to 1000	Hz

This data must be read in conjunction with GENERAL SAFETY RECOMMENDATIONS – OPTOELECTRONIC DEVICES

MECHANICAL DATA

Dimensions in mm

SOT-49F (low profile TO-5)

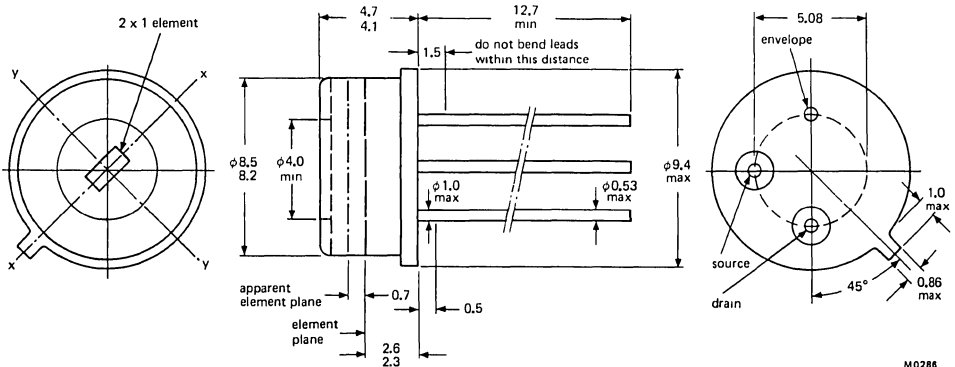

M0286

PRODUCT SAFETY

Modern high technology materials have been used in the manufacture of this device to ensure high performance. Some of these materials are toxic in certain circumstances. Mechanical or electrical damage is unlikely to give rise to any hazard, but toxic vapours may be generated if the device is heated to destruction. Disposal of large quantities should therefore be carried out in accordance with the latest local legislation.

SOLDERING

1. When making soldered connections to the leads, a thermal shunt should be used.
2. It is essential that any mains operated soldering iron should be both screened and earthed. Failure to observe these precautions could lead to the introduction of line voltage and possible damage to the device.

RATINGS

Limiting values in accordance with the Absolute Maximum System (IEC134)

Supply voltage	max.	30	V
Temperature, operating	max.	+60	°C
	min.	-40	°C
Temperature, storage	max.	+70	°C
	min.	-40	°C
Lead soldering temperature, ≥ 6 mm from header, $t_{sld} \leq 3$ s	max.	+350	°C

CHARACTERISTICS (at $T_{amb} = 25 \pm 3$ °C and with recommended circuit).

		min.	typ.	max.	
Spectral Response		6.5 ± 0.5	—	> 14	μm
Responsivity ($10 \mu\text{m}, 10$)	notes 1 and 4	95	130	—	VW^{-1}
N.E.P. ($10 \mu\text{m}, 10, 1$)	notes 1 and 4	—	3.5×10^{-9}	9×10^{-9}	$\text{WHz}^{-1/2}$
Field of View,	note 2	—	150	—	degrees
Operating voltage	note 3	8	9	10	V

Notes

1. These characteristics apply throughout the spectral response range.
2. Field of view to 50% of the maximum responsivity level.
3. The detector will operate outside the quoted range but may have a degraded performance.
4. For performance as a function of frequency and temperature, see pages 4 and 5.

RECOMMENDED CIRCUIT

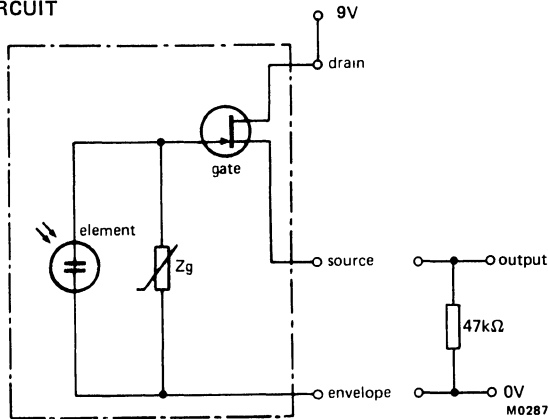

OPERATING NOTES

1. The case potential must not be allowed to become positive with respect to the other two terminals.
2. It is inadvisable to operate the detector at mains related frequencies.
3. To avoid the possibility of optical microphony, the detector must be firmly mounted.
4. An increase in temperature of the element will produce a negative going signal at the output.

DEFINITIONS

1. Responsivity VW^{-1}

This is the ratio of the r.m.s. signal in volts to the r.m.s. value of the incident, chopped radiant power.

2. N.E.P. (Noise Equivalent Power), $WHz^{-1/2}$

This is the r.m.s. value of the incident, chopped radiant power necessary to produce an r.m.s. signal to r.m.s. noise ratio of unity. The r.m.s. noise refers to the value calculated for unit square root bandwidth $VHz^{-1/2}$.

MECHANICAL AND ENVIRONMENTAL STANDARDS

As part of the Quality Assurance programme, the detectors are assessed at regular intervals against the requirements of the following IEC standards. The frequency of testing and the limits and conditions for the pre-and post-test measurements are based on those stipulated for the CECC 50 000 series of approved transistors.

	Test		Severity	Duration	Note
IEC 68-2-3	Ca	Damp Heat, steady state	+40 °C, 95% RH	168 hours	1
68-2-20	Ta	Solderability	+235 °C, 1.5 mm from header	5 seconds	1
68-2-21	Ub	Lead Fatigue	4 cycles	—	1
68-2-1	A	Low Temperature Storage	-40 °C	2000 hours	2
68-2-2	Ba	High Temperature Storage	+70 °C	2000 hours	2
68-2-14	Nb	Change of Temperature	-40 °C to +70 °C	10 cycles	2
68-2-6	Fc (B4)	Vibration, swept frequency	125 Hz to 2 kHz 196 ms^{-2}	2 h in each orientation	2
68-2-7	Ga	Acceleration, steady state	196000 ms^{-2}	60 seconds	2
68-2-27	Ea	Shock	14700 ms^{-2}	3 pulses 6 orientations	2
68-2-20	Tb	Resistance to Solder Heat	+350 °C, 6 mm from header	3 seconds	3

Notes

1. The detectors are checked on a production batch release principle at approximately weekly intervals. This is equivalent to Group B.
2. The detectors are checked at quarterly intervals. This is equivalent to Group C.
3. This is an annual check.

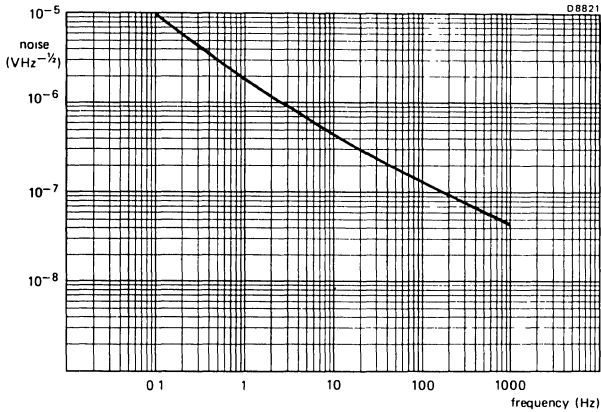
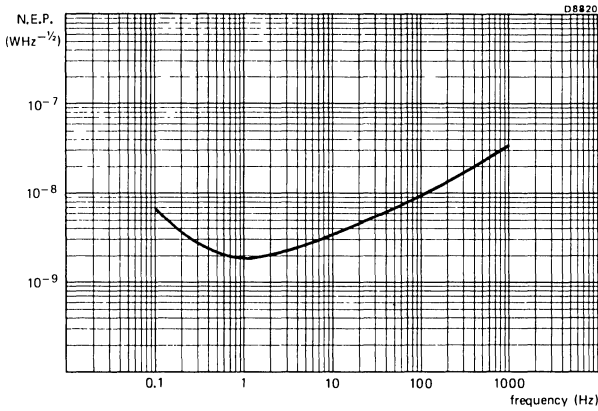
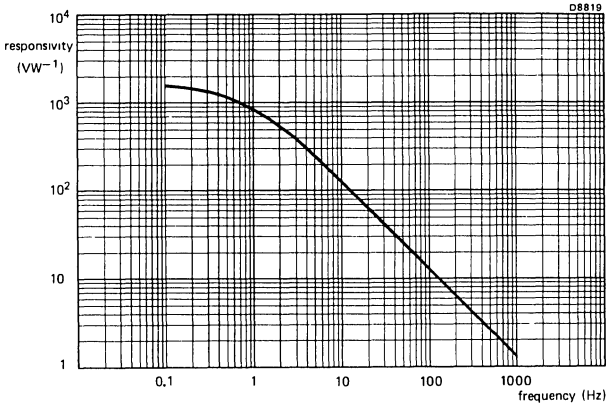

Typical Responsivity, N.E.P., and Noise as functions of Frequency

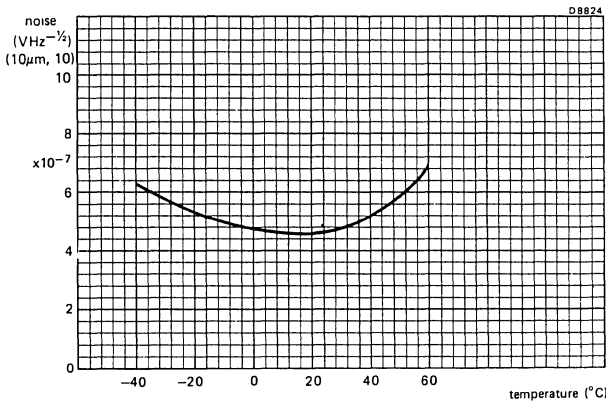
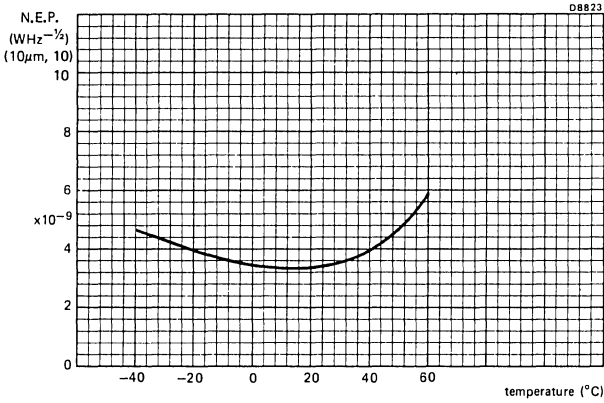
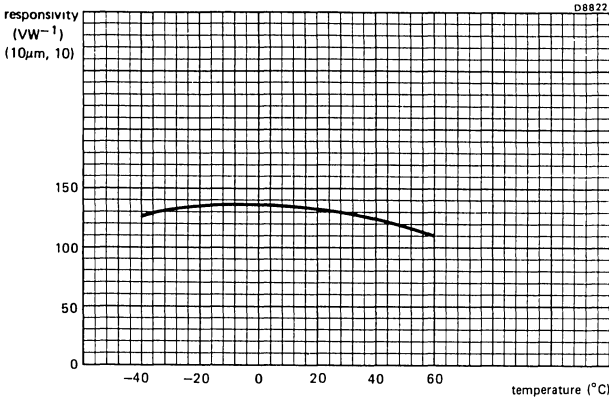

Typical Responsivity, N.E.P., and Noise as functions of Temperature

POLAR DIAGRAMS

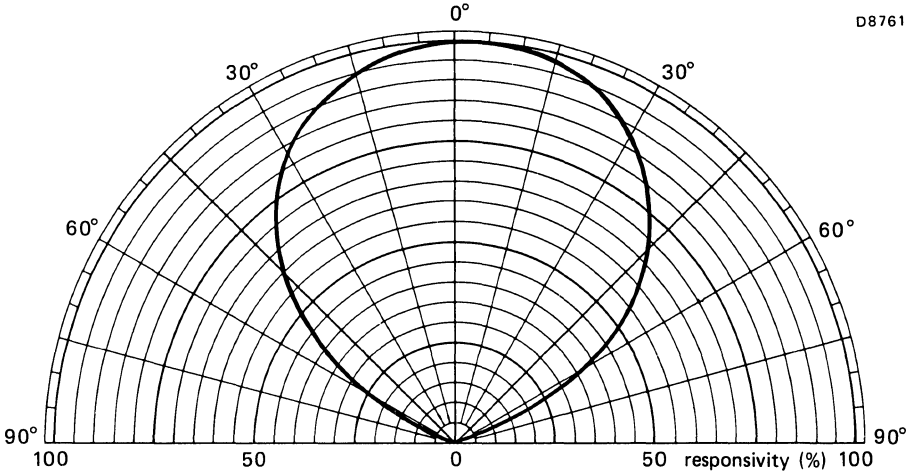

Typical Field of View in x-x plane (see Mechanical Data)

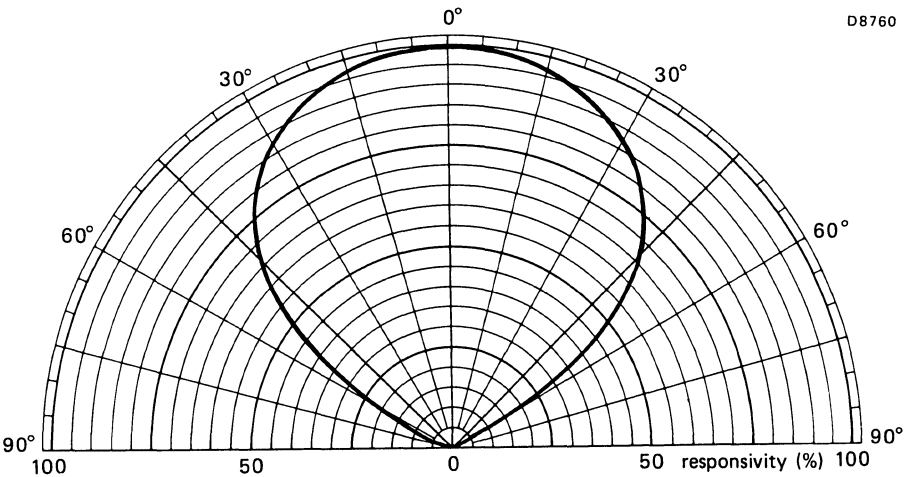

Typical Field of View in y-y plane (see Mechanical Data)

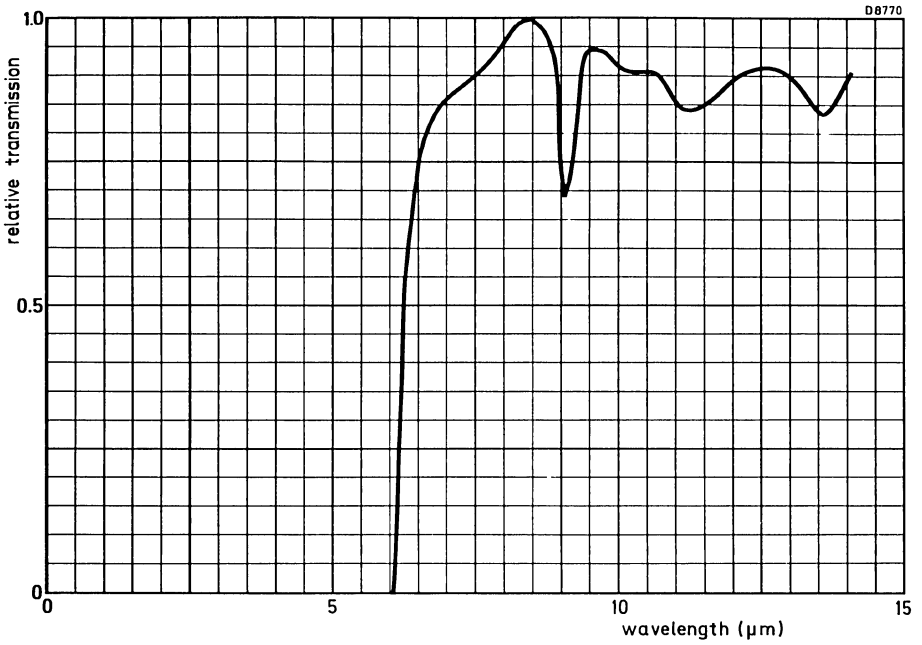

Typical normalized window transmission characteristic



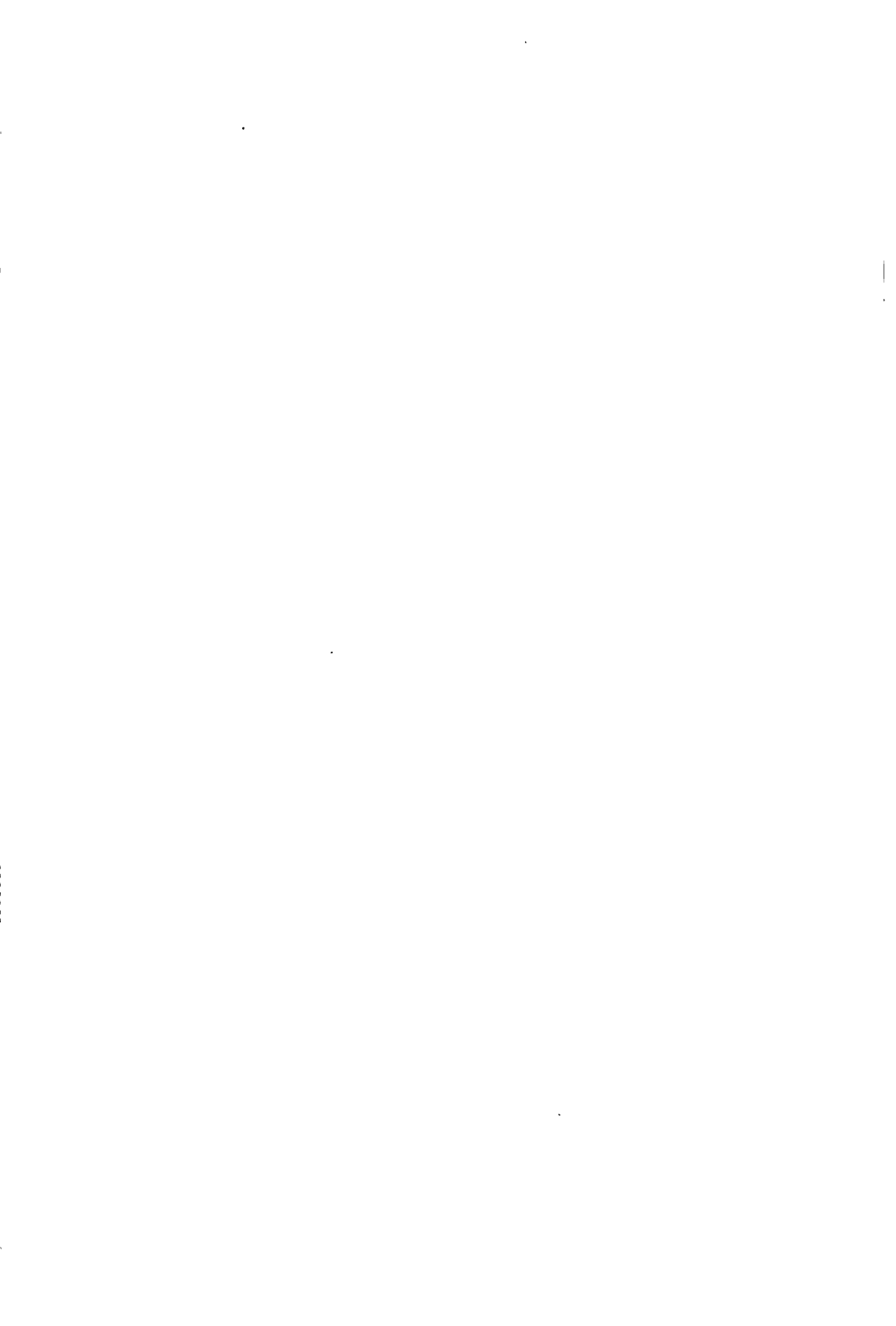

DUAL ELEMENT PYROELECTRIC INFRARED DETECTOR

This is an infrared sensitive device specifically designed for battery operated passive infrared movement sensors such as intruder alarms and light switches. It has differentially connected dual elements which provide immunity from common mode signals such as those generated by variations in ambient temperature, background radiation and acoustic noise. The wide separation of the elements makes this detector compatible with most optical systems. The dual elements are combined with a single impedance converting amplifier, which is specially designed to function from low voltage supplies with low current consumption. The detector will give an output signal only when the radiation falling on the elements is unbalanced, as in a focused system. It is sealed in a low profile TO-5 can with a window optically coated to restrict the response to wavelengths greater than 6.5 μm .

QUICK REFERENCE DATA

Spectral Response		6.5 ± 0.5 to > 14	μm
Responsivity (10 μm , 10), each element (see circuit 1)	typ.	150	VW^{-1}
Responsivity (10 μm , 10), each element (see circuit 2)	typ.	720	VW^{-1}
Noise Equivalent Power (N.E.P.) (10 μm , 10, 1), each element	typ.	1.5×10^{-9}	$\text{WHz}^{-1/2}$
Element dimensions, each element	nom.	2.1×0.9	mm
Element separation	nom.	1.0	mm
Field of View in horizontal plane (x-x)	typ.	130	degrees
Operating voltage	min.	3	V
Optimum operating frequency range		0.1 to 20	Hz

This data must be read in conjunction with GENERAL SAFETY RECOMMENDATIONS – OPTOELECTRONIC DEVICES

MECHANICAL DATA

Dimensions in mm

SOT-49H (TO-5 variant)

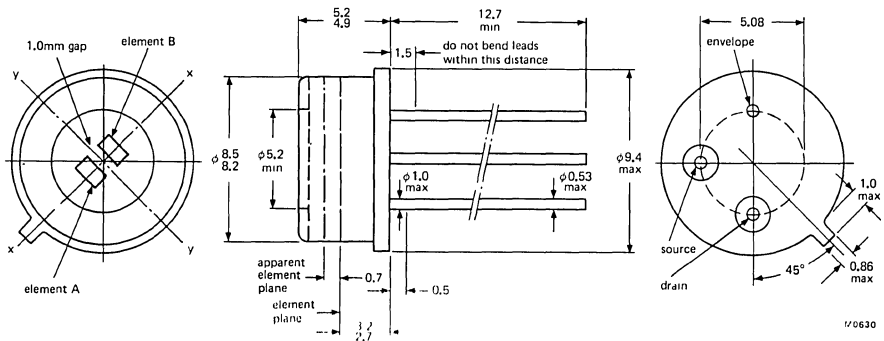

PRODUCT SAFETY

Modern high technology materials have been used in the manufacture of this device to ensure high performance. Some of these materials are toxic in certain circumstances. Mechanical or electrical damage is unlikely to give rise to any hazard, but toxic vapours may be generated if the device is heated to destruction. Disposal of large quantities should therefore be carried out in accordance with the latest local legislation.

SOLDERING

1. When making soldered connections to the leads, a thermal shunt should be used.
2. It is essential that any mains operated soldering iron used should be both screened and earthed. Failure to observe these precautions may lead to the introduction of line voltages and possible damage to the device.

RATINGS

Limiting values in accordance with the Absolute Maximum System (IEC134).

Supply voltage		30	V
Temperature, operating range		-40 to +70	°C
Temperature, storage range		-55 to +85	°C
Lead soldering temperature, ≥ 6 mm from header, $t_{sld} \leq 3$ s max.		+350	°C

OPERATING CONDITIONS

		min.	max.	
Voltage	note 5	3	10	V
Frequency	note 5	0.1	20	Hz

OPERATING NOTES

1. The case potential must not be allowed to become positive with respect to the other two terminals.
2. It is inadvisable to operate the detector at mains related frequencies.
3. To avoid the possibility of optical microphony, the detector must be firmly mounted.
4. An increase in temperature of element A will produce a negative going signal at the output. For element B, the corresponding output will be positive going.
5. The detector will operate outside the quoted range but may have a degraded performance.

CHARACTERISTICS (at $T_{amb} = 25 \text{ }^\circ\text{C} \pm 3 \text{ }^\circ\text{C}$ and with recommended circuit 1).

	min.	typ.	max.	
Spectral Response	6.5 ± 0.5	—	> 14	μm
Responsivity ($10 \mu\text{m}, 10$) note 1	100	150	—	VW^{-1}
Responsivity ($10 \mu\text{m}, 10$) note 4	—	720	—	VW^{-1}
N.E.P. ($10 \mu\text{m}, 10, 1$) note 1	—	1.5×10^{-9}	6×10^{-9}	$\text{WHz}^{-\frac{1}{2}}$
Element matching note 2	—	—	± 20	%
Field of View (x-x plane) note 3	—	130	—	degrees
Quiescent current	—	10	—	μA
Element dimensions	2.1×0.9 nominal			mm
Element separation	1.0 nominal			mm

Notes

- Each element. These characteristics apply throughout the spectral response range.
- With both elements irradiated, the matching of the element signals is derived from:—

$$\frac{\Delta S}{\frac{1}{2}(S_A + S_B)} \times 100$$
 where S_A and S_B are the signals of the two elements and ΔS is the signal with both elements irradiated.
- Field of view to 50% of the maximum responsivity level.
- The RPY97 has been specified in conjunction with a source follower circuit with a typical gain of 0.9. For comparison with the RPY93, RPY94 and RPY95 dual element detectors, the alternative circuit shown should be used. This explains the difference in responsivity levels.

CIRCUIT 1 (RECOMMENDED)

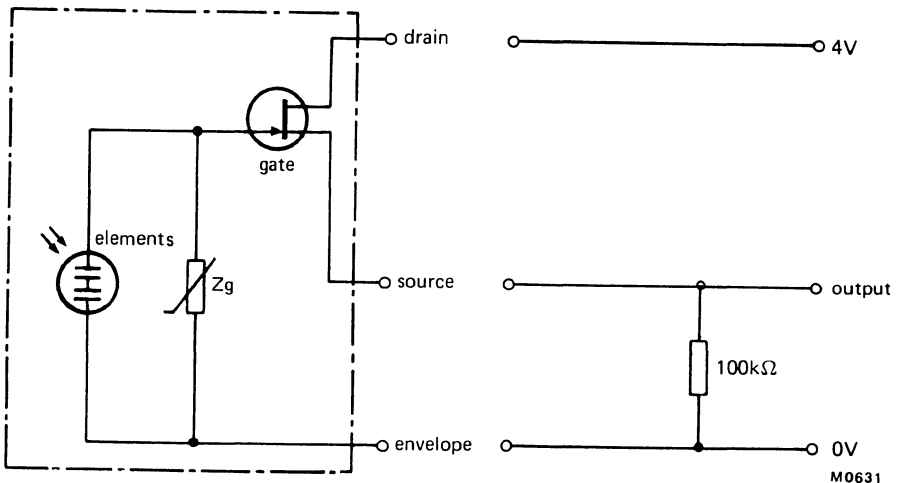

CIRCUIT 2 (ALTERNATIVE, X5 GAIN)

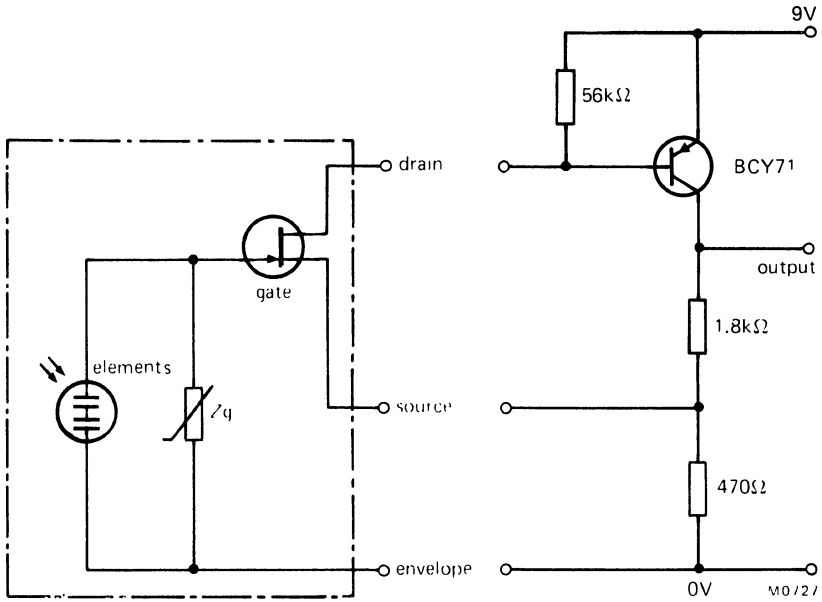

DEFINITIONS

1. Responsivity VW^{-1}

This is the ratio of the r.m.s. signal in volts to the r.m.s. value of the incident, chopped radiant power.

2. N.E.P. (Noise Equivalent Power), $WHz^{-1/2}$

This is the r.m.s. value of the incident, chopped radiant power necessary to produce an r.m.s. signal to r.m.s. noise ratio of unity. The r.m.s. noise refers to the value calculated for unit square root bandwidth $VHz^{-1/2}$.

MECHANICAL AND ENVIRONMENTAL STANDARDS

As part of the Quality Assurance programme, the detectors are assessed at regular intervals against the requirements of the following IEC standards. The frequency of testing and the limits and conditions for the pre- and post-test measurements are based on those stipulated for the CECC 50 000 series of approved transistors.

	Test		Severity	Duration	Note
IEC 68-2-3	Ca	Damp Heat, steady state	+40 °C, 95% RH	168 hours	1
68-2-20	Ta	Solderability	+235 °C, 1.5 mm from header	5 seconds	1
68-2-21	Ub	Lead Fatigue	4 cycles	—	1
68-2-1	Aa	Low Temperature Storage	-55 °C	2000 hours	2
68-2-2	Ba	High Temperature Storage	+85 °C	2000 hours	2
68-2-14	Nb	Change of Temperature	-55 °C to +85 °C	10 cycles	2
68-2-6	Fc (B4)	Vibration, swept frequency	125 Hz to 2 kHz 196 ms ⁻²	2 h in each orientation	2
68-2-7	Ga	Acceleration, steady state	196000 ms ⁻²	60 seconds	2
68-2-27	Ea	Shock	14700 ms ⁻²	3 pulses 6 orientations	2
68-2-20	Tb	Resistance to Solder Heat	+350 °C, 6 mm from header	3 seconds	3

Notes

1. The detectors are checked on a production batch release principle at approximately weekly intervals. This is equivalent to Group B.
2. The detectors are checked at quarterly intervals. This is equivalent to Group C.
3. This is an annual check.

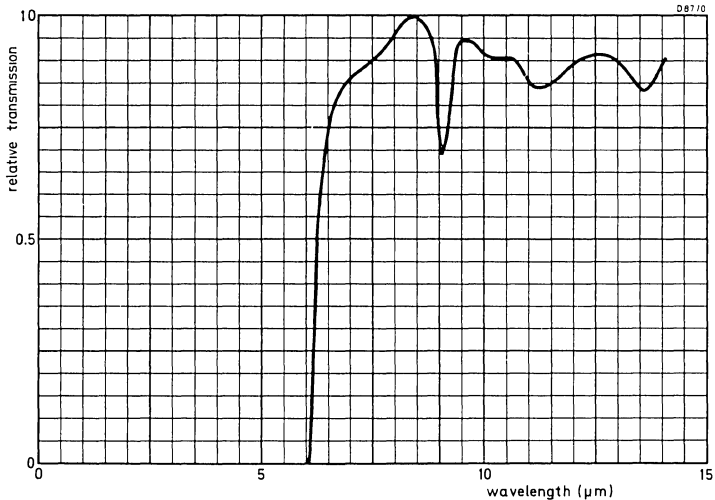

Typical normalized window transmission characteristic

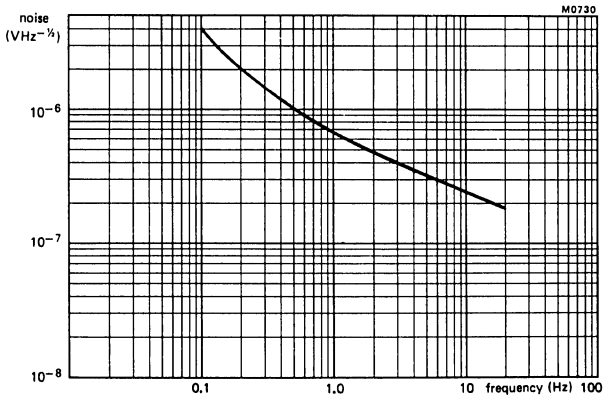
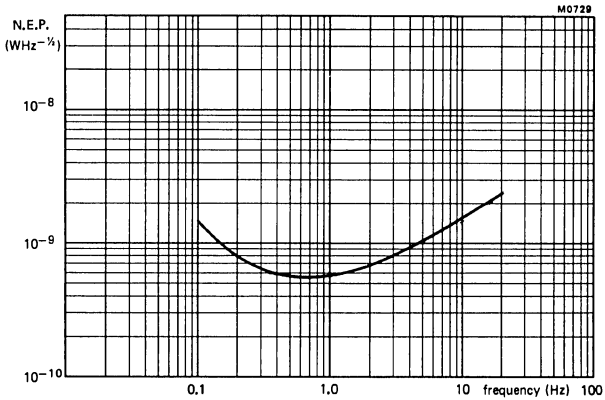
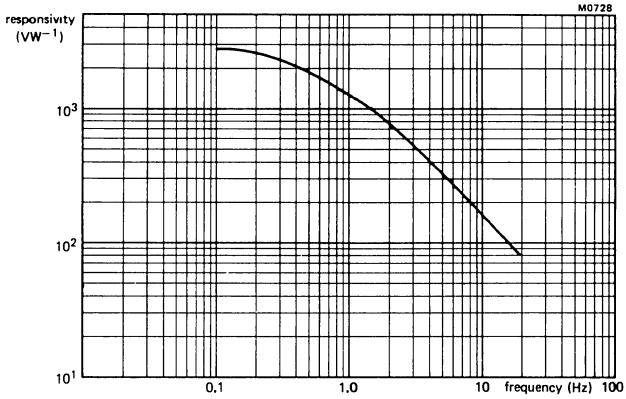

Typical Responsivity, N.E.P., and Noise as functions of Frequency
(one element screened)

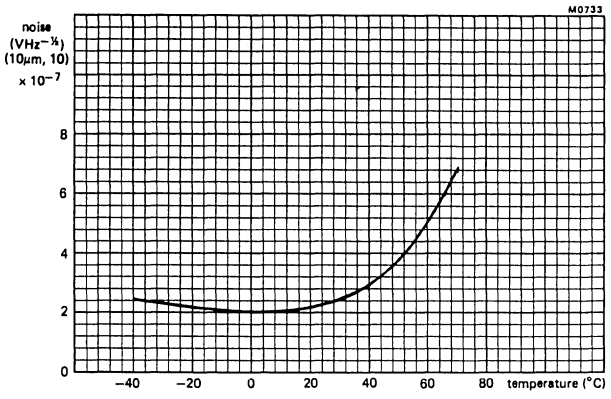
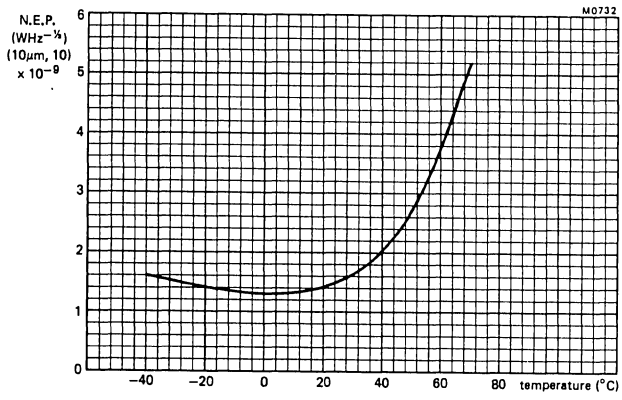
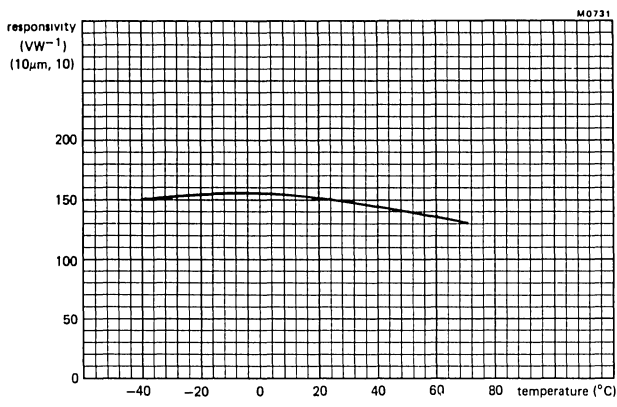

Typical Responsivity, N.E.P., and Noise as functions of Temperature
(one element screened)

POLAR DIAGRAMS

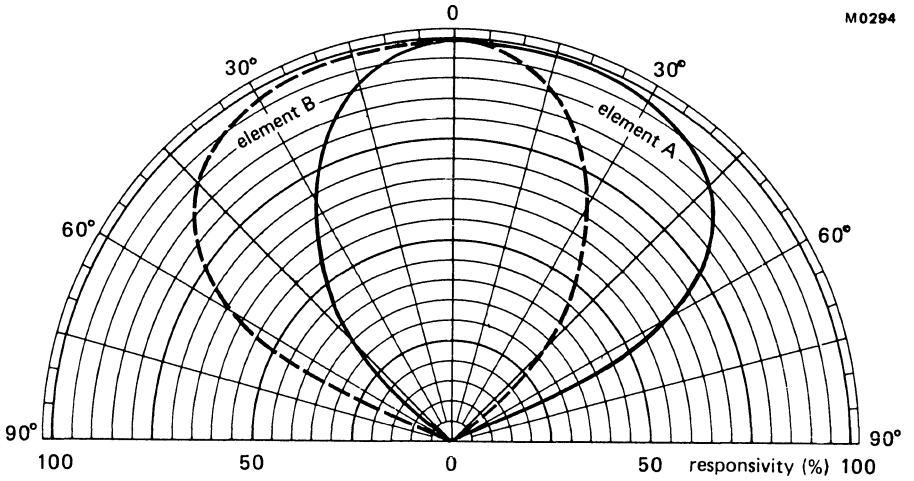

Typical Field of View in x-x plane (see Mechanical Data)

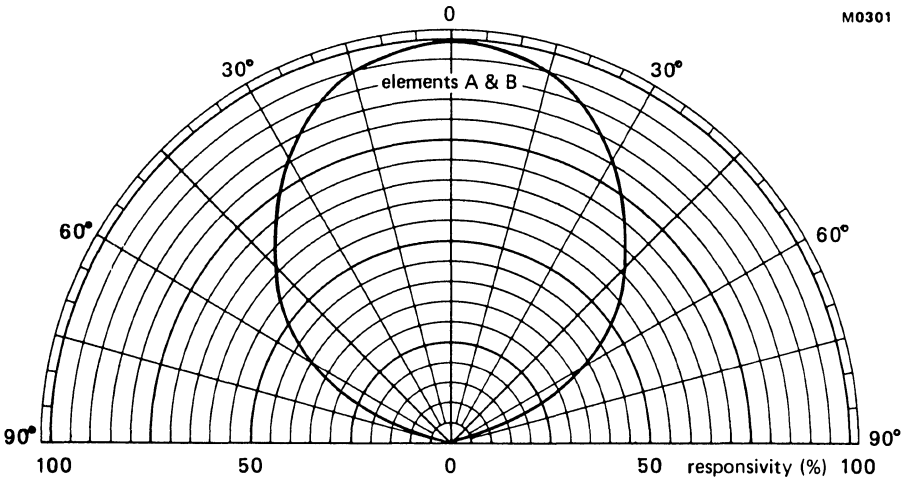

Typical Field of View in y-y plane (see Mechanical Data)

PHOTOCONDUCTIVE DEVICES



LIST OF SYMBOLS

Cell voltage	V
Cell current	I
Illumination current	I_l
Initial illumination current	I_{l0}
Equilibrium illumination current	I_{le}
Dark current	I_d
Initial dark current	I_{d0}
Equilibrium dark current	I_{de}
Illumination resistance	r_l
Initial illumination resistance	r_{l0}
Equilibrium illumination resistance	r_{le}
Dark resistance	r_d
Initial dark resistance	r_{d0}
Equilibrium dark resistance	r_{de}
Current rise time	t_{ri}
Current decay time	t_{fi}
Pulse duration	t_p
Averaging time	t_{av}
Pulse repetition rate	P_{rr}
Illumination sensitivity	N
Illumination response	γ
Voltage response	α
Ambient temperature	T_{amb}
Thermal resistance	R_{th}
Temperature of CdS tablet	T_{tablet}
Colour temperature	$T_c (T_K)$
Dissipation	P
Illumination	E
Initial drift	D_0
Peak value (subscript)	M

GENERAL OPERATIONAL RECOMMENDATIONS PHOTOCONDUCTIVE DEVICES

1. GENERAL

- 1.1 These application directions are valid for all types of photoconductive cells, unless otherwise stated on the individual technical data sheets.
- 1.2 A photoconductive device is a light-sensitive device whose resistance varies with the illumination on the device.
- 1.3 Where the term illumination is used in the following sections it shall be taken to mean the radiant energy which is normally used to excite the device.
- 1.4 Also in the following sections, history is taken to mean the duration of the specified conditions plus a sufficient description of previous conditions.

2. OPERATING CHARACTERISTICS

- 2.1 The data given on the individual technical data sheets are based on the devices being uniformly illuminated.
- 2.2 The illumination resistance is the ratio of the voltage across the device to the current through the device when illumination is applied to the device.
 - 2.2.1 For a particular set of conditions the equilibrium illumination resistance is the illumination resistance after such a time under these conditions that the rate of change of the illumination resistance is less than 1% per 5 minutes.
 - 2.2.2 For a particular set of conditions the initial illumination resistance is the first virtually constant value of the illumination resistance after a period of storage or other operating conditions.

The initial-illumination resistance usually occurs after a few seconds under the specified conditions.
- 2.3 The illumination current is the current which passes when a voltage and illumination are applied to the device.
 - 2.3.1 For a particular set of conditions the equilibrium illumination current is the illumination current after such a time under these conditions that the rate of change of the illumination current is less than 1% per 5 minutes.

- 2.3.2 For a particular set of conditions the initial illumination current is the first virtually constant value of the illumination current after a period of storage or other operating conditions. The initial illumination current usually occurs after a few seconds under the specified conditions.

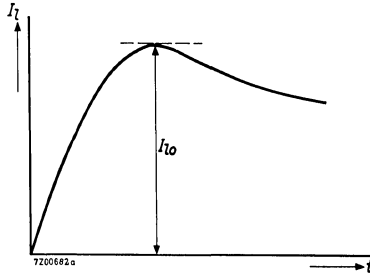

- 2.4 The dark resistance is the resistance of the device in the absence of illumination.
- 2.4.1 For a particular set of conditions the equilibrium dark resistance is the dark resistance after such a time under these conditions that the rate of change of the dark resistance is less than 2% per 5 minutes.
- 2.4.2 For a particular set of conditions the initial dark resistance is the dark resistance after a specified time under these conditions following a specified history.
- 2.5 The dark current is the current which passes when a voltage is applied to the device in the absence of illumination.
- 2.5.1 For a particular set of conditions the equilibrium dark current is the dark current after such a time under these conditions that the rate of change of the dark current is less than 2% per 5 minutes.
- 2.5.2 For a particular set of conditions the initial dark current is the dark current after a specified time under these conditions immediately following a specified history.

2.6.1 For a particular set of conditions and history the current rise time is the time taken for the current through the device to rise to 90% to its initial illumination current measured from the instant of starting the illumination.

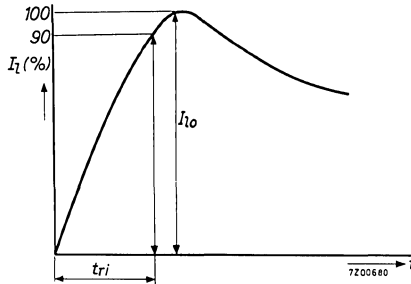

2.6.2 For a particular set of conditions and history the current decay time is the time taken for the current through the device to fall to 10% of its value at the instant of stopping the illumination, measured from that instant.

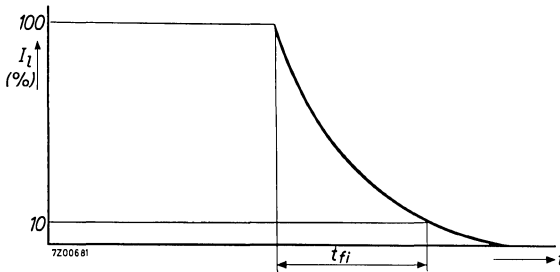

- 2.7 The illumination sensitivity is the quotient of illumination current by the incident illumination.
- 2.8 The illumination resistance (current) temperature response is the relationship between the illumination resistance (current) and the ambient temperature of the device under constant illumination and voltage conditions.
- 2.9 For a particular set of conditions the initial drift is the difference between the equilibrium and initial illumination current, expressed as a percentage of the initial illumination current.
- 2.10 The illumination response is the relationship between the initial illumination resistance and the illumination, defined as $\frac{\Delta \log r_{i0}}{\Delta \log E}$

3. THERMAL DATA

3.1 Ambient temperature. The ambient temperature of a device is the temperature of the surrounding air of that device in its practical situation, which means that other elements in the same space or apparatus must have their normal maximum dissipation and that the same apparatus envelope must be used. This ambient temperature can normally be measured by using a mercury thermometer the mercury container of which has been blackened, placed at a distance of 5 mm from the envelope in the horizontal plane through the centre of the effective area of the CdS tablet.

It shall be exposed to substantially the same radiant energy as that incident on the CdS tablet.

3.2 The thermal resistance of a device is defined as the temperature difference between the hottest point of the device and the dissipating medium, divided by the power dissipated in the device.

4. OPERATIONAL NOTES

4.1 When a photoconductive device is subjected to a change of operating conditions there may be a transient change of current in excess of that due to the difference between the equilibrium illumination currents. This transient change is called overshoot.

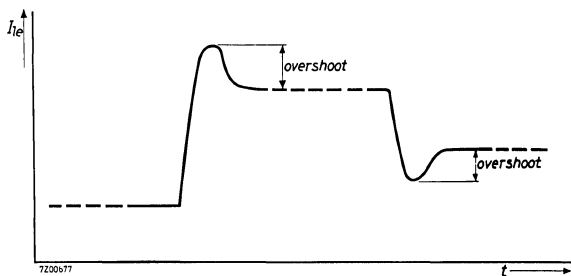

4.2 Direct sunlight irradiation should be avoided.

5. MOUNTING

5.1 If no restrictions are made on the individual published data sheets, the device may be mounted in any position.

5.2 Most of the photoconductive devices may be soldered directly into the circuit, which is indicated on the individual published data sheets. However, the heat conducted to the seal of the device should be kept to a minimum by the use of a thermal shunt. If not otherwise indicated, the device may be dip-soldered at a solder temperature of 240 °C for a maximum of 10 seconds up to a point 5 mm from the seals.

6. STORAGE

It is recommended that the devices be stored in the dark. At any rate direct sunlight irradiation should be avoided.

7. LIMITING VALUES

The limiting values of photoconductive devices are given in the absolute maximum rating system.

8. OUTLINE DIMENSIONS

The outline dimensions are given in mm.

9. MECHANICAL ROBUSTNESS

The conditions for shock and vibration given on the individual data sheets are intended only to give an indication of the mechanical quality of the device. It is not advisable to subject the device to such conditions.

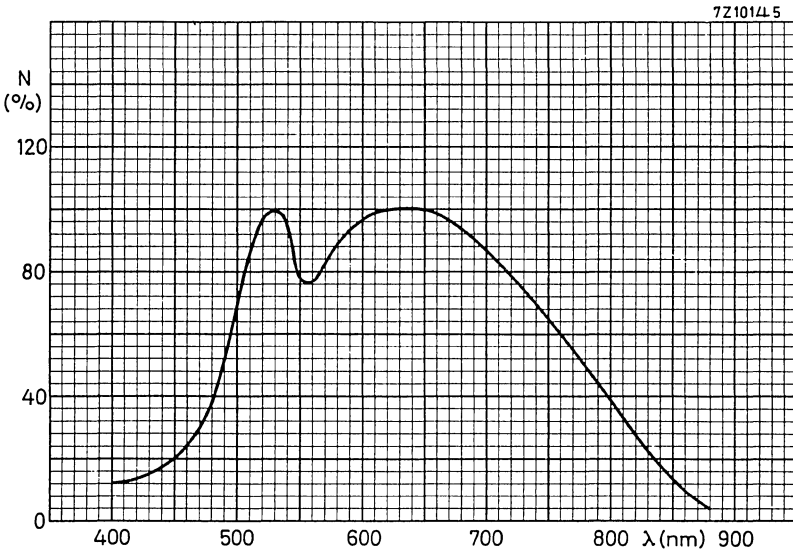

Type D response curve

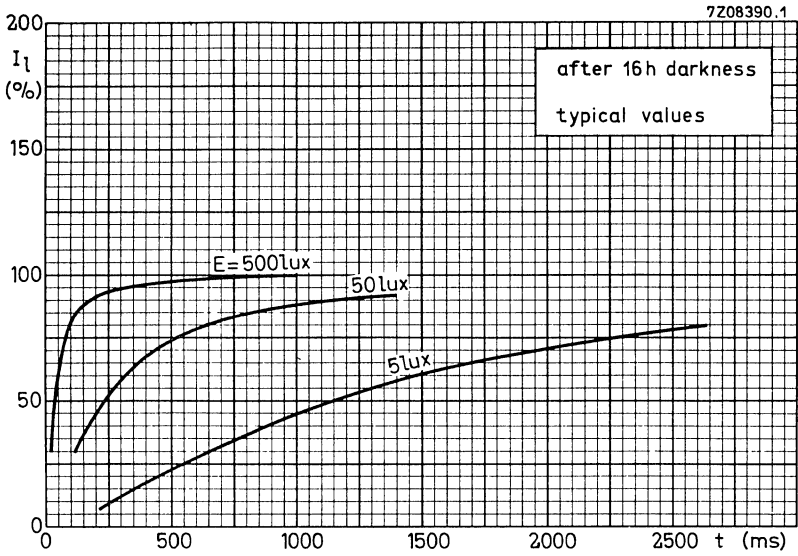

Current rise curves for cells with type D response curve

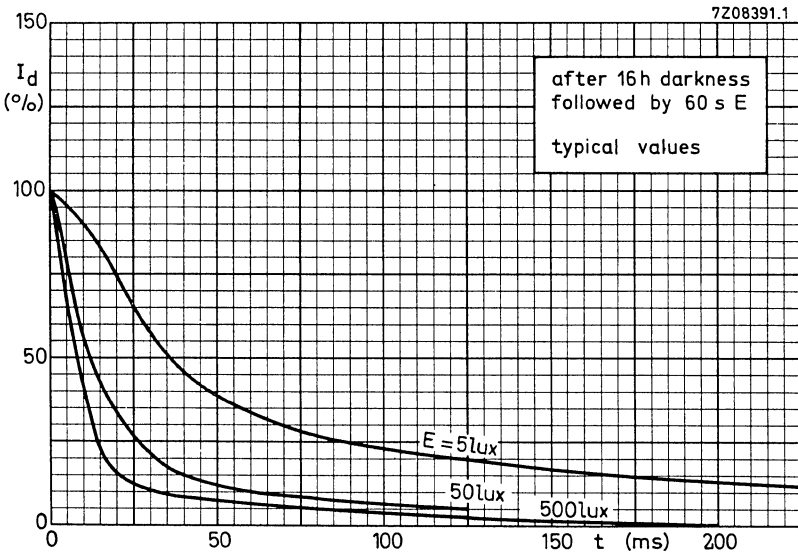

Current decay curves for cells with type D response curve

CADMIUM SULPHIDE PHOTOCONDUCTIVE CELLS

Top sensitive cadmium sulphide photoconductive cells in hermetically sealed all-glass envelope intended for on-off applications such as flame failure circuits, and for automatic brightness and contrast control in television receivers.

The cells are shock and vibration resistant.

QUICK REFERENCE DATA

Power dissipation at $T_{amb} = 25\text{ }^{\circ}\text{C}$	P max.	70 mW
Cell voltage, d. c. and repetitive peak	V max.	350 V
Cell resistance at 50 lx, 2700 K colour temperature, ORP60	r_{10} typ.	60 $k\Omega$
ORP66	$r_{10} <$	55 $k\Omega$
Spectral response, current rise and decay curves		type D
Outline dimensions		max. 6 dia. x 15,5 mm

MECHANICAL DATA

Dimensions in mm

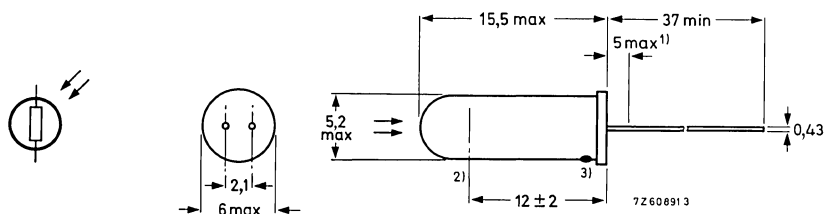

Soldering

The cell may be soldered directly into the circuit but heat conducted to the tablet should be kept to a minimum by the use of a thermal shunt. The cell may be dip-soldered at a solder temperature of $240\text{ }^{\circ}\text{C}$ for maximum 10 s up to a point 5 mm from the seals.

- 1) Not tinned.
- 2) Sensitive surface.
- 3) Blue dot on ORP66.

ELECTRICAL DATA

General

The electrical properties of CdS cells are dependent on many factors such as illumination, colour temperature of the light source, voltage, current, temperature, total time of operation in the circuit and time of operation during the last 24 hours prior to the measurement. The following basic characteristics are therefore only check points of the electrical properties of these devices measured with defined values of the various conditions and at delivery.

Basic characteristics at $T_{amb} = 25\text{ }^{\circ}\text{C}$, illumination with colour temperature of 2700 K and at delivery

		ORP60	ORP66
Initial dark resistance			
measured at 300 V d. c. applied via 1 M Ω , 20 s after switching off the illumination	r_{d0} >	200	200 M Ω ¹⁾
Initial illumination resistance			
measured at 30 V d. c., illumination = 50 lx, after 16 hrs in darkness ²⁾	r_{l0} >	37,5	- k Ω
	typ.	60	- k Ω
	<	150	55 k Ω
Equilibrium illumination resistance			
measured at 30 V d. c., illumination = 50 lx, after 15 min under the measuring conditions	r_{le} >	37,5	- k Ω
	typ.	75	- k Ω
	<	190	90 k Ω
Negative temperature response of illumination resistance	typ.	0,2	%/ $^{\circ}\text{C}$
	<	0,5	%/ $^{\circ}\text{C}$
Voltage response $\frac{r \text{ at } 0,5 \text{ V d. c.}}{r \text{ at } 30 \text{ V d. c.}}$	α typ.	1,5	

¹⁾ The spread of the dark resistance is large and values higher than 1000 M Ω are possible for the initial dark resistance.

²⁾ After 16 hours in darkness changes in the CdS material are still occurring but have only insignificant effect on the illumination resistance.

CADMIUM SULPHIDE PHOTOCONDUCTIVE CELLS

Side sensitive cadmium sulphide photoconductive cells in hermetically sealed all-glass envelope intended for on-off applications such as flame failure circuits, and for automatic brightness and contrast control in television receivers.

The cells are shock and vibration resistant.

QUICK REFERENCE DATA

		ORP61		ORP62
Power dissipation at $T_{amb} = 25\text{ }^{\circ}\text{C}$	P	max.	70	100 mW
Cell voltage, d. c. and repetitive peak	V	max.	350	350 V
Cell resistance at 50 lx, 2700 K colour temperature	r_{10}	typ.	60	45 k Ω
Spectral response, current rise and decay curves	type D			
Outline dimensions	max. 6 dia. x 15,5 mm			

MECHANICAL DATA

Dimensions in mm

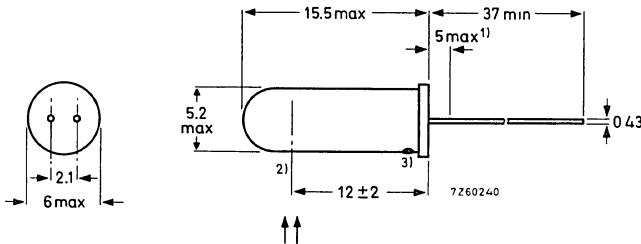

Soldering

The cell may be soldered directly into the circuit but heat conducted to the tablet should be kept to a minimum by the use of a thermal shunt. The cell may be desoldered at a solder temperature of 240 $^{\circ}\text{C}$ for maximum 10 s up to a point 5 mm from the seals.

- 1) Not tinned
- 2) Centre of sensitive area
- 3) ORP61 brown dot; ORP62 red dot.

ELECTRICAL DATA

General

The electrical properties of CdS cells are dependent on many factors such as illumination, colour temperature of the light source, voltage, current, temperature, total time of operation in the circuit and time of operation during the last 24 hours prior to the measurement. The following basic characteristics are therefore only check points of the electrical properties of these devices measured with defined values of the various conditions and at delivery.

Basic characteristics at $T_{amb} = 25\text{ }^{\circ}\text{C}$, illumination with colour temperature of 2700 K and at delivery.

		ORP61	ORP62
Initial dark resistance			
measured at 300 V d.c. applied via 1 M Ω , 20 s after switching off the illumination	$r_{do} >$	200	150 M Ω ¹⁾
Initial illumination resistance	$>$	37,5	30 k Ω
measured at 30 V d.c., illumination = 50 lx, after 16 hrs in darkness ²⁾	r_{lo} typ. $<$	60 150	45 k Ω 100 k Ω
Equilibrium illumination resistance	$>$	37,5	30 k Ω
measured at 30 V d.c., illumination = 50 lx, after 15 min under the measuring conditions	r_{le} typ. $<$	75 190	60 k Ω 170 k Ω
Negative temperature response of illumination resistance	typ. $<$	0,2 0,5	0,2 %/ $^{\circ}\text{C}$ 0,5 %/ $^{\circ}\text{C}$
Voltage response	$\frac{r \text{ at } 0,5 \text{ V d.c.}}{r \text{ at } 30 \text{ V d.c.}}$	α typ. 1,5	1,4

- 1) The spread of the dark resistance is large and values higher than 1000 M Ω are possible for the initial dark resistance.
- 2) After 16 hours in darkness changes in the CdS material are still occurring but have only insignificant effect on the illumination resistance.

CADMIUM SULPHIDE PHOTOCONDUCTIVE CELLS

Top and side sensitive cadmium sulphide photoconductive cells in hermetically sealed all-glass envelope intended for on-off applications such as flame failure circuits, and for automatic brightness and contrast control in television receivers. The cells are shock and vibration resistant.

QUICK REFERENCE DATA			
Power dissipation at $T_{amb} = 25\text{ }^{\circ}\text{C}$	P	max.	100 mW
Cell voltage, d. c. and repetitive peak	V	max.	350 V
Cell resistance at 50 lx, 2700 K colour temperature, ORP68	r_{10}	typ.	64 $k\Omega$
ORP69	r_{10}	typ.	30 $k\Omega$
Spectral response, current rise and decay curves	type D		
Outline dimensions	max.	6 dia. x 15,5 mm	

MECHANICAL DATA

Dimensions in mm

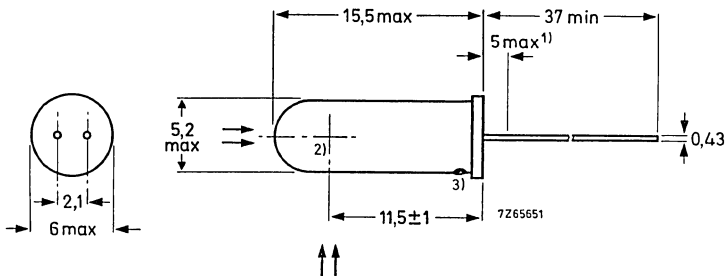

Soldering

The cell may be soldered directly into the circuit but heat conducted to the tablet should be kept to a minimum by the use of a thermal shunt. The cell may be desoldered at a solder temperature of 240 $^{\circ}\text{C}$ for maximum 10 s up to a point 5 mm from the seals.

- 1) Not tinned.
- 2) Centre of sensitive area.
- 3) ORP68: gray dot; ORP69: white dot.

ELECTRICAL DATA

General

The electrical properties of CdS cells are dependent on many factors such as illumination, colour temperature of the light source, voltage, current, temperature, total time of operation in the circuit and the time of operation during the last 24 hours prior to the measurement. The following basic characteristics are therefore only check points of the electrical properties of these devices measured with defined values of the various conditions and at delivery.

Basic characteristics at $T_{amb} = 25\text{ }^{\circ}\text{C}$, illumination with colour temperature of 2700 K and at delivery

		ORP68	ORP69	
Initial dark resistance measured with 300 V d.c. applied via 1 M Ω , 20 s after switching off the illumination	r_{do} >	150	100	M Ω ¹⁾
Initial illumination resistance measured at 30 V d.c., illumination = 50 lx, after 16 h in darkness ²⁾ ³⁾	>	30	20	k Ω
	typ.	46	30	k Ω
	<	100	60	k Ω
Equilibrium illumination resistance measured at 30 V d.c., illumination = 50 lx, after 15 min under the measuring conditions	>	30	27	k Ω
	typ.	60	46	k Ω
	<	170	115	k Ω
Negative temperature response of illumination resistance	typ.	0,2		%/ $^{\circ}\text{C}$
	<	0,5		%/ $^{\circ}\text{C}$
Voltage response $\frac{r \text{ at } 0,5 \text{ V d.c.}}{r \text{ at } 30 \text{ V d.c.}}$	typ.	1,4		

¹⁾ The spread of the dark resistance is large and values higher than 1000 M Ω are possible for the initial dark resistance.

²⁾ After 16 hours in darkness changes in the CdS material are still occurring but have only insignificant effect on the illumination resistance.

³⁾ Measured at top sensitivity.

CADMIUM SULPHIDE PHOTOCONDUCTIVE DEVICE

Cadmium sulphide photoconductive device with side sensitivity in plastic encapsulation. The device consists of two cells connected in series and is intended for general applications.

QUICK REFERENCE DATA			
Power dissipation at $T_{amb} \leq 25 \text{ }^\circ\text{C}$	P	100	mW
Voltage, d. c. and repetitive peak	V	max. 50	V
Resistance at 50 lux, $T_c = 2700 \text{ }^\circ\text{K}$	r_{l_0}	600	Ω
Wavelengths at 50% sensitivity	λ	500 and 675	nm
Outline dimensions		max. 5,3 x 5,3 x 1,4	mm

MECHANICAL DATA

Dimensions in mm

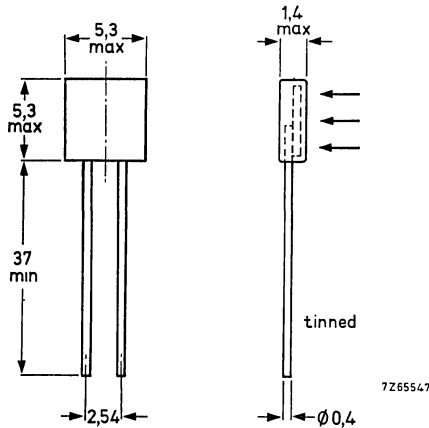

Soldering

The device may be soldered direct into the circuit but heat conducted to the tablet should be kept to a minimum by the use of a thermal shunt.

It may be dip-soldered at a solder temperature of 270 $^\circ\text{C}$ for a maximum of 2 s up to a point 6 mm from the envelope.

RATINGS Limiting values in accordance with the Absolute Maximum System (IEC134)

Cell voltage, d.c. and repetitive peak	V	max.	50	V
Cell voltage, $P_{RR} \leq$ once per minute, $t_p \leq 5$ ms	V_M	max.	100	V
Power dissipation, $t_{av} = 0,5$ s, $T_{amb} \leq 25$ °C	P	max.	100	mW
Cell current, d.c. and repetitive peak	I	max.	25	mA
Ambient temperature, storage and operating storage	T_{amb}	min.	-40	°C
	T_{stg}	max.	+50	°C
Temperature of CdS tablet	T_{tablet}	max.	+70	°C

THERMAL RESISTANCE

Thermal resistance from CdS tablet to ambient	$R_{th t-a}$	=	0,45	°C/mW
---	--------------	---	------	-------

CHARACTERISTICS

Initial dark resistance, measured with 50 V d.c. applied via 1 M Ω , 20 s after switching off the illumination	r_{do}	>	200	k Ω
--	----------	---	-----	------------

Initial illumination resistance measured at 1 V d.c., illumination 50 lx, $T_c = 2700$ K	r_{lo}	typ.	0,6	k Ω
			0,35-1,4	k Ω

Initial drift	D_o	typ.	0	%
---------------	-------	------	---	---

F_{4700} ($= \frac{r_1 \text{ at } 4700 \text{ K}}{r_1 \text{ at } 2856 \text{ K}}$ at constant illumination and using a Davis-Gibson filter)		typ.	1,2	
---	--	------	-----	--

OPERATING NOTES

1. The device consists of two photoconductive cells connected in series. The resistance of the device is mainly governed by the resistance of that cell receiving the lower luminous flux.
If it is required for any application that the device is partly shaded, the shadow line should be perpendicular to the axis of the device.
2. For optimum heat dissipation use the shortest permissible lead length.

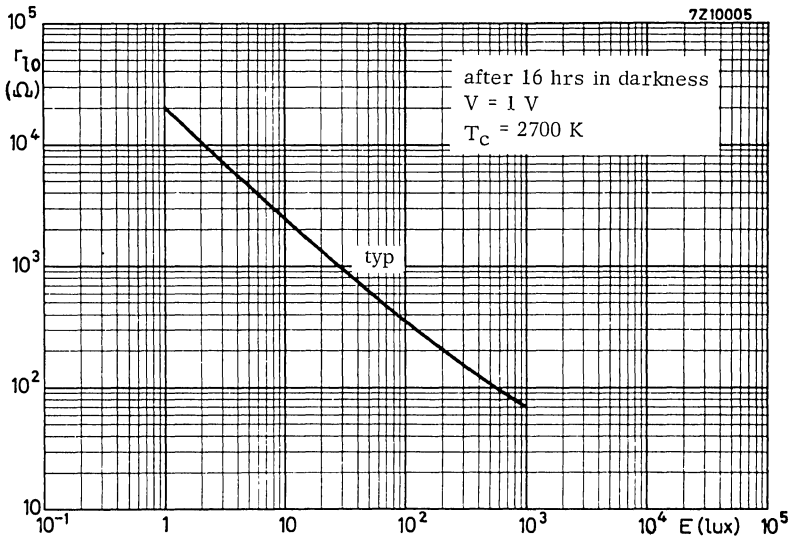

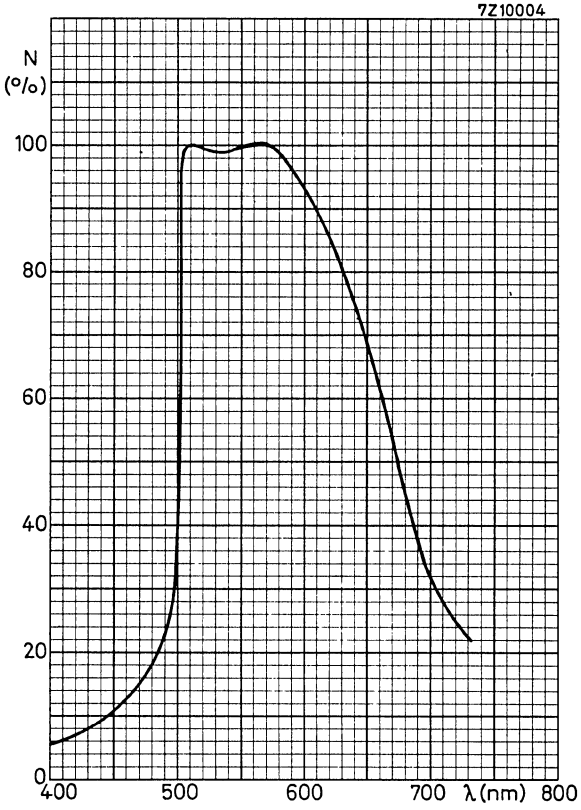

DEVELOPMENT SAMPLE DATA

This information is derived from development samples made available for evaluation. It does not necessarily imply that the device will go into regular production

RPY76B

PHOTOCONDUCTIVE CELL

Lead sulphide, chemically deposited, photoconductive cell recommended for room temperature operation. It is encapsulated in a hermetically sealed envelope similar to TO-5, with an end-viewing window. It incorporates a germanium filter to cut off radiation at wavelengths below $1.5 \mu\text{m}$.

QUICK REFERENCE DATA

Wavelength range at maximum response		1.8 to 2.2 μm
Operating temperature		20 $^{\circ}\text{C}$
Current responsivity (2.0 μm , 800)	typ.	2500 mA W^{-1}
Voltage responsivity (2.0 μm , 800)	typ.	$6 \times 10^5 \text{ V W}^{-1}$
D^* (2.0 μm , 800, 1)	min.	$1.0 \times 10^{10} \text{ cm Hz}^{1/2} \text{ W}^{-1}$
Time constant	typ.	250 μs
Sensitive area		$1.0 \times 1.0 \text{ mm}$

This data must be read in conjunction with GENERAL SAFETY RECOMMENDATIONS – OPTOELECTRONIC DEVICES

MECHANICAL DATA

SOT-49/1 (similar to TO-5)

Dimensions in mm

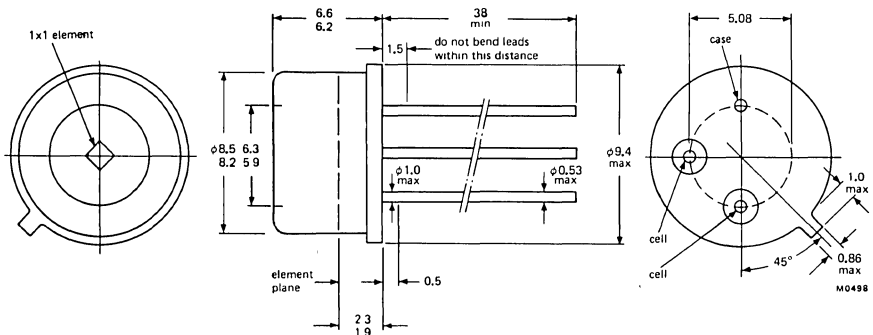

PRODUCT SAFETY

Modern high technology materials have been used in the manufacture of this device to ensure high performance. Some of these materials are toxic in certain circumstances. Mechanical or electrical damage is unlikely to give rise to any hazard, but toxic vapours may be generated if the device is heated to destruction. Disposal of large quantities should therefore be carried out in accordance with the latest local legislation.

RATINGS

Limiting values in accordance with the Absolute Maximum System (IEC 134)

Power dissipation (note 2)	P	max.	20	mW
Storage temperature range	T _{stg}		-20 to +50	°C
Ambient operating temperature range	T _{amb}		-20 to +50	°C

CHARACTERISTICS T_{amb} = 20 °C (see notes)

Wavelength range at maximum response			1.8 to 2.2	μm
Spectral response range (see page 5)			1.5 to 2.9	μm
Cell resistance		min.	100	kΩ
		typ.	240	kΩ
Time constant (note 3)		typ.	250	μs
Field of view		typ.	70	deg

BLACK BODY PERFORMANCE

Current responsivity (500K, 800)		min.	10	mAW ⁻¹
		typ.	25	mAW ⁻¹
Voltage responsivity (500K, 800)		typ.	6 × 10 ³	VW ⁻¹
D* (500K, 800, 1)		min.	1.0 × 10 ⁸	cmHz ^{1/2} W ⁻¹
		typ.	2.3 × 10 ⁸	cmHz ^{1/2} W ⁻¹
N.E.P. (500K, 800, 1)		max.	1.0 × 10 ⁻⁹	WHZ ^{-1/2}

MONOCHROMATIC PERFORMANCE (2.0 μm radiation)

Current responsivity (2.0 μm, 800)		min.	1000	mAW ⁻¹
		typ.	2500	mAW ⁻¹
Voltage responsivity (2.0 μm, 800)		typ.	6 × 10 ⁵	VW ⁻¹
D* (2.0 μm, 800, 1)		min.	1.0 × 10 ¹⁰	cmHz ^{1/2} W ⁻¹
		typ.	2.3 × 10 ¹⁰	cmHz ^{1/2} W ⁻¹
N.E.P. (2.0 μm, 800, 1)		max.	1.0 × 10 ⁻¹¹	WHZ ^{-1/2}

The above characteristics should be used in conjunction with the following notes.

1. Test conditions

The cell is operated at a temperature of 20 °C. The sensitive element is situated at a distance of 264 mm from a black body source limited by an aperture of 3 mm diameter.

The radiation path is interrupted at 800 Hz by a chopper blade at ambient temperature. Under these conditions the r.m.s. power at the element (chopping factor 2.2) is 4.5 μW cm⁻².

A bias voltage of 24 V is applied to the cell. Measurements of the detector output are made using a low value resistive load, followed by a current pre-amplifier, as shown in figure 1. The output is fed into an amplifier tuned to 800 Hz with a bandwidth of 50 Hz.

The figures in brackets, which follow responsivity, D* and N.E.P. refer to the test conditions, for example, D* (2.0 μm, 800, 1) denotes monochromatic radiation incident on the detector of wavelength 2.0 μm, modulation frequency 800 Hz and electronic bandwidth of 1 Hz.

The characteristics shown in the data for D* and N.E.P. are normalized to 1 Hz bandwidth. This means that with the 50 Hz bandwidth recommended for the test amplifier (figure 1), D* will be $\sqrt{50}$ higher than the normalized value and, conversely, N.E.P. will be reduced by the same factor. (See following definitions of D* and N.E.P.).

D* and N.E.P.

These are figures of merit for the materials of detectors and are fully discussed in most textbooks on infrared. D* is derived from the expression:

$$D^* = \frac{I_s \times A (\Delta f)^{1/2}}{I_n W}$$

where	I_s	= Signal current
	I_n	= Noise current
	A	= Detector area
	(Δf)	= Bandwidth of measuring amplifier
	W	= Radiation power incident on detector sensitive element (r.m.s. value in watts)

The Noise Equivalent Power (N.E.P.) is related to D* by the expression:

$$N.E.P. = \frac{A^{1/2}}{D^*}$$

2. Variation of performance with bias

Both signal and noise vary with bias in this type of cell. At bias levels at which the cell dissipation is less than 2.5 mW the maximum level of D* is maintained. At higher levels of dissipation the noise increases more rapidly than the signal so that although the responsivity increases, D* falls. The maximum responsivity typically occurs at a dissipation level of 10 mW, beyond which element heating takes place with a consequent reduction in responsivity.

Variation of performance with temperature/life

The quoted values are those which may be expected after storage or operation up to 20 °C. These values may change after storage or operation at temperatures up to the absolute maximum temperature of 50 °C.

3. Time constant

The detector time constant figure is based on the response to a step function of incident radiation. The quoted time indicates the interval between the moment of application and the output pulse reaching 63% of its peak value.

4. Recommended operating conditions

A suitable circuit is shown in Fig. 1. With this mode of operation, the signal is the short-circuit current, which is related to the open-circuit cell voltage by the expression:

$$V_{oc} = I_{sc} \times R_{cell}$$

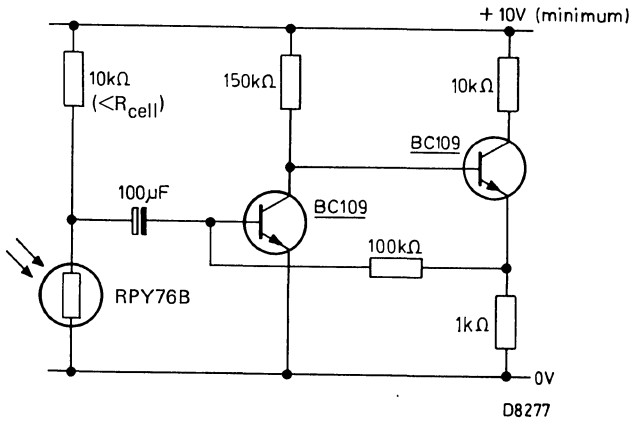
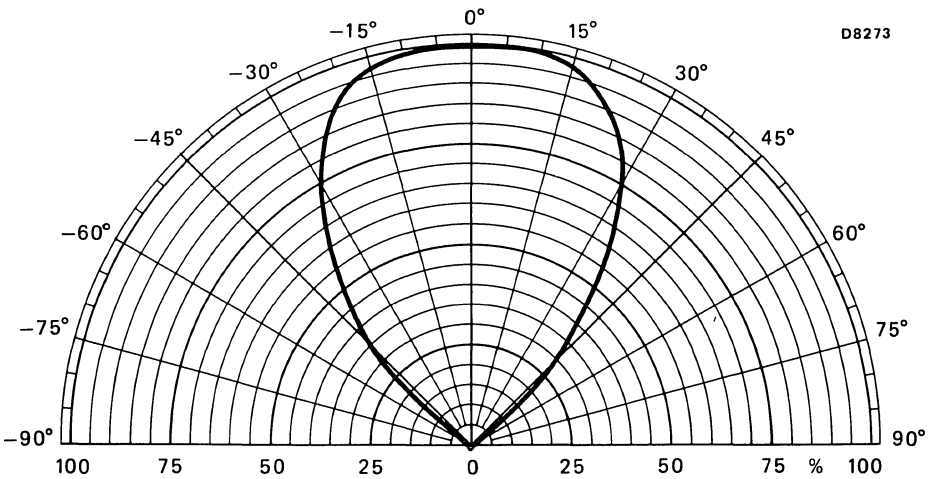
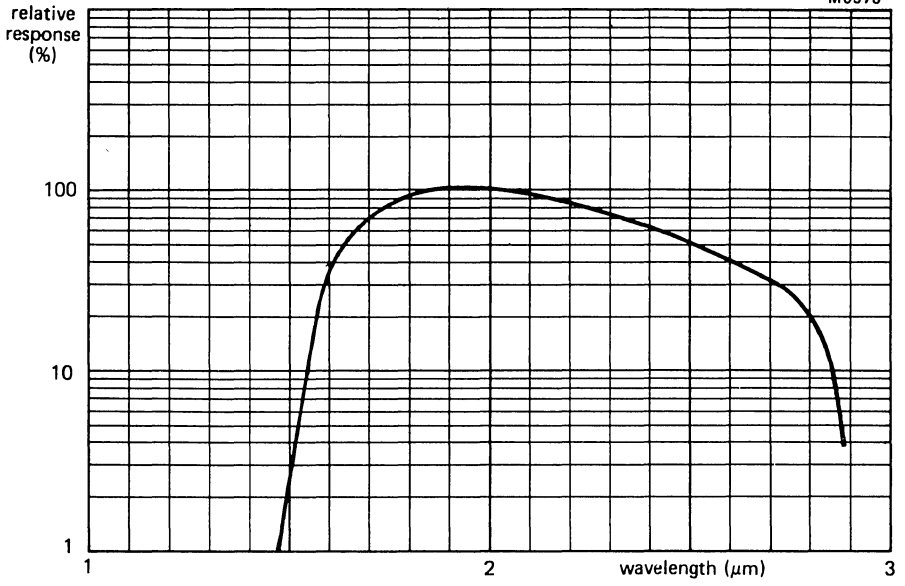

Fig.1



Typical polar response of relative sensitivity

M0578



Typical relative spectral response

DEVELOPMENT SAMPLE DATA

NOTES

NOTES

NOTES

NOTES

NOTES

NOTES



INDEX AND MAINTENANCE TYPE LIST

GENERAL

PHOTOSENSITIVE DIODES AND TRANSISTORS

LIGHT EMITTING DIODES
AND SELECTION GUIDE

DISPLAYS

PHOTOCOUPLERS

INFRARED SENSITIVE DEVICES

PHOTOCONDUCTIVE DEVICES

Electronic components and materials for professional, industrial and consumer uses from the world-wide Philips Group of Companies

Argentina: PHILIPS ARGENTINA S.A., Div. Elcoma, Vedia 3892, 1430 BUENOS AIRES, Tel. 541-7141/7242/7343/7444/7545.
Australia: PHILIPS INDUSTRIES HOLDINGS LTD., Elcoma Division, 67 Mars Road, LANE COVE, 2066, N.S.W., Tel. 427 08 88.
Austria: ÖSTERREICHISCHE PHILIPS BAUELEMENTE Industrie G.m.b.H., Triester Str. 64, A-1101 WIEN, Tel. 62 91 11.
Belgium: N.V. PHILIPS & MBLÉ ASSOCIATED, 9, rue du Pavillon, B-1030 BRUXELLES, Tel. (02) 242 74 00.
Brazil: IBRAPE, Caixa Postal 7383, Av. Brigadeiro Faria Lima, 1735 SÃO PAULO, SP, Tel. (011) 211-2600.
Canada: PHILIPS ELECTRONICS LTD., Electron Devices Div., 601 Milner Ave., SCARBOROUGH, Ontario, M1B 1M8, Tel. 292-5161.
Chile: PHILIPS CHILENA S.A., Av. Santa Maria 0760, SANTIAGO, Tel. 39-4001.
Colombia: SADAPE S.A., P.O. Box 9805, Calle 13, No. 51 + 39, BOGOTÁ D.E. 1., Tel. 600 600.
Denmark: MINIWATT A/S, Strandlodsvej 2, P.O. Box 1919, DK 2300 COPENHAGEN S, Tel. (01) 54 11 33.
Finland: OY PHILIPS AB, Elcoma Division, Kaivokatu 8, SF-00100 HELSINKI 10, Tel. 1 72 71.
France: R.T.C. LA RADIOTECHNIQUE-COMPELEC, 130 Avenue Ledru Rollin, F-75540 PARIS 11, Tel. 355-44-99.
Germany: VALVO, UB Bauelemente der Philips G.m.b.H., Valvo Haus, Burchardstrasse 19, D-2 HAMBURG 1, Tel. (040) 3296-0.
Greece: PHILIPS S.A. HELLENIQUE, Elcoma Division, 52, Av. Syngrou, ATHENS, Tel. 9215111.
Hong Kong: PHILIPS HONG KONG LTD., Elcoma Div., 15/F Philips Ind. Bldg., 24-28 Kung Yip St., KWAI CHUNG, Tel. (01)-24 51 21.
India: PEICO ELECTRONICS & ELECTRICALS LTD., Elcoma Div., Ramon House, 169 Backbay Reclamation, BOMBAY 400020, Tel. 295144.
Indonesia: P.T. PHILIPS-RALIN ELECTRONICS, Elcoma Div., Panim Bank Building, 2nd Fl., Jl. Jend. Sudirman, P.O. Box 223, JAKARTA, Tel. 716 131.
Ireland: PHILIPS ELECTRICAL (IRELAND) LTD., Newstead, Clonskeagh, DUBLIN 14, Tel. 69 33 55.
Italy: PHILIPS S.p.A., Sezione Elcoma, Piazza IV Novembre 3, I-20124 MILANO, Tel. 2-6752.1.
Japan: NIHON PHILIPS CORP., Shuwa Shinagawa Bldg., 26-33 Takanawa 3-chome, Minato-ku, TOKYO 108, Tel. 448-5611.
(IC Products) SIGNETICS JAPAN LTD., 8-7 Sanbancho Chiyoda-ku, TOKYO 102, Tel. (03)230-1521.
Korea: PHILIPS ELECTRONICS (KOREA) LTD., Elcoma Div., Philips House, 260-199 Itaewon-dong, Yongsan-ku, C.P.O. Box 3680, SEOUL, Tel. 794-4202.
Malaysia: PHILIPS MALAYSIA SDN. BERHAD, No. 4 Persiaran Barat, Petaling Jaya, P.O.B. 2163, KUALA LUMPUR, Selangor, Tel. 77 44 11.
Mexico: ELECTRONICA, S.A. de C.V., Carr. Mexico-Toluca km. 62.5, TOLUCA, Edo. de Mexico 50140, Tel. Toluca 91(721)613-00.
Netherlands: PHILIPS NEDERLAND, Marktgroep Elconco, Postbus 90050, 5600 PB EINDHOVEN, Tel. (040) 79 33 33.
New Zealand: PHILIPS ELECTRICAL IND. LTD., Elcoma Division, 110 Mt. Eden Road, C.P.O. Box 1041, AUCKLAND, Tel. 605-914.
Norway: NORSK A/S PHILIPS, Electronica Dept., Sandstuveien 70, OSLO 6, Tel. 68 02 00.
Paru: CADESA, Av. Alfonso Ugarte 1268, LIMA 5, Tel. 326070.
Philippines: PHILIPS INDUSTRIAL DEV. INC., 2246 Pasong Tamo, P.O. Box 911, Makati Comm. Centre, MAKATI-RIZAL 3116, Tel. 86-89-51 to 59.
Portugal: PHILIPS PORTUGESA S.A.R.L., Av. Eng. Duarte Pacheco 6, LISBOA 1, Tel. 68 31 21.
Singapore: PHILIPS PROJECT DEV. (Singapore) PTE LTD., Elcoma Div., Lorong 1, Toa Payoh, SINGAPORE 1231, Tel. 25 38 811.
South Africa: EDAC (Pty.) Ltd., 3rd Floor Rainer House, Upper Railway Rd. & Ove St., New Doornfontein, JOHANNESBURG 2001, Tel. 614-2362/9.
Spain: MINIWATT S.A., Balmes 22, BARCELONA 7, Tel. 301 63 12.
Sweden: PHILIPS KOMPONENTER A.B., Lidingsvägen 50, S-11584 STOCKHOLM 27, Tel. 08/67 97 80.
Switzerland: PHILIPS A.G., Elcoma Dept., Allmendstrasse 140-142, CH-8027 ZÜRICH, Tel. 01 488 22 11.
Taiwan: PHILIPS TAIWAN LTD., 3rd Fl., San Min Building, 57-1, Chung Shan N. Rd, Section 2, P.O. Box 22978, TAIPEI, Tel. (02)-5631717.
Thailand: PHILIPS ELECTRICAL CO. OF THAILAND LTD., 283 Silom Road, P.O. Box 961, BANGKOK, Tel. 233-6330-9.
Turkey: TÜRK PHILIPS TICARET A.Ş., EMET Department, İnönü Cad. No. 78-80, İSTANBUL, Tel. 43 59 10.
United Kingdom: MULLARD LTD., Mullard House, Torrington Place, LONDON WC1E 7HD, Tel. 01-580 6633.
United States: (Active Devices & Materials) AMPEREX SALES CORP., Providence Pike, SLATERSVILLE, R.I. 02876, Tel. (401) 762-9000.
(Passive Devices) MEPCO/ELECTRA INC., Columbia Rd., MORRISTOWN, N.J. 07960, Tel. (201)539-2000.
(Passive Devices & Electromechanical Devices) CENTRALAB INC., 5855 N. Glen Park Rd., MILWAUKEE, WI 53201, Tel. (414)228-7380.
(IC Products) SIGNETICS CORPORATION, 811 East Arques Avenue, SUNNYVALE, California 94086, Tel. (408) 739-7700.
Uruguay: LUZILECTRON S.A., Avda Uruguay 1287, P.O. Box 907, MONTEVIDEO, Tel. 91 43 21.
Venezuela: IND. VENEZOLANAS PHILIPS S.A., Elcoma Dept., A. Ppal de los Ruices, Edif. Centro Colgate, CARACAS, Tel. 36 05 11.

For all other countries apply to: Philips Electronic Components and Materials Division, Corporate Relations & Projects, Building BAE-3, P.O. Box 218, 5600 MD EINDHOVEN, The Netherlands, Tel. +31 40 72 33 04, Telex 35000 phic nl/nl be vec.

A33

© 1983 Philips Export B.V.

This information is furnished for guidance, and with no guarantee as to its accuracy or completeness; its publication conveys no licence under any patent or other right, nor does the publisher assume liability for any consequence of its use; specifications and availability of goods mentioned in it are subject to change without notice; it is not to be reproduced in any way, in whole or in part, without the written consent of the publisher.