

SIEMENS

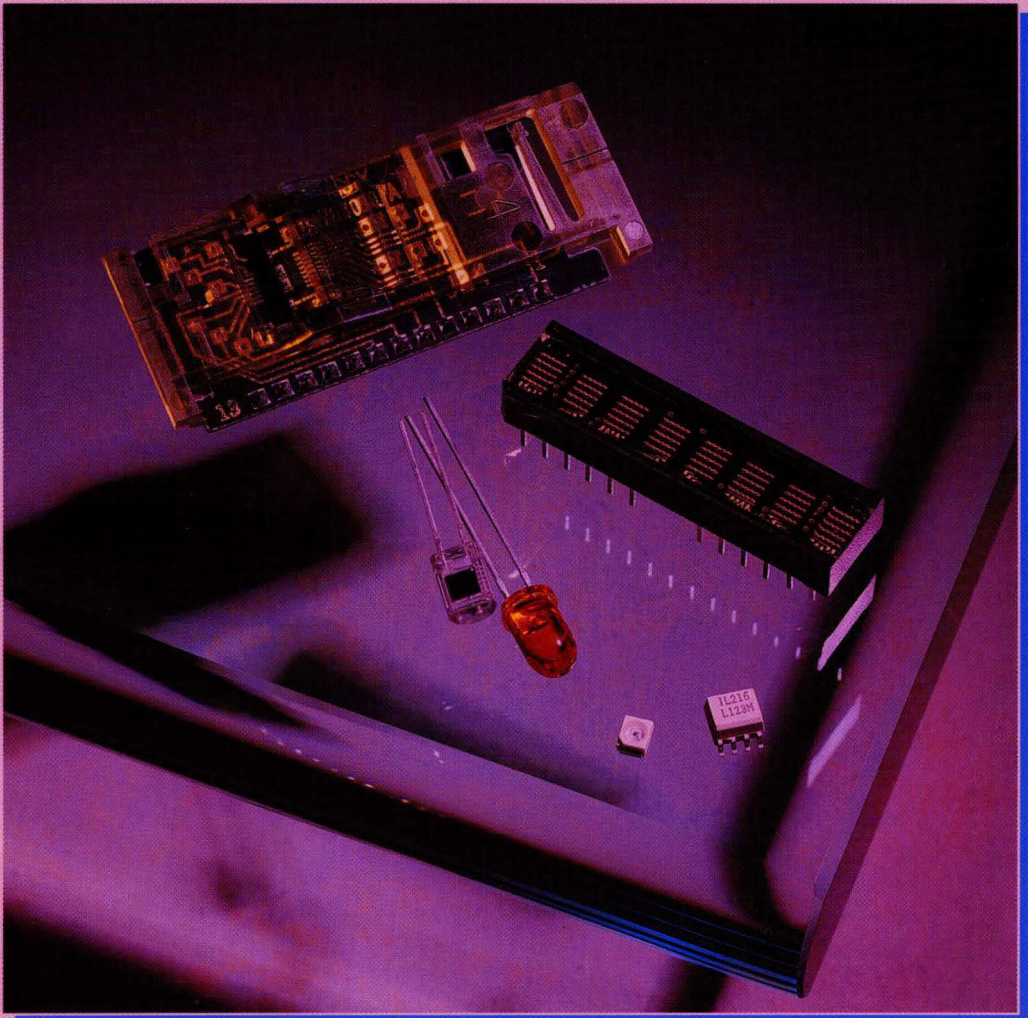

OPTOELECTRONICS

Data Book 1993

SIEMENS

1993
**OPTOELECTRONICS
DATA BOOK**

Siemens: Innovators in Opto Technology

Company Overview

Siemens Components is a major producer in the semiconductor industry, with facilities virtually world wide. The U.S. Optoelectronics Division is headquartered in Cupertino, California—the heart of Silicon Valley. The U.S. Opto Division, teamed with the Opto-Semiconductor Group in Munich and Regensburg, Germany, are world leaders in light emitting diode (LED) technology, sophisticated CMOS IC design, optics, fiber optics, and packaging.

Our combined product line is one of the most complete in the world:

- Small Alphanumeric Displays
- Programmable Display™ Devices
- Intelligent Display™ Devices
- Military Displays
- Application-Specific Intelligent Displays
- Numeric Displays
- Bar Graphs
- LED Lamps, Light Bars
- Optocouplers
- Infrared Emitting Diodes & Photodetectors
- Fiber Optic Products & Laser Diodes
- Interrupters
- Custom Optoelectronic Products

Our materials technology includes visible and IR LEDs (GaAsP, GaP or combinations of these; GaAlAs; and Silicon Carbide) and photodetectors. Our Malaysia plant, where final product assembly is done, is a showcase of automation and efficiency, featuring the latest automated assembly and test equipment—resulting in high yields and high quality products.

History

Siemens has been in the optoelectronics market since 1875, when Werner v. Siemens developed selenium photodetectors. Since then, Siemens has been at the forefront of opto component technology, with light and infrared emitting detectors in Germanium and Silicon; all types of lasers; and Silicon Carbide blue LEDs.

Siemens Optoelectronics Division began in 1969 as Litronix to manufacture LED lamps, numeric displays, and optocouplers for the OEM market, and calculators and watches for the consumer market. In 1977, Siemens acquired Litronix and refocused

priorities toward the basic business of producing and marketing LED materials and components to complement its European optoelectronics activities.

Siemens Optoelectronics is a division of Siemens Components, Inc., which is part of Siemens USA, with sales of \$4.5 billion and over 35,000 employees. Siemens USA includes Siemens Corporation, 11 U.S. operating companies, Siemens affiliates, and joint ventures. The 11 operating companies are Siemens Automotive, Siemens Components, Siemens Energy and Automation, Siemens Industrial Automation, Siemens KWU, Siemens Medical Corporation, Siemens Private Communication Systems, Siemens Stromberg-Carlson, Siemens Transportation Systems, OSRAM Corporation, and Potter & Brumfield.

Siemens USA is part of Siemens' worldwide organization, with sales of \$73 billion, 402,000 employees, and 172 production facilities in 35 countries.

Technology Strengths

Our strengths are in the following areas:

- Continual process development/ improvement in LED & IRED materials
- In-house design of complex CMOS integrated circuits using the latest CAD/CAM and CAE equipment
- Sophisticated optics and packaging capabilities
- State-of-the-art system know-how for complex IC/LED hybrids
- Leading supplier of custom optoelectronic products
- World leader in low dark current, high-sensitivity photodetectors
- Specialists in VDE procedures, particularly in optocoupler design
- A history of innovation:
 - Invented Intelligent Display devices, 1977
 - Invented Programmable Display devices, 1984
 - Both feature built-in CMOS IC control circuits for easy interface with microprocessors
 - Over 30 years of state-of-the-art Silicon photodetector production
 - Developed the first reliable optocoupler, CNY17
 - Second sourced by competitors, due to strong market acceptance

Quality and Reliability

Every aspect of day-to-day production is closely monitored and verified to ensure that all materials, processes, manufacturing, and testing meet precise engineering standards. Rigorous quality control checks are built into each stage of production. Finished products undergo thorough electrical, optical, dimensional, and visual inspections, resulting in products of superior quality, with an overall quality average of 50 parts per million (PPM). Our worldwide quality system—including PPM and statistical quality control (SQC)—programs, and our flexible manufacturing capabilities allow us to produce the industry's highest quality products with just-in-time deliveries at competitive prices.

Service

Siemens' worldwide network includes subsidiaries in all major countries.

Product Applications

Siemens optoelectronic products are used in a broad range of electronic, commercial, industrial, and military market segments, such as test instrumentation, medical equipment, computers and peripherals, telecommunications, process/industrial controls, terminals, and power supplies.

Conclusion

Siemens is strategically positioned to concentrate efforts on innovative products and systems, offering value-added, cost-effective features to our customers. All our resources and capabilities in producing LED materials (visible and infrared), R&D engineering, IC design, optics/packaging, automated assembly, and a strong focus on reliability keep Siemens at the leading edge of opto technology.

TABLE OF CONTENTS

	Page Number(s)
Alphanumeric Index	iv
Quality and Reliability Information	
Quality at Siemens Optoelectronics	1
Optoelectronics, Quality and Reliability	2
High Reliability and Military Optoelectronic Devices	6
Optocoupler Manufacturing and Reliability	7
Custom Optoelectronic Products	
Custom Optoelectronic Products	1-2
Epitaxial Wafer	1-5
Custom Optoelectronic Materials and Die	1-6
Custom LED Materials Table	1-8
LED Intelligent Display®, Slimline Intelligent Display® and Programmable Display™ Devices, Military/Industrial Displays, Small Alphanumeric Displays	
Selector Guide	2-2
High Reliability Testing Tables	2-9
Data Sheets: LED Intelligent Display & Programmable Display Devices, Military Displays, Small Alphanumeric Displays	2-12
Selector Guide: Intelligent Display Assemblies	2-182
Data Sheets: Intelligent Display Assemblies	2-183
LED Numeric Displays, LED Bar Graphs and Light Bars	
Selector Guide	3-2
Data Sheets: Numeric Display, Light Bar, Bar Graph	3-5
Display Graphs	3-22
LED Lamps	
Selector Guide	4-1
Lamp Accessories	4-11
LED Lamp Part Numbering System	4-13
LED Lamp-Tape and Packaging	4-15
Packaging of Surface Mount LEDs	4-16
Data Sheets: Lamps	4-17
Lamp Graphs	4-61
Optocouplers (Optoisolators)	
Selector Guide	5-2
Optocoupler Options Table	5-13
Optocoupler Options	5-17
Tape and Reel Packaging	5-25
Agency Approvals Table	5-31
Data Sheets: Optocouplers	5-36
Fiber Optic and Laser Diode Devices	
Selector Guide	6-2
Data Sheets: Fiber Optic Devices	6-6
Data Sheets: Laser Diodes	6-17
Infrared Emitters	
Selector Guide	7-1
Data Sheets: Infrared Emitters	7-5
Photodiodes	
Selector Guide	8-1
Data Sheets: Photodiodes	8-7
Phototransistors	
Selector Guide	9-1
Data Sheets: Phototransistors	9-4
Photovoltaic Cells	
Selector Guide	10-1
Data Sheets: Photovoltaic Cells	10-2
Application Notes	
List of Application Notes	11-1
Application Notes	11-2
Siemens AG, Bereich Halbleiter Sales Offices	
Siemens Components, Sales Offices	

Custom Optoelectronic Products
 Intelligent Display Devices
 Num. Displays Bar Graphs
 LED Lamps
 Optocouplers (Optoisolators)
 Fiber Optic Laser Diode Devices
 Infrared Emitters
 Photodiodes
 Phototransistors/Photodarlington
 Photovoltaic Cells
 Application Notes

ALPHANUMERIC INDEX (use ordering code numbers when ordering in Europe)

PART NO.	ORDERING CODE NO.	DESCRIPTION	PAGE
4N25	Q68000-A5018	Optocoupler, 6 Pin Single, 20% CTR, 7500V	5-36
4N26	Q68000-A5017	Optocoupler, 6 Pin Single, 20% CTR, 7500V	5-36
4N27	Q68000-A5707	Optocoupler, 6 Pin Single, 10% CTR, 7500V	5-36
4N28	Q62703-N26	Optocoupler, 6 Pin Single, 10% CTR, 7500V	5-36
4N32	Q62703-N51	Optocoupler, 6 Pin Single, 500% CTR, 7500V, Photodarlington	5-39
4N33	Q62703-N52	Optocoupler, 6 Pin Single, 500% CTR, 7500V, Photodarlington	5-39
4N35	Q68000-A7302	Optocoupler, 6 Pin Single, 100% CTR, 7500V	5-41
4N36	Q68000-A7303	Optocoupler, 6 Pin Single, 100% CTR, 7500V	5-41
4N37	Q68000-A7304	Optocoupler, 6 Pin Single, 100% CTR, 7500V	5-41
4N38	Q68000-A8086	Optocoupler, 6 Pin Single, 20% CTR, 7500V	5-41
6N135	Q68000-A7961	Optocoupler, 8 Pin Single, 7% CTR, 2500V, 1 Mbit/s	5-44
6N136	Q68000-A5646	Optocoupler, 8 Pin Single, 19% CTR, 2500V, 1 Mbit/s	5-44
6N138	Q68000-A6410	Optocoupler, 8 Pin Single, 300% CTR, 2500V, Split Darlington	5-47
6N139	Q68000-A6411	Optocoupler, 8 Pin Single, 400% CTR, 2500V, Split Darlington	5-47
	Q62902-B65	Clip & Collar, T1 3/4 (5 mm), Black	4-11
	Q62902-B64	Clip & Collar, T1 3/4 (5 mm), Clear	4-11
	Q62902-B61	Clip & Collar, T1 (3 mm), Clear	4-11
	Q62902-B62	Clip & Collar, T1 (3 mm), Black	4-11
	Q62902-B155-F222	Mount, Angular, Black	4-12
	Q62902-B156-F222	Mount, Right Angle, T1 3/4 (5 mm), Black	4-12
	Q62902-B141-F222	Reflector, T1 1/4, Polished	4-12
	Q62902-B154-F222	Reflector, T1, Polished	4-12
2004-9053	Q62902-B166	Disc, Slotted, for SFH910	7-49
2600-7056		Wafer, Epitaxial, 655 nm, 3° GaAsP/GaAs	1-5
BP103-2	Q62702-P79-S1	Phototransistor, TO-18, Plastic Lens, 55°	9-4
BP103-3	Q62702-P79-S2	Phototransistor, TO-18, Plastic Lens, 55°	9-4
BP103-4	Q62702-P79-S4	Phototransistor, TO-18, Plastic Lens, 55°	9-4
BP103-5	Q62702-P781	Phototransistor, TO-18, Plastic Lens, 55°	9-4
BP103-6	Q62702-P768	Phototransistor, TO-18, Plastic Lens, 55°	9-4
BP103B-2	Q62702-P85-S2	Phototransistor, T1 3/4 (5 mm), Plastic, 25°	9-7
BP103B-3	Q62702-P85-S3	Phototransistor, T1 3/4 (5 mm), Plastic, 25°	9-7
BP103B-4	Q62702-P85-S4	Phototransistor, T1 3/4 (5 mm), Plastic, 25°	9-7
BP104	Q62702-P84	Photodiode, Plastic with Filter, 60°, PIN	8-7
BP104BS	Q62702-P917	Photodiode, Plastic with Filter, SMD, 60°, PIN	8-9
BPW21	Q62702-P885	Photodiode, TO-5, Hermetic, 60°, V _L	8-11
BPW32	Q62702-P74	Photodiode, Clear Plastic, 60°, Low Dark Current	8-13
BPW33	Q62702-P76	Photodiode, Clear Plastic, 60°, Low Dark Current	8-15
BPW34	Q62702-P73	Photodiode, Clear Plastic, 60°, PIN	8-17
BPW34B	Q62702-P945	Photodiode, Clear Plastic, 60°, PIN, High Blue Sensitivity	8-19
BPW34F	Q62702-P929	Photodiode, Plastic with Filter, 60°, PIN	8-9
BPW34FA	Q62702-P1129	Photodiode, Plastic with Filter, 60°, PIN	8-21
BPX38-2	Q62702-P15-S2	Phototransistor, TO-18, Hermetic, 40°	9-9
BPX38-3	Q62702-P15-S3	Phototransistor, TO-18, Hermetic, 40°	9-9
BPX38-4	Q62702-P15-S4	Phototransistor, TO-18, Hermetic, 40°	9-9
BPX38-5	Q62702-P15-S5	Phototransistor, TO-18, Hermetic, 40°	9-9
BPX43-2	Q62702-P16-S2	Phototransistor, TO-18, Hermetic, 15°	9-12
BPX43-3	Q62702-P16-S3	Phototransistor, TO-18, Hermetic, 15°	9-12
BPX43-4	Q62702-P16-S4	Phototransistor, TO-18, Hermetic, 15°	9-12
BPX43-5	Q62702-P16-S5	Phototransistor, TO-18, Hermetic, 15°	9-12
BPX48	Q62702-P17-S1	Photodiode, Clear Plastic, Differential, 60°	8-23
BPX48F	Q62702-P305	Photodiode, Plastic with Filter, Differential, 60°	8-23
BPX60	Q62702-P54	Photodiode, TO-5, Flat Glass Lens, 55°, High Blue Sensitivity	8-25
BPX61	Q62702-P25	Photodiode, TO-5, Flat Glass Lens, 55°, PIN	8-27
BPX63	Q62702-P55	Photodiode, TO-18, Plastic Lens, 75°, Low Dark Current	8-29
BPX65	Q62702-P27	Photodiode, TO-18, Flat Glass Lens, Hermetic, 40°, PIN	8-31
BPX66	Q62702-P80	Photodiode, TO-18, Flat Glass Lens, Hermetic, 40°, PIN	8-31
BPX79	Q62702-P51	Photovoltaic Cell, 60°, High Blue Sensitivity	10-2
BPX80	Q62702-P28	Phototransistor, Plastic, 10 Element Array, 18°	9-15
BPX81-2	Q62702-P43-S2	Phototransistor, Plastic, 1 Element, 18°	9-15
BPX81-3	Q62702-P43-S3	Phototransistor, Plastic, 1 Element, 18°	9-15
BPX81-4	Q62702-P43-S4	Phototransistor, Plastic, 1 Element, 18°	9-15

ALPHANUMERIC INDEX (use ordering code numbers when ordering in Europe)

PART NO.	ORDERING CODE NO.	DESCRIPTION	PAGE
BPX82	Q62702-P21	Phototransistor Plastic, 2 Element Array, 18°	9-15
BPX83	Q62702-P25	Phototransistor Plastic, 3 Element Array, 18°	9-15
BPX84	Q62702-P30	Phototransistor Plastic, 4 Element Array, 18°	9-15
BPX85	Q62702-P31	Phototransistor Plastic, 5 Element Array, 18°	9-15
BPX86	Q62702-P22	Phototransistor Plastic, 6 Element Array, 18°	9-15
BPX87	Q62702-P32	Phototransistor Plastic, 7 Element Array, 18°	9-15
BPX88	Q62702-P33	Phototransistor Plastic, 8 Element Array, 18°	9-15
BPX89	Q62702-P26	Phototransistor Plastic, 9 Element Array, 18°	9-15
BPX90	Q62702-P47	Photodiode, Plastic, 60°	8-33
BPX90F	Q62702-P928	Photodiode, Plastic with Filter, 60°	8-33
BPX91B	Q62702-P48-S	Photodiode, Plastic, 60°, Low Dark Current, High Blue Sensitivity	8-35
BPX92	Q62702-P49	Photodiode, Plastic, 60°	8-37
BPY11P-4	Q60215-Y111-S4	Photovoltaic, 0.47-0.63 nA/lx, 60°	10-4
BPY11P-5	Q60215-Y111-S5	Photovoltaic, ≥0.56 nA/lx, 60°	10-4
BPY12	Q62702-P9	Photodiode, 60°, PIN	8-39
BPY12-H1	Q62702-P1029	Photodiode, 60°, PIN	8-39
BPY47P	Q60215-Y66	Photovoltaic Cell, 1.4 μA/lx, 60°	10-6
BPY48P	Q60215-Y65	Photovoltaic Cell, 0.5 μA/lx, 60°	10-8
BPY62-2	Q60215-Y1111	Phototransistor, TO-18, Hermetic, 8°	9-17
BPY62-3	Q60215-Y1112	Phototransistor, TO-18, Hermetic, 8°	9-17
BPY62-4	Q60215-Y1113	Phototransistor, TO-18, Hermetic, 8°	9-17
BPY62-5	Q62702-P1113	Phototransistor, TO-18, Hermetic, 8°	9-17
BPY63P	Q60215-Y63-S1	Photovoltaic Cell, 0.65 μA/lx, 60°	10-10
BPY64P	Q60215-Y67	Photovoltaic Cell, 0.25 μA/lx, 60°	10-12
BRT11H	C67079-A1000-A6	Optocoupler, 6 Pin Single, SITAC, AC Switch	5-49
BRT11M	C67079-A1000-A10	Optocoupler, 6 Pin Single, SITAC, AC Switch	5-49
BRT12H	C67079-A1001-A6	Optocoupler, 6 Pin Single, SITAC, AC Switch	5-49
BRT12M	C67079-A1001-A10	Optocoupler, 6 Pin Single, SITAC, AC Switch	5-49
BRT13H	C67079-A1002-A6	Optocoupler, 6 Pin Single, SITAC, AC Switch	5-49
BRT13M	C67079-A1002-A10	Optocoupler, 6 Pin Single, SITAC, AC Switch	5-49
BRT21H	C67079-A1020-A6	Optocoupler, 6 Pin Single, SITAC, AC Switch	5-51
BRT21M	C67079-A1020-A10	Optocoupler, 6 Pin Single, SITAC, AC Switch	5-51
BRT22H	C67079-A1021-A6	Optocoupler, 6 Pin Single, SITAC, AC Switch	5-51
BRT22M	C67079-A1202-A1	Optocoupler, 6 Pin Single, SITAC, AC Switch	5-51
BRT23H	C67079-A1022-A6	Optocoupler, 6 Pin Single, SITAC, AC Switch	5-51
BRT23M	C67079-A1022-A10	Optocoupler, 6 Pin Single, SITAC, AC Switch	5-51
CNY17-1	Q62703-N86	Optocoupler, 6 Pin Single, 40-80% CTR, 5300V	5-53
CNY17-2	Q62703-N87	Optocoupler, 6 Pin Single, 63-125% CTR, 5300V	5-53
CNY17-3	Q62703-N88	Optocoupler, 6 Pin Single, 100-200% CTR, 5300V	5-53
CNY17-4	Q62703-N89	Optocoupler, 6 Pin Single, 160-320% CTR, 5300V	5-53
CNY17F-1	Q62703-N49	Optocoupler, 6 Pin Single, 40-80% CTR, 5300V, No Base	5-57
CNY17F-2	Q62703-N21	Optocoupler, 6 Pin Single, 63-125% CTR, 5300V, No Base	5-57
CNY17F-3	Q62703-N50	Optocoupler, 6 Pin Single, 100-200% CTR, 5300V, No Base	5-57
CNY17F-4	Q62703-N54	Optocoupler, 6 Pin Single, 160-320% CTR, 5300V	5-57
CNY17G-F-1,-2,-3		Replaced by CNYF-1,-2,-3 Option 6	
DL330M	Q68000-A5993	Display, .11", Red, Common Cathode MPX, 3 Digit	3-5
DL340M	Q68000-A5994	Display, .11", Red, Common Cathode MPX, 4 Digit	3-5
DL430M	Q68000-A5995	Display, .15", Red, Common Cathode MPX, 3 Digit	3-5
DL440M	Q68000-A5996	Display, .15", Red, Common Cathode MPX, 2 Digit	3-5
DL1414T	Q68000-A5559	Intelligent Display, 4 Char, .112", Red	2-12
DL2416T	Q68000-A5577	Intelligent Display, 4 Char, .160", Red	2-16
DL3416	Q68000-A6366	Intelligent Display, 4 Char, .225", Red	2-22
DLG1414	Q68000-A8093	Intelligent Display, 4 Char, .145", Green, 5x7 Dot Matrix	2-36
DLG2416	Q68000-A8096	Intelligent Display, 4 Char, .200", Green, 5x7 Dot Matrix	2-41
DLG3416	Q68000-A8099	Intelligent Display, 4 Char, .270", Green, 5x7 Dot Matrix	2-47
DLG4137	Q68000-A4299	Intelligent Display, Single, .43", Green, 5x7 Dot Matrix	2-28
DLG5735	Q68000-A6377	Display, .68", Green, 5x7 Dot Matrix, Common Row Cathode	2-53
DLG5736	Q68000-A8246	Display, .68", Green, 5x7 Dot Matrix, Common Row Anode	2-53
DLG7137	Q68000-A7159	Intelligent Display, Single, .68", Green, 5x7 Dot Matrix	2-32
DLO1414	Q68000-A8092	Intelligent Display, 4 Char, .145", HER, 5x7 Dot Matrix	2-36

ALPHANUMERIC INDEX (use ordering code numbers when ordering in Europe)

PART NO.	ORDERING CODE NO.	DESCRIPTION	PAGE
DLO2416	Q68000-A8095	Intelligent Display, 4 Char, .200", HER,5x7 Dot Matrix	2-41
DLO3416	Q68000-A8098	Intelligent Display, 4 Char, .270", HER,5x7 Dot Matrix	2-47
DLO4135	Q68000-A4297	Intelligent Display, Single, .43", HER, 5x7 Dot Matrix	2-28
DLO7135	Q68000-A7157	Intelligent Display, Single, .68", HER, 5x7 Dot Matrix	2-32
DLR1414	Q68000-A8091	Intelligent Display, 4 Char, .145", Red, 5x7 Dot Matrix	2-36
DLR2416	Q68000-A8094	Intelligent Display, 4 Char, .200", Red, 5x7 Dot Matrix	2-41
DLR3416	Q68000-A8097	Intelligent Display, 4 Char, .270", Red, 5x7 Dot Matrix	2-47
DLR5735	Q68000-A6374	Display, .68", Red 5x7 Dot Matrix, Common Row Cathode	2-53
DLR5736	Q68000-A8181	Display, .68", Red 5x7 Dot Matrix, Common Row Anode	2-53
GBG1000	Q68000-A5970	Bar Graph, Green, 10 Element	3-18
GBG4850	Q68000-A4404	Bar Graph, Green, 10 Element	3-20
GL56	Q68000-A5962	Lamp, Axial, Green, 1.0 mcd/10mA, 40°	4-57
H11A1	Q68000-A8116	Optocoupler, 6 Pin Single, 50% CTR, 7500V	5-61
H11A2	Q68000-A8117	Optocoupler, 6 Pin Single, 20% CTR, 7500V	5-61
H11A3	Q68000-A8118	Optocoupler, 6 Pin Single, 20% CTR, 7500V	5-61
H11A4	Q68000-A8119	Optocoupler, 6 Pin Single, 10% CTR, 7500V	5-61
H11A5	Q68000-A8120	Optocoupler, 6 Pin Single, 30% CTR, 7500V	5-61
H11AA1	Q68000-A7811	Optocoupler, 6 Pin Single, 20% CTR, 7500V, AC Input	5-64
H11B1	Q68000-A8121	Optocoupler, 6 Pin Single, 500% CTR, 7500V, Photodarlington	5-67
H11B2	Q68000-A8122	Optocoupler, 6 Pin Single, 200% CTR, 7500V, Photodarlington	5-67
H11B3	Q68000-A8123	Optocoupler, 6 Pin Single, 100% CTR, 7500V, Photodarlington	5-67
H11C4	Q68000-A8649	Optocoupler, 6 Pin Single, Photo SCR, 7500V	5-69
H11C5	Q68000-A8751	Optocoupler, 6 Pin Single, Photo SCR, 7500V	5-69
H11C6	Q68000-A8661	Optocoupler, 6 Pin Single, Photo SCR, 7500V	5-69
H11D1	Q68000-A8663	Optocoupler, 6 Pin, Single, ≥20% CTR, 5300V, High Reverse Voltage	5-70
H11D2	Q68000-A5747	Optocoupler, 6 Pin, Single, ≥20% CTR, 5300V, High Reverse Voltage	5-70
H11D3	Q68000-A5457	Optocoupler, 6 Pin, Single, ≥20% CTR, 5300V, High Reverse Voltage	5-70
HD1075G	Q68000-A6346	Display, .28", Green, Common Anode, DP Right	3-7
HD1075O	Q68000-A5746	Display, .28", Super-Red, Common Anode, DP Right	3-7
HD1075R	Q68000-A5747	Display, .28", Red, Common Anode, DP Right	3-7
HD1077G	Q68000-A6348	Display, .28", Green, Common Cathode, DP Right	3-7
HD1077O	Q68000-A5758	Display, .28", Super-Red, Common Cathode, DP Right	3-7
HD1077R	Q68000-A5759	Display, .28", Red, Common Cathode, DP Right	3-7
HD1105G	Q68000-A6350	Display, .39", Green, Common Anode, DP Right	3-9
HD1105O	Q68000-A5766	Display, .39", Super-Red, Common Anode, DP Right	3-9
HD1105R	Q68000-A5741	Display, .39", Red, Common Anode, DP Right	3-9
HD1107G	Q68000-A6352	Display, .39", Green, Common Cathode, DP Right	3-9
HD1107O	Q68000-A5772	Display, .39", Super-Red, Common Cathode, DP Right	3-9
HD1107R	Q68000-A5743	Display, .39", Red, Common Cathode, DP Right	3-9
HD1131G	Q68000-A7820	Display, .53", Green, Common Anode, DP Right	3-11
HD1131O	Q68000-A7822	Display, .53", Super-Red, Common Anode, DP Right	3-11
HD1131R	Q68000-A7821	Display, .53", Red, Common Anode, DP Right	3-11
HD1133G	Q68000-A7871	Display, .53", Green, Common Cathode, DP Right	3-11
HD1133O	Q68000-A7872	Display, .53", Super-Red, Common Cathode, DP Right	3-11
HD1133R	Q68000-A7873	Display, .53", Red, Common Cathode, DP Right	3-11
HDN1075O	Q68000-A4315	Display, .28" (7 mm), Super Red, Common Anode, DP Right, Low Current	3-13
HDN1077O	Q68000-A4317	Display, .28" (7 mm), Super Red, Common Cathode, DP Right, Low Current	3-13
HDN1105O	Q68000-A4319	Display, .39" (10 mm), Super Red, Common Anode, DP Right, Low Current	3-14
HDN1107O	Q68000-A4321	Display, .39" (10 mm), Super Red, Common Cathode, DP Right, Low Current	3-14
HDN1131O	Q68000-A6433	Display, .59" (13 mm), Super Red, Common Anode, DP Right, Low Current	3-15
HDN1133O	Q68000-A6434	Display, .59" (13 mm), Super Red, Common Cathode, DP Right, Low Current	3-15
HDSP2000LP	Q68000-A8131	Small Alphanumeric Serial Input Display, 4 Char, .15" Dot Matrix Red	2-55
HDSP2001LP	Q68000-A8304	Small Alphanumeric Serial Input Display, 4 Char, .15" Dot Matrix Yellow	2-55
HDSP2002LP	Q68000-A8132	Small Alphanumeric Serial Input Display, 4 Char, .15" Dot Matrix HER	2-55
HDSP2003LP	Q68000-A8133	Small Alphanumeric Serial Input Display, 4 Char, .15" Dot Matrix Green	2-55
HDSP2110S	Q68000-A8560	Programmable Display, 8 Char, .200", 5x7 Dot Matrix Red	2-62
HDSP2111S	Q68000-A8561	Programmable Display, 8 Char, .200", 5x7 Dot Matrix Yellow	2-62

ALPHANUMERIC INDEX (use ordering code numbers when ordering in Europe)

PART NO.	ORDERING CODE NO.	DESCRIPTION	PAGE
HDSP2112S	Q68000-A8562	Programmable Display, 8 Char, .200", 5x7 Dot Matrix HER	2-62
HDSP2113S	Q68000-A8563	Programmable Display, 8 Char, .200", 5x7 Dot Matrix Green	2-62
HDSP2114S	Q68000-A8564	Programmable Display, 8 Char, .200", 5x7 Dot Matrix HEG	2-62
HLMP-2300	Q68000-A7782	Light Bar, .15"x.35", Red, Two Die	3-16
HLMP-2350	Q68000-A4312	Light Bar, .15"x.75", Red, Four Die	3-16
HLMP-2400	Q68000-A7785	Light Bar, .15"x.35", Yellow, Two Die	3-16
HLMP-2450	Q68000-A4507	Light Bar, .15"x.75", Yellow, Four Die	3-16
HLMP-2500	Q68000-A7779	Light Bar, .15"x.35", Green, Two Die	3-16
HLMP-2550	Q68000-A2436	Light Bar, .15"x.75", Green, Four Die	3-16
HLMP-2600	Q68000-A1627	Light Bar, .15"x.35", Red, Four Die	3-16
HLMP-2620	Q68000-A4505	Light Bar, .15"x.35", Red, Eight Die	3-16
HLMP-2655	Q68000-A7783	Light Bar, .35"x.35", Red, Four Die	3-16
HLMP-2685	Q68000-A7784	Light Bar, .35"x.75", Red, Eight Die	3-16
HLMP-2700	Q68000-A1226	Light Bar, .15"x.35", Yellow, Four Die	3-16
HLMP-2720	Q68000-A4508	Light Bar, .15"x.35", Yellow, Eight Die	3-16
HLMP-2755	Q68000-A7786	Light Bar, .35"x.35", Yellow, Four Die	3-16
HLMP-2785	Q68000-A7787	Light Bar, .35"x.75", Yellow, Eight Die	3-16
HLMP-2800	Q68000-A1210	Light Bar, .15"x.35", Green, Four Die	3-16
HLMP-2820	Q68000-A3867	Light Bar, .15"x.35", Green, Eight Die	3-16
HLMP-2855	Q68000-A7780	Light Bar, .35"x.35", Green, Four Die	3-16
HLMP-2885	Q68000-A7781	Light Bar, .35"x.75", Green, Eight Die	3-16
IDA1414-16-1	Q68000-A6380	Intelligent Display Assembly, 16 Char with Buffer	2-183
IDA2416-16	Q68000-A6375	Intelligent Display Assembly, 16 Char	2-187
IDA2416-32	Q68000-A6376	Intelligent Display Assembly, 32 Char	2-187
IDA3416-16	Q68000-A7239	Intelligent Display Assembly, 16 Char	2-191
IDA3416-20	Q68000-A7242	Intelligent Display Assembly, 20 Char	2-191
IDA3416-32	Q68000-A7164	Intelligent Display Assembly, 32 Char	2-191
IDA7135-16	Q68000-A6385	Intelligent Display Assembly, 16 Char	2-195
IDA7135-20	Q68000-A6386	Intelligent Display Assembly, 20 Char	2-195
IDA7137-16	Q68000-A6389	Intelligent Display Assembly, 16 Char	2-195
IDA7137-20	Q68000-A6390	Intelligent Display Assembly, 20 Char	2-195
IL1	Q68000-A590	Optocoupler, 6 Pin Single, 20% CTR, 7500V	5-73
IL2	Q68000-A8124	Optocoupler, 6 Pin Single, 100% CTR, 7500V	5-73
IL2B-1	Q68000-A8734	Optocoupler, 6 Pin Single, 100% CTR, 7500V	5-78
IL2B-2	Q68000-A8735	Optocoupler, 6 Pin Single, 30% CTR, 7500V	5-78
IL2B-3	Q68000-A8736	Optocoupler, 6 Pin Single, 100% CTR, 7500V	5-78
IL2B-4	Q68000-A8737	Optocoupler, 6 Pin Single, 40% CTR, 7500V	5-78
IL2B-5	Q68000-A8738	Optocoupler, 6 Pin Single, 20% CTR, 7500V	5-78
IL5	Q68000-A5931	Optocoupler, 6 Pin Single, 50% CTR, 7500V	5-73
IL8	Q68000-A8739	Optocoupler, 4 Pin Single, 20% CTR, 8KV without Base Lead	5-81
IL9	Q68000-A8740	Optocoupler, 6 Pin Single, 20% CTR, 8KV with Base Lead	5-81
IL10	Q68000-A879	Optocoupler, 4 Pin Single, 50% CTR, 8KV without Base Lead	5-81
IL11	Q68000-A8325	Optocoupler, 6 Pin Single, 50% CTR, 8KV with Base Lead	5-81
IL30	Q62703-N27	Optocoupler, 6 Pin Single, 100% CTR, 7500V, Photodarlington	5-83
IL31	Q62703-N177	Optocoupler, 6 Pin Single, 200% CTR, 7500V, Photodarlington	5-83
IL55	Q62703-N29	Optocoupler, 6 Pin Single, 100% CTR, 7500V, Photodarlington	5-83
IL66-1	Q68000-A8741	Optocoupler, 6 Pin Single, 100% CTR, 7500V, Photodarlington	5-86
IL66-2	Q68000-A8742	Optocoupler, 6 Pin Single, 300% CTR, 7500V, Photodarlington	5-86
IL66-3	Q68000-A8743	Optocoupler, 6 Pin Single, 400% CTR, 7500V, Photodarlington	5-86
IL66-4	Q68000-A8744	Optocoupler, 6 Pin Single, 500% CTR, 7500V, Photodarlington	5-86
IL66B-1	Q68000-A8745	Optocoupler, 6 Pin Single, 200% CTR, 7500V, Photodarlington	5-89
IL66B-2	Q68000-A8746	Optocoupler, 6 Pin Single, 750% CTR, 7500V, Photodarlington	5-89
IL74	Q62703-N28	Optocoupler, 6 Pin Single, 12.5% CTR, 7500V	5-91

ALPHANUMERIC INDEX (use ordering code numbers when ordering in Europe)

PART NO.	ORDERING CODE NO.	DESCRIPTION	PAGE
IL201	Q62703-N0042	Optocoupler, 6 Pin Single, 10% CTR, 7500V	5-96
IL202	Q62703-N0041	Optocoupler, 6 Pin Single, 30% CTR, 7500V	5-96
IL203	Q62703-N162	Optocoupler, 6 Pin Single, 50% CTR, 7500V	5-96
IL205	Q68000-A7834	Optocoupler, SMD, Phototransistor, 40-80% CTR, 2500V	5-99
IL205T	Q68000-A7926	Optocoupler, SMD, Phototransistor, 40-80% CTR, 2500V, Tape/Reel	5-99
IL206	Q68000-A7835	Optocoupler, SMD, Phototransistor, 63-125% CTR, 2500V	5-99
IL206T	Q68000-A7927	Optocoupler, SMD, Phototransistor, 63-125% CTR, 2500V, Tape/Reel	5-99
IL207	Q68000-A7836	Optocoupler, SMD, Phototransistor, 100-200% CTR, 2500V	5-99
IL207T	Q68000-A7928	Optocoupler, SMD, Phototransistor, 100-200% CTR, 2500V, Tape/Reel	5-99
IL208	Q68000-A8782	Optocoupler, SMD, Phototransistor, 160-320% CTR, 2500V, Tape/Reel	5-99
IL208T	Q68000-A8783	Optocoupler, SMD, Phototransistor, 160-320% CTR, 2500V, Tape/Reel	5-99
IL211	Q68000-A7837	Optocoupler, SMD, Phototransistor, 20% CTR, 2500V	5-101
IL211T	Q68000-A8251	Optocoupler, SMD, Phototransistor, 20% CTR, 2500V, Tape/Reel	5-101
IL212	Q68000-A7838	Optocoupler, SMD, Phototransistor, 50% CTR, 2500V	5-101
IL212T	Q68000-A8252	Optocoupler, SMD, Phototransistor, 50% CTR, 2500V, Tape/Reel	5-101
IL213	Q68000-A7839	Optocoupler, SMD, Phototransistor, 100% CTR, 2500V	5-101
IL213T	Q68000-A8253	Optocoupler, SMD, Phototransistor, 100% CTR, 2500V, Tape/Reel	5-101
IL215	Q68000-A7840	Optocoupler, SMD, Phototransistor, 20% CTR, 2500V	5-103
IL215T	Q68000-A7929	Optocoupler, SMD, Phototransistor, 20% CTR, 2500V, Tape/Reel	5-103
IL216	Q68000-A7841	Optocoupler, SMD, Phototransistor, 50% CTR, 2500V	5-103
IL216T	Q68000-A7930	Optocoupler, SMD, Phototransistor, 50% CTR, 2500V, Tape/Reel	5-103
IL217	Q68000-A7842	Optocoupler, SMD, Phototransistor, 100% CTR, 2500V	5-103
IL217T	Q68000-A7931	Optocoupler, SMD, Phototransistor, 100% CTR, 2500V, Tape/Reel	5-103
IL221	Q68000-A7843	Optocoupler, SMD, Photodarlington, 100% CTR, 2500V	5-106
IL221T	Q68000-A8254	Optocoupler, SMD, Photodarlington, 100% CTR, 2500V, Tape/Reel	5-106
IL222	Q68000-A7844	Optocoupler, SMD, Photodarlington, 200% CTR, 2500V	5-106
IL222T	Q68000-A8255	Optocoupler, SMD, Photodarlington, 200% CTR, 2500V, Tape/Reel	5-106
IL223	Q68000-A7845	Optocoupler, SMD, Photodarlington, 500% CTR, 2500V	5-106
IL223T	Q68000-A8256	Optocoupler, SMD, Photodarlington, 500% CTR, 2500V, Tape/Reel	5-106
IL250	Q62703-N80	Optocoupler, 6 Pin Single, 50% CTR, 7500V, AC Input	5-109
IL251	Q68000-A7811	Optocoupler, 6 Pin Single, 20% CTR, 7500V, AC Input	5-109
IL252	Q68000-A8687	Optocoupler, 6 Pin Single, 100% CTR, 7500V, AC Input	5-109
IL256	Q68000-A7846	Optocoupler, SMD, 20% CTR, 2500V, AC Input	5-112
IL256T	Q68000-A8372	Optocoupler, SMD, 20% CTR, 2500V, AC Input, Tape/Reel	5-112
IL300	Q68000-A8483	Optocoupler, 8 Pin DIP, Linear 7500V	5-115
IL400	Q68000-A4376	Optocoupler, 6 Pin Single, Photo SCR, 7500V	5-123
IL410	Q68000-A8476	Optocoupler, 6 Pin Single, Zero Voltage Crossing, Triac, 7500V	5-124
IL420	Q68000-A8577	Optocoupler, 6 Pin Single, Triac, 7500V	5-131
IL755-1	Q68000-A8694	Optocoupler, 6 Pin Single, P/darlington, 750% CTR, 7500V, AC Input	5-135
IL755-2	Q68000-A8695	Optocoupler, 6 Pin Single, P/darlington, 1000% CTR, 7500V, AC Input	5-135
IL755B-1	Q68000-A8696	Optocoupler, 6 Pin Single, P/darlington, 750% CTR, 7500V, AC Input, No Base	5-138
IL755B-2	Q68000-A8697	Optocoupler, 6 Pin Single, P/darlington, 1000% CTR, 7500V, AC Input, No Base	5-138
IL766-1	Q68000-A7938	Optocoupler, 6 Pin Single, P/darlington, 500% CTR, 7500V, AC Input	5-141
IL766-2	Q68000-A7939	Optocoupler, 6 Pin Single, P/darlington, 500% CTR, 7500V, AC Input	5-141
IL766B-1	Q68000-A8785	Optocoupler, 6 Pin Single, P/darlington, 400% CTR, 7500V, Bidirectional	5-144
IL766B-2	Q68000-A8786	Optocoupler, 6 Pin Single, P/darlington, 900% CTR, 7500V, Bidirectional	5-144
IL4116	Q68000-A8688	Optocoupler, 6 Pin Single, Zero Voltage Crossing, Triac, 7500V	5-145
IL4117	Q68000-A8689	Optocoupler, 6 Pin Single, Zero Voltage Crossing, Triac, 7500V	5-145
IL4118	Q68000-A8690	Optocoupler, 6 Pin Single, Zero Voltage Crossing, Triac, 7500V	5-145
IL4216	Q68000-A8691	Optocoupler, 6 Pin Single, Triac, 7500V	5-149
IL4217	Q68000-A8692	Optocoupler, 6 Pin Single, Triac, 7500V	5-149
IL4218	Q68000-A8693	Optocoupler, 6 Pin Single, Triac, 7500V	5-149
ILCT6	Q62703-N48	Optocoupler, 8 Pin Dual, 20% CTR, 7500V	5-153
ILD1	Q68000-A5972	Optocoupler, 8 Pin Dual, 20% CTR, 7500V	5-156
ILD2	Q68000-A4357	Optocoupler, 8 Pin Dual, 100% CTR, 7500V	5-156
ILD5	Q68000-A8024	Optocoupler, 8 Pin Dual, 50% CTR, 7500V	5-156
ILD30	Q68000-A4377	Optocoupler, 8 Pin Dual, 100% CTR, 7500V, Photodarlington	5-83
ILD31	Q68000-A8698	Optocoupler, 8 Pin Dual, 200% CTR, 7500V, Photodarlington	5-83
ILD32	Q68000-A8445	Optocoupler, 8 Pin Dual, 500% CTR, 7500V, Photodarlington	5-160
ILD55	Q68000-A4378	Optocoupler, 8 Pin Dual, 100% CTR, 7500V, Photodarlington	5-83
ILD66-1	Q68000-A8699	Optocoupler, 8 Pin Dual, 100% CTR, 7500V, Photodarlington	5-86
ILD66-2	Q68000-A8700	Optocoupler, 8 Pin Dual, 300% CTR, 7500V, Photodarlington	5-86
ILD66-3	Q68000-A8701	Optocoupler, 8 Pin Dual, 400% CTR, 7500V, Photodarlington	5-86

ALPHANUMERIC INDEX (use ordering code numbers when ordering in Europe)

PART NO.	ORDERING CODE NO.	DESCRIPTION	PAGE
ILD66-4	Q68000-A8702	Optocoupler, 8 Pin Dual, 500% CTR, 7500V, Photodarlington	5-86
ILD74	Q68000-A5973	Optocoupler, 8 Pin Dual, 12.5% CTR, 7500V	5-91
ILD205	Q68000-A8703	Optocoupler, SMD, Dual, Phototransistor, 40-80% CTR, 2500V	5-163
ILD206	Q68000-A8704	Optocoupler, SMD, Dual, Phototransistor, 63-125% CTR, 2500V	5-163
ILD207	Q68000-A8720	Optocoupler, SMD, Dual, Phototransistor, 100-200% CTR, 2500V	5-163
ILD213	Q68000-A8721	Optocoupler, SMD, Dual, Phototransistor, 100% CTR, 2500V	5-163
ILD223	Q68000-A8722	Optocoupler, SMD, Dual, Photodarlington, 500% CTR, 2500V	5-165
ILD250	Q68000-A8457	Optocoupler, 8 Pin Dual, 50% CTR, 7500V, AC Input	5-109
ILD251	Q68000-A8458	Optocoupler, 8 Pin Dual, 20% CTR, 7500V, AC Input	5-109
ILD252	Q68000-A8459	Optocoupler, 8 Pin Dual, 100% CTR, 7500V, AC Input	5-109
ILD255	Q68000-A8784	Optocoupler, 8 Pin Dual, 50% CTR, 7500V, AC Input, Bidirectional	5-167
ILD610-1	Q68000-A4467	Optocoupler, 8 Pin Dual, 40-80% CTR, 7500V	5-169
ILD610-2	Q68000-A4468	Optocoupler, 8 Pin Dual, 63-125% CTR, 7500V	5-169
ILD610-3	Q68000-A6542	Optocoupler, 8 Pin Dual, 100-200% CTR, 7500V	5-169
ILD610-4	Q68000-A7818	Optocoupler, 8 Pin Dual, 160-320% CTR, 7500V	5-169
ILD615-1	Q68000-A8460	Optocoupler, 8 Pin Dual, 40-80% CTR, 7500V	5-172
ILD615-2	Q68000-A8461	Optocoupler, 8 Pin Dual, 63-125% CTR, 7500V	5-172
ILD615-3	Q68000-A8462	Optocoupler, 8 Pin Dual, 100-200% CTR, 7500V	5-172
ILD615-4	Q68000-A8463	Optocoupler, 8 Pin Dual, 160-320% CTR, 7500V	5-172
ILD620	Q68000-A8464	Optocoupler, 8 Pin Dual, 50% CTR, 7500V, AC Input	5-177
ILD620GB	Q68000-A8478	Optocoupler, 8 Pin Dual, 100% CTR, 7500V, AC Input	5-177
ILD621	Q68000-A8465	Optocoupler, 8 Pin Dual, 50% CTR, 7500V	5-181
ILD621GB	Q68000-A8466	Optocoupler, 8 Pin Dual, 100% CTR, 7500V	5-181
ILD755-1	Q68000-A6048	Optocoupler, 8 Pin Dual, Photodarlington, 750% CTR, 7500V, AC Input	5-143
ILD755-2	Q68000-A6049	Optocoupler, 8 Pin Dual, Photodarlington, 1000% CTR, 7500V, AC Input	5-143
ILD766-1	Q68000-A6050	Optocoupler, 8 Pin Dual, Photodarlington, 500% CTR, 7500V, I _F =2 mA, AC Input	5-149
ILD766-2	Q68000-A8787	Optocoupler, 8 Pin Dual, Photodarlington, 500% CTR, 7500V, I _F =1 mA, AC Input	5-149
ILH100	Q68000-A8705	Optocoupler, 8 Pin Single, Ceramic	5-186
ILH200	Q68000-A8708	Optocoupler, 8 Pin Dual, Ceramic	5-193
ILQ1	Q68000-A5974	Optocoupler, 16 Pin Quad, 20% CTR, 7500V	5-156
ILQ2	Q68000-A4358	Optocoupler, 16 Pin Quad, 100% CTR, 7500V	5-156
ILQ5	Q68000-A7995	Optocoupler, 16 Pin Quad, 50% CTR, 7500V	5-156
ILQ30	Q68000-A4379	Optocoupler, 16 Pin Quad, 100% CTR, 7500V, Photodarlington	5-83
ILQ31	Q68000-A8520	Optocoupler, 16 Pin Quad, 200% CTR, 7500V, Photodarlington	5-83
ILQ32	Q68000-A8723	Optocoupler, 16 Pin Quad, 500% CTR, 7500V, Photodarlington	5-160
ILQ55	Q68000-A4380	Optocoupler, 16 Pin Quad, 100% CTR, 7500V, Photodarlington	5-83
ILQ66-1	Q68000-A8711	Optocoupler, 16 Pin Quad, 100% CTR, 7500V, Photodarlington	5-86
ILQ66-2	Q68000-A8712	Optocoupler, 16 Pin Quad, 300% CTR, 7500V, Photodarlington	5-86
ILQ66-3	Q68000-A8713	Optocoupler, 16 Pin Quad, 400% CTR, 7500V, Photodarlington	5-86
ILQ66-4	Q68000-A8714	Optocoupler, 16 Pin Quad, 500% CTR, 7500V, Photodarlington	5-86
ILQ74	Q68000-A6185	Optocoupler, 16 Pin Quad, 12.5% CTR, 7500V	5-91
ILQ615-1	Q68000-A8450	Optocoupler, 16 Pin Quad, 40-80% CTR, 7500V	5-172
ILQ615-2	Q68000-A8451	Optocoupler, 16 Pin Quad, 63-125% CTR, 7500V	5-172
ILQ615-3	Q68000-A8452	Optocoupler, 16 Pin Quad, 100-200% CTR, 7500V	5-172
ILQ615-4	Q68000-A8453	Optocoupler, 16 Pin Quad, 160-320% CTR, 7500V	5-172
ILQ620	Q68000-A8454	Optocoupler, 16 Pin Quad, 50% CTR, 7500V, AC Input	5-177
ILQ620GB	Q68000-A8479	Optocoupler, 16 Pin Quad, 100% CTR, 7500V, AC Input	5-177
ILQ621	Q68000-A8455	Optocoupler, 16 Pin Quad, 50% CTR, 7500V	5-181
ILQ621GB	Q68000-A8456	Optocoupler, 16 Pin Quad, 100% CTR, 7500V	5-181
IP-251B		LED Die, 0.4x0.4 GaAsP/GaAs	1-8
IPD2131		Programmable Display, 8 Char, .200", Dot Matrix Yellow, Industrial	2-81
IPD2132		Programmable Display, 8 Char, .200", Dot Matrix HER, Industrial	2-81
IPD2133		Programmable Display, 8 Char, .200", Dot Matrix HEG, Industrial	2-81
IPD2545A	Q68000-A7888	Programmable Display, 4 Char, .15", Dot Matrix HER, Industrial	2-95
IPD2547A	Q68000-A7889	Programmable Display, 4 Char, .15", Dot Matrix Green, Industrial	2-95
IPD2548A		Programmable Display, 4 Char, .15", Dot Matrix Yellow, Industrial	2-95
IR-B2	Q62901-B79	Infrared Indicator Card	8-106
IRL80A	Q68000-A7851	Emitter, IR, Side Facing, GaAs	7-5
IRL81A	Q68000-A8000	Emitter, IR, Side Facing, GaAlAs	7-5

ALPHANUMERIC INDEX (use ordering code numbers when ordering in Europe)

PART NO.	ORDERING CODE NO.	DESCRIPTION	PAGE
ISD2010	Q68000-A8134	Small Alphanumeric Indus. Display, 4 Char, 15° Dot Matrix Yellow	2-104
ISD2011	Q68000-A8135	Small Alphanumeric Indus. Display, 4 Char, 15° Dot Matrix Yellow	2-104
ISD2012	Q68000-A8136	Small Alphanumeric Indus. Display, 4 Char, 15° Dot Matrix HER	2-104
ISD2013	Q68000-A8137	Small Alphanumeric Indus. Display, 4 Char, 15° Dot Matrix Green	2-104
ISD2310	Q68000-A8138	Small Alphanumeric Indus. Display, 4 Char, 20° Dot Matrix Red	2-111
ISD2311	Q68000-A8139	Small Alphanumeric Indus. Display, 4 Char, 20° Dot Matrix Yellow	2-111
ISD2312	Q68000-A8140	Small Alphanumeric Indus. Display, 4 Char, 20° Dot Matrix HER	2-111
ISD2313	Q68000-A8141	Small Alphanumeric Indus. Display, 4 Char, 20° Dot Matrix Green	2-111
ISD2351	Q68000-A8142	Small Alphanum. Indus. Display, 4 Char, 20° Dot Matrix Yellow, Sunlight View	2-118
ISD2352	Q68000-A8143	Small Alphanum. Indus. Display, 4 Char, 20° Dot Matrix HER, Sunlight View	2-118
ISD2353	Q68000-A8144	Small Alphanum. Indus. Display, 4 Char, 20° Dot Matrix Green, Sunlight View	2-118
KOM 2033A	Q62702-K2	Photodiode, 6 Chip, Array, 60°	8-41
KOM 2033AF	Q62702-K39	Photodiode, 6 Chip, Array, 60°, Daylight Filter	8-41
KOM 2033B	Q62702-K26	Photodiode, 6 Chip, Array, 60°	8-44
KOM 2033BF	Q62702-K38	Photodiode, 6 Chip, Array, 60°, Daylight Filter	8-44
KOM 2045	Q62702-K3	Photodiode, 8 Chip, Array, 60°, Low Dark Current	8-47
KOM 2057L	Q62702-K8	Photodiode, 3 Chip, Array, 60°	8-49
KOM 2059	Q62702-K4	Photodiode, 64 Element Circular Array	8-51
KOM 2084	Q62702-K15	Photodiode, 4 Chip, Array, 60°	8-53
KOM 2085	Q62702-K16	Photodiode, 4 Chip, Array, 60°	8-55
KOM 2100A	Q62702-K37	Photodiode, 6 Chip, Array, 60°, SMD	8-41
KOM 2100AF	Q62702-K36	Photodiode, 6 Chip, Array, 60°, Daylight Filter, SMD	8-41
KOM 2100B	Q62702-K35	Photodiode, 6 Chip, Array, 60°, SMD	8-44
KOM 2100BF	Q62702-K34	Photodiode, 6 Chip, Array, 60°, Daylight Filter, SMD	8-44
LA-200A		LED Material, 8.0x0.4, GaAsP/GaAs	1-9
LA-300A		LED Material, 5.4x0.4, GaAsP/GaAs	1-9
LA-300B		LED Material, 5.4x0.4, GaAsP/GaAs	1-9
LA-300C		LED Material, 5.4x0.4, GaAsP/GaAs	1-9
LA-300D		LED Material, 5.4x0.4, GaAsP/GaAs	1-9
LA-301A		LED Material, 5.4x0.4, GaAsP/GaAs	1-9
LB 5410-HO	Q68000-A5700	Lamp, Blue, T1 ¼ (5 mm), 2.5 mcd/20 mA, 35°	4-17
LD242-2	Q62703-Q198	Emitter, IR, TO-18, 40°, 4-8 mW/sr	7-7
LD242-3	Q62703-Q199	Emitter, IR, TO-18, 40° 6.3-12.5 mW/sr	7-7
LD242-4	Q62703-Q1912	Emitter, IR, TO-18, 40° >10 mW/sr	7-7
LD242-L E7800	Q62703-Q2157	Emitter, IR, TO-18, 40°	7-7
LD242-M E7800	Q62703-Q2158	Emitter, IR, TO-18, 40°	7-7
LD260	Q62703-Q78	Emitter, IR, 10 Element Array, 30°	7-9
LD261-4	Q62703-Q66	Emitter, IR, 1 Element, 30°	7-9
LD261-5	Q62703-Q67	Emitter, IR, 1 Element, 30°	7-9
LD261-6	Q62703-Q236	Emitter, IR, 1 Element, 30°	7-9
LD262	Q62703-Q70	Emitter, IR, 2 Element Array, 30°	7-9
LD263	Q62703-Q71	Emitter, IR, 3 Element Array, 30°	7-9
LD264	Q62703-Q72	Emitter, IR, 4 Element Array, 30°	7-9
LD265	Q62703-Q73	Emitter, IR, 5 Element Array, 30°	7-9
LD266	Q62703-Q74	Emitter, IR, 6 Element Array, 30°	7-9
LD267	Q62703-Q75	Emitter, IR, 7 Element Array, 30°	7-9
LD268	Q62703-Q76	Emitter, IR, 8 Element Array, 30°	7-9
LD269	Q62703-Q77	Emitter, IR, 9 Element Array, 30°	7-9
LD271	Q62703-Q148	Emitter, IR, T1 ¼ (5 mm), Plastic, 25°, >10 mW/sr	7-11
LD271L	Q62703-Q833	Emitter, IR, T1 ¼ (5 mm), Plastic, 25°, >10 mW/sr, 1' Leads	7-11
LD274-1	Q62703-Q1818	Emitter, IR, T1 ¼ (5 mm), Plastic, 10°, 30-60 mW/sr	7-13
LD274-2	Q62703-Q1819	Emitter, IR, T1 ¼ (5 mm), Plastic, 10°, 50-100mW/sr	7-13
LD274-3	Q62703-Q1920	Emitter, IR, T1 ¼ (5 mm), Plastic, 10°, >80 mW/sr	7-13
LD275-1	Q62703-Q1919	Emitter, IR, T1 ¼ (5 mm), Plastic, 18°, 10-20mW/sr	7-13
LD275-2	Q62703-Q1918	Emitter, IR, T1 ¼ (5 mm), Plastic, 18°, 16-32 mW/sr	7-13
LD275-3	Q62703-Q1917	Emitter, IR, T1 ¼ (5 mm), Plastic, 18°, >25 mW/sr	7-13
LD1005		Replaced by LU 5351-GL	
LD1006		Replaced by LU 5351-GL	
LD1007		Replaced by LU 5351-JM	
LD1103		Replaced by LU B371-EJ	
LD1104		Replaced by LU B371-EJ	
LD1105		Replaced by LU B371-GK	

ALPHANUMERIC INDEX (use ordering code numbers when ordering in Europe)

PART NO.	ORDERING CODE NO.	DESCRIPTION	PAGE
LDB5410		Replaced by LB 5410-HO	
LDG1151		Replaced by LG 3360-GK	
LDG1152		Replaced by LG 3360-JM	
LDG1153		Replaced by LG 3360-JM	
LDG3901		Replaced by LG B480-EH	
LDG3902		Replaced by LG B480-EH	
LDG3903		Replaced by LG B480-GK	
LDG5071		Replaced by LG 5360-GK	
LDG5072		Replaced by LG 5360-JM	
LDG5171		Replaced by LG 5360-GK	
LDG5172		Replaced by LG 5360-JM	
LDG5591		Replaced by LG 5410-MQ	
LDG5592		Replaced by LG 5410-PS	
LDH1111		Replaced by LS 3360-HL	
LDH1112		Replaced by LS 3360-KN	
LDH1113		Replaced by LS 3360-KN	
LDH3601		Replaced by LS B480-EH	
LDH3602		Replaced by LS B480-GK	
LDH3603		Replaced by LS B480-GK	
LDH5021		Replaced by LS 5360-HL	
LDH5022		Replaced by LS 5360-KN	
LDH5023		Replaced by LS 5360-KN	
LDH5121		Replaced by LS 5460-HL	
LDH5122		Replaced by LS 5460-KN	
LDH5123		Replaced by LS 5460-KN	
LDH5191		Replaced by LS 5420-LP	
LDH5192		Replaced by LS 5420-NR	
LDH5193		Replaced by LS 5420-P	
LDR1101		Replaced by LR 3360-DG	
LDR1102		Replaced by LR 3360-FJ	
LDR1103		Replaced by LR 3360-G	
LDR3701		Replaced by LR B480-BD	
LDR3702		Replaced by LR B480-C	
LDR5001		Replaced by LR 5360-DG	
LDR5002		Replaced by LR 5360-FJ	
LDR5003		Replaced by LR 5360-G	
LDR5091		Replaced by LR 5420-GK	
LDR5092		Replaced by LR 5420-GK	
LDR5093		Replaced by LR 5420-H	
LDR5101		Replaced by LR 5460-DG	
LDR5102		Replaced by LR 5460-FJ	
LDR5103		Replaced by LR 5460-G	
LDY1131		Replaced by LY 3360-HL	
LDY1132		Replaced by LY 3360-HL	
LDY1133		Replaced by LY 3360-JM	
LDY3801		Replaced by LY B480-EH	
LDY3802		Replaced by LY B480-EH	
LDY3803		Replaced by LY B480-GK	
LDY5061		Replaced by LY 5360-GK	
LDY5062		Replaced by LY 5360-HL	
LDY5161		Replaced by LY 5460-GK	
LDY5162		Replaced by LY 5460-JM	
LDY5163		Replaced by LY 5460-JM	
LDY5391		Replaced by LY 5420-LP	
LDY5392		Replaced by LY 5420-NR	
LDY5393		Replaced by LY 5420-P	
LG 3330-KN	Q62703-Q1698	Lamp, Green, T1 (3 mm), 6.3–50 mcd/10 mA, 50°	4–29
LG 3330-L	Q62703-Q1699	Lamp, Green, T1 (3 mm), 10–20 mcd/10 mA, 50°	4–29
LG 3330-LP	Q62703-Q2011	Lamp, Green, T1 (3 mm), 10–80 mcd/10 mA, 50°	4–29
LG 3330-M	Q62703-Q1700	Lamp, Green, T1 (3 mm), 16–32 mcd/10 mA, 50°	4–29
LG 3330-N	Q62703-Q2010	Lamp, Green, T1 (3 mm), 25–50 mcd/10 mA, 50°	4–29
LG 3341-JM	Q62703-Q2153	Lamp, Green, T1 (3 mm), 4–32 mcd/10 mA, 40°	4–30
LG 3341-L	Q62703-Q2154	Lamp, Green, T1 (3 mm), 10–20 mcd/10 mA, 40°	4–30
LG 3341-LP	Q62703-Q2156	Lamp, Green, T1 (3 mm), 10–80 mcd/10 mA, 40°	4–30
LG 3341-M	Q62703-Q2155	Lamp, Green, T1 (3 mm), 16–32 mcd/10 mA, 40°	4–30
LG 3360-GK	Q62703-Q1331	Lamp, Green, T1 (3 mm), 1.6–12.5 mcd/10 mA, 70°	4–22
LG 3360-J	Q62703-Q1865	Lamp, Green, T1 (3 mm), 4.0–8.0 mcd/10 mA, 70°	4–22
LG 3360-JM	Q62703-Q2009	Lamp, Green, T1 (3 mm), 4.0–32.0 mcd/10 mA, 70°	4–22
LG 3360-K	Q62703-Q2008	Lamp, Green, T1 (3 mm), 6.3–12.5 mcd/10 mA, 70°	4–22
LG3369-EH	Q62703-Q1750	Lamp, Green, T1 (3 mm) Low Current, 0.63–5.0 mcd/2 mA, 60°	4–31

ALPHANUMERIC INDEX (use ordering code numbers when ordering in Europe)

PART NO.	ORDERING CODE NO.	DESCRIPTION	PAGE
LG3369-EO		Replaced by LG 3369-EH	
LG3369-FH	Q62703-Q1713	Lamp, Green, T1 (3 mm), Low Current, 1.0–5.0 mcd/2 mA, 60°	4-31
LG3369-FO		Replaced by LG 3369-FH	
LG 3380-GK	Q62703-Q1356	Lamp, Green, T1 (3 mm), Wide Angle, 1.6–12.0 mcd/10 mA, 100°	4-32
LG 3380-HL	Q62703-Q1359	Lamp, Green, T1 (3 mm), Wide Angle, 2.5–20 mcd/10 mA, 100°	4-32
LG 3380-H	Q62703-Q1358	Lamp, Green, T1 (3 mm), Wide Angle, 2.5–5.0 mcd/10 mA, 100°	4-32
LG 3380-J	Q62703-Q2318	Lamp, Green, T1 (3 mm), Wide Angle, 4.0–8.0 mcd/10 mA, 100°	4-32
LG 5360-GK	Q62703-Q1391	Lamp, Green, T1 ¼ (5 mm), Diffuse, 1.6–12.5 mcd/10 mA, 50°	4-23
LG 5360-H	Q62703-Q1390	Lamp, Green, T1 ¼ (5 mm), Diffuse, 2.5–5.0 mcd/10 mA, 50°	4-23
LG 5360-J	Q62703-Q1866	Lamp, Green, T1 ¼ (5 mm), Diffuse, 4.0–8.0 mcd/10 mA, 50°	4-23
LG 5360-JM	Q62703-Q2013	Lamp, Green, T1 ¼ (5 mm), Diffuse, 4.0–32.0 mcd/10 mA, 50°	4-23
LG 5360-K	Q62703-Q2012	Lamp, Green, T1 ¼ (5 mm), Diffuse, 6.3–12.5 mcd/10 mA, 50°	4-23
LG 5380-FJ	Q62703-Q1463	Lamp, Green, T1 ¼ (5 mm), Wide Angle, 1.0–8.0 mcd/10 mA, 80°	4-33
LG 5380-H	Q62703-Q2032	Lamp, Green, T1 ¼ (5 mm), Wide Angle, 2.5–5.0 mcd/10 mA, 80°	4-33
LG 5380-HL	Q62703-Q2017	Lamp, Green, T1 ¼ (5 mm), Wide Angle, 2.5–20 mcd/10 mA, 80°	4-33
LG 5380-J	Q62603-Q2016	Lamp, Green, T1 ¼ (5 mm), Wide Angle, 4.0–8.0 mcd/10 mA, 80°	4-33
LG 5410-MQ	Q62703-Q1439	Lamp, Green, T1 ¼ (5 mm), Clear, 16–125 mcd/10 mA, 24°	4-34
LG 5410-P	Q62703-Q1838	Lamp, Green, T1 ¼ (5 mm), Clear, 40–80 mcd/10 mA, 24°	4-34
LG 5410-PS	Q62703-Q2022	Lamp, Green, T1 ¼ (5 mm), Clear, 40–320 mcd/10 mA, 24°	4-34
LG 5410-Q	Q62703-Q2020	Lamp, Green, T1 ¼ (5 mm), Clear, 63–125 mcd/10 mA, 24°	4-34
LG 5410-R	Q62703-Q2021	Lamp, Green, T1 ¼ (5 mm), Clear, 100–200 mcd/10 mA, 24°	4-34
LG 5411-LO		Replaced by LG 5411-MQ	
LG 5411-NR	Q62703-Q2023	Lamp, Green, T1 ¼ (5 mm), Clear, Superbright, 25–200 mcd/10 mA, 20°	4-35
LG 5411-NO		Replaced by LG 5411-PS	
LG 5411-Q	Q62703-Q1739	Lamp, Green, T1 ¼ (5 mm), Clear, Superbright, 63–125 mcd/10 mA, 20°	4-35
LG 5411-PO		Replaced by LG 5411-PS	
LG 5411-QT	Q62703-Q2024	Lamp, Green, T1 ¼ (5 mm), Clear, Superbright, 63–500 mcd/10 mA, 20°	4-35
LG 5411-R	Q62703-Q1451	Lamp, Green, T1 ¼ (5 mm), Clear, Superbright, 100–200 mcd/10 mA, 20°	4-35
LG 5411-S	Q62703-Q2321	Lamp, Green, T1 ¼ (5 mm), Clear, Superbright, 160–320 mcd/10 mA, 20°	4-35
LG 5460-GK	Q62703-Q1407	Lamp, Green, T1 ¼ (5 mm), Diffuse, 1.6–12.5 mcd/10 mA, 50°	4-24
LG 5460-H	Q62703-Q1406	Lamp, Green, T1 ¼ (5 mm), Diffuse, 2.5–5.0 mcd/10 mA, 50°	4-24
LG 5460-J	Q62703-Q1867	Lamp, Green, T1 ¼ (5 mm), Diffuse, 4.0–8.0 mcd/10 mA, 50°	4-24
LG 5460-JM	Q62703-Q2015	Lamp, Green, T1 ¼ (5 mm), Diffuse, 4.0–32.0 mcd/10 mA, 50°	4-24
LG 5460-K	Q62703-Q2014	Lamp, Green, T1 ¼ (5 mm), Diffuse, 6.3–12.5 mcd/10 mA, 50°	4-24
LG 5469-EH	Q62703-Q1753	Lamp, Green, T1 ¼ (5 mm), Diffuse, Low Current, 0.63–5.0 mcd/2 mA, 60°	4-36
LG 5469-EO		Replaced by LG5469-EH	
LG 5469-FH	Q62703-Q1716	Lamp, Green, T1 ¼ (5 mm), Diffuse, Low Current, 1.0–5.0 mcd/2 mA, 60°	4-36
LG 5469-FO		Replaced by LG5469-FH	
LG 5480-GK	Q62703-Q1423	Lamp, Green, T1 ¼ (5 mm), Wide Angle, 1.6–12.5 mcd/10 mA, 80°	4-25
LG 5480-H	Q62703-Q1422	Lamp, Green, T1 ¼ (5 mm), Wide Angle, 2.5–5.0 mcd/10 mA, 80°	4-25
LG 5480-J	Q62703-Q1869	Lamp, Green, T1 ¼ (5 mm), Wide Angle, 4.0–8.0 mcd/10 mA, 80°	4-25
LG 5480-JM	Q62703-Q2019	Lamp, Green, T1 ¼ (5 mm), Wide Angle, 4.0–32.0 mcd/10 mA, 80°	4-25
LG 5480-K	Q62703-Q2018	Lamp, Green, T1 ¼ (5 mm), Wide Angle, 6.3–12.5 mcd/10 mA, 80°	4-25
LG B480-EH	Q62703-Q1477	Lamp, Green, Rectangular, 0.63–5.0 mcd/10 mA, 100°	4-26
LG B480-G	Q62703-Q1870	Lamp, Green, Rectangular, 1.6–3.2 mcd/10 mA, 100°	4-26
LG B480-GK	Q62703-Q2026	Lamp, Green, Rectangular, 1.6–12.5 mcd/10 mA, 100°	4-26
LG B480-H	Q62703-Q2025	Lamp, Green, Rectangular, 2.5–5.0 mcd/10 mA, 100°	4-26
LG H380-EH	Q62703-Q1491	Lamp, Green, Cylindrical, 0.63–5.0 mcd/10 mA, 100°	4-27
LG H380-G	Q62703-Q1871	Lamp, Green, Cylindrical, 1.6–3.2 mcd/10 mA, 100°	4-27
LG H380-GK	Q62703-Q2027	Lamp, Green, Cylindrical, 1.6–12.5 mcd/10 mA, 100°	4-27
LG H380-H	Q62703-Q1872	Lamp, Green, Cylindrical, 2.5–5.0 mcd/10 mA, 100°	4-27
LG K380-LP	Q62703-Q1770	Lamp, Green, T1 (3mm), ARGUS®, 10–80 mlm/15 mA	4-41
LG K380-N	Q62703-Q0759	Lamp, Green, T1 (3mm), ARGUS®, 25–50 mlm/15 mA	4-41
LG K380-NR	Q62703-Q2225	Lamp, Green, T1 (3mm), ARGUS®, 25–200 mlm/15 mA	4-41
LG K380-P	Q62703-Q1034	Lamp, Green, T1 (3mm), ARGUS®, 40–80 mlm/15 mA	4-41
LG K382-RO	Q62703-Q1959	Lamp, Green, T1 (3mm), 160 mlm/50 mA, Super ARGUS	4-44
LG K389-FO	Q62703-Q1773	Lamp, Green, 3.2 mlm/2 mA, Low Current ARGUS®	4-45
LG S260-DO	Q62703-Q1608	Lamp, Green, SOT23 SMD, 0.4 mcd/10 mA, 140°	4-46
LG S269-BO	Q62703-Q1570	Lamp, Green, SOT23 SMD, Low Current, 0.16 mcd min/2 mA, 140°	4-47
LG T670-HK	Q62703-Q2312	Lamp, Green, SMT-TOP-LED, 2.5–12.5 mcd/10 mA, 120°	4-48

ALPHANUMERIC INDEX (use ordering code numbers when ordering in Europe)

PART NO.	ORDERING CODE NO.	DESCRIPTION	PAGE
LG T670-J	Q62703-Q2377	Lamp, Green, SMT-TOP-LED, 4.0–8.0 mcd/10 mA, 120°	4-48
LG T670-JL	Q62703-Q2505	Lamp, Green, SMT-TOP-LED, 4.0–20.0 mcd/10 mA, 120°	4-48
LG T670-K	Q62703-Q2378	Lamp, Green, SMT-TOP-LED, 6.3–12.5 mcd/10 mA, 120°	4-48
LG T672-MO	Q62703-Q2333	Lamp, Green, SMT-Super-TOP-LED, 30 mcd/10 mA, 120°	4-49
LG T679-CO	Q62703-Q2385	Lamp, Green, SMT-TOP-LED, 1 mcd/2 mA, 120°	4-50
LG U260-EO	Q62703-Q1494	Lamp, Green, Miniature, 1 mm, 0.63 mcd min /10 mA, 120°	4-51
LG Z180-CO	Q62703-Q1515	Lamp, Green, 10 Element Array, 0.25 mcd min/10 mA, 100°	4-18
LG Z181-CO	Q62703-Q1506	Lamp, Green, 1 Element Array, 0.25 mcd min/10 mA, 100°	4-18
LG Z182-CO	Q62703-Q1507	Lamp, Green, 2 Element Array, 0.25 mcd min/10 mA, 100°	4-18
LG Z183-CO	Q62703-Q1508	Lamp, Green, 3 Element Array, 0.25 mcd min/10 mA, 100°	4-18
LG Z184-CO	Q62703-Q1509	Lamp, Green, 4 Element Array, 0.25 mcd min/10 mA, 100°	4-18
LG Z185-CO	Q62703-Q1510	Lamp, Green, 5 Element Array, 0.25 mcd min/10 mA, 100°	4-18
LG Z186-CO	Q62703-Q1511	Lamp, Green, 6 Element Array, 0.25 mcd min/10 mA, 100°	4-18
LG Z188-CO	Q62703-Q1513	Lamp, Green, 8 Element Array, 0.25 mcd min/10 mA, 100°	4-18
LH1056	Q68000-A8675	Optocoupler, 6 Pin Single, High Voltage, Solid State Relay	5-197
LH1298	Q68000-A7966	Optocoupler, 6 Pin Single, High Voltage, Solid State Relay	5-197
LH 3344-QO	Q62703-Q2231	Lamp, Hyper Red, T1 (3 mm), Double Hetero Junction, 150 mcd/10 mA, 25°	4-19
LH 3364-MO	Q62703-Q2233	Lamp, Hyper Red, T1 (3 mm), Double Hetero Junction, 40 mcd/10 mA, 45°	4-19
LH 5424-QO	Q62703-Q2242	Lamp, Hyper Red, T1 ¾ (5 mm), Double Hetero Junction, 320 mcd/10 mA, 16°	4-20
LH 5464-LO	Q62703-Q2244	Lamp, Hyper Red, T1 ¾ (5 mm), Double Hetero Junction, 60 mcd/10 mA, 35°	4-20
LH T674-KM	Q62703-Q2329	Lamp, Hyper Red, SMT-TOP-LED, 6.3–32 mcd/10 mA, 120°	4-21
LH T674-L	Q62703-Q2282	Lamp, Hyper Red, SMT-TOP-LED, 10–20 mcd/10 mA, 120°	4-21
LH T674-LN	Q62703-Q2617	Lamp, Hyper Red, SMT-TOP-LED, 10–50 mcd/10 mA, 120°	4-21
LH T674-M	Q62703-Q2288	Lamp, Hyper Red, SMT-TOP-LED, 16–32 mcd/10 mA, 120°	4-21
LO 3340-KN	Q62703-Q1886	Lamp, Orange, T1 (3 mm), Clear, 6.3–20 mcd/10 mA, 50°	4-29
LO 3340-M	Q62603-Q2255	Lamp, Orange, T1 (3 mm), Clear, 10–20 mcd/10 mA, 50°	4-29
LO 3340-MP	Q62603-Q2628	Lamp, Orange, T1 (3 mm), Clear, 10–80 mcd/10 mA, 50°	4-29
LO 3340-N	Q62603-Q2473	Lamp, Orange, T1 (3 mm), Clear, 16–32 mcd/10 mA, 50°	4-29
LO 3360-HL	Q62703-Q1887	Lamp, Orange, T1 (3 mm), Diffuse, 2.5–20 mcd/10 mA, 70°	4-22
LO 3360-J	Q62703-Q2399	Lamp, Orange, T1 (3 mm), Diffuse, 4–8 mcd/10 mA, 70°	4-22
LO 3360-JM	Q62703-Q2410	Lamp, Orange, T1 (3 mm), Diffuse, 4–32 mcd/10 mA, 70°	4-22
LO 3360-K	Q62703-Q2400	Lamp, Orange, T1 (3 mm), Diffuse, 6.3–12.5 mcd/10 mA, 70°	4-22
LO K380-LP	Q62703-Q1888	Lamp, Orange, T1 (3 mm), ARGUS®, 10–80 mlm/15 mA	4-41
LO K380-N	Q62703-Q2227	Lamp, Orange, T1 (3 mm), ARGUS®, 25–50 mlm/15 mA	4-41
LO K380-NR	Q62703-Q2201	Lamp, Orange, T1 (3 mm), ARGUS®, 25–200 mlm/15 mA	4-41
LO K380-P	Q62703-Q2228	Lamp, Orange, T1 (3 mm), ARGUS®, 40–80 mlm/15 mA	4-41
LO K382-RO	Q62703-Q1957	Lamp, Orange, T1, Super ARGUS, 160 mlm/50 mA	4-44
LOP K370-KO	Q62703-Q2529	Lamp, Orange/Pure Green Bicolor, T1 (3 mm), ARGUS®	4-38
LO T670-HK	Q62703-Q2310	Lamp, Orange, SMT-TOP-LED®, 2.5–12.5 mcd/10 mA, 120°	4-48
LO T670-J	Q62703-Q2475	Lamp, Orange, SMT-TOP-LED®, 4.0–8.0 mcd/10 mA, 120°	4-48
LO T670-JL	Q62703-Q2503	Lamp, Orange, SMT-TOP-LED®, 4.0–20.0 mcd/10 mA, 120°	4-48
LO T670-K	Q62703-Q2476	Lamp, Orange, SMT-TOP-LED®, 6.3–12.5 mcd/10 mA, 120°	4-48
LO T672-MO	Q62703-Q2330	Lamp, Orange, SMT-Super-TOP-LED, 30 mcd/50 mA, 120°	4-49
LP 3360-GK	Q62703-Q2467	Lamp, Pure Green, T1 (3 mm), Diffuse, 1.6–12.5 mcd/10 mA, 70°	4-22
LP K380-KO	Q62703-Q2506	Lamp, Pure Green, T1 (3 mm), 10 mlm/15 mA, ARGUS®	4-41
LP K382-PO	Q62703-Q2123	Lamp, Pure Green, T1 (3 mm), Super ARGUS®, 100 mlm/50 mA	4-44
LP T80A	Q68000-A7852	Phototransistor, NPN, Side Facing, Plastic, 40°	9-20
LP T670-GO	Q62703-Q2456	Lamp, Pure Green, SMT-TOP-LED, 5.0 mcd/10 mA, 120°	4-48
LP T672-LO	Q62703-Q2334	Lamp, Pure Green, SMT-Super-TOP-LED, 15 mcd/10 mA, 120°	4-49
LR 3360-DG	Q62703-Q1316	Lamp, Red, T1 (3 mm), Diffuse, 0.4–3.2 mcd/10 mA, 70°	4-22
LR 3360-F	Q62703-Q1317	Lamp, Red, T1 (3 mm), Diffuse, 1.0–2.0 mcd/10 mA, 70°	4-22
LR 3360-FJ	Q62703-Q1319	Lamp, Red, T1 (3 mm), Diffuse, 1.0–8.0 mcd/10 mA, 70°	4-22
LR 3360-G	Q62703-Q1318	Lamp, Red, T1 (3 mm), Diffuse, 1.6–3.2 mcd/10 mA, 70°	4-22
LR 5360-DG	Q62703-Q1376	Lamp, Red, T1 ¾ (5 mm), Diffuse, 0.4–3.2 mcd/10 mA, 50°	4-23
LR 5360-F	Q62703-Q1377	Lamp, Red, T1 ¾ (5 mm), Diffuse, 1.0–2.0 mcd/10 mA, 50°	4-23
LR 5360-FJ	Q62703-Q1379	Lamp, Red, T1 ¾ (5 mm), Diffuse, 1.0–8.0 mcd/10 mA, 50°	4-23
LR 5360-G	Q62703-Q1378	Lamp, Red, T1 ¾ (5 mm), Diffuse, 1.6–3.2 mcd/10 mA, 50°	4-23
LR 5460-DG	Q62703-Q1392	Lamp, Red, T1 ¾ (5 mm), Diffuse, 0.4–3.2 mcd/10 mA, 50°	4-24
LR 5460-F	Q62703-Q1393	Lamp, Red, T1 ¾ (5 mm), Diffuse, 1.0–2.0 mcd/10 mA, 50°	4-24

ALPHANUMERIC INDEX (use ordering code numbers when ordering in Europe)

PART NO.	ORDERING CODE NO.	DESCRIPTION	PAGE
LR 5460-FJ	Q62703-Q1395	Lamp, Red, T1 ¾ (5 mm), Diffuse, 1.0–8.0 mcd/10 mA, 50°	4-24
LR 5460-G	Q62703-Q1394	Lamp, Red, T1 ¾ (5 mm), Diffuse, 1.6–3.2 mcd/10 mA, 50°	4-24
LR 5480-CF	Q62703-Q1986	Lamp, Red, T1 ¾ (5 mm), Wide Angle, 0.25–2.0 mcd/10 mA, 80°	4-25
LR 5480-DG	Q62703-Q1408	Lamp, Red, T1 ¾ (5 mm), Wide Angle, 0.4–3.2 mcd/10 mA, 80°	4-25
LR 5480-E	Q62703-Q1734	Lamp, Red, T1 ¾ (5 mm), Wide Angle, 0.63–1.25 mcd/10 mA, 80°	4-25
LR 5480-F	Q62703-Q1987	Lamp, Red, T1 ¾ (5 mm), Wide Angle, 1.0–2.0 mcd/10 mA, 80°	4-25
LR B480-BD	Q62703-Q1464	Lamp, Red, Rectangular, 0.16–0.8 mcd/10 mA, 100°	4-26
LR B480-C	Q62703-Q1465	Lamp, Red, Rectangular, 0.25–0.5 mcd/10 mA, 100°	4-26
LR B480-D	Q62703-Q2648	Lamp, Red, Rectangular, 0.4–0.8 mcd/10 mA, 100°	4-26
LR H380-BD	Q62703-Q1478	Lamp, Red, Cylindrical, 0.16–0.8 mcd/10 mA, 100°	4-27
LR H380-C	Q62703-Q1479	Lamp, Red, Cylindrical, 0.25–0.5 mcd/10 mA, 100°	4-27
LR H380-D	Q62703-Q1988	Lamp, Red, Cylindrical, 0.40–0.80 mcd/10 mA, 100°	4-27
LR Z180-CO	Q62703-Q1504	Lamp, Red, 10 Element Array, 0.25 mcd min/10 mA, 100°	4-28
LR Z181-CO	Q62703-Q1495	Lamp, Red, 1 Element Array, 0.25 mcd min/10 mA, 100°	4-28
LR Z182-CO	Q62703-Q1496	Lamp, Red, 2 Element Array, 0.25 mcd min/10 mA, 100°	4-28
LR Z183-CO	Q62703-Q1497	Lamp, Red, 3 Element Array, 0.25 mcd min/10 mA, 100°	4-28
LR Z184-CO	Q62703-Q1498	Lamp, Red, 4 Element Array, 0.25 mcd min/10 mA, 100°	4-28
LR Z185-CO	Q62703-Q1499	Lamp, Red, 5 Element Array, 0.25 mcd min/10 mA, 100°	4-28
LR Z186-CO	Q62703-Q1500	Lamp, Red, 6 Element Array, 0.25 mcd min/10 mA, 100°	4-28
LR Z187-CO	Q62703-Q1501	Lamp, Red, 7 Element Array, 0.25 mcd min/10 mA, 100°	4-28
LR Z188-CO	Q62703-Q1502	Lamp, Red, 8 Element Array, 0.25 mcd min/10 mA, 100°	4-28
LR Z189-CO	Q62703-Q1503	Lamp, Red, 9 Element Array, 0.25 mcd min/10 mA, 100°	4-28
LS 3340-KN	Q62703-Q1701	Lamp, Super-Red, T1 (3 mm), Clear, 6.3–50 mcd/10 mA, 50°	4-29
LS 3340-MP	Q62703-Q1703	Lamp, Super-Red, T1 (3 mm), Clear, 16–80 mcd/10 mA, 50°	4-29
LS 3340-M	Q62703-Q1704	Lamp, Super-Red, T1 (3 mm), Clear, 16–32 mcd/10 mA, 50°	4-29
LS 3340-N	Q62703-Q2320	Lamp, Super-Red, T1 (3 mm), Clear, 25–50 mcd/10 mA, 50°	4-29
LS 3341-KN	Q62703-Q2145	Lamp, Super-Red, T1 (3 mm), Clear, 6.3–50 mcd/10 mA, 40°	4-30
LS 3341-M	Q62703-Q2146	Lamp, Super-Red, T1 (3 mm), Clear, 16–32 mcd/10 mA, 40°	4-30
LS 3341-MQ	Q62703-Q2148	Lamp, Super-Red, T1 (3 mm), Clear, 16–125 mcd/10 mA, 40°	4-30
LS 3341-N	Q62703-Q2147	Lamp, Super-Red, T1 (3 mm), Clear, 25–50 mcd/10 mA, 40°	4-30
LS 3360-HL	Q62703-Q1320	Lamp, Super-Red, T1 (3 mm), Diffuse, 2.5–2.0 mcd/10 mA, 70°	4-22
LS 3360-J	Q62703-Q1736	Lamp, Super-Red, T1 (3 mm), Diffuse, 4.0–8.0 mcd/10 mA, 70°	4-22
LS 3360-K	Q62703-Q1321	Lamp, Super-Red, T1 (3 mm), Diffuse, 6.3–12.5 mcd/10 mA, 70°	4-22
LS 3360-KN	Q62703-Q1323	Lamp, Super-Red, T1 (3 mm), Diffuse, 6.3–50 mcd/10 mA, 70°	4-22
LS 3369-EH	Q62703-Q1748	Lamp, Super-Red, T1 (3 mm), Low Current, 0.63–5.0 mcd/2 mA, 60°	4-31
LS 3369-EO		Replaced by LS 3369-EH	
LS 3369-FH	Q62703-Q1711	Lamp, Super-Red, T1 (3 mm), Low Current, 1.0–5.0 mcd/2 mA, 60°	4-31
LS 3369-FO		Replaced by LS 3369-FH	
LS 3380-FJ	Q62703-Q1452	Lamp, Super-Red, T1 (3 mm), Wide Angle, 1–8 mcd/10 mA, 100°	4-32
LS 3380-H	Q62703-Q1726	Lamp, Super-Red, T1 (3 mm), Wide Angle, 2.5–5.0 mcd/10 mA, 100°	4-32
LS 3380-J	Q62703-Q1349	Lamp, Super-Red, T1 (3 mm), Wide Angle, 4.0–8.0 mcd/10 mA, 100°	4-32
LS 3380-HL	Q62703-Q1455	Lamp, Super-Red, T1 (3 mm), Wide Angle, 2.5–20 mcd/10 mA, 100°	4-32
LS 5360-HL	Q62703-Q1380	Lamp, Super-Red, T1 ¾ (5 mm), Diffuse, 2.5–20 mcd/10 mA, 50°	4-23
LS 5360-J	Q62703-Q1744	Lamp, Super-Red, T1 ¾ (5 mm), Diffuse, 4–8 mcd/10 mA, 50°	4-23
LS 5360-K	Q62703-Q1381	Lamp, Super-Red, T1 ¾ (5 mm), Diffuse, 6.3–12.5 mcd/10 mA, 50°	4-23
LS 5360-KN	Q62703-Q1383	Lamp, Super-Red, T1 ¾ (5 mm), Diffuse, 6.3–50 mcd/10 mA, 50°	4-23
LS 5360-L	Q62703-Q1382	Lamp, Super-Red, T1 ¾ (5 mm), Diffuse, 10–20 mcd/10 mA, 50°	4-23
LS 5380-FJ	Q62703-Q1452	Lamp, Super-Red, T1 ¾ (5 mm), Wide Angle, 1–8 mcd/10 mA, 140°	4-33
LS 5380-H	Q62703-Q1453	Lamp, Super-Red, T1 ¾ (5 mm), Wide Angle, 2.5–5 mcd/10 mA, 140°	4-33
LS 5380-HL	Q62703-Q1455	Lamp, Super-Red, T1 ¾ (5 mm), Wide Angle, 2.5–20 mcd/10 mA, 140°	4-33
LS 5380-J	Q62703-Q1454	Lamp, Super-Red, T1 ¾ (5 mm), Wide Angle, 4–8 mcd/10 mA, 140°	4-33
LS 5420-MQ	Q62703-Q1428	Lamp, Super-Red, T1 ¾ (5 mm), Clear, 16–125 mcd/10 mA, 24°	4-34
LS 5420-PS	Q62703-Q1431	Lamp, Super-Red, T1 ¾ (5 mm), Clear, 40–320 mcd/10 mA, 24°	4-34
LS 5420-P	Q62703-Q1430	Lamp, Super-Red, T1 ¾ (5 mm), Clear, 40–80 mcd/10 mA, 24°	4-34
LS 5420-Q	Q62703-Q1993	Lamp, Super-Red, T1 ¾ (5 mm), Clear, 63–125 mcd/10 mA, 24°	4-34
LS 5420-R	Q62703-Q1429	Lamp, Super-Red, T1 ¾ (5 mm), Clear, 100–200 mcd/10 mA, 24°	4-34
LS 5421-MO		Replaced by LS 5421-NR	
LS 5421-NR	Q62703-Q1994	Lamp, Super-Red, T1 ¾ (5 mm) Superbright, 25–200 mcd/2 mA, 20°	4-35
LS 5421-PO		Replaced by LS 5421-QT	
LS 5421-Q	Q62703-Q1442	Lamp, Super-Red, T1 ¾ (5 mm) Superbright, 63–125 mcd/10 mA, 20°	4-35
LS 5421-QO		Replaced by LS 5421-QT	

ALPHANUMERIC INDEX (use ordering code numbers when ordering in Europe)

PART NO.	ORDERING CODE NO.	DESCRIPTION	PAGE
LS 5421-QT	Q62703-Q1995	Lamp, Super-Red, T1 ¼, (5 mm) Superbright, 63–500 mcd/10 mA, 20°	4-35
LS 5421-R	Q62703-Q1738	Lamp, Super-Red, T1 ¼, (5 mm) Superbright, 100–200 mcd/10 mA, 20°	4-35
LS 5460-HL	Q62703-Q1396	Lamp, Super-Red, T1 ¼ (5 mm), Diffuse, 2.5–20 mcd/10 mA, 50°	4-24
LS 5460-J	Q62703-Q1746	Lamp, Super-Red, T1 ¼ (5 mm), Diffuse, 4–8 mcd/10 mA, 50°	4-24
LS 5460-K	Q62703-Q1397	Lamp, Super-Red, T1 ¼ (5 mm), Diffuse, 6.3–12.5 mcd/10 mA, 50°	4-24
LS 5460-KN	Q62703-Q1399	Lamp, Super-Red, T1 ¼ (5 mm), Diffuse, 6.3–50 mcd/10 mA, 50°	4-24
LS 5460-L	Q62703-Q1398	Lamp, Super-Red, T1 ¼ (5 mm), Diffuse, 10–20 mcd/10 mA, 50°	4-24
LS 5469-EH	Q62703-Q1751	Lamp, Super-Red, T1 ¼ (5 mm), Low Current, 0.63–5 mcd/2 mA, 50°	4-36
LS 5469-EO		Replaced by LS 5469-EH	
LS 5469-FH	Q62703-Q1714	Lamp, Super-Red, T1 ¼ (5 mm), Low Current, 1–5 mcd/2 mA, 50°	4-36
LS 5469-FO		Replaced by LS 5469-FH	
LS 5480-GK	Q62703-Q1989	Lamp, Super-Red, T1 ¼ (5 mm), Wide Angle, 1.6–12.5 mcd/10 mA, 80°	4-25
LS 5480-J	Q62703-Q1414	Lamp, Super-Red, T1 ¼ (5 mm), Wide Angle, 4–8 mcd/10 mA, 80°	4-25
LS 5480-JM	Q62703-Q1992	Lamp, Super-Red, T1 ¼ (5 mm), Wide Angle, 4–32 mcd/10 mA, 80°	4-25
LS 5480-K	Q62703-Q1990	Lamp, Super-Red, T1 ¼ (5 mm), Wide Angle, 6.3–12.5 mcd/10 mA, 80°	4-25
LS B480-EH	Q62703-Q1466	Lamp, Super-Red, Rectangular, 0.63–5.0 mcd/10 mA, 100°	4-26
LS B480-G	Q62703-Q1467	Lamp, Super-Red, Rectangular, 1.6–3.2 mcd/10 mA, 100°	4-26
LS B480-GK	Q62703-Q1469	Lamp, Super-Red, Rectangular, 1.6–12.5 mcd/10 mA, 100°	4-26
LS B480-H	Q62703-Q1468	Lamp, Super-Red, Rectangular, 2.5–5.0 mcd/10 mA, 100°	4-26
LSG 3331-JO	Q62703-Q2296	Lamp, Super-Red/Green Bicolor, T1 (3 mm), Clear, 18 mcd/10 mA, 40°	4-37
LSG 3351-HO	Q62703-Q2297	Lamp, Super-Red/Green Bicolor, T1 (3 mm), Diffuse, 2.5 mcd min./10 mA, 50°	4-37
LSG K370-LO	Q62703-Q2298	Lamp, Super-Red/Green Bicolor, T1 (3 mm), ARGUS®, 32 mlm/15 mA	4-38
LSG K372-RO	Q62703-Q2299	Lamp, Super-Red/Green Bicolor, T1 (3 mm), Super ARGUS®, 160 mlm/50 mA	4-39
LSG T670-HO	Q62703-Q2531	Lamp, Super-Red/Green Bicolor, SMT-TOP-LED®, 8 mcd/10 mA	4-40
LS H380-EH	Q62703-Q1480	Lamp, Super-Red, Cylindrical, 0.63–5.0 mcd/10 mA, 100°	4-27
LS H380-G	Q62703-Q1481	Lamp, Super-Red, Cylindrical, 1.6–3.2 mcd/10 mA, 100°	4-27
LS H380-GK	Q62703-Q1483	Lamp, Super-Red, Cylindrical, 1.6–12.5 mcd/10 mA, 100°	4-27
LS H380-H	Q62703-Q1482	Lamp, Super-Red, Cylindrical, 2.5–5.0 mcd/10 mA, 100°	4-27
LS K380-LP	Q62703-Q1768	Lamp, Super-Red, T1 (3 mm), ARGUS®, 10–80 mlm/15 mA	4-41
LS K380-N	Q62703-Q0760	Lamp, Super-Red, T1 (3 mm), ARGUS®, 25–50 mlm/15 mA	4-41
LS K380-NR	Q62703-Q2223	Lamp, Super-Red, T1 (3 mm), ARGUS®, 25–200 mlm/15 mA	4-41
LS K380-P	Q62703-Q1003	Lamp, Super-Red, T1 (3 mm), ARGUS®, 40–80 mlm/15 mA	4-41
LS K382-RO	Q62703-Q1956	Lamp, Super-Red, T1 (3 mm), Super ARGUS®, 160 mlm min/50 mA	4-44
LS K389-FO	Q62703-Q1771	Lamp, Super-Red, T1 (3 mm), Low Current ARGUS®, 5 mcd/2 mA	4-45
LSP K370-KO	Q62703-Q2379	Lamp, Super-Red/Pure Green Bicolor, T1 (3 mm), ARGUS®, 20/15 mA	4-38
LSP K372-PO	Q62703-Q2380	Lamp, Super-Red/Pure Green Bicolor, T1 (3 mm), Super ARGUS®, 100 mlm/15mA	4-39
LSP T670-GO	Q62703-Q2532	Lamp, Super-Red/Pure Green, SMT-TOP-LED®, 5 mcd/10 mA	4-40
LS S260-DO	Q62703-Q1640	Lamp, Super-Red, SOT23, 0.4 mcd min/10 mA, 140°	4-46
LS S269-BO	Q62703-Q1566	Lamp, Super-Red, SOT23, Low Current, 0.16 mcd min/2 mA, 140°	4-47
LS T670-HK	Q62703-Q2309	Lamp, Super-Red, SMT-TOP-LED, 2.5–12.5 mcd/10 mA, 120°	4-48
LS T670-J	Q62703-Q2357	Lamp, Super-Red, SMT-TOP-LED, 4–8 mcd/10 mA, 120°	4-48
LS T670-JL	Q62703-Q2502	Lamp, Super-Red, SMT-TOP-LED, 4–20 mcd/10 mA, 120°	4-48
LS T670-K	Q62703-Q2358	Lamp, Super-Red, SMT-TOP-LED, 6.3–12.5 mcd/10 mA, 120°	4-48
LS T672-MO	Q62703-Q2331	Lamp, Super-Red, SMT-Super-TOP-LED, 30 mcd/10 mA, 120°	4-49
LS T679-CO	Q62703-Q2383	Lamp, Super-Red, SMT-TOP-LED, 1 mcd/2 mA, 120°	4-50
LS U260-EO	Q62703-Q1492	Lamp, Super-Red, Miniature, 1 mm, 0.63 mcd min./10 mA, 60°	4-51
LU 5351-GL	Q62703-Q2046	Lamp, Super-Red/Green Bicolor, T1 ¼ (5 mm), 1.6–20 mcd/10 mA, 50°	4-52
LU 5351-JM	Q62703-Q2047	Lamp, Super-Red/Green Bicolor, T1 ¼ (5 mm), 4.0–32 mcd/10 mA, 50°	4-52
LU B371-FJ	Q62703-Q2048	Lamp, Super-Red/Green Bicolor, Rectangular, 1–8 mcd/10 mA, 100°	4-52
LU B371-GK	Q62703-Q2049	Lamp, Super-Red/Green Bicolor, Rectangular, 1.6–12.5 mcd/10 mA, 100°	4-52
LU H371-FJ	Q62703-Q2050	Lamp, Super-Red/Green Bicolor, Cylindrical, 1–8 mcd/10 mA, 100°	4-52
LU H371-GK	Q62703-Q2051	Lamp, Super-Red/Green Bicolor, Cylindrical, 1.6–12.5 mcd/10 mA, 100°	4-52
LU S250-DO	Q62703-Q1642	Lamp, Super-Red/Green Bicolor, SOT23, 0.4 mcd/10 mA, 140°	4-46
LY 3340-JM	Q62703-Q1789	Lamp, Yellow, T1 (3 mm), Clear, 4–32 mcd/10 mA, 50°	4-29
LY 3340-LP	Q62703-Q1792	Lamp, Yellow, T1 (3 mm), Clear, 10–80 mcd/10 mA, 50°	4-29
LY 3340-L	Q62703-Q1791	Lamp, Yellow, T1 (3 mm), Clear, 10–20 mcd/10 mA, 50°	4-29
LY 3340-M	Q62703-Q1999	Lamp, Yellow, T1 (3 mm), Clear, 16–32 mcd/10 mA, 50°	4-29

ALPHANUMERIC INDEX (use ordering code numbers when ordering in Europe)

PART NO.	ORDERING CODE NO.	DESCRIPTION	PAGE
LY 3341-JM	Q62703-Q2149	Lamp, Yellow, T1 (3 mm), Clear, 4–32 mcd/10 mA, 40°	4-30
LY 3341-L	Q62703-Q2150	Lamp, Yellow, T1 (3 mm), Clear, 10–20 mcd/10 mA, 40°	4-30
LY 3341-LP	Q62703-Q2152	Lamp, Yellow, T1 (3 mm), Clear, 10–80 mcd/10 mA, 40°	4-30
LY 3341-M	Q62703-Q2151	Lamp, Yellow, T1 (3 mm), Clear, 16–32 mcd/10 mA, 40°	4-30
LY 3360-HL	Q62703-Q1324	Lamp, Yellow, T1 (3 mm), Diffuse, 2.5–20 mcd/10 mA, 70°	4-22
LY 3360-J	Q62703-Q1737	Lamp, Yellow, T1 (3 mm), Diffuse, 4.0–8.0 mcd/10 mA, 70°	4-22
LY 3360-JM	Q62703-Q1998	Lamp, Yellow, T1 (3 mm), Diffuse, 4.0–32 mcd/10 mA, 70°	4-22
LY 3360-K	Q62703-Q1325	Lamp, Yellow, T1 (3 mm), Diffuse, 6.3–12.5 mcd/10 mA, 70°	4-22
LY 3369-EH	Q62703-Q1749	Lamp, Yellow, T1 (3 mm), Low Current, 0.63–5.0 mcd/2 mA, 60°	4-31
LY 3369-EO		Replaced by LY 3369-EH	
LY 3369-FH	Q62703-Q1712	Lamp, Yellow, T1 (3 mm), Low Current, 1.0–5.0 mcd/2 mA, 60°	4-31
LY 3369-FO		Replaced by LY 3369-FH	
LY 3380-FJ	Q62703-Q1352	Lamp, Yellow, T1 (3 mm), Wide Angle, 1.0–8.0 mcd/10 mA, 100°	4-32
LY 3380-H	Q62703-Q1353	Lamp, Yellow, T1 (3 mm), Wide Angle, 2.5–5.0 mcd/10 mA, 100°	4-32
LY 3380-HL	Q62703-Q1355	Lamp, Yellow, T1 (3 mm), Wide Angle, 2.5–20.0 mcd/10 mA, 100°	4-32
LY 3380-J	Q62703-Q1354	Lamp, Yellow, T1 (3 mm), Wide Angle, 4.0–8.0 mcd/10 mA, 100°	4-32
LY 3380-K	Q62703-Q2317	Lamp, Yellow, T1 (3 mm), Wide Angle, 6.3–12.5 mcd/10 mA, 100°	4-32
LY 5360-HL	Q62703-Q2000	Lamp, Yellow, T1 ¾ (5 mm), 2.5–20 mcd/10 mA, 50°	4-23
LY 5360-JM	Q62703-Q1387	Lamp, Yellow, T1 ¾ (5 mm), 4–32 mcd/10 mA, 50°	4-23
LY 5360-J	Q62703-Q1386	Lamp, Yellow, T1 ¾ (5 mm), 4.0–8.0 mcd/10 mA, 50°	4-23
LY 5360-K	Q62703-Q2001	Lamp, Yellow, T1 ¾ (5 mm), 6.3–12.5 mcd/10 mA, 50°	4-23
LY 5360-L	Q62703-Q2404	Lamp, Yellow, T1 ¾ (5 mm), 10–20 mcd/10 mA, 50°	4-23
LY 5380-EH	Q62703-Q2002	Lamp, Yellow, T1 ¾ (5 mm), Wide Angle, 0.63–5.0 mcd/10 mA, 140°	4-33
LY 5380-GK	Q62703-Q2003	Lamp, Yellow, T1 ¾ (5 mm), Wide Angle, 1.6–12.5 mcd/10 mA, 140°	4-33
LY 5380-H	Q62703-Q1457	Lamp, Yellow, T1 ¾ (5 mm), Wide Angle, 2.5–5.0 mcd/10 mA, 140°	4-33
LY 5380-J	Q62703-Q2319	Lamp, Yellow, T1 ¾ (5 mm), Wide Angle, 4.0–8.0 mcd/10 mA, 140°	4-33
LY 5420-MQ	Q62703-Q1432	Lamp, Yellow, T1 ¾ (5 mm), Clear, 16–125 mcd/10 mA, 24°	4-34
LY 5420-PS	Q62703-Q1435	Lamp, Yellow, T1 ¾ (5 mm), Clear, 40–320 mcd/10 mA, 24°	4-34
LY 5420-P	Q62703-Q1434	Lamp, Yellow, T1 ¾ (5 mm), Clear, 40–80 mcd/10 mA, 24°	4-34
LY 5420-Q	Q62703-Q2004	Lamp, Yellow, T1 ¾ (5 mm), Clear, 63–125 mcd/10 mA, 24°	4-34
LY 5421-MO		Replaced by LY 5421-MQ	
LY 5421-NR	Q62703-Q1444	Lamp, Yellow, T1 ¾ (5 mm), Superbright, 25–200 mcd/10 mA, 20°	4-35
LY 5421-PO		Replaced by LY 5421-PS	
LY 5421-QT	Q62703-Q1447	Lamp, Yellow, T1 ¾ (5 mm), Superbright, 63–500 mcd/10 mA, 20°	4-35
LY 5421-Q	Q62703-Q1446	Lamp, Yellow, T1 ¾ (5 mm), Superbright, 63–125 mcd/10 mA, 20°	4-35
LY 5421-QO		Replaced by LY 5421-Q	
LY 5421-R	Q62703-Q2005	Lamp, Yellow, T1 ¾ (5 mm), Superbright, 100–200 mcd/10 mA, 20°	4-35
LY 5460-HL	Q62703-Q1400	Lamp, Yellow, T1 ¾ (5 mm), Diffuse, 2.5–20 mcd/10 mA, 50°	4-24
LY 5460-J	Q62703-Q1401	Lamp, Yellow, T1 ¾ (5 mm), Diffuse, 4.0–8.0 mcd/10 mA, 50°	4-24
LY 5460-JM	Q62703-Q1403	Lamp, Yellow, T1 ¾ (5 mm), Diffuse, 4.0–32 mcd/10 mA, 50°	4-24
LY 5460-K	Q62703-Q1402	Lamp, Yellow, T1 ¾ (5 mm), Diffuse, 6.3–12.5 mcd/10 mA, 50°	4-24
LY 5460-L	Q62703-Q2403	Lamp, Yellow, T1 ¾ (5 mm), Diffuse, 10–20 mcd/10 mA, 50°	4-24
LY 5469-EH	Q62703-Q1752	Lamp, Yellow, T1 ¾ (5 mm), Low Current, 0.63–5.0 mcd/2 mA, 50°	4-36
LY 5469-EO		Replaced by LY 5469-EH	
LY 5469-FH	Q62703-Q1715	Lamp, Yellow, T1 ¾ (5 mm), Low Current, 1.0–5.0 mcd/2 mA, 50°	4-36
LY 5469-FO		Replaced by LY 5469-FH	
LY 5480-GK	Q62703-Q1416	Lamp, Yellow, T1 ¾ (5 mm), 1.6–12.5 mcd/10 mA, 80°, Wide Angle	4-25
LY 5480-H	Q62703-Q	Lamp, Yellow, T1 ¾ (5 mm), 1.6–12.5 mcd/10 mA, 80°, Wide Angle	4-25
LY 5480-JM	Q62703-Q1419	Lamp, Yellow, T1 ¾ (5 mm), 4.0–32 mcd/10 mA, 80°, Wide Angle	4-25
LY 5480-K	Q62703-Q1418	Lamp, Yellow, T1 ¾ (5 mm), 6.3–12.5 mcd/10 mA, 80°, Wide Angle	4-25
LY 5480-L	Q62703-Q2402	Lamp, Yellow, T1 ¾ (5 mm), 10–20 mcd/10 mA, 80°, Wide Angle	4-25
LY B480-EH	Q62703-Q1470	Lamp, Yellow, Rectangular, 0.63–5.0 mcd/10 mA, 100°	4-26
LY B480-G	Q62703-Q1471	Lamp, Yellow, Rectangular, 1.6–3.2 mcd/10 mA, 100°	4-26
LY B480-GK	Q62703-Q2007	Lamp, Yellow, Rectangular, 1.6–12.5 mcd/10 mA, 100°	4-26
LY B480-H	Q62703-Q2006	Lamp, Yellow, Rectangular, 2.5–5.0 mcd/10 mA, 100°	4-26
LY H380-EH	Q62703-Q1484	Lamp, Yellow, Cylindrical, 0.63–5.0 mcd/10 mA, 100°	4-27
LY H380-G	Q62703-Q1485	Lamp, Yellow, Cylindrical, 1.6–3.2 mcd/10 mA, 100°	4-27
LY H380-GK	Q62703-Q1487	Lamp, Yellow, Cylindrical, 1.6–12.5 mcd/10 mA, 100°	4-27
LY H380-H	Q62703-Q1486	Lamp, Yellow, Cylindrical, 2.5–5.0 mcd/10 mA, 100°	4-27
LY K380-LP	Q62703-Q1769	Lamp, Yellow, T1 (3 mm), ARGUS®, 10–80 mlm/15 mA	4-41
LY K380-N	Q62703-Q0575	Lamp, Yellow, T1 (3 mm), ARGUS®, 25–50 mlm/15 mA	4-41

ALPHANUMERIC INDEX (use ordering code numbers when ordering in Europe)

PART NO.	ORDERING CODE NO.	DESCRIPTION	PAGE
LY K380-NR	Q62703-Q2224	Lamp, Yellow, T1 (3 mm), ARGUS®, 25–200 mlm/15 mA	4-41
LY K380-P	Q62703-Q0576	Lamp, Yellow, T1 (3 mm), ARGUS®, 40–80 mlm/15 mA	4-41
LY K382-RO	Q62703-Q1958	Lamp, Yellow, T1 (3 mm), Super ARGUS®, 160 mlm min/50 mA	4-44
LY K389-FO	Q62703-Q1772	Lamp, Yellow, T1 (3 mm), Low Current ARGUS®, 3.2 mlm/2 mA	4-45
LY S260-DO	Q62703-Q1657	Lamp, Yellow, SOT23 SMD, 0.4 mcd min/10 mA, 140°	4-46
LY S269-BO	Q62703-Q1568	Lamp, Yellow, SOT23 SMD, Low Current, 0.16 mcd min/2 mA, 140°	4-47
LY T670-HK	Q62703-Q2311	Lamp, Yellow, SMT-TOP-LED, 2.5–12.5 mcd/10 mA, 120°	4-48
LY T670-J	Q62703-Q2376	Lamp, Yellow, SMT-TOP-LED, 4–8 mcd/10 mA, 120°	4-48
LY T670-JL	Q62703-Q2504	Lamp, Yellow, SMT-TOP-LED, 4.0–20.0mcd/10 mA, 120°	4-48
LY T670-K	Q62703-Q2375	Lamp, Yellow, SMT-TOP-LED, 6.3–12.5 mcd/10 mA, 120°	4-48
LY T670-H	Q62703-Q2618	Lamp, Yellow, SMT-TOP-LED, 2.5–5 mcd/10 mA, 120°	4-48
LY T672-MO	Q62703-Q2332	Lamp, Yellow, SMT-Super-TOP-LED SMT, 30 mcd/50 mA, 120°	4-49
LY T679-CO	Q62703-Q2384	Lamp, Yellow, SMT-TOP-LED SMT, 1 mcd/2 mA, 120°	4-50
LY U260-EO	Q62703-Q1493	Lamp, Yellow, Miniature, 1 mm, 0.63 mcd min /10 mA, 60°	4-51
LY Z181-CO	Q62703-Q1505	Lamp, Yellow, Element Array, 0.25 mcd min/10 mA, 100°	4-54
MCA230	Q68000-A7247	Optocoupler, 6 Pin Single, 100% CTR, 7500V, Photodarlington	5-200
MCA231	Q62703-Q40	Optocoupler, 6 Pin Single, 200% CTR, 7500V, Photodarlington	5-200
MCA255	Q68000-A6460	Optocoupler, 6 Pin Single, 100% CTR, 7500V, Photodarlington	5-200
MCT2	Q68000-A7247	Optocoupler, 6 Pin Single, 20% CTR, 7500V	5-202
MCT2E	Q62703-Q40	Optocoupler, 6 Pin Single, 20% CTR, 7500V	5-202
MCT6	Q62703-Q136	Optocoupler, 8 Pin Dual, 20% CTR, 7500V	5-205
MCT1270	Q68000-A8724	Optocoupler, 6 Pin Single, 50% CTR, 7500V	5-208
MCT1272	Q68000-A8725	Optocoupler, 6 Pin Single, 75% CTR, 7500V	5-208
MCT1273	Q68000-A8726	Optocoupler, 6 Pin Single, 125% CTR, 7500V	5-208
MCT1274	Q68000-A8727	Optocoupler, 6 Pin Single, 225% CTR, 7500V	5-208
MCT1275	Q68000-A8728	Optocoupler, 6 Pin Single, 70% CTR, 7500V	5-208
MCT1276	Q68000-A8729	Optocoupler, 6 Pin Single, 15% CTR, 7500V	5-208
MCT1277	Q68000-A8730	Optocoupler, 6 Pin Single, 100% CTR, 7500V	5-208
MCT5210	Q68000-A8731	Optocoupler, 6 Pin Single, 70% CTR, 5300V	5-211
MCT5211	Q68000-A8732	Optocoupler, 6 Pin Single, 110% CTR, 5300V	5-211
MPD2131 TXVB		Programmable Display, 8 Char, 200° Dot Matrix Yellow, Hi-Rel	2-81
MPD2132 TXVB	Q68000-A8776	Programmable Display, 8 Char, 200° Dot Matrix HER, Hi-Rel	2-81
MPD2133 TXVB		Programmable Display, 8 Char, 200° Dot Matrix HEG, Hi-Rel	2-81
MDL2416C	Q68000-A7309	Intelligent Display, 4 Char, 15°, Red, Hi-Rel	2-76
MDL2416 TXVB	Q68000-A8481	Intelligent Display, 4 Char, 15°, Red, Hi-Rel	2-76
MPD2545A TXVB	Q68000-A7898	Programmable Display, 4 Char, 25°, Dot Matrix HER, Hi-Rel	2-95
MPD2547A TXVB	Q68000-A7899	Programmable Display, 4 Char, 25°, Dot Matrix Green, Hi-Rel	2-95
MPD2548A TXVB	Q68000-A8406	Programmable Display, 4 Char, 25°, Dot Matrix Yellow, Hi-Rel	2-95
MSD2010 TXVB	Q68000-A8411	Small Alphanumeric Mil. Display, 4 Char, 15° Dot Matrix Red	2-104
MSD2011 TXVB	Q68000-A8412	Small Alphanumeric Mil. Display, 4 Char, 15° Dot Matrix Yellow	2-104
MSD2012 TXVB	Q68000-A8413	Small Alphanumeric Mil. Display, 4 Char, 15° Dot Matrix HER	2-104
MSD2013 TXVB	Q68000-A8414	Small Alphanumeric Mil. Display, 4 Char, 15° Dot Matrix Green	2-104
MSD2310 TXVB	Q68000-A8419	Small Alphanumeric Mil. Display, 4 Char, 20° Dot Matrix Red	2-111
MSD2311 TXVB	Q68000-A8420	Small Alphanumeric Mil. Display, 4 Char, 20° Dot Matrix Yellow	2-111
MSD2312 TXVB	Q68000-A8421	Small Alphanumeric Mil. Display, 4 Char, 20° Dot Matrix HER	2-111
MSD2313 TXVB	Q68000-A8422	Small Alphanumeric Mil. Display, 4 Char, 20° Dot Matrix Green	2-111
MSD2351 TXVB	Q68000-A8428	Small Alphanumeric Mil. Display, 4 Char, 20° Dot Matrix Yellow, Sunlight View	2-118
MSD2352 TXVB	Q68000-A8429	Small Alphanumeric Mil. Display, 4 Char, 20° Dot Matrix HER, Sunlight View	2-118
MSD2353 TXVB	Q68000-A8430	Small Alphanumeric Mil. Display, 4 Char, 20° Dot Matrix Green, Sunlight View	2-118
OBG1000	Q68000-A5968	Bar Graph, HER, 10 Element	3-18
OBG4830	Q68000-A4407	Bar Graph, HER, 10 Element	3-20
PD2435	Q68000-A3561	Programmable Display, 4 Char, 200°, 5x7 Dot Matrix HER	2-125
PD2436	Q68000-A8366	Programmable Display, 4 Char, 200°, 5x7 Dot Matrix Red	2-125
PD2437	Q68000-A3562	Programmable Display, 4 Char, 200°, 5x7 Dot Matrix Green	2-125
PD3535	Q68000-A7964	Programmable Display, 4 Char, 270°, 5x7 Dot Matrix HER	2-125
PD3536	Q68000-A8365	Programmable Display, 4 Char, 270°, 5x7 Dot Matrix Red	2-125
PD3537	Q68000-A-7965	Programmable Display, 4 Char, 270°, 5x7 Dot Matrix Green	2-125

ALPHANUMERIC INDEX (use ordering code numbers when ordering in Europe)

PART NO.	ORDERING CODE NO.	DESCRIPTION	PAGE
PD4435	Q68000-A8367	Programmable Display, 4 Char, .45", 5x7 Dot Matrix HER	2-125
PD4436	Q68000-A8368	Programmable Display, 4 Char, .45", 5x7 Dot Matrix Red	2-125
PD4437	Q68000-A8369	Programmable Display, 4 Char, .45", 5x7 Dot Matrix Green	2-125
PDSP2110	Q68000-A8474	Programmable Display, 8 Char, .200", 5x7 Dot Matrix Red	2-136
PDSP2111	Q68000-A8503	Programmable Display, 8 Char, .200", 5x7 Dot Matrix Yellow	2-136
PDSP2112	Q68000-A8504	Programmable Display, 8 Char, .200", 5x7 Dot Matrix HER	2-136
PDSP2113	Q68000-A8505	Programmable Display, 8 Char, .200", 5x7 Dot Matrix Green	2-136
PDSP2114	Q68000-A8533	Programmable Display, 8 Char, .200", 5x7 Dot Matrix HEG	2-136
RB-42B		LED Die, 0.4x0.4, GaAsP/GaAs	1-8
RBG1000	Q68000-A5967	Bar Graph, Red, 10 Element	3-22
RBG4820	Q68000-A4408	Bar Graph, Red, 10 Element	3-24
RM-14A		LED Die, Mask-Diffused GaAsP, Monolithic with Cursor	1-8
RM-15B		LED Die, Mask-Diffused GaAsP, Monolithic	1-8
RM-62A		LED Die, Mask-Diffused GaAsP, Monolithic	1-8
RM-64A		LED Die, Mask-Diffused GaAsP, Monolithic	1-8
RM-73A		LEDDie, Mask-Diffused GaAsP, Monolithic	1-8
RM-81A		LED Die, Mask-Diffused GaAsP, Monolithic	1-8
RM-85D		LED Die, Mask-Diffused GaAsP, Monolithic	1-8
RM-86A		LED Die, Mask-Diffused GaAsP, Monolithic	1-8
RM-95A		LED Die, 1.9x2.2 mm, GaAsP/GaAs	1-8
RP-12C		LED Die, Mask-Diffused GaAsP	1-8
RP-13B		LED Die, Mask-Diffused GaAsP, Point Source	1-8
RP-212A		LED Die, 0.3x0.3 mm, GaAsP/GaAs	1-8
RL50	Q68000-A5954	Lamp, Axial, Red, 0.5 mcd/10mA, 90°	4-55
RL54	Q68000-A5958	Lamp, Axial, Red, 0.4 mcd/10mA, 90°	4-55
RL55	Q68000-A5959	Lamp, Axial, Red, 2.0 mcd/10mA, 90°	4-57
RRL5601	Q68000-A7180-F114	Lamp, Axial, Red, 0.3 mcd/5 V, 20°, Resistor	4-59
RRL5621	Q68000-A7177-F114	Lamp, Axial, Red, 0.6 mcd/5 V, 20°, Resistor	4-59
RRL5641	Q68000-A7178-F114	Lamp, Axial, Red, 1.0 mcd/5 V, 20°, Resistor	4-59
SCD5580	Q68000-A8630	Intelligent Display, 8 Char, .145", 5x5 Dot Matrix Red, Serial Input, Slimline	2-147
SCD5581	Q68000-A8631	Intelligent Display, 8 Char, .145", 5x5 Dot Matrix Yellow, Serial Input, Slimline	2-147
SCD5582	Q68000-A8632	Intelligent Display, 8 Char, .145", 5x5 Dot Matrix HER, Serial Input, Slimline	2-147
SCD5583	Q68000-A8633	Intelligent Display, 8 Char, .145", 5x5 Dot Matrix Green, Serial Input, Slimline	2-147
SCD5584	Q68000-A8634	Intelligent Display, 8 Char, .145", 5x5 Dot Matrix HEG, Serial Input, Slimline	2-147
SCD55100	Q68000-A8635	Intelligent Display, 10 Char, .145", 5x5 Dot Matrix Red, Serial Input, Slimline	2-162
SCD55101	Q68000-A8636	Intelligent Display, 10 Char, .145", Yellow, 5x5 Dot Matrix, Serial Input, Slimline	2-162
SCD55102	Q68000-A8637	Intelligent Display, 10 Char, .145", HER, 5x5 Dot Matrix, Serial Input, Slimline	2-162
SCD55103	Q68000-A8638	Intelligent Display, 10 Char, .145", Green, 5x5 Dot Matrix, Serial Input, Slimline	2-162
SCD55104	Q68000-A8639	Intelligent Display, 10 Char, .145", HEG, 5x5 Dot Matrix, Serial Input, Slimline	2-162
SFH100	Q62702-P595	Photodiode, Clear Plastic, 60°, Low Dark Current, High Blue Sensitivity	8-57
SFH200	Q62702-P86	Photodiode, Clear Plastic, 60°, Low Dark Current	8-59
SFH205	Q62702-P102	Photodiode, Plastic with Filter, TO-92, 60°, PIN	8-61
SFH205Q2	Q62702-P896	Photodiode, Plastic with Filter, TO-92, 60°, PIN	8-61
SFH206	Q62702-P128	Photodiode, Plastic with Filter, TO-92, 60°, PIN	8-61
SFH206K	Q62702-P129	Photodiode, Clear Plastic, TO-92, 60°, PIN	8-63
SFH207A	Q62702-P863	Photodiode, PCB, Clear Plastic, 60°, PIN	8-65
SFH212	Q62702-P145	Photodiode, TO-18, Hermetic, 15°, Low Dark Current	8-67
SFH216	Q62702-P936	Photodiode, TO-18, Hermetic, 12°, PIN	8-69
SFH217	Q62702-P946	Photodiode, T1 ¾ (5 mm), Clear Plastic, Flat Top, 75°, PIN	8-71
SFH217F	Q62702-P947	Photodiode, T1 ¾ (5 mm), Plastic with Filter, Flat Top, 75°, PIN	8-71
SFH219	Q62702-P948	Photodiode, TO-18, Flat Glass Lens, 60°, Low Dark Current	8-73
SFH221S	Q62702-P270	Photodiode, TO-5, Hermetic, Differential, 55°	8-75
SFH225	Q62702-P1051	Photodiode, SOD67, Plastic with Filter, 60°, PIN	8-77
SFH229	Q62702-P215	Photodiode, T1 (3 mm), Clear Plastic, 17°, PIN	8-79
SFH229F	Q62702-P216	Photodiode, T1 (3 mm), Plastic with Filter, 17°, PIN	8-79
SFH229P	Q62702-P217	Photodiode, T1 (3 mm), Clear Plastic, 85°, PIN	8-82
SFH229PF	Q62702-P218	Photodiode, T1 (3 mm), Plastic with Filter, 85°, PIN	8-82
SFH231	Q62702-P1052	Ge-Photodiode, TO-18, 10°, PIN	8-85
SFH232	Q62702-P1053	Ge-Photodiode, TO-18, 55°, PIN	8-87
SFH233	Q62702-P1054	Ge-Photodiode, TO-5, PIN, 54°, PIN	8-89
SFH234S	Q62702-P211	Photodiode, TO-39, Hermetic, 4-Quadrants, Insulated, 60°	8-91

ALPHANUMERIC INDEX (use ordering code numbers when ordering in Europe)

PART NO.	ORDERING CODE NO.	DESCRIPTION	PAGE
SFH235	Q62702-P273	Photodiode, SOD67, Plastic with Filter, 65°, PIN	8-93
SFH244S	Q62702-P212	Photodiode, TO-39, Hermetic, 4-Quadrant, Insulted, 60°	8-95
SFH250	Q62702-P1012	Photodiode Detector, Plastic, Fiber Optic	6-6
SFH250V	Q62702-P263	Photodiode Detector, Plastic Connector Housing, Fiber Optic	6-6
SFH263	Q62702-P1081	Photodiode, T1 ¾ (5 mm), Clear Plastic, 75°, Low Dark Current	8-97
SFH291	Q62702-P1038	Photodiode, TO-5, Hermetic, 55°, High UV-Sensitivity	8-99
SFH303-2	Q62702-P228	Phototransistor, T1 ¾ (5 mm), Clear Plastic, 20°	9-22
SFH303-3	Q62702-P229	Phototransistor, T1 ¾ (5 mm), Clear Plastic, 20°	9-22
SFH303-4	Q62702-P230	Phototransistor, T1 ¾ (5 mm), Clear Plastic, 20°	9-22
SFH303F-2	Q62702-P222	Phototransistor, T1 ¾ (5 mm), Plastic with Filter, 20°	9-22
SFH303F-3	Q62702-P223	Phototransistor, T1 ¾ (5 mm), Plastic with Filter, 20°	9-22
SFH303F-4	Q62702-P224	Phototransistor, T1 ¾ (5 mm), Plastic with Filter, 20°	9-22
SFH305-2	Q62702-P848	Phototransistor, Mini, Plastic, 16°	9-24
SFH305-3	Q62702-P849	Phototransistor, Mini, Plastic, 16°	9-24
SFH309-2	Q62702-P996	Phototransistor, T1 (3 mm), Clear Plastic, 12°	9-26
SFH309-3	Q62702-P997	Phototransistor, T1 (3 mm), Clear Plastic, 12°	9-26
SFH309-4	Q62702-P998	Phototransistor, T1 (3 mm), Clear Plastic, 12°	9-26
SFH309-5	Q62702-P999	Phototransistor, T1 (3 mm), Clear Plastic, 12°	9-26
SFH309-6	Q62702-P1000	Phototransistor, T1 (3 mm), Clear Plastic, 12°	9-26
SFH309F-2	Q62702-P174	Phototransistor, T1 (3 mm), Plastic with Filter, 12°	9-26
SFH309F-3	Q62702-P176	Phototransistor, T1 (3 mm), Plastic with Filter, 12°	9-26
SFH309F-4	Q62702-P178	Phototransistor, T1 (3 mm), Plastic with Filter, 12°	9-26
SFH309F-5	Q62702-P180	Phototransistor, T1 (3 mm), Plastic with Filter, 12°	9-26
SFH309P-2	Q62702-P231	Phototransistor, T1 (3 mm), Clear Plastic, 75°	9-29
SFH309P-3	Q62702-P232	Phototransistor, T1 (3 mm), Clear Plastic, 75°	9-29
SFH309P-4	Q62702-P233	Phototransistor, T1 (3 mm), Clear Plastic, 75°	9-29
SFH309PF-2	Q62702-P235	Phototransistor, T1 (3 mm), Plastic with Filter, 75°	9-29
SFH309PF-3	Q62702-P236	Phototransistor, T1 (3 mm), Plastic with Filter, 75°	9-29
SFH309PF-4	Q62702-P237	Phototransistor, T1 (3 mm), Plastic with Filter, 75°	9-29
SFH317-2	Q62702-P225	Phototransistor, T1 ¾ (5 mm), Plastic, 75°	9-32
SFH317-3	Q62702-P226	Phototransistor, T1 ¾ (5 mm), Plastic, 75°	9-32
SFH317-4	Q62702-P227	Phototransistor, T1 ¾ (5 mm), Plastic, 75°	9-32
SFH317F-2	Q62702-P219	Phototransistor, T1 ¾ (5 mm), Plastic with Filter, 75°	9-32
SFH317F-3	Q62702-P220	Phototransistor, T1 ¾ (5 mm), Plastic with Filter, 75°	9-32
SFH317F-4	Q62702-P221	Phototransistor, T1 ¾ (5 mm), Plastic with Filter, 75°	9-32
SFH320-1	Q62702-P388	Phototransistor, SMT-TOP-LED, 60°	9-34
SFH320-2	Q62702-P389	Phototransistor, SMT-TOP-LED, 60°	9-34
SFH320-3	Q62702-P390	Phototransistor, SMT-TOP-LED, 60°	9-34
SFH320F-1	Q62702-P391	Phototransistor, SMT-TOP-LED with Filter, 60°	9-34
SFH320F-2	Q62702-P392	Phototransistor, SMT-TOP-LED with Filter, 60°	9-34
SFH320F-3	Q62702-P393	Phototransistor, SMT-TOP-LED with Filter, 60°	9-34
SFH350	Q62702-P1033	Phototransistor, Plastic, Fiber Optic	6-8
SFH350V	Q62702-P264	Phototransistor, Plastic Connector Housing, Fiber Optic	6-8
SFH400-2	Q62702-P783	Emitter, IR, TO-18, 6°, 20-40 mW/sr	7-15
SFH400-3	Q62702-P784	Emitter, IR, TO-18, 6°, >32 mW/sr	7-15
SFH401-2	Q62702-P786	Emitter, IR, TO-18, 15°, 10-20 mW/sr	7-15
SFH401-3	Q62702-P787	Emitter, IR, TO-18, 15°, 16-32 mW/sr	7-15
SFH402-2	Q62702-P789	Emitter, IR, TO-18, 40°, 2.5-5 mW/sr	7-15
SFH402-3	Q62702-P790	Emitter, IR, TO-18, 40°, >4 mW/sr	7-15
SFH405-2	Q62702-P856	Emitter, IR, Mini, 16°	7-18
SFH405-3	Q62702-P857	Emitter, IR, Mini, 16°	7-18
SFH409-1	Q62702-P1001	Emitter, IR, T1 (3 mm), Plastic, 20°, 6.3-12.5 mW/sr	7-20
SFH409-2	Q62702-P1002	Emitter, IR, T1 (3 mm), Plastic, 20°, 10-20 mW/sr	7-20
SFH409-3	Q62702-P1003	Emitter, IR, T1, Plastic, 20°, >16 mW/sr	7-20
SFH414-T	Q62703-P1154	Emitter, IR, T1 ¾ (5 mm), Plastic, 25-50 mW/sr, 11°	7-22
SFH414-U	Q62703-P1155	Emitter, IR, T1 ¾ (5 mm), Plastic, 40-80 mW/sr, 11°	7-22
SFH415-S	Q62703-P1135	Emitter, IR, T1 ¾ (5 mm), Plastic, 16-22 mW/sr, 17°	7-22
SFH415-T	Q62703-P1136	Emitter, IR, T1 ¾ (5 mm), Plastic, 25-50 mW/sr, 17°	7-22
SFH415-U	Q62703-P1137	Emitter, IR, T1 ¾ (5 mm), Plastic, 40-80 mW/sr, 17°	7-22
SFH416-Q	Q62703-P1138	Emitter, IR, T1 ¾ (5 mm), Plastic, 6.3-12 mW/sr, 28°	7-22
SFH416-R	Q62703-P1139	Emitter, IR, T1 ¾ (5 mm), Plastic, 10-20 mW/sr, 28°	7-22

ALPHANUMERIC INDEX (use ordering code numbers when ordering in Europe)

PART NO.	ORDERING CODE NO.	DESCRIPTION	PAGE
SFH420	Q62702-P1132	Emitter, IR, SMT-TOPLED, 2.5–5 mW/sr, 60°	7-25
SFH421	Q62703-Q2407	Emitter, IR, SMT-TOPLED, 4–8 mW/sr, 60°	7-27
SFH450	Q62702-P1034	Emitter, IR, GaAs, Plastic Fiber Optic	6-10
SFH450V	Q62702-P265	Emitter, IR, GaAs, Plastic Connector Housing, Fiber Optic	6-10
SFH452V	Q62702-P281	Emitter, IR, GaAlAs, Plastic Connector Housing, Fiber Optic	6-10
SFH462	Q62702-P1182	Emitter, IR, TO-18, 23°	7-30
SFH462-K E7800	Q62702-P332	Emitter, IR, TO-18, 23°, 0.63–1.25 mW/sr	7-30
SFH462-L E7800	Q62702-P1116	Emitter, IR, TO-18, 23°, 1–2 mW/sr	7-30
SFH480-1	Q62703-Q1661	Emitter, IR, TO-18, GaAlAs, 6°, 25–50 mW/sr	7-32
SFH480-2	Q62703-Q1662	Emitter, IR, TO-18, GaAlAs, 6°, 40–80 mW/s	7-32
SFH481-1	Q62703-Q1664	Emitter, IR, TO-18, GaAlAs, 15°, 10–20 mW/s	7-32
SFH481-2	Q62703-Q1665	Emitter, IR, TO-18, GaAlAs, 15°, 16–32 mW/s	7-32
SFH481-3	Q62703-Q1666	Emitter, IR, TO-18, GaAlAs, 15°, >25 mW/s	7-32
SFH482-1	Q62703-Q1667	Emitter, IR, TO-18, GaAlAs, 30°, 3.15–6.3 mW/s	7-32
SFH482-2	Q62703-Q1668	Emitter, IR, TO-18, GaAlAs, 30°, 5–10 mW/s	7-32
SFH482-3	Q62703-Q1669	Emitter, IR, TO-18, GaAlAs, 30°, >8 mW/s	7-32
SFH482-L E7800	Q62703-Q2185	Emitter, IR, TO-18, GaAlAs, 30°, 1–2 mW/s	7-32
SFH482-M E7800	Q62703-Q2186	Emitter, IR, TO-18, GaAlAs, 30°, 1.6–3.2 mW/s	7-32
SFH483	Q62703-Q1090	Emitter, IR, TO-18, GaAlAs, 23°	7-35
SFH483-L E7800	Q62703-Q2162	Emitter, IR, TO-18, GaAlAs, 23°, 1–2 mW/s	7-35
SFH483-M E7800	Q62703-Q2163	Emitter, IR, TO-18, GaAlAs, 23°, 1.6–3.2 mW/s	7-35
SFH484-1	Q62703-Q1755	Emitter, IR, T1 ¼ (5 mm), GaAlAs, 8°, 50–100 mW/sr	7-37
SFH484-2	Q62703-Q1756	Emitter, IR, T1 ¼ (5 mm), GaAlAs, 8°, 80–160 mW/sr	7-37
SFH485-1	Q62703-Q1546	Emitter, IR, T1 ¼ (5 mm), GaAlAs, 20°, 16–32 mW/sr	7-37
SFH485-2	Q62703-Q1547	Emitter, IR, T1 ¼ (5 mm), GaAlAs, 20°, 25–50 mW/sr	7-37
SFH485P	Q62703-Q516	Emitter, IR, T1 ¼ (5 mm), GaAlAs, 40°, Flat Top, 3.15–6.3 mW/sr	7-39
SFH487-1	Q62703-Q1760	Emitter, IR, T1 (3 mm), GaAlAs, 20°, 12.5–25 mW/sr	7-41
SFH487-2	Q62703-Q1761	Emitter, IR, T1 (3 mm), GaAlAs, 20°, 20–40 mW/sr	7-41
SFH487-3	Q62703-P767	Emitter, IR, T1 (3 mm), GaAlAs, 20°, >32 mW/sr	7-41
SFH487P	Q62703-Q517	Emitter, IR, T1 (3 mm), Flat Top, 65°, 2–4 mW/sr	7-43
SFH501-1	Q62702-P110	Phototransistor, TO-18, Hermetic, Darlington, 7°	9-37
SFH501-2	Q62702-P111	Phototransistor, TO-18, Hermetic, Darlington, 7°	9-37
SFH505A	Q62702-P373	Photodiode, Receiver/Demodulator, Plastic with Filter, ±50°	8-101
SFH551	Q62703-P1161	Photodetector for Plastic Fiber, T1 ¾ (5 mm), Plastic	6-13
SFH551V	Q62703-P287	Photodetector for Plastic Fiber, Right Angle Housing, Plastic	6-13
SFH600-0	Q68000-A7313	Optocoupler, 6 Pin Single, 40–80% CTR, 5300V	5-215
SFH600-1	Q68000-A7314	Optocoupler, 6 Pin Single, 63–125% CTR, 5300V	5-215
SFH600-2	Q68000-A7315	Optocoupler, 6 Pin Single, 100–200% CTR, 5300V	5-215
SFH600-3	Q68000-A7316	Optocoupler, 6 Pin Single, 160–320% CTR, 5300V	5-215
SFH601-1	Q68000-A7318	Optocoupler, 6 Pin Single, 40–80% CTR, 5300V	5-219
SFH601-2	Q68000-A7319	Optocoupler, 6 Pin Single, 63–125% CTR, 5300V	5-219
SFH601-3	Q68000-A7320	Optocoupler, 6 Pin Single, 100–200% CTR, 5300V	5-219
SFH601-4	Q68000-A7321	Optocoupler, 6 Pin Single, 160–320% CTR, 5300V	5-219
SFH601G-1		Replaced by SFH601-1, Option 6	
SFH601G-2		Replaced by SFH601-2, Option 6	
SFH601G-3		Replaced by SFH601-3, Option 6	
SFH601G-4		Replaced by SFH601-4, Option 6	
SFH606	Q68000-A8727	Replaced by SFH600-1, Option 4	
SFH608-2	Q62703-N0169	Optocoupler, 6 Pin Single, 63–125% CTR, 5300V, Low Current	5-223
SFH608-3	Q62703-N0170	Optocoupler, 6 Pin Single, 100–200% CTR, 5300V, Low Current	5-223
SFH608-4	Q62703-N0171	Optocoupler, 6 Pin Single, 160–320% CTR, 5300V, Low Current	5-223
SFH608-5	Q62703-N0172	Optocoupler, 6 Pin Single, 250–500% CTR, 5300V, Low Current	5-223
SFH609-1		Replaced by SFH601-1	
SFH609-2		Replaced by SFH601-2	
SFH609-3		Replaced by SFH601-3	
SFH610-1	Q62703-N75	Optocoupler, 4 Pin Single, 40–80% CTR, 5300V	5-226
SFH610-2	Q62703-N76	Optocoupler, 4 Pin Single, 63–125% CTR, 5300V	5-226
SFH610-3	Q62703-N77	Optocoupler, 4 Pin Single, 100–200% CTR, 5300V	5-226
SFH610-4	Q62703-N78	Optocoupler, 4 Pin Single, 160–320% CTR, 5300V	5-226
SFH611-1	Q62703-N82	Optocoupler, 4 Pin Single, 40–80% CTR, 5300V	5-226

ALPHANUMERIC INDEX (use ordering code numbers when ordering in Europe)

PART NO.	ORDERING CODE NO.	DESCRIPTION	PAGE
SFH611-2	Q62703-N83	Optocoupler, 4 Pin Single, 63–125% CTR, 5300V	5–226
SFH611-3	Q62703-N84	Optocoupler, 4 Pin Single, 100–200% CTR, 5300V	5–226
SFH611-4	Q62703-N85	Optocoupler, 4 Pin Single, 160–320% CTR, 5300V	5–226
SFH615-1	Q62703-N109	Optocoupler, 4 Pin Single, 40–80% CTR, 5300V	5–226
SFH615-2	Q62703-N110	Optocoupler, 4 Pin Single, 63–125% CTR, 5300V	5–226
SFH615-3	Q62703-N111	Optocoupler, 4 Pin Single, 100–200% CTR, 5300V	5–226
SFH615-4	Q62703-N112	Optocoupler, 4 Pin Single, 160–320% CTR, 5300V	5–226
SFH617G-1	Q62703-N127	Optocoupler, 4 Pin Single, 40–80% CTR, 5300V	5–229
SFH617G-2	Q62703-N128	Optocoupler, 4 Pin Single, 63–125% CTR, 5300V	5–229
SFH617G-3	Q62703-N129	Optocoupler, 4 Pin Single, 100–200% CTR, 5300V	5–229
SFH617G-4	Q62703-N120	Optocoupler, 4 Pin Single, 160–320% CTR, 5300V	5–229
SFH618-2	Q62703-N173	Optocoupler, 4 Pin Single, 63–125% CTR, 5300V, Low Current	5–232
SFH618-3	Q62703-N174	Optocoupler, 4 Pin Single, 100–200% CTR, 5300V, Low Current	5–232
SFH618-4	Q62703-N175	Optocoupler, 4 Pin Single, 160–320% CTR, 5300V, Low Current	5–232
SFH618-5	Q62703-N176	Optocoupler, 4 Pin Single, 250–500% CTR, 5300V, Low Current	5–232
SFH620-1	Q62703-N115	Optocoupler, 4 Pin Single, 40–125% CTR, 5300V, AC Input	5–235
SFH620-2	Q62703-N116	Optocoupler, 4 Pin Single, 63–200% CTR, 5300V, AC Input	5–235
SFH620-3	Q62703-N117	Optocoupler, 4 Pin Single, 100–320% CTR, 5300V, AC Input	5–235
SFH628-2	Q68000-A8654	Optocoupler, 4 Pin Single, 63–200% CTR, 5300V, Low Current, AC Input	5–238
SFH628-3	Q68000-A8655	Optocoupler, 4 Pin Single, 100–320% CTR, 5300V, Low Current, AC Input	5–238
SFH628-4	Q68000-A8656	Optocoupler, 4 Pin Single, 160–500% CTR, 5300V, Low Current, AC Input	5–238
SFH640-1	Q68000-A8664	Optocoupler, 6 Pin Single, 40–80% CTR, 5300V, High Reverse Voltage	5–241
SFH640-2	Q68000-A8665	Optocoupler, 6 Pin Single, 63–125% CTR, 5300V, High Reverse Voltage	5–241
SFH640-3	Q68000-A8666	Optocoupler, 6 Pin Single, 100–200% CTR, 5300V, High Reverse Voltage	5–241
SFH750	Q62702-P1031	Emitter, Vis. Red, GaAsP, Plastic Fiber Optic	6–14
SFH750V	Q62702-P266	Emitter, Vis. Red, GaAsP, Plastic Connector Housing, Fiber Optics	6–14
SFH751		Discontinued	
SFH752	Q62702-P210	Emitter, Vis. Red, GaAsP, Plastic Fiber Optic	6–14
SFH752V	Q62702-P284	Emitter, Vis. Red, GaAsP, Plastic Connector Housing, Fiber Optics	6–14
SFH900-1	Q62702-P935	Reflector Sensor, Mini, Plastic Emitter Detector Pair	7–45
SFH900-2	Q62702-P141	Reflector Sensor, Mini, Plastic Emitter Detector Pair	7–45
SFH900-3	Q62702-P1088	Reflector Sensor, Mini, Plastic Emitter Detector Pair	7–45
SFH900-4	Q62702-P1087	Reflector Sensor, Mini, Plastic Emitter Detector Pair	7–45
SFH905-1	Q62702-P1117	Reflector Sensor, Mini, Plastic Emitter Detector Pair	7–45
SFH905-2	Q62702-P1118	Reflector Sensor, Mini, Plastic Emitter Detector Pair	7–45
SFH910	Q62702-P866	Interrupter, Differential Photodiode, Photo IC	7–49
SFH2030	Q62702-P955	Photodiode, T1 ¾ (5 mm), Clear Plastic, 20°, PIN	8–104
SFH2030F	Q62702-P956	Photodiode, T1 ¾ (5 mm) Plastic with Filter, 20°, PIN	8–104
SFH2115	Q62702-P2215	GaAs Energy Converter	6–17
SFH2210	Q62702-P967	Ternary PIN Photodiode, TO	6–18
SFH2212	Q62702-	IRED, TO18	6–19
SFH2213	Q62702-P968	Ternary PIN Photodiode, TO	6–20
SFH2215	Q62702-P321	Ternary PIN Photodiode, Receptacle	6–21
SFH2223	Q62702-P2007	Ternary PIN Photodiode, Pigtail	6–22
SFH2224	Q62702-P269	Ternary PIN Photodiode, Pigtail	6–22
SFH2249	Q62702-P425	Ternary PIN Photodiode, Pigtail	6–23
SFH2310	Q62702-P193	Ge-Avalanche Photodiode, TO	6–24
SFH2323	Q62702-P194	Ge-Avalanche Photodiode, Pigtail	6–25
SFH2324	Q62702-P260	Ge-Avalanche Photodiode, Pigtail	6–25
SFH2325	Q62702-P382	Ge-Avalanche Photodiode, Pigtail	6–26
SFH2326	Q62702-P383	Ge-Avalanche Photodiode, Pigtail	6–26
SFH4210	Q62702-P979	IRED, TO18	6–27
SFH4212	Q62702-P369	IRED, TO18	6–28
SFH4410	Q62702-P288	Laser Diode, Low Power, TO18	6–30
SFH4413	Q62702-P409	Laser Diode, Low Power, TO18	6–32
SFH4415-I	Q62702-P325	Laser Diode, Low Power, FC Receptacle	6–34
SFH4415-II	Q62702-P372	Laser Diode, High Power, FC Receptacle	6–35
SFH4423	Q62702-P326	Laser Diode, Low Power, SM Fiber Pigtail with Flange	6–36
SFH4424	Q62702-P327	Laser Diode, Low Power, SM Fiber Pigtail	6–36
SFH4445	Q62702-P208	Laser Diode, Transceiver Optical Module, BIDI™	6–38
SFH4446	Q62702-P423	Laser Diode, Transceiver Optical Module, BIDI™	6–40
SFH4448	Q62702-P397	Laser Diode, Transceiver Optical Module, BIDI™	6–42
SFH4646	Q62702-P424	Laser Diode, Transceiver Optical Module, BIDI™	6–44

ALPHANUMERIC INDEX (use ordering code numbers when ordering in Europe)

PART NO.	ORDERING CODE NO.	DESCRIPTION	PAGE
SFH6011		Replaced by SFH601-2,-3, Option 3	
SFH6016-1		Replaced by SFH601-1, Option 7	
SFH6016-2		Replaced by SFH601-2, Option 7	
SFH6016-3		Replaced by SFH601-3, Option 7	
SFH6016-4		Replaced by SFH601-4, Option 7	
SFH6106-1	Q68000-7775	Optocoupler, 4 Pin Single, SMT Lead Bend, 40-80% CTR, 5300V	5-244
SFH6106-2	Q68000-7776	Optocoupler, 4 Pin Single, SMT Lead Bend, 63-125% CTR, 5300V	5-244
SFH6106-3	Q68000-7777	Optocoupler, 4 Pin Single, SMT Lead Bend, 100-200% CTR, 5300V	5-244
SFH6106-4	Q68000-7778	Optocoupler, 4 Pin Single, SMT Lead Bend, 160-320% CTR, 5300V	5-244
SFH6116-1	Q68000-A8622	Optocoupler, 4 Pin Single, SMT Lead Bend, 40-80% CTR, 5300V	5-244
SFH6116-2	Q68000-A8623	Optocoupler, 4 Pin Single, SMT Lead Bend, 63-125 CTR, 5300V	5-244
SFH6116-3	Q68000-A8624	Optocoupler, 4 Pin Single, SMT Lead Bend, 100-200% CTR, 5300V	5-244
SFH6116-4	Q68000-A8625	Optocoupler, 4 Pin Single, SMT Lead Bend, 160-320% CTR, 5300V	5-244
SFH6135	Q62703-N135	Optocoupler, 8 Pin Single, 7% CTR, 5300V, 1 Mbit/s	5-245
SFH6136	Q62703-N133	Optocoupler, 8 Pin Single, 19% CTR, 5300V, 1 Mbit/s	5-245
SFH6138	Q62703-N0190	Optocoupler, 8 Pin Single, 800% CTR, 5300V	5-248
SFH6139	Q62703-N0191	Optocoupler, 8 Pin Single, 800% CTR, 5300V	5-248
SFH6156-1	Q68000-A8626	Optocoupler, 4 Pin Single, SMT Lead Bend, 40-80% CTR, 5300V	5-244
SFH6156-2	Q68000-A8627	Optocoupler, 4 Pin Single, SMT Lead Bend, 63-125 CTR, 5300V	5-244
SFH6156-3	Q68000-A8628	Optocoupler, 4 Pin Single, SMT Lead Bend, 100-200% CTR, 5300V	5-244
SFH6156-4	Q68000-A8629	Optocoupler, 4 Pin Single, SMT Lead Bend, 160-320% CTR, 5300V	5-244
SFH6186-1	Q68000-A8292	Optocoupler, 4 Pin Single, SMT Lead Bend, 63-125% CTR, 5300V, Low Current	5-244
SFH6186-2	Q68000-A8293	Optocoupler, 4 Pin Single, SMT Lead Bend, 100-200% CTR, 5300V, Low Current	5-244
SFH6186-3	Q68000-A8294	Optocoupler, 4 Pin Single, SMT Lead Bend, 160-320% CTR, 5300V, Low Current	5-244
SFH6186-4	Q68000-A8295	Optocoupler, 4 Pin Single, SMT Lead Bend, 250-500% CTR, 5300V, Low Current	5-244
SFH6206-1	Q68000-A8288	Optocoupler, 4 Pin Single, SMT Lead Bend, 40-80% CTR, 5300V, AC Input	5-244
SFH6206-2	Q68000-A8289	Optocoupler, 4 Pin Single, SMT Lead Bend, 63-125 CTR, 5300V, AC Input	5-244
SFH6206-3	Q68000-A8290	Optocoupler, 4 Pin Single, SMT Lead Bend, 100-200% CTR, 5300V, AC Input	5-244
SFH6206-4	Q68000-A8291	Optocoupler, 4 Pin Single, SMT Lead Bend, 160-320% CTR, 5300V, AC Input	5-244
SFH6286-2	Q68000-A8491	Optocoupler, 4 Pin Single, SMT Lead Bend, 63-200% CTR, 5300V, Low Current	5-244
SFH6286-3	Q68000-A8492	Optocoupler, 4 Pin Single, SMT Lead Bend, 100-320% CTR, 5300V, Low Current	5-244
SFH6286-4	Q68000-A8493	Optocoupler, 4 Pin Single, SMT Lead Bend, 160-500% CTR, 5300V, Low Current	5-244
SFH480301	Q62702-P153	Laser Diode, 12-Stripe Laser Array	6-46
SFH482201	Q62702-P334	Laser Diode, GaAlAs, 50 μ m Broad Area Laser	6-48
SFH482301	Q62702-P156	Laser Diode, 12-Stripe Laser Array	6-50
SFH483401	Q62702-P363	Laser Diode, 200 μ m Stripe Laser Array	6-52
SFH483406	Q62702-P2022	Laser Diode, 200 μ m Stripe Laser Array	6-52
SFH483501	Q62702-P344	Laser Diode, 40-Stripe Laser Array, 5 x 20 Stripe Laser Array	6-54
SFH484401	Q62702-P403	Laser Diode, GaAlAs	6-56
SFH484501	Q62702-P353	Laser Diode, 5x40 Stripe Laser Array	6-57
SFH487401	Q62702-P367	Laser Diode, GaAlAs, FC Connector	6-58
SFH487406	Q62702-P368	Laser Diode, GaAlAs, FC Connector	6-58
SFH487501	Q62702-P1186	Laser Diode, GaAlAs, FC Connector	6-61
SFH487506	Q62702-P1194	Laser Diode, GaAlAs, FC Connector	6-61
SFK610-1		Replaced by SFH610-1	
SFK610-2		Replaced by SFH610-2	
SFK610-3		Replaced by SFH610-3	
SFK610-4		Replaced by SFH610-4	
SFK611-1		Replaced by SFH611-1	
SFK611-2		Replaced by SFH611-2	
SFK611-3		Replaced by SFH611-3	
SFK611-4		Replaced by SFH611-4	
SLR2016	Q68000-A8640	Intelligent Display, 4 Char, .186", Red, 5x7 Dot Matrix	2-177
SLO2016	Q68000-A8641	Intelligent Display, 4 Char, .186", HER, 5x7 Dot Matrix	2-177
SLG2016	Q68000-A8642	Intelligent Display, 4 Char, .186", Green, 5x7 Dot Matrix	2-177
Sly2016	Q68000-A8643	Intelligent Display, 4 Char, .186", Yellow, 5x7 Dot Matrix	2-177
TP60P	Q62707-S60	Photovoltaic Cell, Round Plastic, 1 μ A/Ix, 60°	10-14
TP61P	Q62707-S61	Photovoltaic Cell, Hex, 1 μ A/Ix, 60°, Chip with Litz Wires	10-14
YBG1000	Q68000-A5969	Bar Graph, Yellow, 10 Element	3-18
YBG4840	Q68000-A4409	Bar Graph, Yellow, 10 Element	3-20
YL56	Q68000-A5961	Lamp, Yellow, Axial, 20 mcd/10 mA, 40°	4-57

SIEMENS

Quality at Siemens Optoelectronics

At Siemens Optoelectronics, quality means more than today's satisfied customer. It means measuring up to our customer's plans for tomorrow.

It means a sophisticated process: Quality manufacturing and assurance programs, ongoing training and statistical quality control. It means continuously using customer feedback to build in improvements, ensuring just-in time

delivery. And it means measurable results. During the past decade, we've continually reduced the cost of quality while increasing our productivity and reducing ppm.

In short, quality has become our way of life, permeating everything we do. It's become the art and science of exceeding our customer's expectations.

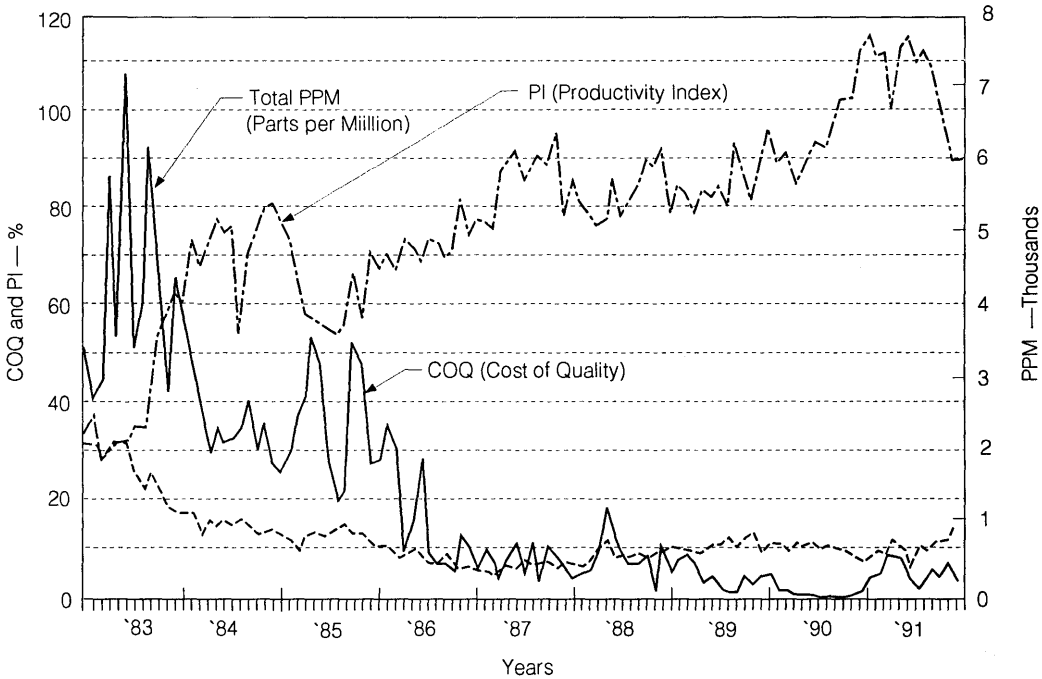

Quality Means Measurable Results at Siemens Optoelectronics

SIEMENS

Optoelectronics Quality and Reliability

Introduction

In the technological community as a whole, the terms "quality" and "reliability" are frequently reduced to little more than advertising platitudes—heavily promised, but seldom delivered in the form of highly reliable, precision-made products. At Siemens Optoelectronics Division, however, we strive for continually increasing product excellence through increased quality and reliability reflecting a company-wide commitment of the highest priority.

Our ability to produce quality optoelectronic products offering long term reliability is directly related to intensive research and development, advanced manufacturing, a quality-oriented work force, and a company-wide philosophy attuned to the changing needs of a technologically sophisticated customer base.

Another important facet of our total commitment to manufacturing excellence is a program of quality control and reliability testing, under the Reliability and Quality Assurance (R&QA) Department. R&QA's responsibility is to interface directly with the customers, not only to determine their present satisfaction level, but to assess their future needs as well. In this way, R&QA makes certain that we will successfully meet all current and future quality/reliability requirements of our customers.

Similarly, it is also R&QA's responsibility to maintain open communication with customers, keeping them informed of our latest capabilities and achievements in the areas of product quality and reliability through detailed reports.

Although the concepts of quality and reliability are closely related, they are somewhat divergent, specialized activities. Simply put, **Quality Assurance** makes certain that products are "made right," ranging from rigid inspection and monitoring of all materials used in production processes, to monitoring the actual production processes themselves. **Reliability**, on the other hand, ensures that products "work right" after assembly. At Siemens, component reliability results from an extensive program of routine monitoring and special testing activities which will be detailed later.

Parts Per Million (PPM) Program

The intensive, quality-oriented efforts of every group have enabled us to achieve one of the lowest defect percentages in the industry. Our Parts Per Million (PPM) program meets all industry expectations and is at a level sufficient to supply high-caliber OEM customers including IBM, DEC, AT&T, ITT, and Ford.

The annual improvement of the PPM level is vital to our ability to remain a cost-effective, on-time supplier of high quality components to the industry. Our PPM program is at the heart of the quality/reliability "revolution" that has occurred in the semiconductor industry during the last few years.

Designed to control and monitor every step of the manufacturing process, as well as assist in predictability studies, our PPM program represents the key to our long-term success in a highly competitive industry. To this end, we are heavily committed to:

- Maximum automation of processes to obtain consistent, reproducible results.
- A system of stringent process controls to ensure the achievement of expected results.
- Effective quality systems to continuously audit the PPM level actually being achieved.

Customer benefits of the PPM system are numerous:

- A low PPM defect rate enabling you to eliminate incoming QA testing.
- Dependable on-time delivery for a "just-in-time" inventory system, significantly reducing inventory costs.
- Efficient, highly automated manufacturing to keep long-term price increases as low as possible.
- Fewer production line failures; lower assembly costs; increased profit margin.
- Fewer field failures on end products; lower warranty and service costs.

The 1991/92 PPM goal for Siemens Optoelectronics is 10 PPM for critical defects.

Customer Quality Return Performance 1990 – 1991

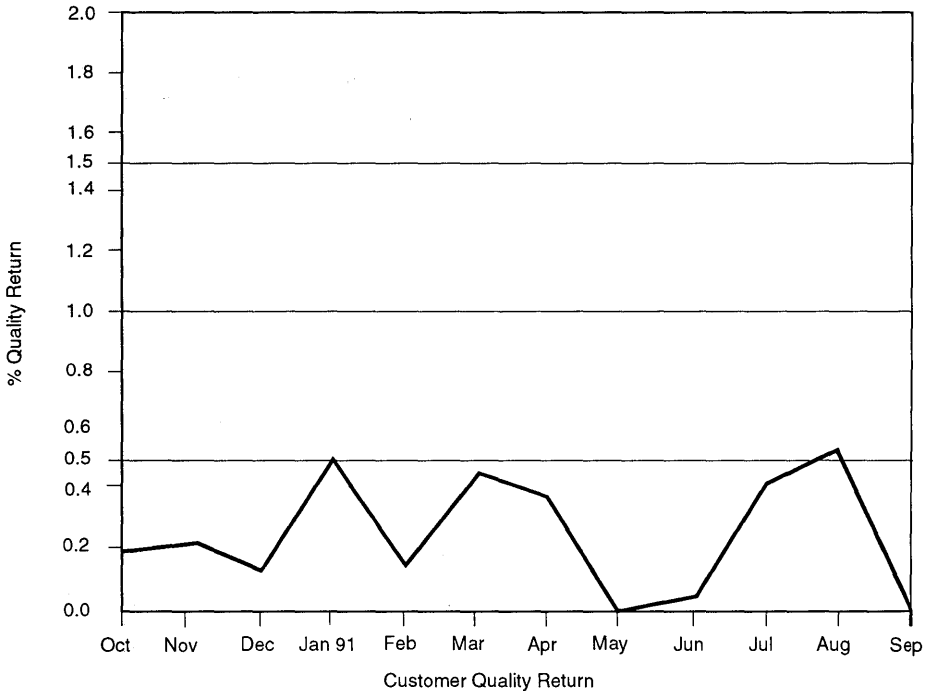

Statistical Quality Control (SQC)

To achieve our PPM goals efficiently, we have implemented a sophisticated program of Statistical Quality Control (SQC). In effect, SQC ensures highly-reproducible, controlled manufacturing processes and "just-in-time" delivery. It enables us to meet our PPM goals without resorting to a "brute force" approach. SQC is consistent with William E. Deming's principal theory that productivity improves as a product's variability rate decreases.

We recognize the necessity of meeting our customers' ever-increasing quality requirements through a carefully developed, well-implemented program of Statistical Quality Control. After considerable research and careful planning, our SQC program was developed using the following six-point plan for Statistical Process Control:

- Establishment of goals and objectives for company-wide implementation of Quality program
- Assessment of SQC technical capability and quantification of training aids
- Provision for training managers, engineers, supervisors, and analysts in methods and practices of SQC, as needed
- Managerial involvement in gaining statistical evidence pertaining to specific processes
- Identification of examples of successful SQC implementation to be used as models for emulation
- Monitoring progress toward established goals through a program of periodic self-audits

Quality Assurance

At Siemens the Quality Assurance Group serves the vital function of maintaining constant product quality standards. Quality Assurance activities begin with the careful assessment of raw materials, continues through in-process monitoring, and concludes with outgoing audits as outlined below:

- Raw Material
 - Vendor surveys
 - Vendor qualifications
 - Incoming inspections
 - Vendor rating systems
- In-process Monitors
 - Die attach monitors
 - Lead bond monitors
 - Encapsulation monitors
 - Finishing operations monitors
- Outgoing Audits
 - Outgoing audits (all lots)
 - Finished goods monitor (random)

The flowchart on the opposite page shows the basic quality control procedures employed by Siemens Opto in the production of LEDs.

LED Quality Assurance Flowchart

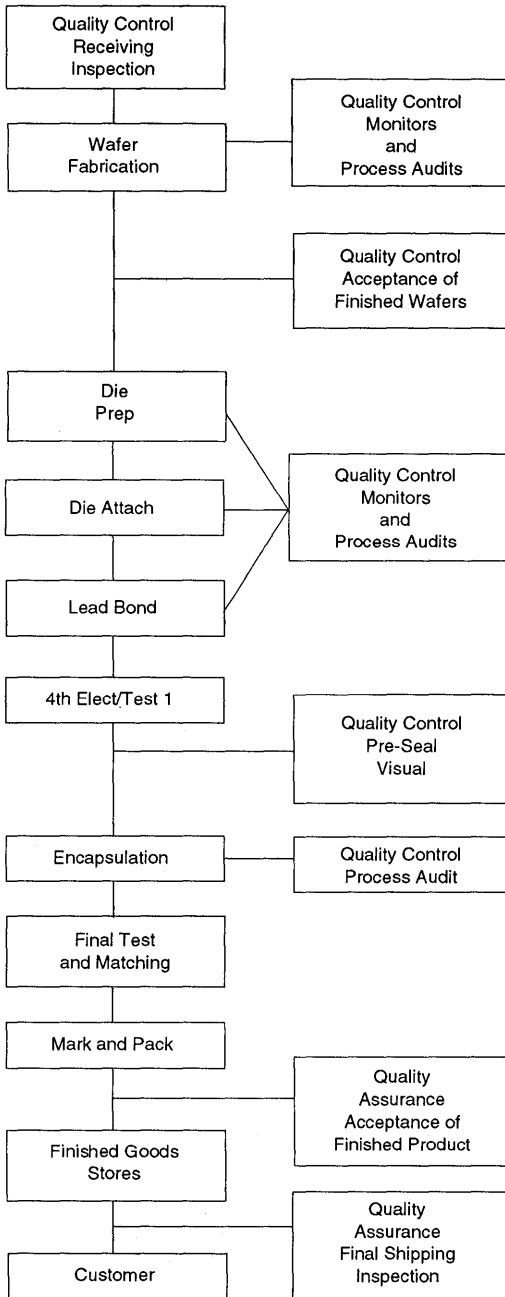

Reliability

The fundamental objective of our reliability program is to ensure that all our products meet or exceed, quantitatively and qualitatively, the performance requirements of our customers and our Engineering Group. To achieve this goal, the Reliability Group constantly monitors products by generic groups. This monitoring provides continuous updated measurement of product reliability in specific operating environments.

The following are typical Reliability Tests performed for the monitoring program:

- Temperature Cycle: 100 Cycles from -40°C to 100°C*
- Thermal Shock: 30 Cycles from 0°C to 100°C*
- Ambient Life Test: Max rated power for 1000 hours
- Elevated Life Test: Max rated power at 70°C for 1000 hours
- High Temperature Storage: Max storage temperature, 1000 hours
- Low Temperature Storage: Minimum storage temperature, 1000 hours
- Temperature Humidity: 85°C - 85% RH, 500 hours
- Solder Heat Test: 260°C, 5 seconds

*Typical temp cycle and thermal shock condition. Exact conditions vary with product family.

Reliability Test Data (1984 – 1990 Monitoring Data)

Type of Test Displays	Lamps	Standard Displays	Intelligent Display Devices	Opto-couplers
Temperature Cycle (1000 CY)				
Sample Size	10.024	6421	7473	18.981
Total Cycles	1002K	652K	747%	1898K
Total Reject	0	0	2	0
Percent Reject	0.0%	0.0%	0.03%	0.01%
Thermal Shock (30CY)				
Sample Size	8.475	4490	4629	13.269
Total Cycles	254K	134K	138K	398K
Total Reject	2	1	0	2
Percent Reject	0.02%	0.02%	0.0%	0.02%
Room Temperature Burn-In (1000 Hrs)				
Sample Size	3652	1372	3422	4620
Total Hours	3652K	1372K	1088K	4619K
Total Reject	0	0	0	0
FR* (%)	0.0%	0.0%	0.0%	0.02%
Solder Heat Test (260°C, 5 sec.)				
Sample Size	2730	2244	2203	10.023
Total Reject	2	0	0	3
Percent Reject	0.0%	0.0%	0.0%	0.03%

*FR = Failure Rate, % per 1000 hours

Type of Test	Military Standard	PreTest Readings	Test	Post Test Readings
Temp Cycle (T/C)	MIL STD 883B, Method 1010.2	GO/NO GO	10 cycles per sub group, 15 min. swell, 5 sec. transfer time, max. storage temp. ranges vary by product	GO/NO GO
Thermal Shock (T/S)	MIL STD 883B, Method 1011.1	GO/NO GO	30 cycles: boiling water; then ice water with 5 min. dwell time	GO/NO GO
Life Test (L/T)	MIL STD 833B, Method 1005.2	Read/Record	Room temperature burn-in at max. rated conditions, 1000 hours duration	Read/Record at 168,500 and 1000 hours
High Temp Burn In (HI BI)	MIL STD 883B, MIL STD 883B,	Read/Record Read/Record	Maximum rated operating temp. determined from product spec.and derated current as compensation for thermal disipation, 1000 hours duration 1000 hours	Read/Record at 168,500 and
Solder Heat Test	—	GO/NO GO	Temp = 260°C, dwell time = 5 seconds	GO/NO GO

Reliability test equipment ranges from multiple burn-in racks and table testers to a scanning electron-beam microscope. We've even designed and produced our own automatic microprocessor-based read/record tester.

Special testing covers a broad spectrum of environmental and life-stress tests. How well a sample performs under these highly accelerated conditions indicates its reliability potential under service-life conditions.

Special testing affords us vital information in many important areas:

- New product performance
- New processes
- New manufacturing techniques
- New material quality
- Special customer specifications
- Long-term reliability prediction

Reliability is also concerned with failure analysis. To determine the cause of failures, we selectively test and section products to localize and identify their failure mechanism. Selective isolation enables us to gauge the precise effects of stresses induced during reliability testing.

Continuous Improvement Program

In order to assure continuous improvement of our process and products, we are continuously evaluating and adopting new approaches and new procedures. Some of the new procedures and techniques adopted in the past ten years are:

- Tasuchi Method
- Six Sigma
- TQC/TQM
- Total Productive Maintenance
- Process Capability Studies, Cp Cpk

The latest approaches we are now evaluating are ISO9000 and Kaizen.

Conclusion

Siemens is firmly committed to the design, development, and production of innovative optoelectronic components and assemblies of the highest quality and reliability. Working to achieve this goal, every group within the Division—Management, Engineering, Reliability and Quality Assurance, Manufacturing, and Marketing—provides a vital service, enabling us to achieve and maintain the consistent product quality and the high levels of reliability required by our customers in the electronics industry.

Due in large part to the efforts of the Reliability and Quality Assurance Department and to our successful PPM and SQC efforts, we will continue to maintain our leadership position in a highly competitive future-oriented industry.

SIEMENS

High Reliability and Military Optoelectronic Devices

Capabilities

High reliability products must function under severe environmental, mechanical, and electrical stress. To meet this challenge Siemens Optoelectronics has established closely monitored product designs and process control techniques, insuring long product life.

Testing

We maintain a well equipped high reliability lab for electrical, mechanical, and environmental tests. All testing for JAN and Hi-rel products is done in Cupertino, California and for Industrial products, in Penang, Malaysia.

Calibration and Quality Control Systems

For calibration systems Siemens complies with the requirements of MIL-S-45662, and for quality control systems, MIL-Q-9858.

Certification

Siemens is a QPL supplier and approved by DESC to supply qualified MIL-D-87157/3 devices in accordance with

the requirements of MIL-S-19500G. Electrical, environmental, and mechanical testing is done per MIL-STD-750 and MIL-STD-883 test methods and procedures. Our military lines are staffed by highly trained and experienced people who are certified on a periodic basis as required by DESC.

High Reliability Custom Optoelectronic Products

In addition to our standard displays, Siemens has the capability to design, manufacture and test custom optoelectronic devices—ranging from components to assemblies.

High Reliability Displays

Our Hi-rel, Intelligent Display devices are qualified to quality level A of MIL-D-87157 test levels.

Military Specifications

Siemens Hi-rel and military optoelectronic devices conform to the following Military Specifications:

Military Specifications

MIL-D-87157	General specification for display, light emitting diode, and solid state devices
MIL-S-19500	General specification for semiconductor devices
MIL-Q-9858	Quality program requirements
MIL-STD-105	Standard for sampling procedures and tables for inspection by attributes
MIL-STD-202	Standard for test methods for electronics and electrical components
MIL-STD-750	Standard for test methods for semiconductor devices
MIL-STD-883	Standard for test methods and procedures for microelectronics
MIL-STD-45662	Standard for calibration system requirements
DOD-STD-1686	Electrostatic discharge control program
MIL-HDBK-52A	Evaluation of contractor calibration system handbook
DOD-HDBK-263	Electrostatic discharge control handbook

OPTOCOUPLER MANUFACTURING and RELIABILITY

Single, Dual, and Quad Channel Optocouplers

THE CONCERN FOR OPTOCOUPLER RELIABILITY

Because of the widespread use of optocouplers as an interface device, optocoupler reliability has been a major concern to circuit designers and components engineers. Published studies of comparative tests have indicated a lack of manufacturing consistency with individual manufacturers as well as from manufacturer to manufacturer. This has resulted in user uncertainty about designing in optocouplers despite the fact that these devices often offer the better solution in the circuit.

This report is intended to demonstrate Siemens' concern, efforts, and results in addressing these manufacturing issues to assure users of the quality (out-going) and reliability (long term) of our opto-isolated products. First, aspects of optocoupler characteristics are discussed along with the measures Siemens has taken to assure their quality and reliability. Secondly, the reliability tests used to approximate worst case conditions and the latest results of these tests are described.

OPTOCOUPLER OUTPUT

There are a variety of outputs available in optocouplers. A standard bipolar phototransistor is the most common. They are available with different ratings to fit most applications, including versions without access to the base of the transistor to reduce noise transmission. Darlington transistor outputs offer high gain with reduced input current requirements, but typically trade-off speed. Logic optocouplers provide speed but trade-off working voltage range. Logic couplers are normally only used in data transmission applications. Silicon Controlled Rectifier (SCR) devices allow control of much higher voltages and typically are applied to control AC loads. They are also offered in inverse-parallel (anti-parallel) SCR (triac) configurations that both cycles of an AC sinusoid can be switched. In the Siemens manufacturing flow, all these devices are 100% monitored at a high temperature hot rail (see Figure 4) to eliminate potential failures due to marginal die attaches and lead bends, resulting in a more reliable product. Siemens offers all the above types of products.

In optocouplers, especially the transistor, the slow change over several days in the electrical parameters when voltage is applied, is termed the field effect. This process is extreme particularly at high temperatures (100°C) and with a high DC voltage (1kV). Changes in the electrical parameters of the silicon phototransistor can occur due to the release of charge carriers. In this way, a similar effect as takes place in a MOS transistor (inversion at the surface) is caused by the strong electrical field. This may result in changes in the gain, the reverse current, and the reverse voltage. In this case, the direction of the electrical field is a decisive factor.

In Siemens' optocouplers, the pn junctions of the silicon phototransistor are protected by a TRIOS (transparent ion screen) from influences of the electrical field. In this way, changes of electrical parameters by the electrical field are limited to an extremely low value or do not occur at all.

OPTOCOUPLER INPUT

The area of greatest concern in optocoupler reliability has been the IR LED. The decrease in LED light output power over current flow time has been the object of considerable attention in order to reduce its effects. (Circuit designs which have not included allowances for parametric changes with temperature, input current, phototransistor bias, etc. have been attributed to LED degradation. To insure reliable system operation over time, the variation of circuit from data sheet conditions must be considered.)

Siemens has focused on the infrared LED to improve CTR degradation, and consequently achieved a significant improvement in coupler reliability. The improvements have included die geometry to improve coupling efficiency, metalization techniques to increase die shear strength and to increase yields while reducing user cost, and junction coating techniques to protect against mechanical stresses, thus stabilizing long term output.

CURRENT TRANSFER RATIO

The Current Transfer Ratio (CTR) is the amount of output current derived from the amount of input current. CTR is normally expressed as a percent. For example, if 10 mA of input current is applied to the input (LED) and 10 mA of collector current is obtained, then the CTR is 100 or 100%. CTR is affected by a variety of influences: LED output power, Hfe of the transistor, temperature, diode current, and device geometry. If all these factors remain constant, the principle cause of CTR degradation is the degradation of the input LED. As mentioned earlier, Siemens has made tremendous progress in manufacturing techniques to reduce CTR degradation. Figure 1 graphs the CTR degradation of Siemens' optocouplers. The data is presented under two conditions. Both conditions apply a constant stress over the 4000-hour period. This is unlikely to occur in actual application, and therefore can be considered as a worst case condition. The first condition ($I_F = 10 \text{ mA}$) is a typical operating point for actual application. The second condition ($I_F = 60 \text{ mA}$) stresses the LED at an extremely high, forward current to demonstrate worst case conditions, and magnifies CTR degradation. Siemens' manufacturing techniques maximize coupling efficiency which realize high transfer ratios and low input current requirements. Additionally this allows a large variety of standard CTR values, and the capability of special selection in production volumes.

ISOLATION BREAKDOWN VOLTAGE

Isolation voltage is the maximum voltage which may be applied across the input and output of the device without breaking down. This breakdown will not normally occur inside the package between the LED and the transistor, but rather on the boundary surfaces across which partial discharges can occur. Siemens uses a double mold manufacturing technique where the LED and transistor are encapsulated in an infrared transparent inner mold. The next step in the process is an epoxy over mold. The double mold technique lengthens the leakage path for high voltage

discharges appreciably, allowing the device to achieve very high isolation voltages. All of Siemens optocouplers are built using U.L. approved process. A standard line of V.D.E. approved optocouplers is also available.

COLLECTOR TO EMITTER BREAKDOWN VOLTAGE

Collector to emitter breakdown voltage (BV_{CEO}) can be thought of as a transistor's working voltage. When considering the application, the selection should be made to include a safety margin to insure the device is off when it is supposed to be off. Siemens transistor technology in wafer processing offers a variety of BV_{CEO} devices. Each is parametrically (see Figure 4) tested to insure proper operation.

BLOCKING VOLTAGE

Blocking voltage (V_{DRM} , expressed in peak value) is used when describing the working voltage for SCR or triac type devices. Siemens offers products through 600 volts of blocking capability.

DV/DT RATING

DV/DT, an important safety specification, describes a triac type device's capability to withstand a rapidly rising voltage without turning on or false firing. Siemens triac type devices have the highest available DV/DT rating offered on the market. Siemens manufacturing process yields a 10,000 $V/\mu s$ DV/DT rating. This rating eliminates the need for snubber (RC) networks which negatively affect loads sensitive to leakage currents, while reducing component count for circuit implementation and cost. An example of such a load would be neon indicator lamps. Siemens' triac type devices also carry a load current rating three times the industry standard. This 300 mA current capability allows the device to drive most AC loads without the need for a follow-on triac or interposing an electromechanical relay. Siemens manufactures this device with or without zero crossing detector logic.

Figure 1. CTR Degradation vs. Time

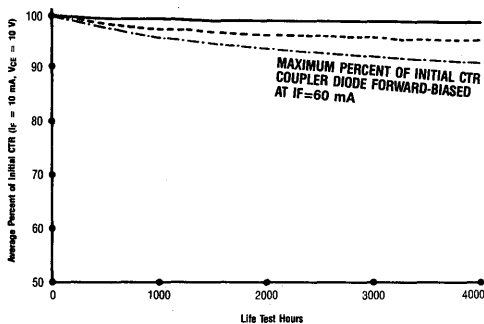

Relative degradation in current-transfer ratio (CTR) over a period of time with the coupler diode forward-biased.

- Life Test Condition: Coupler diode forward-biased at $I_F = 10\text{ mA}$, $T_{amb} = 25^\circ\text{C}$
- - - Life Test Condition: Coupler diode forward-biased at $I_F = 60\text{ mA}$, $T_{amb} = 25^\circ\text{C}$

Figure 2: Reliability Requirements for Optocouplers

MECHANICAL/ENVIRONMENTAL TESTS

Test	MIL-STD-883 Reference	Test Condition
Temperature Cycle	1010	-55°C to +150°C, 100 Cycles
Thermal Shock	1011	0°C to +100°C, 50 Cycles
Solder Heat		260°C, 10 Seconds
Solderability	2003	260°C, 5 Seconds
Pressure Pot	—	15 PSIG ± 1 , 121°C, Steam 96 Hours
Solvent Resistance	2015	—
Moisture Resistance*	1004	10 Days, 90-98% RH, -10°C to +65°C, Non-Operating
Shock*	2002 Condition B	5 Blows each X ₁ , Y ₁ , Z ₁ , Axis 1500G, 0.5 ms
Vibration Fatigue*	2005 Condition A	32 ± 8 Hrs., each X ₁ , Y ₁ , Z ₁ , 96 Hours, 60 Hz, 20G
Constant Acceleration*	2001 Condition A	1 Min. each Axis X,Y,Z, 5KG
Terminal Strength*	2004	1 lb. for 30 Seconds, then 8 oz., 3 Bends 15°

*Monitored periodically.

LIFE TESTS

Tests	Test Conditions			
	Temp (°C)	RH (%)	Bias	Hours
Ambient Life Test	25	$\leq 60\%$	Max Rating	1000
Elevated Life Test	70	$\leq 60\%$	Derated Max Rating	1000
High Temp Life Test	150	$\leq 60\%$	0	1000
Low Temp Life Test	-55	$\leq 60\%$	0	1000
Temp/Humidity Life	85	85%	0	1000
Intermittent Operating Life	25	$\leq 60\%$	Max Rating	1000
High Temperature Reverse Bias	125	$\leq 60\%$	80% of Max Voltage Rating	1000

QUALITY AND RELIABILITY TESTS

The tests in Figure 2 were performed on Siemens optocouplers. The tests allow early detection of weak points, and provide information regarding the reliability characteristics of the component.

From the Life Test information assumptions of useful life expectancy can be obtained. All quality and reliability tests are performed in conditions that either exceed or are equivalent to the limits defined in our data sheets. International standards are also considered. Assuming that no new additional failure mechanisms are created by the stress conditions, the results of the stress test will correlate to conditions in the field and can be used to estimate useful lifetime. The environmental stress tests ensure Siemens manufacturing capabilities will provide package integrity in the most rigorous conditions. The Life Test results highlight our ability in packaging and electrical performance to achieve MTBF hours which meet and exceed the highest expectations for the semiconductor industry.

Figure 3. Environmental and Life Test Results

Single Channel Optocouplers

ENVIRONMENTAL TESTS					
Test	Test Condition	Sample Size	Good	Reject	%Reject
Temperature Cycle	-55°C to +150°C, 100 Cycles	6056	6056	0	0.00%
Thermal Shock	0°C to +100°C, 30 Cycles	4596	4595	1	0.02%
Solder Heat Test	260°C, 10 Seconds	3392	3392	0	0.00%
High Temp Storage	150°C, 1000 Hours	1442	1441	1	0.07%
Low Temp Storage	-55°C, 1000 Hours	1442	1442	0	0.00%
Temp Humidity	+85°C/85% RH, 1000 Hours	454	454	0	0.00%

LIFE TESTS						
Test	Test Condition	Sample Size	Unit Hours (k)	Good	Reject	MTBF* (Unit Hours)
Ambient Life Test	60 mA, 25°C, P _D = 255 mW Max.	1442	1442	1442	0	2,030,000
Elevated Life Test	40 mA, 70°C, P _D = 104 mW	1442	1442	1442	0	2,030,000
Intermittent Op Test	On = 3 Minutes, Off = 2 Minutes 60 mA, 25°C, P _D = 235 mW Max.	1442	1442	1442	0	2,030,000
Total		4326	4326	4326	0	6,200,000

*Based on the life test results presented, an overall MTBF of 6,200,000 unit hours can be demonstrated on a "Best Estimate" basis.

Dual Channel Optocouplers

ENVIRONMENTAL TESTS					
Test	Test Condition	Sample Size	Good	Reject	%Reject
Temperature Cycle	-55°C to +150°C, 100 Cycles	6160	6159	1	0.02%
Thermal Shock	0°C to +100°C, 30 Cycles	3969	3968	1	0.03%
Solder Heat Test	260°C, 5 Seconds	2840	2838	2	0.07%
High Temp Storage	150°C, 1000 Hours	1442	1442	0	0.00%
Low Temp Storage	-55°C, 1000 Hours	1442	1442	0	0.00%
Temp Humidity	+85°C/85% RH, 1000 Hours	402	402	0	0.00%

LIFE TESTS						
Test	Test Condition	Sample Size	Unit Hours (k)	Good	Reject	MTBF* (Unit Hours)
Ambient Life Test	37.5 mA/Channel, P _D = 388 mW Max., 25°C	1442	1442	1442	0	2,030,000
Elevated Life Test	19.6 mA/Channel, P _D = 138 mW Max., 70°C	1442	1442	1442	0	2,030,000
Intermittent Op Life	On = 3 Minutes, Off = 2 Minutes 37.5 mA/Channel, P _D = 388 mW Max., 25°C	1338	1338	1338	0	1,940,000
Total		4222	4222	4222	0	6,000,000

*Based on the life test results presented, an overall MTBF of 6,000,000 unit hours can be demonstrated on a "Best Estimate" basis.

Quad Channel Optocoupler

ENVIRONMENTAL TESTS					
Test	Test Condition	Sample Size	Good	Reject	%Reject
Temperature Cycle	-55°C to +150°C, 100 Cycles	6056	6055	1	0.02%
Thermal Shock	0°C to +100°C, 30 Cycles	4296	4296	0	0.00%
Solder Heat Test	260°C, 10 Seconds	3406	3405	1	0.03%
High Temp Storage	150°C, 1000 Hours	1442	1442	0	0.00%
Low Temp Storage	-55°C, 1000 Hours	1442	1442	0	0.00%
Temp Humidity	+85°C/85% RH, 1000 Hours	402	402	0	0.00%

LIFE TESTS						
Test	Test Condition	Sample Size	Unit Hours (k)	Good	Reject	MTBF* (Unit Hours)
Ambient Life Test	37.5 mA/Channel, P _D = 388 mW Max., 25°C	1442	1442	1442	0	2,030,000
Elevated Life Test	19.6 mA/Channel, P _D = 138 mW Max., 70°C	1442	1441	1440	2	530,000
Intermittent Life Test	On = 3 Minutes, Off = 2 Minutes 37.5 mA/Channel, P _D = 138 mW Max., 25°C	1442	1442	1442	0	2,030,000
Total		4326	4325	4324	2	1,600,000

*Based on the life test results presented (at maximum rated conditions), an overall MTBF of 1,600,000 unit hours can be demonstrated on a "Best Estimate" basis.

PACKAGE INTEGRITY

Although packaged in standard IC configurations, optocouplers have some unique package considerations. The use of two chip and internal light transfer medium require careful selection of materials to insure compatibility under a variety of operating conditions. In addition to the high isolation voltages achieved by Siemens optocouplers, our devices are tested to assure high levels of mechanical integrity and moisture resistance. For example, a ninety-six hour pressure pot test has been recently implemented to more stringently verify moisture resistance. As meaningful test results are accumulated, they will be included in future reports.

PACKAGE DENSITY

Board space has become increasingly more important in the electronic industry. Siemens uses a plate molding technique to achieve reduction in cost, allowing us to offer a wide selection of packages. These consist of single channel optocouplers in 4, 6, 8, and 16 pin DIP packages, dual channel devices in 8 pin DIP packages, and quad channel devices in 16 pin DIP packages. All of the above devices are available in three surface mount lead configurations, as well as the standard through-the-hole lead. Siemens has also introduced a standard single channel optocoupler in a SOIC-8 footprint package. All of these packages have been designed and tested to meet the highest quality and reliability expectation of the semiconductor industry.

ASSEMBLY QA INSPECTIONS

1. Die Attach and Lead Bond Inspection – Random sampling of die bonding integrity by a shear strength test and wire attach integrity by a wire pull test.
2. Visual QC Monitor – Microscopic inspection of die placement, die and wire bonds, wire loops, damaged die and wire and emitter junction coat coverage.
3. Encapsulation Inspection – Sample lot inspection for molding defects.
4. Temperature Cycle Test – Sample lot temperature cycling from -55°C to +150°C for 10 cycles subjecting the parts to thermal stresses in order to eliminate marginal die attach, wire bonds and misalignments.
5. Hot Rail Test – 100% electrical continuity testing at 100°C to insure removal of thermal intermittent parts.
6. HiPot Test – 100% testing of isolation voltage parameter per UL/VDE requirements.
7. Parametric Tests – 100% electrical tests to data book or customer-selection parameters.
8. QA Final Tests – Lot audits to assure conformance to all product requirements.

Figure 4. Coupler Process Flow & Inspections

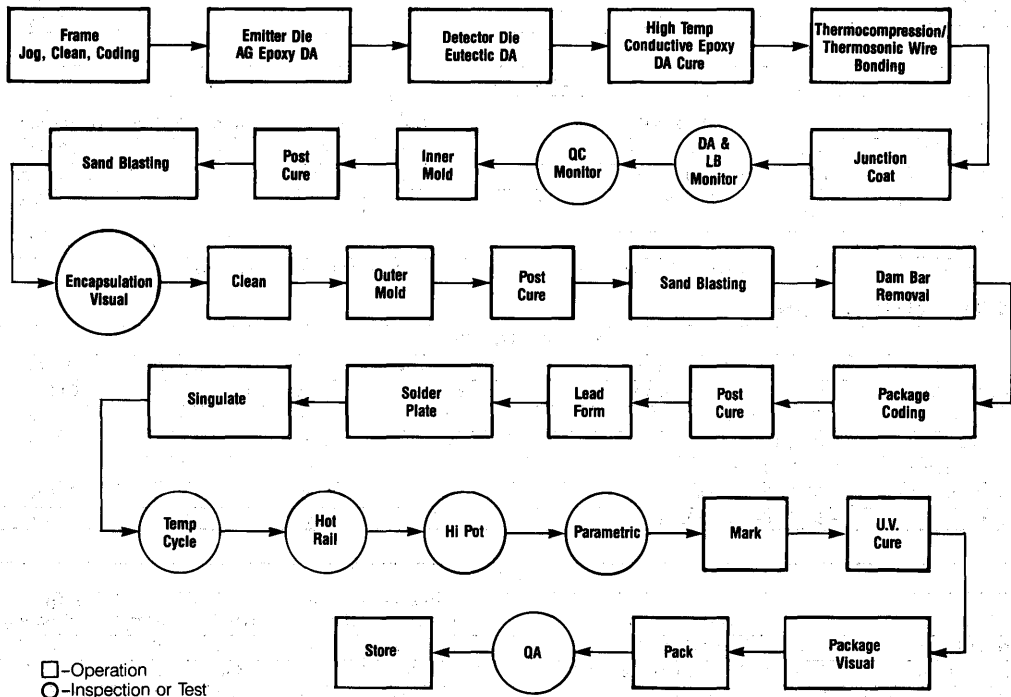

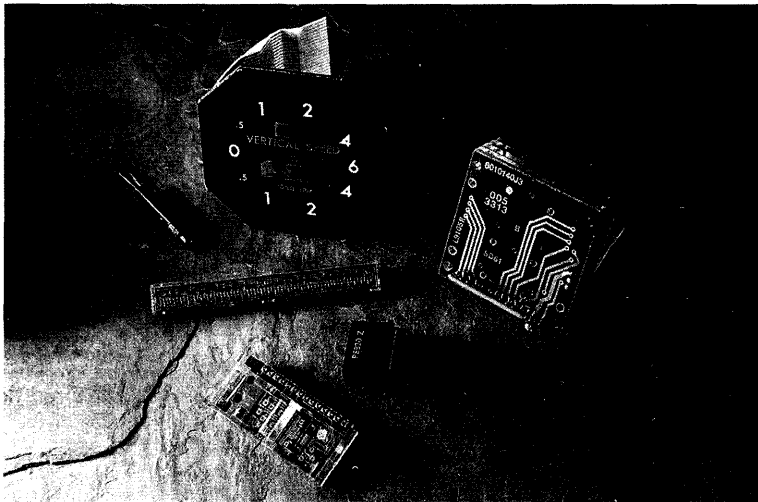

Custom Optoelectronic Products

Material and Die

SIEMENS

CUSTOM OPTOELECTRONIC PRODUCTS

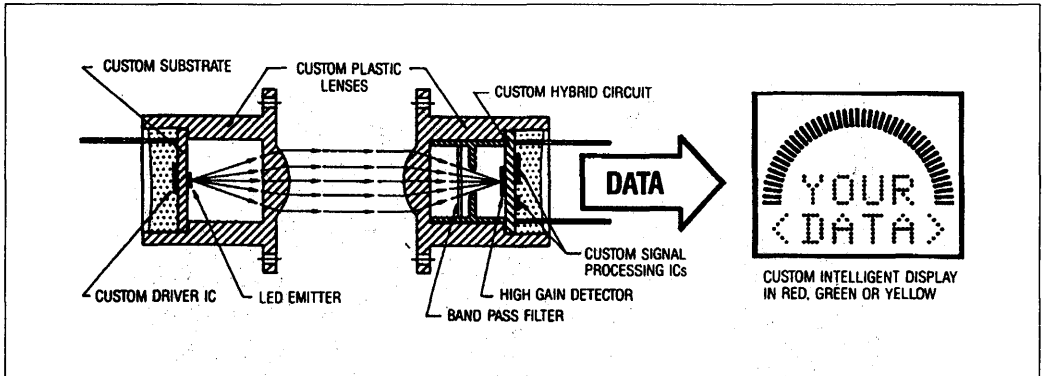

A representative example of our broad custom capabilities described below.

INTRODUCTION

Siemens Custom Optoelectronic Products are designed typically for unique applications or specific performance requirements using optical devices. Because of our over 15 years experience as an optoelectronics supplier, you benefit from this long time experience and tested performance. Our custom engineering resources include an engineering expertise in solid state optical devices and plastic optics, full custom packaging capability, complex hybrid system capability, IC design, and an optical design and measurements lab. Our custom product approach gives you reduced system cost, improved performance, design ownership, improved reliability, high product quality, and many more benefits and features.

OUR CAPABILITIES

- **Optical Design Expertise**
 - Solid State Optical Device Solutions
 - Plastic Lens Capabilities
 - Multi-Element Lens Capability
 - Multi-Channel Fiber Optic Design Techniques
- **Full Range of Custom Packaging Options**
 - Modular Assemblies Designed and Built Using:
 - Custom Leadframes
 - Molded Plastic Optics
 - Hybrid Chip-on-Substrate Assemblies
 - Polymer Thick-Film Multilayer Substrates
 - Transfer Molded Packages
 - Hermetic Packages
- **Specialize in Hybrid Functional Modules**
 - Extensive Chip-On-Board Experience
 - Precise Die Positioning in Single Units or Arrays
 - Board Component Design
 - Surface Mount Technology
- **Optical Measurements Facility**
 - Absolute Characterization of Optical Performance
 - Fast and Accurate Responses to Customer Requirements
 - Measurements Traceable to National Bureau of Standards
- **Computer Aided Design Facility**
- **In-House IC Design Capability**
 - High Speed Silicon Gate CMOS and Bipolar Technology
 - Complete IC Test, Process and Product Engineering
- **Quality and Reliability Control**
 - Established QC System
 - Average Quality Level, under 50 PPM
 - Extensive Product Characterization
- **State-of-the-Art Materials**
 - Full Spectrum of Visible LEDs, Infrared Emitters, and Detectors
- **Wafer Fabrication Facility**
 - Complete Control of Device Fabrication
 - State-of-the-Art Process and Materials
 - Custom Die Designs
- **Model, Offshore Assembly Facility**
 - Latest Automated Assembly Equipment
 - Test and Burn-in Capability
 - “Just-in-Time” Philosophy
 - Over 15 Years Experience in Optical Hybrid

- **Customer Benefits**
 - Reduced System and Program Costs
 - Higher Level of Integration
 - Reduction in Components Required
- **Optimum Product Performance**
 - Use of Latest Technology
 - Improved Optical Design Techniques
- **Uniquely Competitive Designs**
 - Special Functions and Features
 - Proprietary Customer Design
- **Reduced Product Development Time**
 - Allows Quicker Entry to Market
- **Improved Reliability and Quality**

Listed below are a few of our optical laboratory's capabilities:

- **LED spectral irradiance from 280 to 1070 nm.**
- **LED spectral luminosity from 380 to 780 nm.**
- **Radiometric and photometric intensity.**
- **Detector response versus wavelength from 280 to 1070 nm.**
- **Precise computer based measurement system.**
- **Other optical capabilities available to support customer needs.**

CUSTOM ENGINEERING RESOURCES

Siemens is an expert in evaluating customer requirements and proposing systems solutions. For example, our engineers are specialists at integrating LED displays with microprocessors to form display subsystems.

Also, our expertise in optical engineering allows us to optimize emitter/detector system designs. This includes: unique plastic lens design, multi-element lens designs, multichannel fiber optics design techniques as well as the use of other optical elements such as apertures, reflectors, mirrors, etc.

CUSTOM PACKAGING AND HYBRID CAPABILITIES

Custom packaging is another option available to you offering a significant size reduction and resulting cost savings over most existing designs. Our modular assemblies are designed and built using custom leadframes, custom molded plastic lenses, hybrid chip-on-substrate assemblies or polymer thick-film multilayer substrates. We have extensive chip-on-board experience for airgap, concoat, and epoxy encapsulated modules. We support air gap assemblies with metal or plastic housings. We also have the technology to transfer mold epoxy packages. For harsh environmental conditions we offer hermetic processing using glass, ceramic or metal assemblies.

Another area of expertise is in precise die positioning in single units or arrays. Our surface mount technology supports both ceramic and PCB substrates. Our component design capability includes visible LEDs, IR LEDs, Op Amps, Photodiodes, Phototransistors, LSI CMOS Chips, Bipolar ICs, Optocouplers, and Discretes. In summary, we are the optoelectronic specialists in the design of hybrid modules.

OPTICAL DESIGN AND MEASUREMENTS LABORATORY

The Siemens Optics Lab, a versatile and precise optical measurement facility, provides fast and accurate absolute characterization of optical radiation performance. This insures fast and accurate responses to customer requirements and on-site field support available on complex issues. The lab is coordinated with standards organizations worldwide insuring the latest conventions for optical measurement procedures. All measurements are traceable to the National Bureau of Standards.

WAFER FABRICATION FACILITIES

For your custom requirements, Siemens wafer fabrication facilities use state-of-the-art materials such as Gallium Arsenide (GaAs), Gallium Aluminum Arsenide (GaAlAs), Gallium Phosphide (GaP), and Gallium Arsenide Phosphide (GaAsP). We can control wavelength in a range from 560 nm to 840 nm. Our quality material gives you higher reliability and more brightness with lower power. We also provide a material foundry service for your custom die requirements.

CAD/CAM: DESIGN AND ASSEMBLY

We design custom assemblies and subassemblies by computer and assemble by computer-controlled automated assembly equipment. This vastly improves the reliability and quality control while offering more features at the lowest possible cost.

AUTOMATED OFFSHORE ASSEMBLY FACILITY

The Siemens assembly plant, in Penang, Malaysia, uses the latest in automated assembly and test equipment allowing effective and flexible approaches to varying technologies and products yielding competitive costs and prices. Our automated computer tracking system supports a "just-in-time" delivery philosophy. A total quality concept includes a statistical process control program, a continuous calibration program, a preventive maintenance program, and an employee job awareness enhancement program is an ongoing commitment. A complete test and burn-in facility is supported by a failure analysis group and reliability monitors. Production lots are traceable guaranteeing predictability of quality and yield. A dedicated product development group supports a variety of customer needs. We have accumulated a total of over 14 years experience in the assembly and test of high density optoelectronic hybrid assemblies.

CUSTOMER BENEFITS

Your program benefits in many ways, through a combination of the engineering resources and available technology. We can reduce your system and overall program costs through higher levels of integration, reduced component inventory/ lower component costs, elimination of in-house assembly labor costs, lower inventory costs, reduction of warranty expenses, and lower administrative costs. We can offer optimum product performance with improved optical design techniques using leading edge technology. Our state-of-the-art packaging techniques offer significant size reductions as well as improved operating conditions. All this leads to improved product quality and reliability characteristics since the final product is 100% tested and guaranteed operational.

Your design will be uniquely competitive since it will use features and technologies not available to your competitors. The design will be your proprietary product. Our ability to dedicate engineering resources to your custom project frees up your resources for other programs enabling your products quicker introduction to the market. You receive only fully tested and quality assured product (100% yield) for improved reliability and quality.

CUSTOM APPLICATIONS AND MARKETS SERVED

Siemens Custom Products have applications in virtually every OEM market. We currently serve the industrial, medical, EDP and computer peripherals, telecommunica-

tions, office equipment, and transportation markets. Some high volume applications now in production include: medical fluid flow sensor, medical oximetry probes, electronic coin sensing, industrial controller displays, currency validation, computer touch screen sensing, instrumentation panels, sign boards, information of data terminal displays, and custom lamps and bar graphs.

INQUIRIES

Your inquiries should include mechanical, electrical, and environmental requirements. Also include anticipated product volumes, price objectives and lead times since these considerations affect the design and tooling approach.

Examples of Products in Production:

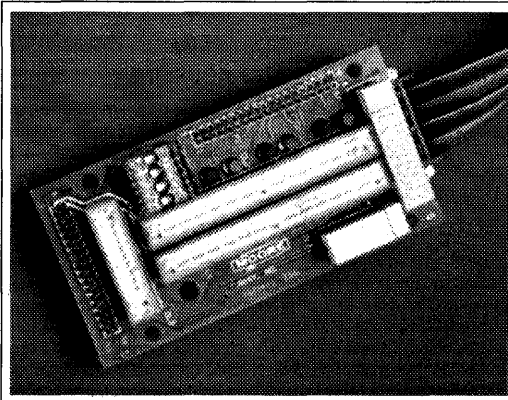

Industrial Display

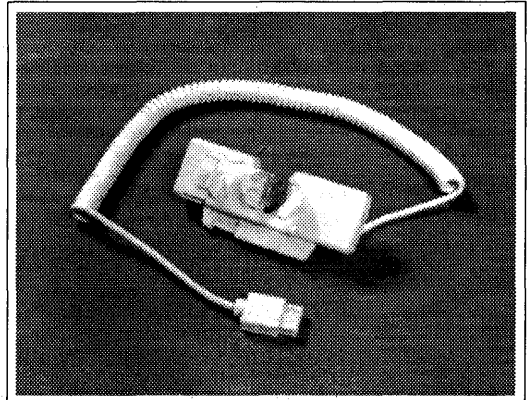

Fluid Flow Sensor

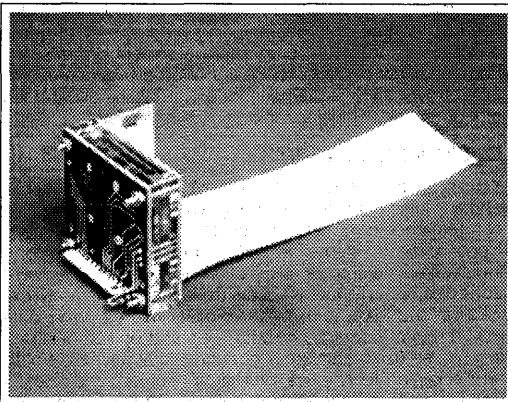

Coin Sensor

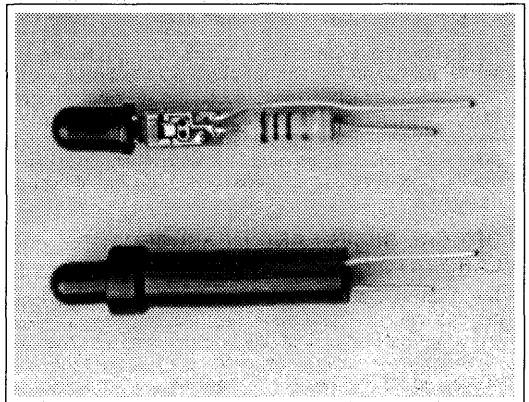

Telephone Switch Indicator Lamp

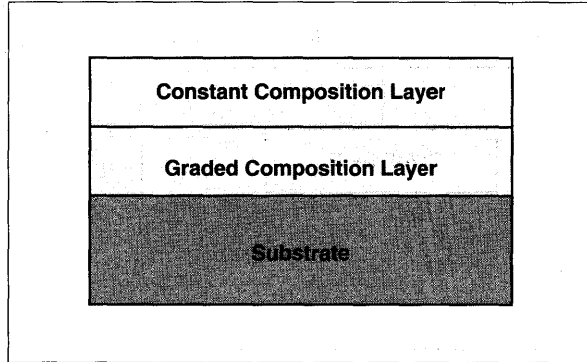
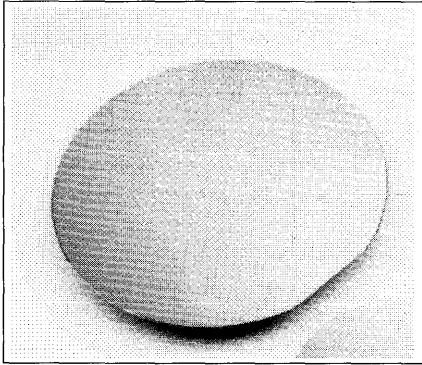

DESCRIPTION

Siemens epitaxial layers are grown by Hydride Vapor-Phase Epitaxy (HVPE). High quantum efficiencies and uniformity make these wafers ideal for visible displays and solid-state, near-monochromatic light sources.

EPITAXIAL LAYER

Material: GaAs_{1-x}P_x:Te
 Conductivity: n-type
 Carrier
 Concentration: 0.5-5.0 x 10¹⁷cm⁻³
 Peak PL
 Wavelength:⁽¹⁾ 655 ±5 nm
 Brightness: 0.8 mCd min. at 15 A/cm²
 Graded Layer
 Thickness: 15 μm min.
 Constant Layer
 Thickness: 15 μm min.

Substrate

Material: GaAs
 Growth Type: Czochralski or Boat-Grown
 Conductivity: n-type
 Orientation: (100), off 3 ±0.5° toward the (111-Bar)

PHYSICAL PROPERTIES

Size: Grown on 3" diameter SEMI spec substrate
 Thickness: 500 ±50 μm
 Bow: -50 ±100 μm
 Pits:⁽²⁾ 15 per square inch maximum
 Voids:⁽²⁾ 3 per wafer maximum larger than 1 mm diameter
 Projections:⁽²⁾ 3 per square inch maximum higher than 15 μm
 Scratches:⁽²⁾ 3 per wafer maximum; none longer than 10 mm
 Chips: None penetrating further than 2 mm
 Cracks: None
 Polycrystal:⁽²⁾ None
 Broken Lattice:⁽²⁾ None
 Twin Lines:⁽²⁾ None

Notes:

1. Other wavelengths also available.
2. Excludes outer 2 mm perimeter of wafer.

Custom Optoelectronic Materials and Die

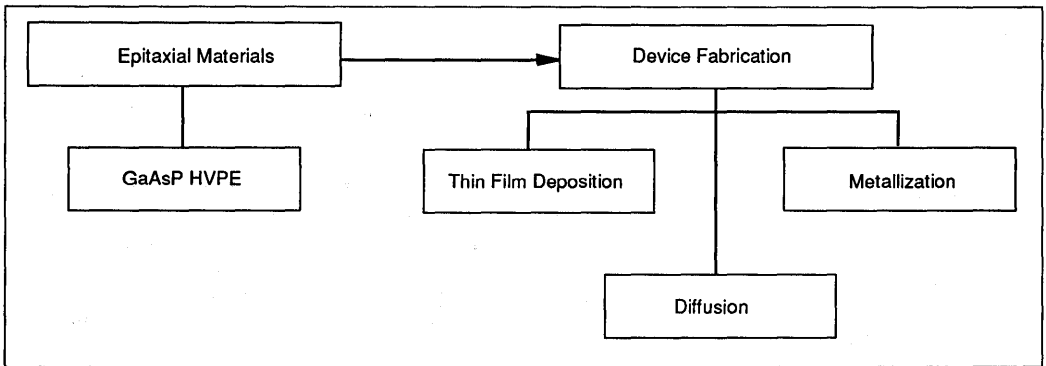

Introduction

- **Custom Materials Growth**
 - State-of-the-Art Proprietary Reactor Designs
 - GaAsP Growth Capability
 - Complete Materials Analysis Facility
 - Systems Handle Prototype & Production Volumes
 - 3" Diameter Wafers and Custom Shapes
- **Custom Device Fabrication**
 - Thermal & Plasma Thin Film Deposition
 - Optimized Diffusions for Each Composition
 - Customized N- and P-Type Metallizations
- **In-House Computer-Aided Device Design**
 - Custom Electro-Optical Devices
 - Library of Point-Source, Multi-Segment, and Fiber Optic Designs Available
- **Optical Measurements Facility**
 - Absolute Characterization of Optical Performance
 - Fast, Accurate Response to Customer Requests
 - All Measurements are NBS-Traceable
 - 100% Analytical Test Capability
- **Modern Testing and Assembly Facility**
 - Manufacturing Facility in Penang, Malaysia
 - Latest Automated Assembly Equipment
 - 100% Test and Burn-in Capability
 - "Just-in-Time" Philosophy
 - Over 15 Years Experience in Optical Hybrid Assemblies

- **Additional Product Design Expertise**
 - Multi-Element Lens Capability
 - Multi-Channel Fiber Optic Design Techniques
 - Hermetic Packages
 - Board Component Design
 - Surface Mount Technology

Epitaxial Materials Growth Facility

For your custom materials requirements, Siemens' epitaxial growth facility offers optoelectronic products in several compound semiconductor systems. We have over 15 years of experience in the growth of GaAsP/GaAs materials. Siemens is recognized worldwide for the superior quality and uniformity of our 655 nm "Standard Red" materials, but we also produce and have characterized compositions ranging from 560 nm pure green through 880 nm infrared.

An important consideration for our customers is the shape and size of the wafers we produce. To that end, Siemens offers a selection of 3"-diameter wafers sized to SEMI specifications or wafers shaped to match your specific needs.

Device Fabrication Facility

Siemens has a fully equipped fabrication facility for processing epitaxial wafers into finished devices. The processes available include thin-film deposition, photolithography, diffusion, metallization, lapping, and parametric testing and analysis. We employ statistical quality control (SOC) to ensure consistency of the most critical processes. In-house control of the fabrication process enables us to select a customized combination of technologies that best match your product needs.

Each application has its own pattern requirements dictated by available drive power, optical output power, human recognition, reliability, etc. Siemens helps you choose from a wide selection of device designs. We maintain a library of extensively characterized standard designs for point-source, multi-segment, and fiber optic emitters, or you can pick your own proprietary configuration. You can apply our design rules to produce your own masks, or give us your mechanical drawing and let us turn it into a working device. We are experienced in the design of large area, high density devices with as many as 600 uniform emitting areas on a single chip!

If you prefer, Siemens can also produce the fully assembled product by computer design of custom assemblies and sub-assemblies and use of automated manufacturing equipment. This vertical integration vastly improves reliability and quality control while offering more features at the lowest possible cost.

Optical Design and Measurements Lab

The Siemens Optics Lab, a versatile and precise optical measurement facility, provides fast and accurate characterization of optical radiation performance. This insures prompt and reliable responses to customer requirements. The lab is coordinated with standards organizations worldwide and employs the latest conventions for optical measurement procedures. All measurements are traceable to the National Bureau of Standards.

Automated Offshore Assembly Facility

The Siemens assembly facility in Penang, Malaysia, uses automated test, dicing, and assembly equipment providing both flexibility in device characterization and highest quality/lowest cost for finished products. The test and burn-in operations are supported by a failure analysis group and reliability monitors. The product is fully traceable back to the raw materials, guaranteeing predictability of quality and yield.

Worldwide Technical Commitment

One of our chief strengths lies in Siemens' commitment to establishing leading-edge semiconductor technologies. Divisions throughout the world are involved in the manufacture of optical components for signal processing, ultrahigh-speed communication, and long-haul data transmission. Supporting the efforts are the Corporate Research and Technology Laboratories. They are responsible for research in evolving sciences and supporting the manufacturing divisions with technical advice, coordinated literature access, the latest process technology, and in-depth material and device analysis.

A Typical Cycle from Plan to Product

Your program begins with the "request for quotation (RFQ)" which outlines your product requirements, anticipated delivery and volume, and target price. After review by our technical and manufacturing staffs, we will contact you with any additional questions. If we feel that Siemens can adequately service your needs we will submit a program plan, schedule, and quotation. This cycle is typically completed within five working days of receiving the RFQ.

Upon receipt of your order, we will jointly establish milestones and review dates for tracking the progress of your program. This will include a detailed listing of all key deliverables and evaluations, as well as points where reviews and decisions are required. At the end of the development phase of the program a final summary report will be submitted to complete your records and ensure a smooth transition into manufacturing.

How Do Siemens' Customers Benefit?

Successful development and production of optoelectronic devices requires many qualities. Your supplier must deliver:

A FIRM THEORETICAL FOUNDATION – to guarantee that the latest technology and best equipment put you on the shortest path to the solution,

STABLE PROCESSES – to ensure that every step of the product evolution is reliable and reproducible,

FLEXIBILITY – to provide the materials, processing, and degree of integration that are most performance- and cost-effective,

INFORMATION – to understand how the device will perform in your application,

CONSISTENCY – to expeditiously and reliably meet your product needs.

Siemens has been demonstrating these qualities for over 15 years. Whether it is an interactive development of a new product or volume production of an established part, we are the best supplier to service your optoelectronic needs!

Inquiries







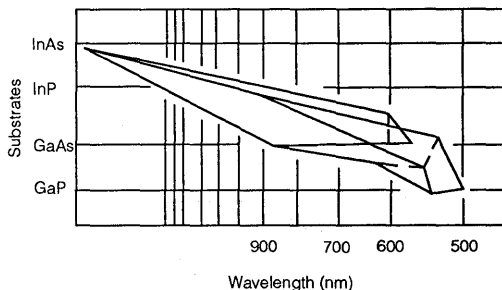



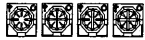



Address all correspondence and telephone calls to the Custom Materials and Devices organization at:

Siemens Components, Inc.
Optoelectronics Division
19000 Homestead Road
Cupertino, CA 95014 USA
TEL (408) 725-3529
FAX (408) 725-3420







Materials Selection Guide



Custom LED Materials

Chip	Diagram	Material	Size(mm)	Cathode	Anode	Vf	Vr	λ (nm)	LI (μ Cd)	RI (μ W/str)
IP-251B		GaAsP/GaAs	0.4 x 0.4	Au-Ge	Al	1.50	-10.0	705		50
RB-42B		GaAsP/GaAs	1.7 x 0.5	Au-Ge	Al	1.59	-25.0	655	500	
RM-14A		GaAsP/GaAs	2.7 x 3.7	Au-Ge	Al	1.57	-23.0	655	240	
RM-15B		GaAsP/GaAs	3.4 x 4.0	Au-Ge	Al	1.56	-23.0	655	350	
RM-62A		GaAsP/GaAs	2.0 x 2.7	Au-Ge	Al	1.60	-23.0	655	440	
RM-64A		GaAsP/GaAs	2.4 x 2.7	Au-Ge	Al	1.60	-24.0	655	350	
RM-73A		GaAsP/GaAs	1.5 x 2.0	Au-Ge	Al	1.60	-23.0	655	400	
RM-81A		GaAsP/GaAs	2.8 x 3.4	Au-Ge	Al	1.57	-23.0	655	220	
RM-85D		GaAsP/GaAs	1.9 x 2.2	Au-Ge	Al	1.59	-23.0	655	320	
RM-86A		GaAsP/GaAs	1.8 x 2.3	Au-Ge	Al	1.60	-23.0	655	280	
RM-95A		GaAsP/GaAs	1.9 x 2.2	Au-Ge	Al	1.59	-23.0	655	320	
RP-12C		GaAsP/GaAs	0.3 x 0.3	Au-Ge	Al	1.64	-25.0	655	500	
RP-13B		GaAsP/GaAs	0.4 x 0.4	Au-Ge	Al	1.59	-25.0	655	450	
RP-212A		GaAsP/GaAs	0.3 x 0.3	Au-Ge	Al	1.80	-25.0	655	300	

Custom LED Materials

Chip	Diagram	DPI	Material	Size(mm)	Cathode	Anode	Typical		
							Vf	λ (nm)	RI (μ W/str)
LA-200A		200	GaAsP/GaAs	8.0 x 0.4	Au-Ge	Al	1.90	740	6.27
LA-300A		300	GaAsP/GaAs	5.4 x 0.4	Au-Ge	Al	1.90	740	6.27
LA-300B		300	GaAsP/GaAs	5.4 x 0.4	Au-Ge	Al	1.90	710	6.27
LA-300C		300	GaAsP/GaAs	5.4 x 0.4	Au-Ge	Al	1.90	720	6.27
LA-300D		300	GaAsP/GaAs	5.4 x 0.4	Au-Ge	Al	1.90	685	6.27
LA-301A		300	GaAsP/GaAs	5.4 x 0.4	Au-Ge	Al	1.90	740	6.27

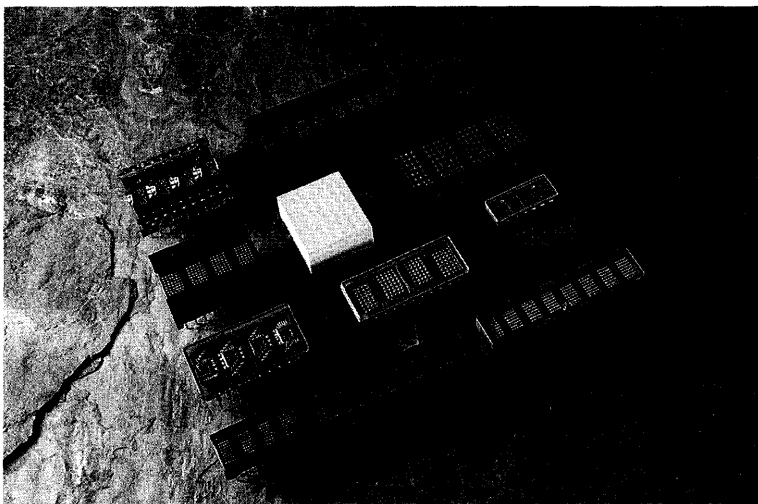

Intelligent Display® Devices

Slimline Intelligent Display® Devices

Programmable Display™ Devices

Military/Industrial Displays



Small Alphanumeric Displays

Intelligent Display Assemblies

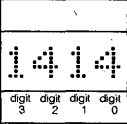
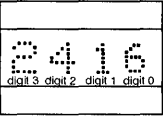
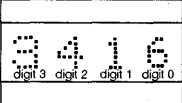
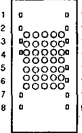
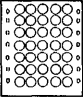
Intelligent Display[®] Devices—Dot Matrix

Package Outline	Part No./ Color	No. of Characters	Viewing Angle	Description	Page
		Character Height			
	DLR1414 Red	4	X Axis ±50° Y Axis ±75°	Dot matrix drop-in replacement for DL1414T. Four 5x7 dot matrix characters. 128 ASCII characters (English plus 5 other lan- guages). Access time: 110 ns. For portable applications, telecommunications equipment.	2-36
	DLO1414 HER	0.145"			
	DLG1414 Green				
	DLR2416 Red	4	X Axis ±50° Y Axis ±75°	Dot matrix drop-in replacement for DL2416T. Four 5x7 dot matrix characters. 128 ASCII characters (English plus 5 other lan- guages). Access time: 110 ns. For bench equipment, instrumentation.	2-41
	DLO2416 HER	0.200"			
	DLG2416 Green				
	DLR3416 Red	4	X Axis ±50° Y Axis ±75°	Dot matrix drop-in replacement for DL3416T. Four 5x7 dot matrix characters. 128 ASCII characters (English plus 5 other lan- guages). Access time: 110 ns. For bench equipment, instrumentation.	2-47
	DLO3416 HER	0.270"			
	DLG3416 Green				
	DLO4135 HER	1	±75°	Single 5x7 dot matrix character. Readable to 20 feet plus, wide viewing angle; lamp test, brightness control. One chip-enable for easy system expansion. 128 ASCII character format. Access time: 150 ns Telecommunications equipment, table top equipment, instrumentation.	2-28
	DLG4137 Green	0.43"			
	DLO7135 HER	1	±75°	Single 5x7 dot matrix character. Readable to 30 feet plus, wide viewing angle; lamp test, brightness control. One chip-enable for easy system expansion. 128 ASCII character format. Access time: 150 ns Ideal for scales, POS terminals, instrumenta- tion, mainframe peripherals.	2-32
	DLG7137 Green	0.68"			

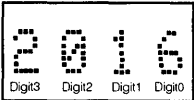
Slimline Intelligent Display® Devices—Dot Matrix

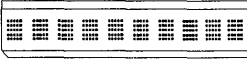
Package Outline	Part No./ Color	No. of Characters	Viewing Angle	Description	Page
		Character Height			
	SLR2016 Red	4	X Axis ±50° Y Axis ±75°	Slimline package. Four 5x7 dot matrix characters. Very close multi-line spacing, 0.4" centers. 128 ASCII characters (English plus 5 other languages). Operating temperature: -40°C to +85°C.	2-177
	SLO2016 HER				
	SLG2016 Green	0.180"			
	SLY2016 Yellow				
	SCD5580 Red	8	X Axis ±55° Y Axis ±65°	Slimline package. Eight 5x5 dot matrix characters. Serial input dot addressable display. 200 bit RAM for user defined characters. Low power: 30% less power dissipation than 5x7 format. Operating temperature: -40°C to +85°C.	2-147
	SCD5581 Yellow				
	SCD5582 HER	0.145"			
	SCD5583 Green				
	SCD5584 High Eff. Green				
	SCD55100 Red	10	X Axis ±55° Y Axis ±65°	Slimline package. Ten 5x5 dot matrix characters. Serial input dot addressable display. 200 bit RAM for user defined characters. Low power: 30% less power dissipation than 5x7 format. Operating temperature: -40°C to +85°C.	2-162
	SCD55101 Yellow				
	SCD55102 HER	0.145"			
	SCD55103 Green				
	SCD55104 High Eff. Green				

Intelligent Display Devices

Intelligent Display, Devices—Segmented

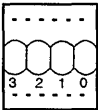
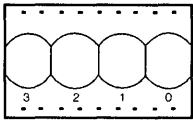
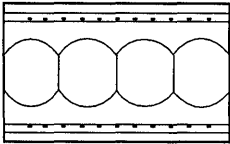
Package Outline	Part No./ Color	No. of Characters	Viewing Angle	Description	Page
		Character Height			
	DL1414T Red	4	X Axis $\pm 40^\circ$ Y Axis $\pm 55^\circ$	17 segment, 4 character display with built-in CMOS ASCII decoder, multiplexer, memory and driver. Access time: 110 ns. Low power consumption. For portable applications, telecommunications equipment.	2-12
0.112"					
	DL2416T Red	4	X Axis $\pm 45^\circ$ Y Axis $\pm 55^\circ$	17 segment, 4 character display with built-in CMOS ASCII decoder, multiplexer, memory and driver. Access time: 110 ns. Characters readable up to 8 feet, memory clear function, independent cursor function. Two chip enables for easy system expansion. For medical equipment, instrumentation, table top equipment.	2-16
0.160"					
	DL3416T Red	4	X Axis $\pm 50^\circ$ Y Axis $\pm 75^\circ$	17 segment, 4 character display with built-in CMOS ASCII decoder, multiplexer, memory and driver. Access time: 110 ns. Characters readable up to 12 feet, memory clear function, independent cursor function. Two chip enables for easy system expansion. Telecommunications equipment, instrumentation, table top equipment.	2-22
0.225"					

Programmable Display™ Devices—Dot Matrix

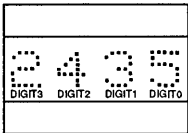
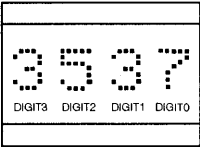
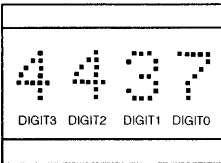
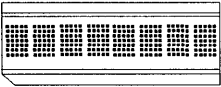
Package Outline	Part No./ Color	No. of Characters	Viewing Angle	Description	Page
		Character Height			
	PD2435 HER	4	X Axis ±55° Y Axis ±65°	Four dot matrix characters. Built-in CMOS ASCII decoder, multiplexers memory and driver. Software driven-true micro- processor peripherals. Additional features of Programmable Display devices include: control and display memory read/write, dimming (3 levels) and blanking, blinking cursor/character and lamp test. 128 ASCII characters format. Extended operating temperature range: -40°C to +85°C.	2-125
	PD2436 Red	0.200"			
	PD2437 Green				
	PD3535 HER	4			
	PD3536 Red	0.270"			
	PD3537 Green				
	PD4435 HER	4			
	PD4436 Red	0.45"			
	PD4437 Green				
	PDSP2110 Red	8	X Axis ±55°	Eight dot matrix characters. Built-in CMOS ASCII decoder, multiplexers memory and driver. Software driven-true microprocessor peripherals. Additional features of Programma- ble Display devices include: control and dis- play memory read/write, dimming (3 levels) and blanking, blinking cursor/character and lamp test. 256 ASCII characters format. Access time: 110 ns. Extended operating temperature range: -40°C to +85°C.	2-136
	PDSP2111 Yellow				
	PDSP2112 HER				
	PDSP2111 Green	8	Y Axis ±65°	Eight dot matrix characters. Built-in CMOS ASCII decoder, multiplexers memory and driver. Software driven-true microprocessor peripherals. Additional features of Programma- ble Display devices include: control and dis- play memory read/write, dimming (3 levels) and blanking, blinking cursor/character and lamp test. 128 ASCII characters format. 16 user definable characters. Access time: 110 ns. Extended operating temperature range: -40°C to +85°C.	2-62
	PDSP2112 High Eff.				
	PDSP2112 Green				
HDSP2110S Red	8	Y Axis ±65°	Eight dot matrix characters. Built-in CMOS ASCII decoder, multiplexers memory and driver. Software driven-true microprocessor peripherals. Additional features of Programma- ble Display devices include: control and dis- play memory read/write, dimming (3 levels) and blanking, blinking cursor/character and lamp test. 128 ASCII characters format. 16 user definable characters. Access time: 110 ns. Extended operating temperature range: -40°C to +85°C.	2-62	
HDSP2111S Yellow					
HDSP2112S HER					
HDSP2113S Green					
HDSP2114S High Eff.					
HDSP2114S Green					

Military/Industrial Alphanumeric Displays

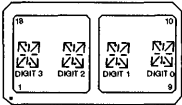
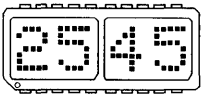
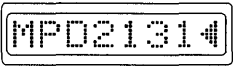
Package Outline	Part No./Color	No. of Characters	Operating Temperature Range	Description	Page
		Character Height			
	MDL2416C Red	4	-55°C to +100°C	Intelligent Display Device Four 17 segment characters. Built-in CMOS CMOS circuitry—TTL and microprocessor compatible. Rugged ceramic package, hermetically sealed flat glass lens. Low profile package. Conforms to Quality Level A.	2-76
	MDL2416TXVB Red	0.15"			
	MPD2545ATXVB IPD2545A HER	4	-55°C to +100°C	Programmable Display Device Four 5x7 dot matrix characters. Built-in CMOS ASCII decoder, multiplexer, memory, and driver. 128 character ASCII character set. Rugged ceramic package, hermetically sealed flat glass lens. Conforms to Quality Level A.	2-95
	MPD2547ATXVB IPD2547A Green	0.15"			
	MPD2548ATXVB IPD2548A Yellow				
	MPD2131TXVB IPD2131 Yellow	8	-55°C to +85°C	Programmable Display Device Eight 5x7 dot matrix characters. Built-in CMOS ASCII decoder, multiplexer, memory, and driver. 128 character ASCII character set. Rugged ceramic package, hermetically sealed flat glass lens. Conforms to Quality Level A.	2-81
	MPD2132TXVB IPD2132 HER	0.200"			
	MPD2133TXVB IPD2133 High Eff. Grn.				

Military/Industrial Small Alphanumeric Displays

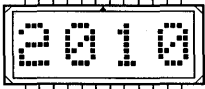
Package Outline	Part No./Color	No. of Characters	Operating Temperature Range	Description	Page
		Character Height			
	MSD2010TXVB ISD2010 Red	4	-55°C to +100°C	MSD versions only—Military alphanumeric displays, conforms to Quality Level A. ISD versions—Industrial alphanumeric displays. Four 5x7 dot matrix characters. Rugged ceramic package, hermetically sealed flat glass lens. Serial input/parallel output. Easily cascaded for multiple displays. Low power on-board CMOS shift register and constant current LED row drivers. External column strobing allows use of full ASCII and customized fonts.	2-104
	MSD2011TXVB ISD2011 Yellow	0.150"			
	MSD2012TXVB ISD2012 HER				
	MSD2013TXVB ISD2013 High Eff. Green				

Military/Industrial Small Alphanumeric Displays

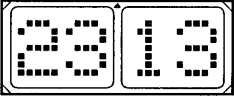
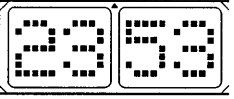
Package Outline	Part No./Color	No. of Characters	Operating Temperature Range	Description	Page
		Character Height			
	MSD2310TXVB ISD2310 Red	4	-55°C to +100°C	<p>MSD versions only—Military alphanumeric displays, conforms to Quality Level A. ISD versions—Industrial alphanumeric displays.</p> <p>Four 5x7 dot matrix characters. Rugged ceramic package, hermetically sealed flat glass lens. Serial input/parallel output. Easily cascaded for multiple displays. Low power on-board CMOS shift register and constant current LED row drivers. External column strobing allows use of full ASCII and customized fonts.</p>	2-111
	MSD2311TXVB ISD2311 Yellow				
	MSD2312TXVB ISD2312 HER	0.150"			
	MSD2351TXVB ISD2351 Yellow	4	-55°C to +100°C	<p>Sunlight viewable. MSD versions only—Military alphanumeric displays, conforms to Quality Level A. ISD versions—Industrial alphanumeric displays.</p> <p>Four 5x7 dot matrix characters. Rugged ceramic package, hermetically sealed flat glass lens. Serial input/parallel output. Easily cascaded for multiple displays. Low power on-board CMOS shift register and constant current LED row drivers. External column strobing allows use of full ASCII and customized fonts.</p>	2-118
	MSD2352TXVB ISD2352 HER				
	MSD2353TXVB ISD2353 High Eff. Green	0.200"			

Intelligent Display Devices

Commercial Small Alphanumeric Displays

Package Outline	Part No./Color	No. of Characters	Operating Temperature Range	Description	Page
		Character Height			
	HDSP2000LP Red	4	-40°C to +85°C	<p>Commercial Displays</p> <p>Four 5x7 dot matrix characters. Plastic package. Serial input/parallel output. Easily cascaded for multiple displays. Low power on-board CMOS shift register and constant current LED row drivers. External column strobing allows use of full ASCII and customized fonts.</p>	2-55
	HDSP2001LP Yellow				
	HDSP2002LP HER	0.150"			
	HDSP2003LP Green				

Alphanumeric Display

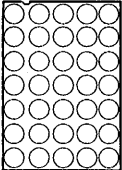
Package Outline	Part No./ Color	No. of Characters	Polarity	Luminous Intensity per Segment		Description	Page
		Character Height		Typ. (μ cd)	mA		
	DLR5735 Red	1	Common Cathode Row	200	20	Single 5x7 dot matrix character. No built-in CMOS drive circuitry.	2-53
	DLG5735 Green	0.69*					
	DLR5736 Red	1	Common Anode Row	650	10		
	DLG5736 Green	0.69*					

HIGH RELIABILITY TEST TABLES

Two high reliability testing programs are available. The normal test program conforms with MIL-D-87157 Test Table I, Quality Level A and Group A, Table II.

The TXVB program conforms to MIL-D-87157 Level A Test Tables I, II, IIIa and IVa⁽³⁾.

Table I. Quality Level A of MIL-D-87157

Test Screen	Method	Conditions
1. Precap Visual	2072, MIL-STD-750	
2. High Temperature Storage	1032, MIL-STD-750	$T_A = 125^\circ\text{C}$, Time=24 hours
3. Temperature Cycling	1051, MIL-STD-750	Condition B, 10 Cycles, 15 min. dwell $T_A = -65^\circ\text{C}$ to $+125^\circ\text{C}$
4. Constant Acceleration	2006, MIL-STD-750	See individual product specs for conditions.
5. Fine Leak	1071, MIL-STD-750	Condition H, Leak Rate $\leq 5 \times 10^{-7}$ cc/s
6. Gross Leak	1071, MIL-STD-750	Condition C
7. Interim Electrical/Optical Tests ⁽²⁾		See individual product specs for conditions
8. Burn-in ⁽¹⁾	1015, MIL-STD-883	See individual product specs for conditions
9. Final Electrical Test ⁽²⁾		Same as Step 7
10. Delta Determinants		See individual product specs for conditions
11. External Visual	2009, MIL-STD-883	

Table II. Group A Electrical Tests—MIL-D-87157

Subgroup/Test	Parameters	LTPD
Subgroup 1 DC Electrical Test at 25°C	See individual product specs for conditions	5
Subgroup 2 Selected DC Electrical Test at High Temperatures ⁽²⁾	Same as Subgroup 1, except delete I_V and Visual Function, $T_A = 100^\circ\text{C}$	7
Subgroup 3 Selected DC Electrical Tests at Low Temperatures ⁽²⁾	Same as Subgroup 1, except delete I_V and Visual Function, $T_A = -55^\circ\text{C}$	7
Subgroup 4, 5 and 6 Not Applicable		
Subgroup 7 Optical and Functional Tests at 25°C	Satisfied by Subgroup 1	5
Subgroup 8 External Visual	MIL-STD-883, Method 2009	7

Notes:

- MIL-STD-883 test method applies.
- Limits and conditions are per the Electrical/Optical Characteristics.
The I_{OH} and I_{OL} tests are the inverse of V_{OH} and V_{OL} specified in the Electrical Characteristics.
- Frequency: Group A every lot, Group B semi-annually, Group C annually.

Table IIIa. Group B, Classes A and B of MIL-STD-87157

Subgroup/Test	MIL-STD-750 Method	Conditions	Sample Size
Subgroup 1 Resistance to Solvents Internal Visual and Mechanical	1022 2075	Inspection may be performed through glass cover, includes front and back cavities	4 Devices/0 Failures 1 Device/0 Failures
Subgroup 2 ^(1,2) Solderability	2026	TA=245°C for 5 seconds	LTPD=15
Subgroup 3 Thermal Shock (Temp Cycle) Moisture Resistance ⁽³⁾ Visual Inspection Endpoints Hermetic Seal Fine Leak Gross Leak Electrical/Optical Endpoints ⁽⁴⁾	1051 1021 1071 1071 1071	Condition B, 15 min. dwell Within 24 hours after completion of moisture resistance test Condition G or H Condition C See individual product specs	LTPD=15
Subgroup 4 Operating Life Test (340 hours) Electrical/Optical Endpoints ⁽⁴⁾	1027	See individual product specs for conditions. Same as Subgroup 3	LTPD=10
Subgroup 5 Non-Operating (Storage) Life Test (340 hours) Electrical/Optical Endpoints ⁽⁴⁾	1032	TA=+125°C Same as Subgroup 3	LTPD=10

Notes:

- Whenever electrical/optical tests are not required as end-points, electrical rejects may be used.
- The LTPD applies to the number of leads inspected. Always use three or more displays to provide the number of leads required.
- Initial conditioning shall be a 15 degree inward bend and back to original position, one cycle.
- Limits and conditions are per the Electrical/Optical Characteristics. The I_{OH} and I_{OL} tests are the inverse of V_{OH} and V_{OL} specified in the Electrical Characteristics.

Table IVa. Group C, Classes A and B of MIL-STD-87157

Subgroup/Test	MIL-STD-750 Method	Conditions	Sample Size
Subgroup 1 Physical Dimensions	2066		2 Devices/0 Failures
Subgroup 2 ^(1,2) Lead Integrity Hermetic Seal Fine Leak Gross Leak	2004 1071 1071 1071	Condition B2 Condition G or H Condition C	LTPD= 15
Subgroup 3 Shock Vibration, Variable Frequency Constant Acceleration External Visual ⁽³⁾ Electrica/Optical Endpoints	2016 2056 2006 2009	1500 Gs, Time=0.5 ms, 5 blows in each orientation X1, Y1, Z1 See individual product specs for conditions.	LTPD= 15
Subgroup 4 ^(5,6) Salt Atmosphere External Visual(3)	1041 2009		LTPD= 15
Subgroup 5 Bond Strength ⁽⁷⁾	2037	Condition A	LTPD=20 (C=0)
Subgroup 6 Operating Life Test ⁽⁸⁾ Electrical/Optical Endpoints ⁽⁴⁾	1026	See individual product specs for conditions. Same as Subgroup 3	$\lambda=10$

- Notes:**
1. The LTPD applies to the number of leads inspected. Always use three or more displays to provide the number of leads required.
 2. MIL-STD-883 test method applies.
 3. Visual requirements shall be as specified in MIL-STD-883, Methods 2009.
 4. Limits and conditions are per the electrical/optical characteristics.
 5. Whenever electrical/optical tests are not required as endpoints, electrical rejects may be used.
 5. Solderability samples shall not be used.
 7. Displays may be selected prior to seal.
 3. If any given inspection lot undergoing Group B inspection has been selected to satisfy Group C inspection requirements, the 340-hour life tests may be continued on test to 1000 hours to satisfy the Group C Test requirements. In such cases, either the 340-hour endpoint measurement shall be made a basis for Group B lot acceptance or the 1000-hour endpoint measurement shall be used as the basis for both Group B and Group C acceptance.

SIEMENS

DL1414T

.112" Red, 4-Character 16 Segment Plus Decimal Alphanumeric Intelligent Display® With Memory/Decoder/Driver

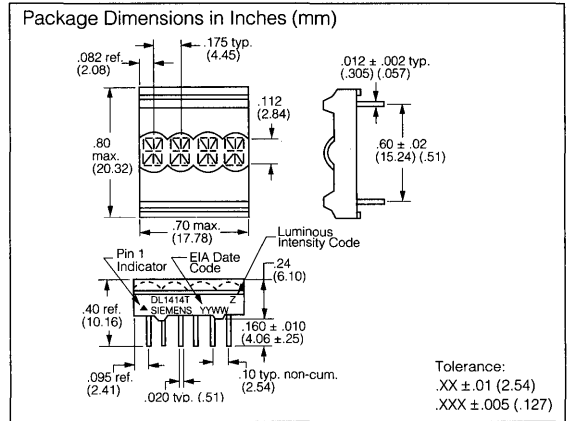
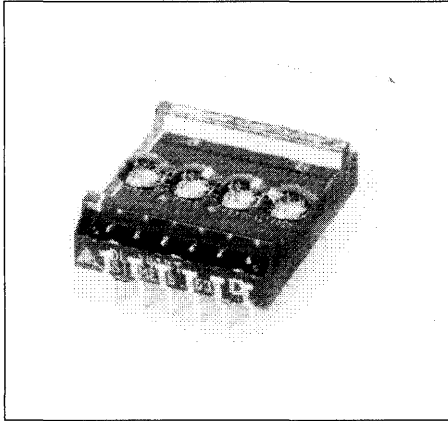

FEATURES

- 0.112" High, Magnified Monolithic Character
- Wide Viewing Angle, X Axis $\pm 40^\circ$, Y Axis $\pm 55^\circ$
- Close Vertical Row Spacing, .800" Centers
- Rugged Solid Plastic Encapsulated Package
- Fast Access Time, 110 ns at 25° C
- Compact Size for Hand Held Equipment
- Built-in Memory
- Built-in Character Generator
- Built-in Multiplex and LED Drive Circuitry
- Direct Access to Each Digit Independently and Asynchronously
- TTL Compatible, 5 Volt Power
- 17th Segment for Improved Punctuation Marks
- Low Power Consumption, Typically 10 mA per Character
- Intensity Coded for Display Uniformity
- Extended Operating Temperature Range:
-40°C to +85°C
- End Stackable, 4 Character Package
- 100% Burned-in and Tested
- Superior ESD Immunity

DESCRIPTION

The DL1414T is a four digit display module with 16 bar segments plus a decimal and a built-in CMOS integrated circuit.

The integrated circuit contains memory, ASCII character generator, LED multiplexing and drive circuitry. Inputs are TTL compatible. A single 5-volt power supply is required. Data entry is asynchronous and random access. A display system can be built using any number of DL1414s since each digit in any DL1414T can be addressed independently and will continue to display the character last stored until replaced by another.

Loading data into the DL1414T is straightforward. The desired data code (D0-D6 and digit address (A0, A1) is presented in parallel and held stable during a write cycle. Data entry may be asynchronous and in random order. (Digit 0 is defined as right hand digit with A1 = A0 = 0 = low).

System interconnection is very straightforward. The least significant two address bits (A0 A1) are normally connected to the like named inputs of all DL1414Ts in the system. Data lines are connected to all DL1414Ts directly and in parallel. Multiple DL1414T systems usually use an external one-of-N decoder chip. The "write" pulse is connected to the CE of the decoder. A 3-to-8 line decoder multiplexer (74138) or a 4-to-16 line decoder/multiplexer (74154) are possible choices. All higher-order address bits (above A1) become inputs to the decoder.

All product are 100% burned-in and tested, then subjected to out-going AQL's of 0.25% for brightness matching, visual alignment and dimensions, 0.065% for electrical and functional.

Important: Refer to Appnote 18, "Using and Handling Intelligent Displays." Since this is a CMOS device, normal precautions should be taken to avoid static damage.

See Appnote 15 for applications information.

Maximum Ratings

Supply Voltage, V_{CC} -0.5 to +7.0 Vdc
 Voltage, Any Pin Respect to GND -0.5 to ($V_{CC} + 0.5$) Vdc
 Operating Temperature -40°C to +85°C
 Storage Temperature -40°C to +100°C
 Maximum Solder Temperature, .063" (1.59mm) below Seating Plane, $t < 5$ sec. 260°C
 Relative Humidity (non condensing) at 85°C 85%

TOP VIEW

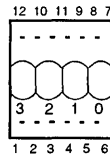

Pin	Function
1	D5 Data Input
2	D4 Data Input
3	WR Write
4	A1 Digit Select
5	A0 Digit Select
6	V_{CC}
7	GND
8	D0 Data Input (LSB)
9	D1 Data Input
10	D2 Data Input
11	D3 Data Input
12	D6 Data Input (MSB)

Optical Characteristics at 25°C

Spectral Peak Wavelength 660 nm typ.
 Viewing Angle (off normal axis)
 Horizontal ±40°
 Vertical ±55°
 Magnified Digit Size 0.112" X 0.085"
 Time Averaged Luminous Intensity (100% brightness, 0.40 mcd/digit min.
 8 Segments/Digit, $V_{CC} = 5$ V 0.75 mcd/digit typ.
 LED to LED Intensity Matching 1.8:1.0 max.
 Device to Device Intensity Matching (one bin) 1.5:1.0 max.
 Bin to Bin Intensity Matching 1.9:1.0 max.

TIMING CHARACTERISTICS WRITE CYCLE WAVEFORMS

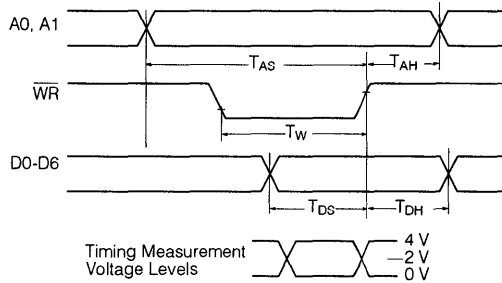

DC CHARACTERISTICS

Parameter	-40°C			+25°C			+85°C			Units	Conditions
	Min.	Typ.	Max.	Min.	Typ.	Max.	Min.	Typ.	Max.		
I_{CC} 4 Digits on 10 segments/digit		60	75		50	65		40	55	mA	$V_{CC} = 5$ V
I_{CC} Blank		1.5	3.5		1.0	2.7		0.5	2.0	mA	$V_{CC} = \overline{WR} = 5$ V $V_{IN} = 0$ V
I_{IL} (all inputs)		60	120		55	100		30	70	μA	$V_{IN} = 0.8$ V $V_{CC} = 5$ V
V_{IH}	2.0			2.0			2.0			V	$V_{CC} = 5$ V ± 0.5 V
V_{IL}			0.8			0.8			0.8	V	$V_{CC} = 5$ V ± 0.5 V

AC CHARACTERISTICS Guaranteed Minimum Timing Parameters at 4.5 V ≤ V_{CC} ≤ 5.5 V

Parameter	Symbol	-40°C	+25°C (ns)	+85°C (ns)
Address Set Up Time	T_{AS}	10	10	10
Address Hold Time	T_{AH}	20	30	40
Write Time	T_W	60	70	90
Data Set Up Time	T_{DS}	20	30	50
Data Hold Time	T_{DH}	20	30	40
Access Time ⁽²⁾	T_{ACC}	90	110	140

Notes: 1. Access time $T_{ACC} = T_{ACC} + T_W + T_{DH}$
 2. Digit multiplex frequency may vary from 200 Hz to 800 KHz.

LOADING DATA STATE TABLE

WR A1 A0 D6 D5 D4 D3 D2 D1 D0										Digit			
previously loaded display										3	2	1	0
H										G	R	E	Y
L	L									G	R	E	E
L	L	H								G	R	U	E
L	H	L								G	L	U	E
L	H	H								B	L	U	E
L	L	H								B	L	E	E
L	L	L								B	L	E	W
L	X	X								see character set			

X = don't care

CHARACTER SET

				D0	L	H	L	H	L	H	L	H	
				D1	L	L	L	H	H	L	H	H	
				D2	L	L	L	L	H	H	H	H	
D6	D5	D4	D3										
L	H	L	L		!	"	#	\$	%	&	'	/	
L	H	L	H		<	>	*	+	,	-	.	/	
L	H	H	L	0	1	2	3	4	5	6	7		
L	H	H	H	8	9	:	;	<	=	>	?		
H	L	L	L	a	A	B	C	D	E	F	G		
H	L	L	H	H	I	J	K	L	M	N	O		
H	L	H	L	P	Q	R	S	T	U	V	W		
H	L	H	H	X	Y	Z	[\]	^	_		

All other input codes display "blank"

BLOCK DIAGRAM

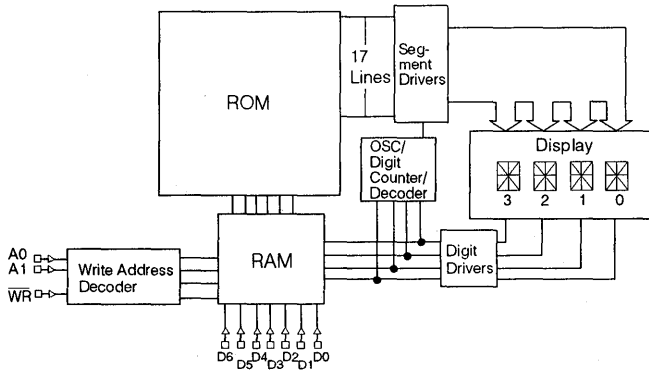

TYPICAL INTERCONNECTION FOR 32 DIGITS

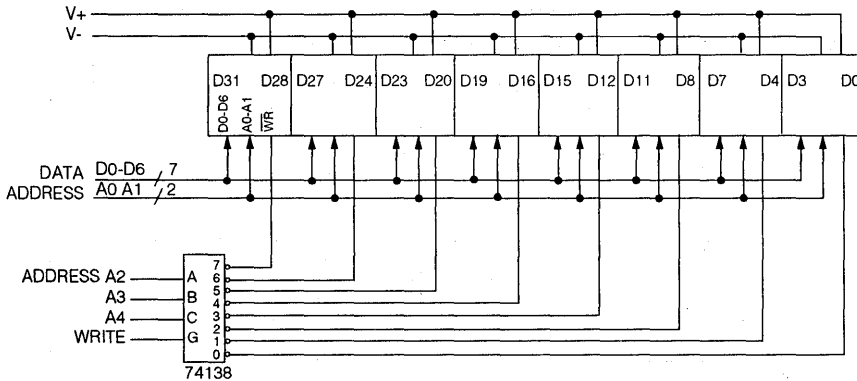

DESIGN CONSIDERATIONS

For details on design and applications of the DL1414T using standard bus configurations in multiple display systems, or parallel I/O devices, such as the 8255 with an 8080 or memory mapped addressing on processors such as the 8080, Z80, 6502, 8748, or 6800, refer to Appnote 15 in the current Siemens Optoelectronic Data Book.

ELECTRICAL & MECHANICAL CONSIDERATIONS

VOLTAGE TRANSIENT SUPPRESSION

We strongly recommend that the same power supply be used for the display and the components that interface with the display to avoid logic inputs higher than V_{CC} . Additionally, the LEDs may cause transients in the power supply line while they change display states. The common practice is to place .01 μ F capacitors close to the displays across V_{CC} and GND, one for each display, and one 10 μ F capacitor for every second display.

ESD PROTECTION

The metal gate CMOS IC of the DL1414T is extremely immune to ESD damage. However, users of these devices are encouraged to take all the standard precautions, normal for CMOS components. These include properly grounding personnel, tools, tables, and transport carriers that come in contact with unshielded parts. Where these conditions are not, or cannot be met, keep the leads of the device shorted together or the parts in anti-static packaging.

SOLDERING CONSIDERATIONS

The DL1414T can be hand soldered with SN63 solder using a grounded iron set to 260°C.

Wave soldering is also possible following these conditions: Preheat that does not exceed 93°C on the solder side of the PC board or a package surface temperature of 85°C. Water soluble organic acid flux (except carboxylic acid) or resin-based RMA flux without alcohol can be used.

Wave temperature of 245°C \pm 5°C with a dwell between 1.5 sec. to 3.0 sec. Exposure to the wave should not exceed temperatures above 260°C for five seconds at 0.063" below the seating plane. The packages should not be immersed in the wave.

POST SOLDER CLEANING PROCEDURES

The least offensive cleaning solution is hot D.I. water (60°C) for less than 15 minutes. Addition of mild saponifiers is acceptable. Do not use commercial dishwasher detergents.

For faster cleaning, solvents may be used. Exercise care in choosing solvents as some may chemically attack the nylon package. Maximum exposure should not exceed two minutes at elevated temperatures. Acceptable solvents are TF (trichlorotrifluoroethane), TA, 111 Trichloroethane, and unheated acetone.

Note: Acceptable commercial solvents are: Basic TF, Arklone P, Genesolve D, Blaco-tron TF, Freon TA, Genesolve DA, and Blaco-tron TA.

Unacceptable solvents contain alcohol, methanol, methylene chloride, ethanol, TP35, TCM, TMC, TMS+, TE, or TES. Since many commercial mixtures exist, contact a solvent vendor for chemical composition information. Some major solvent manufacturers are: Allied Chemical

Corporation, Specialty Chemical Division, Morristown, NJ; Baron-Blakeslee, Chicago, IL; Dow Chemical, Midland, MI; E.I. DuPont de Nemours & Co., Wilmington, DE.

For further information refer to Appnotes 18 and 19 in the current Siemens Optoelectronic Data Book.

An alternative to soldering and cleaning the display modules is to use sockets. Eighteen pin DIP sockets .600" wide with .100" centers work well for single displays. Multiple display assemblies are best handled by longer SIP sockets or DIP sockets when available for uniform package alignment. Socket manufacturers are Aries Electronics, Inc., Frenchtown, NJ; Garry Manufacturing, New Brunswick, NJ; Robinson-Nugent, New Albany, IN; and Samtec Electronic Hardware, New Albany, IN.

For further information refer to Appnote 22 in the current Siemens Optoelectronic Data Book.

OPTICAL CONSIDERATIONS

The .112" high characters of the DL1414T gives readability up to eight feet. The user can build a display that enhances readability over this distance by proper filter selection.

Using filters emphasizes the contrast ratio between a lit LED and the character background. This will increase the discrimination of different characters. The only limitation is cost. Remember to take into consideration the ambient lighting environment for the best cost/benefit ratio for filters.

Incandescent (with almost no green) or fluorescent (with almost no red) lights do not have the flat spectral response of sunlight. Plastic band-pass filters are an inexpensive and effective way to strengthen contrast ratios. The DL1414T is a standard red display and should be matched with long wavelength pass filter in the 600 nm to 620 nm range. For displays of multiple colors, neutral density grey filters offer the best compromise.

Additional contrast enhancement can be gained by shading the displays. Plastic band-pass filters with built-in louvers offer the next step up in contrast improvement. Plastic filters can be improved further with anti-reflective coatings to reduce glare. The trade-off is fuzzy characters. Mounting the filters close to the display reduces this effect. Take care not to overheat the plastic filter by allowing for proper air flow.

Optimal filter enhancements are gained by using circular polarized, anti-reflective, band-pass filters. The circular polarizing further enhances contrast by reducing the light that travels through the filter and reflects back off the display to less than 1%.

Several filter manufacturers supply quality filter materials. Some of them are: Panelgraphic Corporation, W. Caldwell, NJ; SGL Homalite, Wilmington, DE; 3M Company, Visual Products Division, St. Paul, MN; Polaroid Corporation, Polarizer Division, Cambridge, MA; Marks Polarized Corporation, Deer Park, NY; Hoya Optics, Inc., Fremont, CA.

One last note on mounting filters: recessing displays and bezel assemblies is an inexpensive way to provide a shading effect in overhead lighting situations. Several bezel manufacturers are: R.M.F. Products, Batavia, IL; Nobex Components, Griffith Plastic Corp., Burlingame, CA; Photo Chemical Products of California, Santa Monica, CA; I.E.E.-Atlas, Van Nuys, CA.

Refer to Siemens Appnote 23 for further information.

SIEMENS

DL2416T

.160" Red, 4-Character 16 Segment Plus Decimal Alphanumeric Intelligent Display® With Memory/Decoder/Driver

Preliminary Data Sheet

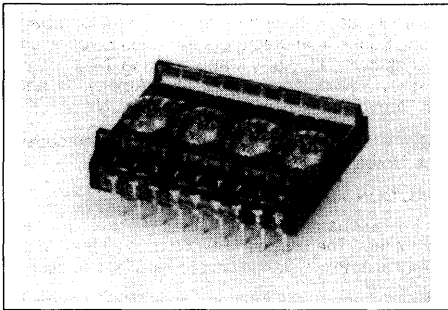

FEATURES

- 0.16" x 0.125 Magnified Character
- Wide Viewing Angle, X Axis $\pm 45^\circ$, Y Axis $\pm 55^\circ$
- Close Multi-line Spacing, 0.8" Centers
- Rugged Solid Plastic Encapsulated Package
- Fast Access Time, 110 ns at 25°C
- Full Size for Stationary Equipment
- Built-in Memory
- Built-in Character Generator
- Built-in Multiplex and LED Drive Circuitry
- Direct Access to Each Digit Independently and Asynchronously
- Independent Cursor Function
- 17th Segment for Improved Punctuation Marks
- Memory Clear Function that Clears Character and Cursor Memory Simultaneously
- True Blanking for Intensity Dimming Applications
- Brightness Control for 100%, 85%, 70%, and 57% Brightness Levels
- End Stackable, 4 Character Package
- Intensity Coded for Display Uniformity
- Extended Operating Temperature Range: -40°C to $+85^\circ\text{C}$
- Superior ESD Immunity
- 100% Burned in and Tested
- Wave Solderable
- TTL Compatible over Operating Temperature Range

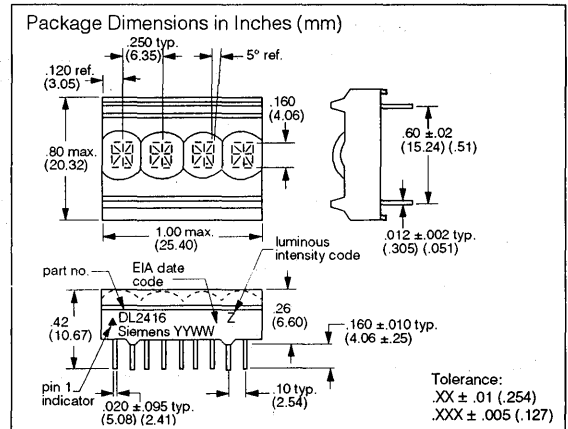

DESCRIPTION

The DL2416T is a four digit display module with 16 bar segments plus a decimal and a built-in CMOS integrated circuit.

The integrated circuit contains memory, ASCII character generator, multiplexing circuitry and drivers. Data entry is asynchronous and can be random. A display system can be built using any number of DL2416s since each digit in any DL2416T can be addressed independently and will continue to display the character last stored until replaced by another.

System interconnection is also straightforward. The least significant two address bits (A0, A1) are normally connected to the like named inputs of all DL2416Ts in the system. With two chip enables (CE1 and CE2), four DL2416Ts (16 characters) can easily be interconnected without a decoder.

Data lines are connected to all DL2416Ts directly and in parallel, as is the write line (WR). The display will then behave as a write-only memory.

The DL2416T has several features superior to competitive devices. 100% pre-burned in processing assures users that the device will function in more stressful assembly and use environments. The full width character "J" gives better readability under adverse conditions, and the "true blanking" allows the designer to dim the display for more flexibility of display presentation. The CLR clear function will clear the cursor RAM and the ASCII character RAM, simultaneously. Finally, a new brightness control feature allows programming the displays at 100%, 85%, 70%, and 57% brightness levels.

All products are 100% burned in and tested, then subjected to outgoing AQL's of 0.25% for brightness matching, visual alignment, and dimensions, 0.065% for electrical and functional.

TOP VIEW

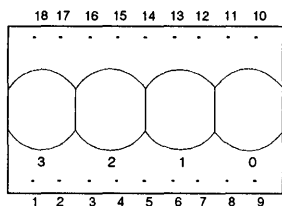

Pin	Function	Pin	Function
1	CE1 Chip Enable	10	GND
2	CE2 Chip Enable	11	D0 Data Input
3	CLR Clear	12	D1 Data Input
4	CUE Cursor Enable	13	D2 Data Input
5	CD Cursor Select	14	D3 Data Input
6	WR Write	15	D6 Data Input
7	A1 Digit Select	16	D5 Data Input
8	A0 Digit Select	17	D4 Data Input
9	V _{CC}	18	BL Display Blank

Maximum Ratings

Supply Voltage, V _{CC}	-0.5 to +6.0 Vdc
Voltage, Any Pin Respect to GND	-0.5 to (V _{CC} +0.5) Vdc
Operating Temperature	-40°C to +85°C
Storage Temperature	-40°C to +100°C
Relative Humidity (non condensing) @ 85°C	85%
Maximum Solder Temperature, .063" (1.59mm) below Seating Plane, t<5 sec.	260°C

Optical Characteristics

Spectral Peak Wavelength	660 nm typ.
Magnified Digit Size0.160" X 0.125"
Time Averaged Luminous Intensity (100% brightness,	0.5 mcd/digit min.
8 Segments/Digit, V _{CC} = 5V	1.0 mcd/digit typ.
LED to LED Intensity Matching	1.8:1.0 max.
Device to Device Intensity Matching (one bin)	1.5:1.0 max.
Bin to Bin Intensity Matching	1.9:1.0 max.
Viewing Angle (off normal axis)	
Horizontal	±45°
Vertical	±55°

DC CHARACTERISTICS

Parameter	-40°C			+25°C			+85°C			Units	Conditions
	Min.	Typ.	Max.	Min.	Typ.	Max.	Min.	Typ.	Max.		
I _{CC} ⁽¹⁾ 4 Digits on 10 segments/digit		100	130		85	115		70	100	mA	V _{CC} = 5 V
I _{CC} Cursor ^(1,2)		140	185		120	165		100	145	mA	V _{CC} = 5 V
I _{CC} Blank ⁽¹⁾		2.0	5.0		1.5	4.0		1.0	2.7	mA	V _{CC} = 5 V, BL = 0.8 V
I _{IN} (all inputs)		80	180		60	160		45	90	µA	V _{IN} = 0.8 V, V _{CC} = 5 V
V _{IH}	2.0			2.0			2.0			V	V _{CC} = 5 V ± 0.5 V
V _{IL}			0.8			0.8			0.8	V	V _{CC} = 5 V ± 0.5 V

Notes: 1. Measured at 5 sec.
 2. 60 sec. maximum duration.

AC CHARACTERISTICS Guaranteed Minimum Timing Parameters @ $V_{cc} = 4.5V \leq V_{cc} \leq 5.5V$

Parameter	Symbol	-40°C (ns)	+25°C (ns)	+85°C (ns)	Units
Address Set Up Time	T_{AS}	10	10	10	ns
Cursor Set Up Time	T_{CUS}	10	10	10	ns
Chip Enable Set Up Time	T_{CES}	0	0	0	ns
Clear Disable	$T_{CLR D}$	1	1	1	μ s
Write Time	T_W	60	70	90	ns
Data Set Up Time	T_{DS}	20	30	50	ns
Chip Enable Hold Time	T_{CEH}	0	0	0	ns
Cursor Hold Time	T_{CUH}	20	30	40	ns
Address Hold Time	T_{AH}	20	30	40	ns
Data Hold Time	T_{DH}	20	30	40	ns
Clear Time	T_{CLR}	1	1	1	μ s
Total Access Time ⁽¹⁾	T_{ACC}	90	110	140	ns

- Notes: 1. Access time $T_{ACC} = T_{AS} + T_W + T_{DH}$
 2. Digit multiplex frequency may vary from 200 Hz to 800 Hz.
 3. T_{CLR} = Time to clear character RAM, cursor RAM, counter chain, and the display.
 4. $T_{CLR D}$ = Must be inactive before next write cycle.

LOADING DATA

Setting the chip enable ($\overline{CE1}$, $\overline{CE2}$) to their true state will enable data loading. The desired data code (D0-D6) and digit address (A0, A1) must be held stable during the write cycle for storing new data.

Data entry may be asynchronous and random. (Digit 0 is defined as right hand digit with $A1 = A2 = 0$.)

Clearing the entire internal four-digit memory can be accomplished by holding the clear (CLR) low for one μ s minimum. The clear function will clear both the ASCII RAM and the cursor RAM. Loading an illegal data code will display a blank.

**TIMING CHARACTERISTICS
WRITE CYCLE WAVEFORMS**

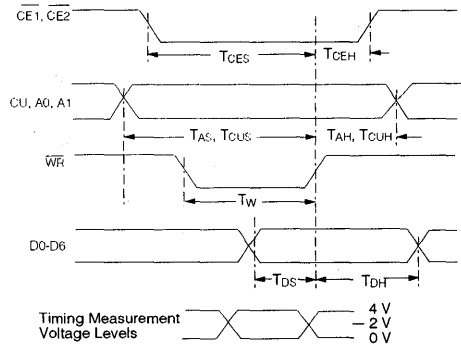

TYPICAL LOADING DATA STATE TABLE

BL	Control						Address		Data								Display Digit			
	CE1	CE2	CUE	CU	WR	CLR	A1	A0	D6	D5	D4	D3	D2	D1	D0	3	2	1	0	
H	X	X	L	X	H	H			previously loaded display								G	R	E	Y
H	H	X	L	X	X	H	X	X	X	X	X	X	X	X	X	G	R	E	Y	
H	X	H	L	X	X	H	X	X	X	X	X	X	X	X	X	G	R	E	Y	
H	L	L	L	H	L	H	L	L	H	L	L	L	H	L	H	G	R	E	E	
H	L	L	L	H	L	H	L	H	H	L	H	L	H	L	H	G	R	U	E	
H	L	L	L	H	L	H	H	L	H	L	L	H	H	L	L	G	L	U	E	
H	L	L	L	H	L	H	H	H	H	L	L	L	L	H	L	B	L	U	E	
L	X	X	X	X	H	H	X	X	blank display											
H	L	L	L	H	L	H	H	H	H	L	L	L	H	H	H	G	L	U	E	
H	X	X	L	X	H	L	X	X	clears character displays								see character set			
H	L	L	L	H	L	H	X	X	see character code											

X = don't care

LOADING CURSOR

Setting the chip enables ($\overline{CE1}$, $\overline{CE2}$) and cursor select (\overline{CU}) to their true state will enable cursor loading. A write (\overline{WR}) pulse will now store or remove a cursor into the digit location addressed by A0, A1, as defined in data entry. A cursor will be stored if D0=1; and will be removed if D0=0. The cursor (\overline{CU}) pulse width should not be less than the write (\overline{WR}) pulse or erroneous data may appear in the display.

If the cursor isn't required, the cursor enable signal (\overline{CUE}) may be tied low to disable the display of the cursor function. For a flashing cursor, simply pulse \overline{CUE} . If the cursor has been loaded to any or all positions in the display, then \overline{CUE} will control whether the cursor(s) or the characters appear. \overline{CUE} does not affect the contents of cursor memory.

DISPLAY BLANKING

To blank the display, load a blank or space into each digit of the display or use the (\overline{BL}) display blank input.

Setting the (\overline{BL}) input low does not affect the contents of either data or cursor memory. A flashing display will result by pulsing (\overline{BL}).

A flashing circuit can be easily constructed using a 555 astable multivibrator. Figure 1 illustrates a circuit in which varying R1 (100K~10K) will have a flash rate of 1Hz~10Hz.

The display can be dimmed by pulse width modulating the (\overline{BL}) at a frequency sufficiently fast not to interfere with the internal clock. This clock frequency may vary from 200 Hz to 1.3KHz. The dimming signal frequency should be 2.5KHz or higher. Dimming the display also reduces power consumption.

See Figure 2 for an example of a simple dimming circuit using a 556. Adjusting potentiometer R2 will dim the display through frequency modulation (2.5 KHz to 4.4 KHz). Adjusting potentiometer R3 will dim the display by increasing the negative pulse width (10% to 50%).

FIGURE 1. FLASHING CIRCUIT FOR DL2416T USING A 555

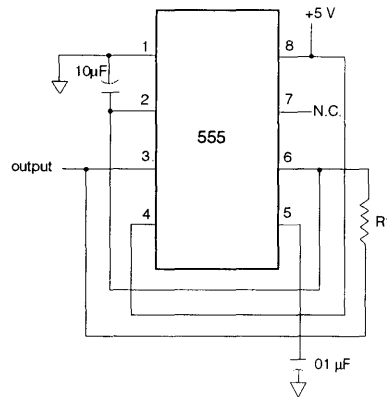
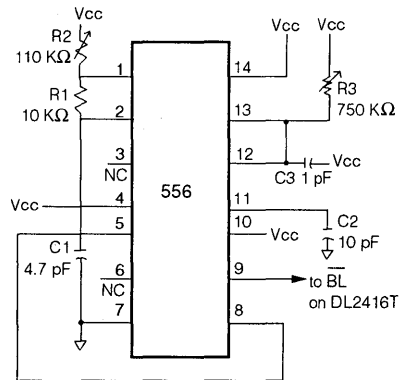

FIGURE 2. DIMMING CIRCUIT FOR DL2416T USING A 556



LOADING CURSOR STATE TABLE

Control						Address		Data							Display Digit			
\overline{BL}	$\overline{CE1}$	$\overline{CE2}$	\overline{CUE}	\overline{CU}	\overline{CLR}	A1	A0	D6	D5	D4	D3	D2	D1	D0	3	2	1	0
H	X	X	L	X	H	H									B	E	A	R
H	X	X	H	X	H	H									B	E	A	R
H	L	L	H	L	L	H	L	L	X	X	X	X	X	X	B	E	A	■
H	L	L	H	L	L	H	L	H	X	X	X	X	X	X	B	E	■	■
H	L	L	H	L	L	H	H	L	X	X	X	X	X	X	B	■	■	■
H	L	L	H	L	L	H	H	H	X	X	X	X	X	X	■	■	■	■
H	L	L	H	L	L	H	H	L	X	X	X	X	X	L	B	E	■	■
H	X	X	L	X	H	H									B	E	A	R
H	L	L	L	L	L	H	H	H	X	X	X	X	X	L	B	E	A	R
H	X	X	H	X	H	H									B	E	■	■

X = don't care

■ =

INTERNAL BLOCK DIAGRAM

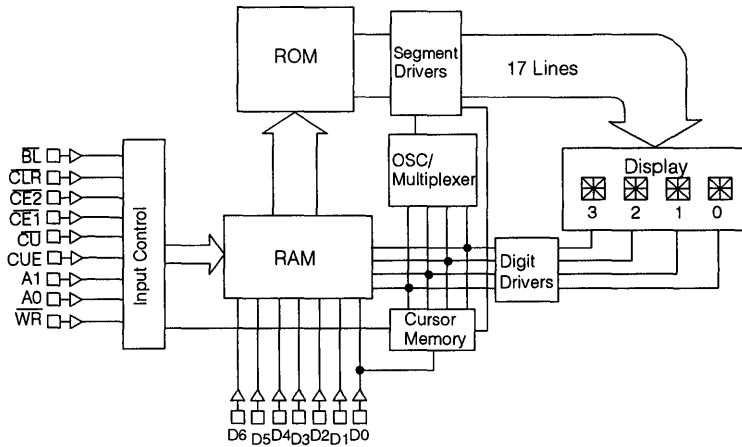

TYPICAL SCHEMATIC FOR 16 DIGIT SYSTEM

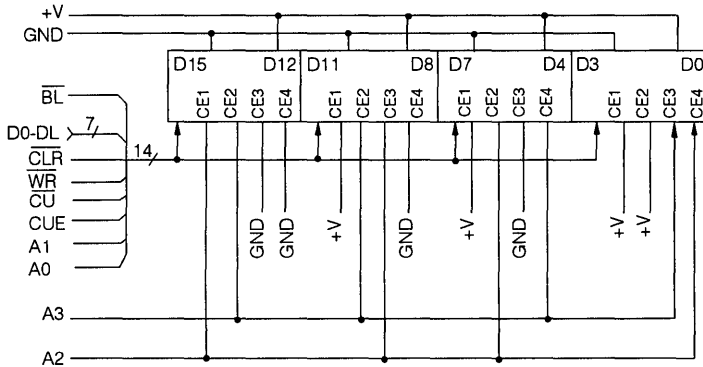

CHARACTER SET

D6	D5	D4	HEX	0	1	2	3	4	5	6	7	8	9	A	B	C	D	E	F
L	H	L	2		!	"	#	\$	%	&	'	<	>	*	+	,	--	.	/
L	H	H	3	0	1	2	3	4	5	6	7	8	9	-	:	;	=	>	?
H	L	L	4	a	A	B	C	D	E	F	G	H	I	J	K	L	M	N	O
H	L	H	5	P	Q	R	S	T	U	V	W	X	Y	Z	[\]	^	_

All other input codes display "blank"

DESIGN CONSIDERATIONS

For details on design and applications of the DL2416T using standard bus configurations in multiple display systems, or parallel I/O devices, such as the 8255 with an 8080 or memory mapped addressing on processors such as the 8080, Z80, 6502, 8748, or 6800, refer to Appnote 14 and 20 in the current Siemens Optoelectronic Data Book.

ELECTRICAL & MECHANICAL CONSIDERATIONS

VOLTAGE TRANSIENT SUPPRESSION

We strongly recommend that the same power supply be used for the display and the components that interface with the display to avoid logic inputs higher than V_{CC} . Additionally, the LEDs may cause transients in the power supply line while they change display states. The common practice is to place .01 μ F capacitors close to the displays across V_{CC} and GND, one for each display, and one 10 μ F capacitor for every second display.

ESD PROTECTION

The metal gate CMOS IC of the DL2416T is extremely immune to ESD damage. However, users of these devices are encouraged to take all the standard precautions, normal for CMOS components. These include properly grounding personnel, tools, tables, and transport carriers that come in contact with unshielded parts. Where these conditions are not, or cannot be met, keep the leads of the device shorted together or the parts in anti-static packaging.

SOLDERING CONSIDERATIONS

The DL2416T can be hand soldered with SN63 solder using a grounded iron set to 260°C.

Wave soldering is also possible following these conditions: Preheat that does not exceed 93°C on the solder side of the PC board or a package surface temperature of 85°C. Water soluble organic acid flux (except carboxylic acid) or resin-based RMA flux without alcohol can be used.

Wave temperature of 245°C \pm 5°C with a dwell between 1.5 sec. to 3.0 sec. Exposure to the wave should not exceed temperatures above 260°C for five seconds at 0.063" below the seating plane. The packages should not be immersed in the wave.

POST SOLDER CLEANING PROCEDURES

The least offensive cleaning solution is hot D.I. water (60°C) for less than 15 minutes. Addition of mild saponifiers is acceptable. Do not use commercial dishwasher detergents.

For faster cleaning, solvents may be used. Exercise care in choosing solvents as some may chemically attack the nylon package. Maximum exposure should not exceed two minutes at elevated temperatures. Acceptable solvents are TF (trichlorotrifluoroethane), TA, 111 Trichloroethane, and unheated acetone.

Note: Acceptable commercial solvents are: Basic TF, Arkione P, Genesolve D, Blaco-tron TF, Freon TA, Genesolve DA, and Blaco-tron TA.

Unacceptable solvents contain alcohol, methanol, methylene chloride, ethanol, TP35, TCM, TMC, TMS+, TE, or TES. Since many commercial mixtures exist, contact a solvent vendor for chemical composition information.

Some major solvent manufacturers are: Allied Chemical Corporation, Specialty Chemical Division, Morristown, NJ; Baron-Blakeslee, Chicago, IL; Dow Chemical, Midland, MI; E.I. DuPont de Nemours & Co., Wilmington, DE.

For further information refer to Appnotes 18 and 19 in the current Siemens Optoelectronic Data Book.

An alternative to soldering and cleaning the display modules is to use sockets. Eighteen pin DIP sockets .600" wide with .100" centers work well for single displays. Multiple display assemblies are best handled by longer SIP sockets or DIP sockets when available for uniform package alignment. Socket manufacturers are Aries Electronics, Inc., Frenchtown, NJ; Garry Manufacturing, New Brunswick, NJ; Robinson-Nugent, New Albany, IN; and Samtec Electronic Hardware, New Albany, IN.

For further information refer to Appnote 22 in the current Siemens Optoelectronic Data Book.

OPTICAL CONSIDERATIONS

The .160" high characters of the DL2416T gives readability up to eight feet. The user can build a display that enhances readability over this distance by proper filter selection.

Using filters emphasizes the contrast ratio between a lit LED and the character background. This will increase the discrimination of different characters. The only limitation is cost. Remember to take into consideration the ambient lighting environment for the best cost/benefit ratio for filters.

Incandescent (with almost no green) or fluorescent (with almost no red) lights do not have the flat spectral response of sunlight. Plastic band-pass filters are an inexpensive and effective way to strengthen contrast ratios. The DL2416T is a standard red display and should be matched with long wavelength pass filter in the 600 nm to 620 nm range. For displays of multiple colors, neutral density grey filters offer the best compromise.

Additional contrast enhancement can be gained by shading the displays. Plastic band-pass filters with built-in louvers offer the next step up in contrast improvement. Plastic filters can be improved further with anti-reflective coatings to reduce glare. The trade-off is fuzzy characters. Mounting the filters close to the display reduces this effect. Take care not to overheat the plastic filter by allowing for proper air flow.

Optimal filter enhancements are gained by using circular polarized, anti-reflective, band-pass filters. The circular polarizing further enhances contrast by reducing the light that travels through the filter and reflects back off the display to less than 1%.

Several filter manufacturers supply quality filter materials. Some of them are: Panelgraphic Corporation, W. Caldwell, NJ; SGL Homalite, Wilmington, DE; 3M Company, Visual Products Division, St. Paul, MN; Polaroid Corporation, Polarizer Division, Cambridge, MA; Marks Polarized Corporation, Deer Park, NY; Hoya Optics, Inc., Fremont, CA.

One last note on mounting filters: recessing displays and bezel assemblies is an inexpensive way to provide a shading effect in overhead lighting situations. Several bezel manufacturers are: R.M.F. Products, Batavia, IL; Nobex Components, Griffith Plastic Corp., Burlingame, CA; Photo Chemical Products of California, Santa Monica, CA; I.E.E.-Atlas, Van Nuys, CA.

Refer to Siemens Appnote 23 for further information.

.225" Red, 4-Character 16 Segment Plus Decimal Alphanumeric Intelligent Display® With Memory/Decoder/Driver Preliminary Data Sheet

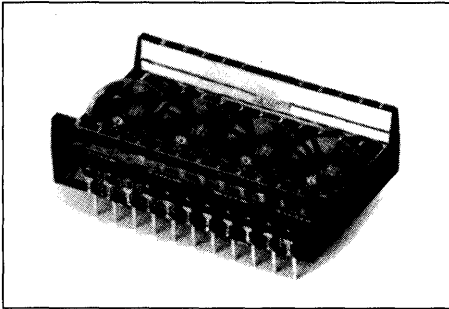

FEATURES

- 0.225" x 0.192 Magnified Monolithic Character
- Wide Viewing Angle, X Axis $\pm 45^\circ$, Y Axis $\pm 55^\circ$
- Close Multi-line Spacing, 0.8" Centers
- Rugged Solid Plastic Encapsulated Package
- Fast Access Time, 110 ns at 25°C
- Full Size Size for Stationery Equipment
- Built-in Memory
- Built-in Character Generator
- Built-in Multiplex and LED Drive Circuitry
- Each Digit Independently Addressed
- Independent Cursor Function
- 17th Segment for Improved Punctuation Marks
- Memory Clear Function
- Display Blank Function for Blinking and Dimming
- End Stackable, 4 Character Package
- Intensity Coded for Display Uniformity
- Extended Operating Temperature Range:
-40°C to +85°C
- Wave Solderable
- 100% Burned in and Tested
- Superior ESD Immunity

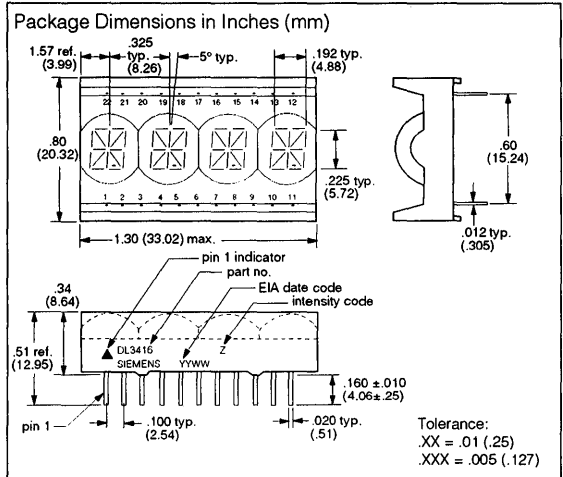

DESCRIPTION

The DL3416 is a four digit display module with 16 segments plus a decimal and a built-in CMOS integrated circuit.

The integrated circuit contains memory, ASCII ROM decoder, multiplexing circuitry, and drivers. Data entry is asynchronous and can be random. A display system can be built using any number of DL3416s since each digit in any DL3416 can be addressed independently and will continue to display the character last stored until replaced by another.

System interconnection is also straightforward. The least significant two address bits (A0 A1) are normally connected to the like named inputs of all DL3416s in the system. With four chip enables, four DL3416s (16 characters) can easily be interconnected without a decoder.

Alternately, one-of-n decoder ICs can be used to extend the address for large displays.

Data lines are connected to all DL3416s directly and in parallel, as is the write line (WR). The display will then behave as a write-only memory.

All products are 100% burned in and tested, then subjected to outgoing AQL's of 0.25% for brightness matching, visual alignment, and dimensions, 0.065% for electrical and functional.

TOP VIEW

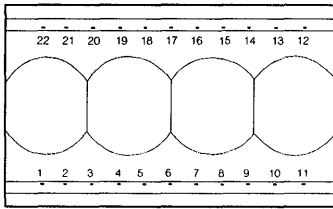

Pin	Function	Pin	Function
1	CE1 Chip Enable	12	GND
2	CE2 Chip Enable	13	NC
3	CE3 Chip Enable	14	BL Blanking
4	CE4 Chip Enable	15	NC
5	CLR Clear	16	D0 Data Input
6	V _{CC}	17	D1 Data Input
7	A0 Digit Select	18	D2 Data Input
8	A1 Digit Select	19	D3 Data Input
9	WR Write	20	D4 Data Input
10	CJ Cursor Select	21	D5 Data Input
11	CUE Cursor Enables	22	D6 Data Input

Maximum Ratings

Supply Voltage, V_{CC}-0.5 to +6.0 Vdc
 Voltage, Any Pin Respect
 to GND-0.5 to (V_{CC} +0.5) Vdc
 Operating Temperature-40°C to +85°C
 Storage Temperature-40°C to +100°C
 Relative Humidity (non condensing) @ 85°C 85%
 Maximum Solder Temperature, .063" (1.59mm)
 below Seating Plane, t<5 sec.260°C

Optical Characteristics

Spectral Peak Wavelength 660 nm typ.
 Magnified Digit Size 0.225" X 0.192"
 Time Averaged Luminous Intensity
 (100% brightness, 0.5 mcd/digit min.
 8 Segments/Digit, V_{CC} = 5V 1.0 mcd/digit typ.
 LED to LED Intensity Matching 1.8:1.0 max.
 Device to Device Intensity Matching
 (one bin) 1.5:1.0 max.
 Bin to Bin Intensity Matching 1.9:1.0 max.
 Viewing Angle (off normal axis)
 Horizontal ±45°
 Vertical ±55°

Intelligent Display Devices

DC CHARACTERISTICS

Parameter	-40°C			+25°C			+85°C			Units	Conditions
	Min.	Typ.	Max.	Min.	Typ.	Max.	Min.	Typ.	Max.		
I _{CC} ⁽¹⁾ 4 Digits on 10 segments/digit		100	130		85	115		70	100	mA	V _{CC} = 5 V
I _{CC} Cursor ^(1,2)		140	170		120	150		100	130	mA	V _{CC} = 5 V
I _{CC} Blank ⁽¹⁾		2.0	5.0		1.5	4.0		1.0	2.7	mA	V _{CC} = 5 V, BL = 0.8 V
I _{IL} (all inputs)		80	180		60	160		45	90	µA	V _{IN} = 0.8 V, V _{CC} = 5 V
V _{IH}	2.7			2.7			2.7			V	V _{CC} = 5 V ±0.5 V
V _{IL}			0.6			0.6			0.6	V	V _{CC} = 5 V ±0.5 V

Notes: 1. Measured at 5 sec.
 2. 60 sec. maximum duration.

AC CHARACTERISTICS Guaranteed Minimum Timing Parameters @ $V_{cc}=4.5\text{ V} \leq V_{cc} \leq 5.5\text{ V}$

Parameter	Symbol	-40°C	+25°C	+85°C	Unit
Chip Enable Hold Time	T_{CES}	0	0	0	ns
Address Set Up Time	T_{AS}	10	10	10	ns
Cursor Set Up Time	T_{CUS}	10	10	10	ns
Chip Enable Hold Time	T_{CEH}	0	0	0	ns
Address Hold Time	T_{AH}	20	30	40	ns
Cursor Hold Time	T_{CUH}	20	30	40	ns
Clear Disable Time	T_{CLRD}	1	1	1	μs
Write Time	T_W	60	70	90	ns
Data Set Up Time	T_{DS}	20	30	50	ns
Data Hold Time	T_{DH}	20	30	40	ns
Clear Time ⁽⁶⁾	T_{CLR}	1	1	1	μs
Access Time ⁽²⁾	T_{ACC}	90	110	140	ns

- Notes: 1. $V_{cc}=4.5$ is worst case. All timing parameters improve as V_{cc} increases.
 2. Access time $T_{ACC}=T_{AS} + T_W + T_{DH}$
 3. T_{CLR} =time to clear ch. RAM, cursor RAM, counter RAM, counter chain, and the display.
 4. T_{CLRD} =must be inactive before next write cycle.

LOADING DATA

Setting the chip enable ($\overline{CE1}$, $\overline{CE2}$, $\overline{CE3}$, $\overline{CE4}$) to their true state will enable data loading. The desired data code (D0-D6) and digit address (A0, A1) must be held stable during the write cycle for storing new data.

Data entry may be asynchronous and random. (Digit 0 is defined as right hand digit with $A1 = A2 = 0$.)

To clear the entire internal four-digit memory, hold the clear (\overline{CLR}) low for one complete display multiplex cycle, 15 mS minimum. The clear function will clear both the ASCII RAM and the cursor RAM. Loading an illegal data code will display a blank.

**TIMING CHARACTERISTICS
WRITE CYCLE WAVEFORMS**

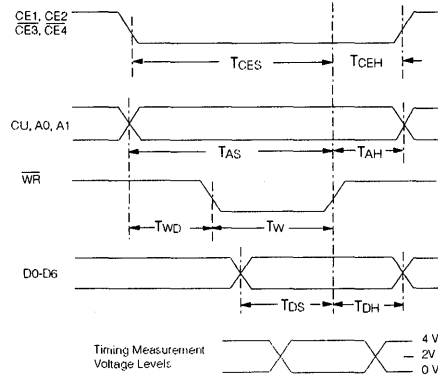

TYPICAL LOADING DATA STATE TABLE

\overline{BL}	$\overline{CE1}$	$\overline{CE2}$	$\overline{CE3}$	$\overline{CE4}$	\overline{CUE}	\overline{CU}	\overline{WR}	\overline{CLR}	A1	A0	D6	D5	D4	D3	D2	D1	D0	Digit 3 2 1 0	
H	X	X	X	X	L	X	H	H										previously loaded display	G R E Y
H	L	X	X	X	L	X	X	H	X	X	X	X	X	X	X	X	X		G R E Y
H	X	L	X	X	L	X	X	H	X	X	X	X	X	X	X	X	X		G R E Y
H	X	X	H	X	L	X	X	H	X	X	X	X	X	X	X	X	X		G R E Y
H	X	X	X	H	L	X	X	H	X	X	X	X	X	X	X	X	X		G R E Y
H	X	X	X	X	L	X	H	H	X	X	X	X	X	X	X	X	X		G R E Y
H	H	H	L	L	L	H	L	H	L	L	H	L	L	L	H	L	H		G R E E
H	H	H	L	L	L	H	L	H	L	H	H	L	H	L	H	L	H		G R U E
H	H	H	L	L	L	H	L	H	H	L	H	L	L	H	L	L	H		G L U E
H	H	H	L	L	L	H	L	H	H	H	H	L	L	L	L	H	L		B L U E
L	X	X	X	X	X	X	H	H	X	X								blank display	
H	H	H	L	L	L	H	L	H	H	H	L	L	L	L	H	H	H		G L U E
H	X	X	X	X	L	X	X	L										clears character display	
H	H	H	L	L	L	H	L	H	X	X								see character code	see character set

LOADING CURSOR

Setting the chip enables ($\overline{CE1}$, $\overline{CE2}$, $\overline{CE3}$, $\overline{CE4}$) and cursor select (\overline{CU}) to their true state will enable cursor loading. A write (\overline{WR}) pulse will now store or remove a cursor into the digit location addressed by $A0$, $A1$, as defined in data entry. A cursor will be stored if $D0=1$ and will be removed if $D0=0$. Cursor will not be cleared by the \overline{CLR} signal. The cursor (\overline{CU}) pulse width should not be less than the write (\overline{WR}) pulse or erroneous data may appear in the display.

If the cursor is not needed, the cursor enable signal (\overline{CUE}) may be tied low to disable the display of the cursor function. Pulsing \overline{CUE} will give a flashing cursor. If the cursor has been loaded to any or all positions in the display, then \overline{CUE} will control whether the cursor(s) or the characters appear. \overline{CUE} does not affect the contents of cursor memory.

DISPLAY BLANKING

Blank the display by loading a blank or space into each digit of the display or by using the (\overline{BL}) display blank input.

Setting the (\overline{BL}) input low does not affect the contents of either data or cursor memory. A flashing display will result by pulsing (\overline{BL}). A flashing circuit can be constructed easily using a 555 astable multivibrator.

Figure 1 illustrates a circuit in which varying $R1$ ($100K \sim 10K$) will have a flash rate of $1Hz \sim 10Hz$.

The display can be dimmed by pulsing the (\overline{BL}) at a frequency sufficiently fast to not interfere with the internal clock. This clock frequency may vary from 200 Hz to 1.3KHz. The dimming signal frequency should be 2.5KHz or higher. Dimming the display also reduces power consumption.

See Figure 2 for a simple dimming circuit using a 556. Adjusting potentiometer $R2$ will dim the display through frequency modulation (2.5 KHz to 4.4 KHz). Adjusting potentiometer $R3$ will dim the display by increasing the negative pulse width (10% to 50%).

LOADING CURSOR STATE TABLE

\overline{BL}	$\overline{CE1}$	$\overline{CE2}$	$\overline{CE3}$	$\overline{CE4}$	\overline{CUE}	\overline{CU}	\overline{WR}	\overline{CLR}	$A1$	$A0$	$D6$	$D5$	$D4$	$D3$	$D2$	$D1$	$D0$	Digit									
																			3	2	1	0					
H	X	X	X	X	L	X	H	H	previously loaded display									B	E	A	R						
H	X	X	X	X	H	X	H	H	display previously stored cursors									B	E	A	R						
H	H	H	L	L	H	L	L	H	L	L	X	X	X	X	X	X	X	H	B	E	A	■					
H	H	H	L	L	H	L	L	H	L	L	X	X	X	X	X	X	H	B	■	■	■	■					
H	H	H	L	L	H	L	L	H	H	H	X	X	X	X	X	X	H	■	■	■	■	■					
H	H	H	L	L	H	L	L	H	H	L	X	X	X	X	X	L	■	E	■	■	■	■					
H	X	X	X	X	L	X	H	H	disable cursor display									B	E	A	R						
H	H	H	L	L	L	L	L	H	H	H	X	X	X	X	X	L	B	E	A	R							
H	X	X	X	X	H	X	H	H	display stored cursors									B	E	■	■						

X = don't care

■ =

FIGURE 1. FLASHING CIRCUIT FOR DL3416 USING A 555

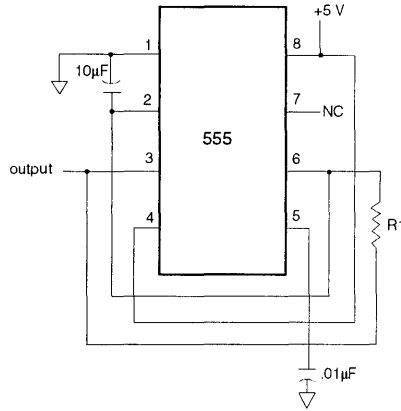
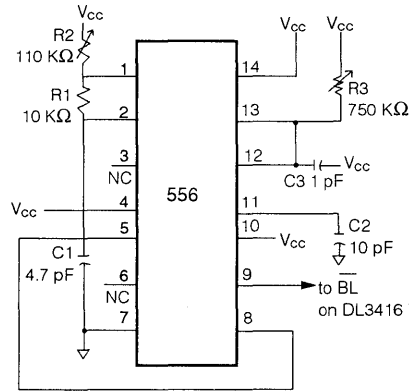
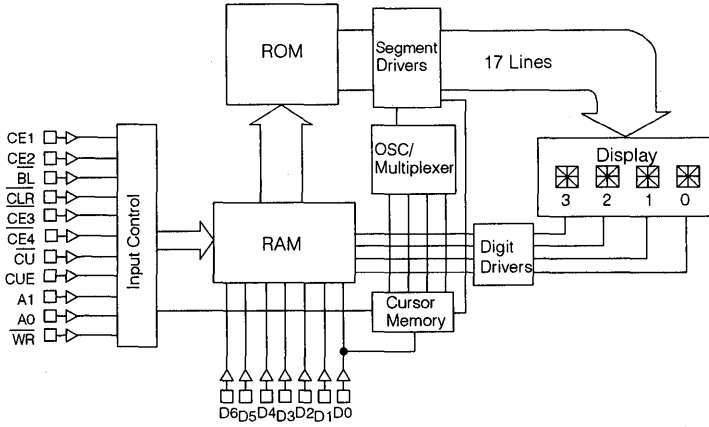

FIGURE 2. DIMMING CIRCUIT FOR DL3416 USING A 556



INTERNAL BLOCK DIAGRAM



TYPICAL SCHEMATIC FOR 16 DIGITS

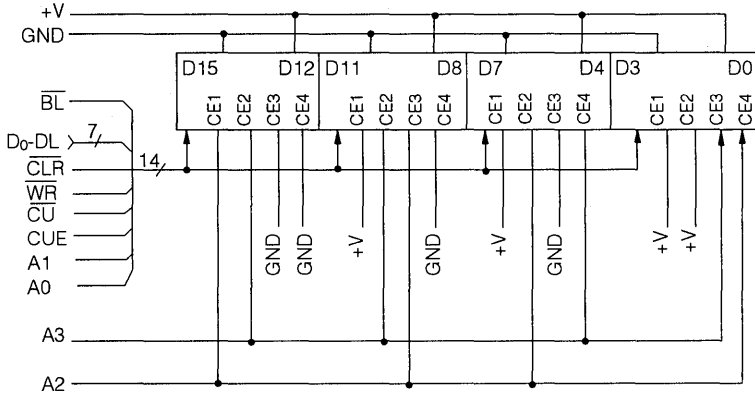

CHARACTER SET

D0	L	H	L	H	L	H	L	H	L	H	L	H	L	H	L	H			
D1	L	L	H	H	L	L	H	H	L	L	H	H	L	L	H	H			
D2	L	L	L	L	L	H	H	H	L	L	L	L	H	H	H	H			
D3	L	L	L	L	L	L	L	L	L	H	H	H	H	H	H	H			
D6	D5	D4	HEX	0	1	2	3	4	5	6	7	8	9	A	B	C	D	E	F
L	H	L	2		!	"	#	\$	%	&	'	<	>	*	+	/	--	.	/
L	H	H	3	0	1	2	3	4	5	6	7	8	9	:	;	<	=	>	?
H	L	L	4	a	A	B	C	D	E	F	G	H	I	J	K	L	M	N	O
H	L	H	5	P	Q	R	S	T	U	V	W	X	Y	Z	[\]	^	_

All other input codes display "blank"

DESIGN CONSIDERATIONS

For details on design and applications of the DL3416 using standard bus configurations in multiple display systems, or parallel I/O devices, such as the 8255 with an 8080 or memory mapped addressing on processors such as the 8080, Z80, 6502, 8748, or 6800, refer to Appnote 14 and 20 in the current Siemens Optoelectronic Data Book.

ELECTRICAL & MECHANICAL CONSIDERATIONS

VOLTAGE TRANSIENT SUPPRESSION

We strongly recommend that the same power supply be used for the display and the components that interface with the display to avoid logic inputs higher than V_{CC} . Additionally, the LEDs may cause transients in the power supply line while they change display states. The common practice is to place .01 μ F capacitors close to the displays across V_{CC} and GND, one for each display, and one 10 μ F capacitor for every second display.

ESD PROTECTION

The metal gate CMOS IC of the DL3416 is extremely immune to ESD damage. However, users of these devices are encouraged to take all the standard precautions, normal for CMOS components. These include properly grounding personnel, tools, tables, and transport carriers that come in contact with unshielded parts. Where these conditions are not, or cannot be met, keep the leads of the device shorted together or the parts in anti-static packaging.

SOLDERING CONSIDERATIONS

THE DL3416 can be hand soldered with SN63 solder using a grounded iron set to 260°C.

Wave soldering is also possible following these conditions: Preheat that does not exceed 93°C on the solder side of the PC board or a package surface temperature of 85°C. Water soluble organic acid flux (except carboxylic acid) or resin-based RMA flux without alcohol can be used.

Wave temperature of 245°C \pm 5°C with a dwell between 1.5 sec. to 3.0 sec. Exposure to the wave should not exceed temperatures above 260°C for five seconds at 0.063" below the seating plane. The packages should not be immersed in the wave.

POST SOLDER CLEANING PROCEDURES

The least offensive cleaning solution is hot D.I. water (60°C) for less than 15 minutes. Addition of mild saponifiers is acceptable. Do not use commercial dishwasher detergents.

For faster cleaning, solvents may be used. Exercise care in choosing solvents as some may chemically attack the nylon package. Maximum exposure should not exceed two minutes at elevated temperatures. Acceptable solvents are TF (trichlorotrifluoroethane), TA, 111 Trichloroethane, and unheated acetone.

Note: Acceptable commercial solvents are: Basic TF, Arklone P, Genesolve D, Blaco-tron TF, Freon TA, Genesolve DA, and Blaco-tron TA.

Unacceptable solvents contain alcohol, methanol, methylene chloride, ethanol, TP35, TCM, TMC, TMS+, TE, or TES. Since many commercial mixtures exist, contact a solvent vendor for chemical composition information.

Some major solvent manufacturers are: Allied Chemical Corporation, Specialty Chemical Division, Morristown, NJ; Baron-Blakeslee, Chicago, IL; Dow Chemical, Midland, MI; E.I. DuPont de Nemours & Co., Wilmington, DE.

For further information refer to Appnotes 18 and 19 in the current Siemens Optoelectronic Data Book.

An alternative to soldering and cleaning the display modules is to use sockets. Eighteen pin DIP sockets .600" wide with .100" centers work well for single displays. Multiple display assemblies are best handled by longer SIP sockets or DIP sockets when available for uniform package alignment. Socket manufacturers are Aries Electronics, Inc., Frenchtown, NJ; Garry Manufacturing, New Brunswick, NJ; Robinson-Nugent, New Albany, IN; and Samtec Electronic Hardware, New Albany, IN.

For further information refer to Appnote 22 in the current Siemens Optoelectronic Data Book.

OPTICAL CONSIDERATIONS

The .225" high characters of the DL3416 gives readability up to eight feet. The user can build a display that enhances readability over this distance by proper filter selection.

Using filters emphasizes the contrast ratio between a lit LED and the character background. This will increase the discrimination of different characters. The only limitation is cost. Remember to take into consideration the ambient lighting environment for the best cost/benefit ratio for filters.

Incandescent (with almost no green) or fluorescent (with almost no red) lights do not have the flat spectral response of sunlight. Plastic band-pass filters are an inexpensive and effective way to strengthen contrast ratios. The DL3416 is a standard red display and should be matched with long wavelength pass filter in the 600 nm to 620 nm range. For displays of multiple colors, neutral density grey filters offer the best compromise.

Additional contrast enhancement can be gained by shading the displays. Plastic band-pass filters with built-in louvers offer the next step up in contrast improvement. Plastic filters can be improved further with anti-reflective coatings to reduce glare. The trade-off is fuzzy characters. Mounting the filters close to the display reduces this effect. Take care not to overheat the plastic filter by allowing for proper air flow.

Optimal filter enhancements are gained by using circular polarized, anti-reflective, band-pass filters. The circular polarizing further enhances contrast by reducing the light that travels through the filter and reflects back off the display to less than 1%.

Several filter manufacturers supply quality filter materials. Some of them are: Panelgraphic Corporation, W. Caldwell, NJ; SGL Homalite, Wilmington, DE; 3M Company, Visual Products Division, St. Paul, MN; Polaroid Corporation, Polarizer Division, Cambridge, MA; Marks Polarized Corporation, Deer Park, NY; Hoya Optics, Inc., Fremont, CA.

One last note on mounting filters: recessing displays and bezel assemblies is an inexpensive way to provide a shading effect in overhead lighting situations. Several bezel manufacturers are: R.M.F. Products, Batavia, IL; Nobex Components, Griffith Plastic Corp., Burlingame, CA; Photo Chemical Products of California, Santa Monica, CA; I.E.E.-Atlas, Van Nuys, CA.

Refer to Siemens Appnote 23 for further information.

SIEMENS

HIGH EFFICIENCY RED **DLO4135** GREEN **DLG4137**

.43" SINGLE CHARACTER
5 X 7 DOT MATRIX Intelligent Display®
with MEMORY/DECODER/DRIVER

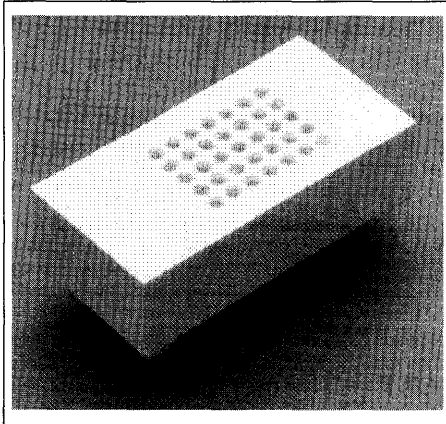

FEATURES

- .43" High, Dot Matrix Characters
- Wide Viewing Angle $\pm 75^\circ$
- 96 Character ASCII Set - Both Upper Case and Lower Case Characters
- Fully Encapsulated, Rugged Solid Plastic Package
- Built-in Memory
- Built-in Character Generator
- Built-in Multiplex and LED Drive Circuitry
- Built-in Lamp Test
- Intensity Control (4 levels)
- Microprocessor Bus Compatible
- Intensity Coded for Display Uniformity
- Single 5-Volt Power Supply
- X/Y Stackable
- Available in High Efficiency Red and Green

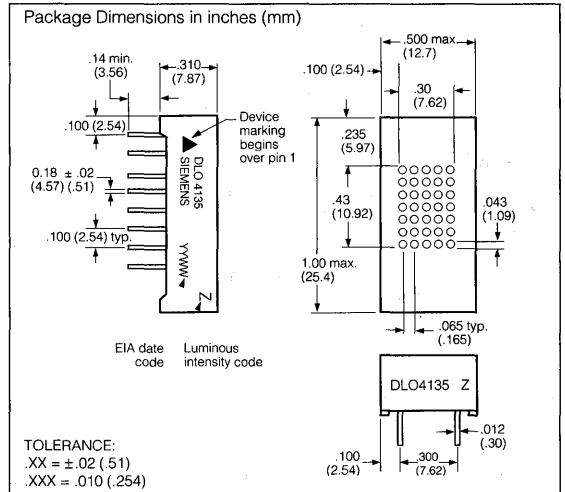

DESCRIPTION

The DLO4135/DLG4137 are single digit 5x7 dot matrix Intelligent Display devices with 0.43 character height. The built-in CMOS integrated circuit contains memory, ASCII character generator, LED multiplexing and drive circuitry; thereby eliminating the need for additional circuitry. They will display the 96 ASCII characters.

These devices are TTL and microprocessor compatible and offer the possibility of cascading the displays, allowing for multi-character messages. These displays were designed for viewing distances of up to 20 feet. They require a single 5-volt power supply and parallel ASCII input.

All products are 100% burned-in and tested, then subjected to out-going AQL's of .25% for brightness matching, visual alignment and dimensions, .065% for electrical and functional.

Important: Refer to Appnote 18, "Using and Handling Intelligent Displays." Since this is a CMOS device, normal precautions should be taken to avoid static damage.

Maximum Ratings

V_{CC} Range (max.)	-0.5 to +7.0 Vdc
Voltage, Any Pin	
Respect to GND	-0.5 to V_{CC} +0.5 Vdc
Operating Temperature	-40°C to +85°C
Storage Temperature	-40°C to +100°C
Maximum Solder Temperature, .063"	
below Seating Plane, t<5 sec.	260°C
Relative Humidity @ 85°C (non condensing)	85%

Optical Characteristics (Typical) @ 25°C

Time Averaged Luminous Intensity/Dot @ 5 V

DLO4135	1500 μ cd typ.
DLG4137	1500 μ cd typ.
Digit Size	0.43"
Viewing Angle (Note 1)	$\pm 75^\circ$
Spectral Peak Wavelength	
DLO4135	635 nm typ.
DLG4137	565 nm typ.
Dot to Dot Intensity Ratio	1.8:1.0 max.

Timing Parameters @ 25°C, $V_{CC} = 5.0 V \pm 0.5 V$

Symbol	Parameter	Units (ns)
T_{CES}	Chip Enable Set-Up	10
T_{DS}	Data Set Up	100
T_W	Write Pulse	120
T_{DH}	Data Hold	20
T_{CEH}	Chip Enable Hold	20
T_{ACC}	Access Time	150

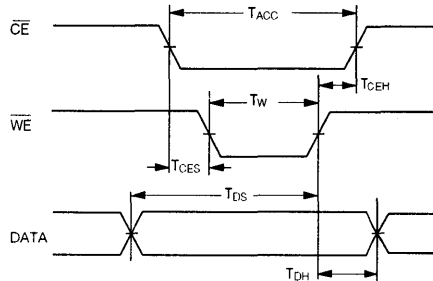
**TIMING CHARACTERISTICS
WRITE CYCLE WAVEFORMS**

DC CHARACTERISTICS

Parameter	-40°C			+25°C			+85°C			Units	Conditions
	Min.	Typ.	Max.	Min.	Typ.	Max.	Min.	Typ.	Max.		
I_{CC} (20 dots on)		135	180		100	140		85	115	mA	$V_{CC} = 5 V$ $\overline{BL0} = \overline{BL1} = 5 V$
I_{CC} Blank		2.0	5.5		1.5	4.0		0.8	3.5	mA	$V_{CC} = WR = 5.0 V$ $\overline{BL0} = \overline{BL1} = 0 V$
I_{IL} (all inputs)				25	50	100				μA	$V_{IN} = 0.8 V$ $V_{CC} = 5 V \pm 0.5 V$
V_{IH}	2.0			2.0			2.0			V	$V_{CC} = 5 V \pm 0.5 V$
V_{IL}			0.8			0.8			0.8	V	$V_{CC} = 5 V \pm 0.5 V$
V_{CC}	4.5	5.0	5.5	4.5	5.0	5.5	4.5	5.0	5.5	V	

Notes:

- "Off Axis Viewing Angle" is here defined as: "the minimum angle in any direction from the normal to the display surface at which any part of any dot in the display is not visible."
- This display contains a CMOS Integrated circuit. Normal CMOS handling precautions should be taken to avoid damage due to high static voltages or electric fields. See Appnote 18.**
- Unused inputs must be tied to an appropriate logic voltage level (either V+ or GND).
- $V_{CC} = 5.0 VDC \pm 10\%$.
- Clean only in water, isopropyl alcohol, freon TF, or TE (or equivalent).

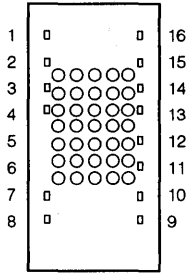
TOP VIEW



PIN FUNCTIONS

Pin	Function	Pin	Function
1	\overline{LT} Lamp Test	9	D0 Data LSB
2	\overline{WR} Write	10	D1 Data
3	$\overline{BL1}$ Brightness	11	D2 Data
4	$\overline{BL0}$ Brightness	12	D3 Data
5	No Pin	13	D4 Data
6	No Pin	14	D5 Data
7	\overline{CE} Chip Enable	15	D6 Data MSB
8	GND	16	+V _{cc}

LAMP TEST

When the lamp test (\overline{LT}) is activated, all dots on the display are illuminated at $1/7$ brightness. The lamp test function is independent of write (\overline{WR}) and the settings of the blanking inputs ($\overline{BL0}$, $\overline{BL1}$).

This convenient test gives a visual indication that all dots are functioning properly. Lamp test also may be used as a cursor function or pointer which does not destroy previously displayed characters.

DIMMING AND BLANKING THE DISPLAY

Brightness Level	$\overline{BL1}$	$\overline{BL0}$
Blank	0	0
$1/7$ Brightness	0	1
$1/2$ Brightness	1	0
Full Brightness	1	1

LOADING DATA

Loading data into the DLO4135/DLG4137 is straightforward. Chip enable (\overline{CE}) should be present and stable during a write pulse (\overline{WR}). Parallel data information should be stable for the minimum time (T_w) and held for T_{DH} after write has gone high. No synchronization is necessary and each character will continue to be displayed until it is replaced with another. Multiple displays may be stacked together with only an additional decoder IC for chip enable decoding.

Note 6: Either $\overline{BL0}$ or $\overline{BL1}$ should be held high for display to light up.

DATA LOADING EXAMPLE

\overline{CE} \overline{WR} $\overline{BL0}$ $\overline{BL1}$ \overline{LT}						Data Input						
D6	D5	D4	D3	D2	D1	D0						
H	X	H	X	H	X	X	X	X	X	X	X	NC
X	X	L	L	H	X	X	X	X	X	X	X	BLANK
X	X	X	X	L	X	X	X	X	X	X	X	LMP TEST
L	L	H	H	H	H	L	L	L	L	L	H	A
L	L	H	H	H	H	H	H	L	L	H	L	r
L	L	H	H	H	L	H	H	L	L	H	H	3
L	L	H	H	H	L	H	L	H	L	H	H	+

X = don't care
NC = no change

16 DIGITS INTERCONNECTION

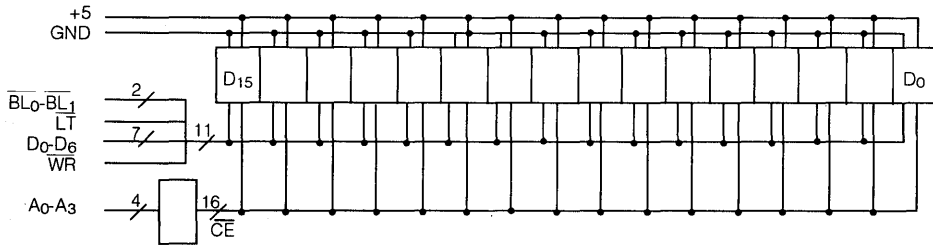

Intelligent Display Devices

CHARACTER SET

ASCII CODE	D0	0	1	0	1	0	1	0	1	0	1	0	1	0	1	0	1		
	D1	0	0	1	1	0	0	1	1	0	0	1	1	0	0	1	1		
	D2	0	0	0	0	1	1	1	1	0	0	0	0	1	1	1	1		
	D3	0	0	0	0	0	0	0	0	1	1	1	1	1	1	1	1		
D6	D5	D4	HEX	0	1	2	3	4	5	6	7	8	9	A	B	C	D	E	F
0	0	0	0	THESE CODES DISPLAY BLANK															
0	0	1	1	THESE CODES DISPLAY BLANK															
0	1	0	2	!	@	#	\$	%	&	'	()	*	+	,	-	.	:	;
0	1	1	3	<	=	>	?	[\]	^	_	`	{		}	~		
1	0	0	4																
1	0	1	5																
1	1	0	6																
1	1	1	7																

- Notes: 1. High = 1 level.
 2. Low = 0 level.
 3. Upon power up, the device will initialize in a random state.

SIEMENS

HIGH EFFICIENCY RED DLO7135 GREEN DLG7137

.68" SINGLE CHARACTER 5 X 7 DOT MATRIX Intelligent Display® with MEMORY/DECODER/DRIVER

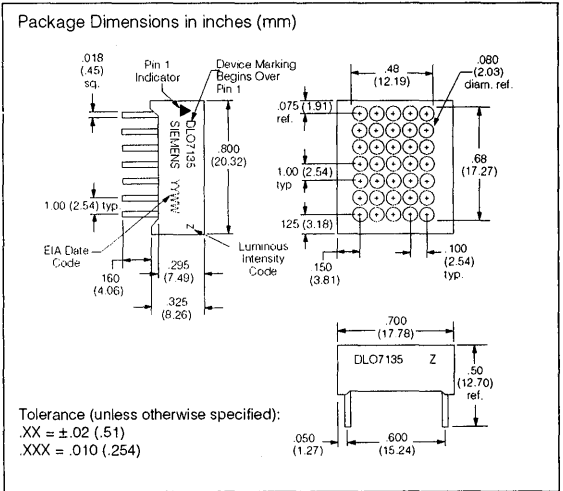
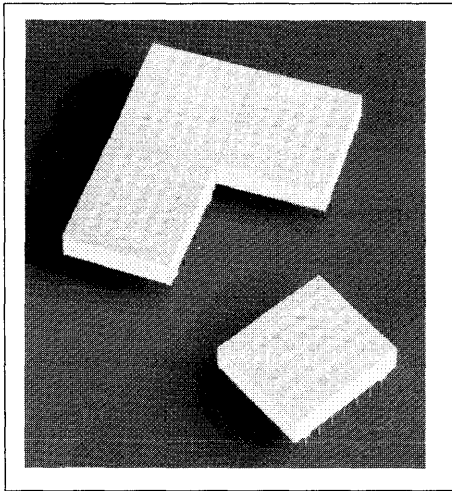

FEATURES

- .68" High, Dot Matrix Characters
- Wide Viewing Angle $\pm 75^\circ$
- 96 ASCII Character Set – Both Upper and Lower Case
- Fully Encapsulated, Rugged Solid Plastic Package
- Built-in Memory
- Built-in Character Generator
- Built-in Multiplex and LED Drive Circuitry
- Built-in Lamp Test
- Intensity Control (4 levels)
- Microprocessor Bus Compatible
- Intensity Coded for Display Uniformity
- Single 5-Volt Power Supply
- X/Y Stackable
- Available in High Efficiency Red and Green

DESCRIPTION

The DLO7135/DLG7137 are single digit 5x7 dot matrix Intelligent Display devices with 0.68 character height. The built-in CMOS integrated circuit contains memory, ASCII character generator, LED multiplexing and drive circuitry; thereby eliminating the need for additional circuitry. The DLO7135/DLG7137 will display 96 ASCII characters.

These devices are TTL and microprocessor compatible and offer the possibility of cascading the displays, allowing for multi-character messages. These displays were designed for viewing distances of up to 30 feet. They require a single 5-volt power supply and parallel ASCII input.

All products are 100% tested, then subjected to out-going AQL's of 0.25% for brightness matching, visual alignment and dimensions, 0.065% for electrical and functional.

Important: Refer to Appnote 18, "Using and Handling Intelligent Displays." Since this is a CMOS device, normal precautions should be taken to avoid static damage.

Maximum Ratings

V_{CC} Range (max.)	-0.5 to +7.0 Vdc
Voltage, Any Pin	
Respect to GND	-0.5 to ($V_{CC} + 0.5$) Vdc
Operating Temperature	-40°C to +85°C
Storage Temperature	-40°C to +100°C
Maximum Solder Temperature, .063" below Seating Plane, t<5 sec.	260°C
Relative Humidity @ 85°C (non condensing)	85%

Optical Characteristics (Typical) @ 25°C

Time Averaged Luminous Intensity/Dot @ 5 V	
DLO7135	1500 μ cd typ.
DLG7137	1500 μ cd typ.
Digit Size	0.68"
Viewing Angle (Note 1)	$\pm 75^\circ$
Spectral Peak Wavelength	
DLO7135	635 nm typ.
DLG7137	565 nm typ.
Dot to Dot Intensity Ratio	1.8:1.0 max.

Timing Parameters @ 25°C, $V_{CC} = 5.0 V \pm 0.5 V$

Symbol	Parameter	Units (ns)
T_{CES}	Chip Enable Set-Up	10
T_{DS}	Data Set Up	100
T_W	Write Pulse	120
T_{EH}	Data Hold	20
T_{CEH}	Chip Enable Hold	20
T_{ACC}	Access Time	150

TIMING CHARACTERISTICS WRITE CYCLE WAVEFORMS

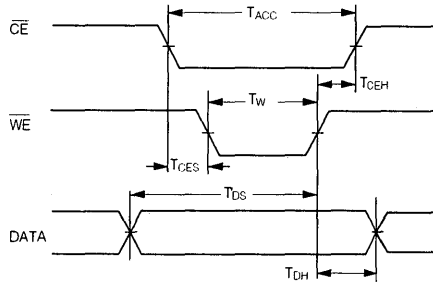

DC CHARACTERISTICS

Parameter	-40°C			+25°C			+85°C			Units	Conditions
	Min.	Typ.	Max.	Min.	Typ.	Max.	Min.	Typ.	Max.		
I_{CC} (20 dots on)		155	200		125	160		105	135	mA	$V_{CC} = 5 V$ $\overline{BL0} = \overline{BL1} = 5 V$
I_{CC} Blank		2.0	5.5		1.5	4.5		0.8	3.5	mA	$V_{CC} = \overline{WR} = 5.0 V$ $\overline{BL0} = \overline{BL1} = 0 V$
I_{IL} (all inputs)				25	55	100				μ A	$V_{IN} = 0.8 V$ $V_{CC} = 5 V \pm 0.5 V$
V_{IH}	2.0			2.0			2.0			V	$V_{CC} = 5 V \pm 0.5 V$
V_{IL}			0.8			0.8			0.8	V	$V_{CC} = 5 V \pm 0.5 V$
V_{CC}	4.5	5.0	5.5	4.5	5.0	5.5	4.5	5.0	5.5	V	

Notes:

- "Off Axis Viewing Angle" is here defined as: "the minimum angle in any direction from the normal to the display surface at which any part of any dot in the display is not visible."
- This display contains a CMOS Integrated circuit. Normal CMOS handling precautions should be taken to avoid damage due to high static voltages or electric fields. See Appnote 18.**
- Unused inputs must be tied to an appropriate logic voltage level (either V+ or GND).
- $V_{CC} = 5.0 VDC \pm 10\%$.
- Clean only in water, isopropyl alcohol, freon TF, or TE (or equivalent).

TOP VIEW

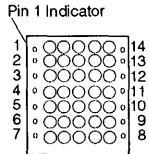

PIN FUNCTIONS

Pin	Function	Pin	Function
1	V _{CC}	8	D0 Data Input LSB
2	\overline{LT} Lamp Test	9	D1 Data Input
3	\overline{CE} Chip Enable	10	D2 Data Input
4	\overline{WR} Write	11	D3 Data Input
5	$\overline{BL1}$ Brightness	12	D4 Data Input
6	$\overline{BL0}$ Brightness	13	D5 Data Input
7	GND	14	D6 Data Input MSB

LAMP TEST

When the lamp test (\overline{LT}) is activated, all dots on the display are illuminated at 1/2 brightness. The lamp test function is independent of write (\overline{WR}) and the settings of the blanking inputs ($\overline{BL0}$, $\overline{BL1}$).

This convenient test gives a visual indication that all dots are functioning properly. Lamp test also may be used as a cursor function or pointer which does not destroy previously displayed characters.

DIMMING AND BLANKING THE DISPLAY

Brightness Level	$\overline{BL1}$	$\overline{BL0}$
Blank	0	0
1/2 Brightness	0	1
1/2 Brightness	1	0
Full Brightness	1	1

LOADING DATA

Loading data into the DLO7135/DLG7137 is straightforward. Chip enable (\overline{CE}) should be present and stable during a write pulse (\overline{WR}). Parallel data information should be stable for the minimum time (T_w) and held for T_{DH} after write has gone high. No synchronization is necessary and each character will continue to be displayed until it is replaced with another. Multiple displays may be stacked together with only an additional decoder IC for chip enable decoding.

Note 6: Either $\overline{BL0}$ or $\overline{BL1}$ should be held high for display to light up.

DATA LOADING EXAMPLE

	Data Input												
	\overline{CE}	\overline{WR}	$\overline{BL0}$	$\overline{BL1}$	\overline{LT}	D6	D5		D4	D3	D2	D1	D0
H	X	H	X	H	X	X	X	X	X	X	X	X	NC
X	X	L	L	H	X	X	X	X	X	X	X	X	BLANK
X	X	X	X	L	X	X	X	X	X	X	X	X	LMP TEST
L	L	H	H	H	L	L	L	L	L	L	L	H	A
L	L	H	H	H	H	H	L	L	L	L	H	L	r
L	L	H	H	H	L	H	H	L	L	H	H	H	3
L	L	H	H	H	L	L	L	H	L	H	H	H	+

X = don't care
NC = no change

16 DIGITS INTERCONNECTION

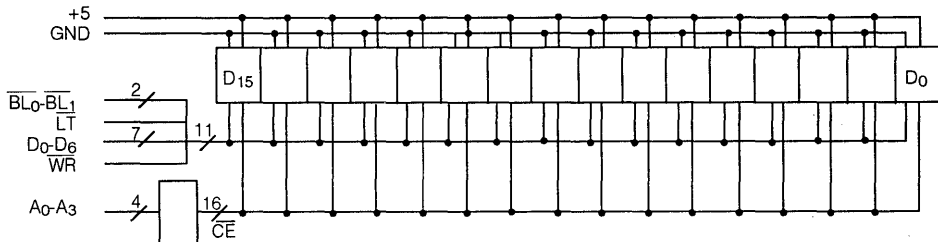

CHARACTER SET – 96 Characters

ASCII CODE				D0	0	1	0	1	0	1	0	1	0	1	0	1	0	1		
D1				0	0	1	1	0	0	1	1	0	0	1	1	0	0	1	1	
D2				0	0	0	0	1	1	1	1	0	0	0	0	1	1	1	1	1
D3				0	0	0	0	0	0	0	0	0	1	1	1	1	1	1	1	1
D6	D5	D4	HEX	0	1	2	3	4	5	6	7	8	9	A	B	C	D	E	F	
0	0	0	0																	
0	0	1	1	THESE CODES DISPLAY BLANK																
0	1	0	2																	
0	1	1	3																	
1	0	0	4																	
1	0	1	5																	
1	1	0	6																	
1	1	1	7																	

- Notes: 1. High = 1 level.
 2. Low = 0 level.
 3. Upon power up, the device will initialize in a random state.

Intelligent Display Devices

SIEMENS

RED DLR1414 HIGH EFFICIENCY RED DLO1414 GREEN DLG1414 .145" 4-Character, Dot Matrix Alphanumeric Intelligent Display" With Memory/Decoder/Driver

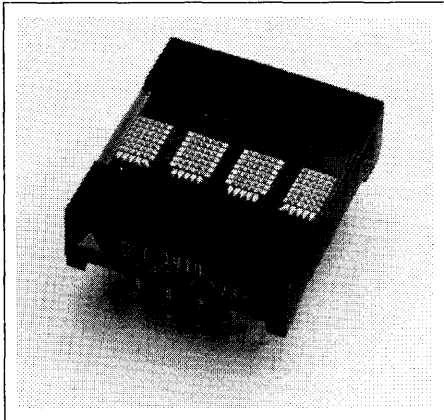

FEATURES

- Dot Matrix Replacement for DL1414T
- 0.145" High, Dot Matrix Character
- 128 Special ASCII Characters for English, German, Italian, Swedish, Danish, and Norwegian Languages
- Wide Viewing Angle: X Axis $\pm 50^\circ$, Y Axis $\pm 75^\circ$
- Close Vertical Row Spacing, 0.800" Centers
- Fast Access Time, 110 ns at 25° C
- Compact Size for Hand Held Equipment
- Built-in Memory
- Built-in Character Generator
- Built-in Multiplex and LED Drive Circuitry
- Direct Access to Each Digit Independently and Asynchronously
- TTL Compatible, 5 Volt Power
- Low Power Consumption, 2 mA per Character Typical
- Intensity Coded for Display Uniformity
- Extended Operating Temperature Range: -40°C to $+85^\circ\text{C}$
- End Stackable, 4 Character Package

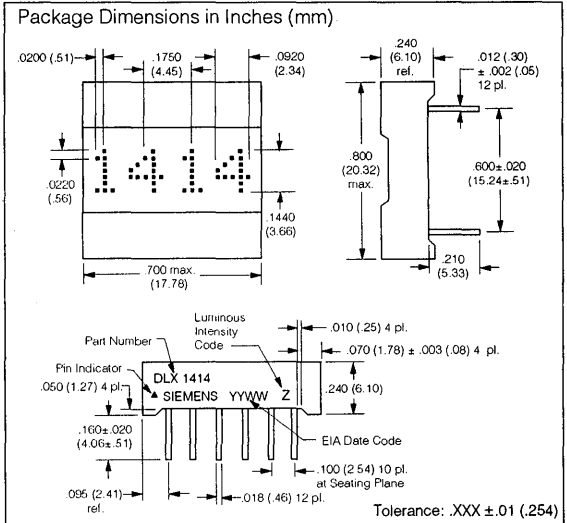

DESCRIPTION

The DLR/DLO/DLG1414 is a four digit 5x7 dot matrix display module with a built-in CMOS integrated circuit. This display is a drop-in dot matrix replacement for the DL1414T with segmented characters.

The integrated circuit contains memory, ASCII ROM decoder, multiplex circuitry and drivers. Data entry is asynchronous and random. A display system can be built using any number of DLX1414s since each character in any DLX1414 can be addressed independently and will continue to display the character last stored until replaced by another.

System interconnection is very straightforward. The least significant two address bits (A0, A1) are normally connected to the like named inputs of all displays in the system. Data lines are connected to all DLX1414s directly and in parallel as is the write line (WR). The display then will behave as a write only memory.

The DLX1414 has several features superior to competitive devices. The character set consists of 128 special ASCII characters for English, German, Italian, Swedish, Danish, and Norwegian.

See Appnotes 18, 19, 22, and 23 for additional information.

Maximum Ratings

DC Supply Voltage-0.5 to +7.0 Vdc
Input Voltage Levels Relative to GND (all inputs)-0.5 to $V_{CC} + 0.5$ Vdc
Operating Temperature-40°C to +85°C
Storage Temperature-40°C to +100°C
Maximum Solder Temperature, .063" (1.59 mm) below Seating Plane, t<5 sec.260°C
Relative Humidity at 85°C85%

Optical Characteristics

Spectral Peak Wavelength	
Red660 nm typ.
High Efficiency Red (HER)630 nm typ.
Green565 nm typ.
Viewing Angle (off normal axis)	
Horizontal±50°
Vertical±75°
Character Height0.145"
Time Averaged Luminous Intensity ¹ (100% brightness, $V_{CC} = 5$ V)	
Red50 μ cd/LED typ.
HER60 μ cd/LED typ.
Green70 μ cd/LED typ.
LED to LED Intensity Matching1.8:1.0 max.
LED to LED Hue Matching at $V_{CC}=5$ V (Green only)±2 nm max.

TOP VIEW

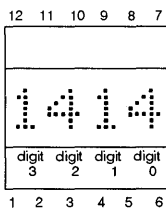

Pin Function

1	D5 Data Input
2	D4 Data Input
3	WR Write
4	A1 Digit Select
5	A0 Digit Select
6	V_{CC}
7	GND
8	D0 Data Input (LSB)
9	D1 Data Input
10	D2 Data Input
11	D3 Data Input
12	D6 Data Input (MSB)

TIMING CHARACTERISTICS ($V_{CC}=4.5$ v)

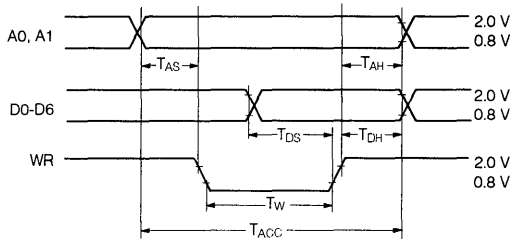

Note: These waveforms are not edge triggered.

Note:

1. Peak luminous intensity values can be calculated by multiplying these values by 7.

DC CHARACTERISTICS

Parameter	-40°C		+25°C		+85°C		Units	Conditions			
	Min.	Typ. Max.	Min.	Typ. Max.	Min.	Typ. Max.					
I_{CC} 4 Digits on 20 dots/digit		90	120		80	105	70	95	mA	$V_{CC}=5$ V	
I_{CC} Blank		2.8	4.0		2.3	3.0	2.0	2.5	mA	$V_{CC}=WR=5$ V $V_{IN}=0$ V	
I_{IL} (all inputs)	30	60	120	25	50	100	20	40	80	mA	$V_{IN}=0.8$ V $V_{CC}=5$ V
V_{IH}	2.0			2.0			2.0			V	$V_{CC}=5$ V±0.5 V
V_{IL}			0.8			0.8			0.8	V	$V_{CC}=5$ V±0.5 V
V_{CC}	4.5	5.0	5.5	4.5	5.0	5.5	4.5	5.0	5.5	V	

AC CHARACTERISTICS

Guaranteed Minimum Timing Parameters at $V_{CC} = 5.0$ V ± 0.5 V

Parameter	Symbol	-40°C (ns)	+25°C (ns)	+85°C (ns)
Address Set Up Time	T_{AS}	10	10	10
Address Hold Time	T_{AH}	20	30	40
Write Time	T_W	60	70	90
Data Set Up Time	T_{DS}	20	30	50
Data Hold Time	T_{DH}	20	30	40
Access Time ⁽¹⁾	T_{ACC}	90	110	140

Note: 1. T_{ACC} =Set Up Time + Write Time + Hold Time.

LOADING DATA STATE TABLE

WR	A1	A0	D6	D5	D4	D3	D2	D1	D0	Digit			
										3	2	1	0
H	previously loaded display									G	R	E	Y
L	L	L	H	L	L	L	H	L	H	G	R	E	E
L	L	H	H	L	H	L	H	L	H	G	R	U	E
L	H	L	H	L	L	H	H	L	L	G	L	U	E
L	H	H	H	L	L	L	L	H	L	B	L	U	E
L	L	H	H	L	L	L	H	L	H	B	L	E	E
L	L	L	H	L	H	L	H	H	H	B	L	E	W
L	X	X	see character code							see character set			

X = don't care

TYPICAL INTERCONNECTION FOR 32 CHARACTERS

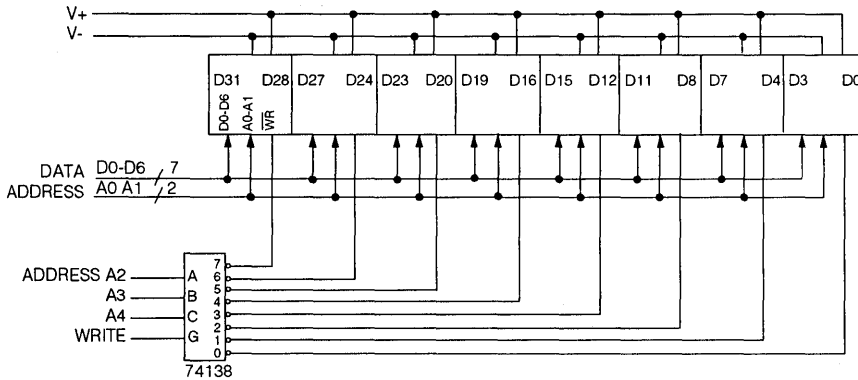

BLOCK DIAGRAM

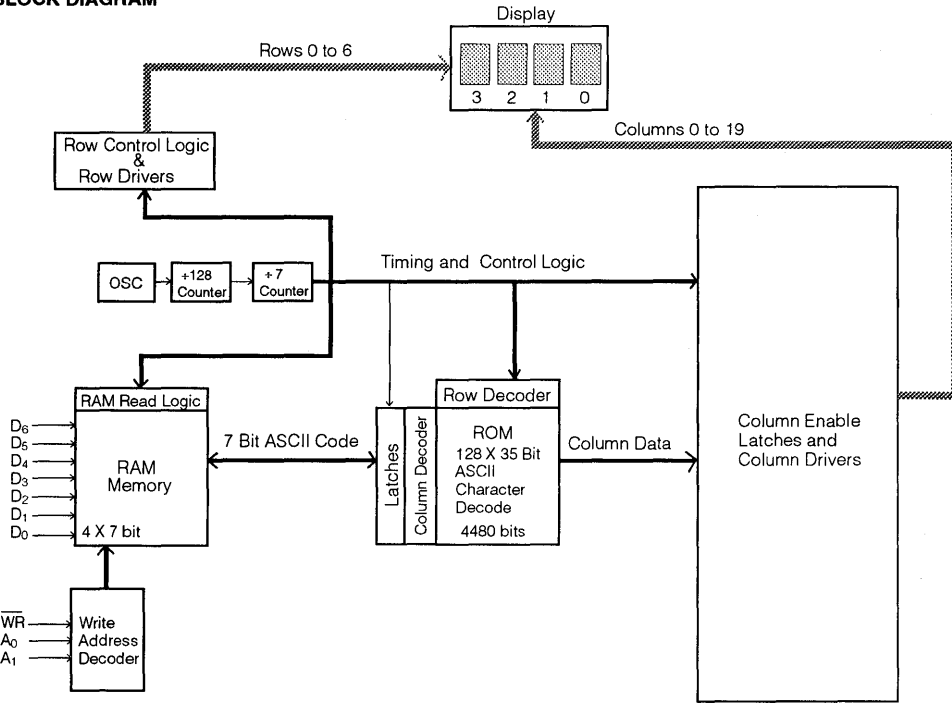

Intelligent Display Devices

CHARACTER SET

ASCII CODE		D0	0	1	0	1	0	1	0	1	0	1	0	1	0	1	0	1	0	1
D6	D5	D4	HEX	0	1	2	3	4	5	6	7	8	9	A	B	C	D	E	F	
0	0	0	0	0	1	2	3	4	5	6	7	8	9	A	B	C	D	E	F	
0	0	1	1	0	1	2	3	4	5	6	7	8	9	A	B	C	D	E	F	
0	1	0	2	0	1	2	3	4	5	6	7	8	9	A	B	C	D	E	F	
0	1	1	3	0	1	2	3	4	5	6	7	8	9	A	B	C	D	E	F	
1	0	0	4	0	1	2	3	4	5	6	7	8	9	A	B	C	D	E	F	
1	0	1	5	0	1	2	3	4	5	6	7	8	9	A	B	C	D	E	F	
1	1	0	6	0	1	2	3	4	5	6	7	8	9	A	B	C	D	E	F	
1	1	1	7	0	1	2	3	4	5	6	7	8	9	A	B	C	D	E	F	

- Notes: 1. High = 1 level.
- 2. Low = 0 level.
- 3. Upon power up, the device will initialize in a random state.

DESIGN CONSIDERATIONS

For details on design and applications of the DLX1414 using standard bus configurations in multiple display systems, or parallel I/O devices, such as the 8255 with an 8080 or memory mapped addressing on processors such as the 8080, Z80, 6502, 8748, or 6800, refer to Appnote 15 in the current Siemens Optoelectronic Data Book.

ELECTRICAL & MECHANICAL CONSIDERATIONS

VOLTAGE TRANSIENT SUPPRESSION

We strongly recommend that the same power supply be used for the display and the components that interface with the display to avoid logic inputs higher than V_{CC} . Additionally, the LEDs may cause transients in the power supply line while they change display states. The common practice is to place .01 mF capacitors close to the displays across V_{CC} and GND, one for each display, and one 10 mF capacitor for every second display.

ESD PROTECTION

The metal gate CMOS IC of the DLX1414 is extremely immune to ESD damage. However, users of these devices are encouraged to take all the standard precautions, normal for CMOS components. These include properly grounding personnel, tools, tables, and transport carriers that come in contact with unshielded parts. Where these conditions are not, or cannot be met, keep the leads of the device shorted together or the parts in anti-static packaging.

SOLDERING CONSIDERATIONS

The DLX1414 can be hand soldered with SN63 solder using a grounded iron set to 260°C.

Wave soldering is also possible following these conditions: Preheat that does not exceed 93°C on the solder side of the PC board or a package surface temperature of 85°C. Water soluble organic acid flux (except carboxylic acid) or resin-based RMA flux without alcohol can be used.

Wave temperature of 245°C \pm 5°C with a dwell between 1.5 sec. to 3.0 sec. Exposure to the wave should not exceed temperatures above 260°C for five seconds at 0.063" below the seating plane. The packages should not be immersed in the wave.

POST SOLDER CLEANING PROCEDURES

The least offensive cleaning solution is hot D.I. water (60°C) for less than 15 minutes. Addition of mild saponifiers is acceptable. Do not use commercial dishwasher detergents.

For faster cleaning, solvents may be used. Carefully select solvents as some may chemically attack the nylon package. Maximum exposure should not exceed two minutes at elevated temperatures. Acceptable solvents are TF (trichlorotrifluoroethane), TA, 111 Trichloroethane, and unheated acetone.

Note: Acceptable commercial solvents are: Basic TF, Arklone P, Genesolve D, Blaco-tron TF, Freon TA, Genesolve DA, and Blaco-tron TA.

Unacceptable solvents contain alcohol, methanol, methylene chloride, ethanol, TP35, TCM, TMC, TMS+, TE, or TES. Since many commercial mixtures exist, contact a solvent vendor for chemical composition information. Some major solvent manufacturers are: Allied Chemical Corporation, Specialty Chemical Division, Morristown, NJ; Baron-Blakeslee, Chicago, IL; Dow Chemical, Midland, MI; E.I. DuPont de Nemours & Co., Wilmington, DE.

For further information refer to Appnotes 18 and 19 in the current Siemens Optoelectronic Data Book.

An alternative to soldering and cleaning the display modules is to use sockets. Eighteen pin DIP sockets .600" wide with .100" centers work well for single displays. Multiple display assemblies are best handled by longer SIP sockets or DIP sockets when available for uniform package alignment. Socket manufacturers are Aries Electronics, Inc., Frenchtown, NJ; Garry Manufacturing, New Brunswick, NJ; Robinson-Nugent, New Albany, IN; and Samtec Electronic Hardware, New Albany, IN.

For further information refer to Appnote 22 in the current Siemens Optoelectronic Data Book.

OPTICAL CONSIDERATIONS

The .145" high characters of the DLX1414 gives readability up to eight feet. The user can build a display that enhances readability over this distance by proper filter selection.

Using filters emphasizes the contrast ratio between a lit LED and the character background. This will increase the discrimination of different characters. The only limitation is cost. Remember to take into consideration the ambient lighting environment for the best cost/benefit ratio for filters.

Incandescent (with almost no green) or fluorescent (with almost no red) lights do not have the flat spectral response of sunlight. Plastic band-pass filters are an inexpensive and effective way to strengthen contrast ratios. The DLR1414 is a standard red display and should be matched with long wavelength pass filter in the 600 nm to 620 nm range. For displays of multiple colors, neutral density grey filters offer the best compromise.

The DLO1414 is a high efficiency red display and should be matched with a long wavelength pass filter in the 570 nm to 590 range. The DLG1414 should be matched with a yellow-green band-pass filter that peaks at 565 nm. For displays of multiple colors, neutral density gray filters offer the best compromise.

Additional contrast enhancement can be gained by shading the displays. Plastic band-pass filters with built-in louvers offer the next step up in contrast improvement. Plastic filters can be improved further with anti-reflective coatings to reduce glare. The trade-off is fuzzy characters. Mounting the filters close to the display reduces this effect. Take care not to overheat the plastic filter by allowing for proper air flow.

Optimal filter enhancements are gained by using circular polarized, anti-reflective, band-pass filters. The circular polarizing further enhances contrast by reducing the light that travels through the filter and reflects back off the display to less than 1%.

Several filter manufacturers supply quality filter materials. Some of them are: Panelgraphic Corporation, W. Caldwell, NJ; SGL Homalite, Wilmington, DE; 3M Company, Visual Products Division, St. Paul, MN; Polaroid Corporation, Polarizer Division, Cambridge, MA; Marks Polarized Corporation, Deer Park, NY; Hoya Optics, Inc., Fremont, CA.

One last note on mounting filters: recessing displays and bezel assemblies is an inexpensive way to provide a shading effect in overhead lighting situations. Several bezel manufacturers are: R.M.F. Products, Batavia, IL; Nobex Components, Griffith Plastic Corp., Burlingame, CA; Photo Chemical Products of California, Santa Monica, CA; I.E.E.-Atlas, Van Nuys, CA.

Refer to Siemens Appnote 23 for further information.

RED DLR2416 HIGH EFFICIENCY RED DLO2416 GREEN DLG2416

.200" 4-Character 5 x 7 Dot Matrix Alphanumeric Intelligent Display with Memory/Decoder/Driver

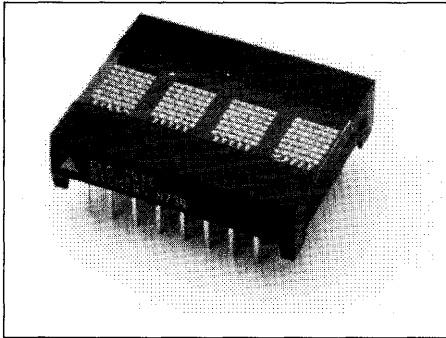

FEATURES

- Dot Matrix Replacement for DL2416T
- 0.200" 5 x 7 Dot Matrix Characters
- 128 Special ASCII Characters for English, German, Italian, Swedish, Danish, and Norwegian Languages
- Wide Viewing Angle: X Axis 50° Maximum, Y Axis ±75° Maximum
- Close Multi-line Spacing, 0.8" Centers
- Fast Access Time, 110 ns at 25°C
- Full Size Display for Stationary Equipment
- Built-in Memory
- Built-in Character Generator
- Built-in Multiplex and LED Drive Circuitry
- Direct Access to Each Digit Independently and Asynchronously
- Independent Cursor Function
- Memory Function: Clears Character and Cursor Memory Simultaneously
- True Blanking for Intensity Dimming Applications
- End-Stackable, 4-Character Package
- Intensity Coded for Display Uniformity
- Extended Operating Temperature Range: -40°C to +85°C
- Superior ESD Immunity
- Wave Solderable
- TTL Compatible over Operating Temperature Range
- Interdigit Blanking

See Appnotes 18, 19, 22, and 23 for additional information.

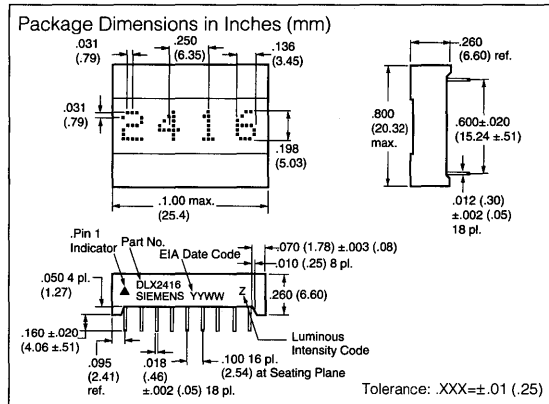

DESCRIPTION

The DLR/DLO/DLG2416 is a four digit 5x7 dot matrix display module with a built-in CMOS integrated circuit. This display is X/Y stackable.

The integrated circuit contains memory, ASCII ROM decoder, multiplexing circuitry and drivers. Data entry is asynchronous and can be random. A display system can be built using any number of DLX2416s since each digit can be addressed independently and will continue to display the character last stored until replaced by another.

System interconnection is very straightforward. The least significant two address bits (A0, A1) are normally connected to the like-named inputs of all displays in the system. With two chip enables (CE1 and CE2) four displays (16 characters) can easily be interconnected without a decoder.

Data lines are connected to all DLX2416s directly and in parallel, as is the write line (WR). The display will then behave as a write-only memory.

The cursor function causes all dots of a digit position to illuminate at half brightness. The cursor is *not* a character, and when removed the previously displayed character will reappear.

The DLX2416 has several features superior to competitive devices. True "blanking" allows the designer to dim the display for more flexibility of display presentation. Finally the CLR clear function will clear the cursor RAM and the ASCII character RAM simultaneously.

The character set consists of 128 special ASCII characters for English, German, Italian, Swedish, Danish, and Norwegian.

All products are subjected to out-going AQL's of 0.25% for brightness matching, visual alignment and dimensions, 0.065% for electrical and functional.

Maximum Ratings

DC Supply Voltage-0.5 V to +7.0 Vdc
Input Voltage, Respect to GND (all inputs)-0.5 V to $V_{CC} + 0.5$ Vdc
Operating Temperature-40°C to +85°C
Storage Temperature-40°C to +100°C
Relative Humidity at 85°C85%
Maximum Solder Temperature, 0.063" (1.59 mm) below Seating Plane, $t < 5$ sec260 °C

Optical Characteristics

Spectral Peak Wavelength	
Red660 nm typ.
HER630 nm typ.
Green565 nm typ.
Character Height0.200" (5.08 mm)
Time Averaged Luminous Intensity ⁽¹⁾	
at $V_{CC} = 5$ V	
Red60 μ cd/LED typ.
HER100 μ cd/LED typ.
Green120 μ cd/LED typ.
LED to LED Intensity Matching	
at $V_{CC} = 5$ V	
LED to LED Hue Matching (Green only)	
at $V_{CC} = 5$ V	
Viewing Angle (off normal axis)	
Horizontal $\pm 50^\circ$ max.
Vertical $\pm 75^\circ$ max.

Note 1: Peak luminous intensity values can be calculated by multiplying these values by 7.

TOP VIEW

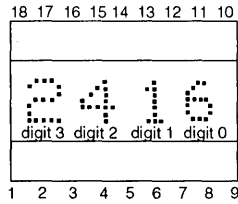

Pin Function

- 1 $\overline{CE1}$ Chip Enable
- 2 $\overline{CE2}$ Chip Enable
- 3 \overline{CLR} Clear
- 4 CUE Cursor Enable
- 5 CU Cursor Select
- 6 WR Write
- 7 A1 Digit Select
- 8 A0 Digit Select
- 9 V_{CC}

Pin Function

- 10 GND
- 11 D0 Data Input
- 12 D1 Data Input
- 13 D2 Data Input
- 14 D3 Data Input
- 15 D6 Data Input
- 16 D5 Data Input
- 17 D4 Data Input
- 18 \overline{BL} Display Blank

TIMING CHARACTERISTICS WRITE CYCLE WAVEFORMS

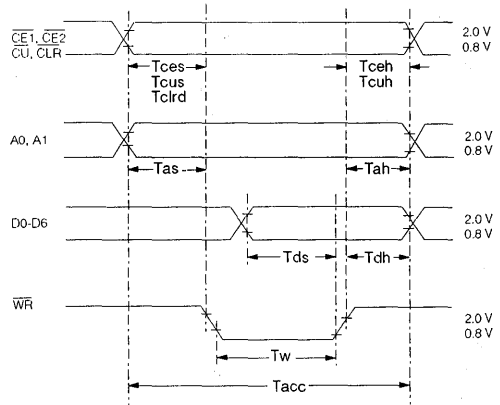

Note: These waveforms are not edge triggered.

DC CHARACTERISTICS

Parameter	-40°C			+25°C			+85°C			Units	Conditions
	Min.	Typ.	Max.	Min.	Typ.	Max.	Min.	Typ.	Max.		
I_{CC} 80 dots on		135	160		110	130		95	115	mA	$V_{CC} = 5$ V
I_{CC} Cursor all dots @ 50%			135			100			100	mA	$V_{CC} = 5$ V
I_{CC} Blank		2.8	4.0		2.3	3.0		2.0	2.5	mA	$V_{CC} = 5$ V, $\overline{BL} = 0.8$ V
I_{IL} (all inputs)	30	60	120	25	50	100	20	40	80	μ A	$V_{IN} = 0.8$ V, $V_{CC} = 5$ V
V_{IH} (all inputs)	2.0			2.0			2.0			V	$V_{CC} = 5$ V ± 0.5 V
V_{IL} (all inputs)			0.8			0.8			0.8	V	$V_{CC} = 5$ V ± 0.5 V
V_{CC}	4.5	5.0	5.5	4.5	5.0	5.5	4.5	5.0	5.5	V	

AC CHARACTERISTICS Guaranteed Minimum Timing Parameters @ $V_{CC}=5.0V \pm 0.5$

Parameter	Symbol	-40°C	+25°C	+85°C	Units
Chip Enable Set Up Time	T_{CES}	0	0	0	ns
Address Set Up Time	T_{AS}	10	10	10	ns
Cursor Set Up Time	T_{CUE}	10	10	10	ns
Chip Enable Hold Time	T_{CEH}	0	0	0	ns
Address Hold Time	T_{AH}	20	30	40	ns
Cursor Hold Time	T_{CUH}	20	30	40	ns
Clear Disable Time	T_{CLRD}	1	1	1	μ s
Write Time	T_W	60	70	90	ns
Data Set Up Time	T_{DS}	20	30	50	ns
Data Hold Time	T_{DH}	20	30	40	ns
Clear Time	T_{CLR}	1	1	1	μ s
Access Time	T_{ACC}	90	110	140	ns

Note: 1. $T_{ACC} = \text{Set Up Time} + \text{Write Time} + \text{Hold Time}$.

LOADING DATA

Setting the chip enable ($\overline{CE1}$, $\overline{CE2}$) to their true state will enable data loading. The desired data code (D0-D6) and digit address (A0, A1) must be held stable during the write cycle for storing new data.

Data entry may be asynchronous and random. Digit 0 is defined as right hand digit with $A1=A2=0$.

To clear the entire internal four-digit memory hold the clear (\overline{CLR}) low for 1 μ s. All illuminated dots will be turned off within one complete display multiplex cycle, 1 msec minimum. The clear function will clear both the ASCII RAM and the cursor RAM.

LOADING CURSOR

Setting the chip enables ($\overline{CE1}$, $\overline{CE2}$) and cursor select (CU) to their true state will enable cursor loading. A write (WR) pulse will now store or remove a cursor into the digit location addressed by A0, A1, as defined in data entry. A cursor will be stored if $D0=1$ and will be removed if $D0=0$. The cursor (CU) pulse width should not be less than the write (WR) pulse or erroneous data may appear in the display.

If the cursor is not required, the cursor enable signal (CUE) may be tied low to disable the cursor function. For a flashing cursor, simply pulse CUE. If the cursor has been loaded to any or all positions in the display, then CUE will control whether the cursor(s) or the characters will appear. CUE does not affect the contents of cursor memory.

TYPICAL LOADING DATA STATE TABLE

Control								Address		Data								Display Digit				
\overline{BL}	$\overline{CE1}$	$\overline{CE2}$	CUE	CU	WR	\overline{CLR}		A1	A0	D6	D5	D4	D3	D2	D1	D0	3	2	1	0		
H	X	X	L	X	H	H				previously loaded display								G	R	E	Y	
H	X	L	X	X	H	H	X	X	X	X	X	X	X	X	X	X	G	R	E	Y		
H	X	H	L	X	X	H	X	X	X	X	X	X	X	X	X	X	G	R	E	Y		
H	L	L	L	H	L	H	L	L	H	L	L	L	L	H	L	H	G	R	E	E		
H	L	L	L	H	L	H	L	L	H	L	H	L	H	L	H	H	G	R	U	E		
H	L	L	L	H	L	H	H	L	H	L	H	L	H	H	L	L	G	L	U	E		
H	L	L	L	H	L	H	H	H	H	L	L	L	L	H	L	L	B	L	U	E		
L	X	X	X	X	H	H	X	X			blank display											
H	L	L	L	H	L	H	H	H	H	L	L	L	L	H	H	H	G	L	U	E		
H	X	X	L	X	H	L	X	X			clears character displays											
H	L	L	L	H	L	H	X	X			see character code											

X = don't care

LOADING CURSOR STATE TABLE

Control								Address								Digit						
\overline{BL}	$\overline{CE1}$	$\overline{CE2}$	$\overline{CE3}$	$\overline{CE4}$	CUE	CU	\overline{WR}	\overline{CLR}	A1	A0	D6	D5	D4	D3	D2	D1	D0	3	2	1	0	
H	X	X	X	X	L	X	H	H			previously loaded display								B	E	A	R
H	X	X	X	X	H	X	H	H			display previously stored cursors								B	E	A	R
H	H	H	L	L	H	L	L	H	L	L	X	X	X	X	X	X	H	B	E	A	■	
H	H	H	L	L	H	L	L	H	L	H	X	X	X	X	X	X	H	B	E	■	■	
H	H	H	L	L	H	L	L	H	H	L	X	X	X	X	X	X	H	B	■	■	■	
H	H	H	L	L	H	L	L	H	H	H	X	X	X	X	X	X	H	■	■	■	■	
H	H	H	L	L	H	L	L	H	H	L	X	X	X	X	X	X	L	■	E	■	■	
H	X	X	X	X	L	X	H	H			disable cursor display								B	E	A	R
H	H	H	L	L	L	L	L	H	H	H	X	X	X	X	X	X	L	B	E	A	R	
H	X	X	X	X	H	H	X	H			display stored cursors								B	E	■	■

X = don't care ■ = all dots on

DISPLAY BLANKING

Blanking the display may be accomplished by loading a blank or space into each digit of the display or by using the (BL) display blank input.

Setting the ($\overline{\text{BL}}$) input low does not affect the contents of either data or cursor memory.

A flashing circuit can easily be constructed using a 555 astable multivibrator. Figure 1 illustrates a circuit in which varying R2 (100K~10K) will have a flash rate of 1 Hz~10 Hz.

FIGURE 1. FLASHING CIRCUIT FOR DLX2416 USING A 555

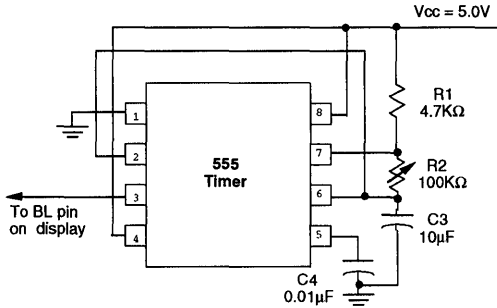
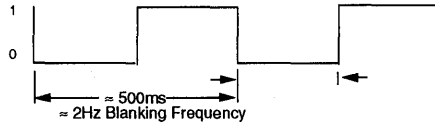
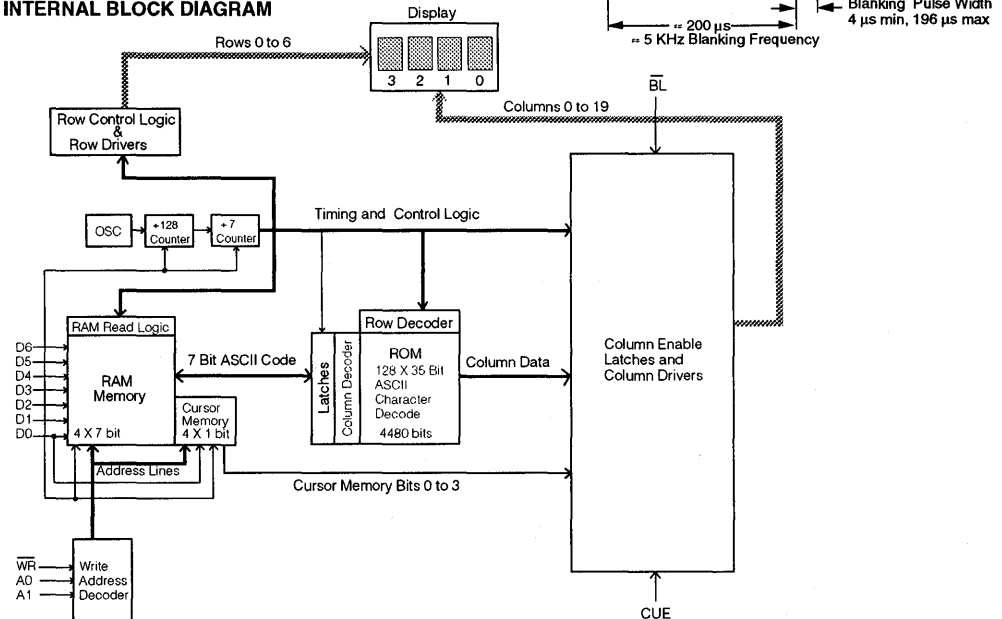

FIGURE 1a. FLASHING (Blanking) TIMING



INTERNAL BLOCK DIAGRAM



The display can be dimmed by pulse width modulating the (BL) at a frequency sufficiently fast to not interfere with the internal clock. The dimming signal frequency should be 2.5 KHz or higher. Dimming the display also reduces power consumption.

An example of a simple dimming circuit using a 556 is illustrated in Figure 2. Adjusting potentiometer R3 will dim the display by changing the blanking pulse duty cycle.

FIGURE 2. DIMMING CIRCUIT FOR DLX2416 USING A 556

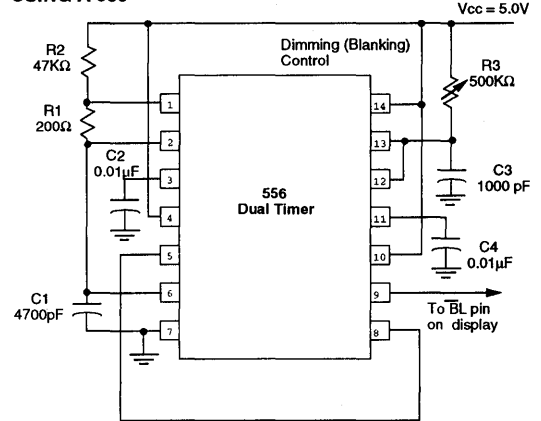
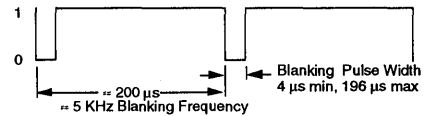

FIGURE 2a. DIMMING (Blanking) TIMING



CHARACTER SET

ASCII CODE		D0	0	1	0	1	0	1	0	1	0	1	0	1	0	1			
D6	D5	D4	Hex	0	1	2	3	4	5	6	7	8	9	A	B	C	D	E	F
0	0	0	0	0	0	0	0	0	0	0	0	0	0	0	0	0	0	0	0
0	0	1	1	0	0	0	0	0	0	0	0	0	0	0	0	0	0	0	0
0	1	0	2	0	0	0	0	0	0	0	0	0	0	0	0	0	0	0	0
0	1	1	3	0	0	0	0	0	0	0	0	0	0	0	0	0	0	0	0
1	0	0	4	0	0	0	0	0	0	0	0	0	0	0	0	0	0	0	0
1	0	1	5	0	0	0	0	0	0	0	0	0	0	0	0	0	0	0	0
1	1	0	6	0	0	0	0	0	0	0	0	0	0	0	0	0	0	0	0
1	1	1	7	0	0	0	0	0	0	0	0	0	0	0	0	0	0	0	0

Notes:

1. High = 1 level.
2. Low = 0 level.
3. Upon power up, the device will initialize in a random state.

TYPICAL SCHEMATIC – 16 CHARACTER SYSTEM

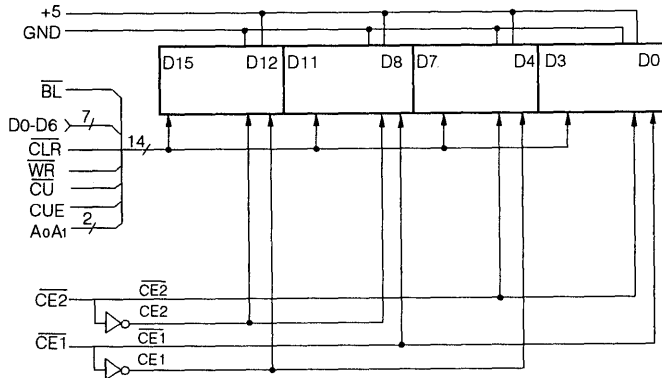

DESIGN CONSIDERATIONS

For details on design and applications of the DLX2416 using standard bus configurations in multiple display systems, or parallel I/O devices, such as the 8255 with an 8080 or memory mapped addressing on processors such as the 8080, Z80, 6502, or 6800, refer to Appnote 15 in the current Siemens Optoelectronics Data Book.

ELECTRICAL & MECHANICAL CONSIDERATIONS

VOLTAGE TRANSIENT SUPPRESSION

We recommend that the same power supply be used for the display and the components that interface with the display to avoid logic inputs higher than V_{CC} . Additionally, the LEDs may cause transients in the power supply line while they change display states. The common practice is to place .01 mF capacitors close to the displays across V_{CC} and GND, one for each display, and one 10 mF capacitor for every second display.

ESD PROTECTION

The silicon gate CMOS IC of the DLX2416 is quite resistant to ESD damage and capable of withstanding discharges greater than 2 KV. However, take all the standard precautions, normal for CMOS components. These include properly grounding personnel, tools, tables, and transport carriers that come in contact with unshielded parts. If these conditions are not, or cannot be met, keep the leads of the device shorted together or the parts in anti-static packaging.

SOLDERING CONSIDERATIONS

The DLX2416 can be hand soldered with SN63 solder using a grounded iron set to 260°C.

Wave soldering is also possible following these conditions: Preheat that does not exceed 93°C on the solder side of the PC board or a package surface temperature of 85°C. Water soluble organic acid flux (except carboxylic acid) or resin-based RMA flux without alcohol can be used.

Wave temperature of 245°C \pm 5°C with a dwell between 1.5 sec. to 3.0 sec. Exposure to the wave should not exceed temperatures above 260°C for five seconds at 0.063" below the seating plane. The packages should not be immersed in the wave.

POST SOLDER CLEANING PROCEDURES

The least offensive cleaning solution is hot D.I. water (60°C) for less than 15 minutes. Addition of mild saponifiers is acceptable. Do not use commercial dishwasher detergents.

For faster cleaning, solvents may be used. Carefully select any solvent as some may chemically attack the nylon package. Maximum exposure should not exceed two minutes at elevated temperatures. Acceptable solvents are TF (trichlorotribluorethane), TA, 111 Trichloroethane, and unheated acetone.

Note: Acceptable commercial solvents are: Basic TF, Arklone, P. Genesolv, D. Genesolv DA, Blaco-Tron TF, Blaco-Tron TA, and Freon TA.

Unacceptable solvents contain alcohol, methanol, methylene chloride, ethanol, TP35, TCM, TMC, TMS+, TE, or TES. Since many commercial mixtures exist, contact a solvent vendor for chemical composition information. Some major solvent manufacturers are: Allied Chemical Corporation, Specialty Chemical Division, Morristown, NJ; Baron-Blakeslee, Chicago, IL; Dow Chemical, Midland, MI; E.I. DuPont de Nemours & Co., Wilmington, DE.

For further information refer to Siemens Appnotes 18 and 19.

An alternative to soldering and cleaning the display modules is to use sockets. Standard pin DIP sockets .600" wide with 0.100" centers work well for single displays. Multiple display assemblies are best handled by longer SIP sockets or DIP sockets when available for uniform package alignment. Socket manufacturers are Aries Electronics, Inc., Frenchtown, NJ; Garry Manufacturing, New Brunswick, NJ; Robinson-Nugent, New Albany, IN; and Samtec Electronic Hardware, New Albany, IN.

For further information refer to Siemens Appnote 22.

OPTICAL CONSIDERATIONS

The 0.200" high characters of the DLX2416 gives readability up to eight feet. Proper filter selection enhances readability over this distance.

Filters enhance the contrast ratio between a lit LED and the character background intensifying the discrimination of different characters. The only limitation is cost. Take into consideration the ambient lighting environment for the best cost/benefit ratio for filters.

Incandescent (with almost no green) or fluorescent (with almost no red) lights do not have the flat spectral response of sunlight. Plastic band-pass filters are an inexpensive and effective way to strengthen contrast ratios.

The DLR2416 is a standard red display and should be matched with long wavelength pass filter in the 600 nm to 620 nm range. The DLO2416 is a high efficiency red display and should be matched with a long wavelength pass filter in the 470 nm to 590 range. The DLG2416 should be matched with a yellow-green band-pass filter that peaks at 565 nm. For displays of multiple colors, neutral density gray filters offer the best compromise.

Additional contrast enhancement is gained by shading the displays. Plastic band-pass filters with built-in louvers offer the next step up in contrast improvement. Plastic filters can be improved further with anti-reflective coatings to reduce glare. The trade-off is fuzzy characters. Mounting the filters close to the display reduces this effect. Take care not to overheat the plastic filter by allowing for proper air flow.

Optimal filter enhancements are gained by using circular polarized, anti-reflective, band-pass filters. Circular polarizing further enhances contrast by reducing the light that travels through the filter and reflects back off the display to less than 1%.

Several filter manufacturers supply quality filter materials. Some of them are: Panelgraphic Corporation, W. Caldwell, NJ; SGL Homalite, Wilmington, DE; 3M Company, Visual Products Division, St. Paul, MN; Polaroid Corporation, Polarizer Division, Cambridge, MA; Marks Polarized Corporation, Deer Park, NY; Hoya Optics, Inc., Fremont, CA.

One last note on mounting filters: recessing displays and bezel assemblies is an inexpensive way to provide a shading effect in overhead lighting situations. Several Bezel manufacturers are: R.M.F. Products, Batavia, IL; Nobex Components, Griffith Plastic Corp., Burlingame, CA; Photo Chemical Products of California, Santa Monica, CA; E.E.-Atlas, Van Nuys, CA.

Refer to Siemens Appnote 23 for further information.

SIEMENS

RED DLR3416 HIGH EFFICIENCY RED DLO3416 GREEN DLG3416

.270" 4-Character 5 x 7 Dot Matrix Alphanumeric Intelligent Display with Memory/Decoder/Driver

Intelligent
Display Devices

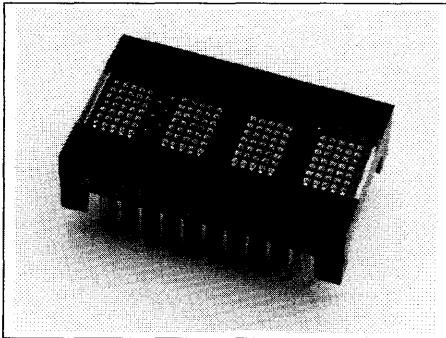

FEATURES

- Dot Matrix Replacement for DL3416
- 0.270" 5x7 Dot Matrix Characters
- 128 Special ASCII Characters for English, German, Italian, Swedish, Danish, and Norwegian Languages
- Wide Viewing Angle: X Axis 50° Maximum, Y Axis ±75° Maximum
- Close Vertical Row Spacing, 0.800" Centers
- Fast Access Time, 110 ns at 25°C
- Full Size Display for Stationary Equipment
- Built-in Memory
- Built-in Character Generator
- Built-in Multiplex and LED Drive Circuitry
- Each Character Independently Accessed
- TTL Compatible, 5 Volt Power, $V_{IH}=2.0\text{ V}$, $V_{IL}=0.8\text{ V}$
- Independent Cursor Function
- Memory Clear Function
- Display Blank Function for Blinking and Dimming
- End-Stackable, 4-Character Package
- Intensity Coded for Display Uniformity
- Extended Operating Temperature Range: -40°C to +85°C
- Wave Solderable

See Appnotes 18, 19, 22, and 23 for additional information.

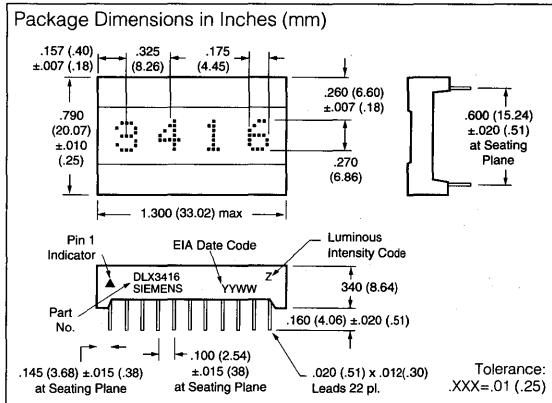

DESCRIPTION

The DLR/DLO/DLG3416 is a four character 5x7 dot matrix display module with a built-in CMOS integrated circuit. This display is a "drop-in" replacement for the DL3416.

The integrated circuit contains memory, ASCII ROM decoder, multiplexing circuitry and drivers. Data entry is asynchronous and can be random. A display system can be built using any number of DLX3416s since each character can be addressed independently and will continue to display the character last stored until replaced by another.

System interconnection is very straightforward. The least significant two address bits (A0, A1) are normally connected to the like-named inputs of all displays in the system. With four chip enables, four displays (16 characters) can easily be interconnected without a decoder.

Data lines are connected to all DLX3416s directly and in parallel, as is the write line (WR). The display will then behave as a write-only memory.

The cursor function causes all dots of a character position to illuminate at half brightness. The cursor is *not* a character, and when removed the previously displayed character will reappear.

The DLX3416 has several features superior to competitive devices. True "blanking" allows the designer to dim the display for more flexibility of display presentation. Finally the CLR clear function will clear the cursor RAM and the ASCII character RAM simultaneously.

The character set consists of 128 special ASCII characters for English, German, Italian, Swedish, Danish, and Norwegian.

All products are subjected to out-going AQL's of 0.25% for brightness matching, visual alignment and dimensions, 0.065% for electrical and functional.

Maximum Ratings

DC Supply Voltage-0.5 V to +7.0 Vdc
Input Voltage, Respect to GND (all inputs)-0.5 V to $V_{CC} + 0.5$ Vdc
Operating Temperature-40°C to +85°C
Storage Temperature-40°C to +100°C
Relative Humidity at 85°C (non-condensing)85%
Maximum Solder Temperature, 0.063" (1.59 mm) below Seating Plane, t<5 sec260 °C

Optical Characteristics

Spectral Peak Wavelength	
Red660 nm typ.
HER630 nm typ.
Green565 nm typ.
Character Height0.270" (6.86 mm)
Time Averaged Luminous Intensity ⁽¹⁾ at $V_{CC}=5$ V	
Red60 μ cd/LED typ.
HER120 μ cd/LED typ.
Green140 μ cd/LED typ.
Dot to Dot Intensity Matching at $V_{CC}=5$ V	
LED to LED Hue Matching (Green only) at $V_{CC}=5$ V1.8:1.0 max. ± 2 nm max.
Viewing Angle (off normal axis)	
Horizontal $\pm 50^\circ$ max.
Vertical $\pm 75^\circ$ max.

Note 1: Peak luminous intensity values can be calculated by multiplying these values by 7.

TOP VIEW

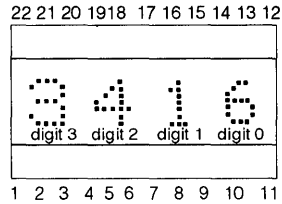

Pin Function

- 1 CE1 Chip Enable
- 2 CE2 Chip Enable
- 3 CE3 Chip Enable
- 4 CE4 Chip Enable
- 5 CLR Clear
- 6 V_{CC}
- 7 A0 Digit Select
- 8 A1 Digit Select
- 9 WR Write
- 10 CU Cursor Select

Pin Function

- 11 CUE Cursor Enable
- 12 GND
- 13 NC
- 14 BL Blanking
- 15 NC
- 16 D0 Data Input
- 17 D1 Data Input
- 18 D2 Data Input
- 19 D3 Data Input
- 22 D6 Data Input

TIMING CHARACTERISTICS WRITE CYCLE WAVEFORMS

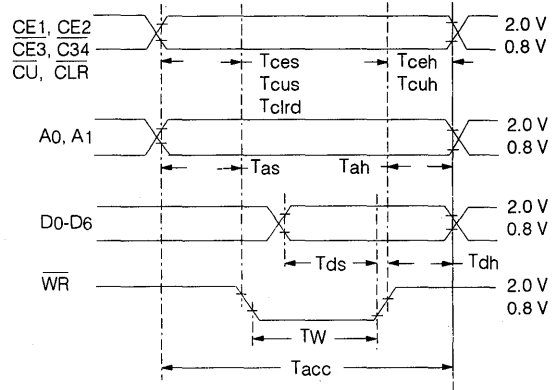

Note: These waveforms are not edge triggered.

DC CHARACTERISTICS

Parameter	-40°C			+25°C			+85°C			Units	Conditions
	Min.	Typ.	Max.	Min.	Typ.	Max.	Min.	Typ.	Max.		
I_{CC} 80 dots on		150	190	135	165		115	150		mA	$V_{CC}=5$ V
I_{CC} Cursor all dots at 50%			170			140		125		mA	$V_{CC}=5$ V
I_{CC} Blank		2.8	4.0	2.3	3.0		2.0	2.5		mA	$V_{CC}=5$ V, $\overline{BL}=0.8$ V
I_{IL} (all inputs)	30	60	120	25	50	100	20	40	80	μ A	$V_{IN}=0.8$ V, $V_{CC}=5$ V
V_{IH} (all inputs)	2.0			2.0			2.0			V	$V_{CC}=5$ V ± 0.5 V
V_{IL} (all inputs)			0.8			0.8			0.8	V	$V_{CC}=5$ V ± 0.5 V
V_{CC}	4.5	5.0	5.5	4.5	5.0	5.5	4.5	5.0	5.5	V	

AC CHARACTERISTICS Guaranteed Minimum Timing Parameters at $V_{CC}=5.0V \pm 0.5V$

Parameter	Symbol	-40°C	+25°C	+85°C	Units
Chip Enable Set Up Time	T_{CES}	0	0	0	ns
Address Set Up Time	T_{AS}	10	10	10	ns
Cursor Set Up Time	T_{CUS}	10	10	10	ns
Chip Enable Hold Time	T_{CEH}	0	0	0	ns
Address Hold Time	T_{AH}	20	30	40	ns
Cursor Hold Time	T_{CUH}	20	30	40	ns
Clear Disable Time	$T_{CLR D}$	1	1	1	μs
Write Time	T_W	60	70	90	ns
Data Set Up Time	T_{DS}	20	30	50	ns
Data Hold Time	T_{DH}	20	30	40	ns
Clear Time	T_{CLR}	1	1	1	μs
Access Time	T_{ACC}	90	110	140	ns

Note: 1. $T_{ACC} = \text{Set Up Time} + \text{Write Time} + \text{Hold Time}$.

LOADING DATA

Setting the chip enable ($\overline{CE1}$, $\overline{CE2}$, $\overline{CE3}$, $\overline{CE4}$) to their true state will enable loading. The desired data code (D0-D6) and digit address (A0, A1) must be held stable during the write cycle for storing new data.

Data entry may be asynchronous and random. Digit 0 is defined as right hand digit with $A1=A2=0$.

To clear the entire internal four-digit memory hold the clear (\overline{CLR}) low for 1 μs . All illuminated dots will be turned off within one complete display multiplex cycle, 1 msec minimum. The clear function will clear both the ASCII RAM and the cursor RAM.

LOADING CURSOR

Setting the chip enables ($\overline{CE1}$, $\overline{CE2}$, $\overline{CE3}$, $\overline{CE4}$) and cursor select (\overline{CU}) to their true state will enable cursor loading. A write (\overline{WR}) pulse will now store or remove a cursor into the digit location addressed by A0, A1, as defined in data entry. A cursor will be stored if D0=1 and will be removed if D0=0. The cursor (\overline{CU}) pulse width should not be less than the write (\overline{WR}) pulse or erroneous data may appear in the display.

If the cursor is not required, the cursor enable signal (CUE) may be tied low to disable the cursor function. For a flashing cursor, simply pulse CUE. If the cursor has been loaded to any or all positions in the display, then CUE will control whether the cursor(s) or the characters will appear. CUE does not affect the contents of cursor memory.

TYPICAL LOADING DATA STATE TABLE

\overline{BL}	$\overline{CE1}$	$\overline{CE2}$	$\overline{CE3}$	$\overline{CE4}$	CUE	\overline{CU}	\overline{WR}	\overline{CLR}	A1	A0	D6	D5	D4	D3	D2	D1	D0	Digit										
																		3	2	1	0							
H	X	X	X	X	L	X	H	H	PREVIOUSLY LOADED DISPLAY										G	R	E	Y						
H	L	X	X	X	L	X	X	H	X	X	X	X	X	X	X	X	X	X	G	R	E	Y						
H	X	L	X	X	L	X	X	H	X	X	X	X	X	X	X	X	X	G	R	E	Y							
H	X	X	H	X	L	X	X	H	X	X	X	X	X	X	X	X	X	G	R	E	Y							
H	X	X	X	H	L	X	X	H	X	X	X	X	X	X	X	X	X	G	R	E	Y							
H	X	X	X	X	L	X	H	H	X	X	X	X	X	X	X	X	X	G	R	E	Y							
H	H	H	L	L	L	H	L	H	L	L	H	L	L	L	H	L	H	G	R	E	E							
H	H	H	L	L	L	H	L	H	L	H	H	L	H	L	H	L	H	G	R	U	E							
H	H	H	L	L	L	H	L	H	H	L	H	L	L	H	H	L	L	G	L	U	E							
H	H	H	L	L	L	H	L	H	H	H	L	L	L	L	H	L	H	B	L	U	E							
L	X	X	X	X	X	X	H	H	X	X	BLANK DISPLAY																	
H	H	H	L	L	L	H	L	H	H	H	L	L	L	H	H	H	H	G	L	U	E							
H	X	X	X	X	L	X	X	L	CLEARS CHARACTER DISPLAY																			
H	H	H	L	L	L	H	L	H	X	X	SEE CHARACTER CODE										SEE CHARACTER SET							

X = don't care

LOADING CURSOR STATE TABLE

\overline{BL}	$\overline{CE1}$	$\overline{CE2}$	$\overline{CE3}$	$\overline{CE4}$	CUE	\overline{CU}	\overline{WR}	\overline{CLR}	A1	A0	D6	D5	D4	D3	D2	D1	D0	Digit								
																		3	2	1	0					
H	X	X	X	X	L	X	H	H	PREVIOUSLY LOADED DISPLAY										B	E	A	R				
H	X	X	X	X	H	X	H	H	DISPLAY PREVIOUSLY STORED CURSORS										B	E	A	R				
H	H	H	L	L	H	L	L	H	L	L	X	X	X	X	X	X	H	B	E	A	■					
H	H	H	L	L	H	L	L	H	L	H	X	X	X	X	X	X	H	B	E	■	■					
H	H	H	L	L	H	L	L	H	H	L	X	X	X	X	X	X	H	B	■	■	■					
H	H	H	L	L	H	L	L	H	H	H	X	X	X	X	X	X	H	■	■	■	■					
H	H	H	L	L	H	L	L	H	H	L	X	X	X	X	X	X	L	■	E	■	■					
H	X	X	X	X	L	X	H	H	DISABLE CURSOR DISPLAY										B	E	A	R				
H	H	H	L	L	L	L	L	H	H	H	X	X	X	X	X	X	L	B	E	A	R					
H	X	X	X	X	H	X	H	H	DISPLAY STORED CURSORS										B	E	■	■				

X = don't care ■ = all dots on

DISPLAY BLANKING

Blank the display by loading a blank or space into each digit of the display or by using the (BL) display blank input.

Setting the (BL) input low does not affect the contents of either data or cursor memory. A flashing display can be achieved by pulsing (BL). A flashing circuit can be constructed using a 555 astable multivibrator. Figure 1 illustrates a circuit in which varying R2 (100K-10K) will have a flash rate of 1 Hz-10 Hz.

FIGURE 1. FLASHING CIRCUIT USING A 555

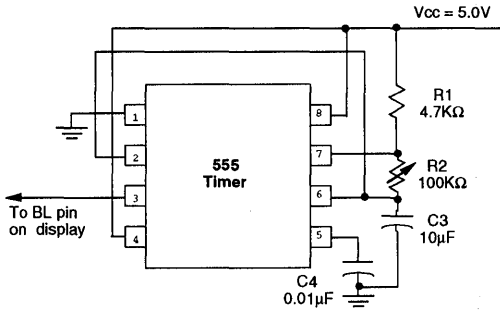
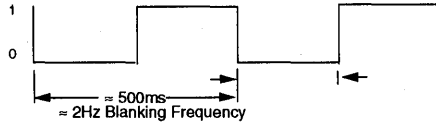
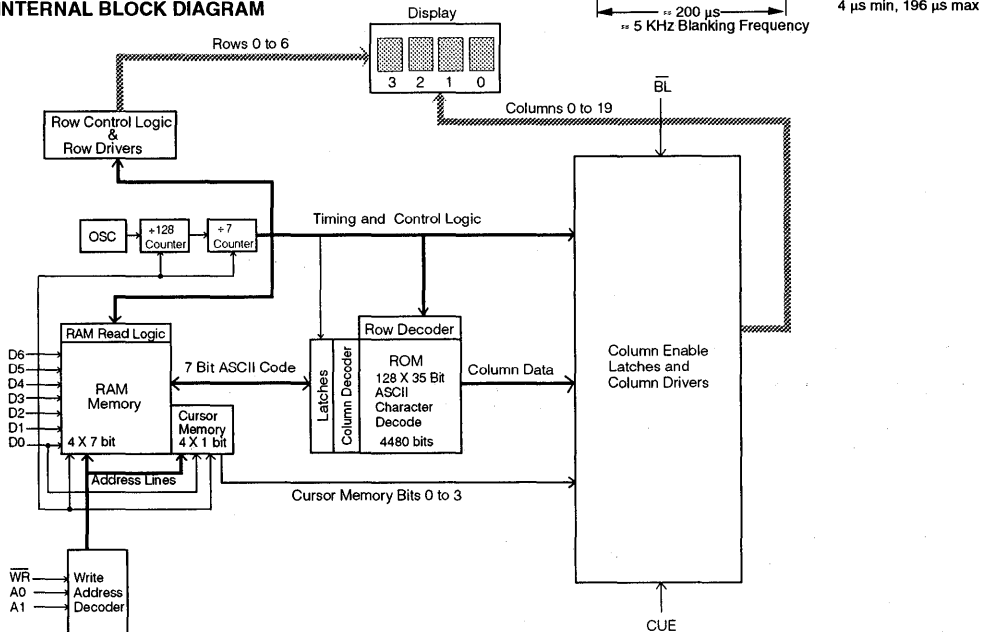

FIGURE 1a. FLASHING (Blanking) TIMING



INTERNAL BLOCK DIAGRAM



The display can be dimmed by pulsing (BL) line at a frequency sufficiently fast to not interfere with the internal clock. The dimming signal frequency should be 2.5 KHz or higher. Dimming the display also reduces power consumption.

An example of a simple dimming circuit using a 556 is illustrated in Figure 2. Adjusting potentiometer R3 will dim the display by changing the blanking pulse duty cycle.

FIGURE 2. DIMMING CIRCUIT USING A 556

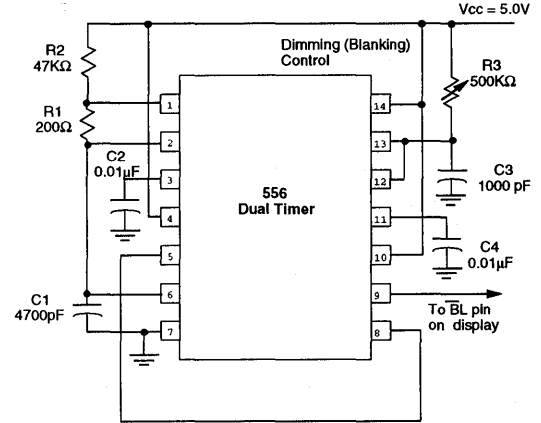
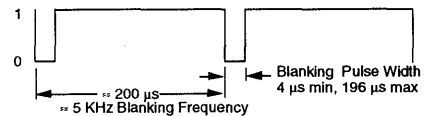

FIGURE 2a. DIMMING (Blanking) TIMING



CHARACTER SET

ASCII CODE		D0	D1	D2	D3	D4	D5	D6	D7	D8	D9	D10	D11	D12	D13	D14	D15
Hex		0	1	2	3	4	5	6	7	8	9	A	B	C	D	E	F
0	0	0	0	0	0	0	0	0	0	0	0	0	0	0	0	0	0
0	1	1	1	1	1	1	1	1	1	1	1	1	1	1	1	1	1
1	0	0	0	0	0	0	0	0	0	0	0	0	0	0	0	0	0
1	1	1	1	1	1	1	1	1	1	1	1	1	1	1	1	1	1
1	0	0	0	0	0	0	0	0	0	0	0	0	0	0	0	0	0
1	1	1	1	1	1	1	1	1	1	1	1	1	1	1	1	1	1
1	0	0	0	0	0	0	0	0	0	0	0	0	0	0	0	0	0
1	1	1	1	1	1	1	1	1	1	1	1	1	1	1	1	1	1

- Notes:
1. High = 1 level.
 2. Low = 0 level.
 3. Upon power up, the device will initialize in a random state.

TYPICAL SCHEMATIC – 16 CHARACTER SYSTEM

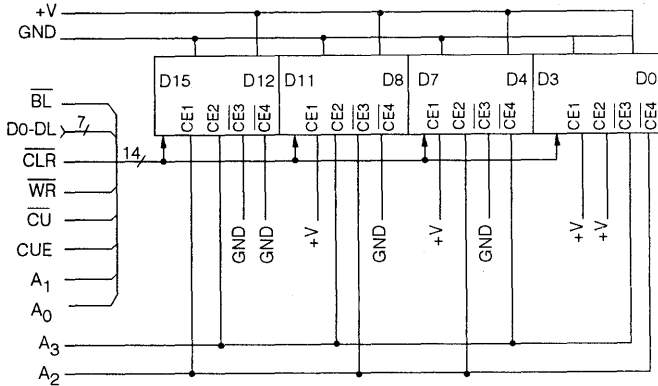

Intelligent Display Devices

DESIGN CONSIDERATIONS

For details on design and applications of the DLX3416 using standard bus configurations in multiple display systems, or parallel I/O devices, such as the 8255 with an 8080 or memory mapped addressing on processors such as the 8080, Z80, 6502, or 6800, refer to Appnote 15 in the current Siemens Optoelectronics Data Book.

ELECTRICAL & MECHANICAL CONSIDERATIONS

VOLTAGE TRANSIENT SUPPRESSION

We recommend that the same power supply be used for the display and the components that interface with the display to avoid logic inputs higher than V_{CC} . Additionally, the LEDs may cause transients in the power supply line while they change display states. The common practice is to place .01 mF capacitors close to the displays across V_{CC} and GND, one for each display, and one 10 mF capacitor for every second display.

ESD PROTECTION

The silicon gate CMOS IC of the DLX3416 is quite resistant to ESD damage and capable of withstanding discharges greater than 2 KV. However, take all the standard precautions, normal for CMOS components. These include properly grounding personnel, tools, tables, and transport carriers that come in contact with unshielded parts. If these conditions are not, or cannot be met, keep the leads of the device shorted together or the parts in anti-static packaging.

SOLDERING CONSIDERATIONS

The DLX3416 can be hand soldered with SN63 solder using a grounded iron set to 260°C.

Wave soldering is also possible following these conditions: Preheat that does not exceed 93°C on the solder side of the PC board or a package surface temperature of 85°C. Water soluble organic acid flux (except carboxylic acid) or resin-based RMA flux without alcohol can be used.

Wave temperature of 245°C \pm 5°C with a dwell between 1.5 sec. to 3.0 sec. Exposure to the wave should not exceed temperatures above 260°C for five seconds at 0.063" below the seating plane. The packages should not be immersed in the wave.

POST SOLDER CLEANING PROCEDURES

The least offensive cleaning solution is hot D.I. water (60°C) for less than 15 minutes. Addition of mild saponifiers is acceptable. Do not use commercial dishwasher detergents.

For faster cleaning, solvents may be used. Carefully select any solvent as some may chemically attack the nylon package. Maximum exposure should not exceed two minutes at elevated temperatures. Acceptable solvents are TF (trichlorotribluorethane), TA, 111 Trichloroethane, and unheated acetone.

Note: Acceptable commercial solvents are: Basic TF, Arklone, P. Genesolv, D. Genesolv DA, Blaco-Tron TF, Blaco-Tron TA, and Freon TA.

Unacceptable solvents contain alcohol, methanol, methylene chloride, ethanol, TP35, TCM, TMC, TMS+, TE, or TES. Since many commercial mixtures exist, contact a solvent vendor for chemical composition information. Some major solvent manufacturers are: Allied Chemical Corporation, Specialty Chemical Division, Morristown, NJ; Baron-Blakeslee, Chicago, IL; Dow Chemical, Midland, MI; E.I. DuPont de Nemours & Co., Wilmington, DE.

For further information refer to Siemens Appnotes 18 and 19.

An alternative to soldering and cleaning the display modules is to use sockets. Standard pin DIP sockets .600" wide with 0.100" centers work well for single displays. Multiple display assemblies are best handled by longer SIP sockets or DIP sockets when available for uniform package alignment. Socket manufacturers are Aries Electronics, Inc., Frenchtown, NJ; Garry Manufacturing, New Brunswick, NJ; Robinson-Nugent, New Albany, IN; and Samtec Electronic Hardware, New Albany, IN.

For further information refer to Siemens Appnote 22.

OPTICAL CONSIDERATIONS

The 0.270" high characters of the DLX3416 gives readability up to eight feet. Proper filter selection enhances readability over this distance.

Filters enhance the contrast ratio between a lit LED and the character background intensifying the discrimination of different characters. The only limitation is cost. Take into consideration the ambient lighting environment for the best cost/benefit ratio for filters.

Incandescent (with almost no green) or fluorescent (with almost no red) lights do not have the flat spectral response of sunlight. Plastic band-pass filters are an inexpensive and effective way to strengthen contrast ratios.

The DLR3416 is a standard red display and should be matched with long wavelength pass filter in the 600 nm to 620 nm range. The DLO3416 is a high efficiency red display and should be matched with a long wavelength pass filter in the 470 nm to 590 range. The DLG3416 should be matched with a yellow-green band-pass filter that peaks at 565 nm. For displays of multiple colors, neutral density gray filters offer the best compromise.

Additional contrast enhancement is gained by shading the displays. Plastic band-pass filters with built-in louvers offer the next step up in contrast improvement. Plastic filters can be improved further with anti-reflective coatings to reduce glare. The trade-off is fuzzy characters. Mounting the filters close to the display reduces this effect. Take care not to overheat the plastic filter by allowing for proper air flow.

Optimal filter enhancements are gained by using circular polarized, anti-reflective, band-pass filters. Circular polarizing further enhances contrast by reducing the light that travels through the filter and reflects back off the display to less than 1%.

Several filter manufacturers supply quality filter materials. Some of them are: Panelgraphic Corporation, W. Caldwell, NJ; SGL Homalite, Wilmington, DE; 3M Company, Visual Products Division, St. Paul, MN; Polaroid Corporation, Polarizer Division, Cambridge, MA; Marks Polarized Corporation, Deer Park, NY; Hoya Optics, Inc., Fremont, CA.

One last note on mounting filters: recessing displays and bezel assemblies is an inexpensive way to provide a shading effect in overhead lighting situations. Several Bezel manufacturers are: R.M.F. Products, Batavia, IL; Nobex Components, Griffith Plastic Corp., Burlingame, CA; Photo Chemical Products of California, Santa Monica, CA; E.E.-Atlas, Van Nuys, CA.

Refer to Siemens Appnote 23 for further information.

**.69" (17.5mm) Single Character
 5x7 Dot Matrix Alphanumeric Display
 (No Built-In CMOS Drive Circuitry)**

Intelligent
Display Devices

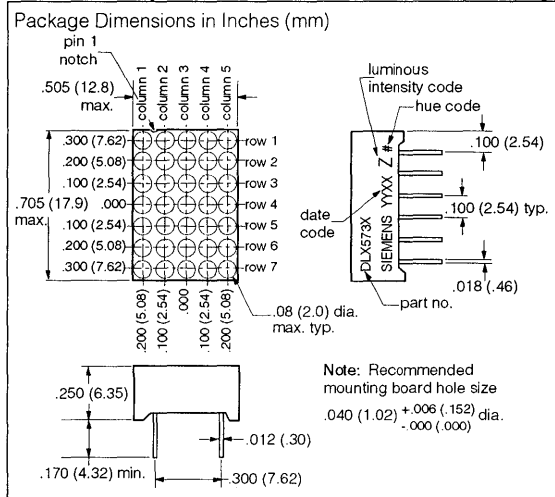
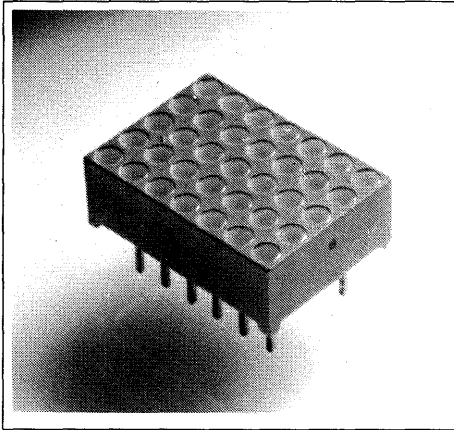

FEATURES

- DLR/DLG 5735 Common Row Cathode
- DLR/DLG 5736 Common Row Anode
- 5 x 7 Matrix Array with Row-Column Select
- End & Side Stackable
- Rugged Encapsulation (Filled Reflector Construction)
- Compatible with ASCII and EBCDIC Format
- Standard 12 pin, 0.3" Pin Spacing, Dual-Inline Package
- Good "OFF" Segment Contrast
- Grey Face with Clear Segments

DESCRIPTION

The DLR 5735/5736 Series (gallium arsenide phosphide) and the DLG 5735/5736 Series (gallium phosphide) are 5 x 7 dot matrix light emitting diode alphanumeric displays.

Compatible with ASCII and EBCDIC formats, these displays are well suited for use in keyboard verifiers, computer peripheral equipment, and other applications requiring an alphanumeric display. They are stackable both horizontally and vertically to generate large alphanumeric or even graphic displays.

Maximum Ratings

Power Dissipation (Package)	750 mW
Derate Linearly from 25°C	11.5 mW/°C
Storage /Operating Temperature	-20°C to + 70°C
Continuous Forward Current Per Segment	20 mA
Pulse Peak Current/Segment, 20% DutyCycle	100mA
Reverse Voltage	
DLR 5735, 5736	3 V
DLG 5735, 5736	5 V
Solder Temperature, $1/16"$ below seating plane, 5 sec.	260°C

Electrical/Optical Characteristics (T_A = 25°C)

Parameter	Min.	Typ.	Max.	Unit	Condition
Luminous Intensity					
Digit Average (Per Dot)					
DLR 5735/5736	100	200		μcd	I _F = 20 mA
DLG 5735/5736	320	650		μcd	I _F = 10 mA
Forward Voltage					
DLR 5735/5736	1.7	2.0		V	I _F = 20 mA
DLG 5735/5736	2.3	3.0		V	I _F = 20 mA
Reverse Current					
DLR 5735/5736			100	μA	V _R = 3 V
DLG 5735/5736			100	μA	V _R = 5 V
Peak Emission Wavelength					
DLR 5735/5736		650		nm	
DLG 5735/5736		565		nm	
Spectral Line Half-Width					
DLR 5735/5736		40		nm	
DLG 5735/5736		30		nm	

PIN CONFIGURATIONS

DLR5735
DLG5735

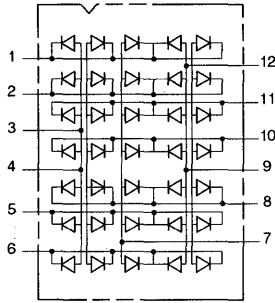
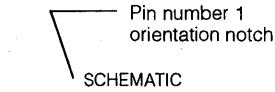

PIN	FUNCTION
1	Row 1 Cathode
2	Row 2 Cathode
3	Column 2 Anode
4	Column 1 Anode
5	Row 6 Cathode
6	Row 7 Cathode
7	Column 3 Anode
8	Row 5 Cathode
9	Column 4 Anode
10	Row 4 Cathode
11	Row 3 Cathode
12	Column 5 Anode

DLR5736
DLG5736

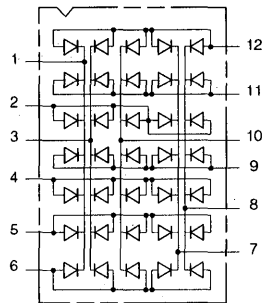
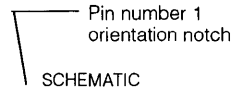

PIN	FUNCTION
1	Column 1 Cathode
2	Row 3 ANODE
3	Column 2 Cathode
4	Row 5 Anode
5	Row 6 Anode
6	Row 7 Anode
7	Column 4 Cathode
8	Column 5 Cathode
9	Row 4 Anode
10	Column 3 Cathode
11	Row 2 Anode
12	Row 1 Anode

BLOCK DIAGRAM

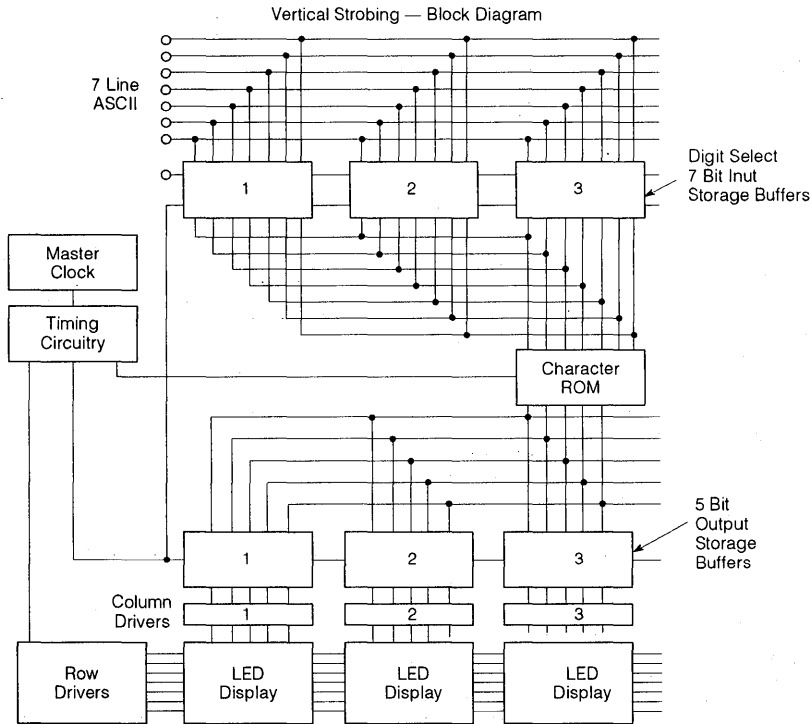

RED HDSP2000LP
YELLOW HDSP2001LP
HIGH EFFICIENCY RED HDSP2002LP
GREEN HDSP2003LP
.150" 4-Character 5x7 Dot Matrix
Serial Input Alphanumeric Display

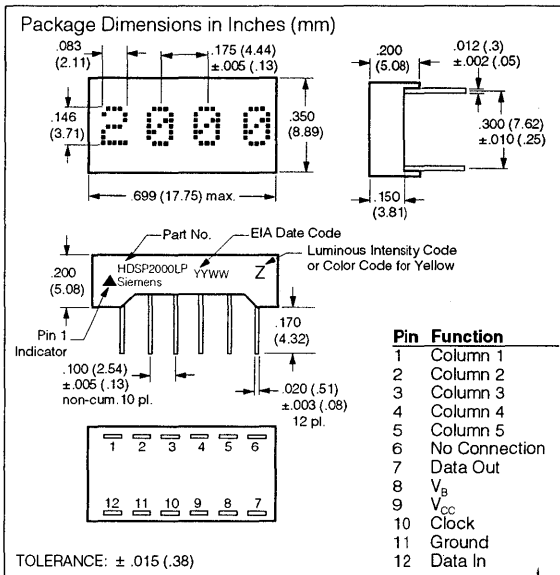
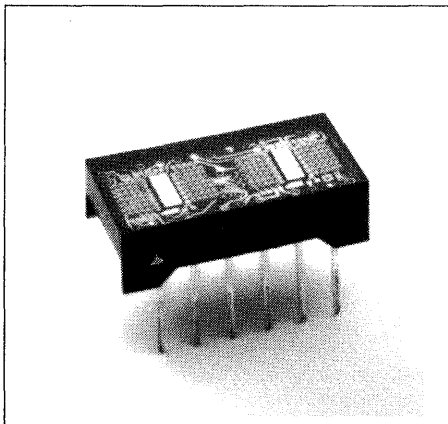

FEATURES

- Four 0.150" Dot Matrix Characters
- Four Colors: Red, Yellow, High Efficiency Red, Green
- Wide Viewing Angle: X Axis +50°
Y Axis +75°
- Built-in CMOS Shift Registers with Constant Current LED Row Drivers
- Shift Registers Allow Custom Fonts
- Easily Cascaded for Multiple Displays
- TTL Compatible
- End Stackable
- Extended Operating Temperature Range: -40 ° to + 85 °C
- Categorized for Luminous Intensity
- All Displays Color Matched
- Compact Plastic Package
- 100% Burned In and Tested

DESCRIPTION

The HDSP200XLP are four digit 5x7 dot matrix serial input alphanumeric displays. The displays are available in red, yellow, high efficiency red, or bright green. The package is a standard twelve-pin DIP with a flat plastic lens. The display can be stacked horizontally or vertically to form messages of any length.

The HDSP200XLP has two fourteen-bit CMOS shift registers with built-in row drivers. These shift registers drive twenty-eight rows and enable the design of customized fonts. Cascading multiple displays is possible because of the Data In and Data Out pins. Data In and Out are easily input with the clock signal and displayed in parallel on the row drivers. Data Out represents the output of the 7th bit of digit number four shift register. The shift register is level triggered. The like columns of each character in a display cluster are tied to a single pin (see Block Diagram). High true data in the shift register enables the output current mirror driver stage associated with each row of LEDs in the 5x7 diode array.

The TTL compatible V_B input may either be tied to V_{CC} for maximum display intensity or pulse width modulated to achieve intensity control and reduce power consumption.

—Continued

See Appnote 44 for application information.

DESCRIPTION (Continued)

In the normal mode of operation, input data for digit four, column one is loaded into the seven on-board shift register locations one through seven. Column one data for digits 3, 2, and 1 is shifted into the display shift register locations. Then column one input is enabled for an appropriate period of time, T. A similar process is repeated for columns 2, 3, 4, and 5. If the decode time and load data time into the shift register is t, then with five columns, each column of the display is operating at a duty factor of:

$$DF = \frac{T}{5(T+t)}$$

T+t, allotted to each display column, is generally chosen to provide the maximum duty factor consistent with the minimum refresh rate necessary to achieve a flicker free display. For most strobed display systems, each column of the display should be refreshed (turned on) at a minimum rate of 100 times per second.

With columns to be addressed, this refresh rate then gives a value for the time T+t of: $1/[5 \times (100)] = 2$ msec. If the device is operated at 5.0 MHz clock rate maximum, it is possible to maintain $t < T$. For short display strings, the duty factor will then approach 20%.

Maximum Ratings

Supply Voltage V_{CC} to GND -0.5 V to + 7.0 V
 Inputs, Data Out and V_B -0.5 V to $V_{CC} + 0.5$ V
 Column Input Voltage, V_{COL} -0.5 V to + 6.0 V
 Operating Temperature Range -40°C to +85°C
 Storage Temperature Range -40°C to + 100°C
 Maximum Solder Temperature, 0.063" (1.59 mm)
 below Seating Plane, t<5 sec 260°C
 Maximum Allowable Power Dissipation
 at $T_{amb} = 25$ C⁽¹⁾ 0.86 W

Note:

- Maximum allowable dissipation is derived from $V_{CC} = 5.25$ V, $V_B = 2.4$ V, $V_{COL} = 3.5$ V, 20 LEDs on per character, 20% DF.

FIGURE 1. TIMING CHARACTERISTICS

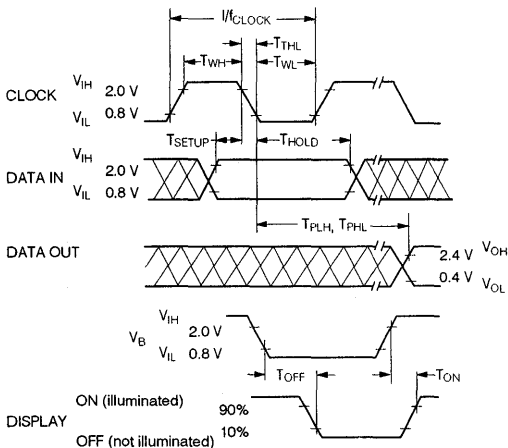
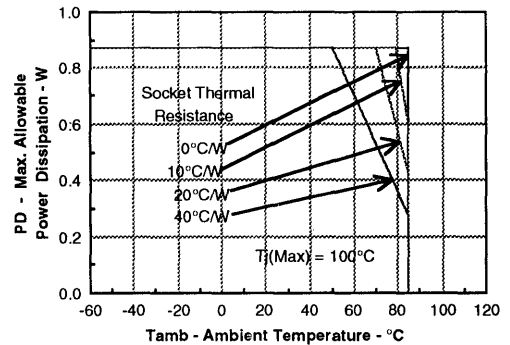

FIGURE 2. MAX. ALLOWABLE POWER DISSIPATION VS. TEMPERATURE



AC ELECTRICAL CHARACTERISTICS

($V_{CC} = 4.75$ to 5.25 V, $T_{amb} = -40$ °C to 85 °C)

Symbol	Description	Min.	Typ.	Max. ⁽¹⁾	Units	Fig.
T_{SETUP}	Setup Time	50			ns	1
T_{HOLD}	Hold Time	25			ns	1
T_{WL}	Clock Width Low	75			ns	1
T_{WH}	Clock Width High	75			ns	1
$F_{(CLK)}$	Clock Frequency	0	5		MHz	1
T_{THL} T_{TLH}	Clock Transition Time			200	ns	1
T_{PHL} T_{PLH}	Propagation Delay Clock to Data Out			125	ns	1

Note:

- V_B Pulse Width Modulation Frequency—50 KHz (max).

CLEANING THE DISPLAYS

IMPORTANT—Do not use cleaning agents containing alcohol of any type with this display. The least offensive cleaning solution is hot D.I. water (60°C) for less than 15 minutes. Addition of mild saponifiers is acceptable. Do not use commercial dishwasher detergents.

For post solder cleaning use water or non-alcohol mixtures formulated for vapor cleaning processing or non-alcohol mixtures formulated for room temperature cleaning. Nonalcohol vapor cleaning processing for up to two minutes in vapors at boiling is permissible. For suggested solvents refer to Siemens Appnote 19.

RECOMMENDED OPERATING CONDITIONS

Parameter	Symbol	Min.	Nom.	Max.	Units
Supply Voltage	V_{CC}	4.75	5.0	5.25	V
Data Out Current, Low State	I_{OL}			1.6	mA
Data Out Current, High State	I_{OH}	-0.5			mA
Column Input Voltage, Column On HDSP2000LP ⁽¹⁾	V_{COL}	2.4		3.5	V
Column Input Voltage, Column On, HDSP2001LP/2002LP/2003LP ⁽¹⁾	V_{COL}	2.75		3.5	V
Setup Time	T_{SETUP}	70			ns
Hold Time	T_{HOLD}	30			ns
Width of Clock	$T_{W(CLK)}$	75			ns
Clock Frequency	T_{CLK}			5	MHz
Clock Transition Time	T_{THL}			200	ns

Note: 1. See Figure 3: Peak Column Current vs. Column Voltage

OPTICAL CHARACTERISTICS
Red HDSP2000LP

Description	Symbol	Min.	Typ. ⁽⁴⁾	Max.	Units	Test Conditions
Peak Luminous Intensity per LED ^(1,3) (Character Average)	I_{VPEAK}	105	200		μcd	$V_{CC} = 5.0\text{ V}$, $V_{COL} = 3.5\text{ V}$ $T_{amb} = 25^\circ\text{C}$, $V_B = 2.4\text{ V}$
Peak Wavelength	λ_{VPEAK}		655		nm	
Dominant Wavelength ⁽²⁾	λ_D		639		nm	

Yellow HDSP2001LP

Description	Symbol	Min.	Typ. ⁽⁴⁾	Max.	Units	Test Conditions
Peak Luminous Intensity per LED ^(1,3) (Character Average)	I_{VPEAK}	400	1140		μcd	$V_{CC} = 5.0\text{ V}$, $V_{COL} = 3.5\text{ V}$ $T_{amb} = 25^\circ\text{C}$, $V_B = 2.4\text{ V}$
Peak Wavelength	λ_{VPEAK}		583		nm	
Dominant Wavelength ⁽²⁾	λ_D		585		nm	

High Efficiency Red HDSP2002LP

Description	Symbol	Min.	Typ. ⁽⁴⁾	Max.	Units	Test Conditions
Peak Luminous Intensity per LED ^(1,3) (Character Average)	I_{VPEAK}	400	1430		μcd	$V_{CC} = 5.0\text{ V}$, $V_{COL} = 3.5\text{ V}$ $T_{amb} = 25^\circ\text{C}$, $V_B = 2.4\text{ V}$
Peak Wavelength	λ_{VPEAK}		635		nm	
Dominant Wavelength ⁽²⁾	λ_D		626		nm	

Green HDSP2003LP

Description	Symbol	Min.	Typ. ⁽⁴⁾	Max.	Units	Test Conditions
Peak Luminous Intensity per LED ^(1,3) (Character Average)	I_{VPEAK}	650	1550		μcd	$V_{CC} = 5.0\text{ V}$, $V_{COL} = 3.5\text{ V}$ $T_{amb} = 25^\circ\text{C}$, $V_B = 2.4\text{ V}$
Peak Wavelength	λ_{VPEAK}		565		nm	
Dominant Wavelength ⁽²⁾	λ_D		569		nm	

Notes:

- The displays are categorized for luminous intensity with the intensity category designated by a letter code on the bottom of the package.
- Dominant wavelength (λ_D) is derived from the CIE chromaticity diagram and represents the single wavelength which defines the color of the device
- The luminous sterance of the LED may be calculated using the following relationships:
 $L_v (\text{cd}/\text{m}^2) = I_v (\text{Candela})/A (\text{Meter})^2$
 $L_v (\text{Footlamberts}) = \pi I_v (\text{Candela})/A (\text{Foot})^2$
 HDSP2000LP, $A = 5.58 \times 10^{-8} \text{ m}^2 = 6 \times 10^{-7} \text{ ft}^2$
 HDSP2001/2/3LP, $A = 7.8 \times 10^{-9} \text{ m}^2 = 8.4 \times 10^{-7} \text{ ft}^2$
- All typical values specified at $V_{CC} = 5.0\text{ V}$ and $T_{amb} = 25^\circ\text{C}$ unless otherwise noted.

ELECTRICAL CHARACTERISTICS (-40°C to +85°C) (unless otherwise specified)

Description	Symbol	Min.	Typ. ⁽¹⁾	Max.	Units	Test Conditions
Supply Current (quiescent)	I_{CC}		1	5	mA	$V_B = 0.4 V$ $V_{CC} = 5.25 V$ $V_{CLK} = V_{DATA} = 2.4 V$ All SR Stages = Logical 1
			1	5	mA	$V_B = 2.4 V$
Supply Current (operating)	I_{CC}		1.5	10.0	mA	$F_{CLK} = 5 MHz$
Column Current at any Column Input ⁽²⁾	$I_{COL} (All)$			10	μA	$V_B = 0.4 V$ $V_{CC} = 5.25 V$ $V_{COL} = 3.5 V$ All SR Stages = Logical 1
	I_{COL}		335	410	mA	$V_B = 2.4 V$
V_B , Clock or Data Input Threshold Low	V_{IL}			0.8	V	$V_{CC} = 4.75 V - 5.25 V$
V_B , Clock or Data Input Threshold High	V_{IH}	2.0			V	
Data Out Voltage	V_{OH}	2.4			V	$I_{OH} = -0.5 mA$ $V_{CC} = 4.75 V$ $I_{COL} = 0 mA$
	V_{OL}			0.4	V	
Input Current Logical 0 V_B only	I_{IL}	-30	-110	-300	μA	$V_{CC} = 4.75 V - 5.25 V, V_{IL} = 0.8 V$
Input Current Logical 0 Data, Clock	I_{IL}		-1	-10	μA	
Power Dissipation per Package ⁽²⁾	P_D		0.4		W	$V_{CC} = 5.0, V_{COL} = 3.5 V, 17.5\% DF$ 15 LEDs on per character, $V_B = 2.4 V$
Thermal Resistance IC Junction-to-Ambient	$R\theta_{J-A}$		85		$^{\circ}C/W/Device$	

Notes:

1. All typical values specified at $V_{CC} = 5.0 V$ and $T_{amb} = 25^{\circ}C$ unless otherwise noted.
2. See Figure 3—Peak Column Current vs. Column Voltage

FIGURE 3. PEAK COLUMN CURRENT VS. COLUMN VOLTAGE

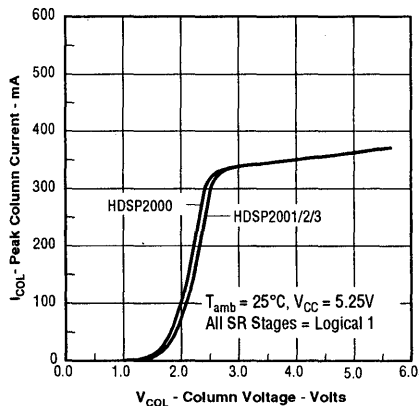
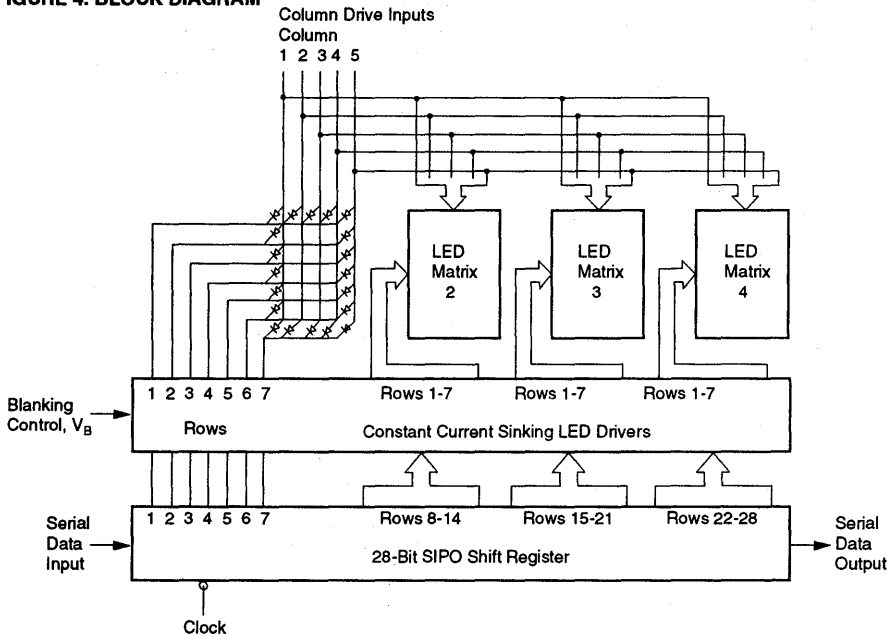

FIGURE 4. BLOCK DIAGRAM



Intelligent Display Devices

CONTRAST ENHANCEMENT FILTERS

Display Color	Ambient Lighting		
	Dim	Moderate	Bright
HDSP2000LP Red	Panelgraphic Dark Red 63 Panelgraphic Ruby Red 60 Chequers Red 118 Plexiglass 2423	Polaroid HNC37 3M Light Control Film Panelgraphic Gray 10 Chequers Gray 105	
HDSP2001LP Yellow	Panelgraphic Yellow 27		Polaroid HNC10-Glass* Marks Polarized MPC 30-25C**
HDSP2002LP HER	Panelgraphic Ruby Red 60 Chequers Red 112		Note 1 Polaroid HNC10-Glass* Marks Polarized MPC 20-15C**
HDSP2003LP Bright Green	Panelgraphic Green 48 Chequers Green 107		Polaroid HNC10-Glass* Marks Polarized MPC 50-12C**

Note:
1. Optically coated circular polarized filters, such as Polaroid HNC10.

* Polaroid Corp.
1 Upland Rd., Bldg #2
Norwood, MA 02062
800/225-2770

** Marks Polarized Corp.
25-B Jefryn Blvd. W
Deer Park, NY 11729
516/242-1300
FAX 516/242-1347
Marks Polarized Corp. manufactures
to MIL-1-45208 inspection system.

GENERAL QUALITY ASSURANCE LEVELS

Generic data available.

THERMAL CONSIDERATIONS

The small alphanumeric displays are hybrid LED and CMOS assemblies that are designed for reliable operation in commercial, industrial, and military environments. Optimum reliability and optical performance will result when the junction temperature of the LEDs and CMOS ICs are kept as low as possible.

THERMAL MODELING

HDSP200XLP displays consist of two driver ICs and four 5x7 LED matrixes. A thermal model of the display is shown in Figure 5. It illustrates that the junction temperature of the semiconductor = junction self heating + the case temperature rise + the ambient temperature. Equation 1 shows this relationship.

FIGURE 5. THERMAL MODEL

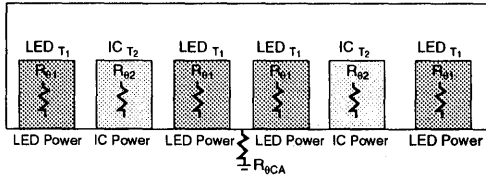

See Equation 1 below.

The junction rise within the LED is the product of the thermal impedance of an individual LED (37°C/W, DF = 20%, F = 200 Hz), times the forward voltage, $V_{F(LED)}$, and forward current $I_{F(LED)}$, of 13 - 14.5 mA. This rise averages $T_{J(LED)} = 1^\circ\text{C}$. The table below shows the $V_{F(LED)}$ for the respective displays.

Model Number	VF		
	Min.	Typ.	Max.
HDSP2000LP	1.6	1.7	2.0
HDSP2001/2/3LP	1.9	2.2	3.0

The junction rise within the LED driver IC is the combination of the power dissipated by the IC quiescent current and the 28 row driver current sinks. The IC junction rise is given in Equation 2.

A thermal resistance of 28°C/W results in a typical junction rise of 6°C.

See Equation 2 below.

Equation 1.

$$T_{J(LED)} = P_{LED} Z_{\theta JC} + P_{CASE} (R_{\theta JC} + R_{\theta CA}) + T_A$$

$$T_{J(LED)} = [(I_{COL}/28) V_{F(LED)} Z_{\theta JC}] + [(n/35) I_{COL} DF (5 V_{COL}) + V_{CC} I_{CC}] \cdot [R_{\theta JC} + R_{\theta CA}] + T_A$$

Equation 2.

$$T_{J(IC)} = P_{COL} (R_{\theta JC} + R_{\theta CA}) + T_A$$

$$T_{J(IC)} = [5 (V_{COL} - V_{F(LED)}) \cdot (I_{COL} / 2) \cdot (n/35) DF + V_{CC} \cdot I_{CC}] \cdot [R_{\theta JC} + R_{\theta CA}] + T_A$$

For ease of calculations the maximum allowable electrical operating condition is dependent upon the aggregate thermal resistance of the LED matrixes and the two driver ICs. All of the thermal management calculations are based upon the parallel combination of these two networks which is 15°C/W. Maximum allowable power dissipation is given in Equation 3.

Equation 3.

$$P_{DISPLAY} = \frac{T_{J(MAX)} - T_A}{R_{\theta JC} + R_{\theta CA}}$$

$$P_{DISPLAY} = 5 V_{COL} I_{COL} (n/35) DF + V_{CC} I_{CC}$$

For further reference see Figures 2, 7, 8, 9, 10 and 11.

KEY TO EQUATION SYMBOLS

DF	Duty factor
I_{CC}	Quiescent IC current
I_{COL}	Column current
n	Number of LEDs on in a 5 x 7 array
P_{CASE}	Package power dissipation excluding LED under consideration
P_{COL}	Power dissipation of a column
$P_{DISPLAY}$	Power dissipation of the display
P_{LED}	Power dissipation of an LED
$R_{\theta CA}$	Thermal resistance case to ambient
$R_{\theta JC}$	Thermal resistance junction to case
T_A	Ambient temperature
$T_{J(IC)}$	Junction temperature of an IC
$T_{J(LED)}$	Junction temperature of a LED
$T_{J(MAX)}$	Maximum junction temperature
V_{CC}	IC voltage
V_{COL}	Column voltage
$V_{F(LED)}$	Forward voltage of LED
$Z_{\theta JC}$	Thermal impedance junction to case

OPTICAL CONSIDERATIONS

The light output of the LEDs is inversely related to the LED diode's junction temperature as shown in Figure 6. For optimum light output, keep the thermal resistance of the socket or PC board as low as possible.

FIGURE 6. NORMALIZED LUMINOUS INTENSITY VS. JUNCTION TEMPERATURE

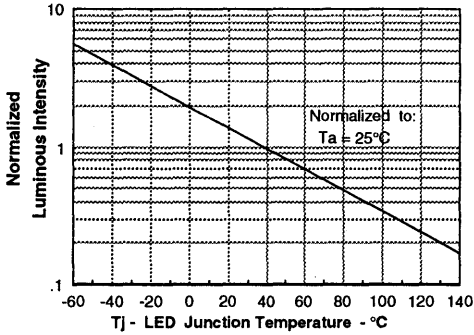

When mounted in a 10°C/W socket and operated at Absolute Maximum Electrical conditions, the HDSP200XLP will show an LED junction rise of 17°C . If $T_a = 40^\circ\text{C}$, then the LED's TJ will be 57°C . Under these conditions Figure 7 shows that the I_v will be 75% of its 25°C value.

FIGURE 7. MAX. LED JUNCTION TEMPERATURE VS. SOCKET THERMAL RESISTANCE

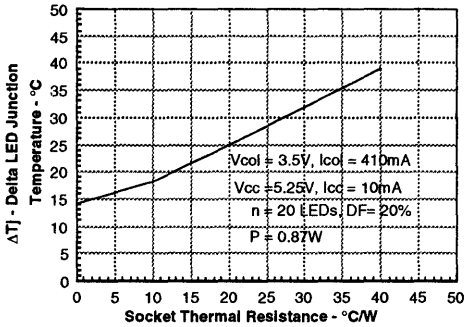

FIGURE 8. MAX. PACKAGE POWER DISSIPATION

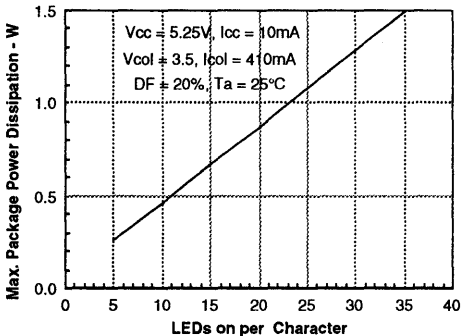

FIGURE 9. PACKAGE POWER DISSIPATION

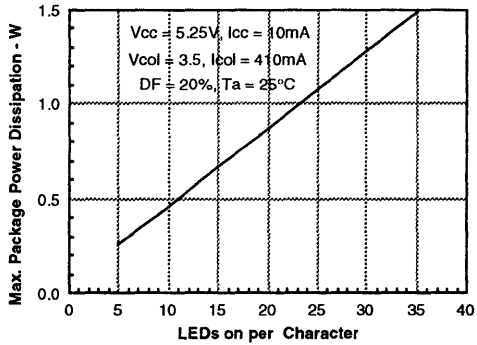

FIGURE 10. MAX. CHARACTER POWER DISSIPATION

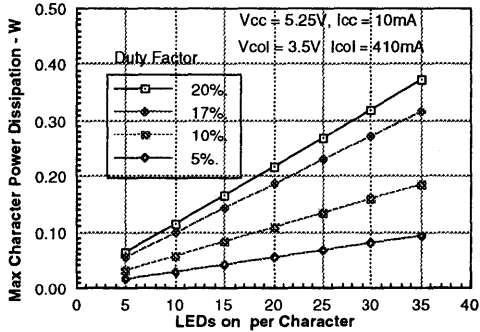
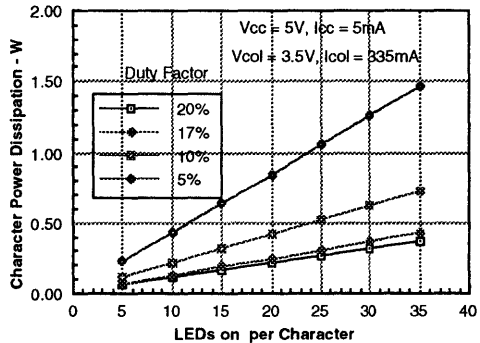
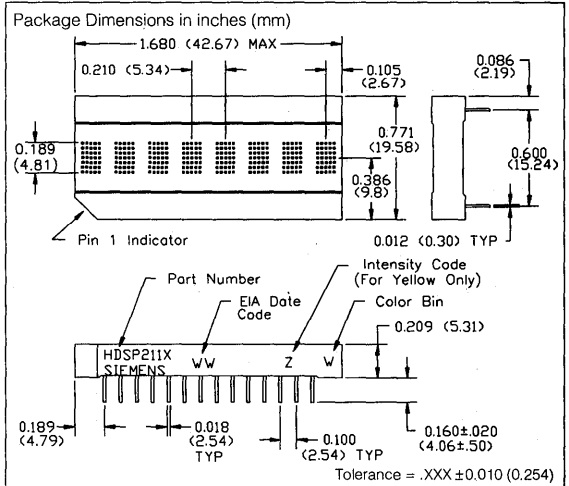
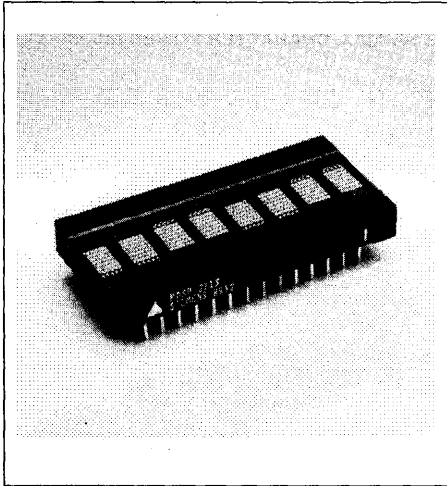

FIGURE 11. CHARACTER POWER DISSIPATION



SIEMENS

RED HDSP2110S
YELLOW HDSP2111S
HIGH EFFICIENCY RED HDSP2112S
GREEN HDSP2113S
HIGH EFFICIENCY GREEN HDSP2114S
0.200" 8-Character 5x7 Dot Matrix
Alphanumeric Programmable Display™



FEATURES

- Eight 0.200" Dot Matrix Characters in Red, Yellow, High Efficiency Red, Green, or High Efficiency Green
- Built-in 128 Character ROM Mask Programmable for Custom Fonts
- Readable from 8 Feet (2.5 meters)
- Built-in Decoders, Multiplexers and Drivers
- Wide Viewing Angle, X Axis ± 55°, Y Axis ± 65°
- Programmable Features:
 - Individual Flashing Character
 - Full Display Blinking
 - Multi-Level Dimming and Blanking
 - Clear Function
 - SelfTest
- Internal or External Clock
- End Stackable Dual-In-Line Plastic Package
- Read/Write Capability
- 16 User Definable Characters

DESCRIPTION

The HDSP2110S (Red), HDSP2111S (Yellow), HDSP2112S (High Efficiency Red), HDSP2113S (Green), and HDSP2114S (High Efficiency Green) are eight digit, 5x7 dot matrix, alphanumeric Programmable Displays. The 0.20 inch high digits are packaged in a rugged, high quality, optically transparent, 0.6 inch lead spacing, 28 pin plastic DIP.

The on-board CMOS has a built-in 128 character ROM. The HDSP211XS also has a user definable character (UDC) feature, which uses a RAM that permits storage of 16 arbitrary characters, symbols or icons that are software-definable by the user. The character ROM itself is mask programmable and easily modified by the manufacturer to provide specified custom characters.

The HDSP211XS is designed for standard microprocessor interface techniques, and is fully TTL compatible. The Clock I/O and Clock Select pins allow the user to cascade multiple display modules.

ESD Warning: Standard precautions for CMOS handling should be observed.

Maximum Rating, $T_A=25^\circ\text{C}$

DC Supply Voltage,
 V_{CC} to GND (max. voltage with no LEDs on) -0.3 to +7.0 VDC
 Input Voltage Levels,
 All Inputs -0.3 V to $V_{CC}+0.3$ V
 Operating Temperature -40°C to $+85^\circ\text{C}$
 Storage Temperature -40°C to $+100^\circ\text{C}$
 Relative Humidity (non-condensing) 85%
 Operating Voltage, V_{CC} to GND
 (Max. voltage with 20 dots/digits on) 5.5V
 Maximum Solder Temperature 260°C
 (0.063 inch below the seating plane, $t<5$ sec.)
 ESD Protection at 1.5 K Ω ,
 100 pF $V_z=4$ KV (each pin)

Switching Specifications

(over operating temperature range and $V_{CC} = 4.5\text{V}$)

Symbol	Description	Min.	Units
Tacc	Display Access Time - Write	210	ns
Tacc	Display Access Time - Read	230	ns
Tacs	Address Setup Time to CE	10	ns
Tce	Chip Enable Active Time - Write	140	ns
Tce	Chip Enable Active Time - Read	160	ns
Tach	Address Hold Time to CE	20	ns
Tcer	Chip Enable Recovery Time	60	ns
Tces	Chip Enable Active Prior to Rising Edge - Write	140	ns
Tces	Chip Enable Active Prior to Rising Edge - Read	160	ns
Tceh	Chip Enable Hold to Rising Edge of Read/Write Signal	0	ns
Tw	Write Active Time	100	ns
Twd	Data Valid Prior to Rising Edge of Write Signal	50	ns
Tdh	Data Write Time	20	ns
Tr	Chip Enable Active Prior to Valid Data	160	ns
Trd	Read Active Prior to Valid Data	95	ns
Tdf	Read Data Float Delay	10	ns
Trc	Reset Active Time	300	ns

Enlarged Character Font

Dimensions in inches (mm)

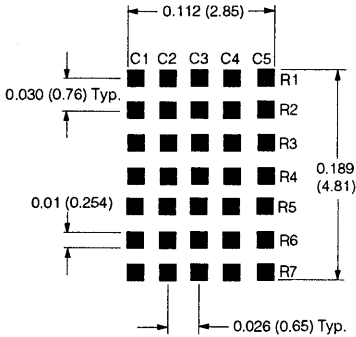

Write Cycle Timing Diagram

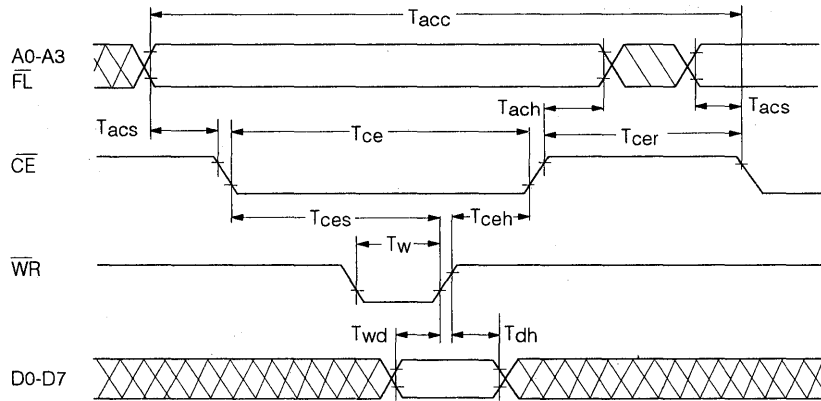

Input pulse levels -0.6 V to 2.4 V

Read Cycle Timing Diagram

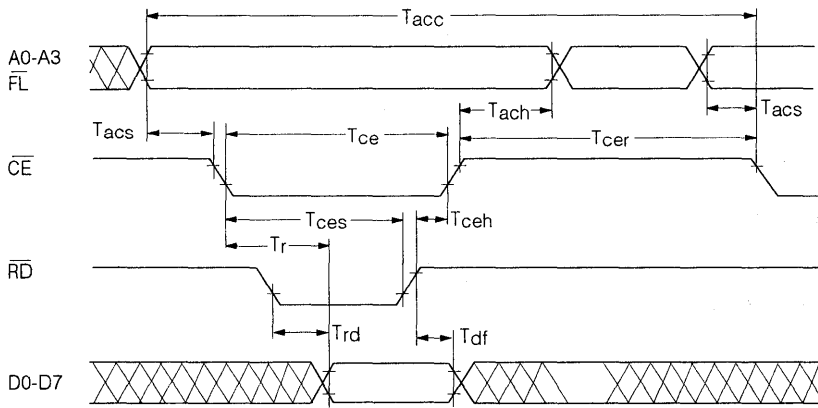

Optical Characteristics at 25 °C $V_{cc} = 5.0 \text{ V}$ at Full Brightness

Red HDSP2110S

Description	Symbol	Min.	Typ.	Max.	Units
Luminous Intensity Character Average (# displayed)	I_v	1.4	2.5		mcd
Peak Wavelength	$\lambda(\text{peak})$		660		nm
Dominant Wavelength	$\lambda(\text{d})$		639		nm

Yellow HDSP2111S

Description	Symbol	Min.	Typ.	Max.	Units
Luminous Intensity Character Average (# displayed)	I_v	2.5	4.1		mcd
Peak Wavelength	$\lambda(\text{peak})$		579		nm
Dominant Wavelength	$\lambda(\text{d})$		584		nm

High Efficiency Red HDSP2112S

Description	Symbol	Min.	Typ.	Max.	Units
Luminous Intensity Character Average (# displayed)	I_v	2.5	7.0		mcd
Peak Wavelength	$\lambda(\text{peak})$		630		nm
Dominant Wavelength	$\lambda(\text{d})$		620		nm

Green HDSP2113S

Description	Symbol	Min.	Typ.	Max.	Units
Luminous Intensity Character Average (# displayed)	I_v	2.5	5.5		mcd
Peak Wavelength	$\lambda(\text{peak})$		558		nm
Dominant Wavelength	$\lambda(\text{d})$		567		nm.

High Efficiency Green HDSP2114S

Description	Symbol	Min.	Typ.	Max.	Units
Luminous Intensity Character Average (# displayed)	I_v	3.0	10		mcd
Peak Wavelength	$\lambda(\text{peak})$		566		nm
Dominant Wavelength	$\lambda(\text{d})$		570		nm.

DC ELECTRICAL CHARACTERISTICS at 25°C

Parameters	Limits			Units	Conditions
	Min	Typ	Max		
V_{CC}	4.5	5.0	5.5	V	
I_{CC} Blank		0.65	1.0	mA	$V_{CC}=5V, V_{IN}=5V$
I_{CC} 12 dots/digit on ⁽¹⁾⁽²⁾		185	255	mA	$V_{CC}=5V, "V"$ in all 8 digits
I_{CC} 20 dots/digit on ⁽¹⁾⁽²⁾		284	370	mA	$V_{CC}=5V, "#"$ in all 8 digits
I_{LP} (with pull-up) Input Leakage	-18	-11	-5	μA	$V_{CC}=5V, V_{IN}=0V$ to V_{CC} (WR, CE, FL, RST, RD, CLKSEL)
I_{IL} (no pull-up) Input Leakage	-1		+1	μA	$V_{CC}=5V, V_{IN}=0-5V$ (CLK, A0-A3, D0-D7)
V_{IH} Input Voltage High	2.0		$V_{CC}+0.3$	V	$V_{CC}=4.5V$ to $5.5V$
V_{IL} Input Voltage Low	Gnd -0.3			V	$V_{CC}=4.5V$ to $5.5V$
V_{OL} (D0-D7) Output Voltage Low			0.4	V	$V_{CC}=4.5V, I_{OL}=1.6mA$
V_{OL} (CLK) Output Voltage Low			0.4	V	$V_{CC}=4.5V, I_{OL}=40\mu A$
V_{OH} Output Voltage High	2.4			V	$V_{CC}=4.5V, I_{OH}=-40\mu A$
θ_{JC} Thermal Resistance Junction to Case		25		$^{\circ}C/W$	
Clock I/O Frequency	28	57.34	81.14	KHz	$V_{CC}=4.5V$ to $5.5V$
FM, Digit Multiplex Frequency	125	256	362.5	Hz	$V_{CC}=4.5V$ to $5.5V$
Blinking Rate	0.98	2.0	2.83	Hz	
Clock $\times 10$ Bus Loading			2.40	pF	
Clock Out Rise Time			500	nsec	$V_{CC}=4.5V, V_{OH}=2.4V$
Clock Out Fall Time			500	nsec	$V_{CC}=4.5V, V_{OH}=0.4V$

Notes: 1. I_{CC} is an average value.

2. I_{CC} is measured with the display at full brightness. Peak $I_{CC}=2^{2/3} I_{CC}$ average (#displayed).

Recommended Operating Conditions ($T_A=-40^{\circ}C$ to $+85^{\circ}C$)

Parameter	Symbol	Min.	Max.	Units
Supply Voltage	V_{CC}	4.5	5.5	V
Input Voltage Low	V_{IL}		0.8	V
Input Voltage High	V_{IH}	2.0		V
Output Voltage Low	V_{OL}		0.4	V
Output Voltage High	V_{OH}	2.4		V

TOP VIEW

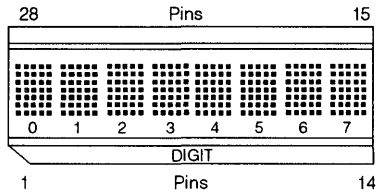

PIN ASSIGNMENTS AND DEFINITIONS

Pin	Function	Definition
1	\overline{RST}	Used for initialization of a display and synchronization of blinking for multiple displays
2	\overline{FL}	Low input accesses the Flash RAM
3	A0	Address input LSB
4	A1	Address input
5	A2	Address input MSB
6	A3	Mode selector
7	Substr. bias	Used to bias IC substrate, must be connected to V_{CC} . Can't be used to supply power to display.
8	Substr. bias	
9	Substr. bias	
10	A4	Mode Selector

Pin	Function	Definition
11	CLKSEL	Selects internal/external clock source
12	CLKI/O	Outputs master clock or inputs external clock
13	\overline{WR}	A low will write data into the display if \overline{CE} is low
14	V_{CC}	Positive power supply input
15	GND supply	Analog Ground for LED drivers
16	GND logic	Digital Ground for internal logic
17	\overline{CE}	Enables access to the display
18	\overline{RD}	A low will read data from the display if \overline{CE} is low. If read from display is not required, then \overline{RD} can be tied to V_{CC} .
19	D0	Data input LSB
20	D1	Data input
21	No pin	
22	No pin	
23	D2	Data input
24	D3	Data input
25	D4	Data input
26	D5	Data input
27	D6	Data input
28	D7	Data input MSB, selects ROM, page 1 or 2

Cascading Displays

The HDSP211XS oscillator is designed to drive up to 16 other HDSP211XSs with input loading of 15 pF each.

The following are the general requirements for cascading 16 displays together:

- Determine the correct address for each display.
- Use \overline{CE} from an address decoder to select the correct display.
- Select one of the Displays to provide the Clock for the other displays. Connect CLKSEL to V_{CC} for this display.
- Tie CLKSEL to ground on other displays.
- Use \overline{RST} to synchronize the blinking between the

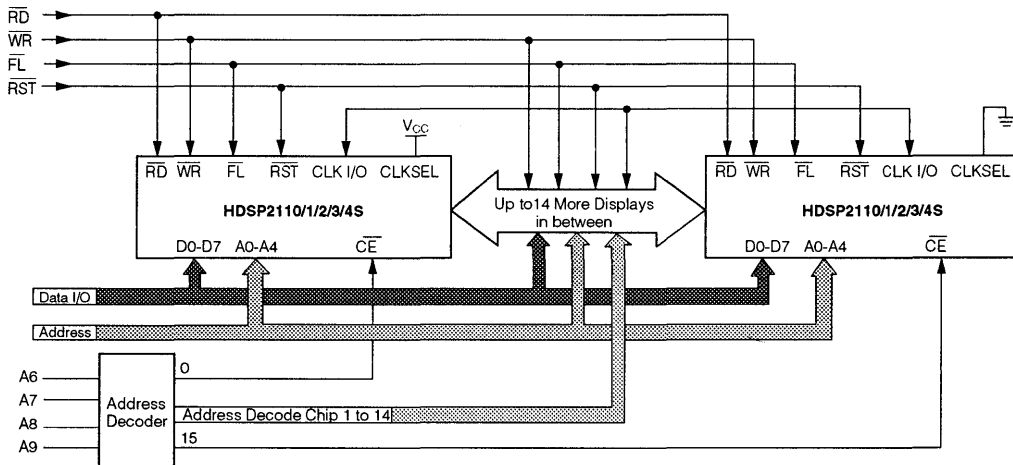

CHARACTER SET

ASCII CODE		D0	0	1	0	1	0	1	0	1	0	1	0	1	0	1				
		D1	0	0	1	1	0	0	1	1	0	0	1	1	0	0	1			
		D2	0	0	0	0	0	1	1	1	1	0	0	0	0	1	1	1		
		D3	0	0	0	0	0	0	0	0	1	1	1	1	1	1	1	1		
D7	D6	D5	D4	HEX	0	1	2	3	4	5	6	7	8	9	A	B	C	D	E	F
0	0	0	0	0																
0	0	0	1	1																
0	0	1	0	2																
0	0	1	1	3																
0	1	0	0	4																
0	1	0	1	5																
0	1	1	0	6																
0	1	1	1	7																
1	X	X	X	8	UDC 0	UDC 1	UDC 2	UDC 3	UDC 4	UDC 5	UDC 6	UDC 7	UDC 8	UDC 9	UDC 10	UDC 11	UDC 12	UDC 13	UDC 14	UDC 15

- Notes: 1. Upon power up, the device will initialize in a random state.
 2. X=don't care.

BLOCK DIAGRAM

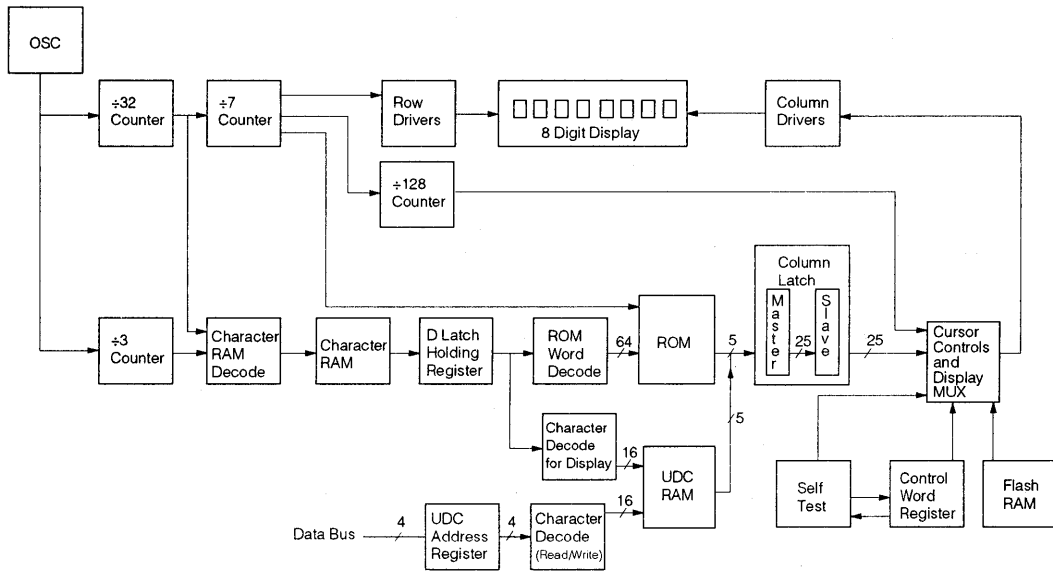

FUNCTIONAL DESCRIPTION

The display's user interface is organized into five memory areas. They are accessed using the Flash Input, \overline{FL} , and address lines, A3 and A4. All the listed RAMs and Registers may be read or written through the data bus. See Table 1. Each input pin is described in Pin Definitions. The five basic memory areas are:

Character RAM	Stores either ASCII (Katakana) character data or an UDC RAM address
Flash RAM	1x 8 RAM which stores Flash data
User-Defined Character RAM (UDC RAM)	Stores dot pattern for custom characters.
User-Defined Address Register (UDC Address Register)	Provides address to UDC RAM when user is writing or reading a custom character
Control Word Register	Enables adjustment of display brightness, flash individual characters, blink, self test or clearing the display.

\overline{RST} can be used to initialize display operation upon power up or during normal operation. When activated, \overline{RST} will clear the Flash RAM and Control Word Register (00H) and reset the internal counter. All eight display memory locations will be set to 20H to show blanks in all digits.

\overline{FL} pin enables access to the **Flash RAM**. The **Flash RAM** will set (D0=1) or reset (D0=0) flashing of the character addressed by A0-A2.

The 1 x 8 bit **Control Word Register** is loaded with attribute data if A3=0.

The **Control Word Logic** decodes attribute data for proper implementation.

Character ROM is designed for 128 ASCII characters. The ROM is Mask Programmable for custom fonts.

The **Clock Source** could either be the internal oscillator (CLKSEL=1) of the device or an external clock (CLKSEL=0) could be an input from another HDSP211X display for the synchronization of blinking for multiple displays.

The **Display Multiplexer** controls the Row Drivers so no additional logic is required for a display system.

The **Display** has eight digits. Each digit has 35 LEDs clustered into a 5 x 7 dot matrix.

FL	A4	A3	Section of Memory	A2–A0	Data Bits Used
0	X	X	Flash RAM	Character Address	D0
1	0	0	UDC Address Register	Don't Care	D3–D0
1	0	1	UDC RAM	Row Address	D4–D0
1	1	1	Character RAM	Character Address	D7–D0
1	1	0	Control Word Register	Don't Care	D7–D0

TABLE 1. MEMORY SELECTION

THEORY OF OPERATION

The HDSP211XS Programmable Display is designed to work with all major microprocessors. Data entry is via an eight bit parallel bus. Three bits of address route the data to the proper digit location in the RAM. Standard control signals like \overline{WR} and \overline{CE} allow the data to be written into the display.

D0–D7 data bits are used for both Character RAM and control word data input. A3 acts as the mode selector. If A3=1, character RAM is selected. Then input data bit D7 will determine whether input data bits D0–D6 is ASCII coded data (D7=0) or UDC data (D7=1). See section on UDC Address Register and RAM.

For normal operation \overline{FL} pin should be held high. When \overline{FL} is held low, Flash RAM is accessed to set character blinking.

The seven bit ASCII code is decoded by the Character ROM to generate Column data. Twenty columns worth of data is sent out each display cycle, and it takes fourteen display cycles to write into eight digits.

The rows are multiplexed in two sets of seven rows each. The internal timing and control logic synchronizes the turning on of rows and presentation of column data to assure proper display operation.

POWER UP SEQUENCE

Upon power up display will come on at random. Thus the display should be reset on power-up. The reset will clear the Flash RAM, Control Word Register and reset the internal counter. All the digits will show blanks and display brightness level will be 100%.

The display must not be accessed until three clock pulses (110 μ seconds minimum using the internal clock) after the rising edge of the reset line.

MICROPROCESSOR INTERFACE

The interface to a microprocessor is through the 8-bit data bus (D0–D7), the 4-bit address bus (A0–A3) and control lines \overline{FL} , \overline{CE} and \overline{WR} .

To write data (ASCII/Control Word) into the display \overline{CE} should be held low, address and data signals stable and \overline{WR} should be brought low. The data is written on the low to high transition of \overline{WR} .

The Control Word is decoded by the Control Word Decode Logic. Each code has a different function. The code for display brightness changes the duty cycle for the column drivers. The peak LED current stays the same but the average LED current diminishes depending on the intensity level.

The character Flash Enable causes 2 Hz coming out of the counter to be ANDed with column drive signal and makes the column driver to cycle at 2 Hz. Thus the character flashes at 2 Hz.

The display Blink works the same way as the Flash Enable but causes all twenty column drivers to cycle at 2 Hz thereby making all eight digits to blink at 2 Hz.

The Self Test function of the IC consists of two internal routines which exercise major portions of the IC and illuminates all the LEDs.

Clear bit clears the character RAM and writes a blank into the display memory. it however does not clear the control word.

ASCII Data or Control Word Data can be written into the display at this point. For multiple display operation, CLK I/O must be properly selected. CLK I/O will output the internal clock if CLKSEL=1, or will allow input from an external clock if CLKSEL=0.

Character RAM

The Character RAM is selected when \overline{FL} , A4 and A3 are set to 1, 1, 1 during a read or write cycle. The Character RAM is a 8 by 8 bit RAM with each of the eight locations corresponding to a digit on the display. Digit 0 is on the left side of the display and digit 7 is on the right side of the display. Address lines, A2–A0 select the digit address with A2 being the most significant bit and A0 being the least significant bit. The two types of data stored in the Character RAM are the ASCII coded data and the UDC Address Data. The type of data stored in the Character RAM is determined by data bit, D7. If D7 is low, then ASCII coded data is stored in data bits D6–D0. If D7 is high, then UDC Address Data is stored in data bit D3–D0.

The ASCII coded data is a 7 bit code used to select one of 128 ASCII characters permanently stored in the ASCII ROM.

The UDC Address data is a 4 bit code used to select one of the UDC characters in the UDC RAM. There are up to 16 characters available. See Figure 1.

UDC Address Register and UDC RAM

The UDC Address Register and UDC RAM allows the user to generate and store up to 16 custom characters. Each custom character is defined in 5 x 7 dot matrix pattern. It takes 8 write cycles to define a custom character, one cycle to load the UDC Address Register and 7 cycles to define the character. The contents of the UDC Address Register will store the 4 bit address for one of the 16 UDC RAM locations. The UDC RAM is used to store the custom character.

UDC Address Register

The UDC Address Register is selected by setting $\overline{FL}=1$, A4=0, A3=0. It is a 4 bit register and uses data bits, D3–D0 to store the 4 bit address code (D7–D4 are ignored). The address code selects one of 16 UDC RAM locations for custom character generation.

UDC RAM

The UDC RAM is selected by setting $\overline{FL}=1$, A4=0, A3=1. The RAM is comprised of a 7 x 5 bit RAM. As shown in Figure 4, address lines, A2–A0 select one of the 7 rows of the custom character. Data bits, D4–D0 determine the 5 bits of column data in each row. Each data bit corresponds to a LED. If the data bit is high, then the LED is on. If the data bit is low, the LED is off. To create a character, each of the 7 rows of column data need to be defined. See Figures 2 and 3 for logic.

Flash RAM

The Flash RAM allows the display to flash one or more of the characters being displayed. The Flash Ram is accessed by setting \overline{FL} low. A4 and A3 are ignored. The Flash RAM is a 8 x 1 bit RAM with each bit corresponding to a digit address. Digit 0 is on the left side of the display and digit 7 is on the right side of the display. Address lines, A2–A0 select the digit address with A2 being the most significant digit and A0 being the least significant digit. Data bit, D0, sets and resets the flash bit for each digit. When D0 is high, the flash bit is set and when D0 is low, it is reset. See Figure 4.

\overline{RST}	\overline{CE}	\overline{WR}	\overline{RD}	\overline{FL}	A4	A3	A2	A1	A0	D7	D6	D5	D4	D3	D2	D1	D0
1	0	0	1	1	1	1	Character Address for Digits 0–7			0	7 bit ASCII code for a Write Cycle						
1	0	1	0	1	1	1	Character Address for Digits 0–7			0	7 bit ASCII code read during a Read Cycle						
1	0	0	1	1	0	0	Character Address for Digits 0–7			1	D3–D0=UDC address for a Write Cycle						
1	0	1	0	1	0	0	Character Address for Digits 0–7			1	D3–D0=UDC address for Read Data						

FIGURE 1. CHARACTER RAM ACCESS LOGIC

\overline{RST}	\overline{CE}	\overline{WR}	\overline{RD}	\overline{FL}	A4	A3	A2	A1	A0	D7	D6	D5	D4	D3	D2	D1	D0	
1	0	0	1	1	0	0	Not used for UDC Address Register			D3–D0=UDC RAM Address Code for the Write Cycle							UDC Address Register	
1	0	1	0	1	0	0	Not used for UDC Address Register			D3–D0=UDC RAM Address Code during a Read Cycle								
1	0	0	1	1	0	1	A2–A0=Character Row Address			D4–D0=Character Column Data for Write Cycle							UDC RAM	
1	0	1	0	1	0	1	A2–A0=Character Row Address			D4–D0=Character Column Data read during a Read Cycle								

FIGURE 2. UDC ADDRESS REGISTER AND UDC CHARACTER RAM

Control Word

The Control Word is used to set up the attributes required by the user. It is addressed by setting $\overline{FL}=1$, $A4=1$, $A3=0$. The Control Word is an 8 bit register and is accessed using data bits, D7–D0. See Figures 5 and 6 for the logic and attributed control. The Control Word has 5 functions. They are brightness control, flashing character enable, blinking character enable, self test, and clear (Flash and Character RAMS only).

Brightness Control

Control Word bits, D2–D0, control the brightness of the display with a binary code of 000 being 100% brightness and 111 being display blank. See Figure 6 for brightness level versus binary code. The average I_{cc} can be calculated by multiplying the 100% brightness level I_{cc} value by the display's brightness level. For example, a display set to 80% brightness with a 100% average I_{cc} value of 200 mA will have an average I_{cc} value of $200 \text{ mA} \times 80\% = 160 \text{ mA}$.

Flash Function

Control Word bit, D3, enables or disables the Flash Function. When D3 is 1, the Flash Function is enabled and any digit with its corresponding bit set in the Flash RAM will flash at approximately 2 hertz. When using an external clock, the flash rate can be determined by dividing the clock rate by 28,672. When D3 is 0, the Flash Function is disabled and the contents of the Flash RAM is ignored. For synchronized flashing on multiple displays, see the Reset Section.

Blink Function

Control Word bit, D4, enables or disables the Blink Function. When D4 is 1, the Blink Function is enabled and all characters on the display will blink at approximately 2 hertz. The Blink Function will override the Flash Function if both functions are enabled. When D4 is 0, the Blink Function is disabled. When using an external clock, the blink rate can be determined by dividing the clock rate by 28,672. For synchronized blinking on multiple displays, see the Reset Section.

Self Test

Before starting Self Test, Reset must first be activated. Control Word bits, D6 and D5, are used for the Self Test

Row Data				Column Data				
				C1	C2	C3	C4	C5
A2	A1	A0	Row #	D4	D3	D2	D1	D0
0	0	0	1	5 x 7 Dot Matrix Pattern				
0	0	1	2					
0	1	0	3					
0	1	1	4					
1	0	0	5					
1	0	1	6					
1	1	0	7					

FIGURE 3. UDC CHARACTER MAP

Function. When D6 is 1, the Self Test is initiated. Results of the Self Test are stored in bits D5. Control Word bit, D5, is a read only bit. When D5 is 1, Self Test passed is indicated. When D5 is 0, Self Test failed is indicated. The Self Test function of the IC consists of two internal routines which exercise major portions of the IC and illuminates all of the LEDs. The first routine cycles the ASCII decoder ROM through all states and performs a check sum on the output. If the check sum agrees with the correct value, D5 is set to a 1.

The second routine provides a visual test of the LEDs using the drive circuitry. This is accomplished by writing checkered and inversed checkered patterns to the display. Each pattern is displayed for approximately 2 seconds. During the self test function the display must not be accessed. The time needed to execute the self test function is calculated by multiplying the clock time by 262,144 (typical time=4.6 sec.). At the end of the self test function, the Character RAM is loaded with blanks; the Control Word Register is set to zeroes except D5, and the Flash RAM is cleared and the UDC Address Register is set to all 1s.

\overline{RST}	\overline{CE}	\overline{WR}	\overline{RD}	\overline{FL}	A4	A3	A2	A1	A0	D7	D6	D5	D4	D3	D2	D1	D0
1	0	0	1	1	X	X	Flash RAM Address for Digits 0–7			D0=Flash Data, 0=Flash Off and 1=Flash On (Write Cycle)							
1	0	1	1	0	X	X	Flash RAM Address for Digits 0–7			D0=Flash Data, 0=Flash Off and 1=Flash On (Read Cycle)							

FIGURE 4. FLASH RAM ACCESS LOGIC

\overline{RST}	\overline{CE}	\overline{WR}	\overline{RD}	\overline{FL}	A4	A3	A2	A1	A0	D7	D6	D5	D4	D3	D2	D1	D0
1	0	0	1	1	1	0	Not used for Control Word			Control Word data for a Write Cycle, see Figure 6.							
1	0	1	0	1	1	0	Not used for Control Word			Control Word data for a Read during a Read Cycle.							

FIGURE 5. CONTROL WORD ACCESS LOGIC

Clear Function (see Figures 6 and 7)

Control Word bit, D7 clears the character RAM to 20 hex and the flash RAM to all zeroes. The RAMs are cleared within three clock cycles (110 μs minimum, using the internal clock) when D7 is set to 1. During the clear time the display must not be accessed. When the clear function is finished, bit 7 of the Control Word RAM will be reset to a "0".

Reset Function

The display should be reset on power up of the display ($\overline{RST}=\text{LOW}$). When the display is reset, the Character RAM, Flash RAM, and Control Word Register are cleared.

The display's internal counters are reset. Reset cycle takes three clock cycles (110 μseconds minimum using the internal clock). The display must not be accessed during this time.

To synchronize the flashing and blinking of multiple displays, it is necessary for the display to use a common clock source and reset all the displays at the same time to start the internal counters at the same place.

While \overline{RST} is low, the display must not be accessed by RD nor WR.

D7	D6	D5	D4	D3	D2	D1	D0
C	ST	ST	BL	FL	Br	Br	Br

Key

- C Clear function
- ST Self test
- BL Blink function
- FL Flash function
- Br Brightness control

0	0	0	100% Brightness
0	0	1	80% Brightness
0	1	0	53% Brightness
0	1	1	40% Brightness
1	0	0	27% Brightness
1	0	0	20% Brightness
1	1	0	13% Brightness
1	1	1	Blank Display

- 0 Flash Function Disabled
- 1 Flash Function Enabled
- 0 Blink Function Disabled
- 1 Blink Function Enabled (overrides Flash Function)

- 0 X Normal Operation X=bit ignored
- 1 R Run Self Test, R=Test Result, R=1/pass, 0=fail

- 0 Normal Operation
- 1 Clear Flash RAM & Character RAM (Character RAM=20 Hex)

FIGURE 6. CONTROL WORD DATA DEFINITION

\overline{CE}	\overline{WR}	\overline{FL}	A3	A2	A1	A0	D7	D6	D5	D4	D3	D2	D1	D0	Operation
0	0	1	0	X	X	X	0	X	X	X	X	X	X	X	Clear Disabled
0	0	1	0	X	X	X	1	X	X	X	X	X	X	X	Clear User RAM, Flash RAM and Display

FIGURE 7. CLEAR FUNCTION

X=don't care

FIG 8. DISPLAY CYCLE USING BUILT-IN ROM EXAMPLE

Display message "Showtime." Digit 0 is leftmost – Closest to Pin 1.
 Logic levels; 0=Low, 1=High, X=Don't care.

RST	CE	WR	RD	FL	A4	A3	A2	A1	A0	D7	D6	D5	D4	D3	D2	D1	D0	Operation	Display
0	0	1	1	1	X	X	X	X	X	X	X	X	X	X	X	X	X	Reset. No Read/Write Within 3 Clock Cycles	All Blank
1	0	0	1	1	1	0	X	X	X	0	0	X	0	0	0	1	1	53% Brightness Selected	All Blank
1	0	0	1	1	1	1	0	0	0	0	1	0	1	0	0	1	1	Write "S" to Digit 0	S
1	0	0	1	1	1	1	0	0	1	0	1	0	0	1	0	0	0	Write "H" to Digit 1	SH
1	0	0	1	1	1	1	0	1	0	0	1	0	0	1	1	1	1	Write "O" to Digit 2	SHO
1	0	0	1	1	1	1	0	1	1	0	1	0	1	0	1	1	1	Write "W" to Digit 3	SHOW
1	0	0	1	1	1	1	1	0	0	0	1	0	1	0	1	0	0	Write "T" to Digit 4	SHOWT
1	0	0	1	1	1	1	1	0	1	0	1	0	0	1	0	0	1	Write "I" to Digit 5	SHOWTI
1	0	0	1	1	1	1	1	1	0	0	1	0	0	1	1	0	1	Write "M" to Digit 6	SHOWTIM
1	0	0	1	1	1	1	1	1	1	0	1	0	0	0	1	0	1	Write "E" to Digit 7	SHOWTIME

FIG 9. DISPLAYING USER DEFINED CHARACTER EXAMPLE

Load character "A" into UDC-5 and then display it in digit 2
 Logic levels: 0=Low, 1=High, X=Don't care.

RST	CE	WR	RD	FL	A4	A3	A2	A1	A0	D7	D6	D5	D4	D3	D2	D1	D0	Operation	Display
0	X	1	1	1	X	X	X	X	X	X	X	X	X	X	X	X	X	Reset. No Read/Write Within 3 Clock Cycles	All Blank
1	0	0	1	1	0	0	X	X	X	X	X	X	X	0	1	0	1	Select UDC-5	All Blank
1	0	0	1	1	0	1	0	0	0	X	X	X	0	1	1	1	0	Write Into Row 1 of UDC-5	All Blank
1	0	0	1	1	0	1	0	0	1	X	X	X	1	0	0	0	1	Write Into Row 2 of UDC-5	All Blank
1	0	0	1	1	0	1	0	1	0	X	X	X	1	0	0	0	1	Write Into Row 3 of UDC-5	All Blank
1	0	0	1	1	0	1	0	1	1	X	X	X	1	1	1	1	1	Write Into Row 4 of UDC-5	All Blank
1	0	0	1	1	0	1	1	0	0	X	X	X	1	0	0	0	1	Write Into Row 5 of UDC-5	All Blank
1	0	0	1	1	0	1	1	0	1	X	X	X	1	0	0	0	1	Write Into Row 6 of UDC-5	All Blank
1	0	0	1	1	0	1	1	1	0	X	X	X	1	0	0	0	1	Write Into Row 7 of UDC-5	All Blank
1	0	0	1	1	1	1	0	1	0	1	X	X	X	0	1	0	1	Write UDC-5 Into Digit 2	(Digit2) A

ELECTRICAL & MECHANICAL CONSIDERATIONS

VOLTAGE TRANSIENT SUPPRESSION

For best results power the display and the components that interface with the display to avoid logic inputs higher than V_{CC} . Additionally, the LEDs may cause transients in the power supply line while they change display states. The common practice is to place a parallel combination of a .01 μF and a 22 μF capacitor between V_{CC} and GND for all display packages.

ESD PROTECTION

The input protection structure of the HDSP211XS provides significant protection against ESD damage. It is capable of withstanding discharges greater than 4 KV. Take all the standard precautions, normal for CMOS components. These include properly grounding personnel, tools, tables, and transport carriers that come in contact with unshielded parts. If these conditions are not, or cannot be met, keep the leads of the device shorted together or the parts in anti-static packaging.

SOLDERING CONSIDERATIONS

THE HDSP211XS can be hand soldered with SN63 solder using a grounded iron set to 260°C.

Wave soldering is also possible following these conditions: Preheat that does not exceed 93°C on the solder side of the PC board or a package surface temperature of 85°C. Water soluble organic acid flux (except carboxylic acid) or resin-based RMA flux without alcohol can be used.

Direct contact with alcohol or alcohol vapor will cause degradation of the package.

Wave temperature of 245°C \pm 5°C with a dwell between 1.5 sec. to 3.0 sec. Exposure to the wave should not exceed temperatures above 260°C for five seconds at 0.063" below the seating plane. The packages should not be immersed in the wave.

POST SOLDER CLEANING PROCEDURES

The least offensive cleaning solution is hot D.I. water (60°C) for less than 15 minutes. Addition of mild saponifiers is acceptable. Do not use commercial dishwasher detergents.

For faster cleaning, solvents may be used. Exercise care in choosing solvents as some may chemically attack the nylon package. Maximum exposure should not exceed two minutes at elevated temperatures. Acceptable solvents are TF (trichlorotrifluoroethane), TA, 111 Trichloroethane, and unheated acetone.⁽¹⁾

Note: 1. Acceptable commercial solvents are: Basic TF, Arklone, P. Genesolv, D. Genesolv DA, Blaco-Tron TF, Blaco-Tron TA, and Freon TA.

Unacceptable solvents contain alcohol, methanol, methylene chloride, ethanol, TP35, TCM, TMC, TMS+, TE, or TES. Since many commercial mixtures exist, contact a solvent vendor for chemical composition information. Some major solvent manufacturers are: Allied Chemical Corporation, Specialty Chemical Division, Morristown, NJ; Baron-Blakeslee, Chicago, IL; Dow Chemical, Midland, MI; E.I. DuPont de Nemours & Co., Wilmington, DE.

For further information refer to Appnotes 18 and 19 in the current Siemens Optoelectronic Data Book.

An alternative to soldering and cleaning the display modules is to use sockets. Naturally, 28 pin DIP sockets .600" wide with .100" centers work well for single displays. Multiple display assemblies are best handled by longer SIP sockets or DIP sockets when available for uniform package alignment. Socket manufacturers are Aries Electronics, Inc., Frenchtown, NJ; Garry Manufacturing, New Brunswick, NJ; Robinson-Nugent, New Albany, IN; and Samtec Electronic Hardware, New Albany, IN.

For further information refer to Appnote 22 in the current Siemens Optoelectronic Data Book.

OPTICAL CONSIDERATIONS

The .200" high character of the HDSP211XS gives readability up to eight feet. Proper filter selection enhances readability over this distance.

Using filters emphasizes the contrast ratio between a lit LED and the character background. This will increase the discrimination of different characters. The only limitation is cost. Take into consideration the ambient lighting environment for the best cost/benefit ratio for filters.

Incandescent (with almost no green) or fluorescent (with almost no red) lights do not have the flat spectral response of sunlight. Plastic band-pass filters are an inexpensive and effective way to strengthen contrast ratios. The HDSP2110/2112S are red/high efficiency red displays and should be matched with long wavelength pass filter in the 570 nm to 590 nm range. The HDSP2113S should be matched with a yellow-green band-pass filter that peaks at 565 nm. For displays of multiple colors, neutral density grey filters offer the best compromise.

Additional contrast enhancement is gained by shading the displays. Plastic band-pass filters with built-in louvers offer the next step up in contrast improvement. Plastic filters can be improved further with anti-reflective coatings to reduce glare. The trade-off is fuzzy characters. Mounting the filters close to the display reduces this effect. Take care not to overheat the plastic filter by allowing for proper air flow.

Optimal filter enhancements are gained by using circular polarized, anti-reflective, band-pass filters. The circular polarizing further enhances contrast by reducing the light that travels through the filter and reflects back off the display to less than 1%.

Several filter manufacturers supply quality filter materials. Some of them are: Paneigraphic Corporation, W. Caldwell, NJ; SGL Homalite, Wilmington, DE; 3M Company, Visual Products Division, St. Paul, MN; Polaroid Corporation, Polarizer Division, Cambridge, MA; Marks Polarized Corporation, Deer Park, NY; Hoya Optics, Inc., Fremont, CA.

One last note on mounting filters: recessing displays and bezel assemblies is an inexpensive way to provide a shading effect in overhead lighting situations. Several bezel manufacturers are: R.M.F. Products, Batavia, IL; Nobex Components, Griffith Plastic Corp., Burlingame, CA; Photo Chemical Products of California, Santa Monica, CA; I.E.E.-Atlas, Van Nuys, CA.

SIEMENS

MDL2416C MDL2416TXVB

.15" Red, 4-Digit, 16 Segment Plus Decimal
HI-REL Alphanumeric Intelligent Display®
With Memory/Decoder/Driver

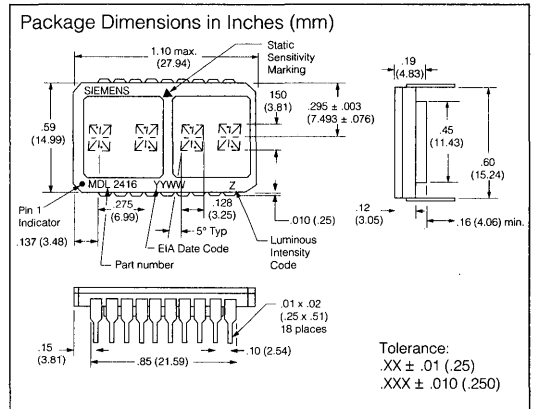
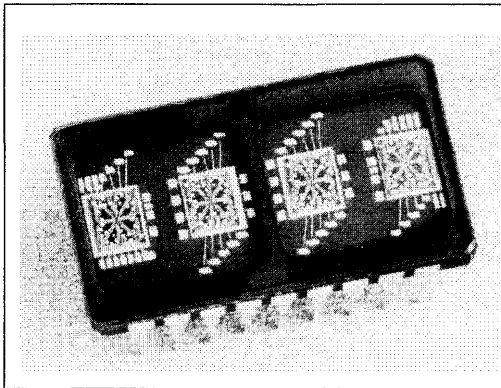

FEATURES

- 150 Mil High, Non-Magnified Monolithic Character
- Rugged Ceramic Package, Hermetically Sealed Flat Glass Window
- Low Profile Package
- Dual in Line Configuration
- Close Vertical Row Spacing, 0.600"
- 100 Mil Pin Spacing
- Wide Viewing Angle
- Wide Temperature Operating Range, -55°C to +100°C
- Fully Integrated CMOS Drive Electronics
- Direct Access to Each Digit Independently and Asynchronously
- TTL Compatible, 5 Volt Power Supply
- Independent Cursor Function
- 17th Segment for Improved Punctuation Marks
- Two Chip Enables
- Interdigit Blanking
- Display Blank Function
- Memory Clear Function
- End-Stackable, Four Character Package
- Intensity Coded for Display Uniformity
- MDL2416C Process Conforms to MIL-D-87157 Quality Level A Test Tables I, II and also can meet Groups B and C Testing Specified in MIL-D-87157
- MDL2416 TXVB Process Conforms to MIL-D-87157 Quality Level A Test Tables I, II, IIIa and IVa (See High Reliability Test Tables)

DESCRIPTION

The MDL2416 is a military alphanumeric four digit display module with a 17 segment font and a built-in CMOS drive circuitry that is TTL and microprocessor compatible.

The integrated circuit contains memory, ASCII ROM decoder, multiplexing circuitry and drivers. The MDL2416 is designed for use in extremely harsh environments where only the most reliable product is acceptable.

Data entry is asynchronous and can be random. A display system can be built using any number of MDL2416s since each digit in any MDL2416 can be addressed independently and will continue to display the character last stored until replaced by another.

System interconnection is straightforward. The least significant two address bits (A0, A1) are normally connected to the like named inputs of all MDL2416s in the system. With two chip enables (CE1 and CE2), four MDL2416s (16 characters) can easily be interconnected without an external decoder.

Important: Since this is a CMOS device, normal precautions should be taken to avoid static damage due to high static voltages or electric fields. See Appnote 18 for further information.

OPTOELECTRONIC CHARACTERISTICS at 25°C

Absolute Maximum Ratings

DC Supply Voltage	-0.5 to +6.0 VDC
Input Voltage Relative to Gnd (all inputs)	-0.5 to V_{CC} +0.5 VDC
Operating Temperature	-55°C to +100°C
Storage Temperature	-65°C to +125°C

Optical Characteristics

Spectral Peak Wavelength	660 nm typ.
Spectral Line Half-Width	40 nm typ.
Viewing Angle (see Note)	$\pm 50^\circ$
Digit Size	0.15"
Luminous Intensity (typ.)	0.1 mcd/segment at $V_{CC}=5$ V
Intensity Matching, Segment to Segment	1.8:1 at $V_{CC}=5$ V

Note: "Off axis viewing angle" is defined as, the minimum angle in any direction from the normal to the display surface at which any part of any segment in the display is not visible.

TOP VIEW

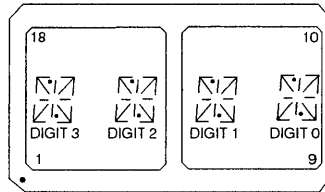

Pin	Function	Pin	Function
1	$\overline{CE1}$ Chip Enable	10	GND
2	$\overline{CE2}$ Chip Enable	11	D0 Data Input
3	\overline{CLR} Clear	12	D1 Data Input
4	CUE Cursor Enable	13	D2 Data Input
5	\overline{CU} Cursor Select	14	D3 Data Input
6	\overline{WR} Write	15	D6 Data Input
7	A1 Digit Select	16	D5 Data Input
8	A0 Digit Select	17	D4 Data Input
9	V_{CC}	18	BL Display Blank

DC CHARACTERISTICS at 25°C

Parameter	Min.	Typ.	Max.	Units	Conditions
V_{CC}	4.5	5.0	5.5	V	25°C
I_{CC} (Blank) ⁽¹⁾	0.10	1.5	4.0	mA	$V_{CC}=5$ V, $WR=V_{CC}$, $V_{IN}=0$ V all other pins
I_{CC} (10 segments/character 4 digits on)	65	85	115	mA	$V_{CC}=5$ V
I_{CC} (all segments on cursor in 4 digits) ^(1,2)	85	120	165	mA	$V_{CC}=5$ V measured at 5 sec., 60 sec. max.
V_{IL} (all inputs)			0.6	V	$V_{CC}=5$ V ± 0.5 V
V_{IH} (all inputs)	2.4			V	$V_{CC}=5$ V ± 0.5 V
I_{IL} (all inputs)		60	160	μ A	$V_{CC}=5$ V, $V_{IN}=0.8$ V

1. Measured at 5 seconds.

2. 60 seconds maximum duration.

AC CHARACTERISTICS

Parameter	Symbol	-55°C	+25°C	+100°C	Units
Chip Enable Set Up Time	T_{CES}	190	275	410	ns
Address Set Up Time	T_{AS}	190	275	410	ns
Cursor Set Up Time	T_{CUS}	190	275	410	ns
Chip Enable Hold Time	T_{CEH}	25	25	25	ns
Address Hold Time	T_{AH}	25	25	25	ns
Cursor Hold Time	T_{CUH}	25	25	25	ns
Write Delay Time	T_{WD}	40	50	60	ns
Write Pulse	T_W	150	225	350	ns
Data Set Up Time	T_{DS}	100	150	300	ns
Data Hold Time	T_{DH}	25	25	25	ns
Clear Pulse	T_{CLR}	0.9	1	1.2	μ s

Note: 1. Unused inputs must be tied to an appropriate logic voltage level (either V+ or V-).

TIMING CHARACTERISTICS WRITE CYCLE WAVEFORMS

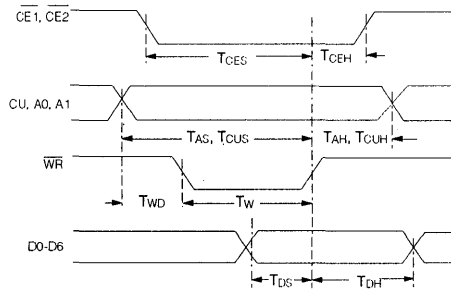

(for tester calibration only)

CHARACTER SET

D0	L	H	L	H	L	H	L	H	L	H	L	H	L	H	L	H			
D1	L	L	H	H	L	L	H	H	L	L	H	H	L	L	H	H			
D2	L	L	L	L	H	H	L	L	L	L	H	H	L	L	H	H			
D3	L	L	L	L	L	L	L	L	H	H	H	H	H	H	H	H			
D6 D5 D4	hex	0	1	2	3	4	5	6	7	8	9	A	B	C	D	E	F		
L	H	L	2	!	"	#	\$	%	&	'	<	>	*	+	,	--	.	/	
L	H	H	3	0	1	2	3	4	5	6	7	8	9	-	_	^	~	?	
H	L	L	4	@	A	B	C	D	E	F	G	H	I	J	K	L	M	N	O
H	L	H	5	P	Q	R	S	T	U	V	W	X	Y	Z	[\]	^	_

All other input codes display "blank"

INTERNAL BLOCK DIAGRAM

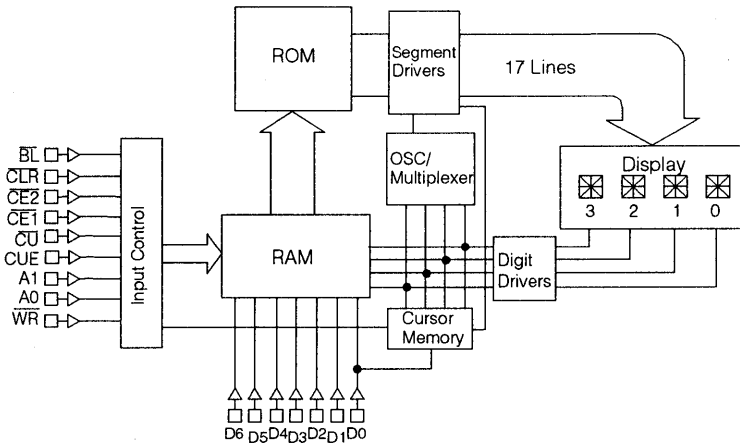

Intelligent
Display Devices

TYPICAL SCHEMATIC FOR 16 DIGIT SYSTEM

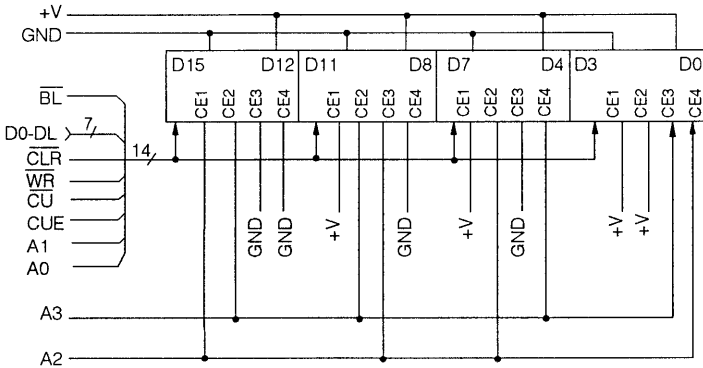

LOADING DATA

Setting the chip enable ($\overline{CE1}$, $\overline{CE2}$) to their true state will enable data loading. The desired data code (D0-D6) and digit address (A0, A1) must be held stable during the write cycle for storing new data.

Data entry may be asynchronous and random. (Digit 0 is defined as right hand digit with A1 = A2 = 0.)

Clearing the entire internal four-digit memory can be accomplished by holding the clear (\overline{CLR}) low for one μ S minimum. The clear function will clear both the ASCII RAM and the cursor RAM. Loading an illegal data code will display a blank.

LOADING CURSOR

Setting the chip enables ($\overline{CE1}$, $\overline{CE2}$) and cursor select (\overline{CU}) to their true state will enable cursor loading. A write (\overline{WR}) pulse will now store or remove a cursor into the digit location addressed by A0, A1, as defined in data entry. A cursor will be stored if D0=1; and will be removed if D0=0. The cursor (\overline{CU}) pulse width should not be less than the write (\overline{WR}) pulse or erroneous data may appear in the display.

If the cursor isn't required, the cursor enable signal (CUE) may be tied low to disable the display of the cursor function. For a flashing cursor, simply pulse CUE. If the cursor has been loaded to any or all positions in the display, then CUE will control whether the cursor(s) or the characters appear. CUE does not affect the contents of cursor memory.

DISPLAY BLANKING

To blank the display, load a blank or space into each digit of the display or use the (\overline{BL}) display blank input.

Setting the (\overline{BL}) input low does not affect the contents of either data or cursor memory. A flashing display will result by pulsing (\overline{BL}).

A flashing circuit can be easily constructed using a 555 astable multivibrator. Figure 1 illustrates a circuit in which varying R1 (100K~10K) will have a flash rate of 1Hz~10Hz.

The display can be dimmed by pulse width modulating the (\overline{BL}) at a frequency sufficiently fast not to interfere with the internal clock. This clock frequency may vary from 200 Hz to 1.3KHz. The dimming signal frequency should be 2.5KHz or higher. Dimming the display also reduces power consumption.

TYPICAL LOADING DATA STATE TABLE

Control								Address		Data								Display Digit				
\overline{BL}	$\overline{CE1}$	$\overline{CE2}$	CUE	\overline{CU}	\overline{WR}	\overline{CLR}	A1	A0	D6	D5	D4	D3	D2	D1	D0	3	2	1	0			
H	X	X	L	X	H	H			previously loaded display								G	R	E	Y		
H	H	X	L	X	X	H	X	X	X	X	X	X	X	X	X	G	R	E	Y			
H	X	H	L	X	X	H	X	X	X	X	X	X	X	X	X	G	R	E	Y			
H	L	L	L	H	L	H	L	L	H	L	L	L	H	L	H	G	R	E	E			
H	L	L	L	H	L	H	L	H	H	L	H	L	H	L	H	G	R	U	E			
H	L	L	L	H	L	H	H	L	H	L	L	H	H	L	L	G	L	U	E			
H	L	L	L	H	L	H	H	H	H	L	L	L	L	H	L	B	L	U	E			
L	X	X	X	X	H	H	X	X	blank display													
H	L	L	L	H	L	H	H	H	H	L	L	L	H	H	H	G	L	U	E			
H	X	X	L	X	H	L	X	X	clears character displays								see character set					
H	L	L	L	H	L	H	X	X	see character code													

X = don't care

LOADING CURSOR STATE TABLE

Control								Address		Data								Display Digit			
\overline{BL}	$\overline{CE1}$	$\overline{CE2}$	CUE	\overline{CU}	\overline{WR}	\overline{CLR}	A1	A0	D6	D5	D4	D3	D2	D1	D0	3	2	1	0		
H	X	X	L	X	H	H			previously loaded display								B	E	A	R	
H	X	X	H	X	H	H			display previously stored cursors								B	E	A	R	
H	L	L	H	L	L	H	L	L	X	X	X	X	X	X	H	B	E	A	■		
H	L	L	H	L	L	H	L	H	X	X	X	X	X	X	H	B	E	■	■		
H	L	L	H	L	L	H	H	L	X	X	X	X	X	X	H	B	■	■	■		
H	L	L	H	L	L	H	H	L	X	X	X	X	X	X	L	■	E	■	■		
H	X	X	L	X	H	H			disable cursor display								B	E	A	R	
H	L	L	L	L	L	H	H	H	X	X	X	X	X	L	B	E	A	R			
H	X	X	H	X	H	H			display stored cursors								B	E	■	■	

X = don't care

■ = \boxtimes

SIEMENS

YELLOW MPD2131 TXVB, IPD2131 HER MPD2132 TXVB, IPD2132 HIGH EFF. GREEN MPD2133 TXVB, IPD2133

0.200" 8-Character 5 X 7 Dot Matrix X-Y Stackable, HI-REL Alphanumeric Programmable Display™

Intelligent
Display Devices

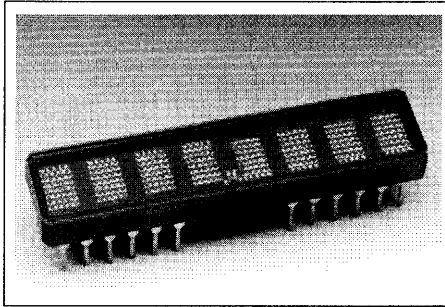

FEATURES

- Eight .2" Dot Matrix Characters in a Ceramic Package
- True Hermetic Glass Frit Seal for all Colors
- Internal ROM with 128 ASCII Characters
- Internal RAM for up to 16 User Definable Characters
- Programable Control Word Allows user to select from 8 Brightness Levels, Display Blink, Character Flash, Self Test, or Clear Functions
- Internal or External Clock Capability
- 8 Bit Bidirectional Data Bus Allows for Read/Write Capability
- Contains all Display Drive and Multiplexing Circuitry
- Reset Pin for Display Initialization, Multiple Display Blinking and Flashing Synchronization
- TTL Compatible
- Operating Temperature Range: -55 to +100°C
Storage Temperature: -65 to +125°C
- Categorized for Luminous Intensity and Color
- X-Y Stackable
- MPD2131/2/3 Process Conforms to MIL-D-87157, Quality Level A Test Tables I and Group A Table II and can meet Groups B and C Testing Specified in MIL-D-87157
- MPD2131/2/3 TXVB Process Conforms to MIL-D-87157 Quality Level A Test Tables I, II, IIIa, IVa (See High Reliability Test Tables).

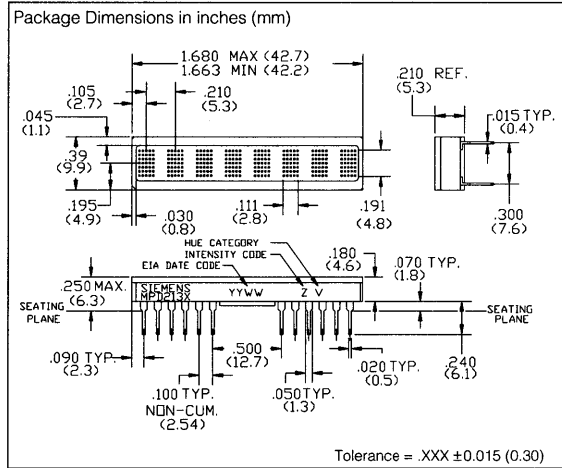

DESCRIPTION

The MPD2131 (yellow), MPD2132 (High Efficiency Red) and MPD2133 (High Efficiency Green) are eight-digit high reliability 5 x 7 dot matrix Programmable Displays that are aimed at satisfying the most demanding military display requirements. They are designed for use in extremely harsh environments where only the most reliable parts are acceptable. These devices are processed to meet the requirements of High-Rel applications. The devices are constructed in ceramic packages with eight .20 inch high 5x7 dot matrix digits. The devices incorporate the latest in CMOS technology which is the heart of the device intelligence. The CMOS IC is controll-ed by a user supplied eight-bit data word on a bidirectional BUS. The ASCII data and attribute data are word driven. This approach allows the displays to interface using similar techniques as a microprocessor peripheral.

APPLICATIONS

- Military Control Panels
- Night Viewing Applications
- Cockpit Monitors
- Portable and Vehicle Technology
- Industrial Controllers

ESD Warning: Standard precautions for CMOS handling should be observed.

Maximum Rating, $T_A=25^\circ\text{C}$

DC Supply Voltage,

V_{CC} to GND (max. voltage with no LEDs on)-0.3 to +7.0 VDC

Input Voltage Levels,

All Inputs-0.3 V to ($V_{CC}+0.3$) V

Operating Temperature-55°C to 100°C

Storage Temperature-65°C to 125°C

Relative Humidity (non-condensing)85%

Operating Voltage, V_{CC} to GND

(Max. voltage with 20 dots/digits on)5.5V

Maximum Solder Temperature260°C

(0.063 inch below the seating plane, $t<5$ sec.)

ESD Protection at 1.5 K Ω ,

100 pF $V_2=4$ KV (each pin)

Switching Specifications

(over operating temperature range and $V_{CC} = 4.5\text{V to }5.5\text{V}$)

Symbol	Description	Min.	Units
Tacc	Display Access Time - Write	210	ns
Tacc	Display Access Time - Read	230	ns
Tacs	Address Setup Time to CE	10	ns
Tce	Chip Enable Active Time - Write	140	ns
Tce	Chip Enable Active Time - Read	160	ns
Tach	Address Hold Time to CE	20	ns
Tcer	Chip Enable Recovery Time	60	ns
Tces	Chip Enable Active Prior to Rising Edge - Write	140	ns
Tces	Chip Enable Active Prior to Rising Edge - Read	160	ns
Tceh	Chip Enable Hold to Rising Edge of Read/Write Signal	0	ns
Tw	Write Active Time	100	ns
Twd	Data Valid Prior to Rising Edge of Write Signal	50	ns
Tdh	Data Write Time	20	ns
Tr	Chip Enable Active Prior to Valid Data	160	ns
Trd	Read Active Prior to Valid Data	95	ns
Tdf	Read Data Float Delay	10	ns
Trc	Reset Active Time	300	ns

Enlarged Character Font

Dimensions in inches (mm)

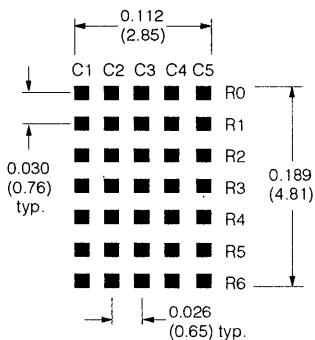

Oscillator, Refresh, Flash and Self Test Characteristics

Parameters	Min	Typ	Max	Units	Conditions
Clock I/O Frequency	28	57.34	81.14	KHz	$V_{CC}=4.5\text{ V to }5.5\text{ V}$
FM, Digit Multiplex Frequency	125	256	362.5	Hz	$V_{CC}=4.5\text{ V to }5.5\text{ V}$
Blinking Rate	0.98	2.0	2.83	Hz	
Clock I/O Bus Loading			2.40	pF	
Clock Out Rise Time			500	nsec	$V_{CC}=4.5\text{ V}, V_{OH}=2.4\text{ V}$
Clock Out Fall Time			500	nsec	$V_{CC}=4.5\text{ V}, V_{OH}=0.4\text{ V}$

Write Cycle Timing Diagram

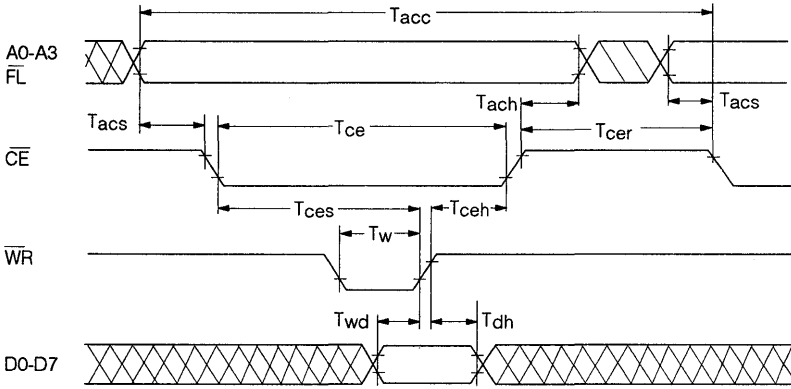

Input pulse levels -0.6 V to 2.4 V

Read Cycle Timing Diagram

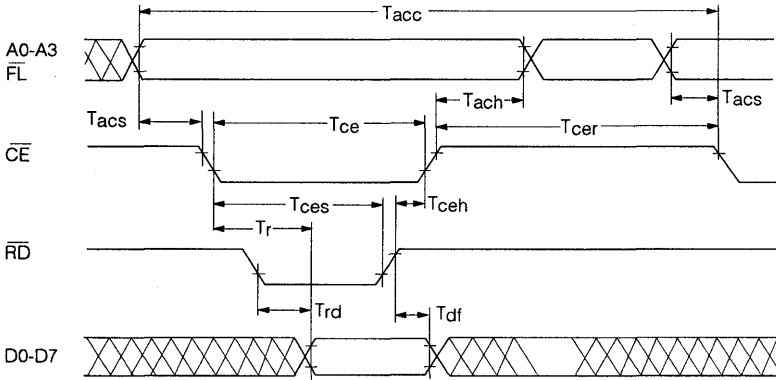

Maximum Power Dissipation vs. Ambient Temperature Derating Based on T_J Max = 125°C

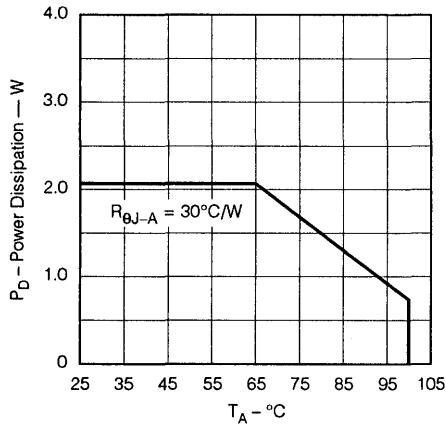

Optical Characteristics at 25°C $V_{CC}=5.0$ V at Full Brightness**Yellow IPD/MPD2131**

Description	Symbol	Min.	Typ.	Max.	Units
Luminous Intensity Character Average (# displayed)	I_v	2.5	4.1		mcd
Peak Wavelength	$\lambda(\text{peak})$		583		nm
Dominant Wavelength	$\lambda(d)$		585		nm

High Efficiency Red IPD/MPD2132

Description	Symbol	Min.	Typ.	Max.	Units
Luminous Intensity Character Average (# displayed)	I_v	2.5	7.0		mcd
Peak Wavelength	$\lambda(\text{peak})$		635		nm
Dominant Wavelength	$\lambda(d)$		626		nm

High Efficiency Green IPD/MPD2133

Description	Symbol	Min.	Typ.	Max.	Units
Luminous Intensity Character Average (# displayed)	I_v	3.0	10		mcd
Peak Wavelength	$\lambda(\text{peak})$		568		nm
Dominant Wavelength	$\lambda(d)$		574		nm.

DC ELECTRICAL CHARACTERISTICS at 25°C

Parameters	Limits			Units	Conditions
	Min	Typ	Max		
V_{CC}	4.5	5.0	5.5	V	
I_{CC} Blank		0.5	1.0	mA	$V_{CC}=5\text{ V}$, $V_{IN}=5\text{ V}$
I_{CC} 12 dots/digit on ⁽¹⁾⁽²⁾		200	255	mA	$V_{CC}=5\text{ V}$, "V" in all 8 digits.
I_{CC} 20 dots/digit on ⁽¹⁾⁽²⁾		300	370	mA	$V_{CC}=5\text{ V}$, "#" in all 8 digits
I_{ILP} (with pull-up) Input Leakage	-18	-11	-5	μA	$V_{CC}=5\text{ V}$, $V_{IN}=0\text{ V}$ to V_{CC} (\overline{WR} , \overline{CE} , \overline{FL} , \overline{RST} , \overline{RD} , \overline{CLKSEL})
I_{IL} (no pull-up) Input Leakage	-1		+1	μA	$V_{CC}=5\text{ V}$, $V_{IN}=0-5\text{ V}$ (\overline{CLK} , A0-A3, D0-D7)
V_{IH} Input Voltage High	2.0		$V_{CC}+0.3$	V	$V_{CC}=4.5\text{ V}$ to 5.5 V
V_{IL} Input Voltage Low	Gnd -0.3		0.8	V	$V_{CC}=4.5\text{ V}$ to 5.5 V
V_{OL} (D0-D7) Output Voltage Low			0.4	V	$V_{CC}=4.5\text{ V}$, $I_{OL}=1.6\text{ mA}$
V_{OL} (CLK) Output Voltage Low			0.4	V	$V_{CC}=4.5\text{ V}$, $I_{OL}=40\ \mu\text{A}$
V_{OH} Output Voltage High	2.4			V	$V_{CC}=4.5\text{ V}$, $I_{OH}=-40\ \mu\text{A}$
θ_{JC} Thermal Resistance Junction to Case		15		$^{\circ}\text{C/W}$	

- Notes:** 1. I_{CC} is an average value.
2. I_{CC} is measured with the display at full brightness. Peak $I_{CC}=29/15 I_{CC}$ average (#displayed).

Recommended Operating Conditions ($T_A=-55^{\circ}\text{C}$ to $+100^{\circ}\text{C}$)

Parameter	Symbol	Min.	Max.	Units
Supply Voltage	V_{CC}	4.5	5.5	V
Input Voltage Low	V_{IL}		0.8	V
Input Voltage High	V_{IH}	2.0		V
Output Voltage Low	V_{OL}		0.4	V
Output Voltage High	V_{OH}	2.4		V

Pin No.	Pin Description Function	Description	Explanation
1	CLS	Clock Select	Selects an internal or external clock source. CLS=1 the internal clock selected (master clock), CLS=0 then external clock selected (slave operation).
2	CLK	Clock I/O	Inputs or outputs the clock as determined by the CLS pin.
3	\overline{WR}	Write	Writes data into the display when $\overline{WR}=0$ and $\overline{CE}=0$.
4	\overline{CE}	Chip Enable	Enables the read/write access when low.
5	RST	Reset	Initializes the display; clears the Character RAM (20 Hex), Flash RAM (00 Hex), Control Word (00 Hex) and resets the internal counters. UDC Address Register and UDC RAM are unaffected.
6	\overline{RD}	Read	Outputs data from the display when $\overline{RD}=0$ and $\overline{CE}=0$.
7	No Pin		
8	No Pin		
9	No Pin		
10	No Pin		
11	D0	Data Bus	8 bit bidirectional data bus. Character RAM and Control Word uses D7–D0, UDC Address Register uses D3–D0, UDC RAM uses D4–D0, and Flash RAM uses D0.
12	D1	Data Bus	Same as D0
13	D2	Data Bus	Same as D0
14	D3	Data Bus	Same as D0
15	NC		
16	V _{cc}		Positive power supply.
17	GND	Supply	Analog ground for the LED drivers.
18	GND	Logic	Digital ground for the logic circuitry.
19	D4	Data Bus	Same as D0
20	D5	Data Bus	Same as D0
21	D6	Data Bus	Same as D0
22	D7	Data Bus	Same as D0
23	No Pin		
24	No Pin		
25	No Pin		
26	No Pin		
27	FL	Flash	Accesses the Flash RAM. Address inputs, A2–A0, select the digit address while data bit D0 sets (D0=1) or resets (D0=0) the Flash bit. A4 and A3 are ignored.
28	A0	Address Inputs	A4 and A3 select a section of the display's memory. A2–A0 select specific locations in the different sections. If FL is low the Flash RAM is accessed regardless of the status of A4 and A3.
29	A1	Address Inputs	Same as A0
30	A2	Address Inputs	Same as A0
31	A3	Address Inputs	Same as A0
32	A4	Address Inputs	Same as A0

CHARACTER SET

ASCII CODE				D0	L	H	L	H	L	H	L	H	L	H	L	H	L	H		
D7	D6	D5	D4	Hex	D	1	2	3	4	5	6	7	8	9	A	B	C	D	E	F
L	L	L	L	0																
L	L	L	H	1																
L	L	H	L	2																
L	L	H	H	3																
L	H	L	L	4																
L	H	L	H	5																
L	H	H	L	6																
L	H	H	H	7																
H	X	X	X	8	UDC	UDC	UDC	UDC	UDC	UDC	UDC	UDC	UDC	UDC	UDC	UDC	UDC	UDC	UDC	UDC
					0	1	2	3	4	5	6	7	8	9	10	11	12	13	14	15

Notes:

1. On power up, the device will initialize in a random state.
2. X = don't care

Cascading Displays

The display's oscillator is designed to drive up to 16 other displays with input loading of 15 pF each.

The following are the general requirements for cascading 16 displays together:

- Determine the correct address for each display.
- Use \overline{CE} from an address decoder to select the correct display.

- Select one of the Displays to provide the Clock for the other displays. Connect CLKSEL to V_{CC} for this display.
- Tie CLKSEL to ground on other displays.
- Use \overline{RST} to synchronize the blinking between the displays.

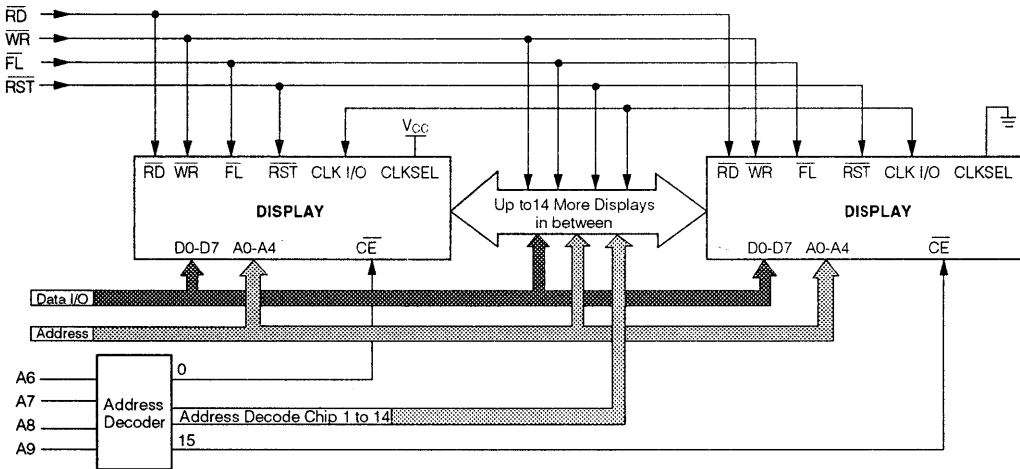

BLOCK DIAGRAM

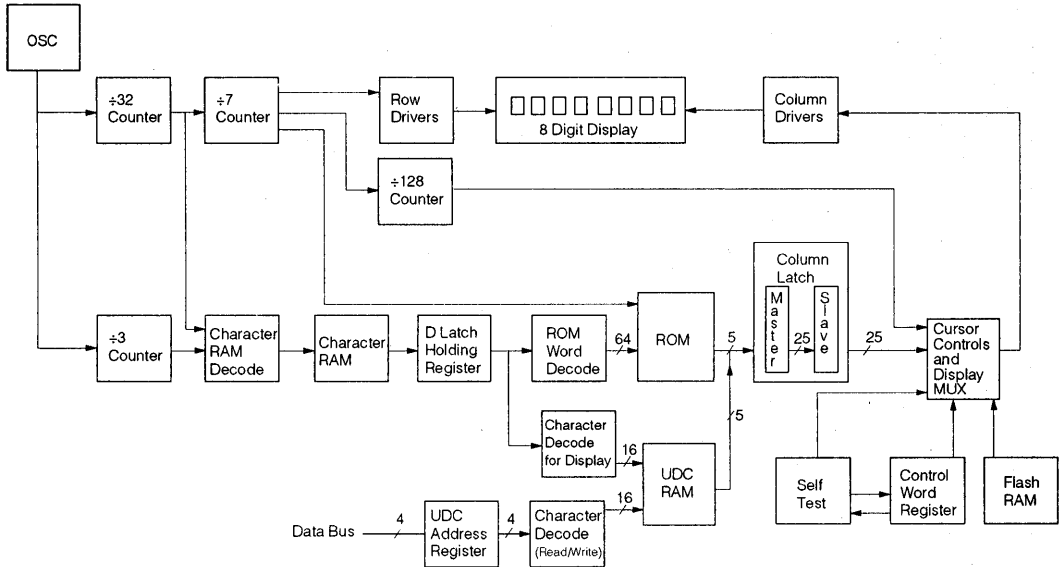

FUNCTIONAL DESCRIPTION

The display's user interface is organized into five memory areas. They are accessed using the Flash Input, \overline{FL} , and address lines, A3 and A4. All the listed RAMs and Registers may be read or written through the data bus. See Table 1. Each input pin is described in Pin Definitions. The five basic memory areas are:

Character RAM	Stores either ASCII character data or an UDC RAM address
Flash RAM	1x 8 RAM which stores Flash data
User-Defined Character RAM (UDC RAM)	Stores dot pattern for custom characters.
User-Defined Character Address Register (UDC Address Register)	Provides an address to UDC RAM when user is writing or reading a custom character
Control Word Register	Enables adjustment of display brightness, flash individual characters, blink, self test or clearing the display.

\overline{RST} can be used to initialize display operation upon power up or during normal operation. When activated, \overline{RST} will clear the Flash RAM and Control Word Register (00H) and reset the internal counter. All eight display memory locations will be set to 20H to show blanks in all digits.

\overline{FL} pin enables access to the **Flash RAM**. The **Flash RAM** will set (D0=1) or reset (D0=0) flashing of the character addressed by A0-A2.

The 1 x 8 bit **Control Word Register** is loaded with attribute data if A3=0.

The **Control Word Logic** decodes attribute data for proper implementation.

Character ROM is designed for 128 ASCII characters. The ROM is Mask Programmable for custom fonts.

The **Clock Source** could either be the internal oscillator (CLKSEL=1) of the device or an external clock (CLKSEL=0) could be an input from another MPD213X display for the synchronization of blinking for multiple displays.

The **Display Multiplexer** controls the Row Drivers so no additional logic is required for a display system.

The **Display** has eight digits. Each digit has 35 LEDs

FL	A4	A3	Section of Memory	A2–A0	Data Bits Used
0	X	X	Flash RAM	Character Address	D0
1	0	0	UDC Address Register	Don't Care	D3–D0
1	0	1	UDC RAM	Row Address	D4–D0
1	1	1	Character RAM	Character Address	D7–D0
1	1	0	Control Word Register	Don't Care	D7–D0

TABLE 1. MEMORY SELECTION

THEORY OF OPERATION

The IPD/MPD213X Display is designed to work with all major microprocessors. Data entry is via an eight bit parallel bus. Three bits of address route the data to the proper digit location in the RAM. Standard control signals like \overline{WR} and \overline{CE} allow the data to be written into the display.

D0–D7 data bits are used for both Character RAM and control word data input. A3 acts as the mode selector. If A3=1, character RAM is selected. Then input data bit D7 will determine whether input data bits D0–D6 is ASCII coded data (D7=0) or UDC data (D7=1). See section on UDC Address Register and RAM.

For normal operation \overline{FL} pin should be held high. When \overline{FL} is held low, Flash RAM is accessed to set character blinking.

The seven bit ASCII code is decoded by the Character ROM to generate Column data. Twenty columns worth of data is sent out each display cycle, and it takes fourteen display cycles to write into eight digits.

The rows are multiplexed in two sets of seven rows each. The internal timing and control logic synchronizes the turning on of rows and presentation of column data to assure proper display operation.

POWER UP SEQUENCE

Upon power up the display will come on at random. Thus the display should be reset on power-up. Reset will clear the Flash RAM, Control Word Register and reset the internal counter. All the digits will show blanks and display brightness level will be 100%.

The display must not be accessed until three clock pulses (110 μ seconds minimum using the internal clock) after the rising edge of the reset line.

MICROPROCESSOR INTERFACE

The interface to a microprocessor is through the 8-bit data bus (D0–D7), the 4-bit address bus (A0–A3) and control lines \overline{FL} , \overline{CE} and \overline{WR} .

To write data (ASCII/Control Word) into the display \overline{CE} should be held low, address and data signals stable and \overline{WR} should be brought low. The data is written on the low to high transition of \overline{WR} .

The Control Word is decoded by the Control Word Decode Logic. Each code has a different function. The code for display brightness changes the duty cycle for the column drivers. The peak LED current stays the same but the average LED current diminishes depending on the intensity level.

The character Flash Enable causes 2 Hz coming out of the counter to be ANDED with the column drive signal to make the column driver cycle at 2 Hz. Thus the character flashes at 2 Hz.

The display Blink works the same way as the Flash Enable but causes all twenty column drivers to cycle at 2 Hz thereby making all eight digits blink at 2 Hz.

The Self Test function of the IC consists of two internal routines which exercise major portions of the IC and illuminates all the LEDs.

Clear bit clears the character RAM and writes a blank into the display memory. It however does not clear the control word.

ASCII Data or Control Word Data can be written into the display at this point. For multiple display operation, CLK I/O must be properly selected. CLK I/O will output the internal clock if CLKSEL=1, or will allow input from an external clock if CLKSEL=0.

Character RAM

The Character RAM is selected when \overline{FL} , A4 and A3 are set to 1, 1, 1 during a read or write cycle. The Character RAM is a 8 by 8 bit RAM with each of the eight locations corresponding to a digit on the display. Digit 0 is on the left side of the display and digit 7 is on the right side of the display. Address lines, A2–A0 select the digit address with A2 being the most significant bit and A0 being the least significant bit. The two types of data stored in the Character RAM are the ASCII coded data and the UDC Address Data. The type of data stored in the Character RAM is determined by data bit, D7. If D7 is low, then ASCII coded data is stored in data bits D6–D0. If D7 is high, then UDC Address Data is stored in data bit D3–D0.

The ASCII coded data is a 7 bit code used to select one of 128 ASCII characters permanently stored in the ASCII ROM.

The UDC Address data is a 4 bit code used to select one of the UDC characters in the UDC RAM. There are up to 16 characters available. See Figure 1.

UDC Address Register and UDC RAM

The UDC Address Register and UDC RAM allows the user to generate and store up to 16 custom characters. Each custom character is defined in 5 x 7 dot matrix pattern. It takes 8 write cycles to define a custom character, one cycle to load the UDC Address Register and 7 cycles to define the character. The contents of the UDC Address Register will store the 4 bit address for one of the 16 UDC RAM locations. The UDC RAM is used to store the custom character.

UDC Address Register

The UDC Address Register is selected by setting $\overline{FL}=1$, A4=0, A3=0. It is a 4 bit register and uses data bits, D3–D0 to store the 4 bit address code (D7–D4 are ignored). The address code selects one of 16 UDC RAM locations for custom character generation.

UDC RAM

The UDC RAM is selected by setting $\overline{FL}=1$, A4=0, A3=1. The RAM is comprised of a 7 x 5 bit RAM. As shown in Figure 4, address lines, A2–A0 select one of the 7 rows of the custom character. Data bits, D4–D0 determine the 5 bits of column data in each row. Each data bit corresponds to a LED. If the data bit is high, then the LED is on. If the data bit is low, the LED is off. To create a character, each of the 7 rows of column data need to be defined. See Figures 2 and 3 for logic.

Flash RAM

The Flash RAM allows the display to flash one or more of the characters being displayed. The Flash Ram is accessed by setting \overline{FL} low. A4 and A3 are ignored. The Flash RAM is a 8 x 1 bit RAM with each bit corresponding to a digit address. Digit 0 is on the left side of the display and digit 7 is on the right side of the display. Address lines, A2–A0 select the digit address with A2 being the most significant digit and A0 being the least significant digit. Data bit, D0, sets and resets the flash bit for each digit. When D0 is high, the flash bit is set and when D0 is low, it is reset. See Figure 4.

\overline{RST}	\overline{CE}	\overline{WR}	\overline{RD}	\overline{FL}	A4	A3	A2	A1	A0	D7	D6	D5	D4	D3	D2	D1	D0
1	0	0	1	1	1	1	Character Address for Digits 0–7			0	7 bit ASCII code for a Write Cycle						
1	0	1	0	1	1	1	Character Address for Digits 0–7			0	7 bit ASCII code read during a Read Cycle						
1	0	0	1	1	0	0	Character Address for Digits 0–7			1	D3–D0=UDC address for a Write Cycle						
1	0	1	0	1	0	0	Character Address for Digits 0–7			1	D3–D0=UDC address for Read Cycle						

FIGURE 1. CHARACTER RAM ACCESS LOGIC

\overline{RST}	\overline{CE}	\overline{WR}	\overline{RD}	\overline{FL}	A4	A3	A2	A1	A0	D7	D6	D5	D4	D3	D2	D1	D0	
1	0	0	1	1	0	0	Not used for UDC Address Register			D3–D0=UDC RAM Address Code for the Write Cycle							UDC Address Register	
1	0	1	0	1	0	0	Not used for UDC Address Register			D3–D0=UDC RAM Address Code during a Read Cycle								
1	0	0	1	1	0	1	A2–A0=Character Row Address			D4–D0=Character Column Data for Write Cycle							UDC RAM	
1	0	1	0	1	0	1	A2–A0=Character Row Address			D4–D0=Character Column Data read during a Read Cycle								

FIGURE 2. UDC ADDRESS REGISTER AND UDC CHARACTER RAM

Control Word

The Control Word is used to set up the attributes required by the user. It is addressed by setting $\overline{FL}=1$, $A4=1$, $A3=0$. The Control Word is an 8 bit register and is accessed using data bits, D7–D0. See Figures 5 and 6 for the logic and attributed control. The Control Word has 5 functions. They are brightness control, flashing character enable, blinking character enable, self test, and clear (Flash and Character RAMS only).

Brightness Control

Control Word bits, D2–D0, control the brightness of the display with a binary code of 000 being 100% brightness and 111 being display blank. See Figure 6 for brightness level versus binary code. The average I_{CC} can be calculated by multiplying the 100% brightness level I_{CC} value by the display's brightness level. For example, a display set to 80% brightness with a 100% average I_{CC} value of 200 mA will have an average I_{CC} value of $200\text{ mA} \times 80\% = 160\text{ mA}$.

Flash Function

Control Word bit, D3, enables or disables the Flash Function. When D3 is 1, the Flash Function is enabled and any digit with its corresponding bit set in the Flash RAM will flash at approximately 2 hertz. When using an external clock, the flash rate can be determined by dividing the clock rate by 28,672. When D3 is 0, the Flash Function is disabled and the contents of the Flash RAM is ignored. For synchronized flashing on multiple displays, see the Reset Section.

Blink Function

Control Word bit, D4, enables or disables the Blink Function. When D4 is 1, the Blink Function is enabled and all characters on the display will blink at approximately 2 hertz. The Blink Function will override the Flash Function if both functions are enabled. When D4 is 0, the Blink Function is disabled. When using an external clock, the blink rate can be determined by dividing the clock rate by 28,672. For synchronized blinking on multiple displays, see the Reset Section.

Row Data				Column Data				
				C1	C2	C3	C4	C5
A2	A1	A0	Row #	D4	D3	D2	D1	D0
0	0	0	1	5 x 7 Dot Matrix Pattern				
0	0	1	2					
0	1	0	3					
0	1	1	4					
1	0	0	5					
1	0	1	6					
1	1	0	7					

FIGURE 3. UDC CHARACTER MAP

Self Test

Control Word bits, D6 and D5, are used for the Self Test Function. When D6 is 1, the Self Test is initiated. Results of the Self Test are stored in bit D5. Control Word bit, D5, is a read only bit. When D5 is 1, Self Test has passed. When D5 is 0, Self Test failed is indicated. The Self Test function of the IC consists of two internal routines which exercise major portions of the IC and illuminates all of the LEDs. The first routine cycles the ASCII decoder ROM through all states and performs a check sum on the out-put. If the check sum is correct, D5 is set to a 1 (Pass).

The second routine provides a visual test of the LEDs. This is accomplished by writing checkered and inversed checkered patterns to the display. Each pattern is displayed for approximately 2 seconds. During the self test function the display must not be accessed. The time needed to execute the self test function is calculated by multiplying the clock time by 262,144 (typical time=4.6 sec.). At the end of the self test, the Character RAM is loaded with blanks; the Control Word Register is set to zeroes except D5; the Flash RAM is cleared and the UDC Address Register is set to all 1s.

\overline{RST}	\overline{CE}	\overline{WR}	\overline{RD}	\overline{FL}	A4	A3	A2	A1	A0	D7	D6	D5	D4	D3	D2	D1	D0
1	0	0	1	1	X	X	Flash RAM Address for Digits 0–7			D0=Flash Data, 0=Flash Off and 1=Flash On (Write Cycle)							
1	0	1	1	0	X	X	Flash RAM Address for Digits 0–7			D0=Flash Data, 0=Flash Off and 1=Flash On (Read Cycle)							

FIGURE 4. FLASH RAM ACCESS LOGIC

\overline{RST}	\overline{CE}	\overline{WR}	\overline{RD}	\overline{FL}	A4	A3	A2	A1	A0	D7	D6	D5	D4	D3	D2	D1	D0
1	0	0	1	1	1	0	Not used for Control Word			Control Word data for a Write Cycle, see Figure 6.							
1	0	1	0	1	1	0	Not used for Control Word			Control Word data for a Read during a Read Cycle.							

FIGURE 5. CONTROL WORD ACCESS LOGIC

Clear Function (see Figures 6 and 7)

Control Word bit, D7 clears the character RAM to 20 hex and the flash RAM to all zeroes. The RAMs are cleared within three clock cycles (110 μs minimum, using the internal clock) when D7 is set to 1. During the clear time the display must not be accessed. When the clear function is finished, bit 7 of the Control Word RAM will be reset to a "0".

Reset Function

The display should be reset on power up of the display (RST=LOW). When the display is reset, the Character RAM, Flash RAM, and Control Word Register are cleared.

The display's internal counters are reset. Reset cycle takes three clock cycles (110 μseconds minimum using the internal clock). The display must not be accessed during this time.

To synchronize the flashing and blinking of multiple displays, it is necessary for the display to use a common clock source and reset all the displays at the same time to start the internal counters at the same place.

While \overline{RST} is low, the display must not be accessed by RD nor \overline{WR} .

D7	D6	D5	D4	D3	D2	D1	D0
C	ST	ST	BL	FL	Br	Br	Br

Key

- C Clear function
- ST Self test
- BL Blink function
- FL Flash function
- Br Brightness control

					0	0	0	100% Brightness
					0	0	1	80% Brightness
					0	1	0	53% Brightness
					0	1	1	40% Brightness
					1	0	0	27% Brightness
					1	0	1	20% Brightness
					1	1	0	13% Brightness
					1	1	1	Blank Display

- 0 Flash Function Disabled
- 1 Flash Function Enabled
- 0 Blink Function Disabled
- 1 Blink Function Enabled (overrides Flash Function)
- 0 X Normal Operation X=bit ignored
- 1 R Run Self Test, R=Test Result, R=1/pass, 0=fail
- 0 Normal Operation
- 1 Clear Flash RAM & Character RAM (Character RAM=20 Hex)

FIGURE 6. CONTROL WORD DATA DEFINITION

\overline{CE}	\overline{WR}	\overline{FL}	A3	A2	A1	A0	D7	D6	D5	D4	D3	D2	D1	D0	Operation
0	0	1	0	X	X	X	0	X	X	X	X	X	X	X	Clear Disabled
0	0	1	0	X	X	X	1	X	X	X	X	X	X	X	Clear User RAM, Flash RAM and Display

FIGURE 7. CLEAR FUNCTION

X=don't care

FIG 8. DISPLAY CYCLE USING BUILT-IN ROM EXAMPLE

Display message "Showtime." Digit 0 is leftmost - Closest to Pin 1.
Logic levels; 0=Low, 1=High, X=Don't care.

\overline{RST}	\overline{CE}	\overline{WR}	\overline{RD}	\overline{FL}	A4	A3	A2	A1	A0	D7	D6	D5	D4	D3	D2	D1	D0	Operation	Display
0	0	1	1	1	X	X	X	X	X	X	X	X	X	X	X	X	X	Reset. No Read/Write Within 3 Clock Cycles	All Blank
1	0	0	1	1	1	0	X	X	X	0	0	X	0	0	0	1	1	53% Brightness Selected	All Blank
1	0	0	1	1	1	1	0	0	0	0	1	0	1	0	0	1	1	Write "S" to Digit 0	S
1	0	0	1	1	1	1	0	0	1	0	1	0	0	1	0	0	0	Write "H" to Digit 1	SH
1	0	0	1	1	1	1	0	1	0	0	1	0	0	1	1	1	1	Write "O" to Digit 2	SHO
1	0	0	1	1	1	1	0	1	1	0	1	0	1	0	1	1	1	Write "W" to Digit 3	SHOW
1	0	0	1	1	1	1	1	0	0	0	1	0	1	0	1	0	0	Write "T" to Digit 4	SHOWT
1	0	0	1	1	1	1	1	0	1	0	1	0	0	1	0	0	1	Write "I" to Digit 5	SHOWTI
1	0	0	1	1	1	1	1	1	0	0	1	0	0	1	1	0	1	Write "M" to Digit 6	SHOWTIM
1	0	0	1	1	1	1	1	1	1	0	1	0	0	0	1	0	1	Write "E" to Digit 7	SHOWTIME

FIG 9. DISPLAYING USER DEFINED CHARACTER EXAMPLE

Load character "A" into UDC-5 and then display it in digit 2
Logic levels: 0=Low, 1=High, X=Don't care.

\overline{RST}	\overline{CE}	\overline{WR}	\overline{RD}	\overline{FL}	A4	A3	A2	A1	A0	D7	D6	D5	D4	D3	D2	D1	D0	Operation	Display
0	0	1	1	1	X	X	X	X	X	X	X	X	X	X	X	X	X	Reset. No Read/Write Within 3 Clock Cycles	All Blank
1	0	0	1	1	0	0	X	X	X	X	X	X	X	0	1	0	1	Select UDC-5	All Blank
1	0	0	1	1	0	1	0	0	0	X	X	X	0	1	1	1	0	Write Into Row 1 of UDC-5	All Blank
1	0	0	1	1	0	1	0	0	1	X	X	X	1	0	0	0	1	Write Into Row 2 of UDC-5	All Blank
1	0	0	1	1	0	1	0	1	0	X	X	X	1	0	0	0	1	Write Into Row 3 of UDC-5	All Blank
1	0	0	1	1	0	1	0	1	1	X	X	X	1	1	1	1	1	Write Into Row 4 of UDC-5	All Blank
1	0	0	1	1	0	1	1	0	0	X	X	X	1	0	0	0	1	Write Into Row 5 of UDC-5	All Blank
1	0	0	1	1	0	1	1	0	1	X	X	X	1	0	0	0	1	Write Into Row 6 of UDC-5	All Blank
1	0	0	1	1	0	1	1	1	0	X	X	X	1	0	0	0	1	Write Into Row 7 of UDC-5	All Blank
1	0	0	1	1	1	1	0	1	0	1	X	X	X	1	0	0	1	Write UDC-5 Into Digit 2	(Digit2) A

ELECTRICAL & MECHANICAL CONSIDERATIONS

VOLTAGE TRANSIENT SUPPRESSION

For best results power the display and the components that interface with the display to avoid logic inputs higher than V_{CC} . Additionally, the LEDs may cause transients in the power supply line while they change display states. The common practice is to place a parallel combination of a .01 μF and a 22 μF capacitor between V_{CC} and GND for all display packages.

ESD PROTECTION

The input protection structure of the IPD/MPD2131X provides significant protection against ESD damage. It is capable of withstanding discharges greater than 4 KV. Take all the standard precautions normal for CMOS components. These include properly grounding personnel, tools, tables, and transport carriers that come in contact with unshielded parts. If these conditions are not, or cannot be met, keep the leads of the device shorted together or the parts in anti-static packaging.

SOLDERING CONSIDERATIONS

THE IPD/MPD213X can be hand soldered with SN63 solder using a grounded iron set to 260°C.

Wave soldering is also possible. Use water soluble organic acid flux or resin based RMA flux.

A wave temperature of 245°C \pm 5°C with a dwell between 1.5 sec. to 3.0 sec. can be used. Exposure to the wave should not exceed temperatures above 260°C for five seconds at 0.063" below the seating plane. The packages should not be immersed in the wave.

POST SOLDER CLEANING PROCEDURES

The least offensive cleaning solution is hot D.I. water (60°C) for less than 15 minutes. Addition of mild saponifiers is acceptable. Do not use commercial dishwasher detergents.

For faster cleaning, solvents may be used. Suggested solvents include Freon TE, Freon TF, Genesolv DE-15, Genesolv DI-15, and Genesolv DES.

An alternative to soldering and cleaning the display modules is to use sockets. Multiple display assemblies are best handled by longer SIP sockets or DIP sockets when available for uniform package alignment. Socket manufacturers are Aries Electronics, Inc., Frenchtown, NJ; Garry Manufacturing, New Brunswick, NJ; Robinson-Nugent, New Albany, IN; and Samtec Electronic Hardware, New Albany, IN.

For further information refer to Appnote 22 in the current Siemens Optoelectronic Data Book.

OPTICAL CONSIDERATIONS

The .200" high character of the IPD/MPD213X gives readability up to eight feet. Proper filter selection enhances readability over this distance.

Using filters emphasizes the contrast ratio between a lit LED and the character background. This will increase the discrimination of different characters. The only limitation is cost. Take into consideration the ambient lighting environment for the best cost/benefit ratio for filters.

Incandescent (with almost no green) or fluorescent (with almost no red) lights do not have the flat spectral response of sunlight. Plastic band-pass filters are an inexpensive and effective way to strengthen contrast ratios. The high efficiency red displays should be matched with a long wavelength pass filter in the 570 nm to 590 nm range. The IPD/MPD2133 should be matched with a yellow-green band-pass filter that peaks at 565 nm. For displays of multiple colors, neutral density grey filters offer the best compromise.

Additional contrast enhancement is gained by shading the displays. Plastic band-pass filters with built-in louvers offer the next step up in contrast improvement. Plastic filters can be improved further with anti-reflective coatings to reduce glare. The trade-off is fuzzy characters. Mounting the filters close to the display reduces this effect. Take care not to overheat the plastic filter by allowing for proper air flow.

Optimal filter enhancements are gained by using circular polarized, anti-reflective, band-pass filters. The circular polarizing further enhances contrast by reducing the light that travels through the filter and reflects back off the display to less than 1%.

Several filter manufacturers supply quality filter materials. Some of them are: Panelgraphic Corporation, W. Caldwell, NJ; SGL Homalite, Wilmington, DE; 3M Company, Visual Products Division, St. Paul, MN; Polaroid Corporation, Polarizer Division, Cambridge, MA; Marks Polarized Corporation, Deer Park, NY; Hoya Optics, Inc., Fremont, CA.

One last note on mounting filters: recessing displays and bezel assemblies is an inexpensive way to provide a shading effect in overhead lighting situations. Several bezel manufacturers are: R.M.F. Products, Batavia, IL; Nobex Components, Griffith Plastic Corp., Burlingame, CA; Photo Chemical Products of California, Santa Monica, CA; I.E.E.-Atlas, Van Nuys, CA.

SIEMENS

HER **MPD2545A TXVB, IPD2545A**
GREEN **MPD2547A TXVB, IPD2547A**
YELLOW **MPD2548A TXVB, IPD2548A**

.25" 4 Character 5x7 Dot Matrix, X-Y Stackable
Industrial and HI-REL/Military Alphanumeric Programmable Display™
with Built-in CMOS Control Functions

Intelligent
Display Devices

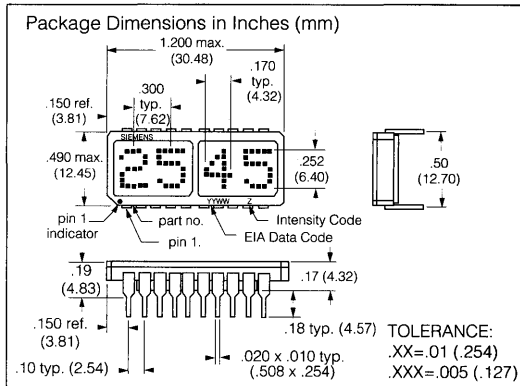
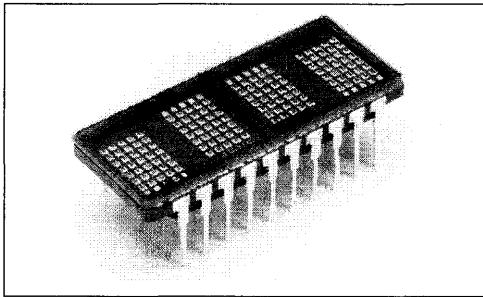

FEATURES

- Four .25" Dot Matrix Characters in Hermetic Package
- Built-in Memory, Decoders, Multiplexer and Drivers
- Viewing Angle, X Axis $\pm 40^\circ$, Y Axis $\pm 75^\circ$
- 128 Character ASCII Format (Upper and Lower Case Characters)
- Rugged Ceramic Package, Hermetic Sealed Flat Glass Window
- Wide Temperature Operating Range for Industrial and HI-REL Use, -55°C to $+100^\circ\text{C}$
- 8 Bit Bidirectional Data BUS
- READ/WRITE Capability
- Built-in Character Generator ROM
- TTL Compatible
- Easily Cascaded for Multidisplay Operation
- Less CPU Time Required
- Software Controlled Features:
 - Programmable Highlight Attribute (Blinking, Non-Blinking)
 - Asynchronous Memory Clear Function
 - Lamp Test
 - Display Blank Function
 - Single or Multiple Character Blinking Function
 - Three Programmable Brightness Levels
- MPD2545/7/8A Process Conforms to MIL-D-87157, Quality Level A Test Tables I, and Group A Table II and can meet Groups B and C Testing Specified in MIL-D-87157
- MPD2545/7/8A TXVB Process Conforms to MIL-D-87157 Quality Level A Test Tables I, II, IIIa, IVa (See High Reliability Test Tables)

DESCRIPTION

The IPD2545A, MPD2545A (high efficiency red), IPD2547A, MPD2547A (green), and IPD2548A, MPD2548A (yellow) are four digit, Industrial/High Reliability, dot matrix, Programmable Displays that are aimed at satisfying the most demanding industrial/ military display requirements.

They are designed for use in extremely harsh environments where only the most reliable product is acceptable. These devices are processed to meet the requirements of HI-REL/Military applications. The devices are constructed in a hermetic package using four 0.25-inch high 5x7 dot matrix displays.

The devices incorporate the latest in CMOS technology which is the heart of the device intelligence. The CMOS controller chip is controlled by a user supplied eight bit data word on the bidirectional BUS. The ASCII data and attribute data are word driven. This approach allows the IPD254XA and MPD254XA to interface using the same techniques as a microprocessor peripheral.

Applications include: military control panels, night viewing applications (red light), cockpit monitors, night vision goggle viewable displays (green), portable and vehicle technology as well as industrial controllers.

Maximum Ratings

DC Supply	-0.5 V to +6.0 Vdc
Input Voltage Relative to GND (all inputs)	-0.5 V to $V_{cc} + 0.5$ Vdc
Operating Temperature	-55°C to $+100^\circ\text{C}$
Storage Temperature	-65°C to $+125^\circ\text{C}$
Thermal Resistance (θ_{JC})	30°C/W

Important: Refer to Appnote 18, "Using and Handling Intelligent Displays." Since this is a CMOS device, normal precautions should be taken to avoid static damage.

OPTICAL CHARACTERISTICS

High Efficiency Red IPD/MPD2545A

Description	Symbol	Min.	Typ. (4)	Max.	Units	Test Conditions
Peak Luminous Intensity per LED (1,3) (Character Average)	I_{Vave}	75	150		μcd	$V_{CC} = 5.0\text{ V}$, # sign "ON" on all digits at full brightness, $T_A = 25^\circ\text{C}$
Peak Wavelength	λ_{PEAK}		635		nm	
Dominant Wavelength (2)	λ_D		626		nm	

High Efficiency Green IPD/MPD2547A

Description	Symbol	Min.	Typ. (4)	Max.	Units	Test Conditions
Peak Luminous Intensity per LED (1,3) (Character Average)	I_{Vave}	75	150		μcd	$V_{CC} = 5.0\text{ V}$, # sign "ON" on all digits at full brightness, $T_A = 25^\circ\text{C}$
Peak Wavelength	λ_{PEAK}		568		nm	
Dominant Wavelength (2)	λ_D		574		nm	

Yellow IPD/MPD2548A

Description	Symbol	Min.	Typ. (4)	Max.	Units	Test Conditions
Peak Luminous Intensity per LED (1,3) (Character Average)	I_{Vave}	75	150		μcd	$V_{CC} = 5.0\text{ V}$, # sign "ON" on all digits at full brightness, $T_A = 25^\circ\text{C}$
Peak Wavelength	λ_{PEAK}		585		nm	
Dominant Wavelength (2)	λ_D		590		nm	

Notes:

- The displays are categorized for luminous intensity with the intensity category designated by a letter code on the bottom of the package.
- Dominant wavelength λ_D is derived from the CIE chromaticity diagram and represents the single wavelength which defines the color of the device.
- The lumious stearence of the LED may be calculated using the following relationships.
 - $LV (\text{cd}/\text{m}^2) = IV (\text{Candela})/A (\text{Meter})^2$
 - $LV (\text{Footlamberts}) = \pi IV (\text{Candela})/A (\text{Foot})^2$
 - $A = 8.4 \times 10^{-7} \text{ ft}^2, 7.8 \times 10^{-8} \text{ m}^2$
- All typical values specified at $V_{CC} = 5.0\text{ V}$ and $T_A = 25^\circ\text{C}$ unless otherwise noted.

DC CHARACTERISTICS

Parameter	-55°C			+25°C			+100°C			Units	Conditions
	Min.	Typ.	Max.	Min.	Typ.	Max.	Min.	Typ.	Max.		
I_{CC} Blank (All Inputs Low)		4	10		2.0	5.0		1	2.5	mA	$V_{CC} = 5\text{ V}$
I_{CC} 80 dots/units (100% Brightness)		220	250		160	190		125	160	mA	$V_{CC} = 5\text{ V}$
V_{IL} (all inputs)			0.8			0.8			0.8	V	$V_{CC} = 5\text{ V} \pm 0.5\text{ V}$
V_{IH} (all inputs)	2.0			2.0			2.0			V	$V_{CC} = 5\text{ V} \pm 0.5\text{ V}$
I_{IL} (all inputs)		70	120		60	100		50	80	μA	$V_{IH} = 0.8\text{ V}$ $V_{CC} = 5.0\text{ V}$

SWITCHING SPECIFICATIONS ($V_{CC}=4.5\text{ V}$)

WRITE CYCLE TIMING					
Parameter	Description	Specification Minimum			
		-55°C	+25°C	+100°C	Units
$T_{CLR}^{(1)}$	Clear RAM	1	1	1	μs
$T_{CLR}^{(1)}$	Clear RAM Disable	1	1	1	μs
T_{AS}	Address Setup	10	10	10	ns
T_{CES}	Chip Enable Setup	0	0	0	ns
T_{RS}	Read Enable Setup	10	10	10	ns
T_{DS}	Data Setup	20	30	50	ns
T_W	Write Pulse	60	70	90	ns
T_{AH}	Address Hold	20	30	40	ns
T_{DH}	Data Hold	20	30	40	ns
T_{CEH}	Chip Enable Hold	0	0	0	ns
T_{RH}	Read Enable Hold	20	30	40	ns
T_{ACC}	Total Access Time=Setup Time + Write Time + Hold Time	90	110	140	ns

SWITCHING SPECIFICATIONS ($V_{CC} = 4.5\text{ V}$)

READ CYCLE TIMING					
Parameter	Description	Specification Minimum			
		-55°C	+25°C	+100°C	Units
T_{AS}	Address Setup	0	0	0	ns
T_{CES}	Chip Enable	0	0	0	ns
T_{WS}	Write Enable Setup	20	30	40	ns
T_{DD}	Data Delay Time	100	150	175	ns
T_R	Read Pulse	150	175	200	ns
T_{AH}	Address Hold	0	0	0	ns
T_{DH}	Data Hold	0	0	0	ns
T_{TRI}	Time to Tristate (Max. time)	30	40	50	ns
T_{CEH}	Chip Enable Hold	0	0	0	ns
T_{WH}	Write Enable Hold	30	40	50	ns
T_{ACC}	Total Access Time = Setup Time + Write Time + Time to Tristate	200	245	290	ns
$T_{WAIT}^{(1)}$	Wait Time between Reads	0	0	0	ns

Notes:

1. Wait 1 μs between any Reads or Writes after writing a Control Word with a Clear ($D7=1$). Wait 1 μs between any Reads or Writes after clearing a Control Word with a Clear ($D7=0$). All other Reads and Writes can be back to back.
2. All input voltages are ($V_{IL}=0.8\text{ V}$, $V_{IH}=2.0\text{ V}$)
3. Data out voltages are measured with 100 pF on the data bus and the ability to source=-40 μA and sink=1.6 mA The rise and fall times are 60 ns. $V_{OL}=0.4\text{ V}$, $V_{OH}=2.4\text{ V}$.

TOP VIEW

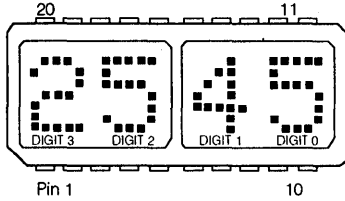

PIN ASSIGNMENTS

1	\overline{RD}	Read	11	\overline{WR}	Write
2	CLK I/O	Clock I/O	12	D7	Data MSB
3	CLKSEL	Clock Select	13	D6	Data
4	RST	Reset	14	D5	Data
5	CE1	Chip Enable	15	D4	Data
6	$\overline{CE0}$	Chip Enable	16	D3	Data
7	A2	Address MSB	17	D2	Data
8	A1	Address	18	D1	Data
9	A0	Address LSB	19	D0	Data LSB
10	GND		20	V_{CC}	

PIN DEFINITIONS

- \overline{RD} Active low, will enable a processor to read all registers.
- CLK I/O If CLK SEL (pin 3) is low, then expect an external clock source into this pin. If CLK SEL is high, then this pin will be the master or source for all other devices which have CLK SEL low.
- CLK SEL CLock SElect determines the action of pin 2, CLK I/O. See the section on Cascading for an example.
- \overline{RST} Reset. Must be held low until $V_{CC} > 4.5 V$. Reset is used only to synchronize blinking and will not clear the display.
- CE1 Chip enable (active high).
- $\overline{CE0}$ Chip enable (active low).
- A2 Address input (MSB).
- A1 Address input.
- A0 Address input (LSB).
- GND Ground.
- \overline{WR} Write. Active low. If the device is selected, a low on the write input loads the data into memory.
- D7 Data Bus bit 7 (MSB).
- D6 Data Bus bit 6.
- D5 Data Bus bit 5.
- D4 Data Bus bit 4.
- D3 Data Bus bit 3.
- D2 Data Bus bit 2.
- D1 Data Bus bit 1.
- D0 Data Bus bit 0 (LSB).
- V_{CC} Positive power pin.

TIMING CHARACTERISTICS DATA "WRITE" CYCLE

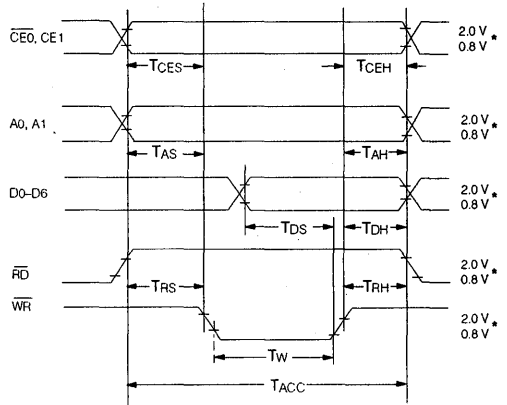

DATA "READ" CYCLE

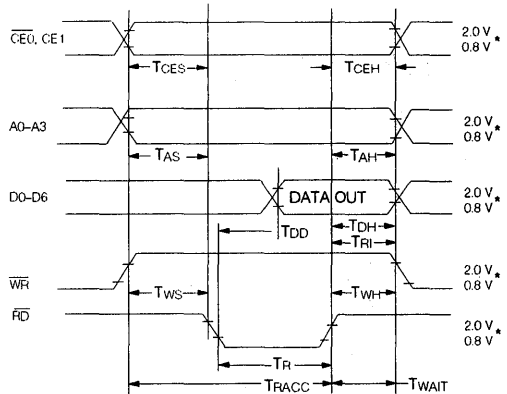

*Notes:

- All input voltages are $V_{IL}=0.8 V$, $V_{IH}=2.0 V$.
- These waveforms are not edge triggered.

BLOCK DIAGRAM

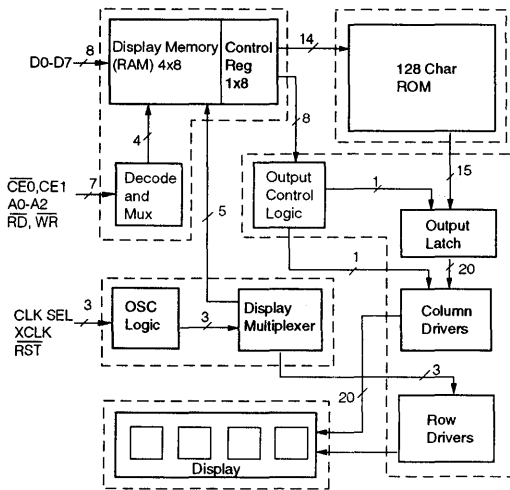

FUNCTIONAL DESCRIPTION

The block diagram includes 5 major blocks and internal registers (indicated by dotted lines).

Display Memory consists of a 5x8 bit RAM block. Each of the four 8-bit words holds the 7-bits of ASCII data (bits D0-D6) and an attribute select bit (Bit D7). The fifth 8-bit memory word is used as a control word register. A detailed description of the control register and its functions can be found under the heading Control Word. Each 8-bit word is addressable and can be read from or written to.

The **Control Logic** dictates all of the features of the display device and is discussed in the Control Word section of this data sheet.

MODE SELECTION

$\overline{CE0}$	CE1	\overline{RD}	\overline{WR}	OPERATION
0	1	0	0	None
1	X	X	X	None
X	0	X	X	None
X	X	1	1	None

Note: 0 = Low Logic Level, 1 = High Logic Level, X = Don't Care.

DATA INPUT COMMANDS

$\overline{CE0}$	CE1	\overline{RD}	\overline{WR}	A2	A1	A0	D7	D6	D5	D4	D3	D2	D1	D0	OPERATION
1	0	X	X	X	X	X	X	X	X	X	X	X	X	X	No Change
0	1	0	1	1	0	0	X	X	X	X	X	X	X	X	Read Digit 0 Data to Bus
0	1	1	0	1	0	0	0	0	1	0	0	1	0	0	(\$) Written to Digit 0
0	1	1	0	1	0	1	0	1	0	1	1	1	1	1	(W) Written to Digit 1
0	1	1	0	1	1	0	0	1	1	0	0	1	1	0	(f) Written to Digit 2
0	1	1	0	1	1	1	0	0	1	1	1	0	0	1	(3) Written to Digit 3
0	1	1	0	1	0	0	1	X	X	X	X	X	X	X	Char Written to Digit 0 and Cursor Enabled

The **Character Generator** converts the 7-bit ASCII data into the proper dot pattern for the 128 characters shown in the character set chart.

The **Clock Source** can originate either from the internal oscillator clock or from an external source—usually from the output of another IPD2545/7/8A and MPD2545/7/8A in a multiple module display.

The **Display Multiplexer** controls all display output to the digit drivers so no additional logic is required for a display system.

The **Column Drivers** are connected directly to the display.

The **Display** has four digits. Each of the four digits is comprised of 35 LEDs in a 5 x 7 dot array which makes up the alphanumeric characters.

The intensity of the display can be varied by the Control Word in steps of 0% (Blank), 25%, 50%, and full brightness.

MICROPROCESSOR INTERFACE

The interface to the microprocessor is through the address lines, (A0–A2), the data bus (D0–D7), two chip select lines ($\overline{CE0}$, CE1), and read (\overline{RD}) and write (\overline{WR}) lines.

The $\overline{CE0}$ should be held low when executing a read, or write operation. CE1 must be held high.

The read and write lines are both active low. During a valid read the data lines (D0–D7) become outputs. A valid write will enable the data lines as inputs.

INPUT BUFFERING

If a cable length of 6 inches or more is used, all inputs to the display should be buffered with a tri-state non-inverting buffer mounted as close to the display as conveniently possible. Recommended buffers are: 74LS245 for the data lines and 74LS244 for the control lines.

PROGRAMMING the IPD2545/7/8A and MPD2545/7/8A

There are five registers within the IPD2545/7/8A and MPD2545/7/8A display. Four of these registers are used to hold the ASCII/attribute code of the four display characters. The fifth register is the Control Word, which is used to blink, blank, clear, or dim the entire display, or to change the presentation (attributes) of individual characters.

ADDRESSING

The addresses within the display device are shown below. Digit 0 is the rightmost digit of the display, while digit 3 is on the left. Although there is only one Control Word, it is duplicated at the four address locations 0-3. Data can be read from any of these locations. When one of these locations is written to, all of them will change together.

Address	Contents
A2 A1 A0	
0 X X	Control Word
1 0 0	Digit 0 (rightmost)
1 0 1	Digit 1
1 1 0	Digit 2
1 1 1	Digit 3 (leftmost)

Bit D7 of any of the display digit locations is used to allow an attribute to be assigned to that digit. The attributes are discussed in the next section. If Bit D7 is set to a one, that character will be displayed using the attribute. If bit D7 is cleared, the character will display normally.

CONTROL WORD

When address bit A2 is taken low, the Control Word is accessed. The same Control Word appears in all four of the lower address spaces of the display. Through the Control Word, the display can be cleared, the lamps can be tested, display brightness can be selected, and attributes can be set for any characters which have been loaded with their most significant bit (D7) set high.

Brightness (D0, D1): The state of the lower two bits of the Control Word are used to set the brightness of the entire display, from 0% to 100%. The table below shows the correspondence of these bits to the brightness.

D7	D6	D5	D4	D3	D2	D1	D0	Operation
0	0	X	X	X	X	0	0	Blank
0	0	X	X	X	X	0	1	25% brightness
0	0	X	X	X	X	1	0	50% brightness
0	0	X	X	X	X	1	1	Full brightness

X = don't care

Attributes (D2-D4): Bits D2, D3, and D4 control the visual attributes (i.e., blinking, alternate) of those display digits which have been written with bit D7 set high. In order to use any of the four attributes, the Cursor Enable bit (D4 in the Control Word) must be set. When the Cursor Enable bit is set, and bit D7 in a character location is set, the character will take on one of the following display attributes.

CONTROL WORD FORMAT

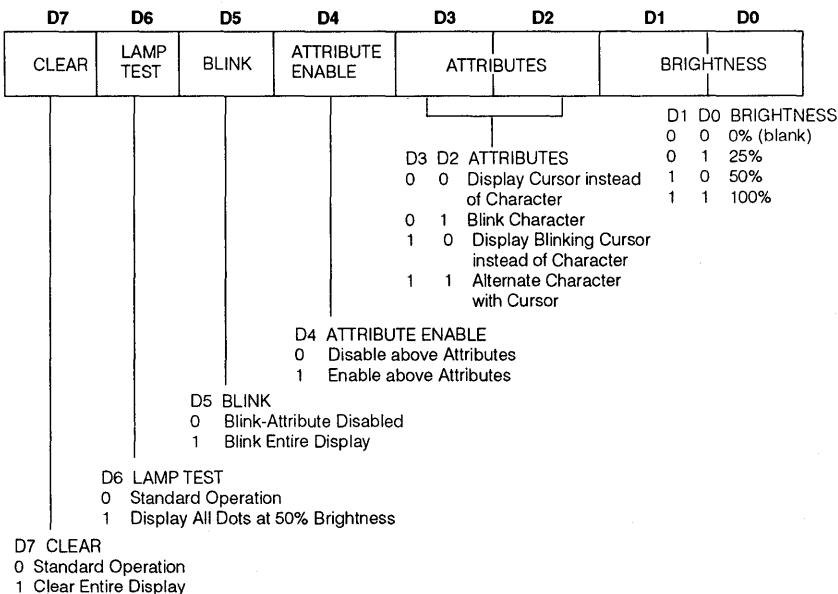

D7	D6	D5	D4	D3	D2	D1	D0	Operation
0	0	0	0	X	X	B	B	Disable highlight attribute
0	0	0	1	0	0	B	B	Display cursor* instead of character
0	0	0	1	0	1	B	B	Blink single character
0	0	0	1	1	0	B	B	Display blinking cursor* instead of character
0	0	0	1	1	1	B	B	Alternate character with cursor*

*"Cursor" refers to a condition when all dots in a single character space are lit to half brightness.
 X = don't care
 B = depends on the selected brightness

Attributes are non-destructive. If a character with bit D7 set is replaced by a cursor (Control Word bit D4 is set, and D3=D2=0) the character will remain in memory and can be revealed again by clearing D4 in the Control Word.

Blink (D5): The entire display can be caused to blink at a rate of approximately 2 Hz by setting bit D5 in the Control Word. This blinking is independent of the state of D7 in all character locations.

To synchronize the blink rate in a bank of these devices, it is necessary to tie all devices' clocks and resets together as described in a later section of this data sheet.

D7	D6	D5	D4	D3	D2	D1	D0	Operation
0	0	1	X	X	X	B	B	Blinking display

Lamp Test (D6): When the Lamp Test bit is set, all dots in the entire display are lit at half brightness. When this bit is cleared, the display returns to the characters that were showing before the lamp test.

D7	D6	D5	D4	D3	D2	D1	D0	Operation
0	1	0	0	X	X	X	X	Lamp test

CASCADING THE DISPLAY

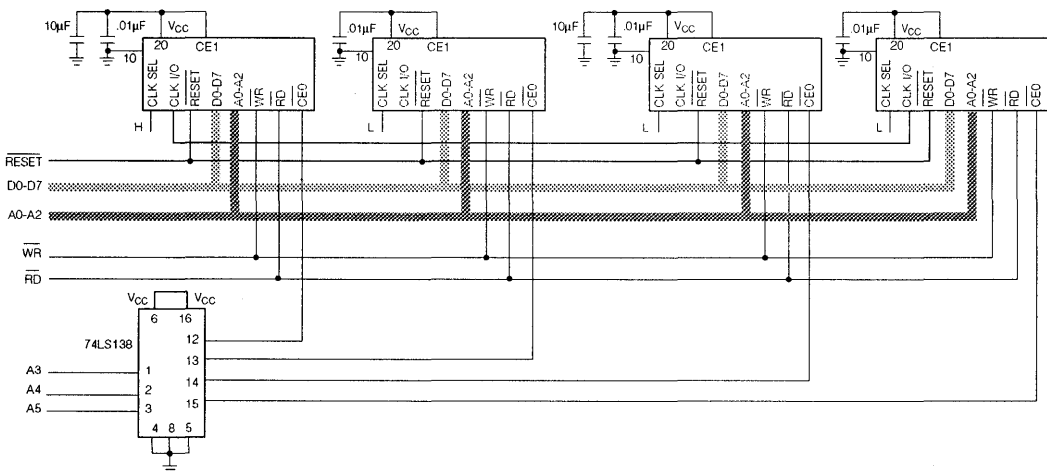

Clear Data (D7): When D7 (D7=1) is set in the Control Word, all display memory bits are reset to zero. A second Control Word must be written into the chip with D7 (D7=0) reset to set up attributes and brightness levels.

D7	D6	D5	D4	D3	D2	D1	D0	Operation
1	0	X	X	X	X	X	X	Clear

CASCADING

Cascading the display is a simple operation. The requirements for cascading are: 1) decoding the correct address to determine the chip select for each additional device, 2) assuring that all devices are reset simultaneously, and 3) selecting one display as the clock source and setting all others to accept clock input (the reason for cascading the clock is to synchronize the flashing of multiple displays). One display as a source is capable of driving six other displays. If more displays are required, a buffer will be necessary. The source display must have pin 3 tied high to output clock signals. All other displays must have pin 3 tied low.

VOLTAGE TRANSIENTS

It has become common practice to provide 0.01 μ f bypass capacitors liberally in digital systems. Like other CMOS circuitry, the Intelligent Display controller chip has very low power consumption and the usual 0.01 μ f would be adequate were it not for the LEDs. To prevent power supply transients, capacitors with low inductance and high capacitance at high frequencies are required. This suggests a solid tantalum or ceramic disc for high frequency bypass. For larger displays, distribute the bypass capacitors evenly, keeping capacitors as close to the power pins as possible. We recommend a 10 μ f and 0.01 μ f for every Intelligent Display to decouple the displays themselves, at the display.

HOW TO LOAD INFORMATION INTO THE IPD25545/7/8A AND THE MPD2545A/7/8A

Information loaded into the IPD2545/7/8A and the MPD2545A/7/8A can be either ASCII data or Control Word data. The following procedure (see also Typical Loading Sequence) will demonstrate a typical loading sequence and the resulting visual display. The word STOP is used in all of the following examples.

SET BRIGHTNESS

Step 1 Set the brightness level of the entire display to your preference (example: 100%)

LOAD FOUR CHARACTERS

Step 2 Load a "S" in the left hand digit.

Step 3 Load a "T" in the next digit.

Step 4 Load an "O" in the next digit.

Step 5 Load a "P" in the right hand digit.
If you loaded the information correctly, the MPD2545A now should show the word "STOP."

BLINK A SINGLE CHARACTER

Step 6 Into the digit, second from the right, load the hex code "CF," which is the code for an "O" with the D7 bit added as a control bit.

Note: the "O" is the only digit which has the control bit (D7) added to normal ASCII data.

Step 7 Load enable blinking character into the control word register. The display now should show "STOP" with a flashing "O".

ADD ANOTHER BLINKING CHARACTER

Step 8 Into the left hand digit, load the hex code "D3" which gives an "S" with the D7 bit added as a control bit. The display should show "STOP" with flashing "O" and a flashing "S."

ALTERNATE CHARACTER/ CURSOR ENABLE

Step 9 Load enable alternate character/cursor into the control word register. The display now should show "STOP" with the "O" and the "S" alternating between the letter and cursor (all dots lit).

INITIATE FOUR CHARACTER BLINKING

(Regardless of Control Bit setting)

Step 10 Load enable display blinking. The display now should show the entire word "STOP" blinking.

TYPICAL LOADING SEQUENCE

	$\overline{CE0}$	CE1	\overline{RD}	\overline{WR}	A2	A1	A0	D7	D6	D5	D4	D3	D2	D1	D0	DISPLAY
1.	L	H	H	L	L	X	X	0	0	0	0	0	0	1	1	S
2.	L	H	H	L	H	H	H	0	1	0	1	0	0	1	1	ST
3.	L	H	H	L	H	H	L	0	1	0	1	0	1	0	0	STO
4.	L	H	H	L	H	L	H	0	1	0	0	1	1	1	1	STOP
5.	L	H	H	L	H	L	L	0	1	0	1	0	0	0	0	STOP
6.	L	H	H	L	H	L	H	1	1	0	0	1	1	1	1	STOP
7.	L	H	H	L	L	X	X	0	0	0	1	0	1	1	1	STOP*P
8.	L	H	H	L	H	H	H	1	1	0	1	0	0	1	1	S*TO*P
9.	L	H	H	L	L	X	X	0	0	0	1	1	1	1	1	S†TO†P
10.	L	H	H	L	L	X	X	0	0	1	0	0	0	1	1	S*†O*P*

* Blinking character
† Character alternating with cursor (all dots lit)

ELECTRICAL AND MECHANICAL CONSIDERATIONS

The CMOS IC of the IPD2545/7/8A and the MPD2545/7/8A are designed to provide resistance to both Electrostatic and Discharge Damage and Latch Up due to voltage or current surges. Several precautions are strongly recommended for the user, to avoid overstressing these built-in safeguards.

ESD PROTECTION

Users of the IPD2545/7/8A and the MPD2545/7/8A should be careful to handle the devices consistent with standard ESD protection procedures. Operators should wear appropriate wrist, ankle or foot ground straps and avoid clothing that collects static charges. Work surfaces, tools and transport carriers that come into contact with unshielded devices or assemblies also should be appropriately grounded.

LATCH UP PROTECTION

Latch up is condition that occurs in CMOS ICs after the input protection diodes have been broken down. These diodes can be reversed through several means.

$V_{IN} < GND$, $V_{IN} > V_{CC} + 0.5 V$, or through excessive currents begin forced on the inputs. When these situations exist, the IC may develop the response of an SCR and begin conducting as much as one amp through the V_{CC} pin. This destructive condition will persist (latched) until device failure or the device is turned off.

The Voltage Transient Suppression Techniques and buffer interfaces for longer cable runs help considerably to prevent latch conditions from occurring. Additionally, the following Power Up and Power Down sequence should be observed.

POWER UP SEQUENCE

1. Float all active signals by tri-stating the inputs to the displays.
2. Apply V_{CC} and GND to the display.
3. Apply active signals to the displays by enabling all input signals per applications.

POWER DOWN SEQUENCE

1. Float all active signals by tri-stating the inputs to the displays.
2. Turn off the power to the display.

CHARACTER SET

ASCII CODE	D0	0	1	0	1	0	1	0	1	0	1	0	1	0	1	0	1		
	D1	0	0	1	1	0	0	1	1	0	0	1	1	0	0	1	1		
	D2	0	0	0	0	1	1	1	1	0	0	0	0	1	1	1	1		
	D3	0	0	0	0	0	0	0	0	1	1	1	1	1	1	1	1		
D6	D5	D4	HEX	0	1	2	3	4	5	6	7	8	9	A	B	C	D	E	F
0	0	0	0	0	1	2	3	4	5	6	7	8	9	A	B	C	D	E	F
0	0	1	1	0	1	2	3	4	5	6	7	8	9	A	B	C	D	E	F
0	1	0	2	3	4	5	6	7	8	9	A	B	C	D	E	F			
0	1	1	3	4	5	6	7	8	9	A	B	C	D	E	F				
1	0	0	4	5	6	7	8	9	A	B	C	D	E	F					
1	0	1	5	6	7	8	9	A	B	C	D	E	F						
1	1	0	6	7	8	9	A	B	C	D	E	F							
1	1	1	7	8	9	A	B	C	D	E	F								

Notes:
 1. A2 must be held high for ASCII data.
 2. Bit D7 = 1 enables attributes for the assigned digit.

GENERAL QUALITY ASSURANCE LEVELS

The parts are tested in conformance with Quality Level A of MIL-D-87157 for hermetically sealed LED displays with 100% screening.

Intelligent Display Devices

SIEMENS

RED MSD2010 TXVB, ISD2010
YELLOW MSD2011 TXVB, ISD2011
HIGH EFF. RED MSD2012 TXVB, ISD2012
HIGH EFF. GREEN MSD2013 TXVB, ISD2013
.150" 4-Character 5x7 Dot Matrix
Serial Input Alphanumeric Industrial/Hi-REL Display

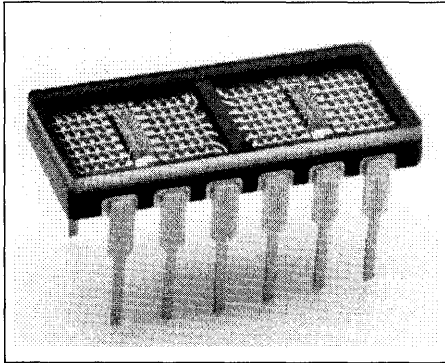

FEATURES

- Four 0.150" Dot Matrix Characters
- Four Colors: Red, Yellow, High Efficiency Red, High Efficiency Green
- Wide Viewing Angle
- Built-in CMOS Shift Registers with Constant Current LED Row Drivers
- Shift Registers Allow Custom Fonts
- Easily Cascaded for Multiple Displays
- TTL Compatible
- End Stackable
- HI-REL Operating Temperature Range: -55 ° to + 100 °C
- Categorized for Luminous Intensity
- Ceramic Package, Hermetically Sealed Flat Glass Window
- MSD2010/1/2/3 Process Conforms to MIL-D-87157 Quality Level A Test Tables I and II and also can meet Groups B and C Testing Specified in MIL-D-87157
- MSD2010/1/2/3 TXVB Conforms to MIL-D-87157 Quality Level A Test Tables I, II, III and IVa (See High Reliability Test Tables)

See Appnote 44 for application information and Appnotes 18, 19, 22, 23 for additional information.

Package Dimensions in Inches (mm)

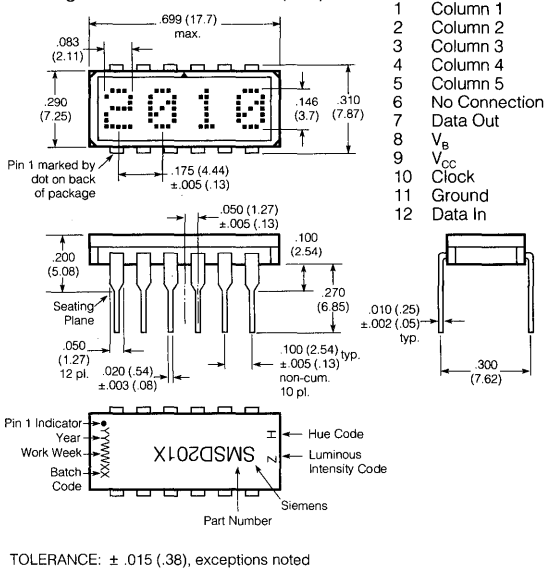

DESCRIPTION

The ISD2010/1/1/3, MSD2010/1/1/3 TXVB are four digit 5x7 dot matrix serial input alphanumeric displays. The displays are available in red, yellow, high efficiency red, or high efficiency green. The package is a standard twelve-pin hermetic DIP with glass lens. The display can be stacked horizontally or vertically to form messages of any length.

The IDS201X and MSD201X have two fourteen-bit CMOS shift registers with built-in row drivers. These shift registers drive twenty-eight rows and enable the design of customized fonts. Cascading multiple displays is possible because of the Data In and Data Out pins. Data In and Out are easily input with the clock signal and displayed in parallel on the row drivers. Data Out represents the output of the 7th bit of digit number four shift register. The shift register is level triggered. The like columns of each character in a display cluster are tied to a single pin (see Block Diagram). High true data in the shift register enables the output current mirror driver stage associated with each row of LEDs in the 5x7 diode array.

The TTL compatible V_B input may either be tied to V_{CC} for maximum display intensity or pulse width modulated to achieve intensity control and reduce power consumption.

—Continued

DESCRIPTION (Continued)

In the normal mode of operation, input data for digit four, column one is loaded into the seven on-board shift register locations one through seven. Column one data for digits 3, 2, and 1 is shifted into the display shift register locations. Then column one input is enabled for an appropriate period of time, T. A similar process is repeated for columns 2, 3, 4, and 5. If the decode time and load data time into the shift register is t, then with five columns, each column of the display is operating at a duty factor of:

$$DF = \frac{T}{5(T+t)}$$

T+t, allotted to each display column, is generally chosen to provide the maximum duty factor consistent with the minimum refresh rate necessary to achieve a flicker free display. For most strobed display systems, each column of the display should be refreshed (turned on) at a minimum rate of 100 times per second.

With columns to be addressed, this refresh rate then gives a value for the time T+t of: $1/[5 \times (100)] = 2$ msec. If the device is operated at 5.0 MHz clock rate maximum, it is possible to maintain $t < T$. For short display strings, the duty factor will then approach 20%.

Maximum Ratings

- Supply Voltage V_{CC} to GND -0.5 V to + 7.0 V
- Inputs, Data Out and V_B -0.5 V to V_{CC} + 0.5 V
- Column Input Voltage, V_{COL} -0.5 V to + 6.0 V
- Operating Temperature Range -55°C to +100°C
- Storage Temperature Range -65°C to + 125°C
- Maximum Solder Temperature, 0.063" (1.59 mm) below Seating Plane, $t < 5$ sec 260°C
- Maximum Allowable Power Dissipation, $T_A = 25$ C⁽²⁾
- Red 0.91 W
- Yellow, HER, High Efficiency Green 0.86 W

Notes:

1. Operation above +100°C ambient is possible if the following conditions are met. The junction should not exceed $T_J = 125^\circ\text{C}$ and the case temperature (as measured at pin 1 or the back of the display) should not exceed $T_C = 100^\circ\text{C}$.
2. Maximum allowable dissipation is derived from $V_{CC} = 5.25$ V, $V_B = 2.4$ V, $V_{COL} = 3.5$ V, 20 LEDs on per character, 20% DF.

FIGURE 2. MAX. ALLOWABLE POWER DISSIPATION VS. TEMPERATURE

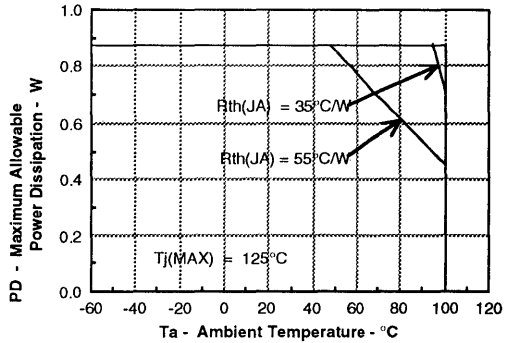

AC ELECTRICAL CHARACTERISTICS

($V_{CC} = 4.75$ to 5.25 V, $T_A = -55^\circ\text{C}$ to $+100^\circ\text{C}$)

Symbol	Description	Min.	Typ.	Max. ⁽¹⁾	Units	Fig.
T_{SETUP}	Setup Time	50	10		ns	1
T_{HOLD}	Hold Time	25	20		ns	1
T_{WL}	Clock Width Low	75	45		ns	1
T_{WH}	Clock Width High	75	45		ns	1
$F_{(CLK)}$	Clock Frequency		6	5	MHz	1
T_{THL} T_{TLH}	Clock Transition Time		75	200	ns	1
T_{PHL} T_{PLH}	Propagation Delay Clock to Data Out		50	125	ns	1

Notes:

1. All typical values specified at $V_{CC} = 5.0$ V and $T_A = 25^\circ\text{C}$ unless otherwise noted.
2. V_B Pulse Width Modulation Frequency—50 KHz (max).

FIGURE 1. TIMING CHARACTERISTICS

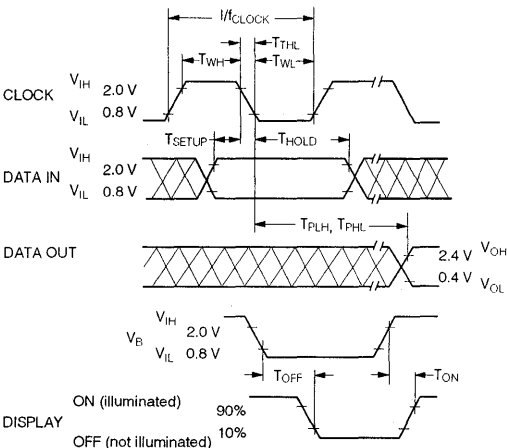

RECOMMENDED OPERATING CONDITIONS

Parameter	Symbol	Min.	Nom.	Max.	Units
Supply Voltage	V_{CC}	4.75	5.0	5.25	V
Data Out Current, Low State	I_{OL}			1.6	mA
Data Out Current, High State	I_{OH}			-0.5	mA
Column Input Voltage, Column On ⁽¹⁾	V_{COL}	2.75		3.5	V
Setup Time	T_{SETUP}	70	45		ns
Hold Time	T_{HOLD}	30			ns
Width of Clock	$T_{W(CLK)}$	75			ns
Clock Frequency	T_{CLK}			5	MHz
Clock Transition Time	T_{THL}			200	ns
Free Air Operating Temperature Range	T_{amb}	-55		+100	°C

Note: 1. See Figure 3—Peak Column Current vs. Column Voltage

OPTICAL CHARACTERISTICS

Red ISD/MSD2010

Description	Symbol	Min.	Typ. ⁽⁴⁾	Max.	Units	Test Conditions
Peak Luminous Intensity per LED ^(1,3) (Character Average)	I_{VPEAK}	105	200		μcd	$V_{CC} = 5.0\text{ V}$, $V_{COL} = 3.5\text{ V}$ $T_J^{(5)} = 25^\circ\text{C}$, $V_B = 2.4\text{ V}$
Peak Wavelength	λ_{VPEAK}		655		nm	
Dominant Wavelength ⁽²⁾	λ_D		639		nm	

Yellow ISD/MSD2011

Description	Symbol	Min.	Typ. ⁽⁴⁾	Max.	Units	Test Conditions
Peak Luminous Intensity per LED ^(1,3) (Character Average)	I_{VPEAK}	400	750		μcd	$V_{CC} = 5.0\text{ V}$, $V_{COL} = 3.5\text{ V}$ $T_J^{(5)} = 25^\circ\text{C}$, $V_B = 2.4\text{ V}$
Peak Wavelength	λ_{VPEAK}		583		nm	
Dominant Wavelength ⁽²⁾	λ_D		585		nm	

High Efficiency Red ISD/MSD2012

Description	Symbol	Min.	Typ. ⁽⁴⁾	Max.	Units	Test Conditions
Peak Luminous Intensity per LED ^(1,3) (Character Average)	I_{VPEAK}	400	1430		μcd	$V_{CC} = 5.0\text{ V}$, $V_{COL} = 3.5\text{ V}$ $T_J^{(5)} = 25^\circ\text{C}$, $V_B = 2.4\text{ V}$
Peak Wavelength	λ_{VPEAK}		635		nm	
Dominant Wavelength ⁽²⁾	λ_D		626		nm	

High Efficiency Green ISD/MSD2013

Description	Symbol	Min.	Typ. ⁽⁴⁾	Max.	Units	Test Conditions
Peak Luminous Intensity per LED ^(1,3) Character Average)	I_{VPEAK}	850	1550		μcd	$V_{CC} = 5.0\text{ V}$, $V_{COL} = 3.5\text{ V}$ $T_J^{(5)} = 25^\circ\text{C}$, $V_B = 2.4\text{ V}$
Peak Wavelength	λ_{VPEAK}		568		nm	
Dominant Wavelength ⁽²⁾	λ_D		574		nm	

Notes:

- The displays are categorized for luminous intensity with the intensity category designated by a letter code on the bottom of the package.
- Dominant wavelength (λ_D) is derived from the CIE chromaticity diagram and represents the single wavelength which defines the color of the device
- The luminous sterance of the LED may be calculated using the following relationships:

$$L_v (\text{cd/m}^2) = I_v (\text{Candela})/A (\text{Meter})^2$$

$$L_v (\text{Footlamberts}) = \pi I_v (\text{Candela})/A (\text{Foot})^2$$

$$A = 5.3 \times 10^{-6} \text{ M}^2 = 5.8 \times 10^{-7} (\text{Foot})^2$$
- All typical values specified at $V_{CC} = 5.0\text{ V}$ and $T_A = 25^\circ\text{C}$ unless otherwise noted.
- The luminous intensity is measured at $T_A = T_J = 25^\circ\text{C}$. No time is allowed for the device to warm up prior to measurement.

ELECTRICAL CHARACTERISTICS (-55°C to +100°C) (unless otherwise specified)

Description	Symbol	Min.	Typ. ⁽¹⁾	Max.	Units	Test Conditions	
Supply Current (quiescent)	I_{CC}		2	5.0	mA	$V_B = 0.4\text{ V}$	$V_{CC} = 5.25\text{ V}$ $V_{CLK} = V_{DATA} = 2.4\text{ V}$ All SR Stages = Logical 1
			2.5	5.0	mA	$V_B = 2.4\text{ V}$	
Supply Current (operating)	I_{CC}		3	10.0	mA	$F_{CLK} = 5\text{ MHz}$	
Column Current at any Column Input ⁽²⁾	All I_{COL}			10	μA	$V_B = 0.4\text{ V}$	$V_{CC} = 5.25\text{ V}$ $V_{COL} = 3.5\text{ V}$ All SR Stages = Logical 1
	Red I_{COL}		350	435			
	Yellow, HER, Green I_{COL}		335	410	mA	$V_B = 2.4\text{ V}$	
V_B , Clock or Data Input Threshold Low	V_{IL}			0.8	V	$V_{CC} = 4.75\text{ V} - 5.25\text{ V}$	
V_B , Clock or Data Input Threshold High	V_{IH}	2.0			V		
Data Out Voltage	V_{OH}	2.4	3.6		V	$I_{OH} = -0.5\text{ mA}$	$V_{CC} = 5.25\text{ V}$ $I_{COL} = 0\text{ mA}$
	V_{OL}		0.2	0.4	V	$I_{OL} = 1.6\text{ mA}$	
Input Current Logical 0 V_B only	I_{IL}	-30	-110	-300	μA	$V_{CC} = 4.75\text{ V} - 5.25\text{ V}$, $V_{IL} = 0.8\text{ V}$	
Input Current Logical 0 Data, Clock	I_{IL}		-1	-10	μA		
Power Dissipation per Package	P_D		0.44		W	$V_{CC} = 5.0$, $V_{COL} = 3.5\text{ V}$, 17.5% DF 15 LEDs on per character, $V_B = 2.4\text{ V}$	
Thermal Resistance IC Junction-to-Pin	$R\theta_{J-PIN}$		30		$^{\circ}\text{C/W/Device}$		

Notes:

1. All typical values specified at $V_{CC} = 5.0\text{ V}$ and $T_A = 25^{\circ}\text{C}$ unless otherwise noted.
2. See Figure 3-Peak Column Current vs. Column Voltage

FIGURE 3. PEAK COLUMN CURRENT VS. COLUMN VOLTAGE

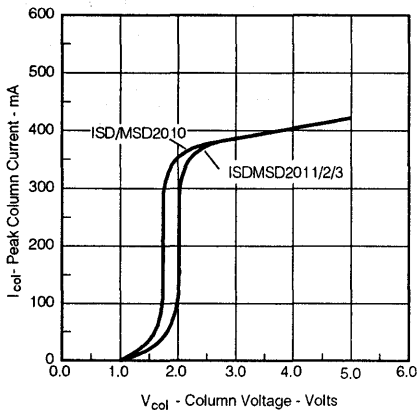
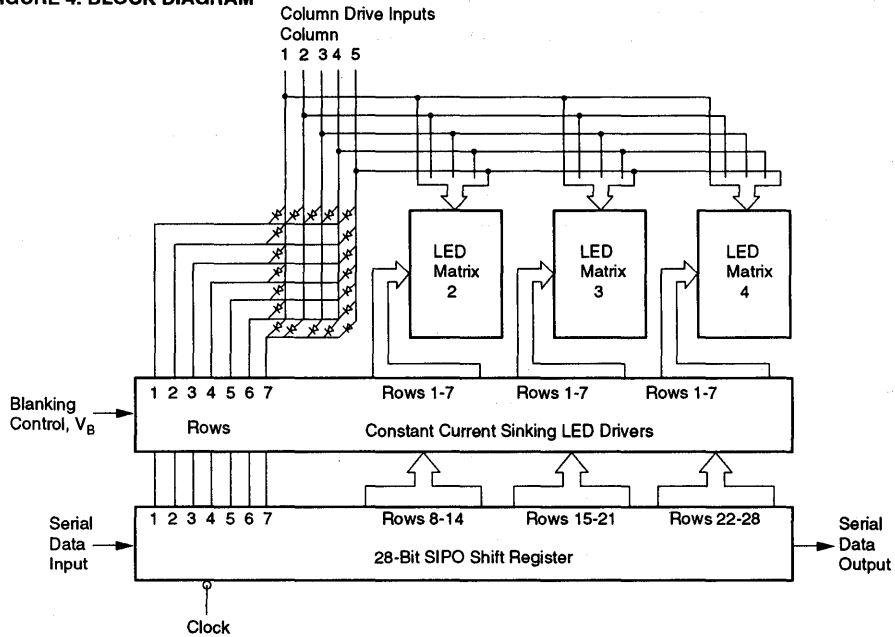

FIGURE 4. BLOCK DIAGRAM



CONTRAST ENHANCEMENT FILTERS for SUNLIGHT READABILITY

Display Color Part No.	Filter Color	Marks Polarized Corp.*	Optical Characteristics of Filter
Red, HER ISD/MSD2010/2	Red	MPC 20-15C	25% at 635 nm, Circular Polarizer
Yellow IDS/MSD2011	Amber	MPC 30-25C	25% at 583 nm, Circular Polarizer
Green IDS/MSD2013	Yellow/Green	MPC 50-22C	22% at 568 nm, Circular Polarizer
Multiple Colors High Ambient Light	Neutral Gray	MPC 80-10C	10% Neutral, Circular Polarizer
Multiple Colors	Neutral Gray	MPC 80-37C	37% Neutral, Circular Polarizer

* Marks Polarized Corp.
25-B Jefryn Blvd. W.
Deer Park, NY 11729
516/242-1300
FAX 516/242-1347
Marks Polarized Corp. manufactures
to MIL-1-45208 inspection system.

THERMAL CONSIDERATIONS

The small alphanumeric displays are hybrid LED and CMOS assemblies that are designed for reliable operation in commercial, industrial, and military environments. Optimum reliability and optical performance will result when the junction temperature of the LEDs and CMOS ICs are kept as low as possible.

THERMAL MODELING

MSD201X displays consist of two driver ICs and four 5x7 LED matrixes. A thermal model of the display is shown in Figure 5. It illustrates that the junction temperature of the semiconductor = junction self heating + the case temperature rise + the ambient temperature. Equation 1 shows this relationship.

FIGURE 5. THERMAL MODEL

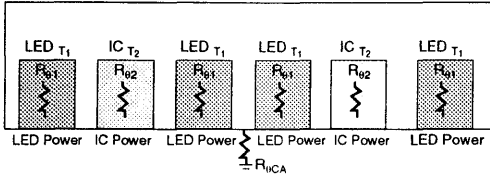

See Equation 1 below.

The junction rise within the LED is the product of the thermal impedance of an individual LED (37°C/W, DF=20%, F=200 Hz), times the forward voltage, $V_{F(LED)}$, and forward current $I_{F(LED)}$, of 13 - 14.5 mA. This rise averages $T_{J(LED)} = 1^\circ\text{C}$. The table below shows the $V_{F(LED)}$ for the respective displays.

Model Number	VF		
	Min.	Typ.	Max.
MSD2010	1.6	1.7	2.0
MSD2011/2/3	1.9	2.2	3.0

The junction rise within the LED driver IC is the combination of the power dissipated by the IC quiescent current and the 28 row driver current sinks. The IC junction rise is given in Equation 2.

A thermal resistance of 28°C/W results in a typical junction rise of 6°C.

See Equation 2 below.

Equation 1.

$$T_{J(LED)} = P_{LED} Z_{\theta JC} + P_{CASE} (R_{\theta JC} + R_{\theta CA}) + T_A$$

$$T_{J(LED)} = [(I_{COL}/28) V_{F(LED)} Z_{\theta JC}] + [(n/35) I_{COL} DF (5 V_{COL}) + V_{CC} I_{CC}] \cdot [R_{\theta JC} + R_{\theta CA}] + T_A$$

Equation 2.

$$T_{J(IC)} = P_{COL} (R_{\theta JC} + R_{\theta CA}) + T_A$$

$$T_{J(IC)} = [5 (V_{COL} - V_{F(LED)}) \cdot (I_{COL}/2) \cdot (n/35) DF + V_{CC} \cdot I_{CC}] \cdot [R_{\theta JC} + R_{\theta CA}] + T_A$$

For ease of calculations the maximum allowable electrical operating condition is dependent upon the aggregate thermal resistance of the LED matrixes and the two driver ICs. All of the thermal management calculations are based upon the parallel combination of these two networks which is 15°C/W. Maximum allowable power dissipation is given in Equation 3.

Equation 3.

$$P_{DISPLAY} = \frac{T_{J(MAX)} - T_A}{R_{\theta JC} + R_{\theta CA}}$$

$$P_{DISPLAY} = 5 V_{COL} I_{COL} (n/35) DF + V_{CC} I_{CC}$$

For further reference see Figures 2, 7, 8, 9, 10 and 11.

KEY TO EQUATION SYMBOLS

- DF Duty factor
- I_{CC} Quiescent IC current
- I_{COL} Column current
- n Number of LEDs on in a 5 x 7 array
- P_{CASE} Package power dissipation excluding LED under consideration
- P_{COL} Power dissipation of a column
- $P_{DISPLAY}$ Power dissipation of the display
- P_{LED} Power dissipation of an LED
- $R_{\theta CA}$ Thermal resistance case to ambient
- $R_{\theta JC}$ Thermal resistance junction to case
- T_A Ambient temperature
- $T_{J(IC)}$ Junction temperature of an IC
- $T_{J(LED)}$ Junction temperature of a LED
- $T_{J(MAX)}$ Maximum junction temperature
- V_{CC} IC voltage
- V_{COL} Column voltage
- $V_{F(LED)}$ Forward voltage of LED
- $Z_{\theta JC}$ Thermal impedance junction to case

OPTICAL CONSIDERATIONS

The light output of the LEDs is inversely related to the LED diode's junction temperature as shown in Figure 6. For optimum light output, keep the thermal resistance of the socket or PC board as low as possible.

FIGURE 6. NORMALIZED LUMINOUS INTENSITY VS. JUNCTION TEMPERATURE

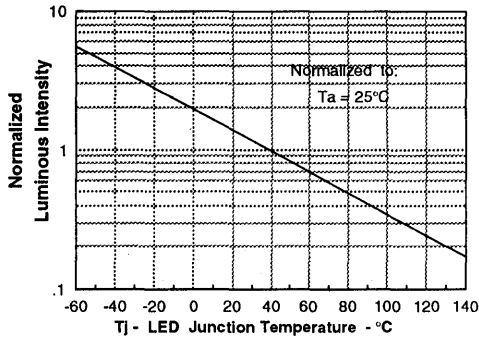

When mounted in a 10°C/W socket and operated at Absolute Maximum Electrical conditions, the HDSP230XLP will show an LED junction rise of 17°C. If T_A = 40°C, then the LED's T_J will be 57°C. Under these conditions Figure 7 shows that the I_V will be 75% of its 25°C value.

FIGURE 7. MAX. LED JUNCTION TEMPERATURE VS. SOCKET THERMAL RESISTANCE

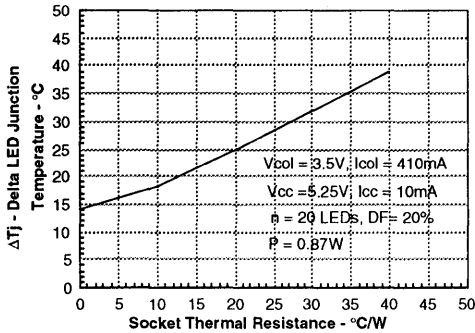

FIGURE 8. MAX. PACKAGE POWER DISSIPATION

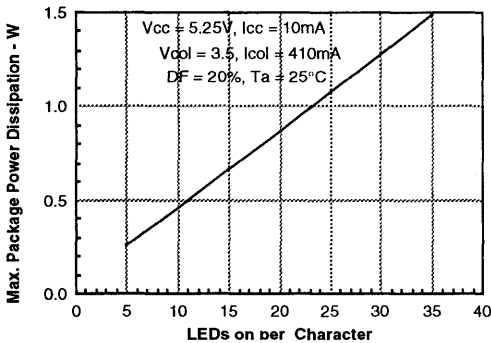

FIGURE 9. PACKAGE POWER DISSIPATION

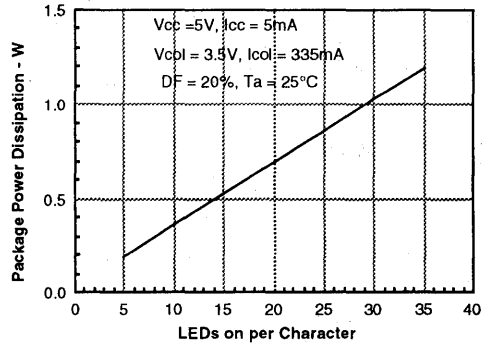

FIGURE 10. MAX. CHARACTER POWER DISSIPATION

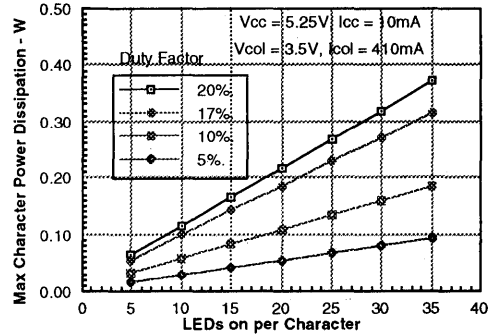
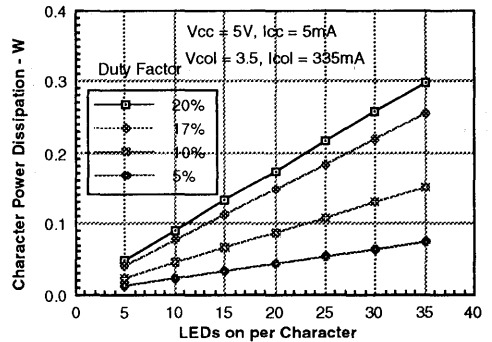
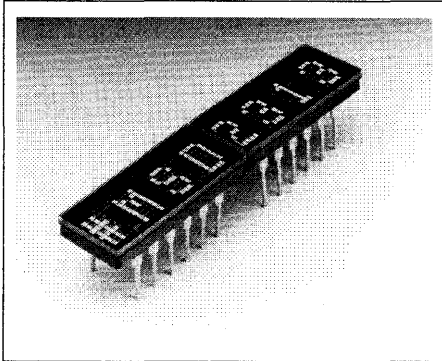

FIGURE 11. CHARACTER POWER DISSIPATION



SIEMENS

RED MSD2310 TXVB, ISD2310 YELLOW MSD2311 TXVB, ISD2311 HIGH EFF. RED MSD2312 TXVB, ISD2312 HIGH EFF. GREEN MSD2313 TXVB, ISD2313 .200" 4-Character 5x7 Dot Matrix Serial Input Alphanumeric Industrial/Hi-REL Display



FEATURES

- Four 0.200" Dot Matrix Characters
- Four Colors: Red, Yellow, High Efficiency Red, High Efficiency Green
- Wide Viewing Angle
- Built-in CMOS Shift Registers with Constant Current LED Row Drivers
- Shift Registers Allow Custom Fonts
- Easily Cascaded for Multiple Displays
- TTL Compatible
- End Stackable
- HI-REL Operating Temperature Range: -55 ° to + 100 °C
- Categorized for Luminous Intensity
- Ceramic Package, Hermetically Sealed Flat Glass Window
- MSD2310/1/2/3 Process Conforms to MIL-D-87157 Quality Level A Test Tables I and II and also can meet Groups B and C Testing Specified in MIL-D-87157
- MSD2310/1/2/3 TXVB Conforms to MIL-D-87157 Quality Level A Test Tables I, II, III and IVa (See High Reliability Test Tables)

See Appnote 44 for application information and Appnotes 18, 19, 22, 23 for additional information.

Package Dimensions in Inches (mm)

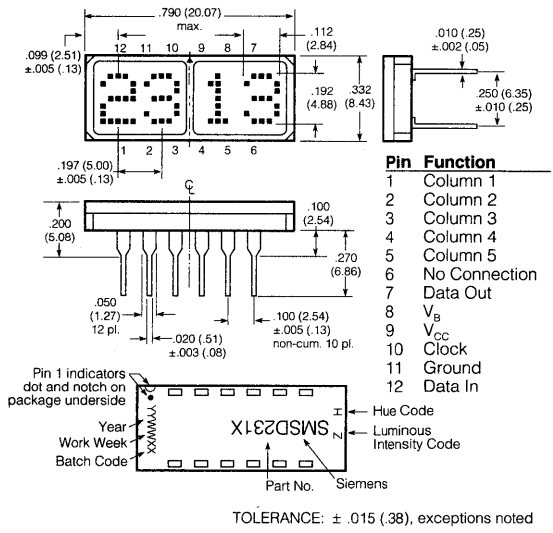

DESCRIPTION

The ISD2310/1/2/3, MSD2310/1/2/3 TXVB are four digit 5 x 7 dot matrix serial input alphanumeric displays. The displays are available in red, yellow, high efficiency red, or high efficiency green. The package is a standard twelve-pin hermetic DIP with glass lens. The display can be stacked horizontally or vertically to form messages of any length.

The ISD231X and MSD231X have two fourteen-bit CMOS shift registers with built-in row drivers. These shift registers drive twenty-eight rows and enable the design of customized fonts. Cascading multiple displays is possible because of the Data In and Data Out pins. Data In and Out are easily input with the clock signal and displayed in parallel on the row drivers. Data Out represents the output of the 7th bit of digit number four shift register. The shift register is level triggered. The like columns of each character in a display cluster are tied to a single pin (see Block Diagram). High true data in the shift register enables the output current mirror driver stage associated with each row of LEDs in the 5x7 diode array.

The TTL compatible V_B input may either be tied to V_{CC} for maximum display intensity or pulse width modulated to achieve intensity control and reduce power consumption.

—Continued

DESCRIPTION (Continued)

In the normal mode of operation, input data for digit four, column one is loaded into the seven on-board shift register locations one through seven. Column one data for digits 3, 2, and 1 is shifted into the display shift register locations. Then column one input is enabled for an appropriate period of time, T . A similar process is repeated for columns 2, 3, 4, and 5. If the decode time and load data time into the shift register is t , then with five columns, each column of the display is operating at a duty factor of:

$$DF = \frac{T}{5(T+t)}$$

$T+t$, allotted to each display column, is generally chosen to provide the maximum duty factor consistent with the minimum refresh rate necessary to achieve a flicker free display. For most strobed display systems, each column of the display should be refreshed (turned on) at a minimum rate of 100 times per second.

With columns to be addressed, this refresh rate then gives a value for the time $T+t$ of: $1/[5 \times (100)] = 2$ msec. If the device is operated at 5.0 MHz clock rate maximum, it is possible to maintain $t \ll T$. For short display strings, the duty factor will then approach 20%.

Maximum Ratings

Supply Voltage V_{CC} to GND -0.5 V to + 7.0 V
 Inputs, Data Out and V_B -0.5 V to $V_{CC} + 0.5$ V
 Column Input Voltage, V_{COL} -0.5 V to + 6.0 V
 Operating Temperature Range -55°C to +100°C
 Storage Temperature Range -65°C to + 125°C
 Maximum Solder Temperature, 0.063" (1.59 mm)
 below Seating Plane, $t < 5$ sec 260°C
 Maximum Allowable Power Dissipation,
 $T_A = 25$ C⁽²⁾ 1.1 W

Notes:

- Operation above +100°C ambient is possible if the following conditions are met. The junction should not exceed $T_J = 125^\circ\text{C}$ and the case temperature (as measured at pin 1 or the back of the display) should not exceed $T_C = 100^\circ\text{C}$.
- Maximum allowable dissipation is derived from $V_{CC} = 5.25$ V, $V_B = 2.4$ V, $V_{COL} = 3.5$ V 20 LEDs on per character, 20% DF.

FIGURE 1. TIMING CHARACTERISTICS

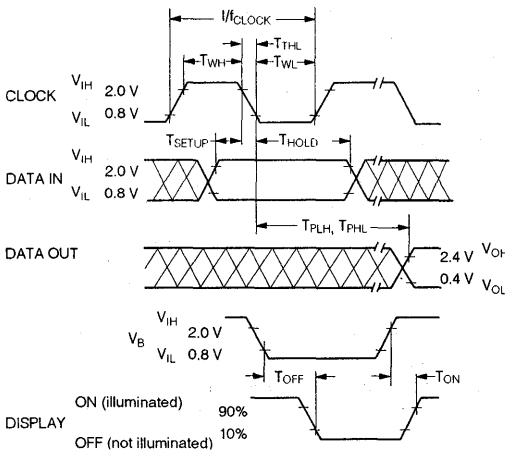
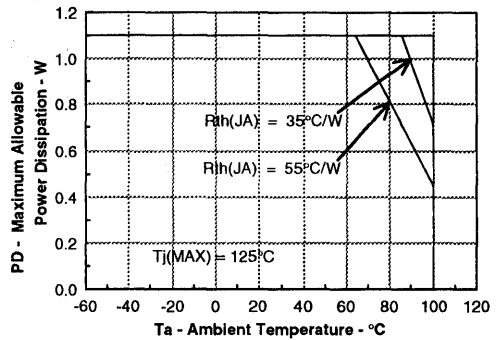

FIGURE 2. MAX. ALLOWABLE POWER DISSIPATION VS. TEMPERATURE



AC ELECTRICAL CHARACTERISTICS

($V_{CC} = 4.75$ to 5.25 V, $T_A = -55^\circ\text{C}$ to $+100^\circ\text{C}$)

Symbol	Description	Min.	Typ.	Max. ⁽¹⁾	Units	Fig.
T_{SETUP}	Setup Time	50	10		ns	1
T_{HOLD}	Hold Time	25	20		ns	1
T_{WL}	Clock Width Low	75	45		ns	1
T_{WH}	Clock Width High	75	45		ns	1
$F_{(CLK)}$	Clock Frequency		6	5	MHz	1
T_{THL} T_{TLH}	Clock Transition Time		75	200	ns	1
T_{PHL} T_{PLH}	Propagation Delay Clock to Data Out		50	125	ns	1

Notes:

- All typical values specified at $V_{CC} = 5.0$ V and $T_A = 25^\circ\text{C}$ unless otherwise noted.
- V_B Pulse Width Modulation Frequency—50 KHz (max).

RECOMMENDED OPERATING CONDITIONS (Guaranteed over operating temperature range)

Parameter	Symbol	Min.	Nom.	Max.	Units
Supply Voltage	V_{CC}	4.75	5.0	5.25	V
Data Out Current, Low State	I_{OL}			1.6	mA
Data Out Current, High State	I_{OH}			-0.5	mA
Column Input Voltage, Column On ⁽¹⁾	V_{COL}	2.75		3.5	V
Setup Time	T_{SETUP}	70	45		ns
Hold Time	T_{HOLD}	30			ns
Width of Clock	$T_{W(CLK)}$	75			ns
Clock Frequency	T_{CLK}			5	MHz
Clock Transition Time	T_{THL}			200	ns
Free Air Operating Temperature Range	T_{amb}	-55		+100	°C

Note: 1. See Figure 3: Peak Column Current vs. Column Voltage

OPTICAL CHARACTERISTICS
Red ISD/MSD2310

Description	Symbol	Min.	Typ. ⁽⁴⁾	Max.	Units	Test Conditions
Peak Luminous Intensity per LED ^(1,3) (Character Average)	I_{VPEAK}	220	370		μcd	$V_{CC} = 5.0\text{ V}$, $V_{COL} = 3.5\text{ V}$ $T_J^{(5)} = 25^\circ\text{C}$, $V_B = 2.4\text{ V}$
Peak Wavelength	λ_{VPEAK}		655		nm	
Dominant Wavelength ⁽²⁾	λ_D		639		nm	

Yellow ISD/MSD2311

Description	Symbol	Min.	Typ. ⁽⁴⁾	Max.	Units	Test Conditions
Peak Luminous Intensity per LED ^(1,3) (Character Average)	I_{VPEAK}	650	1140		μcd	$V_{CC} = 5.0\text{ V}$, $V_{COL} = 3.5\text{ V}$ $T_J^{(5)} = 25^\circ\text{C}$, $V_B = 2.4\text{ V}$
Peak Wavelength	λ_{VPEAK}		583		nm	
Dominant Wavelength ⁽²⁾	λ_D		585		nm	

High Efficiency Red ISD/MSD2312

Description	Symbol	Min.	Typ. ⁽⁴⁾	Max.	Units	Test Conditions
Peak Luminous Intensity per LED ^(1,3) (Character Average)	I_{VPEAK}	650	1430		μcd	$V_{CC} = 5.0\text{ V}$, $V_{COL} = 3.5\text{ V}$ $T_J^{(5)} = 25^\circ\text{C}$, $V_B = 2.4\text{ V}$
Peak Wavelength	λ_{VPEAK}		635		nm	
Dominant Wavelength ⁽²⁾	λ_D		626		nm	

High Efficiency Green ISD/MSD2313

Description	Symbol	Min.	Typ. ⁽⁴⁾	Max.	Units	Test Conditions
Peak Luminous Intensity per LED ^(1,3) Character Average)	I_{VPEAK}	1280	2410		μcd	$V_{CC} = 5.0\text{ V}$, $V_{COL} = 3.5\text{ V}$ $T_J^{(5)} = 25^\circ\text{C}$, $V_B = 2.4\text{ V}$
Peak Wavelength	λ_{VPEAK}		568		nm	
Dominant Wavelength ⁽²⁾	λ_D		574		nm	

Notes:

- The displays are categorized for luminous intensity with the intensity category designated by a letter code on the bottom of the package.
- Dominant wavelength (λ_D) is derived from the CIE chromaticity diagram and represents the single wavelength which defines the color of the device
- The luminous sterance of the LED may be calculated using the following relationships:

$$L_v (\text{cd}/\text{m}^2) = I_v (\text{Candela})/\text{A (Meter)}^2$$

$$L_v (\text{Footlamberts}) = \pi I_v (\text{Candela})/\text{A (Foot)}^2$$

$$A = 5.3 \times 10^{-8} \text{ M}^2 = 5.8 \times 10^{-7} (\text{Foot})^2$$
- All typical values specified at $V_{CC} = 5.0\text{ V}$ and $T_A = 25^\circ\text{C}$ unless otherwise noted.
- The luminous intensity is measured at $T_A = T_J = 25^\circ\text{C}$. No time is allowed for the device to warm up prior to measurement.

ELECTRICAL CHARACTERISTICS (-55°C to +100°C) (unless otherwise specified)

Description	Symbol	Min.	Typ. ⁽¹⁾	Max.	Units	Test Conditions
Supply Current (quiescent)	I_{CC}		2	5.0	mA	$V_B = 0.4 V$
			2.5	5.0	mA	$V_B = 2.4 V$
Supply Current (operating)	I_{CC}		3	10.0	mA	$F_{CLK} = 5 MHz$
Column Current at any Column Input ⁽²⁾	All I_{COL}			10	μA	$V_B = 0.4 V$
	I_{COL}		380	520		$V_{CC} = 5.25 V$ $V_{COL} = 3.5 V$ All SR Stages = Logical 1
V_B , Clock or Data Input Threshold Low	V_{IL}			0.8	V	$V_{CC} = 4.75 V - 5.25 V$
V_B , Clock or Data Input Threshold High	V_{IH}	2.0			V	
Data Out Voltage	V_{OH}	2.4	3.6		V	$I_{OH} = -0.5 mA$
	V_{OL}		0.2	0.4	V	$I_{OL} = 1.6 mA$
Input Current Logical 0 V_B only	I_{IL}	-30	-110	-300	μA	$V_{CC} = 4.75 V - 5.25 V, V_{IL} = 0.8 V$
Input Current Logical 0 Data, Clock	I_{IL}		-1	-10	μA	
Power Dissipation per Package	P_D		0.52		W	$V_{CC} = 5.0, V_{COL} = 3.5 V, 17.5\% DF$ 15 LEDs on per character, $V_B = 2.4 V$
Thermal Resistance IC Junction-to-Pin	$R\theta_{J-PIN}$		20		$^{\circ}C/W/Device$	

Notes:

1. All typical values specified at $V_{CC} = 5.0 V$ and $T_A = 25^{\circ}C$ unless otherwise noted.
2. See Figure 3—Peak Column Current vs. Column Voltage

FIGURE 3. PEAK COLUMN CURRENT VS. COLUMN VOLTAGE

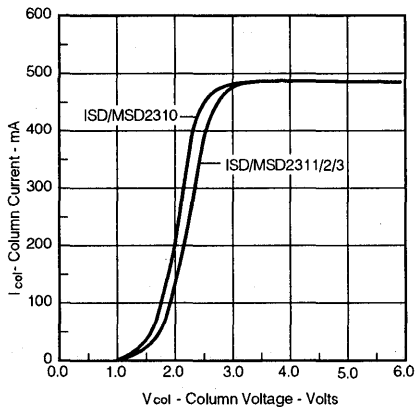
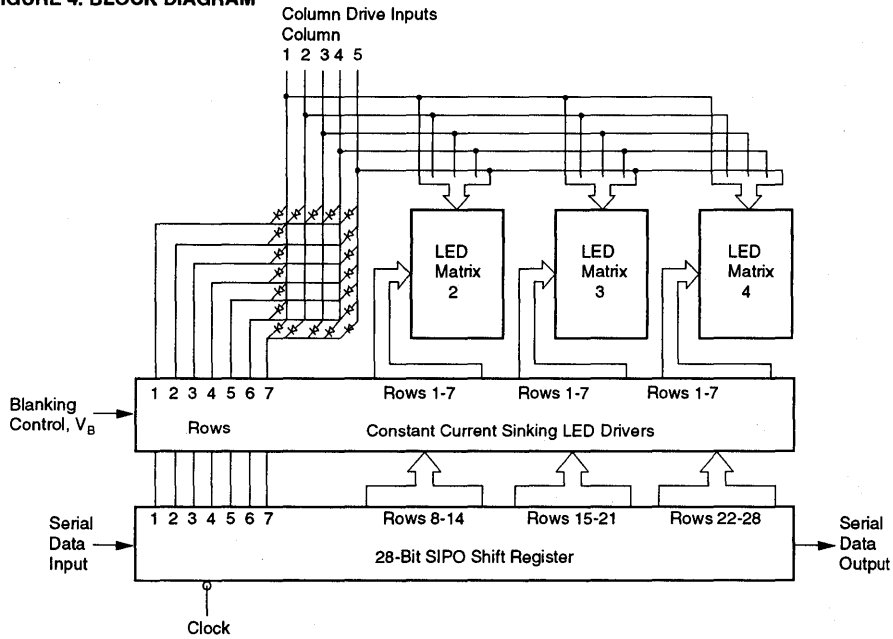

FIGURE 4. BLOCK DIAGRAM



Intelligent Display Devices

CONTRAST ENHANCEMENT FILTERS for SUNLIGHT READABILITY

Display Color Part No.	Filter Color	Marks Polarized Corp.*	Optical Characteristics of Filter
Red, HER ISD/MSD2310, 2312	Red	MPC 20-15C	25% at 635 nm, Circular Polarizer
Yellow ISD/MSD2311	Amber	MPC 30-25C	25% at 583 nm, Circular Polarizer
Green ISD/MSD2313	Yellow/Green	MPC 50-22C	22% at 568 nm, Circular Polarizer
Multiple Colors High Ambient Light	Neutral Gray	MPC 80-10C	10% Neutral, Circular Polarizer
Multiple Colors	Neutral Gray	MPC 80-37C	37% Neutral, Circular Polarizer

* Marks Polarized Corp.
25-B Jefryn Blvd. W.
Deer Park, NY 11729
516/242-1300
FAX 516/242-1347
Marks Polarized Corp. manufactures
to MIL-1-45208 inspection system.

THERMAL CONSIDERATIONS

The small alphanumeric displays are hybrid LED and CMOS assemblies that are designed for reliable operation in commercial, industrial, and military environments. Optimum reliability and optical performance will result when the junction temperature of the LEDs and CMOS ICs are kept as low as possible.

THERMAL MODELING

ISD/MSD231X displays consist of two driver ICs and four 5x7 LED matrixes. A thermal model of the display is shown in Figure 5. It illustrates that the junction temperature of the semiconductor = junction self heating + the case temperature rise + the ambient temperature. Equation 1 shows this relationship.

FIGURE 5. THERMAL MODEL

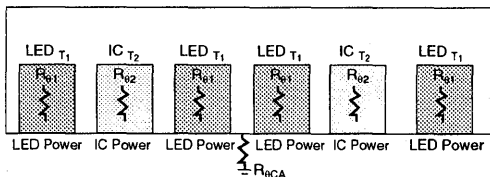

See Equation 1 below.

The junction rise within the LED is the product of the thermal impedance of an individual LED (37°C/W, DF = 20%, F = 200 Hz), times the forward voltage, $V_{F(LED)}$, and forward current $I_{F(LED)}$, of 13 - 14.5 mA. This rise averages $T_{J(LED)} = 1^\circ\text{C}$. The table below shows the $V_{F(LED)}$ for the respective displays.

Model Number	VF		
	Min.	Typ.	Max.
ISD/MSD2310	1.6	1.7	2.0
ISD/MSD2311/2/3	1.9	2.2	3.0

The junction rise within the LED driver IC is the combination of the power dissipated by the IC quiescent current and the 28 row driver current sinks. The IC junction rise is given in Equation 2.

A thermal resistance of 28°C/W results in a typical junction rise of 6°C.

See Equation 2 below.

Equation 1.

$$T_{J(LED)} = P_{LED} Z_{\theta JC} + P_{CASE} (R_{\theta JC} + R_{\theta CA}) + T_A$$

$$T_{J(LED)} = [(I_{COL}/28) V_{F(LED)} Z_{\theta JC}] + [(n/35) I_{COL} DF (5 V_{COL}) + V_{CC} I_{CC}] \cdot [R_{\theta JC} + R_{\theta CA}] + T_A$$

Equation 2.

$$T_{J(IC)} = P_{COL} (R_{\theta JC} + R_{\theta CA}) + T_A$$

$$T_{J(IC)} = [5 (V_{COL} - V_{F(LED)}) \cdot (I_{COL} / 2) \cdot (n/35) DF + V_{CC} \cdot I_{CC}] \cdot [R_{\theta JC} + R_{\theta CA}] + T_A$$

For ease of calculations the maximum allowable electrical operating condition is dependent upon the aggregate thermal resistance of the LED matrixes and the two driver ICs. All of the thermal management calculations are based upon the parallel combination of these two networks which is 15°C/W. Maximum allowable power dissipation is given in Equation 3.

Equation 3.

$$P_{DISPLAY} = \frac{T_{J(MAX)} - T_A}{R_{\theta JC} + R_{\theta CA}}$$

$$P_{DISPLAY} = 5 V_{COL} I_{COL} (n/35) DF + V_{CC} I_{CC}$$

For further reference see Figures 2, 7, 8, 9, 10 and 11.

KEY TO EQUATION SYMBOLS

DF	Duty factor
I_{CC}	Quiescent IC current
I_{COL}	Column current
n	Number of LEDs on in a 5 x 7 array
P_{CASE}	Package power dissipation excluding LED under consideration
P_{COL}	Power dissipation of a column
$P_{DISPLAY}$	Power dissipation of the display
P_{LED}	Power dissipation of an LED
$R_{\theta CA}$	Thermal resistance case to ambient
$R_{\theta JC}$	Thermal resistance junction to case
T_A	Ambient temperature
$T_{J(IC)}$	Junction temperature of an IC
$T_{J(LED)}$	Junction temperature of a LED
$T_{J(MAX)}$	Maximum junction temperature
V_{CC}	IC voltage
V_{COL}	Column voltage
$V_{F(LED)}$	Forward voltage of LED
$Z_{\theta JC}$	Thermal impedance junction to case

OPTICAL CONSIDERATIONS

The light output of the LEDs is inversely related to the LED diode's junction temperature as shown in Figure 6. For optimum light output, keep the thermal resistance of the socket or PC board as low as possible.

FIGURE 6. NORMALIZED LUMINOUS INTENSITY VS. JUNCTION TEMPERATURE

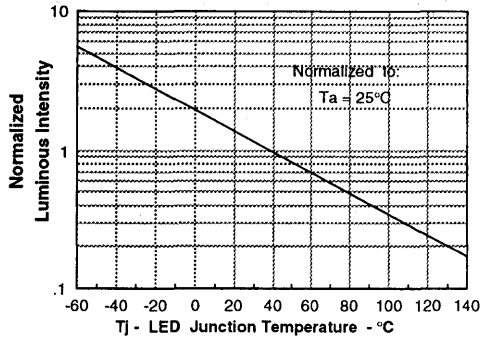

When mounted in a 10°C/W socket and operated at Absolute Maximum Electrical conditions, the displays will show an LED junction rise of 17°C. If T_A = 40°C, then the LED's T_J will be 57°C. Under these conditions Figure 7 shows that the I_p will be 75% of its 25°C value.

FIGURE 7. MAX. LED JUNCTION TEMPERATURE VS. SOCKET THERMAL RESISTANCE

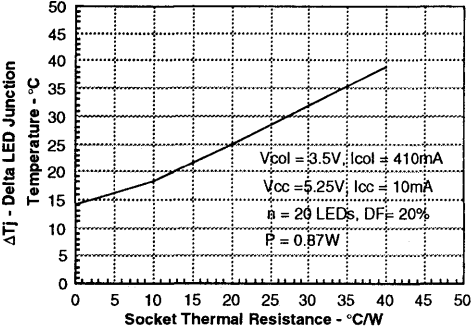

FIGURE 8. MAX. PACKAGE POWER DISSIPATION

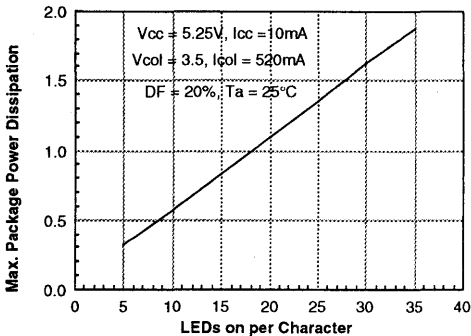

FIGURE 9. PACKAGE POWER DISSIPATION

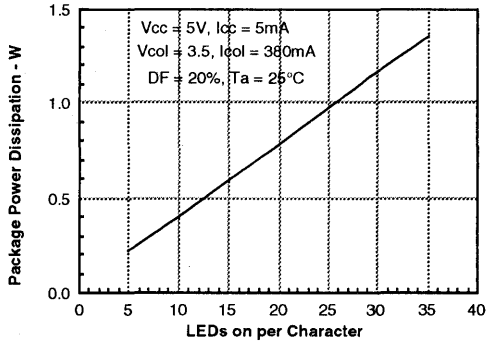

FIGURE 10. MAX. CHARACTER POWER DISSIPATION

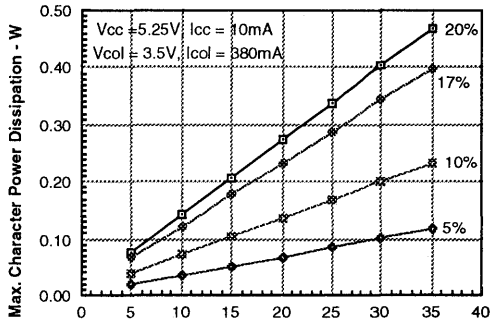
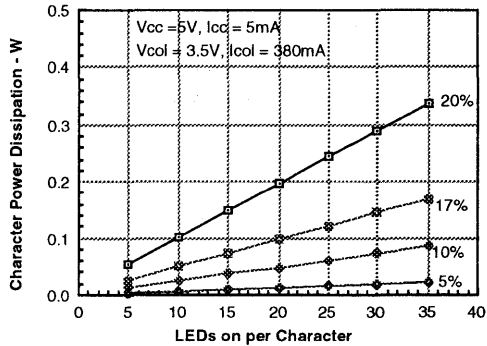
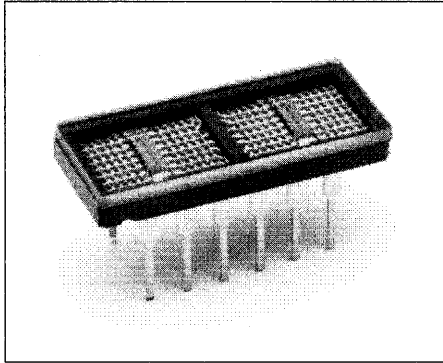

FIGURE 11. CHARACTER POWER DISSIPATION



SIEMENS YELLOW MSD2351 TXVB, ISD2351 HIGH EFF. RED MSD2352 TXVB, ISD2352 HIGH EFF. GREEN MSD2353 TXVB, ISD2353

Sunlight Viewable .200" 4-Character 5x7 Dot Matrix
Serial Input Alphanumeric Industrial/Hi-REL Display



FEATURES

- Four 0.200" Dot Matrix Characters
- Three Colors: Yellow, High Efficiency Red, High Efficiency Green
- Sunlight Viewable
- Wide Viewing Angle
- Built-in CMOS Shift Registers with Constant Current LED Row Drivers
- Shift Registers Allow Custom Fonts
- Easily Cascaded for Multiple Displays
- TTL Compatible
- End Stackable
- HI-REL Operating Temperature Range: -55° to + 100°C
- Categorized for Luminous Intensity
- Ceramic Package, Hermetically Sealed Flat Glass Window
- MSD2351/2/3 Process Conforms to MIL-D-87157 Quality Level A Test Tables I and II and also can meet Groups B and C Testing Specified in MIL-D-87157
- MSD2351/2/3 TXVB Conforms to MIL-D-87157 Quality Level A Test Tables I, II, III and IVa (See High Reliability Test Tables)

See Appnote 44 for application information and Appnotes 18, 19, 22,23 for additional information.

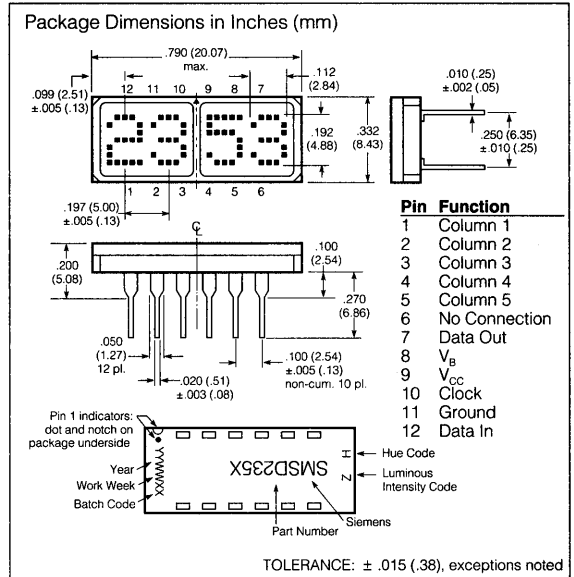

DESCRIPTION

The ISD2351/2/3, MSD2351/2/3 TXVB are four digit 5x7 dot matrix serial input alphanumeric displays. The displays are available in red, yellow, high efficiency red, or high efficiency green. The package is a standard twelve-pin hermetic DIP with glass lens. The display can be stacked horizontally or vertically to form messages of any length.

The ISD235X and MSD235X have two fourteen-bit CMOS shift registers with built-in row drivers. These shift registers drive twenty-eight rows and enable the design of customized fonts. Cascading multiple displays is possible because of the Data In and Data Out pins. Data In and Out are easily input with the clock signal and displayed in parallel on the row drivers. Data Out represents the output of the 7th bit of digit number four shift register. The shift register is level triggered. The like columns of each character in a display cluster are tied to a single pin (see Block Diagram). High true data in the shift register enables the output current mirror driver stage associated with each row of LEDs in the 5x7 diode array.

The TTL compatible V_B input may either be tied to V_{CC} for maximum display intensity or pulse width modulated to achieve intensity control and reduce power consumption.

—Continued

DESCRIPTION (Continued)

In the normal mode of operation, input data for digit four, column one is loaded into the seven on-board shift register locations one through seven. Column one data for digits 3, 2, and 1 is shifted into the display shift register locations. Then column one input is enabled for an appropriate period of time, T . A similar process is repeated for columns 2, 3, 4, and 5. If the decode time and load data time into the shift register is t , then with five columns, each column of the display is operating at a duty factor of:

$$DF = \frac{T}{5(T+t)}$$

$T+t$, allotted to each display column, is generally chosen to provide the maximum duty factor consistent with the minimum refresh rate necessary to achieve a flicker free display. For most strobed display systems, each column of the display should be refreshed (turned on) at a minimum rate of 100 times per second.

With columns to be addressed, this refresh rate then gives a value for the time $T+t$ of: $1/[5 \times (100)] = 2$ msec. If the device is operated at 5.0 MHz clock rate maximum, it is possible to maintain $t < T$. For short display strings, the duty factor will then approach 20%.

Maximum Ratings

Supply Voltage V_{CC} to GND -0.5 V to + 7.0 V
 Inputs, Data Out and V_B -0.5 V to $V_{CC} + 0.5$ V
 Column Input Voltage, V_{COL} -0.5 V to + 6.0 V
 Operating Temperature Range -55°C to + 100°C
 Storage Temperature Range -65°C to + 125°C
 Maximum Solder Temperature, 0.063" (1.59 mm)
 below Seating Plane, $t < 5$ sec 260°C
 Maximum Allowable Power Dissipation,
 $T_A = 25$ °C⁽²⁾ 1.35 W

Notes:

- Operation above + 100°C ambient is possible if the following conditions are met. The junction should not exceed $T_J = 125$ °C and the case temperature (as measured at pin 1 or the back of the display) should not exceed $T_C = 100$ °C.
- Maximum allowable dissipation is derived from $V_{CC} = 5.25$ V, $V_B = 2.4$ V, $V_{COL} = 3.5$ V 20 LEDs on per character, 20% DF.

FIGURE 1. TIMING CHARACTERISTICS

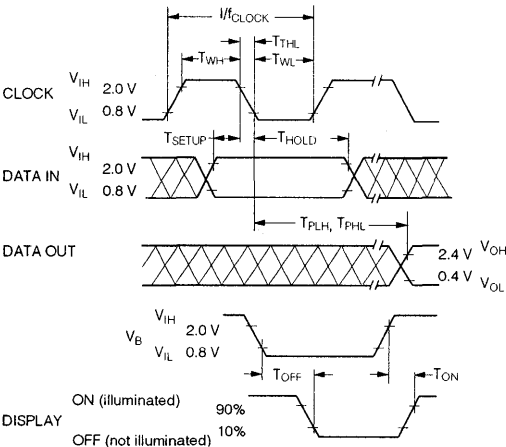
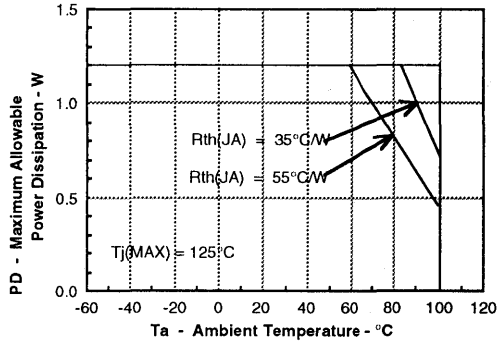

FIGURE 2. MAX. ALLOWABLE POWER DISSIPATION VS. TEMPERATURE



AC ELECTRICAL CHARACTERISTICS

($V_{CC} = 4.75$ to 5.25 V, $T_A = -55$ °C to + 100°C)

Symbol	Description	Min.	Typ.	Max. ⁽¹⁾	Units	Fig.
T_{SETUP}	Setup Time	50	10		ns	1
T_{HOLD}	Hold Time	25	20		ns	1
T_{WL}	Clock Width Low	75	45		ns	1
T_{WH}	Clock Width High	75	45		ns	1
$F_{(CLK)}$	Clock Frequency		6	5	MHz	1
T_{THL} T_{TLH}	Clock Transition Time		75	200	ns	1
T_{PHL} T_{PLH}	Propagation Delay Clock to Data Out		50	125	ns	1

Notes:

- All typical values specified at $V_{CC} = 5.0$ V and $T_A = 25$ °C unless otherwise noted.
- V_B Pulse Width Modulation Frequency—50 KHz (max).

RECOMMENDED OPERATING CONDITIONS

Parameter	Symbol	Min.	Nom.	Max.	Units
Supply Voltage	V_{CC}	4.75	5.0	5.25	V
Data Out Current, Low State	I_{OL}			1.6	mA
Data Out Current, High State	I_{OH}			-0.5	mA
Column Input Voltage, Column On ⁽¹⁾	V_{COL}	2.75		3.5	V
Setup Time	T_{SETUP}	70	45		ns
Hold Time	T_{HOLD}	30			ns
Width of Clock	$T_{W(CLK)}$	75			ns
Clock Frequency	T_{CLK}			5	MHz
Clock Transition Time	T_{THL}			200	ns
Free Air Operating Temperature Range	T_{amb}	-55		+100	°C

Note: 1. See Figure 3: Peak Column Current vs. Column Voltage

OPTICAL CHARACTERISTICS Yellow ISD/MSD2351

Description	Symbol	Min.	Typ. ⁽⁴⁾	Max.	Units	Test Conditions
Peak Luminous Intensity per LED ^(1,3) (Character Average)	I_{VPEAK}	2400	3400		μcd	$V_{CC} = 5.0\text{ V}$, $V_{COL} = 3.5\text{ V}$ $T_J^{(5)} = 25^\circ\text{C}$, $V_B = 2.4\text{ V}$
Peak Wavelength	λ_{VPEAK}		583		nm	
Dominant Wavelength ⁽²⁾	λ_D		585		nm	

High Efficiency Red ISD/MSD2352

Description	Symbol	Min.	Typ. ⁽⁴⁾	Max.	Units	Test Conditions
Peak Luminous Intensity per LED ^(1,3) (Character Average)	I_{VPEAK}	853	2500		μcd	$V_{CC} = 5.0\text{ V}$, $V_{COL} = 3.5\text{ V}$ $T_J^{(5)} = 25^\circ\text{C}$, $V_B = 2.4\text{ V}$
Peak Wavelength	λ_{VPEAK}		635		nm	
Dominant Wavelength ⁽²⁾	λ_D		626		nm	

High Efficiency Green ISD/MSD2353

Description	Symbol	Min.	Typ. ⁽⁴⁾	Max.	Units	Test Conditions
Peak Luminous Intensity per LED ^(1,3) Character Average)	I_{VPEAK}	2400	3000		μcd	$V_{CC} = 5.0\text{ V}$, $V_{COL} = 3.5\text{ V}$ $T_J^{(5)} = 25^\circ\text{C}$, $V_B = 2.4\text{ V}$
Peak Wavelength	λ_{VPEAK}		568		nm	
Dominant Wavelength ⁽²⁾	λ_D		574		nm	

Notes:

- The displays are categorized for luminous intensity with the intensity category designated by a letter code on the bottom of the package.
- Dominant wavelength (λ_D) is derived from the CIE chromaticity diagram and represents the single wavelength which defines the color of the device
- The luminous sterance of the LED may be calculated using the following relationships:

$$L_v (\text{cd/m}^2) = I_v (\text{Candela})/A (\text{Meter})^2$$

$$L_v (\text{Footlamberts}) = \pi I_v (\text{Candela})/A (\text{Foot})^2$$

$$A = 5.3 \times 10^{-8} \text{ M}^2 = 5.8 \times 10^{-7} (\text{Foot})^2$$
- All typical values specified at $V_{CC} = 5.0\text{ V}$ and $T_A = 25^\circ\text{C}$ unless otherwise noted.
- The luminous intensity is measured at $T_A = T_J = 25^\circ\text{C}$. No time is allowed for the device to warm up prior to measurement.

ELECTRICAL CHARACTERISTICS (-55°C to +100°C) (unless otherwise specified)

Description	Symbol	Min.	Typ. ⁽¹⁾	Max.	Units	Test Conditions	
Supply Current (quiescent)	I_{CC}			5.0	mA	$V_B = 0.4$ V	$V_{CC} = 5.25$ V $V_{CLK} = V_{DATA} = 2.4$ V All SR Stages = Logical 1
				5.0	mA	$V_B = 2.4$ V	
Supply Current (operating)	I_{CC}			10.0	mA	$F_{CLK} = 5$ MHz	
Column Current at any Column Input ⁽²⁾	All I_{COL}			10	μ A	$V_B = 0.4$ V	$V_{CC} = 5.25$ V $V_{COL} = 3.5$ V All SR Stages = Logical 1
	I_{COL}		550	650			
V_B , Clock or Data Input Threshold Low	V_{IL}			0.8	V	$V_{CC} = 4.75$ V–5.25 V	
V_B , Clock or Data Input Threshold High	V_{IH}	2.0			V		
Data Out Voltage	V_{OH}	2.4	3.6		V	$I_{OH} = -0.2$ mA	$V_{CC} = 4.75$ V $I_{OL} = 0$ mA
	V_{OL}			0.4	V	$I_{OL} = 1.6$ mA	
Input Current Logical 0 V_B only	I_{IL}	-30	-110	-300	μ A	$V_{CC} = 4.75$ V–5.25 V, $V_{IL} = 0.8$ V	
Input Current Logical 0 Data, Clock	I_{IL}		-1	-10	μ A		
Power Dissipation per Package	P_D		0.74		W	$V_{CC} = 5.0$, $V_{COL} = 3.5$ V, 17.5% DF 15 LEDs on per character, $V_B = 2.4$ V	
Thermal Resistance IC Junction-to-Pin	$R\theta_{J-PIN}$		25		$^{\circ}$ C/W/Device		

Notes:

- All typical values specified at $V_{CC} = 5.0$ V and $T_A = 25^{\circ}$ C unless otherwise noted.
- See Figure 3–Peak Column Current vs. Column Voltage

FIGURE 3. PEAK COLUMN CURRENT VS. COLUMN VOLTAGE

FIGURE 4. BLOCK DIAGRAM



CONTRAST ENHANCEMENT FILTERS for SUNLIGHT READABILITY

Display Color Part No.	Filter Color	Marks Polarized Corp.*	Optical Characteristics of Filter
HER ISD/MSD2352	Red	MPC 20-15C	25% @ 635 nm, Circular Polarizer
Yellow ISD/MSD2351	Amber	MPC 30-25C	25% @ 583 nm, Circular Polarizer
Green ISD/MSD2353	Yellow/Green	MPC 50-22C	22% @ 568 nm, Circular Polarizer
Multiple Colors High Ambient Light	Neutral Gray	MPC 80-10C	10% Neutral, Circular Polarizer
Multiple Colors	Neutral Gray	MPC 80-37C	37% Neutral, Circular Polarizer

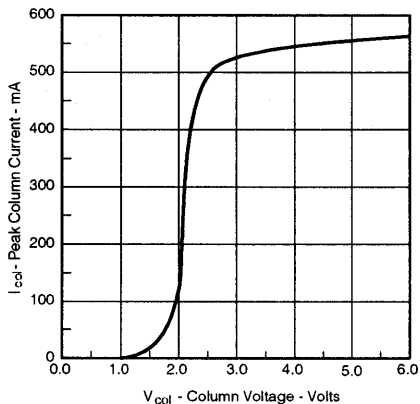
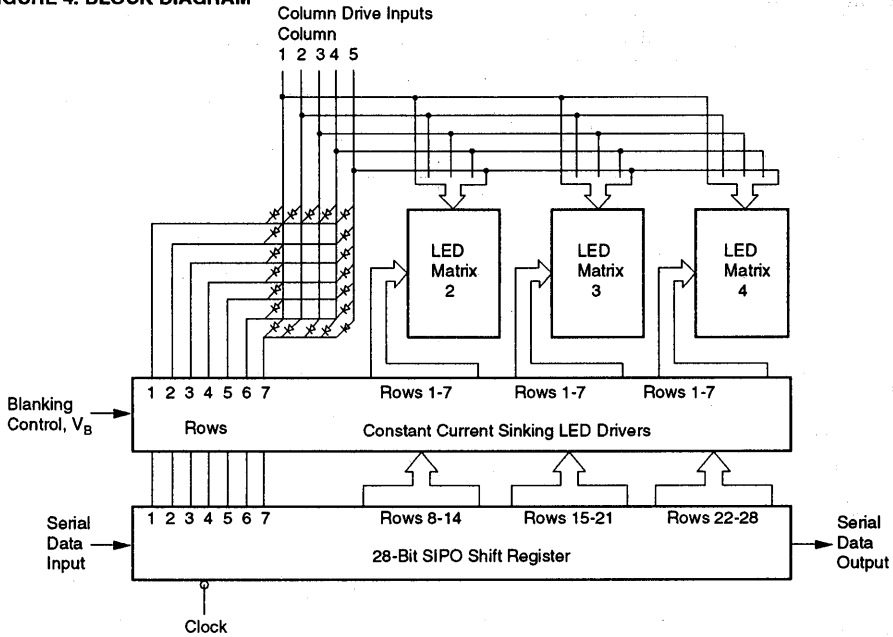
* Marks Polarized Corp.
25-B Jeffry Blvd. W
Deer Park, NY 11729
516/242-1300
FAX 516/242-1347
Marks Polarized Corp. manufactures
to MIL-1-45208 inspection system.

THERMAL CONSIDERATIONS

The small alphanumeric displays are hybrid LED and CMOS assemblies that are designed for reliable operation in commercial, industrial, and military environments. Optimum reliability and optical performance will result when the junction temperature of the LEDs and CMOS ICs are kept as low as possible.

THERMAL MODELING

ISD/MSD235X displays consist of two driver ICs and four 5x7 LED matrixes. A thermal model of the display is shown in Figure 5. It illustrates that the junction temperature of the semiconductor = junction self heating + the case temperature rise + the ambient temperature. Equation 1 shows this relationship.

FIGURE 5. THERMAL MODEL

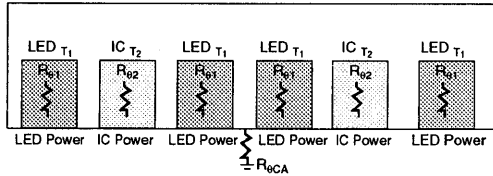

See Equation 1 below.

The junction rise within the LED is the product of the thermal impedance of an individual LED (37°C/W, DF = 20%, F = 200 Hz), times the forward voltage, $V_{F(LED)}$, and forward current $I_{F(LED)}$, of 13 - 14.5 mA. This rise averages $T_{J(LED)} = 1^\circ\text{C}$. The table below shows the $V_{F(LED)}$ for the respective displays.

Model Number	VF		
	Min.	Typ.	Max.
ISD/MSD2351/2/3	1.9	2.2	3.0

The junction rise within the LED driver IC is the combination of the power dissipated by the IC quiescent current and the 28 row driver current sinks. The IC junction rise is given in Equation 2.

A thermal resistance of 28°C/W results in a typical junction rise of 6°C.

See Equation 2 below.

Equation 1.

$$T_{J(LED)} = P_{LED} Z_{\theta JC} + P_{CASE} (R_{\theta JC} + R_{\theta CA}) + T_A$$

$$T_{J(LED)} = [(I_{COL}/28) V_{F(LED)} Z_{\theta JC}] + [(n/35) I_{COL} DF (5 V_{COL}) + V_{CC} I_{CC}] \cdot [R_{\theta JC} + R_{\theta CA}] + T_A$$

Equation 2.

$$T_{J(IC)} = P_{COL} (R_{\theta JC} + R_{\theta CA}) + T_A$$

$$T_{J(IC)} = [5 (V_{COL} - V_{F(LED)}) \cdot (I_{COL} / 2) \cdot (n/35) DF + V_{CC} \cdot I_{CC}] \cdot [R_{\theta JC} + R_{\theta CA}] + T_A$$

For ease of calculations the maximum allowable electrical operating condition is dependent upon the aggregate thermal resistance of the LED matrixes and the two driver ICs. All of the thermal management calculations are based upon the parallel combination of these two networks which is 15°C/W. Maximum allowable power dissipation is given in Equation 3.

Equation 3.

$$P_{DISPLAY} = \frac{T_{J(MAX)} - T_A}{R_{\theta JC} + R_{\theta CA}}$$

$$P_{DISPLAY} = 5 V_{COL} I_{COL} (n/35) DF + V_{CC} I_{CC}$$

For further reference see Figures 2, 7, 8, 9, 10 and 11 .

KEY TO EQUATION SYMBOLS

- DF Duty factor
- I_{CC} Quiescent IC current
- I_{COL} Column current
- n Number of LEDs on in a 5 x 7 array
- P_{CASE} Package power dissipation excluding LED under consideration
- P_{COL} Power dissipation of a column
- $P_{DISPLAY}$ Power dissipation of the display
- P_{LED} Power dissipation of an LED
- $R_{\theta CA}$ Thermal resistance case to ambient
- $R_{\theta JC}$ Thermal resistance junction to case
- T_A Ambient temperature
- $T_{J(IC)}$ Junction temperature of an IC
- $T_{J(LED)}$ Junction temperature of a LED
- $T_{J(MAX)}$ Maximum junction temperature
- V_{CC} IC voltage
- V_{COL} Column voltage
- $V_{F(LED)}$ Forward voltage of LED
- $Z_{\theta JC}$ Thermal impedance junction to case

OPTICAL CONSIDERATIONS

The light output of the LEDs is inversely related to the LED diode's junction temperature as shown in Figure 6. For optimum light output, keep the thermal resistance of the socket or PC board as low as possible.

FIGURE 6. NORMALIZED LUMINOUS INTENSITY VS. JUNCTION TEMPERATURE

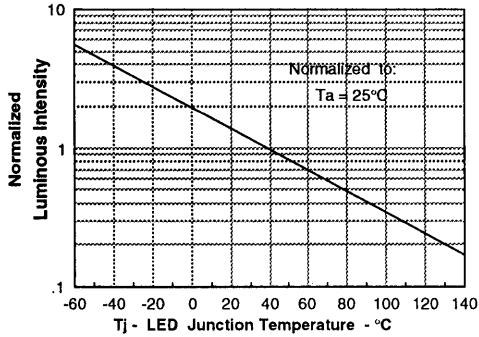

When mounted in a 10°C/W socket and operated at Absolute Maximum Electrical conditions, the displays will show an LED junction rise of 17°C. If $T_A = 40^\circ\text{C}$, then the LED's T_J will be 57°C. Under these conditions Figure 7 shows that the I_V will be 75% of its 25°C value.

FIGURE 7. MAX. LED JUNCTION TEMPERATURE VS. SOCKET THERMAL RESISTANCE

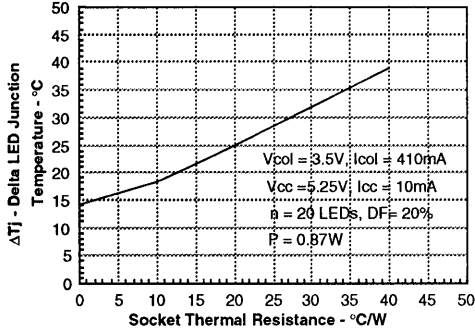

FIGURE 8. MAX. PACKAGE POWER DISSIPATION

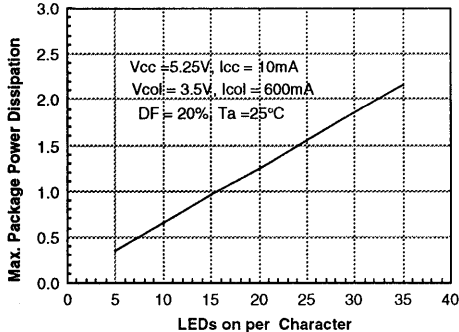

FIGURE 9. PACKAGE POWER DISSIPATION

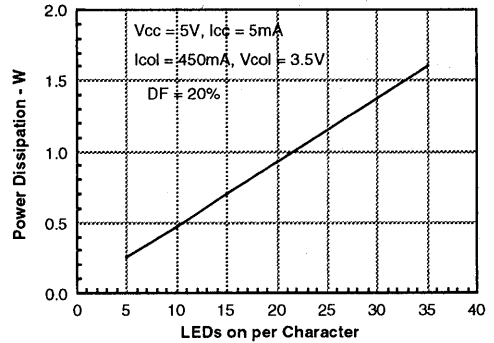

FIGURE 10. MAX. CHARACTER POWER DISSIPATION

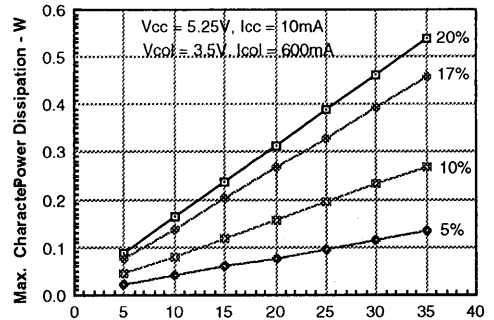
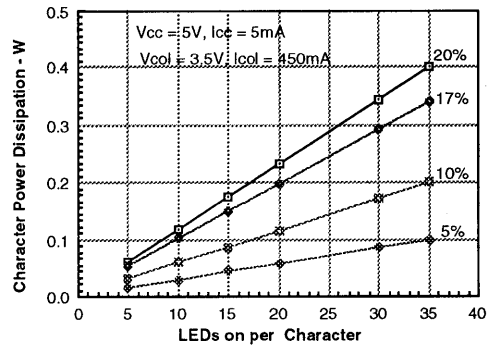

FIGURE 11. CHARACTER POWER DISSIPATION



SIEMENS

HER PD2435/PD3535/PD4435

RED PD2436/PD3536/PD4436

BRIGHT GREEN PD2437/PD3537/PD4437

.200" Character, PD2435/6/7

.270" Character, PD3535/6/7

.45" Character, PD4435/6/7

Four Character 5x7 Dot Matrix Alphanumeric Programmable Display™ with Built-in CMOS Control Functions

Intelligent
Display Devices

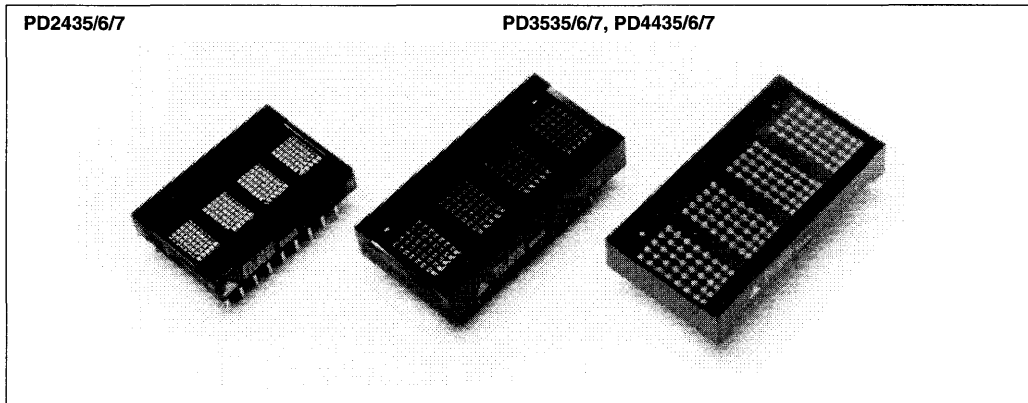

FEATURES

- Four Dot Matrix Characters in High Efficiency Red, Red, and Bright Green
 - PD2435/6/7, 0.200" High
 - PD3535/6/7, 0.270" High
 - PD4435/6/7, 0.45" High
- Built-in Memory, Decoders, Multiplexer and Drivers
- Wide Viewing Angle, X Axis $\pm 55^\circ$, Y Axis $\pm 65^\circ$
- Categorized for Luminous Intensity
- 128 Character ASCII Format (Upper and Lower Case Characters)
- 8 Bit Bidirectional Data BUS
- READ/WRITE Capability
- Dual In-Line Package Configuration, 0.600" Wide, 0.100" Pin Centers
- End-Stackable Package
- Internal or External Clock
- Built-in Character Generator ROM
- TTL Compatible
- Easily Cascaded for Multidisplay Operation
- Less CPU Time Required
- Software Controlled Features:
 - Programmable Highlight Attribute (Blinking, Non-Blinking)
 - Asynchronous Memory Clear Function
 - Lamp Test
 - Display Blank Function
 - Single or Multiple Character Blinking Function
 - Programmable Intensity
 - Three Brightness Levels
- Extended Operating Temperature Range:
 - PD243X, PD353X: -40°C to $+85^\circ\text{C}$
 - PD443X: -40°C to $+70^\circ\text{C}$

Package Dimensions in Inches (mm)

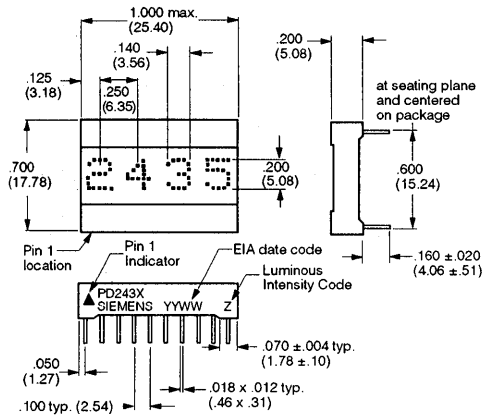

Tolerance: .XXX=0.02 (.51)

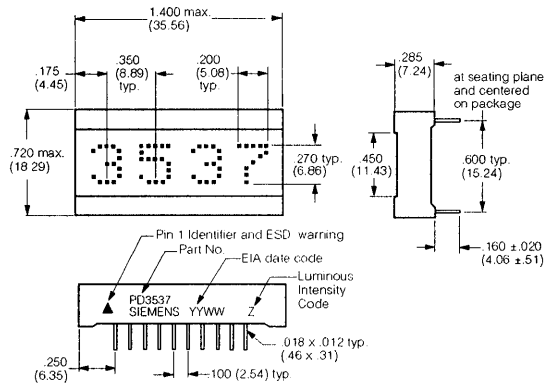

Tolerance: .XXX=0.010 (.25) unless max.

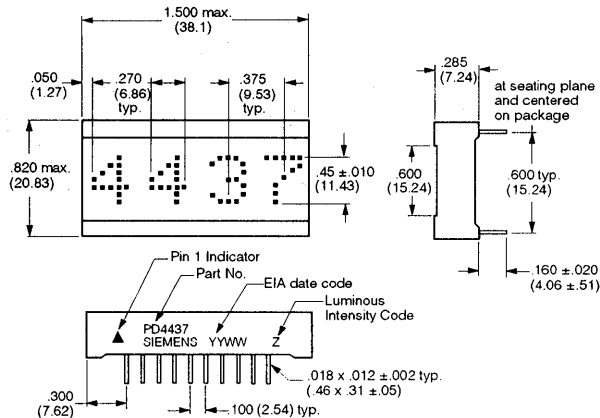

Tolerance: .XXX=±0.020 (.51)

DESCRIPTION

These Programmable Displays are four digit display system modules. The characters are 0.20" by 0.14" (PD243X), 0.27" by 0.20" (PD353X), and 0.45" by 0.27" (PD443X) 5x7 dot matrix arrays constructed with the latest solid state technology in light emitting diodes. Driving and controlling the LED arrays is a silicon gate CMOS integrated circuit. This integrated circuit provides all necessary LED drivers and complete multiplexing control logic.

Additionally, the IC has the necessary ROM to decode 128 ASCII alphanumeric characters and enough RAM to store the display's complete four digit ASCII message with special attributes. These attributes, all software programmable at the user's discretion, include a lamp test, brightness control, displaying cursors, alternating cursors and characters, and flashing cursors or characters.

The CMOS IC also incorporates special interface control circuitry to allow the user to control the module as a fully

supported microprocessor peripheral. The module, under internal or external clock control, has asynchronous read, write, and memory clear over an eight bit parallel, TTL compatible, bi-directional data bus. Each module is fully encapsulated within a package 1.0" x 0.7" x 0.2" (PD253X), 1.4" x 0.72" x 0.285" (PD353X), and 1.5" x 0.82" x 0.285" (PD443X). The standard 20 pin DIP construction with two rows spaced at 0.6" on 0.1" centers is wave solderable.

See the end of this data sheet or refer to Appnotes 18, 19, 22, and 23 for further details on handling and assembling Siemens Programmable Displays.

Maximum Ratings

DC Supply Voltage	-0.5 V to +7.0 Vdc
Input Voltage Relative to GND (all inputs)	-0.5 V to $V_{CC} + 0.5$ Vdc
Operating Temperature	
PD243X/353X	-40°C to +85°C
PD443X	-40°C to +70°C
Storage Temperature	-40°C to +100°C
Maximum Solder Temperature, .063" (1.59 mm) below Seating Plane, t<5 sec.	260°C

Optical Characteristics at 25° C

Spectral Peak Wavelength	(HER) 635 nm typ.
	(Red) 660 nm typ.
	(Green) 565 nm typ.

Viewing Angle

Horizontal	
PD243X/353X	±55°
PD443X	±40°
Vertical (off normal axis)	±65°

Digit Height

PD243X	0.200" (5.08 mm)
PD353X	0.270" (6.86 mm)
PD443X	0.45" (11.43 mm)

Time Averaged Luminous Intensity¹

Red	30 μ cd/LED min.
HER/Green	90 μ cd/LED min.

LED to LED Intensity Matching	1.8:1.0 max.
Device to Device (one bin)	1.5:1.0 max.
Bin to Bin (adjacent bins)	1.9:1.0 max.

Note: 1. Peak luminous intensity values can be calculated by multiplying these values by 7.

TIMING CHARACTERISTICS

DATA "WRITE" CYCLE

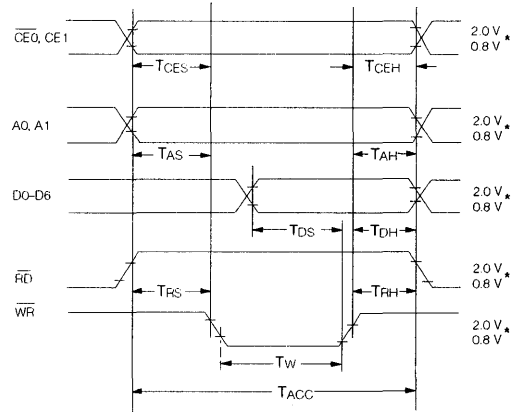

*Notes:

1. All input voltage are $V_{IL}=0.8$ v, $V_{IH}=2.0$ V.
2. These waveforms are not edge triggered.

DATA "READ" CYCLE

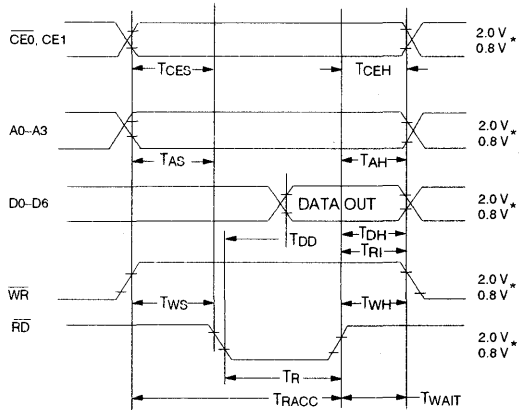

SWITCHING SPECIFICATIONS ($V_{CC}=4.5\text{ V}$)

WRITE CYCLE TIMING					
Parameter	Description	Specification Minimum			
		-40°C	25°C	85°C	Units
$T_{CLR}^{(1)}$	Clear RAM	1	1	1	μs
$T_{CLR\overline{D}}^{(1)}$	Clear RAM Disable	1	1	1	μs
T_{AS}	Address Setup	10	10	10	ns
T_{CES}	Chip Enable Setup	0	0	0	ns
T_{RS}	Read Enable Setup	10	10	10	ns
T_{DS}	Data Setup	20	30	50	ns
T_W	Write Pulse	60	70	90	ns
T_{AH}	Address Hold	20	30	40	ns
T_{DH}	Data Hold	20	30	40	ns
T_{CEH}	Chip Enable Hold	0	0	0	ns
T_{RH}	Read Enable Hold	20	30	40	ns
T_{ACC}	Total Access Time=Setup Time + Write Time + Hold Time	90	110	140	ns

SWITCHING SPECIFICATIONS ($V_{CC} = 4.5\text{ V}$)

READ CYCLE TIMING					
Parameter	Description	Specification Minimum			
		-40°C	25°C	85°C	Units
T_{AS}	Address Setup	0	0	0	ns
T_{CES}	Chip Enable	0	0	0	ns
T_{WS}	Write Enable Setup	20	30	40	ns
T_{DD}	Data Delay Time	100	150	175	ns
T_R	Read Pulse	150	175	200	ns
T_{AH}	Address Hold	0	0	0	ns
T_{DH}	Data Hold	0	0	0	ns
T_{TRI}	Time to Tristate (Max. time)	30	40	50	ns
T_{CEH}	Chip Enable Hold	0	0	0	ns
T_{WH}	Write Enable Hold	30	40	50	ns
T_{ACC}	Total Access Time = Setup Time + Write Time + Time to Tristate	200	245	290	ns
$T_{WAIT}^{(2)}$	Wait Time between Reads	0	0	0	ns

Notes:

- Wait 1 μs between any Reads or Writes after writing a Control Word with a Clear ($D7=1$). Wait 1 μs between any Reads or Writes after Clearing a Control Word with a Clear ($D7=0$). All other Reads and Writes can be back to back.
- Wait 1 μs between any Reads or Writes after writing a Control Word with a Clear ($D7=1$). Wait 1 μs between any Reads or Writes after clearing a Control Word with a Clear ($D7=0$). All other Reads and Writes can be back to back.
- All input voltages are ($V_L=0.8\text{ V}$, $V_{IH}=2.0\text{ V}$)
- Data out voltages are measured with 100 pF on the data bus and the ability to source=-40 μA and sink=1.6 mA The rise and fall times are 60 ns. $V_{OL}=0.4\text{ V}$, $V_{OH}=2.4\text{ V}$.

DC CHARACTERISTICS at 25°C

Parameter	Limits			Units	Conditions
	Min.	Typ.	Max.		
V _{CC}	4.5	5.0	5.5	Volts	Nominal
Blank (All Inputs Low)		2.5	3.5	mA	V _{CC} =5 V, All inputs =0.8 V
I _{CC} 80 LEDs/unit (100% Bright)					
PD243X		115	130	mA	V _{CC} =5 V
PD353X		145	165	mA	V _{CC} =5 V
PD443X		150	170	mA	V _{CC} =5 V
V _{IL}			0.8	Volts	V _{CC} =4.5 V to 5.5 V
V _{IH}	2.0			Volts	V _{CC} =4.5 V to 5.5 V
I _{IL} (except D0 to D7) ⁽¹⁾	25		100	μA	V _{CC} =4.5 V to 5.5 V, V _{IN} =0.8 V
V _{OL}			0.4	Volts	V _{CC} = 4.5 V to 5.5 V
V _{OH}	2.4			Volts	V _{CC} =4.5 V to 5.5 V
I _{OH}	-8.9			mA	V _{CC} =4.5 V, V _{OH} =2.4 V
I _{OL}	1.6			mA	V _{CC} =4.5 V, V _{OL} =0.4 V
Data I/O Bus Loading			100	pF	
Clock I/O Bus Loading			240	pF	

Note: 1. D0 to D7 have no pull-up resistors so current is negligible.

TOP VIEW

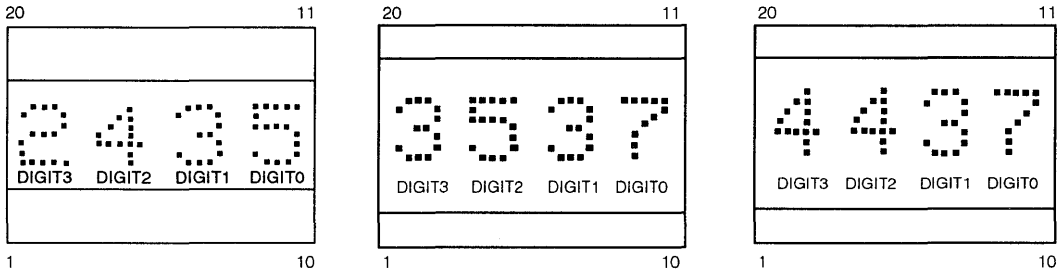

PIN ASSIGNMENTS and DEFINITIONS

- | | | | | | |
|---|------------------|---|----|-----------------|--|
| 1 | \overline{RD} | Active low, will enable a processor to read all registers in the display. | 7 | A2 | Address input (MSB). |
| 2 | CLK I/O | If CLK SEL (pin 3) is low, then expect an external clock source into this pin. If CLK SEL is high, then this pin will be the master or source into this pin. If CLK SEL is high, then this pin will be the master or source for all other devices which have CLK SEL low. | 8 | A1 | Address input. |
| 3 | CLK SEL | CLOCK SELECT determines the action of pin2. CLK I/O, see the section on Cascading for an example. | 9 | A0 | Address input (LSB). |
| 4 | \overline{RST} | Reset. Must be held low until V _{CC} > 4.5 V. Reset is used only to synchronize blinking and will not clear the display. | 10 | GND | Ground. |
| 5 | CE1 | Chip enable (active high). | 11 | \overline{WR} | Write. Active low. If the device is selected, a low on the write input loads the data into memory. |
| 6 | CE0 | Chip enable (active low). | 12 | D7 | Data Bus bit 7 (MSB). |
| | | | 13 | D6 | Data Bus bit 6. |
| | | | 14 | D5 | Data Bus bit 5. |
| | | | 15 | D4 | Data Bus bit 4. |
| | | | 16 | D3 | Data Bus bit 3. |
| | | | 17 | D2 | Data Bus bit 2. |
| | | | 18 | D1 | Data Bus bit 1. |
| | | | 19 | D0 | Data Bus bit 0 (LSB). |
| | | | 20 | V _{CC} | Positive power pin. |

Intelligent Display Devices

FUNCTIONAL DESCRIPTION

The block diagram includes 5 major blocks and internal registers (indicated by dotted lines).

Display Memory consists of a 5x8 bit RAM block. Each of the four 8-bit words holds 7-bits of ASCII data (bits D0-D6) and an attribute select bit (Bit D6). The fifth 8-bit memory word is used as a control word register. A detailed description of the control register and its functions can be found in the Control Word section. Each 8-bit word is addressable and can be read from or written to.

The **Control Logic** dictates all of the features of the display device and is discussed in the Control Word section of this data sheet.

The **Character Generator** converts the 7-bit ASCII data into the proper dot pattern for the 128 characters shown in the character set chart.

The **Clock Source** can originate either from the internal oscillator clock or from an external source—usually from the output of another display in a multiple module array.

The **Display Multiplexer** controls all display output to the digit drivers so no additional logic is required for a display system.

The **Column Drivers** are connected directly to the display.

The **Display** has four digits. Each of the four digits is comprised of 35 LEDs in a 5 x 7 dot array which makes up the alphanumeric characters.

The intensity of the display can be varied by the Control Word in steps of 0% (Blank), 25%, 50%, and full brightness.

MICROPROCESSOR INTERFACE

The interface to the microprocessor is through the address lines, (A0–A2), the data bus (D0–D7), two chip select lines (CE0, CE1), and read (RD) and write (WR) lines.

The $\overline{CE0}$ should be held low when executing a read, or write operation. CE1 must be held high.

The read and write lines are both active low. During a valid read the data input lines (D0–D7) become outputs. A valid write will enable the data as input lines.

INPUT BUFFERING

If a cable length of 6 inches or more is used, all inputs to the display should be buffered with a tri-state non-inverting buffer mounted as close to the display as conveniently possible. Recommended buffers are: 74LS245 for the data lines and 74LS244 for the control lines.

BLOCK DIAGRAM

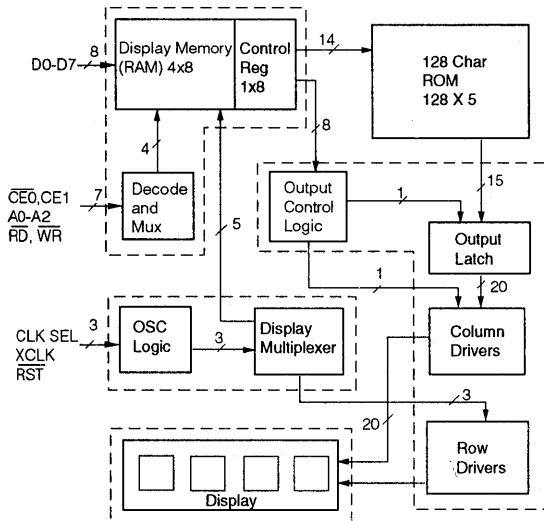

MODE SELECTION

$\overline{CE0}$	CE1	\overline{RD}	\overline{WR}	OPERATION
0	1	0	0	None
1	X	X	X	None
X	0	X	X	None
X	X	1	1	None

0=Low logic level, 1=High logic level, X= Don't care.

DATA INPUT COMMANDS

$\overline{CE0}$	CE1	\overline{RD}	\overline{WR}	A2	A1	A0	D7	D6	D5	D4	D3	D2	D1	D0	OPERATION
1	0	X	X	X	X	X	X	X	X	X	X	X	X	X	No Change
0	1	0	1	1	0	0	X	X	X	X	X	X	X	X	Read Digit 0 Data to Bus
0	1	1	0	1	0	0	0	0	1	0	0	1	0	0	(\$) Written to Digit 0
0	1	1	0	1	0	1	0	1	0	1	0	1	1	1	(W) Written to Digit 1
0	1	1	0	1	1	0	0	1	1	0	0	1	1	0	(f) Written to Digit 2
0	1	1	0	1	1	1	0	0	1	1	0	0	1	1	(3) Written to Digit 3
0	1	1	0	1	0	0	1	X	X	X	X	X	X	X	Char Written to Digit 0 and Cursor Enabled

PROGRAMMING THE DISPLAY

There are five registers within the display. Four of these registers are used to hold the ASCII/attribute code of the four display characters. The fifth register is the Control Word, which is used to blink, blank, clear, or dim the entire display, or to change the presentation (attributes) of individual characters.

ADDRESSING

The addresses within the display device are shown below. Digit 0 is the rightmost digit of the display, while digit 3 is on the left. Although there is only one Control Word, it is duplicated at the four address locations 0-3. Data can be read from any of these locations. When one of these locations is written to, all of them will change together.

Address			Contents
A2	A1	A0	
0	X	X	Control Word
1	0	0	Digit 0 (rightmost)
1	0	1	Digit 1
1	1	0	Digit 2
1	1	1	Digit 3 (leftmost)

Bit D7 of any of the display digit locations is used to allow an attribute to be assigned to that digit. The attributes are discussed in the next section. If Bit D7 is set to a one, that character will be displayed using the attribute. If bit D7 is cleared, the character will display normally.

CONTROL WORD

When address bit A2 is taken low, the Control Word is accessed. The same Control Word appears in all four of the lower address spaces of the display. Through the Control Word, the display can be cleared, the lamps can be tested, display brightness can be selected, and attributes can be set for any characters which have been loaded with their most significant bit (D7) set high.

Brightness (D0, D1): The state of the lower two bits of the Control Word are used to set the brightness of the entire display, from 0% to 100%. The table below shows the correspondence of these bits to the brightness.

D7	D6	D5	D4	D3	D2	D1	D0	Operation
0	0	X	X	X	X	0	0	Blank
0	0	X	X	X	X	0	1	25% brightness
0	0	X	X	X	X	1	0	50% brightness
0	0	X	X	X	X	1	1	Full brightness

X = don't care

Attributes (D2-D4): Bits D2, D3, and D4 control the visual attributes (i.e., blinking) of those display digits which have been written with bit D7 set high. In order to use any of the four attributes, the Cursor Enable bit (D4 in the Control Word) must be set. When the Cursor Enable bit is set, and bit D7 in a character location is set, the character will take on one of the following display attributes.

CONTROL WORD FORMAT

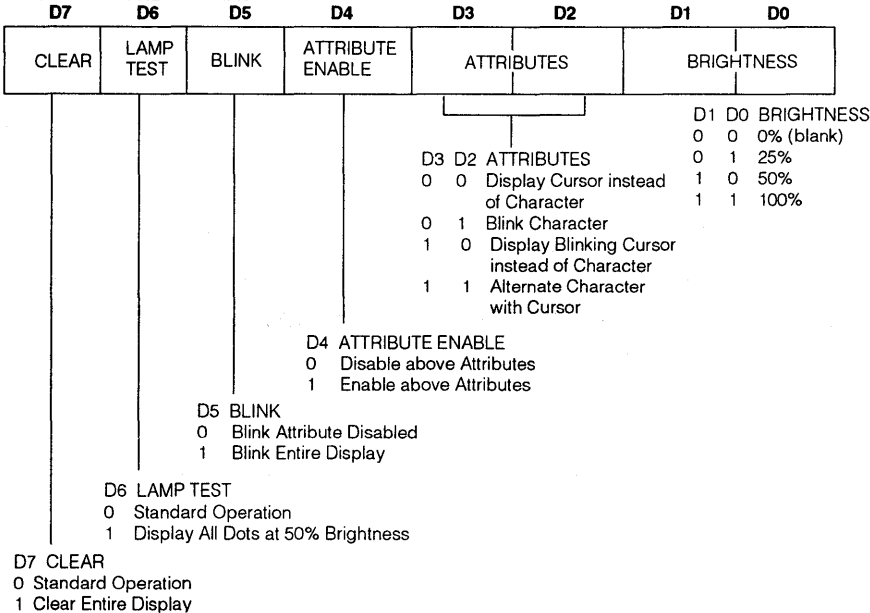

D7	D6	D5	D4	D3	D2	D1	D0	Operation
0	0	0	0	X	X	B	B	Disable highlight attribute
0	0	0	1	0	0	B	B	Display cursor* instead of character
0	0	0	1	0	1	B	B	Blink single character
0	0	0	1	1	0	B	B	Display blinking cursor* instead of character
0	0	0	1	1	1	B	B	Alternate character with cursor*

*"Cursor"=all dots in a single character space lit to half brightness, X=Don't care, B=Depends on the selected brightness.

Attributes are non-destructive. If a character with bit D7 set is replaced by a cursor (Control Word bit D4 is set, and D3=D2=0) the character will remain in memory and can be revealed again by clearing D4 in the Control Word.

Blink (D5): The entire display can be caused to blink at a rate of approximately 2 Hz by setting bit D5 in the Control Word. This blinking is independent of the state of D7 in all character locations.

To synchronize the blink rate in a bank of these devices, it is necessary to tie all devices' clocks and resets together as described in a later section of this data sheet.

D7	D6	D5	D4	D3	D2	D1	D0	Operation
0	0	1	X	X	X	B	B	Blinking display

Lamp Test (D6): When the Lamp Test bit is set, all dots in the entire display are lit at half brightness. When this bit is cleared, the display returns to the characters that were showing before the lamp test.

D7	D6	D5	D4	D3	D2	D1	D0	Operation
0	1	0	X	X	X	X	X	Lamp test

Clear Data (D7): When D7 is set (D7=1) in the Control Word, all (display) memory bits are reset to zero and the display goes blank.

D7	D6	D5	D4	D3	D2	D1	D0	Operation
1	0	X	X	X	X	X	X	Clear

A second control word must be written into the chip with D7 reset (D7=0) to set up attributes and brightness levels.

The SMC-4740 oscillator is designed to drive up to 16 displays with input loading of 15 pF each.

The general requirements for cascading 16 displays are:

1. Determine the correct address for each display
2. Tie $\overline{CE0}$ to ground and use CE1 from an address.
3. Select one of the displays to provide the clock for the other displays.
4. Tie $\overline{CLK SEL}$ to ground on other displays.
5. Use RST to synchronize the blinking between the displays.

CASCADING DIAGRAM

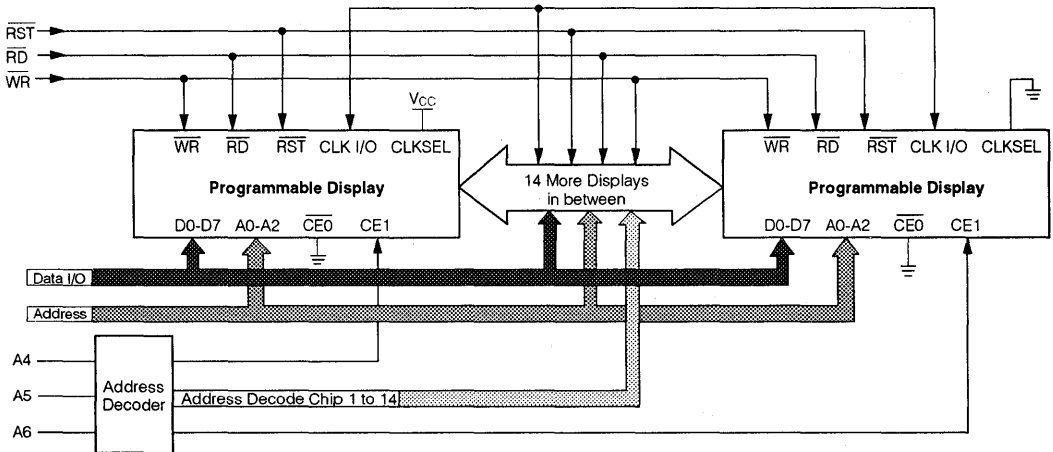

HOW TO LOAD INFORMATION INTO THE DISPLAY

Information loaded into the display can be either ASCII data or Control Word data. The following procedure (see also Typical Loading Sequence) will demonstrate a typical loading sequence and the resulting visual display. The word STOP is used in all of the following examples.

SET BRIGHTNESS

Step 1 Set the brightness level of the entire display to your preference (example: 100%)

LOAD FOUR CHARACTERS

Step 2 Load an "S" in the left hand digit.

Step 3 Load an "T" in the next digit.

Step 4 Load an "O" in the next digit.

Step 5 Load an "P" in the right hand digit.
If you loaded the information correctly, the PD2435 now should show the word "STOP."

BLINK A SINGLE CHARACTER

Step 6 Into the digit, second from the right, load the hex code "CF," which is the code for an "O" with the D7 bit added as a control bit.

Note: the "O" is the only digit which has the control bit (D7) added to normal ASCII data.

Step 7 Load enable blinking character into the control word register. The display should show "STOP" with a flashing "O".

ADD ANOTHER BLINKING CHARACTER

Step 8 Into the left hand digit, load the hex code "D3" which gives an "S" with the D7 bit added as a control bit. The display should show "STOP" with flashing "O" and a flashing "S."

ALTERNATE CHARACTER/ CURSOR ENABLE

Step 9 Load enable alternate character/cursor into the control word register. The display now should show "STOP" with the "O" and the "S" alternating between the letter and cursor (all dots lit).

INITIATE FOUR CHARACTER BLINKING

(Regardless of Control Bit setting)

Step 10 Load enable display blinking. The display now should show the entire word "STOP" blinking.

TYPICAL LOADING SEQUENCE

	CE0	CE1	RD	WR	A2	A1	A0	D7	D6	D5	D4	D3	D2	D1	D0	DISPLAY
1.	L	H	H	L	L	X	X	0	0	0	0	0	0	1	1	
2.	L	H	H	L	H	H	H	0	1	0	1	0	0	1	1	S
3.	L	H	H	L	H	H	L	0	1	0	1	0	1	0	0	ST
4.	L	H	H	L	H	L	H	0	1	0	0	1	1	1	1	STO
5.	L	H	H	L	H	L	L	0	1	0	1	0	0	0	0	STOP
6.	L	H	H	L	H	L	H	1	1	0	0	1	1	1	1	STOP
7.	L	H	H	L	L	X	X	0	0	0	1	0	1	1	1	STO*P
8.	L	H	H	L	H	H	H	1	1	0	1	0	0	1	1	S*TO*P
9.	L	H	H	L	L	X	X	0	0	0	1	1	1	1	1	S=TO=P
10.	L	H	H	L	L	X	X	0	0	1	0	0	0	1	1	S*T*O*P*

* Blinking character†Character alternating with cursor (all dots lit)

ELECTRICAL AND MECHANICAL CONSIDERATIONS

The CMOS IC of the display is designed to provide resistance to both Electrostatic Discharge Damage and Latch Up due to voltage or current surges. Several precautions are strongly recommended to avoid overstressing these built-in safeguards.

ESD PROTECTION

Display users should be careful to handle the devices consistent with Standard ESD protection procedures. Operators should wear appropriate wrist, ankle or feet ground straps and avoid clothing that collects static charges. Work surfaces, tools and transport carriers that come into contact with unshielded devices or assemblies should also be appropriately grounded.

LATCH UP PROTECTION

Latch up is a condition that occurs in CMOS ICs after the input protection diodes have been broken down. These diodes can be reversed through several means:

$V_{IN} < GND$, $V_{IN} > V_{CC} + 0.5 V$, or through excessive currents forced on the inputs. When these situations exist, the IC may develop the response of an SCR and begin conducting as much as one amp through the V_{CC} pin. This destructive condition will persist (latched) until device failure or the device is turned off.

The Voltage Transient Suppression Techniques and buffer interfaces for longer cable runs help considerably to prevent latch conditions from occurring. Additionally, the following Power Up and Power Down sequence should be observed.

POWER UP SEQUENCE

1. Float all active signals by tri-stating inputs to displays.
2. Apply V_{CC} and GND to the display.
3. Apply active signals to the displays by enabling all input signals per application.

POWER DOWN SEQUENCE

1. Float all active signals by tri-stating the inputs to the display.
2. Turn off the power to the display.

SOLDERING CONSIDERATIONS

These displays can be hand soldered with SN63 solder using a grounded iron set to 160°C.

Wave soldering is also possible following these conditions: Preheat that does not exceed 93°C on the solder side of the PC board or a package surface temperature of 85°C. Water soluble organic acid flux (except carboxylic acid) or resin-based RMA flux without alcohol can be used.

Wave temperature is 245°C ±5°C with a dwell between 1.5 seconds to 3.0 seconds. Exposure to the wave should not exceed temperatures above 260°C, for 5 seconds at 0.063" below the seating plane. The packages should not be immersed in the wave.

VOLTAGE TRANSIENT SUPPRESSION

It has become common practice to provide 0.01 µf bypass capacitors liberally in digital systems. Like other CMOS circuitry, the Intelligent Display controller chip has very low power consumption and the usual 0.01 µf would be adequate were it not for the LEDs. To prevent power supply transients, capacitors with low inductance and high capacitance at high frequencies are required. This suggests a solid tantalum or ceramic disc for high frequency bypass. For multiple display module systems distribute the bypass capacitors evenly, keeping capacitors as close to the power pins as possible. Use a 0.01 µF capacitor for each display module and a 22 µF for every third display module.

CHARACTER SET

ASCII CODE		D0	0	1	0	1	0	1	0	1	0	1	0	1	0	1	0	1	
D8	D6	D4	HEX	0	1	2	3	4	5	6	7	8	9	A	B	C	D	E	F
0	0	0	0	0	1	2	3	4	5	6	7	8	9	A	B	C	D	E	F
0	0	1	1	0	1	1	0	0	1	1	0	0	1	1	0	0	1	1	1
0	1	0	2	0	0	0	0	1	1	1	0	0	0	0	1	1	1	1	1
0	1	1	3	0	0	0	0	0	0	0	1	1	1	1	1	1	1	1	1
1	0	0	4	0	0	0	0	0	0	0	0	1	1	1	1	1	1	1	1
1	0	1	5	0	0	0	0	0	0	0	0	1	1	1	1	1	1	1	1
1	1	0	6	0	0	0	0	0	0	0	0	1	1	1	1	1	1	1	1
1	1	1	7	0	0	0	0	0	0	0	0	1	1	1	1	1	1	1	1

Notes:

1. A2 must be held high for ASCII data.
2. Bit D7=1 enables attributes for the assigned digit.

POST SOLDER CLEANING PROCEDURES

The least offensive cleaning solution is hot D.I. water (60°C) for less than 15 minutes. Addition of mild saponifiers is acceptable. Do not use commercial dishwasher detergents.

For faster cleaning, solvents may be used. Carefully choose the solvents as some may chemically attack the package. Maximum exposure should not exceed two minutes at elevated temperatures. Acceptable solvents are: TF (trichlorotrifluoroethane), TA, 111 Trichloroethane, and unheated acetone.¹

Note: 1. Acceptable commercial solvents are: Basic TF Arklone P, Genesolv D, Genesolv DA, BlacoTron TF, Blaco-Tron TA and, Freon TA.

Do not use solvents containing alcohol, methanol, methylene chloride, ethanol, TP35, TCM, TMC, TMS+, TE, and TES. Since many commercial mixtures exist, you should contact your preferred solvent vendor for chemical composition information. Some major solvent manufacturers are: Allied Chemical Corporation, Specialty Chemical Division, Morristown, NJ; Baron-Blakeslee, Chicago, IL; Dow Chemical, Midland, MI; E.I. DuPont de Nemours & Co., Wilmington, DE.

For further information refer to Appnotes 18 and 19 in the current Siemens Optoelectronics Data Book.

An alternative to soldering and cleaning the display modules is to use sockets. Naturally, 20 pin DIP sockets 0.600" wide with 0.100" centers work well for single displays. Multiple display assemblies are best handled by longer SIP sockets or DIP sockets when available for uniform package alignment. Socket manufacturers include: Aries Electronics, Inc., Frenchtown, NJ; Garry Manufacturing, New Brunswick, NJ; Robinson-Nugent, New Albany, IN; and Samtec Electronic Hardware, New Albany, IN.

For further information refer to Appnote 22 in the current Siemens Optoelectronics Data Book.

OPTICAL CONSIDERATIONS

The character heights of these displays allows readability up to eight feet. Proper filter selection allows the user to build a display that can be used over this distance.

Filters allow the user to enhance the contrast ratio between a lit LED and the character background. This will maximize discrimination of different characters as perceived by the display user. The only limitation is cost. So first consider the ambient lighting environment to maximize the cost benefit ratio for using filters.

Incandescent (with almost no green) or fluorescent (with almost no red) lights do not have the flat spectral response of sunlight. Plastic band-pass filters are inexpensive and effective in optimizing contrast ratios. The PD2435/3535/4435 is high efficiency red display and should be matched with a long wavelength pass filter in the 570 nm to 590 nm range. The PD2436/3536/4436 is a standard red display and should be matched with a long wavelength pass filter in the 600 nm to 620 nm range. The PD2437/3537/4437 should be matched with a yellow-green band-pass filter that peaks at 565 nm. For displays of multiple colors, neutral density grey filters offer the best compromise.

Additional contrast enhancement can be gained through shading the displays. Plastic band-pass filters with built-in louvers offer the "next step up" in contrast improvement. Plastic filters can be further improved with anti-reflective coatings to reduce glare. The trade-off is "fuzzy" characters. Mounting the filters close to the display reduces this effect. Care should be taken not to overheat the plastic filters by allowing for proper air flow.

Optimal filter enhancements for any condition can be gained through the use of circular polarized, anti-reflective, band-pass filters. The circular polarizing further enhances contrast by reducing the light that travels through the filter and reflects back off the display to less than 1%. Proper intensity selection of the displays will allow 10,000 foot candle sunlight viewability.

Several filter manufacturers supply quality filter materials. Some of them are: Panelgraphic Corporation, W. Caldwell, NJ; SGL Homalite, Wilmington, DE; 3M Company, Visual Products Division, St. Paul, MN; Polaroid Corporation, Polarizer Division, Cambridge, MA; Marks Polarized Corporation, Deer Park, NY; Hoya Optics, Inc., Fremont, CA.

One last note on mounting filters: recessing display and bezel assemblies is an inexpensive way to provide a shading effect in overhead lighting situations. Several Bezel manufacturers are: R.M.F Products, Batavia, IL; Nobex Components, Griffith Plastic Corp., Burlingame, CA; Photo Chemical Products of California, Santa Monica, CA; I.E.E. Atlas, Van Nuys, CA.

See Siemens Appnote 23 for further information.

SIEMENS

RED PDSP2110
YELLOW PDSP2111
HIGH EFFICIENCY RED PDSP2112
GREEN PDSP2113
HIGH EFFICIENCY GREEN PDSP2114
0.200" 8-Character 5x7 Matrix
Alphanumeric Programmable Display™

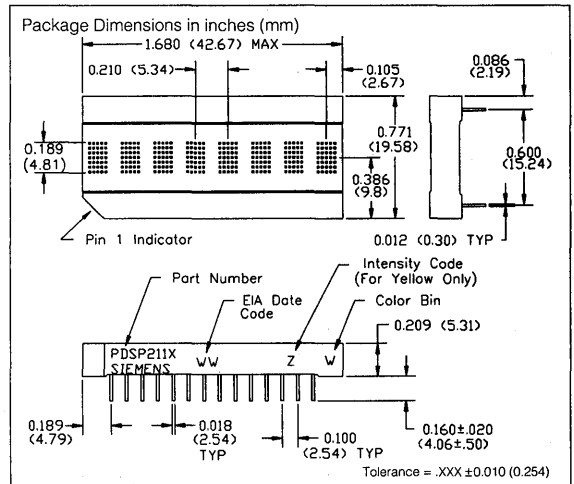
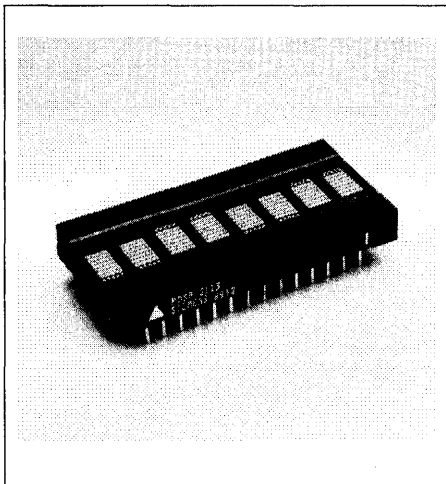

FEATURES

- Eight 0.200" Dot Matrix Characters in Red, Yellow, High Efficiency Red, Green, or High Efficiency Green
- Built-in 2 Page, 256 Character ROM. Both pages are Mask Programmable for Custom Fonts
- Readable from 8 Feet (2.5 meters)
- Built-in Decoders, Multiplexers and Drivers
- Wide Viewing Angle, X Axis $\pm 55^\circ$, Y Axis $\pm 65^\circ$
- Programmable Features:
 - Individual Flashing Character
 - Full Display Blinking
 - Multi-Level Dimming and Blanking
 - Clear Function
 - Lamp Test
- Internal or External Clock
- End Stackable Dual-In-Line Package

DESCRIPTION

The PDSP2110 (Red), PDSP2111 (Yellow), PDSP2112 (High Efficiency Red), PDSP2113 (Green), and PDSP2114 (High Efficiency Green) are eight digit, 5x7 dot matrix, alphanumeric Programmable Displays. The 0.20 inch high digits are packaged in a rugged, high quality, optically transparent, standard 0.6 inch 28 pin plastic DIP.

The on-board CMOS has a built-in two page, 256 character ROM. Both pages are mask programmable for 256 custom characters. The first page of ROM of a standard product contains 128 characters including ASCII, selected European and Scientific symbols. The second page contains Katakana Japanese characters, more European characters, Avionics, and other graphic symbols.

The PDSP211X is designed for standard microprocessor interface techniques, and is fully TTL compatible. The Clock I/O and Clock Select pins allow the user to cascade multiple display modules.

Maximum Rating

DC Supply Voltage -0.5 to +7.0 Vdc
 Input Voltage Levels Relative to Ground -0.5 to $V_{CC} + 0.5$ Vdc
 Operating Temperature -40°C to +85°C
 Storage Temperature -40°C to +100°C
 Maximum Solder Temperature 0.063" below Seating Plane, $t < 5$ sec 260°C
 Relative Humidity @ 85°C 85%

Note: Maximum voltage is with no LEDs illuminated

Enlarged Character Font

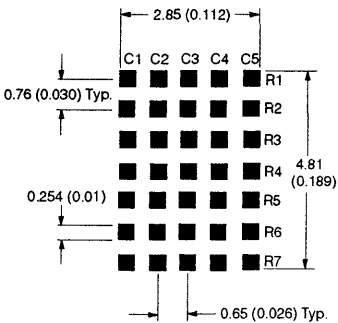

Switching Specifications

(over operating temperature range and $V_{CC} = 4.5V$)

Symbol	Description	Min.	Units
Tbw	Time Between Writes	30	ns
Tacc ⁽²⁾	Display Access Time	130	ns
Tas	Address Setup Time	10	ns
Tces	Chip Enable Setup Time	0	ns
Tah	Address Hold Time	20	ns
Tceh	Chip Enable Hold Time	0	ns
Tw	Write Active Time	100	ns
Tds	Data Valid Prior to Rising Edge of Write	50	ns
Tdh	Data Hold Time	20	ns
Trc ⁽¹⁾	Reset Active Time	300	ns
Tclr ⁽³⁾	Clear Cycle Time	3	μs

1. Wait 300 ns min. after the reset function is turned off.
2. $T_{acc} = T_{as} + T_w + T_{ah}$
3. The Clear Cycle Time may be shortened by writing a second Control Word with the Clear Bit disabled, 160 ns after the first control word that enabled the Clear Bit.

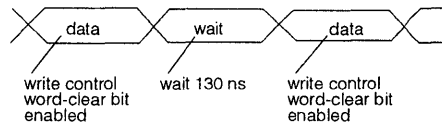

The Flash RAM and Character RAM may not be accessed until the Clear Cycle is complete.

Write Cycle Timing Diagram

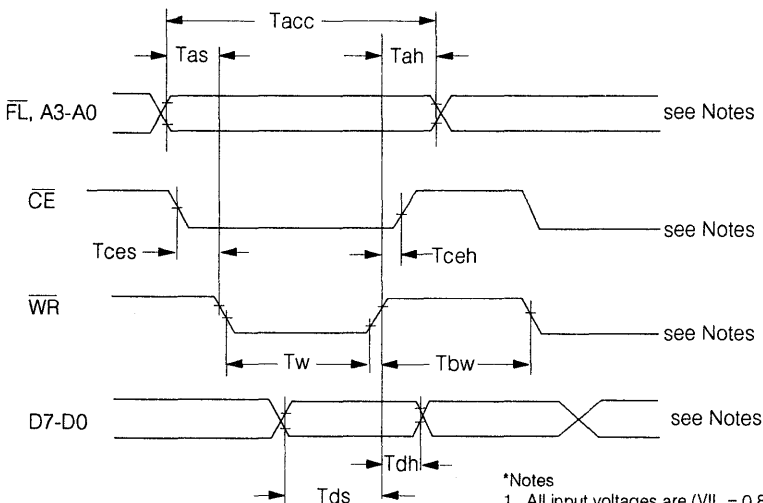

***Notes**

1. All input voltages are ($V_{IL} = 0.8 V, V_{IH} = 2.0 V$).
2. These wave forms are not edge triggered.
3. $T_{bw} = T_{as} + T_{ah}$

Optical Characteristics at 25 °C $V_{CC} = 5.0$ V at Full Brightness

Red PDSP2110

Description	Symbol	Min.	Typ.	Max.	Units
Luminous Intensity Character Average (# displayed)	I_v	1.4	2.5		mcd
Peak Wavelength	$\lambda(\text{peak})$		660		nm
Dominant Wavelength	$\lambda(d)$		639		nm

Yellow PDSP2111

Description	Symbol	Min.	Typ.	Max.	Units
Luminous Intensity Character Average (# displayed)	I_v	2.5	7.5		mcd
Peak Wavelength	$\lambda(\text{peak})$		585		nm
Dominant Wavelength	$\lambda(d)$		583		nm

High Efficiency Red PDSP2112

Description	Symbol	Min.	Typ.	Max.	Units
Luminous Intensity Character Average (# displayed)	I_v	2.5	7.5		mcd
Peak Wavelength	$\lambda(\text{peak})$		630		nm
Dominant Wavelength	$\lambda(d)$		626		nm

Green PDSP2113

Description	Symbol	Min.	Typ.	Max.	Units
Luminous Intensity Character Average (# displayed)	I_v	2.5	7.5		mcd
Peak Wavelength	$\lambda(\text{peak})$		565		nm
Dominant Wavelength	$\lambda(d)$		570		nm.

High Efficiency Green PDSP2114

Description	Symbol	Min.	Typ.	Max.	Units
Luminous Intensity Character Average (# displayed)	I_v	3.0	9.0		mcd
Peak Wavelength	$\lambda(\text{peak})$		568		nm
Dominant Wavelength	$\lambda(d)$		574		nm.

ELECTRICAL CHARACTERISTICS @ 25°C

Parameters	Limits				Conditions
	Min	Typ	Max	Units	
V_{CC}	4.5	5.0	5.5	V	
I_{CC} Blank		0.5	1.0	mA	$V_{CC} = 5V, V_{IN} = 5V$
I_{CC} 8 digits ⁽¹⁾ 12 dots/character		200	255	mA	$V_{CC} = 5V$, "V" displayed in all eight digits
I_{CC} 8 digits ⁽¹⁾ 20 dots/character		300	370	mA	$V_{CC} = 5V$, "#" displayed in all eight digits
I_{IF} Current (with pull-up)		11	18	μA	$V_{CC} = 5V, V_{IN} = 0V$ to V_{CC} , (\overline{WR} , \overline{CE} , \overline{FL} , \overline{RST} , \overline{ClkSel})
I_I Input leakage current (without pull-up)			± 1	μA	$V_{CC} = 5V, V_{IN} = 0V$ to V_{CC} , (\overline{Clk} I/O, A0-A3, D0-D7)
V_{IH} Input Voltage High	2.0		$V_{CC} + 0.3$	V	$V_{CC} = 4.5V$ to $5.5V$
V_{IL} Input Voltage Low	Gnd -0.3		0.8	V	$V_{CC} = 4.5V$ to $5.5V$
V_{OL} Output Voltage Low (Clock Pin)			0.4	V	$V_{CC} = 4.5V$ to $5.5V$, $I_{OL} = 1.6mA$
V_{OH} Output Voltage High (Clock Pin)	2.4			V	$V_{CC} = 4.5V$ to $5.5V$, $I_{OH} = 40\mu A$
I_{OH} Output Current High (Clock I/O)	-0.9			mA	$V_{CC} = 4.5V, V_{OH} = 2.4V$
I_{OL} Output Current Low (Clock I/O)	1.6	2		mA	$V_{CC} = 4.5V, V_{OL} = 0.4V$
θ_{JC} Thermal Resistance Junction to Case		25		$^{\circ}C/W$	
F_{ext} External Clock Input Frequency ⁽²⁾	28		81.14	KHz	$V_{CC} = 5.0V, \overline{CLKSEL} = 0$
F_{osc} Internal Clock Output Frequency ⁽²⁾	28		81.14	KHz	$V_{CC} = 5.0V, \overline{CLKSEL} = 1$
Clock I/O Buss Loading			240	pF	
Clock Out Rise Time			500	ns	$V_{CC} = 4.5V, V_{OH} = 2.4V$
Clock Out Fall Time			500	ns	$V_{CC} = 4.5V, V_{OL} = 0.4V$
FM, Digit Multiplex Frequency	125	256	362.5	Hz	
Blinking Rate	0.98	2	2.83	Hz	

- Note:** 1. Average I_{CC} measured at full brightness. Peak $I_{CC} = 2 \times I_{AVG}$ (# displayed).
2. Internal/external frequency duty factor is 50%.

TOP VIEW

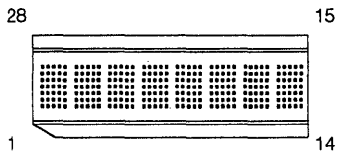

Pin 1 Location

PIN ASSIGNMENTS

Pin	Function	Pin	Function
1	RST	28	D7
2	FL	27	D6
3	A0	26	D5
4	A1	25	D4
5	A2	24	D3
6	A3	23	D2
7	Substr. bias	22	No Pin
8	Substr. bias	21	No Pin
9	Substr. bias	20	D1
10	No Connect	19	D0
11	CLKSEL	18	No Connect
12	CLK I/O	17	CE
13	WR	16	GND (logic)
14	V _{cc}	15	GND (supply)

PIN DEFINITIONS

Pin	Function	Definition
1	RST	Used for initialization of a display and synchronization of blinking for multiple displays
2	FL	Low input accesses the Flash RAM
3	A0	Address input LSB
4	A1	Address input
5	A2	Address input MSB
6	A3	Mode selector
7	Substr. bias	Used to bias IC substrate, must be connected to V _{cc} . Can't be used to supply power to display.
8	Substr. bias	
9	Substr. bias	
10	No connect	
11	CLKSEL	Selects internal/external clock source
12	CLK I/O	Outputs master clock or inputs external clock
13	WR	A low will write data into the display if CE is low
14	V _{cc}	Positive power supply input
15	GND	Analog Ground for LED drivers
16	GND	Digital Ground for internal logic
17	CE	Enables access to the display
18	No Connect	
19	D0	Data input LSB
20	D1	Data input
21	No pin	
22	No pin	
23	D2	Data input
24	D3	Data input
25	D4	Data input
26	D5	Data input
27	D6	Data input
28	D7	Data input MSB, selects ROM, page 1 or 2

CASCADING THE PDSP211X DISPLAYS

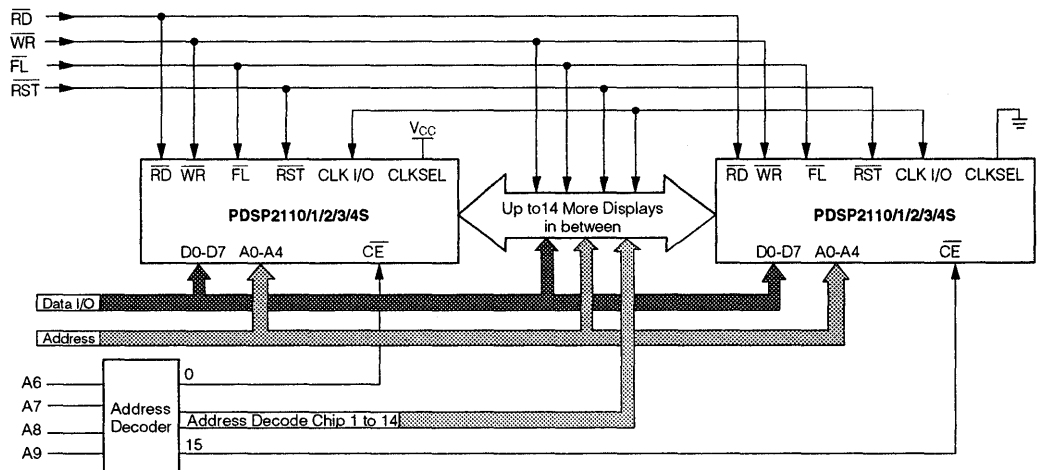

CHARACTER SET

ROM Page 1 (D7 = 0)

ASCII CODE			D0	0	1	0	1	0	1	0	1	0	1	0	1	0	1		
D1			0	0	1	1	0	0	1	1	0	0	1	1	0	0	1	1	
D2			0	0	0	0	1	1	1	1	0	0	0	0	1	1	1	1	
D3			0	0	0	0	0	0	0	0	1	1	1	1	1	1	1	1	
D6	D5	D4	Hex	0	1	2	3	4	5	6	7	8	9	A	B	C	D	E	F
0	0	0	0																
0	0	1	1																
0	1	0	2																
0	1	1	3																
1	0	0	4																
1	0	1	5																
1	1	0	6																
1	1	1	7																

ROM Page 2 (D7 = 1)

ASCII CODE			D0	0	1	0	1	0	1	0	1	0	1	0	1	0	1		
D1			0	0	1	1	0	0	1	1	0	0	1	1	0	0	1	1	
D2			0	0	0	0	1	1	1	1	0	0	0	0	1	1	1	1	
D3			0	0	0	0	0	0	0	0	1	1	1	1	1	1	1	1	
D6	D5	D4	Hex	0	1	2	3	4	5	6	7	8	9	A	B	C	D	E	F
0	0	0	0																
0	0	1	1																
0	1	0	2																
0	1	1	3																
1	0	0	4																
1	0	1	5																
1	1	0	6																
1	1	1	7																

BLOCK DIAGRAM

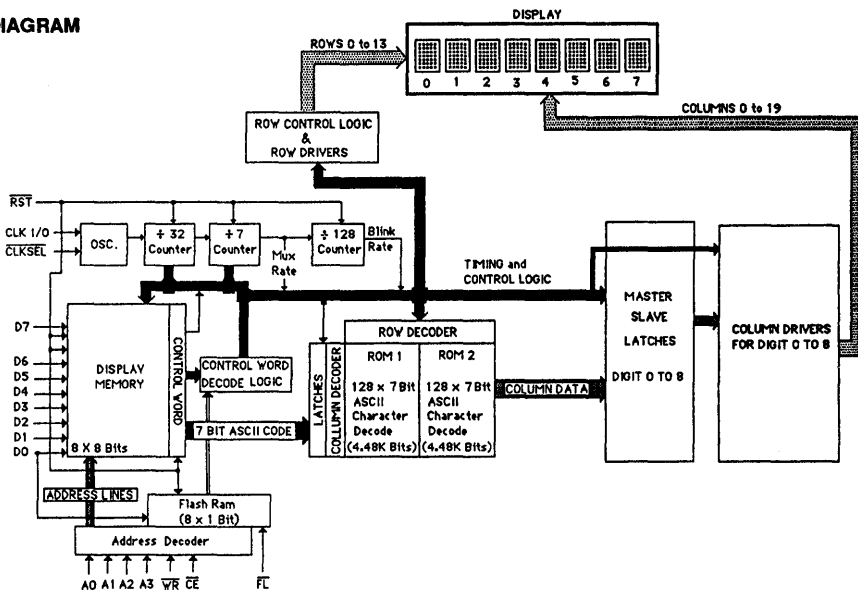

FUNCTIONAL DESCRIPTION

The PDSP211X block diagram is comprised of the following major blocks and registers.

Display Memory consists of a 8x8 bit RAM block. Each of the eight 8-bit words holds the 7-bit ASCII data (bit D0-D6). The 8th bit, D7 selects 1 of the 2 pages of character ROM. D7=0 selects Page 1 of the ROM and D7=1 selects Page 2 of the ROM. A3 = 1.

$\overline{\text{RST}}$ can be used to initialize display operation upon power up or during normal operation. When activated, $\overline{\text{RST}}$ will clear the Flash RAM and Control Word Register (00H) and reset the internal counter. All eight display memory locations will be set to 20H to show blanks in all digits.

$\overline{\text{FL}}$ pin enables access to the **Flash RAM**. The **Flash RAM** will set (D0 = 1) or reset (D0 = 0) flashing of the character addressed by A0-A2.

The 1x8 bit **Control Word RAM** is loaded with attribute data if A3=0.

The **Control Word Logic** decodes attribute data for proper implementation.

Character ROM is designed for two pages of 128 characters each. Both pages of the ROM are Mask Programmable for custom fonts. On the standard product page one contains standard ASCII, selected European characters and some scientific symbols. Page two contains Katakana characters, more European characters, avionics, and other graphic symbols.

The **Clock Source** could either be the internal oscillator (CLKSEL = 1) of the device or an external clock (CLKSEL = 0) could be an input from another PDSP211X display for the synchronization of blinking for multiple displays.

The **Display Multiplexer** controls the Row Drivers so no additional logic is required for a display system.

The **Display** has eight digits. Each digit has 35 LEDs clustered into a 5x7 dot matrix.

THEORY OF OPERATION

The PDSP211X Programmable display is designed to work with all major microprocessors. Data entry is via an eight bit parallel bus. Three bits of address route the data to the proper digit location in the RAM. Standard control signals like $\overline{\text{WR}}$ and $\overline{\text{CE}}$ allow the data to be written into the display.

D0 - D7 data bits are used for both ASCII and control word data input. A3 acts as the mode selector. If A3=0, D0 - D7 load the RAM with control word data. If A3=1, D0 - D7 will load the RAM with ASCII and page select data. In the later mode, D7=0 selects Page 1 of Character ROM and D7=1 selects Page 2 of Character ROM.

For normal operation $\overline{\text{FL}}$ pin should be held high. When $\overline{\text{FL}}$ is held low, Flash RAM is accessed to set character blinking.

The seven bit ASCII code is decoded by the Character ROM to generate Column data. Twenty columns worth of data is sent out each display cycle and it takes fourteen display cycles to write into eight digits.

The rows are being multiplexed in two sets of seven rows each. The internal timing and control logic synchronizes the turning on of rows and presentation of column data to assure proper display operation.

DATA INPUT COMMANDS

Signals							Operation
\overline{CE}	\overline{WR}	\overline{FL}	A3	A2	A1	A0	
1	X	X	X	X	X	X	No operation
X	1	X	X	X	X	X	No operation
0	0	1	0	0	0	0	Write Control Register
0	0	1	1	0	0	0	Digit 0 (left)
0	0	1	1	0	0	1	Digit 1
0	0	1	1	0	1	0	Digit 2
0	0	1	1	0	1	1	Digit 3
0	0	1	1	1	0	0	Digit 4
0	0	1	1	1	0	1	Digit 5
0	0	1	1	1	1	0	Digit 6
0	0	1	1	1	1	1	Digit 7 (right)
							Write display data to user RAM and Page Select Register
							D0-D6 = ASCII Data D7 = 0 Select ROM 1 D7 = 1 Select ROM 2
0	0	0	X	0	0	0	Digit 0 (left)
0	0	0	X	0	0	1	Digit 1
0	0	0	X	0	1	0	Digit 2
0	0	0	X	1	1	1	Digit 3
0	0	0	X	1	0	0	Digit 4
0	0	0	X	1	0	1	Digit 5
0	0	0	X	1	1	0	Digit 6
0	0	0	X	1	1	1	Digit 7 (right)
							Write Flash RAM Register
							D0 = 0 Flashing Charac. off D0 = 1 Flashing Charac. on D1-D7 = X

X = Don't care

POWER UP SEQUENCE

Upon power up display will come on at random. Thus the display should be reset on power-up. The reset will clear the Flash RAM, Control Word Register and reset the internal counter. All the digits will show blanks and display brightness level will be 100%.

MICROPROCESSOR INTERFACE

The interface to a microprocessor is through the 8-bit data bus (D0-D7), the 4-bit address bus (A0-A3) and control lines \overline{FL} , \overline{CE} and \overline{WR} .

To write data (ASCII/ Control Word) into the display \overline{CE} should be held low, address and data signals stable and \overline{WR} should be brought low.

The Control Word is decoded by the Control Word Decode Logic. Each code has a different function. The code for display brightness changes the duty cycle for the column drivers. The peak LED current stays the same but the average LED current diminishes depending on the intensity level.

The character Flash Enable causes 2 Hz coming out of the counter to be ANDED with column drive signal and makes the column driver to cycle at 2 Hz. Thus the character flashes at 2 Hz.

The display Blink works the same way as the Flash Enable but causes all twenty column drivers to cycle at 2 Hz thereby making all eight digits to blink at 2 Hz.

The Lamp Test causes the column drivers to run at 1/2 duty cycle thus all the LEDs in all eight digits turn on at 50% intensity.

Clear bit clears the character RAM and writes a blank into the display memory. It however does not clear the control word.

ASCII Data or Control Word Data can be written into the display at this point. For multiple display operation, CLK I/O must be properly selected. CLK I/O will output the internal clock if $\overline{CLKSEL} = 1$, or will allow input from an external clock if $\overline{CLKSEL} = 0$.

CONTROL WORD FORMAT

DISPLAY BRIGHTNESS

The display can be programmed to vary between blank, 13%, 20%, 27%, 40%, 53%, 80% and full brightness. Bits D0, D1 and D2 control the display brightness.

\overline{CE}	\overline{WR}	\overline{FL}	A3	A2	A1	A0	D7	D6	D5	D4	D3	D2	D1	D0	Display Brightness
0	0	1	0	X	X	X	0	0	X	X	X	0	0	0	100% Brightness
0	0	1	0	X	X	X	0	0	X	X	X	0	0	1	80% Brightness
0	0	1	0	X	X	X	0	0	X	X	X	0	1	0	53% Brightness
0	0	1	0	X	X	X	0	0	X	X	X	0	1	1	40% Brightness
0	0	1	0	X	X	X	0	0	X	X	X	1	0	0	27% Brightness
0	0	1	0	X	X	X	0	0	X	X	X	1	0	1	20% Brightness
0	0	1	0	X	X	X	0	0	X	X	X	1	1	0	13% Brightness
0	0	1	0	X	X	X	0	0	X	X	X	1	1	1	Blank Display

X = Don't Care

FLASH RAM FUNCTION

Character Flash is controlled by \overline{FL} pin, bit D0 and control word bit D3. Combination of \overline{FL} being low, proper digit address and D0 being high will write a flash bit into the Flash RAM Register. In the control word mode when D3 is brought high, the above mentioned character will flash.

SETTING THE FLASH BIT

\overline{CE}	\overline{WR}	\overline{FL}	A3	A2	A1	A0	D7	D6	D5	D4	D3	D2	D1	D0	Operation
0	0	0	X	A	A	A	X	X	X	X	X	X	X	0	Flash RAM Disabled
0	0	0	X	A	A	A	X	X	X	X	X	X	X	1	Flash RAM Enabled

X = Don't Care A = Selected Address

CHARACTER FLASH CONTROL WORD

\overline{CE}	\overline{WR}	\overline{FL}	A3	A2	A1	A0	D7	D6	D5	D4	D3	D2	D1	D0	Operation
0	0	1	0	X	X	X	0	0	X	0	0	B	B	B	Disable Flashing Character
0	0	1	0	X	X	X	0	0	X	0	1	B	B	B	Enable Flashing Character

X = Don't Care B = Selected Brightness

DISPLAY BLINKING

Blinking Function is independent of Flash function. When D4 is held high, entire display blinks at 2 Hz.

\overline{CE}	\overline{WR}	\overline{FL}	A3	A2	A1	A0	D7	D6	D5	D4	D3	D2	D1	D0	Operation
0	0	1	0	X	X	X	0	0	X	0	0	B	B	B	Display Blinking Disabled
0	0	1	0	X	X	X	0	0	X	1	0	B	B	B	Display Blinking Enabled

X = Don't Care B = Selected Brightness

LAMP TEST

Bit D6 when brought high will cause all the LEDs in all eight digits to light up at 53% brightness. Selecting or de-selecting Lamp Test bit has no effect on the display memory.

\overline{CE}	\overline{WR}	\overline{FL}	A3	A2	A1	A0	D7	D6	D5	D4	D3	D2	D1	D0	Operation
0	0	1	0	X	X	X	0	0	X	0	X	X	X	X	Lamp Test Disabled
0	0	1	0	X	X	X	0	1	X	0	0	X	X	X	Lamp Test Enabled

X = Don't Care

CLEAR FUNCTION

Clear function will clear the display. The Flash RAM will be set to all zeros. An ASCII blank code (20H) will be written into the display memory. The user must wait 3 μ s or write a new control word to the display with control word bit D7 = 0 to disable clear before writing any data to the display memory, otherwise all new data to the display memory will remain cleared. See Switching Specifications for clear function timing.

\overline{CE}	\overline{WR}	\overline{FL}	A3	A2	A1	A0	D7	D6	D5	D4	D3	D2	D1	D0	Operation
0	0	1	0	X	X	X	0	X	X	X	X	X	X	X	Clear Disabled
0	0	1	0	X	X	X	1	X	X	X	X	X	X	X	Clear User RAM, Page RAM, Flash RAM and Display

X = Don't Care

CONTROL WORD FORMAT

D7	D6	D5	D4	D3	D2	D1	D0
CLEAR ENABLE	LAMP TEST	NOT USED	BLINK ENABLE	FLASH ENABLE	BRIGHTNESS CONTROL		

D2	D1	D0	BRIGHTNESS
0	0	0	100%
0	0	1	80%
0	1	0	53%
0	1	1	40%
1	0	0	27%
1	0	1	20%
1	1	0	13%
1	1	1	0% Blank

D3 FLASH ENABLE

- 0 Disable Flashing Character
- 1 Enable Flashing Character

D4 BLINKING DISPLAY

- 0 Disable Blinking Display
- 1 Enable Blinking Display

D6 LAMP TEST

- 0 Disable Lamp Test
- 1 Enable Lamp Test (all dots on at 53% brightness)

D7 CLEAR ENABLE

- 0 Disable Clear
- 1 Enable Clear (Clear Data RAM, Page RAM, Flash RAM)

ELECTRICAL & MECHANICAL CONSIDERATIONS

VOLTAGE TRANSIENT SUPPRESSION

For best results power the display and the components that interface with the display to avoid logic inputs higher than V_{cc} . Additionally, the LEDs may cause transients in the power supply line while they change display states. The common practice is to place a parallel combination of a .01 μ F and a 22 μ F capacitor between V_{cc} and GND for all display packages.

ESD PROTECTION

The input protection structure of the PDSP2110/1/2/3/4 provides significant protection against ESD damage. It is capable of withstanding discharges greater than 2 KV. Take all the standard precautions, normal for CMOS components. These include properly grounding personnel, tools, tables, and transport carriers that come in contact with unshielded parts. If these conditions are not, or cannot be met, keep the leads of the device shorted together or the parts in anti-static packaging.

SOLDERING CONSIDERATIONS

THE PDSP2110/1/2/3/4 can be hand soldered with SN63 solder using a grounded iron set to 260°C.

Wave soldering is also possible following these conditions: Preheat that does not exceed 93°C on the solder side of the PC board or a package surface temperature of 85°C. Water soluble organic acid flux (except carboxylic acid) or resin-based RMA flux without alcohol can be used.

Wave temperature of 245°C \pm 5°C with a dwell between 1.5 sec. to 3.0 sec. Exposure to the wave should not exceed temperatures above 260°C for five seconds at 0.063" below the seating plane. The packages should not be immersed in the wave.

POST SOLDER CLEANING PROCEDURES

The least offensive cleaning solution is hot D.I. water (60°C) for less than 15 minutes. Addition of mild saponifiers is acceptable. Do not use commercial dishwasher detergents.

For faster cleaning, solvents may be used. Exercise care in choosing solvents as some may chemically attack the nylon package. Maximum exposure should not exceed two minutes at elevated temperatures. Acceptable solvents are TF (trichlorotrifluoroethane), TA, 111 Trichloroethane, and unheated acetone.⁽¹⁾

Note: 1. Acceptable commercial solvents are: Basic TF, Arklone, P. Genesolv, D. Genesolv DA, Blaco-Tron TF, Blaco-Tron TA, and Freon TA.

Unacceptable solvents contain alcohol, methanol, methylene chloride, ethanol, TP35, TCM, TMC, TMS+, TE, or TES. Since many commercial mixtures exist, contact a solvent vendor for chemical composition information. Some major solvent manufacturers are: Allied Chemical Corporation, Specialty Chemical Division, Morristown, NJ; Baron-Blakeslee, Chicago, IL; Dow Chemical, Midland, MI; E.I. DuPont de Nemours & Co., Wilmington, DE.

For further information refer to Appnotes 18 and 19 in the current Siemens Optoelectronic Data Book.

An alternative to soldering and cleaning the display modules is to use sockets. Naturally, 28 pin DIP sockets .600" wide with .100" centers work well for single displays.

Multiple display assemblies are best handled by longer SIP sockets or DIP sockets when available for uniform package alignment. Socket manufacturers are Aries Electronics, Inc., Frenchtown, NJ; Garry Manufacturing, New Brunswick, NJ; Robinson-Nugent, New Albany, IN; and Samtec Electronic Hardware, New Albany, IN.

For further information refer to Appnote 22 in the current Siemens Optoelectronic Data Book.

OPTICAL CONSIDERATIONS

The .200" high character of the PDSP211X gives readability up to eight feet. Proper filter selection enhances readability over this distance.

Using filters emphasizes the contrast ratio between a lit LED and the character background. This will increase the discrimination of different characters. The only limitation is cost. Take into consideration the ambient lighting environment for the best cost/benefit ratio for filters.

Incandescent (with almost no green) or fluorescent (with almost no red) lights do not have the flat spectral response of sunlight. Plastic band-pass filters are an inexpensive and effective way to strengthen contrast ratios. The PDSP2110/2112 are red/high efficiency red displays and should be matched with long wavelength pass filter in the 570 nm to 590 nm range. The PDSP2111/2113/2114 should be matched with a yellow-green band-pass filter that peaks at 565 nm. For displays of multiple colors, neutral density grey filters offer the best compromise.

Additional contrast enhancement is gained by shading the displays. Plastic band-pass filters with built-in louvers offer the next step up in contrast improvement. Plastic filters can be improved further with anti-reflective coatings to reduce glare. The trade-off is fuzzy characters. Mounting the filters close to the display reduces this effect. Take care not to overheat the plastic filter by allowing for proper air flow.

Optimal filter enhancements are gained by using circular polarized, anti-reflective, band-pass filters. The circular polarizing further enhances contrast by reducing the light that travels through the filter and reflects back off the display to less than 1%. Selecting the proper intensity of the displays allows 10,000 foot candle sunlight viewability.

Several filter manufacturers supply quality filter materials. Some of them are: Panelgraphic Corporation, W. Caldwell, NJ; SGL Homalite, Wilmington, DE; 3M Company, Visual Products Division, St. Paul, MN; Polaroid Corporation, Polarizer Division, Cambridge, MA; Marks Polarized Corporation, Deer Park, NY; Hoya Optics, Inc., Fremont, CA.

One last note on mounting filters: recessing displays and bezel assemblies is an inexpensive way to provide a shading effect in overhead lighting situations. Several bezel manufacturers are: R.M.F. Products, Batavia, IL; Nobex Components, Griffith Plastic Corp., Burlingame, CA; Photo Chemical Products of California, Santa Monica, CA; I.E.E.-Atlas, Van Nuys, CA.

SIEMENS

STANDARD RED SCD5580

YELLOW SCD5581

HIGH EFFICIENCY RED SCD5582

GREEN SCD5583

HIGH EFFICIENCY GREEN SCD5584

Slimline Serial Input Dot Addressable Intelligent Display®

Intelligent
Display Devices

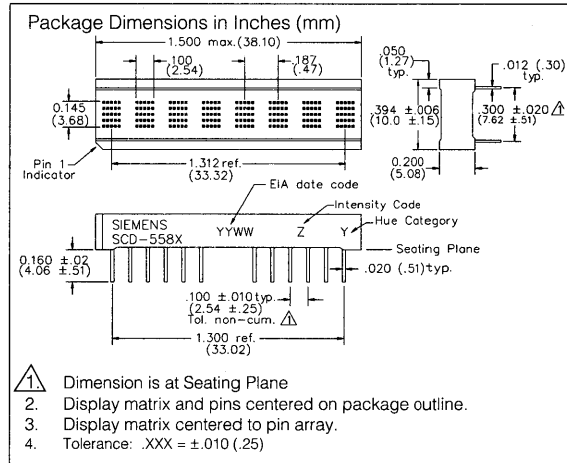
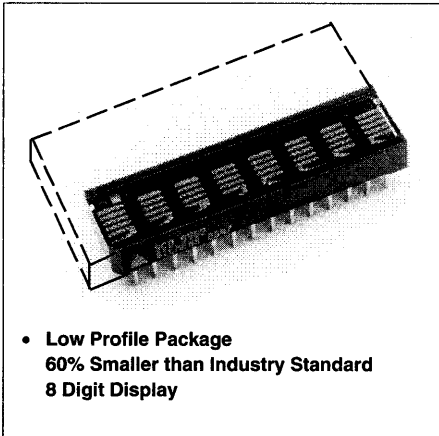

FEATURES

- **Eight 0.145" (3.68 mm) 5 X 5 Dot Matrix Characters in Red, Yellow, High Efficiency Red, Green, or High Efficiency Green**
- **Optimum Display Surface Efficiency (display area to package ratio)**
- **Low Power—30% Less Power Dissipation than 5 X 7 Format**
- **High Speed Data Input Rate—5 MHz**
- **ROMless Serial Input, Dot Addressable Display—Ideal for User Defined Characters**
- **Built-in Decoders, Multiplexers and LED Drivers**
- **Readable from 6 Feet (1.8 meters)**
- **Wide Viewing Angle, X Axis ±55°, Y Axis ±65°**
- **Attributes**
 - **200 Bit RAM For User Defined Characters**
 - **Eight Dimming Levels**
 - **Power Down Mode (<250 μW)**
 - **Hardware/Software Clear Function**
 - **Lamp Test**
- **Internal or External Clock**
- **End-Stackable Dual-In-Line Plastic Package**
- **3.3 V Capability**

DESCRIPTION

The SCD5580 (Red), SCD5581 (Yellow), SCD5582 (HER), SCD5583 (Green) and SCD5584 (HEG) are eight digit dot addressable 5 X 5 matrix, Serial Input, Intelligent Displays. The eight 0.145" (3.68mm) high digits are packaged in a rugged, high quality optically transparent, standard 0.3" pin spacing 28 pin plastic DIP.

The on-board CMOS has a 200 bit RAM, one bit associated with one LED, each to generate User Defined Characters. Due to the reduced LED count, power requirement and heat dissipation are reduced by 30%. Additionally in Power Down Mode quiescent current is <50 μA.

The SCD558X is designed to work with the Serial port of most common microprocessors. The multiplex Clock I/O (CLK I/O) and multiplex Clock Select (CLK SEL) pins offer the user the capability to supply a high speed external multiplex clock. This feature can minimize audio in-band interference for portable communication equipment or eliminate the visual synchronization effects found in high vibration environments such as avionic equipment.

Maximum Rating

DC Supply Voltage	-0.5 to +7.0 Vdc
Input Voltage Levels Relative to Ground	-0.5 to $V_{CC} + 0.5$ Vdc
Operating Temperature	-40°C to +85°C
Storage Temperature	-40°C to +100°C
Maximum Solder Temperature 0.063" below Seating Plane, $t < 5$ sec	260°C
Relative Humidity at 85°C	85%
Maximum Number of LEDs on at 100% Brightness	128
Maximum Power Dissipation	1.7 Watts
IC Junction Temperature	125°C
ESD (100 pF, 1.5 K Ω)	2 KV
Maximum Input Current	± 100 mA

Switching Specifications

(over operating temperature range and $V_{CC} = 4.5$ V to 5.5 V)

Symbol	Description	Min.	Units
T_{RC}	Reset Active Time	600	ns
T_{LDS}	Load Setup Time	50	ns
T_{DS}	Data Setup Time	50	ns
T_{SDCLK}	Clock Period	200	ns
T_{SDCW}	Clock Width	70	ns
T_{LDH}	Load Hold Time	0	ns
T_{DH}	Data Hold Time	25	ns
T_{WR}	Total Write Time	2.2	μ s
T_{BL}	Time Between Loads	600	ns

Note:

T_{SDCW} is the minimum time the SDCLK may be low or high. The SDCLK period must be a minimum of 200 ns.

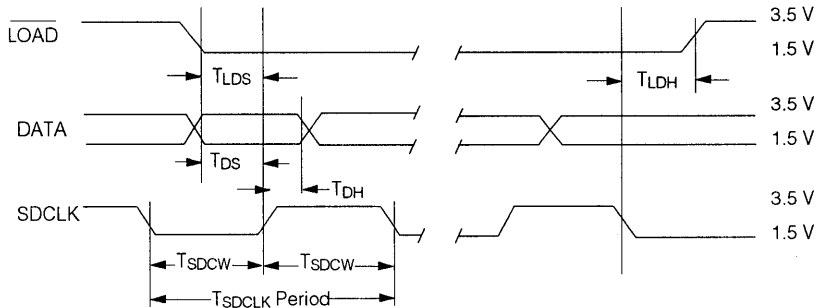

FIGURE 1. DATA WRITE CYCLE

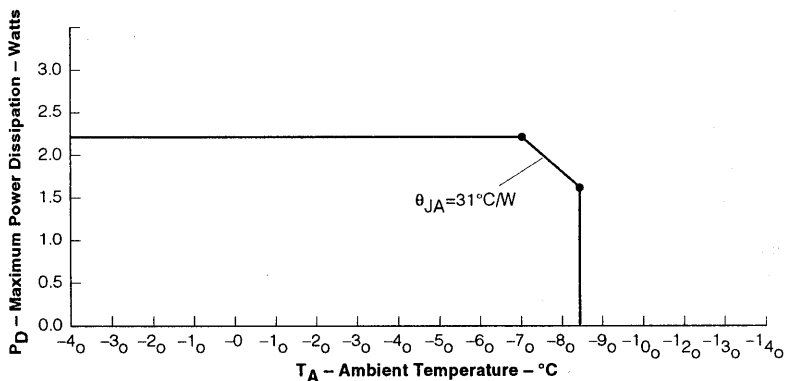

FIGURE 2. MAXIMUM POWER DISSIPATION VERSUS TEMPERATURE

ELECTRICAL CHARACTERISTICS (over Operating Temperature)

Parameters	Min.	Typ.	Max.	Units	Conditions
V_{CC}	4.5	5.0	5.5	V	
I_{CC} (Pwr Dwn Mode) ⁽⁴⁾			50	μ A	$V_{CC}=5$ V, all inputs=0 V or V_{CC}
I_{CC} 8 digits 16 dots/character		200	290	mA	$V_{CC}=5$ V, "#" displayed in all 8 digits at 100% brightness at 25°C
I_{IL} Input current			-10	μ A	$V_{CC}=5$ V, $V_{IN}=0$ V (all inputs)
I_{IH} Input current			+10	μ A	$V_{CC}=V_{IN}=5.0$ V (all inputs)
V_{IH}	3.5			V	$V_{CC}=4.5$ to 5.5 V
V_{IL}			1.5	V	$V_{CC}=4.5$ to 5.5 V
I_{OH} (Clk I/O)		-8.9		mA	$V_{CC}=4.5$, $V_{OH}=2.4$ V
I_{OL} (Clk I/O)		1.6		mA	$V_{CC}=4.5$, $V_{OL}=0.4$ V
θ_{JC-PIN}			31	$^{\circ}$ C/W	
F_{ext} External Clock Input Frequency	120		347	KHz	$V_{CC}=5.0$ V, $\overline{CLKSEL}=0$
F_{osc} Internal Clock Input Frequency	120		347	KHz	$V_{CC}=5.0$ V, $\overline{CLKSEL}=1$
Clock I/O Bus Loading			240	pF	
Clock Out Rise Time			500	ns	$V_{CC}=4.5$, $V_{OH}=2.4$ V
Clock Out Fall Time			500	ns	$V_{CC}=4.5$, $V_{OH}=0.4$ V
FM, Digit	375	768	1086	Hz	

Notes:

1. Peak current= $5/3 \times I_{CC}$.
2. Unused inputs must be tied high.
3. Contact Siemens for 3.3 volt operation.
4. External oscillator must be stopped if being used to maintain an $I_{CC}<50 \mu$ A.

INPUT/OUTPUT CIRCUITS

Figures 3 and 4 show the input and output resistor/diode networks used for ESD protection and to eliminate substrate latch-up caused by input voltage over/under shoot.

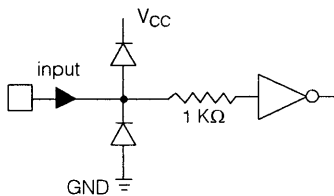
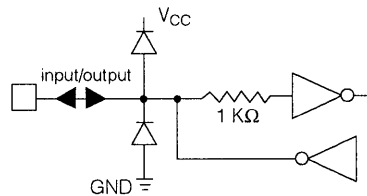
FIGURE 3. INPUTS

FIGURE 4. CLOCK I/O

Optical Characteristics at 25 °C, $V_{CC} = 5.0$ V at 100% Brightness Level
Viewing Angle: X Axis $\pm 55^\circ$, Y Axis $\pm 65^\circ$

Red SCD5580

Description	Symbol	Min.	Typ.	Units
Luminous Intensity Character Average (# displayed all digits)	I_V	0.48	1.8	mcd
Peak Wavelength	$\lambda(\text{peak})$		665	nm
Dominant Wavelength	$\lambda(d)$		639	nm

Yellow SCD5581

Description	Symbol	Min.	Typ.	Units
Luminous Intensity Character Average (# displayed all digits)	I_V	1.8	5.4	mcd
Peak Wavelength	$\lambda(\text{peak})$		583	nm
Dominant Wavelength	$\lambda(d)$		585	nm

High Efficiency Red SCD5582

Description	Symbol	Min.	Typ.	Units
Luminous Intensity Character Average (# displayed all digits)	I_V	1.8	5.4	mcd
Peak Wavelength	$\lambda(\text{peak})$		630	nm
Dominant Wavelength	$\lambda(d)$		626	nm

Green SCD5583

Description	Symbol	Min.	Typ.	Units
Luminous Intensity Character Average (# displayed all digits)	I_V	1.8	5.4	mcd
Peak Wavelength	$\lambda(\text{peak})$		565	nm
Dominant Wavelength	$\lambda(d)$		570	nm.

High Efficiency Green SCD5584

Description	Symbol	Min.	Typ.	Units
Luminous Intensity Character Average (# displayed all digits)	I_V	2.1	6.4	mcd
Peak Wavelength	$\lambda(\text{peak})$		568	nm
Dominant Wavelength	$\lambda(d)$		574	nm

Notes:

1. Dot to dot intensity matching at 100% brightness is 1.8:1.
2. Displays are binned for hue at 2 nm intervals.
3. Displays within a given intensity category have an intensity matching of 1.5:1 (max.).

TOP VIEW

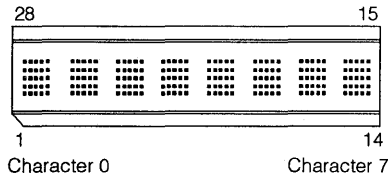

PIN ASSIGNMENTS

Pin	Function	Pin	Function
1	SDCLK	28	GND
2	LOAD	27	DATA
3	NC	26	NC
4	NC	25	NC
5	NC	24	NC
6	V _{CC}	23	V _{CC}
7	NP	22	NP
8	NP	21	NP
9	V _{CC}	20	V _{CC}
10	NC	19	V _{CC}
11	NC	18	NC
12	NC	17	NC
13	RST	16	CLKSEL
14	GND	15	CLK I/O

DISPLAY COLUMN AND ROW FORMAT

	C	C	C	C	C
	0	1	2	3	4
ROW 0	1	1	1	1	1
ROW 1	0	0	1	0	0
ROW 2	0	0	1	0	0
ROW 3	0	0	1	0	0
ROW 4	0	0	1	0	0

1 = Display Dot "On"
0 = Display Dot "Off"

COLUMN DATA RANGES

Row 0 : 00H to 1FH
Row 1 : 20H to 3FH
Row 2 : 40H to 5FH
Row 3 : 60H to 7FH
Row 4 : 80H to 9FH

PIN DEFINITIONS

Pin	Function	Definition
1	SDCLK	Used for loading data into the 8-bit serial data register on a low to high transition.
2	LOAD	Low input enables data clocking into 8-bit serial shift register. When LOAD goes high, the contents of 8-bit serial Shift Register will be decoded.
3	NC	No connection
4	NC	No connection
5	NC	No connection
6	V _{CC}	Power supply/heat sink
7	NP	No pin
8	NP	No pin
9	V _{CC}	Power supply/heat sink
10	NC	No connection
11	NC	No connection
12	NC	No connection
13	RST	Asynchronous input, when low will clear the Multiplex Counter, User RAM and Data Register. Control Word Register is set to 100% brightness and the Address Register is set to select Digit 0. The display is blanked.
14	GND	Power supply ground
15	CLK I/O	Outputs master clock or inputs external clock.
16	CLKSEL	H = internal clock, L = external clock
17	NC	No connection
18	NC	No connection
19	V _{CC}	Power supply/heat sink
20	V _{CC}	Power supply/heat sink
21	NP	No pin
22	NP	No pin
23	V _{CC}	Power supply/heat sink
24	NC	No connection
25	NC	No connection
26	NC	No connection
27	DATA	Serial data input
28	GND	Power supply ground

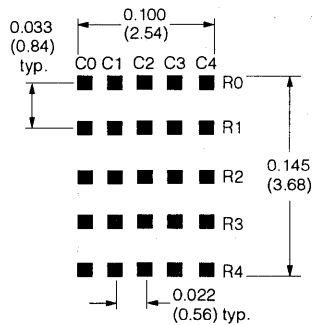

Dimensions in Inches (mm)
TOLERANCE: .XXX = ±.010 (.25)

FIGURE 5. DOT MATRIX FORMAT

Operation of the SCD558X

The SCD558X display consists of a CMOS IC containing control logic and drivers for eight 5 X 5 characters. These components are assembled in a compact (38 mm x 10 mm) plastic package.

Individual LED dot addressability allows the user great freedom in creating special characters or mini-icons. The User Definable Character Set Examples illustrate 200 different character and symbol possibilities.

The use of a serial data interface provides a highly efficient interconnection between the display and the

mother board. The SCD558X requires only 4 lines as compared to 15 for an equivalent 8 character parallel input part.

The on-board CMOS IC is the electronic heart of the display. The IC accepts decoded serial data, which is stored in the internal RAM. Asynchronously the RAM is read by the character multiplexer at a strobe rate that results in a flicker free display. Figure 6 shows the three functional areas of the IC. These include: the input serial data register and control logic, a 200 bits two port RAM, and an internal multiplexer/display driver.

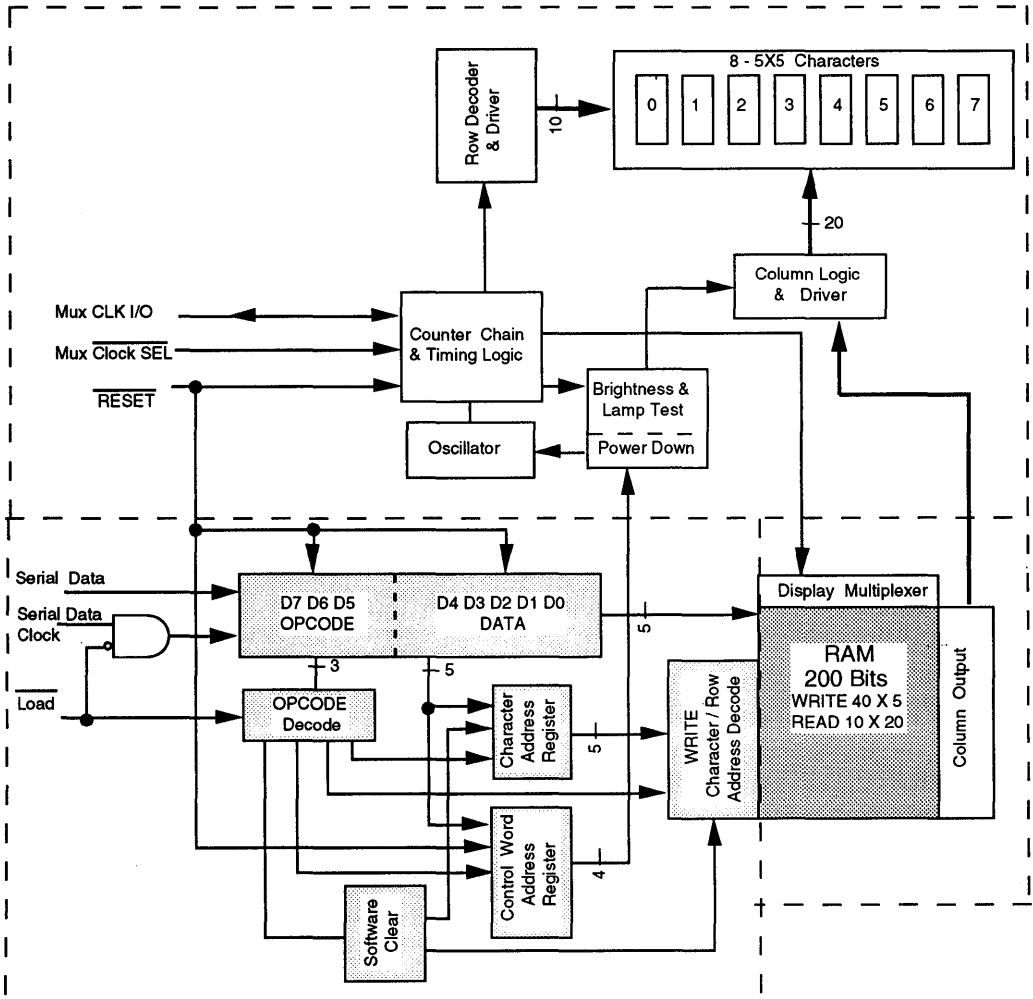

FIGURE 6. SCD558X BLOCK DIAGRAM

The following explains how to format the serial data to be loaded into the display. The user supplies a string of bit mapped decoded characters. The contents of this string is shown in Figure 7a. Figure 7b shows that each character consist of six 8 bit words. The first word encodes the display character location and the succeeding five bytes are row data. The row data represents the status (On, Off) of individual column LEDs. Figure 7c shows that each that each 8 bit word is formatted to include a three bit Operational Code (OPCODE) defined by bits D7-D5 and five bits (D4-D0) representing Column Data, Character Address, or Control Word Data.

Figure 7d shows the sequence for loading the bytes of data. Bringing the LOAD line low enables the serial register to accept data. The shift action occurs on the low to high transition of the serial data clock (SDCLK). The least significant bit (D0) is loaded first. After eight clock pulses the LOAD line is brought high. With this transition the OPCODE is decoded. The decoded OPCODE directs D4-D0 to be latched in the Character Address register, stored in the RAM as Column data, or latched in the Control Word register. The control IC requires a minimum 600 ns delay between successive byte loads. As indicated in Figure 7a, a total of 528 bits of data are required to load all eight characters into the display.

The Character Address Register bits, D4-D0 (Table 2), and Row Address Register bits, D7-D5 (Table 3), direct the Column Data bits, D4-D0 (Table 3) to specific RAM location. Table 1 shows the Row Address for the example character "D." Column data is written and read asynchronously from the 200 bit RAM. Once loaded the internal oscillator and character multiplexer reads the data from the RAM. These characters are row strobed with column data as shown in Figures 8 and 9. The character strobe rate is determined by the internal or user supplied external MUX Clock and the IC's + 320 counter.

TABLE 1. CHARACTER "D"

	Opcode D7 D6 D5			Column Data D4 D3 D2 D1 D0					Hex
	C0	C1	C2	C3	C4				
Row 0	0	0	0	1	1	1	1	0	1E
Row 1	0	0	1	1	0	0	0	1	31
Row 2	0	1	0	1	0	0	0	1	51
Row 3	0	1	1	1	0	0	0	1	71
Row 4	1	0	0	1	1	1	1	0	9E

EXAMPLE : Serial Clock = 5MHz, Clock Period = 200ns

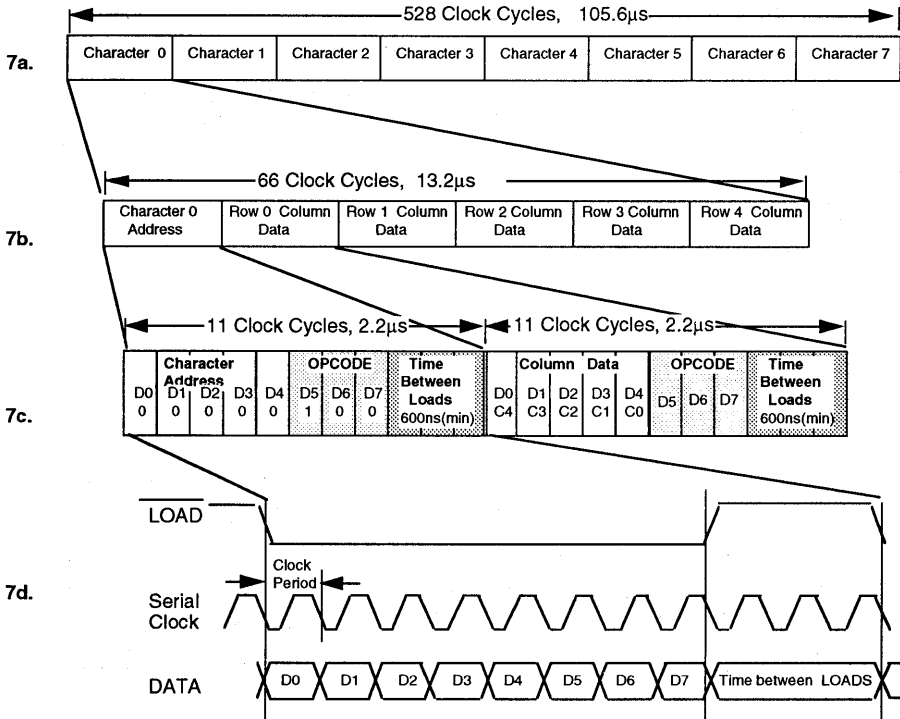

FIGURE 7a-d. LOADING SERIAL CHARACTER DATA

The user can activate four Control functions. These include: LED Brightness Level, Lamp Test, IC Power Down, or Display Clear. OPCODEs and five bit words are used to initiate these functions. The OPCODEs and Control Words for the Character Address and Loading Column Data are shown in Tables 2 and 3.

TABLE 2. LOAD CHARACTER ADDRESS

Opcode D7 D6 D5	Character Address D4 D3 D2 D1 D0	Hex	Operation Load
1 0 1	0 0 0 0 0	A0	Character 0
1 0 1	0 0 0 0 1	A1	Character 1
1 0 1	0 0 0 1 0	A2	Character 2
1 0 1	0 0 0 1 1	A3	Character 3
1 0 1	0 0 1 0 0	A4	Character 4
1 0 1	0 0 1 0 1	A5	Character 5
1 0 1	0 0 1 1 0	A6	Character 6
1 0 1	0 0 1 1 1	A7	Character 7

TABLE 3. LOAD COLUMN DATA

Opcode D7 D6 D5	Column Data D4 D3 D2 D1 D0	Operation Load
0 0 0	C0 C1 C2 C3 C4	Row 0
0 0 1	C0 C1 C2 C3 C4	Row 1
0 1 0	C0 C1 C2 C3 C4	Row 2
0 1 1	C0 C1 C2 C3 C4	Row 3
1 0 0	C0 C1 C2 C3 C4	Row 4

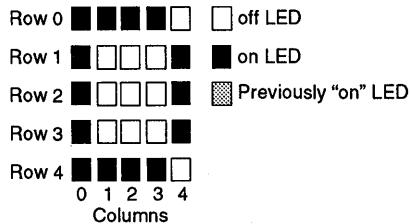

FIGURE 8. ROW AND COLUMN LOCATION

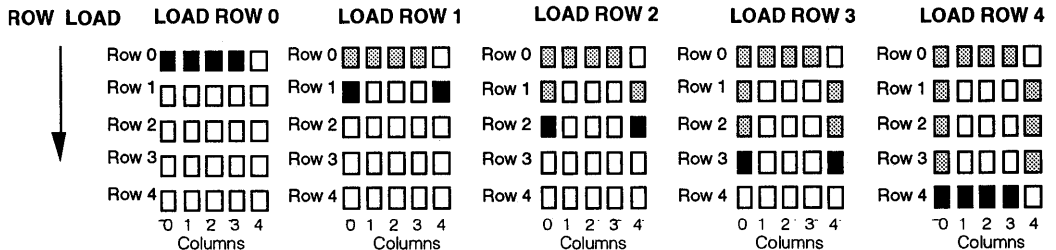

FIGURE 9. ROW STROBING

The user can select seven specific LED brightness levels, Table 4. These brightness levels (in percentages of full brightness of the display) include: 100% (F0_{HEX}), 53% (F1_{HEX}), 40% (F2_{HEX}), 27% (F3_{HEX}), 20% (F4_{HEX}), 13% (F5_{HEX}), and 6.6% (F6_{HEX}). The brightness levels are controlled by changing the duty factor of the row strobe pulse.

TABLE 4. DISPLAY BRIGHTNESS

Opcode D7 D6 D5	Control Word D4 D3 D2 D1 D0	Hex	Operation Level
1 1 1	1 0 0 0 0	F0	100%
1 1 1	1 0 0 0 1	F1	53%
1 1 1	1 0 0 1 0	F2	40%
1 1 1	1 0 0 1 1	F3	27%
1 1 1	1 0 1 0 0	F4	20%
1 1 1	1 0 1 0 1	F5	13%
1 1 1	1 0 1 1 0	F6	6.6%

The SCD558X offers a unique Display Power Down feature which reduces I_{CC} to less than 50 μ A. When FF_{HEX} is loaded, as shown in Table 5, the display is set to 0% brightness and the internal multiplex clock is stopped. When in the Power Down mode data may still be written into the RAM. The display is reactivated by loading a new Brightness Level Control Word into the display.

TABLE 5. POWER DOWN

Opcode D7 D6 D5	Control Word D4 D3 D2 D1 D0	Hex	Operation
1 1 1	1 1 1 1 1	FF	0% Brightness

ELECTRICAL & MECHANICAL CONSIDERATIONS**INTERCONNECT CONSIDERATIONS**

Optimum product performance can be had when the following electrical and mechanical recommendations are adopted. The SCD558X's IC is constructed in a high speed CMOS process, consequently high speed noise on the SERIAL DATA, SERIAL DATA CLOCK, LOAD and RESET lines may cause incorrect data to be written into the serial shift register. Adhere to transmission line termination procedures when using fast line drivers and long cables (>10 cm).

Good digital grounds (pins 14, 28) and power supply decoupling (pins 6, 9, 20, 23) will insure that I_{CC} (<400 mA peak) switching currents do not generate localized ground bounce. Therefore it is recommended that each display package use a 0.1µF and 20 µF capacitor between V_{CC} and ground.

When the internal MUX Clock is being used connect the CLKSEL pin to V_{CC}. In those applications where RESET will not be connected to the system's reset control, it is recommended that this pin be connected to the center node of a series 0.1, µF and 100 KΩ RC network. Thus upon initial power up the RESET will be held low for 10 ms allowing adequate time for the system power supply to stabilize.

The SCD558X allows up to 1.7 W of power dissipation at 70° and 1.29 W power dissipation at a maximum operating temperature of 85°C. Approximately 60% of this power is dissipated by the IC to the PC board via the V_{CC} connection (pins 6, 9, 20, 23). Optimum thermal reliability is obtained by connecting all of the V_{CC} pins to a common pad located on both sides of the PC board. This technique offers a low thermal resistance for IC to system ambient.

ESD PROTECTION

The input protection structure of the SCD5580/1/2/3/4 provides significant protection against ESD damage. It is capable of withstanding discharges greater than 2 KV. Take all the standard precautions, normal for CMOS components. These include properly grounding personnel, tools, tables, and transport carriers that come in contact with unshielded parts. If these conditions are not, or cannot be met, keep the leads of the device shorted together or the parts in anti-static packaging.

SOLDERING CONSIDERATIONS

THE SCD5580/1/2/3/4 can be hand soldered with SN63 solder using a grounded iron set to 260°C.

Wave soldering is also possible following these conditions: Preheat that does not exceed 93°C on the solder side of the PC board or a package surface temperature of 85°C. Water soluble organic acid flux (except carboxylic acid) or resin-based RMA flux without alcohol can be used.

Wave temperature of 245°C ± 5°C with a dwell between 1.5 sec. to 3.0 sec. Exposure to the wave should not exceed temperatures above 260°C for five seconds at 0.063" below the seating plane. The packages should not be immersed in the wave.

POST SOLDER CLEANING PROCEDURES

The least offensive cleaning solution is hot D.I. water (60°C) for less than 15 minutes. Addition of mild saponifiers is acceptable. Do not use commercial dishwasher detergents.

The Lamp Test is enabled by loading F8_{HEX}, Table 6, into the serial shift register. This Control Word sets all of the LEDs to a 53% brightness level. Operation of the Lamp Test has no effect on the RAM and is cleared by loading a Brightness Control Word.

TABLE 6. LAMP TEST

Opcode			Control Word				Hex	Operation
D7	D6	D5	D4	D3	D2	D1		
1	1	1	1	0	B	B	B	Lamp Test (OFF)
1	1	1	1	1	0	0	0	F8 Lamp Test (ON)

The Software Clear (C0_{HEX}), given in Table 7, clears the Address Register and the RAM. The display is blanked and the Character Address Register will be set to Character 0. The internal counter and the Control Word Register are unaffected. The Software Clear will remain active until the next data input cycle is initiated.

TABLE 7. SOFTWARE CLEAR

Opcode			Control Word				Hex	Operation
D7	D6	D5	D4	D3	D2	D1		
1	1	0	0	0	0	0	0	C0 CLEAR

MULTIPLEXER AND DISPLAY DRIVER

The eight characters are row multiplexed with RAM resident column data. The strobe rate is established by the internal or external MUX Clock rate. The MUX Clock frequency is divided by a 320 counter chain. This results in a typical strobe rate of 750Hz. By pulling the Clock SEL line low, the display can be operated from an external MUX Clock. The external clock is attached to the CLK I/O connection (pin 15). The maximum external MUX Clock frequency should be limited to 1 MHz.

An asynchronous hardware Reset (pin 13) is also provided. Bringing this pin low will clear the Character Address Register, Control Word Register, RAM, and blanks the display. This action leaves the display set at Character Address 0, and the Brightness Level set at 100%.

For faster cleaning, solvents may be used. Exercise care in choosing solvents as some may chemically attack the nylon package. Maximum exposure should not exceed two minutes at elevated temperatures. Acceptable solvents are TF (trichlorotrifluoroethane), TA, 111 Trichloroethane, and unheated acetone.⁽¹⁾

Note: 1. Acceptable commercial solvents are: Basic TF, Arklone, P. Genesol, D. Genesol DA, Blaco-Tron TF, Blaco-Tron TA, and Freon TA.

Unacceptable solvents contain alcohol, methanol, methylene chloride, ethanol, TP35, TCM, TMC, TMS+, TE, or TES. Since many commercial mixtures exist, contact a solvent vendor for chemical composition information. Some major solvent manufacturers are: Allied Chemical Corporation, Specialty Chemical Division, Morristown, NJ; Baron-Blakeslee, Chicago, IL; Dow Chemical, Midland, MI; E.I. DuPont de Nemours & Co., Wilmington, DE.

For further information refer to Appnotes 18 and 19 in the current Siemens Optoelectronic Data Book.

An alternative to soldering and cleaning the display modules is to use sockets. Naturally, 28 pin DIP sockets .300" wide with .100" centers work well for single displays. Multiple display assemblies are best handled by longer SIP sockets or DIP sockets when available for uniform package alignment. Socket manufacturers are Aries Electronics, Inc., Frenchtown, NJ; Garry Manufacturing, New Brunswick, NJ; Robinson-Nugent, New Albany, IN; and Samtec Electronic Hardware, New Albany, IN.

For further information refer to Appnote 22 in the current Siemens Optoelectronic Data Book.

OPTICAL CONSIDERATIONS

The 0.145" high character of the SCD5510X gives readability up to eight feet. Proper filter selection enhances readability over this distance.

Using filters emphasizes the contrast ratio between a lit LED and the character background. This will increase the discrimination of different characters. The only limitation is cost. Take into consideration the ambient lighting environment for the best cost/benefit ratio for filters.

Incandescent (with almost no green) or fluorescent (with almost no red) lights do not have the flat spectral response of sunlight. Plastic band-pass filters are an inexpensive and effective way to strengthen contrast ratios. The SCD55100/2 are red/high efficiency red displays and should be matched with long wavelength pass filter in the 570 nm to 590 nm range. The SCD55103/4 should be matched with a yellow-green band-pass filter that peaks at 565 nm. For displays of multiple colors, neutral density grey filters offer the best compromise.

Additional contrast enhancement is gained by shading the displays. Plastic band-pass filters with built-in louvers offer the next step up in contrast improvement. Plastic filters can be improved further with anti-reflective coatings to reduce glare. The trade-off is fuzzy characters. Mounting the filters close to the display reduces this effect. Take care not to overheat the plastic filter by allowing for proper air flow.

Optimal filter enhancements are gained by using circular polarized, anti-reflective, band-pass filters. The circular polarizing further enhances contrast by reducing the light that travels through the filter and reflects back off the display to less than 1%.

Several filter manufacturers supply quality filter materials. Some of them are: Panelgraphic Corporation, W. Caldwell, NJ; SGL Homalite, Wilmington, DE; 3M Company, Visual Products Division, St. Paul, MN; Polaroid Corporation, Polarizer Division, Cambridge, MA; Marks Polarized Corporation, Deer Park, NY; Hoya Optics, Inc., Fremont, CA.

One last note on mounting filters: recessing displays and bezel assemblies is an inexpensive way to provide a shading effect in overhead lighting situations. Several Bezel manufacturers are: R.M.F. Products, Batavia, IL; Nobex Components, Griffith Plastic Corp., Burlingame, CA; Photo Chemical Products of California, Santa Monica, CA; I.E.E.-Atlas, Van Nuys, CA.

MICROPROCESSOR INTERFACE

The microprocessor interface is through the serial port, SPI port or one out of eight data bits on the eight bit parallel port and also control lines SDCLK and LOAD.

POWER UP SEQUENCE

Upon power up display will come on at random. Thus the display should be reset at power-up. The reset will set the Address Register to Digit 0, User RAM is set to 0 (display blank) the Control Word is set to 0 (100% brightness with Lamp Test off) and the internal counters are reset.

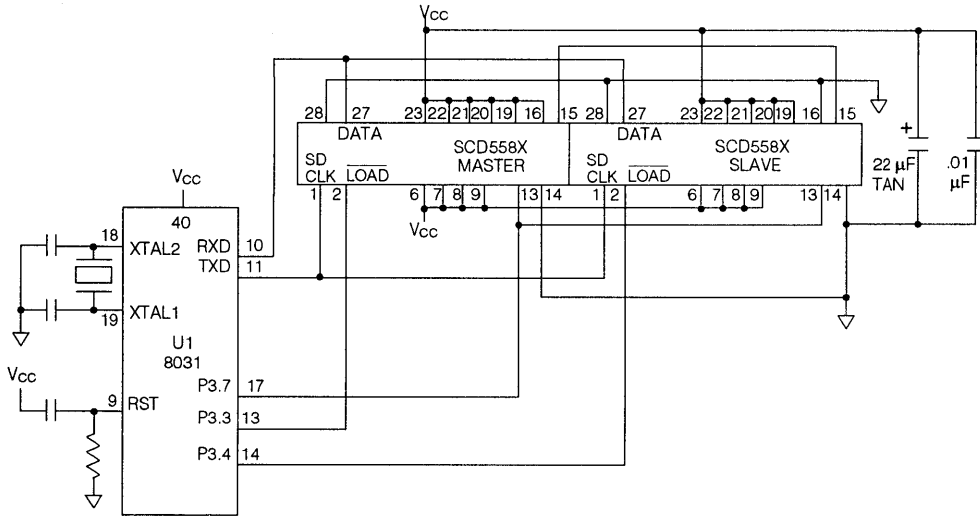

FIGURE 10. SCD INTERFACE TO SIEMENS/INTEL 8031 MICROPROCESSOR (using serial port in mode 0)

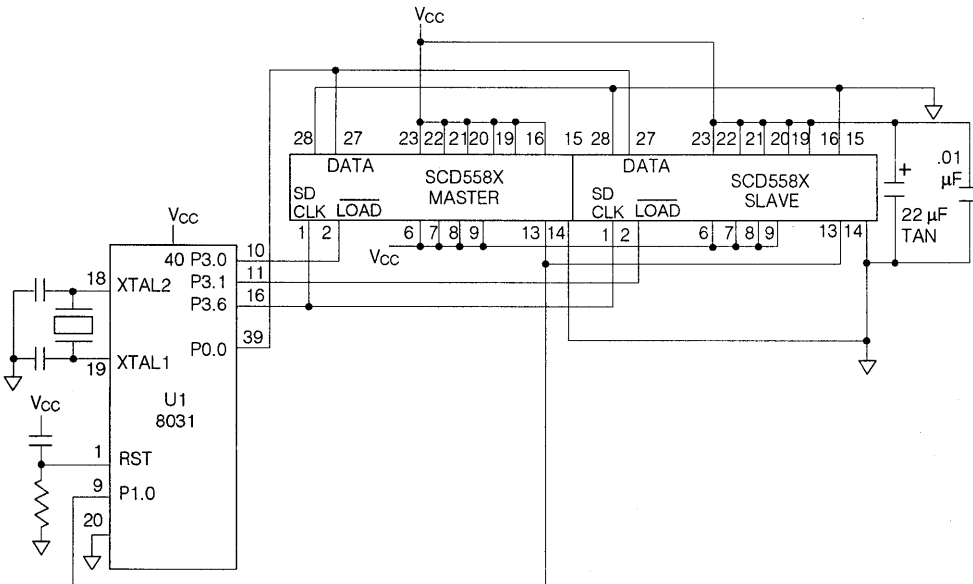

FIGURE 11. SCD558X INTERFACE WITH INTEL/SIEMENS 8031 MICROPROCESSOR (using one bit of parallel port as serial input)

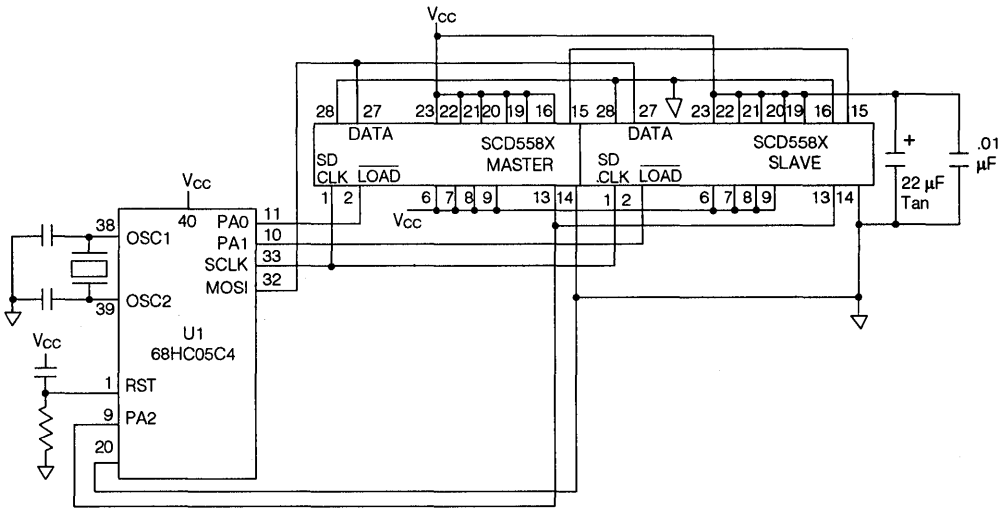

FIGURE 12. SCD558X INTERFACE WITH MOTOROLA 68HC05C4 MICROPROCESSOR (using SPI Port)

CASCADING MULTIPLE DISPLAYS

Multiple displays can be cascaded using the CLK SEL and CLK I/O pins as shown below. The display designated as the Master Clock source should have its CLK SEL pin tied high and the slaves should have their CLK SEL pins tied low. All CLK I/O pins should be tied together. One display CLK I/O can drive 15 slave CLK I/Os. Use RST to synchronize all display counters.

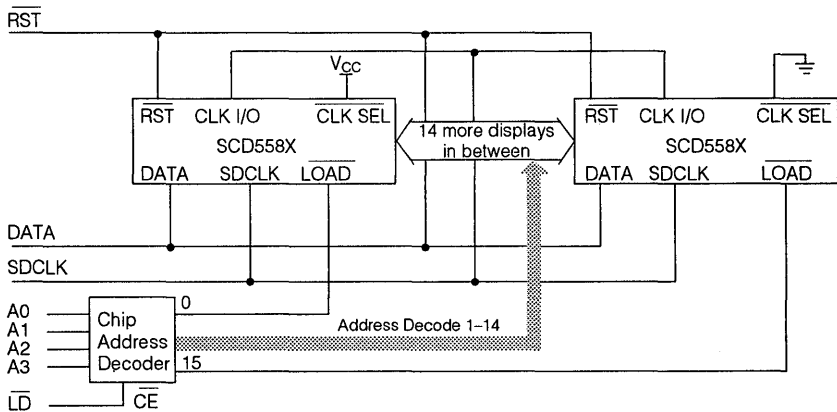

FIGURE 13. CASCADING MULTIPLE DISPLAYS

LOADING DATA INTO THE DISPLAY

Use following procedure to load data into the display:

1. Power up the display.
2. Bring RST low (600 ns duration minimum) to clear the Multiplex Counter, Address Register, Control Word Register, User Ram and Data Register. The display will be blank. Display brightness is set to 100%.
3. If a different brightness is desired, load the proper brightness opcode into the Control Word Register.
4. Load the Digit Address into the display.
5. Load display row and column data for the selected digit.
6. Repeat steps 4 and 5 for all digits.

DATA CONTENTS FOR THE WORD "DISPLAYS"

Step	D 7	D 6	D 5	D 4	D 3	D 2	D 1	D 0	Function
A	1	1	0	0	0	0	0	0	CLEAR
B (optional)	1	1	1	1	0	B	B	B	BRIGHTNESS SELECT
1	1	0	1	0	0	0	0	0	DIGIT D0 SELECT
2	0	0	0	1	1	1	1	0	ROW 0 D0 (D)
3	0	0	1	1	0	0	0	1	ROW 1 D0 (D)
4	0	1	0	1	0	0	0	1	ROW 2 D0 (D)
5	0	1	1	1	0	0	0	1	ROW 3 D0 (D)
6	1	0	0	1	1	1	1	0	ROW 4 D0 (D)
7	1	0	1	0	0	0	0	1	DIGIT D1 SELECT
8	0	0	0	0	1	1	1	0	ROW 0 D1 (I)
9	0	0	1	0	0	1	0	0	ROW 1 D1 (I)
10	0	1	0	0	0	1	0	0	ROW 2 D1 (I)
11	0	1	1	0	0	1	0	0	ROW 3 D1 (I)
12	1	0	0	0	1	1	1	0	ROW 4 D1 (I)
13	1	0	1	0	0	0	1	0	DIGIT D2 SELECT
14	0	0	0	0	1	1	1	1	ROW 0 D2 (S)
15	0	0	1	1	0	0	0	0	ROW 1 D2 (S)
16	0	1	0	0	1	1	1	0	ROW 2 D2 (S)
17	0	1	1	0	0	0	0	1	ROW 3 D2 (S)
18	1	0	0	1	1	1	1	0	ROW 4 D2 (S)
19	1	0	1	0	0	0	1	1	DIGIT D3 SELECT
20	0	0	0	1	1	1	1	0	ROW 0 D3 (P)
21	0	0	1	1	0	0	0	1	ROW 1 D3 (P)
22	0	1	0	1	1	1	1	0	ROW 2 D3 (P)
23	0	1	1	1	0	0	0	0	ROW 3 D3 (P)
24	1	0	0	1	0	0	0	0	ROW 4 D3 (P)
25	1	0	1	0	0	1	0	0	DIGIT D4 SELECT
26	0	0	0	1	0	0	0	0	ROW 0 D4 (L)
27	0	0	1	1	0	0	0	0	ROW 1 D4 (L)
28	0	1	0	1	0	0	0	0	ROW 2 D4 (L)
29	0	1	1	1	0	0	0	0	ROW 3 D4 (L)
30	1	0	0	1	1	1	1	1	ROW 4 D4 (L)
31	1	0	1	0	0	1	0	1	DIGIT D5 SELECT
32	0	0	0	0	0	1	0	0	ROW 0 D5 (A)
33	0	0	1	0	1	0	1	0	ROW 1 D5 (A)
34	0	1	0	1	1	1	1	1	ROW 2 D5 (A)
35	0	1	1	1	0	0	0	1	ROW 3 D5 (A)
36	1	0	0	1	0	0	0	1	ROW 4 D5 (A)
37	1	0	1	0	0	1	1	0	DIGIT D6 SELECT
38	0	0	0	1	0	0	0	1	ROW 0 D6 (Y)
39	0	0	1	0	1	0	1	0	ROW 1 D6 (Y)
40	0	1	0	0	0	1	0	0	ROW 2 D6 (Y)
41	0	1	1	0	0	1	0	0	ROW 3 D6 (Y)
42	1	0	0	0	0	1	0	0	ROW 4 D6 (Y)
43	1	0	1	0	0	1	1	1	DIGIT D7 SELECT
44	0	0	0	0	1	1	1	1	ROW 0 D7 (S)
45	0	0	1	1	0	0	0	0	ROW 1 D7 (S)
46	0	1	0	0	1	1	1	0	ROW 2 D7 (S)
47	0	1	1	0	0	0	0	1	ROW 3 D7 (S)
48	1	0	0	1	1	1	1	0	ROW 4 D7 (S)

Note:

If the display is already reset at Power Up, there is no need for Software Clear.

USER DEFINABLE CHARACTER SET EXAMPLES*

Upper and Lower Case Alphabets

HEX CODE		HEX CODE		HEX CODE		HEX CODE		HEX CODE		HEX CODE		HEX CODE		HEX CODE			
04	■	1E	■■■■	0F	■■■■	1E	■■■■	1F	■■■■	1F	■■■■	0F	■■■■	11	■	0E	■■■
2A	■	29	■	30	■	29	■	30	■	30	■	30	■	31	■	24	■
5F	■	4E	■	50	■	49	■	5E	■	5E	■	53	■	5F	■	44	■
71	■	69	■	70	■	69	■	70	■	70	■	71	■	71	■	64	■
91	■	9E	■■■■	8F	■■■■	9E	■■■■	9F	■■■■	90	■	8F	■■■■	91	■	8E	■■■
01	■	13	■	10	■	11	■	11	■	0E	■■■	1E	■■■■	0C	■	1E	■■■■
21	■	34	■	30	■	3B	■	39	■	31	■	31	■	32	■	31	■■■
41	■	58	■	50	■	55	■	55	■	51	■	5E	■■■■	56	■	5E	■■■■
71	■	74	■	70	■	71	■	73	■	71	■	70	■	72	■	74	■
8E	■■■■	93	■■■■	9F	■■■■	91	■■■■	91	■■■■	8E	■■■■	90	■	8D	■■■■	92	■■■
0F	■■■■	1F	■■■■	11	■	11	■	11	■	11	■	11	■	1F	■■■■		
30	■	24	■	31	■	31	■	31	■	2A	■	2A	■	22	■		
4E	■	44	■	51	■	51	■	55	■	44	■	44	■	44	■		
61	■	64	■	71	■	6A	■	7B	■	6A	■	64	■	64	■		
9E	■■■■	84	■	7E	■■■■	8A	■	91	■■■■	9A	■■■■	84	■	9F	■■■■		
00	■■■■	10	■	00	■■■■	01	■	00	■■■■	04	■	00	■■■■	10	■	04	■
2E	■■■■	30	■	2F	■■■■	21	■	2E	■■■■	2A	■	2F	■■■■	30	■	20	■
52	■■■■	5E	■■■■	50	■	4F	■■■■	5F	■■■■	48	■	50	■■■■	56	■	4C	■
72	■■■■	71	■	70	■	71	■	70	■	7C	■■■■	73	■	79	■	64	■
8D	■■■■	9E	■■■■	8F	■■■■	8F	■■■■	8E	■■■■	88	■	8F	■■■■	91	■	8E	■■■
00	■	10	■	0C	■	00	■	00	■	00	■	00	■	00	■	00	■
26	■	30	■	24	■	2A	■	36	■	2E	■	3E	■■■■	2F	■■■■	33	■■■
42	■	56	■	44	■	55	■	59	■	51	■	51	■	51	■	54	■■■
72	■	78	■	64	■	71	■	71	■	7E	■■■■	71	■	6F	■■■■	78	■■■
8C	■■	96	■■	8E	■■	91	■■	91	■■	8E	■■	90	■■	81	■■	90	■■
00	■	08	■	00	■	00	■	00	■	00	■	00	■	00	■		
23	■	3C	■	32	■	31	■	31	■	32	■	31	■	3E	■■■■		
44	■	48	■	52	■	51	■	55	■	4C	■	4A	■	44	■		
62	■	6A	■	72	■	6A	■	7B	■	6C	■	64	■	68	■		
8C	■■	84	■■	8D	■■	84	■■	91	■■	92	■■	98	■■	9E	■■		

Dot on = 1

Dot off = 0

Numerals and Punctuation

HEX CODE		HEX CODE		HEX CODE		HEX CODE		HEX CODE		HEX CODE		HEX CODE		HEX CODE			
0E	■■■■	04	■	1E	■■■■	1E	■■■■	06	■	1F	■■■■	06	■■■	1F	■■■■	0E	■■■
33	■	2C	■	21	■	21	■	2A	■	30	■	28	■	22	■	31	■■■
55	■	44	■	46	■	4E	■	5F	■■■■	5E	■■■■	5E	■■■■	44	■	4E	■■■
79	■	64	■	68	■	61	■■■■	62	■	61	■■■■	61	■■■■	68	■	71	■■■
8E	■■■■	8E	■■■■	9F	■■■■	9E	■■■■	82	■■■■	9E	■■■■	8E	■■■■	88	■■	8E	■■■
0E	■■■■	0A	■■■■	0F	■■■■	06	■	19	■	08	■	0C	■	02	■	08	■
31	■	3F	■■■■	34	■■■■	29	■	3A	■	34	■	2C	■	24	■	24	■
4F	■	4A	■■■■	4E	■■■■	5C	■■■■	44	■	4D	■■■■	44	■	44	■	44	■
62	■	7F	■■■■	65	■■■■	68	■■■■	6B	■■■■	72	■■■■	68	■	64	■	64	■
8C	■■	8A	■■	9E	■■	9F	■■	93	■■	8D	■■	80	■■	82	■■	88	■■
0C	■■	04	■	00	■■	00	■■	00	■■	01	■	04	■	0A	■■	07	■■■
2C	■	24	■	2C	■	20	■■■■	20	■■	22	■	24	■	2A	■	24	■
48	■	5F	■■■■	4C	■	5F	■■■■	40	■	44	■	44	■	40	■	44	■
64	■	64	■	60	■	60	■	6C	■	68	■	60	■	60	■	64	■
80	■■	84	■■	88	■■	80	■■	8C	■■	90	■■	84	■■	80	■■	87	■■■
10	■	1C	■■	0E	■■■■	00	■■	0C	■■	0C	■■	02	■	00	■	08	■
28	■	24	■	35	■■■■	20	■■	2C	■■	20	■■	24	■	3F	■■■■	24	■
44	■	44	■	57	■■■■	40	■■	40	■■	4C	■	48	■	40	■	42	■
62	■	64	■	70	■■■■	60	■■	6C	■■	64	■	64	■	7F	■■■■	64	■
81	■	9C	■■	8E	■■	9F	■■	8C	■■	88	■	82	■■	80	■■	88	■■
0E	■■	06	■■	0C	■■	04	■	11	■	15	■■■■	04	■	08	■		
31	■	24	■	24	■	24	■	44	■	2E	■	2A	■	35	■■■		
42	■	48	■	42	■	40	■	44	■	5F	■■■■	51	■	42	■		
64	■	64	■	64	■	60	■	6E	■	6E	■■■■	60	■	60	■		
88	■■	86	■■	8C	■■	84	■■	84	■■	95	■■	80	■■	80	■■		

Dot on = 1

Dot off = 0

* CAUTION: No more than 128 LEDs "on" at one time at 100% brightness.

USER DEFINABLE CHARACTER SET EXAMPLES* (continued)

Scientific Notations, etc.

HEX CODE		HEX CODE		HEX CODE		HEX CODE		HEX CODE		HEX CODE		HEX CODE		HEX CODE			
06	■ ■	04	■ ■	1F	■ ■ ■ ■	1F	■ ■ ■ ■	0E	■ ■ ■	0D	■ ■ ■ ■	0C	■ ■ ■	0E	■ ■ ■	00	■ ■ ■
2E	■ ■ ■ ■	24	■ ■ ■	20	■ ■ ■ ■	20	■ ■ ■ ■	20	■ ■ ■	32	■ ■ ■ ■	32	■ ■ ■ ■	24	■ ■ ■ ■	24	■ ■ ■ ■
5E	■ ■ ■ ■	48	■ ■ ■	59	■ ■ ■ ■	56	■ ■ ■ ■	4A	■ ■ ■	52	■ ■ ■ ■	56	■ ■ ■ ■	4E	■ ■ ■ ■	4A	■ ■ ■ ■
6E	■ ■ ■	71	■ ■ ■	75	■ ■ ■ ■	79	■ ■ ■ ■	6A	■ ■ ■	72	■ ■ ■ ■	71	■ ■ ■ ■	7E	■ ■ ■ ■	71	■ ■ ■ ■
86	■ ■ ■	8E	■ ■ ■	93	■ ■ ■ ■	91	■ ■ ■ ■	84	■ ■ ■	8D	■ ■ ■ ■	96	■ ■ ■ ■	8E	■ ■ ■ ■	9F	■ ■ ■ ■
10	■ ■ ■ ■	0E	■ ■ ■ ■	10	■ ■ ■ ■	09	■ ■ ■ ■	01	■ ■ ■ ■	04	■ ■ ■ ■	0E	■ ■ ■ ■	01	■ ■ ■ ■	0F	■ ■ ■ ■
3C	■ ■ ■ ■	31	■ ■ ■ ■	28	■ ■ ■ ■	29	■ ■ ■ ■	2E	■ ■ ■ ■	2E	■ ■ ■ ■	31	■ ■ ■ ■	2E	■ ■ ■ ■	32	■ ■ ■ ■
52	■ ■ ■ ■	5F	■ ■ ■ ■	44	■ ■ ■ ■	49	■ ■ ■ ■	54	■ ■ ■ ■	55	■ ■ ■ ■	51	■ ■ ■ ■	5A	■ ■ ■ ■	52	■ ■ ■ ■
72	■ ■ ■ ■	71	■ ■ ■ ■	6A	■ ■ ■ ■	6E	■ ■ ■ ■	54	■ ■ ■ ■	6E	■ ■ ■ ■	6A	■ ■ ■ ■	6A	■ ■ ■ ■	72	■ ■ ■ ■
81	■ ■ ■ ■	8E	■ ■ ■ ■	91	■ ■ ■ ■	90	■ ■ ■ ■	84	■ ■ ■ ■	84	■ ■ ■ ■	9B	■ ■ ■ ■	8A	■ ■ ■ ■	8C	■ ■ ■ ■
1F	■ ■ ■ ■	18	■ ■ ■	1C	■ ■ ■	12	■ ■ ■	06	■ ■ ■	07	■ ■ ■	1C	■ ■ ■	0F	■ ■ ■	04	■ ■ ■
28	■ ■ ■ ■	24	■ ■ ■	28	■ ■ ■	36	■ ■ ■	21	■ ■ ■	22	■ ■ ■	34	■ ■ ■	28	■ ■ ■	2E	■ ■ ■
44	■ ■ ■ ■	48	■ ■ ■	44	■ ■ ■	5A	■ ■ ■	5A	■ ■ ■	59	■ ■ ■	5C	■ ■ ■	48	■ ■ ■	5F	■ ■ ■
68	■ ■ ■ ■	7C	■ ■ ■	78	■ ■ ■	67	■ ■ ■	67	■ ■ ■	66	■ ■ ■	60	■ ■ ■	78	■ ■ ■	6E	■ ■ ■
9F	■ ■ ■ ■	80	■ ■ ■	80	■ ■ ■	80	■ ■ ■	80	■ ■ ■	80	■ ■ ■	80	■ ■ ■	88	■ ■ ■	80	■ ■ ■
00	■ ■ ■ ■	00	■ ■ ■ ■	0E	■ ■ ■ ■	04	■ ■ ■ ■	04	■ ■ ■ ■	0E	■ ■ ■ ■	00	■ ■ ■ ■	04	■ ■ ■ ■	04	■ ■ ■ ■
24	■ ■ ■ ■	2E	■ ■ ■ ■	3F	■ ■ ■ ■	3E	■ ■ ■ ■	2F	■ ■ ■ ■	2E	■ ■ ■ ■	3F	■ ■ ■ ■	2E	■ ■ ■ ■	24	■ ■ ■ ■
4E	■ ■ ■ ■	5F	■ ■ ■ ■	4E	■ ■ ■ ■	5F	■ ■ ■ ■	4E	■ ■ ■ ■	4E	■ ■ ■ ■	5F	■ ■ ■ ■	55	■ ■ ■ ■	55	■ ■ ■ ■
7F	■ ■ ■ ■	6E	■ ■ ■ ■	64	■ ■ ■ ■	7E	■ ■ ■ ■	5F	■ ■ ■ ■	6E	■ ■ ■ ■	7F	■ ■ ■ ■	64	■ ■ ■ ■	6E	■ ■ ■ ■
8E	■ ■ ■ ■	84	■ ■ ■ ■	80	■ ■ ■ ■	84	■ ■ ■ ■	84	■ ■ ■ ■	8E	■ ■ ■ ■	80	■ ■ ■ ■	84	■ ■ ■ ■	84	■ ■ ■ ■
04	■ ■ ■ ■	04	■ ■ ■ ■	1F	■ ■ ■ ■	08	■ ■ ■ ■	0A	■ ■ ■ ■	15	■ ■ ■ ■	1F	■ ■ ■ ■	00	■ ■ ■ ■	0E	■ ■ ■ ■
22	■ ■ ■ ■	28	■ ■ ■ ■	31	■ ■ ■ ■	2C	■ ■ ■ ■	35	■ ■ ■ ■	2A	■ ■ ■ ■	35	■ ■ ■ ■	3F	■ ■ ■ ■	3F	■ ■ ■ ■
5F	■ ■ ■ ■	5F	■ ■ ■ ■	51	■ ■ ■ ■	4A	■ ■ ■ ■	4A	■ ■ ■ ■	55	■ ■ ■ ■	5F	■ ■ ■ ■	5F	■ ■ ■ ■	5B	■ ■ ■ ■
62	■ ■ ■ ■	68	■ ■ ■ ■	71	■ ■ ■ ■	78	■ ■ ■ ■	75	■ ■ ■ ■	6A	■ ■ ■ ■	75	■ ■ ■ ■	7C	■ ■ ■ ■	7F	■ ■ ■ ■
84	■ ■ ■ ■	84	■ ■ ■ ■	9F	■ ■ ■ ■	98	■ ■ ■ ■	8A	■ ■ ■ ■	95	■ ■ ■ ■	9F	■ ■ ■ ■	80	■ ■ ■ ■	8E	■ ■ ■ ■
00	■ ■ ■ ■	00	■ ■ ■ ■	00	■ ■ ■ ■	00	■ ■ ■ ■	00	■ ■ ■ ■	0C	■ ■ ■ ■	15	■ ■ ■ ■				
27	■ ■ ■ ■	3C	■ ■ ■ ■	20	■ ■ ■ ■	20	■ ■ ■ ■	23	■ ■ ■ ■	3C	■ ■ ■ ■	2E	■ ■ ■ ■				
4F	■ ■ ■ ■	5F	■ ■ ■ ■	40	■ ■ ■ ■	40	■ ■ ■ ■	5F	■ ■ ■ ■	44	■ ■ ■ ■	44	■ ■ ■ ■				
78	■ ■ ■ ■	63	■ ■ ■ ■	60	■ ■ ■ ■	67	■ ■ ■ ■	67	■ ■ ■ ■	7C	■ ■ ■ ■	64	■ ■ ■ ■				
9C	■ ■ ■ ■	87	■ ■ ■ ■	83	■ ■ ■ ■	9F	■ ■ ■ ■	9F	■ ■ ■ ■	9C	■ ■ ■ ■	84	■ ■ ■ ■				

Dot on = 1

Dot off = 0

Foreign Characters

HEX CODE		HEX CODE		HEX CODE		HEX CODE		HEX CODE		HEX CODE		HEX CODE		HEX CODE			
1F	■ ■ ■ ■	1F	■ ■ ■ ■	01	■ ■ ■	02	■ ■ ■	00	■ ■ ■	02	■ ■ ■	08	■ ■ ■	1F	■ ■ ■ ■	04	■ ■ ■
21	■ ■ ■ ■	21	■ ■ ■ ■	22	■ ■ ■	3F	■ ■ ■	3F	■ ■ ■	3F	■ ■ ■	3F	■ ■ ■	21	■ ■ ■	3F	■ ■ ■
5F	■ ■ ■ ■	46	■ ■ ■	46	■ ■ ■	51	■ ■ ■	44	■ ■ ■	46	■ ■ ■	49	■ ■ ■	45	■ ■ ■	51	■ ■ ■
62	■ ■ ■ ■	64	■ ■ ■	6A	■ ■ ■	61	■ ■ ■	64	■ ■ ■	6A	■ ■ ■	6A	■ ■ ■	67	■ ■ ■	62	■ ■ ■
84	■ ■ ■ ■	88	■ ■ ■	82	■ ■ ■	86	■ ■ ■	86	■ ■ ■	92	■ ■ ■	88	■ ■ ■	8C	■ ■ ■	8C	■ ■ ■
08	■ ■ ■ ■	04	■ ■ ■	0F	■ ■ ■ ■	08	■ ■ ■	0F	■ ■ ■ ■	0A	■ ■ ■	19	■ ■ ■	0F	■ ■ ■	01	■ ■ ■
3F	■ ■ ■ ■	3F	■ ■ ■ ■	29	■ ■ ■	2F	■ ■ ■	21	■ ■ ■	3F	■ ■ ■	21	■ ■ ■	29	■ ■ ■	3E	■ ■ ■
49	■ ■ ■ ■	44	■ ■ ■	51	■ ■ ■	52	■ ■ ■	41	■ ■ ■	4A	■ ■ ■	59	■ ■ ■	55	■ ■ ■	42	■ ■ ■
69	■ ■ ■ ■	7F	■ ■ ■	62	■ ■ ■	62	■ ■ ■	61	■ ■ ■	62	■ ■ ■	62	■ ■ ■	63	■ ■ ■	7F	■ ■ ■
92	■ ■ ■ ■	84	■ ■ ■	8C	■ ■ ■	82	■ ■ ■	9F	■ ■ ■	8C	■ ■ ■	9C	■ ■ ■	8C	■ ■ ■	86	■ ■ ■
15	■ ■ ■ ■	0E	■ ■ ■	08	■ ■ ■	04	■ ■ ■	0E	■ ■ ■	1F	■ ■ ■ ■	04	■ ■ ■	02	■ ■ ■	04	■ ■ ■
35	■ ■ ■ ■	20	■ ■ ■	28	■ ■ ■	3F	■ ■ ■	20	■ ■ ■	21	■ ■ ■	3E	■ ■ ■	22	■ ■ ■	22	■ ■ ■
55	■ ■ ■ ■	5F	■ ■ ■	4C	■ ■ ■	44	■ ■ ■	40	■ ■ ■	4A	■ ■ ■	44	■ ■ ■	42	■ ■ ■	51	■ ■ ■
62	■ ■ ■ ■	64	■ ■ ■	6A	■ ■ ■	64	■ ■ ■	60	■ ■ ■	64	■ ■ ■	6E	■ ■ ■	64	■ ■ ■	71	■ ■ ■
8C	■ ■ ■ ■	98	■ ■ ■	8A	■ ■ ■	98	■ ■ ■	9F	■ ■ ■	9A	■ ■ ■	95	■ ■ ■	88	■ ■ ■	91	■ ■ ■
10	■ ■ ■ ■	1F	■ ■ ■ ■	0E	■ ■ ■	04	■ ■ ■	01	■ ■ ■	1F	■ ■ ■ ■	1E	■ ■ ■	1F	■ ■ ■	0E	■ ■ ■
3F	■ ■ ■ ■	21	■ ■ ■	20	■ ■ ■	28	■ ■ ■	21	■ ■ ■	28	■ ■ ■	22	■ ■ ■	21	■ ■ ■	20	■ ■ ■
50	■ ■ ■ ■	41	■ ■ ■	4E	■ ■ ■	51	■ ■ ■	4A	■ ■ ■	5F	■ ■ ■	42	■ ■ ■	5F	■ ■ ■	5F	■ ■ ■
70	■ ■ ■ ■	62	■ ■ ■	60	■ ■ ■	7F	■ ■ ■	64	■ ■ ■	68	■ ■ ■	62	■ ■ ■	61	■ ■ ■	61	■ ■ ■
8F	■ ■ ■ ■	8C	■ ■ ■	8F	■ ■ ■	81	■ ■ ■	8A	■ ■ ■	87	■ ■ ■	9F	■ ■ ■	9F	■ ■ ■	8E	■ ■ ■
12	■ ■ ■ ■	04	■ ■ ■	1E	■ ■ ■ ■	0F	■ ■ ■	0F	■ ■ ■	0F	■ ■ ■	0F	■ ■ ■	00	■ ■ ■	08	■ ■ ■
32	■ ■ ■ ■	34	■ ■ ■	25	■ ■ ■	34	■ ■ ■	30	■ ■ ■	33	■ ■ ■	34	■ ■ ■	2A	■ ■ ■	24	■ ■ ■
52	■ ■ ■ ■	54	■ ■ ■	4F	■ ■ ■	5F	■ ■ ■	4F	■ ■ ■	55	■ ■ ■	57	■ ■ ■	5F	■ ■ ■	4E	■ ■ ■
64	■ ■ ■ ■	75	■ ■ ■	74	■ ■ ■	74	■ ■ ■	64	■ ■ ■	79	■ ■ ■	74	■ ■ ■	74	■ ■ ■	72	■ ■ ■
88	■ ■ ■ ■	96	■ ■ ■	8F	■ ■ ■	97	■ ■ ■	98	■ ■ ■	9E	■ ■ ■	8F	■ ■ ■	8B	■ ■ ■	8F	■ ■ ■
0A	■ ■ ■ ■	02	■ ■ ■	04	■ ■ ■	0A	■ ■ ■	08	■ ■ ■	02	■ ■ ■	04	■ ■ ■				
2E	■ ■ ■ ■	24	■ ■ ■	2A	■ ■ ■	34	■ ■ ■	24	■ ■ ■	24	■ ■ ■	2A	■ ■ ■				
51	■ ■ ■ ■	4C	■ ■ ■	4E	■ ■ ■	52	■ ■ ■	51	■ ■ ■	51	■ ■ ■	51	■ ■ ■				
7F	■ ■ ■ ■	64	■ ■ ■	71	■ ■ ■	7A	■ ■ ■	71	■ ■ ■	71	■ ■ ■	71	■ ■ ■				
91	■ ■ ■ ■	8E	■ ■ ■	8E	■ ■ ■	96	■ ■ ■	8E	■ ■ ■	8E	■ ■ ■	8E	■ ■ ■				

Dot on = 1

Dot off = 0

* CAUTION: No more than 128 LEDs "on" at one time at 100% brightness.

SIEMENS

STANDARD RED **SCD55100**

YELLOW **SCD55101**

HIGH EFFICIENCY RED **SCD55102**

GREEN **SCD55103**

HIGH EFFICIENCY GREEN **SCD55104**

Slimline

**0.145" 10-Character, 5 x 5 Dot Matrix
Serial Input Dot Addressable Intelligent Display®**

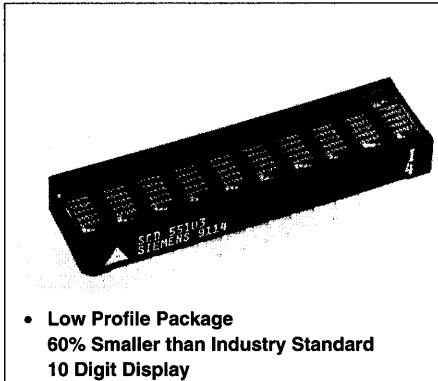

FEATURES

- **Ten 0.145" (3.68 mm) 5 X 5 Dot Matrix Characters in Red, Yellow, High Efficiency Red, Green, or High Efficiency Green**
- **Optimum Display Surface Efficiency (display area to package ratio)**
- **Low Power—30% Less Power Dissipation than 5 X 7 Format**
- **High Speed Data Input Rate—5 MHz**
- **ROMless Serial Input, Dot Addressable Display—Ideal for User Defined Characters**
- **Built-in Decoders, Multiplexers and LED Drivers**
- **Readable from 6 Feet (1.8 meters)**
- **Wide Viewing Angle, X Axis $\pm 55^\circ$, Y Axis $\pm 65^\circ$**
- **Attributes**
 - 250 Bit RAM For User Defined Characters
 - Eight Dimming Levels
 - Power Down Mode (<250 μ W)
 - Hardware/Software Clear Function
 - Lamp Test
- **Internal or External Clock**
- **End-Stackable Dual-In-Line Plastic Package**
- **3.3 V Capability**

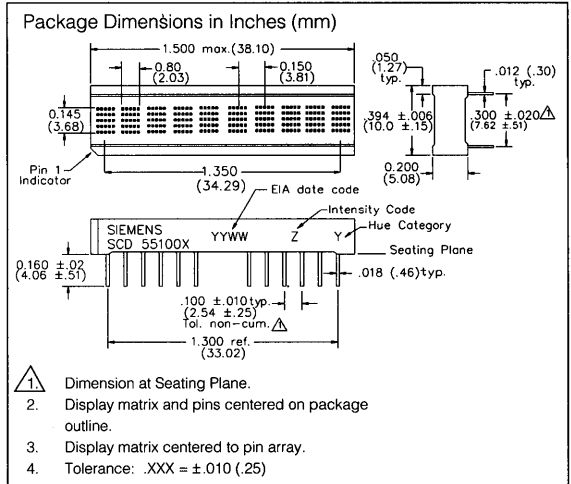

DESCRIPTION

The SCD55100 (Red), SCD55101 (Yellow), SCD55102 (HER), SCD55103 (Green) and SCD55104 (HEG) are ten digit dot addressable 5 X 5 matrix, Serial Input, Intelligent Displays. The ten 0.145" (3.68mm) high digits are packaged in a rugged, high quality optically transparent, standard 0.3" pin spacing 28 pin plastic DIP.

The on-board CMOS has a 250 bit RAM, one bit associated with one LED, each to generate User Defined Characters. Due to the reduced LED count, power requirement and heat dissipation are reduced by 30%. Additionally in Power Down Mode quiescent current is <50 μ A.

The SCD5510X is designed to work with the Serial port of most common microprocessors. The multiplex Clock I/O (CLK I/O) and multiplex Clock Select (CLK SEL) pins offer the user the capability to supply a high speed external multiplex clock. This feature can minimize audio in-band interference for portable communication equipment or eliminate the visual synchronization effects found in high vibration environments such as avionic equipment.

Maximum Rating

DC Supply Voltage	-0.5 to +7.0 Vdc
Input Voltage Levels Relative to Ground	-0.5 to $V_{CC} + 0.5$ Vdc
Operating Temperature	-40°C to +85°C
Storage Temperature	-40°C to +100°C
Maximum Solder Temperature 0.063" below Seating Plane, $t < 5$ sec	260°C
Relative Humidity at 85°C	85%
Maximum Number of LEDs on at 100% Brightness	160
Maximum Power Dissipation	1.7 Watts
IC Junction Temperature	125°C
ESD (100 pF, 1.5 K Ω)	2 KV
Maximum Input Current	± 100 mA

Switching Specifications

(over operating temperature range and $V_{CC} = 4.5$ V to 5.5 V)

Symbol	Description	Min.	Units
T_{RC}	Reset Active Time	600	ns
T_{LDS}	Load Setup Time	50	ns
T_{DS}	Data Setup Time	50	ns
T_{SDCLK}	Clock Period	200	ns
T_{SDCW}	Clock Width	70	ns
T_{LDH}	Load Hold Time	0	ns
T_{DH}	Data Hold Time	25	ns
T_{WR}	Total Write Time	2.2	μ s
T_{BL}	Time Between Loads	600	ns

Note:

T_{SDCW} is the minimum time the SDCLK may be low or high. The SDCLK period must be a minimum of 200 ns.

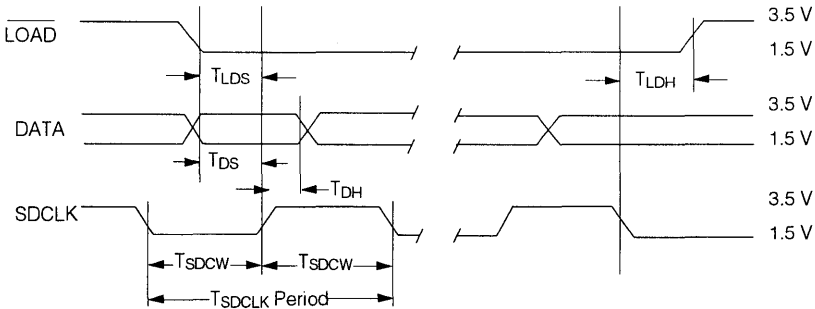

FIGURE 1. DATA WRITE CYCLE

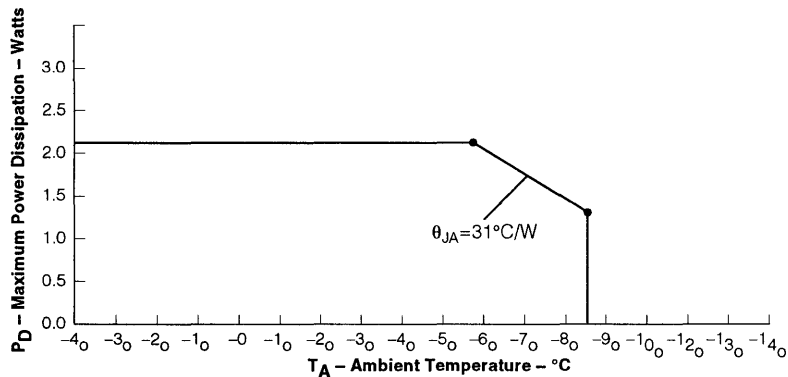

FIGURE 2. MAXIMUM POWER DISSIPATION VS. TEMPERATURE

ELECTRICAL CHARACTERISTICS (over Operating Temperature)

Parameters	Min.	Typ.	Max.	Units	Conditions
V_{CC}	4.5	5.0	5.5	V	
I_{CC} (Pwr Dwn Mode) ⁽⁴⁾		50		μ A	$V_{CC}=5$ V, all inputs=0 V or V_{CC}
I_{CC} 10 digits 16 dots/character		250	365	mA	$V_{CC}=5$ V, “#” displayed in all 10 digits at 100% brightness at 25°C
I_{IL} Input current			-10	μ A	$V_{CC}=5$ V, $V_{IN}=0$ V (all inputs)
I_{IH} Input current			+10	μ A	$V_{CC}=V_{IN}=5.0$ V (all inputs)
V_{IH}	3.5			V	$V_{CC}=4.5$ to 5.5 V
V_{IL}			1.5	V	$V_{CC}=4.5$ to 5.5 V
I_{OH} (Clk I/O)		-8.9		mA	$V_{CC}=4.5$, $V_{OH}=2.4$ V
I_{OL} (Clk I/O)		1.6		mA	$V_{CC}=4.5$, $V_{OL}=0.4$ V
θ_{JA}			31	°C/W	
F_{ext} External Clock Input Frequency	120		347	KHz	$V_{CC}=5.0$ V, $\overline{CLKSEL}=0$
F_{osc} Internal Clock Input Frequency	120		347	KHz	$V_{CC}=5.0$ V, $\overline{CLKSEL}=1$
Clock I/O Bus Loading			240	pF	
Clock Out Rise Time			500	ns	$V_{CC}=4.5$, $V_{OH}=2.4$ V
Clock Out Fall Time			500	ns	$V_{CC}=4.5$, $V_{OH}=0.4$ V
FM, Digit	375	768	1086	Hz	

Notes:

1. Peak current= $5/3 \times I_{CC}$.
2. Unused inputs must be tied high.
3. Contact Siemens for 3.3 volt operation.
4. External oscillator must be stopped if being used to maintain an $I_{CC} < 50 \mu$ A.

INPUT/OUTPUT CIRCUITS

Figures 3 and 4 show the input and output resistor/diode networks used for ESD protection and to eliminate substrate latch-up caused by input voltage over/under shoot.

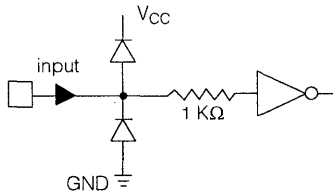

FIGURE 3. INPUTS

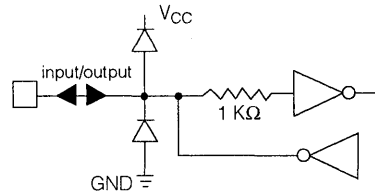

FIGURE 4. CLOCK I/O

Optical Characteristics at 25 °C, $V_{CC} = 5.0$ V at 100% Brightness Level
Viewing Angle: X Axis $\pm 55^\circ$, Y Axis $\pm 65^\circ$

Red SCD55100

Description	Symbol	Min.	Typ.	Units
Luminous Intensity Character Average (# displayed all digits)	I_V	0.48	1.8	mcd
Peak Wavelength	$\lambda(\text{peak})$		665	nm
Dominant Wavelength	$\lambda(d)$		639	nm

Yellow SCD55101

Description	Symbol	Min.	Typ.	Units
Luminous Intensity Character Average (# displayed all digits)	I_V	1.8	5.4 2.2	mcd
Peak Wavelength	$\lambda(\text{peak})$		583	nm
Dominant Wavelength	$\lambda(d)$		585	nm

High Efficiency Red SCD55102

Description	Symbol	Min.	Typ.	Units
Luminous Intensity Character Average (# displayed all digits)	I_V	1.8	5.4 2.57	mcd
Peak Wavelength	$\lambda(\text{peak})$		630	nm
Dominant Wavelength	$\lambda(d)$		626	nm

Green SCD55103

Description	Symbol	Min.	Typ.	Units
Luminous Intensity Character Average (# displayed all digits)	I_V	1.8	5.4 2.47	mcd
Peak Wavelength	$\lambda(\text{peak})$		565	nm
Dominant Wavelength	$\lambda(d)$		570	nm

High Efficiency Green SCD55104

Description	Symbol	Min.	Typ.	Units
Luminous Intensity Character Average (# displayed all digits)	I_V	2.1	6.4 5.46	mcd
Peak Wavelength	$\lambda(\text{peak})$		568	nm
Dominant Wavelength	$\lambda(d)$		574	nm

Notes:

1. Dot to dot intensity matching at 100% brightness is 1.8:1.
2. Displays are binned for hue at 2 nm intervals.
3. Displays within a given intensity category have an intensity matching of 1.5:1 (max.).

TOP VIEW

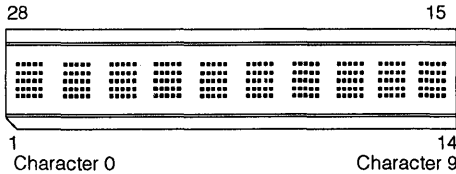

PIN ASSIGNMENTS

Pin	Function	Pin	Function
1	SDCLK	28	GND
2	LOAD	27	DATA
3	NC	26	NC
4	NC	25	NC
5	NC	24	NC
6	V _{CC}	23	V _{CC}
7	NP	22	NP
8	NP	21	NP
9	V _{CC}	20	V _{CC}
10	NC	19	V _{CC}
11	NC	18	NC
12	NC	17	NC
13	RST	16	CLKSEL
14	GND	15	CLK I/O

DISPLAY COLUMN AND ROW FORMAT

	C	C	C	C	C
	0	1	2	3	4
ROW 0	1	1	1	1	1
ROW 1	0	0	1	0	0
ROW 2	0	0	1	0	0
ROW 3	0	0	1	0	0
ROW 4	0	0	1	0	0

1 = Display Dot "On"
0 = Display Dot "Off"

COLUMN DATA RANGES

Row 0 : 00H to 1FH
Row 1 : 20H to 3FH
Row 2 : 40H to 5FH
Row 3 : 60H to 7FH
Row 4 : 80H to 9FH

PIN DEFINITIONS

Pin Function Definition

- | | | |
|----|-----------------|---|
| 1 | SDCLK | Used for loading data into the 8-bit serial data register on a low to high transition. |
| 2 | LOAD | Low input enables data clocking into 8-bit serial shift register. When LOAD goes high, the contents of 8-bit serial Shift Register will be decoded. |
| 3 | NC | No connection |
| 4 | NC | No connection |
| 5 | NC | No connection |
| 6 | V _{CC} | Power supply/heat sink |
| 7 | NP | No Pin |
| 8 | NP | No Pin |
| 9 | V _{CC} | Power supply/heat sink |
| 10 | NC | No connection |
| 11 | NC | No connection |
| 12 | NC | No connection |
| 13 | RST | Asynchronous input, when low will clear the Multiplex Counter, User RAM and Data Register. Control Word Register is set to 100% brightness and the Address Register is set to select Digit 0. The display is blanked. |
| 14 | GND | Power supply ground |
| 15 | CLK I/O | Outputs master clock or inputs external clock. |
| 16 | CLKSEL | H = internal clock, L = external clock |
| 17 | NC | No connection |
| 18 | NC | No connection |
| 19 | V _{CC} | Power supply/heat sink |
| 20 | V _{CC} | Power supply/heat sink |
| 21 | NP | No Pin |
| 22 | NP | No Pin |
| 23 | V _{CC} | Power supply/heat sink |
| 24 | NC | No connection |
| 25 | NC | No connection |
| 26 | NC | No connection |
| 27 | DATA | Serial data input |
| 28 | GND | Power supply ground |

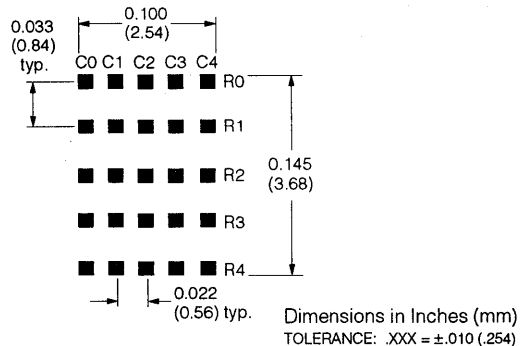

FIGURE 5. DOT MATRIX FORMAT

Operation of the SCD5510X

The SCD5510X display consists of a CMOS IC containing control logic and drivers for ten 5 X 5 characters. These components are assembled in a compact (38 mm x 10 mm) plastic package.

Individual LED dot addressability allows the user great freedom in creating special characters or mini-icons. The User Definable Character Set Examples illustrate 200 different character and symbol possibilities.

The use of a serial data interface provides a highly efficient interconnection between the display and the

mother board. The SCD5510X requires only 4 lines as compared to 15 for an equivalent 8 character parallel input part.

The on-board CMOS IC is the electronic heart of the display. The IC accepts decoded serial data, which is stored in the internal RAM. Asynchronously the RAM is read by the character multiplexer at a strobe rate that results in a flicker free display. Figure 6 shows the three functional areas of the IC. These include: the input serial data register and control logic, a 250 bits two port RAM, and an internal multiplexer/display driver.

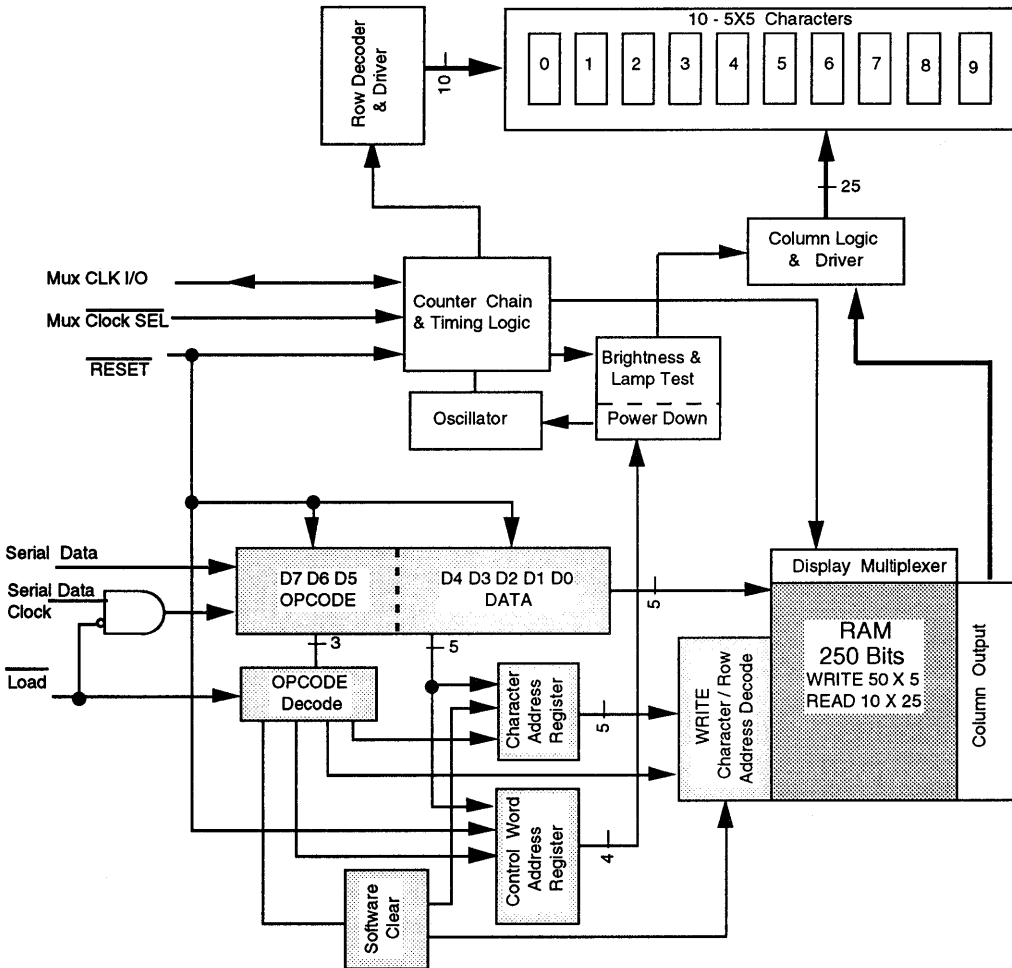

FIGURE 6. SCD5510X BLOCK DIAGRAM

The following explains how to format the serial data to be loaded into the display. The user supplies a string of bit mapped decoded characters. The contents of this string is shown in Figure 7a. Figure 7b shows that each character consist of six 8 bit words. The first word encodes the display character location and the succeeding five bytes are row data. The row data represents the status (On, Off) of individual column LEDs. Figure 7c shows that each that each 8 bit word is formatted to include a three bit Operational Code (OPCODE) defined by bits D7-D5 and five bits (D4-D0) representing Column Data, Character Address, or Control Word Data.

Figure 7d shows the sequence for loading the bytes of data. Bringing the **LOAD** line low enables the serial register to accept data. The shift action occurs on the low to high transition of the serial data clock (SDCLK). The least significant bit (D0) is loaded first. After eight clock pulses the **LOAD** line is brought high. With this transition the OPCODE is decoded. The decoded OPCODE directs D4-D0 to be latched in the Character Address register, stored in the RAM as Column data, or latched in the Control Word register. The control IC requires a minimum 600 ns delay between successive byte loads. As indicated in Figure 7a, a total of 660 clock cycles (60-8 bit words) are required to load all ten characters into the display.

The Character Address Register bits, D4-D0 (Table 2), and Row Address Register bits, D7-D5 (Table 3), direct the Column Data bits, D4-D0 (Table 3) to specific RAM location. Table 1 shows the Row Address for the example character "D." Column data is written and read asynchronously from the 250 bit RAM. Once loaded the internal oscillator and character multiplexer reads the data from the RAM. These characters are row strobed with column data as shown in Figures 8 and 9. The character strobe rate is determined by the internal or user supplied external MUX Clock and the IC's + 320 counter.

TABLE 1. CHARACTER "D"

	Opcode			Column Data					Hex
	D7	D6	D5	D4	D3	D2	D1	D0	
Row 0	0	0	0	1	1	1	1	0	1E
Row 1	0	0	1	1	0	0	0	1	31
Row 2	0	1	0	1	0	0	0	1	51
Row 3	0	1	1	1	0	0	0	1	71
Row 4	1	0	0	1	1	1	1	0	9E

LOADING SERIAL CHARACTER DATA

EXAMPLE : Serial Clock = 5MHz, Clock Period = 200ns

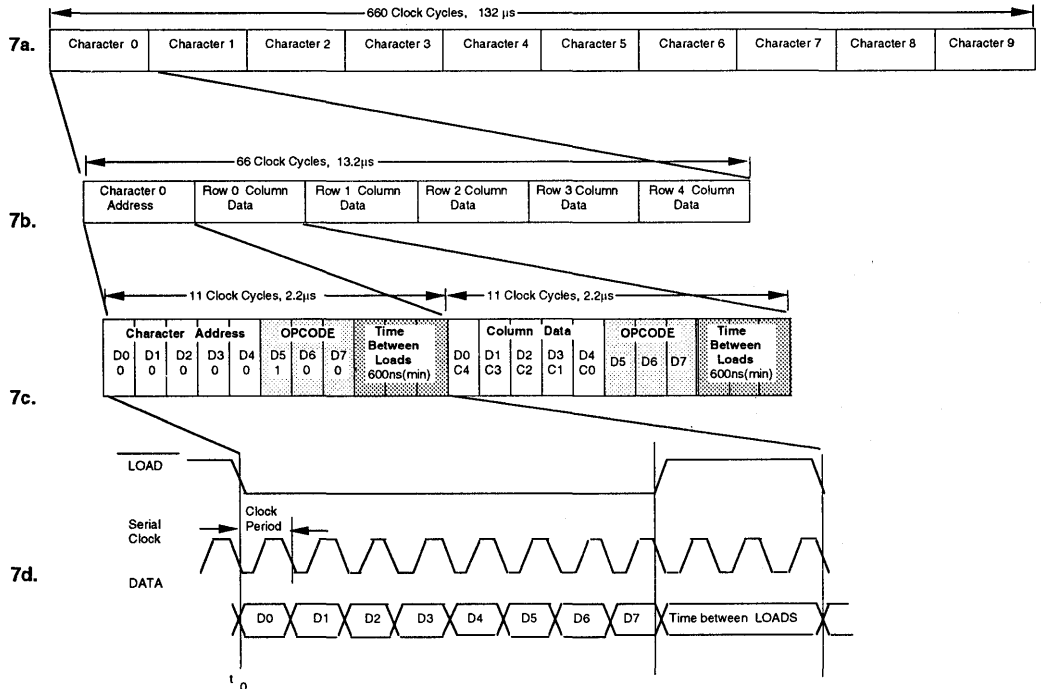

FIGURE 7a-d. LOADING SERIAL CHARACTER DATA

The user can activate four Control functions. These include: LED Brightness Level, Lamp Test, IC Power Down, or Display Clear. OPCODEs and five bit words are used to initiate these functions. The OPCODEs and Control Words for the Character Address and Loading Column Data are shown in Tables 2 and 3 .

TABLE 2. LOAD CHARACTER ADDRESS

Opcode D7 D6 D5	Character Address D4 D3 D2 D1 D0	Hex	Operation Load
1 0 1	1 0 0 0 0	B0	Character 0
1 0 1	1 0 0 0 1	B1	Character 1
1 0 1	1 0 0 1 0	B2	Character 2
1 0 1	1 0 0 1 1	B3	Character 3
1 0 1	1 0 1 0 0	B4	Character 4
1 0 1	1 0 1 0 1	B5	Character 5
1 0 1	1 0 1 1 0	B6	Character 6
1 0 1	1 0 1 1 1	B7	Character 7
1 0 1	1 1 0 0 0	B8	Character 8
1 0 1	1 1 0 0 1	B9	Character 9

TABLE 3. LOAD COLUMN DATA

Opcode D7 D6 D5	Column Data D4 D3 D2 D1 D0	Operation Load
0 0 0	C0 C1 C2 C3 C4	Row 0
0 0 1	C0 C1 C2 C3 C4	Row 1
0 1 0	C0 C1 C2 C3 C4	Row 2
0 1 1	C0 C1 C2 C3 C4	Row 3
1 0 0	C0 C1 C2 C3 C4	Row 4

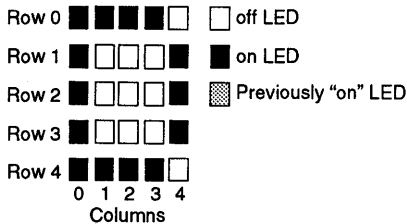

FIGURE 8. ROW AND COLUMN LOCATION

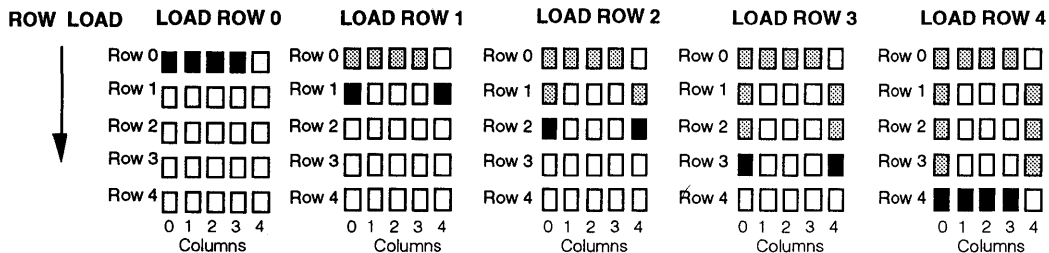

FIGURE 9. ROW STROBING

The user can select seven specific LED brightness levels, Table 4. These brightness levels (in percentages of full brightness of the display) include: 100% (F0_{HEX}), 53% (F1_{HEX}), 40% (F2_{HEX}), 27% (F3_{HEX}), 20% (F4_{HEX}), 13% (F5_{HEX}), and 6.6% (F6_{HEX}). The brightness levels are controlled by changing the duty factor of the row strobe pulse.

TABLE 4. DISPLAY BRIGHTNESS

Opcode D7 D6 D5	Control Word D4 D3 D2 D1 D0	Hex	Operation Level
1 1 1	1 0 0 0 0	F0	100%
1 1 1	1 0 0 0 1	F1	53%
1 1 1	1 0 0 1 0	F2	40%
1 1 1	1 0 0 1 1	F3	27%
1 1 1	1 0 1 0 0	F4	20%
1 1 1	1 0 1 0 1	F5	13%
1 1 1	1 0 1 1 0	F6	6.6%

The SCD5510X offers a unique Display Power Down feature which reduces I_{CC} to less than 50 μA. When FF_{HEX} is loaded, as shown in Table 5, the display is set to 0% brightness and the internal multiplex clock is stopped. When in the Power Down mode data may still be written into the RAM. The display is reactivated by loading a new Brightness Level Control Word into the display.

TABLE 5. POWER DOWN

Opcode D7 D6 D5	Control Word D4 D3 D2 D1 D0	Hex	Operation
1 1 1	1 1 1 1 1	FF	0% Brightness

The Lamp Test is enabled by loading $F8_{HEX}$, Table 6, into the serial shift register. This Control Word sets all of the LEDs to a 53% brightness level. Operation of the Lamp Test has no effect on the RAM and is cleared by loading a Brightness Control Word.

TABLE 6. LAMP TEST

Opcode			Control Word					Hex	Operation
D7	D6	D5	D4	D3	D2	D1	D0		
1	1	1	1	0	B	B	B		Lamp Test (OFF)
1	1	1	1	1	0	0	0	F8	Lamp Test (ON)

The Software Clear ($C0_{HEX}$), given in Table 7, clears the Address Register and the RAM. The display is blanked and the Character Address Register will be set to Character 0. The internal counter and the Control Word Register are unaffected. The Software Clear will remain active until the next data input cycle is initiated.

TABLE 7. SOFTWARE CLEAR

Opcode			Control Word					Hex	Operation
D7	D6	D5	D4	D3	D2	D1	D0		
1	1	0	0	0	0	0	0	C0	CLEAR

MULTIPLEXER AND DISPLAY DRIVER

The eight characters are row multiplexed with RAM resident column data. The strobe rate is established by the internal or external MUX Clock rate. The MUX Clock frequency is divided by a 320 counter chain. This results in a typical strobe rate of 750Hz. By pulling the Clock SEL line low, the display can be operated from an external MUX Clock. The external clock is attached to the CLK I/O connection (pin 15). The maximum external MUX Clock frequency should be limited to 1 MHz.

An asynchronous hardware Reset (pin 13) is also provided. Bringing this pin low will clear the Character Address Register, Control Word Register, RAM, and blanks the display. This action leaves the display set at Character Address 0, and the Brightness Level set at 100%.

ELECTRICAL & MECHANICAL CONSIDERATIONS

INTERCONNECT CONSIDERATIONS

Optimum product performance can be had when the following electrical and mechanical recommendations are adopted. The SCD5510X's IC is constructed in a high speed CMOS process, consequently high speed noise on the SERIAL DATA, SERIAL DATA CLOCK, LOAD and RESET lines may cause incorrect data to be written into the serial shift register. Adhere to transmission line termination procedures when using fast line drivers and long cables (>10 cm).

Good digital grounds (pins 14, 28) and power supply decoupling (pins 6, 9, 20, 23) will insure that I_{CC} (<400 mA peak) switching currents do not generate localized ground bounce. Therefore it is recommended that each display package use a 0.1 μ F and 20 μ F capacitor between V_{CC} and ground.

When the internal MUX Clock is being used connect the CLKSEL pin to V_{CC} . In those applications where RESET will not be connected to the system's reset control, it is recommended that this pin be connected to the center node of a series 0.1, μ F and 100 K Ω RC network. Thus upon initial power up the RESET will be held low for 10 ms allowing adequate time for the system power supply to stabilize.

The SCD5510X allows up to 1.7 W of power dissipation at 70°C and 1.29 W of power dissipation at a maximum operating temperature of 85°C. Approximately 60% of this power is dissipated by the IC to the PC board via the V_{CC} connection (pins 6, 7, 20, 23). Optimum thermal reliability is obtained by connecting all of the V_{CC} pins to a common pad located on both sides of the PC board. This technique offers a low thermal resistance for IC to system ambient.

ESD PROTECTION

The input protection structure of the SCD55100/1/2/3/4 provides significant protection against ESD damage. It is capable of withstanding discharges greater than 2 KV. Take all the standard precautions, normal for CMOS components. These include properly grounding personnel, tools, tables, and transport carriers that come in contact with unshielded parts. If these conditions are not, or cannot be met, keep the leads of the device shorted together or the parts in anti-static packaging.

SOLDERING CONSIDERATIONS

THE SCD55100/1/2/3/4 can be hand soldered with SN63 solder using a grounded iron set to 260°C.

Wave soldering is also possible following these conditions: Preheat that does not exceed 93°C on the solder side of the PC board or a package surface temperature of 85°C. Water soluble organic acid flux (except carboxylic acid) or resin-based RMA flux without alcohol can be used.

Wave temperature of 245°C \pm 5°C with a dwell between 1.5 sec. to 3.0 sec. Exposure to the wave should not exceed temperatures above 260°C for five seconds at 0.063" below the seating plane. The packages should not be immersed in the wave.

POST SOLDER CLEANING PROCEDURES

The least offensive cleaning solution is hot D.I. water (60°C) for less than 15 minutes. Addition of mild saponifiers is acceptable. Do not use commercial dishwasher detergents.

For faster cleaning, solvents may be used. Exercise care in choosing solvents as some may chemically attack the nylon package. Maximum exposure should not exceed two minutes at elevated temperatures. Acceptable solvents are TF (trichlorotrifluoroethane), TA, 111 Trichloroethane, and unheated acetone.⁽¹⁾

Note: 1. Acceptable commercial solvents are: Basic TF, Arklone, P. Genesolv, D. Genesolv DA, Blaco-Tron TF, Blaco-Tron TA, and Freon TA.

Unacceptable solvents contain alcohol, methanol, methylene chloride, ethanol, TP35, TCM, TMC, TMS+, TE, or TES. Since many commercial mixtures exist, contact a solvent vendor for chemical composition information. Some major solvent manufacturers are: Allied Chemical Corporation, Specialty Chemical Division, Morristown, NJ; Baron-Blakeslee, Chicago, IL; Dow Chemical, Midland, MI; E.I. DuPont de Nemours & Co., Wilmington, DE.

For further information refer to Appnotes 18 and 19 in the current Siemens Optoelectronic Data Book.

An alternative to soldering and cleaning the display modules is to use sockets. Naturally, 28 pin DIP sockets .300" wide with .100" centers work well for single displays. Multiple display assemblies are best handled by longer SIP sockets or DIP sockets when available for uniform package alignment. Socket manufacturers are Aries Electronics, Inc., Frenchtown, NJ; Garry Manufacturing, New Brunswick, NJ; Robinson-Nugent, New Albany, IN; and Samtec Electronic Hardware, New Albany, IN.

For further information refer to Appnote 22 in the current Siemens Optoelectronic Data Book.

OPTICAL CONSIDERATIONS

The 0.145" high character of the SCD5510X gives readability up to eight feet. Proper filter selection enhances readability over this distance.

Using filters emphasizes the contrast ratio between a lit LED and the character background. This will increase the discrimination of different characters. The only limitation is cost. Take into consideration the ambient lighting environment for the best cost/benefit ratio for filters.

Incandescent (with almost no green) or fluorescent (with almost no red) lights do not have the flat spectral response of sunlight. Plastic band-pass filters are an inexpensive and effective way to strengthen contrast ratios. The SCD55100/2 are red/high efficiency red displays and should be matched with long wavelength pass filter in the 570 nm to 590 nm range. The SCD55103/4 should be matched with a yellow-green band-pass filter that peaks at 565 nm. For displays of multiple colors, neutral density grey filters offer the best compromise.

Additional contrast enhancement is gained by shading the displays. Plastic band-pass filters with built-in louvers offer the next step up in contrast improvement. Plastic filters can be improved further with anti-reflective coatings to reduce glare. The trade-off is fuzzy characters. Mounting the filters close to the display reduces this effect. Take care not to overheat the plastic filter by allowing for proper air flow.

Optimal filter enhancements are gained by using circular polarized, anti-reflective, band-pass filters. The circular polarizing further enhances contrast by reducing the light that travels through the filter and reflects back off the display to less than 1%.

Several filter manufacturers supply quality filter materials. Some of them are: Panelgraphic Corporation, W. Caldwell, NJ; SGL Homalite, Wilmington, DE; 3M Company, Visual Products Division, St. Paul, MN; Polaroid Corporation, Polarizer Division, Cambridge, MA; Marks Polarized Corporation, Deer Park, NY, Hoya Optics, Inc., Fremont, CA.

One last note on mounting filters: recessing displays and bezel assemblies is an inexpensive way to provide a shading effect in overhead lighting situations. Several Bezel manufacturers are: R.M.F. Products, Batavia, IL; Nobex Components, Griffith Plastic Corp., Burlingame, CA; Photo Chemical Products of California, Santa Monica, CA; I.E.E.—Atlas, Van Nuys, CA.

MICROPROCESSOR INTERFACE

The microprocessor interface is through the serial port, SPI port or one out of eight data bits on the eight bit parallel port and also control lines \overline{SDCLK} and \overline{LOAD} .

POWER UP SEQUENCE

Upon power up display will come on at random. Thus the display should be reset at power-up. The reset will set the Address Register to Digit 0, User RAM is set to 0 (display blank) the Control Word is set to 0 (100% brightness with Lamp Test off) and the internal counters are reset.

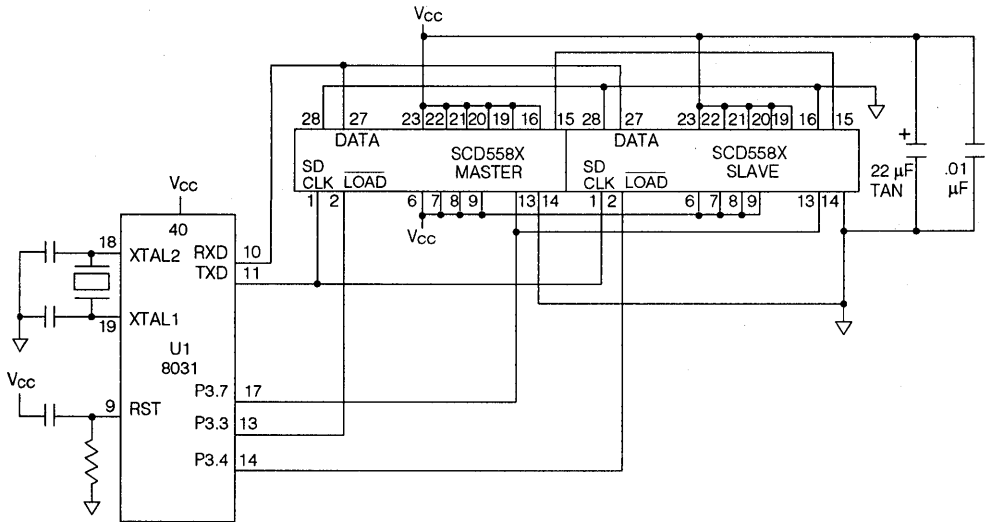

FIGURE 10. SCD INTERFACE TO SIEMENS/INTEL 8031 MICROPROCESSOR (using serial port in mode 0)

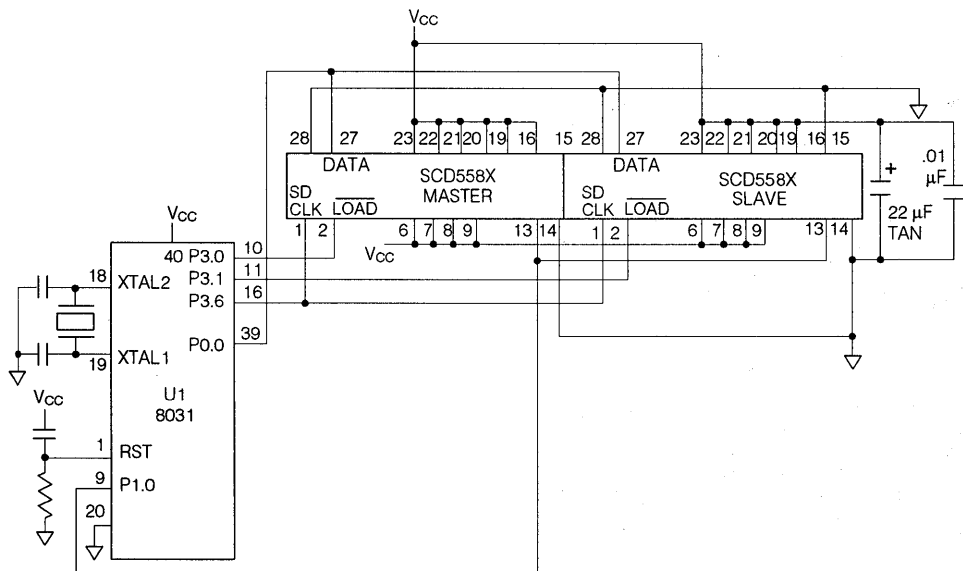

FIGURE 11. SCD5510X INTERFACE WITH INTEL/SIEMENS 8031 MICROPROCESSOR

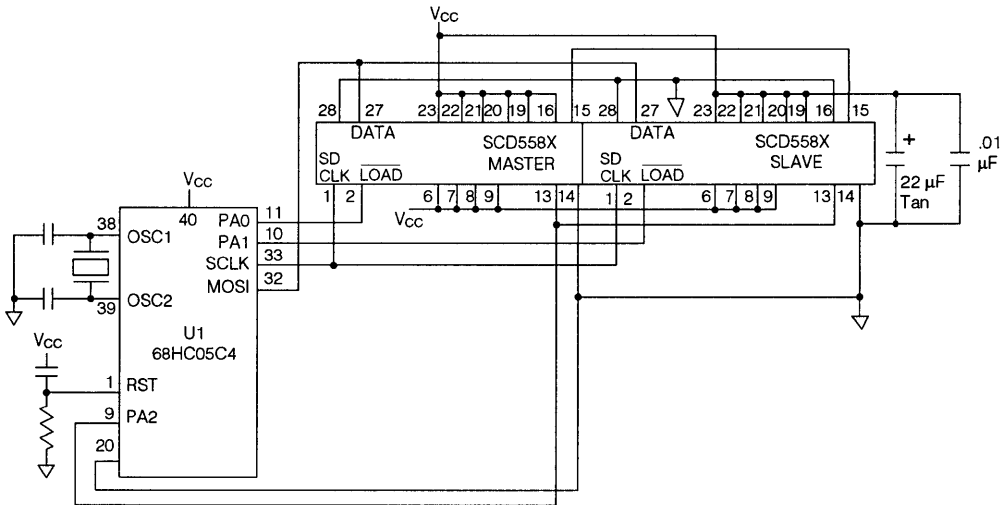

FIGURE 12. SCD5510X INTERFACE WITH MOTOROLA 68HC05C4 MICROPROCESSOR (using SPI Port)

CASCADING MULTIPLE DISPLAYS

Multiple displays can be cascaded using the CLK SEL and CLK I/O pins as shown below. The display designated as the Master Clock source should have its CLK SEL pin

tied high and the slaves should have their CLK SEL pins tied low. All CLK I/O pins should be tied together. One display CLK I/O can drive 15 slave CLK I/Os. Use RST to synchronize all display counters.

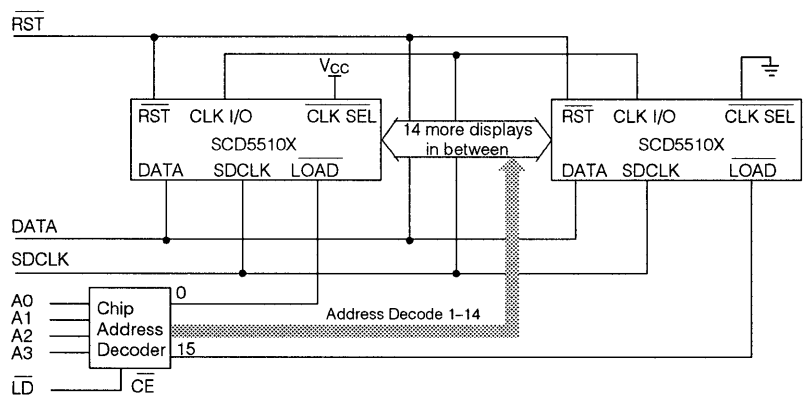

FIGURE 13. CASCADING MULTIPLE DISPLAYS

LOADING DATA INTO THE DISPLAY

Use following procedure to load data into the display:

1. Power up the display.
2. Bring RST low (600 ns duration minimum) to clear the Multiplex Counter, Address Register, Control Word Register, User Ram and Data Register. The display will be blank. Display brightness is set to 100%.
3. If a different brightness is desired, load the proper brightness opcode into the Control Word Register.
4. Load the Digit Address into the display.
5. Load display row and column data for the selected digit.
6. Repeat steps 4 and 5 for all digits.

DATA CONTENTS FOR THE WORD "DISPLAYS"

Step	D 7	D 6	D 5	D 4	D 3	D 2	D 1	D 0	Function
A	1	1	0	0	0	0	0	0	CLEAR
B(optional)	1	1	1	1	0	B	B	B	BRIGHTNESS SELECT
1	1	0	1	1	0	0	0	0	DIGIT D0 SELECT
2	0	0	0	1	1	1	1	0	ROW 0 D0 (D)
3	0	0	1	1	0	0	0	1	ROW 1 D0 (D)
4	0	1	0	1	0	0	0	1	ROW 2 D0 (D)
5	0	1	1	1	0	0	0	1	ROW 3 D0 (D)
6	1	0	0	1	1	1	1	0	ROW 4 D0 (D)
7	1	0	1	1	0	0	0	1	DIGIT D1 SELECT
8	0	0	0	0	1	1	1	0	ROW 0 D1 (I)
9	0	0	1	0	0	1	0	0	ROW 1 D1 (I)
10	0	1	0	0	0	1	0	0	ROW 2 D1 (I)
11	0	1	1	0	0	1	0	0	ROW 3 D1 (I)
12	1	0	0	0	1	1	1	0	ROW 4 D1 (I)
13	1	0	1	1	0	0	1	0	DIGIT D2 SELECT
14	0	0	0	0	1	1	1	1	ROW 0 D2 (S)
15	0	0	1	1	0	0	0	0	ROW 1 D2 (S)
16	0	1	0	0	1	1	1	0	ROW 2 D2 (S)
17	0	1	1	0	0	0	0	1	ROW 3 D2 (S)
18	1	0	0	1	1	1	1	0	ROW 4 D2 (S)
19	1	0	1	1	0	0	1	1	DIGIT D3 SELECT
20	0	0	0	1	1	1	1	0	ROW 0 D3 (P)
21	0	0	1	1	0	0	0	1	ROW 1 D3 (P)
22	0	1	0	1	1	1	1	0	ROW 2 D3 (P)
23	0	1	1	1	0	0	0	0	ROW 3 D3 (P)
24	1	0	0	1	0	0	0	0	ROW 4 D3 (P)
25	1	0	1	1	0	1	0	0	DIGIT D4 SELECT
26	0	0	0	1	0	0	0	0	ROW 0 D4 (L)
27	0	0	1	1	0	0	0	0	ROW 1 D4 (L)
28	0	1	0	1	0	0	0	0	ROW 2 D4 (L)
29	0	1	1	1	0	0	0	0	ROW 3 D4 (L)
30	1	0	0	1	1	1	1	1	ROW 4 D4 (L)
31	1	0	1	1	0	1	0	1	DIGIT D5 SELECT
32	0	0	0	0	0	1	0	0	ROW 0 D5 (A)
33	0	0	1	0	1	0	1	0	ROW 1 D5 (A)
34	0	1	0	1	1	1	1	1	ROW 2 D5 (A)
35	0	1	1	1	0	0	0	1	ROW 3 D5 (A)
36	1	0	0	1	0	0	0	1	ROW 4 D5 (A)
37	1	0	1	1	0	1	1	0	DIGIT D6 SELECT
38	0	0	0	1	0	0	0	1	ROW 0 D6 (Y)
39	0	0	1	0	1	0	1	0	ROW 1 D6 (Y)
40	0	1	0	0	0	1	0	0	ROW 2 D6 (Y)
41	0	1	1	0	0	1	0	0	ROW 3 D6 (Y)
42	1	0	0	0	0	1	0	0	ROW 4 D6 (Y)
43	1	0	1	1	0	1	1	1	DIGIT D7 SELECT
44	0	0	0	0	1	1	1	1	ROW 0 D7 (S)
45	0	0	1	1	0	0	0	0	ROW 1 D7 (S)
46	0	1	0	0	1	1	1	0	ROW 2 D7 (S)
47	0	1	1	0	0	0	0	1	ROW 3 D7 (S)
48	1	0	0	1	1	1	1	0	ROW 4 D7 (S)

Note:

If the display is already reset at Power Up, there is no need for Software Clear.

USER DEFINABLE CHARACTER SET EXAMPLES*

Upper and Lower Case Alphabets

HEX CODE		HEX CODE		HEX CODE		HEX CODE		HEX CODE		HEX CODE		HEX CODE		HEX CODE		HEX CODE	
04	•	1E	••••	0F	••••	1E	••••	1F	••••	1F	••••	0F	••••	11	••	0E	••
2A	••	29	•••	30	••••	29	••••	30	••••	30	••••	53	••••	31	••	24	••
5F	••••	4E	••••	50	••	49	••	5E	••••	5E	••••	53	••	5F	••••	44	••
71	•	69	•••	70	••	69	••	70	••	70	••	71	••	71	••	64	••
91	•	9E	••••	8F	••••	9E	••••	9F	••••	90	••	8F	••••	91	••	8E	••
01	••	13	••	10	••	11	••	11	••	0E	••	1E	••••	0C	••	1E	••••
21	•	34	•••	30	••	3B	••	39	••	31	••	31	••	32	••	31	••••
41	•	58	••	50	••	55	••	55	••	51	••	5E	••	56	••	5E	••
71	••	74	••	70	••	71	••	73	••	71	••	70	••	72	••	74	••
8E	••••	93	••	9F	••••	91	••	91	••	8E	••	90	••	8D	••	92	••
0F	••••	1F	••••	11	••	11	••	11	••	11	••	11	••	1F	••••		
30	••	24	••	31	••	31	••	31	••	2A	••	2A	••	22	••		
4E	••••	44	••	51	••	51	••	55	••	44	••	44	••	44	••		
61	••	64	••	71	••	6A	••	7B	••	6A	••	64	••	68	••		
9E	••••	84	••	8E	••	84	••	91	••	91	••	84	••	9F	••		
00	••	10	••	00	••	01	••	00	••	04	••	00	••	10	••	04	••
2E	••	30	••	2F	••	21	••	2E	••	2A	••	2F	••	30	••	20	••
52	••	5E	••	50	••	4F	••	5F	••	48	••	50	••	56	••	4C	••
72	••	71	••	70	••	71	••	70	••	7C	••	73	••	79	••	84	••
8D	••	9E	••	8F	••	8F	••	8E	••	88	••	8F	••	91	••	8E	••
00	••	10	••	0C	••	00	••	00	••	00	••	00	••	00	••	00	••
26	••	30	••	24	••	2A	••	36	••	2E	••	3E	••	2F	••	33	••
42	••	56	••	44	••	55	••	59	••	51	••	51	••	51	••	54	••
72	••	78	••	64	••	71	••	71	••	71	••	7E	••	6F	••	78	••
8C	••	96	••	8E	••	91	••	91	••	8E	••	90	••	81	••	90	••
00	••	08	••	00	••	00	••	00	••	00	••	00	••	00	••		
23	••	3C	••	32	••	31	••	31	••	32	••	31	••	3E	••		
44	••	48	••	52	••	51	••	55	••	4C	••	4A	••	44	••		
62	••	6A	••	72	••	6A	••	7B	••	6C	••	64	••	68	••		
8C	••	84	••	8D	••	84	••	91	••	92	••	98	••	9E	••		

Dot on = 1
Dot off = 0

Numerals and Punctuation

HEX CODE		HEX CODE		HEX CODE		HEX CODE		HEX CODE		HEX CODE		HEX CODE		HEX CODE		HEX CODE	
0E	••••	04	••	1E	••••	1E	••••	06	••	1F	••••	06	••	1F	••••	0E	••••
33	••	2C	••	21	••••	21	••••	2A	••	30	••••	28	••	31	••••	31	••
55	••	44	••	46	••	4E	••	5F	••	5E	••	5E	••	44	••	4E	••
79	••	68	••	68	••	61	••	62	••	61	••	71	••	68	••	71	••
8E	••	8E	••	9F	••••	9E	••	82	••	9E	••	8E	••	88	••	8E	••
0E	••	0A	••	0F	••••	06	••	19	••	08	••	0C	••	02	••	08	••
31	••	3F	••	34	••••	29	••	3A	••	34	••	2C	••	24	••	24	••
4F	••	4A	••	4E	••	5C	••	44	••	4D	••	44	••	44	••	44	••
62	••	7F	••	65	••	68	••	6B	••	72	••	68	••	64	••	64	••
8C	••	8A	••	9E	••	9F	••	93	••	8D	••	80	••	82	••	88	••
0C	••	04	••	00	••	00	••	00	••	01	••	04	••	0A	••	07	••
2C	••	24	••	2C	••	20	••	20	••	22	••	24	••	2A	••	24	••
48	••	5F	••	4C	••	5F	••	40	••	44	••	44	••	40	••	44	••
64	••	84	••	64	••	60	••	6C	••	38	••	60	••	60	••	64	••
80	••	84	••	88	••	80	••	8C	••	90	••	84	••	80	••	87	••
10	••	1C	••	0E	••	00	••	0C	••	0C	••	02	••	0F	••	08	••
28	••	24	••	35	••	20	••	2C	••	20	••	24	••	3F	••	24	••
44	••	44	••	57	••	40	••	40	••	4C	••	48	••	40	••	42	••
62	••	6C	••	70	••	60	••	6C	••	64	••	64	••	7F	••	64	••
81	••	94	••	8E	••	9F	••	8C	••	88	••	82	••	80	••	88	••
0E	••	06	••	0C	••	04	••	11	••	15	••	04	••	08	••		
31	••	24	••	24	••	24	••	2A	••	2E	••	2A	••	35	••		
42	••	48	••	42	••	40	••	44	••	5F	••	51	••	42	••		
64	••	6A	••	64	••	64	••	6E	••	6E	••	60	••	60	••		
88	••	86	••	8C	••	84	••	84	••	95	••	80	••	80	••		

Dot on = 1
Dot off = 0
* CAUTION: No more than 128 LEDs "on" at one time at 100% brightness.

SIEMENS

RED SLR2016 HIGH EFFICIENCY RED SLO2016 GREEN SLG2016 YELLOW SLY2016

**X/Y Stackable .180" 4-Digit 5 x 7 Dot Matrix
ALPHANUMERIC Intelligent Display
with Memory/Decoder/Driver**

Preliminary

Intelligent
Display Devices

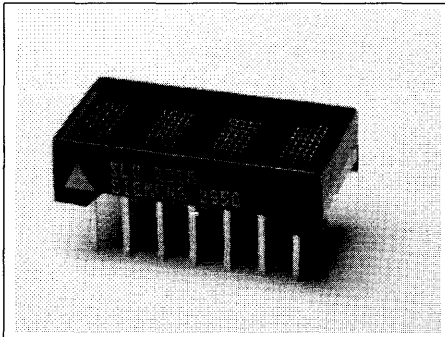

FEATURES

- Very Close Multi-line Spacing, 0.4" Centers
- .180" 5 x 7 Dot Matrix Characters
- 128 Special ASCII Characters for English, German, Italian, Swedish, Danish, and Norwegian Languages
- Wide Viewing Angle: X Axis 50° Maximum, Y Axis ±75° Maximum
- Fast Access Time, 110 ns at 25°C
- Full Size Display for Stationary Equipment
- Built-in Memory
- Built-in Character Generator
- Built-in Multiplex and LED Drive Circuitry
- Direct Access to Each Digit Independently and Asynchronously
- Clear Function that Clears Character Memory
- True Blanking for Intensity Dimming Applications
- End-Stackable, 4-Character Package
- Intensity Coded for Display Uniformity
- Extended Operating Temperature Range: -40°C to +85°C
- Superior ESD Immunity
- 100% Burned In and Tested
- Wave Solderable
- TTL Compatible over Operating Temperature Range

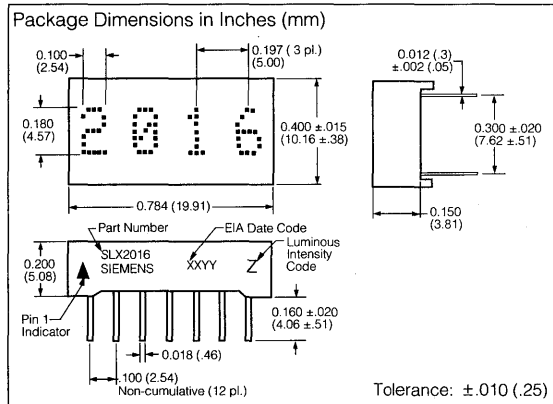

DESCRIPTION

The SLR/SLO/SLG/SLY2016 is a four digit 5x7 dot matrix display module with a built-in CMOS integrated circuit. This display is X/Y stackable.

The integrated circuit contains memory, a 128 ASCII ROM decoder, multiplexing circuitry and drivers. Data entry is asynchronous. A display system can be built using any number of SLR/SLO/SLG/SLY2016 since each digit can be addressed independently and will continue to display the character last stored until replaced by another.

System interconnection is very straightforward. Two address bits (A0, A1) are normally connected to the like-named inputs of all displays in the system.

Data lines are connected to all SLR/SLO/SLG/SLY2016s directly and in parallel as is the write line (WR). The display will then behave as a write-only memory.

The SLR/SLO/SLG/SLY2016 has several features superior to competitive devices. 100% burn-in processing insures that the SLR/SLO/SLG/SLY2016 will function in more stressful assembly and use environments. True "blanking" allows the designer to dim the display for more flexibility of display presentation. Finally the CLR clear function will clear the ASCII character RAM.

—Continued

See Appnotes 18, 19, 22, and 23 for additional information.

DESCRIPTION (Continued)

The character set consists of 128 special ASCII characters for English, German, Italian, Swedish, Danish, and Norwegian.

All products are 100% burned-in and tested, then subjected to out-going AQL's of .25% for brightness matching, visual alignment and dimensions, .065% for electrical and functional.

Maximum Ratings

DC Supply Voltage	-0.5 V to +7.0 Vdc
Input Voltage, Respect to GND (all inputs)	-0.5 V to $V_{CC} + 0.5$ Vdc
Operating Temperature	-40°C to +85°C
Storage Temperature	-40°C to +100°C
Relative Humidity at 85°C	85%
Maximum Solder Temperature, 0.063" (1.59 mm) below Seating Plane, t<5 sec	260 °C

Optical Characteristics

Spectral Peak Wavelength

Red	660 nm typ.
HER	635 nm typ.
Green	565 nm typ.
Yellow	585 nm typ.
Digit Height	0.180" (4.57 mm)

Time Averaged Luminous Intensity⁽¹⁾

at $V_{CC}=5$ V

Red	50 μ cd/LED min.
HER/Yellow	60 μ cd/LED min.
Green	75 μ cd/LED min.
LED to LED Intensity Matching, $V_{CC}=5$ V	1.8:1.0 max.
Viewing Angle (off normal axis)	
Horizontal	$\pm 50^\circ$ max.
Vertical	$\pm 75^\circ$ max.

Note 1: Peak luminous intensity values can be calculated by multiplying these values by 7.

TOP VIEW

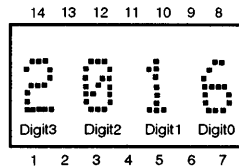

Pin Function

1	WR Write
2	A1 Digit Select
3	A0 Digit Select
4	V_{CC}
5	D0 Data
6	D1 Data
7	D2 Data

Pin Function

8	D3 Data
9	D4 Data
10	D5 Data
11	D6 Data
12	BL Display Blank
13	CLR Clear
14	GND

TIMING CHARACTERISTICS WRITE CYCLE WAVEFORMS

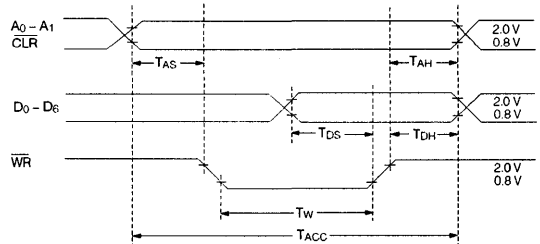

DC CHARACTERISTICS at 25°C

Parameters	Min.	Typ.	Max.	Units	Conditions
V_{CC}	4.5	5.0	5.5	V	
I_{CC} Blank		2.3	3.0	mA	$V_{CC}=5.0$ V
I_{CC} (80 dots on)		80	105	mA	$V_{CC}=5.0$ V
V_H (all inputs)			0.8	V	4.5 V < V_{CC} < 5.5 V
V_{IH} (all inputs)	2.0			V	4.5 V < V_{CC} < 5.5 V
I_{IL} (all inputs)	25		100	μ A	4.5 V < V_{CC} < 5.5 V, $V_{IN}=0.8$ V

AC CHARACTERISTICS Guaranteed Minimum Timing Parameters at $V_{CC} = 5.0 V \pm 0.5 V$

Parameter	Symbol	-40°C	+25°C	+85°C	Units
Address Set Up Time	T_{AS}	10	10	10	ns
Write Time	T_W	60	70	90	ns
Data Set Up Time	T_{DS}	20	30	50	ns
Address Hold Time	T_{AH}	20	30	40	ns
Data Hold Time	T_{DH}	20	30	40	ns
Access Time	$T_{ACC}^{(1)}$	90	110	140	ns
Clear Disable Time	T_{CLRD}	1	1	1	μs
Clear Time	T_{CLR}	1	1	1	ms

Note: 1. $T_{ACC} = \text{Set Up Time} + \text{Write Time} + \text{Hold Time}$.

LOADING DATA

The desired data code (D0-D6) and digit address (A0, A1) must be held stable during the write cycle for storing new data.

Data entry may be asynchronous. Digit 0 is defined as right hand digit with $A1=A2=0$.

Clearing the entire internal four-digit memory can be accomplished by holding the clear (CLR) low for 1 msec minimum. The clear function will clear the ASCII RAM. Loading an illegal data code will display a blank.

TYPICAL LOADING STATE TABLE

WR	A1	A0	D6	D5	D4	D3	D2	D1	D0	DIGIT			
previously loaded display										3	2	1	0
L	L	L	H	L	L	L	H	L	H	G	R	E	Y
L	L	H	H	L	H	L	H	L	H	G	R	U	E
L	H	L	H	L	L	H	H	L	L	G	L	U	E
L	H	H	H	L	L	L	L	L	H	B	L	U	E
L	L	H	H	L	L	L	H	L	H	B	L	E	E
L	L	L	H	L	H	L	H	H	H	B	L	E	W
L	X	X	see character code							see character set			

FIGURE 1. FLASHING CIRCUIT USING A 555

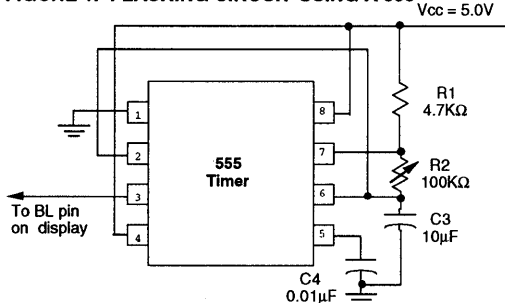
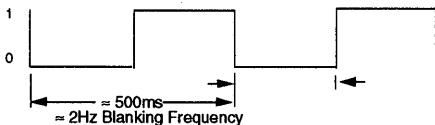

FIGURE 1a. FLASHING (Blanking) TIMING



DISPLAY BLANKING

Blank the display by loading a blank or space into each digit of the display or by using the (BL) display blank input. Setting the (BL) input low does not affect the contents of data memory.

A flashing circuit can easily be constructed using a 555 astable multivibrator. Figure 1 illustrates a circuit in which varying R1 (100K~10K) will have a flash rate of 1 Hz~10 Hz.

The display can be dimmed by pulse width modulating the (BL) at a frequency sufficiently fast to not interfere with the internal clock. The dimming signal frequency should be 2.5 KHz or higher. Dimming the display also reduces power consumption.

An example of a simple dimming circuit using a 556 is illustrated in Figure 2. Adjusting potentiometer R3 will dim the display by changing the blanking pulse duty cycle.

FIGURE 2. DIMMING CIRCUIT USING A 556

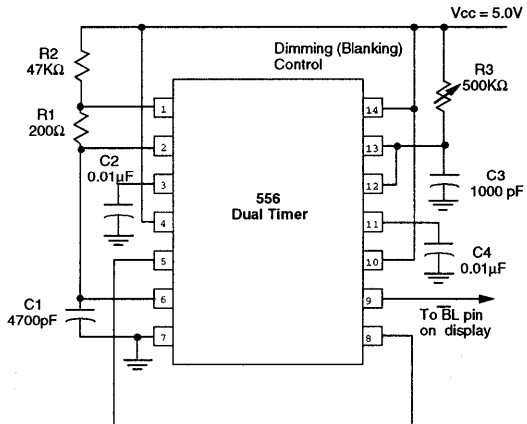
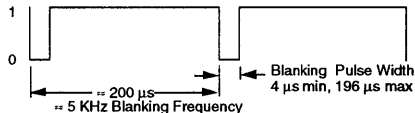

FIGURE 2a. DIMMING (Blanking) TIMING



CHARACTER SET

ASCII CODE		D0	0	1	0	1	0	1	0	1	0	1	0	1	0	1	0	1	
		D1	0	0	1	1	0	0	1	1	0	0	1	1	0	0	1	1	
		D2	0	0	0	0	1	1	1	1	0	0	0	0	0	1	1	1	
		D3	0	0	0	0	0	0	0	0	1	1	1	1	1	1	1	1	
D6	D5	D4	HEX	0	1	2	3	4	5	6	7	8	9	A	B	C	D	E	F
0	0	0	0	0	1	2	3	4	5	6	7	8	9	A	B	C	D	E	F
0	0	1	1	0	1	2	3	4	5	6	7	8	9	A	B	C	D	E	F
0	1	0	2	0	1	2	3	4	5	6	7	8	9	A	B	C	D	E	F
0	1	1	3	0	1	2	3	4	5	6	7	8	9	A	B	C	D	E	F
1	0	0	4	0	1	2	3	4	5	6	7	8	9	A	B	C	D	E	F
1	0	1	5	0	1	2	3	4	5	6	7	8	9	A	B	C	D	E	F
1	1	0	6	0	1	2	3	4	5	6	7	8	9	A	B	C	D	E	F
1	1	1	7	0	1	2	3	4	5	6	7	8	9	A	B	C	D	E	F

- Notes:
1. High = 1 level
 2. Low = 0 level
 3. Upon power up, the device will initialize in a random state

BLOCK DIAGRAM

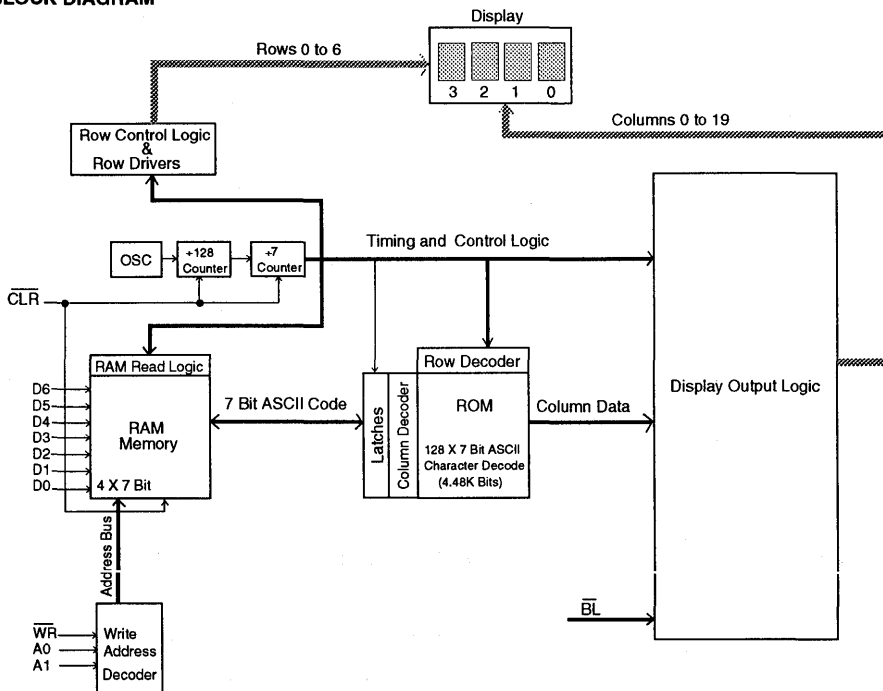

DESIGN CONSIDERATIONS

For details on design and applications of the SLX2016 in multiple display systems, refer to Appnote 15 in the current Siemens Optoelectronics Data Book.

ELECTRICAL & MECHANICAL CONSIDERATIONS

VOLTAGE TRANSIENT SUPPRESSION

We recommend that the same power supply be used for the display and the components that interface with the display to avoid logic inputs higher than V_{CC} . Additionally, the LEDs may cause transients in the power supply line while they change display states. The common practice is to place .01 μF capacitors close to the displays across V_{CC} and GND, one for each display, and one 10 μF capacitor for every second display.

ESD PROTECTION

The CMOS IC of the SLX2016 is resistant to ESD damage and capable of withstanding discharges less than 2 KV. However, take all the standard precautions, normal for CMOS components. These include properly grounding personnel, tools, tables, and transport carriers that come in contact with unshielded parts. If these conditions are not, or cannot be met, keep the leads of the device shorted together or the parts in anti-static packaging.

SOLDERING CONSIDERATIONS

The SLX2016 can be hand soldered with SN63 solder using a grounded iron set to 260°C.

Wave soldering is also possible following these conditions: Preheat that does not exceed 93°C on the solder side of the PC board or a package surface temperature of 85°C. Water soluble organic acid flux (except carboxylic acid) or resin-based RMA flux without alcohol can be used.

Wave temperature of 245°C \pm 5°C with a dwell between 1.5 sec. to 3.0 sec. Exposure to the wave should not exceed temperatures above 260°C for five seconds at 0.063" below the seating plane. The packages should not be immersed in the wave.

POST SOLDER CLEANING PROCEDURES

The least offensive cleaning solution is hot D.I. water (60°C) for less than 15 minutes. Addition of mild saponifiers is acceptable. Do not use commercial dishwasher detergents.

For faster cleaning, solvents may be used. Carefully select any solvent as some may chemically attack the nylon package. Maximum exposure should not exceed two minutes at elevated temperatures. Acceptable solvents are TF (trichlorotrifluoroethane), TA, 111 Trichloroethane, and unheated acetone.

Note: Acceptable commercial solvents are: Basic TF, Arklone, P. Genesolv, D. Genesolv DA, Blaco-Tron TF, Blaco-Tron TA, and Freon TA.

Unacceptable solvents contain alcohol, methanol, methylene chloride, ethanol, TP35, TCM, TMC, TMS+, TE, or TES. Since many commercial mixtures exist, contact a solvent vendor for chemical composition information. Some major solvent manufacturers are: Allied Chemical Corporation, Specialty Chemical Division, Morristown, NJ; Baron-Blakeslee, Chicago, IL; Dow Chemical, Midland, MI; E.I. DuPont de Nemours & Co., Wilmington, DE.

For further information refer to Siemens Appnotes 18 and 19.

An alternative to soldering and cleaning the display modules is to use sockets. Standard pin DIP sockets .300" wide with .100" centers work well for single displays. Multiple display assemblies are best handled by longer SIP sockets or DIP sockets when available for uniform package alignment. Socket manufacturers are Aries Electronics, Inc., Frenchtown, NJ; Garry Manufacturing, New Brunswick, NJ; Robinson-Nugent, New Albany, IN; and Samtec Electronic Hardware, New Albany, IN.

For further information refer to Siemens Appnote 22.

OPTICAL CONSIDERATIONS

The .180" high characters of the SLX2016 gives readability up to eight feet. Proper filter selection enhances readability over this distance.

Filters enhance the contrast ratio between a lit LED and the character background intensifying the discrimination of different characters. The only limitation is cost. Take into consideration the ambient lighting environment for the best cost/benefit ratio for filters.

Incandescent (with almost no green) or fluorescent (with almost no red) lights do not have the flat spectral response of sunlight. Plastic band-pass filters are an inexpensive and effective way to strengthen contrast ratios. The SLR2016 is a standard red display and should be matched with long wavelength pass filter in the 600 nm to 620 nm range.

The SLO2016 is a high efficiency red display and should be matched with a long wavelength pass filter in the 470 nm to 590 range. The SLG/SLY2016 should be matched with a yellow-green band-pass filter that peaks at 565 nm. For displays of multiple colors, neutral density gray filters offer the best compromise.

Additional contrast enhancement is gained by shading the displays. Plastic band-pass filters with built-in louvers offer the next step up in contrast improvement. Plastic filters can be improved further with anti-reflective coatings to reduce glare. The trade-off is fuzzy characters. Mounting the filters close to the display reduces this effect. Take care not to overheat the plastic filter by allowing for proper air flow.

Optimal filter enhancements are gained by using circular polarized, anti-reflective, band-pass filters. Circular polarizing further enhances contrast by reducing the light that travels through the filter and reflects back off the display to less than 1%.

Several filter manufacturers supply quality filter materials. Some of them are: Panelgraphic Corporation, W. Caldwell, NJ; SGL Homalite, Wilmington, DE; 3M Company, Visual Products Division, St. Paul, MN; Polaroid Corporation, Polarizer Division, Cambridge, MA; Marks Polarized Corporation, Deer Park, NY; Hoya Optics, Inc., Fremont, CA.

One last note on mounting filters: recessing displays and bezel assemblies is an inexpensive way to provide a shading effect in overhead lighting situations. Several Bezel manufacturers are: R.M.F. Products, Batavia, IL; Nobex Components, Griffith Plastic Corp., Burlingame, CA; Photo Chemical Products of California, Santa Monica, CA; I.E.E.-Atlas, Van Nuys, CA.

Refer to Siemens Appnote 23 for further information.

Intelligent Display Assemblies

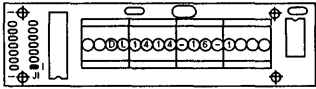
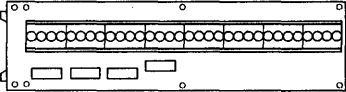
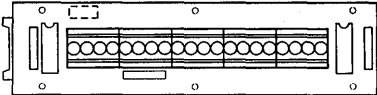
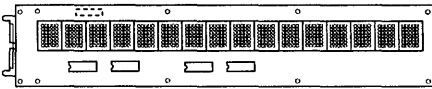
Package Outline	Part No./ Color	No. of Characters Character Height	Description	Page
	IDA1414-16-1 Red	16 0.112"	Intelligent Display assembly with four segmented DL1414 displays, decoder, and interface buffer on a single circuit board. Buffered input lines.	2-183
	IDA2416-16 Red	16 0.160"	Intelligent Display assembly with four segmented DL2416 displays, decoder, and interface buffer on a single circuit board.	2-187
	IDA2416-32 Red	32 0.160"	Intelligent Display assembly with eight segmented DL2416 displays, decoder, and interface buffer on a single circuit board.	
	IDA3416-16 Red	16 0.225"	Intelligent Display assembly with four segmented DL3416 displays, decoder, and interface buffer on a single circuit board.	2-191
	IDA3416-20 Red	20 0.225"	Intelligent Display assembly with five segmented DL3416 displays, decoder, and interface buffer on a single circuit board.	
	IDA3416-32 Red	32 0.225"	Intelligent Display assembly with eight segmented DL3416 displays, decoder, and interface buffer on a single circuit board.	
	IDA7135-16 HER IDA7137-16 Green	16 0.68"	Intelligent Display assembly with sixteen dot matrix DLO7135 or DLG7137 displays, decoder, and interface buffer on a single circuit board.	2-195
	IDA7135-20 HER IDA7137-20 Green	20 0.68"	Intelligent Display assembly with twenty dot matrix DLO7135 or DLG7137 displays, decoder, and interface buffer on a single circuit board.	

.112" Red, 17 Segment, 16 Character DL1414 Intelligent Display® Assembly IDA1414-16-1 Buffered Input Data Lines

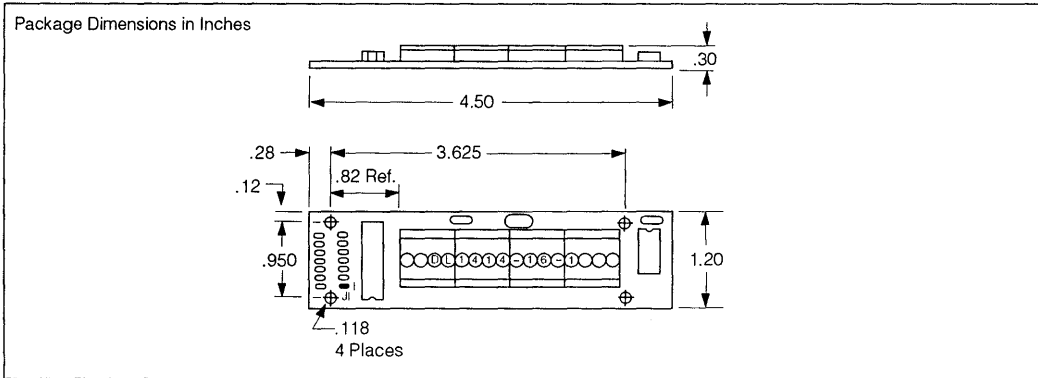

FEATURES

- 112" Magnified Monolithic Character
- Wide Viewing Angle $\pm 40^\circ$
- Complete Alphanumeric Display Assembly Using the DL1414T
 - Built-in Multiplex and LED Drive Circuitry
 - Built-in Memory
 - Built-in Character Generator
- 64 Character ASCII Set
- Direct Access to Each Digit Independently
- Single 5.0 Volt Power Supply
- TTL Compatible
- Easily Interfaced to a Microprocessor
- IDA1414-16-1 Buffered Input Data Lines

DESCRIPTION

The IDA1414-16 assembly is an extension of the DL1414T Intelligent Display. This assembly provides the designer with circuitry for display maintenance. It also minimizes interaction and interface normally required between the user's system and a multiplexed alphanumeric display.

The assembly consists of four DL1414s in a single row, together with decoder and interface buffer on a single printed circuit board. Each DL1414 provides its own memory, ASCII ROM character decoder, multiplexing circuitry, and drivers for the four 17-segment LEDs.

Intelligent Display Assemblies can be used for applications such as data terminals, controllers, instruments, and other products which require an alphanumeric display.

Maximum Ratings

V_{cc}	6.0 V
Voltage, Applied to Any Input	-0.5 to V_{cc} +0.5 Vdc
Operating Temperature	0°C to +65°C
Storage Temperature	-20°C to +70°C
Relative Humidity (non condensing) at 65°C	85%

OPTOELECTRONIC CHARACTERISTICS at 25°C

Parameter	Symbol	Min.	Typ.	Max	Units	Conditions
Supply Voltage	V_{CC}	4.75		5.25	V	
Supply Current-1(Total)	I_{CC}			400	mA	$V_{CC} = 5.0\text{ V}$ (10 segments/digit)
Supply Current-2(Total)	I_{CC}			380	mA	
Supply Current-1 (Display Blank)	$I_{CC\text{ BLANK}}$			75	mA	$V_{CC} = 5.0\text{ V}, V_{IN} = 0$
Supply Current-2 (Display Blank)	$I_{CC\text{ BLANK}}$			25	mA	
Input Voltage-High -1 (D_0 - D_6 , A_2 , A_3 , \overline{WR}) -1 (A_0 , A_1)	V_{IH}	2.0 2.7 3.5			V	$V_{CC} = 4.5\text{ V}$ $V_{CC} = 5.5\text{ V}$ $V_{CC} = 4.5\text{ V}$ $V_{CC} = 5.5\text{ V}$
-2 (D_0 - D_6 , A_0 , A_1)	V_{IH}	2.7 3.5			V	
-2 (A_2 , A_3 , \overline{WR})	V_{IH}	2.0			V	
Input Voltage-Low, All Inputs	V_{IL}			0.8	V	$V_{CC} = 4.5\text{ V}$
Input Current-High, Any Input	I_{IH}			20	μA	$V_{CC} = 5.5\text{ V}, V_I = 2.7\text{ V}$
Input Current-Low, Any Input	I_{IL}			400	μA	$V_{CC} = 5.5\text{ V}, V_I = 0.4\text{ V}$
Luminous Intensity, Average/Digit	I_V		0.5		mcd	$V_{CC} = 5.0\text{ V}$ (8 segments/digit)
Peak Emission Wavelength	λ_{pk}		660		nm	
Viewing Angle			± 40		Deg.	

SWITCHING CHARACTERISTICS @ 5 V

Parameter	Symbol	0°C Typ.	+25°C Min.	+65°C Typ.	Unit
Write Pulse	T_W	300	325	350	nS
Address/DE Setup Time	T_{AS}	350	400	450	nS
Data Set Up Time	T_{DS}	350	400	450	nS
Write Set Up Time	T_{WD}	50	75	100	nS
Data Hold Time	T_{DH}	50	75	100	nS
Address/DE Hold Time	T_{AH}	50	75	100	nS

TIMING CHARACTERISTICS

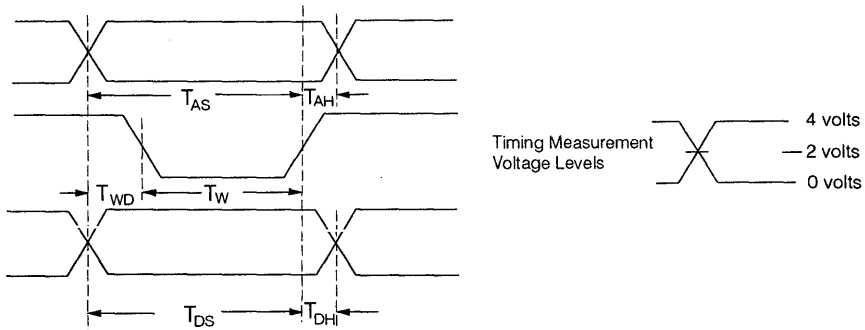

Optical Characteristics at 25°C

The IDA1414-16, Intelligent Display Assembly, has 16 alphanumeric characters and operates from just a 5 V supply. Based on the the DL1414T, four character Intelligent Display, the IDA1414-16 adds all the support logic required for direct connection to most microprocessor buses. The system interface takes place through a 14 hole dual in line pattern. Wires may be soldered directly to these holes or contact can be made with a ribbon cable and a connector, such as Berg 65493-006 or Amp 86383-1/86383-2.

System Power Requirements

Operating from a single +5 volt power supply, the IDA1414-16 requires a maximum operating current of 400 mA with ten of the segments lit on each character. With the display blanked, the board circuitry draws 75 mA maximum.

Display Interface

The display interface on the 14 pin dual in line pattern consists of seven data lines (D0 to D6), four address lines (A0 to A3), write pulse, V_{CC} , and GND.

\overline{WR} (Write, active low) line must be pulsed low for minimum of 325 ns to store a character in the display memory. See the Timing Characteristics diagram for timing and relationships to other signals.

Address lines A0 to A3 are set up so that the right most character is the lowest address. The left most character is the highest address. Data lines are set up so that D0 is the least significant bit and D6 is the most significant bit.

Using The Display Interface

By using memory mapped I/O techniques, the IDA can be treated almost like a memory location—supply the data, address and proper control signals and the characters appear, with each character location independently addressable. The basic signal flow sequence to load a character would start with the address lines going to the desired address. After the address has stabilized, the data can change to the desired values. After the data have stabilized, the \overline{WR} pulse is started and must remain low for at least 325 ns. Signals must be held stable for 75 ns minimum after the rising edge of the \overline{WR} pulse to ensure correct loading while the addresses must be stable for 400 ns preceding the same rising edge of the \overline{WR} pulse. Refer to the Timing Characteristics diagram.

System Design Considerations

It is often necessary, because of the nature of displays, to use a ribbon cable from the CPU board. The IDA has a 14 pin dual in line pattern for this purpose. Use IDA1414-16-1 (buffered version) rather than IDA1414-16-2 (non-buffered version) when the ribbon cable is over twelve inches. Voltage transients from noisy systems may couple through the cables into the Intelligent Display and can cause serious damage.

Avoid handling the IDA other than by the edges of the PCB. Static damage can still be a problem, so take the necessary precautions. Keep in conductive material, grounded work areas, etc.

The IDAs should need minimal cleaning, i.e., a gentle wiping with a soft damp cloth. Alcohol should *never* be used on any Intelligent Display device. Always check the chemical composition of any solvent before using on any Intelligent Display device.

Interconnection

Wires may be soldered directly to 14 hole dual in line position or contact can be made with ribbon cable and connector such as Berg 65493-006 or Amp 86383-1/86383-2.

CHARACTER SET

		D0	D1	D2	D3	D4	D5	D6	D7	D8	D9	D10	D11	D12	D13	D14	D15		
		L	H	L	H	L	H	L	H	L	H	L	H	L	H	L	H		
		L	L	H	H	L	L	H	H	L	L	H	H	L	L	H	H		
		L	L	L	L	L	L	L	L	H	H	H	H	H	H	H	H		
D6	D5	D4	hex	0	1	2	3	4	5	6	7	8	9	A	B	C	D	E	F
L	H	L	2		'	"	#	\$	%	&	'	<	>	*	+	,	--	.	/
L	H	H	3	0	1	2	3	4	5	6	7	8	9	-	/	z	==	\	?
H	L	L	4	a	A	B	C	D	E	F	G	H	I	J	K	L	M	N	O
H	L	H	5	P	Q	R	S	T	U	V	W	X	Y	Z	[\]	^	_

All other input codes display "blank"

Schematic

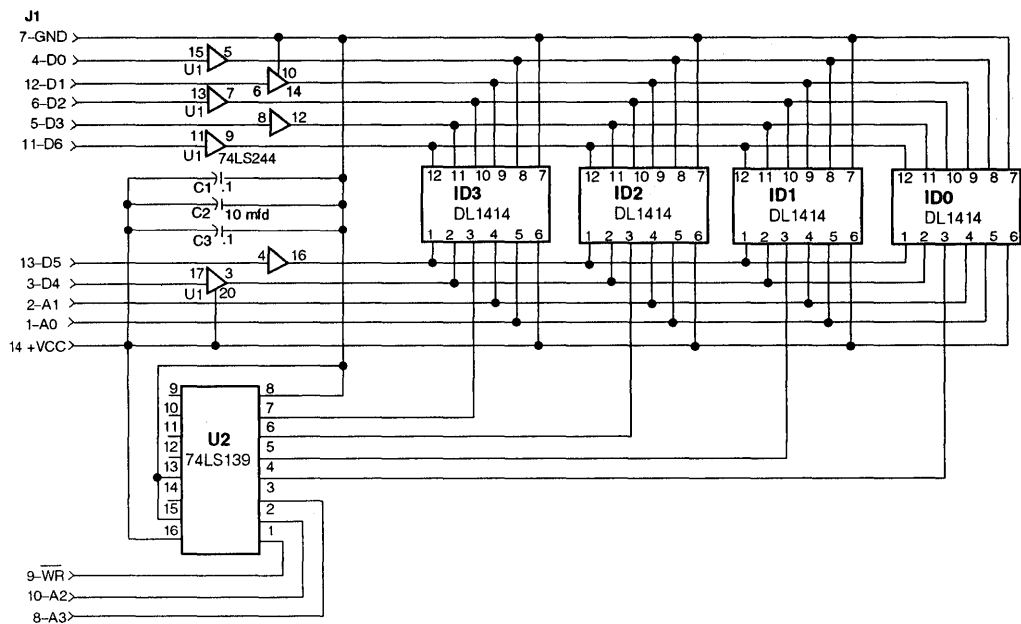

Pin	Function
1	A0 Digit Select
2	A1 Digit Select
3	D4 Data Input
4	D0 Data input (LSB)
5	D3 Data Input
6	D2 Data Input
7	GND
8	A3 Digit Select
9	WR Write
10	A2 Digit Select
11	D6 Data Input (MSB)
12	D1 Data Input
13	D5 Data Input
14	+VCC

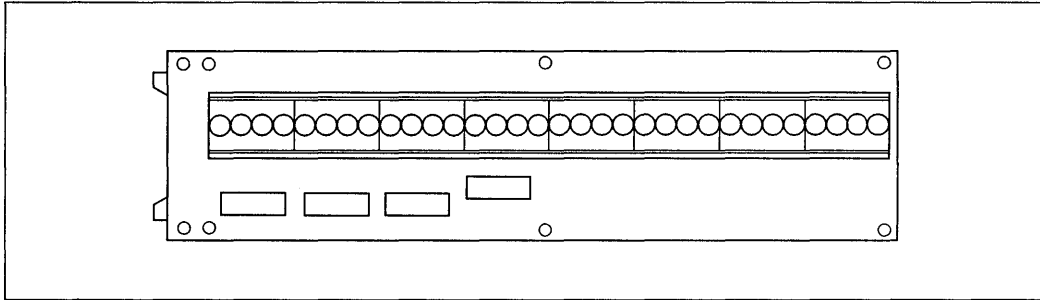

FEATURES

- .160" Magnified Monolithic Character
- Wide Viewing Angle $\pm 45^\circ$
- Complete Alphanumeric Display Assembly Using the DL2416
 - Built-in Multiplex and LED Drive Circuitry
 - Built-in Memory
 - Built-in Character Generator
- 64 Character ASCII Set
- Direct Access to Each Digit Independently
- Display Blank Function
- Memory Clear Function
- Cursor Function
- 16 or 32 Character Display Length
Custom Lengths by Request (Increments of 4 Characters)
- Single 5.0 Volt Power Supply
- TTL Compatible
- Easily Interfaced to a Microprocessor
- Tri-State or Open Collector Input Circuitry
- Schmitt Trigger Inputs on Control Lines

DESCRIPTION

The IDA2416-16/32 assembly is an extension of the DL2416 Intelligent Display. This assembly provides the designer with circuitry for display maintenance. It also minimizes interaction and interface normally required between the user's system and a multiplexed alphanumeric display.

The assembly consists of four/eight DL2416s in a single row, together with decoder and interface buffers on a single printed circuit board. Each DL2416 provides its own memory, ASCII ROM character decoder, multiplexing circuitry, and drivers for the four 17-segment LEDs.

Intelligent Display Assemblies can be used for applications such as data terminals, controllers, instruments, and other products which require an alphanumeric display.

Maximum Ratings

V_{CC}	6.0 V
Voltage, Applied to Any Input	-0.5 to $V_{CC} + 0.5$ Vdc
Operating Temperature	0°C to +65°C
Storage Temperature	-20°C to +70°C
Relative Humidity (non-condensing) at 65°C	85%

Package Dimensions in Inches

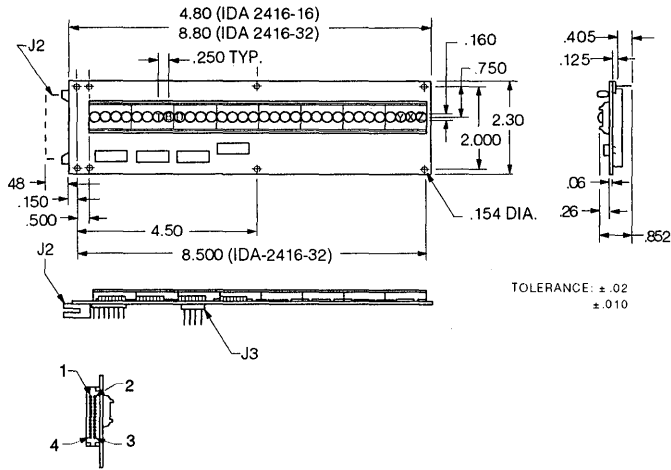

Pin	Function
J2-1	A2 Address Line
J2-2	DE4 Display Enable
J2-3	A3 Address Line
J2-4	DE3 Display Enable
J2-5	A4 Address Line
J2-6	DE1 Display Enable
J2-7	No Connection
J2-8	DE2 Display Enable
J2-9	D0 Data Line
J2-10	No Connection
J2-11	D1 Data Line
J2-12	No Connection
J2-13	D2 Data Line
J2-14	No Connection
J2-15	D6 Data Line
J2-16	No Connection
J2-17	D4 Data Line
J2-18	Cue Cursor Enable
J2-19	D5 Data Line
J2-20	CU Cursor Select
J2-21	A0 Address Line
J2-22	CLR Clear
J2-23	A1 Address Line
J2-24	WR Write
J2-25	D3 Data Line
J2-26	BL Blanking
J3-1	GND
J3-2	V _{CC}
J3-3	V _{CC}
J3-4	GND

Recommended Mating Connector

Connector	Function	Type	Suggested Manufacturer
J2	Control/Data	26 Pin Ribbon	Berg P/N 65484-011
J3	Power	Amp	Pin P/N 87026-2 Housing P/N 1-87025-3

IDA Schematic

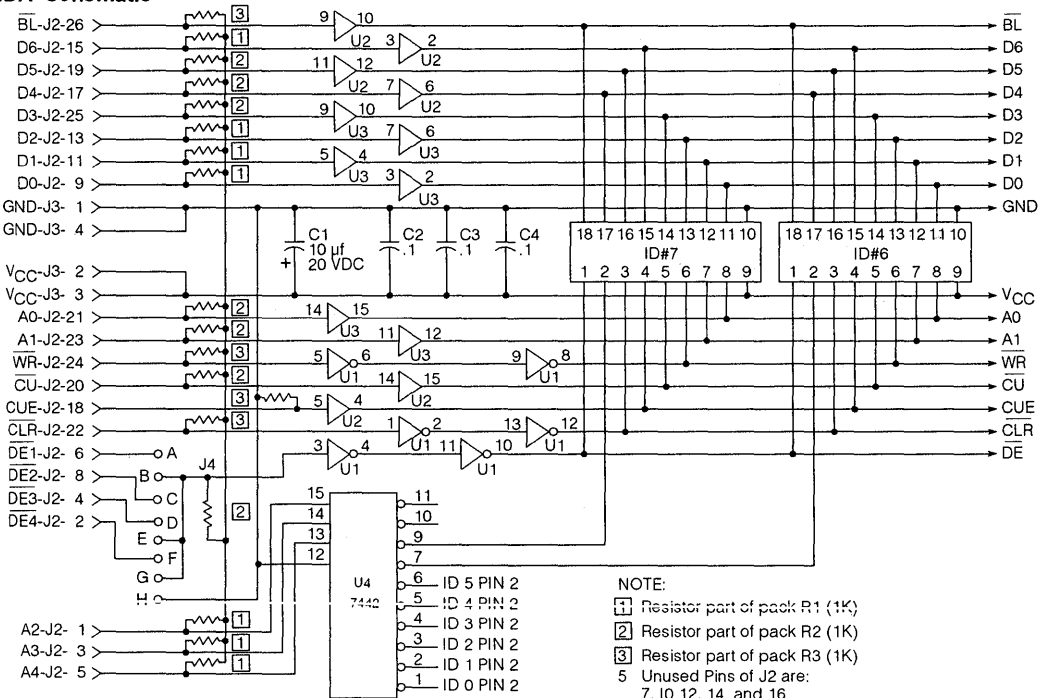

OPTOELECTRONIC CHARACTERISTICS at 25°C

Parameter	Symbol	Min.	Typ.	Max	Units	Conditions
Supply Voltage	V_{CC}	4.75	5.00	5.25	V	
Supply Current-Digit	I_{CC}		25		mA	$V_{CC} = 5\text{ V}$, 8 segments/digit
Supply Current-IDA2416-16	I_{CC}			650	mA	$V_{CC} = 5\text{ V}$, all segments/digit
Supply Current-IDA2416-32	I_{CC}			1250	mA	$V_{CC} = 5\text{ V}$, all segments/digit
Input Voltage-High, all inputs	V_{IH}	3.3			V	$V_{CC} = 5\text{ V}$, $\pm 0.25\text{ V}$
Input Voltage-Low, all inputs	V_{IL}			0.8	V	$V_{CC} = 5\text{ V}$
Input Current-High, all inputs	I_{IH}			40	μA	$V_{CC} = 5.25\text{ V}$, $V_I = 2.4\text{ V}$
Input Current-Low, all inputs	I_{IL}			2.2	mA	$V_{CC} = 5.25\text{ V}$, $V_I = 0.4\text{ V}$
Luminous Intensity, Average/Digit	I_V		0.5		mcd	$V_{CC} = 5\text{ V}$, 8 segments/digit
Peak Emission Wavelength	λ_{peak}		660		nm	
Viewing Angle			± 45		Deg.	Vertical and horizontal from normal to display plane

SWITCHING CHARACTERISTICS @ 5 V

Parameter @+25°C	Symbol	Min.	Unit
Write Pulse	T_W	350	nS
Data Set Up Time	T_{DS}	550	nS
Data Hold Time	T_{DH}	75	nS
Address/DE Setup Time	T_{AS}	550	nS
Address/DE Hold Time	T_{AH}	75	nS
Write Set Up Time	T_{WD}	200	nS
Clear Time	T_{CLR}	15	mS

TIMING CHARACTERISTICS

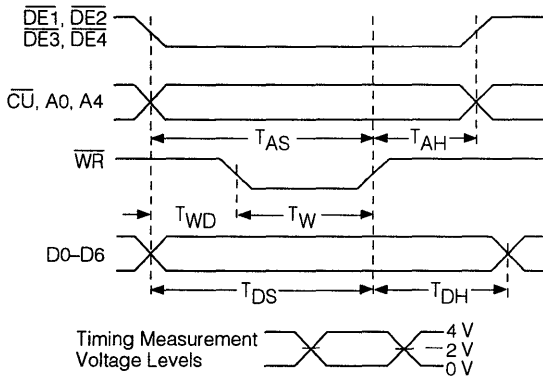

System Overview

The IDA2416-16/-32, Intelligent Display Assembly, has 16 or 32 alphanumeric characters and operates from just a +5 V supply. Based on the DL2416, four character Intelligent Display, the IDA2416 adds all the support logic required for direct connection to most microprocessor buses. The system interface takes place through a connector that has the data address lines as well as the control signals needed. Two additional connectors are included on the IDA2416—one for power and ground connections, the other to implement display enable selection.

System Power Requirements

Operating from a single +5 volt power supply, the IDA2416 requires a typical operating current of 450 mA with eight of the segments lit on each character. For the 32 character display, the current increases to 850 mA, typical. For the worst case condition with all segments lit, the 16 character display draws 650 mA and the 32 character requires 1250 mA. With the display blanked, the board circuitry draws about 70 mA.

Display Interface

The display interface on the 26 pin connector consists of seven data lines (D0 to D6), five address lines (A0 to A4), four display enable lines (DE1 to DE4), several unused pins, and various control signals. All address, data, control lines have either pull-up or pull-down 1K ohm resistors.

\overline{BL} (Blanking, active low): When this line is pulled low, it causes the entire IDA display to go blank without affecting the contents of the display memory on the DL2416s. \overline{BL} is active regardless of address or display enable lines. A flashing display can be achieved by pulsing this line.

\overline{WR} (Write, active low): To store a character in the display memory, this line must be pulsed low for a minimum of 350 ns. See Timing Diagram for timing and relationships to other signals. The \overline{WR} input drives a Schmitt-Trigger.

CUE (Cursor Enable, active high): When high, this line permits the cursor to be displayed, and when brought low, it disables the cursor function without affecting the stored value. CUE is active regardless of address or display enable lines. A flashing cursor can be created by pulsing the CUE line low.

\overline{CU} (Cursor Select, active low): The cursor function (character with all segments lit) is loaded by selecting the digit address and holding \overline{CU} true. A "1" on D0 writes the cursor. A "0" on D0 removes the cursor. The change occurs during the next write pulse per the timing diagram.

\overline{CLR} (Clear, active low): When held low for one display multiplex cycle (see DL 2416 data sheet for more information) of 15 ms, this line will cause all stored characters in the display, except for the cursor, to be cleared. \overline{CLR} is active regardless of address or display enable lines. The \overline{CLR} input drives a Schmitt trigger.

$\overline{DE1}$ to $\overline{DE4}$ (Display Enable, active low): There are four jumper selectable lines, any one of which can be selected to provide one of four board addresses that can be used when multiple IDAs are built into a system. When low, this line enables the selected display to permit data loading. The display enable input drives a schmitt-trigger. Address lines A0 to A4 are set up so that the right most character is the lowest address. The left-most character is the highest address. Data lines are set up so that D0 is the least significant bit and D6 is the most significant bit.

Using the Display Interface

Through the use of memory-mapped I/O techniques, the IDA can be treated almost like a memory location—supply the data, address and proper control signals and the characters appear, with each character location independently addressable. The basic signal flow sequence to load a character would start with the address lines going to the desired address while the \overline{CLR} and \overline{BL} lines are high to permit the data to be loaded in and displayed. After the address has stabilized, the data can change to the desired values (including the cursor). After the data has stabilized, the \overline{WR} pulse is started, and must remain low for at least 350 ns. Signals must be held stable for 75 ns, minimum, after the rising edge of the \overline{WR} pulse to ensure correct loading, while the addresses must be stable for 650 ns preceding the same rising edge of the \overline{WR} pulse. See the Timing Diagram.

Enable Selection

For board enable (the $\overline{DE1}$ through $\overline{DE4}$ lines) the user can choose any one of the four enable signals he has provided on the cable. This signal will be used to provide a master enable to each IDA. All that need be done is to insert the shorting plug in the appropriate position on the pins provided. This allows the user to make the system display the same information on two or more different IDAs or display different information on each of up to four groups of IDAs.

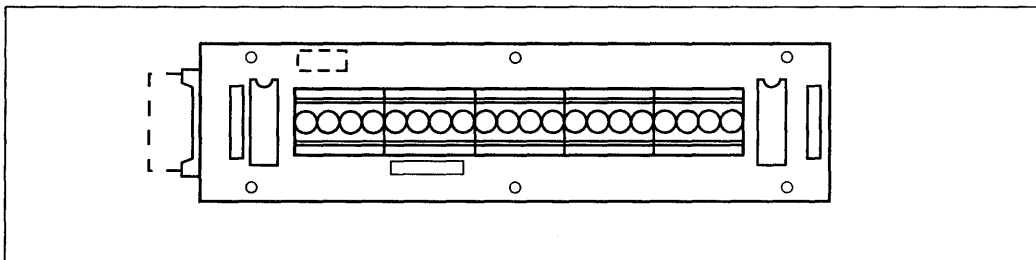

FEATURES

- .225" Magnified Monolithic Character
- Wide Viewing Angle $\pm 40^\circ$
- Complete Alphanumeric Display Assembly Using the DL3416
 - Built-in Multiplex and LED Drive Circuitry
 - Built-in Memory
 - Built-in Character Generator
- 64 Character ASCII Set
- Direct Access to Each Digit Independently
- Display Blank Function
- Memory Clear Function
- Cursor Function
- 16, 20, or 32 Character Display Length Custom Lengths (Increments of 4 Characters) by Request
- Single 5.0 Volt Power Supply
- TTL Compatible
- Easily Interfaced to a Microprocessor
- Schmitt Trigger Inputs on Data and Write Lines

DESCRIPTION

The IDA3416-16/-20/-32 assembly is an extension of the DL3416 Intelligent Display. This assembly provides the designer with circuitry for display maintenance. It also minimizes interaction and interface normally required between the user's system and a multiplexed alphanumeric display.

The assembly consists of four/five/eight DL3416s in a single row, together with decoder and interface buffers on a single printed circuit board. Each DL3416 provides its own memory, ASCII ROM character decoder, multiplexing circuitry, and drivers for the four 17-segment LEDs.

Intelligent Display Assemblies can be used for applications such as data terminals, controllers, instruments, and other products which require an alphanumeric display.

Maximum Ratings

V_{cc}	6.0 V
Voltage, Applied to Any Input	-0.5 to V_{cc} +0.5 Vdc
Operating Temperature	0°C to +65°C
Storage Temperature	-20°C to +70°C

Package Dimensions in Inches (mm)

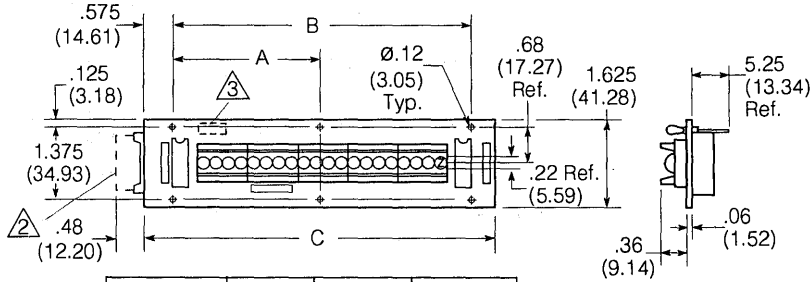

Part No.	A	B	C
IDA3416-16	3.00 (76.20)	6.00 (152.40)	6.95 (176.58)
IDA3416-20	3.65 (92.71)	7.30 (185.42)	8.25 (209.55)

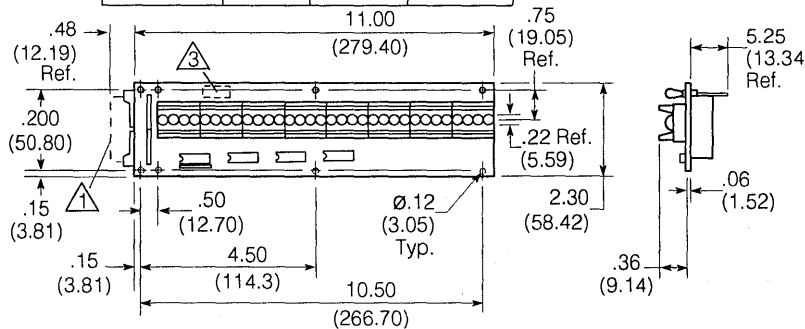

IDA3416-16, -20

Pin	Function
J2-1	D6 Data Line
J2-2	BL Blanking
J2-3	D5 Data Line
J2-4	Unused
J2-5	D4 Data Line
J2-6	A1 Address Line
J2-7	D3 Data Line
J2-8	A0 Address Line
J2-9	D2 Data Line
J2-10	CLR Clear
J2-11	D1 Data Line
J2-12	CE2 Chip Enable
J2-13	D0 Data Line
J2-14	CU Cursor Select
J2-15	WR Write
J2-16	Cue Cursor Enable
J2-17	A3 Address Line
J2-18	Unused
J2-19	A4 Address Line
J2-20	A2 Address Line
J3-1	GND
J3-2	V _{cc}
J3-3	V _{cc}
J3-4	GND

IDA3416-32

Pin	Function
J2-1	A2 Address Line
J2-2	DE4 Display Enable
J2-3	A3 Address Line
J2-4	DE3 Display Enable
J2-5	A4 Address Line
J2-6	DE1 Display Enable
J2-7	No Connection
J2-8	DE2 Display Enable
J2-9	D0 Data Line
J2-10	No Connection
J2-11	D1 Data Line
J2-12	No Connection
J2-13	D2 Data Line
J2-14	No Connection
J2-15	D6 Data Line
J2-16	No Connection
J2-17	D4 Data Line
J2-18	Cue Cursor Enable
J2-19	D5 Data Line

Pin	Function
J2-20	CU Cursor Select
J2-21	A0 Address Line
J2-22	CLR Clear
J2-23	A1 Address Line
J2-24	WR Write
J2-25	D3 Data Line
J2-26	BL Blanking
J3-1	GND
J3-2	V _{cc}
J3-3	V _{cc}
J3-4	GND

IDA3416-16, -20

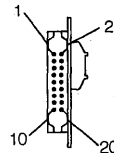

IDA3416-32

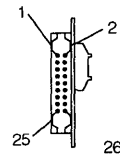

Recommended Mating Connector

Connector	Function	Type	Suggested Manufacturer
J2	Control/Data	20 Pin Ribbon	Berg P/N 65496-007
J2	Control/Data	26 Pin Ribbon	Berg P/N 65484-011
J3	Power	Amp	Pin P/N 87026-2 Housing P/N 1-87025-3

OPTOELECTRONIC CHARACTERISTICS at 25°C

Parameter	Symbol	Min.	Typ.	Max	Units	Conditions
Supply Voltage	V_{CC}	4.75	5.00	5.25	V	
Supply Current/Digit	I_{CC}		25		mA	$V_{CC} = 5\text{ V}$, 8 segments/digit
Supply Current/Digit	I_{CC}			6	mA	$V_{CC} = 5\text{ V}$, display blank $V_{IN} = 0\text{ V}$, $WR = 5\text{ V}$
Total-IDA3416-16	I_{CC}			850	mA	$V_{CC} = 5\text{ V}$, all segments/digit ¹
Total-IDA3416-20	I_{CC}			1050	mA	$V_{CC} = 5\text{ V}$, all segments/digit ¹
Total-IDA3416-32	I_{CC}			1680	mA	$V_{CC} = 5\text{ V}$, all segments/digit ¹
Input Voltage-High, all inputs	V_{IH}	3.5			V	$V_{CC} = 5\text{ V}$, $\pm 0.25\text{ V}$
Input Voltage-Low, all inputs	V_{IL}			0.8	V	$V_{CC} = 5\text{ V}$
Input Current-High, all inputs	I_{IH}			40	μA	$V_{CC} = 5.25\text{ V}$, $V_I = 2.4\text{ V}$
Input Current-Low, all inputs	I_{IL}			6.4	mA	$V_{CC} = 5.25\text{ V}$, $V_I = 0.4\text{ V}$
Luminous Intensity, Average/Digit	I_V		0.8		mcd	$V_{CC} = 5\text{ V}$, 8 segments/digit
Peak Emission Wavelength	λ_{peak}		660		nm	
Viewing Angle			± 40		Deg.	Vertical and horizontal from normal to display plane

SWITCHING CHARACTERISTICS @ 5 V

Parameter @ +25°C	Symbol	(min.)	Unit
Write Pulse	T_W	350	nS
Data Set Up Time	T_{DS}	550	nS
Data Hold Time	T_{DH}	75	nS
Address/DE Setup Time	T_{AS}	550	nS
Address/DE Hold Time	T_{AH}	75	nS
Write Set Up Time	T_{WD}	200	nS
Clear Time	T_{CLR}	15	mS

Note: Cursor should not be on longer than 60 seconds.

TIMING CHARACTERISTICS

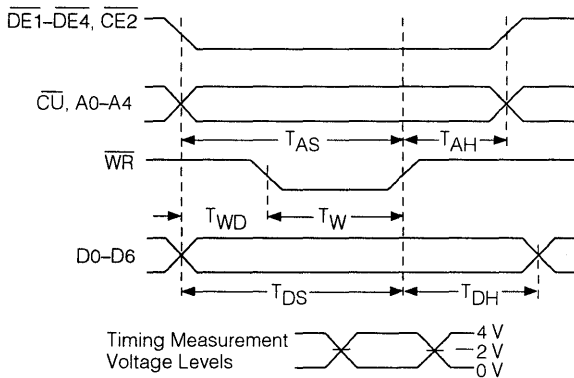

System Overview

The IDA3416-16/-32, Intelligent Display Assembly, has 16, 20, or 32 alphanumeric characters and operates from just a +5 V supply. Based on the the DL3416, four character Intelligent Display, the IDA3416 adds all the support logic required for direct connection to most microprocessor buses. The system interface takes place through a 20 or 26 pin connector that has data address lines as well as the control signals needed. One additional connector is included on the IDA3416 and is used for power and ground connections.

System Power Requirements

Operating from a single +5 volt power supply, the IDA3416 requires a typical operating current of 30 mA with eight of the segments lit on each character. For the 32 character display, the current increases to 850 mA, typical. For the worst case condition with all segments lit, the current is 52 mA per digit. With the display blanked, the current is 6 mA per digit.

Display Interface

The display interface on the 20 or 26 pin connector consists of seven data lines (D0 to D6), five address lines (A0 to A4), and various control signals. All address, data, control lines have either pull-up or pull-down 1K ohm resistors.

$\overline{\text{BL}}$ (Blanking, active low): When this line is pulled low, it causes the entire IDA display to go blank without affecting the contents of the display memory on the DL3416s. $\overline{\text{BL}}$ is active regardless of address or display enable lines. A flashing display can be achieved by pulsing this line.

$\overline{\text{WR}}$ (Write, active low): To store a character in the display memory, this line must be pulsed low for a minimum write time. See Timing Diagram for timing and relationships to other signals.

CUE (Cursor Enable, active high): When high, this line permits the cursor to be displayed¹, and when brought low, it disables the cursor function without affecting the stored value. CUE is active regardless of address or display enable lines. A flashing cursor can be created by pulsing the CUE line low.

$\overline{\text{CU}}$ (Cursor Select, active low): The cursor function (character with all segments lit) is loaded by selecting the digit address and holding $\overline{\text{CU}}$ true. A "1" on D0 inserts the cursor. A "0" on D0 removes the cursor. The change occurs during the next write pulse per the Timing Diagram.

$\overline{\text{CLR}}$ (Clear, active low): When held low for one display multiplex cycle (see DL 3416 data sheet for more information) of 15 ms, this line will cause all stored characters in the display, except for the cursor, to be cleared. $\overline{\text{CLR}}$ is active regardless of address or display enable lines.

CE2 (Chip Enable, active low): To store character in the display memory, this line must be held low at least 550 nS preceding the leading edge of the WR pulse.

Address lines A0 to A4 are set up so that the rightmost character is the lowest address. The left-most character is the highest address. Data lines are set up so that D0 is the least significant bit and D6 is the most significant bit.

Using the Display Interface

Through the use of memory-mapped I/O techniques, the IDA can be treated almost like a memory location—supply the data, address and proper control signals and the characters appear, with each character location independently addressable. The basic signal flow sequence to load a character would start with the address lines going to the desired address while the $\overline{\text{CLR}}$ and $\overline{\text{BL}}$ lines are high to permit the data to be loaded in and displayed. After the address has stabilized, the data can change to the desired values (including the cursor). After the data has stabilized, the WR pulse is started and must remain low for at least 350 ns. Signals must be held stable for 75 ns, minimum, after the rising edge of the WR pulse to ensure correct loading, while the addresses must be stable for 650 ns preceding the same rising edge of the WR pulse. See the Timing Diagram.

Notes:

1. CMOS handling precaution, see Appnote 18.
2. Cleaning agents—NO alcohol.

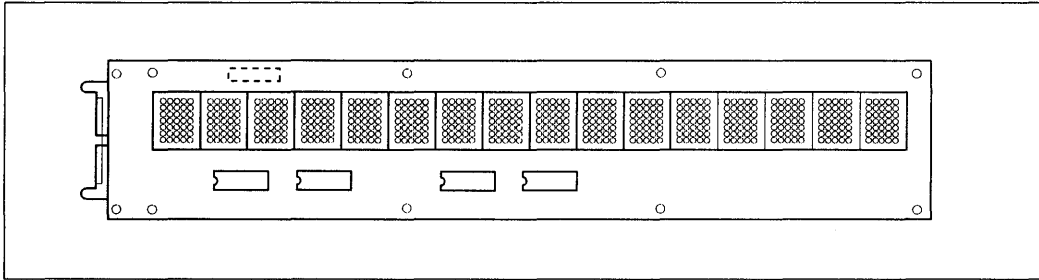

FEATURES

- .68" 5 X 7 Dot Matrix Character
- Complete Alphanumeric Display Assembly Using the DLO7135/DLG7137
 - Built-in Multiplex and LED Drive Circuitry
 - Built-in Memory
 - Built-in Character Generator
- 96 Character ASCII Set, Upper and Lower Case
- Direct Access to Each Digit Independently
- Three Brightness Levels
- Display Blank Function
- Lamp Test Function
- Wide Viewing Angle: $\pm 50^\circ$
- Readable in High Ambient Lighting
- Colors: High Efficiency Red and Green
- 16 or 20 Character Display Lengths
 - Custom Lengths (Increments of 4 Characters) by Request
- Single 5.0 Volt Power Supply
- Easily Interfaced to a Microprocessor
- TTL Compatible
- Fully Buffered Inputs

DESCRIPTION

The IDA7135/7137-16/-20 assembly is an extension of the DLO7135 (high efficiency red) and DLG7137 (green) 5 X 7 dot matrix Intelligent Display. This assembly provides the designer with circuitry for display maintenance. It also minimizes interaction and interface normally required between the user's system and a multiplexed alphanumeric display.

The assembly consists of sixteen/twenty DLX7135/7s in a single row, together with decoder and interface buffers on a single printed circuit board. Each DLX7135/7 provides its own memory, ASCII ROM character decoder, multiplexing circuitry, and drivers for 35 LED dots.

Intelligent Display Assemblies can be used for applications such as P.O.S. terminals, message systems, industrial equipment, instrumentation, and other products requiring a large, easily readable, user friendly alphanumeric display.

For additional information refer to Appnote 25. For cleaning we recommend de-ionized water, isopropyl alcohol, Freon TE or Freon TF.

Important: Refer to Appnote 18, "Using and Handling Intelligent Displays." Since this is a CMOS device, normal precautions should be taken to avoid static damage.

Maximum Ratings

V_{CC}	6.0 V
Voltage, Applied to Any Input	-0.5 to V_{CC} +0.5 Vdc
Operating Temperature	0°C to +65°C
Storage Temperature	-20°C to +65°C
Relative Humidity (non-condensing) at 65°C	85%

Package Dimensions in Inches (mm)

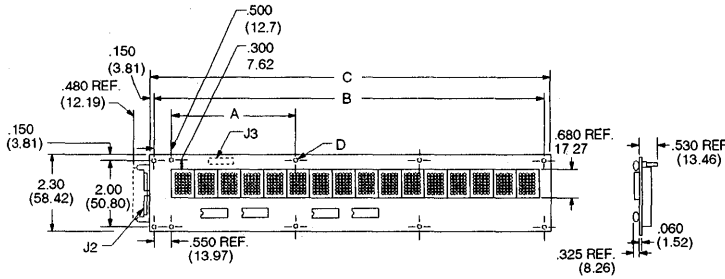

TOLERANCE: ±.01

Part No.	A	B	C	D
IDA7135/7-16	3.80 typ. (96.52)	11.90 (302.26)	12.20 (309.88)	.120 typ. 10 plcs. (3.05)
IDA7135/7-20	3.55 typ. (90.17)	14.70 (373.38)	15.00 (381.00)	.155 typ. 12 plcs. (3.94)

Recommended Mating Connector

Connector	Function	Type	Suggested Manufacturer
J2	Control/Data	26 Pin Ribbon	Berg P/N 65948-011
J3	Power	Amp	Pin P/N 87026-2 Housing P/N 1-87025-3

Pin	Function
J2-1	A2 Address Line
J2-2	No Connection
J2-3	A3 Address Line
J2-4	No Connection
J2-5	A4 Address Line
J2-6	No Connection
J2-7	No Connection
J2-8	No Connection
J2-9	D0 Data Line
J2-10	No Connection
J2-11	D1 Data Line
J2-12	No Connection
J2-13	D2 Data Line
J2-14	No Connection
J2-15	D6 Data Line
J2-16	No Connection
J2-17	D4 Data Line
J2-18	BL1 Brightness
J2-19	D5 Data Line
J2-20	No Connection
J2-21	A0 Address Line
J2-22	BL0 Brightness
J2-23	A1 Address Line
J2-24	WR Write
J2-25	D3 Data Line
J2-26	LT Lamp Test
J3-1	GND
J3-2	V _{cc}
J3-3	V _{cc}
J3-4	GND

IDA Schematic

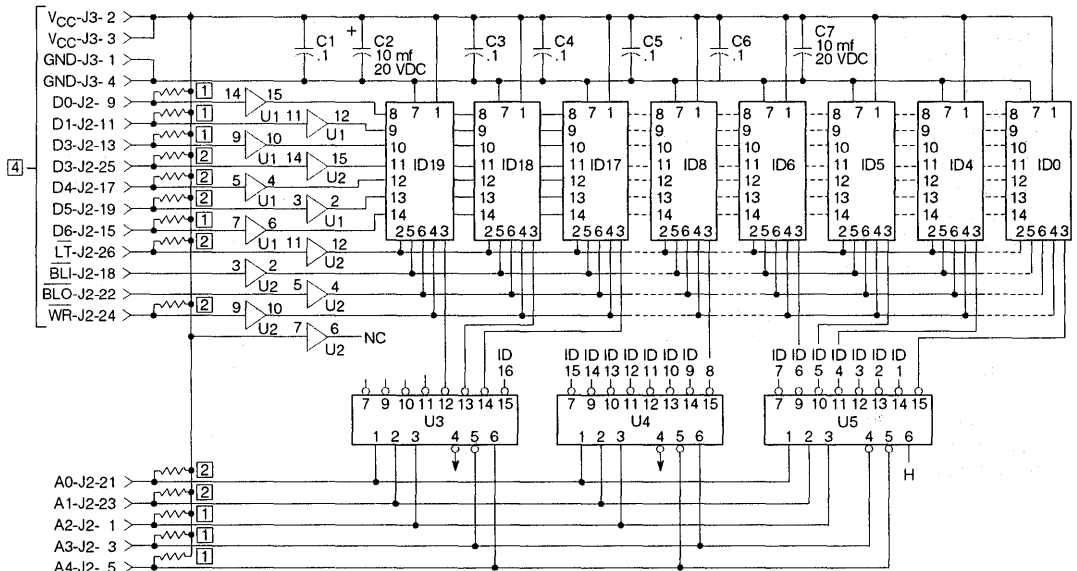

Note:

- ① Part of Resistor Pack RP1 (1K SIP)
- ② Part of Resistor Pack RP2 (1K SIP)
- ③ Address bits A0-A4 are decoded by ICs, U3-U5 to enable ID0-ID19.
- ④ All like lines on all displays are tied together; e.g., LT, WR, BL1, BL0, etc.

OPTOELECTRONIC CHARACTERISTICS at 25°C

Parameter	Symbol	Min.	Typ.	Max	Units	Conditions
Supply Current/Digit	I_{CC}		170	220	mA	$V_{CC} = 5\text{ V}$, $\overline{BL0} = \overline{BL1} = 1$
Supply Current/Digit (blank)	I_{CC}		5	10	mA	$V_{CC} = 5\text{ V}$, $\overline{BL0} = \overline{BL1} = 0$
Supply Current /Digit	I_{CC}		85		mA	$V_{CC} = 5\text{ V}$, $\overline{BL0} = 0$, $\overline{BL1} = 1$
Supply Current/Digit	I_{CC}		42		mA	$V_{CC} = 5\text{ V}$, $\overline{BL0} = 1$, $\overline{BL1} = 0$
Supply Voltage	V_{CC}	4.75		5.25	VDC	
Input Voltage—High, all inputs	V_{IH}	2.7			VDC	$V_{CC} = 5\text{ V}$, $\pm 0.25\text{ V}$
Input Voltage—Low, all inputs	V_{IL}			1.0	VDC	$V_{CC} = 5\text{ V}$
Input Current	I_{IL}			160	μA	$V_{CC} = 5\text{ V}$
Luminous Intensity, Dot Average	I_V		250		μcd	$V_{CC} = 5\text{ V}$
Peak Wavelength IDA7135 (HER) IDA7137 (green)	λ_{peak} λ_{peak}		640 565		nm nm	
Viewing Angle			± 50		Deg.	

SWITCHING CHARACTERISTICS @ 5 V

Parameter at +25°C	Symbol	Min.	Unit
Write Pulse	T_W	200	nS
Data Set Up Time	T_{DS}	230	nS
Data Hold Time	T_{DH}	100	nS
Address Setup Time	T_{AS}	30	nS

Display Interface

The display interface on the 26 pin connector consists of seven data lines (D0 to D6¹), five address lines (A0 to A4²), two brightness inputs $\overline{BL0}$ to $\overline{BL1}$, lamp test (LT), the Chip Enable (\overline{CE}), and the write line (WR). All address and data lines have 1K ohm pull up resistors.

$\overline{BL0}$ and $\overline{BL1}$ (Brightness, active low): When both of these are pulled low, it causes the entire IDA display to go blank without affecting the contents of the display memory on the DLX713Xs. \overline{BL} is active regardless of address or display enable lines. These two lines are used to vary the intensity of the display to one of four levels.

\overline{WR} (Write, active low): To store a character in the display memory, this line must be pulsed low for a minimum of 200 ns. See Timing Diagram for timing and relationships to other signals.

\overline{LT} (Lamp test, active low): This line can be achieved to light all display dots.

Notes:

1. For IDA713X-16 only. Four address bits are used.
2. Four address bits are used.

DIMMING AND BLANKING THE DISPLAY

Brightness Level	$\overline{BL1}$	$\overline{BL0}$
Blank	0	0
¼ Brightness	0	1
½ Brightness	1	0
Full Brightness	1	1

TIMING CHARACTERISTICS

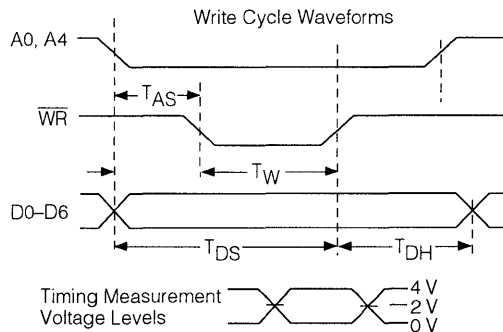

System Overview

This Intelligent Display Assembly offers the designer a choice of either 16 (IDA713X-16) or 20 (IDA713X-20) alphanumeric characters. Based on the the DLX713X dot matrix Intelligent Display, the IDA713X adds all the support logic required for direct connection to most microprocessor buses. The system interface takes place through a 26 pin connector which has data and address lines as well as the control signals available on it. One additional connector is used for power and ground connections.

System Power Requirements

Operating from a single +5 volt power supply, the IDA713X-16 requires a typical operating current of 2720 mA at the brightness level. For the 20 character display, the typical operating current is 3400 mA. With the display blanked, the board circuitry for the 16 character assembly draws 80 mA, and the 20 character assembly draws 100 mA.

Using the Display Interface

By using memory-mapped 1/0 techniques, the IDA can be treated almost like a memory location—supply the data, address and proper control signals and the characters appear, with each character location independently addressable. The basic signal flow sequence to load a character would start with the address lines going to the desired address. After the address has stabilized, the data can change to the desired values. After the data has stabilized, the WR pulse is started, and must remain low for at least 200 ns to ensure correct loading. See the Timing Diagram. Either BL0 or BL1 should be held high for displays to light up.

Lamp Test

When the lamp test (LT) is activated, all dots on the display are illuminated at half brightness. The lamp test function is independent of write (WR) and the settings of the blanking inputs (BL0, BL1).

This convenient test gives a visual indication that all dots are functioning properly. Lamp test also may be used as a cursor function or pointer which does not destroy previously displayed characters.

DIGIT ADDRESSING TRUTH TABLE

Address Bit					Device
A4	A3	A1	A2	A0	Addressed
0	0	0	0	0	0
0	0	0	0	1	1
0	0	0	1	0	2
0	0	0	1	1	3
0	0	1	0	0	4
0	0	1	0	1	5
0	0	1	1	0	6
0	0	1	1	1	7
0	1	0	0	0	8
0	1	0	0	1	9
0	1	0	1	0	10
0	1	0	1	1	11
0	1	1	0	0	12
0	1	1	0	1	13
0	1	1	1	0	14
0	1	1	1	1	15
1	0	0	0	0	16
1	0	0	0	1	17
1	0	0	1	0	18
1	0	0	1	1	19

Notes:

1. Entire area is for 20 characters; smaller portion is for 16 characters.
2. Right most character is digit 0.

CHARACTER SET

D6	D5	D4	HEX	D0	0	1	0	1	0	1	0	1	0	1	0	1	0	1	0	1	0	1	0	1	0	1	0	1	0	1			
				D1	0	0	1	1	0	0	1	1	0	0	1	1	0	0	1	1	0	0	1	1	0	0	1	1	0	0	1	1	
				D2	0	0	0	0	1	1	1	1	1	0	0	0	0	1	1	1	1	0	0	1	1	1	1	1	1	1	1	1	1
				D3	0	0	0	0	0	0	0	0	0	1	1	1	1	1	1	1	1	1	1	1	1	1	1	1	1	1	1	1	1
				THESE CODES DISPLAY BLANK																													
				[Character set grid showing digits 0-9, letters A-Z, and symbols]																													

- Notes: 1. High = 1 level.
 2. Low = 0 level.
 3. Upon power up, the device will initialize in a random state.

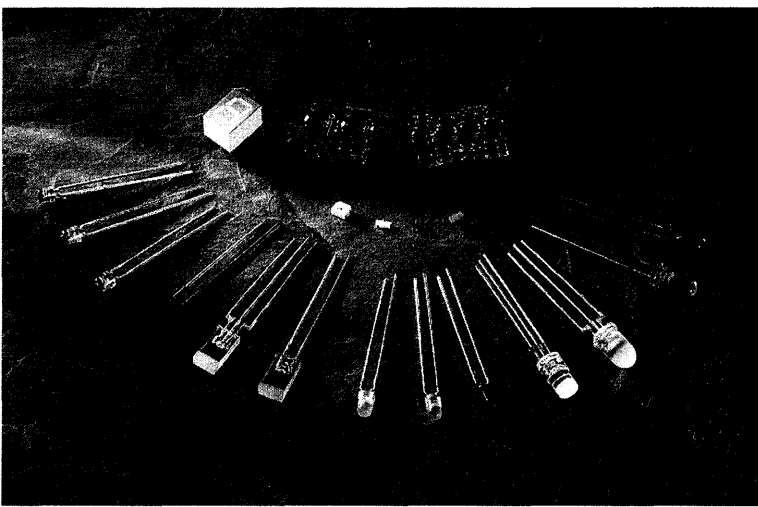





Numeric Displays

Light Bars



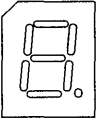

Bar Graphs

LED Lamps

LED Numeric Displays

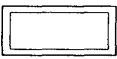

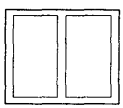
Package Type	Package Outline	Part Number	Character Height	Description	Polarity	Color	Luminous Intensity per Segment		Page	
							$\mu\text{cd (typ.)}$	mA		
Multi-digit magnified monolithic		DL-330M	0.11" (2.8 mm)	7 segment 3 digit	C.C. multi-plex	Red	2500 per digit	5	3-5	
		DL-340M		7 segment 4 digit						
		DL-430M	0.15" (3.8 mm)	7 segment 3 digit						
		DL-440M		7 segment 2 digit						
Compact single digit encapsulated (filled reflector)		HD1075R HD1077R	0.28" (7 mm)	7 segment, decimal point right	C.A. C.C.	Red	550	10	3-7	
Compact single digit encapsulated (filled reflector)		HD1075O HD1077O			C.A. C.C.	Super-red	2500			
		HD1075G HD1077G			C.A. C.C.	Green	3000			
		HD1105R HD1107R	0.39" (10 mm)	7 segment, decimal point right	C.A. C.C.	Red	550	10	3-9	
HD1105O HD1107O		C.A. C.C.			Super-red	2500				
HD1105G HD1107G		C.A. C.C.			Green	3000				
Compact single digit encapsulated (filled reflector)		HD1131R HD1133R	0.53" (13.5 mm)	7 segment, decimal point right	C.A. C.C.	Red	550	1100	10	3-11
Single digit encapsulated (filled reflector), low current		HD1131O HD1133O			C.A. C.C.	Super-red	260			
		HD1131G HD1133G			C.A. C.C.	Green				
		HDN1075O HDN1077O	0.28" (7 mm)	7 segment, decimal point right	C.A. C.C.	Super-red		260	10	3-13
Single digit encapsulated (filled reflector), low current		HDN1105O HDN1107O	0.39" (10 mm)	7 segment, decimal point right	C.A. C.C.	Super-red	260	10	3-14	
Single digit encapsulated (filled reflector), low current		HDN1131O HDN1133O	0.53" (13.5 mm)	7 segment, decimal point right	C.A. C.C.	Super-red	260	10	3-15	

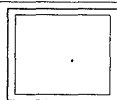
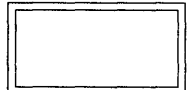
Light Bars

Package Type	Package Outline	Part Number	Color	Light Emitting Area	Description	Luminous Intensity per Segment		Page
						μ cd (typ.)	mA	
Small rectangular, rugged encapsulated.		HLMP2300	Red	0.15"x0.35"	Two die light bar.	10	20 per die	3-16
		HLMP2400	Yellow			6		
		HLMP2500	Green			10		
Large rectangular, rugged encapsulated.		HLMP2350	Red	0.15"x0.75"	Four die light bar (1x4)	20	20 per die	3-16
		HLMP2450	Yellow			12		
		HLMP2550	Green			20		
Small rectangular, rugged encapsulated.		HLMP2600	Red	0.15"x0.35"	Four die light bar, mechanical barrier creates 2 isolated rectangular light emitting areas (2x2).	10	20 per die	3-16
		HLMP2700	Yellow			6		
		HLMP2800	Green			10		
Large rectangular, 4 section, rugged encapsulated.		HLMP2620	Red	0.15"x0.35"	Eight die light bar, mechanical barrier creates 4 isolated rectangular light emitting areas (2x4).	10	20 per die	3-16
		HLMP2720	Yellow			6		
		HLMP2820	Green			10		
Square rectangular, rugged encapsulated.		HLMP2655	Red	0.35"x0.35"	Four die light bar.	20	20 per die	3-16
		HLMP2755	Yellow			12		
		HLMP2855	Green			20		
Large rectangular, rugged encapsulated.		HLMP2685	Red	0.35"x0.75"	Eight die light bar.	40	20	3-16
		HLMP2785	Yellow			24		
		HLMP2885	Green			40		

Num. Displays
Bar Graphs

Bar Graphs

Package Type	Package Outline	Part Number	Color	Light Emitting Area	Polarity	Luminous Intensity per Segment		Page
						$\mu\text{cd (typ.)}$	mA	
10 element encapsulated (filled reflector DIP)		RBG-1000	Red	0.04"x0.15"	Separately addressable anode and cathode.	500	20	3-18
		OBG-1000	Super-red			2500		
		YBG-1000	Yellow			2000		
		GBG-1000	Green					
10 element encapsulated (filled reflector DIP)		RBG-4820	Red	0.06"x0.20"	Separately addressable anode and cathode.	500	20	3-20
		OBG-4830	Super-red			2500		
		YBG-4840	Yellow					
		GBG-4850	Green			2000		

.11" 3 DIGIT **DL-330M**
 .11" 4 DIGIT **DL-340M**
 .15" 3 DIGIT **DL-430M**
 .15" 2 DIGIT **DL-440M**

Red Seven Segment

Magnified Monolithic Numeric Display

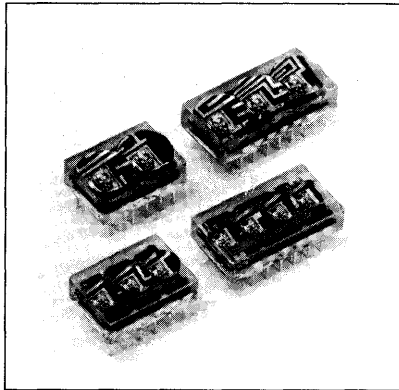

Package Dimensions in Inches (mm)

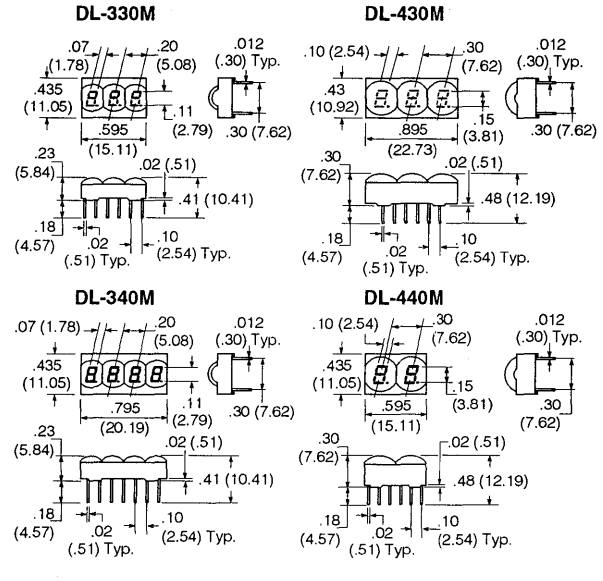

FEATURES

- Rugged Encapsulated Package
- Integrated Magnifier Lens
- Monolithic Construction for Maximum Brightness at Minimum Power
- Common Cathode for Multiplexing Ease
- Standard Dual-In-Line Package
- Categorized for Brightness Uniformity

DESCRIPTION

The DL-330M/340M and DL-430/440M are numeric red LED displays with a right hand decimal point. Low cost is achieved through minimum use of monolithic GaAsP material and magnification to full height using a simple integrated lens construction. A red plexiglass or circularly polarized filter is recommended to enhance visibility and to eliminate glare from the surface of the package.

These displays are designed for multiplex operation; the desired digit is displayed by selecting the appropriate cathode.

All devices are optimized for low power portable battery operated equipment using MOS and CMOS integrated logic circuits such as DMMs and digital thermometers.

Maximum Ratings (at 25°C)

Operating Temperature and Storage Temperature	-20°C to +70°C
Continuous Forward Current per Segment and Decimal	7 mA
Peak Pulse Current (10 μs)	50 mA
Peak Inverse Voltage per Segment and Decimal	3 V
Power Dissipation	320 mW
Derating Factor from 25°C/Digit	4.3 mW/°C

Characteristics (T_A=25°C)

Parameter	Min.	Typ.	Max.	Unit	Test Condition
Luminous Intensity (Total Digit)	1.0	2.5		mcd	I _F =5 mA/segment
Peak Emission Wavelength			660	nm	
Line Half-Width	40			nm	
Forward Voltage		1.7	2.0		I _F =20 mA/digit, V=0
Reverse Current			100	μA	V _R =3.0 V

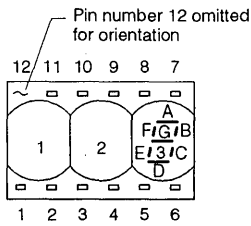

DL-330M

Pin	Function
1	Cathode D1
2	Anode E
3	Anode D
4	Cathode D2
5	Anode C
6	Anode DP
7	Cathode D3
8	Anode B
9	Anode G
10	Anode A
11	Anode F
12	No pin

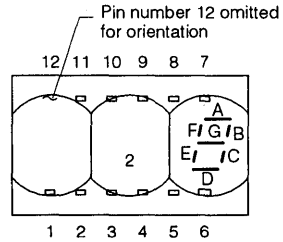

DL-430M

Pin	Function
1	Cathode D1
2	Anode E
3	Anode D
4	Cathode D2
5	Anode C
6	Anode DP
7	Cathode D3
8	Anode B
9	Anode G
10	Anode A
11	Anode F
12	No pin

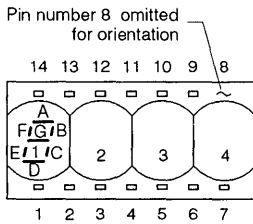

DL-340M

Pin	Function
1	No connection
2	Anode E
3	Anode D
4	Anode C
5	Anode DP
6	Anode G
7	Cathode 4
8	No pin
9	Anode B
10	Cathode 3
11	Anode F
12	Cathode 2
13	Anode A
14	Cathode 1

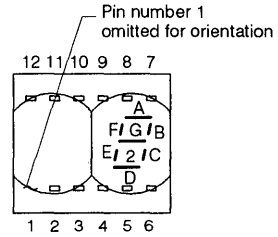

DL-340M

Pin	Function
1	No pin
2	Anode E
3	Anode D
4	No pin
5	Anode C
6	Anode DP
7	Cathode D2
8	Anode B
9	Anode G
10	Anode A
11	Anode F
12	Cathode D1

Block Diagram for Typical Display Drive Circuitry

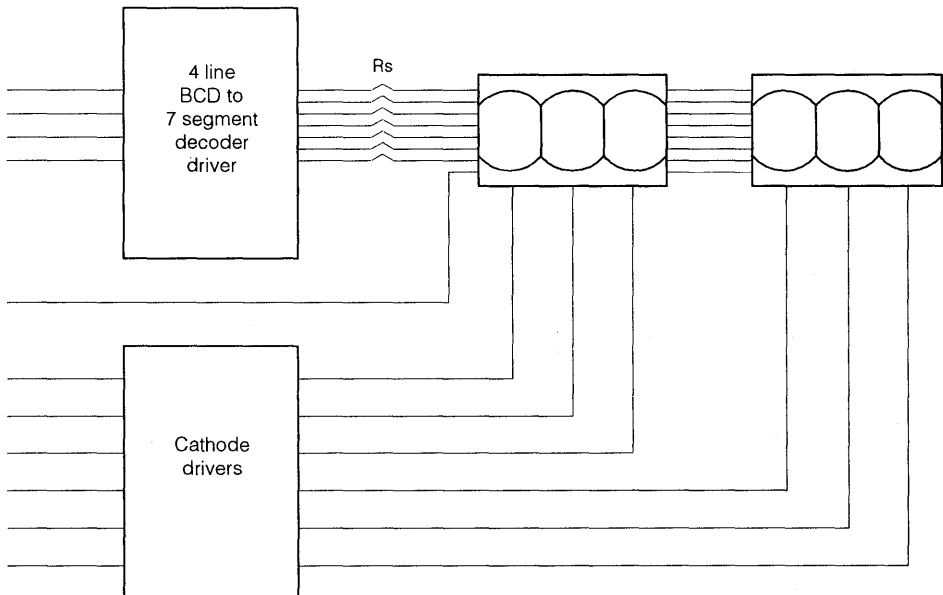

SIEMENS

RED HD1075R/1077R SUPER-RED HD1075O/1077O GREEN HD1075G/1077G

Common Anode/Common Cathode 0.28" (7 mm) Seven Segment Numeric Display

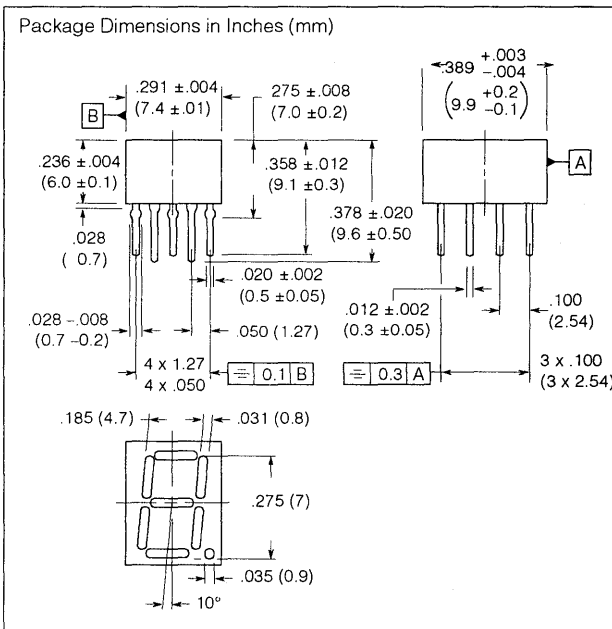
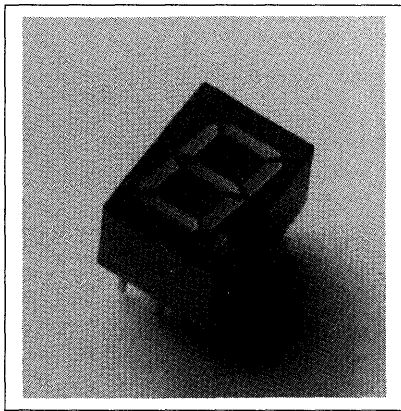

Num. Displays
Bar Graphs

FEATURES

- Rugged Encapsulated Package
- 0.28 Inch (7 mm) Digit Height
- Choice of Colors: Red, Super-Red, Green
- Common Anode or Common Cathode
- Wide Viewing
- Intensity Coded for Display Uniformity

DESCRIPTION

The HD1075X/1077X are displays with 0.28 inch (7 mm) digits with either a common anode or common cathode and a right hand decimal point.

These displays have good viewing and can be used in electronic instruments, point-of-sale systems, clocks, and other general industrial and consumer applications. All displays have a light gray face.

Contrast enhancement filters are recommended for use with these displays.

Maximum Ratings

Operating Temperature (T_{OP})	0°C to +85°C
Storage Temperature (T_{STG})	-40°C to +85°C
Lead Soldering Temperature, 2 mm from base (T_S) $t=3$ s	260°C
Peak Forward Current per Segment or DP ⁽¹⁾ (I_{FM}) $t_p \leq 10$ μ s	
HD1075/7R	500 mA
HD1075/7O/G	150 mA
DC Forward Current per Segment or DP ⁽²⁾ (I_F)	
HD1075/7R	25 mA
HD1075/7O/G	17 mA
Pulse Peak Forward Current per Segment (I_{FM})	
20% Duty Cycle	100 mA
Reverse Voltage per Segment or DP (V_R)	6 V
Total Power Dissipation (P_{TOT}) $T_A \leq 45^\circ\text{C}$	400 mW

Notes:

1. Do not exceed maximum average current per segment (see graph of permissible pulse handling capability).
2. Derate maximum average current above $T_A=75^\circ\text{C}$ at 0.5 mA/°C per segment.

See graph numbers 1A, 2A, 3A, 5A, 6A, 7A, 8B, 9A, 11A at the end of this section.

Characteristics ($T_A=25^{\circ}\text{C}$)

Parameter	Symbol	Min.	Values		Unit
			Typ.	Max.	
Luminous Intensity per Segment ($I_F=10\text{ mA}$)					
HD1075/7R	I_V	180	550		μcd
HD1075/7O	I_V	700	2500		μcd
HD1075/7G	I_V	700	3000		μcd
Peak Wavelength ($I_F=10\text{ mA}$)					
HD1075/7R	λ_{PEAK}		660		nm
HD1075/7O	λ_{PEAK}		630		nm
HD1075/7G	λ_{PEAK}		565		nm
Dominant Wavelength Digit Average					
HD1075/7R	λ_{DOM}		645		nm
HD1075/7O	λ_{DOM}	612		625	nm
HD1075/7G	λ_{DOM}	562		575	nm
Forward Voltage per Segment ⁽¹⁾ ($I_F=20\text{ mA}$)					
HD1075/7R	V_F		1.6	2.0	V
HD1075/7O	V_F		2.0	3.0	V
HD1075/7G	V_F		2.4	3.0	V
Breakdown Voltage per Segment ⁽¹⁾ ($I_R=10\ \mu\text{A}$)	V_{BR}	6	15		V
Thermal Resistance	R_{thJA}			140	$^{\circ}\text{C/W/Seg.}$

Notes:

1. AQL=0.4%.
2. Deviation of the absolute values within one digit $I_{\text{VMAX}}/I_{\text{VMIN}} \leq 2$.

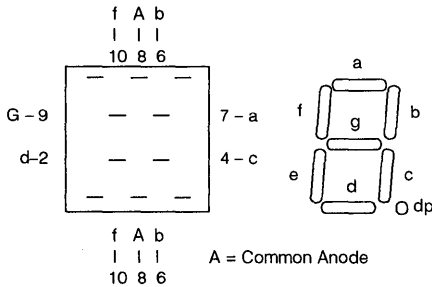

HD1075

- 1 Cathode E
- 2 Cathode D
- 3 Common Anode
- Cathode C
- Cathode DP
- Cathode B
- Cathode A
- Common Anode
- Cathode G
- Cathode F

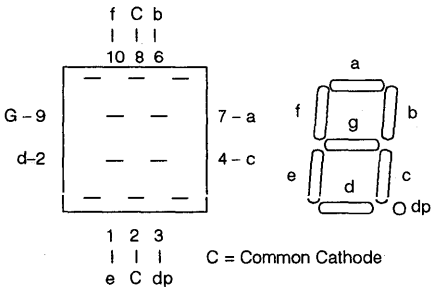

HD1077

- Anode E
- Anode D
- Common Cathode
- Anode C
- Anode DP
- Anode B
- Anode A
- Common Cathode
- Anode G
- Anode F

SIEMENS

RED HD1105R/1107R
SUPER-RED HD1105O/1107O
GREEN HD1105G/1107G

Common Anode/Common Cathode

0.39" (10 mm) Seven Segment Numeric Display

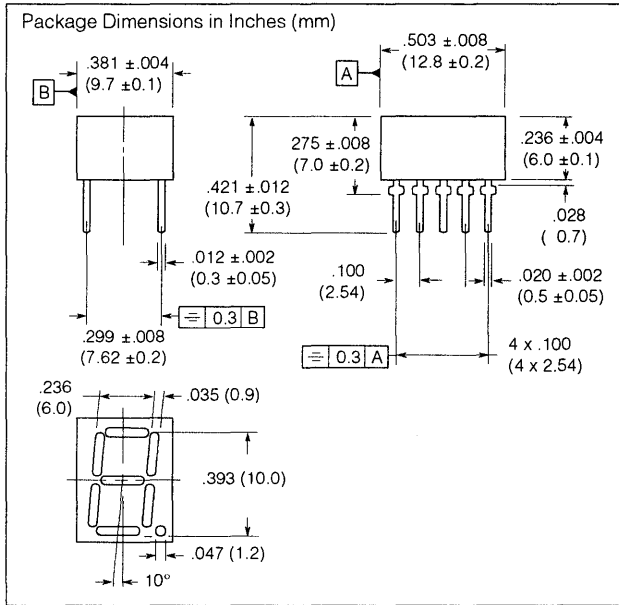
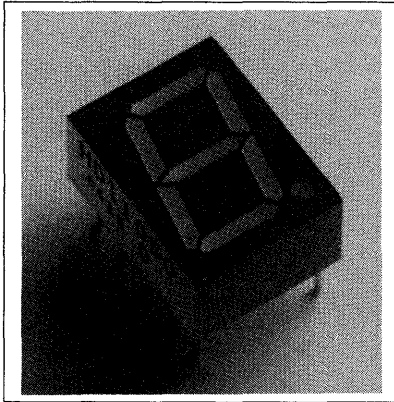

Num. Displays
Bar Graphs

FEATURES

- Rugged Encapsulated Package
- 0.39" (10 mm) Digit Height
- Choice of Colors: Red, Super-Red, Green
- Common Anode or Common Cathode
- Wide Viewing
- Intensity Coded for Display Uniformity

DESCRIPTION

The HD1105X/1107X are displays with 0.39 inch (10 mm) digits with either a common anode or common cathode and a right hand decimal point.

These displays were designed for viewing distances of up to 10 feet and can be used in electronic instruments, point-of-sale systems, clocks, and other general industrial and consumer applications. All displays have a light gray face.

Contrast enhancement filters are recommended for use with these displays.

Maximum Ratings

Operating Temperature (T _{OP})	0°C to +85°C
Storage Temperature (T _{STG})	-40°C to +85°C
Lead Soldering Temperature, 2 mm from base (T _S) t=3 s	260°C
Peak Forward Current per Segment or DP ⁽¹⁾ (I _{FM}) t _p ≤ 10 μs	
HD1105/7R	500 mA
HD1105/7O/G	150 mA
DC Forward Current per Segment or DP ⁽²⁾ (I _F)	
HD1105/7R	30 mA
HD1105/7O/G	20 mA
Reverse Voltage per Segment or DP (V _R)	6 V
Total Power Dissipation (P _{TOT}) T _A ≤ 45°C	480 mW

Notes:

1. Do not exceed maximum average current per segment (see graph of permissible pulse handling capability).
2. Derate maximum average current above T_A = 75°C at 0.5 mA/°C per segment.

See graph numbers 1A, 2A, 3A, 5A, 6A, 8C, 8D, 9B, 11B at the end of this section.

Characteristics ($T_A=25^\circ\text{C}$)

Parameter	Symbol	Min.	Values		Unit
			Typ.	Max.	
Luminous Intensity per Segment ($I_F=10\text{ mA}$)					
HD1105/7R	I_V	180	550		μcd
HD1105/7O	I_V	1100	3500		μcd
HD1105/7G	I_V	1100	4000		μcd
Peak Wavelength ($I_F=10\text{ mA}$)					
HD1105/7R	λ_{PEAK}		660		nm
HD1105/7O	λ_{PEAK}		630		nm
HD1105/7G	λ_{PEAK}		565		nm
Dominant Wavelength Digit Average					
HD1105/7R	λ_{DOM}		645		nm
HD1105/7O	λ_{DOM}	612		625	nm
HD1105/7G	λ_{DOM}	562		575	nm
Forward Voltage per Segment ⁽¹⁾ ($I_F=20\text{ mA}$)					
HD1105/7R	V_F		1.6	2.0	V
HD1105/7O	V_F		2.0	3.0	V
HD1105/7G	V_F		2.4	3.0	V
Breakdown Voltage per Segment ⁽¹⁾ ($I_R=10\ \mu\text{A}$)	V_{BR}	6	15		V
Thermal Resistance	R_{thJA}			120	$^\circ\text{C/W/Seg.}$

Notes:

1. AQL=0.4%.
2. Deviation of the absolute values within one digit $I_{V\text{MAX}}/I_{V\text{MIN}} \leq 2$.

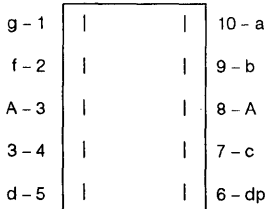

A = Common Anode

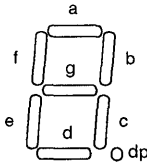

HD1105

- 1 Cathode G
- 2 Cathode F
- 3 Common Anode
- 4 Cathode E
- 5 Cathode D
- 6 Cathode DP
- 7 Cathode C
- 8 Common Anode
- 9 Cathode B
- 10 Cathode A

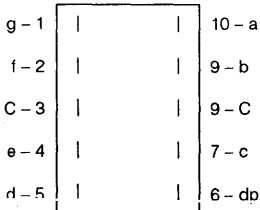

C = Common Cathode

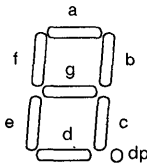

HD1107

- 1 Anode G
- 2 Anode F
- 3 Common Cathode
- 4 Anode E
- 5 Anode D
- 6 Anode DP
- 7 Anode C
- 8 Common Cathode
- 9 Anode B
- 10 Anode A

SIEMENS

RED HD1131R/1133R
SUPER-RED HD1131O/1133O
GREEN HD1131G/1133G

Common Anode/Common Cathode

0.53" (13.5 mm) Seven Segment Numeric Display

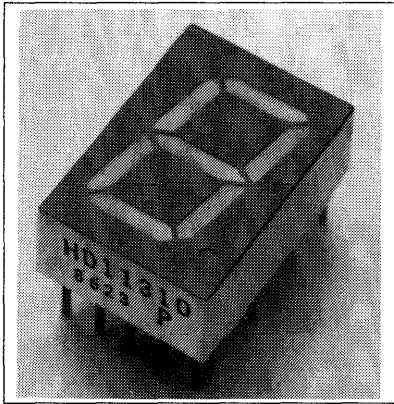

FEATURES

- Rugged Encapsulated Package
- 0.39" (10 mm) Digit Height
- Choice of Colors: Red, Super-Red, Green
- Common Anode or Common Cathode
- Wide Viewing
- Intensity Coded for Display Uniformity

DESCRIPTION

The HD1131X/1133X are displays with 0.53 inch (13.5 mm) digits with either a common anode or common cathode and a right hand decimal point.

These displays were designed for viewing distances of up to 20 feet and can be used in electronic instruments, point-of-sale systems, clocks, and other general industrial and consumer applications. All displays have a light grey face.

Contrast enhancement filters are recommended for use with these displays.

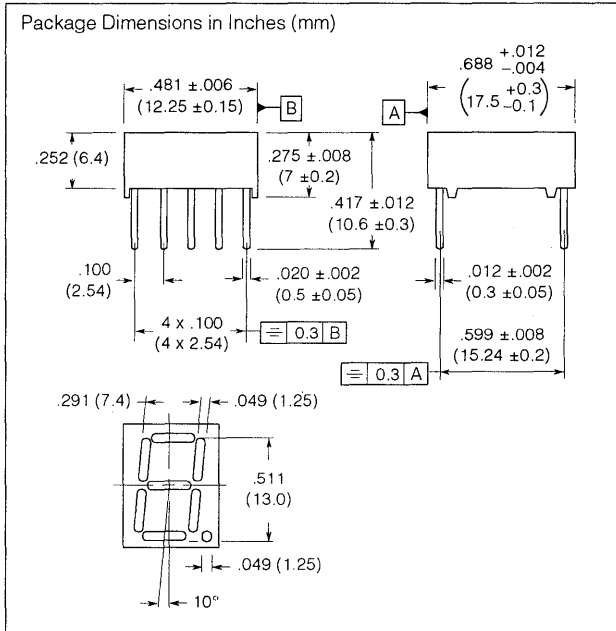

Num. Displays
Bar Graphs

Maximum Ratings

Operating Temperature (T_{OP})	0°C to +85°C
Storage Temperature (T_{STG})	-40°C to +85°C
Lead Soldering Temperature, 2 mm from base (T_S) $t \leq 3$ s	260°C
Peak Forward Current per Segment or DP ⁽¹⁾ (I_{FM}) $t_p \leq 10$ μ s	
HD1131/3R	500 mA
HD1131/3O/G	150 mA
DC Forward Current per Segment or DP ⁽²⁾ (I_F)	
HD1131/3R	35 mA
HD1131/3O/G	25 mA
Reverse Voltage per Segment or DP (V_R)	6 V
Total Power Dissipation (P_{TOT}) $T_A \leq 45^\circ\text{C}$	600 mW

Notes:

1. Do not exceed maximum average current per segment (see graph of permissible pulse handling capability).
2. Derate maximum average current above $T_A = 75^\circ\text{C}$ at 0.5 mA/°C per segment.

See graph numbers 1A, 2A, 3A, 5A, 6A, 8E, 8F, 9C, 11C at the end of this section.

Characteristics ($T_A=25^{\circ}\text{C}$)

Parameter	Symbol	Values			Unit
		Min.	Typ.	Max.	
Luminous Intensity per Segment ($I_F=10\text{ mA}$)					
HD1131/3R	I_V	180	550		μcd
HD1131/3O	I_V	1100	4000		μcd
HD1131/3G	I_V	1100	4500		μcd
Peak Wavelength ($I_F=10\text{ mA}$)					
HD1131/3R	λ_{PEAK}		660		nm
HD1131/3O	λ_{PEAK}		630		nm
HD1131/3G	λ_{PEAK}		565		nm
Dominant Wavelength Digit Average					
HD1131/3R	λ_{DOM}		645		nm
HD1131/3O	λ_{DOM}	612		625	nm
HD1131/3G	λ_{DOM}	562		575	nm
Forward Voltage per Segment ⁽¹⁾ ($I_F=20\text{ mA}$)					
HD1131/3R	V_F		1.6	2.0	V
HD1131/3O	V_F		2.0	3.0	V
HD1105/7G	V_F		2.4	3.0	V
Breakdown Voltage per Segment ⁽¹⁾ ($I_R=10\text{ }\mu\text{A}$)	V_{BR}	6	15		V
Thermal Resistance	R_{thJA}			100	$^{\circ}\text{C/W/Seg.}$

Notes:

1. AQL=0.4%.
2. Deviation of the absolute values within one digit $I_{\text{VMAX}}/I_{\text{VMIN}} \leq 2$.

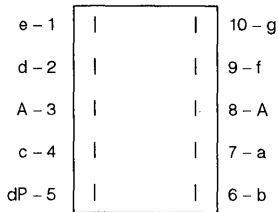

A = Common Anode

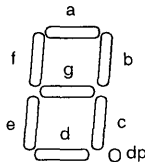

HD1131

- 1 Cathode E
- 2 Cathode D
- 3 Common Anode
- 4 Cathode C
- 5 Cathode DP
- 6 Cathode B
- 7 Cathode A
- 8 Common Anode
- 9 Cathode F
- 10 Cathode G

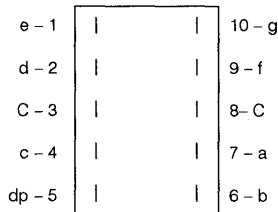

C = Common Cathode

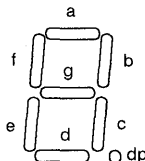

HD1133

- 1 Anode E
- 2 Anode D
- 3 Common Cathode
- 4 Anode C
- 5 Anode DP
- 6 Anode B
- 7 Anode A
- 8 Common Cathode
- 9 Anode F
- 10 Anode G

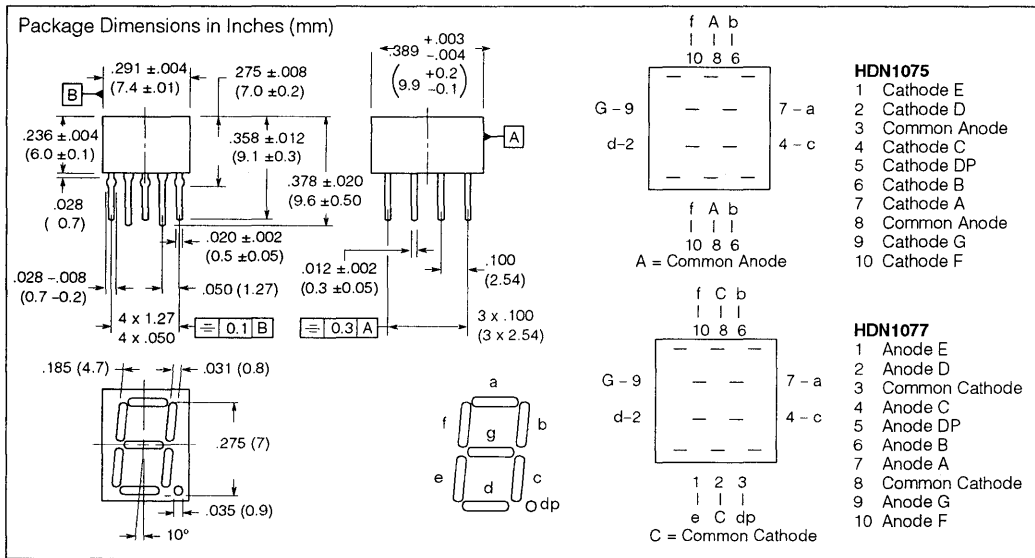

Num. Displays
Bar Graphs

FEATURES

- Current Consumption 2 mA
- Direct Drive by CMOS Microprocessor, Gate and LSTTL Modules
- Space Saving
- Lower Assembly Costs
- No Display and LED Driver Modules
- Good Readability in Unfavorable Lighting Conditions
- Climate Proof
- High Packing Density
- Gray Package for Optimal Contrast
- Long Service Life
- Shock and Vibration Resistant

DESCRIPTION

The HDN1075/1077 are one digit, seven segment, low current LED displays. The character height is 0.28" (7 mm). The displays are available in super-red.

Applications include state-of-the-art industrial and consumer electronics, especially where low current consumption is required, i.e., portable appliances and battery-operated appliances.

See graph numbers 1A, 2A, 4A, 5B, 7A, 9D, 10A, 12A at the end of this section.

Maximum Ratings

Operating Temperature (T _{OP})	0°C to +85°C
Storage Temperature (T _{STG})	-40°C to +85°C
Lead Soldering Temperature, 2 mm from base (T _S)	260°C
Peak Forward Current per Segment or DP ⁽¹⁾ (I _{FM})	100 mA
DC Forward Current per Segment or DP ⁽²⁾ (I _F)	15 mA
Reverse Voltage per Segment or DP (V _R)	6 V
Total Power Dissipation (P _{TOT})	320 mW

Notes:

1. Do not exceed maximum average current per segment (see graph of peak forward current).
2. Derate maximum average current above T_A=75°C at 0.5 mA/°C per segment.

Characteristics (T_A=25°C)

Parameter	Symbol	Values		Max.	Unit
		Min.	Typ.		
Luminous Intensity per Segment (Digit Ave.)					
2 mA	I _V	180	260		μcd
5 mA	I _V		1000		μcd
20 mA PK: 1:4 Duty Factor	I _V		1300		μcd
Peak Wavelength	λ _{PEAK}		635		nm
Dominant Wavelength (Digit Average)	λ _{DOM}	612		625	nm
Forward Voltage per Segment or DP (I _F =2 mA)	V _F		1.8		V
Breakdown Voltage per Segment (I _R =10 μA)	V _{BR}	6	15		V
Thermal Resistance LED Junction to Pin	R _{THJFIN}			180	°C/W/Seg.

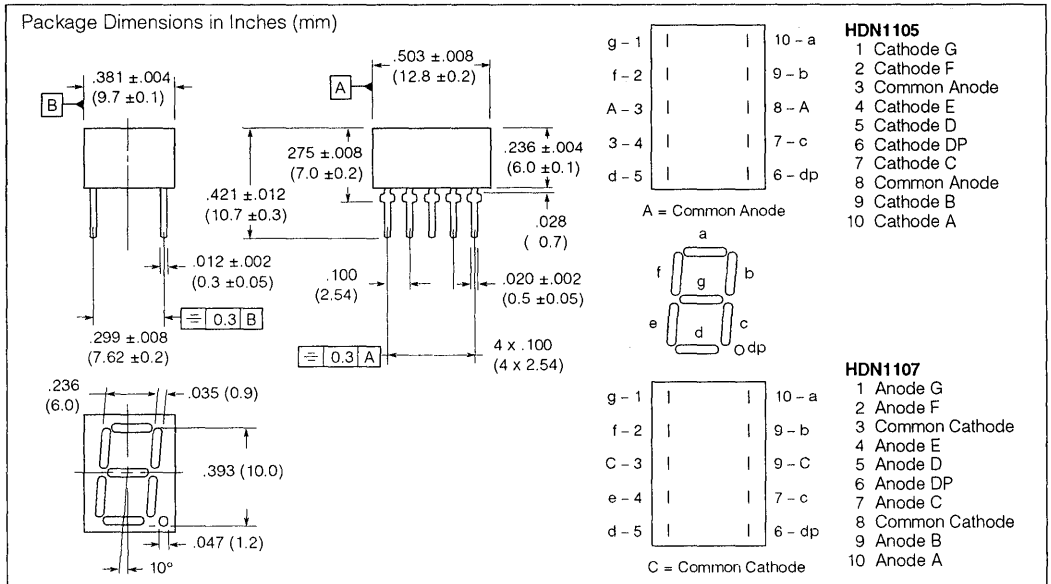

FEATURES

- Current Consumption 2 mA
- Direct Drive by CMOS Microprocessor, Gate and LSTTL Modules
- Space Saving
- Lower Assembly Costs
- No Display and LED Driver Modules
- Good Readability in Unfavorable Lighting Conditions
- Climate Proof
- High Packing Density
- Gray Package for Optimal Contrast
- Long Service Life
- Shock and Vibration Resistant

DESCRIPTION

The HDN1105/1107 are one digit, seven segment, low current LED displays. The character height is 0.39" (10 mm). The displays are available in super-red.

Applications include state-of-the-art industrial and consumer electronics, especially where low current consumption is required, i.e., portable appliances and battery-operated appliances.

See graph numbers 1A, 2A, 4A, 5B, 7A, 9D, 10A, 12A at the end of this section.

Maximum Ratings

Operating Temperature (T_{OP})	0°C to +85°C
Storage Temperature (T_{STG})	-40°C to +85°C
Lead Soldering Temperature, 2 mm from base (T_S)	260°C
Peak Forward Current per Segment or DP ⁽¹⁾ (I_{FM})	100 mA
DC Forward Current per Segment or DP ⁽²⁾ (I_F)	15 mA
Reverse Voltage per Segment or DP (V_R)	6 V
Total Power Dissipation (P_{TOT})	320 mW

Notes:

1. Do not exceed maximum average current per segment (see graph of peak forward current).
2. Derate maximum average current above $T_A=75^\circ\text{C}$ at 0.5 mA/°C per segment.

Characteristics ($T_A=25^\circ\text{C}$)

Parameter	Symbol	Values			Unit
		Min.	Typ.	Max.	
Luminous Intensity					
per Segment (Digit Ave.)					
2 mA	I_V	180	260		μcd
5 mA	I_V		1000		μcd
20 mA PK: 1:4					
Duty Factor	I_V		1300		μcd
Peak Wavelength	λ_{PEAK}		635		nm
Dominant Wavelength	λ_{DOM}	612		625	nm
Forward Voltage					
per Segment or DP					
($I_F=2\text{ mA}$)	V_F		1.8		V
Breakdown Voltage					
per Segment ($I_R=10\ \mu\text{A}$)	V_{BR}	6	15		V
Thermal Resistance					
LED Junction to Pin	$R_{\theta J-PIN}$			180	°C/W/Seg.

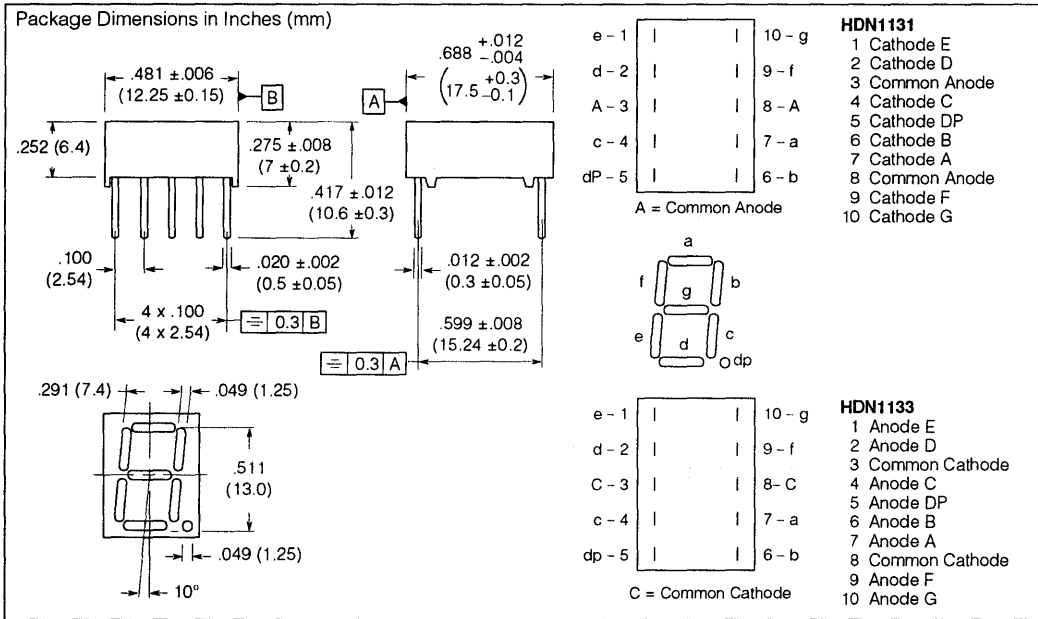

Num. Displays
Bar Graphs

FEATURES

- Current Consumption 2 mA
- Direct Drive by CMOS Microprocessor, Gate and LSTTL Modules
- Space Saving
- Lower Assembly Costs
- No Display and LED Driver Modules
- Good Readability in Unfavorable Lighting Conditions
- Climate Proof
- High Packing Density
- Gray Package for Optimal Contrast
- Long Service Life
- Shock and Vibration Resistant

DESCRIPTION

The HDN1131/1133 are one digit, seven segment, low current LED displays. The character height is 0.59" (13 mm). The displays are available in super-red.

Applications include state-of-the-art industrial and consumer electronics, especially where low current consumption is required, i.e., portable appliances and battery-operated appliances.

See graph numbers 1A, 2A, 4A, 5B, 7B, 9D, 10A, 12A at the end of this section.

Maximum Ratings

Operating Temperature (T_{OP})	0°C to +85°C
Storage Temperature (T_{STG})	-40°C to +85°C
Lead Soldering Temperature, 2 mm from base (T_S)	260°C
Peak Forward Current per Segment or DP ⁽¹⁾ (I_{FM})	100 mA
DC Forward Current per Segment or DP ⁽²⁾ (I_F)	15 mA
Reverse Voltage per Segment or DP (V_R)	6 V
Total Power Dissipation (P_{TOT})	320 mW

Notes:

1. Do not exceed maximum average current per segment (see graph of peak forward current).
2. Derate maximum average current above $T_A=75^\circ\text{C}$ at 0.5 mA/°C per segment.

Characteristics ($T_A=25^\circ\text{C}$)

Parameter	Symbol	Values			Unit
		Min.	Typ.	Max.	
Luminous Intensity per Segment (Digit Ave.)					
2 mA	I_V	180	260		μcd
5 mA	I_V		1000		μcd
20 mA PK: 1:4 Duty Factor	I_V		1300		μcd
Peak Wavelength	λ_{PEAK}		635		nm
Dominant Wavelength (Digit Average)	λ_{DOM}	612		625	nm
Forward Voltage per Segment or DP ($I_F=2\text{ mA}$)	V_F		1.8		V
Breakdown Voltage per Segment ($I_R=10\ \mu\text{A}$)	V_{BR}	6	15		V
Thermal Resistance LED Junction to Pin	R_{thJPIN}			180	°C/W/Seg.

SIEMENS SUPER-RED HLMP-2300/-2600 Series YELLOW HLMP-2400/-2700 Series GREEN HLMP-2500/-2800 Series

LED Light Bars

Package Dimensions in Inches (mm)

HLMP-2300, -2400, -2500

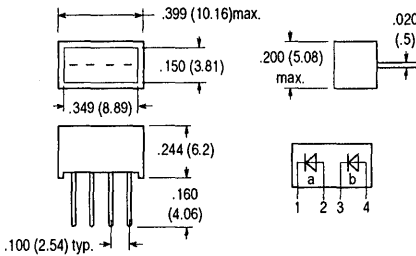

Light emitting area: .350 x .149 (8.9 x 3.8)

HLMP-2350, -2450, -2550

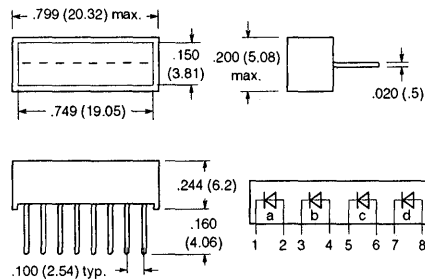

Light emitting area: .747 x .149 (19.0 x 3.8)

HLMP-2600, -2700, -2800

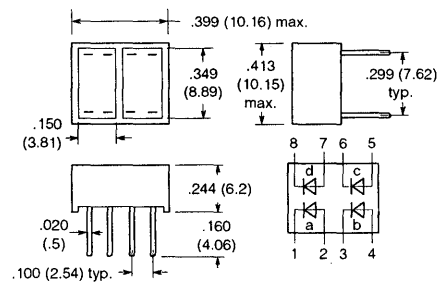

Light emitting area: .350 x .350 (8.9 x 8.9)

HLMP-2620, -2720, -2820

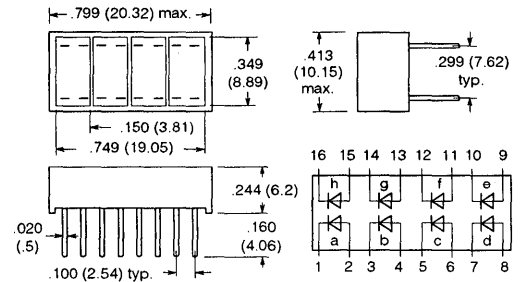

Light emitting area: .747 x .350 (19.0 x 8.9)

HLMP-2655, -2755, -2855

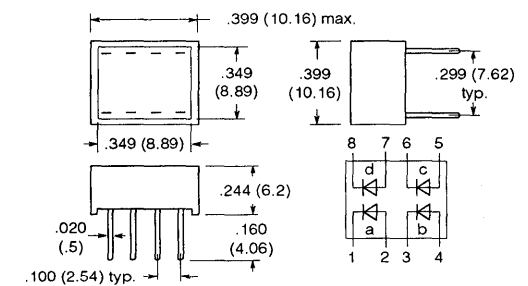

Light emitting area: .350 x .350 (8.9 x 8.9)

HLMP-2685, -2785, -2885

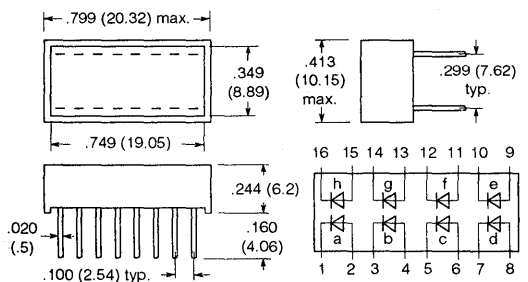

Light emitting area: .747 x .350 (19.0 x 8.9)

FEATURES

- Large Bright, Uniform Light Emitting Areas
- Excellent On-Off Contrast
- Mounts Easily on PC Boards or Industry Standard SIP/DIP Sockets

- X-Y Stackable
- Suitable for Multiplex Operation
- IC Compatible

See graph numbers 1E, 2A, 3F, 5A, 6G, 8N, 9L, 10H, 11D at the end of this section.

Maximum Ratings

Operating Temperature Range (T_{OP})	-20°C to +85°C
Storage Temperature Range (T_{STG})	-40°C to +85°C
Lead Soldering Temperature, 1.6 mm from base (T_S) $t=3$ s	260°C
Peak Forward Current/LED Chip (I_{FPEAK}), $T_A=50^\circ\text{C}$, $t_p=2$ ms	
Super-Red, Green	90 mA
Yellow	60 mA
Time Average Forward Current/LED Chip, $T_A=25^\circ\text{C}$	
Super-Red, Green	25 mA
Yellow	20 mA
Reverse Voltage/LED Chip (V_R)	6 V
DC Forward Current/LED Chip (I_F), $T_A=50^\circ\text{C}$	
Super-Red, Green	30 mA
Yellow	25 mA
Average Power Dissipation (P_{TOT}) $T_A=25^\circ\text{C}$	
Super-Red, Green	135 mW
Yellow	85 mW

Notes:

1. Super-red and green: derate above $T_A=25^\circ\text{C}$ at 1.8 mW/°C per LED chip. Yellow: $T_A=50^\circ\text{C}$ at 1.8 mW/°C per LED chip. See Figure 2.
2. See Figure 1 for pulsed operating conditions.
3. Super-red and green: derate above $T_A=50^\circ\text{C}$ at 0.50 mA/°C per LED chip. Yellow: $T_A=60^\circ\text{C}$ at 0.50 mA/°C per LED chip. See Figure 3.

Super-Red Characteristics ($T_A=25^\circ\text{C}$)

Parameter	Symbol	Values		
		Min.	Typ	Unit
Peak Wavelength	λ_{PEAK}	635		nm
Dominant Wavelength	λ_{DOM}	626		nm
Forward Voltage $I_F=20$ mA	V_F	2.0		V
Breakdown Voltage $I_R=100$ μA	V_R	6	15	V
Thermal Resistance	R_{thJA}	150		K/W per LED chip
Luminous Intensity per Light Emitting Area				
HLMP2300				
$I_F=20$ mA	I_V	6	23	mcd
$I_F=60$ mA PK:1:3	I_V		26	mcd
HLMP2350				
$I_F=20$ mA	I_V	13	45	mcd
$I_F=60$ mA PK:1:3	I_V		52	mcd
HLMP2600				
$I_F=20$ mA	I_V	6	22	mcd
$I_F=60$ mA PK:1:3	I_V		25	mcd
HLMP2620				
$I_F=20$ mA	I_V	6	25	mcd
$I_F=60$ mA PK:1:3	I_V		29	mcd
HLMP2655				
$I_F=20$ mA	I_V	13	43	mcd
$I_F=60$ mA PK:1:3	I_V		49	mcd
HLMP2685				
$I_F=20$ mA	I_V	22	80	mcd
$I_F=60$ mA PK:1:3	I_V		92	mcd

Yellow Characteristics ($T_A=25^\circ\text{C}$)

Parameter	Symbol	Values		
		Min.	Typ	Unit
Peak Wavelength	λ_{PEAK}		583	nm
Dominant Wavelength	λ_{DOM}		585	nm
Forward Voltage $I_F=20$ mA	V_F		2.1	V
Breakdown Voltage $I_R=100$ μA	V_R	6	15	V
Thermal Resistance	R_{thJA}		150	K/W per LED chip
Luminous Intensity per Light Emitting Area				
HLMP2400				
$I_F=20$ mA	I_V	6	20	mcd
$I_F=60$ mA PK:1:3	I_V		24	mcd
HLMP2450				
$I_F=20$ mA	I_V	13	38	mcd
$I_F=60$ mA PK:1:3	I_V		46	mcd
HLMP2700				
$I_F=20$ mA	I_V	6	18	mcd
$I_F=60$ mA PK:1:3	I_V		22	mcd
HLMP2720				
$I_F=20$ mA	I_V	6	18	mcd
$I_F=60$ mA PK:1:3	I_V		22	mcd
HLMP2755				
$I_F=20$ mA	I_V	13	35	mcd
$I_F=60$ mA PK:1:3	I_V		43	mcd
HLMP2785				
$I_F=20$ mA	I_V	26	70	mcd
$I_F=60$ mA PK:1:3	I_V		85	mcd

Green Characteristics ($T_A=25^\circ\text{C}$)

Parameter	Symbol	Values		
		Min.	Typ	Unit
Peak Wavelength	λ_{PEAK}		565	nm
Dominant Wavelength	λ_{DOM}		572	nm
Forward Voltage $I_F=20$ mA	V_F		2.2	V
Breakdown Voltage $I_R=100$ μA	V_R	6	15	V
Thermal Resistance	R_{thJA}		150	K/W per LED chip
Luminous Intensity per Light Emitting Area				
HLMP2500				
$I_F=20$ mA	I_V	5	25	mcd
$I_F=60$ mA PK:1:3	I_V		28	mcd
HLMP2550				
$I_F=20$ mA	I_V	11	50	mcd
$I_F=60$ mA PK:1:3	I_V		56	mcd
HLMP2800				
$I_F=20$ mA	I_V	5	25	mcd
$I_F=60$ mA PK:1:3	I_V		28	mcd
HLMP2820				
$I_F=20$ mA	I_V	5	25	mcd
$I_F=60$ mA PK:1:3	I_V		28	mcd
HLMP2855				
$I_F=20$ mA	I_V	11	50	mcd
$I_F=60$ mA PK:1:3	I_V		56	mcd
HLMP2885				
$I_F=20$ mA	I_V	22	100	mcd
$I_F=60$ mA PK:1:3	I_V		11	mcd

Num. Displays
Bar Graphs

SIEMENS

RED RBG-1000 SUPER-RED OBG-1000 YELLOW YBG-1000 GREEN GBG-1000 10 Element Bar Graph

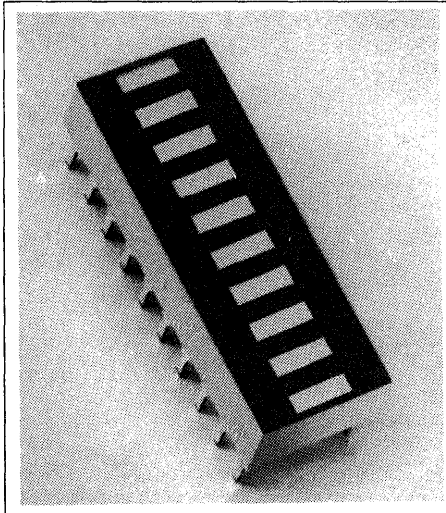

FEATURES

- 10 Element Display
- End Stackable Module
- Individual Addressable Anode and Cathode
- Intensity Coded for Display Uniformity
- Rugged Encapsulation
- Choice of Colors

DESCRIPTION

The Red RBG-1000, Super-Red OBG-1000, Yellow YBG-1000, and Green GBG-1000 are 10 individual element bar graphs. The package is an one inch long, 20 pin dual-in-line type that can be end stacked as bar graph displays of various lengths.

Applications include: bar graph, solid state meter movement, position indicator.

Package Dimensions in Inches (mm)

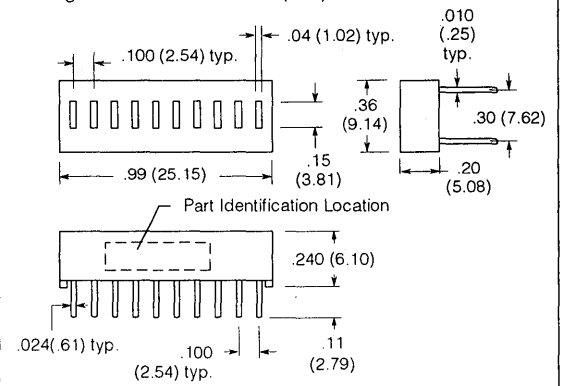

Maximum Ratings

Storage Temperature Range	-20°C to +85°C
Operating Temperature Range	-20°C to +85°C
Continuous Forward Current		
RBG-1000 per Display	200mA
RBG-1000 per Element	20mA
OBG/YBG/GBG-1000 per Display	156mA
OBG/YBG/GBG-1000 per Element	20mA
Peak Inverse Voltage per Element	3V
Derating Factor from 25°C	7.5 mW/°C
Power Dissipation at 25°C	450mW

Optoelectronic Characteristics (at 25°C)

Parameter	Typ.	Max.	Unit	Test Condition
Peak Wavelength				
RBG-1000	660		nm	
OBG-1000	630		nm	
YBG-1000	585		nm	
GBG-1000	565		nm	
Forward Voltage				
RBG-1000	1.7	2.0	V	I _F =20mA
OBG-1000	2.2	2.8	V	I _F =20mA
YBG-1000	2.4	3.0	V	I _F =20mA
GBG-1000	2.4	3.0	V	I _F =20mA
Reverse Leakage	0.1	100	µA	V _R = 3V
Luminous Intensity per Element (Display Average)				
RBG-1000	0.5		mcd	I _F =20mA/Seg.
OBG-1000	2.5		mcd	I _F =20mA/Seg.
YBG-1000	2.0		mcd	I _F =20mA/Seg.
GBG-1000	2.0		mcd	I _F =20mA/Seg.

Top View

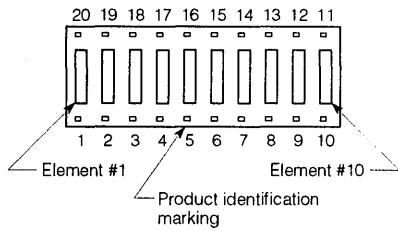

Pin	Function	Pin	Function
1	Anode 1	11	Cathode 10
2	Anode 2	12	Cathode 9
3	Anode 3	13	Cathode 8
4	Anode 4	14	Cathode 7
5	Anode 5	15	Cathode 6
6	Anode 6	16	Cathode 5
7	Anode 7	17	Cathode 4
8	Anode 8	18	Cathode 3
9	Anode 9	19	Cathode 2
10	Anode 10	20	Cathode 1

TYPICAL APPLICATIONS

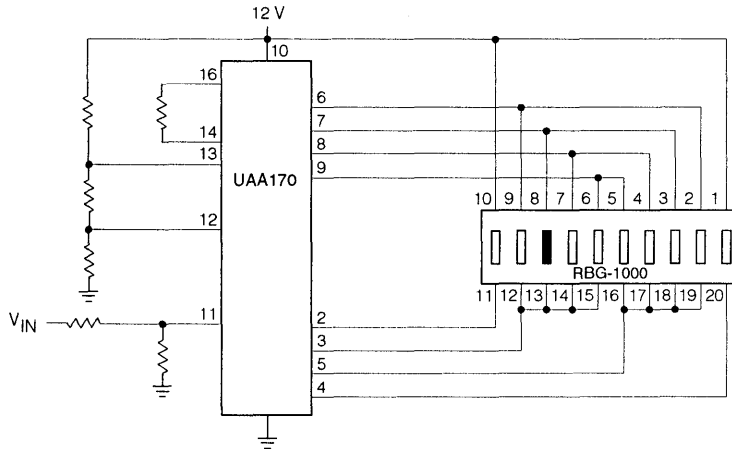

Light Spot Display

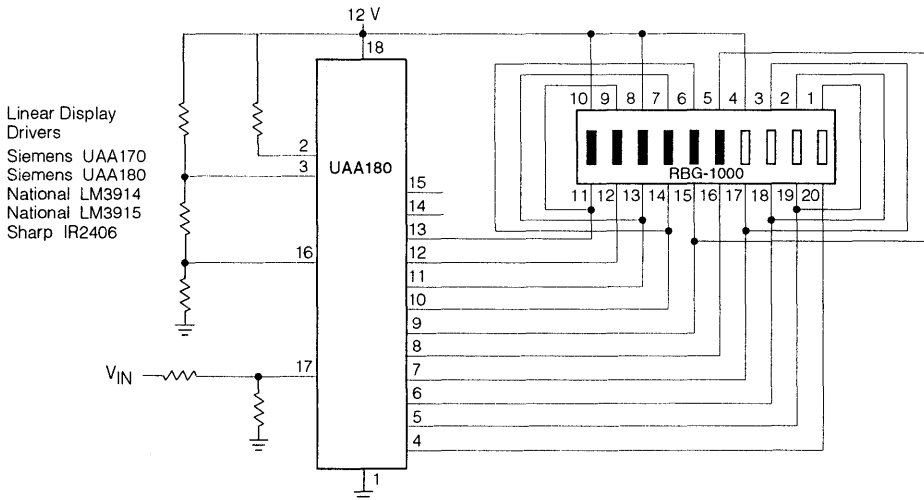

Light Band Display

Linear Display Drivers
 Siemens UAA170
 Siemens UAA180
 National LM3914
 National LM3915
 Sharp IR2406

No endorsement or warranty of other manufacturer's products is intended

SIEMENS

RED RBG-4820 SUPER-RED OBG-4830 YELLOW YBG-4840 GREEN GBG-4850 10 Element Linear Display

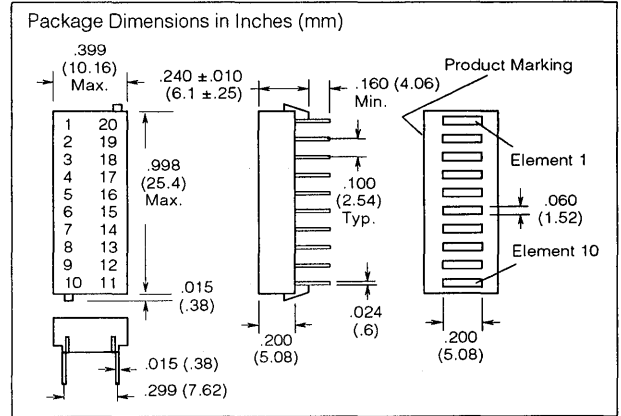
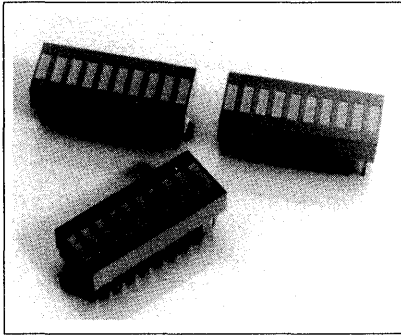

FEATURES

- 10 Element Display
- End Stackable—Package Interlock for Alignment
- Matched LEDs for Uniform Display
- Anode and Cathode, Individually Addressable
- Intensity Coded for Display Uniformity
- Wide Viewing Angle
- Rugged Encapsulated Construction
- Standard Dual-In-Line Package
- High On-Off Contrast, Segment to Segment Hue Coded for Uniformity
- Choice of Four Colors

DESCRIPTION

The Red RBG-4820, Super-Red OBG-4830, Yellow YBG-4840, and Green GBG-4850 have 10 individual linear elements per bar display. These linear displays are designed to show information in easily recognizable bar graph form.

They are end stackable for expanded display lengths. The package interlock ensures that each bar graph will align accurately and correctly with the next one.

Applications include solid state meters, position indicators, and instrumentation.

Maximum Ratings

Storage/Operating Temperature Range	-20°C to +85°C
Lead Soldering Temperature, t=3 sec. (.063" below seating plane)	260°
Continuous Forward Current		
Red, Super-Red, Green	30 mA
Yellow	20 mA
Peak Reverse Voltage per LED	3 V
Derating Factor from 25°C	7.5 mW/°C
Power Dissipation at 25°C	450 mW

Optoelectronic Characteristics (T_A=25°C)

Parameter	Min.	Typ.	Max.	Unit	Condition
Peak Wavelength					
Red		655		μcd	
Super-Red		635		μcd	
Yellow		583		μcd	
Green		566		μcd	
Dominant Wavelength					
Red		645		nm	
Super-Red		626		nm	
Yellow		585		nm	
Green		571		nm	
Forward Voltage/LED					
Red	1.6		2.0	V	I _F =20mA
Super-Red	2.1		2.5	V	I _F =20mA
Yellow	2.2		2.6	V	I _F =20mA
Green	2.1		2.5	V	I _F =10mA
Reverse Voltage/LED					
Red	3		12	V	I _R =100 μA
Super-Red	3		30	V	I _R =100 μA
Yellow, Green	3		50	V	I _R =100 μA
Luminous Intensity/LED					
Red		500		μcd	I _F =20mA
Super-Red		2500		μcd	I _F =20mA
Yellow, Green		2000		μcd	I _F =20mA

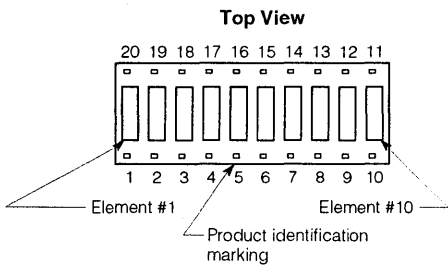

Pin	Function	Pin	Function
1	Anode 1	11	Cathode 10
2	Anode 2	12	Cathode 9
3	Anode 3	13	Cathode 8
4	Anode 4	14	Cathode 7
5	Anode 5	15	Cathode 6
6	Anode 6	16	Cathode 5
7	Anode 7	17	Cathode 4
8	Anode 8	18	Cathode 3
9	Anode 9	19	Cathode 2
10	Anode 10	20	Cathode 1

TYPICAL APPLICATIONS

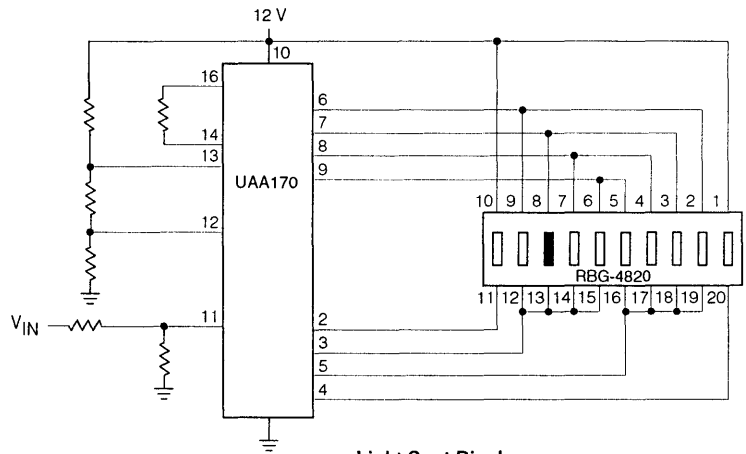

Light Spot Display

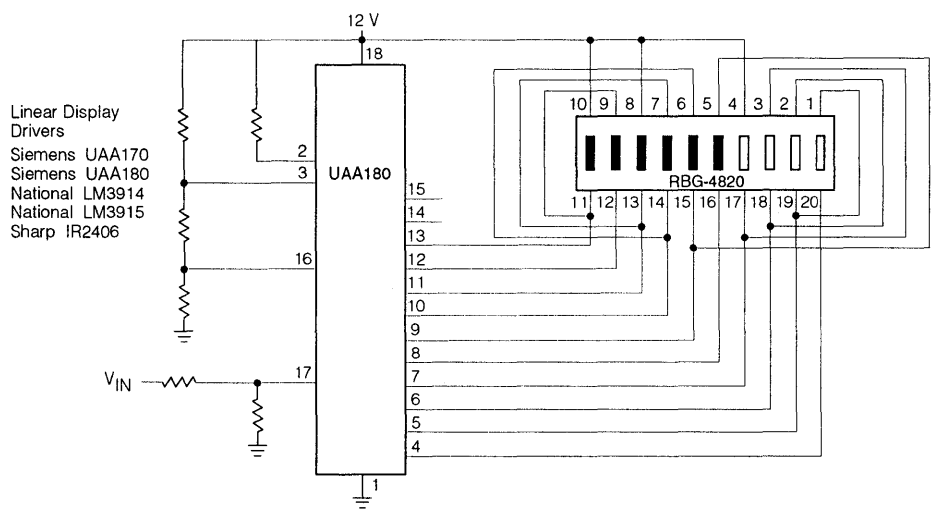

Light Band Display

Linear Display Drivers
 Siemens UAA170
 Siemens UAA180
 National LM3914
 National LM3915
 Sharp IR2406

No endorsement or warranty of other manufacturer's products is intended

Num. Displays
Bar Graphs

1A
 Relative spectral emission $I_{REL}=f(\lambda)$; $T_A=25^\circ\text{C}$, $V(\lambda)$ =standard eye response curve

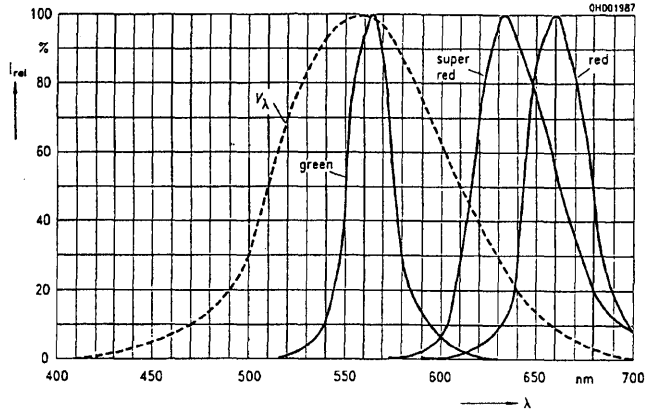

1B
 Relative spectral emission $I_{REL}=f(\lambda)$; $T_A=25^\circ\text{C}$, $V(\lambda)$ =standard eye response curve

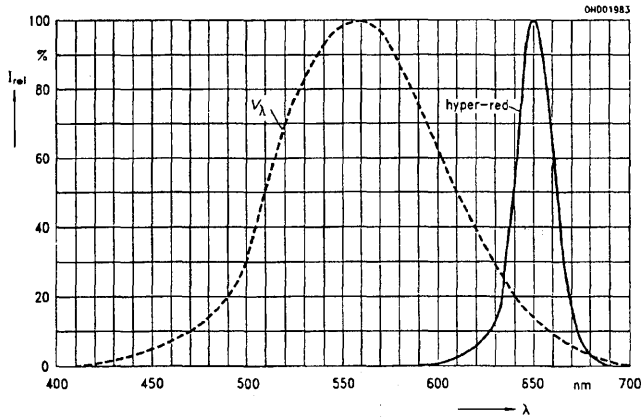

1C
 Relative spectral emission $I_{REL}=f(\lambda)$; $T_A=25^\circ\text{C}$, $V(\lambda)$ =standard eye response curve

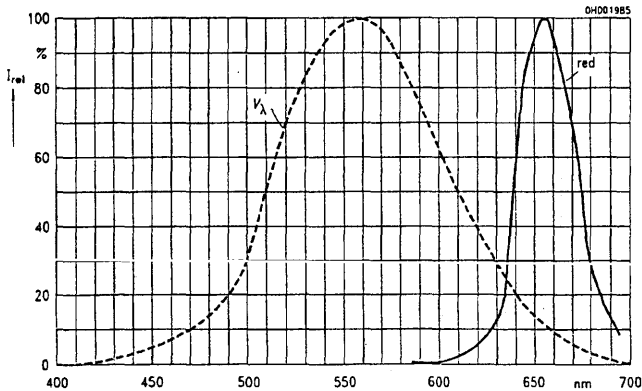

1D
 Relative spectral emission $I_{REL}=f(\lambda)$; $T_A=25^\circ\text{C}$, $V(\lambda)$ =standard eye response curve

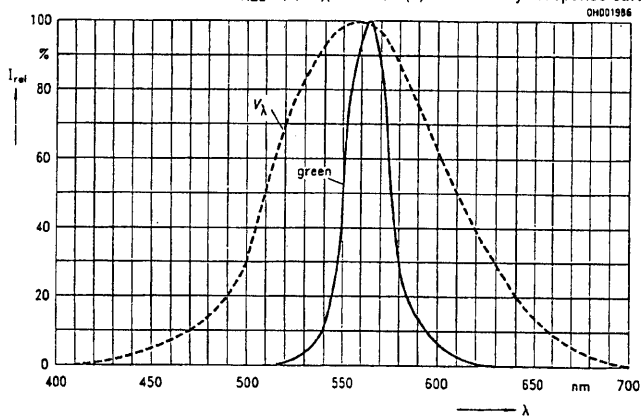

Num. Displays
 Bar Graphs

1E
 Relative spectral emission $I_{REL}=f(\lambda)$; $T_A=25^\circ\text{C}$, $V(\lambda)$ =standard eye response curve

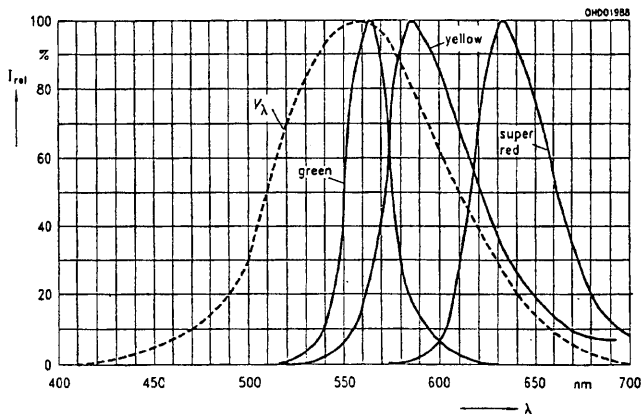

2A
 Relative spectral emission $I_{REL}=f(\lambda)$; $T_A=25^\circ\text{C}$, $V(\lambda)$ =standard eye response curve

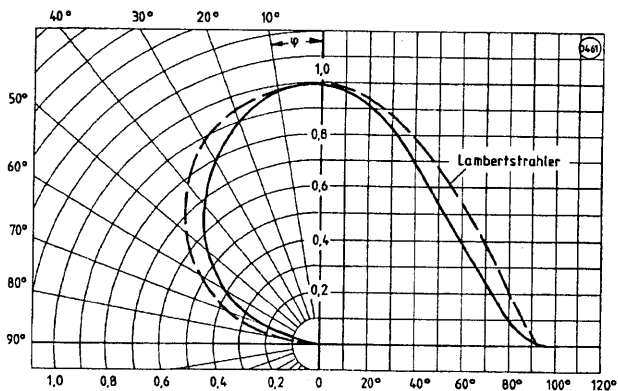

3A Forward current $I_F=f(V_F)$, $T_A=25^\circ\text{C}$

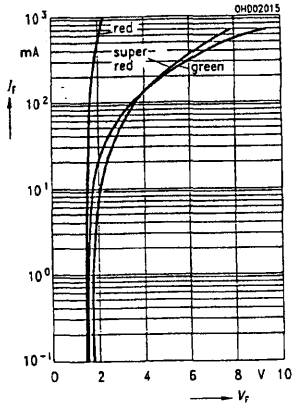

3B Forward current $I_F=f(V_F)$, $T_A=25^\circ\text{C}$

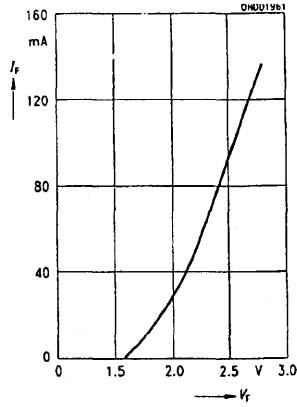

3C Forward current $I_F=f(V_F)$, $T_A=25^\circ\text{C}$

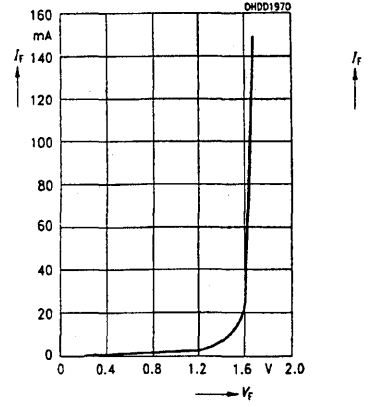

3D Forward current $I_F=f(V_F)$, $T_A=25^\circ\text{C}$

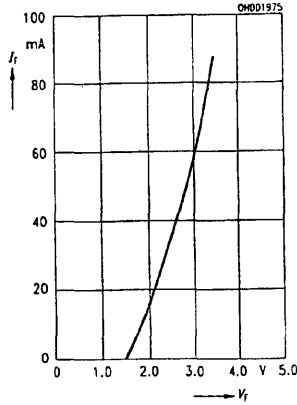

3E Forward current $I_F=f(V_F)$, $T_A=25^\circ\text{C}$

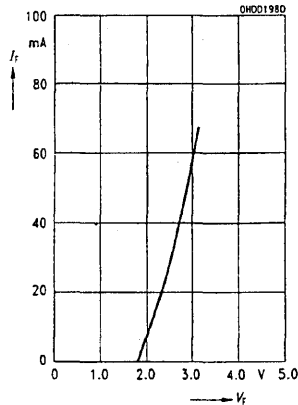

3F Forward current $I_F=f(V_F)$, $T_A=25^\circ\text{C}$

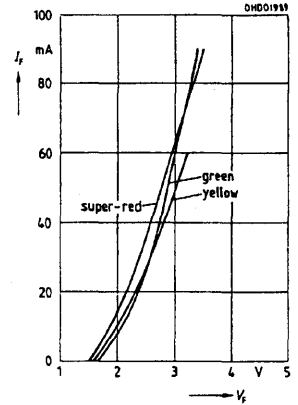

4A Peak forward current $I_{FM}=f(V_{FM})$, $T_A=25^\circ\text{C}$

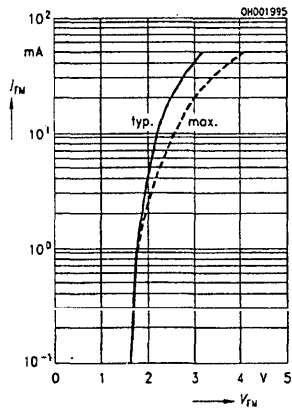

4B Peak forward current $I_{FM}=f(V_{FM})$, $T_A=25^\circ\text{C}$

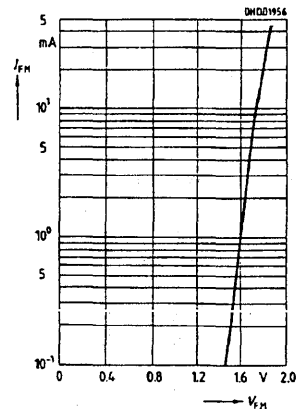

4C Peak forward current $I_{FM}=f(V_{FM})$, $T_A=25^\circ\text{C}$

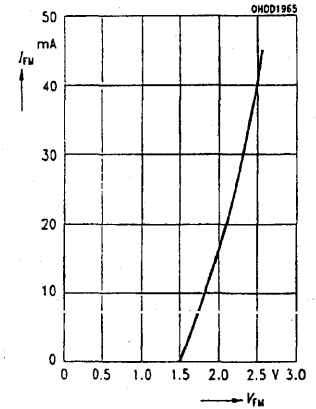

5A Relative luminous intensity

$I_v/I_{v(25^\circ\text{C})}=f(I_F), T_A=25^\circ\text{C}$

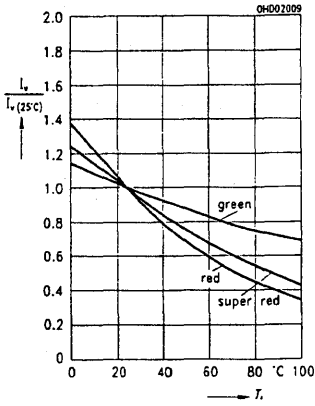

5B Relative luminous intensity

$I_v/I_{v(25^\circ\text{C})}=f(V_{FM}), T_A=25^\circ\text{C}$

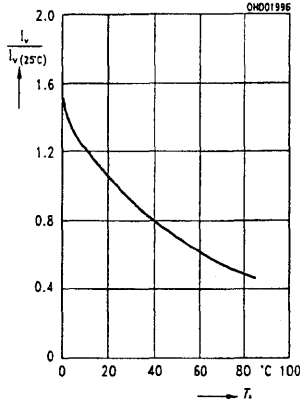

6A Relative luminous intensity

$I_v/I_{v(10\text{mA})}=f(I_F), T_A=25^\circ\text{C}$

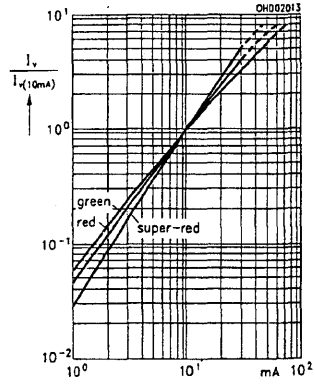

6B Relative luminous intensity

$I_v/I_{v(10\text{mA})}=f(I_F), T_A=25^\circ\text{C}$

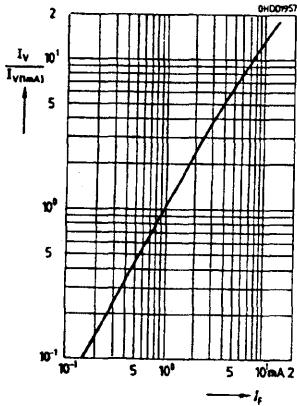

6C Relative luminous intensity

$I_v/I_{v(10\text{mA})}=f(I_F), T_A=25^\circ\text{C}$

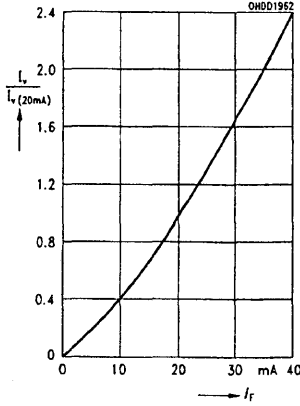

6D Relative luminous intensity

$I_v/I_{v(10\text{mA})}=f(I_F), T_A=25^\circ\text{C}$

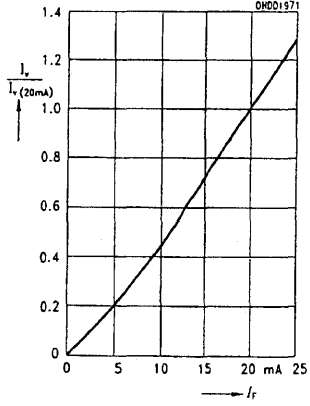

6E Relative luminous intensity

$I_v/I_{v(10\text{mA})}=f(I_F), T_A=25^\circ\text{C}$

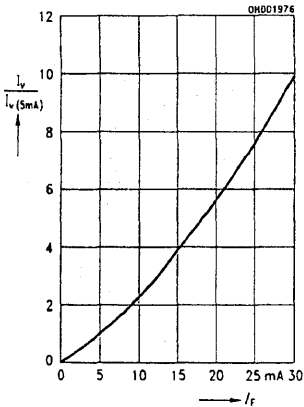

6F Relative luminous intensity

$I_v/I_{v(10\text{mA})}=f(I_F), T_A=25^\circ\text{C}$

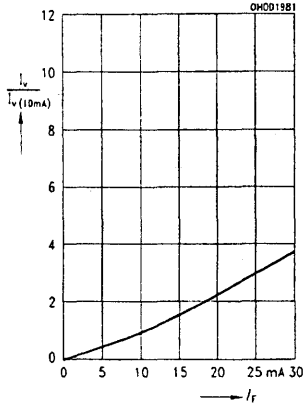

6G Relative luminous intensity

$I_v/I_{v(10\text{mA})}=f(I_F), T_A=25^\circ\text{C}$

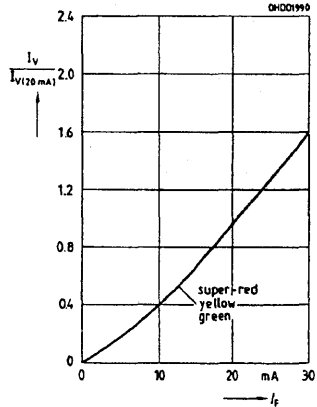

7A Luminous intensity $I_V=f(I_F)$, $T_A=25^\circ\text{C}$

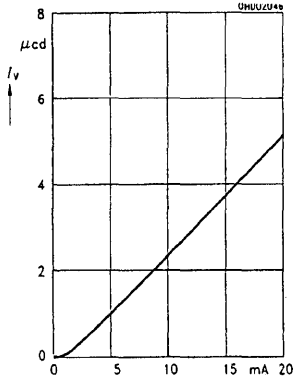

7B Luminous intensity $I_V=f(I_F)$, $T_A=25^\circ\text{C}$

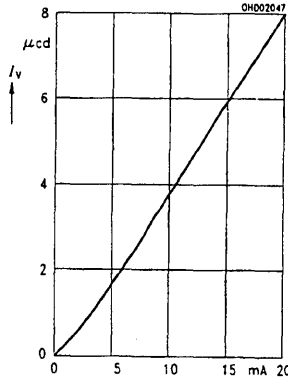

8A Permissible pulse handling capability $I_F=f(t_p)$, $T_A=25^\circ\text{C}$; Duty cycle D =parameter

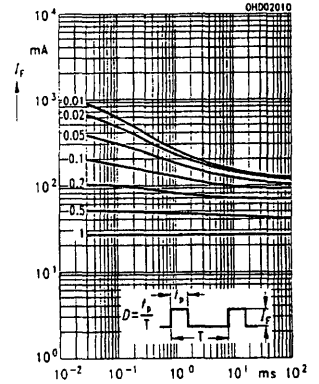

8B Permissible pulse handling capability $I_F=f(t_p)$, $T_A=25^\circ\text{C}$; Duty cycle D =parameter

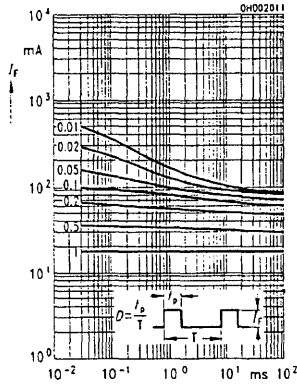

8C Permissible pulse handling capability $I_F=f(t_p)$, $T_A=25^\circ\text{C}$; Duty cycle D =parameter

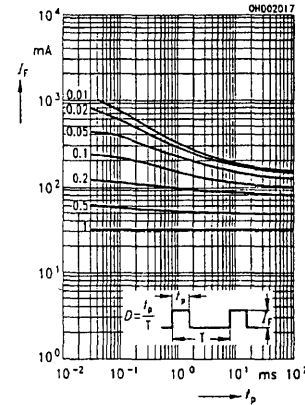

8D Permissible pulse handling capability $I_F=f(t_p)$, $T_A=25^\circ\text{C}$; Duty cycle D =parameter

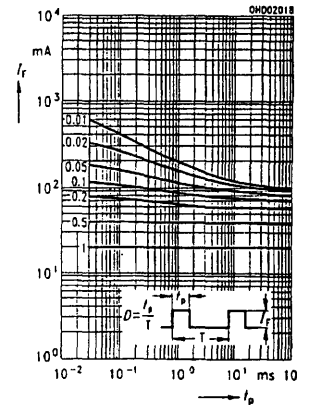

8E Permissible pulse handling capability $I_F=f(t_p)$, $T_A=25^\circ\text{C}$; Duty cycle D =parameter

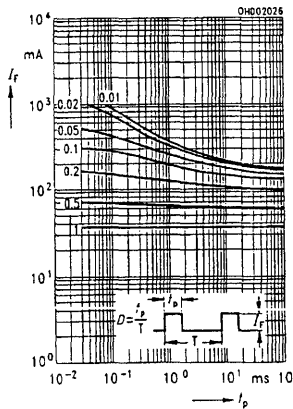

8F Permissible pulse handling capability $I_F=f(t_p)$, $T_A=25^\circ\text{C}$; Duty cycle D =parameter

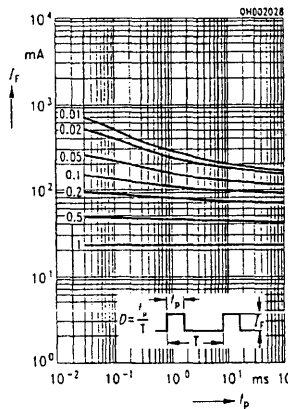

8G Permissible pulse handling capability $I_{peak}/I_{Tmax}=f(t_p)$, $T_A=25^\circ\text{C}$; Duty cycle D =parameter

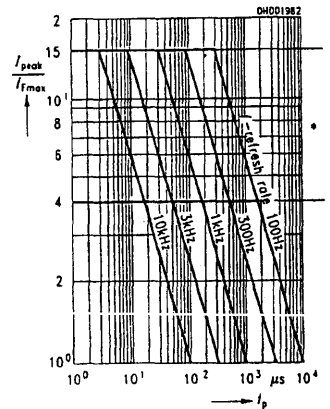

8H Permissible pulse handling capability
 $I_F=f(f_p)$, $T_A=25^\circ\text{C}$; Duty cycle D =parameter

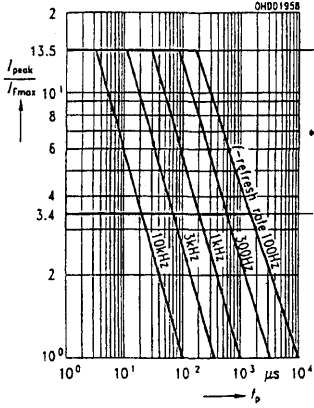

8I Permissible pulse handling capability
 $I_F=f(f_p)$, $T_A=25^\circ\text{C}$; Duty cycle D =parameter

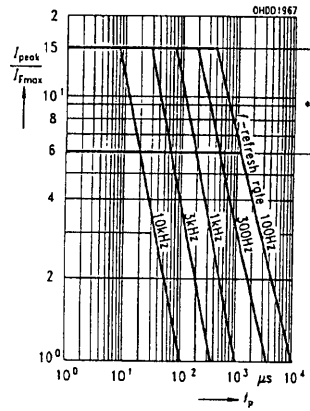

8K Permissible pulse handling capability
 $I_F=f(f_p)$, $T_A=25^\circ\text{C}$; Duty cycle D =parameter

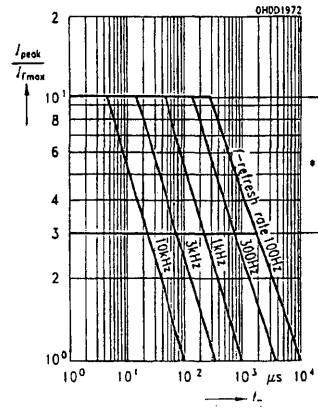

8L Permissible pulse handling capability
 $I_F=f(f_p)$, $T_A=25^\circ\text{C}$; Duty cycle D =parameter

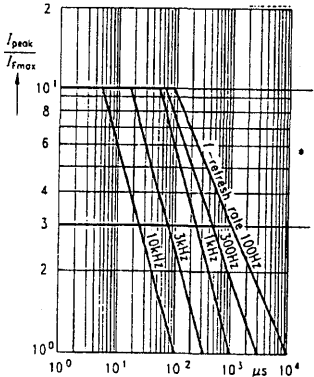

8M Permissible pulse handling capability
 $I_F=f(f_p)$, $T_A=25^\circ\text{C}$; Duty cycle D =parameter

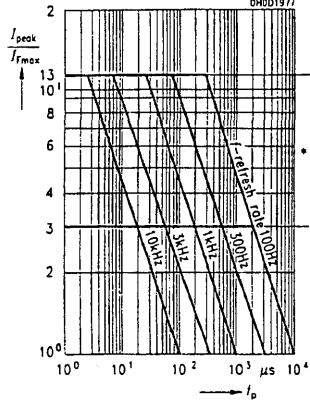

8N Permissible pulse handling capability
 $I_F=f(f_p)$, $T_A=25^\circ\text{C}$; Duty cycle D =parameter

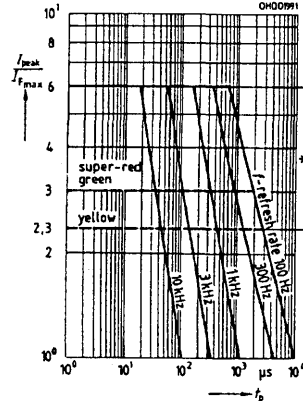

9A Maximum permissible forward current
 $I_F=f(T_A)$

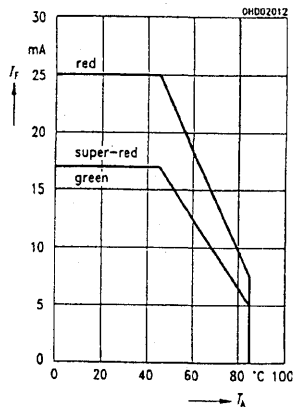

9B Maximum permissible forward current
 $I_F=f(T_A)$

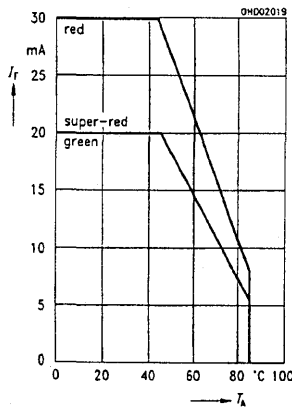

9C Maximum permissible forward current
 $I_F=f(T_A)$

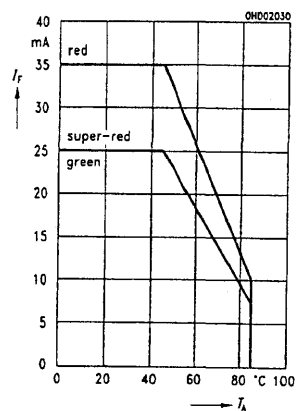

9D Maximum permissible forward current
 $I_F=f(T_A)$

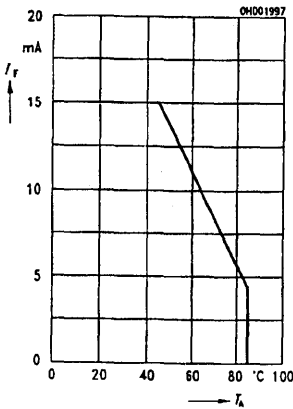

9E Maximum permissible forward current
 $I_F=f(T_A)$

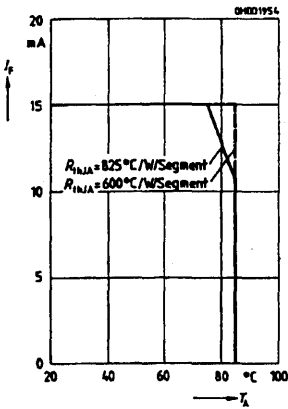

9F Maximum permissible forward current
 $I_F=f(T_A)$

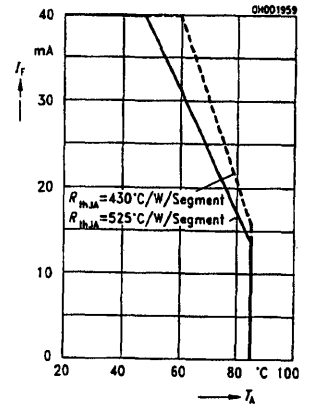

9G Maximum permissible forward current
 $I_F=f(T_A)$

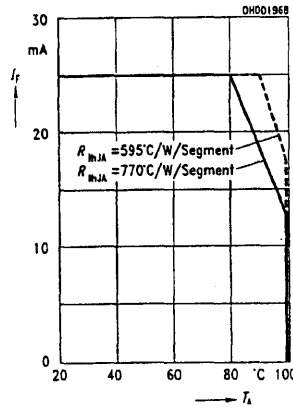

9H Maximum permissible forward current
 $I_F=f(T_A)$

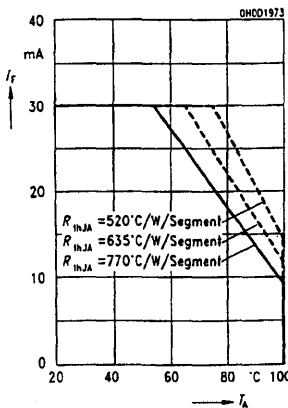

9I Maximum permissible forward current
 $I_F=f(T_A)$

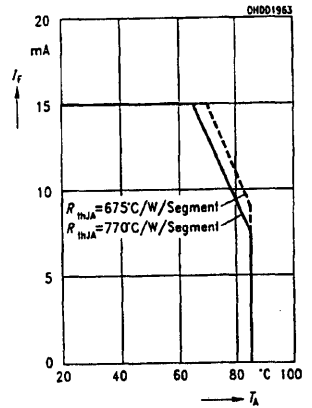

9K Maximum permissible forward current
 $I_F=f(T_A)$

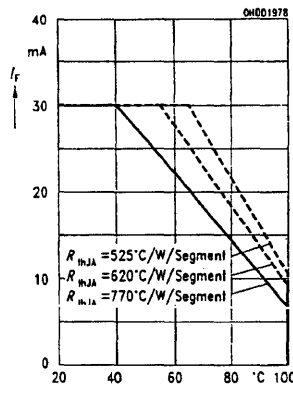

9L Maximum permissible forward current
 $I_F=f(T_A)$

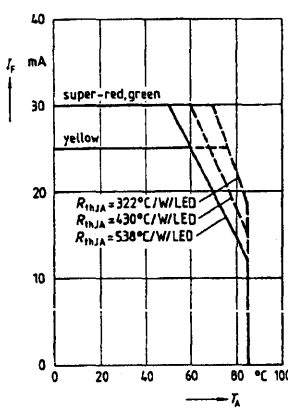

10A Relative efficiency
 $I_V/I_V(\dots mA) = (I_{FM})$, $T_A=25^\circ\text{C}$

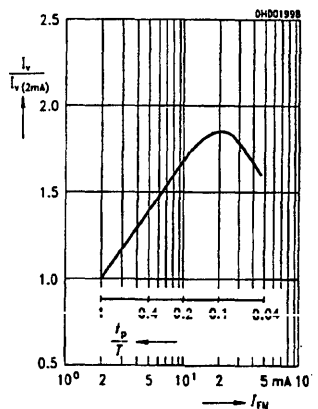

10B Relative efficiency

$I_V/I_{V(\dots mA)} = f(I_{FM}), T_A = 25^\circ\text{C}$

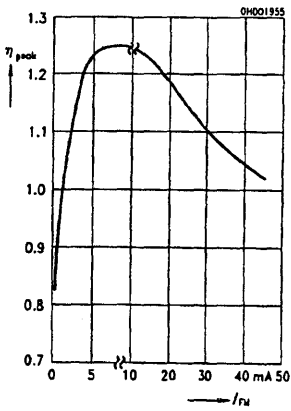

10C Relative efficiency

$I_V/I_{V(\dots mA)} = f(I_{FM}), T_A = 25^\circ\text{C}$

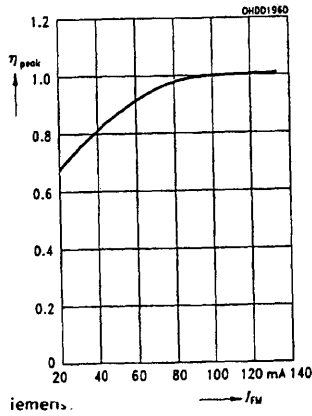

10D Relative efficiency

$I_V/I_{V(\dots mA)} = f(I_{FM}), T_A = 25^\circ\text{C}$

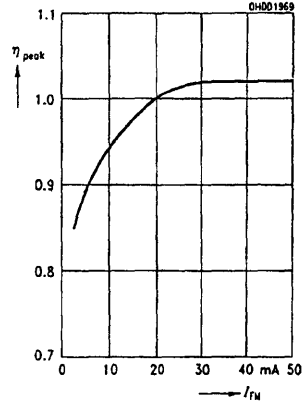

10E Relative efficiency

$I_V/I_{V(\dots mA)} = f(I_{FM}), T_A = 25^\circ\text{C}$

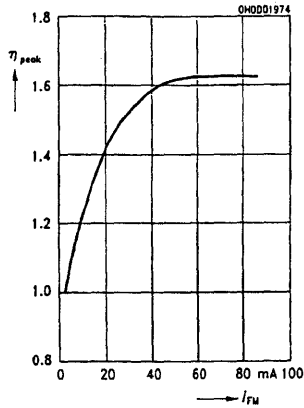

10F Relative efficiency

$I_V/I_{V(\dots mA)} = f(I_{FM}), T_A = 25^\circ\text{C}$

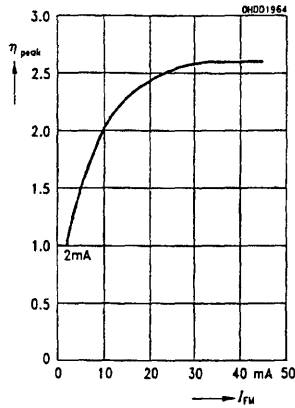

10G Relative efficiency

$I_V/I_{V(\dots mA)} = f(I_{FM}), T_A = 25^\circ\text{C}$

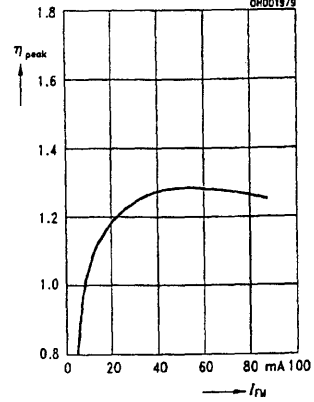

10H Relative efficiency

$I_V/I_{V(\dots mA)} = f(I_{FM}), T_A = 25^\circ\text{C}$

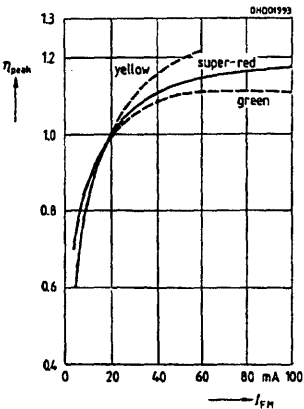

11A Total power dissipation $P_{TOT} = f(T_A)$

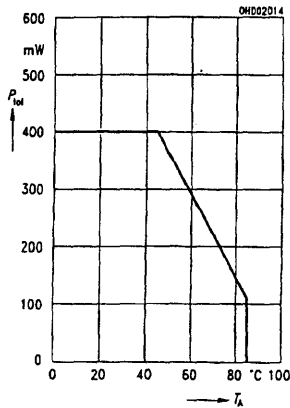

11B Total power dissipation $P_{TOT} = f(T_A)$

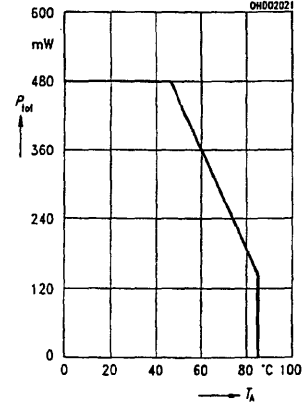

Num. Displays
Bar Graphs

11C Total power dissipation $P_{TOT}=f(T_A)$

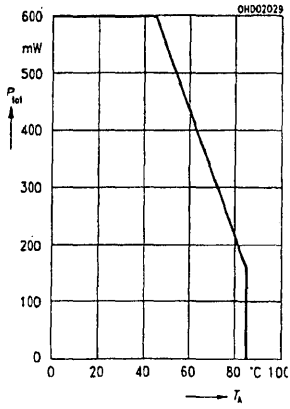

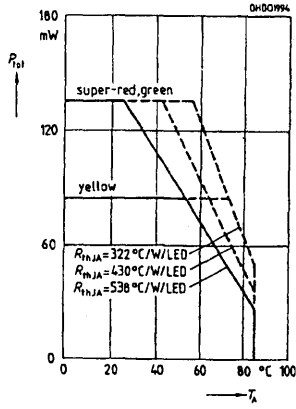

11D Total power dissipation $P_{TOT}=f(T_A)$

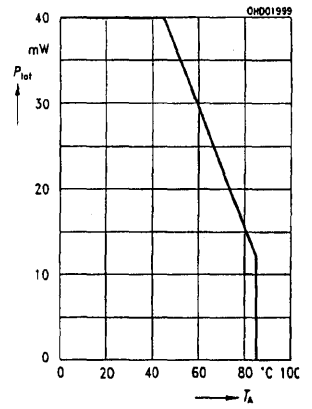

12A Total power dissipation per segment $P_{TOT}=f(T_A)$





LED Lamps

Package & Type	Package Outline	Part Number	Color	Lens	λ Peak nm	Viewing Angle Degrees	Luminous Intensity per Segment		Page
							mcd	mA	
SMT-TOP-LED [®]		LH T674-KM LH T674-L LH T674-LN LH T674-M	Hyper-red	Colorless clear	660	120	6.3-32 10-20 10-50 16-32	10	4-21
SMT-TOP-LED [®]		LS T670-HK LS T670-J LS T670-K LS T670-JL	Super-red	Colorless clear	635	120	2.5-12.5 4-8 6.3-12.5 4-20	10	4-48
		LO T670-HK LO T670-J LO T670-K LO T670-JL	Orange		610		2.5-12.5 4-8 6.3-12.5 4-20		
		LY T670-HK LY T670-J LY T670-K LY T670-JL	Yellow		586		2.5-12.5 4-8 6.3-12.5 4-20		
		LG T670-HK LG T670-J LG T670-K LG T670-JL	Green		565		2.5-12.5 4-8 6.3-12.5 4-20		
		LP T670-GO	Pure green		557		5 (≥ 1.6)		
		SMT-Super-TOP-LED [®]	LS T672-MO		Super-red		Colorless clear		
LO T672-MO			Orange	610					
LY T672-MO			Yellow	586					
LG T672-MO			Green	565	15 (≥ 10)				
LP T672-LO			Pure green	557					
Low Current SMT-TOP-LED [®]		LS T679-CO	Super-red	Colorless clear	635	120	1 (≥ 0.25)	2	4-50
		LY T679-CO	Yellow		586				
		LG T679-CO	Green		565				
SMT-MULTI-LED [®]			LSG T670-HO	Super-red/ green	Colorless clear	635/565	120	8 (≥ 2.5)	10
	LSP T670-GO		Super-red/pure green	635/557		5 (≥ 1.6)			

LED Lamps

LED Lamps

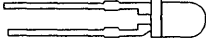
Package & Type	Package Outline	Part Number	Color	Lens	λ Peak nm	Viewing Angle Degrees	Luminous Intensity per Segment		Page	
							mcd	mA		
SMT-SOT-23		LS S260-DO	Super-red	Red diffused	635	140	≥ 0.4	10	4-46	
		LY S260-DO	Yellow	Yellow diffused	586					
LG S260-DO		Green	Green diffused	565						
SMT-SOT-23 MULTI-LED [®]			LU S250-DO	Super-red/green	Colorless diffused	635/565				
SMT-SOT-23 Low current		LS S269-BO	Super-red	Red diffused	635	140	≥ 0.16	2	4-47	
		LY S269-BO	Yellow	Yellow diffused	586					
		LG S269-BO	Green	Green diffused	565					
T1 (3 mm) Flat top MULTI-LED [®]		LSG K370-LO	Super-red/green	Colorless clear	635/565	—	32 (≥ 10)	15	4-38	
		LSP K370-KO	Super-red/pure green		635/557					20 (≥ 6.3)
		LOP K370-KO	Orange/pure green		610/557					
T1 (3 mm)		LH 3344-QO	Hyper-red	Red clear	660	25	150 (≥ 63)	10	4-19	
		LH 3364-LO		Red diffused		45	40 (≥ 10)			
T1 (3 mm)		LS 3341-KN LS 3341-M LS 3341-N LS 3341-MQ	Super-red	Red clear	635	40	6.3-50 16-32 25-50 16-125	10	4-30	
		LY 3341-JM LY 3341-L LY 3341-M LY 3341-LP	Yellow	Yellow clear	586		4-32 10-20 16-32 10-80			
		LG 3341-JM LG 3341-L LG 3341-M LG 3341-LP	Green	Green clear	565		4-32 10-20 16-32 10-80			

LED Lamps

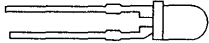
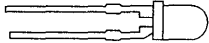

Package & Type	Package Outline	Part Number	Color	Lens	λ Peak nm	Viewing Angle Degrees	Luminous Intensity per Segment		Page
							mcd	mA	
T1 (3 mm)		LS 3340-KN LS 3340-M LS 3340-N LS3340-MP	Super-red	Red clear	635	50	6.3-50 16-32 25-50 16-80	10	4-29
		LO 3340-KN LO 3340-M LO 3340-MP LO 3340-N	Orange	Orange clear	610		6.3-20 10-20 10-80 16-32		
		LY 3340-JM LY 3340-L LY 3340-M LY 3340-LP	Yellow	Yellow clear	586		4-32 10-20 16-32 10-80		
		LG 3330-KN LG 3330-L LG 3330-M LG 3330-N LG 3330-LP	Green	Colorless clear	565		6.3-50 10-20 16-32 25-50 10-80		
T1 (3 mm)		LR 3360-DG LR 3360-F LR 3360-G LR 3360-FJ	Red	Red diffused	660	70	0.4-3.2 1-2 1.6-3-2 1-8	10	4-22
		LS 3360-HL LS 3360-J LS 3360-K LS 3360-KN	Super Red	Red diffused	635		2.5-20 4-8 6.3-12.5 6.3-50		
		LO 3360-HL LO 3360-J LO 3360-K LO 3360-JM	Orange	Orange diffused	610		2.5-20 4-8 6.3-12.5 4-32		
		LY 3360-HL LY 3360-J LY 3360-K LY 3360-JM	Yellow	Yellow diffused	586		2.5-20 4-8 6.3-12.5 4-32		
		LG 3360-GK LG 3360-J LG 3360-K LG 3360-JM	Green	Green diffused	565		1.6-12.5 4-8 6.3-12.5 4-32		
		LP 3360-GK	Pure green	Green diffused	557		1.6-12.5		

LED Lamps

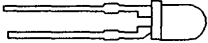
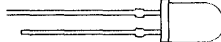
LED Lamps

Package & Type	Package Outline	Part Number	Color	Lens	λ Peak nm	Viewing Angle Degrees	Luminous Intensity per Segment		Page
							mcd	mA	
T1 (3 mm)		LS 3380-FJ LS 3380-H LS 3380-J LS 3380-HL	Super-red	Red diffused	635	100	1-8 2.5-5 4-8 2.5-20	10	4-32
		LY 3380-FJ LY 3380-H LY 3380-J LY 3380-K LY 3380-HL	Yellow	Yellow diffused	586		1-8 2.5-5 4-8 6.3-12.5 2.5-20		
		LG 3380-GK LG 3380-H LG 3380-J LG 3380-HL	Green	Green diffused	565		1.6-12.5 2.5-5 4-8 2.5-20		
T1 (3 mm) Low current		LS 3369-EH LS 3369-FH	Super-red	Red diffused	635	60	0.63-5 1-5	2	4-31
		LY 3369-EH LY 3369-FH	Yellow	Yellow diffused	586		0.63-5 1-5		
		LG 3369-EH LG 3369-FH	Green	Green diffused	565		0.63-5 1-5		
T1 (3 mm) MULTI-LED®		LSG 3331-JO	Super-red/ green	Colorless clear	635	40	18 (≥240)	10	4-37
		LSG 3351-HO			565		50		
T 1 ³ / ₄ (5 mm)		LH 5424-QO	Hyper-red	Red clear	660	16	320 (≥63)	10	4-20
LH 5464-LO		Red diffused		35		60 (≥10)			
T 1 ³ / ₄ (5 mm)		LB 5410-HO	Blue	Colorless clear	480	16	≥2.5	20	4-17
T 1 ³ / ₄ (5 mm)		LS 5420-MQ LS 5420-P LS 5420-Q LS 5420-R LS 5420-PS	Super-red	Red clear	635	24	16-125 40-80 63-125 100-200 40-320	10	4-34
		LY 5420-MQ LY 5420-P LY 5420-Q LY 5420-PS	Yellow	Yellow clear	586		16-125 40-80 63-125 40-320		
		LG 5410-MQ LG 5410-P LG 5410-Q LG 5410-R LG 5410-PS	Green	Colorless clear	565		16-125 40-80 63-125 100-200 40-320		

LED Lamps

Package & Type	Package Outline	Part Number	Color	Lens	λ Peak nm	Viewing Angle Degrees	Luminous Intensity per Segment		Page
							mcd	mA	
T 1 ³ / ₄ (5 mm)		LS 5421-NR LS 5421-Q LS 5421-R LS 5421-QT	Super-red	Red clear	635	20	25-200 63-125 100-200 63-500	10	4-35
		LY 5421-NR LY 5421-Q LY 5421-R LY 5421-QT	Yellow	Yellow clear	586		25-200 63-125 100-200 63-500		
		LG 5411-NR LG 5411-Q LG 5411-R LG 5411-S LG 5411-QT	Green	Colorless clear	565		25-200 63-125 100-200 160-320 63-500		
T 1 ³ / ₄ (5 mm)		LR 5360-DG LR 5360-F LR 5360-G LR 5360-FJ	Red	Red diffused	660	50	0.4-3.2 1-2 1.6-3.2 1-8	10	4-23
		LS 5360-HL LS 5360-J LS 5360-K LS 5360-L LS 5360-KN	Super red	Red diffused	635		2.5-20 4-8 6.3-12.5 10-20 6.3-50		
		LY 5360-HL LY 5360-J LY 5360-K LY 5360-JM LY 5360-L	Yellow	Yellow diffused	586		2.5-20 4-8 6.3-12.5 4-32 10-20		
		LG 5360-GK LG 5360-H LG 5360-J LG 5360-K LG 5360-JM	Green	Green diffused	565		1.6-12.5 2.5-5 4-8 6.3-12.5 4-32		





LED Lamps

LED Lamps

Package & Type	Package Outline	Part Number	Color	Lens	λ Peak nm	Viewing Angle Degrees	Luminous Intensity per Segment		Page
							mcd	mA	
T 1 ³ / ₄ (5 mm)		LR 5460-DG LR 5460-F LR 5460-G LR 5460-FJ	Red	Red diffused	660	50	0.4-3.2 1-2 1.6-3.2 1-8	10	4-24
		LS 5460-HL LS 5460-J LS 5460-K LS 5460-L LS 5460-KN	Super-red	Red diffused	635		2.5-20 4-8 6.3-12.5 10-20 6.3-50		
		LY 5460-HL LY 5460-J LY 5460-K LY 5460-JM LY 5460-L	Yellow	Yellow diffused	586		2.5-20 4-8 6.3-12.5 4-32 10-20		
		LG 5460-GK LG 5460-H LG 5460-J LG 5460-K LG 5460-JM	Green	Green diffused	565		1.6-12.5 2.5-5 4-8 6.3-12.5 4-32		
T 1 ³ / ₄ (5 mm)		LR 5480-CF LR 5480-E LR 5480-F LR 5480-DG	Red	Red diffused	660	80	0.25-2.0 .63-1.25 1-2 0.4-3.2	10	4-25
		LS 5480-GK LS 5480-J LS 5480-K LS 5480-JM	Super-red	Red diffused	635		1.6-12.5 4-8 6.3-12.5 4-32		
		LY 5480-GK LY 5480-J LY 5480-K LY 5480-JM	Yellow	Yellow diffused	586		1.6-12.5 4-8 6.3-12.5 4-32		
		LG 5480-GK LG 5480-H LG 5480-K LG 5480-L LG 5480-JM	Green	Green diffused	565		1.6-12.5 2.5-5 6.3-12.5 10-20 4-32		

LED Lamps



LED Lamps

Package & Type	Package Outline	Part Number	Color	Lens	λ Peak nm	Viewing Angle Degrees	Luminous Intensity per Segment		Page
							mcd	mA	
T 1 ³ / ₄ (5 mm)		LS 5380-FJ LS 5380-H LS 5380-J LS 5380-HL	Super-red	Red diffused	635	140	1-8 2.5-5 4-8 2.5-20	10	4-33
		LY 5380-EH LY 5380-H LY 5380-J LY 5380-GK	Yellow	Yellow diffused	586		0.63-5 2.5-5 4-8 1.6-12.5		
		LG 5380-FJ LG 5380-H LG 5380-J LG 5380-HL	Green	Green diffused	565		1-8 2.5-5 4-8 2.5-20		
T 1 ³ / ₄ (5 mm) Low current		LS 5469-EH LS 5469-FH	Super-red	Red diffused	635	50	0.63-5 1-5	2	4-36
		LY 5469-EH LY 5469-FH	Yellow	Yellow diffused	586		0.63-5 1-5		
		LG 5469-EH LG 5469-FH	Green	Green diffused	565		0.63-5 1-5		
T 1 ³ / ₄ (5 mm) MULTI-LED [®]		LU 5351-GL LU 5351-JM	Super-red and green	Colorless clear, partly diffused	635/565	50	1.6-20 4-32	10	4-52
T1 (3 mm) ARGUS [®]		LS K380-LP LS K380-N LS K380-P LS K380-NR	Super-red	Red clear	635	—	10-80 25-50 40-80 25-200	15	4-41
		LO K380-LP LO K380-N LO K380-P LO K380-NQ	Orange	Orange clear	610		10-80 25-50 40-80 25-125		
		LY K380-LP LY K380-N LY K380-P LY K380-NR	Yellow	Yellow clear	586		10-80 25-50 40-80 25-200		
		LG K380-LP LG K380-N LG K380-P LG K380-NR	Green	Green clear	565		10-80 25-50 40-80 25-200		
		LP K380-KO	Pure green	Colorless clear	557		10 (63)		

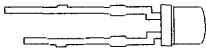
LED Lamps



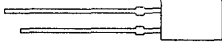
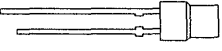

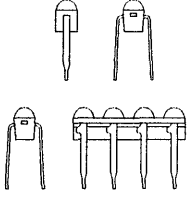
Package & Type	Package Outline	Part Number	Color	Lens	λ Peak nm	Viewing Angle Degrees	Luminous Intensity per Segment		Page
							mcd	mA	
T1 (3 mm) Super ARGUS®		LS K382-RO	Super-red	Red clear	635	—	160 (≥100)	50	4-44
		LO K382-RO	Orange	Orange clear	610				
		LY K382-RO	Yellow	Yellow clear	586				
		LG K382-RO	Green	Green clear	565				
		LP K382-PO	Pure green	Colorless clear	557				
T1 (3 mm) Low current ARGUS®		LS K389-FO	Super-red	Red clear	635	—	5 (≥1)	2	4-45
		LY K389-FO	Yellow	Yellow clear	586		3.2 (≥1)		
		LG K389-FO	Green	Green clear	565				
T1 (3 mm) MULTI-LED® ARGUS®		LSG K370-LO	Super-red & green	Colorless clear	635/565	—	32 (≥10)	15	4-38
		LSP K370-KO	Super-red & pure green		635/557		20 (≥6.3)		
	LOP K370-KO	Orange & pure green	610/557						
T1 (3 mm) MULTI-LED® Super ARGUS®	LSG K372-RO	Sup-red & green	Colorless clear	635/565	—	160 (≥100)	50	4-39	
	LSP K372-PO	Sup-red & pure green		635/557		100 (≥40)			

LED Lamps

Package & Type	Package Outline	Part Number	Color	Lens	λ Peak nm	Viewing Angle Degrees	Luminous Intensity per Segment		Page
							mcd	mA	
Rectangular (5 mm)		LR B480-BD LR B480-C LR B480-D	Red	Red, partly diffused	660	100	0.16-0.8 0.25-0.5 0.4-0.8	10	4-26
		LS B480-EH LS B480-G LS B480-H LS B480-GK	Super-red	Red, partly diffused	635		0.63-5 1.6-3.2 2.5-5 1.6-12.5		
		LY B480-EH LY B480-G LY B480-H LY B480-GK	Yellow	Yellow, partly diffused	586		0.63-5 1.6-3.2 2.5-5 1.6-12.5		
		LG B480-EH LG B480-G LG B480-H LG B480-GK	Green	Green, partly diffused	565		0.63-5 1.6-3.2 2.5-5 1.6-12.5		
Cylindrical (5 mm)		LR H380-BD LR H380-C LR H380-D	Red	Red, partly diffused	660	100	0.16-0.8 0.25-0.5 0.40-0.8	10	4-27
		LS H380-EH LS H380-G LS H380-H LS H380-GK	Super-red	Red, partly diffused	635		0.63-5 1.6-3.2 2.5-5 1.6-12.5		
		LY H380-EH LY H380-G LY H380-H LY H380-GK	Yellow	Yellow, partly diffused	586		0.63-5 1.6-3.2 2.5-5 1.6-12.5		
		LG H380-EH LG H380-G LG H380-H LG H380-GK	Green	Green, partly diffused	565		0.63-5 1.6-3.2 2.5-5 1.6-12.5		
Rectangular MULTI-LED [®]		LU B371-FJ LU B371-GK	Super-red & green	Colorless clear, partly diffused	635 565	100	1-8 1.6-12.5	10	4-52
Cylindrical MULTI-LED [®]		LU H371-FJ LU H371-GK	Super-red & green	Colorless clear, partly diffused	635 565		1-8 1.6-12.5		
1 diode 2 diodes 3 diodes 4 diodes 5 diodes 6 diodes 7 diodes 8 diodes 9 diodes 10 diodes		LR Z181-CO LR Z182-CO LR Z183-CO LR Z184-CO LR Z185-CO LR Z186-CO LR Z187-CO LR Z188-CO LR Z189-CO LR Z180-CO	Red	Red diffused	660	100	≥ 0.25	10	4-28

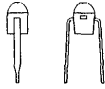
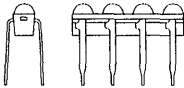
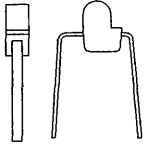
LED Lamps

LED Lamps

Package & Type	Package Outline	Part Number	Color	Lens	λ Peak nm	Viewing Angle Degrees	Luminous Intensity per Segment		Page
							mcd	mA	
1 diode		LY Z181-CO	Yellow	Yellow diffused	586	100	≥ 0.25	10	4-54
1 diode 2 diodes 3 diodes 4 diodes 5 diodes 6 diodes 8 diodes 10 diodes		LG Z181-CO LG Z182-CO LG Z183-CO LG Z184-CO LG Z185-CO LG Z186-CO LG Z188-CO LG Z180-CO	Green	Green diffused	565	100	≥ 0.25	10	4-18
Miniature (1 mm)		LS U260-EO	Super-red	Red diffused	635	60	≥ 0.63	10	4-51
		LY U260-EO	Yellow	Yellow diffused	586				
		LG U260-EO	Green	Green diffused	565				
Miniature, axial leads		RL50	Red	Water Clear	660	90°	≥ 0.5	10	4-55
		RL54		Red Diffused			≥ 0.4		
Miniature, axial leads, high dome lens		RL55	Red	Red Diffused	660	50°	≥ 2.0	10	4-57
		YL56	Yellow	Yellow Diffused	585	40°			
		GL56	Green	Green Diffused	565		≥ 1.0		
Miniature, axial leads		RRL-5601	Red	Red Diffused	650	20	≥ 0.3	5 V	4-59
		RRL-5621					≥ 0.6		
		RRL-5641					≥ 1.0		

Mounting Clip & Collar for T1^{3/4} (5 mm) LED
 Q 62901-B64, Clear and Q 62901-B65, Black

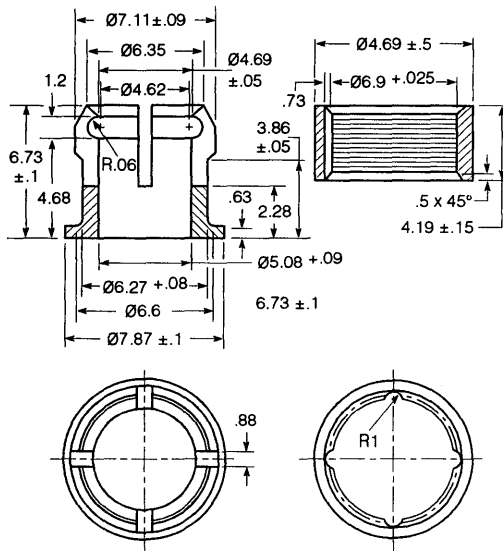

LED Lamps

Mounting Clip & Collar for T1 (3 mm) LED
 Q 62901-B61, Clear and Q 62901-B62, Black

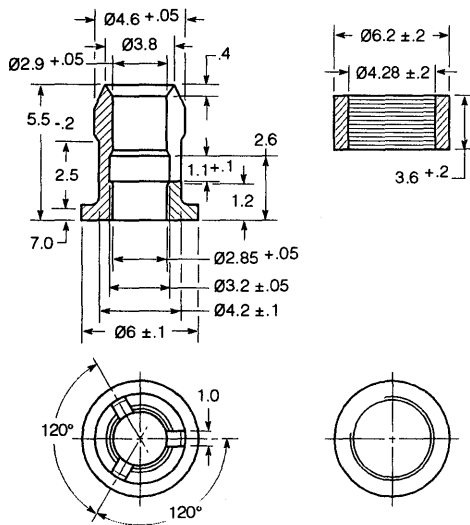

Right Angle Mount

Q 62902-B156-F222, Black

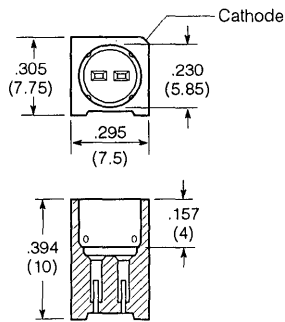

Angular Mount

Q 62902-B155-F222, Black

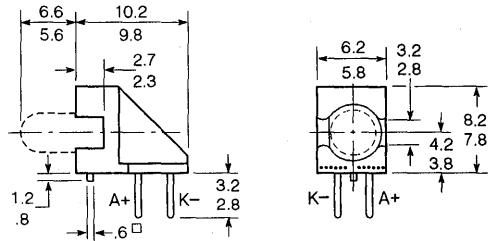

Reflector for T1 3/4 (5 mm) LED

Q 62902-B141-F222, Polished

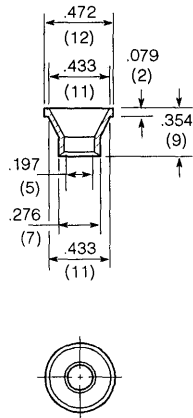

Reflector for T1 (3 mm) LED

Q 62902-B154-F222, Polished

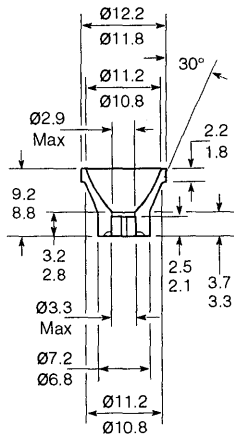

LED Lamp Part Numbering System

New LED type designation system

The range of Siemens light emitting diodes has received new type designations and ordering codes. The new type designation now indicates the most important characteristics of an LED.

LED type designation system

Wavelength λ peak typ.	Emission Color	Type	
M 635/557 nm	super-red/pure green	3 3 mm	round (standard version)
T 635/586 nm	super-red/yellow	5 5 mm	round (standard version)
U 635/565 nm	super-red/green	B 2.5 x 2.5 mm	rectangular (symbol LED)
V 635 nm	super-red/super-red	H 4 mm	round (symbol LED)
W 565 nm	green/green	S SOT-23 package	SMT-LED
B 467 nm	SiC blue	U 1 mm	Mini-LED
P 557 nm	pure green	Z 2 mm	round (array version)
G 565 nm	green	K 3 mm	ARGUS [®] -LED/Super ARGUS [®] -LED
Y 586 nm	yellow	T PL-CC-2 package	SMT-TOP-LED [™]
O 610 nm	orange		
S 635 nm	super-red		
R 66 nm	GaAsP red		
H 66 nm	hyper-red		

Product
L-light emitting diode

LS 3360-KN

Length of leads		Luminous intensity groups
3 <30 mm	with stand-off	A 0.1 to 0.2 P 40 to 80
4 <30 mm	without stand-off	B 0.16 to 0.34 Q 63 to 125
5 gull-wing leads		C 0.25 to 0.5 R 100 to 200
6 J-leads		D 0.4 to 0.8 S 160 to 320
		E 0.63 to 1.25 T 250 to 500
		F 1 to 2 U 400 to 800
		G 1.6 to 3.2 V 630 to 1250
		H 2.5 to 5 W 1000 to 2000
		J 4 to 8 X 1600 to 3200
		K 6.3 to 12.5 Y 2500 to 5000
		L 10 to 20 Z >5000
		M 16 to 32 O open top
		N 25 to 50

Case	Viewing angle (typ.)
1 colorless clear	15 to 30 degrees
2 colored clear	15 to 30 degrees
3 colorless clear	30 to 70 degrees
4 colored clear	30 to 70 degrees
5 colorless diffused	40 to 80 degrees
6 colored diffused	40 to 80 degrees
7 colorless diffused	>80 degrees
8 colored diffused	>80 degrees

(SOT-23 requires no angle)

Special versions
1 aspherical lenses
2 high-current LED
3 GaAlAs single hetero LED
4 GaAlAs double hetero LED
7 resistor LED
8 constant current LED
9 low-current LED

Array versions: digit 4=Z
Number of lamps per array

Explanation of example:

LS 3360-KN	L	Light emitting diode
	S	Emission color: super-red, $\lambda_{\text{peak}}=635$ nm (typ.)
	3	Standard version: 3 mm
	3	Length of leads <30 mm with stand-off
	6	Colored case, diffused; viewing angle 70 degrees (typ.)
	0	No special version
	KN	Luminous intensity of family group, minimum 6.3 mcd, maximum 50 mcd

Grouping of luminous intensities (I_v)

The different luminous intensities throughout one type family are grouped according to the following plan ($I_F = 10 \text{ mA}$)¹⁾:

Group	A	B	C	D	E	F	G	H	J	K	L	M	N
I_v mcd	0,1...0,2	0,16...0,32	0,25...0,50	0,40...0,80	0,63...1,25	1...2	1,6...3,2	2,5...5	4...8	6,3...12,5	10...20	16...32	25...50

Group	P	Q	R	S	T	U	V	W	X	Y	Z	O
I_v mcd	40...80	63...125	100...200	160...320	250...500	400...800	630...1250	1000...2000	1600...3200	2500...5000	> 5000	top open

¹⁾ For blue LED: $I_F = 20 \text{ mA}$:

ARGUS LED: Luminous flux Φ_{v} in mlm at $I_F = 15 \text{ mA}$ (at low current $I_F = 2 \text{ mA}$). Super ARGUS, $I_F = 50 \text{ mA}$.

Matching factor of brightness—Single-color LEDs/MULTILED

	I_{vmin}/I_{vmax} , Φ_{vmin}/Φ_{vmax}	
	within one packing unit	within one LED
LEDs	'1/2'	—
MULTILED	'1/2'	'1/3'
MULTILED, with pure green	'1/2'	'1/4'
LU 5351-GL, LU B371-FJ, LU H371-FJ	'1/2'	'1/4'
LU 5351-JM, LU B371-GK, LU H371-GK	'1/2'	'1/2'
LU S250-DO	'1/2'	'1/4'

The brightness of the darker chip in one package determines the brightness group of the LED.

In case of MULTILED with two chips of the same color, the mean value of the chips determines the brightness of the LED.

Soldering conditions for LEDs

When soldering the component into position, make sure that it is not thermally overloaded. The maximum junction temperature may only be exceeded briefly (for no more than 1 min.). Maximum permissible soldering temperatures and soldering times are:

Types	Dip, wave and drag soldering			Iron soldering (with 1.5 mm iron tip)			Reflow soldering	
	Temperature of the soldering bath	Max. perm. soldering time	Distance between solder joint and case	Temperature of soldering iron	Max. perm. soldering time	Distance between solder joint and case	Temperature of soldering zone	Max. transit time
3 mm dia	235 °C 260 °C	8 s 5 s	≥ 2 mm	300 °C	3 s	≥ 2 mm	—	—
5 mm dia Symbol LED Two-color LED	235 °C 260 °C	8 s 5 s	≥ 1,5 mm	300 °C	3 s	≥ 1,5 mm	—	—
LED arrays	235 °C 260 °C	5 s 3 s	≥ 2 mm	300 °C	3 s	≥ 2 mm	—	—
SOT-23 LED SMT-TOP-LED [®]	260 °C	8 s	—	—	—	—	260 °C ... 215 °C Preheating: 150 °C	10 s ... 30 s Approx. 1 min

Cleaning solvents for soldered-in LEDs

Organic solvents consisting of alcohols or hydrocarbon-fluorides or a mixture of both groups are suitable for cleaning soldered-in LEDs. In no way should solvents

or solvent mixtures be used which contain chlorinated hydrocarbons or ketones. This type of solvents may attack or corrode the display housing or casting.

Lamp-Tape and Packaging

Light emitting diodes are available in taped form. Packaging of LEDs on continuous tapes is based on IEC standard 286.2.

The component tapes are wound on reels and supplied in boxes containing two reels each. One reel consists 1000 pieces of the 5 mm type or 2000 pieces of the 3 mm type.

For components with 2.54 mm lead spacing add "E7500" to the last position of the part number, e.g., LR 5460-DG E7500.

For components with 5.08 mm spacing add "E7501" to the last position of the part number, e.g., LG 5460-GK E7500.

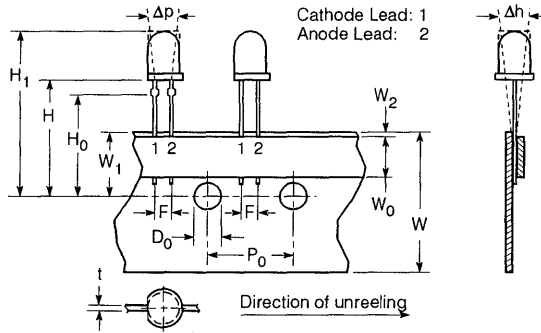

Symbol	Designation	Dimensions		Tolerance	
		inch	mm	inch	mm
W	Carrier tape width	.709	18	+0.039 -0.020	+1 -0.5
W ₀	Hold down tape width	.236	6	±.12	±0.3
W ₁	Sprocket hole position	.354	9	+0.030 -0.020	+0.75 -0.5
W ₂	Hold down tape position	≤.118	≤3		
t	Total thickness of carrier and hold down tape	.035 max.	0.9 max.		
D ₀	Sprocket hole diameter	.157	4	±.008	±0.2
H	Sprocket hole center to bottom of component	.709	18	+0.079	+2
H ₀	Sprocket hole center of seating plane	.630	16	±.020	±0.5
H ₁	Sprocket hole center to top of component body	1.268 max.	32.2 max.		
P ₀	Sprocket hole pitch	.500	12.7	±.012	±0.3
F	Component lead pitch	.100 or .200	2.54 or 5.08	+0.024 -0.004	+0.6 -0.1
Δp	Maximum deviation of component in tape plane			+0.040	±1
Δh	Maximum deviation of component vertical to tape plane			±.079	±2

Packaging of Surface Mount LEDs

LED in SOT 23 and TOP-LED packages are available on continuous tapes— IEC publication 40 (secretariat) 458 applies.

The 8 mm broad tape is wound on an 18 cm or 33 cm film reel. The reels have either 3000 or 10,000 components.

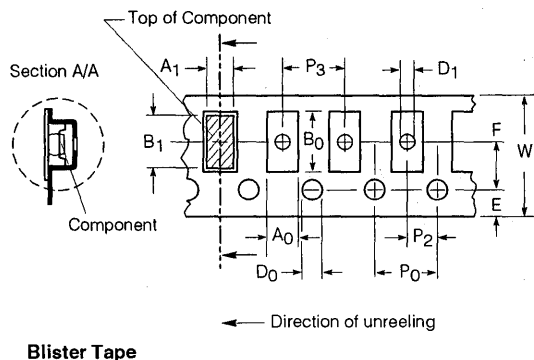
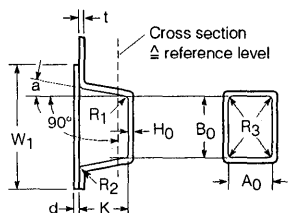

Dimensional Table for Blister Tape

Designation	Symbol	Dimensions in inches (mm)	Notes
Tape width	W	.315 ± .012 (8 ± .3)	—
Carrier tape thickness	t	.012 max. (.3)	—
Pitch of sprocket holes	P ₀	.157 ± .004 (4 ± .1)	Cumulative pitch error +.2 mm/10 pitches
Diameter of sprocket holes	D ₀	.039 +.008 (1 +.2)	—
Distance of sprocket holes	E	.069 ± .004 (1.75 ± .1)	—
Distance of components	F	.138 ± .002 (3.5 ± .05)	Center hole to center compartment
	P ₂	.079 ± .002 (2 ± .05)	
Distance compartment to compartment	P ₃	.157 (4)	—
Compartment dimensions	K	.098 max. (2.5)	Exact dimensions are given with component dimensions
	a	15° max.	
	R ₁ , R ₂	.012 max. (.3)	
	H ₀	.012 +.004/-.002 (0.3 +.1/-.05)	Between inner side of the compartment bottom and reference level for measuring A ₀ , B ₀
Compartment	A ₀ B ₀	The tolerances are chosen so that the components can only move within permissible limits, yet still be easily removed from the tape.	
Hole in compartment	D ₁	.039 +.008/-.002 (1 +.2/-.05)	Tolerance to the center of the sprocket hole: .1 mm
Width of fixing tape	W ₁	.217 typ. (5.5)	Fixing tape shall not cover sprocket holes, nor protrude beyond carrier tape so as not to exceed maximum tape width
	d	.004 max. (.1)	
Device tilt in compartment	—	15° max.	—
Minimum bending radius	—	1.181 min. (30)	—

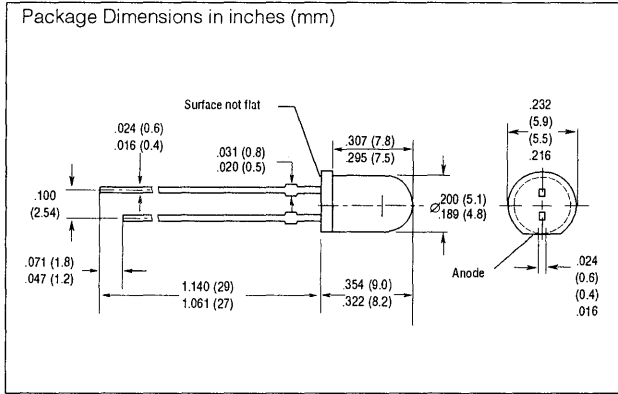
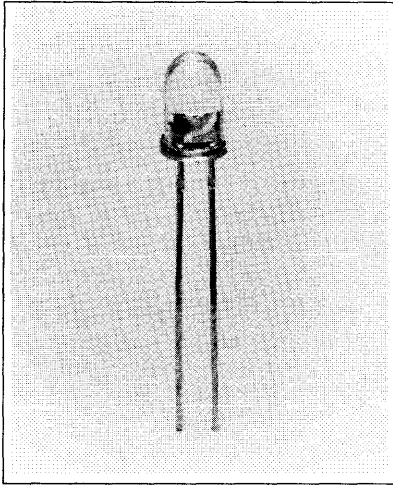

LED Lamps

FEATURES

- Pure Blue Light (480 nm)
- Clear T1¼ (5 mm) Plastic Package
- 1" Minimum Lead Length
- High Brightness
- TTL Compatible

DESCRIPTION

The LB 5410 is a Silicon Carbide (SiC) LED, emitting a pure blue light from a clear T1¼ (5 mm) plastic package. The LB 5410 is ideal for such applications as: spectroscopy, calibration, and light sources in medical equipment.

Maximum Ratings

Operating Temperature Range (T_{OP})	-55°C to +100°C
Storage Temperature Range (T_{STG})	-55°C to +100°C
Junction Temperature (T_J)	+100°C
Forward Current (I_F)	50 mA
Surge Current (I_{FM}) $t_p=10 \mu s$	0.5 A
Reverse Voltage (V_R)	5 V
Power Dissipation (P_{TOT} , $T_A=25^\circ C$)	180 mW
Thermal Resistance, Junction-to-Air (R_{THJA})	400 K/W

Characteristics (T=25°C) All values typical unless otherwise noted.

Parameter	Symbol	Value	Unit	Condition
Peak Wavelength	λ_{PEAK}	467	nm	$I_F=20 \text{ mA}$
Dominant Wavelength	λ_{DOM}	480	nm	$I_F=20 \text{ mA}$
Spectral Bandwidth, 50%	$\Delta\lambda$	75	nm	I_{RELMAX} , $I_F=20 \text{ mA}$
Viewing Angle, 50% I_v	2ϕ	35	Deg.	
Forward Voltage	V_F	3.7	V	$I_F=20 \text{ mA}$
(max.)	V_F	4.0	V	$I_F=20 \text{ mA}$
Switching Time				$I_F=100 \text{ mA}$,
I_v , 10% to 90%	t_R	800	ns	$t_\sigma=10 \mu s$,
I_v , 90% to 10%	t_F	800	ns	$R_L=50 \Omega$
Luminous Intensity*	I_v	6(≥ 1.6)	mcd	$I_F=20 \text{ mA}$

* Luminous intensity factor of I_v of one packaging unit $I_{VMAX}/I_{VMIN} \geq 2$

See graph numbers 1, 2J, 3C, 4C, 5B, 6B in the back of this section.

SIEMENS

SINGLE LG Z181 2 to 6 DIODE ARRAYS LG Z182-186 8, 10 DIODE ARRAYS LG Z188, 180

Green Miniature LED Lamp

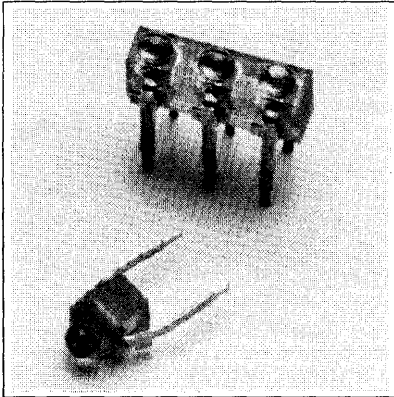

FEATURES

- Green Diffused Lens
- Miniature Size
- 0.100" (2.54 mm) Lead Spacing
- End Stackable to Arrays of Any Length
- I/C Compatible

DESCRIPTION

The LG Z18X series are green gallium arsenide phosphide LED solid state lamps, single and arrays. They have a green plastic encapsulation formed as a lens where the light is emitted. The single lamps or arrays may be used individually or stacked together to form arrays of any length. Typical applications are position indicators such as meters and scales.

Maximum Ratings (Individual Diode)

Operating/Storage Temperature	
Range (T_{OP}, T_{STG})	-40°C to +80°C
Junction Temperature (T_J)	
Range	100°C
Forward Current (I_F)	30 mA
Surge Current (I_{FM}), $t \leq 10 \mu s$	0.5 A
Reverse Voltage (V_R)	5 V
Power Dissipation (P_{TOT}), $T_A = 25^\circ C$	90 mW
Thermal Resistance	
Junction to Air ($R_{\theta JA}$)	750 K/W

Note:

Soldered on PC board: pad size $\geq 16 \text{ mm}^2$

Package Dimensions in inches (mm)

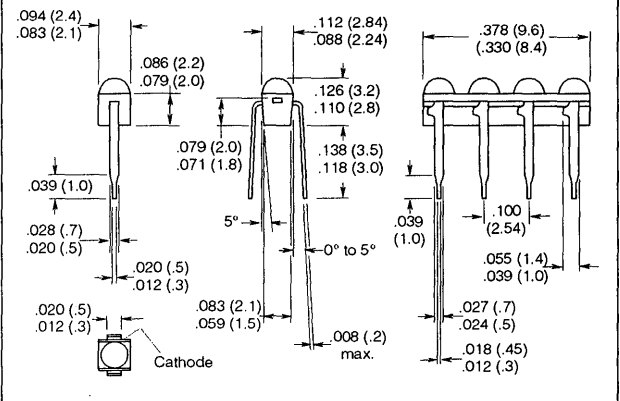

Characteristics ($T_A = 25^\circ C$)

Parameter	Symbol	Value	Unit	Condition
Wavelength, Peak Emission (typ.)	λ_{PEAK}	565	nm	$I_F = 20 \text{ mA}$
Dominant Wavelength (typ.)	λ_{DOM}	570	nm	$I_F = 20 \text{ mA}$
Spectral Bandwidth, 50% I_{RELMAX} (typ.)	$\Delta\lambda$	25	nm	$I_F = 20 \text{ mA}$
Viewing Angle, 50% I_V	ϕ	100	Deg.	
Forward Voltage (typ.)	V_F	2.0	V	$I_F = 10 \text{ mA}$
(max.)	V_F	2.6	V	$I_F = 10 \text{ mA}$
Reverse Current (typ.)	I_R	0.01	μA	$V_R = 5 \text{ V}$
(max.)	I_R	10	μA	$V_R = 5 \text{ V}$
Capacitance (typ.)	C_0	15	pF	$V_R = 0 \text{ V}$, $f = 1 \text{ MHz}$
Switching Time				
I_V , 10% to 90% (typ.)	t_R	450	ns	$I_F = 100 \text{ mA}$
I_V , 90% to 10% (max.)	t_F	200	ns	$t_\phi = 10 \mu s$, $R_L = 50 \Omega$
Luminous Intensity (mcd)*				

Part Number	No. of LEDs	Min.	Test Condition
LG Z181-CO	1	0.25	10 mA
LG Z182-CO	2	0.25	10 mA
LG Z183-CO	3	0.25	10 mA
LG Z184-CO	4	0.25	10 mA
LG Z185-CO	5	0.25	10 mA
LG Z186-CO	6	0.25	10 mA
LG Z188-CO	8	0.25	10 mA
LG Z180-CO	10	0.25	10 mA

* Luminous intensity factor of I_V of one packaging unit $I_{VMAX}/I_{VMIN} \geq 2$.

See graph numbers 1, 2U, 3A, 4A, 5G, 6F, 7A, 8A, 9A, 10A in the back of this section.

Hyper-Red GaAlAs T1 (3mm) LED Lamp

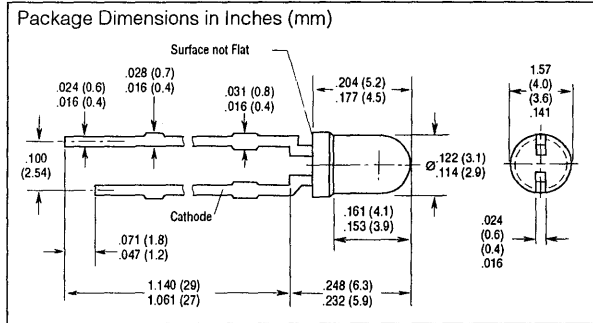
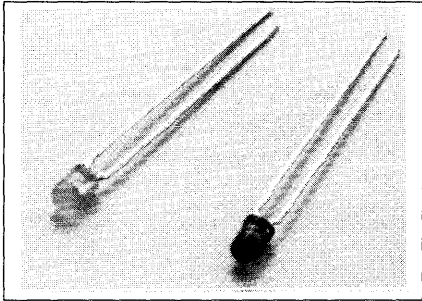

FEATURES

- T1 (3mm) Package
- Double Hetero Junction Technology
- Choice of Diffused Lens—LH3364 or Red Clear Lens—LH 3344
- High Luminous Intensity
- Excellent Light Efficiency for Low Current Operation
- IC Compatible

DESCRIPTION

The T1 hyper-red GaAlAs LED lamps use double hetero junction material to produce very high luminous intensities. When operated at very low currents (1 mA) these lamps can produce luminous intensities comparable to standard and high efficiency LEDs that operate at 10 mA to 20 mA.

Luminous Intensity and Lens Type

Part No.	Lens Type	Luminous Intensity $I_f = 10 \text{ mA}, I_v (\text{mcd})$	
		Typ.	Min.
LH 3344-QO	red clear	150	63
LH 3364-MO	red diffused	40	16

See graph numbers 1, 2G (LH 3344), 2H (LH 3364), 3A, 4B, 5A, 6A, 7A, 8A, 9A, 10A, 10B (LH3344, LH 3364) in the back of this section.

Maximum Ratings

Operating Temperature Range (T_{OP})	-55°C to +100°C
Storage Temperature Range (T_{STG})	-55°C to +100°C
Junction Temperature (T_J)	+100°C
Reverse Voltage (V_R)	3 V
Forward Current (I_F)	40 mA
Surge Current (I_{FM})	0.5 A
Power Dissipation (P_{TOT}) $T_A = 25^\circ\text{C}$	120 mW
Thermal Resistance, Junction to Air ($R_{TH(A)}$)	400 K/W

Characteristics ($T_A = 25^\circ\text{C}$) All values typical unless otherwise noted.

Parameter	Symbol	Unit
Peak Wavelength ($I_F = 20 \text{ mA}$)	λ_{PEAK}	660 nm
Dominant Wavelength ($I_F = 20 \text{ mA}$)	λ_{DOM}	645 nm
Spectral Bandwidth (50% I_{RELMAX} , $I_F = 20 \text{ mA}$)	$\Delta\lambda$	22 nm
Viewing Angle 50% I_v LH3343/3344	2ϕ	25 Deg.
LH3363/3364	2ϕ	45 Deg.
Forward Voltage ($I_F = 10 \text{ mA}$)	V_F	1.75 V (≤ 2.6)
Reverse Current ($V_R = 3 \text{ V}$)	I_R	0.01 μA (≤ 10) μA
Capacitance ($V_R = 0 \text{ V}, f = 1 \text{ MHz}$)	C_0	25 pF
Switching Times ($I_F = 100 \text{ mA}, t_p = 10 \mu\text{s}, R_L = 50 \Omega$)		
Rise time—10% to 90%	t_R	140 ns
Fall time—90% to 10%		
LH3344/3364	t_F	110 ns

SIEMENS

DOUBLE HETERO JUNCTION LH 5424-QO DOUBLE HETERO JUNCTION LH 5464-LO HYPER RED GaAlAs T1³/₄ (5mm) LED LAMP

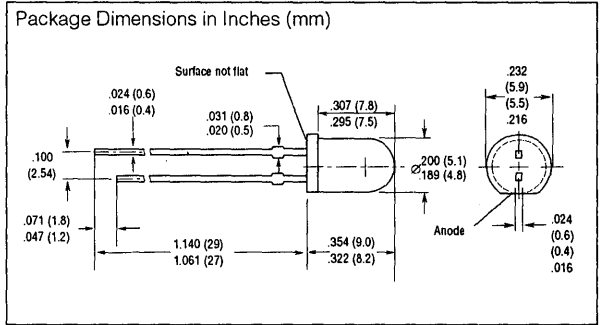
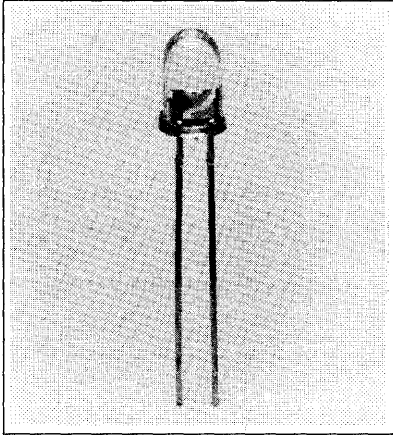

FEATURES

- T1³/₄ (5mm) Package
- Double Hetero Junction Technology
- Choice of Diffused Lens—LH 5464 or Red Clear Lens—LH 5424
- High Luminous Intensity
- Excellent Light Efficiency for Low Current Operation
- IC Compatible

DESCRIPTION

The T1³/₄ hyper red GaAlAs LED lamps use double hetero junction material to produce very high luminous intensities. When operated at very low currents (1 mA) these lamps can produce luminous intensities comparable to standard and high efficiency LEDs that operate at 10 mA to 20 mA.

Luminous Intensity and Lens Type

Part No.	Lens Type	Luminous Intensity $I_f = 10 \text{ mA}, I_v (\text{mcd})$	
		typ.	min.
LH 5424-QO	red clear	320	63
LH 5464-LO	red diffused	60	10

Maximum Ratings

Operating Temperature Range (T_{OP})	-55°C to + 100°C
Storage Temperature Range (T_{STG})	-55°C to + 100°C
Junction Temperature (T_j)	+ 100°C
Reverse Voltage (V_R)	3 V
Forward Current (I_f)	40 mA
Surge Current (I_{FM})	0.5 A
Power Dissipation (P_{TOT} , $T_A = 25^\circ\text{C}$)	120 mW
Thermal Resistance, Junction to Air (R_{thJA})	400 K/W

Characteristics ($T_A = 25^\circ\text{C}$) All values typical unless otherwise noted.

Parameter	Symbol	Value	Unit	Test Condition
Peak Wavelength	λ_{PEAK}	660	nm	$I_f = 20 \text{ V}$
Dominant Wavelength	λ_{DOM}	645	nm	$I_f = 20 \text{ V}$
Spectral Bandwidth				
50% I_v	$\Delta\lambda$	22	nm	$I_f = 20 \text{ mA}$
Viewing Angle 50% I_v				
LH 5424	2 ϕ	16	Deg.	
LH 5464	2 ϕ	35	Deg.	
Forward Voltage	V_F	1.75 (≤ 2.6)	V	$I_f = 10 \text{ mA}$
Reverse Current	I_R	0.01 (≤ 10)	μA	$V_R = 3 \text{ V}$
Capacitance	C_0	25	pF	$V_R = 0, f = 1 \text{ MHz}$
Switching Times				$I_f = 100 \text{ mA}$
Rise time—10% to 90%	t_R	140	ns	$t_p = 10 \mu\text{s}$
Fall time—90% to 10%	t_F	110	ns	$R_L = 50 \Omega$
LH5424/5464				

See graph numbers 1, 2I (LH5424), 2J (LH5464), 3A, 4B, 5A, 6A, 7A, 8A, 9A, 10B in the back of this section.

Hyper Red, SMT-TOP-LED™ Surface Mount LED Lamp

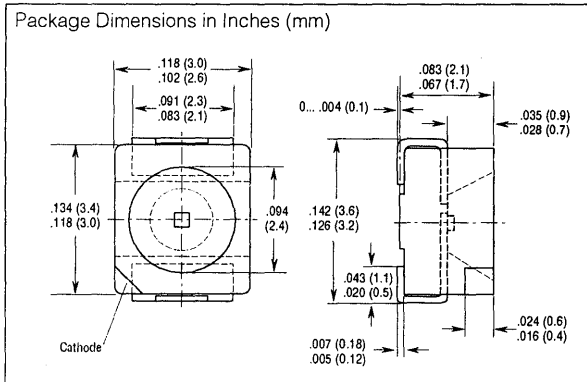
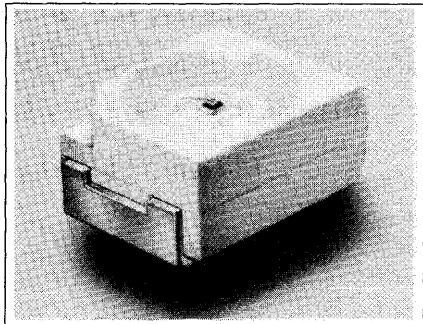

FEATURES

- PL-CC-2 Package
- Internal Reflector
- Colorless Clear Window
- Low Power Dissipation
- Wide Viewing Angle
- Compatible with Automatic Placement Equipment
- Suitable for Vapor-Phase Reflow, Infrared Reflow and Wave Solder Processes
- Ideal for Backlight and Light Pipe Applications

DESCRIPTION

The LH T674 is a double heterojunction LED with a package that incorporates an internal reflector to optimize light coupling. This feature makes the SMT-TOPLED ideal for light pipe applications.

Maximum Ratings

Operating Temperature Range (T_{OP})	-55°C to + 100°C
Storage Temperature Range (T_{STG})	-55°C to +100°C
Junction Temperature (T_J)	+ 100°C
Reverse Voltage (V_R)	3 V
Forward Current (I_F)	30 mA
Surge Current (I_{FS}) $t_p = 10$ ms	0.5 A
Power Dissipation (P_{TOT}) $T_A \leq 25^\circ\text{C}$	100 mW
Thermal Resistance, Junction to Ambient	
For mounting on PC Board, ≥ 16 mm ² (R_{THJA})	400 K/W

Characteristics ($T_A=25^\circ\text{C}$)

Parameter	Symbol	Value	Units
Peak Wavelength ($I_F=10$ mA)	λ_{PEAK}	660	nm
Dominant Wavelength ($I_F=10$ mA)	λ_{DOM}	645	nm
Spectral Bandwidth (50%, I_{RELMAX} , $I_F=10$ mA)	$\Delta\lambda$	22	nm
Viewing Angle 50% I_V	2ϕ	120	Deg.
Forward Voltage ($I_F=10$ mA)	V_F	1.75 (≤ 2.6)	V
Reverse Current ($V_R=5$ V)	I_R	0.01 (≤ 10)	μA
Capacitance ($V_R=0$ V, $f=1$ MHz)	C_O	25	pF
Response Time ($I_F=100$ mA, $t_p=10$ μs , $R_L=50$ Ω)			
Rise Time/ I_V , 10%-90%	t_R	140	ns
Fall Time/ I_V , 10%-90%	t_F	110	ns
Luminous Intensity (mcd)*			

Part Number	Symbol	Min.	Max.	Test Condition
LH T674-KM	I_V	6.3	32.0	10 mA
LH T674-L	I_V	10.0	20.0	10 mA
LH T674-LN	I_V	10.0	50.0	10 mA
LH T674-M	I_V	16.0	32.0	10 mA

See graph number 1, 2V, 3A, 4B, 5G, 6H, 7A, 8A, 9A, 10B in the back of this section.

* Luminous intensity factor of I_V of one packaging unit $I_{VMAX}/I_{VMIN} \geq 2$

SIEMENS

RED LR 3360
SUPER-RED LS 3360
ORANGE LO 3360
YELLOW LY 3360
GREEN LG 3360
PURE GREEN LP 3360
T1 (3 mm) LED Lamp

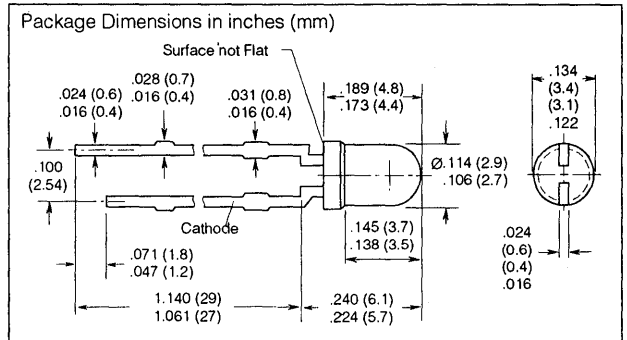
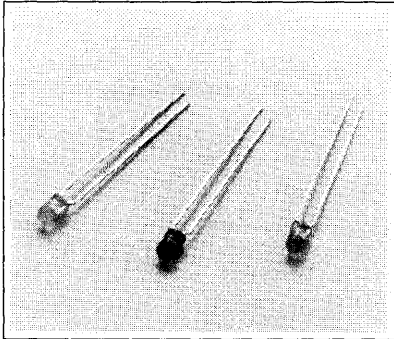

FEATURES

- High Light Output
- Diffused Lens
- Wide Viewing Angle 70°
- With Standoffs
- T1 (3 mm) Package Size
- 1" Lead Length
- I/C Compatible

DESCRIPTION

The LR 3360 series is a standard red gallium arsenide phosphide (GaAsP) LED lamp. The LS 3360 super-red, LY 3360 yellow and LO 3360 orange are premium high efficiency light emitting diode lamps fabricated with TSN (transparent substrate nitrogen) technology. The LG 3360 green and LP 3360 pure green are gallium phosphide (GaP) lamps. All have a diffused plastic lens which emits a full flooded intense light.

Maximum Ratings

Operating and Storage Temperature
 Range T_{OP} , (T_{STG}) -55°C to +100°C
 Junction Temperature (T_J) 100°C
 Reverse Voltage (V_R) 5 V
 Forward Current (I_F) 40 mA
 Surge Current (I_{FS}), $t \leq 10 \mu s$ 0.5 A
 Total Power Dissipation (P_{TOT}), $T_A = 25^\circ C$ 140 mW
 Thermal Resistance,
 Junction to Air (R_{THJA}) 400 K/W

Characteristics ($T_A = 25^\circ C$)

Parameter	Sym	Super-				Pure		Unit
		Red	Red	Orange	Yellow	Green	Green	
Peak Wavelength (typ.)	λ_{PEAK}	660	635	610	586	565	557	nm
Dominant Wavelength (typ.)	λ_{DCM}	645	628	605	590	520	560	nm
Spectral Bandwidth 50% I_{RELMAX} , $I_F = 20$ mA	$\Delta\lambda$	35	45	40	45	25	22	nm
Viewing Angle (50%, I_V)	2ϕ	70	70	70	70	70	70	Deg.
Forward Voltage ($I_F = 10$ mA)	V_F	1.6	2.0	2.0	2.0	2.0	2.0	V
Reverse Current ($V_R = 5$ V)	I_R	0.01	0.01	0.01	0.01	0.01	0.01	μA
Capacitance ($V_R = 0$ V, $f = 1$ MHz)	C_0	25	12	8	10	15	75	pF
Rise Time	t_R	120	300	300	300	450	450	ns
Fall Time	t_F	50	150	150	150	200	200	ns
Luminous Intensity (mcd)								

Part Number	Test			Part Number	Test		
	Min.	Max.	Condition		Min.	Max.	Condition
LR 3360-DG	0.4	3.2	10 mA	LY 3360-HL	2.5	20	10 mA
LR 3360-F	1	2	10 mA	LY 3360-J	4	8	10 mA
LR 3360-FJ	1	8	10 mA	LY 3360-JM	4	32	10 mA
LR 3360-G	1.6	3.2	10 mA	LY 3360-K	6.3	12.5	10 mA
LS 3360-HL	2.5	20	10 mA	LG 3360-GK	1.6	12.5	10 mA
LS 3360-J	4	8	10 mA	LG 3360-J	4	8	10 mA
LS 3360-K	6.3	12.5	10 mA	LG 3360-JM	4	32	10 mA
LS 3360-KN	6.3	50	10 mA	LG 3360-K	6.3	12.5	10 mA
LO 3360-HL	2.5	20.0	10 mA	LP 3360-GK	1.6	12.5	10 mA
LO 3360-J	4	8	10 mA				
LO-3360-K	6.3	12.5	10 mA				
LO-3360JM	4	32	10 mA				

See graph numbers 1, 2A, 3A, 4A, 5A, 6A, 7A, 8A, 9A, 10A in the back of this section.

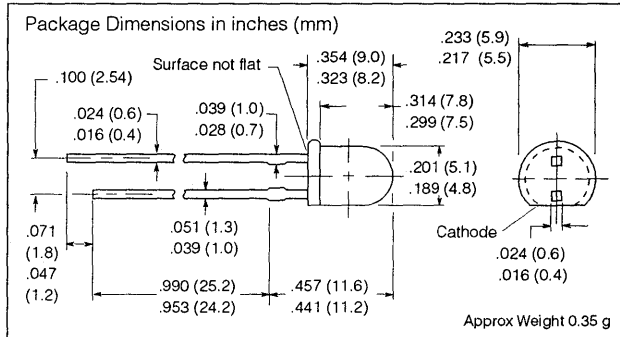
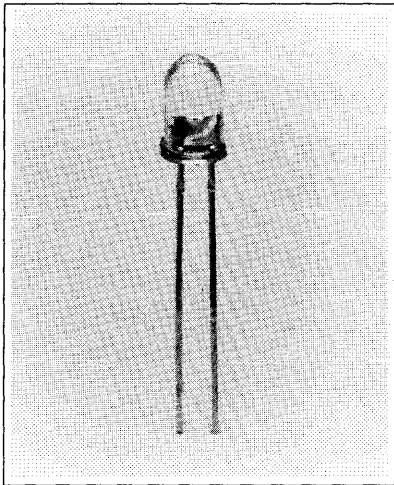

LED Lamps

FEATURES

- High Light Output
- Diffused Lens
- Wide Viewing Angle 50°
- With Standoffs
- T1³/₄ (5 mm) Package Size
- 1" Lead Length
- I/C Compatible

DESCRIPTION

The LR 5360 is a standard red gallium arsenide phosphide (GaAsP) LED lamp. The LS 5360 super-red and LY 5360 yellow are premium high efficiency light emitting diode lamps fabricated with TSN (transparent substrate nitrogen) technology. The LG 5360 green is a gallium phosphide (GaP) lamp. All have a diffused plastic lens which emits a full flooded intense light.

See graph numbers 1, 2D, 3A, 4A, 5A, 6A, 7A, 8A, 9A, 10A in the back of this section.

Maximum Ratings

Operating Temperature Range (T _{OP})	-55°C to +100°C
Storage Temperature Range (T _{STG})	-55°C to +100°C
Junction Temperature (T _J)	100°C
Reverse Voltage (V _R)	5 V
Forward Current (I _F)	40 mA
Surge Current (I _{FC}) t≤10 μs	0.5 A
Total Power Dissipation (P _{TOT}) T _A =25°C	140 mW
Thermal Resistance Junction to Air (R _{THJA})	400 K/W

Characteristics (T_A=25°C)

Parameter	Symbol	LED Type				Unit
		LR 5360 Red	LS 5360 Super-Red	LY 5360 Yellow	LG 5360 Green	
Peak Wavelength	λ _{PEAK}	660	635	586	565	nm
Dominant Wavelength	λ _{DOM}	645	628	590	570	nm
Spectral Bandwidth (50% I _{RELMAX} , I _F =20 mA)	Δλ	35	45	45	25	nm
Viewing Angle 50% I _V	2 φ	50	50	50	50	Deg.
Forward Voltage (I _F =10 mA)	V _F	1.6(±2.0)	2.0(±2.6)	2.0(±2.6)	2.0(±2.6)	V
Reverse Current (V _R ≤5 V)	I _R	0.01(≤10)	0.01(≤10)	0.01(≤10)	0.01(≤10)	μA
Capacitance (V _R =0 V, f = 1 MHz)	C ₀	25	12	10	15	pF
Rise Time	t _R	120	300	300	450	ns
Fall Time	t _F	50	150	150	200	ns
Luminous Intensity (mcd)*						

Part Number	Test			Part Number	Test		
	Min.	Max.	Condition		Min.	Max.	Condition
LR 5360-DG	0.4	3.2	10 mA	LY 5360-HL	2.5	20	10 mA
LR 5360-F	1	2	10 mA	LY 5360-JM	4	32	10 mA
LR 5360-FJ	1	8	10 mA	LY 5360-J	4	8	10 mA
LR 5360-G	1.6	3.2	10 mA	LY 5360-K	6.3	12.5	10 mA
LS 5360-HL	2.5	20	10 mA	LY5360-L	10	20	10 mA
LS 5360-J	4	8	10 mA	LG 5360-GK	1.6	12.5	10 mA
LS 5360-K	6.3	12.5	10mA	LG 5360-H	2.5	5	10 mA
LS 5360-KN	6.3	50	10 mA	LG 5360-J	4	8	10 mA
LS 5360-L	10	20	10 mA	LG 5360-JM	4	32	10 mA
				LG 5360-K	6.3	12.5	10 mA

* Luminous intensity factor of I_V of one packaging unit I_{VMAX}/I_{VMIN} ≥ 2

SIEMENS

RED LR 5460
SUPER-RED LS 5460
YELLOW LY 5460
GREEN LG 5460
T1³/₄ (5 mm) LED Lamp

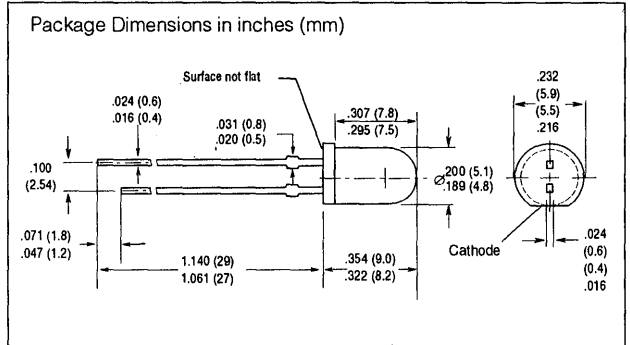
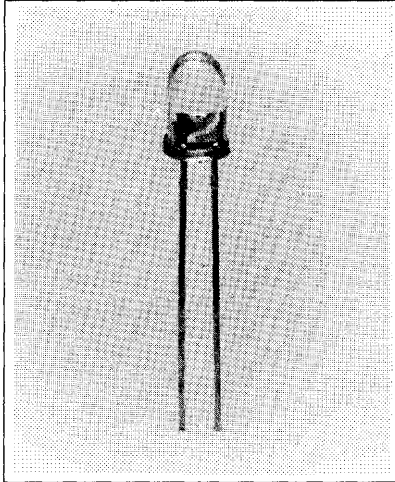

FEATURES

- High Light Output
- Diffused Lens
- Wide Viewing Angle 50°
- With Standoffs
- T1³/₄ (5 mm) Package Size
- 1" Lead Length
- I/C Compatible

DESCRIPTION

The LR 5460 series is a standard red gallium arsenide phosphide (GaAsP) LED lamp. The LS 5460 super-red and LY 5460 yellow are premium high efficiency light emitting diode lamps fabricated with TSN (transparent substrate nitrogen) technology. The LG 5460 green is a gallium phosphide (GaP) lamp. All have a diffused plastic lens which emits a full flooded intense light.

See graph numbers 1, 2D, 3A, 4A, 5A, 6A, 7A, 8A, 9A, 10A in the back of this section.

Maximum Ratings

Operating Temperature Range (T _{OP})	-55°C to +100°C
Storage Temperature Range (T _{STG})	-55°C to +100°C
Junction Temperature (T _J)	100°C
Reverse Voltage (V _R)	5 V
Forward Current (I _F)	40 mA
Surge Current (I _{FS}), t ≤ 10 μs	0.5 A
Total Power Dissipation (P _{TOT}), T _A = 25°C	140 mW
Thermal Resistance Junction to Air (R _{THJA})	400 K/W

Characteristics (T_A = 25°C)

Parameter	Sym	Red	Super-Red	Yellow	Green	Unit
Peak Wavelength	λ _{PEAK}	660	635	586	565	nm
Dominant Wavelength	λ _{DOM}	645	628	590	570	nm
Spectral Bandwidth (typ.) (50% I _{RELMAX} , I _F = 20 mA) Δλ		35	45	45	25	nm
Viewing Angle (50% I _V)	2φ	50	50	50	50	Deg.
Forward Voltage (I _F = 10 mA)	V _F	1.6 (≤2.0)	2.0 (≤2.6)	2.0 (≤2.6)	2.0 (≤2.6)	V
Reverse Current (V _R = 5 V)	I _R	0.01 (≤10)	0.01 (≤10)	0.01 (≤10)	0.01 (≤10)	μA
Capacitance (V _R = 0 V, f = 1 MHz)	C ₀	25	12	10	15	pF
Rise Time	t _R	120	300	300	450	ns
Fall Time	t _F	50	150	150	200	ns

Luminous Intensity (mcd)				Test		
Part Number	Min.	Max.	Condition	Part Number	Min.	Max.
LR 5460-DG	0.4	3.2	10 mA	LY 5460-HL	2.5	20
LR 5460-F	1	2	10 mA	LY 5460-J	4	8
LR 5460-FJ	1	8	10 mA	LY 5460-JM	4	32
LR 5460-G	1.6	3.2	10 mA	LY 5460-K	6.3	12.5
LS 5460-HL	2.5	20	10 mA	LY 5460-L	10	20
LS 5460-J	4	8	10 mA	LG 5460-GK	1.6	12.5
LS 5460-K	6.3	12.5	10 mA	LG 5460-H	2.5	5
LS 5460-KN	6.3	50	10 mA	LG 5460-J	4	8
LS 5460-L	10	20	10 mA	LG 5460-JM	4	32
				LG 5460-K	6.3	12.5

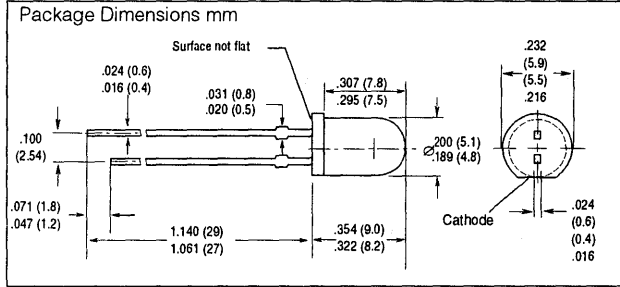
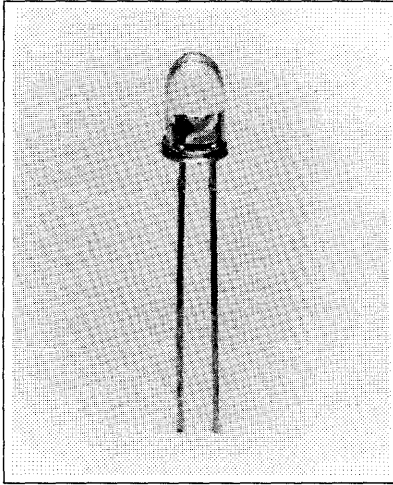

LED Lamps

FEATURES

- Diffused Lens
- Wide Viewing Angle 80°
- Without Standoffs
- T1³/₄ (5 mm) Package Size
- 1≤ Lead Length
- I/C Compatible

DESCRIPTION

The LR 5480 series is a standard red gallium arsenide phosphide (GaAsP) LED lamp. The LS 5480 super-red and LY 5480 yellow are premium high efficiency light emitting diode lamps fabricated with TSN (transparent substrate nitrogen) technology. The LG 5480 green is a gallium phosphide (GaP) lamp. All have a diffused plastic lens, which emits a full flooded intense light.

Maximum Ratings

Storage Temperature Range (T _{STG})	-55°C to +100°C
Junction Temperature (T _J)	100°C
Reverse Voltage (V _R)	5 V
Forward Current (I _F)	40 mA
Surge Current (t ≤ 10 μs) (I _{FS})	0.5 A
Total Power Dissipation (P _{TOT}) (T _A = 25°C)	140 mW
Thermal Resistance Junction to Air (R _{THJA})	400 K/W

Characteristics (T_A=25°C)

Parameter	Sym	LR 5480 Red	LS 5480 Super-Red	LY 5480 Yellow	LG 5480 Green	Unit
Wavelength at						
Peak Emission	λ _{PEAK}	660	635	586	565	nm
Dominant Wavelength	λ _{DOM}	645	628	590	570	nm
Spectral Bandwidth (50% I _{RELMAX} , I _F =20 mA)	Δλ	35	45	45	25	nm
Viewing Angle (Limits for 50% of Luminous Intensity I _V)	φ	80	80	80	80	Deg.
Forward Voltage (I _F =10 mA)	V _F	1.6(≤2.0)	2.0(≤2.6)	2.0(≤2.6)	2.0(≤2.6)	V
Reverse Current (V _R =5 V)	I _R	0.01(≤10)	0.01(≤10)	0.01(≤10)	0.01(≤10)	μA
Capacitance (V _R =0 V, f = 1 MHz)	C ₀	25	12	10	15	pF
Rise Time	t _R	120	300	300	450	ns
Fall Time	t _F	50	150	150	200	ns
Luminous Intensity (mcd)*						

Part Number	Min.	Max.	Condition	Part Number	Min.	Max.	Condition
LR 5480-CF	0.25	2	10 mA	LY 5480-GK	1.6	12.5	10 mA
LR 5480-DG	0.4	3.2	10 mA	LY 5480-L	10	20	10 mA
LR 5480-E	0.63	1.25	10 mA				
LR 5480-F	1	2	10 mA	LY 5480-JM	4	32	10 mA
LS 5480-GK	1.6	12.5	10 mA	LY 5480-K	6.3	12.5	10 mA
LS 5480-J	4	8	10 mA	LG 5480-GK	1.6	12.5	10 mA
LS 5480-JM	4	32	10 mA	LG 5480-H	2.5	5	10 mA
LS 5480-K	6.3	12.5	10 mA	LG 5480-J	4	8	10 mA
				LG 5480-JM	4	32	10 mA
				LG 5480-K	6.3	12.5	10 mA

See graph numbers 1, 2R, 3A, 4A, 5A, 6A, 7A, 8A, 9A, 10A in the back of this section.

* Luminous intensity factor of I_V of one packaging unit I_{VMAX}/I_{VMIN} ≥

SIEMENS

RED LR B480
SUPER-RED LS B480
YELLOW LY B480
GREEN LG B480

Rectangular LED Lamp

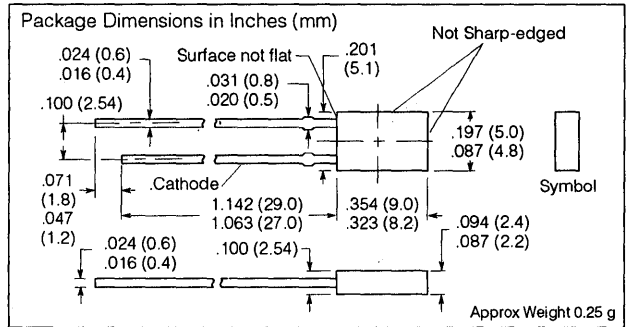
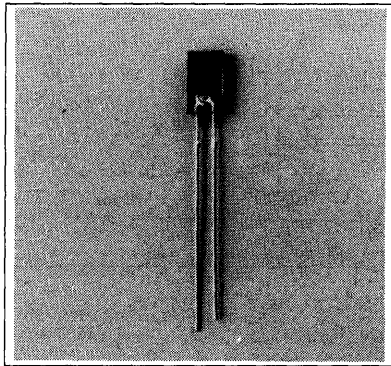

FEATURES

- Partly Diffused Colored Lens
- Rectangular Shape
- 1" Minimum Lead Length
- .100" Lead Spacing
- I/C Compatible

DESCRIPTION

The LR B480 is a standard red GaAsP LED lamp. The LS B480 super-red and LY B480 yellow are light emitting diode lamps fabricated with TSN (transparent substrate nitrogen) technology. The LGB480 green is a gallium phosphide LED lamp. All these lamps have a diffused lens which forms an evenly dispersed rectangular head-on light. They can be used separately as indicators or stacked together to form arrays.

See graph numbers 1, 2P, 3A, 4A, 5A, 6A, 7A, 8A, 9A, 10A in the back of this section.

Maximum Ratings

Operating Temperature Range (T_{OP})	-55°C to +100°C
Storage Temperature Range (T_{STG})	-55°C to +100°C
Junction Temperature (T_J)	100°C
Reverse Voltage (V_R)	5 V
Forward Current (I_F)	40 mA
Surge Current (I_{FS}) $t \leq 10 \mu s$	0.5 A
Total Power Dissipation (P_{TOT}) $T_A = 25^\circ C$	140 mW
Thermal Resistance, Junction/Air (R_{THJA})	400 K/W

Characteristics ($T_A = 25^\circ C$)

Parameter	Sym	LR B480	LS B480	LY B480	LG B480	Unit	
		Red	Super-Red	Yellow	Green		
Wavelength of Emitted Light	λ_{PEAK}	660	635	586	565	nm	
Dominant Wavelength	λ_{DOM}	645	628	590	570	nm	
Spectral Bandwidth (50% I_{RELMAX} , $I_F = 20$ mA)	$\Delta\lambda$	35	45	45	25	nm	
Viewing Angle 50% I_V	2ϕ	100	100	100	100	Deg.	
Forward Voltage ($I_F = 10$ mA)	V_F	1.6 (≤ 2.0)	2.0 (≤ 2.6)	2.0 (≤ 2.6)	2.0 (≤ 2.6)	V	
Reverse Current ($V_R = 5$ V)	I_R	0.1 (≤ 10)	0.01 (≤ 10)	0.01 (≤ 10)	0.01 (≤ 10)	μA	
Capacitance ($V_R = 0$ V)	C_0	25	12	10	15	pF	
Rise Time	t_R	120	300	300	450	ns	
Fall Time	t_F	50	150	150	200	ns	
Luminous Intensity (mcd)*							
		<i>Test</i>			<i>Test</i>		
<i>Part Number</i>	<i>Min.</i>	<i>Max.</i>	<i>Condition</i>	<i>Part Number</i>	<i>Min.</i>	<i>Max.</i>	<i>Condition</i>
LR B480-BD	0.16	0.8	10 mA	LY B480-EH	0.63	5	10 mA
LR B480-C	0.25	0.5	10 mA	LY B480-G	1.6	3.2	10 mA
LR B480-D	0.4	0.8	10 mA	LY B480-GK	1.6	12.5	10 mA
LS B480-EH	0.63	5	10 mA	LY B480-H	2.5	5.0	10 mA
LS B480-G	1.6	3.2	10 mA	LG B480-G	1.6	3.2	10 mA
LS B480-GK	1.6	12.5	10 mA	LG B480-GK	1.6	12.5	10 mA
LS B480-H	2.5	5	10 mA	LG B480-H	2.5	5.0	10 mA

* Luminous intensity factor of I_V of one packaging unit $I_{VMAX}/I_{VMIN} \geq 2$

RED LR H380 SUPER-RED LS H380 YELLOW LY H380 GREEN LG H380 Cylindrical LED Lamp

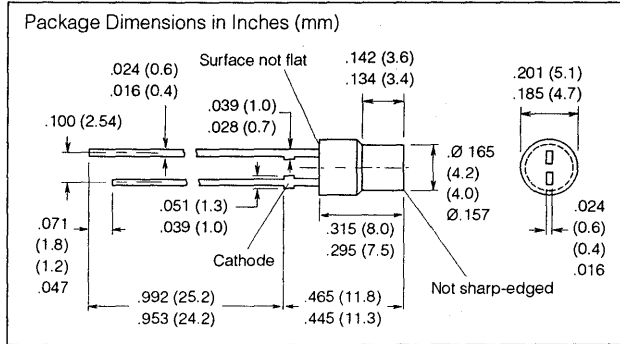
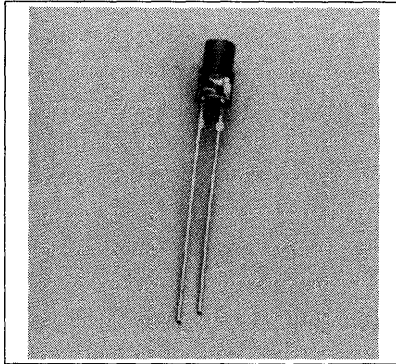

FEATURES

- Lens, Partly Diffused
 - Red, LR H380 and LS H380
 - Yellow, LY H380
 - Green, LG H380
- Cylindrical Shape
- 1" Minimum Lead Length
- 0.100" (2.54 mm) Lead Spacing
- I/C Compatible

DESCRIPTION

The LR H380 is a standard red GaAsP LED lamp. The LS H380 and LY H380 are light emitting diode lamps fabricated with TSN (transparent substrate nitrogen) technology. The LG H380 is a gallium phosphate LED lamp. All the series have a diffused lens which forms an evenly dispersed circular head-on light.

See graph numbers 1, 2P, 3A, 4A, 5A, 6A, 7A, 8A, 9A, 10A in the back of this section.

Maximum Ratings

Operating Temperature Range (T_{OP})	-55°C to +100°C
Storage Temperature Range (T_{STG})	-55°C to +100°C
Junction Temperature (T_J)	100°C
Reverse Voltage (V_R)	5 V
Forward Current (I_F)	40 mA
Surge Current (I_{FS}) $t \leq 10 \mu s$	0.5 A
Power Dissipation (P_{TOT}) $T_A = 25^\circ C$	140 mW
Thermal Resistance Junction to Air (R_{THJA})	400 K/W

Characteristics ($T_A = 25^\circ C$)

Parameter	LR H380				LS H380		LY H380		LG H380		Unit	
	Sym	Red	Super-Red	Yellow	Green	Green	Green	Green	Green			
Wavelength of Emitted Light	λ_{PEAK}	660	635	586	565					nm		
Dominant Wavelength	λ_{DOM}	645	628	590	570					nm		
Spectral Bandwidth, (50% I_{RELMAX} , $I_F = 20 \text{ mA}$)	$\Delta\lambda$	35	45	45	25					nm		
Viewing Angle (50% I_V)	2ϕ	100	100	100	100					Deg.		
Forward Voltage ($I_F = 10 \text{ mA}$)	V_F	1.6 (≤ 2.0)	2.0 (≤ 2.6)	2.0 (≤ 2.6)	2.0 (≤ 2.6)					V		
Reverse Current ($V_R = 5 \text{ V}$)	I_R	0.01 (≤ 10)	0.01 (≤ 10)	0.01 (≤ 10)	0.01 (≤ 10)					μA		
Capacitance ($V_R = 0 \text{ V}$)	C_D	25	12	10	15					pF		
Rise Time	t_r	120	300	300	450					ns		
Fall Time	t_f	50	150	150	200					ns		
Luminous Intensity (mcd)*	<i>Test</i>				<i>Test</i>				<i>Test</i>			
	<i>Part Number</i>	<i>Min.</i>	<i>Max.</i>	<i>Condition</i>	<i>Part Number</i>	<i>Min.</i>	<i>Max.</i>	<i>Condition</i>	<i>Part Number</i>	<i>Min.</i>	<i>Max.</i>	<i>Condition</i>
	LR H380-BD	0.16	0.8	10 mA	LY H380-EH	0.63	5	10 mA				
	LR H380-C	0.25	0.5	10 mA	LY H380-G	1.6	3.2	10 mA				
	LR H380-D	0.4	0.8	10 mA	LY H380-GK	1.6	12.5	10 mA				
	LS H380-EH	0.63	0.5	10 mA	LY H380-H	2.5	5	10 mA				
	LS H380-G	1.6	3.2	10 mA	LG H380-EH	0.63	5	10 mA				
	LS H380-GK	1.6	12.5	10 mA	LG H380-G	1.6	3.2	10 mA				
	LS H380-H	2.5	5	10 mA	LG H380-GK	1.6	12.5	10 mA				
					LG H380-H	2.5	5.0	10 mA				

* Luminous intensity factor of I_V of one packaging unit $I_{VMAX}/I_{VMIN} \geq 2$

SIEMENS

SINGLE LR Z181 2 to 10 DIODE ARRAYS LR Z182-189/180 Red Miniature LED Lamp

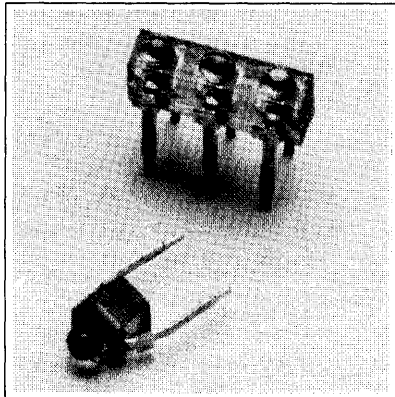

FEATURES

- Red Diffused Lens, Emits Red Light
- Miniature Size
- Single Lamp and 2 to 10 Diode Arrays
- 0.100" (2.54 mm) Lead Spacing
- End Stackable to Arrays of Any Length
- I/C Compatible

DESCRIPTION

The LR Z18X series are red gallium arsenide phosphide LED solid state lamps. The single lamps or arrays may be used individually or stacked together to form arrays of any length. Typical applications are position indicators such as meters and scales.

Maximum Ratings (Individual Diode)

Operating/Storage Temperature	
Range (T_{OP} , T_{STG})	-40°C to +80°C
Junction Temperature (T_J)	100°C
Forward Current (I_F)	30 mA
Surge Current (I_{FM}) $t \leq 10 \mu s$	0.5 A
Reverse Voltage (V_R)	5 V
Power Dissipation (P_{TOT}), $T_A = 25^\circ C$	90 mW
Thermal Resistance	
Junction to Air (R_{THJA})	750 K/W

Note:

Mounted on PC board: pad size $\geq 16 \text{ mm}^2$

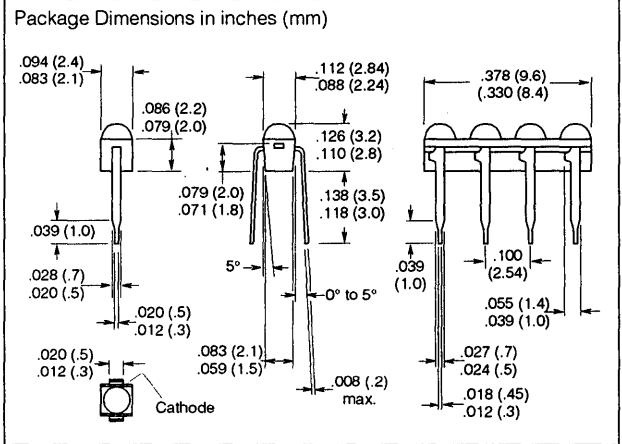

Characteristics ($T_A = 25^\circ C$)

Parameter	Symbol	Value	Unit	Condition
Wavelength, Peak Emission (typ.)	λ_{PEAK}	660	nm	$I_F = 20 \text{ mA}$
Dominant Wavelength (typ.)	λ_{DOM}	645	nm	$I_F = 20 \text{ mA}$
Spectral Bandwidth (typ.)	$\Delta\lambda$	35	nm	$I_F = 20 \text{ mA}$
50% I_{RELMAX}				
Viewing Angle, 50% I_V	2ϕ	100	Deg.	
Forward Voltage (typ.)	V_F	1.6	V	$I_F = 10 \text{ mA}$
(max.)	V_F	2.0	V	$I_F = 10 \text{ mA}$
Reverse Current (typ.)	I_R	0.01	μA	$V_R = 5 \text{ V}$
(max.)	I_R	10	μA	$V_R = 5 \text{ V}$
Capacitance (typ.)	C_0	25	pF	$V_R = 0 \text{ V}$, $f = 1 \text{ MHz}$
Switching Time				
I_V , 10% to 90% (typ.)	t_R	120	ns	$I_F = 100 \text{ mA}$, $t_F = 10 \mu s$,
I_V , 90% to 10% (max.)	t_F	50	ns	$R_L = 50 \Omega$

Luminous Intensity*

Part Number	No. of LEDs	Test Min.	Test Condition	Part Number	No. of LEDs	Test Min.	Test Condition
LR Z181-CO	1	0.25	10 mA	LR Z186-CO	6	0.25	10 mA
LR Z182-CO	2	0.25	10 mA	LR Z187-CO	7	0.25	10 mA
LR Z183-CO	3	0.25	10 mA	LR Z188-CO	8	0.25	10 mA
LR Z184-CO	4	0.25	10 mA	LR Z189-CO	9	0.25	10 mA
LR Z185-CO	5	0.25	10 mA	LR Z180-CO	10	0.25	10 mA

* Luminous intensity factor of I_V of one packaging unit $I_{VMAX}/I_{VMIN} \geq 2$

See graph numbers 1, 2U, 3A, 4A, 6F, 7A, 8A, 9A, 10A in the back of this section.

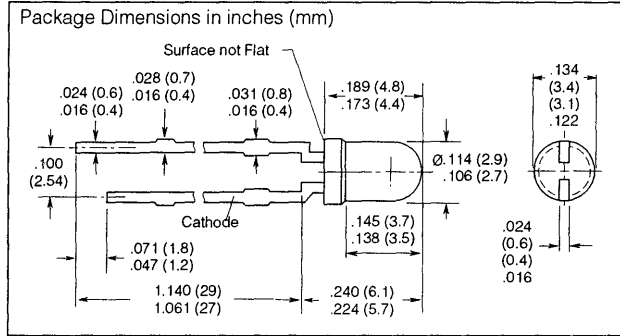
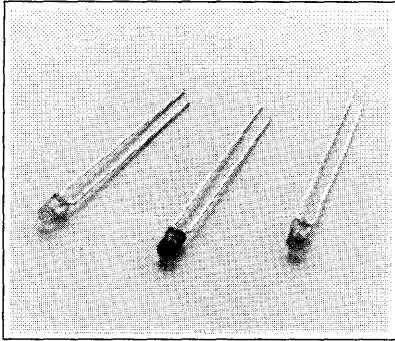

FEATURES

- High Light Output
- Lens:
 - Super-Red, Orange, Yellow: Tinted Clear
 - Green: Colorless Clear
- Viewing Angle 50°
- T1 (3 mm) Package Size
- 1" Lead Length
- IC Compatible

DESCRIPTION

The LS 3340 super-red, LO 3340 orange and the LY 3340 yellow are premium high efficiency light emitting diode lamps fabricated with TSN (transparent substrate nitrogen) technology. The LG 3330 green series is a gallium phosphide (GaP) lamp. All have tinted colored lenses (except green which has a colorless lens).

Maximum Ratings

Operating Temperature Range (T_{OP}) -55°C to +100°C
Storage Temperature Range (T_{STG}) -55°C to +100°C
Junction Temperature (T_J) 100°C
Reverse Voltage (V_R) 5 V
Forward Current (I_F) 40 mA
Surge Current (I_{FS}) $t=10 \mu s$ 0.5 A
Total Power Dissipation (P_{TOT}) $T_A=25^\circ C$ 140 mW
Thermal Resistance Junction to Air (R_{THJA}) 400 K/W

Characteristics ($T_A=25^\circ C$) All values typical unless otherwise noted.

Parameter	Sym	LS 3340	LY 3340	LO 3340	LG 3330	Unit
		Super-Red	Yellow	Orange	Green	
Peak Wavelength	λ_{PEAK}	635	586	610	565	nm
Dominant Wavelength	λ_{DOM}	628	590	605	570	nm
Spectral Bandwidth (50% I_{RELMAX} , $I_F=20$ mA)	$\Delta\lambda$	45	45	40	25	nm
Viewing Angle (50% of I_V)	2ϕ	50	50	50	50	Deg.
Forward Voltage ($I_F=10$ mA)	V_F	2.0 (≤ 2.6)	2.0 (≤ 2.6)	2.0 (≤ 2.6)	2.0 (≤ 2.6)	V
Reverse Current ($V_R=5$ V)	I_R	0.01 (≤ 10)	0.01 (≤ 10)	0.01 (≤ 10)	0.01 (≤ 10)	μA
Capacitance ($V_R=0$ V, $f=1$ MHz)	C_0	12	10	8	15	pF
Rise Time	t_R	300	300	300	450	ns
Fall Time	t_F	150	150	150	200	ns

Luminous Intensity (mcd)*

Part Number	Test			Part Number	Test		
	Min.	Max.	Condition		Min.	Max.	Condition
LS 3340-KN	6.3	50	10 mA	LY3340-JM	4	32	10 mA
LS 3340-MP	16	80	10 mA	LY 3340-LP	10	80	10 mA
LS 3340-M	16	32	10 mA	LY 3340-L	10	20	10 mA
LS 3340-N	25	50	10 mA	LY 3340-M	16	32	10 mA
LO 3340-KN	6.3	20	10 mA	LG 3330-KN	6.3	50	10 mA
LO 3340-M	10	20	10 mA	LG 3330-L	10	20	10 mA
LO 3340-MP	10	80	10 mA	LG 3330-LP	10	80	10 mA
LO 3340-N	16	32	10 mA	LG 3330-M	16	32	10 mA
				LG 3330-N	25	50	10 mA

* Luminous intensity factor of I_V of one packaging unit $I_{VMAX}/I_{VMIN} \geq 2$.

See graphs 1, 2B, 3A, 4A, 5A, 6A, 7B, 8A, 9A, 10A in the back of this section.

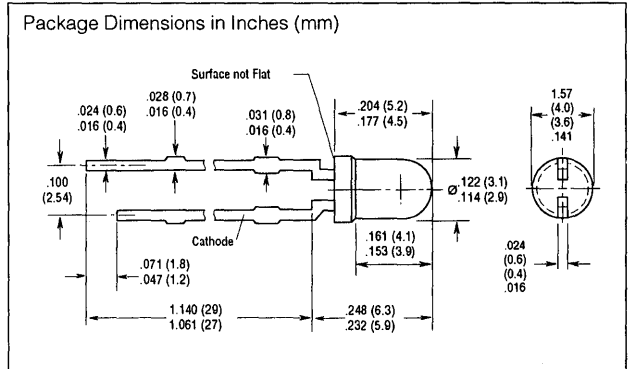
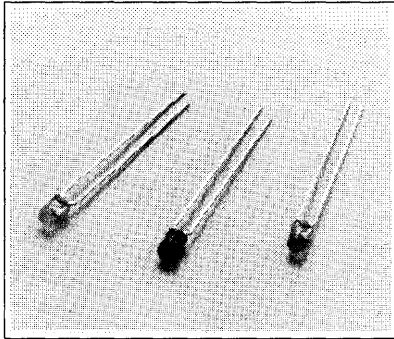

FEATURES

- High Light Output
- Lens-Tinted Clear
- Viewing Angle 40°
- T1 (3 mm) Package Size
- 1" Lead Length
- I/C Compatible

DESCRIPTION

The LS 3341 super-red series and the LY 3341 yellow are premium high efficiency light emitting diode lamps fabricated with TSN (transparent substrate nitrogen) technology. The LG 3341 green series is a gallium phosphide (GaP) lamp. All have a clear plastic lens.

Maximum Ratings

Operating Temperature	
Range (T_{OP})	-55°C to +100°C
Storage Temperature	
Range (T_{STG})	-55°C to +100°C
Junction Temperature (T_J)	
	100°C
Reverse Voltage (V_R)	5 V
Forward Current (I_F)	40 mA
Surge Current (I_{FS}) $t=10 \mu s$	0.5 A
Total Power Dissipation	
(P_{TOT}) $T_A=25^\circ C$	140 mW
Thermal Resistance	
Junction to Air (R_{THJA})	400 K/W

Note: Soldered on PC board: pad size $\geq 16 \text{ mm}^2$

Characteristics ($T_A=25^\circ C$)

Parameter	Sym	LS 3341 Super-Red	LY 3341 Yellow	LG 3341 Green	Unit			
Peak Wavelength ($I_F=20 \text{ mA}$) (typ.)	λ_{PEAK}	635	586	565	nm			
Dominant Wavelength ($I_F=20 \text{ mA}$) (typ.)	λ_{DOM}	628	590	570	nm			
Spectral Bandwidth (typ.) (50% I_{RELMAX} , $I_F=20 \text{ mA}$)	$\Delta\lambda$	45	45	25	nm			
Viewing Angle (50% I_V)	2 ϕ	40	40	40	Deg.			
Forward Voltage ($I_F=10 \text{ mA}$)	V_F	2.0(≤ 2.6)	2.0(≤ 2.6)	2.0(≤ 2.6)	V			
Reverse Current ($V_R=5 \text{ V}$)	I_R	0.01(≤ 10)	0.01(≤ 10)	0.01(≤ 10)	μA			
Capacitance ($V_R=0 \text{ V}$, $f=1 \text{ MHz}$)	C_O	12	10	15	pF			
Rise Time	t_R	300	300	450	ns			
Fall Time	t_F	150	150	200	ns			
Luminous Intensity (mcd)*	<i>Test</i>				<i>Test</i>			
	<i>Part Number</i>	<i>Min.</i>	<i>Max.</i>	<i>Condition</i>	<i>Part Number</i>	<i>Min.</i>	<i>Max.</i>	<i>Condition</i>
	LS 3341-KN	6.3	50	10 mA	LG 3341-JM	4	32	10 mA
	LS3341-M	16	32	10 mA	LG 3341-L	10	20	10 mA
	LS 3341-MQ	16	125	10 mA	LG 3341-LP	10	80	10 mA
	LS 3341-N	25	50	10 mA	LG 3341-M	16	32	10 mA
	LY3341-JM	4	32	10 mA				
	LY 3341-L	10	20	10 mA				
	LY 3341-LP	10	80	10 mA				
	LY3341-M	16	32	10 mA				

* Luminous intensity factor of I_V of one packaging unit $I_{VMAX}/I_{VMIN} \geq 2$

See graph numbers 1, 2C, 3A, 4A, 5A, 6A, 7A, 8A, 9A, 10A in the back of this section.

Low Current T1 (3 mm) LED Lamp

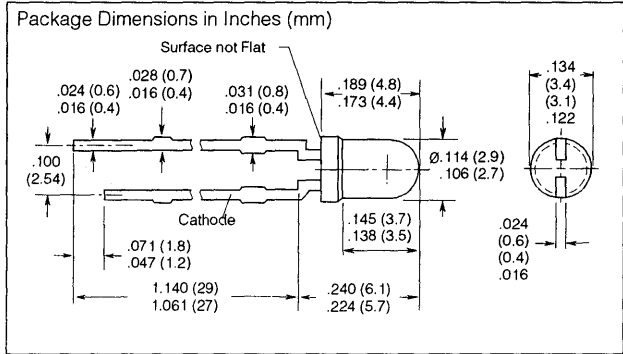
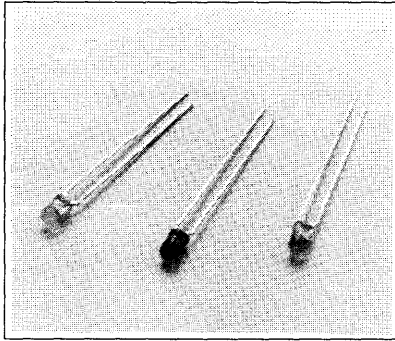

FEATURES

- Low Power Requirement
- 60° Viewing Angle
- Diffused Lens
- 1" Lead Length
- I/C Compatible

DESCRIPTION

The 3369 series are low current LED lamps that have been designed to optimize light output at very low currents. These parts are ideally suited for applications where power is at a premium, such as portable equipment.

Maximum Ratings

Operating Temperature Range (T_{OP})	-55°C to +100°C
Storage Temperature Range (T_{STG})	-55°C to +100°C
Junction Temperature (T_J)	100°C
Reverse Voltage (V_R)	5 V
Forward Current (I_F)	7.5 mA
Surge Current (I_{FS}) $t=10 \mu s/D \leq 0.005$	150 mA
Total Power Dissipation (P_{TOT}) $T_A=25^\circ C$	20 mW
Thermal Resistance Junction to Air (R_{THJA})	750 K/W

Note:
Soldered on PC board: pad size $\geq 16 \text{ mm}^2$.

Characteristics ($T_A=25^\circ C$) All values typical unless otherwise noted.

Parameter	Sym	LS 3369	LY 3369	LG 3369	Unit
		Super-Red	Yellow	Green	
Peak Wavelength ($I_F=7.5 \text{ mA}$)	λ_{PEAK}	635	586	565	nm
Dominant Wavelength ($I_F=7.5 \text{ mA}$)	λ_{DOM}	628	590	570	nm
Spectral Bandwidth (50% I_{RELMAX} , $I_F=7.5 \text{ mA}$)	$\Delta\lambda$	45	45	25	nm
Viewing Angle	2ϕ	60	60	60	Deg.
Forward Voltage ($I_F=2 \text{ mA}$)	V_F	1.8(≤ 2.6)	2.0(≤ 2.7)	1.9(≤ 2.6)	V
Reverse Current ($V_R=5 \text{ V}$)	I_R	0.01(≤ 10)	0.01(≤ 10)	0.01(≤ 10)	μA
Capacitance ($V_R=0 \text{ V}$, $f=1 \text{ MHz}$)	C_0	3	3	15	pF
Response Time ($I_F=100 \text{ mA}$, $t=10 \mu s$ $R_L=50\Omega$)					
Rise Time I_V from 10% to 90%	t_R	200	200	450	ns
Fall Time I_V from 90% to 10%	t_F	150	150	200	ns
Luminous Intensity					
Part Number	Min.	Typ.	Unit	Test Condition	
LS/LY/LG 3369-EH	0.63	5	mcd	2 mA	
LS/LY/LG 3369-FH	1	5	mcd	2 mA	

See graph numbers 1, 2L, 3B, 4D, 5C, 6C, 7A, 8A, 9B, 10A in the back of this section

SIEMENS

SUPER-RED LS 3380 YELLOW LY 3380 GREEN LG 3380

T1 (3 mm) Wide Angle LED Lamp

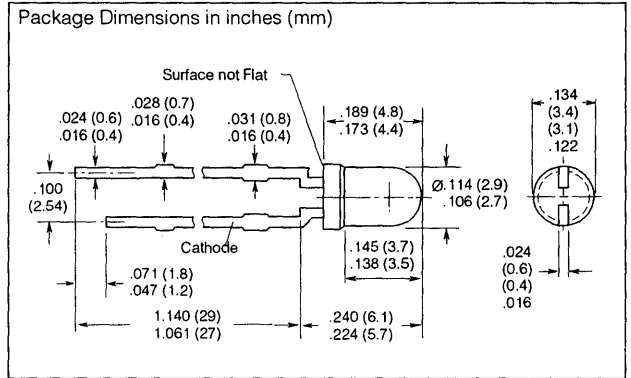
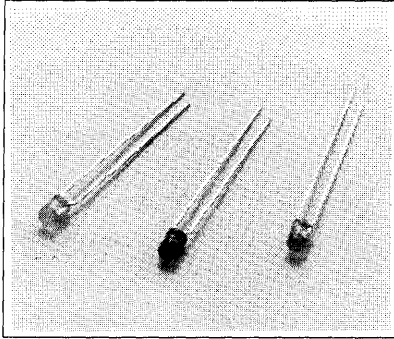

FEATURES

- Colors: Super-Red, Yellow, Green
- Lens: Red Diffused, Yellow Diffused, Green Diffused
- Low Power Dissipation
- Suitable for Multiplex Operation
- Wide Angle 100°

DESCRIPTION

The LS/LY/LG 3380 are T1 (3 mm) wide angle LED lamps. The 3 mm plastic package has colored diffused lenses to match the emission color and 2.54 mm lead spacing.

Maximum Ratings

Operating Temperature	
Range (T_{OP})	-55°C to +100°C
Storage Temperature	
Range (T_{STG})	-55°C to +100°C
Junction Temperature (T_J)	
	100°C
Reverse Voltage (V_R)	
	5 V
Forward Current (I_F)	
	40 mA
Surge Current (I_{FS}) $t=10 \mu s$	
	0.5 A
Total Power Dissipation	
(P_{TOT}) $T_A=25^\circ C$	140 mW
Thermal Resistance	
Junction to Air (R_{THJA})	400 K/W

Characteristics ($T_A=25^\circ C$)

Parameter	Sym	LS 3380	LY 3380	LG 3380	Unit
		Super-Red	Yellow	Green	
Peak Wavelength ($I_F=20$ mA)	λ_{PEAK}	635	586	565	nm
Dominant Wavelength	λ_{DOM}	628	590	570	nm
Spectral Bandwidth (typ.) (50% I_{RELMAX} , $I_F=20$ mA)	$\Delta\lambda$	45	45	25	nm
Viewing Angle 50% I_V	2ϕ	100	100	100	Deg.
Forward Voltage ($I_F=10$ mA)	V_F	2.0(≤ 2.6)	2.0(≤ 2.6)	2.0(≤ 2.6)	V
Reverse Current ($V_R=5$ V)	I_R	0.01(≤ 10)	0.01(≤ 10)	0.01(≤ 10)	μA
Capacitance ($V_R=0$ V, $f=1$ MHz)	C_0	12	10	45	pF
Rise Time, I_V					
I_V from 10% to 90%	t_R	300	300	450	ns
Fall Time, I_V					
I_V from 90% to 10%	t_F	150	150	200	ns
Luminous Intensity (mcd)*					

Part Number	Test			Part Number	Test		
	Min.	Max.	Condition		Min.	Max.	Condition
LS 3380-FJ	1.0	8.0	10 mA	LG 3380-GK	1.6	12.5	10 mA
LS 3380-H	2.5	5	10 mA	LG 3380-HL	2.5	2.0	10 mA
LS 3380-J	4	8	10 mA	LG 3380-H	2.5	5	10 mA
LS 3380-HL	2.5	20	10 mA	LG 3380-J	4.0	8.0	10 mA
LY 3380-FJ	1	8	10 mA				
LY 3380-H	2.5	5	10 mA				
LY 3380-HL	2.5	20	10 mA				
LY 3380-J	4	32	10 mA				
LY 3380-K	6.3	12.5	10 mA				

See graph numbers 1, 2P, 3A, 4A, 5A, 6A, 7A, 8A, 9A, 10A in the back of this section.

*Luminous intensity factor of I_V of one packaging unit $I_{VMAX}/I_{VMIN} \leq 2$.

T1³/₄ (5 mm) LED Lamp

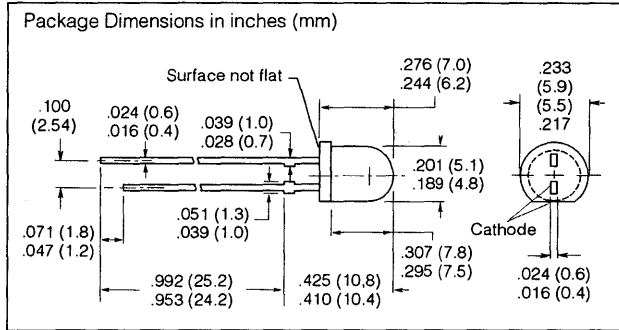
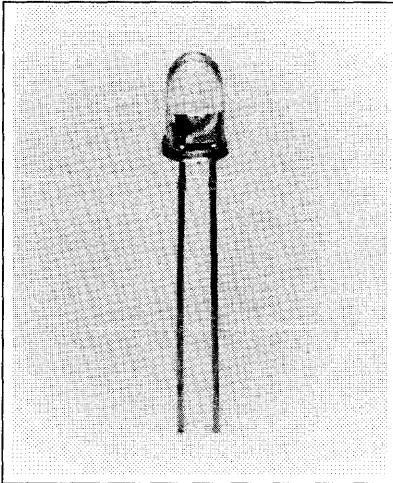

LED Lamps

FEATURES

- Diffused Lens
- Wide Viewing Angle 140°
- With Standoffs
- T1³/₄ (5 mm) Package Size
- 1" Lead Length
- IC Compatible

DESCRIPTION

The LS 5380 super-red and LY 5380 yellow are premium high efficiency light emitting diode lamps fabricated with TSN (transparent substrate nitrogen) technology. The LG 5380 green is a gallium phosphide (GaP) lamp. All have a diffused plastic lens which emits a full flooded intense light.

Maximum Ratings

Operating Temperature Range (T _{OP})-55°C to +100°C
Storage Temperature Range (T _{STG})-55°C to +100°C
Junction Temperature (T _J)100°C
Reverse Voltage (V _R)5 V
Forward Current (I _F)40 mA
Surge Current (I _{FS}) t=10 μs0.5 A
Total Power Dissipation (P _{TOT}) T _A =25°C140 mW
Thermal Resistance Junction to Air (R _{THJA})400 K/W

Characteristics (T_A=25°C)

Parameter	Sym	LS 5380 Super-Red	LY 5380 Yellow	LG 5380 Green	Unit
Peak Wavelength	λ _{PEAK}	635	586	565	nm
Dominant Wavelength	λ _{DOM}	628	590	570	nm
Spectral Bandwidth (50% I _{RELMAX} , I _F =20 mA)	Δλ	45	45	25	nm
Viewing Angle (50% I _V)	2 φ	140	140	140	Deg.
Forward Voltage (I _F =10 mA)	V _F	2.0 (≤2.6)	2.0 (≤2.6)	2.0 (≤2.6)	V
Reverse Current (V _R =5 V)	I _R	0.01 (≤10)	0.01 (≤10)	0.01 (≤10)	μA
Capacitance (V _R =0 V, f=1 MHz)	C ₀	12	10	15	pF
Rise Time	t _R	300	300	450	ns
Fall Time	t _F	150	150	200	ns

Luminous Intensity (mcd)*

Part Number	Test			Part Number	Test		
	Min.	Max.	Condition		Min.	Max.	Condition
LS 5380-FJ	1	8	10 mA	LG 5380-FJ	1	8	10 mA
LS 5380-H	2.5	5	10 mA	LG 5380-H	2.5	5	10 mA
LS 5380-HL	2.5	20	10 mA	LG 5380-HL	2.5	20	10 mA
LS 5380-J	4	8	10 mA	LG 5380-J	4	8	10 mA
LY 5380-EH	0.63	5	10 mA				
LY 5380-GK	1.6	12.5	10 mA				
LY 5380-H	2.5	5	10 mA				
LY 5380-J	4	8	10 mA				

See graph numbers 1, 2Q, 3A, 4A, 5A, 6A, 7A, 8A, 9A, 10A in the back of this section.

* Luminous intensity factor of I_V of one packaging unit I_{V MAX}/I_{V MIN} ≤ 2.

SIEMENS

SUPER-RED LS 5420 YELLOW LY 5420 GREEN LG 5410 T1³/₄ (5 mm) LED Lamp

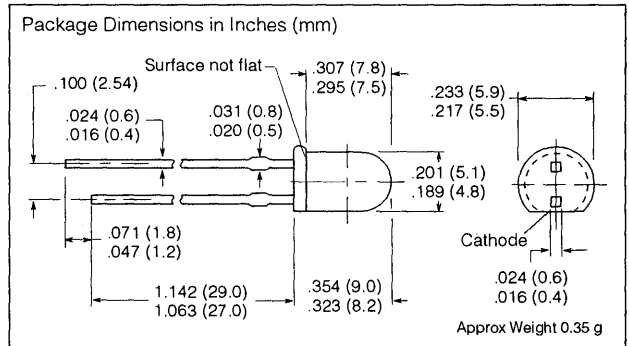
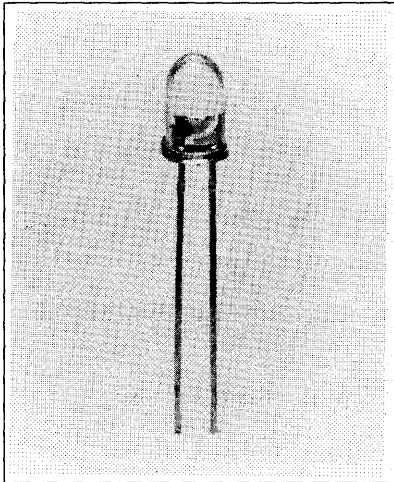

FEATURES

- High Light Output
- Water Clear Lens: Green Lightly Tinted
Clear Lens: Super-Red, Yellow
- Viewing Angle, 24°
- T1³/₄ (5 mm) Package Size
- 1" Lead Length
- Front Panel Mounting Snap-in Mounting
Clips Available
- I/C Compatible

DESCRIPTION

The LS 5420 super-red and LY 5420 yellow lamps are fabricated with TSN (transparent substrate nitrogen) technology. The LG 5410 is a gallium phosphide LED lamp. All three have a narrow viewing angle for the concentration of intense brightness in a head-on position. This is particularly desirable for legend back lighting applications.

See graph numbers 1, 2E, 3A, 4A, 5A, 6A, 7A, 8A, 9A, 10A in the back of this section.

Maximum Ratings

Operating Temperature Range (T_{OP})	-55°C to +100°C
Storage Temperature Range (T_{STG})	-55°C to +100°C
Junction Temperature (T_J)	100°C
Reverse Voltage (V_R)	5 V
Forward Current (I_F)	40 mA
Surge Current (I_{FS}) $t = 10 \mu s$	0.5 A
Total Power Dissipation (P_{TOT}) $T_A = 25^\circ C$	140 mW
Thermal Resistance: Junction/Air (R_{THJA})	400 K/W

Characteristics ($T_A = 25^\circ C$)

Parameter	Symbol	LS 5420	LY 5420	LG 5410	Unit		
		Super-Red	Yellow	Green			
Peak Wavelength	λ_{PEAK}	635	586	565	nm		
Dominant Wavelength	λ_{DOM}	628	590	570	nm		
Spectral Bandwidth (50% I_{RELMAX} , $I_F = 20$ mA)	$\Delta\lambda$	45	45	25	nm		
Viewing Angle 50% I_V	2ϕ	24	24	24	Deg.		
Forward Voltage ($I_F = 10$ mA)	V_F	2.0 (≤ 2.6)	2.0 (≤ 2.6)	2.0 (≤ 2.6)	V		
Reverse Current ($V_R = 5$ V)	I_R	0.01 (≤ 10)	0.01 (≤ 10)	0.01 (≤ 10)	μA		
Capacitance ($V_R = 0$ V, $f = 1$ MHz)	C_0	12	10	15	pF		
Rise Time	t_R	300	300	450	ns		
Fall Time	t_F	150	150	200	ns		
Luminous Intensity (mcd)*							
		<i>Test</i>					
<i>Part Number</i>	<i>Min.</i>	<i>Max.</i>	<i>Condition</i>	<i>Part Number</i>	<i>Min.</i>	<i>Max.</i>	<i>Condition</i>
LS 5420-MQ	16	125	10 mA	LY 5420-P	40	80	10 mA
LS 5420-PS	40	320	10 mA	LY 5420-Q	63	125	10 mA
LS 5420-P	40	80	10 mA	LG 5410-MQ	16	125	10 mA
LS 5420Q	63	125	10 mA	LG 5410-P	40	80	10 mA
LS 5420 R	100	200	10 mA	LG 5410P°C	40	320	10 mA
LY 5420-MQ	16	125	10 mA	LG 5410-Q	63	125	10 mA
LY 5420-PS	40	320	10 mA	LG 5410-R	100	200	10 mA

* Luminous intensity factor of I_V of one packaging unit $I_{VMAX}/I_{VMIN} \geq 2$.

Superbright T1³/₄ (5 mm) LED Lamp

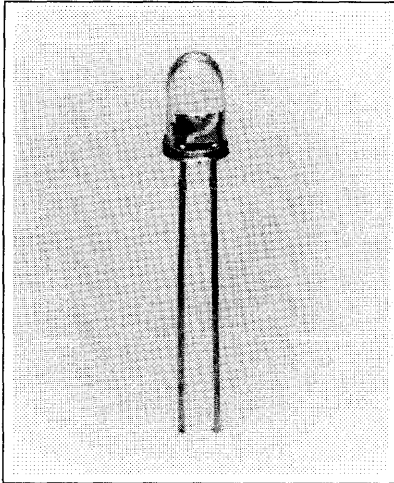

Package Dimensions in inches (mm)

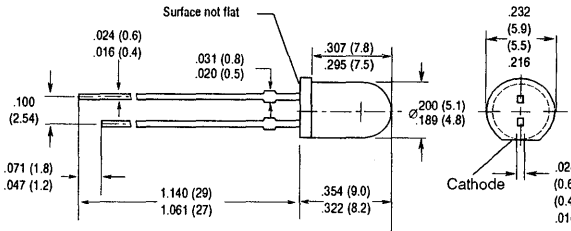

LED Lamps

FEATURES

- High Light Output
- New Lens to Optimize Output
- 20° Viewing Angle
- Super-Red, Red Tinted Lens Yellow, Green, Water Clear Lens
- 1" Lead Length

DESCRIPTION

The 5421/5411 series are superbright T1³/₄ (5mm) LED lamps. Improvements in materials and optimization of lens and reflectors have resulted in a dramatic increase in luminous intensity.

Maximum Ratings

Operating Temperature	
Range (T _{OP})	-55°C to +100°C
Storage Temperature	
Range (T _{STG})	-55°C to +100°C
Junction Temperature (T _J)	+100°C
Reverse Voltage (V _R)	5 V
Continuous Forward Current (I _F)	40 mA
Surge Current (t=10 μs) (I _{FS})	0.5 A
Power Dissipation (P _{TOT})	
T _{OP} =25°C	140 mW
Thermal Resistance,	
Junction to Air (R _{THJA})	400 K/W

See graph numbers 1, 2F, 3A, 4A, 5A, 6A, 7A, 8A, 9A, 10A in the back of this section.

Characteristics (T_A=25°C)

Parameter	Symbol	LS 5421 Super-Red	LY 5421 Yellow	LG 5411 Green	Unit
Peak Wavelength (I _F =10 mA) (typ.)	λ _{PEAK}	635	586	565	nm
Dominant Wavelength (I _F =20 mA) (typ.)	λ _{DCM}	628	590	570	nm
Spectral Bandwidth (typ.) (50% I _{RELMAX} , I _F =20 mA)	Δλ	45	45	25	nm
Viewing Angle	2φ	20	20	20	Deg.
Forward Voltage (I _F =10 mA)	V _F	2.0 (≤2.6)	2.0 (≤2.6)	2.0 (≤2.6)	V
Reverse Current (I _R =5 V)	I _R	0.01 (≤100)	0.01 (≤100)	0.01 (≤100)	μA
Capacitance (V _R =5 V) (typ.)	C ₀	12	10	15	pF
Switching Time (I _F =100 mA, t _p =10 μs, R _L =50 Ω)					
I _V , 10% to 90%	t _R	300	300	450	ns
I _V , 90% to 10%	t _F	150	150	200	ns

Luminous Intensity*

Part Number	Min.	Typ.	Unit	Test Condition
LS 5421-NR	25	200	mcd	10 mA
LS 5421-Q	63	125	mcd	10 mA
LS 5421-NR	63	500	mcd	10 mA
LS 5421-R	100	200	mcd	10 mA
LY 5421-NR	25	200	mcd	10 mA
LY 5421-QT	63	500	mcd	10 mA
LY 5421-Q	63	125	mcd	10 mA
LY 5421-R	100	200	mcd	10 mA
LG 5411-NR	25	200	mcd	10 mA
LG 5411-Q	63	125	mcd	10 mA
LG 5411-QT	63	500	mcd	10 mA
LG 5411-R	100	200	mcd	10 mA
LG 5411-S	160	320	mcd	10 mA

* Luminous intensity factor of I_V of one packaging unit I_{VMAX}/I_{VMIN} ≥ 2.

SIEMENS

SUPER-RED LS 5469 YELLOW LY 5469 GREEN LG 5469

Low Current T1^{3/4} (5mm) LED Lamp

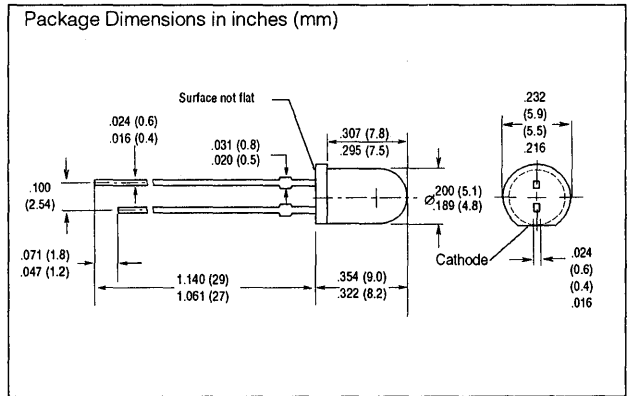
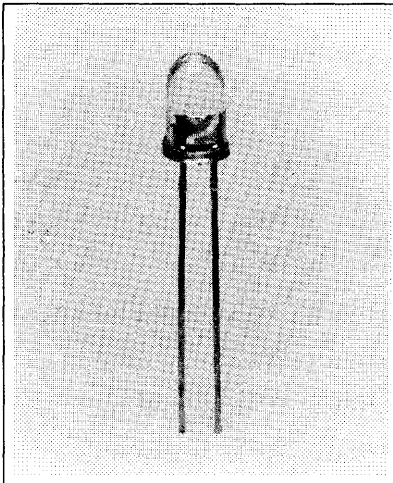

FEATURES

- Low Power Requirement
- 50° Viewing Angle
- Diffused Lens
- 1" Lead Length
- IC Compatible

DESCRIPTION

The 5469 series are low current LED lamps that have been designed to optimize light output at very low currents. These parts are ideally suited for applications where power is at a premium, such as portable equipment.

Both the super-red and yellow lamps utilize GaAsP on GaP semiconductor materials while the green lamps utilize GaP on GaP.

See graph numbers 1, 2D, 3B, 4D, 5C, 6C, 7A, 8A, 9B, 10A in the back of this section.

Maximum Ratings

Operating Temperature Range (T_{OP})	-55°C to +100°C
Storage Temperature Range (T_{STG})	-55°C to +100°C
Junction Temperature (T_J)	100°C
Reverse Voltage (V_R)	5 V
Forward Current (I_F)	7.5 mA
Surge Current (I_{FS} , $t=10 \mu s/D \leq 0.005$)	150 mA
Total Power Dissipation (P_{TOT} , $T_A=25^\circ C$)	20 mW
Thermal Resistance Junction to Air (R_{THJA})	750 K/W

Note: Soldered on PC board; pad size $\geq 16 \text{ mm}^2$

Characteristics ($T_A=25^\circ C$) All values typical unless otherwise noted.

Parameter	Sym	LS 5469 LY 5469 LG 5469			Unit
		Super-Red	Yellow	Green	
Peak Wavelength ($I_F=2 \text{ mA}$)	λ_{PEAK}	635	586	565	nm
Dominant Wavelength ($I_F=2 \text{ mA}$)	λ_{DOM}	628	590	570	nm
Spectral Bandwidth					
(50%, I_{RELMAX} , $I_F=7.5 \text{ mA}$)	$\Delta\lambda$	45	45	25	nm
Viewing Angle	2ϕ	50	50	50	Deg.
Forward Voltage ($I_F=2 \text{ mA}$)	V_F	1.8 (≤ 2.5)	2.0 (≤ 2.7)	1.9 (≤ 2.6)	V
Reverse Current ($V_R=5 \text{ V}$)	I_R	.01 (≤ 10)	.01 (≤ 10)	.01 (≤ 10)	μA
Capacitance					
($V_R=0 \text{ V}$, $f=1 \text{ MHz}$)	C_0	3	3	15	pF
Response Time					
($I_F=25 \text{ mA}$, $t=1 \mu s$)					
Rise Time I_V , 10% to 90%	t_R	200	200	450	ns
Fall Time I_V , 90% to 10%	t_F	150	150	200	ns
Luminous Intensity					
Part Number	Min.	Typ.	Unit	Test Condition	
LS/LY/LG 5469-EH	0.63	5	mcd	$I_F=2 \text{ mA}$	
LS/LY/LG 5469-FH	1	5	mcd	$I_F=2 \text{ mA}$	

* Luminous intensity factor of I_V of one packaging unit $I_{VMAX}/I_{VMIN} \geq 2$.

T1 (3mm) Two Color, Red and Green LED Lamp

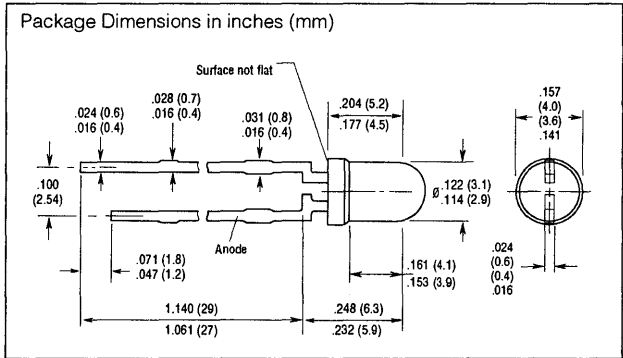
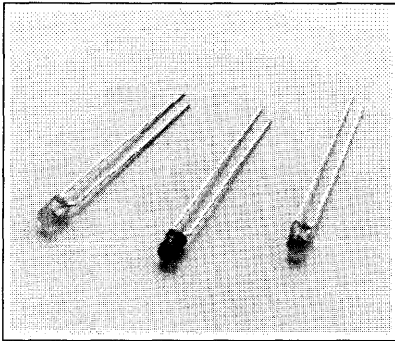

FEATURES

- High Light Output
- Lens
 - LSG 3331: Colorless Clear
 - LSG 3351: Colorless Diffused
- Viewing Angle 150°
- T1 (3mm) Package Size
- 1" Lead Length
- I/C Compatible

DESCRIPTION

The LSG 3331 and LSG 3351 are both super-red/green, two color LED lamps with their chips in an anti-parallel arrangement. By reversing the current the lamp can be switched from super-red to green. With the appropriate circuitry, it is also possible to produce orange and yellow.

Maximum Ratings

Operating Temperature (T_{OP})-55°C to +100°C
Storage Temperature (T_{STG})-55°C to +100°C
Junction Temperature (T_J)100°C
Forward Current (I_F)40 mA
Surge Current (I_{FS} , $t = 10 \mu S$)0.5 A
Power Dissipation (P_{TOT} , $T_A = 25^\circ C$)140 mW
Thermal Resistance Junction-to-Air (R_{THJA})400 K/W

Note 1. With simultaneous operation of both diodes of two-color LEDs the sum of the currents as well as the power dissipation must not exceed the specified limits.

Characteristics ($T_A = 25^\circ C$)

Parameter	Symbol	Red	Green	Unit
Peak Wavelength (typ.) ($I_F = 20$ mA)	λ_{PEAK}	635	565	nm
Dominant Wavelength ($I_F = 20$ mA)	λ_{DOM}	628	570	nm
Spectral Bandwidth (typ.) (50% I_{RELMAX} , $I_F = 20$ mA)	$\Delta\lambda$	45	25	nm
Viewing Angle, 50% I_V				
LSG 3331	2 ϕ	40	40	Deg.
LSG 3351	2 ϕ	50	50	Deg.
Forward Voltage ($I_F = 10$ mA)	V_F	2.0 (≤ 2.6)	2.0 (≤ 2.6)	V
Capacitance ($V_R = 0$ V, $f = 1$ MHz)	C_O	27	27	pF
Rise Time	t_R	300	450	ns
Fall Time	t_F	150	200	ns
Luminous Intensity (mcd)				Test
Part Number	Min.	Typ.	Unit	Condition
LSG 3331-JO	4	18	mcd	10 mA
LSG 3351-HO	2.5	--	mcd	10 mA

Note

1. Luminous intensity factor (I_V) in one packaging unit $I_{VMAX}/I_{VMIN} \leq$
2. Luminous intensity factor (I_V) in one LED $I_{VMAX}/I_{VMIN} \leq 3.0$.
3. The brightness of the darker chip in one package determines the brightness group of the LED.

See graph numbers 1, 2C (LSG 3331), 2B (LSG 3351), 3A, 4A, 5A, 6A, 7A, 8A, 9A, 10A in the back of this section.

SIEMENS

SUPER-RED/GREEN LSG K370-LO SUPER-RED/PURE GREEN LSP K370-KO ORANGE/PURE GREEN LOP K370-KO

Two-Color, T1 (3 mm) ARGUS LED Lamp

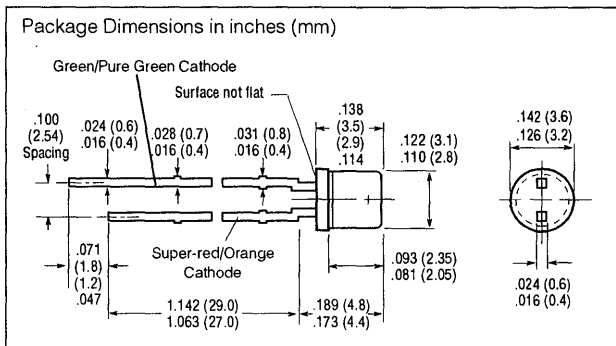
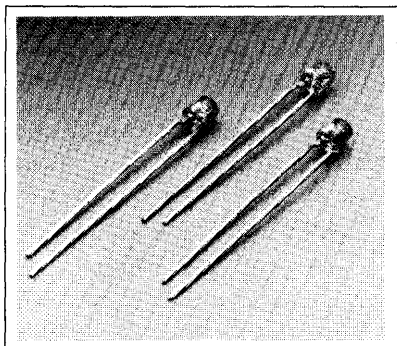

FEATURES

- Clear Colorless Lens
- High Luminous Flux
- Rugged Design
- Applications—Backlighting Display Panels
 - Front Panels
 - Graphic Control and Display Boards
 - Sealed Keyboards

DESCRIPTION

The LSG K370 is a T1 (3mm) two leaded bi-color (super-red/green) ARGUS LED lamp with their chips in an anti-parallel arrangement. The LSP K370 is a super-red/pure green ARGUS LED and the LOP K370 is an orange/pure green unit.

ARGUS lamps are used with an additional custom built reflector (i.e., white plastic, such as Pocan B7375). The front end of the reflector is covered by a diffuser (see package dimensions). Uniform illuminations can be enhanced by the reflector design tailored to the LED and/or by using appropriate diffuser material.

Note: Siemens does not supply the reflector or diffuser.

Maximum Ratings

Operating Temperature Range (T_{OP})	-55°C to +100°C
Storage Temperature Range (T_{STG})	-55°C to +100°C
Junction Temperature (T_J)	+100°C
Forward Current (I_F)	40 mA
Surge Current (I_{FM}), $t \leq 10 \mu S$	0.5 A
Power Dissipation (P_{TOT}), $T_A = 25^\circ C$	140 mW
Thermal Resistance Junction to Air (R_{THJA})	400 K/W

Characteristics ($T_A = 25^\circ C$) All values typical unless otherwise noted.

Parameter	Symbol	Super-			Unit	
		Red	Orange	Pure Green		
Peak Wavelength ($I_F = 20 \text{ mA}$)	λ_{PEAK}	635	610	565	557	nm
Dominant Wavelength ($I_F = 20 \text{ mA}$)	λ_{DOM}	628	605	570	560	nm
Spectral Bandwidth 50%, $I_V (I_F = 20 \text{ mA})$	$\Delta\lambda$	45	40	25	22	nm
Forward Voltage ($I_F = 10 \text{ mA}$)	V_F	2.0	2.0	2.0	2.0	V
Capacitance ($V_R = 0 \text{ V}$, $f = 1 \text{ MHz}$)	C_0	12	8	8	15	pF
Switching Times ($I_F = 100 \text{ mA}$, $t_p = 10 \mu s$, $R_L = 50 \Omega$)						
Rise Time, 10% to 90%	t_R	300	300	450	450	ns
Fall Time, 90% to 10%	t_F	150	150	200	200	ns
Luminous Flux ⁽¹⁾ ($I_F = 15 \text{ mA}$)	Φ_V	32	20	32	20	mIm
		(≥ 10)	(≥ 6.3)	(≥ 10)	(≥ 6.3)	mIm

Notes:

1. Luminous flux factor of Φ_V in one packaging unit $\Phi_V \text{ max}/\Phi_V \text{ min.} \leq 2$.
Luminous flux factor of Φ_V in one LED unit $\Phi_V \text{ max}/\Phi_V \text{ min.} \leq 4$. (LSP...)
Luminous flux factor of Φ_V in one LED unit $\Phi_V \text{ max}/\Phi_V \text{ min.} \leq 3$. (LSG...)
2. The brightness of the darker chip in one package determines the brightness group of the LED.

See graph numbers 1, 2W, 3A, 4H, 5A, 6A, 7A, 8A, 9A, 10D in the back of this section.

SUPER-RED/GREEN LSG K372-RO SUPER-RED/PURE GREEN LSP K372-PO

Two-Color, T1 (3 mm) Super ARGUS LED Lamp

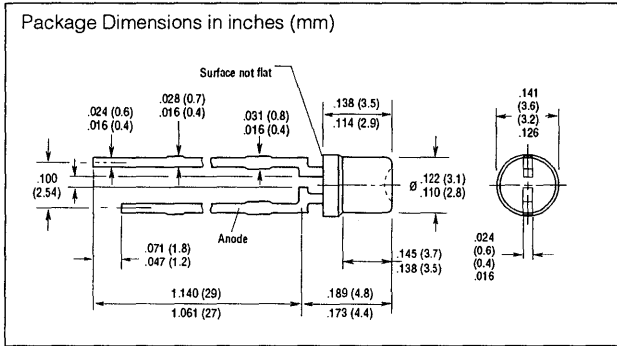
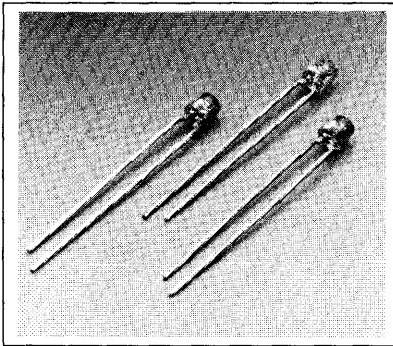

FEATURES

- Super-Red/Green and Super-Red/Pure Green LEDs in One Package
- Clear Colorless Lens
- High Luminous Flux
- Rugged Design
- Cathode Designations
 - Shorter Lead: Super-Red Cathode
 - Longer Lead: Green or Pure Green Cathode
- Applications—Backlighting Display Panels
 - Front Panels
 - Graphic Control and Display Boards
 - Sealed Keyboards
 - Large Scale Displays, Dot Matrix Displays

DESCRIPTION

The LSG K372 is a T1 (3mm) two leaded bi-color (super-red/green) Super ARGUS LED lamp with their chips in an anti-parallel arrangement. The LSP K372 is a super-red/pure green Super ARGUS LED.

ARGUS lamps are used with an additional custom built reflector (i.e., white plastic, such as Pocan B7375). The front end of the reflector is covered by a diffuser (see package dimensions). Uniform illuminations can be enhanced by the reflector design tailored to the LED and/or by using appropriate diffuser material.

Super ARGUS LEDs are designed to operate at 50 mA and provide as much as 10X luminous flux as standard ARGUS LEDs.

Note: Siemens does not supply the reflector or diffuser.

Maximum Ratings

Operating Temperature Range (T_{OP})	-55°C to +100°C
Storage Temperature Range (T_{STG})	-55°C to +100°C
Junction Temperature (T_J)	+100°C
Forward Current (I_F)	75 mA
Pulse Current (I_{FM}), $t \leq 10 \mu S$	1 A
Power Dissipation (P_{TOT}), $T_A=25^\circ C$	300 mW
Thermal Resistance Junction to Air (R_{THJA}) ⁽¹⁾	250 K/W

Note 1. Mounted on PC board up to stand off pad size $\geq 16 \text{ mm}^2$.

Characteristics ($T_A=25^\circ C$) All values typical unless otherwise noted.

Parameter	Symbol	Super-Red	Green	Pure Green	Unit
Peak Wavelength ($I_F=20 \text{ mA}$)	λ_{PEAK}	635	565	557	nm
Dominant Wavelength ($I_F=20 \text{ mA}$)	λ_{DOM}	628	570	560	nm
Spectral Bandwidth 50%, $I_V(I_F=20 \text{ mA})$	$\Delta\lambda$	45	25	22	nm
Forward Voltage ($I_F=10 \text{ mA}$)	V_F	2.4	2.4	2.4	V
Capacitance ($V_R=0 \text{ V}$, $f=1 \text{ MHz}$)	C_0	(≤ 3.8)	(≤ 3.8)	(≤ 3.8)	(≤ 3.8)
Switching Times ($I_F=100 \text{ mA}$, $t_p=10 \mu s$, $R_L=50 \Omega$)					
Rise Time, 10% to 90%	t_R	55	55	80	pF
Fall Time, 90% to 10%	t_F	300	450	450	ns
Luminous Flux ⁽¹⁾ ($I_F=15 \text{ mA}$)	Φ_V	150	200	200	ns
		(≥ 100)	(≥ 100)	(≥ 40)	mIm

Notes:

1. Luminous flux factor of Φ_V in one packaging unit $\Phi_{VMAX}/\Phi_{VMIN} \leq 2$.
2. Luminous intensity factor of I_V of one packaging unit $I_{VMAX}/I_{VMIN} \geq 2$.

See graph numbers 1, 2X, 3E, 3F, 4F, 5D (super-red), 5E (green), 6D, 7A, 8A, 9E, 10C in the back of this section.

SIEMENS

SUPER-RED/GREEN LSG T670-HO SUPER-RED/PURE GREEN LSP T670-GO SMT-MULTILED®, Surface Mount LED Lamp

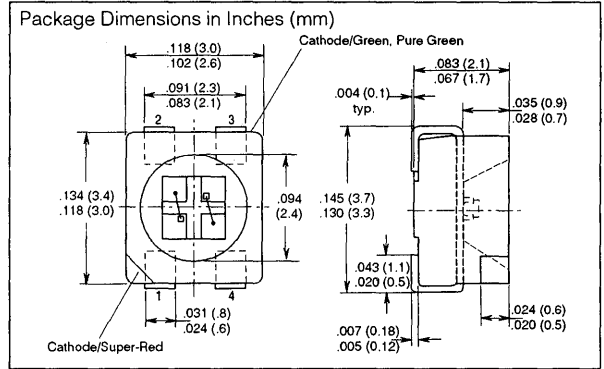
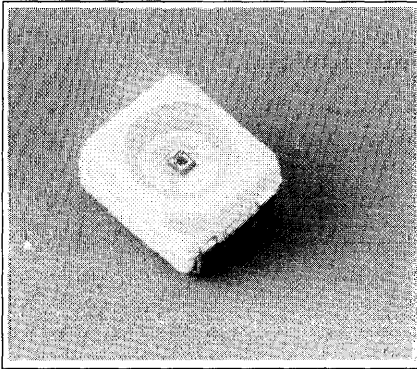

FEATURES

- PL-CC-2 Package
- Multicolor Operation
- Suitable for Surface Mounting
- Available on Tape and Reel (8 mm Tape)
- Applications: Backlighting, Optical Coupling into Light Pipes and Lenses, Optical Indicator

DESCRIPTION

The LSG T670 (MULTILED for surface mount applications) is available in super-red/green and super-red/pure green. The four lead design allows the user to lay out a P.C.B. for completely independent access to the super-red or green/pure green LED, common cathode or common anode arrangements or in an anti-parallel configuration.

The package includes an internal reflector to optimize light coupling. This feature makes this MULTILED ideal for light pipe applications.

Maximum Ratings

Operating Temperature Range (T_{OP})	-55°C to + 100°C
Storage Temperature Range (T_{STG})	-55°C to + 100°C
Junction Temperature (T_J)	+ 100°C
Forward Current (I_F)	30 mA
Surge Current (I_{FS}) $t_p \leq 10 \mu s$, $D=0.005$	0.5 A
Reverse Voltage (V_R)	5 V
Power Dissipation (P_{TOT}) $T_A \leq 25^\circ C$	190 mW
Thermal Resistance, Junction to Ambient Mounting on PC Board, Copper area: 16 mm ² (R_{thJA})	300 K/W

Characteristics ($T_A=25^\circ C$)

Parameter	Symbol	Super-Red	Green	Pure Green	Unit
Peak Wavelength (typ.) ($I_F=10$ mA)	λ_{PEAK}	635	565	557	nm
Dominant Wavelength (typ.) ($I_F=10$ mA)	λ_{DOM}	628.	570	560	nm
Spectral Bandwidth, 50% I_V (typ.) ($I_F=10$ mA)	$\Delta\lambda$	45	25	22	nm
Viewing Angle, 50% I_V (typ.)	2ϕ	120	120	120	Deg.
Forward Voltage ($I_F=10$ mA)	V_F	2.0 (≤ 2.6)	2.0 (≤ 2.6)	2.0 (≤ 2.6)	V
Reverse Current ($V_R=5$ V)	I_R	0.01 (≤ 10)	0.01 (≤ 10)	0.01 (≤ 10)	μA
Capacitance ($V_R=0$ V, $f=1$ MHz)	C_0	12	15	15	pF
Switching Time ($I_F=100$ mA, $t_p=10 \mu s$, $R_L=50 \Omega$)					
Rise Time/ I_V , 10%–90%	t_R	300	450	450	ns
Fall Time/ I_V , 90%–10%	t_F	150	200	200	ns
Luminous Intensity ($I_F=10$ mA)	I_V	8 (≥ 2.5)	5 (≥ 1.6)		mcd
Luminous Flux ($I_F=10$ mA)	Φ_V	25	15		mm

Notes

1. Luminous intensity factor of I_V in LED $I_{Vmax}/I_{Vmin} \leq 3^*$ or $\leq 4^{**}$.
2. Luminous intensity factor of I_V in one packaging unit $I_{Vmax}/I_{Vmin} \leq 2$.
3. The brightness of the darker chip in one package determines the brightness group of the LED.

See graph numbers 1, 2V, 5G, 6H in the back of this section.

SUPER-RED LS K380
ORANGE LO K380
YELLOW LY K380
GREEN LG K380
PURE GREEN LP K380
T1 (3mm) ARGUS LED Lamp

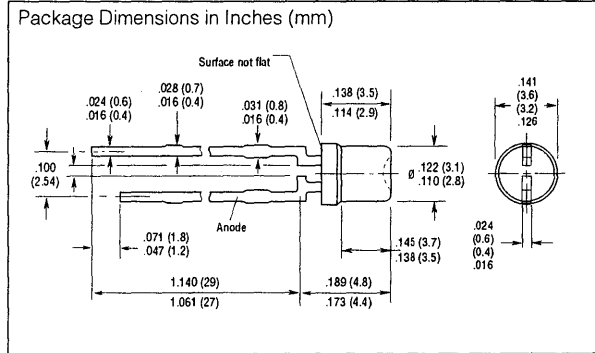
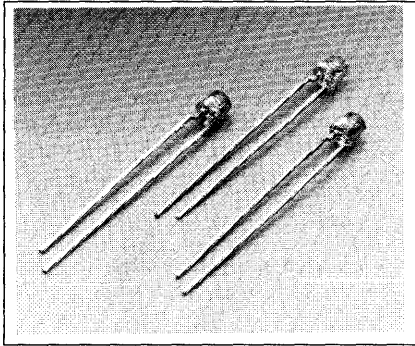

LED Lamps

FEATURES

- Colors: Super-Red, Orange, Yellow, Green, Pure Green
- Lens: Tinted Transparent
- Low Power Dissipation
- Low Self-Heating
- Rugged Design
- Applications—Backlighting Display Panels
 - Front Panels
 - Graphic Control and Displays Boards
 - Sealed Keyboards

DESCRIPTION

ARGUS lamps can be used only with an additional, customer supplied (i.e., white plastic, such as Pocan B7375). The front end of the reflector is covered by a diffuser (see package dimensions). Uniform illumination can be enhanced by the reflector design tailored to the LED and/or by the use of appropriate diffuser material. If the diffuser is tinted, the spectral transmission must be adjusted to the wavelength emitted by the LED.

Maximum Ratings

Operating Temperature Range (T_A) -55°C to + 100°C
 Storage Temperature Range (T_{STG}) -55°C to + 100°C
 Junction Temperature (T_J) + 100°C
 Reverse Voltage (V_R) 5 V
 Forward Current (I_F) 40 mA
 Surge Current (I_{FM}) $t_p < 10 \mu s$ 0.5 A
 Total Power Dissipation (P_{TOT}) $T_A = 25^\circ C$ 140 mW
 Thermal Resistance Junction to Air (R_{THJA}) 400 K/W

Characteristics ($T_A = 25^\circ C$)

Parameter	Symbol	Super-				Pure	Unit
		Red	Orange	Yellow	Green	Green	
Wavelength at Peak							
Emission ($I_F = 20$ mA)	λ_{PEAK}	635	610	586	565	557	nm
Dominant Wavelength	λ_{DOM}	628.	605	590	570	560	nm
Spectral Bandwidth							
50% Φ_v ($I_F = 20$ mA)	$\Delta\lambda$	45	40	45	25	22	nm
Forward Voltage	V_F	2.1	2.1	2.1	2.1	2.1	V
($I_F = 15$ mA)		(≤ 2.6)	(≤ 2.6)	(≤ 2.6)	(≤ 2.6)	(≤ 2.6)	V
Reverse Current	I_R	0.01	0.01	0.01	0.01	0.01	μA
($V_R = 5$ V)		(≤ 10)	(≤ 10)	(≤ 10)	(≤ 10)	(≤ 10)	μA
Capacitance							
($V_R = 0V$, $f = 1$ MHz)	C_0	12	8	10	15	15	pF
Switching Times							
($I_F = 100$ mA, $t_p = 10 \mu s$)							
Rise Time, 10% to 90% T_R		200	300	300	450	450	ns
Fall Time, 90% to 10% T_F		150	150	150	200	200	ns
Luminous Flux*	Φ_v (mim)	$I_F = 15$ mA				Φ_v (mim)	$I_F = 15$ mA
Part Number	Min.	Max.	Part Number	Min.	Max.		
LS K380-LP	10	80	LY K380-LP	10	80		
LS K380-N	25	50	LY K380-N	25	50		
LS K380-P	40	80	LY K 380-P	40	80		
LS K380-NR	25	200	LY K380-NR	25	200		
LO K380-LP	10	80	LG K380-LP	10	80		
LO K380-N	25	50	LG K380-N	25	50		
LO K380-P	40	80	LG K380-P	40	80		
LO K380-NR	25	200	LG K380-NR	25	200		
LP K380-KO	10	63 typ.					

* Luminous intensity factor of I_v of one packaging unit $I_{VMAX}/I_{VMIN} \geq 2$

See graph numbers 1, 2N, 3E, 4H, 5A, 6A, 7A, 8A, 9C, 10D in the back of this section.

Back Lighting Using ARGUS LEDs

Siemens developed ARGUS® LEDs for applications requiring uniform light over large areas. Their light emission covers a fairly large solid angle versus conventional LEDs which concentrate their radiation in the axial direction.

Construction

ARGUS diodes are fabricated on the same production line and with the same design concepts as Siemens standard LEDs. The difference between the two is the radiation characteristic. The radiation from standard LEDs is focused in the axial direction (Fig. 1a). The chip is mounted into a reflector cup. The leadframe is placed into a mold and the body is formed with a spherical lens.

The ARGUS LED, however, is designed to produce light over an enlarged viewing angle (Fig. 1b). This is done by eliminating the reflector cup and molding a concave shaped lens into the body instead of the normal spherical type. To avoid hot spots within the illuminated area, the light emitted in the axial direction is reduced to about 20% of the maximum luminous intensity.

Applications and Benefits of ARGUS LEDs

The full benefit of ARGUS LEDs is achieved when used with an external reflector and diffuser. When properly configured, a large area of evenly distributed light is produced ($1\text{cm}^2/\text{lamp}$) that can be used to back light symbols, characters, and LCD displays.

- No longer will designers of systems such as dashboard instrumentation and car radios have to provide access for replacing incandescent bulbs. With extended warranties being offered by most auto makers, the labor cost to replace an incandescent bulb makes the ARGUS LED a cost effective alternative.

- With its ability to evenly illuminate a large area and its low heat generation, ARGUS LEDs provide an excellent source of light for LCD displays.
- ARGUS' compact size, large light area, low heat generation and reliability make it an ideal choice for illuminated switches instead of incandescent bulbs.
- ARGUS LEDs can be supplied on tape and reel for auto-insertion, eliminating the need to hand insert odd shaped light bars for large area back lighting applications.
- Reflectors for ARGUS LEDs can be designed to have a height from the board that equals the height of most seven-segment displays, so that panels with mechanically matched components can be built.

ARGUS LEDs as Substitutes for Lamps

In many cases incandescent lamps are easily replaced directly by ARGUS LEDs, but for best results, an appropriately shaped reflector (Figure 2) with a high diffuse reflection characteristic (above 90%) should be used. Pocan B7375 and Pocan B7376 thermoplastics have been used successfully in many applications. Requirements differ for individual applications. For optimum results, reflectors and diffusers must be matched.

Lumens (lm) Versus Candela (cd)*

One major difference between the ARGUS LED standard LEDs is that the light output for ARGUS is measured in millilumens (mlm) while standard LEDs are measured in millicandela (mcd). The ARGUS is designed to use almost all of the light produced over a large area while standard LEDs have a focusing lens and for most applications is a point source.

* See Appnote 1, "LEDs and Photometry" for detailed information.

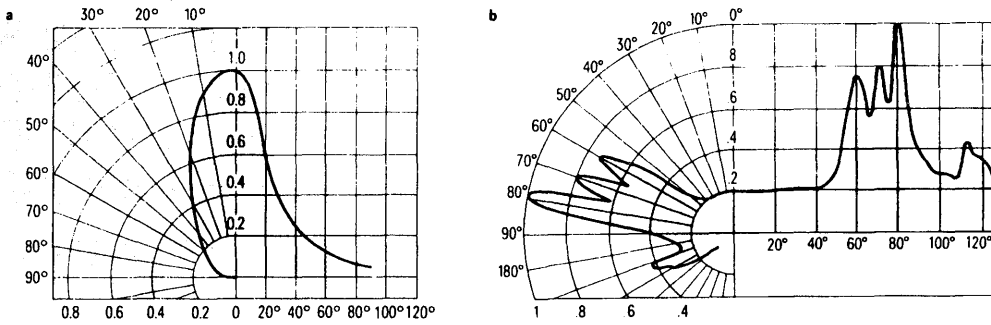

FIGURE 1. ARGUS LEDs emit their light over an enlarged solid angle. Both graphs show polar coordinates on the left and rectangular coordinates on the right. a) Standard LED-viewing angle b) ARGUS LED-radiation characteristic. Relative spatial emission vs. half angle.

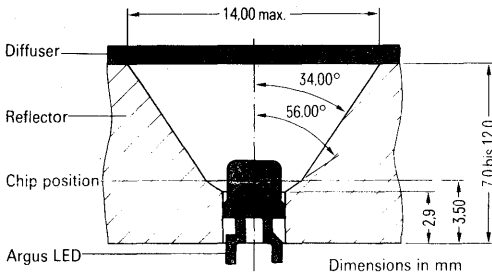
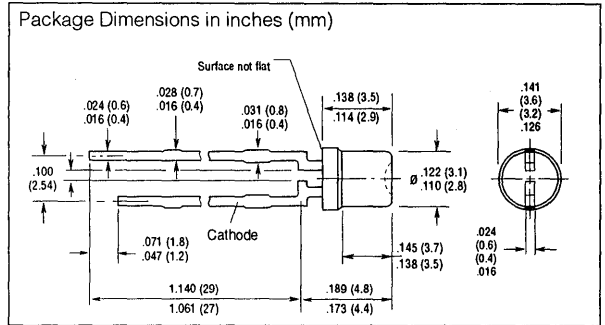
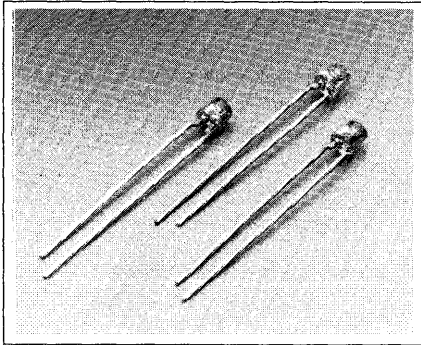

FIGURE 2. Section through a reflector with an ARGUS LED.

SIEMENS

SUPER-RED LS K382-RO
YELLOW LY K382-RO
GREEN LG K382-RO
ORANGE LO K382-RO
PURE GREEN LP K382-PO

T1 (3mm) Super ARGUS LED Lamp



FEATURES

- Colors: Super-Red, Yellow, Green, Orange, Pure Green
- Lens: Tinted Transparent
- High Luminous Flux
- Rugged Design
- Cathode: Shorter Lead
- Applications—Backlighting Display Panels
 - Front Panels
 - Graphic Control and Display Boards
 - Sealed Keyboards

DESCRIPTION

The LS/LY/LG/LO/LPK382 are T1 (3 mm) Super ARGUS LED lamps. ARGUS lamps are used with an additional, custom-built reflector (i.e., white plastic, such as Pocan B7375). The front end of the reflector is covered by a diffuser (see illustration). Uniform illumination can be enhanced by the reflector design tailored to the LED and/or by the use of appropriate diffuser material.

Super ARGUS LEDs are designed to operate at 50 mA and provide as much as 10X luminous flux as standard ARGUS LEDs.

Note: Siemens does not supply the reflector or diffuser.

Maximum Ratings

Operating Temperature Range (T_A)	-55°C to +100°C
Storage Temperature Range (T_{STG})	-55°C to +100°C
Junction Temperature (T_J)	+100°C
Reverse Voltage (V_R)	5 V
Forward Current (I_F)	75 mA
Surge Current (I_{FM})	1 A
Total Power Dissipation (P_{TOT}) $T_A=25^\circ\text{C}$	300 mW
Thermal Resistance Junction to Air (R_{THJA})	250 K/W

Note: Mounted on PC board up to stand-off; pad size $\leq 16 \text{ mm}^2$.

Characteristics ($T_A=25^\circ\text{C}$)

Parameter	Symbol	Super-				Pure	Unit
		Red	Yellow	Green	Orange	Green	
Peak Wavelength							
($I_F=20 \text{ mA}$)	λ_{PEAK}	635	586	565	610	557	nm
Dominant Wavelength	λ_{DOM}	628.	590	570	605	560	nm
Spectral Bandwidth							
50% Φ_V ($I_F=20 \text{ mA}$)	$\Delta\lambda$	45	45	25	40	22	nm
Forward Voltage	V_F	2.4	2.4	2.4	2.4	2.5	
($I_F=50 \text{ mA}$)		(≤ 3.8)	(≤ 3.8)	(≤ 3.8)	(≤ 3.8)	(≤ 3.8)	V
Reverse Current	I_R	0.01	0.01	0.01	0.01	0.01	
($V_R=5 \text{ V}$)		(≤ 10)	(≤ 10)	(≤ 10)	(≤ 10)	(≤ 10)	μA
Capacitance							
($V_R=0\text{V}$, $f=1 \text{ MHz}$)	C_0	55	30	55	40	120	pF
Luminous Flux*							
($I_F=50 \text{ mA}$)	Φ_V	160	160	160	160	100	
		(≥ 100)	(≥ 100)	(≥ 100)	(≥ 100)	(≥ 40)	mlm

* Luminous flux factor of Φ_V in one packaging unit $\frac{\Phi_{VMAX}}{\Phi_{VMN}} < 2$.

See graph numbers 1, 2S, 3F, 4F, 5D, 6D, 7A, 8A, 9D in the back of this section.

SIEMENS

SUPER-RED LS K389-FO YELLOW LY K389-FO GREEN LG K389-FO

T1 (3mm) ARGUS Low Current LED Lamp

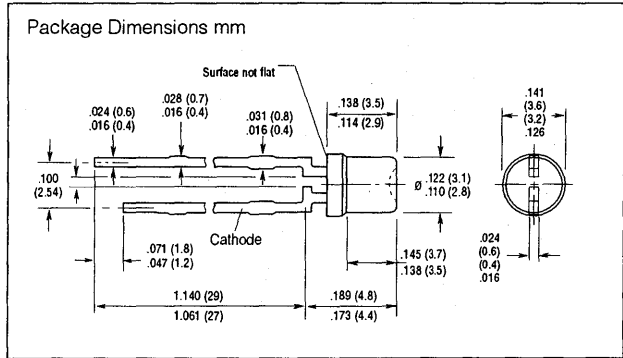
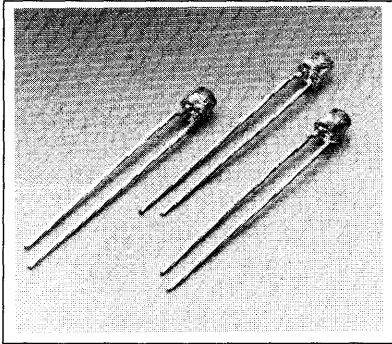

LED Lamps

FEATURES

- Colors: Super-Red, Yellow, Green
- Lens: Tinted Transparent
- Direct Drive is Possible by Means of CMOS Microprocessor, Gate and LSTTL Components
- Prolonged Service Life of Batteries in Mobile Equipment
- Low Power Dissipation in the Driving Circuitry as well as in the LED
- Suitable for Multiplex Operation
- Cathode: Shorter Solder Tab

DESCRIPTION

The LS/LY/LG K389-FO are T1 (3 mm) ARGUS LED lamps. ARGUS lamps can be used only with an additional, customer supplied reflector (i.e., white plastic, such as Pocan B7375). The front end of the reflector is covered by a diffuser (see package dimensions). Uniform illumination can be enhanced by the reflector design tailored to the LED and/or by the use of appropriate diffuser material. If the diffuser is tinted, the spectral transmission must be adjusted to the wavelength emitted by the LED.

Applications include backlighting of display panels, e.g. front panels, graphic control and display boards, sealed keyboards, large-scale displays, dot matrix displays.

See graph numbers 1, 2N, 3B, 4D, 5C, 6C, 7A, 8A, 9B, 10A in the back of this section.

Maximum Ratings

Operating Temperature Range (T_A)	-55°C to +100°C
Storage Temperature Range (T_{STG})	-55°C to +100°C
Junction Temperature (T_J)	+100°C
Reverse Voltage (V_R)	5 V
Forward Current (I_F)	7.5 mA
Surge Current (I_{FM}) $t_p=10 \mu s$	150 mA
Total Power Dissipation (P_{TOT}) $T_A=25^\circ C$	20 mW
Thermal Resistance: Junction/Air (R_{THJA})	750 K/W

Note: Soldered on PC board: pad size $\geq 16 \text{ mm}^2$.

Characteristics ($T_A=25^\circ C$)

Parameter	LS K389-FO LYK389-FO LGK389-FO			Unit	
	Sym	Super-Red	Yellow		Green
Peak Wavelength ($I_F=2 \text{ mA}$) typ.	λ_{PEAK}	635	586	565	nm
Dominant Wavelength, typ.	λ_{DOM}	628	590	570	nm
Spectral Bandwidth at 50% ϕ_V ($I_F=2 \text{ mA}$)	$\Delta\lambda$	45	45	25	nm
Forward Voltage ($I_F=2 \text{ mA}$)	V_F	1.8 (≤ 2.6)	2.0 (≤ 2.7)	1.9 (≤ 2.6)	V
Reverse Current ($V_R=5 \text{ V}$)	I_R	0.01 (≤ 10)	0.01 (≤ 10)	0.01 (≤ 10)	μA
Capacitance ($V_R=0 \text{ V}$, $f=1 \text{ MHz}$)	C_0	3	3	15	pF
Switching Times ($I_F=25 \text{ mA}$, $t_p=1 \mu s$)					
Rise Time from 10% to 90%	t_R	200	200	450	ns
Fall Time from 90% to 10%	t_F	150	150	200	ns
Luminous Flux * ($I_F=2 \text{ mA}$)	ϕ_V	5 (≥ 1)	3.2 (≥ 1)	3.2 (≥ 1)	mIm

* Luminous flux factor of ϕ_V in one packaging unit $\phi_{VMAX}/\phi_{VMIN} \leq 2$.

SIEMENS

SUPER-RED LS S260-DO
YELLOW LY S260-DO
GREEN LG S260-DO
SUPER-RED/GREEN LU S250-DO

SOT23 Surface Mount LED Lamp

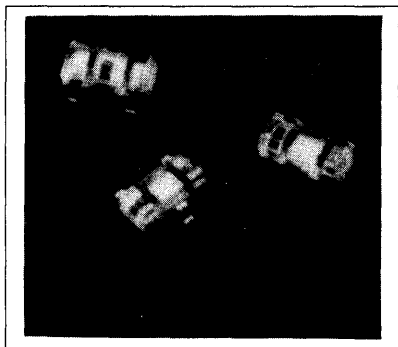

FEATURES

- **Colors:**
 Super-Red, LS S260-DO
 Yellow, LY S260-DO
 Green, LG S260-DO
 Super-Red/Green, LU S250-DO
- **Rectangular Package, 1.3 mm by 3 mm by 1 mm thick**
- **Wide Viewing Angle 140°**
- **Ideal for Use as Failure Indicators Mounted on Printed Circuit Boards**
- **IC Compatible**

DESCRIPTION

The SOT23 LED is available in super-red, green, and yellow package. Supplied on 8 mm wide reels with 3,000 components per reel, the packaging conforms to IEC standards and can be used on all commercial automatic surface mount insertion equipment. Standard reels are 18 cm in diameter, however, special 38 cm reels with 10,000 components per reel are available.

For 3,000 pieces per reel option add suffix E7502 to the part number. For 10,000 pieces per reel option, add E7503 to the part number.

See graphs number 1, 2M, 3A, 4A, 5G, 6G, 7A, 8A, 9A, 10A in the back of this section.

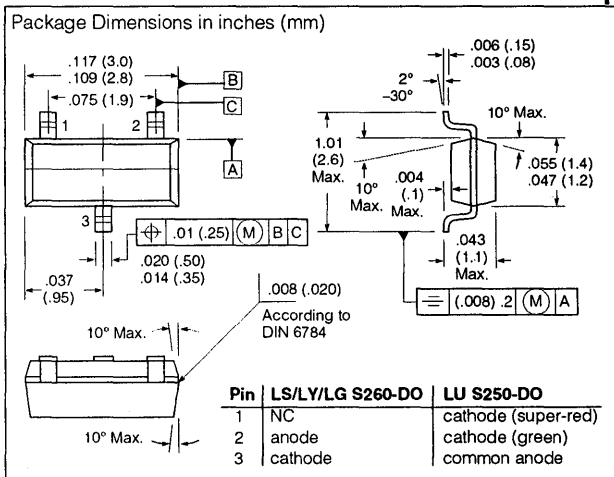

Maximum Ratings (All Devices)

(For LU S250: the following operating conditions apply when one diode is on while the other diode is off)

Operating Temperature Range (T_{OP})	-55°C to +100°C
Storage Temperature Range (T_{STG})	-55°C to +100°C
Junction Temperature (T_J)	100°C
Reverse Voltage (V_R)	5 V
Forward Current (I_F)	30 mA
Surge Current (I_{FS}) $t = 10 \mu s$	0.5 A
Power Dissipation (P_{TOT})	100 mW
Thermal Resistance Junction to Air T_A (R_{THJA}) (1)	750 K/W

- Notes: 1. Soldered on PC board: pad size $\geq 16 \text{ mm}^2$.
 2. With simultaneous operation of both diodes of two-color LEDs, the sum of the currents as well as the power dissipation must not exceed the specified limits.

Characteristics ($T_A = 25^\circ\text{C}$) All values typical unless otherwise noted.

Parameter	Sym	Super-Red	Yellow	Green	Unit
Wavelength of Emitted Light ($I_F = 20 \text{ mA}$)	λ_{PEAK}	635	586	565	nm
Dominant Wavelength ($I_F = 20 \text{ mA}$)	λ_{DOM}	628	590	570	nm
Spectral Bandwidth (50% I_{RELMAX} , $I_F = 20 \text{ mA}$)	$\Delta\lambda$	45	45	25	nm
Viewing Angle (50% I_V)	2ϕ	140	140	140	Deg.
Forward Voltage ($I_F = 10 \text{ mA}$)	V_F	2.0 (≤ 2.6)	2.0 (≤ 2.6)	2.0 (≤ 2.6)	V
Reverse Current ($V_R = 5 \text{ V}$)	I_R	0.01 (≤ 10)	0.01 (≤ 10)	0.01 (≤ 10)	μA
Capacitance ($V_R = 0 \text{ V}$, $f = 1 \text{ MHz}$)	C_0	12	10	15	pF
Switching Time					
t_V , 10% to 90%	t_R	300	300	450	μs
t_V , 90% to 10%	t_F	150	150	200	μs
Luminous Intensity* ($I_F = 10 \text{ mA}$)	I_V	1.0 (≥ 0.4)	1.0 (≥ 0.4)	1.0 (≥ 0.4)	mcd

* Luminous intensity factor of I_V of one packaging unit $I_{VMAX}/I_{VMIN} \geq 2$.

SOT23 Low Current Surface Mount LED Lamp

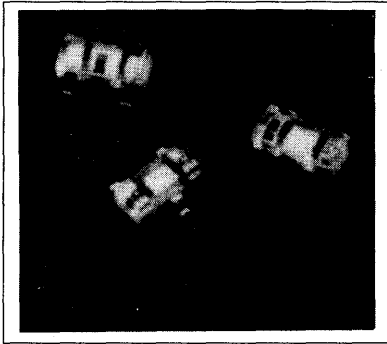

FEATURES

- Lens: Colored Diffused
- Can Be Directly Driven by CMOS Micro-processors, Gate and LSTTL Components
- Prolongs Service Life of Batteries in Mobile Equipment
- Low Power Dissipation

DESCRIPTION

The LS/LY/LG S269-BO are low current, plastic SOT23 surface mountable LED lamps. They are available in three colors: LS S269-BO: super-red, LY S269-BO: yellow, LG S269-BO: green.

These SOT23 LEDs are supplied only on tape and reel. Standard reels are 18 cm in diameter with tape width of 8 mm and 3,000 pieces per reel. Special 38 cm reels with 10,000 pieces per reel are also available.

To order reels with 3,000 pieces, add suffix E7502 to the part number. To order reels with 10,000 pieces, add suffix E7503 to the part number.

See graph numbers 1, 2M, 3B, 4D, 5C, 6C, 7A, 8A, 9B, 10A in the back of this section.

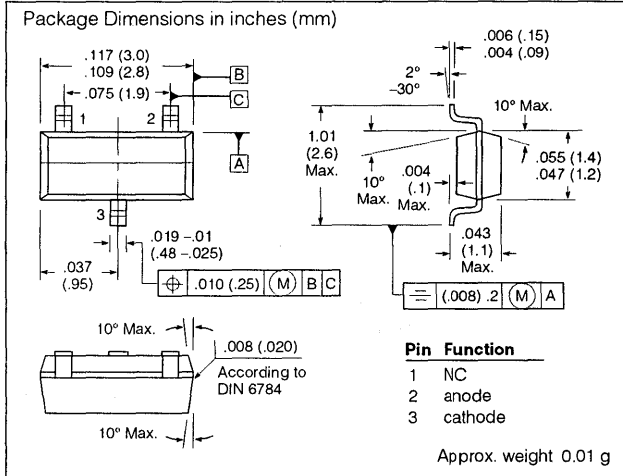

Maximum Ratings

Operating Temperature (T_{OP})	-55°C to +100°C
Storage Temperature (T_{STG})	-55°C to +100°C
Junction Temperature (T_J)	+100°C
Reverse Voltage (V_R)	5 V
Forward Current (I_F)	7.5 mA
Surge Current (I_{FS}) $t \leq 10 \mu s$, $D \leq 0.005$	150 mA
Power Dissipation (P_{TOT}) $T_A = 25^\circ C$	20 mW
Thermal Resistance: Junction/Air (R_{THJA}) ⁽¹⁾	750 K/W

Note: 1. Soldered on PC board: pad size $\geq 16 \text{ mm}^2$.

Characteristics ($T_A = 25^\circ C$) Values are typical unless otherwise specified.

Parameter	Sym	LS S269-BO	LY S269-BO	LG S269-BO	Unit
		Super-Red	Yellow	Green	
Wavelength, Emitted Light ($I_F = 7.5 \text{ mA}$)	λ_{PEAK}	635	586	565	nm
Dominant Wavelength ($I_F = 7.5 \text{ mA}$)	λ_{DOM}	628	590	570	nm
Spectral Bandwidth (50%, I_{RELMAX} , $I_F = 7.5 \text{ mA}$)	$\Delta\lambda$	45	45	25	nm
Viewing Angle, 50% I_V	2ϕ	140	140	140	Deg.
Forward Voltage ($I_F = 2 \text{ mA}$)	V_F	1.8 (≤ 2.6)	2.0 (≤ 2.7)	1.9 (≤ 2.6)	V
Reverse Current ($V_R = 5 \text{ V}$)	I_R	0.01 (≤ 10)	0.01 (≤ 10)	0.01 (≤ 10)	μA
Switching Times ($I_F = 100 \text{ mA}$, $t_P = 10 \mu s$, $R_L = 50 \Omega$)					
t_V from 10% to 90%	t_R	200	200	450	ns
t_V from 90% to 10%	t_F	150	150	200	ns
Capacitance ($V_R = 0 \text{ V}$, $f = 1 \text{ MHz}$)	C_O	3	3	15	pF
Luminous Intensity ($I_F = 2 \text{ mA}$)	I_V	≥ 0.16	≥ 0.16	≥ 0.16	mcd

SIEMENS

SUPER-RED LS T670
ORANGE LO T670
YELLOW LY T670
GREEN LG T670
PURE GREEN LP T670

SMT-TOP-LED®, Surface Mount LED Lamp

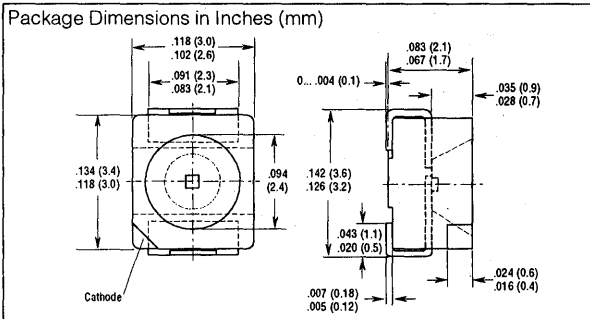
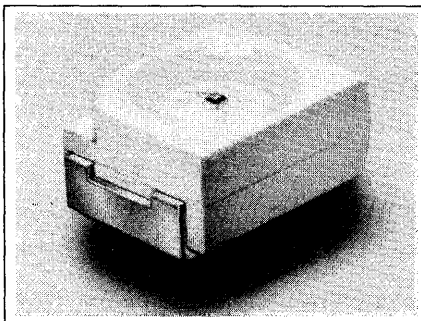

FEATURES

- PL-CC-2 Package
- Internal Reflector
- Colorless Clear Window
- Low Power Dissipation
- Wide Viewing Angle
- Compatible with Automatic Placement Equipment
- Suitable for Vapor-Phase Reflow, Infrared Reflow and Wave Solder Processes
- Ideal for Backlight and Light Pipe Applications

DESCRIPTION

The LX T670-HO (SMT-TOP-LED for surface mount applications) is available in super-red, orange, yellow, green, and pure green. The package incorporates an internal reflector to optimize light coupling. This feature makes the SMT-TOP-LED ideal for light pipe applications.

Maximum Ratings

Operating Temperature Range (T_{OP}) -55°C to + 100°C
 Storage Temperature Range (T_{STG}) -55°C to + 100°C
 Junction Temperature (T_J) + 100°C
 Forward Current (I_F) 30 mA
 Surge Current (I_{FS}) $t_p = 10 \mu s$ 0.5 A
 Reverse Voltage (V_R) 5 V
 Power Dissipation (P_{TOT}) $T_A \leq 25^\circ C$ 100 mW
 Thermal Resistance, Junction to Ambient⁽¹⁾ 400 K/W
 Note: Soldered on PC board: pad size $\geq 16 \text{ mm}^2$.

Characteristics ($T_A = 25^\circ C$)

Parameter	Symbol	Super-				Pure	Unit
		Red	Orange	Yellow	Green	Green	
Peak Wavelength ($I_F = 10 \text{ mA}$)	λ_{PEAK}	635	610	586	565	557	nm
Dominant Wavelength ($I_F = 10 \text{ mA}$)	λ_{DOM}	628.	605	590	570	560	nm
Spectral Bandwidth (50% I_{RELMAX} , $I_F = 20 \text{ mA}$)	$\Delta\lambda$	45	45	45	25	22	nm
Viewing Angle 50% I_V	2 ϕ	120	120	120	120	120	Deg.
Forward Voltage ($I_F = 10 \text{ mA}$)	V_F	2.0 (≤ 2.6)	2.0 (≤ 2.6)	2.0 (≤ 2.6)	2.0 (≤ 2.6)	2.0 (≤ 2.6)	V
Reverse Current ($V_R = 5 \text{ V}$)	I_R	0.01 (≤ 10)	0.01 (≤ 10)	0.01 (≤ 10)	0.01 (≤ 10)	0.01 (≤ 10)	μA
Capacitance ($V_R = 0 \text{ V}$, $f = 1 \text{ MHz}$)	C_0	12	8	10	15	15	pF
Response Time ($I_F = 100 \text{ mA}$, $t_p = 10 \mu s$, $R_L = 50 \Omega$)							
Rise Time/ I_V , 10%–90%	t_R	300	450	300	450	450	ns
Fall Time/ I_V , 90%–10%	t_F	150	200	150	200	200	ns
Luminous Intensity (mcd) $I_F = 10 \text{ mA}$							
Part Number	Min.	Max.	Part Number	Min.	Typ.		
LS/LO/LY/LG T670-HK	2.5	12.5	LP T670-GO	1.6	5.0		
LS/LO/LY/LG T670-J	4.0	8.0					
LS/LO/LY/LG T670-K	6.3	12.5					
LS/LO/LY/LG T670-JL	4.0	20.0					

See graph numbers 1, 2V, 3A, 4A, 5G, 6G, 7A, 8A, 9A, 10A in the back of this section.

* Luminous intensity factor of I_V of one packaging unit $I_{VMAX}/I_{VMIN} \geq 2$

SUPER-RED LS T672-MO
ORANGE LO T672-MO
YELLOW LY T672-MO
GREEN LG T672-MO
PURE GREEN LP T672-LO

Super-TOP-LED®, Surface Mount LED Lamp

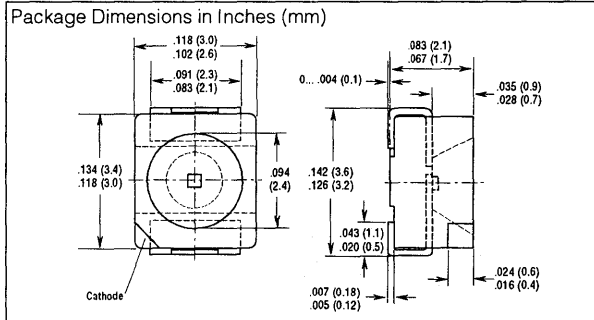
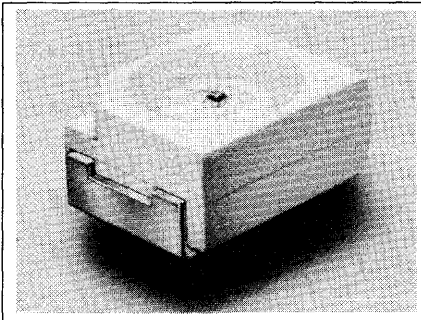

LED Lamps

FEATURES

- PL-CC-2 Package
- Internal Reflector
- Colorless Clear Window
- Low Power Dissipation
- Wide Viewing Angle
- Compatible with Automatic Placement Equipment
- Suitable for Vapor-Phase Reflow, Infrared Reflow and Wave Solder Processes
- Ideal for Backlight and Light Pipe Applications

DESCRIPTION

The LX T672 (Super-TOP-LED for surface mount applications) is available in super-red, orange, yellow, green, and pure green. The package incorporates an internal reflector to optimize light coupling. This feature makes the SMT-TOP-LED ideal for light pipe applications.

The large LED chip allows the part to be driven at a current of 50 mA for increased luminous intensity.

Maximum Ratings

Operating Temperature Range (T_{OP}) -55°C to $+100^{\circ}\text{C}$
 Storage Temperature Range (T_{STG}) -55°C to $+100^{\circ}\text{C}$
 Junction Temperature (T_J) $+100^{\circ}\text{C}$
 Forward Current (I_F) 50 mA
 Surge Current (I_{FS}) $t_p = 10 \mu\text{s}$ 1 A
 Reverse Voltage (V_R) 5 V
 Power Dissipation (P_{TOT}) $T_A \leq 25^{\circ}\text{C}$ 190mW
 Thermal Resistance, Junction to Ambient⁽¹⁾ 300 K/W
 Note: 1. Soldered on PC board: pad size $\geq 16 \text{ mm}^2$.

Characteristics ($T_A = 25^{\circ}\text{C}$)

Parameter	Symbol	Super-				Pure	Unit
		Red	Orange	Yellow	Green	Green	
Peak Wavelength (typ.) ($I_F = 10 \text{ mA}$)	λ_{PEAK}	635	610	586	565	557	nm
Dominant Wavelength (typ.) ($I_F = 10 \text{ mA}$)	λ_{DOM}	628.	605	590	570	560	nm
Spectral Bandwidth (typ.) 50%, I_V ($I_F = 10 \text{ mA}$)	$\Delta\lambda$	45	40	45	25	22	nm
Viewing Angle 50%, I_V	2ϕ	120	120	120	120	120	Deg.
Forward Voltage ($I_F = 50 \text{ mA}$)	V_F	2.4 (≤ 3.8)	2.4 (≤ 3.8)	2.4 (≤ 3.8)	2.4 (≤ 3.8)	2.5 (≤ 3.8)	V
Reverse Current ($V_R = 5 \text{ V}$)	I_R	0.01 (≤ 10)	0.01 (≤ 10)	0.01 (≤ 10)	0.01 (≤ 10)	0.01 (≤ 10)	μA
Capacitance (typ.) ($V_R = 0 \text{ V}$, $f = 1 \text{ MHz}$)	C_0	40	35	35	60	80	pF
Response Time ($I_F = 100 \text{ mA}$, $t_p = 10 \mu\text{s}$, $R_L = 50 \Omega$)							
Rise Time/ I_V , 10%–90%	t_R	350	500	350	500	500	ns
Fall Time/ I_V , 90%–10%	t_F	200	250	200	250	250	ns

Luminous Intensity (mcd)*

($I_F = 50 \text{ mA}$)

Part Number	Min.	Typ.	Unit
LS/LO/LY/LG T672-MO	16	30	mcd
LP T672-LO	10	20	mcd

* Luminous intensity factor of I_V of one packaging unit $I_{VMAX}/I_{VMIN} \geq 2$.

See graph numbers 1, 2V, 3F, 4F, 5D, 6H, 7A, 8A, 9D, 10E in the back of this section.

SIEMENS

SUPER-RED LS T679-CO YELLOW LY T679-CO GREEN LG T679-CO

Low Current SMT-TOP-LED®, Surface Mount LED Lamp

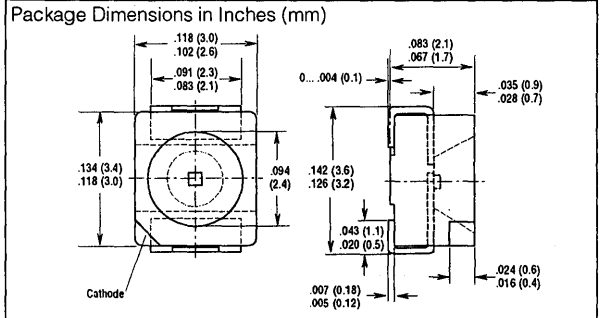
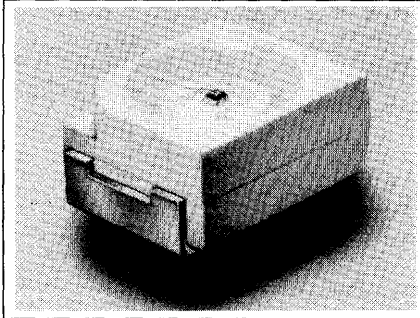

FEATURES

- PL-CC-2 Package
- Internal Reflector
- Colorless Clear Window
- Low (2 mA) Current Operation
- Wide Viewing Angle
- Compatible with Automatic Placement Equipment
- Suitable for Vapor-Phase Reflow, Infrared Reflow and Wave Solder Processes
- Ideal for Backlight and Light Pipe Applications

DESCRIPTION

The LX T679-CO (SMT-TOP-LED for surface mount applications) is available in super-red, yellow, and green. The package incorporates an internal reflector to optimize light coupling. This feature makes the SMT-TOP-LED ideal for light pipe applications.

The low current requirement makes this part ideal for portable equipment or any other application where power is at a premium.

See graph numbers 1, 2V, 3B, 4D, 5C, 6C, 7A, 8A, 9B, 10A in the back of this section.

Maximum Ratings

Operating Temperature Range (T_{OP})	-55°C to + 100°C
Storage Temperature Range (T_{STG})	-55°C to + 100°C
Junction Temperature (T_J)	+ 100°C
Forward Current (I_F)	7.5 mA
Surge Current (I_{FS}) $t_0 = 10 \mu s$	0.15 A
Reverse Voltage (V_R)	5 V
Power Dissipation (P_{TOT}) $T_A \leq 25^\circ C$	20 mW
Thermal Resistance, Junction to Ambient ⁽¹⁾	500 K/W
For mounting on Al_2O_3 ceramic substrate		
15 mm X 16.7 mm X 0.7 mm (R_{thJA})	300 K/W
For mounting on PC Board (R_{thJA})	450 K/W

Note:

1. Soldered on PC board: pad size $\geq 16 \text{ mm}^2$.

Characteristics ($T_A = 25^\circ C$)

Parameter	Symbol	Super-			Unit
		Red	Yellow	Green	
Peak Wavelength ($I_F = 7.5 \text{ mA}$)	λ_{PEAK}	635	586	565	nm
Dominant Wavelength ($I_F = 7.5 \text{ mA}$)	λ_{DOM}	628.	590	570	nm
Viewing Angle 50%, I_V	2ϕ	120	120	120	Deg.
Forward Voltage ($I_F = 2 \text{ mA}$)	V_F	1.8 (≤ 2.6)	2.0 (≤ 2.7)	1.9 (≤ 2.6)	V
Reverse Current ($V_R = 5 \text{ V}$)	I_R	0.01 (≤ 10)	0.01 (≤ 10)	0.01 (≤ 10)	μA
Capacitance ($V_R = 0 \text{ V}$, $f = 1 \text{ MHz}$)	C_0	3	3	15	pF
Response Time ($I_F = 100 \text{ mA}$, $t_p = 10 \mu s$, $R_L = 50 \Omega$)					
Rise Time/ I_V , 10%–90%	t_R	200	200	450	ns
Fall Time/ I_V , 90%–10%	t_F	150	150	200	ns
Luminous Intensity ($I_F = 2 \text{ mA}$)	I_V	1 ($\geq .25$)	1 ($\geq .25$)	1 ($\geq .25$)	mcd

* Luminous intensity factor of I_V of one packaging unit $I_{VMAX}/I_{VMIN} \geq 2$

SUPER-RED LS U260-EO YELLOW LY U260-EO GREEN LG U260-EO

Miniature LED Lamp

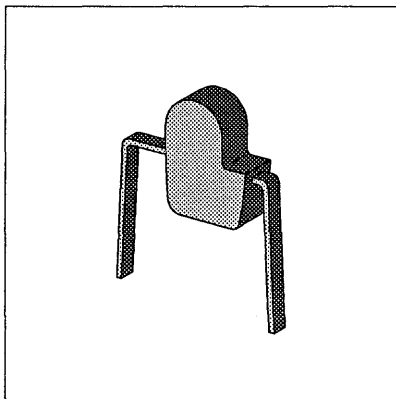

Package Dimensions in Inches (mm)

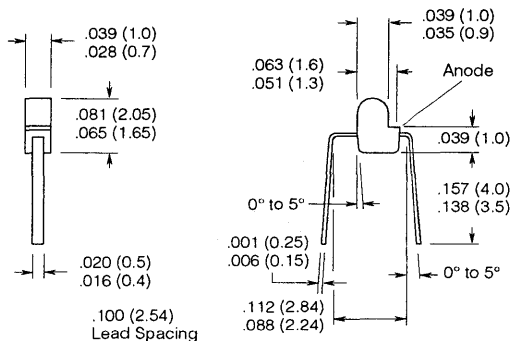

LED Lamps

FEATURES

- Diffused Lens
- Miniature Size, 1 mm Package
- 0.100" (2.54 mm) Lead Spacing
- I/C Compatible

DESCRIPTION

The LS U260 super-red and LY U260 yellow are high efficiency lamps fabricated with TSN (transparent substrate nitrogen) technology. The LG U260 is a gallium phosphide (GaP) lamp.

Maximum Ratings

Operating Temperature Range (T_{OP})	-40°C to +80°C
Storage Temperature Range (T_{STG})	-40°C to +80°C
Junction Temperature (T_J)	100°C
Reverse Voltage (V_R)	5 V
Forward Current (I_F)	15 mA
Surge Current (I_{FS}) $t=10 \mu s$	0.35 A
Total Power Dissipation (P_{TOT}) $T_A=25^\circ C$	50 mW
Thermal Resistance Junction to Air (R_{THJA})	1100 K/W

Characteristics ($T_A=25^\circ C$) All values are typical unless otherwise noted.

Parameter	Sym	LS U260	LY U260	LG U260	Unit
		Super-Red	Yellow	Green	
Peak Wavelength ($I_F=20 \text{ mA}$)	λ_{PEAK}	635	586	565	nm
Dominant Wavelength ($I_F=20 \text{ mA}$)	λ_{DOM}	628	590	570	nm
Spectral Bandwidth (50% I_{RELMAX} , $I_F=20 \text{ mA}$)	$\Delta\lambda$	45	45	25	nm
Viewing Angle 50% I_V	2ϕ	60	60	60	Deg.
Forward Voltage ($I_F=10 \text{ mA}$)	V_F	2.0(≤ 2.6)	2.0(≤ 2.6)	2.0(≤ 2.6)	V
Reverse Current ($V_R=5 \text{ V}$)	I_R	0.01(≤ 10)	0.01(≤ 10)	0.01(≤ 10)	μA
Capacitance ($V_R=0 \text{ V}$, $f=1 \text{ MHz}$)	C_0	12	10	15	pF
Rise Time, I_V I_V from 10% to 90%	t_R	300	300	450	ns
Fall Time, I_V I_V from 90% to 10%	t_F	150	150	200	ns
Luminous Intensity* ($I_F=10 \text{ mA}$)	I_V	≥ 0.63	≥ 0.63	≥ 0.63	med

See graph numbers 1, 2T, 3A, 4A, 5F, 6E, 7A, 8A, 9A, 10A in the back of this section.

* Luminous intensity factor of I_V of one packaging unit $I_{VMAX}/I_{VMIN} \geq 2$

SIEMENS

T¹/₄ (5mm) LU 5351-GL/-JM RECTANGULAR LU B371-EJ/-GK CYLINDRICAL LU H371-EJ/-GK

Two Color Super Red and Green LED Lamp

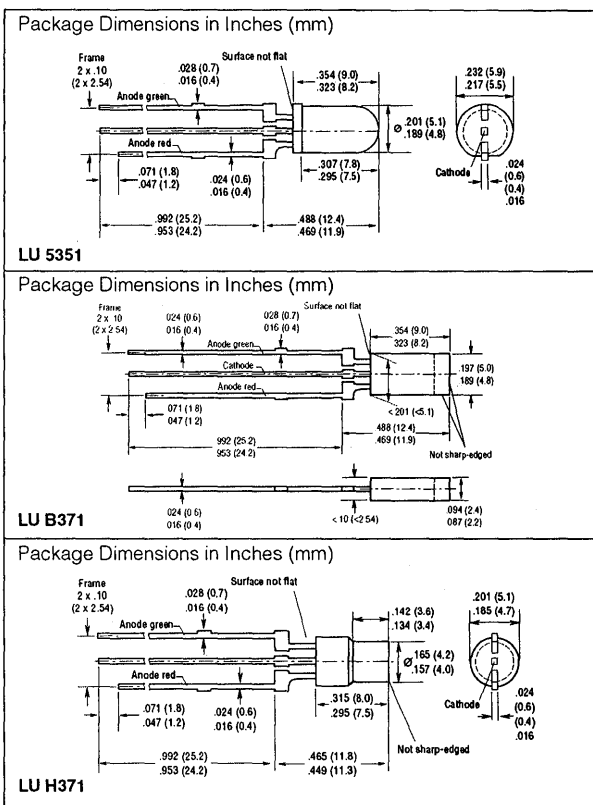
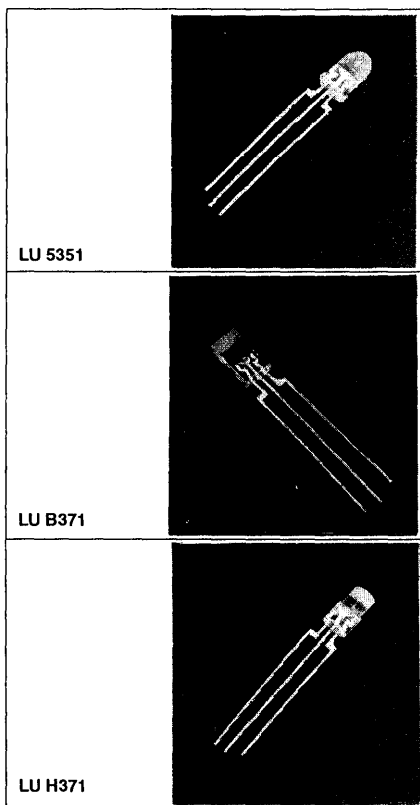

FEATURES

- LU 5351 – T¹/₄
- LU B371 – Rectangular
- LU H371 – Cylindrical
- Two Color Operation, Red and Green
- Lens: Colorless Partly Diffused
- Three Leads, Middle Lead Is Common Cathode
- Minimum Lead Length 1"
- 0.100" Lead Spacing

DESCRIPTION

These LED lamps have a colorless lens with a diffused surface. Two chips (green and super red) allow for use as an optical indicator with multiple functions.

See graph numbers 1, 2D (LU 5351), 2P (LU B371, LU H371), 3A, 4A, 5A, 6A, 7A, 8A, 9A, 10A in the back of this section.

Maximum Ratings

Forward Current* (I_F)	40 mA
Surge Current* (I_{FM}) $t_P < 10 \mu s$	0.5 A
Operating Temperature Range (T_{OP})	-55°C to +100°C
Storage Temperature Range (T_{STG})	-55°C to +100°C
Junction Temperature (T_J)	+100°C
Reverse Voltage (V_R)	5 V
Total Power Dissipation* (P_{TOT}) $T_A = 25^\circ C$	140 mW
Thermal Resistance, Junction to Air (R_{THJA})	400 K/W

* The ratings indicated for the forward current I_F , the surge current I_{FS} or power dissipation P_{TOT} , respectively, are maximum ratings of the component. If both chips are operated simultaneously, the sum of the forward current ratings is not allowed to exceed the indicated maximum value.

Characteristics ($T_A=25^\circ C$)

Parameter	Symbol	Super Red	Green	Unit
Wavelength of Emitted Light				
Light	λ_{PEAK}	635	565	nm
Dominant Wavelength	λ_{DOM}	628	570	nm
Spectral Bandwidth (50% I_{RELMAX} , $I_F=20$ mA)	$\Delta\lambda$	45	25	nm
Viewing Angle 50%				
LU 5351	ϕ	50	50	Deg.
LU B371, LUH371	ϕ	100	100	Deg.
Forward Voltage ($I_F=10$ mA)	V_F	2.0	2.0	V
Capacitance ($V_R=0$ V, $f=1$ MHz)	C_0	12	15	pF
Rise Time	t_R	300	450	ns
Fall Time	t_F	150	200	ns
Luminous Intensity ($I_F=10$ mA)	Min.	Max.	Unit	
LU 5351-GL	1.6	20	mcd	
LU 5351-JM	4	32	mcd	
LU B371-EJ, LU H371-EJ	0.63	8	mcd	
LU B371-GK, LU H371-GK	1.6	12.5	mcd	

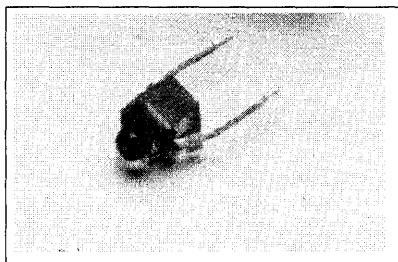

FEATURES

- Yellow Diffused Lens
- Miniature Size
- 0.100" (2.54 mm) Lead Spacing
- End Stackable to Arrays of Any Length
- I/C Compatible

DESCRIPTION

The LY Z181-CO is a gallium arsenide phosphide LED solid state lamp. It has a yellow plastic encapsulated lens where the light is emitted.

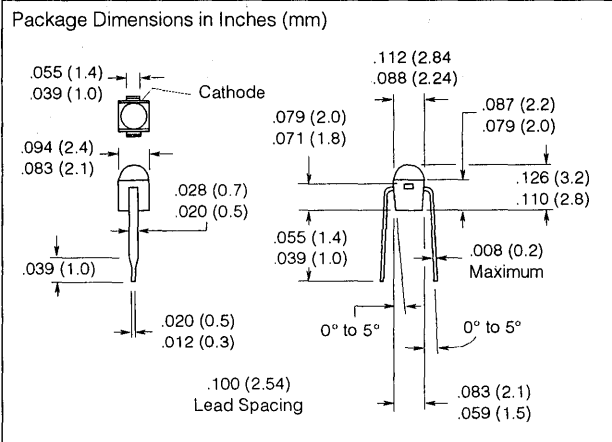

Maximum Ratings (Individual Diode)

Operating Temperature (T_{OP})	-40°C to +80°C
Storage Temperature (T_{STG})	-40°C to +80°C
Junction Temperature (T_J)	100 °C
Soldering Temperature, 2 mm from case bottom (T_S), $t \leq 3$ sec.	230°C
Forward Current (I_F)	30 mA
Surge Current (I_{FM}), $t \leq 10 \mu s$	0.5 A
Reverse Voltage (V_R)	5 V
Power Dissipation (P_{TOT}), $T_A = 25^\circ C$	90 mW
Thermal Resistance Junction to Air (R_{THJA})	750 K/W

Note: Soldered on PC board: pad size $\geq 16 \text{ mm}^2$.

Characteristics ($T_A = 25^\circ C$)

Parameter	Symbol	Value	Unit	Condition
Wavelength, Peak Emission (typ.)	λ_{PEAK}	586	nm	$I_F = 20 \text{ mA}$
Dominant Wavelength (typ.)	λ_{DOM}	590	nm	$I_F = 20 \text{ mA}$
Spectral Bandwidth (typ.)	$\Delta\lambda$	45	nm	$I_F = 20 \text{ mA}$
50% I_{RELMAX}				
Viewing Angle, 50% I_V	2ϕ	100	Deg.	
Forward Voltage (typ.)	V_F	2.0	V	$I_F = 10 \text{ mA}$
(max.)	V_F	2.6	V	$I_F = 10 \text{ mA}$
Reverse Current (typ.)	I_R	0.01	μA	$V_R = 5 \text{ V}$
(max.)	I_R	10	μA	$V_R = 5 \text{ V}$
Capacitance (typ.)	C_0	15	pF	$V_R = 0 \text{ V}$, $f = 1 \text{ MHz}$
Switching Time				
I_V , 10% to 90% (typ.)	t_R	300	ns	$I_F = 100 \text{ mA}$, $t_P = 10 \mu s$,
I_V , 90% to 10% (max.)	t_F	150	ns	$R_L = 50 \Omega$
Luminous Intensity	I_V	≥ 0.25	mcd	$I_F = 10 \text{ mA}$

See graph numbers 1, 2U, 3A, 4A, 5G, 6F, 7A, 8A, 9A, 10A in the back of this section.

WATER CLEAR DIFFUSED LENS RL-50 RED DIFFUSED LENS RL-54 Red Miniature Axial Lead LED Lamp

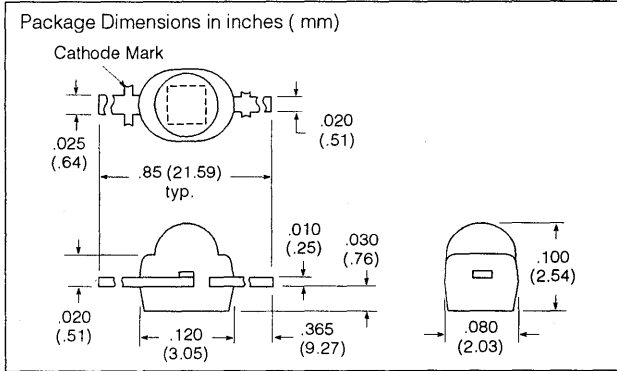
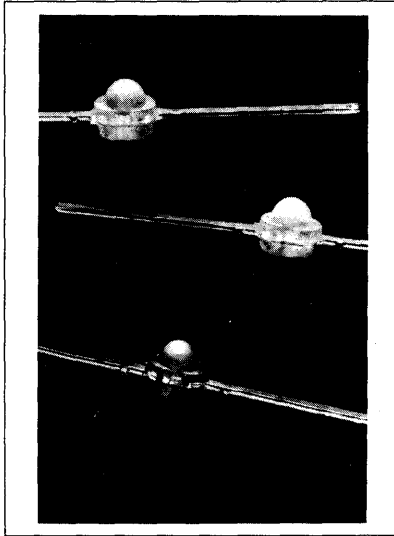

LED Lamps

FEATURES

- High Luminance—1.0 mcd at 20 mA, typical
- Optimum Packaging Design for Maximum Strength at Minimum Linear Spacing
- Operates from 5 Volt IC Logic Supply
- Small Size
- High Reliability
- Lens
 - RL-50: Water Clear
 - RL-54: Red Diffused

Maximum Ratings

Operating and Storage Temperature Range	-55°C to +100°C
Lead Solder Time, 260°C (.063" from case)	5 sec.
Peak Reverse Voltage	3 V
Continuous Forward Current	40 mA
Power Dissipation (T _A =25 °C)80 mW
Derate Linearly from 25°C	-1.1 mW/°C

Electrical/Optical Characteristics (T_A=25°C)

Parameter	Min.	Typ.	Max.	Unit	Test Condition
Wavelength, Peak Emission		660		nm	
Viewing Angle		90		Deg.	
Forward Voltage		1.6	2.0	V	I _F =20 mA
Reverse Current			100	µA	V _R =3 V
Luminous Intensity					
RL-50	0.5	1.0		mcd	I _F =20 mA
RL-54	0.4	0.6		mcd	I _F =20 mA

DESCRIPTION

The RL-50 and RL-54 are intended for high volume use in array and indicator light applications. Major advantages of these devices are high luminance at low currents, long life and low cost.

Luminous intensity versus forward current RL-50

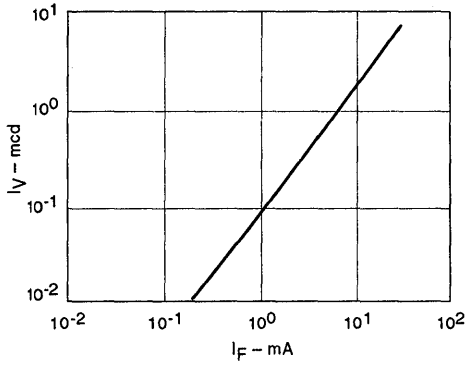

Forward Current versus forward voltage

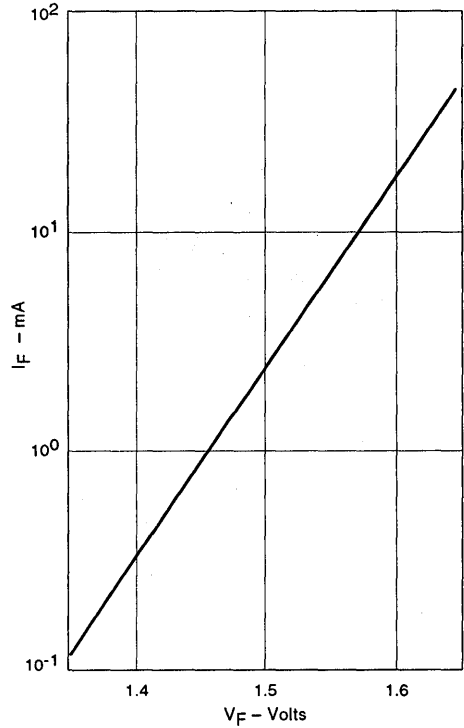

Luminous intensity versus forward current RL-54

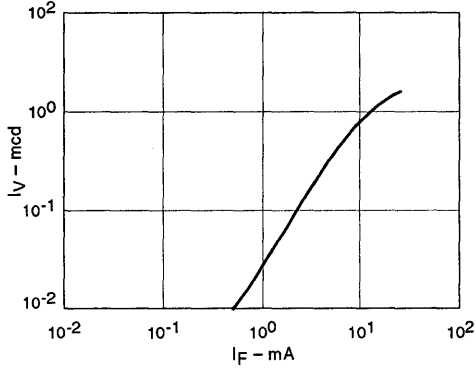

Radiation characteristics

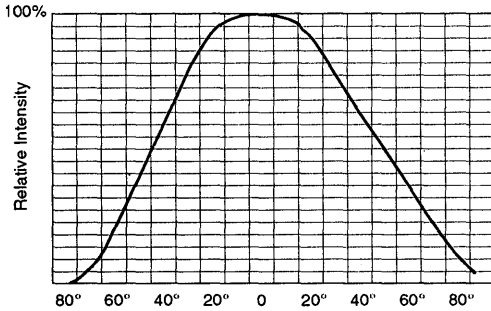

Relative spectral emission

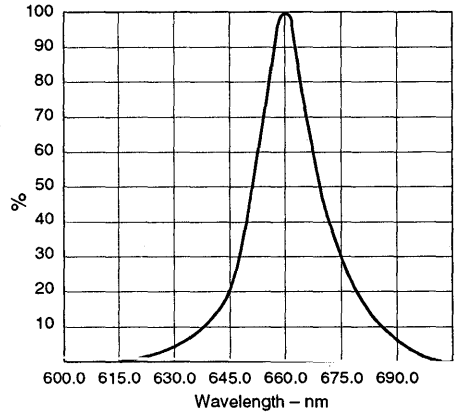

Miniature Axial Lead LED Lamp

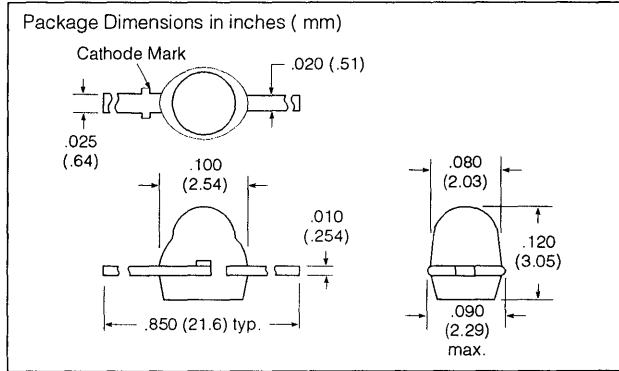
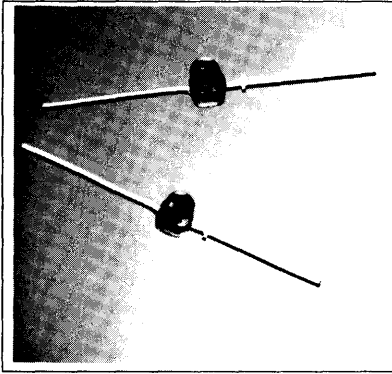

FEATURES

- High on Axis Intensity
- Optimum Packaging Design for Maximum Strength at Minimum Linear Spacing
- Operates from 5 Volt IC Logic Supply
- Miniature Axial Lead
- High Reliability
- Low Cost Version (Red), RL-55-5

DESCRIPTION

The RL-55 is a gallium arsenide phosphide lamp and the GL-56/YL-56 are gallium phosphide lamps that have on-axis intensity, long life and low cost. They have diffused lenses and provide a full 0.080° flooded light with good contrast.

Applications include mounting on PC boards at low current as diagnostic and circuit status indicators.

Maximum Ratings

Operating and Storage Temperature Range	-55°C to +100°C
Lead Solder Time, 260°C (.063" from case)	5 sec.
Peak Inverse Voltage	3 V
Continuous Forward Current	
RL-55	40 mA
GL-56, YL-56	25 mA
Peak Forward Current (1 μs pulse, 0.1% duty cycle)	250 mA
Power Dissipation (T _A =25°C)	80 mW
Derate Linearly from 25°C	-1.1 mW/°C

Electrical/Optical Characteristics (T_A=25°C)

Parameter	Min.	Typ.	Max.	Unit	Test Condition
Wavelength, Peak Emission					
RL-55		660		nm	
GL-56		565		nm	
YL-56		585		nm	
Spectral Line Half Width		40		nm	
Viewing Angle					
RL-55		50		Deg.	
GL-56, YL-56		40		Deg.	
Forward Voltage					
RL-55		1.6	2.0	V	I _F =20 mA
GL-56		2.2	3.5	V	I _F =20 mA
YL-56		2.4	3.5	V	I _F =20 mA
Reverse Current		0.15	10	μA	V _R =3 V
Luminous Intensity					
RL-55	2.0	2.2		mcd	I _F =10 mA
GL-56	1.0	1.3		mcd	I _F =10 mA
YL-56	2.0	2.2		mcd	I _F =10 mA

Red, RL-55

Luminous intensity versus forward current

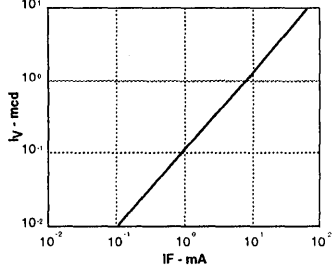

Relative spectral emission

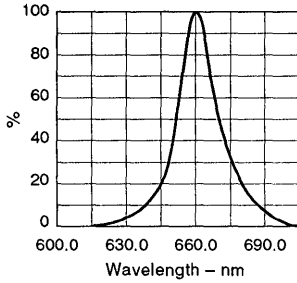

Forward current versus forward voltage

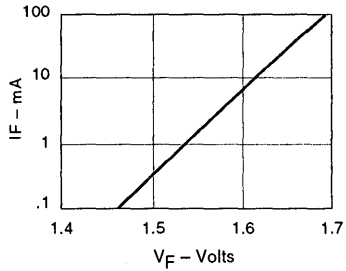

Radiation characteristics

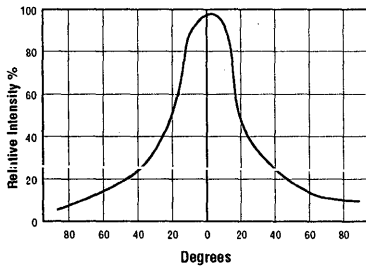

Yellow, YL-56

Luminous intensity versus forward current

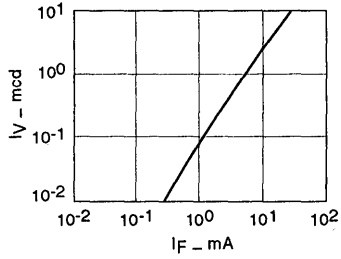

Relative spectral emission

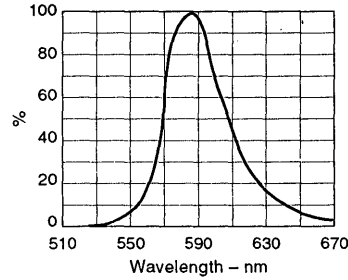

Forward current versus forward voltage

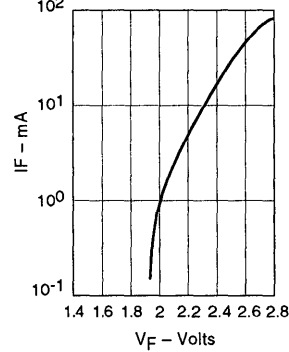

Green, GL-56

Luminous intensity versus forward current

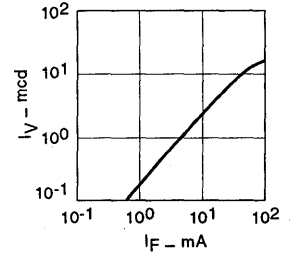

Relative spectral emission

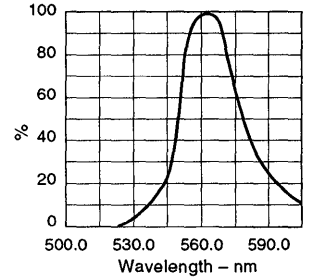

Forward current vs. forward voltage

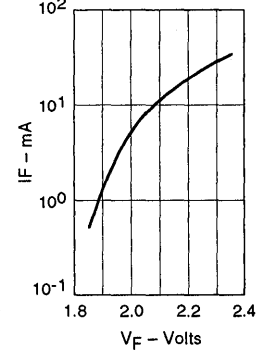

Red, Resistor, Miniature Axial Lead LED Lamp

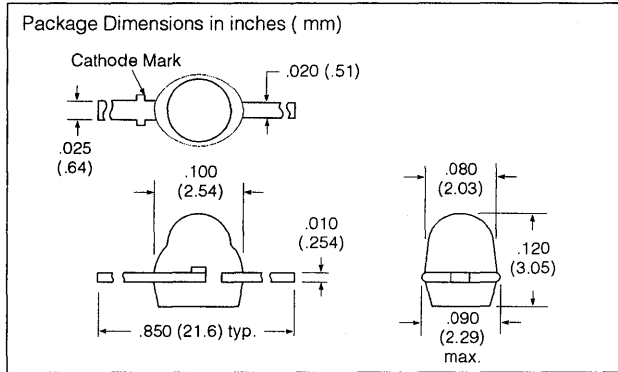
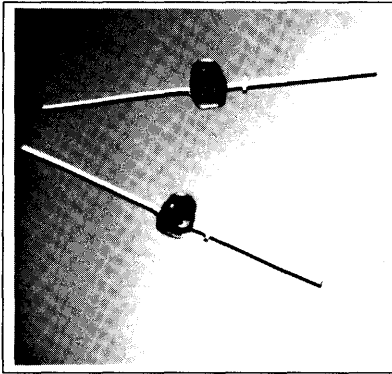

FEATURES

- Integral Current Limiting Resistor
- No External Resistor Required with 5 Volt Supply
- Miniature Axial Lead Package
- Red Diffused Lens
- Three Light Intensity Ranges
- High Reliability

DESCRIPTION

The RRL-5601/5621/5641 are gallium arsenide phosphide LED red lamps with integral resistor chips in series with the LED. This construction allows operation from a 5 volt source without an external current limiting resistor.

Applications include mounting on PC boards as diagnostic and circuit status indicators.

Maximum Ratings

Operating Temperature Range	-55°C to +100°C
Storage Temperature Range	-55°C to +100°C
Soldering Time, 260°C (.063" from case)	5 sec.
Reverse Voltage	6 V
DC Forward Voltage	6 V

Optoelectronic Characteristics (T_A=25°C)

Parameter	Min.	Typ.	Max.	Unit	Test Condition
Wavelength, Peak Emission		650		nm	
Half Angle		20		Deg.	
Forward Current					
RRL-5601	2.0	3.0	4.0	mA	5 V
RRL-5621	4.0	6.0	8.0	mA	5 V
RRL-5641	13.0	16.0	21.0	mA	5 V
Reverse Current		0.1	10	μA	6 V
Luminous Intensity					
RRL-5601	0.3			mcd	5 V
RRL-5621	0.6	1.2		mcd	5 V
RRL-5641	1.0	2.0		mcd	5 V

Forward current versus forward voltage

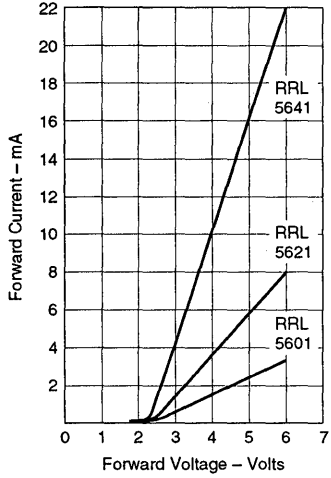

Relative luminous intensity versus forward voltage

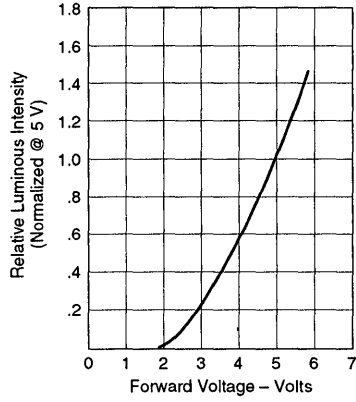

Spectral distribution

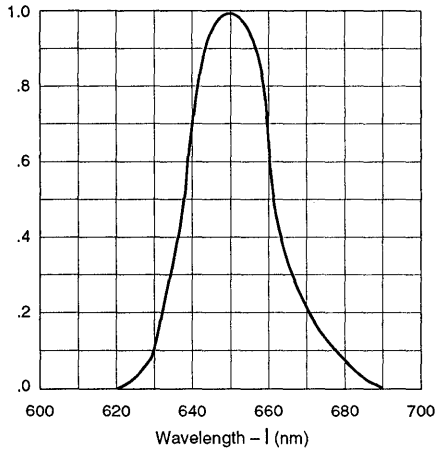

1
 Relative spectral emission $I_{rel}=f(\lambda)$, $T_A=25^\circ\text{C}$
 $V(\lambda)$ =standard eye response curve

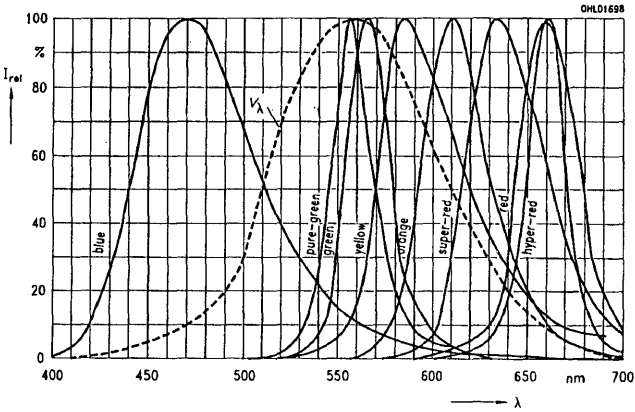

2A
 Radiation characteristics $I_{rel}=f(\rho)$

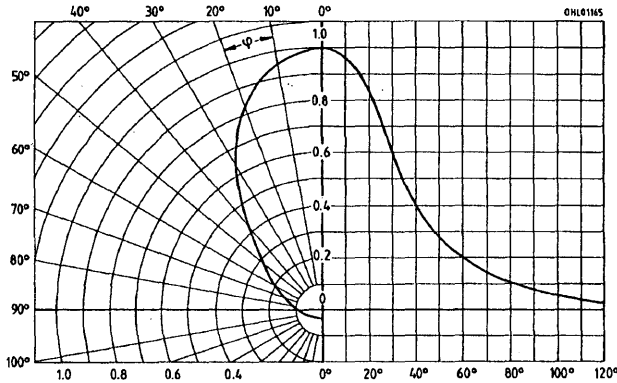

2B
 Radiation characteristics $I_{rel}=f(\rho)$

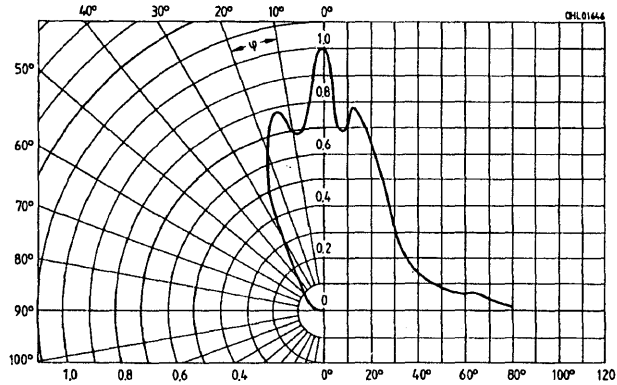

2C

Radiation characteristics $I_{rel}=f(\rho)$

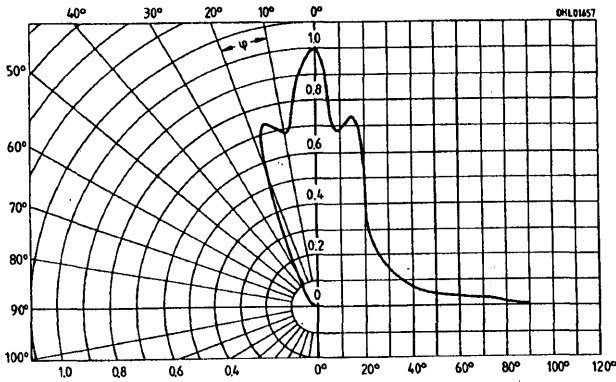

2D

Radiation characteristics $I_{rel}=f(\rho)$

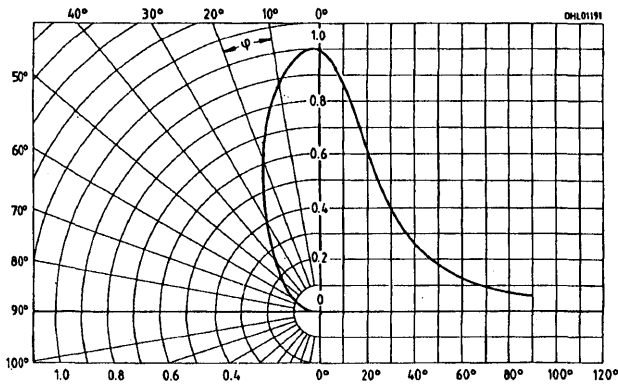

2E

Radiation characteristics $I_{rel}=f(\rho)$

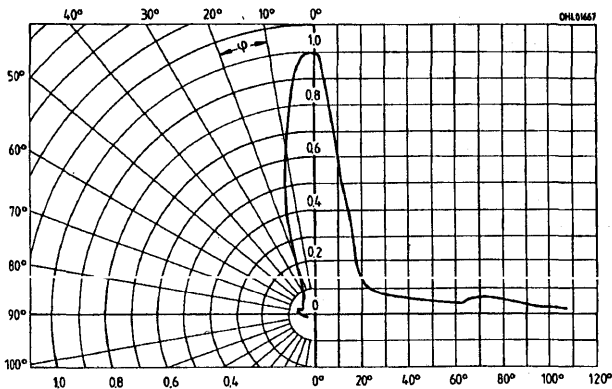

2F

Radiation characteristics $I_{rel}=f(\rho)$

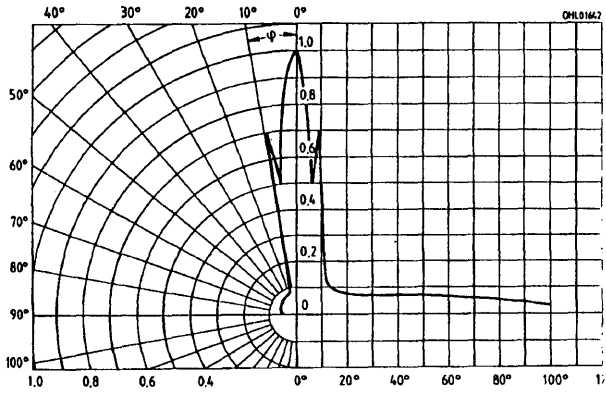

2G

Radiation characteristics $I_{rel}=f(\rho)$

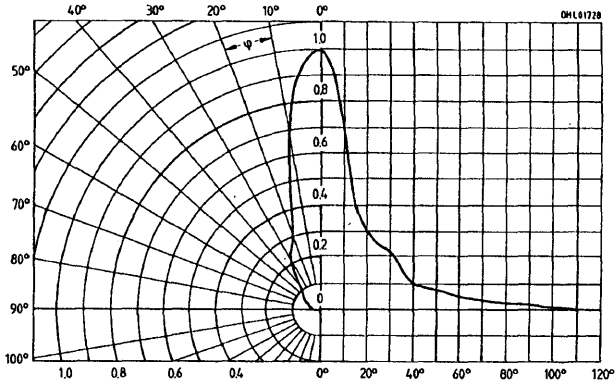

2H

Radiation characteristics $I_{rel}=f(\rho)$

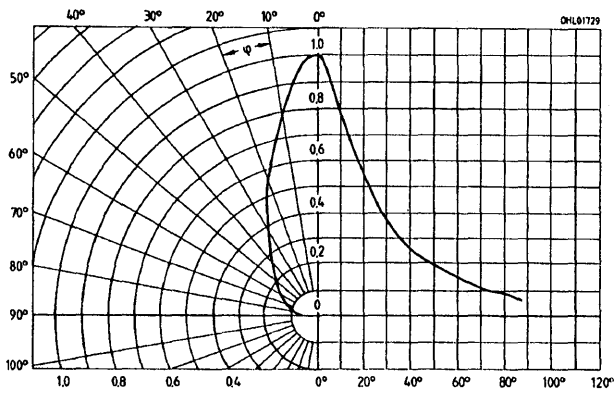

2I

Radiation characteristics $I_{rel}=f(\rho)$

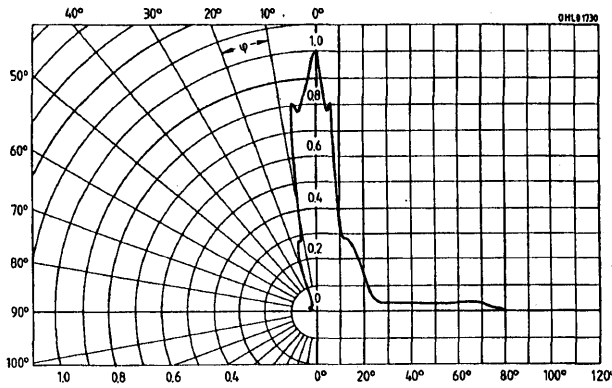

2J

Radiation characteristics $I_{rel}=f(\rho)$

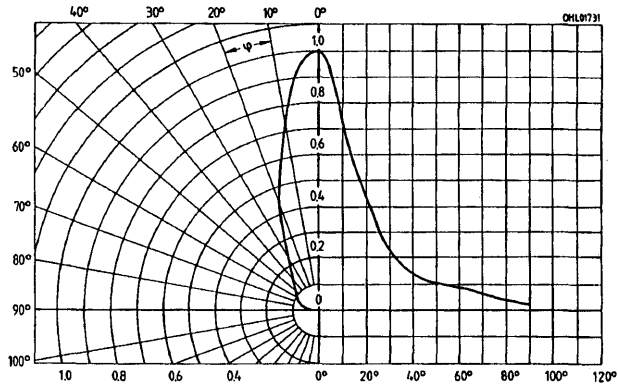

2K

Radiation characteristics $I_{rel}=f(\rho)$

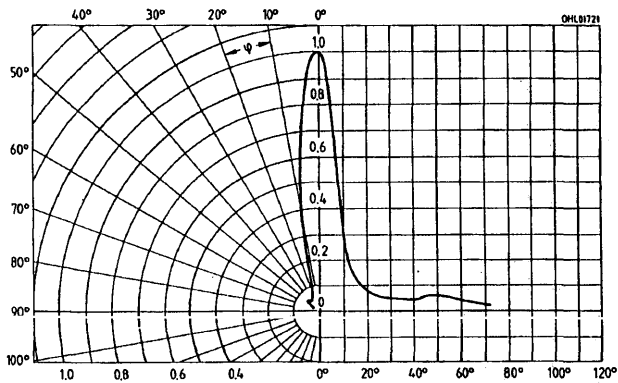

2L

Radiation characteristics $I_{rel}=f(\rho)$

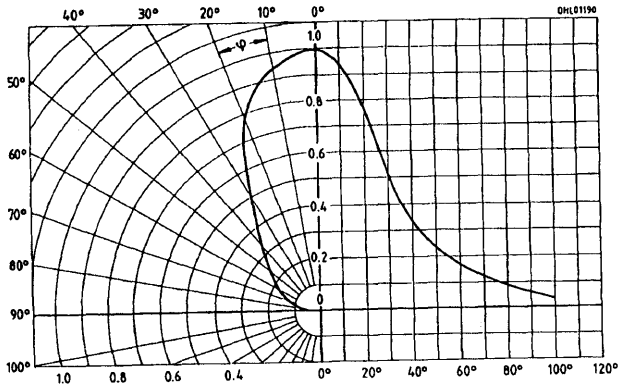

2M

Radiation characteristics $I_{rel}=f(\rho)$

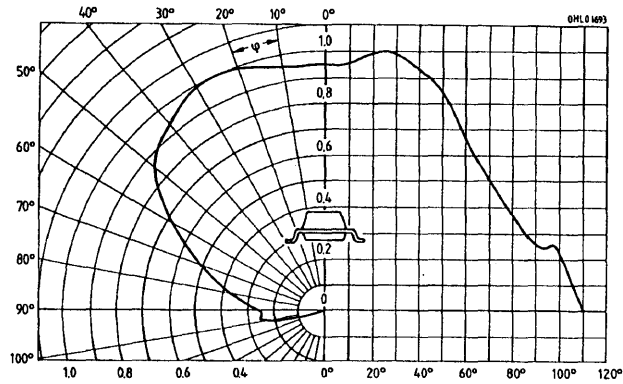

2K

Radiation characteristics $I_{rel}=f(\rho)$

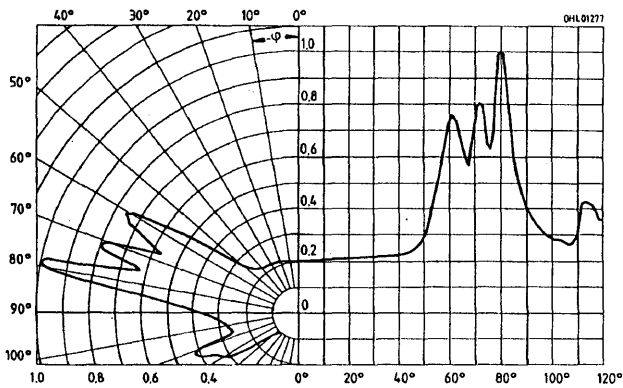

2O

Radiation characteristics $I_{rel}=f(\rho)$

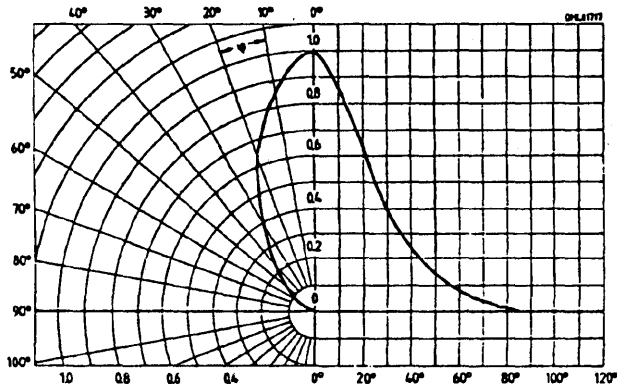

2P

Radiation characteristics $I_{rel}=f(\rho)$

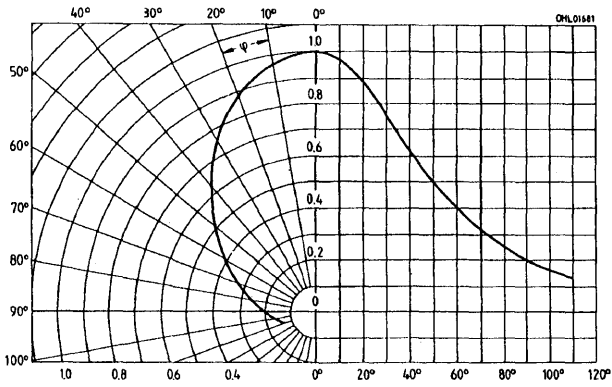

2Q

Radiation characteristics $I_{rel}=f(\rho)$

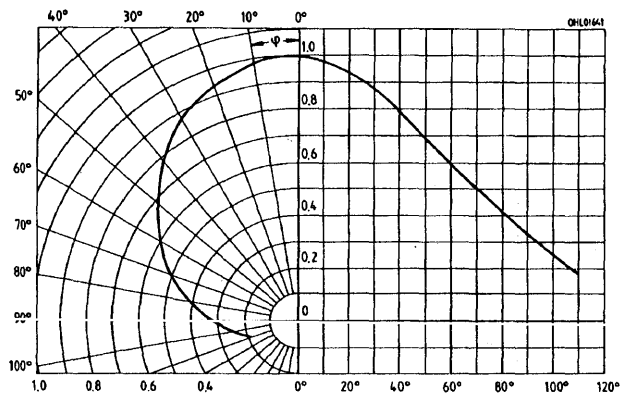

2R

Radiation characteristics $I_{rel}=f(\rho)$

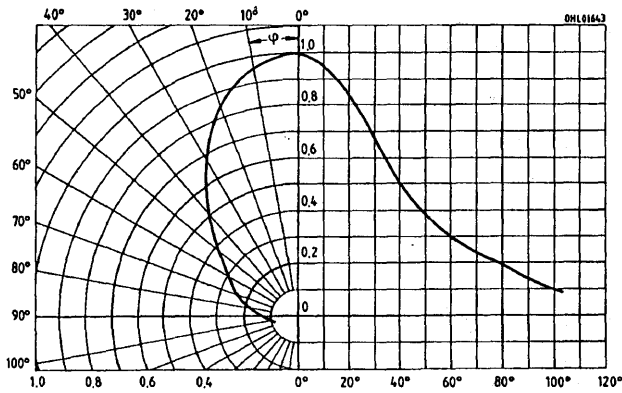

2S

Radiation characteristics $I_{rel}=f(\rho)$

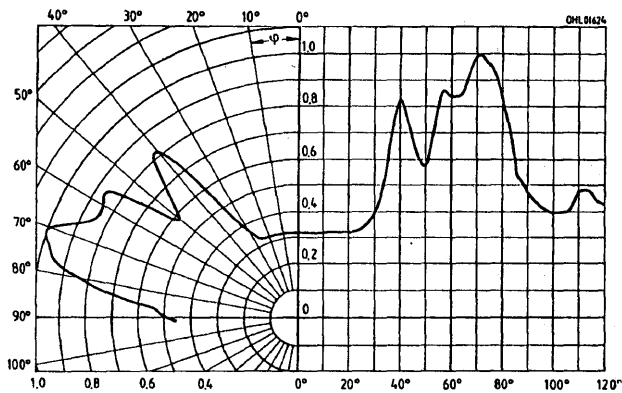

2T

Radiation characteristics $I_{rel}=f(\rho)$

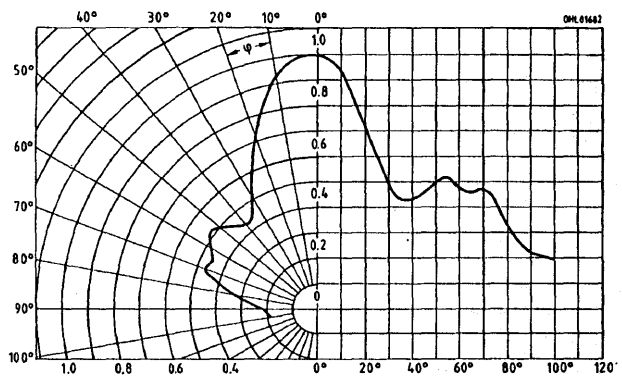

LED Lamps

2U

Radiation characteristics $I_{rel} = f(\rho)$

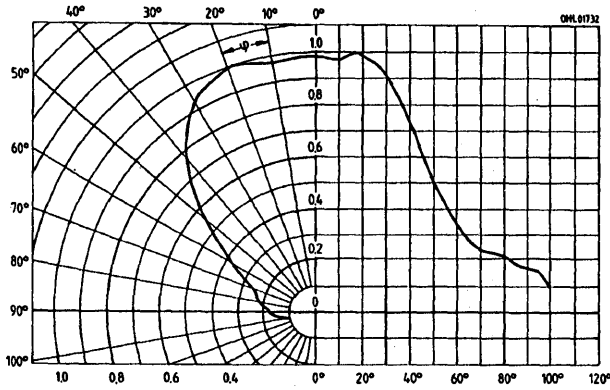

2V

Radiation characteristics $I_{rel} = f(\rho)$

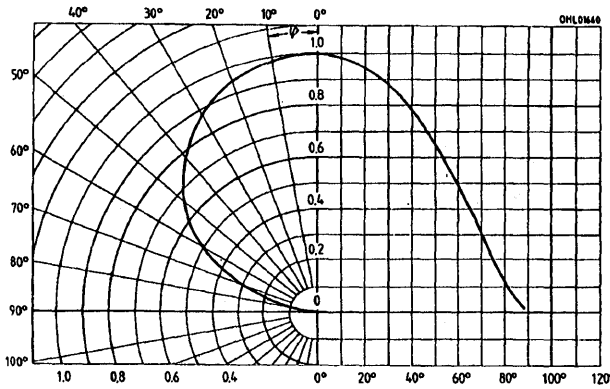

2W

Radiation characteristics $I_{rel} = f(\rho)$

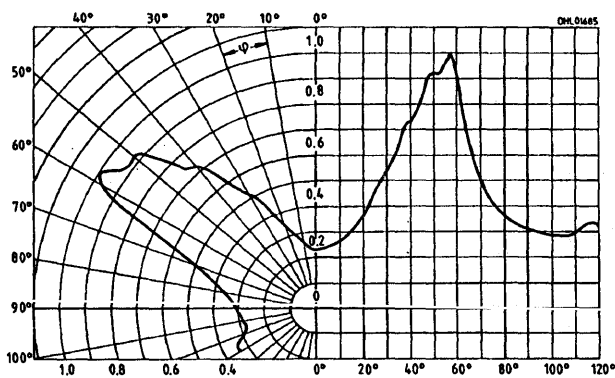

Radiation characteristics $I_{rel}=f(\rho)$

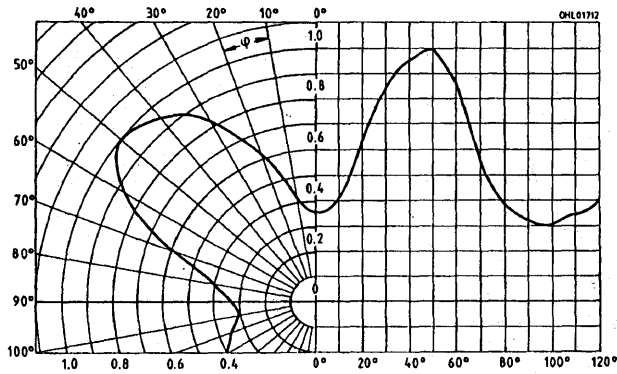

3A Forward current $I_F=f(V_F)$

$T_A=25^\circ\text{C}$

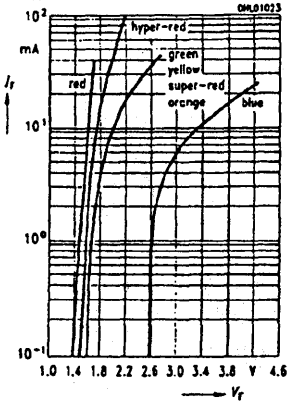

3B Forward current $I_F=f(V_F)$

$T_A=25^\circ\text{C}$

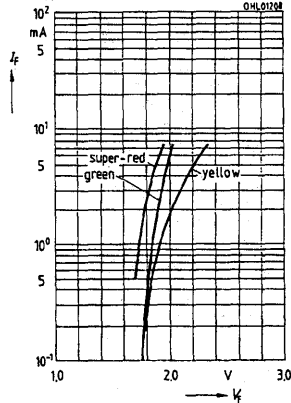

3C Forward current $I_F=f(V_F)$

$T_A=25^\circ\text{C}$

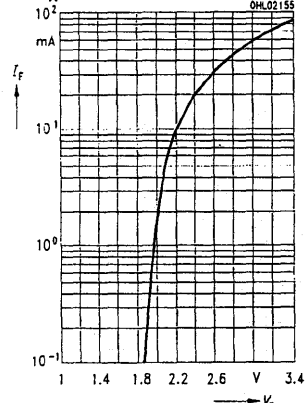

3E Forward current $I_F=f(V_F)$

$T_A=25^\circ\text{C}$

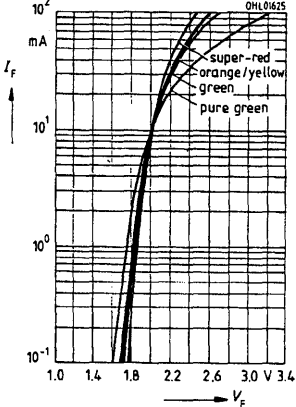

3F Forward current $I_F=f(V_F)$

$T_A=25^\circ\text{C}$

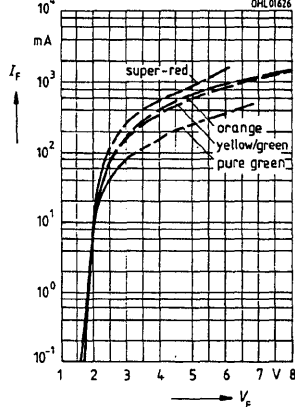

3G
Forward current $I_F = f(V_F)$
 $T_A = 25^\circ\text{C}$

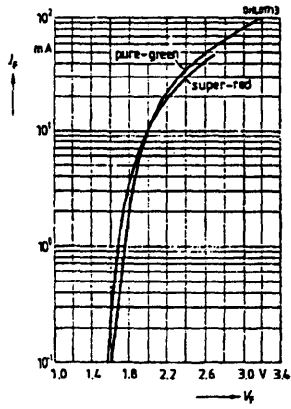

4A
Rel. luminous intensity $I_V/I_V(10\text{ mA}) = f(I_F)$

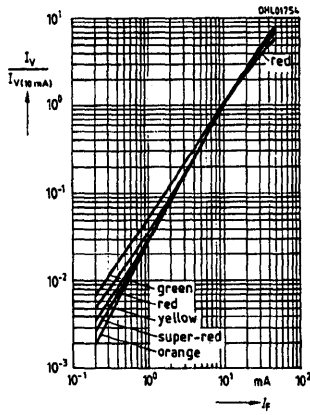

4B
Rel. luminous intensity $I_V/I_V(10\text{ mA}) = f(I_F)$

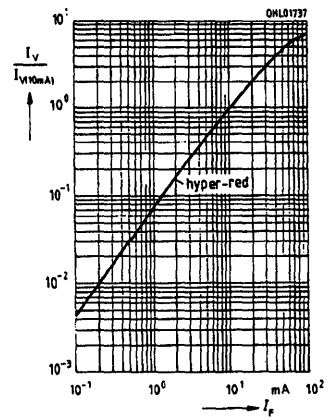

4C
Rel. luminous intensity $I_V/I_V(10\text{ mA}) = f(I_F)$

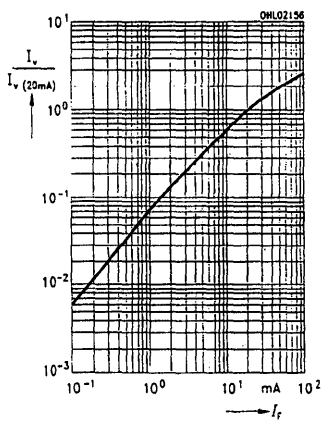

4D
Rel. luminous intensity $I_V/I_V(10\text{ mA}) = f(I_F)$

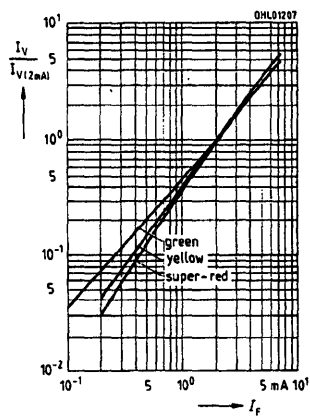

4F
Rel. luminous intensity $I_V/I_V(50\text{ mA}) = f(I_F)$

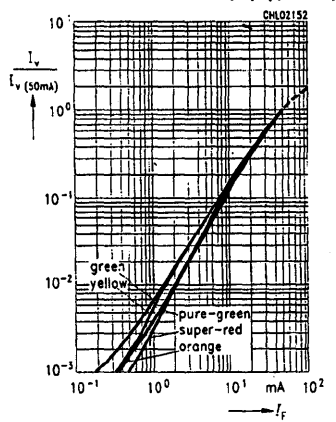

4H
Rel. luminous flux $\Phi_V/\Phi_V(15\text{ mA}) = f(I_F)$

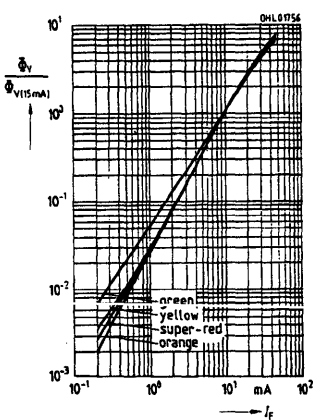

5A
Permissible pulse handling capability
 $I_F=f(t_p)$, $T_A=25^\circ\text{C}$
Duty cycle d =parameter

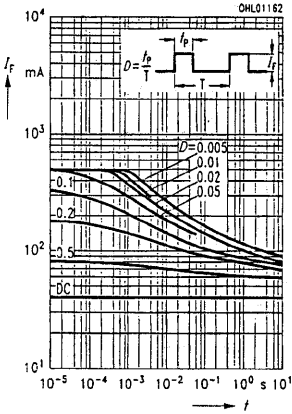

5B
Permissible pulse handling capability
 $I_F=f(t_p)$, $T_A=25^\circ\text{C}$
Duty cycle d =parameter

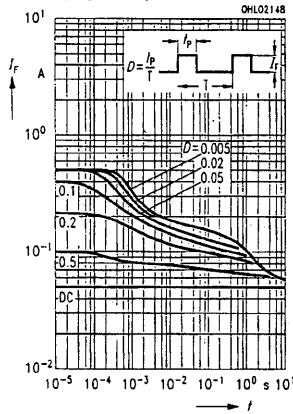

5C
Permissible pulse handling capability
 $I_F=f(t_p)$, $T_A=25^\circ\text{C}$
Duty cycle d =parameter

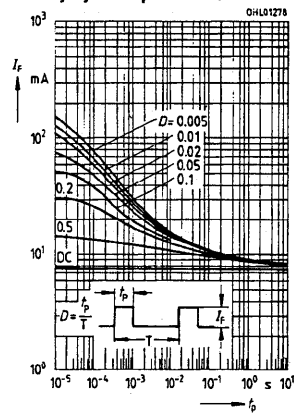

5D
Permissible pulse handling capability
 $I_F=f(t_p)$, $T_A=25^\circ\text{C}$
Duty cycle d =parameter

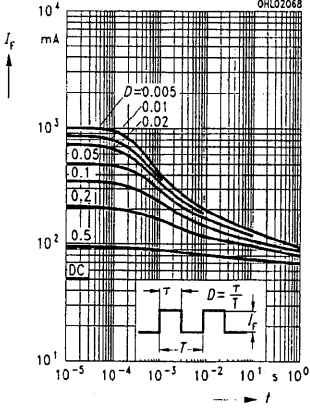

5E
Permissible pulse handling capability
 $I_F=f(t_p)$, $T_A=25^\circ\text{C}$
Duty cycle d =parameter

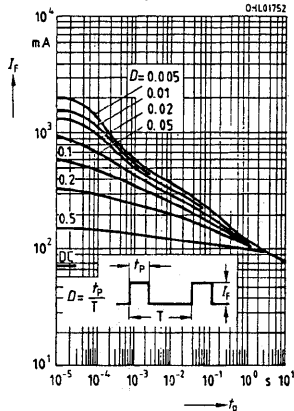

5F
Permissible pulse handling capability
 $I_F=f(t_p)$, $T_A=25^\circ\text{C}$
Duty cycle d =parameter

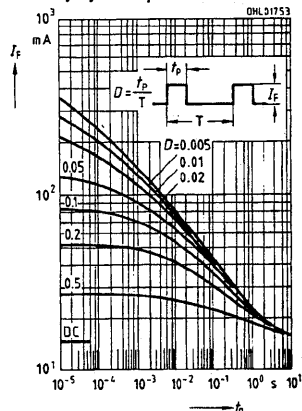

5G
Permissible pulse handling capability
 $I_F=f(t_p)$, $T_A=25^\circ\text{C}$
Duty cycle d =parameter

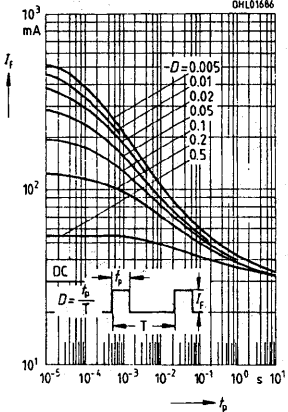

6A
Max. permissible forward current
 $I_F=f(T_A)$

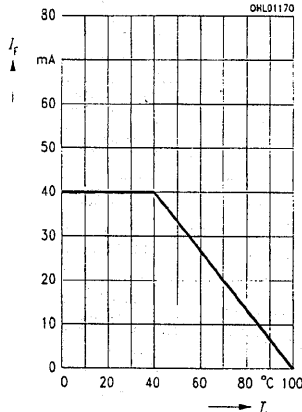

6B
Max. permissible forward current
 $I_F=f(T_A)$

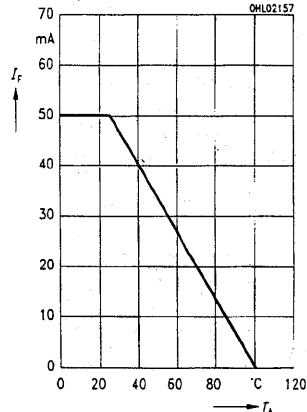

6C
Max. Permissible forward current
 $I_F=f(T_A)$

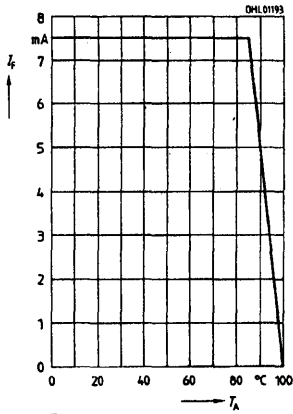

6D
Max. Permissible forward current
 $I_F=f(T_A)$

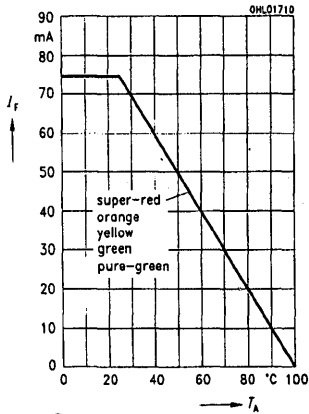

6E
Max. Permissible forward current
 $I_F=f(T_A)$

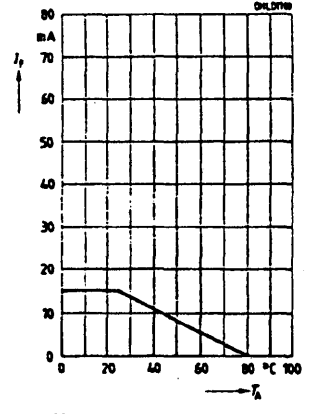

6F
Max. Permissible forward current
 $I_F=f(T_A)$

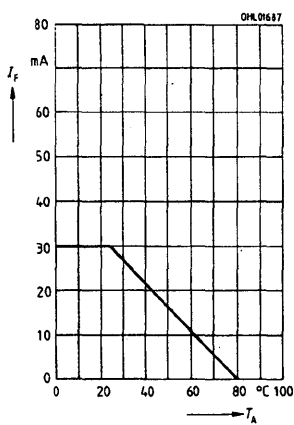

6G
Max. Permissible forward current
 $I_F=f(T_A)$

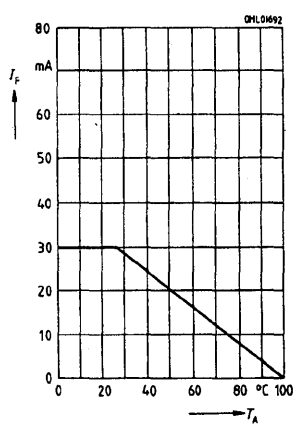

6H
Max. Permissible forward current
 $I_F=f(T_A)$

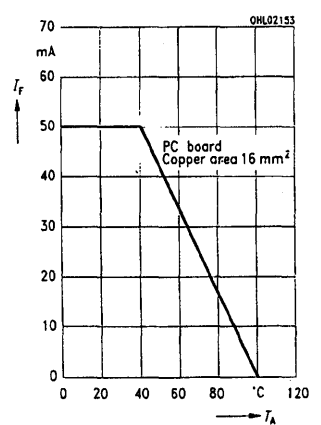

7A
Wavelength at peak emission
 $\lambda_{PEAK}=f(T_A)$

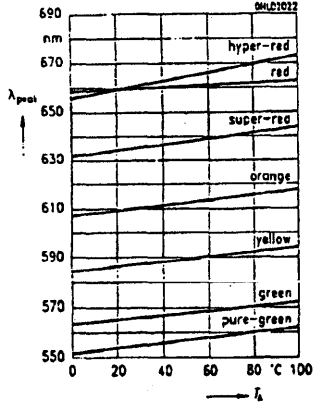

8A
Dominant wavelength
 $\lambda_{DOM}=f(T_A)$

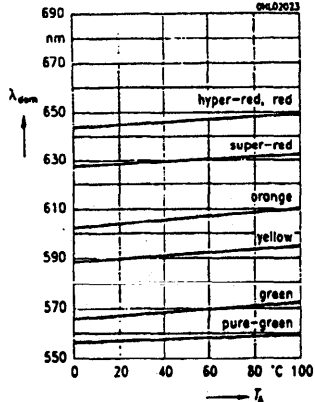

9A
Forward voltage
 $V_F=f(T_A)$

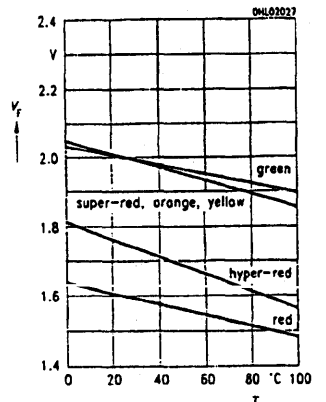

9B
Forward voltage
 $V_F=f(T_A)$

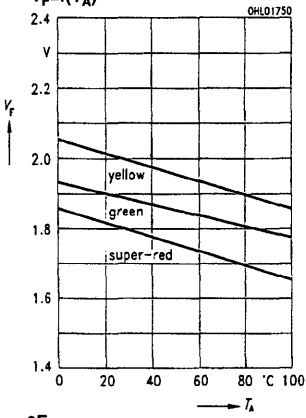

9C
Forward voltage
 $V_F=f(T_A)$

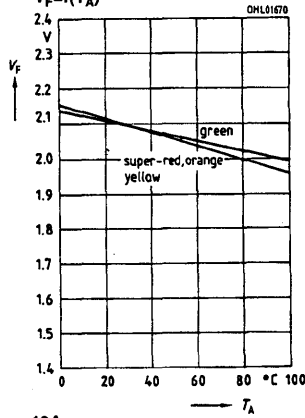

9D
Forward voltage
 $V_F=f(T_A)$

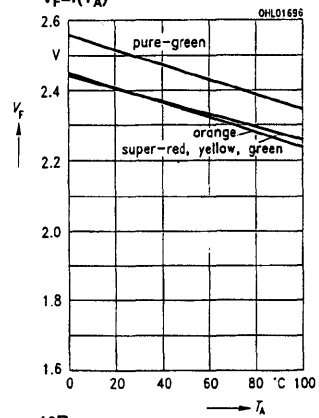

9E
Forward voltage
 $V_F=f(T_A)$

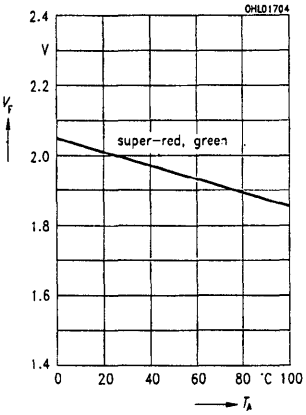

10A
Rel. luminous intensity
 $I_v/I_v(25^\circ\text{C})=f(T_A)$

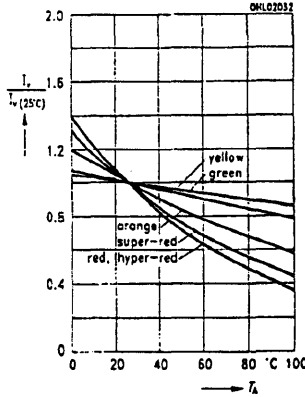

10B
Rel. luminous intensity
 $I_v/I_v(25^\circ\text{C})=f(T_A)$

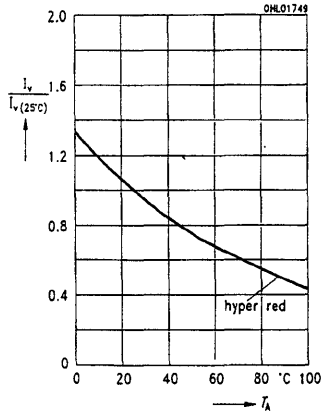

10C
Rel. luminous flux
 $\Phi_v/\Phi_v(25^\circ\text{C})=f(T_A)$

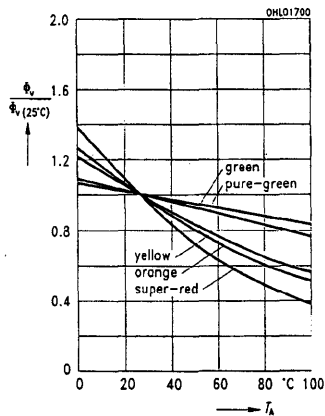

10D
Rel. luminous flux
 $\Phi_v/\Phi_v(25^\circ\text{C})=f(T_A)$

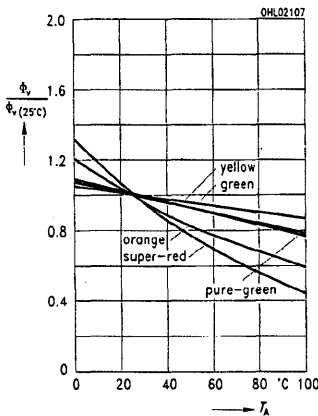

10E
Rel. luminous intensity
 $I_v/I_v(25^\circ\text{C})=f(T_A)$

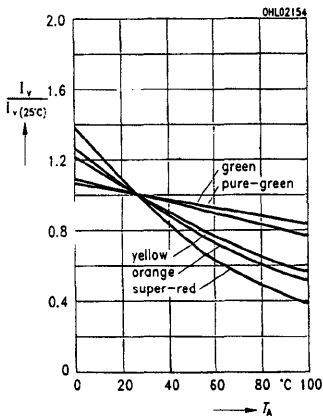

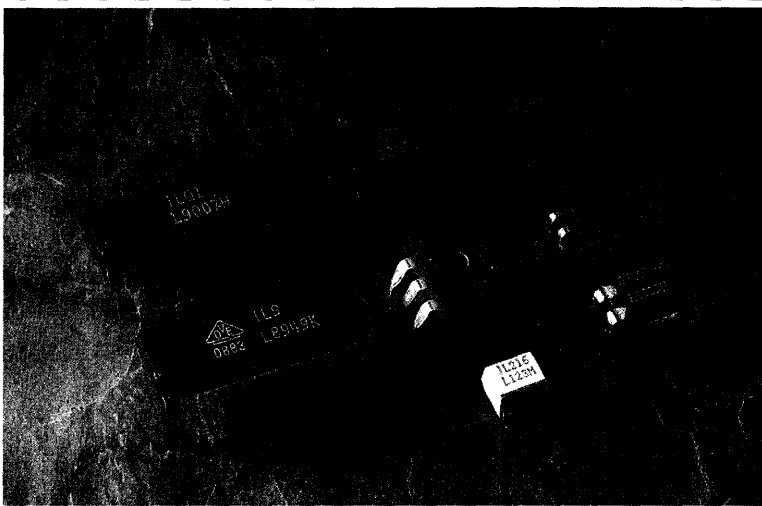

Optocouplers

Optocouplers

Package and Type	Package Outline	Part Number	Features	Current Transfer Ratio (%) $I_F=10\text{ mA}$	(V_{DC}) ¹ Withstand Test Voltage	BV_{CEO}	Page	
8 pin SOIC-8 DIP, single photo-transistor	<p>Single</p> <p>A=Anode K=Cathode</p>	IL205	Small outline surface mount SOIC-8 footprint. 0.05" standard lead spacing. Available on tape and reel.	40-80	2500 V_{RMS}	70	5-99	
		IL206		63-125				
		IL207		100-200				
		IL208		160-320				
		IL211		20 Min.				
		IL212		50 Min.			$I_F=1\text{ mA}$	30
		IL213		100 Min.				
		IL215		20 Min.				
		IL216		50 Min.				
		IL217		100 Min.				
8 pin SOIC-8 DIP, dual photo-transistor	<p>Dual</p> <p>A=Anode K=Cathode</p>	ILD205	Small outline surface mount SOIC-8 footprint. 0.05" standard lead spacing. Available on tape and reel.	40-80	2500	70	5-163	
		ILD206		63-125				
		ILD207		100-200				
		ILD213		100 min.				
4 pin DIP surface mount, photo-transistor	<p>SFH6106</p> <p>A=Anode K=Cathode</p> <p>SFH6116</p> <p>A=Anode K=Cathode</p> <p>SFH6156/6186</p> <p>A=Anode K=Cathode</p>	SFH6106-1	TRIOS (TRansparent IOn Shield).	40-80	5300	70	5-244	
		SFH6106-2		63-125				
		SFH6106-3		100-200				
		SFH6106-4		160-320				
		SFH6116-1	TRIOS (TRansparent IOn Shield).	40-80	5300	70		
		SFH6116-2		63-125				
		SFH6116-3		100-200				
		SFH6116-4		160-320				
		SFH6156-1	TRIOS (TRansparent IOn Shield).	40-80	5300	70		
		SFH6156-2		63-125				
		SFH6156-3		100-200				
		SFH6156-4		160-320				
		SFH6186-2	TRIOS (TRansparent IOn Shield).	63-125	5300	55		
		SFH6186-3		100-200				
		SFH6186-4		160-320				
		SFH6186-5		250-500				

1. 1 sec. unless otherwise specified.
2. UL qualified voltage.

Optocouplers (Continued)

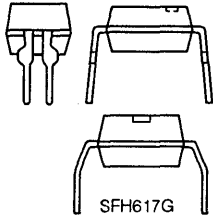
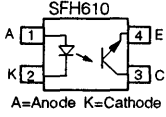
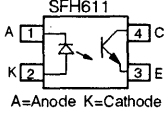
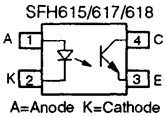
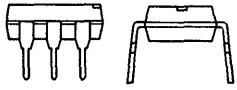
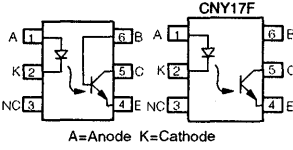
Package and Type	Package Outline	Part Number	Features	Current Transfer Ratio (%) $I_F=10\text{ mA}$	(V_{DC}) ¹ Withstand Test Voltage	BV_{CEO}	Page				
4 pin DIP single channel, photo-transistor	   	SFH610-1	TRIOS (TRansparent IO n Shield).	40-80	5300	70	5-226				
		SFH610-2		63-125							
		SFH610-3		100-200							
		SFH610-4		160-320							
		SFH611-1		40-80							
		SFH611-2		63-125							
		SFH611-3		100-200							
		SFH611-4		160-320							
		SFH615-1		40-80							
		SFH615-2		63-125							
		SFH615-3		100-200							
		SFH615-4		160-320							
		SFH617G-1		TRIOS (TRansparent IO n Shield). 10 mm lead spacing, input to output.				40-80.	5300	70	5-229
		SFH617G-2						63-125			
		SFH617G-3						100-200			
		SFH617G-4						160-320			
		SFH618-2	Low current input. TRIOS (TRansparent IO n Shield).	5300	55	5-232	5300	70	5-229		
		SFH618-3								63-125	
		SFH618-4								100-200	
		SFH618-5								160-320	
SFH618-5				250-500							
6 pin DIP single channel, photo-transistor	 	CNY17-1	CTR groupings.	40-80	5300	70	5-53				
		CNY17-2		63-125							
		CNY17-3		100-200							
		CNY17-4		160-320							
		CNY17F-1	No base pin connection. CTR groupings.	5300	70	5-57	5300	70	5-57		
		CNY17F-2								40-80	
		CNY17F-3								63-125	
		CNY17F-4								100-200	
		SFH600-0	CTR groupings.	5300	70	5-215	5300	70	5-215		
		SFH600-1								40-80	
		SFH600-2								63-125	
		SFH600-3								100-200	

Optocouplers (Optoisolators)

1. 1 sec. unless otherwise specified.
2. UL qualified voltage.

Optocouplers (Continued)

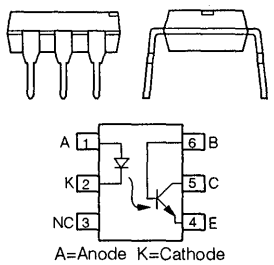
Package and Type	Package Outline	Part Number	Features	Current Transfer Ratio (%) $I_F=10\text{ mA}$	(V_{DC}) ¹ Withstand Test Voltage	BV_{CEO}	Page	
6 pin DIP single channel photo-transistor		SFH601-1	CTR groupings.	40-80	5300	70	5-219	
		SFH601-2		63-125				
		SFH601-3		100-200				
		SFH601-4		160-320				
		SFH608-2	Low current. TRIOS (TRansparent IOn Shield).	63-125	$I_F=1\text{ mA}$	5300	55	5-223
		SFH608-3		100-200				
		SFH608-4		160-320				
		SFH608-5		250-500				
		SFH640-1	High BV_{CER} voltage. TRIOS (TRansparent IOn Shield).	40-80	5300	300	5-241	
		SFH640-2		63-125				
		SFH640-3		100-200				
		4N25	Low cost industry standard.	20 Min.	7500 ² 5300	30	5-36	
		4N26						
		4N27		10 Min.				
		4N28	Low cost industry standard.	100 Min.	7500 ² 5300	30	5-41	
		4N35						
		4N36						
		4N37						
		H11A1	Low cost industry standard.	50 Min.	7500 ² 5300	30	5-61	
		H11A2		20 Min.				
		H11A3		20 Min.				
		H11A4		10 Min.				
		H11A5		30 Min.				
		H11D1	High BV_{CER} voltage. TRIOS (TRansparent IOn Shield).	20	5300	300	5-70	
		H11D2				300		
		H11D3				200		
		IL1	TRIOS (TRansparent IOn Shield).	20-300	7500 ² 5300	30	5-73	
		IL2		100-500				
IL5	50-400							
IL74	12.5 Min.							
					70			
					20	5-91		

1. 1 sec. unless otherwise specified.
2. UL qualified voltage.

Optocouplers (Continued)

Package and Type	Package Outline	Part Number	Features	Current Transfer Ratio (%) $I_F=10 \text{ mA}$	(V_{DC}) ¹ Withstand Test Voltage	BV_{CEO}	Page
6 pin DIP single channel, photo-transistor	<p>A=Anode K=Cathode</p>	IL2B-1	No base pin connection.	100-300	7500 ² 5300	50	5-78
		IL2B-2		30, $I_F=2 \text{ mA}$			
		IL2B-3		100-300, $I_F=1 \text{ mA}$			
		IL2B-4		40, $I_F=.5 \text{ mA}$			
		IL2B-5		20, $I_F=.25 \text{ mA}$			
		MCT2	Low cost industry standard.	20 Min.	7500 ² 5300	30	5-202
		MCT2E		20 Min.			
		MCT270		50 Min.			
		MCT271		45-90			
		MCT272		75-150			
		MCT273		125-250			
		MCT274		225-400			
		MCT275		70-210			
		MCT276		15-60			
		MCT277		100 Min.			
		MCT5210	AlGaAs LED.	70, $I_F=3.0 \text{ mA}$	7500 ² 5300	70	5-211
		MCT5211		110, $I_F=1 \text{ mA}$			
		IL201	Low input forward current.	10 Min.	$I_F=1 \text{ mA}$ 7500 ² 5300	70	5-96
30 Min.							
50 Min.							
4 or 6 pin DIP single channel, photo-transistor	<p>A=Anode K=Cathode</p>	IL8 (4 pin)	Very high isolation breakdown voltage. VDE approved #0700, #0804, #0860, IEC#601/ VDE#0750, IEC#380/ VDE#0806, IEC#435/ VDE#0805	20 Min.	8 KV_{RMS}^2 (1min.) 7 KV_{RMS}^3 10KVDC.	30	5-81
		IL9 (6 pin)					
		IL10 (4 pin)		50 Min.			
		IL11 (6 pin)					

Optocouplers (Optoisolators)

1. 1 sec. unless otherwise specified.
2. UL qualified voltage.

Optocouplers (Continued)

Package and Type	Package Outline	Part Number	Features	Current Transfer Ratio (%) $I_F=10\text{ mA}$	(V_{DC}) ¹ Withstand Test Voltage	BV_{CEO}	Page	
8 pin DIP dual channel, photo-transistor		ILCT6	TRIOS (TRansparent IOn Shield).	20 Min.	7500 ² 5300	30	5-153	
		ILD1		20-300		50	5-156	
		ILD2		100-500		70		
		ILD5		50-400		20	5-91	
		ILD74		12.5 Min.				
		MCT6	Low cost industry standard.	20 Min.	7500 ²	30	5-205	
		ILD610-1	Pinout of emitter and detector is repetitive. CTR groupings.	40-80	7500 ²	70	5-169	
		ILD610-2		63-125				
		ILD610-3		100-200				
		ILD610-4		160-320				
		ILD615-1	Pinout of emitter and detector is repetitive. CTR groupings.	40-80	7500 ²	70	5-172	
		ILD615-2		63-125				
		ILD615-3		100-200				
		ILD615-4		160-320				
ILD621	Pinout of emitter and detector is repetitive.	50-600	$I_F=5\text{ mA}$	70	5-181			
ILD621GB		100-600						
16 pin DIP quad channel, photo-transistor		ILQ1	TRIOS (TRansparent IOn Shield).	20-300	7500 ² 5300	50	5-156	
		ILQ2		100-500		70		
		ILQ5		50-400		20	5-91	
		ILQ74		12.5 Min.				
		ILQ615-1	Pinout of emitter and detector is repetitive.	40-80	7500 ²	70	5-172	
		ILQ615-2		63-125				
		ILQ615-3		100-200				
		ILQ615-4		160-320				
		ILQ621	Pinout of emitter and detector is repetitive.	50-600	$I_F=5\text{ mA}$	70	5-181	
		ILQ621GB		100-600				
8 pin SOIC8 DIP single channel photo-darlington		IL221	Small outline surface mount. 0.05" standard lead spacing. Available on tape and reel.	100 Min.	$I_F=1\text{ mA}$	2500 V_{RMS}	30	5-106
		IL222		200 Min.				
		IL223		500 Min.				

1. 1 sec. unless otherwise specified.
2. UL qualified voltage.

Optocouplers

Package and Type	Package Outline	Part Number	Features	Current Transfer Ratio (%)		$(V_{oc})^1$ Withstand Test Voltage	BV_{CEO}	Page	
				$I_F=10\text{ mA}$					
8 pin SOIC8 DIP dual channel photo-darlington	<p>A=Anode K=Cathode</p>	ILD223	Small outline surface mount. 0.05" standard lead spacing. Available on tape and reel.	500	$I_F=1\text{ mA}$	2500	30	5-165	
6 pin DIP single channel photo-darlington	<p>A=Anode K=Cathode</p> <p>IL66</p> <p>IL66B</p>	IL30	High gain.	100 Min.	$I_F=1\text{ mA}$	7500 ² 5300	30	5-83	
		IL31		200 Min.					
		IL55		100 Min.					
		4N32		500 Min.					
		4N33	High gain. Low cost industry standard.	H11B1	500 Min.	7500 ² 5300	25	30	5-67
		H11B2		200 Min.					
		H11B3		100 Min.					
		MCA230		100 Min.					
		MCA231		200 Min.					
		MCA255	100 Min.	55	5-200				
		IL66-1	Internal R_{BE} for high stability.	100 Min. $I_F=2\text{ mA}$		7500 ²	60	5-86	
		IL66-2		300 Min. $I_F=2\text{ mA}$					
		IL66-3		400 Min. $I_F=0.7\text{ mA}$					
		IL66-4		500 Min. $I_F=2\text{ mA}$					
		IL66B-1	Internal R_{BE} for high stability. No base lead.	100	7500 ²	60	5-89		
IL66B-2	300								
8 pin DIP dual channel photo-darlington	<p>A=Anode K=Cathode</p>	ILD30	High gain.	100 Min.	7500 ² 5300	30	5-83		
		ILD31		200 Min.					
		ILD55		100 Min.			55		
		ILD32		500 Min.			30	5-160	

Optocouplers (Optoisolators)

1. 1 sec. unless otherwise specified.
2. UL qualified voltage.

Optocouplers (Continued)

Package and Type	Package Outline	Part Number	Features	Current Transfer Ratio (%) $I_F=10\text{ mA}$	(V_{DC}) ¹ Withstand Test Voltage	BV_{CEO}	Page	
8 pin DIP dual channel photo-darlington	<p>A=Anode K=Cathode</p>	ILD66-1	Internal R_{BE} for high stability.	100 Min. $I_F=2\text{ mA}$	7500 ²	60	5-86	
		ILD66-2		300 Min. $I_F=2\text{ mA}$				
		ILD66-3		400 Min. $I_F=0.7\text{ mA}$				
		ILD66-4		500 Min. $I_F=2\text{ mA}$				
16 pin DIP quad channel photo-darlington	<p>A=Anode K=Cathode</p>	ILQ30	High gain.	100 Min.	7500 ² 5300	30	5-83	
		ILQ31		200 Min.				
		ILQ32		100 Min.				
		ILQ66-1	Internal R_{BE} for high stability.	ILQ66-1	100 Min. $I_F=2\text{ mA}$	7500 ²	60	5-86
				ILQ66-2	300 Min. $I_F=2\text{ mA}$			
				ILQ66-3	400 Min. $I_F=0.7\text{ mA}$			
				ILQ66-4	500 Min. $I_F=2\text{ mA}$			
8 pin SOIC8 DIP AC/bi-directional	<p>A=Anode K=Cathode</p>	IL256	Small outline surface mount. 0.05" standard lead spacing. Available on tape and reel.	20 Min.	2500 V_{RMS}	30	5-112	
		4 pin DIP AC/bi-directional	<p>A=Anode K=Cathode</p>	SFH620-1	40-125	5300	70	5-235
SFH620-2	63-200							
SFH620-3	100-320							
<p>SFH6206</p>	SFH628-2		63-200	5300	55	5-238		
	SFH628-3		100-320					
	SFH628-4		160-500					
4 pin DIP surface mount AC/bi-directional	<p>A=Anode K=Cathode</p>	SFH6206-1	40-125	5300	70	5-244		
		SFH6206-2	63-200					
		SFH6206-3	100-320					

1. 1 sec. unless otherwise specified.
2. UL qualified voltage.

Optocouplers (Continued)

Optocouplers
(Optoisolators)

Package and Type	Package Outline	Part Number	Features	Current Transfer Ratio (%) $I_F=10\text{ mA}$	$(V_{OC})^1$ Withstand Test Voltage	BV_{CEO}	Page
4 pin DIP surface mount, AC/bidirectional	<p>A=Anode K=Cathode</p>	SFH6286-2	TRIOS (TRansparent IOn Shield).	63-200	5300	55	5-244
		SFH6286-3		100-320			
		SFH6286-4		160-500			
6 pin DIP single channel AC/bidirectional	<p>A=Anode K=Cathode</p>	H11AA1	3:1 CTR matching.	20 Min.	7500 ² 5300	30	5-64
		IL250	2:1 CTR matching.	50 Min.			5-109
		IL251		20 Min.			
		IL252		100 Min.			
8 pin DIP dual channel AC/bidirectional	<p>A=Anode K=Cathode</p>	ILD250	2:1 CTR matching.	50 Min.	7500	30	5-109
		ILD251		20 Min.			
		ILD252		100 Min.			
		ILD255	Bidirectional input.	50 Min.	6000	30	5-167
		ILD620	Pinout of emitter and detector are repetitive. VDE applied for.	50-600	7500 ²	70	5-177
		ILD620GB		100-600			
16 pin DIP quad channel AC/bidirectional	<p>A=Anode K=Cathode</p>	ILQ620	Pinout of emitter and detector are repetitive.	50-600	7500 ²	70	5-177
		ILQ620GB		100-600			
6 pin DIP AC/bidirectional photo-clarlington	<p>A=Anode K=Cathode</p>	IL755-1	High CTR.	750 Min. $I_F=2\text{ mA}$	7500 ² 5300	60	5-135
		IL755-2		1000 Min. $I_F=1\text{ mA}$			
		IL755B-1	No base pin connection.	750 Min. $I_F=2\text{ mA}$			5-138
		IL755B-2		1000 Min. $I_F=1\text{ mA}$			

1. 1 sec. unless otherwise specified.
2. UL qualified voltage.

Optocouplers (Continued)

Package and Type	Package Outline	Part Number	Features	Current Transfer Ratio (%) $I_F=10\text{ mA}$	$(V_{DC})^1$ Withstand Test Voltage	BV_{CEO}	Page	
6 pin DIP AC/bi-directional photodarlington		IL766-1	Internal R_{BE} for better stability.	500 Min $I_F=2\text{ mA}$	7500 ² 5300	60	5-141	
		IL766-2		500 Min $I_F=1\text{ mA}$				
		IL766B-1	No base pin connection.	400 $I_F=1\text{ mA}$	7500 ² 5300		60	5-144
		IL766B-2		900 $I_F=0.5\text{ mA}$				
8 pin DIP AC/bi-directional photodarlington		ILD755-1	High CTR.	750 $I_F=2\text{ mA}$	7500 ² 5300	60	5-143	
		ILD755-2		1000 $I_F=1\text{ mA}$				
		ILD766-1	Internal R_{BE} for better stability.	500 $I_F=2\text{ mA}$	7500 ² 5300		60	5-149
		ILD766-2		500 $I_F=1\text{ mA}$				
8 pin DIP single channel, low input current		6N138	High gain. Low input forward current.	300 Min.	6000	NA	5-47	
		6N139		500 Min.				
		SFH6138	High gain. Low input forward current.	300 Min.	5300		NA	5-248
		SFH6139		500 Min.				
8 pin DIP high speed		6N135	High speed, high bit rates-1 Mbits.	16 (≥ 7)	2500	NA	5-44	
		6N136		35 (≥ 19)				
		SFH6135	High speed, high bit rates-1 Mbits VDE	16 (≥ 7)	5300		NA	5-245
		SFH6136		35 (≥ 19)				
6 pin DIP, SCR output		H11C4	Optically coupled SCR	11 mA	7500	Fwd. blocking voltage $V_{DRM}=600\text{ V}$	5-69	
		H11C5		11 mA				
		H11C6		14 mA				
		IL400		10 mA				

1. 1 sec. unless otherwise specified.
2. UL qualified voltage.

Optocouplers (Continued)

Package and Type	Package Outline	Part Number	Features	Current Transfer Ratio (%) $I_F=10\text{ mA}$	(V_{OC}) ¹ Withstand Test Voltage	BV_{CEO}	Page			
6 pin DIP triac	<p>Pin 1 LED Anode Pin 2 LED Cathode Pin 3 NC Pin 4 Triac MT1 Pin 5 Substrate, NC Pin 6 Triac MT2</p>	IL410	Optically coupled triac driver. Zero crossing detector. High dv/dt. Low input current required.	2 mA LED Trigger Current	7500	NA	5-124			
		IL4116	Optically coupled triac driver. Zero crossing detector. AlGaAs LED.- Very low input LED current.	600 V	7500	NA	5-145			
		IL4117		700 V						
		IL4118		800 V						
		IL420	Optically coupled triac driver. High dv/dt. Low input required.	2 mA LED Trigger Current	7500	NA	5-131			
		IL4216	Optically coupled triac driver. AlGaAs LED. Very low input LED current.	600 V	7500	NA	5-149			
		IL4217		700 V						
		IL4218		800 V						
		8 pin DIP, linear	<p>A=Anode K=Cathode</p>	IL300	0.05% servo linearity. High gain stability 0.005%/°C.	A B C D E F G H I J	Gain Ratio Categories	7500	15	5-115
		6 pin DIP, solid state relay.	<p>A=Anode K=Cathode</p>	LH1056 Normally open	Single pole single throw (SPST) solid state relay. Controls AC or DC load currents up to 100 mA.	$I_{FT}=2.5\text{ mA max.}$	7500	350	5-197	
LH1298 Normally closed	$I_{FT}=2.5\text{ mA max.}$			7500		350	5-199			
8 pin DIP, single channel	<p>A=Anode K=Cathode</p>	ILH100	Single channel, hermetically sealed. High current transfer ratio at low input current.	100 min.	3000	70	5-186			
8 pin DIP, dual channel	<p>A=Anode K=Cathode</p>	ILH200	Dual channel, hermetically sealed. High current transfer ratio at low input current.	100 min.	3000	70	5-193			

Optocouplers (Optoisolators)

1. 1 sec. unless otherwise specified.
2. UL qualified voltage.

Optocouplers (Continued)

Package and Type	Package Outline	Part Number	Features	Current Transfer Ratio (%) $I_F=10\text{ mA}$	(V _{DC}) ¹ Withstand Test Voltage	BV _{CEO}	Page		
6 pin DIP AC switches	<p>Pin 1 LED Anode Pin 2 LED Cathode Pin 3 NC Pin 4 Triac MT1 Pin 5 Substrate, NC Pin 6 Triac MT2</p>	BRT11H	AC switch, non-zero crossing.	$I_{FT}=2\text{ mA}$	Peak Off-state Voltage	7500	NA	5-49	
		BRT12H							400
		BRT13H							600
		BRT11M		800					
		BRT12M		400					
		BRT13M		600					
		BRT21H	AC switch, zero crossing.	$I_{FT}=2\text{ mA}$		800			
		BRT22H				400			
		BRT23H				600			
		BRT21M		$I_{FT}=3\text{ mA}$		800			
		BRT22M				400			
		BRT23M				600			

1. 1 sec. unless otherwise specified.
2. UL qualified voltage.

Optocoupler Options

Siemens offers couplers in single, dual, quad, and small outline surface mount packages. The coupler types offered are high reliability, high voltage, triacs and linear, and high current transfer ratio. In addition to our true surface mount couplers, most of the standard couplers can be ordered with optional gull wing, surface mount lead bends. Most surface mount lead couplers are available on tape and reel.

All couplers are recognized under the Component Program of Underwriters Laboratories, File #E52744.

Options:

1. Safe electrical isolation per VDE #0884.
2. Very high long-term stability of coupling factor (CTR).
3. Specified characteristics from 0°C to 70°C.
4. Faster switching times.
5. No longer available.
6. Wide lead spacing: 0.4" (10.16).
7. Surface mount leads (SMD).
8. No longer available.
9. Surface mount leads (SMD).

Examples of ordering optocouplers with options:

1. IL420 with option 1: IL420-X001, 2600-2267-X001
2. IL420 with option 1 and option 6: IL420-X016, 2600-2267-X016

The following optocouplers will be replaced by options:

Old Part No.	New Part No.	Option
4N25-004	4N25	9
4N25-009	4N25	9
CNY17GF	CNY17F	6
SFH601G	SFH601	6
SFH6016	SFH601	7
SFH6011	SFH601-2,-3	3
SFH606	SFH600-1	4
SFH609	SFH601	-

Device	Option 1	Option 2	Option 3	Option 4	Option 6	Option 7	Option 9
4N25/26/27/28	X				X	X	X
4N32/33	X				X	X	X
4N35/36/37	X				X	X	X
6N135/136					X	X	X
6N138/139					X	X	X
BRT11/12	X				X	X	
BRT13	X				X	X	
BRT21/22	X				X	X	
BRT23	X				X	X	
CNY17/F	X	X			X	X	X
H11A1/2/3/4/5	X				X	X	X
H11AA1	X				X	X	X
H11B1/2	X				X	X	X
H11C4/5/6	X				X	X	X

Option 5-Discontinued. Option 8-Not recommended for new designs

Device	Option 1	Option 2	Option 3	Option 4	Option 6	Option 7	Option 9
H11D1/2/3	X				X	X	X
IL1/2/5	X				X	X	X
IL2B	X				X	X	X
IL8/9/10/11	*						
IL30/31/55	X				X	X	X
IL66	X				X	X	X
IL66B	X				X	X	X
IL74	X				X	X	X
IL201/2/3	X				X	X	X
IL205/6/7/8							
IL211/2/3							
IL215/6/7							
IL221/2/3							
IL250/1/2	X				X	X	X
IL256							
IL300	X				X	X	X
IL400	X				X	X	X
IL410	X				X	X	X
IL411-6,-7,-8	X				X	X	X
IL420	X				X	X	X
IL421-6,-7,-8	X				X	X	X
IL755	X				X	X	X
IL755B	X				X	X	X
IL766	X				X	X	X
IL766B	X				X	X	X
ILCT6	X				X	X	X
ILD1/2/5	X				X	X	X
ILD30/31/55	X				X	X	X
ILD32	X				X	X	X
ILD66	X				X	X	X
ILD74	X				X	X	X
ILD205/6/7/13							
ILD223							

Option 5-Discontinued. Option 8-Not recommended for new designs

*applied for

Device	Option 1	Option 2	Option 3	Option 4	Option 6	Option 7	Option 9
ILD250/1/2	X				X	X	X
ILD255	X				X	X	X
ILD610	X				X	X	X
ILD615	X				X	X	X
ILD620 ILD620GB	X				X	X	X
ILD621 ILD621GB	X				X	X	X
ILD755	X				X	X	X
ILD766	X				X	X	X
ILH100							
ILH200							
ILQ1/2/5	X				X	X	X
ILQ30/31/55	X				X	X	X
ILQ32	X				X	X	X
ILQ66	X				X	X	X
ILQ74	X				X	X	X
ILQ615	X				X	X	X
ILQ620 ILQ620GB	X				X	X	X
ILQ621 ILQ621GB	X				X	X	X
LH1056							
LH1298							
MCA230/31/55	X				X	X	X
MCT2/E	X				X	X	X
MCT6	X				X	X	X
MCT270-77	X				X	X	X
MCT5210/11	X				X	X	X
SFH600	X	X	X	X	X	X	X
SFH601	X	X	X		X	X	X
SFH608	X				X	X	X
SFH610	X	X	X		X		
SFH611	X	X	X		X		
SFH615	X	X	X		X		

Optocouplers
(Optoisolators)

Option 5-Discontinued. Option 8-Not recommended for new designs

Device	Option 1	Option 2	Option 3	Option 4	Option 6	Option 7	Option 9
SFH617G	X	X	X				
SFH618	X				X		
SFH620	X				X		
SFH628	X				X		
SFH640	X				X	X	X
SFH6106	X						
SFH6116	X						
SFH6135/6	X				X	X	X
SFH6138/9	X				X	X	X
SFH6156	X						
SFH6206	X						
SFH6186	X						
SFH6286	X						

Optocouplers for safe electrical insulation per DIN VDE 0884*

Option 1: Insulation Characteristics

Description	Symbol	Dip 4, DIP8, DIP 16	SFH600/ 601 CNY17/ 17F	SFH610/ 11/15 SFH618 SFH628 SFH620 SFH617G	BRT11/12 BRT21/22	IL410 IL420	IL300	SFH6135 SFH6136	IL8/9 IL10/11	Unit
		(System 1)	(System 2)	(System 3)	(System 4)	(System 4)	(System 4)	(System 5)	(System 6)	
Installation Category (DIN VDE 0110) for rated line voltages $\leq 300 V_{RMS}$ for rated line voltages $\leq 600 V_{RMS}$ for rated line voltages $\leq 1000 V_{RMS}$		I-IV I-III -	I-IV I-III -	I-IV I-III -	I-IV I-III -	I-IV I-III -	I-IV I-III -	I-IV I-III -	I-IV I-IV I-III	
IEC climatic category (DIN IEC 68 part 1/9.80)		55/100/21	55/100/21	55/100/21	40/100/21	55/100/21	55/100/21	55/100/21	55/100/21	
Pollution degree (DIN VDE 0110 part 1/ 1.89)		2	2	2	2	2	2	2	2	
Maximum Operation Insulation Voltage	V_{IORM}	890	630	890	630	850	850	630	1420	V
Test voltage input/output, procedure b ⁽¹⁾ $V_{Pr}=1.6 \times V_{IORM}$, Sample test, $t_p=1$ s Partial Discharge <5 pC	V_{Pr}	1424	1000	1424	1000	1360	1360	1000	2270	V
Test voltage input/output, procedure b ⁽¹⁾ $V_{Pr}=1.2 \times V_{IORM}$, Type and sampling test, $t_p=60$ s Partial Discharge <5 pC	V_{Pr}	1070	760	1070	760	1020	1020	760	1700	V
Maximum permissible overvoltage (Transient overvoltage)	V_{TR}	8000	6000	6000	6000	6000	6000	6000	8000	V
Partial Discharge Test Voltage	$V_{INITIAL}$	8000	6000	6000	6000	6000	6000	6000	8000	V
Safety maximum ratings (maximum permissible ratings in case of a fault, also refer to diagram) Package temperature Current (input current I_F , $P_{Si}=0$, $T_A=25^\circ C$) Derating with higher ambient temperature Power (Output or total power dissipation, $T_A=25^\circ C$) Derating with higher ambient temperature	T_{Si} I_{Si} ΔI_{Si} P_{Si} ΔP_{Si}	175 400 -2.67 700 -4.67	175 400 -2.67 700 -4.67	175 400 -2.67 700 -4.67	175 400 -2.67 2000 -13.3	165 250 -1.67 500 -3.33	165 235 -1.68 465 -3.32	175 300 -2 500 -3.33	175 295 -2 500 -3.33	$^\circ C$ mA mA/K mW mW/K
Insulation resistance at T_{Si} $V_{IO}=500$ V	R_{IS}	$\geq 10^9$	$\geq 10^9$	$\geq 10^9$	$\geq 10^9$	$\geq 10^9$	$\geq 10^9$	$\geq 10^9$	$\geq 10^9$	Ω

All voltages referred to are peak values 1. See time-test voltage diagram * DIN VDE 0884, edition 8.87

Optocoupler Options

Option 1 VDE 0884

These optocouplers are suitable for safe electrical isolation only within the safety maximum ratings. Compliance with the safety maximum ratings must be ensured by protective circuits.

The partial discharge measurement ensures that no partial discharge occurs during operation at maximum permissible operating isolation voltage (V_{IORM}). Permanent partial discharge affects the insulating materials and can result in a high-voltage breakdown.

Time-Test Voltage Diagram per DIN VDE 0884

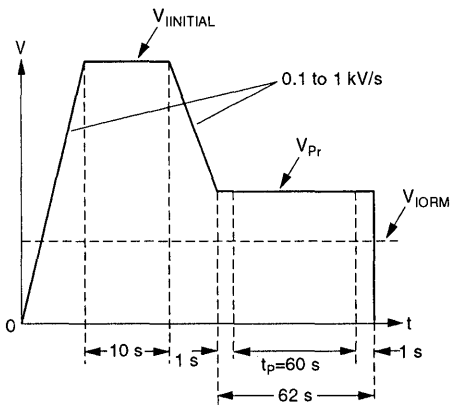

t_p —measuring time for partial discharge

Procedure a. Type & sampling tests, destructive tests

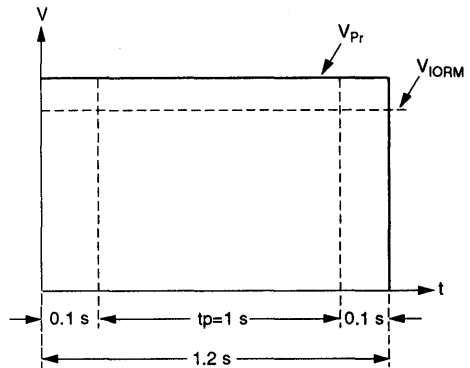

t_p —measuring time for partial discharge

Procedure b. Sample tests, non-destructive tests

It is recommended that tests with the isolation test voltage (V_{ISOL}) should not be made, otherwise partial discharge may occur impairing the isolation characteristics. Thus partial discharges also may occur at the maximum permissible operating isolation voltage.

The isolation test per VDE 0884 is carried out after all the other high voltage tests.

Optocoupler Options

Option 2 High-Rel Optocoupler With Very High Long-Term Stability of Coupling Factor (CTR)

Each optocoupler is tested for its degradation characteristics (change of current transfer ratio). The degradation behavior of the optocouplers tested during a short burn-in provides information on the long-term stability. Only optocouplers showing a minimum change in the current transfer ratio during burn-in are supplied. These optocouplers feature excellent long-term stability.

Test procedure:

• First data logging

The coupling factor (CTR_1) at $I_F = 1 \text{ mA}$, $V_{CE} = 5 \text{ V}$ is logged.

• Load

Short-time burn-in: The emitter is loaded with a forward current of $I_F = 200 \text{ mA}$ at room temperature (25°C) for 30 minutes.

• Second data logging

The coupling factor (CTR_2) at $I_F = 1 \text{ mA}$, $V_{CE} = 5 \text{ V}$ is logged.

• Evaluation

Determination of the relative change of the coupling factor: $\Delta CTR (\%) = 100 \times (1 - CTR_2 / CTR_1)$

The change of the coupling factor ΔCTR caused by the burn-in may not be greater than $\pm 2 \%$. Thus the high long-term stability of the coupling factor shown in the graph can be specified. All couplers show a similar degradation behavior meaning that even after a longer operating time the coupling factor spread is not very wide.

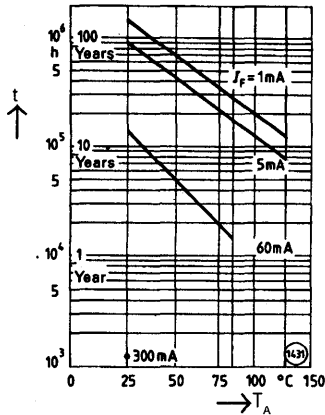

Service life relative to temperature and current-load

Average expected service life extrapolated from laboratory tests. The end of the service life is defined as the time when the CTR falls to 50% of the initial value. Confidence level is 90%.

Optocoupler Options

Option 3 Optocouplers With Specified Characteristics From 0°C to 70°C

Parameter	Symbol	Values	Unit
Emitter (IR GaAs LED)			
Forward voltage ($I_F = 60 \text{ mA}$)	V_F	1.25 (≤ 1.65)	V
Breakdown voltage ($I_R = 10 \text{ }\mu\text{A}$)	V_{BR}	≥ 6	
Reverse current ($V_R = 6 \text{ V}$)	I_R	0.01 (≤ 10)	μA
Detector (Si phototransistor)			
Collector-emitter breakdown voltage ($I_{CE} = 10 \text{ }\mu\text{A}$)	V_{CEO}	≥ 70	V
Emitter-base breakdown voltage ($I_{EBO} = 10 \text{ }\mu\text{A}$)	V_{EBO}	≥ 7	
Optocoupler			
Collector-emitter saturation voltage ($I_F = 10 \text{ mA}$, $I_C = 2.5 \text{ mA}$)	V_{CEsat}	0.25 (≤ 0.4)	V

These optocouplers are grouped according to their current transfer ratio I_C/I_F at $V_{CE} = 5 \text{ V}$ and are marked by dash numbers.

Parameter	Symbol	Values				Unit
		-1	-2	-3	-4	
Dash Numbers		-1	-2	-3	-4	
Dash Numbers for SFH600 only		-0	-1-	-2	-3	
Current transfer ratio ($I_F = 10 \text{ mA}$) ($I_F = 1 \text{ mA}$)	I_C/I_F	35-85 30 (>10)	55-135 45 (>17)	80-210 70 (>28)	140-340 90 (>45)	%
Collector-emitter leakage current ($V_{CE} = 10 \text{ V}$)	I_{CEO}	≤ 500	≤ 500	≤ 1000	≤ 1000	nA

Optocoupler Options

Option 4 Selection of Optocouplers With Fast Switching Time (For SFH 600 Only)

These optocouplers comply with the switching times listed in the table below. In addition, the devices are 100% tested to ensure the values.

Parameter	Symbol	Values			Unit
		-0 $I_F = 20 \text{ mA}$	-1 $I_F = 10 \text{ mA}$	-2 $I_F = 10 \text{ mA}$	
Turn-on time	t_{on}	≤ 2.5	≤ 4.5	≤ 4.5	μs
Rise time	t_r	≤ 1.5	≤ 3	≤ 2.7	
Turn-off time	t_{off}	≤ 12	≤ 14	≤ 20	
Fall time	t_f	≤ 7	≤ 10	≤ 12	

Optocouplers
(Optoisolators)

Pulse Definition

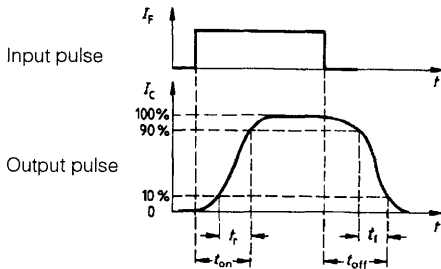

Test circuit (saturated, $V_{CEsat} \leq 0.4 \text{ V}$)

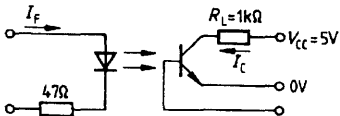

Optocoupler Options

Option 6 Leads with 0.4" (10.16 mm) Spacing

The leads of the optocouplers are bent according to a spacing of 0.4" (10.16 mm). Dimensions deviating from the standard type are:

Lead spacing	10.16 mm (0.4")
Creepage distance	>8.0 mm
Clearance	>8.0 mm

This version additionally complies with the following standards:

- DIN IEC 380/VDE 0806/8.81
Reinforced insulation up to an operating voltage of 250 VAC_{RMS}
- DIN IEC 435/VDE 0805 draft Nov. 84
Reinforced insulation up to an operating voltage of 250 VAC_{RMS}

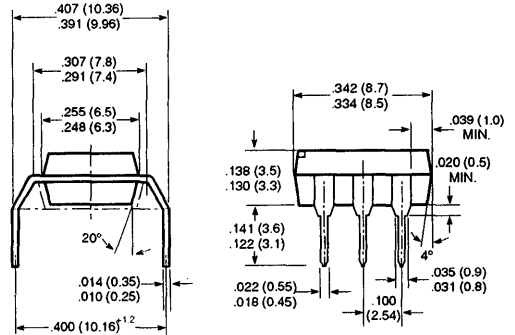

Clearance-creepage distance = 8.0 min

See standard version for pin configuration.

Optocoupler Options

Option 7 Lead Bends for Surface Mount (SMD) Optocouplers

These optocouplers are suitable for surface mounting. Dimensions deviating from the standard type are:

Creepage distance >8.0 mm
Clearance >8.0 mm

This version additionally complies with the following standards:

- DIN IEC 380/VDE 0806/8.81
Reinforced insulation up to an operating voltage of 250 VAC_{RMS}
- DIN IEC 435/VDE 0805 draft Nov. 84
Reinforced insulation up to an operating voltage of 250 VAC_{RMS}

During the soldering process, the package should not be wetted with tin-lead solder to prevent the impairment of the isolation features. Apart from iron soldering, only reflow soldering methods (vapor phase, infrared and hot gas) are permissible.

Permissible soldering conditions:
260°C at 10 seconds to 215°C at 30 seconds

The soldering process may be repeated two times at the most. Attention must be paid to the cooling down of the device to 25°C between the soldering processes.

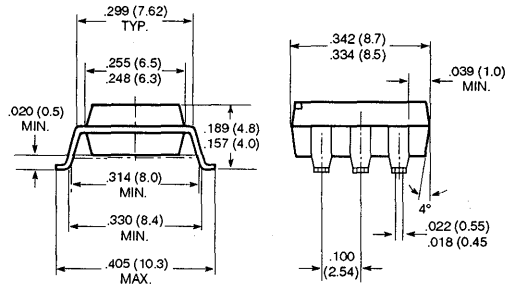

Clearance and creepage distances must be considered for the solder pad design.

Clearance-creepage distance = 8.0 min.

See standard version for pin configuration.

Optocoupler Options

Option 9 Lead Bends for Surface Mount (SMD) Optocouplers

During the soldering process, the package should not be wetted with tin-lead solder to prevent the impairment of the isolation features. Apart from iron soldering, only reflow soldering methods (vapor phase, infrared and hot gas) are permissible.

Permissible soldering conditions:
260°C at 10 seconds to 215°C at 30 seconds

The soldering process may be repeated two times at the most. Attention must be paid to the cooling down of the device to 25°C between the soldering processes.

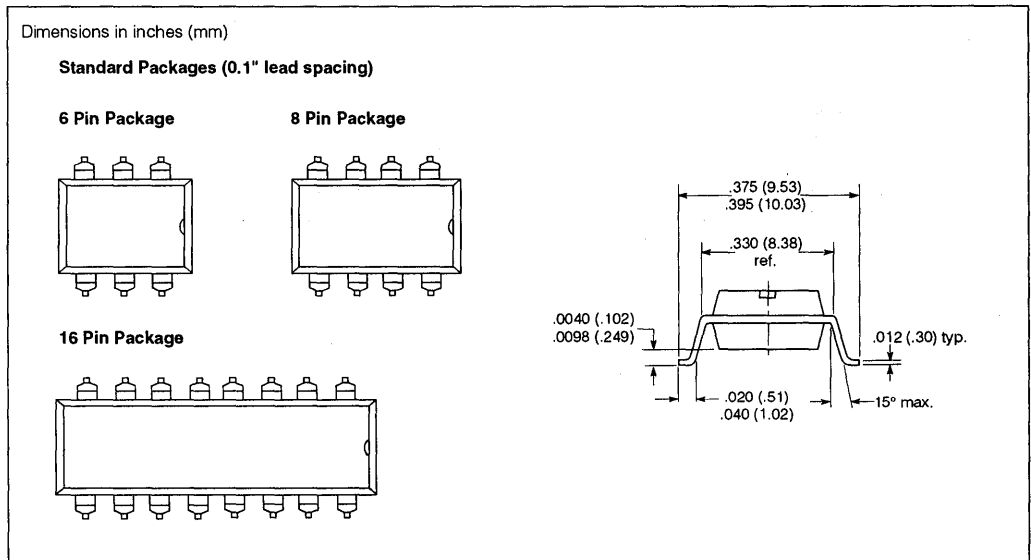

Tape and Reel Packaging for SOIC8 Optocouplers

All SOIC8 optocouplers are available in tape and reel format. To order any surface mount IL2XX optocoupler on tape and reel, add a suffix "T" after the part number.

The tape is 12 mm and is wound on a 33 cm reel. There are 2000 parts per reel. Taped and reeled SOIC8 optocouplers conform to EIA-481.

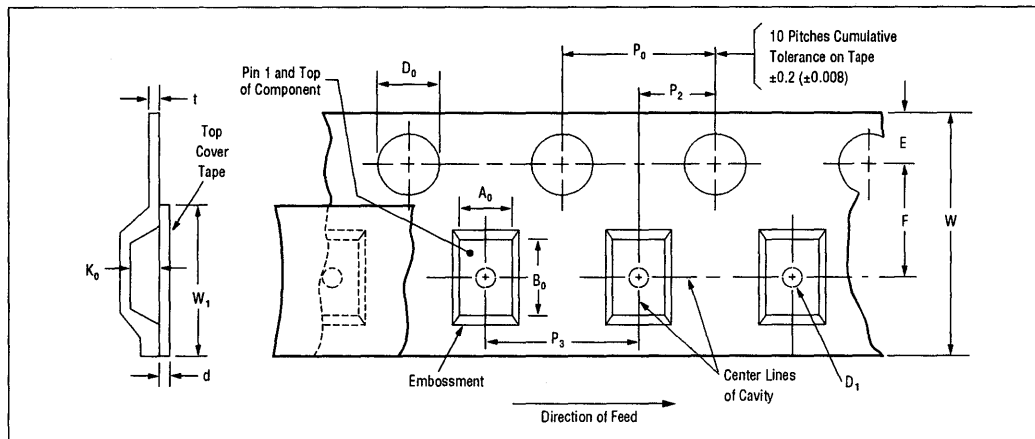

Description	Symbol	Dimensions in Inches (mm) SOIC8	Notes
Tape width	W	.472 ± .012 (12 ± .3)	
Carrier tape thickness	t	.012 (0.3) max.	
Pitch of sprocket holes	P ₀	.157 ± .004 (4 ± 0.1)	Cummulative pitch error +0.2 mm/10 pitches
Diameter of sprocket holes	D ₀	.059 (1.5) min.	
Distance of sprocket holes	E	.069 ± .004 (1.75 ± 0.1)	
Distance of compartment	F	.217 ± .002 (5.5 ± .005)	Center hole to center compartment
	P ₂	.079 ± .002 (2 ± 0.05)	
Distance compartment to compartment	P ₃	.315 ± .004 (8.0 ± 0.1)	
Compartment	K ₀	.140 (3.5)	
	A ₀	.252 (6.4)	
	B ₀	.205 (5.2)	
Hole in compartment	D ₁	.054 (1.5)	
Width of fixing tage	W ₁	.325 (8.3) tape	The fixing tape shall not cover the sprocket holes, nor protrude beyond the carrier tape so not to exceed maximum tape width
	d	.004 (0.1) max.	
Device tilt in the compartment		15° max.	
Minimum bending radius		1.18 (30)	

Tape and Reel Packaging for 4-Pin Optocouplers

All 4-pin optocouplers are available in tape and reel format. To order any SFH6XX6 optocoupler on tape and reel, add a suffix "T" after the part number, i.e., SFH6156-3T.

The tape is 16 mm and is wound on a 33 cm reel. There are 1000 parts per reel. Taped and reeled 4-pin optocouplers conform to EIA-481.

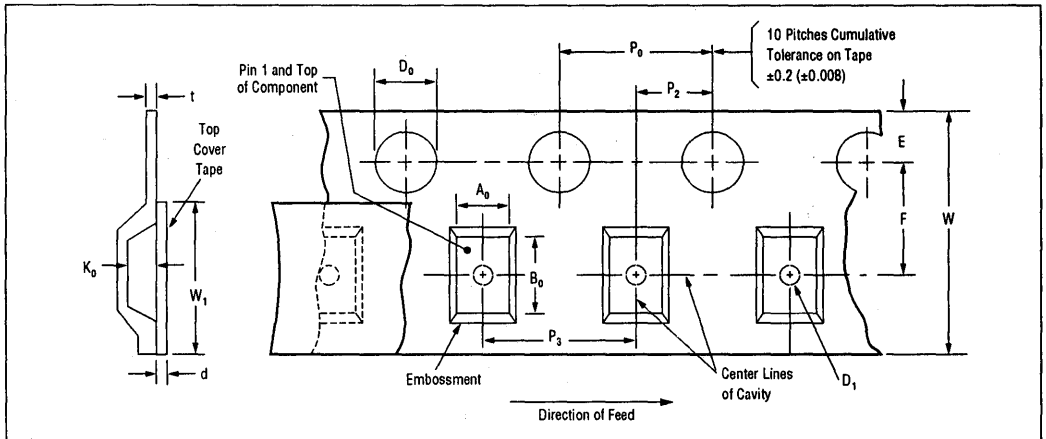

Description	Symbol	Dimensions in Inches (mm) 4-Pin	Notes
Tape width	W	.630 ± .012 (16 ± .3)	
Carrier tape thickness	t	.012 (0.3) max.	
Pitch of sprocket holes	P ₀	.157 ± .004 (4 ± 0.1)	Cummulative pitch error +0.2 mm/10 pitches
Diameter of sprocket holes	D ₀	.059 (1.5) min.	
Distance of sprocket holes	E	.069 ± .004 (1.75 ± 0.1)	
Distance of compartment	F	.295 ± .002 (7.5 ± .005)	Center hole to center compartment
	P ₂	.079 ± .002 (2 ± 0.05)	
Distance compartment to compartment	P ₃	.472 (12.0)	
Compartment	K ₀	.167 (4.25)	
	A ₀	.409 (10.39)	
	B ₀	.209 (5.3)	
Hole in compartment	D ₁	.059 (1.5)	
Width of fixing tange	W ₁	.512 – .531 (13.0 – 13.5)	The fixing tape shall not cover the sprocket holes, nor protrude beyond the carrier tape so not to exceed maximum tape width
	d	.004 (0.1) max.	
Device tilt in the compartment		10° max.	
Minimum bending radius		1.18 (30)	

Tape and Reel Packaging for 6-Pin Optocouplers with Option 7

All 6-pin optocouplers with Option 7 are available in tape and reel format. To order any 6-pin optocoupler with option 7 on tape and reel, add a suffix "T" after the option,

i.e., CNY17-3-X007T. The tape is 16 mm and is wound on a 33 cm reel. There are 1000 parts per reel. Taped and reeled 6-pin optocouplers conform to EIA-481.

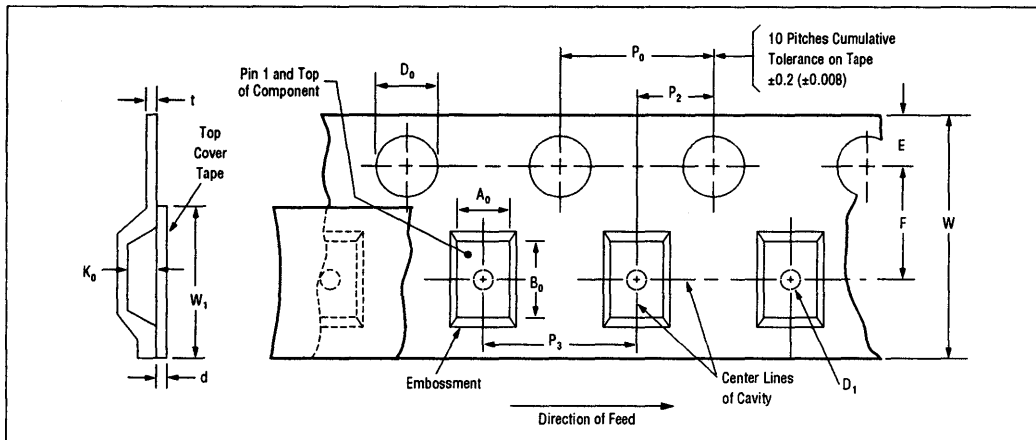

Description	Symbol	Dimensions in Inches (mm) 6-Pin with Option 7	Notes
Tape width	W	.630 ± .012 (16 ± .3)	
Carrier tape thickness	t	.012 (0.3) max.	
Pitch of sprocket holes	P ₀	.157 ± .004 (4 ± 0.1)	Cummulative pitch error +0.2 mm/10 pitches
Diameter of sprocket holes	D ₀	.059 (1.5) min.	
Distance of sprocket holes	E	.069 ± .004 (1.75 ± 0.1)	
Distance of compartment	F	.295 ± .002 (7.5 ± .005)	Center hole to center compartment
	P ₂	.079 ± .002 (2 ± 0.05)	
Distance compartment to compartment	P ₃	.472 (12.0)	
Compartment	K ₀	.194 (4.93)	
	A ₀	.358 (9.1)	
	B ₀	.378 (9.6)	
Hole in compartment	D ₁	.059 (1.5)	
Width of fixing tage	W ₁	.512 - .531 (13.0 - 13.5)	The fixing tape shall not cover the sprocket holes, nor protrude beyond the carrier tape so not to exceed maximum tape width
	d	.004 (0.1) max.	
Device tilt in the compartment		10° max.	
Minimum bending radius		1.18 (30)	

Tape and Reel Packaging for 6-Pin Optocouplers with Option 9

All 6-pin optocouplers with Option 9 are available in tape and reel format. To order any 6-pin optocoupler with Option 9 on tape and reel, add a suffix "T" after the option,

i.e., CNY17-3-X009T. The tape is 16 mm and is wound on a 33 cm reel. There are 1000 parts per reel. Taped and reeled 6-pin optocouplers conform to EIA-481.

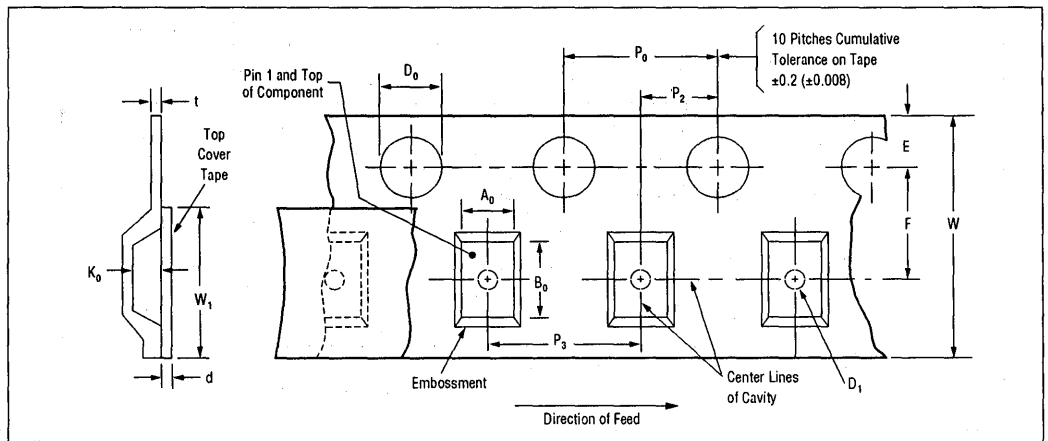

Description	Symbol	Dimensions in Inches (mm) 6-Pin with Option 9	Notes
Tape width	W	.630 ± .012 (16 ± .3)	
Carrier tape thickness	t	.012 (0.3) max.	
Pitch of sprocket holes	P ₀	.157 ± .004 (4 ± 0.1)	Cummulative pitch error +0.2 mm/10 pitches
Diameter of sprocket holes	D ₀	.059 (1.5) min.	
Distance of sprocket holes	E	.069 ± .004 (1.75 ± 0.1)	
Distance of compartment	F	.295 ± .002 (7.5 ± .005)	Center hole to center compartment
	P ₂	.079 ± .002 (2 ± 0.05)	
Distance compartment to compartment	P ₃	.472 (12.0)	
Compartment	K ₀	.167 (4.25)	
	A ₀	.406 (10.3)	
	B ₀	.378 (9.6)	
Hole in compartment	D ₁	.059 (1.5)	
Width of fixing tage	W ₁	.512 - .531 (13.0 - 13.5)	The fixing tape shall not cover the sprocket holes, nor protrude beyond the carrier tape so not to exceed maximum tape width
	d	.004 (0.1) max.	
Device tilt in the compartment		10° max.	
Minimum bending radius		1.18 (30)	

Tape and Reel Packaging for 8-Pin Optocouplers with Option 7

All 8-pin optocouplers with Option 7 are available in tape and reel format. To order any 8-pin optocoupler with option 7 on tape and reel, add a suffix "T" after the option,

i.e., ILCT6-X007T. The tape is 16 mm and is wound on a 33 cm reel. There are 1000 parts per reel. Taped and reeled 8-pin optocouplers conform to EIA-481.

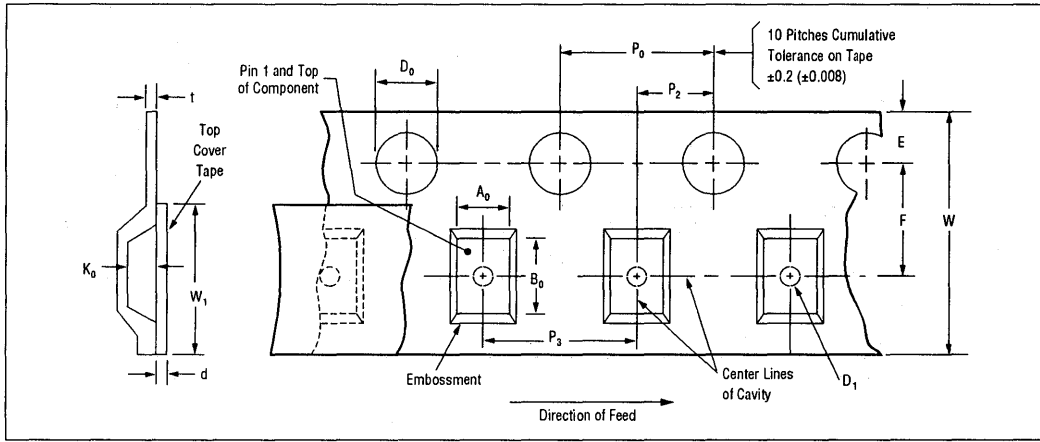

Description	Symbol	Dimensions in Inches (mm) 8-Pin with Option 7	Notes
Tape width	W	.630 ± .012 (16 ± .3)	
Carrier tape thickness	t	.012 (0.3) max.	
Pitch of sprocket holes	P ₀	.157 ± .004 (4 ± 0.1)	Cummulative pitch error +0.2 mm/10 pitches
Diameter of sprocket holes	D ₀	.059 (1.5) min.	
Distance of sprocket holes	E	.069 ± .004 (1.75 ± 0.1)	
Distance of compartment	F	.295 ± .002 (7.5 ± .005)	Center hole to center compartment
	P ₂	.079 ± .002 (2 ± 0.05)	
Distance compartment to compartment	P ₃	.472 (12.0)	
Compartment	K ₀	.194 (4.93)	
	A ₀	.421 (10.7)	
	B ₀	.406 (10.3)	
Hole in compartment	D ₁	.059 (1.5)	
Width of fixing tague	W ₁	.512 - .531 (13.0 - 13.5)	The fixing tape shall not cover the sprocket holes, nor protrude beyond the carrier tape so not to exceed maximum tape width
	d	.004 (0.1) max.	
Device tilt in the compartment		10° max.	
Minimum bending radius		1.18 (30)	

Optocouplers (Optoisolators)

Tape and Reel Packaging for 8-Pin Optocouplers with Option 9

All 8-pin optocouplers with Option 9 are available in tape and reel format. To order any 8-pin optocoupler with option 9 on tape and reel, add a suffix "T" after the option,

i.e., ILCT6-X009T. The tape is 16 mm and is wound on a 33 cm reel. There are 1000 parts per reel. Taped and reeled 8-pin optocouplers conform to EIA-481.

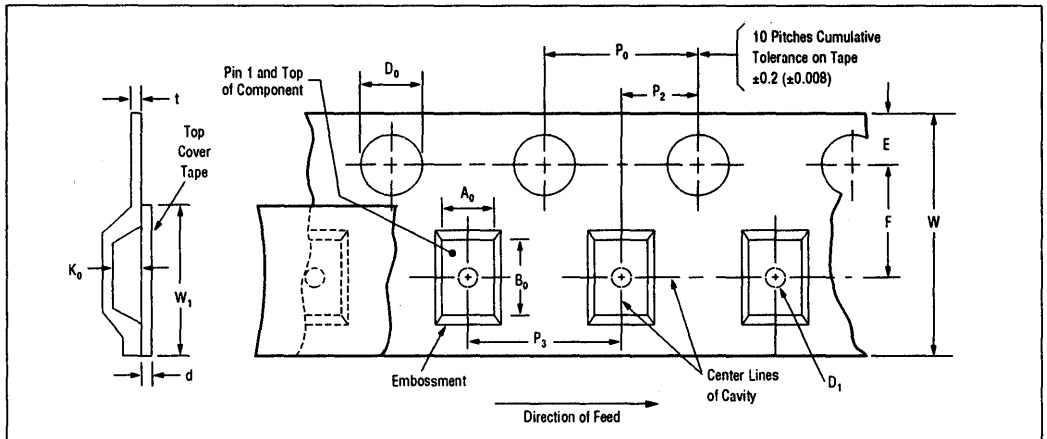

Description	Symbol	Dimensions in Inches (mm) 8-Pin with Option 9	Notes
Tape width	W	.630 ± .012 (16 ± .3)	
Carrier tape thickness	t	.012 (0.3) max.	
Pitch of sprocket holes	P ₀	.157 ± .004 (4 ± 0.1)	Cummulative pitch error +0.2 mm/10 pitches
Diameter of sprocket holes	D ₀	.059 (1.5) min.	
Distance of sprocket holes	E	.069 ± .004 (1.75 ± 0.1)	
Distance of compartment	F	.295 ± .002 (7.5 ± .005)	Center hole to center compartment
Distance compartment to compartment	P ₂	.079 ± .002 (2 ± 0.05)	
Distance compartment to compartment	P ₃	.472 (12.0)	
Compartment	K ₀ A ₀ B ₀	.167 (4.25) .402 (10.2) .406 (10.3)	
Hole in compartment	D ₁	.059 (1.5)	
Width of fixing tage	W ₁	.512 - .531 (13.0 - 13.5)	The fixing tape shall not cover the sprocket holes, nor protrude beyond the carrier tape so not to exceed maximum tape width
Device tilt in the compartment	d	.004 (0.1) max	
Minimum bending radius		1.18 (30)	

Agency Approvals Table—Optocouplers

Device	UL E52744 System Code	VDE0884	VDE0804	VDE0805 IEC435	VDE0806 IEC380	VDE0860 IEC65	VDE0700	VDE0750	CECC	BSI	Demko	SETI	Bergbau	Deutsche Bundesbahn	CNET (FrancePost)	British Telecom	CSA LRD93751
4N25/26/27/28	H or J	X															
4N32/33	H or J	X															
4N35/36/37	H or J	X															
6N135/136	H	X									X						
6N138/139	H	X									X						
BRT11/12/13	H or J	X															
BRT21/22/23	H or J	X															
CNY17/CNY17F	H or J	X	X	X	X	X				X	X	X					
H11A1/2/3/4/5	H or J	X															
H11AA1	H	X	X														
H11B1/2/3	H or J	X															
H11C4/5/6	H or J	X															
H11D1/2/3	H or J	X															
IL1/2/5	H or J	X	X														
IL2B	H or J	X															
IL8/9	K	1															
IL10/11	K	1	X	X	X	X	X					X					
IL30/31/55	H or J	X															
IL66	H or J	X															
IL66B	H or J	X															

1E-5

1 - Pending approval



Device	UL E52744 System Code	VDE0884	VDE0804	VDE0805 IEC435	VDE0806 IEC380	VDE0860 IEC65	VDE0700	VDE0750	CECC	BSI	Demko	SETI	Bergbau	Deutsche Bundesbahn	CNET (FrancePost)	British Telecom	CSA LFD93751
IL74	H or J	X	X														
IL201/202/203	H or J	X															
IL205/206/207	H or J																
IL211/212/213	P or M																
IL215/216/217	P or M																
IL221/222/223	P or M																
IL250/251/252	H	X	X														
IL256	P or M																
IL300/IL300G	H	X															
IL400	H	X															
IL410	H or J	X															
IL411-6,-7,-8	H or J	X															
IL420	H or J	X															
IL421-6,-7,-8	H or J	X															
IL755	H	X															
IL755B	H	X															
IL766	H	X															
IL766B	H	X															
ILCT6	H	1	X														
ILD1/2/5	H	1	X														
ILD30	H	1	X														
ILD31	H	1															

Device	UL E52744 System Code	VDE0884	VDE0804	VDE0805 IEC435	VDE0806 IEC380	VDE0860 IEC65	VDE0700	VDE0750	CECC	BSI	Demko	SETI	Bergbau	Deutsche Bundesbahn	CNET (FrancePost)	British Telecom	CSA LPD93751
ILD32	H	1															
ILD55	H	1	X														
ILD66	H	1															
ILD74	H	1	X														
ILD205/206/207/ 213	Y																
ILD223	Y																
ILD250/251/252	H	1															
ILD255	H																
ILD610	H	1															
ILD615	H	1															
ILD620/GB	H	1															
ILD621/GB	H	1															
ILD755	H	1															
ILD766	H	1															
ILH100																	
ILH200																	
ILQ1/2/5	H	1	X														
ILQ30	H	1	X														
ILQ31	H	1															
ILQ32	H	1															
ILQ55	H	1		X	X												

1 - Pending approval

Device	UL E52744 System Code	VDE0884	VDE0804	VDE0805 IEC435	VDE0806 IEC380	VDE0860 IEC65	VDE0700	VDE0750	CECC	BSI	Demko	SETI	Bergbau	Deutsche Bundesbahn	CNET (FrancePost)	British Telecom	CSA LFD93751
ILQ66	H	1															
ILQ74	H	1	X														
ILQ615	H	1															
ILQ620/LQ620GE	H	1															
ILQ621/LQ621GE	H	1															
LH1056	H																
MCA230/231/255	H or J	X															
MCT2/E	H or J	X															
MCT6	H	X															
MCT270-77	H or J	X															
MCT5210 MCT5211	H or J H or J	X															
SFH600	H or J	X	X	X, X	X, X	X				X	X	X					
SFH601	H or J	X							X	X	X	X					
SFH608	H or J	X															
SFH610	N	X	X	X, X	X, X	X					X						
SFH611	N	X									X						
SFH615	N	X									X						
SFH617G	N	X	X	X	X	X											
SFH618	N	X															
SFH620	N	X															
SFH628	N	X															

Device	UL E52744 System Code	VDE0884	VDE0804	VDE0805	IEC435	VDE0806	IEC380	VDE0860	IEC65	VDE0700	VDE0750	CECC	BSI	Demko	SETI	Bergbau	Deutsche Bundesbahn	CNET (FrancePost)	British Telecom	CSA LRD93751
SFH640	H or J	X																		
SFH6106	H	1																		
SFH6116	H or J	1																		
SFH6135/6136	H	X														X				
SFH6138/6139	H or J	X															X			
SFH6156	H or J	1															X			
SFH6186	H or J	1																		
SFH6206	H or J	1																		
SFH6286	H or J	1																		

FEATURES

- I/O Compatible with Integrated Circuits
- Coupling Capacitance, 0.5 pF
- Underwriters Lab File #E52744
-  VDE Approval #0884 Available with Option 1

DESCRIPTION

The 4N25, 4N26, 4N27, and 4N28 are optically coupled isolated pairs, each consisting of a Gallium Arsenide infrared LED and a silicon NPN phototransistor. Signal information, including a DC level, can be transmitted by the device while maintaining a high degree of electrical isolation between input and output. They can be used to replace relays and transformers in many digital interface applications. They have excellent frequency response when used in analog applications.

Maximum Ratings

Emitter

Peak Reverse Voltage	3.0 V
Continuous Forward Current	60 mA
Forward Current Peak (1 μs pulse, 300 pps)	3.0 A
Power Dissipation at 25°C	100 mW
Derate Linearly from 25°C	1.33 mW/°C

Detector

Collector-Emitter Breakdown Voltage, BV_{CEO}	30 V
Emitter-Collector Breakdown Voltage BV_{ECO}	7.0 V
Collector-Base Breakdown Voltage, BV_{CBO}	70 V
Power Dissipation at 25°C	150 mW
Derate Linearly from 25°C	2.0 mW/°C

Package

Isolation Text Voltage	
per DIN57883/6.80	5300 VDC/3750 VAC _{RMS}
Total Package Dissipation at 25°C Ambient (equal power in each element)	250 mW
Derate Linearly from 25°C	3.3 mW/°C
Creepage Path	8 mm min.
Clearance Path	7 mm min
Tracking Index per VDE 0303	KB100/A
Storage Temperature	-55°C to +150°C
Operating Temperature	-55°C to +100°C
Lead Soldering Time at 260°C	10 sec.

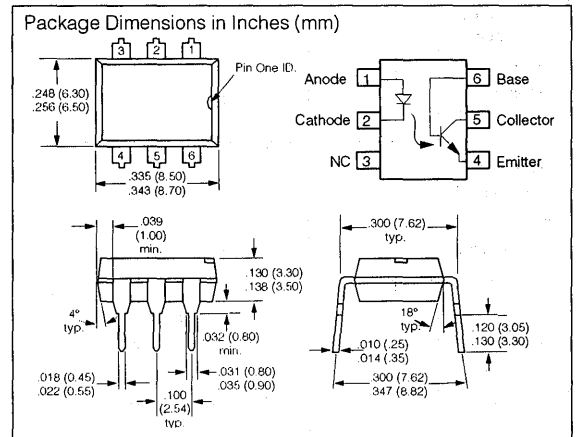

Characteristics ($T_A=25^\circ\text{C}$)

	Symbol	Min.	Typ.	Max.	Unit	Condition
Emitter						
Forward Voltage*	V_F	1.3	1.5		V	$I_F=50\text{ mA}$
Reverse Current*	I_R	0.1	100		μA	$V_R=3.0\text{ V}$
Capacitance	C_O		25		pF	$V_R=0$
Detector						
BV_{CEO} *		30			V	$I_C=1\text{ mA}$
BV_{ECO} *		7			V	$I_E=100\text{ μA}$
BV_{CBO} *		70			V	$I_C=100\text{ μA}$
I_{CEO} *(dark)						
4N25/26/27		5	50		nA	$V_{CE}=10\text{ V}$ (base open)
4N28		10	100		nA	
I_{CBO} *(dark)		2	20		nA	$V_{CB}=10\text{ V}$ (emitter open)
Collector-Emitter Capacitance	C_{CE}		6		pF	$V_{CE}=0$
Package						
DC Current Transfer						
Ratio*						
4N25/26	CTR	20	50		%	$V_{CE}=10\text{ V}$ $I_F=10\text{ mA}$
4N27/28	CTR	10	30		%	
Breakdown Voltage						
4N25*	V_{BR}	2500			V	Peak, 60 Hz
4N26/27*	V_{BR}	1500			V	Peak, 60 Hz
4N28*	V_{BR}	500			V	Peak, 60 Hz
UL Qualified for				7500	VDC	
Collector-Emitter Saturation Voltage	$V_{CE(sat)}$		0.5		V	$I_{CE}=2.0\text{ mA}$ $I_F=50\text{ mA}$
Resistance, Input to Output*	R_{IO}	100			GΩ	$V_{IO}=500\text{ V}$
Coupling Capacitance	C_{IO}		0.5		pF	$f=i\text{ MHz}$
Rise and Fall Times	t_r, t_f		2		μs	$I_F=10\text{ mA}$ $V_{CE}=10\text{ V}$

* Indicates JEDEC registered values

Fig. 1. Forward voltage versus forward current

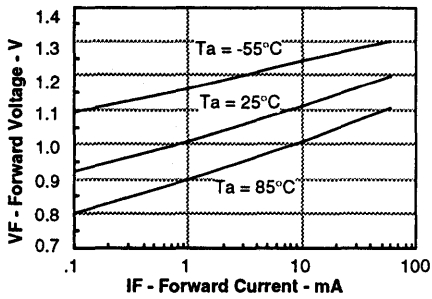

Fig. 2. Normalized non-saturated and saturated CTR at $T_a = 25^\circ\text{C}$ versus LED current

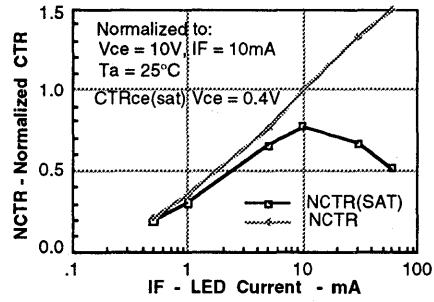

Fig. 3. Normalized non-saturated and saturated CTR at $T_a = 50^\circ\text{C}$ versus LED current

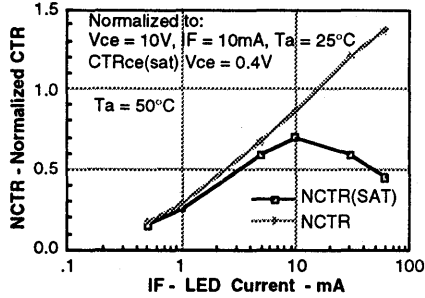

Fig. 4. Normalized non-saturated and saturated CTR at $T_a = 70^\circ\text{C}$ versus LED current

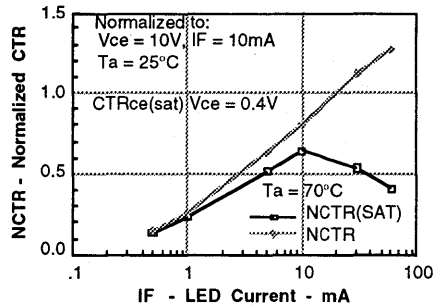

Fig. 5. Normalized non-saturated and saturated CTR at $T_a = 85^\circ\text{C}$ versus LED current

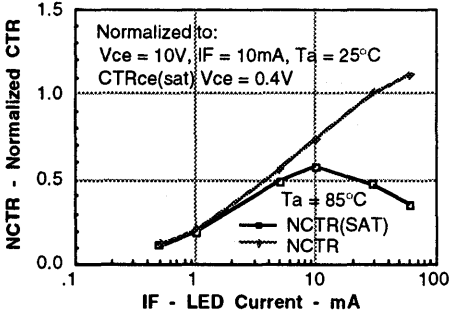

Fig. 6. Collector-emitter current versus temperature and LED current

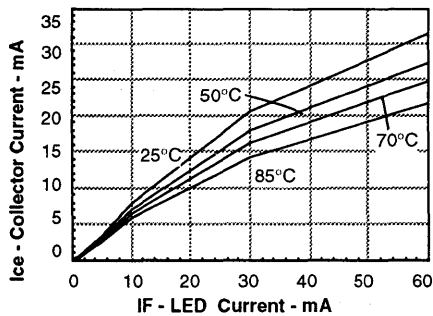

Fig. 7. Collector-emitter leakage current versus temperature

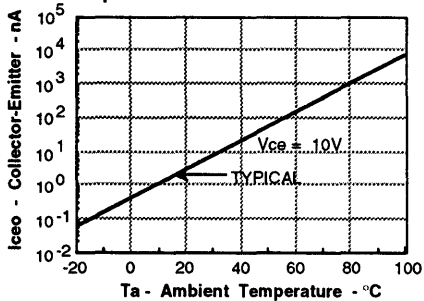

Fig. 8. Normalized CTR_{cb} versus LED current and temperature

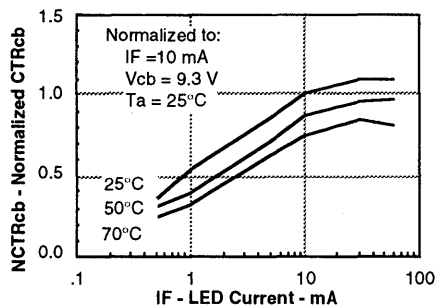

Figure 9. Collector base photocurrent versus LED current

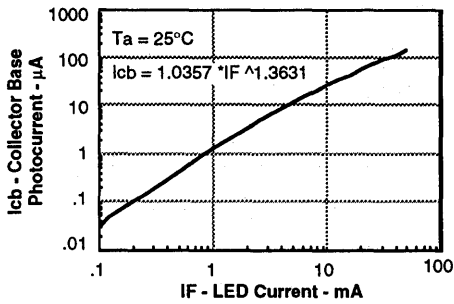

Figure 11. Normalized non-saturated HFE versus base current and temperature

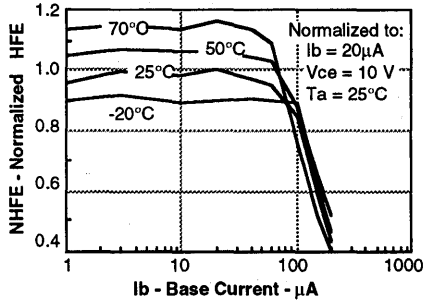

Figure 13. Propagation delay versus collector load resistor

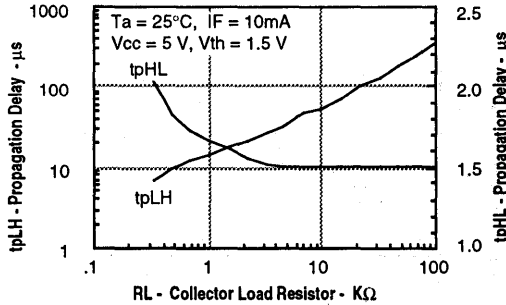

Figure 15. Switching Schematic

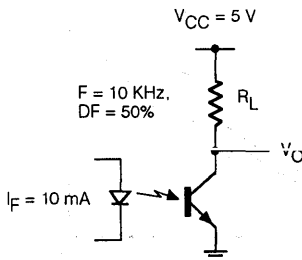

Figure 10. Normalized photocurrent versus IF and temperature

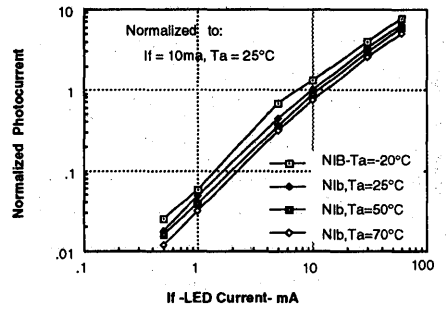

Figure 12. Normalized saturated HFE versus base current and temperature

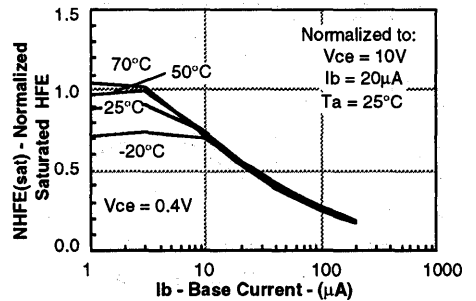
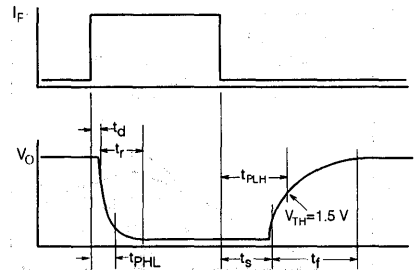



Figure 14. Switching Waveform



FEATURES

- **Very High Current Transfer Ratio, 500% Min.**
- **High Isolation Resistance, $10^{11} \Omega$ Typical**
- **Standard Plastic DIP Package**
- **Underwriters Lab File #E52744**
-  **VDE Approvals #0884 (Optional with Option 1, -Add -X001 Suffix)**

DESCRIPTION

The 4N32 and 4N33 are optically coupled isolators with a Gallium Arsenide infrared LED and a silicon photodarlington sensor. Switching can be achieved while maintaining a high degree of isolation between driving and load circuits. These optocouplers can be used to replace reed and mercury relays with advantages of long life, high speed switching and elimination of magnetic fields.

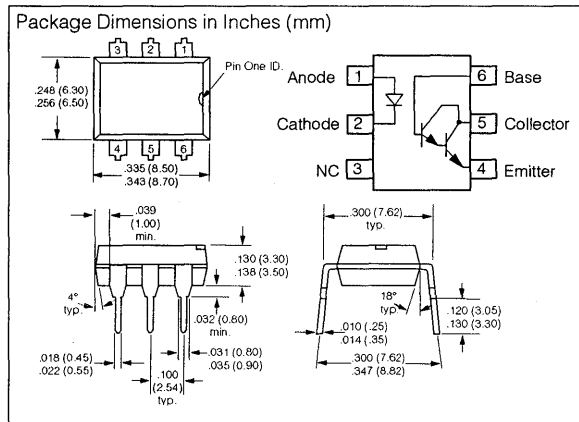

Maximum Ratings

Emitter	
Peak Reverse Voltage	3 V
Continuous Forward Current	60 mA
Power Dissipation at 25°C	100 mW
Derate Linearly from 55°C	1.33 mW/°C
Detector	
Collector-Emitter Breakdown Voltage, BV_{CEO}	30 V
Emitter-Base Breakdown Voltage, BV_{EBO}	8 V
Collector-Base Breakdown Voltage, BV_{CBO}	50 V
Emitter-Collector Breakdown Voltage BV_{ECO}	5 V
Collector (load) Current	125 mA
Power Dissipation at 25°C Ambient	150 mW
Derate Linearly from 25°C	2.0 mW/°C
Package	
Total Dissipation at 25°C Ambient	250 mW
Derate Linearly from 25°C	3.3 mW/°C
Withstand Test Voltage	$V_{IO}=5300Vdc$
Between Emitter and Detector	
Referred to Standard Climate	
23°C/50%RH, DIN 50014	
Leakage Path DIN 57883, 6.80	min. 8.2 mm
Air Path, VDE 0883 6.80	min. 7.3 mm
Tracking Resistance, Group III	
($KC > 600$ per VDE 110 § 6,	
Table 3 and DIN 53480/	
VDE 0330, Part 1	
$V_{IO}=500V$	$R_{IO}=10^{11}\Omega$
Storage Temperature	-55°C to +150°C
Operating Temperature	-55°C to +100°C
Lead Soldering Time at 260°C	10 sec.

Electrical Characteristics ($T_A=25^\circ C$)

Parameter	Min.	Typ.	Max.	Unit	Condition
Emitter					
Forward Voltage*		1.25	1.5	V	$I_F=50$ mA
Reverse Current*		0.1	100	μA	$V_R=3.0$ V
Capacitance			25	pF	$V_R=0$ V
Detector					
BV_{CEO} *	30			V	$I_C=100 \mu A, I_F=0$
BV_{CBO} *	50			V	$I_C=100 \mu A, I_F=0$
BV_{EBO} *	8			V	$I_C=100 \mu A, I_F=0$
BV_{ECO} *	5	10		V	$I_E=100 \mu A, I_F=0$
I_{CEO}		1.0	100	nA	$V_{CE}=10$ V, $I_F=0$
HFE		13K			$V_{CE}=5$ V, $I_C=0.5$ mA
Package					
Current Transfer Ratio*	500			%	$I_F=10$ mA $V_{CE}=10$ V
V_{CEsat}		1.0		V	$I_C=2$ mA $I_F=8$ mA
Dielectric Leakage Current					
I_{IO}	3.3	≤ 10		$\mu A_{AC(RMS)}$	$V_{IO}=4420 V_{AC(RMS)}$, 1 min., 60 Hz
I_{IO}	4.7	≤ 14.2		$\mu A_{AC(PK)}$	$V_{IO}=6250 V_{AC(PK)}$, 1 min., 60 Hz
I_{IO}	4.0	≤ 12		$\mu A_{AC(RMS)}$	$V_{IO}=5304 V_{AC(RMS)}$, 1 sec., 60 Hz
I_{IO}	5.7	≤ 17		$\mu A_{AC(PK)}$	$V_{IO}=7500 V_{AC(PK)}$, 1 sec., 60 Hz
Isolation Resistance*	10^{11}			Ω	$V_{IO}=500$ V
Coupling Capacitance		1.5		pF	
Turn-On Time		5		μs	$V_{CC}=10$ V $I_C=50$ mA
Turn -Off Time			100	μs	$I_F=200$ mA $R_L=180 \Omega$

*Indicates JEDEC registered values

Figure 1. Forward voltage versus forward current

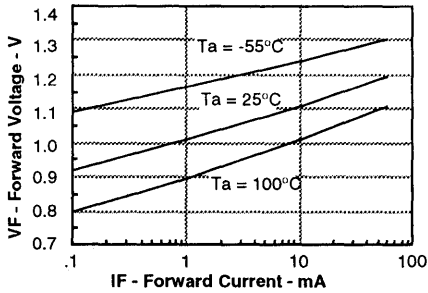

Figure 2. Normalized non-saturated and saturated CTRce versus LED current

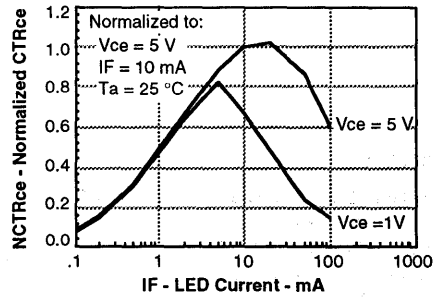

Figure 3. Normalized non-saturated and saturated collector-emitter current versus LED current

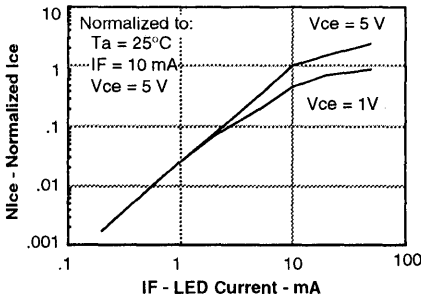

Figure 4. Normalized collector-base photocurrent versus LED current

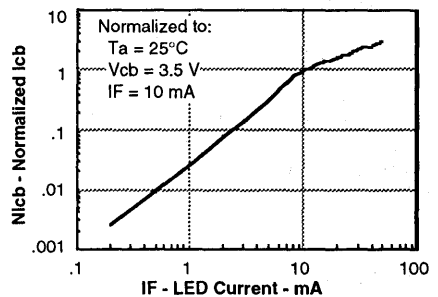

Figure 5. Non-saturated and saturated HFE versus base current

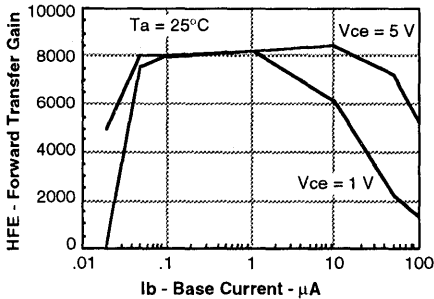

Figure 6. Low to high propagation delay versus collector load resistance and LED current

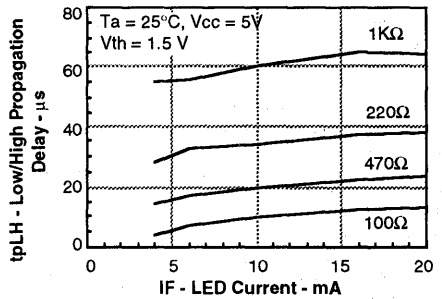

Figure 7. High to low propagation delay versus collector load resistance and LED current

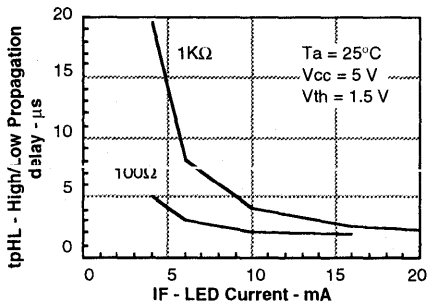
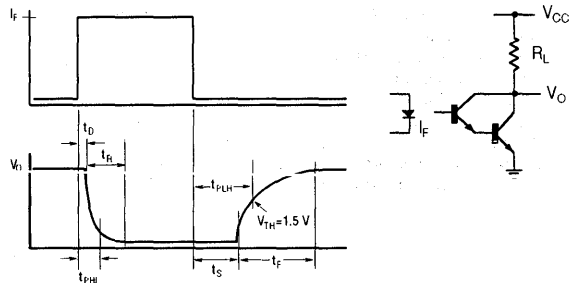

Figure 8. Switching waveform and switching schematic



PHOTOTRANSISTOR OPTOCOUPLER

FEATURES

- High Current Transfer Ratio—4N35/6/7, 100% Min.
- Coupling Capacitance, 0.5 pF
- Standard Dual-In-Line
- Underwriters Lab File #E52744
- VDE Approval #0884 (Optional with Option 1, add -X001 Suffix)

DESCRIPTION

The 4N35, 4N36, 4N37, and 4N38 are optically coupled pairs with a Gallium Arsenide infrared LED and a silicon NPN phototransistor.

Maximum Ratings

Emitter

Peak Reverse Voltage	6.0 V
Continuous Forward Current	60 mA
Power Dissipation at 25°C	100 mW
Derate Linearly from 25°C	1.33 mW/°C

Detector

Collector-Emitter Breakdown Voltage, BV_{CE0}	
4N35/6/7	30 V
4N38	80 V
Emitter-Collector Breakdown Voltage BV_{ECO}	7 V
Collector-Base Breakdown Voltage, BV_{CBO}	
4N35/6/7	70 V
4N38	80 V
Power Dissipation at 25°C	300 mW
Derate Linearly from 25°C	4.0 mW/°C

Package

Withstand Test Voltage	$V_{IO}=5300Vdc$
Between Emitter and Detector	
Referred to Standard Climate	
23°C/50%RH, DIN 50014	
Leakage Path	min. 8.2 mm
Air Path	min. 7.3 mm
Storage Temperature	-55°C to +150°C
Operating Temperature	-55°C to +100°C
Lead Soldering Time at 260°C	10 sec.
Relative Humidity at 85°C	85%

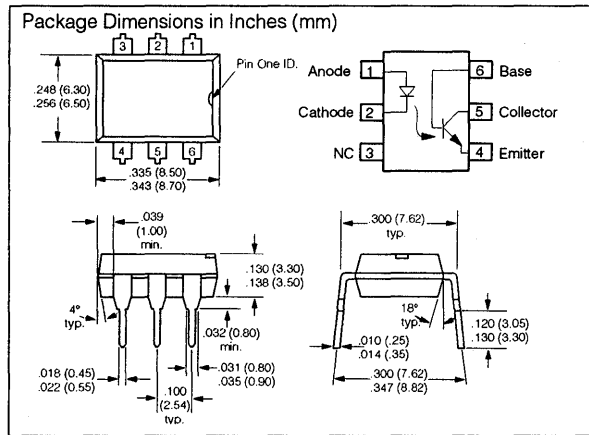

Electrical Characteristics ($T_A=25^\circ C$)

	Sym	Min.	Typ.	Max.	Unit	Condition
Emitter						
Forward Voltage*	V_F	0.9	1.3	1.5	V	$I_F=10\text{ mA}$
				1.7	V	$I_F=10\text{ mA}, T_A=-55^\circ C$
Reverse Current	I_R	0.1	10		μA	$V_R=6.0\text{ V}$
Capacitance	C_O	25			pF	$V_R=0, f=1\text{ MHz}$
Detector						
BV_{ECO}^*		7			V	$I_E=100\ \mu A$
BV_{CE0}^*					V	
4N35/6/7		30			V	$I_C=1\text{ mA}$
4N38		80			V	$I_C=1\text{ mA}$
I_{CE0}					nA	$V_{CE}=10\text{ V}, I_F=0$
4N35/6/7		5	50		nA	$V_{CE}=60\text{ V}, T_A=25^\circ C$
4N38					nA	
I_{CE0}					μA	$V_{CE}=30\text{ V}, I_F=0$
4N35/6/7			500		μA	$V_{CE}=60\text{ V}, T_A=100^\circ C$
4N38					μA	
BV_{CBO}^*					V	$I_C=100\ \mu A$
4N35/6/7		70			V	$I_B=1\ \mu A$
4N38		80			V	
Capacitance					pF	$V_{CE}=0$
Collector-Emitter	C_{CE}	6			pF	
Package						
DC Current Transfer Ratio*					%	$I_F=10\text{ mA}, V_{CE}=10\text{ V}$
4N35/6/7	CTR	100			%	$T_A=25^\circ C$
4N38	CTR	10			%	$V_{CE}=10\text{ V}, I_F=10\text{ mA}$
DC Current Transfer Ratio—4N35/6/7	CTR	40			%	$I_F=10\text{ mA}, V_{CE}=10\text{ V}$
					%	$T_A=-55^\circ C\text{ to }100^\circ C$
Saturation Voltage						
Collector-Emitter					V	
4N35/6/7	$V_{CE(SAT)}$	0.3			V	$I_F=10\text{ mA}, I_C=0.5\text{ mA}$
4N38	$V_{CE(SAT)}$	1			V	$I_F=20\text{ mA}, I_C=4\text{ mA}$

Electrical Characteristics ($T_A=25^\circ\text{C}$)—continued

	Sym	Min.	Typ.	Max.	Unit	Condition
Isolation, Input to Output Current*						Pulse Width=8 msec.
4N35/4N38				100	μA	$V_{IO}=2500$ VRMS
4N36				100	μA	$V_{IO}=1750$ VRMS
4N37				100	μA	$V_{IO}=1050$ VRMS
Resistance, Input to Output*		10^{11}			Ω	$V_{IO}=500$ V
Coupling Capacitance*			0.5		pF	$f=1.0$ MHz
Switching Time*	T_{on}, T_{off}		10		μs	$I_C=2$ mA, $R_E=100$ Ω , $V_{CC}=10$ V
						$RH \leq 50\%$

Dielectric Leakage Current

$V_{IO} = 4420$ V _{AC(RMS)} , 1 min., 60 Hz	I_{IO}	3.3	10.0	$\mu\text{A}_{AC(RMS)}$
$V_{IO} = 6250$ V _{AC(PK)} , 1 min., 60 Hz	I_{IO}	4.7	14.2	$\mu\text{A}_{AC(PK)}$
$V_{IO} = 5304$ V _{AC(RMS)} , 1 sec., 60 Hz	I_{IO}	4.0	12.0	$\mu\text{A}_{AC(RMS)}$
$V_{IO} = 7500$ V _{AC(PK)} , 1 sec., 60 Hz	I_{IO}	5.7	17.0	$\mu\text{A}_{AC(PK)}$

* Indicates JEDEC registered values

Figure 1. Forward voltage versus forward current

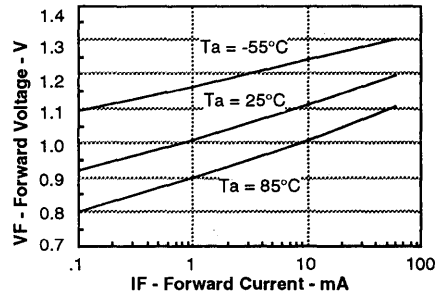

Figure 2. Normalized non-saturated and saturated CTR at $T_A=25^\circ\text{C}$ versus LED current

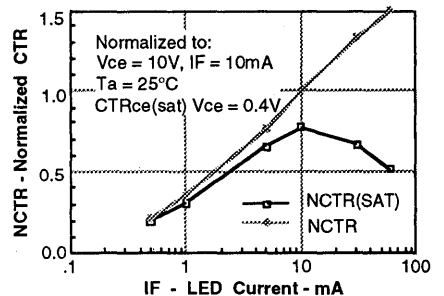

Figure 3. Normalized non-saturated and saturated CTR at $T_A=50^\circ\text{C}$ versus LED current

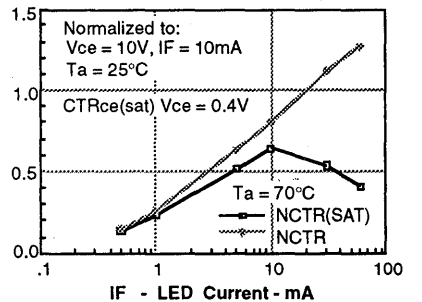
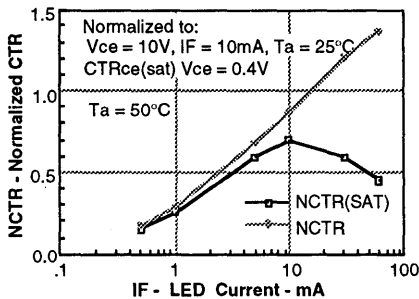

Figure 5. Normalized non-saturated and saturated CTR at $T_A=85^\circ\text{C}$ versus LED current

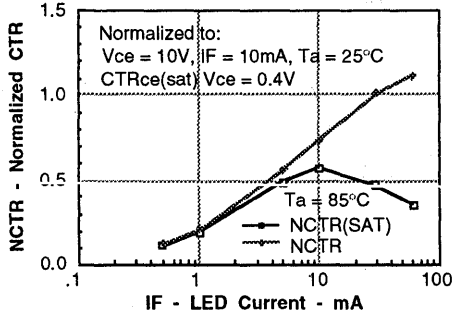

Figure 6. Collector-emitter current versus temperature and LED current

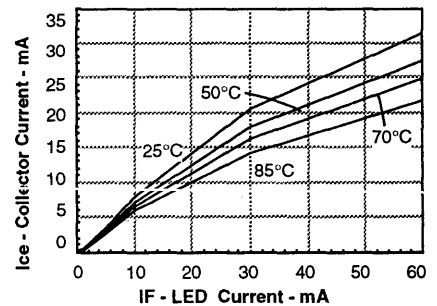

Figure 7. Collector-emitter leakage current versus temperature

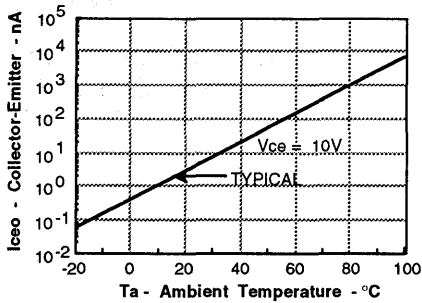

Figure 9. Collector base photocurrent versus LED current

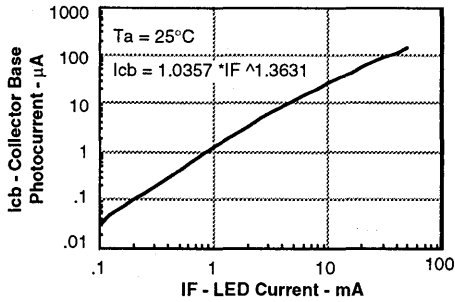

Figure 11. Normalized non-saturated HFE versus base current and temperature

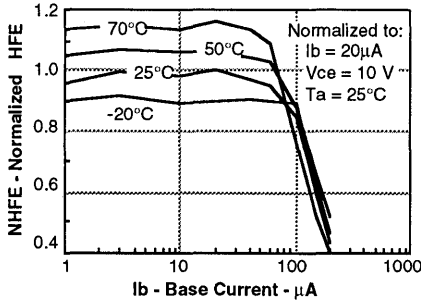

Figure 13. Propagation delay versus collector load resistor

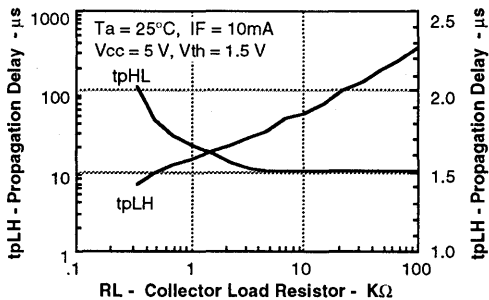

Figure 8. Normalized CTRcb versus LED current and temperature

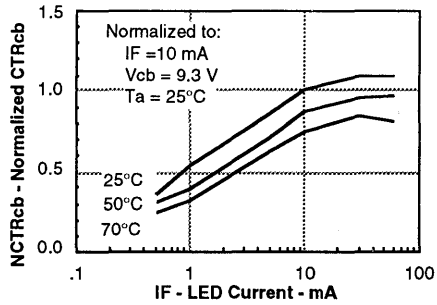

Figure 10. Normalized photocurrent versus IF and temperature

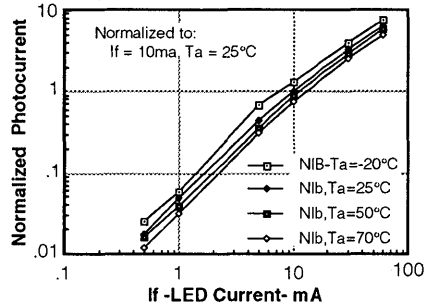

Figure 12. Normalized saturated HFE versus base current and temperature

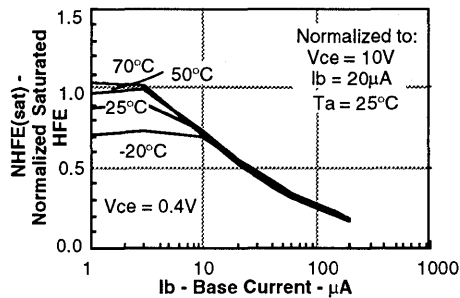
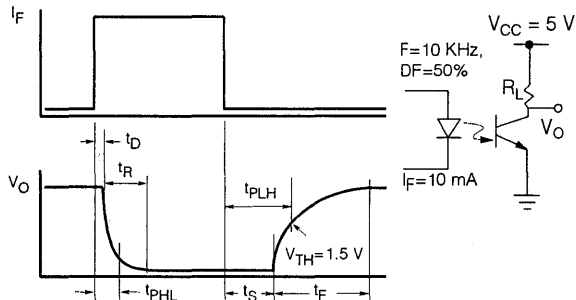

Figure 14. Switching waveform and switching schematic



HIGH-SPEED 2.5 kV TRIOS® OPTOCOUPLER

FEATURES

- Isolation Test Voltage: 2500 VAC, 1 min.
- TTL Compatible
- High Bit Rates: 1 Mbit/s
- High Common-Mode Interference Immunity
- Bandwidth 2 MHz
- Open-Collector Output
- External Base Wiring Possible
- Field-Effect Stable by TRIOS*
- Underwriters Lab File #E52744

DESCRIPTION

The 6N135 and 6N136 are optocouplers with a GaAlAs infrared emitting diode, optically coupled with an integrated photodetector which consists of a photodiode and a high-speed transistor in a DIP-8 plastic package.

Signals can be transmitted between two electrically separated circuits up to frequencies of 2 MHz. The potential difference between the circuits to be coupled is not allowed to exceed the maximum permissible reference voltages.

Maximum Ratings

Emitter

Reverse Voltage	5 V
Forward Current	25 mA
Peak Forward Current (t=1 ms, duty cycle 50%)	50 mA
Maximum Surge Forward Current (t≤1 μs, 300 pulses/s)	1 A
Thermal Resistance	700 K/W
Total Power Dissipation (T _A ≤70°C)	45 mW

Detector

Supply Voltage	-0.5 to 15 V
Output Voltage	-0.5 to 15 V
Emitter-Base Voltage	5 V
Output Current	8 mA
Maximum Output Current	16 mA
Base Current	5 mA
Thermal Resistance	300 K/W
Total Power Dissipation (T _A ≤70°C)	100 mW

Package

Isolation Test Voltage (between emitter and detector climate per DIN 40046, part 2, Nov. 74 (t=1min.))	2.5 K VAC
Pollution Degree (DIN VDE 0109)	2
Creepage Distance	≥7 mm
Clearance	≥7 mm
Comparative Tracking Index per DIN IEC112/ VDE 0303 part 1, Group IIIa per DIN VDE 0109	175
Isolation Resistance	
V _{IO} =500 V, T _A = 25°C	>10 ¹² Ω
V _{IO} =500 V, T _A = 100°C	≥10 ¹¹ Ω
Storage Temperature Range	-55°C to +125°C
Ambient Temperature Range	-55°C to +100°C
Soldering Temperature (max. ≤10 sec., dip soldering ≥0.5 mm from case bottom)	260°C

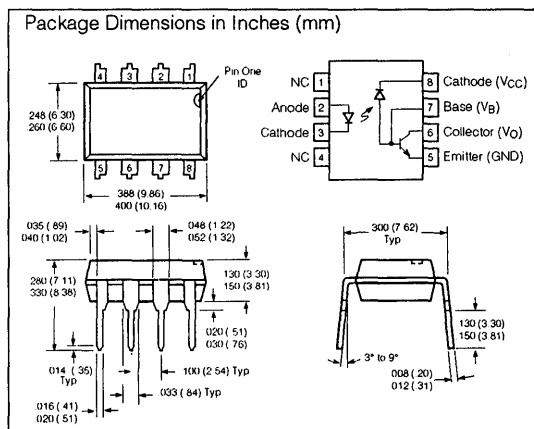

Characteristics

(T_A=0 to 70°C unless otherwise specified, T_A=25°C typ.)

Emitter	Symbol	Unit	Condition
Forward Voltage	V _F	1.5 (≤1.7) V	I _F =16 mA
Breakdown Voltage	V _{BR}	≥5 V	I _F =0 mA
Reverse Current	I _R	0.5 (≤10) μA	V _R =5 V
Capacitance	C _O	125 pF	V _R =0 V, f=1 MHz
Temperature Coefficient of Forward Voltage	ΔV _F /ΔT _A	1.7 mV/°C	I _F =16 mA
Detector			
Supply Current			I _F =16 mA, V _O open, V _{CC} =15 V
Logic Low	I _{CCL}	150 μA	I _F =0 mA, V _O open, V _{CC} =15 V
Supply Current			I _F =16 mA, V _O open, V _{CC} =15 V
Logic High	I _{CCH}	0.01 (≤1) μA	I _F =16 mA, V _{CC} =15 V
Output Voltage			V _{CC} =4.5 V
Output Low			I _O =1.1 mA
6N135	V _{OL}	0.1 (≤0.4) V	I _O =2.4 mA
6N136	V _{OL}	0.1 (≤0.4) V	
Output Current			V _O =V _{CC} =5.5 V
Output High	I _{OH}	3 (≤500) nA	I _F =0 mA, V _O =V _{CC} =15 V
Output Current			V _O =V _{CC} =15 V
Output High	I _{OH}	0.01 (≤1) μA	I _F =0 mA, V _O =5 V, I _O =3 mA
Current Gain	H _{FE}	150	
Package			
Coupling Capacitance			f=1 MHz
Input-Output	C _{IO}	0.6 pF	I _F =16 mA, V _O =0.4 V, V _{CC} =4.5 V, T _A =25°C
Current Transfer Ratio			
6N135	CTR	16 (≥7) %	
6N136	CTR	35 (≥19) %	
Current Transfer Ratio			I _F =16 mA, V _O =0.5 V, V _{CC} =4.5 V
CTR	7.5	%	

*TRIOS - TRansparent IO n Shield

SWITCHING TIMES

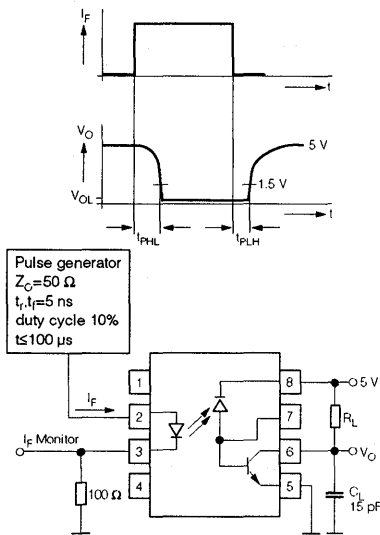

Delay Time ($I_F=16 \text{ mA}$, $V_{CC}=5 \text{ V}$, $T_A=25^\circ\text{C}$)

High - Low			
6N135 ($R_L=4.1 \text{ kW}$)	t_{FHL}	0.3 (≤ 1.5)	μs
6N136 ($R_L=1.9 \text{ kW}$)	t_{FHL}	0.2 (≤ 0.8)	μs
Low - High			
6N135 ($R_L=4.1 \text{ kW}$)	t_{PHL}	0.3 (≤ 1.5)	μs
6N136 ($R_L=1.9 \text{ kW}$)	t_{PHL}	0.2 (≤ 0.8)	μs

COMMON-MODE INTERFERENCE IMMUNITY

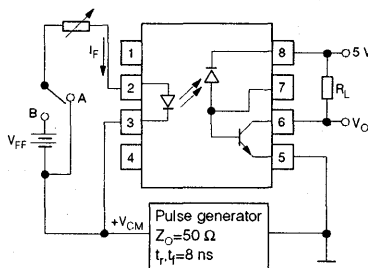
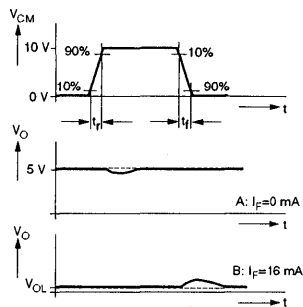

Common Mode Interference Immunity

($V_{CM}=10 \text{ V}_{P-P}$, $V_{CC}=5 \text{ V}$, $T_A=25^\circ\text{C}$)

High ($I_F=0 \text{ mA}$)			
6N135 ($R_L=4.1 \text{ kW}$)	CM_H	1000	$\text{V}/\mu\text{s}$
6N136 ($R_L=1.9 \text{ kW}$)	CM_H	1000	$\text{V}/\mu\text{s}$
Low ($I_F=16 \text{ mA}$)			
6N135 ($R_L=4.1 \text{ kW}$)	CM_L	1000	$\text{V}/\mu\text{s}$
6N136 ($R_L=1.9 \text{ kW}$)	CM_L	1000	$\text{V}/\mu\text{s}$

Output characteristics—6N135
 Output current versus output
 voltage ($T_A=25^\circ\text{C}$, $V_{CC}=5 \text{ V}$)

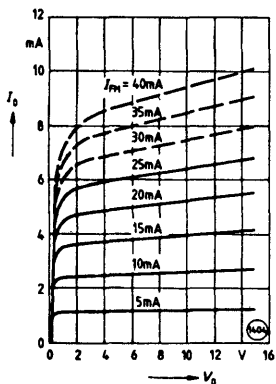

Output characteristics—6N136
 Output current versus output
 voltage ($T_A=25^\circ\text{C}$, $V_{CC}=5 \text{ V}$)

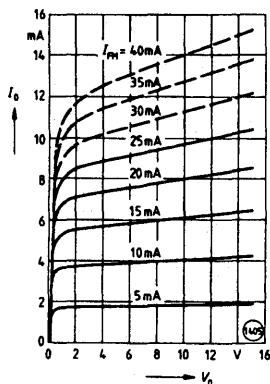

Permissible forward current of emitting diode versus ambient temperature

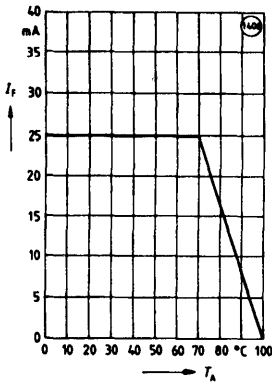

Permissible total power dissipation versus ambient temperature

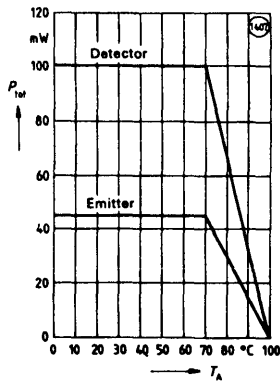

Forward current of emitting diode versus forward voltage ($T_A=25^\circ\text{C}$)

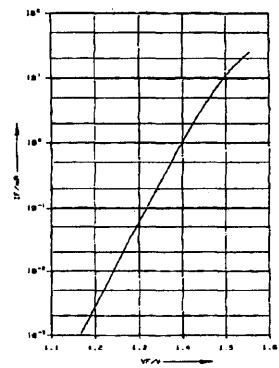

Small signal transfer ratio versus forward current ($V_{CC}=5\text{ V}$, $T_A=25^\circ\text{C}$)

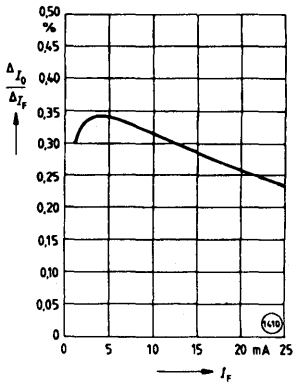

Current transfer ratio (normalized) versus ambient temperature (normalized to $I_F=16\text{ mA}$, $V_O=0.4\text{ V}$, $V_{CC}=5\text{ V}$, $T_A=25^\circ\text{C}$)

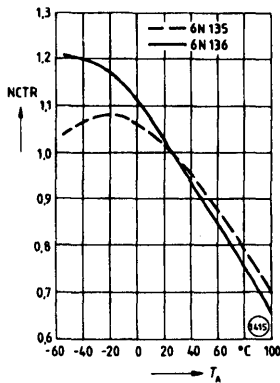

Output current (high) versus ambient temperature ($V_O=V_{CC}=5\text{ V}$, $I_F=0$)

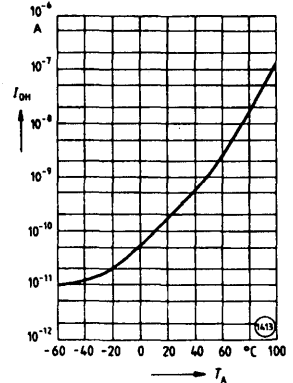

Delay times versus ambient temperature ($I_F=16\text{ mA}$, $V_{CC}=5\text{ V}$, 6N135: $R_L=4.1\text{ kW}$, 6N136: $R_L=1.9\text{ kW}$)

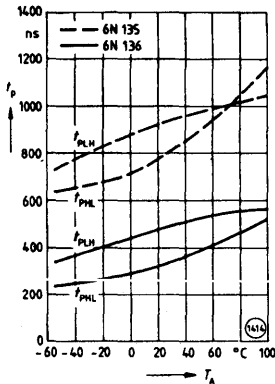

Current transfer ratio (normalized) versus forward current ($I_F=16\text{ mA}$, $V_O=0.4\text{ V}$, $V_{CC}=5\text{ V}$, $T_A=25^\circ\text{C}$)

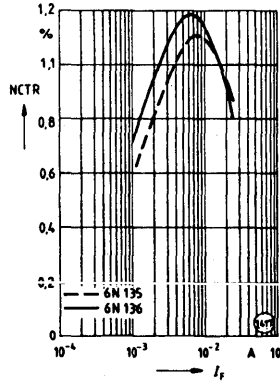

LOW INPUT CURRENT, HIGH GAIN OPTOCOUPLER

FEATURES

- High Current Transfer Ratio, 800%
- Low Input Current, 0.5mA
- High Output Current, 60mA
- Isolation Test Voltage, 2500 VAC min.
- TTL Compatible Output, $V_{OL} = 0.1$ V
- High Common Mode Rejection, 500V/ μ sec.
- Adjustable Bandwidth—Access to Base
- Standard Molded Dip Plastic Package
- Underwriters Lab File #E52744

APPLICATIONS

- Logic Ground Isolation—TTL/TTL, TTL/CMOS, CMOS/CMOS, CMOS/TTL
- EIA RS 232C Line Receiver
- Low Input Current Line Receiver—Long Lines, Party Lines
- Telephone Ring Detector
- 117 VAC Line Voltage Status Indication—Low Input Power Dissipation
- Low Power Systems—Ground Isolation

DESCRIPTION

High common mode transient immunity and very high current ratio together with 2500 VAC insulation are achieved by coupling an LED with an integrated high gain photo detector in an eight pin dual-in-line package. Separate pins for the photodiode and output stage enable TTL compatible saturation voltages with high speed operation. Photodarlington operation is achieved by tying the V_{CC} and V_O terminals together. Access to the base terminal allows adjustment to the gain bandwidth.

The 6N138 is ideal for TTL applications since the 300% minimum current transfer ratio with an LED current of 1.6 mA enables operation with one unit load-in and one unit load-out with a 2.2 K Ω pull-up resistor.

The 6N139 is best suited for low power logic applications involving CMOS and low power TTL. A 400% current transfer ratio with only 0.5 mA of LED current is guaranteed from 0°C to 70°C.

Caution:

Due to the small geometries of this device, it should be handled with Electrostatic Discharge (ESD) precautions. Proper grounding would prevent damage further and/or degradation which may be induced by ESD.

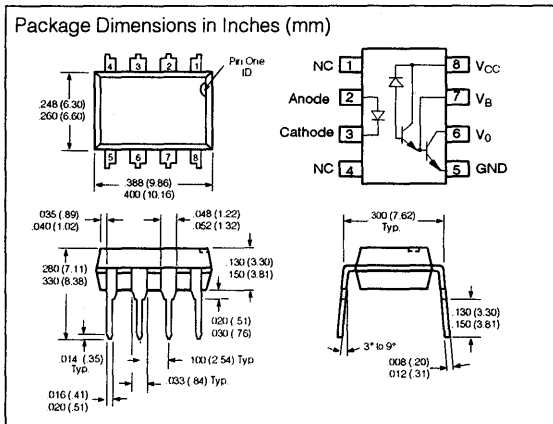

Maximum Ratings

Reverse Input Voltage	5 V
Supply and Output Voltage, V_{CC} (pin 8-5), V_O (pin 6-5)	
6N138	-0.5 to 7 V
6N139	-0.5 to 18 V
Emitter-Base Reverse Voltage (pin 5-7)	0.5 V
Average Input Current	20 mA
Peak Input Current	40 mA
(50% Duty Cycle—1 ms pulse width)	
Peak Transient Input Current	
($t_p \leq 1$ μ sec, 300 pps)	1.0 A
Output Current I_O (pin 6)	60 mA
Derate linearly above 25°C, free air temperature at 0.7 mA/°C	
Input Power Dissipation	35 mW
Derate linearly above 50%, free air temperature at 0.7 mW/°C	
Output Power Dissipation	100 mW
Derate linearly above 25°C, free air temperature at 0.2 mA/°C	
Storage Temperature	-55°C to +125°C
Operating Temperature	-55°C to +100°C
Lead Soldering Temperature ($t = 10$ sec.)	260°C

Electro-Optical Characteristics ($T_A=0^{\circ}\text{C}$ to 70°C , $T_A=25^{\circ}\text{C}$ –Typical, unless otherwise specified)

Parameter	Device	Min	Typ	Max	Units	Test Conditions	Note
Current Transfer Ratio (CTR)	6N138	300	1600		%	$I_F=1.6\text{ mA}$, $V_O=0.4\text{ V}$, $V_{CC}=4.5\text{ V}$	5,6
	6N139	400 500	1600 2000		%	$I_F=0.5\text{ mA}$, $V_O=0.4\text{ V}$, $V_{CC}=4.5\text{ V}$ $I_F=1.6\text{ mA}$, $V_O=0.4\text{ V}$, $V_{CC}=4.5\text{ V}$	5,6
Logic Low	6N138		0.1	0.4	V	$I_F=1.6\text{ mA}$, $I_O=4.8\text{ mA}$, $V_{CC}=4.5\text{ V}$	6
Output Voltage (V_{OL})	6N139		0.1	0.4	V	$I_F=1.6\text{ mA}$, $I_O=8\text{ mA}$, $V_{CC}=4.5\text{ V}$	6
	6N139		0.15	0.4		$I_F=5\text{ mA}$, $I_O=15\text{ mA}$, $V_{CC}=4.5\text{ V}$	
	6N139		0.25	0.4		$I_F=12\text{ mA}$, $I_O=24\text{ mA}$, $V_{CC}=4.5\text{ V}$	
Logic High	6N138		0.1	250	μA	$I_F=0\text{ mA}$, $V_O=V_{CC}=7\text{ V}$	6
Output Current (I_{OH})	6N139		0.05	100	μA	$I_F=0\text{ mA}$, $V_O=V_{CC}=18\text{ V}$	6
Logic Low Supply Current (I_{OCL})			0.2	1.5	mA	$I_F=1.6\text{ mA}$, $V_O=\text{OPEN}$, $V_{CC}=18\text{ V}$	6
Logic High Supply Current (I_{OCH})			0.001	10	μA	$I_F=0\text{ mA}$, $V_O=\text{OPEN}$, $V_{CC}=18\text{ V}$	6
Input Forward Voltage (VF)			1.4	1.7	V	$I_F=1.6\text{ mA}$, $T_A=25^{\circ}\text{C}$	
Input Reverse Breakdown Voltage (BV_R)		5			V	$I_R=10\text{ }\mu\text{A}$	
Temperature Coefficient of Forward Voltage			-1.8		mV/ $^{\circ}\text{C}$	$I_F=1.6\text{ mA}$	
Input Capacitance (C_{IN})			25		pF	$f=1\text{ MHz}$, $V_F=0$	
Input-Output Insulation Leakage Current (I-O)				1.0	μA	45% Relative Humidity, $T_A=25^{\circ}\text{C}$ $t=5\text{ s}$, $V_{I-O}=3000\text{ VDC}$	7
Resistance (Input-Output) (R_{I-O})			10^{12}		Ω	$V_{I-O}=500\text{ VDC}$	7
Capacitance (Input-Output) (C_{I-O})			0.6		pF	$f=1\text{ MHz}$	7

Switching Specifications ($T_A=25^{\circ}\text{C}$)

Parameter	Device	Min	Typ	Max	Units	Test Conditions	Note
Propagation Delay Time	6N138		2	10	μS	$I_F=1.6\text{ mA}$, $R_L=2.2\text{ K}\Omega$	
	6N139		6	25	μS	$I_F=0.5\text{ mA}$, $R_L=4.7\text{ K}\Omega$ $I_F=12\text{ mA}$, $R_L=270\text{ }\Omega$	6,8
Propagation Delay Time	6N138		2	35	μS	$I_F=1.6\text{ mA}$, $R_L=2.2\text{ K}\Omega$	
	6N139		4	60	μS	$I_F=0.5\text{ mA}$, $R_L=4.7\text{ K}\Omega$ $I_F=12\text{ mA}$, $R_L=270\text{ }\Omega$	6,8
Common Mode Transient Immunity at Logic High Level (CM_{HL}) Output			500		V/ μS	$I_F=0\text{ mA}$, $R_L=2.2\text{ K}\Omega$ $R_{CC}=0/V_{CM}/10\text{ V}_{P-P}$	9,10
Common Mode Transient Immunity at Logic Low Level (CM_{LL}) Output			-500		V/ μS	$I_F=1.6\text{ mA}$, $R_L=2.2\text{ K}\Omega$ $R_{CC}=0/V_{CM}/10\text{ V}_{P-P}$	9,10

Notes

- Derate linearly above 50°C free-air temperature at a rate of $0.4\text{ mA}/^{\circ}\text{C}$.
- Derate linearly above 50°C free-air temperature at a rate of $0.7\text{ mW}/^{\circ}\text{C}$.
- Derate linearly above 25°C free-air temperature at a rate of $0.7\text{ mA}/^{\circ}\text{C}$.
- Derate linearly above 25°C free-air temperature at a rate of $2.0\text{ mW}/^{\circ}\text{C}$.
- DC current transfer ratio is defined as the ratio of output collector current, I_O , to the forward LED input current, I_F times 100%.
- Pin 7 open.
- Device considered a two-terminal device: pins 1, 2, 3 and 4 shorted together and pins 5, 6, 7 and 8 shorted together.
- Using a resistor between pin 5 and 7 will decrease gain and delay time.
- Common mode transient immunity in logic high level is the maximum tolerable (positive) dV_{CM}/dt on the leading edge of the common mode pulse, V_{CM} , to assure that the output will remain in a logic high state (i.e. $V_O > 2.0\text{ V}$) common mode transient immunity in logic low level is the maximum tolerable (negative) dV_{CM}/dt on the trailing edge of the common mode pulse signal, V_{CM} , to assure that the output will remain in a logic low state (i.e. $V_O < 0.8\text{ V}$).
- In applications where dv/dt may exceed $50,000\text{ V}/\mu\text{s}$ (such as state discharge) a series resistor, R_{CC} should be included to protect I_C from destructively high surge currents. The recommended value is $R_{CC} = \frac{I_V}{0.15 I_F}$ k Ω .

FEATURES

- $V_{DRM}=400$ to 800 V
- $I_{TRMS}=300$ mA
- $dv/dt_{cr} \geq 10,000$ V/ μ s
- Electrically Insulated Between Input and Output Circuit
- Microcomputer Compatible—Very Low Trigger Current
- Trigger Current:
 - BRT11/12/13 H, <2 mA
 - BRT11/12/13 M, <3
- Options Available:
 - Option 1—Per VDE 0884
 - Option 6—Leads with 0.4" (10.16 mm) Spacing
 - Option 7—Lead Bends for Surface Mounting
- DIP-6 Package
- Underwriters Lab File #E52744, Code Letter "J"

Maximum Ratings ($T_J=25^\circ\text{C}$ unless otherwise specified)

Input Circuit	
Reverse Voltage	6 V
Continuous Forward Current	20 mA
Surge Forward Current, $\leq 10 \mu\text{s}$	1.5 A
Maximum Power Dissipation	30 mW

Output Circuit

Repetitive Peak Off-State Voltage	
BRT11	400 V
BRT12	600 V
BRT13	800 V
RMS On-State Current	300 mA
Single Cycle Surge Current (50 Hz)	3 A
Maximum Power Dissipation	600 mW

AC Switch

Insulation Test Voltage	
Between Input/Output Circuit	
(Climate per DIN 40 046, Part 2, Nov. 74)	5300 VDC
Reference Voltage per VDE 0110b	
(Insulation Group C)	500VAC _{eff} /600 VDC
Creepage Distance (input/output circuit)	≥ 8.2 mm
Clearance (input/output circuit)	7.2 mm
Creepage Tracking Resistance	
per DIN IEC 112/VDE 0303,	
part 1	175 Group IIIa per DIN VDE 0109
Insulation Resistance	
$V_{IO}=500$ V, $T_A=25^\circ\text{C}$	$10^{12} \Omega$
$V_{IO}=500$ V, $T_A=100^\circ\text{C}$	$10^{11} \Omega$
Humidity Category (DIN 40 040)	F
Maximum Power Dissipation	630 mW
Operating Temperature Range	-40°C to $+100^\circ\text{C}$
Storage Temperature Range	-40°C to $+150^\circ\text{C}$

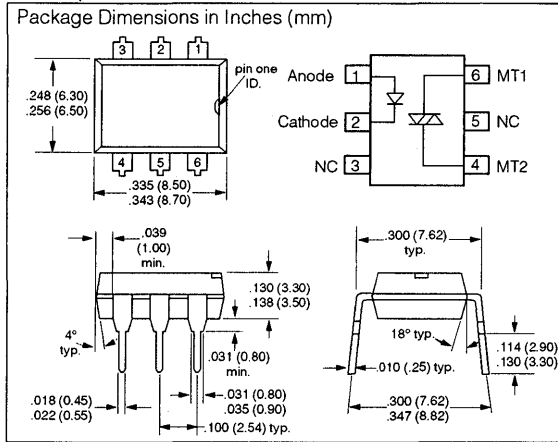

DESCRIPTION

The BRT11/12/13 are AC switch optocouplers without zero voltage detectors consisting of two electrically insulated lateral power ICs which integrate a thyristor system, a photo detector and noise suppression at the output and an IR GaAs diode at the input.

Characteristics ($T_J=25^\circ\text{C}$, unless otherwise specified)

	Symbol	Min.	Typ.	Max.	Unit	Condition
Input Circuit						
Forward Voltage	V_F		1.1		V	$I_F=10$ mA
Reverse Current	I_R		10		μ A	$V_R=6$ V
Thermal Resistance ⁽¹⁾						
Junction to Ambient R_{thJA}			750		K/W	
Output Circuit						
On-State Voltage	V_T		2.3		V	$I_T=300$ mA
Off-State Current	I_D	0.5	100		μ A	$T_J=100^\circ\text{C}$, V_{DRM}
Holding Current	I_H	80	500		μ A	$V_D=10$ V
Critical Rate of Rise						
Off-Stage Voltage	dv/dt_{cr}	1000			V/ μ s	$T_J=25^\circ\text{C}$, $V_D=0.67 V_{DRM}$
	dv/dt_{cr}	5000			V/ μ s	$T_J=80^\circ\text{C}$, $V_D=0.67 V_{DRM}$
On-Stage Voltage	dv/dt_{cr}		8		A/ μ s	
Voltage at Current						
Commutation	dv/dt_{crq}	10,000			V/ μ s	
$T_J=25^\circ\text{C}$,						$V_D=0.67 V_{DRM}$ $di/dt_{crq} \leq 15$ A/ms V/ μ s
$T_J=80^\circ\text{C}$,						$di/dt_{crq} \leq 15$ A/ms
Thermal Resistance						
Junction to Ambient R_{thJA}			125		K/W	
Package						
Trigger Current	I_{FT}					
Type H			2.0		mA	$V_D=10$ V
Type M			3.0		mA	$V_D=10$ V
Input-Output						
Capacitance	C_{IO}		2		pF	$V_R=0$, $x=1$ KHz

Optocouplers
(Optoisolators)

Typical trigger delay time

$t_{gd} = f(I_T / I_{FT25^{\circ}C}), V_D = 200 \text{ V}, \text{Parameter: } T_J$

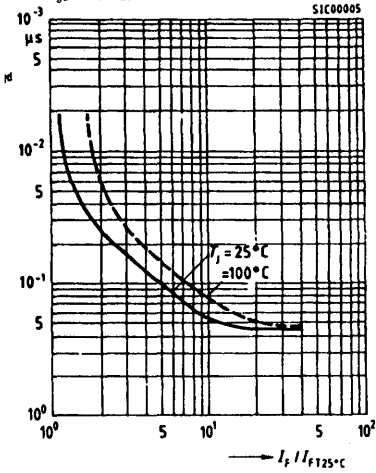

Typical off-state current

$I_D = f(T_J), V_D = 800 \text{ V}, \text{Parameter: } T_J$

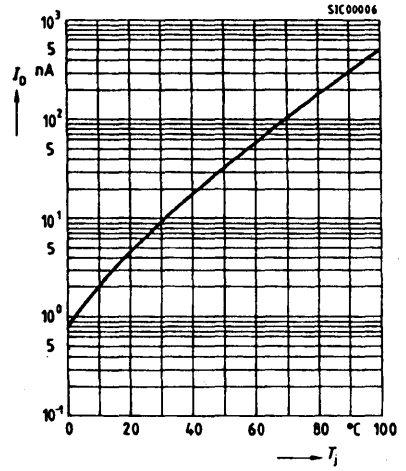

Power dissipation—for 40 to 60 Hz line operation

$P_{tot} = f(I_{TRMS})$

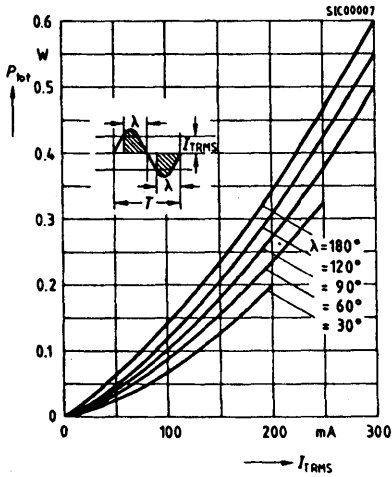

Pulse trigger current

$I_{FTN} = f(t_{PIF}), I_{FTN}$ normalized to I_{FT} , referring to $t_{PIF} \leq 1 \text{ ms}, V_{OD} = 220 \text{ V}, f = 40 \text{ to } 60 \text{ Hz typical}$

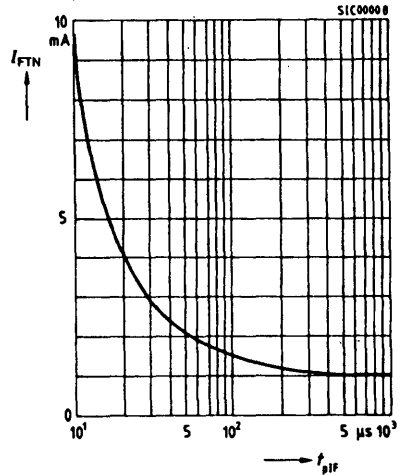

FEATURES

- $V_{DRM}=400$ to 800 V
- $I_{TRMS}=300$ mA
- $dv/dt_{cr} \geq 10,000$ V/ μ s
- Electrically Insulated Between Input and Output Circuit
- Microcomputer Compatible—Very Low Trigger Current
- Trigger Current:
 - BRT21/22/23 H, <2 mA
 - BRT21/22/23 M, <3
- Options Available:
 - Option 1—Per VDE 0884
 - Option 6—Leads with 0.4" (10.16 mm) Spacing
 - Option 7—Lead Bends for Surface Mounting
- DIP-6 Package
- Underwriters Lab File #E52744, Code Letter "J"

Maximum Ratings

($T_J=25^\circ\text{C}$ unless otherwise specified)

Input Circuit

Reverse Voltage	6 V
Continuous Forward Current	20 mA
Surge Forward Current, $t_s \leq 10 \mu\text{s}$	1.5 A
Maximum Power Dissipation	30 mW

Output Circuit

Repetitive Peak Off-State Voltage	
BRT21	400 V
BRT22	600 V
BRT23	800 V
RMS On-State Current	300 mA
Single Cycle Surge Current (50 Hz)	3 A
Maximum Power Dissipation	600 mW

AC Switch

Insulation Test Voltage	
Between Input/Output Circuit	
(Climate per DIN 40 046, Part 2, Nov. 74)	5300 VDC
Reference Voltage per VDE 0110b	
(Insulation Group C)	500VAC _{eff} /600 VDC
Creepage Distance (input/output circuit)	≥ 8.2 mm
Clearance (input/output circuit)	7.2 mm
Creepage Tracking Resistance per DIN IEC 112/VDE 0303, part 1	175 Group IIIa per DIN VDE 0109
Insulation Resistance	
$V_{IO}=500$ V, $T_A=25^\circ\text{C}$	$10^{12} \Omega$
$V_{IO}=500$ V, $T_A=100^\circ\text{C}$	$10^{11} \Omega$
Humidity Category (DIN 40 040)	F
Maximum Power Dissipation	630 mW
Operating Temperature Range	-40°C to $+100^\circ\text{C}$
Storage Temperature Range	-40°C to $+150^\circ\text{C}$

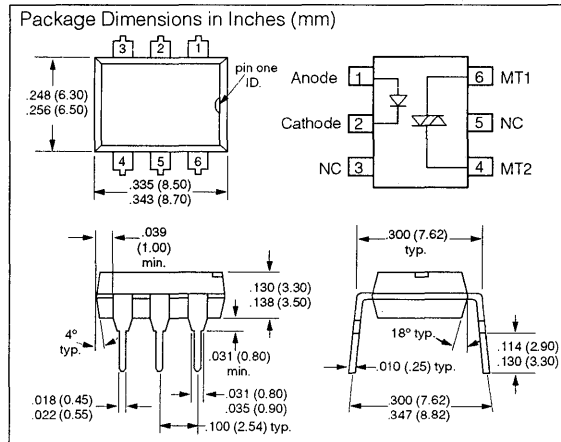

DESCRIPTION

The BRT21/22/23 are AC switch optocouplers without zero voltage detectors consisting of two electrically insulated lateral power ICs which integrate a thyristor system, a photo detector and noise suppression at the output and an IR GaAs diode at the input.

Characteristics ($T_J=25^\circ\text{C}$, unless otherwise specified)

Symbol	Min.	Typ.	Max.	Unit	Condition
Output Circuit					
On-State Voltage	V_T		2.3	V	$I_T=300$ mA
Reverse Current	I_D	7	30	μ A	$T_J=25^\circ\text{C}$, V_{DRM}
		12	100	μ A	$T_J=100^\circ\text{C}$, V_{DRM}
Holding Current	I_H	80	500	μ A	$V_D=10$ V
Critical Rate of Rise					
Off-Stage Voltage	dv/dt_{cr}	1000		V/ μ s	$T_J=25^\circ\text{C}$, $V_D=0.67 V_{DRM}$
		5000		V/ μ s	$T_J=80^\circ\text{C}$, $V_D=0.67 V_{DRM}$
Voltage at Current					
Commutation	dv/dt_{crq}	10,000		V/ μ s	$V_D=0.67 V_{DRM}$, $di/dt_{crq} \leq 15$ A/ms
$T_J=25^\circ\text{C}$,					V/ μ s
$T_J=80^\circ\text{C}$,					$V_D=0.67 V_{DRM}$, $di/dt_{crq} \leq 15$ A/ms
On-Stage Voltage	dv/dt_{cr}		8	A/ μ s	
Thermal Resistance					
Junction-Ambient	R_{thJA}		125	K/W	
Package					
Trigger Current	I_{FT}				
Type H			2.0	mA	$V_D=10$ V
Type M			3.0	mA	$V_D=10$ V
Input-Output					
Capacitance	C_{IO}		2	pF	$V_R=0$, $x=1$ KHz

Trigger delay time (typ.)

$t_{gd} = f(I_F / I_{FT25^\circ C})$, $V_D = 200$ V, Parameter: T_J

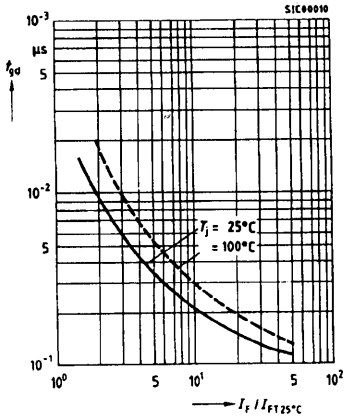

Off-state current (typ.)

$I_{D} = f(T_J)$, $V_D = 800$ V, Parameter: T_J

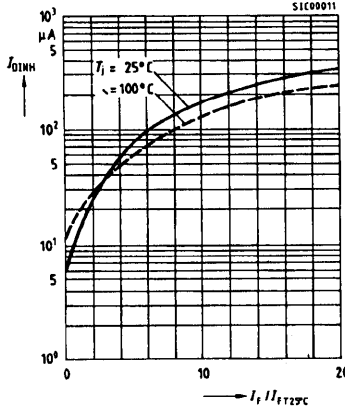

Power dissipation, 40 to 60 Hz line operation, $P_{tot} = f(I_{TRMS})$

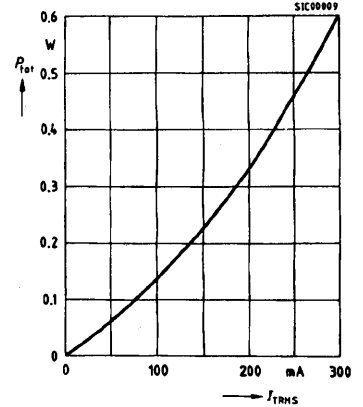

Static inhibit voltage limit (typ.)

$V_{DINHmin} = f(I_F / I_{FT25^\circ C})$, parameter: T_J
SITAC zero voltage triggered only in hatched area below T_J curves

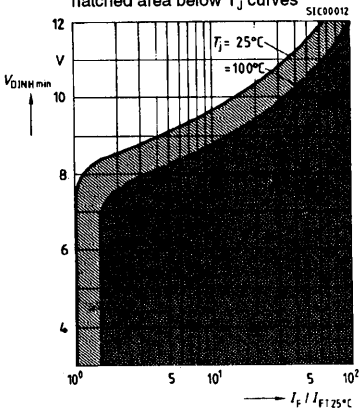

Input characteristics (typ.)

$I_F = f(V_F)$, parameter: T_J

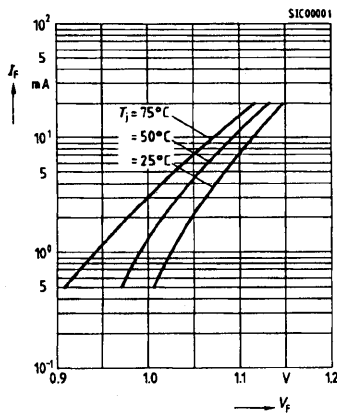

Output characteristics (typ.)

$I_T = f(V_T)$, parameter: T_J

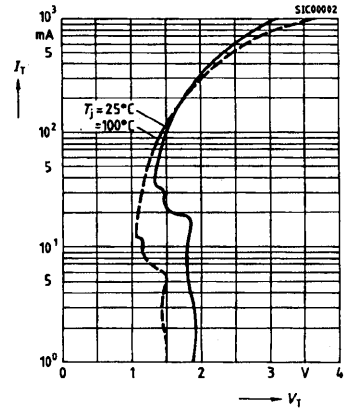

Current reduction $I_{TRMS} = f(T_A)$, $R_{thJA} = 125$ K/W
SITAC switch soldered in PCB or base plate

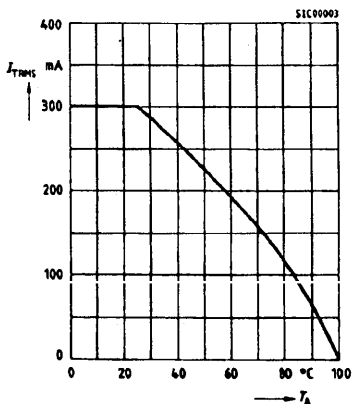

Current reduction $I_{TRMS} = f(T_{PIN S})$, $R_{thJPIN S} = 16.5$ K/W
Thermocouple measurement must be performed potentially separated to A1 and A2. Measuring junction near to case as possible.

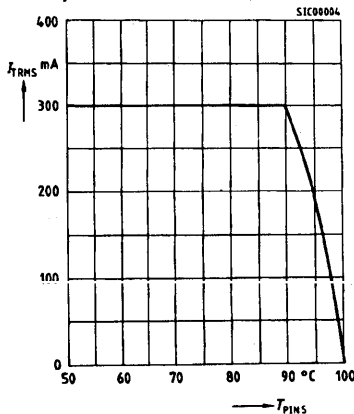

FEATURES

- **High Current Transfer Ratio**
CNY17-1, 40 to 80%
CNY17-2, 63 to 125%
CNY17-3, 100 to 200%
CNY17-4, 160 to 320%
- **Breakdown Voltage, 5300 V**
- **Field-Effect Stable by TRIOS***
- **Long Term Stability**
- **Industry Standard Dual-in-Line Package**
- **Underwriters Lab File #E52744**
- **Option 1:  VDE #0884, add -X001 suffix**

DESCRIPTION

The CNY17 is an optically coupled pair consisting of a Gallium Arsenide infrared emitting diode optically coupled to a silicon NPN phototransistor.

Signal information, including a DC level, can be transmitted by the device while maintaining a high degree of electrical isolation between input and output.

The CNY17 can be used to replace relays and transformers in many digital interface applications, as well as analog applications such as CRT modulation.

Maximum Ratings (T_A=25°C)

Emitter	
Reverse Voltage	6 V
Forward Current	60 mA
Surge Current (t ≤ 10 μs)	2.5 A
Power Dissipation	100 mW
Detector	
Collector-Emitter Breakdown Voltage	70 V
Emitter-Base Breakdown Voltage	7 V
Collector Current	50 mA
Collector Current (t < 1 ms)	100 mA
Power Dissipation	150 mW

Package

Isolation Test Voltage (Between emitter & detector referred to climate DIN 40046, part 2, Nov. 74)		5300 VDC
Creepage Distance		≥ 7 mm
Clearance Distance		≥ 7 mm
Isolation Thickness between		
Emitter and Detector	≥ 0.4 mm	
Comparative Tracking Index per DIN IEC 112/ VDE0303, part 1		175
Isolation Resistance		
V _{IO} =500 V, T _A =25°C	10 ¹² Ω	
V _{IO} =500 V, T _A =100°C	10 ¹¹ Ω	
Storage Temperature		-55°C to +150°C
Operating Temperature		-55°C to +100°C
Junction Temperature		100°C
Soldering Temperature (max. 10 s, dip soldering: distance to seating plane ≥ 1.5 mm)		260°C

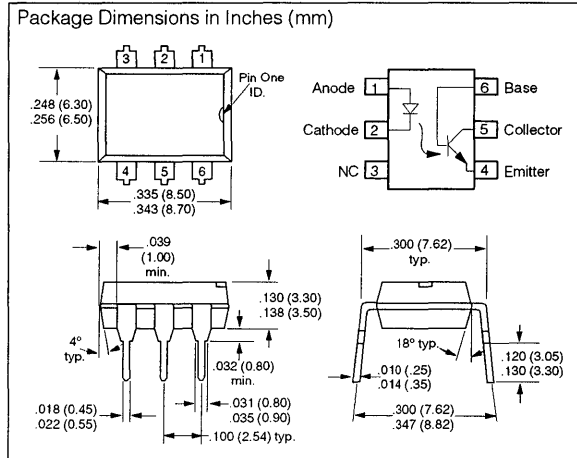

Characteristics (T_A=25°C)

	Symbol	Unit	Condition
Emitter			
Forward Voltage	V _F	1.25 (≤ 1.65) V	I _F = 60 mA
Breakdown Voltage	V _{BR}	≥ 6 V	I _R = 10 μA
Reverse Current	I _R	0.01 (≤ 10) μA	V _R = 6 V
Capacitance		25 pF	V _R = 0 V, f = 1 MHz
Thermal Resistance	R _{thjamb}	750 K/W	
Detector			
Capacitance	C _{CE}	5.2 pF	V _{CE} = 5 V, f = 1 MHz
	C _{CB}	6.5 pF	V _{CB} = 5 V, f = 1 MHz
	C _{EB}	7.5 pF	V _{EB} = 5 V, f = 1 MHz
Thermal Resistance	R _{thjamb}	500 K/W	
Package			
Collector-Emitter			I _F = 10 mA,
Saturation Voltage	V _{CEsat}	0.25 (≤ 0.4) V	I _C = 2.5 mA
Coupling Capacitance	C _C	0.6 pF	

*TRIOS—Transparent IO Shield

Current Transfer Ratio and Collector-Emitter Leakage Current by dash number ($T_A=25^\circ\text{C}$)

	-1	-2	-3	-4	Unit
I_C/I_F at $V_{CE}=5\text{ V}$ ($I_F=10\text{ mA}$)	40-80	63-125	100-200	160-320	%
I_C/I_F at $V_{CE}=5\text{ V}$ ($I_F=1\text{ mA}$)	30 (>13)	45 (>22)	70 (>34)	90 (>56)	%
Collector-Emitter Leakage Current ($V_{CE}=10\text{ V}$) (I_{CEO})	2 (≤ 50)	2 (≤ 50)	5 (≤ 100)	5 (≤ 100)	nA

Linear Operation (without saturation)

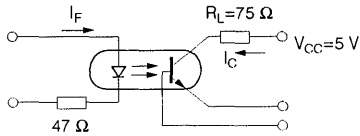

$I_F=10\text{ mA}$, $V_{CC}=5\text{ V}$, $T_A=25^\circ\text{C}$

Load Resistance	R_L	75	Ω
Turn-On Time	t_{ON}	3.0	μs
Rise Time	t_R	2.0	μs
Turn-Off Time	t_{OFF}	2.3	μs
Fall Time	t_f	2.0	μs
Cut-Off Frequency	f_{CO}	250	kHz

Switching Operation (with saturation)

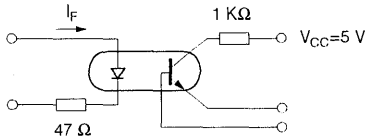

	-1 ($I_F=20\text{ mA}$)	-2 and -3 ($I_F=10\text{ mA}$)	-4 ($I_F=5\text{ mA}$)	
Turn-On Time t_{ON}	3.0	4.2	6.0	μs
Rise Time t_R	2.0	3.0	4.6	μs
Turn-Off Time t_{OFF}	18	23	25	μs
Fall Time t_f	11	14	15	μs

Current transfer ratio versus diode current ($T_A=-25^\circ\text{C}$, $V_{CE}=5\text{ V}$)

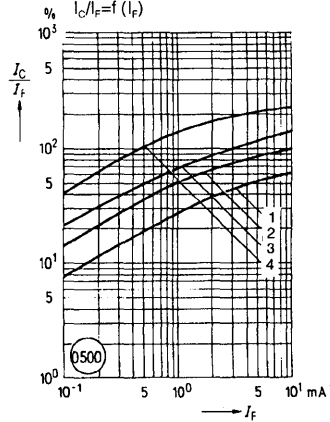

Current transfer ratio versus diode current ($T_A=0^\circ\text{C}$, $V_{CE}=5\text{ V}$)

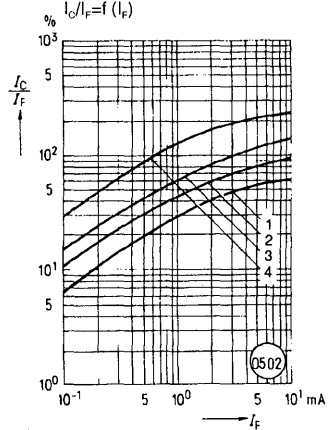

Current transfer ratio versus diode current ($T_A=25^\circ\text{C}$, $V_{CE}=5\text{ V}$)

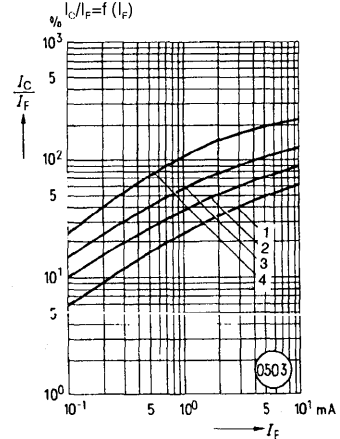

Current transfer ratio versus diode current ($T_A=50^\circ\text{C}$) $V_{CE}=5\text{ V}$

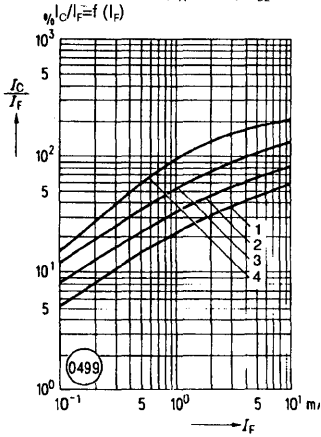

Transistor characteristics ($B=550$)
CNY17-3, -4 $I_C=f(V_{CE})$ ($T_A=25^\circ\text{C}$, $I_F=0$)

Current transfer ratio versus diode current ($T_A=75^\circ\text{C}$) $V_{CE}=5\text{ V}$

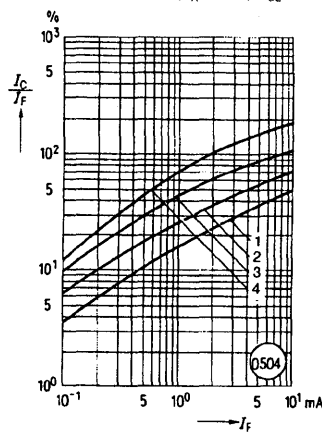

Output characteristics
CNY17-3, -4 ($T_A=25^\circ\text{C}$) $I_C=f(V_{CE})$

Current transfer ratio versus temperature ($I_F=10\text{ mA}$, $V_{CE}=5\text{ V}$)

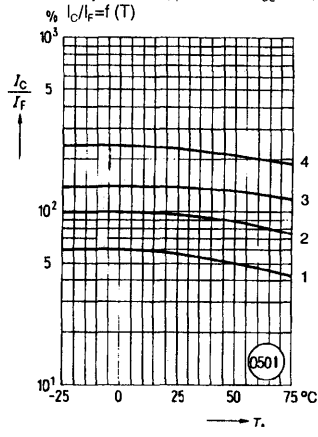

Forward voltage $V_F=f(I_F)$

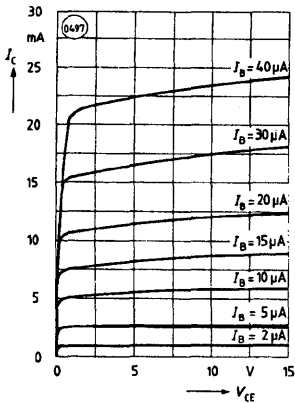

Collector emitter off-state current
 $I_{CEO}=f(V, T)$ ($T_A=25^\circ\text{C}$, $I_F=0$)

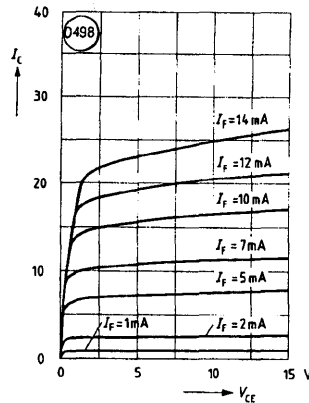

Saturation voltage versus collector current and modulation depth
CNY17-1 $V_{CESat}=f(I_C)$ ($T_A=25^\circ\text{C}$)

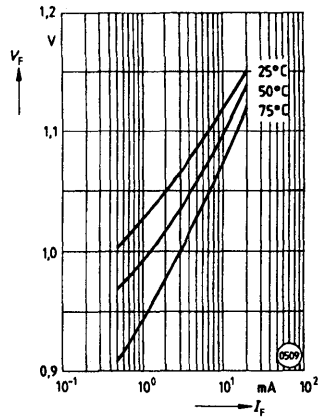

Saturation voltage versus collector current and modulation depth
CNY17-2 $V_{CESat}=f(I_C)$ ($T_A=25^\circ\text{C}$)

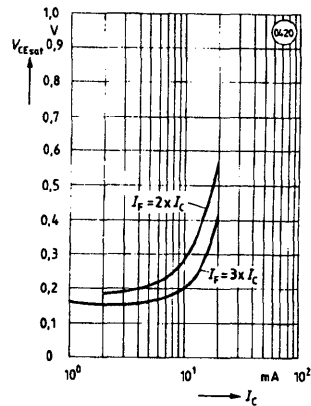
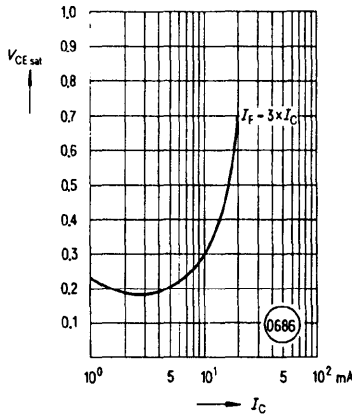
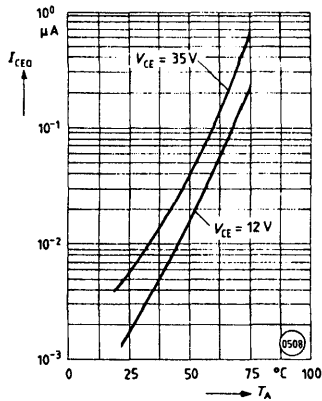

Optocouplers
(Optoisolators)

Saturation voltage versus collector current and modulation depth
CNY17-3 $V_{CEsat}=f(I_C)$ ($T_A=25^\circ\text{C}$)

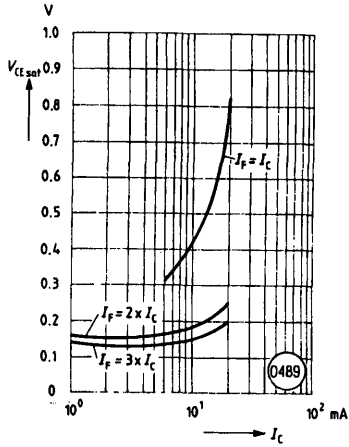

Saturation voltage versus collector current and modulation depth
CNY17-4 $V_{CEsat}=f(I_C)$ ($T_A=25^\circ\text{C}$)

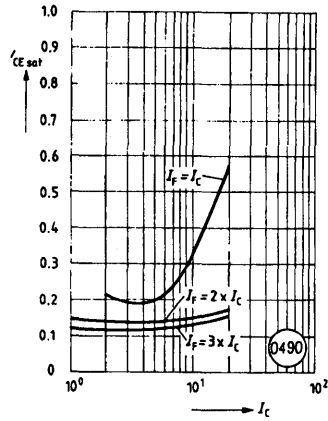

Permissible pulse load
 $D = \text{parameter}$, $T_A=25^\circ\text{C}$, $I_f=f(t_p)$

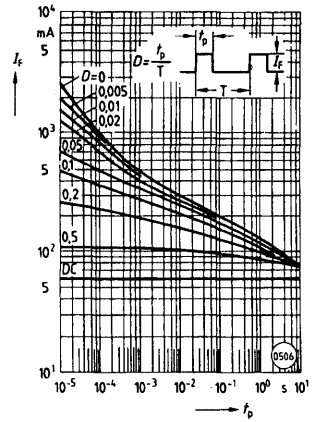

Permissible power dissipation transistor and diode
 $P_{tot}=f(T_A)$

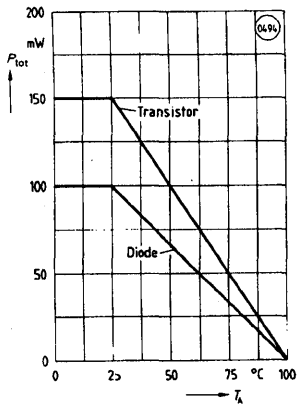

Permissible forward current
 $P_{tot}=f(T_A)$

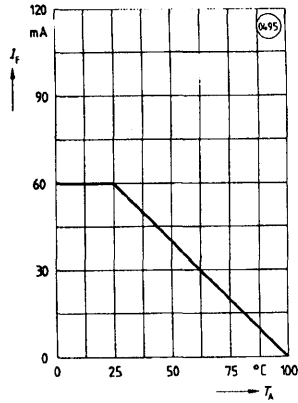

Transistor capacitance
 $C=f(V_C)$ ($T_A=25^\circ\text{C}$, $f=1 \text{ MHz}$)

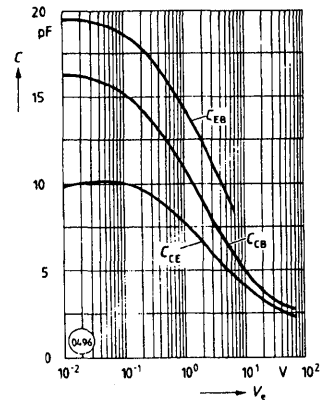

FEATURES

- High Current Transfer Ratio
CNY17F-1, 40-80%
CNY17F-2, 63-125%
CNY17F-3, 100-200%
CNY17F-4, 160-320%
- Breakdown Voltage, 5300 Volt
- High Collector-Emitter Voltage
- $V_{CEO} = 70\text{ V}$
- No Base Terminal Connection for Improved Common Mode Interface Immunity
- Field-Effect Stable by TRIOS*
- Long Term Stability
- Industry Standard Dual-in-Line Package
- Underwriters Lab File #E52744
- Option 1:  VDE #0884, add -X001 suffix

DESCRIPTION

The CNY17F is an optocoupler consisting of a Gallium Arsenide infrared emitting diode optically coupled to a silicon planar phototransistor detector in a plastic plug-in DIP-6 package.

The coupling device is suitable for signal transmission between two electrically separated circuits. The potential difference between the circuits to be coupled is not allowed to exceed the maximum permissible reference voltages.

In contrast to the CNY17 Series, the base terminal of the F type is not connected, resulting in a substantially improved common-mode interference immunity.

Package Dimensions in Inches (mm)

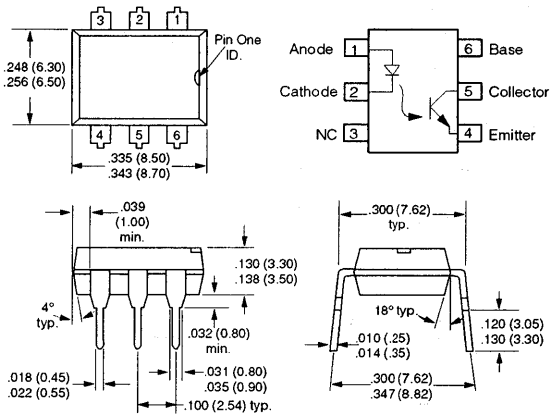

Maximum Ratings ($T_A=25^\circ\text{C}$)

Emitter	Reverse Voltage	6 V
	DC Forward Current	60 mA
	Surge Forward Current ($t \leq 10\mu\text{s}$)	2.5 A
	Total Power Dissipation	100 mW
Detector	Collector-Emitter Breakdown Voltage	70 V
	Collector Current	50 mA
	Collector Current ($t \leq 1\text{ ms}$)	100 mA
	Total Power Dissipation	150 mW
Package	Isolation Test Voltage between emitter and detector referred to standard climate 23/50 DIN 50014	5300 VDC
	Leakage Path	>8 mm
	Air Path	>7.3 mm
	Comparative Tracking Index per DIN IEC 112/ VDE 0303, part 1	175
	Isolation Resistance ($V_{10} = 500\text{ V}$)	$10^{11}\ \Omega$
	Storage Temperature Range	-55 to +150°C
	Ambient Temperature Range	-55 to +100°C
	Junction Temperature	100°C
	Soldering Temperature (max. 10 s, dip soldering: distance to seating plane $\geq 1.5\text{ mm}$)	260°C

Characteristics ($T_A=25^\circ\text{C}$)

	Symbol	Unit	Condition
Emitter			
Forward Voltage	V_F	1.25 (≤ 1.65)	V $I_F=60\text{ mA}$
Breakdown Voltage	V_{BR}	≥ 6	V $I_R=10\ \mu\text{A}$
Reverse Current	I_R	0.01 (≤ 10)	μA $V_R=6\text{ V}$
Capacitance	C_O	25	pF $V_R=0\text{ V}, f=1\text{ MHz}$
Thermal Resistance	R_{thJA}	750	K/W
Detector			
Capacitance	C_{CE}	5.2	pF $V_{CE}=5\text{ V}, f=1\text{ MHz}$
Thermal Resistance	R_{thJA}	500	K/W
Package			
Collector-Emitter			$I_F=10\text{ mA}$

Optocouplers (Optoisolators)

Current Transfer Ratio (I_C/I_F at $V_{CE}=5\text{ V}$, 25°C) and Collector-Emitter Leakage Current by dash number

	-1	-2	-3	-4	Unit
I_C/I_F at $V_{CE}=5\text{ V}$, ($I_F=10\text{ mA}$)	40-80	63-125	100-200	160-320	%
I_C/I_F at $V_{CE}=5\text{ V}$ ($I_F=1\text{ mA}$)	30 (>13)	45 (>22)	70 (>34)	90 (>56)	%
Collector-Emitter Leakage Current ($V_{CE}=10\text{ V}$) (I_{CEO})	2 (≤ 50)	2 (≤ 50)	5 (≤ 100)	5 (≤ 100)	nA

Linear Operation (without saturation)

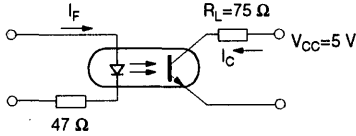

$I_F=10\text{ mA}$, $V_{CC}=5\text{ V}$, $T_A=25^\circ\text{C}$

Load Resistance	R_L	75	Ω
Turn-On Time	t_{ON}	3.0	μs
Rise Time	t_R	2.0	μs
Turn-Off Time	t_{OFF}	2.3	μs
Fall Time	t_f	2.0	μs
Cut-Off Frequency	f_{CO}	250	kHz

Switching Operation (with saturation)

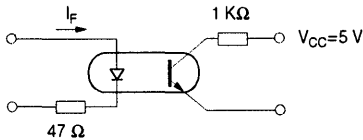

	-1 ($I_F=20\text{ mA}$)	-2 and -3 ($I_F=10\text{ mA}$)	-4 ($I_F=5\text{ mA}$)	
Turn-On Time t_{ON}	3.0	4.2	6.0	μs
Rise Time t_R	2.0	3.0	4.6	μs
Turn-Off Time t_{OFF}	18	23	25	μs
Fall Time t_f	11	14	15	μs

Current transfer ratio versus diode current ($T_A=-25^\circ\text{C}$, $V_{CE}=5\text{ V}$)
 $I_C/I_F=f(I_F)$

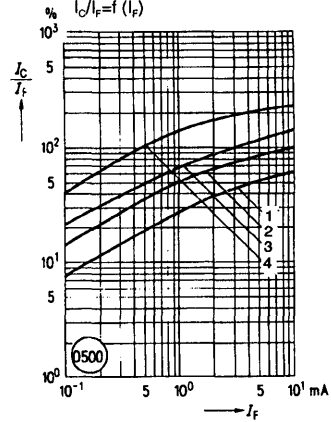

Current transfer ratio versus diode current ($T_A=0^\circ\text{C}$, $V_{CE}=5\text{ V}$)
 $I_C/I_F=f(I_F)$

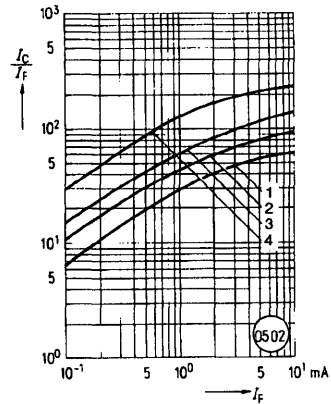

Current transfer ratio versus diode current ($T_A=25^\circ\text{C}$, $V_{CE}=5\text{ V}$)
 $I_C/I_F=f(I_F)$

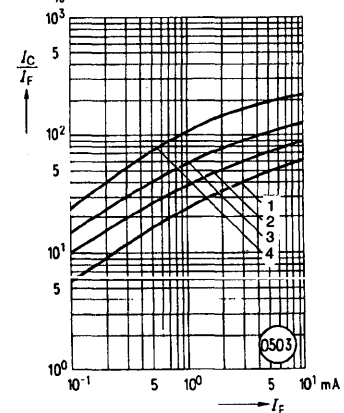

Current transfer ratio versus diode current ($T_A=50^\circ\text{C}$, $V_{CE}=5\text{ V}$, $\%I_C/I_F=f(I_F)$)

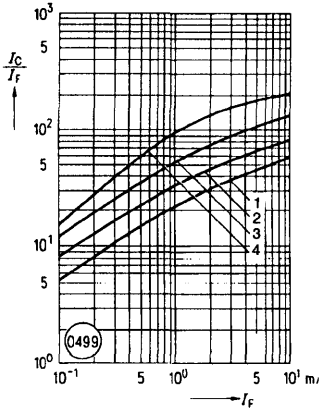

Current transfer ratio versus diode current ($T_A=75^\circ\text{C}$, $V_{CE}=5\text{ V}$, $\%I_C/I_F=f(I_F)$)

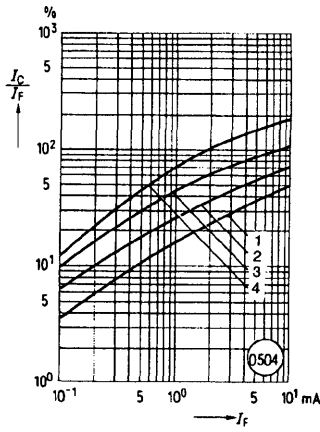

Current transfer ratio versus temperature ($I_F=10\text{ mA}$, $V_{CE}=5\text{ V}$, $\%I_C/I_F=f(T)$)

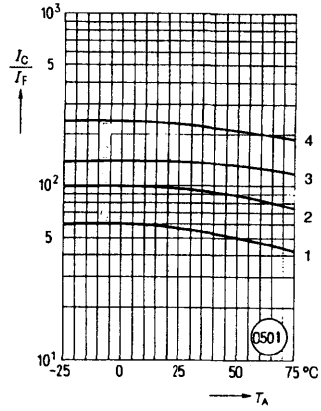

Output characteristics CNY17F-2, -3 ($T_A=25^\circ\text{C}$, $I_C=f(V_{CE})$)

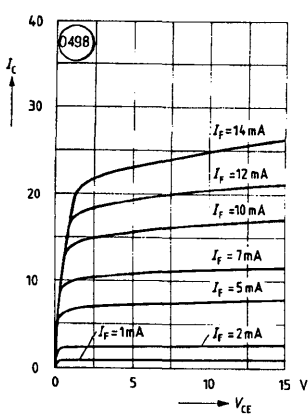

Forward voltage $V_F=f(I_F)$

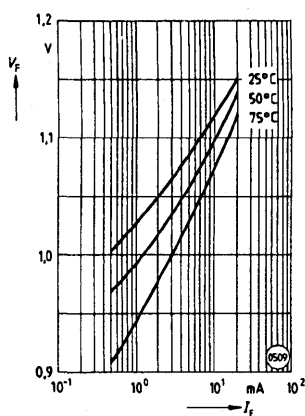

Collector emitter off-state current $I_{CEO}=f(V, T)$ ($T_A=25^\circ\text{C}$, $I_F=0$)

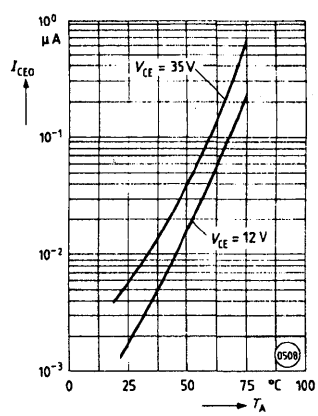

Saturation voltage versus collector current and modulation depth CNY17F-1 ($V_{CEsat}=f(I_C)$, $T_A=25^\circ\text{C}$)

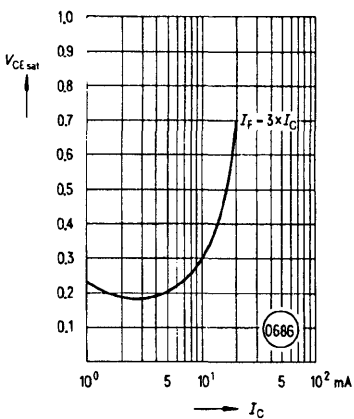

Saturation voltage versus collector current and modulation depth CNY17F-2 ($V_{CEsat}=f(I_C)$, $T_A=25^\circ\text{C}$)

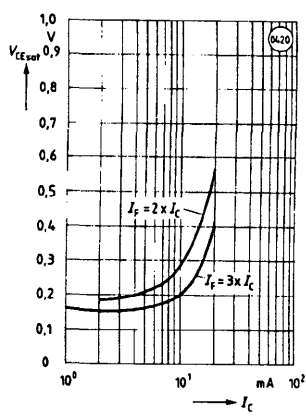

Saturation voltage versus collector current and modulation depth CNY17F-3 ($V_{CEsat}=f(I_C)$, $T_A=25^\circ\text{C}$)

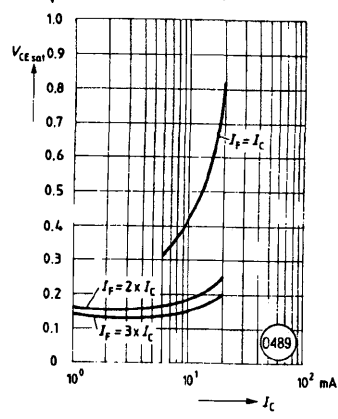

Optocouplers
(Optoisolators)

Saturation voltage versus collector current and modulation depth
CNY17F-4 $V_{CEsat}=f(I_C)$ ($T_A=25^\circ\text{C}$)

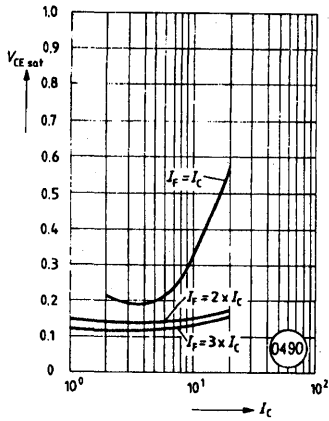

Permissible pulse load
 $D=\text{parameter}$, $T_A=25^\circ\text{C}$, $I_f=f(t_p)$

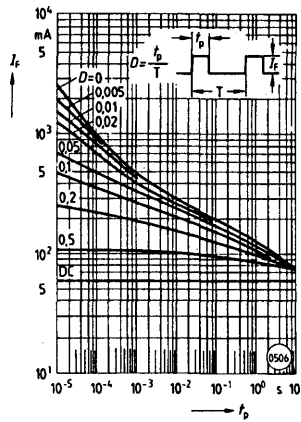

Permissible power dissipation transistor and diode $P_{tot}=f(T_A)$

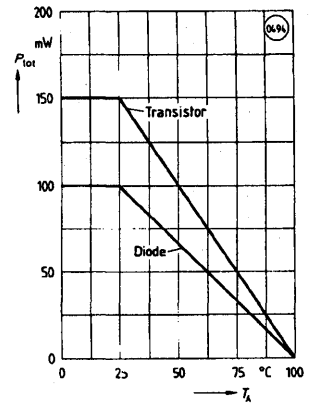

Permissible forward current diode
 $I_f=f(T_A)$

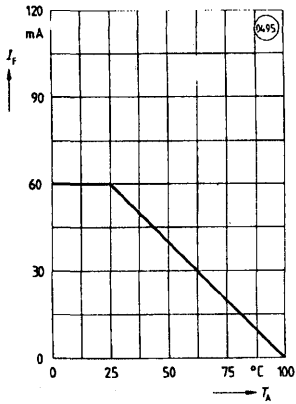

Transistor capacitance
 $C=f(V_e)$ ($T_A=25^\circ\text{C}$, $f=1\text{ MHz}$)

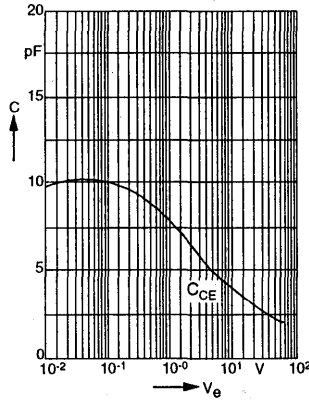

FEATURES

- **CTR Minimum**
H11A1, 50%
H11A2/H11A3, 20%
H11A4, 10%
H11A5, 30%
- **Withstand Test Voltage, 5300 VDC**
- **Coupling Capacitance, 0.5 pF**
- **Underwriters Lab File #E52744**
- **VDE Approval #0884 (optional with Option 1, add -X001 suffix)**

DESCRIPTION

The H11A1 thru H11A5 are industry standard optocouplers, consisting of a GaAs infrared LED and a silicon phototransistor. These optocouplers are constructed with a high voltage insulation, double molded packaging process which offers 7.5 KV withstand test capability.

Maximum Ratings

Emitter
Reverse Voltage 3 V
Continuous Forward Current 60 mA
Power Dissipation at 25°C 100 mW
Derate Linearly from 25°C 1.33 mW/°C

Detector

Collector-Emitter Breakdown Voltage, BV_{CEO} 30 V
Emitter-Collector Breakdown Voltage, BV_{ECO} 7 V
Collector-Base Breakdown Voltage, BV_{CBO} 70 V
Power Dissipation at 25°C 150 mW
Derate Linearly from 25°C 3.3 mW/°C

Package

Total Package Dissipation at 25°C
(Emitter plus Detector) 250 mW
Derate Linearly from 25°C 3.3 mW/°C
Withstand Test Voltage $V_{IO}=5300Vdc$
Between Emitter and Detector
Referred to Standard Climate
23°C/50%RH, DIN 50014
Leakage Path DIN 57883 6.80 min. 8.2 mm
Air Path, VDE 0883 6.80 min. 7.3 mm
Tracking Resistance, Group III
(KC>600 per VDE 110 § 6,
Table 3 and DIN 53480/
VDE 0330, Part 1
 $V_{IO}=500 V$ $R_{IO}=10^{11}\Omega$
Storage Temperature Range -55°C to +150°C
Operating Temperature Range -55°C to +100°C
Lead Soldering Time at 260°C 10 sec.

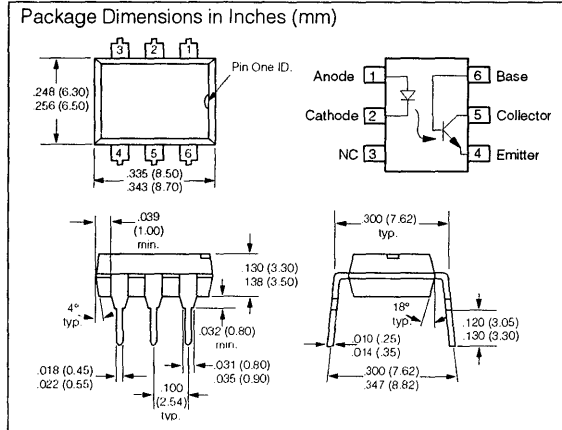

Characteristics ($T_A=25^\circ C$)

	Symbol	Min.	Typ.	Max.	Unit	Condition
Emitter						
Forward Voltage	V_F		1.1	1.5	V	$I_F=10 mA$
Forward Voltage (H11A5 only)	V_F		1.1	1.7	V	$I_F=10 mA$
Reverse Current	I_R			10	μA	$V_R=3 V$
Capacitance	C_O		50		pF	$V_R=0 V$, $f=1 MHz$
Detector						
	BV_{CEO}	30			V	$I_C=1 mA$, $I_F=0 mA$
	BV_{ECO}	7			V	$I_E=100 \mu A$, $I_F=0 mA$
	BV_{CBO}	70			V	$I_C=10 \mu A$, $I_F=0 mA$
Collector-Emitter Leakage Current	I_{CEO}	5	50		nA	$V_{CE}=10 V$, $I_F=0 mA$
Collector-Emitter Capacitance			6		pF	$V_{CE}=0$
Package						
DC Current Transfer Ratio	CTR				%	$V_{CE}=10 V$, $I_F=10 mA$
	H11A1		50			
	H11A2, H11A3		20			
	H11A4		10			
	H11A5		30			
Collector-Emitter Saturation Voltage	V_{CESat}			0.4	V	$I_{CE}=0.5 mA$, $I_F=10 mA$
Capacitance Input to Output	C_{IO}		0.5		pF	

Optocouplers (Phototransistors)

Characteristics ($T_A=25^\circ\text{C}$)—continued

	Symbol	Min.	Typ.	Max.	Unit	Condition
Switching Time	t_{on}, t_{off}		3.0		μs	$R_E = 100 \Omega$, $V_{CE} = 10 \text{ V}$, $I_C = 2 \text{ mA}$
Dielectric Leakage Current	I_{IO}		3.3	≤ 10	$\mu\text{A}_{AC(RMS)}$	$RH \leq 50\%$ $V_{IO} = 4420 \text{ V}_{AC(RMS)}$, 1 min., 60 Hz
	I_{IO}		4.7	≤ 14.2	$\mu\text{A}_{AC(PK)}$	$V_{IO} = 6250 \text{ V}_{AC(PK)}$, 1 min., 60 Hz
	I_{IO}		4.0	≤ 12	$\mu\text{A}_{AC(RMS)}$	$V_{IO} = 5304 \text{ V}_{AC(RMS)}$, 1 sec., 60 Hz
	I_{IO}		5.7	≤ 17	$\mu\text{A}_{AC(PK)}$	$V_{IO} = 7500 \text{ V}_{AC(PK)}$, 1 sec., 60 Hz

Figure 1. Forward voltage versus forward current

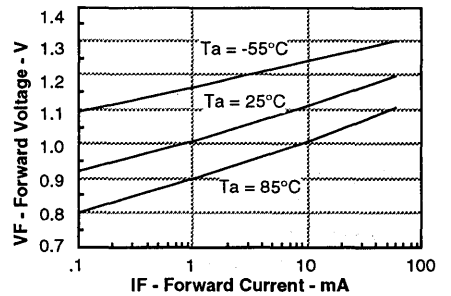

Figure 2. Normalized non-saturated and saturated CTR at $T_A=25^\circ\text{C}$ versus LED current

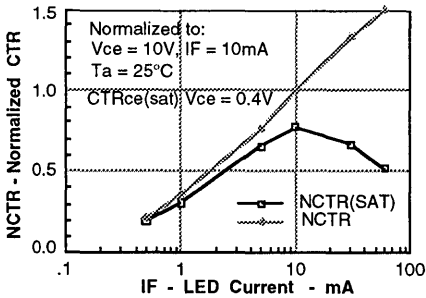

Figure 3. Normalized non-saturated and saturated CTR at $T_A=50^\circ\text{C}$ versus LED current

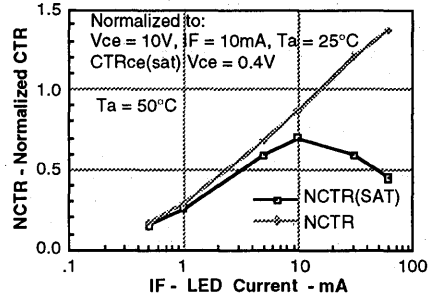

Figure 4. Normalized non-saturated and saturated CTR at $T_A=70^\circ\text{C}$ versus LED current

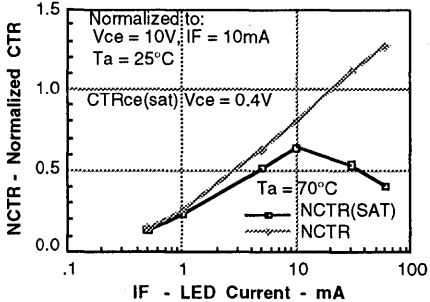

Figure 5. Normalized non-saturated and saturated CTR at $T_A=85^\circ\text{C}$ versus LED current

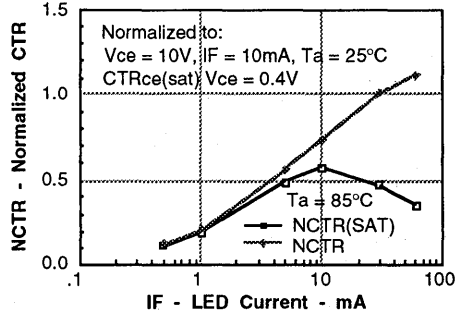

Figure 6. Collector-emitter current versus temperature and LED current

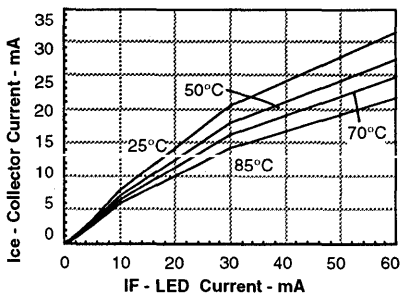

Figure 7. Collector-emitter leakage current versus temperature

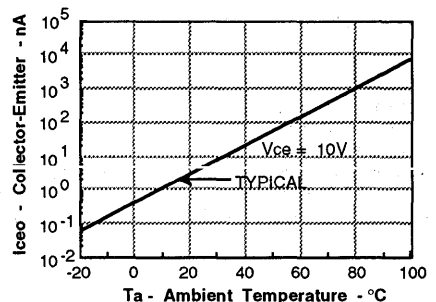

Figure 8. Normalized CTRcb versus LED current and temperature

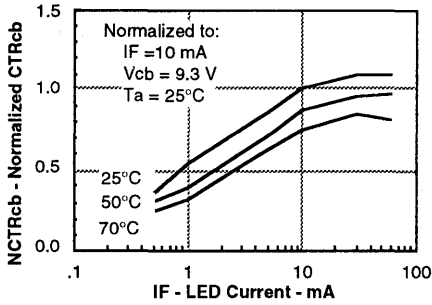

Figure 10. Normalized photocurrent versus If and temperature

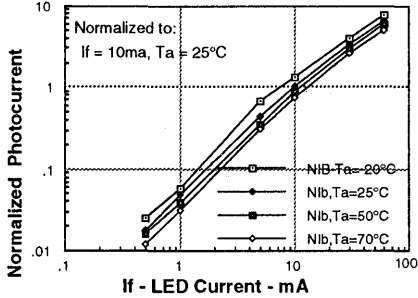

Figure 12. Normalized saturated HFE versus base current and temperature

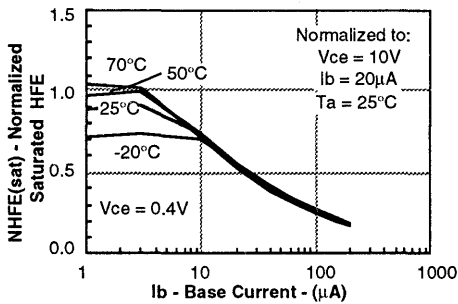

Figure 14. Switching waveform

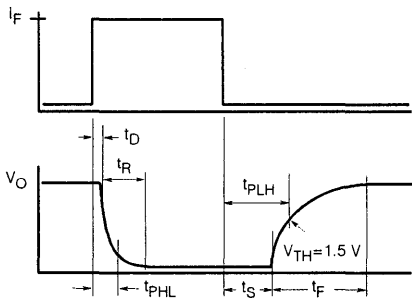

Figure 9. Collector base photocurrent versus LED current

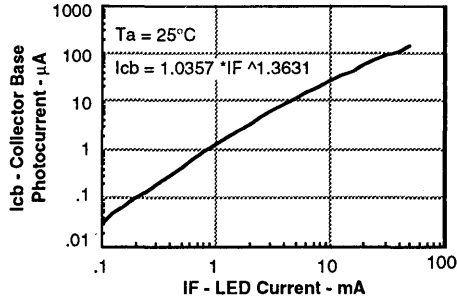

Figure 11. Normalized non-saturated HFE versus base current and temperature

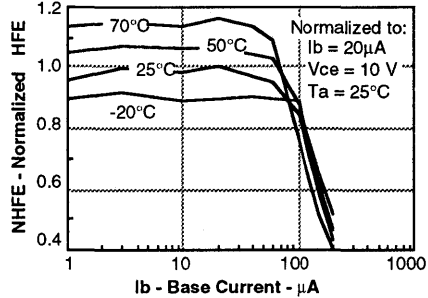

Figure 13. Propagation delay versus collector load resistor

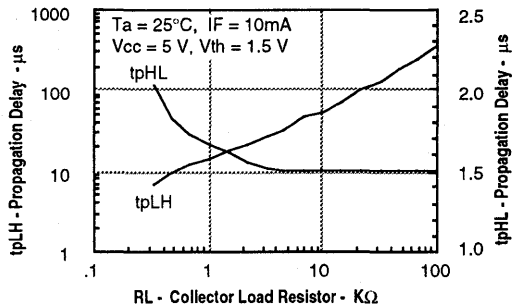
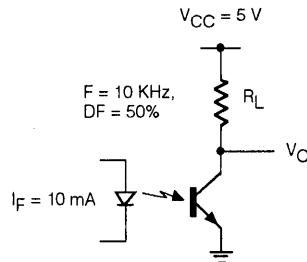



Figure 15. Switching schematic



Optocouplers (Optoisolators)

FEATURES

- **Current Transfer Ratio, 20% Min.**
- **AC or Polarity Insensitive Input**
- **Built-in Reverse Polarity Input Protection**
- **I/O Compatible with Integrated Circuits**
- **Industry Standard DIP Package**
- **Underwriters Lab File #E52744**
-  **VDE Approvals #0884 (Optional with Option 1, Add -001 Suffix)**

DESCRIPTION

The H11AA1 is a bi-directional input optically coupled isolator consisting of two Gallium Arsenide infrared LEDs coupled to a silicon NPN phototransistor in a 6-pin DIP package. The H11AA1 has a minimum CTR of 20% and a CTR symmetry of 1:3 and is designed for applications requiring detection or monitoring of AC signals.

Maximum Ratings

Emitter

Continuous Forward Current 60 mA
 Power Dissipation at 25°C 100 mW
 Derate Linearly from 25°C 1.3 mW/°C

Detector

Power Dissipation at 25°C Ambient 200 mW
 Derate Linearly from 25°C 2.6 mW/°C
 Collector-Emitter Breakdown Voltage, BV_{CEO} 30 V
 Emitter-Base Breakdown Voltage, BV_{EBO} 5 V
 Collector-Base Breakdown Voltage, BV_{CBO} ... 70 V

Package

Withstand Test Voltage $V_{IO}=5300$ Vac
 Between Emitter and Detector
 Referred to Standard Climate
 23°C/50%RH, DIN 50014
 Leakage Path DIN 45883, 6.80 min. 8.2 mm
 Air Path, VDE 0883 6.80 min. 7.3 mm
 Tracking Resistance, Group III
 (KC \geq 600 per VDE 110 § 6,
 Table 3 and Din 53480/
 VDE 0330, Part 1
 $V_{IO} = 500$ V $R_{IO}=10^{10}$ Ω
 Storage Temperature -55°C to +150°C
 Operating Temperature -55°C to +100°C
 Lead Soldering Time at 260°C 10 sec.

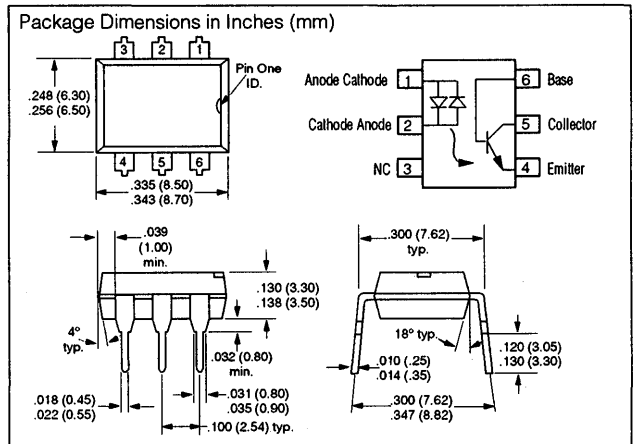

Electrical Characteristics ($T_A=25^\circ\text{C}$)

Parameter	Min.	Typ.	Max.	Unit	Condition
Emitter					
Forward Voltage, V_F		1.2	1.5	V	$I_F = \pm 10$ mA
Detector					
BV_{CEO}	30			V	$I_C = 1$ mA
BV_{EBO}	7			V	$I_E = 100$ μ A
BV_{CBO}	70			V	$I_C = 100$ μ A
I_{CEO}		5	100	nA	$V_{CE} = 10$ V
Package					
V_{CEsat}			0.4	V	$I_F = \pm 10$ mA, $I_C = 0.5$ mA
DC Current Transfer Ratio	20			%	$I_F = \pm 10$ mA, $V_{CE} = 10$ V
Symmetry					
CTR at +10 mA	0.33	1.0	3.0		
CTR at -10 mA					
Dielectric Leakage					
Current, I_{IO}					RH \leq 50%
$V_{IO} = 4420$ V _{AC} (RMS), 1 min., 60Hz		3.3	10	μ A _{AC} (RMS)	
$V_{IO} = 6250$ V _{AC} (PK), 1 min., 60 Hz		4.7	14.2	μ A _{AC} (PK)	
$V_{IO} = 5304$ V _{AC} (RMS), 1 sec., 60 Hz		4.0	12	μ A _{AC} (RMS)	
$V_{IO} = 7500$ V _{AC} (PK), 1 sec., 60 Hz		5.7	17	μ A _{AC} (PK)	

Figure 1. LED forward current versus forward voltage

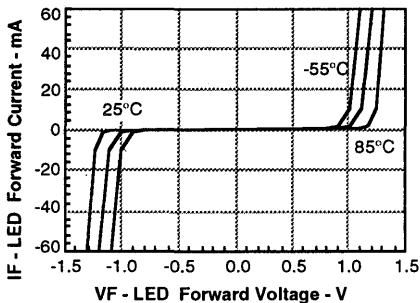

Figure 3. Normalized non-saturated and saturated CTR at $T_A=50^\circ\text{C}$ versus LED current

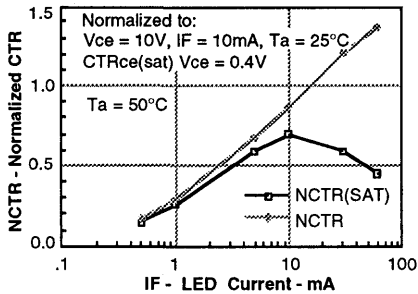

Figure 5. Normalized non-saturated and saturated CTR at $T_A=85^\circ\text{C}$ versus LED current

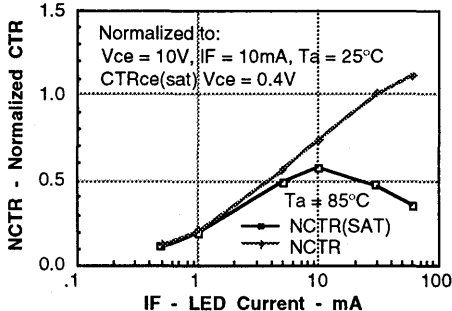

Figure 7. Collector-emitter leakage current versus temperature

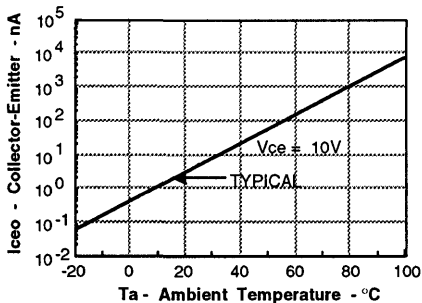

Figure 2. Normalized non-saturated and saturated CTR at $T_A=25^\circ\text{C}$ versus LED current

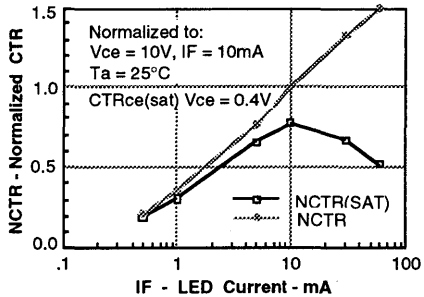

Figure 4. Normalized non-saturated and saturated CTR at $T_A=70^\circ\text{C}$ versus LED current

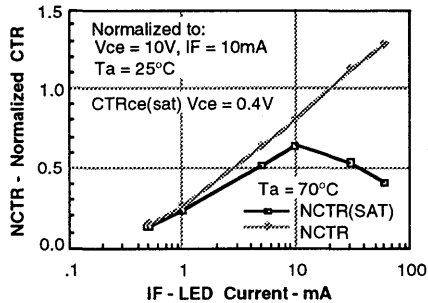

Figure 6. Collector-emitter current versus temperature and LED current

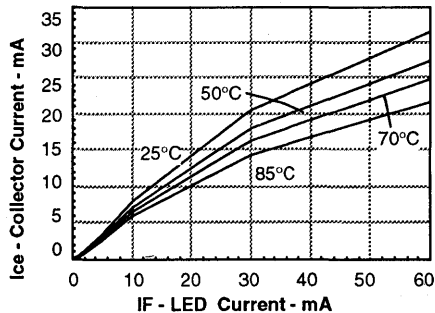

Figure 8. Normalized CTRcb versus LED current and temperature

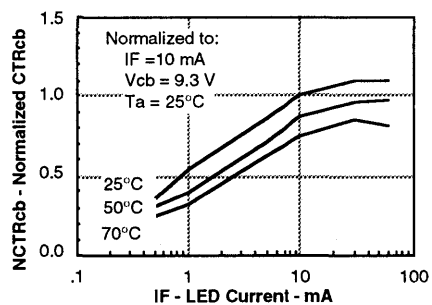

Figure 9. Collector base photocurrent versus LED current

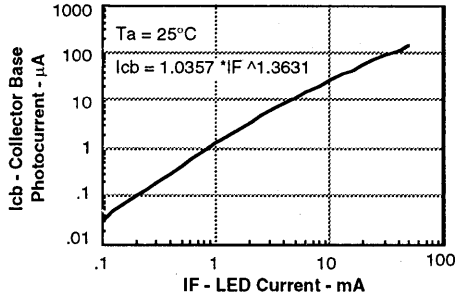

Figure 10. Normalized photocurrent versus LED current

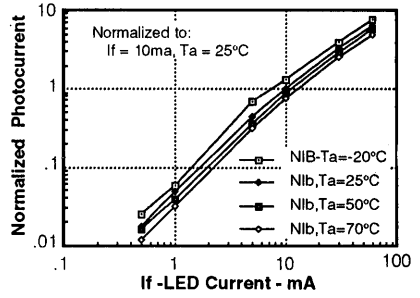

Figure 11. Normalized saturated HFE versus base current and temperature

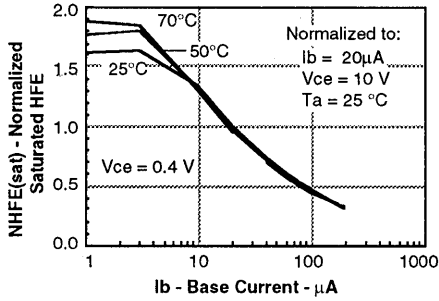

Figure 12. Normalized saturated HFE versus base current and temperature

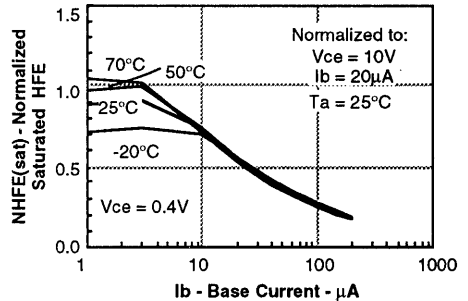

Figure 13. Propagation delay versus collector load resistor

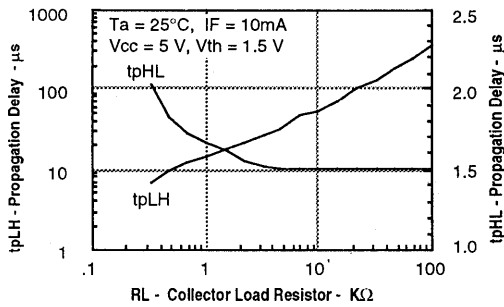

Figure 14. Switching waveform

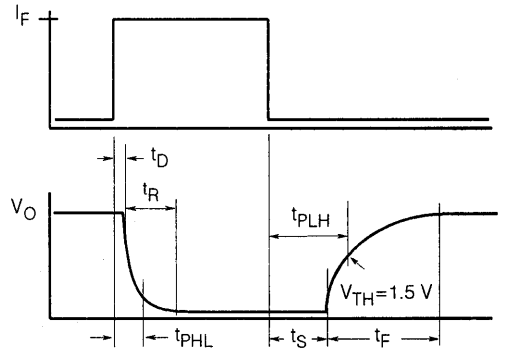
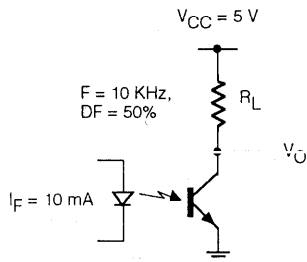

Figure 15. Switching schematic



FEATURES

- **CTR Minimum at $I_F = 1 \text{ mA}$**
H11B1, 500%
H11B2, 200%
H11B3, 100%
- **Withstand Test Voltage, 7500 Volt**
- **Coupling Capacitance, 0.5 pF**
- **Underwriters Lab File #E52744**
- **VDE Approval #0884 (Optional with Option 1, add -X001 Suffix)**

DESCRIPTION

The H11B1/H11B2/H11B3 are industry standard optocouplers, consisting of a Gallium Arsenide infrared LED and a silicon photodarlington. These optocouplers are constructed with a high voltage insulation, double molded packaging process which offers 7.5 KV withstand test capability.

Maximum Ratings

Emitter

Reverse Voltage	3 V
Continuous Forward Current	60 mA
Power Dissipation at 25°C	100 mW
Derate Linearly from 25°C	1.33 mW/°C

Detector

Collector-Emitter Breakdown Voltage, BV_{CEO}	25 V
Emitter-Collector Breakdown Voltage BV_{ECO}	7 V
Collector-Base Breakdown Voltage, BV_{CBO}	30 V
Collector-Current (Continuous)	100 mA
Power Dissipation at 25°C	150 mW
Derate Linearly from 25°C	2.0 mW/°C

Package

Withstand Test Voltage	$V_{IO}=5300\text{Vdc}$
Between Emitter and Detector	
Referred to Standard Climate	
23°C/50%RH, DIN 50014	
Leakage Path DIN 57883.6.80	min. 8.2 mm
Air Path, VDE 0883 6.80	min. 7.3 mm
Tracking Resistance, Group III	
($KC>600$ per VDE 110 § 6,	
Table 3 and DIN 53480/	
VDE 0330, Part 1	
$V_{IO}=500\text{V}$	$R_{IO}=10^{11}\Omega$
Total Package Dissipation at 25°C	
(LED plus Detector)	260 mW
Derate Linearly from 25°C	3.5 mW/°C
Storage Temperature	-55°C to +150°C
Operating Temperature	-55°C to +100°C
Lead Soldering Time at 260°C	10 sec.

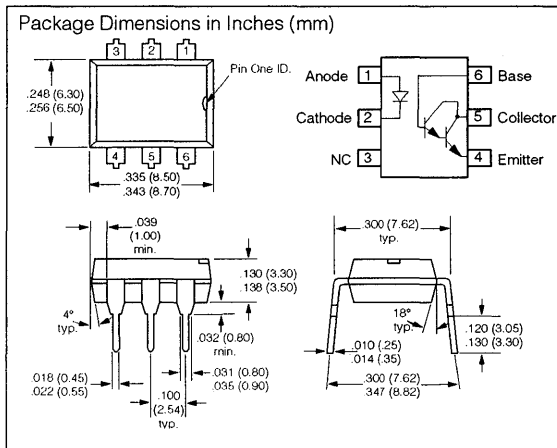

Characteristics ($T_A=25^\circ\text{C}$)

	Sym	Min.	Typ.	Max.	Unit	Condition
Emitter						
Forward Voltage						
H11B1, B2	V_F	1.1	1.5		V	$I_F=10 \text{ mA}$
H11B3	V_F	1.1	1.5		V	$I_F=50 \text{ mA}$
Reverse Current	I_R		10		μA	$V_R=3 \text{ V}$
Junction Capacitance	C_J	50			pF	$V_F=0 \text{ V}, f=1 \text{ MHz}$
Detector						
BV_{CEO}		30			V	$I_C=1.0 \text{ mA}, I_E=0 \text{ mA}$
BV_{ECO}		7			V	$I_E=100 \mu\text{A}, I_F=0 \text{ mA}$
BV_{CBO}		30			V	$I_C=100 \mu\text{A}, I_F=0 \text{ mA}$
I_{CEO}			100		nA	$V_{CE}=10 \text{ V}, I_F=0 \text{ mA}$
Package						
V_{CEsat}			1.0		V	$I_C=1 \text{ mA}, I_E=1 \text{ mA}$
DC Current Transfer Ratio						
H11B1	CTR	500			%	$V_{CE}=5 \text{ V}, I_F=1 \text{ mA}$
H11B2	CTR	200			%	$V_{CE}=5 \text{ V}, I_F=1 \text{ mA}$
H11B3	CTR	100			%	$V_{CE}=5 \text{ V}, I_F=1 \text{ mA}$
Dielectric Leakage Current						
$V_{IO} = 4420 V_{AC(RMS)}$	I_{IO}		3.3	10	$\mu\text{A}_{AC(RMS)}$	
1 min., 60Hz						
$V_{IO} = 6250 V_{AC(PK)}$	I_{IO}		4.7	14.2	$\mu\text{A}_{AC(PK)}$	
1 min., 60 Hz						
$V_{IO} = 5304 V_{AC(RMS)}$	I_{IO}		4.0	12	$\mu\text{A}_{AC(RMS)}$	
1 sec., 60 Hz						
$V_{IO} = 7500 V_{AC(PK)}$	I_{IO}		5.7	17	$\mu\text{A}_{AC(PK)}$	
1 sec., 60 Hz						
Capacitance Input to Output						
	C_{IO}	0.5			pF	
Switching Times						
	t_{on}	125			μs	$I_F=10 \text{ mA}$ $V_{CE}=10 \text{ V}$ $I_C=10 \text{ mA}$
	t_{off}	100			μs	

Optocouplers
(Optoisolators)

Figure 1. Forward voltage versus forward current

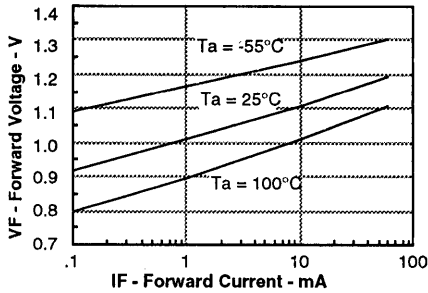

Figure 3. Normalized non-saturated and saturated I_{ce} versus LED current

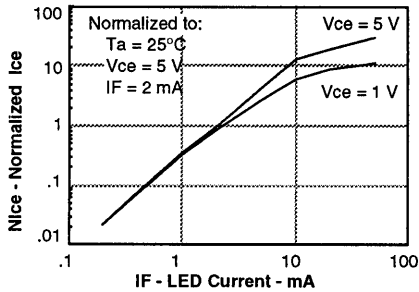

Figure 5. Non-saturated and saturated HFE versus base current

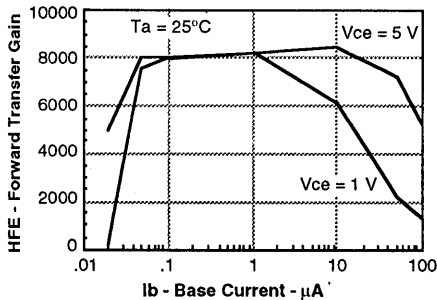

Figure 7. High to low propagation delay versus collector load resistance and LED current

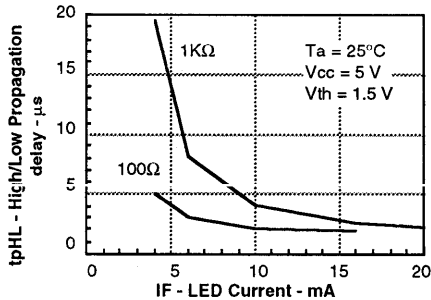

Figure 2. Normalized non-saturated and saturated CTR_{ce} versus LED current

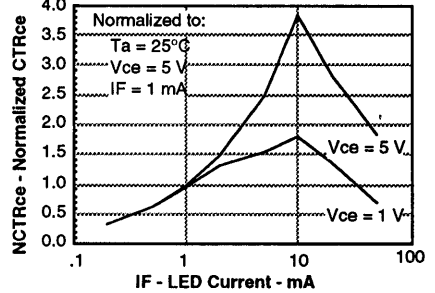

Figure 4. Normalized non-saturated and saturated collector-emitter current versus LED current

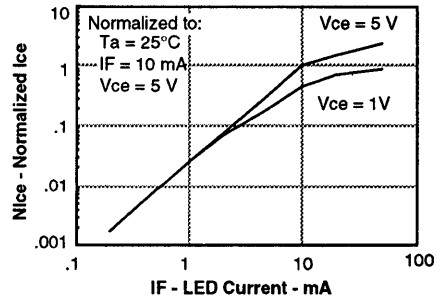

Figure 6. Low to high propagation delay versus collector load resistance and LED current

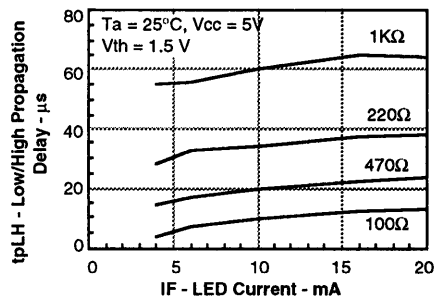

Figure 9. Switching waveform

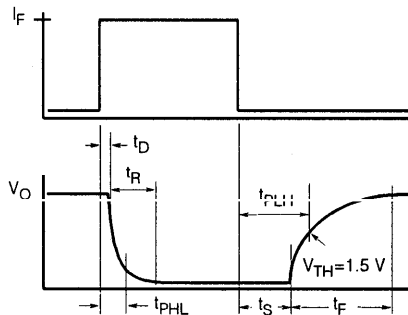
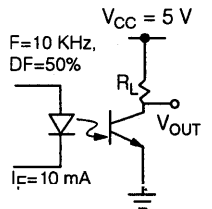

Figure 10. Switching schematic



FEATURES

- Turn On Current (I_{FT}), 5.0 mA Typical
- Gate Trigger Current (I_{GT}), 20 μ A Typical
- Surge Anode Current, 5.0 A
- Blocking Voltage, 400 V
- Gate Trigger Voltage (V_{GT}), 0.6 V Typical
- Isolation Voltage, 7500 V
- Solid State Reliability
- Standard DIP Package
- Underwriters Lab File #E52744

DESCRIPTION

The H11C4/H11C5/H11C6 are optically coupled SCRs with a Gallium Arsenide infrared emitter and a silicon photo SCR sensor. Switching can be achieved while maintaining a high degree of isolation between triggering and load circuits. These optocouplers can be used in SCR triac and solid state relay applications where high blocking voltages and low input current sensitivity are required.

The H11C4 and H11C5 has a maximum turn-on-current of 11 mA. The H11C6 has a maximum of 14 mA.

Maximum Ratings

Emitter

Peak Reverse Voltage	6.0 V
Continuous Forward Current	60 mA
Peak Forward Current (1 μ s, 1% Duty Cycle)	3.0 A
Power Dissipation at 25°C	100 mW
Derate Linearly from 25°C	1.33 mW/°C

Detector

Reverse Gate Voltage	6.0 V
Anode Voltage (DC or AC Peak)	400 V
RMS Forward Current	300 mA
Surge Anode Current (10 ms duration)	5.0 A
Peak Forward Current (100 μ s, 1% Duty Cycle)	10 A
Surge Gate Current (5 ms duration)	200 mA
Power Dissipation, 25°C case	1000 mW
Derate Linearly from 25°C	13.3 mW/°C

Package

Withstand Test Voltage	$V_{IO}=5300Vdc$
Between Emitter and Detector	
Referred to Standard Climate	
23°C/50%RH, DIN 50014	
Leakage Path DIN 57883,6.80	min. 8.2 mm
Air Path, VDE 0883 6.80	min. 7.3 mm
Tracking Resistance, Group III	
(KC>600 per VDE 110 § 6,	
Table 3 and DIN 53480/	
VDE 0330, Part 1	
$V_{IO}=500V$	$R_{IO}=10^{11}\Omega$
Total Package Dissipation	400 mW
Derate Linearly from 25°C	5.3 mW/°C
Operating Temperature Range	-55°C to +100°C
Storage Temperature Range	-55°C to +150°C
Lead Soldering Time at 260°C	10 sec.

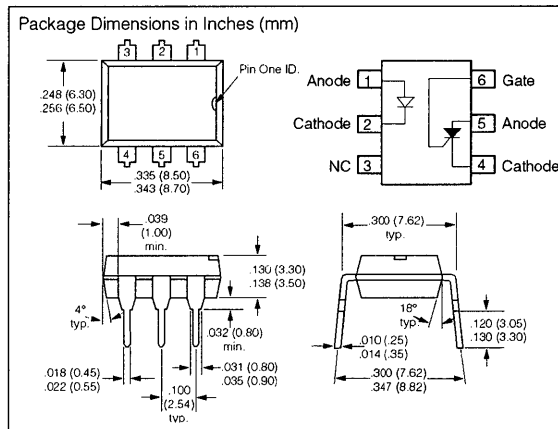

Characteristics ($T_A=25^\circ C$)

	Sym	Min.	Typ.	Max.	Unit	Condition
Emitter						
Forward Voltage	V_F		1.2	1.5	V	$I_F=10\text{ mA}$
Reverse Current	I_R			10	μ A	$V_R=3\text{ V}$
Capacitance	C_O		50		pF	$V_R=0, f=1\text{ MHz}$
Detector						
Forward Blocking Voltage	V_{DM}	400			V	$R_{GK}=10\text{ K}\Omega,$ $T_A=100^\circ C,$ $I_G=150\text{ mA}$
Reverse Blocking Volt.	V_{DM}	400			V	
On-state Voltage	V_t	1.1	1.3		V	
Holding Current	I_H			500	μ A	$R_{GK}=27\text{ K}\Omega$
Gate Trigger Voltage	V_{GT}	0.6	1.0		V	$V_{FX}=100V,$ $R_{GK}=27\text{ K}\Omega,$ $R_L=10\text{ K}\Omega,$ $R_{GK}=10\text{ K}\Omega,$
Forward Leakage Current	I_D		150		μ A	$I_F=0,$ $V_{DM}=400\text{ V}$ $T_A=100^\circ C$
Reverse Leakage Current	I_R		150		μ A	$R_{GK}=10\text{ K}\Omega,$ $V_{RM}=400\text{ V},$ $I_F=0, T_A=100^\circ C:$
Gate Trigger Current	I_{GT}	20	50		μ A	$V_{FX}=100V,$ $R_{GK}=27\text{ K}\Omega,$ $R_L=10\text{ K}\Omega,$
Capacitance Anode to Gate			20		pF	$V=0, f=1\text{ MHz}$
Capacitance Gate to Cathode			350		pF	
Package						
Turn-On Current	I_{FT}				mA	$V_{DM}=50\text{ V},$
H11C4/H11C5			20		mA	$R_{GK}=10\text{ K}\Omega$
H11C6			30		mA	$V_{DM}=100\text{ V},$
H11C4/H11C5			5	11	mA	$R_{GK}=27\text{ K}\Omega$
H11C6			7	14	mA	
Dielectric Leakage Current, 1 min., 60Hz	I_{CO}				μ A	RH \leq 50%
$V_{IO}=4420\text{ V}_{AC(RMS)}$		3.3	10		μ A	μ A $_{AC(RMS)}$
$V_{IO}=6250\text{ V}_{AC(PK)}$		4.7	14.2		μ A	μ A $_{AC(PK)}$
$V_{IO}=5304\text{ V}_{AC(RMS)}$		4.0	12		μ A	μ A $_{AC(RMS)}$
$V_{IO}=7500\text{ V}_{AC(PK)}$		5.7	17		μ A	μ A $_{AC(PK)}$

H11D1/H11D2/H11D3 PHOTOTRANSISTOR, 5.3 KV, TRIOS® HIGH BV_{CER} VOLTAGE OPTOCOUPLER

FEATURES

- CTR at I_F=10 mA, BV_{CER}=10 V: ≥20%
- Good CTR Linearity with Forward Current
- Low CTR Degradation
- Very High Collector-Emitter Breakdown Voltage
 - H11D1/H11D2, BV_{CER}=300 V
 - H11D3, BV_{CER}=200 V
- Isolation Test Voltage: 5300 VDC
- Low Coupling Capacitance
- High Common Mode Transient Immunity
- Phototransistor Optocoupler in 6 Pin DIP Package with Base Connection
- Field Effect Stable: TRIOS*
- Options Available
 - Option 1: Tested per VDE #0884
 - Option 6: Lead Bend
 - Option 7: SMD Lead Bend
- Underwriters Lab File #E52744
- Applications
 - Telecommunications
 - Replace Relays

DESCRIPTION

The H11D1/2/3 are optocouplers with very high BV_{CER}. They are intended for telecommunications applications or any DC application requiring a high blocking voltage.

Maximum Ratings (T_A = 25°C)

Emitter

Reverse Voltage	6 V
DC Forward Current	60 mA
Surge Forward Current (tp ≤ 10 μs)	2.5 A
Total Power Dissipation	100 mW

Detector

Collector-Emitter Voltage	
H11D1/2	300 V
H11D3	200 V
Collector-Base Voltage	
H11D1/2	300 V
H11D3	200 V
Emitter-Base Voltage	7 V
Collector Current	100 mA
Total Power Dissipation	300 mW

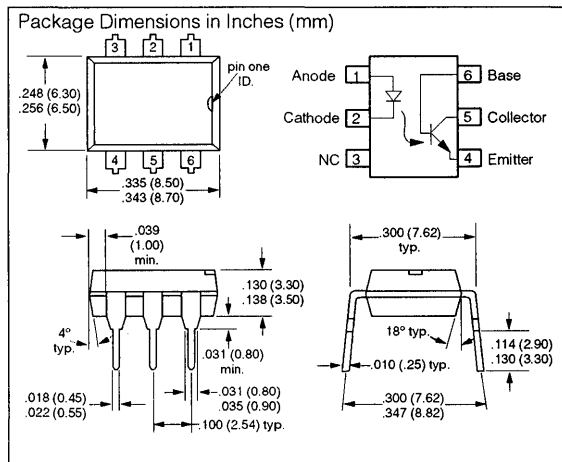

Maximum Ratings (continued)

Package

Withstand Test Voltage (between emitter and detector referred to climate DIN 40046, part 2, Nov. 74)	5300 V
Insulation Thickness between Emitter and Detector	≥0.4 mm
Creepage Distance	≥7 mm
Clearance Distance	≥7 mm
Comparative Tracking Index (per DIN IEC 112/VDE 0303, part 1)	175
Insulation Resistance	
V _{IO} =500 V, T _A =25°C	≥10 ¹² Ω
V _{IO} =500 V, T _A =100°C	≥10 ¹¹ Ω
Storage Temperature Range	-55°C to +150°C
Operating Temperature Range	-55°C to +100°C
Junction Temperature	100°C
Soldering Temperature (max. 10 sec., dip soldering: distance to seating plane ≥ 1.5 mm)	260°C

Characteristics ($T_A = 25^\circ\text{C}$, unless otherwise specified)

	Symbol	Min.	Typ.	Max.	Unit	Condition
Emitter						
Forward Voltage	V_F		1.1	1.5	V	$I_F = 10\text{ mA}$
Reverse Voltage	V_R	6			V	$I_R = 10\ \mu\text{A}$
Reverse Current	I_R		0.01	10	μA	$V_R = 6\text{ V}$
Capacitance	C_O		25		pF	$V_R = 0\text{ V}$, $f = 1\text{ MHz}$
Thermal Resistance	$R_{\theta\text{NJA}}$		750		K/W	
Detector						
Voltage						
Collector-Emitter H11D1/H11D2	BV_{CER}	300			V	$I_{\text{CE}} = 1\text{ mA}$, $R_{\text{BE}} = 1\ \text{M}\Omega$
H11D3		200			V	
Emitter-Base	BV_{EBO}	7			V	$I_{\text{EB}} = 100\ \mu\text{A}$
Capacitance						
	C_{CE}		7		pF	$V_{\text{CE}} = 10\text{ V}$, $f = 1\text{ MHz}$
	C_{CB}		8		pF	$V_{\text{CB}} = 10\text{ V}$, $f = 1\text{ MHz}$
	C_{EB}		38		pF	$V_{\text{EB}} = 5\text{ V}$, $f = 1\text{ MHz}$
Thermal Resistance	$R_{\theta\text{NJA}}$		250		K/W	
Package						
Coupling Capacitance	C_C		0.6		pF	
Coupling Transfer Ratio	I_C/I_F	20			%	$I_F = 10\text{ mA}$, $V_{\text{CE}} = 10\text{ V}$, $R_{\text{BE}} = 1\ \text{M}\Omega$
Collector-Emitter Saturation Voltage	V_{CESAT}		0.25	0.4	V	$I_F = 10\text{ mA}$, $I_C = 0.5\text{ mA}$, $R_{\text{BE}} = 1\ \text{M}\Omega$
Leakage Current						
Collector-Emitter H11D1/H11D2	I_{CER}			100	nA	$V_{\text{CE}} = 200\text{ V}$, $R_{\text{BE}} = 1\ \text{M}\Omega$
H11D3				100	nA	$V_{\text{CE}} = 100\text{ V}$, $R_{\text{BE}} = 1\ \text{M}\Omega$
Collector-Emitter H11D1/H11D2	I_{CER}			250	μA	$V_{\text{CE}} = 200\text{ V}$, $R_{\text{BE}} = 1\ \text{M}\Omega$, $T_A = 100^\circ\text{C}$
H11D3				250	μA	$V_{\text{CE}} = 100\text{ V}$, $R_{\text{BE}} = 1\ \text{M}\Omega$, $T_A = 100^\circ\text{C}$

Optocouplers
(Optoisolators)

Switching Times Measurement—Test Circuit and Waveforms

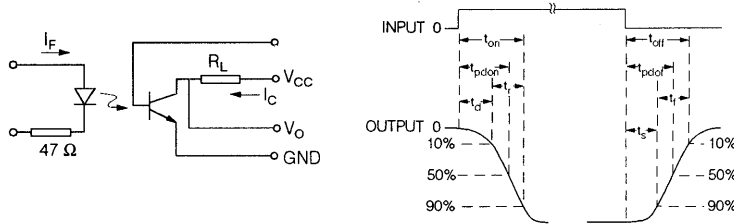

Switching Times (typ.)

$I_C = 2\text{ mA}$ (to be adjusted by varying I_F), $R_L = 100\ \Omega$,
 $T_A = 25^\circ\text{C}$, $V_{\text{CC}} = 10\text{ V}$

Description	Symbol	Values	Unit
Turn-On Time	t_{ON}	5	μs
Rise Time	t_{R}	2.5	μs
Turn-Off Time	t_{OFF}	6	μs
Fall Time	t_{F}	5.5	μs

Current transfer ratio (typ.)

$V_{CE}=10\text{ V}$, $T_A=25^\circ\text{C}$, normalized to $I_F=10\text{ mA}$
 $NCTR=f(I_F)$

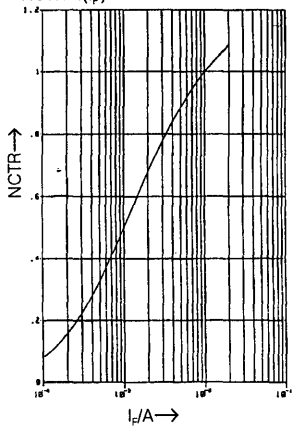

Diode forward voltage (typ.)

$V_F=f(I_F, T_A)$

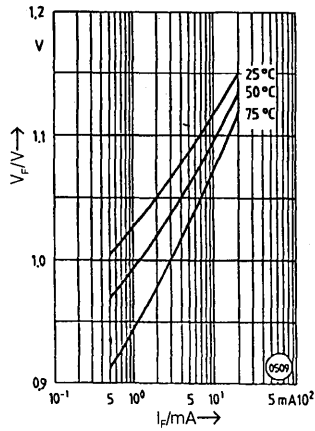

Output characteristics (typ.)

$T_A=25^\circ\text{C}$, $I_{CE}=f(V_{CE}, I_B)$

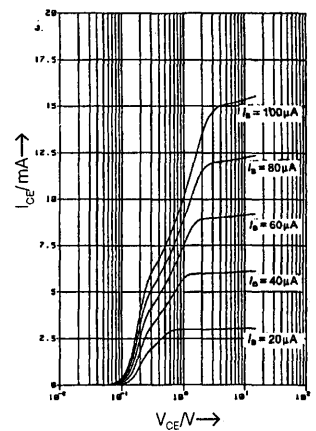

Output characteristics (typ.)

$T_A=25^\circ\text{C}$, $I_{CE}=f(V_{CE}, I_F)$

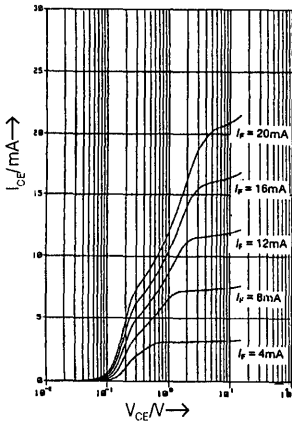

Transistor capacitances (typ.)

$T_A=25^\circ\text{C}$, $f=1\text{ MHz}$, $C_{CE}=f(V_{CE})$
 $C_{CB}=f(V_{CB})$, $C_{EB}=f(V_{EB})$

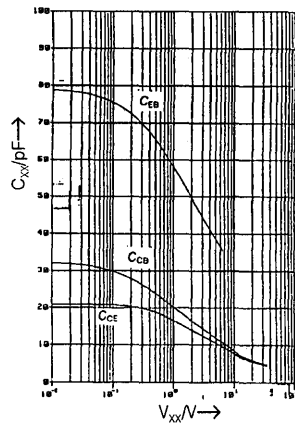

Collector-emitter leakage current (typ.)

$I_F=0$, $R_{BE}=1\text{ M}\Omega$, $I_{CER}=f(V_{CE})$

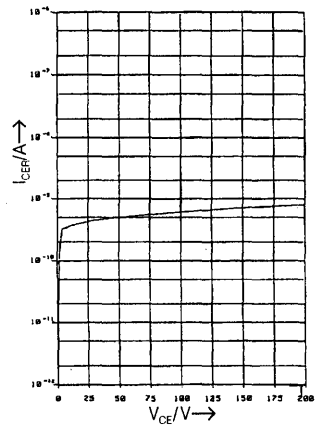

Permissible loss diode

$I_F=f(T_A)$

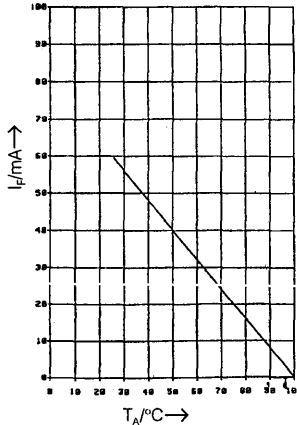

Permissible power dissipation

$P_{TOT}=f(T_A)$

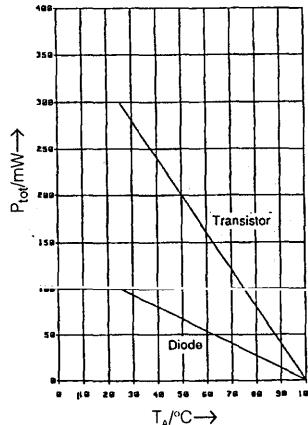

PHOTOTRANSISTOR OPTOCOUPLER

FEATURES

- **Current Transfer Ratio at $I_f = 10$ mA**
IL1, 20% Min.
IL2, 100% Min.
IL5, 50% Min.
- **High Collector-Emitter Voltage**
IL1 – $BV_{CEO} = 50$ V
IL2, IL5 – $BV_{CEO} = 70$ V
- **Field-Effect Stable by TRansparent ION Shield (TRIOS)**
- **Double Molded Package Offers Withstand Test Voltage**
7500 VAC_{PEAK}, 1 sec.
4420 VAC_{RMS}, 1 min.
- **Underwriters Lab File #E52744**
- **VDE Approvals #0884 (Optional with Option1, Add -X001 Suffix)**

DESCRIPTION

The IL1/2/5 are optically coupled isolated pairs employing GaAs infrared LEDs and silicon NPN phototransistor. Signal information, including a DC level, can be transmitted by the drive while maintaining a high degree of electrical isolation between input and output. The IL1/2/5 are especially designed for driving medium-speed logic and can be used to eliminate troublesome ground loop and noise problems. These couplers can be used also to replace relays and transformers in many digital interface applications such as CRT modulation.

Maximum Ratings

Emitter

Reverse Voltage	6 V
Forward Current	60 mA
Surge Current	2.5 A
Power Dissipation	100 mW
Derate Linearly from 25°C	1.33 mW/°C

Detector

Collector-Emitter Reverse Voltage	
IL1	50 V
IL2, IL5	70 V
Emitter-Base Reverse Voltage	7 V
Collector-Base Reverse Voltage	70 V
Collector Current	50 mA
Collector Current ($t < 1$ ms)	400 mA
Power Dissipation	200 mW
Derate Linearly from 25°C	2.6 mW/°C

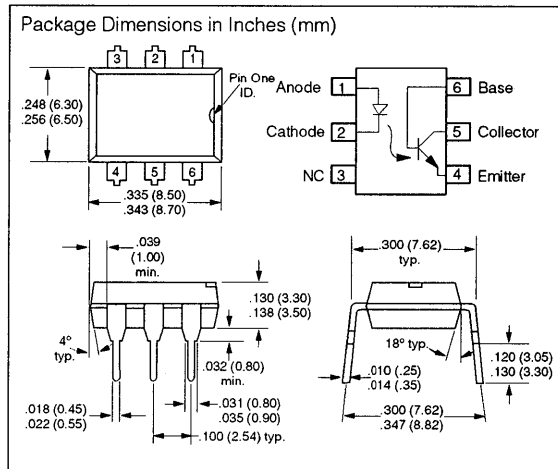

Maximum Ratings—continued

Package

Working Voltage	1700 VAC _{RMS}
Insulation Resistance	$10^{11} \Omega$
Package Power Dissipation	250 mW
Derate Linearly from 25°C	3.3 mW/°C
Withstand Test Voltage	$V_{IO} = 5300$ Vdc
Between Emitter and Detector	
Referred to Standard Climate	
23°C/50%RH, DIN 50014	
Leakage Path DIN 57883, 6.80	min. 8.2 mm
Air Path, VDE 0883 6.80	min. 7.3 mm
Tracking Resistance, Group III	
(KC > 600 per VDE 110 § 6,	
Table 3 and DIN 53480/	
VDE 0330, Part 1	
$V_{IO} = 500$ V	$R_{IO} = 10^{11} \Omega$
Storage Temperature	-40°C to +150°C
Operating Temperature	-40°C to +100°C
Junction Temperature	100°C
Soldering Temperature (2 mm from case bottom)	260°C

See Appnote 45, "How to Use Optocoupler Normalized Curves."

Characteristics

	Symbol	Min.	Typ.	Max.	Unit	Condition
Emitter						
Forward Voltage	V_F		1.25	1.65	V	$I_F=60$ mA
Breakdown Voltage	V_{BR}	6	30		V	$I_R=10$ μ A
Reverse Current	I_R		0.01	10	μ A	$V_R=6$ V
Capacitance	C_0		40		pF	$V_R=0$ V, $f=1$ MHz
Thermal Resistance Junction to Lead	R_{THL}		750		$^{\circ}$ C/W	
Detector						
Capacitance	C_{CE}		6.8		pF	$V_{CE}=5$ V, $f=1$ MHz
	C_{CB}		8.5		pF	$V_{CB}=5$ V, $f=1$ MHz
	C_{EB}		11		pF	$V_{EB}=5$ V, $f=1$ MHz
Collector-Emitter Leakage Current	I_{CEO}		5	50	nA	$V_{CE}=10$ V
Collector-Emitter Saturation Voltage	V_{CESAT}		0.25	0.4	V	$I_{CE}=1$ mA, $I_B=20$ μ A
Base-Emitter Voltage	V_{BE}		0.65		V	$V_{CE}=10$ V, $I_B=20$ μ A
DC Forward Current Gain	HFE	200	650	1800		$V_{CE}=10$ V, $I_B=20$ μ A
Saturated DC Forward Current Gain	HFE _{SAT}	120	400	600		$V_{CE}=0.4$ V, $I_B=20$ μ A
Thermal Resistance Junction to Lead	R_{THL}		500		$^{\circ}$ C/W	
Package Transfer Characteristics						
IL1						
Saturated Current Transfer Ratio (Collector-Emitter)	CTR _{CESAT}		75		%	$I_F=10$ mA, $V_{CE}=0.4$ V
Current Transfer Ratio (Collector-Emitter)	CTR _{CE}	20	80	300	%	$I_F=10$ mA, $V_{CE}=10$ V
Current Transfer Ratio (Collector-Base)	CTR _{CB}		0.25		%	$I_F=10$ mA, $V_{CB}=9.3$ V
IL2						
Saturated Current Transfer Ratio (Collector-Emitter)	CTR _{CESAT}		170		%	$I_F=10$ mA, $V_{CE}=0.4$ V
Current Transfer Ratio (Collector-Emitter)	CTR _{CE}	100	200	500	%	$I_F=10$ mA, $V_{CE}=10$ V
Current Transfer Ratio	CTR _{CB}		0.35		%	$I_F=10$ mA, $V_{CB}=9.3$ V
IL5						
Saturated Current Transfer Ratio (Collector-Emitter)	CTR _{CESAT}		100		%	$I_F=10$ mA, $V_{CE}=0.4$ V
Current Transfer Ratio (Collector-Emitter)	CTR _{CE}	50	130	400	%	$I_F=10$ mA, $V_{CE}=10$ V
Current Transfer Ratio	CTR _{CB}		0.3		%	$I_F=10$ mA, $V_{CB}=9.3$ V
Isolation and Insulation						
Common Mode Rejection Output High	CMH		5000		V/ μ s	$V_{CM}=50$ V _{P-P} , $R_L=1$ k Ω , $I_F=0$ mA
Common Mode Rejection Output Low	CML		5000		V/ μ s	$V_{CM}=50$ V _{P-P} , $R_L=1$ k Ω , $I_F=10$ mA
Common Mode Coupling Capacitance	C_{CM}		0.01		pF	
Package Capacitance	C_{I-O}		0.8		pF	$V_{I-O}=0$ V, $f=1$ MHz.
Insulation Resistance	R_S	5×10^9	10^{14}		Ω	$V_{I-O}=500$ V
Dielectric Leakage Current, 1 min., 60 Hz						RH \leq 50%
$V_{IO}=4420$ V _{AC(RMS)}			3.3	10	μ A _{AC(RMS)}	
$V_{IO}=6250$ V _{AC(FK)}			4.7	14.2	μ A _{AC(FK)}	
$V_{IO}=5304$ V _{AC(RMS)}			4.0	12	μ A _{AC(RMS)}	
$V_{IO}=7500$ V _{AC(FK)}			5.7	17	μ A _{AC(FK)}	

SWITCHING TIMES

Non-Saturated Switching Timing

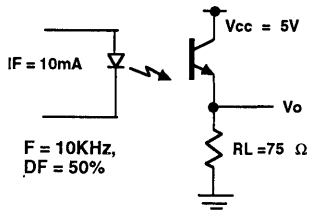

Saturated Switching Timing

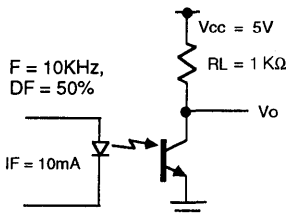

Non-Saturated Switching Timing

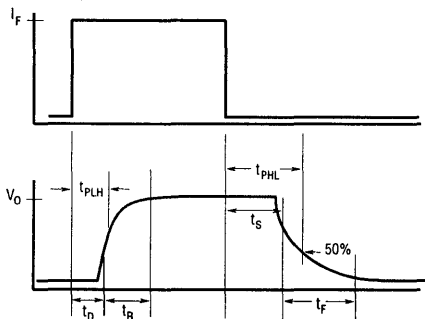

Saturated Switching Timing

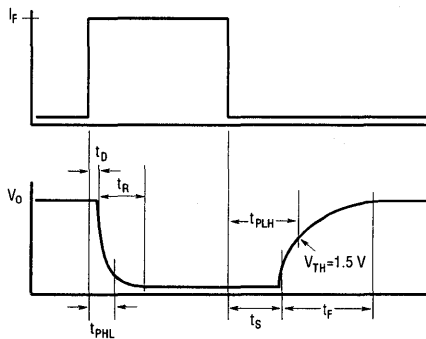

Non-Saturated Switching Time Table—Typical

Characteristic	IL1 $I_F=20\text{ mA}$	IL2 $I_F=5\text{ mA}$	IL5 $I_F=10\text{ mA}$	Unit	Test Condition
Delay	T_D 0.8	1.7	1.7	μs	
Rise Time	t_R 1.9	2.6	2.6	μs	$V_{CC}=5\text{ V}$
Storage	t_S 0.2	0.4	0.4	μs	$R_L=75\ \Omega$
Fall Time	t_F 1.4	2.2	2.2	μs	
Propagation H-L	t_{PHL} 0.7	1.2	1.1	μs	t_p measured at 50% of output
Propagation L-H	t_{PLH} 1.4	2.3	2.5	μs	

Saturated Switching Time Table—Typical

Characteristic	IL1 $I_F=20\text{ mA}$	IL2 $I_F=5\text{ mA}$	IL5 $I_F=10\text{ mA}$	Unit	Test Condition
Delay	T_D 0.8	1	1.7	μs	
Rise Time	t_R 1.2	2	7	μs	$V_{CL} = 5.0\text{ V}$
Storage	t_S 7.4	5.4	4.6	μs	$V_{CE} = 0.4$
Fall Time	t_F 7.6	13.5	20	μs	$R_L = 1\text{ K}$
Propagation H-L	t_{PHL} 1.6	5.4	2.6	μs	$V_{TH}=1.5\text{ V}$
Propagation L-H	t_{PLH} 8.6	7.4	7.2	μs	

Figure 1. Forward voltage versus forward current

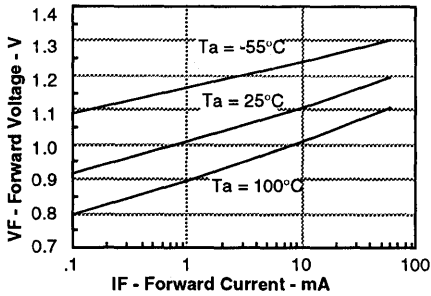

Figure 3. Normalized non-saturated and saturated CTR at $T_A=50^\circ\text{C}$ versus LED current

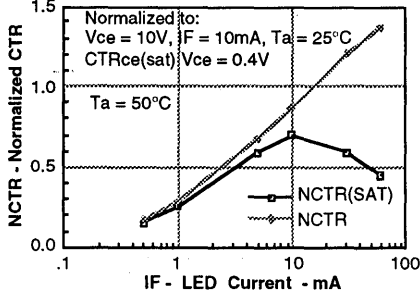

Figure 5. Normalized non-saturated and saturated CTR at $T_A=100^\circ\text{C}$ versus LED current

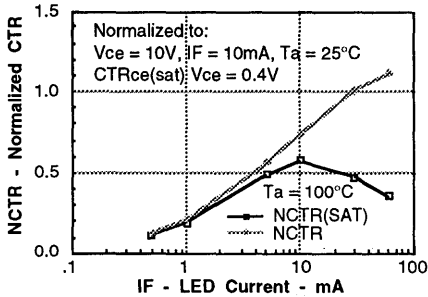

Figure 7. Collector-emitter leakage current versus temperature

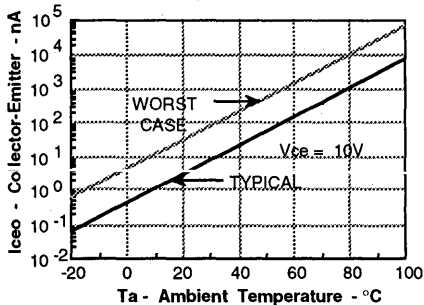

Figure 2. Normalized non-saturated and saturated CTR at $T_A=25^\circ\text{C}$ versus LED current

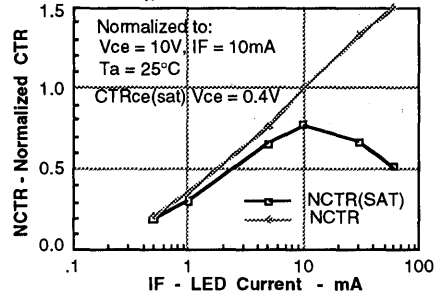

Figure 4. Normalized non-saturated and saturated CTR at $T_A=70^\circ\text{C}$ versus LED current

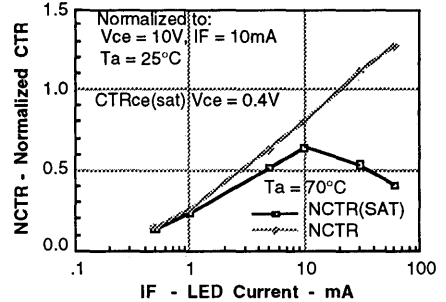

Figure 6. Collector-emitter current versus temperature and LED current

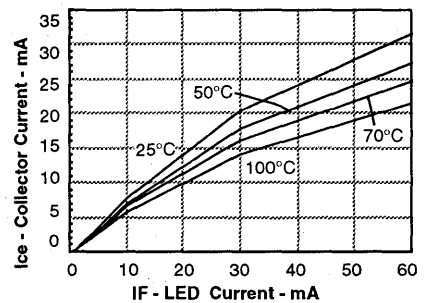

Figure 8. Normalized CTRcb versus LED current and temperature

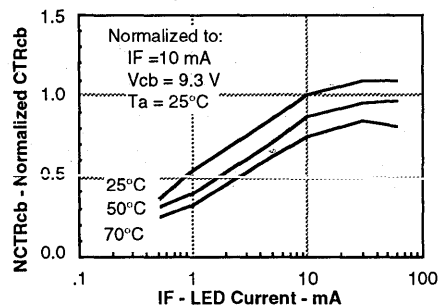

Figure 9. Collector base photocurrent versus LED current

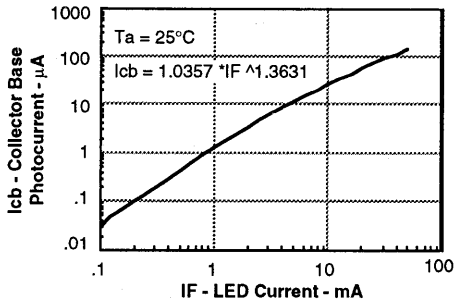

Figure 10. Normalized photocurrent versus If and temperature

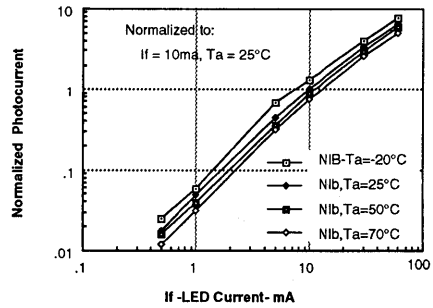

Figure 11. Normalized non-saturated HFE versus base current and temperature

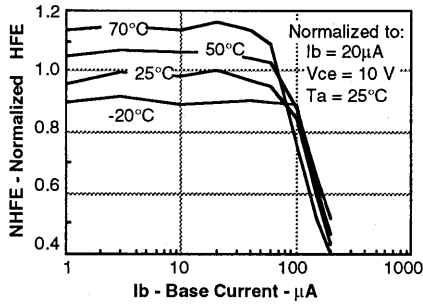

Figure 12. Normalized saturated HFE versus base current and temperature

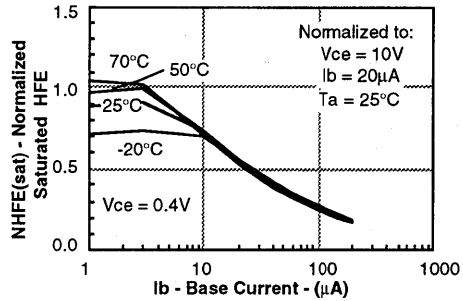
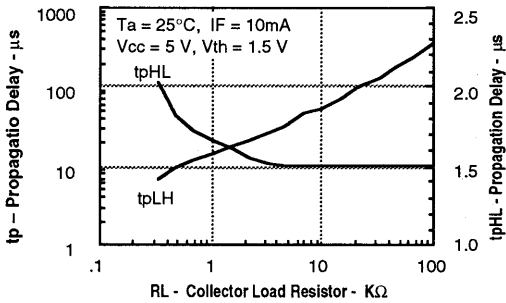

Figure 13. Propagation delay versus collector load resistor



PHOTOTRANSISTOR OPTOCOUPLER

FEATURES

- Five CTR Selections
- High Collector-Emitter Voltage, $BV_{CEO} = 50\text{ V}$
- No Base Connection
- Field-Effect Stable by TRIOS Transparent ION Shield (TRIOS)
- Double Molded Package Offers Withstand Test Voltage 7500 VAC_{PEAK} , 1 sec. 4420 VAC_{RMS} , 1 min.
- Underwriters Lab Approval #E52744
- VDE Approvals #0884 (Optional with Option 1, Add -X001 Suffix)

DESCRIPTION

The IL2B is an optically coupled isolated pair employing a GaAs infrared LED and silicon NPN phototransistor. Signal information, including a DC level, can be transmitted by the drive while maintaining a high degree of electrical isolation between input and output. These optocouplers are especially designed for driving medium-speed logic and can be used to eliminate troublesome ground loop and noise problems. These couplers can be used also to replace relays and transformers in many digital interface applications such as CRT modulation.

Maximum Ratings

Emitter	
Reverse Voltage	6 V
Forward Current	60 mA
Surge Current	2.5 A
Power Dissipation	100 mW
Derate Linearly from 25°C	1.33 mW/°C
Detector	
Collector-Emitter Reverse Voltage	50 V
Collector Current	50 mA
Collector Current ($t < 1\text{ ms}$)	400 mA
Power Dissipation	200 mW
Derate Linearly from 25°C	2.6 mW/°C
Package	
UL Withstand Test Voltage (PK) ($t = 1\text{ sec.}$)	7500 VDC/5300 VAC_{RMS}
VDE Isolation Test Voltage per DIN 57883/6.80	5300 VDC/3750 VAC_{RMS}
Working Voltage	1700 VAC_{RMS}
Insulation Resistance	$10^{11}\ \Omega$
Package Power Dissipation	250 mW
Derate Linearly from 25°C	3.3 mW/°C
Creepage Path	8 min mm
Clearance Path	7 min mm
Storage Temperature	-40°C to +150°C
Operating Temperature	-40°C to +100°C
Junction Temperature	100°C
Soldering Temperature (2 mm from case bottom)	260°C

Package Dimensions in Inches (mm)

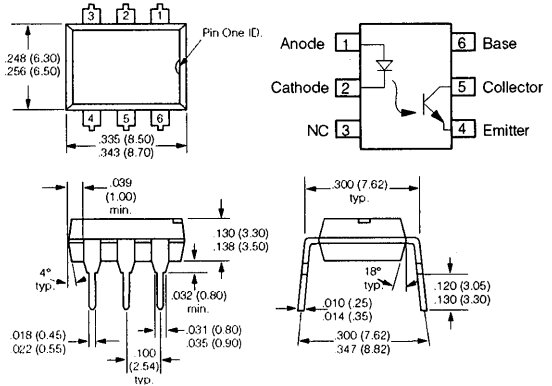

Characteristics ($T_A = 25^\circ\text{C}$)

	Symbol	Min.	Typ.	Max.	Unit	Condition
Emitter						
Forward Voltage	V_F	1.25	1.50		V	$I_F = 10\text{ mA}$
Breakdown Voltage	V_{BR}	6			V	$I_R = 10\ \mu\text{A}$
Reverse Current	I_R	0.01	10		μA	$V_R = 6\text{ V}$
Capacitance	C_O	40			pF	$V_R = 0, f = 1\text{ MHz}$
Thermal Resistance						
Junction to Lead	R_{thJL}	750			°C/W	
Detector						
Collector-Emitter						
Leakage Current	I_{CEO}	5	50		nA	$V_{CE} = 15\text{ V}$
Capacitance	C_{CE}	6.8			pF	$V_{CE} = 5\text{ V}, f = 1\text{ MHz}$
Thermal Resistance						
Junction to Lead	R_{thJL}	375			°C/W	
Isolation and Insulation						
Common Mode Rejection						$V_{CM} = 50\text{ V}_{P-P}$
Output High	CMH	5000			V/ μs	$R_L = 1\text{ K}\Omega, I_F = 0\text{ mA}$
Common Mode Rejection						$V_{CM} = 50\text{ V}_{P-P}$
Output Low	CML	5000			V/ μs	$R_L = 1\text{ K}\Omega, I_F = 10\text{ mA}$
Common Mode Coupling						
Capacitance	C_{CM}	0.01			pF	
Coupling Capacitance	C_{IO}	0.8			pF	$V_{IO} = 0\text{ V}, f = 1\text{ MHz}$
Dielectric Leakage						
Current	I_{IO}	3.3	10		μA	$V_{IO} = 4420\text{ AC}_{RMS}$
						1 min., 60 Hz
		0.5	10		μA	$V_{IO} = 6250\text{ VDC}, 1\text{ min.}$
		4	10		μA	$V_{IO} = 5304\text{ AC}_{RMS}$
						1 sec., 60 Hz
		0.6	12		μA	$V_{IO} = 7500\text{ VDC}, 1\text{ sec.}$

See Appnote 45, "How to Use Optocoupler Normalized Curves."

Package Transfer Characteristics

Symbol	Min.	Typ.	Max.	Unit	Condition
Saturated Current					
Transfer Ratio					
Collector-Emitter	CTR _{CE(sat)}				
IL2B-1, -2, -3	10	75		%	V _{CE} =0.4 V, I _F =10 mA
IL2B-4	10	75		%	V _{CE} =0.4 V, I _F =1 mA
IL2B-5	10	75		%	V _{CE} =0.4 V, I _F =0.25 mA
Current Transfer Ratio					
Collector-Emitter	CTR _{CE}				
IL2B-1	100	200	300	%	V _{CE} =10 V, I _F =10 mA
IL2B-2	30	100		%	V _{CE} =5 V, I _F =2 mA
IL2B-3	100		300	%	V _{CE} =10 V, I _F =1 mA
IL2B-4	40			%	V _{CE} =5 V, I _F =0.5 mA
IL2B-5	20			%	V _{CE} =5 V, I _F =0.25 mA

SWITCHING TIMES

Saturated Switching Timing

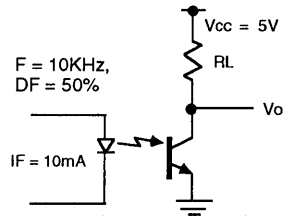

SWITCHING TIMES

Non-Saturated Switching Timing

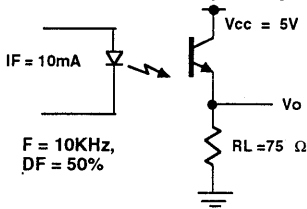

Non-Saturated Switching Timing

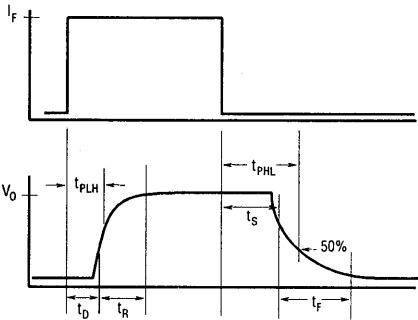

V_{CC}=5 V, R_L=75 Ω

Characteristic		Typical 25°C			Unit
		I _F =20 mA	I _F =5 mA	I _F =10 mA	
Delay	t _D	0.8	1.7	1.7	μs
Rise Time (V _{CC} =5 V)	t _R	1.9	2.6	2.6	μs
Storage (R _L =75 Ω)	t _S	0.2	0.4	0.4	μs
Fall Time	t _F	1.4	2.2	2.2	μs
Propagation H-L (50% of V _{FP})	t _{PHL}	0.7	1.2	1.1	μs
Propagation L-H	t _{PLH}	1.4	2.3	2.5	μs

Saturated Switching Timing

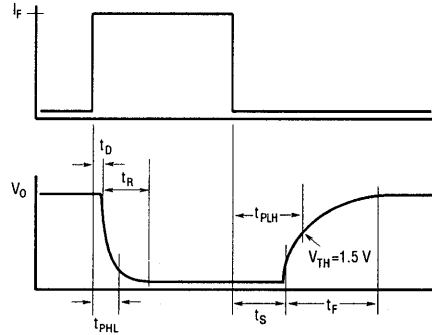

R_L=1 KΩ, V_{CC}=5 V

Characteristic		Typical 25°C			Unit
		I _F =20 mA	I _F =5 mA	I _F =10 mA	
Delay	t _D	0.8	1	1.7	μs
Rise Time (V _{CE} =0.4 V)	t _R	1.2	2	7	μs
Storage (R _L =1 kΩ)	t _S	7.4	5.4	4.6	μs
Fall Time (V _{CC} =5 V)	t _F	7.6	13.5	20	μs
Propagation H-L (V _{TH} =1.5 V)	t _{PHL}	1.6	5.4	2.6	μs
Propagation L-H	t _{PLH}	8.6	7.4	7.2	μs

Figure 1. Normalization factor for non-saturated and saturated CTR, $T_A=70^\circ\text{C}$ vs. I_F

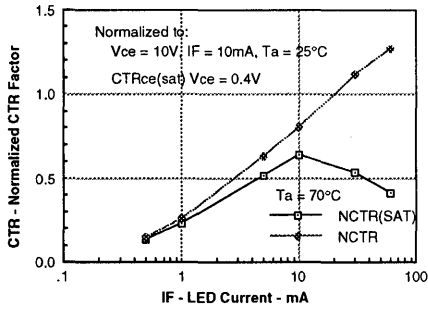

Figure 3. Collector current versus diode forward current

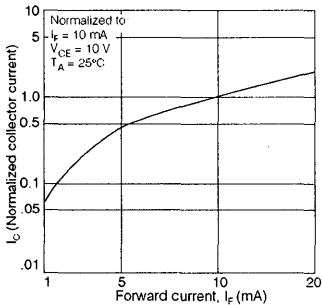

Figure 5. Propagation delays versus collector load resistor

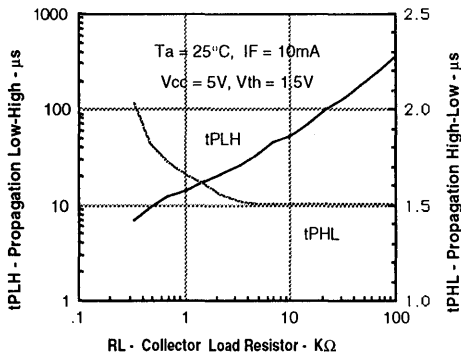

Figure 7. Collector current versus collector-emitter voltage

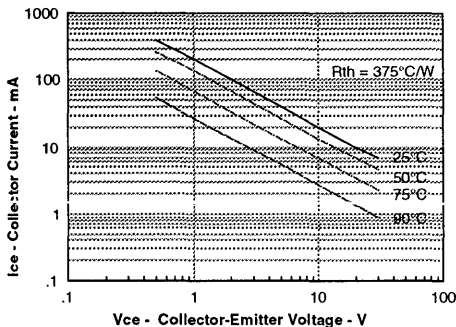

Figure 2. Normalization factor for non-saturated and saturated CTR, $T_A=70^\circ\text{C}$ vs. I_F

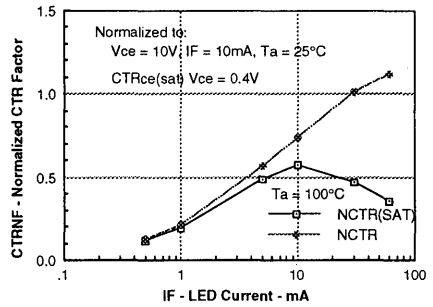

Figure 4. Collector-emitter leakage versus temperature

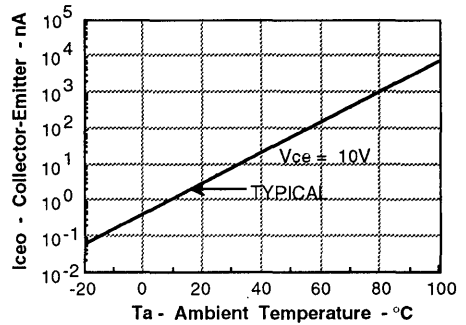
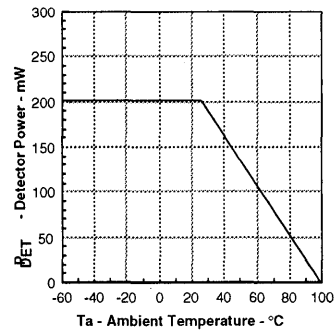

Figure 6. Detector power versus ambient temperature



FEATURES

- **IL8/IL10: Four Leads**
- **IL9/IL11: Six Leads with Base Contact**
- **2.0 mm Min. Internal Separation between Conductive Parts**
- **13 mm Min. External Separation of Leads and Creepage Distance**
- **Standard DIP Profile on Leads and Package**
- **Machine Insertable on PCB**
- **Underwriters Lab Approval #E52744**
- **VDE and IEC Approvals 0700, 0804/1.83, 0860/8.86, IEC601/VDE0750, IEC380/VDE806/8.81, IEC435/VDE0805**
- **VDE Approval #0884 (Optional with Option 1, add -X001 Suffix)**

DESCRIPTION

The IL8/IL9/IL10/IL11 are optically coupled isolators consisting of a gallium arsenide infrared emitter and a silicon phototransistor.

Maximum Ratings

Emitter

Reverse Voltage	5.0 V
Forward DC Current	60 mA
Peak Forward Current (1 μsec pulse, 300 pps)	3.0
Power Dissipation	100 mW
Derate Linearly from 25°C	1.33 mW/°C

Detector

Collector-Emitter Reverse Voltage	30 V
Emitter-Base Voltage	7 V
Collector Current	100 mA
Power Dissipation at 25°C	300 mW
Derate Linearly from 25°C	4.0 mW/°C

Package

Withstand Test Voltage	$V_{IO}=5300V_{dc}$
Between Emitter and Detector	
Referred to Standard Climate	
23°C/50%RH, DIN 50014	
Leakage Path DIN 57883.6.80	min. 8.2 mm
Air Path, VDE 0883.6.80	min. 7.3 mm
Tracking Resistance, Group III (KC>600 per VDE 110 § 6, Table 3 and DIN 53480/ VDE 0330, Part 1, $V_{IO}=500V$)	$R_{IO}=10^{11}\Omega$
Storage Temperature Range	-55°C to +150°C
Operating Temperature Range	-55°C to +100°C
Lead Soldering Time at 260°C (1.6 mm from case)	5 sec.

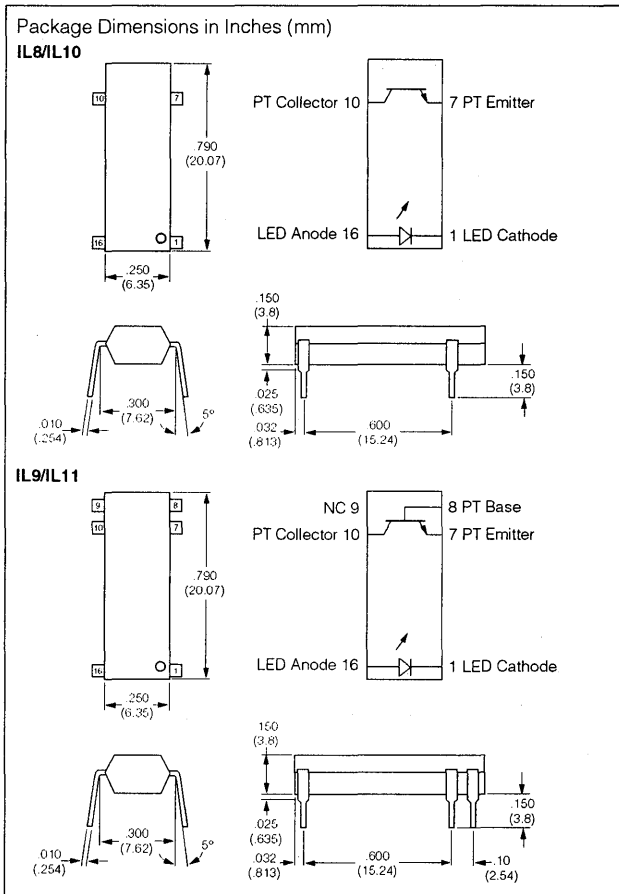

Electrical Characteristics ($T_A=25^\circ C$)

Parameter	Symbol	Min.	Typ.	Max.	Unit	Condition
Emitter						
Forward Voltage	V_F			1.5	V	$I_F=10\text{ mA}$
Reverse Current	I_R			10	μA	$V_R=5\text{ V}$
Detector						
	BV_{CEO}	30			V	$I_C=1.0\text{ mA}$
	BV_{EBO}	7			V	$I_E=10\ \mu A$
	I_{CEO}			50	nA	$V_{CE}=10\text{ V}$
Package						
DC Current Transfer Ratio						
IL8/IL9	CTR	20			%	$I_F=10\text{ mA}, V_{CE}=10\text{ V}$
IL10/IL11	CTR	50			%	$I_F=10\text{ mA}, V_{CE}=10\text{ V}$
	V_{CEsat}			0.4	V	$I_F=20\text{ mA}, I_C=2\text{ mA}$
	T_{on}	14			μs	$I_C=2\text{ mA}, R_E=100\ \Omega,$ 100 μs Pulsewidth, 1% Duty Cycle
	T_{off}	11			μs	
Input to Output Resistance				$10^{10}\ \Omega$		VDC=500

Figure 1. Forward voltage versus forward current

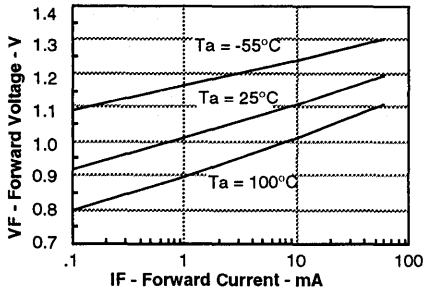

Figure 2. Normalized non-saturated and saturated CTR_{ce} versus LED current

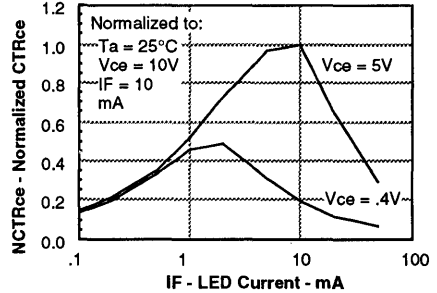

Figure 3. Normalized collector-emitter current versus LED current

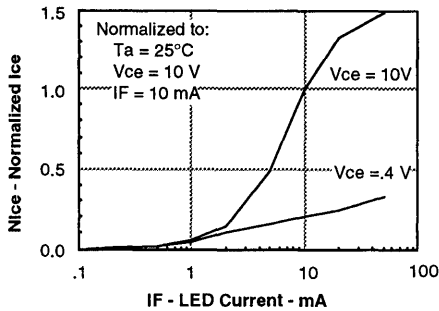

Figure 4. Normalized collector-base photocurrent versus LED current

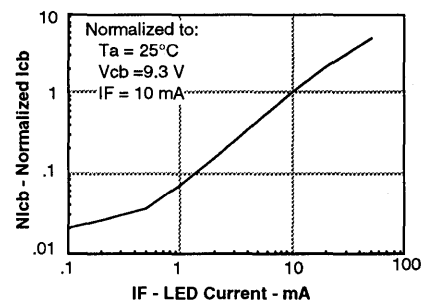

Figure 5. Non-saturated and saturated HFE versus base current

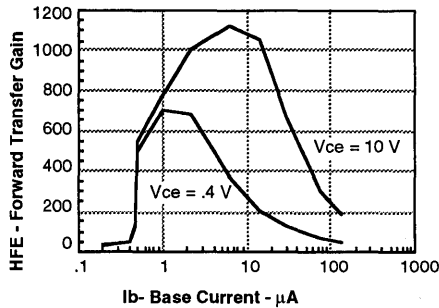

Figure 6. High to low propagation delay versus collector load resistance and LED current

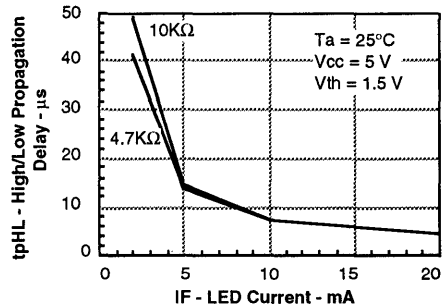

Figure 7. Low to high propagation delay versus collector load resistance and LED current

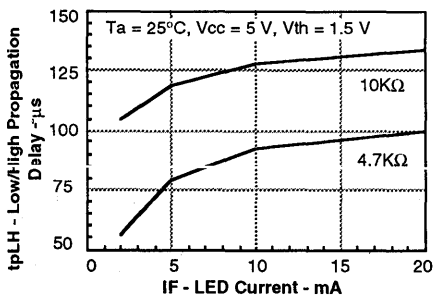

Figure 8. Switching waveform

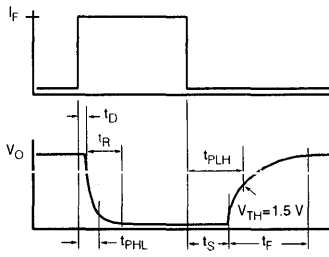
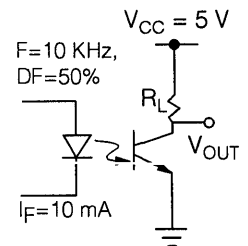



Figure 9. Switching schematic



SINGLE CHANNEL IL30/31/55 DUAL CHANNEL ILD30/31/55 QUAD CHANNEL ILQ30/31/55 PHOTODARLINGTON OPTOCOUPLER

FEATURES

- Current Transfer Ratio
IL/D/Q30/55, 100% Min.
IL/D/Q31, 200% Min.
- 125 mA Load Current Rating
- Fast Rise Time, 10 μ S
- Fast Fall Time, 35 μ S
- Single, Dual, & Quad Channel
- Solid State Reliability
- Standard DIP Package
- Underwriters Lab File #E52744
-  VDE Approvals #0884 (Optional with Option 1, Add -X001 Suffix)

DESCRIPTION

The IL30/31/55, ILD30/31/55 and ILQ30/31/55 are optically coupled isolators with a Gallium Arsenide infrared emitter and a silicon photodarlington sensor. Switching can be achieved while maintaining a high degree of isolation between driving and load circuits, with no cross talk between channels. These optocouplers can be used to replace reed and mercury relays with advantages of long life, high speed switching and elimination of magnetic fields.

The IL30/31/55 are equivalent to MCA230/MCA231/MCA255. The ILD/Q30/31/55 are designed to reduce board space requirements in high density applications.

Package Dimensions in Inches (mm)

IL30/31/55 (Single Channel)

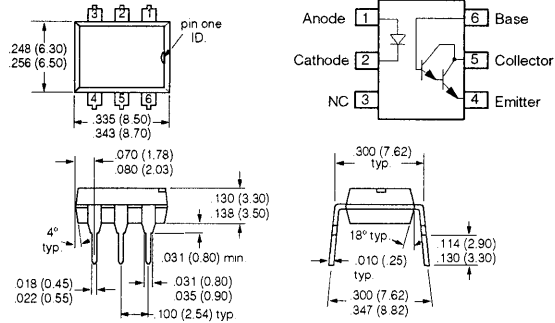

ILD30/31/55 (Dual Channel)

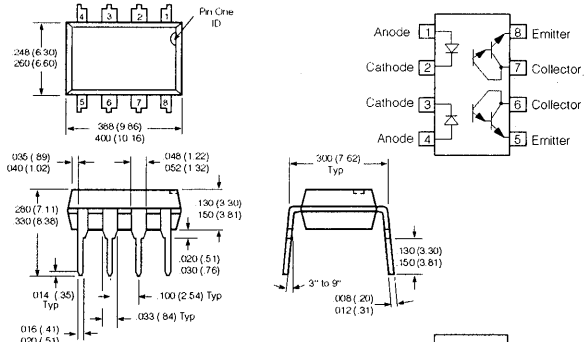

ILQ30/31/55 (Quad Channel)

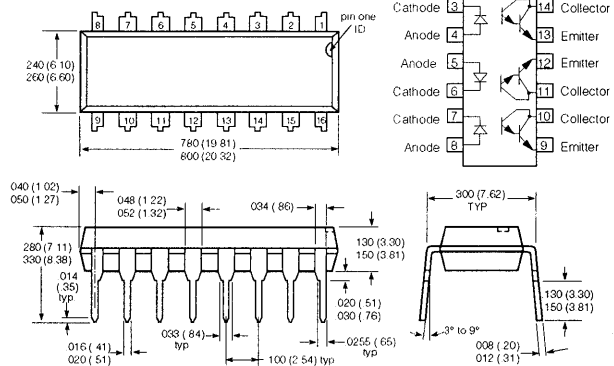

Maximum Ratings

Emitter (each channel)

Peak Reverse Voltage	3 V
Continuous Forward Current	60 mA
Power Dissipation at 25°C	100 mW
Derate Linearly from 25°C	1.33mW/°C

Detector (each channel)

Collector-Emitter Breakdown Voltage IL/D/Q30	30 V
Collector-Emitter Breakdown Voltage IL/D/Q55	55 V
Collector (Load) Current	125 mA
Power Dissipation at 25°C Ambient	150 mW
Derate Linearly from 25°C	2.0 mW/°C

Package

Total Package Dissipation at 25°C		
IL30/31/55	250 mW
ILD30/31/55	400 mW
IL7Q30/31/55	500 mW
Derate Linearly from 25°C		
IL30/31/55	3.3 mW/°C
ILD30/31/55	5.33 mW/°C
ILQ30/31/55	6.67 mW/°C
Isolation Test Voltage per DIN57883/6.80		
Creepage Path	3750 VAC/5300 VDC
Clearance Path		
IL30/31/55	8 mm min.
ILD/Q30/31/55	7 mm min.
Clearance Path		
IL30/31/55	7 mm min
Tracking Index per VDE 0303	KB100/A
Storage Temperature	-55°C to +125°C
Operating Temperature	-55°C to +100°C
Lead Soldering Time at 260°C	10 sec.

Electrical Characteristics (T_A=25°C)

Parameter	Symbol	Min.	Typ.	Max.	Unit	Condition
-----------	--------	------	------	------	------	-----------

Emitter

Forward Voltage	V _F	1.25	1.5		V	I _F = 20 mA
Reverse Current	I _R	0.1	10		μA	V _R = 3.0 V
Capacitance	C _O	25			pF	V _R = 0

Detector

Collector-Emitter Breakdown Voltage	BV _{CEO}	30/55			V	I _C = 100 μA
Collector-Emitter Leakage Current	I _{CEO}	1.0	100		nA	V _{CE} = 10 V, I _F = 0
Collector-Emitter Capacitance	C _{CE}	3.4			pF	V _{CE} = 10 V f = 1 MHz

Package

Current Transfer Ratio	CTR				%	I _F = 10 mA, V _{CE} = 5 V
IL/D/Q30/55		100	400		%	I _F = 10 mA, V _{CE} = 5 V
IL/D/Q31		200	400		%	I _F = 10 mA, V _{CE} = 5 V
Collector-Emitter Saturation Voltage	V _{CEsat}	0.9	1.0		V	I _C = 50 mA, I _F = 50 mA
UL Qualified for Isolation Resistance	H _{ISOL}	7500			VDC	
Coupling Capacitance	C _{ISOL}	0.5			pF	
Rise Time	t _r	10			μs	V _{CC} = 13.5 V I _F = 50 mA R _C = 100 Ω
Fall Time	t _f	35			μs	

Figure 1. Forward voltage versus forward current

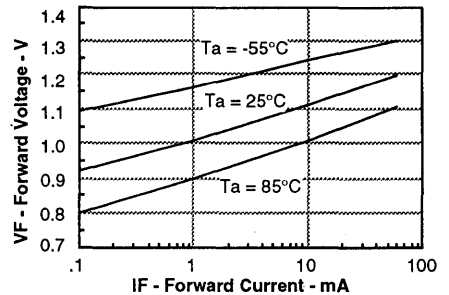

Figure 2. Normalized non-saturated and saturated CTRce at T_A=25°C versus LED current

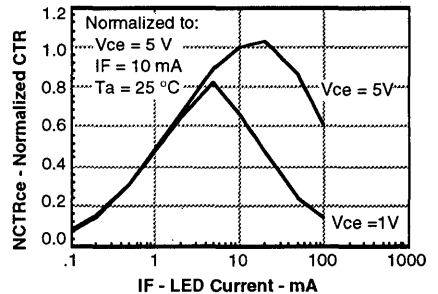

Figure 3. Normalized non-saturated and saturated collector-emitter current versus LED current

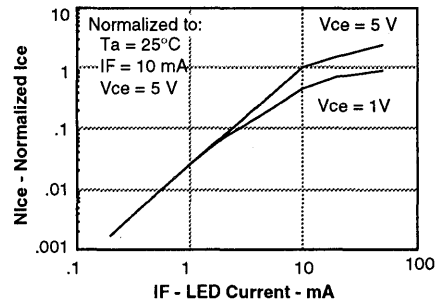

Figure 4. Normalized collector-base photocurrent versus LED current

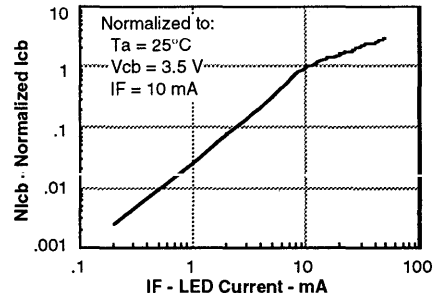

Figure 5. Non-saturated and saturated HFE versus base current

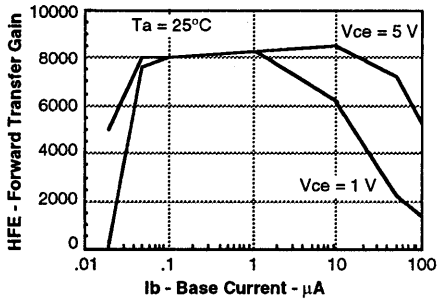

Figure 7. High to low propagation delay versus collector load resistance and LED current

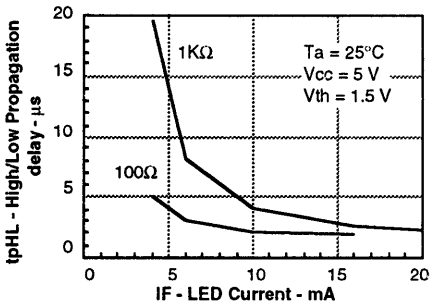

Figure 9. Switching schematic

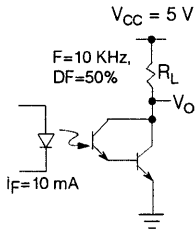

Figure 6. Low to high propagation delay versus collector load resistance and LED current

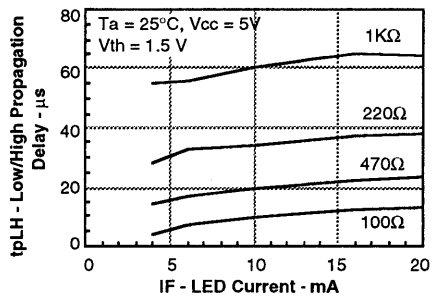
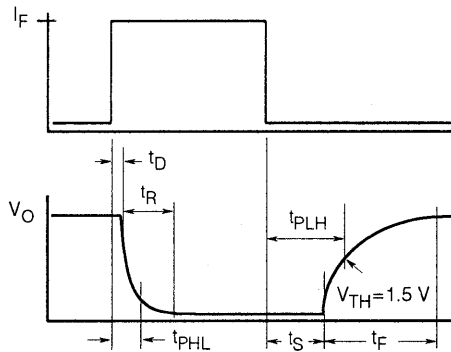

Figure 8. Switching waveforms



Optocouplers
(Optoisolators)

SINGLE CHANNEL IL66 SERIES DUAL CHANNEL ILD66 SERIES QUAD CHANNEL ILQ66 SERIES

PHOTODARLINGTON OPTOCOUPLER

FEATURES

- Internal R_{BE} for High Stability
- Current Transfer Ratio is Tested at 2.0 mA and 0.7 mA Input
IL/ILD/ILQ66 Series:
-1, 100% min. at $I_F=2$ mA, $V_{CE}=10$ V
-2, 300% min. at $I_F=2$ mA, $V_{CE}=10$ V
-3, 400% min. at $I_F=0.7$ mA, $V_{CE}=10$ V
-4, 500% min. at $I_F=2$ mA, $V_{CE}=5$ V
- Four Available CTR Categories per Package Type
- $BV_{CEO} > 60$ V
- Standard DIP Packages
- Underwriters Lab File #E52744
-  VDE Approvals #0884 (Optional with Option 1, Add -X001 Suffix)

DESCRIPTION

IL66, ILD66, and ILQ66 are optically coupled isolators employing Gallium Arsenide infrared emitters and silicon photodarlington detectors. Switching can be accomplished while maintaining a high degree of isolation between driving and load circuits, with no crosstalk between channels.

Maximum Ratings

Emitter (Each Channel)	
Peak Reverse Voltage	6 V
Continuous Forward Current	60 mA
Power Dissipation at 25°C	100 mW
Derate Linearly from 25°C	1.33 mW/°C
Detector (Each Channel)	
Power Dissipation at 25°C Ambient	150 mW
Derate Linearly from 25°C	2.0 mW/°C

Package

UL Withstand Test Voltage	
(t=1 sec.)	7500 VAC _{PK} /5300 VAC _{RMS}
VDE Isolation Test Voltage	
per DIN 57883/6.80	5300 VAC _{PK} /3750 VAC _{RMS}
Working Voltage 1700 VAC _{RMS}	
Total Package Power Dissipation at 25°C	
IL66	250 mW
ILD66	400 mW
ILQ66	500 mW
Derate Linearly from 25°C	
IL66	3.3 mW/°C
ILD66	5.33 mW/°C
ILQ66	6.67 mW/°C
Creepage Path 8 min mm	
Clearance Path 7 min mm	
Tracking Index per VDE 0303 KB 100/A	
Insulation Resistance 10 ¹¹ Ω	
Storage Temperature -55°C to +125°C	
Operating Temperature -55°C to +100°C	
Lead Soldering Time at 260°C 10 sec.	

Package Dimensions in Inches (mm)

IL66 (Single Channel)

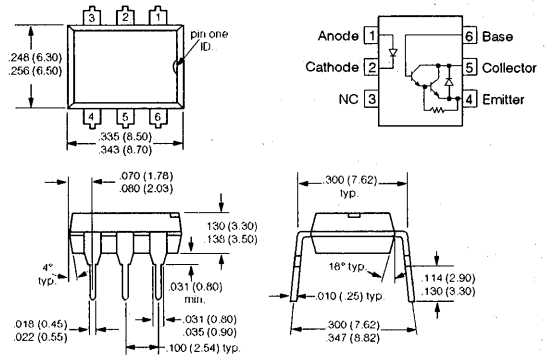

ILD66 (Dual Channel)

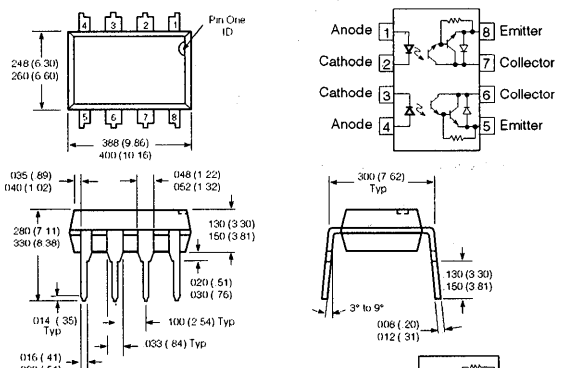

ILQ66 (Quad Channel)

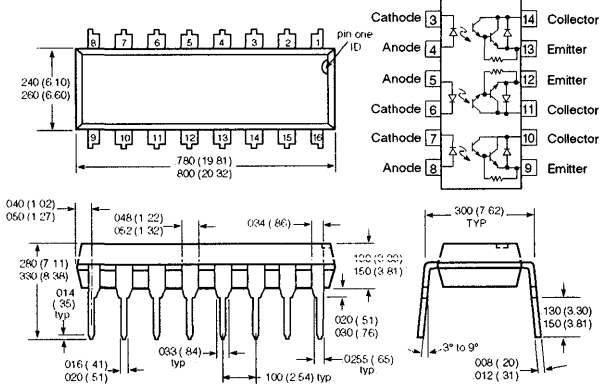

Electrical Characteristics (T_A=25°C)

	Symbol	Min.	Typ.	Max.	Unit	Condition
GaAs Emitter						
Forward Voltage	V _F		1.25	1.5	V	I _F =20 mA
Reverse Current	I _R	0.1		10	μA	V _R =6.0 V
Capacitance	C _O	25			pF	V _R =0 V
Photodarlington						
Breakdown Voltage						
Collector-Emitter	BV _{CEO}	60			V	I _C =1 mA, I _F =0
Collector-Base (ILQ66)	BV _{CBO}	60			V	I _C =10 μA
Collector-Emitter						
Leakage Current	I _{CEO}		1.0	100	nA	V _{CE} =50 V, I _F =0
Capacitance						
Collector-Emitter			3.4		pF	V _{CE} =10 V
Coupled Characteristics						
Current Transfer						
Ratio						
	CTR					
IL/ILD/ILQ66-1		100	400		%	I _F =2 mA, V _{CE} =10 V
IL/ILD/ILQ66-2		300	500		%	I _F =2 mA, V _{CE} =10 V
IL/ILD/ILQ66-3		400	500		%	I _F =0.7 mA, V _{CE} =10 V
IL/ILD/ILQ66-4		500	750		%	I _F =2 mA, V _{CE} =5 V
Collector-Emitter						
Saturation Voltage	V _{CEsat}	0.9	1.0		V	I _C =10 mA, I _F =10 mA
Rise Time -1, -2, -4	t _R		200		μs	V _{CC} =10 V
Fall Time -1, -2, -4	t _F		200		μs	I _F =2 mA, R _C =100 Ω
Rise Time -3	t _R		200		μs	I _F =0.7 mA
Fall Time -3	t _F		200		μs	V _{CC} =10 V, R _L =100 Ω

Figure 1. Forward voltage versus forward current

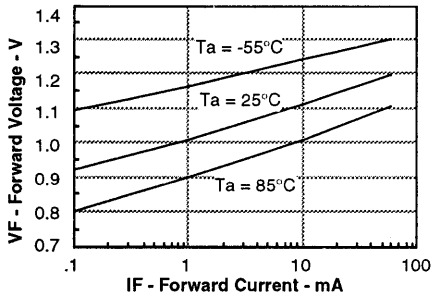

Figure 3. Normalized non-saturated and saturated CTRce versus LED current

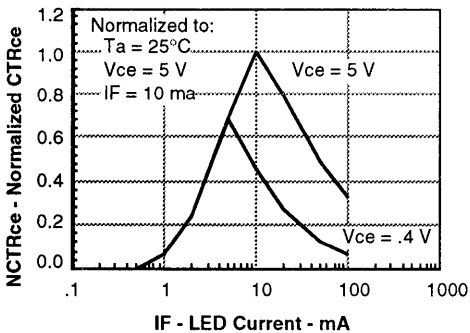

Figure 2. Normalized non-saturated and saturated CTRce versus LED current

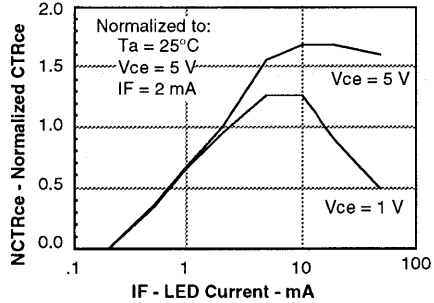

Figure 4. Non-saturated and saturated collector emitter current versus LED current

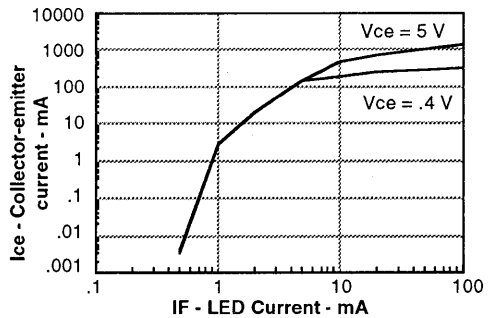

Figure 5. Collector-base photocurrent versus LED current

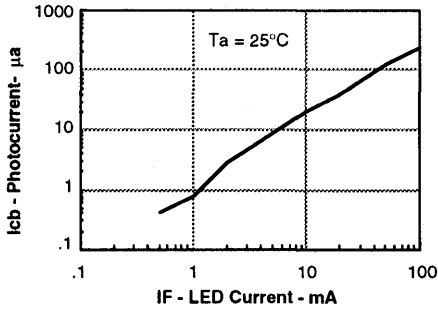

Figure 7. Non-saturated and saturated HFE versus LED current

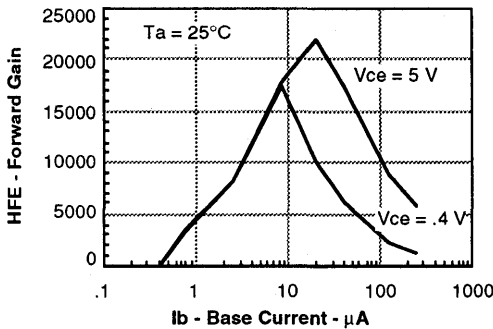

Figure 9. Low/high propagation delay versus collector load resistance and LED current

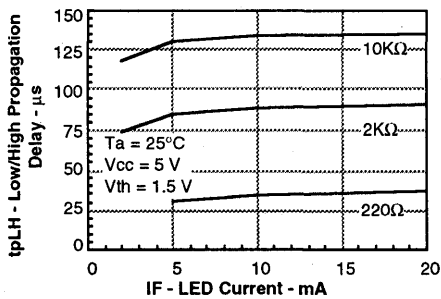

Figure 11. Switching Schematic

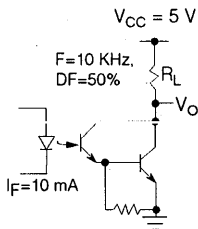

Figure 6. Collector-emitter current versus LED current

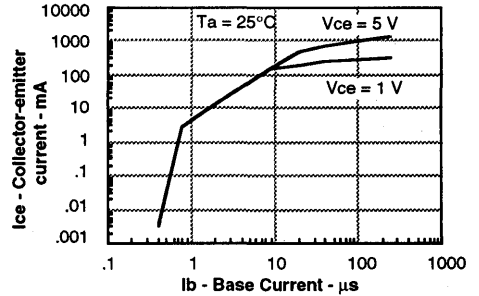

Figure 8. High/low propagation delay versus collector load resistance and LED current

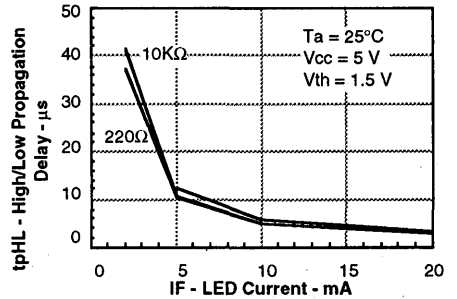
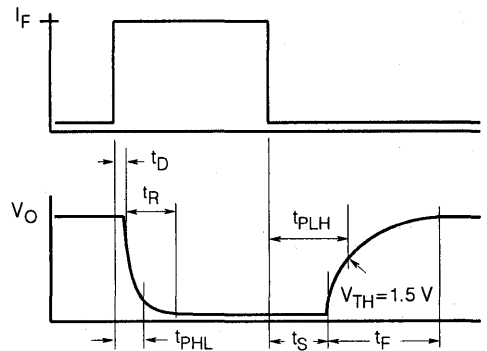



Figure 10. Switching Waveform



PHOTODARLINGTON OPTOCOUPLER

FEATURES

- Internal R_{BE} for High Stability
- High Current Transfer Ratio at $I_F=2\text{ mA}$, $V_{CE}=5\text{ V}$
IL66B-1, 200% min.
IL66B-2, 750% min.
- Withstand Test Voltage, 7500 V
- No Base Connection
- High Isolation Resistance, $10^{11}\ \Omega$ Typical
- Standard Plastic DIP Package
- Underwriters Lab Approval #E52744
-  VDE Approvals #0884 (Optional with Option 1, Add -X001 Suffix)

DESCRIPTION

The IL66B is an optically coupled isolator employing a Gallium Arsenide infrared emitter and a silicon photodarlington detector. Switching can be accomplished while maintaining a high degree of isolation between driving and load circuits. They can be used to replace reed and mercury relays with advantages of long life, high speed switching and elimination of magnetic fields.

Maximum Ratings (at 25°C)

Emitter

Peak Reverse Voltage 6 V
 Continuous Forward Current 60 mA
 Power Dissipation at 25°C 100 mW
 Derate Linearly from 55°C 1.33 mW/°C

Detector

Collector-Emitter Breakdown Voltage 60 V
 Emitter-Collector Breakdown Voltage 5 V
 Power Dissipation at 25°C Ambient 200 mW
 Derate Linearly from 25°C 2.6 mW/°C

Package

UL Withstand Test Voltage
 ($t=1\text{ sec.}$) 7500 VAC_{PK}/5300 VAC_{RMS}
 Total Dissipation at 25°C 250 mW
 Derate Linearly from 25°C 3.3 mW/°C
 Creepage Path 8 min mm
 Clearance Path 7 min mm
 Storage Temperature -55°C to +150°C
 Operating Temperature -55°C to +100°C
 Lead Soldering Time at 260°C 10 sec.

Package Dimensions in Inches (mm)

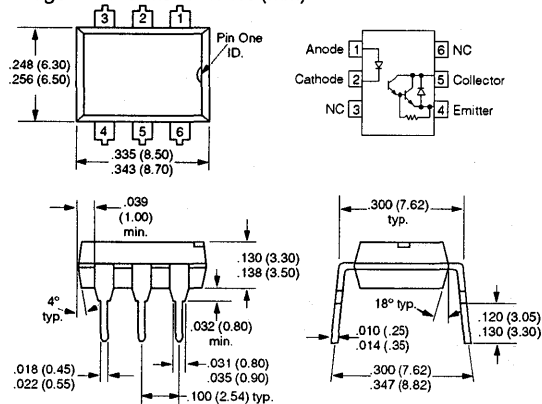

Electrical Characteristics ($T_A=25^\circ\text{C}$)

	Symbol	Min.	Typ.	Max.	Unit	Condition
Emitter						
Forward Voltage	V_F	1.25	1.5		V	$I_F=10\text{ mA}$
Reverse Current	I_R	0.01	100		μA	$V_R=3.0\text{ V}$
Capacitance	C_O	25			pF	$V_R=0\text{ V}$
Detector						
Breakdown Voltage						
Collector-Emitter	BV_{CEO}	60			V	$I_C=100\ \mu\text{A}$, $I_F=0$
Leakage Current						
Collector-Emitter	I_{CEO}	1.0	100		nA	$V_{CE}=50\text{ V}$, $I_F=0$
Package						
Current Transfer Ratio						
IL66B-1	CTR	200			%	$I_F=2\text{ mA}$, $V_{CE}=5\text{ V}$
IL66B-2		750	1000		%	
Saturation Voltage						
Collector-Emitter	V_{CEsat}		1.0		V	$I_C=10\text{ mA}$, $I_F=10\text{ mA}$
Turn-On, Turn-Off Time						
	t_{on} , t_{off}		200		μs	$V_{CC}=10\text{ V}$ $I_F=2\text{ mA}$, $R_L=100\ \Omega$

Figure 1. Forward voltage versus forward current

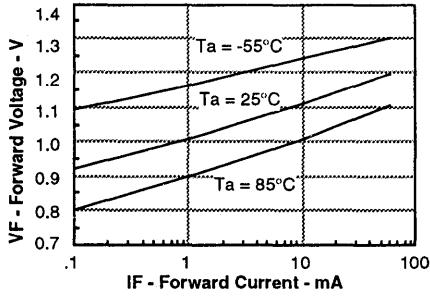

Figure 2. Normalized non-saturated and saturated CTR_{ce} versus LED current

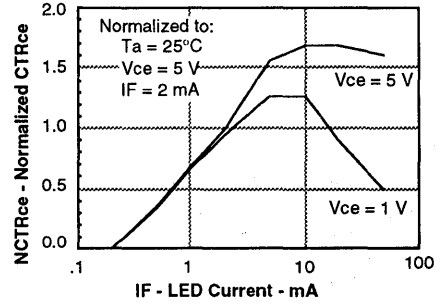

Figure 3. Normalized non-saturated and saturated CTR_{ce} versus LED current

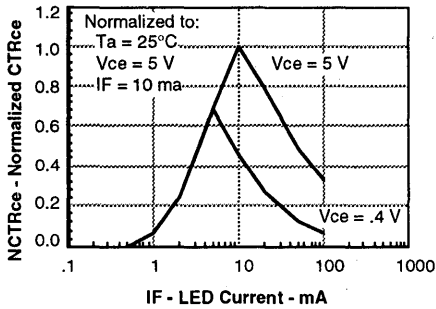

Figure 4. Non-saturated and saturated collector emitter current versus LED current

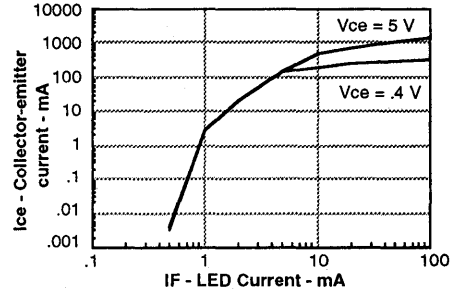

Figure 5. High/low propagation delay versus collector load resistance and LED current

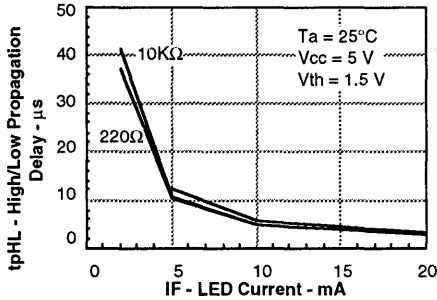
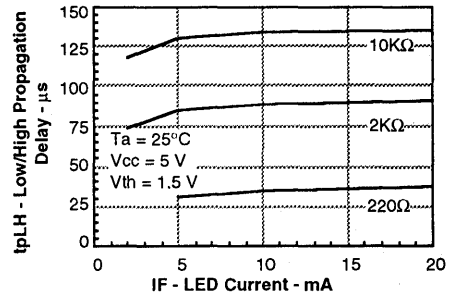



Figure 6. Low/high propagation delay versus collector load resistance and LED current



SINGLE CHANNEL IL74 DUAL CHANNEL ILD74 QUAD CHANNEL ILQ74 PHOTOTRANSISTOR OPTOCOUPLER

FEATURES

- 7400 Series T²L Compatible
- Transfer Ratio, 35% Typical
- Coupling Capacitance, 0.5 pF
- Single, Dual, & Quad Channel
- Industry Standard DIP Package
- Underwriters Lab File #E52744
-  VDE Approvals #0884 (Optional with Option 1, Add -X001 Suffix)

DESCRIPTION

The IL74 is an optically coupled pair with a Gallium Arsenide infrared LED and a silicon NPN phototransistor. Signal information, including a DC level, can be transmitted by the device while maintaining a high degree of electrical isolation between input and output. The IL74 is especially designed for driving medium-speed logic, where it may be used to eliminate troublesome ground loop and noise problems. Also it can be used to replace relays and transformers in many digital interface applications, as well as analog applications such as CRT modulation.

The ILD74 has two isolated channels in a single DIP package; the ILQ74 has four isolated channels per package.

Package Dimensions in Inches (mm)

IL74 (Single Channel)

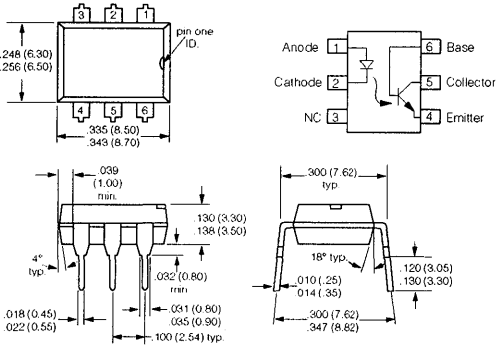

ILD74 (Dual Channel)

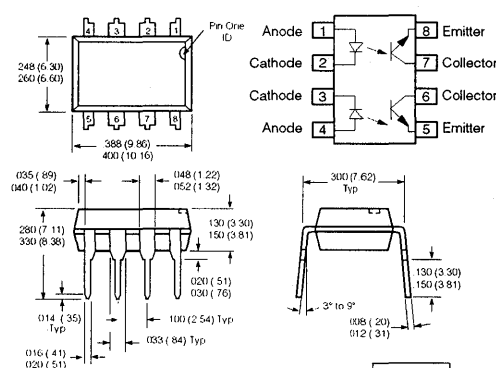

ILQ74 (Quad Channel)

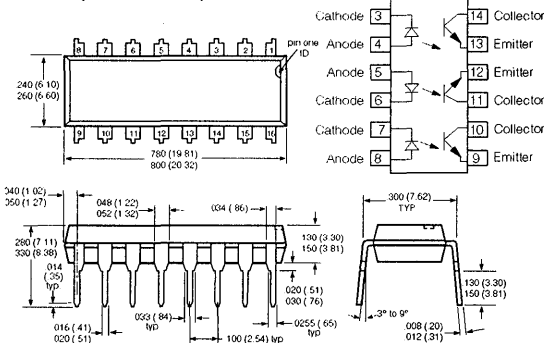

Maximum Ratings

Emitter (each channel)

Peak Reverse Voltage	3.0 V
Continuous Forward Current	60 mA
Power Dissipation at 25°C	100 mW
Derate Linearly from 25°C	1.33 mW/°C

Detector (each channel)

Collector-Emitter Breakdown Voltage	20 V
Emitter-Base Breakdown Voltage	5 V
Collector-Base Breakdown Voltage	70 V
Power Dissipation at 25°C	150 mW
Derate Linearly from 25°C	2.0 mW/°C

Package

Isolation Test Voltage	3750 VAC/5300 VDC
UL Qualified for	7500 VDC
Total Package Dissipation at 25°C Ambient (LED Plus Detector)	
IL74	200 mW
ILD74	400 mW
IL7Q4	500 mW
Derate Linearly from 25°C	
IL74	2.7 mW/°C
ILD74	5.33 mW/°C
ILQ74	6.67 mW/°C
Creepage Path	
IL74	8 mm min.
ILD/Q74	7 mm min.
Clearance Path	7 mm min.
Storage Temperature	-55°C to +150°C
Operating Temperature	-55°C to +100°C
Lead Soldering Time at 260°C	10 sec.

Electrical Characteristics (T_A=25°C)

	Symbol	Min.	Typ.	Max.	Unit	Condition
Emitter						
Forward Voltage	V _F		1.3	1.5	V	I _F =20 mA
Reverse Current	I _R		0.1	100	μA	V _R =3.0 V
Capacitance	C _O		25		pF	V _R =0
Detector						
Collector-Emitter Breakdown Voltage	BV _{CEO}	20	50		V	I _C =1 mA
Collector-Emitter Leakage Current	I _{CEO}		5.0	500	nA	V _{CE} =5 V, I _F =0
Collector-Emitter Capacitance	C _{CE}		10.0		pF	f=1 MHz
Package						
DC Current Transfer Ratio	CTR _{DC}	12.5	35		%	I _F =16 mA, V _{CE} =5 V
Collector-Emitter Saturation Voltage	V _{CEsat}		0.3	0.5	V	I _C =2 mA, I _F =16 mA,
Resistance, Input to Output	R _{IO}		100		GΩ	
Capacitance, Input to Output	C _{IO}		0.5		pF	
Switching Times	t _{ON} , t _{OFF}		3.0		μs	R _E =100 Ω, V _{CE} =10 V, I _C =2 mA

Figure 1. Forward voltage versus forward current

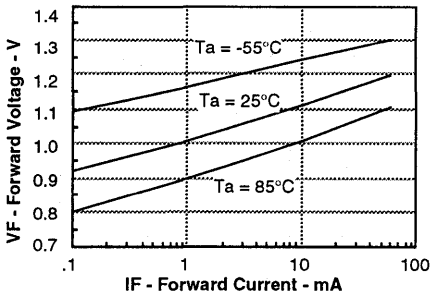

Figure 2. Normalized non-saturated and saturated CTR at $T_A=25^\circ\text{C}$ versus LED current

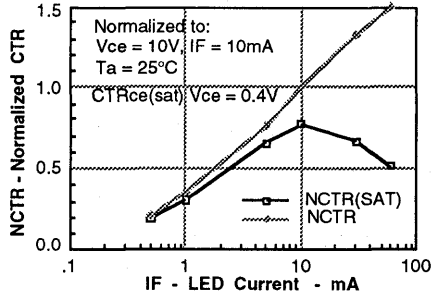

Figure 3. Normalized non-saturated and saturated CTR at $T_A=50^\circ\text{C}$ versus LED current

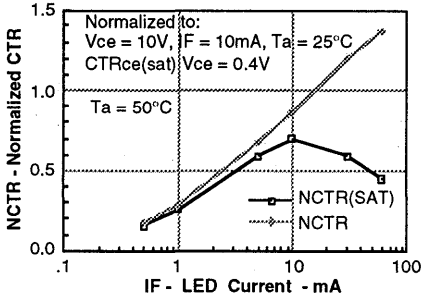

Figure 4. Normalized non-saturated and saturated CTR at $T_A=70^\circ\text{C}$ versus LED current

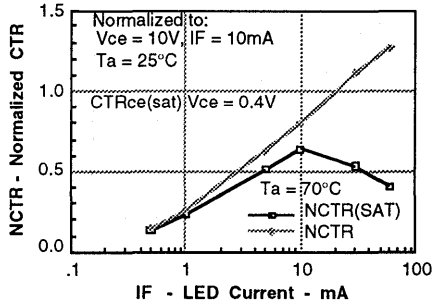

Figure 5. Normalized non-saturated and saturated CTR at $T_A=85^\circ\text{C}$ versus LED current

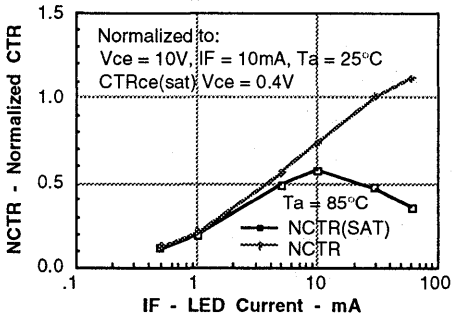

Figure 6. Collector-emitter current versus temperature and LED current

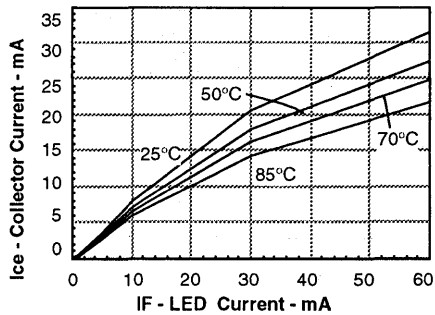

Figure 7. Collector-emitter leakage current versus temperature

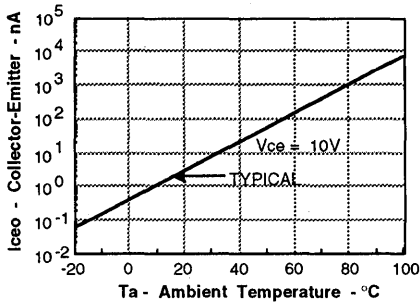

Figure 9. Collector base photocurrent versus LED current

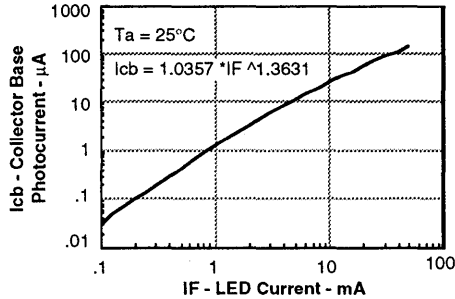

Figure 11. Normalized non-saturated HFE versus base current and temperature

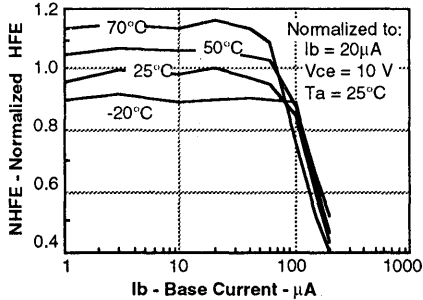

Figure 8. Normalized CTRcb versus LED current and temperature

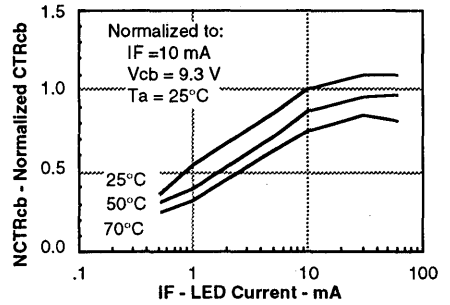

Figure 10. Normalized photocurrent versus I_f and temperature

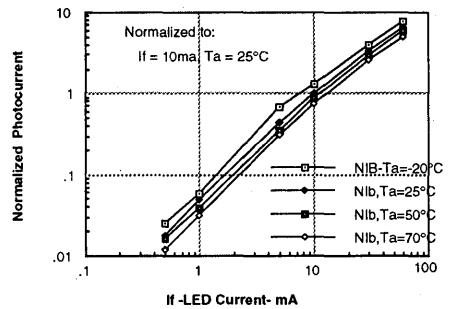

Figure 12. Normalized saturated HFE versus base current and temperature

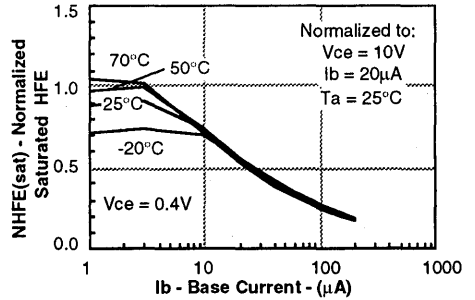

Figure 13. Propagation delay versus collector load resistor

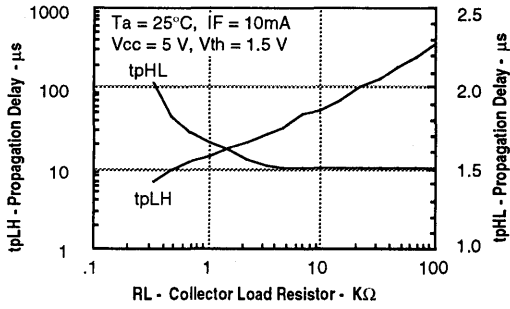
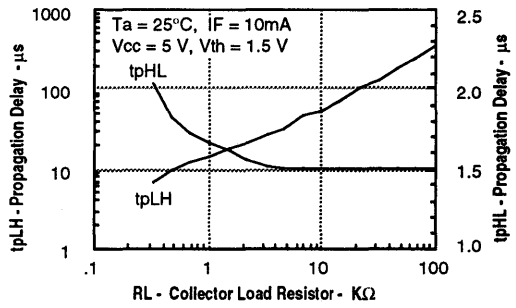



Figure 14. Propagation delay versus collector load resistor



FEATURES

- High Current Transfer Ratio, 75% to 450%
- Minimum Current Transfer Ratio, 10%
Guaranteed @ $I_F = 1\text{mA}$
- High Collector-Emitter Voltage, $BV_{CEO} = 70\text{V}$
- Long Term Stability
- Industry Standard DIP Package
- Underwriters Lab File #E52744
-  VDE Approvals #0884 (Optional with Option 1, Add -X001 Suffix)

DESCRIPTION

The IL201/202/203 are optically coupled pairs employing a Gallium Arsenide infrared LED and a Silicon NPN phototransistor. Signal information, including a DC level, can be transmitted by the device while maintaining a high degree of electrical isolation between input and output. The IL201/202/203 can be used to replace relays and transformers in many digital interface applications, as well as analog applications such as CRT modulation.

Maximum Ratings

Emitter

Peak Reverse Voltage	6V
Continuous Forward Current	60mA
Power Dissipation at 25°C	100mW
Derate Linearly from 25°C	1.33 mW/°C

Detector

Collector-Emitter Breakdown Voltage, BV_{CEO}	70V
Emitter-Collector Breakdown Voltage, BV_{ECO}	7V
Collector-Base Breakdown Voltage, BV_{CBO}	70V
Power Dissipation	200mW
Derate Linearly from 25°C	2.6mW/°C

Package

Isolation Test Voltage	3750 VAC/5300VDC
UL Qualified for	7500VDC
Total Package Dissipation at 25°C A (LED + Detector)	250mW
Derate Linearly from 25°C	3.3mW/°C
Creepage Path	8min mm
Clearance Path	7min mm
Storage Temperature	-55°C to +150°C
Operating Temperature	-55°C to +100°C
Lead Soldering Time at 260°C	10 sec.

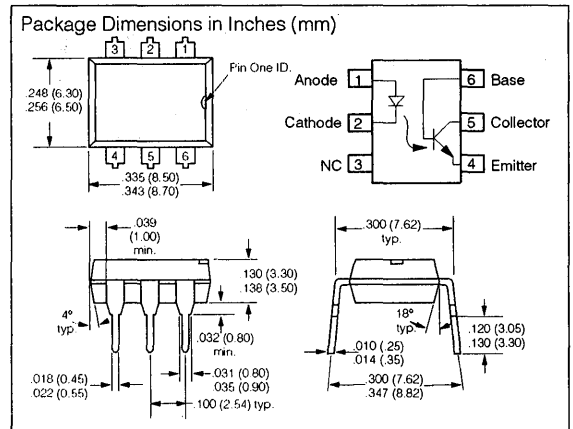

Characteristics (0°C to 70°C unless otherwise specified)

	Symbol	Min.	Typ.	Max.	Unit
Emitter					
Forward Voltage	V_F		1.2	1.5	V $I_F=20\text{mA}$
Forward Voltage	V_F		1.0	1.2	V $I_F=1\text{mA}$
Breakdown Voltage	V_R	6	20		V $I_R=10\mu\text{A}$
Reverse Current	I_R		0.1	10	μA $V_R=6\text{V}$ $T_A=25^\circ\text{C}$
Detector					
	HFE	100	200		$V_{CE}=5\text{V}$ $I_C=100\mu\text{A}$
	BV_{CEO}	70			V $I_C=100\mu\text{A}$
	BV_{ECO}	7	10		V $I_E=100\mu\text{A}$
	BV_{CBO}	70	90		V $I_C=10\mu\text{A}$
	I_{CEO}		5	50	nA $V_{CE}=10\text{V}$ $T_A=25^\circ\text{C}$
Package					
Base Current					$I_F=10\text{mA}$
Transfer Ratio	BCTR	0.15			$V_{CB}=10\text{V}$
	V_{CEsat}			0.4	V $I_F=10\text{mA}$ $I_C=2\text{mA}$
DC Current Transfer Ratio					
IL201	CTR	75	100	150	% $I_F=10\text{mA}$
IL202	CTR	125	200	250	% $V_{CE}=10\text{V}$
IL203	CTR	225	300	450	%
DC Current Transfer Ratio					
IL201	CTR	10			% $I_F=1\text{mA}$
IL202	CTR	30			% $V_{CE}=10\text{V}$
IL203	CTR	50			%

Figure 1. Forward voltage versus forward current

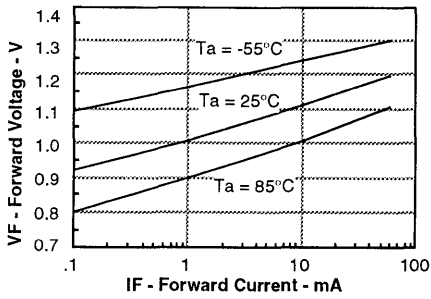

Figure 2. Normalized non-saturated and saturated CTR at Ta = 25°C versus LED current

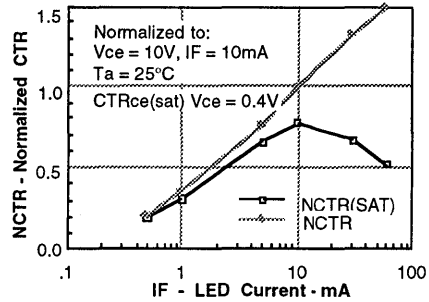

Figure 3. Normalized non-saturated and saturated CTR at Ta = 50°C versus LED current

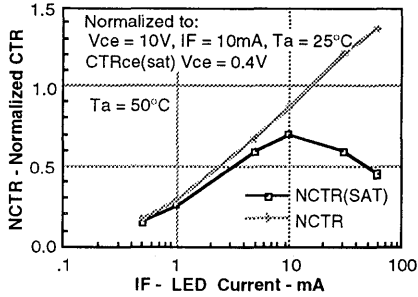

Figure 4. Normalized non-saturated and saturated CTR at Ta = 70°C versus LED current

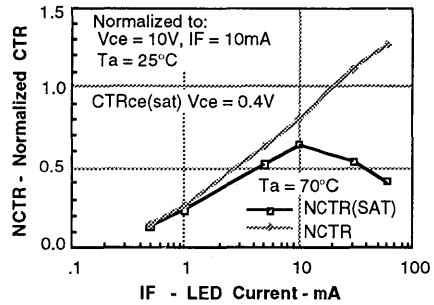

Figure 5. Normalized non-saturated and saturated CTR at Ta = 85°C versus LED current

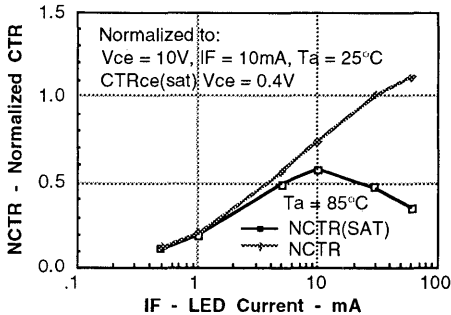

Figure 6. Collector-emitter current versus temperature and LED current

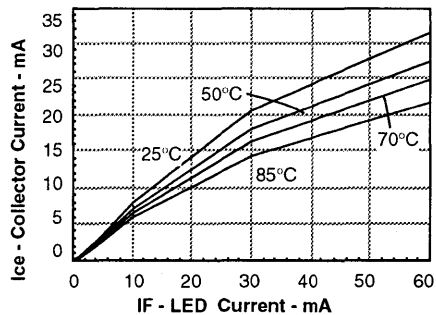

Figure 7. Collector-emitter leakage current versus temperature

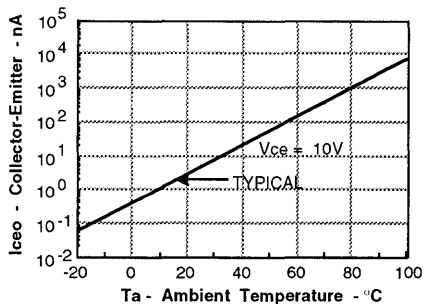

Figure 8. Normalized CTRcb versus LED current and temperature

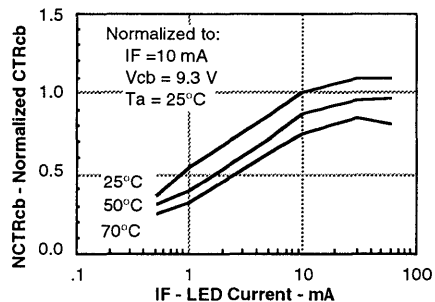

Figure 9. Collector base photocurrent versus LED current

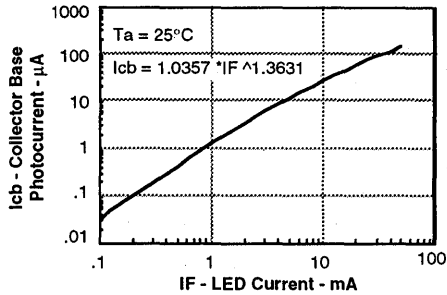

Figure 10. Normalized photocurrent versus If and temperature

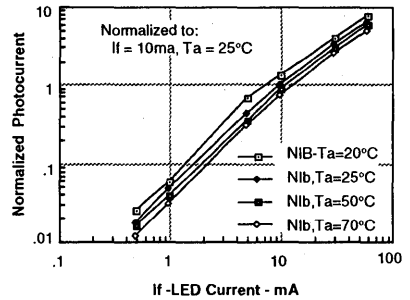

Figure 11. Normalized saturated HFE versus base current and temperature

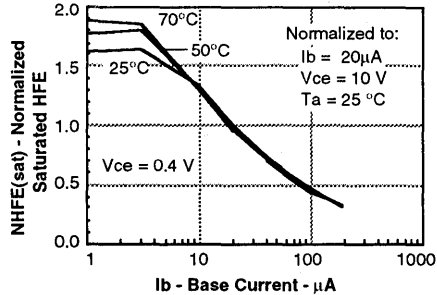

Figure 12. Propagation delay versus collector load resistor

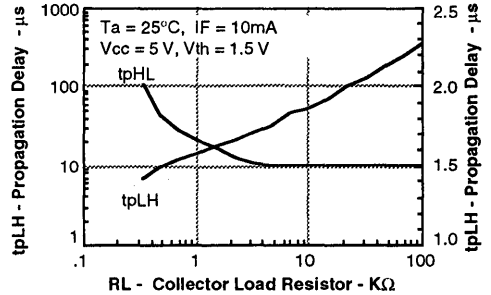

Figure 13. Normalized non-saturated and saturated CTRce versus LED current

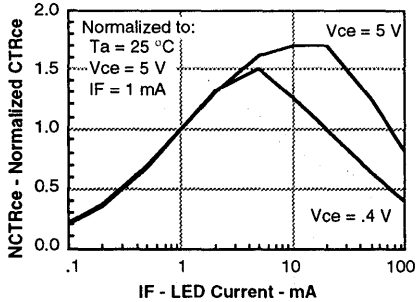
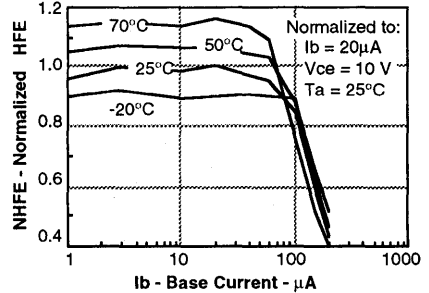

Figure 14. Normalized non-saturated HFE versus base current and temperature



FEATURES

- High Current Transfer Ratios, $I_F=10\text{mA}$, $V_{CE}=5\text{V}$
IL205, 40 – 80%
IL206, 63 – 125%
IL207, 100 – 200%
IL208, 160 – 320%
- High BV_{CEO} , 70 V
- Isolation Voltage, 2500 VRMS
- Industry Standard SOIC-8 Surface Mountable Package
- Standard Lead Spacing, .05"
- Available in Tape and Reel Option—Suffix "T" (Conforms to EIA Standard RS481A)
- Compatible with Dual Wave, Vapor Phase and IR Reflow Soldering
- Underwriters Lab File #E52744 (Code Letter P)

DESCRIPTION

The IL205/206/207/208 are optically coupled pairs with a Gallium Arsenide infrared LED and a silicon NPN phototransistor. Signal information, including a DC level, can be transmitted by the device while maintaining a high degree of electrical isolation between input and output. The IL205/6/7/8 come in a standard SOIC-8 small outline package for surface mounting which makes them ideally suited for high density applications with limited space. In addition to eliminating through-holes requirements, this package conforms to standards for surface mounted devices.

A specified minimum and maximum CTR allows a narrow tolerance in the electrical design of the adjacent circuits. The high BV_{CEO} of 70 volts gives a higher safety margin compared to the industry standard 30 volts.

Maximum Ratings

Emitter	
Peak Reverse Voltage	6.0 V
Continuous Forward Current	60 mA
Power Dissipation at 25°C	90 mW
Derate Linearly from 25°C	1.2 mW/°C
Detector	
Collector-Emitter Breakdown Voltage	70 V
Emitter-Collector Breakdown Voltage	7 V
Collector-Base Breakdown Voltage	70 V
Power Dissipation	150 mW
Derate Linearly from 25°C	2.0 mW/°C
Package	
Total Package Dissipation at 25°C Ambient (LED + Detector)	240 mW
Derate Linearly from 25°C	3.3 mW/°C
Storage Temperature	-55°C to +150°C
Operating Temperature	-55°C to +100°C
Soldering Time at 260°C	10 sec.

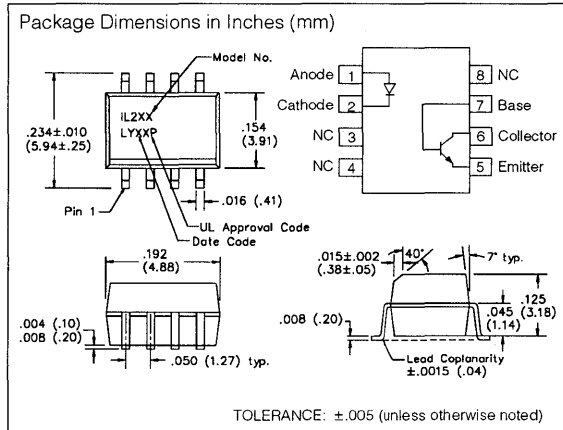

Characteristics ($T_A=25^\circ\text{C}$)

	Symbol	Min.	Typ.	Max.	Unit	Condition
Emitter						
Forward Voltage	V_F	1.3	1.5		V	$I_F=10\text{ mA}$
Reverse Current	I_R	0.1	100		μA	$V_R=6.0\text{ V}$
Capacitance	C_O	25			pF	$V_R=0$
Detector						
Breakdown Voltage						
Collector-Emitter	BV_{CEO}	70			V	$I_C=100\ \mu\text{A}$
Emitter-Collector	BV_{ECO}	7	10		V	$I_E=100\ \mu\text{A}$
Collector-Emitter						$V_{CE}=10\text{ V}$
Dark Current	$I_{CEODark}$	5	50		nA	$I_F=0$
Collector-Emitter						$V_{CE}=0$
Capacitance	C_{CE}	10			pF	
Package						
DC Current Transfer	CTR_{DC}				%	$I_F=10\text{ mA}$, $V_{CE}=5\text{ V}$
		40		80		
		63		125		
		100		200		
		160		320		
DC Current Transfer	CTR_{DC}				%	$I_F=1\text{ mA}$, $V_{CE}=5\text{ V}$
		13	25			
		22	40			
		34	60			
		56	95			
Collector-Emitter						$I_C=2.0\text{ mA}$, $I_F=10\text{ mA}$
Saturation Voltage	V_{CEsat}		0.4		V	$t=1\text{ min.}$
Withstand Test Voltage	WTV	2500			VAC _{RMS}	
Equivalent DC			3535		VDC	
Isolation Voltage						
Capacitance,						
Input to Output	C_{IO}	0.5			pF	
Resistance,						
Input to Output	R_{IO}	100			$\text{G}\Omega$	
Switching Time	t_{ON}, t_{OFF}	3.0			μs	$I_C=2\text{ mA}$, $I_F=100\text{ mA}$, $V_{CE}=10\text{ V}$

See Application Note 39 for solderability information.

Figure 1. Forward voltage versus forward current

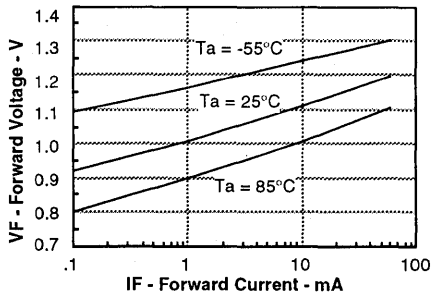

Figure 2. Normalized non-saturated and saturated CTRce versus LED current

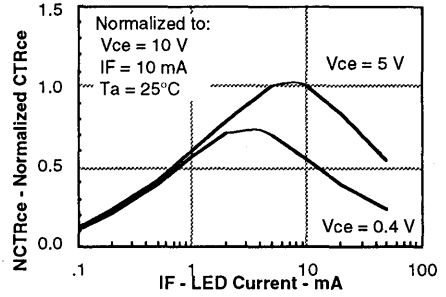

Figure 3. Collector-emitter current versus LED current

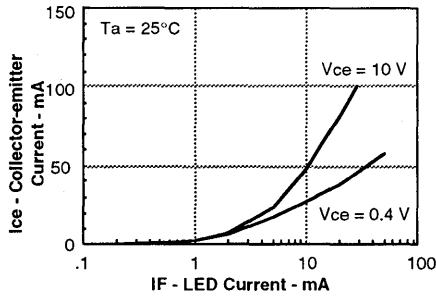

Figure 4. Normalized collector-base photocurrent versus LED current

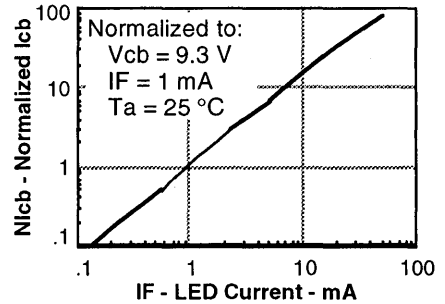

Figure 5. Normalized collector-base photocurrent versus LED current

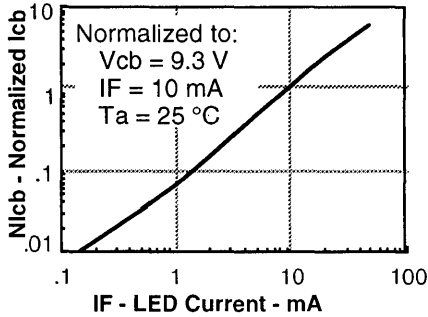

Figure 6. Collector-base photocurrent versus LED current

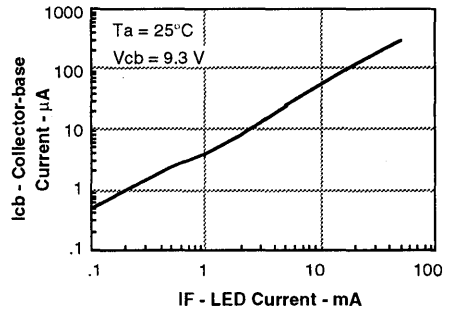

Figure 7. Collector-emitter leakage current versus temperature

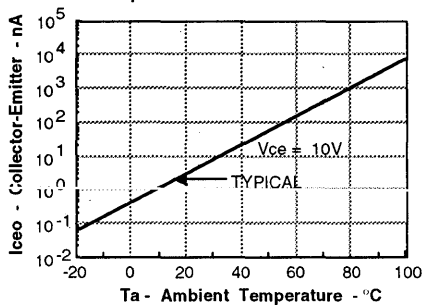
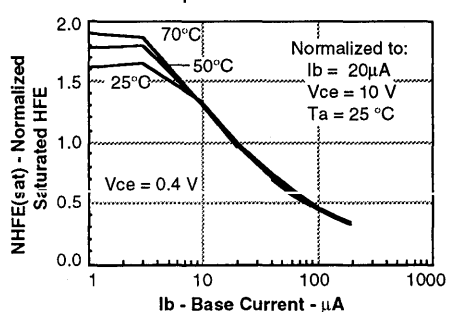

Figure 8. Normalized saturated HFE versus base current and temperature



IL211/212/213 PHOTOTRANSISTOR SMALL OUTLINE SURFACE MOUNT OPTOCOUPLER

FEATURES

- High Current Transfer Ratios
IL211, 20% Minimum
IL212, 50% Minimum
IL213, 100% Minimum
- Isolation Voltage, 2500 VRMS
- Electrical Specifications Similar to Standard 6 Pin Coupler
- Industry Standard SOIC-8 Surface Mountable Package
- Standard Lead Spacing, .05"
- Available in Tape and Reel Option (Conforms to EIA Standard RS481A)
- Compatible with Dual Wave, Vapor Phase and IR Reflow Soldering
- Underwriters Lab File #E52744 (Code Letter P)

DESCRIPTION

The IL211/212/213 are optically coupled pairs with a Gallium Arsenide infrared LED and a silicon NPN phototransistor. Signal information, including a DC level, can be transmitted by the device while maintaining a high degree of electrical isolation between input and output. The IL211/212/213 come in a standard SOIC-8 small outline package for surface mounting which makes it ideally suited for high density applications with limited space. In addition to eliminating through-holes requirements, this package conforms to standards for surface mounted devices.

A choice of 20, 50, and 100% minimum CTR (IL211/212/213, respectively) at $I_F=10$ mA makes these optocouplers suitable for a variety of different applications.

Maximum Ratings

Emitter

Peak Reverse Voltage	6.0 V
Continuous Forward Current	60 mA
Power Dissipation at 25°C	90 mW
Derate Linearly from 25°C	1.2 mW/°C

Detector

Collector-Emitter Breakdown Voltage	30 V
Emitter-Collector Breakdown Voltage	7 V
Collector-Base Breakdown Voltage	70 V
Power Dissipation	150 mW
Derate Linearly from 25°C	2.0 mW/°C

Package

Total Package Dissipation at 25°C Ambient (LED + Detector)	280 mW
Derate Linearly from 25°C	3.3 mW/°C
Storage Temperature	-55°C to +150°C
Operating Temperature	-55°C to +100°C
Soldering Time at 260°C	10 sec.

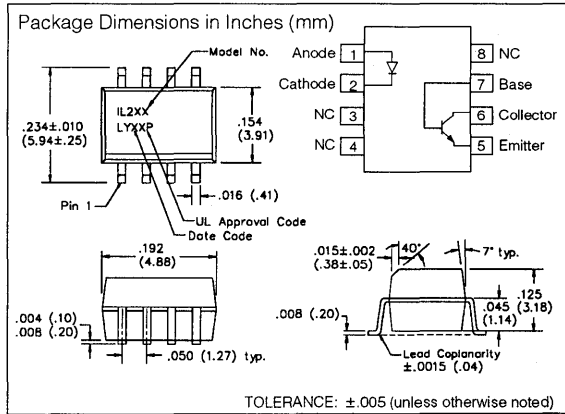

Characteristics ($T_A=25^\circ\text{C}$)

	Symbol	Min.	Typ.	Max.	Unit	Condition
Emitter						
Forward Voltage	V_F	1.3	1.5		V	$I_F=10$ mA
Reverse Current	I_R	0.1	100		mA	$V_R=6.0$ V
Capacitance	C_O	25			pF	$V_R=0$
Detector						
Breakdown Voltage						
Collector-Emitter	BV_{CEO}	30	90		V	$I_C=10$ mA
Emitter-Collector	BV_{ECO}	7	10		V	$I_E=10$ mA
Collector-Emitter						$V_{CE}=10$ V,
Dark Current	$I_{CEO\text{dark}}$	5	50		nA	$I_F=0$
Collector-Emitter						
Capacitance	C_{CE}	10			pF	$V_{CE}=0$
Package						
DC Current Transfer	CTR_{DC}				%	$I_F=10$ mA,
IL211		20	50			$V_{CE}=5$ V
IL212		50	80			
IL213		100	130			
Collector-Emitter						$I_C=2.0$ mA,
Saturation Voltage	$V_{CE\text{sat}}$		0.4			$I_F=10$ mA
Withstand Test						
Voltage	WTV	2500			VAC _{RMS}	$t=1$ min.
Equivalent DC						
Isolation Voltage		3535			VDC	
Capacitance,						
Input to Output	C_{IO}	0.5			pF	
Resistance,						
Input to Output	R_{IO}	100			GW	
Switching Time						
	t_{ON}, t_{OFF}	3.0			ms	$I_C=2$ mA,
						$R_E=100$ W,
						$V_{CE}=10$ V

See Application Note 39 for solderability information.

Figure 1. Forward voltage versus forward current

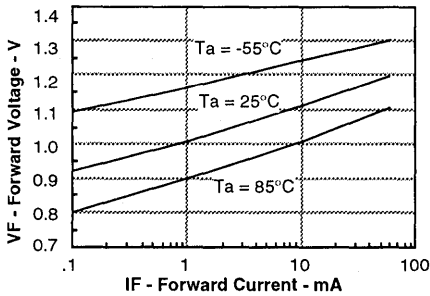

Figure 3. Collector-emitter current versus LED current

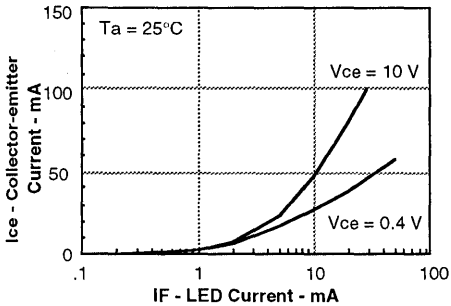

Figure 5. Normalized collector-base photocurrent versus LED current

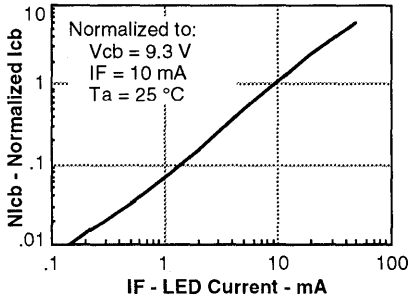

Figure 7. Collector-emitter leakage current versus temperature

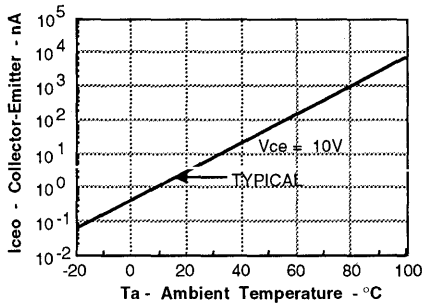

Figure 2. Normalized non-saturated and saturated CTRce versus LED current

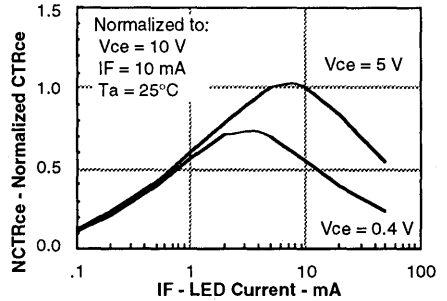

Figure 4. Normalized collector-base photocurrent versus LED current

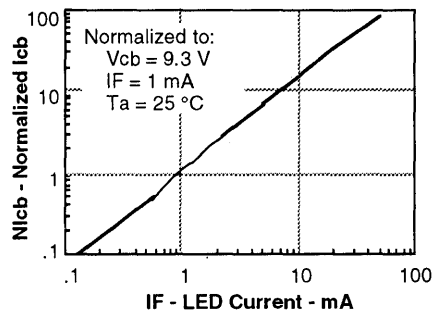

Figure 6. Collector-base photocurrent versus LED current

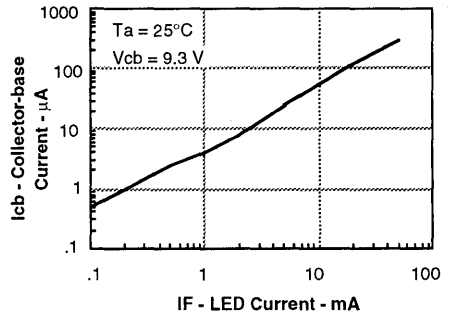
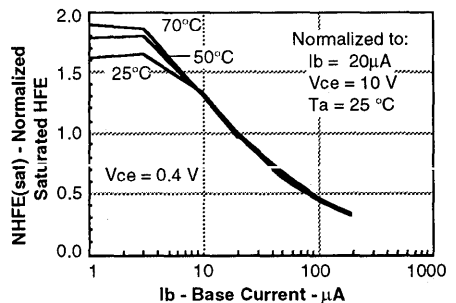

Figure 8. Normalized saturated HFE versus base current and temperature



IL215/216/217 PHOTOTRANSISTOR SMALL OUTLINE SURFACE MOUNT OPTOCOUPLER

FEATURES

- High Current Transfer Ratios, $I_F=1$ mA
IL215, 20% Minimum
IL216, 50% Minimum
IL217, 100% Minimum
- Isolation Voltage, 2500 VRMS
- Electrical Specifications Similar to Standard 6 Pin Coupler
- Industry Standard SOIC-8 Surface Mountable Package
- Standard Lead Spacing, .05"
- Available in Tape and Reel Option (Conforms to EIA Standard RS481A)
- Compatible with Dual Wave, Vapor Phase and IR Reflow Soldering
- Underwriters Lab File #E52744 (Code Letter P)

DESCRIPTION

The IL215/216/217 are optically coupled pairs with a Gallium Arsenide infrared LED and a silicon NPN phototransistor. Signal information, including a DC level, can be transmitted by the device while maintaining a high degree of electrical isolation between input and output. The IL215/216/217 come in a standard SOIC-8 small outline package for surface mounting which makes it ideally suited for high density applications with limited space. In addition to eliminating through-holes requirements, this package conforms to standards for surface mounted devices.

The high CTR at low input current is designed for low power consumption requirements such as CMOS microprocessor interfaces.

Maximum Ratings

Emitter

Peak Reverse Voltage	6.0 V
Continuous Forward Current	60 mA
Power Dissipation at 25°C	90 mW
Derate Linearly from 25°C	1.2 mW/°C

Detector

Collector-Emitter Breakdown Voltage	30 V
Emitter-Collector Breakdown Voltage	7 V
Collector-Base Breakdown Voltage	70 V
Power Dissipation	150 mW
Derate Linearly from 25°C	2.0 mW/°C

Package

Total Package Dissipation at 25°C Ambient (LED + Detector)	280 mW
Derate Linearly from 25°C	3.3 mW/°C
Storage Temperature	-55°C to +150°C
Operating Temperature	-55°C to +100°C
Soldering Time at 260°C	10 sec.

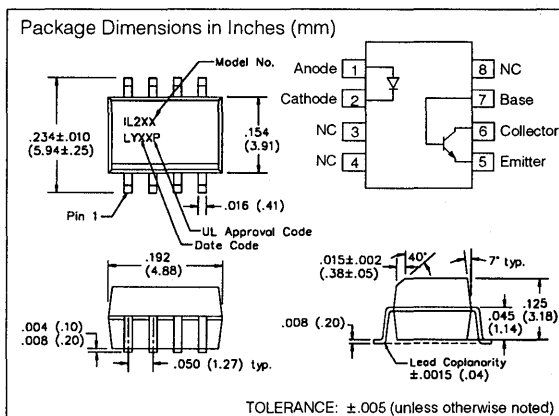

Characteristics ($T_A=25^\circ\text{C}$)

	Symbol	Min.	Typ.	Max.	Unit	Condition
Emitter						
Forward Voltage	V_F		1.3	1.5	V	$I_F=1$ mA
Reverse Current	I_R		0.1	100	μA	$V_R=6.0$ V $V_R=0$
Capacitance	C_O		25		pF	$V_R=0$
Detector						
Breakdown Voltage						
Collector-Emitter	BV_{CEO}	30			V	$I_C=10$ μA
Emitter-Collector	BV_{ECO}	7			V	$I_E=10$ μA $V_{CE}=10$ V, $I_F=0$
Collector-Emitter Dark Current	$I_{CE0\text{dark}}$	5	50		nA	$I_F=0$
Collector-Emitter Capacitance	C_{CE}	10			pF	$V_{CE}=0$
Package						
DC Current Transfer						
IL215	CTR_{DC}	20	50		%	$I_F=1$ mA, $V_{CE}=5$ V
IL216		50	80			
IL217		100	130			
Collector-Emitter Saturation Voltage	$V_{CE\text{sat}}$			0.4	V	$I_C=0.1$ mA, $I_F=1$ mA
Withstand Test						
Voltage	WTV	2500			VAC _{RMS}	$t=1$ min.
Equivalent DC Isolation Voltage		3535			VDC	
Capacitance, Input to Output						
Resistance, Input to Output	C_{IO}	0.5			pF	
Resistance, Input to Output	R_{IO}	100			G Ω	
Switching Time	t_{ON}, t_{OFF}	3.0			μs	$I_C=2$ mA, $R_E=100$ Ω , $V_{CE}=10$ V

See Application Note 39 for solderability information.

Figure 1. Forward voltage versus forward current

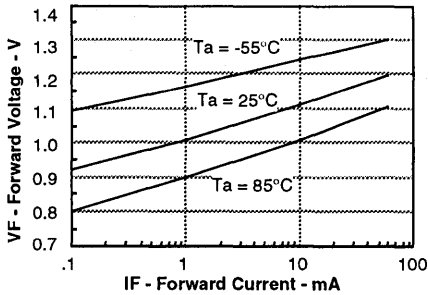

Figure 3. Collector-emitter current versus LED current

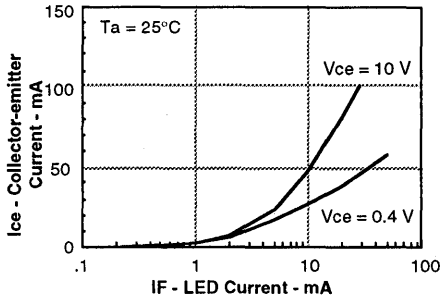

Figure 5. Collector-base photocurrent versus LED current

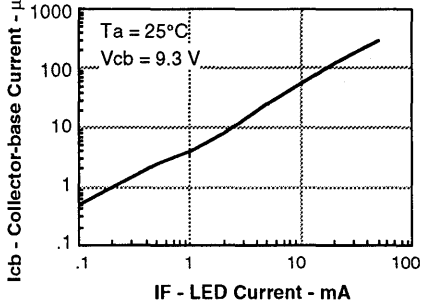

Figure 7. Normalized saturated HFE versus base current and temperature

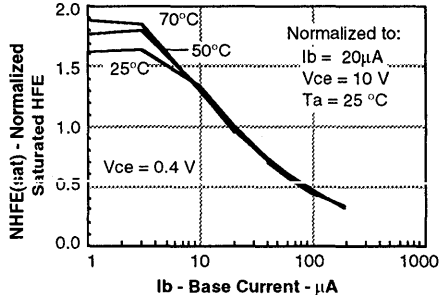

Figure 2. Normalized non-saturated and saturated CTR_{CE} versus LED current

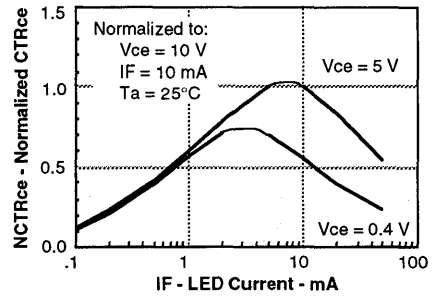

Figure 4. Normalized collector-base photocurrent versus LED current

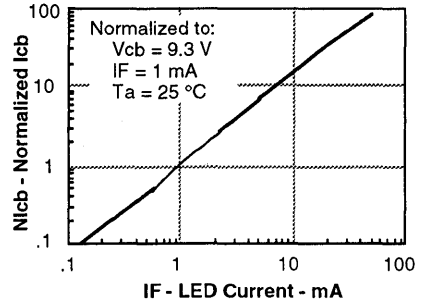

Figure 6. Collector-emitter leakage current versus temperature

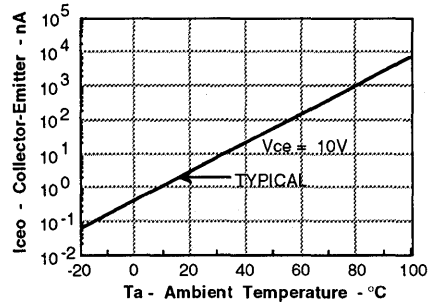

Figure 8. Normalized non-saturated and saturated CTR_{CE} versus LED current

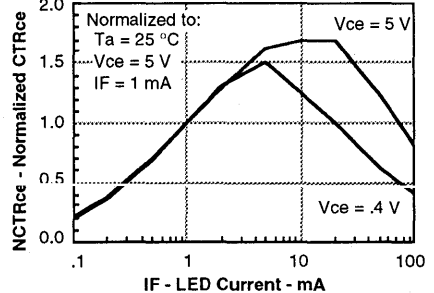

Figure 9. Normalized non-saturated and saturated collector-emitter current versus LED current

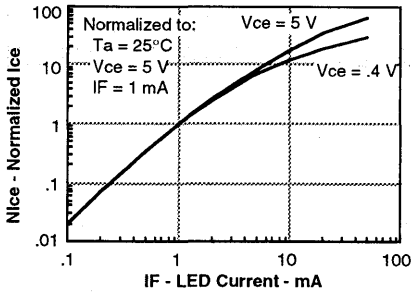

Figure 10. Normalized collector-base photocurrent versus LED current

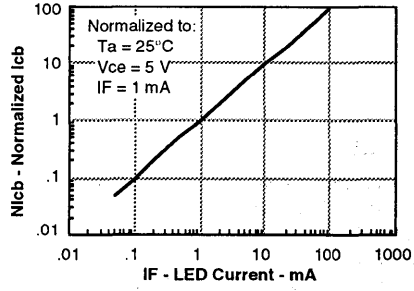

Figure 11. Collector-base photocurrent versus LED current

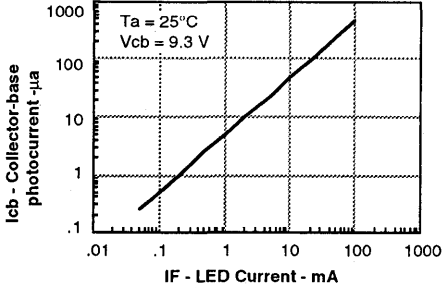

Figure 12. High to low propagation delay versus LED current and load resistor

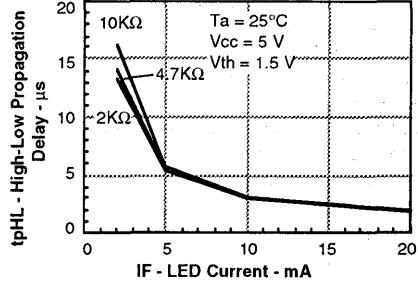

Figure 13. Low to high propagation delay versus LED current and load resistor

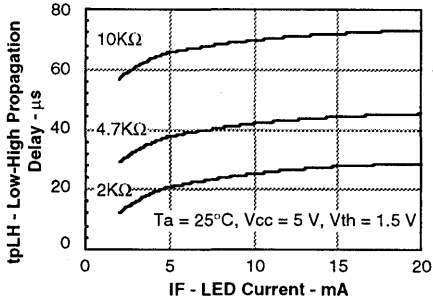
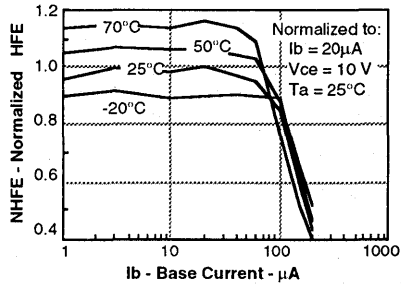

Figure 14. Normalized non-saturated HFE versus base current and temperature



IL221/222/223 PHOTODARLINGTON SMALL OUTLINE SURFACE MOUNT OPTOCOUPLER

FEATURES

- High Current Transfer Ratios, $I_F=1$ mA,
IL221, 100% Minimum
IL222, 200% Minimum
IL223, 500% Minimum
- Withstand Test Voltage, 2500 VRMS
- Electrical Specifications Similar to
Standard 6 Pin Coupler
- Industry Standard SOIC-8 Surface
Mountable Package
- Standard Lead Spacing, .05"
- Available in Tape and Reel Option
(Conforms to EIA Standard RS481A)
- Compatible with Dual Wave, Vapor Phase
and IR Reflow Soldering
- Underwriters Lab File #E52744
(Code Letter P)

DESCRIPTION

The IL221/222/223 family of devices are high current transfer ratio (CTR) optocouplers. They have a Gallium Arsenide infrared LED emitter and a silicon NPN photodarlington transistor detector.

These devices are offered with CTRs tested at an LED current of 1 mA. This low drive current permits easy interfacing from CMOS to LSTTL or TTL.

These optocouplers are constructed in a standard SOIC-8 foot print which makes them ideally suited for high density applications. In addition to eliminating through-holes requirements, this package conforms to standards for surface mounted devices.

Maximum Ratings

Emitter

Peak Reverse Voltage	6.0 V
Continuous Forward Current	.60 mA
Power Dissipation at 25°C	90 mW
Derate Linearly from 25°C	1.2 mW/°C

Detector

Collector-Emitter Breakdown Voltage	30 V
Emitter-Collector Breakdown Voltage	5 V
Collector-Base Breakdown Voltage	70 V
Power Dissipation	150 mW
Derate Linearly from 25°C	2.0 mW/°C

Package

Total Package Dissipation at 25°C Ambient (LED + Detector)	240 mW
Derate Linearly from 25°C	3.3 mW/°C
Storage Temperature	-55°C to +150°C
Operating Temperature	-55°C to +100°C
Soldering Time at 260°C	10 sec.

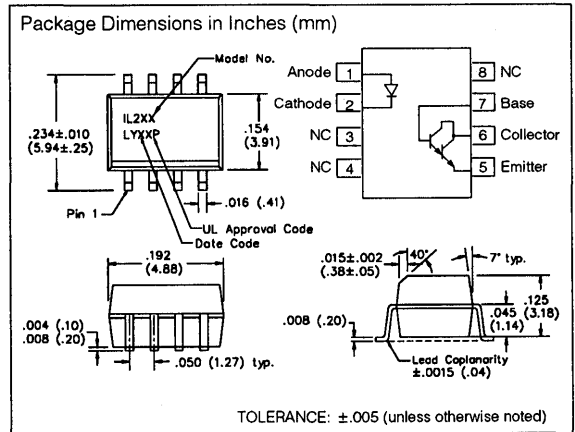

Characteristics ($T_A=25^\circ\text{C}$)

	Symbol	Min.	Typ.	Max.	Unit	Condition
Emitter						
Forward Voltage	V_F		1.3	1.5	V	$I_F=1$ mA
Reverse Current	I_R		0.1	100	μA	$V_R=6.0$ V
Capacitance	C_O		25		pF	$V_F=0$ V, $F=1$ MHz
Detector						
Breakdown Voltage						
Collector-Emitter	BV_{CEO}	30			V	$I_C=100$ μA
Emitter-Collector	BV_{ECO}	5			V	$I_E=100$ μA
Collector-Base Voltage	BV_{CBO}	70			V	$I_C=10$ μA
Collector-Emitter						
Capacitance	C_{CE}		3.4		pF	$V_{CE}=10$ V
Package						
DC Current Transfer	CTR_{DC}				%	$I_F=1$ mA, $V_{CE}=5$ V
IL221		100				
IL222		200				
IL223		500				
Collector-Emitter						
mA,						$I_{CE}=0.5$
Saturation Voltage	$V_{CE\text{ sat}}$			1	V	$I_F=1$ mA
Withstand Test						
Voltage	V_{WT}	2500			VAC _{RMS}	$t=1$ min.
Capacitance,						
Input to Output	C_{IO}		0.5		pF	
Resistance,						
Input to Output	R_{IO}		100		G Ω	

See Application Note 39 for solderability information.

Figure 1. Forward voltage versus forward current

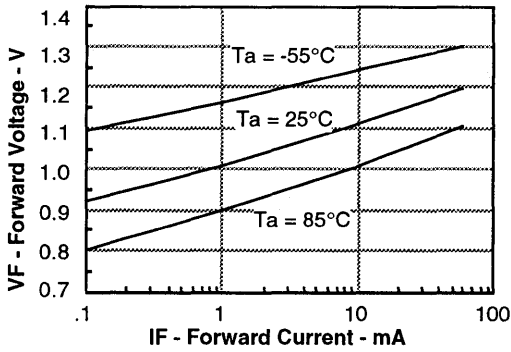

Figure 2. Peak LED current versus duty factor, Tau

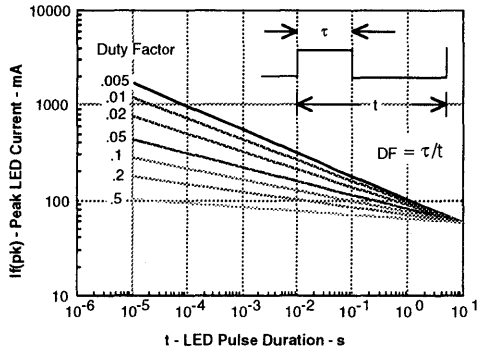

Figure 3. Normalized CTR_{CB} versus I_f

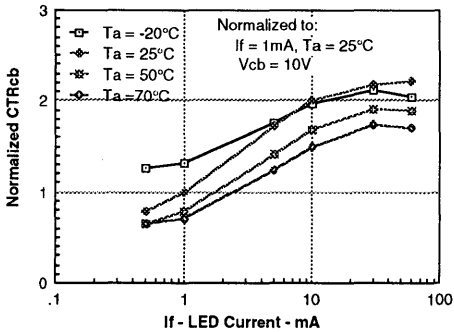

Figure 4. Normalized CTR_{CE} versus LED current

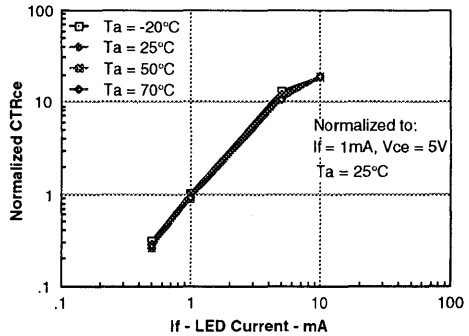

Figure 5. CTR_{CB} versus LED current

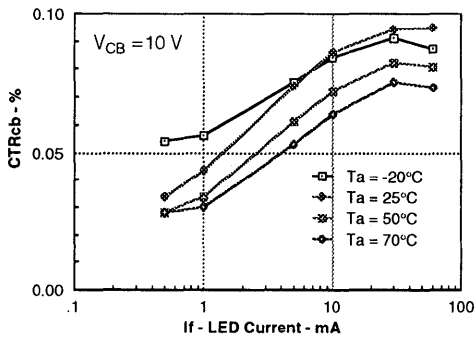

Figure 6. CTR versus LED current

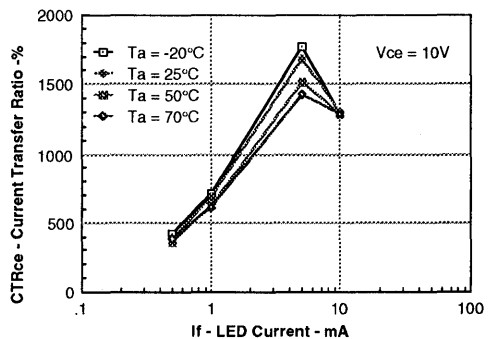

Figure 7. Collector current versus LED current

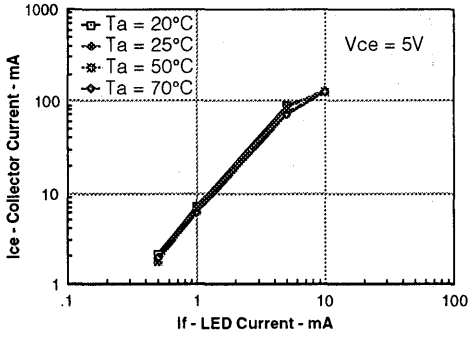

Figure 8. Photocurrent versus LED current

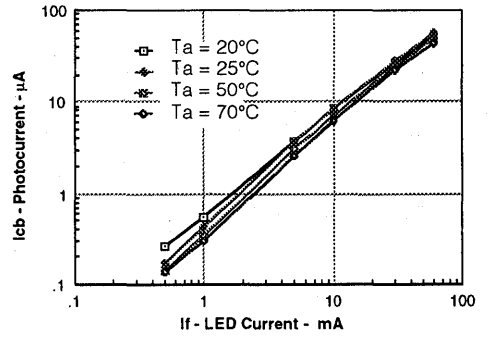
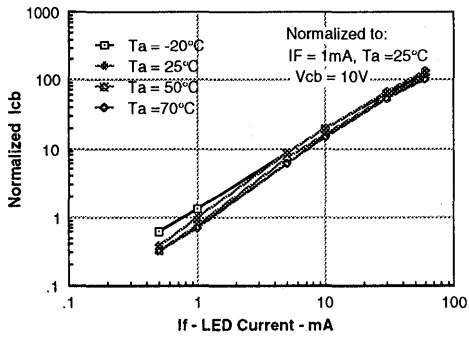



Figure 9. Normalized I_{CB} versus I_f



SINGLE CHANNEL IL250/251/252 DUAL CHANNEL ILD250/251/252 BIDIRECTIONAL INPUT OPTOCOUPLER

FEATURES

- Selected Current Transfer Ratios
20%, 50%, 100% Minimum
- AC or Polarity Insensitive Input
- Built-in Reverse Polarity Input Protection
- Improved CTR Symmetry
- Industry Standard DIP Package
- Underwriters Lab File #E52744
-  VDE Approval #0884 (Optional with Option 1, Add -X001 Suffix)

Maximum Ratings (Each Channel)

Emitter

Continuous Forward Current	60 mA
Power Dissipation at 25°C	100 mW
Derate Linearly from 25°C	1.33 mW/°C

Detector

Collector-Emitter Breakdown Voltage	30 V
Emitter-Base Breakdown Voltage	5 V
Collector-Base Breakdown Voltage	70 V
Power Dissipation at 25°C	
Single Channel	200 mW
Dual Channel	150 mW
Derate Linearly from 25°C	
Single Channel	2.6 mW/°C
Dual Channel	2.0 mW/°C

Package

Withstand Test Voltage	$V_{IO}=5300V_{dc}$
Between Emitter and Detector	
Referred to Standard Climate	
23°C/50%RH, DIN 50014	
Leakage Path	min. 8.2 mm
Air Path	min. 7.3 mm
$V_{IO}=500V$	$R_{IO}=10^{11}\Omega$
Total Dissipation at 25°C	
Single Channel	250 mW
Dual Channel	400 mW
Derate Linearly from 25°C	
Single Channel	3.3 mW/°C
Dual Channel	5.3 mW/°C
Storage Temperature	-55°C to +150°C
Operating Temperature	-55°C to +100°C
Lead Soldering Time at 260°C	10 sec.

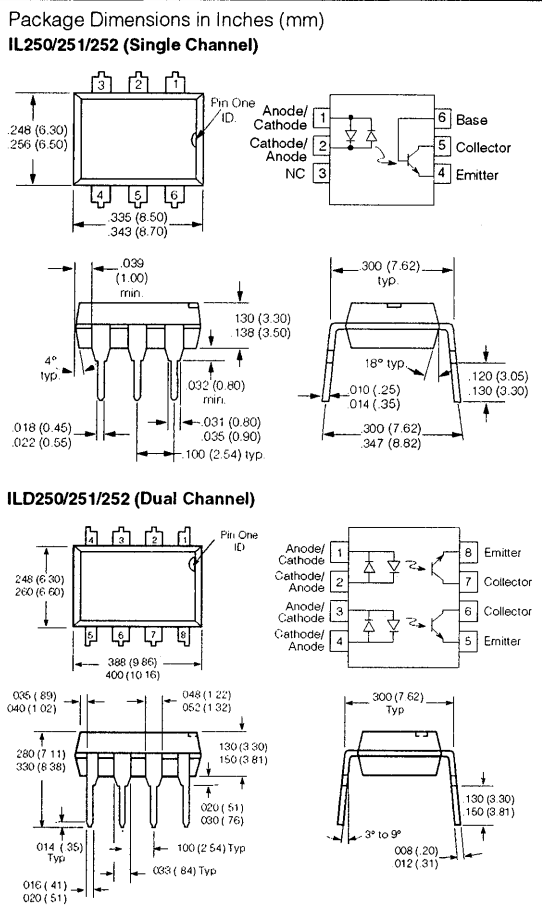

Optocouplers
(Photoisolators)

DESCRIPTION

The IL/ILD250/251/252 are bidirectional input optically coupled isolators consisting of two Gallium Arsenide infrared LEDs coupled to a silicon NPN phototransistor per channel.

The IL/ILD250 has a minimum CTR of 50%, the IL/ILD251 has a minimum CTR of 20%, and the IL/ILD252 has a minimum CTR of 100%.

The IL/IL250/1/2 are single channel optocouplers. The ILD250/1/2 has two isolated channels in a single DIP package.

These optocouplers are ideal for applications requiring AC signal detection and monitoring.

Electrical Characteristics (T_A=25°C)

Parameter	Min.	Typ.	Max.	Unit	Condition
Emitter					
Forward Voltage V _F		1.2	1.5	V	I _F = ±10 mA
Detector					
BV _{CEO}	30	50		V	I _C = 1 mA
BV _{EBO}	7	10		V	I _E = 100 μA
BV _{OBO}	70	90		V	I _C = 10 μA
I _{CEO}		5	50	nA	V _{CE} = 10 V
Package					
V _{CEsat}			0.4	V	I _F = ±16 mA, I _C = 2 mA
DC Current Transfer Ratio				%	I _F = ±10 mA, V _{CE} = 10 V
IL/D250	50				
IL/D251	20				
IL/D252	100				
Symmetry					
CTR @ +10 mA	0.50	1.0	2.0		
CTR @ -10 mA					

Figure 1. LED forward current versus forward voltage

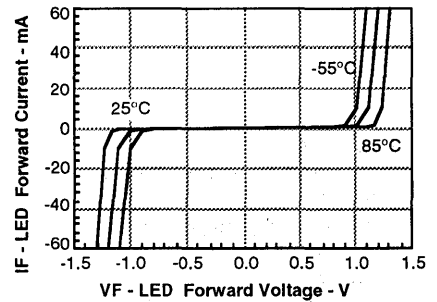

Figure 2. Normalized non-saturated and saturated CTR at T_A = 25°C versus LED current

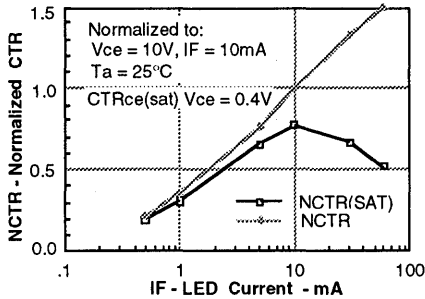

Figure 3. Normalized non-saturated and saturated CTR at T_A = 50°C versus LED current

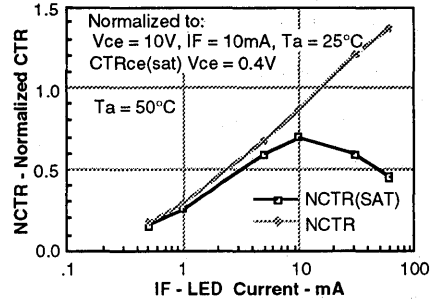

Figure 4. Normalized non-saturated and saturated CTR at T_A = 70°C versus LED current

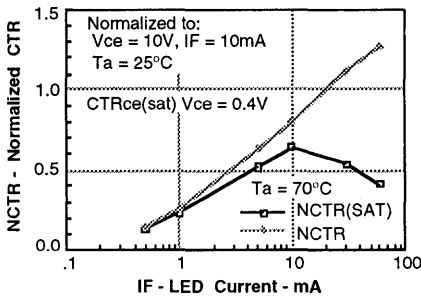

Figure 5. Normalized non-saturated and saturated CTR at T_A = 85°C versus LED current

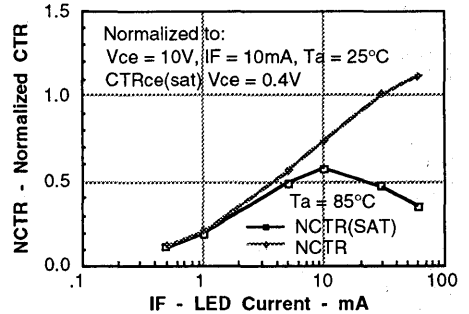

Figure 6. Collector-emitter current versus temperature and LED current

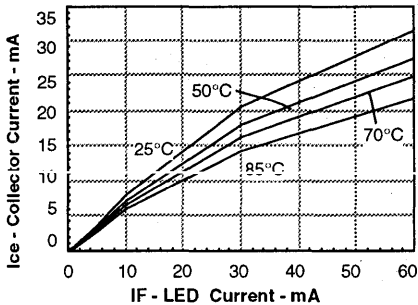

Figure 7. Collector-emitter leakage current versus temperature

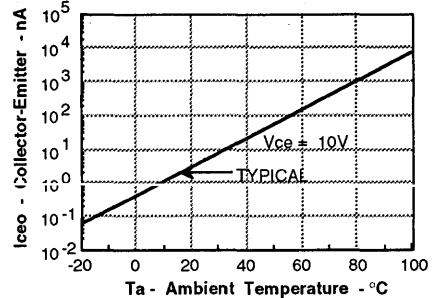

Figure 8. Normalized CTRcb versus LED current and temperature

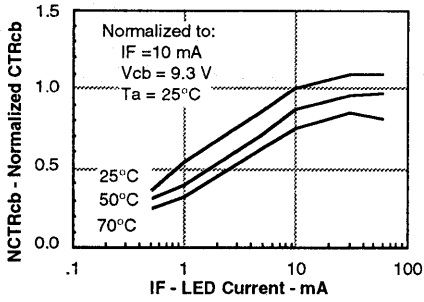

Figure 9. Collector base photocurrent versus LED current

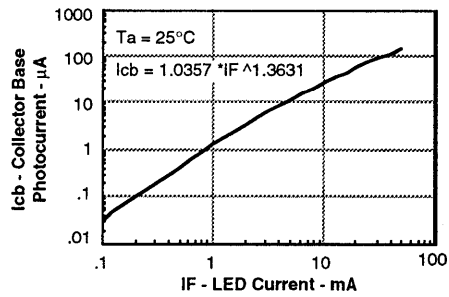

Figure 10. Normalized photocurrent versus If and temperature

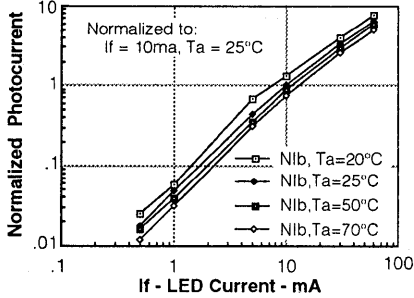

Figure 11. Normalized non-saturated HFE versus base current and temperature

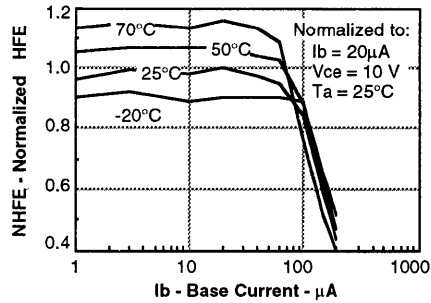

Figure 12. Normalized saturated HFE versus base current and temperature

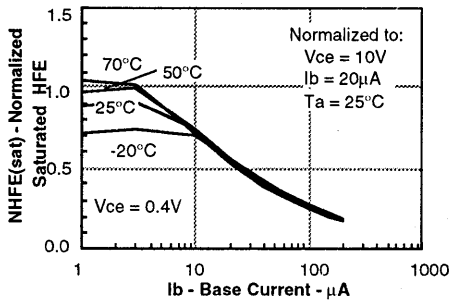

Figure 13. Propagation delay versus collector load resistor

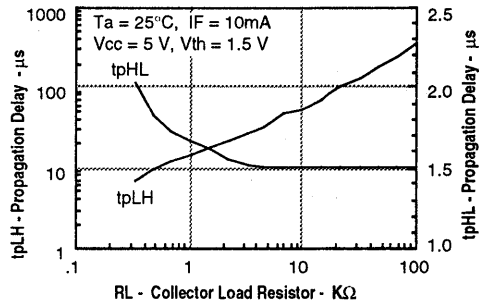

Figure 14. Switching timing

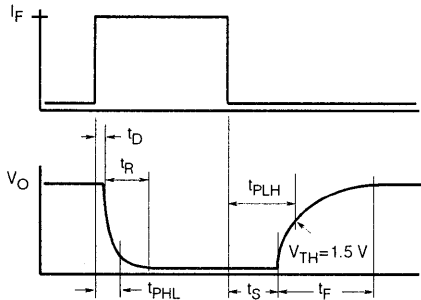
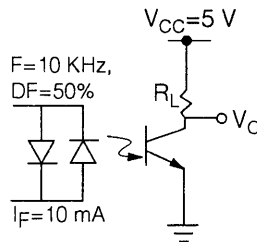

Figure 15. Switching schematic



Optocouplers (Optoisolators)

FEATURES

- Guaranteed CTR Symmetry, 2:1 Maximum
- Bidirectional AC Input
- Industry Standard SOIC-8 Surface Mountable Package
- Standard Lead Spacing, .05"
- Available in Tape and Reel Option (Conforms to EIA Standard RS481A)

DESCRIPTION

The IL256 is an AC input phototransistor optocoupler. The device consists of two infrared emitters connected in anti-parallel and coupled to a silicon NPN phototransistor detector.

These circuit elements are constructed with a standard SOIC-8 foot print. Soldering and assembly with this optocoupler is covered in detail in Appnote 39.

The product is well suited for telecom applications such as ring detection or off/on hook status, given its bidirectional LED input and guaranteed current transfer ratio (CTR) of 20% at $I_F = 10$ mA.

Maximum Ratings

Emitter	
Continuous Forward Current	60 mA
Power Dissipation at 25°C	90 mW
Derate Linearly from 25°C	0.8 mW/°C
Detector	
Collector-Emitter Breakdown Voltage	30 V
Emitter-Collector Breakdown Voltage	5 V
Collector-Base Breakdown Voltage	70 V
Power Dissipation	150 mW
Derate Linearly from 25°C	2.0 mW/°C
Package	
Total Package Dissipation at 25°C Ambient (LED + Detector)	240 mW
Derate Linearly from 25°C	3.1 mW/°C
Storage Temperature	-55°C to +150°C
Operating Temperature	-55°C to +100°C
Soldering Time at 260°C	10 sec.

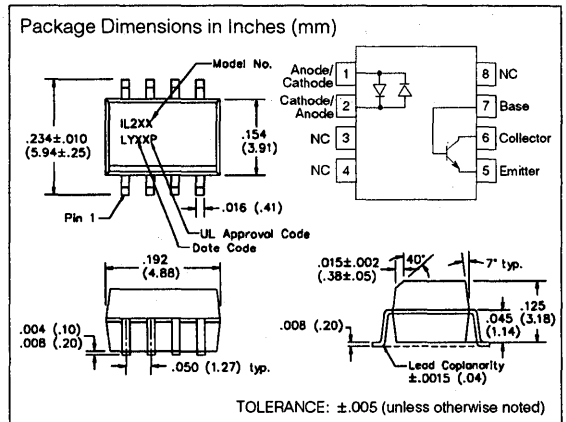

Characteristics ($T_A = 25^\circ\text{C}$)

	Symbol	Min.	Typ.	Max.	Unit	Condition
Emitter						
Forward Voltage	V_F		1.2	1.5	V	$I_F = \pm 10$ mA
Detector						
Breakdown Voltage						
Collector-Emitter	BV_{CEO}	30	50		V	$I_C = 1$ mA
Emitter-Collector	BV_{ECO}	5	10		V	$I_E = 100$ μ A
Collector-Base	BV_{CBO}	70	90		V	$I_C = 100$ μ A
Collector-Emitter						$V_{CE} = 10$ V
Leakage Current	I_{CEO}		5	50	nA	
Package						
DC Current Transfer	CTR	20			%	$I_F = \pm 10$ mA, $V_{CE} = 5$ V
Symmetry						
CTR at +10mA		0.5	1.0	2.0		
CTR at -10 mA						
Collector-Emitter						$I_F = \pm 16$ mA, $I_C = 2$ mA
Saturation Voltage	$V_{CE\text{sat}}$			0.4		
Input to Output						
Withstand Voltage	V_{WIO}	2500				$V_{AC\text{RMS}}$ t=1 min.

Figure 1. LED forward current versus forward voltage

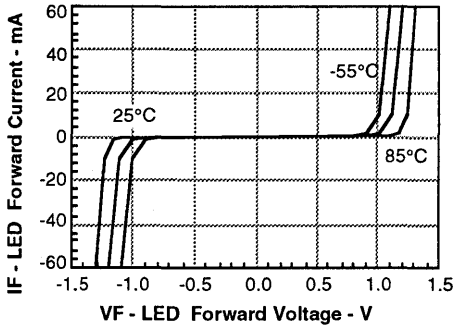

Figure 2. Forward voltage versus forward current

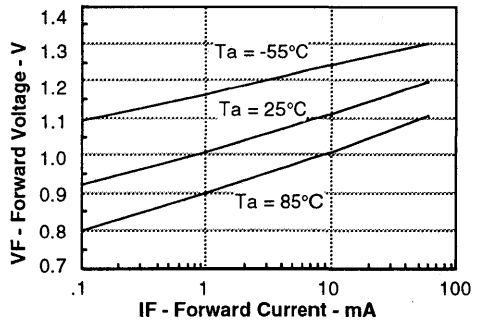

Figure 3. Peak LED current versus duty factor, Tau

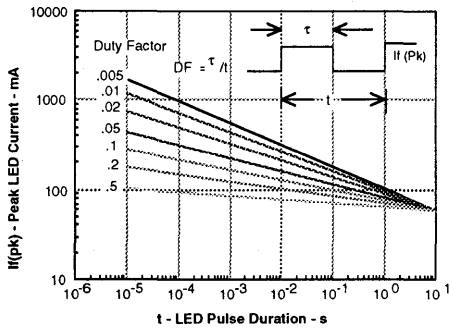

Figure 4. Normalized CTR versus If and Ta

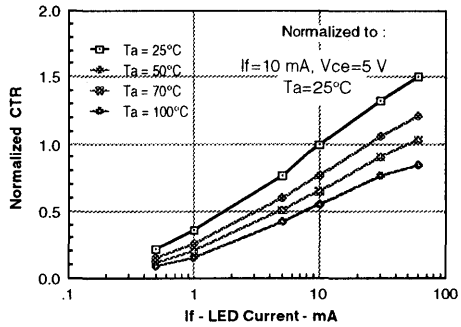

Figure 5. Normalized saturated CTR

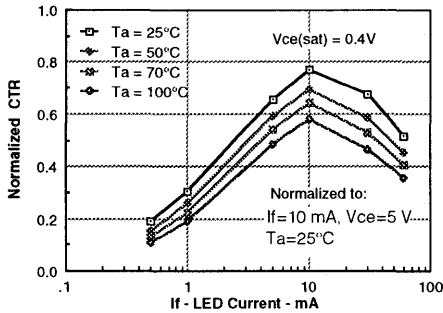

Figure 6. Normalized CTRcb

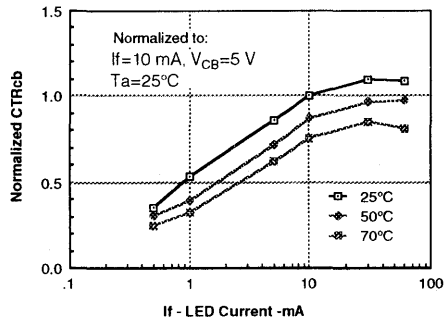

Figure 7. Photocurrent versus LED current

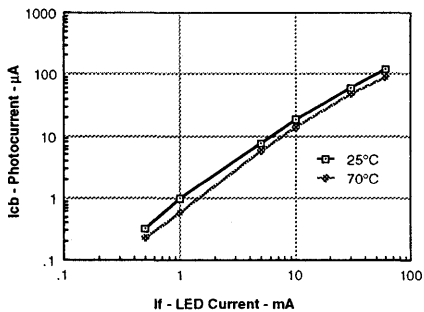
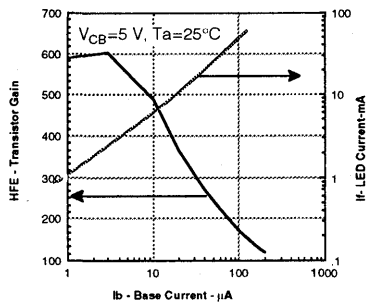

Figure 8. Base current versus If and HFE



Optocouplers
(Optoisolators)

Figure 9. Normalized HFE versus I_b , T_a

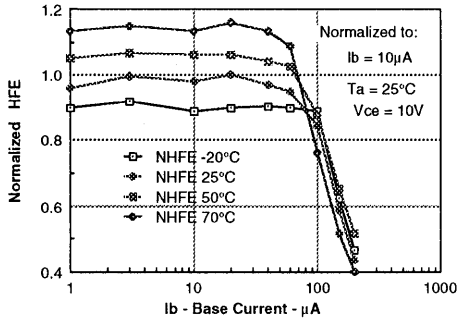

Figure 10. Normalized saturated HFE versus I_b

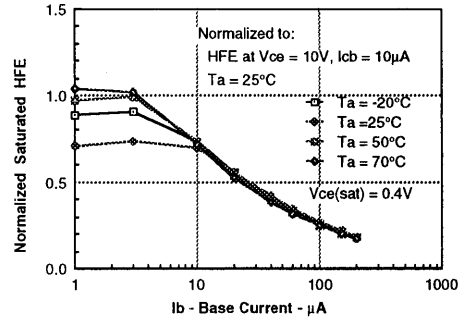

Figure 11. Base emitter voltage versus base current

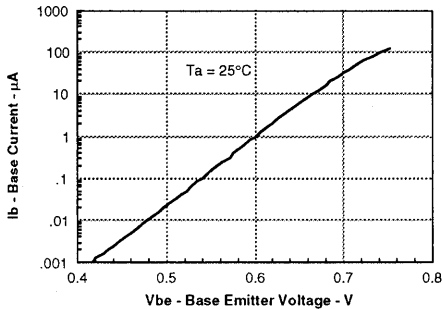
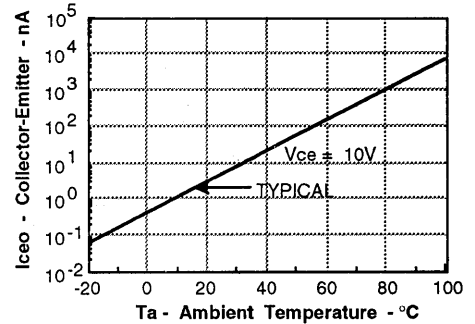

Figure 12. Collector-emitter leakage current versus temperature



FEATURES

- Couples AC and DC signals
- 0.01% Servo Linearity
- Wide Bandwidth, >200 KHz
- High Gain Stability, $\pm 0.005\%/^{\circ}\text{C}$
- Low Input-Output Capacitance
- Low Power Consumption, < 15mw
- Withstand Test Voltage, 7500 VAC_{peak}, 1 sec.
- Internal Insulation Distance, >0.4 mm for VDE
- Underwriters Lab File #E52744
- VDE Approval #0884 (Optional with Option 1, Add -X001 Suffix)
- IL300G Replaced by IL300-X006

APPLICATIONS

- Power Supply Feedback Voltage/Current
- Medical Sensor Isolation
- Audio Signal Interfacing
- Isolate Process Control Transducers
- Digital Telephone Isolation

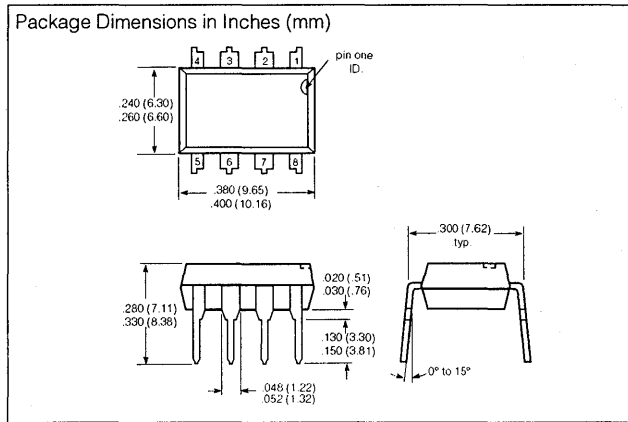

DESCRIPTION

The IL300 Linear Optocoupler consists of an AlGaAs IRLED irradiating an isolated feedback and an output PIN photodiode in a bifurcated arrangement. The feedback photodiode captures a percentage of the LED's flux and generates a control signal (IP₁) that can be used to servo the LED drive current. This technique compensates for the LED's non-linear, time, and temperature characteristics. The output PIN photodiode produces an output signal (IP₂) that is linearly related to the servo optical flux created by the LED.

The time and temperature stability of the input-output coupler gain (K₃) is insured by using matched PIN photodiodes that accurately track the output flux of the LED.

A typical application circuit (Figure 1) uses an operational amplifier at the circuit input to drive the LED. The feedback photodiode sources current to R₁ connected to the inverting input of U₁. The photocurrent, IP₁, will be of a magnitude to satisfy the relationship of (IP₁=V_{IN}/R₁). The magnitude of this current is directly proportional to the feedback transfer gain (K₁) times the LED drive current (V_{IN}/R₁=K₁ · I_p). The op-amp will supply LED current to force sufficient photocurrent to keep the node voltage (V_b) equal to V_a.

FIGURE 1. Typical Application Circuit

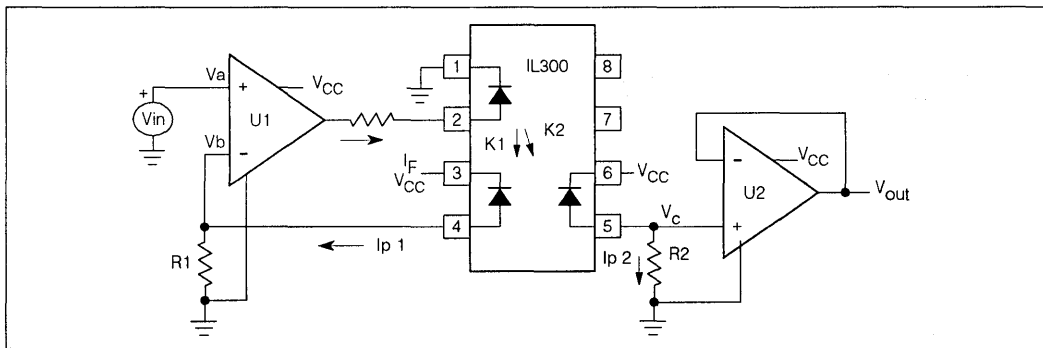

DESCRIPTION (continued)

The output photodiode is connected to a non-inverting voltage follower amplifier. The photodiode load resistor, R2, performs the current to voltage conversion. The output amplifier voltage is the product of the output forward gain (K2) times the LED current and photodiode load, R2 ($V_o = I_f \cdot K2 \cdot R2$).

Therefore, the overall transfer gain (V_o/V_{in}) becomes the ratio of the product of the output forward gain (K2) times the photodiode load resistor (R2) to the product of the feedback transfer gain (K1) times the input resistor (R1). This reduces to $V_o/V_{in} = (K2 \cdot R2)/(K1 \cdot R1)$. The overall transfer gain is completely independent of the LED forward current. The IL300 transfer gain (K3) is expressed as the ratio of the output gain (K2) to the feedback gain (K1). This shows that the circuit gain becomes the product of the IL300 transfer gain times the ratio of the output to input resistors [$V_o/V_{in} = K3 (R2/R1)$].

IL300 TERMS

K1 - Servo Gain

The ratio of the input photodiode current (I_{P1}) to the LED current (I_f), i.e., $K1 = I_{P1}/I_f$.

K2 - Forward Gain

The ratio of the output photodiode current (I_{P2}) to the LED current (I_f), i.e., $K2 = I_{P2}/I_f$.

K3 - Transfer Gain

The Transfer Gain is the ratio of the Forward Gain to the Servo gain, i.e., $K3 = K2/K1$.

ΔK3 - Transfer Gain Linearity

The percent deviation of the Transfer Gain, as a function of LED or temperature from a specific Transfer Gain at a fixed LED current and temperature.

Photodiode

A silicon diode operating as a current source. The output current is proportional to the incident optical flux supplied by the LED emitter. The diode is operated in the photovoltaic or photoconductive mode. In the photovoltaic mode the diode functions as a current source in parallel with a forward biased silicon diode.

The magnitude of the output current and voltage is dependant upon the load resistor and the incident LED optical flux. When operated in the photoconductive mode the diode is connected to a bias supply which reverse biases the silicon diode. The magnitude of the output current is directly proportional to the LED incident optical flux.

LED (Light Emitting Diode)

An infrared emitter constructed of AlGaAs that emits at 890nm operates efficiently with drive current from 500μA to 40mA. Best linearity can be obtained at drive currents between 5mA to 20mA. Its output flux typically changes by -0.5%/°C over the above operational current range.

Absolute Maximum Ratings

	Symbol	Min.	Max.	Unit
Emitter				
Power Dissipation ($T_c=25^\circ\text{C}$)	P_{LED}		160	mW
Derate Linearly from 25°C			2.13	mW/°C
Forward Current	I_f		60	mA
Surge Current (Pulse width <10μs)	I_{pk}		250	mA
Reverse Voltage	V_R		5	V
Thermal Resistance	R_{th}		470	°C/W
Junction Temperature	T_j		100	°C
Detector				
Power Dissipation	P_{DET}		50	mW
Derate linearly from 25°C			0.65	mW/°C
Reverse Voltage	V_R		50	V
Junction Temperature	T_j		100	°C
Thermal Resistance	R_{th}		1500	°C/W
Coupler				
Total Package Dissipation at 25°C	P_t		210	mW
Derate linearly from 25°C			2.8	mW/°C
Storage Temperature	T_s	-55	150	°C
Operating Temp.	T_{op}	-55	100	°C
Withstand Test Voltage 1 min., 60 Hz	WTV		4420	VAC _{RMS}
Withstand Test Voltage 1 min	WTV		6250	VAC _{Peak}
Withstand Test Voltage 1 sec., 60 Hz	WTV		5300	VAC _{RMS}
Withstand Test Voltage 1 sec.	WTV		7500	VAC _{Peak}
Lead Soldering Time at 260°C			10	sec.

Characteristics (T_A=25°C)

	Symbol	Min.	Typ.	Max.	Unit	Test Condition
LED Emitter						
Forward Voltage	V _F		1.25	1.50	V	I _F =10 mA
V _F Temp. Coefficient	ΔV _F /Δ°C		-2.2		mV/°C	
Reverse Current	I _R		1	10	μA	V _R =5 V
Junction Capacitance	C _J		15		pF	V _F =0 V, f=1 MHz
Dynamic Resistance	ΔV _F /ΔI _F		6		Ω	I _F =10 mA
Switching Time	t _R		1		μS	ΔI _F =2 mA, I _{FQ} =10 mA
	t _F		1		μS	ΔI _F =2 mA, I _{FQ} =10 mA
Detector						
Dark Current	I _D		1	25	nA	V _{det} =-15 V, I _F =0 μA
Open Circuit Voltage	V _D		500		mV	I _F =10 mA
Short Circuit Current	I _{SC}		70		μA	I _F =10 mA
Junction Capacitance	C _J		12		pF	V _F =0 V, F=1 MHz
Noise Equivalent Power	NEP		4 X 10 ⁻¹⁴		W/Hz	V _{det} =-15 V
Coupled Characteristics						
K1, Servo Gain (I _{P1} /I _F)	K1	0.0050	0.007	0.011		I _F =10 mA, V _{det} =-15 V
Servo Current, see Note 1, 2	I _{P1}		70		μA	I _F =10 mA, V _{det} =-15 V
K1 Temperature Coefficient	ΔK1/ΔT		-0.5		%/°C	I _F =10 mA, V _{det} =-15 V
K2, Forward Gain (I _{P2} /I _F)	K2	0.0036	0.007	0.011		I _F =10 mA, V _{det} =-15 V
Forward Current	I _{P2}		70		μA	I _F =10 mA, V _{det} =-15 V
K2 Temperature Coefficient	ΔK2/ΔT		-0.5		%/°C	I _F =10 mA, V _{det} =-15 V
K3, Transfer Gain (K2/K1)	K3	0.56	1.00	1.65	K2/K1	I _F =10 mA, V _{det} =-15 V
See Note 1, 2						
Transfer Gain Linearity	ΔK3		±0.25		%	I _F =1 to 10 mA
Transfer Gain Linearity	ΔK3		±0.5		%	I _F =1 to 10 mA, T _A =0°C to 75°C
K3 Temperature Coefficient	ΔK3/ΔT		±0.005		%/°C	I _F =10 mA, V _{det} =-15 V
Photoconductive Operation						
Frequency Response	BW (-3 db)		200		KHz	I _{FQ} =10 mA, MOD=±4 mA, R _L =50 Ω, V _{det} =-15 V
Phase Response at 200 KHz			-45		Deg.	
Rise Time	t _R		1.75		μs	
Fall Time	t _F		1.75		μs	
Insulation – Isolation						
Input-Output Capacitance	C _{IO}		1		pF	V _F =0 V, f=1 MHz
Common Mode Capacitance	C _{cm}		0.5		pF	V _F =0 V, f=1 MHz
Common Mode Rejection Ratio	CMRR		130		dB	f=60 Hz, R _L =2.2 KΩ
Insulation Resistance	R _{IO}		100		GΩ	V _{IO} =500 VDC
Withstand Test Voltage	WTV	4420			VAC _{RMS}	Rel. Humidity ≤ 50% I _{IO} ≤10 μA, 1 min.
	WTV	6250			VAC _{PEAK}	Rel. Humidity ≤ 50% I _{IO} ≤10 μA, 1 min.
	WTV	5300			VAC _{RMS}	Rel. Humidity ≤ 50% I _{IO} ≤0 μA, 1 sec.
	WTV	7500			VAC _{PEAK}	Rel. Humidity ≤ 50% I _{IO} ≤10 μA, 1 sec.

**Optocouplers
(Optoisolators)**
Notes
1. Bin Sorting:

K3 (transfer gain) is sorted into bins that are ±5%, as follows:

Bin A=0.560–0.623

Bin B=0.623–0.693

Bin C=0.693–0.769

Bin D=0.769–0.855

Bin E=0.855–0.950

Bin F=0.950–1.056

Bin G=1.056–1.175

Bin H=1.175–1.304

Bin I=1.304–1.449

Bin J=1.449–1.610

K3=K2/K1. K3 is tested at I_F=10 mA, V_{det}=-15 V.

2. Bin Categories: All IL300s are sorted into a K3 bin, indicated by an alpha character that is marked on the part. The bins range from "A" through "J".

The IL300 is shipped in tubes of 50 each. Each tube contains only one category of K3. The category of the parts in the tube is marked on the tube label as well as on each individual part.

3. Category Options: Standard IL300 orders will be shipped from the categories that are available at the time of the order. Any of the ten categories may be shipped. For customers requiring a narrower selection of bins, four different bin option parts are offered.

IL300-DEFG: Order this part number to receive categories D,E,F,G only.

IL300-EF: Order this part number to receive categories E, F only.

IL300-E: Order this part number to receive category E only.

IL300-F: Order this part number to receive category F only.

FIGURE 2. LED forward current vs. forward voltage

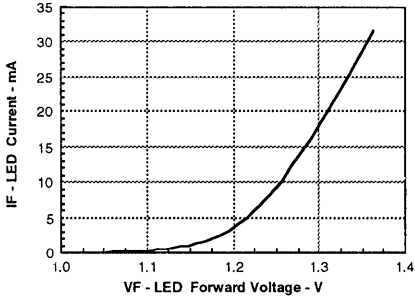

FIGURE 3. LED forward current vs. forward voltage

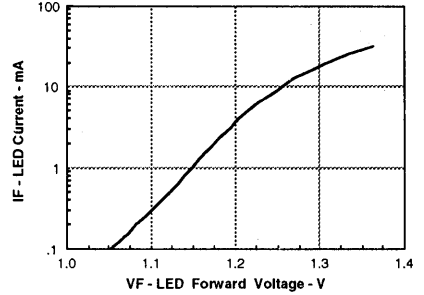

FIGURE 4. Servo photocurrent vs. LED current and temperature

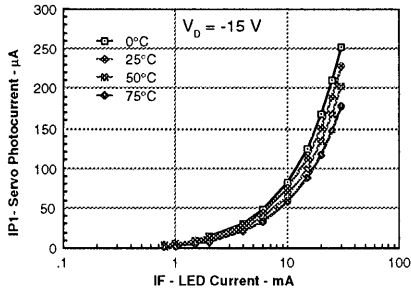

FIGURE 5. Servo photocurrent vs. LED current and temperature

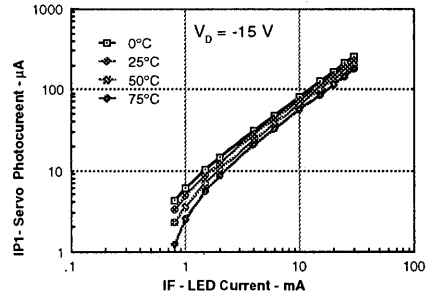

FIGURE 6. Normalized servo photocurrent vs. LED current and temperature

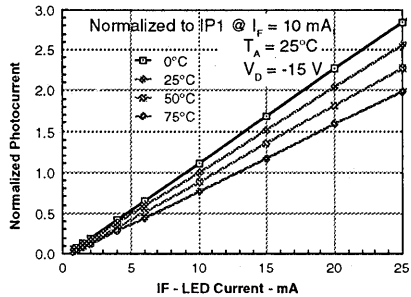

FIGURE 7. Normalized servo photocurrent vs. LED current and temperature

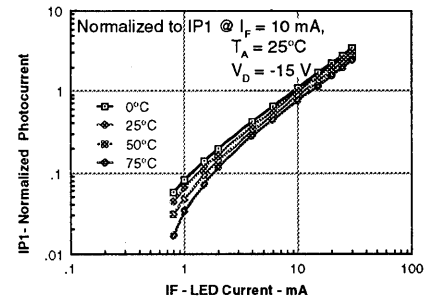

FIGURE 8. Servo gain vs. LED current and temperature

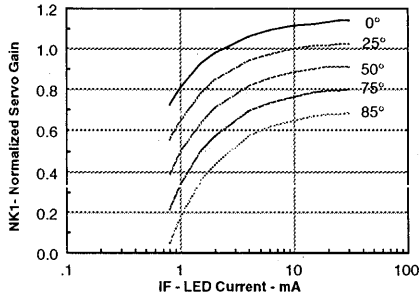

FIGURE 9. Normalized servo gain vs. LED current and temperature

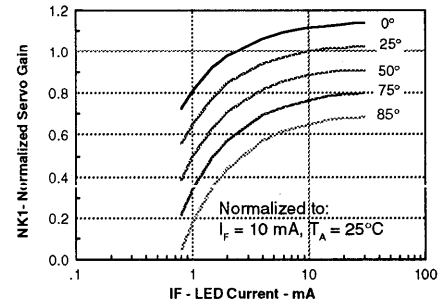

FIGURE 10. Transfer gain vs. LED current and temperature

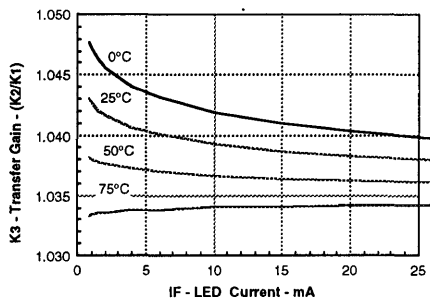

FIGURE 11. Normalized transfer gain vs. LED current and temperature

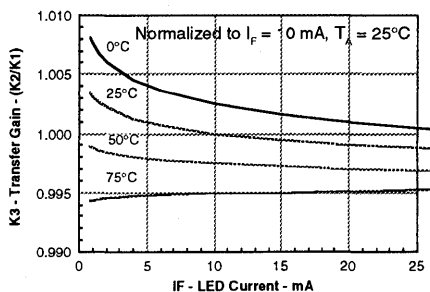

FIGURE 12. Amplitude response vs. frequency

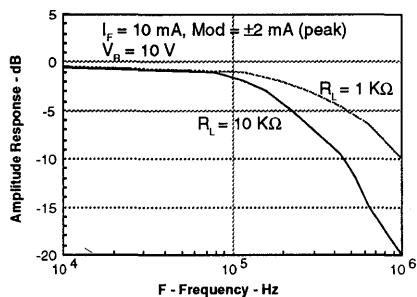

FIGURE 13. Amplitude and phase response vs. frequency

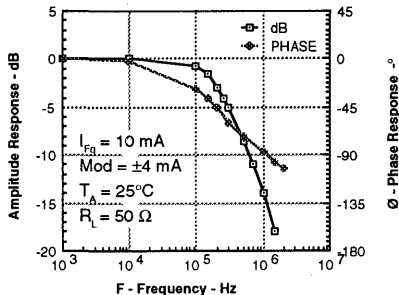

FIGURE 14. Common mode rejection

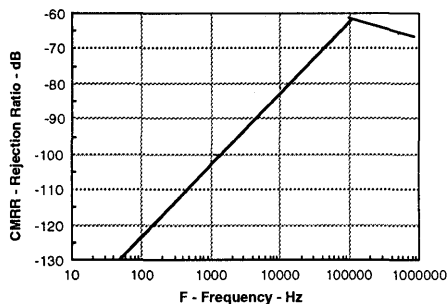
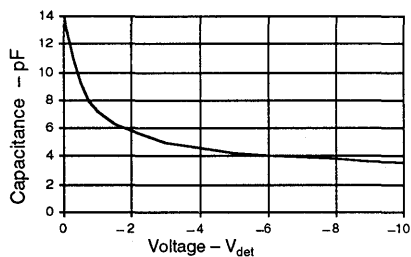

FIGURE 15. Photodiode junction capacitance vs. reverse voltage



APPLICATION CONSIDERATIONS

In applications such as monitoring the output voltage from a line powered switch mode power supply, measuring bioelectric signals, interfacing to industrial transducers, or making floating current measurements, a galvanically isolated, DC coupled interface is often essential. The IL300 can be used to construct an amplifier that will meet these needs.

The IL300 eliminates the problems of gain nonlinearity and drift induced by time and temperature, by monitoring LED output flux.

A PIN photodiode on the input side is optically coupled to the LED and produces a current directly proportional to flux falling on it. This photocurrent, when coupled to an amplifier, provides the servo signal that controls the LED drive current.

The LED flux is also coupled to an output PIN photodiode. The output photodiode current can be directly or amplified to satisfy the needs of succeeding circuits.

ISOLATED FEEDBACK AMPLIFIER

The IL300 was designed to be the central element of DC coupled isolation amplifiers. Designing the IL300 into an amplifier that provides a feedback control signal for a line powered switch mode power is quite simple, as the following example will illustrate.

See Figure 17 for the basic structure of the switch mode supply using the Siemens TDA4918 Push-Pull Switched Power Supply Control Chip. Line isolation and insulation is provided by the high frequency transformer. The voltage monitor isolation will be provided by the IL300.

The isolated amplifier provides the PWM control signal which is derived from the output supply voltage. Figure 16 more closely shows the basic function of the amplifier.

The control amplifier consists of a voltage divider and a non-inverting unity gain stage. The TDA4918 data sheet indicates that an input to the control amplifier is a high quality operational amplifier that typically requires a +3V signal. Given this information, the amplifier circuit topology shown in Figure 18 is selected.

The power supply voltage is scaled by R1 and R2 so that there is +3V at the non-inverting input (Va) of U1. This voltage is offset by the voltage developed by photocurrent flowing through R3. This photocurrent is developed by the optical flux created by current flowing through the LED. Thus as the scaled monitor voltage (Va) varies it will cause a change in the LED current necessary to satisfy the differential voltage needed across R3 at the inverting input.

The first step in the design procedure is to select the value of R3 given the LED quiescent current (I_{Fq}) and the servo gain (K1). For this design, $I_{Fq} = 12\text{mA}$. Figure 4 shows the servo photocurrent at I_{Fq} is found to be $100\mu\text{A}$. With this data R3 can be calculated.

$$R3 = \frac{V_b}{I_{P1}} = \frac{3V}{100\mu\text{A}} = 30K\Omega$$

For best input offset compensation at U1, R2 will equal R3. The value of R1 can easily be calculated from the following:

$$R1 = R2 \left(\frac{V_{\text{MONITOR}}}{V_a} - 1 \right)$$

$$20K\Omega = 30K\Omega \left(\frac{5V}{3V} - 1 \right)$$

The value of R5 depends upon the IL300 Transfer Gain (K3). K3 is targeted to be a unity gain device, however to minimize the part to part Transfer Gain variation, Siemens offers K3 graded into $\pm 5\%$ bins. R5 can be determined using the following equation.

$$R5 = \frac{V_{\text{OUT}}}{V_{\text{MONITOR}}} \cdot \frac{R3 (R1 + R2)}{R2 K3}$$

Or if a unity gain amplifier is being designed ($V_{\text{MONITOR}} = V_{\text{OUT}}$, $R1 = 0$), the equation simplifies to :

$$R5 = \frac{R3}{K3}$$

FIGURE 16. Isolated Control Amplifier

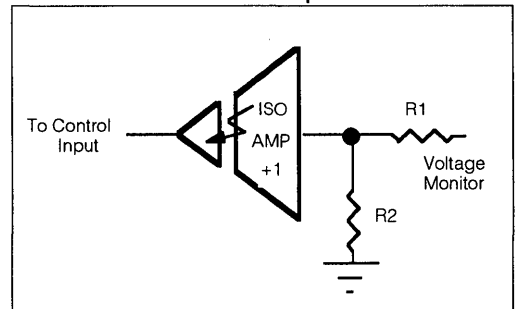

FIGURE 17. Switch Mode Power Supply

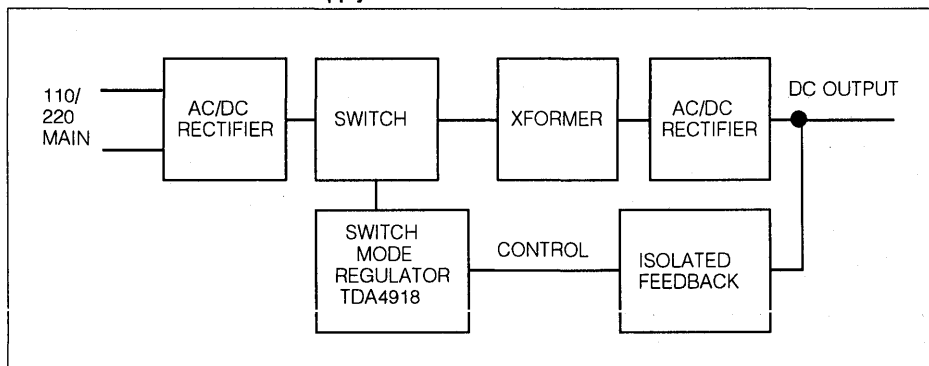

FIGURE 18. DC Coupled Power Supply Feedback Amplifier

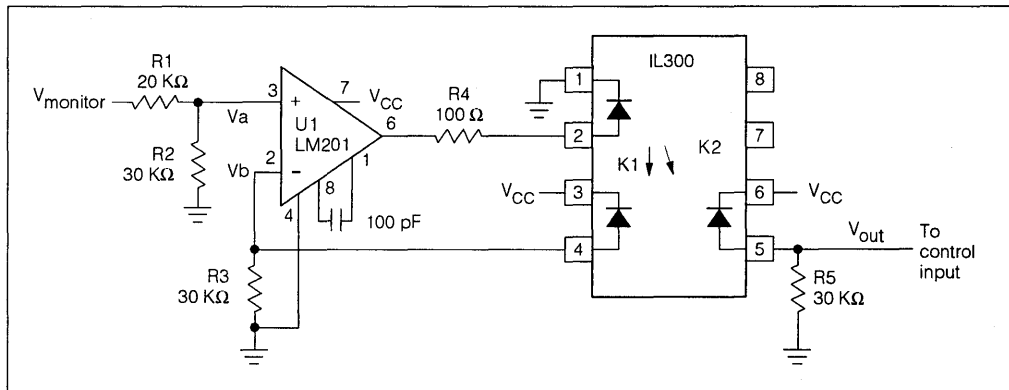

Table 1 gives the value of R5 given the production K3 bins.

TABLE 1. R5 Selection

Bins	Min.	Max.	K3 Typ.	R5 KΩ	1% Resistor KΩ
A	0.560	0.623	0.59	50.85	51.1
B	0.623	0.693	0.66	45.45	45.3
C	0.693	0.769	0.73	41.1	41.2
D	0.769	0.855	0.81	37.04	37.4
E	0.855	0.950	0.93	32.26	32.4
F	0.950	1.056	1.00	30.00	30.0
G	1.056	1.175	1.11	27.03	27.0
H	1.175	1.304	1.24	24.19	24.0
I	1.304	1.449	1.37	21.90	22.0
J	1.449	1.610	1.53	19.61	19.4

The last step in the design is selecting the LED current limiting resistor (R4). The output of the operational amplifier is targeted to be 50% of the Vcc, or 2.5 V. With an LED quiescent current of 12 mA the typical LED (V_F) is 1.3V. Given this and the operational output voltage, R4 can be calculated.

$$R4 = \frac{V_{\text{opamp}} - V_F}{I_{Fq}} = \frac{2.5V - 1.3V}{12 \text{ mA}} = 100\Omega$$

The circuit was constructed with an LM201 differential operational amplifier using the resistors selected. The amplifier was compensated with a 100 pF capacitor connected between pins 1 and 8.

The DC transfer characteristics are shown in Figure 19. The amplifier was designed to have a gain of 0.6 and was measured to be 0.6036. Greater accuracy can be achieved by adding a balancing circuit, and potentiometer in the input divider, or at R5. The circuit shows exceptionally good gain linearity with an RMS error of only 0.0133% over the input voltage range of 4V–6V in a servo mode; see Figure 20.

FIGURE 19. Transfer gain

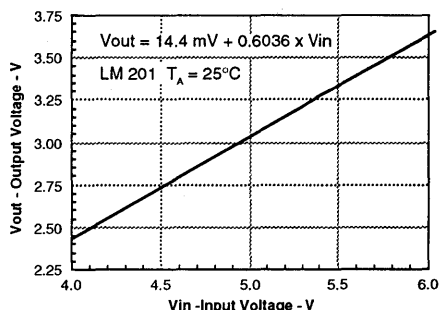
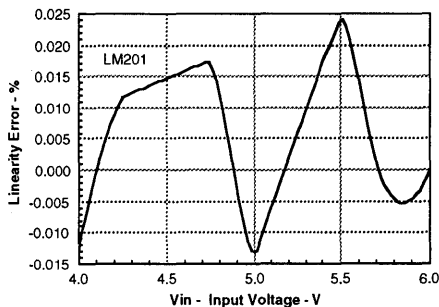

FIGURE 20. Linearity error vs. input voltage



Optocouplers
(Optoisolators)

The AC characteristics are also quite impressive offering a -3dB bandwidth of 100KHz, with a -45° phase shift at 80KHz as shown in Figure 21.

FIGURE 21. Amplitude and phase power supply control

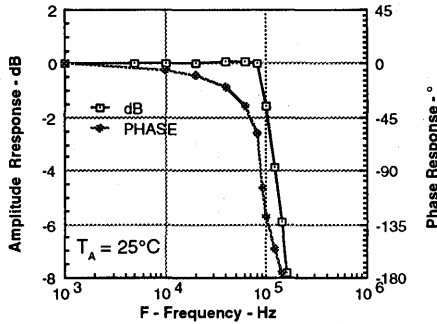

BIPOLAR ISOLATION AMPLIFIERS

The same procedure can be used to design isolation amplifiers that accept bipolar signals referenced to ground. These amplifiers circuit configurations are shown in Figure 22. In order for the amplifier to respond to a signal that swings above and below ground, the LED must be prebiased from a separate source by using a voltage reference source (V_{ref1}). In these designs, R_3 can be determined by the following equation.

$$R_3 = \frac{V_{ref1}}{I_{P1}} = \frac{V_{ref1}}{K_1 I_{Fq}}$$

These amplifiers provide either an inverting or non-inverting transfer gain based upon the type of input and output amplifier. Table 2 shows the various configurations along with the specific transfer gain equations. The offset column refers to the calculation of the output offset or V_{ref2} necessary to provide a zero voltage output for a zero voltage input. The non-inverting input amplifier requires the use of a bipolar supply, while the inverting input stage can be implemented with single supply operational amplifiers that permit operation close to ground.

For best results, place a buffer transistor between the LED and output of the operational amplifier when a CMOS opamp is used or the LED I_{Fq} drive is targeted to operate beyond 15 mA. Finally the bandwidth is influenced by the magnitude of the closed loop gain of the input and output amplifiers. Best bandwidths result when the amplifier gain is designed for unity.

FIGURE 22. Non-Inverting and Inverting Amplifiers

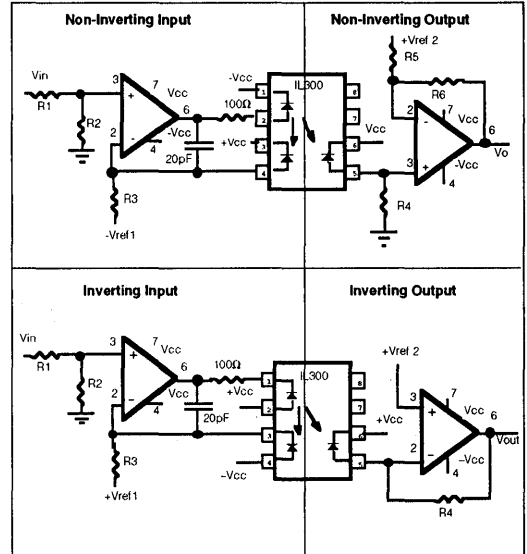

TABLE 2. Optolinear Amplifiers

Amplifier	Input	Output	Gain	Offset
Non-Inverting	Inverting	Inverting	$\frac{V_{OUT}}{V_{IN}} = \frac{K_3 R_4 R_2}{R_3 (R_1 + R_2)}$	$V_{ref2} = \frac{V_{ref1} R_4 K_3}{R_3}$
	Non-Inverting	Non-Inverting	$\frac{V_{OUT}}{V_{IN}} = \frac{K_3 R_4 R_2 (R_5 + R_6)}{R_3 R_5 (R_1 + R_2)}$	$V_{ref2} = \frac{-V_{ref1} R_4 (R_5 + R_6) K_3}{R_3 R_6}$
Inverting	Inverting	Non-Inverting	$\frac{V_{OUT}}{V_{IN}} = \frac{-K_3 R_4 R_2 (R_5 + R_6)}{R_3 R_5 (R_1 + R_2)}$	$V_{ref2} = \frac{V_{ref1} R_4 (R_5 + R_6) K_3}{R_3 R_6}$
	Non-Inverting	Inverting	$\frac{V_{OUT}}{V_{IN}} = \frac{-K_3 R_4 R_2}{R_3 (R_1 + R_2)}$	$V_{ref2} = \frac{-V_{ref1} R_4 K_3}{R_3}$

PHOTOTRANSISTOR OPTOCOUPLER

FEATURES

- Turn On Current (I_{FT}), 5.0 mA Typical
- Gate Trigger Current (I_{GT}), 20 μ A
- Surge Anode Current, 1.0 Amp
- Blocking Voltage, 400 V
- Gate Trigger Voltage (V_{GT}), 0.6 Volt
- Isolation Voltage, 7500 V
- Solid State Reliability
- Standard DIP Package
- Underwriters Lab File #E52744

DESCRIPTION

The IL400 is an optically coupled SCR with a Gallium Arsenide infrared emitter and a silicon photo SCR sensor. Switching can be achieved while maintaining a high degree of isolation between triggering and load circuits. The IL400 can be used in SCR triac and solid state relay applications where high blocking voltages and low input current sensitivity are required.

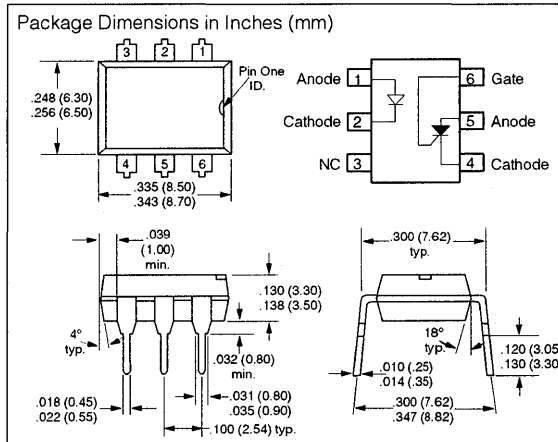

Maximum Ratings

Emitter	
Peak Reverse Voltage	6.0 V
Peak Forward Current (100 μ s, 1% Duty Cycle)	1.0 A
Continuous Forward Current	60 mA
Power Dissipation at 25°C	100 mW
Derate Linearly from 25°C	1.3 mW/°C

Detector

Reverse Gate Voltage	6.0 V
Anode Voltage (DC or AC Peak)	400 V
Anode Current	100 mA
Surge Anode Current (5 ms duration)	1.0 A
Surge Gate Current (5 ms duration)	200 mA
Power Dissipation at 25°C ambient	200 mW
Derate Linearly from 25°C	2.11 mW/°C

Package

Isolation Voltage	7500 VDC
Total Package Dissipation	250 mW
Derate Linearly from 25°C	2.63 mW/°C
Operating Temperature	-55°C to +100°C
Storage Temperature	-55°C to +150°C

Characteristics ($T_A=25^\circ\text{C}$)

	Symbol	Min.	Typ.	Max.	Unit	Condition
Emitter						
Forward Voltage	V_F		1.2	1.5	V	$I_F = 20$ mA
Reverse Voltage	V_R	5.0			V	$I_R = 10$ μ A
Reverse Current	I_R			10	μ A	$V_R = 5$ V
Detector						
Forward Blocking Voltage	V_{DM}	400			V	$R_{GK} = 10$ K Ω $T_A = 100^\circ\text{C}$ $I_d = 150$ mA
Reverse Blocking Voltage	V_{DM}	400			V	$R_{GK} = 10$ K Ω $T_A = 100^\circ\text{C}$ $I_d = 150$ mA
On-state Voltage	V_i			1.2	V	$I_T = 100$ mA
Gate Trigger Voltage	V_{GT}	0.6	1.0		V	$V_{FX} = 100$ V $R_{GK} = 27$ K Ω $R_L = 10$ K Ω
Forward Leakage Current	I_D		0.2	2.0	μ A	$R_{GK} = 27$ K Ω $I_F = 0, T_A = 25^\circ\text{C}$ $V_{RX} = 400$ V
Reverse Leakage Current	I_R		0.2	2.0	μ A	$I_F = 0, T_A = 25^\circ\text{C}$ $V_{RX} = 400$ V
Gate Trigger Current	I_{GT}	20	50		μ A	$I_F = 0, T_A = 250^\circ\text{C}$ $V_{FX} = 100$ V $R_{GK} = 27$ K Ω $R_L = 10$ K Ω
Package						
Turn-On Current	I_{FT}	0.5	5.0	10.0	mA	$V_{FX} = 100$ V, $R_{GK} = 10$ K Ω $t = 1$ sec.
Isolation Voltage		7500			VDC	5300 VAC _{RMS}
Isolation Resistance		100			G Ω	$V_{iso} = 500$ V
Isolation Capacitance			2		pF	$f = 1$ MHz

ZERO VOLTAGE CROSSING 600 V TRIAC DRIVER OPTOCOUPLER

FEATURES

- On-State Current, 300 mA
- Zero Voltage Crossing
- Blocking Voltage, 600 V
- Withstand Test Voltage from Double Molded Package 7500 VAC_{PEAK}
- High Input Sensitivity
I_{FT}=2 mA, PF=1.0
I_{FT}=5 mA, PF≤1.0
- High Static dv/dt 10,000 V/μs
- Inverse Parallel SCRs Provide Commutating dv/dt >10K V/μs
- Very Low Leakage <10 μA
- Small 6-Pin DIP Package
- Underwriters Lab File #E52744
- VDE Approval #0884 (Optional with Option 1, Add -X001 Suffix)

Maximum Ratings

Emitter

Reverse Voltage	6 V
Forward Current	60 mA
Surge Current	2.5 A
Thermal Resistance	750 °C/W
Power Dissipation	100 mW
Derate from 25°C	1.33 mW/°C

Detector

Peak Off-State Voltage	600 V
Peak Reverse Voltage	600 V
RMS On-State Current	300 mA
Single Cycle Surge	3 A
Thermal Resistance	125°C/W
Total Power Dissipation	500 mW
Derate from 25°C	6.6 mW/°C

Package

Withstand Test Voltage	7500 VAC _{PEAK} / 5300 VAC _{RMS}
Storage Temperature	-55°C to +150°C
Operating Temperature	-55°C to +100°C
Lead Soldering Temperature	260°C/5 sec.

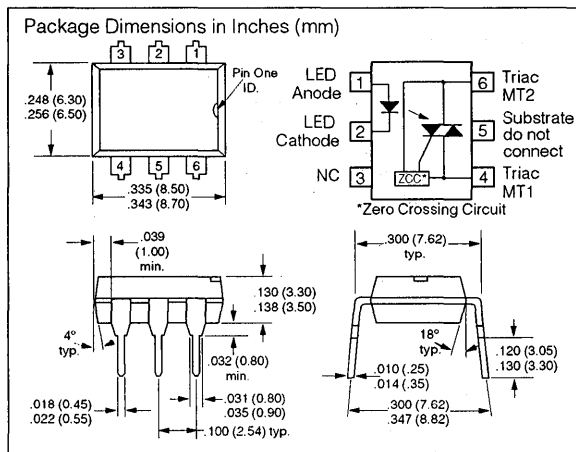

DESCRIPTION

The IL410 consists of a GaAs IRLED optically coupled to a photosensitive zero crossing TRIAC network. The TRIAC consists of two inverse parallel connected monolithic SCRs. These three semiconductors are assembled in a six pin 0.3 inch dual in-line package, using high insulation double molded, over/under leadframe construction.

High input sensitivity is achieved by using an emitter follower phototransistor and a cascaded SCR predriver resulting in an LED trigger current of less than 2 mA (DC).

The IL410 uses two discrete SCRs resulting in a commutating dv/dt greater than 10KV/μs. The use of a proprietary dv/dt clamp results in a static dv/dt of greater than 10KV/μs. This clamp circuit has a MOSFET that is enhanced when high dv/dt spikes occur between MT1 and MT2 of the TRIAC. When conducting, the FET clamps the base of the phototransistor, disabling the first stage SCR predriver.

The zero cross line voltage detection circuit consists of two enhancement MOSFETS and a photodiode. The inhibit voltage of the network is determined by the enhancement voltage of the N-channel FET. The P-channel FET is enabled by a photocurrent source that permits the FET to conduct the main voltage to gate on the N-channel FET. Once the main voltage can enable the N-channel, it clamps the base of the phototransistor, disabling the first stage SCR predriver.

The 600V blocking voltage permits control of off-line voltages up to 240VAC, with a safety factor of more than two, and is sufficient for as much as 380VAC.

The IL410 isolates low-voltage logic from 120, 240, and 380 VAC lines to control resistive, inductive, or capacitive loads including motors, solenoids, high current thyristors or TRIAC and relays.

Applications include solid-state relays, industrial controls, office equipment, and consumer appliances.

Characteristics

	Symbol	Min.	Typ.	Max	Unit	Condition
Emitter						
Forward Voltage	V_F		1.16	1.35	V	$I_F=10\text{ mA}$
Breakdown Voltage	V_{BR}	6	30		V	$I_R=10\text{ }\mu\text{A}$
Reverse Current	I_R		0.1	10	μA	$V_R=6\text{ V}$
Capacitance	C_0		25		pF	$V_F=0\text{ V}, f=1\text{ MHz}$
Thermal Resistance Junction to Lead	R_{THJL}		750		$^{\circ}\text{C/W}$	

Output Detector

Repetitive Peak						
Off-State Voltage	V_{DRM}	600	650		V	$I_{DRM}=100\text{ }\mu\text{A}$
Off-State Voltage	$V_{D(RMS)}$	424	460		V	$I_{D(RMS)}=70\text{ }\mu\text{A}$
Off-State Current	$I_{D(RMS)1}$		10	100	μA	$V_D=600\text{ V}, T_A=100^{\circ}\text{C}, I_F=0\text{ mA}$
Off-State Current	$I_{D(RMS)2}$			200	μA	$V_D=600\text{ V}, I_F=\text{Rated } I_{FT}$
On-State Voltage	V_{TM}		1.7	3	V	$I_T=300\text{ mA}$
On-State Current	I_{TM}			300	mA	$PF=1.0, V_{T(RMS)}=1.7\text{ V}$
Surge (Non-Repetitive)						
On-State Current	I_{TSM}			3	A	$f=50\text{ Hz}$
Trigger Current 1	I_{FT1}			2.0	mA	$V_D=5\text{ V}$
Trigger Current 2	I_{FT2}			6.0	mA	$V_{op}=220\text{ V}, f=50\text{ Hz}, T_J=100^{\circ}\text{C}, t_{pF}>10\text{ ms}$
Trigger Current Temp. Gradient	$\Delta I_{FT1}/\Delta T_j$		7	14	$\mu\text{A/K}$	
	$\Delta I_{FT2}/\Delta T_j$		7	14	$\mu\text{A/K}$	
Inhibit Voltage Temp. Gradient	$\Delta V_{DINH}/\Delta T_i$		-20		mV/K	
Off-state Current in Inhibit State	I_{DINH}		50	200	μA	$I_F=I_{FT1}, V_{DRM}$
Capacitance Between						
Input and Output Circuit	C_{IO}		2.0		pF	$V_D=0, f=1\text{ kHz}$
Holding Current	I_H		65	500	μA	
Latching Current	I_L		5		mA	$V_T=2.2\text{ V}$
Zero Cross Inhibit Voltage	V_{IH}		15	25	V	$I_F=\text{Rated } I_{FT}$
Turn-On Time	t_{ON}		35		μs	$V_{RM}=V_{DM}=424\text{ VAC}$
Turn-Off Time	t_{OFF}		50		μs	$PF=1.0, I_T=300\text{ mA}$
Critical Rate of Rise						
of Off-State Voltage	dv/dt_{cr}	10000			V/ μs	$V_D=0.67 V_{DRM}, T_J=25^{\circ}\text{C}$
	dv/dt_{cr}	5000			V/ μs	$T_J=80^{\circ}\text{C}$
Critical Rate of Rise of Voltage at Current Commutation						
	dv/dt_{crq}	10000			V/ μs	$V_D=0.67 V_{DRM}, di/dt_{crq} \leq 15\text{ A/ms}$
	dv/dt_{crq}	5000			V/ μs	$T_J=25^{\circ}\text{C}$
					V/ μs	$T_J=80^{\circ}\text{C}$
Critical Rate of Rise of On-State Current	di/dt_{cr}			8	A/ μs	
Thermal Resistance						
Junction to Lead	R_{THJL}		150		$^{\circ}\text{C/W}$	

Insulation and Isolation

Critical Rate of Rise of Coupled						
Input/Output Voltage	$dv_{(IO)}/dt$		10000		V/ μs	$I_T=0\text{ A}, V_{RM}=V_{DM}=424\text{ VAC}$
Common Mode Coupling						
Capacitor	C_{CM}		0.01		pF	
Package Capacitance	C_{IO}		0.8		pF	$f=1\text{ MHz}, V_{IO}=0\text{ V}$
Withstand Test Voltage						
Input-Output	WTV	4420			$V_{AC(RMS)}$	Relative Humidity $\leq 50\%$
	WTV	6250			$V_{AC(PEAK)}$	$I_{IO} \leq 10\text{ }\mu\text{A}, 1\text{ min.}$
	WTV	5300			$V_{AC(RMS)}$	Relative Humidity $\leq 50\%$
	WTV	7500			$V_{AC(PEAK)}$	$I_{IO} \leq 10\text{ }\mu\text{A}, 1\text{ sec.}$
Creepage Distance, Input/Output Circuit						
		≥ 8.2			mm	
Clearance, Input /Output Circuit						
		≥ 7.2			mm	
Insulation Test Voltage						
Between Input /Output Circuit	V_{iso}	5300			V _{DC}	
Creepage Tracking Resistance						
per DIN IEC 112/VDE 0303, Part 1	CTI		175			
Group IIIa per DIN VDE 0110						
Insulation Resistance	R_{is}		$\geq 10^{12}$		Ω	$V_{IO}=500\text{ V } T_A=25^{\circ}\text{C}$
	R_{is}		$\geq 10^{11}$		Ω	$T_A+100^{\circ}\text{C}$

POWER FACTOR CONSIDERATIONS

A snubber isn't needed to eliminate false operation of the TRIAC driver because of the IL410's high static and commutating dv/dt with loads between 1 and 0.8 power factors. When inductive loads with power factors less than 0.8 are being driven, include a RC snubber or a single capacitor directly across the device to damp the peak commutating dv/dt spike. Normally a commutating dv/dt causes a turning-off device to stay on due to the stored energy remaining in the turning-off device.

But in the case of a zero voltage crossing optotriac, the commutating dv/dt spikes can inhibit one half of the TRIAC from turning on. If the spike potential exceeds the inhibit voltage of the zero cross detection circuit, half of the TRIAC will be held-off and not turn-on. This hold-off condition can be eliminated by using a snubber or capacitor placed directly across the optotriac as shown in Figure 1. Note that the value of the capacitor increases as a function of the load current.

Figure 1. Shunt capacitance versus load current

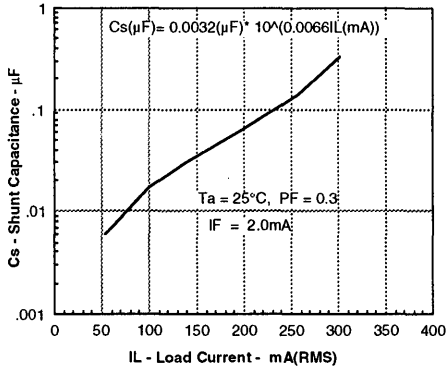

The hold-off condition also can be eliminated by providing a higher level of LED drive current. The higher LED drive provides a larger photocurrent which causes the phototransistor to turn-on before the commutating spike has activated the zero cross network. Figure 2 shows the relationship of the LED drive for power factors of less than 1.0. The curve shows that if a device requires 1.5 mA for a resistive load, then 1.8 times (2.7 mA) that amount would be required to control an inductive load whose power factor is less than 0.3.

Figure 2. Normalized LED trigger current versus power factor

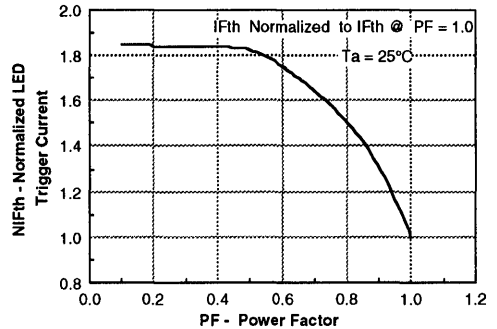

Figure 3. Schematic

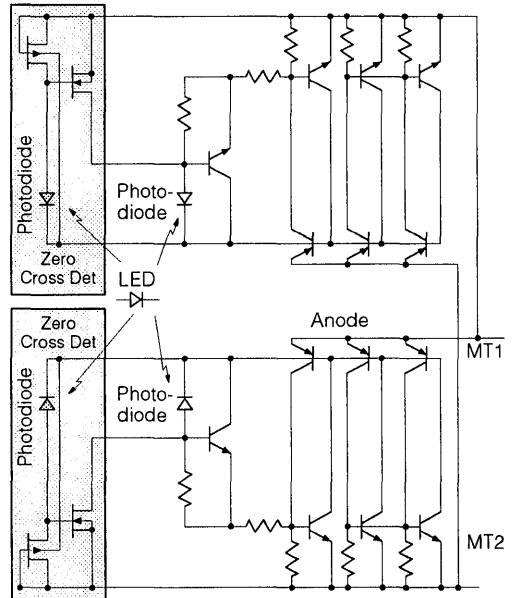

Figure 4. Forward voltage versus forward current

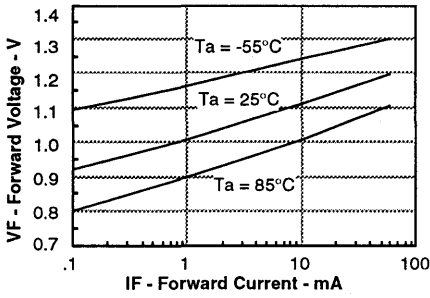

Figure 5. Peak LED current versus duty factor, Tau

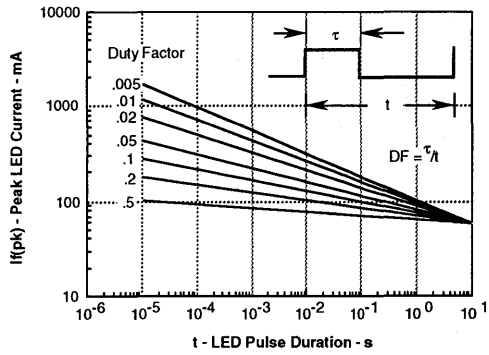

Figure 6. Maximum LED power dissipation

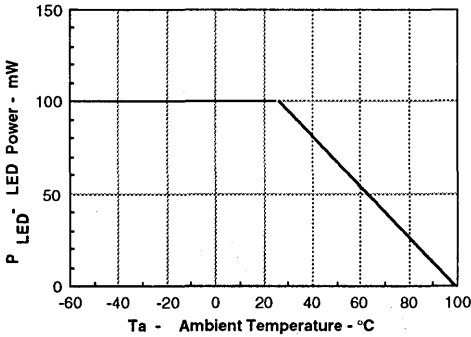

Figure 7. Typical output characteristics

$I_T = f(V_T)$, parameter: T_j

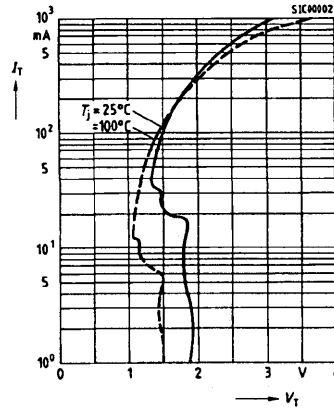

Figure 8. Current reduction

$I_{TRMS} = f(T_A)$, $R_{thJA} = 125 \text{ K/W}$
Device switch soldered in pcb or base plate.

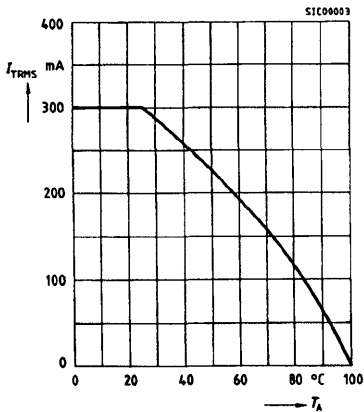

Figure 9. Current reduction

$I_{TRMS} = f(T_{DHW})$, $R_{thJ-PINS} = 16.5 \text{ K/W}$
Thermocouple measurement must be performed potentially separated to A1 and A2. Measuring junction as near as possible at the case.

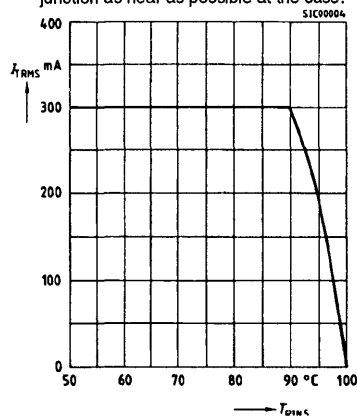

Figure 10. Typical trigger delay time
 $t_{gd} = f(I_F / I_{FT25^\circ C})$, $V_D = 200$ V, $f = 40$ to 60 Hz,
 parameter: T_j

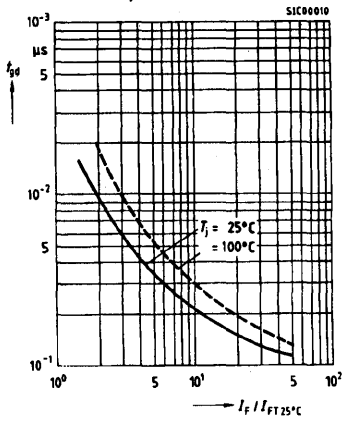

Figure 11. Typical inhibit current
 $I_{DINH} = f(I_F / I_{FT25^\circ C})$
 $V_D = 600$ V, parameter: T_j

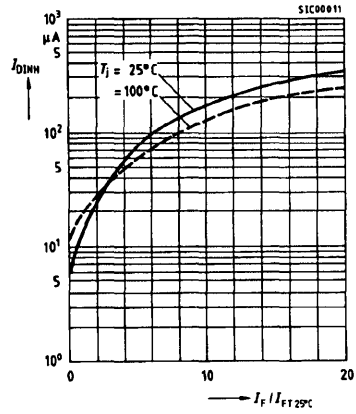

Figure 12. Power dissipation
 40 to 60 Hz line operation, $P_{TOT} = f(I_{TRMS})$

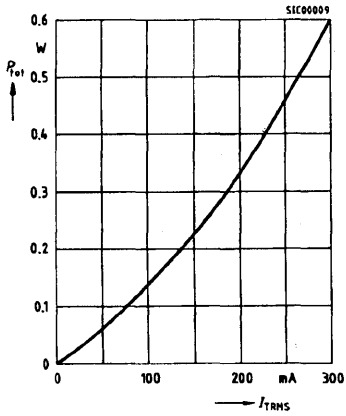
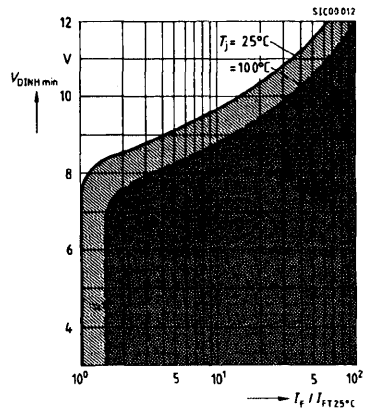

Figure 13. Typical static inhibit voltage limit
 $V_{DINHmin} = f(I_F / I_{FT25^\circ C})$, parameter: T_j
 Device zero voltage switch can be triggered only
 in hatched area below T_j curves.



Current commutation:

The values 100 A/ms with following peak reverse recovery current > 80 mA should not be exceeded.

Avoiding high-frequency turn-off current oscillations:

This effect can occur when switching a circuit. Current oscillations which appear essentially with inductive loads of a higher winding capacity result in current commutation and can generate a relatively high peak reverse recovery current. The following alternating protective measures are recommended for the individual operating states:

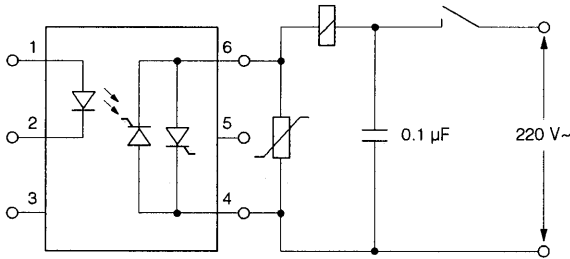

1. Apply a capacitor to the supply pins at the load-side.

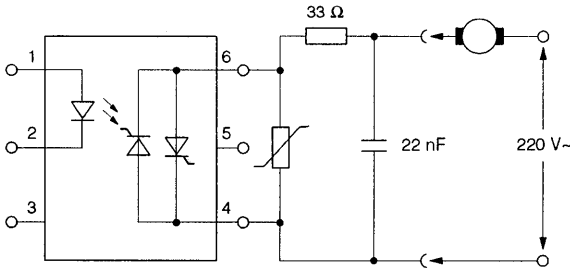

2. Connect a series resistor to the IL410 output and bridge both by a capacitor.

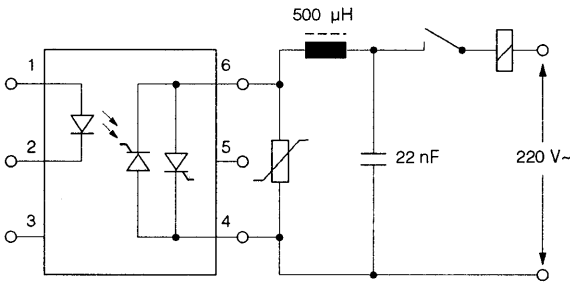

3. Connect a choke of low winding capacity in series e.g., a ringcore choke, with higher load currents.

Note:

Measures 2 to 3 are especially required for the load separated from the IL410 during operation. The above mentioned effects do not occur with IL410 circuits which are connected to the line by transformers and which are not mechanically interrupted. In such cases as well as in applications with a resistive load the corresponding protective circuits can be neglected.

TECHNICAL INFORMATION

Commutating Behavior

The use of a triac at the output creates difficulties in commutation due to both the built-in coupled thyristor systems. The triac can remain conducting by parasitic triggering after turning off the control current. However, if the IL410 is equipped with two separate thyristor chips featuring high dv/dt strength, no RC circuit is needed in case of commutation.

Control And Turn-On Behavior

The trigger current of the IL410 has a positive temperature gradient. The time which expires from applying the control current to the turn-on of the load current is defined as the trigger delay time (t_{gd}). On the whole this is a function of the overdrive meaning the ratio of the applied control current versus the trigger current (I_F/I_{FT}). If the value of the control current corresponds to that of the individual trigger current of IL410 turn-on delay times amounts to a few milliseconds only. The shortest times of 5 to 10 μs can be achieved for an overdrive greater or equal than 10. The trigger delay time rises with an increase in temperature.

For very short control current pulses ($t_{pIF} < 500 \mu s$) a correspondingly higher control current must be used. Only the IL410 without zero voltage switch is suitable for this operating mode.

Zero Voltage Switch

The IL410 with zero voltage switch can only be triggered during the zero crossing the sine AC voltage. This prevents current spikes, e. g. when turning-on cold lamps or capacitive loads.

Applications

Direct switching operation: The IL410 switch is mainly suited to control synchronous motors, valves, relays and solenoids in Grätz circuits. Due to the low latching current (500 μA) and the lack of an RC circuit at the output, very low load currents can easily be switched.

Indirect switching operation: The IL410 switch acts here as a driver and thus enables the driving of thyristors and triacs of higher performance by microprocessors. The driving current pulse should not exceed the maximum permissible surge current of the IL410. For this reason, the IL410 without zero voltage switch often requires current limiting by a series resistor.

The favorably low latching current in this operating mode results in AC current switches which can handle load currents from some milliamperes up to high currents.

Application Notes

- Over voltage protection: A voltage-limiting varistor (e.g. S10 VS05K250) which directly connected to the IL410 output can protect the component against overvoltage.

600 V TRIAC DRIVER OPTOCOUPLER

FEATURES

- High Input Sensitivity $I_{FT}=2$ mA
- Blocking Voltage, 600 V
- 300 mA On-State Current
- High Static dv/dt 10,000 V/ μ s
- Inverse Parallel SCRs Provide Commutating $dv/dt >2K$ V/ μ s
- Very Low Leakage <10 μ A
- Withstand Test Voltage from Double Molded Package 7500 VAC_{PEAK}
- Small 6-Pin DIP Package
- Underwriters Lab File #E52744
- VDE Approval #0884 (Optional with Option 1, Add -X001 Suffix)

Maximum Ratings

Emitter

Reverse Voltage	6 V
Forward Current	60 mA
Surge Current	2.5 A
Power Dissipation	100 mW
Derate from 25°C	1.33 mW/°C
Thermal Resistance	750 °C/W

Detector

Peak Off-State Voltage	600 V
Peak Reverse Voltage	600 V
RMS On-State Current	300 mA
Single Cycle Surge	3 A
Total Power Dissipation	500 mW
Derate from 25°C	6.6 mW/°C
Thermal Resistance	150°C/W

Package

Storage Temperature	-55°C to +150°C
Operating Temperature	-55°C to +100°C
Lead Soldering Temperature	260°C/5 sec.
Withstand Test Voltage	7500 VAC _{PEAK} / 5300 VAC _{RMS}

Package Dimensions in Inches (mm)

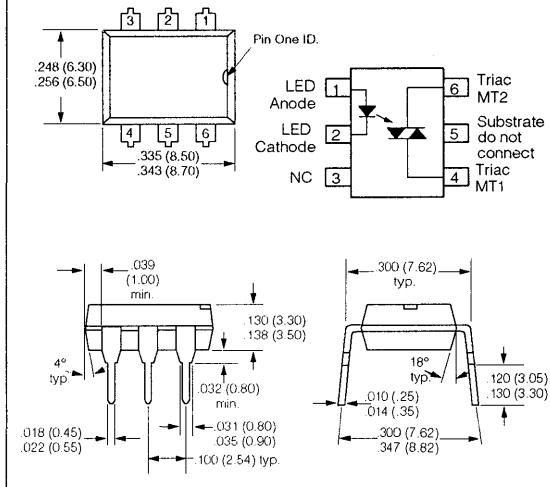

DESCRIPTION

The IL420 consists of a GaAs IRLED optically coupled to a photosensitive non-zero crossing TRIAC network. The TRIAC consists of two inverse parallel connected monolithic SCRs. These three semiconductors are assembled in a six pin 0.3 inch dual in-line package, using high insulation double molded, over/under leadframe construction.

High input sensitivity is achieved by using an emitter follower phototransistor and a cascaded SCR predriver resulting in an LED trigger current of less than 2 mA (DC).

The IL420 uses two discrete SCRs resulting in a commutating dv/dt of greater than 10KV/ms. The use of a proprietary dv/dt clamp results in a static dv/dt of greater than 10KV/ms. This clamp circuit has a MOSFET that is enhanced when high dv/dt spikes occur between MT1 and MT2 of the TRIAC. When conducting, the FET clamps the base of the phototransistor, disabling the first stage SCR predriver.

The 600V blocking voltage permits control of off-line voltages up to 240VAC, with a safety factor of more than two, and is sufficient for as much as 380VAC.

The IL420 isolates low-voltage logic from 120, 240, and 380 VAC lines to control resistive, inductive, or capacitive loads including motors, solenoids, high current thyristors or TRIAC and relays.

Applications include solid-state relays, industrial controls, office equipment, and consumer appliances.

Characteristics

Emitter

	Symbol	Min.	Typ.	Max	Unit	Condition
Forward Voltage	V_F		1.16	1.35	V	$I_F=10\text{ mA}$
Breakdown Voltage	V_{BR}	6	30		V	$I_R=10\text{ }\mu\text{A}$
Reverse Current	I_R		0.1	10	μA	$V_R=6\text{ V}$
Capacitance	C_O		40		pF	$V_F=0\text{ V}$, $f=1\text{ MHz}$
Thermal Resistance Junction to Lead	R_{THJL}		750		$^{\circ}\text{C/W}$	

Output Detector

Repetitive Peak Off-State Voltage	V_{DRM}	600	650		V	$I_{DRM}=100\text{ }\mu\text{A}$
Repetitive Peak Reverse Voltage	V_{RRM}	600	650		V	$I_{RM}=100\text{ }\mu\text{A}$
Off-State Voltage	$V_{D(RMS)}$	424	460		V	$I_{D(RMS)}=70\text{ }\mu\text{A}$
Reverse Voltage	V_R	424	460		V	$I_{R(RMS)}=70\text{ }\mu\text{A}$
Off-State Current	$I_{D(RMS)}$		10	100	μA	$V_D=600\text{ V}$, $T_A=100^{\circ}\text{C}$
Reverse Current	$I_{R(RMS)}$		10	100	μA	$V_R=600\text{ V}$, $T_A=100^{\circ}\text{C}$
On-State Voltage	V_{TM}		1.7	3	V	$I_T=300\text{ mA}$
On-State Current	I_{TM}			300	mA	$\text{PF}=1.0$, $V_{T(RMS)}=1.7\text{ V}$
Surge (Non-Repetitive) On-State Current	I_{TSM}			3	A	$f=50\text{ Hz}$
Holding Current	I_H		65	500	μA	
Latching Current	I_L		5		mA	$V_T=2.2\text{ V}$
LED Trigger Current	I_{FT}		1	2	mA	$V_{AK}=5\text{ V}$
Turn-On Time	t_{ON}		35		μs	$V_{RM}=V_{DM}=424\text{ VAC}$
Turn-Off Time	t_{OFF}		50		μs	$\text{PF}=1.0$, $I_T=300\text{ mA}$
Critical Rate of Rise of Off-State Voltage						$V_D=0.67\text{ V}_{DRM}$ $T_J=25^{\circ}\text{C}$ $T_I=80^{\circ}\text{C}$
	dv/dt_{cr}	10000			V/ μs	
	dv/dt_{cr}	5000			V/ μs	
Critical Rate of Rise of Voltage at Current Commutation						$V_D=0.67\text{ V}_{DRM}$, $di/dt_{crq}\leq 15\text{ A/ms}$ $T_J=25^{\circ}\text{C}$ $T_I=80^{\circ}\text{C}$
	dv/dt_{crq}	10000			V/ μs	
	dv/dt_{crq}	5000			V/ μs	
Critical Rate of Rise of On-State Current	di/dt_{cr}			8	A/ μs	
Thermal Resistance Junction to Lead	R_{THJL}		150		$^{\circ}\text{C/W}$	

Insulation and Isolation

Critical Rate of Rise of Coupled Input/Output Voltage	$dv_{(IO)}/dt$		5000		V/ μs	$I_T=0\text{ A}$, $V_{RM}=V_{DM}=424\text{ VAC}$
Common Mode Coupling Capacitor	C_{CM}		0.01		pF	
Package Capacitance	C_{IO}		0.8		pF	$f=1\text{ MHz}$, $V_{IO}=0\text{ V}$
Withstand Test Voltage Input-Output	WTV	4420			$V_{AC_{RMS}}$	Relative Humidity $\leq 50\%$
	WTV	6250			$V_{AC_{PEAK}}$	$I_{IO}\leq 10\text{ }\mu\text{A}$, 1 min.
	WTV	5300			$V_{AC_{RMS}}$	Relative Humidity $\leq 50\%$
	WTV	7500			$V_{AC_{PEAK}}$	$I_{IO}\leq 10\text{ }\mu\text{A}$, 1 sec.
Creepage Distance, Input/Output Circuit		≥ 8.2			mm	
Clearance, Input/Output Circuit		≥ 7.2			mm	
Insulation Test Voltage, Between Input/Output Circuit		5300			VDC	
Creepage Tracking Resistance per DIN IEC 112/VDE 0303, Part 1 group IIIa per DIN VDE 0110	CTI		175			
Insulation Resistance	R_{is}		$\geq 10^{12}$		Ω	$V_{IO}=500$ $T_A=25^{\circ}\text{C}$
	R_{is}		$\geq 10^{11}$		Ω	$T_A=100^{\circ}\text{C}$
Trigger Current Temperature Gradient	$\Delta I_{FT}/\Delta T_J$		7	14	$\mu\text{A/K}$	
Capacitance Between Input and Output Circuit	C_{IO}			2	pF	$V_R=0$, $f=1\text{ kHz}$

Figure 1. Forward voltage versus forward current

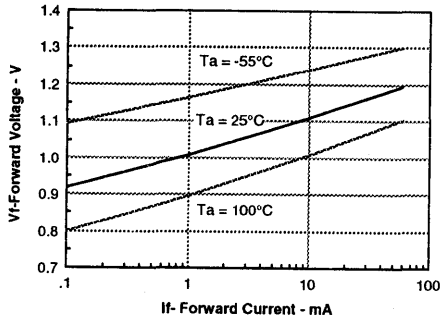

Figure 2. Peak LED current versus duty factor, Tau

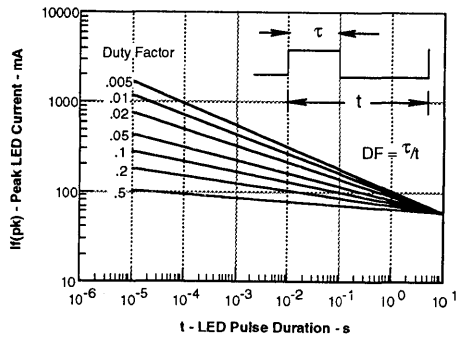

Figure 3. Maximum LED power dissipation

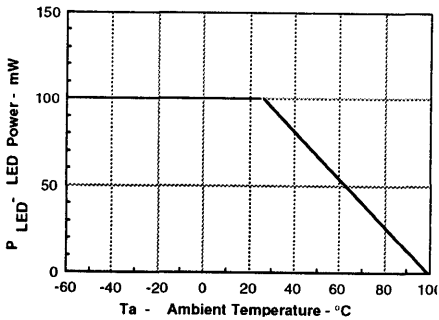

Figure 4. Typical output characteristics
 $I_T = f(V_T)$, parameter: T_j

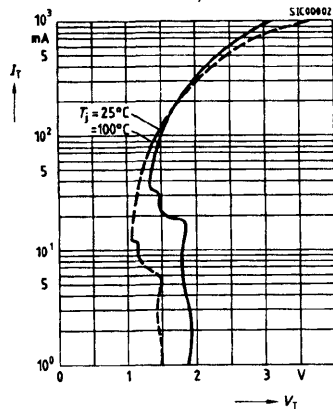

Figure 5. Current reduction $I_{TRMS} = f(T_A)$

$R_{thJA} = 125 \text{ K/W}$

Device is soldered in PCB or base plate

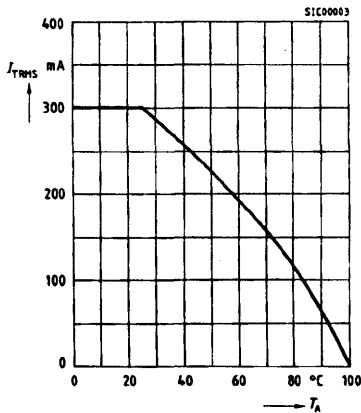

Figure 6. Current reduction

$I_{TRMS} = f(T_{PIN5})$, $R_{thJL} = 16.5 \text{ K/W}$

Thermocouple measurement must be performed potentially separated to A1 and A2. Measuring junction to be as near as possible at case.

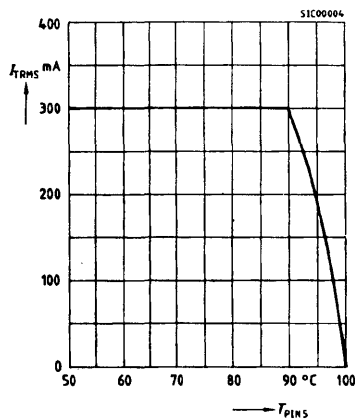

Figure 7. Typical trigger delay time
 $t_{gd}=f(I_P/I_{FT25^{\circ}C})$, $V_D=200$ V, parameter: T_j

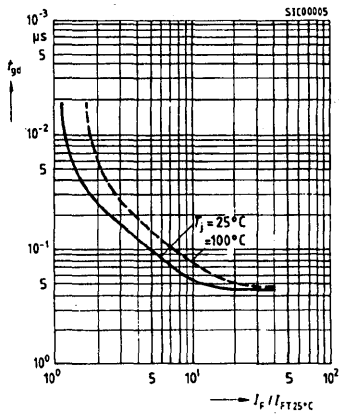

Figure 8. Typical off-state current
 $I_D=f(T_j)$, $V_D=800$ V, parameter: T_j

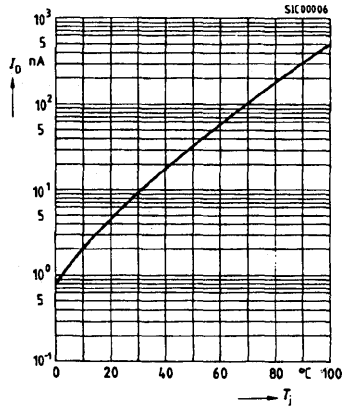

Figure 9. Power dissipation
 for 40 to 60 Hz line operation
 $P_{TOT}=f(I_{TRMS})$

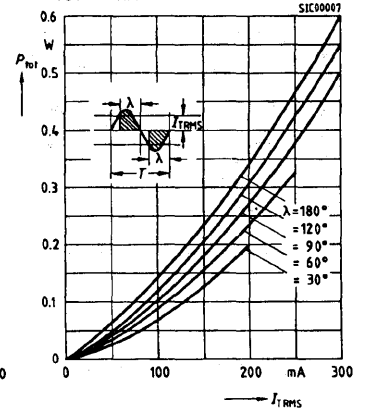

Figure 10. Pulse trigger current $I_{FTN}=f(t_{PIF})$
 I_{FTN} normalized to I_{FT} referring to $t_{PIF} \geq 1$ ms
 $V_{OP}=200$ V, $f=40$ to 60 Hz typ.

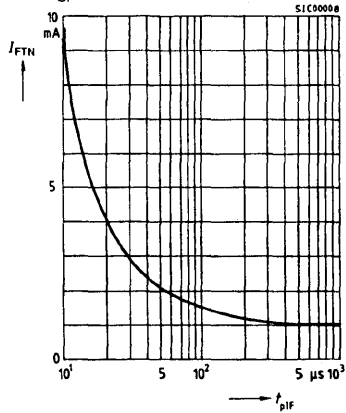
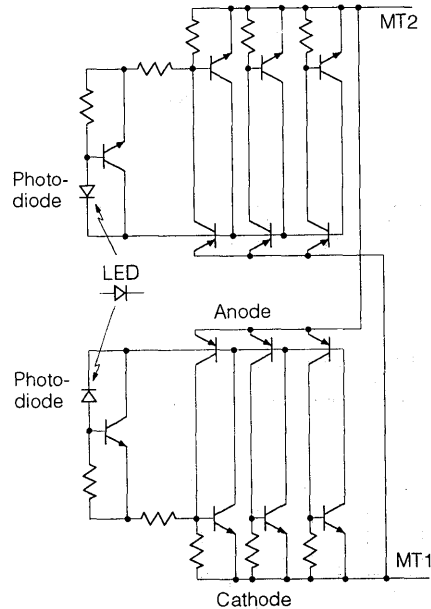

Figure 11. Schematic



The IL420 uses two discrete SCRs resulting in a commutating dV/dt of greater than 10 KV/ μ s.

BIDIRECTIONAL INPUT DARLINGTON OPTOCOUPLEDERS

FEATURES

- High Current Transfer Ratios, $V_{CE}=5\text{ V}$
IL/ILD755-1: 750% at $I_F=2\text{ mA}$
IL/ILD755-2: 1000% at $I_F=1\text{ mA}$
- $BV_{CEO} > 60\text{ V}$
- AC or Polarity Insensitive Inputs
- Built-In Reverse Polarity Input Protection
- Industry Standard DIP Package
- Underwriters Lab File #E52744
- VDE #0884 Available with Option 1

DESCRIPTION

The IL/ILD755 are bidirectional input optically coupled isolators. They consist of two Gallium Arsenide infrared emitting diodes coupled to a silicon NPN photodarlington per channel.

The IL755 are single channel Darlington optocouplers. The ILD755 has two isolated channels in a single DIP package.

They are designed for applications requiring detection or monitoring of AC signals.

Maximum Ratings

Emitter (Each Channel)

Continuous Forward Current	60 mA
Power Dissipation at 25°C	100 mW
Derate Linearly from 25°C	1.33 mW/°C

Detector (Each Channel)

Collector-Emitter Breakdown Voltage	60 V
Collector-Base Breakdown Voltage	70 V
Power Dissipation at 25°C	

IL755	200 mW
ILD755	150 mW

Derate Linearly from 25°C

IL755	2.6 mW/°C
ILD755	2.0 mW/°C

Package

UL Withstand Test Voltage (PK)

(t = 1 sec.) 7500 VDC/5300 VAC_{RMS}

Total Power Dissipation at 25°C Ambient

(LED Plus Detector)	
IL755	250 mW
ILD755	400 mW

Derate Linearly from 25°C

IL755	3.3 mW/°C
ILD755	5.3 mW/°C

Creepage Path 8 mm min.

Clearance Path 7 mm min.

Storage Temperature -55°C to +150°C

Operating Temperature -55°C to +100°C

Lead Soldering Time at 260°C 10 sec.

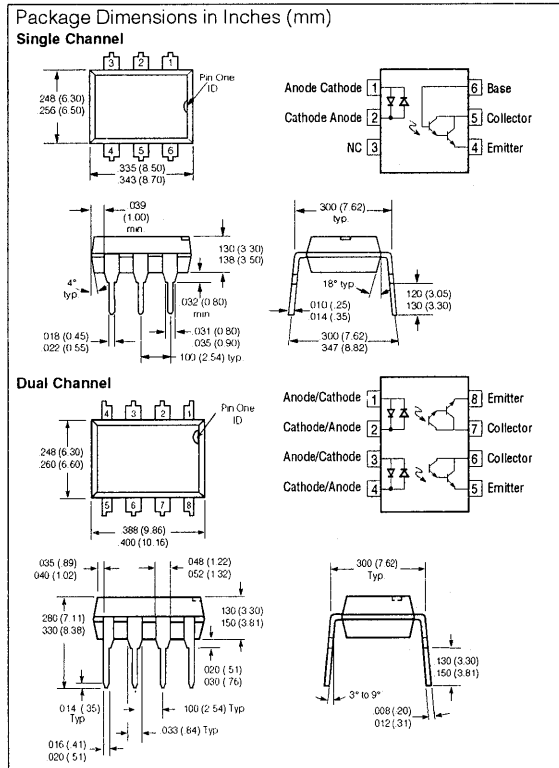

Optocouplers (Optoisolators)

Electrical Characteristics ($T_A=25^\circ\text{C}$)

	Symbol	Min.	Typ.	Max.	Unit	Condition
Emitter						
Forward Voltage	V_F	1.2	1.5		V	$I_F=\pm 10\text{ mA}$
Detector						
BV_{CEO}	60	75			V	$I_C=1\text{ mA}$
BV_{CBO}	60	90			V	$I_C=10\text{ }\mu\text{A}$
I_{CEO}	10	100			nA	$V_{CE}=10\text{ V}$
Package						
V_{CEsat}			1.0		V	$I_F=\pm 10\text{ mA}$, $I_C=10\text{ mA}$
DC Current						
Transfer Ratio	CTR				%	
IL755/ILD755-1		750			%	$I_F=2\text{ mA}$, $V_{CE}=5\text{ V}$
IL755/ILD755-2		1000			%	$I_F=1\text{ mA}$, $V_{CE}=5\text{ V}$
Rise Time/Fall Time					μs	$V_{CC}=10\text{ V}$, $I_F=2\text{ mA}$
IL/ILD755-1			200		μs	$R_L=100\text{ }\Omega$
Rise Time/Fall Time					μs	$V_{CC}=5\text{ V}$, $I_F=1\text{ mA}$, $R_L=100\text{ }\Omega$
IL/ILD755-2			200		μs	

Figure 1. LED forward current versus forward voltage

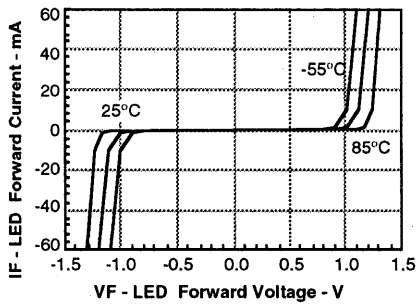

Figure 3. Normalized non-saturated and saturated CTR_{ce} versus LED current

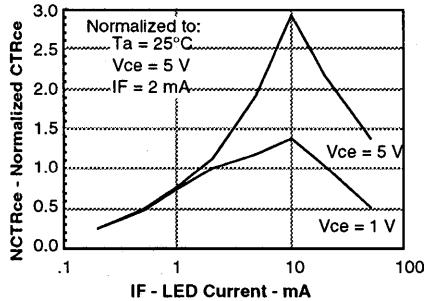

Figure 5. Normalized non-saturated and saturated collector-emitter current versus LED current

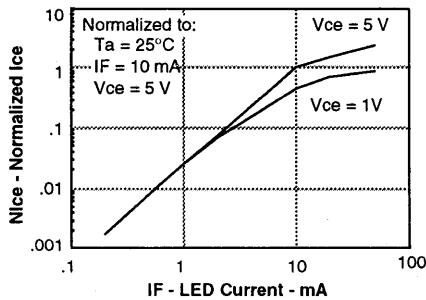

Figure 7. Low to high propagation delay versus collector load resistance and LED current

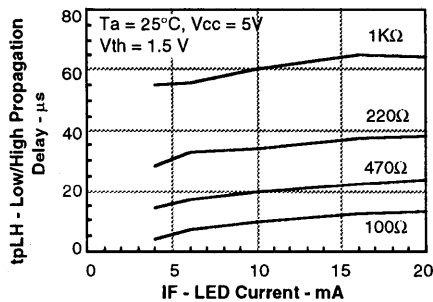

Figure 2. Normalized non-saturated and saturated CTR_{ce} versus LED current

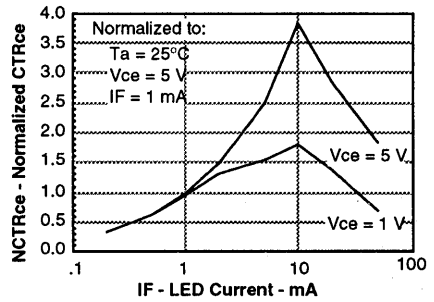

Figure 4. Normalized non-saturated and saturated I_{ce} versus LED current

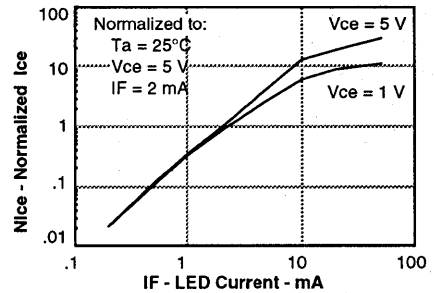

Figure 6. Non-saturated and saturated HFE versus base current

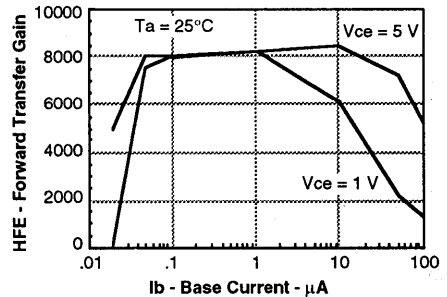

Figure 8. High to low propagation delay versus collector load resistance and LED current

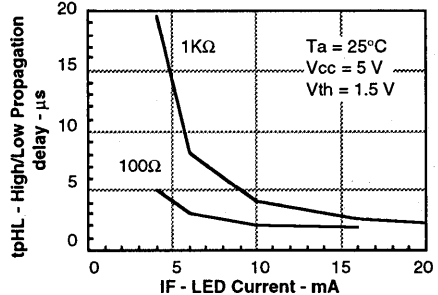

Figure 9. LED forward current versus forward voltage

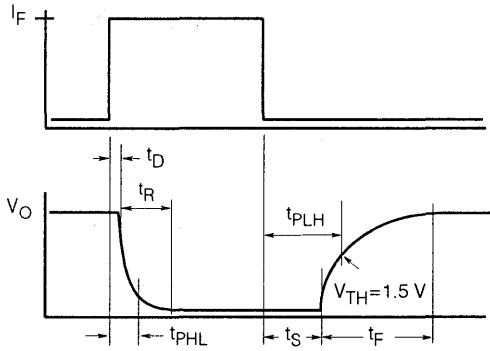
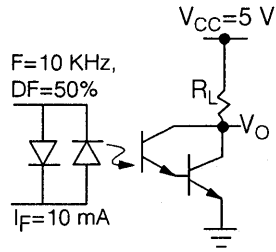

Figure 10. Normalized non-saturated and saturated CTR_{ce} versus LED current



BIDIRECTIONAL INPUT DARLINGTON OPTOCOUPLER

FEATURES

- **Very High Current Transfer Ratio (500% min.)**
IL755B-1: 750% at $I_F=2\text{ mA}$, $V_{CE}=5\text{ V}$
IL755B-2: 1000% at $I_F=1\text{ mA}$, $V_{CE}=5\text{ V}$
- $BV_{CEO} > 60\text{ V}$
- **Withstand Test Voltage, 7500 V**
- **AC or Polarity Insensitive Inputs**
- **No Base Connection**
- **High Isolation Resistance, $10^{11}\ \Omega$ Typical**
- **Low Coupling Capacitance**
- **Standard Plastic DIP Package**
- **Underwriters Lab Approval #E52744**
- **VDE #0884 Available with Option 1**

DESCRIPTION

The IL755B is a bidirectional input, optically coupled isolator consisting of two Gallium Arsenide infrared emitters and a silicon photodarlington sensor.

Maximum Ratings (at 25°C)

Emitter (Drive Circuit)

Continuous Forward Current 60 mA
Power Dissipation at 25°C 100 mW
Derate Linearly from 55°C 1.33 mW/°C

Detector (Load Circuit)

Collector-Emitter Breakdown Voltage 60 V
Emitter-Collector Breakdown Voltage 12 V
Power Dissipation at 25°C Ambient 200 mW
Derate Linearly from 25°C 2.6 mW/°C

Package

UL Withstand Test Voltage
(PK) ($t=1\text{ sec.}$) 7500 VAC_(PK)/5300 VAC_{RMS}
Total Working Voltage 1700 VAC_{RMS}
Dissipation at 25°C 250 mW
Derate Linearly from 25°C⁽²⁾ 3.3 mW/°C
Creepage Path 8 min mm
Clearance Path 7 min mm
Insulation Resistance $10^{11}\ \Omega$
Storage Temperature⁽²⁾ -55°C to +150°C
Operating Temperature -55°C to +100°C
Lead Soldering Time at 260°C 10 sec.

Package Dimensions in Inches (mm)

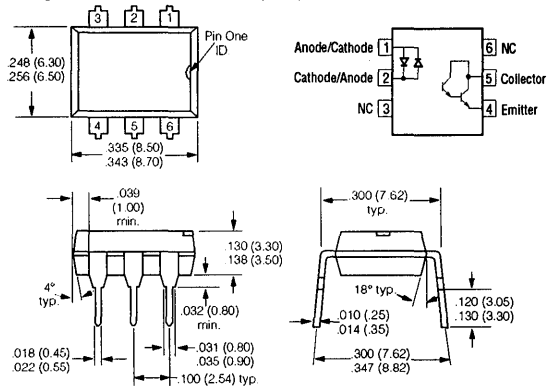

Electrical Characteristics ($T_A=25^\circ\text{C}$)

	Symbol	Min.	Typ.	Max.	Unit	Condition
Emitter						
Forward Voltage ⁽²⁾	V_F	1.25	1.5		V	$I_F=10\text{ mA}$
Detector⁽²⁾						
Collector-Emitter						
Breakdown Voltage BV_{CEO}		60	75		V	$I_C=1\text{ mA}$, $I_F=0$
Collector-Emitter						
Leakage Current	I_{CEO}	1.0	100		nA	$V_{CE}=10\text{ V}$, $I_F=0$
Package						
Current Transfer						
Ratio ⁽²⁾	CTR				%	
IL755B-1		750			%	$I_F=2\text{ mA}$, $V_{CE}=5\text{ V}$
IL755B-2		1000			%	$I_F=1\text{ mA}$, $V_{CE}=5\text{ V}$
Collector-Emitter						
Saturation Voltage	V_{CEsat}		1.0		V	$I_C=10\text{ mA}$, $I_F=10\text{ mA}$
Turn-On Time	t_{on}		200		μs	$V_{CC}=6\text{ V}$
Turn-Off Time	t_{off}		200		μs	$I_F=2\text{ mA}$, $R_L=100\ \Omega$

Notes:

1. Devices are UL approved to 7500 VDC for 1 sec.
2. Indicates JEDEC registered data.

Figure 1. LED forward current versus forward voltage

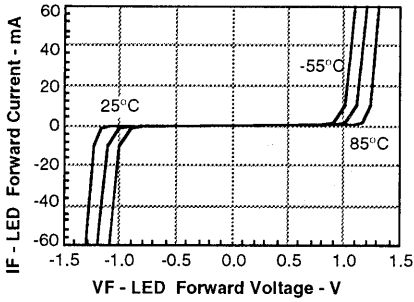

Figure 2. Normalized non-saturated and saturated CTR_{ce} versus LED current

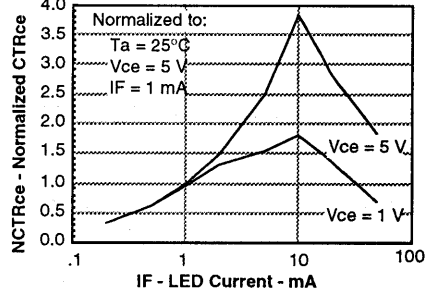

Figure 3. Normalized non-saturated and saturated CTR_{ce} versus LED current

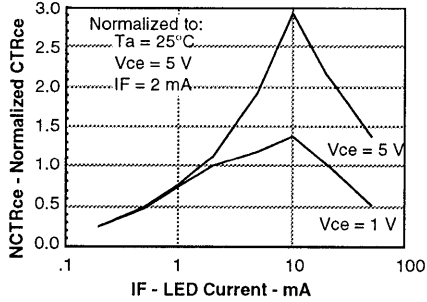

Figure 4. Normalized non-saturated and saturated I_{ce} versus LED current

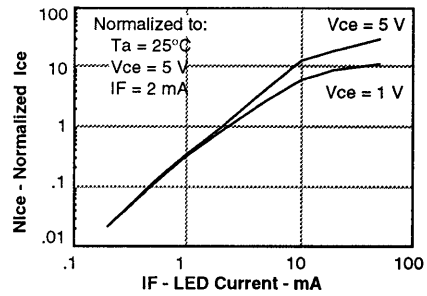

Figure 5. Normalized non-saturated and saturated collector-emitter current versus LED current

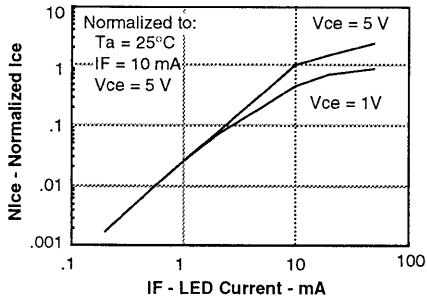

Figure 6. Low to high propagation delay versus collector load resistance and LED current

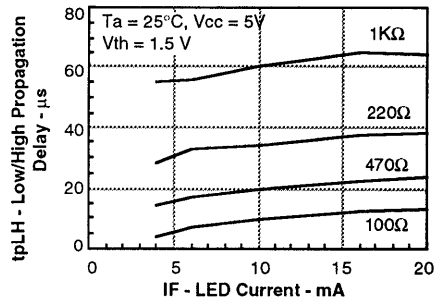

Figure 7. High to low propagation delay versus collector load resistance and LED current

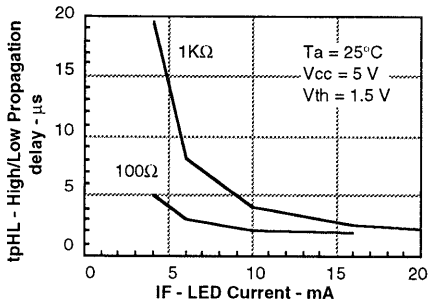

Figure 8. LED forward current versus forward voltage

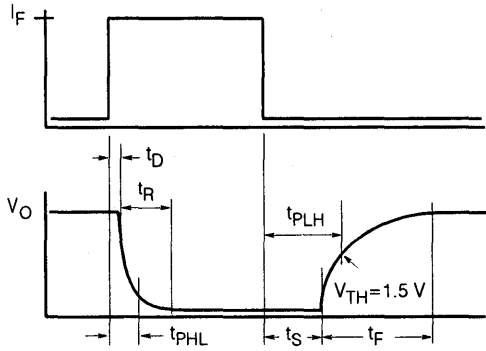
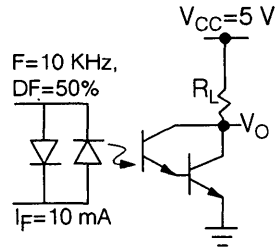

Figure 9. Normalized non-saturated and saturated CTR_{ce} versus LED current



BIDIRECTIONAL INPUT DARLINGTON OPTOCOUPLEDERS

FEATURES

- Internal R_{BE} for Better Stability
- High Current Transfer Ratios, $V_{CE}=5\text{ V}$
IL/ILD766-1: 500% at $I_F=2\text{ mA}$
IL766-2: 500% at $I_F=1.0\text{ mA}$
- $BV_{CEO} > 60\text{ V}$
- AC or Polarity Insensitive Inputs
- Built-In Reverse Polarity Input Protection
- Industry Standard DIP Package
- Underwriters Lab File #E52744

DESCRIPTION

The IL/ILD766 are bidirectional input optically coupled isolators. They consist of two Gallium Arsenide infrared emitting diodes coupled to a silicon NPN photodarlington per channel.

The IL766 are single channel optocouplers. The ILD766 has two isolated channels in a single DIP package. They are designed for applications requiring detection or monitoring of AC signals.

Maximum Ratings

Emitter (Each Channel)

Continuous Forward Current	60 mA
Power Dissipation at 25°C	
Single Channel	200 mW
Dual Channel	90 mW
Derate Linearly from 25°C	
Single Channel	2.6 mW/°C
Dual Channel	1.2 mW/°C

Detector (Each Channel)

Collector-Emitter Breakdown Voltage	60 V
Collector-Base Breakdown Voltage	70 V
Power Dissipation at 25°C	100 mW
Derate Linearly from 25°C	1.33 mW/°C

Package

UL Withstand Test Voltage

($t = 1\text{ sec.}$)	7500 VAC _{PK} /5300 VAC _{RMS}
Insulation Resistance	$10^{11}\ \Omega$
Total Power Dissipation at 25°C Ambient (LED Plus Detector)	
Single Channel	250 mW
Dual Channel	400 mW
Derate Linearly from 25°C	
Single Channel	3.3 mW/°C
Dual Channel	5.3 mW/°C
Creepage Path	8 mm min.
Clearance Path	7 mm min.
Tracking Index per VDE 0303	KB 100/A
Storage Temperature	-55°C to +150°C
Operating Temperature	-55°C to +100°C
Lead Soldering Time at 260°C	10 sec.

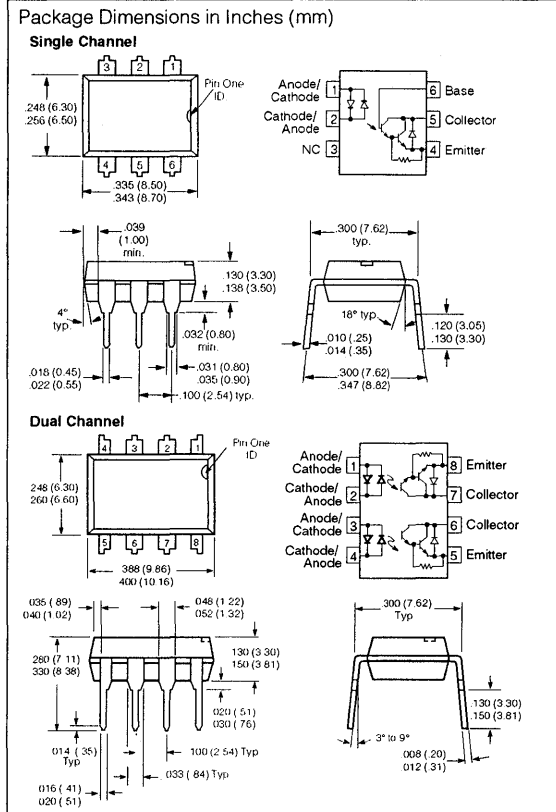

Optocouplers
(Optoisolators)

Electrical Characteristics ($T_A=25^\circ\text{C}$)

	Symbol	Min.	Typ.	Max.	Unit	Condition
Emitter						
Forward Voltage	V_F		1.2	1.5	V	$I_F = \pm 10\text{ mA}$
Detector						
Breakdown Voltage						
Collector-Emitter	BV_{CEO}	60	75		V	$I_C = 1\text{ mA}$
Collector-Base	BV_{CBO}	60	90		V	$I_C = 10\ \mu\text{A}$
Leakage Current						
Collector-Emitter	I_{CEO}		10	100	nA	$V_{CE} = 10\text{ V}$
Package						
V_{CEsat}			1.0		V	$I_F = \pm 10\text{ mA}$, $I_C = 10\text{ mA}$
DC Current						
Transfer Ratio	CTR				%	
IL766/ILD766-1		500			%	$I_F = \pm 2\text{ mA}$, $V_{CE} = 5\text{ V}$
IL766-2		500			%	$I_F = \pm 1.0\text{ mA}$, $V_{CE} = 5\text{ V}$
Rise Time, Fall Time			100		μs	$V_{CC} = 10\text{ V}$, $I_F = \pm 2\text{ mA}$, $R_L = 100\ \Omega$

Figure 1. Input characteristics

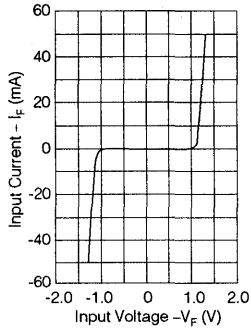

Figure 2. Transistor current versus voltage

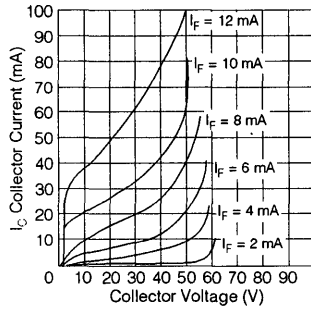

Figure 3. Transistor output current versus voltage

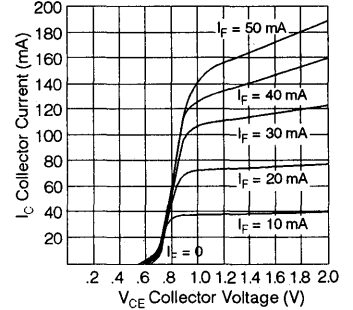

Figure 4. I_CEO at V_CE=10 V versus temperature

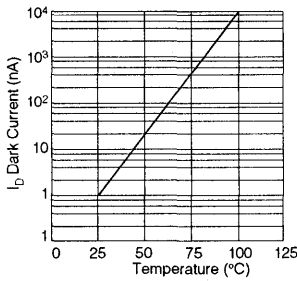

Figure 5. Normalized CTR versus forward current

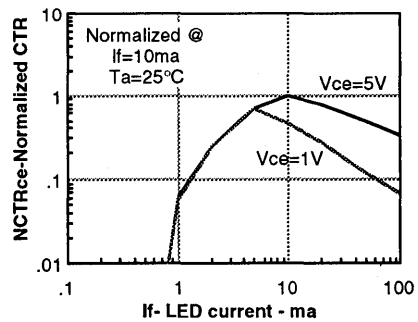

Figure 6. Tr versus forward current

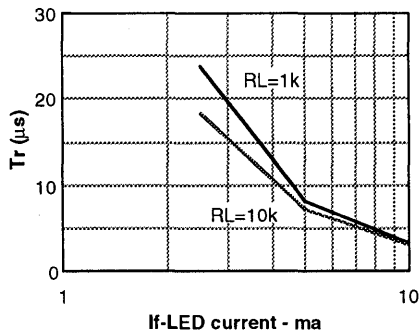

Figure 7. Saturated switching characteristics measurements—schematic and waveform

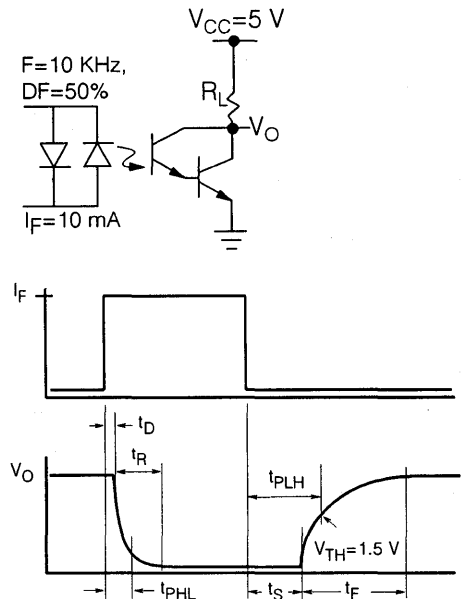

Figure 8. Tfall versus forward current

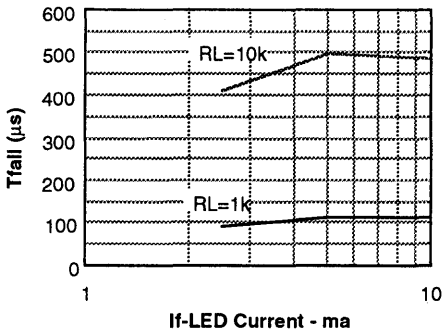

Figure 9. Ton versus forward current

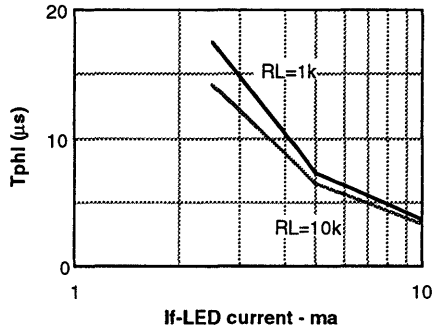

Figure 10. Toff versus forward current

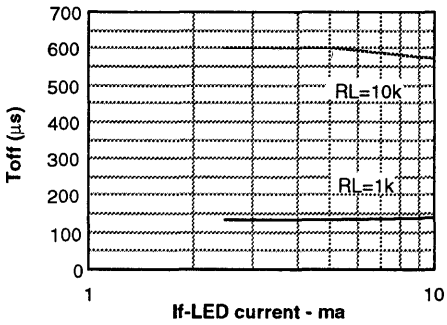

Figure 11. Tphl versus forward current

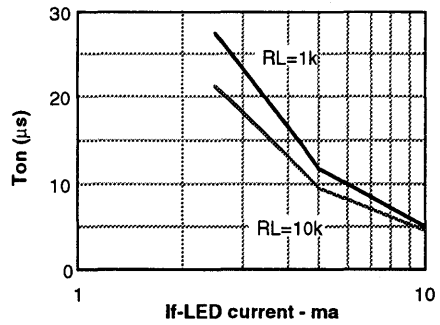
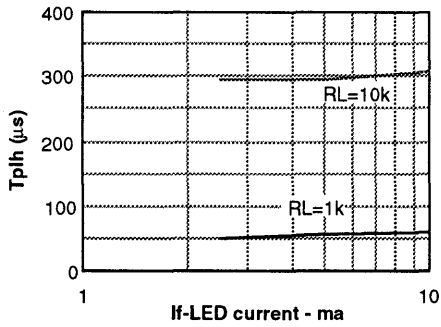

Figure 12. Tplh versus forward current



FEATURES

- **Very High Current Transfer Ratio**
IL766B-1: 400% at $I_F=1\text{ mA}$, $V_{CE}=5\text{ V}$
IL766B-2: 900% at $I_F=0.5\text{ mA}$, $V_{CE}=5\text{ V}$
- **Internal R_{BE} for Better Stability**
- **$BV_{CEO} > 60\text{ V}$**
- **Withstand Test Voltage, 7500 V**
- **AC or Polarity Insensitive Inputs**
- **No Base Connection**
- **High Insulation Resistance, $10^{11}\ \Omega$ Typical**
- **Standard Plastic DIP Package**
- **Underwriters Lab File #E52744**

DESCRIPTION

The IL766B is a bidirectional input, optically coupled isolator consisting of two Gallium Arsenide infrared emitters and a silicon photodarlington sensor.

Maximum Ratings (at 25°C)

Emitter (Drive Circuit)

Continuous Forward Current 100 mA
Power Dissipation at 25°C 200 mW
Derate Linearly from 55°C 2.6 mW/°C

Detector (Load Circuit)

Collector-Emitter Breakdown Voltage 60 V
Collector-Base Breakdown Voltage 70 V
Power Dissipation at 25°C Ambient 200 mW
Derate Linearly from 25°C 2.6 mW/°C

Package

UL Withstand Test Voltage
($t=1\text{ sec.}$) 7500 VAC_{PK}/5300 VAC_{RMS}
Working Voltage 1700 VAC_{RMS}
Dissipation at 25°C 250 mW
Derate Linearly from 25°C 3.3 mW/°C
Creepage Path 8 min mm
Clearance Path 7 min mm
Insulation Resistance $10^{11}\ \Omega$
Storage Temperature -55°C to +150°C
Operating Temperature -55°C to +100°C
Lead Soldering Time at 260°C 10 sec.

Package Dimensions in Inches (mm)

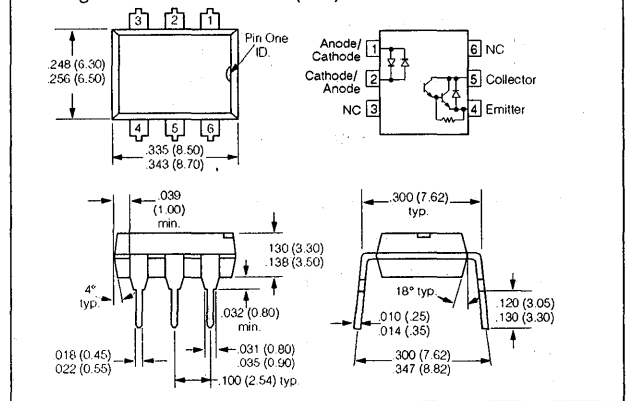

Electrical Characteristics ($T_A=25^\circ\text{C}$)

	Symbol	Min.	Typ.	Max.	Unit	Condition
Emitter						
Forward Voltage	V_F	1.25	1.5		V	$I_F=10\text{ mA}$
Detector						
Breakdown Voltage						
Collector-Emitter	BV_{CEO}	60			V	$I_C=1\text{ mA}$, $I_F=0$
Leakage Current						
Collector-Emitter	I_{CEO}	1.0	100		nA	$V_{CE}=10\text{ V}$, $I_F=0$
Package						
Current Transfer Ratio	CTR				%	
IL766B-1		400			%	$I_F=\pm 1\text{ mA}$, $V_{CE}=5\text{ V}$
IL766B-2		900			%	$I_F=\pm 0.5\text{ mA}$, $V_{CE}=5\text{ V}$
Saturation Voltage						
Collector-Emitter	V_{CEsat}		1.0		V	$I_C=10\text{ mA}$, $I_F=\pm 10\text{ mA}$
Turn-On, Turn-Off Time	t_{on}, t_{off}		200		μs	$V_{CC}=5\text{ V}$, $I_F=\pm 2\text{ mA}$, $R_L=100\ \Omega$

ZERO VOLTAGE CROSSING TRIAC DRIVER OPTOCOUPLER

FEATURES

- **High Input Sensitivity**
 $I_{FT}=1.3$ mA, PF=1.0
 $I_{FT}=3.5$ mA, Typical PF < 1.0
- **Zero Voltage Crossing**
- **600/700/800 V Blocking Voltage**
- **300 mA On-State Current**
- **High Static dv/dt 10,000 V/μsec., typical**
- **Inverse Parallel SCRs Provide Commutating dv/dt >10 KV/μsec.**
- **Very Low Leakage <10 μA**
- **Withstand Test Voltage from Double Molded Package 6000 VAC_{PEAK}**
- **Package, 6-Pin DIP**
- **Underwriters Lab File #E52744**

DESCRIPTION

The IL411 consists of an AlGaAs IRLLED optically coupled to a photosensitive zero crossing TRIAC network. The TRIAC consists of two inverse parallel connected monolithic SCRs. These three semiconductors are assembled in a six pin 0.3 inch dual in-line package, using high insulation double molded, over/under leadframe construction.

High input sensitivity is achieved by using an emitter follower phototransistor and a cascaded SCR predriver resulting in an LED trigger current of less than 1.3 mA(DC).

The IL411 uses two discrete SCRs resulting in a commutating dv/dt greater than 10 KV/μs. The use of a proprietary dv/dt clamp results in a static dv/dt of greater than 10 KV/μs. This clamp circuit has a MOSFET that is enhanced when high dv/dt spikes occur between MT1 and MT2 of the TRIAC. When conducting, the FET clamps the base of the phototransistor, disabling the first stage SCR predriver.

The zero cross line voltage detection circuit consists of two enhancement MOSFETS and a photodiode. The inhibit voltage of the network is determined by the enhancement voltage of the N-channel FET. The P-channel FET is enabled by a photocurrent source that permits the FET to conduct the main voltage to gate on the N-channel FET. Once the main voltage can enable the N-channel, it clamps the base of the phototransistor, disabling the first stage SCR predriver.

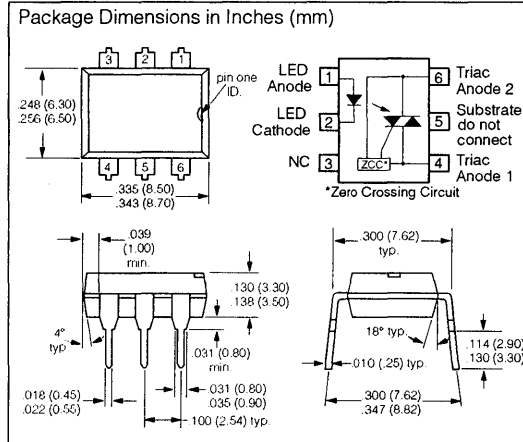

DESCRIPTION (continued)

The blocking voltage of up to 800 V permits control of off-line voltages up to 240 VAC, with a safety factor of more than two, and is sufficient for as much as 380 VAC. Current handling capability is up to 300 mA RMS continuous at 25°C.

The IL411 isolates low-voltage logic from 120, 240, and 380 VAC lines to control resistive, inductive, or capacitive loads including motors, solenoids, high current thyristors or TRIAC and relays.

Applications include solid-state relays, industrial controls, office equipment, and consumer appliances.

Maximum Ratings

Emitter

Reverse Voltage	6 V
Forward Current	60 mA
Surge Current	2.5 A
Power Dissipation	100 mW
Derate Linearly from 25°C	1.33 mW/°C
Thermal Resistance	750 °C/W

Detector

Peak Off-State Voltage	
IL4116	600 V
IL4117	700 V
IL4118	800 V
RMS On-State Current	300 mA
Single Cycle Surge	3 A
Total Power Dissipation	500 mW
Derate Linearly from 25°C	6.6 mW/°C
Thermal Resistance	150 °C/W

Package

Storage Temperature	-55°C to +150°C
Operating Temperature	-55°C to +100°C
Lead Soldering Temperature	260°C/5 sec.
Withstand Test Voltage	6000 VAC _{PEAK}

Characteristics (T_A=25°C)

Parameter	Symbol	Min.	Typ.	Max.	Unit	Condition
Emitter						
Forward Voltage	V _F		1.3	1.5	V	I _F =20 mA
Breakdown Voltage	V _{BR}	6	30		V	I _R =10 μA
Reverse Current	I _R		0.1	10	μA	V _R =6 V
Capacitance	C ₀		40		pF	V _F =0 V, f=1 MHz
Thermal Resistance, Junction to Lead	R _{THJL}		750		°C/W	
Output Detector						
Repetitive Peak						
Off-State Voltage						
IL4116	V _{DRM}	600	650		V	I _{DRM} =100 μA
IL4117	V _{DRM}	700	750		V	I _{DRM} =100 μA
IL4118	V _{DRM}	800	850		V	I _{DRM} =100 μA
Off-State Voltage						
IL4116	V _{D(RMS)}	424	460		V	I _{D(RMS)} =70 μA
IL4117	V _{D(RMS)}	494	536		V	I _{D(RMS)} =70 μA
IL4118	V _{D(RMS)}	565	613		V	I _{D(RMS)} =70 μA
Off-State Current	I _{D(RMS)}		10	100	μA	V _D =600 V, T _A =100°C
On-State Voltage	V _{TM}		1.7	3	V	I _T =300 mA
On-State Current	I _{TM}			300	mA	PF=1.0, V _{T(RMS)} =1.7 V
Surge (Non-Repetitive)						
On-State Current)	I _{TSM}			3	A	f=50 Hz
Holding Current	I _H		65	200	μA	V _T =3 V
Latching Current	I _L		5		mA	V _T =2.2 V
LED Trigger Current	I _{FT}		0.7	1.3	mA	V _{AK} =5 V
Zero Cross Inhibit Voltage	V _{IH}		15	25	V	I _F =Rated I _{FT}
Turn-On Time	t _{ON}		35		μs	V _{RM} =V _{DM} =424 VAC
Turn-Off Time	t _{OFF}		50		μs	PF=1.0, I _T =300 mA
Critical Rate of Rise:						
Off-State Voltage	dv _{(MTY)/dt}	10,000			V/μs	V _{RM} , V _{DM} =400 VAC, T _A =25°C
			2000		V/μs	V _{RM} , V _{DM} =400 VAC, T _A =80°C
Commutating Voltage	dv _{(COM)/dt}	10,000			V/μs	V _{RM} , V _{DM} =400 VAC, T _A =25°C
			2000		V/μs	V _{RM} , V _{DM} =400 VAC, T _A =80°C
Commutating Current	di/dt		100		A/ms	I _T =300 mA
Thermal Resistance, Junction to Lead	R _{THJL}		150		°C/W	
Insulation and Isolation						
Critical Rate of Rise of Coupled						
Input-Output Voltage	dv _{(IO)/dt}	10,000			V/μs	I _T =0 A, V _{RM} =V _{DM} =424 VAC
Common Mode						
Coupling Capacitor	C _{CM}		0.01		pF	
Package Capacitance	C _{IO}		0.8		pF	f=1 MHz, V _{IO} =0 V
Insulation Resistance	R _{IS}		10 ¹¹		Ω	
Withstand Test Voltage						
Input-Output	WTV	4420			VAC _{RMS}	(Relative Humidity ≤50%)
	WTV	6250			VAC _{PEAK}	(I _{IO} ≤10 μA, 1 min.)
	WTV	5300			VAC _{RMS}	(Relative Humidity ≤50%)
	WTV	7500			VAC _{PEAK}	(I _{IO} ≤10 μA, 1 sec.)

Figure 1. LED forward current vs. forward voltage

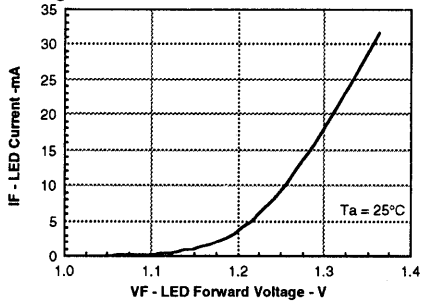

Figure 2. Forward voltage versus forward current

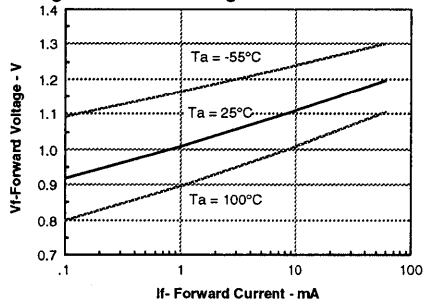

Figure 3. Peak LED current vs. duty factor, Tau

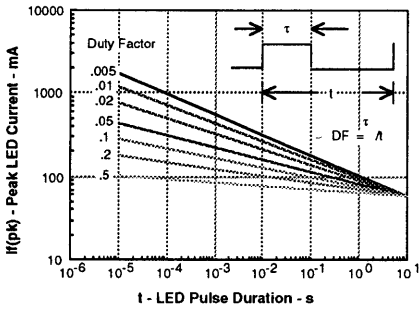

Figure 4. Maximum LED power dissipation

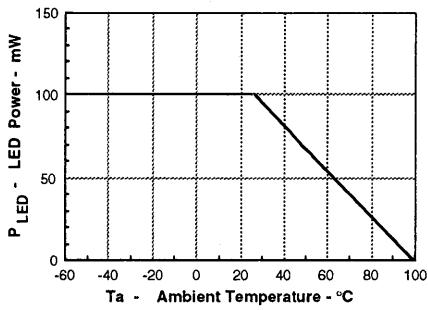

Figure 5. On-state terminal voltage vs. terminal current

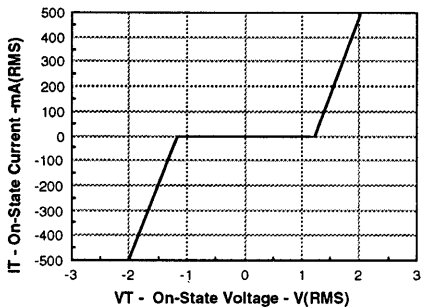
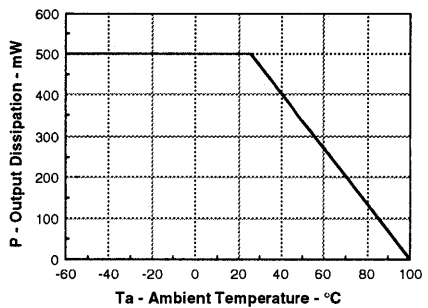

Figure 6. Maximum output power dissipation



POWER FACTOR CONSIDERATIONS

A snubber isn't needed to eliminate false operation of the TRIAC driver because of the IL411's high static and commutating dv/dt with loads between 1 and 0.8 power factors. When inductive loads with power factors less than 0.8 are being driven, include a RC snubber or a single capacitor directly across the device to clamp the peak commutating dv/dt spike. Normally a commutating dv/dt causes a turning-off device to stay on due to the stored energy remaining in the turning-off device.

But in the case of a zero voltage crossing optotriac, the commutating dv/dt spikes can inhibit one half of the TRIAC from turning on. If the spike potential exceeds the inhibit voltage of the zero cross detection circuit,

half of the TRIAC will be held-off and not turn-on. This hold-off condition can be eliminated by using a snubber or capacitor placed directly across the optotriac as shown in Figure 7. Note that the value of the capacitor increases as a function of the load current.

The hold-off condition also can be eliminated by providing a higher level of LED drive current. The higher LED drive provides a larger photocurrent which causes the phototransistor to turn-on before the commutating spike has activated the zero cross network. Figure 8 shows the relationship of the LED drive for power factors of less than 1.0. The curve shows that if a device requires 1.5 mA for a resistive load, then 1.8 times (2.7 mA) that amount would be required to control an inductive load whose power factor is less than 0.3.

Figure 7. Shunt capacitance versus load current versus power factor

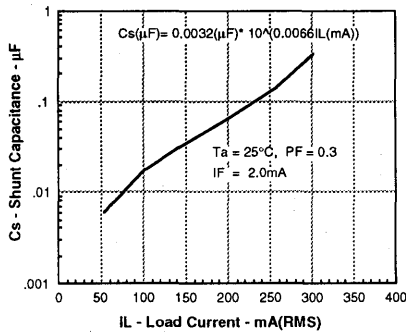

Figure 8. Normalized LED trigger current

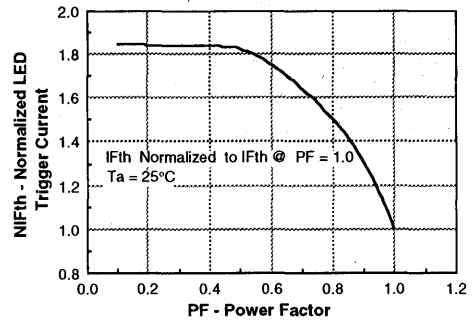
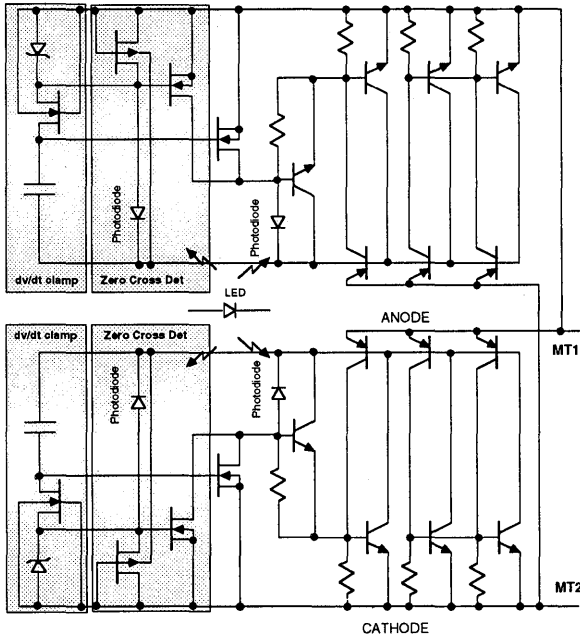

Figure 9. Schematic



TRIAC DRIVER OPTOCOUPLER

FEATURES

- High Input Sensitivity $I_{FT}=1.3$ mA
- 600/700/800 V Blocking Voltage
- 300 mA On-State Current
- High Static dv/dt 10,000 V/ μ sec., typical
- Inverse Parallel SCRs Provide Commutating dv/dt >10 KV/ μ sec
- Very Low Leakage <10 μ A
- Withstand Test Voltage from Double Molded Package 6000 VAC_{PEAK}
- Package, 6-Pin DIP
- Underwriters Lab File #E52744

DESCRIPTION

The IL421 consists of an AlGaAs IRLED optically coupled to a pair of photosensitive non-zero crossing SCR chips and are connected inversely parallel to form a TRIAC. These three semiconductors are assembled in a six pin 0.3 inch dual in-line package, using high insulation double molded, over/under leadframe construction.

High input sensitivity is achieved by using an emitter follower phototransistor and a cascaded SCR predriver resulting in an LED trigger current of less than 1.3 mA (DC).

The IL421 uses two discrete SCRs resulting in a commutating dv/dt of greater than 10KV/ μ s. The use of a proprietary dv/dt clamp results in a static dv/dt of greater than 10KV/ μ s. This clamp circuit has a MOSFET that is enhanced when high dv/dt spikes occur between MT1 and MT2 of the TRIAC. The FET clamps the base of the phototransistor when conducting, disabling the internal SCR predriver.

The blocking voltage of up to 800 V permits control of off-line voltages up to 240 VAC, with a safety factor of more than two, and is sufficient for as much as 380 VAC. Current handling capability is up to 300 mA RMS, continuous at 25°C.

The IL421 isolates low-voltage logic from 120, 240, and 380 VAC lines to control resistive inductive, or capacitive loads including motors solenoids, high current thyristors or TRIAC and relays.

Applications include solid-state relays, industrial controls, office equipment, and consumer appliances.

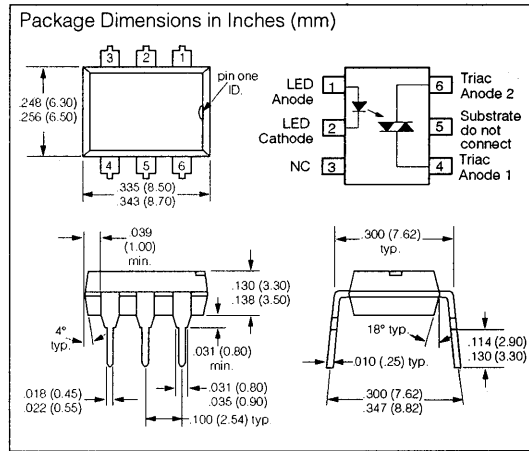

Maximum Ratings

Emitter

Reverse Voltage	6 V
Forward Current	60 mA
Surge Current	2.5 A
Power Dissipation	100 mW
Derate Linearly from 25°C	1.33 mW/°C
Thermal Resistance	750 °C/W

Detector

Peak Off-State Voltage	
IL4216	600 V
IL4217	700 V
IL4218	800 V
RMS On-State Current	300 mA
Single Cycle Surge	3 A
Total Power Dissipation	500 mW
Derate Linearly from 25°C	6.6 mW/°C
Thermal Resistance	150°C/W

Package

Withstand Test Voltage	6000 VAC _{PEAK}
Storage Temperature	-55°C to +150°C
Operating Temperature	-55°C to +100°C
Lead Soldering Temperature	260°C/5 sec.

Characteristics (T_A=25°C)

Parameter	Symbol	Min.	Typ.	Max.	Unit	Condition
Emitter						
Forward Voltage	V _F		1.3	1.5	V	I _F =20 mA
Breakdown Voltage	V _{BR}	6	30		V	I _R =10 μA
Reverse Current	I _R		0.1	10	μA	V _R =6 V
Capacitance	C ₀		40		pF	V _E =0 V, f=1 MHz
Thermal Resistance, Junction to Lead	R _{THJL}		750		°C/W	
Output Detector						
Repetitive Peak						
Off-State Voltage						
IL4216	V _{DRM}	600	650		V	I _{DRM} =100 μA
IL4217	V _{DRM}	700	750		V	I _{DRM} =100 μA
IL4218	V _{DRM}	800	850		V	I _{DRM} =100 μA
Off-State Voltage						
IL4216	V _{D(RMS)}	424	460		V	I _{D(RMS)} =70 μA
IL4217	V _{D(RMS)}	494	536		V	I _{D(RMS)} =70 μA
IL4218	V _{D(RMS)}	565	613		V	I _{D(RMS)} =70 μA
Off-State Current						
Reverse Current	I _{D(RMS)}		10	100	μA	V _D =600 V, T _A =100°C
On-State Voltage	I _{R(RMS)}		10	100	μA	V _R =600 V, T _A =100°C
On-State Current	V _{TM}		1.7	3	V	I _T =300 mA
Surge (Non-Repetitive)	I _{TM}			300	mA	PF=1.0, V _{T(RMS)} =1.7 V
On-State Current	I _{TSM}			3	A	f=50 Hz
Holding Current	I _H		65	200	μA	V _T =3 V
Latching Current	I _L		5		mA	V _T =2.2 V
LED Trigger Current	I _{FT}		0.7	1.3	mA	V _{AK} =5 V
Turn-On Time	t _{ON}		35		μs	V _{RM} =V _{DM} =424 VAC
Turn-Off Time	t _{OFF}		50		μs	PF=1.0, I _T =300 mA
Critical Rate of Rise:						
Off-State Voltage	dv _{(MT)/dt}	10,000			V/μs	V _{RM} , V _{DM} =400 VAC, T _A =25°C
			2000		V/μs	V _{RM} , V _{DM} =400 VAC, T _A =80°C
Commutating Voltage	dv _{(COM)/dt}	10,000			V/μs	V _{RM} , V _{DM} =400 VAC, T _A =25°C
			2000		V/μs	V _{RM} , V _{DM} =400 VAC, T _A =80°C
Off-State Current	di/dt		100		A/ms	I _T =300 mA
Thermal Resistance, Junction to Lead	R _{THJL}		150		°C/W	
Insulation and Isolation						
Critical Rate of Rise of Coupled						
Input-Output Voltage	dv _{(IO)/dt}	5000			V/μs	I _T =0 A, V _{RM} =V _{DM} =300 VAC
Common Mode						
Coupling Capacitor	C _{CM}		0.01		pF	
Package Capacitance	C _{IO}		0.8		pF	f=1MHz, V _{IO} =0 V
Insulation Resistance	R _{IS}		10 ¹¹		Ω	
Withstand Test Voltage						
Input-Output	WTV	4420			VAC _{RMS}	(Relative Humidity ≤50%)
	WTV	6250			VAC _{PEAK}	(I _{IO} ≤10 μA, 1 min.)
	WTV	5300			VAC _{RMS}	(Relative Humidity ≤50%)
	WTV	7500			VAC _{PEAK}	(I _{IO} ≤10 μA, 1 sec.)

Figure 1. LED forward current vs. forward voltage

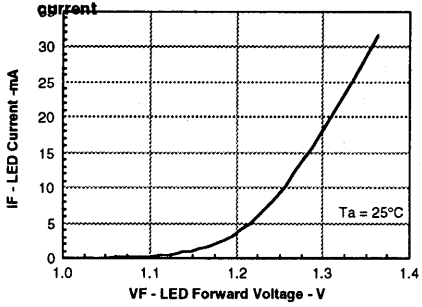

Figure 2. Forward voltage versus forward current

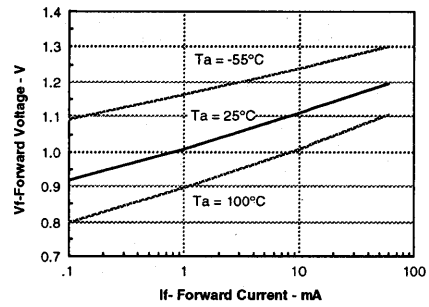

Figure 3. Peak LED current vs. duty factor, Tau

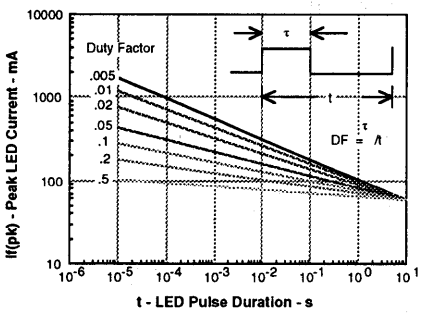

Figure 4. Maximum LED power dissipation

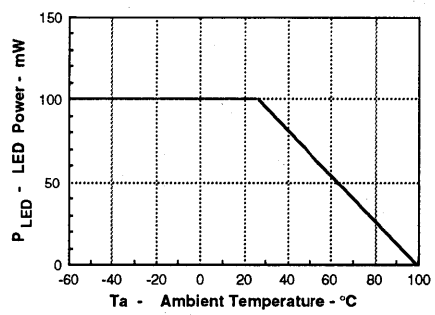

Figure 5. On-state terminal voltage vs. terminal current

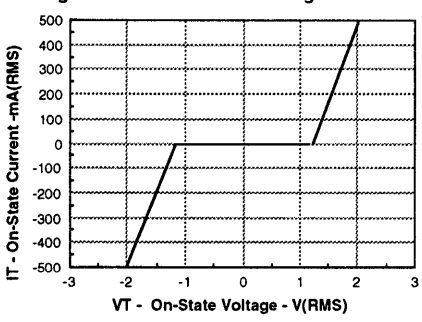
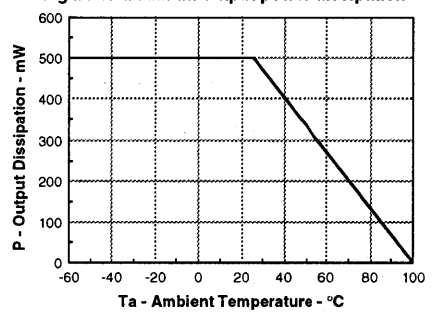

Figure 6. Maximum output power dissipation



Optocouplers
(Optoisolators)

POWER FACTOR CONSIDERATIONS

A snubber isn't needed to eliminate false operation of the TRIAC driver because of the IL411's high static and commutating dv/dt with loads between 1 and 0.8 power factors. When inductive loads with power factors less than 0.8 are being driven, include a RC snubber or a single capacitor directly across the device to damp the peak commutating dv/dt spike. Normally a commutating dv/dt causes a turning-off device to stay on due to the stored energy remaining in the turning-off device.

But in the case of a zero voltage crossing optotriac, the commutating dv/dt spikes can inhibit one half of the TRIAC from turning on. If the spike potential exceeds the inhibit voltage of the zero cross detection circuit, half of the TRIAC will be held-off and not turn-on. This hold-

off condition can be eliminated by using a snubber or capacitor placed directly across the optotriac as shown in Figure 7. Note that the value of the capacitor increases as a function of the load current.

The hold-off condition also can be eliminated by providing a higher level of LED drive current. The higher LED drive provides a larger photocurrent which causes the phototransistor to turn-on before the commutating spike has activated the zero cross network. Figure 8 shows the relationship of the LED drive for power factors of less than 1.0. The curve shows that if a device requires 1.5 mA for a resistive load, then 1.8 times (2.7 mA) that amount would be required to control an inductive load whose power factor is less than 0.3.

Figure 7. Shunt capacitance versus load current versus power factor

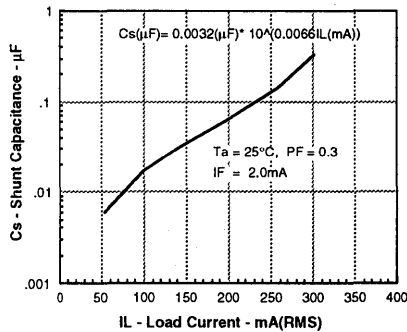

Figure 8. Normalized LED trigger current

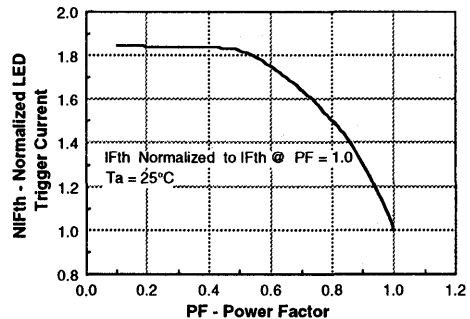
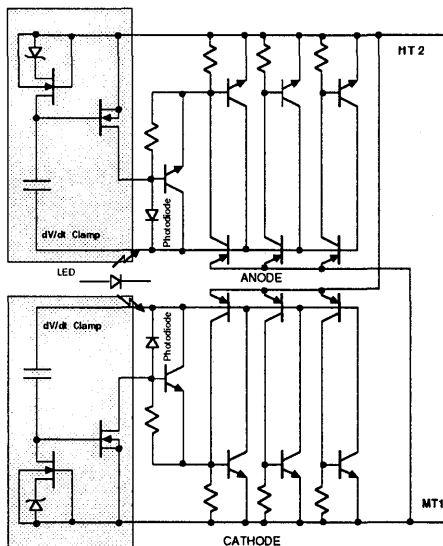



Figure 9. Schematic



The IL421 uses two discrete SCRs resulting in a commutating dv/dt of greater than 10 KV/μs. The use of a proprietary dv/dt clamp results in a static dv/dt of greater than 10 KV/μs.

FEATURES

- Current Transfer Ratio, 50% Typical
- Leakage Current, 1 nA Typ.
- Two Isolated Channels Per Package
- Direct Replacement for MCT6
- Underwriters Lab File #E52744
-  VDE #0884 Available with Option 1

DESCRIPTION

The ILCT6 is a two channel opto isolator for high density applications. Each channel consists of an optically coupled pair with a gallium arsenide infrared LED and a silicon NPN phototransistor. Signal information, including a DC level, can be transmitted by the device while maintaining a high degree of electrical isolation between input and output.

The ILCT6 is especially designed for driving medium-speed logic, where it may be used to eliminate troublesome ground loop and noise problems. It can also be used to replace relays and transformers in many digital interface applications, as well as analog applications such as CRT modulation.

Maximum Ratings

Emitter (each channel)

Rated Forward Current, DC	60 mA
Peak Forward Current, DC (1 μ s pulse, 300 pps)	3 A
Power Dissipation at 25°C Ambient	100 mW
Derate Linearly from 25°C	1.3 mW/°C

Detector (each channel)

Collector Current	30 mA
Collector-Emitter Breakdown Voltage	30 V
Power Dissipation at 25°C Ambient	150 mW
Derate Linearly from 25°C	2 mW/°C

Package

UL Qualified for	7500 VDC
Creepage Path	7 mm min.
Clearance Path	7 mm min.
Total Package Dissipation at 25°C Ambient	400 mW
Derate Linearly from 25°C	5.33 mW/°C
Storage Temperature	-55°C to +150°C
Operating Temperature	-55°C to +100°C
Lead Soldering Time at 260°C	10 sec.

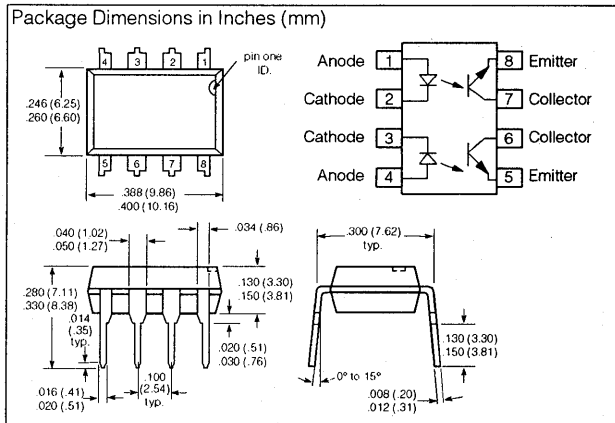

Electrical Characteristics (T_A=25°C)

	Symbol	Min.	Typ.	Max.	Unit	Condition
Emitter						
Forward Voltage	V _F		1.25	1.50	V	I _F =20 mA
Reverse Voltage	V _R	3.0	8.0		V	I _R =10 μ A
Reverse Current	I _R		0.1	10	μ A	V _R =3.0 V
Junction Capacitance	C _J		25		pF	V _F =0 V
Detector						
Breakdown Voltage						
Collector-Emitter	BV _{CEO}	30	65		V	I _C =1.0 mA
Emitter-Collector	BV _{ECCO}	7.0	10		V	I _E =100 μ A
Leakage Current						
Collector-Emitter	I _{CEO}	1.0	100		nA	V _{CE} =10 V
Capacitance						
Collector-Emitter	C _{CE}		8.0		pF	V _{CE} =0 V
Package						
DC Current Transfer Ratio						
	CTR	20	50		%	I _F =10 mA, V _{CE} =10 V, I _C =2.0 mA, I _F =16 mA
Saturation Voltage						
Collector-Emitter	V _{CEsat}		0.40		V	I _F =16 mA, I _C =2.0 mA, V _{CE} =10 V
Isolation Resistance						
	R _{ISOL}		10 ¹²		Ω	V _{I0} =500 V, F=1.0 MHz
Isolation Capacitance						
	C _{ISOL}		0.5		pF	
Withstand Test Voltage						
Channel-Channel	WTV		500		VDC	Relative Humidity=40%
Capacitance between Channels						
			0.4		pF	F=1.0 MHz, I _C =2.0 mA, V _{CC} =10 V, R _L =100 Ω
Bandwidth						
			150		KHz	
Switching Times						
Output Transistor	t _{on} , t _{off}		3.0		μ s	I _C =2 mA, R _E =100 Ω , V _{CE} =10 V

Figure 1. Forward voltage versus forward current

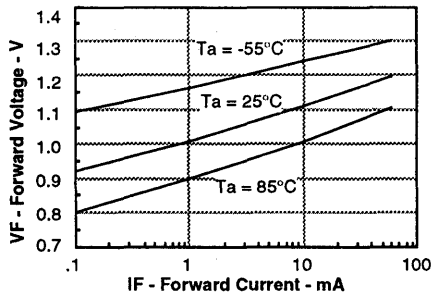

Figure 3. Normalized non-saturated and saturated CTR at Ta = 50°C versus LED current

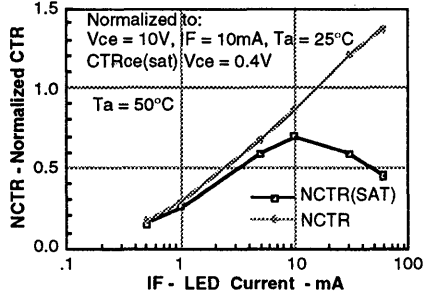

Figure 5. Normalized non-saturated and saturated CTR at Ta = 85°C versus LED current

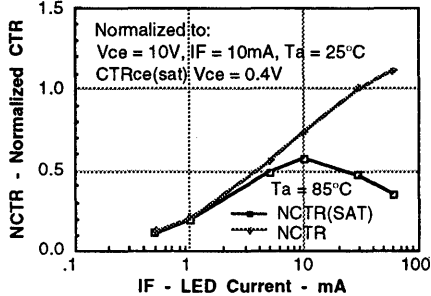

Figure 7. Collector-emitter leakage current versus temperature

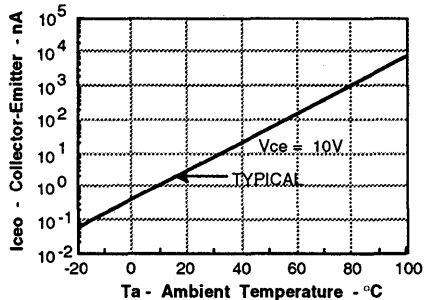

Figure 2. Normalized non-saturated and saturated CTR at Ta = 25°C versus LED current

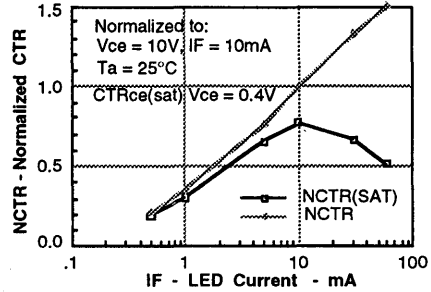

Figure 4. Normalized non-saturated and saturated CTR at Ta = 70°C versus LED current

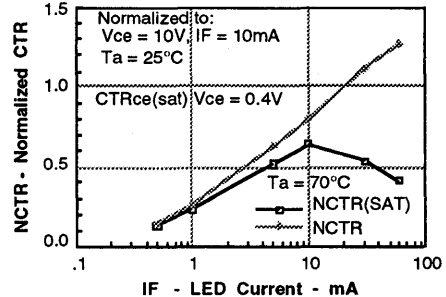

Figure 6. Collector-emitter current versus temperature and LED current

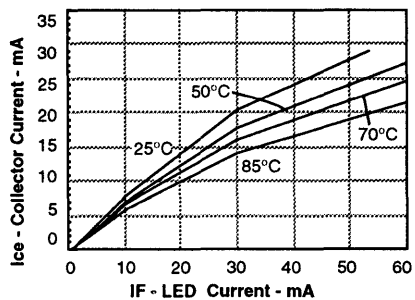

Figure 8. Propagation delay versus collector load resistor

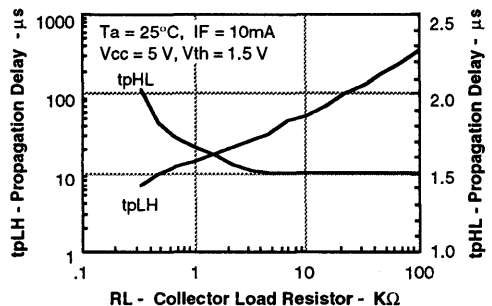

Figure 9. Switching Timing

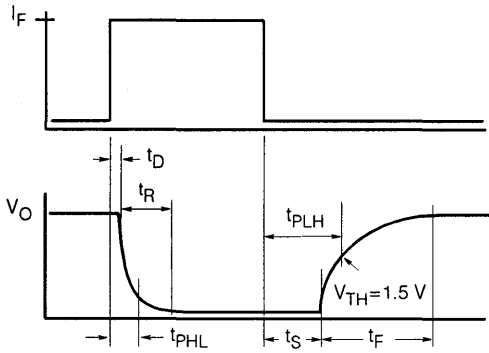
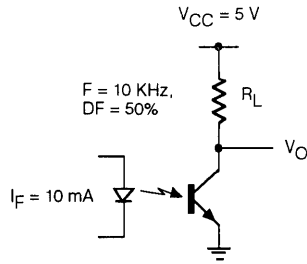



Figure 10. Switching schematic



FEATURES

- **Current Transfer Ratio at $I_F=10$ mA**
ILD/Q1, 20% Min.
ILD/Q2, 100% Min.
ILD/Q5, 50% Min.
- **High Collector-Emitter Voltage**
ILD/Q1 – $BV_{CEO}=50$ V
ILD/Q2, ILD/Q5 – $BV_{CEO}=70$ V
- **Field-Effect Stable by TRansparent IO Shield (TRIOS)**
- **Double Molded Package Offers Withstand Test Voltage**
7500 VAC_{PEAK}, 1 sec.
4420 VAC_{RMS}, 1 min.
- **Underwriters Lab File #E52744**
-  **VDE Approval #0884 Applied For (Available with Option 1)**

Maximum Ratings (Each Channel)

Emitter	
Reverse Voltage	6 V
Forward Current	60 mA
Surge Current	2.5 A
Power Dissipation	100 mW
Derate Linearly from 25°C	1.3 mW/°C

Detector

Collector-Emitter Reverse Voltage	
ILD/Q1	50 V
ILD/Q2, ILD/Q5	70 V
Emitter-Base Reverse Voltage	
.....	7 V
Collector-Base Reverse Voltage	
.....	70 V
Collector Current	50 mA
Collector Current ($t < 1$ ms)	400 mA
Power Dissipation	200 mW
Derate Linearly from 25°C	2.6 mW/°C

Package

Withstand Test Voltage	$V_{IO}=5300$ VAC
Between Emitter and Detector	
Referred to Standard Climate 23°C/ 50%RH, DIN 50014	
Leakage Path	min. 82 mm
Air Path	min. 7.3 mm
$V_{IO}=500$ V	$R_{IO}=10^{11}$ Ω
Package Power Dissipation	250 mW
Derate Linearly from 25°C	3.3 mW/°C
Storage Temperature	-40°C to +150°C
Operating Temperature	-40°C to +100°C
Junction Temperature	100°C
Soldering Temperature	
(2 mm from case bottom)	260°C

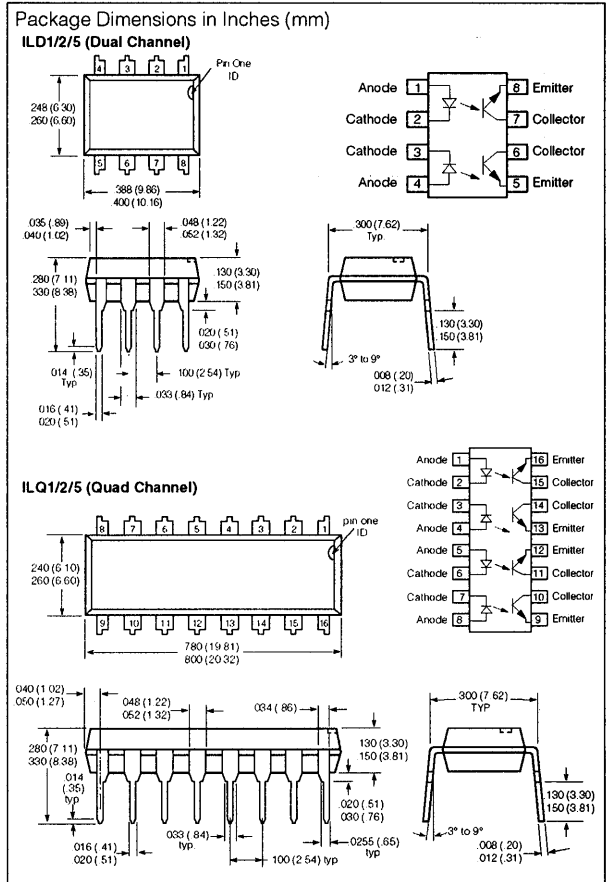

DESCRIPTION

The ILD/Q1/2/5 are optically coupled isolated pairs employing GaAs infrared LEDs and silicon NPN phototransistor. Signal information, including a DC level, can be transmitted by the drive while maintaining a high degree of electrical isolation between input and output. The ILD/Q1/2/5 are especially designed for driving medium-speed logic and can be used to eliminate troublesome ground loop and noise problems. Also these couplers can be used to replace relays and transformers in many digital interface applications such as CRT modulation. The ILD1/2/5 has two isolated channels in a single DIP package and the ILQ1/2/5 has four isolated channels per package.

See Appnote 45, "How to Use Optocoupler Normalized Curves."

Characteristics

	Symbol	Min.	Typ.	Max.	Unit	Condition
Emitter						
Forward Voltage	V_F		1.25	1.65	V	$I_F=60$ mA
Breakdown Voltage	V_{BR}	6	30		V	$I_R=10$ μ A
Reverse Current	I_R		0.01	10	μ A	$V_R=6$ V
Capacitance	C_0		25		pF	$V_R=0$ V, $f=1$ MHz
Thermal Resistance						
Junction to Lead	R_{THJL}		750		$^{\circ}$ C/W	
Detector						
Capacitance	C_{CE}		6.8		pF	$V_{CE}=5$ V, $f=1$ MHz
Collector-Emitter Leakage Current	I_{CEO}		5	50	nA	$V_{CE}=10$ V
Collector-Emitter Saturation Voltage	V_{CESAT}		0.25	0.4		$I_{CE}=1$ mA, $I_B=20$ μ A
DC Forward Current Gain	HFE	200	650	1800		$V_{CE}=10$ V, $I_B=20$ μ A
Saturated DC Forward						
Current Gain	HFE_{SAT}	120	400	600		$V_{CE}=0.4$ V, $I_B=20$ μ A
Thermal Resistance						
Junction to Lead	R_{THJL}		500		$^{\circ}$ C/W	

Package Transfer Characteristics (Each Channel)

	Symbol	Min.	Typ.	Max.	Unit	Condition
ILD/Q1						
Saturated Current Transfer Ratio						
(Collector-Emitter)	CTR_{CESAT}		75		%	$I_F=10$ mA, $V_{CE}=0.4$ V
Current Transfer Ratio						
(Collector-Emitter)	CTR_{CE}	20	80	300	%	$I_F=10$ mA, $V_{CE}=10$ V
ILD/Q2						
Saturated Current Transfer Ratio						
(Collector-Emitter)	CTR_{CESAT}		170		%	$I_F=10$ mA, $V_{CE}=0.4$ V
Current Transfer Ratio						
(Collector-Emitter)	CTR_{CE}	100	200	500	%	$I_F=10$ mA, $V_{CE}=10$ V
ILD/Q5						
Saturated Current Transfer Ratio						
(Collector-Emitter)	CTR_{CESAT}		100		%	$I_F=10$ mA, $V_{CE}=0.4$ V
Current Transfer Ratio						
(Collector-Emitter)	CTR_{CE}	50	130	400	%	$I_F=10$ mA, $V_{CE}=10$ V
Isolation and Insulation						
Common Mode Rejection						
Output High	CMH		5000		V/ μ s	$V_{CM}=50$ V _{P-P} , $R_L=1$ k Ω , $I_F=0$ mA
Output Low	CML		5000		V/ μ s	$V_{CM}=50$ V _{P-P} , $R_L=1$ k Ω , $I_F=10$ mA
Common Mode						
Coupling Capacitance	C_{CM}		0.01		pF	
Package Capacitance	C_{IO}		0.8		pF	$V_{IO}=0$ V, $f=1$ MHz
Dielectric Leakage Current						
$V_{IO}=4420$ V _{AC(RMS)} , 1 min., 60 Hz	I_{IO}		3.3	≤ 10	μ A	AC _(RMS)
$V_{IO}=6250$ V _{AC(PK)} , 1 min., 60 Hz	I_{IO}		4.7	≤ 14.2	μ A	AC _(PK)
$V_{IO}=5304$ AC _(RMS) , 1 sec., 60 Hz	I_{IO}		4.0	≤ 12	μ A	AC _(RMS)
$V_{IO}=7500$ V _{AC(PK)} , 1 sec., 60 Hz	I_{IO}		5.7	≤ 17	μ A	AC _(PK)

TYPICAL SWITCHING TIMES

Figure 1. Non-saturated switching timing

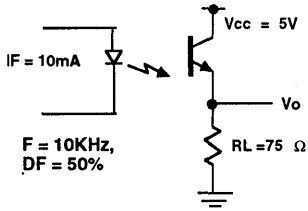

Figure 3. Non-saturated switching timing

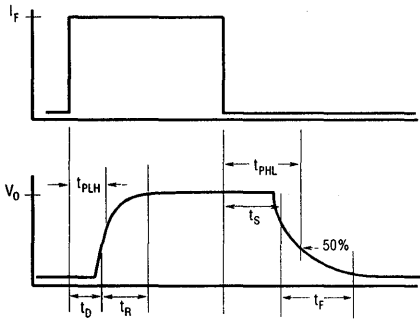

Figure 2. Saturated switching timing

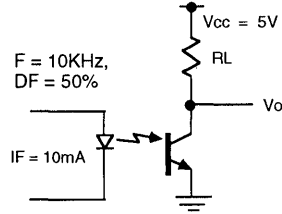
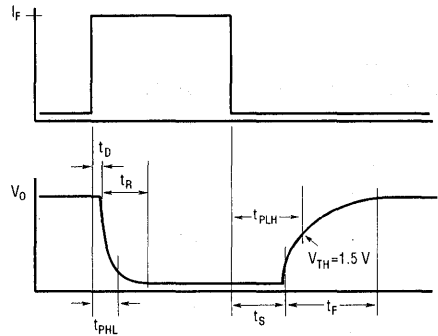

Figure 4. Saturated switching timing



Characteristic	ILD/Q1 If=20 mA	ILD/Q2 If=5 mA	ILD/Q5 If=10 mA	Unit	Condition
Delay, t_D	0.8	1.7	1.7	μs	$V_{CC}=5\text{ V}$ $R_L=75\ \Omega$ 50% of V_{FP}
Rise Time, t_R	1.9	2.6	2.6	μs	
Storage, t_S	0.2	0.4	0.4	μs	
Fall Time, t_F	1.4	2.2	2.2	μs	
Propagation H-L, t_{PHL}	0.7	1.2	1.1	μs	
Propagation L-H, t_{PLH}	1.4	2.3	2.5	μs	

Characteristic	ILD/Q1 If=20 mA	ILD/Q2 If=5 mA	ILD/Q5 If=10 mA	Unit	Condition
Delay, t_D	0.8	1	1.7	μs	$V_{CE}=0.4\text{ V}$ $R_L=1\text{ k}\Omega$ $V_{CC}=5\text{ V}$ $V_{TH}=1.5\text{ V}$
Rise Time, t_R	1.2	2	7	μs	
Storage, t_S	7.4	5.4	4.6	μs	
Fall Time, t_F	7.6	13.5	20	μs	
Propagation H-L, t_{PHL}	1.6	5.4	2.6	μs	
Propagation L-H, t_{PLH}	8.6	7.4	7.2	μs	

Figure 5. Forward voltage versus forward current

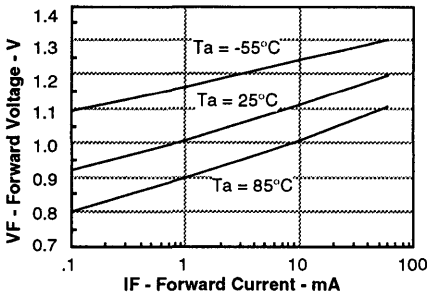

Figure 6. Normalized non-saturated and saturated CTR at $T_A = 25^\circ\text{C}$ versus LED current

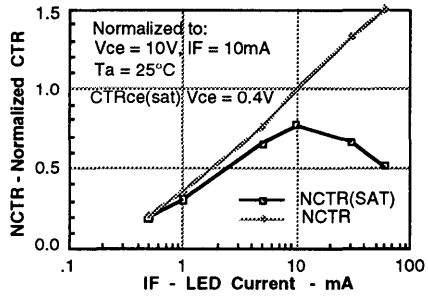

Figure 7. Normalized non-saturated and saturated CTR at $T_A = 50^\circ\text{C}$ versus LED current

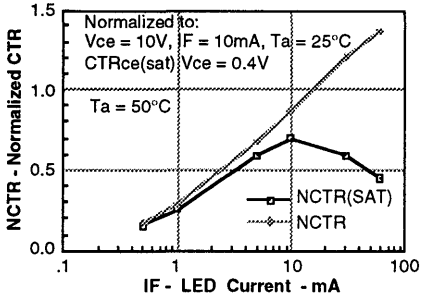

Figure 8. Normalized non-saturated and saturated CTR at $T_A = 70^\circ\text{C}$ versus LED current

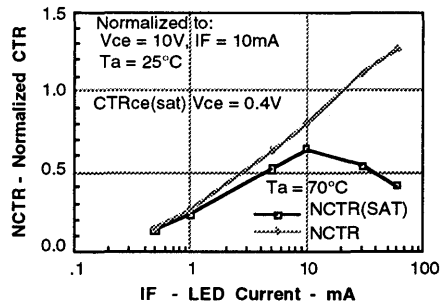

Figure 9. Normalized non-saturated and saturated CTR at $T_A = 85^\circ\text{C}$ versus LED current

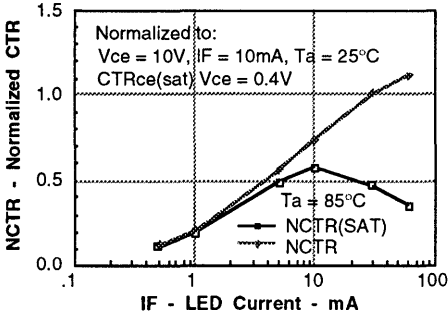

Figure 10. Collector-emitter current versus temperature and LED current

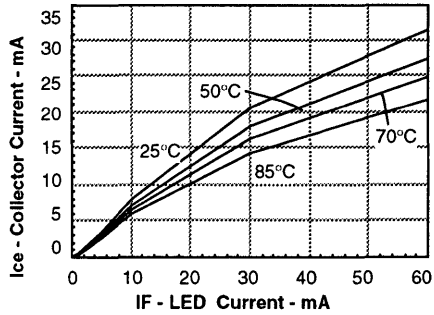

Figure 11. Collector-emitter leakage current versus temperature

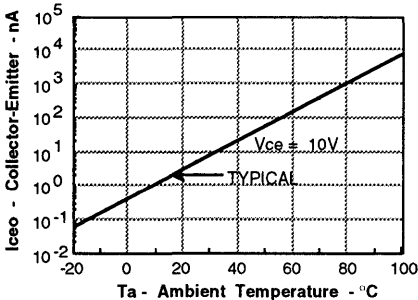
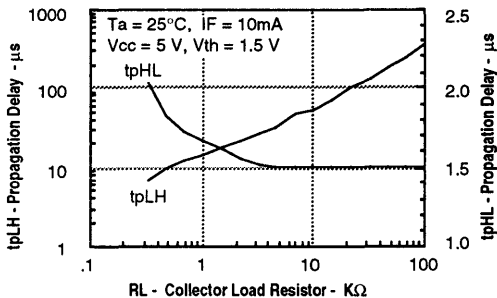



Figure 12. Propagation delay versus collector load resistor



FEATURES

- Very High Current Transfer Ratio, 500% Min.
- Withstand Test Voltage, 7500 V
- High Insulation Resistance, $10^{11} \Omega$ Typical
- Low Coupling Capacitance
- Standard Plastic DIP Package
- Underwriters Lab File #E52744
-  VDE Approval #0884 Available with Option 1

Maximum Ratings (Each Channel)

Emitter	
Peak Reverse Voltage	3 V
Continuous Forward Current	60 mA
Power Dissipation at 25°C	100 mW
Derate Linearly from 25°C	1.33 mW/°C
Detector	
Collector-Emitter Breakdown Voltage	30 V
Emitter-Base Breakdown Voltage	5 V
Collector (Load) Current	125 mA
Power Dissipation at 25°C Ambient	150 mW
Derate Linearly from 25°C	2.0 mW/°C
Package	
Withstand Test Voltage	$V_{IO}=5300Vdc$
Between Emitter and Detector Referred to Standard Climate 23°C/50%RH, DIN 50014	
Leakage Path	min. 8.2 mm
Air Path	min. 7.3 mm
Tracking Resistance, Group III (KC>600 per VDE 110 § 6, Table 3 and DIN 53480/ VDE 0330, Part 1	
$V_{IO}=500V$	$R_{IO}=10^{11}\Omega$
Total Dissipation at 25°C Ambient	
ILD32	400 mW
ILQ32	500 mW
Derate Linearly from 25°C	
ILD32	5.33 mW/°C
ILQ32	6.67 mW/°C
Storage Temperature	-55°C to +150°C
Operating Temperature	-55°C to +100°C
Lead Soldering Time at 260°C	10 sec.

Package Dimensions in Inches (mm)

ILD32 (Dual Channel)

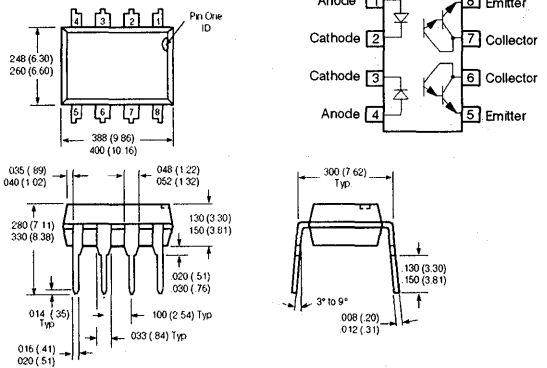

ILQ32 (Quad Channel)

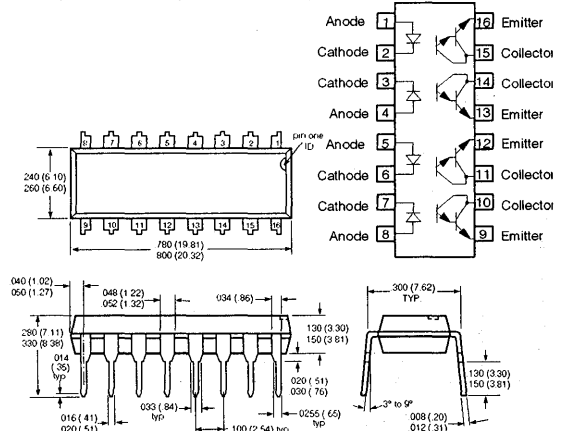

DESCRIPTION

The ILD32/ILQ32 are optically coupled isolators with a Gallium Arsenide infrared LED and a silicon photodarlington sensor. Switching can be achieved while maintaining a high degree of isolation between driving and load circuits. These optocouplers can be used to replace reed and mercury relays with advantages of long life, high speed switching and elimination of magnetic fields.

The ILD32 has two isolated channels in a DIP package, and the ILQ32 has four channels. These devices can be used to replace 4N32s or 4N33s in applications calling for several single channel optocouplers on a board.

Electrical Characteristics (T_A=25°C)

	Symbol	Min.	Typ.	Max.	Unit	Condition
Emitter						
Forward Voltage	V _F		1.25	1.5	V	I _F =10 mA
Reverse Current	I _R		0.1	100	μA	V _R =3.0 V
Capacitance	C _O		25		pF	V _R =0 V
Detector						
Breakdown Voltage						
Collector-Emitter	BV _{CEO}	30			V	I _C =100 μA, I _F =0
Emitter-Collector	BV _{ECO}	5	10		V	I _E =100 μA
Collector-Emitter Leakage Current						
	I _{CEO}		1.0	100	nA	V _{CE} =10 V, I _F =0
Package						
Current Transfer Ratio Collector-Emitter						
	CTR	500			%	I _F =10 mA, V _{CE} =10 V
Saturation Voltage						
	V _{CE sat}			1.0	V	I _C =2 mA, I _F =8 mA
Isolation Voltage (t = 1 sec.)						
	V _{ISOL}	7500			VDC	
		5300			VAC _{RMS}	
Isolation Resistance						
	R _{ISOL}		10 ¹¹		Ω	V ₁₀ =500 V
Isolation Capacitance						
	C _{ISOL}		0.5		pF	
Turn-On Time						
	t _{on}			5	μs	V _{CC} =10 V, I _C =50 mA
Turn-Off Time						
	t _{off}			100	μs	I _F =50 mA, R _L =180 Ω

Figure 1. Forward voltage versus forward current

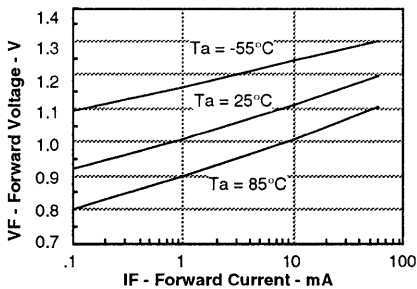

Figure 3. Normalized non-saturated and saturated collector-emitter current versus LED current

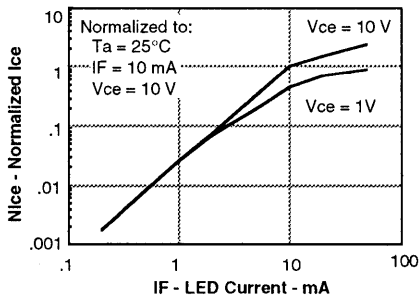

Figure 2. Normalized non-saturated and saturated CTRce at T_A = 25°C versus LED current

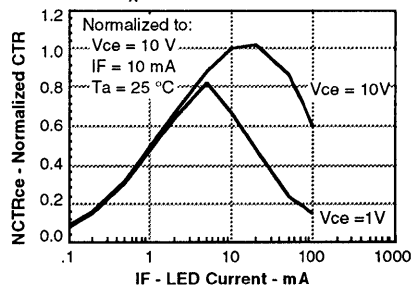

Figure 4. Low to high propagation delay versus collector load resistance and LED current

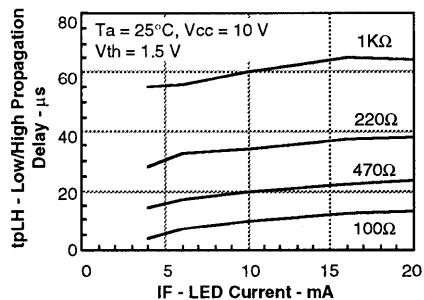

Figure 5. High to low propagation delay versus collector load resistance and LED current

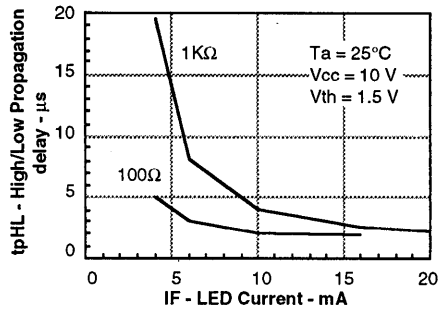

Figure 6. Switching timing

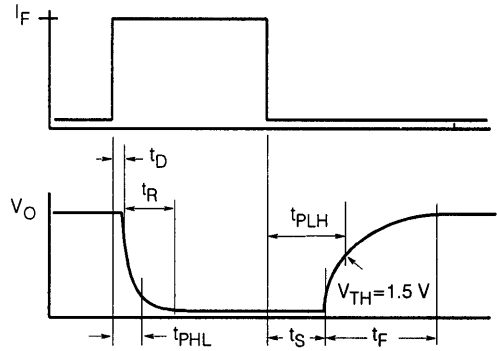
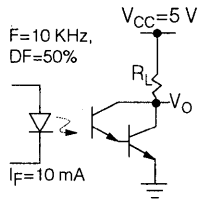

Figure 7. Switching schematic



ILD205/206/207/213 DUAL PHOTOTRANSISTOR SMALL OUTLINE SURFACE MOUNT OPTOCOUPLER

FEATURES

- Two Channel Coupler
- Industry Standard SOIC-8 Surface Mountable Package
- Standard Lead Spacing of .05"
- Available in Tape and Reel Option (Conforms to EIA Standard RS481A)
- Withstand Test Voltage, 2500 VRMS
- High Current Transfer Ratios
ILD205, 40 – 80%
ILD206, 63 – 125%
ILD207, 100 – 200%
ILD213, 100% minimum
- High BV_{CEO} , 70 V
- Compatible with Dual Wave, Vapor Phase and IR Reflow Soldering

DESCRIPTION

The ILD205/206/207/213 are optically coupled pairs with a gallium arsenide infrared LED and a silicon NPN phototransistor. Signal information, including a DC level, can be transmitted by the device while maintaining a high degree of electrical isolation between input and output. The ILD205/6/7/13 come in a standard SOIC-8 small outline package for surface mounting which makes it ideally suited for high density applications with limited space. In addition to eliminating through-holes requirements, this package conforms to standards for surface mounted devices.

A specified minimum and maximum CTR allows a narrow tolerance in the electrical design of the adjacent circuits. The high BV_{CEO} of 70 volts gives a higher safety margin compared to the industry standard of 30 volts.

Maximum Ratings (Each Channel)

Emitter

Peak Reverse Voltage	6.0 V
Peak Pulsed Current (1 μ s, 300 pps)	3 A
Continuous Forward Current per Channel	30 mA
Power Dissipation at 25°C	45 mW
Derate Linearly from 25°C	0.5 mW/°C

Detector

Collector-Emitter Breakdown Voltage	70 V
Emitter-Collector Breakdown Voltage	7 V
Power Dissipation per Channel	55 mW
Derate Linearly from 25°C	0.55 mW/°C

Package

Total Package Dissipation at 25°C Ambient (2 LEDs + 2 Detectors, 2 Channels)	200 mW
Derate Linearly from 25°C	2.0 mW/°C
Storage Temperature	-55°C to +150°C
Operating Temperature	-55°C to +100°C
Soldering Time at 260°C	10 sec.

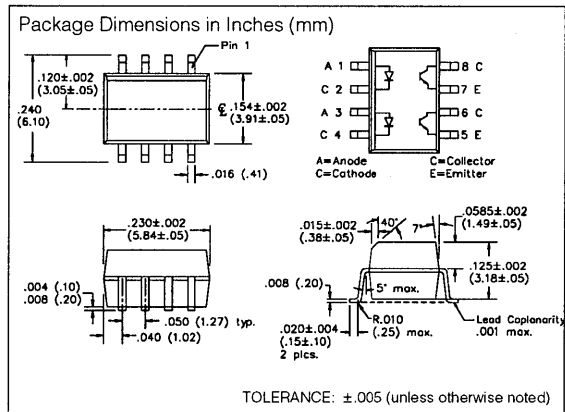

Characteristics ($T_A=25^\circ\text{C}$)

Parameter	Min.	Typ.	Max.	Unit	Test Condition
Emitter					
Forward Voltage		1.2	1.55	V	$I_F=30$ mA
Reverse Current		0.1	100	μ A	$V_R=6.0$ V
Capacitance		30		pF	$V_R=0$
Detector					
BV_{CEO}	70			V	$I_C=100$ μ A
BV_{ECO}	7			V	$I_E=100$ μ A
I_{CEO}		5	50	nA	$V_{CE}=10$ V
					$I_F=0$
Collector-Emitter Capacitance		10		pF	$V_{CE}=0$
Package					
DC Current Transfer					$V_{CE}=5$ V
ILD205	40		80	%	$I_F=10$ mA
ILD206	63		125	%	$I_F=10$ mA
ILD207	100		200	%	$I_F=10$ mA
ILD213	100			%	$I_F=10$ mA
ILD205	13	30		%	$I_F=1$ mA
ILD206	22	45		%	$I_F=1$ mA
ILD207	34	70		%	$I_F=1$ mA
Collector-Emitter Saturation					
Voltage $V_{CE(sat)}$			0.4	V	$I_C=2.5$ mA
Capacitance, Input to Output		0.5		pF	
Withstand Test Voltage	2500			VAC _{RMS}	$t=1$ min.
Resistance, Input to Output		100		G Ω	
Turn-on Time		5.0		μ s	$I_C=2$ mA, $R_E=100$ Ω , $V_{CE}=5$ V
Turn-off Time		4.0		μ s	$V_{CE}=5$ V

See Application Note 39 for solderability information.

Figure 1. Forward current versus forward voltage

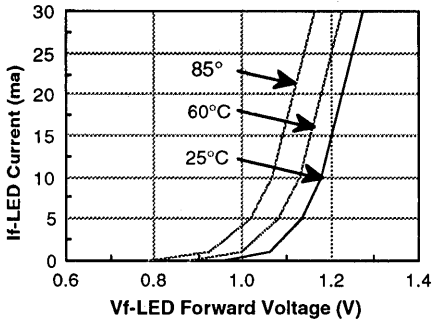

Figure 2. Collector-emitter current versus temperature

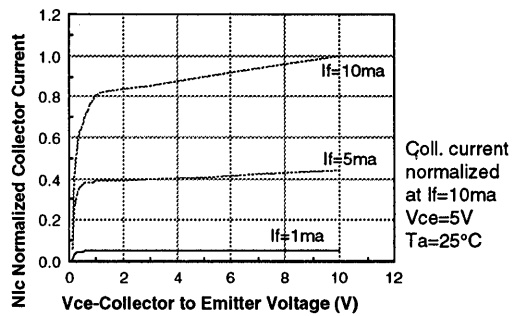

Figure 3. Normalized CTR_{ce} versus forward current

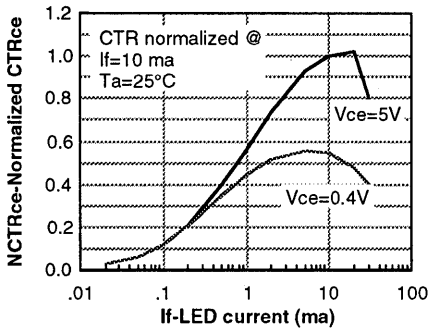

Figure 4. CTR (normalized) versus temperature

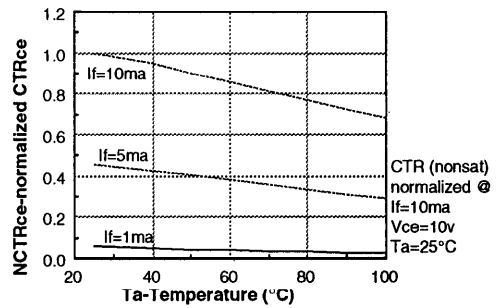

Figure 5. Switching speed versus load resistor

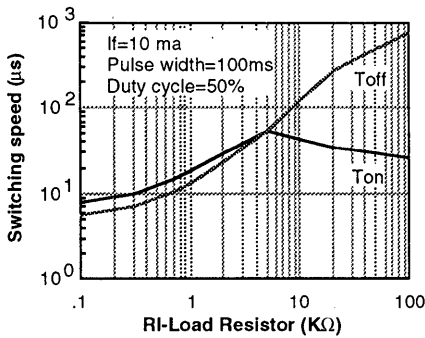

Figure 6. Collector current versus temperature

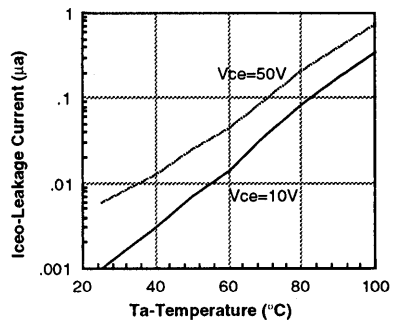

Figure 7. Power dissipation versus ambient temperature

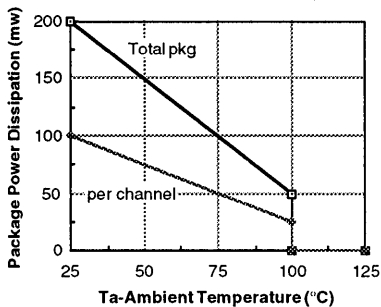
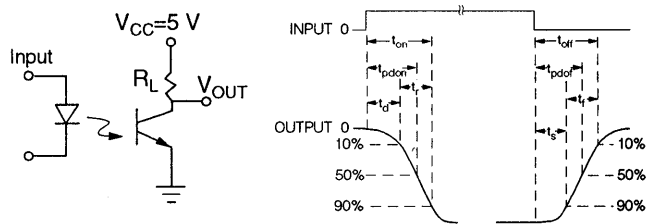

Figure 8. Switching time test schematic and waveform



FEATURES

- Two Channel Optocoupler
- High Current Transfer Ratio at $I_F=1$ mA, 500% Min.
- Withstand Test Voltage, 2500 VRMS
- Electrical Specifications Similar to Standard 6 Pin Coupler
- Compatible with Dual Wave, Vapor Phase and IR Reflow Soldering
- Industry Standard SOIC-8 Surface Mountable Package
- Standard Lead Spacing, .05"
- Available in Tape and Reel Option (Conforms to EIA Standard RS481A)
- Underwriters Lab File #E52744 (Code Letter P)

DESCRIPTION

The ILD223 is a high current transfer ratio (CTR) optocoupler. It has a Gallium Arsenide infrared LED emitter and a silicon NPN photodarlington transistor detector.

This device has CTRs tested at an LED current of 1 mA. This low drive current permits easy interfacing from CMOS to LSTTL or TTL.

The ILD223 is constructed in a standard SOIC-8 foot print which makes it ideally suited for high density applications. In addition to eliminating through-holes requirements, this package conforms to standards for surface mounted devices.

Maximum Ratings (Each Channel)

Emitter

Peak Reverse Voltage	6.0 V
Peak Pulsed Current (1 μ s, 300 pps)	3 A
Continuous Forward Current per Channel	30 mA
Power Dissipation at 25°C	45 mW
Derate Linearly from 25°C	0.5 mW/°C

Detector

Collector-Emitter Breakdown Voltage	30 V
Emitter-Collector Breakdown Voltage	5 V
Power Dissipation per Channel	55 mW
Derate Linearly from 25°C	0.5 mW/°C

Package

Total Package Dissipation at 25°C Ambient (2 LEDs + 2 Detectors, 2 Channels)	200 mW
Derate Linearly from 25°C	2 mW/°C
Storage Temperature	-55°C to +150°C
Operating Temperature	-55°C to +100°C
Soldering Time at 260°C	10 sec.

See Application Note 39 for solderability information.

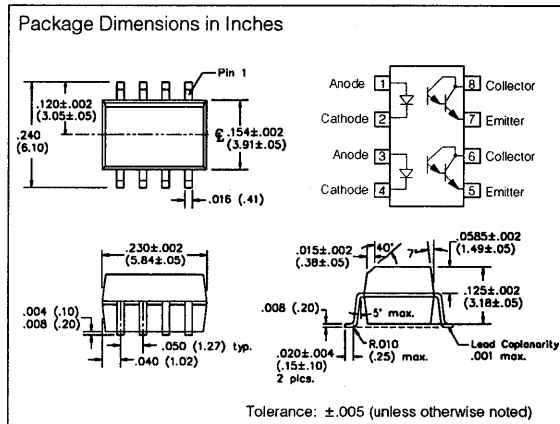

Characteristics ($T_A=25^\circ\text{C}$)

	Symbol	Min.	Typ.	Max.	Unit	Condition
Emitter						
Forward Voltage	V_F			1.3	V	$I_F=1$ mA
Reverse Current	I_R	0.1		100	μ A	$V_R=6.0$ V
Capacitance	C_O	25			pF	$V_F=0$ V, $F=1$ MHz
Detector						
Breakdown Voltage						
Collector-Emitter	BV_{CEO}	30			V	$I_C=100$ μ A
Emitter-Collector	BV_{ECO}	5			V	$I_E=100$ μ A
Collector-Emitter Current						
	I_{CEO}			50	nA	$V_{CE}=5$ V, $I_E=0$
Collector-Emitter Capacitance						
	C_{CE}		3.4		pF	$V_{CE}=5$ V
Package						
DC Current Transfer	CTR_{DC}	500			%	$I_F=1$ mA, $V_{CE}=5$ V
Collector-Emitter Saturation Voltage						
	$V_{CE\ sat}$			1	V	$I_F=1$ mA, $I_{CE}=0.5$ mA
Withstand Test Voltage						
	WTV	2500			VAC _{RMS}	$t=1$ min.
Capacitance, Input to Output						
	C_{IO}	0.5			pF	
Resistance, Input to Output						
	R_{IO}	100			G Ω	

Figure 1. Forward voltage versus forward current

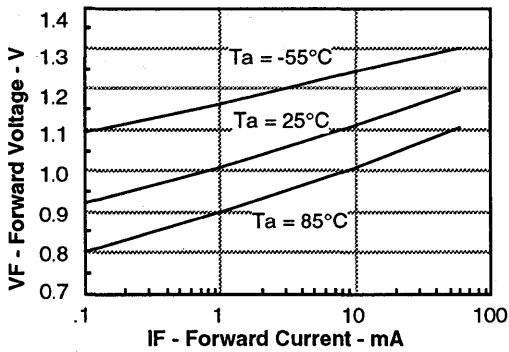

Figure 2. Peak LED current versus duty factor, Tau

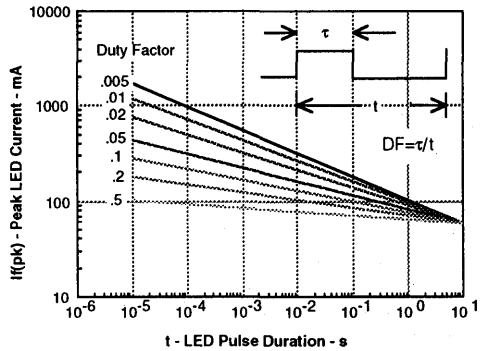

Figure 3. Normalized CTR_{CE} versus LED current

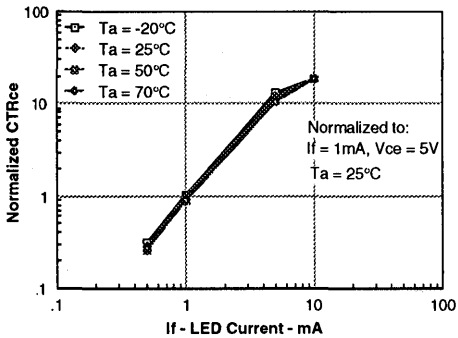

Figure 4. CTR versus LED current

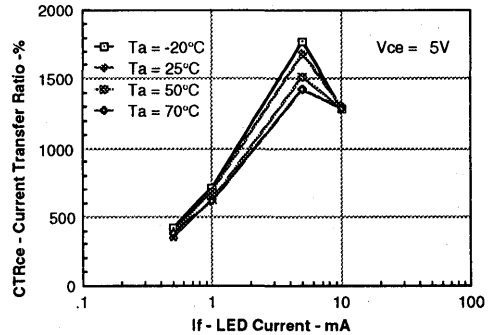
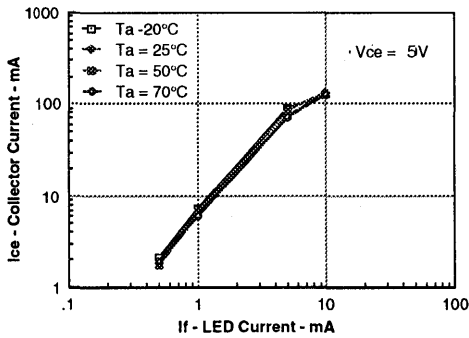



Figure 5. Collector current versus LED current



FEATURES

- AC or Polarity Insensitive Inputs
- Continuous Forward Current, 130 mA
- Applications—Telecommunications
 - Ring Detection
 - Loop Current Detector
- Built-in Reverse Polarity Input Protection
- Improved CTR Symmetry
- Industry Standard DIP Package
- Underwriters Lab File #E52744
-  VDE Approval #0884 Available with Option 1

DESCRIPTION

The ILD255 is a bidirectional input optically coupled isolator consisting of two high current Gallium Arsenide infrared LEDs coupled to a silicon NPN phototransistor per channel. The ILD255 has a minimum CTR of 50%

These optocouplers are ideal for applications requiring AC signal detection and monitoring.

Maximum Ratings (Each Channel)

Emitter

Peak Pulsed Current (1 μ s, 300 pps) 3 A
 Continuous Forward Current 130 mA RMS
 Power Dissipation at 25°C 175 mW
 Derate Linearly from 25°C 2.3 mW/°C

Detector

Collector-Emitter Breakdown Voltage 30 V
 Emitter-Base Breakdown Voltage 5 V
 Collector-Base Breakdown Voltage 70 V
 Power Dissipation at 25°C 200 mW
 Derate Linearly from 25°C 2.6 mW/°C

Package

Withstand Test Voltage $V_{IO}=7500 V_{AC(PK)}$
 Between Emitter and Detector
 Referred to Standard Climate
 23°C/50%RH, DIN 50014
 Leakage Path min. 8.2 mm
 Air Path, VDE 0883 6.80 min. 7.3 mm
 $V_{IO}=500V$ $R_{IO}=10^{11}\Omega$
 Total Dissipation at 25°C 400 mW
 Derate Linearly from 25°C 5.3 mW/°C
 Storage Temperature -55°C to +150°C
 Operating Temperature -55°C to +100°C
 Lead Soldering Time at 260°C 10 sec.

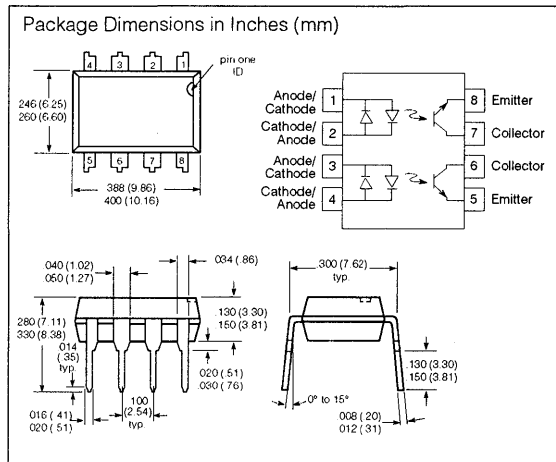

Electrical Characteristics ($T_A=25^\circ\text{C}$)

Parameter	Min.	Typ.	Max.	Unit	Condition
Emitter					
Forward Voltage V_F		1.2	1.5	V	$I_F=\pm 10 \text{ mA}$
Detector					
BV_{CEO}	30	50		V	$I_C=1 \text{ mA}$
BV_{ECO}	7	10		V	$I_E=100 \mu\text{A}$
BV_{CEO}	70	90		V	$I_C=10 \mu\text{A}$
I_{CEO}		5	50	nA	$V_{CE}=10 \text{ V}$
Package					
V_{CEsat}			0.4	V	$I_F=\pm 16 \text{ mA}$, $I_C=2 \text{ mA}$
DC Current Transfer Ratio	50			%	$I_F=\pm 10 \text{ mA}$, $V_{CE}=10 \text{ V}$
Symmetry CTR at +10 mA CTR at -10 mA	0.50	1.0	2.0		

Optocouplers
(Optoisolators)

Figure 1. LED forward current versus forward voltage

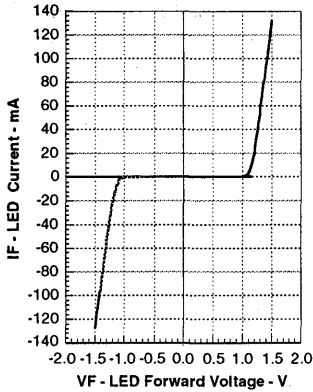

Figure 2. Maximum LED current versus ambient temperature

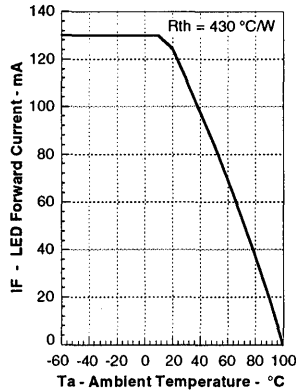

Figure 3. Maximum LED power dissipation

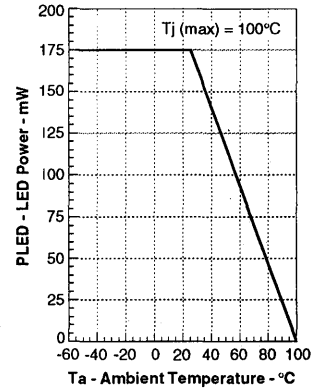

Figure 4. Current transfer ratio versus LED current and collector-emitter voltage

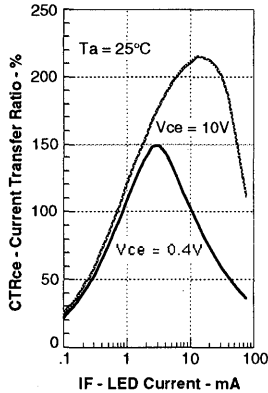

Figure 5. Saturated and nonsaturated collector-emitter current versus LED current

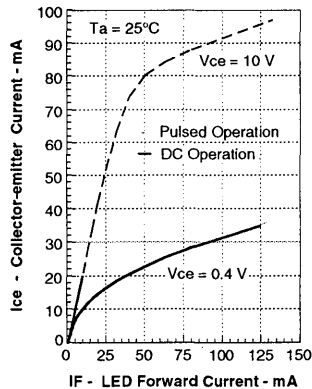

Figure 6. Saturated and nonsaturated collector-emitter current versus LED current

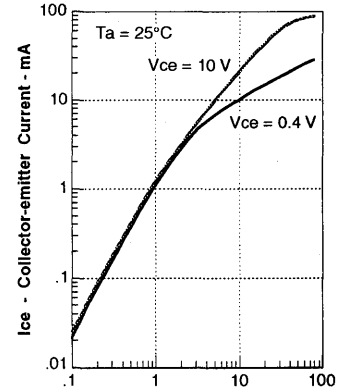
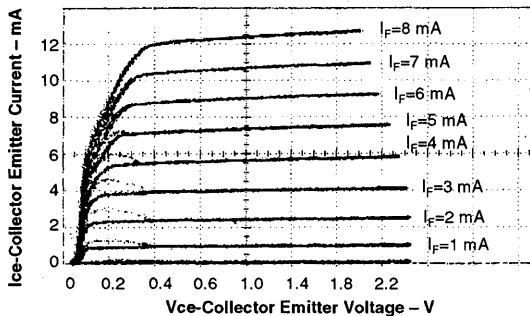

Figure 7. Collector emitter current versus collector emitter voltage



FEATURES

- Dual Version of SFH610 Series
- High Current Transfer Ratios
ILD610-1, 40-80%
ILD610-2, 63-125%
ILD610-3, 100-200%
ILD610-4, 160-320%
- Isolation Test Voltage, 7500 V
- V_{CEsat} 0.25 (≤ 0.4) V
at $I_F=10$ mA, $I_C=2.5$ mA
- $V_{CEO}=70$ V
- Underwriters Lab File #E52744
- VDE #0884 Available with Option 1

DESCRIPTION

The ILD610 Series is a dual channel optocoupler series for high density applications. Each channel consists of an optically coupled pair with a Gallium Arsenide infrared LED and a silicon NPN phototransistor. Signal information, including a DC level, can be transmitted by the device while maintaining a high degree of electrical isolation between input and output. The ILD610 Series is the dual version of SFH610 Series and uses a repetitive pin-out configuration instead of the more common alternating pin-out used in most dual couplers.

Maximum Ratings (Each Channel)

Emitter	
Reverse Voltage	6 V
Surge Forward Current ($t \leq 10 \mu s$)	1.5 A
Total Power Dissipation	100 mW
Derate Linearly from 25°C	1.3 mW/°C
DC Forward Current	60 mA
Detector	
Collector-Emitter Voltage	70 V
Collector Current	50 mA
Collector Current ($t \leq 1$ ms)	100 mA
Total Power Dissipation	150 mW
Derate Linearly from 25°C	2.0 mW/°C
Package	
Isolation Test Voltage ($t=1$ sec.)	7500 VDC
.....	5300 VAC _{RMS}
Isolation Resistance	$10^{11} \Omega$
Storage Temperature	-55°C to +150°C
Operating Temperature	-55°C to +100°C
Junction Temperature	100°C
Lead Soldering Time at 260°C	10 sec.

Package Dimensions in Inches (mm)

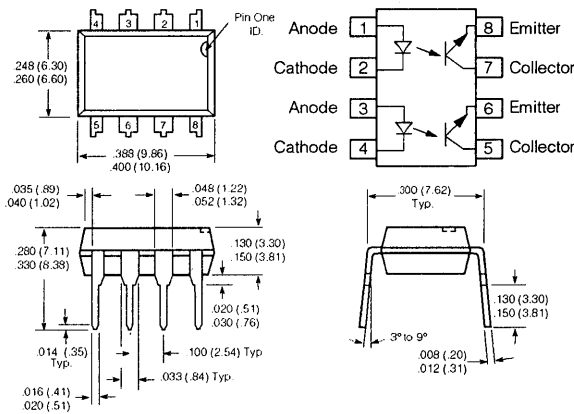

Electrical Characteristics ($T_A=25^\circ C$)

	Symbol	Typ.	Unit	Condition
Emitter				
Forward Voltage	V_F	1.25 (≤ 1.65)	V	$I_F=60$ mA
Reverse Current	I_R	0.01 (≤ 10)	μA	$V_R=6$ V
Breakdown Voltage	V_{BR}	30 (≥ 6)	V	$I_R=10 \mu A$
Capacitance	C_O	25	pF	$V_R=0$ V, $f=1$ MHz
Detector				
Breakdown Voltage				
Collector-Emitter	BV_{CEO}	70	V	$I_C=10 \mu A$
Emitter-Collector	BV_{ECO}	7.0	V	$I_E=10 \mu A$
Collector-Emitter Dark Current	I_{CEO}	2	nA	$V_{CE}=10$ V
Capacitance	C_{CE}	7	pF	$V_{CE}=5$ V, $f=1$ MHz
Package				
Collector-Emitter Saturation Voltage				
	V_{CEsat}	0.25 (< 0.40)	V	$I_F=10$ mA, $I_C=2.5$ mA
Coupling Capacitance	C_C	0.35	pF	

	-1	-2	-3	-4	
CTR ¹ , I _F = 10 mA, V _{CE} = 5 V	40-80	63-125	100-200	160-320	%
CTR ¹ , I _F = 1 mA, V _{CE} = 5 V	13 min.	22 min.	34 min.	56 min.	%
I _{CEO} (V _{CE} = 10 V)	2 (≤50)	2 (≤50)	5 (≤100)	5 (≤100)	nA

CTR will match within a ratio of 1.7:1

Switching Characteristics

Linear Operation (without saturation) I_F = 10 mA, V_{CC} = 5 V, R_C = 75 Ω, Typical

		-1	-2	-3	-4	
Turn on time	t _{on}	3.0	3.2	3.6	4.1	μs
Rise time	t _r	2.0	2.5	2.9	3.3	μs
Turn off time	t _{off}	2.3	2.9	3.4	3.7	μs
Fall time	t _f	2.0	2.6	3.1	3.5	μs

Switching Operation (with saturation) V_{CC} = 5 V, R_C = 1 KΩ, Typical

		-1 I _F = 20 mA	-2 I _F = 10 mA	-3 I _F = 10 mA	-4 I _F = 5 mA	
Turn on time	t _{on}	3.0	4.3	4.6	6.0	μs
Rise time	t _r	2.0	2.8	3.3	4.6	μs
Turn off time	t _{off}	18	2.9	3.4	25	μs
Fall time	t _f	11	2.6	3.1	15	μs

Figure 1. Saturated switching time test waveform and schematic

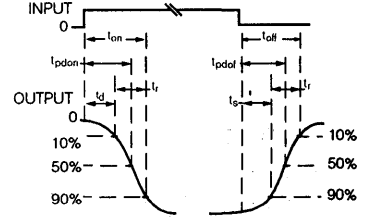

Figure 2. Forward voltage versus forward current

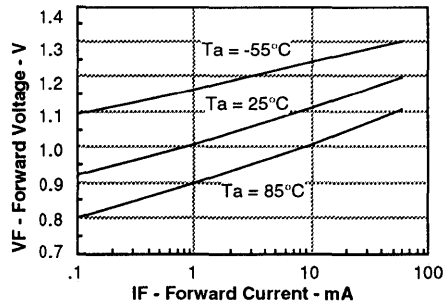

Figure 4. Normalized non-saturated and saturated CTR at T_A = 50°C versus LED current

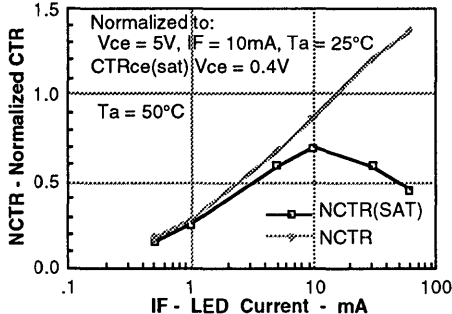

Figure 3. Normalized non-saturated and saturated CTR at T_A = 25°C versus LED current

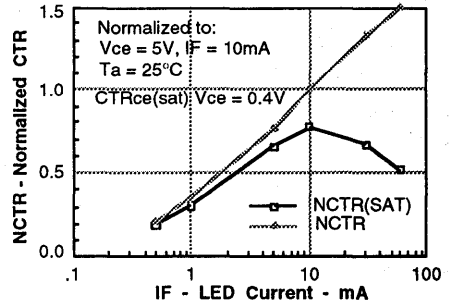

Figure 5. Normalized non-saturated and saturated CTR at T_A = 70°C versus LED current

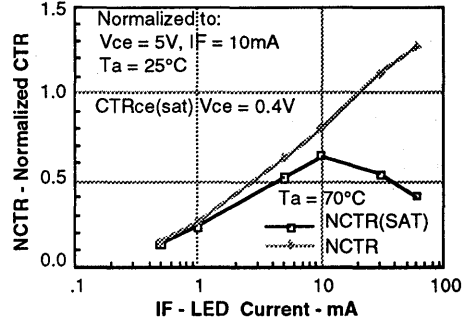

Figure 6. Normalized non-saturated and saturated CTR at $T_A = 85^\circ\text{C}$ versus LED current

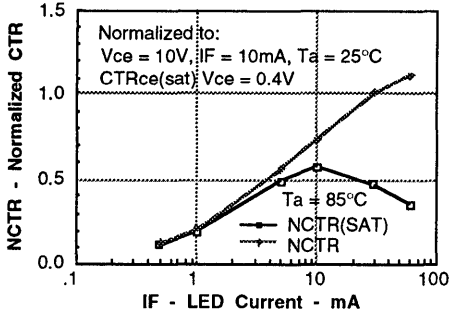

Figure 8. Collector-emitter leakage current versus temperature

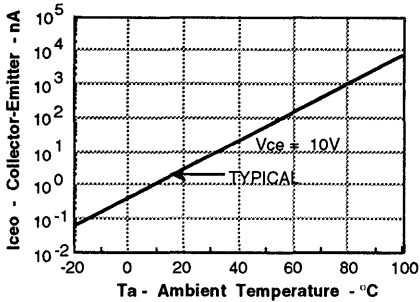

Figure 11. Switching timing

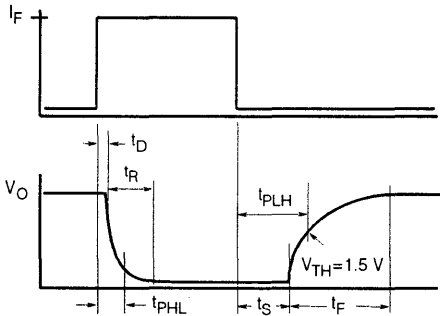

Figure 7. Collector-emitter current versus temperature and LED current

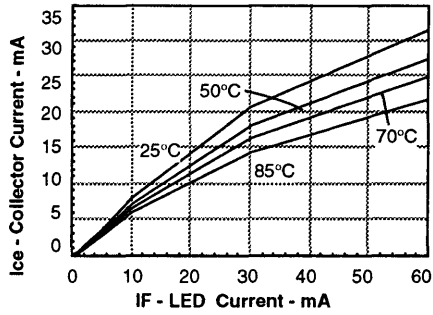

Figure 10. Propagation delay versus collector load resistor

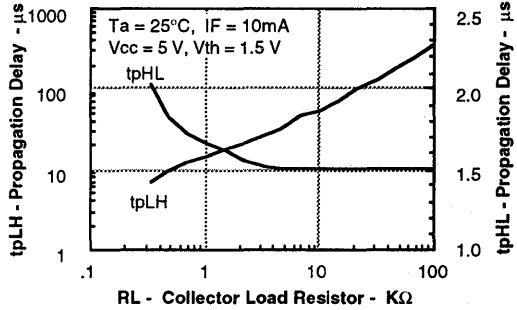
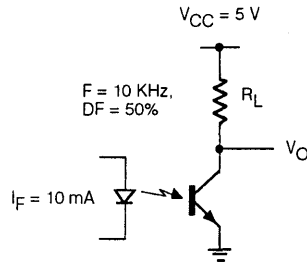

Figure 13. Non-saturated switching schematic



DUAL CHANNEL ILD615 QUAD CHANNEL ILQ615 PHOTOTRANSISTOR OPTOCOUPLER

FEATURES

- Identical Channel to Channel Footprint
- Current Transfer Ratio (CTR) Range @ $I_F = 10 \text{ mA}$
 ILD/Q615-1: 40 – 80% Min.
 ILD/Q615-2: 63 – 125% Min.
 ILD/Q615-3: 100 – 200% Min.
 ILD/Q615-4: 160 – 320% Min.
- Guaranteed CTR @ $I_F = 1 \text{ mA}$
 ILD/Q615-1: 13% Min.
 ILD/Q615-2: 22% Min.
 ILD/Q615-3: 34% Min.
 ILD/Q615-4: 56% Min.
- High Collector-Emitter Voltage $BV_{CEO} = 70 \text{ V}$
- Dual and Quad Packages Feature:
 - Reduced Board Space
 - Lower Pin and Parts Count
 - Better Channel to Channel CTR Match
 - Improved Common Mode Rejection
- Field-Effect Stable by TRansparent IOn Shield (TRIOS)
- Withstand Test Voltage from Double Molded Package
 7500 $V_{AC_{PEAK}}$, 1 sec.
 4420 $V_{AC_{RMS}}$, 1 min.
- UL Approval #E52744
- VDE #0884 Available with Option 1

Maximum Ratings (Each Channel)

Emitter

Reverse Voltage	6 V
Forward Current	60 mA
Surge Current	1.5 A
Power Dissipation	100 mW
Derate Linearly from 25°C	1.33 mW/°C

Detector

Collector-Emitter Reverse Voltage	70 V
Emitter-Collector Reverse Voltage	7 V
Collector Current	50 mA
Collector Current ($t < 1 \text{ ms}$)	100 mA
Power Dissipation	150 mW
Derate Linearly from 25°C	2 mW/°C

Package

Storage Temperature	-55°C to +150°C
Operating Temperature	-55°C to +100°C
Junction Temperature	100°C
Soldering Temperature (2 mm distance from case bottom)	260°C
Package Power Dissipation ILD615	400 mW
Derate Linearly from 25°C	5.33 mW/°C
Package Power Dissipation ILQ615	500 mW
Derate Linearly from 25°C	6.67 mW/°C
Withstand Test Voltage	4420 V_{RMS} (1 min.)/7500 V_{PEAK} (1 sec.)
Leakage Path	8.2 min mm
Air path	7.3 min mm
Working Voltage	1700 $V_{AC_{RMS}}$
Insulation Resistance	$10^{11} \Omega$

Package Dimensions mm
ILD615 (Dual Channel)

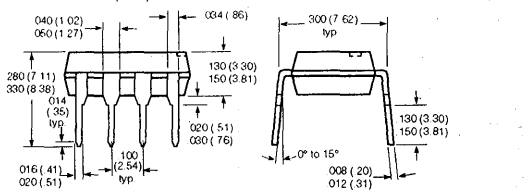
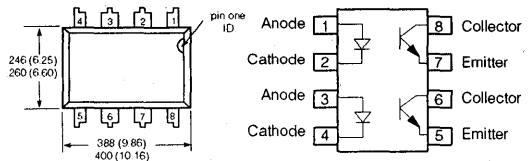

ILQ615 (Quad Channel)

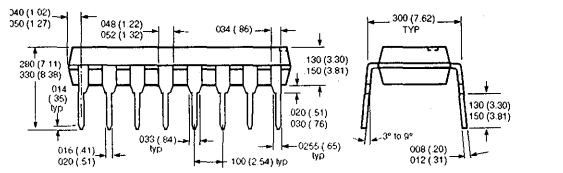
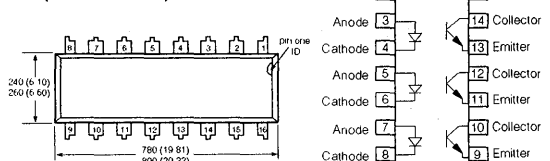

DESCRIPTION

The ILD/Q615 are multi-channel phototransistor optocouplers that use GaAs IRLED emitters and high gain NPN phototransistors. These devices are constructed using over/under leadframe optical coupling and double molded insulation technology resulting a Withstand Test Voltage of 7500 $V_{AC_{PEAK}}$ and a Working Voltage of 1700 $V_{AC_{RMS}}$.

The binned min./max. and linear CTR characteristics combined with the TRIOS (TRansparent IOn Shield) field-effect process make these devices well suited for DC or AC voltage detection. Eliminating the phototransistor base connection provides added electrical noise immunity from the transients found in many industrial control environments.

Because of guaranteed maximum non-saturated and saturated switching characteristics, the ILD/Q615 can be used in medium speed data I/O and control systems. The binned min./max. CTR specification allow easy worst case interface calculations for both level detection and switching applications. Interfacing with a CMOS logic is enhanced by the guaranteed CTR at an $I_F = 1 \text{ mA}$.

See Appnote 45, "How to Use Optocoupler Normalized Curves."

Characteristics ($T_A=25^\circ\text{C}$)

	Symbol	Min.	Typ.	Max.	Unit	Condition
Emitter						
Forward Voltage	V_F	1	1.15	1.3	V	$I_F=10\text{ mA}$
Breakdown Voltage	V_{BR}	6	30		V	$I_R=10\ \mu\text{A}$
Reverse Current	I_R		0.01	10	μA	$V_R=6\text{ V}$
Capacitance	C_0		25		pF	$V_R=0\text{ V}, f=1\text{ MHz}$
Thermal Resistance, Junction to Lead	R_{THUL}		750		$^\circ\text{C}/\text{W}$	
Detector						
Capacitance	C_{CE}		6.8		pF	$V_{CE}=5\text{ V}, f=1\text{ MHz}$
Collector-Emitter Leakage Current, -1, -2	I_{CEO}		2	50	nA	$V_{CE}=10\text{ V}$
Collector-Emitter Leakage Current, -3, -4	I_{CEO}		5	100	nA	$V_{CE}=10\text{ V}$
Collector-Emitter Breakdown Voltage	BV_{CEO}	70			V	$I_{CE}=0.5\text{ mA}$
Emitter-Collector Breakdown Voltage	BV_{ECO}	7			V	$I_E=0.1\text{ mA}$
Thermal Resistance Junction to Lead	R_{THUL}		500		$^\circ\text{C}/\text{W}$	
Package Transfer Characteristics						
Channel/Channel CTR Match	CTR _X /CTR _Y	1 to 1		2 to 1		$I_F=10\text{ mA}, V_{CE}=5\text{ V}$
ILD/Q615-1						
Saturated Current Transfer Ratio	CTR _{CEsat}		25		%	$I_F=10\text{ mA}, V_{CE}=0.4\text{ V}$
Current Transfer Ratio	CTR _{CE}	40	60	80	%	$I_F=10\text{ mA}, V_{CE}=5\text{ V}$
Current Transfer Ratio	CTR _{CE}	13	30		%	$I_F=1\text{ mA}, V_{CE}=5\text{ V}$
ILD/Q615-2						
Saturated Current Transfer Ratio	CTR _{CEsat}		40		%	$I_F=10\text{ mA}, V_{CE}=0.4\text{ V}$
Current Transfer Ratio	CTR _{CE}	63	80	125	%	$I_F=10\text{ mA}, V_{CE}=5\text{ V}$
Current Transfer Ratio	CTR _{CE}	22	45		%	$I_F=1\text{ mA}, V_{CE}=5\text{ V}$
ILD/Q615-3						
Saturated Current Transfer Ratio	CTR _{CEsat}		60		%	$I_F=10\text{ mA}, V_{CE}=0.4\text{ V}$
Current Transfer Ratio	CTR _{CE}	100	150	200	%	$I_F=10\text{ mA}, V_{CE}=5\text{ V}$
Current Transfer Ratio	CTR _{CE}	34	70		%	$I_F=1\text{ mA}, V_{CE}=5\text{ V}$
ILD/Q615-4						
Saturated Current Transfer Ratio	CTR _{CEsat}		100		%	$I_F=10\text{ mA}, V_{CE}=0.4\text{ V}$
Current Transfer Ratio	CTR _{CE}	160	200	320	%	$I_F=10\text{ mA}, V_{CE}=5\text{ V}$
Current Transfer Ratio	CTR _{CE}	56	90		%	$I_F=1\text{ mA}, V_{CE}=5\text{ V}$
Isolation and Insulation						
Common Mode Rejection						
Output High	CMH		5000		V/ μs	$V_{CM}=50\text{ V}_{P,P}, R_L=1\text{ k}\Omega, I_F=0\text{ mA}$
Common Mode Rejection						
Output Low	CML		5000		V/ μs	$V_{CM}=50\text{ V}_{P,P}, R_L=1\text{ k}\Omega, I_F=10\text{ mA}$
Common Mode						
Coupling Capacitance	C_{CM}		0.01		pF	
Package Capacitance	Cl-O	0.8			pF	$V_{I,O}=0\text{ V}, f=1\text{ MHz}$
Insulation Resistance	R_S	5×10^{10}	10^{14}		Ω	$V_{I,O}=500\text{ V}$
Withstand Test Voltage						
Input-Output						
(Rel humidity $\leq 50\%$)	WTV	4420			VAC _{RMS}	
($I_{I,O} \leq 10\ \mu\text{A}, 1\text{ min.}$)	WTV	6250			VAC _{PEAK}	
(Rel humidity $\leq 50\%$)	WTV	5300			VAC _{RMS}	
($I_{I,O} \leq 10\ \mu\text{A}, 1\text{ s.}$)	WTV	7500			VAC _{PEAK}	
Channel to Channel						
Insulation		500			VAC	

SWITCHING TIMES

Figure 1. Non-saturated switching timing

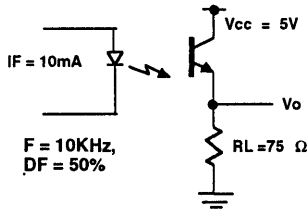

Figure 2. Saturated switching timing

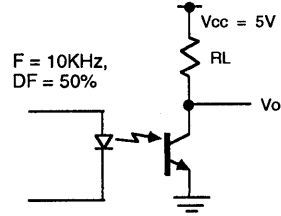

Figure 3. Non-saturated switching timing

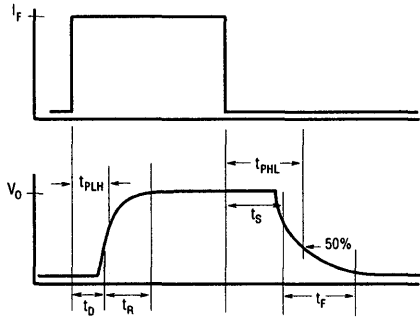
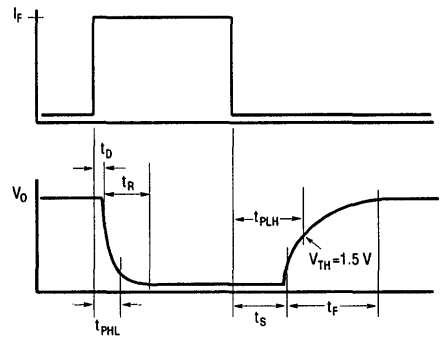

Figure 4. Saturated switching timing



Parameter	Typ.	Unit	Test Condition
t_{ON}	3.0	μs	$R_L = 75 \Omega$ $I_F = 10 \text{ mA}$ $V_{CC} = 5 \text{ V}$
t_R	2.0	μs	
t_{OFF}	2.3	μs	
t_F	2.0	μs	
t_{PHL} Propagation H-L (50% of V_{PP})	1.1	μs	
t_{PLH} Propagation L-H	2.5	μs	

Parameter	-1 $I_F = 20 \text{ mA}$	-2, -3 $I_F = 10 \text{ mA}$	-4 $I_F = 5 \text{ mA}$	Unit	Test Condition
	Typ.	Typ.	Typ.		
t_{ON}	3.0	4.3	6.0	μs	$R_L = 1 \text{ k}\Omega$ $V_{CC} = 5 \text{ V}$ $V_{TH} = 1.5 \text{ V}$
t_R	2.0	2.8	4.6	μs	
t_{OFF}	18	25	25	μs	
t_F	11	14	15	μs	
t_{PHL} Propagation H-L	1.6	2.6	5.4	μs	
t_{PLH} Propagation L-H	8.6	7.2	7.4	μs	

Figure 5. Forward voltage versus forward current

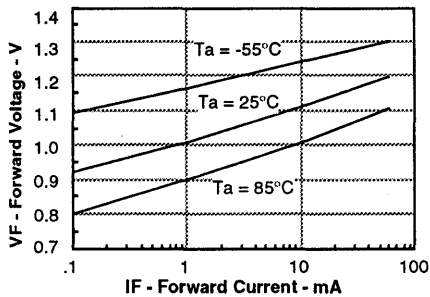

Figure 6. Peak LED current versus pulse duration, Tau

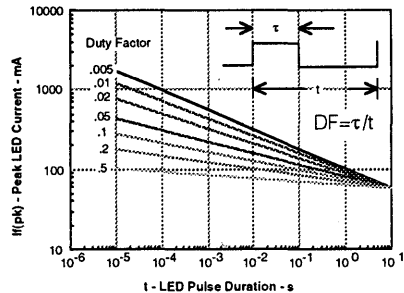

Figure 7. Maximum LED current versus ambient temperature

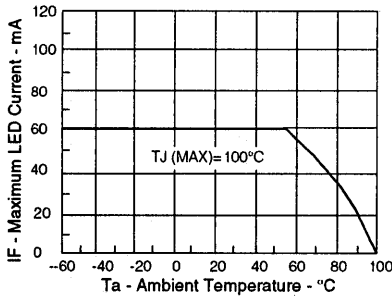

Figure 8. Maximum LED power dissipation

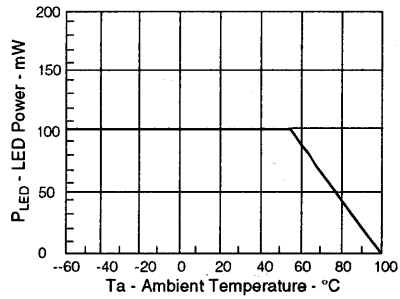

Figure 9. Maximum detector power dissipation

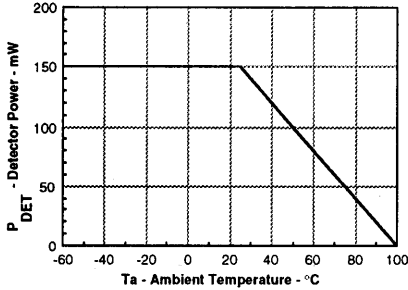

Figure 10. Maximum collector current versus collector voltage

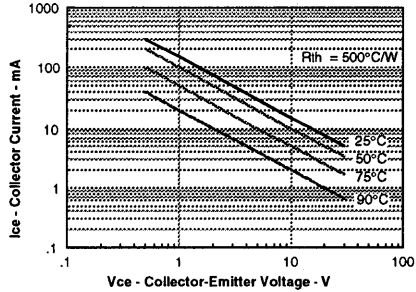

Figure 11. Normalization factor for non-saturated and saturated CTR TA=25°C versus If

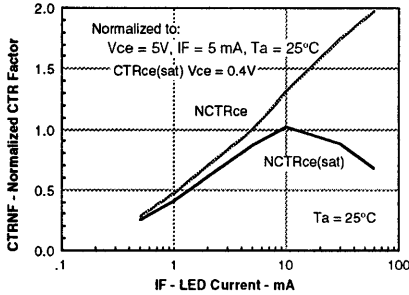

Figure 12. Normalization factor for non-saturated and saturated CTR TA=50°C versus If

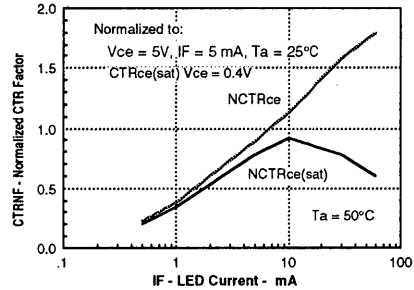

Figure 13. Normalization factor for non-saturated and saturated CTR TA=70°C versus If

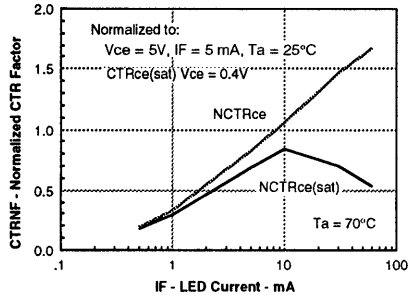
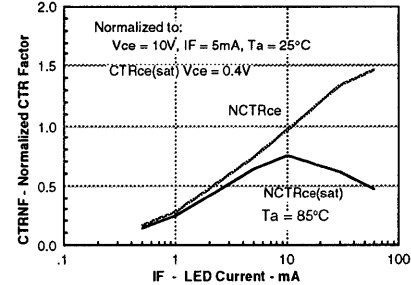

Figure 14. Normalization factor for non-saturated and saturated CTR TA=85°C versus If



Optocouplers (Optoisolators)

Figure 15. Collector-emitter current versus temperature and LED current

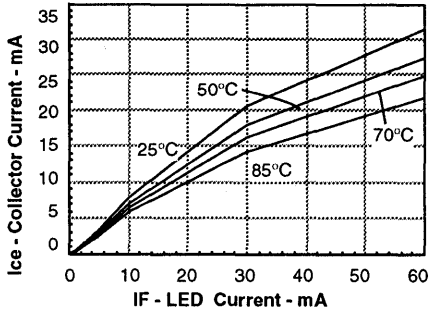

Figure 16. Collector-emitter leakage versus temperature

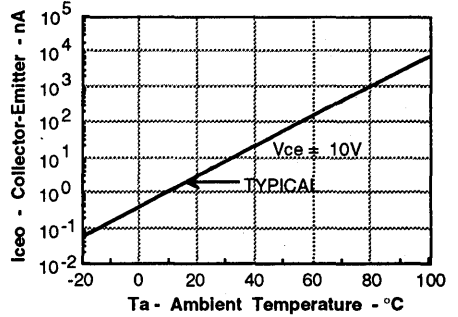

Figure 17. -1 Propagation delay versus collector load resistor

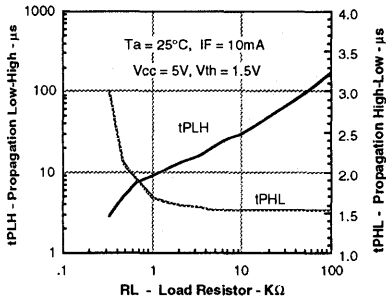

Figure 18. -2, -3 Propagation delay versus collector load resistor

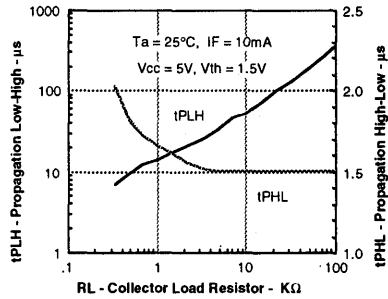
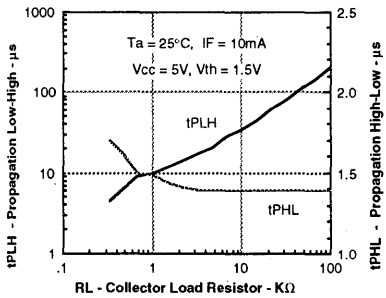

Figure 19. -4 Propagation delay versus collector load resistor



AC INPUT PHOTOTRANSISTOR OPTOCOUPLER

FEATURES

- Identical Channel to Channel Footprint
ILD620 Crosses to TLP620-2
ILQ620 Crosses to TLP620-4
- Current Transfer Ratio (CTR) at $I_F = \pm 5$ mA
ILD/Q620: 50% Min.
ILD/Q620GB: 100% Min.
- Saturated Current Transfer Ratio (CTR_{SAT}) at $I_F = \pm 1$ mA
ILD/Q620: 60% Typ.
ILD/Q620GB: 30% Min.
- High Collector-Emitter Voltage, $BV_{CEO} = 70$ V
- Dual and Quad Packages Feature:
 - Reduced Board Space
 - Lower Pin and Parts Count
 - Better Channel to Channel CTR Match
 - Improved Common Mode Rejection
- Field-Effect Stable by TRIOS (TRansparent IO n Shield)
- Withstand Test Voltage from Double Molded Package
7500 VAC_{PEAK}, 1 sec.
4420 VAC_{RMS}, 1 min.
- Underwriters Lab File #E52744
- VDE #0884 Available with Option 1

Maximum Ratings (Each Channel)

Emitter

Forward Current	±60 mA
Surge Current	±1.5 A
Power Dissipation	100 mW
Derate from 25°C	1.3 mW/°C

Detector

Collector-Emitter Breakdown Voltage	70 V
Collector Current	50 mA
Collector Current (t < 1 ms)	100 mA
Power Dissipation	150 mW
Derate from 25°C	2 mW/°C

Package

Withstand Test Voltage	4420 V _{AC,RMS} (1 min.)
Package Dissipation ILD620/GB	400 mW
Derate from 25°C	5.33 mW/°C
Package Dissipation ILQ620/GB	500 mW
Derate from 25°C	6.67 mW/°C
Leakage Path	8.2 min mm
Air path	7.3 min mm
Insulation Resistance	10 ¹¹ Ω
Storage Temperature	-55°C to +150°C
Operating Temperature	-55°C to +100°C
Junction Temperature	100°C
Soldering Temperature (2 mm from case bottom)	260°C

Package Dimensions in Inches (mm)

ILD620/620GB

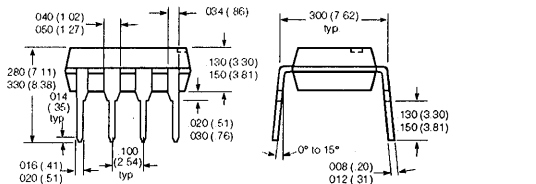
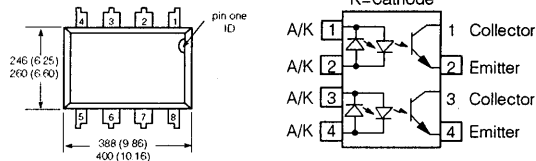

ILQ620/620GB

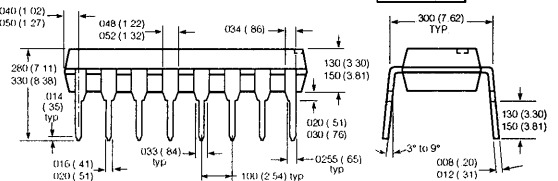
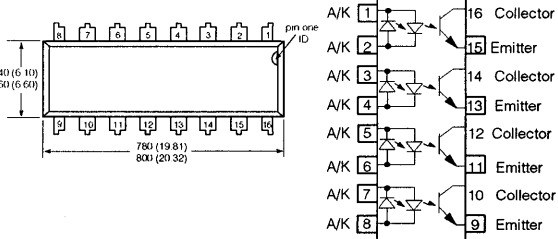

DESCRIPTION

The ILD/Q620 and ILD/Q620GB are multi-channel input phototransistor optocouplers that use inverse parallel GaAs IRLED emitters and high gain NPN silicon phototransistors per channel. These devices are constructed using over/under leadframe optical coupling and double molded insulation resulting in a Withstand Test Voltage of 7500 VAC_{PEAK}.

The LED parameters and the linear CTR characteristics combined with the TRIOS field-effect process make these devices well suited for AC voltage detection. The ILD/Q620GB with its low I_F guaranteed CTR_{CEsat} minimizes power dissipation of the AC voltage detection network that is placed in series with the LEDs. Eliminating the phototransistor base connection provides added electrical noise immunity from the transients found in many industrial control environments.

Characteristics

	Symbol	Min.	Typ.	Max.	Unit	Condition
Emitter						
Forward Voltage	V_F	1	1.15	1.3	V	$I_F = \pm 10 \text{ mA}$
Forward Current	I_F		2.5	20	μA	$V_F = \pm 0.7 \text{ V}$
Capacitance	C_0		25		pF	$V_F = 0 \text{ V}$, $f = 1 \text{ MHz}$
Thermal Resistance Junction to Lead	R_{THJL}		750		$^{\circ}\text{C}/\text{W}$	
Detector						
Capacitance	C_{CE}		6.8		pF	$V_{\text{CE}} = 5 \text{ V}$, $f = 1 \text{ MHz}$
Collector-Emitter Leakage Current	I_{CEO}		10	100	nA	$V_{\text{CE}} = 24 \text{ V}$
Collector-Emitter Leakage Current	I_{CEO}		2	50	μA	$T_A = 85^{\circ}\text{C}$, $V_{\text{CE}} = 24 \text{ V}$
Collector-Emitter Breakdown Voltage	BV_{CEO}	70			V	$I_{\text{CE}} = 0.5 \text{ mA}$
Emitter-Collector Breakdown Voltage	BV_{ECO}	7			V	$I_E = 0.1 \text{ mA}$
Thermal Resistance Junction to Lead	R_{THJL}		500		$^{\circ}\text{C}/\text{W}$	
Package Transfer Characteristics						
Channel/Channel CTR Match	CTR _X /CTR _Y	1 to 1		3 to 1		$I_F = \pm 5 \text{ mA}$, $V_{\text{CE}} = 5 \text{ V}$
CTR Symmetry	$I_{\text{CE}}(\text{RATIO})$	0.5		2		$I_{\text{CE}}(I_F = -5 \text{ mA})/I_F(= +5 \text{ mA})$
Off-State Collector Current	$I_{\text{CE}}(\text{OFF})$		1	10	μA	$V_F = \pm 0.7 \text{ V}$, $V_{\text{CE}} = 24 \text{ V}$
ILD/Q620						
Saturated Current Transfer Ratio	CTR _{CEsat}		60		%	$I_F = \pm 1 \text{ mA}$, $V_{\text{CE}} = 0.4 \text{ V}$
Current Transfer Ratio	CTR _{CE}	50	80	600	%	$I_F = \pm 5 \text{ mA}$, $V_{\text{CE}} = 5 \text{ V}$
Collector-Emitter Saturation Voltage	V_{CEsat}			0.4	V	$I_F = \pm 8 \text{ mA}$, $I_{\text{CE}} = 2.4 \text{ mA}$
ILD/Q620GB						
Saturated Current Transfer Ratio	CTR _{CEsat}	30			%	$I_F = \pm 1 \text{ mA}$, $V_{\text{CE}} = 0.4 \text{ V}$
Current Transfer Ratio	CTR _{CE}	100	200	600	%	$I_F = \pm 5 \text{ mA}$, $V_{\text{CE}} = 5 \text{ V}$
Collector-Emitter Saturation Voltage	V_{CEsat}			0.4	V	$I_F = \pm 1 \text{ mA}$, $I_{\text{CE}} = 0.2 \text{ mA}$
Isolation and Insulation						
Common Mode Rejection, Output High	CMH		5000		V/ μs	$V_{\text{CM}} = 50 \text{ V}_{\text{P-P}}$, $R_L = 1 \text{ k}\Omega$, $I_F = 0 \text{ mA}$
Common Mode Rejection, Output Low	CML		5000		V/ μs	$V_{\text{CM}} = 50 \text{ V}_{\text{P-P}}$, $R_L = 1 \text{ k}\Omega$, $I_F = 10 \text{ mA}$
Common Mode Coupling Capacitance	C_{CM}		0.01		pF	
Package Capacitance	CI-O	0.8			pF	$V_{\text{I-O}} = 0 \text{ V}$, $f = 1 \text{ MHz}$
Insulation Resistance	R_S		10^{12}		Ω	$V_{\text{I-O}} = 500 \text{ V}$
Withstand Test Voltage, Input-Output (Rel humidity $\leq 50\%$)	WTV	4420			VAC _{RMS}	($I_{\text{I-O}} \leq 10 \mu\text{A}$, 1 min.)
	WTV	6250			VAC _{PEAK}	
(Rel humidity $\leq 50\%$)	WTV	5300			VAC _{RMS}	($I_{\text{I-O}} \leq 10 \mu\text{A}$, 1 sec.)
	WTV	7500			VAC _{PEAK}	
Channel to Channel Insulation		500			VAC	

SWITCHING TIMES

Figure 1. Non-saturated switching timing

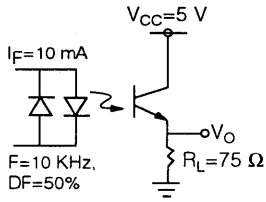

Figure 3. Non-saturated switching timing

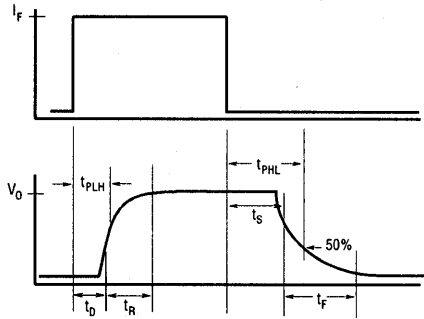

Figure 2. Saturated switching timing

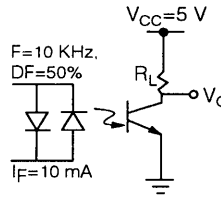
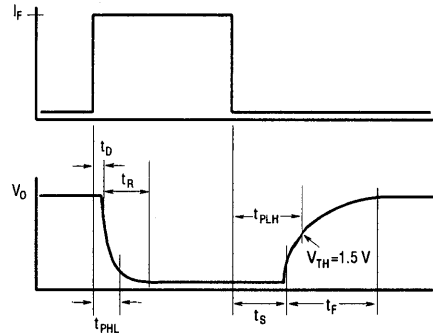

Figure 4. Saturated switching timing



Characteristic	Symbol	Typ.	Unit	Test Condition
On Time	T_{ON}	3.0	μs	$I_F = \pm 10 \text{ mA}$
Rise Time	t_r	20	μs	$V_{CC} = 5 \text{ V}$
Off Time	t_{OFF}	2.3	μs	$R_L = 75 \Omega$
Fall Time	t_f	2.0	μs	
Propagation H-L	t_{PHL}	1.1	μs	50% of V_{PP}
Propagation L-H	t_{PLH}	2.5	μs	

Characteristic	Symbol	Typ.	Unit	Test Condition
On Time	T_{ON}	4.3	μs	$I_F = \pm 10 \text{ mA}$
Rise Time	t_r	2.8	μs	$V_{CC} = 5 \text{ V}$
Off Time	t_{OFF}	2.5	μs	$R_L = 1 \text{ k}\Omega$
Fall Time	t_f	11	μs	
Propagation H-L	t_{PHL}	2.6	μs	$V_{TH} = 1.5 \text{ V}$
Propagation L-H	t_{PLH}	7.2	μs	

Figure 5. LED forward current versus forward voltage

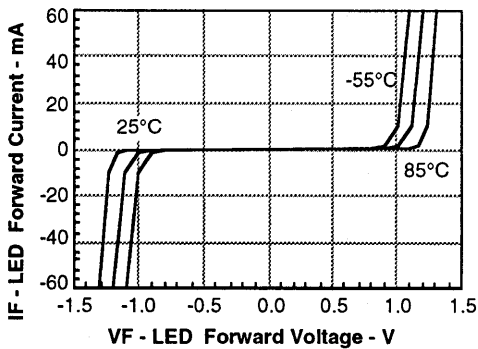

Figure 6. Peak LED current versus peak duration, Tau

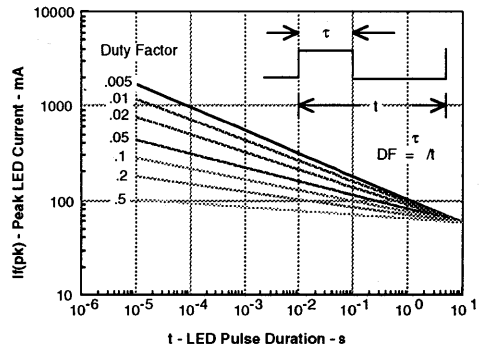

Figure 7. Maximum LED current versus ambient temperature

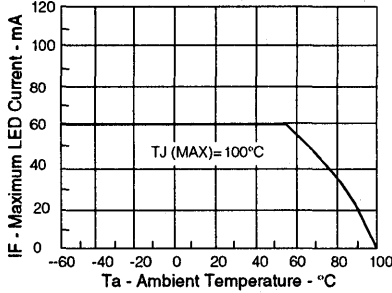

Figure 9. Maximum detector power dissipation

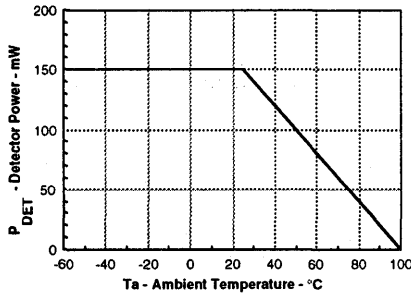

Figure 11. Normalization factor for non-saturated and saturated CTR T_A=50°C versus I_f

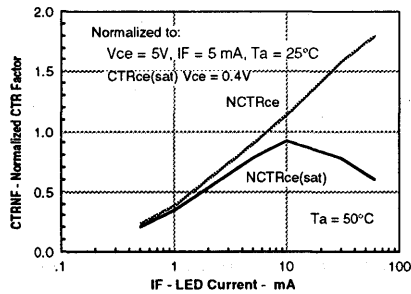

Figure 13. Normalization factor for non-saturated and saturated CTR T_A=100°C versus I_f

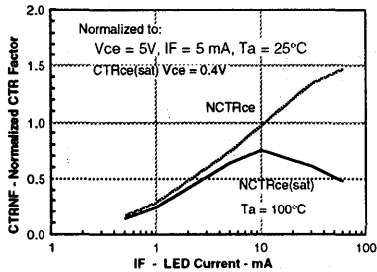

Figure 8. Maximum LED power dissipation

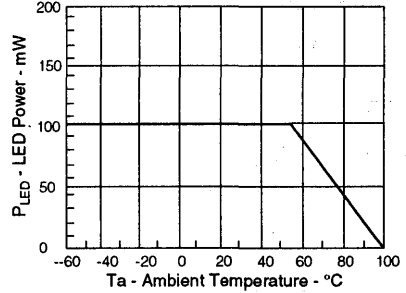

Figure 10. Maximum collector current versus collector voltage

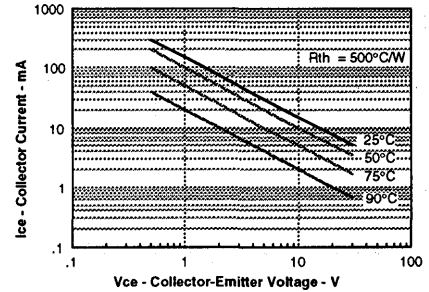

Figure 12. Normalization factor for non-saturated and saturated CTR T_A=70°C versus I_f

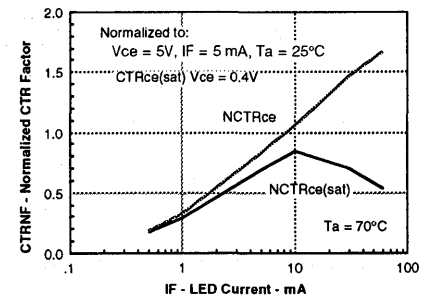

Figure 14. Collector current versus diode forward current

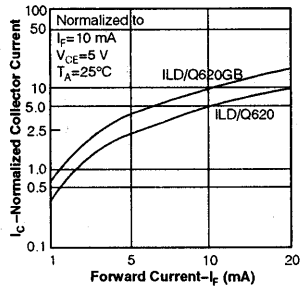
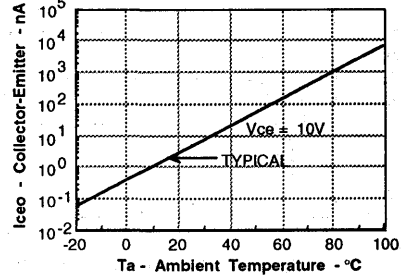

Figure 15. Collector-emitter leakage versus temperature



DUAL CHANNEL ILD621/621GB QUAD CHANNEL ILQ621/621GB

MULTI-CHANNEL PHOTOTRANSISTOR OPTOCOUPLER

FEATURES

- Alternate Source to TLP621-2/-4 and TLP621GB-2/-4
- Current Transfer Ratio (CTR) at $I_F = 5$ mA
ILD/Q621: 50% Min.
ILD/Q621GB: 100% Min.
- Saturated Current Transfer Ratio (CTR_{SAT}) at $I_F = 1$ mA
ILD/Q621: 60% Typ.
ILD/Q621GB: 30% Min.
- High Collector-Emitter Voltage, $BV_{CEO} = 70$ V
- Dual and Quad Packages Feature:
 - Reduced Board Space
 - Lower Pin and Parts Count
 - Better Channel to Channel CTR Match
 - Improved Common Mode Rejection
- Field-Effect Stable by TRIOS (TRansparent IOShield)
- Withstand Test Voltage from Double Molded Package
7500 VDC, 1 sec.
4420 VAC_{RMS}, 1 min.
- Underwriters Lab File #E52744
- VDE #0884 Available with Option 1

Maximum Ratings (Each Channel)

Emitter

Reverse Voltage	6 V
Forward Current	60 mA
Surge Current	1.5 A
Power Dissipation	100 mW
Derate from 25°C	1.33 mW/°C

Detector

Collector-Emitter Reverse Voltage	70 V
Collector Current	50 mA
Collector Current ($t < 1$ ms)	100 mA
Power Dissipation	150 mW
Derate from 25°C	-2mW/°C

Package

Withstand Test Voltage	4420 V (1 min.)
Package Dissipation ILD620/GB	400 mW
Derate from 25°C	5.33 mW/°C
Package Dissipation ILQ620/GB	500 mW
Derate from 25°C	6.67 mW/°C
Leakage Path	8.2 min mm
Air path	7.3 min mm
Insulation Resistance	$10^{11} \Omega$
Storage Temperature	-55°C to +150°C
Operating Temperature	-55°C to +100°C
Junction Temperature	100°C
Soldering Temperature (2 mm from case bottom)	260°C

Package Dimensions in Inches (mm)

ILD621/621GB

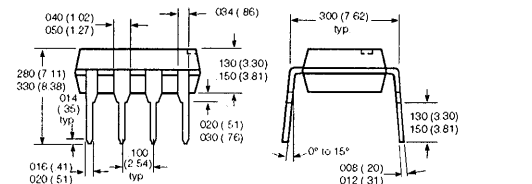
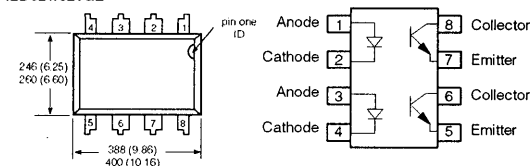

ILQ621/621GB

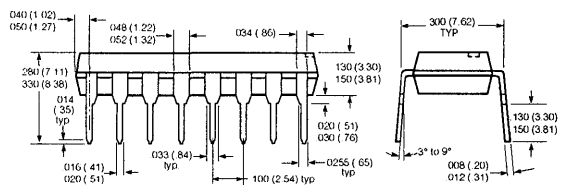
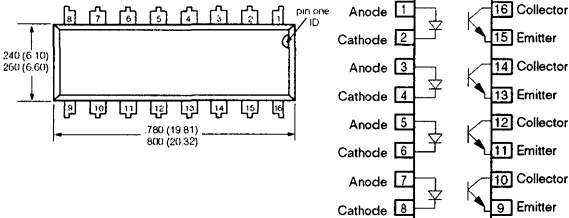

DESCRIPTION

The ILD/Q621 and ILD/Q621GB are multi-channel phototransistor optocouplers that use GaAs IRLD emitters and high gain NPN silicon phototransistors. These devices are constructed using over/under leadframe optical coupling and double molded insulation technology. This assembly process offers a withstand test voltage of 7500 VDC.

The ILD/Q621GB is well suited for CMOS interfacing given the CTR_{CEsat} of 30% minimum at I_F of 1 mA. High gain linear operation is guaranteed by a minimum CTR_{CE} of 100% at 5 mA. The ILD/Q621 has a guaranteed CTR_{CE} of 50% minimum at 5 mA. The TRansparent IOShield insures stable DC gain in applications such as power supply feedback circuits, where constant DC V_{IO} voltages are present.

Characteristics

	Symbol	Min.	Typ.	Max.	Unit	Condition
Emitter						
Forward Voltage	V_F	1	1.15	1.3	V	$I_F=10\text{ mA}$
Breakdown Voltage	V_{BR}	6			V	$I_R=10\text{ }\mu\text{A}$
Reverse Current	I_R		0.01	10	μA	$V_R=6\text{ V}$
Capacitance	C_0		40		pF	$V_F=0\text{ V}$, $f=1\text{ MHz}$
Thermal Resistance Junction to Lead	R_{THJL}		750		$^{\circ}\text{C}/\text{W}$	
Detector						
Capacitance	C_{CE}		6.8		pF	$V_{CE}=5\text{ V}$, $f=1\text{ MHz}$
Collector-Emitter Leakage Current	I_{CEO}		10	100	nA	$V_{CE}=24\text{ V}$
Collector-Emitter Leakage Current	I_{CEO}		2	50	μA	$T_A=85^{\circ}\text{C}$, $V_{CE}=24\text{ V}$
Collector-Emitter Breakdown Voltage	BV_{CEO}	70			V	$I_{CE}=0.5\text{ mA}$
Emitter-Collector Breakdown Voltage	BV_{ECO}	7			V	$I_E=0.1\text{ mA}$
Thermal Resistance Junction to Lead	R_{THJL}		500		$^{\circ}\text{C}/\text{W}$	
Package Transfer Characteristics						
Channel/Channel CTR Match	CTRX/CTRY	1 to 1		3 to 1		$I_F=5\text{ mA}$, $V_{CE}=5\text{ V}$
ILD/Q621						
Saturated Current Transfer Ratio	CTR_{CEsat}		60		%	$I_F=1\text{ mA}$, $V_{CE}=0.4\text{ V}$
Current Transfer Ratio	CTR_{CE}	50	80	600	%	$I_F=5\text{ mA}$, $V_{CE}=5\text{ V}$
Collector-Emitter Saturation Voltage	V_{CEsat}			0.4	V	$I_F=8\text{ mA}$, $I_{CE}=2.4\text{ mA}$
ILD/Q621GB						
Saturated Current Transfer Ratio	CTR_{CEsat}	30			%	$I_F=1\text{ mA}$, $V_{CE}=0.4\text{ V}$
Current Transfer Ratio (Collector-Emitter)	CTR_{CE}	100	200	600	%	$I_F=5\text{ mA}$, $V_{CE}=5\text{ V}$
Collector-Emitter Saturation Voltage	V_{CEsat}			0.4	V	$I_F=1\text{ mA}$, $I_{CE}=0.2\text{ mA}$
Isolation and Insulation						
Common Mode Rejection, Output High	CMH		5000		V/ μs	$V_{CM}=50\text{ V}_{P-P}$, $R_L=1\text{ k}\Omega$, $I_F=0\text{ mA}$
Common Mode Rejection, Output Low	CML		5000		V/ μs	$V_{CM}=50\text{ V}_{P-P}$, $R_L=1\text{ k}\Omega$, $I_F=10\text{ mA}$
Common Mode Coupling Capacitance	C_{CM}		0.01		pF	
Package Capacitance	Cl-O	0.8			pF	$V_{I-O}=0\text{ V}$, $f=1\text{ MHz}$
Insulation Resistance	R_S		10^{12}		Ω	$V_{I-O}=500\text{ V}$
Withstand Test Voltage, Input-Output	WTV	4420			$V_{AC_{RMS}}$	Rel humidity $\leq 50\%$
	WTV	6250			$V_{AC_{PEAK}}$	$I_{I-O} \leq 10\text{ }\mu\text{A}$, 1 min.
	WTV	5300			$V_{AC_{RMS}}$	Rel humidity $\leq 50\%$
	WTV	7500			$V_{AC_{PEAK}}$	$I_{I-O} \leq 10\text{ }\mu\text{A}$, 1 s.
Channel to Channel Insulation		500			VAC	

SWITCHING TIMES

Figure 1. Non-saturated switching timing

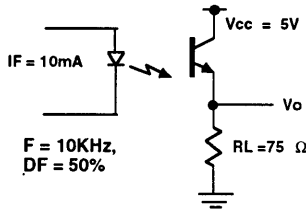

Figure 2. Saturated switching timing

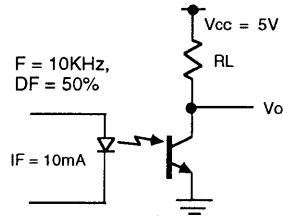

Figure 3. Non-saturated switching timing

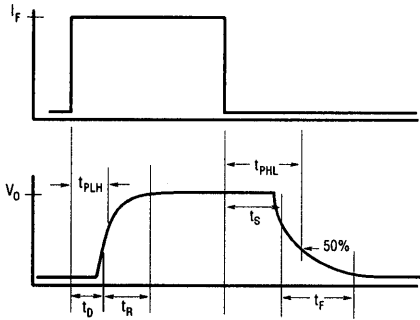
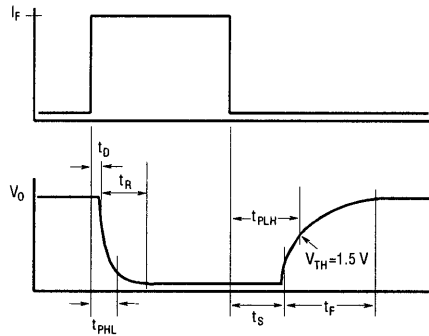

Figure 4. Saturated switching timing



Characteristic	Symbol	Typ.	Unit	Test Condition
On Time	T_{ON}	3.0	μs	$I_F = \pm 10 \text{ mA}$
Rise Time	t_R	20	μs	$V_{CC} = 5 \text{ V}$
Off Time	t_{OFF}	2.3	μs	$R_L = 75 \Omega$
Fall Time	t_F	2.0	μs	50% of V_{PP}
Propagation H-L	t_{PHL}	1.1	μs	
Propagation L-H	t_{PLH}	2.5	μs	

Characteristic	Symbol	Typ.	Unit	Test Condition
On Time	T_{ON}	4.3	μs	$I_F = \pm 10 \text{ mA}$
Rise Time	t_R	2.8	μs	$V_{CC} = 5 \text{ V}$
Off Time	t_{OFF}	2.5	μs	$R_L = 1 \text{ k}\Omega$
Fall Time	t_F	11	μs	$V_{TH} = 1.5 \text{ V}$
Propagation H-L	t_{PHL}	2.6	μs	
Propagation L-H	t_{PLH}	7.2	μs	

Figure 5. Forward voltage versus forward current

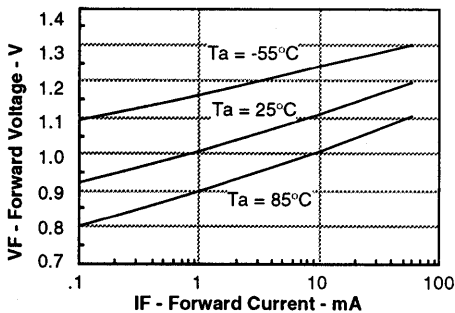

Figure 6. Peak LED current versus pulse duration, Tau

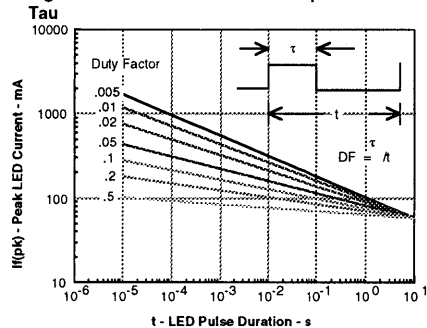

Figure 7. Maximum LED current versus ambient temperature

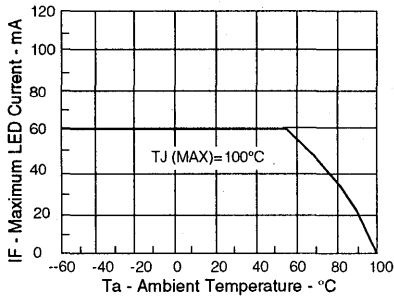

Figure 8. Maximum LED power dissipation

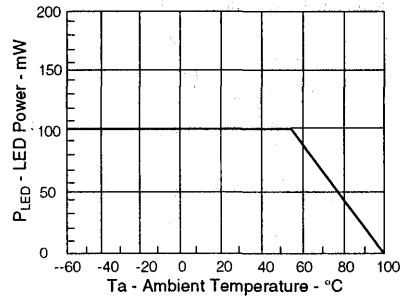

Figure 9. Maximum detector power dissipation

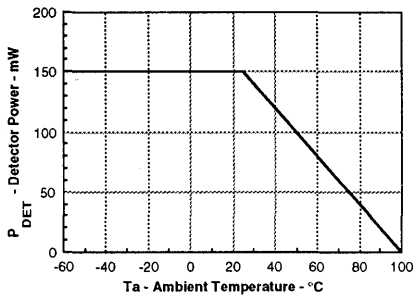

Figure 10. Maximum collector current versus collector voltage

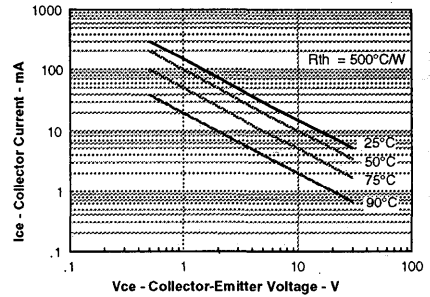

Figure 11. Normalization factor for non-saturated and saturated CTR $T_A=50^\circ\text{C}$ versus If

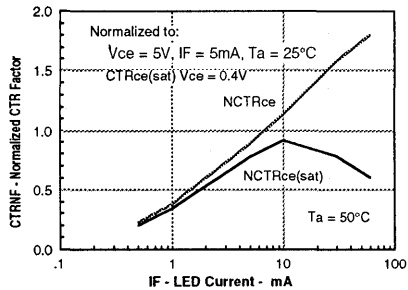

Figure 12. Normalization factor for non-saturated and saturated CTR $T_A=70^\circ\text{C}$ versus If

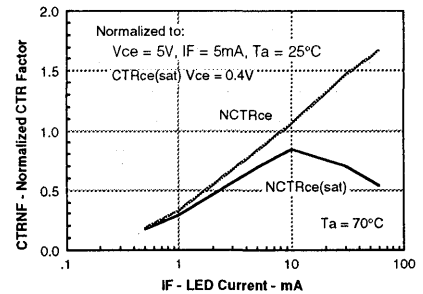

Figure 13. Normalization factor for non-saturated and saturated CTR $T_A=100^\circ\text{C}$ versus If

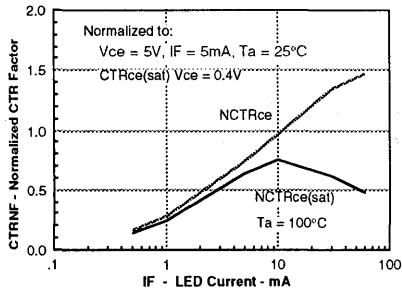

Figure 14. Collector-emitter current versus temperature and LED current

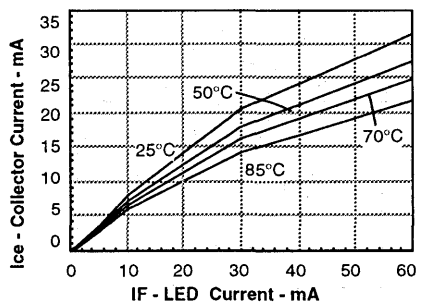

Figure 15. Collector-emitter leakage versus temperature

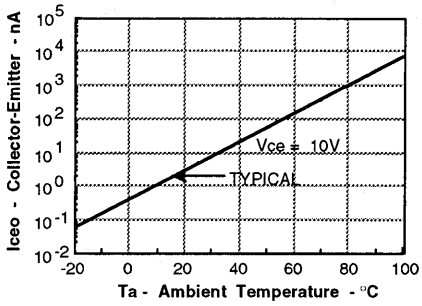
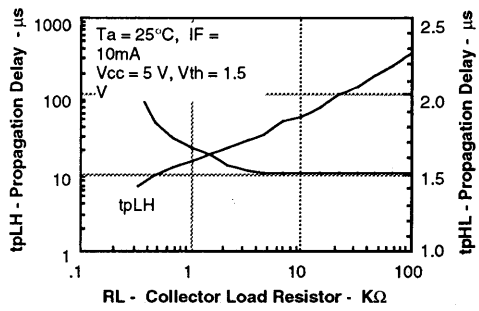

Figure 16. Propagation delay versus collector load resistor



FEATURES

- Operating Temperature Range, -55°C to $+125^{\circ}\text{C}$
- Current Transfer Ratio Guaranteed from -55°C to $+100^{\circ}\text{C}$ Ambient Temperature Range
- High Current Transfer Ratio at Low Input Current
- Withstand Test Voltage, 3000 VDC
- Base Lead Available for Transistor Biasing
- Standard 8 Pin DIP Package

DESCRIPTION

The ILH100 is designed especially for hi-rel applications requiring optical isolation with high current transfer ratio and low saturation V_{CE} . Each optocoupler consists of a light emitting diode and a NPN silicon phototransistor mounted and coupled in an 8 pin hermetically sealed DIP package. The ILH100's low input current makes it well suited for direct CMOS to LSTTL/TTL interfaces.

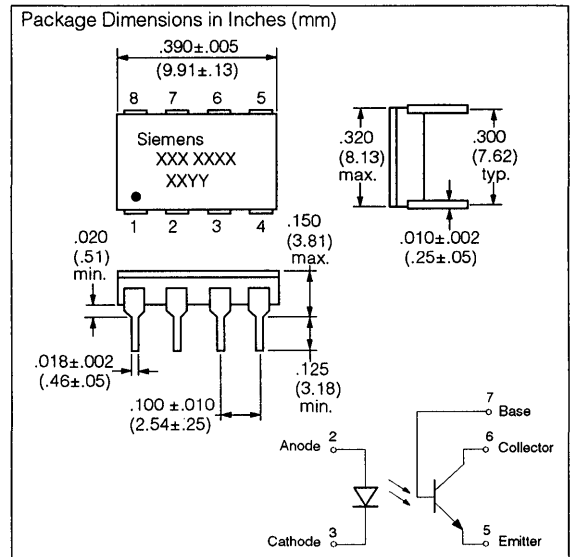

Maximum Ratings

Emitter

Reverse Voltage	6.0 V
Forward Current60 mA
Peak Forward Current ⁽¹⁾	1 A
Power Dissipation	150 mW
Derate Linearly from 25°C	1.5 mW/°C

Detector

Collector-Emitter Voltage	70 V
Emitter-Base Voltage	7 V
Collector-Base Voltage	70 V
Continuous Collector Current50 mA
Power Dissipation	300 mW
Derate Linearly from 25°C	3.0 mW/°C

Package

Input-Output Withstand Test Voltage ⁽²⁾	3000 VDC
Storage Temperature Range	-65°C to $+150^{\circ}\text{C}$
Operating Temperature Range	-55 to $+125^{\circ}\text{C}$
Junction Temperature	150°C
Soldering Time at 240°C, 1.6 mm from case	10 sec.
Power Dissipation	350 mW
Derate Linearly from 25°C	3.5 mW/°C

Notes:

1. Values applies for $P_{W} \leq 1$ ms, $PRR \leq 300$ pps.
2. Measured between pins 1,2,3 and 4 shorted together and pins 5,6,7 and 8 shorted together. $T_A = 25^{\circ}\text{C}$ and duration=1 second, RH=45%.

Characteristics ($T_A=25^\circ\text{C}$, unless otherwise specified)

Parameter	Symbol	Min.	Typ.	Max.	Unit	Condition
Emitter						
Forward Voltage	V_F		1.45	1.7	V	$I_F=60\text{ mA}$
Reverse Breakdown Voltage	V_{BR}	6			V	$I_R=10\text{ }\mu\text{A}$
Reverse Current	I_R		0.01	10	μA	$V_R=6\text{ V}$
Capacitance	C_J		20		pF	$V_F=0\text{ V}$, $f=1\text{ MHz}$
Thermal Resistance	R_{TH}		220		$^\circ\text{C/W}$	Junction to Lead
Detector						
Collector-Emitter Saturation Voltage	$V_{CE(sat)}$		0.25	0.4	V	$I_B=20\text{ }\mu\text{A}$, $I_{CE}=1\text{ mA}$
Base-Emitter Voltage	V_{BE}		0.65		V	$I_B=20\text{ }\mu\text{A}$
Collector-Emitter Leakage Current	I_{CEO}		5	50	nA	$V_{CE}=10\text{ V}$
DC Forward Current Gain	HFE	250	400	750		$V_{CE}=10\text{ V}$, $I_B=20\text{ }\mu\text{A}$
Saturated DC Forward Current Gain	$HFE(sat)$	125	200	325		$V_{CE}=0.4\text{ V}$, $I_B=20\text{ }\mu\text{A}$
Capacitance	C_{CE}		6.8		pF	$V_{CE}=5\text{ V}$, $f=1\text{ MHz}$
	C_{CB}		8.5		pF	
	C_{EB}		11		pF	
Thermal Resistance	R_{TH}		220		$^\circ\text{C/W}$	Junction to Lead
Coupled Characteristics (-55°C to 100°C)						
Saturated Current Transfer Ratio	$CTR(sat)$	70	210	250	%	$I_F=10\text{ mA}$, $V_{CE}=0.4\text{ V}$
Current Transfer Ratio Collector-Emitter	CTR_{ce}	100	300	450	%	$I_F=10\text{ mA}$, $V_{CE}=10\text{ V}$
Current Transfer Ratio Collector-Base	CTR_{cb}	0.4	0.7	0.9	%	$I_F=10\text{ mA}$, $V_{CB}=9.3\text{ V}$
Isolation and Insulation						
Common Mode Rejection Output High	CM_H	1000	>1000		V/ μs	$V_{CM}=500\text{ V}_{P-P}$, $V_{CC}=5\text{ V}$, $R_L=1\text{ K}\Omega$, $I_F=0\text{ mA}$
Common Mode Rejection Output High	CM_L	1000	>1000		V/ μs	$V_{CM}=500\text{ V}_{P-P}$, $V_{CC}=5\text{ V}$, $R_L=1\text{ K}\Omega$, $I_F=10\text{ mA}$
Package Capacitance	C_{IO}		1.5		pF	$V_{IO}=0\text{ V}$, 1 MHz
Insulation Resistance	R_{IO}	10^{11}	10^{14}		Ω	$V_{IO}=500\text{ VDC}$
Leakage Current Input-Output	I_{IO}			10	μA	Relative Humidity $\leq 50\%$, $V_{IO}\ 3000\text{ VDC}$, 5 sec.

 Optocouplers
(Optoisolators)

Typical Switching Speeds ($T_A=25^\circ\text{C}$)

Non-Saturated Switching	Symbol	Typ.	Max.	Unit	Test Condition
Delay	t_d	0.8	2	μs	
Rise	t_r	2	5	μs	$V_{CC}=5\text{ V}$
Storage	t_s	0.4	1.5	μs	$R_L=75\text{ }\Omega$
Fall	t_f	2	5	μs	$I_F=10\text{ mA}$
Propagation-High to Low	tp_{HL}	1	3	μs	50% of V_{PP}
Propagation-Low to High	tp_{LH}	1.5	4	μs	$R_{BE}=\text{open}$
Saturated Switching⁽¹⁾					
Delay	t_d	0.7	2	μs	
Rise	t_r	1	3	μs	$V_{CE}=0.4\text{ V}$
Storage	t_s	13.5	30	μs	$R_L=1\text{ K}\Omega$
Fall	t_f	12	30	μs	$I_F=10\text{ mA}$
Propagation-High to Low	tp_{HL}	1.4	5	μs	$V_{CC}=5\text{ V}$, $V_{TH}=1.5\text{ V}$
Propagation-Low to High	tp_{LH}	15	40	μs	$R_{BE}=\text{open}$

Figure 1. Switching time waveform and test schematic—non-saturated test condition

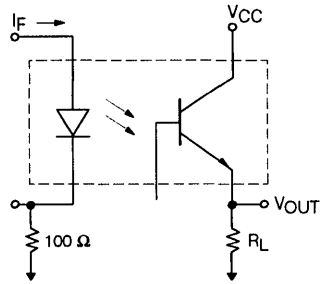
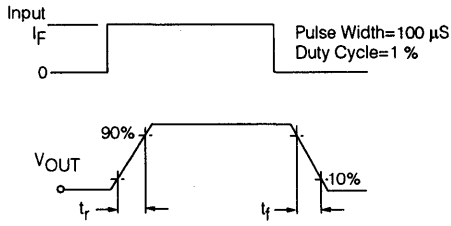

Figure 2. Forward current versus forward voltage and temperature

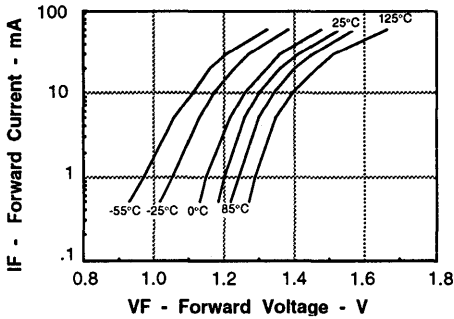

Figure 3. Peak LED current versus duty factor refresh rate and temperature

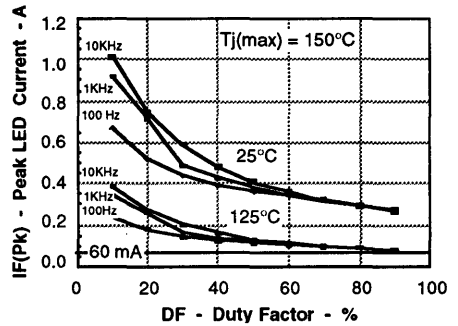

Figure 4. Normalized non-saturated current transfer ratio versus temperature and LED current

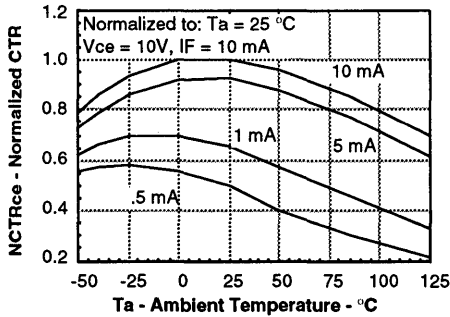

Figure 5. Normalized non-saturated current transfer ratio versus temperature and LED current

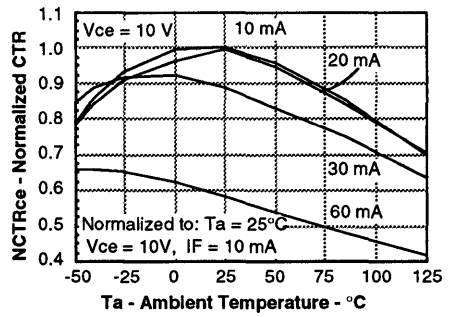

Figure 6. Normalized saturated current transfer ratio versus temperature and LED current

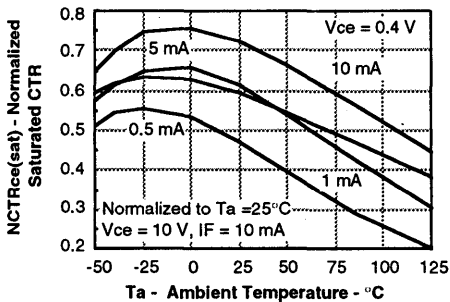

Figure 7. Normalized saturated current transfer ratio versus temperature and LED current

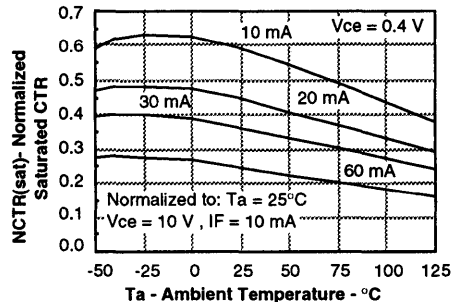

Figure 8. Collector-emitter current versus temperature and LED current

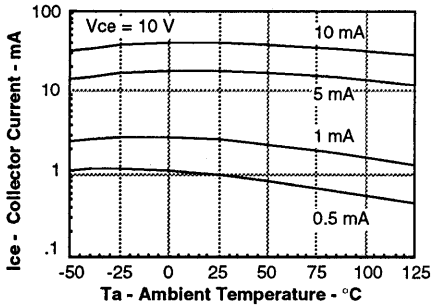

Figure 9. Collector-emitter current versus temperature and LED current

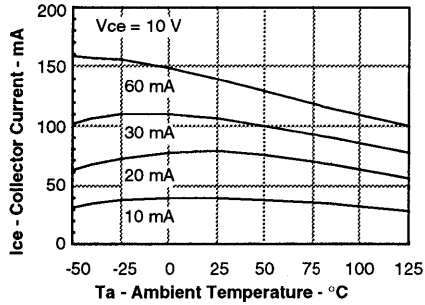

Figure 10. Saturated collector-emitter current versus temperature and LED current

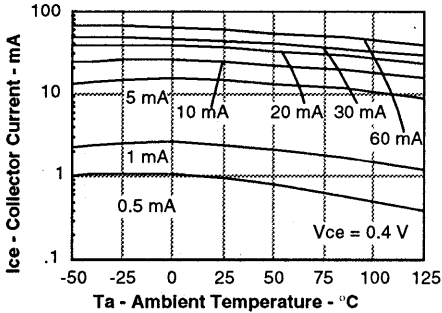

Figure 11. Saturated collector-emitter current versus temperature and LED current

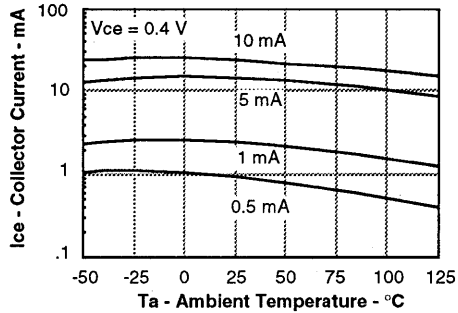

Figure 12. Normalized collector base CRT versus temperature and LED current

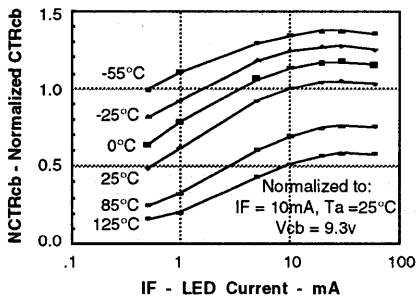

Figure 13. Normalized Icb photocurrent versus temperature and LED current

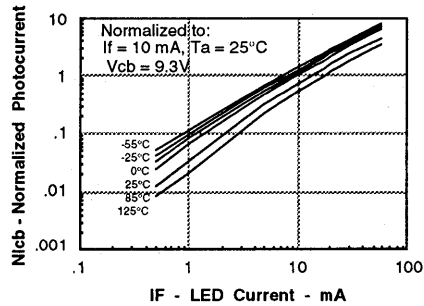

Figure 14. Normalized non-saturated and saturated HFE at Ta=25°C versus base current

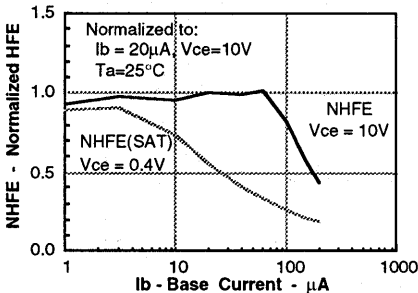

Figure 15. Normalized non-saturated and saturated HFE at Ta=50°C versus base current

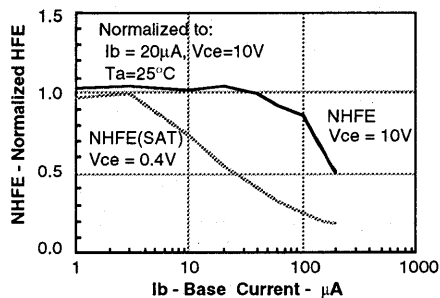

Figure 16. Normalized non-saturated and saturated HFE at $T_A=70^\circ\text{C}$ versus base current

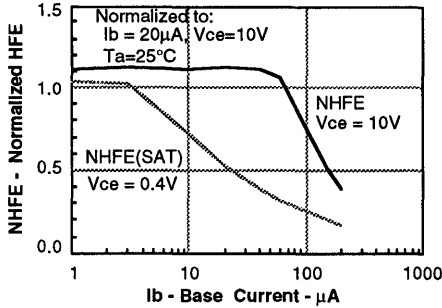

Figure 18. Base emitter voltage versus base current

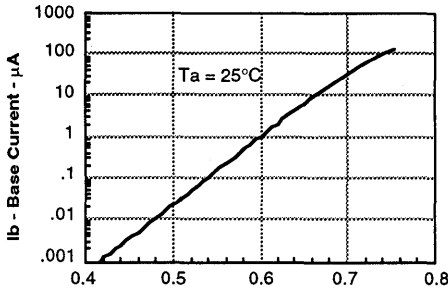

Figure 20. Propagation delay versus temperature and collector load resistance for $I_F=5\text{ mA}$

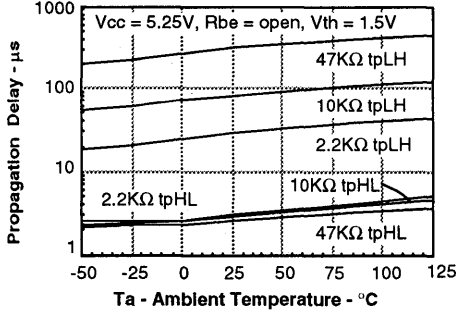

Figure 22. Propagation delay versus temperature and collector load resistance for $I_F=20\text{ mA}$

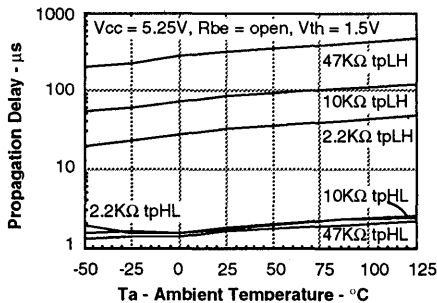

Figure 17. Collector-emitter leakage current versus temperature

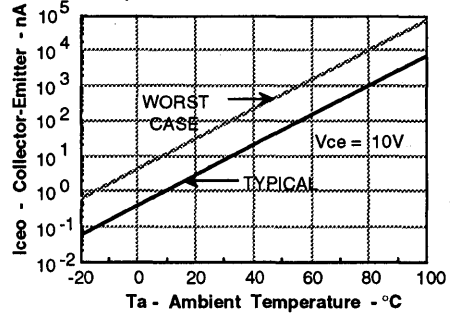

Figure 19. Base emitter capacitance versus base emitter voltage

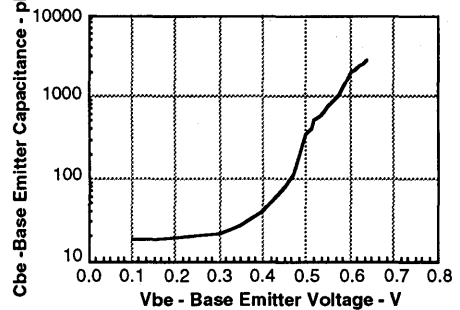

Figure 21. Propagation delay versus temperature and collector load resistance for $I_F=10\text{ mA}$

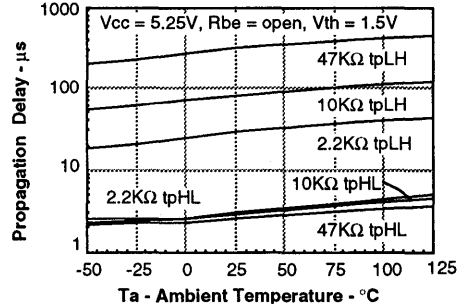

Figure 23. Propagation delay versus temperature and collector load resistance for $I_F=5\text{ mA}$

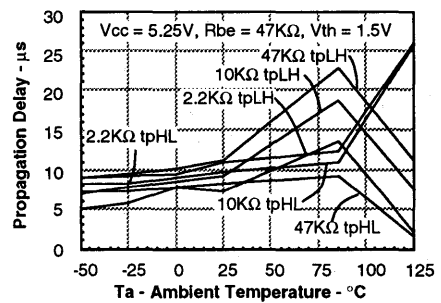

Figure 24. Switching time waveform and test schematic—saturated test condition

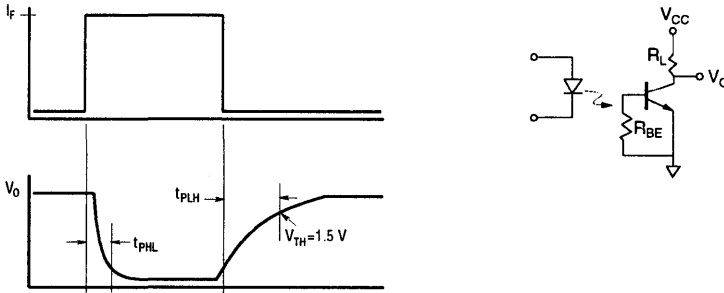

Figure 25. Propagation delay versus temperature and collector load resistance for $I_F=10\text{ mA}$

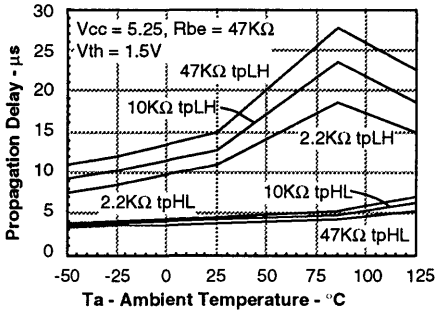

Figure 26. Propagation delay versus temperature and collector load resistance for $I_F=20\text{ mA}$

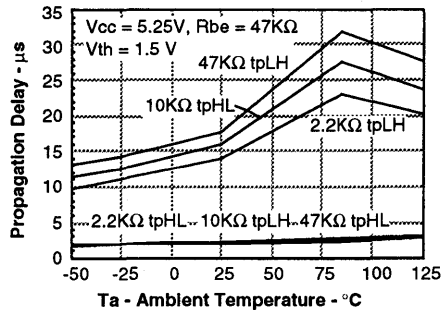

Figure 27. Propagation delay versus collector load and base-emitter resistance for $I_F=5\text{ mA}$

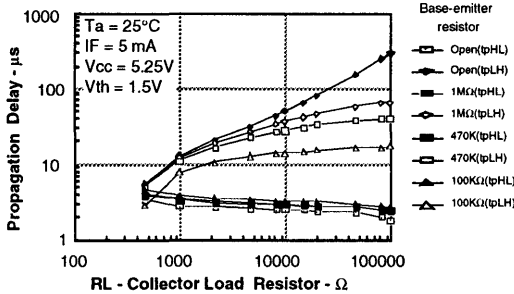

Figure 28. Propagation delay versus collector load and base-emitter resistance for $I_F=5\text{ mA}$

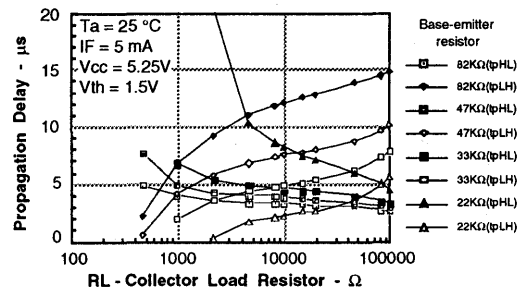

Figure 29. Propagation delay versus collector load and base-emitter resistance for $I_F=10\text{ mA}$

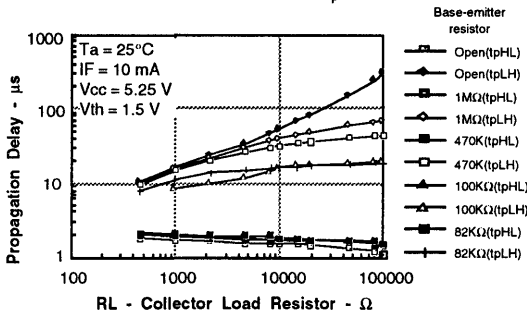

Figure 30. Propagation delay versus collector load and base-emitter resistance for $I_F=10\text{ mA}$

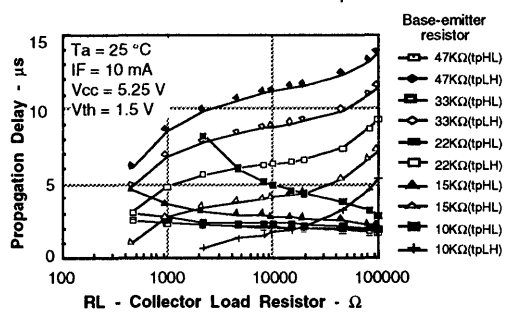

Figure 31. Propagation delay versus collector load and base-emitter resistance for $I_f=15$ mA

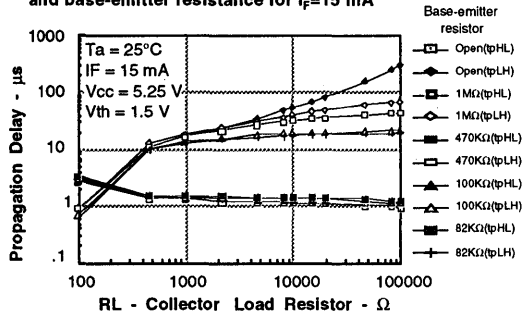

Figure 32. Propagation delay versus collector load and base-emitter resistance for $I_f=15$ mA

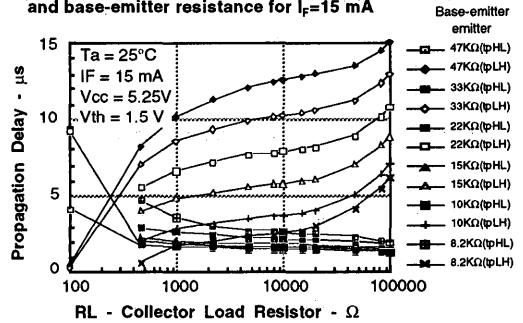

Figure 33. Propagation delay versus collector load and base-emitter resistance for $I_f=15$ mA

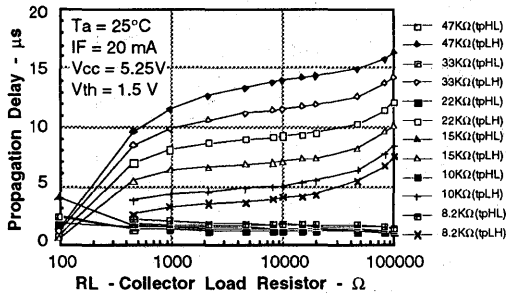

Figure 34. Propagation delay versus collector load and base-emitter resistance for $I_f=15$ mA

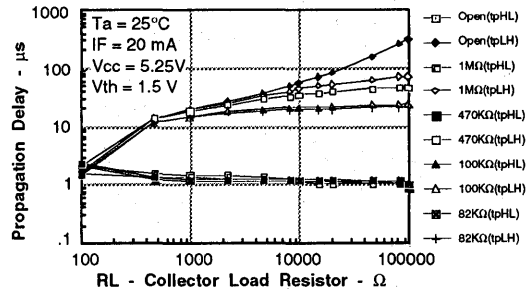
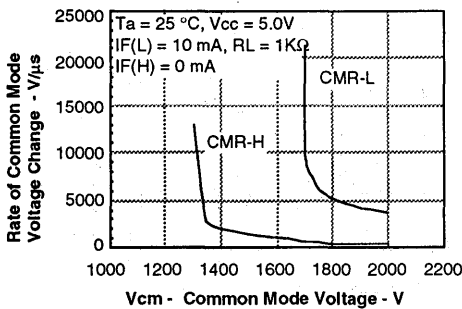

Figure 35. Common mode transient rejection



HERMETIC PHOTOTRANSISTOR DUAL CHANNEL OPTOCOUPLER

FEATURES

- Operating Temperature Range, -55°C to $+125^{\circ}\text{C}$
- Current Transfer Ratio Guaranteed from -55°C to $+100^{\circ}\text{C}$ Ambient Temperature Range
- High Current Transfer Ratio at Low Input Current
- Withstand Test Voltage, 3000 VDC
- Two Isolated Channels per Package
- Standard 8 Pin DIP Package

DESCRIPTION

The ILH200 is designed especially for hi-rel applications requiring optical isolation with high current transfer ratio and low saturation V_{CE} . Each channel of the optocoupler consists of a light emitting diode and a NPN silicon phototransistor mounted and coupled in an 8 pin hermetically sealed DIP package. The low input current makes the ILH200 well suited for direct CMOS to LSTTL/TTL interfaces.

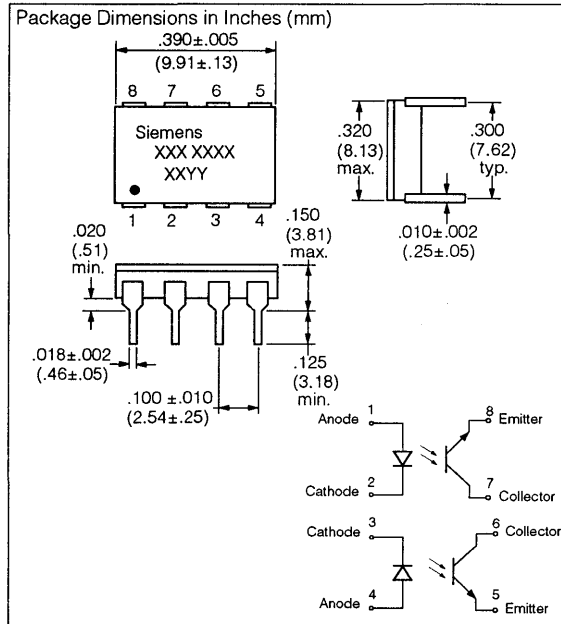

Maximum Ratings

Emitter (per channel)

Reverse Voltage	6.0 V
Forward Current	60 mA
Peak Forward Current ¹	1 A
Power Dissipation	75 mW
Derate Linearly from 25°C	0.75 mW/°C

Detector (per channel)

Collector-Emitter Voltage	70 V
Emitter-Collector Voltage	7 V
Continuous Collector Current	50 mA
Power Dissipation	100 mW
Derate Linearly from 25°C	1.0 mW/°C

Package

Input to Output Withstand Test Voltage ²	3000 VDC
Storage Temperature Range	-65°C to $+150^{\circ}\text{C}$
Operating Temperature Range	-55°C to $+125^{\circ}\text{C}$
Junction Temperature	150°C
Soldering Time at 240°C, 1.6 mm from case	10 sec.
Power Dissipation	350 mW
Derate Linearly from 25°C	3.5 mW/°C

Notes:

1. Values applies for $P_W \leq 1$ ms, $PRR \leq 300$ pps.
2. Measured between pins 1,2,3 and 4 shorted together and pins 5,6,7 and 8 shorted together. $T_A = 25^{\circ}\text{C}$ and duration=1 second, RH=45%.

Characteristics (Each Channel) ($T_A=25^\circ\text{C}$, unless otherwise specified)

Parameter	Symbol	Min.	Typ.	Max.	Unit	Condition
Emitter						
Forward Voltage	V_F		1.46	1.7	V	$I_F=60\text{ mA}$
Reverse Breakdown Voltage	V_{BR}	6			V	$I_R=10\text{ }\mu\text{A}$
Reverse Current	I_R		0.01	10	μA	$V_R=6\text{ V}$
Capacitance	C_J		20		pF	$V_F=0\text{ V}$, $f=1\text{ MHz}$
Thermal Resistance	R_{TH}		220		$^\circ\text{C/W}$	Junction to Lead
Detector						
Collector-Emitter Saturation Voltage	$V_{CE(sat)}$		0.25	0.4	V	$I_B=20\text{ }\mu\text{A}$, $I_{CE}=1\text{ mA}$
Collector-Emitter Leakage Current	I_{CEO}		5	50	nA	$V_{CE}=10\text{ V}$
Capacitance	C_{CE}		6.8		pF	$V_{CE}=5\text{ V}$, $f=1\text{ MHz}$
Thermal Resistance	R_{TH}		220		$^\circ\text{C/W}$	Junction to Lead
Coupled Characteristics						
-55°C to 100°C						
Saturated Current Transfer Ratio	$CTR_{(sat)}$	70	210	250	%	$I_F=10\text{ mA}$, $V_{CE}=0.4\text{ V}$
Current Transfer Ratio Collector-Emitter	CTR_{ce}	100	300	450	%	$I_F=10\text{ mA}$, $V_{CE}=10\text{ V}$
Isolation and Insulation						
Common Mode Rejection Output High	CM_H	1000	>1000		V/ μs	$V_{CM}=500\text{ V}_{p-p}$, $V_{CC}=5\text{ V}$, $R_L=1\text{ K}\Omega$, $I_F=0\text{ mA}$
Common Mode Rejection Output Low	CM_L	1000	>1000		V/ μs	$V_{CM}=500\text{ V}_{p-p}$, $V_{CC}=5\text{ V}$, $R_L=1\text{ K}\Omega$, $I_F=10\text{ mA}$
Package Capacitance	C_{IO}		1.5		pF	$V_{IO}=0\text{ V}$, 1 MHz
Insulation Resistance	R_{IO}	10^{11}	10^{14}		Ω	$V_{IO}=500\text{ VDC}$
Leakage Current Input-Output	I_{IO}			10	μA	Relative Humidity $\leq 50\%$, $V_{IO}\ 3000\text{ VDC}$, 5 sec.

Typical Switching Speeds ($T_A=25^\circ\text{C}$)

Non-Saturated Switching	Symbol	Typ.	Max.	Unit	Test Condition
Delay	td	0.8	2	μs	
Rise	tr	2	5	μs	$V_{CC}=5\text{ V}$
Storage	ts	0.4	1.5	μs	$R_L=75\text{ }\Omega$
Fall	tf	2	5	μs	$I_F=10\text{ mA}$
Propagation-High to Low	tpHL	1	3	μs	50% of V_{PP}
Propagation-Low to High	tpLH	1.5	4	μs	
Saturated Switching ⁽¹⁾	Symbol	Typ.	Max.	Unit	Test Condition
Delay	td	0.7	2	μs	
Rise	tr	1	3	μs	$V_{CE}=0.4\text{ V}$
Storage	ts	13.5	30	μs	$R_L=1\text{ K}\Omega$
Fall	tf	12	30	μs	$I_F=10\text{ mA}$
Propagation-High to Low	tpHL	1.4	5	μs	$V_{CC}=5\text{ V}$, $V_{TH}=1.5\text{ V}$
Propagation-Low to High	tpLH	15	40	μs	

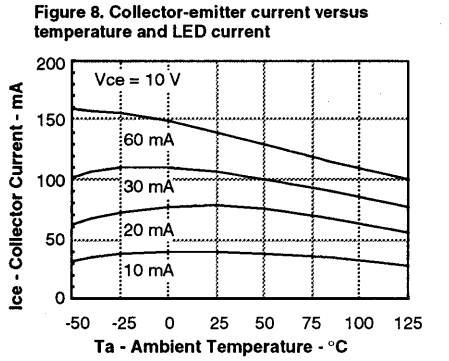
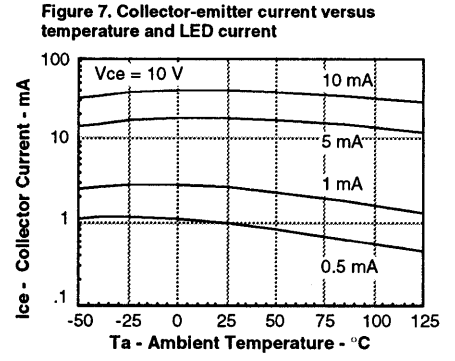
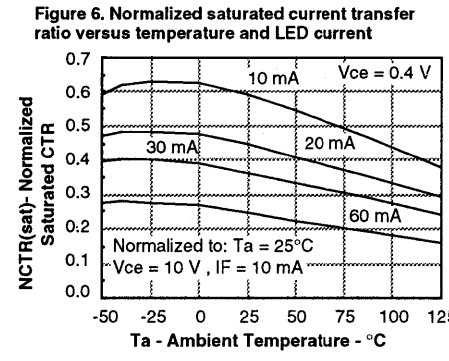
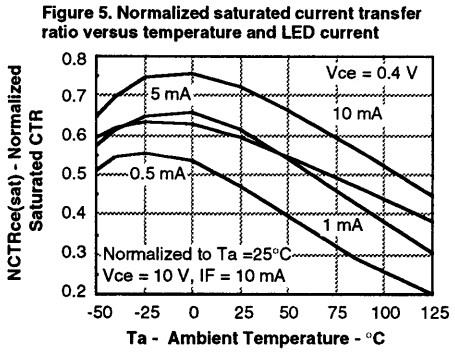
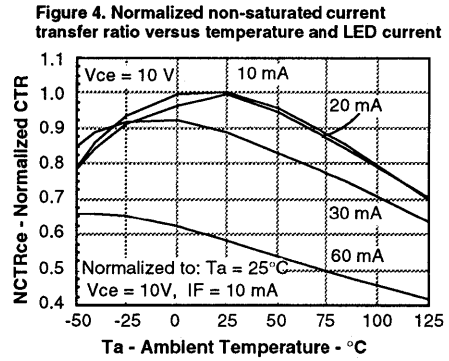
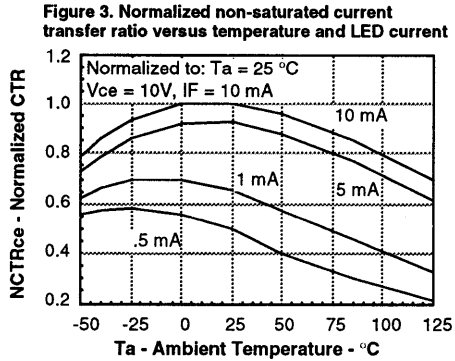
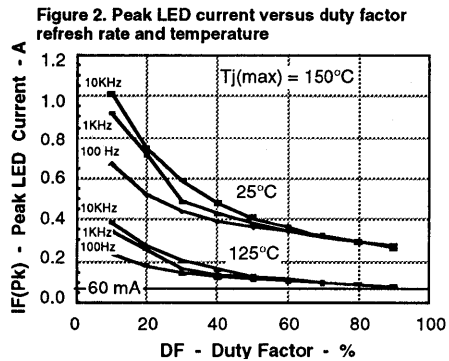
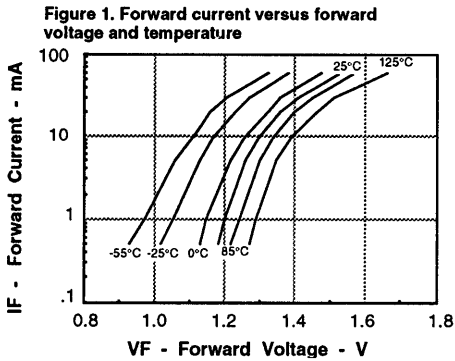

Optocouplers (Optoisolators)

Figure 9. Saturated collector-emitter current versus temperature and LED current

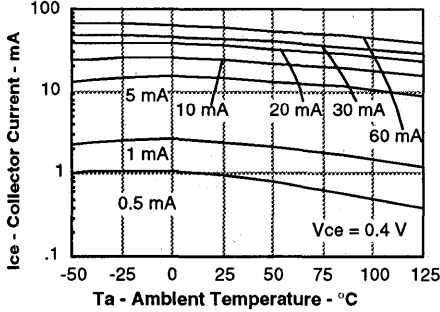

Figure 10. Saturated collector-emitter current versus temperature and LED current

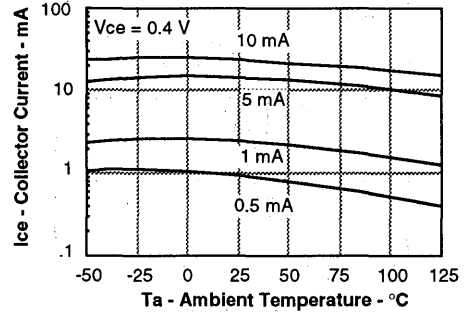

Figure 11. Collector-emitter leakage current versus temperature

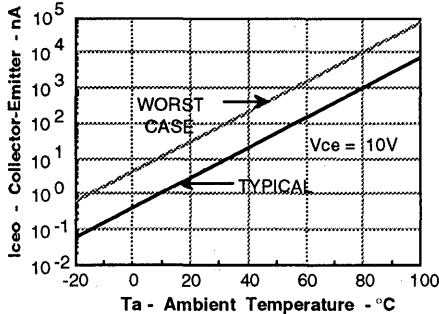

Figure 12. Propagation delay versus temperature and collector load resistance for $I_F=5$ mA

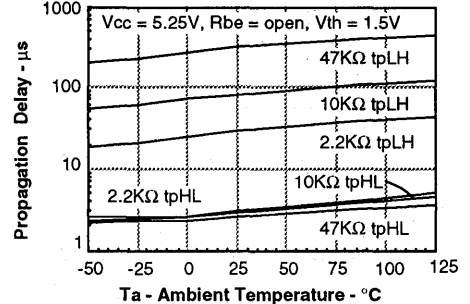

Figure 13. Propagation delay versus temperature and collector load resistance for $I_F=10$ mA

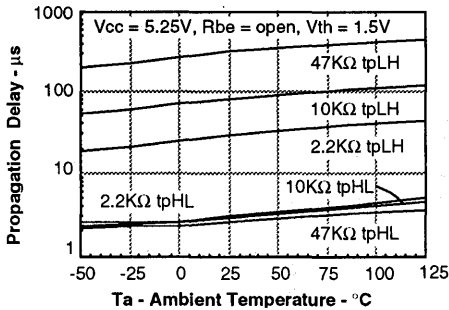

Figure 14. Propagation delay versus temperature and collector load resistance for $I_F=20$ mA

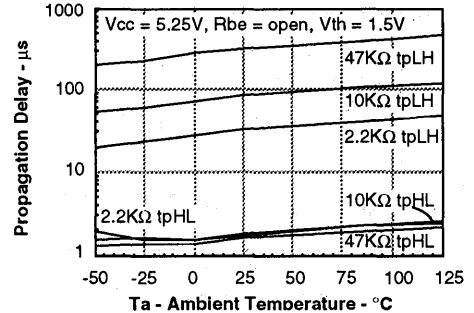

Figure 15. Common mode transient rejection

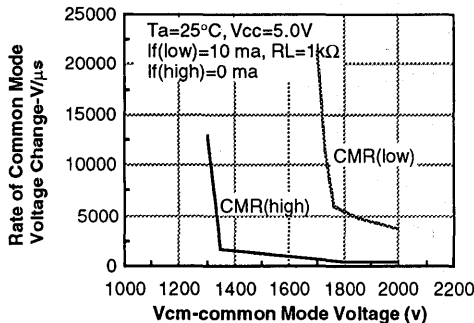
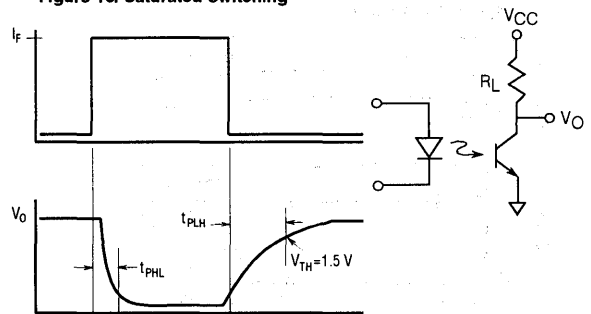

Figure 16. Saturated Switching



Preliminary Data Sheet

FEATURES

- Normally Open, Single Pole Single Throw Operation
- Control 350 VAC or DC Voltage
- Switch 100 mA Loads
- LED Control Current, 1.5 mA
- Low ON-Resistance
- dv/dt , > 500 V/ μ s
- Withstand Test Voltage, 7500 VAC
- Current Limiting
- Underwriters Lab File # E52744
- Applications
 - Telephone Switch Hook
 - High Voltage Test Equipment
 - TRIAC Driver
 - Motor Control
 - Industrial Control Systems

DESCRIPTION

The LH1056 is a single pole single throw (SPST), normally open (NO), solid state relay. The relay can control AC or DC loads currents up to 100 mA, with a supply voltage up to 350 V. The device is packaged in a six pin 0.3 inch dual-in line package. This package offers an insulation dielectric withstand of 7500 VAC_(PK).

The coupler consists of a AlGaAs LED that is optically coupled to a dielectrically isolated photodiode array which drives two series connected high voltage MOS transistors. The typical ON-Resistance is 30 Ω at 25 mA and is linear up to 50 mA. The incremental resistance drops to less than 20 Ω beyond 50 mA while reducing internal power dissipation at high load currents. There is built-in current limiting circuitry in the detector chip.

Maximum Ratings

Terminal Voltage	350 V
Terminal Current	100 mA
LED Forward Current	60 mA
LED Reverse Current	10 μ A
Storage Temperature Range	-40°C to +85°C
Operating Temperature Range	-40°C to +100°C
Lead Soldering Time at 260°C, 2 mm from case	5 sec.

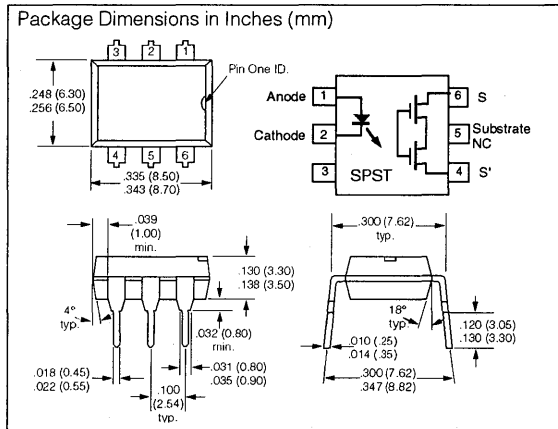

Characteristics (T_A=25°C)

	Symbol	Min.	Typ.	Max.	Unit	Condition
Emitter						
Forward Voltage	V _F		1.25	1.5	V	I _F =10 mA
VF Temperature Coefficient	$\Delta V_F / \Delta T_A$		-2.2		mV/°C	
Reverse Current	I _R	1	10		μ A	V _R =6 V
Junction Capacitance	C _J		15		pF	V _F =0 V, f=1 MHz
Dynamic Resistance	$\Delta V_F / \Delta I_F$		6		Ω	I _F =10 mA
Switching Time	t _R , t _F		1		μ s	I _F =10 mA
Detector						
Output Breakdown Voltage	V _B	350	380		V	I _B =50 μ A
Output OFF-State Leakage Current	I _{T(OFF)}	1	200		nA	V _T =100V, I _F =0 mA
			0.1	2	μ A	V _T =100V, I _F =0.2 mA
			0.1	5	μ A	V _T =300V, I _F =0.2 mA
Terminal Capacitance	C _T		24		pF	V _T =0 V, F=1 MHz
Current Limit				150	mA	
Package						
LED Forward Current for Turn-On	I _{Fth}	1.5	2.5		mA	$\pm I_T=100$ mA, T _A =25°C
			2.5	5	mA	$\pm I_T=80$ mA, T _A =70°C
ON Resistance	R _{ON}	20	30	50	Ω	I _T = ± 25 mA, I _F =5 mA
Turn-On Time	t _{on}		1	2	ms	
Turn-Off Time	t _{off}		0.5	2	ms	

Figure 1. LED forward current versus forward voltage

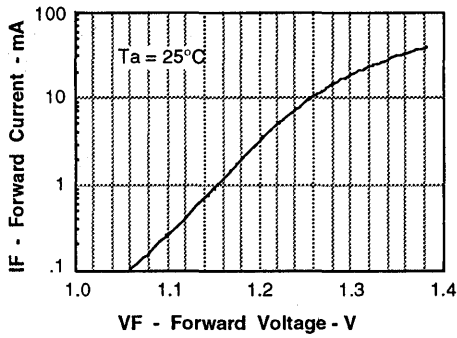

Figure 2. Terminal current versus terminal voltage

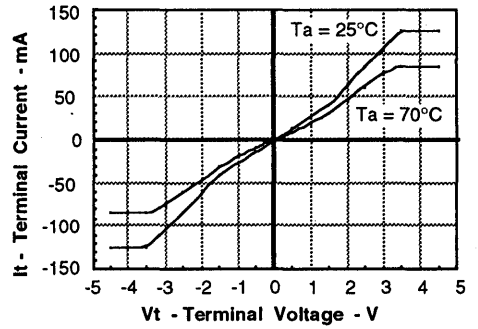
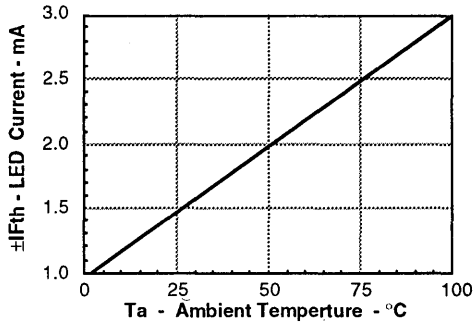

Figure 3. Relay turn-on current versus temperature



HIGH VOLTAGE SOLID STATE RELAY OPTOCOUPLER

FEATURES

- Normally Closed, Single Pole Single Throw Operation
- Control 350 VAC or DC Voltage
- Switch 100 mA Loads
- LED Control Current, 1.5 mA
- Low ON-Resistance
- dv/dt , > 500 V/ μ s
- Withstand Test Voltage, 7500 VAC
- Underwriters Lab File # E52744
- Applications
 - Telephone Switch Hook
 - High Voltage Test Equipment
 - TRIAC Driver
 - Motor Control
 - Industrial Control Systems

DESCRIPTION

The LH1298 is a single pole single throw (SPST), normally closed (NC), solid state relay. The relay can control AC or DC loads currents up to 100 mA, with a supply voltage up to 350 V. The device is packaged in a six pin 0.3 inch dual-in line package. This package offers an insulation dielectric withstand of 7500 VAC_(PK).

The coupler consists of a AlGaAs LED that is optically coupled to a dielectrically isolated monolithic integrated circuit. The IC chip consists of a photodiode array, control circuitry and high voltage DMOS transistors. The typical ON resistance between the output terminals is 30 Ω at 0 mA LED current. The switch offers low off-state leakage current at LED current of 5 mA or greater. There is on board output current limiting circuitry.

Maximum Ratings

Terminal Voltage	350 V
Terminal Current	100 mA
LED Forward Current	60 mA
LED Reverse Voltage	6 V
Operating Temperature Range	-40°C to +85°C
Storage Temperature Range	-40°C to +100°C
Lead Soldering Time at 260°C, 2 mm from case	5 sec.

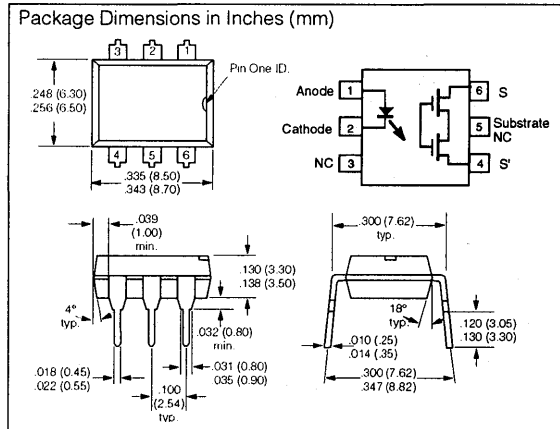

Characteristics (T_A=25°C)

	Symbol	Min.	Typ.	Max.	Unit	Condition
Emitter						
Forward Voltage	V _F		1.25	1.5	V	I _F =10 mA
V _F Temperature Coefficient	$\Delta V_F/\Delta T_A$		-2.2		mV/°C	
Reverse Current	I _R	1	10		μ A	V _R =6 V
Junction Capacitance	C _J		15		pF	V _F =0 V, f=1 MHz
Dynamic Resistance	$\Delta V_F/\Delta I_F$		6		Ω	I _F =10 mA
Switching Time	t _R , t _F		1		μ s	I _F =10 mA
Detector						
Output Breakdown Voltage	V _B	350			V	I _B =50 μ A
Output OFF-State Leakage Current	I _{T(OFF)}	0.1	1		μ A	V _T =100V, I _F =5 mA
		0.1	5		μ A	V _T =300V, I _F =2.5 mA
Terminal Capacitance	C _T		24		pF	V _T =0 V, f=1 MHz
Current Limit			150		mA	
Package						
LED Forward Current for Turn-Off	I _{Fth}	1.5	2.5		mA	V _L = \pm 300 V, T _A =25°C
ON Resistance	R _{ON}	20	30	50	Ω	I _F = \pm 25 mA, I _B =0 mA
Turn-On Time	t _{on}		3		ms	I _F =5 mA
Turn-Off Time	t _{off}		2		ms	V _L =50 V R _L =1 k Ω

FEATURES

- **CTR Minimum**
MCA230/255, 100%
MCA231, 200%
- **Withstand Test Voltage, 7500 V**
- **Coupling Capacitance, 0.5 pF**
- **Fast Rise Time, 10 μ s**
- **Fast Fall Time, 35 μ s**
- **Underwriters Lab File #E52744**
- **VDE #0884 Available with Option 1**

DESCRIPTION

The MCA230/231/255 are industry standard optocouplers, consisting of a Gallium Arsenide infrared LED and a silicon photodarlington. These optocouplers are constructed with a high voltage insulation, double molded packaging process which offers 7.5 KV withstand test capability.

Maximum Ratings

Emitter

Reverse Voltage	6 V
Continuous Forward Current	60 mA
Power Dissipation at 25°C	135 mW
Derate Linearly from 25°C	1.8 mW/°C

Detector

Collector-Emitter Breakdown Voltage	
MCA230/231	30 V
MCA255	55 V
Emitter-Collector Breakdown Voltage	7 V
Collector-Base Breakdown Voltage	
MCA230/231	30 V
MCA255	55 V
Power Dissipation at 25°C	210 mW
Derate Linearly from 25°C	2.8 mW/°C

Package

Total Package Dissipation at 25°C	
(LED plus Detector)	260 mW
Derate Linearly from 25°C	3.5 mW/°C
Storage Temperature	-55°C to +150°C
Operating Temperature	-55°C to +100°C
Lead Soldering Time at 260°C	10 sec.

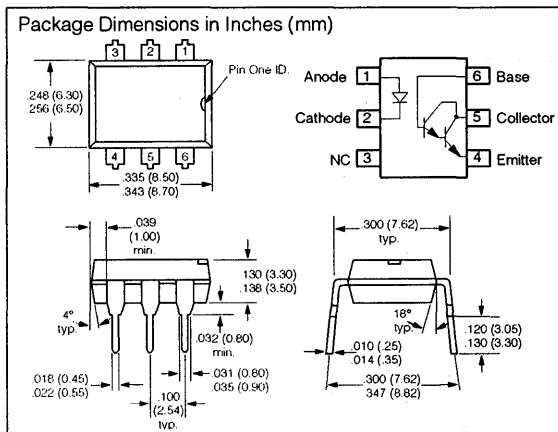

Characteristics (T_A=25°C)

	Symbol	Min.	Typ.	Max.	Unit	Condition
Emitter						
Forward Voltage						
Reverse Current	V _F	1.1	1.5		V	I _F = 50 mA
Junction Capacitance	C _J	50			pF	V _F = 0 V, f = 1 MHz
Detector						
BV _{CEO} , MCA230/231		30			V	I _C = 100 μ A, I _F = 0 mA
BV _{CEO} , MCA255		30			V	I _C = 100 μ A, I _F = 0 mA
BV _{ECCO}		7			V	I _E = 10 μ A, I _F = 0 mA
BV _{CB0} , MCA230/231		30			V	I _C = 10 μ A, I _F = 0 mA
BV _{CB0} , MCA255		55			V	I _C = 10 μ A, I _F = 0 mA
I _{CEO}			100		nA	V _{CE} = 10 V, I _F = 0 mA
Package						
V _{CEsat}			0.8		V	I _{CE} = 2 mA, I _F = 16 mA
			1.0		V	I _C = I _F = 50 mA
			1.0		V	I _C = 2 mA, I _F = 1 mA
			1.0		V	I _C = 10 mA, I _F = 5 mA
			1.2		V	I _C = 50 mA, I _F = 10 mA
DC Current Transfer Ratio						
MCA230/255	CTR	100			%	V _{CE} = 5 V, I _F = 10 mA
MCA231	CTR	200			%	V _{CE} = 5 V, I _F = 1 mA
Withstand Test						
Voltage		7500			VDC	t = 1 sec.
		5300			V _{AC(PK)}	t = 1 sec.
Resistance, Input to Output						
	R _{IO}	100			G Ω	
Capacitance Input to Output						
	C _{IO}	0.5			pF	
Switching Times						
	t _{on}	10			μ s	R _L = 100 Ω V _{CE} = 10 V
	t _{off}	35			μ s	

Figure 1. Forward voltage versus forward current

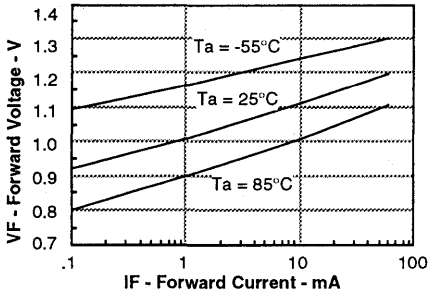

Figure 2. Normalized non-saturated and saturated CTRce at TA = 25°C versus LED current

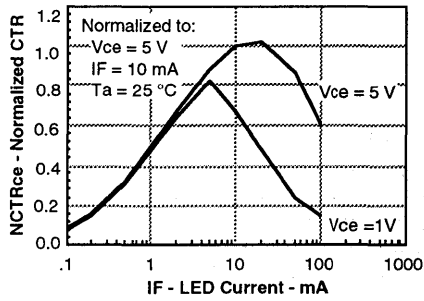

Figure 3. Normalized non-saturated and saturated collector-emitter current versus LED current

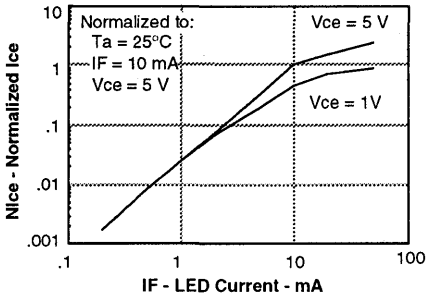

Figure 4. Normalized collector-base photocurrent versus LED current

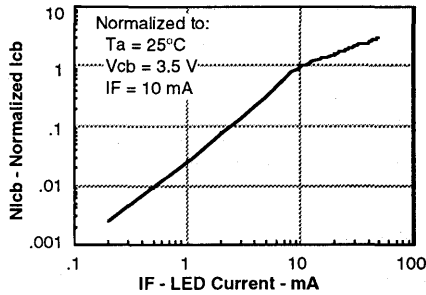

Figure 5. Non-saturated and saturated HFE versus base current

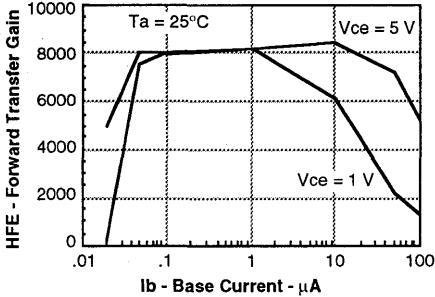

Figure 6. Low to high propagation delay versus collector load resistance and LED current

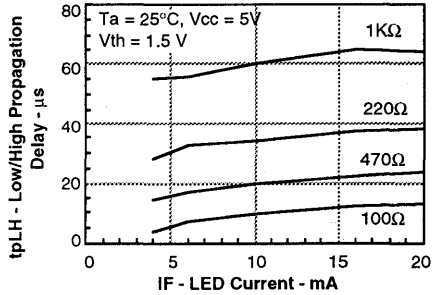

Figure 7. High to low propagation delay versus collector load resistance and LED current

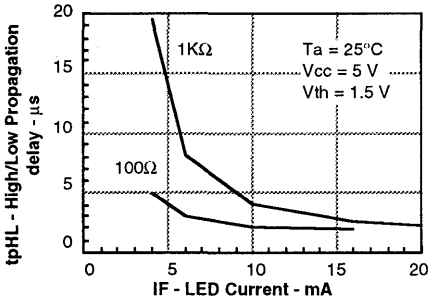
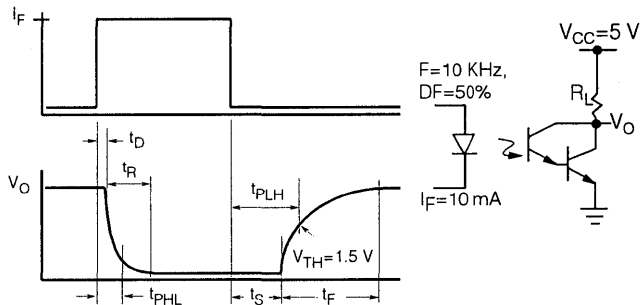

Figure 8. Switching timing waveform and schematic



FEATURES

- CTR Minimum – 20%
- Withstand Test Voltage – 7500 V
- Coupling Capacitance – 0.5 pF
- Underwriters Lab File #E52744
- VDE #0884 Available with Option 1

DESCRIPTION

The MCT2 and MCT2E are optically coupled pairs with a Gallium Arsenide infrared LED and a silicon NPN phototransistor. Signal information, including a DC level, can be transmitted by the device while maintaining a high degree of electrical isolation between input and output.

The MCT2 and MCT2E can be used to replace relays and transformers in many digital interface applications, as well as analog applications, such as CRT modulation.

Maximum Ratings

Emitter	
Reverse Voltage	3 V
Continuous Forward Current	60 mA
Power Dissipation at 25°C	100 mW
Derate Linearly from 25°C	1.3 mW/°C

Detector	
Collector-Emitter Breakdown Voltage	30 V
Emitter-Collector Breakdown Voltage	7 V
Collector-Base Breakdown Voltage	70 V
Power Dissipation at 25°C	200 mW
Derate Linearly from 25°C	2.6 mW/°C

Package	
Total Package Dissipation at 25°C (LED plus Detector)	250 mW
Derate Linearly from 25°C	3.3 mW/°C
Storage Temperature Range	-55°C to +150°C
Operating Temperature Range	-55°C to +100°C
Lead Soldering Time at 260°C	10 sec.

Package Dimensions in Inches (mm)

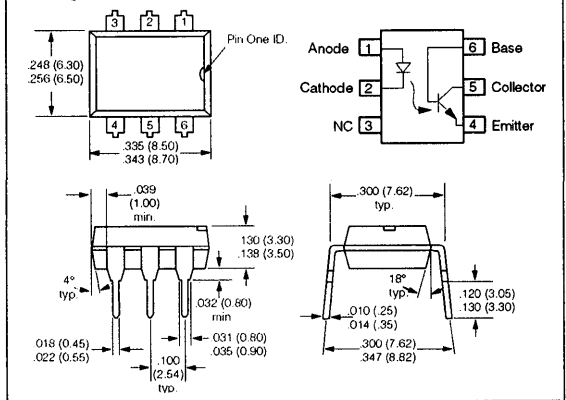

Characteristics (T_A=25°C)

	Symbol	Min.	Typ.	Max.	Unit	Condition
Emitter						
Forward Voltage	V _F	1.1	1.5		V	I _F =20 mA
Reverse Current	I _R		10		μA	V _R =3 V
Capacitance	C _O	25			pF	V _R =0 V, f=1 MHz
Detector						
Breakdown Voltage						
Collector-Emitter	BV _{CEO}	30			V	I _C =1 mA, I _F =0 mA
Emitter-Collector	BV _{ECO}	7			V	I _E =100 μA, I _F =0 mA
Collector-Base	BV _{CBO}	70			V	I _C =10 μA, I _F =0 mA
Leakage Current						
Collector-Emitter	I _{CEO}	5	50		nA	V _{CE} =10 V, I _F =0 mA
Collector-Base	I _{CBO}		20		nA	V _{CE} =10 V, I _F =0 mA
Collector-Emitter Capacitance	C _{CE}	10			pF	V _{CE} =0 V
Package						
DC Current Transfer Ratio						
Ratio	CTR	20	60		%	V _{CE} =10 V, I _F =10 mA
Withstand Test Voltage	WTV	7500			V	V _{AC(PK)}} t=1 sec.
Collector-Emitter Saturation Voltage						
Saturation Voltage	V _{CEsat}	0.1	0.4		V	I _{CE} =2 mA, I _F =16 mA
Capacitance Input to Output						
Capacitance	C _{IO}		0.5		pF	
Resistance						
Input to Output	R _{IO}	100			GΩ	
Switching Time						
Turn On	t _{on}	3.0			μs	R _E =100 Ω, V _{CE} =10 V
Turn Off	t _{off}	3.0			μs	I _C =2 mA

Figure 1. Forward voltage versus forward current

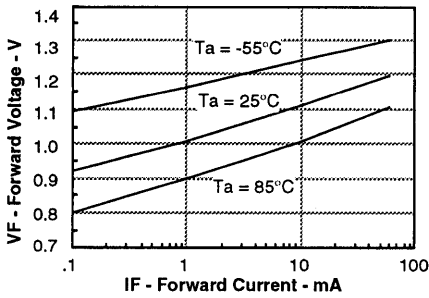

Figure 3. Normalized non-saturated and saturated CTR at Ta = 50°C versus LED current

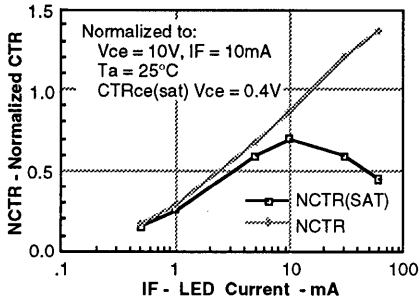

Figure 5. Normalized non-saturated and saturated CTR at Ta = 85°C versus LED current

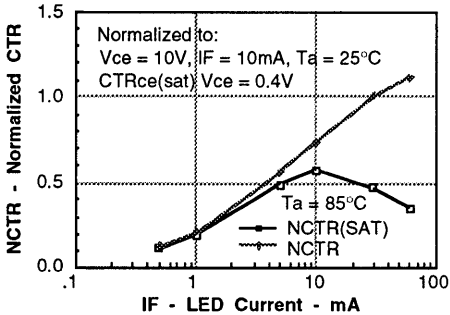

Figure 7. Collector-emitter leakage current versus temperature

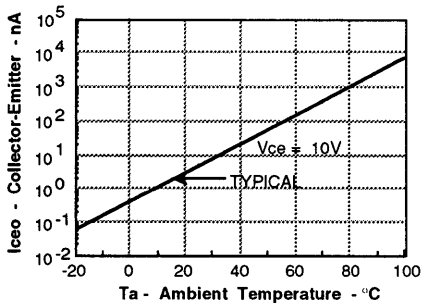

Figure 2. Normalized non-saturated and saturated CTR at Ta = 25°C versus LED current

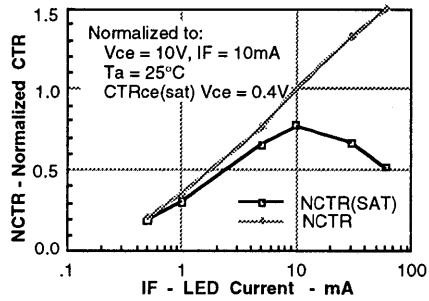

Figure 4. Normalized non-saturated and saturated CTR at Ta = 70°C versus LED current

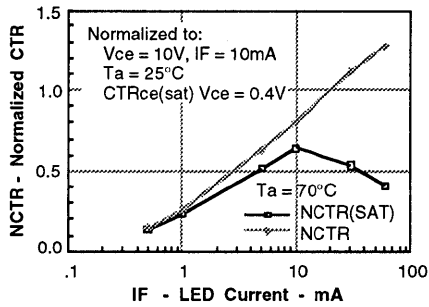

Figure 6. Collector-emitter current versus temperature and LED current

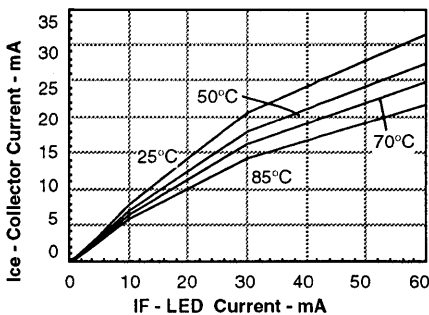

Figure 8. Normalized CTRcb versus LED current and temperature

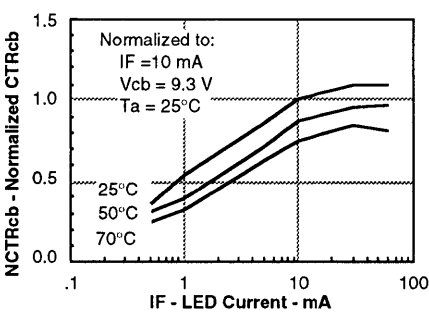

Figure 9. Collector base photocurrent versus LED current

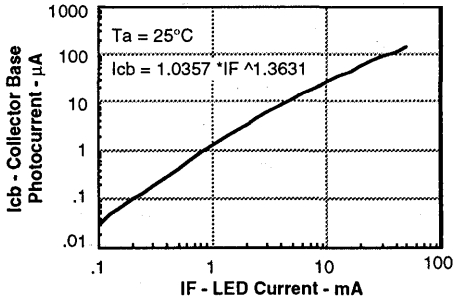

Figure 11. Normalized non-saturated HFE versus base current and temperature

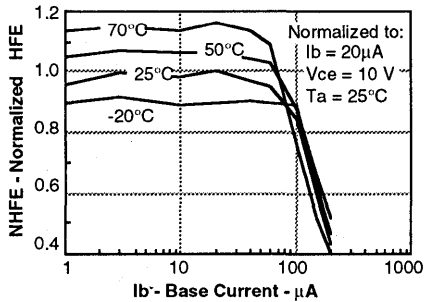

Figure 13. Propagation delay versus collector load resistor

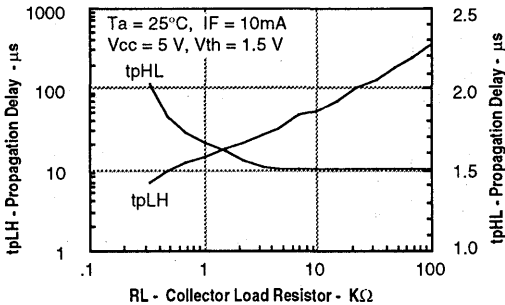

Figure 15. Switching schematic

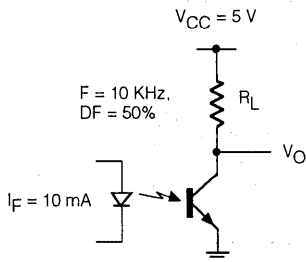

Figure 10. Normalized photocurrent versus If and temperature

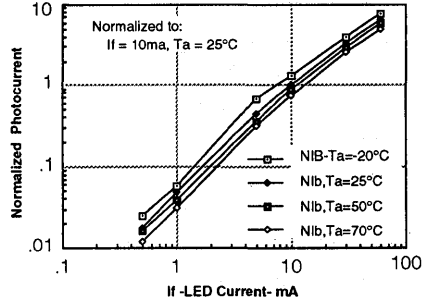

Figure 12. Normalized saturated HFE versus base current and temperature

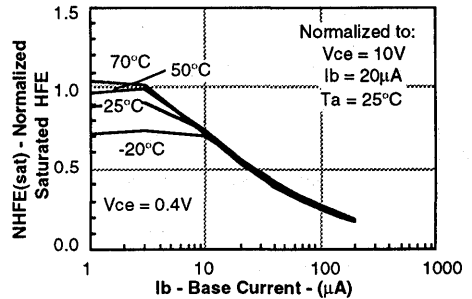
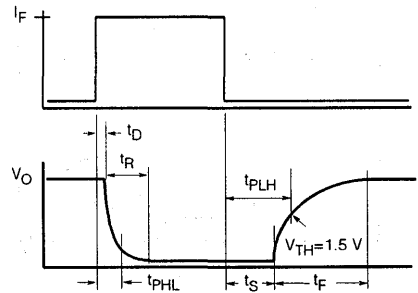

Figure 14. Switching timing



FEATURES

- Current Transfer Ratio, 20% Minimum
- Two Isolated Channels Per Package
- Withstand Text Voltage, 7500 V
- Underwriters Lab File #E52744
- VDE #0884 Available with Option 1

DESCRIPTION

The MCT6 is an industry standard dual optocoupler consisting of a Gallium Arsenide infrared LED and a silicon phototransistor. The MCT6 is constructed with a high voltage insulation, double molded packaging process which offers 7.5 KV withstand test capability.

Maximum Ratings

Emitter (each channel)

Reverse Voltage	3 V
Continuous Forward Current	60 mA
Power Dissipation at 25°C Ambient	100 mW
Derate Linearly from 25°C	1.3 mW/°C

Detector (each channel)

Collector-Emitter Breakdown Voltage	30V
Emitter-Collector Breakdown Voltage	6V
Power Dissipation at 25°C Ambient	150 mW
Derate Linearly from 25°C	2 mW/°C

Package

Total Package Dissipation	
at 25°C (LED + Detector)	400 mW
Derate Linearly from 25°C	5.33 mW/°C
Storage Temperature	-55°C to +150°C
Operating Temperature	-55°C to +100°C
Lead Soldering Time at 260°C	10 sec.

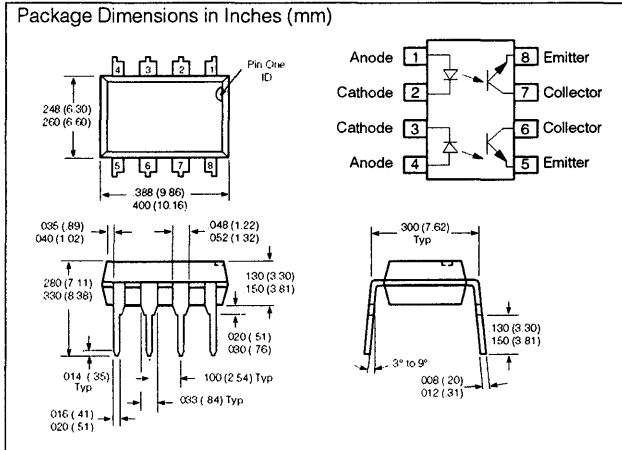

Electrical Characteristics (T_A=25°C)

	Symbol	Min.	Typ.	Max.	Unit	Condition
Emitter						
Forward Voltage	V _F	1.1	1.5		V	I _F = 20 mA
Reverse Current	I _R		10		μA	V _R = 3 V
Junction Capacitance	C _J		25		pF	V _F = 0 V, f = 1 MHz
Detector						
Breakdown Voltage						
Collector-Emitter	BV _{CEO}	30			V	I _C = 100 μA, I _F = 0 mA
Emitter-Collector	BV _{ECC}	6			V	I _E = 100 μA, I _F = 0 mA
Package						
DC Current						
Transfer Ratio	CTR _{DC}	20	50		%	V _{CE} = 10 V, I _F = 10 mA
Saturation Voltage						
Collector-Emitter	V _{CEsat}			0.4	V	I _{CE} = 2 mA, I _F = 16 mA
Withstand Test Voltage	WTV	7500			V	t = 1 sec.
		5300			VAC(RMS)	t = 1 sec.
Resistance						
Input to Output	R _{IO}		100		GΩ	
Switching Times						
Turn On	t _{on}		3		μs	R _E = 100 Ω, V _{CE} = 10 V
Turn Off	t _{off}		15		μs	I _C = 2 mA

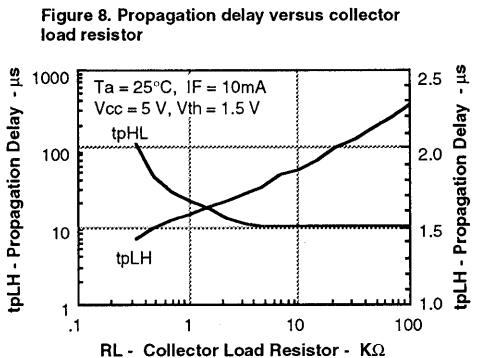
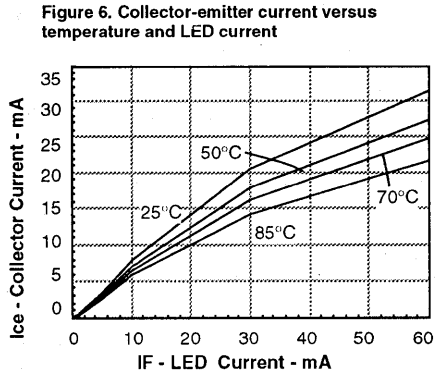
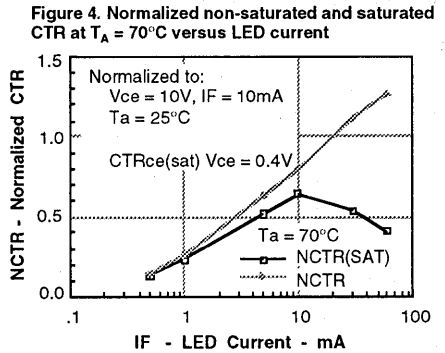
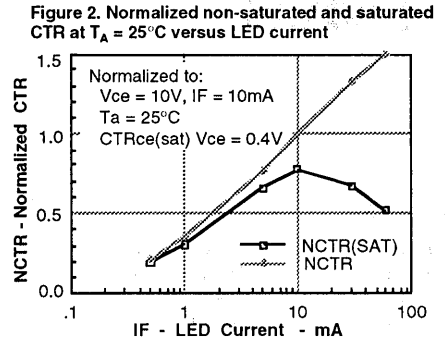
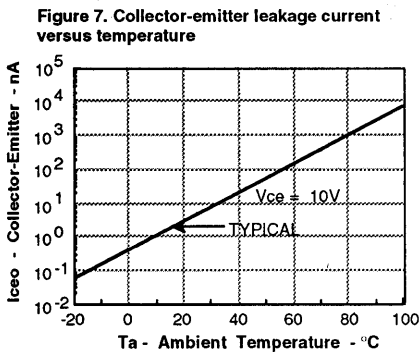
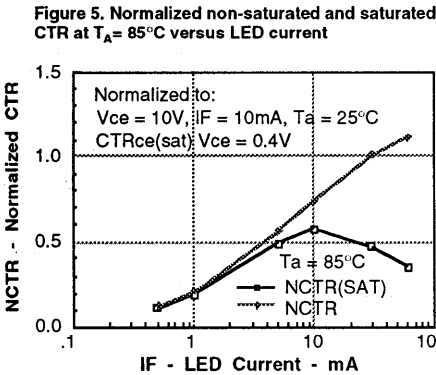
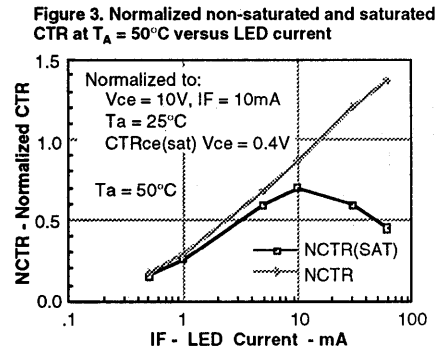
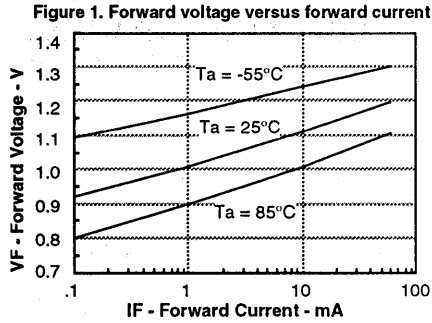

Figure 9. Switching timing

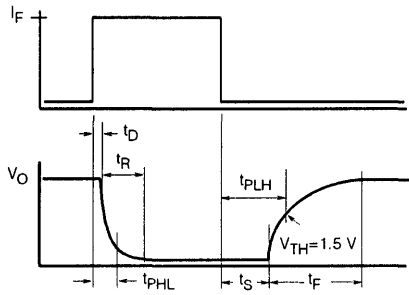
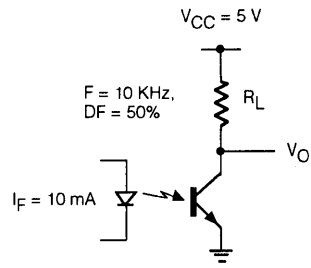

Figure 10. Switching schematic



FEATURES

- **CTR Minimum:** MCT270 – 50%
MCT271 – 45%
MCT272 – 75%
MCT273 – 125%
MCT274 – 225%
MCT275 – 70%
MCT276 – 15%
MCT277 – 100%
- **Withstand Test Voltage – 7500 Volt**
- **Coupling Capacitance – 0.5 pF**
- **Underwriters Lab File #E52744**
- **VDE #0884 Available with Option 1**

DESCRIPTION

The MCT270 through MCT277 are optically coupled pairs with a Gallium Arsenide infrared LED and a silicon NPN phototransistor. Signal information, including a DC level, can be transmitted by the device while maintaining a high degree of electrical isolation between input and output.

The MCT270 through MCT277 can be used to replace relays and transformers in many digital interface applications, as well as analog applications, such as CRT modulation.

Maximum Ratings

Emitter

Reverse Voltage	3 V
Continuous Forward Current	60 mA
Power Dissipation at 25°C	100 mW
Derate Linearly from 25°C	1.33 mW/°C

Detector

Collector-Emitter Breakdown Voltage	30 V
Emitter-Collector Breakdown Voltage	7 V
Collector-Base Breakdown Voltage	70 V
Power Dissipation at 25°C	150 mW
Derate Linearly from 25°C	2 mW/°C

Package

Total Package Dissipation at 25°C (LED plus Detector)	250 mW
Derate Linearly from 25°C	3.3 mW/°C
Storage Temperature Range	-55°C to +150°C
Operating Temperature Range	-55°C to +100°C
Lead Soldering Time at 260°C	10 sec.

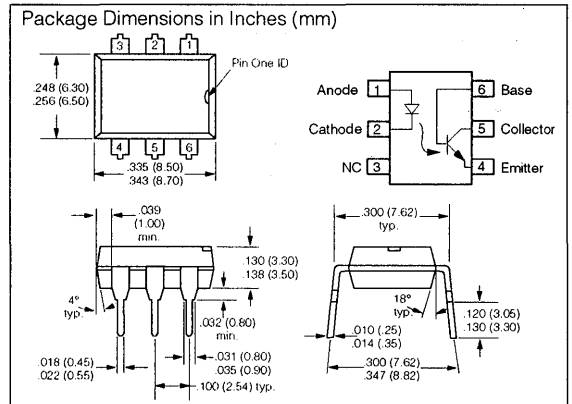

Characteristics (T_A=25°C)

	Symbol	Min.	Typ.	Max.	Unit	Condition
Emitter						
Forward Voltage	V _F			1.5	V	I _F =20 mA
Reverse Current	I _R			10	μA	V _R =3 V
Capacitance	C _O	25			pF	V _R =0 V, f=1 MHz
Detector						
Breakdown Voltage						
Collector-Emitter	BV _{CEO}	30			V	I _C =1.0 mA, I _F =0 mA
Emitter-Collector	BV _{ECO}	5			V	I _E =100 μA, I _F =0 mA
Collector-Base	BV _{CBO}	70			V	I _C =10 μA, I _F =0 mA
Collector-Emitter						
Leakage Current	I _{CBO}		50		nA	V _{CE} =10 V, I _F =0 mA
Package						
DC Current Transfer						
Ratio	CTR				%	V _{CE} =10 V, I _F =10 mA
MCT270		50				
MCT271		45		90		
MCT272		75		150		
MCT273		125		250		
MCT274		225		400		
MCT275		70		210		
MCT276		15		60		
MCT277		100				
Current Transfer						
Ratio, Collector to Emitter	CTR _{CE}				%	V _{CE} =0.4 V, I _F =16 mA
MCT271-276		12.5				
MCT277		40				
Collector-Emitter						
Saturation Voltage	V _{CEsat}		0.4		V	I _{CE} =2 mA, I _F =16 mA
Withstand Test Voltage		7500			V _{AC(PK)}	t=1 sec.
		5300			V _{AC(RMS)}	t=1 sec.
Capacitance Input						
to Output	C _{IO}	0.5			pF	
Resistance						
Input to Output	R _{IO}	100			GΩ	V _{I-O} =500 VDC
Switching Time						
MCT270, 272	t _{on} , t _{off}		10		μs	R _E =100 Ω, V _{CE} =5 V
MCT271			7			I _C =2 mA
MCT273			20			
MCT274			25			
MCT275, 277			15			
MCT276			3.5			

Figure 1. Forward voltage versus forward current

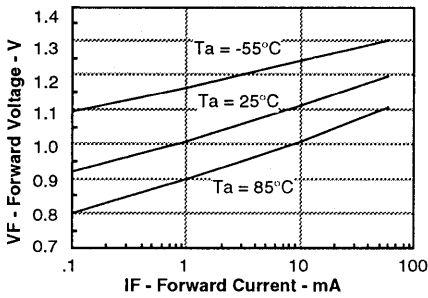

Figure 2. Normalized non-saturated and saturated CTR at Ta = 25°C versus LED current

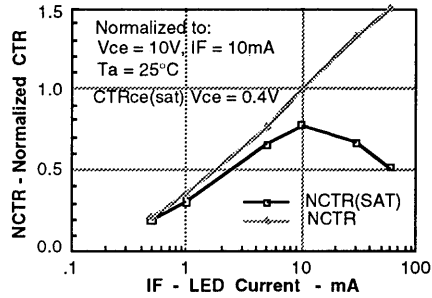

Figure 3. Normalized non-saturated and saturated CTR at Ta = 50°C versus LED current

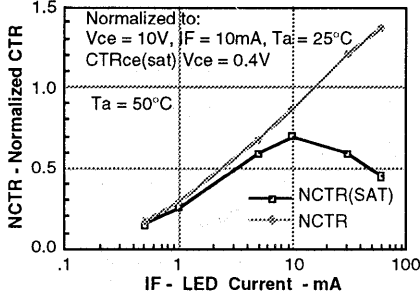

Figure 4. Normalized non-saturated and saturated CTR at Ta = 70°C versus LED current

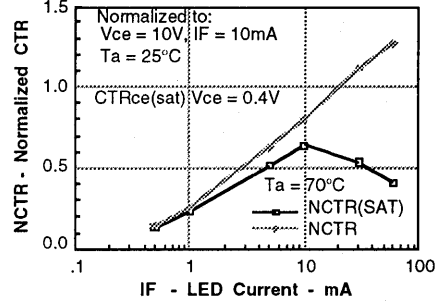

Figure 5. Normalized non-saturated and saturated CTR at Ta = 85°C versus LED current

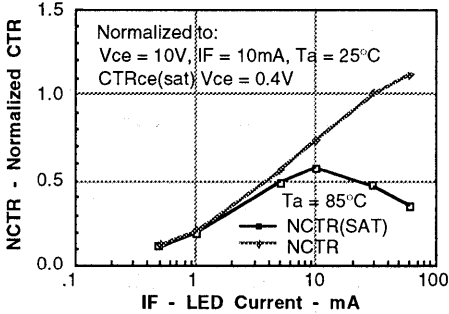

Figure 6. Collector-emitter current versus temperature and LED current

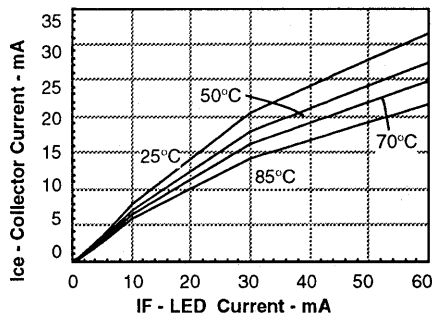

Figure 7. Collector-emitter leakage current versus temperature

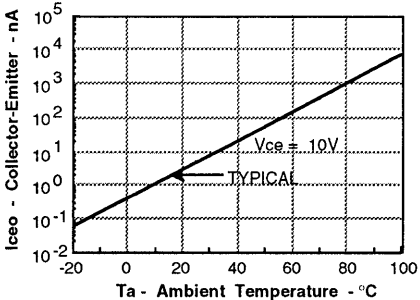

Figure 8. Normalized CTRcb versus LED current and temperature

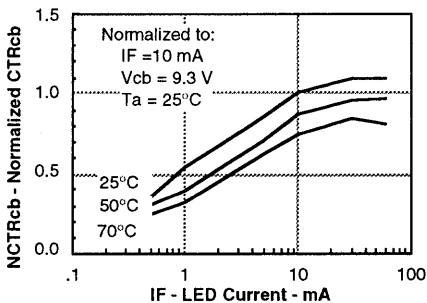

Figure 9. Collector base photocurrent versus LED current

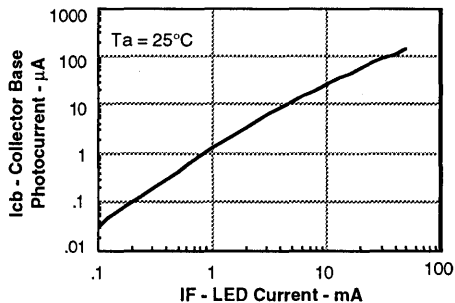

Figure 11. Normalized non-saturated HFE versus base current and temperature

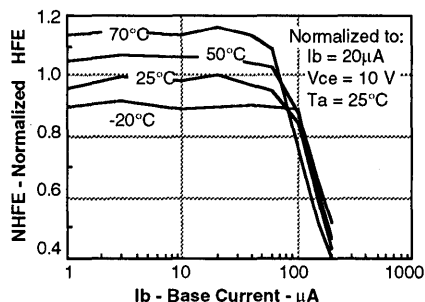

Figure 13. Propagation delay versus collector load resistor

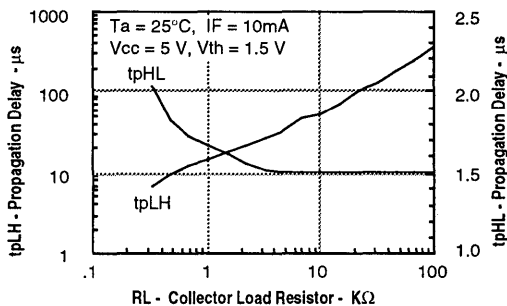

Figure 15. Switching schematic

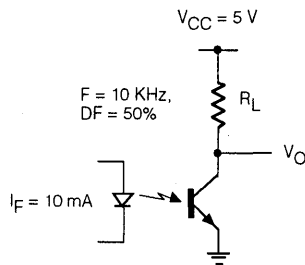

Figure 10. Normalized photocurrent versus If and temperature

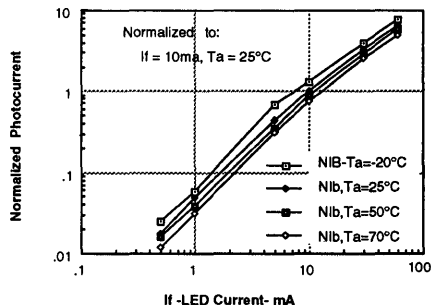

Figure 12. Normalized saturated HFE versus base current and temperature

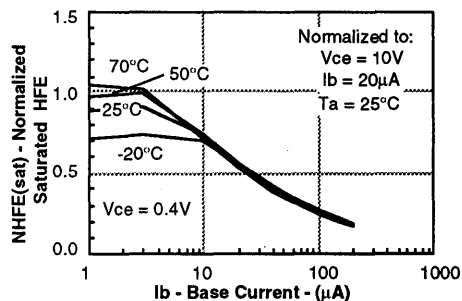
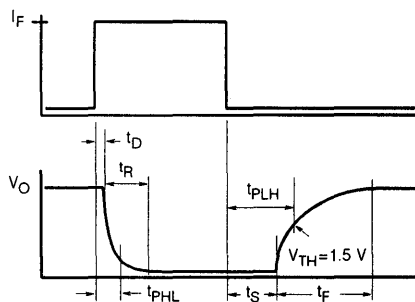

Figure 14. Switching timing



AIGaAs LED/ PHOTOTRANSISTOR OPTOCOUPLER

FEATURES

- **Current Transfer Ratio**
MCT5210, >70% at $I_F = 3.0 \text{ mA}$
- MCT5211, >110% at $I_F = 1.0 \text{ mA}$
- **Saturation CTR—MCT5211, >100%**
at $I_F = 1.6 \text{ mA}$
- **High Isolation Voltage, 5300 VDC**
- **Underwriters Lab File #E52744**
- **VDE #0884 Available with Option 1**

DESCRIPTION

The MCT5210/5211 are optocouplers with a high efficiency AlGaAs LED optically coupled to a NPN phototransistor. The high performance LED makes operation at low input currents practical. The coupler is housed in a double molded, six pin DIP package. Isolation test voltage is 5300 volts DC.

Because these parts have guaranteed CTRs at one and three mA, they are ideally suitable for interfacing from CMOS to TTL or LSTTL to TTL. They are also ideal for telecommunications applications such as ring or off-hook detection.

Maximum Ratings

Emitter

Peak Reverse Voltage 6 V
 Continuous Forward Current 40 mA
 Power Dissipation at 25°C 75 mW
 Derate Linearly from 25°C 1.0 mW/°C

Detector

Collector-Emitter Breakdown Voltage 30 V
 Emitter-Collector Breakdown Voltage 7 V
 Collector-Base Breakdown Voltage 70 V
 Power Dissipation 200 mW
 Derate Linearly from 25°C 2.6 mW/°C

Package

Isolation Test Voltage 3750 VAC/5300 VDC
 Total Package Dissipation at 25°C Ambient
 (LED + Detector) 260 mW
 Derate Linearly from 25°C 3.5 mW/°C
 Leakage Path 8 min mm
 Clearance Path 7 min mm
 Tracking Index per VDE 0330 KB 100/A
 Operating Temperature -55°C to +100°C
 Storage Temperature -55°C to +150°C

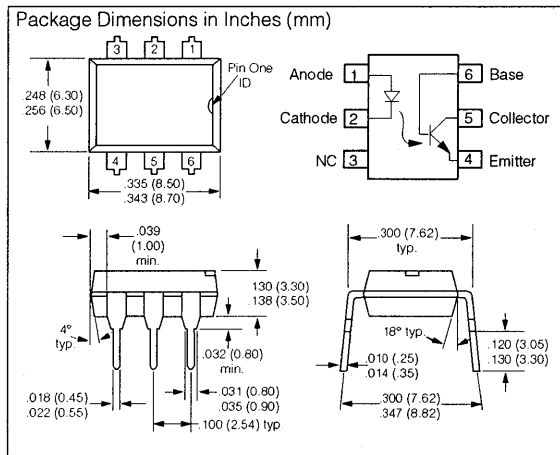

Characteristics (25°C)

	Symbol	Min.	Typ.	Max.	Unit	Condition
--	--------	------	------	------	------	-----------

Emitter

Forward Voltage	V_F		1.2	1.5	V	$I_F = 5 \text{ mA}$
-----------------	-------	--	-----	-----	---	----------------------

Reverse Voltage	V_R	6			V	$I_R = 10 \text{ } \mu\text{A}$
-----------------	-------	---	--	--	---	---------------------------------

Detector

	H_{FE}	100	200			$V_{CE} = 5 \text{ V}$, $I_C = 100 \text{ } \mu\text{A}$
	BV_{CEO}	30			V	$I_C = 100 \text{ } \mu\text{A}$
	BV_{ECO}	7			V	$I_E = 100 \text{ } \mu\text{A}$
	BV_{CBO}	70			V	$I_E = 10 \text{ } \mu\text{A}$
	I_{CEO}		5	100	nA	$V_{CE} = 10 \text{ V}$

Package (0–70°C)

Saturated Current Transfer Ratio						$V_{CE} = 0.4 \text{ V}$
----------------------------------	--	--	--	--	--	--------------------------

MCT5210	CTR_{CEsat}	60	120	%	$I_F = 3.0 \text{ mA}$
MCT5211	CTR_{CEsat}	100	200	%	$I_F = 1.6 \text{ mA}$
MCT5211	CTR_{CEsat}	75	150	%	$I_F = 1.0 \text{ mA}$

Current Transfer Ratio

MCT5210	CTR	70	150	%	$I_F = 3.0 \text{ mA}$
MCT5211	CTR	150	300	%	$I_F = 1.6 \text{ mA}$
MCT5211	CTR	110	225	%	$I_F = 1.0 \text{ mA}$

Collector-Base Current Transfer Ratio

MCT5210	CTR_{CB}	0.2	0.4	%	$I_F = 3.0 \text{ mA}$
MCT5211	CTR_{CB}	0.3	0.6	%	$I_F = 1.6 \text{ mA}$
MCT5211	CTR_{CB}	0.25	0.5	%	$I_F = 1.0 \text{ mA}$

Saturation Voltage

MCT5210	V_{CEsat}	0.25	0.4	V	$I_F = 3.0 \text{ mA}$, $I_C = 1.8 \text{ mA}$
MCT5211	V_{CEsat}	0.25	0.4	V	$I_F = 1.6 \text{ mA}$, $I_C = 1.6 \text{ mA}$

Characteristics—continued

Switching Characteristics (25°C)

	Symbol	Min.	Typ.	Max.	Unit	Condition
<i>Propagation Delay—High to Low</i>						
MCT5210	tPHL		10		μs	$R_L=330\ \Omega, I_F=3.0\ \text{mA}, V_{CC}=5.0\ \text{V}$
MCT5211	tPHL		20		μs	$R_L=750\ \Omega, I_F=1.6\ \text{mA}, V_{CC}=5.0\ \text{V}$
MCT5211	tPHL		40		μs	$R_L=1.5\text{K}\ \Omega, I_F=1.0\ \text{mA}, V_{CC}=5.0\ \text{V}$
<i>Propagation Delay—Low to High</i>						
MCT5210	tPLH		10		μs	$R_L=330\ \Omega, I_F=3.0\ \text{mA}, V_{CC}=5.0\ \text{V}$
MCT5211	tPLH		20		μs	$R_L=750\ \Omega, I_F=1.6\ \text{mA}, V_{CC}=5.0\ \text{V}$
MCT5211	tPLH		40		μs	$R_L=1.5\text{K}\ \Omega, I_F=1.0\ \text{mA}, V_{CC}=5.0\ \text{V}$

Figure 1. LED forward current versus forward voltage

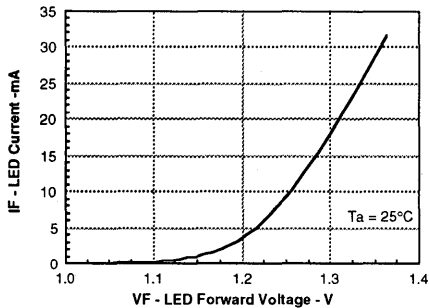

Figure 2. LED forward current versus forward voltage

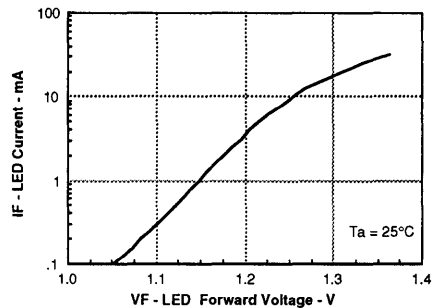

Figure 3. Collector base photocurrent versus LED current

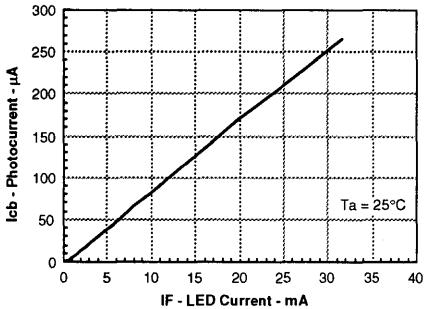

Figure 4. Photocurrent versus LED current

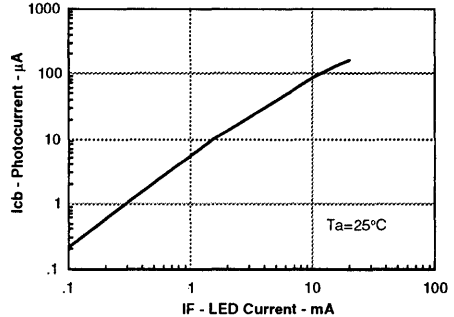

Figure 5. Collector base current transfer ratio versus LED current

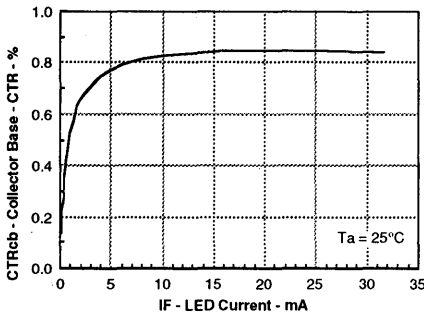

Figure 6. Collector base current transfer ratio versus LED current

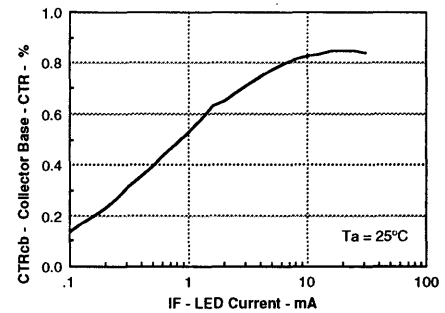

Figure 7. Current transfer ratio versus LED current

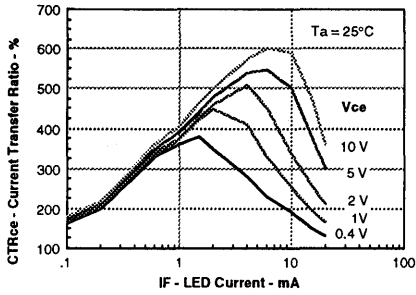

Figure 8. Collector current versus LED current

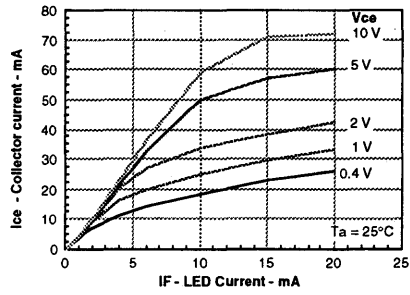

Figure 9. Collector current versus LED current

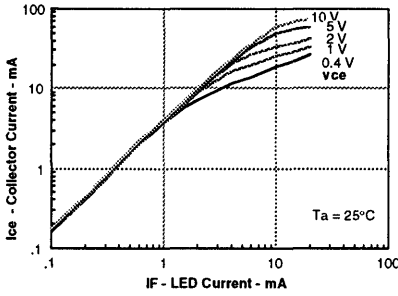

Figure 10. Transistor current gain versus base current

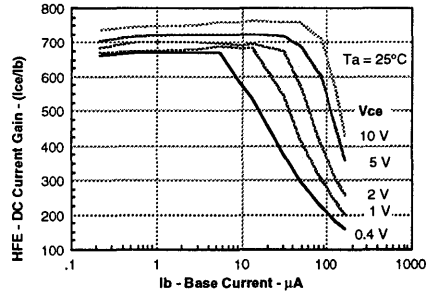

Figure 11. Transfer curve

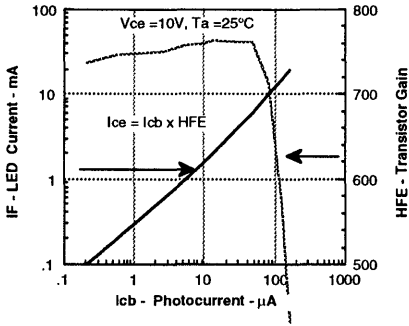

Figure 12. Transfer curve

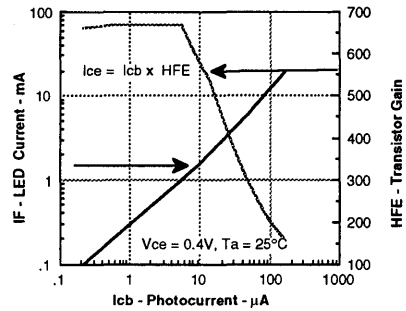

Figure 13. Propagation delay versus base emitter resistor

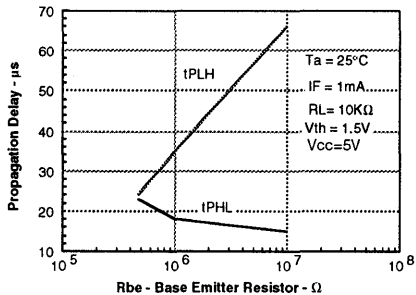

Figure 14. Propagation delay versus base emitter resistor

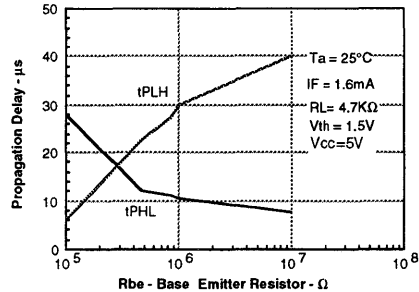

Figure 15. Propagation delay versus base emitter resistor

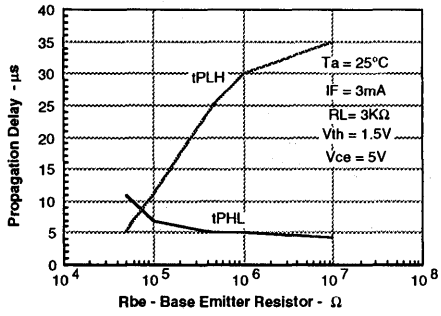

Figure 16. Switching timing

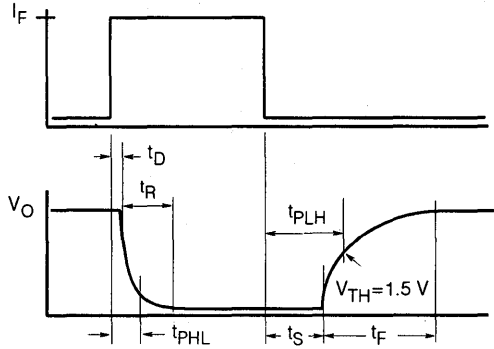
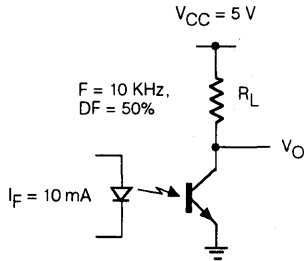

Figure 17. Switching schematic



FEATURES

- **High Current Transfer Ratios**
SFH600-0, 40 to 80%
SFH600-1, 63 to 125%
SFH600-2, 100 to 200%
SFH600-3, 160 to 320%
- **Withstand Test Voltage (1 Minute), 5300 V**
- V_{CEsat} 0.25 (≤ 0.4) V, $I_F = 10$ mA, $I_C = 2.5$ mA
- **High Quality Premium Device**
- **Long Term Stability**
- **Storage Temperature, -55° to $+150^\circ$ C**
- **Underwriters Lab File #E52744**
- **Options Available: 1, 2, 3, 4, 6, 7, 9**

DESCRIPTION

The SFH600 is an optocoupler with a GaAs LED emitter which is optically coupled with a silicon planar phototransistor detector. The component is packaged in a plastic plug-in case, 20 AB DIN 41866.

The coupler transmits signals between two electrically isolated circuits. The potential difference between the circuits to be coupled is not allowed to exceed the maximum permissible insulating voltage.

Maximum Ratings

Emitter	
Reverse Voltage	6 V
DC Forward Current	60 mA
Surge Forward Current ($t_F=10 \mu s$)	2.5 A
Total Power Dissipation	100 mW

Detector	
Collector-Emitter Voltage	70 V
Emitter-Base Voltage	7 V
Collector Current	50 mA
Collector Current ($t=1$ ms)	100 mA
Power Dissipation	150 mW

Package

Isolation Test Voltage between Emitter and Detector referred to Climate DIN 40046, part 2, Nov. 74	5300 VDC
Creepage Distance	≥ 7 mm
Clearance Distance	≥ 7 mm
Isolation Thickness between Emitter & Detector ..	≥ 0.4 mm
Comparative Tracking Index per DIN IEC 112/VDE0303, part 1	175
Isolation Resistance	
$V_{IO}=500$ V, $T_A=25^\circ$ C	$\geq 10^{12}$ Ω
$V_{IO}=500$ V, $T_A=100^\circ$ C	$\geq 10^{11}$ Ω

Package

Storage Temperature Range	-55° C to $+150^\circ$ C
Ambient Temperature Range	-55° C to $+100^\circ$ C
Junction Temperature	100° C
Soldering Temperature (max. 10 s, dip soldering: distance to seating plane ≥ 1.5 mm)	260° C

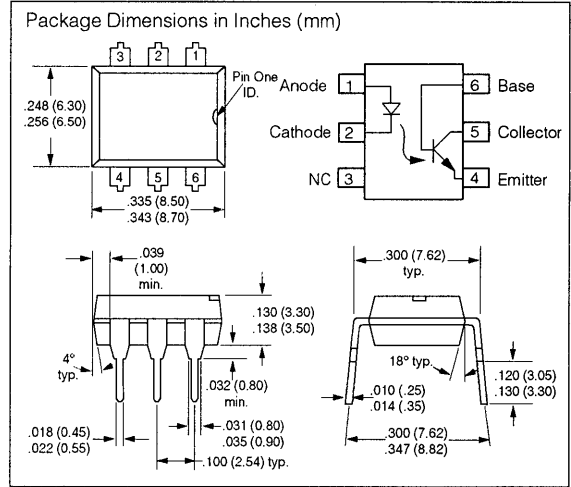

Characteristics ($T_A=25^\circ$ C)

Emitter	Symbol	Unit	Condition
Forward Voltage	V_F	1.25 (≤ 1.65)	V $I_F=60$ mA
Breakdown Voltage	V_{BR}	≥ 6	V $I_R=10 \mu A$
Reverse Current	I_R	0.01 (≤ 10)	μA $V_R=6$ V
Capacitance	C_O	25	pF $V_R=0$ V, $f=1$ MHz
Thermal Resistance	R_{THJamb}	750	K/W
Detector			
Capacitance			pF $f=1$ MHz
Collector-Emitter	C_{CE}	5.2	$V_{CE}=5$ V
Collector-Base	C_{CB}	6.5	$V_{CB}=5$ V
Emitter-Base	C_{EB}	9.5	$V_{EB}=5$ V
Thermal Resistance	R_{THJamb}	500	K/W
Package			
Collector-Emitter Saturation Voltage	V_{CEsat}	0.25 (≤ 0.4)	V $I_F=10$ mA, $I_C=2.5$ mA
Coupling Capacitance	C_C	0.6	pF

*TRIOS-Transparent IO Shield

Optocouplers (Optoisolators)

Current Transfer Ratio and Collector-Emitter Leakage Current by dash number

	-0	-1	-2	-3	Unit
I_C/I_F at $V_{CE}=5\text{ V}$ ($I_F=10\text{ mA}$)	40-80	63-125	100-200	160-320	%
I_C/I_F at $V_{CE}=5\text{ V}$ ($I_F=1\text{ mA}$)	30 (>13)	45 (>22)	70 (>34)	90 (>56)	%
Collector-Emitter Leakage Current ($V_{CE}=10\text{ V}$) (I_{CEO})	2 (≤ 35)	2 (≤ 35)	2 (≤ 35)	5 (≤ 70)	nA

Linear Operation (without saturation)

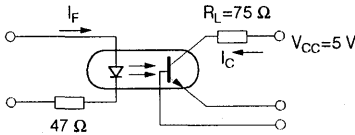

$I_F=10\text{ mA}$, $V_{CC}=5\text{ V}$, $T_A=25^\circ\text{C}$, Typical

Load Resistance	R_L	75	Ω
Turn-On Time	t_{ON}	3.2	μs
Rise Time	t_R	2.0	μs
Turn-Off Time	t_{OFF}	3.0	μs
Fall Time	t_f	2.5	μs
Cut-Off Frequency	F_{CO}	250	kHz

Switching Operation (with saturation)

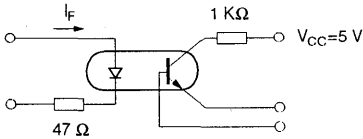

Typical

	-0 ($I_F=20\text{ mA}$)	-1 and -2 ($I_F=10\text{ mA}$)	-3 ($I_F=5\text{ mA}$)	
Turn-On Time t_{ON}	3.7	4.5	5.8	μs
Rise Time t_R	2.5	3.0	4.0	μs
Turn-Off Time t_{OFF}	19	21	24	μs
Fall Time t_f	11	12	14	μs
V_{CESAT}	0.25 (≤ 0.4)			V

Figure 1. Current transfer ratio versus diode current ($T_A=-25^\circ\text{C}$, $V_{CE}=5\text{ V}$)

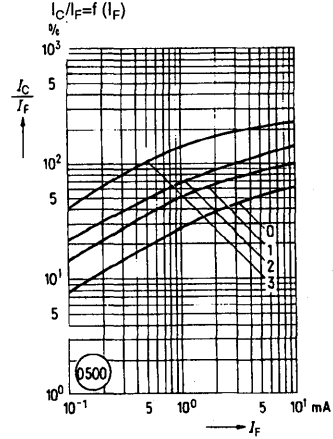

Figure 2. Current Transfer ratio versus diode current ($T_A=0^\circ\text{C}$, $V_{CE}=5\text{ V}$)

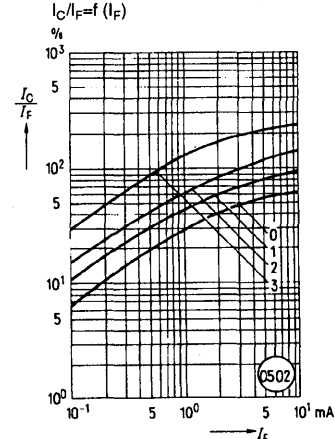

Figure 3. Current Transfer ratio versus diode current ($T_A=25^\circ\text{C}$, $V_{CE}=5\text{ V}$)

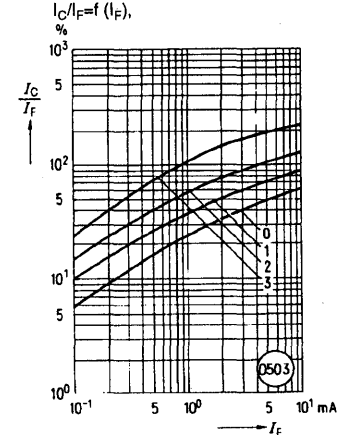

Figure 4. Current transfer ratio versus diode current ($T_A=50^\circ\text{C}$) $V_{CE}=5\text{ V}$
 $I_C/I_F=f(I_F)$

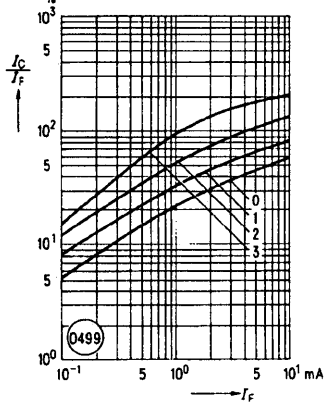

Figure 5. Current transfer ratio versus diode current ($T_A=75^\circ\text{C}$) $V_{CE}=5\text{ V}$
 $I_C/I_F=f(I_F)$

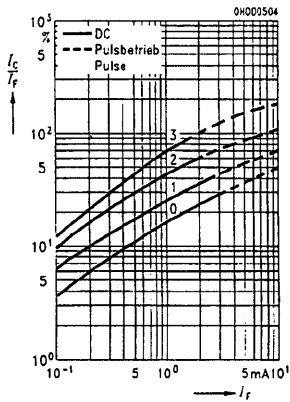

Figure 6. Current transfer ratio versus temperature ($I_F=10\text{ mA}$, $V_{CE}=5\text{ V}$)
 $I_C/I_F=f(T)$

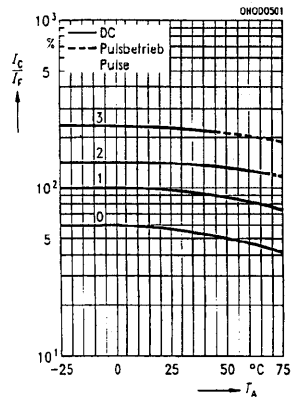

Figure 7. Transistor characteristics (HFE =550)
SFH600-2, -3 $I_C=f(V_{CE})$ ($T_A=25^\circ\text{C}$, $I_F=0$)

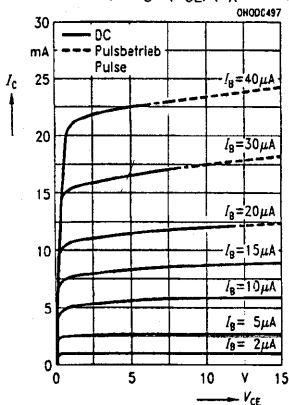

Figure 8. Output characteristics
SFH600-2, -3 ($T_A=25^\circ\text{C}$) $I_C=f(V_{CE})$

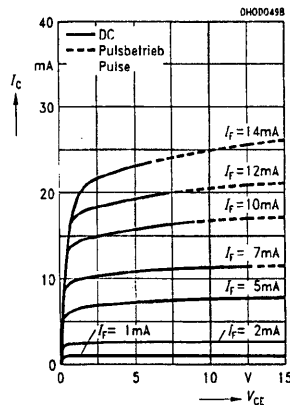

Figure 9. Forward voltage $V_F=f(I_F)$

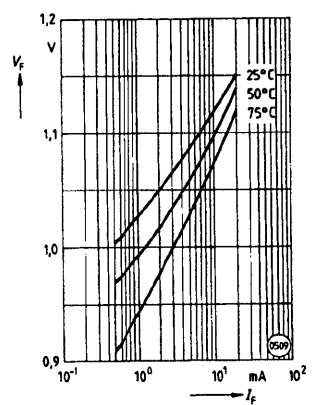

Figure 10. Collector emitter off-state current $I_{CEO}=f(V, T)$ ($T_A=25^\circ\text{C}$, $I_F=0$)

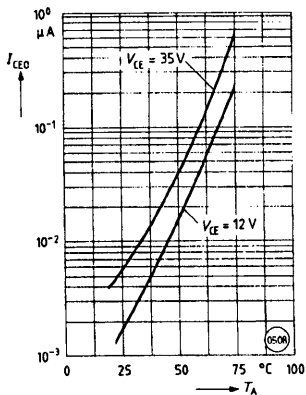

Figure 11. Saturation voltage versus collector current and modulation depth
SFH600-0 $V_{CEsat}=f(I_C)$ ($T_A=25^\circ\text{C}$)

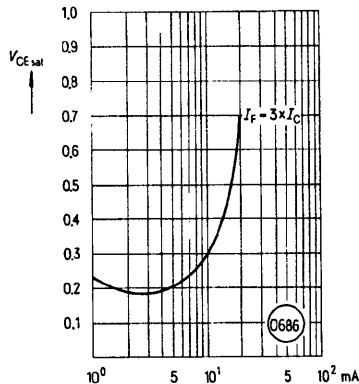

Figure 12. Saturation voltage versus collector current and modulation depth
SFH600-1 $V_{CEsat}=f(I_C)$ ($T_A=25^\circ\text{C}$)

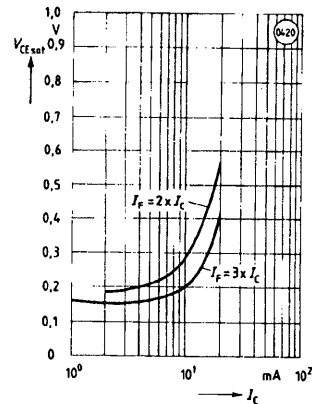

Figure 13. Saturation voltage versus collector current and modulation depth SFH600-2 $V_{CEsat}=f(I_C)$ ($T_A=25^\circ\text{C}$)

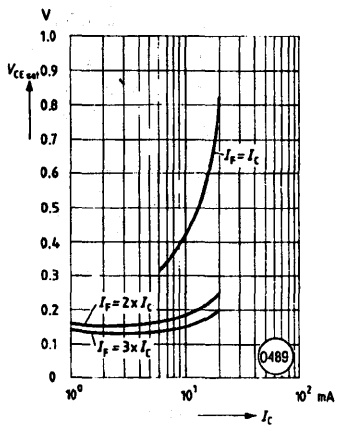

Figure 14. Saturation voltage versus collector current and modulation depth SFH600-3 $V_{CEsat}=f(I_C)$ ($T_A=25^\circ\text{C}$)

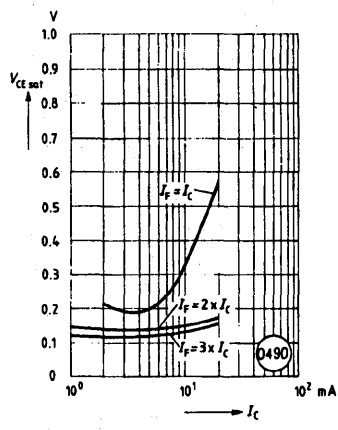

Figure 15. Permissible pulse load $D=\text{parameter}$, $T_A=25^\circ\text{C}$, $I_F=f(t_p)$

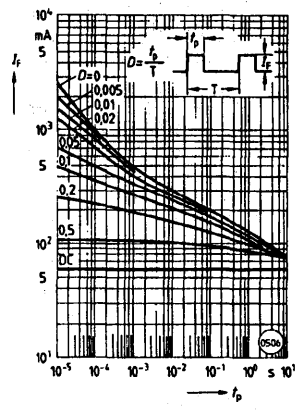

Figure 16. Permissible power dissipation for transistor and diode $P_{tot}=f(T_A)$

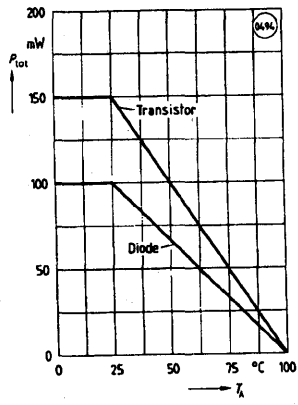

Figure 17. Permissible forward current diode $P_{tot}=f(T_A)$

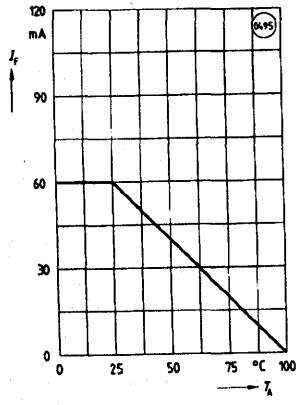
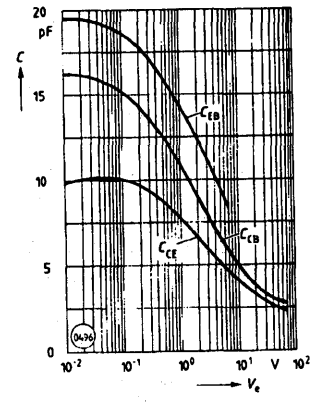

Figure 18. Transistor capacitance $C=f(V_C)$ ($T_A=25^\circ\text{C}$, $f=1\text{ MHz}$)



FEATURES

- **High Current Transfer Ratios**
 SFH601-1, 40 to 80%
 SFH601-2, 63 to 125%
 SFH601-3, 100 to 200%
 SFH601-4, 160 to 320%
- **Withstand Test Voltage (1 Minute), 5300 V**
- **V_{CEsat} 0.25 (≤ 0.4) V at $I_F=10$ mA, $I_C=2.5$ mA**
- **Built to Conform to VDE Requirements**
- **Highest Quality Premium Device**
- **Long Term Stability**
- **Storage Temperature: -55° to $+150^\circ$ C**
- **Underwriters Lab File #E52744**
- **Options Available: 1, 2, 3, 6, 7, 9**
- **CECC Approved**

Maximum Ratings

Emitter	
Reverse Voltage	6 V
DC Forward Current	60 mA
Surge Forward Current ($t_p=10$ μ s)	2.5 A
Total Power Dissipation	100 mW

Detector	
Collector-Emitter Voltage	100 V
Emitter-Base Voltage	7 V
Collector Current	50 mA
Collector Current ($t = 1$ ms)	100 mA
Power Dissipation	150 mW

Package	
Isolation Test Voltage between emitter and detector referred to climate DIN 40046, part 2, Nov. 74	5300 VDC
Creepage Distance	≥ 7 mm
Clearance Distance	≥ 7 mm
Isolation Thickness between Emitter and Detector	≥ 0.4 mm
Comparative Tracking Index per DIN IEC 112/VDE0303, part 1	175
Isolation Resistance $V_{IO}=500$ V, $T_A=25^\circ$ C $V_{IO}=500$ V, $T_A=100^\circ$ C	

Package	
Storage Temperature Range	-55° C to $+150^\circ$ C
Ambient Temperature Range	-55° C to $+100^\circ$ C
Junction Temperature	100° C
Soldering Temperature (max. 10 s, dip soldering; distance to seating plane ≥ 1.5 mm)	260° C

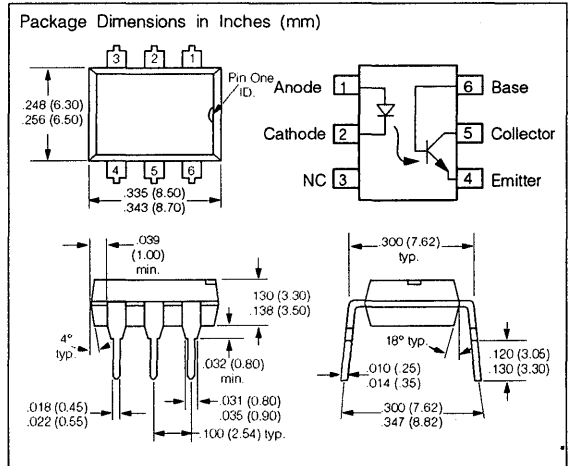

DESCRIPTION

The SFH601 is an optocoupler with a Gallium Arsenide LED emitter which is optically coupled with a silicon planar phototransistor detector. The component is packaged in a plastic plug-in case 20 AB DIN 41866.

The coupler transmits signals between two electrically isolated circuits.

Characteristics ($T_A=25^\circ$ C)

Emitter	Symbol	Unit	Condition
Forward Voltage	V_F	1.25 (≤ 1.65)	V $I_F=60$ mA
Breakdown Voltage	V_{BR}	≥ 6	V $I_R=10$ μ A
Reverse Current	I_R	0.01 (≤ 10)	μ A $V_R=6$ V
Capacitance	C_{JO}	25	pF $V_R=0$ V, $f=1$ MHz
Thermal Resistance	R_{THJamb}	750	K/W

Detector

Capacitance		pF	$f=1$ MHz
Collector-Emitter	C_{CE}	6.8	$V_{CE}=5$ V
Collector-Base	C_{CB}	8.5	$V_{CB}=5$ V
Emitter-Base	C_{EB}	11	$V_{EB}=5$ V
Thermal Resistance	R_{THJamb}	500	K/W

Package

Collector-Emitter	V_{CEsat}	0.25 (< 0.4)	$I_F=10$ mA, $I_C=2.5$ mA
Saturation Voltage			
Coupling Capacitance	$C_{I,O}$	0.6	$V_{I,O}=0$, $f=1$ MHz

*TRIOS-Transparent IO Shield

Current Transfer Ratio and Collector-Emitter Leakage Current by dash number

	-1	-2	-3	-4	Unit
I_C/I_F at $V_{CE}=5\text{ V}$ ($I_F=10\text{ mA}$)	40-80	63-125	100-200	160-320	%
I_C/I_F at $V_{CE}=5\text{ V}$ ($I_F=1\text{ mA}$)	30 (>13)	45 (>22)	70 (>34)	90 (>56)	%
Collector-Emitter Leakage Current ($V_{CE}=10\text{ V}$) (I_{CEO})	2 (≤ 50)	2 (≤ 50)	5 (≤ 100)	5 (≤ 100)	nA

Linear Operation (without saturation)

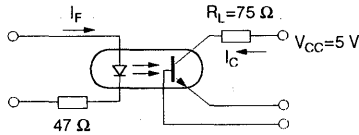

$I_F=10\text{ mA}$, $V_{CC}=5\text{ V}$, $T_A=25^\circ\text{C}$, Typical

Load Resistance	R_L	75	Ω
Turn-On Time	t_{ON}	3.0	μs
Rise Time	t_R	2.0	μs
Turn-Off Time	t_{OFF}	2.3	μs
Fall Time	t_f	2.0	μs
Cut-Off Frequency	F_{CO}	250	kHz

Switching Operation (with saturation)

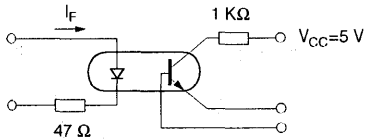

Typical

	-1 ($I_F=20\text{ mA}$)	-2 and -3 ($I_F=10\text{ mA}$)	-4 ($I_F=5\text{ mA}$)	
Turn-On Time t_{ON}	3.0	4.2	6.0	μs
Rise Time t_R	2.0	3.0	4.6	μs
Turn-Off Time t_{OFF}	18	23	25	μs
Fall Time t_f	11	14	15	μs
V_{CESAT}	0.25 (≤ 0.4)			V

Figure 1. Current transfer ratio versus diode current ($T_A=-25^\circ\text{C}$, $V_{CE}=5\text{ V}$) $I_C/I_F=f(I_F)$

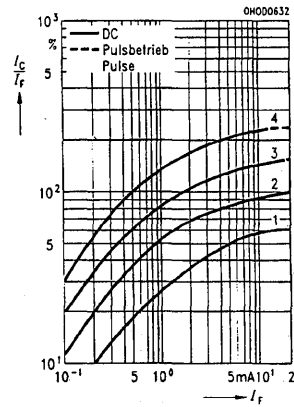

Figure 2. Current transfer ratio versus diode current ($T_A=0^\circ\text{C}$, $V_{CE}=5\text{ V}$) $I_C/I_F=f(I_F)$

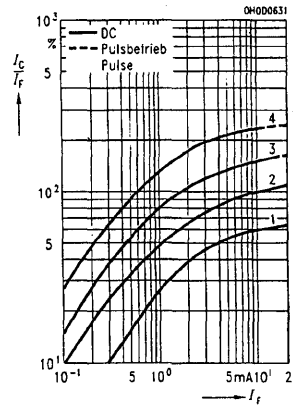

Figure 3. Current transfer ratio versus diode current ($T_A=25^\circ\text{C}$, $V_{CE}=5\text{ V}$) $I_C/I_F=f(I_F)$

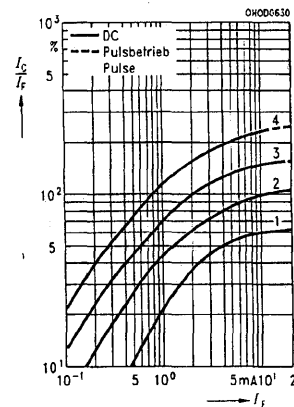

Figure 4. Current transfer ratio versus diode current ($T_A=50^\circ\text{C}$, $V_{CE}=5\text{ V}$) $I_C/I_F=f(I_F)$

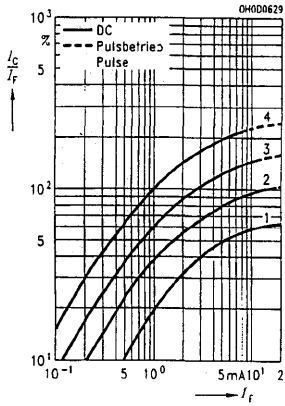

Figure 5. Current transfer ratio versus diode current ($T_A=75^\circ\text{C}$, $V_{CE}=5\text{ V}$) $I_C/I_F=f(I_F)$

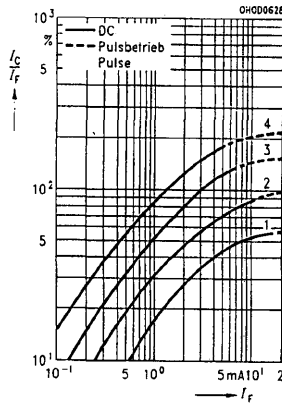

Figure 6. Current transfer ratio versus temperature ($I_F=10\text{ mA}$, $V_{CE}=5\text{ V}$) $I_C/I_F=f(T)$

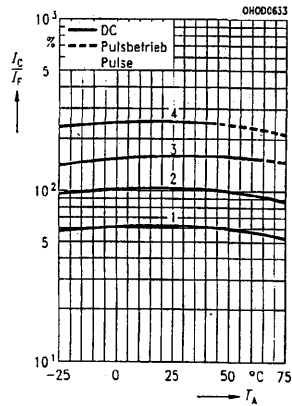

Figure 7. Transistor characteristics ($HFE=550$) $I_C=f(V_{CE})$ ($T_A=25^\circ\text{C}$, $I_F=0$)

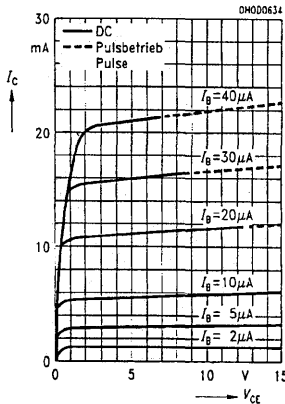

Figure 8. Output characteristics $I_C=f(V_{CE})$ ($T_A=25^\circ\text{C}$)

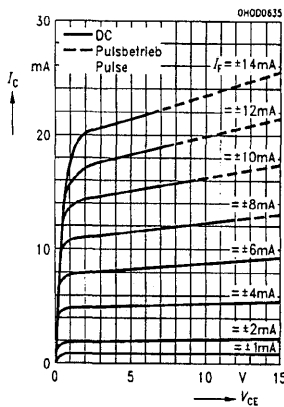

Figure 9. Forward voltage $V_F=f(I_F)$

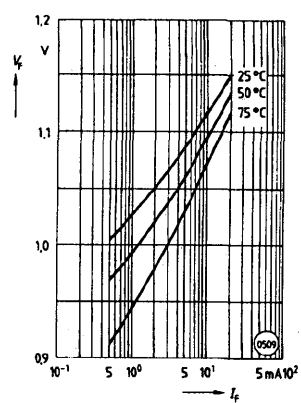

Figure 10. Collector emitter off-state current $I_{CEO}=f(V, T)$ ($T_A=25^\circ\text{C}$, $I_F=0$)

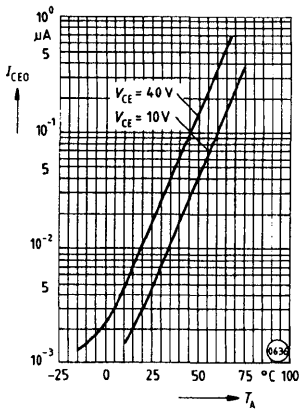

Figure 11. Saturation voltage versus collector current and modulation depth $V_{CEsat}=f(I_C)$ ($T_A=25^\circ\text{C}$)

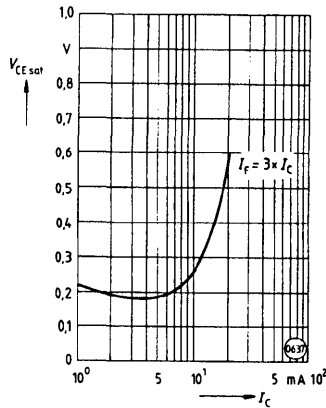

Figure 12. Saturation voltage versus collector current and modulation depth $V_{CEsat}=f(I_C)$ ($T_A=25^\circ\text{C}$)

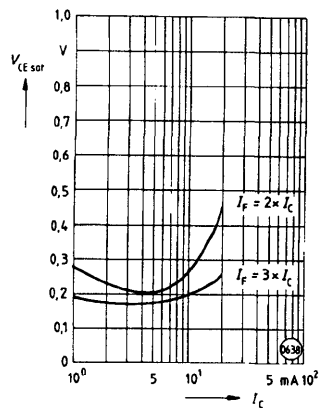

Figure 13. Saturation voltage versus collector current and modulation depth SFH601-3 $V_{CEsat}=f(I_C)$ ($T_A=25^\circ\text{C}$)

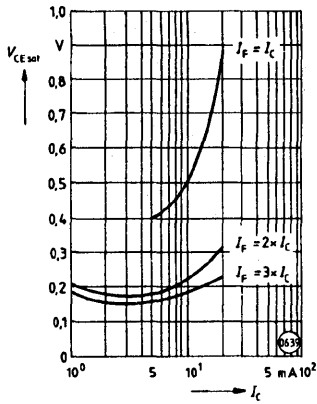

Figure 14. Saturation voltage versus collector current and modulation depth SFH601-4 $V_{CEsat}=f(I_C)$ ($T_A=25^\circ\text{C}$)

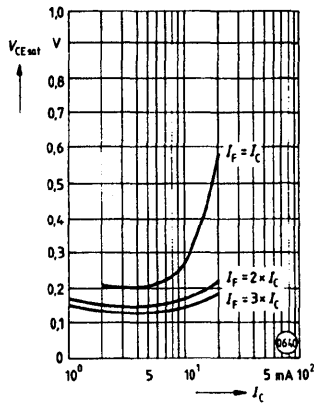

Figure 15. Permissible pulse load D =parameter, $T_A=25^\circ\text{C}$, $I_F=f(t)$

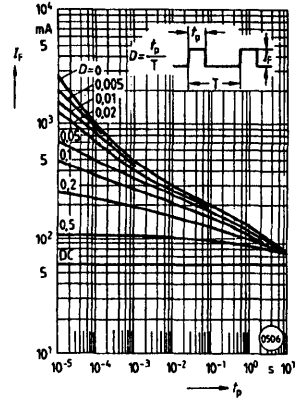

Figure 16. Permissible power dissipation for transistor and diode $P_{tot}=f(T_A)$

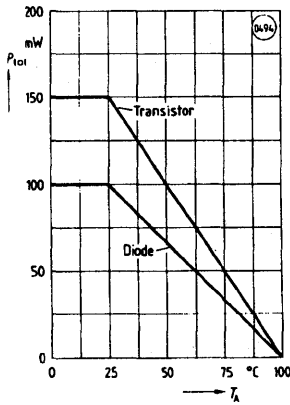

Figure 17. Permissible forward current diode $P_{tot}=f(T_A)$

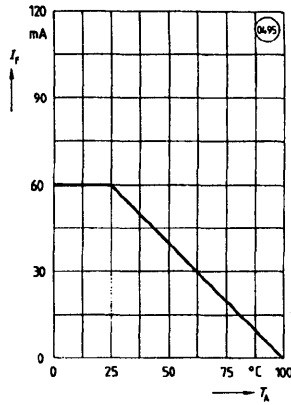
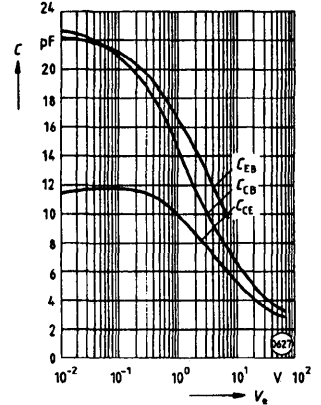

Figure 18. Transistor capacitance $C=f(V_0)$ ($T_A=25^\circ\text{C}$, $f=1$ MHz)



FEATURES

- Very High CTR at $I_F=1$ mA, $V_{CE}=0.5$ V
 - SFH608-2, 63-125%
 - SFH608-3, 100-200%
 - SFH608-4, 160-320%
 - SFH608-5, 250-500%
- Specified Minimum CTR at $I_F=0.5$ mA, $V_{CE}=1.5$ V: $\geq 32\%$ (typ. 120%)
- Good CTR Linearity with Forward Current
- Low CTR Degradation
- High Collector-Emitter Voltage $V_{CEO}=55$ V
- Withstand Test Voltage: 5300 VDC
- Low Current Input
- Low Coupling Capacitance
- High Common Mode Transient Immunity
- Phototransistor Optocoupler in 6 Pin DIP Package
- Field Effect Stable: TRIOS*

Options Available

- Option 1: Tested per VDE 0884
- Option 6: Lead Bend
- Option 7: SMD Lead Bend
- Option 9: SMD Lead Bend
- Underwriters Lab File #E52744

Applications

- Telecommunications
- Industrial Controls
- Office Machines
- Microprocessor System Interfaces

DESCRIPTION

The SFH 608 is an optocoupler designed for high current transfer ratio at low input currents with the output transistor saturated. This makes the device ideal for low current switching applications. The SFH608 is packaged in a six pin plastic DIP.

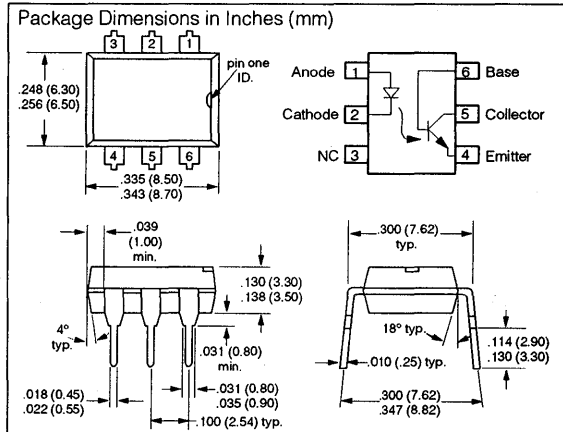

Maximum Ratings ($T_A=25^\circ\text{C}$)

Emitter

Reverse Voltage	6 V
DC Forward Current	50 mA
Surge Forward Current ($t_p \leq 10 \mu\text{s}$)	2.5 A
Total Power Dissipation	70 mW

Detector

Collector-Emitter Voltage	55 V
Collector-Base Voltage	55 V
Emitter-Base Voltage	7 V
Collector Current	50 mA
Surge Collector Current ($t_p \leq 1$ ms)	100 mA
Total Power Dissipation	150 mW
Isolation Test Voltage (between emitter and detector referred to climate DIN 40046 part 2 Nov. 74)	5300 VDC

Isolation Resistance

$V_{IO}=500$ V, $T_A=25^\circ\text{C}$	$\geq 10^{12} \Omega$
$V_{IO}=500$ V, $T_A=100^\circ\text{C}$	$\geq 10^{11} \Omega$

Creepage Distance

Clearance Distance

Comparative Tracking Index

(per DIN IEC 112/VDE 0303, part1)

Storage Temperature Range

Operating Temperature Range

Junction Temperature

Soldering Temperature

(max. 10 sec., dip soldering: distance to

seating plane ≥ 1.5 mm)

*TRIOS—Transparent IO Shield

Characteristics ($T_A=25^\circ\text{C}$, unless otherwise specified)

	Symbol	Typ.	Unit	Condition
Emitter				
Forward Voltage	V_F	1.1 (≤ 1.5)	V	$I_F=5\text{ mA}$
Reverse Voltage	V_R	(≥ 6)	V	$I_R=10\text{ }\mu\text{A}$
Reverse Current	I_R	0.01 (≤ 10)	μA	$V_R=6\text{ V}$
Capacitance	C_O	25	pF	$V_R=0\text{ V}$, $f=1\text{ MHz}$
Thermal Resistance	R_{thJA}	1070	K/W	
Detector				
Collector-Emitter Voltage	V_{CEO}	≥ 55	V	$I_{CE}=10\text{ }\mu\text{A}$
Emitter-Base Voltage	V_{EBO}	≥ 7	V	$I_{EB}=10\text{ }\mu\text{A}$
Capacitance	C_{CE}	10	pF	$V_{CE}=5\text{ V}$, $f=1\text{ MHz}$
Capacitance	C_{CB}	16	pF	$V_{CB}=5\text{ V}$, $f=1\text{ MHz}$
Capacitance	C_{EB}	10	pF	$V_{EB}=5\text{ V}$, $f=1\text{ MHz}$
Thermal Resistance	R_{thJA}	500	K/W	
Package				
Coupling Capacitance	C_C	0.60	pF	
Coupling Transfer Ratio				
SFH 608-2	I_C/I_F	63-125	%	$I_F=1\text{ mA}$, $V_{CE}=0.5\text{ V}$
		75 (≥ 32)	%	$I_F=0.5\text{ mA}$, $V_{CE}=1.5\text{ V}$
SFH 608-3	I_C/I_F	100-200	%	$I_F=1\text{ mA}$, $V_{CE}=0.5\text{ V}$
		120 (≥ 50)	%	$I_F=0.5\text{ mA}$, $V_{CE}=1.5\text{ V}$
SFH 608-4	I_C/I_F	160-320	%	$I_F=1\text{ mA}$, $V_{CE}=0.5\text{ V}$
		200 (≥ 80)	%	$I_F=0.5\text{ mA}$, $V_{CE}=1.5\text{ V}$
SFH 608-5	I_C/I_F	250-500	%	$I_F=1\text{ mA}$, $V_{CE}=0.5\text{ V}$
		300 (≥ 125)	%	$I_F=0.5\text{ mA}$, $V_{CE}=1.5\text{ V}$
Collector-Emitter Saturation Voltage				
SFH 608-2	V_{CEsat}	0.25 (≤ 0.4)	V	$I_C=0.32\text{ mA}$, $I_F=1\text{ mA}$
SFH 608-3	V_{CEsat}	0.25 (≤ 0.4)	V	$I_C=0.5\text{ mA}$, $I_F=1\text{ mA}$
SFH 608-4	V_{CEsat}	0.25 (≤ 0.4)	V	$I_C=0.8\text{ mA}$, $I_F=1\text{ mA}$
SFH 608-5	V_{CEsat}	0.25 (≤ 0.4)	V	$I_C=1.25\text{ mA}$, $I_F=1\text{ mA}$
Collector-Emitter Leakage Current	I_{CEO}	10 (≤ 200)	nA	$V_{CE}=10\text{ V}$

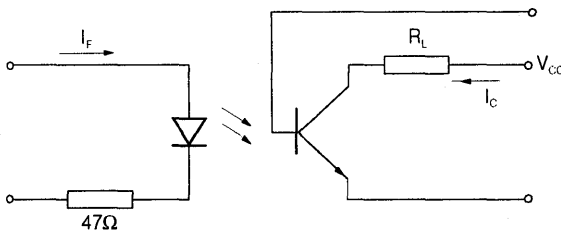

$I_C=2\text{ mA}$ (to adjust by I_F), $R_L=100\text{ }\Omega$, $T_A=25^\circ\text{C}$, $V_{CC}=5\text{ V}$

Description	Symbol	Values	Unit
Turn-On Time	t_{ON}	8	μs
Rise Time	t_R	5	μs
Turn-Off Time	t_{OFF}	7.5	μs
Fall Time	t_F	7	μs

Figure 1. Switching times $T_A=25^\circ\text{C}$, $I_F=1\text{ mA}$, $V_{CC}=5\text{ V}$, t_{ON} , t_R , t_{OFF} , $t_F=f(R_L)$

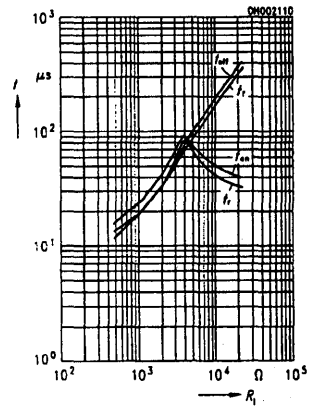

Figure 2. Current transfer ratio (typ.) $V_{CE}=0.5\text{ V}$, $CTR=f(T_A, I_F)$

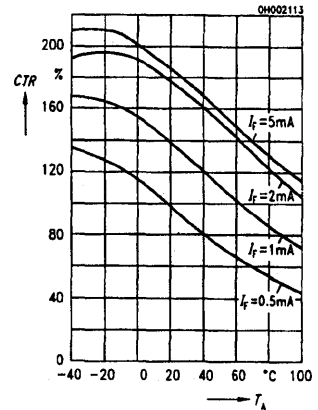

Figure 3. Current transfer ratio (typ.) $V_{CE}=1.5\text{ V}$, $CTR=f(T_A, I_F)$

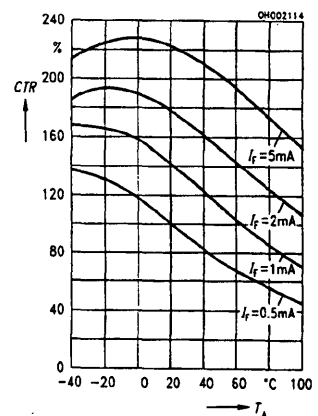

Figure 4. Diode forward voltage (typ.)
 $T_A=25^\circ\text{C}$, $V_F=f(I_F)$

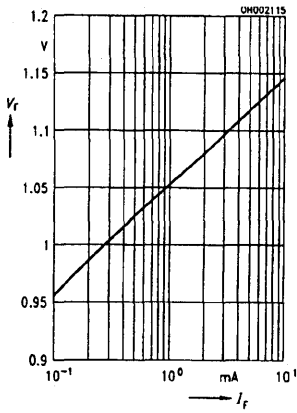

Figure 5. Diode forward voltage (typ.)
 $I_F=1\text{ mA}$, $V_F=f(T_A)$

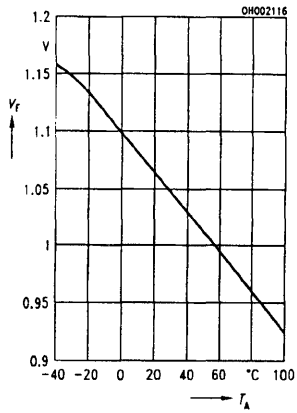

Figure 6. Output characteristics (typ.)
 $T_A=25^\circ\text{C}$, $I_{CE}=f(V_{CE}, I_B)$

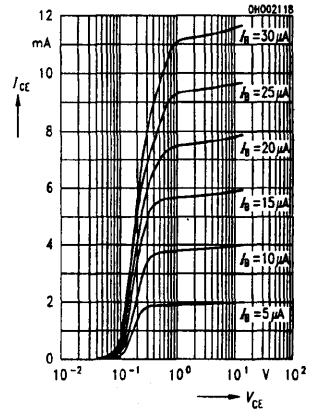

Figure 7. Output characteristics (typ.)
 $T_A=25^\circ\text{C}$, $I_{CE}=f(V_{CE}, I_F)$

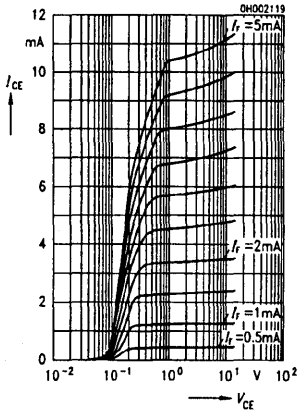

Figure 8. Permissible forward current diode
 $I_F=f(T_A)$

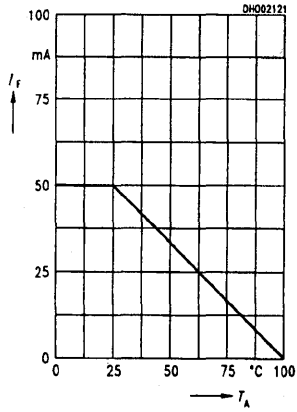

Figure 9. Permissible power dissipation
 $P_{TOT}=f(T_A)$

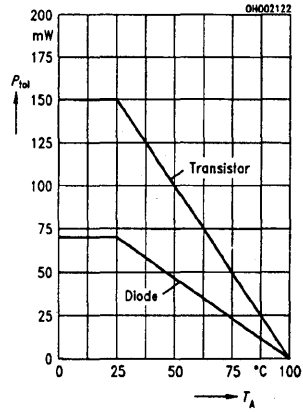

Figure 10. Transistor capacitance (typ.)
 $T_A=25^\circ\text{C}$, $f=1\text{ MHz}$, $C_{CE}=f(V_{CE})$
 $C_{CB}=f(V_{CB})$, $C_{EB}=f(V_{EB})$

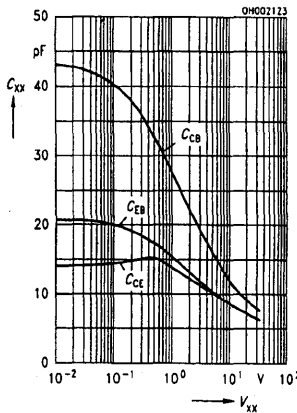
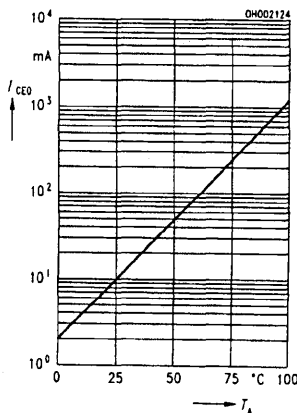

Figure 11. Collector-emitter leakage current
 $I_F=0$, $V_{CE}=10\text{ V}$, $I_{CEO}=f(T_A)$



FEATURES

- High Current Transfer Ratios
at 10 mA: 40-320%
at 1 mA: 60% typical (>13)
- Low CTR Degradation
- Good CTR Linearity Depending on Forward Current
- Withstand Test Voltage, 5300 V
- High Collector-Emitter Voltage, $V_{CE0}=70$ V
- Low Saturation Voltage
- Fast Switching Times
- Field-Effect Stable by TRIOS*
- Temperature Stable
- Low Coupling Capacitance
- End-Stackable, .100" (2.54 mm) Spacing
- High Common-Mode Interference Immunity (Unconnected Base)
- Underwriters Lab File #52744
- Options Available:
Option 1—Tested per VDE #0884
Option 2—Burn-in
Option 3—0° to 70° Guarantee

DESCRIPTION

SFH 610/611/615 are optically coupled isolators that feature a high current transfer ratio, low coupling capacitance and high isolation voltage. They have a GaAs infrared emitting diode emitter, which is optically coupled to a silicon planar phototransistor detector. The component is incorporated in a plastic plug-in DIP-4 package.

The coupling devices are designed for signal transmission between two electrically separated circuits. The potential difference between the circuits to be coupled must not exceed the maximum permissible reference voltages.

The couplers are end-stackable with 2.54 mm spacing and are successor types for optocouplers in metal cases. The SFH610/611/615 differ in their arrangement of the terminal pins. Therefore multicouplers can easily be implemented and conventional multicouplers can be replaced.

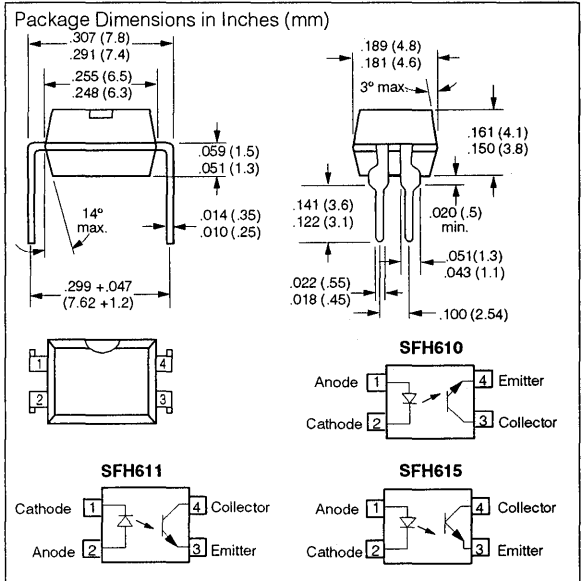

Maximum Ratings

Emitter

Reverse Voltage 6 V
DC Forward Current 60 mA
Surge Forward Current ($t \leq 10 \mu s$) 2.5 A
Total Power Dissipation 100 mW

Detector

Collector-Emitter Voltage 70 V
Emitter-Base Voltage 7 V
Collector Current 50 mA
Collector Current ($t \leq 1$ ms) 100 mA
Total Power Dissipation 150 mW

Package

Isolation Test Voltage between Emitter and Detector referred to Climate DIN 40046, part 2, Nov. 74 5300 VDC
Creepage Distance ≥ 7 mm
Clearance Distance ≥ 7 mm
Isolation Thickness between Emitter and Detector ≥ 0.8 mm
Comparative Tracking Index per DIN IEC 112/VDE 0303, part 1 175
Isolation Resistance $\geq 10^{12} \Omega$
$V_{IO}=500$ V, $T_A=25^\circ C$ $\geq 10^{11} \Omega$
$V_{IO}=500$ V, $T_A=100^\circ C$ $\geq 10^{11} \Omega$
Storage Temperature Range $-55^\circ C$ to $+150^\circ C$
Ambient Temperature Range $-55^\circ C$ to $+100^\circ C$
Junction Temperature $100^\circ C$
Soldering Temperature (max 10 s, Dip Soldering Distance to Seating Plane ≥ 1.5 mm) $260^\circ C$

Notes:

1. Dip soldering minimum clearance from bottom edge of package, 1.5 mm. Special soldering conditions apply when through-contacted circuit boards are used. Request appropriate specification.

*Transparent IO Shield

Characteristics ($T_A=25^\circ\text{C}$)

Emitter	Symbol	Units	Condition
Forward Voltage	V_F	1.25 (≤ 1.65)	V $I_F=60\text{ mA}$
Breakdown Voltage	V_{BR}	(≥ 6)	V $I_R=10\text{ }\mu\text{A}$
Reverse Current	I_R	0.01 (≤ 10)	μA $V_R=6\text{ V}$
Capacitance	C_0	25	pF $V_R=0\text{ V}, f=1\text{ MHz}$
Thermal Resistance	R_{THJA}	750	K/W
Detector			
Capacitance	C_{CE}	6.8	pF $V_{CE}=5\text{ V}, f=1\text{ MHz}$
Thermal Resistance	R_{THJA}	500	K/W
Package			
Collector-Emitter Saturation Voltage	V_{CESAT}	0.25 (≤ 0.4)	V $I_F=10\text{ mA}, I_C=2.5\text{ mA}$
Coupling Capacitance	C_C	0.2	pF

Current Transfer Ratio (I_C/I_F at $V_{CE}=5\text{ V}$) and **Collector-Emitter Leakage Current** by dash number

	-1	-2	-3	-4	
I_C/I_F ($I_F=10\text{ mA}$)	40-80	63-125	100-200	160-320	%
I_C/I_F ($I_F=1\text{ mA}$)	30 (>13)	45 (>22)	70 (>34)	90 (>56)	%
Collector-Emitter Leakage Current ($V_{CE}=10\text{ V}$) (I_{CEO})	2 (≤ 50)	2 (≤ 50)	5 (≤ 100)	5 (≤ 100)	nA

SWITCHING TIMES

Linear Operation (without saturation)

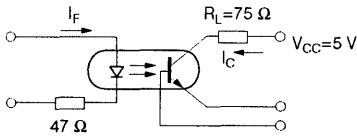

$I_F=10\text{ mA}, V_{CC}=5\text{ V}, T_A=25^\circ\text{C}$

Load Resistance	R_L	75	Ω
Turn-On Time	t_{ON}	3.0	μs
Rise Time	t_R	2.0	μs
Turn-Off Time	t_{OFF}	2.3	μs
Fall Time	t_f	2.0	μs
Cut-Off Frequency	F_{CO}	250	kHz

Switching Operation (with saturation)

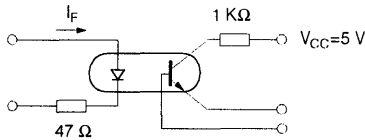

	-1 ($I_F=20\text{ mA}$)	-2 and -3 ($I_F=10\text{ mA}$)	-4 ($I_F=5\text{ mA}$)	
Turn-On Time t_{ON}	3.0	4.2	6.0	μs
Rise Time t_R	2.0	3.0	4.6	μs
Turn-Off Time t_{OFF}	18	23	25	μs
Fall Time t_f	11	14	15	μs

Figure 1. Current transfer ratio (typ.) versus temperature
($I_F = 10 \text{ mA}$, $V_{CE} = 5 \text{ V}$)

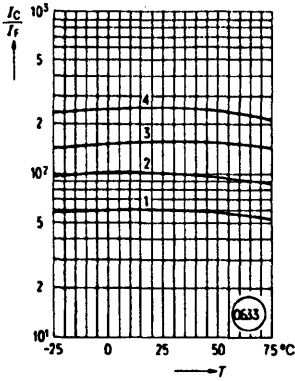

Figure 4. Transistor capacitance (typ.) versus collector-emitter voltage
($T_A = 25^\circ\text{C}$, $f = 1 \text{ MHz}$)

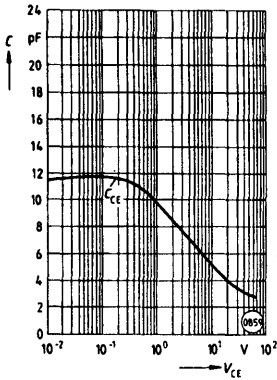

Figure 7. Permissible diode forward current versus ambient temperature

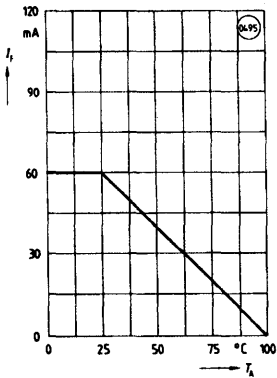

Figure 2. Output characteristics (typ.) Collector current versus collector-emitter voltage
($T_A = 25^\circ\text{C}$)

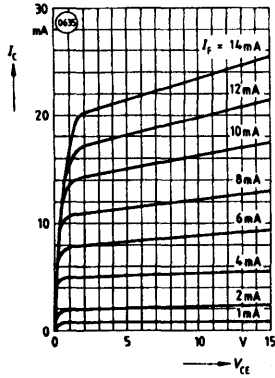

Figure 5. Permissible pulse handling capability. Forward current versus pulse width
(Pulse cycle $D = \text{parameter}$, $T_A = 25^\circ\text{C}$)

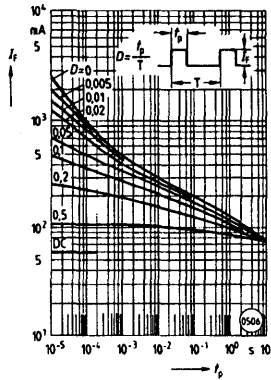

Figure 3. Diode forward voltage (typ.) versus forward current

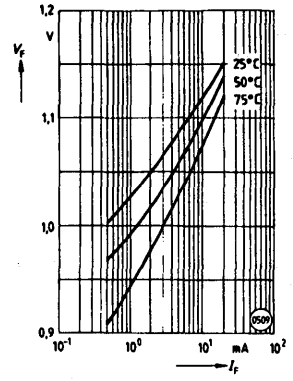
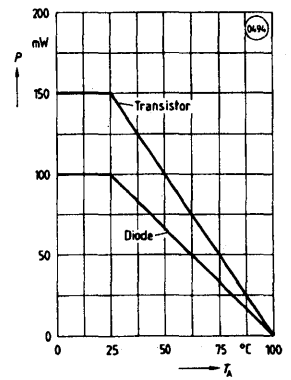

Figure 6. Permissible power dissipation versus ambient temperature



FEATURES

- **Current Transfer Ratios:**
SFH 617G-1, 40-80%
SFH 617G-2, 63-125%
SFH 617G-3, 100-200%
SFH 617G-4, 160-320%
- **Creepage Distances and Clearances per VDE 0110**
- **Insulation Thickness ≥ 0.8 mm**
- **Creepage Distance ≥ 8 mm**
- **High Common-Mode Rejection**
- **Underwriters Lab File #1409**
- **Fulfills VDE Standards: 0804/0805/0806/0860**
- **VDE #0884 Available with Option 1**

DESCRIPTION

The SFH 617G line isolating optocoupler has been designed for especially demanding applications. The reflective coupler without base connection and a 0.80 mm separation between electrically conducting parts results in an excellent high-voltage safety. Despite the small size of the package, modified pins ensure a creepage distance of 8 mm. The pins have been bent up to a spacing of 0.4", which also maintains a creepage distance ≥ 8 mm on the PC board for use in circuits requiring safe electrical isolation in accordance with protection class 11.

Maximum Ratings

Emitter

Reverse Voltage	6 V
DC Forward Current	60 mA
Surge Forward Current ($t \leq 10 \mu\text{s}$)	2.5 A
Total Power Dissipation	100 mW

Detector

Collector-Emitter Voltage	70 V
Emitter-Base Voltage	7 V
Collector Current	50 mA
Collector Current ($t \leq 1$ ms)	100 mA
Total Power Dissipation	150 mW

Package

Isolation Test Voltage between Emitter and Detector referred to Climate DIN 40046, part 2, Nov. 74	5300 VDC
Creepage Distance	≥ 8.0 mm
Clearance Distance	≥ 8.0 mm
Insulation Thickness between Emitter and Detector	≥ 0.8 mm
Comparative Tracking Index per DIN IEC 112/VDE0303, part 1	175
Isolation Resistance	
$V_{IO}=500$ V, $T_A=25^\circ\text{C}$	$10^{12} \Omega$
$V_{IO}=500$ V, $T_A=100^\circ\text{C}$	$10^{11} \Omega$
Storage Temperature Range	-55°C to $+150^\circ\text{C}$
Operating Temperature Range	-55°C to $+100^\circ\text{C}$
Junction Temperature	100°C
Soldering Temperature (max. 10 s, dip soldering: distance to seating plane ≥ 1.5 mm)	260°C

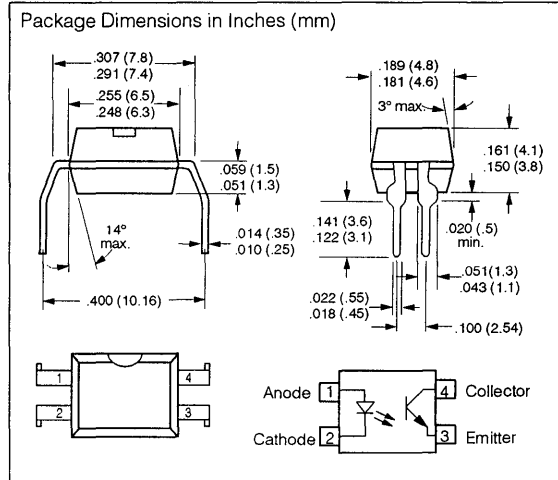

Characteristics ($T_A=25^\circ\text{C}$)

	Symbol	Unit	Condition
Emitter			
Forward Voltage	V_F	1.25 (≤ 1.65) V	$I_F=60$ mA
Breakdown Voltage	V_{BR}	≥ 6 V	$I_R=10$ μA
Reverse Current	I_R	0.01 (≥ 10) μA	$V_R=6$ V
Capacitance	C_O	25 pF	$V_R=0$ V $f=1$ MHz
Thermal Resistance	R_{THJamb}	750 K/W	
Detector			
Capacitance	C_{CE}	6.8 pF	$V_{CE}=5$ V $f=1$ MHz
Thermal Resistance	R_{THJamb}	500 K/W	
Package			
Collector-Emitter Saturation Voltage	V_{CESAT}	0.25 (< 0.4) V	$I_F=10$ mA $I_C=2.5$ mA
Coupling Capacitance	C_C	0.2 pF	

Notes:

1. Dip soldering minimum clearance from bottom edge of package, 1.5 mm. Special soldering conditions apply when through-contacted circuit boards are used. Request appropriate specification.

*TRansparent IO_n Shield

Current Transfer Ratio and Collector-Emitter Leakage Current by dash number

	-1	-2	-3	-4	Unit
I_C/I_F at $V_{CE}=5V$ ($I_F=10mA$)	40-80	63-125	100-200	160-320	%
I_C/I_F at $V_{CE}=5V$ ($I_F=1mA$)	30 (>13)	45 (>22)	70 (>34)	90 (>56)	%
Collector-Emitter Leakage Current ($V_{CE}=10V$) (I_{CEO})	2 (≤ 35)	2 (≤ 35)	5 (≤ 35)	5 (≤ 70)	nA

Linear Operation (without saturation)

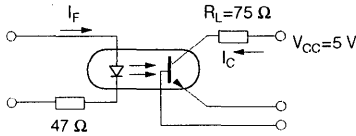

$I_F=10mA, V_{CC}=5V, T_A=25^\circ C$

Load Resistance	R_L	75	Ω
Turn-On Time	t_{ON}	3.0	μs
Rise Time	t_R	2.0	μs
Turn-Off Time	t_{OFF}	2.3	μs
Fall Time	t_F	2.0	μs

Switching Operation (with saturation)

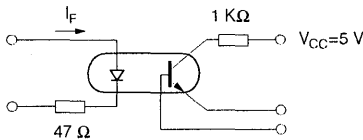

	-1 ($I_F=20mA$)	-2 and -3 ($I_F=10mA$)	-4 ($I_F=5mA$)	
Turn-On Time t_{ON}	3.0	4.2	6.0	μs
Rise Time t_R	2.0	3.0	4.6	μs
Turn-Off Time t_{OFF}	18	23	25	μs
Fall Time t_F	11	14	15	μs
V_{CESAT}	0.25 (≤ 0.4)			V

Figure 1. Current transfer ratio (typ.) vs. temperature
($I_F=10mA, V_{CE}=5V$)

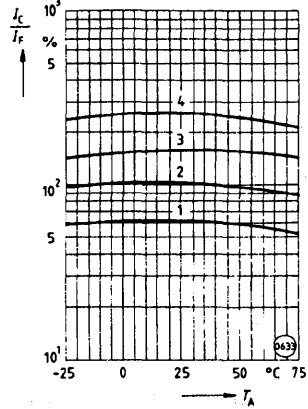

Figure 2. Output characteristics (typ.)
Collector current vs. collector-emitter voltage ($T_A=25^\circ C$)

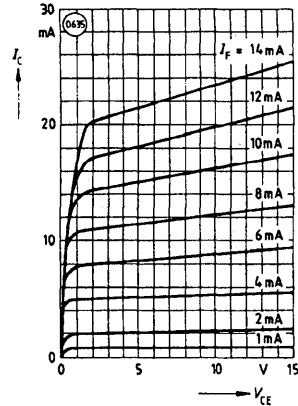

Figure 3. Diode forward voltage (typ.)
Forward voltage vs. forward current

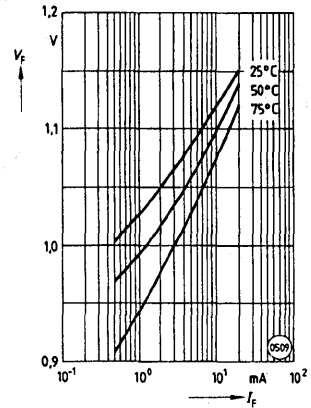

Figure 4. Transistor capacitance (typ.)
 Capacitance versus collector-emitter voltage ($T_A=25^\circ\text{C}$, $f=1\text{ MHz}$)

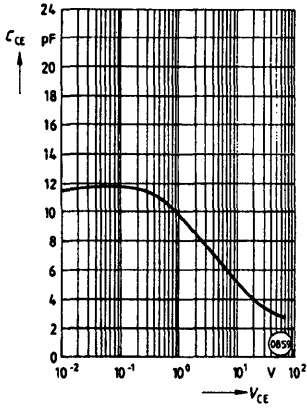

Figure 5. Permissible pulse handling capability. Forward current versus pulse width
 (Pulse duty factor D =parameter, $T_A=25^\circ\text{C}$)

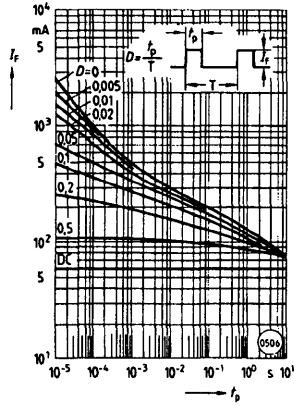

Figure 6. Permissible power dissipation for transistor and diode versus ambient temperature

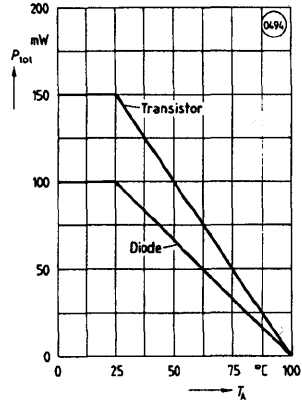
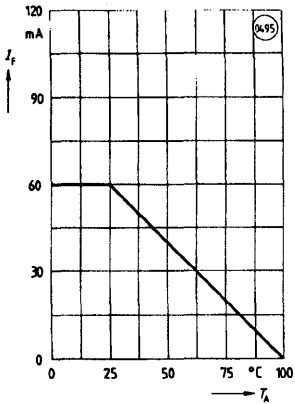

Figure 7. Diode-Permissible forward current versus ambient temperature



FEATURES

- Very High CTR at $I_F=1$ mA, $V_{CE}=0.5$ V
 - SFH618-2, 63–125%
 - SFH618-3, 100–200%
 - SFH618-4, 160–320%
 - SFH618-5, 250–500%
- Specified Minimum CTR at $I_F=0.5$ mA, $V_{CE}=1.5$ V: $\geq 32\%$ (typ. 120%)
- Good CTR Linearity Depending on Forward Current
- Low CTR Degradation
- High Collector-Emitter-Voltage $V_{CEO}=55$ V
- Withstand Test Voltage: 5300 V
- Low Current Input
- Low Coupling Capacitance
- High Common Mode Transient Immunity
- Phototransistor Optocoupler in 4 Pin DIP Package
- End-stackable, .100" (2.54 mm) Spacing
- Applications
 - Telecom
 - Industrial Controls
 - Battery Powered Equipment
 - Office Machines
- VDE #0884 Available with Option 1

DESCRIPTION

The SFH 618 is an optical coupler with a AlGaAs infrared LED and a silicon NPN phototransistor.

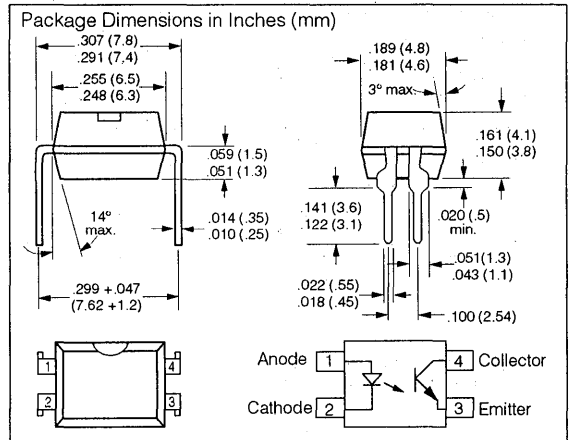

Maximum Ratings ($T_A=25^\circ\text{C}$)

Emitter

Reverse Voltage	6 V
DC Forward Current	50 mA
Surge Forward Current ($t_p \leq 10 \mu\text{s}$)	2.5 A
Total Power Dissipation	70 mW

Detector

Collector-Emitter Voltage	55 V
Emitter-Collector Voltage	7 V
Collector Current	50 mA
Surge Collector Current ($t_p \leq 10$ ms)	100 mA
Total Power Dissipation	150 mW

Package

Isolation Test Voltage (between emitter and detector referred to climate DIN 40046 part 2 Nov. 74)	5300 VDC
Insulation Resistance	
$V_{IO}=500$ V, $T_A=25^\circ\text{C}$	$\geq 10^{12} \Omega$
$V_{IO}=500$ V, $T_A=100^\circ\text{C}$	$\geq 10^{11} \Omega$
Creepage Distance	7 mm
Clearance Distance	7 mm
Isolation Distance, Emitter to Detector	≥ 0.8 mm
Comparative Tracking Index (per DIN IEC 112/VDE 0303, part 1)	175
Storage Temperature Range	-55°C to $+150^\circ\text{C}$
Operating Temperature Range	-55°C to $+100^\circ\text{C}$
Junction Temperature	100°C
Soldering Temperature (max. 10 sec., dip soldering: distance solder joint/case bottom ≥ 1.5 mm)	260°C

Notes:

1. Dip soldering minimum clearance from bottom edge of package, 1.5 mm. Special soldering conditions apply when through-contacted circuit boards are used. Request appropriate specification.

Characteristics (T_A=25°C)

	Symbol	Typ.	Unit	Condition
Emitter				
Forward Voltage	V _F	1.1 (≤ 1.5)	V	I _F =5 mA
Reverse Voltage	V _R	≥ 6	V	I _R =10 μA
Reverse Current	I _R	0.01 (≤ 10)	μA	V _R =6 V
Capacitance	C _O	25	pF	V _R =0 V, f=1 MHz
Thermal Resistance	R _{thJA}	750	K/W	
Detector				
Collector-Emitter Voltage	V _{CEO}	≥ 55	V	I _{CE} =10 μA
Emitter-Collector Voltage	V _{ECO}	≥ 7	V	I _{EC} =10 μA
Capacitance	C _{CE}	7	pF	V _{CE} = 5 V, f = 1 MHz
Thermal Resistance	R _{thJA}	500	K/W	
Package				
Coupling-Capacitance	C _C	0.25	pF	
Coupling Transfer Ratio				
SFH 618-2	I _C /I _F	63-125	%	I _F =1 mA, V _{CE} =0.5 V
		75 (≥ 32)	%	I _F =0.5 mA, V _{CE} =1.5 V
SFH 618-3	I _C /I _F	100-200	%	I _F =1 mA, V _{CE} =0.5 V
		120 (≥ 50)	%	I _F =0.5 mA, V _{CE} =1.5 V
SFH 618-4	I _C /I _F	160-320	%	I _F =1 mA, V _{CE} =0.5 V
		200 (≥ 80)	%	I _F =0.5 mA, V _{CE} =1.5 V
SFH 618-5	I _C /I _F	250-500	%	I _F =1 mA, V _{CE} =0.5 V
		300 (≥ 125)	%	I _F =0.5 mA, V _{CE} =1.5 V
Collector-Emitter Saturation Voltage				
SFH 618-2	V _{CEsat}	0.25 (≤ 0.4)	V	I _C =0.32 mA, I _F =1 mA
SFH 618-3	V _{CEsat}	0.25 (≤ 0.4)	V	I _C =0.5 mA, I _F =1 mA
SFH 618-4	V _{CEsat}	0.25 (≤ 0.4)	V	I _C =0.8 mA, I _F =1 mA
SFH 618-5	V _{CEsat}	0.25 (≤ 0.4)	V	I _C =1.25 mA, I _F =1 mA
Collector-Emitter Leakage Current				
	I _{CEO}	10 (≤ 200)	nA	V _{CE} =10 V

Switching Times Measurement-Test Circuit and Waveforms

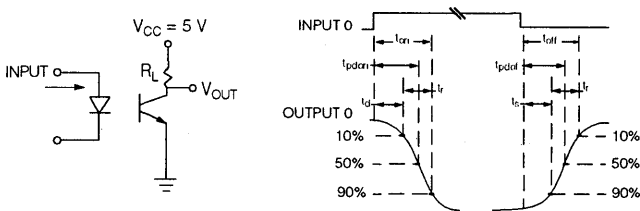

Figure 1. Current transfer ratio (typ.)
 $V_{CE}=0.5\text{ V}$, $CTR=f(T_A)$

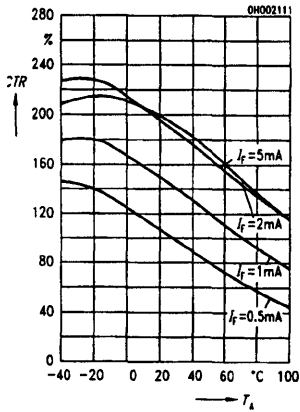

Figure 2. Current transfer ratio (typ.)
 $V_{CE}=1.5\text{ V}$, $CTR=f(T_A)$

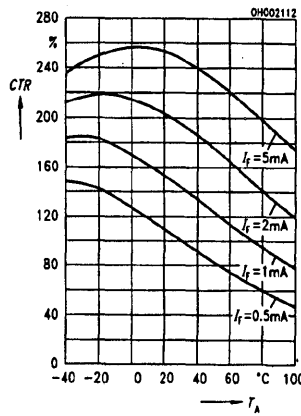

Figure 3. Diode forward voltage
 $T_A=25^\circ\text{C}$, $V_F=f(I_F)$

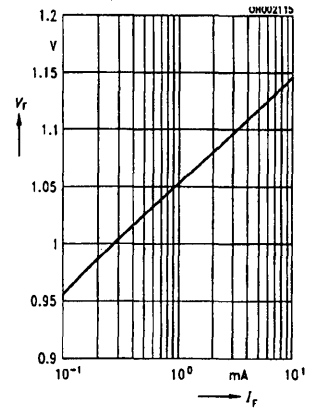

Figure 4. Diode forward voltage
 $I_F=1\text{ mA}$, $V_F=f(T_A)$

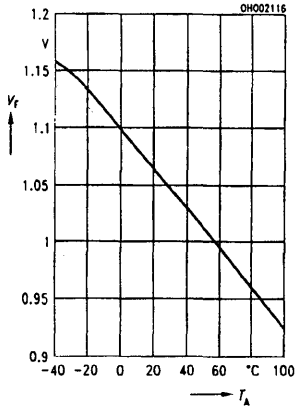

Figure 5. Transistor capacitance
 $T_A=25^\circ\text{C}$, $f=1\text{ MHz}$, $C_{CE}=f(V_{CE})$

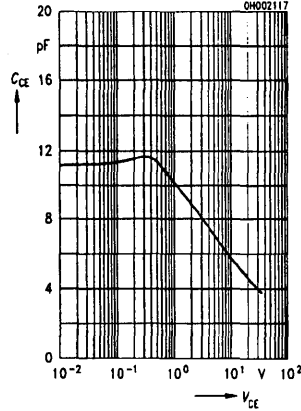

Figure 6. Output characteristics
 $T_A=25^\circ\text{C}$, $I_{CE}=f(V_{CE}, I_F)$

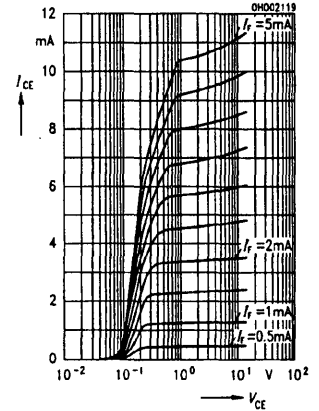

Figure 7. Permissible forward current diode
 $I_F=f(T_A)$

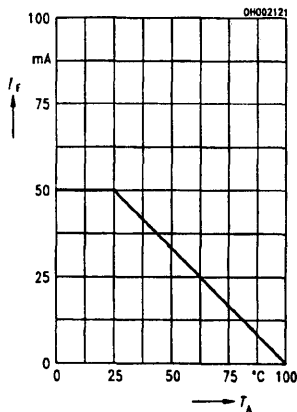

Figure 8. Permissible power dissipation
 $P_{TOT}=f(T_A)$

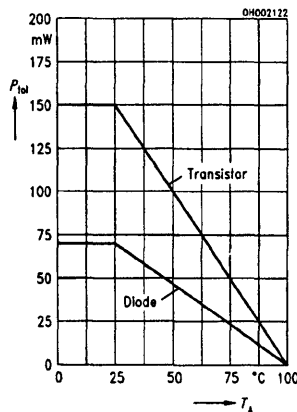
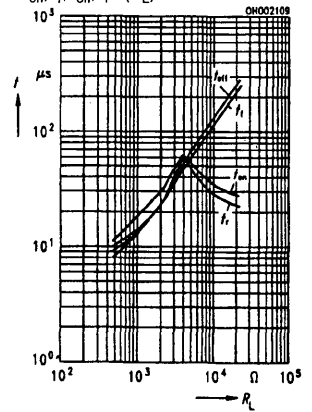

Figure 9. Switching times (typ.)
 $T_A=25^\circ\text{C}$, $I_F=1\text{ mA}$, $V_{CC}=5\text{ V}$
 t_{on} , t_r , t_{off} , $t_f=f(R_L)$



FEATURES

- High Current Transfer Ratios at 10 mA: 40-320% at 1 mA: 45% typical (>13)
- Low CTR Degradation
- Good CTR Linearity Depending on Forward Current
- Withstand Test Voltage, 5300 VAC_{RMS}
- High Collector-Emitter Voltage, V_{CEO}=70 V
- Low Saturation Voltage
- Fast Switching Times
- Field-Effect Stable by TRIOS*
- Temperature Stable
- Low Coupling Capacitance
- End-Stackable, 0.100" (2.54 mm) Spacing
- High Common-Mode Interference Immunity (Unconnected Base)
- VDE #0884 Available with Option 1

DESCRIPTION

The SFH 620 is a DIP-4 optocoupler which has two bidirectional infrared emitters. This enables the transmission of AC voltage signals while the circuits are electrically isolated.

High isolation test voltage and high current transfer ratios characterize this reflective-mode device.

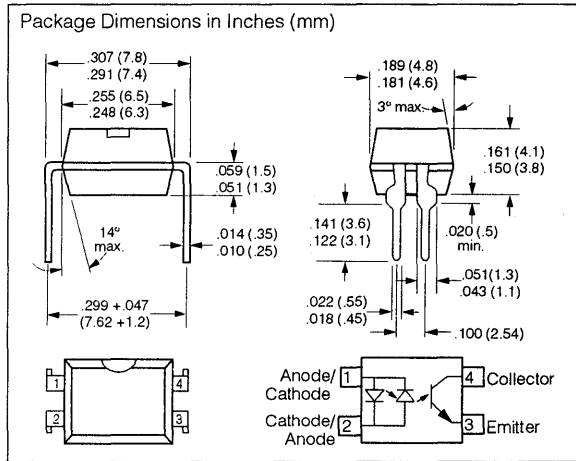

Maximum Ratings

Emitter

DC Forward Current	±60 mA
Surge Forward Current (t ≤ 10 μs)	±2.5 A
Total Power Dissipation	100 mW

Detector

Collector-Emitter Voltage	70 V
Emitter-Collector Voltage	7 V
Collector Current	50 mA
Collector Current (t ≤ 1 ms)	100 mA
Total Power Dissipation	150 mW

Package

Isolation Test Voltage between Emitter and Detector referred to Climate DIN 40046, part 2, Nov. 74	5300 VDC
Creepage Distance	≥ 7 mm
Clearance Distance	≥ 7 mm
Isolation Thickness between Emitter and Detector	≥ 0.8 mm
Comparative Tracking Index per DIN IEC 112/VDE 0303, part 1	175
Isolation Resistance	
V _{IO} =500 V, T _A =25°C	≥ 10 ¹² Ω
V _{IO} =500 V, T _A =100°C	≥ 10 ¹¹ Ω
Storage Temperature Range	-55°C to +150°C
Ambient Temperature Range	-55°C to +100°C
Junction Temperature	100°C
Soldering Temperature (max. 10 s, dip soldering distance: to seating plane ≥ 1.5 mm)	260°C

Notes:

1. Dip soldering minimum clearance from bottom edge of package, 1.5 mm. Special soldering conditions apply when through-contacted circuit boards are used. Request appropriate specification.

*Transparent IO Shield

Characteristics ($T_A=25^\circ\text{C}$)

	Symbol	Units	Condition
Emitter			
Forward Voltage	V_F	± 1.25 (≤ 1.65)	V $I_F=\pm 60$ mA
Capacitance	C_0	50	pF $V_R=0$ V, $f=1$ MHz
Thermal Resistance	R_{THJA}	750	K/W
Detector			
Capacitance	C_{CE}	6.8	pF $V_{CE}=5$ V, $f=1$ MHz
Thermal Resistance	R_{THJA}	500	K/W
Package			
Collector-Emitter Saturation Voltage	V_{CESAT}	0.25 (≤ 0.4)	V $I_F=10$ mA, $I_C=2.5$ mA
Coupling Capacitance	C_C	0.2	pF

Note:

1. Still air, coupler soldered to PCB or base.

Current Transfer Ratio (I_C/I_F at $V_{CE}=5$ V) and Collector-Emitter Leakage Current by dash number

	-1	-2	-3	
I_C/I_F ($I_F=\pm 10$ mA)	40-125	63-200	100-320	%
I_C/I_F ($I_F=\pm 1$ mA)	30 (>13)	45 (>22)	70 (>34)	%
Collector-Emitter Leakage Current ($V_{CE}=10$ V) (I_{CEO})	2 (≤ 50)	2 (≤ 50)	5 (≤ 100)	nA

SWITCHING TIMES

Linear Operation (without saturation)

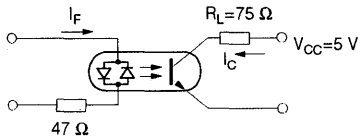

$I_F=\pm 10$ mA, $V_{CC}=5$ V, $T_A=25^\circ\text{C}$

Load Resistance	R_L	75	Ω
Turn-On Time	t_{ON}	3.0	μs
Rise Time	t_R	2.0	μs
Turn-Off Time	t_{OFF}	2.3	μs
Fall Time	t_f	2.0	μs
Cut-Off Frequency	F_{CO}	250	kHz

Figure 1. Current transfer ratio (typ.) versus temperature
($I_F=10\text{ mA}$, $V_{CE}=5\text{ V}$)

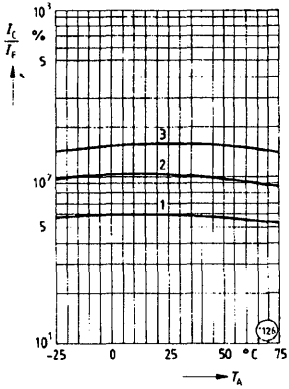

Figure 4. Transistor capacitance (typ.) versus collector-emitter voltage
($T_A=25^\circ\text{C}$, $f=1\text{ MHz}$)

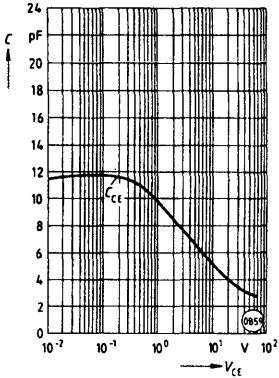

Figure 7. Permissible diode forward current versus ambient temperature

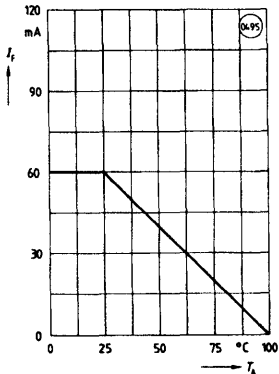

Figure 2. Output characteristics (typ.) Collector current versus collector-emitter voltage
($T_A=25^\circ\text{C}$)

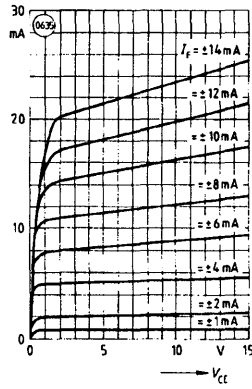

Figure 5. Permissible pulse handling capability. Forward current versus pulse width
(Pulse cycle D =parameter, $T_A=25^\circ\text{C}$)

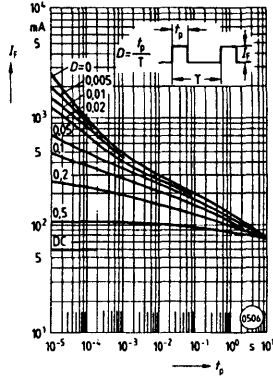

Figure 3. Diode forward voltage (typ.) versus forward current

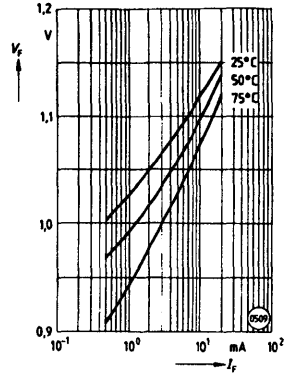
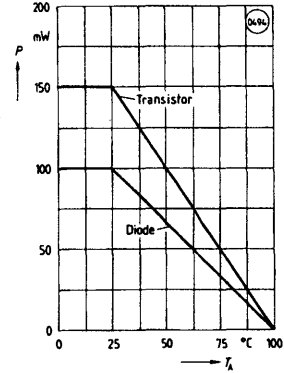

Figure 6. Permissible power dissipation versus ambient temperature



FEATURES

- Very High CTR at $I_F=1$ mA
SFH628-2, 63-200%
SFH628-3, 100-320%
SFH628-4, 160-500%
- Specified Minimum CTR at $I_F=0.5$ mA,
 $V_{CE}=1.5$ V: $\geq 50\%$ (typ. 160%)
- Good CTR Linearity with Forward Current
- Low CTR Degradation
- High Collector-Emitter Voltage $V_{CEO}=55$ V
- Withstand Test Voltage: 5300 V
- AC-Input with Two Bidirectional GaAs-IR-Emitters
- Low Coupling Capacitance
- High Common Mode Transient Immunity
- Phototransistor Optocoupler in 4 Pin DIP Package
- End-stackable, 0.100" (2.54 mm) Spacing
- Applications
 - Telecom
 - Industrial Controls
 - Line Monitoring
- VDE #0884 Available with Option 1

DESCRIPTION

The SFH 628 is an optical coupler with two GaAs infrared LEDs and a silicon NPN phototransistor. Signal information, including a DC level, can be transmitted by the device while maintaining a high degree of electrical isolation between input and output.

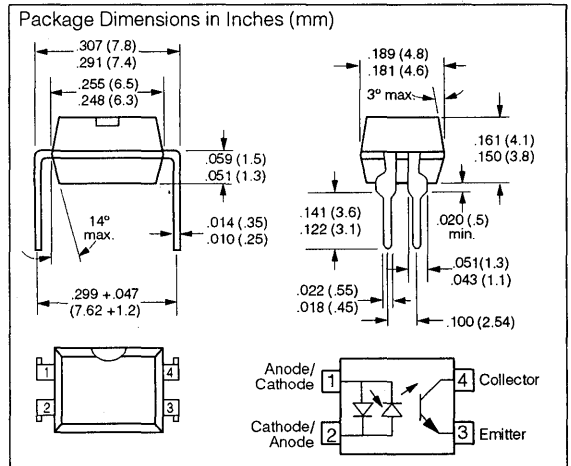

Maximum Ratings ($T_A=25^\circ\text{C}$)

Emitter

DC Forward Current	±50 mA
Surge Forward Current ($t_p \leq 10 \mu\text{s}$)	2.5 A
Total Power Dissipation at 25°C	70 mW

Detector

Collector-Emitter Voltage	55 V
Emitter-Collector Voltage	7 V
Collector Current	50 mA
Surge Collector Current, I_{CSM} ($t_p \leq 10$ ms)	100 mA
Total Power Dissipation at 25°C	150 mW

Package

Isolation Test Voltage between Emitter and Detector referred to Climate DIN 40046 part 2 Nov. 74)	5300 VDC
Insulation Resistance	
$V_{IO}=500$ V, $T_A=25^\circ\text{C}$	$\geq 10^{12} \Omega$
$V_{IO}=500$ V, $T_A=100^\circ\text{C}$	$\geq 10^{11} \Omega$
Creepage Distance	7 mm
Clearance Distance	7 mm
Comparative Tracking Index per DIN IEC 112/VDE 0303, part 1	175
Storage Temperature Range	-55°C to $+150^\circ\text{C}$
Operating Temperature Range	-55°C to $+100^\circ\text{C}$
Junction Temperature	100°C
Soldering Temperature (max. 10 sec., dip soldering: distance to seating plane > 1.5 mm)	260°C

*Transparent IOn Shield

Characteristics ($T_A=25^\circ\text{C}$, if not otherwise specified)

	Symbol	Typ.	Unit	Condition
Emitter				
Forward Voltage	V_F	$\pm 1.1 (\leq 1.5)$	V	$I_F = \pm 5 \text{ mA}$
Capacitance	C_O	45	pF	$V_R = 0 \text{ V}$, $f = 1 \text{ MHz}$
Thermal Resistance	R_{thJA}	750	K/W	
Detector				
Collector-Emitter Voltage	V_{CEO}	≥ 55	V	$I_{\text{CE}} = 10 \mu\text{A}$
Emitter-Collector Voltage	V_{ECO}	≥ 7	V	$I_{\text{EC}} = 10 \mu\text{A}$
Capacitance	C_{CE}	7	pF	$V_{\text{CE}} = 5 \text{ V}$, $f = 1 \text{ MHz}$
Thermal Resistance	R_{thJA}	500	K/W	
Package				
Coupling-Capacitance	C_C	0.25	pF	
Coupling Transfer Ratio				
SFH 628-2	I_C/I_F	63-200	%	$I_F = \pm 1 \text{ mA}$, $V_{\text{CE}} = 0.5 \text{ V}$
		100 (≥ 32)	%	$I_F = \pm 0.5 \text{ mA}$, $V_{\text{CE}} = 1.5 \text{ V}$
SFH 628-3	I_C/I_F	100-320	%	$I_F = \pm 1 \text{ mA}$, $V_{\text{CE}} = 0.5 \text{ V}$
		160 (≥ 50)	%	$I_F = \pm 0.5 \text{ mA}$, $V_{\text{CE}} = 1.5 \text{ V}$
SFH 628-4	I_C/I_F	160-500	%	$I_F = \pm 1 \text{ mA}$, $V_{\text{CE}} = 0.5 \text{ V}$
		250 (≥ 80)	%	$I_F = \pm 0.5 \text{ mA}$, $V_{\text{CE}} = 1.5 \text{ V}$
Collector-Emitter Saturation Voltage				
SFH 628-2	V_{CESat}	$0.25 (\leq 0.4)$	V	$I_C = 0.5 \text{ mA}$, $I_F = \pm 1 \text{ mA}$
SFH 628-3	V_{CESat}	$0.25 (\leq 0.4)$	V	$I_C = 0.8 \text{ mA}$, $I_F = \pm 1 \text{ mA}$
SFH 628-4	V_{CESat}	$0.25 (\leq 0.4)$	V	$I_C = 1.25 \text{ mA}$, $I_F = \pm 1 \text{ mA}$

Optocouplers
(Optoisolators)

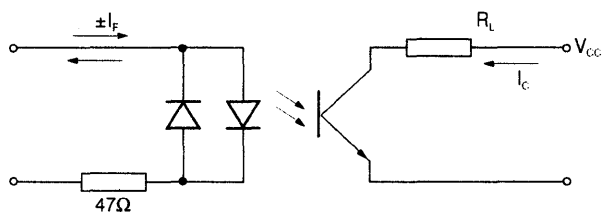

Switching Times, Typical
 $V_{\text{CC}} = 5 \text{ V}$, $I_C = 2 \text{ mA}$, $R_L = 100 \Omega$, $T_A = 25^\circ\text{C}$

Turn-On Time	t_{ON}	6.0	μs
Rise Time	t_R	3.5	μs
Turn-Off Time	t_{OFF}	5.5	μs
Fall Time	t_F	5.0	μs

Figure 1. Current transfer ratio (typ.)
 $V_{CE}=0.5\text{ V}$, $CT=f(T_A)$

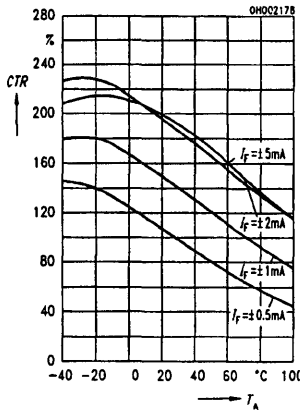

Figure 2. Current transfer ratio (typ.)
 $V_{CE}=1.5\text{ V}$, $CT=f(T_A)$

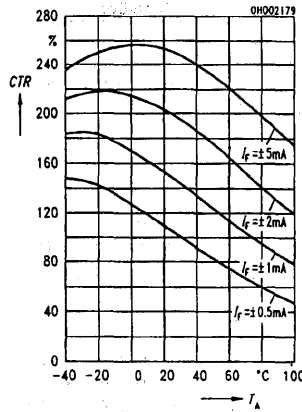

Figure 3. Diode forward voltage
 $T_A=25^\circ\text{C}$, $V_F=f(I_F)$

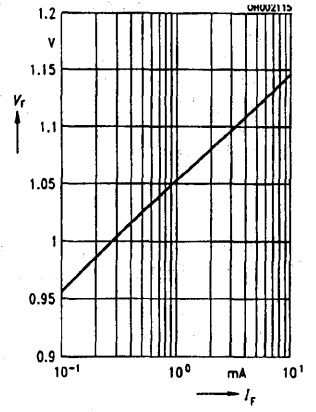

Figure 4. Diode forward voltage
 $I_F=\pm 1\text{ mA}$, $V_F=f(T_A)$

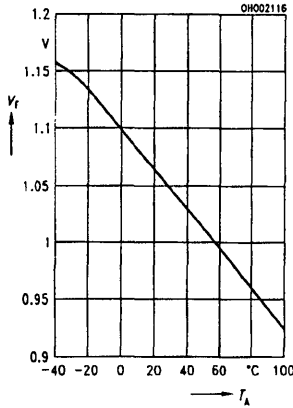

Figure 5. Transistor capacitance
 $T_A=25^\circ\text{C}$, $f=1\text{ MHz}$, $C_{CE}=f(V_{CE})$

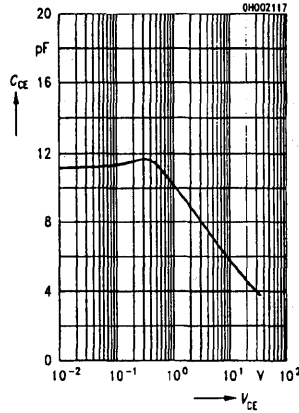

Figure 6. Output characteristics
 $T_A=25^\circ\text{C}$, $I_{CE}=f(V_{CE}, \pm I_F)$

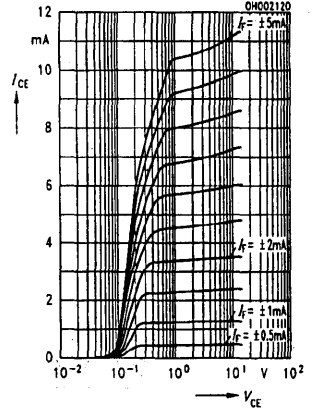

Figure 7. Permissible loss diode
 $I_F=f(T_A)$

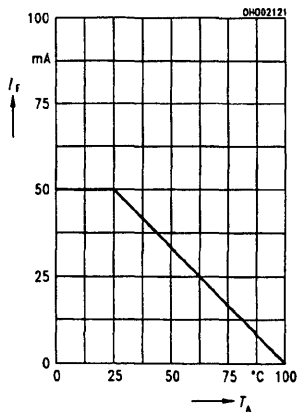

Figure 8. Permissible power dissipation
 $P_{TOT}=f(T_A)$

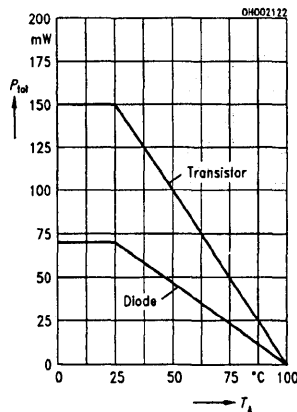
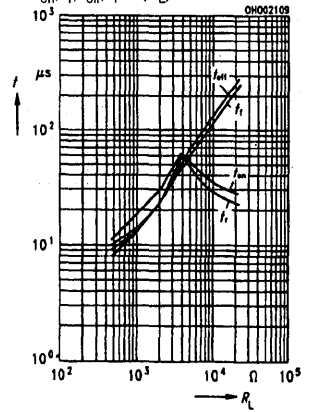

Figure 9. Switching times (typ.)
 $T_A=25^\circ\text{C}$, $I_F=\pm 1\text{ mA}$, $V_{CC}=5\text{ V}$
 t_{ON} , t_r , t_{OFF} , $t_f=f(R_L)$



PHOTOTRANSISTOR 5.3 KV TRIOS® HIGH V_{CER} VOLTAGE OPTOCOUPLER

FEATURES

- CTR at $I_F=10$ mA, $V_{CE}=10$ V
SFH640-1, 40-80%
SFH640-2, 63-125%
SFH640-3*, 100-200%
- Good CTR Linearity with Forward Current
- Low CTR Degradation
- Very High Collector-Emitter Breakdown Voltage, $V_{CER}=300$ V
- Withstand Test Voltage: 5300 VDC
- Low Coupling Capacitance
- High Common Mode Transient Immunity
- Phototransistor Optocoupler
- 6 Pin DIP Package with Base Connection
- Field Effect Stable: TRIOS⁺
- Options Available
 - Option 1: Tested per VDE #0884
 - Option 6: Lead Bend, VDE #0805/0806
 - Option 7: SMD Lead Bend
- Underwriters Lab File #E52744

DESCRIPTION

The SFH 640 is an optocoupler with very high V_{CER} , a minimum of 300 volts. It is intended for telecommunications applications or any DC application requiring a high blocking voltage. The SFH640 is a "better than" replacement for H11D1.

*Supplies from this group can't always be guaranteed due to unforeseeable yield spread.

*TRIOS-TRansparent IOShield

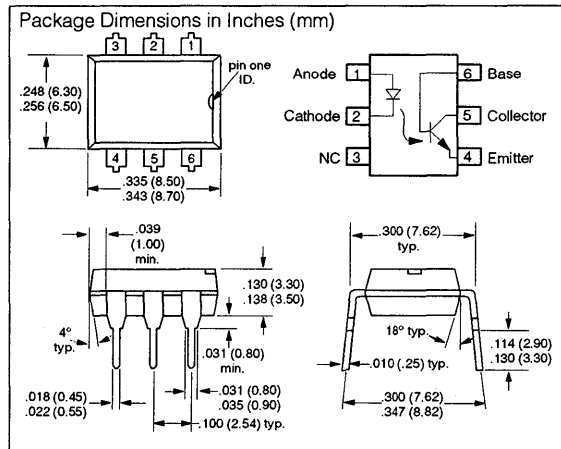

Maximum Ratings ($T_A=25^\circ\text{C}$)

Emitter

Reverse Voltage	6 V
DC Forward Current	60 mA
Surge Forward Current ($t_p \leq 10 \mu\text{s}$)	2.5 A
Total Power Dissipation	100 mW

Detector

Collector-Emitter Voltage	300 V
Collector-Base Voltage	300 V
Emitter-Base Voltage	7 V
Collector Current	100 mA
Total Power Dissipation	300 mW

Package

Withstand Test Voltage between Emitter and Detector referred to Climate DIN 40046 part 2 Nov. 74	5300 VDC
Insulation Resistance	
$V_{IO}=500$ V, $T_A=25^\circ\text{C}$	$\geq 10^{12} \Omega$
$V_{IO}=500$ V, $T_A=100^\circ\text{C}$	$\geq 10^{11} \Omega$
Insulation Thickness between Emitter and Detector	≥ 0.4 mm
Creepage Distance	≥ 7 mm
Clearance Distance	≥ 7 mm
Comparative Tracking Index per DIN IEC 112/VDE 0303, part1)	175
Storage Temperature Range	-55°C to $+150^\circ\text{C}$
Operating Temperature Range	-55°C to $+100^\circ\text{C}$
Junction Temperature	100°C
Soldering Temperature (max. 10 sec., dip soldering): distance to seating plane ≥ 1.5 mm)	260°C

Characteristics ($T_A=25^\circ\text{C}$, unless otherwise specified)

	Symbol	Min.	Typ.	Max.	Unit	Condition
Emitter						
Forward Voltage	V_F		1.1	1.5	V	$I_F=10\text{ mA}$
Reverse Voltage	V_R	6			V	$I_R=10\text{ }\mu\text{A}$
Reverse Current	I_R		0.01	10	μA	$V_R=6\text{ V}$
Capacitance	C_O		25		pF	$V_R=0\text{ V}, f=1\text{ MHz}$
Thermal Resistance	R_{thJA}		750		K/W	
Detector						
Voltage					V	
Collector-Emitter	BV_{CER}	300			V	$I_{CE}=1\text{ mA}, R_{BE}=1\text{ M}\Omega$
Emitter-Base	BV_{EBO}	7			V	$I_{EB}=10\text{ }\mu\text{A}$
Capacitance					pF	
	C_{CE}		7		pF	$V_{CE}=10\text{ V}, f=1\text{ MHz}$
	C_{CB}		8		pF	$V_{CB}=10\text{ V}, f=1\text{ MHz}$
	C_{EB}		38		pF	$V_{EB}=5\text{ V}, f=1\text{ MHz}$
Thermal Resistance	R_{thJA}		250		K/W	
Package						
Coupling Capacitance	C_C		0.6		pF	
Coupling Transfer Ratio					%	
SFH640-1	I_C/I_F	40		80	%	$I_F=10\text{ mA}, V_{CE}=10\text{ V}$
		13	30		%	$I_F=1\text{ mA}, V_{CE}=10\text{ V}$
SFH640-2	I_C/I_F	63		125	%	$I_F=10\text{ mA}, V_{CE}=10\text{ V}$
		22	45		%	$I_F=1\text{ mA}, V_{CE}=10\text{ V}$
SFH640-3	I_C/I_F	100		200	%	$I_F=10\text{ mA}, V_{CE}=10\text{ V}$
		34	70		%	$I_F=1\text{ mA}, V_{CE}=10\text{ V}$
Saturation Voltage					V	
Collector-Emitter	V_{CEsat}		0.25	0.4	V	$I_F=10\text{ mA}, I_C=2\text{ mA}$
SFH640-1	V_{CEsat}		0.25	0.4	V	$I_F=10\text{ mA}, I_C=3.2\text{ mA}$
SFH640-2	V_{CEsat}		0.25	0.4	V	$I_F=10\text{ mA}, I_C=5\text{ mA}$
SFH640-3	V_{CEsat}		0.25	0.4	V	
Leakage Current					nA	
Collector-Emitter	I_{CER}	1		100	nA	$V_{CE}=200\text{ V}, R_{BE}=1\text{ M}\Omega$

Switching Times Measurement – Test Circuit and Waveform

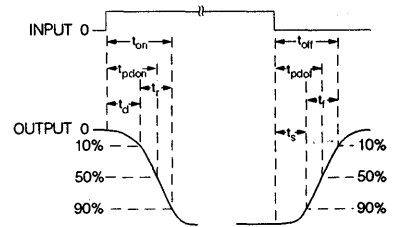
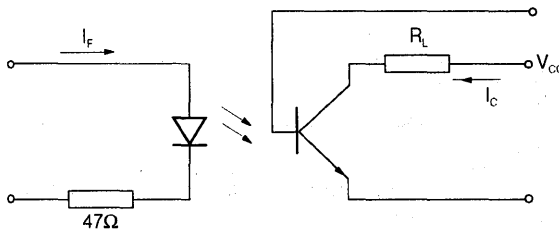

Switching Times (Typical)

$I_C=2\text{ mA}$ (to adjust by I_F), $R_L=100\text{ }\Omega$, $T_A=25^\circ\text{C}$, $V_{CC}=10\text{ V}$

Description	Symbol	Values	Unit
Turn-On Time	t_{ON}	5	μs
Rise Time	t_R	2.5	μs
Turn-Off Time	t_{OFF}	6	μs
Fall Time	t_F	5.5	μs

Figure 1. Current transfer ratio (typ.)
 $V_{CE}=10\text{ V}$, $T_A=25^\circ\text{C}$, normalized to $I_F=10\text{ mA}$
 $NCTR=f(I_F)$

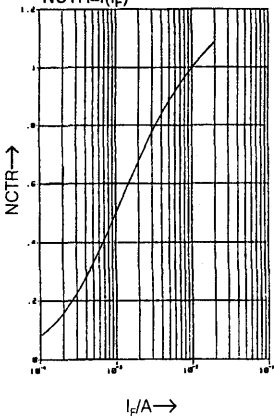

Figure 2. Diode forward voltage (typ.) $V_F=f(I_F, T_A)$

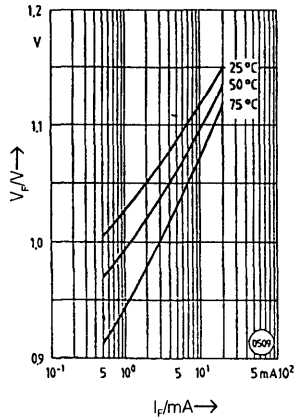

Figure 3. Output characteristics (typ.) $T_A=25^\circ\text{C}$, $I_{CE}=f(V_{CE}, I_B)$

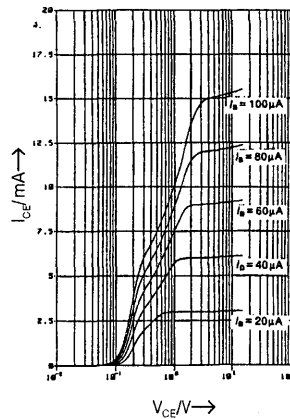

Figure 4. Output characteristics (typ.)
 $T_A=25^\circ\text{C}$, $I_{CE}=f(V_{CE}, I_F)$

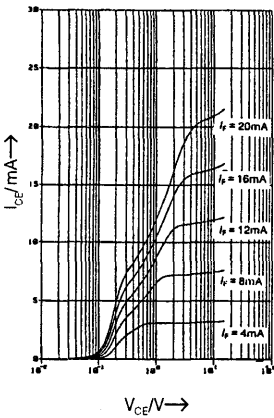

Figure 5. Transistor capacitances (typ.) $T_A=25^\circ\text{C}$, $f=1\text{ MHz}$, $C_{CE}=f(V_{CE})$
 $C_{CB}=f(V_{CB})$, $C_{EB}=f(V_{EB})$

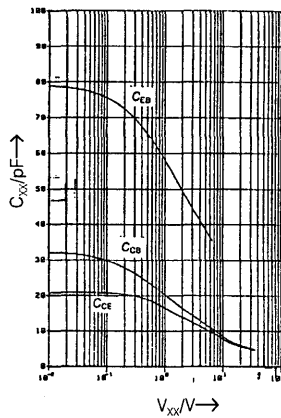

Figure 6. Collector-emitter leakage current (typ.) $I_F=0$, $R_{BE}=1\text{ MW}$, $I_{CER}=f(V_{CE})$

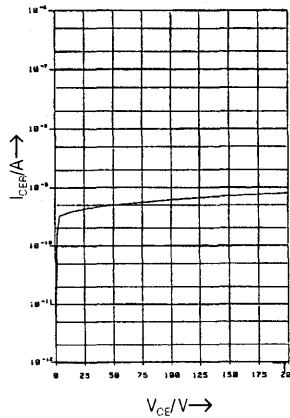

Figure 7. Permissible loss diode
 $I_F=f(T_A)$

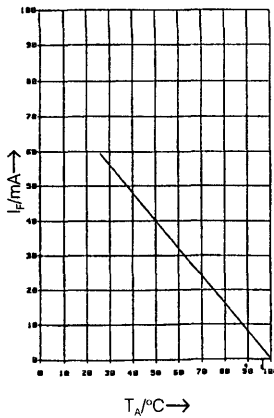
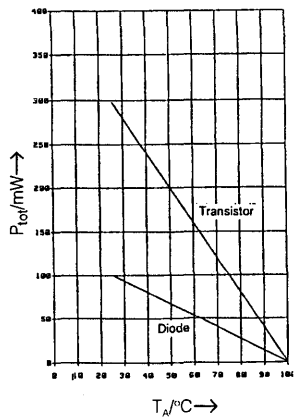

Figure 7. Permissible power dissipation $P_{TOT}=f(T_A)$



Optocouplers
(Optoisolators)

5.3 kV TRIOS®* HIGH RELIABILITY OPTOCOUPLERS

FEATURES

- SMD Versions of SFH610, 611, 615, 618, 620, 628
- Available on Tape and Reel—To Order Use Suffix "T"

DESCRIPTION

The SFH6106, 6116, 6156, 6186, 6206, 6286 families of optocouplers are lead bent for SMD applications. They are electrically equivalent to the SFH610, 611, 615, 618, 620, and 628 families of optocouplers.

CROSS REFERENCE

	Equivalents
SFH6106-1	SFH610-1
SFH6106-2	SFH610-2
SFH6106-3	SFH610-3
SFH6106-4	SFH610-4
SFH6116-1	SFH611-1
SFH6116-2	SFH611-2
SFH6116-3	SFH611-3
SFH6116-4	SFH611-4
SFH6156-1	SFH615-1
SFH6156-2	SFH615-2
SFH6156-3	SFH615-3
SFH6156-4	SFH615-4
SFH6186-2	SFH618-2
SFH6186-3	SFH618-3
SFH6186-4	SFH618-4
SFH6186-5	SFH618-5
SFH6206-1	SFH620-1
SFH6206-2	SFH620-2
SFH6206-3	SFH620-3
SFH6286-2	SFH628-2
SFH6286-3	SFH628-3
SFH6286-4	SFH628-4

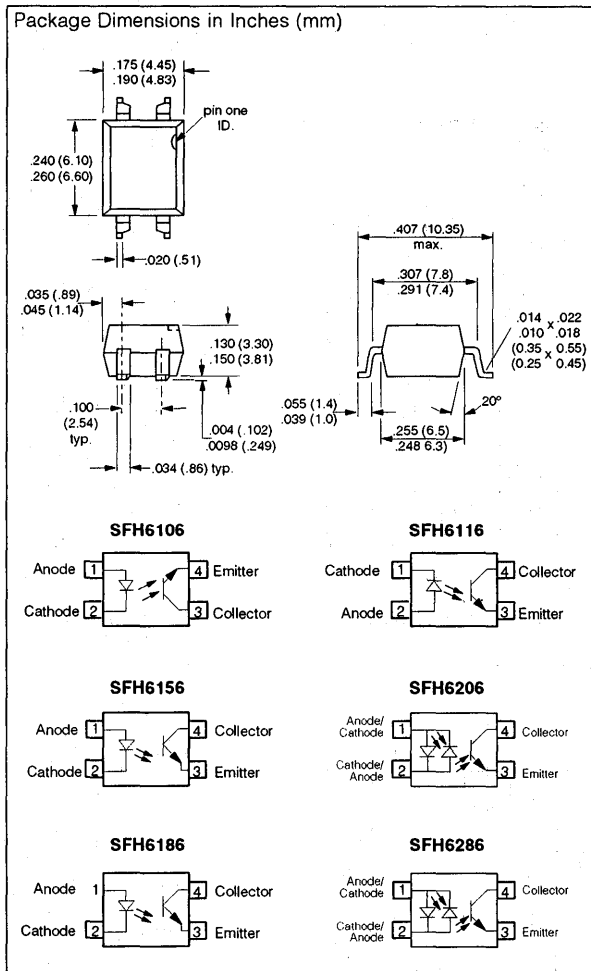

*TRIOS—Transparent IO Shield

FEATURES

- Withstand Test Voltage: 5300 VDC
- TTL Compatible
- High Bit Rates: 1 Mbit/s
- High Common-Mode Interference Immunity
- Bandwidth 2 MHz
- Open-Collector Output
- External Base Wiring Possible
- Field-Effect Stable by TRIOS*
- Underwriters Lab File #52744
-  VDE Approval #0884 (Optional with Option 1, add -X001 Suffix)

DESCRIPTION

The SFH6135 and SFH6136 optocouplers feature a high signal transmission rate and a high isolation resistance. They have a GaAlAs infrared emitting diode, optically coupled with an integrated photodetector which consists of a photodiode and a high-speed transistor in a DIP-8 plastic package.

Signals can be transmitted between two electrically separated circuits up to frequencies of 2 MHz. The potential difference between the circuits to be coupled is not allowed to exceed the maximum permissible reference voltages.

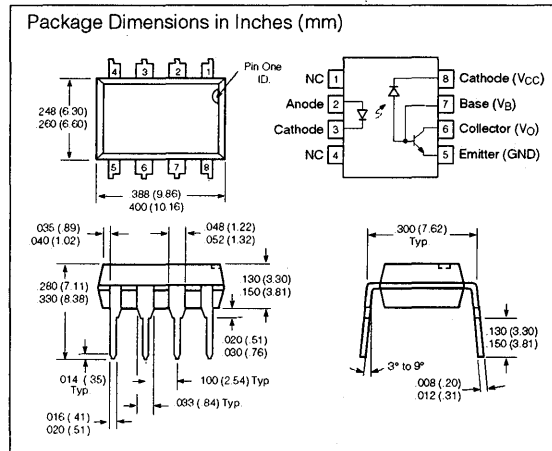

Maximum Ratings

Emitter

Reverse Voltage	3 V
Forward Current	25 mA
Peak Forward Current (t = 1 ms, duty cycle 50%)	50 mA
Maximum Surge Forward Current (t ≤ 1 μs, 300 pulses/s)	1 A
Thermal Resistance	700 K/W
Total Power Dissipation (T _A ≤ 70°C)	45 mW

Detector

Supply Voltage	-0.5 to 15 V
Output Voltage	-0.5 to 15 V
Emitter-Base Voltage	5 V
Output Current	8 mA
Maximum Output Current	16 mA
Base Current	5 mA
Thermal Resistance	300 K/W
Total Power Dissipation (T _A ≤ 70°C)	100 mW

Package

Isolation Test Voltage (between emitter and detector climate)	5300 VDC
Pollution Degree (DIN VDE 0110)	2
Creepage Distance	≥ 7 mm
Clearance	≥ 7 mm
Comparative Tracking Index per DIN IEC112/VDE 0303 part 1	175
Isolation Resistance	
V _{IO} = 500 V, T _A = 25°C	≥ 10 ¹² Ω
V _{IO} = 500 V, T _A = 100°C	≥ 10 ¹¹ Ω
Storage Temperature Range	-55°C to +125°C
Ambient Temperature Range	-55°C to +100°C
Soldering Temperature (max. ≤ 10 s. dip soldering ≥ 0.5 mm distance from case bottom)	260°C

*TRIOS – TRansparent IO Shield

Characteristics

($T_A=0$ to 70°C unless otherwise specified)

Emitter	Symbol	Unit	Condition
Forward Voltage	V_F	1.5 (≤ 1.7) V	$I_F=16$ mA
Breakdown Voltage	V_{BR}	≥ 3 V	$I_R=10$ μ A
Reverse Current	I_R	0.5 (≤ 10) μ A	$V_R=3$ V
Capacitance	C_0	125 pF	$V_R=0$ V, $f=1$ MHz
Temperature Coefficient of Forward Voltage	$\Delta V_F/\Delta T_A$	-1.7 mV/ $^\circ\text{C}$	$I_F=16$ mA
Detector			
Supply Current			$I_F=16$ mA, V_O open, $V_{CC}=15$ V
Logic Low	I_{CCL}	150 μ A	$I_F=0$ mA, V_O open, $V_{CC}=15$ V
Supply Current			$I_F=16$ mA, V_O open, $V_{CC}=4.5$ V
Logic High	I_{CCH}	0.01 (≤ 1) μ A	$I_O=1.1$ mA
Output Voltage			$I_F=16$ mA, $V_{CC}=4.5$ V
Output Low	V_{OL}	0.1 (≤ 0.4) V	$I_O=1.1$ mA
SFH6135	V_{OL}	0.1 (≤ 0.4) V	$I_O=2.4$ mA
SFH6136			
Output Current			$I_F=0$ mA, $V_O=V_{CC}=5.5$ V
Output High	I_{OH}	3 (≤ 500) nA	$I_F=0$ mA
Output Current			$V_O=V_{CC}=15$ V
Output High	I_{OH}	0.01 (≤ 1) μ A	$V_O=5$ V, $I_O=3$ mA
Current Gain	H_{FE}	150	
Package			
Coupling Capacitance			$f=1$ MHz
Input-Output	C_{IO}	0.6 pF	$I_F=16$ mA, $V_O=0.4$ V, $V_{CC}=4.5$ V, $T_A=25^\circ\text{C}$
Current Transfer Ratio			
SFH6135	CTR	16 (≥ 7) %	
SFH6136	CTR	35 (≥ 19) %	
Current Transfer Ratio			$I_F=16$ mA, $V_O=0.4$ V, $V_{CC}=4.5$ V
SFH6135	CTR	≥ 5 %	
SFH6136	CTR	≥ 15 %	

SWITCHING TIMES

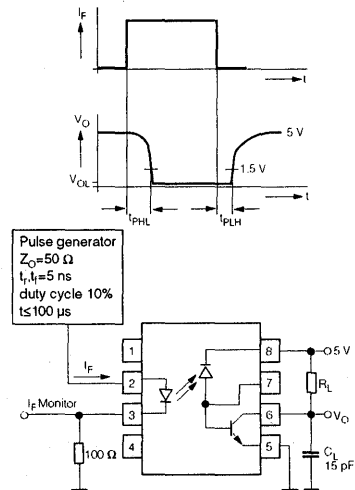

Delay Time ($I_F=16$ mA, $V_{CC}=5$ V, $T_A=25^\circ\text{C}$)

High - Low			
SFH6135 ($R_L=4.1$ k Ω)	t_{PHL}	0.3 (≤ 1.5)	μs
SFH6136 ($R_L=1.9$ k Ω)	t_{PHL}	0.2 (≤ 0.8)	μs
Low - High			
SFH6135 ($R_L=4.1$ k Ω)	t_{PHL}	0.3 (≤ 1.5)	μs
SFH6136 ($R_L=1.9$ k Ω)	t_{PHL}	0.2 (≤ 0.8)	μs

COMMON-MODE INTERFERENCE IMMUNITY

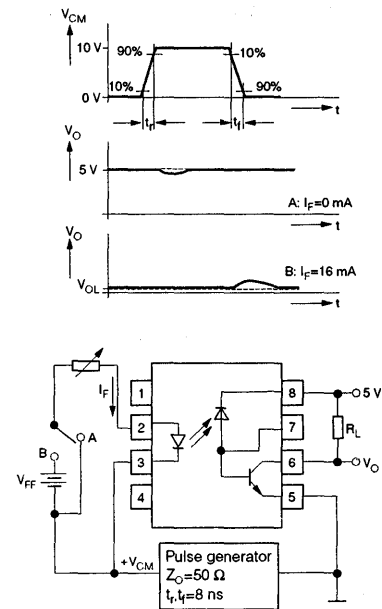

Common Mode Interference Immunity

($V_{CM}=10$ V_{P-P}, $V_{CC}=5$ V, $T_A=25^\circ\text{C}$)

High ($I_F=0$ mA)			
SFH6135 ($R_L=4.1$ k Ω)	CM_H	1000	V/ μs
SFH6136 ($R_L=1.9$ k Ω)	CM_H	1000	V/ μs
Low ($I_F=16$ mA)			
SFH6135 ($R_L=4.1$ k Ω)	CM_L	1000	V/ μs
SFH6136 ($R_L=1.9$ k Ω)	CM_L	1000	V/ μs

Figure 1. Output characteristics—SFH6135
 Output current versus output voltage

($T_A=25^\circ\text{C}$, $V_{CC}=5$ V)

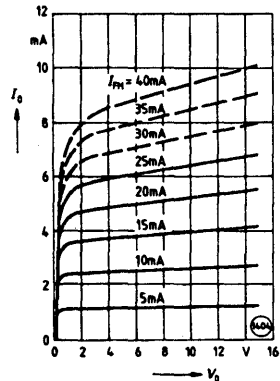

Figure 2. Output characteristics—SFH6136
Output current versus output voltage
($T_A=25^\circ\text{C}$, $V_{CC}=5\text{ V}$)

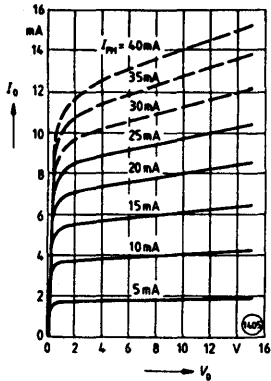

Figure 5. Forward current of emitting diode versus forward voltage ($T_A=25^\circ\text{C}$)

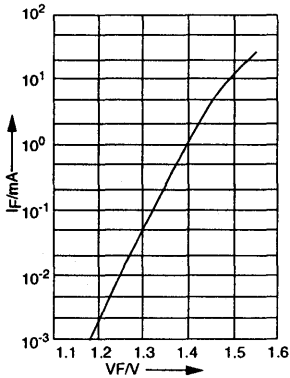

Figure 8. Output current (high) versus ambient temperature ($V_O=V_{CC}=5\text{ V}$, $I_F=0$)

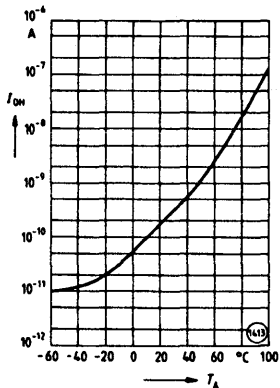

Figure 3. Permissible forward current of emitting diode versus ambient temperature

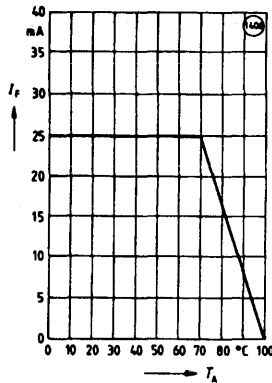

Figure 6. Small signal transfer ratio versus forward current ($V_{CC}=5\text{ V}$, $T_A=25^\circ\text{C}$)

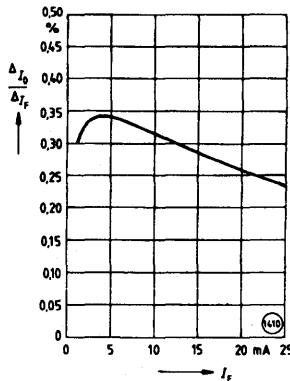

Figure 9. Delay times versus ambient temperature ($I_F=16\text{ mA}$, $V_{CC}=5\text{ V}$, SFH6135: $R_L=4.1\text{ kW}$, SFH6136: $R_L=1.9\text{ kW}$)

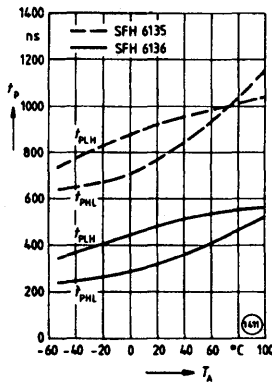

Figure 4. Permissible total power dissipation versus ambient temperature

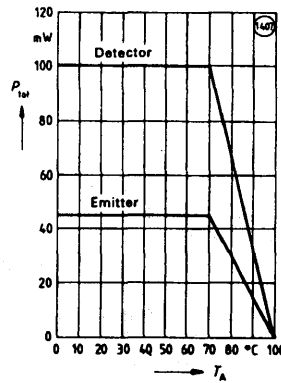

Figure 7. Current transfer ratio (normalized) versus ambient temperature ($I_F=16\text{ mA}$, $V_O=0.4\text{ V}$, $V_{CC}=5\text{ V}$, $T_A=25^\circ\text{C}$)

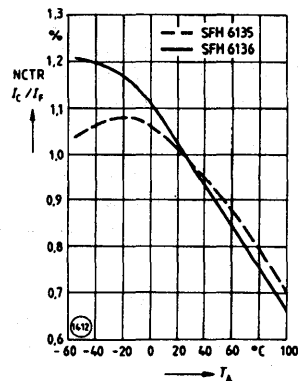
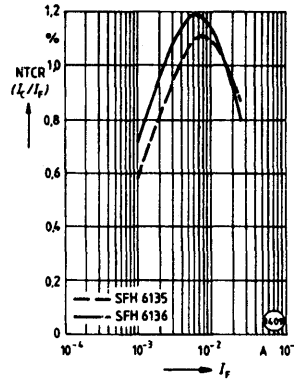

Figure 10. Current transfer ratio (normalized) versus forward current ($I_F=16\text{ mA}$, $V_O=0.4\text{ V}$, $V_{CC}=5\text{ V}$, $T_A=25^\circ\text{C}$)



Optocouplers
(Optoisolators)

FEATURES

- High Current Transfer Ratio, 800%
- Low Input Current Requirement, 0.5mA
- High Output Current, 60mA
- Withstand Test Voltage, 5300 VDC
- TTL Compatible Output, 0.1V V_{OL}
- High Common Mode Rejection, 500V/ μ sec.
- DC to 0.1 Megabit/Sec. Operation
- Adjustable Bandwidth—Access to Base
- Standard Molded Dip Plastic Package
- Underwriters Lab File #E52744
- Option 1 Available: VDE Approval #0884

APPLICATIONS

- Logic Ground Isolation—TTL/TTL, TTL/CMOS, CMOS/CMOS, CMOS/TTL
- EIA RS 232C Line Receiver
- Low Input Current Line Receiver—Long Lines, Party Lines
- Telephone Ring Detector
- 117 VAC Line Voltage Status Indication—Low Input Power Dissipation
- Low Power Systems—Ground Isolation

DESCRIPTION

High common mode transient immunity and very high current ratio together with 5300 VDC insulation are achieved by coupling an LED with an integrated high gain photon detector in an eight pin dual-in-line package. Separate pins for the photodiode and output stage enable TTL compatible saturation voltages with high speed operation. Photodarlington operation is achieved by tying the V_{CC} and V_O terminals together. Access to the base terminal allows adjustment to the gain bandwidth.

The SFH6138 is ideal for TTL applications since the 300% minimum current transfer ratio with an LED current of 1.6 mA enables operation with one unit load-in and one unit load-out with a 2.2 K Ω pull-up resistor.

The SFH6139 is best suited for low power logic applications involving CMOS and low power TTL. A 400% current transfer ratio with only 0.5 mA of LED current is guaranteed from 0°C to 70°C.

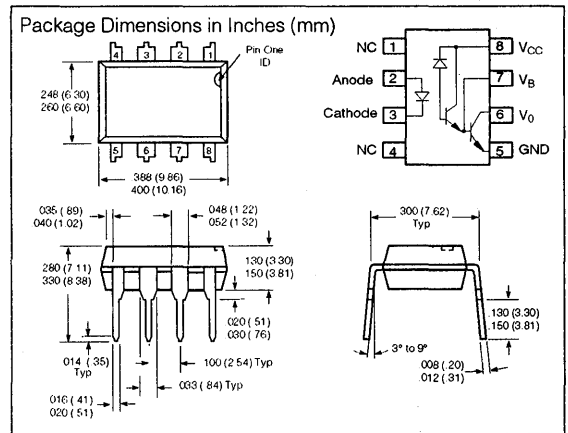

Maximum Ratings

Reverse Input Voltage	5 V
Supply and Output Voltage, V_{CC} (pin 8-5), V_O (pin 6-5)	
SFH6138	-0.5 to 7 V
SFH6139	-0.5 to 18 V
Emitter-Base Reverse Voltage (pin 5-7)	0.5 V
Average Input Current	20 mA
Peak Input Current	40 mA
(50% Duty Cycle—1 ms pulse width)	
Peak Transient Input Current	
($t_p \leq 1 \mu$ sec, 300 pps	1.0 A
Output Current I_O (pin 6)	60 mA
Derate linearly above 25°C, free air temperature at 0.7 mA/°C	
Input Power Dissipation	35 mW
Derate linearly above 50%, free air temperature at 0.7 mW/°C	
Output Power Dissipation	100 mW
Derate linearly above 25°C, free air temperature at 0.2 mA/°C	
Storage Temperature	-55°C to +125°C
Operating Temperature	-55°C to +100°C
Lead Soldering Temperature ($t = 10$ sec.)	260°C

*TRIOS—Transparent IO Shield

Electro-Optical Characteristics ($T_A=0^{\circ}\text{C}$ to 70°C , unless otherwise specified)

Parameter	Device	Min	Typ	Max	Units	Test Conditions	Note
Current Transfer Ratio (CTR)	SFH6138	300	1600		%	$I_F=1.6\text{ mA}, V_O=0.4\text{ V}, V_{CC}=4.5\text{ V}$	5,6
	SFH6139	400	1600		%	$I_F=0.5\text{ mA}, V_O=0.4\text{ V}, V_{CC}=4.5\text{ V}$	5,6
		500	2000			$I_F=1.6\text{ mA}, V_O=0.4\text{ V}, V_{CC}=4.5\text{ V}$	
Logic Low	SFH6138		0.1	0.4	V	$I_F=1.6\text{ mA}, I_O=4.8\text{ mA}, V_{CC}=4.5\text{ V}$	6
Output Voltage (VOL)	SFH6139		0.1	0.4	V	$I_F=1.6\text{ mA}, I_O=8\text{ mA}, V_{CC}=4.5\text{ V}$	6
	SFH6139		0.15	0.4		$I_F=5\text{ mA}, I_O=15\text{ mA}, V_{CC}=4.5\text{ V}$	
	SFH6139		0.25	0.4		$I_F=12\text{ mA}, I_O=24\text{ mA}, V_{CC}=4.5\text{ V}$	
Logic High	SFH6138		0.1	250	μA	$I_F=0\text{ mA}, V_O=V_{CC}=7\text{ V}$	6
Output Current (I_{OH})	SFH6139		0.05	100	μA	$I_F=0\text{ mA}, V_O=V_{CC}=18\text{ V}$	6
Logic Low Supply Current (I_{CCL})			0.2	1.5	mA	$I_F=1.6\text{ mA}, V_O=\text{OPEN}, V_{CC}=18\text{ V}$	6
Logic High Supply Current (I_{CCH})			0.001	10	μA	$I_F=0\text{ mA}, V_O=\text{OPEN}, V_{CC}=18\text{ V}$	6
Input Forward Voltage (VF)			1.4	1.7	V	$I_F=1.6\text{ mA}, T_A=25^{\circ}\text{C}$	
Input Reverse Breakdown Voltage (BV_R)		5			V	$I_R=10\text{ }\mu\text{A}$	
Temperature Coefficient of Forward Voltage			-1.8		mV/ $^{\circ}\text{C}$	$I_F=1.6\text{ mA}$	
Input Capacitance (C_{IN})			25		pF	$f=1\text{ MHz}, V_F=0$	
Input-Output Insulation Leakage Current (I-O)				1.0	μA	45% Relative Humidity, $T_A=25^{\circ}\text{C}$ $t=5\text{ s}, V_{1-0}=5300\text{ VDC}$	7
Resistance (Input-Output) (R_{I-O})			10^{12}		Ω	$V_{I-O}=500\text{ VDC}$	7
Capacitance (Input-Output)			0.6		pF	$f=1\text{ MHz}$	7

Switching Specifications ($T_A=25^{\circ}\text{C}$)

Parameter	Device	Min.	Typ.	Max.	Units	Test Conditions	Note
Propagation Delay Time	SFH6138		2	10	μs	$I_F=1.6\text{ mA}, R_L=2.2\text{ K}\Omega$	
	SFH6139		6	25	μs	$I_F=0.5\text{ mA}, R_L=4.7\text{ K}\Omega$	6,8
		0.6	1		$I_F=12\text{ mA}, R_L=270\text{ }\Omega$		
Propagation Delay Time	SFH6138		4	35	μs	$I_F=1.6\text{ mA}, R_L=2.2\text{ K}\Omega$	
	SFH6139		5	60	μs	$I_F=0.5\text{ mA}, R_L=4.7\text{ K}\Omega$	6,8
		1	7		$I_F=12\text{ mA}, R_L=270\text{ m}\Omega$		
Common Mode Transient Immunity at Logic High Level (CM_H) Output			500		V/ μs	$I_F=0\text{ mA}, R_L=2.2\text{ K}\Omega$ $R_{CC}=0/V_{CM}=10\text{ }V_{p-p}$	9,10
Common Mode Transient Immunity at Logic Low Level (CM_L) Output			-500		V/ μs	$I_F=1.6\text{ mA}, R_L=2.2\text{ K}\Omega$ $R_{CC}=0/V_{CM}=10\text{ }V_{p-p}$	9,10

Notes

- Derate linearly above 50°C free-air temperature at a rate of $0.4\text{ mA}/^{\circ}\text{C}$.
- Derate linearly above 50°C free-air temperature at a rate of $0.7\text{ mW}/^{\circ}\text{C}$.
- Derate linearly above 25°C free-air temperature at a rate of $0.7\text{ mA}/^{\circ}\text{C}$.
- Derate linearly above 25°C free-air temperature at a rate of $2.0\text{ mW}/^{\circ}\text{C}$.
- DC current transfer ratio is defined as the ratio of output collector current, I_O , to the forward LED input current, I_F times 100%.
- Pin 7 open.
- Device considered a two-terminal device: pins 1, 2, 3 and 4 shorted together and pins 5, 6, 7 and 8 shorted together.
- Using a resistor between pin 5 and 7 will decrease gain and delay time.
- Common mode transient immunity in logic high level is the maximum tolerable (positive) dV_{cm}/dt on the leading edge of the common mode pulse, V_{CM} , to assure that the output will remain in a logic high state (i.e. $V_O > 2.0\text{ V}$) common mode transient immunity in logic low level is the maximum tolerable (negative) dV_{cm}/dt on the trailing edge of the common mode pulse signal, V_{CM} , to assure that the output will remain in a logic low state (i.e. $V_O < 0.8\text{ V}$).
- In applications where dv/dt may exceed $50,000\text{ V}/\mu\text{s}$ (such as state discharge) a series resistor, R_{CC} should be included to protect I_C from destructively high surge currents. The recommended value is $R_{CC} \cong \frac{IV}{0.15\text{ I}_F(\text{mA})}$ k Ω .

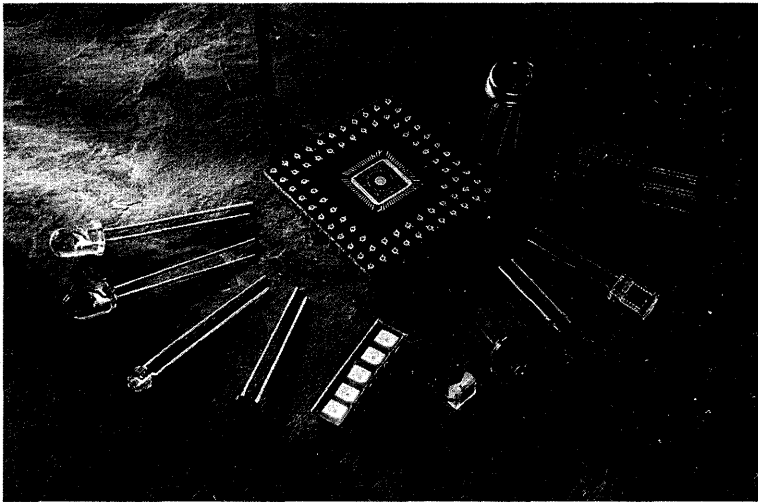

Fiber Optic Devices

Laser Diodes

Infrared Emitters

Photodiodes

Phototransistors

Photovoltaic Cells

Fiber Optic Emitters

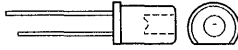
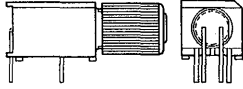
Package Outline	Part No.	Package Type	Infrared/ Visible (Color)	Maximum Wave- length nm	Φ_{in} 10 mA NW	Features	Page
	SFH450	T1 ³ / ₄ light gray plastic	Infrared	950 GaAs	90	Fiber optic short distance data transmission. 2.2 mm aperture holds 1000 micron plastic fiber. Matches SFH250/V or SFH350/V, or SFH551/V.	6-10
	SFH750	T1 ³ / ₄ red plastic	Visible (Red) (Hyper-Red)	660 GaAs	9		6-14
	SFH752			665	80		
	SFH450V	Gray plastic connector housing.	Infrared	950 GaAs	90		6-10
	SFH452V			770	180		
	SFH750V		Visible (Red)	660	9		6-14
	SFH752V		Visible (Hyper-Red)	665	80		

Fiber Optic Photodetectors

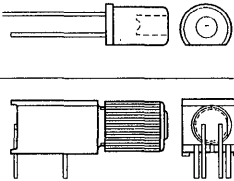
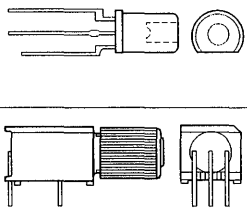
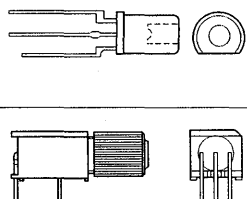
Package Outline	Part No.	Package Type	Aperture mm	Photo-current $\lambda=660$ nm	Max. Wave- length nm	Features	Page
	SFH250	T1 ³ / ₄ clear plastic	2.2	$V_R=5$ V 3(≥ 1.6) μ A	850	PIN Photodiode Fiber optic short distance data transmission. 2.2 mm aperture holds 1000 micron plastic fiber. Matches SFH450/450V, 452V or 750,750V.	6-6
	SFH250V	Black plastic connector housing.			850		
	SFH350	T1 ³ / ₄ clear plastic	2.2	$V_{CE}=5$ V 0.8 (≥ 0.16) mA	850	PIN Phototransistor Fiber optic short distance data transmission. 2.2 mm aperture holds 1000 micron plastic fiber. Matches SFH450/V, 452V, 750V, or 752V.	6-8
	SFH350V	Black plastic connector housing.					
	SFH551	T1 ³ / ₄ right angle mount	2.2	NA	NA	Integrated Photodetector DC coupled trans-impedance amplifier with TTL compatible open collector output.	6-13
	SFH551V	Right angle plastic connector housing.					

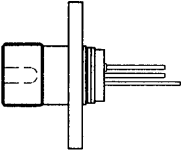
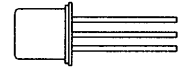
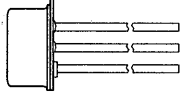
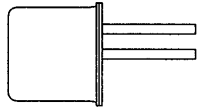
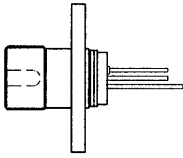
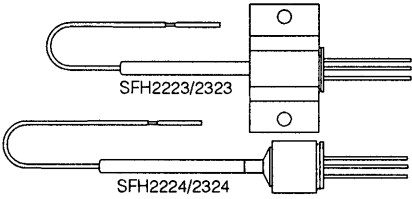
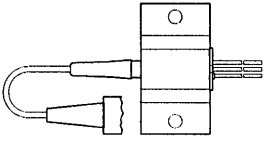
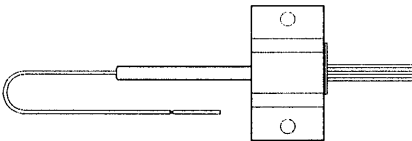
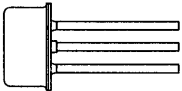

Laser Diodes

Package Outline	Part Number	Package Type	Description	Page
	SFH2115	Similar to TO 18	GaAs energy converter. 8 diodes connected in series.	6-17
	SFH2210	Similar to TO 18, 3 pins.	Ternary PIN photodiode.	6-18
	SFH2310		GE avalanche photodiode.	6-24
	SFH2212	Similar to TO 18	IRED.	6-19
	SFH2213	Similar to TO 18	Ternary PIN photodiode.	6-20
	SFH2215	Hermetically sealed subcomponent similar to TO 18 SFH2215-3 pins SFH4415-4 pins	Ternary PIN photodiode, FC receptacle.	6-21
	SFH4415/I		Low power laserdiode, FC receptacle.	6-34
	SFH4415/II		High power laserdiode, FC receptacle.	6-35
 SFH2223/2323 SFH2224/2324	SFH2223 SFH2224	Hermetically sealed subcomponent similar to TO 18, 3 pins SFH2224/2324, without flange	Ternary PIN photodiode, MM fiber pigtail.	6-22
	SFH2323 SFH2324		GE avalanche photodiode, MM fiber pigtail.	6-25
	SFH2249	Hermetically sealed subcomponent similar to TO 18 with flange	Ternary PIN photodiode, SM fiber pigtail.	6-23
	SFH2325 SFH2326	Hermetically sealed subcomponent with central pin, similar to TO 18, 3 pins	GE avalanche photodiode, MM fiber pigtail.	6-26
	SFH4210	Similar to TO 18, 3 pins	IRED.	6-27
	SFH4212		IRED.	6-28

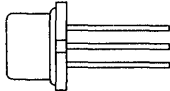
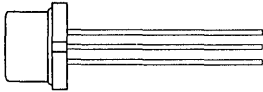
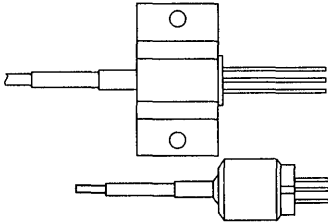
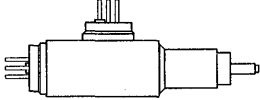
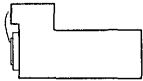
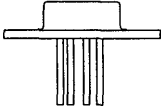
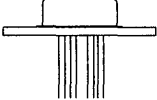
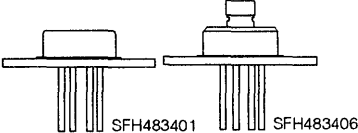
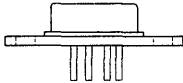
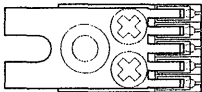
Laser Diodes

Package Outline	Part Number	Package Type	Description	Page
	SFH4410	Hermetically sealed, similar to TO 18, 4 pins	Low power laser diode.	6-30
	SFH4413	Hermetically sealed, similar to TO 18, 4 pins	Low power laser diode, 5.6 mm coaxial package.	6-32
	SFH4423 SFH4424	Similar to TO 18, 4 pins SFH4424—without flange	Low power laser diode, SM fiber pigtail	6-36
	SFH4445	Hermetically sealed subcomponents, similar to TO 18.	Transceiver optical module ((BIDI™)).	6-38
	SFH4446			6-40
	SFH4448			6-42
	SFH4646			6-44
	SFH480301	Chip on carrier	12 stripe laser array.	6-46
	SFH482201	Hermetically sealed, TO 3 with peltier cooler	GaAlAs laser diode, 250 mW.	6-48
	SFH482301	Hermetically sealed, TO 3 with peltier cooler	GaAlAs laser diode, 500 mW.	6-50
	SFH483401 SFH483406	TO 3 with peltier cooler	GaAlAs laser diode, 1000 mW with FC receptacle.	6-52
	SFH483501	TO 3	40 stripe array, 1.5 W GaAlAs laser diode.	6-54
	SFH484401	Row design	GaAlAs laser, 5 W, 5 x 20 stripe array.	6-56

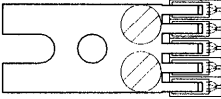
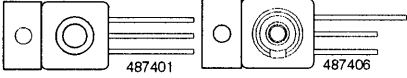
Laser Diodes

Package Outline	Part Number	Package Type	Description	Page
	SFH484501	Row design.	GaAlAs laserdiode, 5 x 40 stripe array.	6-57
	SFH487401 SFH487406	TO 220 SFH487406-FC connector (750 mW)	GaAlAs laserdiode, 1000 mW.	6-58
	SFH487501 SFH487506	TO 220 SFH487506-FC connector (1100 mW)	GaAlAs laserdiode, 1500 mW.	6-61

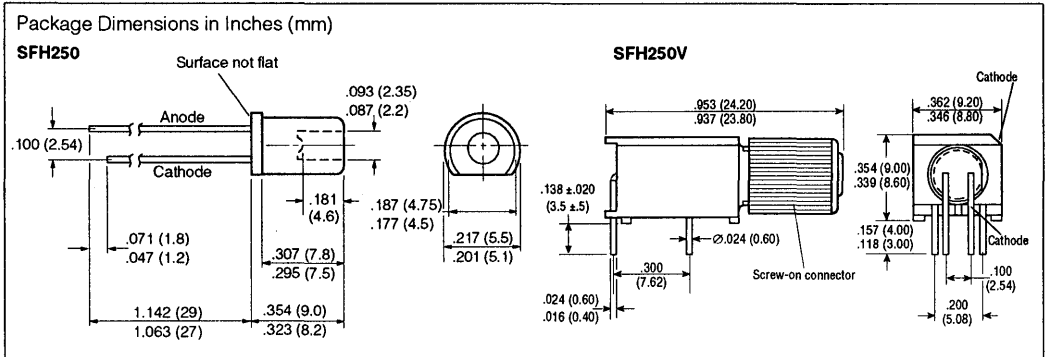

FEATURES

- 2.2 mm Aperture Holds Standard 1000 Micron Plastic Fiber
- No Fiber Stripping Required
- Fast Switching Time
- Very Good Linearity
- Sensitive in Visible and Near IR Range
- Molded Microlens for Efficient Coupling
- SFH250V Only
 - Plastic Connector Housing
 - Mounting Screw Attached to Connector
 - Interference Free Transmission from Light-Tight Housing
 - Transmitter and Receiver Can Be Flexibly Positioned
 - No Cross Talk
 - Auto Insertable and Wave Solderable
 - Supplied in Tubes
- Applications—SFH250/250V
 - Household Electronics
 - Power Electronics
 - Optical Networks
 - Medical Instruments
 - Automotive Electronics
 - Light Barriers

Maximum Ratings

Operating and Storage Temperature Range (T_{OP} , T_{STG})	-55° to +100°C
Soldering Temperature (2 mm from case bottom) (T_S) $t \leq 5$ s	260°C
Reverse Voltage (V_R)	30 V
Power Dissipation (P_{TOT}) $T_A = 25^\circ\text{C}$	100 mW
Thermal Resistance (R_{thJA})	750 K/W

Characteristics ($T_A = 25^\circ\text{C}$)

Parameter	Symbol	Value	Unit
Maximum Photosensitivity Wavelength	$\lambda_{S_{MAX}}$	850	nm
Photosensitivity Spectral Range ($S = 10\%$ of S_{MAX})	λ	400 to 1100	nm
Dark Current ($V_R = 20$ V)	I_R	1 (≤ 10)	nA
Capacitance ($V_R = 0$ V, $f = 1$ MHz, $E_V = 0$ lx)	C_0	11	pF
Rise and Fall Time of Photocurrent 10% to 90% and 90% to 10% ($R_L = 50 \Omega$, $V_R = 30$ V, $\lambda = 880$ nm)	t_R , t_F	10	ns
Noise Equivalent Power	NEP	2.9×10^{-14}	W/ $\sqrt{\text{Hz}}$
Detection Limit ($V_R = 20$ m)	D^*	3.5×10^{12}	$\text{cm} \cdot \sqrt{\text{Hz}}/\text{W}$
Photocurrent ($V_R = 5$ V, $\lambda = 950$ nm)	I_P	3 (≥ 1.6)	μA
Open Circuit Voltage ⁽¹⁾	V_O	300	mV
Temperature Coefficient I_P ($V_R = 5$ V, $\lambda = 560$ to 660 nm)	TC_I	-0.04	%/K
($V_R = 5$ V, $\lambda = 830$ nm)	TC_I	0.04	%/K
($V_R = 5$ V, $\lambda = 950$ nm)	TC_I	0.2	%/K
Temperature Coefficient V_L ($V_R = 5$ V, $\lambda = 560$ to 660 nm)	TC_V	-2.6	mV/K

Note

1. Photocurrent generated at 10 μW light incidence through plastic 1000 micron fiber (distance lens-fiber ≤ 0.1 mm. Fiber type ESKA EH4001, fiber face polished.)

See Appnote 40, 41, 42, 43 for application information.

Relative spectral sensitivity $S_{REL}=f(\lambda)$

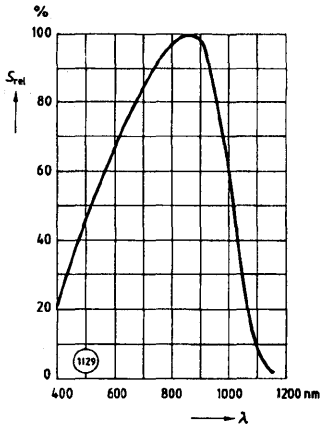

Dark current $I_R=f(V_R, T_A=25^\circ C)$

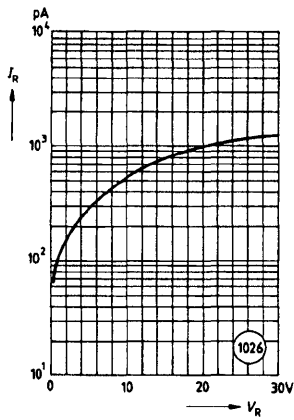

Capacitance $C=f(V_R, f=1 \text{ MHz}, E_V=0)$

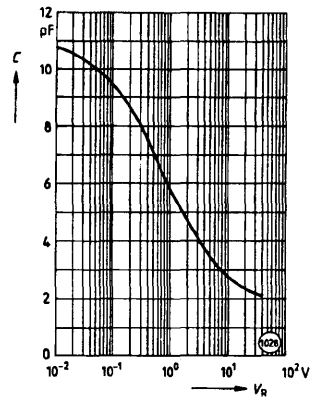

Photocurrent $I_P/I_{P25}=f(T_A)$, λ =parameter

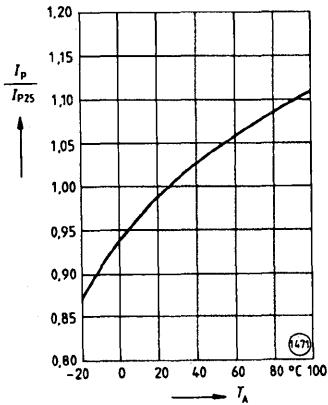

Photocurrent $I_P=f(\Phi_{OUT})$,
Open circuit voltage $V_O=f(\Phi_{OUT})$
 $\lambda=560 \text{ to } 660 \text{ nm}$

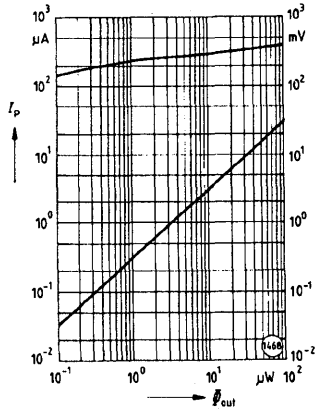

Power dissipation $P_{TOT}=f(T_A)$

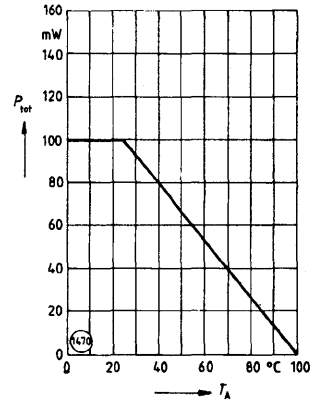

Coupling efficiency $I_{P_{in}}$ versus alignment $I_P/I_{P(x=0)}=f(X)$

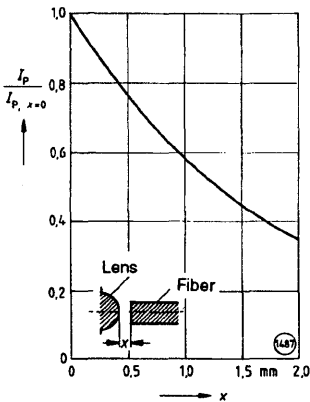

Coupling efficiency $I_{P_{in}}$ versus alignment $I_P/I_{P(x, y=0)}=f(Y)$

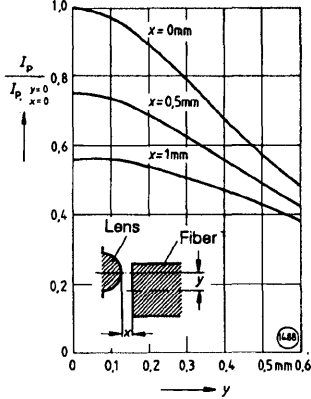

T1 3/4 SFH350 PLASTIC CONNECTOR HOUSING SFH350V PLASTIC FIBER OPTIC PHOTOTRANSISTOR DETECTOR

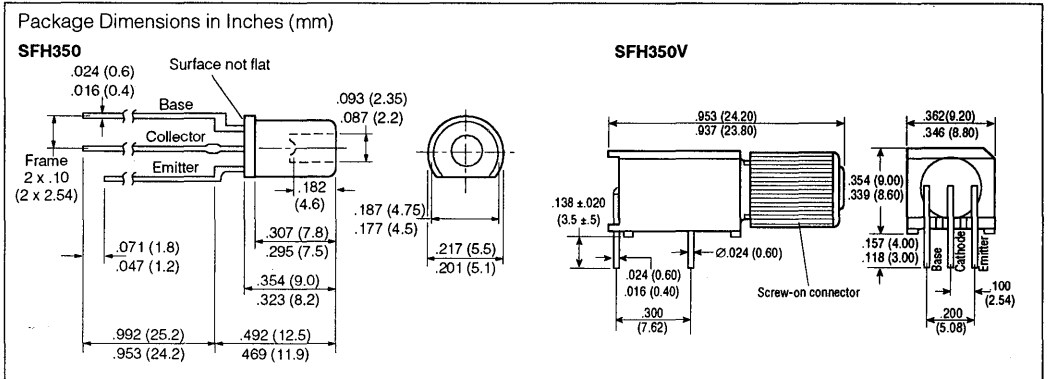

FEATURES

- 2.2 mm Aperture Holds Standard 1000 Micron Plastic Fiber
- No Fiber Stripping Required
- Good Linearity
- Sensitive in Visible and Near IR Range
- Molded Microlens for Efficient Coupling
- SFH350V Only
 - Plastic Connector Housing
 - Mounting Screw Attached to Connector
 - Interference Free Transmission from Light-Tight Housing
 - Transmitter and Receiver Can Be Flexibly Positioned
 - No Cross Talk
 - Auto Insertable and Wave Solderable
 - Supplied in Tubes
- Applications—SFH350/350V
 - Household Electronics
 - Power Electronics
 - Optical Networks
 - Medical Instruments
 - Automotive Electronics
 - Light Barriers

Maximum Ratings

Operating and Storage Temperature Range (T_{OP} , T_{STG})	–55° to +100°C
Soldering Temperature (2 mm from case bottom) (T_S) $t \leq 5$ s	260°C
Collector-Emitter Voltage (V_{CE})	50 V
Collector Current (I_C)	50 mA
Collector Peak Current (I_{CP}) $t \leq 10$ sec	100 mA
Emitter Base Voltage (V_{EB})	7 V
Power Dissipation (P_{TOT}) $T_A = 25^\circ\text{C}$	200 mW
Thermal Resistance ($R_{\theta JA}$)	375 K/W

Characteristics ($T_A = 25^\circ\text{C}$)

Parameter	Symbol	Value	Unit
Maximum Photosensitivity Wavelength	$\lambda_{S\text{MAX}}$	850	nm
Photosensitivity Spectral Range ($S = 10\%$ of S_{MAX})	λ	400 to 1100	nm
Capacitance			
($V_{CE} = 0$ V, $f = 1$ MHz, $E_V = 0$ lx)	C_{CE}	10.5	pF
($V_{CB} = 0$ V, $f = 1$ MHz, $E_V = 0$ lx)	C_{CB}	21.5	pF
($V_{EB} = 0$ V, $f = 1$ MHz, $E_V = 0$ lx)	C_{EB}	20.5	pF
Rise and Fall Time of Photocurrent ($R_L = 1$ K Ω , $I_C = 1.0$ mA, $V_{CE} = 5$ V, $\lambda = 959$ nm)	t_R , t_F	20	μs
Current Gain	HFE	500	–
Collector Dark Current ($V_{CE} = 10$ V)	I_{CEO}	2 (≤ 50)	nA
Photocurrent ($V_{CE} = 5$ V, $\lambda = 660$ nm) ⁽¹⁾	I_{CE}	0.8 (≥ 0.16)	mA
Temperature Coefficient, HFE	TC_{HFE}	0.55	%/K
Temperature Coefficient, I_{CE}			
($\lambda = 560$ to 660 nm)	TC_I	0.66	%/K
($\lambda = 830$ nm)	TC_I	0.49	%/K
($\lambda = 950$ nm)	TC_I	0.34	%/K

Note

1. Photocurrent generated at 10 μW light incidence through plastic 1000 micron fiber (distance lens-fiber ≤ 0.1 mm. Fiber type ESKA EH4001, fiber face polished.)

See Appnote 40, 41, 42, 43 for application information.

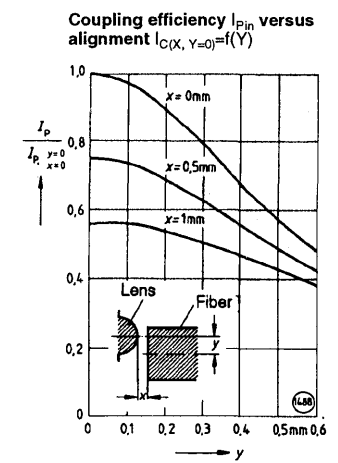
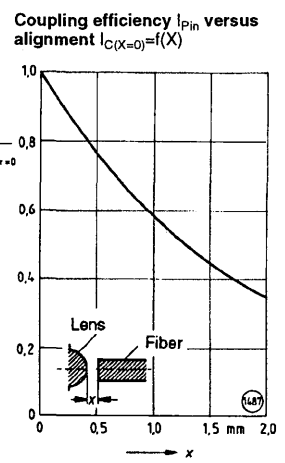
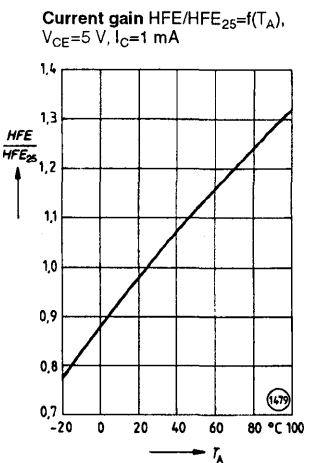
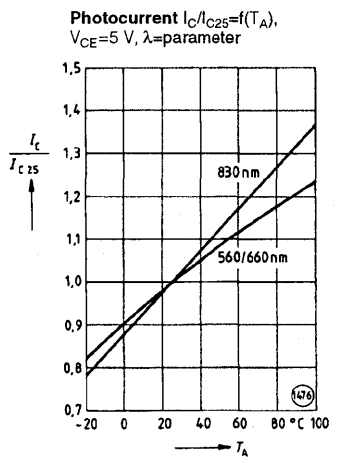
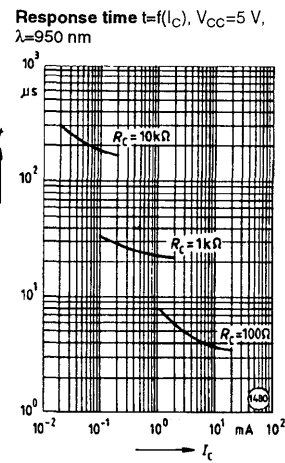
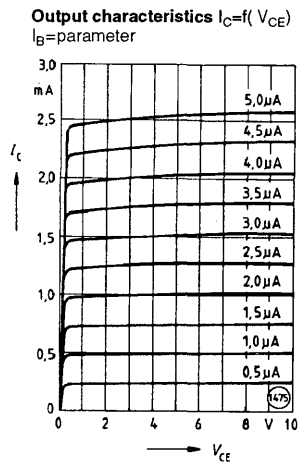
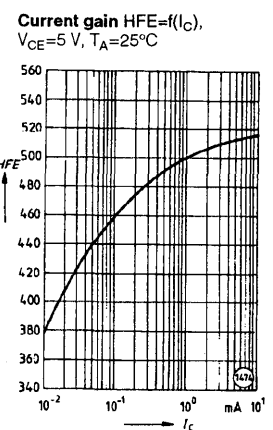
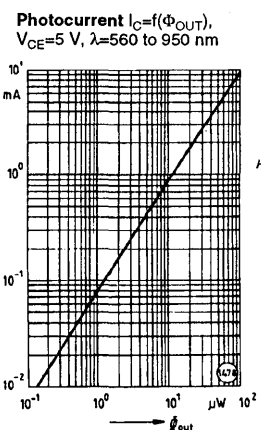
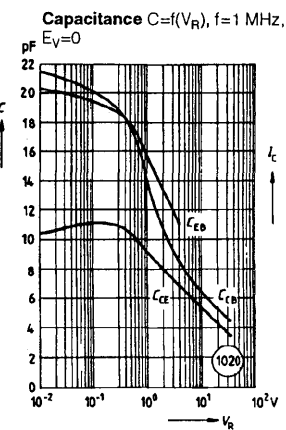
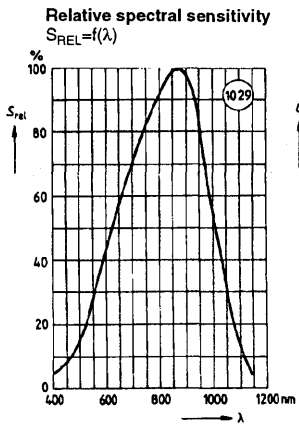

Fiber Optic Laser Diode Devices

T1 3/4 SFH450 PLASTIC CONNECTOR HOUSING SFH450V PLASTIC CONNECTOR HOUSING SFH452V PLASTIC FIBER OPTIC TRANSMITTER DIODE

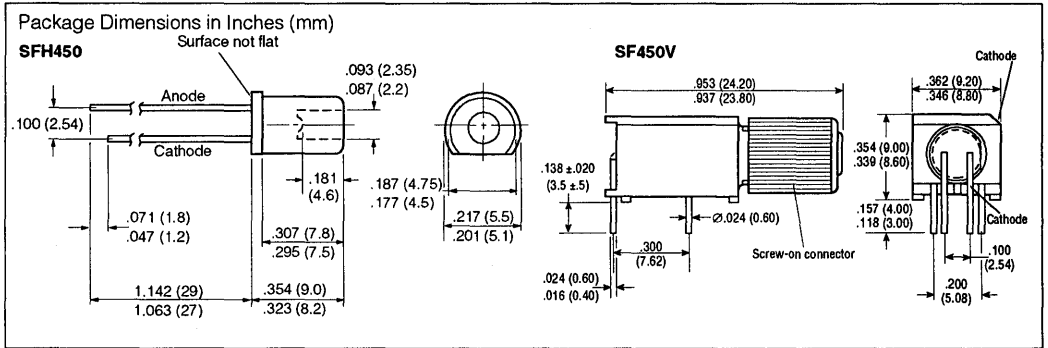

FEATURES

- 2.2 mm Aperture Holds Standard 1000 Micron Plastic Fiber
- No Fiber Stripping Required
- Good Linearity
- Sensitive in Visible and Near IR Range
- Molded Microlens for Efficient Coupling
- SFH450V/452V Only
 - Plastic Connector Housing
 - Mounting Screw Attached to Connector
 - Interference Free Transmission from Light-Tight Housing
 - Transmitter and Receiver Can Be Flexibly Positioned
 - No Cross Talk
 - Auto Insertable and Wave Solderable
 - Supplied in Tubes
- Applications—SFH450/450V/452V
 - Household Electronics
 - Power Electronics
 - Optical Networks
 - Medical Instruments
 - Automotive Electronics
 - Light Barriers

Maximum Ratings

	SFH450	SFH450V	SFH452V
Operating and Storage			
Temperature Range (T_{OP} , T_{STG})	-55° to +100°C	-55° to +100°C	-55° to +100°C
Junction Temperature (T_J)	100°C	100°C	100°C
Soldering Temperature			
(2 mm from case bottom) (T_S) $t_S \leq 5$ s	260°C	260°C	260°C
Reverse Voltage (V_R)	5 V	5 V	3 V
Forward Current, DC (I_F)	130 mA	130 mA	100 mA
Surge Current (I_{FSM}) $t_S \leq 10$ μ sec, D=0	3.5 mA	3.5 mA	2.5 mA
Power Dissipation (P_{TOT})	200 mW	200 mW	200 mW
Thermal Resistance, Junction/Air (R_{THA})	375 K/W	375 K/W	375 K/W

Characteristics ($T_A=25^\circ\text{C}$)

Parameter	Symbol	SFH450		Unit
		SFH450V	SFH452V	
Peak Wavelength	λ_{PEAK}	950	770	nm
Spectral Bandwidth	$\Delta\lambda$	55	40	nm
Switching Times (10% to 90% and 90% to 10%)				
($R_L=472 \Omega$, $I_F=10$ mA)	t_R , t_F	1	0.04	μ s
Capacitance	C_O	40	120	pF
Forward Voltage ($I_F=100$ mA)	V_F	1.3 (≤ 1.5)	-	V
Output Power Coupled into Plastic Fiber (1 mm core diameter), distance lens to fiber ≤ 0.1 mm, polished fiber, $I_F=10$ mA	Φ_{IN}	90 (≥ 25)	180	μ W
Temperature Coefficient, Φ_{IN}	TC_Φ	-0.5	-1.0	%/K
Temperature Coefficient, V_F	TC_V	-0.1	-0.13	%/K
Temperature Coefficient, λ_{PEAK}	TC_λ	0.3	0.2	nm/K

See Appnote 40, 41, 42, 43 for application information.

Relative spectral sensitivity-SFH450/V
 $S_{REL}=f(\lambda)$

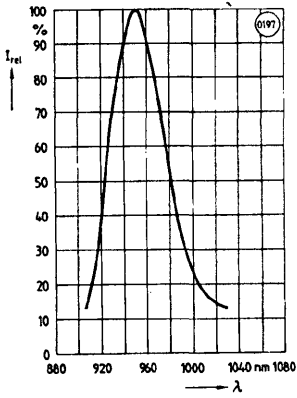

Relative spectral sensitivity-SFH452V
 $S_{REL}=f(\lambda)$

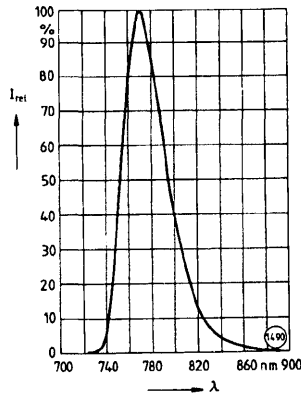

Forward current $I_F=f(V_F)$ -SFH450
 (Single pulse, duration=20μs) SFH450V

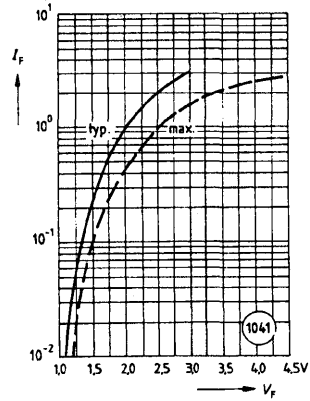

Forward current-SFH452V $I_F=f(V_F)$

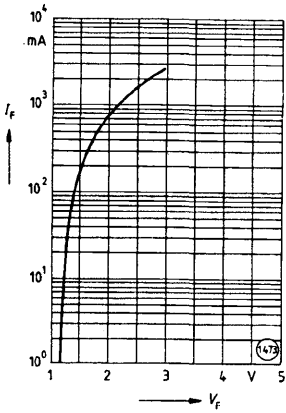

Relative output power
 $\Phi_{IN}/\Phi_{IN(10\text{ mA})}=f(I_F)$

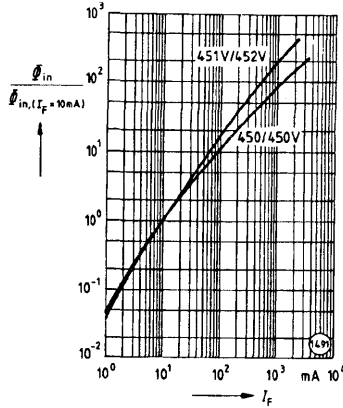

Forward voltage-SFH450/V
 $V_F/V_{F25}=f(T_A)$

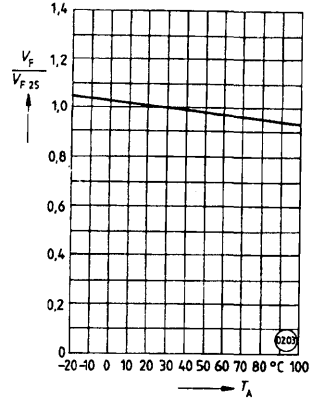

Forward voltage-SFH452V
 $V_F/V_{F25}=f(T_A)$

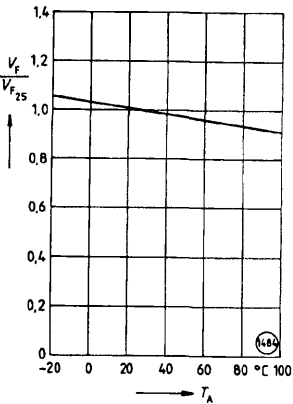

Peak wavelength-SFH450/V
 $\lambda_{PEAK}=f(T_A)$

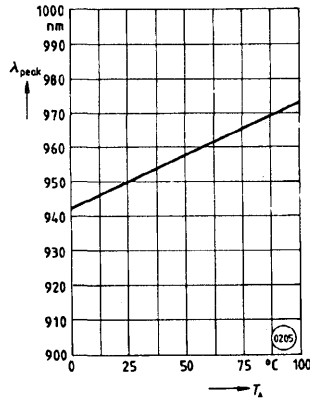

Peak wavelength-SFH452V
 $\lambda_{PEAK}=f(T_A)$

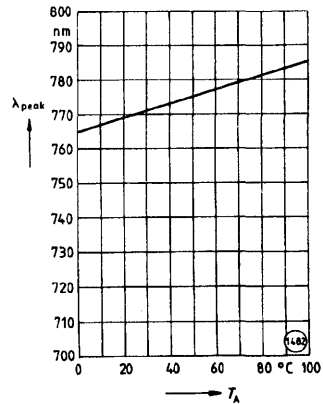

Temperature behavior—SFH450/V
 $\Phi_{IN}/\Phi_{IN25}=f(T_A)$

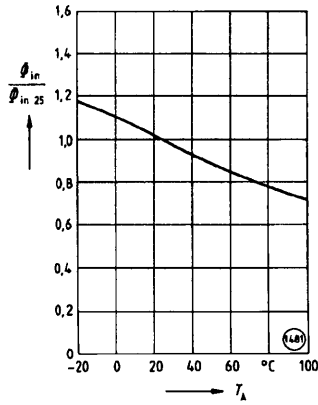

Temperature behavior—SFH452/V
 $\Phi_{IN}/\Phi_{IN25}=f(T_A)$

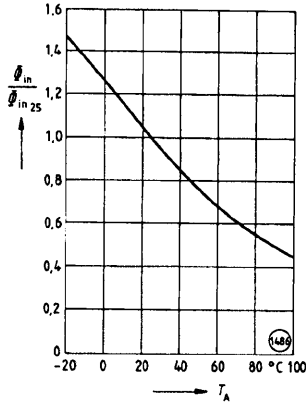

Coupling efficiency $I_{P_{in}}$ versus alignment $I_P/I_{P(x=0)}=f(X)$

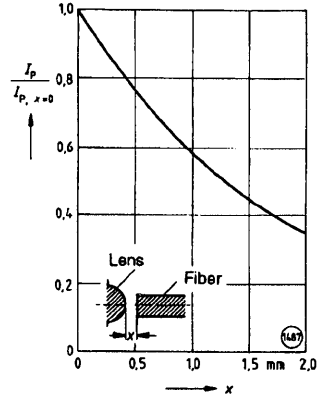

Coupling efficiency $I_{P_{in}}$ versus alignment $I_P/I_{P(x, y=0)}=f(Y)$

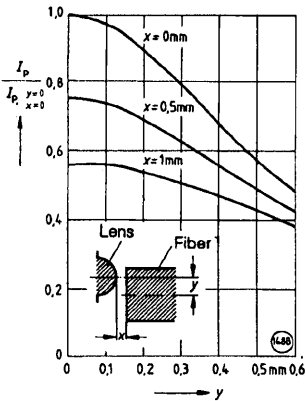

Maximum permissible forward current—SFH450/V $I_F=f(T_A)$

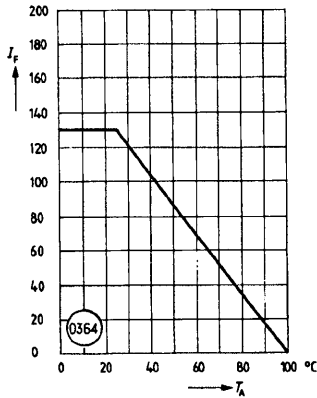

Maximum permissible forward current—SFH452/V $I_F=f(T_A)$

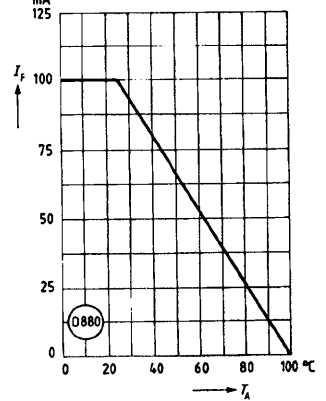

Permissible pulse load—SFH450/V
 $I_F=f(t_p)$, duty cycle D=parameter, $T_A=25^\circ\text{C}$

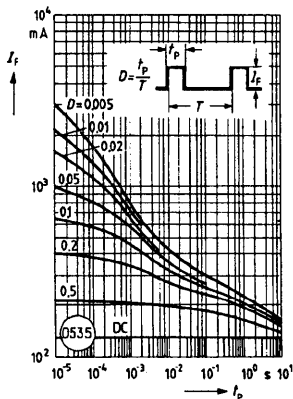

Permissible pulse load—SFH452/V
 $I_F=f(t_p)$, duty cycle D=parameter, $T_A=25^\circ\text{C}$

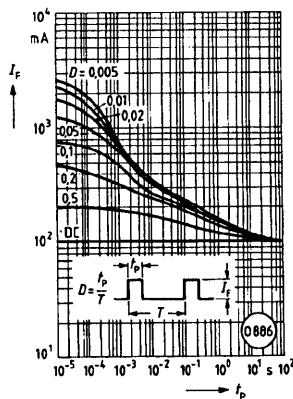

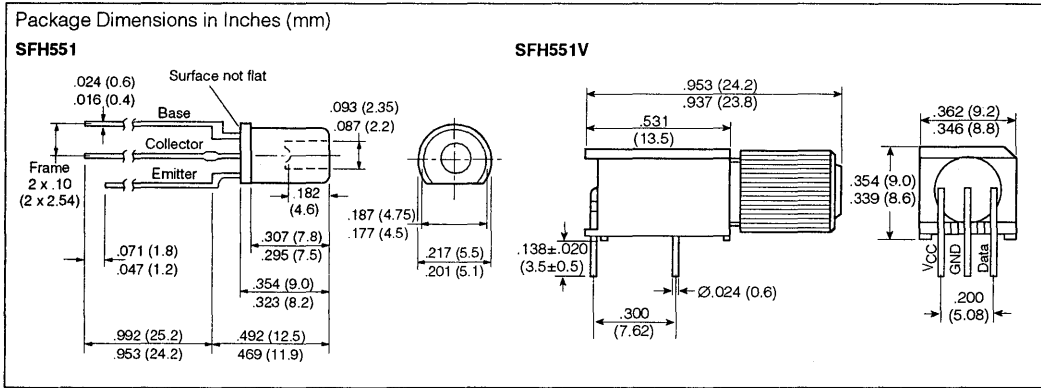

FEATURES

- Bipolar IC with Open-Collector Output
- Digital Output, TTL Compatible
- Suitable for 2.2 mm Plastic Fiber with 1 mm Core Diameter
- Transfer Rate ≤ 5 Mbit/s
- Low Switching Threshold
- High Sensitivity from Integrated μ Lens
- SFH551-T1 3/4 Package
- SFH551V-Right Angle Plastic Housing
- SFH551V-Simple and Fast Reversible Connection between Fiber and Component
- SFH551V-Easy Coupling to Plastic Fiber without Stripping or Declogging

Maximum Ratings

Storage Temperature Range (T_{STG})	-55 to +100°C
Operating Temperature Range (T_{OP})	-40 to +85°C
Supply Voltage (V_{CC})	0.5 to 7 V
Output Voltage (V_O)	0.5 to 7 V
Output Current (I_O)	.50 mA
Power Dissipation (output) (P_O)	.85 mW

Block Diagram

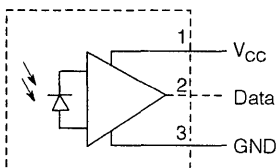

DESCRIPTION

The SFH551/V is a photodetector intended for use with 1000 micron plastic optical fiber. This device amplifies incoming signals via a DC coupled trans-impedance amplifier, and its open collector output is TTL compatible.

The SFH551 comes in a T1 3/4 plastic package with a tubular aperture wide enough to accommodate fiber and cladding. The SFH551V is housed in a unique plastic right angle package for easy coupling between the fiber and the photodetector.

The SFH551/V is suitable for data communications uses such as: LANs, medical equipment, and automotive electronics.

Characteristics ($T_A=25^\circ\text{C}$, $V_{CC}=4.75$ V to 5.25 V)

Parameter	Symbol	Value	Unit
Current Consumption ($V_{CC}=5$ V)	I_{CC}	12 (≤ 18)	mA
Output Voltage, Low ($I_{OL}=13$ mA, $\Phi_{outL} \geq 4$ mW)	V_{OL}	0.4 (≤ 0.6)	V
Output Current, High ($V_{OH}=5.25$ V, $\Phi_{outH} \leq 0.1$ mW)	I_{OH}	5 (≤ 300)	μ A
Optical Power, Low ⁽¹⁾ ($\lambda=820$ nm)	Φ_{outL}	4 to 50	μ W
Optical Power, High ⁽¹⁾ ($\lambda=820$ nm)	Φ_{outH}	-24 to -13	dBm
Optical Power, High ⁽¹⁾ ($\lambda=820$ nm)	Φ_{outH}	≤ 0.1	μ W
Optical Power, High ⁽¹⁾ ($\lambda=820$ nm)	Φ_{outH}	-40	dBm
Delay Times ($\Phi_{outL}=4$ μ W to 50 μ W, $R_L=350$ Ω , $C_L=15$ pF, $l=1$ m)	t_{pHL}	75	ns
	t_{pLH}	75	ns

Delay Time

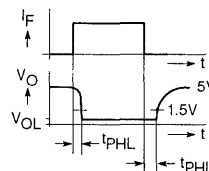

Note

1. Measured at the end of a plastic fiber with 1 mm diameter, distance lens fiber ≤ 0.1 mm, fiber type EH4001, fiber surface polished.

SIEMENS

T1 3/4 SFH750

T1 3/4 SFH752

PLASTIC CONNECTOR HOUSING SFH750V

PLASTIC CONNECTOR HOUSING SFH752V

PLASTIC FIBER OPTIC PHOTOTRANSISTOR DETECTOR

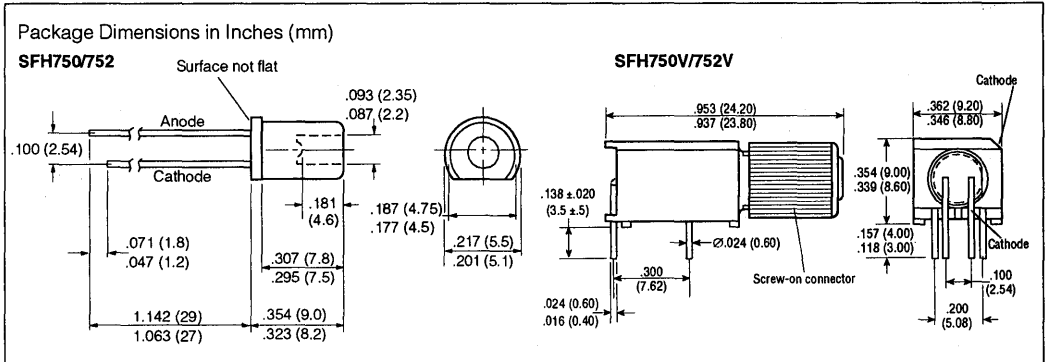

FEATURES

- 2.2 mm Aperture Holds Standard 1000 Micron Plastic Fiber
- No Fiber Stripping Required
- Good Linearity
- Sensitive in Visible and Near IR Range
- Molded Microlens for Efficient Coupling
- SFH750V/752V Only
 - Plastic Connector Housing
 - Mounting Screw Attached to Connector
 - Interference Free Transmission from Light-Tight Housing
 - Transmitter and Receiver Can Be Flexibly Positioned
 - No Cross Talk
 - Auto Insertable and Wave Solderable
 - Supplied in Tubes
- Applications—SFH750/750V/752V
 - Household Electronics
 - Power Electronics
 - Optical Networks
 - Medical Instruments
 - Automotive Electronics
 - Light Barriers
 - Motor Control

Maximum Ratings

	SFH750 SFH750V	SFH752 SFH752V
Operating and Storage		
Temperature Range (T_{OP} , T_{STG})	-55° to +100°C	-55° to +100°C
Junction Temperature (T_J)	100°C	100°C
Soldering Temperature		
(2 mm from case bottom) (T_S) $t_S \leq 5$ s	260°C	260°C
Reverse Voltage (V_R)	5 V	3 V
Forward Current (I_F)	45 mA	45 mA
Surge Current (I_{FSM}) $t \leq 10$ μ sec, $D=0$	1 A	1 A
Power Dissipation (P_{TOT})	150 mW	150 mW
Thermal Resistance, Junction/Air ($R_{\theta JA}$)	500 K/W	500 K/W

Characteristics ($T_A=25^\circ\text{C}$)

Parameter	Symbol	SFH750 SFH750V	SFH752 SFH752V	Unit
Peak Wavelength	λ_{PEAK}	660	665	nm
Spectral Bandwidth	$\Delta\lambda$	35	25	nm
Switching Times ($R_L=50 \Omega$, $I_F=10$ mA)				
(10% to 90%)	t_R	0.12	0.07	μ s
(90% to 10%)	t_F	0.05	0.1	μ s
Capacitance ($f=1$ MHz, $V_R=0$ V)	C_O	25	30	pF
Forward Voltage ($I_F=10$ mA)	V_F	1.6 (≤ 2.0)	2.0 (≤ 2.6)	V
Output Power Coupled into Plastic				
Fiber (1 mm core diameter), distance lens to fiber ≤ 0.1 mm, polished fiber, $I_F=10$ mA				
	Φ_{IN}	9 (≥ 2.5)	80	μ W
Temperature Coefficient, Φ_{IN}	TC_Φ	-0.8	-0.5	%/K
Temperature Coefficient, V_F	TC_V	-0.1	-0.13	%/K
Temperature Coefficient, λ_{PEAK}	TC_λ	0.17	0.16	nm/K

See Appnote 40, 41, 42, 43 for application information.

Relative spectral sensitivity-SFH750V
 $S_{REL}=f(\lambda)$

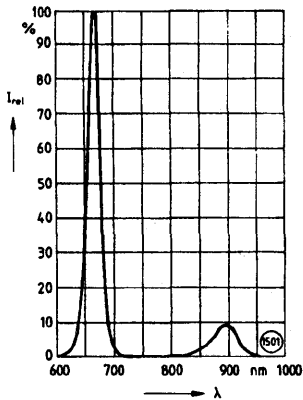

Relative spectral sensitivity-SFH752V
 $S_{REL}=f(\lambda)$

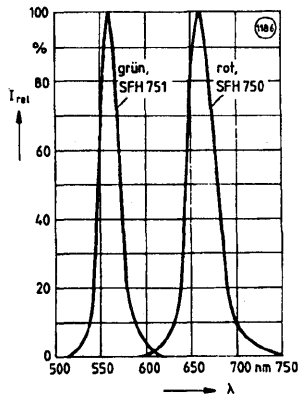

Forward current $I_F=f(V_F)$, single pulse, duration=20 μs

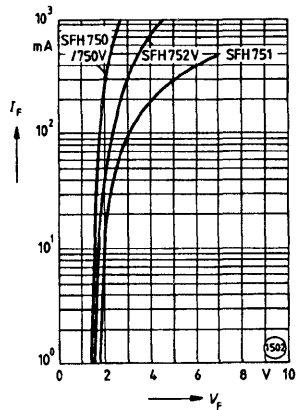

Relative optical output power
 $\Phi_{IN}/\Phi_{IN(10\text{ mA})}=f(I_F)$

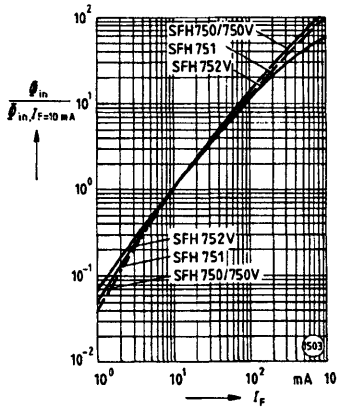

Forward voltage $V_F/V_{F25}=f(T_A)$

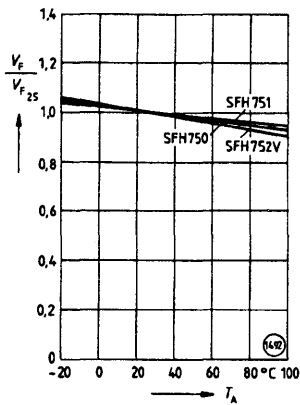

Peak wavelength $\lambda_{PEAK}=f(T_A)$

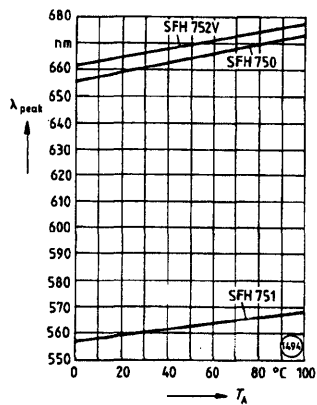

Temperature behavior-SFH750/V
 $\Phi_{IN}/\Phi_{IN25}=f(T_A)$

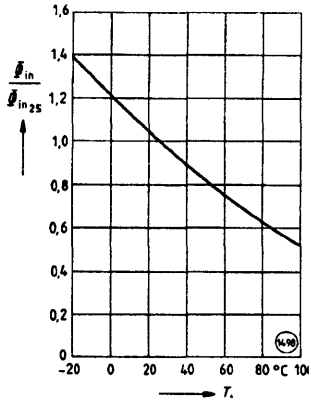

Temperature behavior-SFH752V
 $\Phi_{IN}/\Phi_{IN25}=f(T_A)$

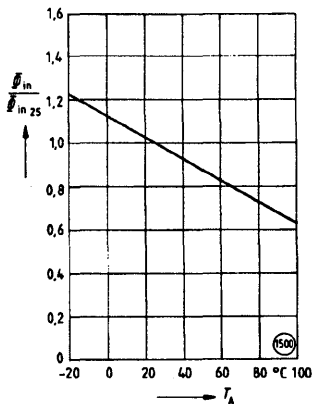

Coupling efficiency Φ_{IN} versus alignment $\Phi_{IN}/\Phi_{IN(x=0)}=f(X)$

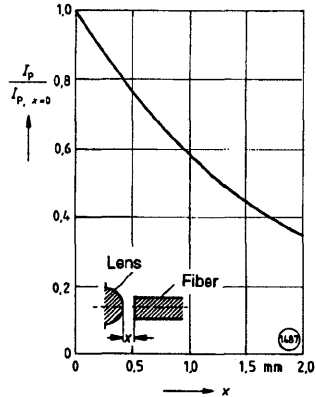

Coupling efficiency Φ_{IN} versus alignment $\Phi_{IN}/\Phi_{IN(X, Y=0)}=f(Y)$

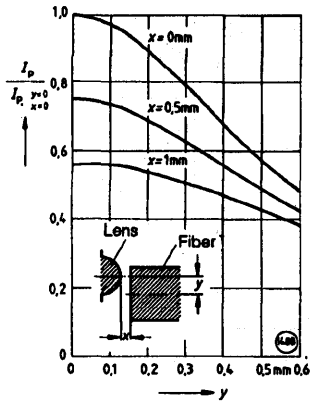

Maximum permissible forward current $I_F=f(T_A)$

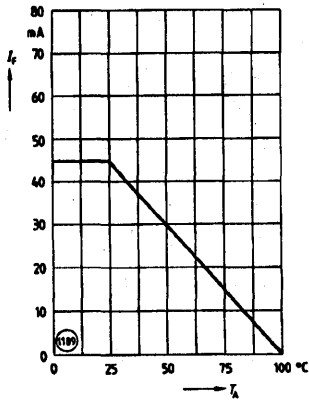

Permissible pulse load $I_F=f(T_A)$, duty cycle $D=\text{parameter}$, $T_A=25^\circ\text{C}$

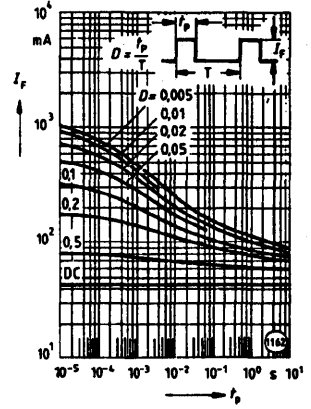

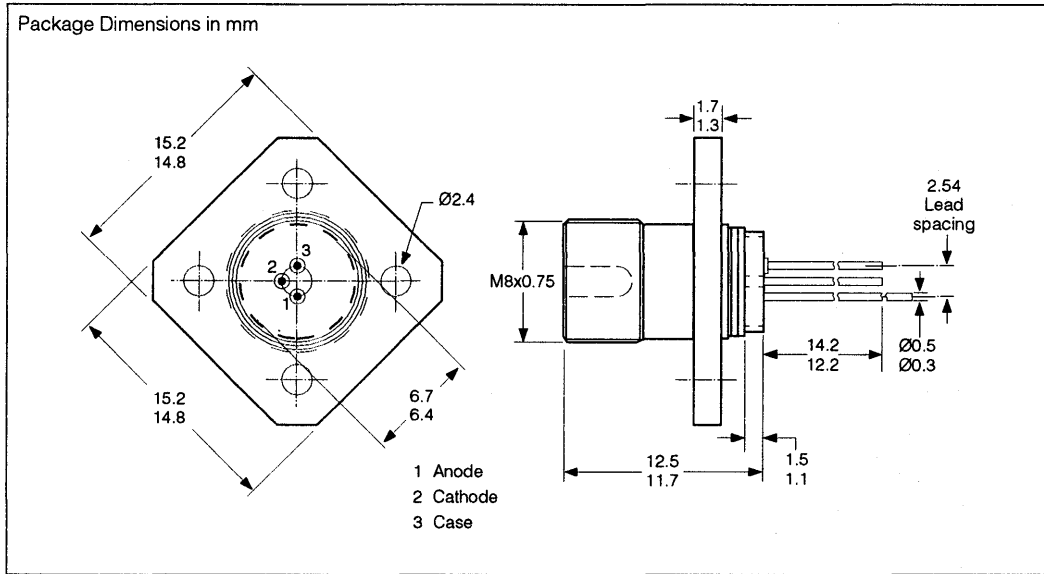

FEATURES

- 8 Diodes Connected in Series
- TO 18 Package
- Floating Output Signal
- FC Connector for use with 200 μm Fiber, NA=0.37

Characteristics ($T_A=25^\circ\text{C}$)

Parameter	Symbol	Value	Unit
Radiant Input Power	P_{IN}	10-500	mW
Electrical Output Power	P_{EL}	3-60	mW
Open Circuit Output Voltage	V_{OC}	>8	V
Short Circuit Current			
$P_{IN}=10$ mW	I_{sc}	0.5	mA
$P_{IN}=250$ mW		11	mA
$P_{IN}=500$ mW		19	mA
Maximum Output Power Occurs at Efficiency		5	V
$P_{IN}=40$ mW	η	28	%
$P_{IN}=350$ mW		14	%
Temperature Coefficient of I_{sc}	TC_I	-0.05	%/K
Temperature Coefficient of V_{OC}	TC_V	-16	mV/K

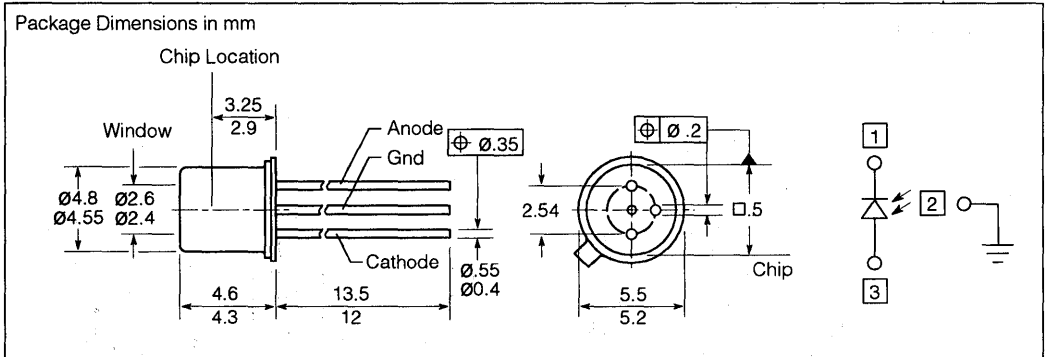

FEATURES

- InGaAs/InP PIN Photodiode
- Sensitive Receiver for the 2nd and 3rd Window (1300 nm and 1500 nm)
- Suitable for Bit Rates up to 1.2 Gbit/s
- Low Junction Capacitance
- Fast Switching Times
- Low Dark Current
- Low Noise
- High Reverse-Current Stability by Planar Structure
- Package: Hermetically Sealed 3-pin Metal Case, Similar to TO 18
- Application: Fiber Optic Communication Systems

Maximum Ratings

Operating and Storage Temperature Range (T_{OP} , T_{STG})	-40° to +85°C
Soldering Temperature (2 mm from case bottom), (T_s) $t_{MAX}=10$ s	260°C
Reverse Voltage (V_R)	20 V
Forward Current (I_F)	10 mA
Maximum Radiant Power into Optical Port		
$V_R > 5$ V (Φ_{PORT})	200 μ W
$V_R \leq 5$ V (Φ_{PORT})	1 mW

Characteristics ($T_A=25^\circ\text{C}$, all optical data refers to an optimally coupled 10/125 μm fiber.)

Parameter	Symbol	Value	Unit
Radiant Sensitive Area	\varnothing	75	μm
Spectral Sensitivity	S_λ	0.75 (≥ 0.7)	A/W
Spectral Sensitivity Change within Operating Temperature Range			
($\lambda=1300$ nm, $V_R=5$ V)	ΔS_λ	<0.2	%/K
Rise and Fall Time	t_R, t_F	0.3 (≤ 0.5)	ns
(R _L =50 Ω , $V_R=5$ V, $\lambda=1300$ nm, $\Phi_{PORT}=100$ μ W)			
Total Capacitance	C_S	0.7 (≤ 1.2)	pF
(V _R =5 V, $\Phi_{PORT}=0$, f=1 MHz)			
Dark Current (V _R =5 V, $\Phi_{PORT}=0$)	I_D	1 (≤ 10)	nA
Noise Equivalent Power (V _R =5 V)	NEP	3.3×10^{-14}	W/Hz
Optical Power Back Reflection into Optical Port	R	<1	%

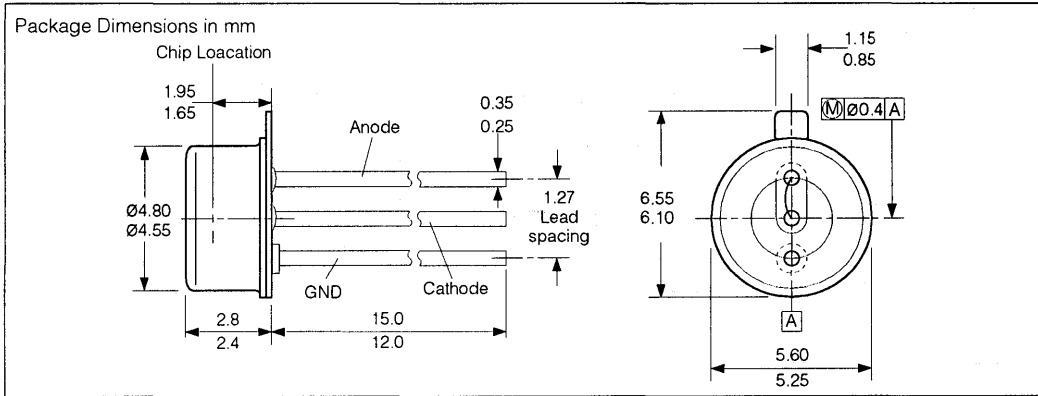

FEATURES

- InGaAsP/InP PIN Photodiode
- Sensitive Receiver for 2nd and 3rd Window (1300 nm and 1500 nm)
- Suitable for Bit Rates up to 1.2 Gbit/s
- Low Junction and Low Package Capacitance
- Fast Switching Times
- Low Dark Current
- Low Noise
- High Reverse Current Stability by Planar Structure
- Package: Hermetically Sealed 3-pin Metal Case, Similar to TO 18
- Application: Fiber Optic Communication Systems

Maximum Ratings

Operating and Storage Temperature Range (T_A , T_{STG})	-40° to +70°C
Soldering Temperature, $t_{max}=10$ s, 2 mm from bottom edge of case (T_S)	260°C
Reverse Voltage (V_R)	20 V
Forward Current (I_F)	10 mA
Maximum Radiant Power into Opt. Port with V_R (ϕ_{port})	200 μ W
with $V_R \leq 5$ V	1 mW

Characteristics (at $T_A=25^\circ\text{C}$, all optical data refer to an optimally coupled 10/125 μm fiber. Spot size diameter at radiant sensitive area < 75 μm .)

Parameter	Symbol	Value	Unit
Radiant Sensitive Area	\varnothing	75	μm
Spectral Sensitivity ($\lambda=1300$ nm, $V_R=5$ V)	S_λ	0.75 (≥ 0.7)	A/W
Change in Spectral Sensitivity in Operating Temperature Range	ΔS_λ	<0.2	%/K
Rise and Fall Time ($R_L=50$ Ω , $V_R=5$ V, $\lambda=1300$ nm, $\Phi_{port}=100$ μW)	t_R , t_F	0.3 (≤ 0.5)	ns
Total Capacitance ($V_R=5$ V, $\Phi_{port}=0$, $f=1$ MHz)	C_S	0.7 (≤ 1.0)	pF
Dark Current ($V_R=5$ V, $\Phi_{port}=0$)	I_R	1 (≤ 10)	nA
Noise Equivalent Power ($V_R=5$ V)	NEP	3.3×10^{-14}	W/√Hz
Back Reflection of Optical Power into Optical Port	R	<1	%

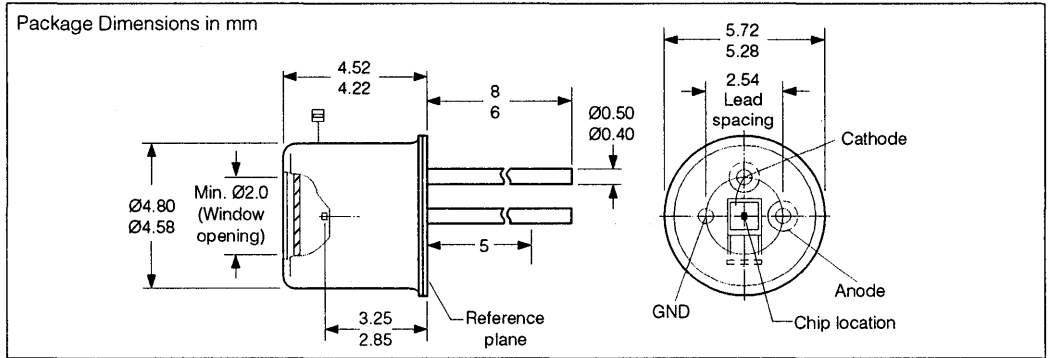

FEATURES

- InGaAs/InP-PIN-photodiode
- Sensitive Receiver for the 2nd and 3rd Window (1300 nm and 1500 nm)
- Suitable for Bit Rates up to 1.2 Gbit/s
- Low Junction Capacitance
- Fast Switching Times
- Low Dark Current
- Low Noise
- High Reverse-Current Stability by Planar Structure
- Package: Hermetically Sealed 3-pin Metal Case, Similar to TO 18
- Application: Fiber-optic Communication Systems

Maximum Ratings

Operating and Storage Temperature Range (T_{OP} , T_{STG})	-40° to +85°C
Soldering Temperature (2 mm from case bottom), (T_s) $t_{MAX}=10$ s	260°C
Reverse Voltage (V_R)	20 V
Forward Current (I_F)	10 mA
Maximum Radiant Power into Opt. Port. $V_R(\Phi_{PORT})$	200 μ W
$V_R \leq 5$ V	1 mW

Characteristics ($T_A=25^\circ\text{C}$, all optical data refers to an optimally coupled 10/125 μm fiber. Spot size diameter at radiant sensitive area $\leq 75 \mu\text{m}$.)

Parameter	Symbol	Value	Unit
Radiant Sensitive Area	\varnothing	75	μm
Spectral Sensitivity ($\lambda=1300$ nm, $V_R=5$ V)	S_λ	0.75 (≥ 0.7)	AW
Spectral Sensitivity Change within Operating Temperature Range	ΔS_λ	<0,2	%/K
Rise and Fall Time ($R_L=50 \Omega$, $V_R=5$ V, $\lambda=1300$ nm, $\Phi_{PORT}=100 \mu\text{W}$)	t_R , t_F	0.3 (≤ 0.5)	ns
Total Capacitance ($V_R=5$ V, $\Phi_{PORT}=0$, $f=1$ MHz)	C_S	0.7 (≤ 1.2)	pF
Dark Current ($V_R=5$ V, $\Phi_{PORT}=0$)	I_R	1 (≤ 5)	nA
Noise Equivalent Power ($V_R=5$ V)	NEP	3.3×10^{-14}	W/Hz
Optical Power Back Reflection into Optical Port	R	<1	%

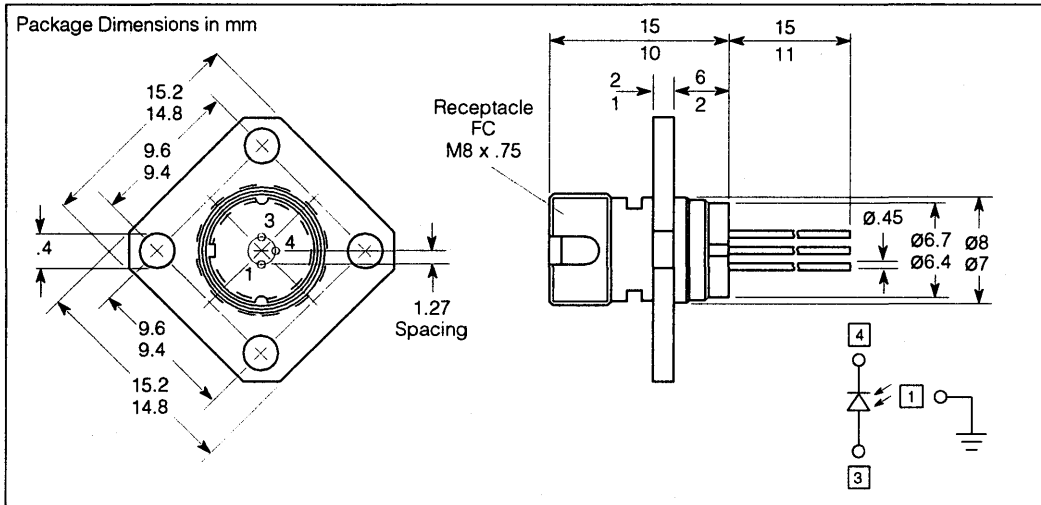

FEATURES

- InGaAs/InP PIN Photodiode
- Sensitive Receiver for the 2nd and 3rd Window (1300 nm and 1500 nm)
- Suitable for Bit Rates up to 1.2 Gbit/s
- Low Junction Capacitance
- Fast Switching Times
- Low Dark Current
- Low Noise
- High Reverse-Current Stability by Planar Structure
- Package: Hermetically Sealed 3-pin Metal Subcomponent, Similar to TO 18
- Application: Fiber Optic Communication Systems

Maximum Ratings

Operating and Storage Temperature Range (T_{OP} , T_{STG})	-40° to +85°C
Soldering Temperature (2 mm from case bottom), (T_S) t_{MAX} =10 s	260°C
Reverse Voltage (V_R)	20 V
Forward Current (I_F)	10 mA
Maximum Radiant Power into Optical Port		
$V_R > 5$ V (Φ_{PORT})	200 μ W
$V_R \leq 5$ V (Φ_{PORT})	1 mW

Characteristics ($T_A=25^\circ\text{C}$, all optical data refers to the optical port with 10/125 μm coupling.)

Parameter	Symbol	Value	Unit
Radiant Sensitive Area	\emptyset	75	μm
Spectral Sensitivity	S_λ	0.75 (≥ 0.7)	A/W
($\lambda=1300$ nm, $V_R=5$ V)			
Spectral Sensitivity Change within Operating Temperature Range	ΔS_λ	<0,2	%/K
Rise and Fall Time	t_R , t_F	0.3 (≤ 0.5)	ns
($R_L=50$ Ω , $V_R=5$ V, $\lambda=1300$ nm, $\Phi_{PORT}=100$ μ W)			
Total Capacitance	C_S	0.7 (≤ 1.2)	pF
($V_R=5$ V, $\Phi_{PORT}=0$, $f=1$ MHz)			
Dark Current ($V_R=5$ V, $\Phi_{PORT}=0$)	I_D	1 (≤ 10)	nA
Noise Equivalent Power ($V_R=5$ V)	NEP	3.3×10^{-14}	W/Hz
Reproducibility of Insertions	ΔS_λ	<10	%
Optical Power Back Reflection into Optical Port	R	<1	%

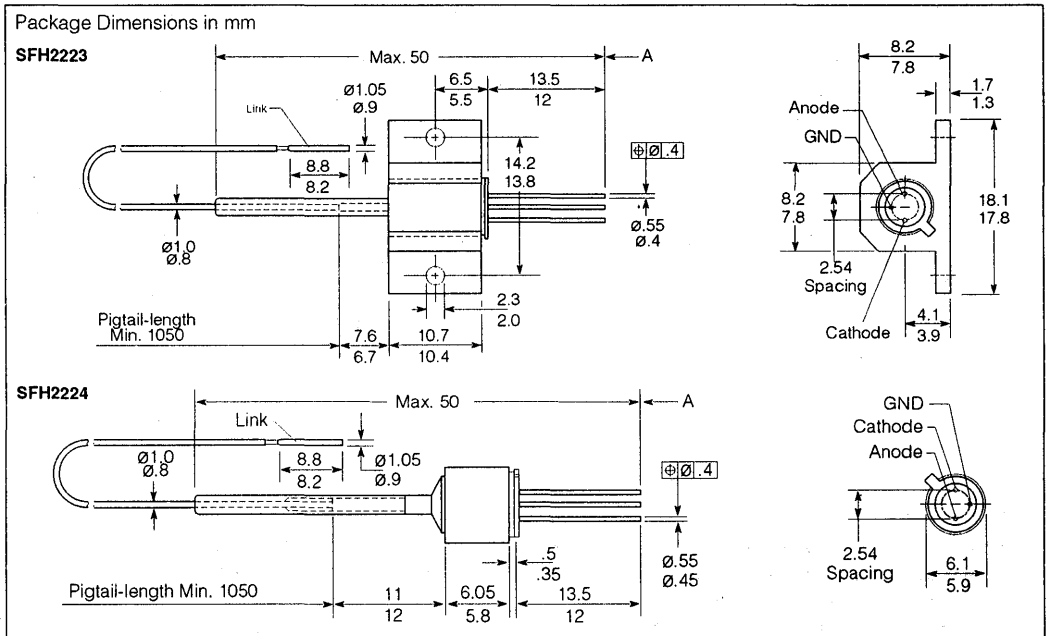

FEATURES

- InGaAs/InP PIN Photodiode
- 50/125 μm Multimode Pigtail
- Sensitive Receiver for the 2nd and 3rd Window (1300 nm and 1500 nm)
- Suitable for Bit Rates up to 1.2 Gbit/s
- Low Junction Capacitance
- Fast Switching Times
- Low Dark Current
- Low Noise
- High Reverse Current Stability by Planar Structure
- Package: Hermetically Sealed 3-pin Metal Subcomponent, Similar to TO 18
- SFH2223 with Additional Flange
- Applications: Fiber Optic Communication Systems, SM and MM Fiber

Maximum Ratings

Operating and Storage Temperature Range (T_{OP} , T_{STG})	-40° to +85°C
Soldering Temperature (2 mm from case bottom), (T_s) $t_{MAX}=10$ s	260°C
Reverse Voltage (V_R)	20 V
Forward Current (I_F)	10 mA
Maximum Radiant Power into Optical Port	
$V_R > 5$ V (Φ_{PORT})	200 μW
$V_R \leq 5$ V (Φ_{PORT})	1 mW

Characteristics ($T_A=25^\circ\text{C}$, all optical data refers to the optical port, optical power coupled with SM fiber.)

Parameter	Symbol	Value	Unit
Radiant Sensitive Area	\varnothing	75	μm
Spectral Sensitivity ($\lambda=1300$ nm, $V_R=5$ V)	S_λ	0.75 (≥ 0.7)	AW
Spectral Sensitivity Change within Operating Temperature Range	ΔS_λ	<0,2	%/K
Rise and Fall Time ($R_L=50$ Ω , $V_R=5$ V, $\lambda=1300$ nm, $\Phi_{PORT}=100$ μW)	t_R , t_F	0.3 (≤ 0.5)	ns
Total Capacitance ($V_R=5$ V, $\Phi_{PORT}=0$, $f=1$ MHz)	C_5	0.7 (≤ 1.2)	pF
Dark Current ($V_R=5$ V, $\Phi_{PORT}=0$)	I_D	1 (≤ 10)	nA
Noise Equivalent Power ($V_R=5$ V)	NEP	3.3×10^{-14}	W/Hz
Optical Power Back Reflection into Optical Port	R	<1	%

SFH 2249 TERNARY PIN PHOTODIODE WITH SM FIBER PIGTAIL WITH BLOCKING FILTER FOR THIRD WINDOW

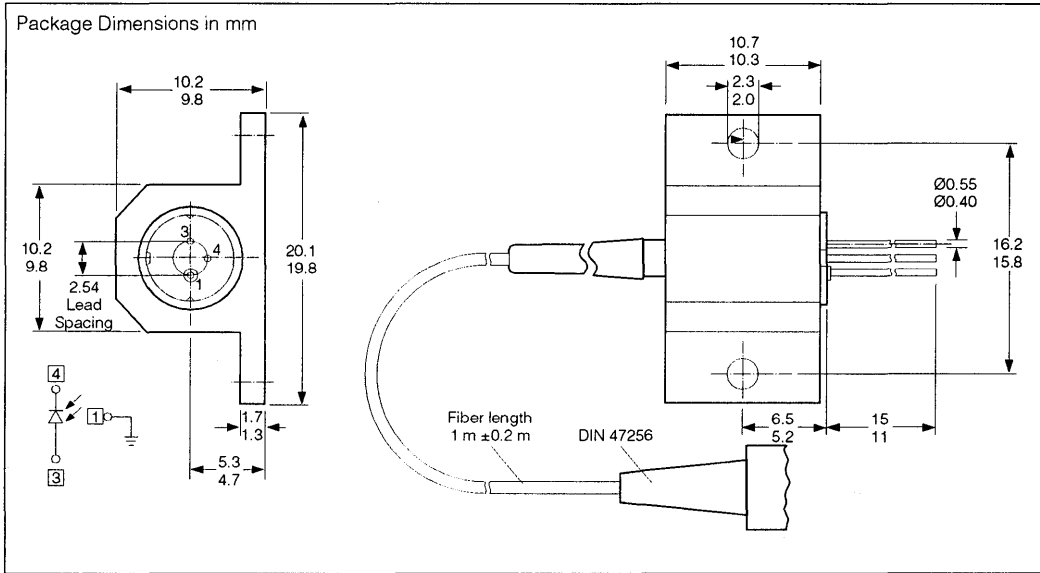

FEATURES

- InGaAs/InP-PIN-Photodiode
- 10/125 μm Singlemode Pigtail and DIN Connector
- Sensitive Receiver for the 2nd Window
- Suitable for Bit Rates up to 1.2 Gbit/s
- Low Junction Capacitance
- Low Dark Current
- Low Noise
- High Reverse-Current Stability by Planar Structure
- Hermetically Sealed 3-pin Metal Subcomponent, Similar to TO 18 with Flange

Maximum Ratings

Reverse Voltage (V_R)	20 V
Forward Current (I_F)	10 mA
Operating and Storage Temperature Range (T_A , T_{STG})	-40° to +70°C
Maximum Radiant Power into Opt. Port, V_R (Φ_{PORT})	200 μW
$V_R \leq 5 \text{ V}$	1 mW
Soldering Temperature (2 mm from case bottom), (T_S) $t_{MAX} = 10 \text{ s}$	260°C

Characteristics (at $T_A = 25^\circ\text{C}$, all optical data refer to the optical port, optical power coupled with SM fiber.

Parameter	Symbol	Value	Unit
Radiant Sensitive Area	\varnothing	75	μm
Spectral Sensitivity ($\lambda = 1300 \text{ nm}$, $V_R = 5 \text{ V}$)	S_λ	0.75 (≥ 0.7)	A/W
Spectral Sensitivity Change within Operating Temperature Range	ΔS_λ	<0.2	%/K
Rise and Fall Time ($R_L = 50 \Omega$, $V_R = 5 \text{ V}$, $\lambda = 1300 \text{ nm}$, $\Phi_{PORT} = 100 \mu\text{W}$)	t_R, t_F	0.3 (≤ 0.5)	ns
Total Capacitance ($V_R = 5 \text{ V}$, $\Phi_{PORT} = 0$, $f = 1 \text{ MHz}$)	C_5	1.3 (≤ 2)	pF
Dark Current ($V_R = 5 \text{ V}$, $\Phi_{PORT} = 0$)	I_D	1 (≤ 10)	nA
Noise Equivalent Power ($V_R = 5 \text{ V}$)	NEP	3.3×10^{-14}	W/ $\sqrt{\text{Hz}}$
Optical Attenuation for 3 rd Window Optical Power	C/T	-35	dB
Back Reflection of Optical Power into Optical Port	R	<1	%

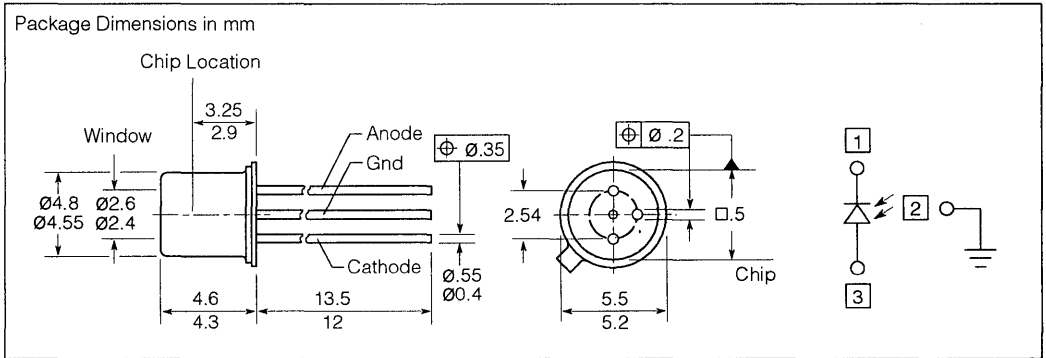

FEATURES

- Sensitive Receiver for the 2nd Window (1300 nm)
- Suitable for Bit Rates up to 1.2 Gbit/s and Long Distances
- High Gain Bandwidth Product
- Planar Structure
- Small Radiant Sensitive Area
- Low Multiplied Dark Current
- Package: Hermetically Sealed 3-pin Case, Similar to TO 18
- Application: Fiber Optic Communication Systems

Maximum Ratings

Operating Temperature Range (T_{OP})	-40° to +85°C
Storage Temperature Range (in original packing) (T_{STG})	-40° to +85°C
Reverse Voltage (without light) (V_{BR})	* V
Forward Current (I_{Fmax})	50 mA
Maximum Optical Power into Optical Port, $M=1$ (Φ_{PORT})	1 mW

* Individual value of V_{BR} is delivered with each component.

Characteristics ($T_A=25^\circ\text{C}$, all optical data refers to an optimally coupled 10/125 μm fiber.)

Parameter	Symbol	Value	Unit
Radiant Sensitive Area	\varnothing	50	μm
Spectral Sensitivity ($M=1$, $\lambda=1300$ nm, $\Phi_{PORT}=1$ μW)	S_λ	≥ 0.7	A/W
Rise and Fall Time ($R_L=50$ Ω , $V_R=10$ V, $\lambda=1300$ nm)	t_R, t_F	≤ 0.5	ns
Breakdown Voltage ($I_R=100$ μA)	V_{BR}	28 to 40	V
Multiplication Factor ($V_R=0.9 \times V_{BR}$)	M	4 (>3)	-
Capacitance ($V_R=0$ V, $f=1$ MHz)	C_0	≤ 7	pF
$\Phi_{PORT}=0$ ($V_R=0.9 \times V_{BR}$)	$C_{0.9 \times V_{BR}}$	≤ 2	pF
Total Dark Current ($V_R=10$ V)	I_R	≤ 200	nA
($V_R=0.9 \times V_{BR}$)		≤ 300	nA
Multiplied Dark Current ($M=10$)	I_{RM}	≤ 20	nA

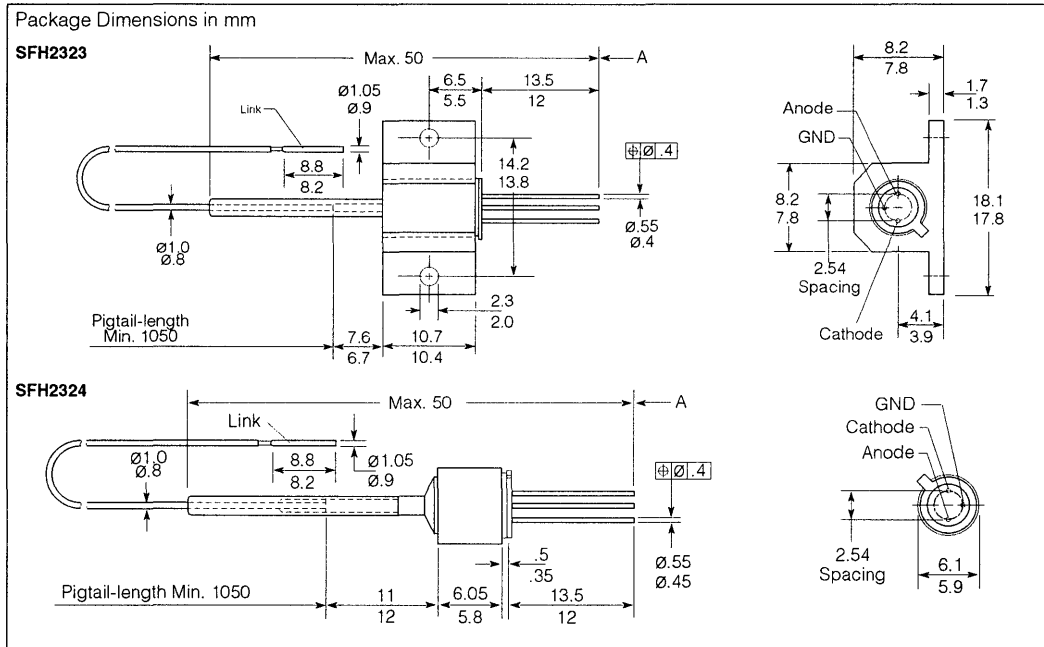

FEATURES

- Sensitive Receiver for the 2nd Window (1300 nm)
- Suitable for Bit Rates up to 1.2 Gbit/s and Long Distances
- High Gain Bandwidth Product
- Planar Structure
- Small Radiant Sensitive Area
- Low Multiplied Dark Current
- Detecting Radiation Coupled into 50/125 μm Graded Index Fiber (Multi-mode)
- Package: Hermetically Sealed 3-pin Subcomponent, Similar to TO 18
- SFH2323 with Additional Flange
- Application: Fiber Optic Communication Systems

Maximum Ratings

Operating Temperature Range (T_{Op})	-40° to +85°C
Storage Temperature Range (in original packing) (T_{STG})	-40° to +85°C
Reverse Voltage (without irradiation) (V_{BR})	* V
Forward Current (I_{Fmax})	50 mA
Maximum Optical Power into Optical Port, $M=1$ (Φ_{PORT})	1 mW

* Individual value of V_{BR} is delivered with each component.

Characteristics ($T_A=25^\circ\text{C}$, all optical data refers to the optical port, optical power coupled with SM fiber.)

Parameter	Symbol	Value	Unit
Radiant Sensitive Area	\varnothing	50	μm
Spectral Sensitivity ($M=1$, $\lambda=1300\text{ nm}$, $\Phi_{PORT}=1\ \mu\text{W}$)	S_λ	≥ 0.7	A/W
Rise and Fall Time ($R_L=50\ \Omega$, $V_R=10\ \text{V}$, $\lambda=1300\text{ nm}$)	t_R, t_F	≤ 0.5	ns
Breakdown Voltage ($I_R=100\ \mu\text{A}$)	V_{BR}	28 to 40	V
Multiplication Factor ($V_R=0.9 \times V_{BR}$)	M	4 (>3)	-
Capacitance ($V_R=0\ \text{V}$, $f=1\ \text{MHz}$)	C_0	≤ 7	pF
$\Phi_{PORT}=0$ ($V_R=0.9 \times V_{BR}$)	$C_{0.9 \times V_{BR}}$	≤ 2	pF
Total Dark Current ($V_R=10\ \text{V}$)	I_R	≤ 200	nA
($V_R=0.9 \times V_{BR}$)		≤ 300	nA
Multiplied Dark Current ($M=10$)	I_{RM}	≤ 20	nA

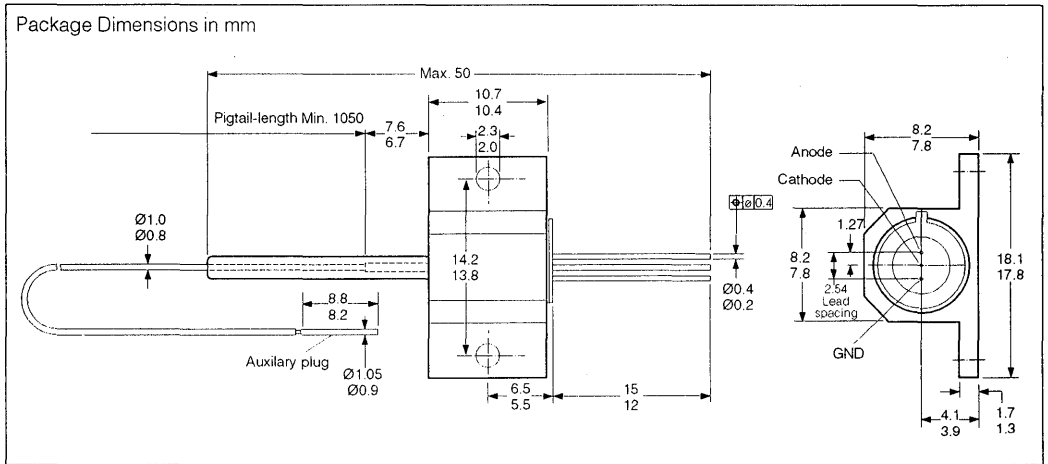

FEATURES

- Designed for Application in Fiber-Optic Communication Systems
- Sensitive Receiver for the 2nd Window (1300 nm)
- Suitable for Bit Rates up to 2.4 Gbit/s and Long Distances
- High Gain Bandwidth Product
- Planar Structure
- Small Radiant-Sensitive Area
- Low Multiplied Dark Current
- Detecting Radiation Coupled into a 50/125 μm Graded Index Fiber (Multimode)
- Hermetically Sealed 3-pin Metal Case with Central Pin, Similar to TO 18
- SFH 2325 with Additional Flange

Maximum Ratings

Maximum Forward Current (I_{FMAX})	50 mA
Max. Reverse Voltage Without Irradiation (V_{BR})	* V
Operating Temperature Range (T_{A})	-40° to +85°C
Storage Temperature Range in Original Packing (T_{STG})	-40° to +85°C
Max. Optical Power at M=1 into the Optical Port (Φ_{PORT})	1 mW

* Individual value of V_{BR} is delivered with each component

Characteristics ($T_{\text{A}}=25^{\circ}\text{C}$, all optical data refer to the optical port, optical power coupled with SM fiber.)

Parameter	Symbol	Value	Unit
Radiant Sensitive Area	\emptyset	50	μm
Spectral Sensitivity ($M=1$, $\lambda=1300$ nm, $\Phi_{\text{PORT}}=1$ μW)	S_{λ}	≥ 0.7	A/W
Rise and Fall Time ($R_{\text{L}}=50$ Ω , $V_{\text{R}}=10$ V, $\lambda=1300$ nm)	$t_{\text{R}}, t_{\text{F}}$	≤ 0.3	ns
Breakdown Voltage ($I_{\text{R}}=100$ μA)	V_{BR}	28-40	V
Multiplication Factor at $V_{\text{R}}=0.9 \times V_{\text{BR}}$	M	4(>3)	-
Capacitance ($\Phi_{\text{PORT}}=0$) $V_{\text{R}}=0$ V, $f=1$ MHz	C_0	≤ 7	pF
$V_{\text{R}}=25$ V	C_{25}	≤ 1.5	pF
Total Dark Current $V_{\text{R}}=10$ V	I_{R}	≤ 200	nA
$V_{\text{R}}=0.9 \times V_{\text{BR}}$		≤ 300	nA
Multiplied Dark Current (M=10)	I_{RM}	≤ 20	nA

Package Dimensions in mm

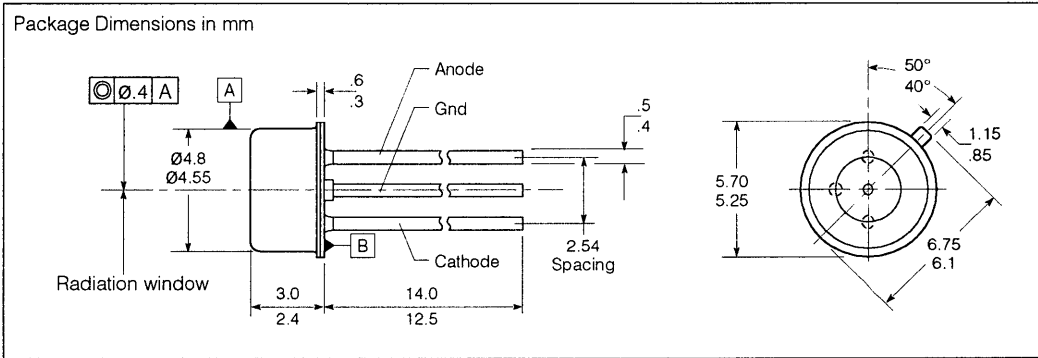

FEATURES

- InGaAsP/InP IRED
- Emission Wavelength: 1310 nm
- Suitable for Bit Rates up to 50 Mbit/s
- 200 Mbits/s with Pulse Shaping of Appropriate Modulation Current
- High Output Power with Double Heterostructure
- High Coupling Efficiency into 50/125 or 62/125 μm Graded Index Fiber from Built-in Optics
- Package: Hermetically Sealed 3-pin Metal Case, Similar to TO 18
- Application: Fiber Optic Communication Systems

Maximum Ratings

Operating Temperature Range at Case (T_C)	-20° to +80°C
Storage Temperature Range (T_{STG})	-40° to +80°C
Junction Temperature (T_J)	125°C
Reverse Voltage (V_R)	0.5 V
Forward Current, DC (I_F)	60 mA
Forward Current, $t \leq 1 \mu\text{s}$, $D \leq 1$ (I_{FSM})	100 mA

Characteristics (Output power ratings refers to an optimally coupled 50/125 μm GI fiber at $T_A=25^\circ\text{C}$)

Parameter	Symbol	Value	Unit
Emission Wavelength ($I_F=50 \text{ mA}$, $f=1 \text{ MHz}$)	ΔP_{PEAK}	1310 \pm 35	nm
Spectral Bandwidth ($I_F=50 \text{ mA}$, $f=1 \text{ MHz}$)	$\Delta\lambda$	130 \pm 30	nm
Radiation Power Coupled into 50/125 μm Graded Index Fiber NA=0.2, $I_F=50 \text{ mA}$	Φ_E	(>10) typ.15	μW
62/125 μm Graded Index Fiber NA=0.27, $I_F=50 \text{ mA}$	Φ_E	(>17) typ.25	μW
Forward Voltage ($I_F=50 \text{ mA}$)	V_F	1.2	V
Rise and Fall Time, 10% to 90% ($R_L=50 \Omega$, $I_F=50 \text{ mA}$)	t_R, t_F	3, 4	ns
Capacitance ($V_R=0 \text{ V}$, $R=1 \text{ MHz}$)	C_0	100	pF
Temperature Coefficient ($I_F=50 \text{ mA}$)			
Forward Voltage	TC_{VF}	-1.3	mV/K
Wavelength	TC_λ	0.5	nm/K
Radiation Power	$TC_{\Phi E}$	-0.7	%/K
Thermal Resistance			
Junction/Air	R_{thJA}	400	K/W
Junction/Case	R_{thJC}	150	K/W

Operating Instructions

To achieve an operating lifetime $>10^5$ h, which is required for telecommunications applications, do not exceed the recommended forward current of $I_F=50 \text{ mA}$.

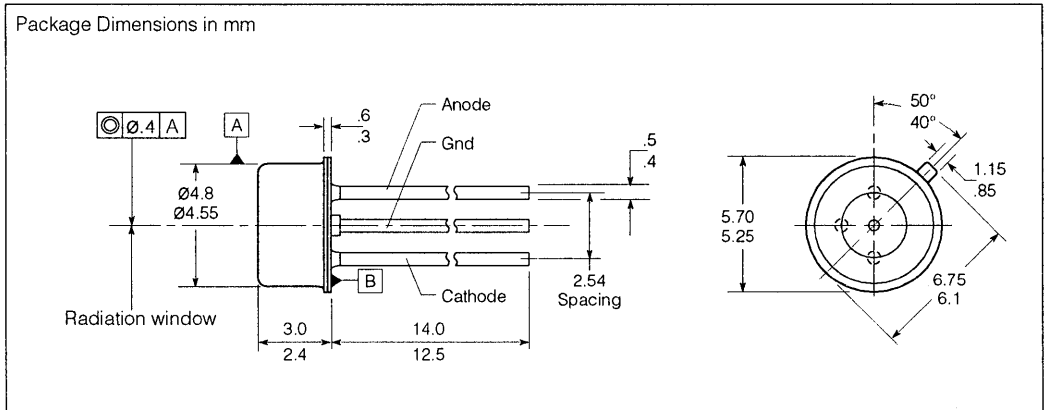

FEATURES

- InGaAsP/InP-IRED
- Emission Wavelength:
2nd Optical Window (1300 nm)
- Suitable for Bit Rates up to 50 Mbit/s
- 200 Mbit/s with Appropriate Pulse Shaping of Modulation Current
- High Output Power with Double Heterostructure
- High Coupling Efficiency into a 62.5/125 μm Graded Index Fiber with Built in Optics and Appropriate Second Lens Configuration
- Hermetically Sealed 3-pin Metal Case, Similar to TO 18, AR-Coated Window
- Application:
 - Fiber Optic Communication System

Maximum Ratings

Forward Current DC (I_F)	60 mA
Forward Current $\tau \leq 10 \mu\text{s}$, $D \leq 1$ (I_{FSM})	100 mA
Reverse Voltage (V_R)	0.5 V
Operating Temperature Range at Case (T_C)	-20° to +80°C
Storage Temperature Range (Ambient Temp.) (T_{STG})	-40° to +80°C
Junction Temperature (T_J)	125°C
Soldering Time (Wave Soldering), Pin Length 2mm, 260°C (T_{S1})	10 s
Soldering Time (Dip Soldering), Pin Length 2mm, 280°C (T_{S2})	3 s

Characteristics (Output power ratings refers to an optimally coupled 62.5/125 μm GI fiber at $T_A=25^\circ\text{C}$)

Parameter	Symbol	Value	Unit
Emission Wavelength (1)	λ_c	1310 \pm 30	nm
Spectral Bandwidth at 50% of Φ_{MAX} (1)	$\Delta\lambda$	130 \pm 30	nm
Radiation Power Coupled into a 62.5/125 μm GI-fiber with Fiber-Lens-Conf., NA = 0.275 (1)	Φ_e	15 to 45	μW
Forward Voltage, $I_F = 50$ mA DC	V_F	1.2	V
Rise and Fall Time (10 to 90%) ($R_L=50 \Omega$, $I_F=50$ mA)	t_{R,I_F}	3, 4	ns
Capacitance ($V_R=0$ V, $f=1$ MHz)	C_0	100	pF
Temperature Coefficient of Forward Voltage ($I_F=50$ mA)	TC_{V_F}	-1.3	mV/K
Temperature Coefficient of Wavelength ($I_F=50$ mA)	TC_λ	0.5	nm/K
Temperature Coefficient of Radiation Power ($I_F=50$ mA) (1)	TC_{Φ_e}	-0.7	%/K
Thermal Resistance			
Junction/Air	R_{thJA}	400	
Junction/Case	R_{thJC}	150	K/W
Frequency Response (2)	$A_{(60/10)}$	0.80	

Notes

1. Measured with optical system as shown in example (see below). Driving current is a square wave, 50% duty cycle, 60 mA_{PK} current at 1 MHz. Φ_e is the average optical power coupled in the described lens configuration.
2. The diode is driven with 30 mA DC and 60 mA_{PK} sine wave at 10 MHz and 60 MHz, respectively. $A_{(60/10)}$ is the ration of the coupled-in optical power of 60 MHz and 10 MHz modulation frequency.

OPERATING INSTRUCTIONS

In order to achieve an operating lifetime $>10^5$ h, which is required for Telcom applications, the value listed below should not be exceeded.

Recommended forward current $I_F=50$ mA DC

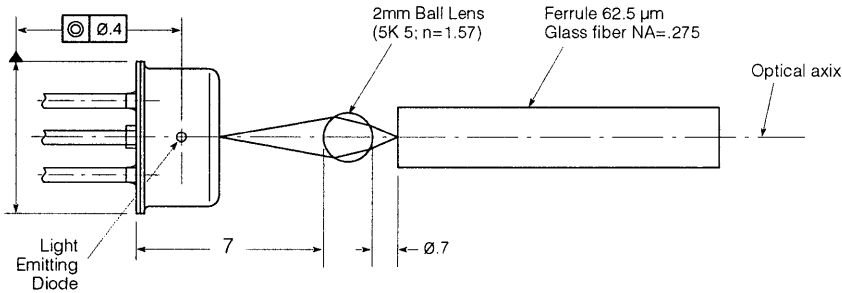

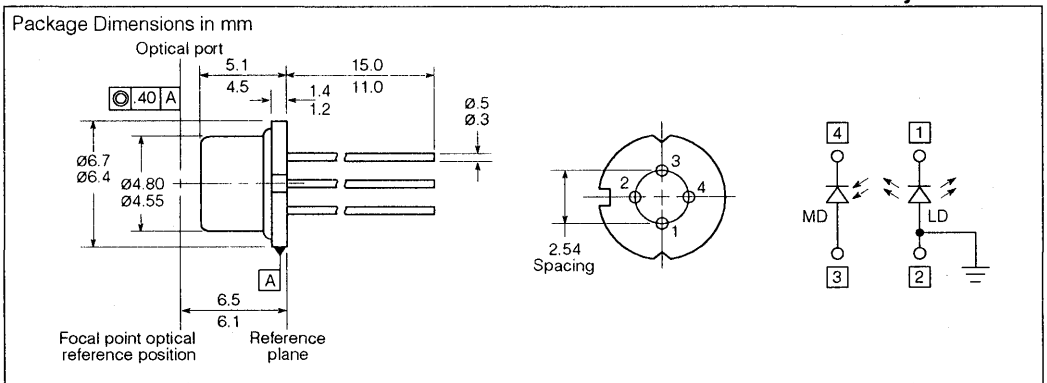

FEATURES

- InGaAsP/InP MCRW Laserdiode
- Emission Wavelength: 1300 nm
- Suitable for Bit Rates up to 565 Mbit/s
- Ternary Photodiode at Rear Mirror to Monitor and Control Radiant Power
- Internal Optical Lens System for Easy Coupling of SM Fiber
- Package: Hermetically Sealed 4-pin Metal Case, Similar to TO 18
- Application: Fiber Optic Communication Systems

Maximum Ratings Output power ratings refer to optimally coupled output power into a 10/125 μm SM fiber. The operating temperature of the laser heatsink is identical to the case temperature.

Module

Operating Temperature Range at Case (T_C)	-20° to +80°C
Storage Temperature Range (T_{STG})	-40° to +85°C
Soldering Temperature (2 mm from case bottom), (T_S) $t_{MAX}=20$ s	260°C
Temperature Gradient (dT/dt) $_{max}$	10 K/min
Acceleration (a_{max})	500 m/s ²

Laserdiode

Direct Forward Current (I_{Fmax})	150 mA
Total Radiation Power CW (Φ_E)	5 mW
Reverse Voltage (V_R)	2 V

Monitoring Diode

Reverse Voltage (V_{Rmax})	20 V
Forward Current (I_{Fmax})	5 mA

Characteristics ($T_A=25^\circ\text{C}$, unless otherwise specified. Output power data refers to a coupled 10/125 μm SM fiber, coupling tolerances for specified output power range (-1 dB loss) are $\pm 8 \mu\text{m}$ typical in radial direction (see notes).)

Laserdiode	Symbol	Value	Unit
Emission Wavelength, Center of Range	λ	1305 \pm 25	nm
Spectral Bandwidth ($\Phi_E=100 \mu\text{W}$)	$\Delta\lambda$	3.5	nm
Threshold Current	I_{TH}	25(\leq 40)	mA
Forward Voltage ($\Phi_E=100 \mu\text{W}$)	V_F	1.3(\leq 1.8)	V
Radiant Power at Threshold Current, I_{TH}	$\Phi_{E TH}$	4	μW
Differential Efficiency	η	>4	$\mu\text{W}/\text{mA}$
Differential Series Resistance ($\Phi_E=100 \mu\text{W}$)	r_s	4(\leq 8)	Ω
Rise and Fall Time ($R_L=50 \Omega$, $V_R=5$ V, $\Phi_E=100 \mu\text{W}$)	t_R , t_F	<500	ns
Temperature Coefficient			
Wavelength	TC_λ	0.5	nm/K
Differential Efficiency	TC_η	-1	%/K
Thermal Resistance, Junction/Case	R_{thJC}	120	K/W
Monitoring Diode			
Dark Current ($V_R=5$ V, $\Phi=0$)	I_R	1(\leq 10)	nA
Photocurrent ($\Phi_E=100 \mu\text{W}$)	I_P	50 to 600	μA
Rise and Fall Time ($R_L=50 \Omega$, $V_R=5$ V, $\Phi_E=100 \mu\text{W}$)	t_R , t_F	<500	ns

Notes

- Equations for temperature dependence of threshold current are:
 $I_{th}(T) = I_{thp}(25^\circ\text{C}) \exp \left[\frac{(T-25^\circ\text{C})}{T_0} \right]$ with
 $I_{thp}(25^\circ\text{C}) = \text{Pulse threshold current without inherent heating, } T_0 = 70 \text{ K (typical)}$
- Maximum possible output power into a SM fiber is 1.5 mW typical. Coupling tolerances for maximum output power (-1 dB loss) are $\pm 4 \mu\text{m}$ (typ.) in radial direction.

Operating Instructions

To achieve an operating lifetime $>10^5$ h, which is required for telecommunication applications, do not exceed the ratings listed below except for short periods (5% of lifetime). Output power data refers to a coupled 10/125 μm SM fiber; coupling tolerances for specified output power range (-1 dB loss) are $\pm 8 \mu\text{m}$ typical in radial direction (see Note 2 on previous page).

Recommended Operating Range

Operating Temperature Range at Case (T_C) +5 to 40 °C

Output Power at Coupled Fiber

CW Power (Φ_{ECWmax}) 100 μW

Pulse Power ($\Phi_{EPULSEmax}$) $t_P < 100 \text{ ns}$, $D \leq 0.1$ 100 μW

Overload Protection

The specified values are observed only as the diodes are not over loaded. For example, pulse spikes from the power supply unit, even if they last only a few nanoseconds, may cause irreversible damage to the laser diode. Pulse spikes may arise when the power supply is turned on or off or they may reach the laser diode from the line via the coupling capacitance of electronically controlled devices. Therefore, the power supply should have appropriate protection circuits.

Eye Protection

The high, optical radiant power may be harmful to the human eye. For safety reasons refer to the relevant safety regulations.

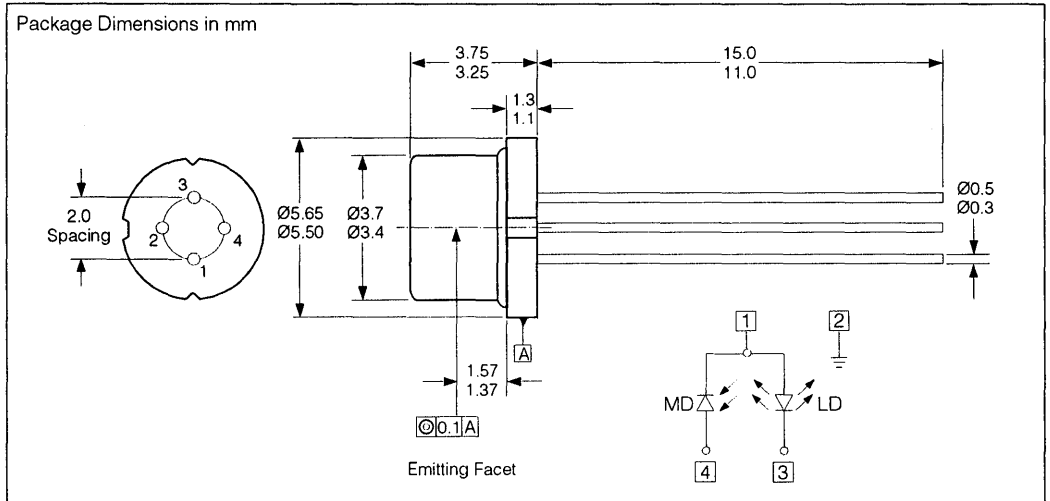

FEATURES

- InGaAsP/InP MCRW-Laser Diode
- Emission Wavelength: 1300 nm
- Suitable for Bit Rates up to 1 Gbit/s
- Ternary Photodiode at Rear Mirror for Monitoring and Control of Radiant Power
- Hermetically Sealed 4-Pin Metal Case, Similar to TO 18, Diameter 5.6mm
- Application
 - Fiber-Optic Communication Systems

Maximum Ratings

Output power ratings refer to the total emitted power at front window. The operating temperature of the submount is identical with the case temperature.

Module

Operating Temperature Range at Case (T_C)	-20° to +80°C
Storage Temperature Range (T_{STG})	-40° to +85°C
Soldering Temperature (2 mm from case bottom), (T_S) $t_{MAX}=20$ s	260°C
Temperature Gradient (dT/dt) $_{MAX}$	10 K/min
Acceleration (A_{MAX})	500 m/s ²

Laser Diode

Direct Forward Current ($I_{F MAX}$)	150 mA
Total Radiant Power CW (Φ_e)	8 mW
Reverse Voltage ($V_{R MAX}$)	2 V

Monitoring Diode

Reverse Voltage ($V_{R MAX}$)	20 V
Forward Current ($I_{F MAX}$)	5 mA

Characteristics ($T_A=25^\circ\text{C}$, unless otherwise specified. Output power data refer to the total emitted power at front window.)

Laser Diode	Symbol	Value	Unit
Emission Wavelength Center of Range ($\Phi_e=3\text{ mW}$)	λ	1305 ± 25	nm
Spectral Bandwidth ($\Phi_e=0.3\text{ mW}$)	$\Delta\lambda$	3.5	nm
Threshold Current	I_{TH}	$25(\leq 40)$	mA
Forward Voltage ($\Phi_e=3\text{ mW}$)	V_F	$1.3(\leq 1.5)$	V
Radiant Power at Threshold Current (I_{TH})	Φ_{eTH}	50	μW
Differential Efficiency	η	> 150	$\mu\text{W}/\text{mA}$
Differential Series Resistance ($\Phi_e=3\text{ mW}$)	r_S	$4(\leq 8)$	Ω
Rise and Fall Time ($\Phi_e=3\text{ mW}$, $R_L=50\ \Omega$)	t_R, t_F	< 400	ps
Temperature Coefficient of Wavelength	TC_λ	0.5	nm/K
Temperature Coefficient of Differential Efficiency	TC_η	-1	%/K
Thermal Resistance Junction/Case	R_{thJC}	120	K/W
Monitoring Diode			
Dark Current ($V_R=5\text{ V}$, $\Phi=0$)	I_R	$1(\leq 10)$	nA
Photocurrent ($\Phi_e=3\text{ mW}$)	I_P	50–600	μA
Rise and Fall Time ($R_L=50\ \Omega$, $V_R=5\text{ V}$, $\Phi_e=3\text{ mW}$)	t_R, t_F	< 500	ns

Note

1. The temperature dependence of the threshold current is given by:

$$I_{TH}(T) = I_{TH}(25^\circ\text{C}) \exp\left[\frac{(T-25^\circ\text{C})}{T_0}\right]$$

with: $I_{TH}(25^\circ\text{C})$ = Threshold current at $T=25^\circ\text{C}$.

$T_0=70\text{ K}$ (typ.)

OPERATING INSTRUCTIONS

To achieve an operating lifetime $> 10^5\text{ h}$, which is required for telecom applications, the ratings listed should not be exceeded except for short periods (5% of lifetime). Refer to the total emitted power at front window for output power data.

Recommended Operating Range

Operating Temperature

Range at Case T_C +5–40 $^\circ\text{C}$

Output Power

– CW Power $\Phi_{eCW}(\text{MAX})$ 3 mW

– Pulse Power ($t_P < 100\text{ ns}$, $D \leq 0.1$) $\Phi_{epulse}(\text{MAX})$ 6 mW

Overload Protection

The specified values are observed only as the diodes are not overloaded.

Pulse spikes from the power supply unit for example, even if they last only a few nanoseconds, may cause irreversible damage to the laser diode. Pulse spikes may arise when the power supply is turned on or off or they may reach the laser diodes from the line via the coupling capacitance of electronically controlled devices.

The power supply should therefore be provided with appropriate protection circuits.

Eye Protection

The high, optical radiant power may be harmful to the human eye. For safety measures refer to the relevant safety regulations.

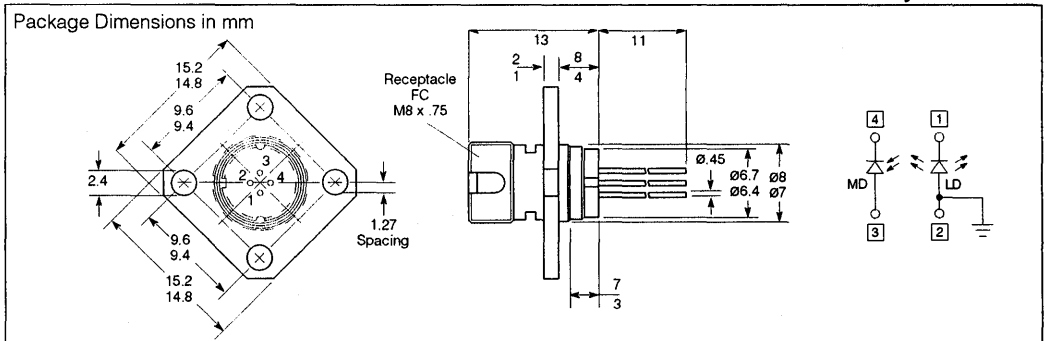

FEATURES

- InGaAsP/InP MCRW Laserdiode
- Emission Wavelength: 1300 nm
- Suitable for Bit Rates up to 565 Mbit/s
- Ternary Photodiode at Rear Mirror to Monitor and Control Radiant Power
- Package: Hermetically Sealed 4-pin Metal Subcomponent, Similar to TO 18
- Application: Fiber Optic Communication Systems

Operating Instructions

To achieve an operating lifetime $>10^5$ h, which is required for telecommunication applications, do not exceed the ratings listed below except for short periods (5% of lifetime).

Recommended Operating Range

Operating Temperature	
Range at Case (T_C)	+5 to 40°C
Output Power at Coupled Fiber	
CW Power	
Pulse Power ($t_p < 100$ ns, $D \leq 0.1$)	
Φ_{ECWmax}	100 μ W
$\Phi_{EPULSEmax}$	150 μ W

Overload Protection

The specified values are observed only if the diodes are not overloaded. For example, pulse spikes from the power supply unit, even if they last only a few nanoseconds, may cause irreversible damage to the laser diode. Pulse spikes may arise when the power supply is turned on or off or they may reach the laserdiode from the line via the coupling capacitance of electronically controlled devices. Therefore the power supply should have the appropriate protection circuits.

Eye Protection

The high, optical radiant power may be harmful to the human eye. Refer to the relevant safety regulations for safety precautions.

Maximum Ratings

Output power ratings refer to the optimally coupled output power into a 10/125 μ m SM fiber. The operating temperature of the laser heatsink is identical with the case temperature.

Module

Operating Temperature Range at Case (T_C)	-20° to +80°C
Storage Temperature Range (T_{STG})	-40° to +85°C
Soldering Temperature (2 mm from case bottom), (T_s) $t_{MAX} < 20$ s	260°C
Temperature Gradient (dT/dt) $_{max}$	10 K/min
Acceleration (a_{max})	500 m/s ²

Laserdiode

Direct Forward Current (I_{Fmax})	150 mA
Radiation Power CW (Φ_E)	150 μ W
Reverse Voltage (V_R)	2 V

Monitoring Diode

Reverse Voltage (V_{Rmax})	20 V
Forward Current (I_{Fmax})	5 mA

Characteristics ($T_A=25^\circ\text{C}$, unless otherwise specified. Output power data refers to a coupled 10/125 μ m SM fiber)

Laserdiode	Symbol	Value	Unit
Emission Wavelength, Center of Range	λ	1305±25	nm
Spectral Bandwidth ($\Phi_E=100$ μ W)	$\Delta\lambda$	3.5	nm
Threshold Current	I_{TH}	25(≤40)	mA
Forward Voltage ($\Phi_E=100$ μ W)	V_F	1.3(≤1.8)	V
Radiant Power at Threshold Current, I_{TH}	Φ_{ETH}	4(≤10)	μ W
Differential Efficiency	η	5 to 30	μ W/mA
Differential Series Resistance ($\Phi_E=100$ μ W)	r_s	4(≤8)	Ω
Rise and Fall Time ($R_L=50$ Ω , $V_R=5$ V, $\Phi_E=100$ μ W)	t_R , t_F	<500	ns
Temperature Coefficient			
Wavelength	$TC\lambda$	0.5	nm/K
Differential Efficiency	$TC\eta$	-1	%/K
Thermal Resistance, Junction/Case	R_{thJC}	120	K/W
Monitoring Diode			
Dark Current ($V_R=5$ V, $\Phi=0$)	I_R	1(≤10)	nA
Photocurrent ($\Phi_E=100$ μ W)	I_P	50 to 600	μ A
Rise and Fall Time ($R_L=50$ Ω , $V_R=5$ V, $\Phi_E=100$ μ W)	t_R , t_F	10	ns

Notes

- Equations for temperature dependence of threshold current:
 $I_{th}(T) = I_{thp}(25^\circ\text{C}) \exp((T - 25^\circ\text{C})/T_0)$ with $I_{thp}(25^\circ\text{C})$ = Pulse threshold current without inherent heating, $T_0=70$ K (typical)

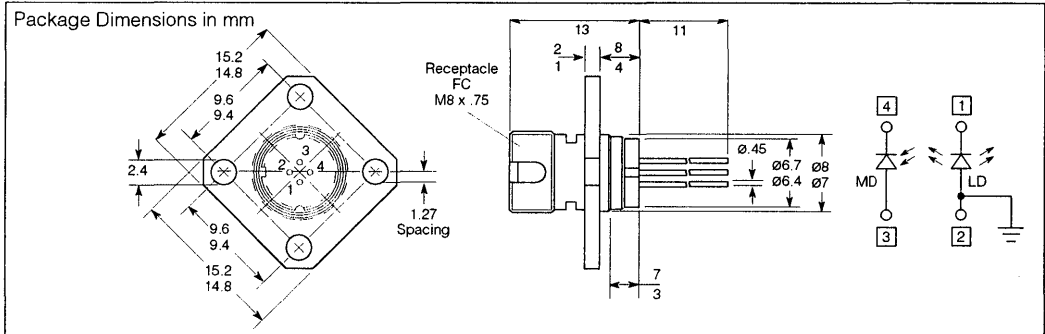

FEATURES

- InGaAsP/InP MCRW Laserdiode
- Emission Wavelength: 1300 nm
- Suitable for Bit Rates up to 565 Mbit/s
- Ternary Photodiode at Rear Mirror to Monitor and Control Radiant Power
- Package: Hermetically Sealed 4-pin Metal Case, Similar to TO 18
- Application: Fiber Optic Communication Systems

Operating Instructions

To achieve an operating lifetime $>10^5$ h, which is required for telecommunication applications, the ratings listed below should not be exceeded except for short periods (5% of lifetime).

Recommended Operating Range

Operating Temperature
 Range at Case (T_C) +5 to 40°C
 Output Power at Coupled Fiber
 CW Power
 Pulse Power ($t_p < 100$ ns, $D \leq 0.1$)
 Φ_{ECWmax} 1 mW
 $\Phi_{EPULSEmax}$ 1.5 mW

Overload Protection

The specified values are observed only if the diodes are not overloaded. Pulse spikes from the power supply unit, for example, even if they last only a few nanoseconds, may cause irreversible damage to the laser diode. Pulse spikes may arise when the power supply is turned on or off or they may reach the laserdiode from the lint via the coupling capacitance of electronically controlled devices. Therefore the power supply should have the appropriate protection circuits.

Eye Protection

The high, optical radiant power may be harmful to the human eye. For safety reasons refer to the relevant safety regulations.

Maximum Ratings

Output power ratings refer to the optimally coupled output power into a 10/125 μ m SM fiber. The operating temperature of the laser heatsink is identical with the case temperature.

Module

Operating Temperature Range at Case (T_C) -20° to +80°C
 Storage Temperature Range (T_{STG}) -40° to +85°C
 Soldering Temperature (2 mm from case bottom), (T_S) $t_{MAX}=20$ s 260°C
 Temperature Gradient (dT/dt) $_{max}$ 10 K/min
 Acceleration (a_{max}) 500 m/s²

Laserdiode

Direct Forward Current (I_{Fmax}) 150 mA
 Radiation Power CW (Φ_E) 1.5 mW
 Reverse Voltage (V_R) 2 V
Monitoring Diode
 Reverse Voltage (V_{Rmax}) 20 V
 Forward Current (I_{Fmax}) 5 mA

Characteristics ($T_A=25^\circ\text{C}$, unless otherwise specified. Output power data refers to a coupled 10/125 μ m SM fiber)

Laserdiode	Symbol	Value	Unit
Emission Wavelength, Center of Range	λ	1305 \pm 25	nm
Spectral Bandwidth ($\Phi_E=100$ μ W)	$\Delta\lambda$	3.5	nm
Threshold Current	I_{TH}	25(\leq 40)	mA
Forward Voltage ($\Phi_E=100$ μ W)	V_F	1.3(\leq 1.8)	V
Radiant Power at Threshold Current, I_{TH}	Φ_{ETH}	20(\leq 50)	μ W
Differential Efficiency	η	25 to 100	μ W/mA
Differential Series Resistance ($\Phi_E=1$ mW)	r_S	4(\leq 8)	Ω
Rise and Fall Time ($R_L=50$ Ω , $V_R=5$ V, $\Phi_E=100$ μ W)	t_R, t_F	<500	ns
Temperature Coefficient			
Wavelength	$TC\lambda$	0.5	nm/K
Differential Efficiency	$TC\eta$	-1	%/K
Thermal Resistance, Junction/Case	R_{thJC}	120	K/W
Monitoring Diode			
Dark Current ($V_R=5$ V, $\Phi=0$)	I_R	1(\leq 10)	nA
Photocurrent ($\Phi_E=1$ mW)	I_P	50 to 800	μ A
Rise and Fall Time ($R_L=50$ Ω , $V_R=5$ V, $\Phi_E=1$ mW)	t_R, t_F	10	ns

Notes

1. Equations for temperature dependence of threshold current:
 $I_{th}(T)=I_{thp}(25^\circ\text{C}) \exp [(T-25^\circ\text{C})/T_0]$ with $I_{thp}(25^\circ\text{C})$ =Pulse threshold current without inherent heating, $T_0=70$ K (typical)

Fiber Optic Laser Diode Devices

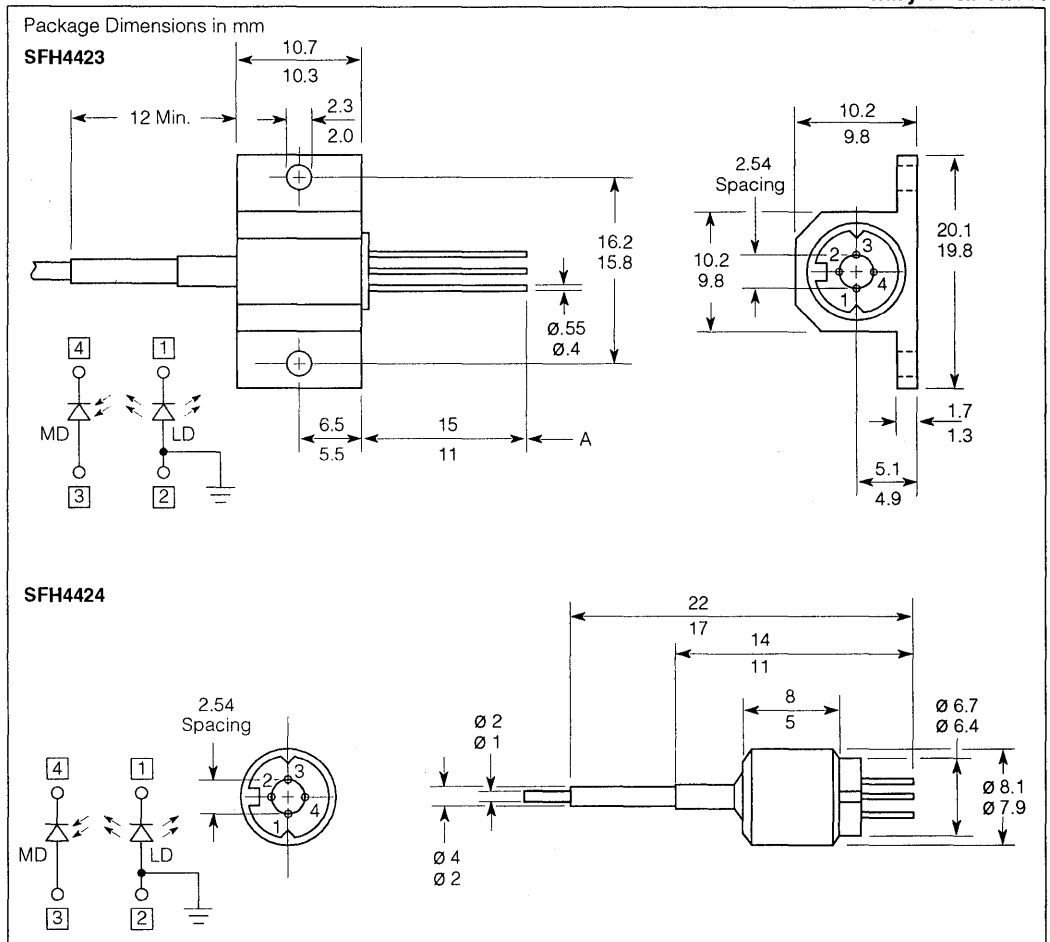

FEATURES

- InGaAsP/InP MCRW Laserdiode
- 10/125 μm Single Mode Pigtail
- Emission Wavelength: 1300 nm
- Suitable for Bit Rates up to 565 Mbit/s
- Ternary Photodiode at Rear Mirror to Monitor and Control Radiant Power
- Package: Hermetically Sealed 4-pin Metal Case, Similar to TO 18
- Applications: Fiber Optic Communication Systems, Bidirectional Uses

Maximum Ratings

Output power ratings refer to the fiber output. The operating temperature of the submount is identical with the case temperature.

Module

Operating Temperature Range at Case (T_{OP})	-20° to +80°C
Storage Temperature Range at Case (T_{STG})	-20° to +85°C
Soldering Temperature (2 mm from case bottom), (T_s) $t_{MAX}=20$ s	260°C
Temperature Gradient (dT/dt) $_{max}$	10 K/min
Acceleration (a_{max})	500 m/s ²

Laserdiode

Direct Forward Current (I_{Fmax})	150 mA
Radiation Power CW (Φ_E)	200 μW
Reverse Voltage (V_R)	2 V

Monitoring Diode

Reverse Voltage (V_{Rmax})	20 V
Forward Current (I_{Fmax})	5 mA

Operating Instructions

To achieve an operating lifetime $> 10^5$ h, which is required for telecommunication applications, the ratings listed below should not be exceeded except for short periods (5% of lifetime).

Recommended Operating Range

Operating Temperature

Range at Case (T_{CASE}) +5 to 40°C

Output Power at Coupled Fiber

CW Power (Φ_{ECWmax}) 100 μ W

Pulse Power ($t_p < 100$ ns, $D \leq 0.1$)

$\Phi_{EPULSE(max)}$ 150 μ W

Overload Protection

The specified values are observed only if the diodes are not overloaded. Pulse spikes from the power supply unit, for example, even if they last only a few nanoseconds, may cause irreversible damage to the laser diode. Pulse spikes may arise when the power supply is turned on or off or they may reach the laser diode from the lint via the coupling capacitance of electronically controlled devices. Therefore the power supply should have the appropriate protection circuits.

Eye Protection

The high, optical radiant power may be harmful to the human eye. For safety reasons refer to the relevant safety regulations.

Characteristics ($T_A=25^\circ\text{C}$, unless otherwise specified. Output power data refers to the fiber end.)

Laserdiode		Symbol	Value	Unit
Emission Wavelength, Center of Range		λ	1305 \pm 25	nm
Spectral Bandwidth ($\Phi_E=100 \mu\text{W}$)		$\Delta\lambda$	3.5	nm
Threshold Current		I_{TH}	25(\leq 40)	mA
Forward Voltage ($\Phi_E=100 \mu\text{W}$)		V_F	1.3(\leq 1.8)	V
Radiant Power at Threshold Current, I_{TH}		Φ_{ETH}	4(\leq 10)	μW
Differential Efficiency		η	5 to 30	$\mu\text{W}/\text{mA}$
Differential Series Resistance ($\Phi_E=1 \text{ mW}$)		r_S	4(\leq 8)	Ω
Rise and Fall Time ($R_L=50 \Omega$, $V_R=5 \text{ V}$, $\Phi_E=100 \mu\text{W}$)		t_R , t_F	<500	ns
Temperature Coefficient, Wavelength		$TC\lambda$	0.5	nm/K
Temperature Coefficient, Differential Efficiency		$TC\eta$	-1	%/K
Thermal Resistance, Junction/Case		R_{thJC}	120	K/W
Monitoring Diode		Symbol	Value	Unit
Dark Current ($V_R=5\text{V}$, $\Phi=0$)		I_R	1(\leq 10)	nA
Photocurrent ($\Phi_E=1 \text{ mW}$)		I_P	50 to 600	μA
Rise and Fall Time ($R_L=50 \Omega$, $V_R=5 \text{ V}$, $\Phi_E=1 \text{ mW}$)		t_R , t_F	10	ns
Photocurrent, External Light in Fiber ($V_R=5 \text{ V}$, $\Phi_E=100 \mu\text{W}$, $I_{FLD}=0$)		I_P	3	μA

Notes

1. The temperature dependence of threshold current is given by:

$$I_{th}(T) = I_{thp}(25^\circ\text{C}) \exp \left[\frac{(T-25^\circ\text{C})}{T_0} \right] \text{ with } I_{thp}(25^\circ\text{C}) = \text{Pulse threshold current without inherent heating, } T_0 = 70 \text{ K (typical)}$$

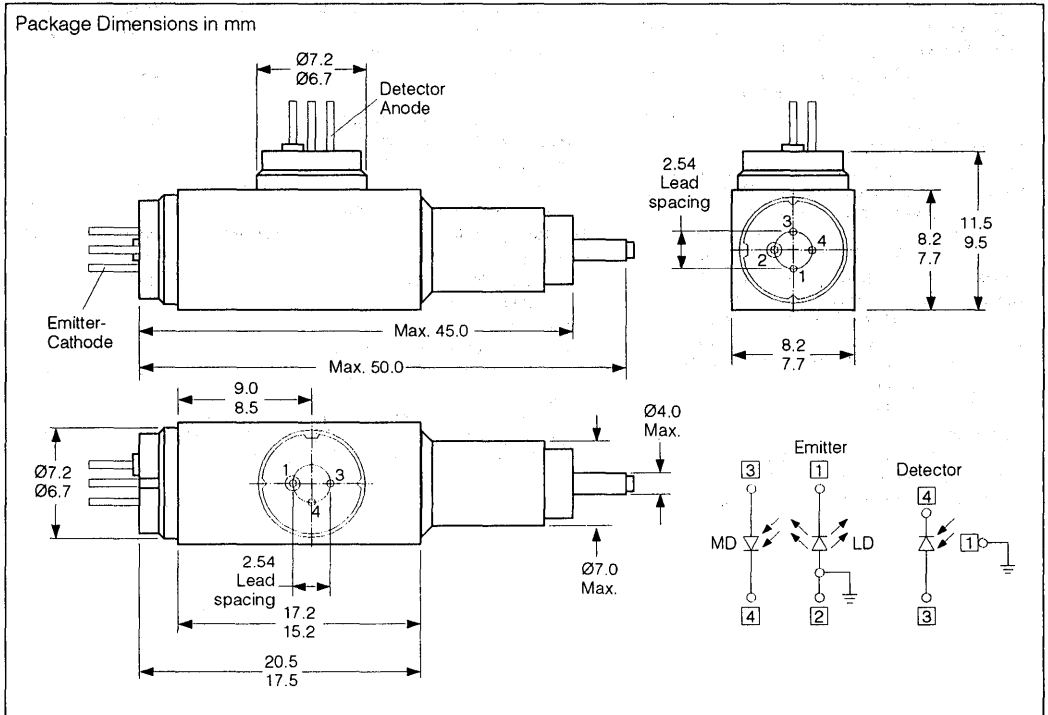

FEATURES

- Bidirectional Module with Integrated WDM
- Emission Wavelength: 1300 nm
- Suitable for Bit Rates up to 565 Mbit/s
- Ternary Photodiode at Rear Mirror for Monitoring and Control of Radiant Power
- Hermetically Sealed Subcomponents, Similar to TO 18
- SM Pigtail with DIN Connector
- Application
 - Fiber-Optic Passive Optical Networks

Maximum Ratings

Output power ratings refer to the SM fiber output. The operating temperature of the submount is identical with the case temperature.

Module

Operating Temperature Range at Case (T_C)	–40° to +70°C
Storage Temperature Range (T_{STG})	–40° to +75°C
Soldering Temperature (2 mm from case bottom), (T_S) $t_{MAX}=10$ s	260°C/min.

Laser Diode

Direct Forward Current ($I_{F MAX}$)	150 mA
Radiant Power CW (Φ_e)	1200 μ W
Reverse Voltage ($V_{R MAX}$)	2 V

Monitoring Diode

Reverse Voltage ($V_{R MAX}$)	20 V
---------------------------------	------

PIN Diode

Reverse Voltage ($V_{R MAX}$)	20 V
Maximum Optical Input Power ($P_{opt MAX}$)	2 mW

Characteristics ($T_A=25^\circ\text{C}$, unless otherwise specified.
Output power data refer to optical port SM fiber.)

Laser Diode	Symbol	Value	Unit
Emission Wavelength Center of Range ($\Phi_e=0.5\text{ mW}$)	λ	1305±25	nm
Spectral Bandwidth ($\Phi_e=0.5\text{ mW}$)	$\Delta\lambda$	4.5	nm
Threshold Current (1)	I_{TH}	25(≤40)	mA
Forward Voltage ($\Phi_e=0.5\text{ mW}$)	V_F	1.3(≤1.5)	V
Radiant Power at			
Threshold Current (I_{TH})	Φ_{eTH}	15(≤30)	μW
Differential Efficiency	η	15–100	μW/mA
Differential Series Resistance ($\Phi_e=0.5\text{ mW}$)	r_S	4(≤8)	Ω
Rise and Fall Time ($\Phi_e=0.5\text{ mW}$ 50 Ω circuit)	$t_{R, f}$	<400	ps
Max Current for 0.5 mW Output Power at Max Temperature	I_{MAX}	130	mA
Temperature Coefficient of Wavelength	TC_λ	0.5	nm/K
Temperature Coefficient of Differential Efficiency	TC_η	-1	%/K
Thermal Resistance Junction/Case	R_{thJC}	120	K/W

PIN Diode

Dark Current ($V_R=5\text{ V}$, $\Phi=0$)	I_R	1(≤10)	nA
Spectral Sensitivity ($\lambda=1550\text{ nm}$)	S_λ	0.7(≥0.6)	AW
Junction Capacitance ($\Phi=0$, $f=1\text{ MHz}$, $V_R=3\text{ V}$)	C_J	1.5(≤2)	pF
Rise and Fall Time ($R_L=50\text{ Ω}$, $V_R=5\text{ V}$, $\lambda=1300\text{ nm}$, $\Phi_e=0.5\text{ mW}$)	$t_{R, f}$	0.5(≤1.5)	ns

Monitoring Diode

Dark Current ($V_R=5\text{ V}$, $\Phi=0$)	I_R	≤0.5	μA
Photocurrent ($\Phi_e=0.5\text{ mW}$)	I_P	100–800	μA
Rise and Fall Time ($R_L=50\text{ Ω}$, $V_R=5\text{ V}$, $\Phi_e=0.5\text{ mW}$)	$t_{R, f}$	<10	ns

Module

Photocurrent PIN due to Optical Crosstalk (2)	I_{CRT}	20	nA
---	-----------	----	----

Notes

- The temperature dependence of the threshold current is given by:

$$I_{TH}(T) = I_{TH}(25^\circ\text{C}) \exp[(T-25^\circ\text{C})/T_0]$$
 with:
 $I_{TH}(25^\circ\text{C})$ = Threshold current at $T=25^\circ\text{C}$.
 $T_0=70\text{ K}$ (typ.)
- Photocurrent of PIN diode caused by internal optical crosstalk measured at $\Phi_e=0.5\text{ mW}$ and $V_R=5\text{ V}$ (without reflections at optical port).

OPERATING INSTRUCTIONS

To achieve an operating lifetime $>10^5\text{ h}$, which is required for Telecom applications, the ratings listed below should not be exceeded except for short periods (5% of lifetime). Refer to the total emitted power at optical port for output power data.

Recommended Operating Range

	Symbol	Value	Unit
Operating Temperature Range at Case	T_C	+5–40	°C
Output Power			
– CW Power	$\Phi_{eCW(MAX)}$	0.5	mW
– Pulse Power ($t_p<100\text{ ns}$, $D\leq 0.1$)	$\Phi_{epulse(MAX)}$	1	mW

Overload Protection

The specified values are observed only if the diodes are not overloaded.

Pulse spikes from the power supply unit, for example, even if they last only a few nanoseconds, may cause irreversible damage to the laser diode. Pulse spikes may arise when the power supply is turned on or off or they may reach the laser diode from the line via the coupling capacitance of electronically controlled devices.

The power supply should therefore be provided with appropriate protection circuits.

Eye Protection

The high, optical radiant power may be harmful to the human eye. For safety measures refer to the relevant safety regulations.

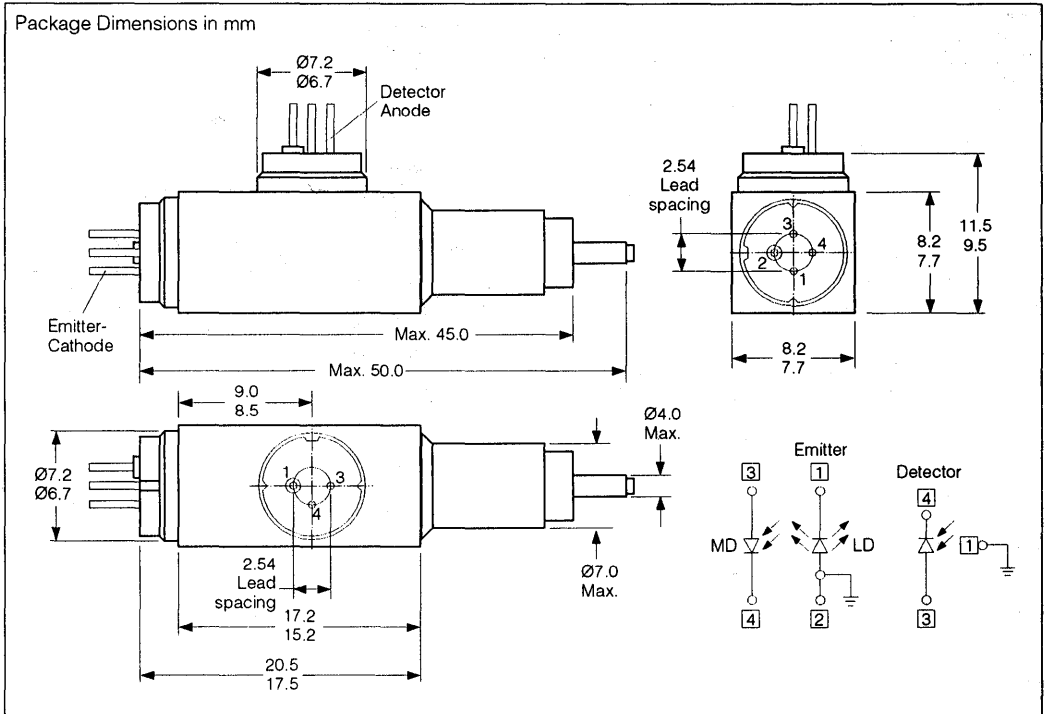

FEATURES

- Bidirectional Module with Integrated WDM
- Emission Wavelength: 1300 nm
- Suitable for Bit Rates up to 565 Mbit/s
- Ternary Photodiode at Rear Mirror for Monitoring and Control of Radiant Power
- Hermetically Sealed Subcomponents, Similar to TO 18
- SM Pigtail with DIN Connector
- Application
 - Fiber-Optic Point to Point Transmission

Maximum Ratings

Output power ratings refer to the SM fiber output. The operating temperature of the submount is identical with the case temperature.

Module

Operating Temperature Range at Case (T_C) -40° to $+70^\circ\text{C}$

Storage Temperature Range (T_{STG}) -40° to $+75^\circ\text{C}$

Soldering Temperature (2 mm from case bottom), (T_S) $t_{MAX}=10$ s $260^\circ\text{C}/\text{min}$

Laser Diode

Direct Forward Current ($I_{F MAX}$) 150 mA

Radiant Power CW (Φ_e) 200 μW

Reverse Voltage ($V_{R MAX}$) 2 V

Monitoring Diode

Reverse Voltage ($V_{R MAX}$) 20 V

PIN Diode

Reverse Voltage ($V_{R MAX}$) 20 V

Maximum Optical Input Power ($P_{opt MAX}$) 1 mW

Characteristics ($T_A=25^\circ\text{C}$, unless otherwise specified.
Output power data refer to optical port SM fiber.)

Laser Diode	Symbol	Value	Unit
Emission Wavelength center of Range ($\Phi_e=0.1\text{ mW}$)	λ	1305±25	nm
Spectral Bandwidth ($\Phi_e=0.1\text{ mW}$)	$\Delta\lambda$	4.5	nm
Threshold Current ⁽¹⁾	I_{TH}	25(≤40)	mA
Forward Voltage ($\Phi_e=0.1\text{ mW}$)	V_F	1.3(≤1.5)	V
Radiant Power at			
Threshold Current (I_{TH})	Φ_{eTH}	10(≤20)	μW
Differential Efficiency	η	8–60	μW/mA
Differential Series Resistance ($\Phi_e=0.1\text{ mW}$)	r_S	4(≤8)	Ω
Rise and Fall Time ($\Phi_e=0.1\text{ mW}$, 50 Ω circuit)	t_R, t_F	<400	ps
Max Current for 0.1 mW Output Power at Max Temperature	I_{MAX}	130	mA
Temperature Coefficient of Wavelength	TC_λ	0.5	nm/K
Temperature Coefficient of Differential Efficiency	TC_η	-1	%/K
Thermal Resistance Junction/Case	R_{thJC}	120	K/W

PIN Diode

Dark Current ($V_R=5\text{ V}$, $\Phi=0$)	I_R	1(≤10)	nA
Spectral Sensitivity ($\lambda=1550\text{ nm}$)	S_λ	0.7(≥0.6)	A/W
Junction Capacitance ($\Phi=0$, $f=1\text{ MHz}$, $V_R=3\text{ V}$)	C_3	1.5(≤2)	pF
Rise and Fall Time ($R_L=50\text{ Ω}$, $V_R=5\text{ V}$, $\lambda=1300\text{ nm}$, $\Phi_e=0.1\text{ mW}$)	t_R, t_F	0.5(≤1.5)	ns

Monitoring Diode

Dark Current ($V_R=5\text{ V}$, $\Phi=0$)	I_R	≤0.5	μA
Photocurrent ($\Phi_e=0.1\text{ mW}$)	I_P	100–800	μA
Rise and Fall Time ($R_L=50\text{ Ω}$, $V_R=5\text{ V}$, $\Phi_e=0.1\text{ mW}$)	t_R, t_F	<10	ns

Module

Photocurrent PIN due to Optical Crosstalk ⁽²⁾	I_{CRT}	10	nA
--	-----------	----	----

Notes

1. The temperature dependence of the threshold current is given by:

$$I_{TH}(T) = I_{TH}(25^\circ\text{C}) \exp[(T - 25^\circ\text{C})/T_0]$$

with:

$$I_{TH}(25^\circ\text{C}) = \text{Threshold current at } T=25^\circ\text{C}.$$

$$T_0 = 70\text{ K (typ.)}$$

2. Photocurrent of PIN diode caused by internal optical crosstalk measured at $\Phi_e=0.1\text{ mW}$ and $V_R=5\text{ V}$ (without reflections at optical port).

OPERATING INSTRUCTIONS

To achieve an operating lifetime $>10^5\text{ h}$, which is required for Telcom applications, the ratings listed below should not be exceeded except for short periods (5% of lifetime). Refer to the total emitted power at optical port for output power data.

Recommended Operating Range

	Symbol	Value	Unit
Operating Temperature Range at Case	T_C	+5–40	°C
Output Power			
– CW Power	$\Phi_{eCW(MAX)}$	0.1	mW
– Pulse Power ($t_P < 100\text{ ns}$, $D \leq 0.1$)	$\Phi_{epulse(MAX)}$	0.2	mW

Overload Protection

The specified values are observed only if the diodes are not overloaded.

Pulse spikes from the power supply unit, for example, even if they last only a few nanoseconds, may cause irreversible damage to the laser diode. Pulse spikes may arise when the power supply is turned on or off or they may reach the laser diode from the line via the coupling capacitance of electronically controlled devices.

The power supply should therefore be provided with appropriate protection circuits.

Eye Protection

The high, optical radiant power may be harmful to the human eye. For safety measures refer to the relevant safety regulations.

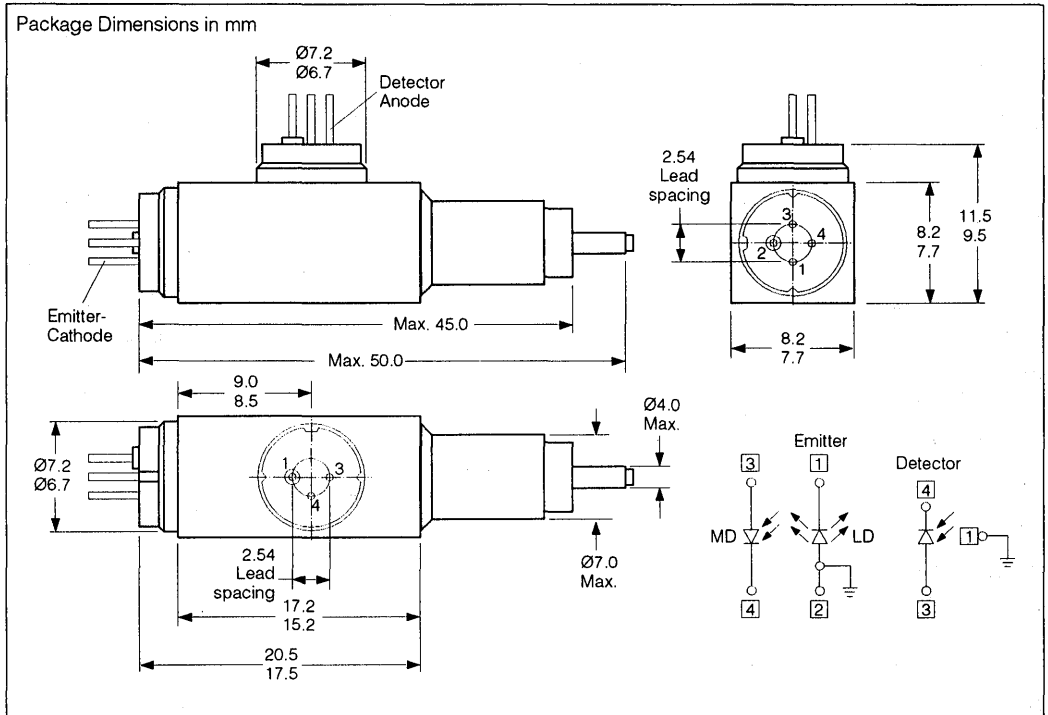

FEATURES

- Bidirectional Module with Integrated Beam Splitter
- Emission Wavelength: 1300 nm
- Suitable for Bit Rates up to 565 Mbit/s
- Ternary Photodiode at Rear Mirror for Monitoring and Control of Radiant Power Similar to TO 18
- SM Pigtail with DIN Connector
- Application
 - Fiber-Optical Communication Systems

Maximum Ratings

Output power ratings refer to the SM fiber output. The operating temperature of the submount is identical with the case temperature.

Module

Operating Temperature Range at Case (T_C) -40° to $+70^\circ\text{C}$
 Storage Temperature Range (T_{STG}) -40° to $+75^\circ\text{C}$
 Soldering Temperature (2 mm from case bottom), (T_S) $t_{MAX}=10$ s $260^\circ\text{C}/\text{min}$.

Laser Diode

Direct Forward Current ($I_{F MAX}$) 150 mA
 Radiant Power CW (Φ_e) 400 μW
 Reverse Voltage ($V_{R MAX}$) 2 V

Monitoring Diode

Reverse Voltage ($V_{R MAX}$) 20 V

PIN Diode

Reverse Voltage ($V_{R MAX}$) 20 V
 Maximum Optical Input Power ($P_{opt MAX}$) 1 mW

Characteristics ($T_A=25^{\circ}\text{C}$, unless otherwise specified.
Output power data refer to optical port SM fiber.)

Laser Diode Parameter	Symbol	Value	Unit
Emission Wavelength center of Range ($\Phi_e=200\ \mu\text{W}$)	λ	1305±25	nm
Spectral Bandwidth ($\Phi_e=200\ \mu\text{W}$)	$\Delta\lambda$	4.5	nm
Threshold Current (1)	I_{TH}	25(≤40)	mA
Forward Voltage ($\Phi_e=200\ \mu\text{W}$)	V_F	1.3(≤1.5)	V
Radiant Power at			
Threshold Current (I_{TH})	Φ_{eTH}	6(≤30)	μW
Differential Efficiency	η	6–30	$\mu\text{W}/\text{mA}$
Differential Series Resistance ($\Phi_e=200\ \mu\text{W}$)	r_S	4(≤8)	Ω
Rise and Fall Time ($\Phi_e=200\ \mu\text{W}$, 50 Ω circuit)	t_R, t_F	<400	ps
Max Current for 200 μW Output Power at Max Temperature	I_{MAX}	130	mA
Temperature Coefficient of Wavelength	TC_λ	0.5	nm/K
Temperature Coefficient of Differential Efficiency	TC_η	-1	%/K
Thermal Resistance Junction/Case	R_{thJC}	120	K/W

PIN Diode

Dark Current ($V_R=5\ \text{V}$, $\Phi=0$)	I_R	1(≤10)	nA
Spectral Sensitivity ($\lambda=1300\ \text{nm}$)	S_λ	0.5(≥0.3)	A/W
Junction Capacitance ($\Phi=0$, $f=1\ \text{MHz}$, $V_R=3\ \text{V}$)	C_3	1.5(≤2)	pF
Rise and Fall Time ($R_L=50\ \Omega$, $V_R=5\ \text{V}$, $\lambda=1300\ \text{nm}$, $\Phi_e=200\ \mu\text{W}$)	t_R, t_F	0.5(≤1.5)	ns

Monitoring Diode

Dark Current ($V_R=5\ \text{V}$, $\Phi=0$)	I_R	≤0.5	μA
Photocurrent ($\Phi_e=200\ \mu\text{W}$)	I_P	100–800	μA
Rise and Fall Time ($R_L=50\ \Omega$, $V_R=5\ \text{V}$, $\Phi_e=200\ \mu\text{W}$)	t_R, t_F	<10	ns

Module

Photocurrent PIN due to Optical Crosstalk (2)	I_{CRT}	3	μA
---	-----------	---	---------------

Notes

- The temperature dependence of the threshold current is given by:
 $I_{TH}(T)=I_{TH}(25^{\circ}\text{C}) \exp[(T-25^{\circ}\text{C})/T_0]$
 with:
 $I_{TH}(25^{\circ}\text{C})$ =Threshold current at $T=25^{\circ}\text{C}$.
 $T_0=70\ \text{K}$ (typ.)
- Photocurrent of PIN diode caused by internal optical crosstalk measured at $\Phi_E=0.2\ \text{mW}$ and $V_R=5\ \text{V}$ (without reflections at optical port).

OPERATING INSTRUCTIONS

To achieve an operating lifetime $>10^5\ \text{h}$, which is required for Telcom applications, the ratings listed below should not be exceeded except for short periods (5% of lifetime). Refer to the total emitted power at optical port for output power data.

Recommended Operating Range

	Symbol	Value	Unit
Operating Temperature Range at Case	T_C	+5–40	$^{\circ}\text{C}$
Output Power			
– CW Power	$\Phi_{eCW}(\text{MAX})$	200	μW
– Pulse Power ($t_P < 100\ \text{ns}$, $D \leq 0.1$)	$\Phi_{epulse}(\text{MAX})$	400	μW

Overload Protection

The specified values are observed only if the diodes are not overloaded.

Pulse spikes from the power supply unit, for example, even if they last only a few nanoseconds, may cause irreversible damage to the laser diode. Pulse spikes may arise when the power supply is turned on or off or they may reach the laser diode from the line via the coupling capacitance of electronically controlled devices.

The power supply should therefore be provided with appropriate protection circuits.

Eye Protection

The high, optical radiant power may be harmful to the human eye. For safety measures refer to the relevant safety regulations.

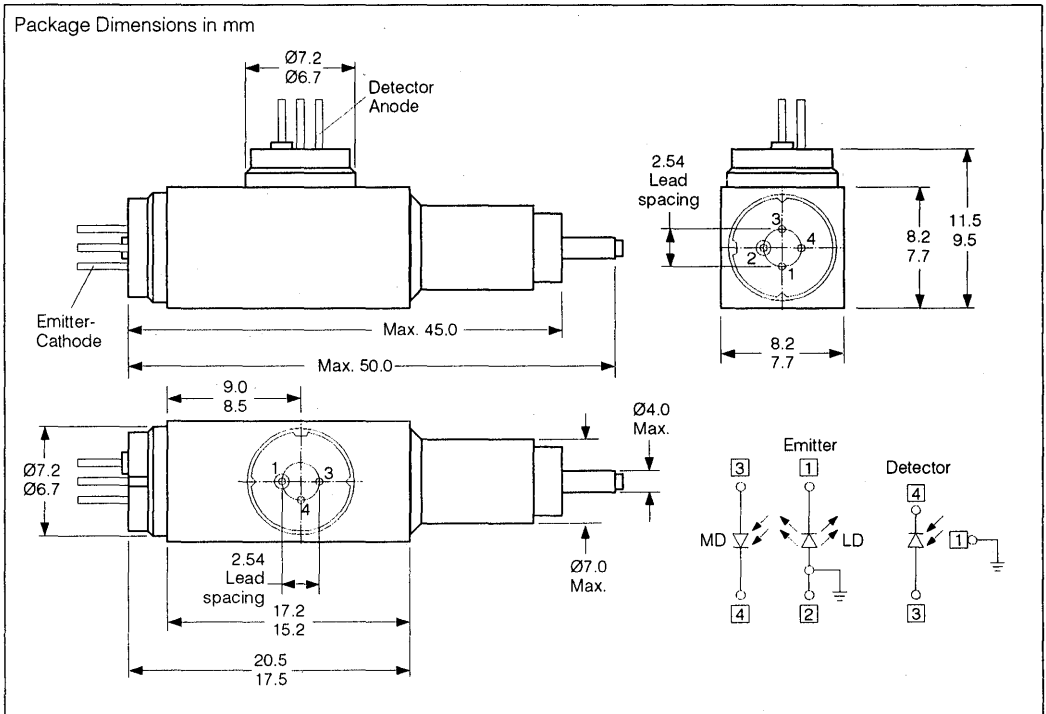

FEATURES

- Bidirectional Module with Integrated WDM
- Emission Wavelength: 1550nm
- Suitable for Bit Rates up to 565 Mbit/s
- Ternary Photodiode at Rear Mirror for Monitoring and Control of Radiant Power
- Hermetically Sealed Subcomponents Similar to TO 18
- SM Pigtail with DIN Connector
- Application
 - Fiber-Optic Point to Point Transmission

Maximum Ratings

Output power ratings refer to the SM fiber output. The operating temperature of the submount is identical with the case temperature.

Module

Operating Temperature Range at Case (T_C)	-40° to +60°C
Storage Temperature Range (T_{STG})	-40° to +75°C
Soldering Temperature (2 mm from case bottom), (T_S) $t_{MAX}=10$ s	260°C/min.

Laser Diode

Direct Forward Current ($I_{F MAX}$)	150 mA
Radiant Power CW (Φ_e)	200 μ W
Reverse Voltage ($V_{R MAX}$)	2 V

Monitoring Diode

Reverse Voltage ($V_{R MAX}$)	20 V
---------------------------------	------

PIN Diode

Reverse Voltage ($V_{R MAX}$)	20 V
Maximum Optical Input Power ($P_{opt MAX}$)	1 mW

Characteristics ($T_A=25^{\circ}\text{C}$, unless otherwise specified.
Output power data refer to optical port SM fiber.)

Laser Diode	Symbol	Value	Unit
Emission Wavelength Center of Range ($\Phi_e=0.1\text{ mW}$)	λ	1550±25	nm
Spectral Bandwidth ($\Phi_e=0.1\text{ mW}$)	$\Delta\lambda$	4.5	nm
Threshold Current (see note 1)	I_{TH}	35(≤50)	mA
Forward Voltage ($\Phi_e=0.1\text{ mW}$)	V_F	1.3(≤1.5)	V
Radiant Power at Threshold Current (I_{TH})	Φ_{eTH}	10(≤30)	μW
Differential Efficiency	η	5-50	μW/mA
Differential Series Resistance ($\Phi_e=0.1\text{ mW}$)	r_s	4(≤8)	Ω
Rise and Fall Time ($\Phi_e=0.1\text{ mW}$, 50 Ω circuit)	$t_{R,F}$	<400	ps
Max Current for 0.1 mW Output Power at Max Temperature	I_{MAX}	130	mA
Temperature Coefficient of Wavelength	TC_λ	0.5	nm/K
Temperature Coefficient of Differential Efficiency	TC_η	-2	%/K
Thermal Resistance Junction/Case	R_{thJC}	120	K/W

PIN Diode

Dark Current ($V_R=5\text{ V}$, $\Phi=0$)	I_R	1(≤10)	nA
Spectral Sensitivity ($\lambda=1300\text{ nm}$)	S_λ	0.7(≥0.6)	A/W
Junction Capacitance ($\Phi=0$, $f=1\text{ MHz}$, $V_R=3\text{ V}$)	C_j	1.5(≤2)	pF
Rise and Fall Time ($R_L=50\ \Omega$, $V_R=5\text{ V}$, $\lambda=1300\text{ nm}$, $\Phi_e=0.1\text{ mW}$)	$t_{R,F}$	0.5(≤1.5)	ns

Monitoring Diode

Dark Current ($V_R=5\text{ V}$, $\Phi=0$)	I_R	≤0.5	μA
Photocurrent ($\Phi_e=0.1\text{ mW}$)	I_P	100-800	μA
Rise and Fall Time ($R_L=50\ \Omega$, $V_R=5\text{ V}$, $\Phi_e=0.1\text{ mW}$)	$t_{R,F}$	<10	ns

Module

Photocurrent PIN due to Optical Crosstalk (2)	I_{CRT}	10	nA
---	-----------	----	----

Notes

1. The temperature dependence of the threshold current is given by:

$$I_{TH}(T) = I_{TH}(25^{\circ}\text{C}) \exp[(T-25^{\circ}\text{C})/T_0]$$

with:

$$I_{TH}(25^{\circ}\text{C}) = \text{Threshold current at } T=25^{\circ}\text{C}.$$

$$T_0=70\text{ K (typ.)}$$

2. Photocurrent of PIN diode caused by internal optical crosstalk measured at $\Phi_e=0.1\text{ mW}$ and $V_R=5\text{ V}$ (without reflections at optical port).

OPERATING INSTRUCTIONS

To achieve an operating lifetime $>10^5\text{ h}$, which is required for Telecom applications, the ratings listed below should not be exceeded except for short periods (5% of lifetime). Refer to the total emitted power at optical port for output power data.

Recommended Operating Range

	Symbol	Value	Unit
Operating Temperature Range at Case	T_C	+5-40	$^{\circ}\text{C}$
Output Power			
- CW Power	$\Phi_{eCW}(\text{MAX})$	0.1	mW
- Pulse Power ($t_p < 100\text{ ns}$, $D \leq 0.1$)	$\Phi_{epulse}(\text{MAX})$	0.2	mW

Overload Protection

The specified values are observed only if the diodes are not overloaded.

Pulse spikes from the power supply unit, for example, even if they last only a few nanoseconds, may cause irreversible damage to the laser diode. Pulse spikes may arise when the power supply is turned on or off or they may reach the laser diode from the line via the coupling capacitance of electronically controlled devices.

The power supply should therefore be provided with appropriate protection circuits.

Eye Protection

The high, optical radiant power may be harmful to the human eye. For safety measures refer to the relevant safety regulations.

FEATURES

- 12-Stripe Laser Array with 10 μm Distance Between Stripes
- GRINSCH-Quantum-Well Structure with Dielectric Coating (asymmetric)
- Monochromatic Coherent Source of Radiation
- High Radiant Power
- Mounted on a Metallic Carrier (Chip on Carrier)
- Cathode Connection by Gold Strip
- Suitable for Customer-Tailored Encapsulation
- Applications:
 - Pumps of Neodym-YAG Lasers
 - Frequency Doubling with Non-Linear Crystals
 - Powerful IR Source of Radiation e.g. for Distance Measurements
 - Optical Communication Systems

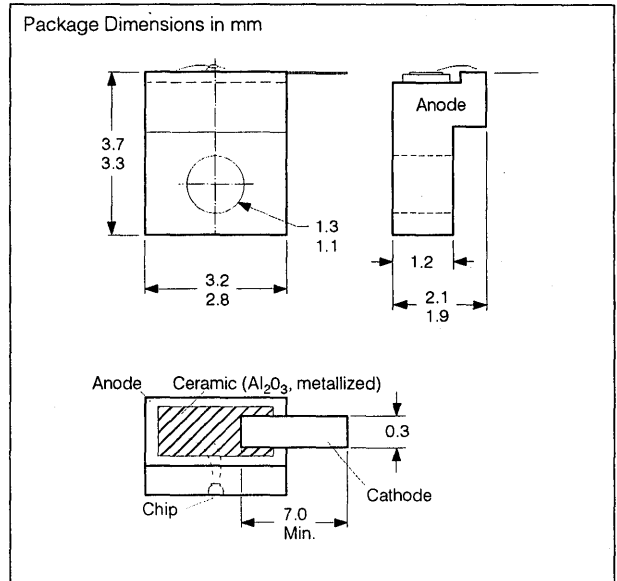

Maximum Ratings (Output power ratings refer to the front mirror)

CW Output Power, $T_{\text{SUB}}=25^{\circ}\text{C}$ (Φ_{eCW})	500 mW
Pulse Output Power, $T_{\text{SUB}}=25^{\circ}\text{C}$ (Φ_{epuls})	700 mW
$\tau < 150 \mu\text{s}$, $D \leq 0.001$	
Reverse Voltage (V_{R})	3 V
Operating Temperature Range (T_{SUB}) ⁽¹⁾	5° to $+60^{\circ}\text{C}$
Storage Temperature Range (T_{STG}) ⁽¹⁾	5° to $+70^{\circ}\text{C}$
Soldering Temperature $t_{\text{MAX}}=5 \text{ s}$ ($T_{\text{S(MAX)}}$)	150°C

Note

1. If moisture is kept out with a hermetically sealed case, an operating temperature range of $T_{\text{SUB}} -5$ to $+60^{\circ}\text{C}$ and a storage temperature range of $T_{\text{STG}} -40$ to $+70^{\circ}\text{C}$ are permissible.

GRINSCH = Graded Index Separate Confinement Hetero Structure

Characteristics (T_{SUB}=25°C, unless otherwise specified)

Parameter	Symbol	Value	Unit
Threshold Current	I _{TH}		
Pulse Operation		220	mA
CW Operation		230	mA
Forward Current	I _F		
Pulse Operation (Φ _{epuls} =200 mW)		900	mA
CW Operation (Φ _{eCW} =200 mW)		950	mA
Forward Voltage (Φ _{epuls} =200 mW)	V _F	2.2	V
Differential Series Resistance	r _G	0.4	Ω
CW Output Power	Φ _{eCW}	500	mW
Pulse Output Power (τ ≤ 150 μs, D ≤ 0.01)	Φ _{epuls}	700	mW
Emission Wavelength (1)	λ _{PEAK}	809 ± 5	nm
Spectral Bandwidth	Δλ	2	nm
Differential Efficiency	η		
Pulse Operation		0.7	W/A
CW Operation		0.7	W/A

Overload Protection

The specified values apply only as long as the diodes are not overloaded. Pulse spikes from the power supply, for example, even if they last only a few nanoseconds, may cause irreversible damage to the laser diode. Pulse spikes may arise when the power supply is turned on or off, or they may reach the laser diode from the line via the coupling capacitance of electronically controlled devices.

The power supply should therefore be provided with appropriate protection circuits.

Eye Protection

The high, optical radiant power may be harmful to the human eye. For safety measures refer to the relevant safety regulations.

Measurement Record

Each laser array is supplied with a measurement record containing the following measured values:

Radiant Power Φ_e versus forward current I_F

Threshold Current I_{TH}

Differential Efficiency η

Forward Voltage at Φ_{epuls} = 500 mW

Emission Wavelength

Emission wavelengths from 790 nm to 890 nm upon request

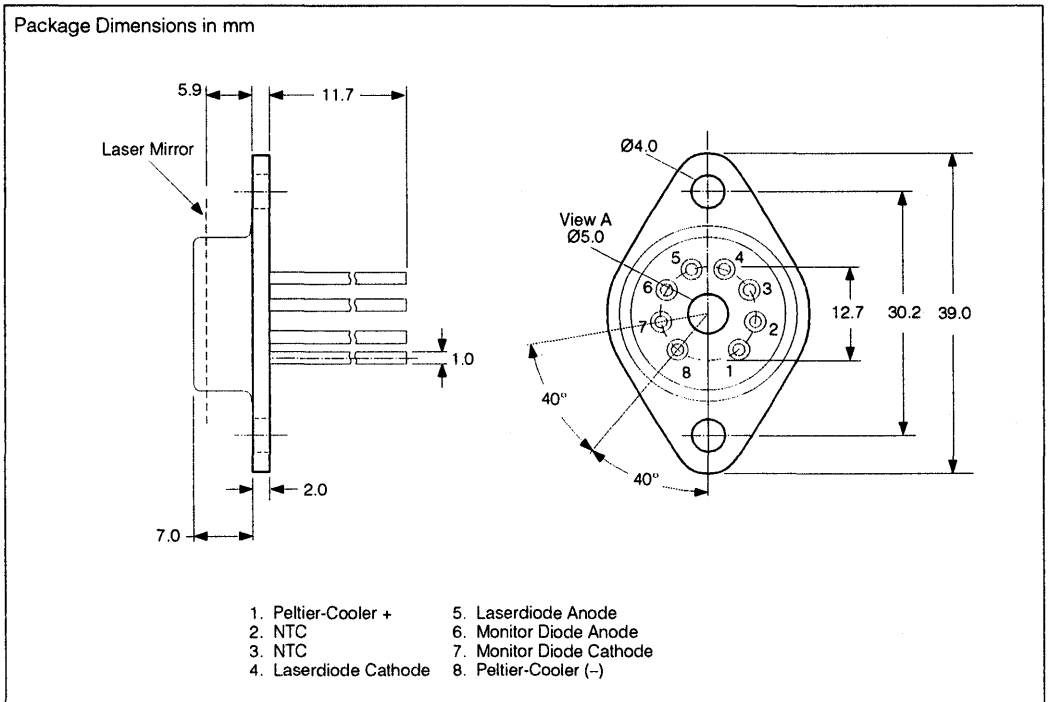

FEATURES

- Quantum-Well Structure Manufactured in MOCVD Epitaxie Process
- Asymmetrically Coated Laser Mirrors
- Width of Emitting Area: μm
- Implemented Monitor Diode for Light Input Regulation
- On-Board Peltier Cooler and Precision Temperature Sensor
- Package: TO 3 Hermetically Sealed, Antireflecting Window
- Applications
 - Pumping of Nd-YAG-Lasers
 - Medical Applications
 - Testing and Measurement Applications

Maximum Ratings

Laser Diode ($T_{\text{SUB}} = 25^\circ\text{C}$)

Light Output (Φ_{eDC})	300 mW
Pulse-Output Power (Φ_{ePuls})	350 mW
$\tau < 150 \mu\text{s}$, $D \leq 0.01$	
Reverse Voltage (V_{R})	3 V
Operating Temperature (T_{OP})	-10° to $+60^\circ\text{C}$
Storage Temperature (T_{S})	-40° to $+70^\circ\text{C}$

Peltier Cooler type MELCOR FC 06-31-040MMTT

Current (I_{MAX})	1.8 A
Voltage (V_{MAX})	3.6 V
Power Dissipation (P_{MAX})	4.1 W

Monitor Diode type SIEMENS F62D

Reverse Voltage (V_{R})	20 V
--	------

DESCRIPTION

The laser diode SFH 482201 is a monochromatical light source with high optical output for DC and pulse applications.

Characteristics (T_{SUB}=25°C, unless otherwise specified)

Parameter	Symbol	Value	Unit
Laser Diode			
Wavelength	λ_{PEAK}	809±5	nm
Spectral Bandwidth	$\Delta\lambda$	2	nm
Light Output Power	Φ_{eDC}	250	mW
Threshold Current, DC	I_{TH}	130–200	mA
Threshold Current, Pulse	I_{TH}	130–200	mA
Differential Efficiency, DC	η	0.5–0.7	W/A
Differential Efficiency, Pulse	η	0.55–0.75	W/A
Operating Current, $\Phi_{\text{eDC}}=250$ mW	I_{F}	490	mA
Forward Voltage, $\Phi_{\text{eDC}}=250$ mW	V_{F}	1.8	V
Differential Series Resistance $I_{\text{F}}=100\text{--}500$ mA	r_{S}	0.6–1.0	Ω

Temperature Sensor Type M867

Resistance	R_{N}	10	k Ω
------------	----------------	----	------------

Test Certificate

Every laser diode is supplied with its individual record of electrical test. In this test record the following parameters and corresponding values are listed.

- Light output, $\Phi_{\text{e}}=f(I_{\text{F}})$ in DC and pulse operation
- Threshold current, I_{TH} in DC and pulse operation
- Differential efficiency, η in DC and pulse operation
- Operating current, I_{F} at $\Phi_{\text{eDC}}=250$ mW
- Forward voltage, V_{F} at $\Phi_{\text{eDC}}=250$ mW
- Sensitivity of monitor diode, S_{MON} at $\Phi_{\text{eDC}}=250$ mW
- Photocurrent of monitor diode, I_{MON} at $\Phi_{\text{eDC}}=250$ mW
- Wavelength, λ_{PEAK} in pulse operation

NOTES FOR OPERATION

Overload Protection

The specified values apply only as long as the diodes are not overloaded. Pulse spikes from the power supply unit, for example, even if they last only a few nanoseconds, may cause irreversible damage to the laser diode. Such spikes may occur when the power supply is turned on or off or they may reach the laser diode from the line via coupling capacitance of electronically controlled devices.

The power supply should therefore be provided with appropriate protection circuits.

Eye protection

This laser diode is a Class 4 Laser product.

Due to high optical output, power damage to the eyes can easily occur. Use proper eye protection as described in the relevant safety regulations.

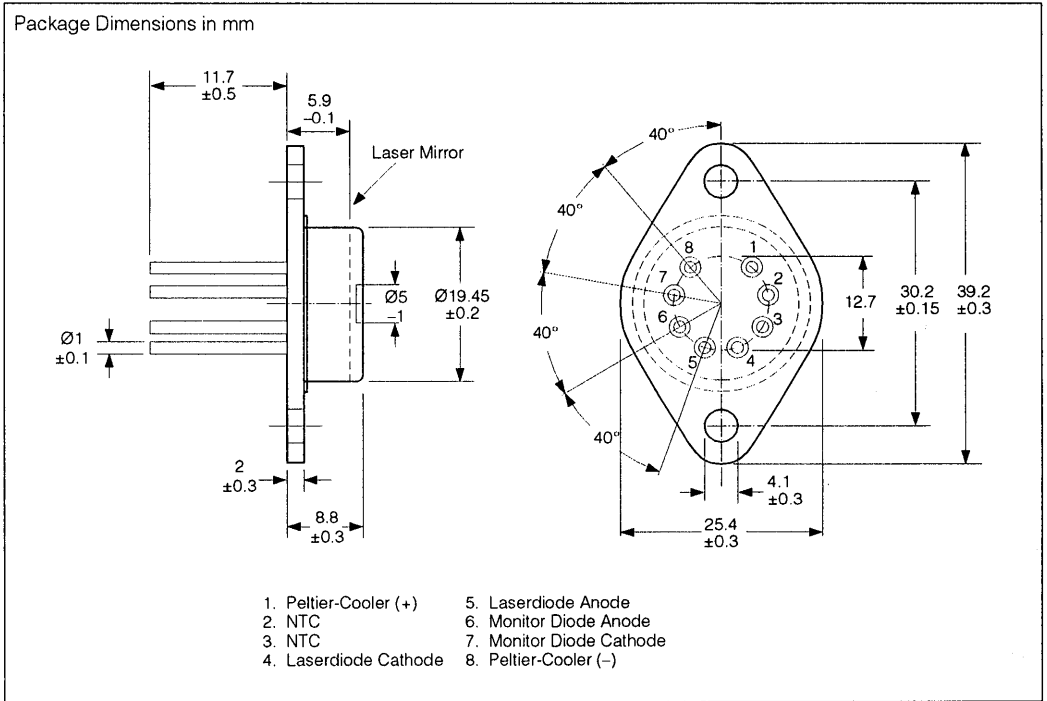

FEATURES

- Monochromatic, Coherent Radiation Source for Pulse and CW-Operation
- MOCVD Quantum-Well Structure
- Dielectric Asymmetric Coated Laser Mirrors
- Emission Width: 120 μm
- Monitor Diode for Control and Regulation of Radiant Power
- Peltier Cooler and NTC Thermistor for Temperature Control and Wavelength Tuning
- Package: TO 3-Package with Antireflecting Window Hermetically Sealed
- Applications
 - Pumping of Nd-YAG-Lasers
 - Medical Applications
 - Testing and Measurement Applications

Maximum Ratings

Laser Diode ($T_{\text{SUB}}=25^\circ\text{C}$)	
CW-Output Power (Φ_{eCW}) (1)	550 mW
Pulse-Output Power (Φ_{epulse}) (1)	700 mW
$\tau < 150 \mu\text{s}$, Duty Cycle $\leq 1\%$	
Reverse Voltage (V_{R})	3 V
Operating Temperature (T_{SUB})	-10° to $+60^\circ\text{C}$
Storage Temperature (T_{STG})	-40° to $+70^\circ\text{C}$
Maximum Lead Soldering Temperature (T_{S}) max. for 5s	250 $^\circ\text{C}$

Peltier Cooler

Current (I_{MAX})	1.8 A
Voltage (V_{MAX})	3.6 V
Power (P_{MAX})	4.1 W

Monitor Diode

Reverse Voltage (V_{R})	20 V
------------------------------------	------

Note

1. In NA=0.6

Characteristics (T_{SUB}=25°C)

Parameter	Symbol	Value	Unit
Laser Diode, CW-Operations			
Recommended Operating			
Temperature	T	-10 to +35	°C
Emission Wavelength	λ_{PEAK}	809±5	nm
Spectral Width	$\Delta\lambda$	2	nm
CW-Output Power (1)	Φ_{eCW}	500	mW
Threshold Current	I _{TH}	270	mA
Differential Efficiency (1)	η	0.75	W/A
Operating Current	I _{OP}	940	mA
Operating Voltage	V _{OP}	2.0	V
Differential Serial Resistance	r _S	0.4(<0.6)	Ω
Characteristic Temperature for			
Threshold Current (2)	T ₀	150	K
Temperature Coefficient of Operating Current	TC _I	0.5	%/K
Temperature Coefficient of Wavelength	TC _λ	0.25-0.30	nm/K
Thermal Resistance			
PN-Junction - NTC	R _{thJNTC}	15	K/W

Monitor Diode

Sensitivity	S	0.5-10	mA/W
-------------	---	--------	------

NTC Thermistor

Resistance	R _{NTC}	10	kΩ
------------	------------------	----	----

Notes

- In NA=0.6
- Thermal behavior of I_{TH} can be modeled as I_{TH2}=I_{TH1} exp((T₂ - T₁)/T₀)

Test Certificate

Each laser diode is supplied with technical information about

- Radiant power
- Threshold current
- Differential efficiency
- Operating current and operating voltage
- Emission wavelength

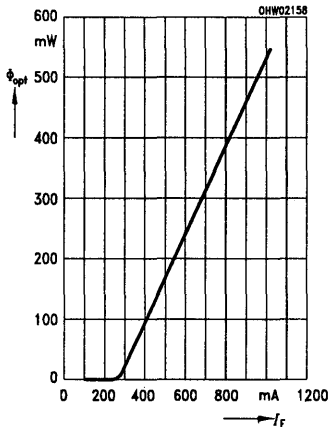

NOTES FOR OPERATION

Overload Protection

The specified values apply only as long as the diodes are not overloaded. Pulse spikes from the power supply unit, for example, even if they last only a few nanoseconds may cause irreversible damage to the laser diode. Such spikes may occur when the power supply is turned on or off or they may reach the laser diode from the line via coupling capacitance of electronically controlled devices.

The power supply should therefore be provided with appropriate protection circuits.

Handling of Package

Observe the same rules as for handling MOS-devices to avoid electrostatic-induced damage.

Eye Protection

This laser diode is a Class 4 Laser product. For safety measures refer to the relevant safety regulations.

GaAlAs-LASER DIODE 1000 mW WITH FC-CONNECTOR 750 mW⁽²⁾

Package Dimensions in mm

SFH 483401

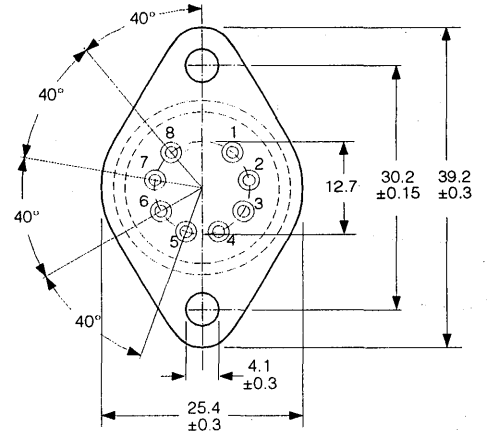
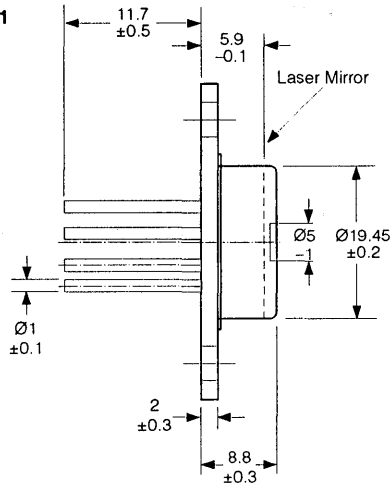

- | | |
|-----------------------|--------------------------|
| 1. N.C. | 5. Laserdiode Anode |
| 2. NTC | 6. Monitor Diode Anode |
| 3. NTC | 7. Monitor Diode Cathode |
| 4. Laserdiode Cathode | 8. N.C. |

SFH 483406

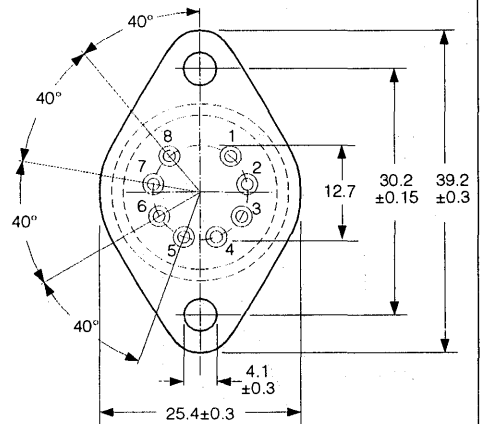
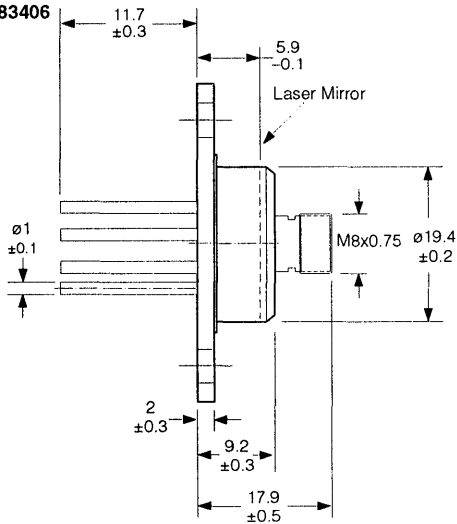

- | | |
|-----------------------|--------------------------|
| 1. N.C. | 5. Laserdiode Anode |
| 2. NTC | 6. Monitor Diode Anode |
| 3. NTC | 7. Monitor Diode Cathode |
| 4. Laserdiode Cathode | 8. N.C. |

FEATURES

- Monochromatic, Coherent Radiation Source for Pulse and CW-Operation
- MOCVD Quantum-Well Structure
- Dielectric Asymmetric Coated Laser Mirrors
- Emission Width: 200 μm
- Monitor Diode for Control and Regulation of Radiant Power
- NTC Thermistor for Temperature Control and Wavelength Tuning
- Package: TO 3-Package with Antireflecting Window SFH 483401 and with FC-Connector SFH 483406
- Applications
 - Pumping of Nd-YAG-Lasers
 - Medical Applications
 - Energy transmission
 - Testing and Measurement Applications
 - Triggering High-Power Thyristors via Glass Fiber

NOTES FOR OPERATION

Overload Protection

The specified values apply only as long as the diodes are not overloaded. Pulse spikes from the power supply unit, for example, even if they last only a few nanoseconds may cause irreversible damage to the laser diode. Such spikes may occur when the power supply is turned on or off or they may reach the laser diode from the line via coupling capacitance of electronically controlled devices.

The power supply should therefore be provided with appropriate protection circuits.

Handling of Package

Observe the same rules as for handling MOS-devices to avoid electrostatic-induced damage.

Eye Protection

This laser diode is a Class 4 Laser product. For safety measures refer to the relevant safety regulations.

Maximum Ratings

Laser Diode ($T_{\text{SUB}}=25^{\circ}\text{C}$)	
CW-Output Power (Φ_{eCW}) ⁽¹⁾	1050 (800) ⁽²⁾ mW
Pulse-Output Power (Φ_{epulse}) ⁽¹⁾	1300 (1100) ⁽²⁾ mW
$\tau < 150 \mu\text{s}$, Duty Cycle $\leq 1\%$	
Reverse Voltage (V_{R})	3 V
Operating Temperature (T_{SUB})	-10° to $+60^{\circ}\text{C}$
Storage Temperature (T_{STG})	-40° to $+70^{\circ}\text{C}$
Maximum Lead Soldering Temperature (T_{S}) max. for 5s	250 $^{\circ}\text{C}$

Monitor Diode

Reverse Voltage (V_{R})	20 V
------------------------------------	------

Notes

1. In NA=0.6
2. Measured with a fiber NA=0.35, core diameter=125 μm

Characteristics ($T_{\text{SUB}}=25^{\circ}\text{C}$)

Parameter	Symbol	Value	Unit
Laser Diode, CW-Operations			
Recommended Operating Temperature	T	-10 to $+35$	$^{\circ}\text{C}$
Emission Wavelength	λ_{PEAK}	809 ± 5	nm
Spectral Width	$\Delta\lambda$	2	nm
CW-Output Power ⁽¹⁾	Φ_{eCW}	1000(750) ⁽²⁾	mW
Threshold Current	I_{TH}	450	mA
Differential Efficiency ⁽¹⁾	η	0.75 (0.56) ⁽²⁾	W/A
Operating Current	I_{OP}	1780(1780) ⁽²⁾	mA
Operating Voltage	V_{OP}	2.1	V
Differential Serial Resistance	r_{S}	0.3(<0.4)	Ω
Characteristic Temperature for Threshold Current ⁽³⁾	T_0	150	K
Temperature Coefficient of Operating Current	TC_I	0.5	%/K
Temperature Coefficient of Wavelength	TC_{λ}	0.25-0.30	nm/K
Thermal Resistance; PN-Junction - NTC	R_{thNNTC}	9	K/W
Thermal Resistance; NTC - Ambient	R_{thNTCA}	1	K/W
Monitor Diode			
Sensitivity	S	0.5-10	mA/W
NTC Thermistor			
Resistance	R_{NTC}	10	k Ω

Notes

1. In NA=0.6
2. Measured with a fiber NA=0.35, core diameter=125 μm
3. Thermal behavior of I_{TH} can be modeled as $I_{\text{TH}2}=I_{\text{TH}1} \exp((T_2 - T_1)/T_0)$

Test Certificate

Each laser diode is supplied with technical information about

- Radiant power
- Threshold current
- Differential efficiency
- Operating current and operating voltage
- Emission wavelength

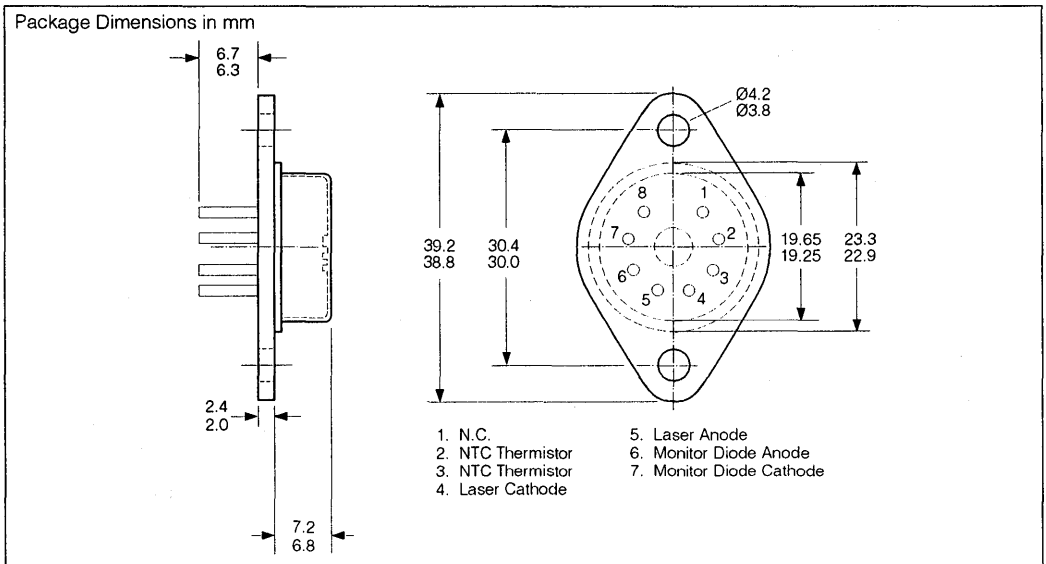

FEATURES

- 40-Stripe Laser Array with 10 μm Distance Between Stripes
- GRINSCH-Quantum-Well Structure with Dielectric Coating (Asymmetrical)
- Monochromatic Coherent Source of Radiation
- High Radiant Power
- Built-in Monitor Diode for Control of Radiant Power
- Applications
 - Pumps of Nd-YAG-Lasers
 - Frequency Doubling with Nonlinear Crystals
 - Triggering High-Power Thyristors by Fiber Optic Conductors
 - Powerful IR Source of Radiation e.g. for Distance Measurements
 - Optical Communication Systems

Maximum Ratings

Laser Diode

CW Output Power, $T_{\text{SUB}}=25^{\circ}\text{C}$ (Φ_{eCW})	1500 mW
Pulse Output Power, $T_{\text{SUB}}=25^{\circ}\text{C}$ (Φ_{epulse})	2000 mW
$\tau < 150 \mu\text{s}$, $D \leq 0.01$	
Reverse Voltage (V_R)	3 V
Operating Temperature (T_{SUB})	-5° to $+60^{\circ}\text{C}$
Storage Temperature Range (T_{STG})	-40° to $+70^{\circ}\text{C}$

NTC Thermistor Siemens type M867

Resistance, $T_{\text{SUB}}=25^{\circ}\text{C}$ (R_R)	10 k Ω
---	---------------

* GRINSCH = Graded Index Separate Confinement Hetero Structure.

Characteristics (T_{SUB}=25°C unless otherwise specified)

Parameter	Symbol	Value	Unit
Threshold Current			
Pulse Operation	I _{TH}	770	mA
CW Operation	I _{TH}	800	mA
Forward Current			
Pulse Operation, Φ _{epuls} = 1500 mW	I _F	2800	mA
CW Operation, Φ _{ecw} = 1500 mW	I _F	2900	mA
Forward Voltage			
Φ _{epuls} = 1500 mW	V _F	2.2	V
Differential Series Resistance	r _S	0.2	Ω
I _F = 400 - 800 mA			
CW Output Power	Φ _{ecw}	1500	mW
Pulse Output Power	Φ _{epuls}	2000	mW
τ < 150 μs, D ≤ 0.01			
Emission Wavelength	λ _{PEAK}	809 (±5)	nm
Spectral Bandwidth	Δλ	2	nm
Differential Efficiency			
Pulse Operation	η	0.7	W/A
CW Operation	η	0.7	W/A
Thermal Resistance Junction/Submount	R _{TH}	5	K/W
Temperature Coefficient of Wavelength	TK _λ	0.28	nm/K

Overload Protection

The specified values apply only as long as the diodes are not overloaded. Pulse spikes from the power supply, for example, even if they last only a few nanoseconds may cause irreversible damage to the laser diode. Pulse spikes may arise when the power supply is turned on or off, or they may reach the laser diode from the line via the coupling capacitance of electronically controlled devices.

The power supply should therefore be provided with appropriate protection circuits.

Eye Protection

The high, optical radiant power may be harmful to the human eye. For safety measures refer to the relevant safety regulations.

Measurement Record

Each laser array is supplied with a measurement record containing the following measured values:

- Radiant Power Φ_e Versus Forward Current I_F
- Threshold Current I_{TH}
- Differential Efficiency η at 1500 mW
- Forward Voltage at Φ_{epuls}
- Emission Wavelength

FEATURES

- MOCVD Quantum-Well Structure
- Dielectric Asymmetric Coated Laser Mirrors
- 5 Laserdiodes on Submount on a Massive Heatsink
- Emission Width : 5 x 200 μm ; Spacing 2mm
- Package: Row Design
- Applications
 - Pumping of Nd-YAG-lasers
 - Medical Applications
 - Test and Measurement Applications

DESCRIPTION

The laser SFH 484401 is a multiple quasi-monochromatic radiation source for pulse and DC-operation.

Test Certificate

Each laser is supplied with technical information about

- Radiant Power
- Threshold Current
- Differential Efficiency
- Operating Current and Voltage
- Emission Wavelength

NOTES FOR OPERATION

Overload Protection

The specified values apply only when the diodes are not overloaded. Pulse spikes from the power supply unit— even for just a few nanoseconds— may cause irreversible damage to the laser diode. Spikes may occur when the power supply is turned on or off, or they may come in from the line via the coupling capacitance of electronically controlled devices. The power supply should therefore be provided with protection circuits.

Handling of Packages

Observe the same rules as for handling MOS-devices to avoid electrostatic-induced damage.

Eye Protection

This laser diode is a Class 4 Laser product. For safety measures refer to the relevant safety regulations.

Storage

Do not expose to moisture or contaminants.

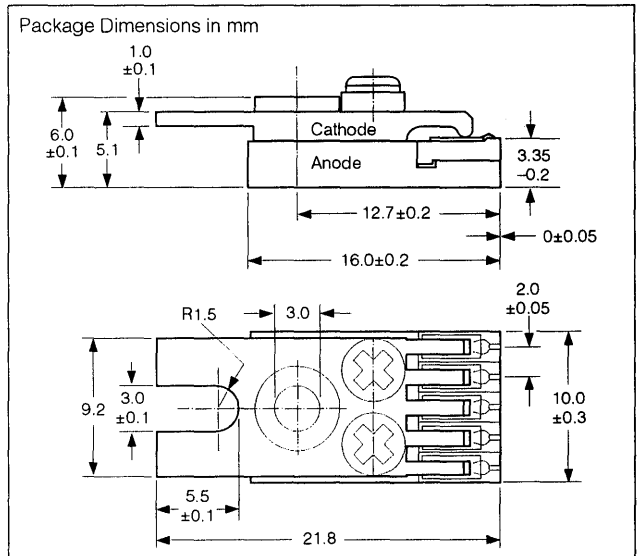

Maximum Ratings

Laser Diode

CW Output Power, $T_{\text{SUB}}=25^\circ\text{C}$ (Φ_{eCW}) ⁽¹⁾ 5.25 W

Pulse Output Power, $T_{\text{SUB}}=25^\circ\text{C}$ (Φ_{epuls}) 7.0 W
 $\tau < 150 \mu\text{s}$, duty cycle $\leq 1\%$

Reverse Voltage (V_R) 3 V

Operating Temperature (T_{SUB}) ⁽²⁾ (without moisture) -10° to $+60^\circ\text{C}$

Storage Temperature Range (T_{STG}) ⁽²⁾ -40° to $+70^\circ\text{C}$

Note

1. In N.A. = 0.6

Characteristics ($T_{\text{SUB}}=25^\circ\text{C}$, cw-operation)

Parameter	Symbol	Value	Unit
Center Emission Wavelength	λ_{peak}	809 (± 5)	nm
Spectral Width	$\Delta\lambda$	4	nm
CW Output Power ⁽¹⁾	Φ_{eCW}	5	W
Threshold Current	I_{TH}	2.3	A
Differential Efficiency ⁽¹⁾	η	0.75	W/A
Operating Current	I_{OP}	9	A
Operating Voltage	V_{OP}	2.2	V
Differential Serial Resistance	r_s	0.06 (<0.1)	Ω
Characteristic Temperature for Threshold Current ⁽²⁾	T_0	150	K
Temperature Coefficient			
Operating Current	TC_I	0.5	%/K
Wavelength	TC_λ	0.25-0.30	nm/K
Thermal Resistance	R_{th}	2.5	K/W

Notes

1. In N.A. = 0.6

2. Thermal behavior of I_{TH} can be modeled as $I_{\text{TH}2} = I_{\text{TH}1} \exp(T_2 - T_1) / T_0$

FEATURES

- GRINSCH-Quantum-Well Structure with Dielectric Coating (Asymmetrical)
- Monochromatic Radiation Source
- High Output Power
- Mounted on a 10 mm Row
- High Package Density (1 w/cm)
- Suitable for Customer-Tailored Encapsulation
- Applications
 - Pumping of Nd-YAG-Lasers
 - Frequency Doubling with Nonlinear Crystals
 - High-Radiance-Infrared Source, Suitable for Distance Measurements
 - Optical Communication

Overload Protection

The specified values apply only as long as the diodes are not overloaded. Pulse spikes from the power supply unit, for example, even if they last only a few nanoseconds may cause irreversible damage to the laser diode. Such pulse spikes may arise when the power supply is turned on or off, or they may reach the laser diode from the line via the coupling capacitance of electronically controlled devices.

The power supply should therefore be provided with appropriate protection circuits.

Eye Protection

The high, optical radiant power may be harmful to the human eye. For safety measures refer to the relevant safety regulations.

Test Conditions

Each laser array is supplied with a measurement record and the following curves:

- Threshold Current
- Radiant Power Versus Forward Current at CW and Pulse Operation
- Differential Efficiency
- Forward Voltage at $\Phi_{\text{epuls}}=5 \text{ W}$
- Emission Wavelength

Note

1. Emission wavelength of 790 nm to 890 nm on request

Package Dimensions in mm

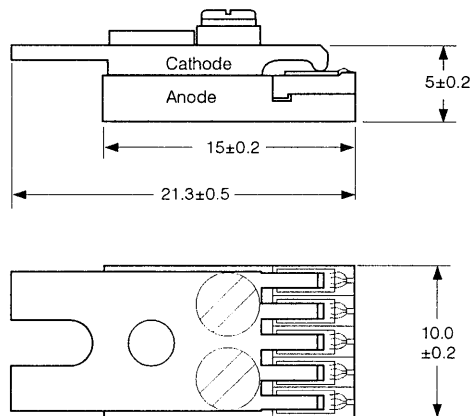

Maximum Ratings

CW Output Power, $T_{\text{SUB}}=25^\circ\text{C}$ (Φ_{eCW})	5 W
Pulse Output Power, $T_{\text{SUB}}=25^\circ\text{C}$ (Φ_{epuls})	7 W
$\tau < 150 \mu\text{s}$, $D \leq 0.01$	
Reverse Voltage (V_R)	3 V
Operating Temperature (T_{SUB})	-5° to $+60^\circ\text{C}$
Storage Temperature Range (T_{STG})	10° to $+70^\circ\text{C}$
Soldering Temperature, $t_{\text{MAX}} = 5\text{s}$ ($T_{\text{S(MAX)}}$)	10° to $+70^\circ\text{C}$

Characteristics ($T_{\text{SUB}}=25^\circ\text{C}$)

Parameter	Symbol	Value	Unit
Threshold Current			
Pulse Operation	I_{TH}	3.8	A
CW Operation	I_{TH}	4.0	A
Forward Current			
$\Phi_{\text{epuls}}=5 \text{ W}$	I_F	11	A
$\Phi_{\text{eCW}}=5 \text{ W}$	I_F	11	A
Forward Voltage	V_F	2	V
$\Phi_{\text{epuls}}=200 \text{ mW}$			
Differential Series Resistance	r_S	0.2	Ω
$I_F=400\text{--}800 \text{ mA}$			
CW Output Power	Φ_{eCW}	5	W
Pulse Output Power	Φ_{epuls}	7	W
$\tau < 150 \mu\text{s}$, $D \leq 0.01$			
Emission Wavelength (1)	λ_{PEAK}	809 ± 5	nm
Spectral Bandwidth	$\Delta\lambda$	4	nm
Differential Efficiency			
Pulse Operation	η	0.7	W/A
CW Operation	η	0.7	W/A
Thermal Resistance Junction/Submount	R_{TH}	5	K/W
Temperature Coefficient of Wavelength	TK_λ	0.28	nm/K

FEATURES

- Monochromatic, Coherent Radiation Source for Pulse and CW-Operation
- MOCVD Quantum-Well Structure
- Small Size Package for Efficient Thermal Coupling
- SFH 487401: Microoptics for Improved Farfield Pattern
- SFH 487406: Microoptics for Efficient Fiber Coupling
- Package: TO 220-Package with Antireflecting Window SFH 487401 and with FC-Connector SFH 487406
- Applications
 - Pumping of Nd-YAG-Lasers
 - Medical Applications
 - Laser Soldering
 - Energy transmission
 - Testing and Measurement Applications
 - Triggering of High-Power Thyristors via Glass Fiber

Maximum Ratings

Laser Diode ($T_{SUB}=25\text{ }^{\circ}\text{C}$)	
CW-Output Power (Φ_{eCW}) (1)	1100 (800)(2) mW
Pulse-Output Power (Φ_{epuls}) (1)	1500 (1100)(2) mW
$\tau < 150\text{ }\mu\text{s}$, Duty Cycle $\leq 1\%$	
Reverse Voltage (V_R)	3 V
Operating Temperature (T_{SUB})	-10° to $+60^{\circ}\text{C}$
Junction Temperature (T_J)	max. 65°C
Storage Temperature (T_{STG})	-40° to $+70^{\circ}\text{C}$
Maximum Lead Soldering Temperature (T_S) max. for 5s	250°C

Notes

1. In NA=0.6
2. Measured with a fiber NA=0.35, core diameter=125 μm , length=5 m, with attenuation=8 dB/km

Characteristics ($T_{sub}=25^{\circ}\text{C}$)

Parameter	Symbol	Value	Unit
Laser Diode, CW-Operations			
Recommended Operating			
Temperature	T	-10 to $+35$	$^{\circ}\text{C}$
Emission Wavelength	λ_{PEAK}	809 ± 5	nm
Spectral Width	$\Delta\lambda$	2	nm
CW-Output Power (1)	Φ_{eCW}	1000 (750)(2)	mW
Threshold Current	I_{TH}	450	mA
Differential Efficiency (1)	η	0.85 (0.56)(2)	W/A
Operating Current	I_{OP}	1630 (1780)(2)	mA
Operating Voltage	V_{OP}	2.1	V
Differential Serial Resistance	r_S	0.3(≤ 0.4)	Ω
Characteristic Temperature for			
Threshold Current (3)	T_0	150	K
Temperature Coefficient of			
Operating Current	TC_I	0.5	%/K
Temperature Coefficient of			
Wavelength	TC_{λ}	0.25–0.30	nm/K
Thermal Resistance;			
PN-Junction - Case	R_{thJC}	9	K/W
NTC Thermistor			
Resistance	R_{NTC}	10	k Ω

Notes

1. In NA=0.6
2. Measured with a fiber NA=0.35, core diameter=125 μm
3. Thermal behavior of I_{TH} can be modeled as $I_{TH2}=I_{TH1} \exp((T_2 - T_1)/T_0)$

Test Certificate

Each laser diode is supplied with technical information about

- Radiant power
- Threshold current
- Differential efficiency
- Operating current and operating voltage
- Emission wavelength

NOTES FOR OPERATION

Overload Protection

The specified values apply only as long as the diodes are not overloaded. Pulse spikes from the power supply unit, for example, even if they last only a few nanoseconds may cause irreversible damage to the laser diode. Such spikes may occur when the power supply is turned on or off or they may reach the laser diode from the line via coupling capacitance of electronically controlled devices.

The power supply should therefore be provided with appropriate protection circuits.

Handling of Package

Observe the same rules as for handling MOS-devices to avoid electrostatic-induced damage.

Eye Protection

This laser diode is a Class 4 Laser product. For safety measures refer to the relevant safety regulations.

MOUNTING NOTES TO 220

1. Mechanical attachment

1.1 Mounting hole (suitable for M 2.5)

Because of the good thermal conductivity of the TO 220 base (material: copper), the heat loss that is produced is properly dissipated even if the component is only attached on one side.

1.2 For exact positioning of the TO component, like when attaching other parts, e.g. lenses, separately from the laser, it is possible to attach the TO 220 package additionally with an appropriate clamping device or by screws (max. M2.5).

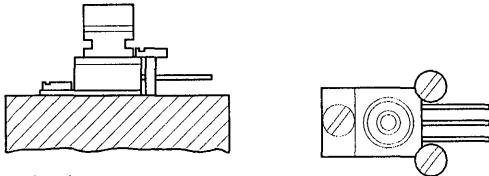

2. Soldering

When soldering the TO base to a heatsink, observe the following guidelines:

Max. Soldering temperature:	125°C
Max. soldering duration:	1 min
Suggested solder:	Sn/In (melting point: 117°C)

Package Dimensions in mm

SFH 487501

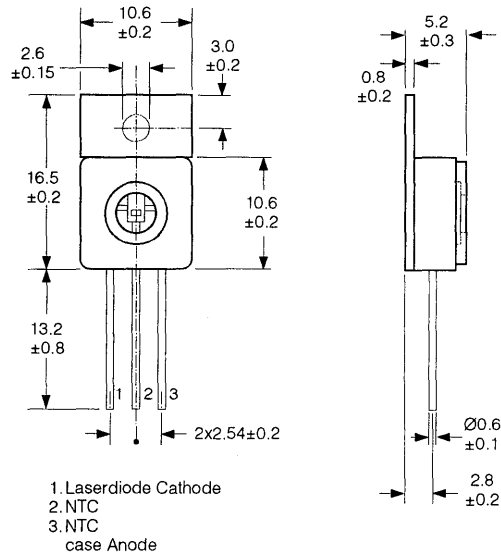

SFH 487506

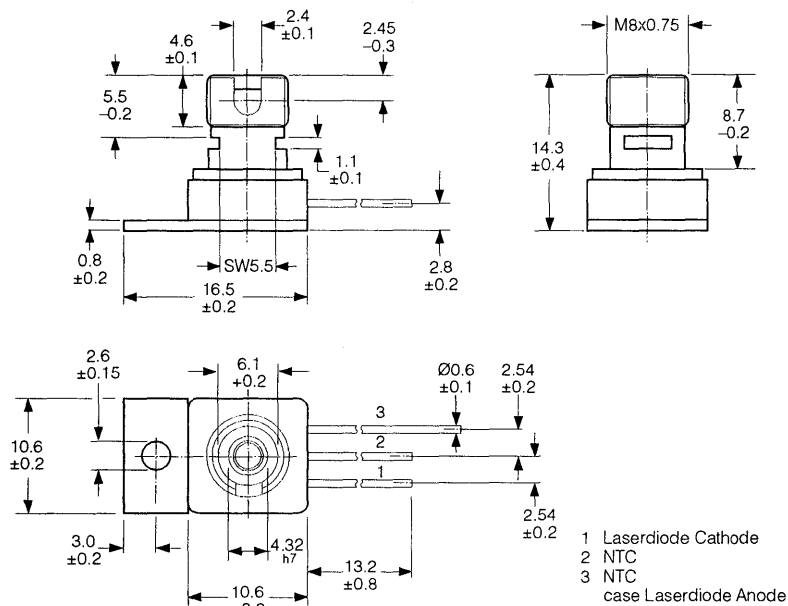

FEATURES

- Monochromatic, Coherent Radiation Source for Pulse and CW-Operation
- MOCVD Quantum-Well Structure
- Small Size Package for Efficient Thermal Coupling
- SFH 487501: Microoptics for Improved Farfield Pattern
- SFH 487506: Microoptics for Efficient Fiber Coupling
- Package: TO 220-Package with Antireflecting Window SFH 487501 and with FC-Connector SFH 487506
- Applications
 - Pumping of Nd-YAG-Lasers
 - Medical Applications
 - Laser Soldering
 - Energy Transmission
 - Testing and Measurement Applications
 - Triggering High-Power Thyristors via Glass Fiber

Maximum Ratings

Laser Diode ($T_{SUB}=25\text{ }^{\circ}\text{C}$)	
CW-Output Power (Φ_{eCW}) ⁽¹⁾	1600 (1200) ⁽²⁾ mW
Pulse-Output Power (Φ_{ePuls}) ⁽¹⁾	2000 (1500) ⁽²⁾ mW
$\tau < 150\text{ }\mu\text{s}$, Duty Cycle $\leq 1\%$	
Reverse Voltage (V_R)	3 V
Operating Temperature (T_{SUB})	-10° to +60°C
Junction Temperature (T_J)	max. 65°C
Storage Temperature (T_{STG})	-40° to +70°C
Maximum Lead Soldering Temperature (T_S) max. for 5s	250°C

Notes

1. In NA=0.6
2. Measured with a fiber NA=0.35, core diameter=200 μm , length=5 m, with attenuation=8 dB/km

Characteristics ($T_{SUB}=25\text{ }^{\circ}\text{C}$)

Parameter	Symbol	Value	Unit
Laser Diode, CW-Operations			
Recommended Operating			
Temperature	T	-10 to +35	°C
Emission Wavelength	λ_{peak}	809±5	nm
Spectral Width	$\Delta\lambda$	2	nm
CW-Output Power (1)	Φ_{eCW}	1500 (1100) ⁽²⁾	mW
Threshold Current	I_{TH}	880	mA
Differential Efficiency (1)	η	0.85 (0.56) ⁽²⁾	W/A
Operating Current	I_{OP}	2650 (2850) ⁽²⁾	mA
Operating Voltage	V_{OP}	2.2	V
Differential Serial Resistance	r_S	0.2	Ω
Characteristic Temperature for			
Threshold Current (3)	T_0	150	K
Temperature Coefficient of			
Operating Current	TC_I	0.5	%/K
Temperature Coefficient of Wavelength	TC_λ	0.25-0.30	nm/K
Thermal Resistance			
PN-Junction - Case	R_{THJC}	6	K/W
NTC Thermistor			
Resistance	R_{NTC}	10	k Ω

Notes

1. In NA=0.6
2. Measured with a fiber NA=0.35, core diameter=200 μm
3. Thermal behavior of I_{TH} can be modeled as $I_{TH2}=I_{TH1} \exp((T_2 - T_1)/T_0)$

Test Certificate

Each laser diode is supplied with technical information about

- Radiant power
- Threshold current
- Differential efficiency
- Operating current and operating voltage
- Emission wavelength

NOTES FOR OPERATION

Overload Protection

The specified values apply only as long as the diodes are not overloaded. Pulse spikes from the power supply unit, for example, even if they last only a few nanoseconds, may cause irreversible damage to the laser diode. Such spikes may occur when the power supply is turned on or off or they may reach the laser diode from the line via coupling capacitance of electronically controlled devices.

The power supply should therefore be provided with appropriate protection circuits.

Handling of Package

Observe the same rules as for handling MOS-devices to avoid electrostatic-induced damage.

Eye Protection

This laser diode is a Class 4 Laser product.
For safety measures refer to the relevant safety regulations.

MOUNTING NOTES TO 220

1. Mechanical attachment

- 1.1 Mounting hole (suitable for M 2.5)
Because of the good thermal conductivity of the TO 220 base (material: copper), the heat loss that is produced is properly dissipated even if the component is only attached on one side.
- 1.2 For exact positioning of the TO component, like when attaching other parts, e.g. lenses, separately from the laser, it is possible to attach the TO 220 package additionally with an appropriate clamping device or by screws (max. M2.5).

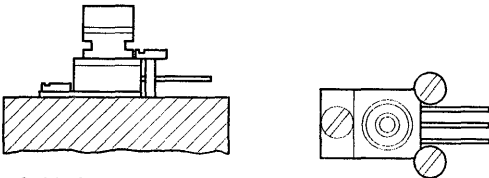





2. Soldering

When soldering the TO base to a heatsink, observe the following guidelines:

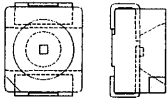
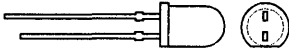

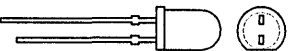

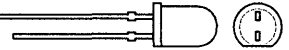
- Max. Soldering temperature: 125°C
- Max. soldering duration: 1 min
- Suggested solder Sn/In (melting point: 117°C)

Infrared Emitters

Package Outline	Part Number	Package Type	Half Angle	Radiant Intensity		Surge Current (t<10 μ s) A	Features	Page
				I _E (mW/sr)	mA			
	SFH420	SMT-TOP-LED	$\pm 60^\circ$	2.5-5	100	—	GaAs, 950 nm. On tape and reel.	7-25
	SFH421	SMT-TOP-LED	$\pm 60^\circ$	4-8	100	—	GaAlAs, 880 nm. On tape and reel.	7-27
	LD271	T1 $\frac{3}{4}$ (5 mm) gray plastic	$\pm 25^\circ$	15 (≥ 10)	100	3.5	IR remote control. Wide angle high power. GaAs, 950 nm. Matches photodiode SFH205, BP104 or phototransistor BP103.	7-11
	LD271L 1" Leads			15 (≥ 10)				
	LD274-1	T1 $\frac{3}{4}$ (5 mm) gray plastic	$\pm 10^\circ$	30-60	100	3.0	IR remote control GaAs, 950 nm, very high intensity, narrow angle. Matches phototransistors SFH205, BP104, BP103B.	7-13
	LD274-2			50-100				
	LD274-3			≥ 80				
	LD275-1	T1 $\frac{3}{4}$ (5 mm) gray plastic	$\pm 18^\circ$	10-20	100	3.0	IR remote control GaAs, 950 nm, very high intensity, narrow angle. Matches phototransistors SFH205, BP104, BP103B.	7-13
	LD275-2			16-32				
	LD275-3			≥ 25				
	SFH414-T	T1 $\frac{3}{4}$ (5 mm) plastic	$\pm 11^\circ$	25-50	100	3	GaAs, 950 nm. Fast switching time.	7-22
	SFH414-U			40-80				
	SFH415-S		$\pm 17^\circ$	16-32				
	SFH415-T			25-50				
	SFH415-U			40-80				
	SFH416-Q		$\pm 28^\circ$	6.3-12				
	SFH416-R			10-20				
	SFH484-1	T1 $\frac{3}{4}$ (5 mm) clear blue tinted plastic	$\pm 8^\circ$	50-100	100	2.5	IR remote control, GaAlAs, 880 nm. Extremely high intensity, narrow angle.	7-37
	SFH484-2			80-160				
	SFH485-1	T1 $\frac{3}{4}$ (5 mm) clear blue tinted plastic	$\pm 20^\circ$	16-32	100	2.5	IR remote control, GaAlAs, 880 nm. High intensity, medium angle.	
	SFH485-2			25-50				

Infrared Emitters

Infrared Emitters (Continued)

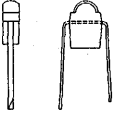
Package Outline	Part Number	Package Type	Half Angle	Radiant Intensity		Surge Current (<10µs) A	Features	Page
				I _E (mW/sr)	mA			
	SFH485P	T1 3/4 (5 mm) clear plastic	±40°	>3.15	100	2.5	IR remote control, GaAlAs, 880 nm. Wide angle remote control. Shaft encoder IR sound transmission. Low cost replacement for metal can package.	7-39
	SFH409-1	T1 (3 mm) gray plastic	±20°	6.3-12.5	100	3	IR remote control. GaAs, 950 nm. Matches phototransistor SFH309.	7-20
	SFH409-2			10-20				
	SFH409-3			≥16				
	SFH487-1	T1 (3 mm) clear blue-tinted plastic.	±20°	12.5-25	100	2.5	IR remote control. GaAs, 88 nm. High intensity, medium angle.	7-41
	SFH487-2			20-40				
	SFH487-3			≥32				
	SFH487P	T1 (3 mm) clear blue-tinted plastic.	±65°	>2	100	2.5	Wide angle. GaAs, 880 nm. Low cost replacement for metal can package.	7-43
	IRL80A	Miniature clear plastic, side-facing.	±30°	≥0.4	20	3	IRL30A-GaAs, 950 nm. IRL81A-GaAlAs, 880 nm. Matches phototransistor LPT80A or photodarlington LPD80A.	7-5
	IRL81A		±25°	≥1.0		2.5		
	SFH405-2	Miniature .039" (1 mm) wide, radial leads	±16°	1.6-3.2	40	1.6	Ideal for very short range light barriers. GaAs, 950 nm. Matches phototransistor SFH305.	7-18
	SFH405-3			≥2.5				

Infrared Emitters (Continued)

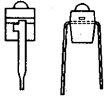
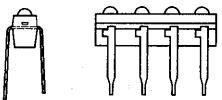
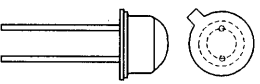
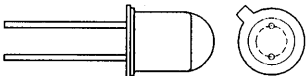
Package Outline	Part Number	Package Type	Half Angle	Radiant Intensity		Surge Current ($t < 10 \mu s$) A	Features	Page
				I_E (mW/sr)	mA			
	LD261-4	Single diode	$\pm 30^\circ$	2-4	50	1.6	GaAs, 950 nm. Miniature, radial leads.	
	LD261-5			3.2-6.3				
	LD261-6			≥ 5				
	LD262	2 diodes	$\pm 30^\circ$	5	50	1.6	GaAs, 950 nm. Miniature, radial leads. Ideal for card readers. Matches phototransistors BPX81, BPX80 series.	7-9
	LD263	3 diodes						
	LD264	4 diodes						
	LD265	5 diodes						
	LD266	6 diodes						
	LD267	7 diodes						
	LD268	8 diodes						
	LD269	9 diodes						
	LD260	10 diode						
	LD242-2	TO-18 round glass lens.	$\pm 4^\circ$	4-8	100	5	Very wide angle, GaAs, 950 nm. Suitable for sound transmission. Ideal for short range light barriers. Matches phototransistor BP103 or photodiode BPX63.	7-7
	LD242-3			6.3-12.5				
	LD242-4			> 10				
	SFH462	TO-18 round glass lens.	$\pm 23^\circ$	—	—	1	GaAlAs, 660 nm.	7-30
	SFH483	TO-18 round glass lens.	$\pm 23^\circ$	—	—	2.5	GaAlAs, 880 nm.	7-35
	SFH400-2	TO-18 round glass lens.	$\pm 6^\circ$	20-40	100	3	Hermetic seal for high rel. use. Very narrow angle. GaAs, 950 nm. Matches phototransistor BPX43.	7-15
	SFH400-3			≥ 32				
	SFH480-1	TO-18 round glass lens.	$\pm 6^\circ$	25-50	100	2.5	Hermetic seal for high rel. use. Narrow angle, very high intensity. GaAlAs, 880 nm.	7-32
	SFH480-2			40-80				

Infrared Emitters (Continued)

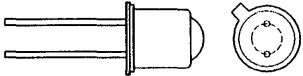
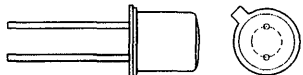
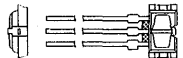
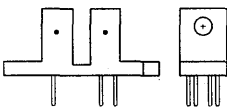
Package Outline	Part Number	Package Type	Half Angle	Radiant Intensity		Surge Current (<10 μ s) A	Features	Page
				I _E (mW/sr)	mA			
	SFH401-2	TO-18 dome glass lens.	$\pm 15^\circ$	10-20	100	3	Hermetic seal for high rel. use. Very narrow angle. GaAs, 950 nm. Matches phototransistor BPY62.	7-15
	SFH401-3			16-32				
	SFH481-1	TO-18 dome glass lens.	$\pm 15^\circ$	10-20	100	2.5	Hermetic seal for high rel. use. Narrow angle. GaAlAs, 880 nm.	7-32
	SFH481-2			16-32				
SFH481-3	≥ 35							
	SFH402-2	TO-18 flat glass lens.	$\pm 40^\circ$	2.5-5.0	100	3	Hermetic seal for high rel. use. Wide angle. GaAs, 950 nm. Matches phototransistor BPX38 or photodiodes BPX65/66.	7-15
	SFH402-3			≥ 4.0				
	SFH482-1	TO-18 flat glass lens.	$\pm 30^\circ$	3.15-6.3	100	2.5	Hermetic seal for high rel. use. Wide angle. GaAlAs, 880 nm.	7-32
	SFH482-2			5-10				
SFH482-3	≥ 8							
	SFH900-1	Miniature plastic, daylight filter.	—	0.25-0.5	Current Transfer Ratio	1.5	Reflective light barrier for short (<5 mm) distances.	7-45
	SFH900-2			0.4-0.8				
	SFH900-3			.63-1.25				
	SFH900-4			≥ 1.0				
	SFH905-1	Miniature plastic, daylight filter.	—	40-125 μ A	Current Transfer Ratio	1.5	Reflective light barrier for short (<5 mm) distances.	7-45
	SFH905-2			$\geq 100 \mu$ A				
	SFH910	Plastic, daylight filter.	Output: Counting pulse Z Directional signal R Resolution $\geq 0.33^\circ$	1	Differential photo interrupter.	Slotted disk—can order separately.	7-49	
	2004-9053	Plastic disk, 96 slots.						

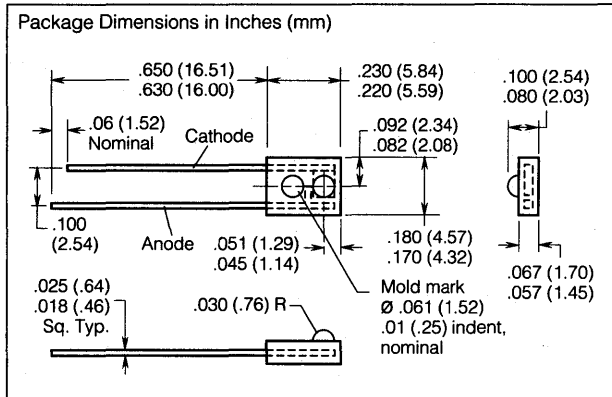
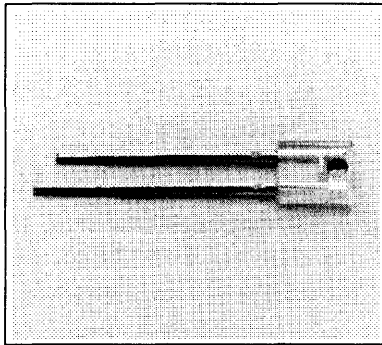

FEATURES

- Low Cost
- Miniature, Clear Plastic, Side Facing Package
- Long Term Stability
- Wide Beam: IRL 80A, 60°; IRL 81A, 50°
- Matches Phototransistor LPT 80A

DESCRIPTION

The IRL 80A is a GaAs infrared emitting diode while the IRL 81A is a GaAlAs IRED. The miniature side-facing device has a chip that emits radiation from the side of the clear package. It matches the phototransistor LPT 80A, and was designed for applications requiring beam interruption.

Maximum Ratings ($T_A=25^\circ\text{C}$)

Operating/Storage Temperature Range (T_{OP} , T_{STG}) -40° to $+100^\circ\text{C}$
 Lead Soldering Temperature (.063" from case) $t=5$ sec 240°C

	IRL 80A	IRL 81A
Reverse Voltage (V_R)	3 V	5 V
Forward Current (I_F)	60 mA	100 mA
Power Dissipation (P_{TOT})	100 mW	200 mW
Derate Above 25°C	1.33 mW/ $^\circ\text{C}$	2.67 mW/ $^\circ\text{C}$

Characteristics ($T_A=25^\circ\text{C}$)

Parameter	Symbol	IRL 80A	IRL 81A	Unit
Radiation Wavelength, λ_{MAX}	λ_{PEAK}	950	880	nm
Spectral Bandwidth, 50% I_{MAX}	$\Delta\lambda$	20	36 to 44	nm
Half Angle	ϕ	± 30	± 25	Deg.
Forward Voltage ($I_F=20$ mA)	V_F	1.5 max.	1.5 (≤ 2.0)	V
Breakdown Voltage ($I_R=10$ μA)	I_R	(≤ 3)	30 (≥ 5)	V
Radiant Intensity ($I_F=20$ mA) ⁽¹⁾	I_E	≥ 0.4	≥ 1.0	mW/sr

Note

1. A 1 cm^2 silicon detector is aligned with the mechanical axis. No aperture is used.

Radiation characteristics-IRL 80A $I_{REL}=f(\varphi)$

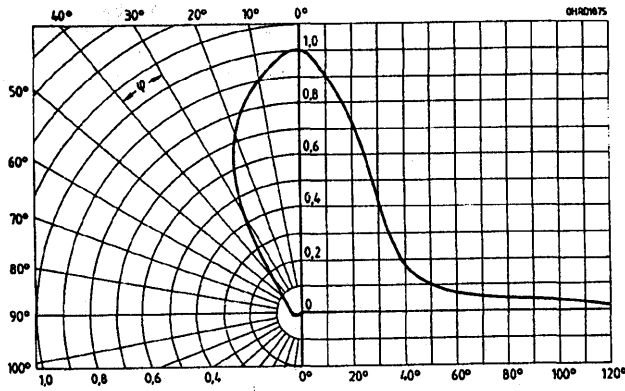

Relative spectral emission-IRL 80A $I_{REL}=f(\lambda)$

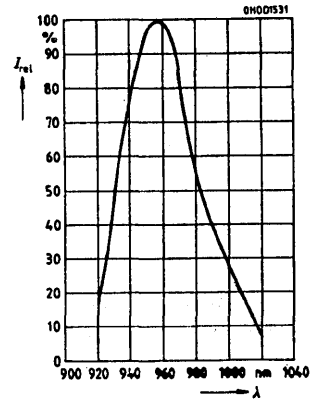

Radiation characteristics-IRL 81A $I_{REL}=f(\varphi)$

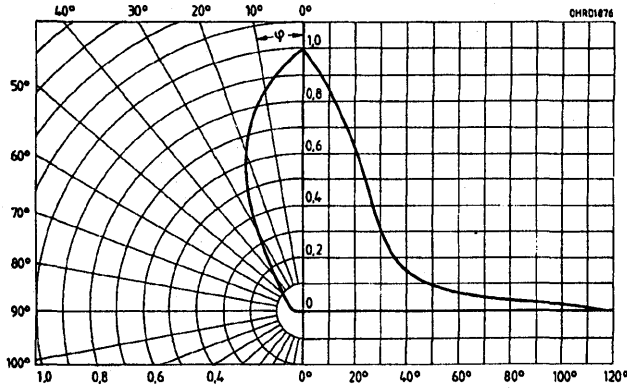

Relative spectral emission-IRL 81A $I_{REL}=f(\lambda)$

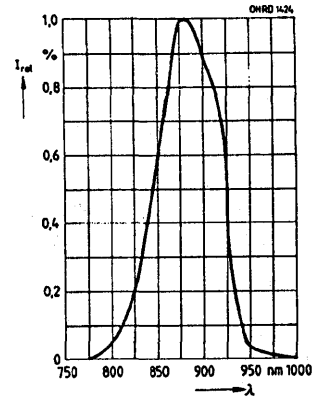

Maximum permissible forward current-IRL 81A $I_F=f(T_A)$

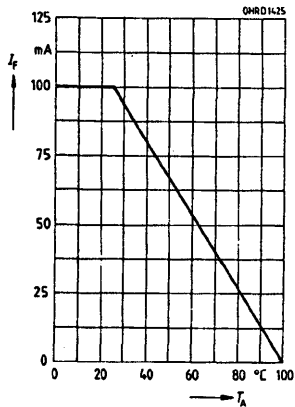

Forward current-IRL 81A $I_F=f(V_F)$

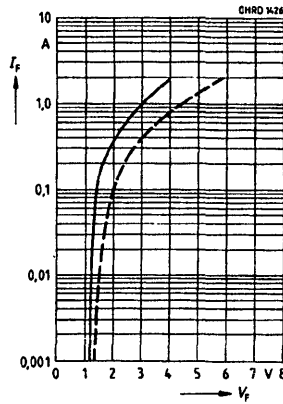

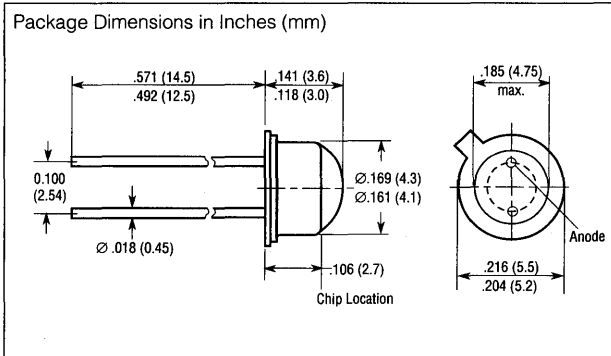
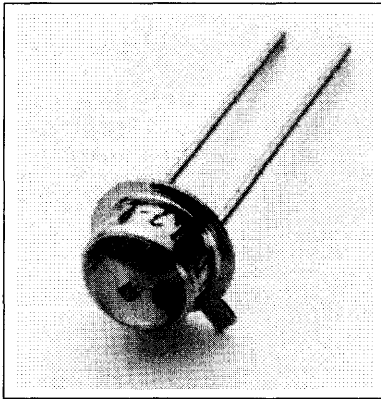

FEATURES

- GaAs Infrared Emitting Diode, Fabricated in a Liquid Phase Epitaxy Process
- Emits Radiation in Near Infrared Range
- Cathode Electrically Connected to Case
- High Efficiency
- High Reliability
- Long Lifetime
- Wide Beam
- High Pulse Power
- Same Package as BP103, BPX63
- DIN Humidity Category per DIN 40040 GQG
- Applications
 - IR Remote Control and Sound Transmission
 - Light Reflecting Switches
- Package
 - Base Plate per 18 A3 DIN 41876 (TO 18)
 - Transparent Epoxy Resin Lens
 - Lead Spacing 0.100" (2.54 mm)
- Cathode Marking: Tab at Case Bottom

Note:

1. An aperture is used in front of the component for measuring the radiant intensity and the half angle (diameter of the aperture: 1.1 mm; distance of aperture to case back side: 4 mm). This ensures that only the radiation in axial direction emitting directly from the chip surface will be evaluated during radiant intensity measurement. This measurement is denoted by "E7800" added to the part number.
2. Availability subject to yield.

Maximum Ratings

Operating and Storage Temperature Range (T_{OP} , T_{STG})	... -40° to +80°C
Junction Temperature (T_J) 100°C
Reverse Voltage (V_R) 5 V
Forward Current (I_F) $T_C=25^\circ\text{C}$ 300 mA
Surge Current (I_{FSM}) $t=10 \mu\text{s}$, $D=0$ 3 A
Power Dissipation (P_{TOT}) $T_C=25^\circ\text{C}$ 470 mW
Thermal Resistance ($R_{\theta JA}$) 450 K/W
($R_{\theta JC}$) 160 K/W

Characteristics ($T_A=25^\circ\text{C}$)

Parameter	Symbol	Value	Unit
Peak Wavelength ($I_F=100 \text{ mA}$, $t_p=20 \text{ ms}$)	λ_{PEAK}	950±20	nm
Spectral Bandwidth, 50% I_{MAX} ($I_F=100 \text{ mA}$, $t_p=20 \text{ ms}$)	$\Delta\lambda$	55	nm
Half Angle	ϕ	±40	Deg.
Active Chip Area	A	0.25	mm ²
Active Chip Area Dimensions	L x W	0.5 x 0.5	mm
Distance, Chip Surface to Case Surface	H	0.3 to 0.7	mm
Switching Times, I_E 10% to 90% and 90% to 10% ($I_F=100 \text{ mA}$, $R_L=50 \Omega$)	t_{R1} , t_F	1	μs
Capacitance ($V_R=0 \text{ V}$)	C_0	40	pF
Forward Voltage ($I_F=100 \text{ mA}$)	V_F	1.3 (≤1.5)	V
($I_F=1 \text{ mA}$, $t_p=100 \mu\text{s}$)	V_F	1.9 (≤2.5)	V
Reverse Current ($V_R=5 \text{ V}$)	I_R	0.01 (≤1)	μA
Radiant Flux, Total ($I_F=100 \text{ mA}$, $t_p=20 \text{ ms}$)			
Temperature Coefficient, I_E or Φ_E ($I_F=100 \text{ mA}$)	TC_I	-0.55	%/K
Temperature Coefficient, V_F ($I_F=100 \text{ mA}$)	TC_V	-1.5	mV/K
Temperature Coefficient, λ_{PEAK} ($I_F=100 \text{ mA}$)	TC_λ	0.3	nm/K

Radiant Intensity Selections

I_E in axial direction at solid angle of $\Omega=0.01 \text{ sr}$

Symbol	LD242	LD242	LD242	LD242	LD242	Unit
	-2	-3	-4(2)	-LE7800(1)	-ME7800(1,2)	
$I_F=100 \text{ mA}$, $t_p=20 \text{ ms}$						
I_E	4 to 8	6.3 to 12.5	>10	1 to 2	1.6 to 3.2	mW/sr
$I_F=1 \text{ mA}$, $t_p=100 \mu\text{s}$						
I_{Etyp}	50	75	100	-	-	mW/sr

Relative spectral emission

$I_{REL} = f(\lambda)$

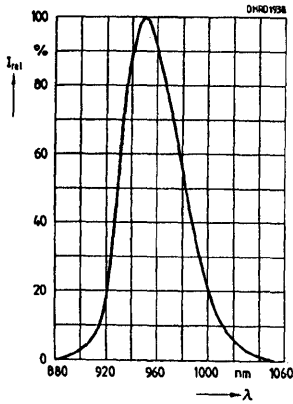

Radiant Intensity $I_E / I_{E50mA} = f(I_F)$

Single pulse, $\tau = 20 \mu s$

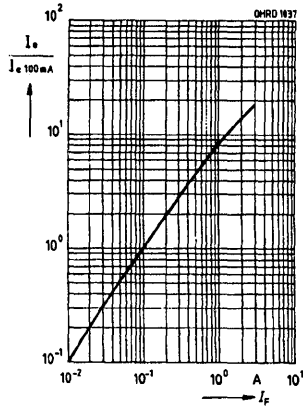

Radiation characteristic

$I_{REL} = f(\varphi)$

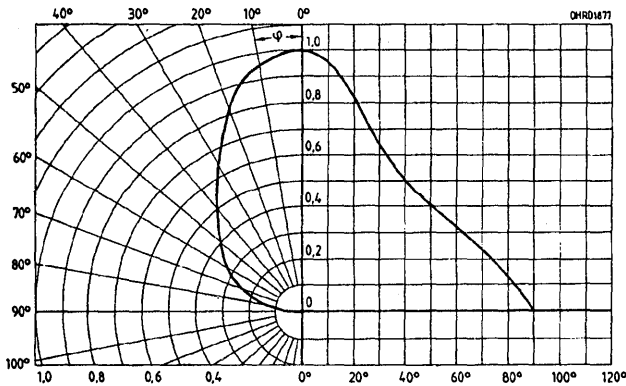

Maximum permissible forward current $I_F = f(T_A)$

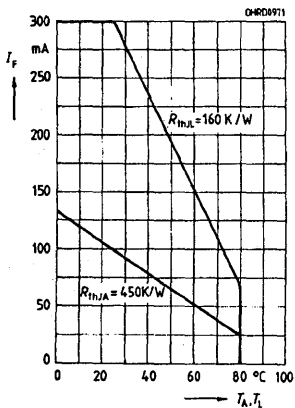

Forward current $I_F = f(V_F)$

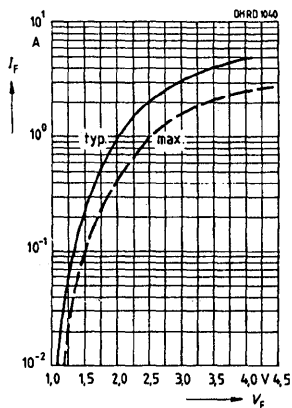

Permissible pulse handling capability $I_F = f(\tau)$, $T_C = 25^\circ C$

duty cycle $D = \text{Parameter}$

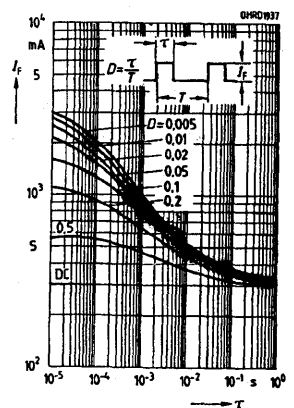

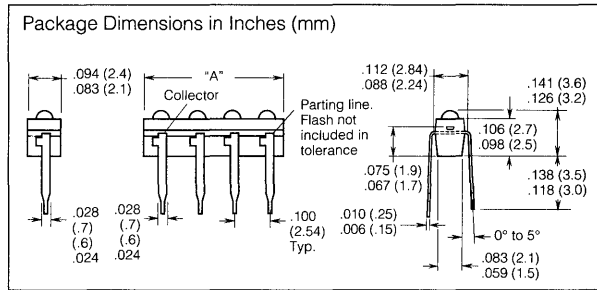
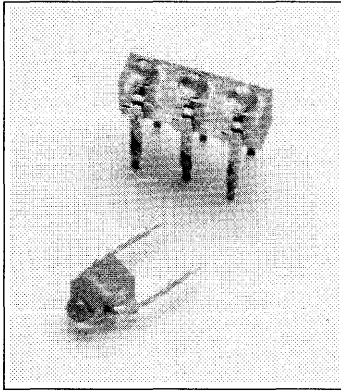

FEATURES

- Low Cost
- Miniature Size
- Availability:
 - One Diode LD 261
 - Two Diodes LD 262
 - Three Diodes LD 263
 - Four Diodes LD 264
 - Five Diodes LD 265
 - Six Diodes LD 266
 - Seven Diodes LD 267
 - Eight Diodes LD 268
 - Nine Diodes LD 269
 - Ten Diodes LD 260
- Medium Wide Beam, 60°

DESCRIPTION

The LD260-269 series, GaAs infrared emitting diodes, emit radiation at a wavelength in the near infrared range. These miniature devices come in a grey plastic package and are available as a single diode or as two- through ten-element arrays. The terminals are solder pins with 0.10" lead spacing. The LD260-269 series is designed for use with BPX 80-89 phototransistor when the spacing between each is approximately 10 mm. These devices can easily be mounted on PC boards and in thick film circuits for simple or complex scanning systems.

Maximum Ratings

Storage Temperature (T)	-40° + 80°C
Soldering Temperature	(Distance from solder joint to package ≥ 2 mm)	
Soldering Time, t ≤ 3 sec (T _S)	230°C
Junction Temperature (T _J)	80°C
Reverse Voltage (V _R)	5 V
Forward Current (I _F)	60 mA
Surge Current (I _{FSM}) t = 10 μs, D = 0	1.6 A
Power Dissipation (P _{TOT})	85 mW
Thermal Resistance (R _{thJA} , R _{thJL})	750, 650 K/W

Characteristics (T_A = 25°C)

	Symbol	Value	Unit	Condition
Wavelength	λ	950 ± 20	nm	I _F = 50 mA, t _p = 20 ms
Spectral Bandwidth	Δλ	55	nm	I _F = 50 mA, t _p = 20 ms
Half Angle	φ	± 30	Deg.	
Active Area	A	0.25	mm ²	
Active Die Area per Die	L x W	0.5 x 0.5	mm	
Distance Die Surface to Package Surface	H	1.3 to 1.9	mm	
Switching Time				I _F = 50 mA
I _e from 10% to 90% and from 90% to 10%				
Capacitance	C ₀	40	pF	V _R = 0 V
Forward Voltage	V _F	1.25 (≤ 1.4)	V	I _F = 50 mA, t _p = 20 ms
Breakdown Voltage	V _{BR}	30 (≥ 5)	V	I _R = 10 μA
Reverse Current	I _R	0.01 (≤ 1)	μA	V _R = 5 V
Temperature Coefficient of I _e or Φ _e	TC _I	-0.55	%/K	
Temperature Coefficient of V _F	TC _V	-1.5	mV/K	
Temperature Coefficient of λ peak	TC _λ	0.3	nm/K	
Radiant Intensity				
Axial Direction				
Measured at a Solid Angle of Ω = 0.01 sr	I _e	2 to 8	mW/sr	I _F = 50 mA, t _p = 20 ms
Radiant Power				
LD 261-4	Φ _e	2 to 4	mW	I _F = 50 mA, t _p = 20 ms
LD 261-5	Φ _e	3.2 to 6.3	mW	
LD 261-6	Φ _e	≥ 5	mW	
LD 262-269, 261	Φ _e	5	mW	

Infrared Emitters

Relative spectral emission
 $I_{REL}=f(\lambda)$

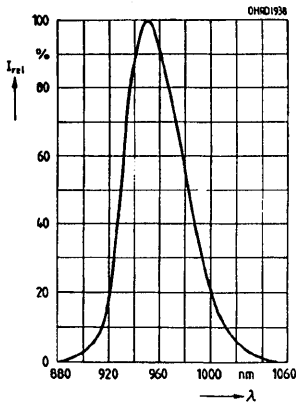

Radiant Intensity $I_e/I_{E50mA}=f(I_F)$
 Single pulse, $\tau = 20 \mu s$

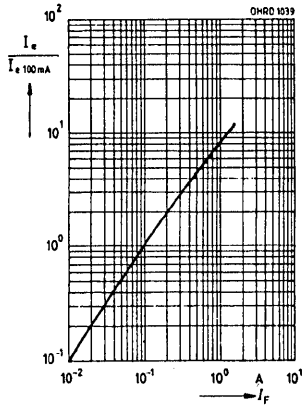

Radiation characteristic $I_{REL}=f(\phi)$

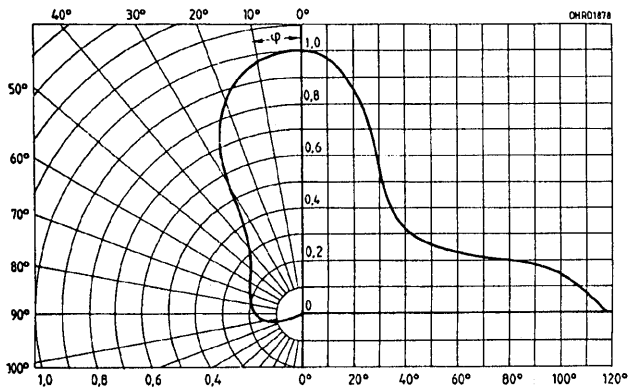

Maximum permissible forward current $I_F=f(T_A)$

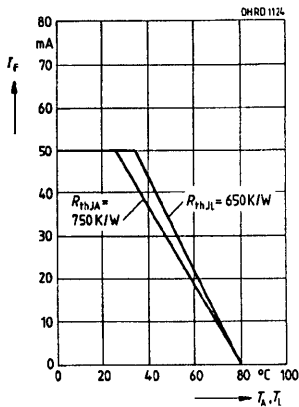

Forward current $I_F=f(V_F)$

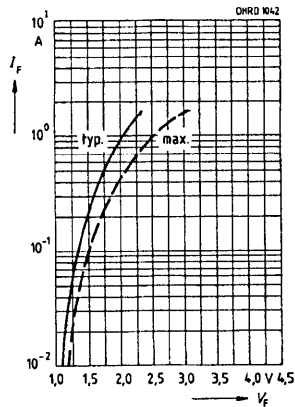

Permissible pulse handling capability $I_F=f(\tau)$, $T_C=25^\circ C$
 duty cycle $D=$ Parameter

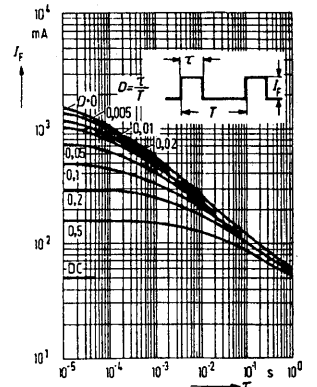

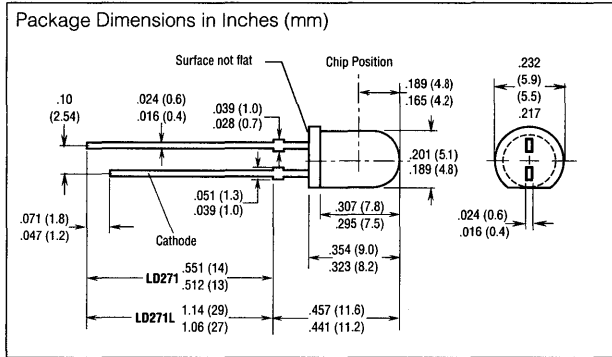
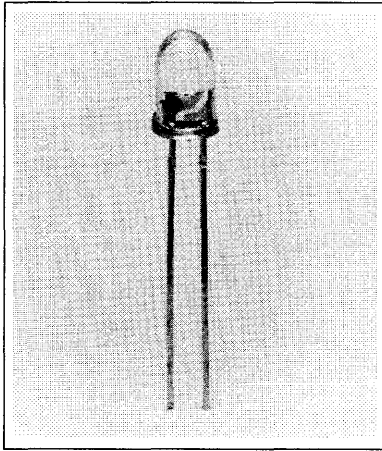

FEATURES

- T1 $\frac{3}{4}$ (5 mm) Package
- Lightly Diffused Gray Plastic Lens
- LD271L, 1" Leads
- Long Term Stability
- Medium Wide Beam, 50°
- High Power
- Matches Photodiodes SFH205 or BP104 or Phototransistors BP103B

DESCRIPTION

LD271/L is an infrared emitting diode and emits radiation in the near infrared range (950 nm peak). The emitted radiation, which can be modulated, is generated by forward flowing current. The device is enclosed in a T1 $\frac{3}{4}$ (5 mm) plastic package.

Maximum Ratings

Operating/Storage Temperature Range (T_{OP} , T_{STG}) -55° to +100°C
 Junction Temperature (T_J) 100°C
 Reverse Voltage (V_R) 5 V
 Forward Current (I_F) 130 mA
 Surge Current (I_{FSM}) $t=10 \mu s$, $D=0$ 3.5 A
 Power Dissipation (P_{TOT}) 210 mW
 Thermal Resistance (R_{thJA}) 210 K/W

Characteristics ($T_A=25^\circ C$)

Parameter	Symbol	Value	Unit
Peak Wavelength ($I_F=100 \text{ mA}$, $t_p=20 \text{ ms}$)	λ_{PEAK}	950±20	nm
Spectral Bandwidth, 50% I_{MAX} ($I_F=100 \text{ mA}$, $t_p=20 \text{ ms}$)	$\Delta\lambda$	55	nm
Half Angle	ϕ	±25	Deg.
Active Chip Area	A	0.25	mm ²
Active Chip Area Dimensions	L x W	0.5 x 0.5	mm
Distance, Chip Surface to Case Surface	H	4.0 to 4.6	mm
Switching Times, t_E 10% to 90% and 90% to 10% ($I_F=50 \text{ mA}$, $R_L=50 \Omega$)	t_R , t_F	1	μs
Capacitance ($V_R=0 \text{ V}$, $f=1 \text{ MHz}$)	C_0	40	pF
Forward Voltage ($I_F=100 \text{ mA}$, $t_p=20 \mu s$)	V_F	1.30 (≤ 1.5)	V
($I_F=1 \text{ mA}$, $t_p=100 \mu s$)	V_F	1.90 (≤ 2.5)	V
Reverse Current ($V_R=5 \text{ V}$)	I_R	0.01 (≤ 1)	μA
Radiant Flux, Total ($I_F=100 \text{ mA}$, $t_p=20 \text{ ms}$)	Φ_E	18	mW
Temperature Coefficient, I_E or Φ_E ($I_F=100 \text{ mA}$)	TC_I	-0.55	%/K
Temperature Coefficient, V_F ($I_F=100 \text{ mA}$)	TC_V	-1.5	mV/K
Temperature Coefficient, λ ($I_F=100 \text{ mA}$)	TC_λ	0.3	nm/K

Radiant Intensity, I_E in axial direction

at solid angle of $\Omega=0.01 \text{ sr}$ ($I_F=100 \text{ mA}$, $t_p=20 \text{ ms}$)	I_E	15 (≥ 10)	mW/sr
($I_F=1 \text{ mA}$, $t_p=100 \mu s$)	I_{Etyp}	120	mW/sr

Relative spectral emission

$I_{REL} = f(\lambda)$

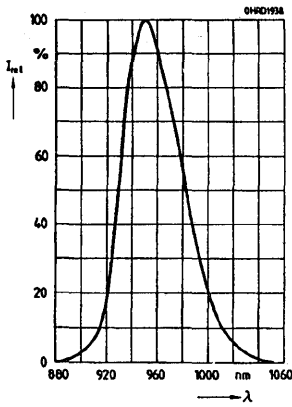

Radiant Intensity

$I_e / I_{e100mA} = f(I_F)$
Single pulse, $\tau = 20 \mu s$

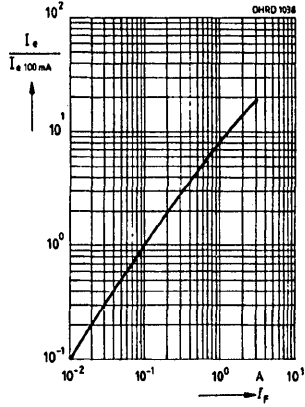

Radiation characteristic $I_{REL} = f(\varphi)$

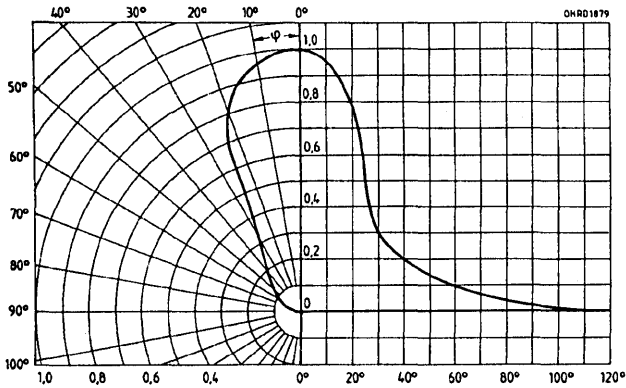

Maximum permissible forward current

$I_F = f(T_A)$

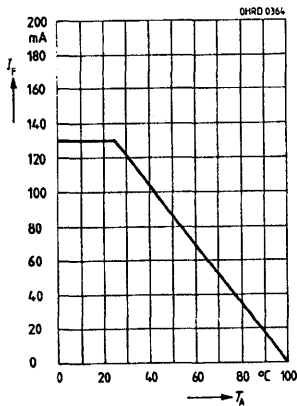

Forward current

Single pulse, $\tau = 20 \mu s$

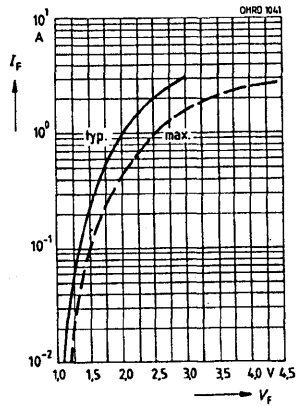

Permissible pulse handling capability

$I_F = f(\tau)$, $T_A \leq 25^\circ C$
duty cycle $D =$ Parameter

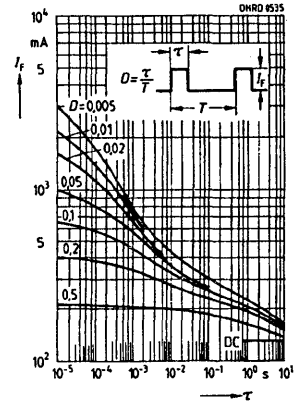

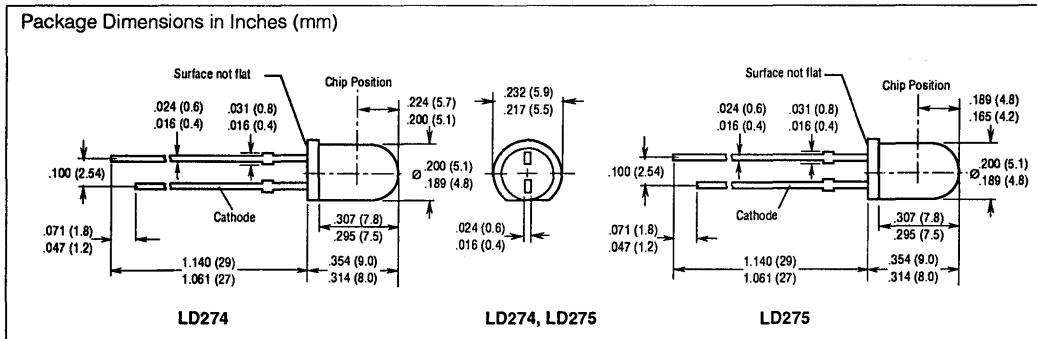

FEATURES

- GaAs Infrared Emitting Diode, Fabricated in a Liquid Phase Epitaxy Process
- Emits Radiation in Near Infrared Range
- High Efficiency
- High Reliability
- Long Lifetime
- LD274: Very High Radiant Intensity
- LD275: High Radiant Intensity
- High Pulse Power
- Radiant Intensity Selections
- LD274: Same Package as SFH484
- LD275: Same Package as BP103B, SFH415, SFH485, SFH2030
- DIN Humidity Category per DIN 40040 GQG
- Package
 - T13/4 (5 mm) LED Package
 - Gray Epoxy Resin Lens
 - Lead Spacing 0.100" (2.54 mm)
- Cathode Marking: Shorter Solder Tab, Flat

DESCRIPTION

The LD274 and LD275 are GaAs IR emitters with an emitted wavelength of 950 nm. The LD274 has a narrow beam and the LD275, a wide beam. These high power devices are suitable for remote control applications.

Maximum Ratings

Operating/Storage Temperature Range (T_{OP} , T_{STG})	-55° to +100°C
Junction Temperature (T_J)	100°C
Reverse Voltage (V_R)	5 V
Forward Current (I_F)	100 mA
Surge Current (I_{FSM}) $t=10 \mu s$, $D=0$	3 A
Power Dissipation (P_{TOT})	165 mW
Thermal Resistance (R_{thJA})	450 K/W

Characteristics ($T_A=25^\circ C$)

Parameter	Symbol	Value	Unit
Peak Wavelength ($I_F=100 \text{ mA}$, $t_p=20 \text{ ms}$)	λ_{PEAK}	950±20	nm
Spectral Bandwidth, 50% I_{MAX} ($I_F=100 \text{ mA}$, $t_p=20 \text{ ms}$)	$\Delta\lambda$	55	nm
Half Angle			
LD274	ϕ	±10	Deg.
LD275	ψ	±18	Deg.
Active Chip Area	A	0.09	mm ²
Active Chip Area Dimensions	L x W	0.3 x 0.3	mm
Distance, Chip Surface to Case Surface			
LD274	H	4.9 to 5.5	mm
LD275	H	4.2 to 4.8	mm
Switching Times, I_E			
10% to 90% and 90% to 10% ($I_F=100 \text{ mA}$, $R_L=50 \Omega$)	t_R , t_F	1	μs
Capacitance ($V_R=0 \text{ V}$, $f=1 \text{ MHz}$)	C_0	25	pF
Forward Voltage			
($I_F=100 \text{ mA}$, $t_p=20 \mu s$)	V_F	1.30 (±1.5)	V
($I_F=1 \text{ mA}$, $t_p=100 \mu s$)	V_F	1.90 (±2.5)	V
Reverse Current ($V_R=5 \text{ V}$)	I_R	0.01 (±1)	μA
Radiant Flux, Total ($I_F=100 \text{ mA}$, $t_p=20 \text{ ms}$)	Φ_E	15	mW
Temperature Coefficient, I_E or Φ_E ($I_F=100 \text{ mA}$)	TC_I	-0.55	%/K
Temperature Coefficient, V_F ($I_F=100 \text{ mA}$)	TC_V	-1.5	mV/K
Temperature Coefficient, λ ($I_F=100 \text{ mA}$)	TC_λ	0.3	nm/K

Radiant Intensity Selections

I_E in axial direction at solid angle of $\Omega=0.001 \text{ sr}$ (LD274) or $\Omega=0.01 \text{ sr}$ (LD275)

	LD	LD	LD	LD	LD	LD	Unit
Symbol	274-1	274-2	274-3*	275-1	275-2	275-3*	
$I_F=100 \text{ mA}$, $t_p=20 \text{ ms}$ I_{Emin}	30	50	80	10	16	25	mW/sr
$I_F=100 \text{ mA}$, $t_p=20 \text{ ms}$ I_{Emax}	60	100	-	20	32	-	mW/sr
$I_F=1 \text{ mA}$, $t_p=100 \text{ ms}$ I_{Etyp}	350	600	800	120	190	250	mW/sr

* Availability subject to yield.

Relative spectral emission

$I_{REL} = f(\lambda)$

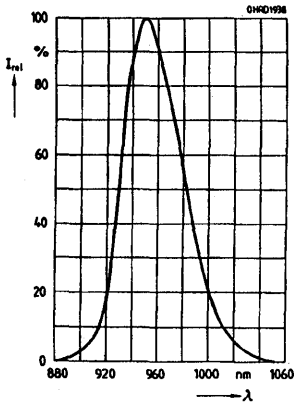

Radiation characteristic-LD274

$I_{REL} = f(\varphi)$

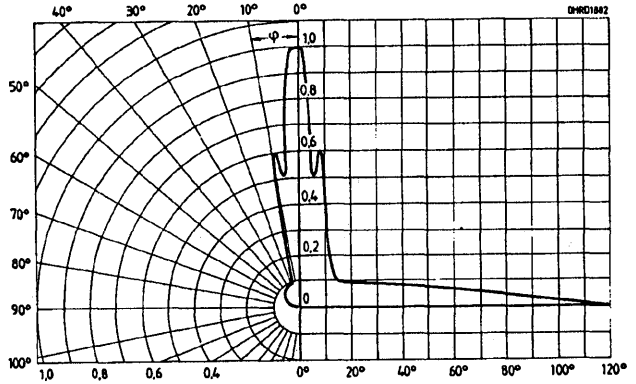

Radiant Intensity $I_E / I_{E50mA} = f(I_F)$

Single pulse, $\tau = 20 \mu s$

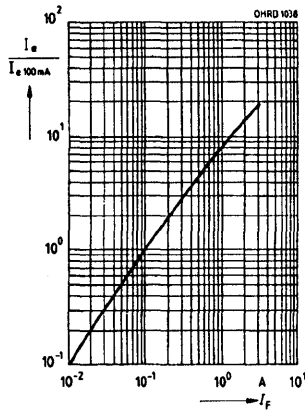

Radiation characteristic-LD275

$I_{REL} = f(\varphi)$

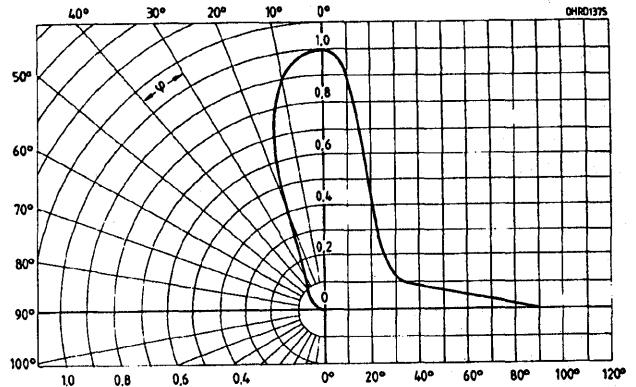

Maximum permissible forward current $I_F = f(T_A)$

Single pulse, $\tau = 20 \mu s$

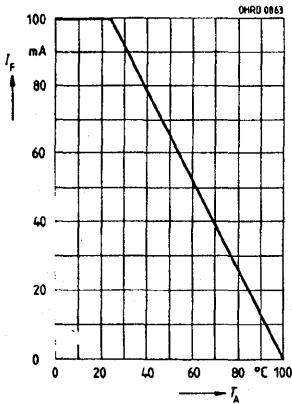

Forward current $I_F = f(V_F)$

Single pulse, $\tau = 20 \mu s$

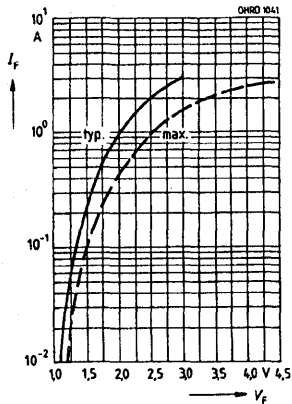

Permissible pulse handling capability $I_F = f(\tau)$, $T_A \leq 25^\circ C$

duty cycle $D = \text{Parameter}$

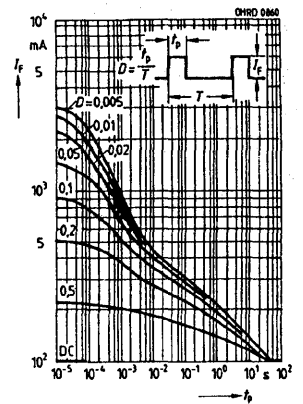

GaAs INFRARED EMITTER

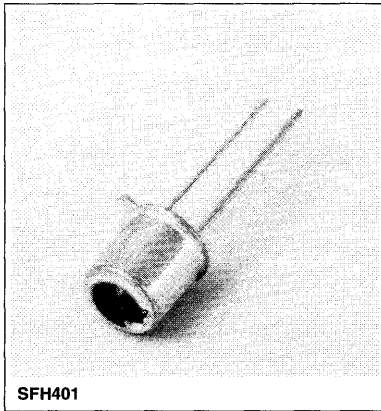

FEATURES

- Half Angle
 - SFH400, $\pm 6^\circ$
 - SFH401, $\pm 15^\circ$
 - SFH402, $\pm 40^\circ$
- GaAs Infrared Emitting Diode, Fabricated in a Liquid Phase Epitaxy Process
- Emits Radiation in Near Infrared Range
- Cathode Electrically Connected to Case
- High Efficiency
- High Reliability
- Long Lifetime
- SFH400/401: High Radiant Intensity
- SFH402: Wide Beam
- High Pulse Power
- Radiant Intensity Selections
- SFH400: Same Package as SFH480
- SFH401: Same Package as SFH481
- SFH402: Same Package as SFH482
- Applications
 - Light-reflecting Switches
 - IR Remote Control
 - Measurement and Control
 - Use in Extreme Environments
- Package
 - 18 A 3 DIN 876 (TO 18), Hermetically Sealed
 - Glass Lens
 - Lead Spacing 0.100" (2.54 mm)
- Cathode Marking: Tab at Case Bottom

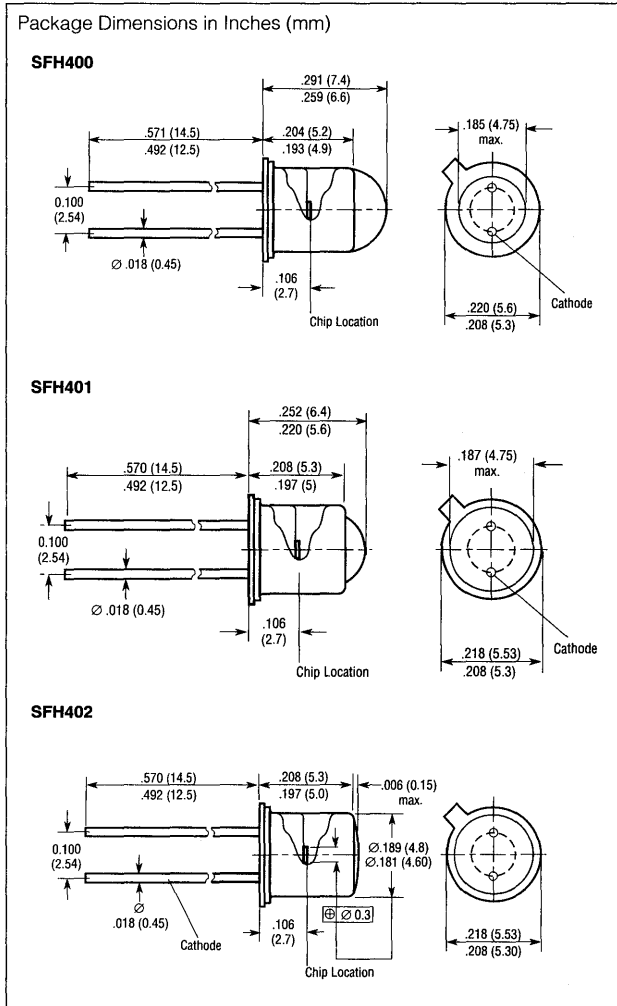

Maximum Ratings

Operating/Storage Temperature Range (T_{OP} , T_{STG})	-55° to $+100^\circ\text{C}$
Junction Temperature (T_J)	100°C max.
Reverse Voltage (V_R)	5 V
Forward Current (I_F)	300 mA
Surge Current (I_{FSM}) $t=10 \mu\text{s}$, $D=0$	3 A
Power Dissipation (P_{TOT})	470 mW
Thermal Resistance (R_{thJA})	450 K/W
(R_{thJC})	160 K/W

Characteristics (T_A=25°C)

Parameter	Symbol	Value	Unit
Peak Wavelength (I _F =100 mA, t _p =20 ms)	λ _{PEAK}	950±20	nm
Spectral Bandwidth, 50% I _{MAX} (I _F =100 mA, t _p =20 ms)	Δλ	55	nm
Half Angle			
SFH400	φ	±6	Deg.
SFH401	φ	±15	Deg.
SFH402	φ	±40	Deg.
Active Chip Area	A	0.25	mm ²
Active Chip Area Dimensions	L x W	0.5 x 0.5	mm
Distance, Chip Surface to Case Surface			
SFH400	H	4.0 to 4.8	mm
SFH401	H	2.8 to 3.7	mm
SFH402	H	2.1 to 2.7	mm
Switching Times, I _E 10% to 90% and 90% to 10% (I _F =100 mA, R _L =50 Ω)	t _R , t _F	1	μs
Capacitance (V _R =0 V, f=1 mHz)	C ₀	40	pF
Forward Voltage (I _F =100 mA, t _p =20 μs)	V _F	1.30 (≤1.5)	V
(I _F =1 mA, t _p =100 μs)	V _F	1.90 (≤2.5)	V
Reverse Current (V _R =5 V)	I _R	0.01 (≤1)	μA
Radiant Flux, Total (I _F =100 mA, t _p =20 ms)	Φ _E	8	mW
Temperature Coefficient, I _E or Φ _E (I _F =100 mA)	TC _I	-0.55	%/K
Temperature Coefficient, V _F (I _F =100 mA)	TC _V	-1.5	mV/K
Temperature Coefficient, λ (I _F =100 mA)	TC _λ	0.3	nm/K

Radiant Intensity Selections

I_E in axial direction at solid angle of Ω=0.01 sr

	SFH	SFH	SFH	SFH	SFH	SFH	Unit
Symbol	400-2	400-3*	401-2	401-3	402-2	402-3*	
I _F =100 mA, t _p =20 ms	I _{Emin}	20	32	10	16	2.5	4 mW/sr
I _F =100 mA, t _p =20 ms	I _{Emax}	40	-	20	32	5	- mW/sr
I _F =1 mA, t _p =100 μs	I _{Etyp}	250	320	120	190	30	40 mW/sr

* Availability subject to yield.

Relative spectral emission

I_{REL}=f(λ)

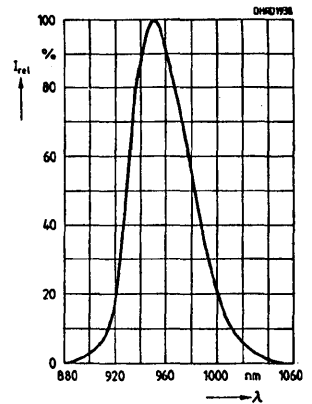

Radiant Intensity I_E/√I_{E50mA}=f(I_F)

Single pulse, τ = 20 μs

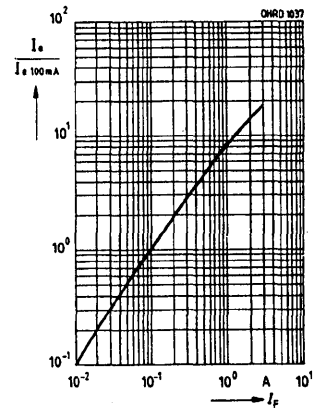

Maximum permissible forward current I_F=f(T_A)

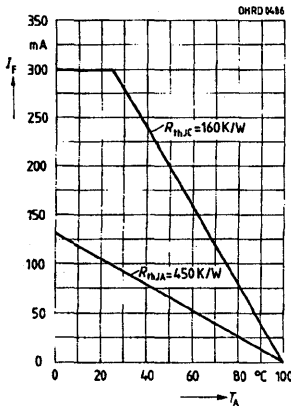

Forward current I_F=f(V_F)

Single pulse, τ = 20 μs

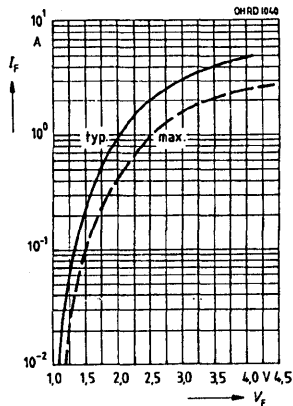

Permissible pulse handling capability I_F=f(τ), T_A≤25°C

duty cycle D=Parameter

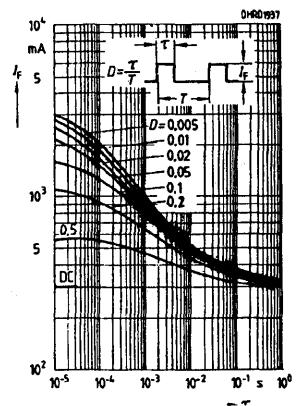

Radiation characteristic-SFH400

$I_{REL}=f(\varphi)$

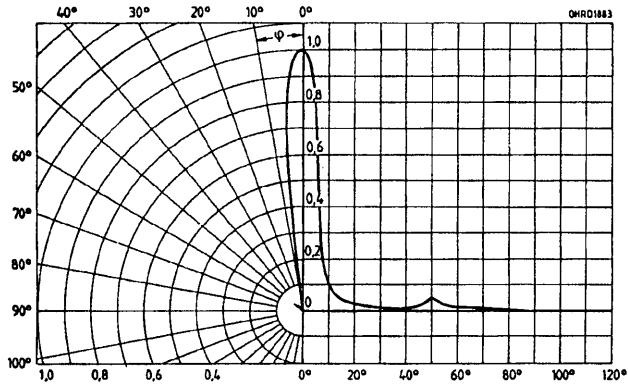

OHRD1883

Radiation characteristic-SFH401

$I_{REL}=f(\varphi)$

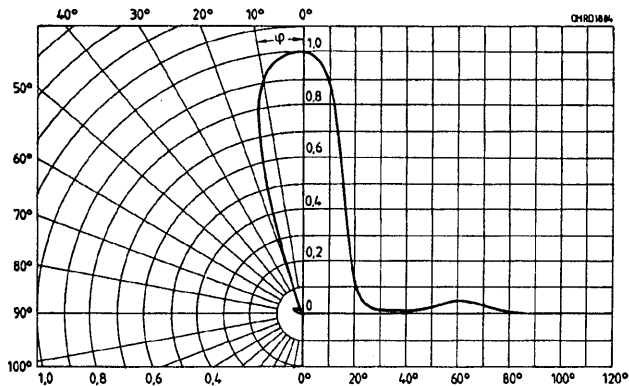

OHRD1884

Radiation characteristic-SFH402

$I_{REL}=f(\varphi)$

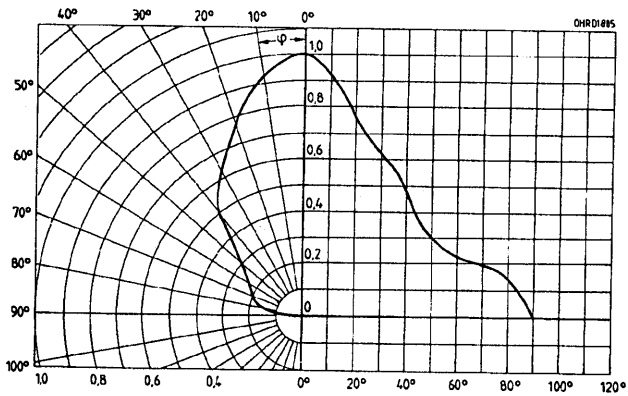

OHRD1885

Infrared
Emitters

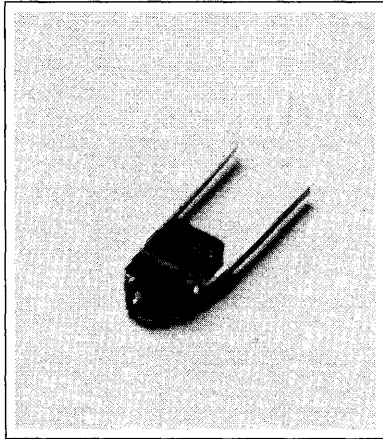

Package Dimensions in Inches (mm)

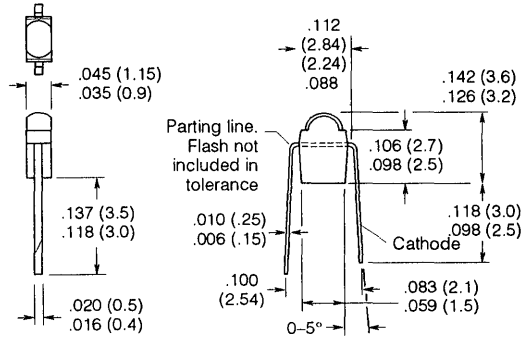

FEATURES

- GaAs Infrared Emitting Diode, Fabricated in a Liquid Phase Epitaxy Process
- Emits Radiation in Near Infrared Range
- High Efficiency
- High Reliability
- Long Lifetime
- High Radiant Intensity
- Same Package as SFH 305

DESCRIPTION

The SFH 405 is a GaAs infrared diode which emits radiation in the near infrared range.

The case is transparent plastic with a lens. The plastic is slightly smoke colored in order to differentiate between phototransistors of the same type (SFH 305). The terminals are solder pins in .100" (2.54 mm) lead spacing. There are two radiant intensity selections. SFH 405 can be used with the phototransistor SFH 305. The cathode is marked with a color dot.

They can be used effectively in miniature light barriers with close spacing between emitter and receiver.

Maximum Ratings

Operating and Storage Temperature Range (T_{OP} , T_{STG})	... -40° to +80°C
Junction Temperature (T_J) 80°C
Reverse Voltage (V_R) 5 V
Forward Current (I_F) 40 mA
Surge Current (I_{FSM}) $t=10 \mu s$, $D=0$ 1.6 A
Power Dissipation (P_{TOT}) 65 mW
Thermal Resistance (R_{thJA}) 950 K/W
(R_{thJL}) 850 K/W

Characteristics ($T_A=25^\circ C$)

Parameter	Symbol	Value	Unit
Peak Wavelength ($I_F=40$ mA, $t_p=20$ ms)	$\lambda_{\text{D PEAK}}$	950±20	nm
Spectral Bandwidth, 50% I_{MAX} ($I_F=40$ mA, $t_p=20$ ms)	$\Delta\lambda$	55	nm
Half Angle	ϕ	± 16	Deg.
Active Chip Area	A	0.25	mm ²
Active Chip Area Dimensions	L x W	0.5 x 0.5	mm
Distance, Chip Surface to Case Surface	H	1.3 to 1.9	mm
Switching Times, I_E 10% to 90% and 90% to 10% ($I_F=40$ mA)	t_{R, I_F}	1	μs
Capacitance ($V_R=0$ V)	C_0	40	pF
Forward Voltage ($I_F=40$ mA)	V_F	1.25 (≤1.4)	V
Reverse Current ($V_R=5$ V)	I_R	0.01 (≤1)	μA
Temperature Coefficient I_E or Φ_E , ($I_F=40$ mA)	TC_I	-0.55	%/K
Temperature Coefficient V_F	TC_V	-1.5	mV/K
Temperature Coefficient λ_{PEAK}	TC_λ	0.3	nm/K

Radiant Intensity Selections I_E in Axial Direction at a solid angle of $\Omega=0.01$ sr

	SFH 405-2	SFH 405-3	
Radiant Intensity ($I_F=40$ mA, $t_p=20$ ms)	≤ 3.2	≥ 2.5	mW/sr

Relative spectral emission $I_{REL}=f(\lambda)$

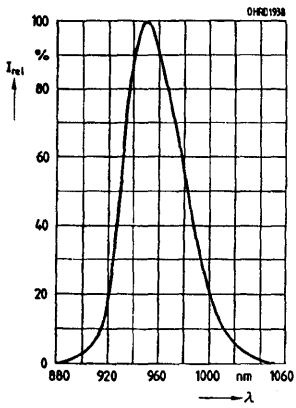

Radiant intensity $\frac{I_E}{I_E 100 \text{ mA}} = f(I_F)$
Single pulse, $\tau=20 \mu\text{s}$

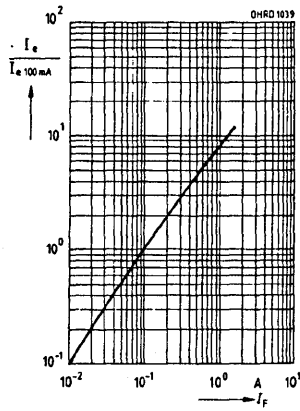

Radiation characteristics $I_{REL}=f(\varphi)$

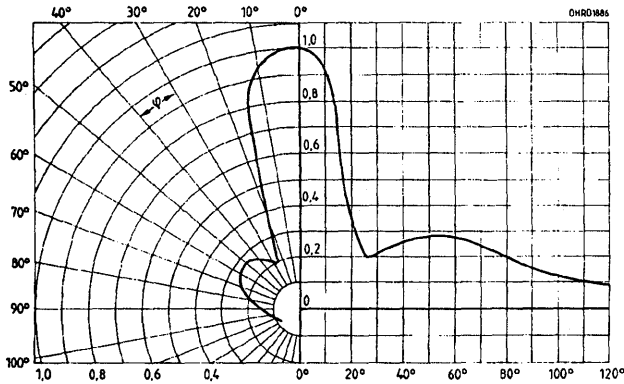

Maximum permissible forward current $I_F=f(T_A)$

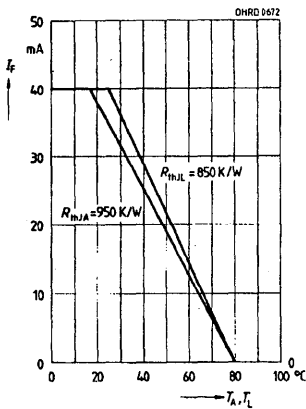

Forward current $I_F=f(V_F)$
Single pulse, $\tau=20 \mu\text{s}$

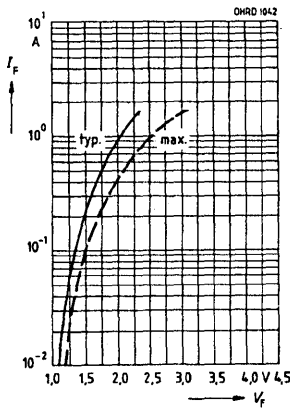

Permissible pulse handling capability $I_F=f(\tau)$, $T_A=25^\circ\text{C}$ duty cycle D =Parameter

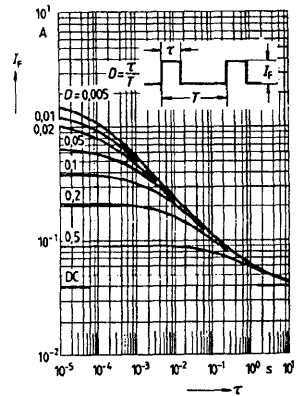

Infrared Emitters

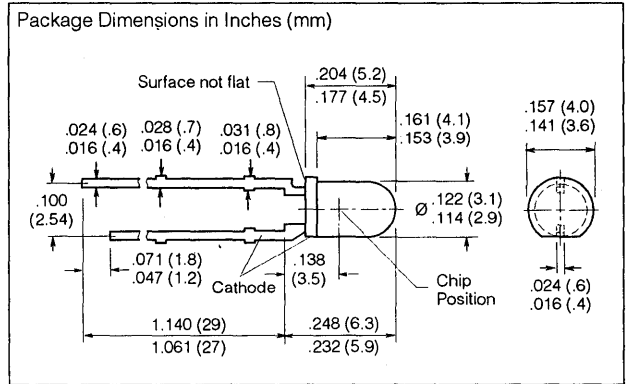
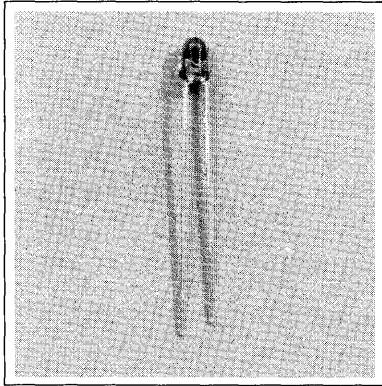

FEATURES

- Radiant Intensity Selections
SFH 409-1, 6.3–12.5 mW/sr
SFH 409-2, 10–20 mW/sr
SFH 409-3, ≤ 16 mW/sr
- High Reliability
- T1 (3 mm) Package
- .100" (2.54 mm) Lead Spacing
- High Pulse Power
- Long Term Stability
- Medium Wide Beam, 40°
- Excellent Match with Photodetector SFH 309

DESCRIPTION

The SFH 409 is a GaAs Infrared Emitting Diode in a standard T1 plastic package. It is designed for a variety of low cost, high volume applications such as IR remote control and other consumer and entertainment products.

Maximum Ratings

Operating and Storage Temperature

Range (T_{OP} , T_{STG})	-55° to +100°C
Junction Temperature (T_J)	100°C
Reverse Voltage (V_R)	5 V
Forward Current (I_F)	100 mA
Surge Current (I_{FSM}) $t=10 \mu s$	3 A
Power Dissipation (P_{TOT}) $T=25^\circ C$	165 mW
Thermal Resistance (R_{thJA})	450 K/W

Characteristics ($T_A=25^\circ C$)

Parameter	Symbol	Value	Unit
Peak Wavelength ($I_F=100$ mA, $t_p=20$ ms)	λ_{PEAK}	950±20	nm
Spectral Bandwidth, 50% I_{MAX} ($I_F=100$ mA, $t_p=20$ ms)	$\Delta\lambda$	55	nm
Half Angle	ϕ	±20	Deg.
Active Chip Area	A	0.09	mm ²
Active Chip Area Dimensions	L x W	0.3 x 0.3	mm
Distance, Chip Surface to Case Surface	D	2.6	mm
Switching Times, t_E 10% to 90% ($I_F=50$ mA)	t_R , t_F	1	μs
Capacitance ($V_R=0$ V, $f=1$ MHz)	C_0	25	pF
Forward Voltage ($I_F=100$ mA)	V_F	1.30 (≤ 1.5)	V
($I_F=1$ mA, $t_p=100 \mu s$)	V_F	1.90 (≤ 2.5)	V
Reverse Current ($V_R=5$ V)	I_R	0.01 (≤ 1)	μA
Temperature Coefficient, t_E or Φ_E	TC_i	-0.55	%/K
Temperature Coefficient, V_F	TC_V	-1.5	mV/K
Temperature Coefficient, λ_{peak}	TC_λ	0.3	nm/K

Radiant Intensity, I_E in Axial Direction at a solid angle of $\Omega=0.01$ sr

	SFH 409-1	SFH 409-2	SFH 409-3	
Radiant Intensity I_E ($I_F=100$ mA, $t_p=20$ ms)	6.3–12.5	10–20	≥ 16	mW/sr
($I_F=1$ A, $t_p=100 \mu s$)	75	120	160	mW/sr
Total Radiant Flux Φ_E (typ) ($I_F=100$ mA, $t_p=20$ ms)	15	15	15	mW

Relative spectral emission $I_{REL}=f(\lambda)$

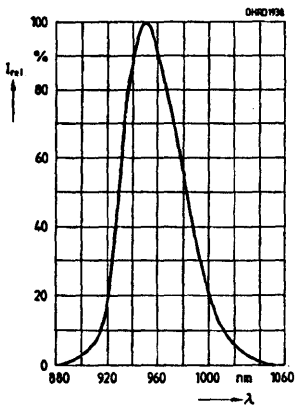

Radiant intensity $\frac{I_E}{I_E 100 \text{ mA}} = f(I_F)$
Single pulse, $\tau=20 \mu\text{s}$

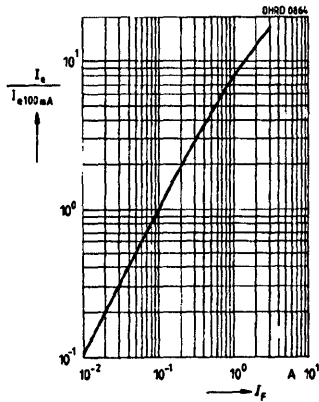

Radiation characteristics $I_{REL}=f(\varphi)$

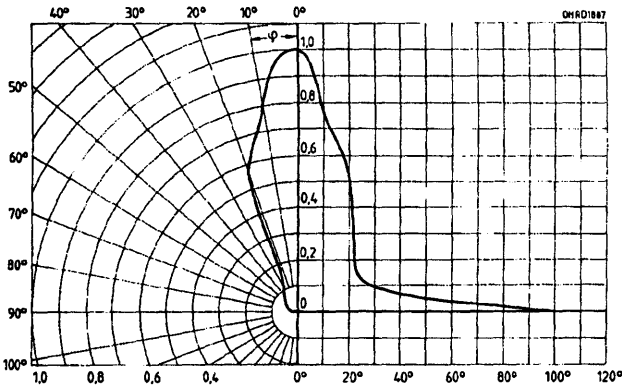

Maximum permissible forward current $I_F=f(T_A)$

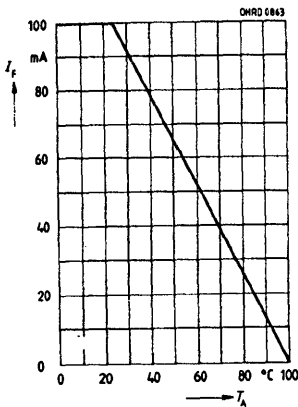

Forward current $I_F=f(V_F)$
Single pulse, $\tau=20 \mu\text{s}$

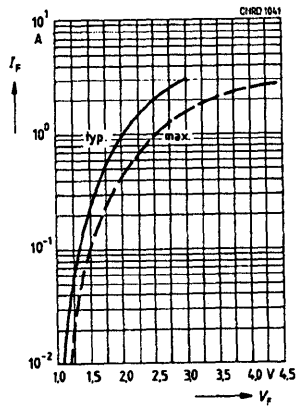

Permissible pulse handling capability $I_F=f(\tau)$, $T_A=25^\circ\text{C}$ duty cycle $D=P$ Parameter

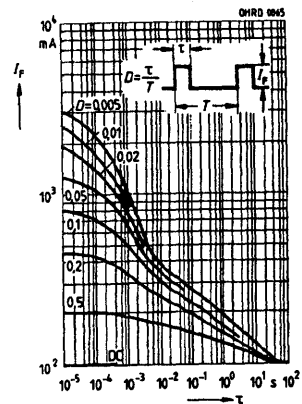

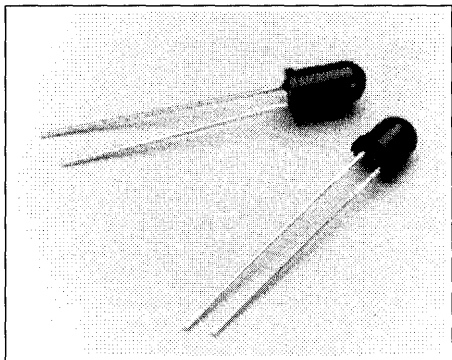

FEATURES

- Half Angle
SFH 414: $\pm 11^\circ$
SFH 415: $\pm 17^\circ$
SFH 416: $\pm 28^\circ$
- T1^{3/4} Package
- Highly Efficient GaAs LEDs
- Good Linearity ($I_E = f(I_F)$) at High Currents
- Radiation in the Near Infrared Range
- High Reliability
- Long-term Stability
- Fast Switching Time
- High Pulse Handling Capability

DESCRIPTION

The SFH414/415/416 are T1^{3/4} (5 mm) epoxy packaged infrared emitters with a peak wavelength of 950 nm. The unique chip used in these devices is GaAs with a GaAlAs "window." This construction allows for a low forward voltage while maintaining strong output power, efficiency, and linearity. Typical applications include remote control for television sets and data transmission.

Package Dimensions in Inches (mm)

SFH 414/415

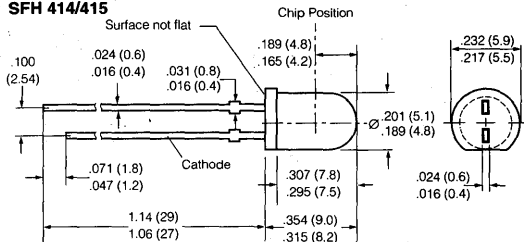

SFH 416

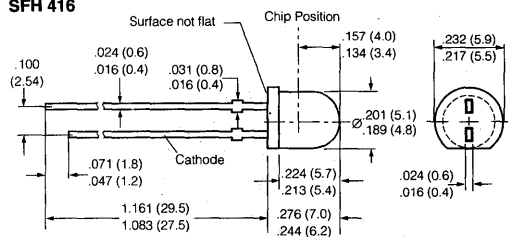

Maximum Ratings

Operating/Storage Temperature (T_{OP} , T_{STG})	-55 to +100°C
Junction temperature (T_J)	100°C
Reverse voltage (V_R)	5V
Forward current (I_F)	100mA
Surge current (I_{FSM}) $t_p \leq 10 \mu s$, $D=0$	3A
Power dissipation (P_{TOT}) $T_A=25^\circ C$	165mW
Thermal resistance (R_{thJA})	450K/W

Characteristics ($T_A=25^\circ\text{C}$)

Parameter	Symbol	Value	Unit
Peak Wavelength, ($I_F=100\text{ mA}$, $t_p=20\text{ ms}$)	λ	950±20	nm
Spectral Bandwidth at 50% of I_{rel} , ($I_F=100\text{ mA}$)	$\Delta\lambda$	55	
Half Angle			
SFH 414	φ	±11	Deg.
SFH 415	φ	±17	Deg.
SFH 416	φ	±28	Deg.
Active Chip Area	A	0.09	mm ²
Active Chip Area Dimensions	L x W	0.3 x 0.3	mm
Distance Chip Surface to Case surface			
SFH 414	H	5.1 to 5.7	mm
SFH 415	H	4.2 to 4.8	mm
SFH 416	H	3.4 to 4.0	mm
Switching Times ($I_F=100\text{ mA}$), I_e from 10% to 90% or from 90% to 10%	t_R, t_F	0.5	μs
Capacitance ($V_R=0\text{ V}$, $f=1\text{ MHz}$)	C_O	25	pF
Forward Voltage ($I_F=100\text{ mA}$, $t_p=20\text{ ms}$) ($I_F=1\text{ A}$, $t_p=100\text{ μs}$)	V_F	1.3 (≤1.5) 2.3 (≤2.8)	V V
Breakdown Voltage ($I_R=1\text{ μA}$)	V_{BR}	≥5	V
Reverse Current ($V_R=5\text{ V}$)	I_R	0.01 (≤1)	μA
Total Radiant Flux ($I_F=100\text{ mA}$, $t_p=20\text{ ms}$)	Φ_e	22	mW
Temperature Coefficient of I_e or Φ_e	TC_I	-0.5	%/K
Temperature Coefficient of V_F	TC_V	-2	mV/K
Temperature Coefficient of λ	TC_λ	+0.3	nm/K

Radiant Intensity Selections

I_E in axial direction at solid angle of $\Omega=0.01\text{ sr}$

	Symbol	SFH 416-Q	SFH 416-R	SFH 415-S	SFH 414-T 415-T	SFH 414-U 415-U	Unit
$I_F = 100\text{ mA}$, $t_p = 20\text{ ms}$	I_{Emin}	6.3	10	16	25	40	mW/sr
$I_F = 100\text{ mA}$, $t_p = 20\text{ ms}$	I_{Emax}	12	20	32	50	80	mW/sr
$I_F = 1\text{ mA}$, $t_p = 100\text{ μs}$	I_{Etyp}	90	150	240	380	600	mW/sr

Relative spectral emission

$I_{REL}=f(\lambda)$

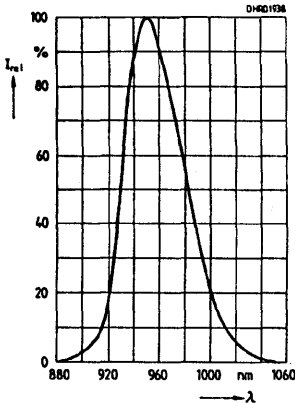

Relative radiant intensity I_e/I_E 100 mAf (I_F)

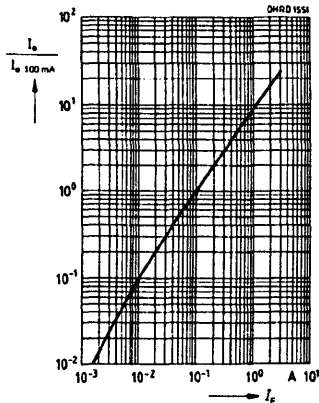

Radiation characteristics—SFH 414

$I_{REL} = f(\varphi)$

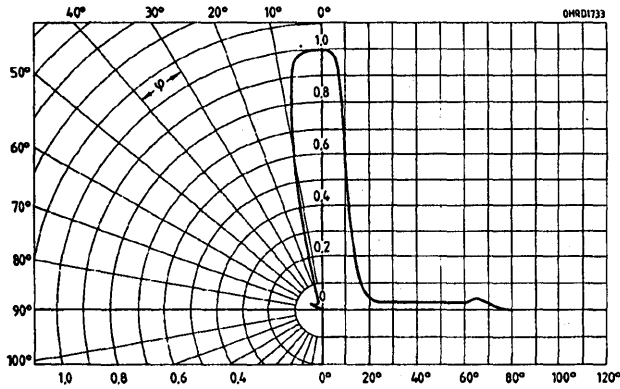

Maximum permissible forward current

$I_F = f(T_A)$

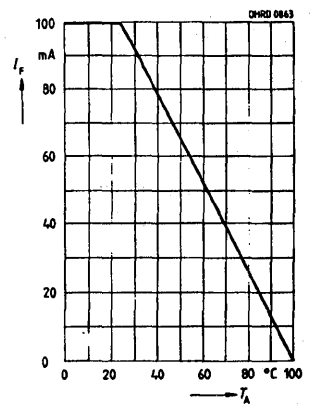

Radiation characteristics—SFH 415

$I_{REL} = f(\varphi)$

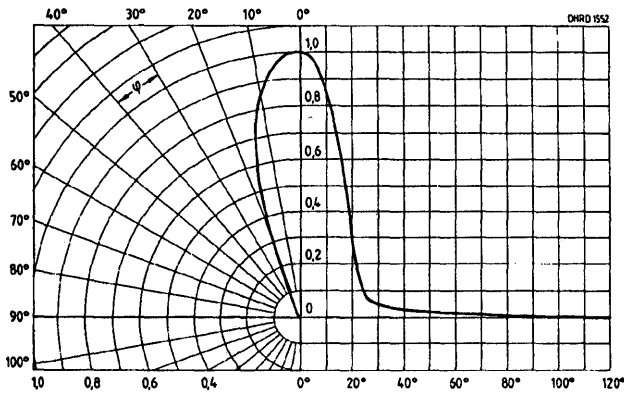

Permissible pulse handling capability

$I_F = f(V_F)$, Duty cycle $D = \text{parameter}$
Single pulse, $\tau = 20 \mu\text{s}$

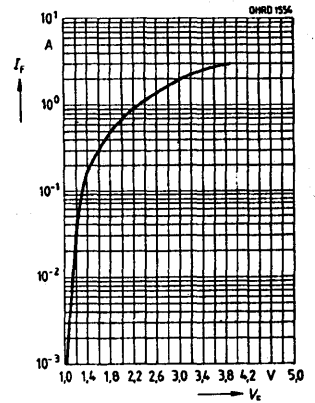

Radiation characteristics—SFH 416

$I_{REL} = f(\varphi)$

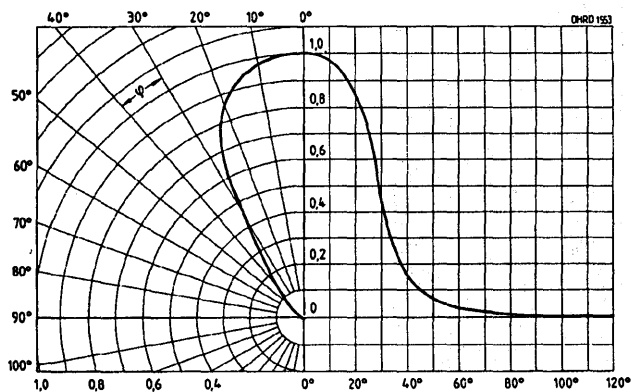

Forward current $I_F = f(V_F)$

Single pulse, $\tau = 20 \mu\text{s}$

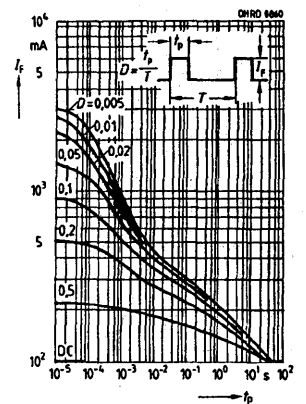

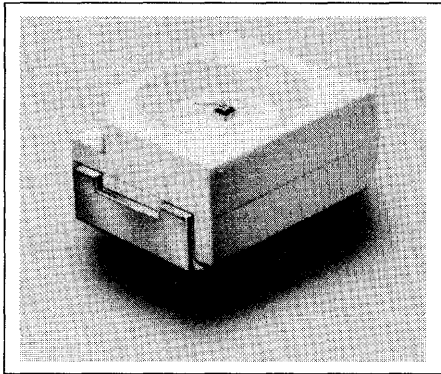

Package Dimensions in Inches (mm)

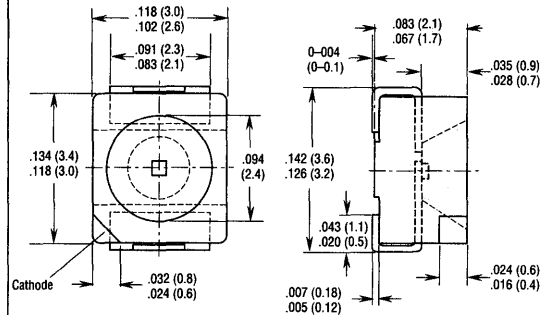

FEATURES

- Surface Mountable PL-CC-2 Package
- Suitable for Vapor-Phase Reflow, Infrared Reflow, Wave Solder Processes
- Compatible with Automatic Placement Equipment
- GaAs IR LED with Wide Viewing Angle
- Good Linearity [$I_e = f(I_F)$] at High Currents
- High Reliability/Long Lifetime
- Fast Response Time
- Matches with SFH320/SFH320F Phototransistor
- Applications
 - Measurement and Control
 - Touch Screens
 - Light Curtains

DESCRIPTION

The SFH420 is a wide angle GaAs LED in a compact surface mountable package. The device is compatible with automatic placement equipment and can withstand IR reflow, vapor phase reflow and solder processes. Their small size makes them suitable for dense packaging in array applications such as touch screens and precise position measurement.

Maximum Ratings

Operating and Storage	
Temperature (T_A , T_{STG})-55 to +100°C
Junction Temperature (T_J) 100°C
Reverse Voltage (V_R) 5 V
Forward Current (I_F) 100 mA
Pulse Current (I_{FSM}) $\tau=10 \mu s$, $D=0$ 1A
Power Dissipation (P_{tot}) $T_A=25^\circ C$ 160 mW
Thermal Resistance, Junction to Ambient	
Mounting on Al_2O_3 Ceramic	
Substrate (R_{thJA}) 300 K/W
Mounting on PC Board (R_{thJA}) 450 K/W
Chip to Solder Area (R_{thJA}) ≈ 200 K/W

Characteristics ($T_A=25^\circ C$)

Parameter	Symbol	Value	Unit
Peak Wavelength ($I_F=100$ mA, $t_p=20$ ms)	λ_{peak}	950 \pm 20	nm
Spectral Bandwidth (50% of I_{max} , $I_F=100$ mA)	$\Delta\lambda$	55	nm
Half Angle	ϕ	± 60	Deg.
Radiant Sensitive Area	A	0.09	mm ²
Radiant Sensitive Area Dimensions	L x W	0.3 x 0.3	mm
Response Time ($I_F=100$ mA, $R_L=50 \Omega$, from 10% to 90% or 90% to 10% of I_E)	t_R , t_F	0.5	μs
Capacitance ($V_R=0$ V, $f=1$ MHz)	C_O	25	pF
Forward Voltage ($I_F=100$ mA, $t_p=20$ ms)	V_F	1.3 (≤ 1.5)	V
($I_F=1$ A, $t_p=100 \mu s$)	V_F	2.3 (≤ 2.8)	V
Reverse Current ($V_R=5$ V)	I_R	0.01 (≤ 1)	μA
Total Radiant Flux ($I_F=100$ mA, $t_p=20$ ms)	Φ_e	22	mW
Temperature Coefficient, (I_e or Φ_e) ($I_F=100$ mA)	TC_I	-0.5	%/K
Temperature Coefficient, V_F ($I_F=100$ mA)	TC_V	-2	mV/K
Temperature Coefficient, λ_{peak} ($I_F=100$ mA)	TC_λ	+0.3	nm/K
Radiant Intensity: SFH420			
($I_F=100$ mA, $t_p=20$ ms)	I_{Emin}	2.5	mW/sr
($I_F=100$ mA, $t_p=20$ ms)	I_{Emax}	5	mW/sr
($I_F=1$ A, $t_p=100 \mu s$)	I_{Etp}	38	mW/sr

Relative spectral emission

$I_{REL} = f(\lambda)$

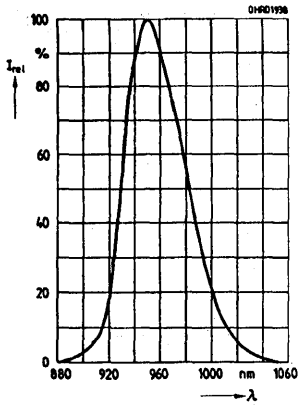

Relative radiant intensity

$I_E / I_E 100 \text{ mA} = f(I_F)$, one pulse, $\tau = 20 \mu\text{s}$

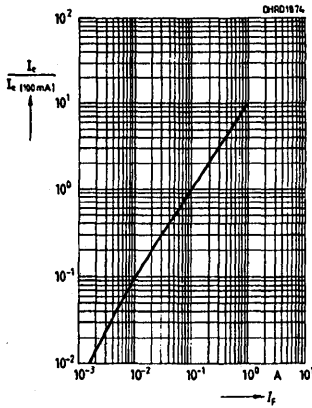

Radiation characteristics $I_{REL} = f(\varphi)$

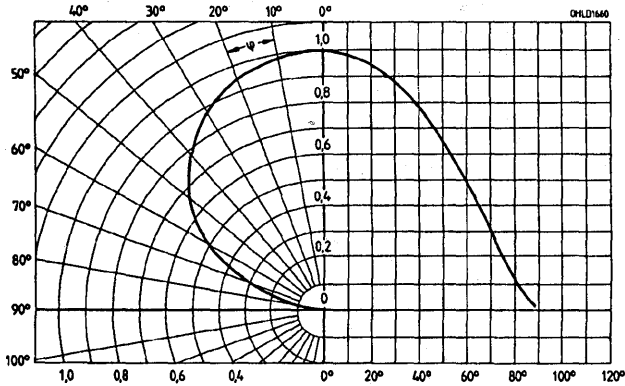

Maximum permissible forward current $I_F = f(T_A)$

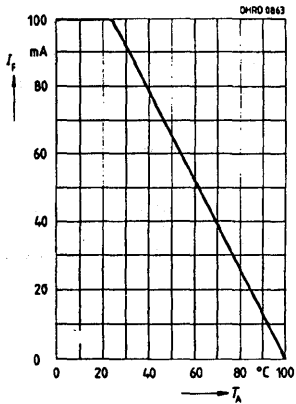

Forward current

$I_F = f(V_F)$, one pulse, $\tau = 20 \mu\text{s}$

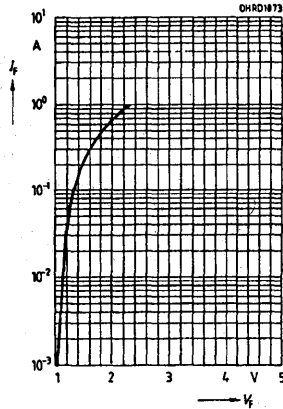

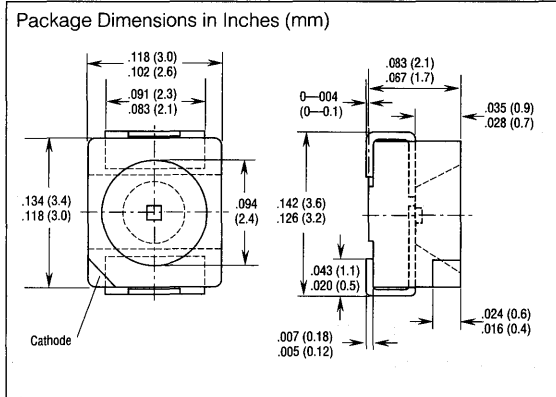
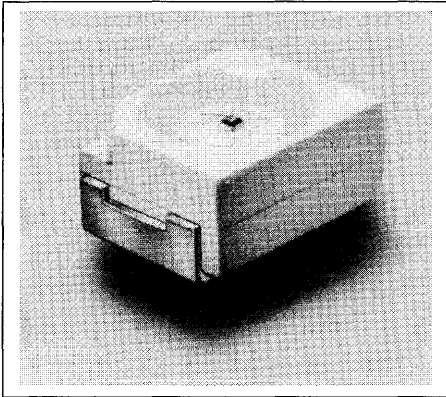

FEATURES

- Surface Mountable Package PL-CC-2
- Very High Efficiency GaAlAs IR IRED
- Good Linearity [$I_e = f(I_f)$]
- Radiation in Near Infrared Range, 880 nm
- High Reliability
- Long Term Stability
- Fast Switching Time
- High Pulse Handling Capability
- On Tape and Reel
- Same Package as SFH320 and SFH420
- Applications
 - Miniature Light Barriers
 - Punched Tape Readers
 - Industrial Electronics
 - Measurement and Control

DESCRIPTION

The SFH421 is a GaAlAs IRED in a compact surface mountable package. The device is compatible with automatic placement equipment and can withstand IR reflow, vapor phase reflow and solder processes. Their small size makes them suitable for dense packaging in array applications such as touch screens and precise position measurement.

Maximum Ratings

Operating and Storage Temperature (T_A, T_{STG})	-55 to +100°C
Junction Temperature (T_J)	100°C
Reverse Voltage (V_R)	5 V
Forward Current (I_F)	100 mA
Surge Current (I_{FSM}) $\tau=10 \mu s, D=0$	2.5 A
Total Power Dissipation (P_{tot})	180 mW
Thermal Resistance		
On Al_2O_3 Ceramic Substrate (R_{thJA})	
($15 \times 16.7 \times 0.7$ mm)	300 K/W
On PC Board (R_{thJA})	450 K/W
Chip to Solder Area (R_{thJA})	≈ 200 K/W
Dip, Wave, and Drag Soldering		
Soldering Bath Temperature	260°C
Maximum Permissible Soldering Time	8 sec.
Reflow Soldering:		
Temperature at Soldering Zone	Maximum Transit Time	
260°C	10 sec.	
215°C	30 sec.	
Preheating Temperature (approx. 1 min.)	150°C

Characteristics (T_A=25 °C)

Parameter	Symbol	Value	Unit	Condition
Peak Wavelength	λ_{peak}	880±20	nm	I _F = 100 mA, t _p =20 ms
Spectral Bandwidth	$\Delta\lambda$	80	nm	50% of I _{REL} , I _F =100 mA
Half Angle	φ	±60	Deg.	
Radiant Sensitive Area	A	0.16	mm ²	
Radiant Sensitive Area Dimensions	L x W	0.4 x 0.4	mm	
Switching Time	t _R	0.6	μs	I _E 10% to 90%
	t _F	0.5	μs	90% to 10%
Capacitance	C _O	25	pF	I _F =100 mA, R _L =50 Ω
				V _R =0 V, f=1 MHz
Forward Voltage	V _F	1.5 (≤1.8)	V	I _F =100 mA, t _p =20 ms
	V _F	3.0 (≤3.8)	V	I _F =1 A, t _p =100 μs
Reverse Current	I _R	0.01 (≤1)	μA	V _R =5 V
Total Radiant Flux	Φ_e	25	mW	I _F =100 mA, t _p =20 ms
Temperature Coefficient of I _e or Φ_e	TC _I	-0.5	%/K	I _F =100 mA
Temperature Coefficient of V _F	TC _V	-2	mV/K	I _F =100 mA
Temperature Coefficient of λ	TC _{λ}	+0.25	nm/K	I _F =100 mA
Radiant Intensity, I_E in axial direction measured at a solid angle of $\Omega=0.01$ sr				
SFH421	I _{Emin}	4	mW/sr	I _F =100 mA, t _p =20 ms
	I _{Emax}	8	mW/sr	I _F =100 mA, t _p =20 ms
	I _{Etyp}	48	mW/sr	I _F =1 A, t _p =100 μs

Radiation characteristics

$I_{REL} = f(\varphi)$

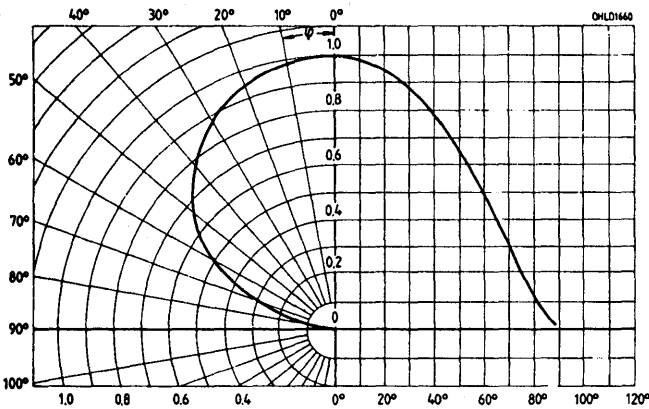

Relative spectral emission

$I_{REL} = f(\lambda)$

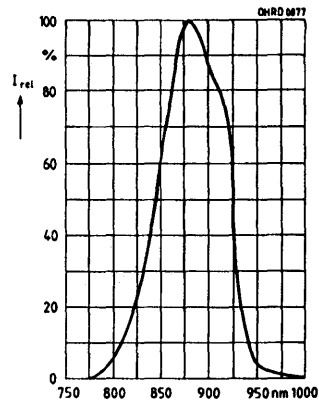

Relative radiant intensity

$I_{\lambda} / I_{\lambda_0} (100 \text{ mA}) = f(I_F)$, one pulse, $\tau = 20 \mu\text{s}$

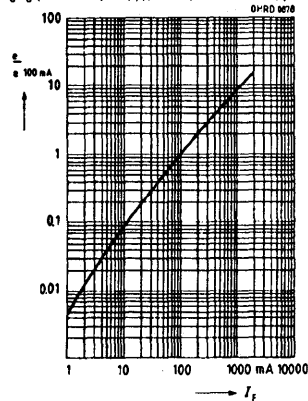

Maximum permissible forward current

$I_F = f(T_A)$

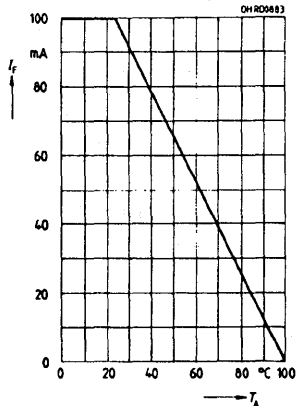

Forward current

$I_F = f(V_F)$, one pulse, $\tau = 20 \mu\text{s}$

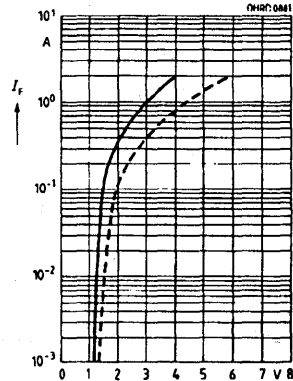

Permissible pulse handling capability

Duty cycle D=Parameter, $T_A = 25^\circ\text{C}$

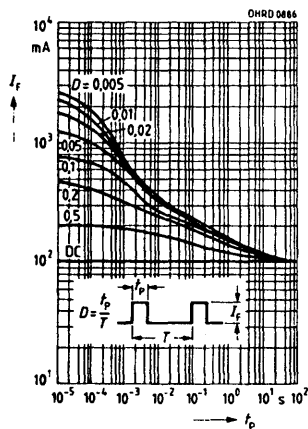

Infrared Emitters

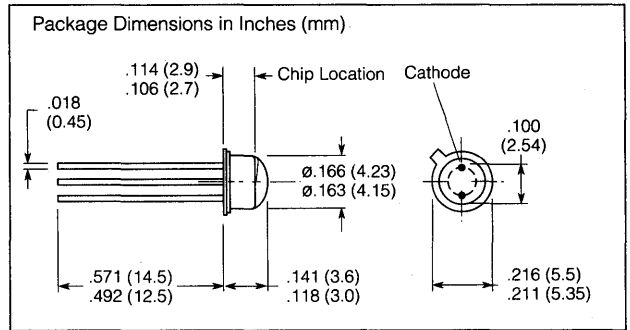
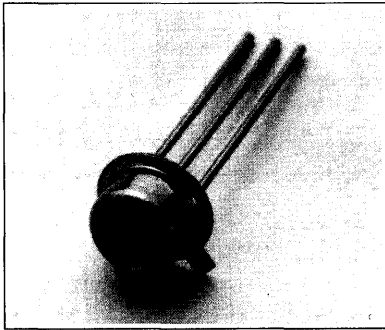

FEATURES

- Radiation: Visible Red Range
- Anode Electrically Connected to Case
- Very High Efficiency
- Short Switching Time
- High Pulse Power
- High Reliability
- Long Life
- Same Package as BP103, LD 242, SFH 463, SFH 483
- Package: 18 A 3 DIN 870 (TO 18), Clear Epoxy Resin, 0.1" (2.54 mm) Lead Spacing
- DIN Humidity Category per DIN 40040 GQG
- Component Subjected to Aperture Measurement
- Cathode Marking: Projection at Case Bottom
- Application
 - Long Range Light Reflecting Switches

Maximum Ratings

Operating and Storage Temperature Range (T_{OP} , T_{STG})	-40 to +80°C
Junction Temperature (T_J)	100°C
Reverse Voltage (V_R)	3 V
Forward Current (I_F)	50 mA
Power Dissipation (P_{TOT})	120 mW
Surge Current (I_{FSM}) $t_p=10\mu s$, $D=0$	1 A
Thermal Resistance (R_{thJA})	450 K/W
(R_{thJC})	160 K/W

Characteristics ($T_A=25^\circ C$)

Parameter	Sym	Value	Unit	Condition
Wavelength, Peak Emission	λ_{peak}	660±20	nm	$I_F=50$ mA, $t_p=20$ ms $I_F=50$ mA
Spectral Bandwidth at 50%	$\Delta\lambda$	25	nm	
Half Angle	ϕ	±23	Deg.	
Active Chip Area	A	0.0625	mm ²	
Chip Area Dimension	LxW	0.25x0.25	mm	
Distance Chip Surface to Case Surface	H	2.8	mm	
Switching Times, t_e from 10% to 90% and from 90% to 10%,	t_r/t_f	100	ns	$I_F=50$ mA, $R_L=50$ Ω
Capacitance	C_O	30	pF	$V_R=0$ V, $f=1$ MHz
Forward Voltage	V_F	2.1 (≤2.8)	V	$I_F=50$ mA, $t_p=20$ ms
Reverse Current	I_R	0.01 (≤10)	μA	$V_R=3$ V
Radiant Flux (Total)	Φ_e	11	mW	$I_F=50$ mA, $t_p=20$ ms
Temperature Coefficient of I_e Resp. Φ_e	TC_I	-0.4	%/K	$I_F=50$ mA
Temperature Coefficient of V_F	TC_V	-3	mV/K	$I_F=50$ mA
Temperature Coefficient of λ	TC_λ	+0.16	nm/K	$I_F=50$ mA

Radiant Intensity Groupings⁽¹⁾

I_e in Axial Direction at solid angle of $\Omega=0.01$ sr			
SFH462-K E 7800	$I_{E \min}$	0.63	mW/sr $I_F=50$ mA
SFH462-L E 7800	$I_{E \min}$	1	mW/sr $I_F=50$ mA
SFH462-K E 7800	$I_{E \max}$	1.25	mW/sr $t_p=20$ ms
SFH462-L E 7800 ⁽²⁾	$I_{E \max}$	2	mW/sr $t_p=20$ ms

Notes:

1. An aperture is used in front of the component for measuring the radiant intensity and the half angle (diameter of the aperture: 1.1 mm; distance of aperture to case back side: 4 mm). This ensures that only the radiation in axial direction emitting directly from the chip surface will be evaluated during radiant intensity measurement. This measurement is denoted by "E7800" added to the part number.
2. Availability subject to yield.

Relative spectral emission

$I_{rel} = f(\lambda)$

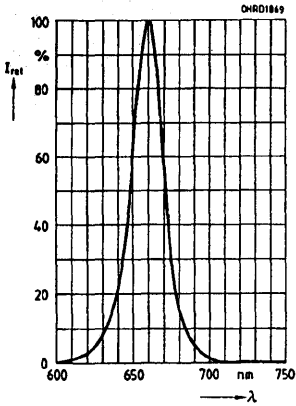

Radiant intensity

$I_e = f(I_f)$
Single Pulse $\tau = 20 \mu s$

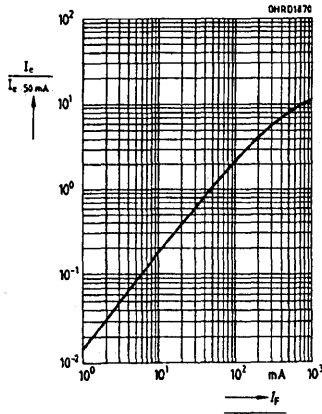

Radiation characteristic

$I_{rel} = f(\phi)$

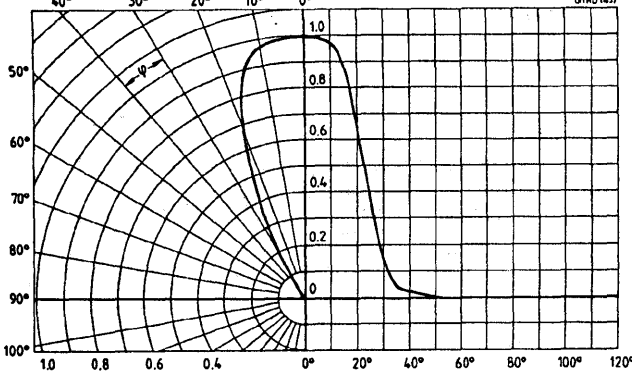

Maximum permissible forward current

$I_F = f(T_A), R_{thJA} = 450 K/W$

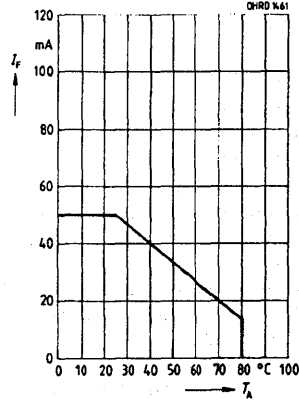

Maximum permissible forward current

$I_F = f(T_A), R_{thJA} = 160 K/W$

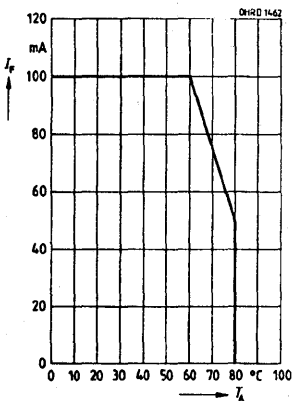

Forward Current

$I_f = f(V_f)$
Single pulse $\tau = 20 \mu s$

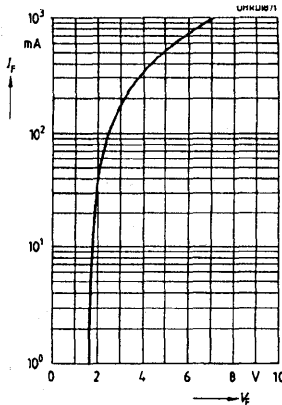

Permissible pulse handling capability

$I_f = f(t_p), T_A = 25 \text{ }^\circ\text{C}$
duty cycle $D = \text{Parameter}$

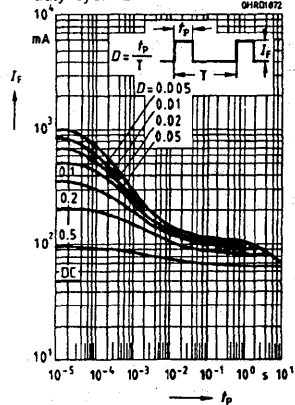

SIEMENS

SFH480 SFH481 SFH482

GaAlAs INFRARED EMITTER

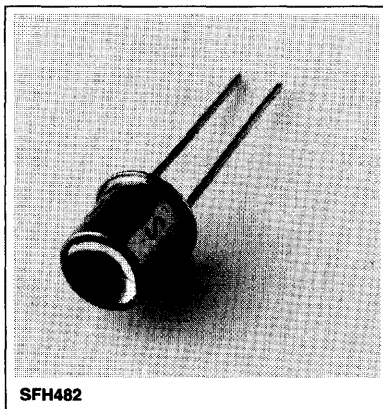

SFH482

FEATURES

- **Half Angle**
 - SFH480, $\pm 6^\circ$
 - SFH481, $\pm 15^\circ$
 - SFH482, $\pm 30^\circ$
- **GaAs Infrared Emitting Diode, Fabricated in a Liquid Phase Epitaxy Process**
- **Emits Radiation in Near Infrared Range**
- **Cathode Electrically Connected to Case**
- **High Reliability**
- **Long Term Stability**
- **SFH480/481: High Radiant Intensity**
- **SFH482: Wide Beam**
- **High Pulse Power**
- **Radiant Intensity Selections**
- **Matches all Si Photodetectors**
- **SFH480: Same Package as SFH400**
- **SFH481: Same Package as BPX43**
- **SFH482: Same Package as BPX38, BPX65, BPX66, SFH402**
- **Applications**
 - Light-reflecting Switches
 - IR Remote Control
- **Package**
 - 18 A 3 DIN 876 (TO 18)
 - Hermetically Sealed
 - Lead Spacing 0.100" (2.54 mm)
- **Cathode Marking: Tab at Case Bottom**

Package Dimensions in Inches (mm)

SFH480

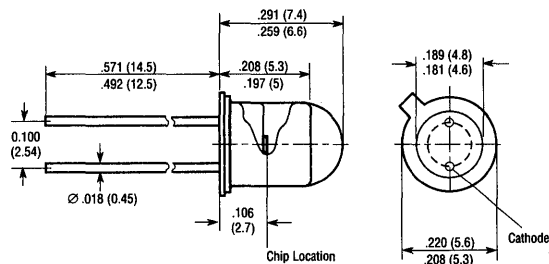

SFH481

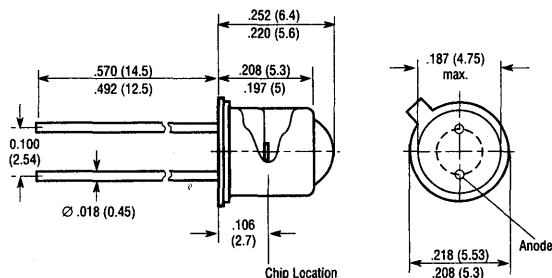

SFH482

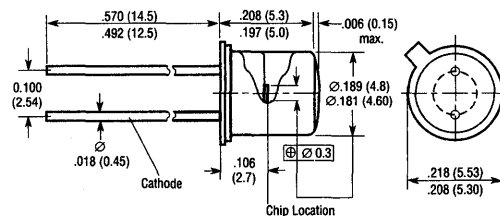

Maximum Ratings

Operating/Storage Temperature Range (T_{OP} , T_{STG})	-55° to $+100^\circ\text{C}$
Junction Temperature (T_J)	100°C
Reverse Voltage (V_R)	5 V
Forward Current (I_F)	200 mA
Surge Current (I_{FSM}) $t=10 \mu\text{s}$, $D=0$	2.5 A
Power Dissipation (P_{TOT})	470 mW
Thermal Resistance (R_{thJA})	450 K/W
Thermal Resistance (R_{thJC})	160 K/W

Characteristics (T_A=25°C)

Parameter	Symbol	Value	Unit
Peak Wavelength (I _F =100 mA)	λ_{PEAK}	880±20	nm
Spectral Bandwidth, 50% I _{MAX} (I _F =100 mA)	$\Delta\lambda$	80	nm
Half Angle			
SFH400	ϕ	±6	Deg.
SFH401	ϕ	±15	Deg.
SFH402	ϕ	±30	Deg.
Active Chip Area	A	0.16	mm ²
Active Chip Area Dimensions	L x W	0.4 x 0.4	mm
Distance, Chip Surface to Case Surface			
SFH400	H	4.0 to 4.8	mm
SFH401	H	2.8 to 3.7	mm
SFH402	H	2.1 to 2.7	mm
Switching Times, I _E			
10% to 90% and 90% to 10% (I _F =100 mA, R _L =50 Ω)	t _R , t _F	0.6/0.5	μs
Capacitance (V _R =0 V, f=1 MHz)	C ₀	25	pF
Forward Voltage			
(I _F =100 mA, t _p =20 μs)	V _F	1.50 (≤1.8)	V
(I _F =1 mA, t _p =100 μs)	V _F	3.00 (≤3.8)	V
Reverse Current (V _R =5 V)	I _R	0.01 (≤1)	μA
Radiant Flux, Total (I _F =100 mA, t _p =20 ms)	Φ _E	12	mW
Temperature Coefficient, I _E or Φ _E (I _F =100 mA)	TC _I	-0.5	%/K
Temperature Coefficient, V _F (I _F =100 mA)	TC _V	-2	mV/K
Temperature Coefficient, λ (I _F =100 mA)	TC _λ	0.25	nm/K

Radiant Intensity Selections

I_E in axial direction at solid angle of Ω=0.01 sr

	SFH	SFH	SFH	SFH	SFH	Unit	
I _F =100 mA, t _p =20 ms	I _{Emin}	25	40	10	16	25	mW/sr
I _F =100 mA, t _p =20 ms	I _{Emax}	50	80	20	32	-	mW/sr
I _F =1 mA, t _p =100 μs	I _{Etyp}	340	540	130	220	250	mW/sr

	SFH	SFH	SFH	SFH	SFH	Unit	
I _F =100 mA, t _p =20 ms	I _{Emin}	3.15	5	8	1 to 2	1.6 to 3.2	mW/sr
I _F =100 mA, t _p =20 ms	I _{Emax}	6.3	10	-	-	-	mW/sr
I _F =1 mA, t _p =100 μs	I _{Etyp}	40	65	80	-	-	mW/sr

Note:

1. An aperture is used in front of the component for measuring the radiant intensity and the half angle (diameter of the aperture: 1.1 mm; distance of aperture to case back side: 4 mm). This ensures that only the radiation in axial direction emitting directly from the chip surface will be evaluated during radiant intensity measurement. This measurement is denoted by "E7800" added to the part number.
2. Availability subject to yield.

Relative spectral emission

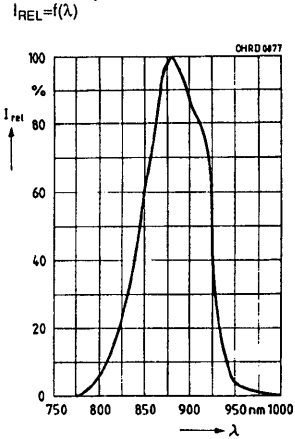

Radiant Intensity I_E/I_{E50mA}=f(I_F)
Single pulse, τ=20 μs

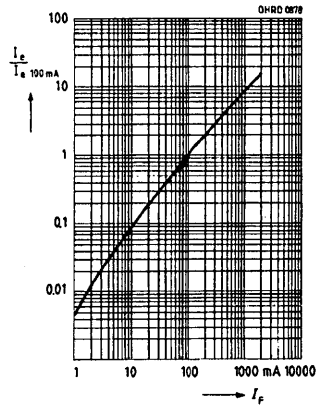

Maximum permissible forward current I_F=f(T_A)

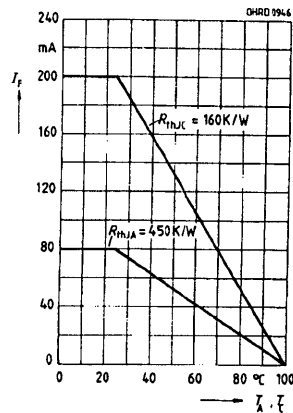

Radiation characteristic-SFH480
 $I_{REL} = f(\varphi)$

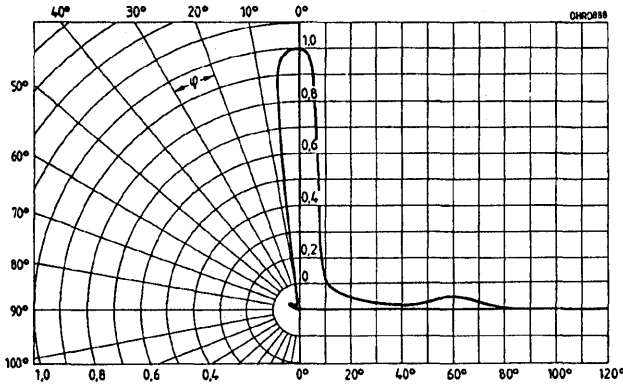

Forward current $I_F = f(V_F)$
 Single pulse, $\tau = 20 \mu s$

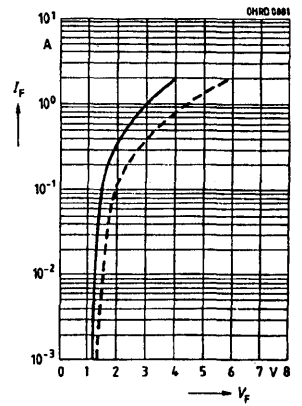

Radiation characteristic-SFH481
 $I_{REL} = f(\varphi)$

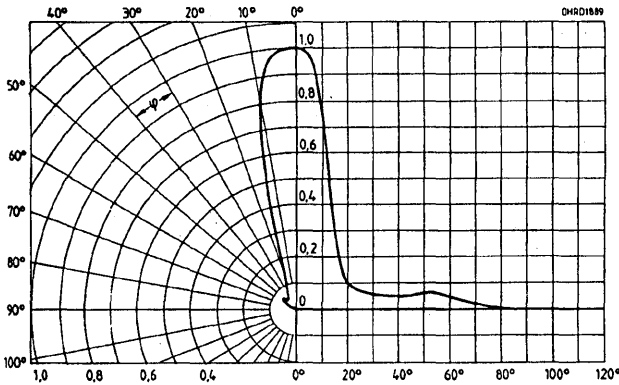

Permissible pulse handling capability $I_F = f(\tau)$, $T_A \leq 25^\circ C$
 duty cycle $D = \text{Parameter}$

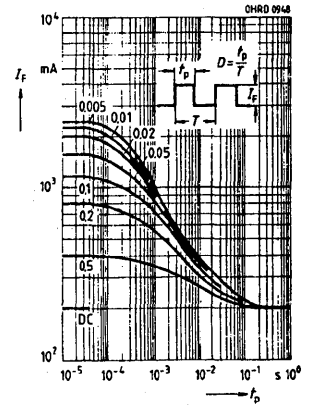

Radiation characteristic-SFH482
 $I_{REL} = f(\varphi)$

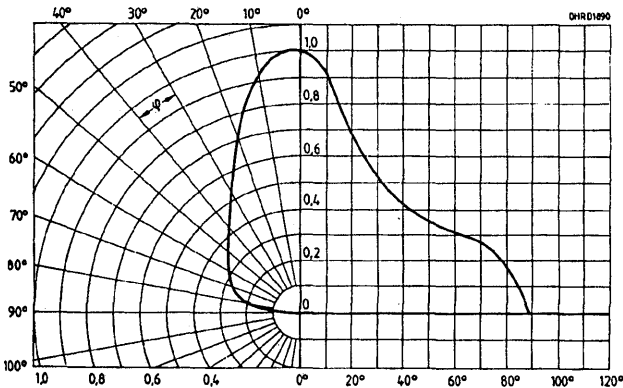

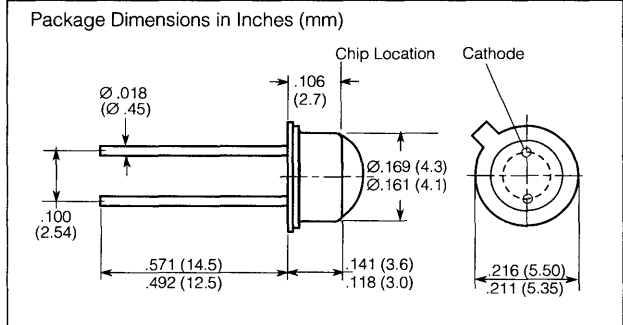
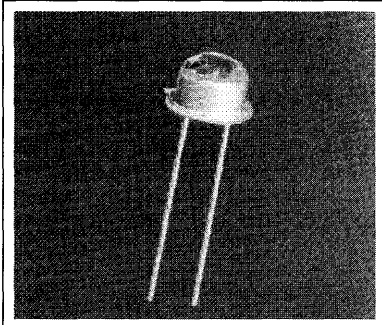

FEATURES

- **Highly Efficient GaAlAs LED**
- **Radiation in Near Infrared Range**
- **Anode Electrically Connected to Case**
- **Short Switching Time**
- **High Pulse Power**
- **High Reliability**
- **Long-Term Stability**
- **Same Package as BPX63, BP103, LD 242, SFH 462, SFH 463**
- **Package: 18 A 3 DIN 870 (TO 18), Clear Epoxy Resin, 0.1" (2.54 mm) Lead Spacing**
- **DIN Humidity Category per DIN 40040 GQG**
- **Applications**
 - IR Remote Controls
 - Light-Reflecting Switches
 - Use with Apertures

Maximum Ratings

Operating and Storage Temperature Range (T_{op} , T_{stg}) -40 to + 80°C

Junction Temperature (T_j) 100°C

Reverse Voltage (V_R) 5 V

Forward Current (I_F) $T_C \leq 25^\circ\text{C}$ 200 mA

Power Dissipation (P_{TOT}) $T_C=25^\circ\text{C}$ 470 mW

Surge Current (I_{FSM}) $t_p=10\mu\text{s}$, $D=0$; $T_C=25^\circ\text{C}$ 2.5 A

Thermal Resistance (R_{thJA}) 450 K/W

(R_{thJC}) 160 K/W

Characteristics ($T_A=25^\circ\text{C}$)

Parameter	Sym	Value	Unit	Condition
Wavelength at Peak Emission	λ_{peak}	880±20	nm	$I_F=100$ mA
Spectral Bandwidth at 50% Half Angle ⁽¹⁾	$\Delta\lambda$	80	nm	$I_F=100$ mA
Active Chip Area	A	0.16	mm ²	
Chip Area Dimension	LxW	0.4x0.4	mm	
Distance Chip Surface to Case Surface	H	2.7 to 2.9	mm	
Switching Times, t_r/t_f	t_r/t_f	0.6/0.5	μs	$I_F=100$ mA, $R_L=50$ Ω
Capacitance	C_O	25	pF	$V_R=0$ V, $f=1$ MHz
Forward Voltage	V_F	1.5 (≤ 1.8)	V	$I_F=100$ mA, $t_p=20$ ms
	V_F	3.0 (≤ 3.8)	V	$I_F=1$ A, $t_p=100$ μs
Reverse Current	I_R	0.01 (≤ 1)	μA	$V_R=5$ V
Radiant Flux (Total)	Φ_e	23	mW	$I_F=100$ mA, $t_p=20$ ms
Temperature Coefficient of I_e Resp. Φ_e	TC_I	-0.5	%/K	$I_F=100$ mA
Temperature Coefficient of V_F	TC_V	-2.5	mV/K	$I_F=100$ mA
Temperature Coefficient of λ	TC_λ	+0.25	nm/K	$I_F=100$ mA

Characteristics ($T_A = 25\text{ }^\circ\text{C}$)

Parameter	Sym	Value	Unit	Condition
Radiant Intensity Groupings⁽¹⁾				
I_e in Axial Direction at a Steradian of $\Omega=0.01$ sr				
SFH483-L E7800	$I_{e\text{min}}$	1	mW/sr	$I_F=100$ mA
SFH483-M E7800	$I_{e\text{min}}$	1.6	mW/sr	$t_p=20$ ms
SFH483-L E7800	$I_{e\text{max}}$	2	mW/sr	$I_F=100$ mA
SFH483-M E7800	$I_{e\text{max}}$	3.2	mW/sr	$t_p=20$ ms
SFH483-L E7800	$I_{e\text{typ}}$	13	mW/sr	$I_F=1$ A
SFH483-M E7800	$I_{e\text{typ}}$	22	mW/sr	$t_p=100$ ms

Notes:

1. An aperture is used in front of the component for measuring the radiant intensity and the half angle (diameter of the aperture: 1.1 mm; distance of aperture to case back side: 4 mm). This ensures that only the radiation in axial direction emitting directly from the chip surface will be evaluated during radiant intensity measurement. This measurement is denoted by "E7800" added to the part number.
2. Availability subject to yield.

Relative spectral emission

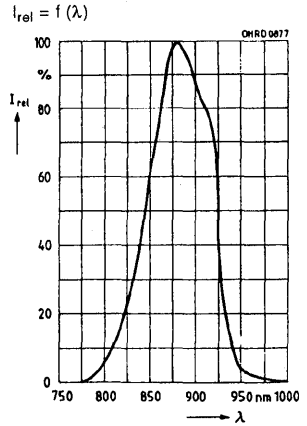

Radiant intensity $\frac{I_e}{I_e 100 \text{ mA}} = f(I_F)$
Single Pulse $\tau = 20\mu\text{s}$

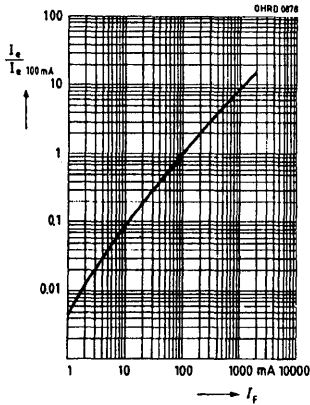

Radiation characteristic

$I_{ref} = f(\varphi)$

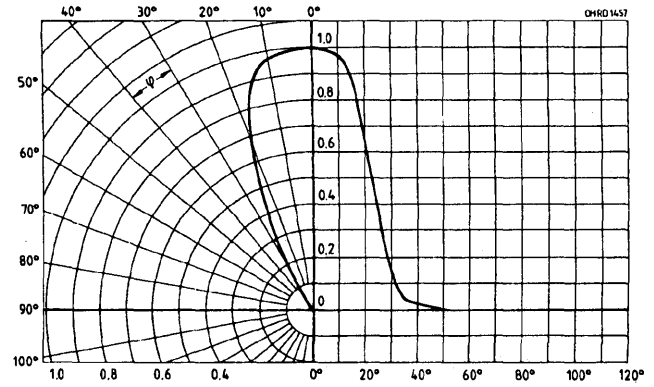

Maximum permissible forward current

$I_F = f(T_A), R_{thJA} = 450 \text{ K/W}$
 $I_F = f(T_A), R_{thJC} = 160 \text{ K/W}$

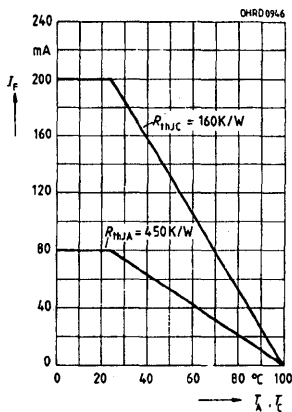

Forward Current $I_F = f(V_F)$

Single pulse $\tau = 20 \mu\text{s}$

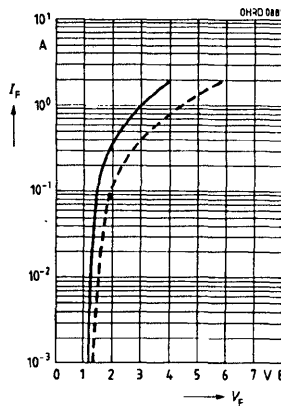

Permissible pulse handling capability

$I_F = f(t_p), T_C = 25\text{ }^\circ\text{C}$
duty cycle $D = \text{Parameter}$

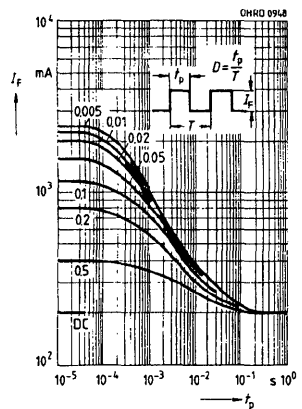

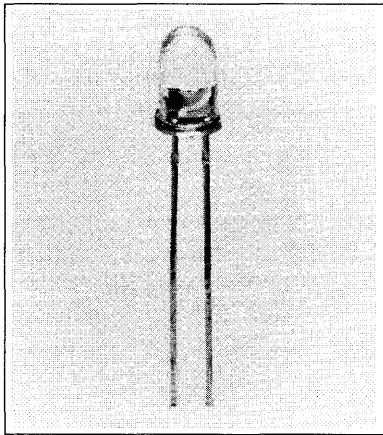

FEATURES

- T1¾ Package
- Clear Plastic Lens
- Long Term Stability
- Very High Power, 20 mW Typical at 100 mA
- Good Spectral Match with Silicon Photo Detector
- Gallium Aluminum Arsenide Material
- SFH 484–16° Narrow Beam, SFH 485–40° Medium Beam
- Smoke Detection Application: SFH484-E7517 (UL Recognized)

DESCRIPTION

SFH 484, an infrared emitting diode, emits radiation in the near infrared range (880 nm peak). The device comes in a T1¾ (5 mm) plastic package. Uses for SFH 484 include IR remote control, smoke detectors, and other applications requiring high power, such as IR touch screens.

The SFH 485 contains the same IR emitter chip as the SFH 484 but features a wider beam.

Maximum Ratings

Operating and Storage Temperature

Range (T _{OP} , T _{STG})-55° to +100°C
Junction Temperature (T _J)100°C
Reverse Voltage (V _R)5 V
Forward Current (I _F)100 mA
Surge Current (I _{FSM})
t = 10 μs2.5 A
Power Dissipation (P _{TOT})200 mW
Thermal Resistance (R _{thJA})375 K/W

Package Dimensions in Inches (mm)

SFH 484

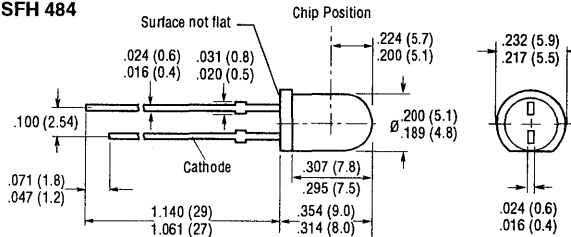

SFH 485

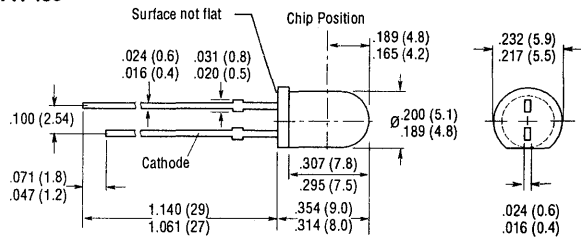

Characteristics (T_A=25°C)

Parameter	Symbol	Value	Unit
Peak Wavelength (I _F =100 mA, t _p =20 ms)	λ _{PEAK}	880±20	nm
Spectral Bandwidth (I _F =100 mA)	Δλ	80	nm
Half Angle	φ	±8	Deg.
SFH 484	φ	±20	Deg.
Active Chip Area	A	0.16	mm ²
Active Chip Area Dimensions	L x W	0.4 x 0.4	mm
Distance, Chip Surface to Case Surface			
SFH 484	D	5.1 to 5.7	mm
SFH 485	D	4.2 to 4.8	mm
Switching Times, I _E			
10% to 90% and 90% to 10% (I _F =100 mA)	t _R , t _F	0.6/0.5	μs
Capacitance (V _R =0 V, f=1 MHz)	C ₀	25	pF
Forward Voltage			
(I _F =100 mA, t _p =20 μs)	V _F	1.5 (≤1.8)	V
(I _F =1 mA, t _p =100 μs)	V _F	3.0 (≤3.8)	V
Reverse Current (V _R =5 V)	I _R	0.01 (≤1)	μA
Temperature Coefficient, I _E or Φ _E	TC _I	-0.5	%/K
Temperature Coefficient, V _F	TC _V	-2	mV/K
Temperature Coefficient, λ	TC _λ	0.25	nm/K

Radiant Intensity, I_E in Axial Direction at a solid angle of Ω=0.01 sr

	Sym	SFH 484-1	SFH 484-2	SFH 485-1	SFH 485-2	Unit
I _F =100 mA,	I _{E min}	50	80	16	25	mW/sr
t _p =20 ms	I _{E max}	100	160	32	50	mW/sr
I _F =1 A, t _p =100 μs	I _{E typ}	700	900	220	340	mW/sr

Relative spectral emission
 $I_{REL} = f(\lambda)$

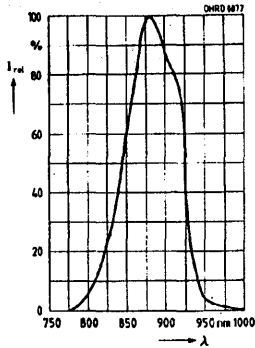

Radiant intensity
 $I_E / I_E 100 \text{ mA} = f(I_F)$
 Single pulse, $\tau = 20 \mu\text{s}$

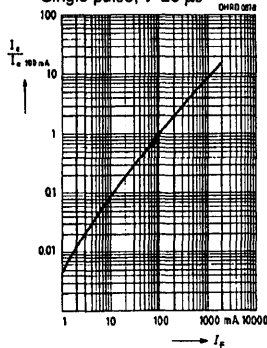

Maximum permissible forward current
 $I_F = f(T_A)$

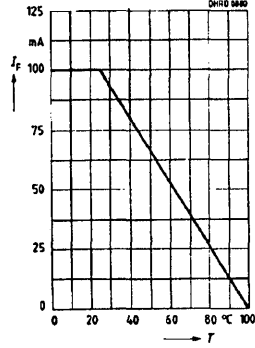

Forward current $I_F = f(V_F)$
 Single pulse, $\tau = 20 \mu\text{s}$

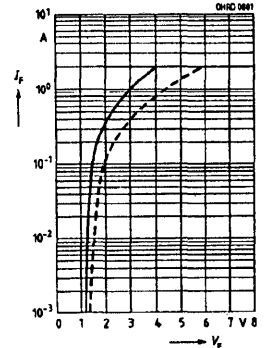

SFH 484—Radiation characteristic
 $I_{REL} = f(\varphi)$

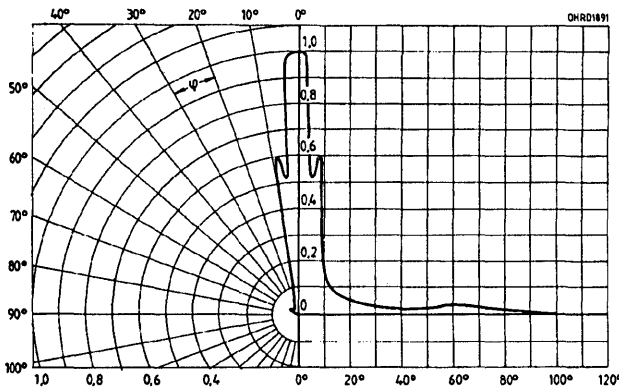

Permissible pulse handling capability
 $I_F = f(\tau)$, $T_A = 25^\circ\text{C}$, duty cycle $D = \text{Parameter}$

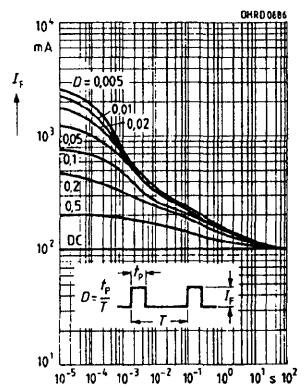

SFH 485—Radiation characteristic
 $I_{REL} = f(\varphi)$

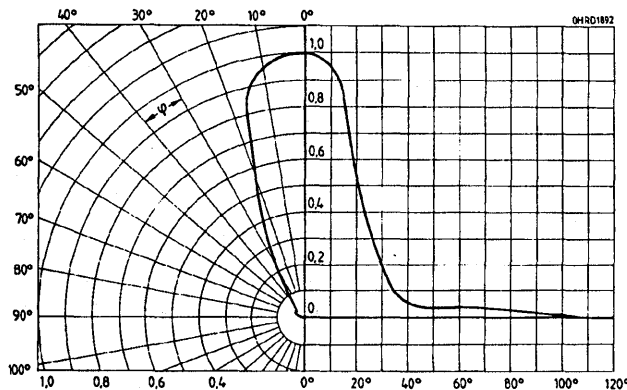

Maximum forward current vs. lead length, package bottom and PC-board
 $I_F = f(l)$, $T_A = 25^\circ\text{C}$

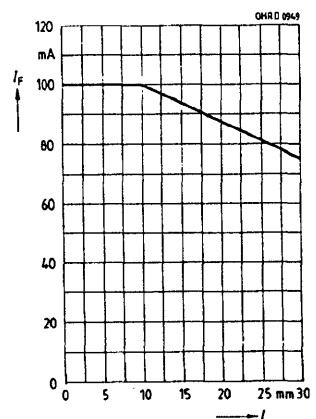

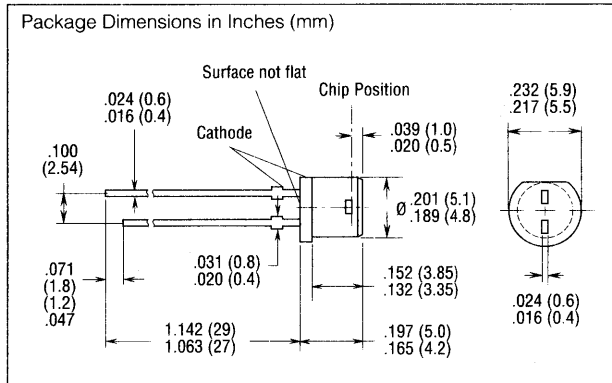
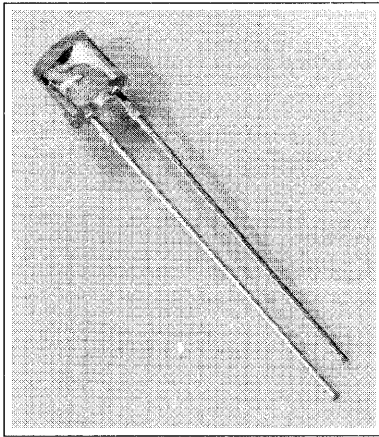

FEATURES

- T1³/₄ (5 mm) Plastic Package
- Flat Lens
- Long Term Stability
- Good Spectral Match with Silicon Photo Detector
- Gallium Aluminum Arsenide Material
- Wide Beam, 80°
- High Efficiency
- High Reliability
- 880 nm Peak Wavelength

Maximum Ratings

Operating and Storage Temperature	
Range (T _{OP} , T _{STG}) -55° to +100°C
Junction Temperature (T _J) 100°C
Reverse Voltage (V _R) 5 V
Forward Current (I _F) 100 mA
Surge Current (I _{FSM}) t ≤ 10 μs 2.5 A
Power Dissipation (P _{TOT}) 200 mW
Thermal Resistance (R _{thJA}) 375 K/W

Characteristics (T_A=25°C)

Parameter	Symbol	Value	Unit
Peak Wavelength (I _F =100 mA)	λ _{PEAK}	880±20	nm
Spectral Bandwidth (I _F =100 mA)	Δλ	80	nm
Half Angle	φ	±40	Deg.
Active Chip Area	A	0.16	mm ²
Active Chip Area Dimensions	L x W	0.4 x 0.4	mm
Distance, Chip Surface to Case Surface	D	0.5 to 1.0	mm
Switching Times, I _E			
10% to 90% and 90% to 10% (I _F =100 mA, R _L =50 Ω)	t _R , t _F	0.6/0.5	μs
Capacitance (V _R =0 V, f=1 MHz)	C ₀	25	pF
Forward Voltage			
(I _F =100 mA, t _p =20 μs)	V _F	1.5 (≤1.8)	V
(I _F =1 A, t _p =100 μs)	V _F	3.0 (≤3.8)	V
Reverse Current (V _R =5 V)	I _R	0.01 (≤1)	μA
Temperature Coefficient, I _E or Φ _E	TC _I	-0.5	%/K
Temperature Coefficient, V _F	TC _V	-2	mV/K
Temperature Coefficient, λ	TC _λ	0.25	nm/K

Radiant Intensity, I_E in Axial Direction at a solid angle of Ω=0.01 sr

Radiant Intensity			
I _F =100 mA, t _p =20 ms	I _E	3.15-6.3	mW/sr
I _F =1 A, t _p =100 μs	I _E	42	mW/sr
Total Radiant Flux			
I _F =100 mA, t _p =20 ms	Φ _E	25	mW

Relative spectral sensitivity
 $I_{REL} = f(\lambda)$

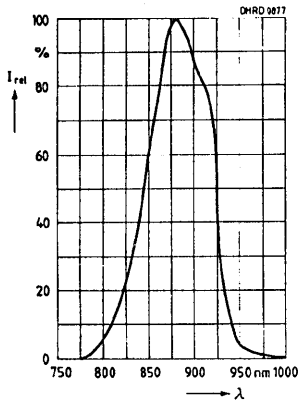

Radiant intensity
 $\frac{I_E}{I_E 100 \text{ mA}} = f(I_F)$
 Single pulse, $\tau = 20 \mu$

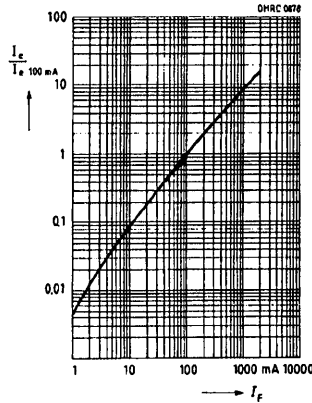

Radiation characteristic
 $I_{REL} = f(\varphi)$

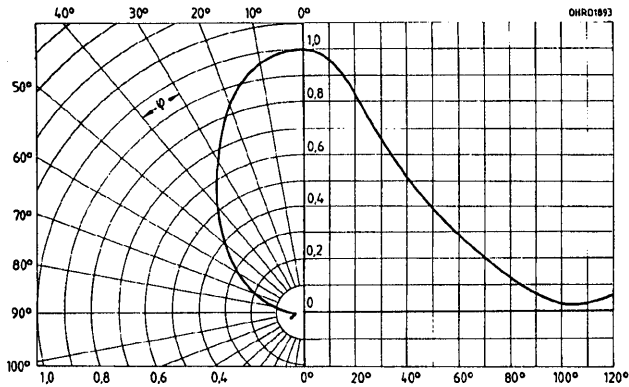

Maximum permissible forward current
 $I_F = f(T_A)$

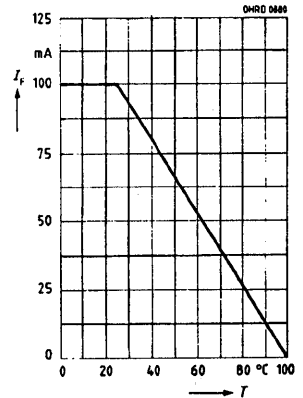

Forward current $I_F = f(V_F)$
 Single pulse, $\tau = 20 \mu$ s

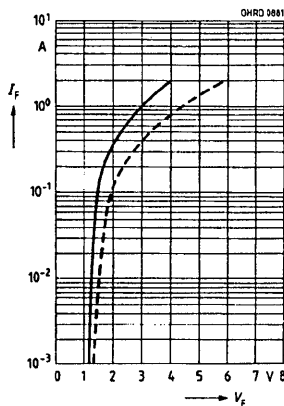

Permissible pulse handling capability
 $I_F = f(\tau)$, $T_A = 25^\circ\text{C}$
 duty cycle $D = \text{Parameter}$

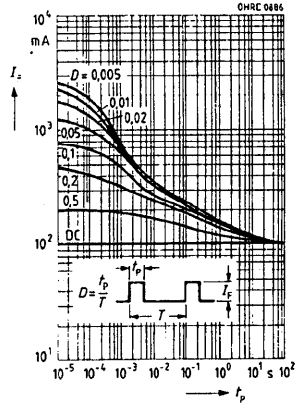

Maximum forward current vs. lead length, package bottom and PC-board
 $I_F = f(l)$, $T_A = 25^\circ\text{C}$

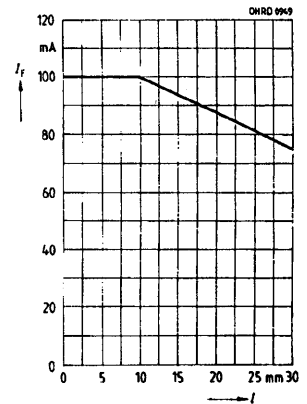

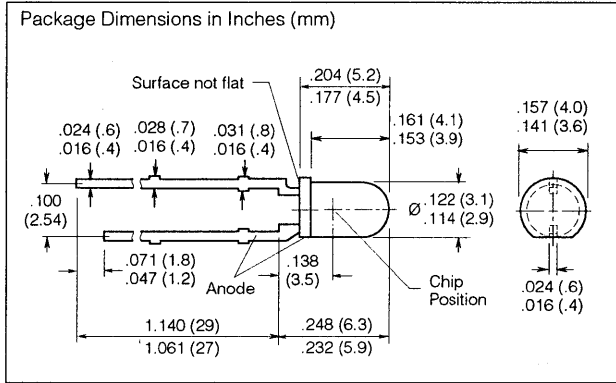
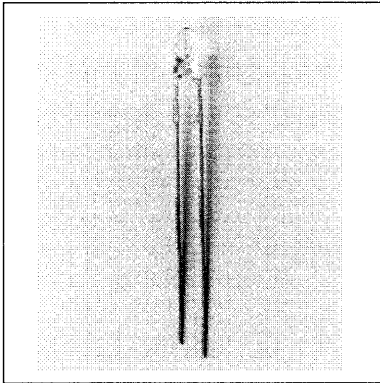

FEATURES

- Radiant Intensity Selections
SFH 487-1, 12.5–5 mW/sr
SFH 487-2, 20–40 mW/sr
SFH 487-3, ≥ 32 mW/sr
- T1 (3mm) Package
- Clear Blue Tinted Plastic Lens
- Long Term Stability
- Good Spectral Match with Silicon Photo Detector
- Gallium Aluminum Arsenide Material
- Medium Wide Beam, 40°

DESCRIPTION

SFH 487, an infrared emitting diode, emits radiation in the near infrared range (880 nm peak). The emitted radiation, which can be modulated, is generated by forward flowing current. The device is enclosed in a T1 (3 mm) plastic package. Uses for SFH 487 include: IR remote control for color TVs, smoke detectors, and other applications requiring very high power, such as IR touch screens.

Maximum Ratings

Operating and Storage Temperature	
Range (T_{OP} , T_{STG})	–55° to +100°C
Junction Temperature (T_J)	100°C
Reverse Voltage (V_R)	5 V
Forward Current (I_F)	100 mA
Surge Current (I_{FSM})	
$t = 10 \mu s$	2.5 A
Power Dissipation (P_{TOT})	200 mW
Thermal Resistance (R_{thJA})	375 K/W

Characteristics ($T_A = 25^\circ C$)

Parameter	Symbol	Value	Unit
Peak Wavelength ($I_F = 100$ mA)	λ_{PEAK}	880 ± 20	nm
Spectral Bandwidth ($I_F = 100$ mA)	$\Delta\lambda$	80	nm
Half Angle	ϕ	± 20	Deg.
Active Chip Area	A	0.16	mm ²
Active Chip Area Dimensions	L x W	0.4 x 0.4	mm
Distance, Chip Surface to Case Surface	D	2.6	mm
Switching Times, I_E			
10% to 90% and 90% to 10% ($I_F = 100$ mA)	t_R, t_F	0.6/0.5	μs
Capacitance ($V_R = 0$ V, $f = 1$ MHz)	C_0	25	pF
Forward Voltage			
($I_F = 100$ mA, $t_p = 20 \mu s$)	V_F	1.5 (≤ 1.8)	V
($I_F = 1$ A, $t_p = 100 \mu s$)	V_F	3.0 (≤ 3.8)	V
Reverse Current ($V_R = 5$ V)	I_R	0.01 (≤ 1)	μA
Temperature Coefficient, I_E or ϕ_E	TC_I	–0.5	%/K
Temperature Coefficient, V_F	TC_V	–0.2	mV/K
Temperature Coefficient, λ	TC_λ	0.25	nm/K

Radiant Intensity, I_E in Axial Direction at a solid angle of $\Omega = 0.01$ sr

	SFH 487-1	SFH 487-2	SFH 487-3	Unit
Radiant Intensity I_E				
$I_F = 100$ mA, $t_p = 20$ ms	12.5–25	20–40	≥ 32	mW/sr
$I_F = 1$ A, $t_p = 100 \mu s$	140	270	300	mW/sr
Total Radiant Flux ϕ_E (typ.)				
$I_F = 100$ mA, $t_p = 20$ ms	—	—	25	mW

Relative spectral sensitivity
 $I_{REL} = f(\lambda)$

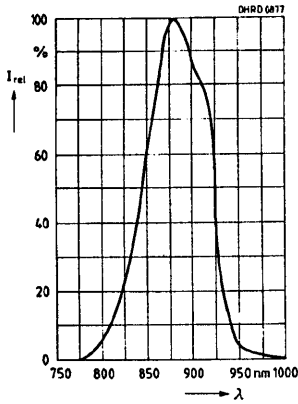

Radiant intensity
 Single pulse, $\tau = 20 \mu s$
 $\frac{I_E}{I_E 100 mA} = f(I_F)$

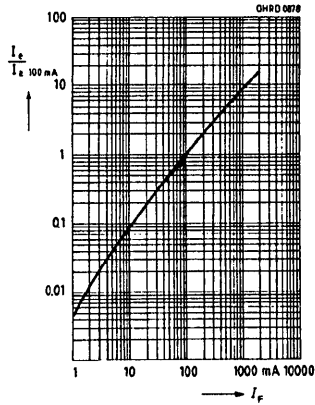

Radiation characteristic

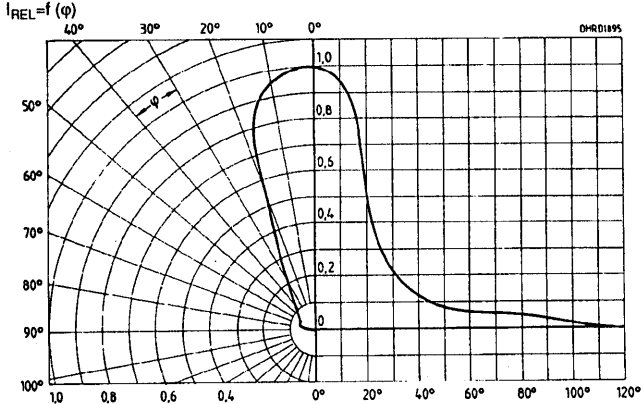

Maximum permissible forward current
 $I_F = f(T_A)$

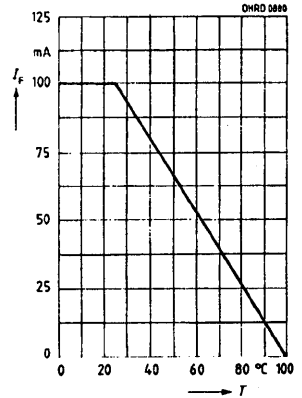

Forward current $I_F = f(V_F)$
 Single pulse, $\tau = 20 \mu s$

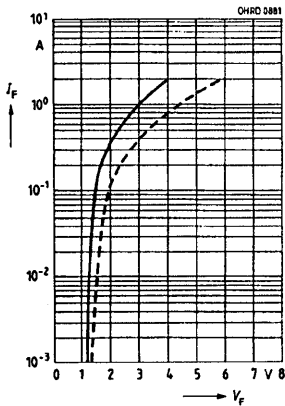

Permissible pulse handling capability
 $I_F = f(\tau)$, $T_A = 25^\circ C$
 Duty cycle $D = \text{Parameter}$

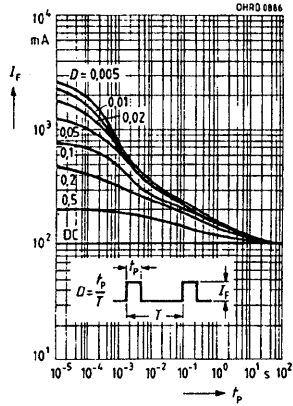

Forward current vs. lead length, package bottom and PC-board
 $I_F = f(l)$, $T_A = 25^\circ$

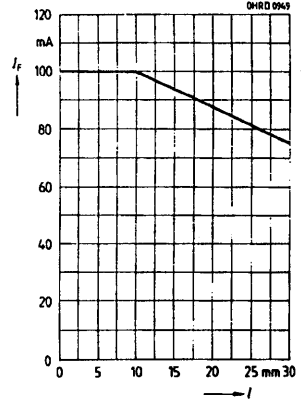

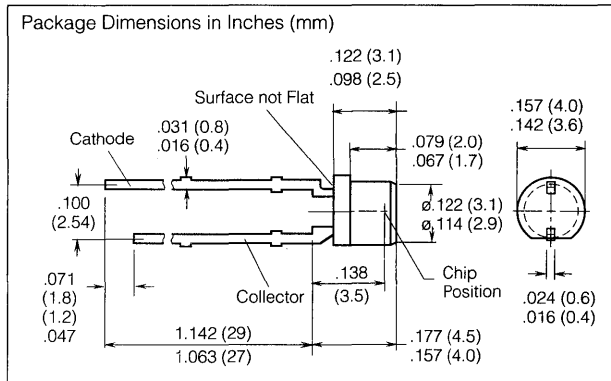
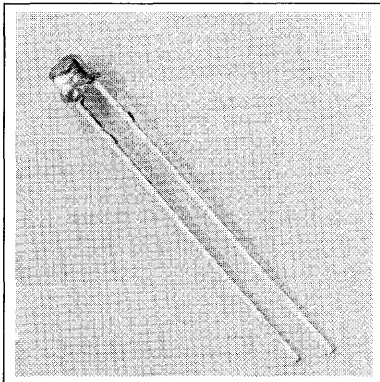

FEATURES

- T1 (3mm) Package
- Flat Plastic Lens
- Long Term Stability
- Good Spectral Match with Silicon Photo Detector
- Gallium Aluminum Arsenide Material
- Very Wide Beam, 130°
- Very High Power, 20 mW Typical at 100 mA

DESCRIPTION

SFH 487P, an infrared emitting diode, emits radiation in the near infrared range (880 nm peak). The emitted radiation, which can be modulated, is generated by forward flowing current. The device is enclosed in a T1 (3 mm) diameter plastic package with a flat lens. Typical applications are digital shaft encoders and light interruptors for DC and AC operation.

Maximum Ratings

Storage Temperature	
Range (T_{OP} , T_{STG})	-55° to +100°C
Junction Temperature (T_J)	100°C
Reverse Voltage (V_R)	5 V
Forward Current (I_F)	100 mA
Surge Current (I_{FSM}) $t=10 \mu s$	2.5 A
Power Dissipation (P_{TOT})	
$T=25^\circ C$	200 mW
Thermal Resistance (R_{thJA})	375 K/W

Characteristics ($T_A=25^\circ C$)

Parameter	Symbol	Value	Unit
Peak Wavelength ($I_F=100 mA$)	λ_{PEAK}	880±20	nm
Spectral Bandwidth ($I_F=100 mA$)	$\Delta\lambda$	80	nm
Half Angle	ϕ	±65	Deg.
Active Chip Area	A	0.16	mm ²
Active Chip Area Dimensions	L x W	0.4 x 0.4	mm
Distance, Chip Surface to Case Surface	D	0.4 to 0.8	mm
Switching Times, I_E			
10% to 90% and 90% to 10% ($I_F=100 mA$)	t_{RI} , t_{F}	0.6/0.5	μs
Capacitance ($V_R=0 V$, $f=1 MHz$)	C_0	25	pF
Forward Voltage			
($I_F=100 mA$, $t_p=20 \mu s$)	V_F	1.5 (≤1.8)	V
($I_F=1 A$, $t_p=100 \mu s$)	V_F	3.0 (≤3.8)	V
Reverse Current ($V_R=5 V$)	I_R	0.01 (≤1)	μA
Temperature Coefficient, I_E or Φ_E ($I_F=100 mA$)	TC_I	-0.5	%/K
Temperature Coefficient, V_F ($I_F=100 mA$)	TC_V	-0.2	mV/K
Temperature Coefficient, λ ($I_F=100 mA$)	TC_λ	0.25	nm/K

Radiant Intensity, I_E in Axial Direction at a solid angle of $\Omega=0.01 sr$

Radiant Intensity	Symbol	Value	Unit
$I_F=100 mA$, $t_p=20 ms$	I_E	>2	mW/sr
$I_F=1 A$, $t_p=100 \mu s$	I_E	25	mW/sr
Total Radiant Flux (typ.)			
$I_F=100 mA$, $t_p=20 ms$	Φ_E	25	mW

Relative spectral sensitivity
 $I_{REL} = f(\lambda)$

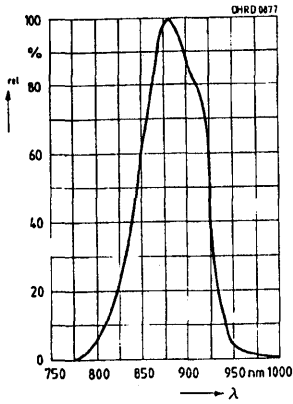

Radiant intensity
 Single pulse, $\tau = 20 \mu s$ $\frac{I_E}{I_E 100 mA} = f(I_F)$

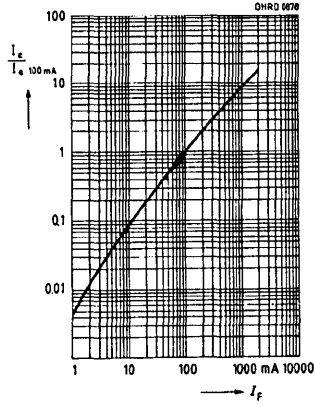

Radiation characteristic
 $I_{REL} = f(\varphi)$

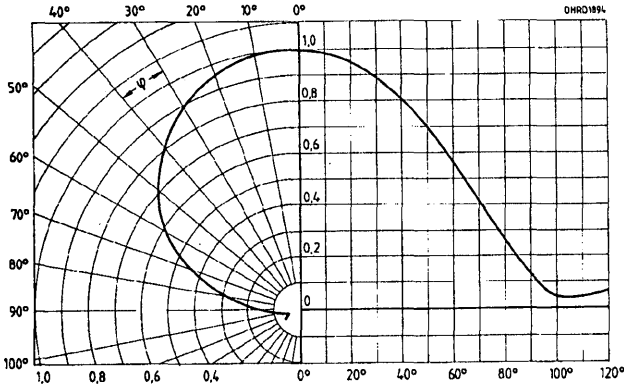

Maximum permissible forward current
 $I_F = f(T_A)$

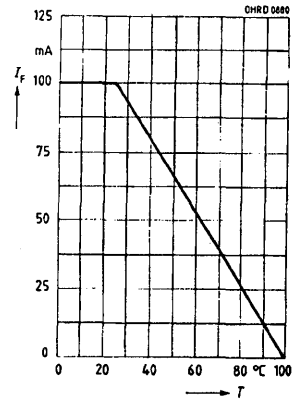

Forward current $I_F = f(V_F)$
 Single pulse, $\tau = 20 \mu s$

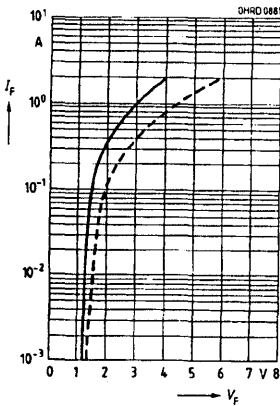

Permissible pulse handling capability
 $I_F = f(\tau)$, $T_A = 25^\circ C$
 Duty cycle $D = \text{Parameter}$

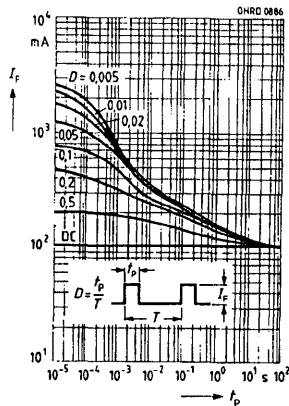

Forward current vs. lead length, package bottom and PC-board
 $I_F = f(l)$, $T_A = 25^\circ C$

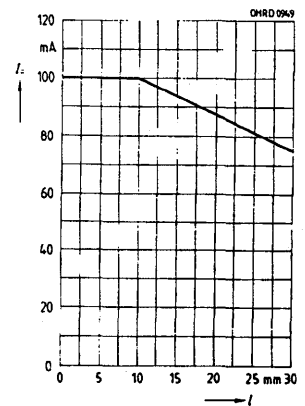

MINIATURE LIGHT REFLECTION EMITTER/SENSOR

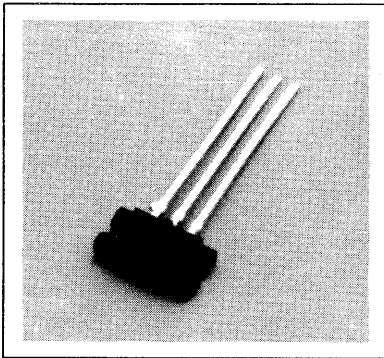

FEATURES

- IR Emitter and NPN Phototransistor Detector
- High Sensitivity (SFH900)
- Low Saturation Voltage
- No Cross Talk (SFH900)
Negligible Cross Talk (SFH905)
- Designed for Short Distances
≤ 5 mm
- Current Transfer Ratio Groups
SFH900-1 — I_{CE} 0.25 to 0.5 mA
SFH900-2 — I_{CE} 0.4 to 0.8 mA
SFH900-3 — I_{CE} 0.63 to 1.25 mA
SFH900-4 — $I_{CE} \geq 1.0$ mA
SFH905-1 — I_{CE} 40 to 125 μ A
SFH905-2 — $I_{CE} \geq 100$ μ A

DESCRIPTION

The SFH900/SFH905 are light reflection switches which include a GaAs IRLED transmitter and an NPN photo-transistor with a high photosensitive receiver for short distances, operating in the infrared range. Both components are manufactured in modern strip-line technique and are mounted side-by-side in a plastic package. A daylight filter screens against undesired light effects. The SFH905 has lower current transfer ratios than the SFH900.

The SFH900/905 are designed for applications in industrial and entertainment electronics, e.g., as position reporting devices and end position switches, for speed monitoring or in general, as sensor elements in various types of motion transmitters.

For applications information see Appnote 26.

Package Dimensions in Inches (mm)

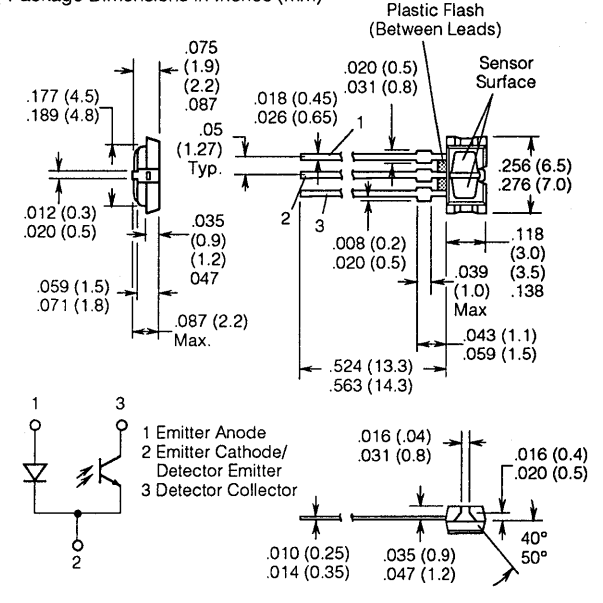

Maximum Ratings ($T_A=40^\circ\text{C}$)

Emitter (GaAs Infrared Diode)

Reverse Voltage (V_R)	6 V
Forward DC Current (I_F)	50 mA
Surge Current (I_{FSM}) $T_P \leq 10 \mu\text{s}$	1.5 A
Total Power Dissipation (P_{TOT})	80 mW

Detector (Silicon Phototransistor)

Collector Emitter Voltage (V_{CEO})	30 V
Emitter Collector Voltage (V_{ECO})	7 V
Collector Current (I_C)	10 mA
Power Dissipation (P_{TOT})	100 mW

Light Reflection Switch

Storage and Ambient Temperature Range (T_{STG} , T_A)	-40° to $+85^\circ\text{C}$
Junction Temperature (T_J)	100°C
Soldering Temperature (T_S) 3 s max. ⁽¹⁾	235°C
With Heat Sink Between Case and Soldering (T_S)	260°C
Total Power Dissipation (P_{TOT})	150 mW

Note: 1. Dip soldering: 3 mm from case bottom.

Characteristics (T_A=25°C)

Parameter	Symbol	Value	Unit
Emitter (GaAs Infrared Diode)			
Forward Voltage (I _F =50 mA)	V _F	1.25 (≤1.65)	V
Breakdown Voltage (I _R =10 μA)	V _{BR}	(≥6)	V
Reverse Current (V _R =6 V)	I _R	.01 (≤10)	μA
Capacitance (V _R =0 V, f=1 MHz)			
SFH900	C ₀	40	pF
SFH905	C ₀	25	pF
Thermal Resistance	R _{thJA}	750	K/W
Detector (Silicon Phototransistor)			
Capacitance (V _{CE} =5 V, f=1 MHz)			
SFH900	C _{CE}	11	pF
SFH905	C _{CE}	5	pF
Collector Emitter Leakage Current (V _{CE} =10 V)			
SFH900	C _{CEO}	20 (≤200)	nA
SFH905	C _{CEO}	20 (≤100)	nA
Photourrent (Outside Light Sensitivity) (V _{CE} =5 V, E _v =1000 Lx)			
SFH900	I _p	3.5	mA
SFH905	I _p	0.5	mA
Thermal Resistance	R _{thJA}	600	K/W
Light Reflection Switch			
Collector Emitter Current (I _F =10 mA; V _{CE} =5 V; d=1 mm)			
SFH900-1	I _{CE}	.25 to .50	mA
SFH900-2	I _{CE}	.40 to .80	mA
SFH900-3	I _{CE}	.63 to 1.25	mA
SFH900-4	I _{CE}	≥1.0	mA
SFH905-1	I _{CE}	.40 to 125	μA
SFH905-2	I _{CE}	≥100	μA
Collector Emitter Saturation Voltage (I _F =10 mA; d=1 mm)			
(I _C =85 μA) SFH900-1	V _{CE(SAT)}	.2 (≤.6)	V
(I _C =135 μA) SFH900-2	V _{CE(SAT)}	.2 (≤.6)	V
(I _C =215 μA) SFH900-3	V _{CE(SAT)}	.2 (≤.6)	V
(I _C =335 μA) SFH900-4	V _{CE(SAT)}	.2 (≤.6)	V
(I _C =13 μA) SFH905-1	V _{CE(SAT)}	.2 (≤.6)	V
(I _C =34 μA) SFH905-2	V _{CE(SAT)}	.2 (≤.6)	V

DESCRIPTION	SFH900	SFH905	UNIT
Load Resistance (R _L)	1	1	kΩ
Turn-On Time (T _{ON})	65	40	μs
Rise Time (T _R)	50	30	μs
Turn-Off Time (T _{OFF})	55	45	μs
Fall Time (T _F)	50	40	μs

Note: SFH900: I_C=1 mA
SFH905: I_C=100 μA, V_S=5 V, I_F=10 mA

TEST CIRCUIT

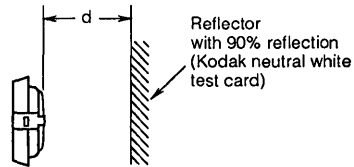
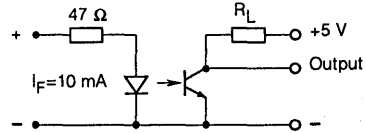

Collector current $\frac{I_C}{I_{Cmax}} = f(d)$

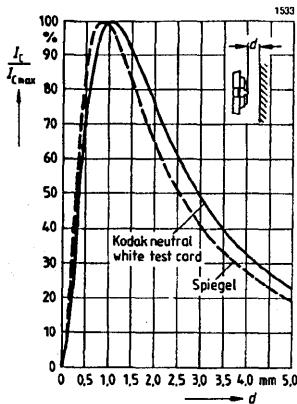

Diode forward voltage (typ.)
V_F=f(I_F)

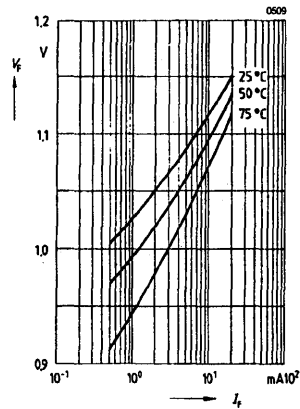

Maximum permissible forward current
I_F=f(T_A)

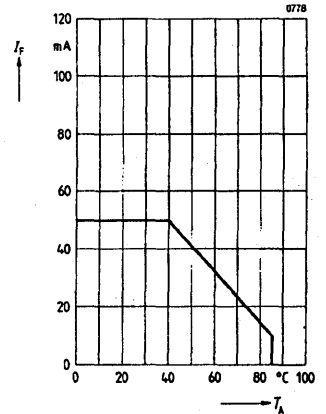

Diode and transistor permissible power dissipation $P_{TOT}=f(T_A)$

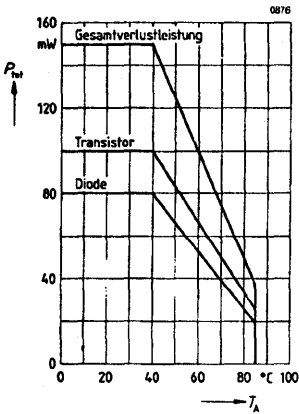

Permissible pulse handling capability $I_F=f(t_p)$, $D=$ Parameter, $T_A=25^\circ\text{C}$

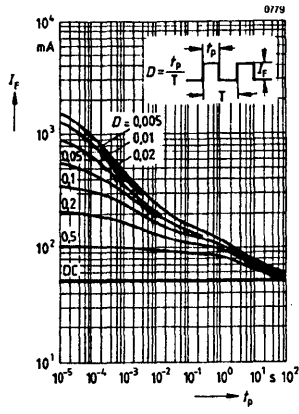

Switching characteristics-SFH900 $t=f(R_L)$, $T_A=25^\circ\text{C}$, $I_F=10\text{ mA}$

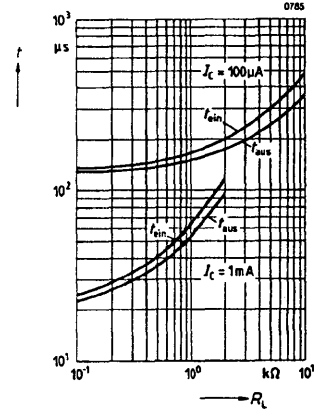

Switching characteristics-SFH905 $t=f(R_L)$, $T_A=25^\circ\text{C}$, $I_F=10\text{ mA}$

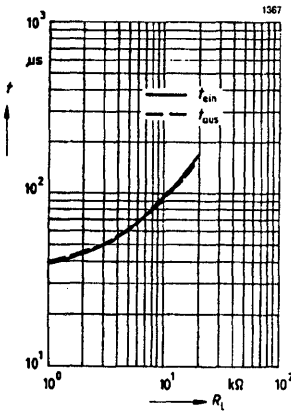

Relative spectral emission, emitter (GaAs) and detector (Si) Detector: $I_{REL}=f(\lambda)$, Emitter: $S_{REL}=f(\lambda)$

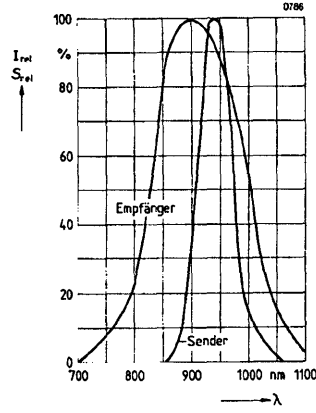

Collector current-SFH900 $I_C=f(I_F)$ Spacing d to reflector=1 mm, 90% reflection

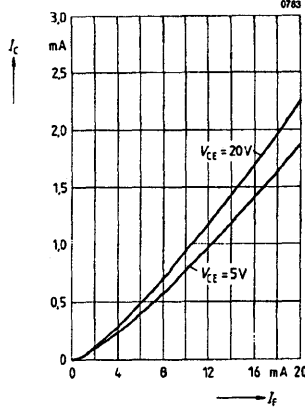

Collector current-SFH905 $I_C=f(I_F)$ Spacing d to reflector=1 mm, 90% reflection

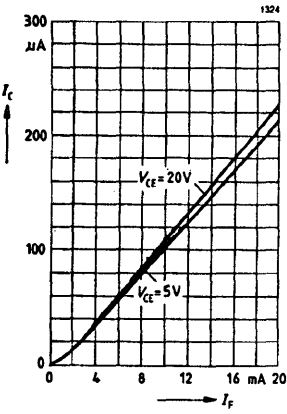

Output characteristics-SFH900 $I_C=f(V_{CE})$ Spacing to reflector: d=1 mm, 90% reflection, $T_A=25^\circ\text{C}$

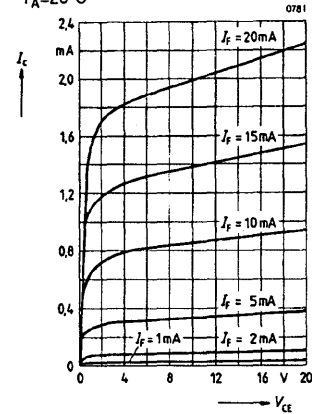

Output characteristics-SFH905 $I_C=f(V_{CE})$ Spacing to reflector: d=1 mm, 90% reflection, $T_A=25^\circ\text{C}$

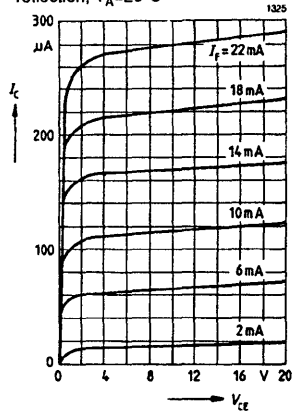

Infrared Emitters

Output characteristics (typ.)—SFH900

$I_C = f(V_{CE})$, spacing to reflector: $d=1$ mm, 90% reflection, $T_A=25^\circ\text{C}$

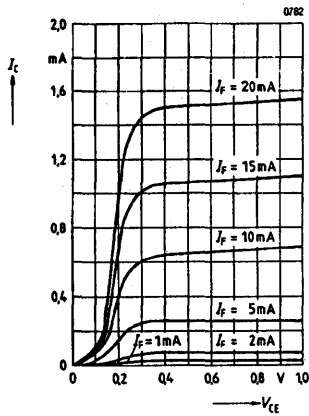

Output characteristics (typ.)—SFH905

$I_C = f(V_{CE})$, spacing to reflector: $d=1$ mm, 90% reflection, $T_A=25^\circ\text{C}$

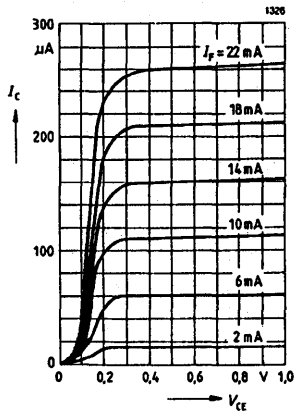

Transistor capacitance (typ.)—SFH900

$C_{CE} = f(V_{CE})$, $T_A=25^\circ\text{C}$, $f=1$ MHz

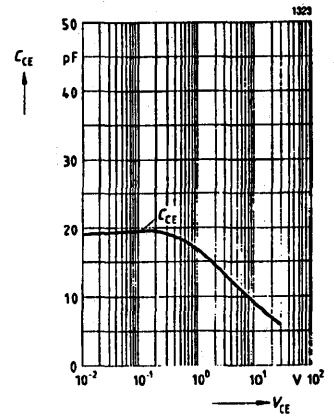

Transistor capacitance (typ.)—SFH905

$C_{CE} = f(V_{CE})$, $T_A=25^\circ\text{C}$, $f=1$ MHz

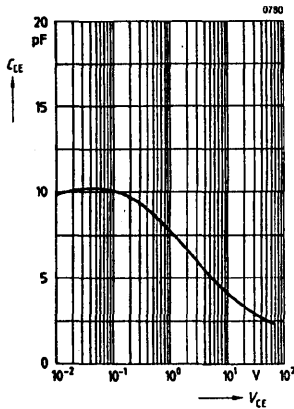

DIFFERENTIAL PHOTO INTERRUPTER WITH COUNTING PULSE & DIRECTION RECOGNITION

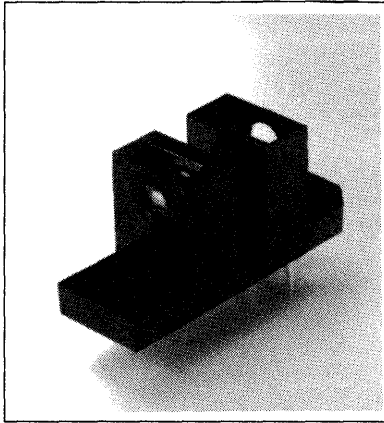

FEATURES

- Counting Mechanism
- Movement Direction Display
- Slot Width: 1.26_0 (3.2 mm)
- Maximum Output Current I_{OL} : 20 mA
- Switching Times t_{R} , t_{F} : 0.3 μ s
- 96 Slot Code Wheel Available (Part Number 2004-9053)

DESCRIPTION

The SFH 910 is a differential photo interrupter with daylight-suppression filter and spherical lens, operating in the infrared range.

A GaAlAs IRED is used as an emitter.

The receiver circuit consists of two narrow photodiodes, next to each other, with amplifiers and Schmitt triggers, and a logic which produces a counting pulse signal and a directional signal. The width of the counting pulse remains constant. The counting pulse (Z) and the directional recognition (R) outputs are open NPN collectors, which are TTL-compatible.

The SFH 910 is used to encode mechanical shaft rotational speed and direction. The Differential Photo Interrupter will accept code wheels with slot widths as small as 0.033" (0.85 mm). An optional 96 slot code wheel as described in the data sheet is available.

Package Dimensions in Inches (mm)

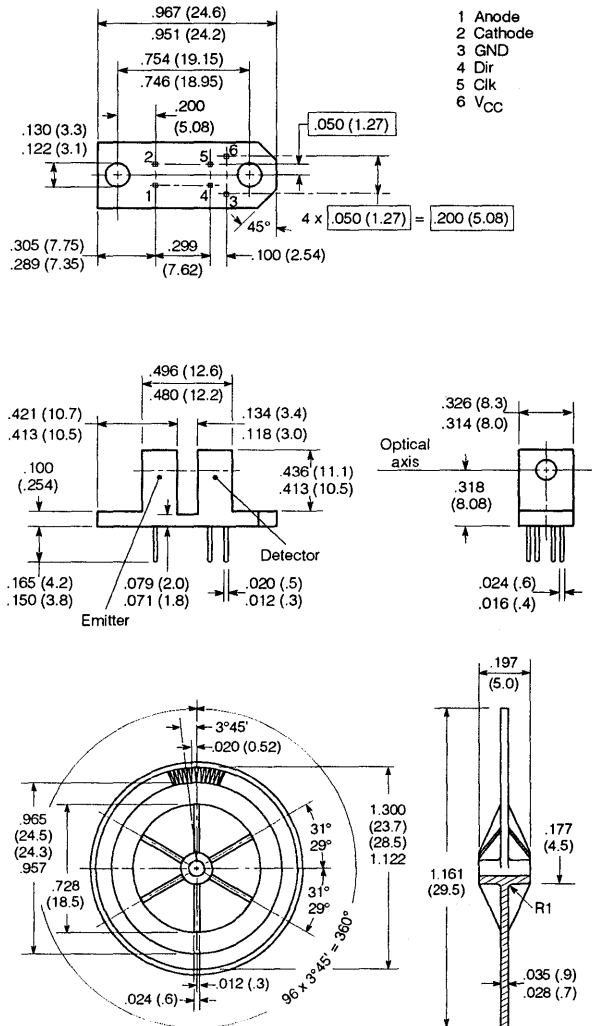

Maximum Ratings ($T_A=25^\circ\text{C}$)

Emitter (GaAs IRED)

Reverse Voltage (V_R)	5 V
Forward Current (I_F) $T_A=55^\circ\text{C}$	50 mA
Surge Current (I_{FSM})	1 A
Total Power Dissipation (P_{TOT}) $T_A=55^\circ\text{C}$	85 mW

Detector (Detector IC)

Supply Voltage (V_{CC})	4 to 18 V
Output Current, Output/Low (I_{OL})	20 mA
Output Voltage, Output/High (V_{OH})	16 V
Total Power Dissipation (P_{TOT}) $T_A=25^\circ\text{C}$	200 mW

Photo Interrupter

Operating Temperature (T_{OP})	-20° to $+85^\circ\text{C}$
Storage Temperature (T_{STG})	-40 to $+100^\circ\text{C}$
Junction Temperature (T_J)	$+100^\circ\text{C}$
Soldering Temperature (1 mm soldering distance from the case bottom: $t_s \leq 5$ s)	260°C

Pulse Diagram

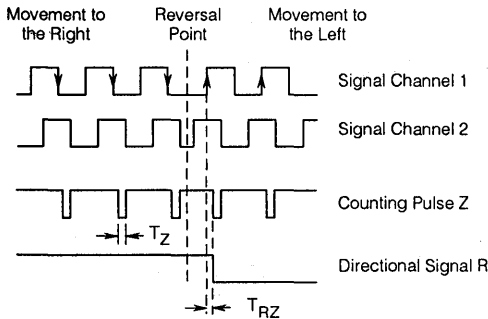

Channels 1 and 2 represent the out-of-phase signals after the Schmitt triggers (see block diagram). This diagram is for reference only and can't be verified by using the output pins of the device.

Positioning of the slotted disk within the photo interrupter

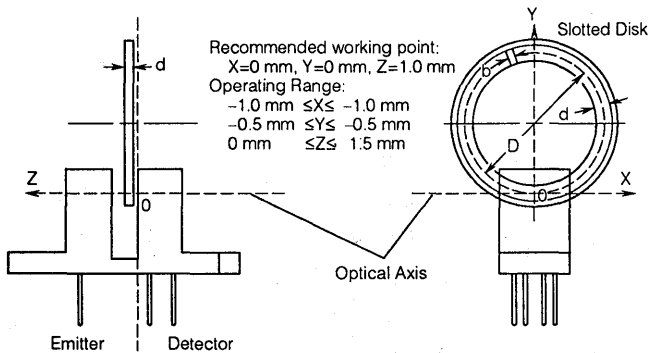

Number of slots on the slotted disk n	= 96
Thickness of the slotted disk	$d = .031"$ (0.8 mm)
Width of the slot center	$b = .015"$ (0.38 mm)
Slot length	$l = .079"$ (2.0 mm)
Diameter of the slotted disk (from slot center to slot center)	$D = 1.043"$ (26.50 mm)

Characteristics ($T_A=25^\circ\text{C}$)

Parameter

Parameter	Symbol	Value	Unit
Emitter (GaAs IRED)			
Forward Voltage ($I_F=20$ mA)	V_F	1.3 (≤ 1.6)	V
Breakdown Voltage ($I_R=10$ μA)	V_{BR}	(≥ 5)	V
Reverse Current ($V_R=5$ V)	I_R	0.01 (≤ 10)	μA
Capacitance ($V_R=0$ V, $f=1$ MHz)	C_0	25	pF
Thermal Resistance	R_{THJA}	500	K/W

Detector (Detector IC)

Supply Voltage	V_{CC}	4.5 to 16	V
Supply Current ($V_{CC}=5$ V, Outputs Open)	I_S	5 (≤ 10)	mA
Output Voltage (Counting Pulse) ($I_{OLZ}=16$ mA, $V_{CC}=5$ V, $I_F=10$ mA)	V_{OLZ}	.2 ($\leq .4$)	V
Output Voltage (Direction) ($I_{OLR}=16$ mA, $V_{CC}=5$ V, $I_F=10$ mA)	V_{OLR}	.2 ($\leq .4$)	V
Output Current ⁽²⁾ (Counting Pulse) ($V_{OHZ}=V_{CC}=16$ V; $I_F=0$)	I_{OHZ}	.01 (≤ 10)	μA
Output Current ⁽²⁾ (Direction) ($V_{OHR}=V_{CC}=16$ V; $I_F=0$)	I_{OHR}	.01 (≤ 10)	μA
Thermal Resistance	R_{THJA}	375	K/W

Photo Interrupter

Operating Range	I_F	20 ± 5	mA
Rise Time, Fall Time ($R_L=280$ Ω , $V_S=V_{S1}=5$ V; $I_F=20$ mA)	t_R, t_F	.3	μs
Counting Pulse Width	T_Z	10 (≤ 20)	μs
Delay Time (Change of Direction/Counting Pulse)	T_{RZ}	1	μs
Hysteresis of Schmitt Triggers	P_H	25	%

1. All characteristics have been measured by means of a slotted disk, as described previously.
2. Without ambient light.

Block Diagram

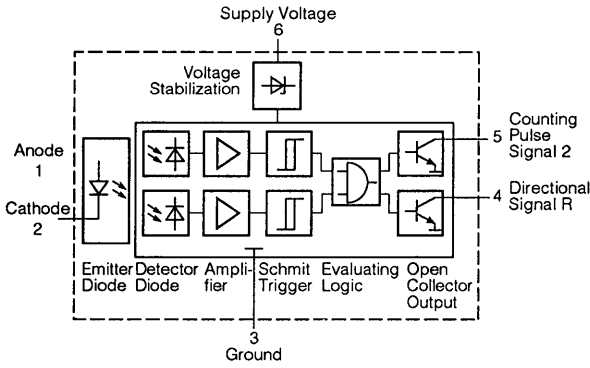

Application

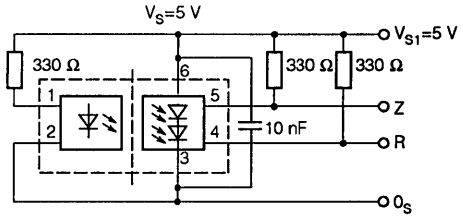

Maximum permissible forward current (Emitter) $I_F = f(T_A)$

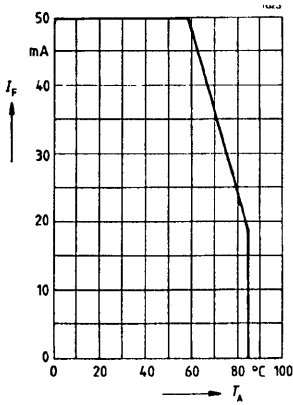

Permissible power dissipation $P_{TOT} = f(T_A)$

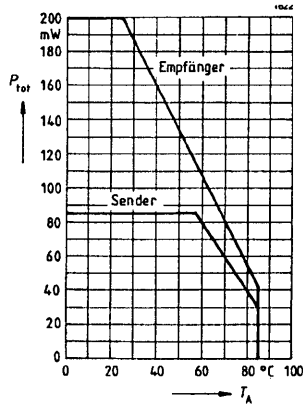



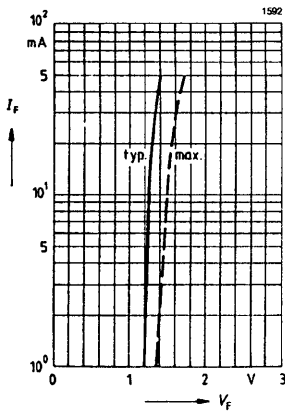

Forward current $I_F = f(V_F)$

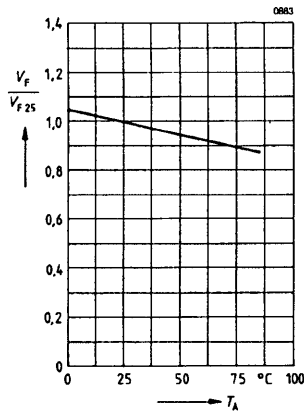

Forward voltage $V_F/V_{F25} = f(T_A)$

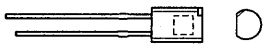
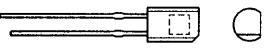

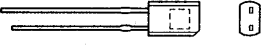
Photodiodes

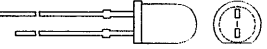

Package Outline	Part Number	Package Type	Half Angle	Dark Current $V_R=10\text{ V}$ nA	Photo-sensitivity $\lambda=950\text{ nm}$ 0.5mW/cm^2 nA	Radiant Sensitive Area mm^2	Peak Wave-length nm	Features	Page
	SFH205	Plastic, daylight filter, solder tabs	$\pm 60^\circ$	2 (≤ 30)	25(≥ 15) μA	7.00	950	PIN type, built-in filter. Superior signal/noise ratio at low luminance.	8-61
	SFH206	Plastic, daylight filter, solder tabs	$\pm 60^\circ$	2(≤ 30)	25(≥ 15) μA	7.00	950	PIN type, built-in filter. Superior signal/noise ratio at low luminance.	8-61
	SFH206K	Clear plastic, solder tabs.	$\pm 60^\circ$	2(≤ 30)	80(≥ 50)	7.00	850	PIN type.	8-63
	SFH205Q2	Plastic, daylight filter, solder tabs	$\pm 60^\circ$	2(≤ 30)	25(≥ 15) μA	7.00	950	PIN type, built in filter. Superior signal/noise ratio at low luminance.	8-61
	SFH225	Plastic, daylight filter.	$\pm 60^\circ$	2(≤ 30)	17 (≥ 12.5) μA	4.84	900	PIN type. Short switching time. Matches emitters SFH484/485, LD271/274.	8-77
	SFH217	$T_{1/4}$ flat, clear plastic.	$\pm 75^\circ$	1(≤ 10) 20 V	9.5(≥ 5)	1	850	PIN type.	8-71
	SFH217F	$T_{1/4}$ flat, plastic, daylight filter.			3.1 (≥ 1.8) μA		900		
	SFH263	$T_{1/4}$ flat, clear plastic.	$\pm 75^\circ$	5 (≤ 20) pA 1 V	10	0.97	850	High photosensitivity. High open circuit voltage. Low noise. Visible and IR range usage.	8-97
	SFH2030	$T_{1/4}$ clear plastic.	$\pm 20^\circ$	1(≤ 5) 20 V	80(≥ 50)	1	850	Low noise, short switching time. Low capacitance, high spectral sensitivity.	8-104
	SFH2030F	$T_{1/4}$ plastic, daylight filter.			25(≥ 15) μA		900		

Photodiodes

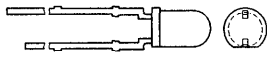
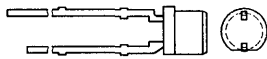
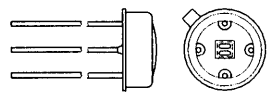
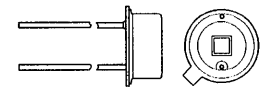
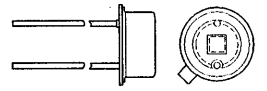
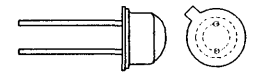
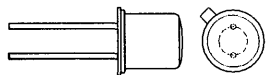
Photodiodes (Continued)

Package Outline	Part Number	Package Type	Half Angle	Dark Current $V_R = 10\text{ V}$ nA	Photo-sensitivity $\lambda = 950\text{ nm}$ 0.5 mW/cm^2 nA	Radiant Sensitive Area mm^2	Peak Wave-length nm	Features	Page
	SFH229	T1 clear plastic.	$\pm 17^\circ$	50 pA	$28(\geq 18)$	0.3	860	PIN type. Short switching time.	8-79
	SFH229F	T1 daylight filter.			$10(\geq 5.4)$ μA				
	SFH229P	T1 flat clear plastic.	$\pm 85^\circ$	50 pA	$3.1(\geq 2.3)$	0.3	860	PIN type.	8-82
	SFH229PF	T1 flat-daylight filter.			$1.0(\geq 0.7)$ μA				
	SFH221S	TO-5 hermetic.	$\pm 55^\circ$	10 (≤ 100)	$24(\geq 15)$	1.54	900	High packing density. Low noise. Short switching time. Low luminance differential detector.	8-75
	SFH233	TO-5 hermetic.	$\pm 54^\circ$	20 (≤ 100) μA 1 V	125	7.02	1550	High photosensitivity. High cutoff frequency. Short switching time. Germanium.	8-89
	SFH291	TO-5 hermetic.	$\pm 55^\circ$	0.3 (≤ 1) 5 V	50	7.45	850		8-99
	BPW21	Modified TO-5, hermetic, flat glass.	$\pm 60^\circ$	$2(\leq 30)$ 5 V	$10(\geq 5.5)$ nA/lux	7.34	550	High reliability. λ filter.	8-11
	BPX60		$\pm 55^\circ$	7 (≤ 300)	70 μA	7.34	850	High reliability. Superior signal/noise ratio at low luminance.	8-25
	BPX61		$\pm 55^\circ$	$2(\leq 30)$	$70(\geq 50)$ μA	7.00	850	High reliability. PIN type. Superior signal/noise ratio at low luminance.	8-27
	BPX63	TO-18, plastic lens.	$\pm 75^\circ$	5 (≤ 20) pA 1 V	$10(\geq 8)$ μA	0.97	800	Extremely low dark current. Matches emitter LD242.	8-29
	BPX65	TO-18 flat plastic lens.	$\pm 40^\circ$	$1(\leq 5)$ 20 V	$10(\geq 5.5)$ μA	1	850	PIN type. Very high speed. Low dark current.	8-31
	BPX66		$\pm 40^\circ$	$0.15(\leq 0.3)$ 1 V	$10(\geq 5.5)$ μA	1	850		

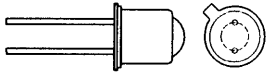
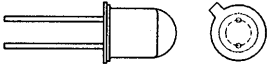
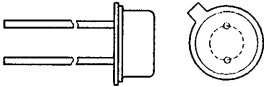
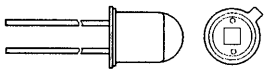
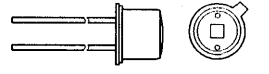
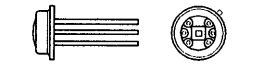
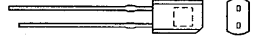
Photodiodes (Continued)

Package Outline	Part Number	Package Type	Half Angle	Dark Current $V_R=10\text{ V}$ nA	Photo-sensitivity $\lambda=950\text{ nm}$ 0.5mW/cm^2 nA	Radiant Sensitive Area mm^2	Peak Wavelength nm	Features	Page
	SFH212	TO-18 hermetic.	$\pm 15^\circ$	$5(\leq 20)$ pA 1 V	$25(\geq 20)$ μA	0.97	800	High packing density. Low noise. Short switching time. High spectral sensitivity.	8-67
	SFH216	TO-18 hermetic.	$\pm 12^\circ$	$1(\leq 5)$ 20 V	$50(\geq 35)$	1	850	High packing density. Low noise. High cutoff frequency. Low capacitance.	8-69
	SFH219	TO-18 hermetic.	$\pm 60^\circ$	$5(\leq 20)$ 1 V	$7(\geq 5)$	0.97	850	High packing density. Low noise. Short switching time. Low luminance detector.	8-73
	SFH231	TO-18 hermetic.	$\pm 10^\circ$	10 (≤ 50) μA 1 V	130	1	1550	High photosensitivity. High cutoff frequency. Short switching time. Germanium.	8-85
	SFH232	TO-18 hermetic.	$\pm 55^\circ$	10 (≤ 50) μA 1 V	18	1	1550		8-87
	SFH234S	TO-39 hermetic	$\pm 60^\circ$	0.1 (≤ 1)	1.85 (≥ 1.2)	0.25	800	Four quadrant.	8-91
	SFH244S	TO-39 hermetic	$\pm 60^\circ$	0.2 (≤ 1)	7.4 (≥ 4.8)	1	800	Four quadrant. Short switching time.	8-95
	SFH235	TOD67 daylight filter	$\pm 65^\circ$	2 (≤ 30)		7	950	PIN type. Short switching time.	8-93
	BP104BS	SMD, plastic, daylight filter.	$\pm 60^\circ$	$2(\leq 30)$	$25(\geq 15)$ μA	7.00	950	IR remote control. PIN type. Surface mount.	8-9

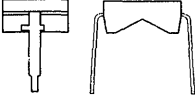
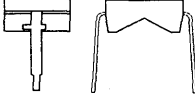
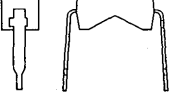
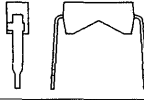

Photodiodes

Package Outline	Part Number	Package Type	Half Angle	Dark Current $V_R=10\text{ V}$ nA	Photo-sensitivity $\lambda=950\text{ nm}$ 0.5mW/cm^2 nA	Radiant Sensitive Area mm^2	Peak Wave-length nm	Features	Page
	BP104	Plastic, daylight filter, solder tabs.	$\pm 60^\circ$	$2(\leq 30)$	$17\ \mu\text{A}$	4.84	950	IR remote control. PIN type.	8-7
	BPW33	Clear plastic, solder tabs.	$\pm 60^\circ$	$2(\leq 100)$ pA 1 V	$72\ \mu\text{A}$	7.34	800	Low dark current. Light measuring applications.	8-15
	BPW34	Clear plastic, solder tabs.	$\pm 60^\circ$	$2(\leq 30)$	$80\ \mu\text{A}$	7.00	850	PIN type. Low junction capacitance.	8-17
	BPW34B	Clear plastic.	$\pm 60^\circ$	$2(\leq 30)$	$75\ \mu\text{A}$	7.45	850	PIN type. High blue sensitivity.	8-19
	BPW34F	Plastic, daylight filter.	$\pm 60^\circ$	$2(\leq 30)$	$25(\geq 16)$ μA	7.00	950	PIN type.	8-9
	BPW34FA				$25(\geq 20)$ μA		880		8-21
	BPX91B	Clear plastic.	$\pm 60^\circ$	$7(\leq 300)$	$65\ \mu\text{A}$	7.45	850	High blue sensitivity.	8-35
	BPW32	Clear plastic, solder tabs.	$\pm 60^\circ$	$5(\geq 20)$ pA 1 V	$10(\geq 7)$ μA	0.97	800	Low dark current	8-13
	BPX90	Plastic, daylight filter, solder tabs.	$\pm 60^\circ$	$5(\leq 200)$	$45(\geq 25)$	5.5	850	High sensitivity. Superior signal/noise ratio at low luminance.	8-33
	BPX90F				$13(\geq 18)$ μA		950		
	SFH200	Clear plastic, solder tabs.	$\pm 60^\circ$	$5(\leq 40)$ pA 1 V	$20(\geq 14)$	2	800	High sensitivity. High zero crossover.	8-59
	BPX92	Plastic, solder tabs.	$\pm 60^\circ$	$1(\leq 100)$	$9.5(\geq 4)$ μA	1	830	High reliability. Superior signal/noise ratio at low luminance.	8-37

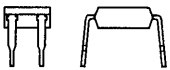
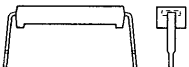
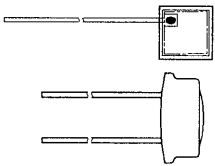
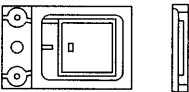
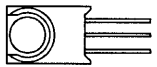
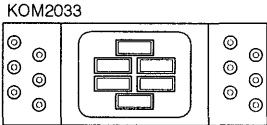
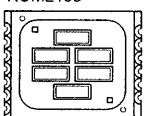
Photodiodes (Continued)

Package Outline	Part Number	Package Type	Half Angle	Dark Current I_{d0} $V_R=10\text{ V}$ nA	Photo-sensitivity $\lambda=950\text{ nm}$ $0.5\text{mW}/\text{cm}^2$ nA	Radiant Sensitive Area mm^2	Peak Wave-length nm	Features	Page
	BPX48	Clear plastic, solder tabs.	$\pm 60^\circ$	10 (≤ 100)	24(≥ 15) μA	2x1.54	900	Fast response, differential type, 90 μm die distance. Precision applications.	8-23
	BPX48F	Plastic, daylight filter, solder tabs.			7.5 (≥ 4.0)		920		
	SFH100	Clear plastic, solder tabs.	$\pm 60^\circ$	0.4	175	21.2	850	Blue enhanced, high sensitivity, superior signal/noise ratio at low luminance.	8-57
	BPY12	Chip with 2 leads.	$\pm 60^\circ$	10 (≤ 100) 20 V	180 (≥ 100) μA	20	920	High spectral sensitivity.	8-39
	BPY12-H1								
	SFH207A	Chip on PC board, encapsulated.	$\pm 60^\circ$	30 (≤ 200)	850 (≥ 750) 5 V	93.9	850	High photo sensitivity, low noise, high cut-off frequency. Short switching time, good linearity.	8-65
	SFH505A	Black epoxy with daylight filter.	$\pm 50^\circ$	—	—	—	950	IR receiver/demodulator device.	8-101
	KOM 2033A, 2100A	6 chip array.	$\pm 60^\circ$	1(≤ 10)	8(≥ 5.2) μA	2.5	840	Low reverse current. N-Si material=positive front & negative back.	8-41
	KOM 2033AF, 2100AF	6 chip array, daylight filter			7.5(≥ 4.9) μA				
	KOM 2033B, 2100B	6 chip array.	$\pm 60^\circ$	1(≤ 10)	9(≥ 7) μA	2.5	870	Low reverse current. N-Si material=positive front & negative back.	8-44
	KOM 2033BF, 2100BF	6 chip array, daylight filter			8.5(≥ 6.6) μA				

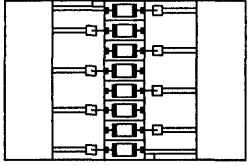
Photodiodes (Continued)

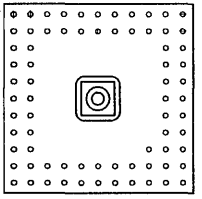
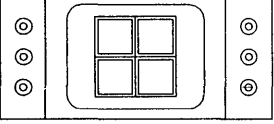
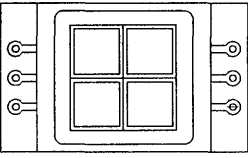
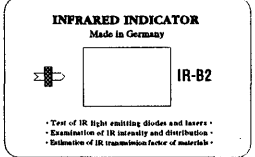
Package Outline	Part Number	Package Type	Half Angle	Dark Current $V_R=10\text{ V}$ nA	Photo-sensitivity $\lambda=950\text{ nm}$ 0.5mW/cm^2 nA	Radiant Sensitive Area mm^2	Peak Wavelength nm	Features	Page
	KOM 2045	8 chip array.	$\pm 60^\circ$	$5(\leq 30)$ 1 V	$17(\geq 12)$	2.6	870	Low reverse current. N-Si material=positive front & negative back.	8-47
	KOM 2057L	3 chip array.	$\pm 60^\circ$	$2(\leq 30)$	$80(\geq 50)$	7	880	Low reverse current. N-Si material=positive front & negative back.	8-49
	KOM 2059	64 chip circular array.	$\pm 60^\circ$	15 (≤ 150) 5V	$2.5(\geq 1.8)$	0.11	850	Low reverse current. N-Si material=positive front & negative back.	8-51
	KOM 2084	4 chip array.	$\pm 60^\circ$	$2(\leq 30)$	$80(\geq 50)$	7	880	N-Si material. Low capacitance. Wide temperature range.	8-53
	KOM 2085	4 chip array.	$\pm 60^\circ$	10 (≤ 100)	180 (≥ 100)	20	920	N-Si material. Low capacitance. Wide temperature range.	8-55
	IR-B2	Infrared indicator card.	—	—	—	—	—	An application: check output of IR LEDs and IR laser diodes.	8-106

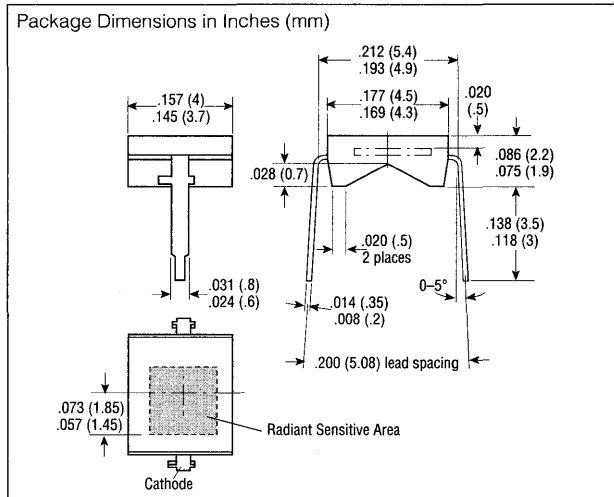
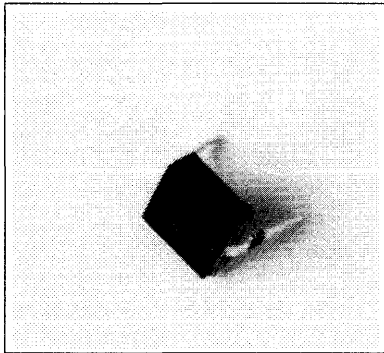

FEATURES

- Silicon Planar PIN Photodiode
- Daylight Filter
- High Spectral Sensitivity
- Short Switching Time
- Usage: Near Infrared Range (780 to 1100 nm)
- Wide Temperature Range
- High Reliability
- No Testable Degradation
- Low Noise
- High Cutoff Frequency
- High Packing Density
- Use as Photodiode or Photovoltaic Cell
- N-Si Material: Anode=Front Contact, Cathode=Back Contact
- Low Capacitance
- Applications
 - IR Remote Control
 - IR Sound Transmission
 - Reflective Switches
- Package: Lead Frame, Black Epoxy Resin, Solder Tabs, 0.200" (5.08 mm) Lead Spacing
- Cathode Marking: Projection on Solder Tab

Maximum Ratings

Operating and Storage Temperature Range (T_{OP} , T_{STG}) -40° to $+80^{\circ}$ C
 Soldering Temperature (2 mm from case bottom), (T_S) $t \leq 3$ s 230° C
 Reverse Voltage (V_R) 20 V
 Power Dissipation (P_{TOT}) $T_A=25^{\circ}$ C 150 mW

Characteristics ($T_A=25^{\circ}$ C, $\lambda=950$ nm)

Parameter	Symbol	Value	Unit
Photosensitivity			
($V_R=5$ V, $E_E=0.5$ mW/cm ²)	S	17 (≥ 12.5)	μ A
Maximum Sensitivity Wavelength	λ_{Smax}	950	nm
Photosensitivity Spectral Range			
(S=10% of S_{MAX})	λ	780 to 1100	nm
Radiant Sensitive Area	A	4.84	mm ²
Radiant Sensitive Area Dimensions	L x W	2.20 x 2.20	mm
Distance, Chip Surface to Case Surface	H	0.5	mm
Half Angle	ϕ	± 60	Deg.
Dark Current ($V_R=10$ V)	I_R	2 (≤ 30)	nA
Spectral Sensitivity	S_{λ}	0.70	A/W
			<u>electrons</u>
Quantum Yield	η	0.90	photon
Open Circuit Voltage ($E_E=0.5$ mW/cm ²)	V_O	330 (≥ 250)	mV
Short Circuit Current ($E_E=0.5$ mW/cm ²)	I_{SC}	17	μ A
Photocurrent Rise and Fall Time			
10% to 90%, and 90% to 10% of Final Value ($R_L=50$ Ω , $V_R=5$ V, $\lambda=850$ nm, $I_F=800$ μ A)	$t_{R,tF}$	20	ns
Forward Voltage ($I_F=100$ mA, $E=0$)	V_F	1.3	V
Capacitance ($V_R=0$ V, $f=1$ MHz, $E_V=0$ lx)	C_0	48	pF
Temperature Coefficient V_O	TC _V	-2.6	mV/K
Temperature Coefficient I_{SC}	TC _I	0.18	%/K
Noise Equivalent Power ($V_R=10$ V)	NEP	3.6×10^{-14}	W/ \sqrt Hz
Detection Limit ($V_R=10$ V)	D*	6.1×10^{12}	cm ² • \sqrt Hz/W

Relative spectral sensitivity

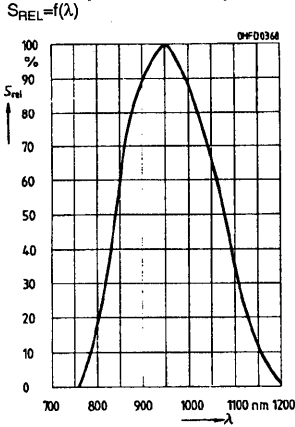

**Photocurrent $I_p=f(E_E)$
Open circuit voltage $V_O=f(E_E)$**

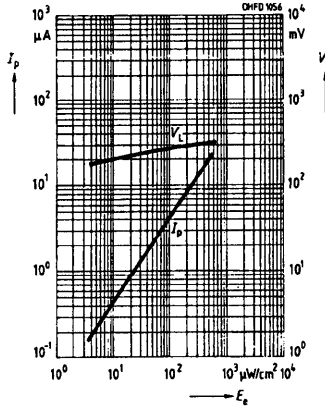

Power dissipation $P_{TOT}=f(T_A)$

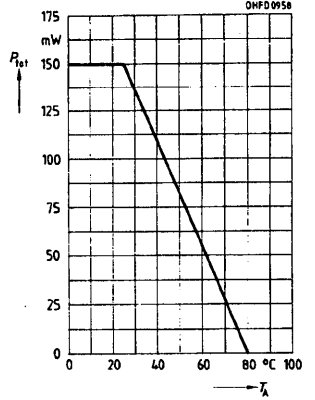

Directional characteristic

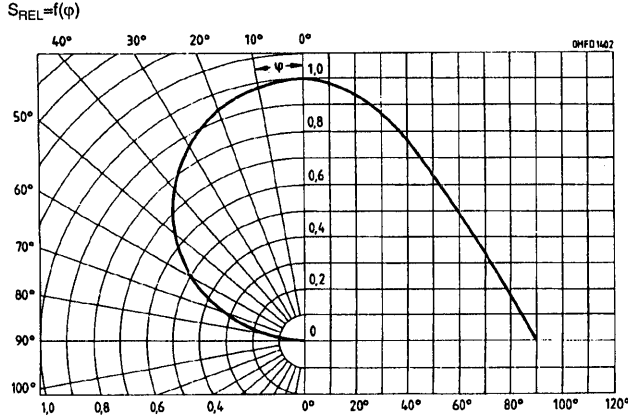

**Dark current $I_R=f(V_R)$
 $T_A=25^\circ\text{C}, E=0$**

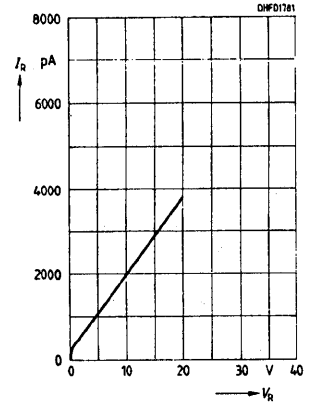

**Capacitance $C=f(V_R)$
 $f=1\text{ MHz}, E=0$**

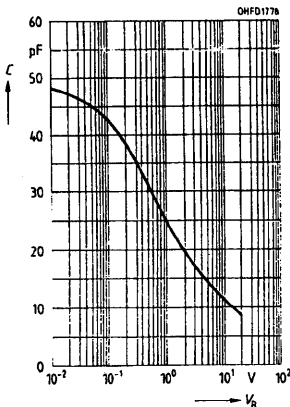

**Dark current $I_R=f(T_A)$
 $V_R=10, E=0$**

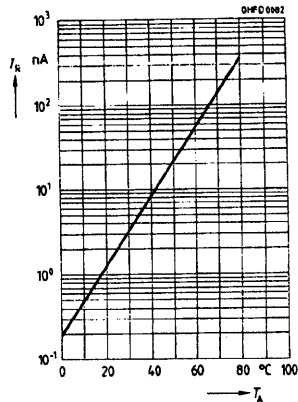

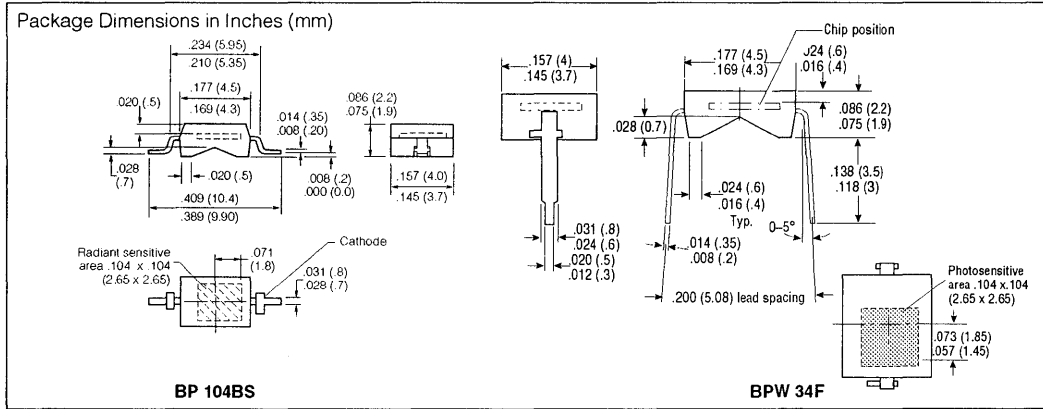

FEATURES

- Silicon Planar PIN Photodiode
- Daylight Filter
- High Spectral Sensitivity
- Short Switching Time
- Usage: Near Infrared Range (780 to 1100 nm)
- Wide Temperature Range
- High Reliability
- No Testable Degradation
- Low Noise
- High Cutoff Frequency
- High Packing Density
- Use as Photodiode or Photovoltaic Cell
- N-Si Material: Anode=Front Contact, Cathode=Back Contact
- Low Capacitance
- Applications
 - IR Remote Control
 - IR Sound Transmission
 - Reflective Switches
- Package: Lead Frame, Black Epoxy Resin, Solder Tabs, 0.200" (5.08 mm) Lead Spacing; BP 104BS Suitable for Surface Mounting
- Cathode Marking: Projection on Solder Tab

Maximum Ratings

Operating and Storage Temperature Range (T_{OP} , T_{STG}) -40° to $+80^{\circ}\text{C}$
 Soldering Temperature (2 mm from case bottom) (T_S) $t \leq 3$ s 230°C
 Reverse Voltage (V_R) 32 V
 Power Dissipation (P_{TOT}) $T_A=25^{\circ}\text{C}$ 150 mW

Characteristics ($T_A=25^{\circ}\text{C}$, $\lambda=950$ nm)

Parameter	Symbol	Value	Unit
Photosensitivity ($V_R=5$ V, $E_E=0.5$ mW/cm ²)	S	25 (≥ 15)	μA
Maximum Photosensitivity Wavelength	λ_{Smax}	950	nm
Photosensitivity Spectral Range ($S=10\%$ of S_{MAX})	λ	780 to 1100	nm
Radiant Sensitive Area	A	7.00	mm ²
Radiant Sensitive Area Dimensions	L x W	2.65 x 2.65	mm
Distance, Chip Surface to Case Surface	H	0.5	mm
Half Angle	ϕ	± 60	Deg.
Dark Current ($V_R=10$ V)	I_R	2 (≤ 30)	nA
Spectral Photosensitivity	S_{λ}	0.59	A/W
Quantum Yield	η	0.77	photon
Open Circuit Voltage ($E_E=0.5$ mW/cm ²)	V_O	330 (≥ 275)	mV
Short Circuit Current ($E_E=0.5$ mW/cm ²)	I_{SC}	25	μA
Rise and Fall Time of Photocurrent 10% to 90%, and 90% to 10% of Final Value, ($R_L=50$ Ω , $V_R=5$ V, $\lambda=850$ nm, $I_P=800$ μA)	t_R , t_F	20	ns
Forward Voltage ($I_F=100$ mA, $E_E=0$, $T_A=25^{\circ}\text{C}$)	V_F	1.3	V
Capacitance ($V_R=0$ V, $E=0$, $f=1$ MHz)	C_0	72	pF
Temperature Coefficient V_O	TC_V	-2.6	mV/K
Temperature Coefficient I_{SC}	TC_I	0.18	%/K
Noise Equivalent Power ($V_R=10$ V)	NEP	4.3×10^{-14}	W/Hz
Detection Limit ($V_R=10$ V)	D^*	6.2×10^{12}	$\text{cm} \cdot \sqrt{\text{Hz}}/\text{W}$

Photodiodes

Relative spectral sensitivity versus wavelength

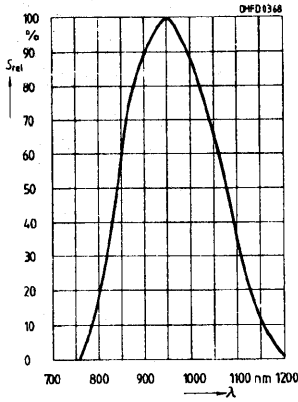

**Photocurrent $I_P=f(E_E)$
Open circuit voltage $V_O=f(E_V)$**

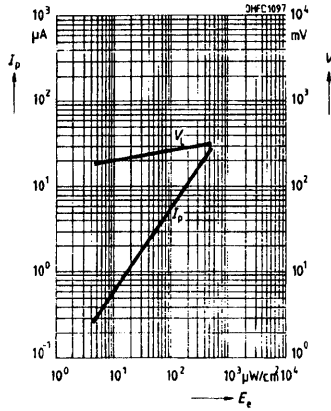

Directional characteristic
 $S_{REL}=f(\theta)$

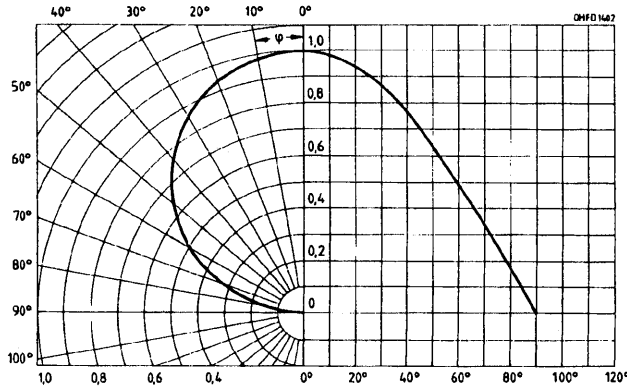

Power dissipation $P_{TOT}=f(T_A)$

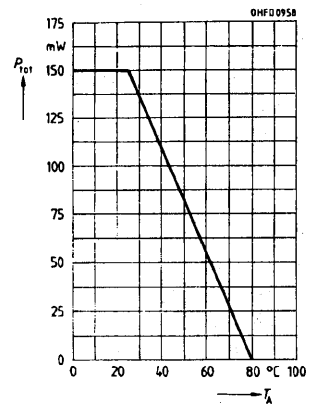

**Dark current $I_R=f(V_R)$
 $T_A=25^\circ\text{C}, E=0$**

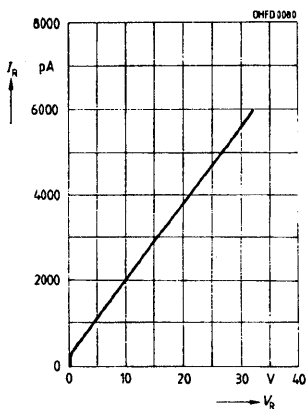

Capacitance versus reverse voltage $f=1\text{ MHz}, E=0$

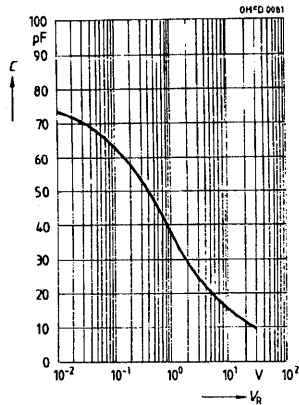

**Dark current $I_R=f(T_A)$
 $V_R=10, E=0$**

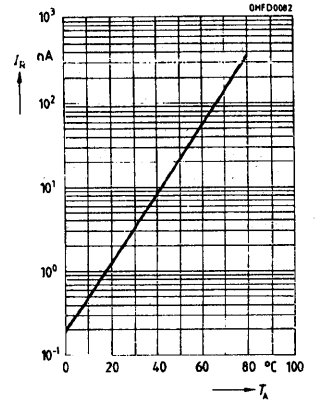

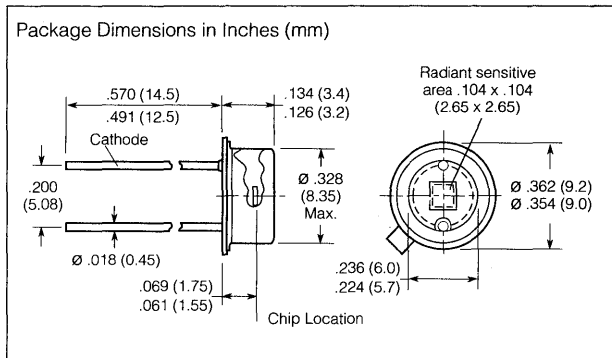
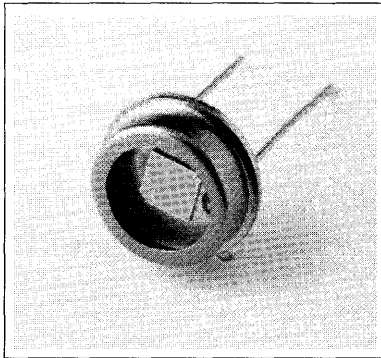

FEATURES

- Incorporates Vλ Filter
- Usage: Visible Light Range (350 to 820 nm)
- High Photosensitivity
- High Reliability
- Short Switching Time
- Wide Temperature Range
- Strong Linearity of Photocurrent vs. Light Level (10^{-2} to 10^5 lux)
- Low Noise
- Silicon Planar Photodiode
- N-Si Material: Anode=Front Contact, Cathode=Back Contact
- Applications
 - Exposure Meters
 - Color Detection and Analysis
 - Visible Light Detection
- Package: Hermetically Sealed—Similar to TO-5, Solder Tabs, Glass Lens (Schott)
- Cathode Marking: Tab at Package Bottom

Maximum Ratings

Operating and Storage Temperature Range (T_{OP} , T_{STG})	-40° to +80°C
Soldering Temperature (1.5 mm from case bottom) (T_S) \leq 3 s	235°C
Reverse Voltage (V_R)	10 V
Power Dissipation (P_{TOT})	250 mW

Characteristics ($T_A=25^\circ\text{C}$, Standard Light A, $T=2856$ K)

Parameter	Symbol	Value	Unit
Photosensitivity			
($V_R=5$ V)	S	10 (≥ 5)	nA/lx
Maximum Photosensitivity Wavelength	$\lambda_{S_{MAX}}$	550	nm
Photosensitivity Spectral Range			
($S=10\%$ of S_{MAX})	λ	350 to 820	nm
Radiant Sensitive Area	A	7.34	mm ²
Radiant Sensitive Area Dimensions	L x W	2.73 x 2.73	mm
Distance, Chip Surface to Case Surface	H	1.9 to 2.3	mm
Half Angle	ϕ	± 60	Deg.
Dark Current ($V_R=5$ V)	I_R	2 (≤ 30)	nA
($V_R=10$ mV)	I_R	8 (≤ 200)	pA
Spectral Photosensitivity ($\lambda=550$ nm)	S_λ	0.34	A/W
Quantum Yield ($\lambda=550$ nm)	η	0.80	photon
Open Circuit Voltage ($E_V=1000$ lx)	V_O	400 (≥ 320)	mV
Short Circuit Current ($E_V=1000$ lx)	I_{SC}	10	μA
Rise and Fall Time of Photocurrent			
($R_L=1$ K Ω , $V_R=5$ V, $\lambda=550$ nm, $I_P=10$ μA)	t_R , t_F	1.5	μs
Forward Voltage ($I_F=100$ mA, $E_E=0$)	V_F	1.2	V
Capacitance			
($V_R=0$ V, $f=1$ MHz, $E_V=0$ lx)	C_O	580	pF
Temperature Coefficient V_O	TC_V	-2.6	mV/K
Temperature Coefficient I_S	TC_I	0.12	%/K
Noise Equivalent Power			
($V_R=5$ V, $\lambda=550$ nm)	NEP	7.2×10^{-14}	W/ $\sqrt{\text{Hz}}$
Detection Limit ($V_R=5$ V, $\lambda=550$ nm)	D^*	1×10^{12}	$\text{cm}^2 \cdot \sqrt{\text{Hz}}/\text{W}$

Relative spectral sensitivity versus wavelength

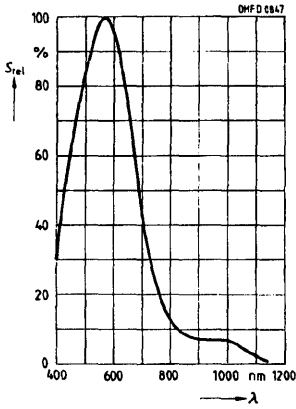

**Photocurrent $I_P=f(E_V)$
Open circuit voltage $V_O=f(E_V)$**

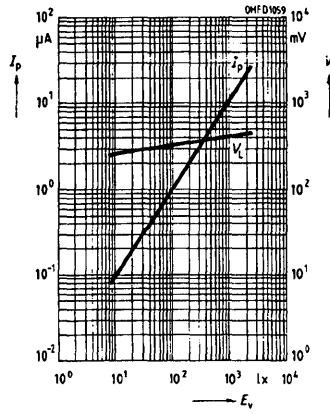

**Directional characteristic
 $S_{REL}=f(\varphi)$**

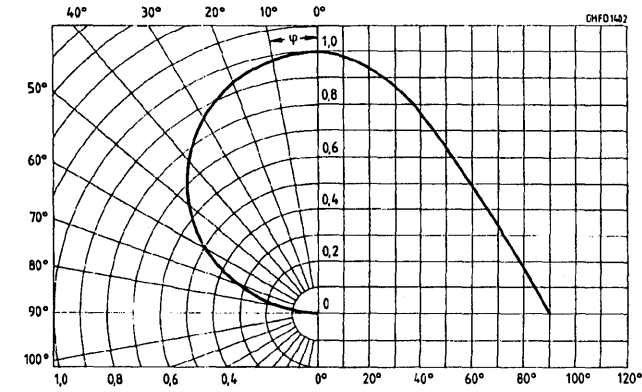

Total power dissipation versus ambient temperature

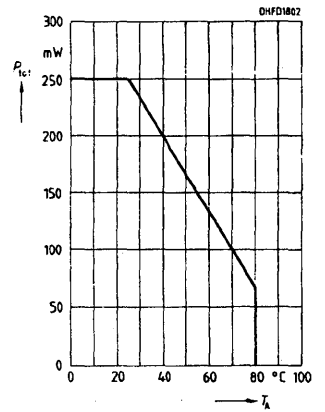

**Dark current versus ambient temperature
 $I_R=f(T_A), V_R=5 V$**

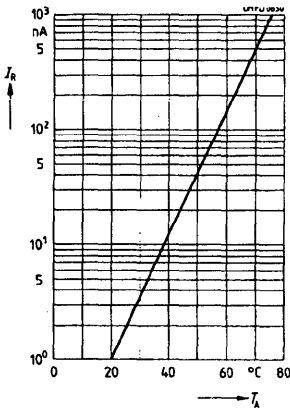

Capacitance $C=f(V_R), f=1 \text{ MHz}$

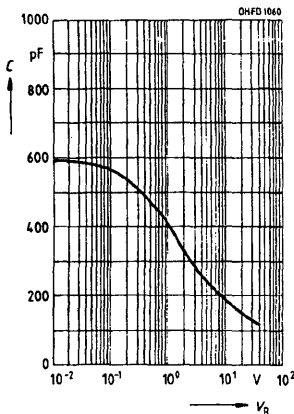

Dark current $I_R=f(V_R)$

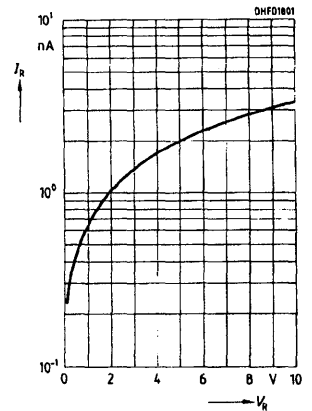

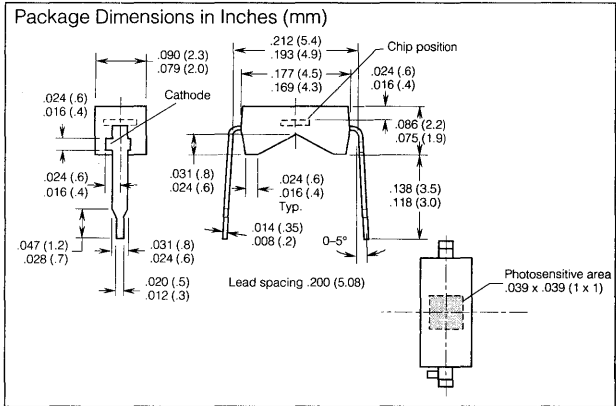
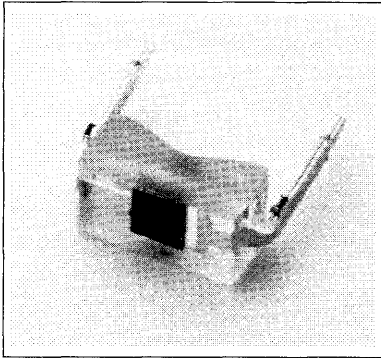

FEATURES

- Silicon Planar Photodiode
- N-Si Material: Anode=Front Contact, Cathode=Back Contact
- High Reliability
- No Testable Degradation
- Low Noise
- High Packing Density
- Short Switching Time
- High Spectral Sensitivity
- Wide Temperature Range
- Usage: Visible and Near Infrared Range (350 to 1100 nm)
- Very Low Dark Current
- Applications
 - Color Analysis
 - Detector for Low Light Levels
 - Photography—Exposure Meters
- Package: Lead Frame, Transparent Epoxy Resin, Solder Tabs, 0.200" (5.08 mm) Lead Spacing
- Cathode Marking: Projection on Solder Tab

Maximum Ratings

Operating and Storage Temperature Range (T_{OP} , T_{STG}) -40° to +80°C
 Soldering Temperature (2 mm from case bottom) (T_S) $t_{\leq 3}$ s 230°C
 Reverse Voltage (V_R) 7 V
 Power Dissipation (P_{TOT}) $T_A=25^\circ\text{C}$ 100 mW

Characteristics ($T_A=25^\circ\text{C}$, Standard Light A, $T=2856$)

Parameter	Symbol	Value	Unit
Photosensitivity ($V_R=5$ V) ⁽¹⁾	S	10 (≥ 7)	nA/lx
Maximum Photosensitivity Wavelength	λ_{Smax}	800	nm
Photosensitivity Spectral Range (S=10% of S_{MAX})	λ	350 to 1100	nm
Radiant Sensitive Area	A	0.97	mm ²
Radiant Sensitive Area Dimensions	L x W	0.985 x 0.985	mm
Distance, Chip Surface to Case Surface	H	0.5	mm
Half Angle	ϕ	± 60	Deg.
Dark Current ($V_R=1$ V)	I_D	5 (≤ 20)	pA
Zero Crossing ($E_E=0$)	S_0	≤ 0.6	pA/mV
Spectral Photosensitivity ($\lambda=850$ nm)	S_λ	0.5	A/W electrons photon
Quantum Efficiency ($\lambda=850$ nm)	η	0.73	
Open Circuit Voltage ($E_V=1000$ lx) ⁽¹⁾	V_O	450 (≥ 380)	mV
Short Circuit Current ($E_V=1000$ lx) ⁽¹⁾	I_{SC}	10	μA
Photocurrent Rise and Fall Time ($R_L=1$ K Ω , $V_R=5$ V, $\lambda=850$ nm, $I_F=10$ μA)	t_R , t_F	1.3	μs
Forward Voltage ($I_F=80$ mA, $E_E=0$)	V_F	1.3	V
Capacitance ($V_R=0$ V, $f=1$ MHz, $E_V=0$ lx)	C_0	100	pF
Temperature Coefficient V_O	TC_V	-2.6	mV/K
Temperature Coefficient I_{SC}	TC_I	0.2	%/K
Noise Equivalent Power ($V_R=1$ V, $\lambda=850$ nm)	NEP	2.5×10^{-15}	W/ $\sqrt{\text{Hz}}$
Detection Limit ($V_R=1$ V, $\lambda=850$ nm) Note	D^*	3.9×10^{13}	$\text{cm} \cdot \sqrt{\text{Hz}}/\text{W}$

1. Illuminance shown refers to unfiltered radiation of tungsten filament lamp at color temperature of 2856 K (standard light A per DIN 5033 and IEC publication 306-1).

Relative spectral sensitivity, $S_{REL}=f(\lambda)$

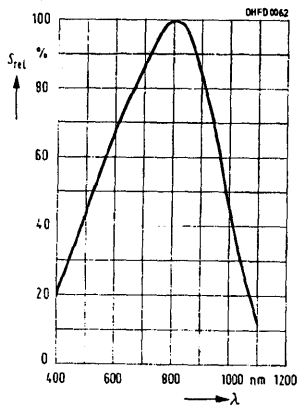

Photocurrent $I_p=f(E_v)$
Open circuit voltage $V_G=f(E_v)$

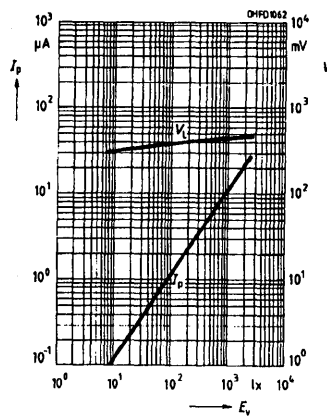

Directional characteristic $S_{REL}=f(\varphi)$

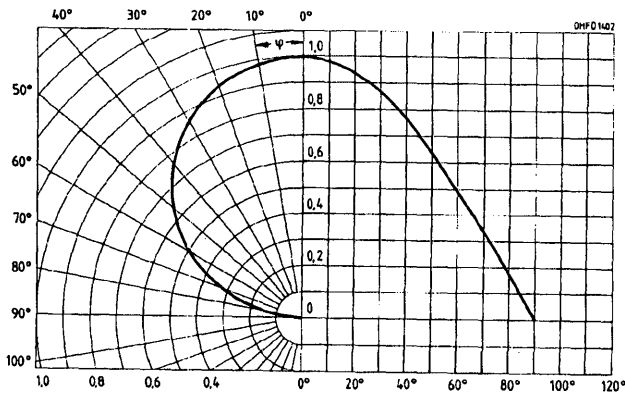

Power dissipation $P_{TOT}=f(T_A)$

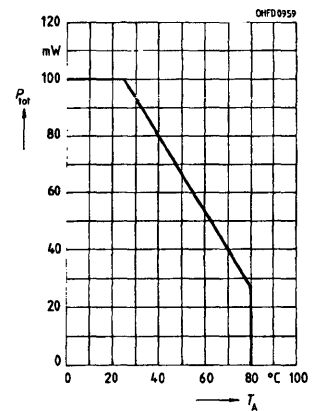

Dark current $I_R=f(V_R)$, $E=0$

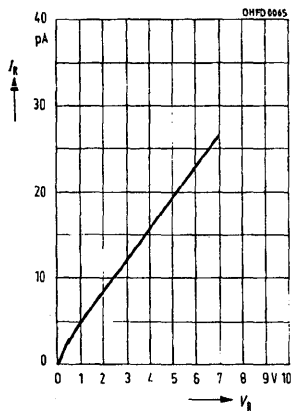

Capacitance $C=f(V_R)$, $f=1$ MHz, $E=0$

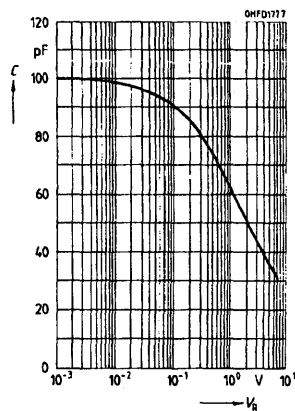

Dark current $I_R=f(T_A)$, $V_R=1$ V, $E=0$

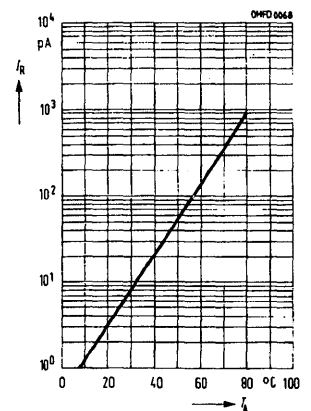

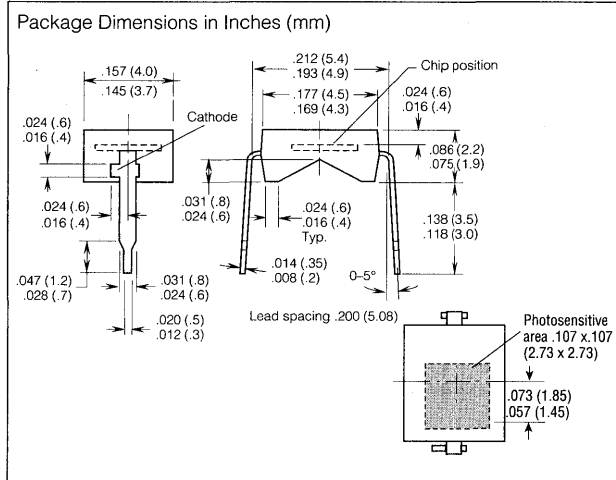
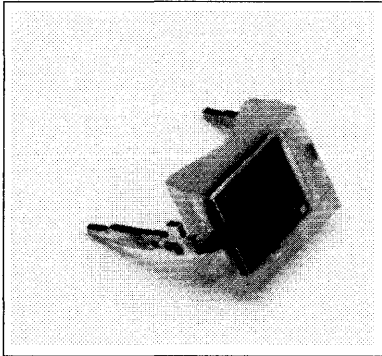

FEATURES

- Silicon Planar Photodiode
- N-Si Material: Anode=Front Contact, Cathode=Back Contact
- High Reliability
- No Testable Degradation
- Low Noise
- High Packing Density
- Short Switching Time
- High Spectral Sensitivity
- Wide Temperature Range
- Usage: Visible and Near Infrared Range (350 to 1100 nm)
- Very Low Dark Current
- Applications
 - Color Analysis
 - Detector for Low Light Levels
 - Photography—Exposure Meters
- Package: Lead Frame, Transparent Epoxy Resin, Solder Tabs, 0.200" (5.08 mm) Lead Spacing
- Cathode Marking: Projection on Solder Tab

Maximum Ratings

Operating and Storage Temperature Range (T_{OP} , T_{STG}) -40° to $+80^{\circ}$ C
 Soldering Temperature (2 mm from case bottom) (T_S) $t \leq 3$ s 230° C
 Reverse Voltage (V_R) 7 V
 Power Dissipation (P_{TOT}) $T_A=25^{\circ}$ C 150 mW

Characteristics ($T_A=25^{\circ}$ C)

Parameter	Symbol	Value	Unit
Photosensitivity ($V_R=5$ V) ⁽¹⁾	S	75 (≥ 35)	nA/lx
Maximum Photosensitivity Wavelength	λ_{Smax}	800	nm
Photosensitivity Spectral Range	λ	350 to 1100	nm
Radiant Sensitive Area	A	7.34	mm ²
Radiant Sensitive Area Dimensions	L x W	2.71 x 2.71	mm
Distance, Chip Surface to Case Surface	H	0.5	mm
Half Angle	ϕ	± 60	Deg.
Dark Current ($V_R=1$ V)	I_R	20 (≤ 100)	pA
Zero Cross Over ($E=0$)	S_0	≤ 2.5	pA/mV
Spectral Sensitivity ($\lambda=850$ nm)	S	0.59	A/W electrons
Quantum Yield ($\lambda=850$ nm)	η	0.86	photon
Open Circuit Voltage ($E_V=1000$ lx) ⁽¹⁾	V_O	440 (≥ 375)	mV
Short Circuit Current ($E_V=1000$ lx) ⁽¹⁾	I_{SC}	72	μ A
Rise and Fall Time of Photocurrent ($R_L=1$ K Ω , $V_R=5$ V, $\lambda=850$ nm, $I_P=70$ μ A)	t_R , t_F	1.5	μ s
Forward Voltage ($I_F=100$ mA, $E=0$)	V_F	1.3	V
Capacitance ($V_R=0$ V, $E=0$, $f=1$ MHz)	C_0	630	pF
Temperature Coefficient V_O	TC_V	-2.6	mV/K
Temperature Coefficient I_{SC}	TC_I	0.2	%/K
Noise Equivalent Power ($V_R=1$ V, $\lambda=850$ nm)	NEP	4.3×10^{-15}	W/Hz
Detection Limit ($V_R=1$ V, $\lambda=850$ nm)	D^*	6.3×10^{13}	$cm \cdot \sqrt{Hz}$

1. Illuminance shown refers to unfiltered radiation of tungsten filament lamp at color temperature of 2856 K (standard light A per DIN 5040 and IEC publication 306-1).

Relative spectral sensitivity $S_{REL}=f(\lambda)$

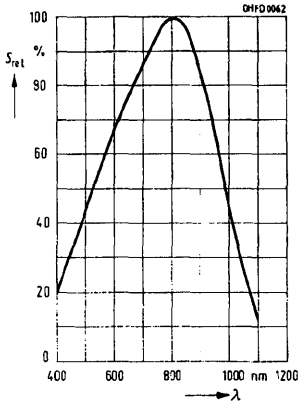

Photocurrent $I_p=f(E_V)$
Open circuit voltage $V_O=f(E_V)$

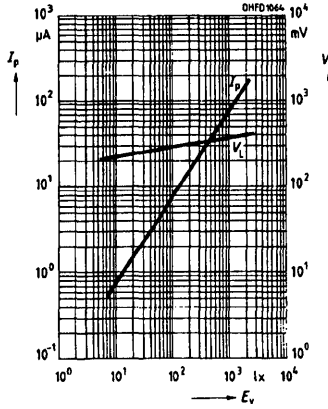

Directional characteristic $S_{REL}=f(\varphi)$

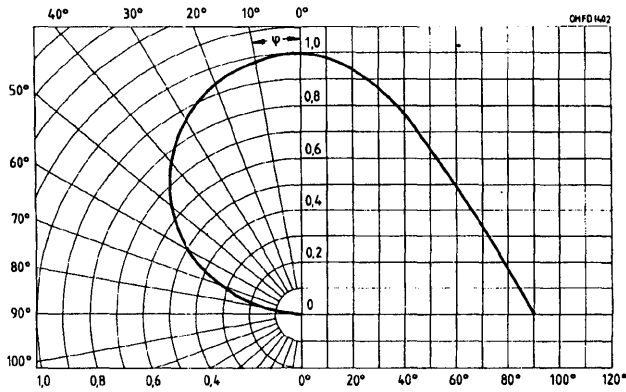

Power dissipation $P_{TOT}=f(T_A)$

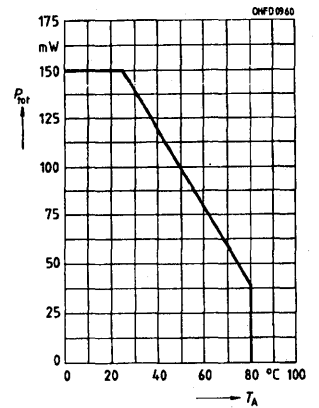

Dark current $I_R=f(V_R)$
 $T_A=25^\circ C, E=0$

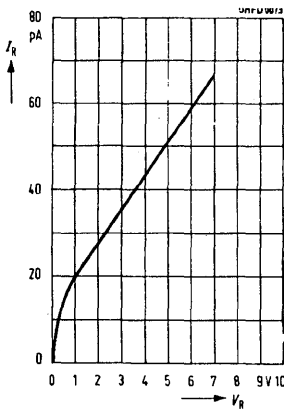

Capacitance $C=f(V_R)$
 $F=1 \text{ MHz}, E=0$

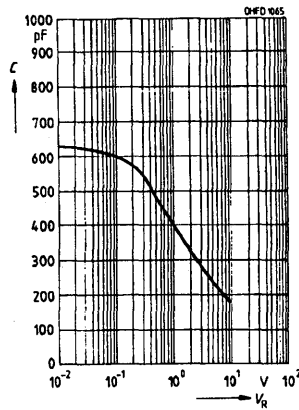

Dark current $I_R=f(T_A)$
 $V_R=1 \text{ V}, E=0$

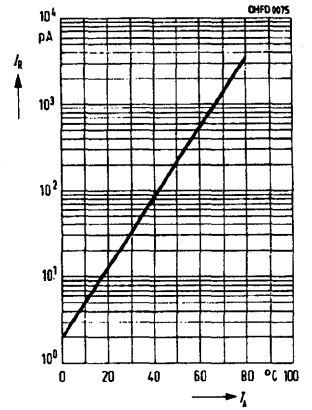

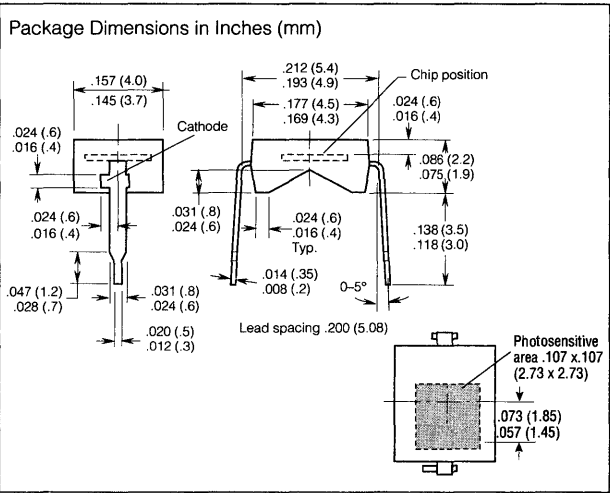
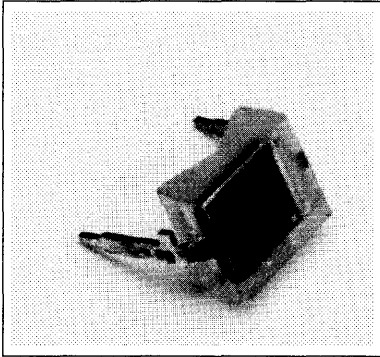

FEATURES

- Large Active Area Photodiode
- Silicon PIN Planar Photodiode
- N-Si Material: Anode=Front Contact, Cathode=Back Contact
- High Reliability
- No Testable Degradation
- Low Noise
- High Cutoff Frequency
- High Packing Density
- Short Switching Time
- Low Capacitance
- High Spectral Sensitivity
- Wide Temperature Range
- Usage: Visible and Near Infrared Range
- Applications
 - Light Reflecting Switches
 - IR Remote Controls
 - Measurement and Control
 - Light Curtains
 - IR Data Transmission
- Package: Lead Frame, Transparent Epoxy Resin, Solder Tabs, 0.200" (5.08 mm) Lead Spacing
- Cathode Marking: Projection on Solder Tab

Maximum Ratings

Operating and Storage Temperature Range (T_{OP} , T_{STG}) -40° to +80°C
 Soldering Temperature (2 mm from case bottom) (T_S) $t \leq 3$ s 230°C
 Reverse Voltage (V_R) 32 V
 Power Dissipation (P_{TOT}) $T_A = 25^\circ\text{C}$ 150 mW

Characteristics ($T_A = 25^\circ\text{C}$)

Parameter	Symbol	Value	Unit
Photosensitivity ($V_R = 5$ V) ⁽¹⁾	S	80 (≥ 50)	nA/lx
Maximum Photosensitivity Wavelength	λ_{Smax}	850	nm
Photosensitivity Spectral Range (S = 10% of S_{MAX})	λ	400 to 1100	nm
Radiant Sensitive Area	A	7.00	mm ²
Radiant Sensitive Area Dimensions	L x W	2.65 x 2.65	mm
Distance, Chip Surface to Case Surface	H	0.5	mm
Half Angle	ϕ	± 60	Deg.
Dark Current ($V_R = 10$ V)	I_R	2 (≤ 30)	nA
Spectral Photosensitivity ($\lambda = 850$ nm)	S	0.62	A/W electrons photon
Quantum Efficiency ($\lambda = 850$ nm)	η	0.90	
Open Circuit Voltage ($E_V = 1000$ lx) ⁽¹⁾	V_O	365 (≥ 300)	mV
Short Circuit Current ($E_V = 1000$ lx) ⁽¹⁾	I_{SC}	80	μA
Rise and Fall Time of Photocurrent ($R_L = 50 \Omega$, $V_R = 5$ V, $\lambda = 850$ nm, $I_P = 800 \mu\text{A}$)	t_R , t_F	20	ns
Forward Voltage ($I_F = 100$ mA, $E = 0$)	V_F	1.3	V
Capacitance ($V_R = 0$ V, $f = 1$ MHz, $E = 0$)	C_0	72	pF
Temperature Coefficient V_O	TC_V	-2.6	mV/K
Temperature Coefficient I_{SC} or I_P	TC_I	0.18	%/K
Noise Equivalent Power ($V_R = 10$ V, $\lambda = 850$ nm)	NEP	4.1×10^{-14}	W/ $\sqrt{\text{Hz}}$
Detection Limit ($V_R = 10$ V, $\lambda = 850$ nm)	D^*	6.6×10^{12}	$\text{cm} \cdot \sqrt{\text{Hz}}$

Note

1. Illuminance shown refers to unfiltered radiation of tungsten filament lamp at color temperature of 2856 K (standard light A per DIN 5033 and IEC publication 306-1).

Photodiodes

Relative spectral sensitivity
 $S_{REL}=f(\lambda)$

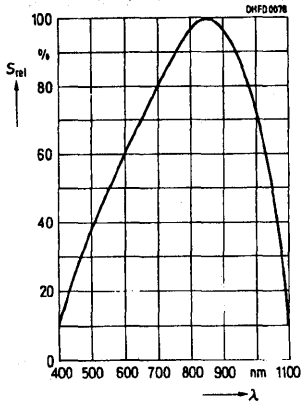

Photocurrent $I_p=f(E_v)$
Open circuit voltage $V_O=f(E_v)$

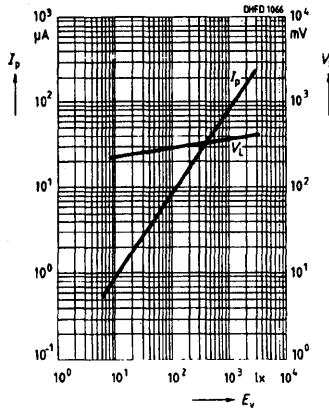

Directional characteristic $S_{REL}=f(\varphi)$

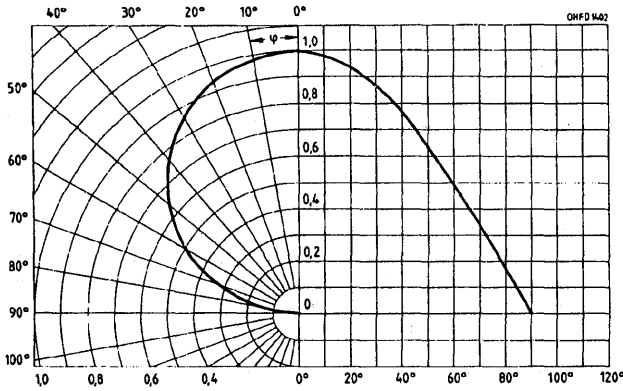

Power dissipation $P_{TOT}=f(T_A)$

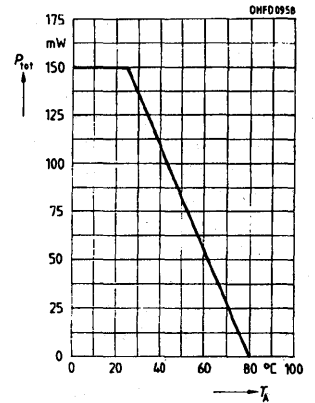

Dark current $I_R=f(V_R)$
 $T_A=25^\circ\text{C}, E=0$

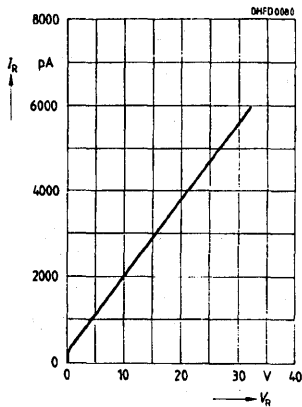

Capacitance $C=f(V_R)$
 $E=0, f=1 \text{ MHz}$

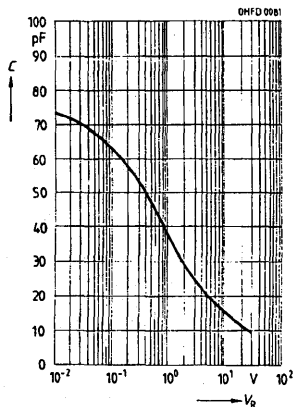

Dark current $I_R=f(T_A)$
 $V_R=10 \text{ V}, E=0$

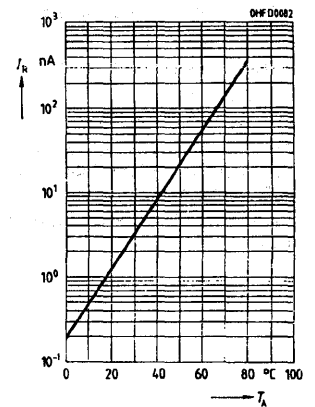

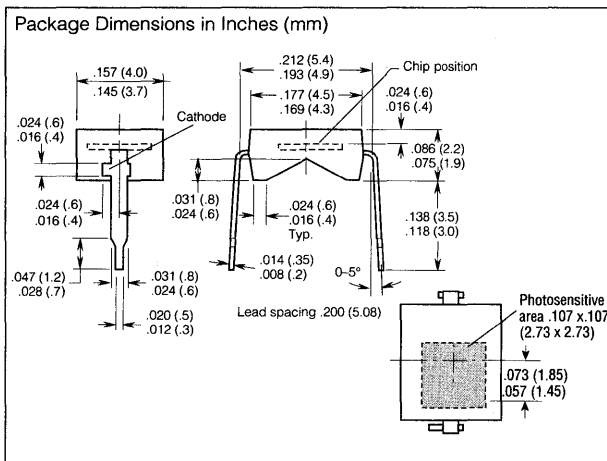
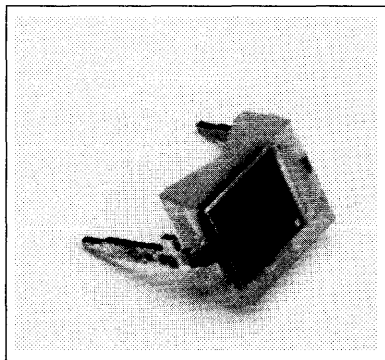

FEATURES

- Large Active Area Photodiode
- Silicon Planar PIN Photodiode
- N-Si Material: Anode=Front Contact, Cathode=Back Contact
- High Reliability
- No Testable Degradation
- Low Noise
- High Cutoff Frequency
- High Packing Density
- Short Switching Time
- Low Capacitance
- High Spectral Sensitivity
- Wide Temperature Range
- Usage: Visible and Near Infrared Range
- Enhanced Blue Sensitivity
- Applications
 - Detection of Halogen Lamps
 - Light Reflecting Switches
 - Detection of Visible Light Sources
 - Measurement and Control
- Package: Lead Frame, Transparent Epoxy Resin, Solder Tabs, 0.200" (5.08 mm) Lead Spacing
- Cathode Marking: Projection on Solder Tab

Maximum Ratings

Operating and Storage Temperature Range (T_{OP} , T_{STG}) -40° to +80°C
 Soldering Temperature (2 mm from case bottom) (T_S) $t \leq 3$ s 230°C
 Reverse Voltage (V_R) 32 V
 Power Dissipation (P_{TOT}) $T_A = 25^\circ\text{C}$ 150 mW

Characteristics ($T_A = 25^\circ\text{C}$)

Parameter	Symbol	Value	Unit
Photosensitivity ($V_R = 5$ V)	S	75	nA/lx
Maximum Photosensitivity Wavelength	$\lambda_{S_{MAX}}$	850	nm
Photosensitivity Spectral Range ($S = 10\%$ of S_{MAX})	λ	350 to 1100	nm
Radiant Sensitive Area	A	7.45	mm ²
Radiant Sensitive Area Dimensions	L x W	2.73 x 2.73	mm
Distance, Chip Surface to Case Surface	H	0.5	mm
Half Angle	ϕ	± 60	Deg.
Dark Current ($V_R = 10$ V, $E = 0$)	I_R	2 (≤ 30)	nA
Spectral Photosensitivity ($\lambda = 400$ nm)	S_λ	0.2	A/W
Quantum Efficiency ($\lambda = 400$ nm)	η	0.62	photon
Open Circuit Voltage ($E_V = 1000$ lx) ⁽¹⁾	V_O	390	mV
Short Circuit Current ($E_E = 0.5$ mW/cm ² , $\lambda = 400$ nm) ⁽¹⁾	I_{SC}	7.4 (≥ 5.4)	μA
Rise and Fall Time of Photocurrent ($R_L = 50 \Omega$, $V_R = 5$ V, $\lambda = 850$ nm, $I_P = 800 \mu\text{A}$)	t_R , t_F	25	ns
Forward Voltage ($I_F = 100$ mA, $E = 0$)	V_F	1.3	V
Capacitance ($V_R = 0$ V, $f = 1$ MHz, $E = 0$)	C_O	72	pF
Temperature Coefficient V_O	TC_V	-2.6	mV/K
Temperature Coefficient I_{SC}	TC_I	0.18	%/K
Noise Equivalent Power ($V_R = 10$ V, $\lambda = 400$ nm)	NEP	1.3×10^{-13}	W/ $\sqrt{\text{Hz}}$
Detection Limit ($V_R = 10$ V, $\lambda = 400$ nm)	D^*	2.1×10^{12}	cm $\cdot\sqrt{\text{Hz}}$ /W

Note

1. Illuminance shown refers to unfiltered radiation of tungsten filament lamp at color temperature of 2856 K (standard light A per DIN 5033 and IEC publication 306-1).

Relative spectral sensitivity
 $S_{REL}=f(\lambda)$

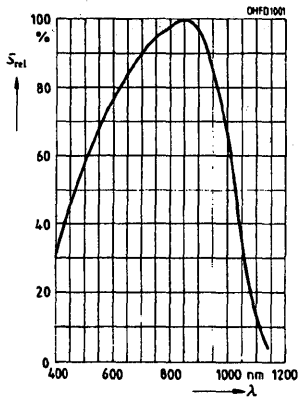

Photocurrent $I_p=f(E_V)$
Open circuit voltage $V_O=f(E_V)$

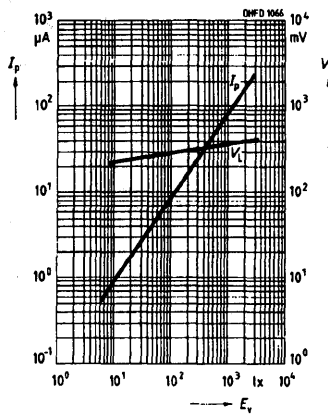

Directional characteristic $S_{REL}=f(\varphi)$

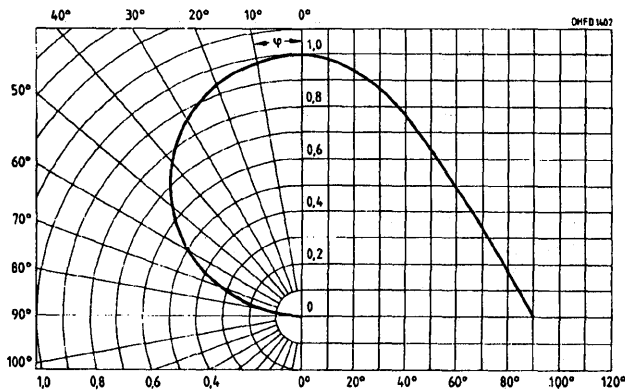

Power dissipation $P_{TOT}=f(T_A)$

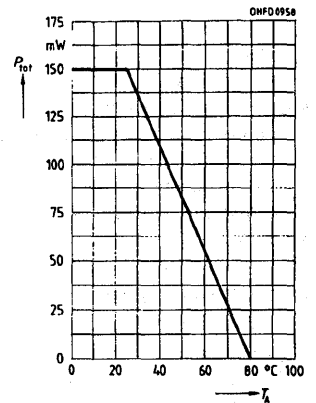

Dark current $I_R=f(V_R), E=0$

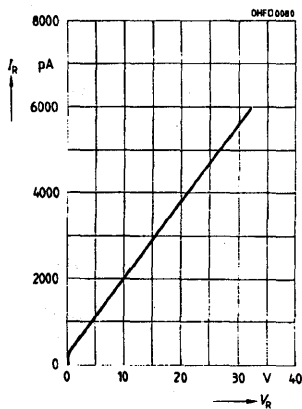

Capacitance $C=f(V_R), f=1$ MHz, $E=0$

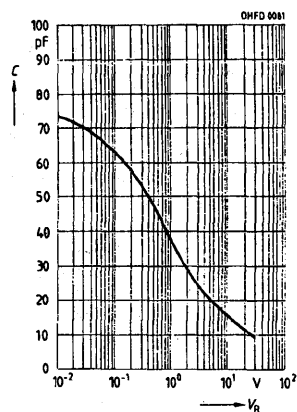

Dark current $I_R=f(T_A)$
 $V_R=10$ V, $E=0$

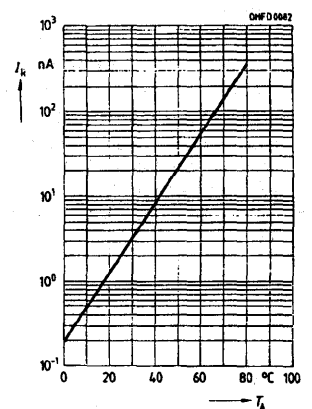

BPW 34FA SILICON PIN PHOTODIODE DAYLIGHT FILTER 830-880 nm RANGE

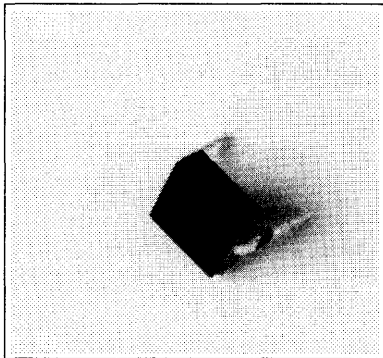

FEATURES

- Silicon Planar PIN Photodiode
- Daylight Filter
- Sensitivity Optimized for 830 to 880 nm Range
- N-Si Material: Anode=Front Contact, Cathode=Back Contact
- High Reliability
- No Testable Degradation
- Low Noise
- High Cutoff Frequency
- High Packing Density
- Short Switching Time
- Low Capacitance
- High Sensitivity
- Wide Temperature Range

DESCRIPTION

The BPW 34FA is a silicon planar PIN photodiode in a filtered plastic package with 0.200" (5.08 mm) lead spacing.

The spectral sensitivity is maximized in the 830 to 880 nm range, which makes it an ideal match for GaAlAs IR emitters with λ_{peak} at 880 nm (SFH 484, SFH 485, SFH 487).

The BPW 34FA's high sensitivity, fast switching times, low capacitance, compact size, and lack of measurable degradation make it suitable for diverse applications, such as TV and appliance remote control, IR sound transmission, video recorders, and measurement and control.

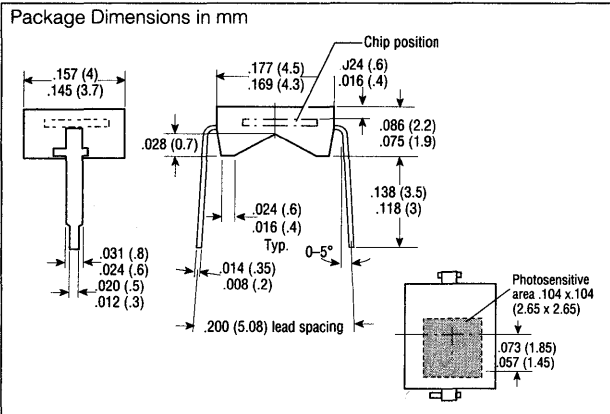

Maximum Ratings

Operating and Storage Temperature Range (T_{OP} , T_{STG}) -40° to +80°C
 Reverse Voltage (V_R) 32 V
 Power Dissipation (P_{TOT}) $T_A=25^\circ\text{C}$ 150 mW

Characteristics ($T_A=25^\circ\text{C}$)

Parameter	Symbol	Value	Unit
Photosensitivity			
($V_R=5\text{ V}$, $E_E=0.5\text{ mW/cm}^2$)	S	25(±20)	μA
Maximum Photosensitivity Wavelength	$\lambda_{S_{\text{MAX}}}$	880	nm
Photosensitivity Spectral Range			
($S=10\%$ of S_{MAX})	λ	730 to 1100	nm
Radiant Sensitive Area	A	7	mm^2
Radiant Sensitive Area Dimensions	L x W	2.65 x 2.65	mm
Distance, Chip Surface to Lens Surface	H	0.5	mm
Half Angle	ϕ	±60	Deg.
Dark Current ($V_R=10\text{ V}$)	I_R	2(±30)	nA
Spectral Sensitivity	S_λ	0.65	A/W
			<u>electrons</u>
Quantum Yield	η	0.93	photon
Open Circuit Voltage ($E_E=0.5\text{ mW/cm}^2$)	V_O	320(±250)	mV
Short Circuit Current ($E_E=0.5\text{ mW/cm}^2$)	I_{SC}	23	μA
Rise and Fall Time of Photocurrent			
10% to 90% and			
90% to 10% of Final Value			
($R_L=50\ \Omega$, $V_R=5\text{ V}$, $\lambda=830\text{ nm}$, $I_P=800\ \mu\text{A}$)	t_R , t_F	20	ns
Forward Voltage ($I_F=100\text{ mA}$, $E=0$)	V_F	1.3	V
Capacitance ($V_R=0\text{ V}$, $f=1\text{ MHz}$, $E=0$)	C_0	72	pF
Temperature Coefficient V_O	TC_{V_O}	-2.6	mV/K
Temperature Coefficient I_P	TC_{I_P}	0.03	%/K
Noise Equivalent Power ($V_R=10\text{ V}$)	NEP	3.9×10^{-14}	W/√Hz
Detection Limit ($V_R=10\text{ V}$)	D^*	6.8×10^{12}	$\text{cm}^2\sqrt{\text{Hz}}/\text{W}$

Relative spectral sensitivity $S_{REL}=f(\lambda)$

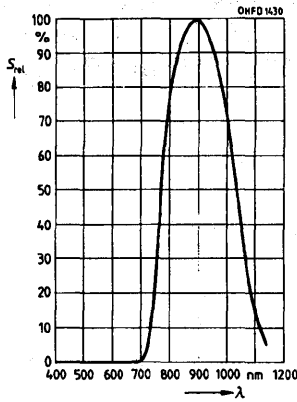

Photocurrent $I_p=f(E_E)$, $V_{REL}=5 V(\lambda)$
Open circuit voltage $V_O=f(E_E)$

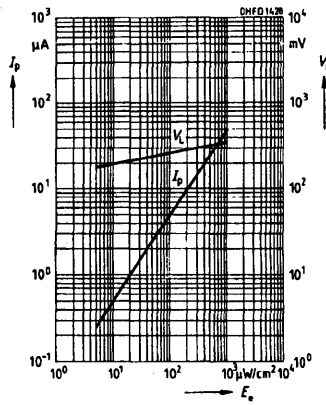

Directional characteristic $S_{REL}=f(\phi)$

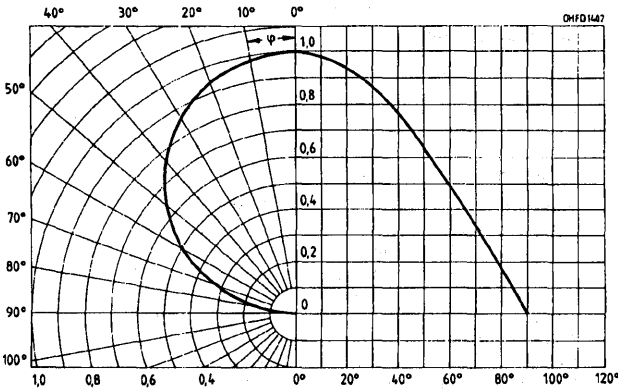

Total power dissipation $P_{TOT}=f(V_R)$, $E=0$

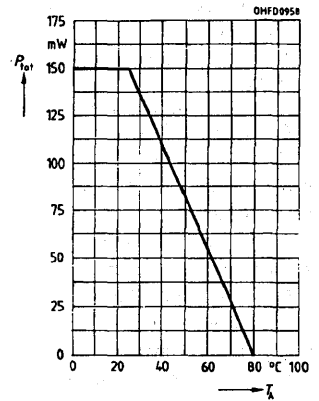

Dark current $I_R=f(V_R)$, $E=0$

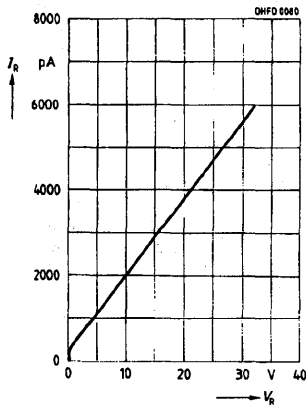

Capacitance $C=f(V_R)$, $f=1 \text{ MHz}$, $E=0$

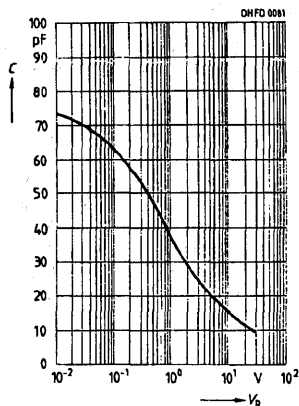

Dark current $I_R=f(T_A)$, $V_R=10 V$, $E=0$

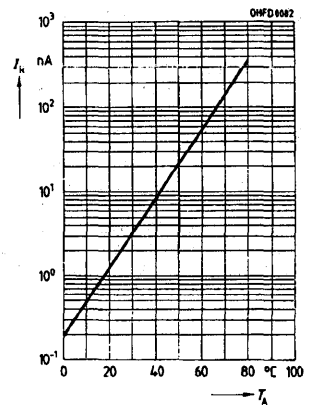

BPX 48 DAYLIGHT FILTER BPX 48F SILICON DIFFERENTIAL PHOTODIODE

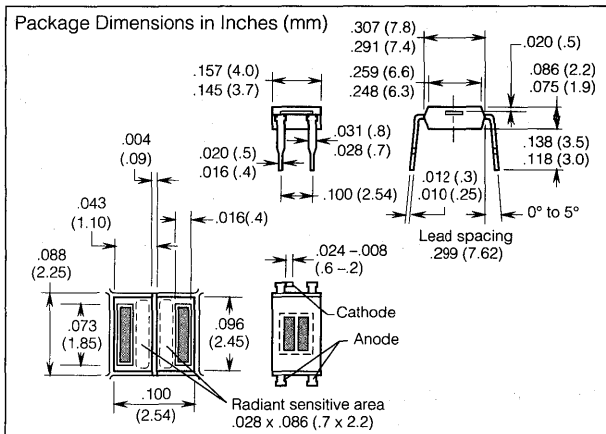
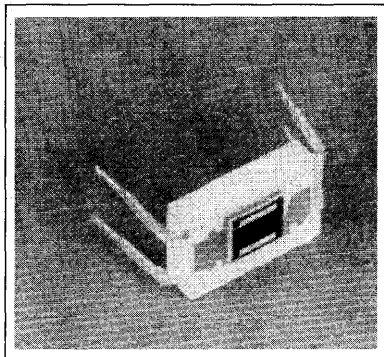

FEATURES

- Differential Photodiode
- Plastic Encapsulated, Strip Line Technique
- Tightly Spaced Diodes for Precise Positional Indication

DESCRIPTION

The differential photodiode BPX 48 is designed for special industrial electronic applications, such as edge detection and path and angle scanning. The individual diodes are spaced 90 μm apart, resulting in a highly precise positional indication. Silicon planar ensures low dark current, low noise, and excellent signal-to-noise relationships.

Maximum Ratings

Operating and Storage Temperature Range (T_{OP} , T_{STG})	-40° to +80°C
Soldering Temperature (2 mm from case bottom) (T_S) $t_S \leq 3$ s	230°C
Reverse Voltage (V_R)	10 V
Power Dissipation (P_{TOT}) $T_A = 25^\circ\text{C}$	50 mW

Characteristics Single Diode ($T_A = 25^\circ\text{C}$)

Parameter	Symbol	Value		Unit
		BPX48	BPX48F	
Spectral Sensitivity ($V_R = 5$ V)	S	24(≥ 15)	-	nA/lx
($V_R = 5$ V, $\lambda = 950$ nm, $E_E = 0.5$ mW/cm 2)	S	-	7.5(≥ 4.0)	μA
Maximum Photosensitivity Wavelength	λ_{Smax}	900	920	nm
Sensitivity Spectral Range ($S = 10\%$ of S_{MAX})	λ	400 to 1150	750 to 1150	nm
Radiant Sensitive Area	A	1.54	1.54	mm 2
Radiant Sensitive Area Dimensions	L x B	0.7 x 2.2	0.7 x 2.2	mm
Distance, Chip Surface to Case Surface	H	0.5	0.5	mm
Half Angle	ϕ	± 60	± 60	Deg.
Dark Current ($V_R = 10$ V)	I_R	10(≤ 100)	10(≤ 100)	nA
Spectral Sensitivity $\lambda = 850$ nm	S_λ	0.55	-	A/W
$\lambda = 950$ nm	S_λ	-	0.65	
Maximum Deviation, Systems Spectral Sensitivity from Mean	ΔS	± 5	± 5	%
Quantum Efficiency $\lambda = 850$ nm	η	0.8	-	electrons photon
$\lambda = 950$ nm		-	0.95	
Open Circuit Voltage ($E_V = 1000$ lx) $^{(1)}$	V_O	330(≥ 280)	-	mV
($E_E = 0.5$ mW/cm 2 , $\lambda = 950$ nm)	V_O	-	300(≥ 280)	mV
Short Circuit Current ($E_V = 1000$ lx) $^{(1)}$	I_{SC}	24	-	μA
($E_E = 0.5$ mW/cm 2 , $\lambda = 950$ nm)	I_{SC}	-	7	μA
Rise and Fall Time of Photocurrent ($R_L = 1$ K Ω , $V_R = 5$ V, $\lambda = 850$ nm, $I_P = 20$ μA)	t_{R1} , t_{F1}	500	500	ns
Forward Voltage ($I_F = 40$ mA, $E = 0$)	V_F	1.3	1.3	V
Capacitance ($V_R = 0$ V, $f = 1$ MHz, $E = 0$)	C_0	25	25	pF
Temperature Coefficient V_O	TC_V	-2.6	-2.6	mV/K
Temperature Coefficient I_{SC}	TC_I	0.18	-	%/K
Temperature Coefficient I_{SC} ($\lambda = 950$ nm)	TC_I	-	0.2	%/K
Noise Equivalent Power ($V_R = 10$ V, $\lambda = 950$ nm)	NEP	1.0×10^{-13}	1.0×10^{-13}	W/Hz
Detection Limit ($V_R = 10$ V, $\lambda = 950$ nm)	D^*	1.2×10^{12}	1.2×10^{12}	cm 2 Hz/W

Note

1. Illuminance shown refers to unfiltered radiation of tungsten filament lamp at color temperature of 2856 K (standard light A per DIN 5033 and IEC publication 306-1).

BPX 48
Relative spectral sensitivity
 $S_{REL}=f(\lambda)$

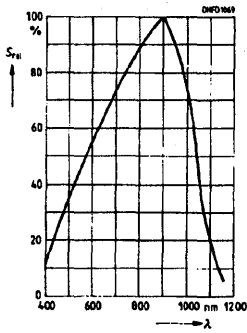

BPX 48F
Relative spectral sensitivity
 $S_{REL}=f(\lambda)$

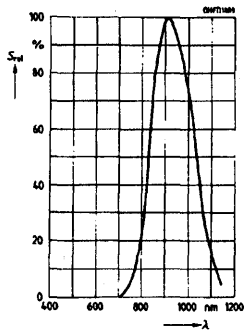

BPX 48
Photocurrent $I_p=f(E_V)$
Open circuit voltage $V_O=f(E_V)$

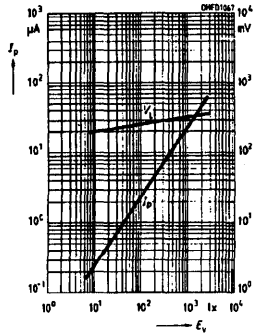

BPX 48F
Photocurrent $I_p=f(E_V)$, $V_R=5$ V
Open circuit voltage $V_O=f(E_V)$

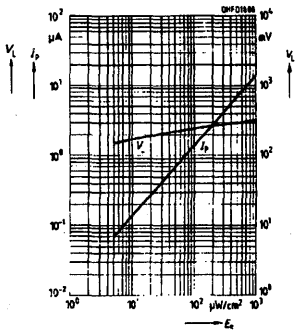

Directional characteristic $S_{REL}=f(\varphi)$

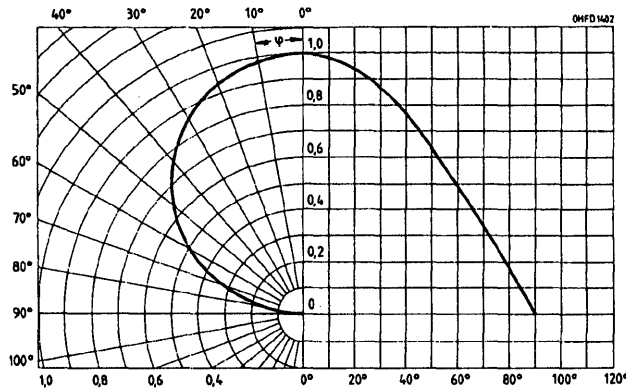

Power dissipation $P_{TOT}=f(T_A)$

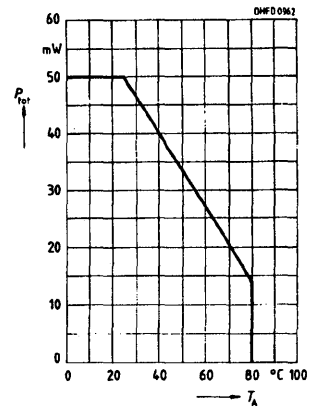

Dark current $I_R=f(V_R)$, $f=1$ MHz, $E=0$

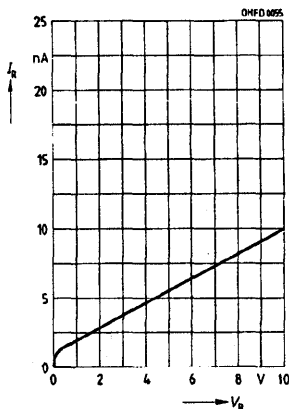

Capacitance $C=f(V_R)$

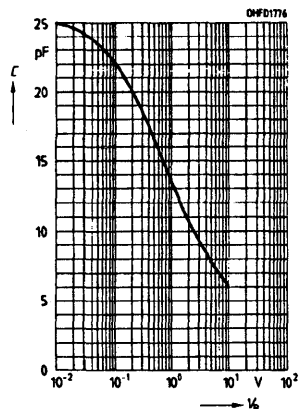

Dark current $I_R=f(T_A)$, $V_R=10$ V

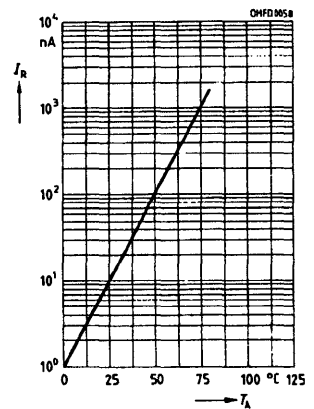

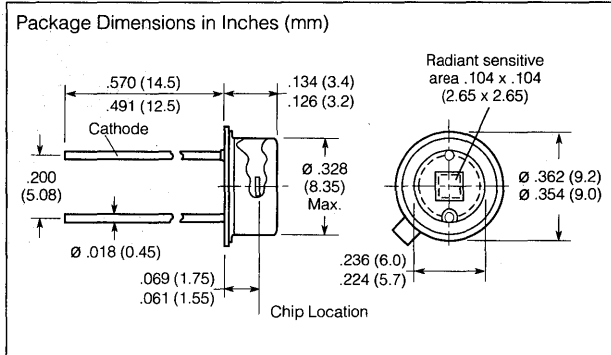
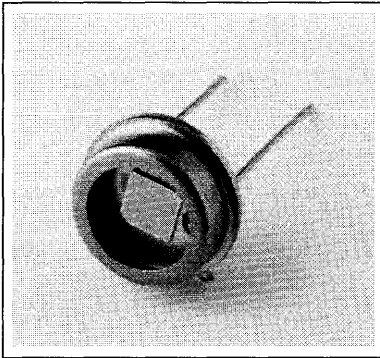

FEATURES

- Silicon Planar Photodiode
- Premium, High-Reliability Device
- Modified TO-5 Hermetic Case
- Flat Glass Lens
- Large Photosensitive Area
- Usage: Visible and IR Ranges

DESCRIPTION

The BPX 60 is a silicon planar photodiode. The hermetically sealed case—a TO-5 modification with a flat glass window—allows use at extreme operating conditions. The signal/noise ratio is favorable, even at low light levels. The open circuit voltage at low light levels is higher than with comparable mesa photovoltaic cells.

Maximum Ratings

Operating and Storage Temperature Range (T_{OP} , T_{STG})	-40° to +80°C
Soldering Temperature (≥ 2 mm from case bottom) (T_S) $t \leq 3$ s	230°C
Reverse Voltage (V_R)	32 V
Power Dissipation (P_{TOT}) $T_A = 25^\circ\text{C}$	250 mW

Characteristics ($T_A = 25^\circ\text{C}$)

Parameter	Symbol	Value	Unit
Photosensitivity ($V_R = 5$ V)	S	70	nA/lx
Maximum Photosensitivity Wavelength	λ_{Smax}	850	nm
Photosensitivity Spectral Range (S=10% of S_{MAX})	λ	350 to 1100	nm
Radiant Sensitive Area	A	7.45	mm ²
Radiant Sensitive Area Dimensions	L x W	2.73 x 2.73	mm
Distance, Chip Surface to Case Surface	H	1.9 to 2.3	mm
Half Angle	ϕ	± 55	Deg.
Dark Current ($V_R = 10$ V)	I_R	7 (≤ 300)	nA
Spectral Photosensitivity ($\lambda = 400$ nm)	S_λ	0.20	A/W
			electrons
			photon
Quantum Efficiency ($\lambda = 400$ nm)	η	0.62	mV
Open Circuit Voltage ($E_v = 1000$ lx) ⁽¹⁾	V_0	460	mV
Short Circuit Current ($E_v = 0.5$ mW/cm ² , $\lambda = 400$ nm)	I_{SC}	7.4 (≥ 5.4)	μA
Rise and Fall Time of Photocurrent ($R_L = 1$ K Ω , $V_R = 5$ V, $\lambda = 850$ nm, $I_p = 70$ μA)	t_R , t_F	3.0	μs
Forward Voltage ($I_F = 100$ mA, $E_E = 0$)	V_F	1.3	V
Capacitance ($V_R = 0$ V, $f = 1$ MHz, $E_v = 0$ lx)	C_0	580	pF
Temperature Coefficient V_0	TC_V	-2.6	mV/K
Temperature Coefficient I_{SC}	TC_I	0.18	%/K
Noise Equivalent Power ($V_R = 10$ V, $\lambda = 400$ nm)	NEP	2.4×10^{-13}	W/Hz
Detection Limit ($V_R = 10$ V, $\lambda = 400$ nm)	D^*	1.2×10^{12}	$\text{cm} \cdot \sqrt{\text{Hz}}/\text{W}$

Note

1. Illuminance shown refers to unfiltered radiation of tungsten filament lamp at color temperature of 2856 K (standard light A per DIN 5033 and IEC publication 306-1).

Relative spectral sensitivity $S_{REL}=f(\lambda)$

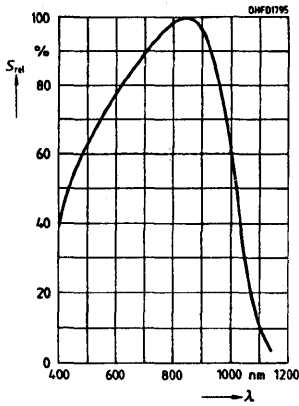

Photocurrent $I_P=f(E_V)$
Open circuit voltage $V_O=f(E_V)$

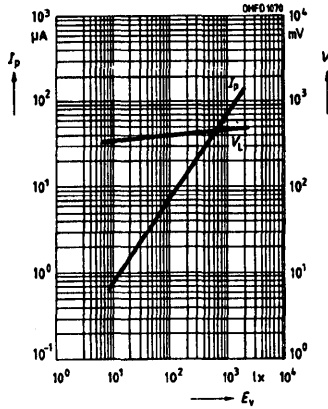

Directional characteristic $S_{REL}=f(\varphi)$

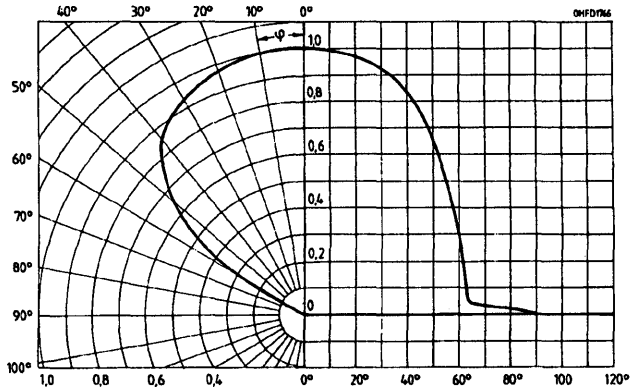

Power dissipation $P_{TOT}=f(T_A)$

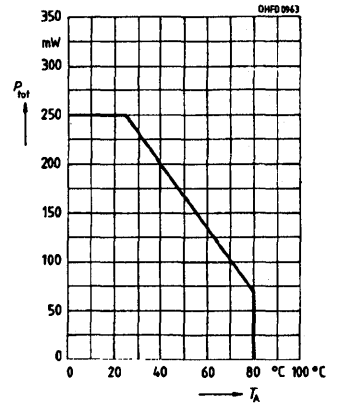

Dark current $I_R=f(V_R), E=0$

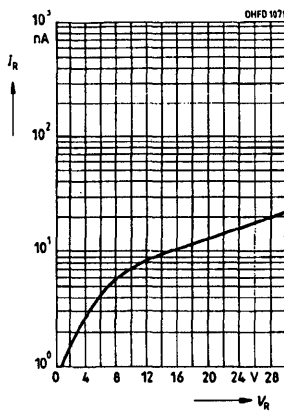

Capacitance $C=f(V_R), f=1$ MHz, $E=0$

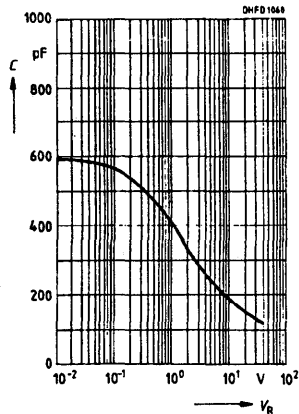

Dark current $I_R=f(T_A), V_R=10$ V

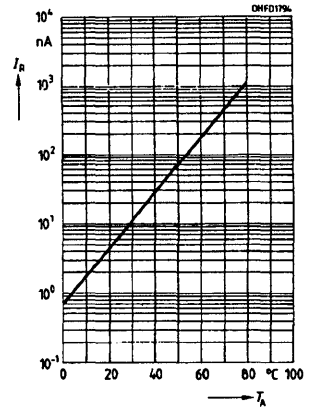

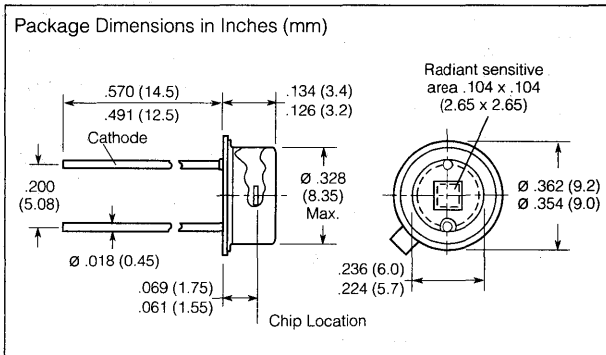
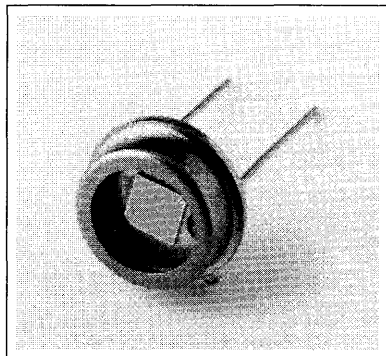

FEATURES

- Silicon Planar PIN Photodiode
- Premium, High-Reliability Device
- Modified TO-5 Hermetic Case
- Flat Glass Lens
- Large Photosensitive Area
- Usage: Visible and IR Ranges
- Low Dark Current
- Short Switching Time

DESCRIPTION

The BPX 61 is a silicon planar PIN photodiode with low reverse current. Its low capacitance permits use up to 10 MHz. The hermetically sealed package—a TO-5 modification with a flat glass window—allows use at extreme operating conditions. The signal/noise ratio is favorable, even at low light levels. The open circuit voltage at low light levels is higher than with comparable mesa photovoltaic cells. The PIN photodiode provides outstanding low junction capacitance, high cut-off frequency, and short switching times.

Maximum Ratings

Operating and Storage Temperature Range (T_{OP} , T_{STG})	-40° to +80°C
Soldering Temperature (≥ 2 mm from case bottom) (T_S) ≤ 3 s	230°C
Reverse Voltage (V_R)	32 V
Power Dissipation (P_{TOT}) $T_A=25^\circ\text{C}$	250 mW

Characteristics ($T_A=25^\circ\text{C}$)

Parameter	Symbol	Value	Unit
Photosensitivity ($V_R=5$ V) ⁽¹⁾	S	70(≥ 50)	nA/lx
Maximum Photosensitivity Wavelength	λ_{Smax}	850	nm
Photosensitivity Spectral Range (S=10% of S_{MAX})	λ	400 to 1100	nm
Radiant Sensitive Area	A	7.00	mm ²
Radiant Sensitive Area Dimensions	L x W	2.65 x 2.65	mm
Distance, Chip Surface to Case Surface	H	1.9 to 2.3	mm
Half Angle	ϕ	± 55	Deg.
Dark Current ($V_R=10$ V)	I_R	2(≤ 30)	nA
Spectral Photosensitivity ($\lambda=850$ nm)	S_λ	0.62	A/W <u>electrons</u> photon
Quantum Efficiency ($\lambda=850$ nm)	η	0.90	
Open Circuit Voltage ($E_v=1000$ lx) ⁽¹⁾	V_0	375(≥ 320)	mV
Short Circuit Current ($E_v=1000$ lx) ⁽¹⁾	I_{SC}	70	μA
Rise and Fall Time of Photocurrent ($R_L=50$ Ω , $V_R=5$ V, $\lambda=850$ nm, $I_p=800$ μA)	t_R , t_F	20	ns
Forward Voltage ($I_F=100$ mA, $E_F=0$)	V_F	1.3	V
Capacitance ($V_R=0$ V, $f=1$ MHz, $E_v=0$ lx)	C_0	72	pF
Temperature Coefficient V_0	TC_V	-2.6	mV/K
Temperature Coefficient I_{SC}	TC_I	0.18	%/K
Noise Equivalent Power ($V_R=10$ V, $\lambda=850$ nm)	NEP	4.1×10^{-14}	W/Hz
Detection Limit ($V_R=10$ V, $\lambda=850$ nm)	D^*	6.6×10^{12}	$\text{cm} \cdot \sqrt{\text{Hz}}/\text{W}$

Note

1. Illuminance shown refers to unfiltered radiation of tungsten filament lamp at color temperature of 2856 K (standard light A per DIN 5033 and IEC publication 306-1).

Relative spectral sensitivity $S_{REL}=f(\lambda)$

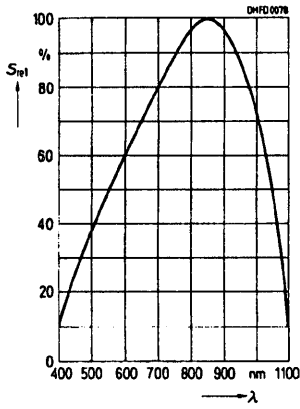

Photocurrent $I_P=f(E_V)$, $V_R=5 V$
Open circuit voltage $V_O=f(E_V)$

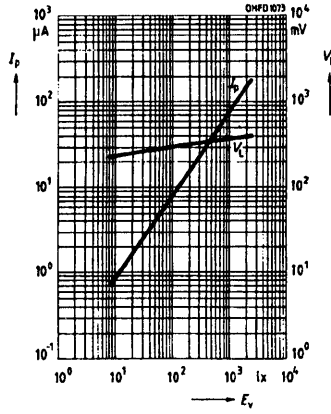

Directional characteristic $S_{REL}=f(\varphi)$

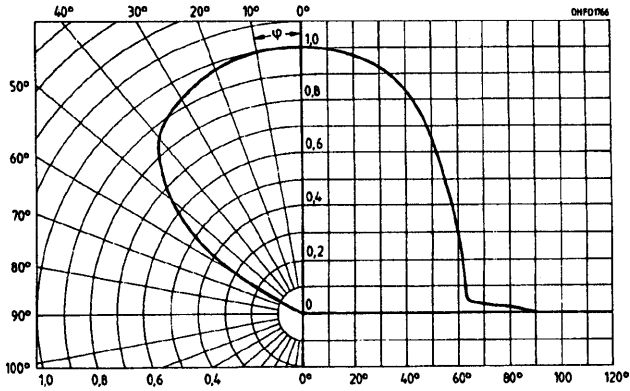

Power dissipation $P_{TOT}=f(T_A)$

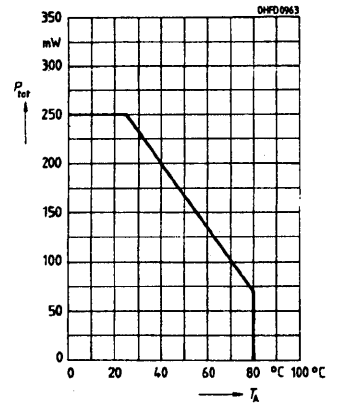

Dark current $I_R=f(V_R)$, $E=0$

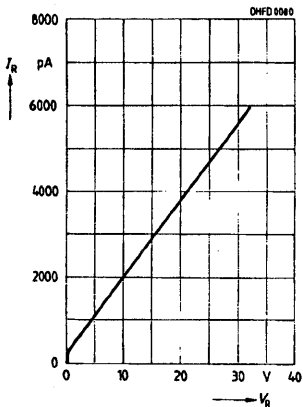

Capacitance $C=f(V_R)$, $f=1 MHz$, $E=0$

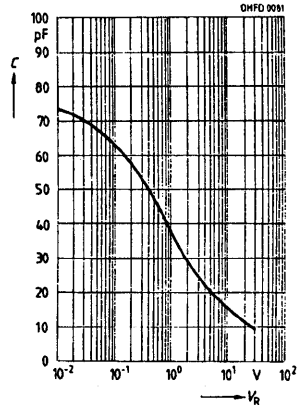

Dark current $I_R=f(T_A)$, $V_R=10$, $E=0$

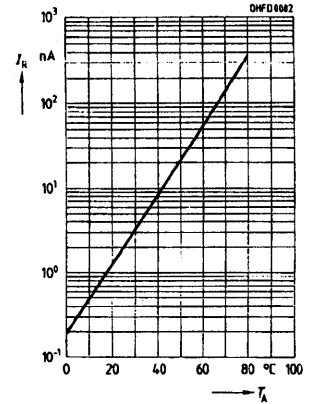

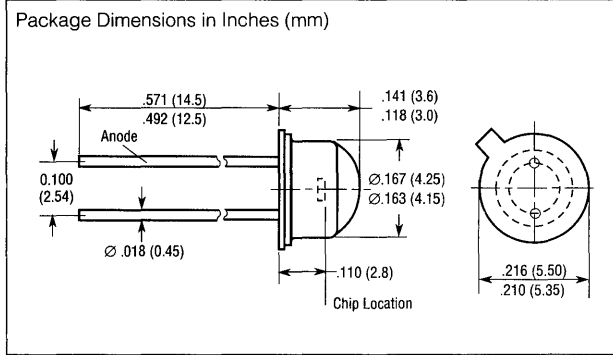
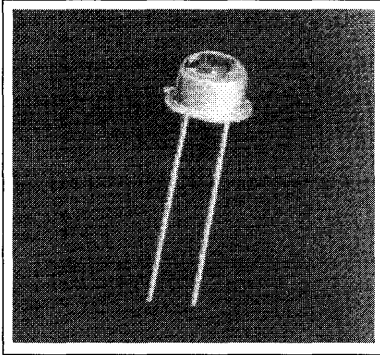

FEATURES

- Silicon Planar Photodiode
- Modified TO18 Hermetic Case
- Very Low Dark Current
- Metal Case and Plastic Lens

DESCRIPTION

The BPX 63 is a silicon planar photodiode, mounted on a TO18 base plate and covered with transparent plastic. The BPX 63 has been developed as a detector for low light levels. It is outstanding for low dark currents and, when used as a voltaic cell, for a high open circuit voltage at low light levels. The cathode of the BPX 63 is electrically connected to the package.

Maximum Ratings

Operating and Storage Temperature Range (T_{OP} , T_{STG}) -40° to $+80^{\circ}$ C
 Soldering Temperature (≥ 2 mm from case bottom) (T_S) $t \leq 3$ s 230° C
 Reverse Voltage (V_R) 7 V
 Power Dissipation (P_{TOT}) $T_A = 25^{\circ}$ C 200 mW

Characteristics ($T_A = 25^{\circ}$ C)

Parameter	Symbol	Value	Unit
Photosensitivity ($V_R = 5$ V) ⁽¹⁾	S	10 (≥ 8)	nA/lx
Maximum Photosensitivity Wavelength	λ_{Smax}	800	nm
Photosensitivity Spectral Range (S=10% of S_{MAX})	λ	350 to 1100	nm
Radiant Sensitive Area	A	0.97	mm ²
Radiant Sensitive Area Dimensions	L x W	0.985 x 0.985	mm
Distance, Chip Surface to Case Surface	H	0.2 to 0.8	mm
Half Angle	ϕ	± 75	Deg.
Dark Current ($V_R = 10$ V)	I_R	5 (≤ 20)	pA
Zero Cross Over ($E_V = 0$)	S_0	≤ 0.4	pA/mV
Spectral Photosensitivity ($\lambda = 850$ nm)	S_λ	0.50	A/W
			<u>electrons</u>
Quantum Efficiency ($\lambda = 850$ nm)	η	0.73	photon
Open Circuit Voltage ($E_V = 1000$ lx) ⁽¹⁾	V_0	450 (≥ 380)	mV
Short Circuit Current ($E_V = 1000$ lx) ⁽¹⁾	I_{SC}	10	μ A
Rise and Fall Time of Photocurrent ($R_L = 1$ K Ω , $V_R = 5$ V, $\lambda = 850$ nm, $I_P = 10$ μ A)	t_R , t_F	1.3	μ s
Forward Voltage ($I_F = 100$ mA, $E_E = 0$)	V_F	1.3	V
Capacitance ($V_R = 0$ V, $f = 1$ MHz, $E_V = 0$ lx)	C_0	100	pF
Temperature Coefficient V_0	TC_V	-2.6	mV/K
Temperature Coefficient I_{SC}	TC_I	0.16	%/K
Noise Equivalent Power ($V_R = 1$ V, $\lambda = 850$ nm)	NEP	2.5×10^{-15}	W/ \sqrt Hz
Detection Limit ($V_R = 1$ V, $\lambda = 850$ nm)	D^*	3.9×10^{13}	cm \cdot \sqrt Hz/W

Note
 1. Illuminance shown refers to unfiltered radiation of tungsten filament lamp at color temperature of 2856 K (standard light A per DIN 5033 and IEC publication 306-1).

Relative spectral sensitivity $S_{REL}=f(\lambda)$

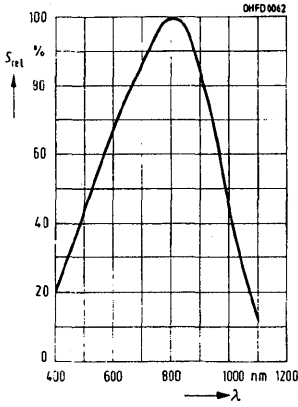

Photocurrent $I_p=f(E_V)$, $V_R=5\text{ V}$
Open circuit voltage $V_O=f(E_V)$

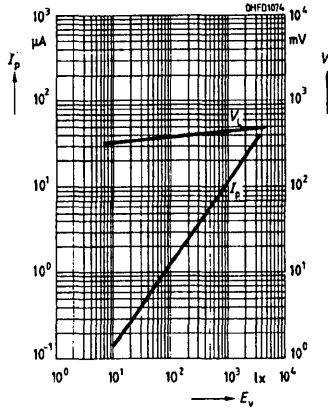

Directional characteristic $S_{REL}=f(\varphi)$

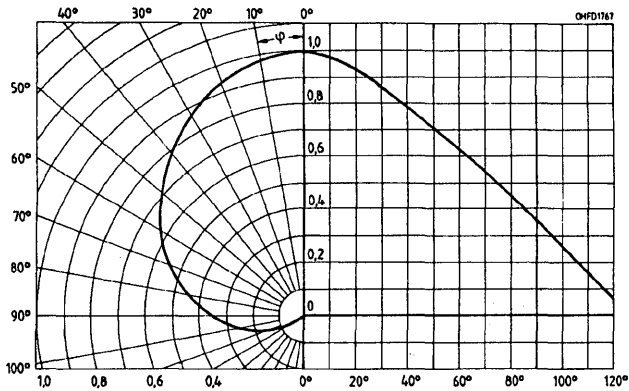

Power dissipation $P_{TOT}=f(T_A)$

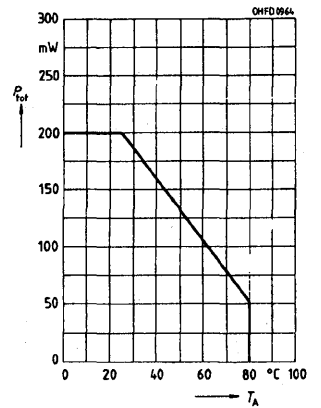

Dark current $I_R=f(V_R)$, $E=0$

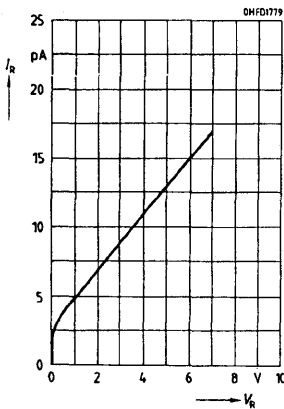

Capacitance $C=f(V_R)$, $f=1\text{ MHz}$, $E=0$

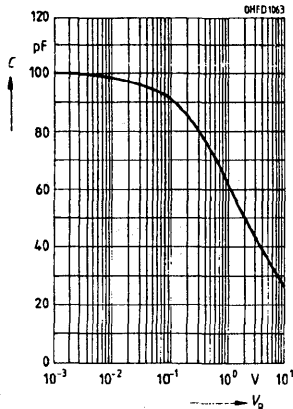

Dark current $I_R=f(T_A)$, $E_V=0$, $V_R=1\text{ V}$

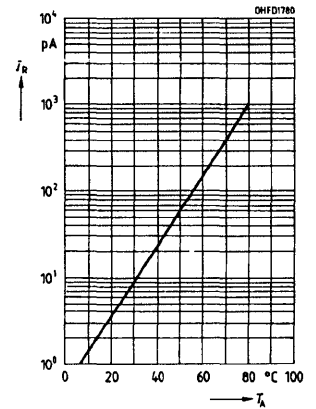

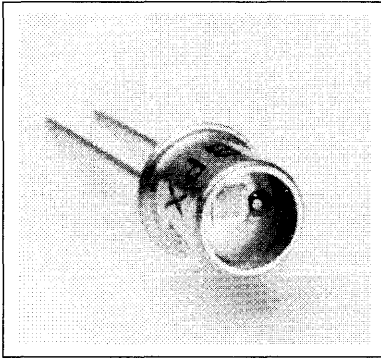

Package Dimensions in Inches (mm)

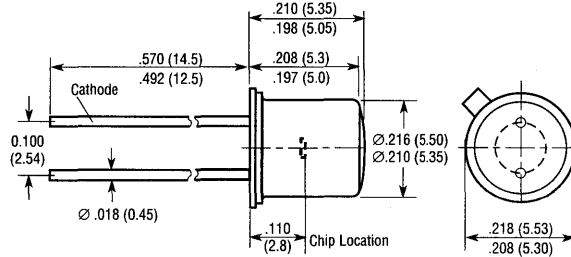

FEATURES

- Silicon Planar PIN Photodiode
- Premium, High-Reliability Device
- TO18 Size Package
- Flat Glass Lens
- High Speed
- Usage: Visible and IR Ranges
- Low Dark Current
- BPX 66: Low Reverse Current

DESCRIPTION

The BPX 65 is a silicon planar PIN photodiode in an 18 A 2 DIN 41876 package (similar to TO18) with a flat window. The cathode is electrically connected to the package. The flat window has no effect on the beam path of optical lens systems. Because of its high cut-off frequency, this diode is well-suited for use as a high-modulation bandwidth optical sensor. The PIN photodiode provides low junction capacitance and short switching times.

Maximum Ratings

Operating and Storage Temperature Range (T_{OP} , T_{STG}) -40° to $+80^{\circ}$ C
 Soldering Temperature (≥ 2 mm from case bottom) (T_S) $t \leq 3$ s 230° C
 Reverse Voltage (V_R) 50 V
 Power Dissipation (P_{TOT}) 230 mW

Characteristics ($T_A = 25^{\circ}$ C)

Parameter	Symbol	Value	Unit
Photosensitivity ($V_R = 5$ V)	S	$10 (\geq 5.5)$	nA/lx
Maximum Photosensitivity Wavelength	λ_{Smax}	850	nm
Photosensitivity Spectral Range ($S = 10\%$ of S_{MAX})	λ	350 to 1100	nm
Radiant Sensitive Area	A	1.00	mm ²
Radiant Sensitive Area Dimensions	L x B	1 x 1	mm
Distance, Chip Surface to Case Surface	H	2.25 to 2.25	mm
Half Angle	ϕ	± 40	Deg.
Dark Current			
BPX 65 ($V_R = 20$ V)	I_R	$1 (\leq 5)$	nA
BPX 66 ($V_R = 1$ V)	I_R	$0.15 (\leq 0.3)$	nA
Spectral Sensitivity ($\lambda = 850$ nm)	S_λ	0.55	A/W electrons
Quantum Yield ($\lambda = 850$ nm)	η	0.80	photon
Open Circuit Voltage ($E_V = 1000$ lx)	V_O	$320 (\geq 270)$	mV
Short Circuit Current ($E_V = 1000$ lx)	I_{SC}	10	μ A
Rise and Fall Time of Photocurrent ($R_L = 50 \Omega$, $V_R = 5$ V, $\lambda = 850$ nm, $I_P = 800 \mu$ A)	t_R , t_F	12	ns
Forward Voltage ($I_F = 100$ mA, $E = 0$)	V_F	1.3	V
Capacitance ($V_R = 0$ V, $f = 1$ MHz, $E_V = 0$)	C_0	11	pF
Temperature Coefficient V_O	TC_V	-2.6	mV/K
Temperature Coefficient I_{SC}	TC_I	0.2	%/K
Noise Equivalent Power ($V_R = 20$ V, $\lambda = 850$ nm)	NEP	3.3×10^{-14}	W/ \sqrt Hz
Detection Limit ($V_R = 20$ V, $\lambda = 850$ nm)	D^*	3.1×10^{12}	$cm \cdot \sqrt$ Hz/W

Relative spectral sensitivity $S_{REL}=f(\lambda)$

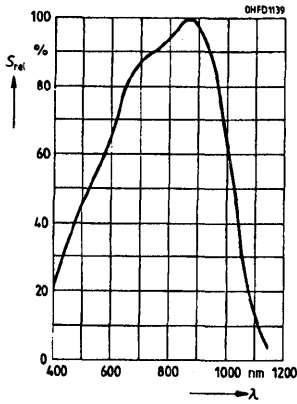

Photocurrent $I_P=f(E_V)$, $V_R=5\text{ V}$
Open circuit voltage $V_O=f(E_V)$

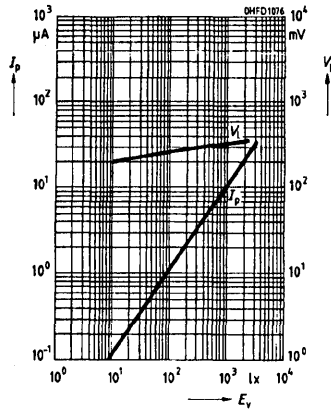

Power dissipation $P_{TOT}=f(T_A)$

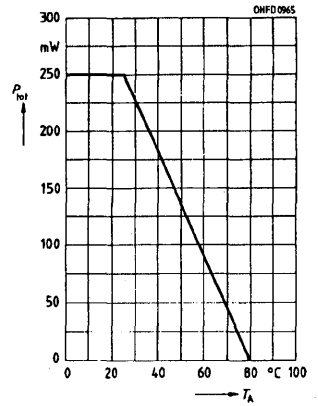

Directional characteristic $S_{REL}=f(\varphi)$

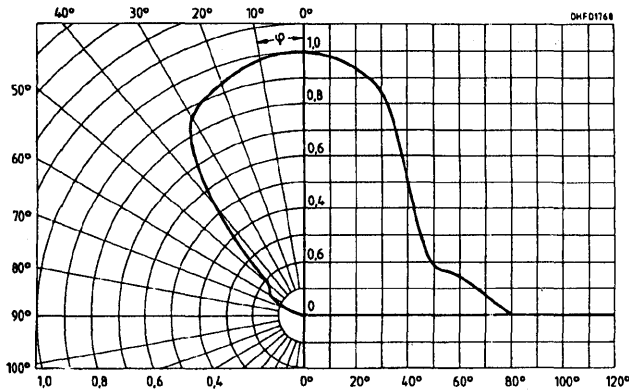

Dark current $I_R=f(V_R)$, $E=0$

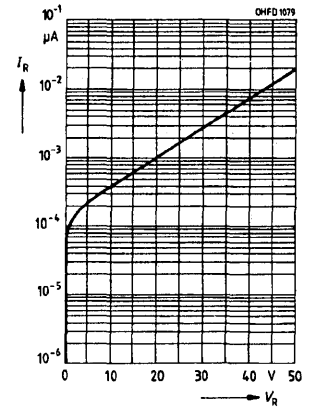

Capacitance $C=f(V_R)$, $E=0$, $f=1\text{ MHz}$

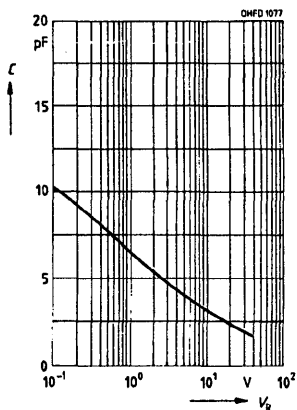

Dark current $I_R=f(T_A)$, $E=0$, $V_R=20\text{ V}$

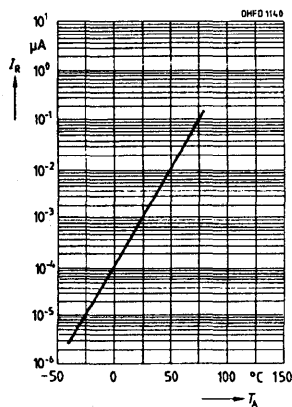

Series resistance $R_S=f(V_R)$, $E=0$, $f=100\text{ MHz}$

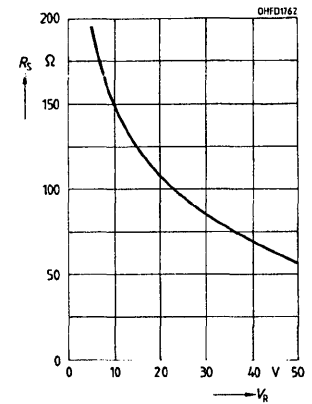

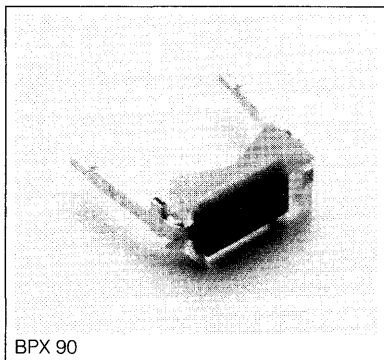

BPX 90

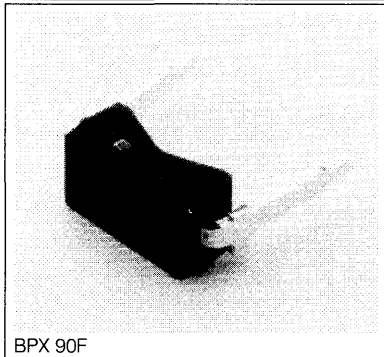

BPX 90F

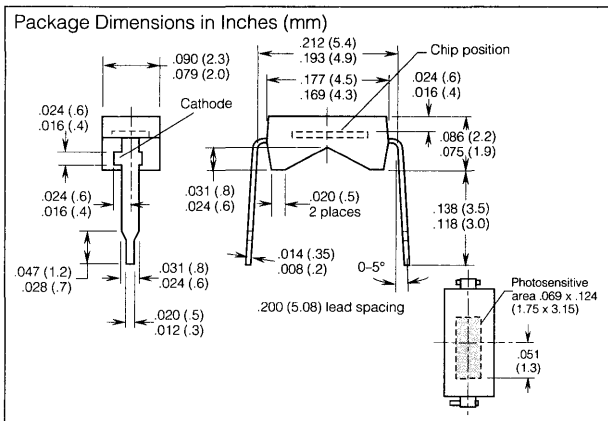

Maximum Ratings

Operating and Storage Temperature Range (T_{OP} , T_{STG}) -40° to +80°C
 Soldering Temperature (2 mm from case bottom) (T_S) $t \leq 3$ s 230°C
 Reverse Voltage (V_R) 32 V
 Power Dissipation (P_{TOT}) $T_A = 25^\circ\text{C}$ 100 mW

Characteristics ($T_A = 25^\circ\text{C}$)

Parameter	Symbol	Value		Unit
		BPX90	BPX90F	
Photosensitivity				
($V_R = 5$ V, Standard Light A, $T = 2856$ K)	S	45 (≥ 25)	-	nA/lx
($V_R = 5$ V, $\lambda = 950$ nm, $E_E = 0.5$ mW/cm ²)	S	-	13 (≥ 8)	μA
Maximum Photosensitivity Wavelength	λ_{Smax}	850	950	nm
Photosensitivity Spectral Range				
($S = 10\%$ of S_{MAX})	λ	400 to 1100	800 to 1150	nm
Radiant Sensitive Area	A	5.5	5.5	mm ²
Radiant Sensitive Area Dimensions	L x W	1.75 x 3.15	1.75 x 3.15	mm
Distance, Chip Surface to Case Surface	H	0.5	0.5	mm
Half Angle	ϕ	± 60	± 60	Deg.
Dark Current ($V_R = 10$ V)	I_R	5 (≤ 200)	5 (≤ 200)	nA
Spectral Photosensitivity ($\lambda = 950$ nm)	S_λ	0.48	0.48	A/W electrons photon
Quantum Yield ($\lambda = 950$ nm)	η	0.62	0.62	
Open Circuit Voltage				
($E_E = 0.5$ mW/cm ² , $\lambda = 950$ nm)	V_0	450 (≥ 380)	400 (≥ 340)	mV
Short Circuit Current				
($E_E = 0.5$ mW/cm ² , $\lambda = 950$ nm)	I_{SC}	45	13	μA
Rise and Fall Time of Photocurrent				
($R_L = 1$ K Ω , $V_R = 5$ V, $\lambda = 850$ nm, $I_P = 30$ μA)	t_R, t_F	1.3	1.3	μs
Forward Voltage ($I_F = 100$ mA, $E_E = 0$)	V_F	1.3	1.3	V
Capacitance ($V_R = 0$ V, $f = 1$ MHz, $E_V = 0$ lx)	C_0	430	430	pF
Temperature Coefficient V_0	TC_V	-2.6	-2.6	mW/K
Temperature Coefficient I_{SC}	TC_I	0.18	0.2	%/K
Noise Equivalent Power ($V_R = 1$ V)	NEP	8×10^{-14}	8×10^{-14}	W/Hz
Detection Limit ($V_R = 1$ V)	D^*	2.9×10^{12}	2.9×10^{12}	cm ² Hz/W

FEATURES

- Silicon Planar Photodiode
- Package
 - BPX 90: Transparent Plastic
 - BPX 90F: Daylight Filter
- 0.2" (5.08 mm) Spacing
- High Sensitivity
 - BPX 90: 45 nA/lx
 - BPX 90F: 13 nA/lx

DESCRIPTION

The BPX 90 and BPX 90F are silicon planar photodiodes. The BPX 90 is in a transparent plastic package. The BPX 90F is in a black plastic package with IR filter. Its terminals are soldering tabs with 0.2" (5.08 mm) lead spacing.

This versatile photodetector is suitable for diode as well as voltaic cell operation, providing an excellent signal/noise ratio, even at low light levels. The open circuit voltage at low light levels is higher than with comparable mesa photovoltaic cells.

Note

1. Illuminance shown refers to unfiltered radiation of tungsten filament lamp at color temperature of 2856 K (standard light A per DIN 5033 and IEC publication 306-1).

BPX 90

Relative spectral sensitivity $S_{REL}=f(\lambda)$

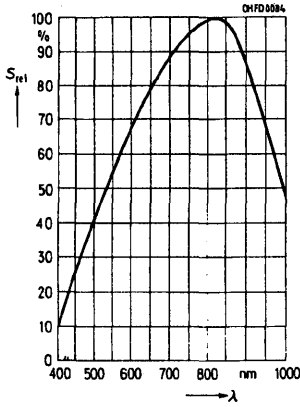

BPX 90F

Relative spectral sensitivity $S_{REL}=f(\lambda)$

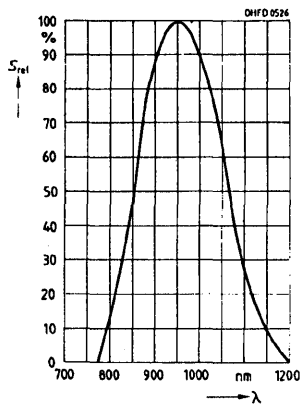

BPX 90

Photocurrent $I_P=f(E_V)$, $V_R=5\text{ V}$
Open current $V_O=f(E_V)$

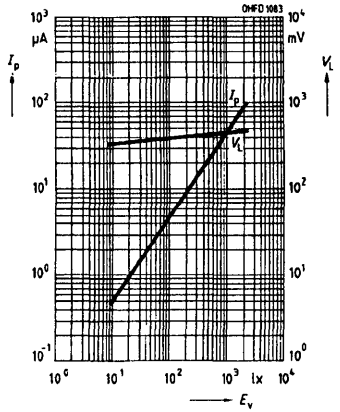

BPX 90F

Photocurrent $I_P=f(E_V)$, $V_R=5\text{ V}$
Open current $V_O=f(E_V)$

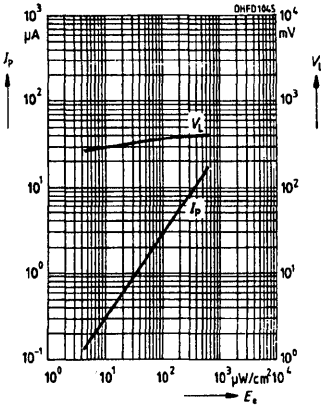

Directional characteristic $S_{REL}=f(\varphi)$

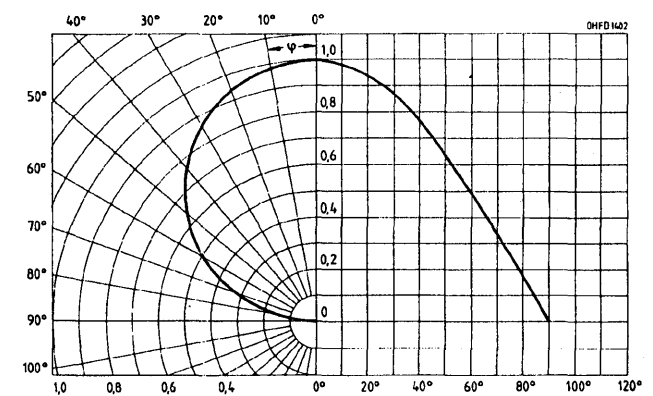

Power dissipation

$P_{TOT}=f(T_A)$

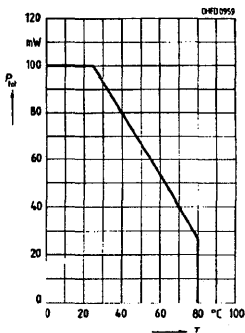

Dark current $I_R=f(V_R)$, $E=0$

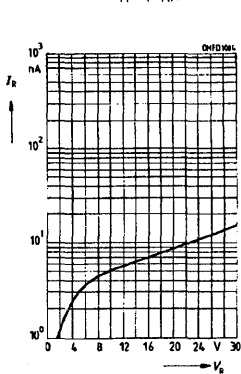

Capacitance $C=f(V_R)$

$f=1\text{ MHz}$, $E=0$

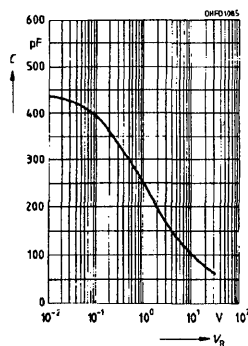

Dark current $I_R=f(T_A)$, $V_R=10\text{ V}$

$E=0$

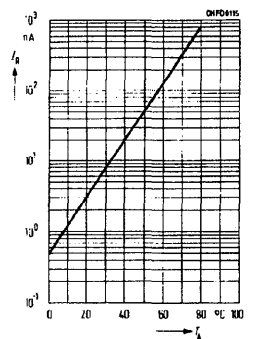

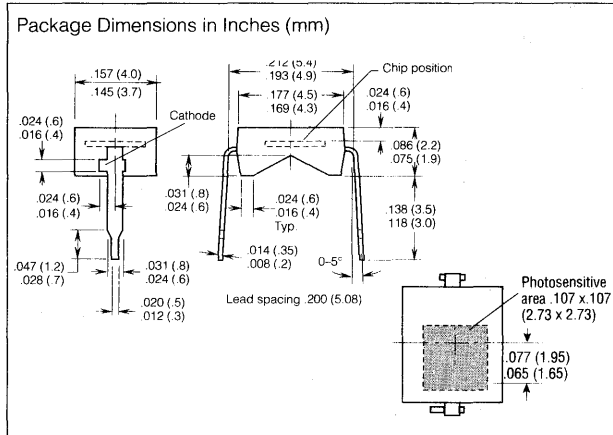
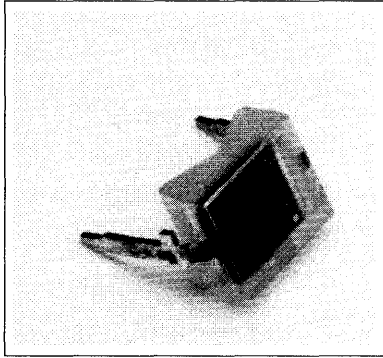

FEATURES

- **Transparent Plastic Package**
- **High Blue Sensitivity: 400 nm=30% S_{REL}**
- **Low Dark Current**

DESCRIPTION

The BPX 91B is a silicon planar photodiode in a transparent plastic package. Its terminals are soldering tabs with 0.2" (5.08 mm) lead spacing. Because of its increased blue sensitivity, the BPX 91B is well-suited for use with high blue light sources. It has an excellent signal/noise ratio, even at low light levels. The open circuit voltage at low light levels is higher than with comparable mesa photovoltaic cells. The cathode is marked by a tab on the solder lead.

Maximum Ratings

Operating and Storage Temperature Range (T _{OP} , T _{STG})	-40° to +80°C
Soldering Temperature (2 mm from case bottom), (T _S) t _S ≤ 3 s	230°C
Reverse Voltage (V _R)	32 V
Power Dissipation (P _{TOT}) T _A =25°C	150 mW

Characteristics (T_A=25°C)

Parameter	Symbol	Value	Unit
Photosensitivity	S	65	nA/lx
Maximum Sensitivity Wavelength	λ _{Smax}	850	nm
Photosensitivity Spectral Range (S=10% of S _{MAX})	λ	320 to 1100	nm
Radiant Sensitive Area	A	7.45	mm ²
Radiant Sensitive Area Dimensions	L x W	2.73 x 2.73	mm
Distance, Chip Surface to Case Surface	H	0.5	mm
Half Angle	φ	±60	Deg.
Dark Current (V _R =10 V, E=0)	I _R	7 (≤300)	nA
Spectral Sensitivity (λ=400 nm)	S _λ	0.20	AW electrons
Quantum Yield (λ=400 nm)	η	0.62	photon
Open Circuit Voltage (E _v =1000 lx) ⁽¹⁾	V _O	450	mV
Short Circuit Current (E _F =0.5 mW/cm ²)	I _{SC}	7.4 (≥5.4)	μA
Photocurrent Rise and Fall Time (R _L =1 KΩ, V _R =5 V, λ=850 nm, I _P =65 μA)	t _R , t _F	1.6	μs
Forward Voltage (I _F =100 mA, E _F =0, T _A =25°C)	V _F	1.3	V
Capacitance (V _R =0 V, f=1 MHz, E=0)	C ₀	580	pF
Temperature Coefficient V _O	TC _V	-2.6	mV/K
Temperature Coefficient I _{SC}	TC _I	0.18	%/K
Noise Equivalent Power (V _R =10 V, λ=400 nm)	NEP	2.4 x 10 ⁻¹³	W/√Hz
Detection Limit (V _R =10 V, λ=400 nm)	D*	1.2 x 10 ¹²	cm ² √Hz/W

Note

1. Illuminance shown refers to unfiltered radiation of tungsten filament lamp at color temperature of 2856 K (standard light A per DIN 5033 and IEC publication 306-1).

Relative spectral sensitivity
 $S_{REL}=f(\lambda)$

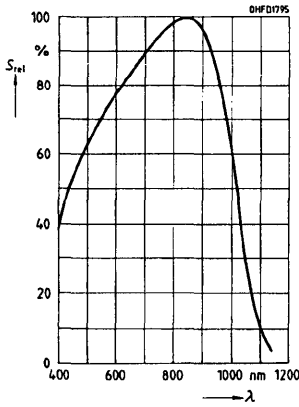

Photocurrent $I_p=f(E_V)$
Open circuit voltage $V_O=f(E_V)$

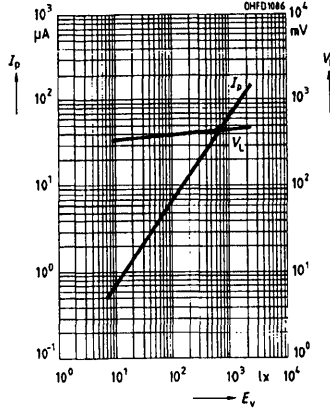

Directional characteristic $S_{REL}=f(\phi)$

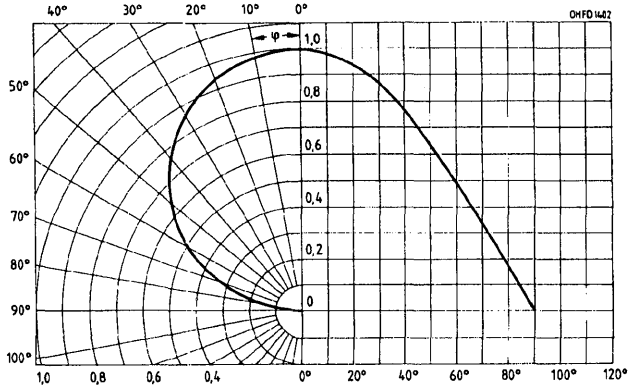

Power dissipation $P_{TOT}=f(T_A)$

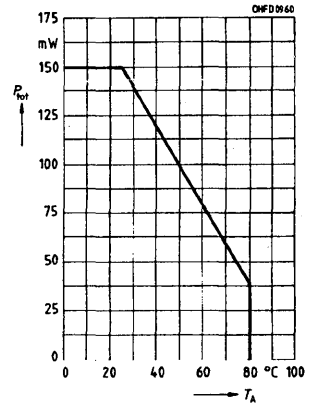

Dark current $I_R=f(V_R)$

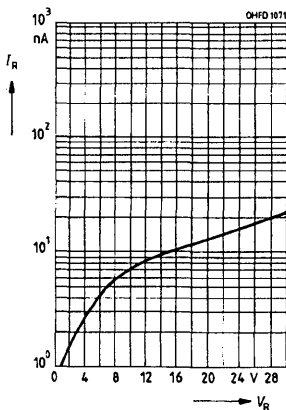

Capacitance $C=f(V_R)$

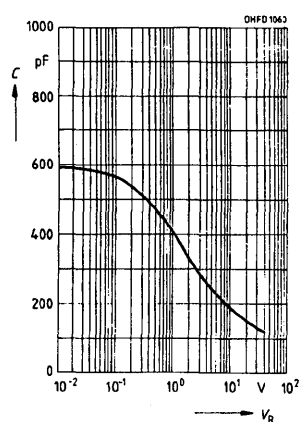

Dark current $I_R=f(T_A)$
 $V_R=1\text{ V}, E=0$

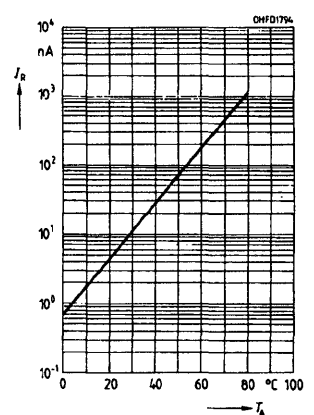

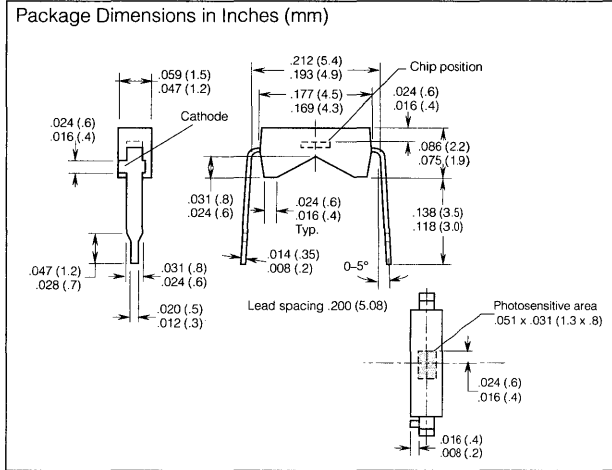
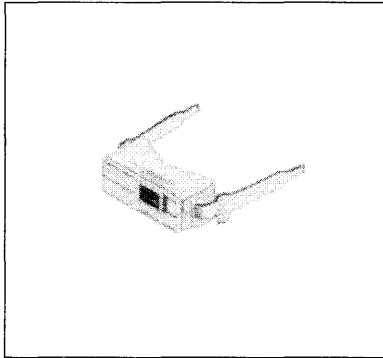

FEATURES

- Silicon Planar Photodiode
- Transparent Plastic Case
- 0.2" (5.08 mm) Lead Spacing
- Low Dark Current, 1 nA

DESCRIPTION

The BPX 92 is a silicon planar photodiode in a transparent plastic package. Its terminals are soldering tabs with 0.2" (5.08 mm) lead spacing. This versatile photodetector can operate as either a diode or a voltaic cell. It has an excellent signal/noise ratio, even at low light levels. The open circuit voltage at low light levels is higher than with comparable mesa photovoltaic cells.

Maximum Ratings

Operating and Storage Temperature Range (T_{OP} , T_{STG})	-40° to +80°C
Soldering Temperature (2 mm from case bottom), (T_S) $t \leq 3$ s	230°C
Reverse Voltage (V_R)	32 V
Power Dissipation (P_{TOT}) $T_A = 25^\circ\text{C}$	50 mW

Characteristics ($T_A = 25^\circ\text{C}$)

Parameter	Symbol	Value	Unit
Photosensitivity ($V_R = 5$ V)	S	9.5 (≥4)	nA/lx
Maximum Sensitivity Wavelength	$\lambda_{S_{MAX}}$	830	nm
Photosensitivity Spectral Range (S = 10% of S_{MAX})	λ	400 to 1100	nm
Radiant Sensitive Area	A	1	mm ²
Radiant Sensitive Area Dimensions	L x W	0.82 x 1.27	mm
Distance, Chip Surface to Case Surface	H	0.5	mm
Half Angle	ϕ	±60	Deg.
Dark Current ($V_R = 10$ V)	I_R	1 (≤100)	nA
Spectral Sensitivity ($\lambda = 850$ nm)	S_λ	0.50	A/W <u>electrons</u>
Quantum Yield ($\lambda = 850$ nm)	η	0.73	photon
Open Circuit Voltage ($E_v = 1000$ lx) ⁽¹⁾	V_O	440 (≥370)	mV
Short Circuit Current ($E_v = 1000$ lx) ⁽¹⁾	I_{SC}	9.5	μA
Photocurrent Rise and Fall Time ($R_L = 1$ KΩ, $V_R = 5$ V, $\lambda = 850$ nm, $I_p = 20$ μA)	$t_{R, F}$	1.2	μs
Forward Voltage ($I_F = 40$ mA, $E_E = 0$)	V_F	1.3	V
Capacitance ($V_R = 0$ V, $f = 1$ MHz, $E_v = 0$ lx)	C_O	90	pF
Temperature Coefficient V_O	TC_V	-2.6	mV/K
Temperature Coefficient I_{SC}	TC_I	0.2	%/K
Noise Equivalent Power ($V_R = 10$ V, $\lambda = 850$ nm)	NEP	3.6×10^{-14}	W/√Hz
Detection Limit ($V_R = 10$ V, $\lambda = 850$ nm)	D^*	2.8×10^{12}	$\text{cm} \cdot \sqrt{\text{Hz}}/\text{W}$

Note

1. Illuminance shown refers to unfiltered radiation of tungsten filament lamp at color temperature of 2856 K (standard light A per DIN 5033 and IEC publication 306-1).

Relative spectral sensitivity $S_{REL}=f(\lambda)$

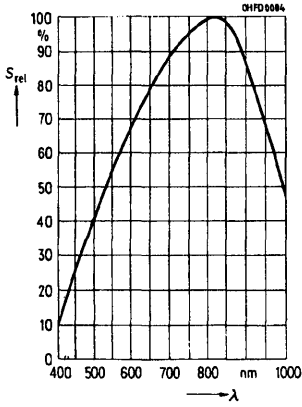

Photocurrent $I_P=f(E_V)$, $V_R=5\text{ V}$
Open circuit voltage $V_O=f(E_V)$

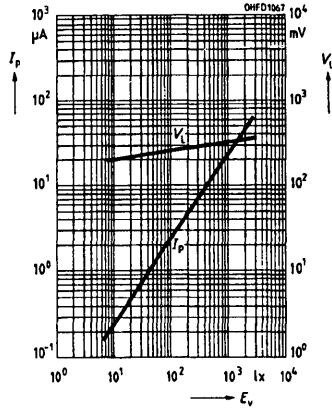

Directional characteristic $S_{REL}=f(\varphi)$

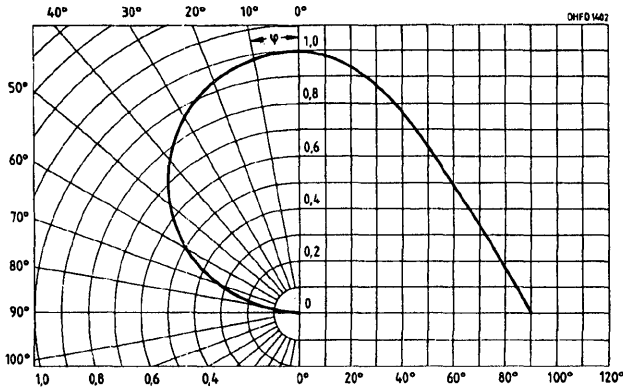

Power dissipation $P_{TOT}=f(T_A)$

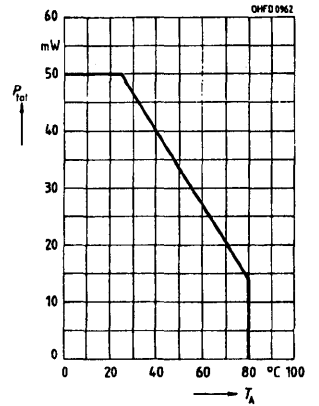

Dark current $I_R=f(V_R)$, $E=0$

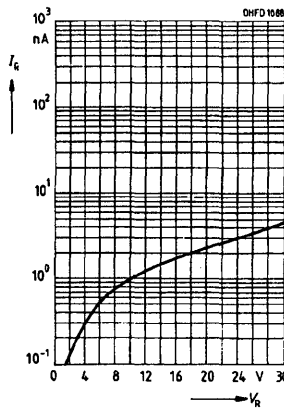

Capacitance $C=f(V_R)$, $f=1\text{ MHz}$, $E=0$

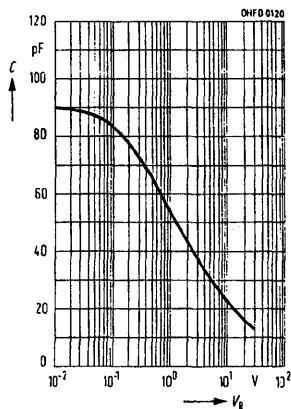

Dark current $I_R=f(T_A)$, $V_R=10\text{ V}$, $E=0$

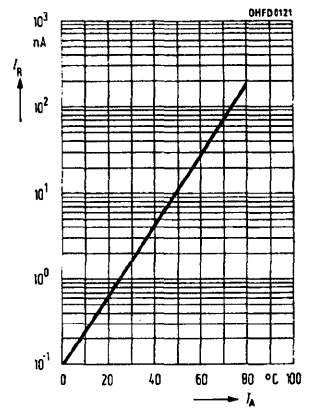

SILICON PIN PHOTODIODE

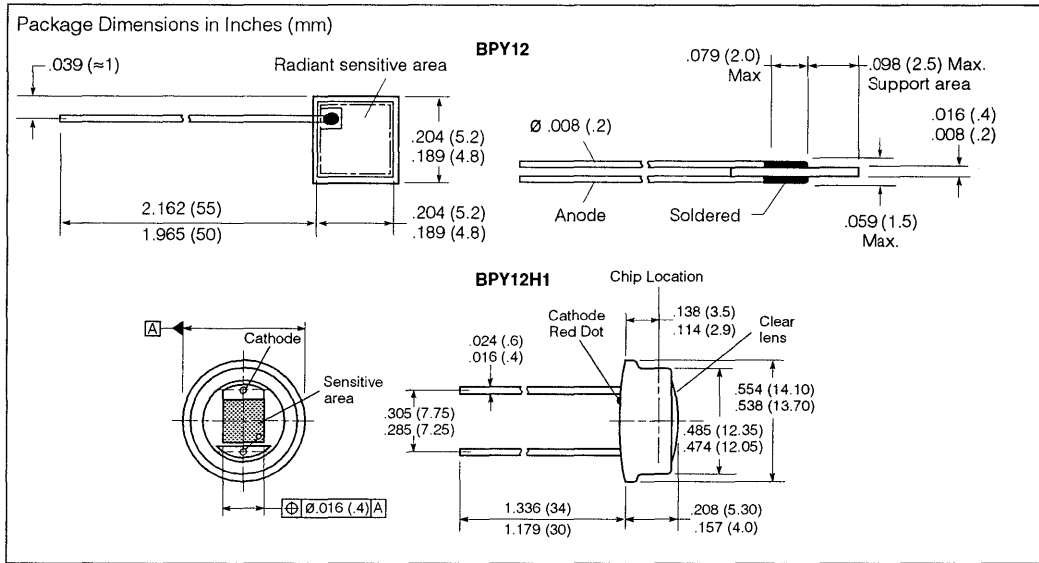

FEATURES

- **Package: Silicon Chip with Two Leads**
- **High Reliability**
- **No Testable Degradation**
- **Low Noise**
- **High Packing Density**
- **High Open-Circuit Voltage as Photo-voltaic Cells**
- **Short Switching Time**
- **High Spectral Sensitivity**
- **Wide Temperature Range**
- **Usage: Visible Light and Near Infrared Range**

DESCRIPTION

The BPY 12 is a silicon planar PIN photodiode. N-Si material provides positive front and negative back contact. These photodetectors can operate as reverse voltage photodiodes or as photovoltaic cells.

Applications include industrial electronics, measurement and control, and particle detection.

Maximum Ratings

Operating and Storage Temperature Range (T_{OP} , T_{STG})	-55° to +100°C
Reverse Voltage (V_R)	20 V
Power Dissipation (P_{TOT}) $T_A=25^\circ\text{C}$	150 mW

Characteristics ($T_A=25^\circ\text{C}$)

Parameter	Symbol	Value	Unit
Spectral Sensitivity			
($V_R=5$ V, standard light A, $T=2856$ K)	S	180(≥ 100)	nA/lx
Maximum Photosensitivity Wavelength	$\lambda_{S_{MAX}}$	920	nm
Spectral Sensitivity Range			
(S=10% of S_{MAX})	λ	400 to 1100	nm
Radiant Sensitive Area	A	20	mm ²
Radiant Sensitive Area Dimensions	L x W	4.47 x 4.47	mm
Half Angle	ϕ	± 60	Deg.
Dark Current ($V_R=20$ V)	I_R	10(≤ 100)	nA
Spectral Sensitivity ($\lambda=850$ nm)	S_λ	0.60	A/W
Quantum Yield ($\lambda=850$ nm)	η	0.86	electron/ photon
Open Circuit Voltage ($E_v=1000$ lx) ⁽¹⁾	V_O	365(≥ 310)	mV
Short Circuit Current ($E_v=1000$ lx) ⁽¹⁾	I_{SC}	180	μA
Rise and Fall Time of Photocurrent			
($R_L=50 \Omega$, $V_R=5$ V, $\lambda=850$ nm, $I_p=800 \mu\text{A}$)	t_R , t_F	25	ns
Forward Voltage ($I_F=100$ mA, $E_E=0$)	V_F	1.3	V
Capacitance ($V_R=0$ V, $f=1$ MHz, $E_v=0$ lx)	C_0	140	pF
Temperature Coefficient V_O	TC_V	-2.6	mV/K
Temperature Coefficient I_{SC}	TC_I	0.15	%/K
Noise Equivalent Power			
($V_R=20$ V, $\lambda=850$ nm)	NEP	9.4×10^{-14}	W/√Hz
Detection Limit ($V_R=20$ V, $\lambda=850$ nm)	D^*	4.7×10^{12}	$\text{cm}^2\cdot\sqrt{\text{Hz}}/\text{W}$

Note

1. Illuminance shown refers to unfiltered radiation of tungsten filament lamp at color temperature of 2856 K (standard light A per DIN 5033 and IEC publication 306-1).

Relative spectral sensitivity $S_{REL}=f(\lambda)$

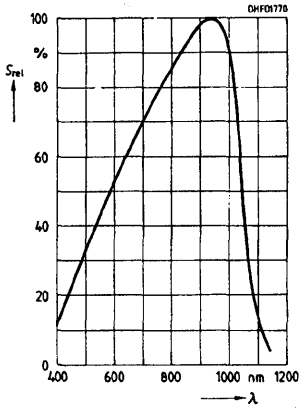

Photocurrent $I_P=f(E_V)$ $V_R=5V$
Open circuit voltage $V_O=f(E_V)$

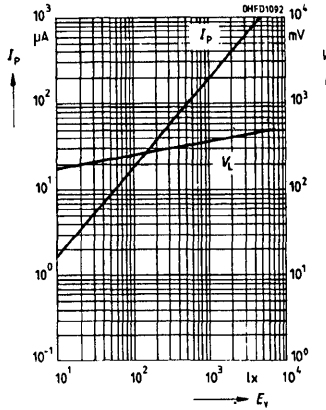

Directional characteristic $S_{REL}=f(\varphi)$

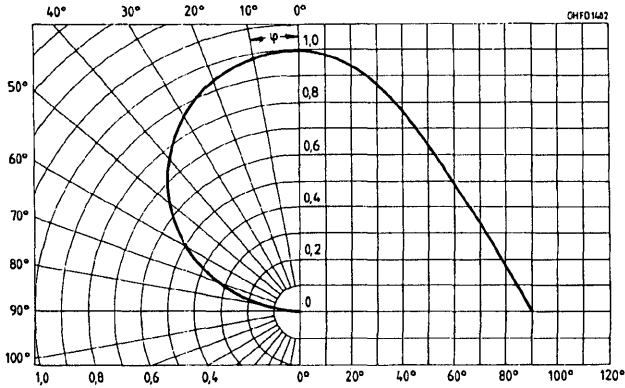

Power dissipation $P_{TOT}=f(T_A)$

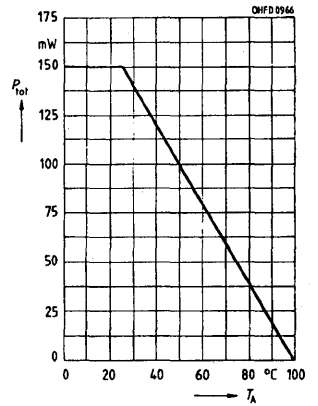

Dark current $I_R=f(V_R)$, $E=0$

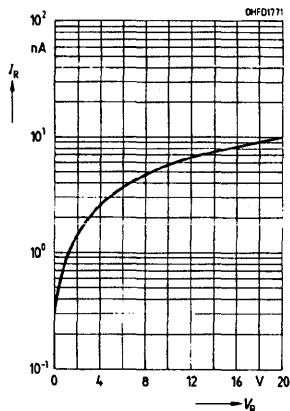

Capacitance $C=f(V_R)$, $f=1\text{ MHz}$, $E=0$

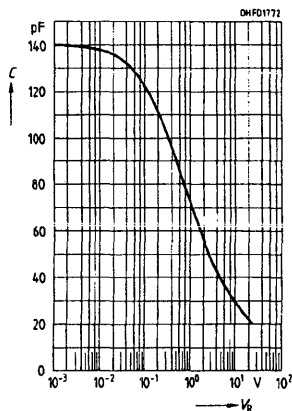

Dark current $I_R=f(T_A)$, $V_R=20V$, $E=0$

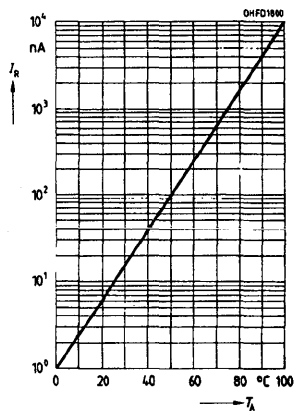

KOM 2033 A DAYLIGHT FILTER KOM 2033 AF KOM 2100 A DAYLIGHT FILTER KOM 2100 AF 6-CHIP SILICON PHOTODIODE ARRAY LOW DARK CURRENT

Package Dimensions in mm

KOM 2033 A/AF

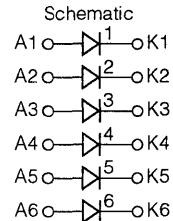
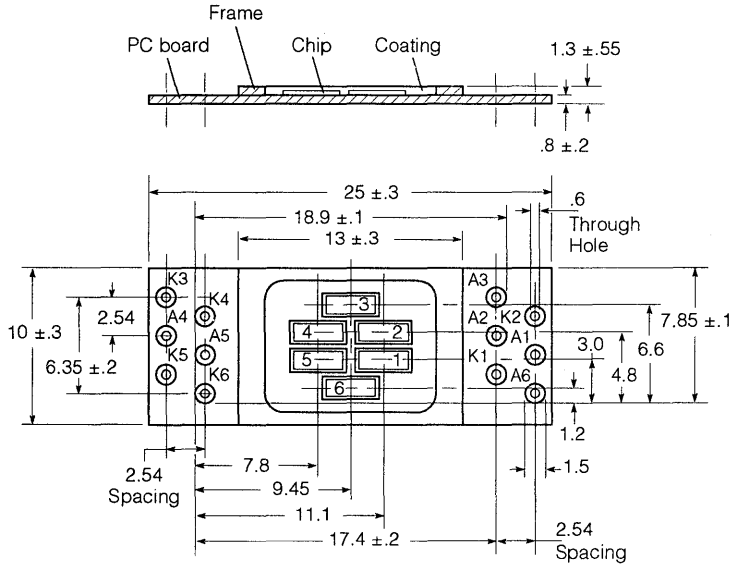

KOM 2100 A/AF

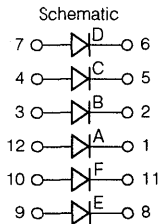
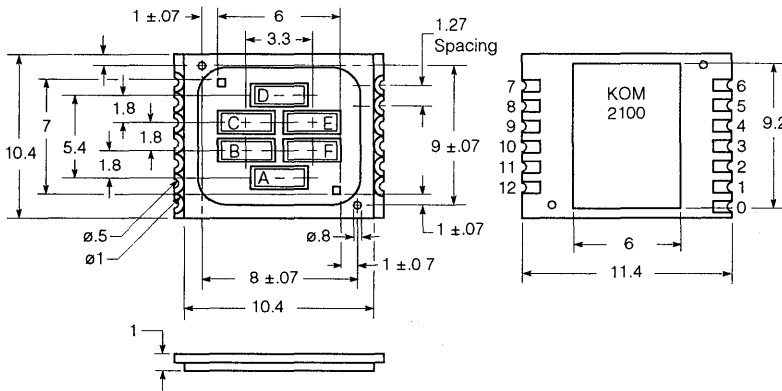

Photodiodes

FEATURES

- Silicon Photodiode in Planar Technology
- N-Si Material
Anode, Front Contact
Cathode, Back Contact
- High Reliability
- No Testable Degradation
- High Spectral Sensitivity
- Wide Temperature Range
- Visible Light and Near Infrared Range Usage (KOM 2033 A, KOM 2100 A)
- Daylight Filter (KOM 2033 AF, KOM 2100 AF)
- KOM 2100 A/AF: Suitable for SMT
- Application: Shaft Encoders, Position Detection

DESCRIPTION

These devices are 6-chip photodiode arrays fabricated in planar technology with low reverse current. The N-Si material used results in a positive front and negative back contact. These photodetectors are suitable for diode operation (with reverse voltage) as well as for photo-element operation.

The package consists of a PC board with solder lugs and an epoxy seal. See drawing for cathode mark

Maximum Ratings

Operating/Storage Temperature Range (T_{OP} , T_{STG})	
2033 A/2100 A	-40 to +80°C
2033 AF/2100 AF	-40 to +125°C
Reverse Voltage (V_R)	20 V
Power Dissipation (P_{TOT}) $T_A=25^\circ\text{C}$	150 mW

Characteristics, Single Segment ($T_A=25^\circ\text{C}$, $\lambda=950\text{ nm}$)

Parameter	Symbol	Value	Unit
Spectral Sensitivity ($V_R=5\text{ V}$, $E_E=0.5\text{ mW/cm}^2$)			
2033A/2100A	S	8 (≥ 5.2)	μA
2033AF/2100AF	S	7.5 (≥ 4.9)	μA
Maximum Sensitivity Wavelength	λ_{Smax}	840	nm
Sensitivity, Spectral Range ($S=10\%$, S_{max})			
2033A/2100A	λ	350 - 1070	nm
2033AF/2100AF	λ	730 - 1070	nm
Radiant Sensitive Area	A	2.5	mm^2
Radiant Sensitive Area Dimension	$L \times W$	1x2.5	mm
Chip Surface to Seal Surface Distance	H	0.4-0.6	mm
Half Angle	ϕ	± 60	Deg.
Dark Current ($V_R=10\text{ V}$)	I_R	1 (≤ 10)	μA
Spectral Sensitivity ($\lambda=850\text{ nm}$)			
2033A/2100A	S_λ	0.6	A/W
2033AF/2100AF	S_λ	0.56	A/W
Quantum Yield			
2033A/2100A	η	0.78	Electrons
2033A/2100A	η	0.73	Photons
Maximum Spectral Sensitivity Tolerance	ΔS	± 10	%
Short Circuit Current ($E_E=0.5\text{ mW/cm}^2$)			
2033A/2100A	I_K	7.5	μA
2033AF/2100AF	I_K	7	μA
Open-Circuit Voltage ($E_E=0.5\text{ mW/cm}^2$)	V_L	390 (≥ 320)	mV
Rise and Fall Time, Photocurrent ($R_L=1\text{ k}\Omega$, $V_R=10\text{ V}$, $\lambda=850\text{ nm}$, $I_P=50\text{ }\mu\text{A}$)	t_{R1} , t_F	1	ns
Forward Voltage ($I_F=100\text{ mA}$, $E=0$)	V_F	1.2	V
Capacitance, Chip ($V_R=0\text{ V}$, $f=1\text{ MHz}$, $E=0$)	C_O	130	pF
Temperature Coefficient, V_L	TC_V	-2.6	mV/K
Temperature Coefficient, I_K	TC_I	0.18	%/K
Noise Equivalent Power ($V_R=10\text{ V}$)	NEP	3.0×10^{-14}	$\frac{\text{W}}{\sqrt{\text{Hz}}}$
Detection Limit ($V_R=10\text{ V}$, $\lambda=850\text{ nm}$)			
2033A/2100A	D^*	5.3×10^{12}	$\frac{\text{cm}^2 \cdot \sqrt{\text{Hz}}}{\text{W}}$
2033AF/2100AF	D^*	5.0×10^{12}	W

Directional characteristics $S_{REL}=f(\phi)$

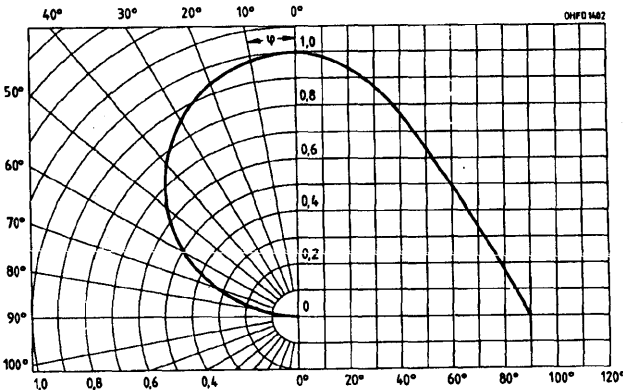

Relative spectral sensitivity
 $S_{rel}=f(\lambda)$
KOM 2033A/2100A

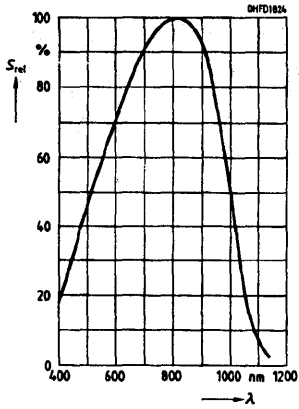

Relative spectral sensitivity
 $S_{rel}=f(\lambda)$
KOM 2033AF/2100AF

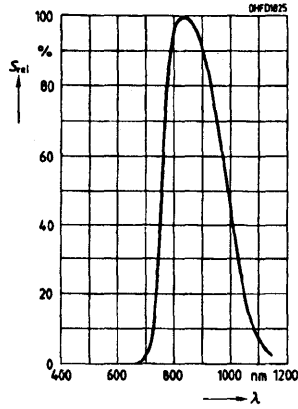

Photocurrent $I_p=f(E_e), V_R=5\text{ V}$
Open circuit voltage $V_L=f(E_e)$

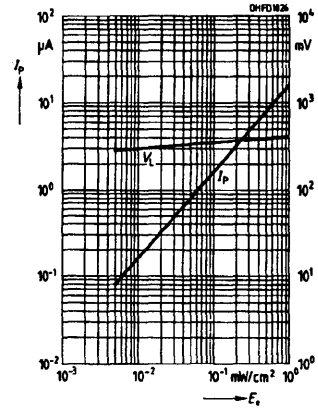

Power dissipation
 $P_{TOT}=f(T_A)$
KOM 2033A/2100A

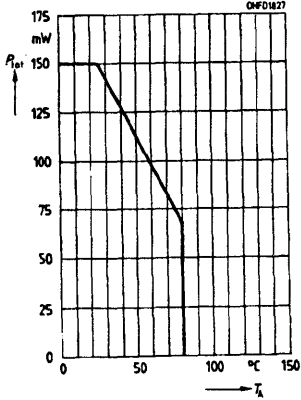

Power dissipation
 $P_{TOT}=f(T_A)$
KOM 2033AF/2100AF

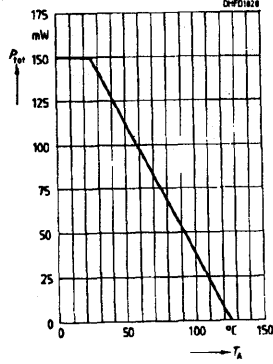

Dark current $I_n=f(V_R), E=0$

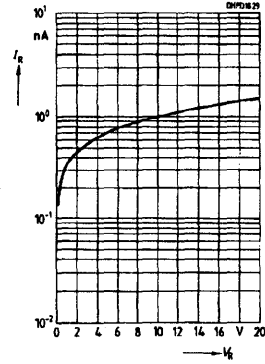

Capacitance
 $C=f(V_R), f=1\text{ MHz}, E=0$

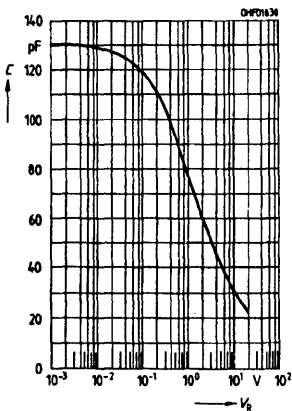

Dark current
 $I_n=f(T_A), V_R=10, E=0$

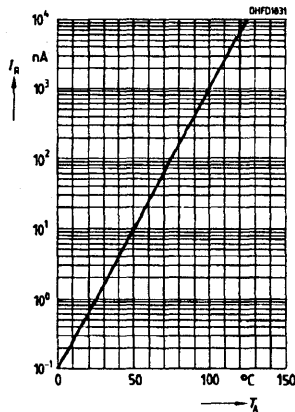

SIEMENS

KOM 2033 B DAYLIGHT FILTER KOM 2033 BF KOM 2100 B DAYLIGHT FILTER KOM 2100 BF 6-CHIP SILICON PHOTODIODE ARRAY LOW DARK CURRENT

Package Dimensions in mm

KOM 2033 B/BF

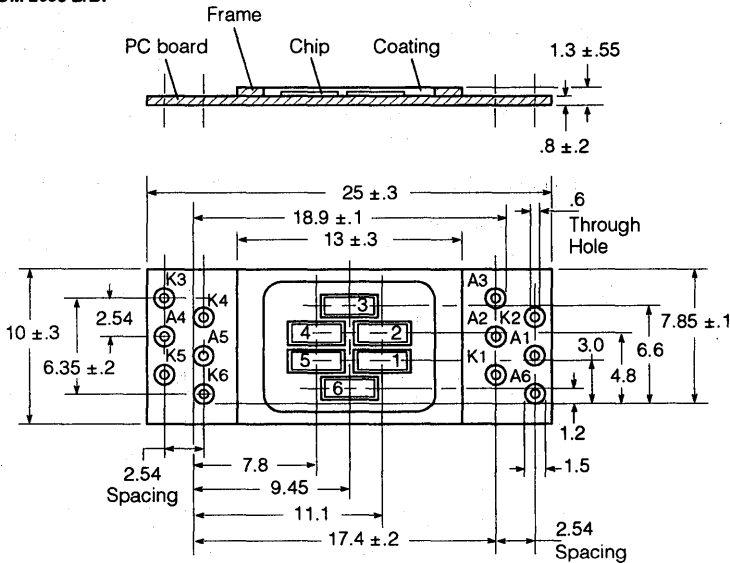

Schematic

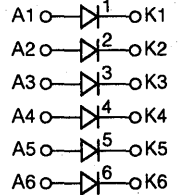

KOM 2100 B/BF

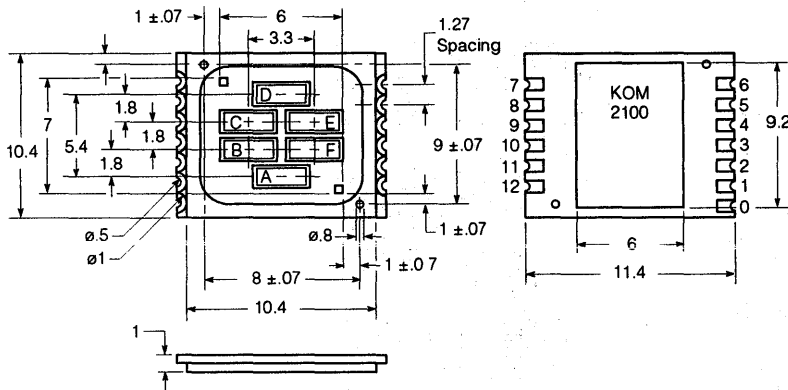

Schematic

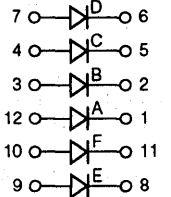

FEATURES

- Silicon Photodiode in Planar Technology
- N-Si Material
 - Anode, Front Contact
 - Cathode, Back Contact
- High Reliability
- No Testable Degradation
- Short Switching Time
- Low Capacitance
- High Spectral Sensitivity
- Wide Temperature Range
- Visible Light and Near Infrared Range Usage (A Version)
- Daylight Filter (AF Version)
- Package: PC Board with Solder Lugs, with Clear or Black Epoxy Seal
- KOM 2100 B/BF : Suitable for SMD
- Application: Shaft Encoders, Position Detection

DESCRIPTION

These devices are 6-chip photodiode arrays fabricated in planar technology with low reverse current. The N-Si material used results in a positive front and negative back contact. These photodetectors are suitable for diode operation (with reverse voltage) as well as for photo-element operation.

The package consists of a PC board with solder lugs and a clear epoxy seal. See drawing for cathode marking.

Maximum Ratings

Operating/Storage Temperature Range (T_{OP} , T_{STG})	
2033 B/2100 B	-40 to +80°C
2033 BF/2100 BF	-40 to +125°C
Reverse Voltage (V_R)	20 V
Power Dissipation (P_{TOT}) $T_A=25^\circ\text{C}$	150 mW

Characteristics, Single Segment ($T_A=25^\circ\text{C}$, $\lambda=950\text{ nm}$)

Parameter	Symbol	Value	Unit
Spectral Sensitivity ($V_R=5\text{ V}$, $E_E=0.5\text{ mW/cm}^2$)			
2033B/2100B	S	9 (≥ 7)	μA
2033BF/2100BF	S	8.5 (≥ 6.6)	μA
Maximum Sensitivity Wavelength	λ_{Smax}	870	nm
Sensitivity, Spectral Range ($S=10\%$, S_{max})			
2033B/2100B	λ	400 - 1100	nm
2033BF/2100BF	λ	730 - 1100	nm
Radiant Sensitive Area	A	2.5	mm^2
Radiant Sensitive Area Dimension	$L \times W$	1x2.5	mm
Chip Surface to Seal Surface Distance	H	0.4-0.6	mm
Half Angle	ϕ	± 60	Deg.
Dark Current ($V_R=10\text{ V}$)	I_R	1 (≤ 10)	μA
Spectral Sensitivity ($\lambda=850\text{ nm}$)			
2033B/2100B	S_λ	0.68	AW
2033BF/2100BF	S_λ	0.64	AW
Quantum Yield			
2033B/2100B	η	0.9	Electrons
2033BF/2100B	η	0.85	Photons
Maximum Spectral Sensitivity Tolerance	ΔS	± 10	%
Short Circuit Current ($E_E=0.5\text{ mW/cm}^2$)			
2033B/2100B	I_K	8.5	μA
2033BF/2100BF	I_K	8	μA
Open-Circuit Voltage ($E_E=0.5\text{ mW/cm}^2$)	V_L	320 (≥ 250)	mV
Rise and Fall Time, Photocurrent ($R_L=50\text{ k}\Omega$, $V_R=10\text{ V}$, $\lambda=850\text{ nm}$, $I_p=800\text{ }\mu\text{A}$)	t_R, t_F	13	ns
Forward Voltage ($I_F=100\text{ mA}$, $E=0$)	V_F	1.2	V
Capacitance, Chip ($V_R=0\text{ V}$, $f=1\text{ MHz}$, $E=0$)	C_O	25	pF
Temperature Coefficient, V_L	TC_V	-2.6	mV/K
Temperature Coefficient, I_K	TC_I	0.18	%/K
Noise Equivalent Power ($V_R=10\text{ V}$)			
2033B/2100B	NEP	2.6×10^{-14}	$\frac{\text{W}}{\sqrt{\text{Hz}}}$
2033BF/2100BF	NEP	2.8×10^{-14}	$\frac{\text{W}}{\sqrt{\text{Hz}}}$
Detection Limit ($V_R=10\text{ V}$, $\lambda=850\text{ nm}$)			
2033B/2100B	D^*	6.1×10^{12}	$\frac{\text{cm} \cdot \sqrt{\text{Hz}}}{\text{W}}$
2033BF/2100BF	D^*	5.7×10^{12}	$\frac{\text{W}}{\text{W}}$

Directional characteristics $S_{REL}=f(\phi)$

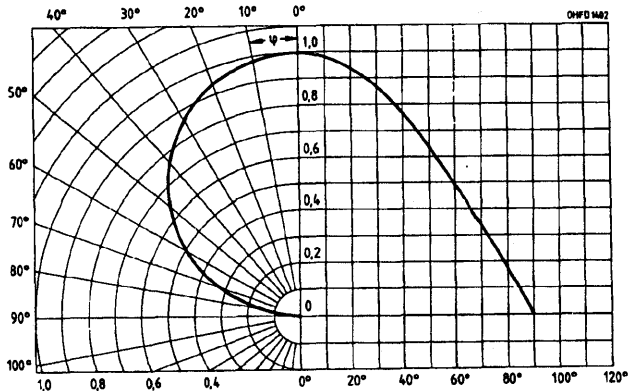

Relative spectral sensitivity
 $S_{rel}=f(\lambda)$
 KOM 2033B/2100B

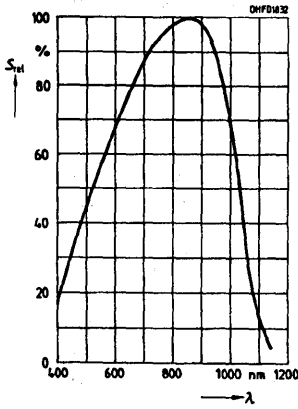

Relative spectral sensitivity
 $S_{rel}=f(\lambda)$
 KOM 2033BF/2100BF

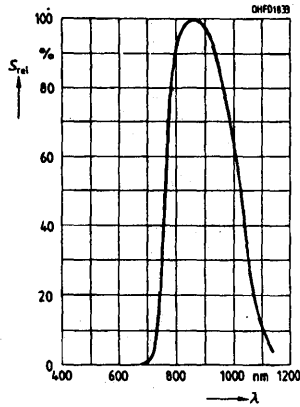

Photocurrent, $I_p=f(E_e)$, $V_R=5V$
 Open circuit voltage, $V_L=f(E_e)$

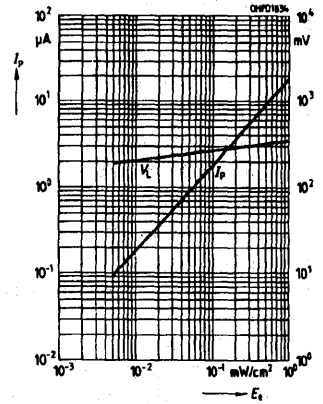

Power dissipation
 $P_{TOT}=f(T_A)$
 KOM 2033B/2100B

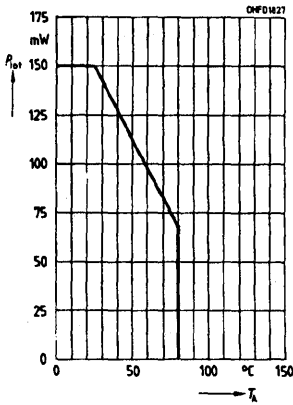

Power dissipation
 $P_{TOT}=f(T_A)$
 KOM 2033BF/2100BF

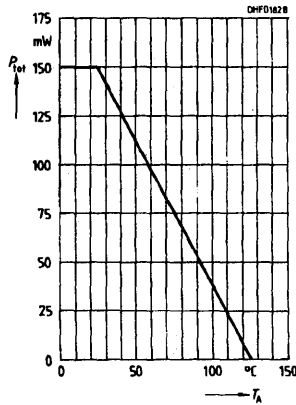

Dark current, $I_R=f(V_R)$, $E=0$

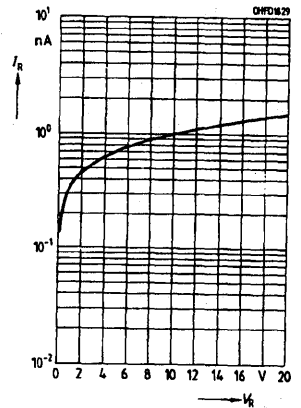

Capacitance, $C=f(V_R)$, $f=1\text{ MHz}$, $E=0$

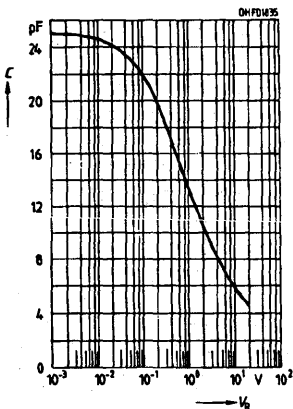

Dark current, $I_R=f(T_A)$, $V_R=10$, $E=0$

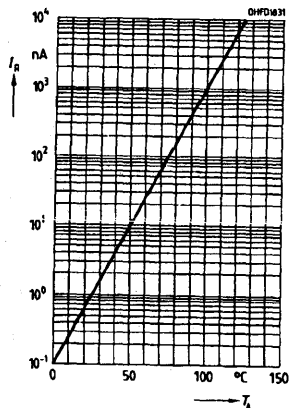

8-CHIP SILICON PHOTODIODE ARRAY VERY LOW DARK CURRENT

FEATURES

- Silicon Photodiode in Planar Technology
- N-Si Material
 - Anode, Front Contact
 - Cathode, Back Contact
- High Reliability
- Low Noise
- Detector for Low Luminance
- No Testable Degradation
- High Spectral Sensitivity
- Wide Temperature Range
- Visible Light and Near Infrared Range Usage
- Package: PC Board with Pin Connectors, with Clear Epoxy Seal, Lead Spacing 2.54 mm,
- Applications
 - Scanning Arrays
 - Edge Detection
 - Path and Corner Scanning
 - Position Detection
 - Measurement and Control

DESCRIPTION

The KOM 2045 is an 8-chip photodiode linear array fabricated in planar technology with low reverse current. The N-Si material used results in a positive front and negative back contact. These photodetectors are suitable for diode operation (with reverse voltage) as well as for photo-element operation.

The package consists of a PC board with pin connectors, with clear epoxy seal, 2.54 mm lead spacing. See drawing for cathode marking.

Maximum Ratings

Operating and Storage Temperature Range (T_{OP} , T_{STG}) -40 + 80°C
 Reverse Voltage (V_R) 10 V
 Power Dissipation (P_{TOT}) $T_A=25^\circ\text{C}$ 150 mW

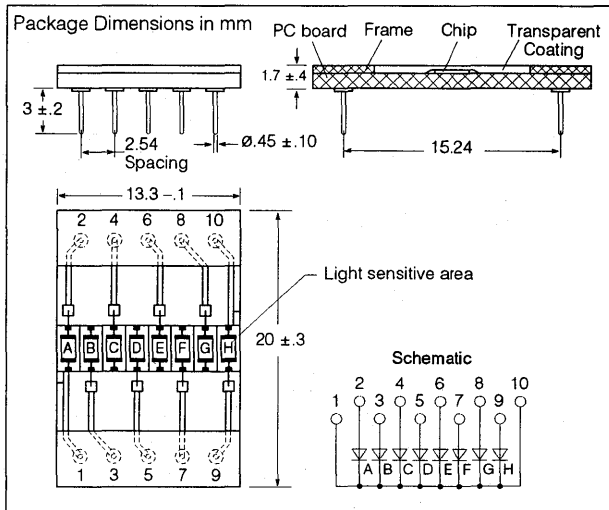

Characteristics, Single Segment ($T_A=25^\circ\text{C}$, std. light A, $T=2856\text{ K}$)

Parameter	Symbol	Value	Unit
Spectral Sensitivity ($V_R=5\text{ V}$)	S	17 (≥ 12)	nA/lx
Maximum Sensitivity Wavelength	$\lambda_{S_{max}}$	850	nm
Sensitivity, Spectral Range ($S=10\%$, S_{max})	λ	400 - 1100	nm
Radiant Sensitive Area	A	2.6	mm ²
Radiant Sensitive Area Dimension	LxW	1.3x2	mm
Chip Surface to Seal Surface Distance	H	0.6	mm
Half Angle	φ	± 60	Deg.
Dark Current ($V_R=1\text{ V}$)	I_R	5 (≤ 30)	pA
Spectral Sensitivity ($\lambda=850\text{ nm}$)	S_λ	0.55	AW
Quantum Yield	η	0.80	Electrons/Photons
Maximum Spectral Sensitivity Tolerance	ΔS	± 5	%
Short Circuit Current ($E_V=1000\text{ lx}$)	I_K	16	μA
Open-Circuit Voltage ($E_V=1000\text{ lx}$)	V_L	450 (≥ 380)	mV
Rise and Fall Time, Photocurrent ($R_L=1\text{ k}\Omega$, $V_R=5\text{ V}$, $\lambda=850\text{ nm}$, $I_P=50\text{ }\mu\text{A}$)	t_R , t_F	1.5	μs
Forward Voltage ($I_F=100\text{ mA}$, $E=0$)	V_F	1.3	V
Capacitance ($V_R=0\text{ V}$, $f=1\text{ MHz}$, $E=0$)	C_O	235	pF
Temperature Coefficient, V_L	TC_V	-2.6	mV/K
Temperature Coefficient, I_K	TC_I	0.18	%/K
Noise Equivalent Power ($V_R=10\text{ V}$, $\lambda=850\text{ nm}$)	NEP	2.3×10^{-15}	$\frac{\text{W}}{\sqrt{\text{Hz}}}$
Detection Limit ($V_R=10\text{ V}$, $\lambda=850\text{ nm}$)	D^*	7.0×10^{13}	$\frac{\text{cm}^2 \cdot \text{m}^2}{\text{W}}$

Relative spectral sensitivity
 $S_{rel}=f(\lambda)$

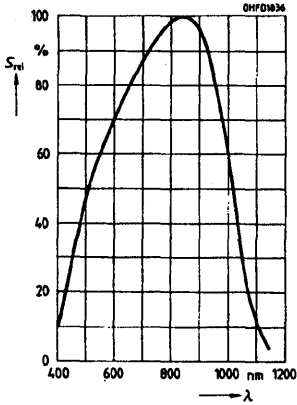

Photocurrent, $I_p=f(E_x), V_R=5\text{ V}$
Open circuit voltage, $V_L=f(E_x)$

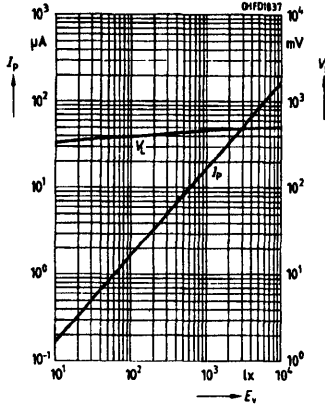

Directional characteristics
 $S_{rel}=f(j)$

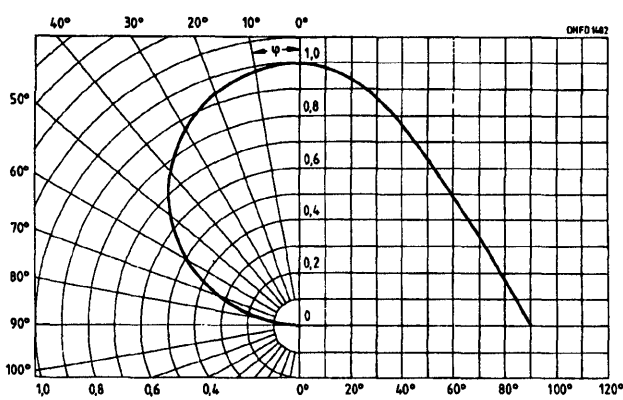

Power dissipation
 $P_{TOT}=f(T_A)$

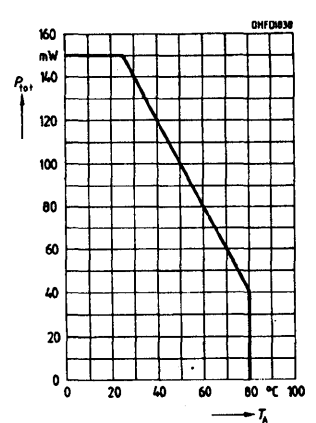

Dark current, $I_R=f(V_R), E=0$

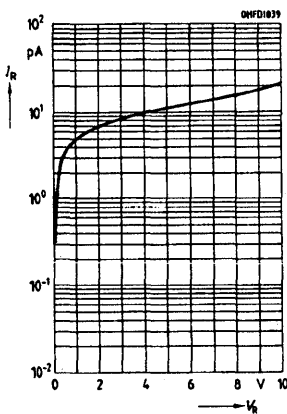

Capacitance, $C=f(V_R), f=1\text{ MHz}, E=0$

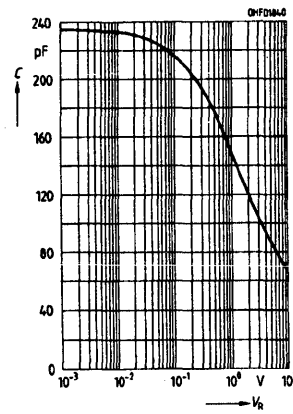

Dark current, $I_R=f(T_A), V_R=1\text{ V}, E=0$

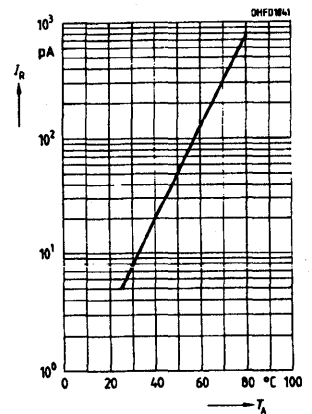

3-CHIP SILICON PHOTODIODE ARRAY

FEATURES

- Silicon Photodiode in Planar Technology
- N-Si Material
 - Anode, Front Contact
 - Cathode, Back Contact
- High Reliability
- High Packing Density
- Low Noise
- No Testable Degradation
- Short Switching Time
- Low Capacitance
- High Spectral Sensitivity
- Wide Temperature Range
- Visible Light and Near Infrared Range Usage
- Package: Lead Frame, Transparent Epoxy Resin, Solder Tabs, Lead Spacing 7.62 mm
- Cathode Marking: Solder Tab Projection
- Applications
 - Scanning Arrays
 - Edge Detection
 - Path and Corner Scanning
 - Position Detection
 - Measurement and Control

DESCRIPTION

The KOM 2057 L is a 3-chip photodiode array fabricated in planar technology. Rugged construction and large area photodiode chips result in a general purpose position detector.

Maximum Ratings

Operating/Storage Temperature Range (T_{OP} , T_{STG}) -40 + 80°C
 Soldering Temperature, 2 mm from case bottom, $t_s \leq 3$ s 230°C
 Reverse Voltage (V_R) 32 V
 Power Dissipation (P_{TOT}) $T_A=25^\circ\text{C}$ 150 mW

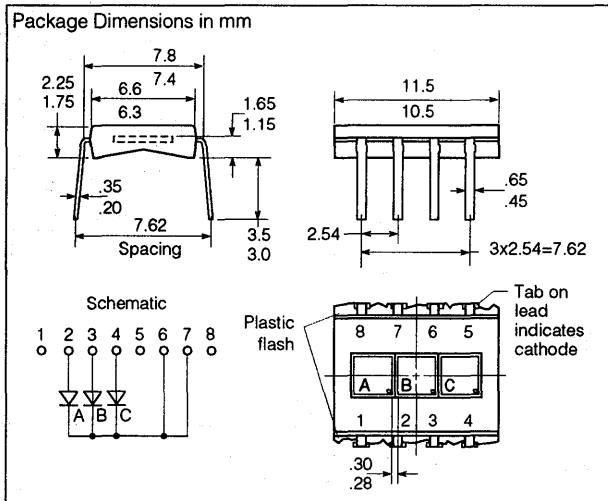

Characteristics, Single Segment ($T_A=25^\circ\text{C}$, std. light A, $T=2856$ K)

Parameter	Symbol	Value	Unit
Spectral Sensitivity ($V_R=5$ V, standard light A)	S	80(≥ 50)	nA/lx
Maximum Sensitivity Wavelength	λ_{max}	880	nm
Sensitivity, Spectral Range ($S=10\%$, S_{max})	λ	400 - 1100	nm
Radiant Sensitive Area	A	7	mm ²
Radiant Sensitive Area Dimension	LxW	2.65x2.65	mm
Chip Surface to Seal Surface Distance	H	0.4-0.6	mm
Half Angle	ϕ	± 60	Deg.
Dark Current ($V_R=10$ V)	I_D	2 (≤ 30)	nA
Spectral Sensitivity ($\lambda=850$ nm)	S_λ	0.62	AW
Quantum Yield	η	0.90	<u>Electrons</u> Photons
Maximum Spectral Sensitivity Tolerance	ΔS	± 10	%
Short Circuit Current ($E_V=1000$ lx)	I_K	80	μA
Open-Circuit Voltage ($E_V=1000$ lx)	V_L	365 (≥ 300)	mV
Rise and Fall Time, Photocurrent ($R_L=50$ k Ω , $V_R=10$ V, $\lambda=850$ nm, $I_F=800$ μA)	t_R , t_F	14	ns
Forward Voltage ($I_F=100$ mA, $E=0$)	V_F	1.3	V
Capacitance ($V_R=0$ V, $f=1$ MHz, $E=0$)	C_O	72	pF
Temperature Coefficient, V_L	TC_V	-2.6	mV/K
Temperature Coefficient, I_K	TC_I	0.18	%/K
Noise Equivalent Power ($V_R=10$ V, $\lambda=850$ nm)	NEP	4.1×10^{-14}	$\frac{\text{W}}{\sqrt{\text{Hz}}}$
Detection Limit ($V_R=10$ V, $\lambda=850$ nm)	D^*	6.6×10^{12}	$\frac{\text{cm} \cdot \sqrt{\text{Hz}}}{\text{W}}$

Relative spectral sensitivity
 $S_{rel}=f(\lambda)$

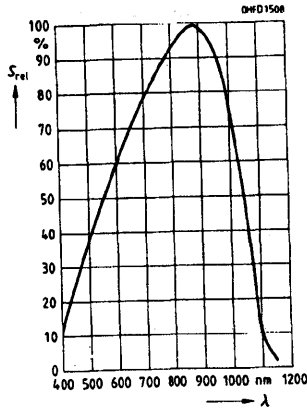

Photocurrent, $I_p=f(E_v)$, $V_R=5$ V
Open circuit voltage, $V_L=f(E_v)$

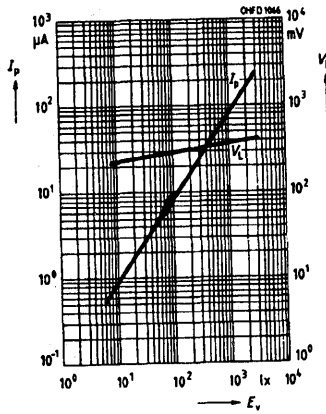

Directional characteristics
 $S_{rel}=f(\theta)$

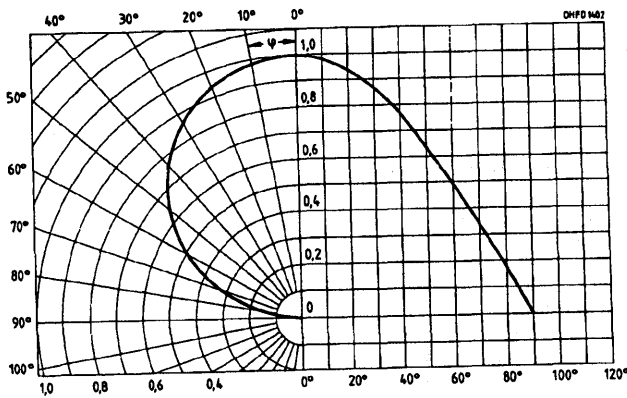

Power dissipation
 $P_{TOT}=f(T_A)$

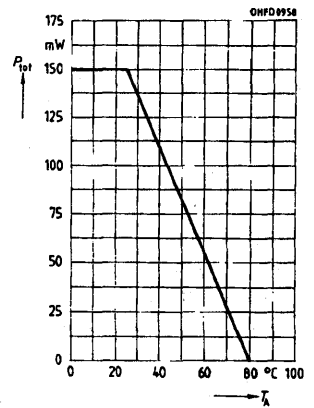

Dark current, $I_R=f(V_R)$, $E=0$

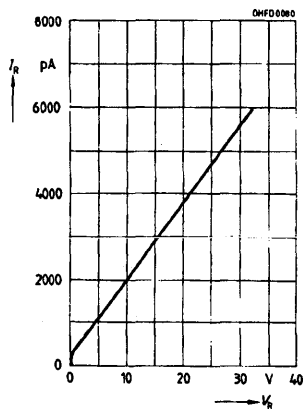

Capacitance, $C=f(V_R)$, $f=1$ MHz, $E=0$

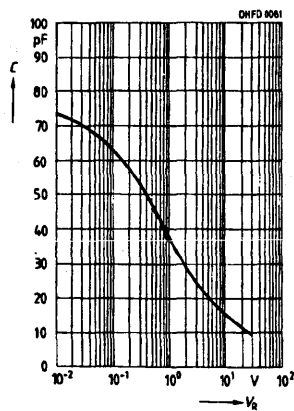

Dark current, $I_R=f(T_A)$, $V_R=1$ V, $E=0$

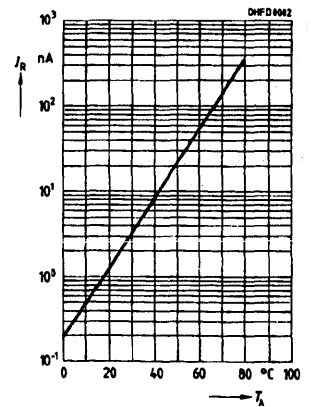

64-ELEMENT SILICON CIRCULAR ARRAY VERY LOW DARK CURRENT

FEATURES

- Silicon Photodiode in Planar Technology
- N-Si Material
Anode, Front Contact
Cathode, Back Contact
- High Reliability
- Low Noise
- Detector for Low Luminance
- No Testable Degradation
- High Spectral Sensitivity
- Wide Temperature Range
- Visible Light and Near Infrared Range Usage
- Chip in Center of PC Board
- Package: Pin-Grid Array with Pin Connectors, Lead Spacing 2.54 mm, Clear Epoxy Seal
- Applications
 - Circular Coordinate Recognition
 - Angle Increment Detector, 5.625° Resolution
 - Surface Control of Ring Shaped Areas (Bottle Necks)
 - Measurement and Control

DESCRIPTION

The KOM 2059 is a 64-element circular array fabricated in planar technology with low reverse current. The N-Si material used results in a positive front and negative back contact. These photodetectors are suitable for diode operation (with reverse voltage) as well as for photo-element operation.

The package consists of PIN-GRID array with pin connectors¹⁾ 2.54 mm lead spacing, with clear epoxy seal. The cathode is pin 65 and marked K (see outline drawing).

Note:

1. Socket: Pin grid array socket UX-1111-084-GH-Y-33.

Maximum Ratings

Operating/Storage Temperature

Range (T_{OP} , T_{STG}) -40 + 80°C

Reverse Voltage (V_R) 5 V

Power Dissipation (P_{TOT}) $T_A=25^\circ\text{C}$ 2 mW

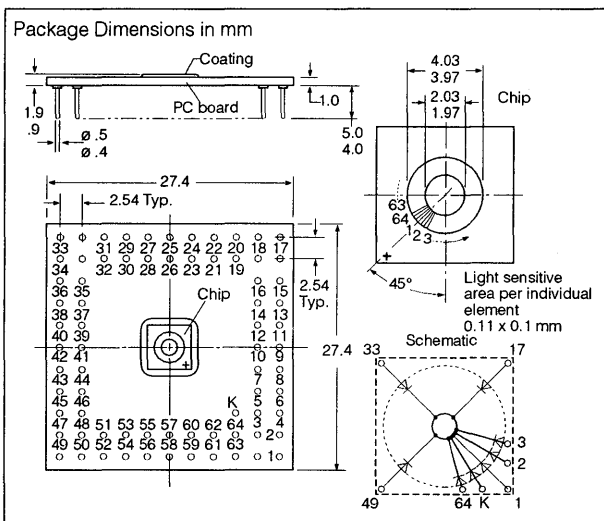

Characteristics, Single Segment ($T_A=25^\circ\text{C}$, std. light A, $T=2856\text{ K}$)

Parameter	Symbol	Value	Unit
Spectral Sensitivity ($V_R=5\text{ V}$, standard light A)	S	2.5 (≥ 1.8)	nA/lx
Maximum Sensitivity Wavelength	λ_{Smax}	850	nm
Sensitivity, Spectral Range ($S=10\%$, S_{max})	λ	400 - 1100	nm
Radiant Sensitive Area	A	0.11	mm ²
Angular Increment		5.625	Deg.
Chip Surface to Seal Surface Distance	H	0.6	mm
Half Angle	ϕ	± 60	Deg.
Dark Current ($V_R=5\text{ V}$)	I_R	15 (≤ 150)	pA
Spectral Sensitivity ($\lambda=850\text{ nm}$)	$S\lambda$	0.35	A/W
Quantum Yield	η	0.5	Electrons/Photons
Maximum Spectral Sensitivity Tolerance	ΔS	± 5	%
Short Circuit Current ($E_V=1000\text{ lx}$)	I_K	2.3	μA
Open-Circuit Voltage ($E_V=1000\text{ lx}$)	V_L	425 (≥ 380)	mV
Rise and Fall Time, Photocurrent ($R_L=1\text{ k}\Omega$, $V_R=5\text{ V}$, $\lambda=850\text{ nm}$, $I_F=20\text{ }\mu\text{A}$)	t_R, t_F	5	μs
Forward Voltage ($I_F=100\text{ mA}$, $E=0$)	V_F	0.9	V
Capacitance ($V_R=0\text{ V}$, $f=1\text{ MHz}$, $E=0$)	C_0	23	pF
Temperature Coefficient, V_L	TC_V	-2.6	mV/K
Temperature Coefficient, I_K	TC_I	0.18	%/K
Noise Equivalent Power ($V_R=6\text{ V}$, $\lambda=850\text{ nm}$)	NEP	6.3×10^{-15}	$\frac{\text{W}}{\sqrt{\text{Hz}}}$
Detection Limit ($V_R=5\text{ V}$, $\lambda=850\text{ nm}$)	D^*	5.3×10^{12}	$\frac{\text{cm}^2 \cdot \sqrt{\text{Hz}}}{\text{W}}$

Relative spectral sensitivity
 $S_{rel} = f(\lambda)$

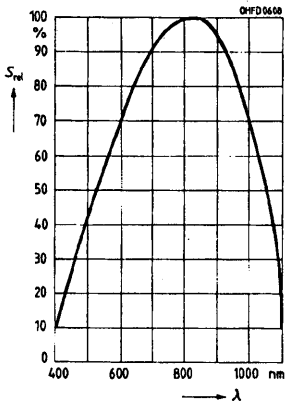

Photocurrent, $I_p = f(E_v), V_R = 5 \text{ V}$
Open circuit voltage, $V_L = f(E_v)$

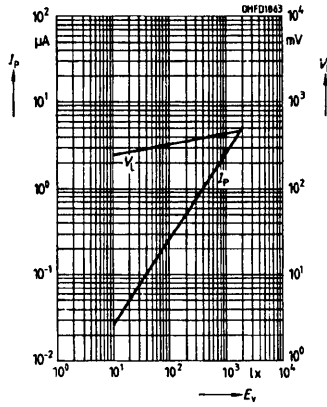

Capacitance
 $C = f(V_R), f = 1 \text{ MHz}, E = 0$

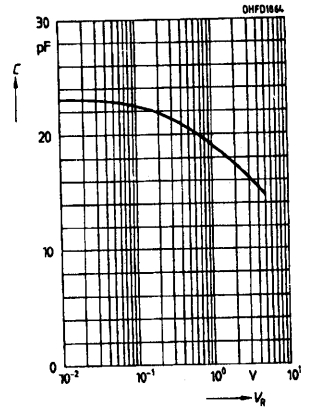

Directional characteristics
 $S_{rel} = f(\psi)$

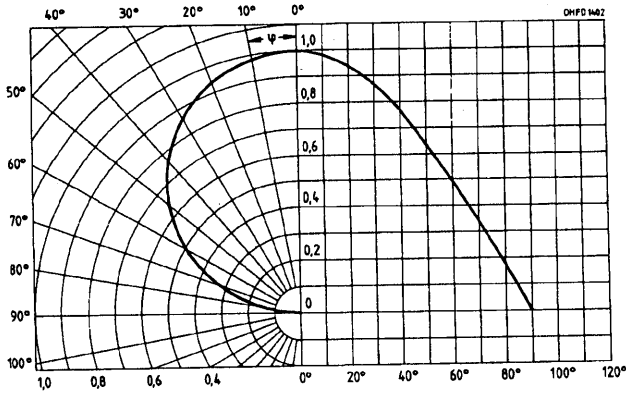

4-CHIP SILICON PIN PHOTODIODE ARRAY

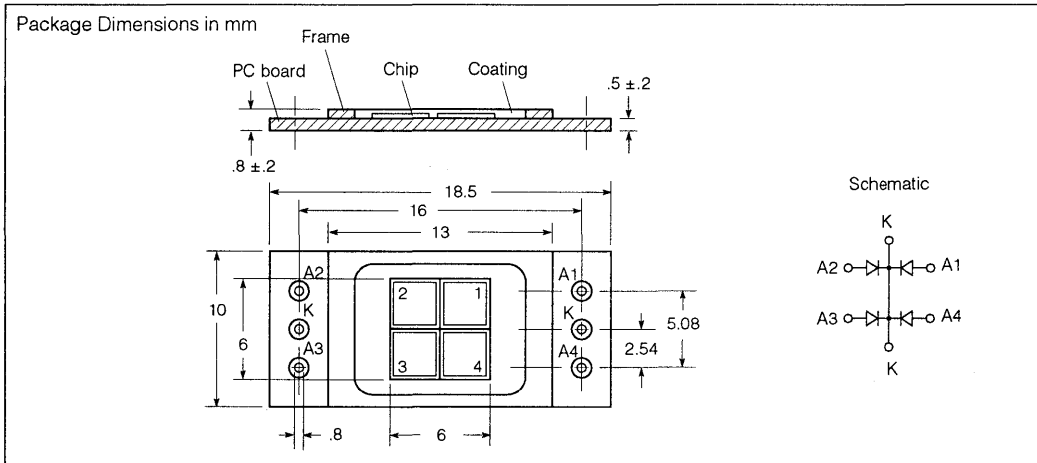

FEATURES

- Silicon Photodiode in Planar Technology
- N-Si Material
 - Anode, Front Contact
 - Cathode, Back Contact
- High Reliability
- Low Noise
- No Testable Degradation
- Short Switching Time
- Low Capacitance
- High Spectral Sensitivity
- Wide Temperature Range
- Visible Light and Near Infrared Range Usage
- Package: PC Board with Solder Lugs, with Clear Epoxy Seal
- Applications
 - Edge Detection
 - Position Detection
 - Measurement and Control

Maximum Ratings

Operating and Storage Temperature Range (T_{OP} , T_{STG}) -40 + 80°C
Reverse Voltage (V_R) 32 V
Power Dissipation (P_{TOT}) $T_A=25^\circ\text{C}$ 150 mW

Characteristics, Single Segment ($T_A=25^\circ\text{C}$, std. light A, $T=2856\text{ K}$)

Parameter	Symbol	Value	Unit
Spectral Sensitivity ($V_R=5\text{ V}$, standard light A)	S	80(≥50)	nA/lx
Maximum Sensitivity Wavelength	λ_{Smax}	880	nm
Sensitivity, Spectral Range ($S=10\%$, S_{max})	λ	400 - 1100	nm
Radiant Sensitive Area	A	7	mm ²
Radiant Sensitive Area Dimension	LxW	2.65x2.65	mm
Chip Surface to Seal Surface Distance	H	0.4-0.6	mm
Half Angle	φ	±60	Deg.
Dark Current ($V_R=10\text{ V}$)	I_D	2 (≤30)	nA
Spectral Sensitivity ($\lambda=850\text{ nm}$)	S_λ	0.62	AW
Quantum Yield	η	0.9	<u>Electrons</u> Photons
Maximum Spectral Sensitivity Tolerance	ΔS	± 10	%
Short Circuit Current ($E_V=1000\text{ lx}$)	I_K	75	μA
Open-Circuit Voltage ($E_V=1000\text{ lx}$)	V_L	365 (≥310)	mV
Rise and Fall Time, Photocurrent ($V_R=5\text{ V}$, $\lambda=850\text{ nm}$)			
($R_L=50\text{ k}\Omega$, $I_F=800\text{ }\mu\text{A}$)	t_R, t_F	20	ns
($R_L=1\text{ k}\Omega$, $I_F=150\text{ }\mu\text{A}$)	t_R, t_F	350	ns
Forward Voltage ($I_F=100\text{ mA}$, $E=0$)	V_F	1.3	V
Capacitance ($V_R=0\text{ V}$, $f=1\text{ MHz}$, $E=0$)	C_O	72	pF
Temperature Coefficient, V_L	TC_V	-2.6	mV/K
Temperature Coefficient, I_K	TC_I	0.15	%/K
Noise Equivalent Power ($V_R=10\text{ V}$, $\lambda=850\text{ nm}$)	NEP	4.1×10^{-14}	$\frac{W}{\sqrt{Hz}}$
Detection Limit ($V_R=10\text{ V}$, $\lambda=850\text{ nm}$)	D^*	6.6×10^{13}	$\frac{cm \cdot \sqrt{Hz}}{W}$

Relative spectral sensitivity
 $S_{rel}=f(\lambda)$

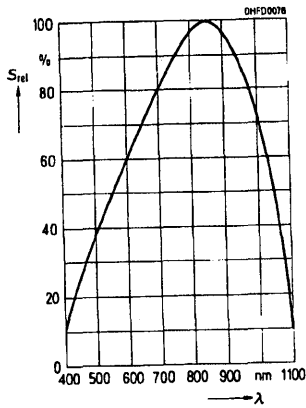

Photocurrent, $I_p=f(E_v)$, $V_R=5V$
Open circuit voltage, $V_L=f(E_v)$

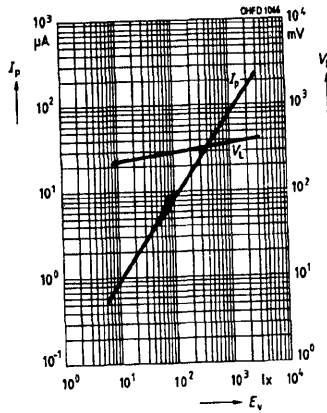

Directional characteristics
 $S_{rel}=f(j)$

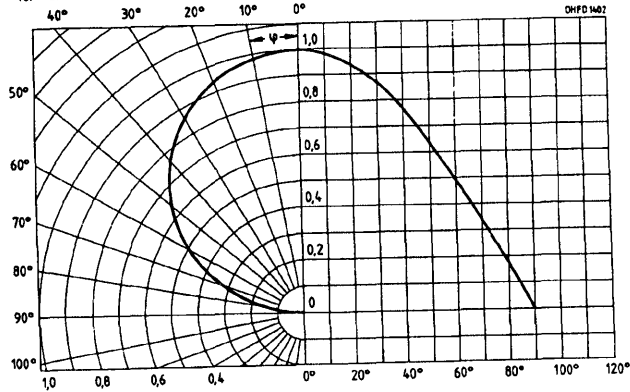

Power dissipation
 $P_{TOT}=f(T_A)$

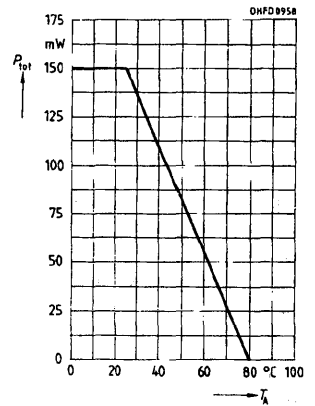

Dark current, $I_R=f(V_R)$, $E=0$

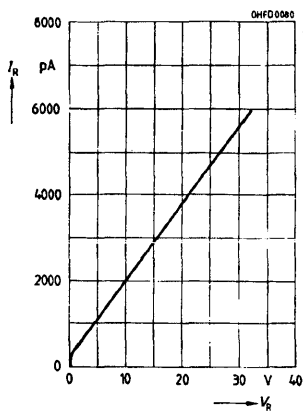

Capacitance, $C=f(V_R)$, $f=1\text{ MHz}$, $E=0$

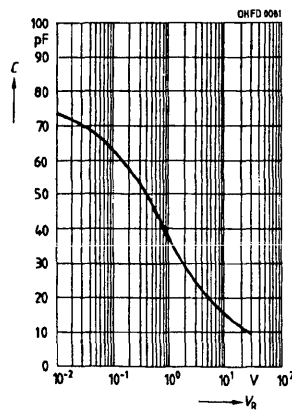

Dark current, $I_R=f(T_A)$, $V_R=1V$, $E=0$

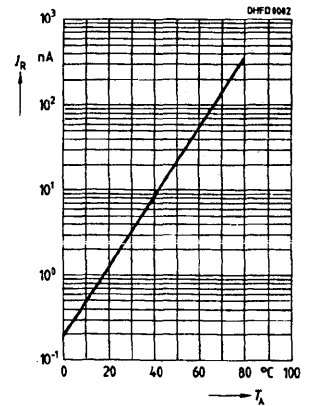

4-CHIP SILICON PIN PHOTODIODE ARRAY

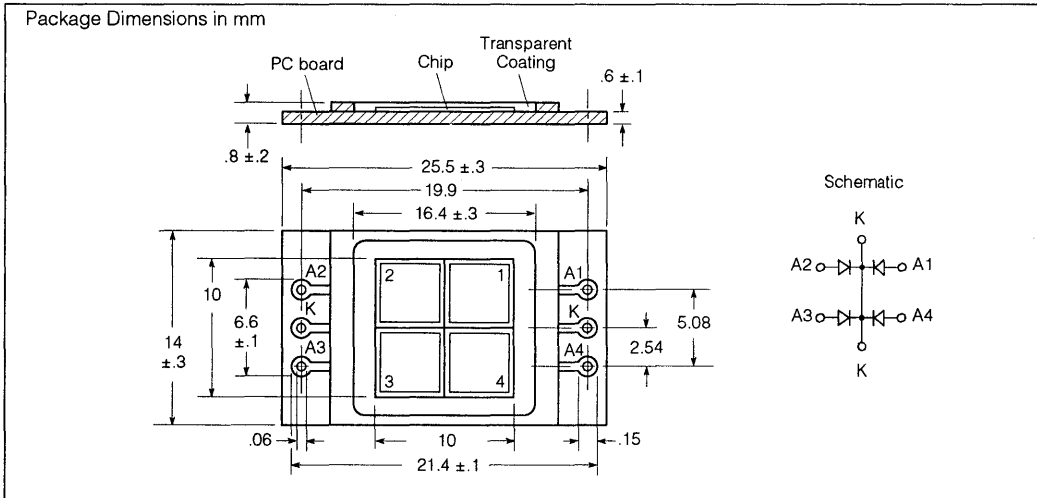

FEATURES

- Silicon Photodiode in Planar Technology
- N-Si Material
 - Anode, Front Contact
 - Cathode, Back Contact
- High Reliability
- Low Noise
- No Testable Degradation
- Short Switching Time
- Low Capacitance
- High Spectral Sensitivity
- Wide Temperature Range
- Visible Light and Near Infrared Range Usage
- Package: PC Board with Solder Lugs, with Clear Epoxy Seal
- Applications
 - Edge Detection
 - Position Detection
 - Measurement and Control

Maximum Ratings

Operating/Storage Temperature Range (T_{OP} , T_{STG})	-40 + 80°C
Reverse Voltage (V_R)	20 V
Power Dissipation (P_{TOT}) $T_A=25^\circ\text{C}$	150 mW

Characteristics, Single Segment ($T_A=25^\circ\text{C}$, std. light A, $T=2856$ K)

Parameter	Symbol	Value	Unit
Spectral Sensitivity ($V_R=5$ V, standard light A)	S	180 (≥ 100)	nA/lx
Maximum Sensitivity Wavelength	λ_{3max}	920	nm
Sensitivity, Spectral Range ($S=10\%$, S_{max})	λ	400 - 1100	nm
Radiant Sensitive Area	A	20	mm ²
Radiant Sensitive Area Dimension	LxW	4.47x4.47	mm
Chip Surface to Seal Surface Distance	H	0.4-0.6	mm
Half Angle	φ	± 60	Deg.
Dark Current ($V_R=10$ V)	I_R	10 (≤ 100)	nA
Spectral Sensitivity ($\lambda=850$ nm)	S_λ	0.60	A/W
Quantum Yield	η	0.86	Electrons/Photons
Maximum Spectral Sensitivity Tolerance	ΔS	± 10	%
Short Circuit Current ($E_V=1000$ lx)	I_K	170	μA
Open-Circuit Voltage ($E_V=1000$ lx)	V_L	365 (≥ 310)	mV
Rise and Fall Time, Photocurrent ($V_R=5$ V, $\lambda=850$ nm)	t_R , t_F	25	ns
($R_L=50$ k Ω , $I_P=800$ μA)	t_R , t_F	500	ns
($R_L=1$ k Ω , $I_P=150$ μA)	t_F	1.3	V
Forward Voltage ($I_F=100$ mA, $E=0$)	V_F	1.3	V
Capacitance ($V_R=0$ V, $f=1$ MHz, $E=0$)	C_O	140	pF
Temperature Coefficient, V_L	TC_V	-2.6	mV/K
Temperature Coefficient, I_K	TC_I	0.15	%/K
Noise Equivalent Power ($V_R=10$ V, $\lambda=850$ nm)	NEP	9.4×10^{-14}	$\frac{W}{\sqrt{\text{Hz}}}$
Detection Limit ($V_R=10$ V, $\lambda=850$ nm)	D^*	4.7×10^{12}	$\frac{\text{cm} \cdot \sqrt{\text{Hz}}}{W}$

Relative spectral sensitivity
 $S_{rel}=f(\lambda)$

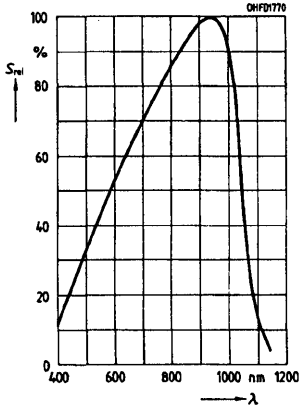

Photocurrent, $I_p=f(E_v), V_R=5 V$
Open circuit voltage, $V_L=f(E_v)$

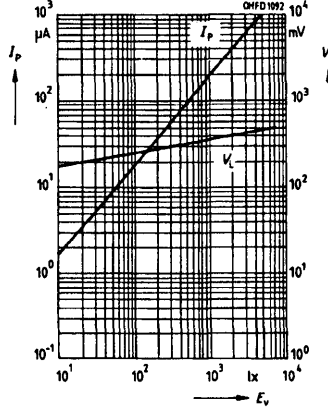

Directional characteristics
 $S_{rel}=f(\psi)$

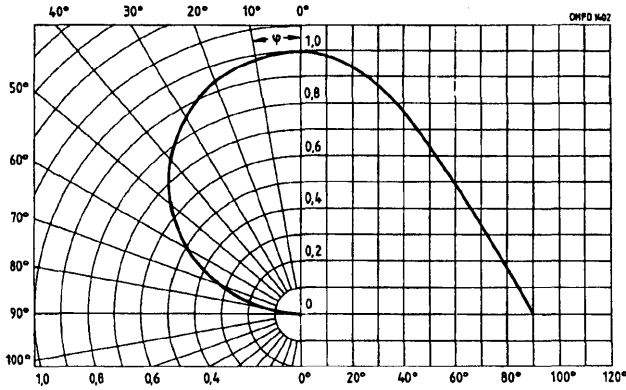

Power dissipation
 $P_{TOT}=f(T_A)$

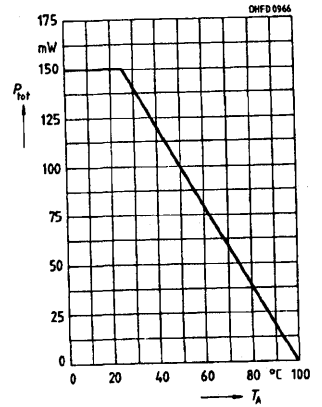

Dark current, $I_R=f(V_R), E=0$

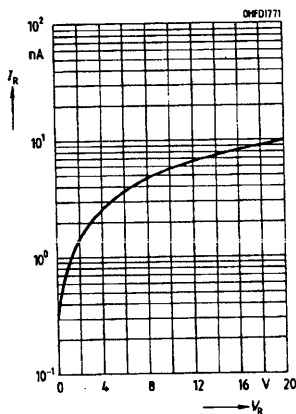

Capacitance, $C=f(V_R), f=1 MHz, E=0$

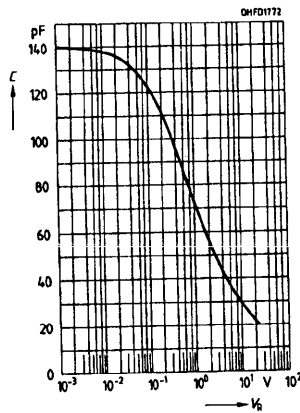

Dark current, $I_R=f(T_A), V_R=1 V, E=0$

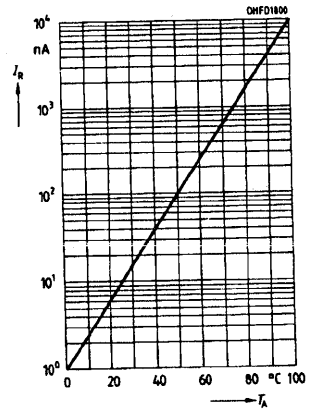

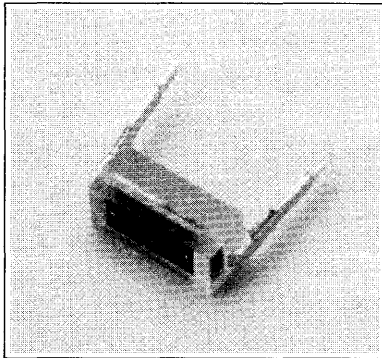

Package Dimensions in Inches (mm)

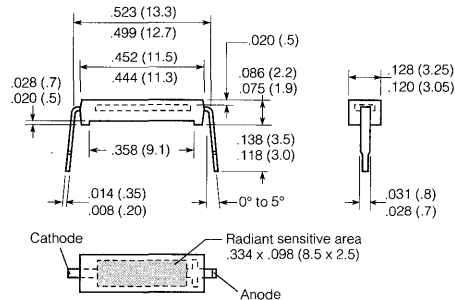

FEATURES

- High Blue Sensitivity
- High Reliability
- Low Reverse Voltage
- Low Noise
- Transparent Plastic Package
- Short Switching Time
- Very Low Dark Current
- Wide Temperature Range

DESCRIPTION

The SFH 100 silicon planar photodiode is suitable for universal applications, particularly with small reverse voltage (approximately 0.1 V) for detecting very limited light levels.

The component comes in a transparent plastic package with solder tabs spaced at 0.500" (12.7 mm).

Switching Applications

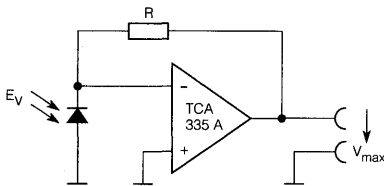

Use operational amplifier with small input current.

Maximum Ratings

Operating and Storage Temperature Range (T_{OP} , T_{STG})	-40° to +80°C
Soldering Temperature (≥ 2 mm from case bottom) (T_S) $t \leq 3$ s	230°C
Reverse Voltage (V_R)	7 V
Power Dissipation (P_{TOT}) $T_A = 25^\circ\text{C}$	100 mW

Characteristics ($T_A = 25^\circ\text{C}$)

Parameter	Symbol	Value	Unit
Photosensitivity			
($V_R = 5$ V, Standard Light A, $T = 2856$ K)	S	175	nA/lx
Maximum Photosensitivity Wavelength	$\lambda_{S_{MAX}}$	850	nm
Photosensitivity Spectral Range			
($S = 10\%$ of S_{MAX})	λ	350 to 1100	nm
Radiant Sensitive Area	A	21.2	mm ²
Radiant Sensitive Area Dimensions	L x W	8.5 x 2.5	mm
Distance, Chip Surface to Case Surface	H	0.5	mm
Half Angle	ϕ	± 60	Deg.
Dark Current ($V_R = 10$ V)	I_R	0.4 (≤ 10)	nA
Spectral Sensitivity ($\lambda = 400$ nm)	S_λ	0.2	A/W
			electrons
Quantum Yield ($\lambda = 400$ nm)	η	0.62	photon
Open Circuit Voltage ($E_V = 1000$ lx) ⁽¹⁾	V_O	430	mV
Short Circuit Current			
($E_E = 0.5$ mW/cm ² , $\lambda = 400$ nm)	I_{SC}	21 (≥ 15)	μA
Rise and Fall Time of Photocurrent			
($R_L = 1$ K Ω , $V_R = 5$ V, $\lambda = 850$ nm, $I_p = 200$ μA)	t_r , t_f	1.8	μs
Forward Voltage			
($I_F = 100$ mA, $E_E = 0$, $T_A = 25^\circ\text{C}$)	V_F	1.3	V
Capacitance ($V_R = 0$ V, $f = 1$ MHz, $E_V = 0$ lx)	C_0	1000	pF
Temperature Coefficient V_O	TC_V	-2.6	mV/K
Temperature Coefficient I_{SC}	TC_I	0.2	%/K
Noise Equivalent Power			
($V_R = 1$ V, $\lambda = 400$ nm)	NEP	5.7×10^{-14}	W/Hz
Detection Limit			
($V_R = 1$ V, $\lambda = 400$ nm)	D^*	8.1×10^{13}	cm ² ·√Hz/W

Note

1. Illuminance shown refers to unfiltered radiation of tungsten filament lamp at color temperature of 2856 K (standard light A per DIN 5033 and IEC publication 306-1).

Relative spectral sensitivity $S_{REL}=f(\lambda)$

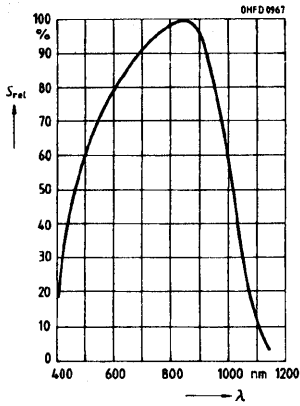

Photocurrent $I_p=f(E_V)$, $V_R=5$ V
Open circuit voltage $V_O=f(E_V)$

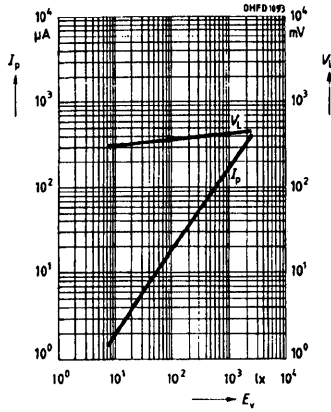

Directional characteristic $S_{REL}=f(\varphi)$

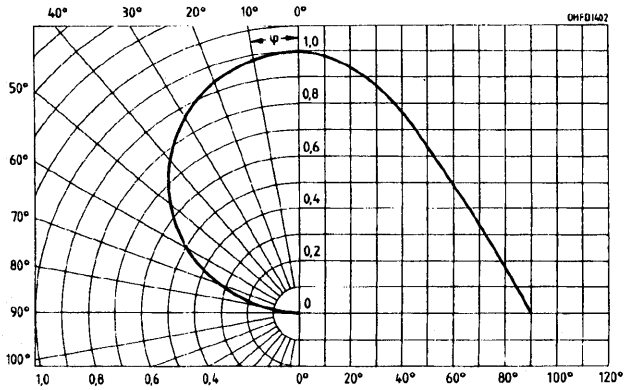

Capacitance $C=f(V_R)$, $f=1$ MHz, $E=0$

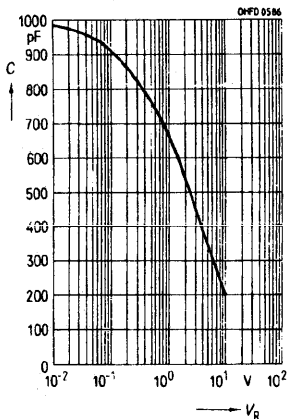

Dark current $I_R=f(V_R)$, $E=0$

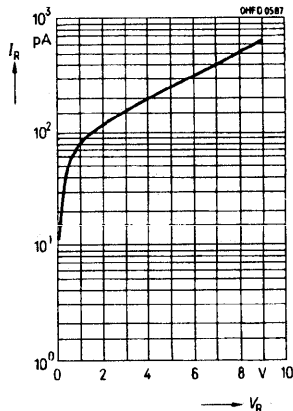

Dark current $I_R=f(T_A)$, $V_R=7$ V, $E=0$

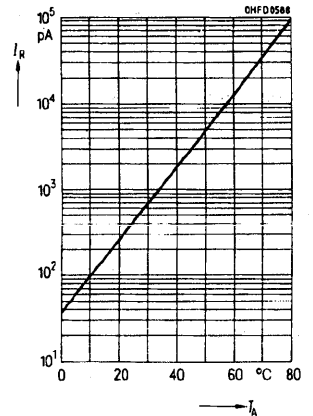

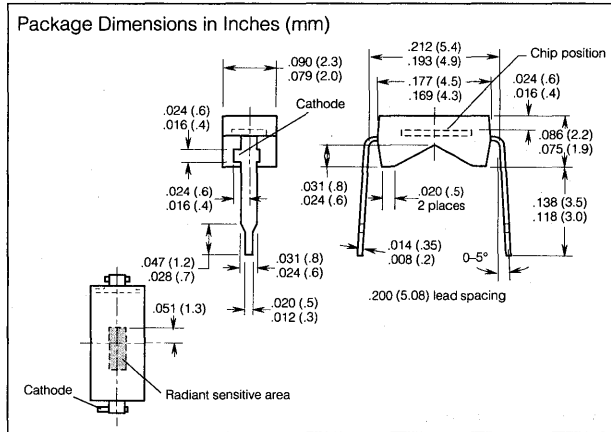
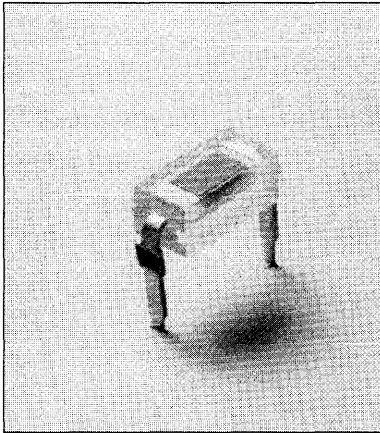

FEATURES

- Very Large Zero Crossover
- High Reliability
- 0.2" (5.08 mm) Lead Spacing
- Low Noise
- Transparent Plastic Package
- Short Switching Time

DESCRIPTION

The SFH 200 silicon planar photodiode, developed as a receiver for low light levels, is suitable for applications such as exposure meters. Key features of this photodiode include large zero point divisions and high open circuit voltage with low light levels.

The component comes in a transparent plastic package with solder tabs at 0.2" (5.08 mm) lead spacing. The cathode is marked by a tab on the solder lead.

Maximum Ratings

Operating and Storage Temperature Range (T_{OP} , T_{STG}) -40° to +80°C
 Soldering Temperature (≥ 2 mm from case bottom) (T_S) $t \leq 3$ s 230°C
 Reverse Voltage (V_R) 7 V
 Power Dissipation (P_{TOT}) $T_A = 25^\circ\text{C}$ 100 mW

Characteristics ($T_A = 25^\circ\text{C}$)

Parameter	Symbol	Value	Unit
Photosensitivity			
($V_R = 5$ V, Standard Light A, $T = 2856$ K)	S	20 (≥ 14)	nA/lx
Maximum Photosensitivity Wavelength	λ_{Smax}	800	nm
Photosensitivity Spectral Range			
($S = 10\%$ of S_{MAX})	λ	350 to 1100	nm
Radiant Sensitive Area	A	2	mm ²
Radiant Sensitive Area Dimensions	L x W	1 x 2	mm
Distance, Chip Surface to Case Surface	H	0.5	mm
Half Angle	ϕ	± 60	Deg.
Dark Current ($V_R = 1$ V)	I_R	5 (≤ 40)	pA
Spectral Sensitivity ($\lambda = 850$ nm)	S_λ	0.5	A/W
Zero Crossing ($E_E = 0$)	S_0	≤ 0.4	pA/mV electrons
Quantum Yield ($\lambda = 850$ nm)	η	0.73	photon
Open Circuit Voltage ($E_V = 1000$ lx) ⁽¹⁾	V_O	450 (≥ 380)	mV
Short Circuit Current ($E_V = 1000$ lx) ⁽¹⁾	I_{SC}	20	μA
Rise and Fall Time of Photocurrent			
($R_L = 1$ K Ω , $V_R = 5$ V, $\lambda = 850$ nm, $I_P = 20$ μA)	t_R , t_F	1.5	μs
Forward Voltage			
($I_F = 80$ mA, $E_E = 0$)	V_F	1.3	V
Capacitance ($V_R = 0$ V, $f = 1$ MHz, $E_V = 0$ lx)	C_O	180	pF
Temperature Coefficient V_O	TC_V	-2.6	mV/K
Temperature Coefficient I_{SC}	TC_I	0.2	%/K
Noise Equivalent Power			
($V_R = 1$ V, $\lambda = 850$ nm)	NEP	2.5×10^{-15}	W/ $\sqrt{\text{Hz}}$
Detection Limit			
($V_R = 1$ V, $\lambda = 850$ nm)	D^*	5.6×10^{13}	$\text{cm}^2 \cdot \sqrt{\text{Hz}}/\text{W}$

Note
 1. Illuminance shown refers to unfiltered radiation of tungsten filament lamp at color temperature of 2856 K (standard light A per DIN 5033 and IEC publication 306-1).

Relative spectral sensitivity $S_{REL}=f(\lambda)$

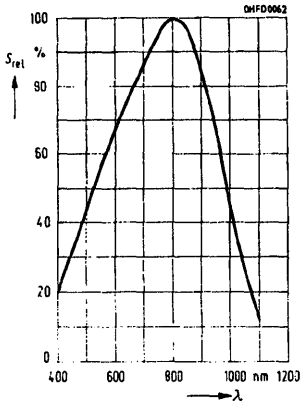

Photocurrent $I_p=f(E_v)$, $V_R=5$ V
Open circuit voltage $V_O=f(E_v)$

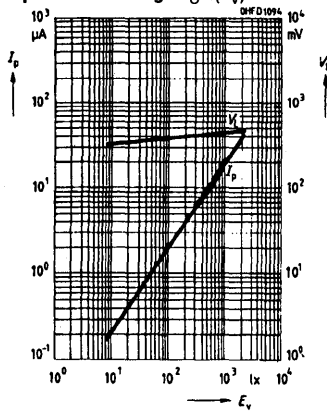

Directional characteristic $S_{REL}=f(\varphi)$

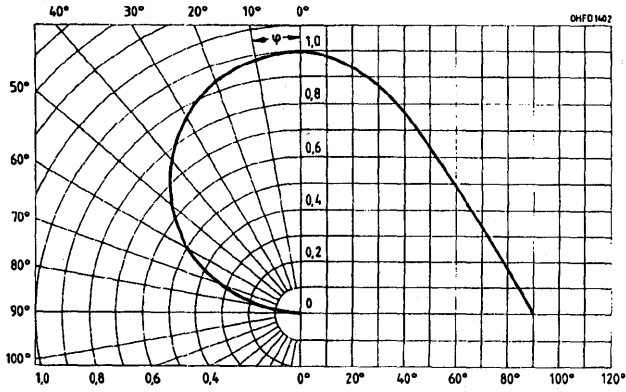

Power dissipation $P_{TOT}=f(T_A)$

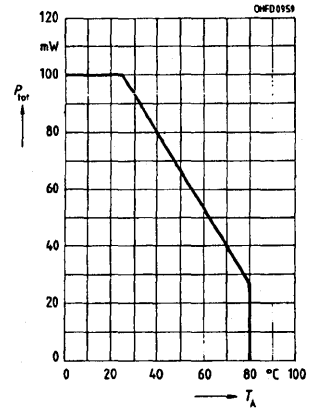

Dark current $I_R=f(V_R)$, $E=0$

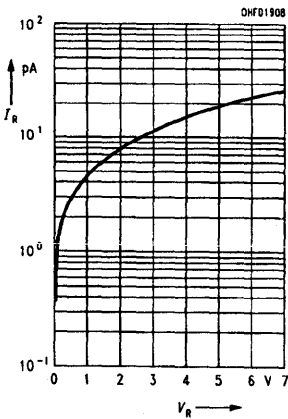

Capacitance $C=f(V_R)$, $f=1$ MHz, $E=0$

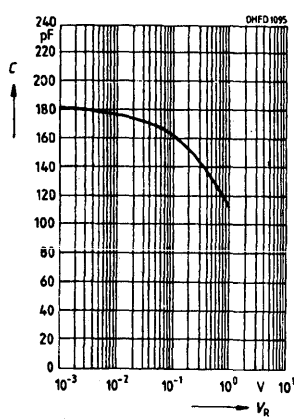

Dark current $I_R=f(T_A)$, $V_R=1$ V, $E=0$

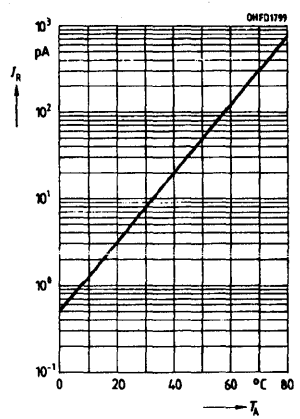

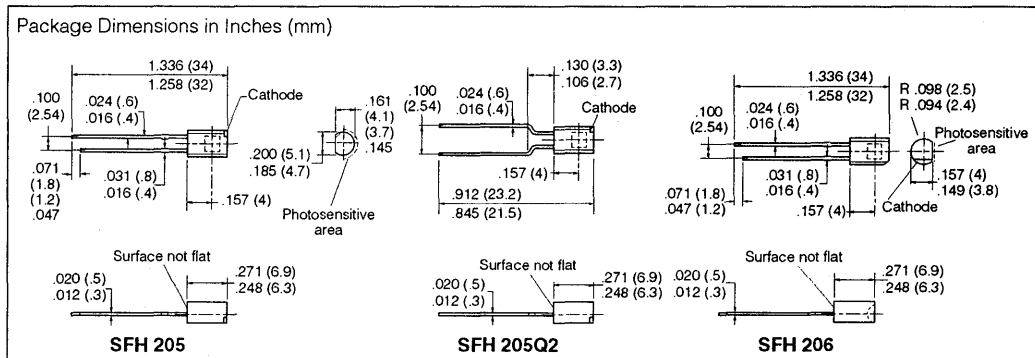

FEATURES

- Built-in Daylight Filter
- High Reliability
- 0.1" (2.54 mm) Lead Spacing
- Low Noise
- Black Plastic Encapsulated Package
- Suitable for IR Sound Transmission

DESCRIPTION

The SFH 205 silicon planar PIN photodiode is housed in a transparent plastic package that serves as both a filter and a window for infrared emission. Its terminals are solder tabs at 0.1" (2.54 mm) lead spacing. The cathode marking is stamped at the package edge.

Key features include low junction capacitance, high cut-off frequency, short switching times, and an excellent signal/noise ratio, even at low light levels.

This versatile photodetector can be used as either a diode or as a voltaic cell. Applications include IR sound transmission and remote control.

Maximum Ratings

Operating and Storage Temperature Range (T_{OP} , T_{STG}) -40° to +80°C
 Soldering Temperature (≥ 2 mm from case bottom) (T_S) $t \leq 3$ s 230°C
 Reverse Voltage (V_R) 32 V
 Power Dissipation (P_{TOT}) $T_A = 25^\circ\text{C}$ 150 mW

Characteristics ($T_A = 25^\circ\text{C}$)

Parameter	Symbol	Value	Unit
Photosensitivity			
($V_R = 5$ V, $\lambda = 950$ nm, $E_E = 0.5$ mW/cm ²)	S	25 (≥ 15)	μA
Maximum Photosensitivity Wavelength	λ_{Smax}	950	nm
Photosensitivity Spectral Range			
(S = 10% of S_{MAX})	λ	800 to 1100	nm
Radiant Sensitive Area	A	7.00	mm ²
Radiant Sensitive Area Dimensions	L x W	2.65 x 2.65	mm
Distance, Chip Surface to Case Surface	H	2.3 to 2.5	mm
Half Angle	ϕ	± 60	Deg.
Dark Current ($V_R = 10$ V)	I_R	2 (≤ 30)	nA
Spectral Sensitivity ($\lambda = 950$ nm)	S_λ	0.59	A/W electrons photon
Quantum Yield ($\lambda = 950$ nm)	η	0.77	
Open Circuit Voltage			
($\lambda = 950$ nm, $E_E = 0.5$ mW/cm ²)	V_O	330 (≥ 250)	mV
Short Circuit Current			
($\lambda = 950$ nm, $E_E = 0.5$ mW/cm ²)	I_{SC}	25	μA
Rise and Fall Time of Photocurrent			
($R_L = 50 \Omega$, $V_R = 5$ V, $\lambda = 850$ nm, $I_P = 800 \mu\text{A}$)	t_R , t_F	20	ns
Forward Voltage			
($I_F = 100$ mA, $E_E = 0$)	V_F	1.3	V
Capacitance ($V_R = 0$ V, $f = 1$ MHz, $E_V = 0$ lx)	C_O	72	pF
Temperature Coefficient V_O	TC_V	-2.6	mV/K
Temperature Coefficient I_{SC}	TC_I	0.18	%/K
Noise Equivalent Power ($V_R = 10$ V)	NEP	4.3×10^{-14}	W/Hz
Detection Limit ($V_R = 10$ V)	D^*	6.2×10^{12}	$\text{cm} \cdot \sqrt{\text{Hz}}$

Relative spectral sensitivity $S_{REL}=f(\lambda)$

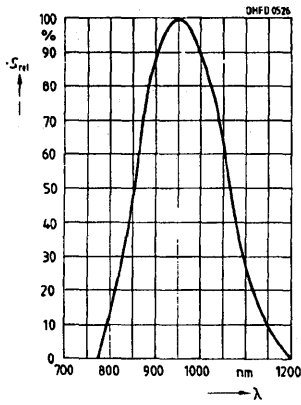

Photocurrent $I_p=f(E_e)$ $V_R=5$ V
Open circuit voltage $V_O=f(E_e)$

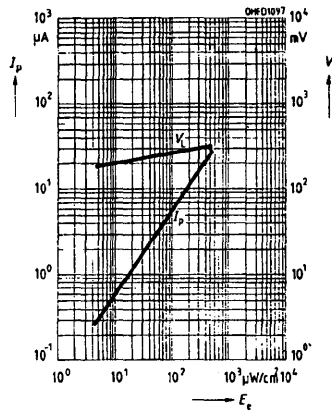

Directional characteristic $S_{REL}=f(\psi)$

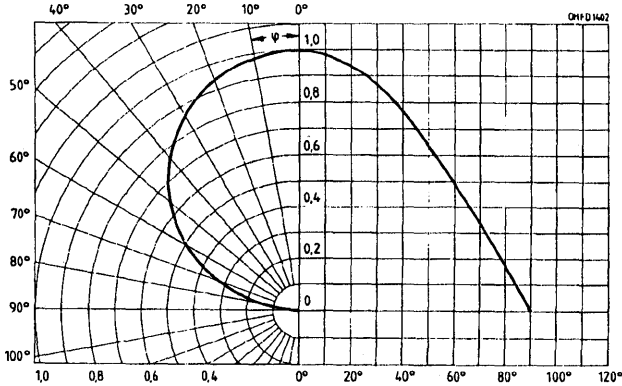

Power dissipation $P_{TOT}=f(T_A)$

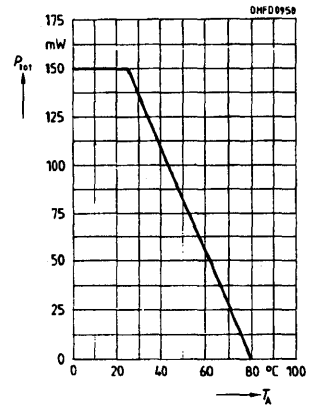

Dark current $I_R=f(V_R)$, $E=0$

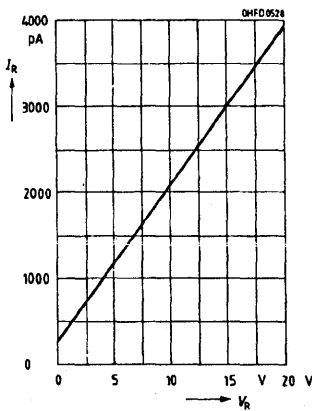

Capacitance $C=f(V_R)$, $f=1$ MHz, $E=0$

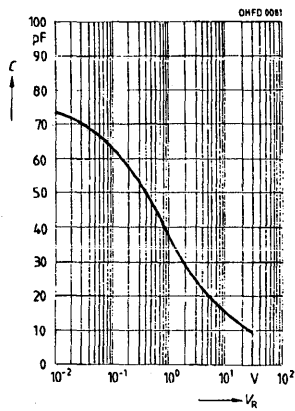

Dark current $I_R=f(T_A)$, $V_R=10$ V, $E=0$

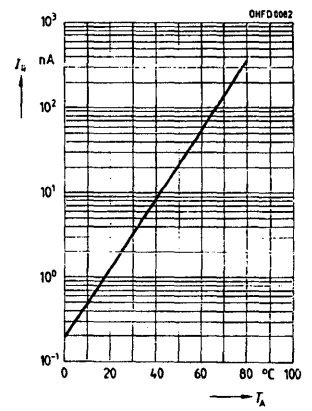

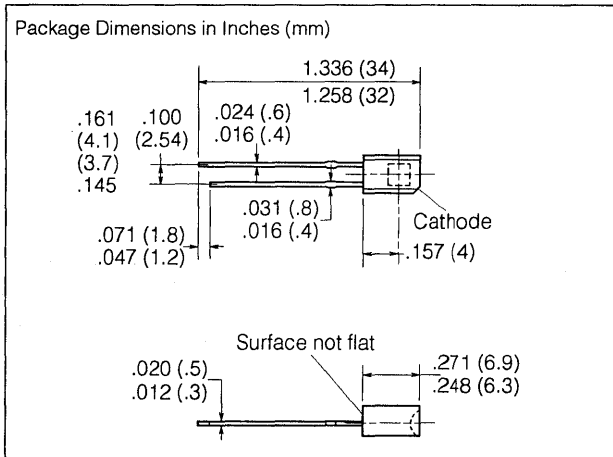
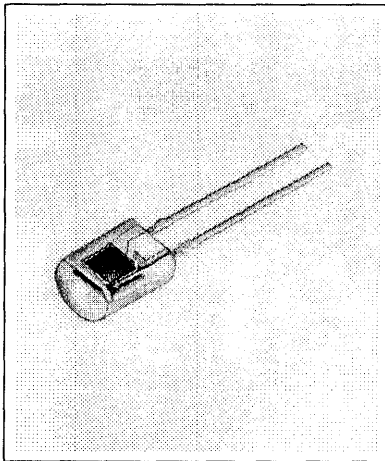

FEATURES

- Colorless Transparent Plastic Package
- Suitable for IR Sound Transmission
- High Reliability
- 0.1" (2.54 mm) Lead Spacing
- Low Noise

DESCRIPTION

The SFH 206K silicon planar PIN photodiode is housed in a colorless transparent plastic package. Its terminals are solder tabs at 0.1" (2.54 mm) lead spacing. The cathode marking is stamped at the package edge.

Key features include low junction capacitance, high cutoff frequency, short switching times, and an excellent signal/noise ratio, even at low light levels.

This versatile photodetector can be used as either a diode or as a voltaic cell. Applications include IR sound transmission and remote control.

Maximum Ratings

Operating and Storage Temperature Range (T_{OP} , T_{STG})	-40° to +80°C
Soldering Temperature (≥ 2 mm from case bottom) (T_S) $t \leq 3$ s	230°C
Reverse Voltage (V_R)	32 V
Power Dissipation (P_{TOT}) $T_A=25^\circ\text{C}$	150 mW

Characteristics ($T_A=25^\circ\text{C}$)

Parameter	Symbol	Value	Unit
Photosensitivity			
($V_R=5$ V, Standard Light A, $T=2856$ K)	S	80(≥ 50)	nA/lx
Maximum Photosensitivity Wavelength	$\lambda_{S_{MAX}}$	850	nm
Photosensitivity Spectral Range			
($S=10\%$ of S_{MAX})	λ	400 to 1100	nm
Radiant Sensitive Area	A	7.00	mm ²
Radiant Sensitive Area Dimensions	L x W	2.65 x 2.65	mm
Distance, Chip Surface to Case Surface	H	1.2 to 1.4	mm
Half Angle	ϕ	± 60	Deg.
Dark Current ($V_R=10$ V)	I_R	2(≤ 30)	nA
Spectral Sensitivity ($\lambda=850$ nm)	S_λ	0.62	AW electrons
Quantum Yield ($\lambda=850$ nm)	η	0.9	photon
Open Circuit Voltage ($E_V=1000$ lx) ⁽¹⁾	V_O	365(≥ 310)	mV
Short Circuit Current ($E_V=1000$ lx) ⁽¹⁾	I_{SC}	80	μA
Rise and Fall Time of Photocurrent			
($R_L=50$ Ω , $V_R=5$ V, $\lambda=850$ nm, $I_P=800$ μA)	t_R , t_F	20	ns
Forward Voltage ($I_F=100$ mA, $E_E=0$)	V_F	1.3	V
Capacitance ($V_R=0$ V, $f=1$ MHz, $E_V=0$ lx)	C_0	72	pF
Temperature Coefficient V_O	TC_V	-2.6	mV/K
Temperature Coefficient I_{SC}	TC_I	0.18	%/K
Noise Equivalent Power			
($V_R=10$ V, $\lambda=850$ nm)	NEP	4.2×10^{-14}	W/Hz
Detection Limit			
($V_R=10$ V, $\lambda=850$ nm)	D^*	6.3×10^{12}	$\text{cm} \cdot \sqrt{\text{Hz}}/\text{W}$

Note

1. Illuminance shown refers to unfiltered radiation of tungsten filament lamp at color temperature of 2856 K (standard light A per DIN 5033 and IEC publication 306-1).

Relative spectral sensitivity $S_{REL}=f(\lambda)$

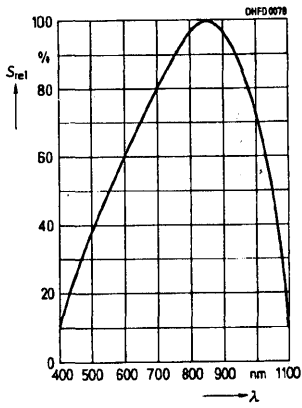

Photocurrent $I_P=f(E_E)$
Open circuit voltage $V_O=f(E_E)$

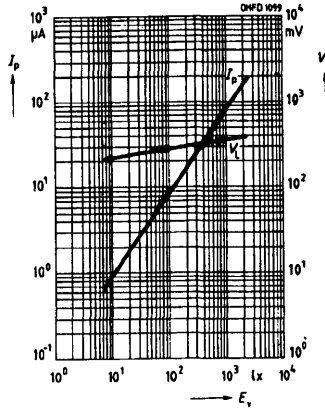

Directional characteristic $S_{REL}=f(\varphi)$

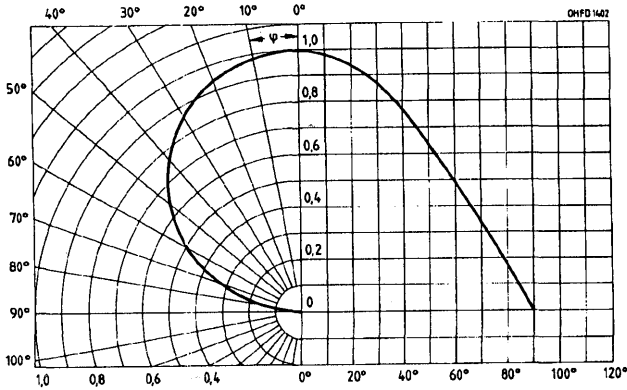

Power dissipation $P_{TOT}=f(T_A)$

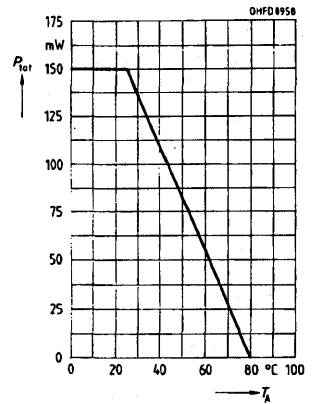

Dark current $I_R=f(V_R), E=0$

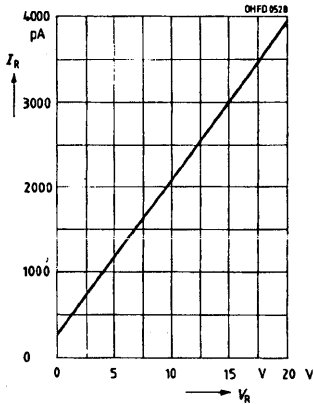

Capacitance $C=f(V_R), f=1 \text{ MHz}, E=0$

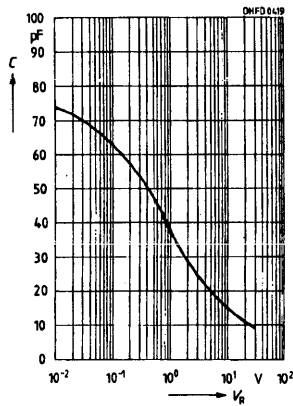

Dark current $I_R=f(T_A), V_R=10 \text{ V}, E=0$

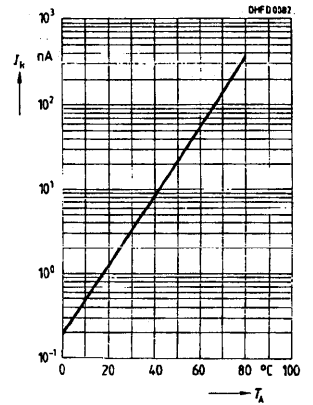

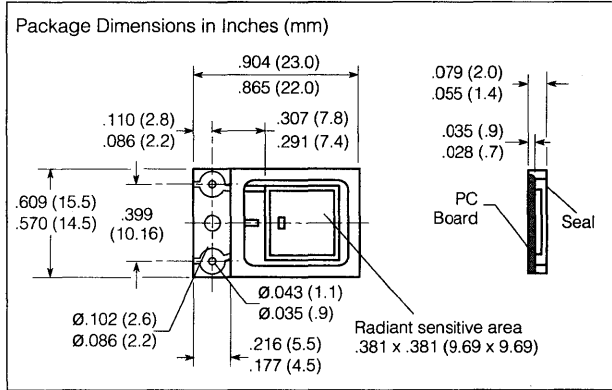
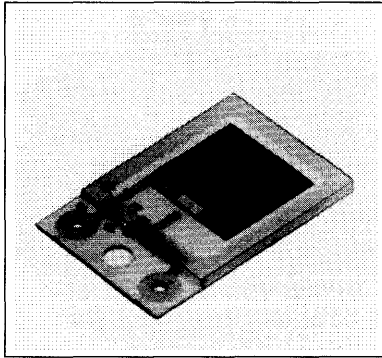

FEATURES

- **Package:** Chip on PC Board, Fully Encapsulated
- **High Reliability**
- **No Testable Degradation**
- **Low Noise**
- **High Cutoff Frequency**
- **High Open Circuit Voltage at Voltaic Cell Operation**
- **Short Switching Time**
- **Low Capacitance**
- **High Spectral Sensitivity**
- **Wide Temperature Range**
- **Usage:** Visible and Near Infrared Range
- **Good Linearity**

DESCRIPTION

The SFH 207A silicon planar PIN photodiode provides positive front and negative back contact. This photodetector can be used as either a diode, with reverse voltage, or as a voltaic cell.

Applications include industrial electronics, measurement and control, and particle detection.

Maximum Ratings

Operating and Storage Temperature Range (T_{OP} , T_{STG}) -40° to $+80^{\circ}$ C
 Soldering Temperature (2 mm from case bottom) (T_S) $t \leq 3$ s 230° C
 Reverse Voltage (V_R) 15 V
 Power Dissipation (P_{TOT}) $T_A = 25^{\circ}$ C 100 mW

Characteristics ($T_A = 25^{\circ}$ C)

Parameter	Symbol	Value	Unit
Photosensitivity			
($V_R = 5$ V, Standard Light A, $T = 2856$ K)	S	850 (≥ 750)	nA/lx
Maximum Photosensitivity Wavelength	$\lambda_{S_{MAX}}$	850	nm
Photosensitivity Spectral Range			
($S = 10\%$ of S_{MAX})	λ	400 to 1100	nm
Radiant Sensitive Area	A	93.9	mm ²
Radiant Sensitive Area Dimensions	L x W	9.69 x 9.69	mm x mm
Distance, Chip Surface to Case Surface	H	0.5 to 0.7	mm
Half Angle	ϕ	± 60	Deg.
Dark Current ($V_R = 10$ V, $E = 0$)	I_R	30 (≤ 200)	nA
Spectral Photosensitivity ($\lambda = 850$ nm)	S_{λ}	0.6	A/W
Quantum Yield ($\lambda = 850$ nm)	η	0.88	electron/ photon
Open Circuit Voltage ($E_V = 1000$ lx) ⁽¹⁾	V_O	370 (≥ 300)	mV
Short Circuit Current ($E_V = 1000$ lx) ⁽¹⁾	I_{SC}	810	μ A
Rise and Fall Time of Photocurrent			
($R_L = 50$ Ω , $V_R = 15$ V, $\lambda = 850$ nm, $I_F = 1$ μ A)	t_R , t_F	30	ns
Forward Voltage ($I_F = 100$ mA, $E = 0$)	V_F	1.2	V
Capacitance ($V_R = 0$ V, $f = 1$ MHz, $E = 0$)	C_0	950	pF
Temperature Coefficient V_O			
(Standard Light A)	TC_V	-2.6	mV/K
Temperature Coefficient I_{SC}			
(Standard Light A)	TC_I	0.2	%/K
Noise Equivalent Power			
($V_R = 10$ V, $\lambda = 850$ nm)	NEP	1.63×10^{-13}	W/ \sqrt Hz
Detection Limit ($V_R = 10$ V, $\lambda = 850$ nm)	D^*	5.94×10^{12}	$cm^2 \sqrt$ Hz/W

Note

1. Illuminance shown refers to unfiltered radiation of tungsten filament lamp at color temperature of 2856 K (standard light A per DIN 5033 and IEC publication 306-1).

Relative spectral sensitivity $S_{REL}=f(\lambda)$

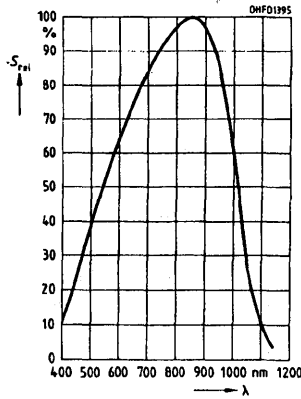

Photocurrent $I_p=f(E_V)$
Open circuit voltage $V_O=f(E_V)$

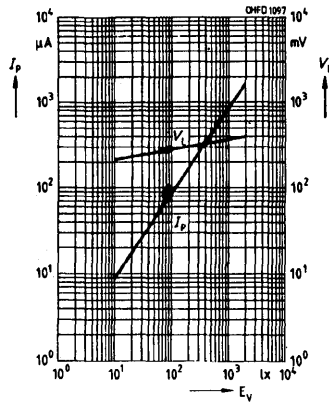

Directional characteristic $S_{REL}=f(\varphi)$

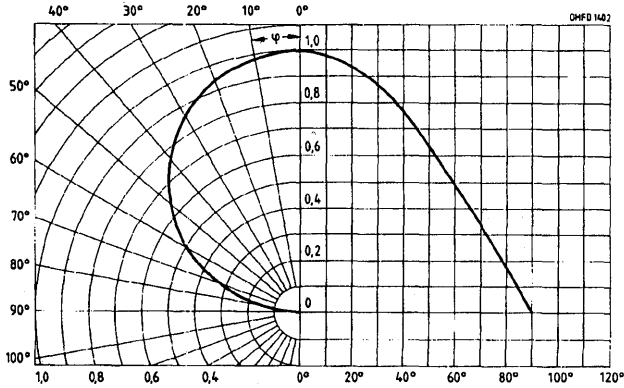

Dark current $I_R=f(V_R), E=0$

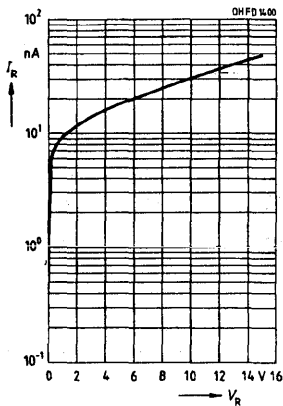

Capacitance $C=f(V_R), f=1 \text{ MHz}, E=0$

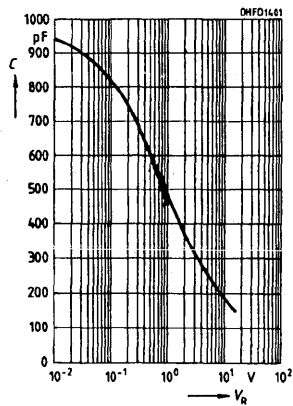

Dark current $I_R=f(T_A), V_R=10 \text{ V}, E=0$

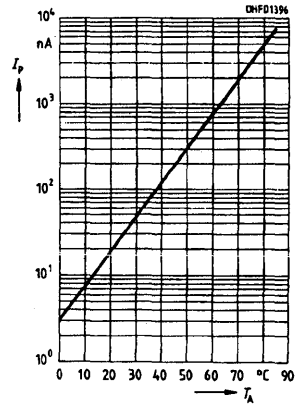

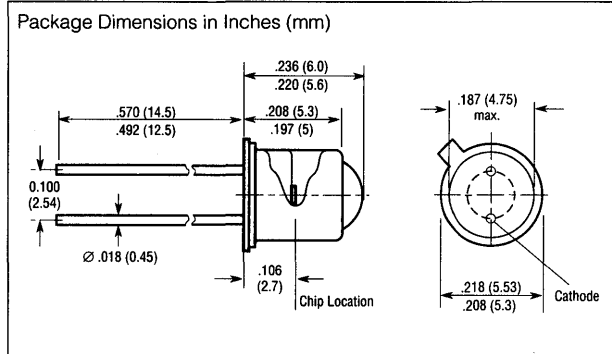
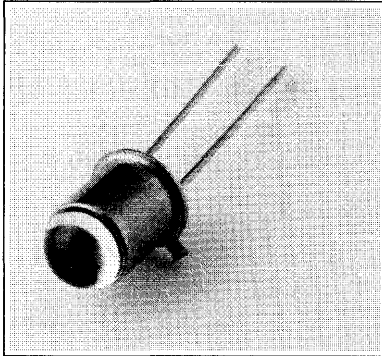

FEATURES

- **Package: 18 A3 DIN 41870 (TO18), Glass Lens, Hermetically Sealed, Solder Tabs, Lead Spacing 0.1" (2.54 mm)**
- **High Reliability**
- **No Testable Degradation**
- **Low Noise**
- **Anode Marking: Tab at Package Bottom**
- **High Open Circuit Voltage as Voltaic Cells**
- **Short Switching Time**
- **High Packing Density**
- **High Spectral Sensitivity**
- **Wide Temperature Range**
- **Usage: Visible and Near Infrared Range**
- **Detector for Low Light Levels**

DESCRIPTION

The SFH 212 silicon planar PIN photodiode includes N-Si material, which provides positive front and negative back contact. This photodetector can be used as either a diode with reverse voltage or as a voltaic cell.

Applications include exposure meters and automatic exposure timers.

Maximum Ratings

Operating and Storage Temperature Range (T_{OP} , T_{STG}) -40° to $+80^{\circ}\text{C}$
 Soldering Temperature (2 mm from case bottom) (T_S) $t \leq 3$ s 230°C
 Reverse Voltage (V_R) 7 V
 Power Dissipation (P_{TOT}) $T_A = 25^{\circ}\text{C}$ 200 mW

Characteristics ($T_A = 25^{\circ}\text{C}$)

Parameter	Symbol	Value	Unit
Photosensitivity ($V_R = 5$ V, Standard Light A, $T = 2856$ K)	S	25 (≥ 20)	nA/lx
Maximum Photosensitivity Wavelength	λ_{Smax}	800	nm
Photosensitivity Spectral Range ($S = 10\%$ of S_{MAX})	λ	350 to 1100	nm
Radiant Sensitive Area	A	0.97	mm ²
Radiant Sensitive Area Dimensions	L x W	0.985 x 0.985	mm
Distance, Chip Surface to Case Surface	D	2.6 to 3.2	mm
Half Angle	ϕ	± 15	Deg.
Dark Current ($V_R = 1$ V)	I_R	5 (≤ 20)	pA
Spectral Photosensitivity ($\lambda = 850$ nm)	S_λ	0.50	A/W
Zero Crossover ($E_E = 0$)	S_0	< 0.4	pA/mV electrons photon
Quantum Yield ($\lambda = 850$ nm)	η	0.73	photon
Open Circuit Voltage ($E_V = 1000$ lx) ⁽¹⁾	V_O	470 (≥ 400)	mV
Short Circuit Current ($E_V = 1000$ lx) ⁽¹⁾	I_{SC}	25	μA
Rise and Fall Time of Photocurrent ($R_L = 1$ K Ω , $V_R = 5$ V, $\lambda = 850$ nm, $I_P = 25$ μA)	t_R , t_F	1.3	μs
Forward Voltage ($I_F = 100$ mA, $E_E = 0$)	V_F	1.3	V
Capacitance ($V_R = 0$ V, $f = 1$ MHz, $E_V = 0$ lx)	C_0	100	pF
Temperature Coefficient V_O	TC_V	-2.6	mV/K
Temperature Coefficient I_{SC}	TC_I	0.16	%/K
Noise Equivalent Power ($V_R = 1$ V, $\lambda = 850$ nm)	NEP	2.5×10^{-15}	W/Hz
Detection Limit ($V_R = 1$ V, $\lambda = 850$ nm)	D^*	4.0×10^{13}	$\text{cm}^2 \cdot \text{Hz/W}$

Note

1. Illuminance shown refers to unfiltered radiation of tungsten filament lamp at color temperature of 2856 K (standard light A per DIN 5033 and IEC publication 306-1).

Relative spectral sensitivity $S_{REL}=f(\lambda)$

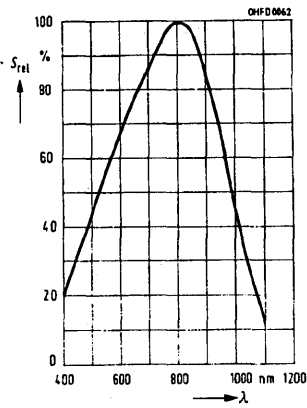

Photocurrent $I_p=f(E_V)$ $V_R=5$ V
Open circuit voltage $V_O=f(E_V)$

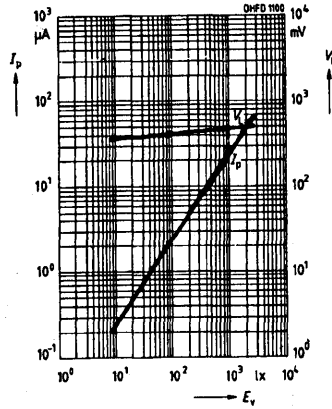

Directional characteristic $S_{REL}=f(\varphi)$

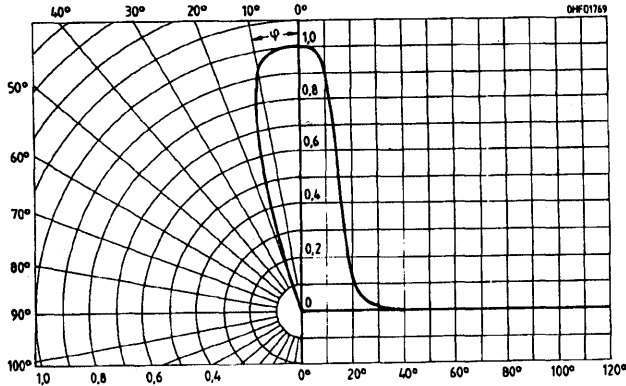

Power dissipation $P_{TOT}=f(T_A)$

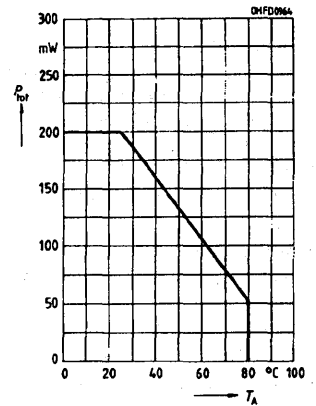

Dark current $I_R=f(V_R)$, $E=0$

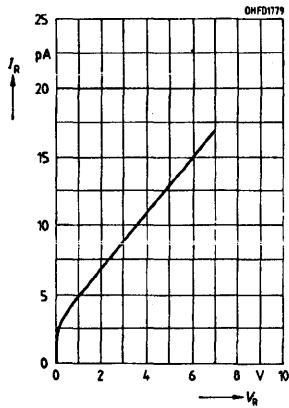

Capacitance $C=f(V_R)$, $f=1$ MHz, $E=0$

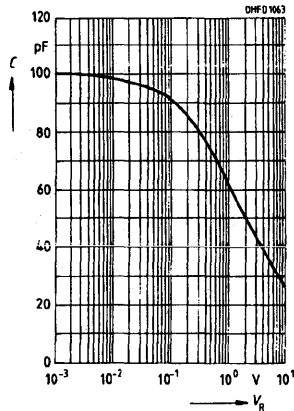

Dark current $I_R=f(T_A)$, $V_R=10$ V, $E=0$

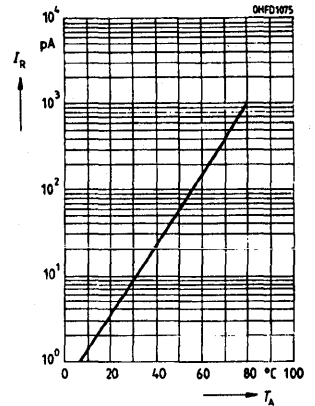

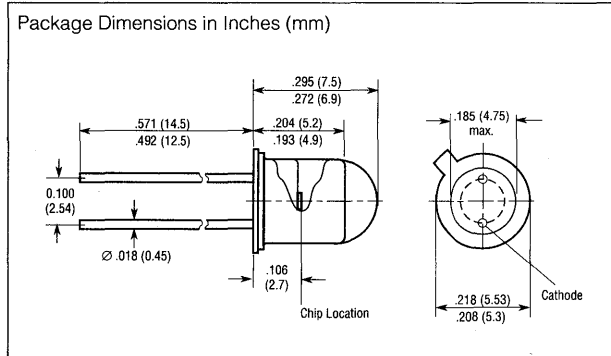
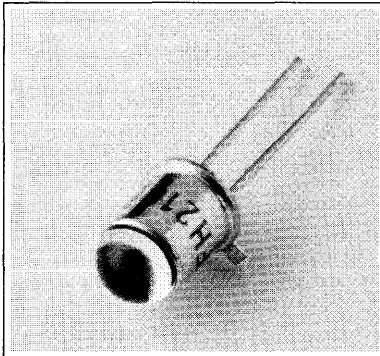

FEATURES

- **Package: 18 A3 DIN 41870 (TO18), Glass Lens, Hermetically Sealed, Solder Tabs, Lead Spacing 0.1" (2.54 mm)**
- **High Reliability**
- **No Testable Degradation**
- **Low Noise**
- **Anode Marking: Tab at Package Bottom**
- **High Open Circuit Voltage as Voltaic Cells**
- **Very Short Switching Time**
- **High Packing Density**
- **High Spectral Sensitivity**
- **Wide Temperature Range**
- **Usage: Visible and Near Infrared Range**
- **Low Capacitance**
- **High Cutoff Frequency**

DESCRIPTION

The SFH 216 silicon planar PIN photodiode includes N-Si material, which provides positive front and negative back contact. This photodetector can be used as either a diode with reverse voltage or as a voltaic cell.

Applications include high-modulation bandwidth optical sensor for light pens.

Maximum Ratings

Operating and Storage Temperature Range (T_{OP} , T_{STG}) -40° to $+80^{\circ}$ C
 Soldering Temperature (2 mm from case bottom) (T_S) $t \leq 3$ s 230° C
 Reverse Voltage (V_R) 50 V
 Power Dissipation (P_{TOT}) $T_A = 25^{\circ}$ C 250 mW

Characteristics ($T_A = 25^{\circ}$ C)

Parameter	Symbol	Value	Unit
Photosensitivity			
($V_R = 5$ V, Standard Light A, $T = 2856$ K)	S	50 (≥ 35)	nA/lx
Maximum Photosensitivity Wavelength	λ_{Smax}	850	nm
Photosensitivity Spectral Range			
($S = 10\%$ of S_{MAX})	λ	350 to 1150	nm
Radiant Sensitive Area	A	1	mm ²
Radiant Sensitive Area Dimensions	L x W	1 x 1	mm
Distance, Chip Surface to Case Top Edge	D	4.2 to 5.0	mm
Half Angle	ϕ	± 12	Deg.
Dark Current ($V_R = 20$ V)	I_R	1 (≤ 5)	nA
Spectral Photosensitivity ($\lambda = 850$ nm)	S_{λ}	0.55	A/W electrons
Quantum Yield ($\lambda = 850$ nm)	η	0.80	photon
Open Circuit Voltage ($E_V = 1000$ lx) ⁽¹⁾	V_O	410 (≥ 350)	mV
Short Circuit Current ($E_V = 1000$ lx) ⁽¹⁾	I_{SC}	50	μ A
Rise and Fall Time of Photocurrent			
($R_L = 50 \Omega$, $V_R = 20$ V, $\lambda = 850$ nm, $I_P = 800 \mu$ A)	t_R , t_F	5	ns
Forward Voltage			
($I_F = 100$ mA, $E_E = 0$, $T_A = 25^{\circ}$ C)	V_F	1.3	V
Capacitance ($V_R = 0$ V, $f = 1$ MHz, $E_V = 0$ lx)	C_O	11	pF
Temperature Coefficient V_O	TC_V	-2.6	mV/K
Temperature Coefficient I_{SC}	TC_I	0.2	%/K
Noise Equivalent Power			
($V_R = 20$ V, $\lambda = 850$ nm)	NEP	3.3×10^{-14}	W/√Hz
Detection Limit ($V_R = 20$ V, $\lambda = 850$ nm)	D^*	3.1×10^{12}	$cm^2 \cdot \sqrt{Hz}/W$

Note

1. Illuminance shown refers to unfiltered radiation of tungsten filament lamp at color temperature of 2856 K (standard light A per DIN 5033 and IEC publication 306-1).

Relative spectral sensitivity $S_{REL}=f(\lambda)$

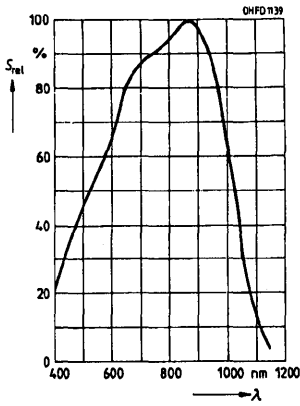

Photocurrent $I_p=f(E_v)$ $V_R=5V$
Open circuit voltage $V_O=f(E_v)$

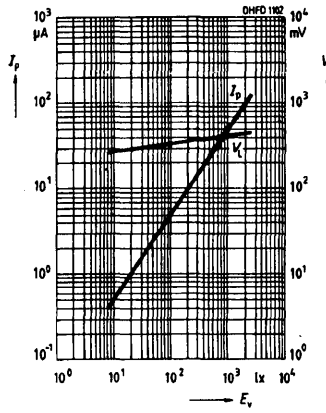

Series resistance $R_S=f(V_R)$, $f=100\text{ MHz}$, $E=0$

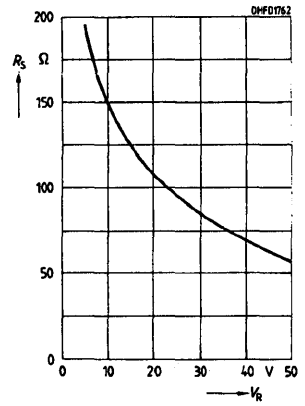

Directional characteristic $S_{REL}=f(\varphi)$

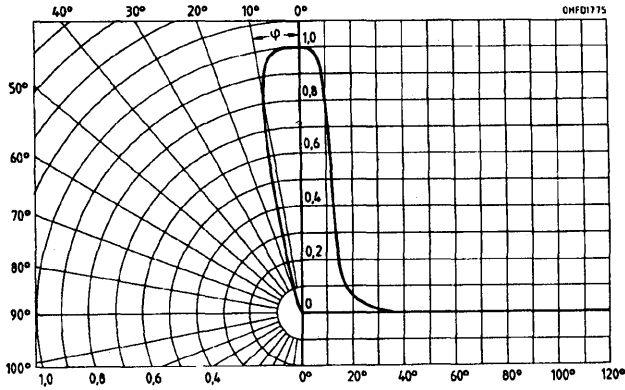

Power dissipation $P_{TOT}=f(T_A)$

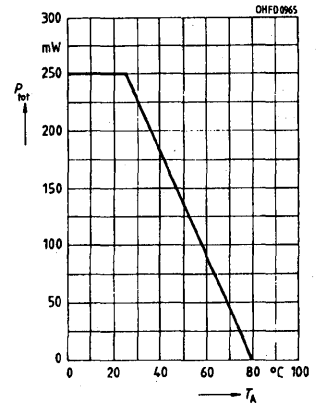

Dark current $I_R=f(V_R)$, $E=0$

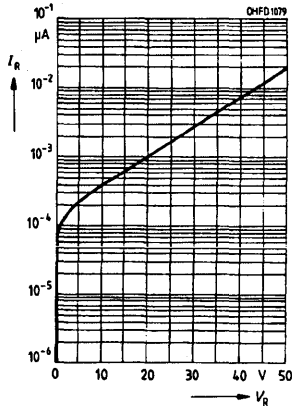

Capacitance $C=f(V_R)$, $f=1\text{ MHz}$, $E=0$

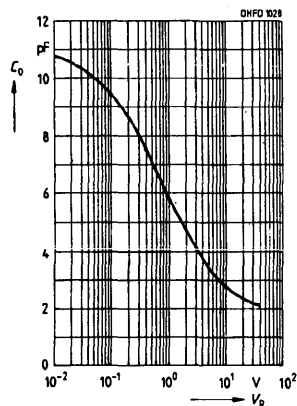

Dark current $I_R=f(T_A)$, $V_R=20V$, $E=0$

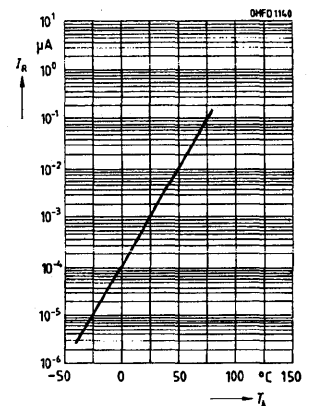

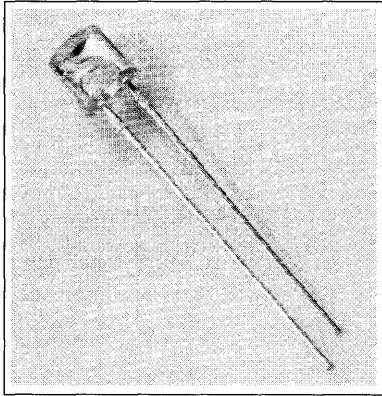

Package Dimensions in Inches (mm)

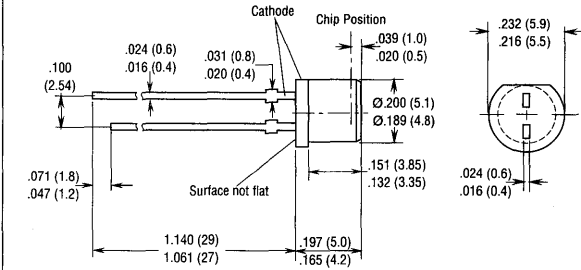

FEATURES

- Silicon Planar PIN Photodiode
- High Speed, 1 ns
- Low Dark Current, 1 nA
- T1³/₄ Package
- Cost Effective
- Flat Top
- IR Filter (SFH 217F)

DESCRIPTION

The SFH 217 and SFH 217F are planar PIN photodiodes in a plastic T1³/₄ package with a flat lens. This flat window has no effect on the beam path of optical lens systems. The cathode is denoted by a shorter lead.

Features include low junction capacitance and fast switching speeds.

Because of its high cutoff frequency, this diode is particularly well-suited for use as a high-modulation bandwidth optical sensor.

Maximum Ratings

Operating and Storage Temperature Range (T_{OP} , T_{STG}) -55° to +100°C
 Soldering Temperature (2 mm from case bottom) (T_S) $t \leq 3$ s 300°C
 Reverse Voltage (V_R) 50 V
 Power Dissipation (P_{TOT}) $T_A = 25^\circ\text{C}$ 100 mW

Characteristics ($T_A = 25^\circ\text{C}$)

Parameter	Symbol	Value		Unit
		SFH 217	SFH 217F	
Photosensitivity				
($V_R = 5$ V, Standard Light A, $T = 2856$ K)	S	9.5(±5)	-	nA/lx
($V_R = 5$ V, $\lambda = 950$ nm, $E_E = 0.5$ mW/cm ²)	S	-	3.1(±1.8)	μA
Maximum Photosensitivity Wavelength	λ_{Smax}	850	900	nm
Photosensitivity Spectral Range				
(S=10% of S_{MAX})	λ	400 to 1100	750 to 1100	nm
Radiant Sensitive Area	A	1	1	mm ²
Radiant Sensitive Area Dimensions	L x W	1 x 1	1 x 1	mm
Distance, Chip Surface to Case Surface	H	0.4 to 0.7	0.4 to 0.7	mm
Half Angle	ϕ	±75	±75	Deg.
Dark Current ($V_R = 20$ V, $E = 0$)	I_D	1(≤10)	1(≤10)	nA
Spectral Sensitivity ($\lambda = 850$ nm)	S_λ	0.62	0.59	A/W
Quantum Yield				
(Electrons per Photon) ($\lambda = 850$ nm)	η	0.89	0.86	electrons/photon
Open Circuit Voltage ($E_E = 0.5$ mW/cm ² , $\lambda = 950$ nm, $E_V = 1000$ lx) ⁽¹⁾	V_0	350(≥300)	300(≥250)	mV
Short Circuit Current ($E_E = 0.5$ mW/cm ² , $\lambda = 950$ nm, $E_V = 1000$ lx) ⁽¹⁾	I_{SC}	9.3	3.0	μA
Rise and Fall Time of Photocurrent				
(Load Resistance $R_L = 50 \Omega$, $V_R = 20$ V, $\lambda = 850$ nm, $I_p = 800 \mu\text{A}$)	t_R, t_F	5	5	ns
Forward Voltage				
($I_F = 80$ mA, $E_E = 0$, $T_A = 25^\circ\text{C}$)	V_F	1.3	1.3	V
Capacitance ($V_R = 0$ V, $f = 1$ MHz, $E = 0$)	C_0	11	11	pF
Temperature Coefficient V_0	TC_V	-2.6	-2.6	mV/K
Temperature Coefficient I_{SC}	TC_I	0.18	0.2	%/K
Noise Equivalent Power				
($V_R = 20$ V, $\lambda = 850$ nm)	NEP	2.9×10^{-14}	2.9×10^{-14}	W/√Hz
Detection Limit ($V_R = 20$ V, $\lambda = 850$ nm)	D^*	3.5×10^{12}	3.5×10^{12}	cm ² √Hz/W

Note

1. Illuminance shown refers to unfiltered radiation of tungsten filament lamp at color temperature of 2856 K (standard light A per DIN 5033 and IEC publication 306-1).

SFH 217
Relative spectral sensitivity
 $S_{REL}=f(\lambda)$

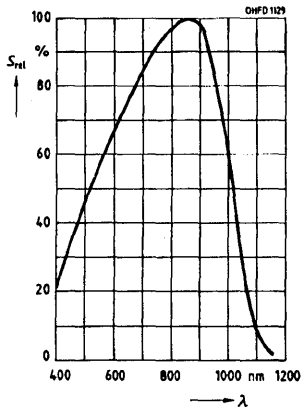

SFH 217F
Relative spectral sensitivity
 $S_{REL}=f(\lambda)$

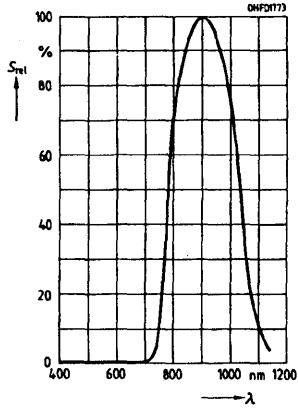

SFH 217
Photocurrent $I_P=f(E_V)$, $V_R=5\text{ V}$
Open circuit voltage $V_O=f(E_V)$

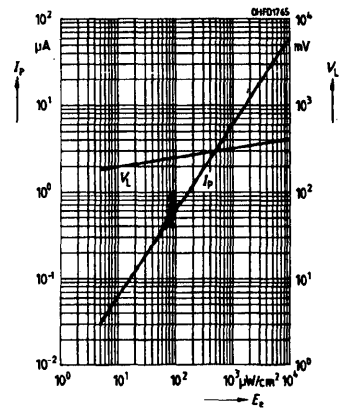

SFH 217F
Photocurrent $I_P=f(E_V)$, $V_R=5\text{ V}$
Open circuit voltage $V_O=f(E_V)$

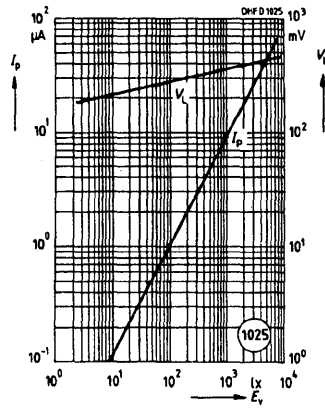

Directional characteristics $S_{REL}=f(\phi)$

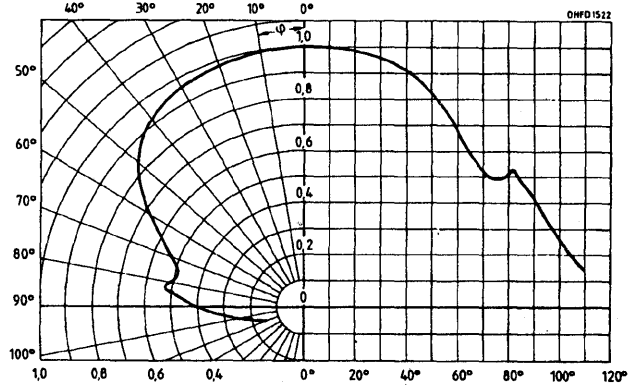

Power dissipation $P_{TOT}=f(T_A)$

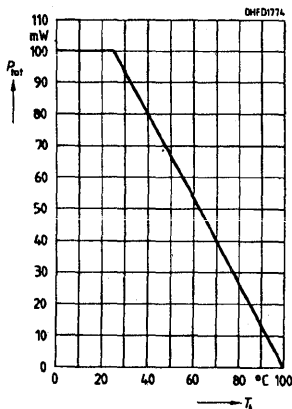

Dark current $I_R=f(V_R)$, $E=0$

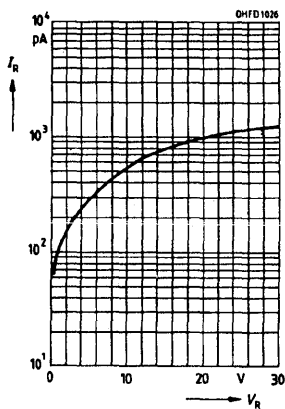

Capacitance $C=f(V_R)$, $f=1\text{ MHz}$, $E=0$

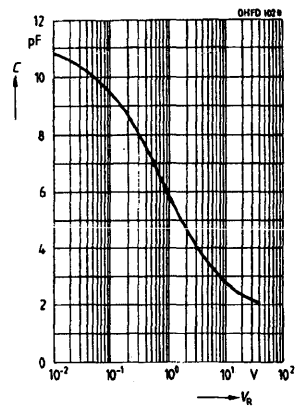

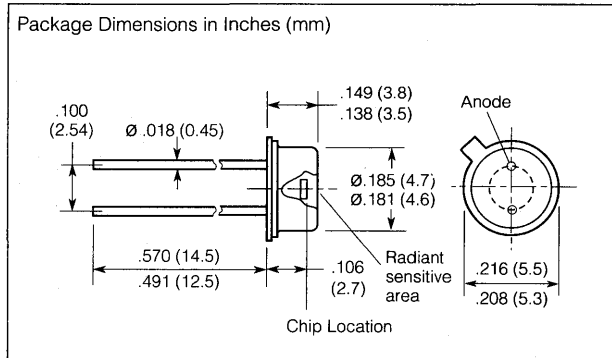
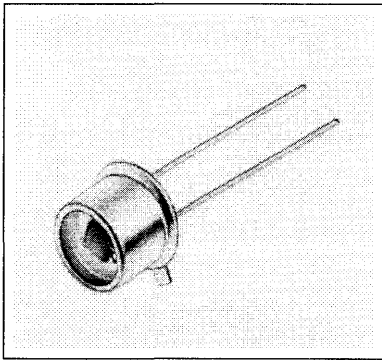

FEATURES

- High Open Circuit Voltage as Photo-voltaic Cells
- Usage: Visible Light and Near Infrared Range
- High Spectral Sensitivity
- High Reliability
- Short Switching Time
- Wide Temperature Range
- Strong Linear Relation Between I_{SC} and Light Level of 10^{-2} to 10^5 lx
- Low Noise
- No Testable Degradation
- High Packing Density
- Detector for Low Light Levels
- Package: 18 A3 DIN 41870 (TO18), Short Hermetically Sealed, Plane Glass Lens, Lead Spacing 0.10" (2.54 mm)
- Anode Marking: Tab at Package Bottom

DESCRIPTION

The SFH 219 is a silicon planar photodiode that can be operated as a photodiode with reverse voltage or as a photovoltaic cell. N-Si material provides positive front and negative back contacts.

Applications include exposure meters, automatic exposure timers, and measurement and control.

Maximum Ratings

Operating and Storage Temperature Range (T_{OP} , T_{STG}) -40° to $+80^{\circ}$ C
 Soldering Temperature (1.5 mm from case bottom) (T_S) ≤ 3 s 230° C
 Reverse Voltage (V_R) 7 V
 Power Dissipation (P_{TOT}) 200 mW

Characteristics ($T_A=25^{\circ}$ C)

Parameter	Symbol	Value	Unit
Photosensitivity			
($V_R=5$ V, Standard Light A, $T=2856$ K)	S	7 (≥ 5)	nA/lx
Maximum Photosensitivity Wavelength	λ_{Smax}	850	nm
Photosensitivity Spectral Range			
($S=10\%$ of S_{MAX})	λ	400 to 1170	nm
Radiant Sensitive Area	A	0.97	mm ²
Radiant Sensitive Area Dimensions	L x W	0.985 x 0.985	mm
Distance, Chip Surface to Case Surface	D	1 to 1.2	mm
Half Angle	ϕ	± 60	Deg.
Dark Current ($V_R=1$ V)	I_R	5 (≤ 20)	pA
Zero Crossover ($E=0$)	S_0	≤ 0.4	pA/mV
Spectral Photosensitivity ($\lambda=850$ nm)	S_λ	0.5	A/W
Quantum Yield ($\lambda=850$ nm)	η	0.73	electrons photon
Open Circuit Voltage ($E_V=1000$ lx) ⁽¹⁾	V_O	390(≥ 320)	mV
Short Circuit Current ($E_V=1000$ lx) ⁽¹⁾	I_{SC}	7	μ A
Rise and Fall Time of Photocurrent			
($R_L=1$ K Ω , $V_R=5$ V, $\lambda=850$ nm, $I_P=10$ μ A)	t_R , t_F	1.3	μ s
Forward Voltage ($I_F=100$ mA, $E_E=0$), Capacitance	V_F	1.3	V
($V_R=0$ V, $f=1$ MHz, $E_V=0$)	C_0	90	pF
Temperature Coefficient V_O	TC_V	-2.6	mV/K
Temperature Coefficient I_{SC}	TC_I	0.16	%/K
Noise Equivalent Power			
($V_R=1$ V, $\lambda=850$ nm)	NEP	2.7×10^{-15}	W/ \sqrt Hz
Detection Limit ($V_R=1$ V, $\lambda=850$ nm)	D^*	3.7×10^{13}	$cm^2 \cdot \sqrt$ Hz/W

Note

1. Illuminance shown refers to unfiltered radiation of tungsten filament lamp at color temperature of 2856 K (standard light A per DIN 5033 and IEC publication 306-1).

Relative spectral sensitivity
 $S_{REL}=f(\lambda)$

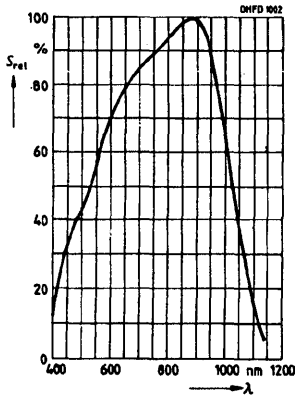

Photocurrent $I_p=f(E_V)$ $V_R=5 V$
Open circuit voltage $V_O=f(E_V)$

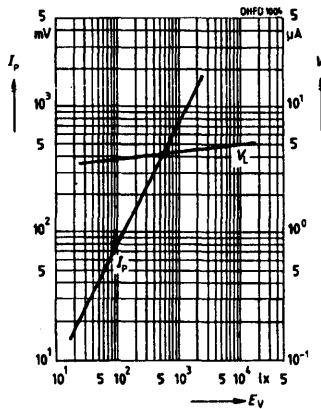

Directional characteristic $S_{REL}=f(\varphi)$

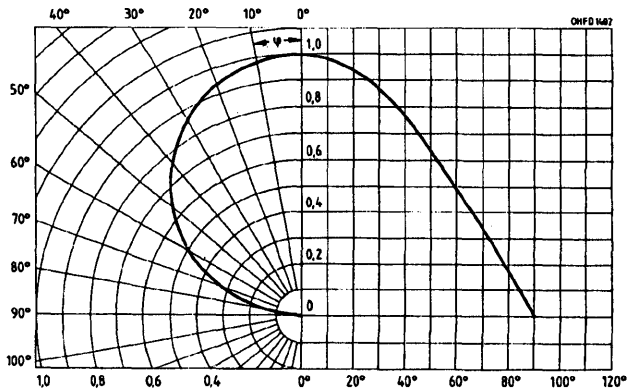

Power dissipation $P_{TOT}=f(T_A)$

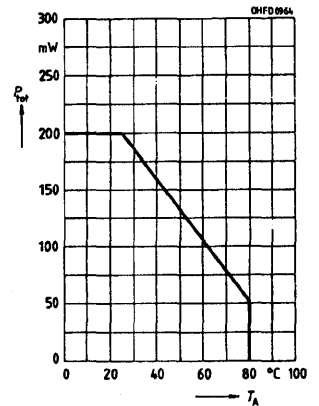

Capacitance $C=f(V_R)$, $f=1 MHz, E=0$

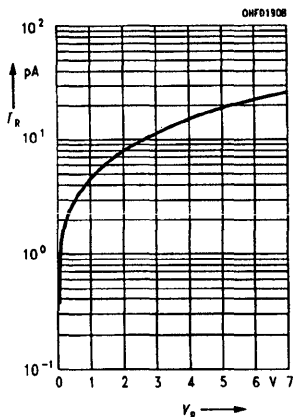

Dark current $I_R=f(V_R), E=0$

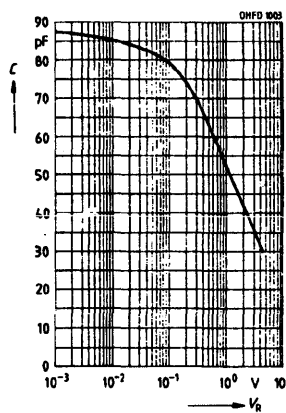

Dark current $I_R=f(T_A), V_R=1 V, E=0$

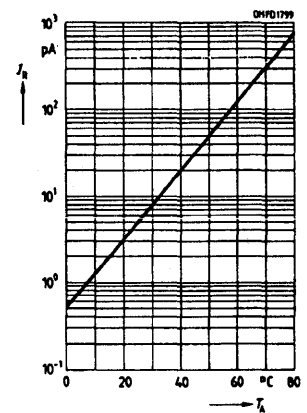

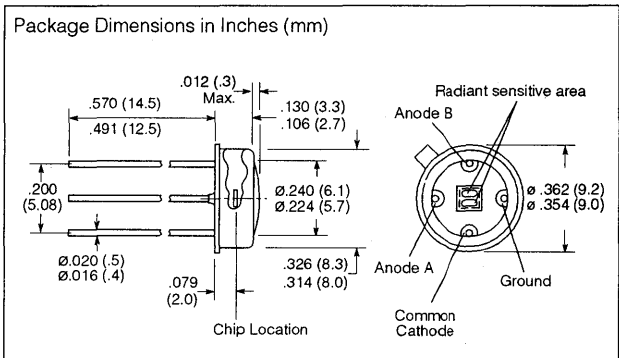
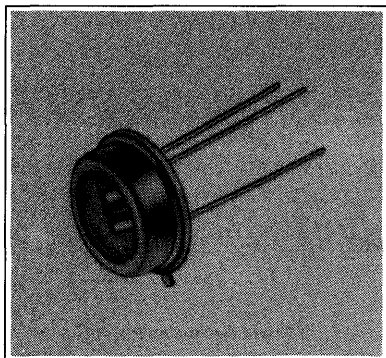

FEATURES

- High Open Circuit Voltage as Photo-voltaic Cells
- Usage: Visible Light and Near Infrared Range
- High Spectral Sensitivity
- High Reliability
- Short Switching Time
- Wide Temperature Range
- Low Capacitance
- Low Noise
- No Testable Degradation
- High Packing Density
- Detector for Low Light Levels
- Package: Hermetically Sealed, Similar to TO5, Solder Tabs, Lead Spacing 0.20" (5.08 mm)

DESCRIPTION

The SFH 221S is a silicon planar photodiode that can be operated as a photodiode with reverse voltage or as a photovoltaic cell. N-Si material provides positive front and negative back contacts.

Applications include follow-up controls, edge drives, path and corner scanning, industrial electronics, and measurement and control.

Note

1. Illuminance shown refers to unfiltered radiation of tungsten filament lamp at color temperature of 2856 K (standard light A per DIN 5033 and IEC publication 306-1).

Maximum Ratings

Operating and Storage Temperature Range (T_{OP} , T_{STG}) -40° to $+80^{\circ}$ C
 Soldering Temperature (1.5 mm from case bottom) (T_S) $t \leq 3$ s 230° C
 Reverse Voltage (V_R) 10 V
 Power Dissipation (P_{TOT}) 50 mW
 Insulation Voltage Versus Package (V_{IS}) 100 V

Characteristics ($T_A=25^{\circ}$ C)

Parameter	Symbol	Value	Unit
Photosensitivity			
($V_R=5$ V, Standard Light A, $T=2856$ K)	S	24 (≥ 15)	nA/lx
Maximum Photosensitivity Wavelength	λ_{3max}	900	nm
Spectral Sensitivity Range ($S=10\%$ S_{MAX})	λ	400 to 1100	nm
Radiant Sensitive Area	A	1.54	mm ²
Radiant Sensitive Area Dimensions	L x W	0.7 x 2.2	mm
Distance, Chip Surface to Case Top	H	1.1 to 1.6	mm
Half Angle	ϕ	± 55	Deg.
Dark Current ($V_R=10$ V)	I_R	10 (≤ 100)	nA
Spectral Sensitivity ($\lambda=850$ nm)	S_{λ}	0.55	A/W
Maximum Deviation, Spectral Sensitivity of Systems from Mean	Δ_S	± 5	%
Quantum Yield ($\lambda=850$ nm)	η	0.80	electron/ photon
Open Circuit Voltage ($E_V=1000$ lx) ⁽¹⁾	V_O	330 (≥ 280)	mV
Short Circuit Current ($E_V=1000$ lx) ⁽¹⁾	I_{SC}	24	μ A
Rise and Fall Time of Photocurrent 10% to 90% and 90% to 10% of Final Value ($R_L=1$ K Ω , $V_R=5$ V, $\lambda=850$ nm, $I_F=10$ μ A)	t_R , t_F	500	ns
Forward Voltage ($I_F=40$ mA, $E_E=0$)	V_F	1.0	V
Capacitance ($V_R=0$ V, $f=1$ MHz, $E=0$)	C_O	25	pF
Temperature Coefficient V_O	TC_V	-2.6	mV/K
Temperature Coefficient I_{SC}	TC_I	0.18	%/K
Noise Equivalent Power ($V_R=10$ V, $\lambda=850$ nm)	NEP	1.0×10^{-13}	W/ \sqrt Hz
Detection Limit ($V_R=10$ V, $\lambda=850$ nm)	D^*	1.2×10^{12}	cm ² ·W/Hz/W
Insulation Current ($V_{IS}=100$ V)	I_{IS}	0.1 (≤ 1)	nA

Relative spectral sensitivity
 $S_{REL}=f(\lambda)$

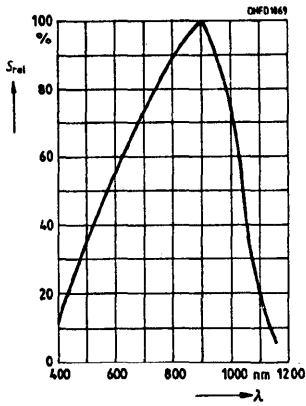

Photocurrent $I_p=f(E_V)$ $V_R=5 V$
Open circuit voltage $V_O=f(E_V)$

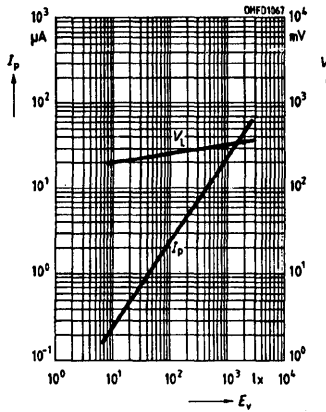

Directional characteristic $S_{REL}=f(\varphi)$

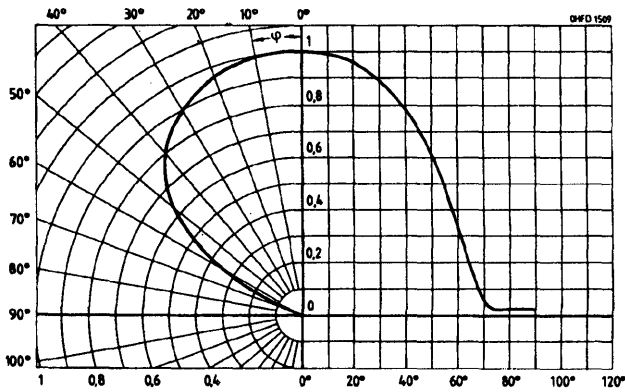

Power dissipation $P_{TOT}=f(T_A)$

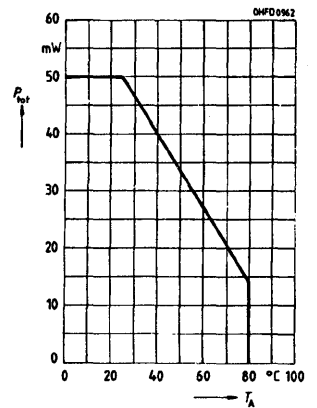

Dark current $I_R=f(V_R)$, $E=0$

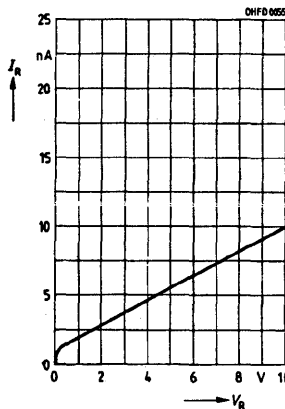

**Capacitance $C=f(V_R)$,
 $f=1 \text{ MHz}$, $E=0$**

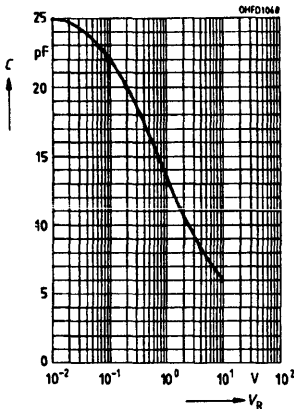

**Dark current $I_R=f(T_A)$,
 $V_R=10 V$, $E=0$**

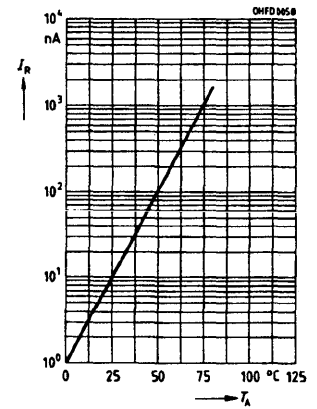

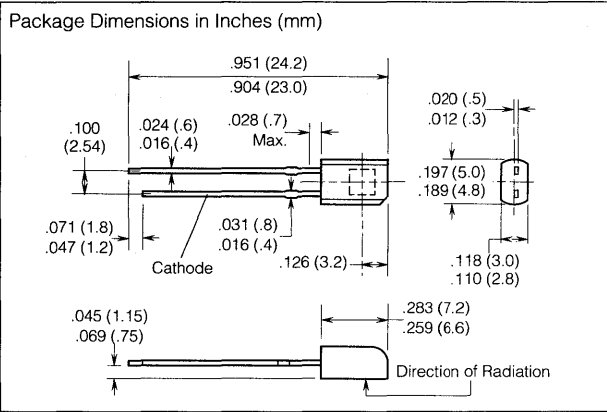
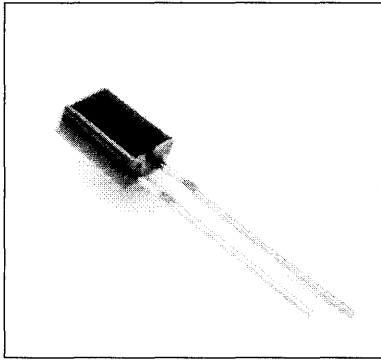

FEATURES

- Built-In IR Filter
- Usage: Near IR Range (880 nm to 950 nm)
- Spectrally Matched to Emitters SFH 484/485 and LD 271/274
- High Reliability
- Short Switching Time: 20 ns Typical
- Low Noise
- No Testable Degradation
- High Cutoff Frequency
- Package: SOD 67

DESCRIPTION

The SFH 225 is a silicon planar PIN photodiode housed in a black epoxy package that acts as a daylight rejection filter. It can be operated as a photodiode with reverse voltage or as a photovoltaic cell.

Features include low junction capacitance, short switching times, and a high cutoff frequency. Its small package and 0.1" (2.54 mm) lead spacing make it suitable for high density packaging. Due to its low signal/noise ratio and IR filter, it is also effective at low light levels.

Applications include remote control, IR sound transmission, dimmers, and light-reflective switches.

Maximum Ratings

Operating and Storage Temperature Range (T_{OP} , T_{STG}) -40° to $+80^{\circ}\text{C}$
 Soldering Temperature (1.5 mm from case bottom) (T_S) ≤ 3 s 230°C
 Reverse Voltage (V_R) 20 V
 Power Dissipation (P_{TOT}) 150 mW

Characteristics ($T_A=25^{\circ}\text{C}$)

Parameter	Symbol	Value	Unit
Photosensitivity ($V_R=5$ V, $\lambda=950$ nm, $E_E=0.5$ mW/cm ²)	S	17 (≥ 12.5)	μA
Maximum Photosensitivity Wavelength	$\lambda_{S_{MAX}}$	900	nm
Spectral Sensitivity Range ($S=10\%$ S_{MAX})	λ	740 to 1120	nm
Radiant Sensitive Area	A	4.84	mm ²
Radiant Sensitive Area Dimensions	L x W	2.20 x 2.20	mm
Distance, Chip Surface to Case Surface	H	0.6 to 0.8	mm
Half Angle	ϕ	± 60	Deg.
Dark Current ($V_R=10$ V)	I_D	2 (≤ 30)	nA
Spectral Sensitivity ($\lambda=950$ nm)	S_{λ}	0.70	A/W electrons photon
Quantum Yield ($\lambda=950$ nm)	η	0.90	
Open Circuit Voltage ($\lambda=950$ nm, $E_E=0.5$ mW/cm ²)	V_O	330 (≥ 250)	mV
Short Circuit Current ($\lambda=950$ nm, $E_E=0.5$ mW/cm ²)	I_{SC}	17	μA
Rise and Fall Time of Photocurrent ($R_L=50$ K Ω , $V_R=5$ V, $\lambda=850$ nm, $I_P=800$ μA)	t_R , t_F	20	ns
Forward Voltage ($I_F=100$ mA, $E=0$.)	V_F	1.3	V
Capacitance ($V_R=0$ V, $f=1$ MHz, $E=0$)	C_0	48	pF
Temperature Coefficient V_O	TC_V	-2.6	mV/K
Temperature Coefficient I_{SC}	TC_I	0.18	%/K
Noise Equivalent Power ($V_R=10$ V)	NEP	3.6×10^{-14}	W/Hz
Detection Limit ($V_R=10$ V)	D^*	6.1×10^{12}	$\text{cm}^2\text{Hz}/\text{W}$

Relative spectral sensitivity $S_{REL}=f(\lambda)$

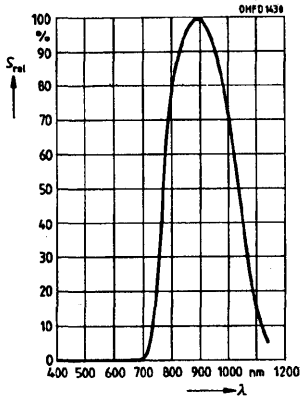

Photocurrent $I_p=f(E_E)$ $V_R=5$ V
Open circuit voltage $V_O=f(E_E)$

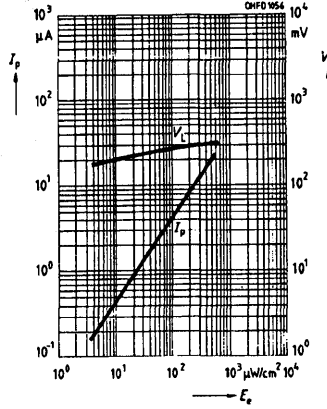

Directional characteristic $S_{REL}=f(\varphi)$

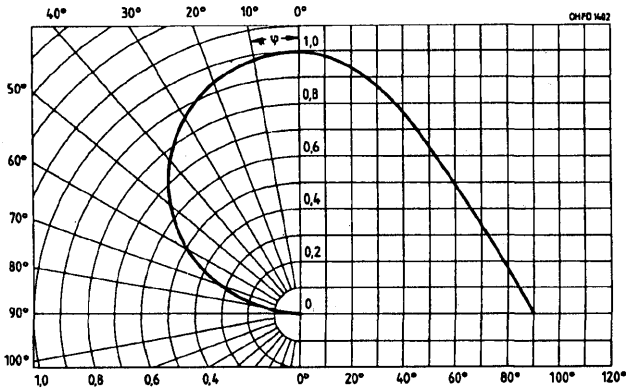

Power dissipation $P_{TOT}=f(T_A)$

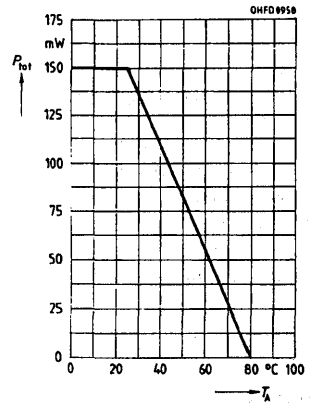

Dark current $I_R=f(V_R)$, $E=0$

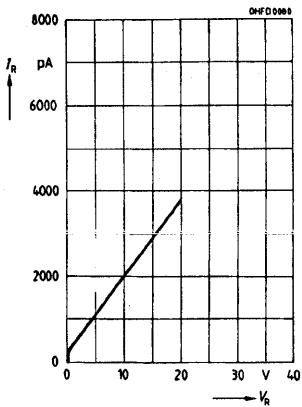

Capacitance $C=f(V_R)$, $f=1$ MHz, $E=0$

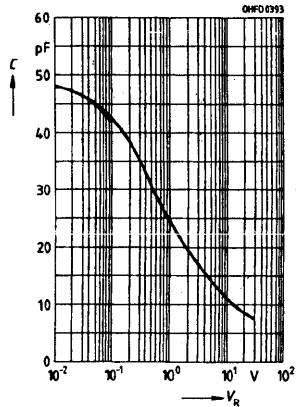

Dark current $I_R=f(T_A)$, $V_R=10$ V, $E=0$

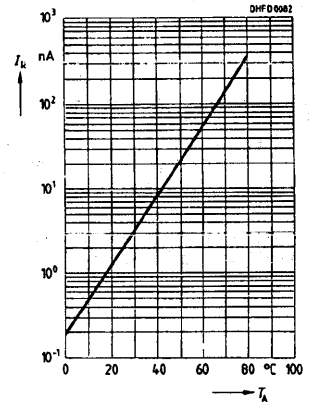

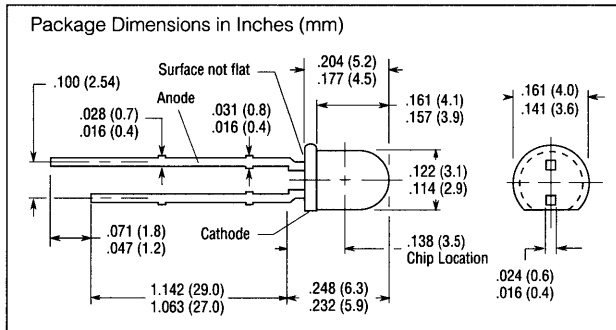
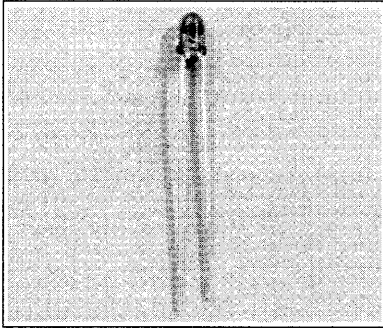

FEATURES

- **Silicon Photodiode in PIN Planar Technology**
- **N-Si Material:**
 - Anode, Front Contact
 - Cathode, Back Contact
- **High Reliability**
- **No Testable Degradation**
- **Short Switching Time**
- **Low Capacitance**
- **High Spectral Sensitivity**
- **Wide Temperature Range**
- **SFH229: Visible Light and Near Infrared Range Usage**
- **SFH229F: Near Infrared Range**
- **Package: T1 (3 mm) Flat Top LED Package, Solder Tabs, 0.1" (2.54 mm) Lead Spacing**
 - SFH229, Transparent Epoxy
 - SFH229F, Black Epoxy
- **Cathode Marking: Shorter Lead**
- **Applications**
 - Light-Reflecting Switches
 - Interrupter Switches
 - Measurement and Control

Maximum Ratings

Operating and Storage Temperature (T_{OP} , T_{STG}) -55°C to $+100^{\circ}\text{C}$
 Soldering Temperature (2 mm from case bottom) (T_S) $t \leq 3$ sec 230°C
 Reverse Voltage (V_R) 20 V
 Total Power Dissipation (P_{TOT}) $T_A = 25^{\circ}\text{C}$ 150 mW

Characteristics (T_A = 25°C)

Parameter

Parameter	Symbol	Value	Unit	Condition
Spectral Sensitivity				
SFH229	S	28 (≥18)	nA/lx	V _R =5 V, Standard Light A, T=2856 K
SFH229F	S	10 (≥5.4)	μA	V _R =5 V, E _E =0.5 mW/cm ² , λ=950nm
Maximum Sensitivity Wavelength				
SFH229	λ _{Smax}	860	nm	
SFH229F	λ _{Smax}	900	nm	
Photosensitivity Spectral Range				S=10% of S _{max}
SFH229	λ	380 to 1100	nm	
SFH229F	λ	730 to 1100	nm	
Radiant Sensitive Area	A	0.3	mm ²	
Radiant Sensitive Area Dimension	LxW	0.56x0.56	mm	
Distance, Chip Surface to Case Surface	H	2.4 to 2.8	mm	
Half Angle	φ	±17	Deg.	
Dark Current	I _R	50(≤5000)	pA	V _R =10 V
Spectral Photosensitivity				λ=850 nm
SFH229	S _λ	0.62	A/W	
SFH229F	S _λ	0.60	A/W	
Quantum Yield				λ=850 nm
SFH229	η	0.90	Photon	
SFH229F	η	0.88	Electrons Photon	
Open-Circuit Voltage				
SFH229	V _O	450 (≥400)	mV	E _v =1000 lx, Standard Light A, T=2856 K
SFH229F	V _O	420 (≥370)	mV	E _E =0.5 mW/cm ² , λ=950 nm
Short-Circuit Current				
SFH229	I _{SC}	27	μA	E _v =1000 lx, Standard Light A, T=2856 K
SFH229F	I _{SC}	9	μA	E _E =0.5 mW/cm ² , λ=950 nm
Rise and Fall Time, Photocurrent	t _R , t _F	10	ns	R _L =50 Ω; V _R =10 V, λ=850 nm, I _p =800 μA
Forward Voltage	V _F	1.3	V	I _F =100 mA, E=0
Capacitance	C ₀	13	pF	V _R =0 V, f=1 MHz, E=0
Temperature Coefficient, V _O	TC _V	-2.6	mV/K	
Temperature Coefficient				
SFH229	TC _I	0.18	%/K	I _K , Standard Light A
SFH229F	TC _I	0.2	%/K	I _K , λ=950 nm
Noise Equivalent Power	NEP	6.5x10 ⁻¹⁵	W/√Hz	V _R =10 V, λ=850 nm
Detection Limit	D*	8.4x10 ¹²	cm ² √Hz/W	V _R =10 V, λ=850 nm

Relative spectral sensitivity—SFH229

S_{rel}=f (λ)

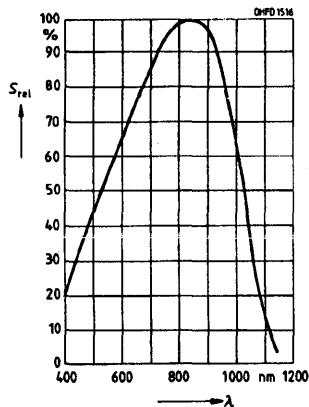

Relative spectral sensitivity—SFH229F

S_{rel}=f (λ)

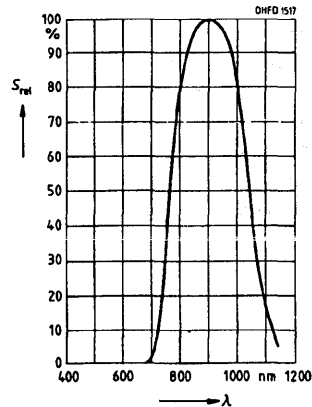

Photocurrent $I_p=f(E_V)$, $V_R=5\text{ V}$,
Open-circuit voltage $V_L=f(E_V)$
SFH229

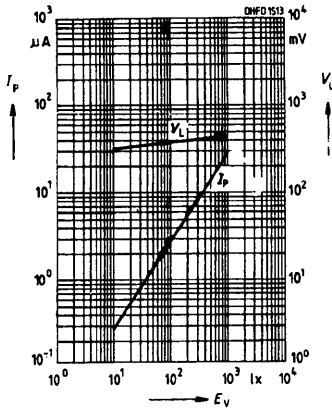

Directional characteristic $S_{rel}=f(\varphi)$

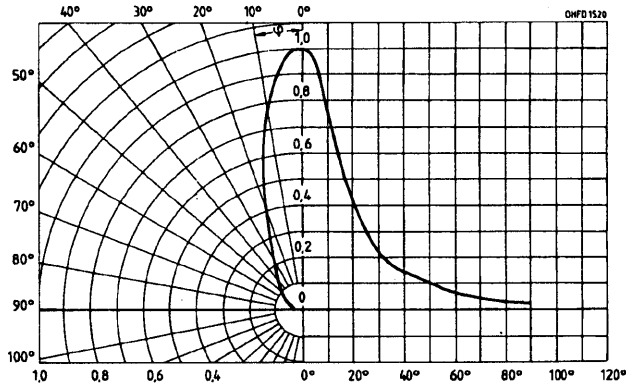

Dark current $I_R=f(V_R)$, $E=0$

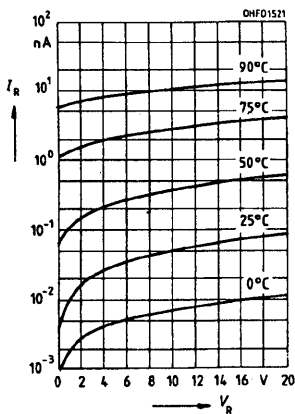

Photocurrent $I_p=f(E_E)$, $V_R=5\text{ V}$
Open-circuit voltage $V_L=f(E_E)$
SFH229F

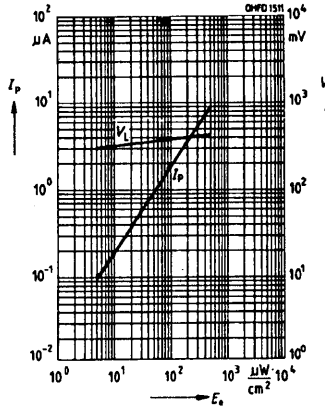

Total power dissipation $P_{TOT}=f(T_A)$

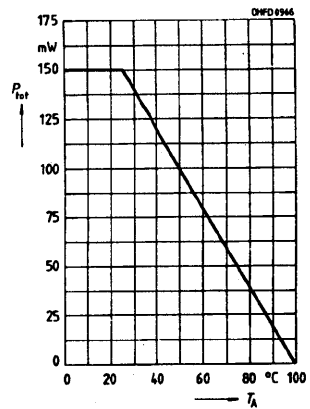

Capacitance $C=f(V_R)$
 $f=1\text{ MHz}$, $E=0$

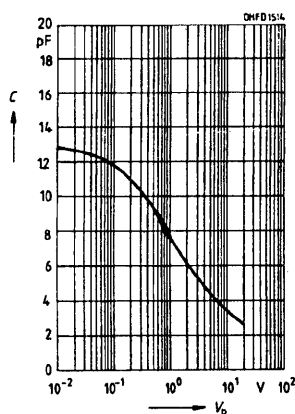

Dark current $I_R=f(T_A)$
 $V_R=10\text{ V}$, $E=0$

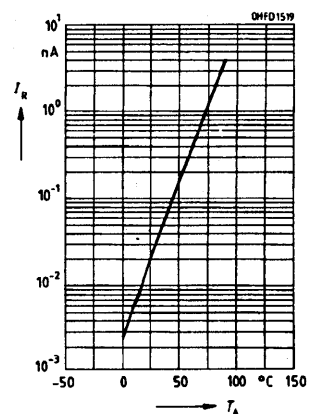

Photodiodes

SIEMENS

SFH229P DAYLIGHT FILTER SFH229PF SILICON PIN PHOTODIODE

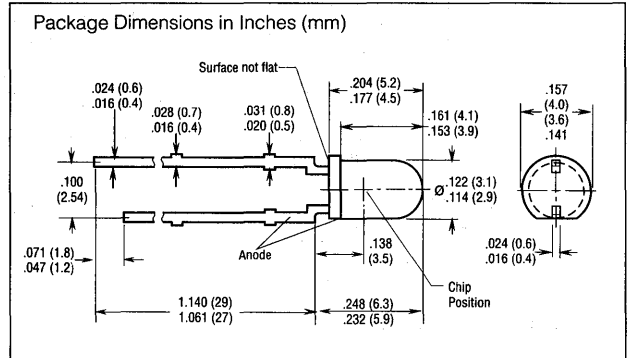
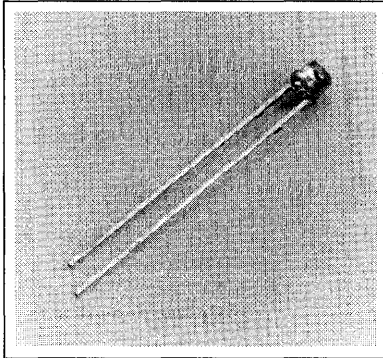

FEATURES

- Silicon Photodiode in PIN Planar Technology
- N-Si Material:
 - Anode, Front Contact
 - Cathode, Back Contact
- Wide Angle
- High Reliability
- No Testable Degradation
- Short Switching Time
- Low Capacitance
- High Spectral Sensitivity
- Wide Temperature Range
- Usage
 - SFH229P: Visible Light and Near Infrared Range
 - SFH229PF: Near Infrared Range
- Package: (3 mm) Flat Top LED Package, Transparent and Black Epoxy Resin, 0.1" (2.54 mm) Lead Spacing
- Cathode Marking: Shorter Lead
- Applications
 - Light-Reflecting Switches
 - Industrial Electronics
 - Measurement and Control

Maximum Ratings

Operating and Storage Temperature (T_{OP} , T_{STG}) -55°C to $+100^{\circ}\text{C}$
Soldering Temperature (2 mm from case bottom) (T_S) $t \leq 3$ sec 230°C
Reverse Voltage (V_R) 20 V
Total Power Dissipation (P_{TOT}) $T_A=25^{\circ}\text{C}$ 150 mW

Characteristics (T_A=25°C)

Parameter

Parameter	Sym	Value	Unit	Condition
Spectral Sensitivity				
SFH229P	S	3.1 (≥2.3)	nA/lx	V _R =5 V, Standard Light A, T=2856 K
SFH229PF	S	1.0 (≥0.7)	μA	V _R =5 V, E _E =0.5 mW/cm ² , λ=950 nm
Maximum Photosensitivity Wavelength				
SFH229P	λ _{Smax}	860	nm	
SFH229PF	λ _{Smax}	900	nm	
Photosensitivity Spectral Range				S=10% of S _{MAX}
SFH229P	λ	380 to 1100	nm	
SFH229PF	λ	730 to 1100	nm	
Radiant Sensitive Area	A	0.3	mm ²	
Radiant Sensitive Area Dimension	LxW	0.56x0.56	mm	
Distance, Chip Surface to Case Surface	H	0.4 to 0.8	mm	
Half Angle	φ	±85	Deg.	
Dark Current	I _R	50(≤5000)	pA	V _R =10 V λ=850 nm
Spectral Sensitivity				
SFH229P	S _λ	0.62	A/W	
SFH229PF	S _λ	0.60	A/W	
Quantum Yield				λ=850 nm
SFH229P	η	0.90	$\frac{\text{Electrons}}{\text{Photon}}$	
SFH229PF	η	0.88	$\frac{\text{Electrons}}{\text{Photon}}$	
Open-Circuit Voltage				
SFH229P	V _L	390 (≥350)	mV	E _V =1000 lx, Standard Light A, T=2856 K
SFH229PF	V _L	360 (≥320)	mV	E _E =0.5 mW/cm ² , λ=950 nm
Short-Circuit Current				
SFH229P	I _{SC}	3.0	μA	E _V =1000 lx, Standard Light A, T=2856 K
SFH229PF	I _{SC}	0.9	μA	E _E =0.5 mW/cm ² , λ=950 nm
Rise and Fall Time, Photocurrent	t _R , t _F	10	ns	R _L =50 Ω; V _R =10 V; λ=850 nm; I _P =800 μA
Forward Voltage	V _F	1.3	V	I _F =100 mA, E=0
Capacitance	C ₀	13	pF	V _R =0 V, f=1 MHz, E=0
Temperature Coefficient of V ₀	TC _V	-2.6	mV/K	
Temperature Coefficient				
SFH229P	TC _I	0.18	%/K	I _K , Standard Light A
SFH229PF	TC _I	0.2	%/K	I _K , λ=950 nm
Noise Equivalent Power	NEP	6.5x10 ⁻¹⁵	W/Hz	V _R =10 V, λ=850 nm
Detection Limit	D*	8.4x10 ¹²	cm·√Hz/W	V _R =10 V, λ=850 nm

Relative spectral sensitivity~SFH229P

$$S_{REL}=f(\lambda)$$

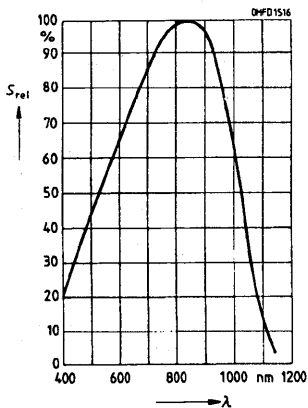

Relative spectral sensitivity~SFH229PF

$$S_{REL}=f(\lambda)$$

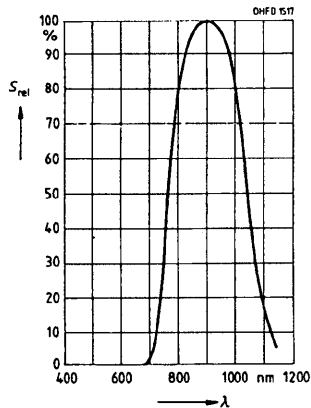

**Photocurrent $I_p=f(E_v)$, $V_R=5\text{ V}$,
Open-circuit voltage $V_L=f(E_v)$
SFH229P**

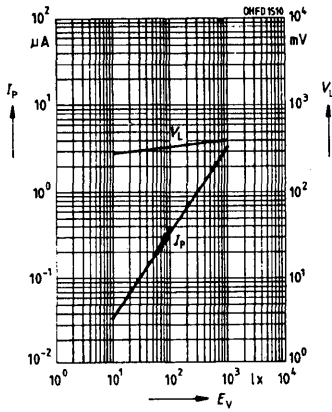

**Photocurrent $I_p=f(E_E)$, $V_R=5\text{ V}$,
Open-circuit voltage $V_L=f(E_E)$
SFH229PF**

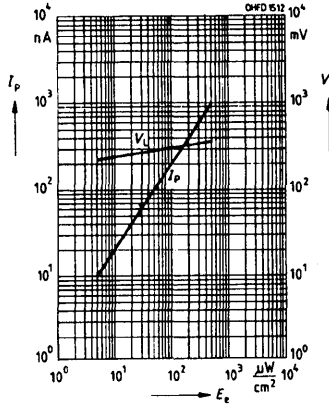

Directional characteristic $S_{REL}=f(\varphi)$

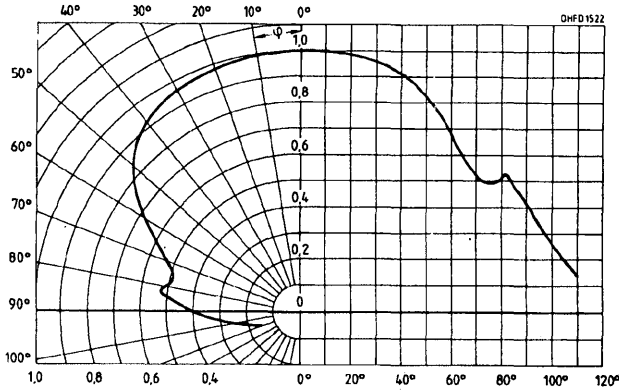

**Total power dissipation
 $P_{TOT}=f(T_A)$**

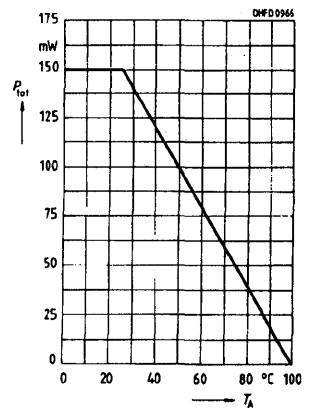

Dark current $I_R=f(V_R)$, $E=0$

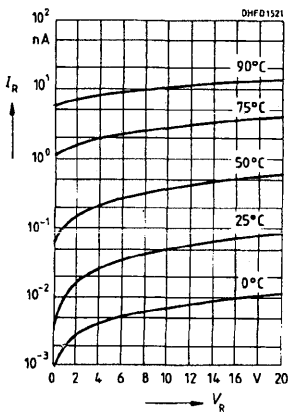

**Capacitance $C=f(V_R)$
 $f=1\text{ MHz}$, $E=0$**

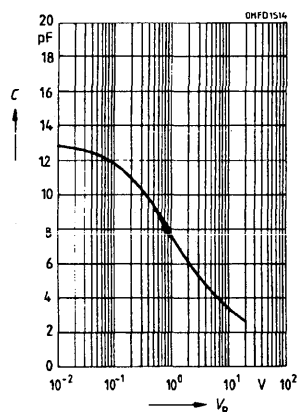

**Dark current $I_R=f(T_A)$
 $V_R=10\text{ V}$, $E=0$**

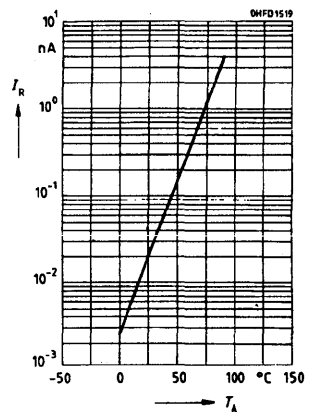

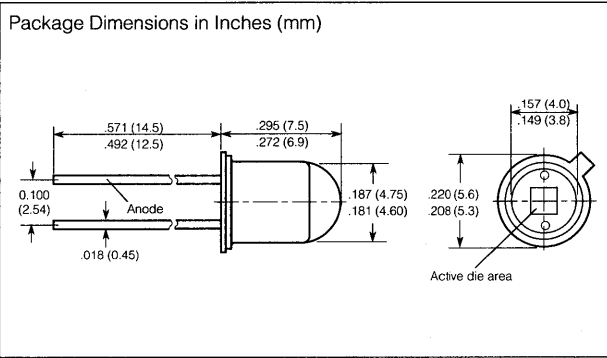
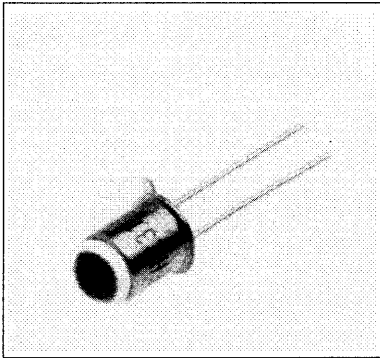

FEATURES

- **Anode Marking: Projection at Package Bottom**
- **Usage: Visible Light and Near Infrared Range**
- **High Spectral Sensitivity**
- **High Reliability**
- **Very Short Switching Time**
- **Wide Temperature Range**
- **Very High Cutoff Frequency**
- **No Testable Degradation**
- **Package: Hermetically Sealed, Similar to TO18 with Lens Cap, Lead Spacing 0.10" (2.54 mm)**

DESCRIPTION

The SFH 231 is a germanium planar PIN photodiode, designed for the 1100 to 1700 nm wavelength range. It can be used as a diode with reverse voltage or for element operation. N-Ge material provides positive front and negative back contacts.

Applications include spectrophotometers, IR laser detector systems, IR distance measuring equipment, optical information transmission, and measuring instruments.

This is a replacement type for APY 12 and APY 13.

Maximum Ratings

Operating and Storage Temperature Range (T_{OP} , T_{STG})	-40° to +80°C
Reverse Voltage (V_R)	15 V
Power Dissipation (P_{TOT})	150 mW
Thermal Resistance (R_{THJA})	450 K/W

Characteristics ($T_A=25^\circ\text{C}$)

Parameter	Symbol	Value	Unit
Photosensitivity			
($V_R=0$ V, Standard Light A, $T=2856$ K)	S_V	130	nA/lx
($V_R=0$ V, $\lambda=1300$ nm)	S_E	52 (≥ 32)	$\mu\text{A}\cdot\text{cm}^2/\text{mW}$
Maximum Photosensitivity Wavelength	$\lambda_{S_{MAX}}$	1550	nm
Spectral Sensitivity Range ($S=10\% S_{MAX}$)	λ	600 to 1800	nm
Radiant Sensitive Area	A	1	mm^2
Radiant Sensitive Area Dimensions	L x W	1 x 1	mm
Distance, Chip Surface to Case Surface	H	4.2 to 5	mm
Half Angle	ϕ	± 10	Deg.
Dark Current ($V_R=1$ V, $E=0$)	I_R	10 (≤ 50)	μA
Spectral Sensitivity ($\lambda=1300$ nm)	S_λ	0.68	A/W
Quantum Yield ($\lambda=1300$ nm)	η	0.65	electron/ photon
Short Circuit Current			
($E_E=0.25$ mW/cm ² , $\lambda=1300$ nm)	I_{SC}	13 (≥ 8)	μA
Rise and Fall Time of Photocurrent			
($R_L=50$ Ω , $V_R=1$ V, $\lambda=1300$ nm, $I_P=100$ μA)	t_R , t_F	9	ns
Forward Voltage ($I_F=100$ mA, $E=0$)	V_F	1	V
Capacitance			
($V_R=1$ V, $f=1$ MHz, $E=0$)	C_0	62	pF
Noise Equivalent Power			
($V_R=1$ V, $\lambda=1300$ nm)	NEP	2.6×10^{-12}	W/√Hz
Detection Limit ($V_R=1$ V, $\lambda=1300$ nm)	D^*	3.8×10^{10}	$\text{cm}\cdot\sqrt{\text{Hz}}/\text{W}$

Relative spectral sensitivity $S_{REL}=f(\lambda)$

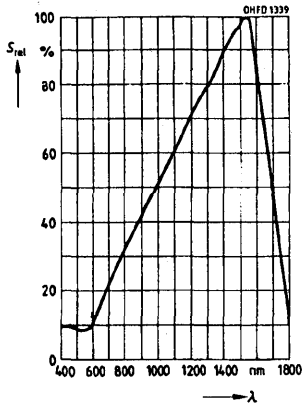

Capacitance $C=f(V_R)$, $f=1$ MHz, $E=0$

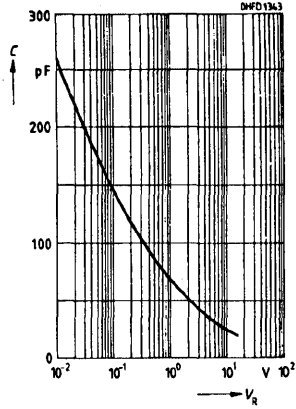

Directional characteristic $S_{REL}=f(\varphi)$

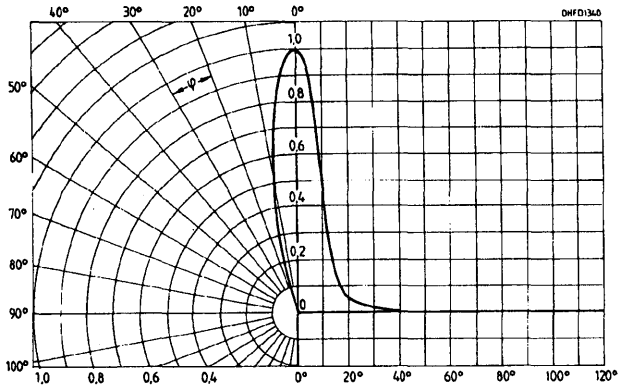

Dark current $I_R=f(V_R)$, $E=0$

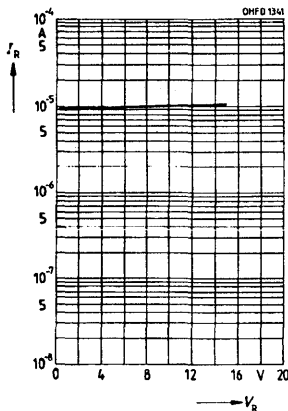

Zero crossover $I_F=f(V_R)$, $E=0$

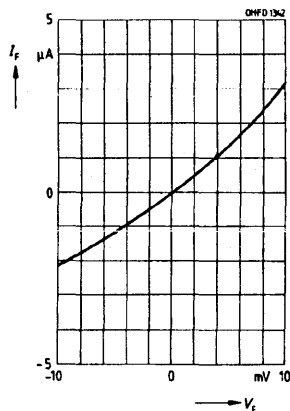

Switching times $t_R/t_F=f(V_R)$, $R_L=50 \Omega$

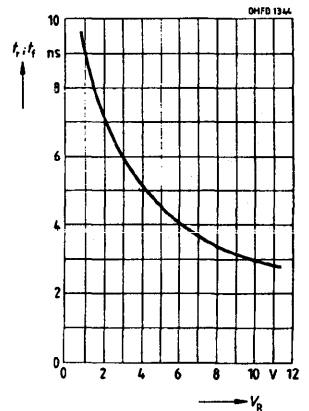

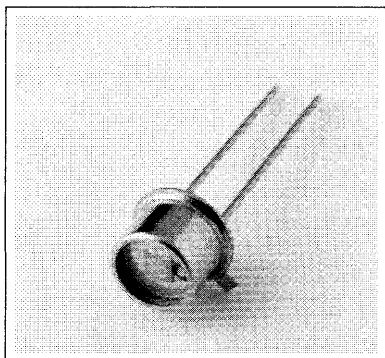

Package Dimensions in Inches (mm)

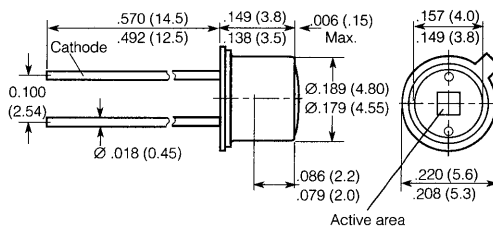

FEATURES

- **Anode Marking:** Tab at Package Bottom
- **Usage:** Visible Light and Near Infrared Range
- **High Spectral Sensitivity**
- **High Reliability**
- **Very Short Switching Time**
- **Wide Temperature Range**
- **Very High Cutoff Frequency**
- **No Testable Degradation**
- **Package:** Hermetically Sealed, Similar to TO18, Lead Spacing 0.10" (2.54 mm)

DESCRIPTION

The SFH 232 is a germanium planar PIN photodiode, designed for the 1100 to 1700 nm wavelength range. It can be used as a photodiode with reverse voltage or as a photovoltaic cell. N-Ge material provides positive front and negative back contacts.

Applications include spectrophotometers, IR laser detector systems, IR distance measuring equipment, optical information transmission, measuring instruments, and measurement and control.

Maximum Ratings

Operating and Storage Temperature Range (T_{OP} , T_{STG})	-40° to +80°C
Reverse Voltage (V_R)	15 V
Power Dissipation (P_{TOT})	150 mW
Thermal Resistance (R_{THJA})	450 K/W

Characteristics ($T_A=25^\circ\text{C}$)

Parameter	Symbol	Value	Unit
Photosensitivity			
($V_R=0$ V, Standard Light A, $T=2856$ K)	S_V	18	nA/lx
($V_R=0$ V, $\lambda=1300$ nm)	S_E	6.8 (≥ 4.8)	$\mu\text{A}\cdot\text{cm}^2/\text{mW}$
Maximum Photosensitivity Wavelength	$\lambda_{S_{MAX}}$	1550	nm
Spectral Sensitivity Range ($S=10\% S_{MAX}$)	λ	600 to 1800	nm
Radiant Sensitive Area	A	1	mm^2
Radiant Sensitive Area Dimensions	L x W	1 x 1	mm
Distance, Chip Surface to Case Surface	H	1 to 1.2	mm
Half Angle	ϕ	± 55	Deg.
Dark Current ($V_R=1$ V, $E=0$)	I_R	10 (≤ 50)	μA
Spectral Sensitivity ($\lambda=1300$ nm)	S_λ	0.68	A/W electrons photon
Quantum Yield ($\lambda=1300$ nm)	η	0.65	
Short Circuit Current			
($E_E=0.25$ mW/cm ² , $\lambda=1300$ nm)	I_{SC}	1.7 (≥ 1.2)	μA
Rise and Fall Time of Photocurrent			
($R_L=50$ Ω , $V_R=1$ V, $\lambda=1300$ nm, $I_F=100$ μA)	t_R , t_F	9	ns
Forward Voltage ($I_F=100$ mA, $E=0$)	V_F	1	V
Capacitance			
($V_R=1$ V, $f=1$ MHz, $E=0$)	C_0	62	pF
Noise Equivalent Power			
($V_R=1$ V, $\lambda=1300$ nm)	NEP	2.6×10^{-12}	W/Hz
Detection Limit ($V_R=1$ V, $\lambda=1300$ nm)	D^*	3.8×10^{10}	$\text{cm}\cdot\sqrt{\text{Hz}}/\text{W}$

Relative spectral sensitivity
 $S_{REL}=f(\lambda)$

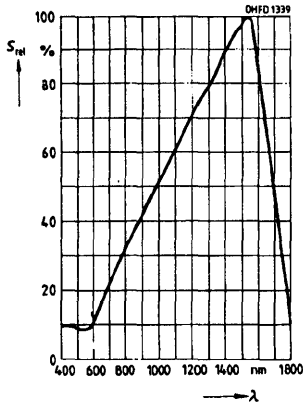

Capacitance $C=f(V_R)$,
 $f=1 \text{ MHz}, E=0$

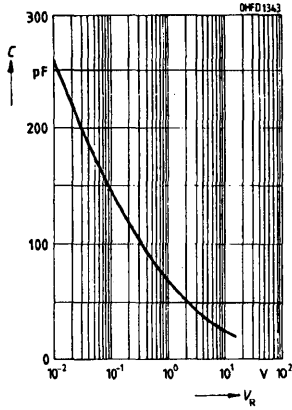

Directional characteristic
 $S_{REL}=f(\varphi)$

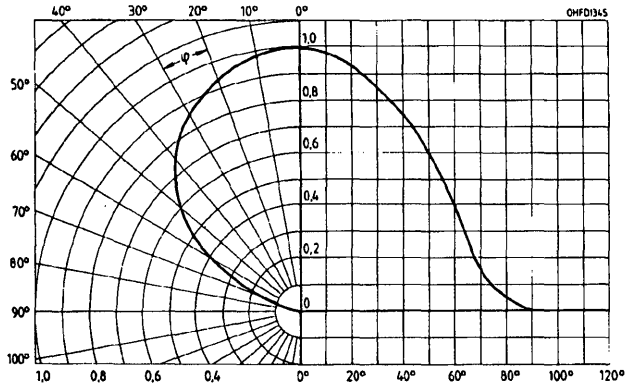

Dark current $I_D=f(V_R), E=0$

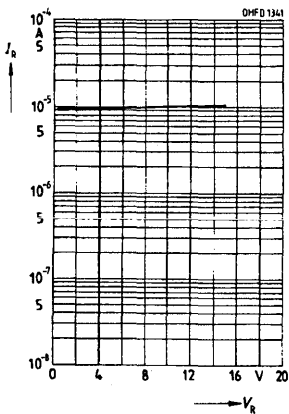

Zero crossover $I_F=f(V_F), E=0$

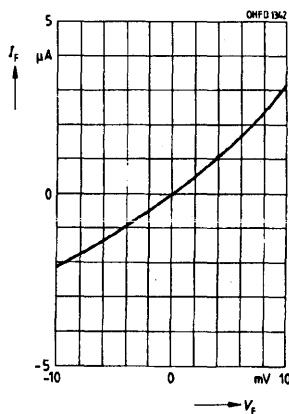

Switching times $t_R/t_F=f(V_R)$,
 $R_L=50 \Omega$

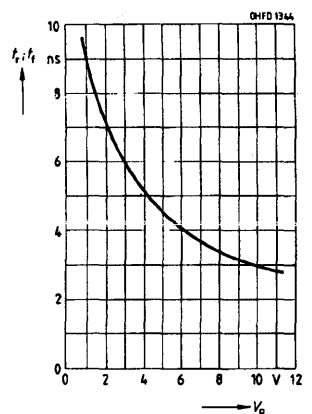

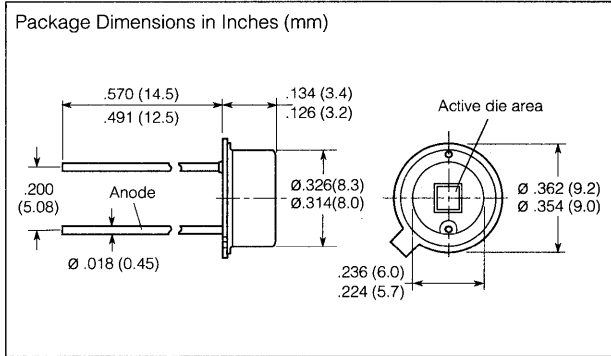
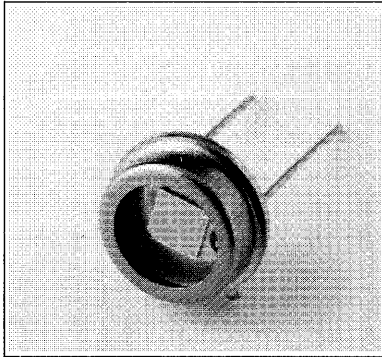

FEATURES

- **Anode Marking: Projection at Package Bottom**
- **Usage: Visible Light and Near Infrared Range**
- **High Spectral Sensitivity**
- **High Reliability**
- **Very Short Switching Time**
- **Wide Temperature Range**
- **Very High Cutoff Frequency**
- **No Testable Degradation**
- **Package: Hermetically Sealed, Similar to TO5, Lead Spacing 0.20" (5.08 mm)**

DESCRIPTION

The SFH 233 is a germanium planar PIN photodiode, designed for the 1100 to 1700 nm wavelength range. It can be used as a diode with reverse voltage or for photoelement operation. N-Ge material provides positive front and negative back contacts.

Applications include spectrophotometers, IR laser detector systems, IR distance measuring equipment, optical information transmission, measuring instruments, and measurement and control.

Maximum Ratings

Operating and Storage Temperature Range (T_{OP} , T_{STG})	-40° to +80°C
Reverse Voltage (V_R)	10 V
Power Dissipation (P_{TOT})	250 mW
Thermal Resistance (R_{THJA})	300 K/W

Characteristics ($T_A=25^\circ\text{C}$)

Parameter	Symbol	Value	Unit
Photosensitivity			
($V_R=0$ V, Standard Light A, $T=2856$ K)	S_V	125	nA/lx
($V_R=0$ V, $\lambda=1300$ nm)	S_E	48 (≥ 36)	$\mu\text{A}\cdot\text{cm}^2/\text{mW}$
Maximum Photosensitivity Wavelength	λ_{Smax}	1550	nm
Spectral Sensitivity Range ($S=10\% S_{MAX}$)	λ	600 to 1800	nm
Radiant Sensitive Area	A	7.02	mm ²
Radiant Sensitive Area Dimensions	L x W	2.65 x 2.65	mm
Distance, Chip Surface to Case Surface	H	1.9 to 2.3	mm
Half Angle	ϕ	± 54	Deg.
Dark Current ($V_R=1$ V, $E=0$)	I_R	20 (≤ 100)	μA
Spectral Sensitivity ($\lambda=1300$ nm)	S_λ	0.70	A/W
			<u>electrons</u> photon
Quantum Yield ($\lambda=1300$ nm)	η	0.67	
Short Circuit Current			
($E_E=0.25$ mW/cm ² , $\lambda=1300$ nm)	I_{SC}	12 (≥ 9)	μA
Rise and Fall Time of Photocurrent			
($R_L=50$ Ω , $V_R=1$ V, $\lambda=1300$ nm, $I_p=100$ μA)	t_R , t_F	40	ns
Forward Voltage ($I_F=100$ mA, $E=0$)	V_F	1	V
Capacitance			
($V_R=1$ V, $f=1$ MHz, $E=0$)	C_0	395	pF
Noise Equivalent Power			
($V_R=1$ V, $\lambda=1300$ nm)	NEP	3.6×10^{-12}	W/ $\sqrt{\text{Hz}}$
Detection Limit ($V_R=1$ V, $\lambda=1300$ nm)	D^*	7.5×10^{10}	$\text{cm}\cdot\sqrt{\text{Hz}}/\text{W}$

Relative spectral sensitivity
 $S_{REL}=f(\lambda)$

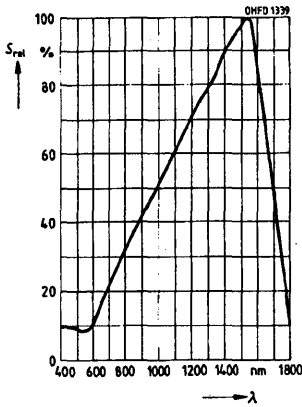

Capacitance $C=f(V_R)$,
 $f=1\text{ MHz}, E=0$

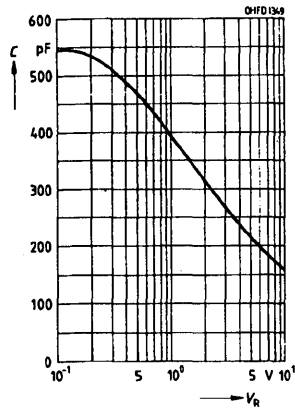

Directional characteristic $S_{REL}=f(\varphi)$

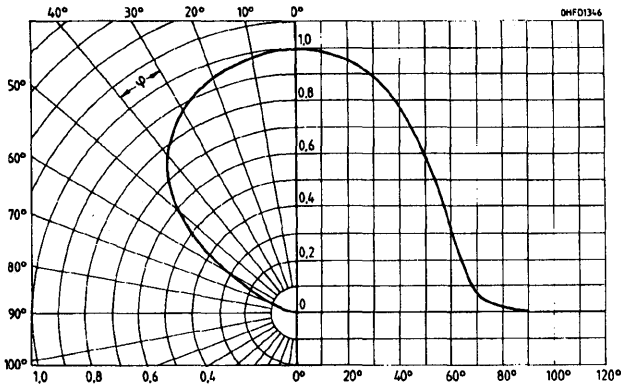

Dark current $I_R=f(V_R), E=0$

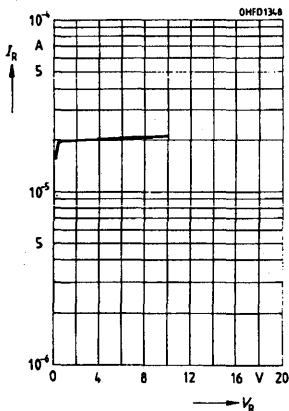

Zero crossover $I_F=f(V_F), E=0$

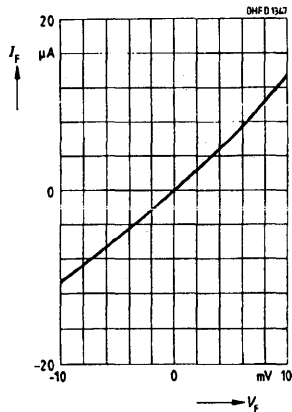

SILICON FOUR-QUADRANT PHOTODIODE

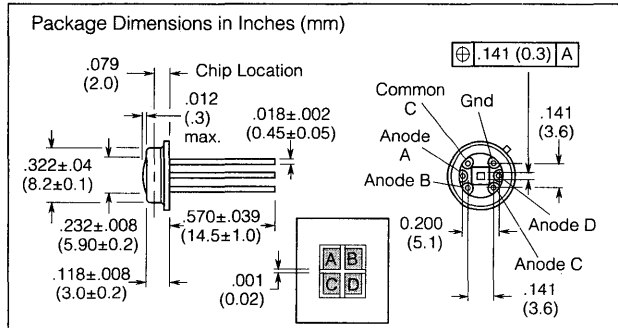
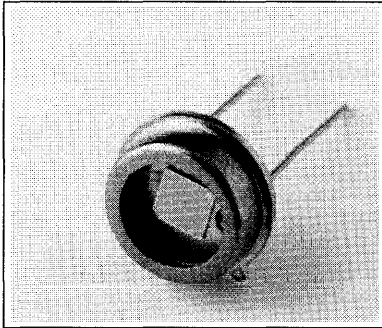

FEATURES

- Silicon Photodiode in Planar Technology
- N-Si Material:
 - Anode, Front Contact
 - Cathode, Back Contact
- Cathode Electrically Isolated
- Available as Photodiodes with Reverse Voltage or Photovoltaic Cells
- High Reliability
- No Testable Degradation
- Short Switching Time
- Low Capacitance
- High Spectral Sensitivity
- Wide Temperature Range
- Visible Light and Near Infrared Range Usage
- Package: Hermetically Sealed, TO 39 with Glass Window

Applications

- Edge Detection
- Path and Corner Scanning
- Industrial Electronics
- Measurement and Control

Maximum Ratings

Operating and Storage Temperature (T_{OP}, T_{STG})	-40°C to +80°C
Isolation Voltage (V_{IS})	100 V
Reverse Voltage (V_R)	20 V
Total Power Dissipation (P_{TOT}) $T_A = 25^\circ C$	50 mW

Characteristics ($T_A = 25^\circ C$, Standard Light A, $T = 2856 K$)

Parameter	Sym	Value	Unit	Condition
Spectral Sensitivity	S	1.85 (≥ 1.2)	nA/lx	
Maximum Photosensitivity				
Wavelength	λ_{Smax}	800	nm	
Photosensitivity Spectral Range	λ	350 to 1050	nm	$S = 10\% \text{ of } S_{MAX}$
Radiant Sensitive Area	A	0.25	mm ²	
Radiant Sensitive Area Dimension	L x W	0.5x0.5	mm	
Distance Chip Surface to Case Surface	H	2.2 to 2.5	mm	
Half Angle	ϕ	± 60	Deg.	
Dark Current	I_R	0.1 (≤ 1)	nA	$V_R = 10 V$
Isolation Current	I_{IS}	0.1 (≤ 1)	nA	$V_{IS} = 100 V$
Spectral Sensitivity	S_λ	0.6	A/W	$\lambda = 850 \text{ nm}$
Maximum Spectral Sensitivity Tolerance	ΔS	± 10	%	
Quantum Yield	η	0.87		$\lambda = 850 \text{ nm}$
Open-Circuit Voltage	V_O	480 (≥ 400)	mV	$E_V = 1000 \text{ lx}$
Short-Circuit Voltage	I_{SC}	1.85	μA	$E_V = 1000 \text{ lx}$
Rise and Fall Time, Photocurrent	t_R, t_F	1	μs	$R_L = 1 \text{ k}\Omega$, $V_R = 5 V$, $\lambda = 850 \text{ nm}$, $I_P = 150 \mu A$
Forward Voltage	V_F	1.0	V	$I_F = 40 \text{ mA}$, $E = 0$
Capacitance	C_O	34	pF	$V_R = 0 V$, $f = 1 \text{ MHz}$, $E = 0$
Temperature Coefficient, V_L	TC_V	-2.6	mV/K	
Temperature Coefficient, I_{SC}	TC_I	0.18	%/K	
Noise Equivalent Power	NEP	9.43×10^{-15}	W/n/Hz	$V_R = 1 V$, $\lambda = 850 \text{ nm}$
Detection Limit	D^*	5.3×10^{12}	$\text{cm} \cdot \sqrt{\text{Hz}}/\text{W}$	$V_R = 1 V$, $\lambda = 850 \text{ nm}$

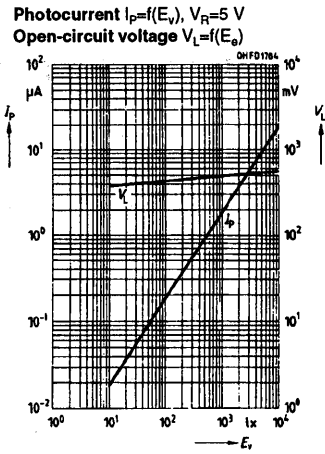
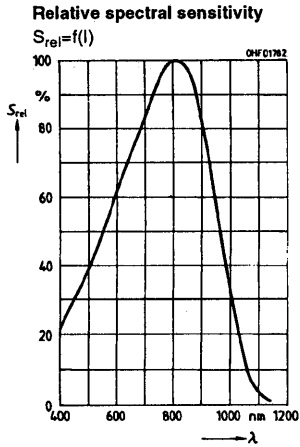

Directional characteristic $S_{rel}=f(\beta)$

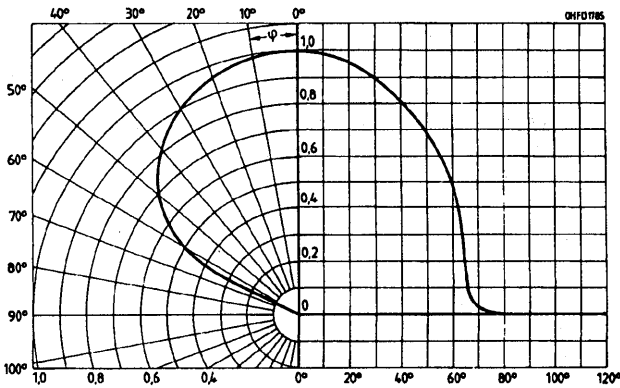

Total power dissipation
 $P_{TOT}=f(T_A)$

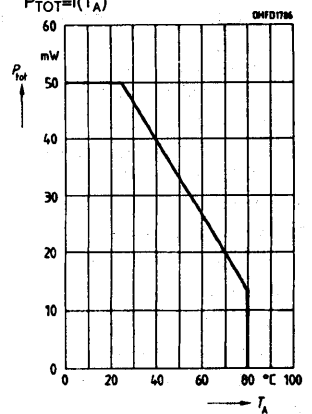

Dark current $I_R=f(V_R)$, $E=0$

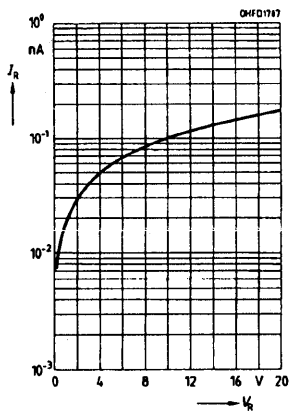

Capacitance $C=f(V_R)$, $f=1\text{ MHz}$, $E=0$

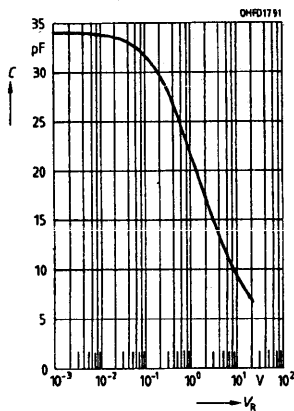

Dark current $I_R=f(T_A)$

$V_R=10\text{ V}$, $E=0$

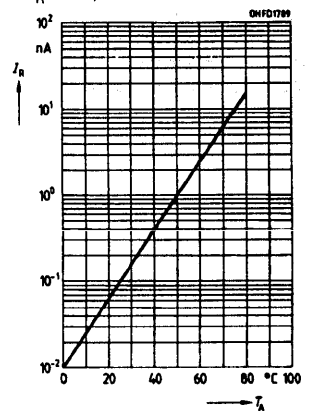

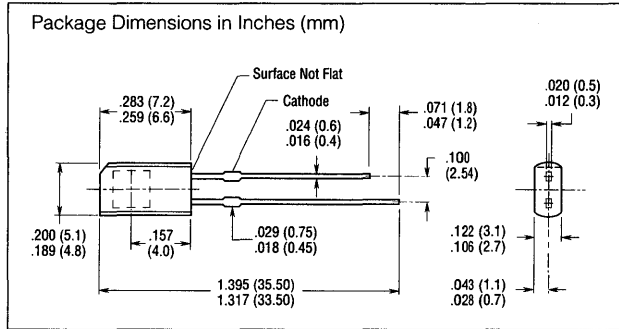
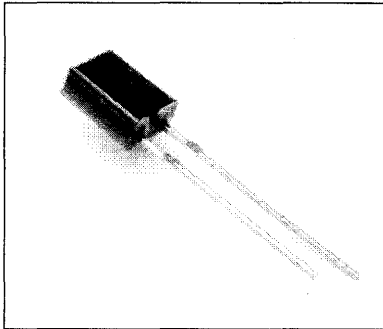

FEATURES

- Silicon Photodiode in PIN Planar Technology
- N-Si Material:
 - Anode, Front Contact
 - Cathode, Back Contact
- High Reliability
- No Testable Degradation
- Low Noise
- High Packing Density
- Short Switching Time
- Low Capacitance
- High Spectral Sensitivity
- Wide Temperature Range
- Near Infrared Range Usage
- Package: SOD 67 Case, Black Epoxy Resin, 0.1" (2.54 mm) Lead Spacing
- Cathode Marking: Shorter Lead

Applications

- IR-Remote Control of Hi-Fi and TV Sets, Video Tape Recorders, Dimmers, Remote Control
- Light Reflecting Switches

Maximum Ratings

Operating and Storage Temperature (T_{OP} , T_{STG})	-40°C to +80°C
Soldering Temperature (2 mm from case bottom) (T_S) $t \leq 3$ sec	230°C
Reverse Voltage (V_R)	32 V
Total Power Dissipation (P_{TOT}) $T_A=25^\circ\text{C}$	150 mW

Characteristics ($T_A=25^\circ\text{C}$, $\lambda=870$ nm)

Parameter	Symbol	Value	Unit	Condition
Photocurrent	I_P	24 (≥ 20)	μA	$V_R=5$ V, $E_E=0.5$ mW/cm ²
Maximum Photosensitivity				
Wavelength	λ_{Smax}	900	nm	
Photosensitivity Spectral Range	λ	740 to 1120	nm	$S=10\%$ of S_{MAX}
Radiant Sensitive Area	A	7	mm ²	
Radiant Sensitive Area Dimension	L x W	2.65x2.65	mm	
Distance Chip Surface to Case Surface	H	0.6 to 0.8	mm	
Half Angle	ϕ	± 65	Deg.	
Dark Current	I_R	2 (≤ 30)	nA	$V_R=10$ V
Spectral Sensitivity	S_λ	0.63	A/W	
				<u>Electrons</u>
Quantum Yield	η	0.9	Photon	
Open-Circuit Voltage	V_O	320 (≥ 250)	mV	$E_E=0.5$ mW/cm ²
Short-Circuit Current	I_{SC}	22	μA	$E_E=0.5$ mW/cm ²
Rise and Fall Time, Photocurrent	t_R , t_F	20	ns	$R_L=50$ Ω , $V_R=5$ V, $\lambda=850$ nm, $I_P=800$ μA
Forward Voltage	V_F	1.3	V	$I_F=100$ mA, $E=0$
Capacitance	C_O	72	pF	$V_R=0$ V, $f=1$ MHz, $E=0$
Temperature Coefficient, V_L	TC_V	-2.6	mV/K	
Temperature Coefficient, I_{SC}	TC_I	0.03	%/K	
Noise Equivalent Power	NEP	4.0×10^{-14}	W/Hz	$V_R=10$ V
Detection Limit	D^*	6.6×10^{12}	$\text{cm} \cdot \sqrt{\text{Hz/W}}$	$V_R=10$ V

Relative spectral sensitivity
 $S_{REL} = f(\lambda)$

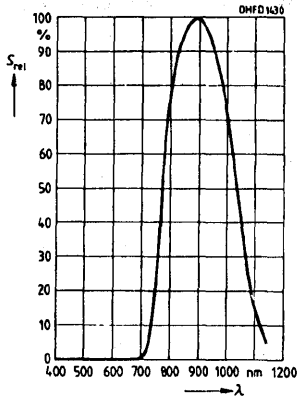

Photocurrent $I_p = f(E_e)$, $V_R = 5\text{ V}$
Open-circuit voltage $V_L = f(E_e)$

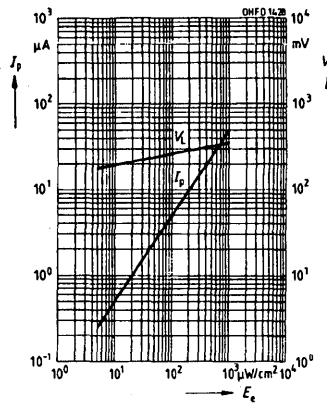

Directional characteristic $S_{REL} = f(\varphi)$

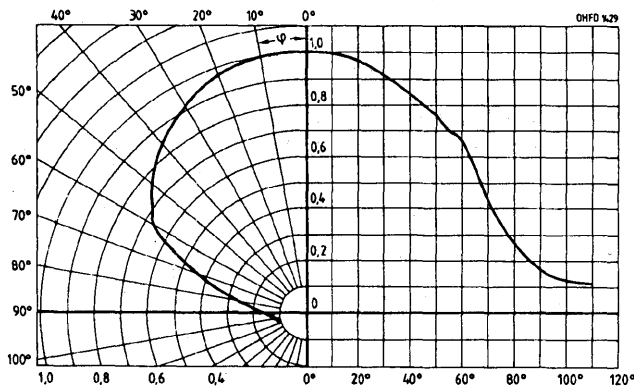

Total power dissipation
 $P_{TOT} = f(T_A)$

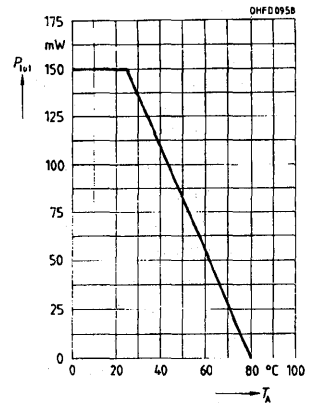

Dark current $I_R = f(V_R)$
 $E = 0$

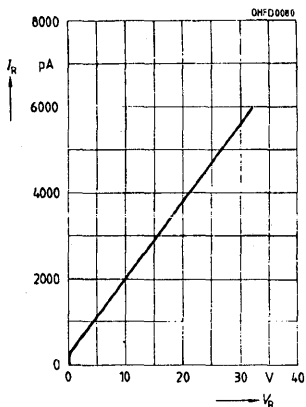

Capacitance $C = f(V_R)$
 $f = 1\text{ MHz}$, $E = 0$

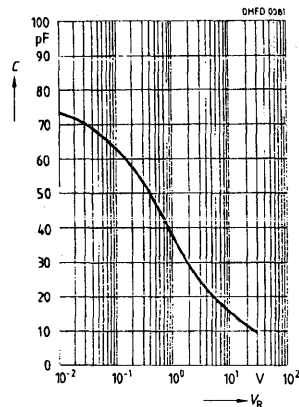

Dark current $I_R = f(T_A)$
 $V_R = 10\text{ V}$, $E = 0$

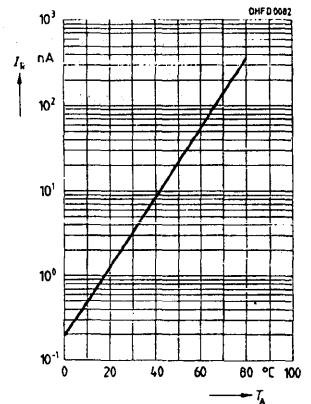

SILICON FOUR QUADRANT PHOTODIODE

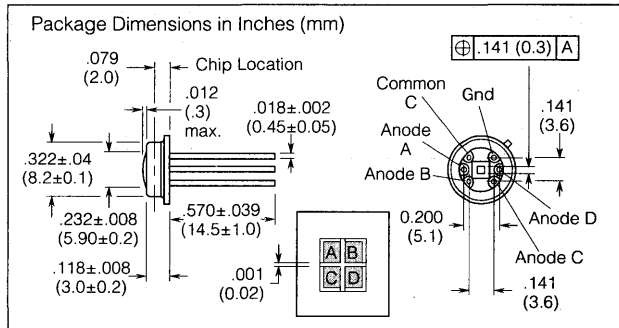
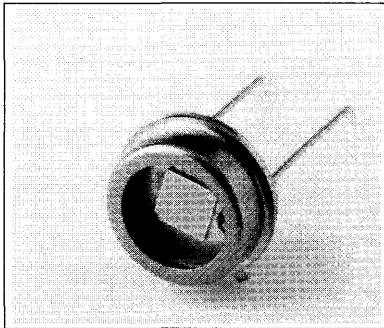

FEATURES

- Silicon Photoelement in Planar Technology
- N-Si Material:
 - Anode, Front Contact
 - Cathode, Back Contact
- Cathode Electrically Isolated
- High Reliability
- No Testable Degradation
- Low Noise
- Short Switching Time
- Low Capacitance
- High Spectral Sensitivity
- Wide Temperature Range
- Visible Light and Near Infrared Range Usage
- Package: Hermetically Sealed, TO39 with Glass Window
- Applications
 - Edge Detection
 - Path and Corner Scanning
 - Measurement and Control

Maximum Ratings

Operating and Storage Temperature (T_{OP} , T_{STG})	-40°C to +80°C
Isolation Voltage (V_{IS})	100 V
Reverse Voltage (V_R)	20 V
Total Power Dissipation (P_{TOT}) $T_A = 25^\circ\text{C}$	50 mW

Characteristics ($T_A = 25^\circ\text{C}$, standard light A, $T = 2856\text{ K}$)

Parameter	Sym	Value	Unit	Condition
Spectral Sensitivity	S	7.4 (≥ 4.8)	nA/lx	
Maximum Photosensitivity				
Wavelength	λ_{Smax}	800	nm	
Photosensitivity Spectral Range	λ	350 to 1050	nm	S=10% of S_{MAX}
Radiant Sensitive Area	A	1	mm ²	
Radiant Sensitive Area Dimension	L x W	1x1	mm	
Distance Chip Surface to Case Surface	H	2.2 to 2.5	mm	
Half Angle	ϕ	± 60	Deg.	
Dark Current	I_R	0.2 (≤ 1)	nA	$V_R = 10\text{ V}$
Isolation Current	I_{IS}	0.1 (≤ 1)	nA	$V_{IS} = 100\text{ V}$
Spectral Sensitivity	S_λ	0.6	A/W	$\lambda = 850\text{ nm}$
Maximum Spectral Sensitivity Tolerance	ΔS	± 10	%	
Quantum Yield	η	0.87	Electrons/Photon	$\lambda = 850\text{ nm}$
Open-Circuit Voltage	V_O	420 (≥ 360)	mV	$E_V = 1000\text{ lx}$
Short-Circuit Current	I_{SC}	7.4	μA	$E_V = 1000\text{ lx}$
Rise and Fall Time, Photocurrent	t_R, t_F	1.5	μs	$R_L = 1\text{ k}\Omega$, $V_R = 5\text{ V}$, $\lambda = 850\text{ nm}$, $I_P = 50\text{ }\mu\text{A}$
Forward Voltage	V_F	1.0	V	$I_F = 40\text{ mA}$, $E = 0$
Capacitance	C_O	120	pF	$V_R = 0\text{ V}$, $f = 1\text{ MHz}$, $E = 0$
Temperature Coefficient, V_O	TC_V	-2.6	mV/K	
Temperature Coefficient, I_{SC}	TC_I	0.18	%/K	
Noise Equivalent Power	NEP	1.33×10^{-14}	W/√Hz	$V_R = 10\text{ V}$, $\lambda = 850\text{ nm}$
Detection Limit	D^*	7.5×10^{12}	$\text{cm} \cdot \sqrt{\text{Hz/W}}$	$V_R = 10\text{ V}$, $\lambda = 850\text{ nm}$

Photodiodes

Relative spectral sensitivity

$S_{REL} = f(\lambda)$

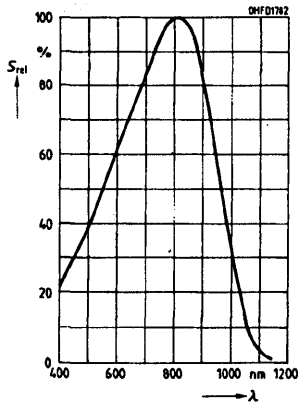

Photocurrent $I_P = f(E_V)$, $V_R = 5\text{ V}$

Open-circuit voltage $V_L = f(E_V)$

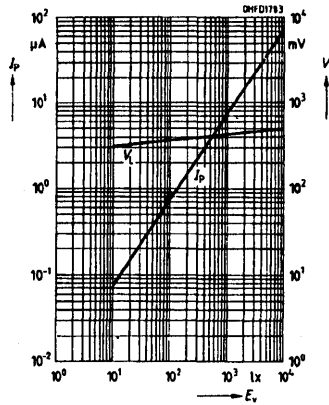

Directional characteristic $S_{REL} = f(\psi)$

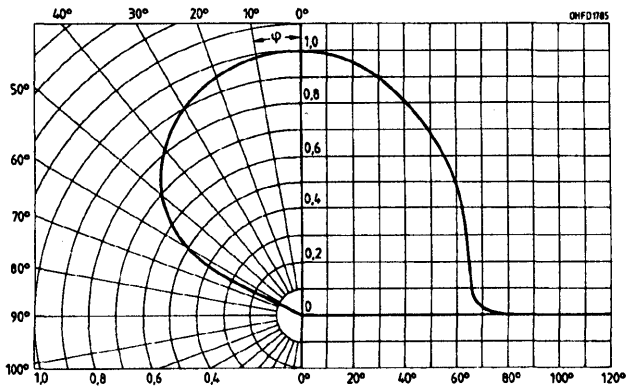

Total power dissipation

$P_{TOT} = f(T_A)$

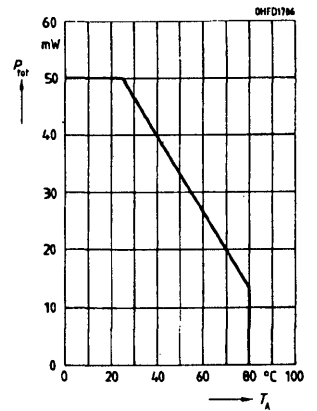

Dark current $I_R = f(V_R)$

$E = 0$

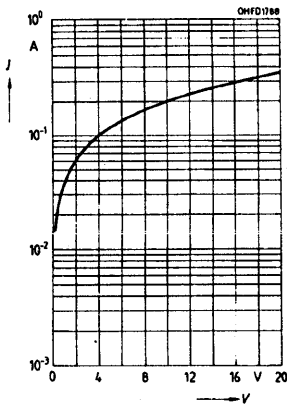

Capacitance $C = f(V_R)$

$f = 1\text{ MHz}, E = 0$

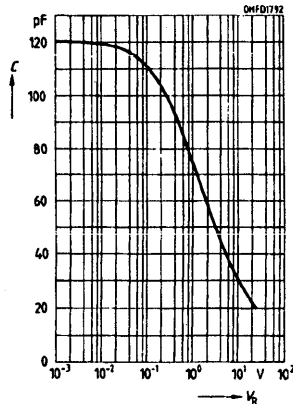

Dark current $I_R = f(T_A)$

$V_R = 10\text{ V}, E = 0$

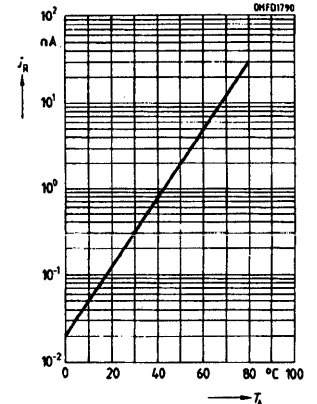

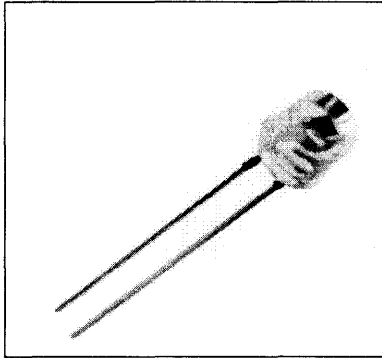

Package Dimensions in Inches (mm)

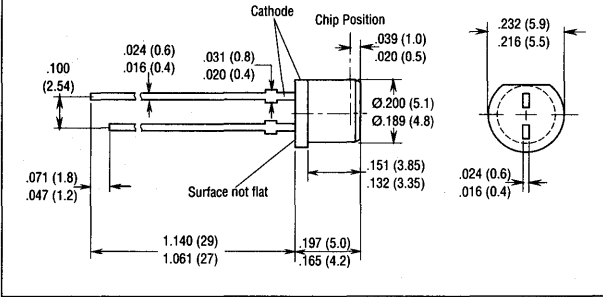

FEATURES

- **Package:** T1¾ (5 mm) LED, Flat Lens, Clear Epoxy Resin, Solder Tabs, Lead Spacing 0.10" (2.54 mm)
- **Cathode Marking:** Short Solder Tab
- **High Reliability**
- **No Testable Degradation**
- **Low Noise**
- **High Open Circuit Voltage During Element Operation**
- **Detector for Low Light Levels**
- **Short Switching Time**
- **High Spectral Sensitivity**
- **Wide Temperature Range**
- **Usage:** Visible and IR Ranges
- **Daylight-Rejection Filter (SFH 263F)**
- **Same Package as Phototransistors SFH 317, SFH 317F, IRED SFH 485P; Photodiodes SFH 217, SFH 217F**

DESCRIPTION

SFH 263 is a silicon planar PIN photodiode that can be used as a diode with reverse voltage, or operated as an element. N-Si material provides positive front and negative back contacts.

Applications include exposure meters, automatic exposure timers, measurement and control, reflective switches, and light curtains.

Maximum Ratings

Operating and Storage Temperature Range (T_{OP} , T_{STG})	-40° to +80°C
Soldering Temperature (2 mm from case bottom) (T_S) $t \leq 3$ s	230°C
Reverse Voltage (V_R)	7 V
Power Dissipation (P_{TOT}) $T_A=25^\circ\text{C}$	100 mW

Characteristics ($T_A=25^\circ\text{C}$)

Parameter	Symbol	Value	Unit
Photosensitivity ($V_R=5$ V, Standard Light A, $T=2856$ K, $\lambda=950$ nm, $E_E=0.5$ mW/cm ²)	S	10(≥8)	nA/lx
Maximum Photosensitivity Wavelength	$\lambda_{S_{MAX}}$	850	nm
Photosensitivity Spectral Range (S=10% of S_{MAX})	λ	350 to 1100	nm
Radiant Sensitive Area	A	0.97	mm ²
Radiant Sensitive Area Dimensions	L x W	0.985 x 0.985	mm
Distance, Chip Surface to Case Surface	H	0.4 to 0.7	mm
Half Angle	ϕ	±75	Deg.
Dark Current ($V_R=1$ V)	I_R	5(≤20)	nA
Spectral Sensitivity ($\lambda=850$ nm)	S_λ	0.50	A/W
Zero Crossover ($E_E=0$)	S_0	<0.4	pA/mV electrons photon
Quantum Yield ($\lambda=850$ nm)	η	0.73	
Open Circuit Voltage ($E_E=0.5$ mW/cm ² , $\lambda=950$ nm, $E_V=1000$ lx) ⁽¹⁾	V_0	450(≥380)	mV
Short Circuit Current ($E_E=0.5$ mW/cm ² , $\lambda=950$ nm, $E_V=1000$ lx) ⁽¹⁾	I_{SC}	10	μA
Rise and Fall Time of Photocurrent ($R_L=1$ KΩ, $V_R=5$ V, $\lambda=850$ nm, $I_P=10$ mA)	t_R , t_F	1.3	μs
Forward Voltage ($I_F=80$ mA, $E=0$, $T_A=25^\circ\text{C}$)	V_F	1.3	V
Capacitance ($V_R=0$ V, $f=1$ MHz, $E=0$)	C_0	100	pF
Temperature Coefficient V_0	TC_V	-2.6	mV/K
Temperature Coefficient I_{SC}	TC_I	0.16	%/K
Noise Equivalent Power ($V_R=1$ V, $\lambda=850$ nm)	NEP	2.5×10^{-15}	W/√Hz
Detection Limit ($V_R=1$ V, $\lambda=850$ nm)	D^*	3.9×10^{13}	cm ² √Hz/W

Note

1. Illuminance shown refers to unfiltered radiation of tungsten filament lamp at color temperature of 2856 K (standard light A per DIN 5033 and IEC publication 306-1).

Relative spectral sensitivity
 $S_{REL} = f(\lambda)$

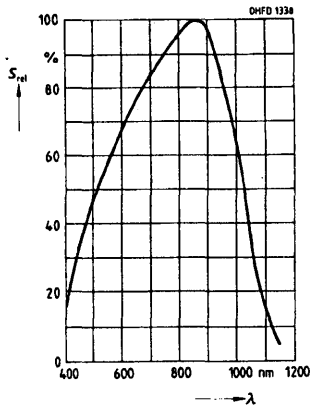

Photocurrent $I_p = f(E_v)$ $V_R = 5$ V
Open circuit voltage $V_O = f(E_v)$

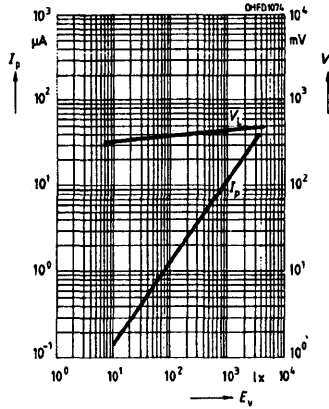

Directional characteristic
 $S_{REL} = f(\varphi)$

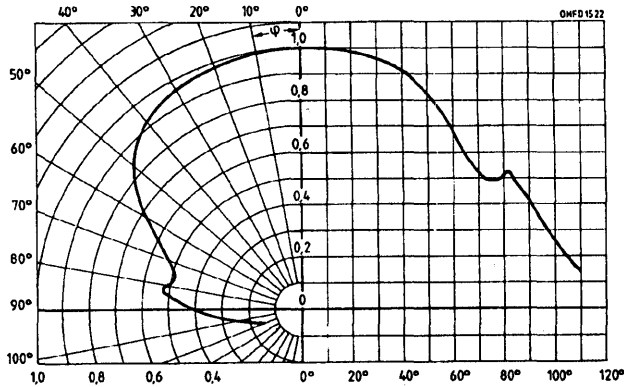

Capacitance $C = f(V_R)$, $f = 1$ MHz, $E = 0$

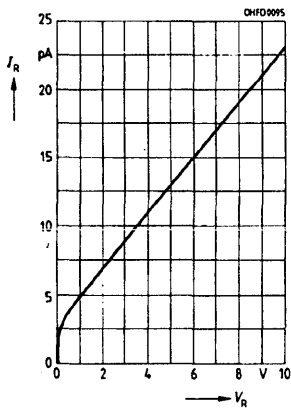

Dark current $I_R = f(V_R)$, $E = 0$

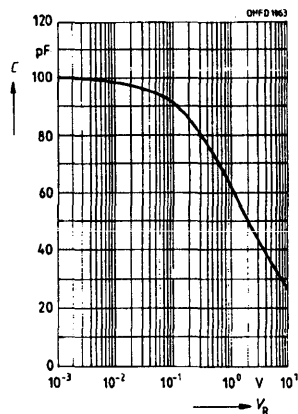

Dark current $I_R = f(T_A)$, $V_R = 1$ V, $E_v = 0$

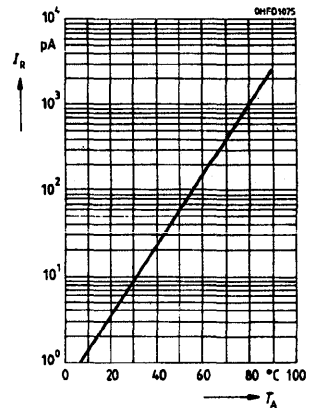

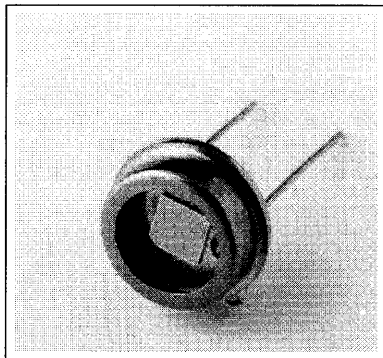

Package Dimensions in Inches (mm)

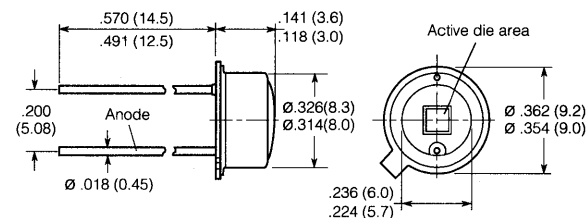

FEATURES

- **Anode Marking:** Tab at Package Bottom
- **Usage:** Visible Light and Near IR Ranges
- **High Spectral Sensitivity in UV Range**
 $S_{\lambda}=0.2$ A/W at $\lambda=350$ nm
- **High Reliability**
- **Short Switching Time**
- **Wide Temperature Range**
- **High Open Circuit Voltage During Element Operation**
- **No Testable Degradation**
- **Package:** Hermetically Sealed, Similar to TO5, Window Cap with Special UV Glass, Lead Spacing 0.20" (5.08 mm)
- **High Linearity**
- **Low Noise**

DESCRIPTION

The SFH 291 is a silicon planar photodiode that can be used as a diode with reverse voltage or for element operation. N-Si material provides positive front and negative back contacts.

Applications include spectrophotometers, UV lasers, industrial electronics, UVA and UVB radiation control in solariums, EPROM eraser instruments, gas burner flame monitoring, arc monitoring, UV water purification facilities, and measurement and control.

Maximum Ratings

Operating and Storage Temperature Range (T_{OP} , T_{STG}) -40° to +80°C
 Soldering Temperature (2 mm from case bottom) (T_S) $t_S \leq 3$ s 230°C
 Reverse Voltage (V_R) 10 V
 Power Dissipation (P_{TOT}) 250 mW

Characteristics ($T_A=25^\circ\text{C}$)

Parameter	Symbol	Value	Unit
Photosensitivity			
($V_R=5$ V, Standard Light A, $T=2856$ K)	S_V	50	nA/lx
Maximum Photosensitivity Wavelength	λ_{Smax}	850	nm
Spectral Sensitivity Range ($S=10\% S_{MAX}$)	λ	230 to 1100	nm
Radiant Sensitive Area	A	7.45	mm ²
Radiant Sensitive Area Dimensions	L x W	2.73 x 2.73	mm
Distance, Chip Surface to Case Surface	H	1.9 to 2.3	mm
Half Angle	ϕ	± 55	Deg.
Dark Current ($V_R=5$ V, E=0)	I_R	0.3 (≤ 1)	nA
Spectral Sensitivity ($\lambda=350$ nm)	S_{λ}	0.2	A/W
			electrons
			photon
Quantum Yield ($\lambda=350$ nm)	η	0.71	
Open Circuit Voltage ($E_V=1000$ lx) ⁽¹⁾	V_O	420	mV
Short Circuit Current			
($E_E=0.2$ mW/cm ² , $\lambda=350$ nm)	I_{SC}	3 (≥ 2)	μ A
($E_V=1000$ lx) ⁽¹⁾	I_{SC}	50	μ A
Rise and Fall Time of Photocurrent			
($R_L=1$ K Ω , $V_R=5$ V, $\lambda=850$ nm, $I_P=50$ μ A)	t_R , t_F	3	μ s
Forward Voltage ($I_F=100$ mA, E=0)	V_F	1.2	V
Capacitance			
($V_R=0$ V, $f=1$ MHz, E=0)	C_0	600	pF
Temperature Coefficient of V_O			
(Standard Light A)	TC_O	-2.6	mV/K
Temperature Coefficient of I_{SC}			
(Standard Light A)	TC_S	0.2	%/K
Noise Equivalent Power			
($V_R=5$ V, $\lambda=350$ nm)	NEP	4.9×10^{-14}	W/ $\sqrt{\text{Hz}}$
Detection Limit ($V_R=5$ V, $\lambda=350$ nm)	D^*	5.6×10^{12}	cm $\cdot\sqrt{\text{Hz}}$ /W

Note

1. Illuminance shown refers to unfiltered radiation of tungsten filament lamp at color temperature of 2856 K (standard light A per DIN 5033 and IEC publication 306-1).

Relative spectral sensitivity
 $S_{REL}=f(\lambda)$

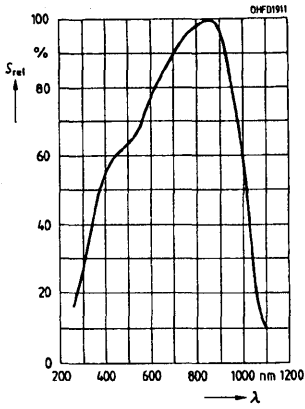

Photocurrent $I_p=f(E_V)$ $V_R=5$ V
Open circuit voltage $V_O=f(E_V)$

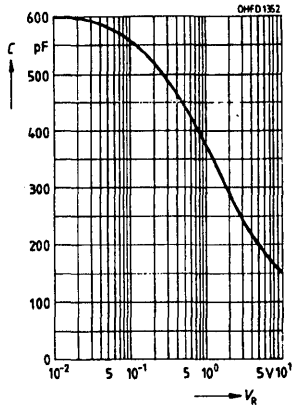

Directional characteristic $S_{REL}=f(\varphi)$

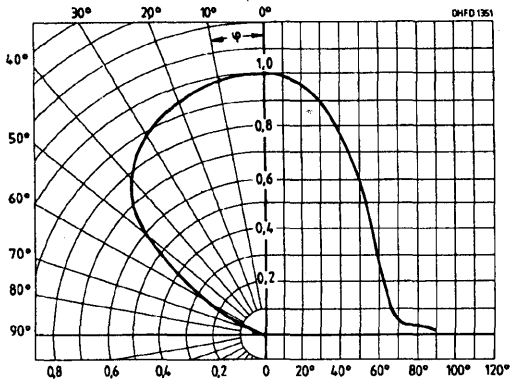

Dark current $I_R=f(V_R)$, $E=0$

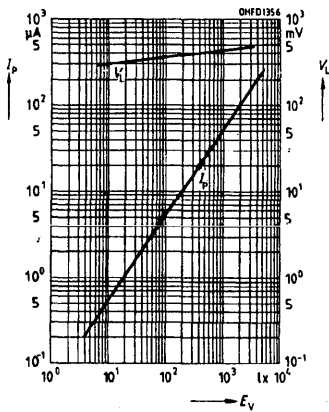

Capacitance $C=f(V_R)$, $f=1$ MHz, $E=0$

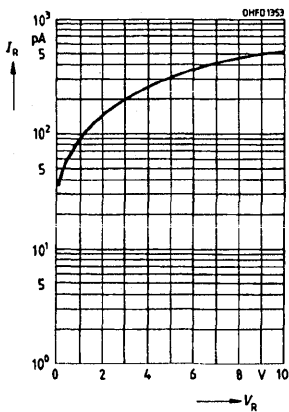

Dark current $I_R=f(T_A)$, $V_R=5$ V, $E=0$

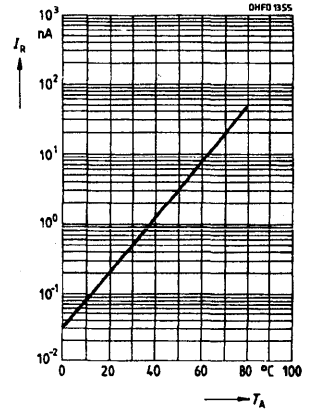

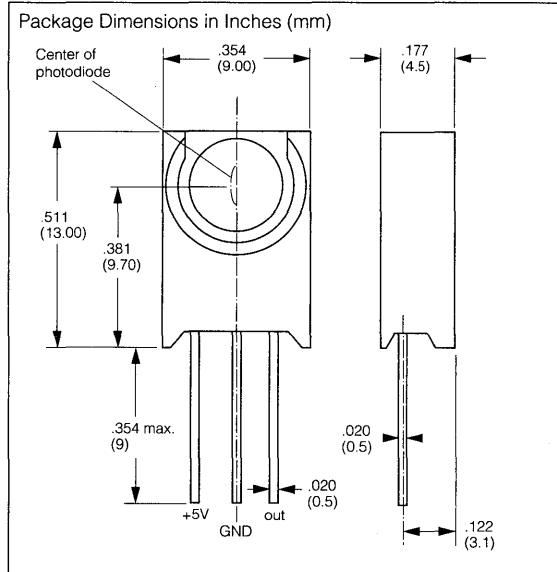
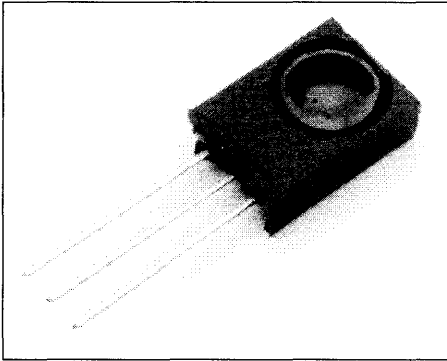

FEATURES

- Photodiode with Hybrid Integrated Circuit
- 30 kHz Carrier Frequency
- Black Epoxy Package with Daylight Filter Optimized for 950 nm
- High Immunity Against Ambient Light
- Low Power Consumption
- 5 V Supply Voltage
- High Sensitivity
- Internal EMI/RFI Shield

DESCRIPTION

The SFH505A incorporates a silicon PIN photodiode, IR detector IC, and demodulator in a lensed and filtered plastic housing. The device is compact, rugged and has a high immunity to ambient light and RFI/EMI interference because of its internal shielding.

Applications include remote control with televisions, video games, garage door openers, electronic toys, and automobiles.

Maximum Ratings

Operating/Storage Temperature (T_{OP} , T_{STG})	-25° to +85°C
Soldering Temperature (≥ 2 mm from case) (T_S) $t_S \leq 3$ s	260°C
Supply Voltage (V_{CC})	-0.3 to +7.0V
Output Voltage (V_Q)	-0.3 to +7.0V
Output Current (I_Q)	3 mA

Characteristics ($T_A=25^\circ\text{C}$)

Parameter	Symbol	Value	Unit
Operating Voltage Range	V_{CC}	4.5 to 5.5	V
Operating Temperature Range	T_A	0 to 70°	°C
Switching Threshold (950 nm, $f=30$ kHz)	$E_{ES}^{(1)}$	40	nW/cm ²
Wavelength, Maximum Sensitivity	λ_{Smax}	950	nm
Spectral Sensitivity Range ($S=10\%$ of S_{MAX})	$\Delta\lambda$	± 160	nm
Half Angle	ϕ	± 50	Deg.
Current Consumption	I_{CC}	0.65	mA
Output Voltage ($I_Q=100$ μ A)	V_{Qlow}	<0.4	V
Output (output high, $V_Q=5$ V)	I_Q	<10	μ A
Turn-on Time ⁽²⁾ ($E_E=250$ nW/cm, $f=30$ kHz)	t_{ON}	100	μ s
Turn-off Time ⁽²⁾ ($E_E=250$ nW/cm, $f=30$ kHz)	t_{OFF}	200	μ s
Conducting Time ($E_E=200$ μ W/cm, $f=30$ kHz)	t_{LOW}	700	μ s
($E_E=250$ μ W/cm, $f=30$ kHz)	t_{LOW}	500	μ s

Notes: 1. A 30 m transmission distance is possible when used with IR emitter SFH415 at $I_F=1$ A ($I_E=400$ mW/sr).
2. See Figure 2.

Figure 1. External Circuit

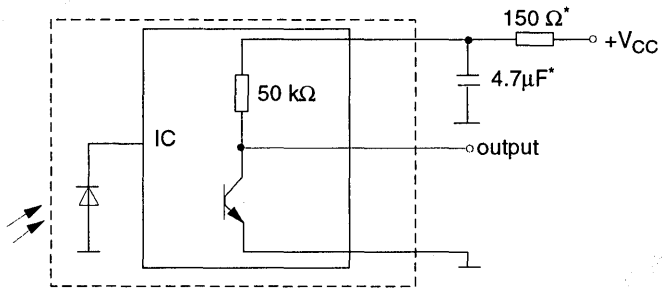

* Blocking devices if required

Figure 2. Timing Diagram

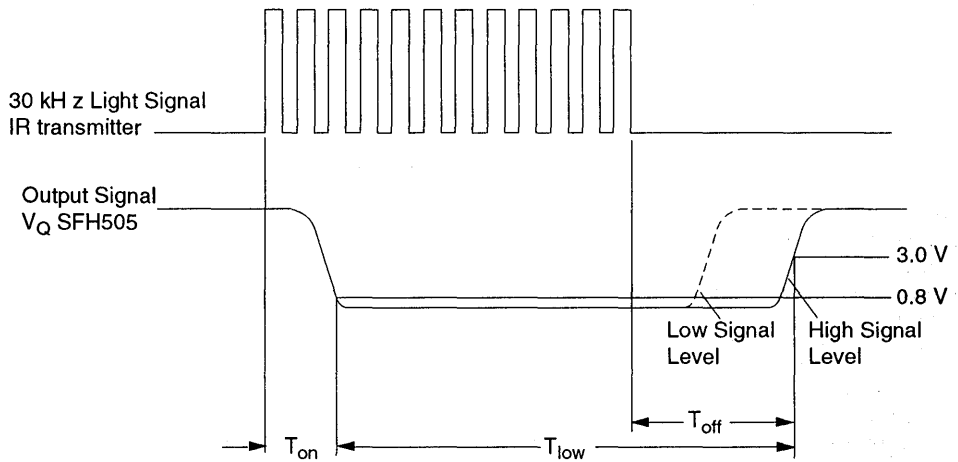

Directional characteristics

$S_{REL} = f(\rho)$

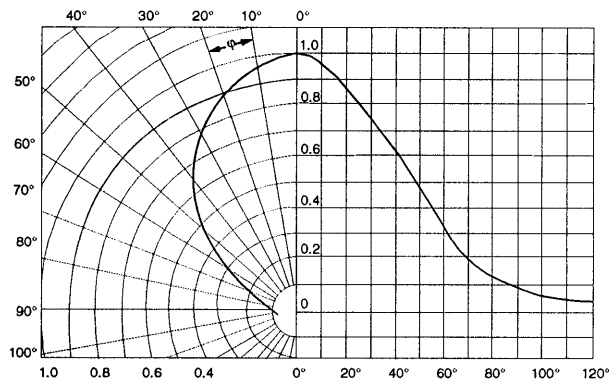

Current consumption

$I_{CCL} = f(V_{CC})$

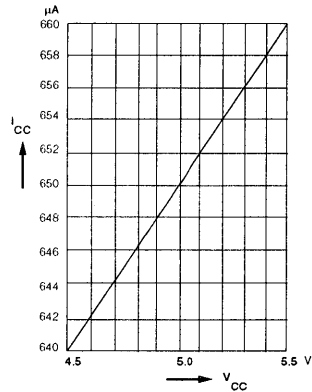

Switching threshold

$E_{ES} = f(T_A)$

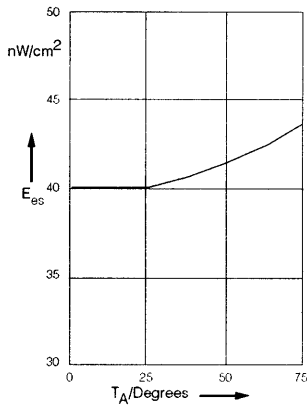

Turn-on time $t_{ON} = f(E_e)$

$f = 30 \text{ kHz}, 12 \text{ pulses}$

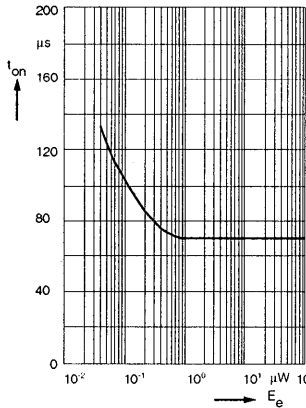

Turn-off time $t_{OFF} = f(E_e)$

$f = 30 \text{ kHz}, 12 \text{ pulses}$

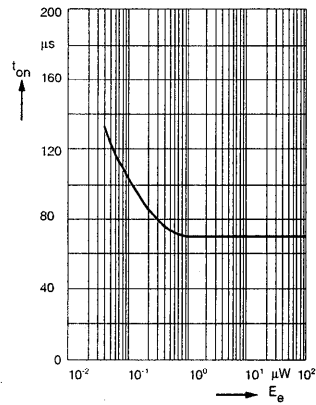

Extraneous light effect to switching threshold

$E_{ES} = f(E_V)$

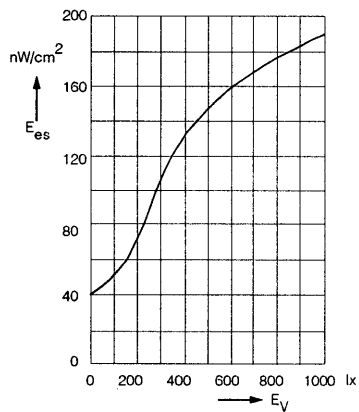

Relative spectral sensitivity

$f = f(\lambda)$

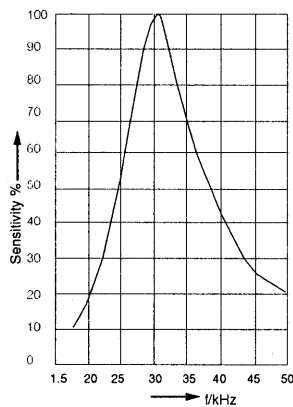

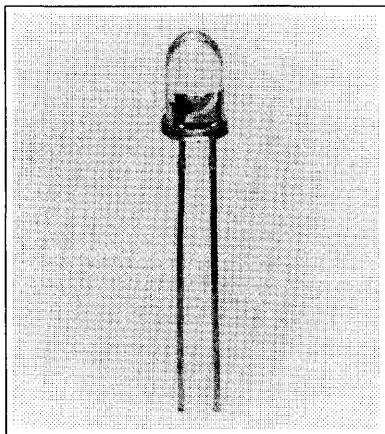

Package Dimensions in Inches (mm)

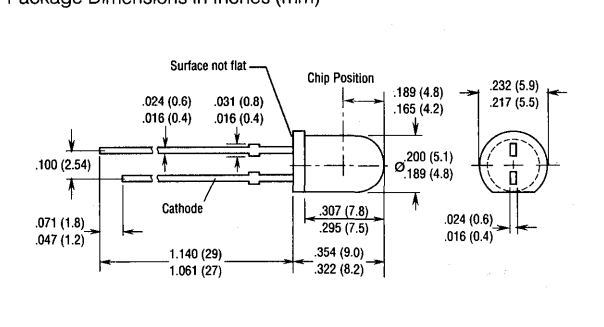

FEATURES

- High Reliability
- Low Noise
- High Open Circuit Voltage as Photo-voltaic Cells
- Short Switching Time
- High Spectral Sensitivity
- Wide Temperature Range
- Low Capacitance
- Usage: Visible and Near IR Ranges
- Clear Plastic Lens (SFH 2030)
- Daylight Filter Option (SFH 2030F)

DESCRIPTION

SFH 2030 and SFH 2030F are silicon planar PIN photodiodes in T1.75 packages. They can be used as photodiodes with reverse voltage, or as photovoltaic cells. The terminals are solder tabs with 0.1" (2.54 mm) lead spacing.

Applications include industrial electronics, light-activated switches, fiber optic transmission systems, and measurement and control.

Maximum Ratings

Operating and Storage Temperature Range (T_{OP} , T_{STG}) -55° to +100°C
Soldering Temperature (2 mm from case bottom) (T_S) $t_S \leq 3$ s 300°C
Reverse Voltage (V_R) 50 V
Power Dissipation (P_{TOT}) $T_A=25^\circ\text{C}$ 100 mW

Characteristics ($T_A=25^\circ\text{C}$)

Parameter	Symbol	Value		Unit
		SFH 2030	SFH 2030F	
Photosensitivity				
($V_R=5$ V, Standard Light A, $T=2856$ K)	S	80(≥ 50)		nA/lx
($V_R=5$ V, $\lambda=950$ nm, $E_E=0.5$ mW/cm ²)	S		25(≥ 15)	μA
Maximum Photosensitivity Wavelength	λ_{Smax}	850	900	nm
Photosensitivity Spectral Range (S=10% of S_{MAX})	λ	400 to 1100	800 to 1100	nm
Radiant Sensitive Area	A	1	1	mm ²
Radiant Sensitive Area Dimensions	L x W	1 x 1	1 x 1	mm
Distance, Chip Surface to Case Surface	H	4.0 to 4.6	4.0 to 4.6	mm
Half Angle	ϕ	± 20	± 20	Deg.
Dark Current ($V_R=20$ V)	I_R	1(≤ 5)	1(≤ 5)	nA
Spectral Sensitivity ($\lambda=850$ nm)	S_λ	0.62	0.59	A/W
Quantum Yield ($\lambda=850$ nm)	η	0.89	0.86	electrons/photon
Open Circuit Voltage ($E_E=1000$ lx) ⁽¹⁾	V_0	420(≥ 350)		mV
($E_E=0.5$ mW/cm ² , $\lambda=950$ nm)	V_0		370(≥ 300)	mV
Short Circuit Current ($E_E=1000$ lx) ⁽¹⁾	I_{SC}	80		μA
($E_E=0.5$ mW/cm ² , $\lambda=950$ nm)	I_{SC}		25	μA
Rise and Fall Time of Photocurrent ($R_L=50$ Ω , $V_R=20$ V, $\lambda=850$ nm, $I_P=800$ μA)	t_{RI} , t_{F}	5	5	ns
Forward Voltage ($I_F=80$ mA, $E_E=0$)	V_F	1.3	1.3	V
Capacitance ($V_R=0$ V, $f=1$ MHz, $E=0$)	C_0	11	11	pF
Temperature Coefficient V_0	TC_V	-2.6	-2.6	mV/K
Temperature Coefficient I_{SC} (Standard Light A)	TC_I	0.18		%/K
Temperature Coefficient I_{SC} ($\lambda=950$ nm)	TC_I		0.2	%/K
Noise Equivalent Power ($V_R=20$ V, $\lambda=850$ nm)	NEP	2.9×10^{-14}	2.9×10^{-14}	W/Hz
Detection Limit ($V_R=20$ V, $\lambda=850$ nm) publication 306-1.	D^*	3.5×10^{12}	3.5×10^{12}	$\text{cm}^2\text{Hz}/\text{W}$

Note

1. Illuminance shown refers to unfiltered radiation of tungsten filament lamp at color temperature of 2856 K (standard light A per DIN 5033 and IEC publication 306-1).

SFH 2030
Relative spectral sensitivity
 $S_{REL}=f(\lambda)$

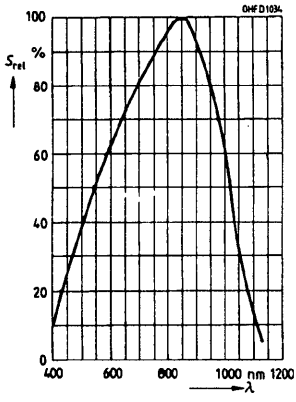

SFH 2030F
Relative spectral sensitivity
 $S_{REL}=f(\lambda)$

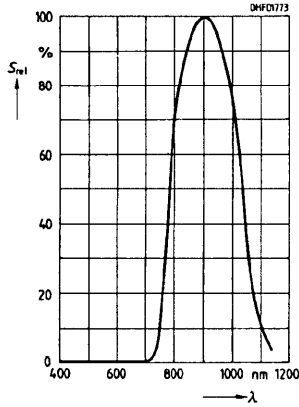

SFH 2030
Photocurrent $I_P=f(E_V)$ $V_R=5$ V
Open circuit voltage $V_O=f(E_V)$

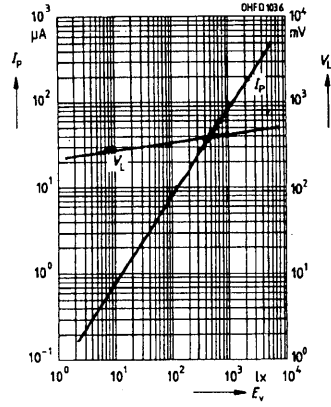

SFH 2030F
Photocurrent $I_P=f(E_V)$ $V_R=5$ V
Open circuit voltage $V_O=f(E_V)$

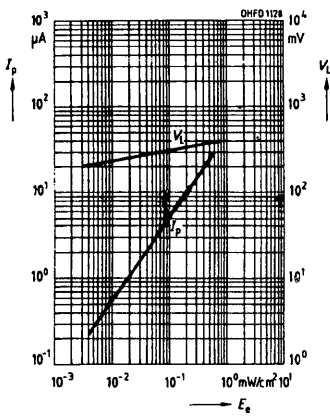

Directional characteristic $S_{REL}=f(\varphi)$

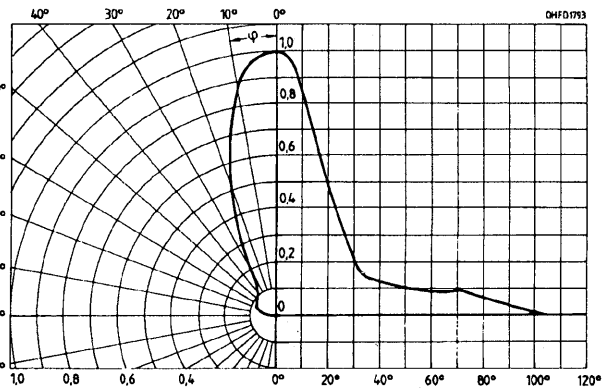

Power dissipation $P_{TOT}=f(T_A)$

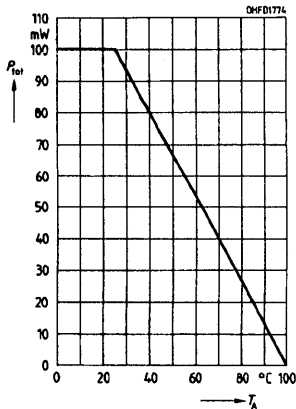

Dark current $I_R=f(V_R)$, $E=0$

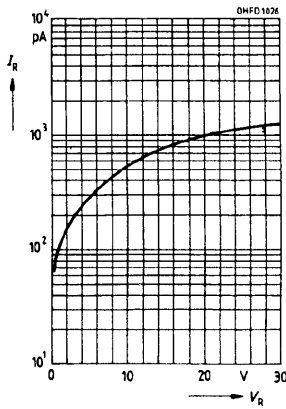

APPLICATIONS

- Check Output of IR LEDs and IR Laser Diodes
- In Test Set-ups, Remote Control Devices, Tone Transmitters, Light Reflection Switches, Light Pens, Optical Fiber Systems, etc.
- Estimate IR Radiant Intensity and Radiation Pattern
- Evaluate IR Transmissiveness of Materials

Operating principle

The active luminous area of the IR-B2 infrared indicator card consists of fine crystalline semiconductor material doped with rare-earth metals, Europium and Samarium. This material is capable of being charged (stimulated) with light and responds best to blue light. When subjected to IR stimulation, this material emits visible light. The brightness of this emitted light is directly proportional to the intensity of the IR stimulation.

Charging

The charging time depends on the intensity of the light source used. A few seconds are sufficient when charging with sunlight, several minutes, however, may be necessary in case of dim light. One should be careful in charging with an incandescent source, as the IR segment of this light source serves to elicit emission, even as the card is excited. So, IR-free light is best and can be obtained by using an IR filter such as a 'SCHOTT' BG39.

Indicator Operation

The indicator card is charged with IR light and emits visible light. The emitted light will be proportional to the intensity of the IR light. The intensity of the emitted light, however, is not constant but declines over time with each stimulation. The rise and fall time for emission is in the microsecond range. Filters such as RG780 through RG1000 from SCHOTT can be used to isolate specific segments of the IR light to be tested.

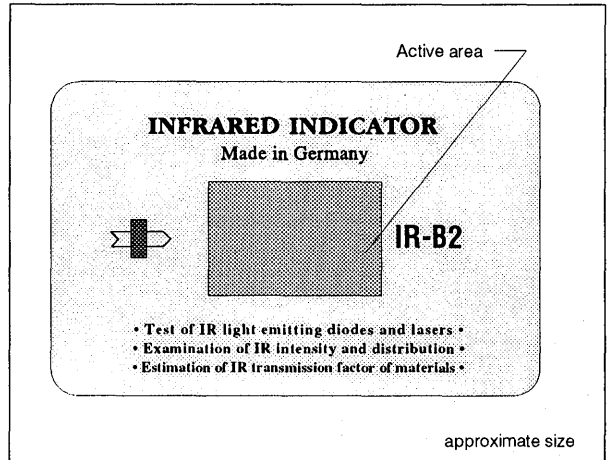

Self-Discharge

Like any other energy storing device, the infrared indicator card IR-B2 tends to a self-discharge, resulting in an extremely low emission. An (almost) complete self-discharge takes several months; the saturation charge is stored for about ten minutes.

Service Life

The charge/discharge cycles and full discharge cause no perceptible aging. Overloading is not possible. Strong, steady UV radiation will cause an irreversible decline in sensitivity. The sudden, abrupt failure of the card is impossible.

Further Notes on Use

The card has to be charged with daylight or fluorescent light. In case of self-discharge or decline in sensitivity after IR stimulation, the card must be recharged. If the IR source is weak, shield the card from ambient light. The card is humidity resistant and can be used in transmissive or reflective mode. The use of an IR-blocking filter is recommended if using an incandescent source (e. g. SCHOTT BG39).

Characteristics

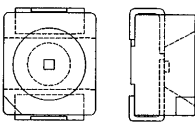
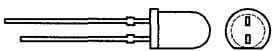
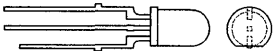
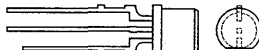
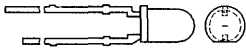

Parameter	Values	Unit
Peak λ for max. charge (excitation)	approx. 480 (blue)	nm
Indication λ (under fluorescent light)	400 to 700 (visible light)	nm
Low-end λ of sensitivity to IR (stimulation) (10% of max. sensitivity)	approx. 700 (dark-red)	nm
High-end λ of sensitivity to IR (stimulation) (10% of max. sensitivity)	approx. 1300 (medium IR)	nm
Peak λ for IR sensitivity	approx. 1020 (near IR)	nm
Active area	30 x 20	mm
Outside dimensions (credit-card size)	85.5 x 54.0 x 0.8	mm
Temperature range	-30 to 70 short-term usage: 100	°C

Phototransistors

Package Outline	Part Number	Package Type	Half Angle	Photo-current $\lambda=950\text{ nm}$ $V_{CE}=5\text{ V}$ $I_{PC}(mA)$	Collector Emitter Voltage $V_{CEO} (V)$	Radiant Sensitive Area mm^2	Features	Page
	SFH320-2	SMT-TOP-LED	$\pm 60^\circ$	16–32 μA	—	0.045	Surface mount PL-CC-2 package. Compatible with automatic placement equipment. Matches IR emitter SFH420.	9–34
	SFH320-3			$\geq 25\ \mu A$				
	SFH320F-2	SMT-TOP-LED, daylight filter		16–32 μA				
	SFH320F-3			$\geq 25\ \mu A$				
	BP103B-2	T1 $\frac{3}{4}$ (5 mm) clear plastic.	$\pm 25^\circ$	0.63–1.25	35	0.12	IR remote control., high gain. λ_{max} 850 nm. Matches IR emitter LD271, LD273, SFH484, or SFH485.	9–7
	BP103B-3			1.0–2.0				
	BP103B-4			≥ 1.6				
	SFH303-2	T1 $\frac{3}{4}$ (5 mm) clear plastic.	$\pm 20^\circ$	1.0–2.0	50	0.30	Good linearity, high photosensitivity. Visual and near IR range usage.	9–22
	SFH303-3			1.6–3.2				
	SFH303-4			≥ 2.5				
	SFH303F-2	T1 $\frac{3}{4}$ (5 mm) plastic, daylight filter.		5.2				
	SFH303F-3			8.4				
	SFH303F-4			13.1 (1000 lux)				
	SFH317-2	T1 $\frac{3}{4}$ (5 mm) flat, clear plastic.	$\pm 60^\circ$	0.16–0.32	50	0.30	Good linearity, high photosensitivity. Fast rise and fall times.	9–32
	SFH317-3			0.25–0.5				
	SFH317-4			≥ 0.4				
	SFH317F-2	T1 $\frac{3}{4}$ (5 mm) flat plastic, daylight filter.		0.16–0.32				
	SFH317F-3			0.25–0.5				
	SFH317F-4			≥ 0.4				
	SFH309-2	T1 (3 mm) clear plastic.	$\pm 12^\circ$	0.5–1.0	35	0.045	IR remote control. Narrow acceptance angle. Matches IR emitter SFH409.	9–26
	SFH309-3			0.63–1.25				
	SFH309-4			1.0–2.0				
	SFH309-5			≥ 1.6				
	SFH309F-2	T1 (3 mm) plastic, daylight filter.		0.5–1.0				
	SFH309F-3			0.63–1.25				
	SFH309F-4			1.0–2.0				
	SFH309F-5			≥ 1.6				

Phototransistors/
Photodarlington

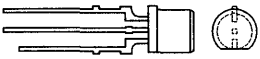
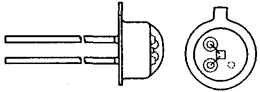
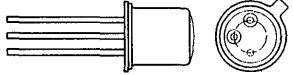
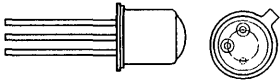
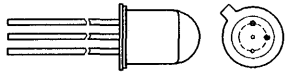
Phototransistors (Continued)

Package Outline	Part Number	Package Type	Half Angle	Photo-current $\lambda=950\text{ nm}$ $V_{CE}=5\text{ V}$ $I_{PCE}(\mu\text{A})$	Collector Emitter Voltage $V_{CEO}(\text{V})$	Radiant Sensitive Area mm^2	Features	Page
	SFH309P-2	T1 flat clear plastic.	$\pm 75^\circ$	63–125 μA	35	0.045	IR remote control. Wide acceptance angle. Matches IR emitter SFH409.	9–29
	SFH309P-3			100–200 μA				
	SFH309P-4			160–320 μA				
	SFH309PF-2	T1 flat plastic, daylight filter.		63–125 μA				
	SFH309PF-3			100–200 μA				
	SFH309PF-4			160–320 μA				
	BP103-2	Similar to TO-18, clear plastic lens.	$\pm 55^\circ$	0.08–0.16	50	0.12	IR remote control. Narrow acceptance angle. $\lambda_{\text{smax}} 850\text{ nm}$. Matches IR emitter LD242.	9–4
	BP103-3			0.125–0.25				
	BP103-4			0.2–0.4				
	BP103-5			0.32–0.63				
	BP103-6			≥ 0.50				
	BPX38-2	TO-18 hermetic package, flat glass lens.	$\pm 40^\circ$	0.2–0.4	50	0.675	Wide acceptance angle 80° . $\lambda_{\text{smax}} 880\text{ nm}$. Matches IR emitter SFH402.	9–9
	BPX38-3			0.32–0.63				
	BPX38-4			0.5–1.0				
	BPX38-5			0.8–1.6				
	BPX43-2	TO-18 hermetic package, glass lens.	$\pm 15^\circ$	0.8–1.6	50	0.675	Narrow acceptance angle 30° . $\lambda_{\text{smax}} 880\text{ nm}$. Matches IR emitter SFH401.	9–12
	BPX43-3			1.25–2.5				
	BPX43-4			2.0–4.0				
	BPX43-5			3.2–6.3				
	BPY62-2	TO-18 hermetic package, glass lens.	$\pm 8^\circ$	0.5–1.0	32	0.12	Very narrow acceptance angle 16° . $\lambda_{\text{smax}} 850\text{ nm}$. Matches IR emitter SFH400.	9–17
	BPY62-3			0.8–1.6				
	BPY62-4			1.25–2.5				
	BPY62-5			2.0–4.0				
	SFH501-1	TO-18	$\pm 7^\circ$	2.5–5	35	0.14	Photodarlington	9–37
	SFH501-2			≥ 4.0				
	LPT-80A	Rectangular clear plastic. Side facing.	$\pm 40^\circ$	≥ 0.2 $H=0.5\text{ mW/cm}^2$	30	—	$\lambda_{\text{smax}} 870\text{ nm}$. Matches IR emitters IRL80A/81A.	9–20

Phototransistors (Continued)

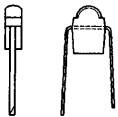
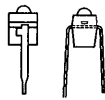
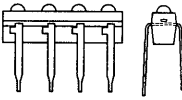
Package Outline	Part Number	Package Type	Half Angle	Photo-current $\lambda=950\text{ nm}$ $V_{CE}=5\text{ V}$ $I_{PCE}(\text{mA})$	Collector Emitter Voltage $V_{CE0}(\text{V})$	Radiant Sensitive Area mm^2	Features	Page
	SFH305-2	Miniature clear plastic, axial leads.	$\pm 16^\circ$	0.25-0.5	32	0.17	Narrow acceptance angle 32° $\lambda_{\text{max}} 850\text{ nm}$. Matches IR emitter SFH405.	9-24
	SFH305-3			0.4-0.8				
	BPX81-2	1 diode	$\pm 18^\circ$	0.25-0.5	32	0.17	Array package. Axial leads. $\lambda_{\text{max}} 850\text{ nm}$. BPX81-matches IR emitter LD261. BPX82-89, BPX80-matches IR emitters LD262-9, LD260.	9-15
	BPX81-3			0.4-0.8				
	BPX81-4			≥ 0.63				
	BPX82	2 diode	$\pm 18^\circ$	0.32-<1	32	0.17 per diode	Array package. Axial leads. $\lambda_{\text{max}} 850\text{ nm}$. BPX81-matches IR emitter LD261. BPX82-89, BPX80-matches IR emitters LD262-9, LD260.	9-15
	BPX83	3 diode						
	BPX84	4 diode						
	BPX85	5 diode						
	BPX86	6 diode						
	BPX87	7 diode						
	BPX88	8 diode						
	BPX89	9 diode						
BPX80	10 diode							

Phototransistors/
Photodarlington

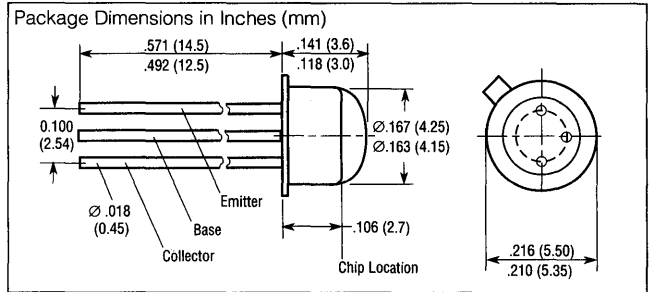
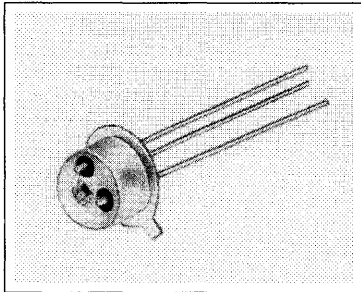

FEATURES

- Silicon NPN Epitaxial Phototransistor
- Wide Acceptance Angle, 110°
- Five Sensitivity Ranges
- High Reliability
- Short Switching Time
- Good Linearity
- Matches IR Emitter LD242
- Package: Modified TO18
- Clear Plastic Lens

FEATURES

The BP103 is an epitaxial NPN silicon planar phototransistor in a modified TO18 (18 A 3 DIN 41876) package with a clear plastic lens. The lens provides a wide angle for incident light.

The emitter lead is marked by a tab on the case bottom. The collector is electrically connected to the metallic case.

Applications include: electronic flashes, light reflecting switches, light curtains, and measurement and control.

The illuminances refer to unfiltered radiation of a tungsten filament lamp at a color temperature of 2856 K (standard light A per DIN 5033 and IEC publication 306-11). Irradiance E_E measured with HP radiant flux meter 8334A with option 013.

Notes

1. Measured with LED $\lambda=950$. I_{PCE} =transistor photocurrent; I_{PCB} =collector-base-diode photocurrent.
2. Availability subject to yield.

Maximum Ratings

Operating and Storage Temperature Range (T_{OP} , T_{STG})	-40° to +80°C
Soldering Temperature (≥ 2 mm from case bottom)	
Dip Soldering Time (T_S) $t \leq 5$ s	260°C
Iron Soldering Time (T_S) $t \leq 3$ s	300°C
Collector Emitter Voltage (V_{CE0})	50 V
Emitter Base Voltage (V_{EB})	7 V
Collector Current (I_C)	100 mA
Collector Peak Current (I_{PK}) $t < 10 \mu s$	200 mA
Power Dissipation (P_{TOT}) $T_A=25^\circ C$	150 mW
Thermal Resistance (R_{THJA})	500 K/W

Characteristics ($T_A=25^\circ C$)

Parameter	Symbol	Value	Unit
Maximum Sensitivity Wavelength	λ_{Smax}	850	nm
Spectral Range, Photosensitivity	λ	420 to 1130	nm
Radiant Sensitive Area	A	0.12	mm ²
Die Area Dimensions	L x W	0.5 x 0.5	mm
Distance, Die Surface to Case Surface	H	0.2 to 0.8	mm
Half Angle	ϕ	± 55	Deg.
Photocurrent, Collector-Base Diode ($E_E=0.5$ mW/cm ² , $V_{CB}=5$ V)	I_{PCB}	0.9	μA
($E_V=1000$ lx, std. light A, $V_{CB}=5$ V)	I_{PCB}	2.7	μA
Capacitance ($V_{CE}=0$ V, $f=1$ MHz, $E=0$)	C_{CE}	8	pF
($V_{CB}=0$ V, $f=1$ MHz, $E=0$)	C_{CB}	11	pF
($V_{EB}=0$ V, $f=1$ MHz, $E=0$)	C_{EB}	19	pF
Collector Emitter Leakage Current ($V_{CE0}=35$ V, $E=0$)	I_{CEO}	5 (≤ 100)	nA

Parameter	-2	-3	-4	-5 ⁽²⁾	-6 ⁽²⁾	Unit
Photocurrent, Collector-Emitter ⁽¹⁾ ($E_E=0.5$ mW/cm ² , $V_{CE}=5$ V) I_{PCE}	.08 - .16	.125 - .25	.20 - .40	.32 - .63	$\geq .50$	μA
($E_V=1000$ lx, standard light A, $V_{CE}=5$ V) I_{PCE}	0.38	0.60	0.95	1.4	1.8	mA
Rise/Fall Time ($I_C=1$ mA, $V_{CC}=5$ V, $R_L=1$ k Ω) $t_{r,f}$	5	7	9	12	15	μs
Collector Emitter Saturation Voltage ($I_C=I_{PCEmin} \cdot 0.3$, $E=1000$ lx) V_{CEsat}	150	150	150	150	150	mV
Current Gain ($E_E=0.5$ mW/cm ² , $\lambda=950$ nm, $V_{CE}=5$ V) I_{PCE}	140	210	340	530	800	

Relative spectral sensitivity
 $S_{REL}=f(\lambda)$

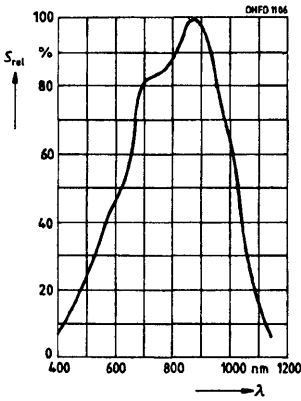

Photocurrent $I_{PCE}=f(E_E), V_{CE}=5 V$

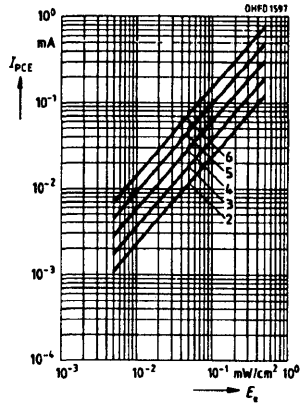

Total power dissipation
 $P_{TOT}=f(T_A)$

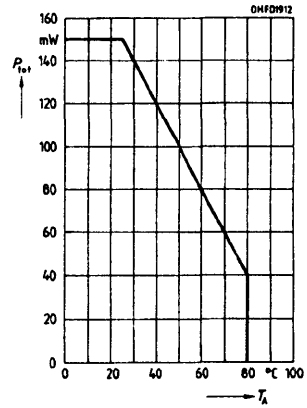

Directional characteristic
 $S_{REL}=f(\varphi)$

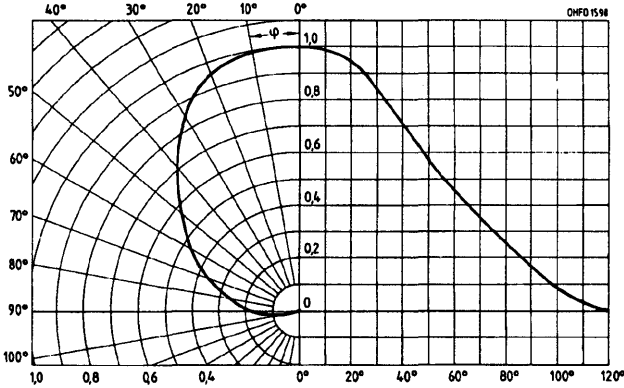

Output characteristics
 $I_C=f(V_{CE}), I_B=Parameter$

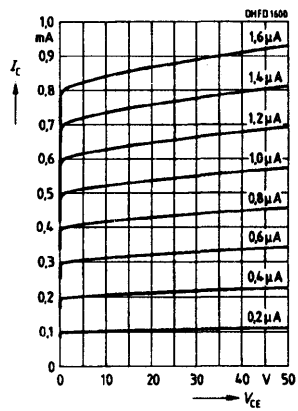

Output characteristics
 $I_C=f(V_{CE}), I_B=Parameter$

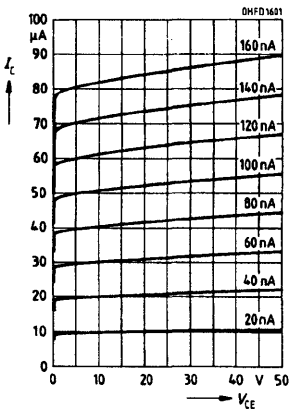

Dark current $I_{CEO}=f(V_{CE}), E=0$

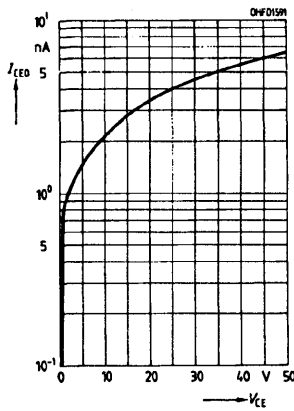

Photocurrent $I_{PCE}/I_{PCE25}=f(T_A), V_{CE}=5 V$

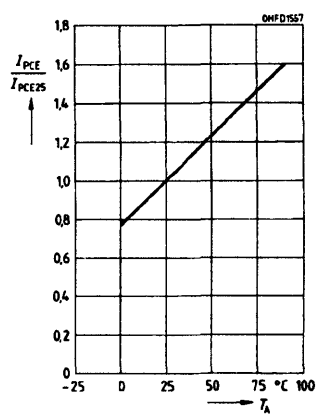

Dark current $I_{CEO}/I_{CEO25}=f(T_A)$,
 $V_{CE}=25\text{ V}$, $E=0$

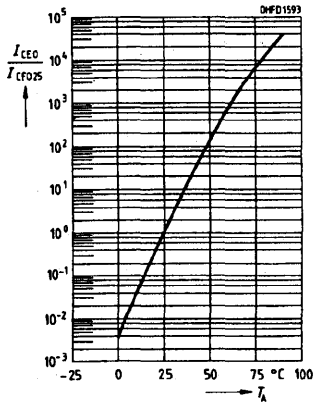

Collector emitter capacitance
 $C_{CE}=f(V_{CE})$, $f=1\text{ MHz}$, $E=0$

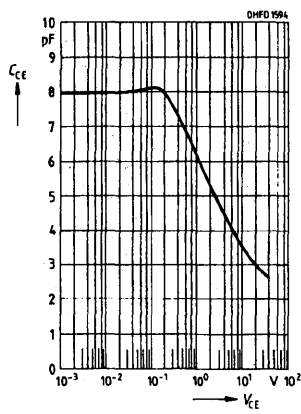

Collector base capacitance
 $C_{CB}=f(V_{CB})$, $f=1\text{ MHz}$, $E=0$

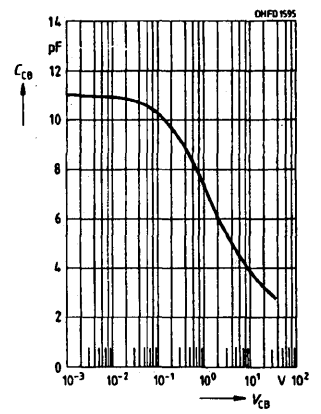

Emitter base capacitance
 $C_{EB}=f(V_{EB})$, $f=1\text{ MHz}$, $E=0$

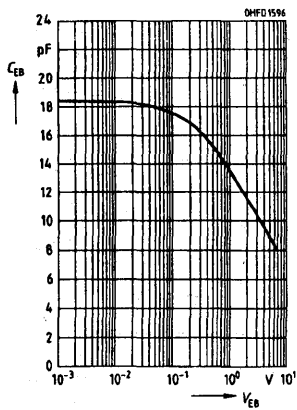

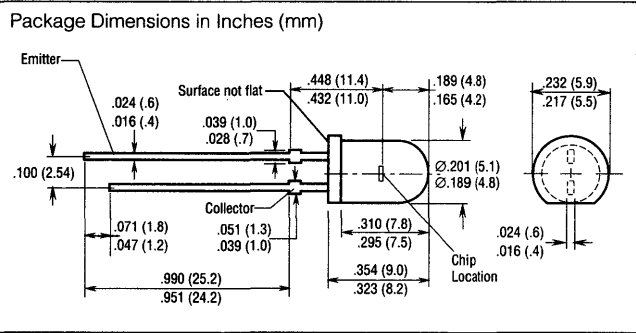
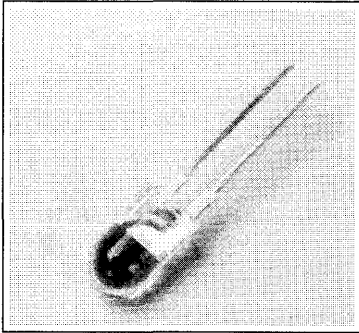

FEATURES

- Silicon NPN Epitaxial Phototransistor
- Acceptance Angle, 50°
- Low Cost
- Very High Gain
- Short Switching Time
- Good Linearity
- Matches IR Emitters LD271, LD273, SFH484 and SFH485
- Package: T1¾
- Clear Plastic Lens

FEATURES

The BP103B is a high-sensitivity epitaxial NPN silicon planar phototransistor. It is enclosed in a T1¾ (5 mm) clear plastic package.

The collector is denoted by a "flat" on the case bottom.

Maximum Ratings

Operating and Storage Temperature Range (T_{OP} , T_{STG})	-55° to +100°C
Soldering Temperature (≥ 2 mm from case bottom)		
Dip Soldering Time (T_S) $t \leq 5$ s	260°C
Iron Soldering Time (T_S) $t \leq 5$ s	300°C
Collector Emitter Voltage (V_{CEO})	35 V
Emitter Base Voltage (V_{EB})	7 V
Collector Current (I_C)	50 mA
Collector Peak Current (I_{PK}) $t < 10 \mu s$	100 mA
Power Dissipation (P_{TOT}) $T_A = 25^\circ C$	200 mW
Thermal Resistance (R_{THJA})	375 K/W

Characteristics ($T_A = 25^\circ C$)

Parameter	Symbol	Value	Unit
Maximum Sensitivity Wavelength	λ_{Smax}	850	nm
Spectral Range, Photosensitivity	λ	420 to 1130	nm
Radiant Sensitive Area	A	0.12	mm ²
Die Area Dimensions	L x W	0.5 x 0.5	mm
Distance, Die Surface to Case Surface	H	4.1 to 4.7	mm
Half Angle	ϕ	± 25	Deg.
Capacitance			
($V_{CE} = 0$ V, $f = 1$ MHz, $E = 0$)	C_{CE}	6.5	pF
Collector Emitter Leakage Current			
($V_{CEO} = 35$ V, $E = 0$ lx)	I_{CEO}	5 (≤ 100)	nA

Parameter	Symbol	-2	-3	-4	Unit
Photocurrent, Collector-Emitter ⁽¹⁾ ($E_E = 0.5$ mW/cm ² , $V_{CE} = 5$ V) ($E_V = 1000$ lx, $V_{CC} = 5$ V)	I_{PCE}	.63 to 1.25	1 to 2	≥ 1.6	mA
	I_{PCE}	3.4	5.4	8.6	mA
Rise/Fall Time ($I_C = 1$ mA, $V_{CC} = 5$ V, $R_L = 1$ k Ω) Collector Emitter	t_r, t_f	7.5	10	10	μs
Saturation Voltage ($I_C = I_{PCEmin}$ • 0.3, $E = 1000$ lx)	V_{CESat}	130	140	150	mV

The illuminances refers to unfiltered radiation of a tungsten filament lamp at a color temperature of 2856 K (standard light A per DIN 5033 and IEC publication 306-11). Irradiance E_E measured with HP radiant flux meter 8334A with option 013.

Note

1. Measured with LED $\lambda = 950$. I_{PCE} = transistor photocurrent; I_{PCE} = collector-base-diode photocurrent.

Relative spectral sensitivity
 $S_{REL}=f(\lambda)$

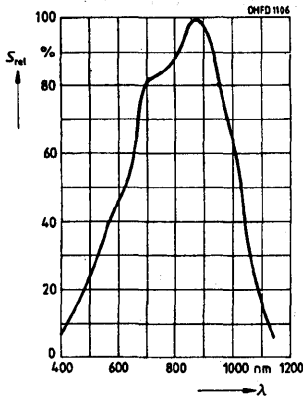

Photocurrent $I_{PCE}=f(E_e), V_{CE}=5\text{ V}$

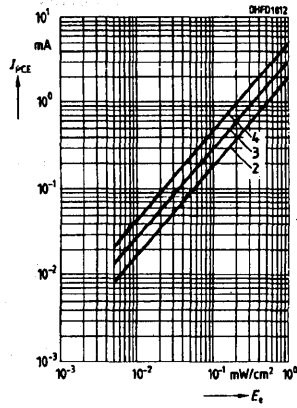

Directional characteristic
 $S_{REL}=f(\varphi)$

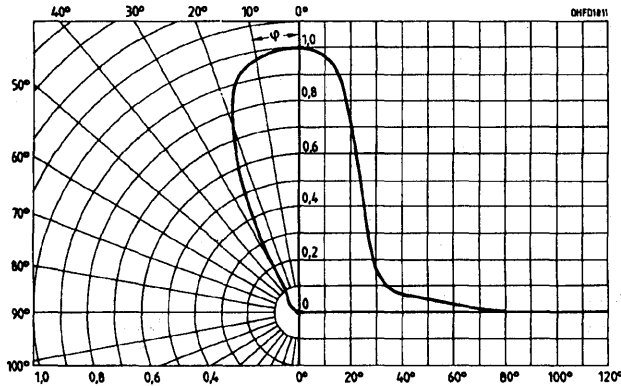

Dark current $I_{CEO}=f(V_{CE}), E=0$

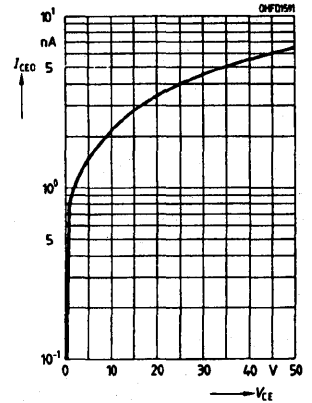

Photocurrent $I_{PCE}/I_{PCE25}=f(T_A), V_{CE}=5\text{ V}$

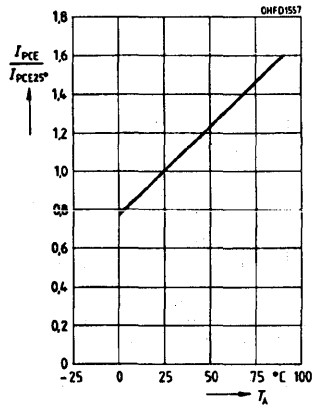

Dark current $I_{CEO}/I_{CEO25}=f(T_A), V_{CE}=25\text{ V}, E=0$

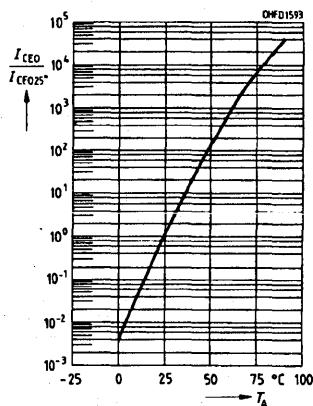

Collector emitter capacitance
 $C_{CE}=f(V_{CE}), f=1\text{ MHz}, E=0$

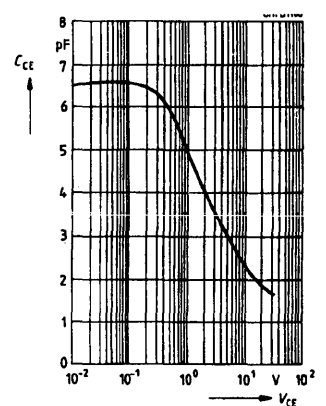

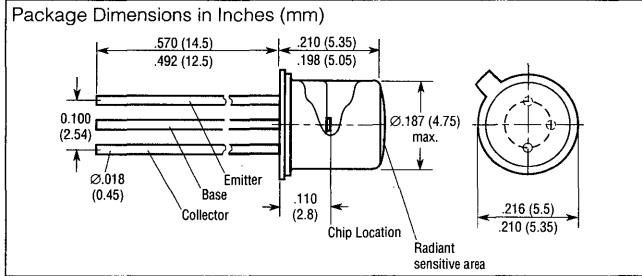
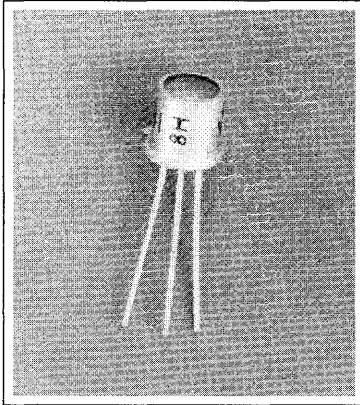

FEATURES

- Silicon NPN Epitaxial Phototransistor
- Premium Hi-Rel Device
- Moderate Gain
- Short Switching Time
- Five Sensitivity Ranges
- Package: TO18 Hermetic
- Flat Glass Lens
- Visible and IR Range Usage

FEATURES

The BPX38 is an high-sensitivity epitaxial NPN silicon planar phototransistor in a TO18 (18 A 3 DIN 41876) package with a flat lens. The collector is electrically connected to the metallic case.

The illuminances refer to unfiltered radiation of a tungsten filament lamp at a color temperature of 2856 K (standard light A per DIN 5033 and IEC publication 306-11). Irradiance E_E measured with HP radiant flux meter 8334A with option 013.

Notes

1. Measured with LED $\lambda=950$. I_{PCE} =transistor photocurrent; I_{PCB} =collector-base-diode photocurrent.
2. Availability subject to yield.

Maximum Ratings

Operating and Storage Temperature Range (T_{OP} , T_{STG})	-55° to +125°C
Soldering Temperature (≥ 2 mm from case bottom)	260°C
Dip Soldering Time (T_S) $t \leq 5$ s	300°C
Iron Soldering Time (T_I) $t \leq 3$ s	260°C
Collector Emitter Voltage (V_{CEO})	50 V
Emitter Base Voltage (V_{EB})	7 V
Collector Current (I_C)	50 mA
Collector Peak Current (I_{PK}) $t < 10 \mu s$	200 mA
Power Dissipation (P_{TOT}) $T_A=25^\circ C$	220 mW
Thermal Resistance (R_{THJA})	450 K/W

Characteristics ($T_A=25^\circ C$)

Parameter	Symbol	Value	Unit
Maximum Sensitivity Wavelength	λ_{Smax}	880	nm
Spectral Range, Photosensitivity	λ	450 to 1120	nm
Radiant Sensitive Area	A	0.675	mm ²
Die Area Dimensions	L x W	1 x 1	mm
Distance, Die Surface to Case Surface	H	2.05 to 2.35	mm
Half Angle	ϕ	± 40	Deg.
Photocurrent, Collector-Base Diode			
($E_E=0.5$ mW/cm ² , $V_{CB}=5$ V)	I_{PCB}	1.8	μA
($E_V=1000$ lx, $V_{CB}=5$ V)	I_{PCB}	5.5	μA
Capacitance			
($V_{CE}=0$ V, $f=1$ MHz, $E=0$)	C_{CE}	23	pF
($V_{CB}=0$ V, $f=1$ MHz, $E=0$)	C_{CB}	39	pF
($V_{EB}=0$ V, $f=1$ MHz, $E=0$)	C_{EB}	47	pF
Collector Emitter Leakage Current			
($V_{CE}=25$ V, $E=0$)	I_{CEO}	20 (≤ 300)	nA

Parameter	-2	-3	-4	-5 ⁽²⁾	Unit
Photocurrent, Collector-Emitter ⁽¹⁾ ($E_V=1000$ lx, standard light A, $V_{CE}=5$ V) ($E_E=0.5$ mW/cm ² , $\lambda=950$ nm, $V_{CE}=5$ V)	I_{PCE} 0.95	1.5	2.3	3.6	mA
	I_{PCE} .2 to .4	.32 to .63	.5 to 1.0	.8 to 1.6	mA
Rise/Fall Time ($I_C=1$ mA, $V_{CC}=5$ V, $R_L=1$ k Ω)	$t_{R,F}$ 9	12	15	18	μs
Collector Emitter Saturation Voltage ($I_C=I_{PCEmin} \cdot 0.3$, $E_E=0.5$ mW/cm ²)	V_{CEsat} 200	200	200	200	mV
Current Gain ($E_E=0.5$ mW/cm ² , $\lambda=950$ nm, $V_{CE}=5$ V)	I_{PCE} 170	280	420	650	
	I_{PCB}				

Relative spectral sensitivity
 $S_{REL}=f(\lambda)$

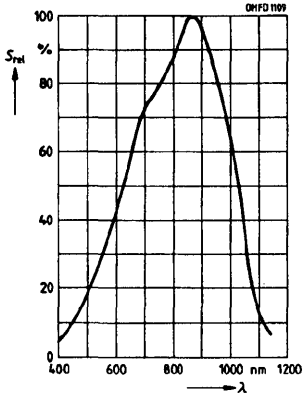

Photocurrent $I_{PCE}=f(E_e), V_{CE}=5\text{ V}$

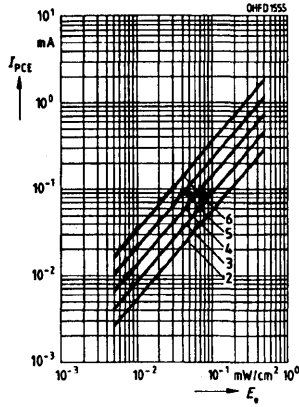

Total power dissipation
 $P_{TOT}=f(T_A)$

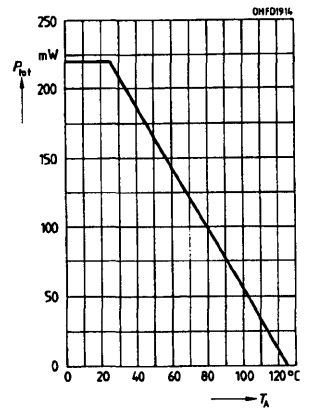

Directional characteristic
 $S_{REL}=f(\varphi)$

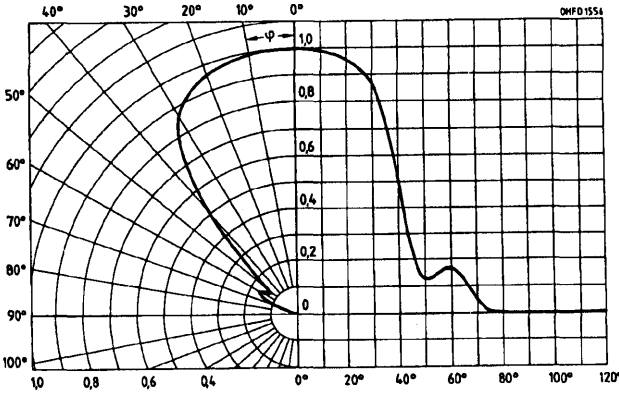

Output characteristics
 $I_C=f(V_{CE}), I_B=\text{Parameter}$

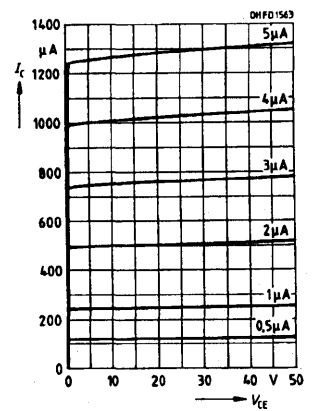

Output characteristics
 $I_C=f(V_{CE}), I_B=\text{Parameter}$

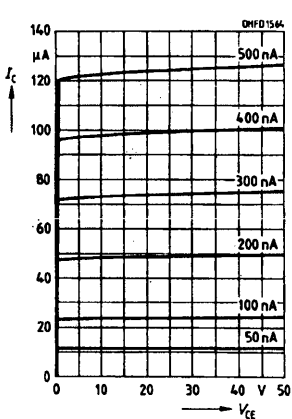

Dark current $I_{CEO}=f(V_{CE}), E=0$

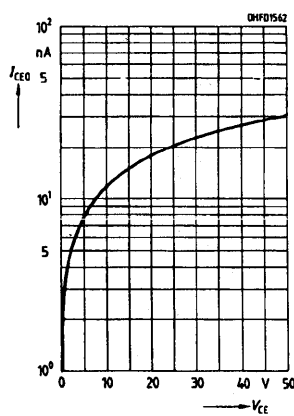

Photocurrent $I_{PCE}/I_{PCE25}=f(T_A), V_{CE}=5\text{ V}$

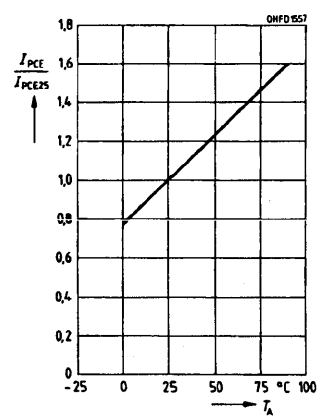

Dark current $I_{CE0}/I_{CE025}=f(T_A)$,
 $V_{CE}=25\text{ V}$, $E=0$

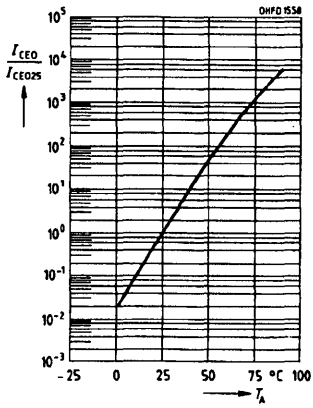

Collector emitter capacitance
 $C_{CE}=f(V_{CE})$, $f=1\text{ MHz}$, $E=0$

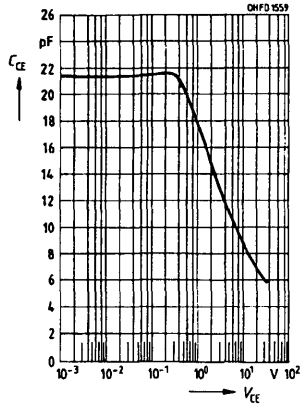

Collector base capacitance
 $C_{CB}=f(V_{CB})$, $f=1\text{ MHz}$, $E=0$

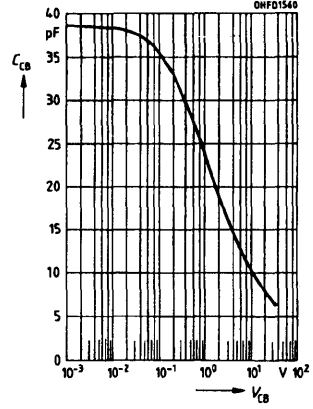

Emitter base capacitance
 $C_{EB}=f(V_{EB})$, $f=1\text{ MHz}$, $E=0$

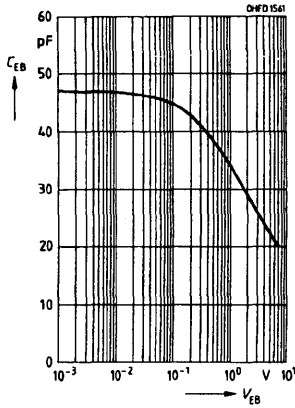

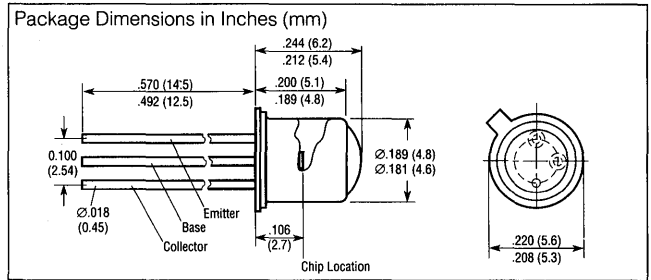
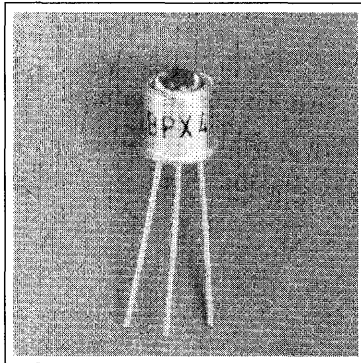

FEATURES

- Silicon NPN Epitaxial Phototransistor
- Narrow Acceptance Angle, 30°
- Premium Hi-Rel Device
- Very High Gain
- Short Switching Time
- Good Linearity
- High Spectral Sensitivity
- Five Sensitivity Ranges
- Package: TO18 Hermetic
- Rounded Glass Lens

FEATURES

The BPX43 is an epitaxial NPN silicon planar phototransistor in a TO18 (18 A 3 DIN 41876) package with a rounded glass lens. The collector is electrically connected to the metallic case.

The illuminances refer to unfiltered radiation of a tungsten filament lamp at a color temperature of 2856 K (standard light A per DIN 5033 and IEC publication 306-11). Irradiance E_E measured with HP radiant flux meter 8334A with option 013.

Notes

1. Measured with LED $\lambda=950$. I_{PCE} =transistor photocurrent; I_{PCB} =photocurrent of collector-base-diode.
2. Availability subject to yield.

Maximum Ratings

Operating and Storage Temperature Range (T_{OP} , T_{STG})	-55° to +125°C
Soldering Temperature (≥ 2 mm from case bottom)	
Dip Soldering Time (T_S) $t \leq 5$ s	260°C
Iron Soldering Time (T_S) $t \leq 3$ s	300°C
Collector Emitter Voltage (V_{CEO})	50 V
Emitter Base Voltage (V_{EB})	7 V
Collector Current (I_C)	50 mA
Collector Peak Current (I_{PK}) $t < 10 \mu s$	200 mA
Power Dissipation (P_{TOT}) $T_A=25^\circ C$	220 mW
Thermal Resistance (R_{THJA})	450 K/W

Characteristics ($T_A=25^\circ C$)

Parameter	Symbol	Value	Unit
Maximum Sensitivity Wavelength	λ_{Smax}	880	nm
Spectral Range, Photosensitivity	λ	450 to 1100	nm
Radiant Sensitive Area	A	0.675	mm ²
Die Area Dimensions	L x W	1 x 1	mm
Distance, Die Surface to Case Surface	H	2.4 to 3.0	mm
Half Angle	φ	± 15	Deg.
Photocurrent, Collector-Base Diode			
($E_E=0.5$ mW/cm ² , $V_{CB}=5$ V)	I_{PCB}	11	μA
($E_V=1000$ lx, $V_{CB}=5$ V)	I_{PCB}	35	μA
Capacitance			
($V_{CE}=0$ V, $f=1$ MHz, $E=0$)	C_{CE}	23	pF
($V_{CB}=0$ V, $f=1$ MHz, $E=0$)	C_{CB}	39	pF
($V_{EB}=0$ V, $f=1$ MHz, $E=0$)	C_{EB}	47	pF
Collector Emitter Leakage Current			
($V_{CE}=25$ V, $E=0$)	I_{CEO}	20 (≤ 300)	nA

Parameter	-2	-3	-4	-5 (2)	Unit
Photocurrent, Collector-Emitter ⁽¹⁾ ($E_E=0.5$ mW/cm ² , $V_{CE}=5$ V)	I_{PCE} 8 to 1.6	1.25 to 2.5	2 to 4	3.2 to 6.3	mA
($E_V=1000$ lx, standard light A, $V_{CE}=5$ V)	I_{PCE} 3.8	6.0	9.5	15.0	mA
Rise/Fall Time ($I_C=1$ mA, $V_{CC}=5$ V, $R_L=1$ k Ω)	$t_{r, f}$ 9	12	15	18	μs
Collector Emitter Saturation Voltage ($I_C=I_{PCEmin} \cdot 0.3$, $E_E=0.5$ mW/cm ²)	V_{CEsat} 200	220	240	260	mV
Current Gain ($E_E=0.5$ mW/cm ² , $\lambda=950$ nm, $V_{CE}=5$ V)	I_{PCE} 110	170	270	430	640
	I_{PCB}				

Relative spectral sensitivity

$S_{REL} = f(\lambda)$

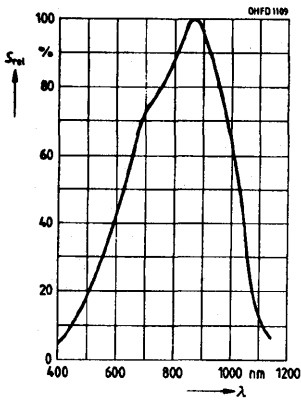

Photocurrent $I_{PCE} = f(E_E)$

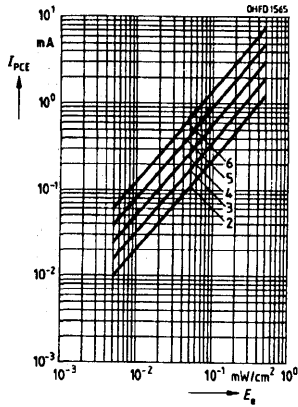

Total power dissipation

$P_{TOT} = f(T_A)$

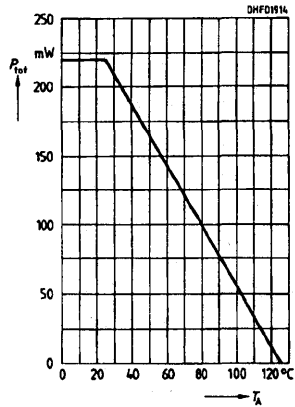

Directional characteristic

$S_{REL} = f(\varphi)$

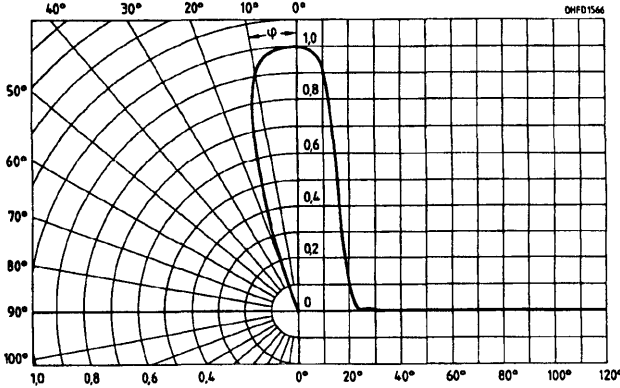

Output characteristics

$I_C = f(V_{CE}), I_B = \text{Parameter}$

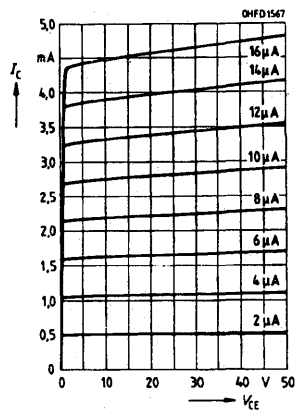

Output characteristics

$I_C = f(V_{CE}), I_B = \text{Parameter}$

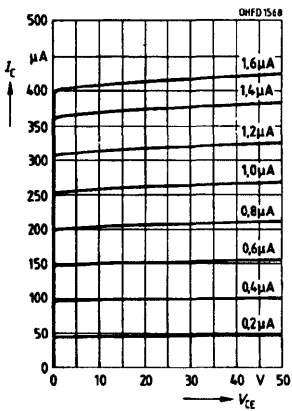

Dark current $I_{CEO} = f(V_{CE}), E = 0$

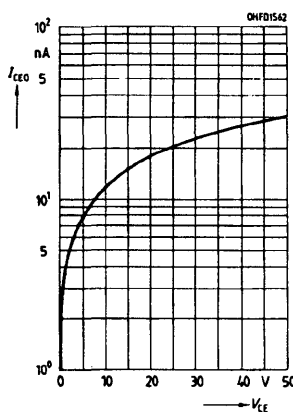

Photocurrent $I_{PCE}/I_{PCE25} = f(T_A), V_{CE} = 5V$

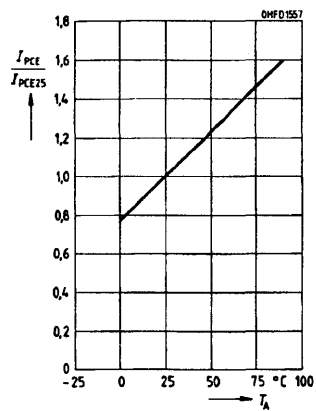

Dark current $I_{CE0}/I_{CE025}=f(T_A)$,
 $V_{CE}=25\text{ V}$, $E=0$

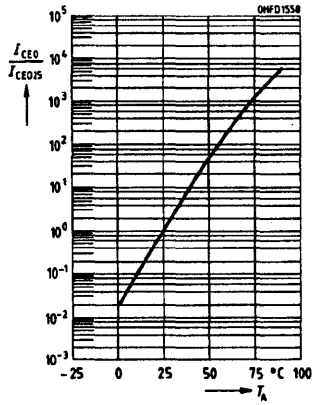

Collector emitter capacitance
 $C_{CE}=f(V_{CE})$, $f=1\text{ MHz}$, $E=0$

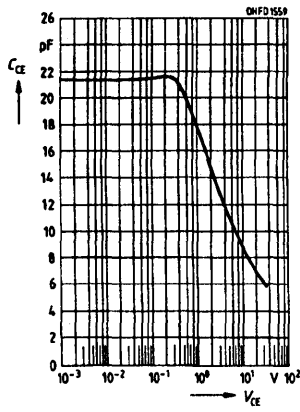

Collector base capacitance
 $C_{CB}=f(V_{CB})$, $f=1\text{ MHz}$, $E=0$

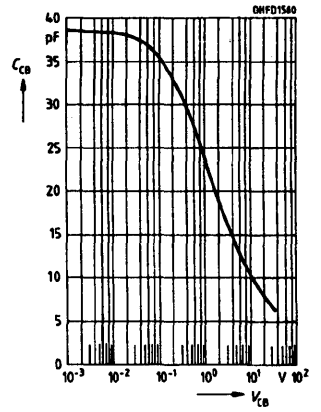

Emitter base capacitance
 $C_{EB}=f(V_{EB})$, $f=1\text{ MHz}$, $E=0$

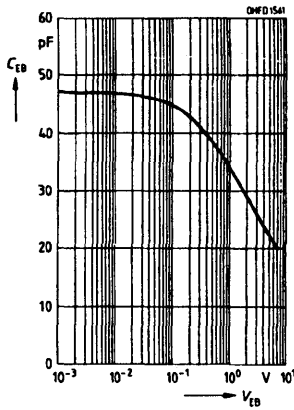

SINGLE DIODE BPX81 2-10 DIODE ARRAYS BPX82-89, 80 SILICON NPN PHOTOTRANSISTOR

Package Dimensions in Inches (mm)

Part No.	Dimension "A".	
	Min.	Max.
BPX 82	.177 (4.5)	.193 (4.9)
BPX 83	.275 (7.0)	.291 (7.4)
BPX 84	.377 (9.6)	.393 (10)
BPX 85	.476 (12.1)	.491 (12.5)
BPX 86	.574 (14.6)	.590 (15)
BPX 87	.676 (17.2)	.692 (17.6)
BPX 88	.774 (19.7)	.790 (20.1)
BPX 89	.876 (22.3)	.892 (22.7)
BPX 80	.975 (24.8)	.990 (25.2)

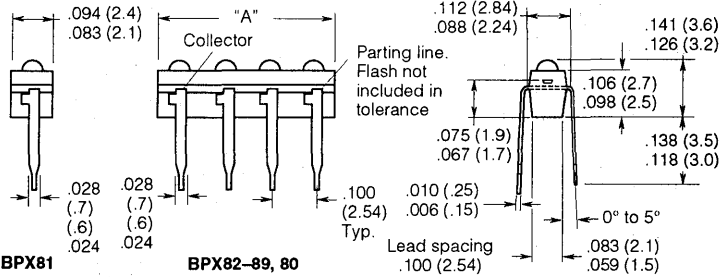

FEATURES

- Silicon NPN Epitaxial Phototransistor
- Narrow Acceptance Angle, 36°
- Low Cost
- High Gain
- Miniature Size
- Available as Single Diode (BPX81) or Arrays
 - BPX82, Two Diodes
 - BPX83, Three Diodes
 - BPX84, Four Diodes
 - BPX85, Five Diodes
 - BPX86, Six Diodes
 - BPX87, Seven Diodes
 - BPX88, Eight Diodes
 - BPX89, Nine Diodes
 - BPX80, Ten Diodes
- Matches IR Emitter LD261

FEATURES

The BPX81 is a single diode plastic encapsulated phototransistor; the BPX82 to BPX89, BPX80 are arrays. These silicon NPN epitaxial planar phototransistors have standard lead spacing of 0.100" (2.54 mm).

The small angle of the lens-shaped window avoids optical "cross modulation" from an adjacent system. The collector leads are marked by tabs.

Applications include use with filament lamps and infrared light. The BPX81 can be mounted on PC boards and also can be used as a detector with IR emitter LD261 in miniature light barriers.

Maximum Ratings

Operating and Storage Temperature Range (T_{OP} , T_{STG})	-40° to +80°C
Soldering Temperature (≥ 2 mm from case bottom)	230°C
Dip Soldering Time (T_S) $t \leq 5$ s	300°C
Iron Soldering Time (T_S) $t \leq 3$ s	300°C
Collector Emitter Voltage (V_{CE0})	32 V
Collector Current (I_C)	50 mA
Collector Peak Current (I_{PK}) $t < 10$ μ s	200 mA
Power Dissipation (P_{TOT}) $T_A = 25^\circ\text{C}$	90 mW
Thermal Resistance (R_{THJA})	750 K/W

Characteristics ($T_A = 25^\circ\text{C}$)

Parameter	Symbol	Value	Unit
Maximum Sensitivity Wavelength	λ_{Smax}	850	nm
Spectral Range, Photosensitivity	λ	440 to 1070	nm
Radiant Sensitive Area	A	0.17	mm ²
Die Area Dimensions	L x W	0.6 x 0.6	mm
Distance, Die Surface to Case Surface	H	1.3 to 1.9	mm
Half Angle	ϕ	± 18	Deg.
Capacitance ($V_{CE} = 0$ V, $f = 1$ MHz, $E = 0$)	C_{CE}	6	pF
Collector Emitter Leakage Current ($V_{CE} = 25$ V, $E = 0$)	I_{CEO}	25 (≤ 200)	nA

Parameter	BPX81-2	BPX81-3	BPX81-4 (2)	BPX82-89 BPX80	Unit
Transistor Photocurrent, Collector-Emitter ⁽¹⁾ ($E_E = 0.5$ mW/cm ² , $V_{CE} = 5$ V)	I_{PCE} .25 to .50	.40 to .80	≥ 63	.32 to <1.0	mA
($E_V = 1000$ lx, standard light A, $V_{CE} = 5$ V)	I_{PCE} 1.4	2.2	3.4	1.7 to <3.4	mA
Rise/Fall Time ($I_C = 1$ mA, $V_{CE} = 5$ V, $R_L = 1$ k Ω)	$t_{R, F}$ 5.5	6	8	5.5 to 8	μ s
Collector Emitter Saturation Voltage ($I_C = I_{PCEmin} * 0.3$, $\lambda = 950$ nm, $V_{CE} = 5$ V)	V_{CEsat} 150	150	150	150	mV

The illuminances refers to unfiltered radiation of a tungsten filament lamp at a color temperature of 2856 K (standard light A per DIN 5033 and IEC publication 306-11). Irradiance E_E measured with HP radiant flux meter 8334A with option 013.

Notes

1. Measured with LED $\lambda = 950$. I_{PCE} =transistor photocurrent; I_{PCB} =collector-base-diode photocurrent.
2. Availability subject to yield.

Relative spectral sensitivity

$S_{REL}=f(\lambda)$

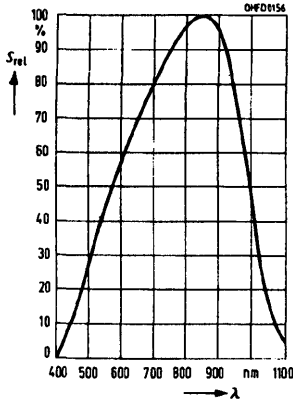

Photocurrent-BPX81 $I_{PCE}=f(E_E)$

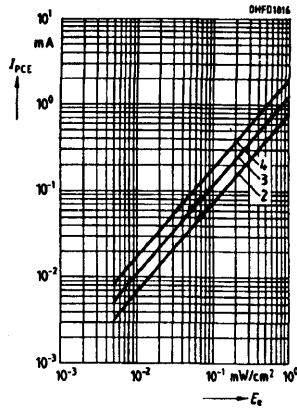

Photocurrent-BPX82-89, 80 $I_{PCE}=f(E_E)$

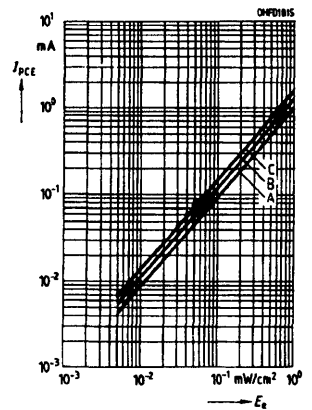

Directional characteristic

$S_{REL}=f(\varphi)$

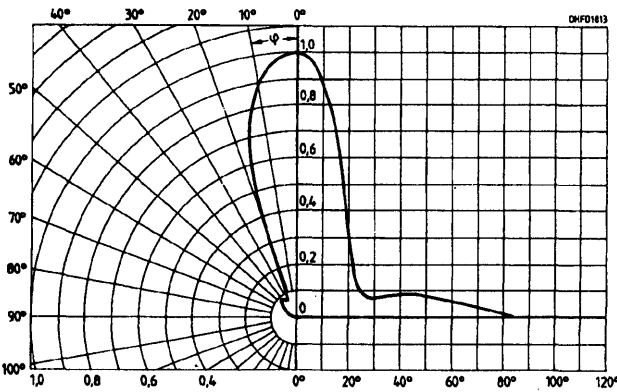

Total power dissipation

$P_{TOT}=f(T_A)$

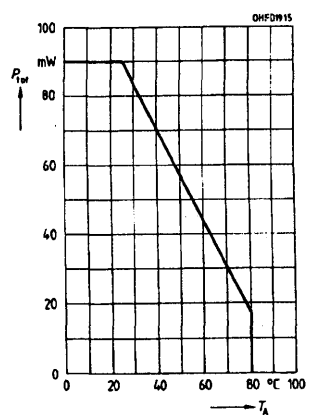

Photocurrent $I_{PCE}/I_{PCE25}=f(T_A)$, $V_{CE}=5V$

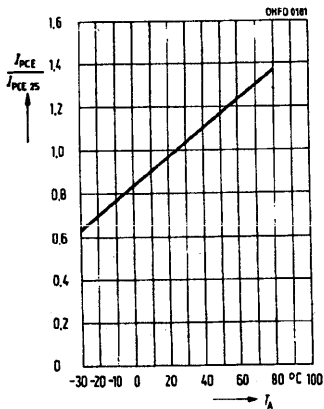

Collector emitter capacitance $C_{CE}=f(V_{CE})$, $f=1\text{ MHz}$, $E=0$

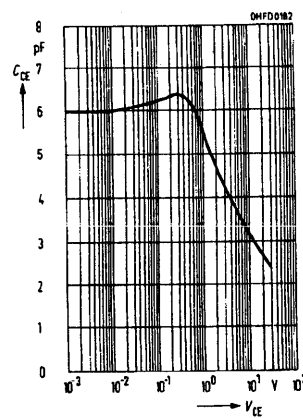

Dark current-BPX81

$I_{CEO}=f(T_A)$, $V_{CE}=25V$, $E=0$

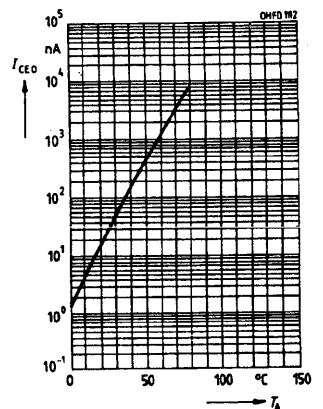

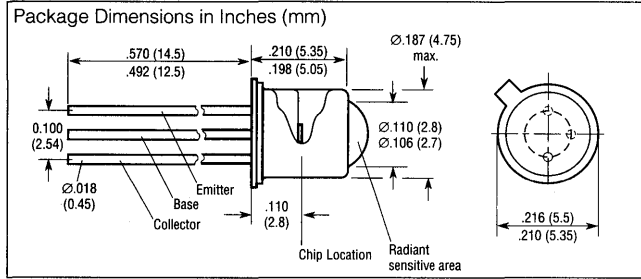
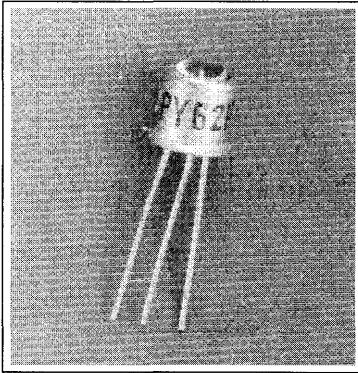

FEATURES

- Silicon NPN Epitaxial Phototransistor
- Very Narrow Acceptance Angle, 16°
- Premium Hi-Rel Device
- Very High Gain
- Short Switching Time
- Good Linearity
- Five Sensitivity Ranges
- Package: TO18 Hermetic
- Rounded Glass Lens

FEATURES

The BPY62 is an epitaxial NPN silicon planar phototransistor in a TO18 (18 A 3 DIN 41876) package with a glass lens.

There is an external base connection. The emitter is marked by a tab on the case bottom. The collector is electrically connected to the metallic case.

The BPX43 is suitable for use with filament lamp light where sensitive photoelectric detectors are required.

The illuminances refer to unfiltered radiation of a tungsten filament lamp at a color temperature of 2856 K (standard light A per DIN 5033 and IEC publication 306-11). Irradiance E_E measured with HP radiant flux meter 8334A with option 013.

Notes

1. Measured with LED $\lambda=950$. I_{PCE} =transistor photocurrent; I_{PCB} =collector-base-diode photocurrent.
2. Availability subject to yield.

Maximum Ratings

Operating and Storage Temperature Range (T_{OP} , T_{STG})	-55° to +125°C
Soldering Temperature (≥ 2 mm from case bottom)		
Dip Soldering Time (T_s) $t \leq 5$ s	260°C
Iron Soldering Time (T_s) $t \leq 3$ s	300°C
Collector Emitter Voltage (V_{CEO})	50 V
Emitter Base Voltage (V_{EB})	7 V
Collector Current (I_C)	100 mA
Collector Peak Current (I_{PK}) $t < 10 \mu s$	200 mA
Power Dissipation (P_{TOT}) $T_A=25^\circ C$	200 mW
Thermal Resistance (R_{THJA})	500 K/W

Characteristics ($T_A=25^\circ C$)

Parameter	Symbol	Value	Unit
Maximum Sensitivity Wavelength	λ_{Smax}	850	nm
Spectral Range, Photosensitivity	λ	420 to 1130	nm
Radiant Sensitive Area	A	0.12	mm ²
Die Area Dimensions	L x W	0.5 x 0.5	mm
Distance, Die Surface to Case Surface	H	2.4 to 3.0	mm
Half Angle	ϕ	± 8	Deg.
Photocurrent, Collector-Base Diode			
($E_E=0.5$ mW/cm ² , $\lambda=950$ nm, $V_{CB}=5$ V)	I_{PCB}	4.5	μA
($E_V=1000$ lx, $V_{CB}=5$ V)	I_{PCB}	17	μA
Capacitance			
($V_{CE}=0$ V, $f=1$ MHz, $E=0$)	C_{CE}	8	pF
($V_{CB}=0$ V, $f=1$ MHz, $E=0$)	C_{CB}	11	pF
($V_{EB}=0$ V, $f=1$ MHz, $E=0$)	C_{EB}	19	pF
Collector Emitter Leakage Current			
($V_{CE}=35$ V, $E=0$)	I_{CEO}	5 (≤ 100)	nA

Parameter	-2	-3	-4	-5 ⁽²⁾	Unit
Photocurrent, Collector-Emitter ⁽¹⁾					
($E_E=0.5$ mW/cm ² , $V_{CE}=5$ V)	I_{PCE} .5 to 1	.8 to 1.6	1.25 to 2.5	2 to 4	mA
($E_V=1000$ lx, standard light A, $V_{CE}=5$ V)	I_{PCE} 3.0	4.6	7.2	11.4	mA
Rise/Fall Time ($I_C=1$ mA, $V_{CC}=5$ V, $R_L=1$ k Ω)	t_R, t_F 5	7	9	12	μs
Collector Emitter Saturation Voltage ($I_C=I_{PCEmin} \cdot 0.3$, $E_E=0.5$ mW/cm ²)	V_{CESat} 150	150	160	180	mV
Current Gain ($E_E=0.5$ mW/cm ² , $V_{CE}=5$ V)	$\frac{I_{PCE}}{I_{PCB}}$ 170	270	420	670	

Relative spectral sensitivity
 $S_{REL}=f(\lambda)$

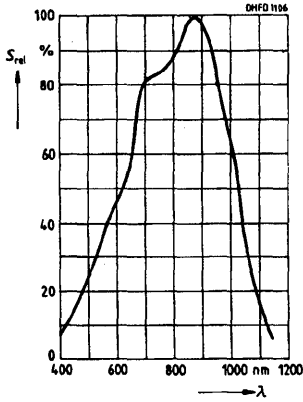

Photocurrent $I_{PCE}=f(E_E), V_{CE}=5\text{ V}$

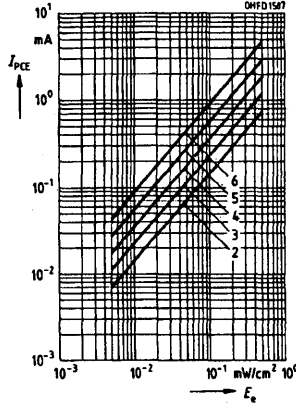

Total power dissipation
 $P_{TOT}=f(T_A)$

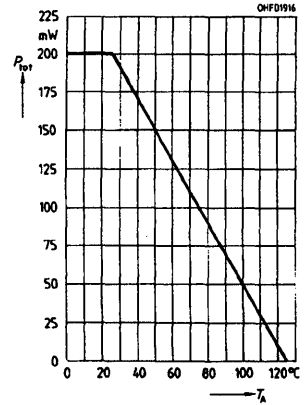

Directional characteristic
 $S_{REL}=f(\phi)$

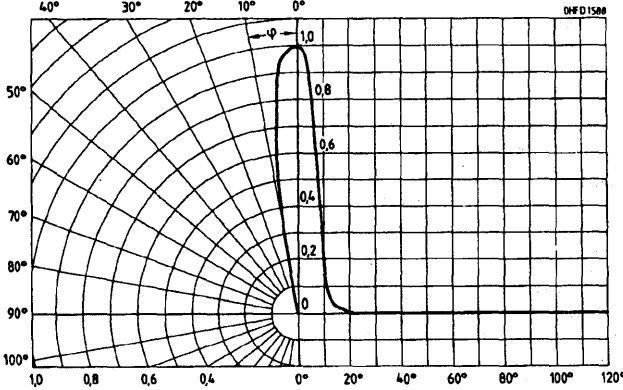

Output characteristics
 $I_C=f(V_{CE}), I_B=\text{Parameter}$

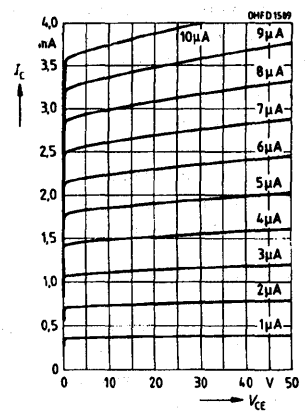

Output characteristics
 $I_C=f(V_{CE}), I_B=\text{Parameter}$

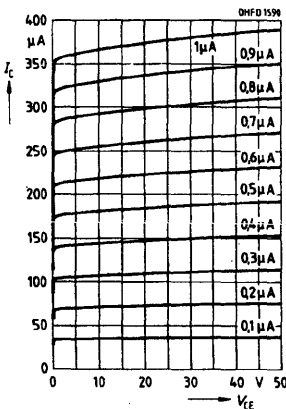

Dark current $I_{CEO}=f(V_{CE}), E=0$

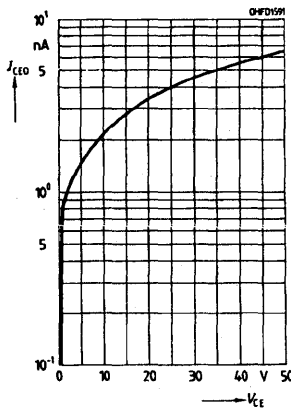

Photocurrent $I_{PCE}/I_{PCE25}=f(T_A), V_{CE}=5\text{ V}$

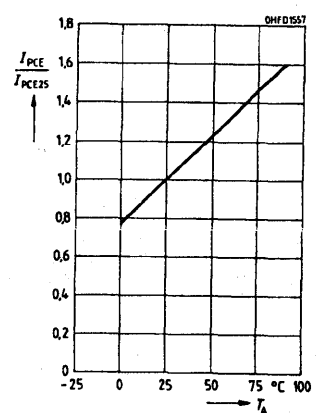

Dark current $I_{CE0}/I_{CE025}=f(T_A)$
 $V_{CE}=25\text{ V}, E=0$

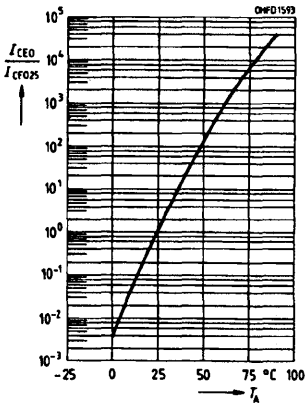

Collector emitter capacitance
 $C_{CE}=f(V_{CE}), f=1\text{ MHz}, E=0$

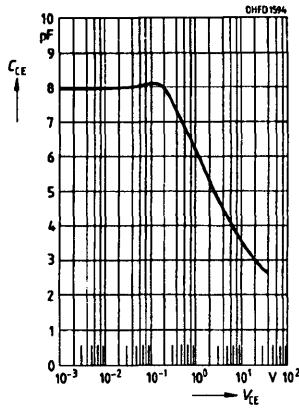

Collector base capacitance
 $C_{CB}=f(V_{CB}), f=1\text{ MHz}, E=0$

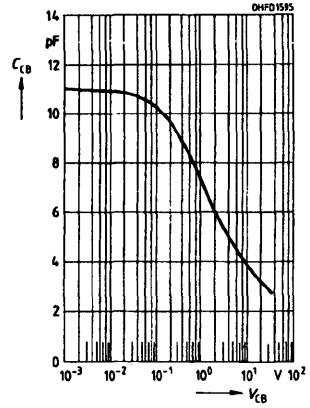

Emitter base capacitance
 $C_{EB}=f(V_{EB}), f=1\text{ MHz}, E=0$

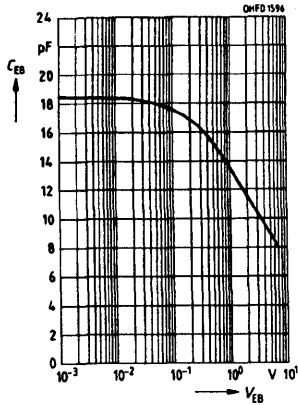

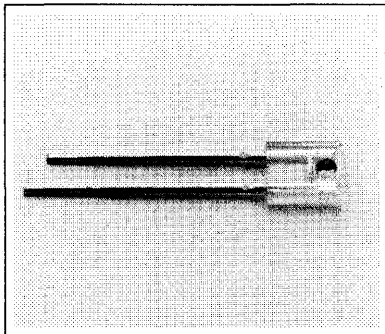

FEATURES

- Low Cost Plastic, Side Facing Package
- High Sensitivity
- Matches Infrared Emitter IRL-80A, IRL-81A

DESCRIPTION

The LPT-80A is a plastic, NPN phototransistor. It comes in a lensed, clear plastic, side-facing, miniature package. The lens accepts light from very wide angles, $\pm 40^\circ$. This detector is ideal for industrial processing and control applications requiring beam interruption.

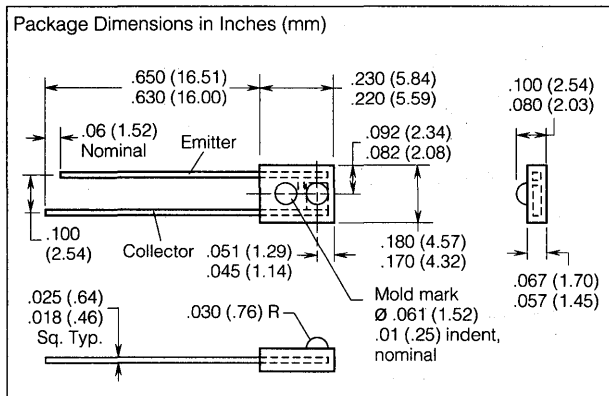

Maximum Ratings

Operating/Storage Temperature Range (T_{OP} , T_{STG})	-40° to $+100^\circ\text{C}$
Soldering Temperature, $t=5$ sec	240°C
Collector Emitter Voltage (V_{CEO})	30 V
Emitter Collector Voltage (V_{ECO})	5 V
Collector Current (I_C)	50 mA
Collector Peak Current (I_{CM}) $t=1$ ms	100 mA
Power Dissipation (P_{TOT}) $T_A=25^\circ\text{C}$	100 mW*
*Derate Linearly Above 25°C	1.33 mW/ $^\circ\text{C}$

Characteristics ($T_A=25^\circ\text{C}$)

Parameter	Symbol	Value	Unit
Maximum Sensitivity Wavelength		870	nm
Acceptance Half Angle	ϕ	± 40	Deg.
Collector Emitter Leakage Current ($V_{CE}=15$ V, $H=0$)	I_{CEO}	≤ 100	nA
Photocurrent (1) ($V_{CE}=5$ V, $H=0.5$ mW/cm 2)	I_p	≥ 200	μA
Breakdown Voltage ($I_C=1$ mA)	BV_{CEO}	30 min.	V
($I_C=100$ μA)	BV_{ECO}	5 min.	V
Saturation Voltage ($I_C=250$ μA , $H=0.5$ mW/cm 2)	V_{CEsat}	0.15 typ.	V
	V_{CEsat}	0.4 max.	V

Note

1. The light source is a tungsten filament bulb used with a 950 ± 30 nm filter. The mechanical axis is aligned with the light source.

Relative spectral emission $S_{REL}=f(\lambda)$

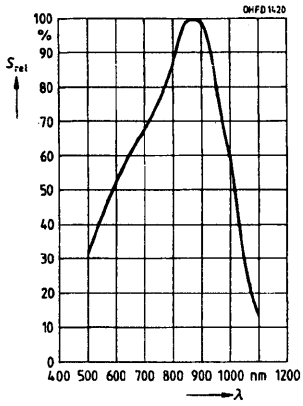

Radiation characteristics $S_{REL}=f(\varphi)$

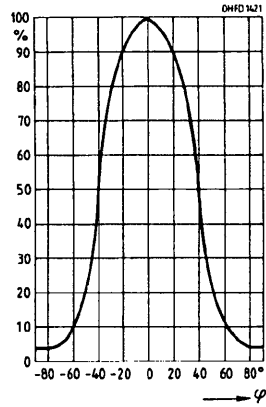

Forward current $I_{PCE}=f(E_E), V_{CE}=5\text{ V}$

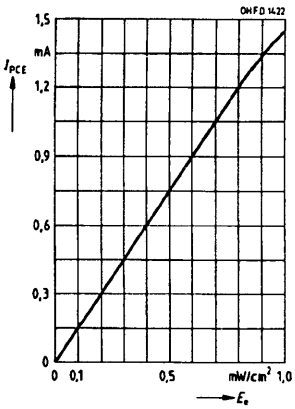

Forward current $I_{PCE}=f(V_{CE}), \text{Parameter}=E_E$

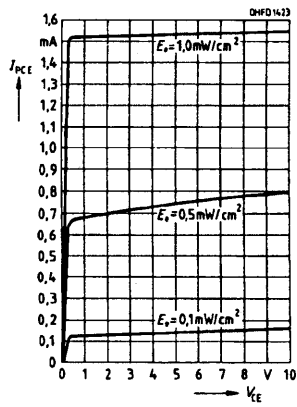

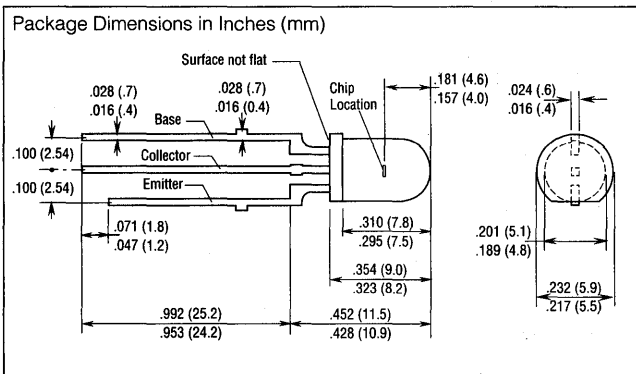
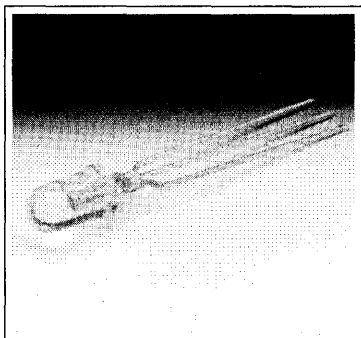

FEATURES

- Daylight Filter—SFH303F
- Acceptance Angle, 40°
- High Reliability
- Short Switching Time
- High Spectral Sensitivity
- Good Linearity
- High Photosensitivity
- Base Connection
- Matches IR Emitter SFH485
- Visible and Near IR Range Usage

FEATURES

The SFH303/303F are silicon phototransistors with external base connections. The SFH303 comes in a standard T1 $\frac{3}{4}$ (5 mm) water-clear plastic package. The SFH303F has a black daylight filter.

The emitter is marked by a tab; the collector lead is the center of the three leads.

The devices can be used in industrial control applications, light barriers, and reflective switches.

Maximum Ratings

Operating and Storage Temperature Range (T_{OP} , T_{STG})	-55° to +100°C
Soldering Temperature (≥ 2 mm from case bottom)		
Dip Soldering Time (T_s) $t \leq 5$ s	260°C
Iron Soldering Time (T_s) $t \leq 3$ s	300°C
Collector Emitter Voltage (V_{CEO})	50 V
Emitter Base Voltage (V_{EB})	7 V
Collector Current (I_C)	50 mA
Collector Peak Current (I_{PK}) $t < 10$ μ s	100 mA
Power Dissipation (P_{TOT}) $T_A = 25^\circ\text{C}$	200 mW
Thermal Resistance (R_{THJA})	375 K/W

Characteristics ($T_A = 25^\circ\text{C}$)

Parameter	Symbol	Value	Unit
Maximum Sensitivity Wavelength, SFH303	λ_{Smax}	860	nm
Maximum Sensitivity Wavelength, SFH303F	λ_{Smax}	870	nm
Spectral Range, Photosensitivity, SFH303	λ	450 to 1100	nm
($S = 10\%$ of S_{max})	λ	720 to 1100	nm
Radiant Sensitive Area	A	0.30	mm ²
Die Area Dimensions	L x W	0.75 x 0.75	mm
Half Angle	ϕ	± 20	Deg.
Photocurrent, Collector Base Diode			
($E_E = 0.5 \text{ mW/cm}^2$, $\lambda = 950 \text{ nm}$, $V_{CB} = 5 \text{ V}$)	I_{PCB}	4.5	μA
($E_V = 1000 \text{ lux}$, $V_{CB} = 5 \text{ V}$)	I_{PCB}	15.8	μA
Capacitance			
($V_{CE} = 0 \text{ V}$, $f = 1 \text{ MHz}$, $E = 0 \text{ lx}$)	C_{CE}	10	pF
($V_{CB} = 0 \text{ V}$, $f = 1 \text{ MHz}$, $E = 0 \text{ lx}$)	C_{CB}	22	pF
($V_{EB} = 0 \text{ V}$, $f = 1 \text{ MHz}$, $E = 0 \text{ lx}$)	C_{EB}	21	pF

Parameter	Symbol	-2	-3	-4(2)	Unit
Photocurrent, Collector-Emitter ($E_E = 0.5 \text{ mW/cm}^2$, $V_{CE} = 5 \text{ V}$)	I_{PCE}	1.0	1.6 to 3.2	≥ 2.5	mA
SFH303. ($E_V = 1000 \text{ lx}$, std. light A, $V_{CE} = 5 \text{ V}$)	I_{PCE}	5.2	8.4	13.1	mA
Rise/Fall Time ($I_C = 1 \text{ mA}$, $V_{CC} = 5 \text{ V}$, $R_L = 1 \text{ k}\Omega$)	t_R, t_F	11	13	15	μs
Collector Emitter Saturation Voltage ($I_C = I_{PCEmin}^{(1)} \cdot 0.3$, $E_E = 0.5 \text{ mW/cm}^2$)	V_{CEsat}	150	150	150	mV
Current Gain ($E_E = 0.5 \text{ mW/cm}^2$, $V_{CE} = 5 \text{ V}$)	$\frac{I_{PCE}}{I_{PCB}}$	330	530	830	

Notes

1. I_{PCEmin} is the minimum photocurrent of the specified group.
2. Availability subject to yield.

Relative spectral sensitivity—SFH303
 $S_{REL}=f(\lambda)$

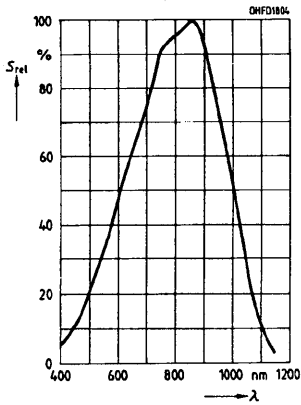

Relative spectral sensitivity—SFH303F
 $S_{REL}=f(\lambda)$

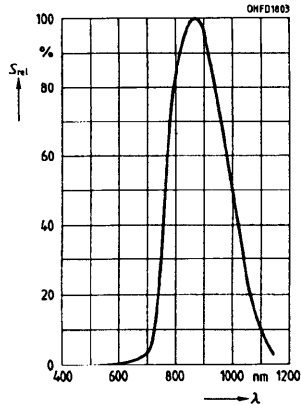

Photocurrent $I_{PCE}=f(E_E, V_{CE}=5V$

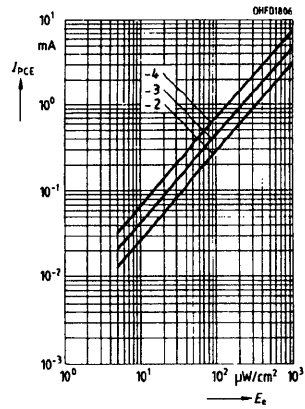

Directional characteristic

$S_{REL}=f(\varphi)$

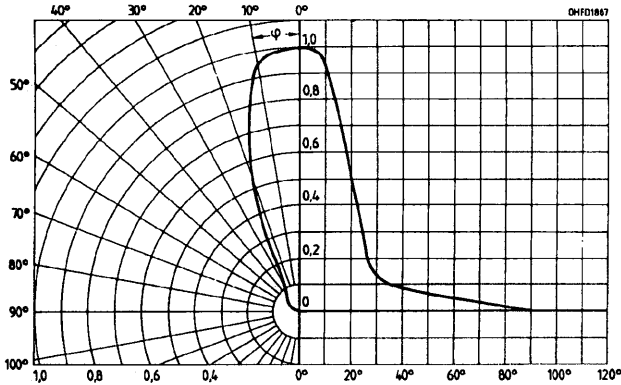

Output characteristics

$I_C=f(V_{CE}, I_B=Parameter)$

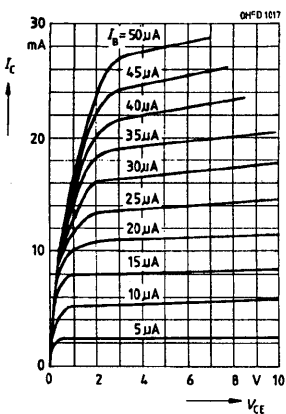

Dark current $I_{CEO}=f(V_{CE}), E=0$

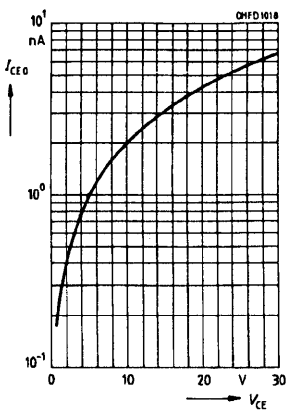

Capacitance

$C=f(V), f=1\text{ MHz}, E=0$

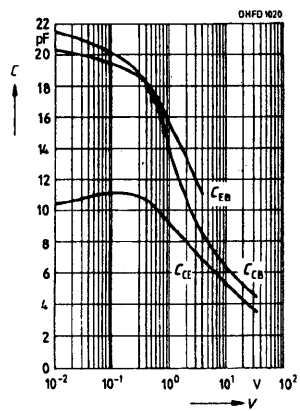

Phototransistors/
Photodiode/ton

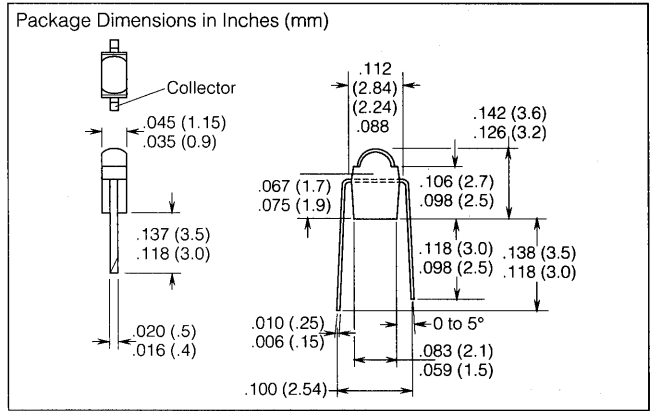
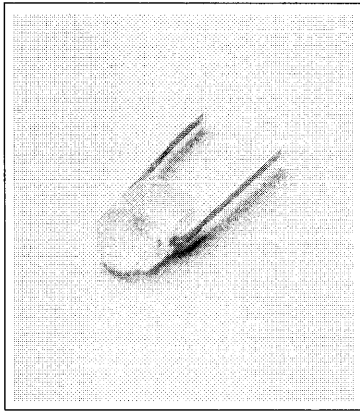

FEATURES

- **Narrow Acceptance Angle, 32°**
- **High Reliability**
- **Short Switching Time**
- **Matches IR Emitter SFH405**
- **Miniature Plastic Package**
- **0.100" (2.54 mm) Lead Spacing**

FEATURES

The SFH305 is a NPN silicon planar phototransistor in clear plastic encapsulation with solder terminals and a marked collector. There are two photosensitivity ranges.

The SFH305 can be used as a detector with IR emitter SFH405 as a miniature light barrier with close spacing between sender and receiver.

Maximum Ratings

Operating and Storage Temperature Range (T_{OP} , T_{STG})	-40° to +80°C
Soldering Temperature (≥ 2 mm from case bottom)	
Dip Soldering Time (T_S) $t \leq 5$ s	230°C
Iron Soldering Time (T_S) $t \leq 3$ s	300°C
Collector Emitter Voltage (V_{CEO})	32 V
Collector Current (I_C)	50 mA
Collector Peak Current (I_{PK}) $t < 10 \mu s$	100 mA
Power Dissipation (P_{TOT}) $T_A = 25^\circ C$	70 mW
Thermal Resistance (R_{THJA})	950 K/W

Characteristics ($T_A = 25^\circ C$)

Parameter	Symbol	Value	Unit
Maximum Sensitivity Wavelength	λ_{Smax}	850	nm
Spectral Range, Photosensitivity	λ	460 to 1060	nm
Radiant Sensitive Area	A	0.17	mm ²
Die Area Dimensions	L x W	0.6 x 0.6	mm
Half Angle	ϕ	± 16	Deg.
Capacitance ($V_{CE} = 0$ V, $f = 1$ MHz, $E = 0$ lx)	C_{CE}	5.5	pF
Collector Emitter Leakage Current ($V_{CE0} = 25$ V, $E = 0$ lx)	I_{CEO}	3 (≤ 20)	nA

Parameter	Symbol	-2	-3	Unit
Photocurrent, Transistor Collector-Emitter ⁽¹⁾ ($E_E = 0.5$ mW/cm ² , $V_{CE} = 5$ V) ($E_V = 1000$ lx, $V_{CE} = 5$ V)	I_{PCE}	.25 to .5	.4 to .8	mA
	I_{PCE}	1.4	2.2	mA
Rise/Fall Time ($I_C = 1$ mA, $V_{CC} = 5$ V, $R_L = 1$ k Ω)	$t_{R, f}$	5.5	6	μs
Collector Emitter Saturation Voltage ($I_C = I_{PCEmin}^{(2)} \pm 0.3$, $E_E = 0.5$ mW/cm ²)	V_{CESat}	≤ 50	≤ 50	mV

The illuminances refers to unfiltered radiation of a tungsten filament lamp at a color temperature of 2856 K (standard light A per DIN 5033 and IEC publication 306-11). Irradiance E_E measured with HP radiant flux meter 8334A with option 013.

Notes

1. Measured with LED $\lambda = 950$. I_{PCE} = transistor photocurrent ; I_{PCB} = collector-base-diode photocurrent.
2. P_{CEmin} = minimum photocurrent of the specified group.

Relative spectral sensitivity

$S_{REL}=f(\lambda)$

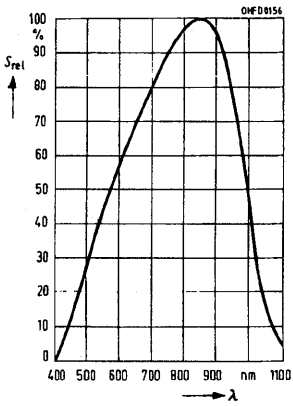

Photocurrent $I_{PCE}=f(E_e), V_{CE}=5V$

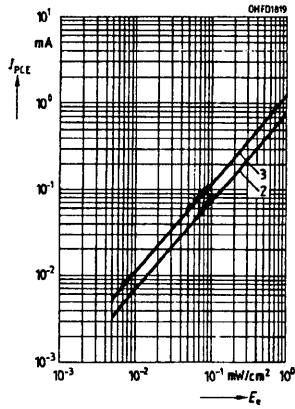

Total power dissipation $P_{TOT}=f(T_A)$

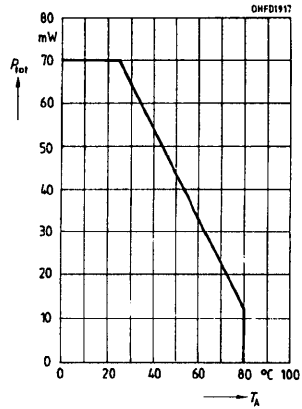

Directional characteristic

$S_{REL}=f(\varphi)$

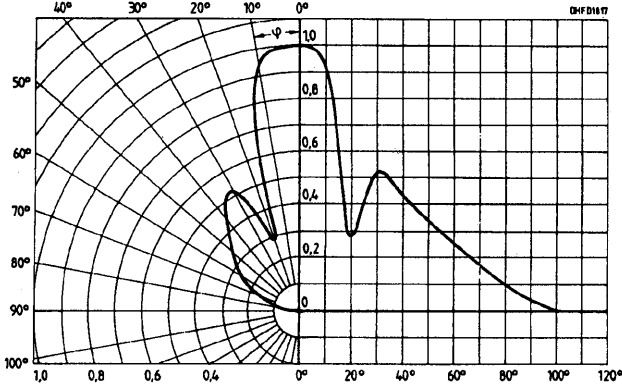

Photocurrent $I_{PCE}/I_{PCE25}=f(T_A), V_{CE}=5V$

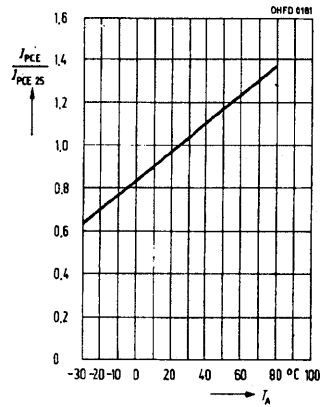

Collector emitter capacitance

$C=f(V_{CE}), f=1\text{ MHz}, E=0$

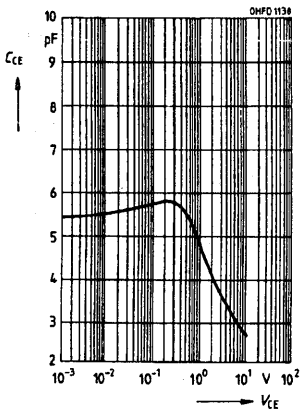

Dark current $I_{CEO}=f(T_A), V_{CE}=25V, E=0$

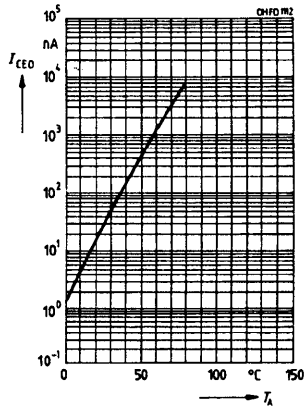

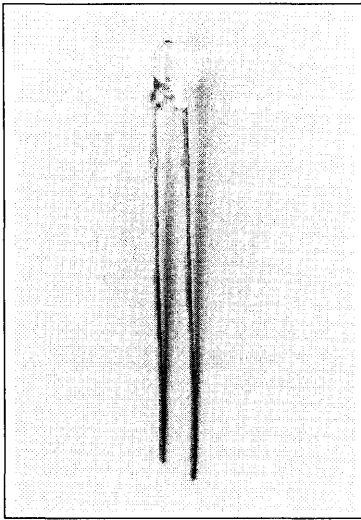

FEATURES

- Daylight Filter-SFH309F
- Narrow Acceptance Angle, 24°
- High Reliability
- Low Cost
- Good Linearity
- No Testable Degradation
- Wide Temperature Range
- Matches IR Emitter SFH409
- Same Package as IR Emitter SFH487
- Package: T1 (3 mm)
- 0.100" (2.54 mm) Lead Spacing

FEATURES

The SFH309/309F are silicon NPN phototransistors in a standard T1 (3 mm) plastic package. The SFH309F has a black daylight filter.

The devices can be used in a variety of low-cost, high-volume applications such as IR remote control and other consumer and entertainment products.

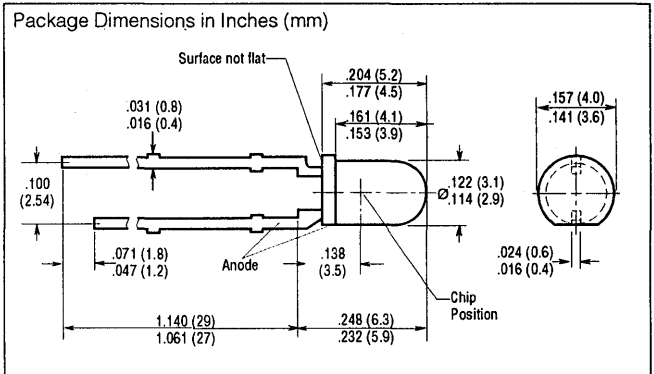

Maximum Ratings

Operating and Storage Temperature Range (T_{OP} , T_{STG})	-55° to +100°C
Soldering Temperature (≥ 2 mm from case bottom)	
Dip Soldering Time (T_S) $t \leq 3$ s	260°C
Iron Soldering Time (T_S) $t \leq 3$ s	300°C
Collector Emitter Voltage (V_{CEO})	35 V
Collector Current (I_C)	15 mA
Collector Peak Current (I_{PK}) $t < 10$ μ s	75 mA
Power Dissipation (P_{TOT}) $T_A = 25^\circ\text{C}$	165 mW
Thermal Resistance (R_{THJA})	450 K/W

Characteristics ($T_A = 25^\circ\text{C}$)

Parameter	Symbol	Value	Unit
Maximum Sensitivity Wavelength, SFH309	λ_{Smax}	860	nm
Maximum Sensitivity Wavelength, SFH309F	λ_{Smax}	900	nm
Spectral Range, Photosensitivity, SFH309	λ	380 to 1150	nm
Spectral Range, Photosensitivity, SFH309F	λ	730 to 1120	nm
Radiant Sensitive Area	A	0.45	mm ²
Distance, Chip Surface and Lens	H	2.4 to 2.8	mm
Half Angle	ϕ	± 12	Deg.
Capacitance			
($V_{CE} = 0$ V, $f = 1$ MHz, $E = 0$ lux)	C_{CE}	5.0	pF
Leakage Current ($V_{CEO} = 25$ V, $E = 0$ lx)	I_{CEO}	1 (≤ 200)	nA

Parameter	Sym	-2	-3	-4	-5	309-6(2)	Unit
Photocurrent, Collector-Emitter(1) ($E_E = 0.5$ mW/cm ² , $V_{CE} = 5$ V)	I_{PCE}	.4-.8	.63 to 1.25	1.0 to 2.0	1.6 to 3.2	≥ 2.5	mA
SFH309: ($E_V = 1000$ lx, std. light A, $V_{CE} = 5$ V)	I_{PCE}	1.5	2.8	4.5	7.2	10.0	mA
Rise/Fall Time ($I_C = 1$ mA, $V_{CC} = 5$ V, $R_L = 1$ k Ω)	$t_{R, F}$	5	6	/	8	9	μ s
Collector Emitter Saturation Voltage ($I_C = I_{PCEmin}^{(1)} \cdot 0.3$, $E_E = 0.5$ mW/cm ²)	V_{CEsat}	200	200	200	200		mV

Notes: 1. I_{PCEmin} = minimum photocurrent of the specified group.
2. Availability subject to yield.

Relative spectral sensitivity—SFH309
 $S_{REL}=f(\lambda)$

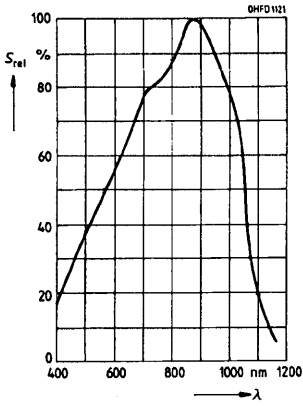

Relative spectral sensitivity—SFH309F
 $S_{REL}=f(\lambda)$

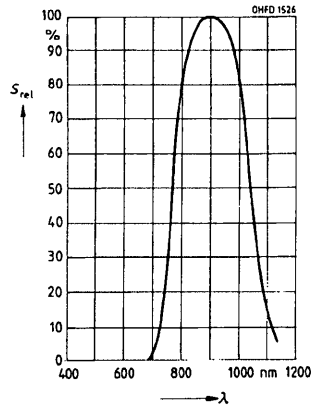

Photocurrent $I_{PCE}=f(E_E, V_{CE}=5 V$

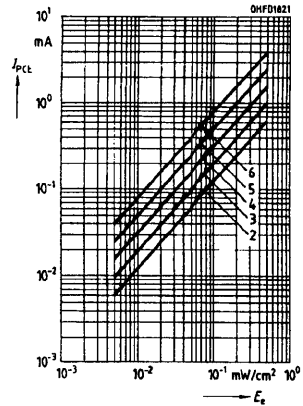

Directional characteristic
 $S_{REL}=f(\varphi)$

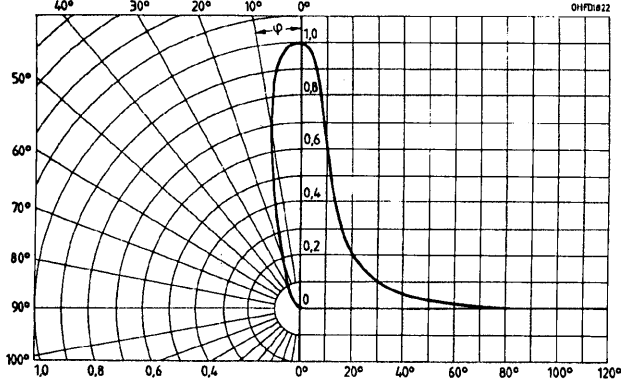

Total power dissipation
 $P_{TOT}=f(T_A)$

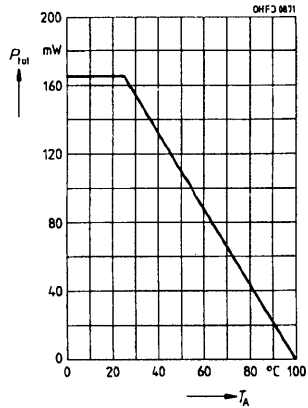

Photocurrent
 $I_{PCE}=f(V_{CE}, E_E=Parameter)$

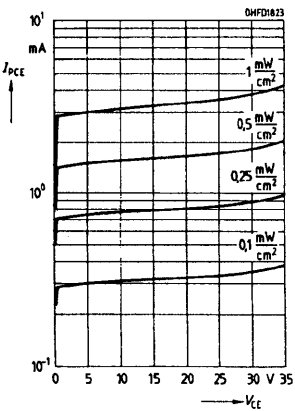

Dark current $I_{CEO}=f(V_{CE}), E=0$

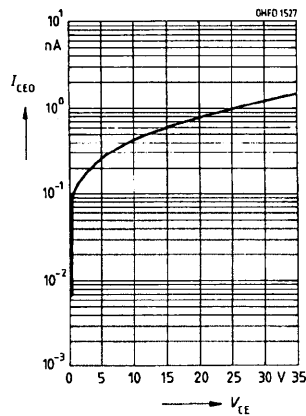

Dark current $I_{CEO}=f(T_A), V_{CE}=25 V, E=0$

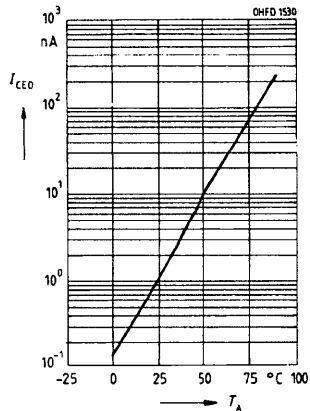

Phototransistors/
Photoerdinlign

Capacitance $C_{CE}=f(V_{CE})$, $f=1$ MHz, $E=0$

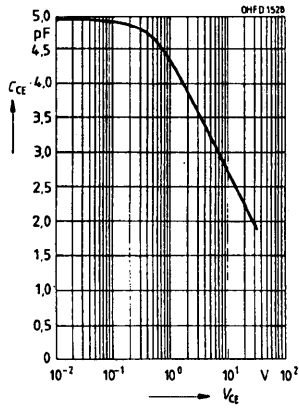

Dark current $I_{PCE}/I_{PCE25}=f(T_A)$, $V_{CE}=25$ V

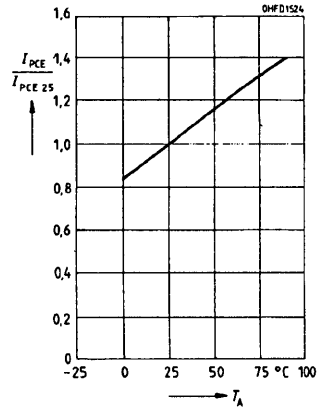

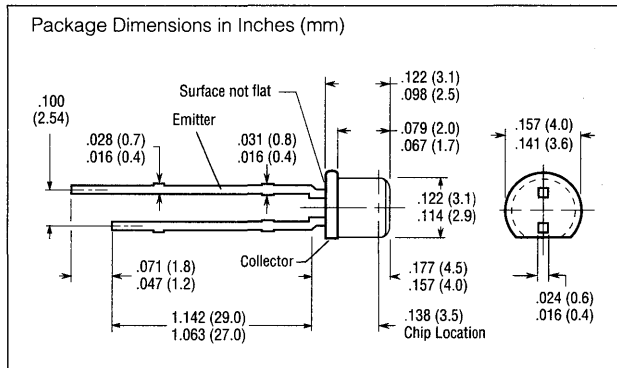
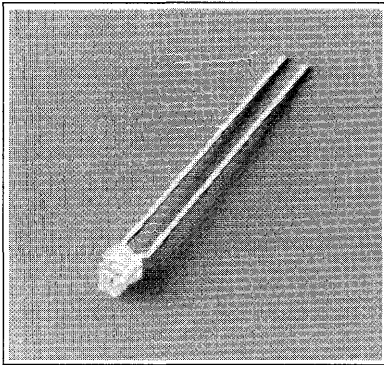

FEATURES

- Silicon NPN Phototransistor in Epitaxial Planar Technology
- No Base Connection
- High Reliability
- No Testable Degradation
- High Spectral Sensitivity
- Good Linearity
- Wide Temperature Range
- SFH309P: Visible Light and Near Infrared Range Usage
- SFH309PF: Daylight Filter
- Spectral Sensitivity Selections
- Same Package as IRED SFH487P
- Package: T1 (3mm) Flat Top LED Package, Transparent and Black Epoxy Resin, Solder Tabs, 0.1" (2.54 mm) Lead Spacing
- Collector Indicator: Shorter Lead, Flat at Case Bottom
- Applications
 - Light-reflecting Switches
 - Measurement and Control

DESCRIPTION

The SFH309P/309PF are silicon NPN phototransistors in a standard T1 (3 mm) plastic package. The SFH309PF has a black daylight filter.

The devices can be used in a variety of low-cost, high-volume applications, such as IR remote control and other consumer and entertainment products.

Maximum Ratings

Operating and Storage Temperature (T_{OP} , T_{STG})	-55°C to +100°C
Soldering Temperature (≥ 2 mm from case bottom)		
Dip Soldering Time (T_{ST}) $t \leq 5$ sec.	260°C
Iron Soldering Time (T_{SK}) $t \leq 3$ sec.	300°C
Collector Emitter Voltage (V_{CE})	35 V
Collector Current (I_C)	15 mA
Collector Peak Current (I_{CS}) $\tau < 10 \mu s$	75 mA
Power Dissipation (P_{TOT}) $T_A = 25^\circ C$	165 mW
Thermal Resistance (R_{thJA})	450 K/W

Characteristics ($T_A = 25^\circ\text{C}$, $\lambda = 950\text{nm}$)

Parameter	Symbol	Value	Unit	Condition
Maximum Photosensitivity Wavelength				
SFH309P	$\lambda_{S\text{max}}$	860	nm	
SFH309PF	$\lambda_{S\text{max}}$	900	nm	
Photosensitivity Spectral Range				$S=10\%$ of S_{MAX}
SFH309P	λ	380–1150	nm	
SFH309PF	λ	730–1120	nm	
Radiant Sensitive Area	A	0.045	mm ²	$\varnothing 240 \mu\text{m}$
Distance Chip Surface to Case Surface	H	0.4 to 0.8	mm	
Half Angle	φ	± 75	Deg.	
Capacitance	C_{CE}	5.0	pF	$V_{\text{CE}}=0 \text{ V}$, $f=1 \text{ MHz}$, $E=0$
Collector Emitter Leakage Current	I_{CEO}	1(≤ 200)	nA	$V_{\text{CEO}}=25 \text{ V}$, $E=0$
Spectral Sensitivity Groupings				
Photocurrent				
SFH309P/PF-2	I_{PCE}	63 to 125	μA	$E_E=0.5 \text{ mW/cm}^2$, $V_{\text{CE}}=5 \text{ V}$
SFH309P/PF-3	I_{PCE}	100 to 200	μA	$E_E=0.5 \text{ mW/cm}^2$, $V_{\text{CE}}=5 \text{ V}$
SFH309P/PF-4(2)	I_{PCE}	160 to 320	μA	$E_E=0.5 \text{ mW/cm}^2$, $V_{\text{CE}}=5 \text{ V}$
SFH309P-2	I_{PCE}	260	μA	$E_V=1000 \text{ lux}$, std. light A, $V_{\text{CE}}=5 \text{ V}$
SFH309P-3	I_{PCE}	420	μA	$E_V=1000 \text{ lux}$, std. light A, $V_{\text{CE}}=5 \text{ V}$
SFH309P-4	I_{PCE}	650	μA	$E_V=1000 \text{ lux}$, std. light A, $V_{\text{CE}}=5 \text{ V}$
Rise and Fall Time				$I_C=1 \text{ mA}$, $V_{\text{CC}}=5 \text{ V}$, $R_L=1\text{k}\Omega$
SFH309P/PF-2	t_R, t_F	5	μs	
SFH309P/PF-3	t_R, t_F	6	μs	
SFH309P/PF-4(2)	t_R, t_F	7	μs	
Collector Emitter Saturation Voltage	V_{CESat}	150	mV	$I_{\text{PCE}}=I_{\text{PCEmin}}^{(1)} \times 0.3$, $E_E=0.5 \text{ mW/cm}^2$

Note:

1. I_{PCEmin} is the minimum photocurrent of the specified group.
2. Supplies out of this group cannot always be guaranteed due to unforeseeable spread of yield. We reserve the right of delivering a substitute group.

Relative spectral sensitivity—SFH309P

$S_{\text{REL}}=f(\lambda)$

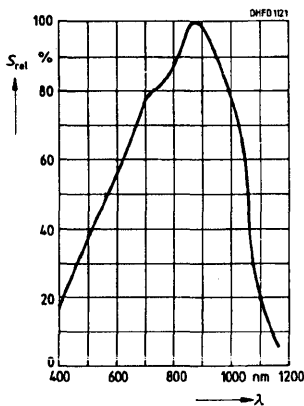

Relative spectral sensitivity—SFH309PF

$S_{\text{REL}}=f(\lambda)$

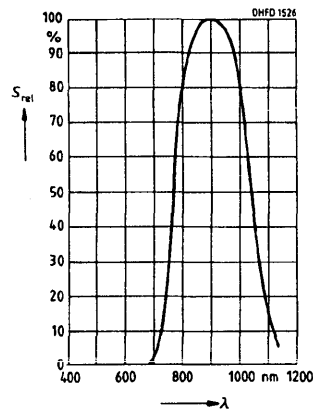

Photocurrent $I_{PCE}=f(E_a)$,
 $V_{CE}=5\text{ V}$, $\lambda=950\text{ nm}$

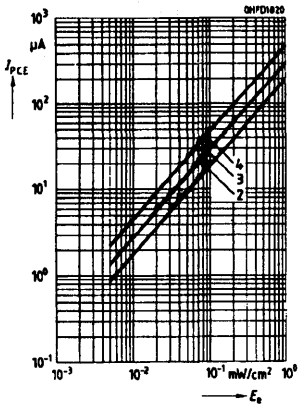

Directional characteristic $S_{REL}=f(\varphi)$

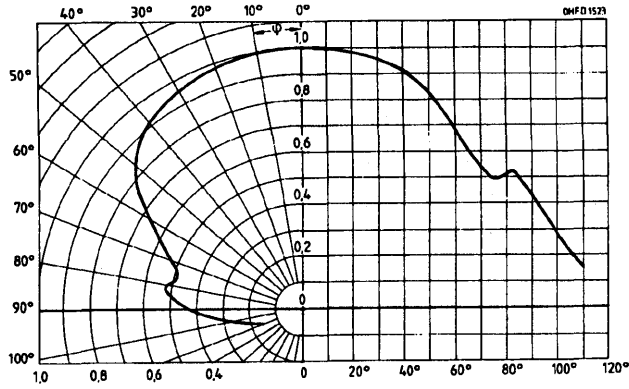

Total power dissipation
 $P_{TOT}=f(T_A)$

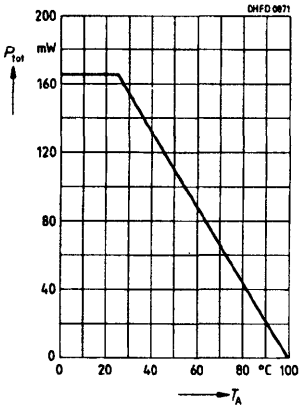

Photocurrent $I_{PCE}=f(V_{CE})$
 $E_C=$ Parameter

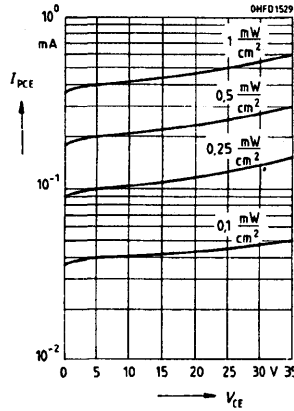

Dark current $I_{CEO}=f(V_{CE})$, $E=0$

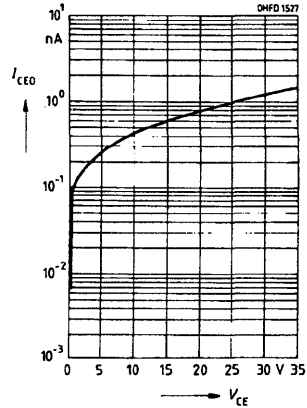

Dark current $I_{CEO}=f(T_A)$
 $V_{CE}=25\text{ V}$, $E=0$

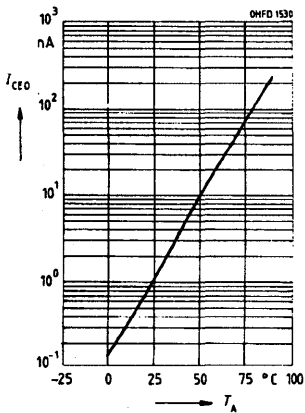

Capacitance $C_{CE}=f(V_{CE})$
 $f=1\text{ MHz}$, $E=0$

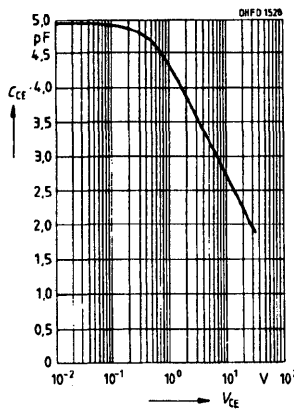

Photocurrent $I_{PCE}/I_{PCE\ 25}=f(T_A)$
 $V_{CE}=5\text{ V}$

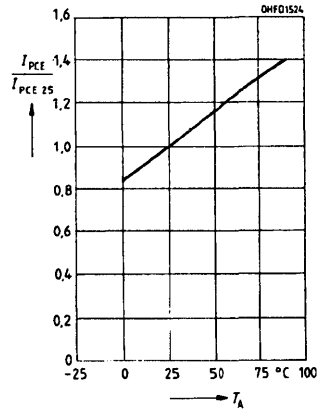

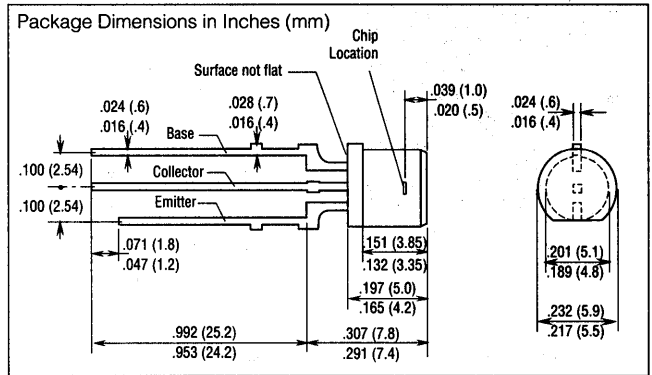
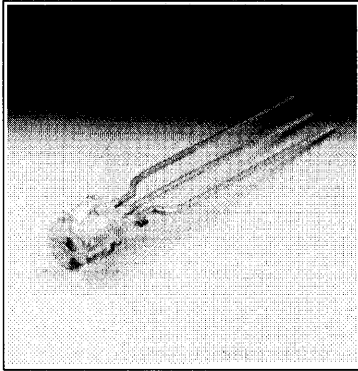

FEATURES

- Daylight Filter—SFH317F
- Wide Acceptance Angle, 120°
- High Reliability
- High Rise and Fall Time
- Good Linearity
- High Photosensitivity
- No Testable Degradation
- Base Connection

FEATURES

The SFH317/317F are highly sensitive silicon planar phototransistors with base connection in a standard T1¾ (5 mm) package. The SFH317 comes in a water-clear, no-lens package; the SFH317F comes in black epoxy.

The emitter is marked by a tab; the collector lead is the center of the three leads.

Maximum Ratings

Operating and Storage Temperature Range (T_{OP} , T_{STG})	-55° to +100°C
Soldering Temperature (≥ 2 mm from case bottom)		
Dip Soldering Time (T_S) $t \leq 5$ s	260°C
Iron Soldering Time (T_I) $t \leq 3$ s	300°C
Collector Emitter Voltage (V_{CEO})	50 V
Emitter Base Voltage (V_{EB})	7 V
Collector Current (I_C)	50 mA
Collector Peak Current (I_{PK}) $t < 10$ μ s	100 mA
Power Dissipation (P_{TOT}) $T_A = 25^\circ\text{C}$	200 mW
Thermal Resistance (R_{THJA})	375 K/W

Characteristics ($T_A = 25^\circ\text{C}$)

Parameter	Symbol	Value	Unit	
Maximum Sensitivity Wavelength, SFH317	λ_{Smax}	860	nm	
	SFH317F	870	nm	
Spectral Range, Photosensitivity, SFH317	λ	450 to 1000	nm	
	($S = 10\%$ of S_{max})	SFH317F	720 to 1100	nm
Radiant Sensitive Area	A	0.30	mm ²	
Die Area Dimensions	L x W	0.75 x 0.75	mm	
Distance, Die Surface to Case Surface	H	0.5 to 1.0	mm	
Half Angle	ϕ	± 75	Deg.	
Photocurrent, Collector Base Diode ($E_E = 0.5 \text{ mW/cm}^2$, $\lambda = 950 \text{ nm}$, $V_{CB} = 5 \text{ V}$)	I_{PCB}	0.65	μ A	
	($E_V = 1000 \text{ lux}$, $V_{CB} = 5 \text{ V}$)	I_{PCB}	2.5	μ A
Capacitance	C_{CE}	10	pF	
	($V_{CE} = 0 \text{ V}$, $f = 1 \text{ MHz}$, $E = 0 \text{ lx}$)	C_{CB}	22	pF
	($V_{EB} = 0 \text{ V}$, $f = 1 \text{ MHz}$, $E = 0 \text{ lx}$)	C_{EB}	21	pF

Parameter	Symbol	-2	-3	-4	Unit
Photocurrent, Collector-Emitter ($E_E = 0.5 \text{ mW/cm}^2$, $V_{CE} = 5 \text{ V}$)	I_{PCE}	16 to .32	25 to .5	≥ 4	mA
	SFH317: ($E_V = 1000 \text{ lx}$, $V_{CE} = 5 \text{ V}$)	I_{PCE}	.9	1.4	2.3
Rise/Fall Time ($I_C = 1 \text{ mA}$, $V_{CC} = 5 \text{ V}$, $R_L = 1 \text{ k}\Omega$)	t_R, t_F	11	13	15	μ s
Collector Emitter Saturation Voltage ($I_C = I_{PCEmin}^{(1)} \cdot 0.3$, $E_E = 0.5 \text{ mW/cm}^2$)	V_{CESat}	130	130	130	mV
Current Gain ($E_E = 0.5 \text{ mW/cm}^2$, $V_{CE} = 5 \text{ V}$)	I_{PCE}	370	570	920	
	I_{PCB}				

Note: 1. I_{PCEmin} = minimum photocurrent of the specified group.

Relative spectral sensitivity-SFH317
 $S_{REL}=f(\lambda)$

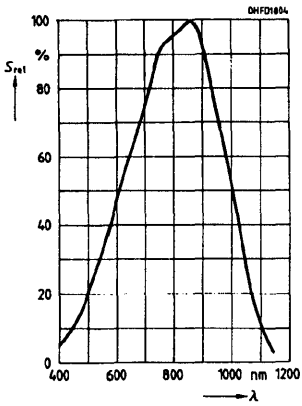

Relative spectral sensitivity-SFH317F
 $S_{REL}=f(\lambda)$

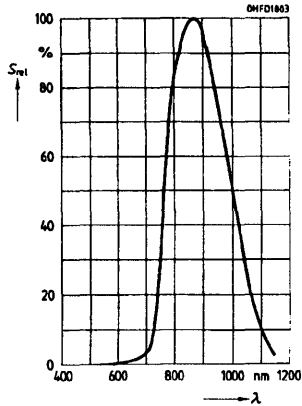

Photocurrent $I_{PCE}=f(E_e), V_{CE}=5V$

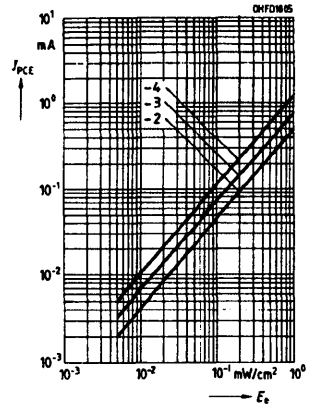

Directional characteristic
 $S_{REL}=f(\varphi)$

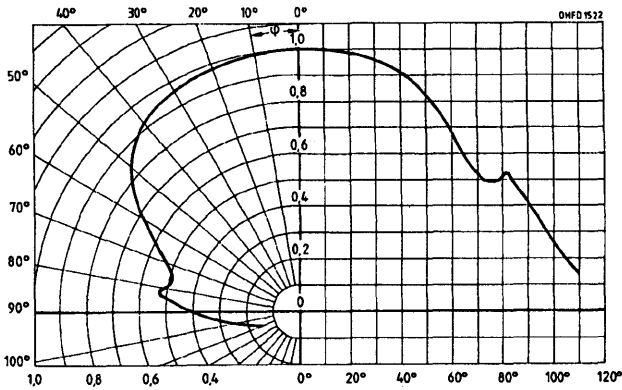

Output characteristics
 $I_C=f(V_{CE}), I_B=Parameter$

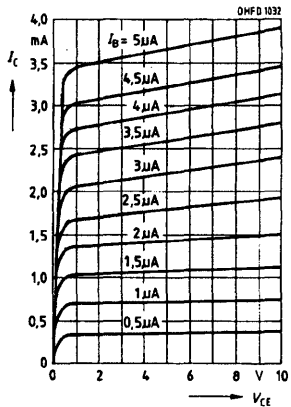

Capacitance
 $C_{CE}=f(V), f=1\text{ MHz}, E=0$

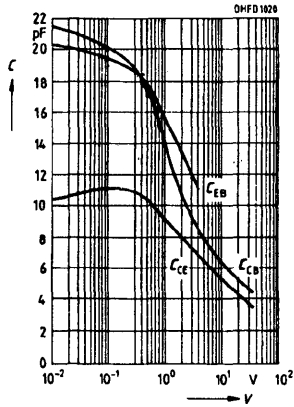

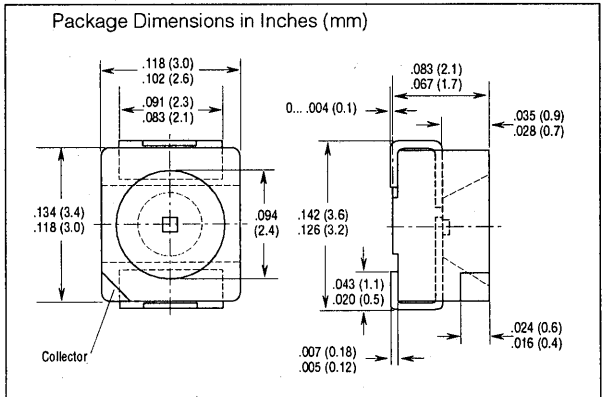
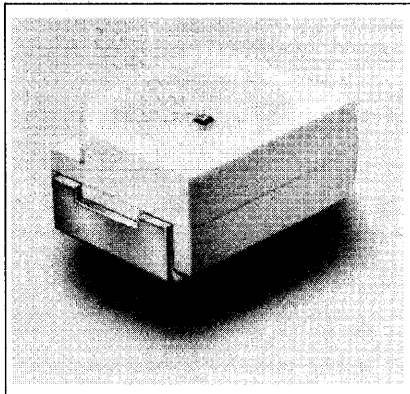

FEATURES

- NPN Silicon Phototransistor
- Daylight Filter Option—SFH320F
- Suitable for Vapor-Phase Reflow, Infrared Reflow, Wave Solder Processes
- Compatible with Automatic Placement Equipment
- High Photosensitivity
- High Reliability
- No Measurable Degradation
- Three Photocurrent Bin Options
- Matches with SFH420—SMT IRED
- Surface Mountable PL-CC-2 Package
- Applications
 - Measurement and Control
 - Touch Screens
 - Miniature Light Curtains

DESCRIPTION

The SFH320/320F are high-sensitivity NPN silicon phototransistors in a compact surface-mountable package. Available with or without a daylight filter, they are compatible with automatic placement equipment and can withstand IR reflow, vapor phase reflow, and wave solder processes. Their small size makes them suitable for dense packaging in array applications such as touch screens and precise position measurement.

Maximum Ratings

Operating & Storage Temperature (T_A , T_{STG})	-55 to +100°C
Collector-Emitter Voltage (V_{CE})	35 V
Collector Current (I_C)	15 mA
Peak Collector Current (I_{CS}) $\tau < 10 \mu s$	75 mA
Power Dissipation (P_{tot}) $T_A = 25^\circ C$	165 mW
Thermal Resistance, Junction to Ambient	
Mounting on PC Board (R_{thJA})	450 K/W

Characteristics ($T_A = 25^\circ C$, $\lambda = 950 \text{ nm}$)

Parameter	Symbol	SFH320	SFH320F	Unit
Maximum Sensitivity Wavelength	λ_{Smax}	860	900	nm
Spectral Range, Photosensitivity				
($S = 10\%$ of S_{max})	λ	380 to 1150	730 to 1120	nm
Radiant Sensitive Area	A	0.045	0.045	mm ²
Radiant Sensitive Area Dimensions	L x W	0.45 x 0.45	0.45 x 0.45	mm
Distance, Chip Surface to Case Surface	H	0.5 to 0.7	0.5 to 0.7	mm
Half Angle	ϕ	± 60	± 60	Deg
Capacitance				
($V_{CE} = 0 \text{ V}$, $f = 1 \text{ MHz}$, $E = 0$)	C_{CE}	5.0	5.0	pF
Dark Current ($V_{CE0} = 25 \text{ V}$, $E = 0$)	I_{CEO}	1 (≤ 200)	1 (≤ 200)	nA

Photosensitivity ranges by dash numbers.

Parameter	Symbol	-1	-2	-3	Unit
Photocurrent					
($E_E = 0.5 \text{ mW/cm}^2$, $V_{CE} = 5 \text{ v}$)	i_{PCE}	10-20	16-32	≥ 25	μA
SFH320: ($E_V = 1000 \text{ lx}$, std. light A, $V_{CE} = 5 \text{ v}$)	I_{PCE}	260	420	650	μA
Rise Time/Fall Time	t_r, t_f	5	6	7	μs
($I_C = 1 \text{ mA}$, $V_{CC} = 5 \text{ V}$, $R_L = 1 \text{ K}\Omega$)					
Collector-emitter Saturation Voltage ($I_{PCE} = I_{PCEmin}^{(1)} \cdot 0.3$, $E_E = 0.1 \text{ mW/cm}^2$)	V_{CEsat}	150	150	150	mV

Note: 1. I_{PCEmin} is the minimum photocurrent for each group.

Relative spectral sensitivity-SFH320

$S_{REL}=f(\lambda)$

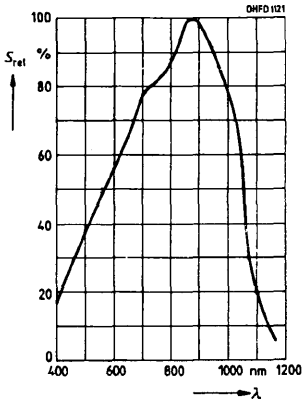

Relative spectral sensitivity-SFH320F

$S_{REL}=f(\lambda)$

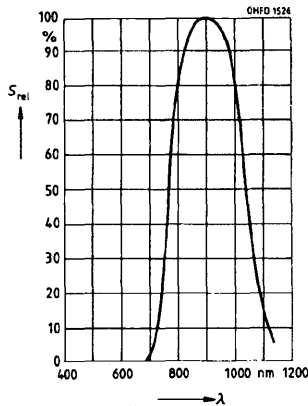

Photocurrent $I_{PCE}=f(E_E, V_{CE}=5 V$

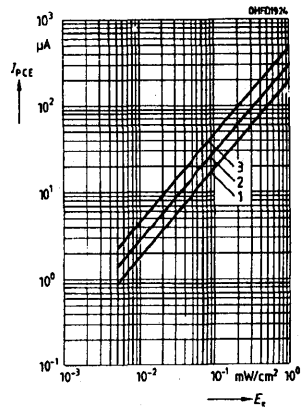

Directional characteristic

$S_{REL}=f(\lambda)$

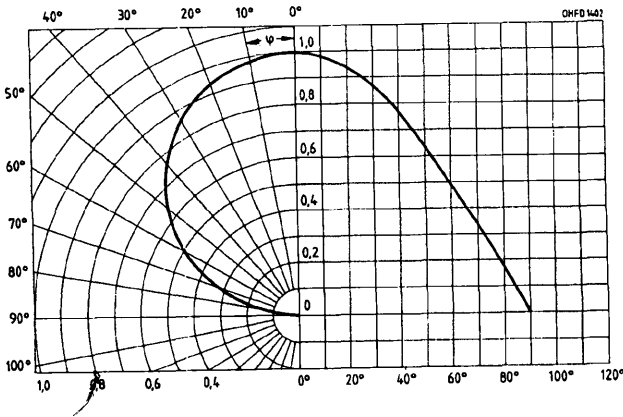

Total power dissipation

$P_{TOT}=f(T_A)$

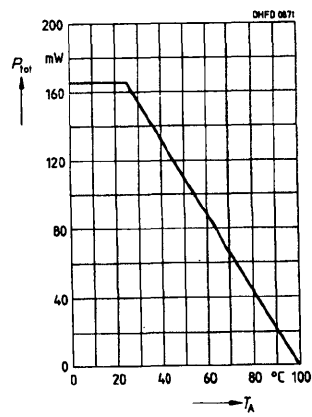

Photocurrent

$I_{PCE}=f(V_{CE}, E_E=Parameter)$

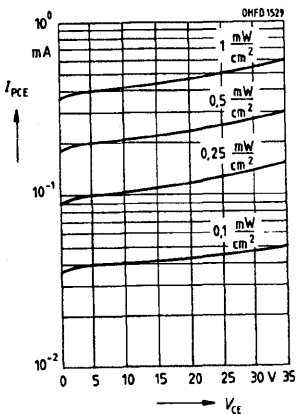

Dark current $I_{CEO}=f(V_{CE}), E=0$

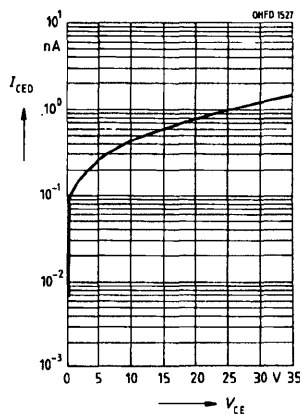

Dark current $I_{CEO}=f(T_A), V_{CE}=25 V, E=0$

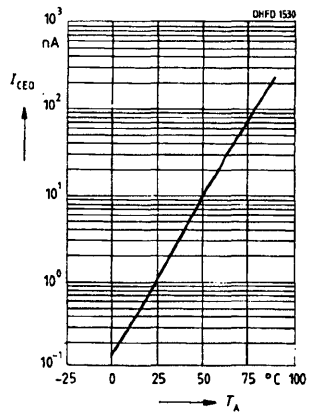

Phototransistors/
Photodarlington

Capacitance

$$C_{CE}=f(V), f=1 \text{ MHz}, E=0$$

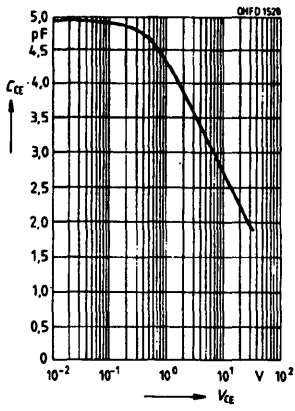

Photocurrent

$$I_{PCE}=f(V_{CE}), E_E=\text{Parameter}$$

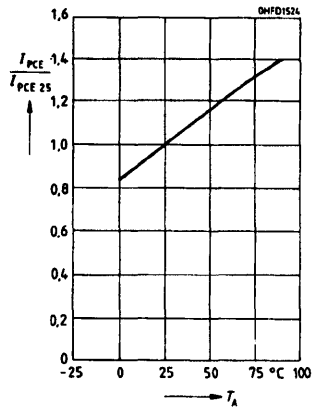

SILICON DARLINGTON PHOTOTRANSISTOR

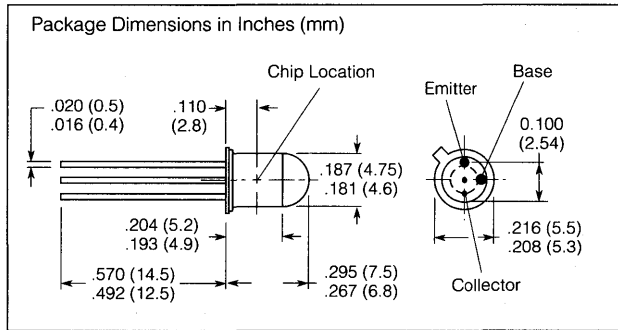
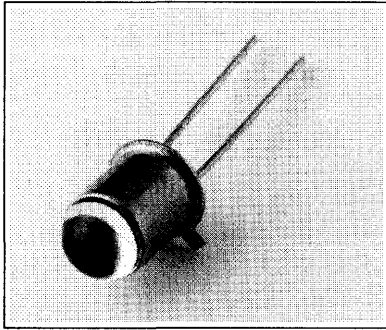

FEATURES

- Silicon Darlington Phototransistor in Epitaxial Planar Technology
- Base Connection, Collector Terminal Electrically Connected to Case
- High Reliability
- No Testable Degradation
- Short Switching Time
- Low Capacitance
- High Spectral Sensitivity
- Good Linearity
- Visible Light and Near Infrared Range Usage
- Spectral Sensitivity Groupings
- Same Package as IRED SFH400
- Package: 18 A3 DIN 41876 (TO18), Glass Lens, Hermetically Sealed Package 0.1" (2.54 mm) Lead Spacing
- Emitter Marking: Projection at Case Bottom
- Applications
 - Light-Reflecting Switches
 - Measurement and Control

Maximum Ratings

Operating and Storage Temperature

Range (T_{OP} , T_{STG}) -55°C to +100°C

Soldering Temperature, ≥ 2 mm from Case Bottom

Soldering Time (T_S) $t \leq 3$ sec 230°C

Collector Emitter Voltage (V_{CE}) 15 V

Emitter Base Voltage (V_{EB}) 7 V

Collector Current (I_C) 20 mA

Power Dissipation (P_{TOT}) $T_A = 25^\circ\text{C}$ 125 mW

Thermal Resistance (R_{thJA}) 600 K/W

Characteristics ($T_A=25^\circ\text{C}$, $\lambda=950\text{ nm}$)

Parameter	Sym	Value	Unit	Condition
Wavelength of Maximum Photosensitivity	λ_{SMAX}	840	nm	
Spectral Range of Sensitivity	λ	400 to 1050	nm	$S=10\%$ of S_{max}
Radiant Sensitive Area	A	0.14	mm ²	
Radiant Sensitive Area Dimension	LxW	0.65x0.65	mm	
Distance Chip Surface to Case Surface	H	4.0 to 4.8	mm	
Half Angle	φ	± 7	Deg.	
Photocurrent of Collector-Base Photodiode	I_{PCB}	22	μA	$E_e = -0.5\text{ mW/cm}^2$, $V_{\text{CB}} = 5\text{ V}$
Capacitance	I_{PCB}	12	μA	$E_v = 100\text{ lx}$, Standard Light A, $V_{\text{CB}} = 5\text{ V}$
	C_{CE}	4.4	pF	$V_{\text{CE}} = 0\text{ V}$, $f = 1\text{ MHz}$, $E = 0$
	C_{CB}	16	pF	$V_{\text{CB}} = 0\text{ V}$, $f = 1\text{ MHz}$, $E = 0$
Collector Emitter Leakage Current	I_{CEO}	2 (≤ 50)	nA	$V_{\text{CE}} = 10\text{ V}$, $E = 0$
Spectral Sensitivity Groupings				
Photocurrent				
SFH501-1	I_{PCE}	2.5 to 5	mA	$E_e = 0.5\text{ mW/cm}^2$, $V_{\text{CE}} = 5\text{ V}$
SFH501-2	I_{PCE}	≥ 4.0	mA	$E_e = 0.5\text{ mW/cm}^2$, $V_{\text{CE}} = 5\text{ V}$
SFH501-1	I_{PCE}	1.5	mA	$E_v = 100\text{ lx}$, Standard Light A, $V_{\text{CE}} = 5\text{ V}$
SFH501-2	I_{PCE}	2.25	mA	$E_v = 100\text{ lx}$, Standard Light A, $V_{\text{CE}} = 5\text{ V}$
Rise and Fall Time				$I_{\text{C}} = 1\text{ mA}$, $V_{\text{CC}} = 5\text{ V}$, $R_{\text{L}} = 1\text{ k}\Omega$
SFH501-1	t_r, t_f	12	μs	
SFH501-2	t_r, t_f	20	μs	
Collector Emitter Saturation Voltage	$V_{\text{CE sat}}$	800	mV	$I_{\text{C}} = I_{\text{PCEmin}}^{(1)} \times 0.3$, $E_e = 0.5\text{ mW/cm}^2$
Current Gain				$V_{\text{CE}} = 5\text{ V}$, $I_{\text{C}} = 2\text{ mA}$
SFH501-1	B	700		
SFH501-2	B	1300		

1. I_{PCEmin} is the minimum photocurrent of the specified group.

Relative spectral sensitivity $S_{\text{rel}} = f(\lambda)$

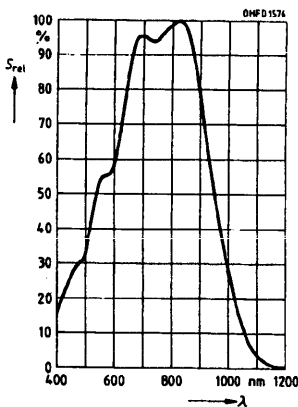

Directional characteristic $S_{\text{rel}} = f(\varphi)$

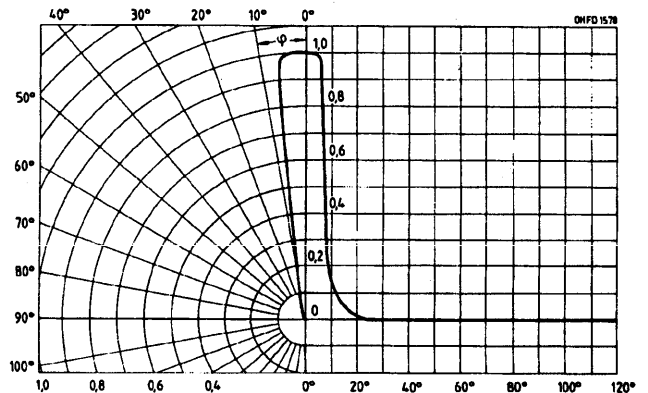

Photocurrent $I_{PCE} = f(E_a), V_{CE} = 5 \text{ V}$

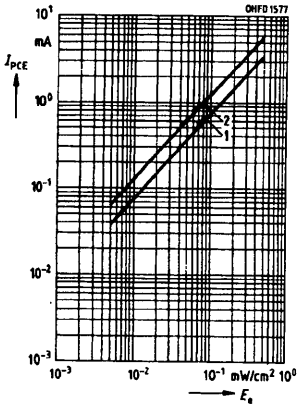

Total power dissipation

$P_{Tot} = f(T_A)$

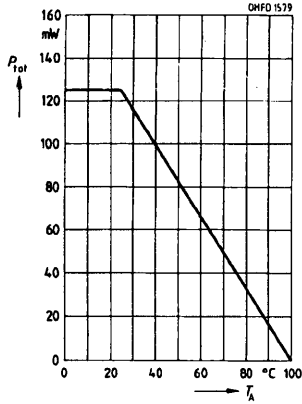

Output characteristics $I_C = f(V_{CE})$

$I_B = \text{Parameter}$

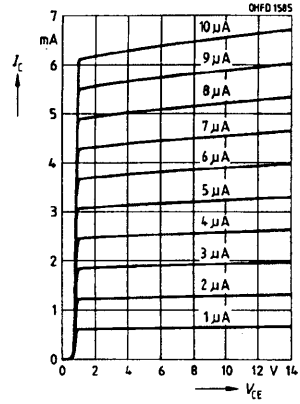

Output characteristics $I_C = f(V_{CE})$

$I_B = \text{Parameter}$

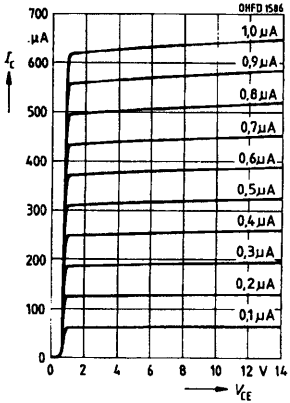

Dark current $I_{CEO} = f(V_{CE}), E = 0$

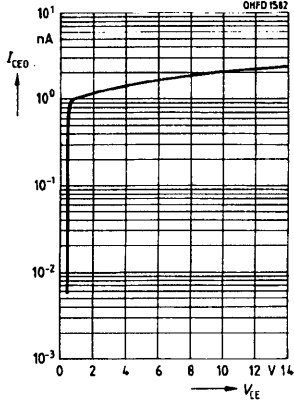

Photocurrent $I_{PCE} / I_{PCE25} = f(T_A)$

$V_{CE} = 5 \text{ V}$

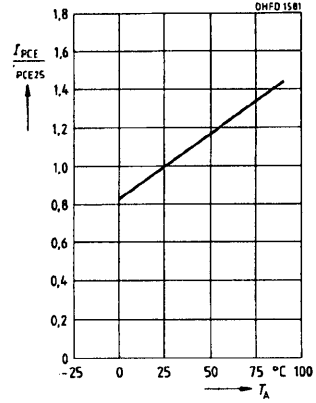

Dark current $I_{CEO} / I_{CEO25} = f(T_A)$

$V_{CE} = 25 \text{ V}, E = 0$

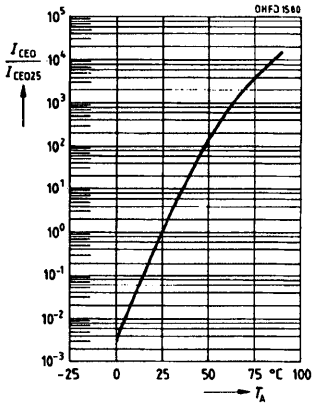

Collector emitter capacitance

$C_{CE} = f(V_{CE}), f = 1 \text{ MHz}, E = 0$

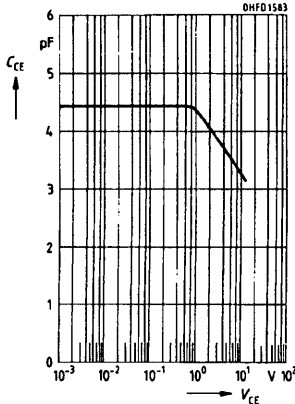

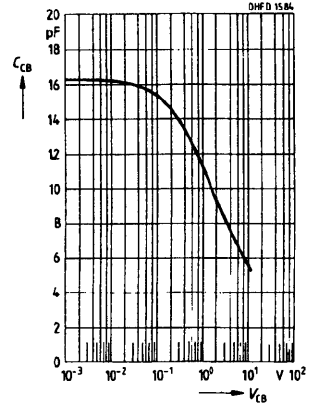

Collector-base capacitance

$C_{CB} = f(V_{CB}), f = 1 \text{ MHz}, E = 0$

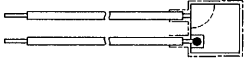
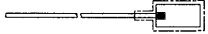
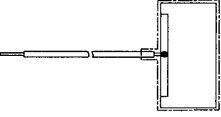
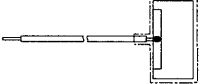

Photovoltaic Cells

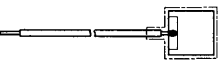
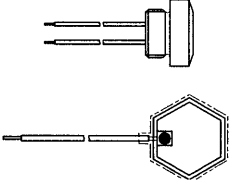
Package Outline	Part Number	Package Type	Half Angle	Sensitivity $s(\mu A/lx)$ Typical	Dark Current $V_R=1 V, E=0 \mu A$	Radiant Sensitive Area mm^2	Peak Wave-length	Capacitance $V_R=0 V, E=0 nF$	Page
	BPX79	Chip with wires.	$\pm 60^\circ$	170 nA/lx	0.3 (<50)	20 mm^2	800	2500 pF	10-2
	BPY11P-4	Chip with wires.	$\pm 60^\circ$	47-63	1(≥ 10)	7.6 mm^2	850	0.8	10-4
	BPY11P-5			≥ 56					
	BPY47P	Chip with wires.	$\pm 60^\circ$	1.4	25	1.9 mm^2	850	16	10-6
	BPY48P	Chip with wires.	$\pm 60^\circ$	0.5	10	0.70 cm^2	850	6	10-8
	BPY63P	Chip with wires.	$\pm 60^\circ$	0.65(≥ 0.45)	10	0.94 cm^2	850	8	10-10
	BPY64P	Chip with wires.	$\pm 60^\circ$	0.25(≥ 0.18) nA/lx	4	0.36 cm^2	850	3	10-12
	TP60P	Plastic, threaded. Anode marked by red lead.	$\pm 60^\circ$	1(≥ 0.7)	0.1 (≥ 2)	1.3 cm^2	900	3	10-14
	TP61P	Chip with wires. Anode marked by red lead.							

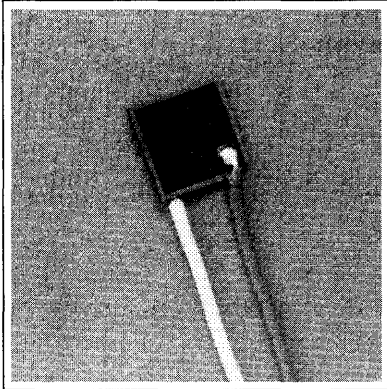

FEATURES

- Silicon Planar Photovoltaic Cell
- Medium Size Active Area
- High Blue Sensitivity
- High Reliability
- No Testable Degradation
- Wide Temperature Range

DESCRIPTION

The BPX79 is a silicon planar photovoltaic cell with low reverse current level and low noise. Its high sensitivity with shorter wavelengths makes it suitable for applications with high-blue light sources. The BPX79 is nitride-passivated and has an anti-reflection coating for a $\lambda=450$ nm wavelength.

Package Dimensions in Inches (mm)

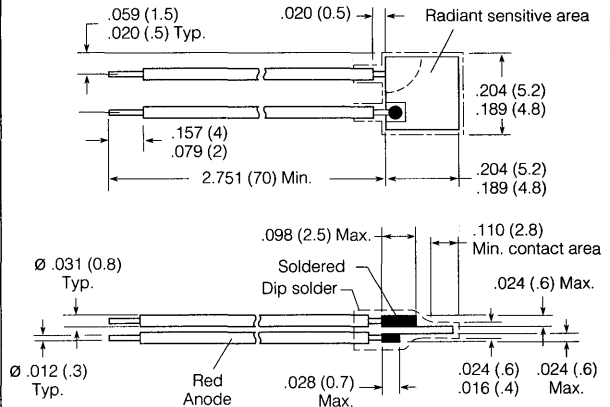

Maximum Ratings

Operating and Storage Temperature Range (T_{OP} , T_{STG}) -55° to $+100^{\circ}\text{C}$
Reverse Voltage (V_R) 1 V

Characteristics ($T_A=25^{\circ}\text{C}$)

Parameter	Symbol	Value	Unit
Photosensitivity (standard light A, $T=2856$ K)	S	170	nA/lx
Maximum Photosensitivity Wavelength	λ_{Smax}	800	nm
Photosensitivity Spectral Range ($S=10\%$ of S_{MAX})	λ	350 to 1100	nm
Radiant Sensitive Area	A	20	mm ²
Radiant Sensitive Area Dimensions	L x W	4.47 x 4.47	mm
Half Angle	ϕ	± 60	Deg.
Dark Current ($V_R=1$ V, $E=0$)	I_R	0.3 (≤ 50)	μA
Spectral Photosensitivity ($\lambda=400$ nm)	S_λ	0.19	A/W electrons photon
Quantum Efficiency ($\lambda=400$ nm)	η	0.60	
Open Circuit Voltage ($E_V=1000$ lx, std. light A, $T=2856$ K)	V_O	450 (≥ 250)	mV
Short Circuit Current ($E_E=5$ mW/cm ²)	I_{SC}	19 (≥ 14)	μA
Photocurrent Rise and Fall Time 10% to 90%, and 90% to 10% of Final Value ($R_L=1$ Ω , $V_R=1$ V, $\lambda=850$ nm, $I_P=150$ μA)	$t_{R,F}$	6	μs
Capacitance ($V_R=0$ V, $f=1$ MHz, $E_V=0$ lx)	C_O	2500	pF
Temperature Coefficient V_O	TC_V	-2.6	mV/K
Temperature Coefficient I_{SC}	TC_I	0.2	%/K

Relative spectral sensitivity
 $S_{REL}=f(\lambda)$

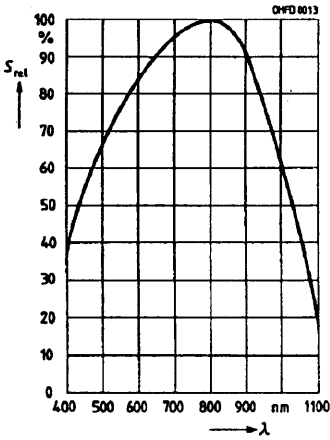

Open circuit voltage $V_O=f(E_V)$
 Short circuit voltage $V_{SC}=f(E_V)$

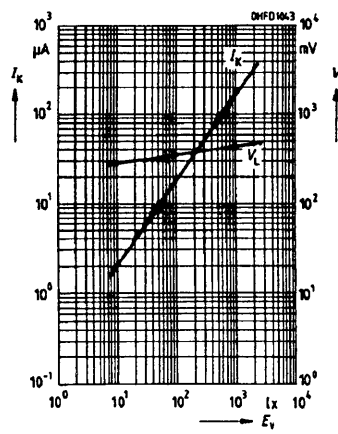

Directional characteristic
 $S_{REL}=f(\varphi)$

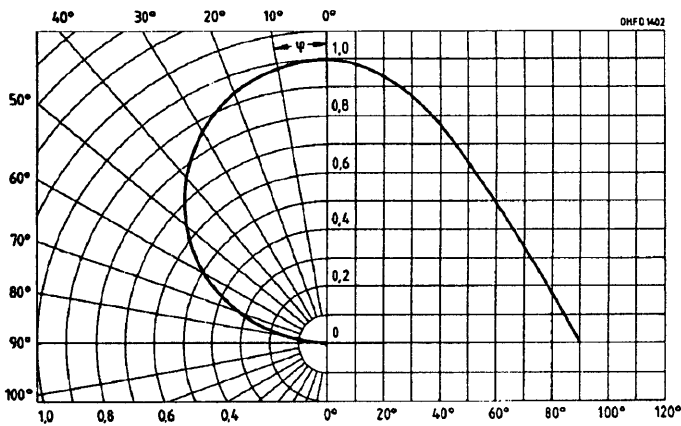

Capacitance
 $C=f(V_R)$, $f=1$ MHz, $E=0$

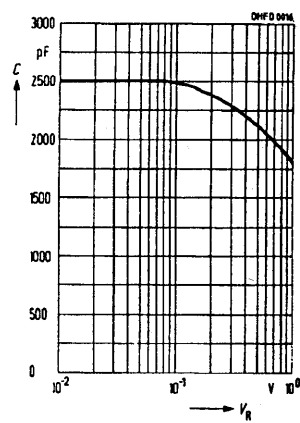

Dark current
 $I_R=f(V_R)$, $V_R=1$ V, $E=0$

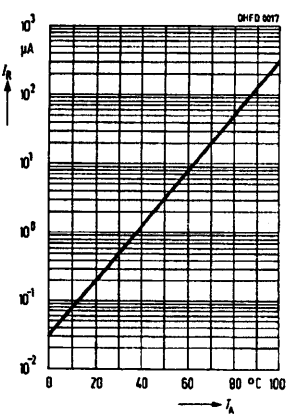

Power dissipation $P_{TOT}=f(T_A)$

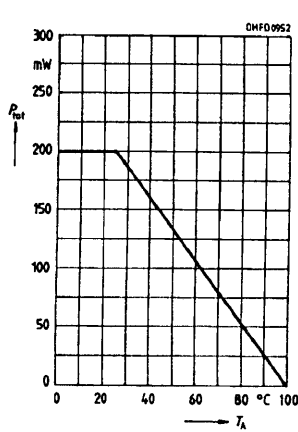

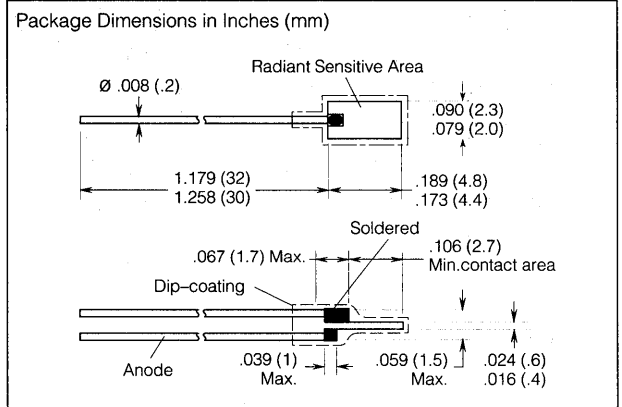
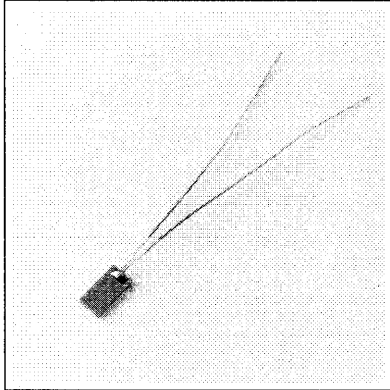

FEATURES

- **Small Package**
- **Two Sensitivity Selections**
- **Fast Response Time**

DESCRIPTION

The BPY11P is a silicon planar photovoltaic cell, which can be used in control and drive circuits, for light pulse scanning, and for quantitative light measurements. Its rapid response, small dimensions, and high permissible operating temperature enable universal application.

Since this cell is not encased, it can be used for the assembly of high-efficiency scanning systems by cementing the cells closely together on suitable mounting assemblies.

Maximum Ratings

Operating and Storage Temperature Range (T_{OP} , T_{STG}) -55° to $+100^{\circ}$ C
Reverse Voltage (V_R) 1 V

Characteristics ($T_A=25^{\circ}$ C)

Parameter	Symbol	Value	Unit	
Photosensitivity (standard light A, $T=2856$ K)	S	60 (≥ 47)	μ A/lx	
Maximum Photosensitivity Wavelength	λ_{Smax}	850	nm	
Photosensitivity Spectral Range ($S=10\%$ of S_{MAX})	λ	420 to 1060	nm	
Radiant Sensitive Area	A	7.6	mm ²	
Radiant Sensitive Area Dimensions	L x W	1.95 x 4.45	mm	
Half Angle	ϕ	± 60	Deg.	
Dark Current ($V_R=1$ V, $E=0$)	I_R	1 (≤ 10)	μ A	
Spectral Photosensitivity ($\lambda=850$ nm)	S_λ	0.55	A/W <u>electrons</u> photon	
Quantum Efficiency ($\lambda=850$ nm)	η	0.80		
Open Circuit Voltage ($E_V=1000$ lx, std. light A, $T=2856$ K)	V_O	440 (≥ 260)	mV	
Short Circuit Current ($E_V=1000$ lx, std. light A, $T=2856$ K)	I_{SC}	60 (≥ 47)	μ A	
Photocurrent Rise and Fall Time 10% to 90%, and 90% to 10% of Final Value ($R_L=1 \Omega$, $V_R=1$ V, $\lambda=850$ nm, $I_P=50 \mu$ A)	t_R, t_F	3	μ s	
Capacitance ($V_R=0$ V, $f=1$ MHz, $E_V=0$ lx)	C_n	0.8	nF	
Temperature Coefficient V_O	TC_V	-2.6	mV/K	
Temperature Coefficient I_{SC}	TC_I	0.2	%/K	
Spectral Photosensitivity	Symbol	-4	-5	Unit
Short Circuit Current ($E_V=1000$ lx, std. light A, $T=2856$ K)	I_{SC}	47 to 63	≥ 56	μ A

Relative spectral sensitivity
 $S_{REL}=f(\lambda)$

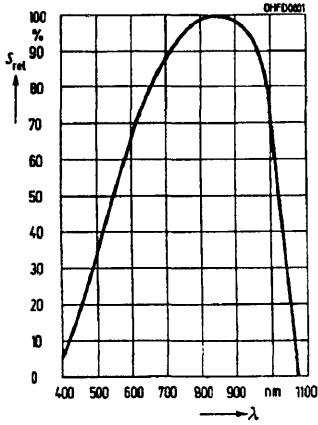

Open circuit voltage $V_O=f(E_V)$
Short circuit voltage $V_{SC}=f(E_V)$

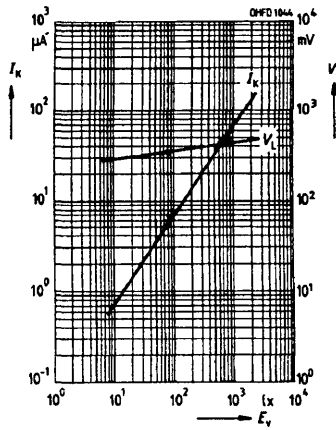

Directional characteristic
 $S_{REL}=f(\varphi)$

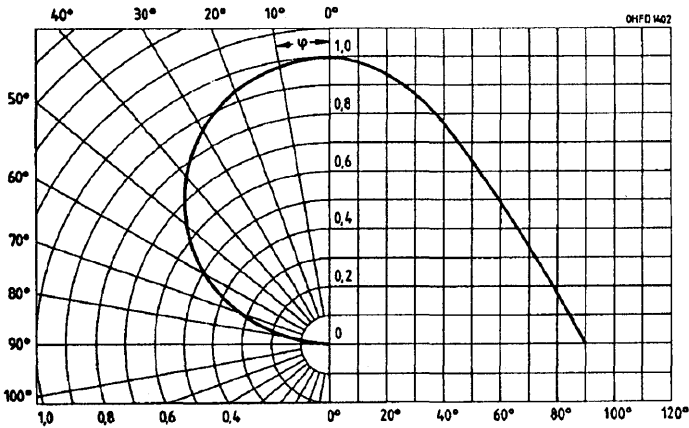

Capacitance
 $C=f(V_R), f=1 \text{ MHz}, E=0$

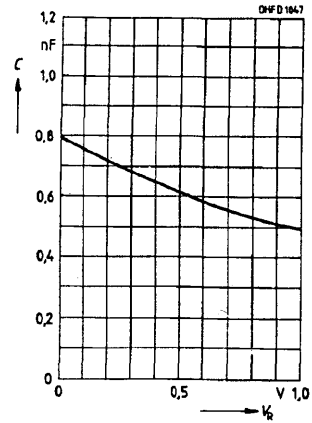

Dark current
 $I_R=f(V_R), E=0$

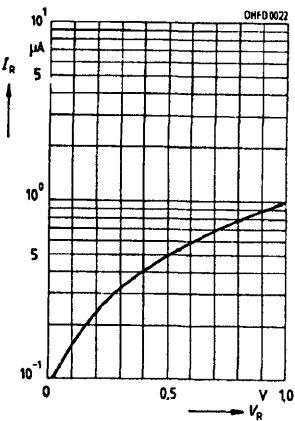

Dark current
 $I_R=f(T_A), V_R=1 \text{ V}, E=0$

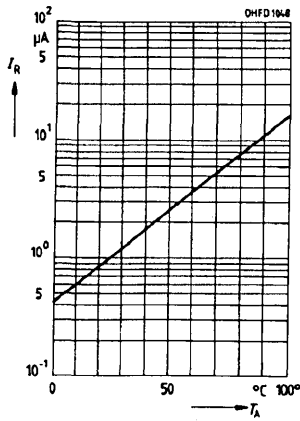

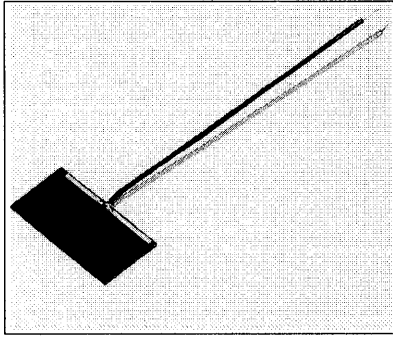

FEATURES

- High Reliability
- No Testable Degradation
- High Packing Density
- Wide Temperature Range

DESCRIPTION

The BPY47P is a silicon planar photovoltaic cell with N-Si material providing positive front and negative back contacts. The Si chip has two leads and is coated with a humidity-proof protective layer.

Applications include control and drive circuits, light pulse scanning, and quantitative light measurements in the visible and near infrared range.

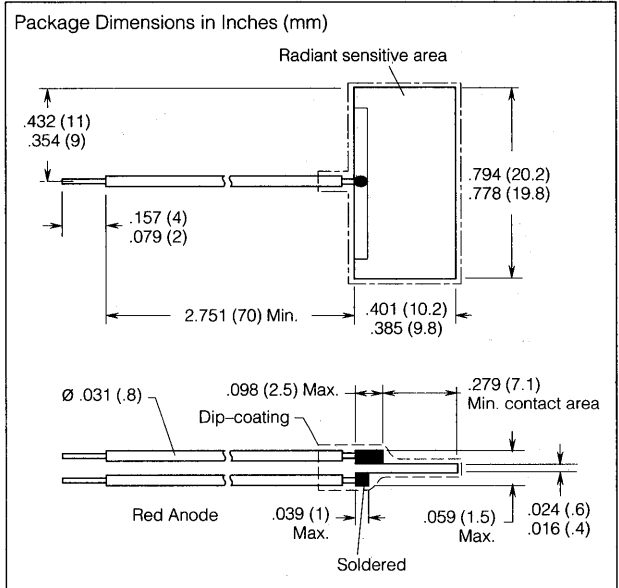

Maximum Ratings

Operating and Storage Temperature Range (T_{OP} , T_{STG}) -55° to +100°C
Reverse Voltage (V_R) 1 V

Characteristics ($T_A=25^\circ\text{C}$)

Parameter	Symbol	Value	Unit
Photosensitivity (standard light A, $T=2856\text{ K}$)	S	1.4 (≥ 0.9)	$\mu\text{A}/\text{lx}$
Maximum Photosensitivity Wavelength	$\lambda_{S\text{max}}$	850	nm
Sensitivity Spectral Range ($S=10\%$ of S_{MAX})	λ	420 to 1060	nm
Radiant Sensitive Area	A	1.9	cm^2
Radiant Sensitive Area Dimensions	L x W	9.58 x 19.58	mm
Half Angle	φ	± 60	Deg.
Dark Current ($V_R=1\text{ V}$, $E=0$)	I_R	25 (≤ 400)	μA
Spectral Sensitivity ($\lambda=850\text{ nm}$)	S_λ	0.51	A/W electrons photon
Quantum Efficiency ($\lambda=850\text{ nm}$)	η	0.73	
Open Circuit Voltage ($E_V=1000\text{ lx}$, std. light A, $T=2856\text{ K}$)	V_O	450 (≥ 280)	mV
Short Circuit Current ($E_V=1000\text{ lx}$, std. light A, $T=2856\text{ K}$)	I_{SC}	1.4 (≥ 0.9)	mA
Photocurrent Rise and Fall Time 10% to 90%, and 90% to 10% of Final Value ($R_L=1\ \Omega$, $V_R=1\text{ V}$, $\lambda=850\text{ nm}$, $I_p=50\ \mu\text{A}$)	t_R, t_F	23	μs
Capacitance ($V_R=0\text{ V}$, $f=1\text{ MHz}$, $E_V=0\text{ lx}$)	C_O	16	nF
Temperature Coefficient V_O	TC_V	-2.6	mV/K
Temperature Coefficient I_{SC}	TC_I	0.2	%/K

Relative spectral sensitivity
 $S_{REL}=f(\lambda)$

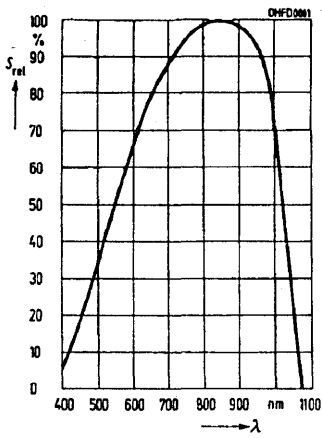

Open circuit voltage $V_{OC}=f(E_V)$
Short circuit current $V_{SC}=f(E_V)$

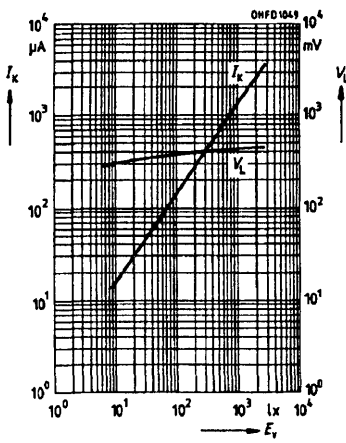

Directional characteristic
 $S_{REL}=f(\varphi)$

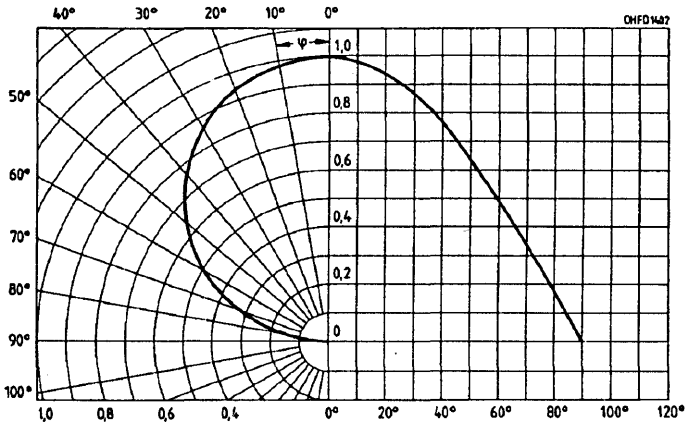

Capacitance
 $C=f(V_R)$, $f=1$ MHz, $E=0$

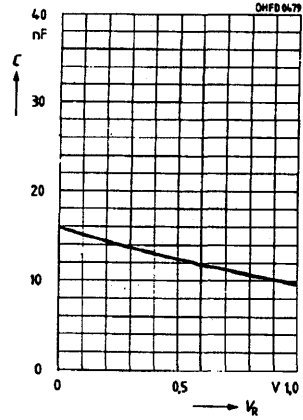

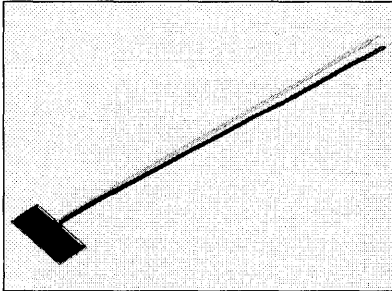

FEATURES

- High Reliability
- No Testable Degradation
- High Packing Density
- Wide Temperature Range

DESCRIPTION

The BPY48P is a silicon planar photovoltaic cell, with N-Si material providing positive front and negative back contacts. The Si chip has two leads and is coated with a humidity-proof protective layer.

Applications include control and drive circuits, light pulse scanning, and quantitative light measurements in the visible and near infrared range.

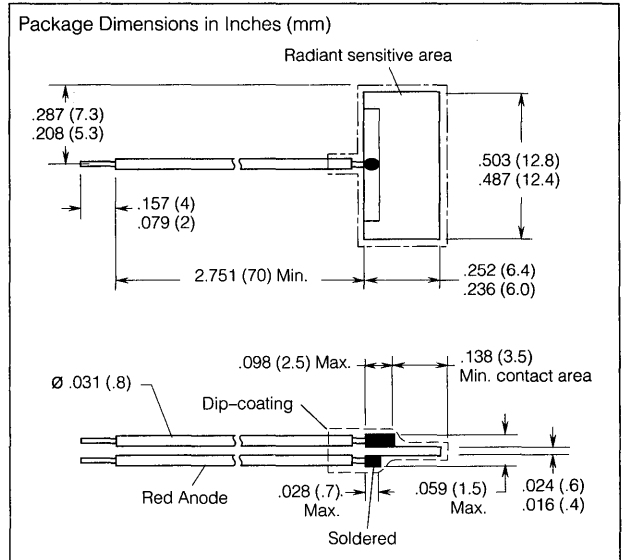

Maximum Ratings

Operating and Storage Temperature Range (T_{OP} , T_{STG}) -55° to $+100^{\circ}\text{C}$
 Reverse Voltage (V_R) 1 V

Characteristics ($T_A=25^{\circ}\text{C}$)

Parameter	Symbol	Value	Unit
Photosensitivity (standard light A, $T=2856\text{ K}$)	S	0.5 (≥ 0.35)	$\mu\text{A}/\text{lx}$
Maximum Photosensitivity Wavelength	$\lambda_{S\text{max}}$	850	nm
Sensitivity Spectral Range ($S=10\%$ of S_{MAX})	λ	420 to 1060	nm
Radiant Sensitive Area	A	0.70	cm^2
Radiant Sensitive Area Dimensions	L x W	5.78 x 12.18	mm
Half Angle	φ	± 60	Deg.
Dark Current ($V_R=1\text{ V}$, $E=0$)	I_R	10 (≤ 180)	μA
Spectral Sensitivity ($\lambda=850\text{ nm}$)	S_λ	0.55	A/W electrons/photon
Quantum Efficiency ($\lambda=850\text{ nm}$)	η	0.80	
Open Circuit Voltage ($E_V=1000\text{ lx}$, std. light A, $T=2856\text{ K}$)	V_O	460 (≥ 280)	mV
Short Circuit Current ($E_V=1000\text{ lx}$, std. light A, $T=2856\text{ K}$)	I_{SC}	0.5 (≥ 0.35)	mA
Photocurrent Rise and Fall Time 10% to 90%, and 90% to 10% of Final Value ($R_L=1\ \Omega$, $V_R=1\text{ V}$, $\lambda=850\text{ nm}$, $I_p=500\ \mu\text{A}$)	t_R, t_F	10	μs
Capacitance ($V_R=0\text{ V}$, $f=1\text{ MHz}$, $E_V=0\text{ lx}$)	C_O	6	nF
Temperature Coefficient V_O	TC_V	-2.6	mV/K
Temperature Coefficient I_{SC}	TC_I	0.2	%/K

Relative spectral sensitivity
 $S_{REL} = f(\lambda)$

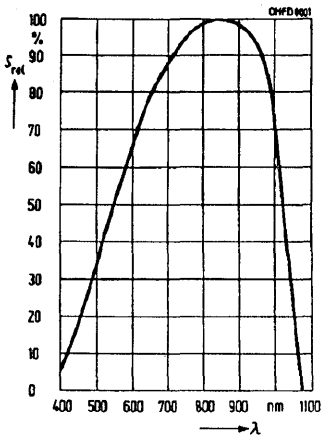

Open circuit voltage $V_{OC} = f(E_r)$
Short circuit current $I_{SC} = f(E_r)$

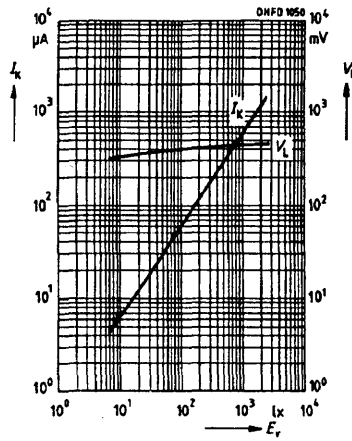

Directional characteristic
 $S_{REL} = f(\psi)$

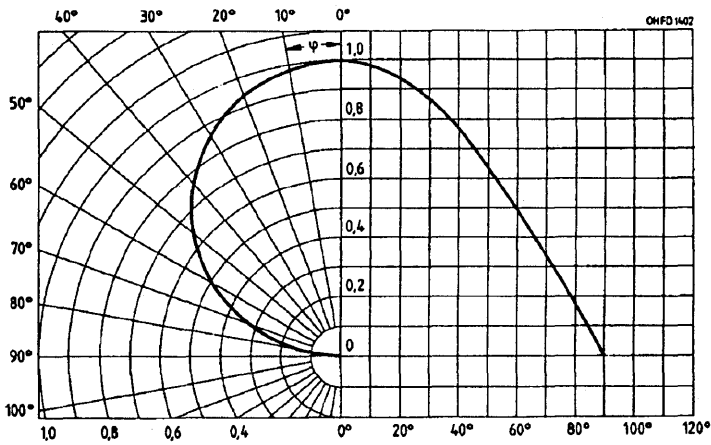

Capacitance
 $C = f(V_R), f = 1 \text{ MHz}, E = 0$

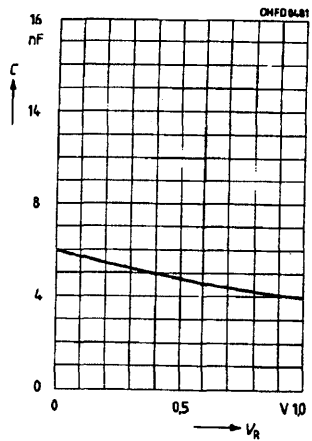

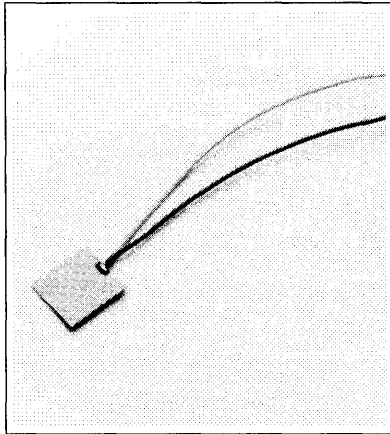

FEATURES

- High Reliability
- High Sensitivity
- Cost Effective Package
- Wide Temperature Range

DESCRIPTION

The BPY63P is a silicon planar photovoltaic cell with two leads and a hydro-protective outer layer. The BPY63P can be used in control and regulation circuits and as a photoelement to detect incandescent light and daylight.

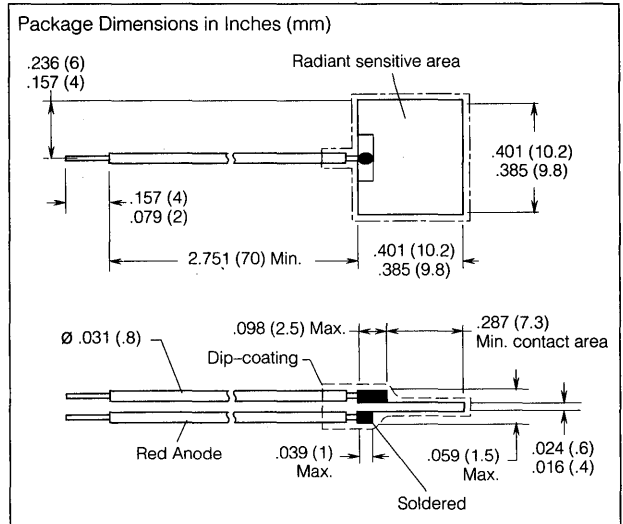

Maximum Ratings

Operating and Storage Temperature Range (T_{OP} , T_{STG}) -55° to +100°C
 Reverse Voltage (V_R) 1 V

Characteristics ($T_A=25^\circ\text{C}$)

Parameter	Symbol	Value	Unit
Photosensitivity (standard light A, $T=2856\text{ K}$)	S	0.65 (≥ 0.45)	$\mu\text{A/lx}$
Maximum Photosensitivity Wavelength	λ_{Smax}	830	nm
Sensitivity Spectral Range ($S=10\%$ of S_{MAX})	λ	400 to 1100	nm
Radiant Sensitive Area	A	0.94	cm^2
Radiant Sensitive Area Dimensions	L x W	9.69 x 9.69	mm
Half Angle	φ	± 60	Deg.
Dark Current ($V_R=1\text{ V}$, $E=0$)	I_R	10 (≤ 60)	μA
Spectral Sensitivity ($\lambda=850\text{ nm}$)	S_λ	0.5	$\frac{\text{A/W}}{\text{electrons}}$
Quantum Efficiency ($\lambda=850\text{ nm}$)	η	0.72	photon
Open Circuit Voltage ($E_V=1000\text{ lx}$, std. light A, $T=2856\text{ K}$)	V_O	430 (≥ 280)	mV
Short Circuit Current ($E_V=1000\text{ lx}$, std. light A, $T=2856\text{ K}$)	I_{SC}	0.65 (≥ 0.45)	mA
Photocurrent Rise and Fall Time 10% to 90%, and 90% to 10% of Final Value ($I_L=1\ \mu\text{A}$, $V_R=1\text{ V}$, $\lambda=850\text{ nm}$, $I_p=50\ \mu\text{A}$)	t_R, t_F	11	μs
Capacitance ($V_R=0\text{ V}$, $f=1\text{ MHz}$, $E_V=0\text{ lx}$)	C_O	8	nF
Temperature Coefficient V_O	TC_V	-2.6	mV/K
Temperature Coefficient I_{SC}	TC_I	0.2	%/K

Notes

1. The illuminance indicated refers to unfiltered radiation of a tungsten filament lamp at a color temperature of 2856K.
2. Plus part of the voltage to be connected to white strands.

Relative spectral sensitivity
 $S_{REL}=f(\lambda)$

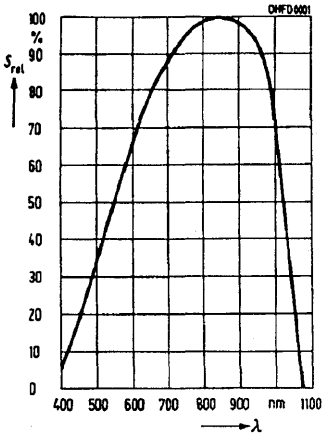

Open circuit voltage $V_{O}=f(E_V)$
 Short circuit voltage $V_{SC}=f(E_V)$

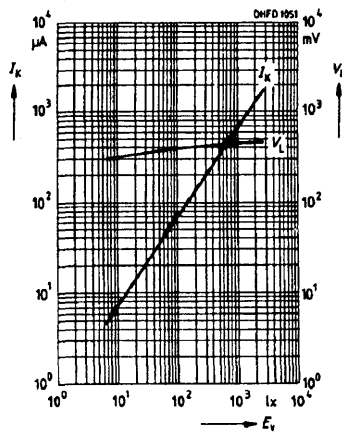

Directional characteristic
 $S_{REL}=f(\varphi)$

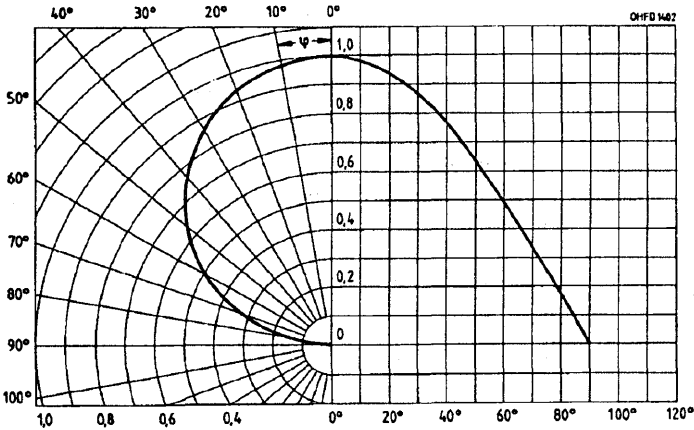

Capacitance
 $C=f(V_R), f=1 \text{ MHz}, E=0$

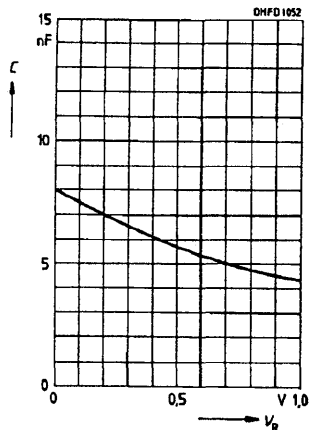

Dark current $I_R=f(V_R), E=0$

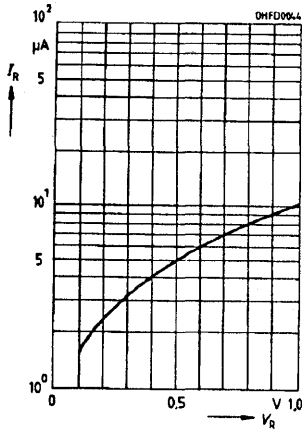

Dark current $I_R=f(T_A), V_R=1 \text{ V}, E=0$

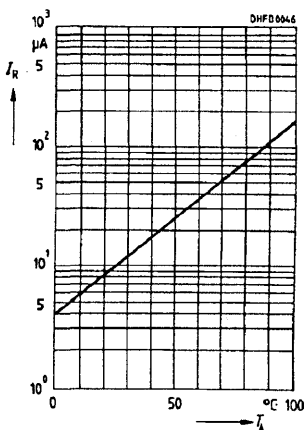

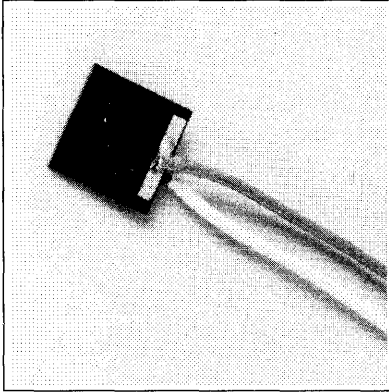

FEATURES

- Medium Size Radiant Sensitive Surface
- High Reliability
- High Sensitivity
- Wide Temperature Range
- No Testable Degradation

DESCRIPTION

The BPY64P is a silicon photovoltaic cell. It can be used in control and drive circuits and as a detector for light of filament lamps or daylight.

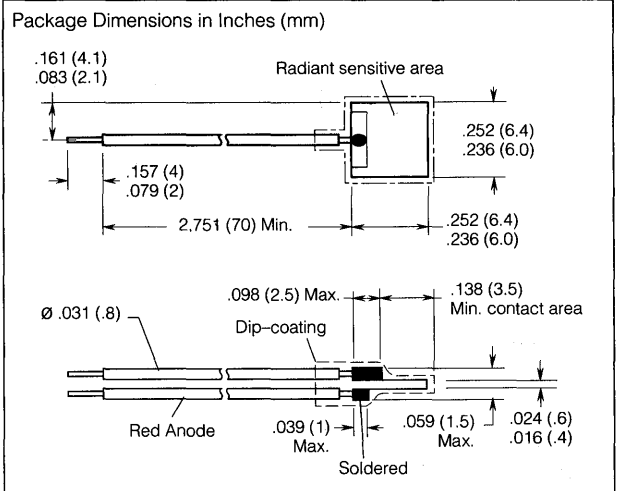

Maximum Ratings

Operating and Storage Temperature Range (T_{OP} , T_{STG}) -55°C to $+100^{\circ}\text{C}$
 Reverse Voltage (V_R) 1 V

Characteristics ($T_A=25^{\circ}\text{C}$)

Parameter	Symbol	Value	Unit
Photosensitivity (standard light A, $T=2856\text{ K}$)	S	0.25 (≥ 0.18)	$\mu\text{A}/\text{lx}$
Maximum Photosensitivity Wavelength	$\lambda_{S\text{max}}$	850	nm
Sensitivity Spectral Range ($S=10\%$ of S_{MAX})	λ	420 to 1060	nm
Radiant Sensitive Area	A	0.36	cm^2
Radiant Sensitive Area Dimensions	L x W	5.98 x 5.98	mm
Half Angle	ϕ	± 60	Deg.
Dark Current ($V_R=1\text{ V}$, $E=0$)	I_R	4 (≤ 80)	μA
Spectral Sensitivity ($\lambda=850\text{ nm}$)	S_λ	0.5	A/W
Quantum Efficiency ($\lambda=850\text{ nm}$)	η	0.72	$\frac{\text{electrons}}{\text{photon}}$
Open Circuit Voltage ($E_V=1000\text{ lx}$, std. light A, $T=2856\text{ K}$)	V_O	450 (≥ 280)	mV
Short Circuit Current ($E_V=1000\text{ lx}$, std. light A, $T=2856\text{ K}$)	I_{SC}	0.25 (≥ 0.18)	mA
Photocurrent Rise and Fall Time 10% to 90%, and 90% to 10% of Final Value ($R_L=1\ \Omega$, $V_R=1\text{ V}$, $\lambda=840\text{ nm}$, $I_P=250\ \mu\text{A}$)	t_R, t_F	5	μs
Capacitance ($V_R=0\text{ V}$, $f=1\text{ MHz}$, $E_V=0\text{ lx}$)	C_O	3	nF
Temperature Coefficient V_O	TC_V	-2.6	mV/K
Temperature Coefficient I_{SC}	TC_I	0.2	%/K

Relative spectral sensitivity
 $S_{REL} = f(\lambda)$

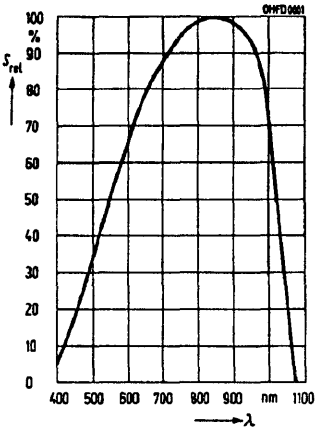

Open circuit voltage $V_O = f(E_V)$
 Short circuit voltage $V_{SC} = f(E_V)$

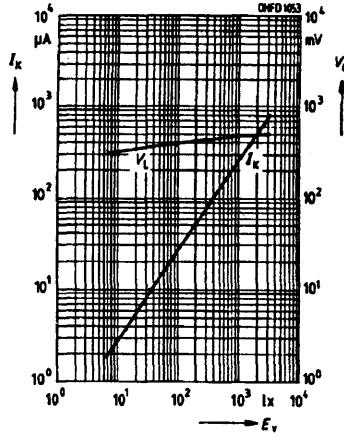

Directional characteristic
 $S_{REL} = f(\varphi)$

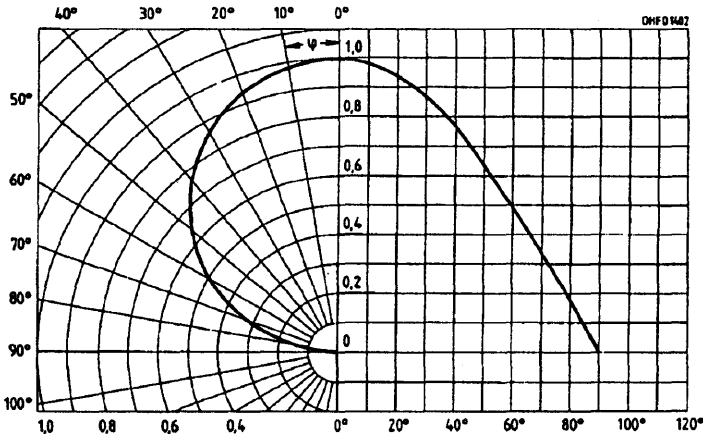

Capacitance
 $C = f(V_R), f = 1 \text{ MHz}, E = 0$

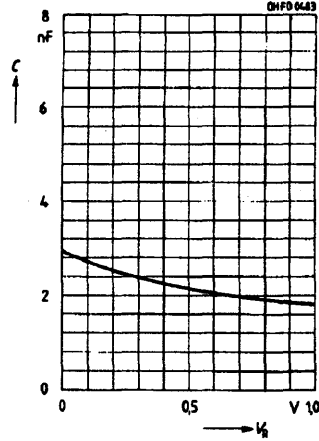

Photovoltaic Cells

SILICON PHOTOVOLTAIC CELL

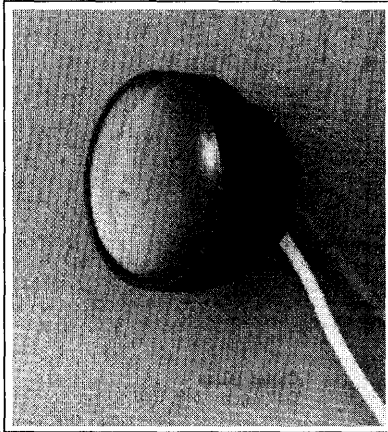

FEATURES

- High Reliability
- Very High Sensitivity, 1000 nA/lx Typical
- Wide Temperature Range:
TP61P, -55° to $+100^{\circ}$ C
- No Testable Degradation

DESCRIPTION

The TP60/61P are silicon photovoltaic cells with the same electrical characteristics; they differ only in packaging. The anode (positive pole of the cell) is denoted by a red lead. They can be used in control and drive circuits.

Maximum Ratings

Operating and Storage Temperature
Range (T_{OP} , T_{STG}) -55° to $+100^{\circ}$ C
Reverse Voltage (V_R) 1 V

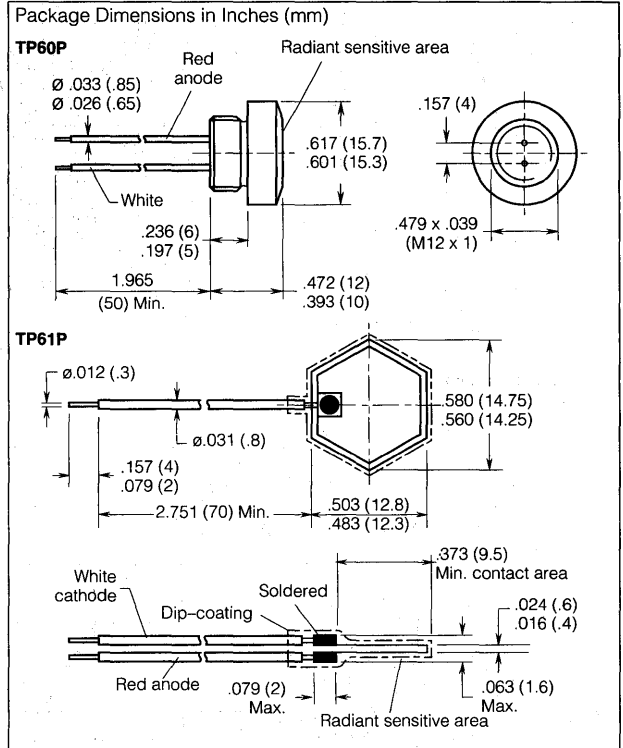

Characteristics ($T_A=25^{\circ}$ C)

Parameter	Symbol	Value	Unit
Photosensitivity (standard light A, $T=2856$ K))	S	1 (≥ 0.7)	μ A/lx
Maximum Photosensitivity Wavelength	λ_{Smax}	900	nm
Sensitivity Spectral Range ($S=10\%$ of S_{MAX})	λ	40 to 1120	nm
Radiant Sensitive Area	A	1.3	cm ²
Half Angle	ϕ	± 60	Deg.
Dark Current ($V_R=1$ V, $E=0$)	I_D	0.1 (≥ 2)	μ A
Spectral Photosensitivity ($\lambda=850$ nm)	S_λ	0.55	A/W electrons photon
Quantum Efficiency ($\lambda=850$ nm)	η	0.80	
Open Circuit Voltage ($E_V=1000$ lx, std. light A, $T=2856$ K) ($E_E=0.5$ mW/cm ² , $\lambda=850$ nm)	V_O $V_{O'}$	450 (≥ 270) 430	mV mV
Short Circuit Current ($E_V=1000$ lx, std. light A, $T=2856$ K)	I_{SC}	1 (≥ 7)	mA
Photocurrent Rise and Fall Time 10% to 90%, and 90% to 10% of Final Value ($R_L=1$ Ω , $V_R=1$ V, $\lambda=840$ nm, $I_p=50$ μ A)	t_R, t_F	18	μ s
Capacitance ($V_R=0$ V, $f=1$ MHz, $E_V=0$ lx)	C_0	11	nF
Temperature Coefficient V_O	TC_V	-2.6	mV/K
Temperature Coefficient I_{SC}	TC_I	0.12	%/K

Relative spectral sensitivity
 $S_{REL}=f(\lambda)$

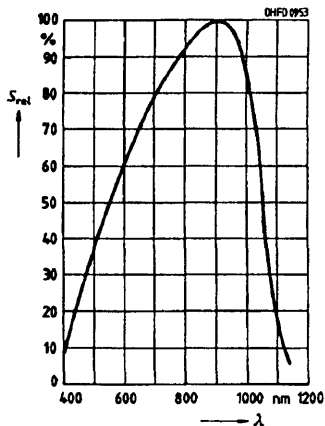

Open circuit voltage-TP60P $V_O=f(E_V)$
 Short circuit voltage $V_{SC}=f(E_V)$

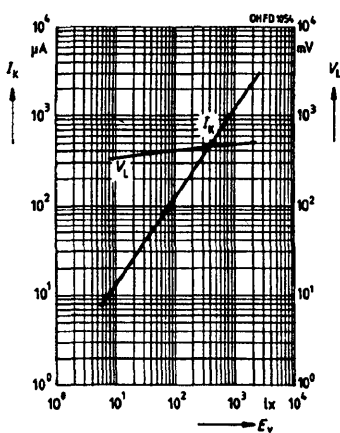

Open circuit voltage-TP61P $V_O=f(E_V)$
 Short circuit voltage $V_{SC}=f(E_V)$

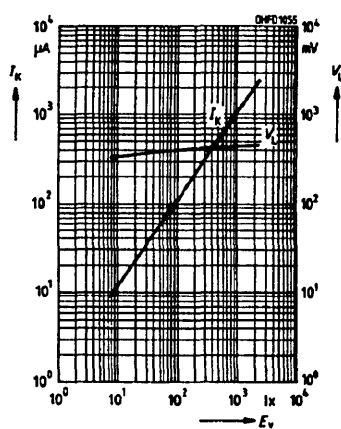

Directional characteristic
 $S_{REL}=f(\varphi)$

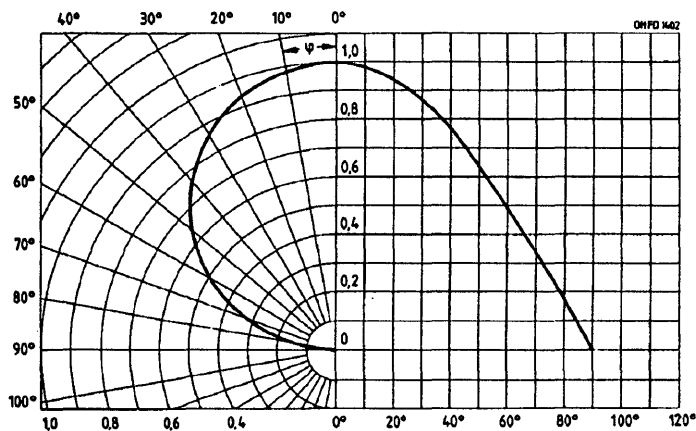

Capacitance
 $C=f(V_R)$, $f=1$ MHz, $E=0$

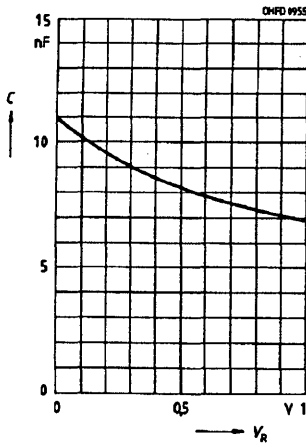

Dark current $I_R=f(V_R)$, $E=0$

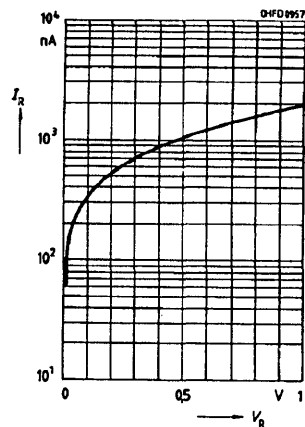

LIST OF APPLICATION NOTES

APPNOTE #	TITLE	PAGE
1	LEDs & Photometry	11-2
2	Applications of Optocouplers	11-6
3	Multiplexing LED Displays	11-10
4	Driving High-Level Loads with Optocouplers	11-14
5	More Speed from Optocouplers	11-18
6	Operating LEDs on AC Power	11-20
9B	Applying the DL 1416B Intelligent Display® Device	11-21
11	Mounting Considerations for LED Lamps and Displays	11-26
13	Displaying Message Systems without a Microprocessor	11-28
14	Applying the DL 2416T/DLX 2416 Intelligent Display® Device	11-30
15	Applying the DL 1414/DLX 1414 Intelligent Display® Device	11-36
16	Silicon Photovoltaic Cells, Silicon Photodiodes and Phototransistors	11-41
17	Applying the DL 3416/DLX 3416 Intelligent Display® Device	11-45
18	Guidelines for Handling and Using Intelligent Displays®	11-51
19	Cleaning LED Opto Products	11-53
20	Moving Messages Using Intelligent Display® Devices and 8748 Microprocessor	11-55
21	Silver Plated Tarnished Leads	11-57
22	Socket Selection Guide	11-58
23	LED Filter Selection Guide	11-59
24	Drivers for Light Emitting Displays	11-61
25	The DLX 713X, 5x7 Dot Matrix Intelligent Display® Device	11-65
26	SFH 900-A Low-Cost Miniature Reflex Optical Sensor	11-68
28	The DLO 4135/DLG 4137 5x7 Dot Matrix Intelligent Display®	11-75
29	Serial Intelligent Display	11-79
31	Blue-Light Emitting Silicon-Carbide Diodes—Materials, Technology, Characteristics	11-84
33	Light Activated Switches	11-87
34	Remote Control	11-95
35	Photographic Aperture, Exposure Controls, and Electronic Flash	11-102
36	General Photoelectric Application Circuits	11-104
37	General IR and Photodetector Information	11-107
38	Surface Mounting	11-121
39	Solderability of the Small Outline Coupler	11-130
40	Low-Cost, Plastic Fiber Optic Systems Using Siemens Light-Link Emitters and Detectors	11-135
41	Light-Link Components Control High-Frequency Switched-Mode Power Supplies	11-141
42	Motor Control with Electrical Isolation of Operator Module and Power Unit Using Light-Link Components	11-147
43	FREDFET Power Half-Bridge: Short-Circuit Proof through Light-Link Components	11-149
44	Designing with the Small AlphaNumeric Display	11-152
45	How to Use Optocoupler Normalized Curves	11-161
47	Sunlight Readability Contrast Measurements for the MSD2351 and MSD2353 Serial Input Small Alphanumeric Military Display	11-164
48	Optocouplers for Safe Electrical Isolation to VDE 0884	11-168
49	Interfacing the PD243X Alphanumeric Programmable Display™ with the SAB80515/SAB80535 Microcontroller	11-170
50	Designing Linear Amplifiers Using the IL300 Optocoupler	11-177
51	Applications of Surface Mount LEDs	11-194
52	Visible and IR LEDs in SMT-TOPLED™ Package	11-203

SIEMENS

LEDs & Photometry Appnote 1

by George Smith

The observed spectrum of electromagnetic radiations, extends from a few Hz, to beyond 10^{24} Hz, covering some 80 octaves. The narrow channel from 430 THz to 750 THz would be entirely negligible, except for the fact that more information is communicated to human beings, in this channel, than is obtained from the rest of the spectrum. This radiation has a wavelength ranging from 400nm to 700nm, and is detectable by the sensory mechanisms of the human eye. Radiation observable by the human eye is commonly called light.

Measurements of the physical properties of light and light sources, can be described in the same terms as any other form of electromagnetic energy. Such measurements are commonly called Radiometric Measurements.

Measurements of the psychophysical attributes of the electromagnetic radiation we call light, are made in terms of units, other than these radiometric units. Those attributes which relate to the luminosity (sometimes called visibility) of light and light sources, are called photometric quantities, and the measurement of these aspects is the subject of Photometry.

The electronics engineer who is starting to apply light emitting diodes and other opto-electronic devices to perform useful tasks, will find the subject of photometry to be a confused mass of strange units, confusing names for photometric quantities, and general disagreement as to what the important requirements are for his application.

The photometric quantities are related to the corresponding radiometric quantities by the C.I.E. Standard Luminosity Function (Fig. 1), which we may colloquially refer to as the standard eyeball. We can think of the luminosity function, as the transfer function of a filter which approximates the behavior of the average human eye under good lighting conditions.

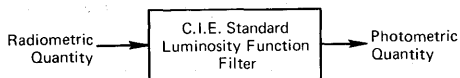

Figure 1. Relationship between radiometric units and photometric units.

The eye responds to the rate at which radiant energy falls on the retina, i.e., on the radiant flux density expressed as Watts/m². The corresponding photometric quantity is Lumens/m². The standard luminosity function is then, a plot of Lumens/Watt as a function of wavelength.

The function has a maximum value of 680 Lumens/Watt at 555nm and the ½ power points occur at 510nm and 610nm (Fig. 2).

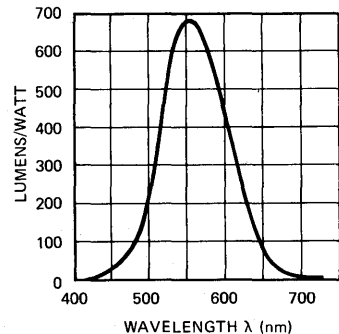

Figure 2. CIE standard photopic luminosity function.

The LUMEN is the unit of LUMINOUS FLUX and corresponds to the watt as the unit of radiant flux.

Thus the total luminous flux emitted by a light source in all directions is measured in lumens, and can be traced back to the power consumed by the source to obtain an efficiency number.

Since it is generally not practical to collect all the flux from a light source, and direct it in some desired direction, it is desirable to know how the flux is distributed spatially about the source. If we treat the source as a point (far field measurement), we can divide the space around the source into elements of solid angle, $(d\omega)$, and inquire as to the luminous flux (dF) contained in each element of solid angle $(\frac{dF}{d\omega})$. The resulting quantity is Lumens/Steradian and is called LUMINOUS INTENSITY (I), (Fig. 3). The unit of Luminous intensity is called the CANDELA, sometimes loosely called the candle, or candle power.

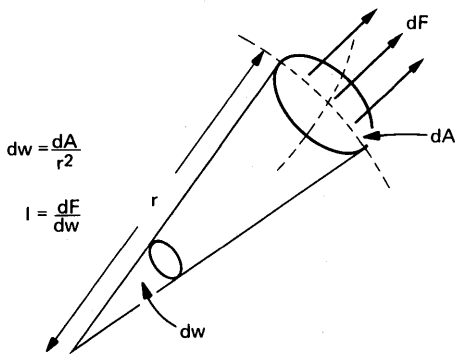

Figure 3. Solid angles and luminous intensity.

Since the space surrounding a point contains 4π steradians, it is apparent that an isotropic radiator of one candela intensity, emits a total luminous flux of 4π Lumens.

No real light source is isotropic, so it is quite common to show a plot of Luminous intensity versus angle off the axis (Fig. 4). If the source has no axis of symmetry, a more complex diagram is required.

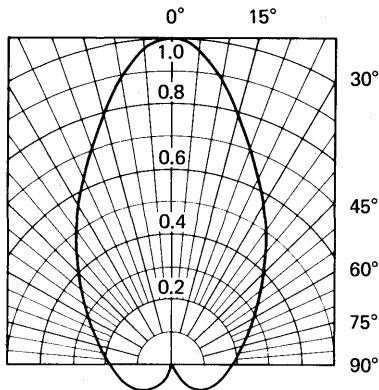

Figure 4. Spatial distribution pattern.

For an extended radiating surface, (such as an LED chip), each element of area contributes to the luminous intensity of the source, in any given direction. The luminous intensity contribution in the given direction, divided by the projected area of the surface element in that direction, is called the LUMINANCE (B) of the source (in that direction), (Fig. 5). The quantity is sometimes called photometric brightness, or simply brightness. The use of the term brightness on its own, should be discouraged, as this involves various subjective properties such as texture, color, sparkle, apparent size, etc. that have psychological implications.

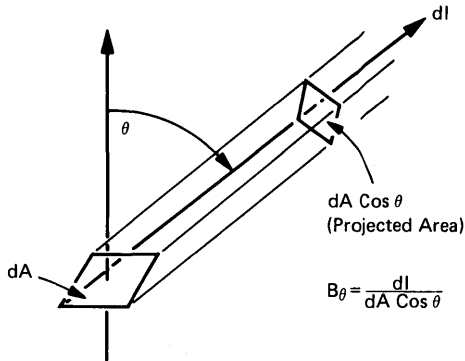

Figure 5. Definition of luminance.

The fundamental quantitative standard of the photometric system of units is the standard of luminance.

The luminance of a black body radiator at the temperature of freezing platinum (2043.8°K) is 60 candela per square centimeter. [A blackbody radiator is a perfect absorber of all electromagnetic energy incident on it. In thermal equilibrium at a given temperature, it emits radiation, spectrally distributed according to Plancks Formula

$$(W_\lambda = \frac{c_1 \lambda^{-5}}{\exp(\frac{c_2}{\lambda}) - 1})$$

The units of Luminance in present use are an engineering nightmare.

- 1 candela/cm² is called a *Stilb*
- 1/π candela/cm² is called a *Lambert*
- 1 candela/m² is called a *Nit*
- 1/π candela/m² is called an *Apostilb*
- 1/π candela/ft² is called a *foot-Lambert*

The foot Lambert is the most commonly used unit in this country.

Of particular interest is a source whose angular distribution pattern is a circle (Fig. 6). For such a source we have $I_\theta = I_0 \cos \theta$, the luminance of such a source in a given direction θ , is then given by

$$B_\theta = \frac{d I_\theta}{d A \cos \theta} = \frac{d I_0 \cos \theta}{d A \cos \theta} = \frac{d I_0}{d A}$$

The luminance is seen to be the same in all directions. Such a source is called a LAMBERTIAN SOURCE. It can be shown that a perfectly diffusing surface behaves in this fashion. The formula governing a diffusing surface $I_\theta = I_0 \cos \theta$ is called Lambert's Cosine Law.

It can be shown that a flat LED chip is a very good approximation to a Lambertian Source.

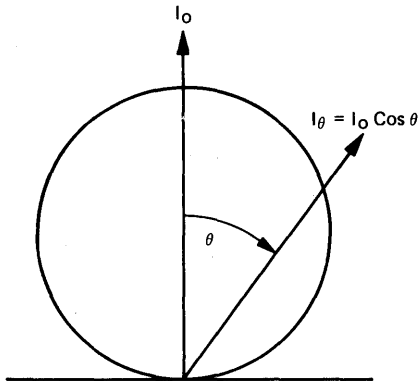

Figure 6. Lambertian radiation pattern.

If we now take a surface element (dA) and determine the intensity contribution in each direction we can determine the total flux (dF) emitted by the surface element. The resultant ratio ($\frac{dF}{dA}$) Lumens/ m^2 is called the LUMINOUS EMITTANCE (L). For a flat surface we may calculate L from

$$L = 2\pi \int_0^{\pi/2} B(\theta) S_{IN} \theta \cos \theta d\theta$$

The corresponding radiant emittance in watts/ m^2 is of considerable interest for GaAs infrared LED's where total output power is an important parameter.

The total luminous flux emitted by a light source can then be calculated from $F_{total} = \int LdA$.

These photometric quantities are sufficient to describe the properties of light sources such as light emitting diodes.

When light falls on a receiving surface, it is either partially reflected in the case of a purely passive surface, or partly converted into some other form of energy by what we may describe as an active surface (such as a phototransistor or photomultiplier cathode). In either case we are interested in how much flux falls on each element of the surface; Lumens/ m^2 in the case of a passive surface which we wish to illuminate, or the eye; and Watts/ m^2 in the case of other active surfaces. The quantity Lumens/ m^2 in this case is called the ILLUMINANCE sometimes loosely referred to as the illumination. The unit of illuminance is the LUX also referred to as the metercandle. Another commonly used unit of illuminance, in the U.S. is the FOOT CANDLE, equal to one lumen per square foot. One lumen per square cm is called a PHOT.

Many of these photometric quantities and units are in common use in the field of illumination engineering. While English units are the most common in this country, a mixed system of units is involved in common usage.

APPLICATION TO LIGHT EMITTING DIODES

The above description of photometric quantities should indicate that there are many ways in which the photometric properties of LEDs can be stated. There is no general agreement among LED makers and users, as to the best way to specify LED performance, and this has led to much confusion and misunderstanding.

Many factors must be taken into account when evaluating LED specifications for a particular application, and electronic engineers will need to develop a knowledge of these factors to put LEDs to effective use in new designs.

Presently available light emitting diodes are made from III-V, II-VI, and IV semiconductors, with Gallium Arsenide Phosphide and Gallium Phosphide being the major materials. Gallium Aluminum Arsenide is also used but is less common. Gallium Arsenide is commonly included in this group, but GaAs emits only infrared radiation around 900 nm, which is not visible to the eye, and is thus not properly called light. All specifications of non-visible emitters must be in radiometric units.

GaP emits green light between 520 and 570 nm peaking at 550 nm, very close to the peak eye sensitivity. It also can emit red light between 630 and 790 nm peaking at 690 nm.

$GaAs_{(1-x)}P_x$ emits light over a broad range from green to infrared depending on the percentage of phosphorus in the material (x). For x in the 0.4 region, red light between 640 and 700 nm peaking at 660 nm, is obtained. For $x = 0.5$, amber light peaking around 610 nm is obtained.

$Ga_{(1-x)}Al_xAs$ as presently available emits red light between 650 and 700 nm peaking at 670 nm. It also emits into the infrared.

The efficiency of these materials is very dependent on the emitted wavelength, with drastic fall off in efficiency as the wavelength gets shorter. Fortunately the standard eyeball filter favors the shorter wavelength (down to 555nm) and gives some measure of compensation. Some typical efficiencies reported by device makers, and the resulting overall luminous efficiency (Lumens/electrical watt) are as follows:

GaP.red	.72% @ 20Lum/Watt =
	.14 Lum/Watt overall
GaAs _{.6} P _{.4} red	.3% @ 50Lum/Watt =
	.15 Lum/Watt overall
GaAlAs red	1.5% @ 40Lum/Watt =
	.024 Lum/Watt overall
GaP green	.006% @ 675Lum/Watt =
	.04 Lum/Watt overall
GaAs _{.5} P _{.5} amber	.0044% @ 340Lum/Watt -
	.015 Lum/Watt overall

For simple status indicator applications, front panel lamps and similar applications, several factors must be taken into account:

- (1) Color. Generally the designer has Henry Ford's color choice; various similar shades of red. Amber and green are available in smaller quantity, because of availability of suitable raw material.
- (2) Apparent source size. Various combinations of chip size and optical systems are available so that apparent source sizes from about 5 mils to about 300 mils diameter are available as standard products. Other things being equal, a larger source size is more visible.
- (3) Angular distribution. GaAsP diode chips are nearly Lambertian, but GaP are nearly isotropic. With suitable optical design, the angular distribution pattern can be changed from very broad to quite narrow. By placing the chip at the focus of the lens system a narrow high intensity beam is obtained. The off axis visibility is drastically reduced. By using diffusing lens materials, a large area source with good off axis visibility is obtained. In this case the luminance is reduced.
- (4) Luminous intensity. This will govern the visibility under optimum background contrast conditions, when viewed at normal distances. 1 millicandela is typical for red lamps of either GaAsP or GaP at normal operating conditions.
- (5) Luminance. When it is not possible to provide a dark contrasting background, or when the source is viewed at very close distances, the luminance becomes important. Values from 100 ft-L to 5000 ft-L are typical.

These factors are all related to the design of the device and the user should understand the trade offs. High luminance values in excess of 10,000 ft-L are easily obtained by running very high current densities in the LED chip, but this can lead to shortened life if carried too far.

For a given drive current the luminous intensity of two different chips will be similar, while the luminance will be inversely proportional to the active area of the chip.

If the designer can use filter screens or circularly polarizing filters in front of the light source, excellent protection from background illumination can be

obtained. In this case a diffusive lens giving a large apparent source with lower luminance, is more visible than a high luminance point source.

When a LED is used with an optical system to activate a remote sensor such as a cadmium sulphide or cadmium selenide cell (red light), or a GaAs IR emitter is used with a silicon photo detector, the performance requirements are somewhat different. It can be shown that for a given optical arrangement the irradiance of the detector determines the detected signal and this is proportional to the radiance of the source, which is comparable to the luminance (brightness) of the source. The intensity of the source will not be a factor unless the detector active area is larger than the incident beam.

When average power consumption must be minimized but good visibility is required, or detection at a considerable distance is required, pulsed operation can be used. With GaAs and GaAsP emitters using low duty cycle short pulses, very high peak intensity levels can be reached permitting communication over considerable distances. This technique is not useful with GaP diodes since they do not exhibit a linear relationship between optical output and instantaneous forward current, becoming saturated at moderate current levels. GaP also has a 50% higher rate of fall off in light output with temperature increase, than GaAsP which further inhibits high power applications.

The use of LED's to give a "Heads Up" projected display, such as for an automobile speedometer read-out, or aircraft cockpit application, places severe requirements on the display luminance. For easy visibility, the projected image must be sufficiently contrasted with the ambient illumination. This requires very high luminance values for the LED's together with the use of photochromic windshields and probably polarizing screens.

The foregoing is a necessarily simplified description of a very complex subject. The reader should avail himself of the standard textbook literature on these subjects.

References:

- R. Kingslake, *Applied Optics & Optical Engineering*
Committee on Colorimetry of the O.S.A., *The Science of Color*.
Warren J. Smith, *Modern Optical Engineering*.

SIEMENS

Applications of Optocouplers

Appnote 2

by George Smith

The IL1 is the first in a family of optocouplers. These products are also called photon coupled isolators, photocouplers, photo-coupled pairs and optically coupled pairs. All of the characteristics of the IL1 are electrical: it has no external optical properties. Hence optoisolators are not OPTOELECTRONIC DEVICES; they are in fact one of the simplest of all ELECTRO-OPTICAL SYSTEMS.

The IL1 consists of a Gallium Arsenide infrared emitting diode, and a silicon phototransistor mounted together in a DIP package.

When forward current (I_F) is passed through the Gallium Arsenide diode, it emits infrared radiation peaking at about 900nm wavelength. This radiant energy is transmitted through an optical coupling medium and falls on the surface of the NPN phototransistor.

Phototransistors are designed to have large base areas; and hence a large base-collector junction area; and a small emitter area. Some fraction of the photons that strike the base area cause the formation of electron-hole pairs in the base region. This fraction is called the QUANTUM EFFICIENCY of the photodetector.

If we ground the base and emitter, and apply a positive voltage to the collector of the photo-transistor, the device operates as a photo diode.

The high field across the collector base junction quickly draws the electrons across into the collector region. The holes drift towards the base terminal attracting electrons from the terminal.

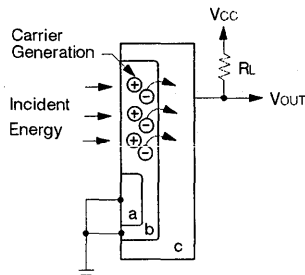

Thus a current flows from collector to base, causing a voltage drop across the load resistance (RL).

The high junction capacitance, C_{cb} , results in an output circuit time constant RLC_{cb} , with a corresponding output voltage rise time.

The output current in this configuration is quite small and hence this connection is not normally used.

The commonest circuit configuration is to leave the base connection open. With this connection, the holes generated in the base region cause the base potential to rise, forward biasing the base-emitter junction. Electrons are then injected into the base from the emitter, to try to neutralize the excess holes. Because of the close proximity of the collector junction, the probability of an electron recombining with a hole is small and most of the injected electrons are immediately swept into the collector region. As a result, the total collector current is much higher than the photogenerated current, and is in fact β times as great.

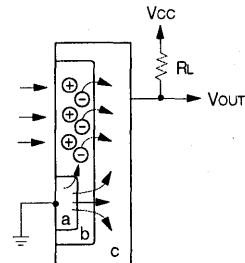

The total collector current is then several hundred times greater than for the previous connection.

This gain comes with a penalty of much slower operation. Any drop in collector voltage is coupled to the base via the collector-base capacitance tending to turn off the injected current. The only current available to charge this junction capacitance is the original photo-current. Thus, the rate of change of the output voltage is the same for both the diode and transistor connections. In the latter case, the voltage swing is β times as great, so the total rise time is β times as great as for the diode connection. Thus the effective output time constant is βRLC_{cb} .

For the IL1 this results in a typical 2 μ s rise time for 100 Ω load.

The ratio of the output current from the phototransistor (I_C or I_E), to the input current in the Gallium Arsenide diode, is called the Current Transfer Ratio (CTR). For the IL1, CTR is specified at 20% minimum with 35% being typical at $I_F = 10 \text{ mA}$. * Thus for 10 mA input current the minimum output current is 2 mA. Other important parameters are V_F typically 1.3V at 100 mA I_F .

DIGITAL INTERFACES

Output Sensing Circuits

The output of the phototransistor can directly drive the input of standard logic circuits such as the 7400 TTL families. The worst case input current for the 74 series gate is -1.6 mA for $V_{IN} = 0.4 \text{ Volts}$. This can be easily supplied by the IL1, with 10 mA input to the infrared diode.

TTL Active Level Low (7400)

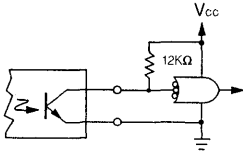

Note: Use smaller pull up resistor for higher speed.

It is more difficult to operate into TTL gates in the active level high configuration. Some possible methods are as follows:

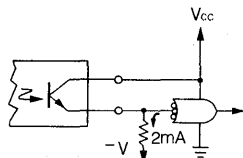

Note: Best method if negative supply is available.

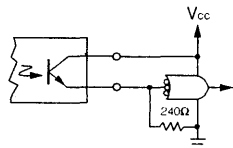

Note: Requires 10 mA from transistor and sacrifices noise margin.

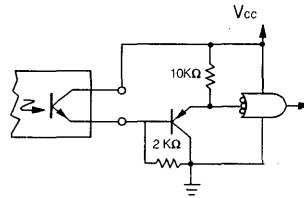

Note: High sensitivity but sacrifices noise margin. Needs extra parts.

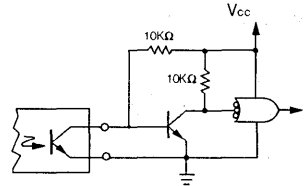

Note: Extra parts cost but high sensitivity.

Obviously, several optocoupler output transistors can be connected to perform logical functions.

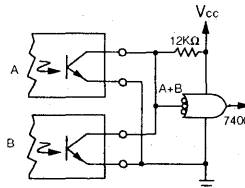

Note: Logical OR connection.

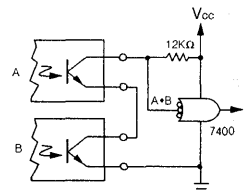

Note: Logical AND connection.

Input Driving Circuits

The input side of the IL1 has a diode characteristic as shown.

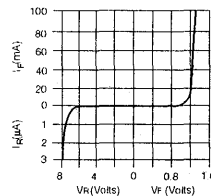

The forward current must be controlled to provide the desired operating condition.

The input can be conveniently driven by integrated circuit logic elements in a number of different ways.

TTL Active Level High (7400 Series)

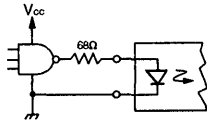

Note: Can omit resistor for about 15 mA into diode.

TTL Active Level Low (7400 Series)

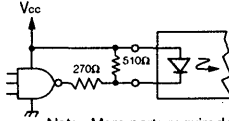

Note: More parts required than above.

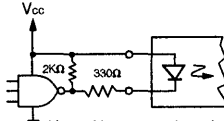

Note: Not as good as above circuit. Not recommended.

There are obviously many other ways to drive the device with logic signals, but the commonest needs can be met with the above circuits. All provide 10 mA into the LED giving 2 mA minimum out of the phototransistor. The 1 Volt diode knee and its high capacitance (typically 100 pF), provides good noise immunity. The rise time and propagation delay can be reduced by biasing the diode on to perhaps 1 mA forward current, but the noise performance will be worse.

All previous configurations show medium speed digital interfaces. These circuits have various advantages over other ways of doing the task.

- (1) They can replace relays and reed relays, giving much faster switching speeds, no contact bounce, better reliability, and usually better electrical isolation except for special configurations. However relays have high current capability, higher output voltage, lower on resistance and offset voltage and higher off resistance.
- (2) They can replace pulse transformers in many floating applications. Opto-isolators can transmit DC signal components and low frequency AC, whereas pulse transformers couple only the high frequency components, and a latch is required to restore the DC information. Pulse transformers have faster rise time than phototransistor optocouplers.

- (3) Integrated circuit line drivers and receivers are used to transmit digital information over long lines in the presence of common mode noise. The maximum common mode noise voltage permissible is usually in the 30 Volt range. There are many practical situations where common mode noise voltages of several hundred Volts can be induced in long lines. For these applications, optocouplers provide protection against several thousand Volts.

LINEAR APPLICATIONS

The curve of input current versus output current for the IL 1 is somewhat non-linear, because of the variation of β with current for the phototransistor, and the variation of infrared radiation out versus forward current in the GaAs diode. The useful range of input current is about 1 mA to 100mA, but higher currents may be used for short duty cycles.

For linear applications the LED must be forward biased to some suitable current (usually 5 mA to 20 mA). Modulating signals can then be impressed on this DC bias. A differential amplifier is a good way to accomplish this.

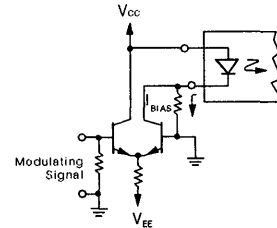

$$\left(1 + \frac{R_1}{V_{CC} - 2V_f} \cdot 0.26 \right)$$

Sensing in linear applications can be done in several ways depending on the requirements. For high frequency performance, the phototransistor should be operated into a low impedance input current amplifier. The simplest such scheme is a grounded base amplifier.

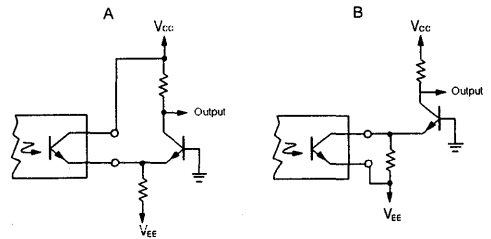

The circuit will work equally well either way, with a phase inversion between the two. Obviously a PNP transistor would work as well.

A feedback amplifier could also be used to get a low impedance input.

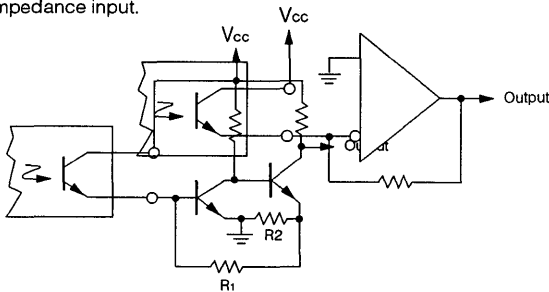

A high speed operational amplifier could be used to give excellent performance.

The current gain is $\left(1 + \frac{R_1}{R_2}\right)$

The input impedance is approximately

For example if $R_1 = 900\Omega$, $R_2 = 100\Omega$, $V_{CC} = 5V$; we would have a current gain of 10 and an input impedance of about 6.3Ω . This would give a considerable speed improvement over a 100Ω load.

Note that in all cases the output can be taken from either the collector, or the emitter of the phototransistor depending on the polarity desired. The operating speed is the same in either case.

CONCLUSION

This appnote covers the most commonly used ways of applying phototransistor optocouplers. The design engineer will see many ways to expand on these circuits to achieve his end goals. The devices are extremely versatile, and can provide better solutions to many systems problems than other competing components. Special designs are possible to optimize certain parameters such as coupling capacitance, or transfer ratio.

SUMMARY OF PROPERTIES OF SIGNAL COUPLING DEVICES

Device	Advantages	Disadvantages
Optocoupler	<ul style="list-style-type: none"> Economical Solid state reliability Medium to high speed signal transmission DC & low frequency transmission High voltage isolation High isolation impedance Small size DIP Package No contact bounce Low power operation 	<ul style="list-style-type: none"> Finite ON Resistance Finite OFF Resistance Limited ON state current Limited OFF state voltage Low transmission efficiency (Low CTR)
Relays	<ul style="list-style-type: none"> High power capability Low ON resistance DC transmission High voltage isolation 	<ul style="list-style-type: none"> High cost High power consumption Unreliable Very slow operation Physically large
Pulse Transformers	<ul style="list-style-type: none"> High speed signal transmission Moderate size Good transmission efficiency 	<ul style="list-style-type: none"> No DC or low frequency transmission Expensive for high isolation impedance or voltage
Differential line Drivers and Receivers	<ul style="list-style-type: none"> Solid state reliability Small size DIP package High speed transmission DC transmission Low cost 	<ul style="list-style-type: none"> Very low breakdown Voltage Low isolation impedance

SIEMENS

Multiplexing LED Displays Appnote 3

by George Smith

In digital displays, such as would be used in a D.V.M. or counter of conventional design, all digits are operated in parallel, with a separate decoder-driver for each digit operated from data generally stored in a quad latch.

In many cases, a reduction in cost can be effected by operating the display in a time division multiplexed mode. The question of cost effectiveness depends on the particular application. As a general rule, the greater the number of digits in the display, the more advantageous the multiplex system becomes from the cost standpoint. Because of the great variety of situations possible, it is difficult to say at what number of digits the change should be made. In some circumstances, non-multiplexed operation of less than 8 digits is more economical. On the other hand, there are circumstances under which multiplexing is used for three and four digit displays at a cost saving. This application note attempts to show some of the many ways of multiplexing digits, and it is left to the designer to decide whether his own system application would be lower in cost if he used a multiplex scheme.

The properties of light emitting diodes (LED) make

them particularly suitable for multiplexed operation, and hence it is the preferred method to use, if a scheme can be designed which is cost competitive with non-multiplexed operation.

Throughout this paper, it will be generally assumed that we are talking of a system using TTL type logic families, with MSI functions being used where applicable. In most production situations this will be the most economical approach. There will be some cases where discrete gates and flip-flops may yield a lower cost. There are also cases where a single MOS chip contains all the necessary logic functions, and only interface driver circuits are required.

The seven segment numeric displays with a common anode connection made by Siemens provide compatibility with the most widely available decoder-drivers, which are active level low outputs. The commonest device is SN7447 or similar. Any of these is suitable for driving the HD107XX, HD110XX, or HD1131XX Series type display. For common cathode displays, such as the Siemens DL330M, DL340M, DL430M, or DL440M, SN7448 decoder can be used, and anode drivers become cathode drivers.

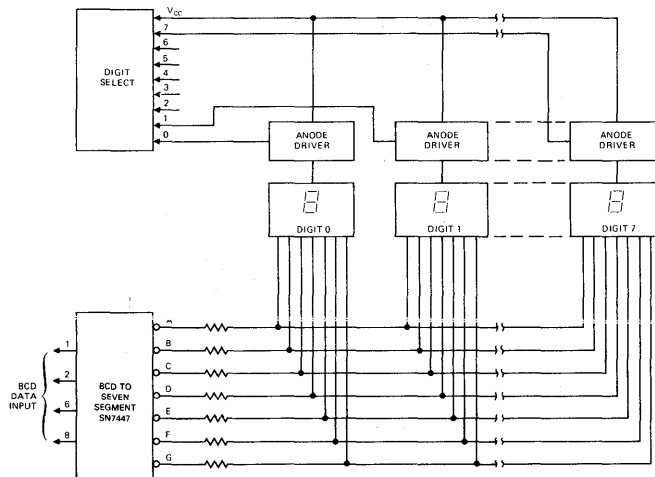

Figure 1

In a multiplex system, the corresponding cathodes of each digit are bussed together, and driven from one seven segment decoder-driver, via the usual current limiting resistors. The display data is presented serially by digit, to the decoder-driver, together with an enable signal to the appropriate digit anode Figure 1.

Each digit anode is driven by a switch, capable of passing the full current of all segments. The simplest switch would be a PNP high current switch or amplifier transistor, such as a core driver type.

In operation, the anode switches are activated one at a time, in the desired sequence, while the appropriate digital data is presented at the input to the decoder-driver. The amount of circuitry required in Figure 1

most of the packages are lower cost than the seven segment decoder. The scheme shown is a 20% cost reduction over non-multiplexed operation, based on O.E.M. prices for the components. For less than eight digits, it would be difficult to compete with non-multiplexed operation using this scheme.

CASE 2:

Multiplexing becomes more attractive, when the data is stored in a shift register, rather than in latches. In this case the data is circulated around the register, at some suitable rate, and is sequentially presented at the input of the seven-segment decoder-driver. The anode drive can be obtained from a counter and decoder as in Figure 2, or from a parallel output shift register – Figure 3.

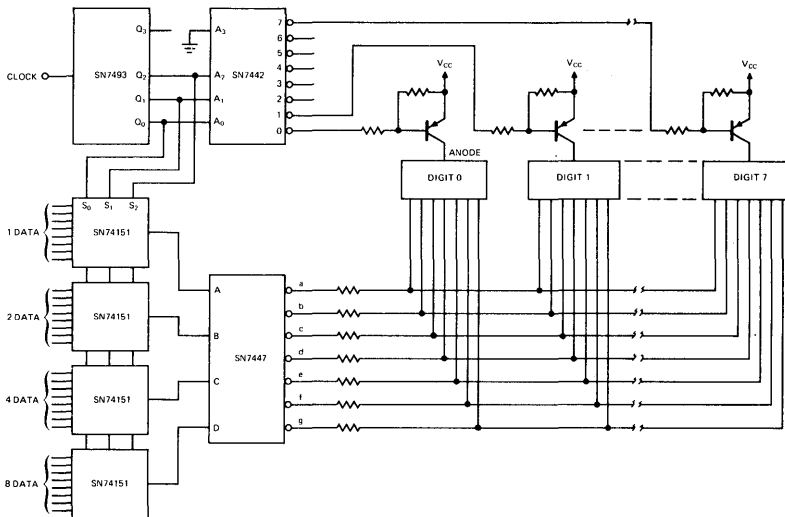

Figure 2

is much less than that used in the non-multiplexed scheme. The question of overall economy is dependent on the amount of circuitry required to sequence the anodes and present the data at the decoder input. Let us consider some typical situations.

CASE 1:

An 8-digit counter-timer display, with the data stored in multiple latch circuits. This is the most common situation present in a counter-timer of conventional design. A quad latch (SN7475) is used to store each digit, and this data is periodically updated. To scan this data, a 4 pole 8 position switch is required (SN74151). To select the appropriate digit, an octal counter (SN7493) and a BCD decoder (SN7442) are required. The complete circuit is as shown in Figure 2.

The total package count is about the same for this arrangement, as for non-multiplexed operation, but

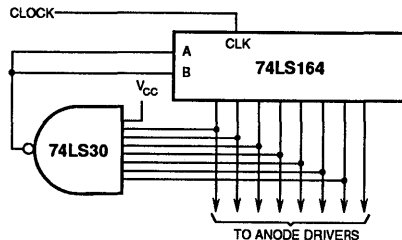

Figure 3

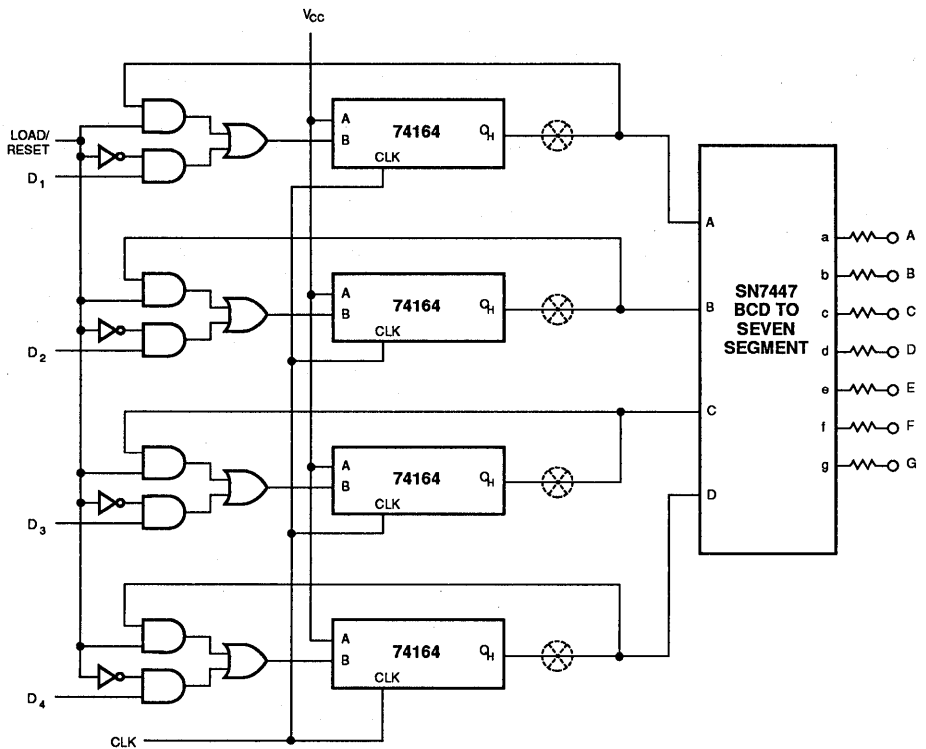

Figure 4

This circuit, which can be expanded to any number of digits, circulates a single zero, and thus can directly drive the PNP anode switches. Systems using recirculating memories generally require this digit timing circuitry for other reasons, so it is generally available in the system already.

For displays of 8 digits; a very common number in counter-timer instruments, the 74164 8 bit shift register makes a very good circulating shift register.

The scheme can be extended to more digits by adding a 4 bit shift register, such as the 7494; the extra shift bits are inserted at the points marked \otimes in Figure 4. The same circuit can be used for less than 8 digits, if a 12½% duty cycle is satisfactory.

The preceding schemes demonstrate that systems containing recirculating data are very effectively coupled to multiplexed LED displays. Many multi-digit systems such as calculating machines use L.S.I. MOS circuits to provide their logic, and these naturally lend themselves to recirculating data. It is now practical to use microprocessors in instruments, which lend

themselves nicely with Siemens Intelligent Display devices.

Apart from the strictly logical problems involved in a multiplexed display, the designer must choose suitable operating conditions for the LED's. Peak forward current, current pulse width, duty cycle and repetition rate, are all factors which the designer must determine.

The luminous intensity, or the luminance of GaAsP LED's, is essentially proportional to forward current over a wide range, but certain phenomena modify this condition. At low currents, the presence of non-radiative recombination processes, results in less light output than the linear relationship would predict. This effect is noticeable in the region below about 5 mA per segment (for 1/4 inch characters). The result is that noticeable difference in luminance from segment to segment can occur at low currents. At high currents, the power dissipation in the chip causes substantial temperature rise, and this reduces the efficiency of the chip. As a result the light output versus forward current curve falls below the straight

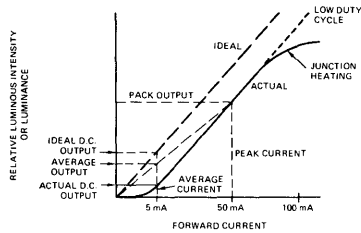

Figure 5

line, at high currents (Figure 5). It should be emphasized that this latter effect is entirely due to self heating. If the power dissipation is limited, by running short pulses at low duty cycle, the output follows the straight line up to very high current densities. Whereas 100 A/cm^2 may be used in DC operation, as much as 10^4 A/cm^2 can be used under pulsed conditions, with a proportionate increase in peak intensity. (If this did not occur, GaAsP lasers could not be built.) Gallium Phosphide, however, has an inherent saturation mechanism that causes a drastic reduction in efficiency at high current densities even if the junction temperature remains constant. This effect is due to competing non-radiative recombination mechanisms at high current density.

As a first approximation the brightness of a pulsed LED will be similar to that when operated at a DC forward current equal to the average pulsed current. For example, for 40 mA peak current at 25% duty cycle, the brightness will be similar to DC operation at 10 mA. The actual brightness comparison will depend on the actual pulsing conditions. Under most legitimate conditions the brightness will be greater for pulsed operation.

Figure 5 shows how the actual light output at 5 mA DC is substantially less than expected from the ideal curve, because of the "foot" on the curve at low currents. Operation at 50 mA peak current and 10% duty cycle yields a high peak output as shown, and an integrated average output that is much closer to the ideal value. It should be obvious that variations in the "foot" from segment to segment cause a significant

variation in light output at a low DC current, but a much smaller variation in the average output when operated in a pulsed mode. As well as an increase in luminance, or luminous intensity due to pulsing, there is an increase in brightness because of the behavior of the eye. The eye does not behave as an integrating photometer, but as a partially integrating and partially peak reading photometer. As a result, the eye perceives a brightness that is somewhere between the peak and the average brightness.

The net result is that a low duty cycle high intensity pulse of light looks brighter than a DC signal equal to the average of the pulsed signal. The practical benefit of multiplexed operation then, is an improvement in display visibility for a given average power consumption besides the lower cost. The brightness variation from segment to segment and digit to digit is also reduced by time-sharing. The gain in brightness over DC operation can be as much as a factor of 5 at low duty cycles of 1 or 2 percent, and peak currents of 50 to 100 mA.

A number of factors must be taken into account when deciding on the design of a multiplexed display. Besides the optical output, thermal considerations are very important.

Most 1/4" size LED numerics are rated at 30 mA DC max per segment. Under pulsed operation, higher currents can be used provided several thermal considerations are taken into account.

- (1) The average power dissipation must not exceed the maximum rated power.
- (2) The power pulse width must be short enough to prevent the junction from overheating during the pulse. This implies that the pulse width must get shorter as the amplitude increases.

Present experience indicates that for pulses of $10 \mu\text{s}$, the amplitude should be limited to 100 mA max. Shorter pulses of higher amplitude may be used but the circuit problems become severe if the pulse width is very short.

SIEMENS

Driving High-Level Loads With Optocouplers

Appnote 4

by David M. Barton

Frequently a load to be driven by an optocoupler requires more current, voltage, or both, than an optocoupler can provide at its output.

Available optocoupler output current, of course, is found by multiplying input (LED section) current by the "CTR" or current-transfer-ratio. For worst-case design, the minimum specified value would be used. The minimum CTR of the IL1 is 20%. Temperature derating is not usually necessary over the 0 to +60 degree Celcius range because the LED light output and transistor beta have approximately compensating coefficients.

Multiplying the minimum CTR by 0.9 would ensure a safe design over this temperature range. Over a wide range, more margin would be required.

The LED source current is limited by its rated power dissipation. Table I shows maximum allowable I_F vs maximum ambient temperature.

Values for Table I are based on a 1.33 mW/°C derate from the 100 mW at 25°C power rating.

Table I

MAXIMUM TEMPERATURE	I_F MAXIMUM
40°C	65 mA
60°C	48 mA
80°C	25 mA

Obviously, one can increase the available output current then by either choosing a higher CTR-rated optocoupler, by providing more current, or both. Table II shows the

Table II

P/N	I_{CE} (MIN) mA
IL1	8.6

minimum available output current of each device assuming 60 °C derating (from Table I) and a 10 percent margin for temperature effects.

If the IL1 is being operated from logic with 5 volt driving transistor and 0.2 volt V_{CE} saturation is assumed for the driving transistor, a 75 ohm R_{IF} resistor will provide the 48 mA. The forward voltage of the IR-emitting LED is about 1.2 volts. Figures 1A and 1B show two such drive circuits.

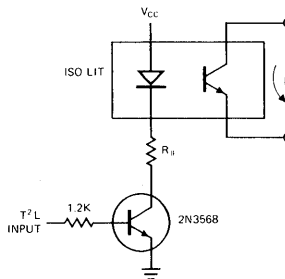

Figure 1A. NPN Driver

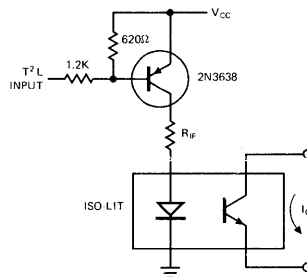

Figure 1B. PNP Driver

A "buffer-gate," such as the SN7440 provides a very good alternative to discrete transistor drivers. Figure 2 shows how this is done. Note that the gate is used in the "current-sinking" rather than the "current-sourcing" mode. In other words, conventional current flows *into* the buffer-gate to turn on the LED. This makes use of the fact that a T²L gate will sink more current than it will source. The SN7440 is specified to drive thirty 1.6 mA loads or 48 mA. Changing R_{IF} from 75 to 68 ohms adjusts for the higher saturation voltage of the monolithic device.

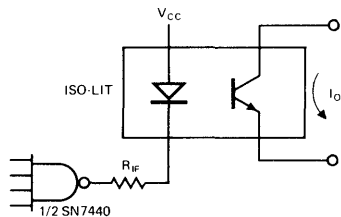

Figure 2. Buffer-Gate Drive

MORE CURRENT

For load currents greater than 8.6 mA, a current amplifier is required. Figures 3A and 3B show two simple one-transistor current amplifier circuits.

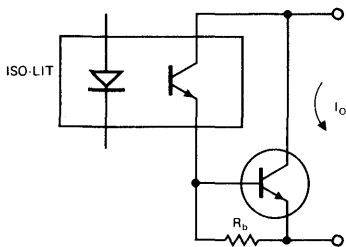

Figure 3A. NPN Current Booster

Since the transistor in the optocoupler is treated as a two-terminal device, no operational difference exists between the NPN and the PNP circuits. R_b provides a return path for I_{CBO} of the output transistor. Its value is: $R_b = 400 \text{ mV} / I_{CBO} (T)$ where I_{CBO}(T) is found for the highest *junction* temperature expected.

Assume that leakage currents double every ten degrees. Use the maximum dissipated power, the specified maximum junction-to-ambient thermal resistance,

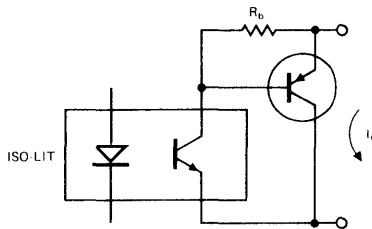

Figure 3B. PNP Current Booster

and the maximum design ambient temperature in conjunction with the specified maximum 25 degree I_{CBO} to calculate I_{CBO}(T).

As an example, suppose a 2N3568 is used to provide a 100 mA load current. Also assume a maximum steady-state transistor power dissipation of 100 mW and a 60°C maximum ambient. The transistor junction-to-ambient thermal resistance is 333°C/watt, so a maximum junction temperature of 60 + 33 or 93°C is expected. This is about 7 decades above 25°C. Therefore, $I_{CBO}(T) = I_{CBO}(\text{max}) \times 27 = 50 \text{ nA} \times 128 = 6.5 \mu\text{A}$. A safe value for R_b is 400 mV/6.5 μA = 62 kilohms.

Working backwards, maximum base current under load will be $I_B/h_{FE}(\text{min}) = 100 \text{ mA} / 100 = 1 \text{ mA}$. Current in R_b is $V_{BE}/R_b = 600 \text{ mV} / 60k = 10 \mu\text{A}$, which is negligible. An IL1 with 9 mA drive would operate effectively.

If the load requires more current than can be obtained with the highest beta transistor available, then more than one transistor must be used in cascade. For example, suppose 3 amperes load current and 10 watt dissipation are needed. A Motorola MJE3055 might be used for the output transistor, driven by a MJE205 as shown in Figure 4. Using a 5°/watt heat sink and the rated MJE3055 junction-to-case thermal resistance of 1.4°/watt, we find that junction temperature rise is 6.4×10 , or 64°. Therefore maximum junction temperature is 124°C. This is 10 decades above 25°C making $I_{CBO}(T) = 2^{10} I_{CBO}(\text{max}) = 10^3 I_{CBO}(\text{max})$.

I_{CBO}(max) at 30 volts or less is not given, but I_{CEO} is. Using (for safety) a value of 20 for the minimum low-current h_{FE} of the device, I_{CBO} could be as large as

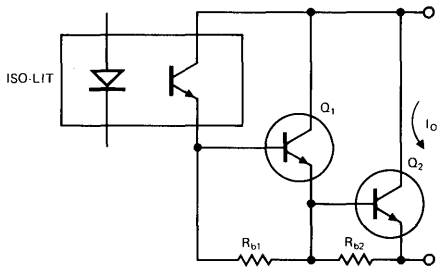

Figure 4. Two-NPN Current Booster

$I_{CEO}/20 = 35 \mu A$. Then $I_{CBO}(T)$ is 35 mA and $R_{b2} = 400 \text{ mV}/35 \text{ mA} = 11 \text{ ohms}$. For I_b use $I_o/h_{FE}(\text{min @ } 4A) = 3A/20 = 150 \text{ mA}$. $I_{Rb2} = 600 \text{ mV}/10 \text{ ohms} = 60 \text{ mA}$, so $I_{e(Q1)} = 210 \text{ mA}$.

Maximum Power in Q_1 will be about 1/14 the power in Q_2 since its current is lower by that ratio and the two collector-to-emitter voltages are nearly the same. This means Q_1 must dissipate 700 mW.

Assuming a small "flag" heat sink having 50°/watt thermal resistance, we find the junction at about 95°C. The 150°C case temperature I_{CBO} rating for this device is 2 mA, so one can work backwards and assume about 1/30 of this value, or 70 μA . On the other hand, the 25° rated I_{CBO} is 100 μA . Choosing the larger of these contradictory specifications, $R_{b1} = 400 \text{ mV}/0.1 \text{ mA} = 4k \approx 3.9k$. Q_1 base current is $I_{E(Q1)}/h_{FE(Q1-\text{min})} = 210 \text{ mA}/50^* = 4.2 \text{ mA}$. Total current is $I_{b(Q1)} + I_{Rb1} = 4.2 + 0.24 = 4.5 \text{ mA}$. Table II shows that an IL1 could be used here.

MORE LOAD VOLTAGES

All of the current-gain circuits shown so far have one common feature: load voltage is limited by the 30 volt rating of the IL1 not by the voltage or power rating of the transistor(s). Figure 5A shows a method of overcoming this limitation. This circuit will stand off BV_{CEO} of Q_1 . The voltage rating of the phototransistor is irrelevant since its maximum collector-emitter voltage is the base-emitter voltage of Q_1 (about 0.7 volts).

Unlike the "Darlington" configurations shown previously, this circuit operates "normally-ON." When no current flows in the LED the phototransistor, being

OFF, allows R_2 current to flow into the base of Q_1 , turning Q_1 ON. When the optocoupler is energized, its phototransistor "shorts out" the R_2 current turning Q_1 OFF.

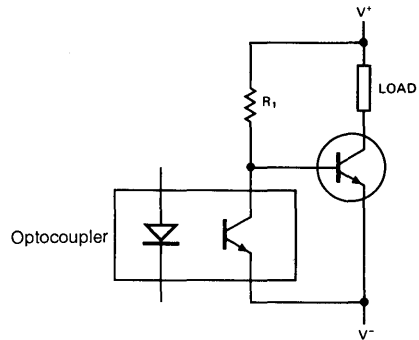

Figure 5A. NPN HV Booster

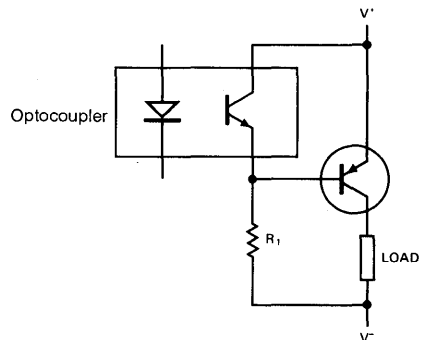

Figure 5B. PNP HV Booster

The value of R_1 depends only on the load-supply voltage $V^+ - V^-$, and the *maximum* required Q_1 base current. This is derived from the minimum beta of Q_1 at minimum temperature and the load current. The required current-drive capability is the same as I_{R1} , since I_{R1} changes negligibly when the circuit goes between its "ON" and "OFF" states.

In some applications either more current gain will be required than one transistor can provide or the power dissipated in R_1 will be objectionable. In these cases, simply use the Darlington high-voltage booster shown in Figure 6A.

*Minimum h_{FE} is obtained using the specification at $I_{CE} = 2A$ and the "Normalized DC Current Gain" graph given in the Motorola "Semiconductor Data Book," 5th Edition, pp. 7 - 232, 3.

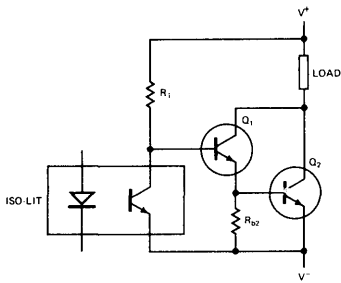

Figure 6A. NPN Darlington HV Booster

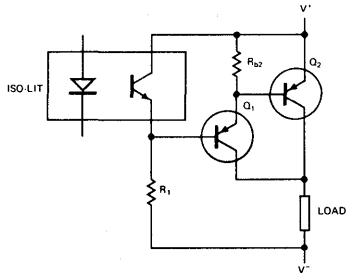

Figure 6B. PNP Darlington HV Booster

If more than one load is being driven and their negative terminals must be in common, use the PNP circuit, Figure 6B. Otherwise, the NPN is better because

the transistors cost less. Of course performance characteristics of the NPN and PNP versions are identical if the device parameters are also the same.

APPLICATIONS

Optocoupler isolated circuits are useful wherever ground loop problems exist in systems, or where dc voltage level translations are needed. In many systems so-called interpose relays are used between a logic circuit section (which may be a mini-computer) and the devices being controlled. Sometimes *two levels* of interpose relays are used in cascade either because of the load power level or because of extreme difficulties with EMI. Optocouplers aided by booster circuits such as those described, can replace many of the relays in these systems.

The reed relays, typically used as the first level of interpose and mounted on the interface logic cards in the electronic part of the system, are almost always replaceable by optocouplers since their load is just the coil of a larger relay. This relay may have a coil power of 1/2 to 5 watts and operate on 12, 24 or 48 volts dc.

Assuming worst-case design techniques are carefully followed, system reliability should improve in proportion to the number of relays replaced.

SIEMENS

More Speed from Optocouplers Appnote 5

by David M. Barton

Figure 1 shows a typical circuit employing an optocoupler to transmit logic signals between electrically isolated parts of a system. In the circuit shown, the optocoupler must "sink" the current from one T²L load plus a pull-up resistor to V_{CC}. The resistor in series with the LED half of the optocoupler must supply the worst-case load current divided by the "current transfer ratio" or CTR of the optocoupler. If an IL1 is used, having a min CTR of 0.2, and 30 percent variation in the load is allowed, 8.1 mA is required. This is supplied by the 430Ω resistor.

The maximum repetition rate at which this circuit will operate is only about 3 kHz. The severe speed limitation is due entirely to the characteristics of the photo-transistor half of the optocoupler. This device has a large base-collector junction area and a very thick base region in order to make it sensitive to light. C_{ob} is typically 25 pF. This capacitance is, in the circuit of Figure 1, effectively multiplied by a large factor due to the "Miller effect." Also, because the base region volume is large, so is base storage time.

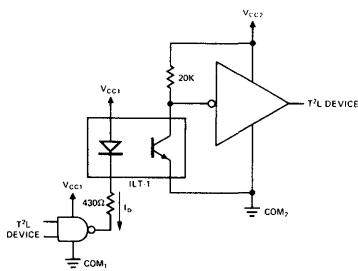

Figure 1

A very simple method of reducing both of these effects is to add a resistor between the base and emitter as shown in Figure 2. This resistor helps by reducing the time constant due to C_{ob} and by removing stored charge from the base region faster than recombination can. When a base-emitter resistor is used, of course, the required LED drive is increased since much of the photo-current generated in the base-collector junction is now deliberately "dumped."

Using this method does not usually result in a large power supply current drain since *average* repetition rate is low in most applications.

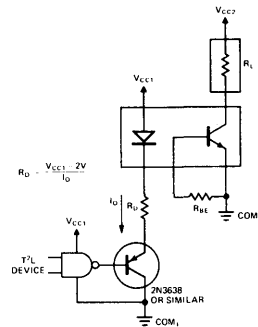

Figure 2

As drive is increased and R_{BE} reduced, turn-on time and turn-off time both decrease. The total amount of charge stored can also be reduced by decreasing the LED drive pulse duration. Also, as higher drive levels are used, the load resistance, R_L can be reduced to further enhance the speed of the circuit. These parameters are related to each other such that all should be changed together for best results.

One important generalization can be made concerning their interdependence. The LED drive pulse duration, T_{in}, output fall time, t_f, output rise time, t_r, and propagation delay, t_p, should occur in a 1.5:1:1:1 ratio, approximately. If this relationship does not occur, the circuit will not operate at as high a repetition rate as it could at the same drive level. T_{out} equals T_{in} at low currents but stretches out at high currents.

Figure 3 is a graph relating the important parameters for a typical IL1 whose CTR is 0.25. The optimum values of T_{in}, R_{BE}, and R_L are shown versus LED pulse current as are the resultant output pulse width and maximum full-swing frequency. Rise, fall and propagation time can be read as 2/3 of T_{in}.

Figure 3 shows that increasing drive to 200 mA and using optimum R_{BE} and R_L will increase the maximum repetition rate from 3 kHz to 500 kHz, a 167:1 improvement.

Lower grade optocouplers will behave similarly if the LED drive level is scaled appropriately to allow for a lower CTR.

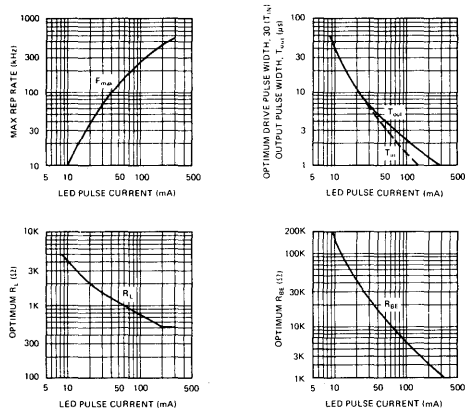

Figure 3. Parameters vs LED Pulse Current

Another method of increasing speed is to operate the photo-transistor as a photo-diode. In this method, bias voltage is supplied between the collector and base terminal, the emitter being unused. Operation to at least 10 MHz is possible this way, but the price is the need for external amplification. Figure 4 is a graph

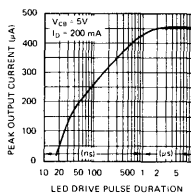

Figure 4. Diode Mode Output Current vs Drive Pulse Duration

showing peak output current versus drive pulse duration for 200 mA peak drive current.

Since output current is small, some type of wide-bandwidth amplifier must be employed in order to drive T²L loads.

One simple solution for intermediate speed operation is the use of MOS inverter (1/2 74HC04). (Figure 5)

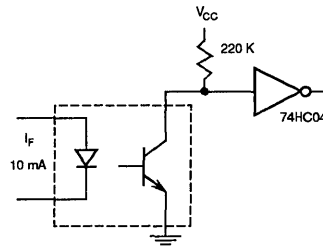

Figure 5

Another device which will provide a good interface is an integrated comparator amplifier. The photo-transistor collector goes to V_{CC}. Its base has a 200Ω load resistor to ground and goes to one input of the comparator. Also, a resistor goes from this node to the minus supply. This resistor is chosen to supply 50 μA. The other comparator input is grounded. The voltage at the comparator input will switch from -10 mV to +10 mV or more when the diode turns on and the output will drive the T²L loads.

Of course discrete-component amplifiers could be used and may be best in some applications.

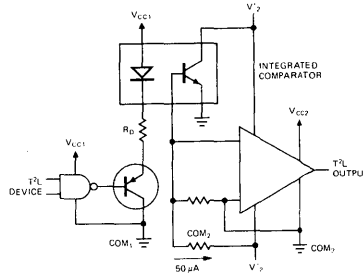

Figure 6

CONCLUSIONS

For operation to 500 kHz, the addition of a base-emitter resistor and a high-current driver is probably the best method of increasing optocoupler speed. Above 500 kHz one must revert to photodiode mode and use an external amplifier to drive most loads, particularly T²L.

Operating LEDs on AC Power Appnote 6

by David M. Barton

Introduction

Frequently it is desirable to operate LEDs on AC rather than DC. Typically, the power source is 120 VRMS 60 Hz. The most obvious method is to rectify this power with a series diode and use a resistor to limit LED current as shown in Figure 1.

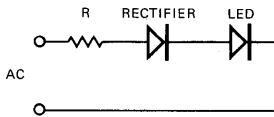

FIGURE 1. The Power Resistor Method

This method, though sound, results in very high power dissipation in the resistor since the LED operates on only 1.6 volts.

The Method

Figure 2 shows a better method. Here a capacitor is used to control LED current and a shunt silicon diode provides rectification.

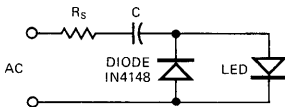

FIGURE 2.

Since, for current in either direction, voltage drop across the LED or rectifier is a negligible part of the supply voltage, current in the capacitor is almost exactly equal to the AC supply voltage divided by the reactance of the capacitor. Average capacitor current is then

$$1. I_C (AV) = .9 \times VRMS / X_C$$

and average half-cycle LED or rectifier current is

$$2. I_{LED} (AV) = 1/2 I_D (AV) = .45 VRMS / X_C$$

or, for 120 VRMS, 60 Hz operation,

$$3. I_{LED} (AV) = 20 \text{ mA} \times C_{\mu F}$$

$$\text{or } C_{\mu F} = \frac{I_{LED} (AV)}{20 \text{ mA}}$$

Figure 3 shows the value of the series capacitor needed for a range of average LED currents assuming 60 Hz, 120 volt power.

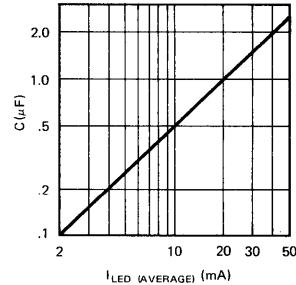

FIGURE 3. Series Capacitor Value vs Average LED Current for 120 VRMS 60 Hz.

A resistor is necessary in series with the capacitor to limit turn-on transient currents. A value of 100 ohms will be adequate in most cases.

The current in the LED, of course, flows almost exactly in quadrature with the line voltage. For this reason, power dissipation is low, being limited to the expected LED and rectifier power loss, the loss in series resistor and to losses in the capacitor. The latter term will be extremely low if high quality capacitors are used. Although power consumption of a circuit may not be of much significance in terms of the cost of the power, it certainly can be important to reduce heat generation within an enclosure.

If more than one LED is to be operated from the same source, simply put the LEDs in series in the same circuit, as shown in Figure 4. For small numbers of LEDs the current will be, for practical purposes, the same as for one.

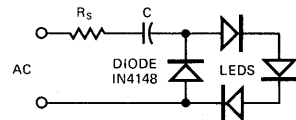

FIGURE 4.

Conclusion

Cost of the series capacitor (mylar) will be similar to the cost of a series power resistor. The shunt diode, a IN4148 or similar, will cost about two cents; much less than a series rectifier which must have a several hundred volt PIV rating.

So, the capacitor method is both lower in cost and lower in heat generation and power consumption than the resistor method.

Applying the DL 1416B Intelligent Display[®] device Appnote 9B

by Dave Takagishi

This application note is intended to serve as design and application guide for users of the DL 1416B Intelligent Display. The information presented covers: device electrical description and operation, considerations for general circuit designs, multi-digit display systems and interfacing to the 6800, Z80, and 8080 microprocessors.

The DL 1416B was designed to provide an easy-to-use alphanumeric display for the 64 character ASCII systems. Only twelve interconnect pins plus power and ground are needed to drive a single four digit display. The overall package is designed to allow end stacking of the DL 1416B to form any desired character length display.

Electrical Description

The on-board electronics of the DL 1416B eliminates all the traditional difficulties of using displays – segment decoding, driving, and multiplexing. The DL 1416B has gone further and provided internal memory for the four digits. This approach allows the user to address one of four digits, load the desired data asynchronously to the multiplex rate and continue.

Figure 1 is a block diagram of the circuitry in the DL 1416B. The unit consists of a display and a single integrated circuit chip. The display is four 16-segment alphanumeric monolithic LED die magnified to a height of 160 mils. The

Figure 1. Block Diagram

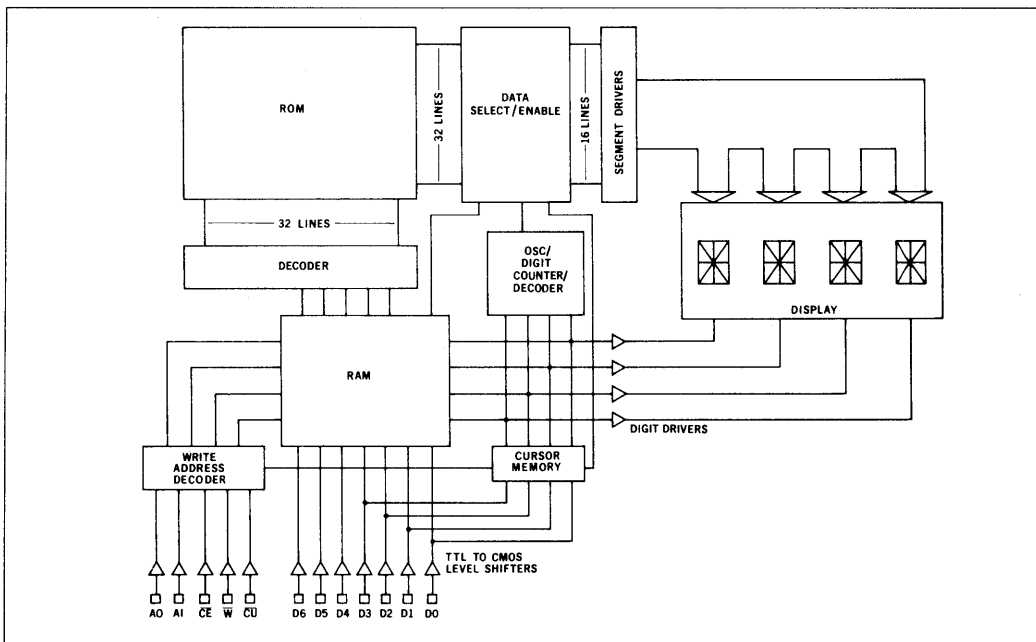

IC chip contains the 16 segment drivers, 4 digit drivers, 64-character ROM, four-word 7-bit RAM, internal oscillator for multiplexing, multiplex counter/decoder, cursor RAM, write address decoder, and level shifters for the inputs.

The inputs to the DL 1416B are:

- \overline{CE} CHIP ENABLE (active low)
This determines which device in an array will actually execute the loading of data. When the chip enable is in the high state, all inputs are inhibited.
- A_0, A_1 DIGIT ADDRESS
The address to the DL 1416B determines the digit in which the data will be written. Address order is right-to-left for positive-true address.
- D_0-D_6 DATA LINES
The seven data input lines are designed to accept the 64 ASCII code set. See Table 1 for character set.
- \overline{W} WRITE (active low)
Data to be written into the DL 1416B must be present before the leading edge of write. The data and address must be stable until after the trailing edge.
- \overline{CU} CURSOR (active low)
When the \overline{CU} is held low, the DL 1416B enables the user to write or remove a cursor in any digit position. The cursor function lights all 16 segments in the selected digits without erasing the data. After the cursor is removed, the digit will again display the previously written character.
- $V+$ POSITIVE SUPPLY
TTL compatible +5 volts
- $V-$ NEGATIVE SUPPLY
Ground

Table 1. Character Set

		D0	L	H	L	H	L	H	L	H			
D3		L	L	H	H	L	L	H	H	L			
D2		L	L	L	L	L	L	L	L	L			
D6 D5 D4 D3		L	H	L	H	L	H	L	H	L			
L	H	L	L			!	"	#	\$	%	&	'	
L	H	L	H			<	>	*	+	/	--	.	/
L	H	H	L			0	1	2	3	4	5	6	7
L	H	H	H			8	9	:	/	<	=	>	?
H	L	L	L			a	A	B	C	D	E	F	G
H	L	L	H			H	I	J	K	L	M	N	O
H	L	H	L			P	Q	R	S	T	U	V	W
H	L	H	H			X	Y	Z	[\]	^	_

Note:
1. All undefined codes will display a blank.

Operation

Loading data into the DL 1416B is similar to writing into a RAM. The data and address must be present before the leading edge of the write signal (\overline{W}) and must be present until after the trailing edge. The waveforms of Figure 2 demonstrate the relationship of the signals required to generate a write cycle utilizing chip enable (\overline{CE}) and write (\overline{W}) (Check data sheet for minimum values).

As can be seen from the waveforms, \overline{CE} and \overline{W} are interchangeable. The true internal "write" function is formed by the "and-of-the-nots".

Figure 2. Address Table

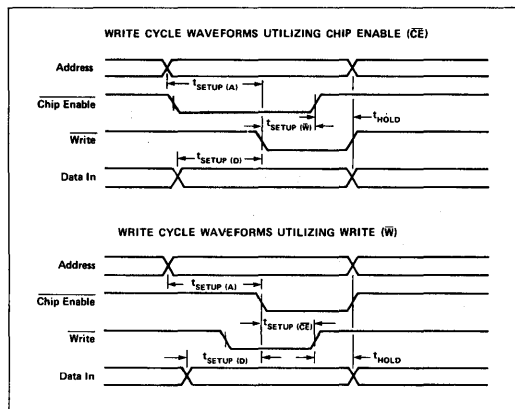

Multiplexed display systems sequentially read and display data from a memory device. In *synchronous* systems, control circuitry must compare the location of data to be read and displayed to the location of new data to be stored, i.e. synchronize, before a write can be done. This can be slow if there are many memory locations. It can also be cumbersome.

Data entry of the DL 1416B is *asynchronous* and data may be stored in random order. Each digit will continue to display the character last "written" until replaced by another.

The cursor function causes all 16 segments of a digit to light. The cursor can indicate the position in the display of the next character to be entered. The cursor *is not* a character but overrides display of the stored character. Upon removal of the cursor, the display will again show the character stored in memory.

The cursor can be written into any digit position by setting the digit position address (A_1, A_0), enabling chip enable (\overline{CE}), cursor select (\overline{CU}), write (\overline{WR}) data (D_0). A high on data line D_0 will place a cursor into position set by the address A_0, A_1 . Conversely, a low on D_0 will remove the cursor.

The cursor will remain displayed after the cursor (\overline{CU}) and write (\overline{W}) signals have been removed. The waveforms in Figure 3 show a cursor being placed in Digit 0.

Figure 3. Cursor Write Cycle

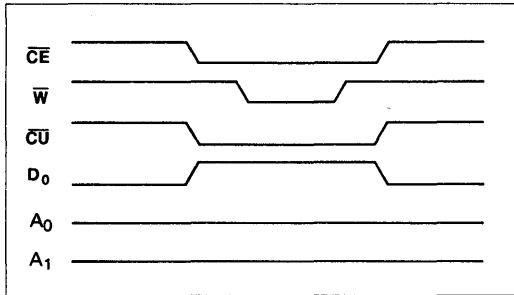

Hardwiring the cursor (\overline{CU}) line high is not recommended. This internal cursor memory will be randomly loaded on power-up and all positions must be cleared before a cursor-free display is ensured.

General Circuit Design Considerations

Using positive-true address logic, address order is from right to left. For left to right address order, use the "ones-complement" or simple inversion of the addresses.

For systems with only a 6 bit ASCII code format, data line D_6 cannot be left open. Data D_6 must be the complement of data line D_5 . If an illegal code is loaded into the DL 1416B, it will display a blank in the digit accessed.

A "display test" function can be realized by simply storing a cursor in all digits.

Because of the random state of the cursor RAM after power up, it is necessary to clear it initially to assure that all the cursors are off.

When using DL 1416Bs on a separate display board having more than 6 inches of cable length, it may be necessary to buffer all DL 1416B inputs. This is most easily achieved with hex-non-inverting buffers such as 74365 ICs. The object is to prevent transient current in the DL 1416B protection diodes. The buffers should be located on the display board near the DL 1416Bs. Local power supply bypass capacitors are also needed in many cases. These should be 6 or 10 volt tantalum type having 10 μ F or greater capacitance. Low internal resistance is important to eliminate voltage transients due to the current steps which result from the internal multiplexing of the DL 1416B.

If small wire cables are used, it is good engineering practice to calculate the wire resistance of the ground plus the +5 volt wires. More than 0.1 volt drop (at 25 mA per digit worst case) should be avoided, since this loss is in addition to any inaccuracies or load regulation limitations of the power supply.

General Interface

The most general and straight-forward interface approach would be to use the parallel I/O device of a micro-processor. This interface scheme can be completely software dependent. One eight bit output port can handle the seven input data bits and the cursor. Another eight bit output port can contain the address and chip enable information with one bit reserved for the write signal.

An 8080 system shown in Figure 4 illustrates a 16 character display using a 8255 programmable peripheral interface I/O device with a 7442 one-of-ten decoder added for ease of programming. The following program will display a simple 16 character message using the parallel I/O interface.

```

INIT:      MVI A, 80H      ;CONTROL DATA MODE 0
           OUT CONTROL    ;LOAD CONTROL REGISTER
CUSR:      MVI A, 00H     ;CLEAR CURSOR DATA
           OUT PORTA      ;LOAD DATA PORT
           MVI B, 0FH     ;SET COUNTER

CUSR1:     MOV A, B
           CALL DSPWT     ;WRITE SUBROUTINE
           DCR B          ;DECREMENT COUNTER
           JNZ CUSR1     ;16 CHARACTERS
           ;SET TABLE

DISP:      LXI H, TABLE ;SET TABLE
DISP1:     MOV A, M
           OUT PORTA      ;LOAD DATA OUTPUT
           MOV A, B
           CALL DSPWT     ;LOAD ADDRESS & WRITE
           INX H          ;INCREMENT TABLE ADDRESS
           INR B          ;INCREMENT COUNTER
           MVI A, 10H     ;SET # OF DIGITS
           CMP B
           JNZ DISP1     ;16 CHARACTERS
           HLT           ;END OF PROGRAM

DSPWT:     ORI 80H        ;SET WRITE BIT OFF
           OUT PORTB      ;LOAD ADDRESS
           ANI 7FH        ;SET WRITE BIT ON
           OUT PORTB      ;LOAD WRITE
           ORI 80H        ;SET WRITE BIT OFF
           OUT PORTB      ;LOAD WRITE
           RET

TABLE:     DB             OC3H
           DB             OC9H
           DB             OD4H
           DB             OD3H
           DB             OC1H
           DB             OD4H
           DB             OCEH
           DB             OC1H
           DB             OC6H
           DB             OA0H
           DB             OD3H
           DB             OD4H
           DB             OC8H
           DB             OC7H
           DB             OC9H
           DB             OCCH
  
```

I/O or Memory Mapped Addressing

Some designers may wish to avoid the additional cost of a parallel I/O in their system. Structuring the addressing architecture for the DL 1416B to look like a set of peripheral or output devices (I/O mapped) or RAMs and ROMs (memory mapped), is very easy. Figure 5 shows the simplicity of interfacing to microprocessors, such as 8080, Z80 and 6502 as examples.

The interface with the 6800 microprocessor in Figure 6 illustrates the need for designers to check the timing requirements of the DL 1416B and the μP . The typical data output hold time is only 30 ns for DBE = 0 timing; two inverters in the DBE line are added to increase the data output hold time for compatibility with the 50 nS minimum spec of the DL 1416B.

Conclusion

Note that although other manufacturer's products are used in examples, this application note does not imply specific endorsement, or recommendation or warranty of other manufacturer's products by Siemens.

The interface schemes shown demonstrate the simplicity of using the DL 1416B with microprocessors. The slight differences encountered with various microprocessors to interface with the DL 1416B are similar to those encountered when using different RAMs. The techniques used in the examples were shown for their generality. The user will undoubtedly invent other schemes to optimize his particular system to its requirements.

Figure 4.

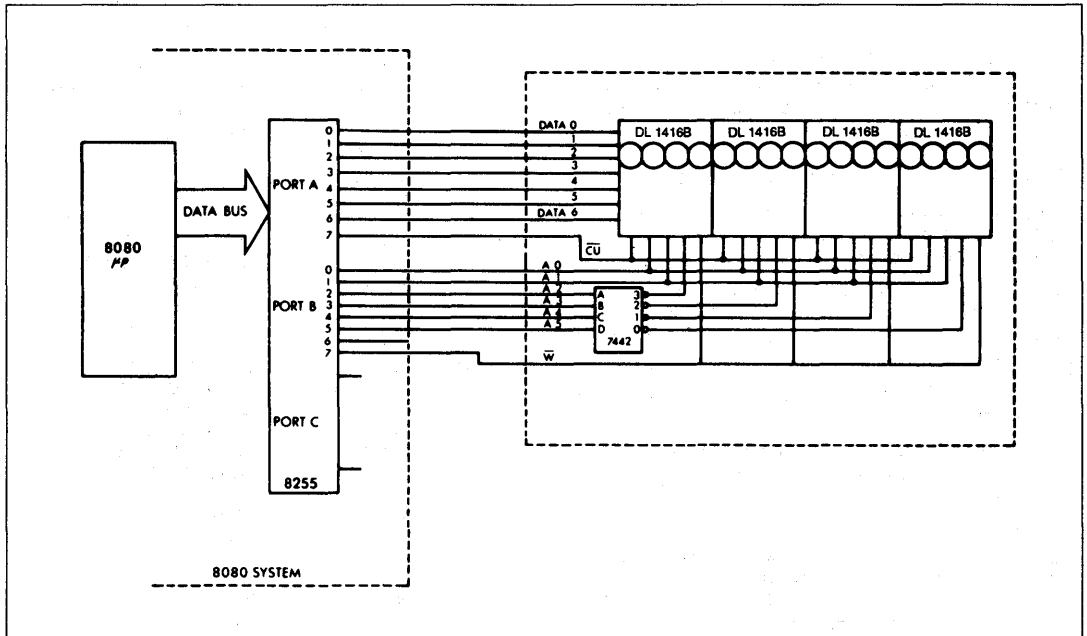

Figure 5. Mapped Interface

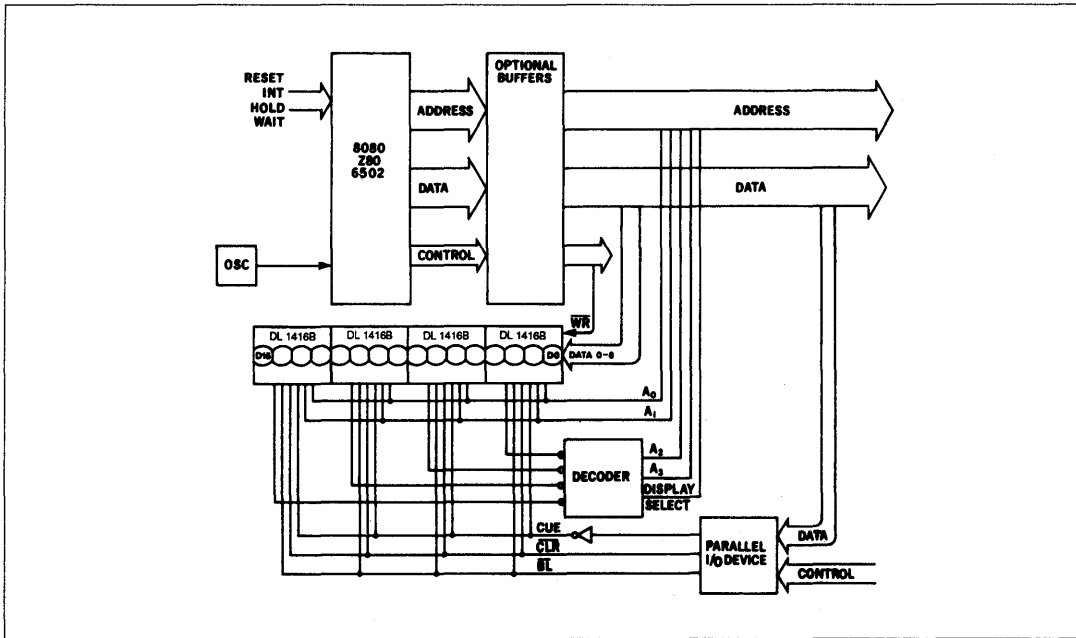
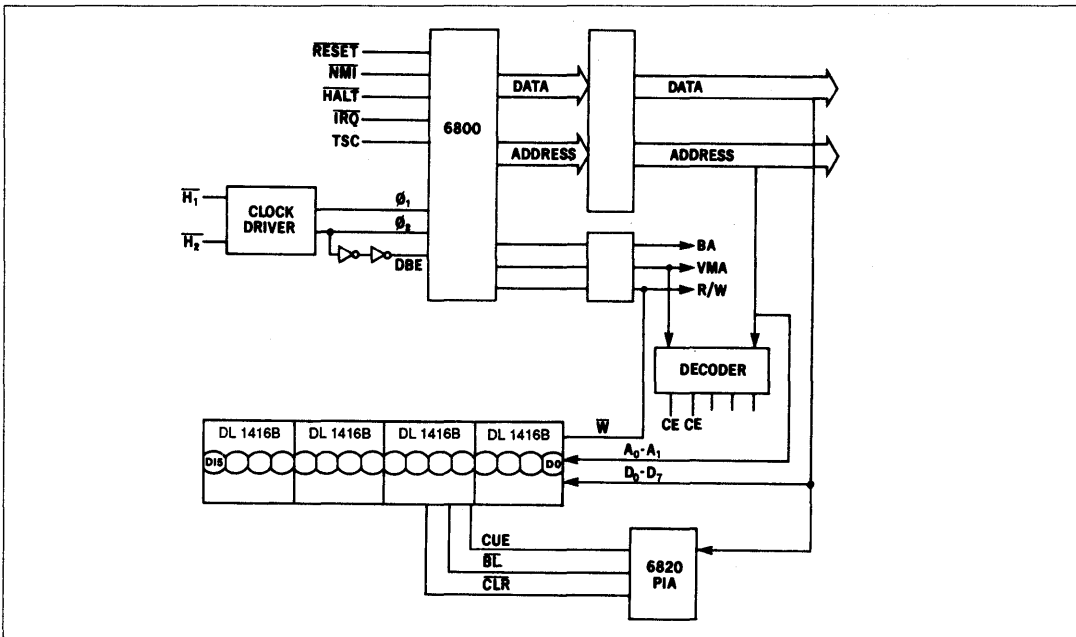

Figure 6.



SIEMENS

Mounting Considerations for LED Lamps and Displays Appnote 11

by Dave Takagishi

There are numerous ways to mount an LED lamp into a panel or a piece of equipment and this application note is written as an aid to designers and engineers when using LED lamps and displays.

MOUNTING TECHNIQUES:

There are several ways to mount LED lamps such as the Siemens LDR5001 by soldering directly into PCB's, plugging into sockets, or panel mounting with or without clips. Bending of the leads is allowed bearing the following guidelines in mind. Leads must not be bent closer than .065 inches from the base of case when leads are not in excess of .020 inch in diameter. Leads should be clamped next to the case during bending of leads to relieve stresses. Under no circumstances must any mechanical force be applied to case while bending the leads. Also, incorrectly spaced holes in the printed circuit board will place mechanical stress on the plastic case which can cause failure during soldering.

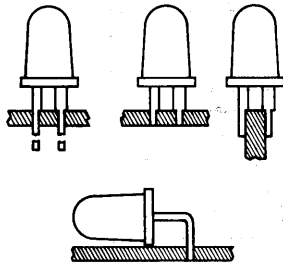

Displays of the HD11XXX type can be soldered directly into a printed circuit board or be plugged into sockets. Many displays can be end-stacked (butted end-to-end) to obtain longer displays with more digits. This usually

causes no break in digit spacing. In applications using screw-down mounting, a flexible washer should be used to avoid strain from misalignment or board warpage.

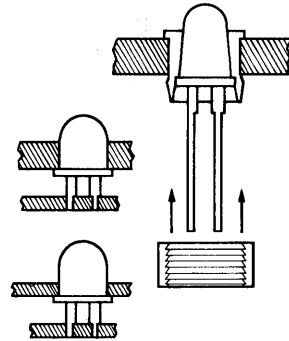

Connector/Socket Suppliers

Aries	Frenchtown, NJ
Augat	Attleboro, MA
Berg	New Cumberland, PA
EMC	Woonsocket, RI
Robinson Nugent	New Albany, IND
Precision Concept, Inc.	Bohemia, NY

(Partial List)

THERMAL CONSIDERATIONS:

Most LED failures can be traced to excess thermal stress. A typical LED chip is mounted on a substrate or lead frame with a wire bond from the top of the chip to a metallized trace on the substrate and is encapsulated in epoxy. Temperature changes cause these various materials to expand and contract at different rates. Extreme low temperatures are most likely to cause structural failure. High temperatures, usually cause reduced lifetime rather than immediate failures.

The internal LED junction temperature depends on ambient temperature, power applied to the LED, and the thermal resistance, LED chip-to-ambient.

Long-term degradation of the LED chips, causing reduced light output, will occur if junction temperature exceeds 125 deg. C. Also the epoxy material overcoating the LED chips may gradually become opaque if it is subjected to temperatures above 125 deg. C.

For these reasons, all Siemens LED products carry derating specifications designed to limit LED junction temperature to 100 deg. C.

Particular care is needed in designing multiplexed systems. Here, increased forward voltage and the effects of the thermal time constant, chip to ambient (about 10mS typical) can cause "thermal ripple" peak excursions above 100 deg. C while calculated average temperature is much lower.

A separate reason for keeping LED chip temperature down is the reduced light output, shown in Figure 1. One can reach a point of diminishing returns, particularly in multiplexed systems, in which an increase in current reduces reliability while actually resulting in little or no increase in display visibility. In such cases, one would be well advised to put his money in higher brightness-grade displays.

A well-designed display system, especially if high power levels or multiplexed operations are involved, should:

1. Allow for convection airflow around the display.
2. Place other heat-generating components* either away from or above, but never below the display (*Display current-control resistors, for example).
3. Take the increased forward voltage and "thermal ripple" peaks into account, in multiplexed systems, and not allow peak temperature to exceed 100 deg. C.

In common with many semiconductor products, LED displays offer the user the most reliable and longest lifetime product available. These good properties do depend, however, on proper usage. Semiconductor products are well-known to be rather unforgiving of abuse when compared to the older technologies. LED's are not different, they are, in fact, hybrid integrated circuits.

LUMINOUS INTENSITY VS AMBIENT TEMPERATURE

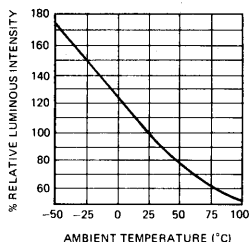

SOLDERING CONSIDERATIONS:

Care should be taken not to overheat LED's when soldering. Effectiveness and safety in soldering are related to three basic parameters: temperature, time, and distance. In general, soldering time should not exceed 3 seconds at 1/16 inch from case at 260°C. Some packages allow greater latitude, as indicated on individual data sheets.

OPTICAL CONSIDERATIONS:

Siemens recommends the use of a contrast enhancing filter in front of LED displays. This filter will increase the contrast ratio of digit to surrounding area and help remove reflected light and glare from the PCB and components around the display. Insetting the display to reduce direct ambient light on the display should also be considered.

ROHM & HAAS red "Plexiglass" #2423 makes a good general purpose filter for the 640-660 nm Peak Emission Wavelength of red LEDs. A 1/16 inch thick sheet of this inexpensive material is quite effective. Additional information on this and other filter materials may be obtained by contacting the following suppliers:

ROHM & HAAS	Philadelphia, PA
HOMALITE	Wilmington, DE
PANELGRAPHIC	West Caldwell, NJ
3M	St. Paul, MN
POLAROID	Cambridge, MA

FOR RED LEDS

ROHM & HAAS	Plexiglass 2423
HOMALITE	1670, 1605
PANELGRAPHIC	Red 60, Red 63,
	Red 65, Purple 90
POLAROID	HRCP

FOR GREEN LEDS

ROHM & HAAS	Plexiglas 38168
PANELGRAPHIC	Green 48
HOMALITE	1425, 1440

FOR YELLOW LEDS

PANELGRAPHICS	Yellow 25, Amber 23
HOMALITE	1720, 1726

NEUTRAL DENSITY FILTER

HOMALITE	Neutral Gray 10
----------	-----------------

Displaying Message Systems Without a Microprocessor

Appnote 13

by Dave Takagishi

Any Siemens 4 digit, alphanumeric Intelligent Display device has on board memory, decoder and drive circuitry. This makes it particularly well suited to marry directly to a microprocessor. However, small multi-message systems of 4, 8, 12, 16 character length need not have a microprocessor to drive the Intelligent Display. With the aid of PROM Intelligent Display devices can combine lighted indicators, status displays, annunciator messages or symbols, or a "canned message" into a single display.

Annunciator Displays

An automobile, for example, has several switches each lighting its own status or annunciator indicator. A single Intelligent Display could easily display messages alternately upon interrogation of the appropriate switches.

Figures 1, 2, and 3 show a DL 1416 but any of our Intelligent Display devices can be substituted. The circuit shown in Figure 1 will display four character messages sequentially for each open switch and continue to display until switches are returned to their normally closed positions. The Counters U4 and U5 address the PROM U6 and select switches on U1. The Data Selector, U1, sequentially selects one of eight switches (oil, temperature, catalytic, generator, brake, door, belt, and null), The eighth switch or null state can display a blank for a normal or off condition. The output of U1 enables the display's CE. When this signal goes high, the Monostable, U2, will fire and inhibit the Oscillator U3 for approximately a two second display time. The PROM, U6, generates the ASCII code data for each word. Expansion of the display can easily be achieved by adding a PROM for each additional display.

Another annunciator type display is shown in Figure 2. This display has a message of up to 16 characters and will continue to display the same line until the 6 bit input code changes state. With this scheme, it can be seen that the 16 character X64 line message PROM can easily be adapted for other message and character length combinations.

Figure 1.

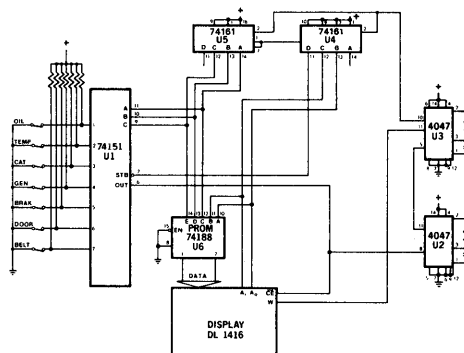
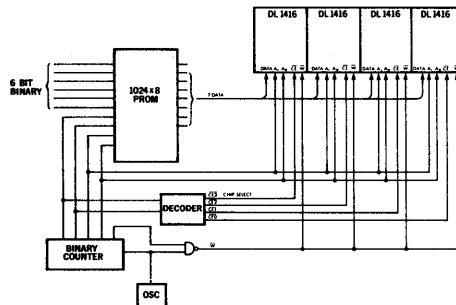

Figure 2. Typical Circuit for 64 Messages of 16 Characters Long



Canned Messages

The canned message type display can be an ideal sales, marketing or instructional aid. The message can be altered by replacing the PROM.

The technique for this display would be to sequentially display a word or group of words, depending on the character length of the display, through the entire message. The system could either continue to repeat itself or could go through the complete sequence once each time a switch is operated.

Figure 3 is the schematic for a sales demo box for the DL 1416. A 256X8 PROM was used to display an 8 digit-

32 word message. The oscillator, U1, increments the counters U2, U3, U4 providing the address for the DL1416's and PROM U9. After eight counts the monostable U10 is fired, inhibiting the oscillator for a two second display time. Devices U5 and U8 were added for cursor control. Decoder U8 will alternately enable or disable a data bit for a cursor to proceed writing new data into each digit. The multiplexer U5 will select the character data or the cursor data for the D0-D3 data lines. Inverters on the address lines cause data entry to occur from the left rather than from the right.

Figure 3.

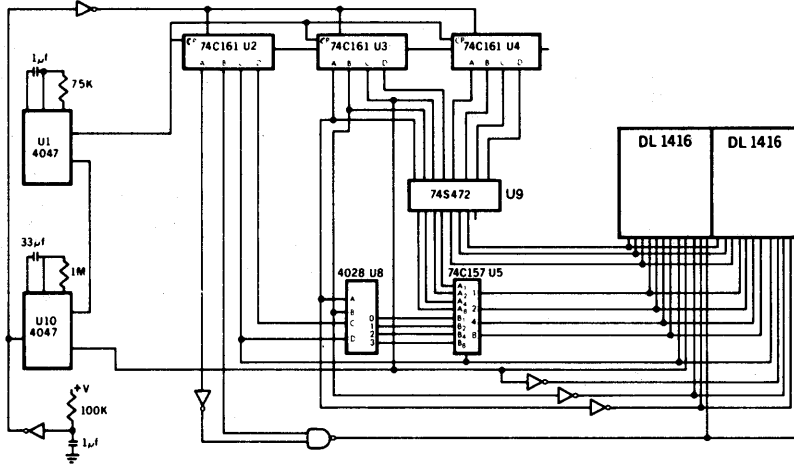

Applying the DL 2416T/DLX 2416* Intelligent Display® Device Appnote 14

by Dave Takagishi

This application note is intended to serve as a design and application guide for the DL 2416T/DLX 2416 (hereafter referred to as 2416) alphanumeric Intelligent Displays. The information presented covers device electrical description and operation, considerations for general circuit design, and interfacing the 2416 to microprocessors. Refer to the specific data sheet and other Siemens Appnotes for more details.

Electrical & Mechanical Description

The internal electronics in these Intelligent Displays eliminates all the traditional difficulties of using multi-digit light emitting displays (segment decoding, drivers, and multi-

plexing). The Intelligent Display also provides internal memory for the four digits. This approach allows the user to asynchronously address one of four digits, and load new data without regard to the LED multiplex timing.

Figure 1a is a block diagram of the DL 2416T. The unit consists of four 17-segment monolithic LED dies and a single CMOS integrated circuit chip. The LED dies are magnified to a height of 160 mils by built-in lenses. The IC chip contains 17 segment drivers, four digit drivers, 64 character ROM, four word x 7 bit Random Access Memory, oscillator for multiplexing, multiplex counter/decoder, cursor memory, address decoder, and miscellaneous control logic.

Figure 1a. Block Diagram – DL 2416T

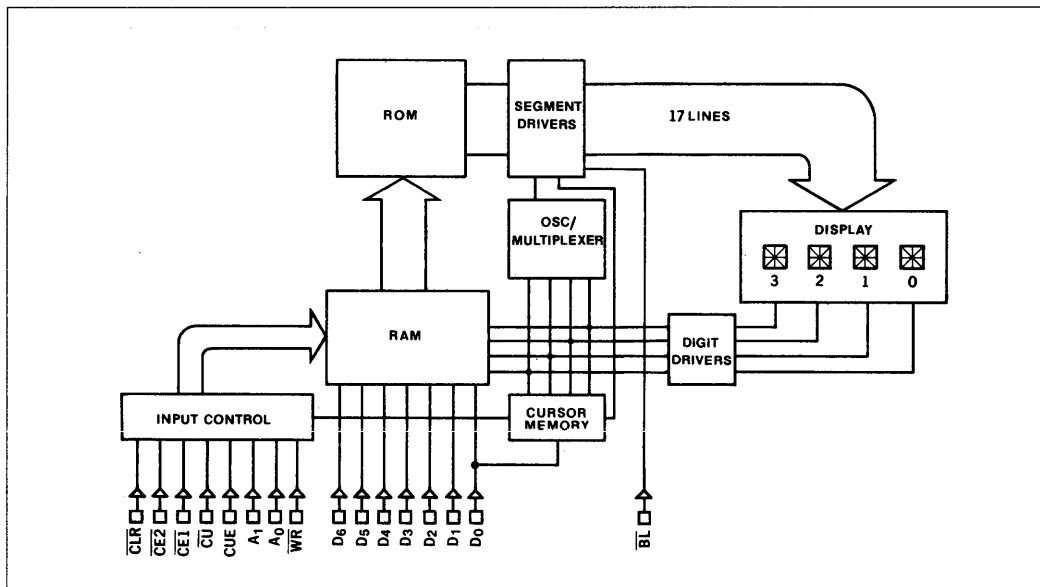

*DL 2416T – segmented display.
DLX 2416 (DLR 2416, DLG 2416, or DLO 2416) – dot matrix displays.

Figure 1b is a block diagram of the DLX 2416. The unit consists of 4 (5x7) LEDs and a single CMOS integrated chip. The IC chip contains the column drivers and row drivers, 128 character ROM, four word x 7 bit Random Access Memory, oscillator for multiplexing, multiplex counter/decoder, cursor memory, address decoder, and miscellaneous control logic.

Packaging

Packaging consists of a transfer-molded nylon lens which also serves as an "encapsulation shell" since it covers five

of the six "faces". The assembled and tested substrate ("PTF" multilayer), is placed within the shell and the entire assembly is then filled with a water-clear IC-grade epoxy.

This yields a very rugged part, which is quite impervious to moisture, shock and vibration. Although not "hermetic", the device will easily withstand total immersion in water/detergent solutions.

Figure 1b. Block Diagram – DLX 2416

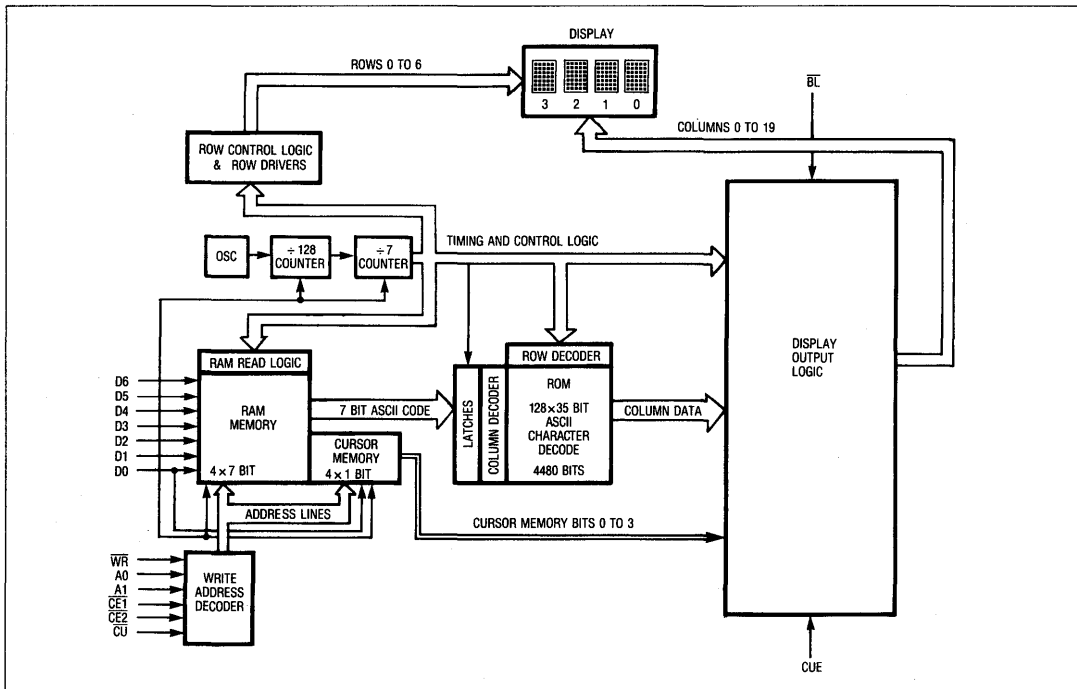

Figure 2.

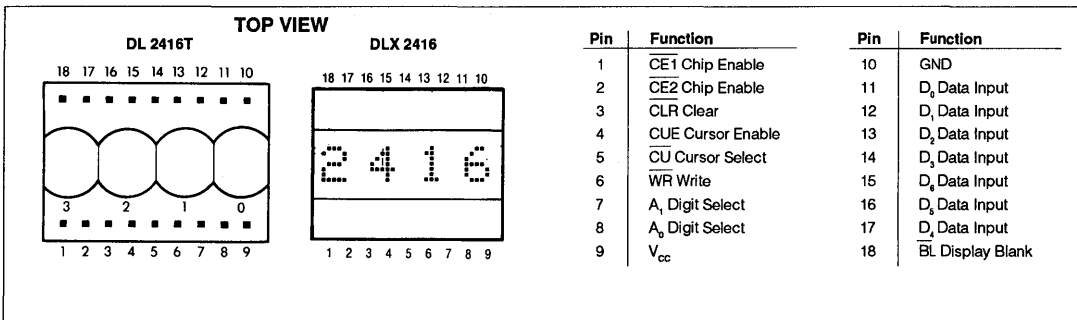
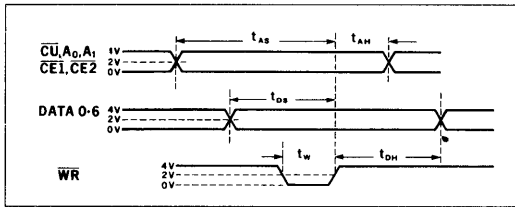

Figure 4.



(Check individual data sheet for minimum values). As can be seen from the waveforms, all signals are referenced from the rising or trailing edge of write.

Cursor

The cursor function of the DL 2416T causes all 16 line-segments of a digit to light. For the DLX 2416 the cursor function causes all dots to light at 50% brightness. The cursor can be used to indicate the position in the display of the next character to be entered. The cursor is not a character but overrides the display of a stored character. Upon removal of the cursor, the display will again show the character stored in memory.

The cursor can be written into any digit position by setting the cursor enable (CUE) high, setting the digit address (A_1 , A_0), enabling Chip Enable, (CE1, CE2), cursor select (CU), Write (WR) and Data (D_0). A high on data line D_0 will place a cursor into the position set by the address A_0 and A_1 . Conversely, a low on D_0 will remove the cursor. The cursor will remain displayed after the cursor (CU) and write (WR) signals have been removed. During the cursor-write sequence, data lines D_1 through D_6 are ignored by the 2416.

Figure 5.

LOADING DATA														DIGIT 3				DIGIT 2				DIGIT 1				DIGIT 0			
BC	CE1	CE2	CUE	CU	WR	CE1	A ₁	A ₀	D6	D5	D4	D3	D2	D1	D0	BLANK				PREVIOUS CHARACTERS									
L	X	X	X	H	X	H	X	X	X	X	X	X	X	X	X	NC	NC	NC	NC	NC	NC	NC	NC	NC	NC	NC	NC		
H	X	H	L	H	X	H	X	X	X	X	X	X	X	X	X	NC	NC	NC	NC	NC	NC	NC	NC	NC	NC	NC	NC		
H	X	X	L	H	H	X	X	X	X	X	X	X	X	X	X	NC	NC	NC	NC	NC	NC	NC	NC	NC	NC	NC	NC		
H	L	L	L	H	L	H	L	H	L	L	L	L	L	L	L	NC	NC	NC	NC	NC	NC	NC	NC	NC	NC	NC	NC		
H	L	L	L	H	L	H	L	H	L	L	L	L	L	L	L	NC	NC	B	A	NC	C	NC	NC	NC	NC	NC			
H	L	L	L	H	L	H	L	H	L	L	L	L	L	L	L	D	C	NC	A	D	C	B	E	D	C	B	E		
H	L	L	L	H	L	H	L	H	L	L	L	L	L	L	L	D	K	B	E	D	K	B	E	D	K	B	E		
H	L	L	L	H	L	H	L	H	L	L	L	L	L	L	L	SEE CHARACTER SET													

LOADING CURSOR														Normal Data Entry				Enable Previous Stored Cursors									
H	L	L	L	L	H	X	H	X	X	X	X	X	X	X	X	NC	NC	NC	NC	NC	NC	NC	NC	NC	NC	NC	NC
H	L	L	L	H	H	H	X	X	X	X	X	X	X	X	X	NC	NC	NC	NC	NC	NC	NC	NC	NC	NC	NC	NC
H	L	L	L	H	L	L	L	L	X	X	X	X	X	X	X	NC	NC	NC	NC	NC	NC	NC	NC	NC	NC	NC	NC
H	L	L	L	H	L	L	L	H	X	X	X	X	X	X	X	NC	NC	NC	NC	NC	NC	NC	NC	NC	NC	NC	NC
H	L	L	L	H	L	L	H	H	L	X	X	X	X	X	X	NC	NC	NC	NC	NC	NC	NC	NC	NC	NC	NC	NC
H	L	L	L	H	L	L	H	H	H	X	X	X	X	X	X	NC	NC	NC	NC	NC	NC	NC	NC	NC	NC	NC	NC
H	L	L	L	H	L	L	H	X	X	X	X	X	X	X	X	D	K	B	E	D	K	B	E	D	K	B	E
H	L	L	L	H	L	L	H	L	L	X	X	X	X	X	X	D	K	B	E	D	K	B	E	D	K	B	E
H	L	L	L	H	L	L	H	X	X	X	X	X	X	X	X	NC	NC	NC	NC	NC	NC	NC	NC	NC	NC	NC	NC

X = Don't care
NC = No change from previously displayed characters

If the user does not wish to utilize the cursor function, the cursor enable (CUE) can be tied low to disable the cursor function. A flashing cursor can be realized by simply pulsing the CUE line after cursor data has been stored.

General Design Considerations

Using Positive true logic, address order is from right to left. For left to right address order, use the "ones complement" or simple inversion of the addresses.

For systems with only a 6-bit (abbreviated ASCII) code format, Data Line D_6 cannot be left open. Data D_6 must be the complement of Data Line D_5 .

A "display test" or "lamp test" function can be realized by simply storing a cursor into all digits.

Because of the random state of the cursor RAM after power up, if the cursor function is to be used, it will be necessary to clear cursors initially to assure that all cursor memories contain its zero state. This is easily accomplished with the CLR input.

When using the 2416 on a separate display board having more than 6 inches of cable length, it may be necessary to buffer all inputs. This is most easily achieved with Hex non-inverting buffers such as the 74365. The object is to prevent transient current in the protection diodes. The buffers should be located on the display board near the displays.

Local power supply bypass capacitors are also needed in many cases. These should be 6 or 10 volt, tantalum type having 10 μ F or greater capacitance. Low internal resistance is important due to current steps which result from the internal multiplexing of the displays.

If small wire cables are used, it is good engineering practice to calculate the wire resistance of the ground plus the +5 volt wires. More than 0.1 volt drop, (at 25 mA per digit worst cast) should be avoided, since this loss is in addition to any inaccuracies or load regulation limitations of the power supply.

The 5-volt power supply for the displays should be the same one supplying V_{CC} to all logic devices which drive the display devices. If a separate supply must be used, then local buffers using hex non-inverting gates should be used on all displays inputs and these buffers should be powered from the display power supply. This precaution is to avoid logic inputs higher than display V_{CC} during power up or line transients.

Interfacing the 2416

A general and straight-forward interface circuit is shown in Figure 6 using the DL 2416T, but any 2416 display can be used interchangeably in these examples (also applies to Figure 7, 8, and 9). This scheme can easily interface to μP systems or any other systems which can provide the seven data lines, appropriate address and control lines.

Figure 6. General Interface Circuit

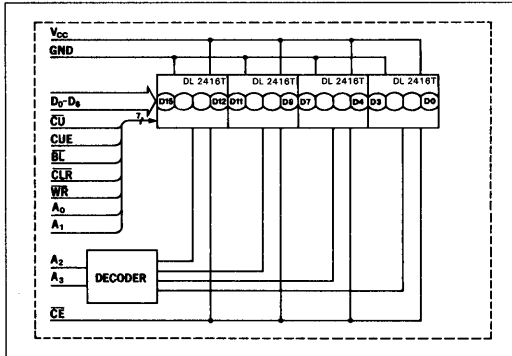

Parallel I/O

The parallel I/O device of a microprocessor can easily be connected to the circuit in Figure 6. One eight bit output port can provide the seven input data bits and the cursor (CU). Another eight bit output port can contain the address and chip enable information and the other control lines.

Figure 7. 16-Digit Parallel I/O System

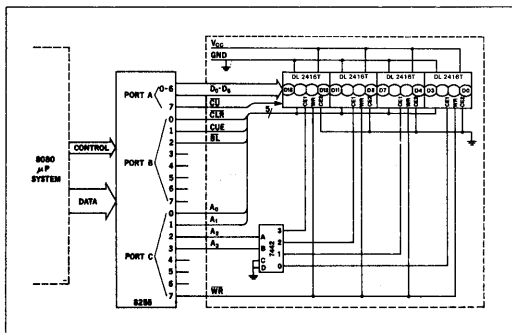

Figure 7 illustrates a 16-character display with an 8080 system using the 8255 programmable peripheral interface I/O device. The following program will display a simple 16-character message using this interface.

```

INIT:      MVI A,80H      ;CONTROL DATA MODE
           OUT CONTROL   ;LOAD CONTROL REGISTER
CUSR:     MVI A,00H     ;CLEAR CURSOR DATA
           OUT PORT A    ;LOAD DATA PORT
           MVI B, 0FH    ;SET CHARACTER COUNTER
CUSR1:    MOV A, B
           CALL DSPWT   ;WRITE SUBROUTINE
           DCR B        ;DECREMENT COUNTER
           JNZ CUSR1    ;DIGIT 0?
           MOV A, B
           CALL DSPWT
           MVI A, FFH   ;SET DATA FOR CONTROL
           OUT PORT B   ;LOAD CONTROL LINES
           LXI H, TABLE ;SET TABLE ADDRESS
           MOV A, M     ;MOVE TABLE DATA INTO
                       ;ACCUMULATOR
           OUT PORT A   ;LOAD DATA PORT
           MOV A, B
           CALL DSPWT  ;LOAD ADDRESS AND
                       ;CONTROL
           INX H        ;INCREMENT TABLE ADDRESS
           INR B        ;INCREMENT COUNTER
           MVI A, 10H  ;SET # OF DIGITS
           CMP B
           JNZ DISP1   ;16 CHARACTERS?
           HALT        ;END OF PROGRAM
           ORI FOH     ;SET CONTROL BITS OFF
           OUT PORT C  ;LOAD CONTROL
           ANI 7FH    ;SET WRITE BIT ON
           OUT PORT C  ;LOAD WRITE
           ORI FOH    ;SET WRITE BIT OFF
           OUT PORT C  ;LOAD CONTROL
           RET

TABLE:    DB          ;0C3H
           DB          ;0C9H
           DB          ;0D4H
           DB          ;0D3H
           DB          ;0C1H
           DB          ;0D4H
           DB          ;0CEH
           DB          ;0C1H
           DB          ;0C6H
           DB          ;0A0H
           DB          ;0D3H
           DB          ;0D4H
           DB          ;0C8H
           DB          ;0C7H
           DB          ;0C9H
           DB          ;0CCH
    
```

Figure 8. Mapped Interface

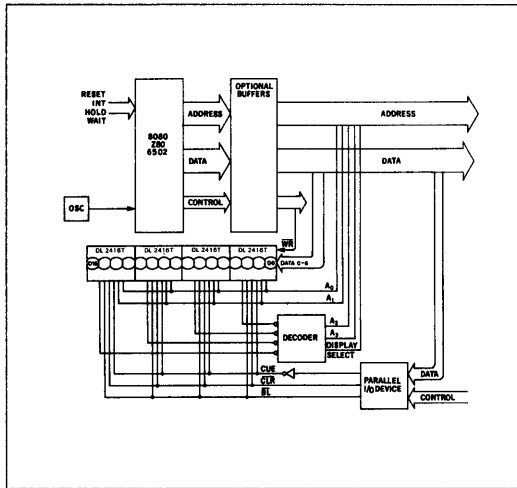
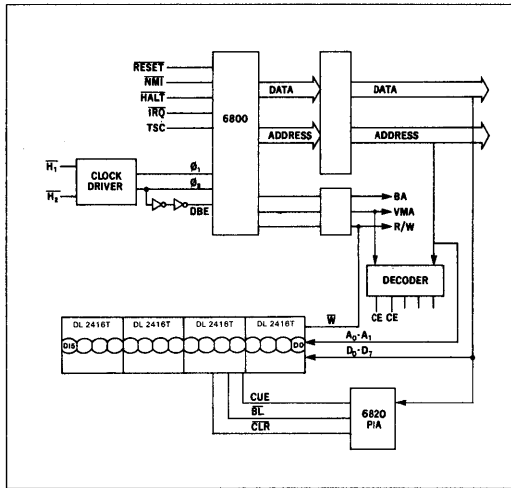

Figure 9.



I/O or Memory Mapped Addressing

Some designers may wish to avoid the additional cost of a parallel I/O in their system. Structuring the addressing architecture for the 2416 to look like a set of peripheral or output devices (I/O mapped) or RAM's and ROM's (memory mapped) is very easy. Figure 8 shows the simplicity of interfacing to microprocessors, such as 8080, Z80 and 6502 as examples.

The interface with the 6800 microprocessor in Figure 9 illustrates the need for designers to check the timing requirements of the DL 2416T and the μ P. The typical data output hold time is only 30 ns for DBE = 02 timing; two inverters in the DBE line are added to increase the data output hold time for compatibility with the 50 nS minimum spec of the DL 2416T.

Conclusion

Note that although other manufacturer's products are used in examples, this application note does not imply specific endorsement, or recommendation or warranty of other manufacturer's products by Siemens.

The interface schemes shown demonstrate the simplicity of using the 2416 with microprocessors. The slight differences encountered with various microprocessors to interface with the 2416 are similar to those encountered when using different RAMs. The techniques used in the examples were shown for their generality. The user will undoubtedly invent other schemes to optimize his particular system to its requirements.

Applying the DL 1414/DLX 1414* Intelligent Display® Device Appnote 15

by Dave Takagishi

This application note is intended to serve as a design and application guide for users of the DL 1414/DLX 1414 (referred to as 1414 hereafter) alphanumeric Intelligent Display. The information presented covers device electrical description and operation, considerations for general circuit design, and interfacing the 1414 to microprocessors.

Electrical & Mechanical Description

General

The internal electronics in these Intelligent Displays eliminates all the traditional difficulties of using multi-digit light

emitting displays (segment decoding, drivers and multiplexing). The Intelligent Display also provides internal memory for the four digits. This approach allows the user to asynchronously address one of four digits, and load new data without regard to the LED multiplex timing.

Figure 1a is a block diagram of the DL 1414. The unit consists of four 17 segment monolithic LED die and a single CMOS integrated circuit chip. The LED die are magnified to a height of 112 mils by the built-in lenses. The IC chip contains 17 segment drivers, four digit drivers, 64 character ROM, four word x 7 bit Random Access Memory, oscillator for multiplexing, multiplex counter/decoder, address decoder and miscellaneous control logic.

Figure 1a. Block Diagram – DL 1414

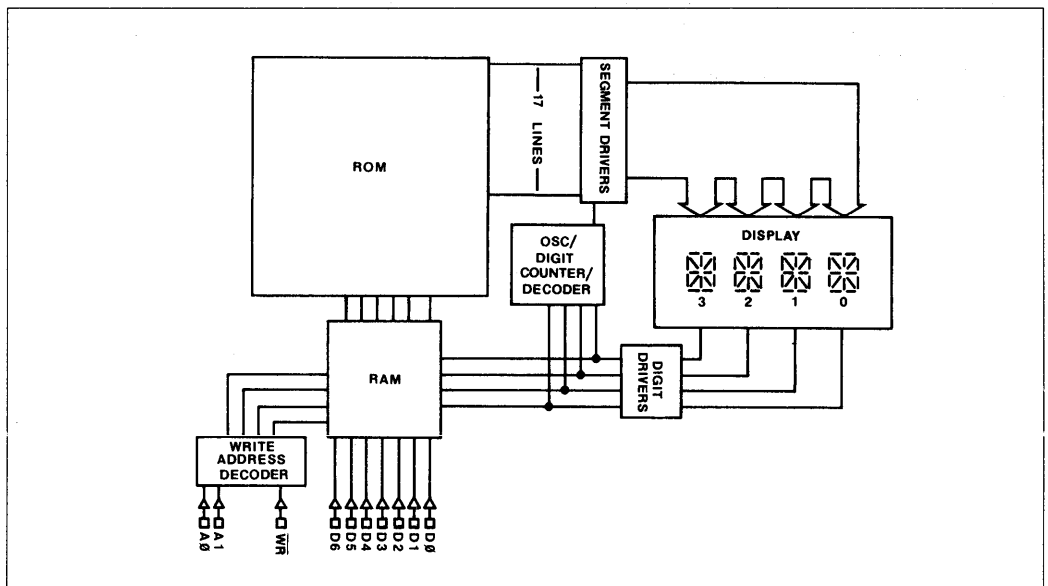

*DL 1414 – segmented display.
DLX 1414 (DLR 1414, DLG 1414, or DLO 1414) – dot matrix displays.

Figure 1b is a block diagram of the DLX 1414. The unit consists of four (5x7) LED arrays and a single CMOS integrated chip. The IC chip contains the column drivers and row drivers, 128 character ROM, four word x 7 bit Random Access Memory, oscillator for multiplexing, multiplex counter/decoder, cursor memory, address decoder, and miscellaneous control logic.

Packaging

Packaging consists of an injection-molded plastic lens which also serves as an "encapsulation shell" since it

covers five of the six "faces". The assembled and tested substrate (ceramic or "PTF" multilayer) is placed within the shell and the entire assembly is then filled with a water-clear IC-grade epoxy.

This yields a very rugged part which is quite impervious to moisture, shock and vibration. Although not "hermetic", the device will easily withstand total immersion in water/detergent solutions.

Figure 1b. Block Diagram – DLX 1414

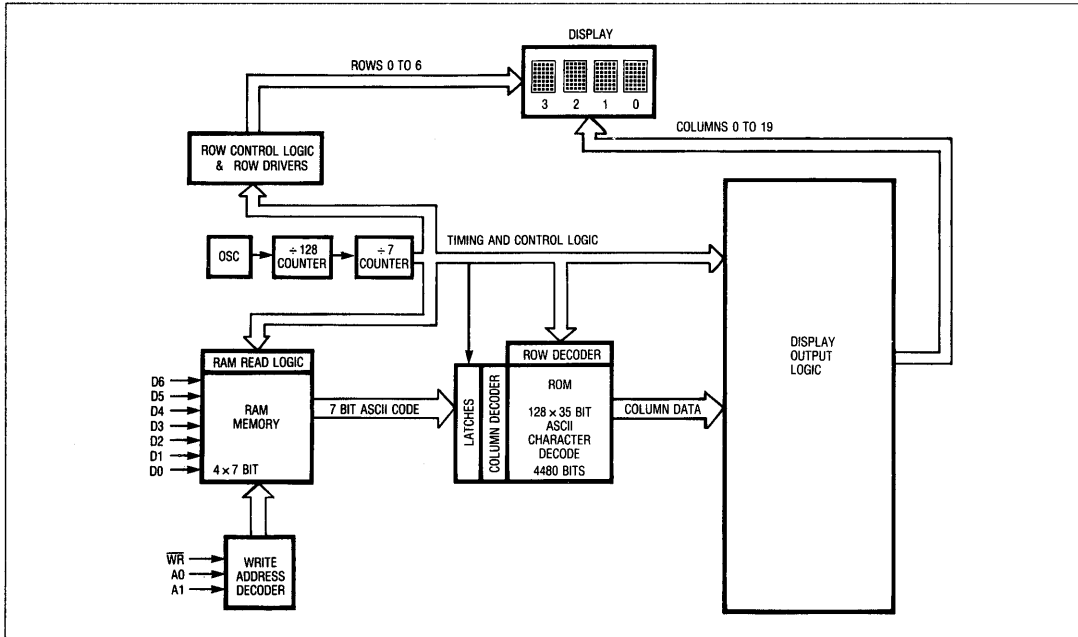
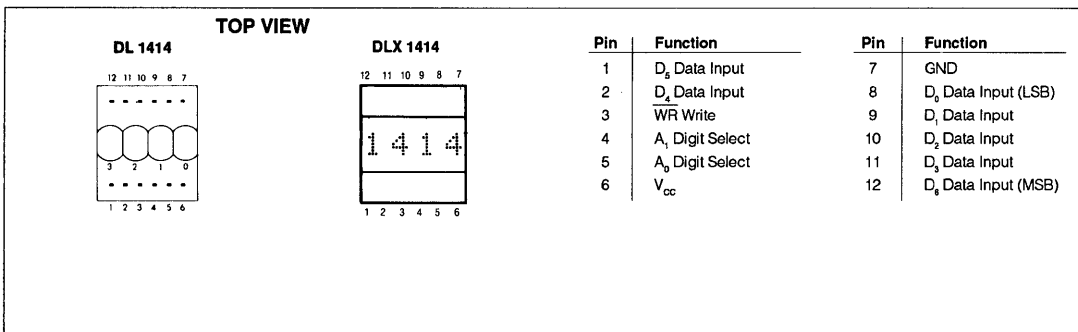

Figure 2.



Electrical Inputs to the DL 1414

- V_{CC} POSITIVE SUPPLY +5 volts
- GND GROUND
- D_0-D_6 DATA LINES
The seven data input lines are designed to accept the first 64 ASCII characters. See Figure 3a for the character set for DL 1414 and Figure 3b for the character set for DLX 1414. (The DL 1414 interprets all undefined codes as a blank).
- A_0, A_1 ADDRESS LINES
The address determines the digit position to which the data will be written. Address order is right to left for positive-true logic.
- \overline{WR} WRITE (Active Low)
Data and address to be loaded must be present and stable before and after the trailing edge of write. (See data sheet for timing info).

Figure 3a. Character Set – DL 1414

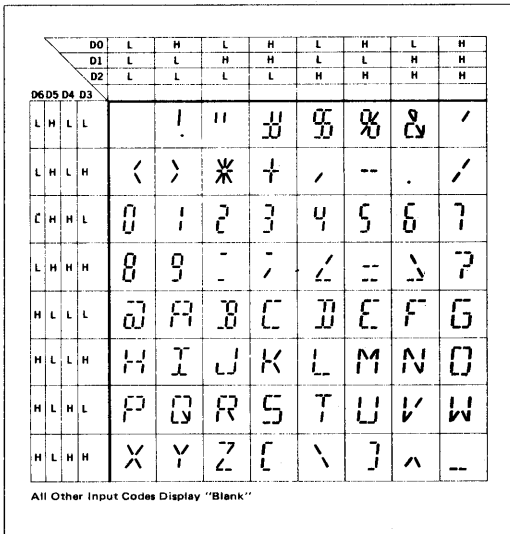
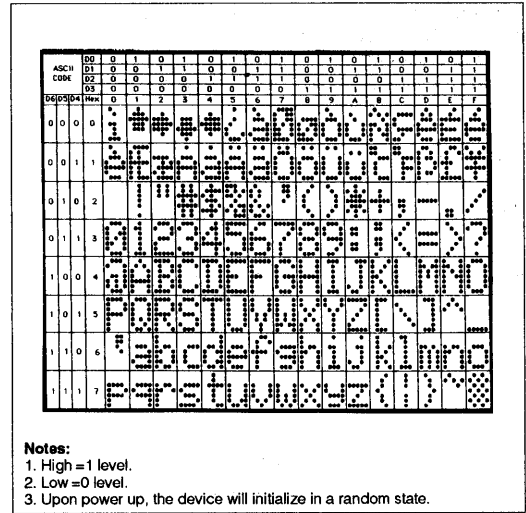

Figure 3b. Character Set – DLX 1414



Operation

Multiplexed display systems sequentially read and display data from a memory device. In synchronous systems, control circuitry must compare the location of data to be read to the location or position of new data to be stored or displayed, i.e., synchronize before a Write can be done. This can be slow and cumbersome.

Data entry in Intelligent Displays is asynchronous and may be done in any random order. Loading data is similar to writing into a RAM. Each digit has its own memory location and will display until replaced by another code.

The waveforms of Figure 4 demonstrate the relationships of the signals required to generate a Write cycle. (Check individual data sheet for minimum values.) As can be seen from the waveforms, all signals are referenced from the rising or trailing edge of Write.

Figure 4. Write Cycle Waveform

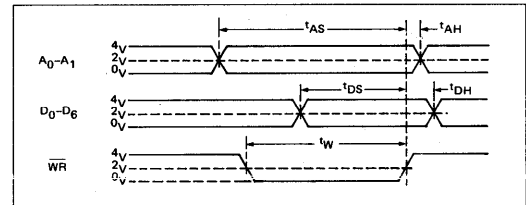
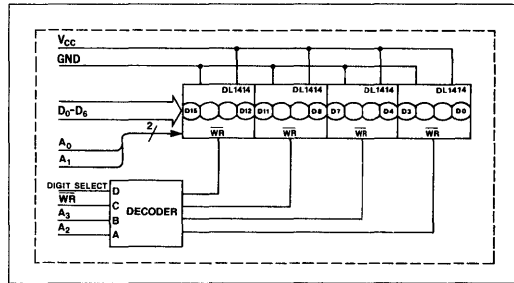

Figure 5. Data Loading Table

WR	ADDRESS			DATA INPUT							DIGIT 3	DIGIT 2	DIGIT 1	DIGIT 0
	A ₂	A ₁	A ₀	D ₆	D ₅	D ₄	D ₃	D ₂	D ₁	D ₀				
H	X	X	X	X	X	X	X	X	X	X	NO CHANGE	NO CHANGE	NO CHANGE	NO CHANGE
L	L	L	L	H	L	L	L	L	L	H	NO CHANGE	NO CHANGE	NO CHANGE	A
L	L	H	H	L	L	L	L	L	H	L	NO CHANGE	NO CHANGE	B	A
L	H	L	H	L	L	L	L	H	H	H	NO CHANGE	C	B	A
L	H	H	H	L	L	L	L	L	L	H	D	C	B	A
L	L	L	H	L	L	L	L	H	L	L	D	C	B	E
L	H	L	H	L	L	H	L	H	H	H	D	K	B	E
L	-	-	-	-	-	-	-	-	-	-	SEE CHARACTER SET			

X = DON'T CARE

Figure 6. General Interface Circuit



General Design Considerations

Using positive true logic, address order is from right to left. For left to right address order, use the "ones complement" or simple inversion of the addresses.

For systems with only a 6-bit (abbreviated ASCII) code format, Data Line D₆ cannot be left open. Data D₆ must be the complement of Data Line D₅.

When using the 1414 on a separate display board having more than 6 inches of cable length, it may be necessary to buffer all inputs. This is most easily achieved with Hex non-inverting buffers such as the 74365. The object is to prevent transient current in the protection diodes. The buffers should be located on the display board near the displays.

Local power supply bypass capacitors are also needed in many cases. These should be 6 or 10 volt, tantalum type having 10 μF or greater capacitance. Low internal resistance is important due to current steps which result from the internal multiplexing of the displays.

If small wire cables are used, it is good engineering practice to calculate the wire resistance of the ground plus the +5 volt wires. More than 0.1 volt drop, (at 25 mA per digit worst case) should be avoided, since this loss is in addition to any inaccuracies or load regulation limitations of the power supply.

The 5-volt power supply for the displays should be the same one supplying V_{CC} to all logic devices which drive the display devices. If a separate supply must be used, then local buffers using hex, non-inverting gates should be used on all inputs and these buffers should be powered from the display power supply. This precaution is to avoid logic inputs higher than display V_{CC} during power up or line transients.

Interfacing the 1414

A general and straight-forward interface circuit is shown in Figure 6 (using DL 1414s but any 1414 display can be used interchangeably in Figures 8, 9, and 10). This scheme can easily interface to μP systems or any other systems which can provide the seven data lines, appropriate address and control lines.

The 1414 does not have a chip enable input. Therefore, each display in a system requires its Write pulse be gated with appropriate address signals. Figure 7a shows the use of a 74154 decoder (4 line to 16 line) for up to a 64 character display. Using the G1 input for display select (address select in a memory mapped system) and the G2 input to gate the Write signal. Another approach (Figure 7b and 7c) which minimizes logic for a 16 or 32 digit display takes advantage of decoding scheme of the 7442 decoder.

Figure 7. Gating the Write Pulse

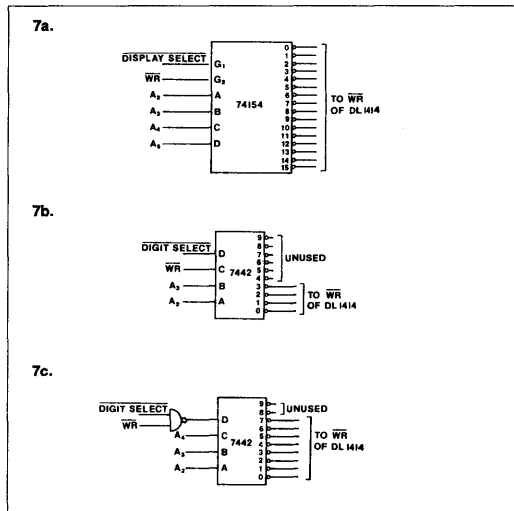

Parallel I/O

The parallel I/O device of a microprocessor can easily be connected to the circuit in Figure 6. One eight bit output port can provide the seven input data bits. Another eight bit output port can contain the address and control signals.

Figure 8 illustrates a 16-character display with an 8080 system using the 8255 programmable peripheral interface

I/O device. The following program will display a simple 16-character message using this interface.

Figure 8. 16-Digit Parallel I/O

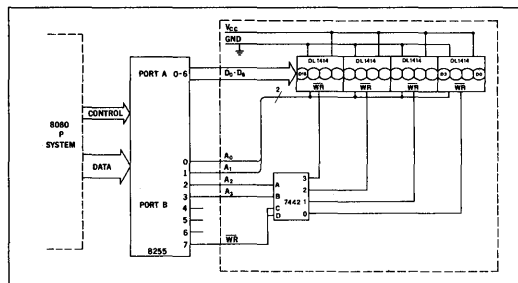

Sample I/O Program

```

INIT:   MVI A, 80H      ;CONTROL DATA MODE 0
        OUT CONTROL   ;LOAD CONTROL REGISTER
        MVI B,00H     ;SET COUNTER = 0
DISP:   LXI H, TABLE ;SET TABLE ADDRESS
DISP1:  MOV A,M        ;MOVE TABLE DATA TO
                          ACCUMULATOR
        OUT PORTA     ;LOAD DATA PORT
        MOV A, B
        CALL DSPWT    ;LOAD ADDRESS AND CONTROL
        INX H         ;INCREMENT TABLE ADDRESS
        INR B         ;INCREMENT COUNTER
        MVI A, 10H    ;SET # OF DIGITS
        CMP B
        JNZ DISP1    ;16 CHARACTERS ?
        HALT          ;END OF PROGRAM
DSPWT:  ORI F0H       ;SET CONTROL BITS OFF
        OUT PORTB    ;LOAD CONTROL
        ANI 7FH      ;SET WRITE BIT ON
        OUT PORTB    ;LOAD WRITE
        ORI F0H     ;SET WRITE BIT OFF
        OUT PORTB    ;LOAD CONTROL
        RET
TABLE:  DL            ;0C3H
        DB            ;0C9H
        DB            ;0D4H
        DB            ;0D3H
        DB            ;0C1H
        DB            ;0D4H
        DB            ;0CEH
        DB            ;0C1H
        DB            ;0C6H
        DB            ;0A0H
        DB            ;0D3H
        DB            ;0D4H
        DB            ;0C8H
        DB            ;0C7H
        DB            ;0C9H
        DB            ;0C3H

```

I/O or Memory Mapped Addressing

Some designers may wish to avoid the additional cost of a parallel I/O in their system. Structuring the addressing architecture for the 1414 to look like a set of peripheral or

output devices (I/O mapped) or RAMs and ROMs (memory mapped), is very easy. Figure 9 shows the simplicity of interfacing to microprocessors, such as 8080, Z80 and 6502 as examples.

The interface with the 6800 microprocessor in Figure 10 illustrates the need for designers to check the timing requirements of the 1414 and the μP . The typical data output hold time is only 30 ns for DBE= $\emptyset 2$ timing; two inverters in the DBE line are added to increase the data output hold time for compatibility with the 50 ns minimum spec of the 1414.

Conclusion

Note that although other manufacturer's products are used in examples, this application note does not imply specific endorsement, or recommendation or warranty of other manufacturer's products by Siemens.

The interface schemes shown demonstrate the simplicity of using the 1414 with microprocessors. The slight differences encountered with different microprocessors to interface with the 1414 are similar to those encountered when using different RAMs. The techniques used in the examples were shown for their generality. The user will undoubtedly invent other schemes to optimize his particular system to its requirements.

Figure 9. Mapped Interface

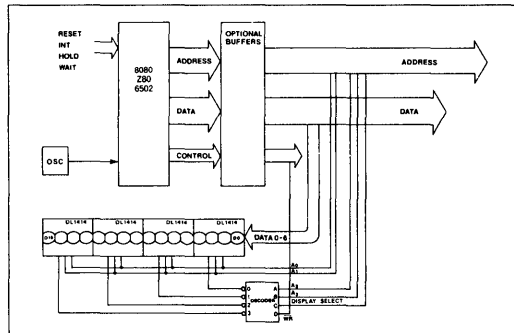
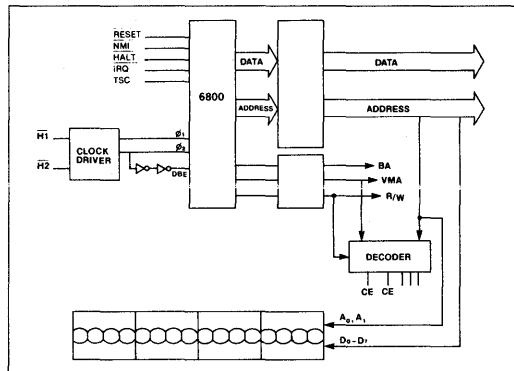

Figure 10. Gating the Write Pulse



Silicon Photovoltaic Cells, Silicon Photodiodes and Phototransistors Appnote 16

Optoelectronic components are increasingly used in modern electronics. Main fields of application are light barriers for production control and safety devices, light control and regulating equipment like twilight switches, fire detectors and facilities for optical heat supervision, scanning of punched cards and perforated tapes, positioning of machine tools (for measuring length, angle and position), of optical apparatus and ignition processes, for signal transmission at electrically separated input and output, as well as conversion of light into electrical energy.

Lately, new fields of application opened up for optoelectronic components in the photo industry in form of exposure and aperture control and for automatic electronic flashes. IR sound transmission and IR remote control are new modes in the radio industry. Computer diagnosis and LED displays in instrument panels are possible applications in the automotive industry.

Depending upon the application either photovoltaic cells or photodiodes are used. Wherever amplifiers with high input impedance are required, photodiodes are to be preferred.

Phototransistors are predominantly used in connection with transistor circuits or to drive integrated circuits, whereas photovoltaic cells are preferred to scan large surfaces, if a strictly linear relation between light and signal level or optimum reliability is required.

PHOTOVOLTAIC CELLS

Photovoltaic cells are active two-poles with a comparably low resistance that has its cause in the voltage of the voltaic cell, which may only be some tenth of a volt. For practical application, this characteristic requires special attention.

The open circuit voltage V_L rises almost logarithmically as a function of the illuminance and, particularly in case of planar photovoltaic cells, reaches high values already at very low illuminances. It is independent of the size of the photovoltaic cell.

The short circuit current I_K increases linearly with the illuminance. It is proportional to the size of the exposed photosensitive area at uniform illuminance.

The maximum energy of the photovoltaic cell is yielded in a load resistance R_L of approx $\frac{V_L}{I_K}$.

Practical short circuit operation and thus proportionality between optical and electrical signal is given at load resistance up to $\frac{V_L}{2 I_K}$. This relation can be applied to an open circuit voltage of ≥ 100 mV.

In any type of application the highest value of I_K has to be used. A simple procedure to gain information on the load resistance required is to measure V_L and I_K at given illumination conditions, irrespective of the radiation source.

In case the voltage yielded by the photovoltaic cell is insufficient it can also be used in diode operation at reverse voltages up to 1 V. In such case the flowing dark current has to be taken into consideration.

The rise time of a signal voltage delivered to a load resistor by the voltaic cell primarily depends on the operating conditions. There are two distinctive borderline cases:

1. Load resistor smaller than the matching resistor (tendency toward short circuit operation).
2. Load resistor larger than the matching resistor (tendency to open circuit operation).

In case 1) the photovoltage rise is analogous to the charging of a capacitor via a resistor from a constant voltage source. In photovoltaic cells the junction capacitance C_j must be charged. The rise occurs by the time constant $\tau = R_L \cdot C_j$, R_L being the load resistor (the low ohmic resistance of the photovoltaic cell is considered negligible).

In case 2) the photovoltage rise is similar to the charging of a capacitor by a constant current mode. The rise time τ_r of the photovoltage follows the equation:

$$\tau_r = \frac{V_P \cdot C_j}{I_K}$$

I_K is the short-circuit current under given illumination conditions. This relation only holds true for values of V_P less than 80% of the final value of the open circuit voltage.

The principal characteristic of the rise time of photo-voltaic cells is shown in the following diagram:

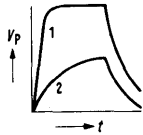

Case 1) Rise time according to the equation

$$V_P = I_K \cdot R_L \cdot \left(1 - e^{-\frac{t}{R_L \cdot C_j}}\right)$$

$$\text{Time constant } \tau = R_L \cdot C_j$$

Case 2) Rise time $t_r = \frac{V_P \cdot C_j}{I_K}$

$$\text{fall time in both cases } \tau = R_L \cdot C_j$$

Modulation transients can, under certain conditions, lead to a modification of the above diagram.

E.g. At very low time constants (particularly in short circuit operation) the actual pulse shape of the short circuit current that deviates from an ideal square pulse has to be noted. See diagram.

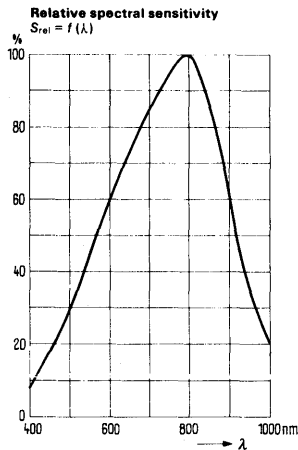
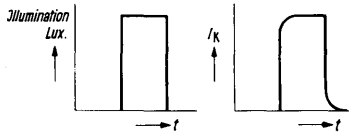

SILICON PHOTODIODES

These photodiodes have a PN junction poled by a reversed bias. The capacitance which decreases with a growing reverse voltage reduces the switching times. The PN junction is of easy access to the light. Without illumination a very small reverse current flows, the so-called dark current. Light falling onto the surrounding of the PN junction generates charge carrier pairs there that lead to an increase of the reverse current. This photocurrent is proportional to the illuminance. Therefore, photodiodes are particularly well suited for quantitative light measurements. The planar technique has 2 essential advantages: The dark currents are considerably smaller than for comparable photo electric components in non-planar technique. This leads to a reduction of the current noise and thus to a decisive improvement of the signal/noise ratio.

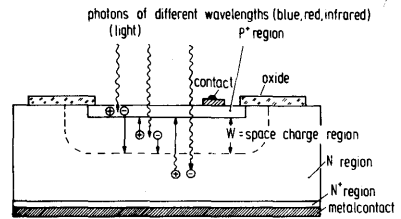

Figure 1

Figure 1 shows the basic design of a photodiode. The limit of the space charge region is indicated by a dashed line.

Without illumination only a small dark current I_D flows through the PN junction as a result of thermally generated carriers.

With light, additional charge carrier pairs (hole electron pairs) are generated in the P and N region by the radiation quantum (internal photo effect). Carriers originating in the space charge region are immediately extracted because of the electrical field present there, i.e. the holes in the P and the electrons in the N direction. Carriers from the remaining field must first diffuse into the space charge region in order to be separated there. If holes and electrons recombine before, they do not contribute to the photocurrent. Thus, the photocurrent I_P is a combination of the drift current of the space charge region and the diffusion current of the P and N area.

I_P is proportional to the incident radiation intensity. Since I_D is very small for diodes, it can be neglected in the equation $I_P = I_P + I_D$. Subsequently one gets a linear correlation between I_P and the incident radiation intensity over a very wide range.

Diodes with a small space charge width are termed PN diodes, diodes with a large space charge width PIN diodes.

PN diodes have the diffusion current as dominating part of the photocurrent whereas it is the drift current in the case of PIN diodes.

As the capacitance of the space charge width W is inversely proportional, the PIN diode is characterized by a smaller capacitance than a PN diode of identical surface. The capacitance of (most of) the diodes reads:

$$C_D \sim \sqrt{\frac{N}{V}}$$

The less the doping N of the basic material and the higher the applied voltage V , the lower the capacitance.

Fig. 2 shows the capacitance as function of the voltage for a PIN diode, e.g. BPY 12.

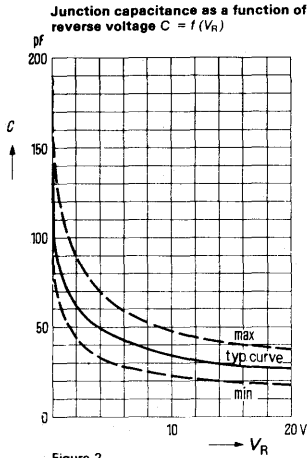

Figure 2

SILICON PHOTOTRANSISTORS

The introduction of the planar technique allows to produce phototransistors of small dimensions. They are used as photoelectric detectors in control and regulating devices. The photoelectric transistors are excellently suited as receivers for incandescent lamp light, as their maximal photosensitivity lies near the infrared limit of the light wave spectrum.

In its mode of operation a photoelectric transistor corresponds to that of a photodiode with built-in amplifier. It has a 100 to 500 times higher photosensitivity than a comparable photoelectric diode.

The photoelectric transistor is preferably operated in an emitter circuit and acts similar to an AF transistor.

Unilluminated only a small collector-emitter leakage current flows. It amounts to approximately $I_0 = B \cdot I_{CBO}$, B standing for the current amplification and I_{CBO} for the reverse current of the base diode.

At illumination the reverse current of the base diode I_{CBO} increases by the photocurrent I_P' . Thus, one receives for the photocurrent $I_P \sim B(I_{CBO} + I_P')$.

Consequently, the photocurrent of a transistor is a function of the photocurrent I_P' of the base diode and the current amplification B . As B cannot be increased indefinitely, an as high as possible photosensitivity of the base diode is aimed at.

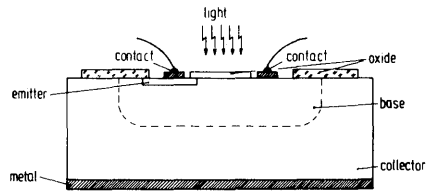

Figure 3

Figure 3 shows the design of a phototransistor. The emitter and base leads are affixed laterally to make the base diode most easily accessible to light. The large collector zone ensures that the most possible radiation quanta are absorbed there and will contribute to the photocurrent.

Contrary to a photodiode, a linear interconnection between the incident radiation intensity and the photocurrent I_P exists only in a small region, since the current gain B depends on the current. Figure 4 shows typical current voltage characteristics of a phototransistor.

Since the reverse current I_{CBO} of the base diode is amplified in the same way as the photocurrent I_P , the signal/noise ratio of the phototransistor is the same as that of the photodiode.

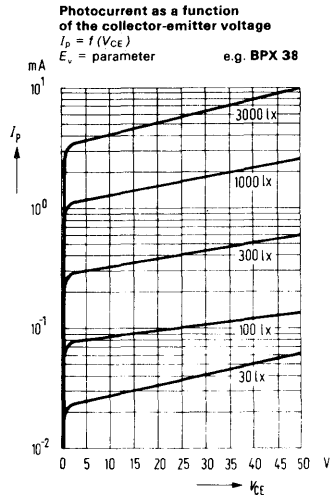

Figure 4

For the versatile applications, special type phototransistors are available. BPY 62, BPX 43, BP 101 and BP 102 requiring no lens on the receiver side are suitable for general applications.

BPY 62 is outstanding for a higher cut off frequency, BPX 43 for a higher photo-sensitivity.

In case the application demands a lens on the detector side, this requirement is met by BPX 38. The flat window of this phototransistor makes a precise reproduction of the focal spot on the photosensitive

surface of the transmitter system possible. On account of the larger system surface, the adjustment and alignment of the transistor case to the light emitter causes less difficulties.

At the types mentioned, the user may preset the operating point of the phototransistor by wiring the base leads. The rapidity of response may thus be increased and the photosensitivity reduced. A fixed bias can reverse the phototransistor. Coincidence circuits can be realized by scanning this bias.

The phototransistor BPY 61 meets the requirement for high packing density. It is enclosed in a miniature glass case of 13 mm x 2.1 mm \varnothing and its photosensitivity is by the factor 500 to 1000 higher than small-surface silicon photovoltaic cells. Also the BPX 62 in micro ceramic case is provided for use on PC boards at minimum space requirements. The tolerance range of the light sensitivity is subdivided into four sensitivity groups. There is no base contact. Light is the controlling element which produces a correspondingly high collector current via the emitter-base path of the transmitter system, multiplied by the factor of the current gain. The rise and fall times depend on the illuminance and decrease with rising intensity.

Main applications are scanning of binary coded discs, films and punched cards.

Under limited mounting conditions the following amplifier must often be connected by relatively long leads. There is only little danger of interference pick-up since a sufficiently large signal to noise ratio is ensured by high photoelectric currents.

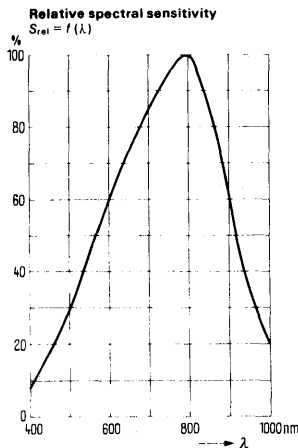

Mounting Instructions For Silicon Voltaic Cells and Photodiodes, open design without casing

As silicon is an inherently brittle material, the photo-electronic component should be shielded from pressure or tension. Contact points are particularly endangered. Should tension come to bear on the solid wire leads which, for technological reasons, are alloyed to a very thin P layer it should only be parallel to the surface and must not exceed 200 p (pond). Leads may only be bent 3 mm off the outer edge of the photoelectric component. Photoelectric components can be cemented onto metallic or plastic supports but the expansion coefficient of the material has to be taken into consideration to prevent mechanical strain between support and photoelectric component at change of temperature. An epoxy resin is to be used to cement or encapsulate the photoelectric component. It has to be colourless and should not grow darker with time. After curing, the epoxy resin must not have any gas occlusions (filter effect). The epoxy resin EPICOTE 162¹⁾ together with the hardener LAROMIN-C 260²⁾ are particularly suited for the encapsulation of photoelectric components. 100 weight parts EPICOTE 162, 38 weight parts LAROMIN-C 260 are to be mixed well and remain workable for about 30 minutes. After that period of time the epoxy becomes viscid. All material to be encapsulated has to be dry, dust- and grease-free. Should bubbles form after the encapsulation it is advisable to raise the curing process temperature to 100°C for a short time. It makes the bubbles come to the surface and burst. The normal curing temperature lies between 60 and 80°C. The curing time is 1 hour, it lessens with higher temperature. When working with epoxy great care should be taken that neither the resin nor the hardener touches the skin. The quickly binding glue SICOMET 85³⁾ proves adequate to cement open-design Si diodes or photovoltaic cells. The light sensitive surface of the photovoltaic cell is coated with a protective lacquer and should not be contaminated while cementing.

1) Registered trademark (Shell Chemical)

2) Registered trademark (BASF)

3) Registered trademark (Sichel-Werke, Hannover)

Applying the DL 3416T/DLX 3416* Intelligent Display® Device Appnote 17

by Dave Takagishi

This application note is intended to serve as a design and application guide for users of the DL 3416/DLX 3416 (referred to as 3416 hereafter) alphanumeric Intelligent Displays. The information presented covers device electrical description and operation, considerations for general circuit design, and interfacing the 3416 to micro-processors. Refer to the specific data sheet and other Siemens Appnotes for more details.

Electrical & Mechanical Description

The internal electronics in these Intelligent Displays eliminates all the traditional difficulties of using multi-digit light emitting displays (segment decoding, drivers, and multi-

plexing). The Intelligent Display also provides internal memory for the four digits. This approach allows the user to asynchronously address one of four digits, and load new data without regard to the LED multiplex timing.

Figure 1a is a block diagram of the DL 3416. The unit consists of four 17-segment monolithic LED dies and a single CMOS integrated circuit chip. The LED dies are magnified to a height of 225 mils by built-in lenses. The IC chip contains 17 segment drivers, four digit drivers, 64 character ROM, four word x 7 bit Random Access Memory, oscillator for multiplexing, multiplex counter/decoder, cursor memory, address decoder, and miscellaneous control logic.

Figure 1a. Block Diagram – DL 3416

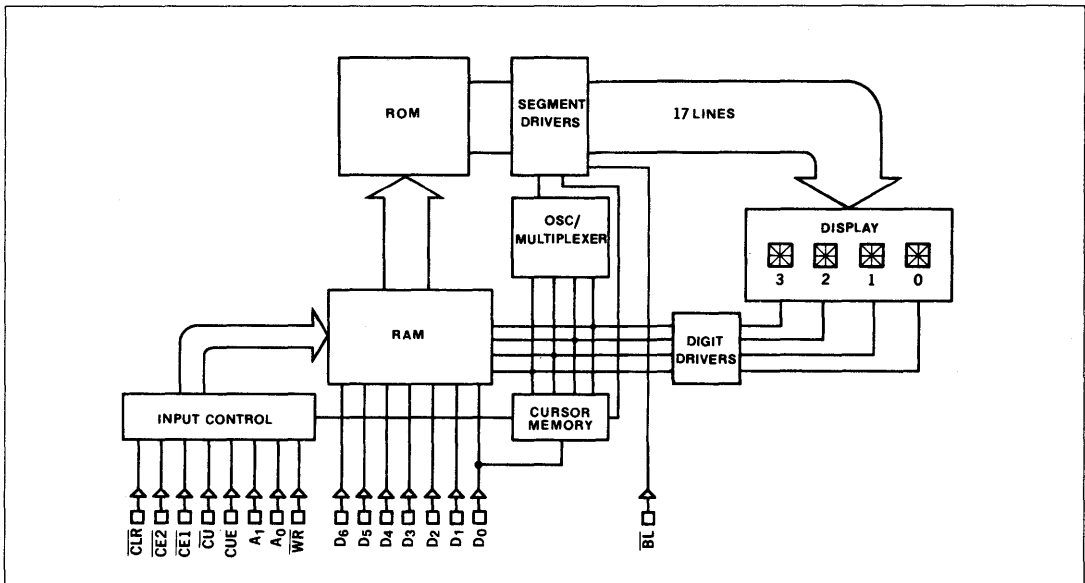

*DL 3416 – segmented display.
DLX 3416 (DLR 3416, DLG 3416, or DLO 3416) – dot matrix displays.

Figure 1b is a block diagram of the DLX 3416. The unit consists of four (5x7) LED arrays and a single CMOS integrated chip. The IC chip contains the column and row drivers, 128 character ROM, four word x 7 bit Random Access Memory, oscillator for multiplexing, multiplex counter/decoder, cursor memory, address decoder, and miscellaneous control logic.

of the six "faces". The assembled and tested substrate ("PTF" multilayer), is placed within the shell and the entire assembly is then filled with a water-clear IC-grade epoxy.

This yields a very rugged part, which is quite impervious to moisture, shock and vibration. Although not "hermetic", the device will easily withstand total immersion in water/detergent solutions.

Packaging

Packaging consists of a transfer-molded nylon lens which also serves as an "encapsulation shell" since it covers five

Figure 1b. Block Diagram – DLX 3416

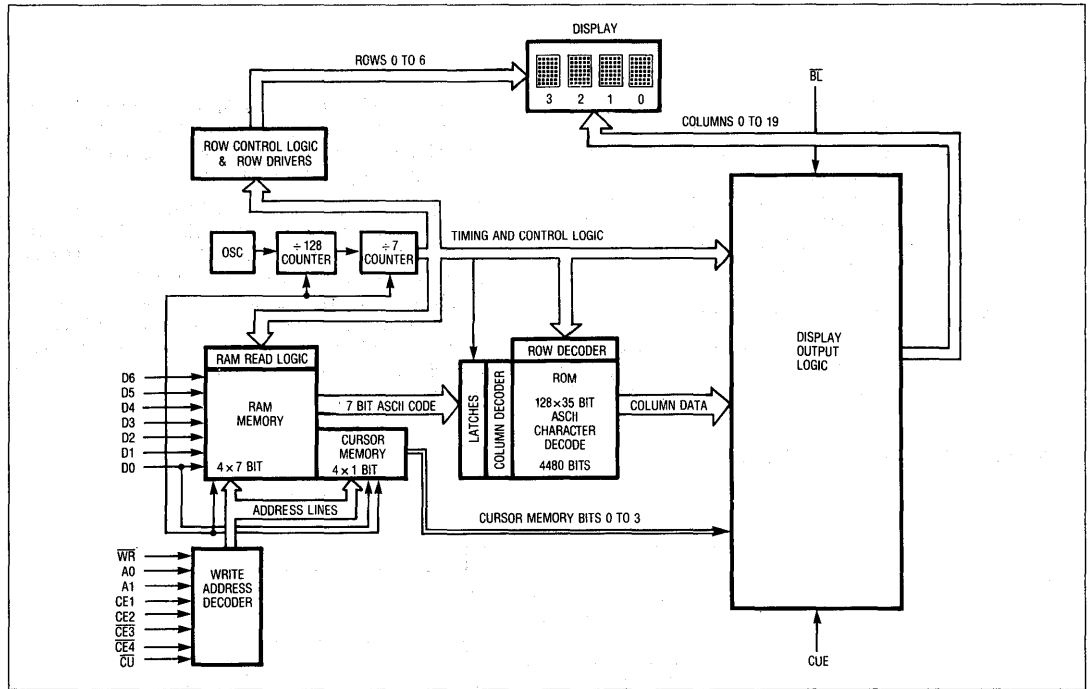
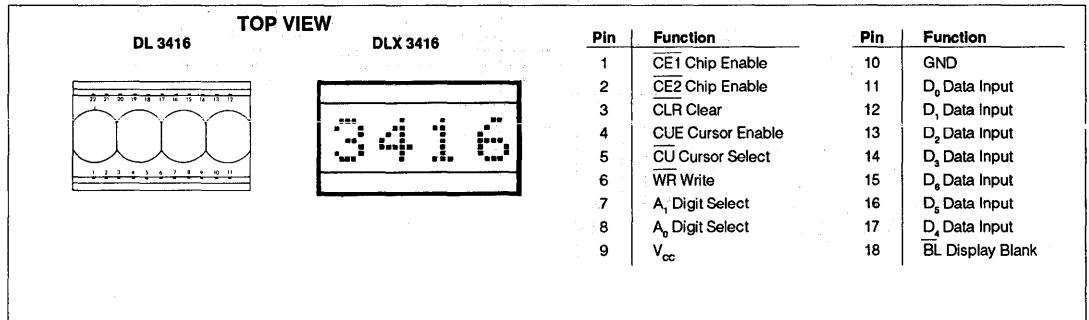

Figure 2.



Interfacing the 3416

A general and straight-forward interface circuit is shown in Figure 6. Figures 6, 7, 8, and 9 show DL 3416's being used, but any displays from the 3416 family can be used interchangeably in these examples. This scheme can easily interface to μ P systems or any other systems which can provide the seven data lines, appropriate address and control lines.

Figure 6. General Interface Circuit

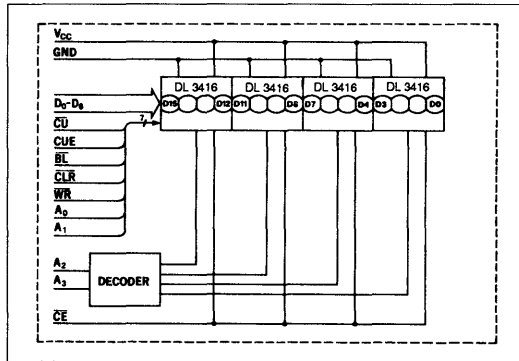

Parallel I/O

The parallel I/O device of a microprocessor can easily be connected to the circuit in Figure 6. One eight bit output port can provide the seven input data bits and the cursor (CU). Another eight bit output port can contain the address and chip enable information and the other control signals.

Figure 7 illustrates a 16-character display with an 8080 system using the 8255 programmable peripheral interface I/O device. The following program will display a simple 16-character message using this interface.

Figure 7. 16-Digit Parallel I/O System

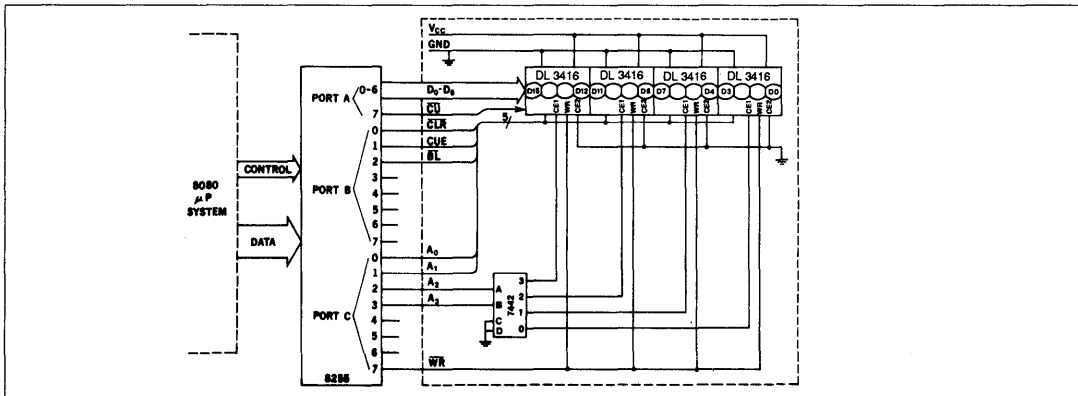

```

INIT:      MVI A,80H      ;CONTROL DATA MODE 0
           OUT CONTROL   ;LOAD CONTROL REGISTER
           MVI A,00H     ;CLEAR CURSOR DATA
           OUT PORT A    ;LOAD DATA PORT
           MVI B,0FH     ;SET CHARACTER COUNTER
           MOV A, B
           CALL DSPWT    ;WRITE SUBROUTINE
           DCR B         ;DECREMENT COUNTER
           JNZ CUSRI    ;DIGIT 0?
           MOV A, B
           CALL DSPWT
           MVI A, FFH    ;SET DATA FOR CONTROL
           OUT PORT B    ;LOAD CONTROL LINES
           LXI H, TABLE ;SET TABLE ADDRESS
           MOV A, M      ;MOVE TABLE DATA INTO
                           ;ACCUMULATOR
           OUT PORT A    ;LOAD DATA PORT
           MOV A, B
           CALL DSPWT    ;LOAD ADDRESS AND
                           ;CONTROL
           INX H         ;INCREMENT TABLE ADDRESS
           INR B         ;INCREMENT COUNTER
           MVI A, 10H    ;SET # OF DIGITS
           CMP B
           JNZ DISP1    ;16 CHARACTERS?
           HALT         ;END OF PROGRAM
           ORI F0H       ;SET CONTROL BITS OFF
           OUT PORT C    ;LOAD CONTROL
           ANI 7FH       ;SET WRITE BIT ON
           OUT PORT C    ;LOAD WRITE
           ORI F0H       ;SET WRITE BIT OFF
           OUT PORT C    ;LOAD CONTROL
           RET

DSPWT:     DB             ;0C3H
           DB             ;0C9H
           DB             ;0D4H
           DB             ;0D3H
           DB             ;0C1H
           DB             ;0D4H
           DB             ;0CEH
           DB             ;0C1H
           DB             ;0C6H
           DB             ;0A0H
           DB             ;0D3H
           DB             ;0D4H
           DB             ;0C8H
           DB             ;0C7H
           DB             ;0C9H
           DB             ;0CCH

TABLE:    DB             ;0C3H
           DB             ;0C9H
           DB             ;0D4H
           DB             ;0D3H
           DB             ;0C1H
           DB             ;0D4H
           DB             ;0CEH
           DB             ;0C1H
           DB             ;0C6H
           DB             ;0A0H
           DB             ;0D3H
           DB             ;0D4H
           DB             ;0C8H
           DB             ;0C7H
           DB             ;0C9H
           DB             ;0CCH
    
```

Figure 8. Mapped Interface

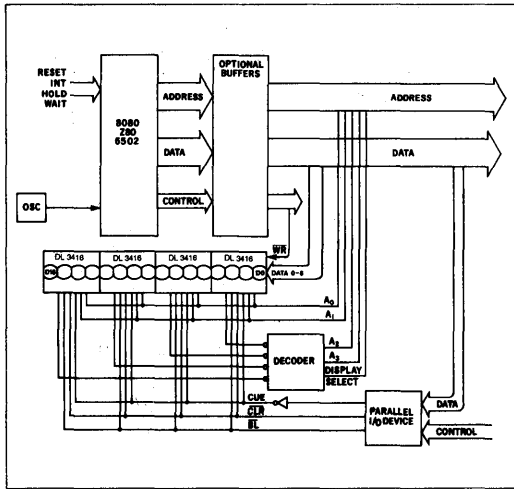

I/O or Memory Mapped Addressing

Some designers may wish to avoid the additional cost of a parallel I/O in their system. Structuring the addressing architecture for the 3416 to look like a set of peripheral or output devices (I/O mapped) or RAM's and ROM's (memory mapped) is very easy. Figure 8 shows the simplicity of interfacing to microprocessors, such as 8080, Z80 and 6502 as examples.

The interface with the 6800 microprocessor in Figure 9 illustrates the need for designers to check the timing requirements of the DL 3416 and the μP . The typical data output hold time is only 30 ns for DBE = $\emptyset 2$ timing; two inverters in the DBE line are added to increase the data output hold time for compatibility with the 50 ns minimum spec of the DL 3416.

Figure 9.

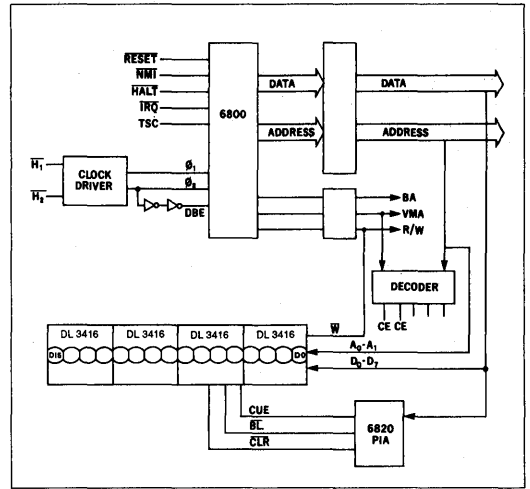

Conclusion

Note that although other manufacturer's products are used in examples, this application note does not imply specific endorsement, or recommendation or warranty of other manufacturer's products by Siemens.

The interface schemes shown demonstrate the simplicity of using the 3416 with microprocessors. The slight differences encountered with various microprocessors to interface with the 3416 are similar to those encountered when using different RAMs. The techniques used in the examples were shown for their generality, and any display of this family are interchangeable in these examples. The user will undoubtedly invent other schemes to optimize his particular system to its requirements.

Guidelines for Handling and Using Intelligent Displays® Appnote 18

by Malcolm Howard and Dave Takagishi

IMPORTANT!

This appnote contains vital information for optimum design and performance of Intelligent Displays.

Siemens Opto Intelligent Displays and Programmable Displays are one, four or eight-digit LED display modules, having 16 or 17 segment or dot matrix fonts with on-board CMOS integrated circuits. The CMOS chip provides segment decoding, drivers, multiplexing and memory for easy interfacing to most microprocessors

Since Siemens first began manufacturing Intelligent Displays, questions concerning their use have arisen. This application note is a guide for the design and handling considerations of these products.

System Design Consideration

In the practical circuit (i.e., design of PCB, etc.) the voltage to any input must never exceed the power inputs (i.e., $GND < V_{IN} < V_{CC}$). If these conditions are not met, then malfunction, or at worst, device destruction can occur. The most common cause of these conditions is circuit noise on the inputs and transient power supply changes.

Good Circuit Layout

The principles of good circuit layout are identical to any logic circuitry, but the deviation tolerance of MOS devices is much less than that of bipolar logic. To reduce the coupling effect between signals, it is important to keep the signal path lengths as short as possible.

Buffering

Although the use of parallel tracking is usually considered good design practice, avoid PCB designs which allow an interconnection track to run parallel to another. This is particularly true if one of the tracks is a high power bus when the fluctuations of power supply current can cause inductive or capacitive coupled charge onto an adjacent input signal.

Possibly the worst example of parallel tracking is the ribbon cable. While physically neat and convenient, ribbon cables can be electrically destructive for the MOS circuits. It is often necessary, because of the very nature of the Intelligent Display, to use ribbon cable from the CPU board to the display assembly board. In those circumstances for PCB trace lengths plus cable lengths over 15.5 cm (6 inches), use a buffer for each input. This is especially true for noisy systems which have motors, relays, etc. The buffers should be physically as close as possible to the displays; thus maintaining a minimum distance between their outputs and the display inputs. Long cables can be poor transmission lines for speed pulses. Line drivers line receivers, or Schmitt trigger gates may be required to shape pulses.

Voltage Transients

It has become common practice to provide 0.01 μf bypass capacitors liberally in digital systems. For Intelligent Displays, the emphasis is on adequate decoupling. Like other CMOS circuitry, the Intelligent Display controller chip has a very low power consumption and the usual 0.01 μf capacitor would be adequate were it not for the LEDs. The module can, in some conditions (depending on the displayed characters), use up to 500 mA pk (average, multiplexed). To prevent power supply transients, use capacitors with low inductance and high capacitance at high frequencies, i.e., a solid tantalum or ceramic disc for high frequency bypass. For longer display lengths, distribute the bypass capacitors evenly keeping capacitors as close to display power pins as possible. Do not rely on into the board decoupling, use a 10 μf and a 0.01 μf capacitor for every three or four Intelligent Displays to decouple the displays themselves, at the displays. See Figure 1.

Figure 1.

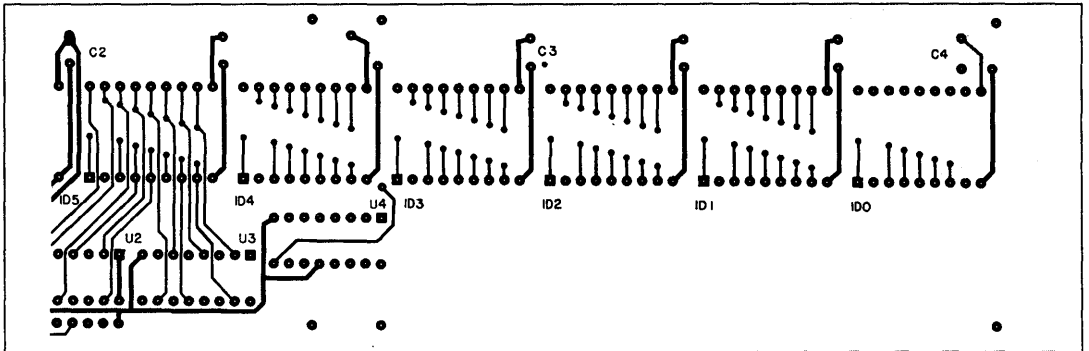

An actual PCB layout for a line of DL2416 Intelligent Displays. Capacitors are spaced evenly and close to the displays with room for additional capacitors should the system require them.

Functional Limitations

Several parameters in an Intelligent Display data sheet which may affect your design are listed below. While some parameters may not be destructive, some may affect reliability and/or functional operation. (Check latest data sheets.)

1. The length of *time that all cursors may be lit* (on the DL2416T and DL3416) should be **1 minute max.**
 - 1a. No more than 20 LEDs/character for HDSP200XLP, Serial Input Displays.
2. The timing parameters at 25°C will increase (slower) with increased temperature.
3. The timing parameters will decrease (faster) with increased V_{CC} .

Manufacturing Considerations

Handling

The static voltages generated by friction with synthetic materials (i.e., carpets, clothing, device carriers, etc.) are often measured in thousands of volts. Although these static charges usually have little energy, it is sufficient to cause destruction to CMOS circuitry if applied to circuit inputs. Our CMOS circuits have input protection diodes which can minimize their vulnerability to these static voltages, but there is a limit to their protection capabilities. Under certain conditions, static charges can exceed that limit. The most effective protection is to avoid the generation of static charges. When static charges are unavoidable, prevent that charge from coming into contact with the device pins.

1. *Avoid touching the pins, handle the body only.*
2. *Keep the devices in anti-static tubes or conductive material when transporting.*
3. *Use conductive and grounded working area* (conductive flooring, conductive workbench tops, conductive individual wrist straps, etc.).

Intensity Brightness Codes

Display uniformity is a concern when two or more displays are in a system. SIEMENS has adopted a letter code (indicating a brightness range) to maintain a uniform display. It is recommended a single letter code be used per system. Because this may be difficult to always achieve due to yield and delivery, adjacent codes (i.e., D with E or E with F) can be used with minimal problems. Jumping over a code (i.e., D with F) may be noticeable.

Soldering

Because of the plastic housing of the Intelligent Displays, it is necessary to control the solder temperature, soldering time, and soldering distance. A maximum of 260°C for three seconds at a distance greater than 1/16 inch is recommended. An additional requirement during wave soldering: the temperature of the plastic package should not exceed the maximum rated storage temperature of the device type.

Cleaning

Refer to Appnote 19, "Cleaning LED Opto Products."

Cleaning LED Opto Products Appnote 19

by Jonathan Wafer

Now that you have selected the proper optoelectronic device for your application and designed the circuitry, the next step is to install the devices. This application note is a cleaning guide for Siemens Opto products.

PURPOSE OF CLEANING

Removal of both flux rosin or resin along with ionic residues after soldering is essential for good product and overall system performance and reliability. Optoelectronic components require special packaging materials with transmissive or reflective optical properties, therefore they must be treated differently than conventional semiconductor devices with respect to cleaning.

CLEANING PROCESSES

Component cleaning or defluxing processes fall into four categories: aqueous, semiaqueous, solvent, and no clean. Both in-line and batch cleaning equipment employ one of the above processes. A brief description of each process, along with approved cleaning solutions from each group, is summarized below. Table 1 lists several cleaning solution suppliers.

Aqueous Cleaning

Siemens Opto components are compatible with most aqueous cleaning agents. These solutions are usually high pH alkyl amine-based products that also contain surfactants, saponifiers, buffers, and inhibitors. The solution reduces organics to form soaps. This is followed by a deionized water rinse. In its simplest form, aqueous processing using a deionized water rinse is useful for removing water-soluble flux residues. The following are approved aqueous cleaning agents and their suppliers:

Indusco Chemicals	WL 1000 Aqua Flux Strip
Altos Group	AQ 1534

Semiaqueous Cleaning

Semiaqueous Cleaning involves utilization of hydrocarbon or citrus extract solutions to solubilize residues followed by a deionized water rinse and dry cycle. Semiaqueous cleaning agents compatible with Siemens Opto products are listed in Table 2 on the following page.

Solvent Cleaning

The most common solvent cleaning technique—vapor degreasing—involves placing parts within a vaporized solvent chamber, thereby condensing the vapor into a liquid solvent and dissolving the soil. Many popular solvents used in this application are CFC 113 azeotropes that face regulation and eventual ban per the 1990 Clean Air Act. Compatibility of these and other solvents with Siemens Opto components is also listed in Table 2.

CONCLUSION

The list of solvents and cleaning solutions in Table 2 represents a small group of all the available cleaning agents on the market. Others may be compatible, but more likely, most will be incompatible. Usage of non-ozone-depleting chemicals (ODCs) is highly recommended for environmental and long-term safety reasons.

Siemens does not assume any responsibility for damage caused to products by use of the cleaning agents mentioned above. This application note is only a guide to products that have been found satisfactory when tested under our controlled lab conditions. We recommend that components be evaluated under client-specific conditions before committing to use on a production basis.

Table 1.

CLEANING SOLUTION SUPPLIERS	
Supplier	Product
Allied Signal Inc. Engineered Solvent Systems	Genesolv CFC 113 Azeotropes
E I DuPont de Nemours	Freon CFC 113 Azeotropes Axarel Semiaqueous Cleaners
Petroferm Inc.	BioAct EC7R Terpene Semiaqueous Cleaners
Kyzen Corp.	Ionox Semiaqueous Cleaners

Table 1.

COMPATIBILITY OF VARIOUS CLEANING SOLUTIONS WITH SIEMENS OPTO PRODUCTS													
Product Type	Cleaning Agent												
	CFC*					NON CFC				SEMIAQUEOUS			
	TF	TE	TES	TA	TMS	Acetone	IPA	111 TCA	Axarel 38	EC7R	Ionox		
											HC	LC	MC
Visible Lamps	S	S	N	N	S	N	S	N	S	S	S	S	S
IR	S	S	N	N	S	N	S	N	S	S	S	S	S
Couplers	S	S	N	N	S	N	S	N	S	S	S	S	S
Displays Group 1 HD XXXX DL 413X DL 573X DL 713X PD 443X XBG 1000 XBG 48XO	S	S	N	N	S	N	S	N	S	S	N	S	S
Displays Group 2 DL 3XXM/4XXM DL 1416 DL 1414 DLX 1414 HDSP 2000XLP DL 2416 DLX 2416 PDSP 211X DL 3416 DLX 3416 SLX 2016 PD 243X PD 353X SCD 558X SCD 5510X	S	S	N	S	N	S	N	N	S	S	N	S	S

S-Suitable for use

N-Not suitable for use

*-Denotes ozone-depleting substance. May be regulated by 1990 Clean Air Act.

Moving Messages Using Intelligent Display® Devices and 8748 Microprocessor Appnote 20

Reprinted from Siemens Design Examples of Integrated Circuits Edition 1980/81

Output and display of texts including an important operator information are not only limited to devices of data processing systems but they are more and more applied in other fields of electronics, e.g. in industrial and consumer as well as control engineering. If data of different kinds (e.g. program results, error indications, decision criteria, test results, etc.) are displayed as moving news, they have a striking effect calling the operator's attention.

The text can easily be read when each character remains for 0.25 s on the display. A special advantage of a moving news panel being controlled by a microcomputer is in that the information can immediately be modified. The described circuit of **Fig. 1** operates with SAB 8748. Its program memory capacity (EPROM) is 1K Byte and up to 900 characters can be stored. If the microcomputer is replaced by another one incorporating a different program, the information which is to be displayed is also exchanged.

The described circuit offers the advantage in requiring a minimum of components. The single-chip microcomputer SAB 8748 operates in conjunction with an alphanumeric 16-segment-LED-display DL-2416. It incorporates memory decoder and driver.

Hardware

The ASCII-coded data is transferred from the SAB 8748 to the display ICs via the bus port (DB0 to DB6) and via the WR-output (strobe). The information at pins P20 and P21 addresses the specific digits of the display-IC DL2416.

The signals at P22 to P26 select the individual ICs via the chip enable input CE1. When one pin of port 1 is connected to ground, the microcomputer supplies the corresponding text. An output of 4 different texts is possible.

The text may have any length as long as the memory capacity of 900 bytes is not exceeded. There are no additional components required than indicated in the circuit of **Fig. 2**.

Software

The first 100 bytes of the EPROM are reserved for the program. As the program counter can only be read as data memory within 256 bytes, additional instructions are necessary (see listing). At the beginning of the program port 1 is read. If a signal with low level is available at one of the pins, the

starting address of the corresponding text is loaded to register 2 (low address) and 3 (high address). Now output registers 20H to 32H have to be filled with blanks. Then the first letter is transferred from text memory to data memory. Now the microprocessor operates in a waiting loop, determining the speed of the moving news. At an oscillator frequency of 3 MHz the timer has an overflow after $\frac{1}{3} \times 10^{-6} \mu s \times 15 \times 32 \times 256 = 40.96$ ms. The moving-news text is stepping four times per second after 6 overflows have occurred, that means the 900 characters need in total 3¾ minutes. If the 8-bit-word zero (figure 0, not the ASCII-character for 0) is read as character, the text end is recognized by the program. Therefore a counting is not necessary, that means all characters have been transferred. Now the program returns to read port 1.

The flowchart is shown in **Fig. 3** and **Fig. 4** presents the complete listing.

Components for circuit 2

- 1 8-bit single chip microcomputer (1-KByte-EPROM, 3-MHz-version) SAB 8748-8-D
- 5 4-digit alphanumeric LED-displays with memory, decoder and driver, (4 mm character height, 16 segments) DL 2416
- 1 Crystal 3 MHz
- 4 Push buttons for pc board mounting, 2 break-make-contacts, lateral operation

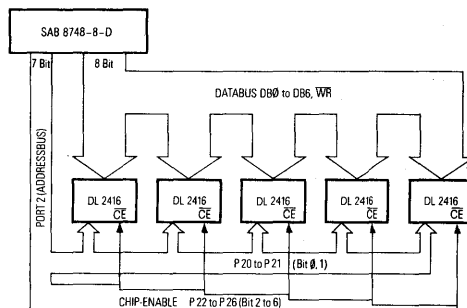

Fig. 1

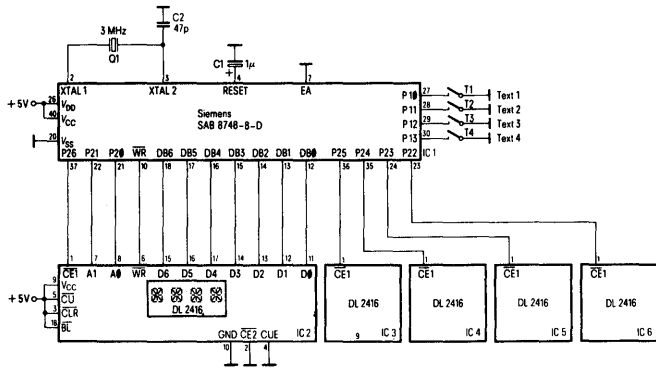

Fig. 2

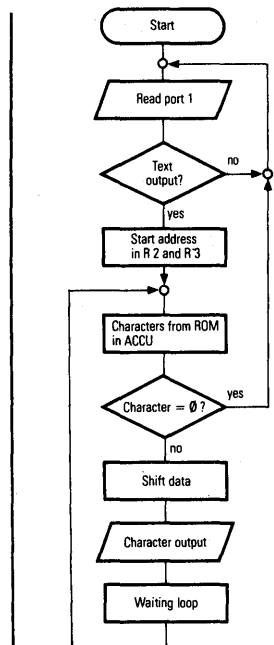

Fig. 3

AS848 APP20

IS16-11 WCS-AB/UP1-41 MACRO ASSEMBLER, V3.0
 APPNOTE 20 MOVING MESSAGE USING DL-2416S

PAGE 1

LOC	OBJ	LINE	SOURCE STATEMENT			
1			LIST PAGING SYMBOLS XREF MACROFILE DEBUG			
2			ATTITLE(*APPNOTE 20 MOVING MESSAGE USING DL-2416S*)			
3						
4			*****			
5			!# THIS PROGRAM WILL DISPLAY FOUR-32 CHARACTER MESSAGES *			
6			!# IN A "TIMES-SQUARE" MOVING MESSAGE FORMAT. IT USES *			
7			!# FIX OF THE TIME TESTED SIEMENS/LITRONIX DL-2416 *			
8			!# INTELLIGENT DISPLAY(S)			
9			*****			
10			17 FEBRUARY 1982			
0000 0A		11	IN A:P2	KEY POLLING		
0001 37		12	CFI			
0002 120C		13	JBO AUS1			
0004 3212		14	JBI AUS2			
0006 5218		15	JB2 AUS3			
0008 721E		16	JB3 AUS4			
0006 0400		17	JMP 0			
000C 8AB0		18	AUS1: MOV R2,HL0A(TEXT1-1)	ADDRESS TEXT 1		
000E 8B0A		19	MOV R3,HLHIGH(TEXT1-1)			
0010 0432		20	JMP ANFANG			
0012 9AA1		21	AUS2: MOV R2,HL0A(TEXT2-1)	ADDRESS TEXT 2		
0014 8B00		22	MOV R3,HLHIGH(TEXT2-1)			
0016 0422		23	JMP ANFANG			
0018 8A62		24	AUS3: MOV R2,HL0A(TEXT3-1)	ADDRESS TEXT 3		
001A 8B00		25	MOV R3,HLHIGH(TEXT3-1)			
001C 0422		26	JMP ANFANG			
001E 8A63		27	AUS4: MOV R2,HL0A(TEXT4-1)	ADDRESS TEXT 4		
0020 8B00		28	MOV R3,HLHIGH(TEXT4-1)			
0022 55		29	ANFANG: STRT I			
0023 8B20		30	MOV R0,#20H			
0025 8B14		32	MOV R5,#20			
0027 2320		33	MOV A,#20H			
0029 A0		34	LOECH: MOV B0,A	BLANK		
002A 1B		35	INC R0			
002B E029		36	DJNZ RS,LOECH	RLANK IN RAM 20H-32H		
002D 1464		37	SCHL1: CALL EIMFUE	TEXT CHARACTER		
002F C600		38	HALT: JZ 0	LAST CHARACTER		
0031 8D14		39	MOV R5,#20			
0033 8B20		40	MOV R0,#20H			
0035 20		41	SCHL1: XCH A,#R0	SHIFT		
0036 1B		42	INC R0			
0037 ED35		43	DJNZ RS,SCHL1			
0039 8B20		44	MOV R5,#20H			
003B 8CF8		45	MOV R4,#0FBH	CHIP SELECT 1 DISPLAY		
003D 140F		46	CALL AUS4B1			
003F BC74		47	MOV R4,#0FAH	CHIP SELECT 2 DISPLAY		
0041 1459		48	CALL AUS4B1			
0043 80C6		49	MOV R4,#0E6H	CHIP SELECT 3 DISPLAY		
0045 1459		50	CALL AUS4B1			
0047 80C6		51	MOV R4,#0E6H	CHIP SELECT 4 DISPLAY		
0049 1459		52	CALL AUS4B1			
004B 80C6		53	MOV R4,#0E6H	CHIP SELECT 5 DISPLAY		
004D 1459		54	CALL AUS4B1			
004F 8B0A		55	MOV R5,#10			
0051 1455		56	MARTE: JIF MARTE	WAIT 240 MS		
0053 0451		57	JMP MARTE			
0055 E551		58	MEITER: DJNZ RS,MARTE			
0057 042D		59	JMP SCHL			
61			!# OUTPUT & DISPLAY SUBROUTINE			
62			!#0 OUTPUT DIBIT POINTER			
63			!#A CHIP SELECT & 2 BIT ADDRESS			
64			!#S LOOP COUNTER			
65						
0069 8B04		66	AUS4B1: MOV RS,#A	USER SYMBOLS		
006B FC		67	AUS4B1: MOV A,#A	ANFANG 0022 AUS1 000C AUS2 0012 AUS3 0018 AUS4 001E		
006D 3C		68	OUTL P1,A	EIMFUE 0064 HALT 002F JMPADR 006F LOECH 0029 SCHL 002D		
006E 1C		69	INC R4	TEXT3 00C3 TEXT4 00E4 UMGEH 006B MARTE 0051 MEITER 0055		
006F 00		70	MOV A,#R0			
006F 02		71	OUTL BUS,A			
006B 1B		72	INC R0			
0061 EP5B		73	DJNZ RS,AUS4B1			
0063 83		74	RET			
006A 1A		81	EIMFUE: INC R2			
0065 FA		82	MOV A,R2			
0065 9A6B		83	JNZ UMGEH			
006B B02D		84	MOV R2,#2			
006A 1B		85	INC R3			
006B F1		86	UMGEH: MOV A,R3			
006C 03AF		87	AUD A,#JMPADR			
006E 83		88	JMP 86			
006E 73		89	JMPADR: DB JMPADR +4			
0070 7C		90	DB JMPADR +7			
0073 79		91	DB JMPADR +10			
0072 7E		92	DB JMPADR +13			
0075 FA		93	MOV A,R2			
0074 047F		94	JMP A,R2			
0076 FA		95	JMP A,R2			
0077 2A00		96	JMP 100H			
0079 FA		97	MOV A,R2			
007A 4A00		98	JMP 200H			
007C FA		99	MOV A,R2			
007E 6A00		100	JMP 300H			
		101				
007F A3		102	DATEN: MOV A,#A			
0080 B3		103	RET			
0081 5A455B54		104	TEXT1: DB 'TEXTAUSGABE 1			,0
0085 41555347						
0089 41424520						
008B 31202020						
0091 20202020						
0099 20202020						
009F 20202020						
00A2 5A455B54		105	TEXT2: DB 'TEXTAUSGABE 2			,0
00A6 41555347						
00AA 41424520						
00AC 32020200						
00B2 20202020						
00BA 20202020						
00C8 20202020						
00D0 00						
00C3 5A455B54		106	TEXT3: DB 'TEXTAUSGABE 3			,0
00C7 41555347						
00CD 41424520						
00D3 32020200						
00DB 20202020						
00E7 20202020						
00F0 20202020						
00F8 20202020						
00FC 20202020						
00E0 00						
00E4 5A455B54		107	TEXT4: DB 'TEXTAUSGABE 4			,0
00E8 41555347						
00EE 41424520						
00F4 3A202020						
00F6 20202020						
00FB 20202020						
0100 A3		108	MOV A,#A			
0101 B3		109	RET			,0
0102 80202020		110	FB			
0104 00		111	END			
		112				

Fig. 4

Silver Plated Tarnished Leads

Appnote 21

by Dave Takagishi

Silver plating, as an alternative to gold plating, has excellent electrical conductivity, LED die attach, and wire bonding properties. But tarnished leads can cause soldering difficulties. This application note will discuss silver tarnish and solderability.

Effects of Tarnish

Solderability means the metals or surfaces to be soldered must be types that will go into solution with tin-lead alloys. When exposed to the atmosphere, all metals form oxides or tarnish of varying degree which reduce the ability of solder alloys to adhere to the metals. Silver tarnish is formed when silver chemically reacts with sulfur to form silver sulfide (Ag₂S). This tarnish is the reason for poor solderability of silver plated products. However, the amount of tarnish and the kind of solder flux used actually determine the solderability. As the tarnish increases, a more active flux must be used to penetrate and remove the tarnish.

Prevention and Handling

Prevention is the best method for inhibiting the formation of tarnish and insuring good solderability of silver plated devices. To inhibit silver tarnish, do not expose the silver plating to sulfur and sulfur compounds. One source of sulfur is free air. Another is paper products such as bags and cardboard.

Listed below are a few suggestions for storing silver plated products.

1. Store the unused devices in polyethylene sheet to keep out free air.
2. Loose devices may be stored in zip-lock or sealed plastic bags.
3. For long term storage, place petroleum naphthalene (mothballs) with product inside plastic packages to help keep out free air.
4. The silver leads may be wrapped in "Silver Saver" paper for protection. "Silver Saver" is manufactured by:
Daubert Coated Products
1200 Jorie Drive
Oak Brook, Ill. 60521
(312) 582-1000
5. Tapes such as adhesive, electrical, and masking should not be used because the adhesive may leave a film and will need to be removed before soldering.

The best defense against the formation of tarnish is to keep silver plated devices in protective packaging until just prior to soldering.

Fluxes

Depending on the amount of tarnish, different types of flux may be required. Below is a list of flux in order of increasing strength.

Type R: Un-activated Rosin Flux

A pure water-white gum rosin without any additives. Flux and its residue are non-conductive and non-corrosive.

Type RMA: Mildly Activated Rosin Flux

A WW rosin flux with a small amount of activating agent. Flux its residue are non-conductive and non-corrosive.

Type RA: Activated Rosin Flux

Similar to RMA flux but with greater amounts of activating agents. Flux and its residue are non-conductive & non-corrosive.

Types AC: Organic Acid Flux

A fully active organic flux with greater flux ability than a rosin flux. Due to its organic nature, the flux residues decompose at soldering temperatures but must be removed to prevent conductive and corrosive aftereffects.

Recommended flux types with respect to the various tarnish amount:

1. Tarnish free may be soldered with Alpha 100, Kester 135, or equivalent Type R flux. (Identified by a bright surface)
2. Minor tarnish will require Alpha 611, Kester 197, or equivalent Type RMA flux. (Identified by a medium bright surface)
3. Mild tarnish will require Alpha 711, Kester 1544, or equivalent Type RA flux. (Identified by a light tint surface)
4. Moderate tarnish will require Alpha 830, Kester 1429, or equivalent Type AC flux. (Identified by a light tan color on the surface)
5. If severe tarnish is present, as identified by a dark tan to black color, a cleaner/surface conditioner Alpha 140, Kester 5560, or equivalent must be used. A few seconds and at room temperature is all that is required. These conditioners are acidic; therefore, a thorough wash and rinse is recommended. Care is advised to only immerse the leads and not the body, because optical properties may be damaged.

Soldering

To obtain reliable circuit operation, good soldering is necessary. For wave soldering, Sn60 is the most commonly used solder for electronic components. Two alternatives are Sn63 and Sn62 solder. A high quality rosin core flux is recommended for hand solder operations. Typically the core is an RMA type flux.

Two major soldering suppliers are:

Alpha Metals
600 Rt 440
Jersey City, NJ 07304
(201) 434-6778
Kester Solder
4201 Wrightwood Ave.
Chicago, Ill 60639
(312) 235-1600

Regardless of the flux and solder technique used, care should be taken to assure the optical properties of the optoelectronic product are not degraded in any manner.

Siemens does not assume any responsibility for damage caused by products mentioned above.

SIEMENS

Socket Selection Guide Appnote 22

by Dave Takagishi

This application note is a guide to locate a suitable socket for various Siemens products.

The selection of a socket is first based on the number of pins and the pin spacing required. Sockets for displays require an orientation and sometimes stackability. Other requirements may be:

- Contact type (i.e., side vs. edge)
- Plating type (i.e., tin vs. gold)
- PCB mounting (i.e., solder vs. wirewrap)
- Height of socket

To use this guide, (1) Find Siemens product part number in Table 1, (2) Note number of pins, (3) Note spacing and orientation... (Example 300 H), (4) Go to Table 2, find # of pin with corresponding spacing/orientation and follow to suggested socket.

The purpose of this application note is to guide you to possible vendors and suggest one out of many possible socket choices. It is recommended that the part numbers given be used as a starting point with a vendor for choosing a socket. The part number will depend on your requirement and application.

This guide is not intended to imply specific endorsement or warranty of other manufacturer's products by Siemens.

Table 1.

Part Number	# of Pins	Spacing
DL330M	12	.300 H
DL340M	14	.300 H
DL430M	12	.300 H
DL440M	12	.300 H
HD1075X	10	(SPC)
HD1077X	10	(SPC)
HD1105X	10	.300 V
HD1107X	10	.300 V
HD1131X	10	.600 H
HD1132X	10	.600 H
HD1133X	10	.600 H
HD1134X	10	.600 H
DLX573X	12	.300 V
HDSP200XLP	12	.300 H
ISD235X	12	.250 H
ISD231X	12	.250 H
ISD201X	12	.300 H
Optocouplers: 6 pin	6	.300 B
8 pin	8	.300 B
16 pin	16	.300 B
Arrays	2 - 20	.100 B

Table 2.

# of Pins	Row-Row Spacing	ARIES New Jersey	GARRY MFG. New Jersey	ROBINSON-NUGENT, Indiana	SAMTEC Indiana
12	.300 H	12-513-10	(2)102-06-X	(2)ICN-063-X	
14	.300 H	14-511-10	102-14-X-X-X	ICL-143-S6-X	ICC-314-T
18	.600 V	18-6511-10	300-18-X-X-X		IC-618-X
22	.600 V	24-6513-10	300-22-XX-X		ICC-624-X
22	SPC	—	—	—	—
13	SPC	—	—	—	—
12	.300 V	12-513-10			
14	.300 V	14-511-10	102-14-X-X-X	ICL-143-S6-X	ICC-314
14	.600 V	14-6511-10	300-14-X-X-X		IC-614-X
20	.300 H	20-511-10	102-20-CC-X-X	ICL-203-S6-X	ICC-320
10	SPC	—	—	—	—
10	.300 V				IC-310-X
10	.600 V	10-6511-10			IC-610-X
18	.300 V	18-511-10	102-18-X-X-X	ICN-063-S3-X	ICC-318
6	.300 B	6-513-10	102-06-X	ICN-083-S3-X	IC-306-X
8	.300 B	8-511-10	102-8-X-X-X		IC-308
16	.300 B				
2-20	.100 B	PIN-LINE SERIES	SERIES 200 SERIES 2002	SB-25-100X	SSA-1XX-XSERIES ICK-1XX-XSERIES
Others		Yes	Yes	Yes	

List of Possible Vendors

Aries Electronics Co.
P.O. Box 130
Frenchtown, NJ 08825
201-996-6841

Garry Manufacturing
1010 Jersey Ave.
New Brunswick, NJ 08902
201-545-2424

Robinson-Nugent
800 E. Eighth St.
New Albany, IN 47150
812-945-0211

Samtec
810 Progress Blvd.
New Albany, IN 47150
812-944-6733

Notes:

1. All sockets are 0.100 pin-to-pin spacing.
2. Products listed are generally tin plated PCB solder type. Contact vendor for other types.
3. Row-row spacing of pins: (H)-pins are horizontal with respect to viewing of display; (V)-pins are vertical with respect to viewing of display; (B)-pins can be either horizontal or vertical; (SPC)-pins not standard 0.100 or row-row spacing.
4. Others — Special sockets for display such as right angle, etc. Contact vendor for details.
5. Consult vendor for stackability.
6. Strip in-line sockets may be used. (Cut to length required.)
7. Vendor may have other products also suitable for your application.

LED Filter Selection Guide Appnote 23

By Dave Takagishi

The most important design consideration for a piece of equipment using LED products is the ability to display information to an observer clearly. This information must be easily and accurately recognized in various ambient light conditions. This application note will discuss the design considerations and recommendations for filtering.

Since the quality of readability is very subjective, the best judge of the performance of a product is the human eye and in the user's conditions. To improve the readability of a display it will be necessary to employ certain techniques such as contrast enhancement, wavelength filtering, special filtering, and mounting.

Contrast Enhancement

The objective of contrast enhancement is to maximize the contrast between the display segments "ON" and "OFF" states. This is done by reducing the ambient light reflected from the surface of the display and allowing as much of the emitted light to reach the observer. This can be accomplished by painting the front surface of the display to match as close as possible the color of an "OFF" segment. This reduces the distracting areas around the display and therefore enhances the "ON" segments.

Contrast enhancement may be improved further by the use of selected wavelength filters. Under bright ambient conditions, contrast enhancement is more difficult and additional techniques such as louvered filters and/or shading may be necessary.

Filters

The majority of display applications use plastic filter material for their low cost and ease of assembly. The filter requirements for different ambient lighting conditions and different color displays make it necessary to become familiar with the various relative transmittance characteristics. Most filter manufacturers will provide transmittance curves for their products.

When selecting a filter, the shape of the transmittance curve vs wavelength should be considered in relationship to the LED radiated spectrum to obtain maximum contrast enhancement. For standard red displays, a long wavelength pass filter having a sharp cutoff in the 600nm to 620nm range is ideal. The same applies for high efficiency red displays with a long wavelength pass filter in the 570nm to 590nm range. The yellow and green displays are more difficult to filter effectively. The most effective filter for yellow displays is a yellow-orange or amber filter. Yellow-only filters are very poor for contrast enhancement. Green displays will require a band-pass yellow-green filter which peaks at 565nm.

A choice among available filters must be made on the basis of which filter and LED combination is most effective, but experimentation with each choice must be made to choose the most esthetic combination.

Effectiveness of Wavelength Filters with Different Lighting

Contrast is very dependent upon the ambient lighting. If the ambient light is outside the spectrum of the LED, then it is very easy to reduce the reflected light. This is the case for a red LED display in fluorescent lighting or a green LED in incandescent lighting. Bright sunlight has a flat spectral distribution curve and when it is directly incident upon a display the background may meet or exceed the light output of the display. It should be obvious that a wavelength filter alone is not sufficient in daylight ambient conditions.

Other Techniques

An acceptable contrast is difficult to achieve if high ambient light is parallel to the viewing axis (the incident light is perpendicular to the face of the display). If the incident light is not parallel to the viewing axis, the use of louvered filters or shading and recessing is recommended. It is the shading of louvered filters that reduces the incident light to allow for more contrast. The drawback to this filter is the restricted viewing angle.

Circular polarizing filters are effective in reducing the reflected light from the highly reflective (glossy) surfaces of bubble lensed products, such as the Intelligent Displays.

Glare can still be present from the surface of filters, therefore, an anti-reflection surface is recommended. This can be incorporated into the filter. The trade-off is that both ambient and display light are diffused and the display may appear fuzzy if not mounted close enough to the filter.

Care should be taken to design the printed circuit board to keep all reflective surfaces away from display area or display side of the board or consider a dark coating on the reflective surfaces

Mounting Considerations

The designer should consider recessing the display and bezel assembly to add some shading effect. The shading will reduce the indirect lighting for better contrast.

It is essential to design the unit to allow sufficient air flow for circulation and mount current limiting resistors on another board or any heat generating components away from the displays.

Filter Recommendations

Visible Filters

Manufacturer	Red	HER	Yellow	Green	Specials
Homalite	1605	1670	1720 1726	1425 1440	
Panelgraphic	Red 60 Red 63	Red 65	Ylw 25 Amb 23	Grn 48	Gray 10
Rohm & Haas	2423	2444			2412
3-M					Louvered Filters
Polaroid					Circular Polarizing

Near IR Filter

Rohm & Haas	Red #2711
-------------	-----------

U.S. Filter Manufacturers

Filter Material Manufacturers

Panelgraphic Corporation
10 Henderson Drive
West Caldwell, NJ 07006
201-227-1500

SGL Homalite
11 Brookside Drive
Wilmington, DE 19804
302-652-3686

3M Company
Visual Products Division
3M Center, Bldg. 220-10W
St. Paul, MN 55101
612-733-0128

Rohm and Haas
Independence Mall West
Philadelphia, PA 19105
215-592-3000

Polaroid Corporation
Polarizer Division
549 Technology Square
Cambridge, MA 02139
617-864-6000

Dontech Inc.
P.O. Box 889
Doylestown, PA 18901
215-348-5010

ESCO Products Inc.
171 Oak Ridge Road
Oak Ridge, NJ 07438
201-697-3700

Bezel & Filter Assembly Manufacturers

R.M.F. PRODUCTS
P.O. Box 413
Batavia, IL 60510
312-879-0020

NOBEX COMPONENTS
Nobex Division
Griffith Plastic Corp.
1027 California Dr.
Burlingame, CA 94010
415-342-8170

PHOTO CHEMICAL PRODUCTS
OF CALIFORNIA
1715 Berkeley St.
Santa Monica, CA 90404
213-828-9561

I.E.E.-ATLAS
Industrial Electronic Engrs. Inc.
7740 Lemona Avenue
Van Nuys, CA 91405
213-787-0311

European Filter Manufacturers

3M Deutschland GmbH
D-4040 NEUSS1, Box 100422
Carl Schurz-Straße 1
☎ (02101) 140, TLX 8517511

CHEQUERS (U.K.) Limited
1-4 Christina Street
LONDON, EC2A 4PA
☎ 01-739/6964-5, TLX 291673

RÖHM GmbH
D-6000 DARMSTADT
Kirschenallee
☎ (06151) 181

POLARIZERS TECHNICAL
PRODUCTS
1800 AL ALKMAAR
P.O. BOX 489
Oude Gracht 90, The Netherlands
☎ 072-121553, TLX 57571

BAYER AG, Geschäftsbereich KU
D 5000 KÖLN 1
Konrad Adenauer Ufer 41
☎ (0221) 16471
A1037 WIEN 3, Box 124
☎ (0222) 732551
CH 8045 ZÜRICH, P.O. Box
☎ (01) 4658111

Drivers For Light Emitting Displays Appnote 24

by Dave Takagishi

The purpose of this application note is to provide some information on the integrated circuits presently available to drive Light Emitting Diodes (LED) displays and how to interface them to the various displays.

Background

LED displays come in various sizes (0.1" to 0.8"), colors (red, high-efficiency red, green, yellow), fonts (7/9/14/16 segment, dot-matrix, or bargraph), and types (common anode, common cathode, multi-digit). The brightness is essentially proportional to the current through an LED and each element within a display should have the same current or a brightness variation may be apparent. A display subsystem can be made up from several elements.

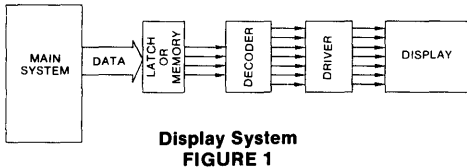

The partitioning of these elements are dependent on the drivers used; therefore, the display driver chosen is dependent on the specifications of the display and the application.

Also some types of displays require using a multiplexing technique because of the internal interconnections. This is only applicable for multi-digit displays.

Typical Circuits

Figure 2 shows a very basic circuit for driving an LED. The series resistance can be easily calculated from the following formula.

$$R_s = \frac{V_b - V_f}{I_f}$$

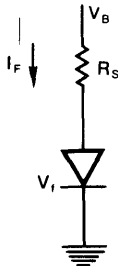

FIGURE 2

For circuits using TTL Logic or transistors (fig 3).

$$R_s = \frac{V_{CC} - V_{CE} - V_f}{I_f}$$

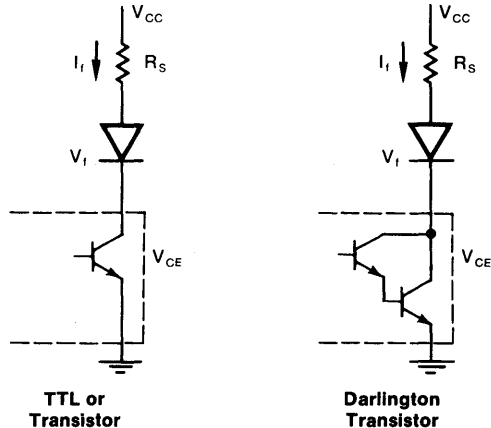
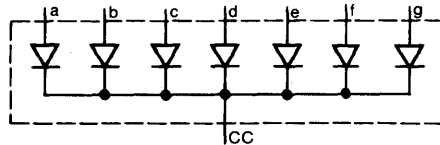

FIGURE 3

It can be seen that the term V_{ce} (saturation voltage) for the driver is going to be a factor in determining the series limiting resistor. Therefore, a darlington vs a single output transistor will have different current limiting resistor values to maintain a constant current through the LED.

Selection

One factor in choosing the display and/or driver will be whether the display is a common cathode or common anode type display.



Common Cathode Display
FIGURE 4

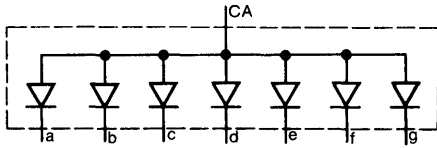

Common Anode Display
FIGURE 5

Another factor is, the different drivers go low or high,

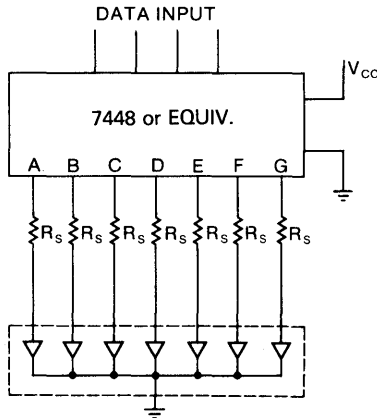

Common Cathode Display w/Driver
FIGURE 6

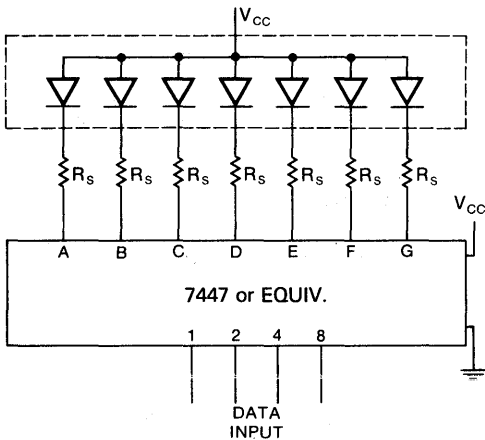

Common Anode Display w/Driver
FIGURE 7

or can be wired into different configurations.

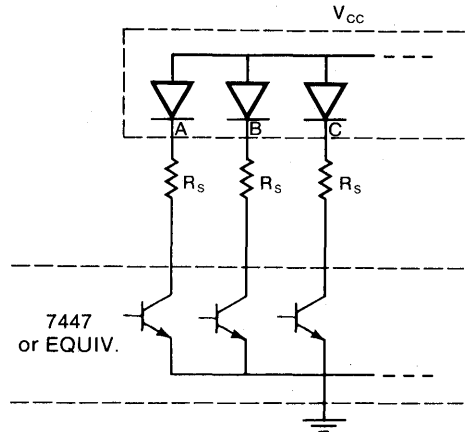

Open Collector Type Driver
w/Common Anode Display
FIGURE 8

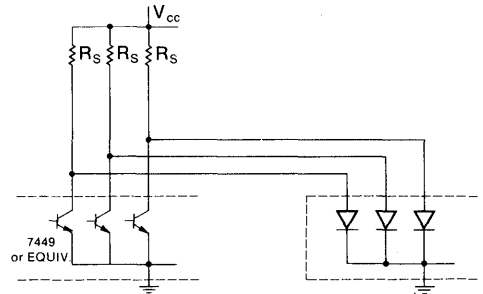

Open Collector Type Driver
w/Common Cathode Display
FIGURE 9

From figures 6/7/8/9, it may appear obvious to combine the seven (7) series resistors (R_s) into one common resistor in the common line. However this should not be done because of the possible variation in V_f from segment to segment. This variation in V_f can cause a variation in current, resulting in segment brightness differences.

Table 1 is a list of some of the most common LED drivers available. Besides having different current drive capabilities, one product may have a feature which may make them easier to use in a particular application.

- Serial vs parallel input data
- Data latching type drivers
- Blanking
 - Drive the ripple blanking input (rbo) with pulse width modulation to vary brightness.
- Multi-digit drivers
- Constant current drivers
- Advantage of a constant current driver is the change of V_f will not affect the brightness. This is important with different color LED's.

Multiplexing

In a multiplex system, the corresponding segment of each digit is bussed together and driven from one segment drive via the usual current limiting resistors. The display data is presented serially by digit to the decoder driver together with the appropriate digit signal (figure 10). For more information on multiplexing, see Appnote #3 (Multiplexing LED Displays).

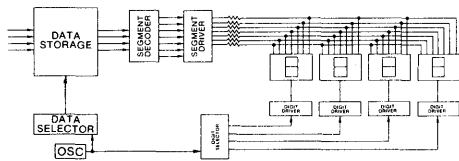

**Block Diagram of a 4-Digit
Multiplexed Display
FIGURE 10**

One way to simplify the design procedure for alphanumeric displays would be to consider the Siemens Intelligent Displays®. This device family incorporates all necessary interface control with drivers and memory built-in with the display. This means the designer need not be concerned about the memory, multiplex circuitry, character generator, or drivers for these are provided inside a modular unit. More information on these products is available in the Siemens Opto Short Form Catalog or general catalog.

Circuits herein mentioned are not the responsibility of Siemens Opto and are for reference only. Products are continually being improved by vendors and/or are obsolete; therefore, consultation with the factory is recommended.

TABLE 1

Single Digit Decoder/Drivers

PART #	MFGR	I/seg	TYPE	COMMENTS
7447 74247 7446	Fairchild Hitachi Motorola National Signetics Teledyne TI	40 ma	CA	BCD-to-7 seg, open coll, ripple blnkng
7448 74248	Fairchild Hitachi Motorola National Signetics TI	6 ma	CC	BCD-to-7 seg, int pull-up, ripple blnkng
7449 74249	Fairchild Hitachi Motorola National Signetics TI	8 ma	CC	BCD-to-7 seg, open coll, blnkng input
DS8857	National	60 ma	CA	BCD-to-7 seg decoder, ripple blnkng
DS8858	National	50 ma	CC	BCD-to-7 seg decoder, ripple blnkng
CD4511 4511B MC14511	Fairchild National Motorola	25 ma	CC	BCD-to-7 seg, latched, blnkng
DS8647 DS8648	National	10 ma	CC	.9 seg drivers
NE587	Signetics	50 ma	CA	BCD-to-7 seg, latched, ripple blnkng, vari current
NE589	Signetics	50 ma	CC	BCD-to-7 seg, latched, ripple blnkng, vari current
CA3161E	RCA	25 ma	CA	BCD-to-7 seg, constant current drivers
9368	Fairchild	20 ma	CC	BCD-to-7 seg, ripple blnkng
9374	Fairchild	15 ma	CA	BCD-to-7 seg, ripple blnkng

TABLE 1, Continued

Multi-Digit Display Drivers:

MM5450	National	25 ma	CA	34 seg serial input, brightness control
MM5451	National	25 ma	CA	35 seg serial input, brightness control
MM74C912	National	100 ma	CC	6 digit, 7 seg+decimal, BCD decoder, output enable
MM74C911	National	100 ma	CC	4 digit, 8 seg controller/seg driver
MM74917	National	100 ma	CC	6 digit, 7 seg+decimal, Hex decoder, output enable
DS8669	National	25 ma	CA	Dual BCD-to-7 seg decoder/driver
CA3168E	RCA	25 ma	CA	Dual BCD-to-7 seg decoder/driver
ICM7212 ICM7212A ICM7212M ICM7212AM	Intersil	8 ma	CA	4 digit, latched, 28 seg drivers, brightness control
ICM7218A	Intersil	20 ma	CA	8 digit, 8 seg (decoded/spcl), w/mem/drivers
ICM7218B	Intersil	10 ma	CC	8 digit, 8 seg (decoded/spcl), w/mem/drivers
ICM7218C	Intersil	20 ma	CA	8 digit, 8 seg(hex/bcd), w/mem drivers
ICM7218D	Intersil	10 ma	CC	8 digit, 8 seg(hex/bcd), w/mem/drivers
ICM7218E	Intersil	20 ma	CA	8 digit, 8 seg (decoded/spcl), w/mem drivers, controls available
TSC700A	Teledyne	11 ma	CA	4 digit decoder/driver, parallel output, brightness control
TSC7212A	Teledyne	5 ma	CA	4 digit decoder/driver, parallel output, brightness control
SAA1060	Signetics	40 ma	CA	16 element serial in/parallel out driver
SDA2014	Siemens	12 ma	CC	2 or 4 digit, serial bcd input
SDA2131	Siemens	20 ma	CA	16 element, serial input

Other Drivers:

XR-2000	Exar	400 ma	sink	5 darlington transistors, MOS-to-LED
XR-2201 XR-2202 XR-2203 XR-2204	Exar	500 ma	sink	7 darlington transistors, open collector w/diodes TTL-to-LED, compatible to Sprague (ULN-xxxx)
CA3081	RCA	100 ma	sink	7 common emitter transistor array
CA3082	RCA	100 ma	source	7 common collector transistor array
9665 9667	Fairchild	250 ma	sink	7 common emitter darlington transistor array

Bar Graph Drivers:

UAA180	Siemens	10 ma	n.a.	12 element bar driver
LM3914	National	2-20 ma	n.a.	10 element dot/bar linear output driver
LM3915	National	1-30 ma	n.a.	10 element dot/bar log output driver

SIEMENS

The DLX 713X, 5 × 7 Dot Matrix Intelligent Display[®] Device Appnote 25

by Dave Takagishi

This application note is intended to serve as a design and application guide for users of the DLO 7135, and DLG 7137 Siemens Optoelectronics Division Intelligent Displays. The information presented covers device electrical description, operation, general circuit design considerations, and interfacing to microprocessors.

Electrical Description

The DLX 713X Intelligent Alphanumeric 5 × 7 Dot Matrix Display contains memory, character generator, multiplexing circuits, and drivers built into a single package.

Figure 1 is a block diagram of the DLX 713x. The unit consists of 35 LED die arranged in a 5x7 pattern and a single CMOS integrated circuit chip. The IC chip contains the column drivers, row drivers, 96 character generator ROM, memory, multiplex and blanking circuitry.

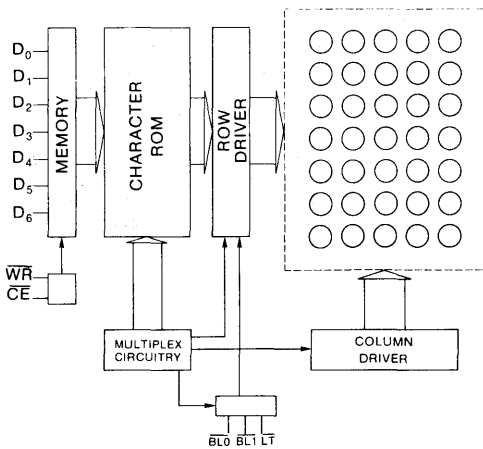

DLX-713x Block Diagram
FIGURE 1

Package

The 35 dots form a 0.48 x 0.68 inch overall character size in a 0.700 x 0.800 inch dual-in-line package. The ±50 degree wide viewing angle complements the large display and is the ideal display for the industrial control application. Display construction is a filled reflector type with the integrated circuit in the back and then filled with IC-grade epoxy. This results in a very rugged part which is quite impervious to moisture, shock, and vibration.

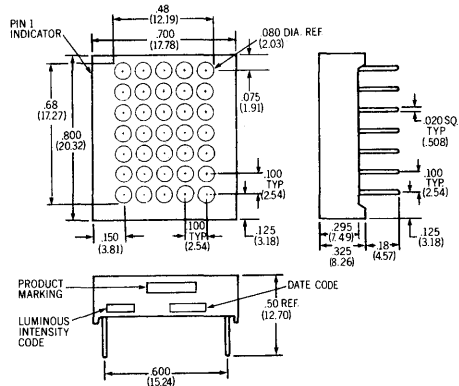

Physical Dimension Inches
FIGURE 2

Electrical Inputs

PIN	Name	PIN	Name
1	V _{cc}	14	D ₆ data input (msd)
2	LT lamp test	13	D ₅ data input
3	CE chip enable	12	D ₄ data input
4	WR write	11	D ₃ data input
5	BL ₁ brightness	10	D ₂ data input
6	BL ₀ brightness	9	D ₁ data input
7	GND	8	D ₀ data input (lsd)

Pin Description

V _{CC}	Positive Supply +5 volts
GND	Ground
D0-D6	Data Lines see figure 3 for character set
$\overline{\text{CE}}$	Chip Enable (active low) This determines which device in an array will accept data
$\overline{\text{WR}}$	Write (active low) Data and chip enable must be present and stable before and after the write pulse (see data sheet for timing)
$\overline{\text{BL0}}, \overline{\text{BL1}}$	Blanking Control Input (active low) Used to control the level of display brightness
$\overline{\text{LT}}$	Lamp Test (active low) Causes all dots to light at 1/4 brightness

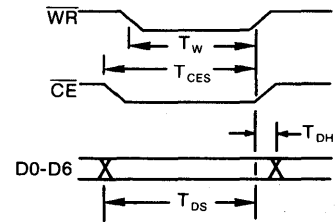

Timing Characteristics
Figure 4

CHARACTER SET

D0	L	H	L	H	L	H	L	H	L	H	L	H	L	H
D1	L	L	H	H	L	L	H	H	L	L	H	H	L	L
D2	L	L	L	L	H	H	H	H	L	L	L	L	H	H
D3	L	L	L	L	L	L	L	L	H	H	H	H	H	H
D0-D3 HEX	0	1	2	3	4	5	6	7	8	9	A	B	C	D
L L L 0	UNDEFINED													
L L H 1	UNDEFINED													
L H L 2	:	:	:	:	:	:	:	:	:	:	:	:	:	:
L H H 3	0	1	2	3	4	5	6	7	8	9	A	B	C	D
H L L 4	A	B	C	D	E	F	G	H	I	J	K	L	M	N
H L H 5	P	Q	R	S	T	U	V	W	X	Y	Z	[]	~
H H L 6	a	b	c	d	e	f	g	h	i	j	k	l	m	n
H H H 7	p	q	r	s	t	u	v	w	x	y	z	{	}	~

Character Set
Figure 3

Display Blanking and Dimming

The DLX 713x Intelligent Display has the capability of three levels of brightness plus blank. Figure 5 shows the combination of $\overline{\text{BL0}}$ and $\overline{\text{BL1}}$ for the different levels of brightness. The $\overline{\text{BL0}}$ and $\overline{\text{BL1}}$ inputs are independent of write and chip enable and does not affect the contents of the internal memory. A flashing display can be achieved by pulsing the blanking pins at a 1-2 hertz rate. Either $\overline{\text{BL0}}$ or $\overline{\text{BL1}}$ should be held high to light up the display.

Dimming and Blanking Control

Brightness Level	$\overline{\text{BL1}}$	$\overline{\text{BL0}}$
Blank	0	0
1/4 brightness	0	1
1/2 brightness	1	0
full brightness	1	1

Figure 5

Operation

In a dot matrix display system, it is advantageous to use a multiplexed approach with 12 drivers (5 digit + 7 segments) rather than 35 segment drivers. This obviously reduces the number of drivers and interconnections required. A multiplexed system must be a synchronous system or the digits or elements may have different on (lit) times and therefore varying brightness.

The DLX 713x is an internally multiplexed display but the data entry is asynchronous. Loading data is similar to writing into a RAM. Present the data, select the chip, and give a write signal. For a multi-digit system, each digit has its own unique location and will display its contents until replaced by another code.

The waveforms of figure 4 demonstrates the relationship of the signals required to generate a write cycle. Check the data sheet for minimum values required for each signal.

Lamp Test

The lamp test when activated causes all dots on the display to be illuminated at half brightness. It does not destroy any previously stored characters. The lamp test function is independent of chip enable, write, and the settings of the blanking inputs.

This convenient test gives a visual indication that all dots are functioning properly. Because of the lamp test not affecting the display memory, it can be used as a cursor or pointer in a line of displays.

General Design Considerations

When using the DLX 713x on a separate display board having more than 6 inches of cable length, it may be necessary to buffer all of the input lines. A non-inverting 74365 hex buffer can be used. The object is to prevent transient current into the DLX 713x protection diodes. The buffers should be located on the display board and as close to the displays as possible.

Because of high switching currents caused by the multiplexing, local power supply by-pass capacitors are also needed in many cases. These should be 6 or 10 volt, tantalum type having 5 - 10 uf capacitance. The capacitors may only be required every 6-7 displays depending on the line regulation and other noise generators.

If small wire cables are used, it is good engineering practice to calculate the wire resistance of the ground and the +5 volt wires. More than 0.2 volt drop (at 100ma per digit) should be avoided, since this loss is in addition to any inaccuracies or load regulation of the power supply.

The 5 volt power supply for the DLX 713x should be the same one supplying the Vcc to all logic devices. If a separate supply must be used, then local buffers should be used on all the inputs and these buffers should be powered from the display power supply. This precaution is to avoid line transients or any logic signals to be higher than Vcc during power up.

Interfacing

For an eight digit display using the DLX 713x, interfacing to a single chip microprocessor such as the 8748 is easy and straight forward. One approach may be to dedicate one port for the seven data signals and another 8-bit port for the write signals. The schematic is shown in Figure 6.

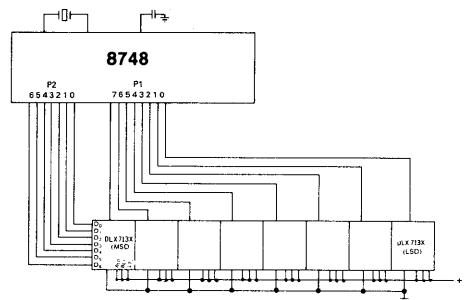

DLX 713x with 8748
Figure 6

```

INIT:   ORL   P1,#0FFH   ; SUBROUTINE TO LOAD AN 8-DIGIT
        ORL   P2,#00H   ; DISPLAY USING THE DL7135
        MOV   R1,#0FH   ; DATA IN RAM 10H-17H (MSD-LSD)
        MOV   R2,#0FEH  ; PORT 2 ALL HIGH (WRITE)
        MOV   R3,#08H   ; PORT 2 ALL LOW (DATA)
        MOV   R1,#08H   ; RAM ADDRESS - 1
        MOV   R1,#08H   ; WRITE PULSE
        MOV   R1,#08H   ; COUNTER
START:  INC   R1         ; INCREMENT RAM POINTER
DATA:   MOV   A,@R1     ; FETCH DATA FROM RAM
        OUTL P2,A       ; LOAD PORT 2
        MOV   A,R2      ; RECALL WRITE
        RR   A          ; SHIFT A TO NEXT WRITE
        MOV   R2,A      ; SAVE WRITE
        OUTL P1,A       ; SEND WRITE PULSE
WRITE:  MOV   A,#0FFH   ; WAIT
        OUTL P1,A       ; RESET WRITE PULSE
        DJNZ R3,START  ; LOAD COMPLETE?
        RET              ; RETURN TO MAIN PROGRAM
    
```

I/O or Memory Mapped System

For a memory mapped system using a processor such as the 8080 or 8085, the interfacing is also straight-forward. Each display is treated as a memory location with its own address, like another I/O or RAM location. See Figure 7.

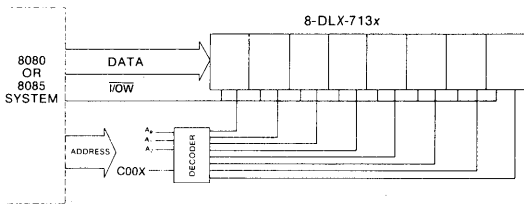

Block Diagram for 8-Digit
DLX 713x Dot Matrix Display
Figure 7

ROUTINE FOR AN 8 DIGIT DISPLAY
USING THE DLX 713x AND
8085 OR 8080 MICROPROCESSOR

DATA TO BE DISPLAYED IS IN
A0(LSD) THRU A8(MSD)

DISPLAY ADDRESS C00X
LSD IS RIGHT MOST DIGIT

DOES NOT SAVE REG A,B,H,L,D,E

```

DADD EQU 0A000H
DPAD EQU 0C000H
LEN EQU 08H
    
```

DATA ADDRESS LOCATION
DISPLAY ADDRESS LOCATION
DISPLAY LENGTH

```

ORG 100H
    
```

```

DISP:  LXI   H,DADD     ; LOAD DATA ADDRESS
        LXI   D,DPAD    ; LOAD DISPLAY ADDRESS
        MVI   B,LEN     ; LOAD DISPLAY LENGTH
DISP1:  MOV   A,M        ; GET DATA
        XCHG H/L & D/E  ; XCHG H/L & D/E
        MOV   M,A       ; LOAD DISPLAY FROM REG A
        XCHG H/L & D/E  ; RESTORE H/L & D/E
        INX   D         ; INCREMENT DISPLAY ADDRESS
        INX   H         ; INCREMENT DATA ADDRESS
        DCR   B         ; DECREMENT LENGTH COUNTER
        JNZ  DISP1      ; END OF DISPLAY?
        RET              ; RETURN TO MAIN PROGRAM
    
```

LOAD DATA ADDRESS
LOAD DISPLAY ADDRESS
LOAD DISPLAY LENGTH
GET DATA
XCHG H/L & D/E
LOAD DISPLAY FROM REG A
RESTORE H/L & D/E
INCREMENT DISPLAY ADDRESS
INCREMENT DATA ADDRESS
DECREMENT LENGTH COUNTER
END OF DISPLAY?
RETURN TO MAIN PROGRAM

Conclusion

Note that although other manufacturer's products are used in the examples, this application note does not imply specific endorsement, or warranty of other manufacturer's products by Siemens. The interface schemes shown demonstrate the simplicity of using the DLX 713x Dot Matrix Intelligent Display. Slight timing differences may be encountered for various microprocessors, but can be resolved similar to those encountered when using different RAM's. The techniques used in the examples were shown for their generality. The user will undoubtedly invent other schemes to optimize his particular system to its requirements.

SFH 900 — A Low-Cost Miniature Reflex Optical Sensor Appnote 26

Whether for an industrial plant or a hobbyists' drilling machine, an electric drive will hardly be acceptable nowadays without speed control. Incremental bar patterns simply applied to rotating shafts can be detected by the new Siemens reflex optical sensor, the SFH 900. The information can be processed with a minimum of circuitry, whether for a high rate of black-to-white transitions or just single, slow transitions.

Construction

The SFH 900 optical sensor is a remarkable component even by virtue of its shape alone. Its maximum height of 2.2 mm is in the trend of today's electronics, of putting a large number of functions into a very small space. The small dimensions allow it to be used where ordinary optical sensors run into space or other problems. **Fig. 1** is an enlarged picture of the device. Dimensions and pin configuration are shown in **Fig. 2**.

Fabricated by lead frame technique in a thermoplastic package, the sensor uses a GaAs infra-red diode as a radiation emitter and a large-area phototransistor as the detector. High sensitivity is ensured by a 1 mm² radiation sensitive area and a current gain of almost 1000. The effect of unwanted ambient light is almost screened out by a filter.

Two fixing notches are a help in mounting the device. Lead frame technology accurately locates the optically active areas relative to these notches and thus to the component body. **Fig. 3** is an example of one form of mounting.

Fig. 1 SFH 900 reflex optical sensor, front and back view, shown here three times normal size

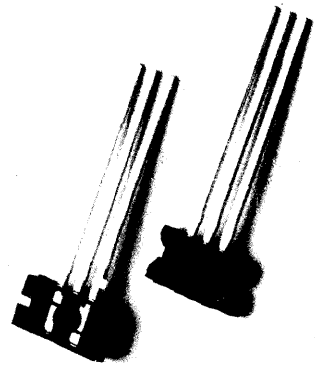
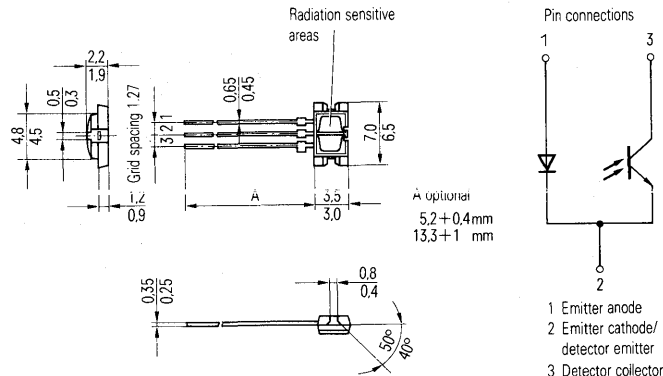

Fig. 2 Outline dimensions and pin connections of SFH 900



Characteristics

Main technical data are given in the **Table**. Turn-on and turn-off times are also important. These depend essentially on the collector current I_C and the load resistance R_L . Typical switching times for $I_C = 1$ mA and $R_L = 1$ k Ω are 50 to 70 μ s.

The user will be mainly concerned with the following points:

- What collector current, I_C , can be expected under given static conditions?
- What are the signal amplitudes when scanning bar patterns of different pitches?
- What is the temperature dependence of the collector current and what is the repeatability of the measured values?

Collector current

Dependence of collector current on emitter diode forward current I_F is almost linear at forward currents above 10 mA, as can be seen from **Fig. 4**. At currents below 1 mA the dependency shows almost a square law. The measurement was made with a standard reflector (Kodak neutral white test card, $r = 90\%$) at a distance of 1 mm.

Fig. 5 shows I_C characteristics for distances of 0.2 to 10 mm at a constant forward current of 10 mA. The curves are for four different reflecting materials: two standard Kodak reflectors with 15% and 90% reflection, polished aluminium and a strongly absorbing foil. DC-fix adhesive tapes and other tapes commonly used for printed circuit layouts proved particularly suitable. It should be mentioned that the curve for polished aluminium in **Fig. 5** is very similar to the Kodak reflector response with $r = 90\%$, in spite of the reflection being mirrored by the metal and diffused by the standard reflector, as a result of the wide directional characteristics of the emitter and detector.

At short distances (e. g. $d = 0.25$ mm) very large changes of current per unit distance are obtained. Because of these steep edges, which can only be used dynamically, the SFH 900 may also be utilized as a microphone.

Fig. 3 Suggestion for mounting the SFH 900. Projections N in the flexible plastic clamp locate in corresponding notches in the body of the optical sensor

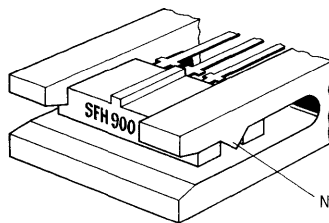

Fig. 4 SFH 900 collector current I_C as a function of forward current I_F with 90% diffuse reflector at distance $d = 1$ mm and with $U_S = 5$ V

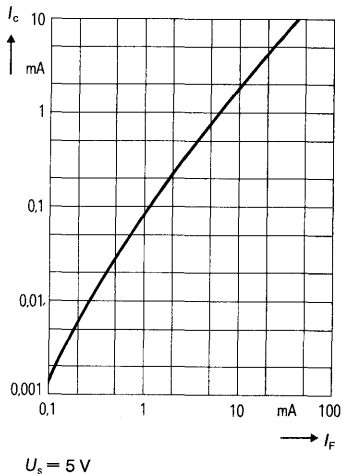
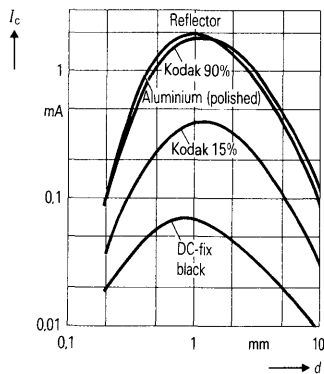
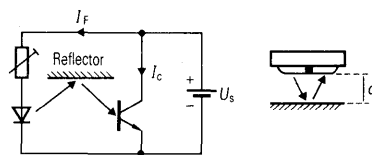

Fig. 5 SFH 900 collector current I_C as a function of reflector distance d with different reflector materials



Forward current $I_F = 10$ mA
Operating voltage $U_S = 5$ V.

Emitter (GaAs infra-red diode)

Reverse voltage
 Forward dc current
 Surge current ($t \leq 10 \mu\text{s}$)
 Power dissipation ($T_{\text{amb}} = 40^\circ\text{C}$)
 Thermal resistance

U_R	6	V
I_F	50	mA
i_{FSM}	1.5	A
P_{tot}	80	mW
R_{thJU}	750	K/W

Detector (silicon phototransistor)

Collector-emitter voltage
 Emitter-collector voltage
 Collector current
 Total power dissipation ($T_{\text{amb}} = 40^\circ\text{C}$)
 Collector-emitter leakage current ($U_{\text{CE}} = 10 \text{ V}$)
 Photocurrent under ambient light ($U_{\text{CE}} = 5 \text{ V}$)
 ($E_E = 0.5 \text{ mW/cm}^2$)

U_{CEO}	30	V
U_{ECO}	7	V
I_C	10	mA
P_{tot}	100	mW
I_{CEO}	20 (≤ 200)	nA
I_F	≤ 3	mA

Reflex optical sensor

Storage temperature range
 Ambient temperature range
 Junction temperature
 Total power dissipation ($T_{\text{amb}} = 40^\circ\text{C}$)
 Collector current
 ($I_F = 10 \text{ mA}$; $U_{\text{CE}} = 5 \text{ V}$; $d = 1 \text{ mm}$)

T_S	-40 to +85	$^\circ\text{C}$
T_U	-40 to +85	$^\circ\text{C}$
T_J	100	$^\circ\text{C}$
P_{tot}	150	mW
I_{CE}	≥ 0.3	mA
I_{CE}	≥ 0.5	mA

Table Selective characteristics of SFH 900**Resolution of black-and-white patterns**

As can be seen from Fig. 5, strongly reflecting and badly reflecting materials give collector currents differing by a factor of about 25. Strongly reflecting means »white«, badly reflecting »black«.

If a black-to-white transition is scanned, the displacement distance between the »fully white« signal and the »fully black« signal is 4 to 5 mm (Fig. 6).

If, in contrast, a regular bar pattern is scanned, the signal amplitude becomes smaller the smaller the bar width. Fig. 7 shows clearly how the excursion is affected: the maximum white signal becomes smaller with decreasing bar width, while the minimum black signal becomes larger. Fig. 8 shows the signal excursion itself, to make it clearer. Here a regular pattern and a single white bar are compared. The excursion is referred to a single black-to-white transition corresponding to a 100% signal excursion.

A bar width of 3 mm can thus be detected without significant loss of sensitivity. The signal excursion, however, drops to as low as 10% using a grid of 1 mm bar

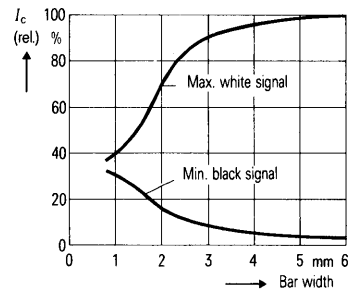
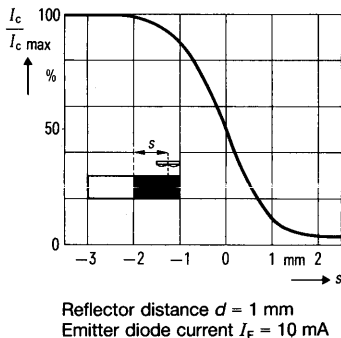
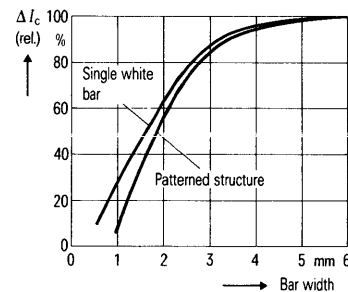
Fig. 7 Maximum and minimum collector current when scanning a black-white pattern**Fig. 6** Resolution of a black-to-white transition. Relative collector current as a function of sensor position s **Fig. 8** Relative signal excursion as a function of white bar width $I_F = 10 \text{ mA}$, $d = 1 \text{ mm}$ 

width. An apparently higher signal excursion is obtained when a single 1 mm wide white bar on a black background is scanned. The result is then about a 30%, as shown in Fig. 8.

The optical sensor can be used for scanning in any position, regardless of whether the emitter-detector axis is at right-angles to the scanning direction. Tests have shown that the device sensitivity is independent of direction. If a white spot on a black background (or vice-versa) is to be detected without loss of sensitivity, this should have a minimum area of 5x5 mm. From this we can conclude that a pattern bar must not be larger than 5 mm.

Thus the resolution capability of the SFH 900 seems to be limited to bar widths of 1 to 2 mm minimum. In fact, however, considerably higher resolutions can be obtained when gratings are used. An example is given below.

Temperature dependence

The temperature dependence of the output signal is shown in Fig. 9. This fortunately very small dependence results from the combination of the temperature dependent diode emission (approx. -0.55%/K) with the temperature dependent current gain of the phototransistor (approx. +0.9%/K). As these two parameters partly compensate for each other the temperature dependence of the output signal is fairly small.

There is a spread of characteristics in the different devices but they remain within the specified tolerance range, allowing for ageing, with a probability of at least 95%.

Applications

Speed control for dc motors

A simple speed regulator circuit for small dc motors can be designed using the TCA 955 device. Fig. 10 is an example. The teeth of a toothed wheel on the motor shaft serve as reflectors (40 teeth on a wheel of approx. 60 mm diameter). Pulses from the optical sensor are converted by the TCA 955 into a dc voltage proportional to speed. The pulse signal is first amplified, then frequency doubled, then fed to a monostable which produces a square wave with a constant pulse duration determined by the R_1 , C_1 product. The mean value of this pulse train is determined by capacitor C_2 and an 8.7 k Ω internal resistor.

The voltage present at C_2 , still with a slight triangular modulation, is compared with an internal set value. The difference is amplified and determines the duty cycle in the subsequent mark-to-space ratio converter. The motor is connected to the operating voltage via a BD 675 switching stage, which runs to the rhythm of the duty cycle. A larger mark-to-space ratio causes the speed to increase. The desired frequency can be set by P1 over a wide range.

Speed control for ac motors

This is mainly intended for use in the consumer field, in such things as kitchen appliances and drilling machines. It is important that the speed indicator should have a very low current consumption as it is supplied from a simple line rectifier circuit using a series resistor. The specimen circuit in Fig. 11 has an emitter diode current of only

Fig. 9 Relative collector current as a function of temperature

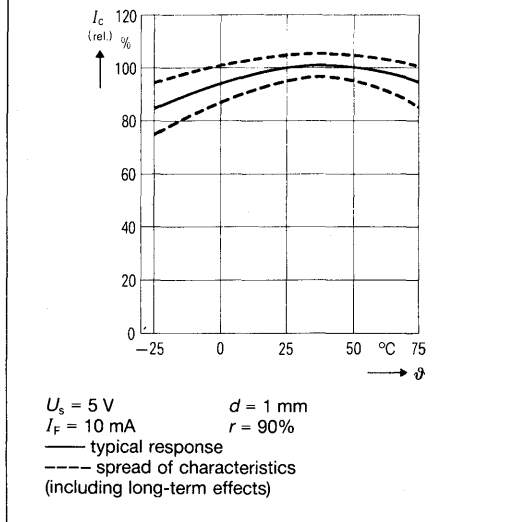

2 mA. Signal processing and triac triggering are done by the new TLB 3101 phase control IC. Total current needed for control is around 7 mA, including the SFH 900.

Pulses from the optical sensor are first amplified, then converted by a monostable to constant pulse width and finally filtered to give a mean value. By comparison with a sawtooth voltage the gate trigger time for the triac is fixed. A soft start is given by transistor T1.

The range of speed regulation is 5000 to 15000 rpm. The reflector is a disc mounted on the motor shaft, and at its periphery this disc has, as an example, 5 pairs of black and white segments.

Shaft encoder with direction sensing

This example shows how gratings can be used to give a considerable increase in resolution. A transparent disc of about 130 mm diameter has an array of 200 opaque bars at its periphery (Fig. 12a). The bar width is thus about 1 mm. A second grating with reflecting white bars is placed under the disc. If the disc pattern and the grating beneath are set gap to gap, the detector «sees» 100% black. If the bars of the two gratings are on top of each other the image appears as 50% white. So, when the disc is rotating the useful amplitude is therefore about 50% of the full black-to-white excursion.

The grating pattern is constructed so that one half is displaced by 90° of a grid period with respect to the other half. If a reflex optical sensor is assigned to each half, on rotation of the disc the output signals will be roughly sinusoidal and displaced by 90° from each other. This means that patterns of half bar width can be successfully resolved.

In further processing both sinewave voltages are converted into square waveforms, also phase-shifted by 90° (Fig. 13).

Fig. 10 Speed regulator using SFH 900 reflex optical sensor and TCA 955 integrated speed control

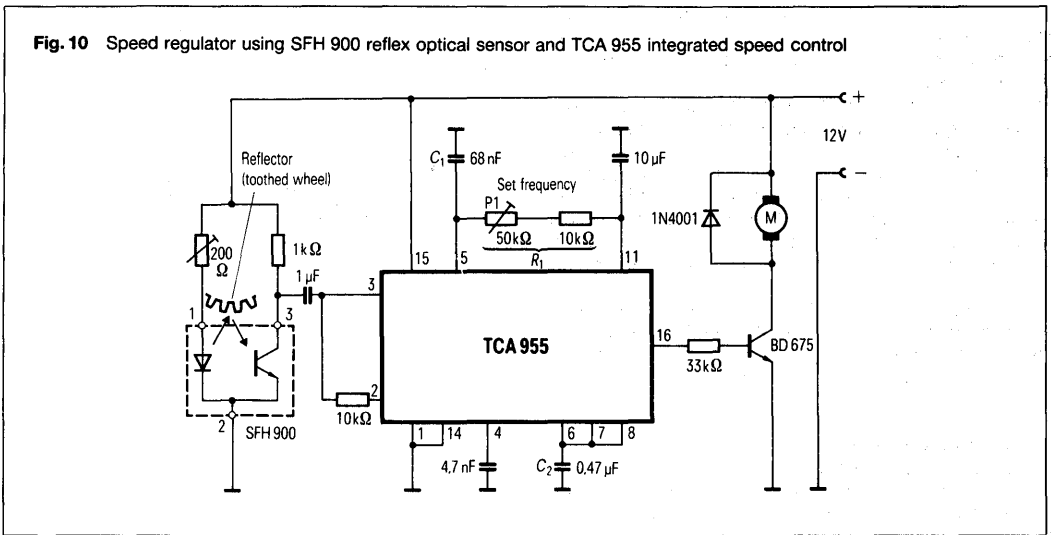
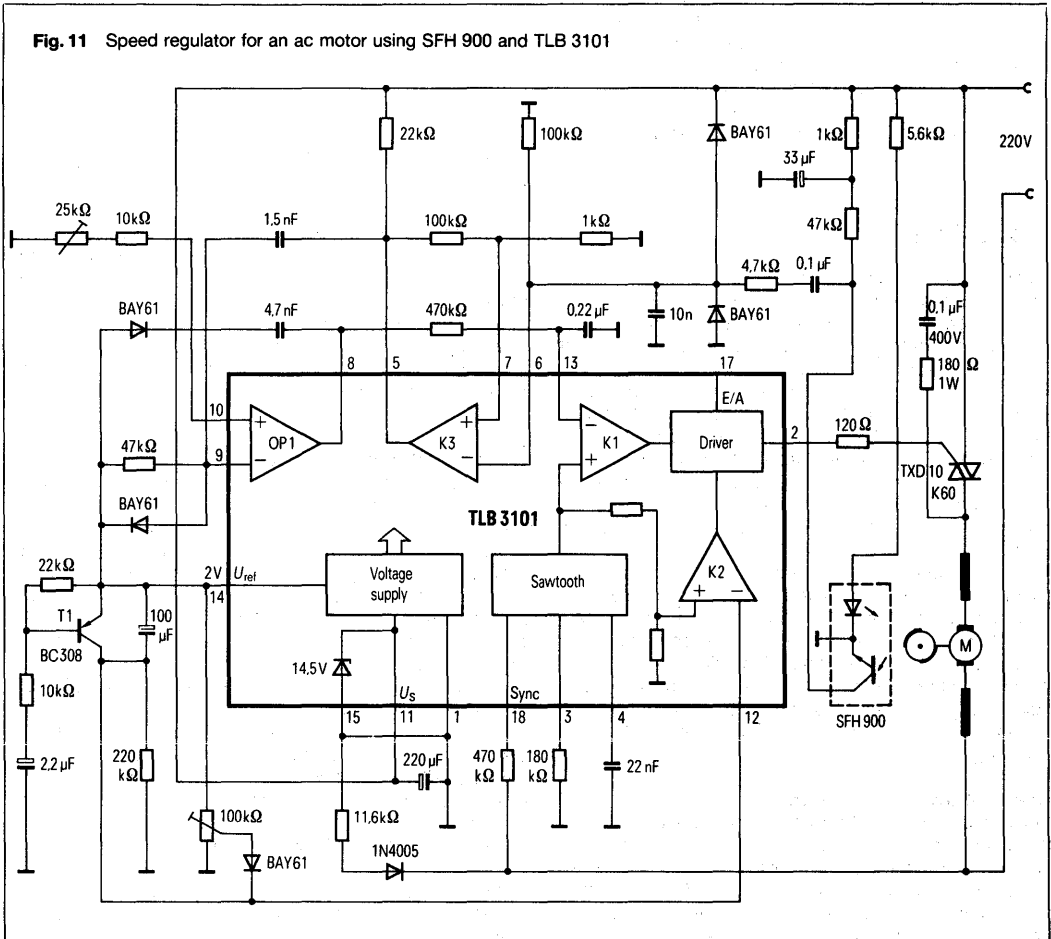

Fig. 11 Speed regulator for an ac motor using SFH 900 and TLB 3101



The rising edge of on square-wave (signal 1) is used for counting. It triggers a monoflop which generates a pulse of short duration relative to the square-wave period. The other, 90° shifted, square-wave controls the direction of the counter (Low = forward, High = backward).

According to the direction command, the conditions in **Fig. 13** come into effect. The active clock edge coincides with either the low level or the high level of signal 2. Counting therefore takes place in accordance with forward or backward rotation of the shaft. **Fig. 14** gives the detailed circuit diagram of the shaft encoder.

The counter used has a range of two decades and gives the BCD separately for each digit.

A 7-segment decoder-driver follows this for each of the two LED displays. The number of digits can be increased by cascading several stages.

For the purposes of explanation any bar in the pattern can be considered as the starting point and the counter reset to zero using the reset key. If now the disc is turned at any speed in either direction with respect to the stationary mark, the counter indicates the bar number difference with respect to the starting point. As only dc voltage coupling is used the rotational speed may have any arbitrary minimum value.

Fig. 13 Waveforms showing the operation of a shaft encoder with direction sensing

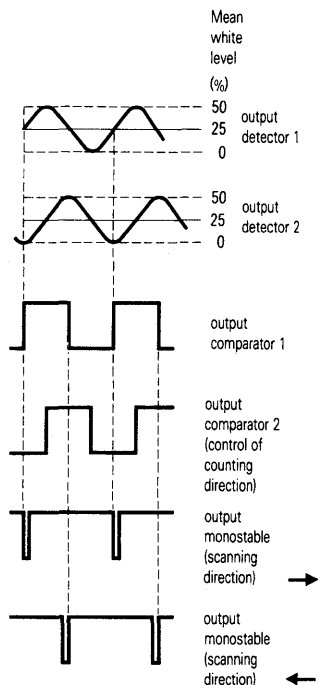

Fig. 12 Example of a patterned disc (a) and its counting grid (b)

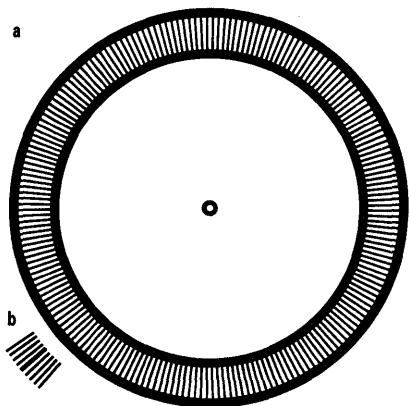
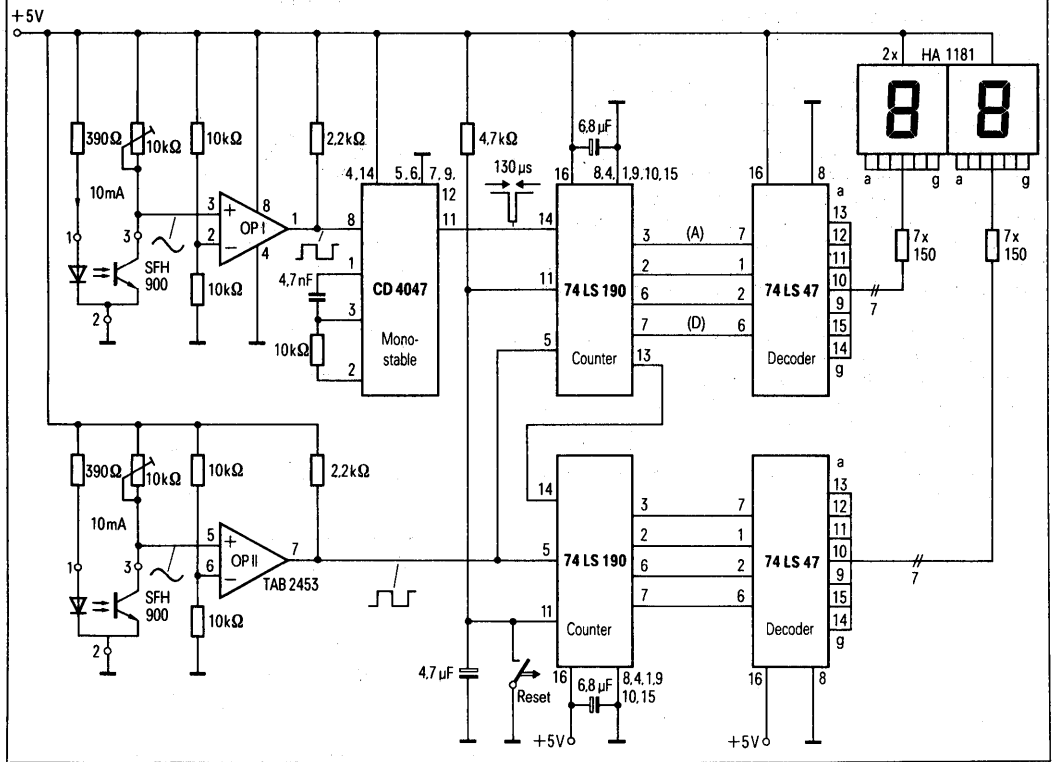

Fig. 14 SFH 900: circuit for shaft encoder with direction sensing



SIEMENS

The DLO 4135/DLG 4137 5 x 7 Dot Matrix Intelligent Display® Appnote 28

by Dave Takagishi

This application note is intended to serve as a design and application guide for users of the DLO 4135 and DLG 4137 Siemens Opto Intelligent Displays. The information presented covers device electrical description, operation, general circuit design considerations, and interfacing to microprocessors.

Electrical Description

The DLO 4135/DLG 4137 Intelligent Alphanumeric 5 x 7 Dot Matrix Display contains memory, character generator, multiplexing circuits, and drivers built into a single package.

Figure 1 is a block diagram of DLO 4135/DLG 4137. The unit consists of 35 LED die arranged in a 5x7 pattern and a single CMOS integrated circuit chip. The IC chip contains the column drivers, row drivers, 96 character generator ROM, memory, multiplex and blanking circuitry.

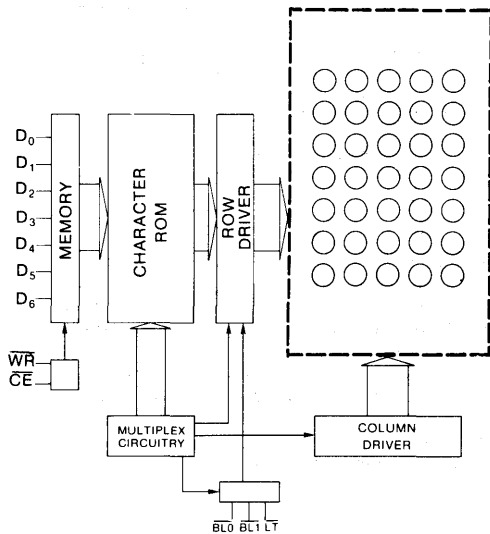

DLO 4135/DLG-4137 BLOCK DIAGRAM
FIGURE 1

Package

The 35 dots form a 0.30 x 0.43 inch overall character size in a .500 x 1.00 inch dual-in-line package. The ± 50 degree wide viewing angle complements the display and is the ideal display for industrial control applications. Display construction is a filled reflector type with the integrated circuit in the back and then filled with IC-grade epoxy. This results in a very rugged part which is quite impervious to moisture, shock, and vibration.

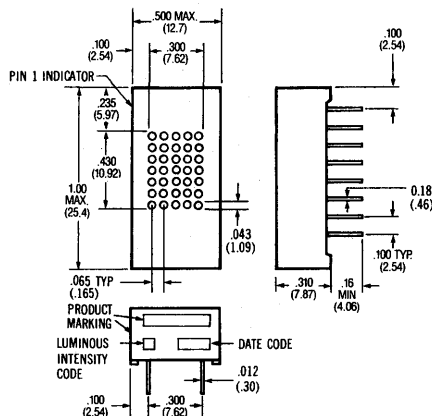

Physical Dimensions in Inches (mm)
FIGURE 2

DLO 4135/DLG 4137 PIN FUNCTIONS			
PIN	FUNCTION	PIN	FUNCTION
1	\overline{LT} LAMP TEST	9	D0 DATA LSB
2	\overline{WR} WRITE	10	D1 DATA
3	$\overline{BL1}$ BRIGHTNESS	11	D2 DATA
4	$\overline{BL0}$ BRIGHTNESS	12	D3 DATA
5	NO PIN	13	D4 DATA
6	NO PIN	14	D5 DATA
7	\overline{CE} CHIP ENABLE	15	D6 DATA MSB
8	GND	16	+ VCC

Pin Description

Vcc	Positive Supply +5 volts
GND	Ground
D0-D6	Data Lines see figure 3 for character set
\overline{CE}	Chip Enable (active low) This determines which device in an array will accept data
\overline{WR}	Write (active low) Data and chip enable must be present and stable before and after the write pulse (see data sheet for timing)
$\overline{BL0}, \overline{BL1}$	Blanking Control Input (active low) Used to control the level of display brightness
\overline{LT}	Lamp Test (active low) Causes all dots to light at 1/2 brightness

The waveforms of Figure 4 shows the relationship of the signals required to generate a write cycle. Check the data sheet for minimum values required for each signal.

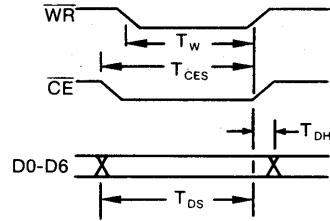

Timing Characteristics
FIGURE 4

CHARACTER SET

D0	L	H	L	H	L	H	L	H	L	H	L	H	L	H	
D1	L	L	H	H	L	L	H	H	L	L	H	H	L	L	
D2	L	L	L	L	H	H	H	H	L	L	L	L	H	H	
D3	L	L	L	L	L	L	L	L	L	H	H	H	H	H	
D4-D6	HEX	0	1	2	3	4	5	6	7	8	9	A	B	C	
	L	L	L	0	UNDEFINED										
	L	L	H	1											
	L	H	L	2	!	"	#	\$	%	&	'	()	*	+
	L	H	H	3	0	1	2	3	4	5	6	7	8	9	:
	H	L	L	4	A	B	C	D	E	F	G	H	I	J	K
	H	L	H	5	P	Q	R	S	T	U	V	W	X	Y	Z
	H	H	L	6	a	b	c	d	e	f	g	h	i	j	k
	H	H	H	7	P	q	r	s	t	u	v	w	x	y	z

Character Set
FIGURE 3

Display Blanking and Dimming

The DLO 4135/DLG 4137 Intelligent Display has the capability of three levels of brightness plus blank. Figure 5 shows the combination of $\overline{BL0}$ and $\overline{BL1}$ for the different levels of brightness. The $\overline{BL0}$ and $\overline{BL1}$ inputs are independent of write and chip enable and does not affect the contents of the internal memory. A flashing display can be achieved by pulsing the blanking pins at a 1-2 hertz rate. Either $\overline{BL0}$ or $\overline{BL1}$ should be held high to light up the display.

Brightness Level	$\overline{BL1}$	$\overline{BL0}$
Blank	0	0
1/2 brightness	0	1
1/2 brightness	1	0
full brightness	1	1

Dimming and Blanking Control
FIGURE 5

Operation

In a dot matrix display system, it is advantageous to use a multiplexed approach with 12 drivers (5 digit + 7 segments) rather than 35 segment drivers. This obviously reduces the number of drivers and interconnections required. A multiplexed system must be a synchronous system, or the digits or elements may have different on (lit) times and therefore varying brightness.

The DLO 4135/DLG 4137 is an internally multiplexed display, but the data entry is asynchronous. Loading data is similar to writing into a RAM. Present the data, select the chip, and give a write signal. For a multi-digit system, each digit has its own unique address location and will display its contents until replaced by another code.

Lamp Test

The lamp test when activated causes all dots on the display to be illuminated at half brightness. It does not destroy any previously stored characters. The lamp test function is independent of chip enable, write, and the settings of the blanking inputs.

This convenient test gives a visual indication that all dots are functioning properly. The lamp test can be used as a cursor or pointer in a line of displays because it does not affect the display memory.

General Design Considerations

When using the DLO 4135/DLG 4137 on a separate display board having more than 6 inches of cable length, it may be necessary to buffer all of the input lines. A non-inverting 74365 hex buffer can be used. The object is to prevent current transient into the DLO 4135/DLG 4137 protection diodes. The buffers should be located on the display board and as close to the displays as possible.

Because of high switching currents caused by the multiplexing, local power supply by-pass capacitors are also needed in many cases. These should be 10 volt, tantalum type having 5 - 10 uf capacitance. The capacitors may only be required every 6-7 displays depending on the line regulation and other noise generators.

If small wire cables are used, it is good engineering practice to calculate the wire resistance of the ground and the +5 volt wires. More than 0.2 volt drop (at 100ma per digit) should be avoided, since this loss is in addition to any inaccuracies or load regulation of the power supply.

The 5 volt power supply for the DLO 4135/DLG 4137 should be the same one supplying the Vcc to all logic devices. If a separate power supply must be used, then local buffers should be used on all the inputs. These buffers should be powered from the display power supply. This precaution is to avoid line transients or any logic signals to be higher than Vcc during power up.

Interfacing

For an eight digit display using the DLO 4135/DLG 4137 interfacing to a single chip microprocessor, such as the 8748, is easy and straight forward. One approach may be to dedicate one port for the seven data signals and another 8-bit port for the write signals. The schematic is shown in Figure 6.

Subroutine to Load an 8-Digit Display using the DLO 4135/DLG 4137

```

INIT:  ORL   P1,#0FFH ; DATA IN RAM 10H-17H (MSD-LSD)
        ORL   P2,#00H ; PORT 1 ALL HIGH (WRITE)
        MOV   R1,#0FH ; PORT 2 ALL LOW (DATA)
        MOV   R2,#0FEH ; RAM ADDRESS — 1
        MOV   R3,#08H ; WRITE PULSE
        MOV   R1 ; COUNTER
START: INC   R1 ; INCREMENT RAM POINTER
DATA:  MOV   A,@R1 ; FETCH DATA FROM RAM
        OUTL  P2,A ; LOAD PORT 2
        MOV   A,R2 ; RECALL WRITE
        RR   A ; SHIFT A TO NEXT WRITE
        MOV   R2,A ; SAVE WRITE
WRITE: OUTL  P1,A ; SEND WRITE PULSE
        MOV   A,#0FFH ; WAIT
        OUTL  P1,A ; RESET WRITE PULSE
        DJNZ R3,START ; LOAD COMPLETE?
        RET   ; RETURN TO MAIN PROGRAM
    
```

I/O or Memory Mapped System

For a memory mapped system using a processor such as the 8080 or 8085, the interfacing is also straight-forward. Each display is treated as a memory location with its own address, like another I/O or RAM location. See figure 7.

Routine for an 8-Digit Display using the DLO 4135/DLG 4137 and 8085 or 8080 Microprocessor

```

; DATA TO BE DISPLAYED IS IN
; A0(LSD) THRU A7 (MSD).
;
; DISPLAY ADDRESS C00H
; LSD IS RIGHT MOST DIGIT
;
; DOES NOT SAVE REG A,B,H,L,D,E
DADD   EQU   0A000H ; DATA ADDRESS LOCATION
DPAD   EQU   0C000H ; DISPLAY ADDRESS LOCATION
LEN    EQU   08H    ; DISPLAY LENGTH
;
ORG    100H
;
DISP:  LXI   H,DADD ; LOAD DATA ADDRESS
        LXI   D,DPAD ; LOAD DISPLAY ADDRESS
        MVI   B,LEN ; LOAD DISPLAY LENGTH
DISP1: MOV   A,M ; GET DATA
        XCHG ; XCHG H/L & D/E
        MOV   M,A ; LOAD DISPLAY FROM REG A
        XCHG ; RESTORE H/L & D/E
        INX   D ; INCREMENT DISPLAY ADDRESS
        INX   H ; INCREMENT DATA ADDRESS
        DCR   B ; DECREMENT LENGTH COUNTER
        JNZ  DISP1 ; END OF DISPLAY?
        RET   ; RETURN TO MAIN PROGRAM
    
```

Conclusion

Note that although other manufacturer's products are used in the examples, this application note does not imply specific endorsement, or warranty of other manufacturer's products by Siemens. The interface schemes shown demonstrate the simplicity of using the DLO 4135/DLG 4137 Dot Matrix Intelligent Display. Slight timing differences may be encountered for various microprocessors, but can be resolved using similar methods as those used when using interfacing microprocessors with various RAMs. The techniques used in the examples were shown for their generality. The user will undoubtedly invent other schemes to optimize his particular system to its requirements.

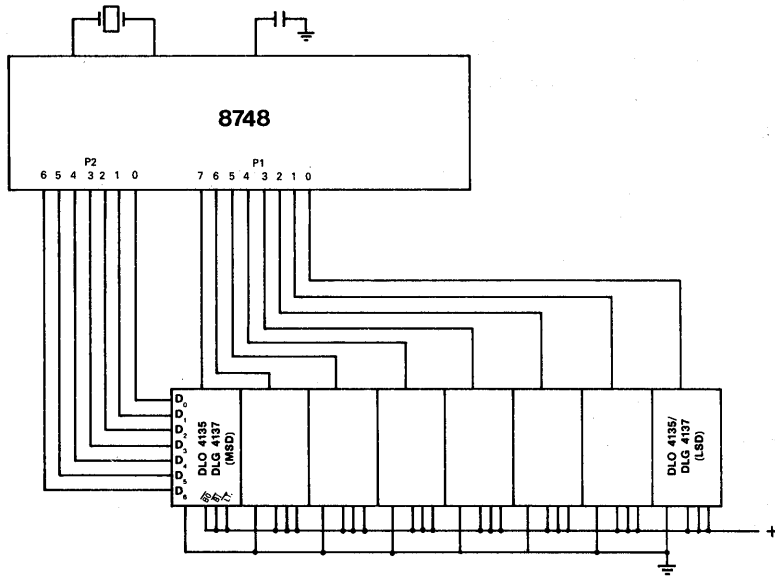

**DLO 4135/DLG 4137 with 8748
FIGURE 6**

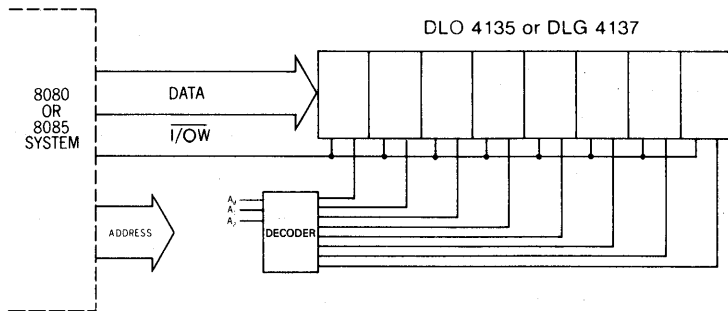

**Block Diagram for 8-Digit
DLO 4135/DLG 4137 Dot Matrix Display
FIGURE 7**

Serial Intelligent Display Appnote 29

by Dave Takagishi

This application note describes a method of obtaining a serial input display with a selected number of digits using an 8051/8031 microprocessor and DL 2416 Intelligent Displays. The very popular DL 2416 has been selected as the example for this Application Note; however, the information contained herein can also be applied to other Intelligent Displays. (Refer to Intelligent Display Product Guide)

Introduction

A parallel bus configuration is frequently used to transfer data to a microprocessor when it is used on a single card system. However, if the system is not physically small in number of chips or has multiple cards, data handling becomes cumbersome and costly. For long distances, serial communications over a two (2) or four (4) wire link is desirable and is economically attractive. However, the trade-off between cost and speed has to be considered by the designer.

Description

The DL 2416 'Intelligent Display' is a .160" four (4) character, 17 segment, LED display module with "On-Board" memory, character generator, multiplexer and display drivers integrated into a custom integrated circuit. This eliminates the necessity to design external circuitry normally required to drive a multiplexed display. Using these important attributes of the Intelligent Display, the designer now only has to provide for interfacing, which is a seven-bit ASCII parallel code, a two-bit address, and a write signal. The procedure for writing these commands is similar to those used for an external Random Access Memory.

The serial/parallel and parallel/serial conversion is normally accomplished by using a UART (Universal Asynchronous Receiver/Transmitter) or a USART (Universal Synchronous/Asynchronous Receiver/Transmitter). The 8031 is a very attractive microcontroller to use in this application because it has an integral UART. This integral UART provides the designer with the means for controlling the conversion of serial into parallel information or vice-versa. The 8031 has more RAM than the popular 8048, but the operation and instruction sets are very similar. Refer to the 8031 data sheet for a complete description of the product.

Circuit Description

The block diagrams of the 8031 (Fig. 1) and the DL 2416 (Fig. 2) show the internal structure of these devices. By combining the DL 2416, an easy to use peripheral device in a parallel system, and the 8031 results in a low cost, simple serial display system. A 32-digit system can be built using an 8031 microprocessor, an 8212 or equivalent latch, a 2716 EPROM, and a 75189 IC for interfacing to 20mA or RS232 input lines. Buffers were added to minimize the long cable noise spikes and interface loading on the bus. See Figure 3 for system schematic.

Software Considerations

This system, as described, is set up to receive data only at 100 baud rate. Additional software is required for transmit routine. For a given data rate and (data format is start bit, 9-data bits and a stop bit) three (3) sections of software and possibly a special crystal oscillator frequency may be required for a given transmit rate. On power-up or reset, the serial port and timer control words must be initialized.

Special control functions have been included in this program as follows:

- Power Up
- Return
- Backspace
- Line Feed

See Figure 5 for the actual program listing.

Conclusion

This Application Note has introduced the reader to the ease of interfacing the DL 2416 to any microprocessor. By combining the DL 2416 and the 8031, difficulties usually associated with serial conversion using software and its attendant timing problems can be easily overcome.

SIEMENS OPTOELECTRONIC DIVISION does not endorse or guarantee other manufacturer's products used in this Application Note.

- FIGURE 1** **8031 BLOCK DIAGRAM**
- FIGURE 2** **DL 2416 BLOCK DIAGRAM**
- FIGURE 3** **SYSTEM SCHEMATIC**
- FIGURE 4** **FLOW CHART**
- FIGURE 5** **PROGRAM LISTING**

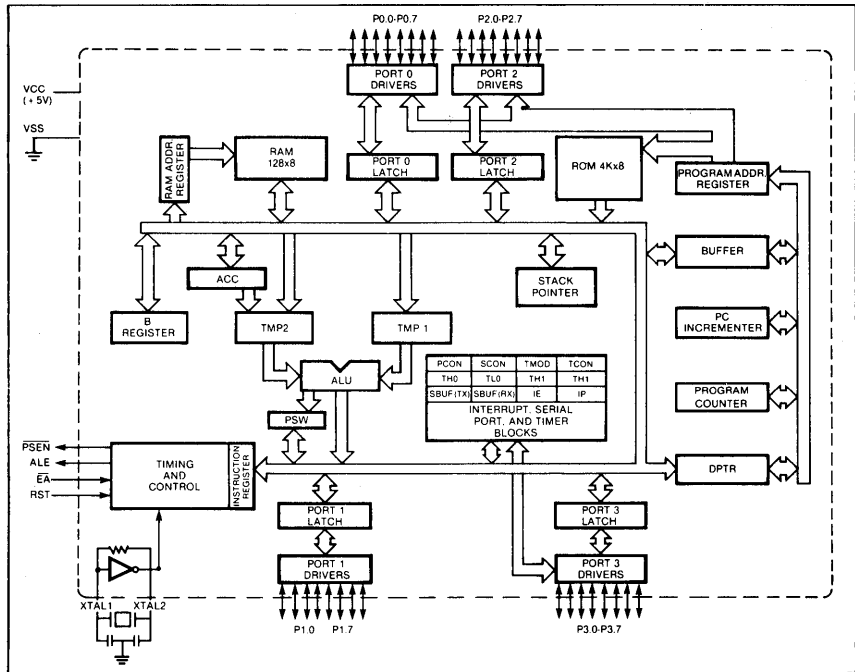

FIGURE 1 — 8031 BLOCK DIAGRAM

Reprinted By Permission Of Intel Corp.
Copyright 1982

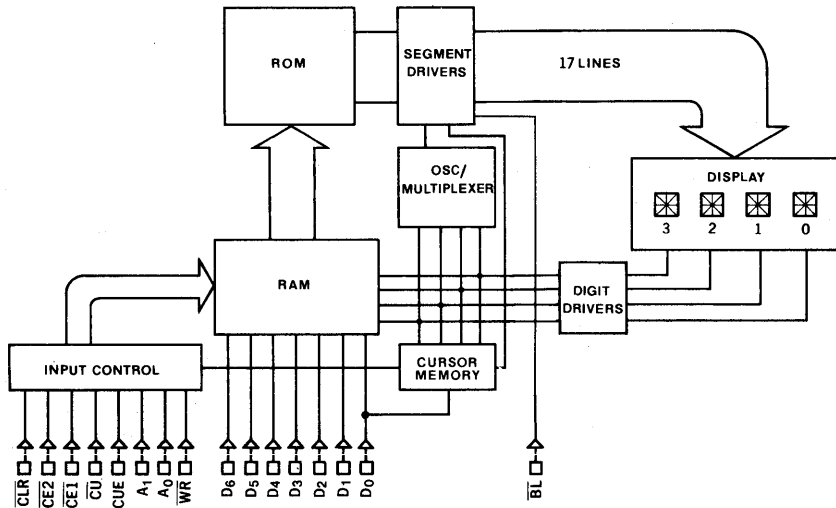

FIGURE 2 — DL 2416 INTERNAL BLOCK DIAGRAM

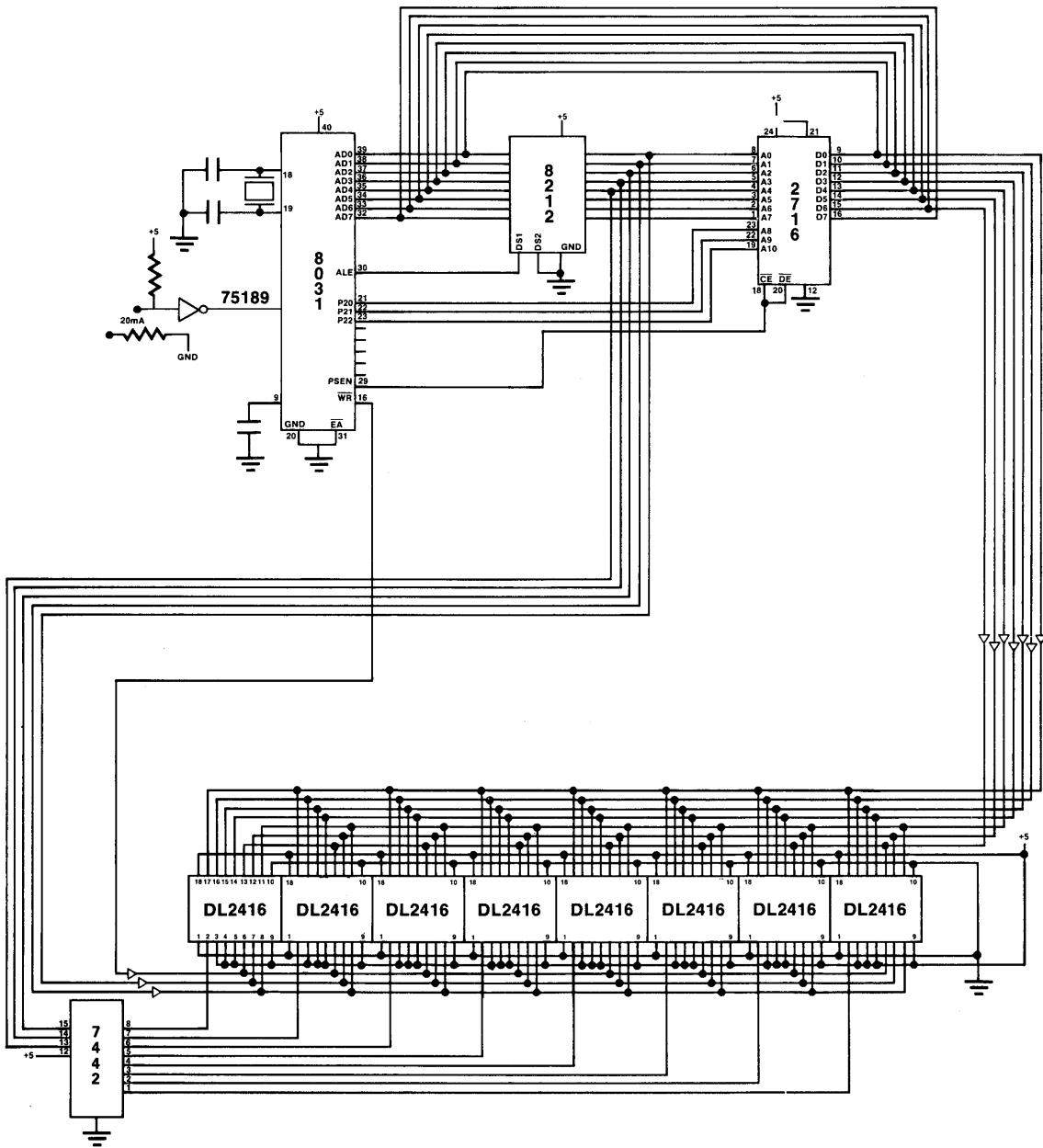

FIGURE 3 — SYSTEM SCHEMATIC

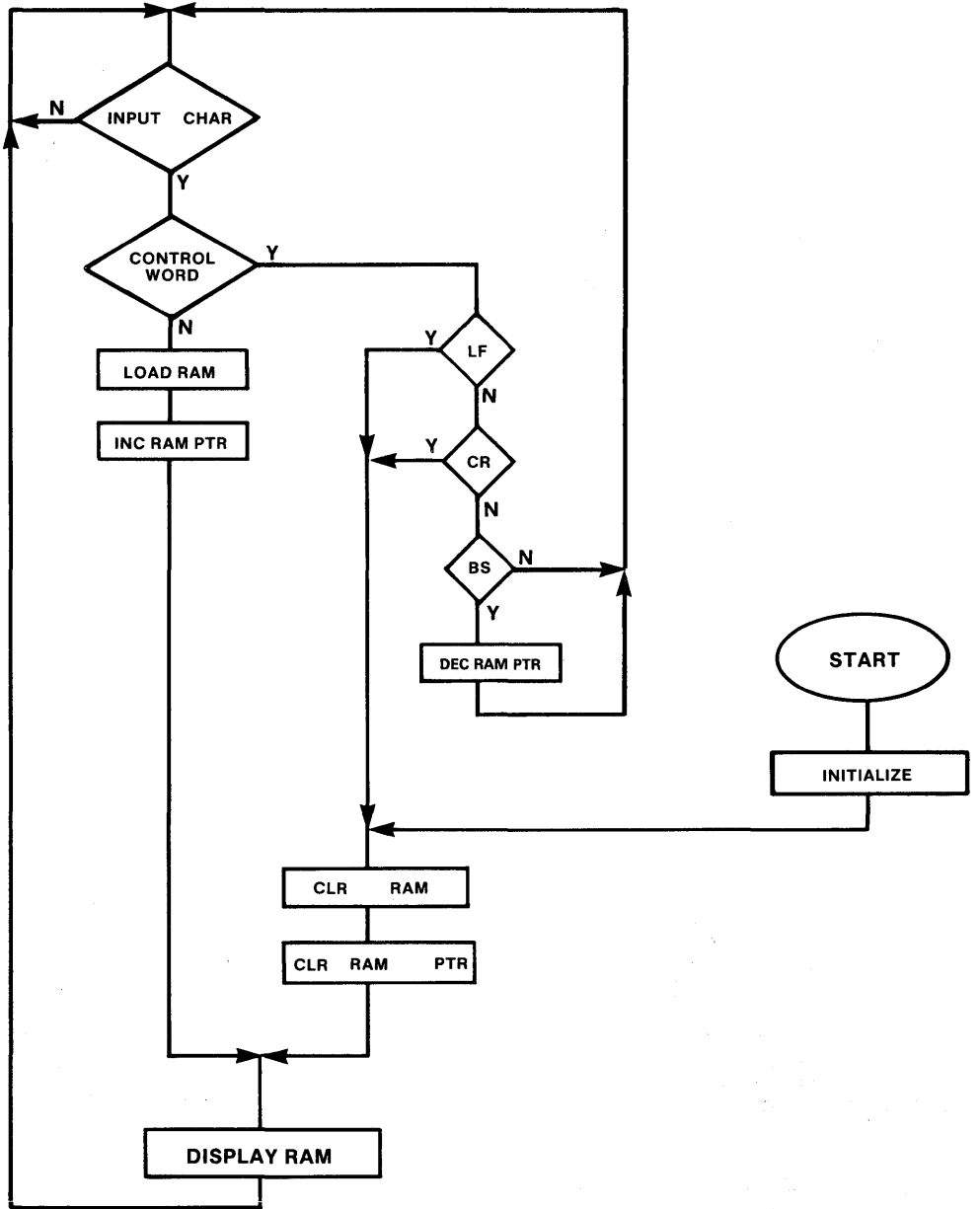

FIGURE 4 — SERIAL IDA FLOW CHART

FIGURE 5 — PROGRAM LISTING

```

                                ;SERIAL IDA USING 8031 UP
                                ;AND IDA2416-32
0000    020040                ORG    0000H
                                LJMP  INIT
                                ORG    0003H    ;EXTERNAL INTERRUPT 0
0003    32                    RTI
                                ORG    000BH    ;TIMER 0 OVERFLOW
000B    32                    RTI
                                ORG    0013H    ;EXTERNAL INTERRUPT 1
0013    32                    RTI
                                ORG    001BH    ;TIMER 1 OVERFLOW
001B    32                    RTI
                                ORG    0023H    ;SERIAL I/O INTERRUPT
0023    32                    RTI

                                ;SETUP SERIAL PORT
                                ;9 BIT UART MODE 3
                                ;SET TIMER

0040    75A800                INIT:  ORG    0040H
0043    758922                MOV    IE,#00H    ;ENABLE INTERRUPTS
0046    758D72                MOV    TMOD,#22H  ;TIMER 0 & 1 AUTO RELOAD
0049    759870                MOV    TH1,#72H  ;RELOAD FOR 110
004C    D28E                  MOV    SCON,#70H ;MODE 3 RCV
                                SETB   #8EH    ;TIMER 1 ON

004E    7920                  CLRAM: MOV R1,#RAM ;RAM INITIAL ADDRESS
0050    E4                    CLR    A
0051    7B20                  MOV    R3,#CNTR  ;LOAD # OF DIGITS
0053    F7                    CLR1: MOV @R1,A   ;LOAD RAM
0054    09                    INC    R1
0055    DBFC                  DJNZ  R3,CLR1
0057    7820                  MOV    R0,#RAM   ;SET RAM INPUT PNTR TO INITIAL

0059    7B20                  DISPRM: MOV R3,#CNTR ;R3= COUNTER
005B    900000                MOV    DPTR,#DSPTR ;DPTR=DISPLAY POINTER
005E    793F                  MOV    R1,#RAM   ;R1=RAM DISPLAY POINTER+LENGTH
0060    E7                    DISP1: MOV A,@R1  ;FETCH DATA FROM RAM
0061    F0                    MOVX  @DPTR,A    ;LOAD DISPLAY
0062    19                    DEC    R1
0063    A3                    INC    DPTR
0064    DBFA                  DJNZ  R3,DISP1

0066    3098FD                SERIN: JNB RI,SERIN ;WAIT UNTIL AN INPUT
0069    C298                  CLR    RI
006B    E599                  MOV    A,SBUF

                                ;CHECK FOR CONTROL WORDS
                                ;SAVE A
006D    FC                    CNTLWD: MOV R4,A
006E    2460                  ADD   A,#060H
0070    4013                  JC    LDATA      ;JUMP IF DATA
0072    EC                    MOV   A,R4
0073    2473                  ADD   A,#073H
0075    40D7                  JC    CLRAM
0077    EC                    MOV   A,R4
0078    2476                  ADD   A,#076H
007A    40D2                  JC    CLRAM
007C    EC                    MOV   A,R4
007D    2478                  ADD   A,#078H
007F    50E5                  JNC  SERIN
0081    18                    DEC   R0
0082    020066                AJMP  SERIN

                                ;OTHER CONTROL
                                ;BS

0085    EC                    LDATA: MOV A,R4
0086    F6                    MOV   @R0,A
0087    08                    INC   R0
0088    E8                    MOV   A,R0
0089    24C0                  ADD   A,#0C0H
008B    5002                  JNC  LDAT1
008D    7820                  MOV   R0,#RAM
008F    020059                LDAT1: AJMP  DISPRM

```

INTERRUPTS NOT USED

INITIALIZE 803 1μP

CLR RAM

CLR RAM PTR

DISPLAY RAM

INPUT CHAR

DATA = CR

DATA = LF

DATA = BS

LOAD

DATA

INTC

RAM

END

ALL MNEMONICS COPYRIGHT INTEL CORP., 1982

Blue-Light Emitting Silicon-Carbide Diodes — Materials, Technology, Characteristics

Appnote 31

by Dr. Claus Weyrich
Siemens Research Laboratories
Munich, West Germany

Introduction

Light-emitting diodes (LEDs) are widely used in the field of electronics as indicator lamps and seven-segment displays because of their excellent characteristics such as high mechanical stability, low operating voltage, compatibility with semiconductor drive circuits, low operating temperature and long service life. LEDs are now mass-produced in the colors red, super-red, yellow and green. The semiconductor materials that are used are III-V compounds such as gallium arsenide phosphide ($\text{GaAs}_{1-x}\text{P}_x$), gallium phosphide (GaP) and, recently, also gallium aluminum arsenide ($\text{Ga}_{1-x}\text{Al}_x\text{As}$). An extension of the color of LEDs into the blue region of the spectrum has been wished by many users. The materials that are suitable for blue-light diodes are discussed here, followed by a survey of the technology and characteristics of blue-light diodes based on silicon carbide (SiC), the material that is preferred for this application by the Siemens company.

Semiconductor materials for blue-light emitting diodes

For emission in the blue region of the spectrum $\text{GaAs}_{1-x}\text{P}_x$ or GaP is out of the question because the band gap is too small, limiting the wavelength of the emitted radiation towards the lower end. But there are other semiconducting compounds such as gallium nitride (GaN), zinc sulfide (ZnS), zinc selenide (ZnSe) and silicon carbide (SiC). GaN was investigated quite intensively for the purpose of creating blue-light LEDs at the beginning of the 70s. With but one exception however, industrial research into this semiconductor material was then discontinued. The major drawback is the fact that GaN cannot be p-doped with sufficiently low resistance. Thus the light in this semiconductor is not produced by the radiative recombination of injected charge carriers at the pn junction

as with the other III-V materials, but by highly accelerated electrons that are generated in the very high-resistance i layer of a metal-i-GaN-n-GaN layer by collision-ionization processes and thus lead to the emission of light. The efficiency of this mechanism, which results in higher operating voltages of the device, decreases with increasing current density (and thus luminous intensity of the diode). The situation is similar in the case of blue-light diodes using ZnS and ZnSe materials, in which likewise no low-resistance pn junction can be produced. The result of this is that with all the materials mentioned, despite the direct band-gap structure that is favorable for the generation of light and which leads to very efficient photoluminescence or cathodoluminescence for instance, the efficiency of the internal conversion of electrical energy into light is lower in comparison.

SiC is the only material that allows reproducible p and n doping and possesses a suitable band gap for the emission of light in the blue region of the spectrum. The advantage of a device that can easily be controlled in all its physical characteristics more than makes up for the fact that SiC has an indirect band-gap structure, which is less favorable for generating light.

Groundwork on SiC blue-emitting LEDs has been performed in Great Britain, the USSR, Japan and in the Federal Republic of Germany at Hannover Technical University. Proceeding from the work done in Hannover, the development of SiC blue-emitting LEDs was pursued in the Siemens research laboratories and diodes were created with the highest efficiencies known to date. Siemens is one of the first semiconductor manufacturers to have successfully produced such diodes in the laboratory.

Technology and design of SiC LEDs

An essential feature of SiC is its appearance in several modifications with different band gaps. For the production of blue-light LEDs the hexagonal modification 6H (α -SiC) is the most favorable. As with all known LEDs, with SiC LEDs too the active light zone consists of epitaxial, monocrystalline material deposited on a p-type substrate crystal. The layer is grown from an Si melt saturated with carbon (liquid-phase epitaxy) at temperatures between 1600 and 1700 °C, the p-type layer being doped with aluminum and the n-type layer additionally with nitrogen. The contacting and the diode structure are produced using the technologies already familiar with LEDs. The structure of an SiC lamp is shown in fig. 1.

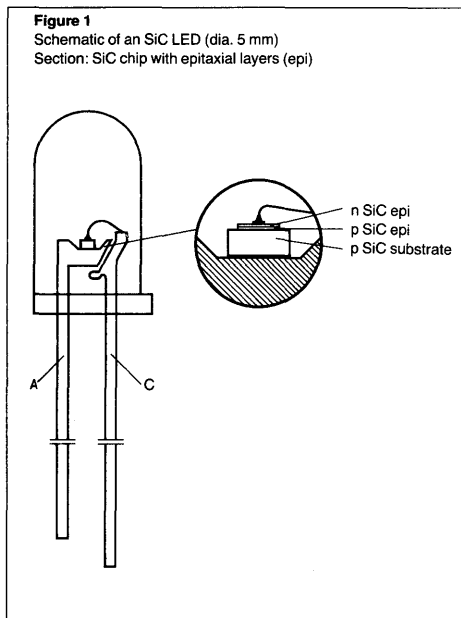

In addition to the, compared to other semiconductor materials, high process temperatures, the major problem in SiC LED technology is the lack of large-area substrate crystals – an absolute necessity where low manufacturing costs are concerned. Up to now it has been necessary to make do by preparing small crystal wafers of the appropriate modification from the kind of crystal clusters that appear as a by-product in the large-scale industrial synthesis of SiC for producing grinding powder, but their diameter is no more than 10 to 14 mm. The big disadvantage of this is that the yield of suitable substrate crystals is only very small. At Siemens a substantial step towards a solution has now been taken. By

means of a newly devised process, involving sublimation followed by condensation, monocrystals with a diameter of 15 mm and a length of 25 mm – that makes about 30 substrate wafers – were produced on a nucleus. This technology is, admittedly, considerably more elaborate than the technology of III-V semiconductors, so one cannot expect the price of blue-emitting diodes from SiC to fall to the level of more common LEDs; on the other hand though, an appreciable step towards mass production has thus been taken.

Characteristics of SiC LEDs

The emission spectrum of SiC LEDs and the dependence of the light current on diode current are illustrated in figs 2 and 3 in comparison with other LEDs. Fig. 4 shows the color locations of different LEDs on a standard color diagram. Whereas the red-, yellow- and green-emitting diodes lie practically on the spectrum locus, the blue-emitting SiC diodes exhibit two peculiarities. Their color location is not on the spectrum locus, and the dominant wavelength experienced by the observer shifts slightly with increasing diode current towards shorter wavelengths. Associated with this is a decrease in the rise and decay

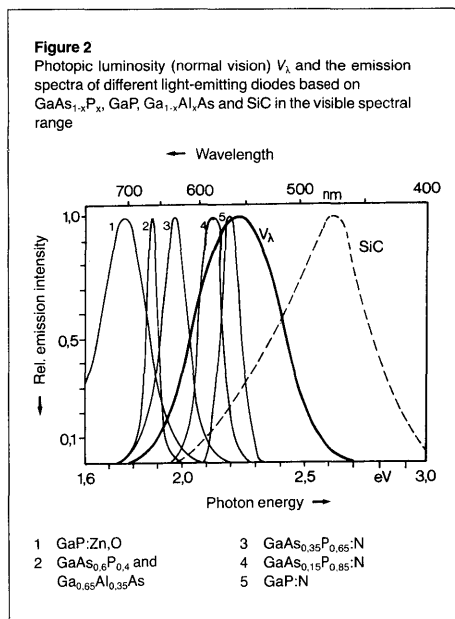

time of the luminescence from typically $0.9 \mu\text{s}$ (90–10%) at 5 mA to typically $0.5 \mu\text{s}$ at 50 mA. For a diode current of 20 mA the diodes have a luminous intensity of typically 4 mcd, the luminous efficiency being approx. 10^{-2} lm/W . A typical current/voltage characteristic is shown in fig. 5.

Applications and prospects

The possible applications for SiC LEDs are all those in which small light emitters are required that are capable of emitting in the blue spectral range and are suitable for fast modulation (up to 500 kHz), in the scientific and technical field as a calibration light source for photomultipliers for example, in TV-camera engineering and photography, and as a radiation source in spectroscopy, biophysics and medicine.

It will no doubt be possible to make this technology cheaper through continuing development of the individual process steps that are involved. It should be emphasized once more, however, that the fundamental problems of SiC technology are such that the prices of conventional LEDs are not likely to be approached. This does not only apply to SiC, incidentally, but also to the other materials being considered for blue-light emitting diodes.

Figure 3

Light current/diode current characteristics $\Phi(I)$ of different LEDs
(VPE = vapor-phase epitaxy, LPE = liquid-phase epitaxy)

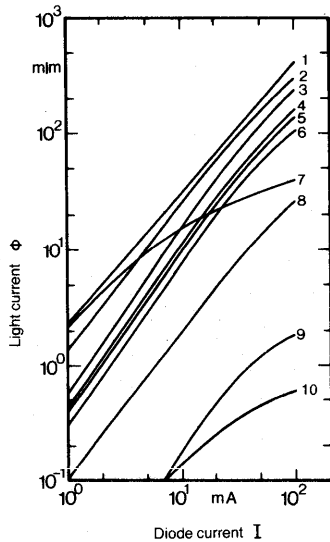

- | | |
|--|---|
| 1 Ga _{0.65} Al _{0.35} As-LPE | 6 GaP:N-VPE |
| 2 GaP:N-LPE | 7 GaP:NZn _{0.4} O-LPE |
| 3 GaAs _{0.35} P _{0.65} N-VPE | 8 GaAs _{0.6} P _{0.4} -VPE |
| 4 GaP:X-LPE | 9 SiC:Al,N-LPE |
| 5 GaAs _{0.15} P _{0.85} N-VPE | 10 GaN-MIS-VPE |

Figure 4

Color location of SiC LEDs (dotted) compared to other LEDs

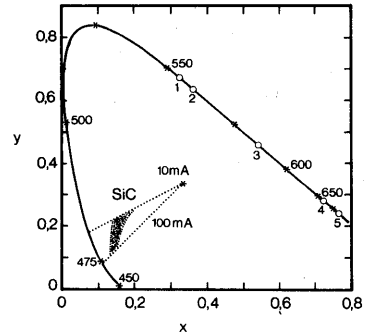

- | | |
|--|---|
| 1 GaP:X | 4 GaP:Zn _{0.4} O and GaAs _{0.35} P _{0.65} N |
| 2 GaP:N | 5 GaAs _{0.6} P _{0.4} and Ga _{0.65} Al _{0.35} As |
| 3 GaAs _{0.15} P _{0.85} N | |

Figure 5

Current/voltage characteristic $I(V_F)$ of a typical SiC LED

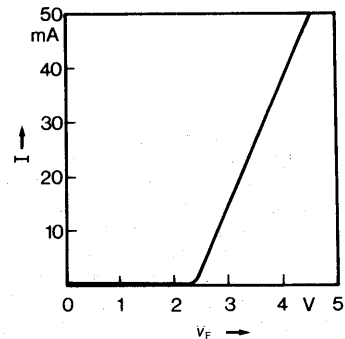

SIEMENS

Light Activated Switches

Appnote 33

1. Miniature Light Barrier for a Shaft Position Encoder or a Revolution Counter

Miniature light barriers are required for shaft position encoders, since light transmitter and receiver are closely facing each other by a distance of a few millimeters. For this application a practical combination is achieved by using the light emitting diode LD261 and the phototransistor BPX81. Both components have the same epoxy case with an edge length of 2.2 mm. The LED operates in the infrared range at about 950 nm, since the efficiency is essentially higher than that of the visible radiation. The circuit described in the following converts interruptions of a light beam into electrical pulses for counting.

The construction of a shaft position encoder is shown in Fig. 1.1. The distance between the transmitting and the receiving components is about 3 to 5 mm. Both are inserted in a hole with a diameter of 3 mm, whereby the opening is diminished to 1.4 mm at its front ends. A plastic disc carrying a line pattern at its circumference as shown in Fig. 1.2 is rotating between transmitter and receiver. A pervious section follows a non-pervious one and the angle position of the disc is determined by counting the quantity of sections having passed.

Fig. 1.1

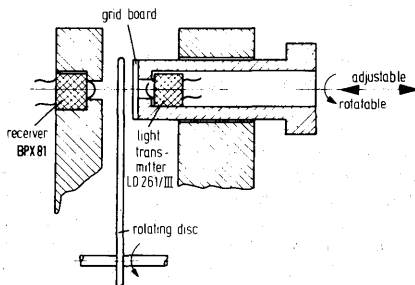
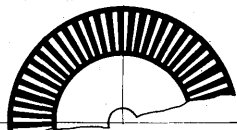

Fig. 1.2



Assuming that the rotating disc with a diameter of about 50 mm has a pattern of 600 lines, the distance between two lines is about 0.25 mm. To increase the light-to-dark ratio at the receivers side a plate with the same grid structure is mounted in front of the transmitter-hole as shown in Fig. 1.3. If the position of the grid on the rotating disc coincides with the one of the plate, the phototransistor receives a maximum of light. If both grid patterns are displaced with half the distance of two lines, the received light becomes a minimum. As the transmitter is rotatable and adjustable in its position an efficiency maximum can be achieved.

Fig. 1.3



The circuit is shown in Fig. 1.4. The emitting diode LD261 is operated at a current of about 20 mA.

Fig. 1.4

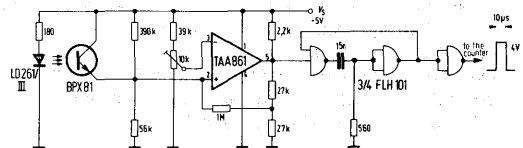

Technical Data

Supply voltage V_s	5 V
Supply current (total) I_s	35 mA
Wave-length of the transmitted light	950 nm
Maximum counting frequency	40 kHz
Duration of the output pulses	10 μ s
Amplitude of the output pulses	4 V

The collector current of the potentiometer varies between about 3 μ A (minimum) and about 12 μ A (maximum) when the disc is rotating. Since the minimum value is to be kept constant, strong ambient light influences have to be eliminated.

The current variation is sufficient to safely trigger the op amp TAA 861, which serves as a Schmitt-trigger. The fol-

lowing NAND-gates (FLH101) operating as monostable multivibrator produce a definite square pulse with a duration of about 10 μ s, for each line passing the light barrier. The circuit operates up to a frequency of 40 kHz, which corresponds to about 4000 r.p.m. of the disc.

2. Light Barrier using TCA105

The light barrier shown in Fig. 2.1 consists of the GaAs light-emitting diode LD261, the phototransistor BPX81 and the integrated threshold switch TCA105. The LED is operated at a constant current to meet the total range of the power supply voltage being between 4.5 V and 27 V. The IC itself is specified for a wider range. The constant current source is realized by the transistor T_1 , the diodes D_1 and D_2 as well as the two resistors R_1 and R_2 . By the two diodes an independent, nearly constant voltage is achieved at the base of T_1 . The constant current of the transistor can be adjusted by the potentiometer R_2 .

Fig. 2.1

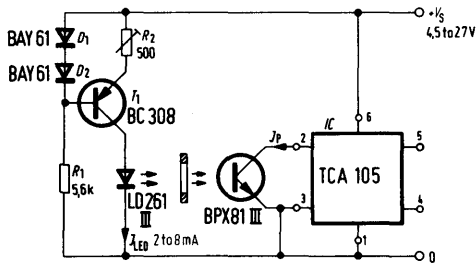

Parameter changes of the components created by temperature and aging effects are compensated for if the photocurrent of the phototransistor is chosen four times higher than the required input threshold current of the TCA105, i.e. about 200 μ A. The output signal is available at the two anti-valent outputs of the IC (pins 4 and 5).

Adjustment

The light barrier is adjusted by setting the LED-current. If the IC is operated in the test circuit as shown in Fig. 2.2, the current of the LED has to be set in such a way that a voltage of 400 mV is available between pins 1 and 2 of the TCA105.

Fig. 2.2

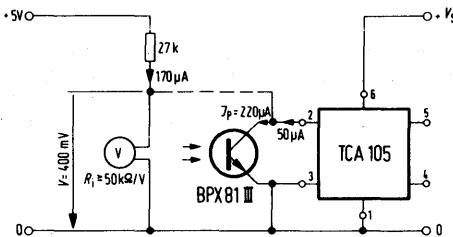

Technical Data

Supply voltage	4.5 to 27 V
Supply current	3.5 to 11.3 mA
LED current	2 to 8 mA
Supply current of the IC	3.3 mA
Ambient temperature range	-25 to +70 °C.

3. Optical Weight-Quantizer for Large Scales

The optoelectronic circuit described in Fig. 3.1 facilitates the weight quantization of large scales, whereby a 3-stage LED-display indicates the difference of the adjustment.

Fig. 3.1

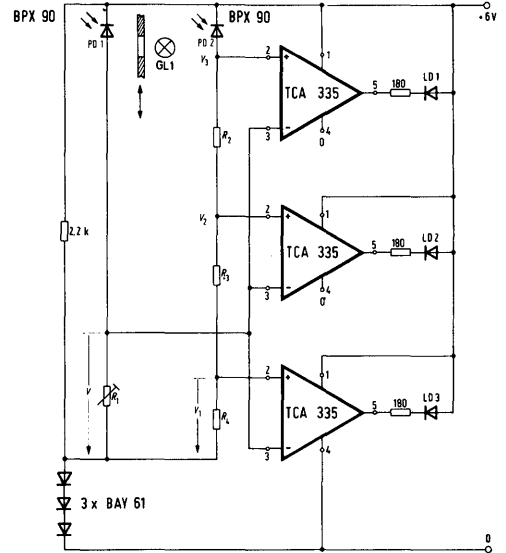

The incandescent lamp GL_1 illuminates the two photodiodes PD_1 and PD_2 . The first is covered by a slot diaphragm, which is moved up and down by the balance arm of the scale with a stroke of 4.5 mm, corresponding to the balance difference. A voltage, being proportional to the balance difference, drops across the resistor R_1 and is supplied to the three op amps TCA335 operating as threshold switches. The reference voltages V_1 , V_2 and V_3 are produced by the photocurrent of the photodiode PD_2 and drop across the resistors R_2 , R_3 and R_4 . They are supplied to the non-inverted inputs of the TCA335. If the voltage across the resistor R_1 exceeds the reference value then the corresponding LED's LD_1 , LD_2 and LD_3 are switched on. An inverse function can be achieved by interchanging inputs 2 and 3 of the op amps. Since both photodiodes are illuminated by the same incandescent lamp, brightness changes created by aging or supply voltage variations are ineffective.

The common mode voltage, necessary for operating the op amps drops across the diodes D_1 , D_2 and D_3 .

4. Optically Code Reading Regardless of whether Different Kinds of Papers have Different Reflexion Coefficients

When identifying stroke markings placed on different kinds of papers, the uncertainty exists that the code is erroneously read due to different reflexion coefficients.

The circuit described in the following and shown in Fig. 4.1 avoids this difficulty by means of an additional compensation track. The two phototransistors FT_1 and FT_2 being connected in series serve as a voltage divider, the center tap of which is joint to the inverted input of the amplifier OP. To each photo-transistor belongs an LED.

Fig. 4.1

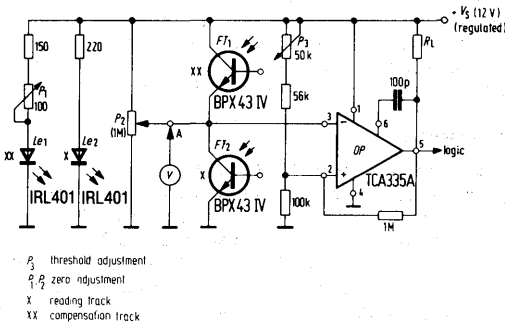

Both are connected in parallel, whereby the pair consisting of Le_1 and FT_1 serves for the compensation track and the one incorporating Le_2 and FT_2 functions for the reading track.

Fig. 5.1

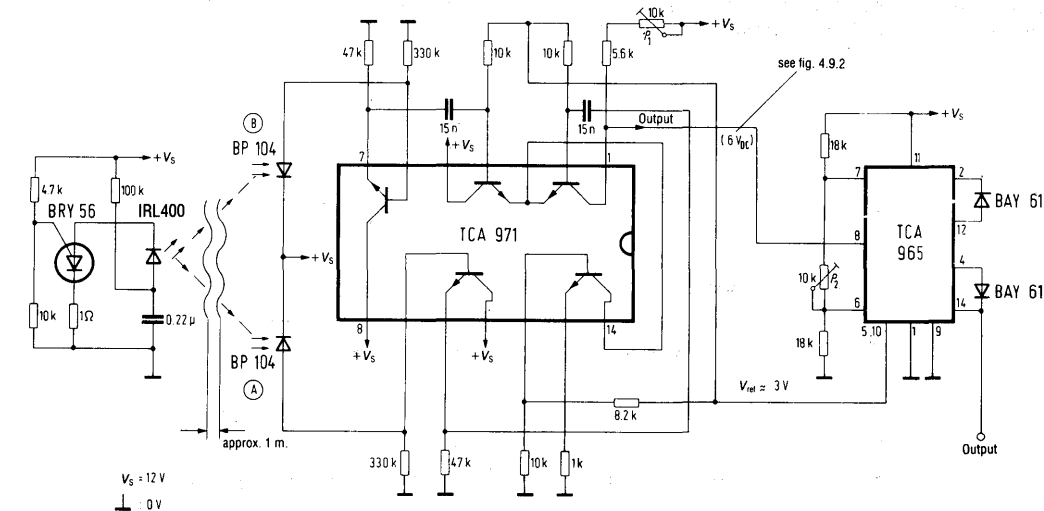

Therefore, the influence of a reflexion coefficient of the paper is eliminated and the reading result is determined only by the different reflexion of the strokes.

Adjustment Procedure

Firstly, the potentiometer P_2 is adjusted so that a level of $0.5 \times V_S$ is measured at point A. During this procedure the phototransistors have to be completely covered. Then a paper of any kind without stroke markings is inserted into the readchannel and P_1 is adjusted in such a way that point A has a level of $0.5 \times V_S$. The threshold for the stroke markings is determined by the potentiometer P_3 .

5. Light Barrier Indicating the Direction of Interruption

It is generally important to know not only that a light barrier has been passed but also from which direction the passing occurred. These requirements can be met by using the window discriminator TCA965 with RS memory function. Two receiver diodes are necessary to indicate the passing direction (see Fig. 5.1).

The LED IRL400 operates as a transmitter diode. It is supplied with short current pulses of approx. 1A peak value and a repetition period of 30 ms. These pulses are generated by the programmable unijunction transistor BRY56. The emitted light pulses are received by the diodes BP104. They are connected to two transistors operating as emitter followers. The transistors are connected to a differential amplifier via a 15 nF-capacitor each. The output signal of the TCA971 is supplied to pin 8 of the window discriminator.

No signal is available from the differential amplifier if both receiver diodes are covered and when both receive light. If the diode A is not met by the light beam, the voltage V_8 at pin 8 is greater than that at pin 7. If the diode B is not met by the light beam, V_8 is lower than V_6 (see Fig. 5.2).

Fig. 5.2

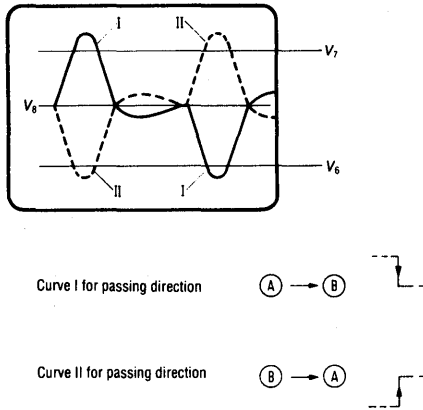

If the light barrier is passed from A to B, an L-level is available at pin 14 (curve I). But if it is passed from B to A, pin 14 shows an H-level (curve II).

The sensitivity of the circuit is adjustable by potentiometer P_2 . Potentiometer P_1 sets the dc level of the output symmetrically to V_6 and V_7 . The five transistors are combined in the transistor-array TCA971.

Thus, a very good temperature behaviour of the differential amplifier is obtained. The reference voltage V_{10} at pin 10 of the TCA965 is also utilized by the constant-current source of the TCA971.

Fig. 6.1

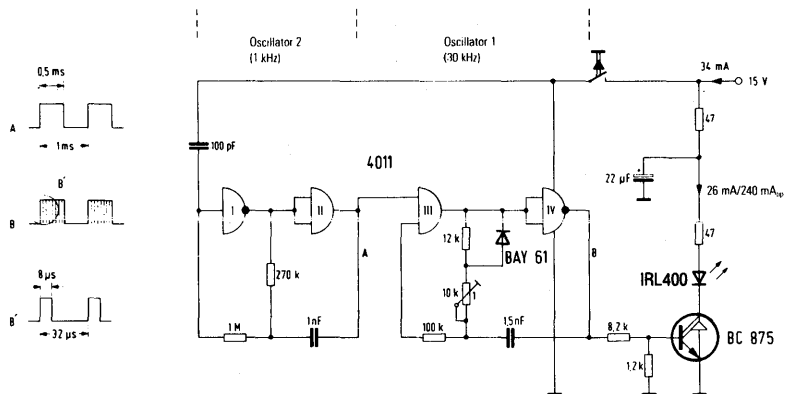

6. Infrared Reflex-Light Barrier with IRL400 and TDA4050

The transmitter of this circuit is an IR-LED, type IRL400, emitting a strongly focused light beam. TDA4050B is used as receiving preamplifier. When using a triplet mirror with an area of about 20 cm² as reflector, the maximum distance is at least 10 m. The allowed interfering light in lens axis is up to 200 lux (incandescent lamp light). This corresponds to a white surface illuminated at 50 klx over the whole irradiation of the receiver. Emitter and receiver can be placed in the same housing. The circuit is particularly suited for decoding fast changing codes (e.g. running bar patterns) and as a light barrier.

Contrary to IR remote controls, IR reflex-light barriers require only very narrow emitting and receiving characteristics. Because of the short reaction time required, a continuous emitter signal is also needed. Therefore, the pulse currents cannot be as high as with remote controls as this operation would exceed the admissible power dissipation.

Transmitter

A circuit consisting of 2 CMOS-NAND-gates (Fig. 6.1) generates a square-wave oscillation with a frequency of approx. 30 kHz. The pulse duty factor is fixed at 4:1. According to experience, a good efficiency is achieved herewith. To obtain the desired ratio between pulse duration and pulse space, the discharging resistor is partially bypassed by a diode. The 30 kHz-carrier is 1 kHz-modulated by a second pair of gates. When decoding running bar patterns, this modulation is not necessary as the object itself will be the source for the modulation.

A Darlington stage with BC875 drives the transmitter diode with peak currents of 200 to 250 mA, resulting in a mean diode current of around 25 mA. Without modulation, the mean diode current would reach twice this value.

Receiver

The IR signal received by the photodiode BP104 (Fig. 6.2) is amplified through a transistor stage by 20 dB. The gain is determined by the collector resistance of 4.7 k Ω as well as by the 1.8 k Ω -input impedance of TDA4050B. The coupling capacitance of 22 nF and the RC circuit of the emitter reduce drastically low frequency-signals, especially the 50 and 100 Hz-components mainly present in artificial light.

The integrated circuit TDA4050B has a gain of about 60 dB between input and output. In order to limit the bandwidth, an active filter consisting of a double-T-section is connected between pin 4 and 5. Thus, the bandwidth is limited to approx. 10 kHz.

The gain of the TDA4050B depends on the potential at the control input (pin 2). Normally only a capacitor, being charged to a level of 1 V without signal, is connected to this terminal. In the circuit, according to Fig. 6.2, a bias of 1.85 V is set via a voltage divider and the gain is reduced by approx. 20 dB therewith. This is necessary as otherwise, with the increased gain at the output, short-time peaks could result from the control action and would disturb the function. Notwithstanding the adjustment of the basic gain at pin 2, the automatic control is preserved, avoiding an overdrive of the receiver. Due to different charging and discharging resistors of the TDA4050B, downward control is very fast but upward control is relatively slow. The controlling time-constant is determined by the capacitor connected to pin 2.

When the input signal at the photodiode exceeds a signal current of 5 nA_{pp}, the output at pin 3 becomes negative.

Acoustic Indication and Evaluation

Should the incoming signal be acoustically indicated, pin 3 has to be connected to an evaluation circuit. It consists, for example, of a loudspeaker with a transistor BC309. Besides that, with this circuit the limit range can be easily defined as the tone becomes undefined when the maximum range is exceeded.

Optics

For the receiver, a collecting lens with a diameter of 15 mm and a focal length of 30 mm is used. Thus an effective receiver area 30 times larger than with photodiode BP104 is achieved. At the same time the angle of irradiation is restricted to $\pm 3^\circ$. With an increase of the lens diameter the range increases proportionally. But an increase of the focal length at the same time will limit the angle of irradiation.

For the transmitter, no additional optic is used, but the parasitic radiation remainder outside the cone becomes inoperative by means of a blackened tubus.

Electrical Features

The transmitter must be well shielded against the receiver so that the highly-sensitive receiver input cannot be disturbed. The electrical separation of the lines signals is sufficiently obtained by the filter circuits mentioned.

Fig. 6.2

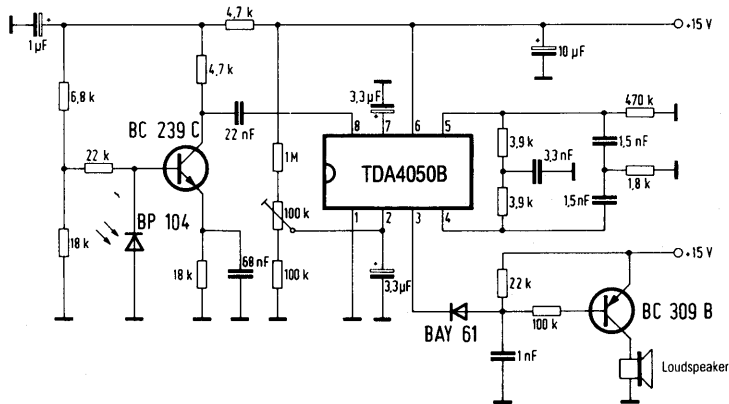

Technical Data

a) Transmitter

Supply current at $V_s = 15$ V	
unmodulated	60 mA
with 1 kHz-modulation, duty cycle 0.5	34 mA
Carrier frequency (square wave oscillation)	30 kHz
Duty cycle of carrier	0.25
Carrier-pulse-peak radiant intensity	100 mW/sr
Opt. wavelength	950 nm
Cone of radiation (half-angle)	6°

b) Receiver

Supply current at $V_s = 15$ V	
without load (loudspeaker)	10 mA
load (loudspeaker) only	18 mA
Angle of irradiation with lens	$\pm 3^\circ$
Intermediate frequency	30 kHz
Bandwidth (3 dB)	10 kHz
Min. pulse-peak-radiant-power to diode BP 104	10 nW
Max. modulation frequency	
at standard sensitivity	5 kHz
at reduced sensitivity	10 kHz
Dynamic range	60 dB
Max. interfering light (incandescent lamp light in lens axis)	200 lux

c) Total circuit

Supply current at $V_s = 15$ V	max. 70 mA ¹⁾
Range with simple triplet mirrors as reflector	
Seize of reflector 20 cm ²	approx. 12 m
Seize of reflector 1000 cm ²	approx. 80 m
Range with top-quality pentaprism as reflector	
seize of reflector 25 cm ²	approx. 20 m

¹⁾ Without modulation and load (loudspeaker)

7. Current Control of LEDs as a Function of Ambient Light

A brightness control of LEDs is required especially when the ambient light intensity varies within a wide range. Fig. 7.1 shows a circuit for this application. It operates sufficiently even at a supply voltage of only 2.5 V. In complete darkness the LED is driven with a current of 100 μ A. If the intensity of the ambient light rises, the current, i.e., the brightness of the LED, increases accordingly. At daylight the LED is operated by an impressed current of 5 mA/100 lux.

The ambient light intensity is sensed by the Silicon photodiode BPW32. The signal is amplified through the Darlington operational amplifier TCA315. The sensitivity of the circuit is determined by the resistances of R_1 and R_2 . The LED current exceeds the one of the photodiode by a factor of 1000 with the exception of in darkness, where the LED-current is 100 μ A, as described above.

Fig. 7.1

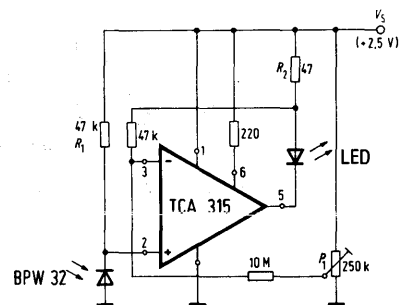

The current referring to a complete darkness is adjusted by the potentiometer P_1 . The total supply current is 220 μ A plus the LED-current (at $V_s = 2.5$ V).

8. Temperature-Response Compensation of the LED IRL401

Fig. 8.1 shows a circuit which is especially favored for compensating temperature effects of the LED IRL401. It is used in a light barrier operating with modulated light. The max. diode current is rated to 50 mA_{pp} and the temperature range is +10° to +55°C.

Fig. 8.1

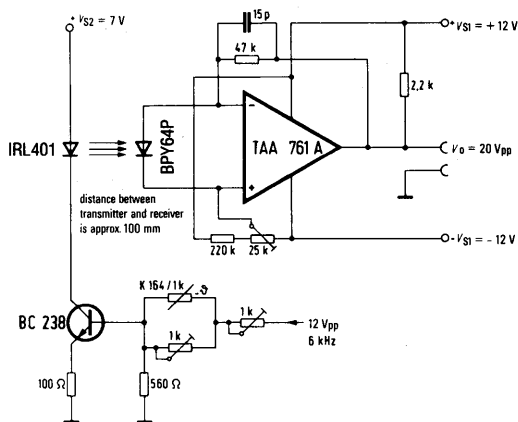

The NTC-resistor K 164 has been connected to the base of the transistor BC238 and not directly to the LED as usually practiced. This measure reduces the self-heating of the thermistor. The control characteristic is adjustable by the two 1-kΩ-potentiometers. To obtain a temperature drift of only 2.5% for the complete circuit in the mentioned temperature range, the resistance of the potentiometers should be set to a value of approx. 500 Ω each.

Fig. 9.1

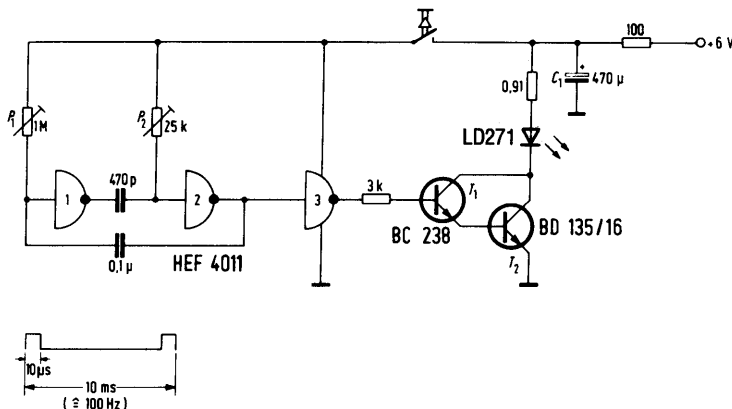

It should be mentioned for comparison purposes that the output voltage shifts about 20% when the circuit has no compensation.

The photovoltaic cell BPY64P operates as a detector in conjunction with an amplifier circuit. For processing a square-wave voltage with a frequency of 6 kHz, it is recommended to drive the photovoltaic cell BPY64P in a short-circuit operation. This will advantageously be realized by using the operational amplifier TAA761A operating with an impressed input current.

9. Reflection Light Barrier

This circuit is applicable for realizing a reflection light barrier. If, however, there are no requirements for improved sensitivity and reduced immunity against undesired influence of ambient light, this circuit can be simplified.

The circuit described in the following reacts within a range of 1 m, regardless as to whether the light is reflected from the human skin or from textiles.

Transmitter

The pulse generator of the transmitter circuit shown in Fig. 9.1 operates with a CMOS-gate, type HEF4011¹, and produces pulses with a duration of 10 μs and a repetition frequency of 100 Hz. The peak current of 1.5 A required by the LED, type LD27, is supplied by the Darlington stage consisting of T_1 and T_2 . The electrolytic capacitor C_1 operates as a buffer. The pulse duration is adjustable by potentiometer P_2 and the repetition frequency is set by potentiometer P_1 . Under the assumption of a duty cycle 1000:1, an average current of 1.7 mA is required for the complete transmitter circuit.

¹ HEF4011 refers to RCACD4011

Characteristics

Supply voltage	6 V
Supply current	1.7 mA at $V_s = 6 V$
Pulse interval	10 ms
Pulse duration	10 μs
Half angle of the radiation cone	35°

Receiver

The broadband receiver circuit shown in Fig. 9.2 is applicable if the ambient light is less than 500 lx. For realizing the infrared filter in front of the photodiode BPW34 a non-exposed but developed color film, type CT18 (Agfa) is used. The signal supplied from the BPW34 is amplified by the transistors T_1 to T_5 and is available at the output with an amplitude of 6 V_{pp}. The gain is about 20,000. The operating point of T_5 is adjusted by the potentiometer P_2 , setting a dc-level of 3 V to the base of T_5 . The output signal is symmetrized by potentiometer P_1 which determines the operating point of the transistor T_2 .

Fig. 9.2

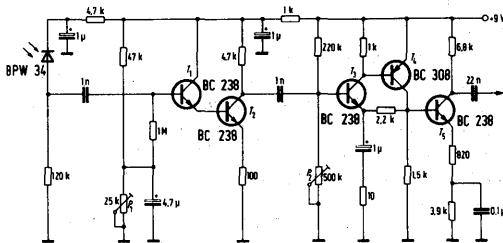

Characteristics

Supply voltage	9 V
Supply current	5 mA at $V_s = 9 V$
Gain	20,000
Output voltage	6 V _{pp}
Noise (without ambient light)	approx. 0.5 V
Operating range in conjunction with the above described transmitter, reflection from skin or textiles	max. 1 m

10. Optoelectronic Steel Tape Reader

Under more adverse conditions steel tape is often used instead of normal punched tape for reading control data into numerically controlled machine tools. The circuit proposed here is based on a configuration with 12 bit parallel read-in. The LEDs associated with the 12 bit are connected in series and supplied through the resistor R_1 from the 24 V supply. Each bit is allocated a phototransistor BPX81 and operational amplifier TCA335A. The phototransistor is connected to the inverting input of its associated operational amplifier, so with incident light (hole in the tape) the voltage at pin 3 of the TCA335A drops. A positive pulse then appears at the output.

Up to an ambient temperature of 40°C the LEDs require no additional cooling. Compared with tape readers employing light bulbs, the LED configuration is more robust, requires less maintenance and its power consumption is a factor of 10 lower. Reader errors cannot occur in practice because if a LED goes open circuit all 12 are without current and the fault is immediately apparent.

Fig. 10.1

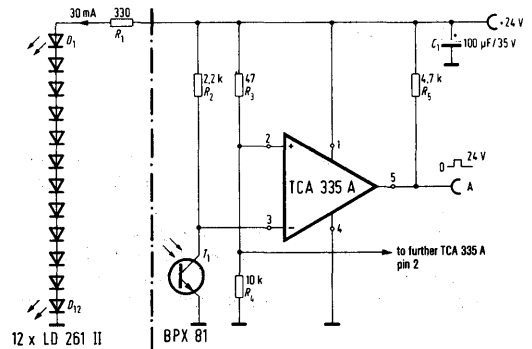

Technical Data

Transmitter

Supply voltage	9 V
Pulse width (single pulse)	approx. 1 ms
Carrier frequency	approx. 20 kHz
Peak current	approx. 1 A

Receiver

Supply voltage	9 V
Supply current (without LED)	2 mA
Intermediate frequency	approx. 20 kHz
Gain	approx. 80 dB
Range	≥ 15 m

2. Power-Saving Infrared Transmission for One Channel

With the transmitter-receiver combination described in the following it is possible to transmit simple instructions, e.g. on-off, over a distance of about 20 m by using the light emitting diode LD271 and the receiving photodiode BPW34. Therefore this device is favored for remote control operations of electrical equipment, e.g. dimmers, motors, switches, model railways or even installations carrying high tensions. Besides that, it can be advantageously used to realize light barriers, since the high carrier frequency guarantees a high interference immunity against continuous and low-frequency modulated light. If an optical system is used for the transmitter as well as for the receiver, much greater distances than the above mentioned can be covered.

An extension to more than one channel is possible, but the current consumption will increase by the number of channels. Thus this operating principle is also applicable for remote controlling of TV-receivers and of other devices demanding higher requirements. If the number of channels is n , $2^n - 1$ different instructions can be transmitted.

Since the information is only transmitted for a short period, the average power dissipation is reduced by a factor of 500 in comparison to the peak power. In the described application the repetition frequency is 10 Hz, i.e. the interval between two instructions is 100 ms.

By the ambient light a noise voltage is generated in the photodiode BPW34. Therefore, the input circuit of the receiver operates with a narrow-band-filter, keeping the noise influence low. Each instruction consists of a pulse train with constant pulse interval (e.g. 50 kHz). The number of pulses per train required for processing a statement depends on the amplifier. Therefore, it has to be considered that a narrow-band amplifier has a transient response which is not

to be negligible. For instance, a resonant circuit with a determined quality factor Q needs pulses in a quantity of $(Q/3)$ in order to reach 50% of the maximum resonant amplitude. Assuming a carrier frequency of 50 kHz, a quality factor of 16 and a bandwidth of 3 kHz, 5 pulses are required to obtain a value, which is 50% of the maximum resonant-circuit voltage. In the described circuit the interval for the total pulse train was chosen with $400\mu\text{s}$ which refers to 20 pulses.

Transmitter

Only one CMOS-IC, type HEF4011¹ has been utilized to realize the two oscillating circuits of the transmitter, operating at 10 Hz resp. 50 kHz (see Fig. 2.1). The 10 Hz-oscillator has a duty cycle of 250:1.

Fig. 2.1

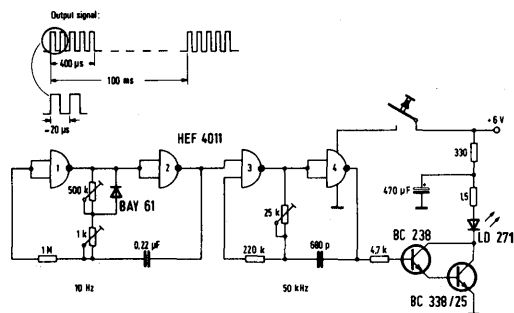

These different intervals are obtained through by-passing the charging capacitor by means of the diode BAY61. The 50 kHz-oscillator is modulated by 10 Hz, i.e. it operates only during a time of $400\mu\text{s}$. The LD27, emitting infrared light, is square-wave modulated by a Darlington stage with reference to the rhythm of the output signal. If the peak current is a 1 A, the average value is only 2 mA. As this peak current is not available from the battery, it is supplied from a $470\mu\text{F}$ -capacitor, the voltage of which decreases by a value of 0.5 V for the duration of the pulse train. The diode current being higher at the start positively effects the resonant circuit of the receiver.

Characteristics

Supply voltage	6 V
Supply current	2 mA at 6 V
Subcarrier frequency	50 kHz
Duration of pulse train to train repetition period	400 μs : 100 ms
Emitted peak power	80 mW/sr
Half-angle of the radiation cone	35°

Receiver

The receiver shown in Fig. 2.2 operates with the photodiode BPW34, which is matched to an input impedance of approx. 80 kΩ at 50 kHz. The dc diode-current should not exceed a value of 20 μA. For the infrared filter placed in front of the photodiode, a non-exposed but developed color film, type CT18 (Agfa) has been used. In the following circuit the pulses are amplified, clipped, rectified and applied to a monostable multivibrator, which covers the space between two pulse trains. Therefore a dc voltage is available at the output of the receiver as long as the push button of the transmitter is operated. Thus the required function can be realized.

The amplifier consisting of transistors T_1 to T_5 offers a gain of 20,000. T_1 operates as an impedance former. The bandwidth is adjusted to a value of 3 kHz by a selective feedback between T_3 and T_4 . T_6 operates as the threshold switch and limiter. The signal is integrated by the capacitor C_s and delayed, so that after the start of the pulse train three to four 50 kHz-oscillations pass before the following monostable multivibrator is triggered. Thus it is guaranteed that short pulse-interferences do not trigger the monovibrator, consisting of two NAND-gates, type HEF4011¹. The duration of the monovibrator pulse is 100 ms. Thus it is assured that the steady state is obtained after a period of 100 ms, if the following pulse train is not emitted from the LED.

¹HEF4011 refers to RCA CD4011

Characteristics

Supply voltage	9 V
Required current (without output circuit)	10 mA at $V_s = 9$ V
Receiving bandwidth	3 kHz
Centre frequency	50 kHz
Admissible ambient light	
day light	max. 4,000 lux
incandescent light	max. 500 lux
fluorescent lamp light	max. 10,000 lux
IR-filter, cut-off wavelength	870 nm

Fig. 2.2

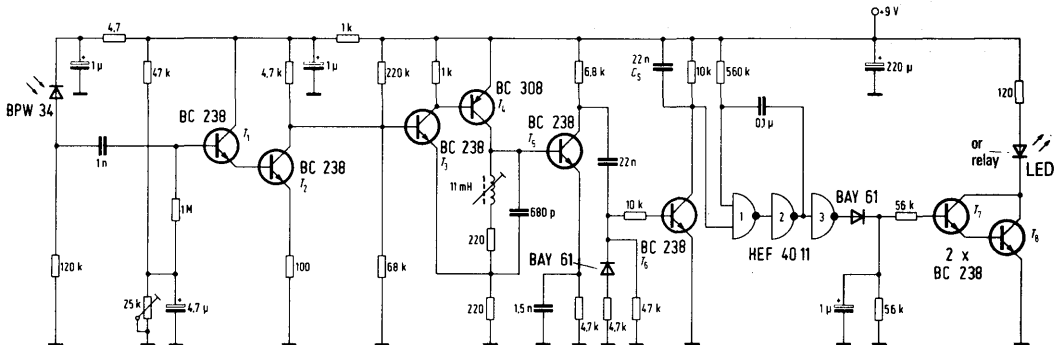

3. IR Preamplifier with the IC TCA440 for Infrared Remote Control Systems

Preamplifiers for IR remote control systems with pulse code modulation must meet additional overdrive requirements compared with frequency coded systems.

Receiver overdrive in conjunction with tuned circuits results in falsification of the envelope pulse duration. However, the receiver can only process such pulse "distortion" to a certain degree. As the input signals can differ by a factor of more than 10^5 , a control loop must be introduced to prevent overdrive. The control circuit must act fast enough to assure correct transmission of the first bit. This is especially important for the transmission of single instructions. The requirements are less critical for repetition instructions; here it suffices when the correct control state condition is achieved by the time transmission of the second instruction commences.

With single instructions, the signal AGC circuit must act within a fraction of the bit duration. This necessitates a response time of less than 100μs. The dwell time in the control state must, however, be much longer, ideally more than 100 ms so that for repetition instructions a more-or-less steady control state condition already exists for the second instruction.

In addition to this control loop driven by the useful signal for single instructions, a control circuit dependent on light level is also advisable. This assures maximum sensitivity under low ambient light conditions and reduces the amplification with increasing light level to maintain the light noise just below its disturbing level.

In practice, the operator can bring the transmitter very close to the receiver. When this form of overdrive occurs it must be assured that correct recognition of the signal is not prevented. For guidance purposes, a minimum separation of 5 cm can be assumed. The resultant level differences of more than 100 dB generally can not be fully handled by the internal control circuit of the IC; additional measures such as peak level limiting are therefore required to hold pulse distortion within the admissible limits.

4. Single Channel IR Receiver with High Interference Resistance

Fig. 4.1 shows an IR receiver circuit which is especially suitable for light barriers or simple IR transmission systems. It features increased resistance to extraneous light interference, for example the switch-on pulses of fluorescent lamps.

The pulse groups emitted by the transmitter ($f_0 = 40$ kHz, $t = 1$ ms, $T = 100$ ms) are received and amplified by approximately 60 dB on OP 1. P_3 sets the switching threshold for the following threshold switch OP 2, at the output of which the pulses are again available at TTL level. The first pulse received by the diode triggers MF1 which produces a pulse of duration t_1 (see Fig. 4.2). This in turn releases after approximately 90 ms a pulse of duration t_2 (G_1 and G_2). The second transmitted pulse can only pass G_4 during the period t_2 . The output signal A (continuous signal) is delivered by MF3, a post-triggered monoflop with $t_3 > T$.

The circuit is therefore insensitive to incoming interference pulses for a time T_{-12} and only responds when at least two pulse groups are received with a spacing T .

It is possible to replace the TTL IC's MF1 to MF3 by C-MOS monoflops (4047). This reduces the power requirements and permits the use of a higher supply voltage, for example from a 9 V battery. The Zener voltage of diode D_1 must in this case be about half the supply voltage.

Technical Data (TTL Version)

Supply voltage	5 V
Supply current	55 mA
Carrier center frequency f_0	40 kHz
Input circuit bandwidth	4 kHz
Pulse group duration t	1 ms
Pulse group repetition frequency $1/T$	10 Hz
Response threshold (max sensitivity) referred to the photodiode useful current	approx. 3 nA
Range measured with a transmitter fitted with $3 \times LD271, f_m = 1$ A	> 12 m

Fig. 4.2

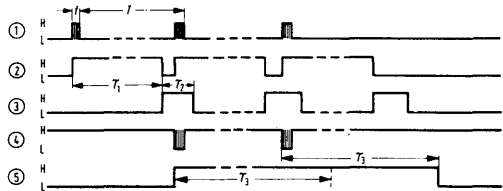
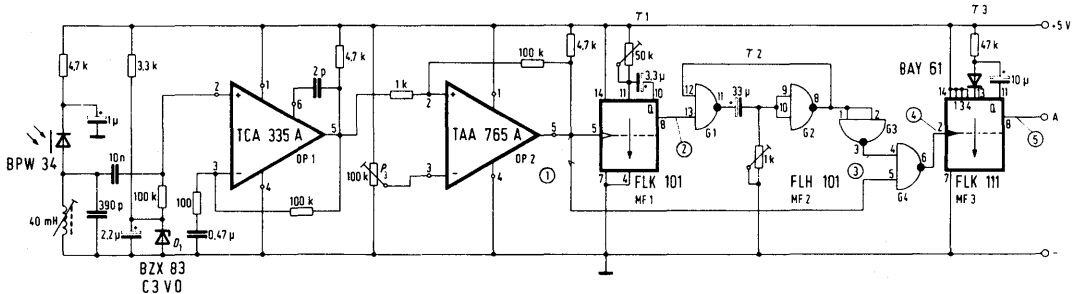

Fig. 4.1



5. Simple Battery-Operated IR Remote Control Transmitter for Single Instructions

The IR transmitter circuit is shown in Fig. 5.1. The capacity of a normal 9 V battery (240 mAh) suffices for about 30,000 switching operations; thus it is not the switching rate which normally determines the battery life but its storage capacity.

Fig. 5.1

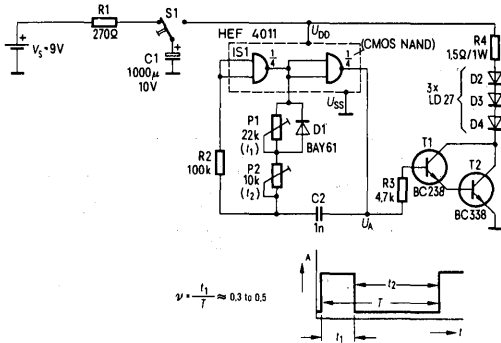

When the switch S_1 is operated, the transmitter radiates a single IR pulse of about 5 ms duration modulated with 31.25 kHz (see Fig. 5.2). After demodulation of the signal, 5 ms square wave pulses corresponding to the envelope of the modulated pulses emitted by the transmitter appear at

Fig. 5.2

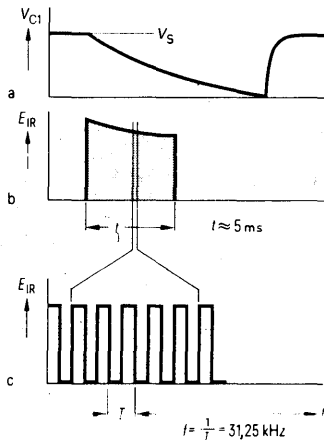

the receiver output. These can be used for various purposes, for example to change over a flip-flop state for switching equipment off or on, to drive counter circuits that actuate different switching processes, etc. The modulating frequency of 31.25 kHz is generated by a stable multivibrator incorporating CMOS NAND gates to minimize the power consumption. The multivibrator supplies the driver stage T_1 , T_2 for the GaAs LEDs (IR radiators) D_2 , D_3 and D_4 . With S_1 in its rest position C_1 charges up through R_1 . When S_1 is pushed, C_1 is connected as a voltage source to the transmitter circuit which then starts to oscillate. The current consumption of the circuit and the value of C_1 determine the duration of transmission.

The center frequency of 31.25 kHz is determined by P_1 and P_2 : P_1 affects the pulse duration t_1 and P_2 the interval t_2 .

The duty cycle $v = t_1/T$ should be between 0.3 and 0.5. This gives the longest range for minimum power consumption. Because of resistance tolerances within the CMOS circuit, the frequency can only be calculated roughly:

$$f = \frac{1}{T} \approx \frac{1}{1.1(P_1 + 2P_2)C_2}$$

Technical Data

DC supply voltage	9 V
Center frequency (adjustable)	31.25 kHz
Duration of transmission per single pulse ($C_1 = 1000 \mu\text{F}$)	5 ms
Energy consumption per switching operation	25 mWs

6. Preamplicator for IR Remote Control Systems

Infrared remote control receivers with MOS-ICs usually require a digital input signal with TTL-levels. Therefore a preamplicator has to be connected between the photodiode and the MOS-circuit. Such a preamplicator has already been described (see Fig. 3). In the following, a circuit, using the IC DA4050 is commented. The TDA4050 was especially developed for applications of IR remote control systems. It comprises a controlled prestage, an amplifier and a threshold amplifier. This IC offers excellent large-signal characteristics, an output with short-circuit protection and a simple driver circuit for active band-pass filters. Although solutions without coils are cheaper, an LC-network is connected to the input of the circuit shown in Fig. 6.1 to obtain a higher selectivity. The photodiode SFH205 is connected directly to the resonant circuit. It is reversely operated and biased with 11 to 14 Volt. The signal from the resonant circuit is supplied to the input of the IC via transistor BC414C. Thus, the signal-to-noise ratio is improved. An active filter is connected to pins 4 and 5. It is

part of the reverse feedback circuit of the operational amplifier. The output signal is available at pin 3, offering a protection against short-circuits to ground ($R_i = 10\text{ k}\Omega$). At L-level, the output has a low impedance.

Fig. 6.1

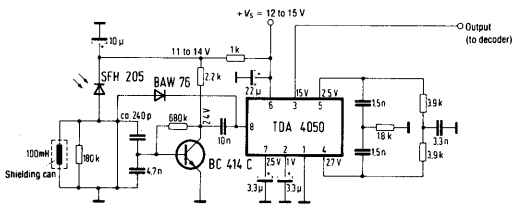
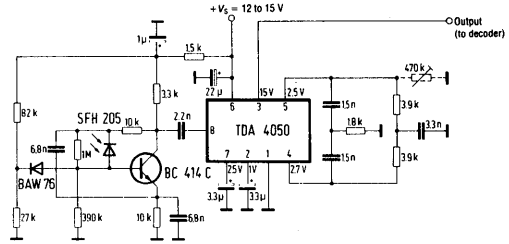

Fig. 6.2 shows a circuit without coils. The large-signal characteristics and noise immunity are improved by a network consisting of resistors and diodes.

Both circuits should advantageously be mounted in a double-screened case.

Fig. 6.2



Without any influence of extraneous light, a distance of 25 to 30 m between transmitter and receiver can be easily realized, whereas the distance is much higher if the circuit with LC-network is used.

The described preamplifier circuit is also applicable for IR remote control systems used in TV sets. In this case, only a range of 15 to 18 m is covered because of the wire-netting protection and the stray influences of the TV deflection coils.

SIEMENS

Photographic Aperture, Exposure Controls, and Electronic Flash

Appnote 35

1. Solar Cell Generator for Exposure Control in Cameras without Moving Parts

Exposure meters normally work with a moving coil instrument. With a field effect liquid crystal display and a solar generator with two photovoltaic cells, type BPY64 a fully electronic light control without mechanical moving parts can be realized. The reversal point of the indicator is reached at an illumination of 100 lux (color temperature of 2850 K). Thus exposure-time display for low-priced cameras is possible.

Circuit Description

A basic requirement is an oscillator which starts oscillating at a voltage below 100 mV. Two photovoltaic cells, type BPY64, feed a blocking oscillator with transistor AC121 VII as shown in Fig. 1.1. Because of the low photo-electric voltage available at low illuminations a germanium transistor with a low threshold voltage has to be used. In operation, the transistor is at first conductive so that a magnetic field can be built up in the primary winding of the transformer T_r . Through the secondary winding, a reverse voltage is induced to the base circuit which turns off the transistor. At this moment the magnetic field of the coil collapses. The potential difference between collector and base is momentarily approx. 5 V at the break-down point of the liquid

Fig. 1.1

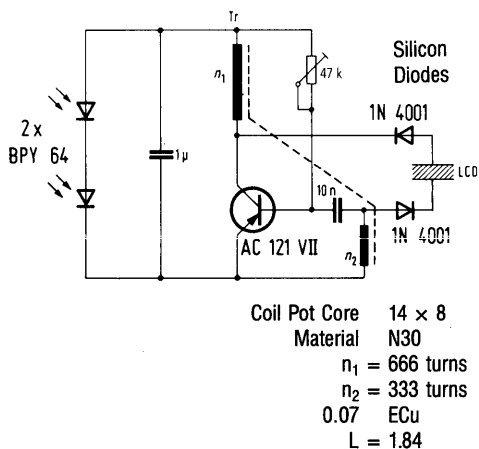

crystal display. To avoid a too strong damping of the base circuit by the capacitor of the display, two diodes are connected in series to the LCD. The pulse duration of the blocking oscillator signal is mainly defined by the self-inductance and self-capacitance of the coil, while the repeating frequency depends on the time constant of the base circuit. The optimum output voltage is achieved at a repeating frequency of approx. 3 kHz. The oscillations start at a collector voltage V_{CE} of -60 mV and a mean current I_C of 30 μ A.

2. Phototransistor Used In a Computerized Photoflash Unit

A new circuit has been designed for the receiving part of the computerized photoflash unit. It offers the advantage in that it essentially compensates all the undesired influences produced by exposure time errors, ambient light, temperature, and tolerances of the photosensitivity. A phototransistor in conjunction with an integrating capacitor connected to the emitter serves as a photodetector.

A computerized photoflash unit differs from a standard one in that the duration of the photoflash is determined by a photodetector. Therefore, the exposure time for a camera film is constant and does not depend on the intensity of the reflected light, i.e. the flash is interrupted sooner or later in dependence on the quantity of reflected light. Fig. 2.1 shows on principle the control circuit of a computerized photoflash unit. The photocurrent of the phototransistor charges the capacitor C_1 and thus the turn-off thyristor shown in the figure with broken lines is triggered.

Fig. 2.1

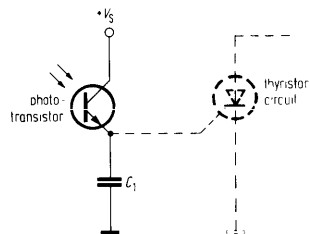

A trial was conducted to find out how far exposure time errors of photoflash devices using the circuit of Fig. 2.1 depend on the sensitivity of the phototransistor. It has been experienced that the sensitivity changes by about 25% in a distance between 0.9 m to 4.0 m. This variation is generated through the change of the current gain depending on the collector current.

The compensation of the linearity error of a phototransistor is only partially possible because of its unavoidable characteristic tolerance. Therefore it is more convenient to use a circuit in which the value of the current gain does not essentially influence the exposure time of a computerized photoflash unit.

The base collector current dependence on the luminous intensity is completely linear whereas this is contrary to the one of the emitter collector current. This is founded in the fact that the base-collector-junction serves as a photodiode. Therefore, a special circuit has been designed. The current generated through the light is integrated by a capacitance not being connected to the emitter of the phototransistor but to its base as shown in Fig. 1.1. At the beginning of the exposure the capacitor is not charged, i.e. the base-emitter-junction is not conductive. If the phototransistor is illuminated charge carriers are generated. A hole moves to the base terminal and positively charges the capacitor C_1 with reference to ground potential. When the capacitor is charged so that the base-collector-junction becomes conductive, the phototransistor starts to amplify, i.e. the emitter current increases. The amplified photocurrent produces a voltage drop across the load resistor R_2 and thus the following turn-off thyristor is triggered.

The disadvantage of the circuit shown in Fig. 2.1 is that the signal slewing rate is not fast enough, because the capacitance of the integrating capacitor C_1 is increased by the gain of the phototransistor at that instant when the base-emitter-junction becomes conductive, i.e. when there is an amplification effect. In order to improve the signal slewing rate the circuit shown in Fig. 2.2 is recommended. Here the capacitor C_1 is connected to the base and emitter. If the voltage across the load resistor R_4 increases, the level at the capacitors low end also rises with nearly the same amount as at the high end of C_1 connected to the base. Therefore, the capacitor C_1 usually requires no charge. The circuit according to Fig. 2.3 assures that at the beginning of each photoflash the capacitor C_1 always has the same charge impedance of the illumination which previously occurred. The resistors R_2 and

Fig. 2.2

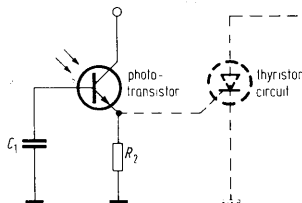

R_3 serve as voltage divider, at which a positive voltage of 1 V referred to the level of the phototransistor emitter is disposable before the photoflash is started. The diode D_1 is turned off. Its voltage difference effects that a current flows via the resistor R_1 into the base of the phototransistor. At its base-emitter-junctions a voltage drop, not being essentially increased by the external illumination is produced. At the beginning of the photoflash, a negative pulse is applied via terminal B to the resistor R_2 . By the current flowing through R_2 the diode D_1 becomes conductive and its level changes from +1 V to -0.7 V. This potential difference is fully transmitted via the integrating capacitor C_1 to the base of the phototransistor, which is therefore reversely biased by this voltage. Thereafter, this bias is compensated by the photocurrent. The negative voltage pulse required at the beginning of the photoflash can be derived from the same voltage source, which generates the collector-emitter-voltage at the beginning of the photoflashing. The voltage at terminal A is taken from a divider being in parallel to the photoflash capacitor, i.e. it is also available before the photoflashing occurs.

Fig. 2.3

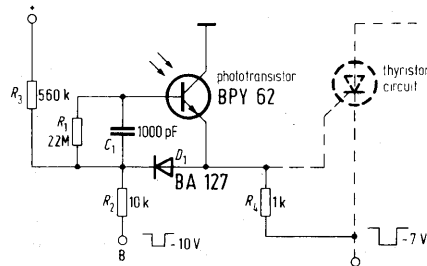

The advantageous features of the circuit according to Fig. 2.3 compared to the one of a conventionally computerized photoflash unit are as follows:

- Exposure time failures are nearly not detectable – presuming an objective lux meter (<5%).
- The phototransistors must not be selected according to their photosensitivity since their base-collector-junction is utilized and there is no difference in sensitivity amongst the phototransistors.
- No neutral absorber is required, since the internal base-collector-diode of the phototransistor operates linearly. Therefore, the photodetector is able to receive more light, i.e. signals with a higher amplitude are produced and the operation is trouble-free. The gate current of the thyristor does not influence the exposure time control. The total temperature coefficient is low (about 0.3% K⁻¹). If necessary the TC can be additionally decreased by applying at terminal B a pulse with a higher amplitude. The charging of the integrating capacitor is extremely low when the supply voltage is suddenly applied to the phototransistor.

SIEMENS

General Photoelectric Application Circuits Appnote 36

1. Suppression of DC Component in Photocurrent of Phototransistors

In many applications, phototransistors are intended to transmit only intensity-modulated light signals. Non-modulated light intensity interferes; the dc component caused by it must be suppressed.

Two circuits are described here in which the dc component remains ineffective. In the first circuit the direct current is kept constant through an automatic control system, in the second an active, frequency-dependent external resistance is used which is much smaller at low frequencies than at high ones.

Phototransistors are particularly suitable as light detectors for many applications since they are economical and, due to their amplification, offer a larger output signal than photodiodes. Thus they are less sensitive to external interferences.

In optoelectronics, a number of applications are used in which an intensity-modulated signal is superimposed upon a non-modulated one, e.g. in optical flame control, in light barriers involving moving objects, and in computerized flashlight equipment as well as slave flashlight equipment in which the primary illumination can cause interference. In many instances the suppression of the dc component is required because of the danger of overdriving through unmodulated light intensity.

Using phototransistors, the dc component of the photocurrent cannot be suppressed by a coupling capacitor.

Circuit for Phototransistors with Base Terminal

In Fig. 1.1 phototransistor T_1 and transistor T_2 form an automatic control system which regulates the voltage drop at resistor R_1 , maintaining it at a constant value, independent of the unmodulated light intensity at phototransistor T_1 . When the light intensity rises, a larger photocurrent I_p flows through T_1 , and the voltage drop at resistor R_1 becomes greater. As a result, a larger current flows to the base of T_2 . The rising collector current T_2 keeps reducing the primary photocurrent of T_2 until the voltage drop at resistor R_1 reaches its original value.

Due to the by-passing of the base-emitter junction of T_2 by capacitor C_1 , this control mechanism is ineffective during rapid changes. The cut-off frequency above, which the control becomes ineffective, is determined by capacitor C_1 and resistor R_2 .

Resistor R_1 determines the quiescent current. R_2 should be as large as possible to permit small values for C_1 . However, when resistance of R_2 becomes too large, the drive of T_2 is too weak. As a result the maximum light intensity at which the control still works is reduced. The maximum light intensity is also limited by the power supply voltage, because the voltage drop at R_1 must not exceed a fixed maximum value.

For the dimensioning given in Fig. 1.1, the maximum light intensity can be 25,000 lx; the voltage drop at R_1 must not exceed the value $V_{R1} = 4$ V. The photosensitivity of phototransistor BPY62 is 2 mA/1000 lx. The dark current of the circuit is smaller than the dark current I_{CEO} of the simple phototransistor, because part of the dark current is split as residual current from T_2 . The lower cut-off frequency of the circuit in the above dimensioning is $f_{gu} = 16$ Hz, the upper frequency $f_{go} = 2.5$ kHz. If an increase in the upper cut-off frequency f_{go} is required, resistance of R_1 must become smaller.

To exclude interference signals, the connection between the collector of T_2 and the base of phototransistor T_1 must be held as short as possible.

Fig. 1.1

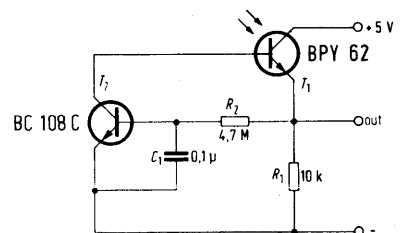

Circuit for Phototransistors Without Base Connection

The circuit shown in Fig. 1.2 is intended for phototransistors without base connection. At low frequencies the base voltage of transistor T_2 remains constant, and is determined by the voltage divider of resistors R_1 and R_2 . The collector resistance of phototransistor T_1 is determined by the relatively low diffusion resistance of the base-emitter junction of transistor T_2 . A large collector current can flow without resulting in a substantial decrease of the collector voltage of phototransistor T_1 . For the diffusion resistance it applies that

$$R_D = \frac{k \times T}{e \times I}$$

k standing for Boltzmann constant (1.38×10^{-23} WsK⁻¹); T for absolute temperature of phototransistor T_1 , in Kelvin; e for elementary charge (1.6×10^{-19} As); and I for emitter current of transistor T_2 in Ampere.

At high frequencies the base-emitter junction is short-circuited by capacitor C_1 . As a result the considerably larger differential resistance of the emitter-collector junction of transistors T_2 functions as external resistance. Parallel to it there is the series circuit consisting of capacitor C_1 and the resistors R_1 and R_2 , parallel-connected through the power supply. In the circuit presented in Fig. 1.2, the maximum light intensity for the given dimensions can amount to 20,000 lx.

Fig. 1.2

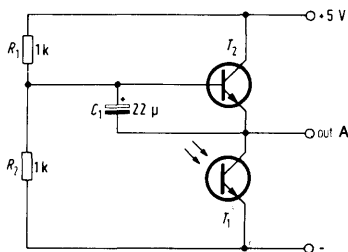

The sensitivity of phototransistor BPX81, used in the experimental circuit, is 2.5 mA/1000 lx. The lower cut-off frequency is $f_{GU} = 80$ Hz, the upper frequency is $f_{GU} = 40$ kHz. The ac voltage at point A can be raised by increasing the resistance of R_1 and R_2 . For a maximum light intensity of 20,000 lx, resistances of up to 10 kΩ are permissible.

List of Capacitors Used in the Circuit 1.1

1 pc Ceramic Capacitor 0.1 μF/63 V

List of Capacitors Used in the Circuit 1.2

1 pc Electrolytic Capacitor 22 μF/40 V

2. Power Supply Using the Photovoltaic Cell BPY64P for Low-Consumption-Devices

In the following, a circuit using the photovoltaic cell BPY64P and a blocking oscillator is described. It is utilized for supplying energy to small electronic devices of low power consumption, e.g., transmitter of infrared remote control systems. Generally a buffer accumulator is connected in parallel to this circuit and thus an operation without any batteries or other power supplies is realized.

On sunny days, transmitted energy of approx. 1 mWh can be generated by a Silicon-diode area of 2 cm² (corresp. to 6 × BPY64P) even in standard-size living rooms. But on cloudy or winter days, a maximum value of only 0.2 mWh can be expected.

Assuming a current of 10 mA for the short operation period of an IR remote control transmitter, a power of 60 mW at a battery voltage of 6 V is necessary. As the sum of all operations for remote control of a TV set does not exceed one minute per day, an electric energy of 1 mWh per day is required.

Under ideal conditions (i.e. power matching $R_i = R_o$, meeting exactly the color temperature for the sensitivity maximum) the photovoltaic cell BPY64P supplies approx. 60 μW at 1000 lx and at a color temperature of 2856 K. In practice, however, an average power generation between 15 and 16 μW can be obtained at diffused daylight and cloudy sky ($E = 1000$ lx).

Six photovoltaic cells, type BPY64P, connected in series as shown in Fig. 2.1 guarantee a safe starting of the blocking oscillator even at a low illuminance of 100 lx (daylight). The oscillator operates at 10 kHz. Its frequency strongly depends on the illuminance and the load. The basic current is adjusted by resistor R_1 . A value of 82 kΩ can be considered as a good compromise especially at a low illuminance. The resistance of R_1 should be lower for higher illuminance values.

The circuit offers an efficiency of approx. 60 to 65%.

Five NiCd-cells (20 DK, Varta, ordering number 3910020001) can be suitably utilized as buffer accumulators. They supply an open-circuit voltage of approx. 6.2 V at a 100% charge. The capacity is 20 mAh.

Fig. 2.1

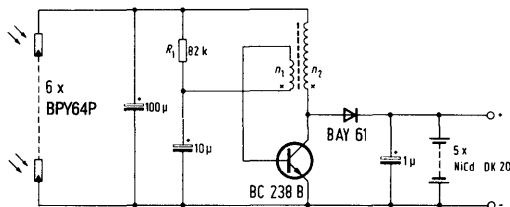

Fig. 2.2 shows the accumulator current as a function of illuminance at an open-circuit voltage of 5.8 V and at a charge without load. The two curves show the dependence on incandescent lighting (60 W-bulb, matt, with white reflector) and on daylight (diffuse, near the window).

Fig. 2.2

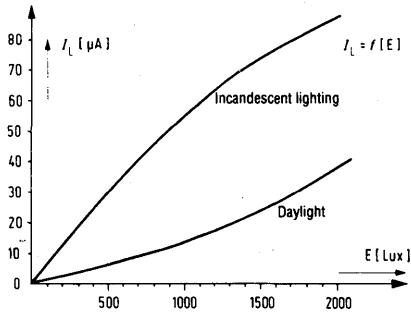
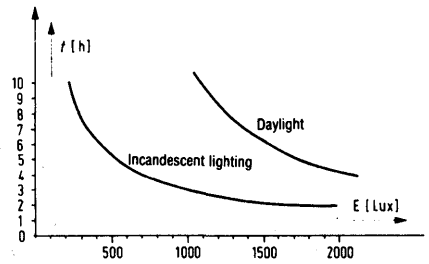

Fig. 2.3 shows the time necessary per day as a function of the illuminance. As reference an energy of $1000 \mu\text{Wh}$ is assumed. This is required by the accumulator if the remote control transmitter is operated 60 times per day for a period of 1 s.

Fig. 2.3



Coil Data

- n_1 : 15 turns 0.07 enamelled copper wire
- n_2 : 340 turns 0.07 enamelled copper wire

SIEMENS

General IR and Photodetector Information

Appnote 37

1. Detectors (Radiation-sensitive components)

Charge Carrier Generation in a Photodiode

Fig. 1.1 shows the basic design of a planar silicon photodiode with an abrupt pn transition. Due to the differing carrier concentrations, a field region free of mobile carriers,

Fig. 1.1
Planar silicon photodiode (schematic)

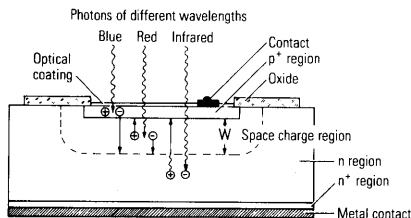

the space charge region, builds up between the p+ and n region, which only reaches into the n region if there is an abrupt p+ n transition. The following applies to the width of the space charge region:

$$(1) \quad w \sim \sqrt{\frac{V_D + V}{n_D}}$$

In this case, V_D is the diffusion voltage, V is the external voltage and n_D is the donor concentration on the n side. For

the junction capacitance $C_j \sim \frac{1}{W}$ with w from equation (1) the g is obtained:

$$(2) \quad C_j \sim \sqrt{\frac{n_D}{V_D + V}}$$

If photons with an energy $h\nu \geq E_g$ penetrate into the diode, electron hole pairs are generated on both sides of the pn junction. The energy difference $(h\nu - E_g)$ is dissipated to the grid on the form of heat. The electrical field in the space charge region repels the majority carriers and attracts the minority carriers on the other respective side (thus, holes from the n side to the p side and, vice versa, electrons from the p side to the n side). In this way, the charge carrier pairs are separated and a photocurrent flows through an external circuit, also without an additional voltage (photovoltaic effect). Carriers occurring in the space charge region are immediately sucked off due to the field prevailing in this layer. The carriers from the other regions must first of all diffuse into the space charge region in order to be

separated. If they recombine beforehand, they are lost with respect to the photocurrent. Thus, the photocurrent I_p consists of a drift current I_{drift} of the space charge region and of a diffusion current I_D from the remaining regions.

Should the p+ region be far thinner than the penetration depth $\frac{1}{\alpha_\lambda}$ ($\alpha_\lambda =$ absorption coefficient) of the radiation, the photocurrent from the p+ region can be neglected and the following relationship can be derived for the photocurrent I_p .

$$(3) \quad I_p = q \Phi_0 \left[1 - \frac{e^{-\alpha_\lambda w}}{1 + \alpha_\lambda L_p} \right]$$

L_0 is the diffusion length of the holes in the n region, q is the elementary charge and Φ_0 the radiant flux. The absorption coefficient α_λ is the only variable in the equation which depends on the wavelength. It predominantly determines the spectral characteristic of the diode's photosensitivity. In accordance with equation (1), the space charge region width w depends on the voltage and the doping which, in addition to the crystal quality, also influences L_D . High sensitivity is achieved with high values for w and/or L_D .

With respect to the electrical mode of operation, we differentiate between diode mode (with bias voltage) and cell mode (without bias voltage). In cell mode, the diode acts as a current generator which converts the radiant energy into electrical energy. If the photodiode is considered as a current source with the photocurrent I_p and a diode of equal polarity is connected in parallel to the load resistance R_{LE} (idealized equivalent circuit diagram), the relationship between the current and voltage can be expressed as follows:

$$(4) \quad I = I_s \left[e^{\frac{V}{nV_T}} - 1 \right] - I_p$$

In this case, I_p is the photocurrent, I_{sat} the saturation current, V the voltage between the p and n contact, V_T the voltage equivalent of the temperature and n is the diode factor. In the case of $I_p = 0$, equation (4) is reduced to a normal diode equation and describes the dark characteristic ($E_V = 0$). When subjected to light, the characteristic is shifted downwards corresponding to the illuminance. The open-circuit voltage

$$(5) \quad V_L = nV_T \ln \left[1 + \frac{I_p}{I_s} \right]$$

belongs to $I = 0$ ($R_{LE} = \infty$) and the short-circuit current $I_s = -I_p$ belongs to $V = 0$ ($R_{LE} = 0$).

There is a linear relationship, depending on the diode type, between the illuminance E_V and the photocurrent I_p , which covers several powers of ten (eight and more). However, due

to $I_p \sim E_v$ and $I_p > I_s$, a logarithmic relationship prevails between the open-circuit voltage V_L and the illuminance E_v . The forward current I_F belonging to the open-circuit voltage V_L is equal to the impressed photocurrent. In diode mode, the photocurrent of one or the other diode type may slightly change together with the applied voltage. This is due to the voltage dependence of the space charge region. In the case of silicon photodiodes, the dark current [first term in equation (4)] once again only plays a role with extremely low illuminances (in the millilux range).

Spectral Sensitivity

Fig. 1.2 shows the graph of the spectral sensitivity of a silicon and a germanium photodiode. The positions of the emission maxima of the most important light emitting diodes and the sensitivity of the human eye are also shown.

Fig. 1.2
Relative sensitivity of a silicon and a germanium diode

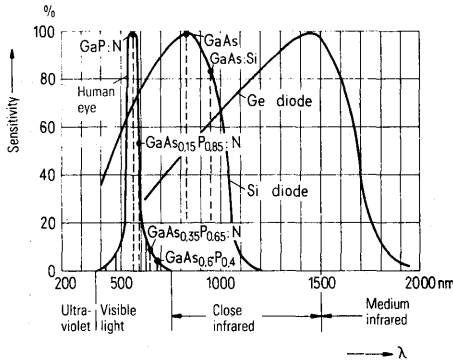

The two photodiodes cover the wavelength band from approximately 300 to 1800 nm. In this case, the silicon diode is of greater significance; it covers the visible range and, with its maximum sensitivity in the near infrared area, is well matched to the GaAs infrared emitting diode, whose best-known field of application covers IR remote controls and light barriers.

The sensitivity limit of semiconductor detectors in the long wave spectral wave band λ_g is determined by the energy gap E_g .

$$\lambda_g [\text{nm}] = \frac{h \cdot c}{E_g} = \frac{1,24}{E_g [\text{eV}]}$$

The run of the spectral sensitivity curve in the remaining wave band is determined by the absorption coefficient α_x and the recombination relationships in the interior and on the surface of the semiconductor (carrier loss). The drop in the curve towards shorter wavelengths is due to the higher absorption for shortwave radiation; for this reason, carrier pairs are only generated in the regions near the surface but, due to the high prevalent recombination rate, are mostly lost with respect to the photocurrent.

Photodiodes (PN and PIN diodes)

Photodiodes can optimally be matched to the desired application by choosing the correct mode of operation and by means of a suitable internal structure. In addition to the schematic structure of each individual diode type, figure 1.3 shows the doping behavior and the field pattern as well as the region in which the avalanche effect takes place at a sufficiently high voltage (ionization region).

Fig. 1.3
Doping behavior and field pattern of photodiodes

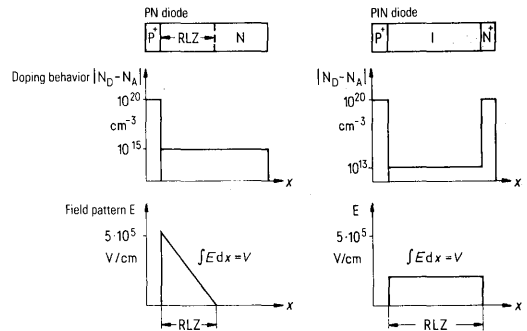

In the case of the *PN photodiode*, the radiation which, as a rule, enters the p+ region vertically, is absorbed in the mainly quasi-neutral p and n regions due to the narrow space charge region; thus, the photocurrent predominantly consists of the diffusion current. As the characters are diffused relatively slowly, PN diodes are frequently used in applications in which the stress is placed rather more on low dark currents than on high speed. (For complete diffusion of a 5 μm thick p layer, an electron needs 3 ns, and a hole needs 15 ns for the same distance in the n region). Therefore, silicon PN diodes can be found in exposure meters which still operate perfectly under starlight; this presupposes dark currents of less than approximately 10^{-11} A/mm². Solar cells also belong to the group of PN photodiodes.

Contrary to the PN diode, in the case of *PIN photodiodes* most of the light is absorbed in the space charge region. These photodiodes are mostly used in applications requiring high speeds. In order to achieve a large space charge region, if possible, in accordance with equation (2), the semiconductor material must be intrinsic (intrinsic I) (mostly weak n or weak p doped) into which a p+ region is diffused on the one side and an n+ region is diffused on the other side. A P+ IN+ structure ("sandwich" structure) is obtained. In accordance with equation (3), the junction capacitance C_j is low due to the large space charge region of the PIN diode. C_j values are used between a few picofarad and a few tenths of a picofarad. The product from C_j and R_L (load resistance) is the time constant of the measurement circuit.

In order to achieve PIN diodes which are as "fast" as possible, the voltage is increased to such an extent that the carriers drift through the space charge region at saturation

speed V_{sat} . In silicon and germanium, a saturation speed V_{sat} from 5×10^6 to 1×10^7 cm/sec is achieved with fields of approximately 2×10^4 V/cm. Accordingly, a carrier requires approximately 50 ps to completely drift through a $5 \mu\text{m}$ thick region.

Photovoltaic Cells

Voltaic cells are active dipole components which convert optical energy into electrical energy without requiring an external voltage source.

The properties of a voltaic cell are essentially characterized by the open-circuit voltage and the short-circuit current. In the case of a short circuit ($V = 0$), the current I_s is a linear function of the illuminance and thus also proportional to the area subjected to radiation. The open-circuit voltage V_0 initially increases logarithmically with the luminous intensity.

This is independent of the size of the cell and amounts to approximately 0.5 V at 1000 lx. In order to extract the maximum amount of energy from a voltaic cell, the load resistance R_L must lie in the order of magnitude of $R_i = \sqrt{V_0/I_s}$. The internal resistance R_i of a voltaic cell should be as low as possible in order to prevent unnecessary loss.

In order to measure the luminous intensity, the proportional relationship between the optical and electrical signals is important, and in practice, this applies up to a load resistance of $R_i \approx V_0/2 I_s$.

In principle, voltaic cells can also be operated in diode mode by applying a voltage in reverse direction. Obviously, this voltage must not exceed the maximum reverse voltage.

Phototransistors

In principle, a phototransistor corresponds to a photodiode (collector-base diode) with a series-connected transistor as amplifier. The phototransistor is the simplest integrated photoelectric component. Figure 1.4 shows one of the practical designs of a bipolar phototransistor (cross-section and

Fig. 1.4
Bipolar phototransistor

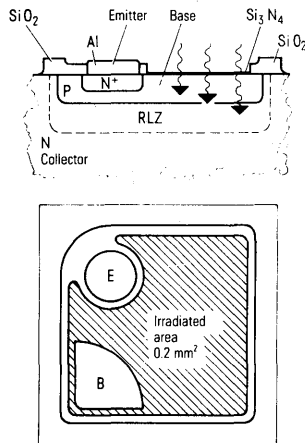

view) with emitter (n^+), base (p) and collector (n); the latter is mostly subdivided into a weakly doped n and a highly doped n^+ region. As the diffusion length L_D of the holes in the n^+ region is low due to the high amount of doping, only the p and n regions provide the maximum amount to the primary photocurrent I_{CB} of the collector-base diode. This is due to the low photosensitivity (also in comparison with photodiodes) of epitaxial transistors in the long wave band. A large part of the long-wave radiation is absorbed in the n^+ region as the n region is mostly extremely thin (10 to $20 \mu\text{m}$) as a result of the requirement for extremely low conductor resistances. The view of the transistor shows a base with a large area in which the emitter and also the base connection are attached to the side; in this way, as uniform as possible a surface sensitivity is achieved. The gain of phototransistors normally lies between 100 and 1000. Gain deviations from the linearity and thus from the linear relationship between the illuminance and the photocurrent amount to (over approximately four powers of ten of the photocurrent I_p , from some 100 nA to some mA) less than 20% and mostly less than 10%. With regard to dynamic behavior, phototransistors are less favorable than photodiodes as, in addition to the collecting and charging processes in photodiodes, there is also a delay due to the amplification mechanism (Miller effect). In addition to the rise and fall times t_r and t_f , the transistor also has the delay time t_d . This is the time required until the photocurrent has reached 10% of its final value after activation of an optical square-wave pulse. For the rise and fall times of a phototransistor, the following relationship applies:

$$t_{r, f} = \sqrt{\left(\frac{1}{2t_f}\right)^2 + a(R \cdot C_{CB} \cdot V)^2}$$

In this case, f_T is the transition frequency, R is the load resistance, C_{CB} is the collector-base capacitance, G is the gain, a is a constant whose value lies between four and five. The rise and fall times of usual phototransistors range from 1 to approximately $30 \mu\text{s}$ with 1 kOhm load resistance. Therefore, they are particularly suitable for utilization within a frequency range up to some 100 kHz, which suffices for important applications such as light barriers, punch tapes, and punch card readers.

2. Emitters (Radiation emitting components)

Principle of Operation and Materials

Light emitting diodes operate in accordance with the principle of injection luminescence. Through a pn junction operated in forward direction, n -type charge carriers are injected into the neutral n and p region where they partially recombine for emission, sending out a photon with the energy $h\nu = hc/\lambda \leq E_g$ (h = Planck's constant, ν = frequency,

c = speed of light, λ = wavelength, E_g = energy gap). This is shown in figure 2.1 in the energy diagram for a pn junction.

Fig. 2.1
The pn junction of a light emitting diode

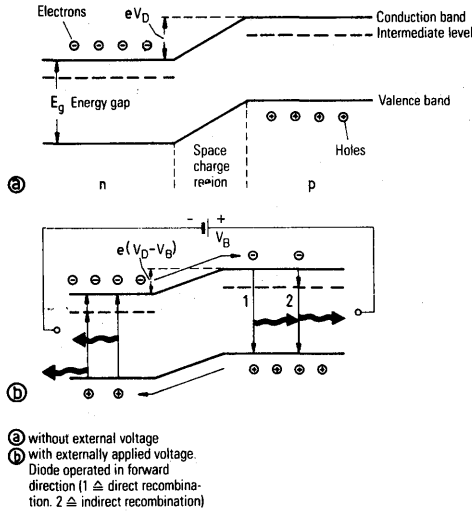

The probability of radiant recombination essentially depends on the band structure type of the corresponding semiconductor material. In the case of direct semiconductors with GaAs as the most important representative, an electron can directly fall from the conduction band into a free state in the

valence band (hole), in which case the released energy is given off as a photon (cp figure 2.2, left). In the case of the so-called indirect semiconductors with Si, Ge, and GaP as the most important representatives, however, this transition is linked with a pulse change of the electron. Recombination is then only possible with the participation of third partners, for example, phonons or impurities. These must ensure pulse compensation. The energy released during the transition is mainly dissipated as heat to the grid. In indirect semiconductors, this leads to the probability of radiant recombination being less by orders of magnitude than in direct semiconductors. Nevertheless, effective radiant recombination can be generated in some indirect semiconductors. This is achieved by doping with isoelectronic impurities. The two most efficient isoelectronic impurities in GaP are the nitrogen atom and the zinc-oxygen pair. Radiant recombination is then achieved by way of the decay of an electron hole pair (exciton) bonded to the isoelectronic impurity (cp figure 2.2, right).

A high degree of crystal perfection is a precondition for the creation of effectively radiant recombination as crystal defects act as centers for non-radiating recombination. For this reason, the active layers of light emitting diodes are produced epitaxially at temperatures far below the melting point of the semiconductor material.

III-V compound semiconductors and mixtures of these can be used as materials for light emitting diodes as their energy gaps cover wide spectrum and the band structure, contrary to the classical semiconductors Si and Ge, enable the creation of effective radiant recombination. Above all, the semiconductors GaAs, GaP, and the ternary mixtures Ga (As, P) and (Ga, Al) As have practical significance.

Fig. 2.2
Dependence of energy states on the wave number k in the case of direct (GaAs) and indirect (GaP) semiconductors.

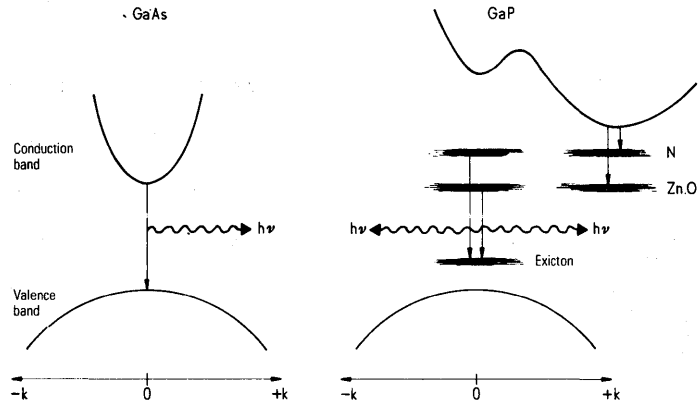

Infrared Emitters (IR LEDs)

IR emitters are based on GaAs which has an energy gap of approximately 1.43 eV, corresponding to emission of approximately 900 nm. Higher external quantum efficiencies can be achieved with these diodes than with light emitting diodes for the visible wave band. The left-hand side of figure 2.3 shows the schematic of the diode body of a silicon-doped GaAs IRED. By means of liquid phase epitaxy (LPE), the active layer with a high crystal perfection can be grown onto a GaAs substrate. Due to the amphoteric characteristic of the silicon impurity, the pn junction forms automatically during the process of epitaxy. Due to the silicon doping, the emission lies at 950 nm and is thus so far underneath the band edge that the radiation created in the diode body is only absorbed to a slight extent. Part of the radiation leaves the diode body on a direct path through the near surface. However, radiation emitted in the direction of the substrate is also useful. For this purpose, the rear of the diode body is mirrored and serves as a reflection surface.

GaAs-IREDs are fitted in plastic packages or in hermetically sealed glass-metal housings.

An essential piece of information for the user is the radiation characteristic. If the light emitting diodes are used in an arrangement without optical lenses, for example, in a punch tape reading head, the radiation should have a small half angle. This is the case with LD260 to 269 and CQY77.

In conjunction with optical lens systems, designs are preferred in which the radiation leaves the component through a flat window (CQY78, SFH402).

Array designs are suitable for a wide range of applications as they can be rowed up in any configuration.

Further developments in the field of silicon-doped liquid phase epitaxial IREDs is aimed at expanding the wave band. The amphoteric character of the silicon doping is retained in the ternary mixed crystal (GaAl) As in that the energy gap can be varied by means of the amount of Al. In this way, it is possible to produce emission wave bands

between 850 and 900 nm and to tune the emitter diodes to the maximum detector sensitivity. With selectively sensitive detectors, it would be possible to create transmission systems with two (or more) optically separate channels.

Electrical and Optical Characteristics of IR LEDs

Figure 2.4 shows the emission spectrum of the most important LEDs and the relative spectral contact sensitivity V_{λ} . With respect to the emission spectrum of the IRED relative to the sensitivity curve of the silicon photodiode, see figure 1.2.

The emission spectrum of the GaP diode ranges from the yellow to the green wave band. By dyeing the plastic seal, the emission band can be limited in such a way that the emitted light appears yellow ($\lambda_p = 575 \text{ nm}$) or green ($\lambda_p = 560 \text{ nm}$) to the viewer.

Fig. 2.4

Emission spectra of the most important LEDs

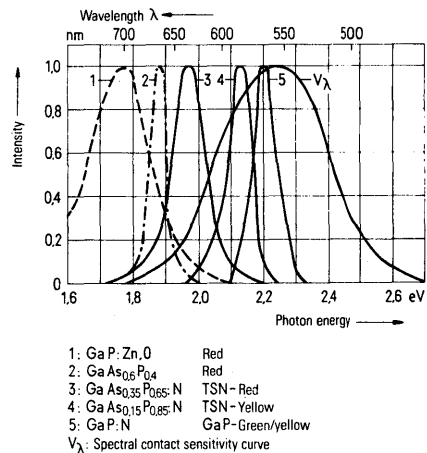
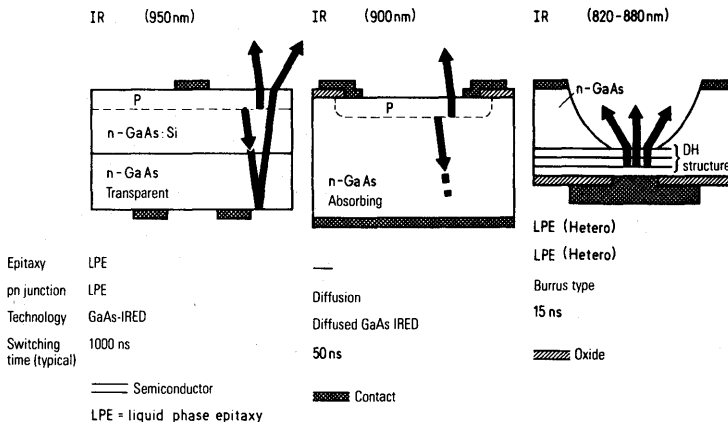

Fig. 2.3

Structure of the diode body of an IRED



In the case of GaAs diodes and the red GaAs_{0.6}P_{0.4} diode, the emitted radiation (or luminous intensity, respectively) of IREDs and LEDs changes in the normal operating range in a linear relationship with the forward current while, in the case of TSN diodes and GaP diodes, it rises slightly over-proportionally (figure 2.5).

Fig. 2.5
Light current – diode current characteristic

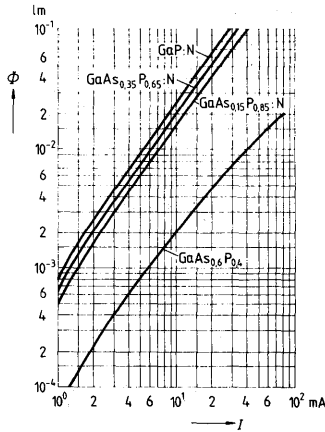

If the forward current is very high, the curve asymptotically approaches a threshold value. This is caused by a strong heating of the semiconductor system. The linearity range can be widened by switching from static to pulse operation. Non-linearity also turns up at small forward currents. It is caused by excess current not contributing to the radiation and cannot be influenced by the customer. Figure 2.6 shows the radiant power versus the forward current.

Fig. 2.6
Radiant power versus forward current

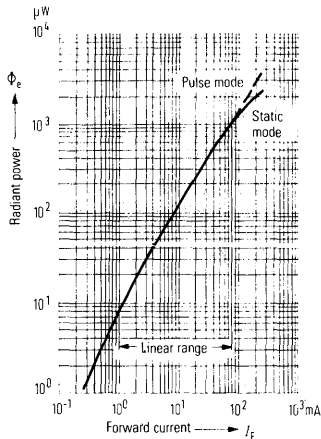

At constant current, the radiant intensity or luminous intensity, respectively, decreases with rising temperature. The temperature coefficient is -0.7% per degree for GaAs, -0.8% per degree for GaAsP, and -0.3% per degree for GaP. This is negligible for many applications. If the temperature dependence proves disturbing, it can widely be eliminated by compensation circuits.

The radiant power emitted by LEDs declines with increasing length of operation ("aging"). A "life" of components was introduced to describe the degree of degradation. It is defined as the time after which the radiant power has fallen to half the value. In the case of IREDs, for example, the average life dependent on the operating current and ambient temperature is approximately 10^5 h (extrapolated from continuous tests). Refer to figure 2.7.

Fig. 2.7
Radiated power versus operating life

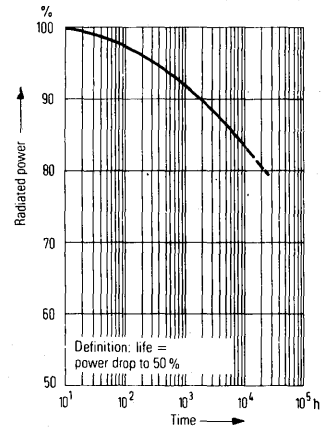

3. Measuring Technique

Detectors (Radiation sensitive components)

Radiation-sensitive semiconductor devices serve to convert radiation energy into an electrical one. Radiation energy can be offered to the component in manifold forms, depending on the source of radiation. For measuring purposes only such radiation sources can be taken into consideration which, in their spectral energy distribution, can easily be covered and are reproducible, i.e. thermic radiation sources like the tungsten filament lamp, which at least in the wavelength range here of interest comes very close to the black body and monochromatic light sources that means those emitting radiation of only one wavelength or at least of a very narrow wavelength range, above all light emitting diodes and a combination of whatever emitters with narrow band filters. Especially for applications with infrared emitting diodes (IREDs), this measurement of the spectral photo-sensitivity is increasingly gaining significance and is taking the place of integral measurement with standard light A.

Because of its high energy, the tungsten filament lamp is mainly used for measuring the radiation sensitivity when set to a "color temperature" of 2856 K, corresponding to standard light A as per IEC306-1 part 1 and DIN5033 while light emitting diodes are primarily employed for cut-off frequency and switching time measurements as they can be modulated or pulsed up to high frequencies. At this instance, we want to draw your attention to the following. The definition "color temperature" is limited in its use for the optoelectronic measuring technique, quasi only as auxiliary. But unfortunately the term has come to stay. In practice the lamps are not calibrated to color temperature but to "relative temperature in the visible range", mostly to a green-red relation. An extension to a red-green-infrared relation and thus an approach to the, for our measuring technique solely correct, "distribution temperature" in the wavelength range 350 to 1200 nm, or even better 300 to 1800 nm, is worth aspiring after. This still meets with objections on the part of lamp manufacturers to extend their calibration equipment and the relatively small quantity of lamps required.

The tungsten filament lamps used for measuring purposes have to be set to a relative spectral energy distribution that corresponds to that of the black body at a temperature of normally 2856 K at least in the wavelength range 350 to 1200 nm, and have to be operated under very stable conditions. It is necessary to have the lamp operated with constant current, the deviation from the rated value must be kept less than $\pm 0.1\%$. This requirement seems to be very high, but one has to consider that a deviation of the lamp current by 0.1% brings about a change of the radiant intensity by 0.7% and, of the color temperature, by 2 K. Naturally, the lamp can also be operated with constant voltage but this is hard to realize in practice because of the inevitable and varying contact resistances in the lamp socket, therefore an operation with constant current is to be preferred.

A lamp voltage check at the same time permits a control of the lamp with regard to a change in its characteristics, for example, by evaporating of coiled filament material which would point to the fact that the lamp is no longer suitable for measuring purposes and has either to be replaced or calibrated anew. This check is mainly recommended for the "standard lamps" which are standard for color temperature, radiant and/or luminous intensity.

For general measuring purposes, serial measurements in particular, the standard lamps gauged by the PTB or the manufacturer are usually not used because of the calibration costs. Therefore, the service lamps are set to the given ratings by a comparison with these standard lamps.

Photosensitivity

For photosensitivity measurements (photocurrent or photovoltage) the components to be measured are placed at the position predetermined for the specific irradiance and there they are held in such a way that the radiant sensitive surface of the semiconductor chip is vertical to the direction of light. Cylindric components such as in TO18, TO5 or similar plastic packages are put up so that the package axis coincide with the direction of radiation. This is of prime importance for components with a highly focusing lens. A holder with a sliding socket for the terminal wires proved useful (see figure 3.1).

Fig. 3.1
 I_p test set-up for photoelectric devices

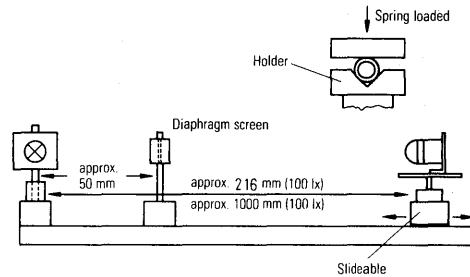

Solid Angle

The solid angle is a part of space. It is limited by all the beams which radiate conically from one point (radiation source) and which end on a closed curve in the space. If this closed curve lies on the unitary sphere (radius $R = 1$ m) and envelopes an area of 1 m^2 , and if all rays originate from the center point of the unitary sphere, the solid angle has one sterad (sr).

Fig. 3.2
Solid angle (1 sterad)

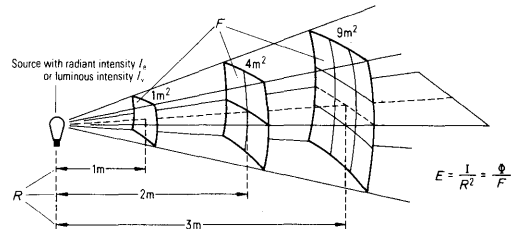

Short-circuit Current

When measuring the short-circuit current I_s of photovoltaic cells care has to be taken that the internal resistance of the measuring instrument used is small enough compared to the internal resistance of the photovoltaic cell. The same applies to measuring the open circuit, the internal resistance of the measuring instrument is large compared to the internal resistance of the photovoltaic cell.

Fig. 3.3
 I or V versus load resistance for photovoltaic cell BPY11

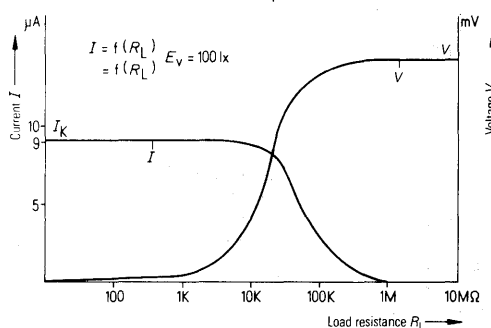

Switching Times

The switching times are measured oscillographically by a set-up as shown in the circuit diagram below (figure 3.4) by means of a pulsed infrared emitting GaAs diode as a measuring source and a double-beam oscillograph. The switching times of the GaAs must, of course, be small compared to the switching times of the component to be measured.

Fig. 3.4

"Measuring the switching times of detectors"

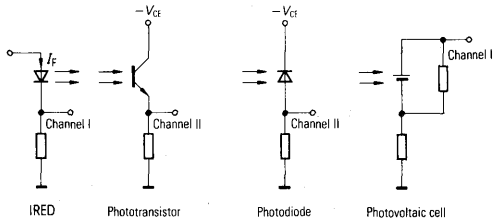
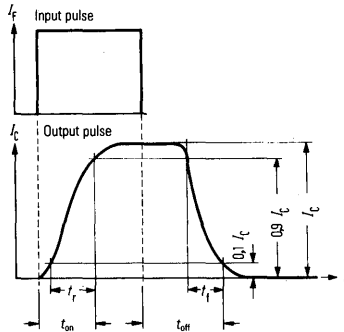

Fig. 3.5

Switching time definitions



Turn-on time t_{on} :

The time in which the collector current I_c rises to 90% of its maximum value after activation of the drive current I_f .

Rise time t_r :

The time in which the collector current I_c rises from 10% to 90% of its final value.

Turn-off time t_{off} :

The time in which the collector current I_c drops to 10% of its maximum value after deactivation of the drive current I_f .

Fall time t_f :

The time in which the collector current I_c drops from 90% to 10% of its maximum value.

Radiation in the Infrared Range

The radiant intensity I_e in the direction of the case axis should be measured by a wavelength independent detector (thermocouple element) but low sensitivity, inertia, and temperature sensitivity cause difficulties. For this reason, one usually measures with a correspondingly calibrated photovoltaic cell. In such case, the spectral sensitivity curve of the photovoltaic cell has to be considered and the

measuring result corrected with regard to the deviations in the emitted wavelength of the radiator to be measured (for example IRED with different production technology). If the total radiation of the component shall be measured, the IRED has to be fitted in a parabolic like reflector to ensure that all radiation emitted by the component reaches the photovoltaic cell that forms the end of the parabola.

Figure 3.6 shows the outline of such a measuring parabola. As for the rest, the same requirements apply as for radiant intensity measurements.

Fig. 3.6

Calibrated photodiode with amplifier (for example BPW33)

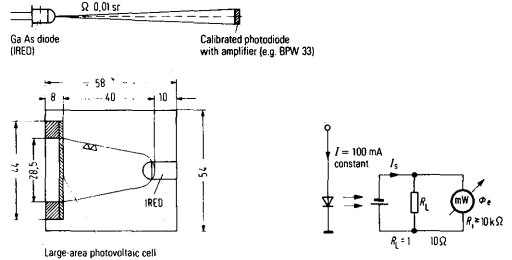

In cases where IRED emitting diodes are used in connection with mirrors or lenses, for example in light barriers, it can prove useful to state the radiant power (radiation capacity) Φ_e defined in a cone with the half angle φ , or the curve $\Phi_e = f(\varphi)$, respectively (see figure 3.7).

Fig. 3.7

Radiation cone and radiant flux Φ_e versus the half angle φ

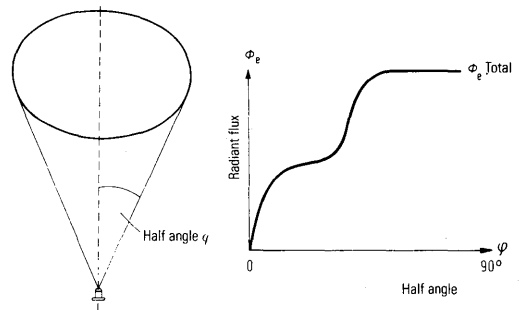



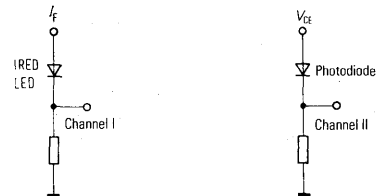

Switching Times

For measuring the switching times the same applies as to the radiant sensitive components except that now a photodiode serves as detector and its switching time must be small compared to that of the IRED or LED to be measured.



4. Terms and Definitions





Radiation and Light Measurements

Radiometric terms					
No.	Term	Symbol	Unit	Relation	Simplified definition
1	Radiant power 	Φ_e, P	W		Radiant power is the total power given in the form of radiation
Emitter					
2	Radiant intensity 	I_e	$\frac{W}{sr}$	$I_e = \frac{d\Phi_e}{d\Omega_1}$	Radiant intensity is radiant power per solid angle
3	Radiance 	L_e	$\frac{W}{m^2 sr}$	$L_e = \frac{d^2\Phi_e}{dA_1 \cdot d\Omega_1}$	Radiance is radiant power per area and solid angle
Sensor					
4	Irradiance 	E_e	$\frac{W}{m^2}$	$E_e = \frac{d\Phi_e}{dA_2}$	Irradiance is incident radiant power per (sensor) surface

Indices "e" (= energetic) and "v" (= visual) may be omitted unless danger of confusion

DIN 1301, DIN 1304, DIN 5031, DIN 5496

International Dictionary of Light Engineering, 3rd Ed. publ. by CIE and IEC

Spectral radiometric terms				Photometric terms		
No.	Term	Symbol	Unit	Term	Symbol	Unit
1	Spectral radiant power distribution 	$\Phi_{e\lambda}$	$\frac{W}{nm}$	Luminous flux	Φ_v	lm Lumen
Emitter						
2	Spectral radiant intensity distribution 	$I_{e\lambda}$	$\frac{W}{sr nm}$	Luminous intensity	I_v	$\frac{lm}{sr} = cd$ Candela
3	Spectral radiance distribution 	$L_{e\lambda}$	$\frac{W}{cm^2 sr nm}$	Luminance	L_v	$\frac{cd}{cm^2} = sb$ Stilb
Sensor						
4	Spectral irradiance distribution 	$E_{e\lambda}$	$\frac{W}{m^2 nm}$	Illuminance	E_v	$\frac{lm}{m^2} = lx$ Lux

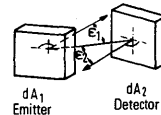

dA_1 = element of area of emitter
 dA_2 = element of area of detector
 ϵ_1 = angle of radiation

Photometric Basic Law

$$d^2\Phi = L \frac{dA_1 \cdot \cos \epsilon_1 \cdot dA_2 \cdot \cos \epsilon_2}{R^2} \Omega_0$$

Inverse Square Law

$$E = \frac{I}{R^2} \cos \epsilon_2 \Omega_0$$

(r should be 10 times the max. spacing of emitter-detector to keep error below 1%).

ϵ_2 = angle of irradiation
 R = spacing emitter-detector
 Ω_0 = sr

Radiation Characteristics

Designation	Symbol	Meas. quant.	Abbr.	Definition
Quantity of radiation	Q	Joule Wattsecond	J Ws	Quantity of radiation through a surface
Radiant power	Φ	Watt	W	Quantity of radiation Q per second through a surface
Point source of radiation	-	-	-	... is a source viewed from such a great distance R that all rays seem to emanate from one point. The max. linear expansion of the source must be substantially smaller than the distance R (example: sun for observer on earth).
Solid angle	Ω	Sterad	sr	$\Omega = \frac{A_1}{R_1^2} = \frac{A_2}{R_2^2} = \frac{A_3}{R_3^2} = \frac{A}{R^2}$; the radiant power Φ [W] of a point source is constant in solid angle. (Prerequisite: homogenous, undamping medium.) $\Omega = 1$ is $A = R^2$ so that $\Omega_{\text{hemisphere}} = \Omega_{\odot} = 2 \pi$ sr; $\Omega_{\text{full sphere}} = \Omega_{\ominus} = 4 \pi$ sr
Radiant intensity	I	$\frac{\text{Watt}}{\text{sterad}}$	$\frac{\text{W}}{\text{sr}}$... is the solid angle density of the radiant power $\left(\frac{d\Phi}{d\Omega}\right)$ I of one source generally varies depending upon viewing direction. I only defined when $R \rightarrow \infty$
Total radiant power of a source	Φ_{tot}	Watt	W	$\Phi_{\text{tot}} = \int_0^{4\pi} I d\Omega$
Irradiance	E	$\frac{\text{Watt}}{\text{meter}^2}$	$\frac{\text{W}}{\text{m}^2}$... is the surface density of the radiant power (spherical surface) for a point source. $E = \frac{d\Phi}{dA}$; $dA = R^2 d\Omega$ $E = \frac{d\Phi}{d\Omega R^2} = \frac{I}{R^2}$; $I = ER^2$
Radiance	L	$\frac{\text{Watt}}{\text{m}^2 \text{ sterad}}$	$\frac{\text{W}}{\text{m}^2 \text{ sr}}$... is the radiant intensity referred to the radiant surface viewed by the observer. $\left(\text{Surface projection } A_p = A \cos \epsilon, \text{ when } \epsilon \text{ is the angle by which the radiant surface is rotated against the connecting line to viewer: } L = \frac{I}{A_p} = \frac{I}{A \cos \epsilon}\right)$ Important optical quantity. 1) In an undamped beam path L is maintained and cannot be increased by any optical measure. 2) The human eye sees differences in radiance as differences in brightness.
Sensitivity of detector	$S = \frac{I}{E}$	$\frac{\text{Ampere}}{\text{irradiance}}$	$\frac{\text{A} \cdot \text{m}^2}{\text{W}}$	Electrical quantity (current, voltage or resistance) in relation to irradiance

Illuminance (units and conversion factors)

	lx	mlx	ph	fc
1 Lux = lx	= 1	10^{-3}	10^{-4}	9.29×10^{-2}
1 Millilux = mlx	= 10^{-3}	1	10^{-7}	9.29×10^{-5}
1 Phot = ph	= 10^4	10^7	1	929
1 Footcandle = fc ¹⁾	= 10.76	10760	1.076×10^{-3}	1

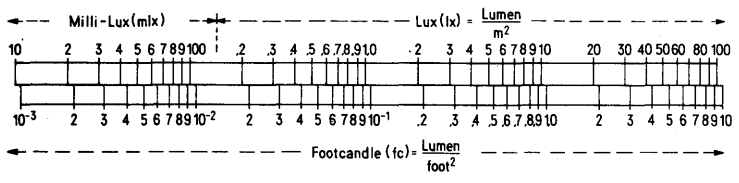
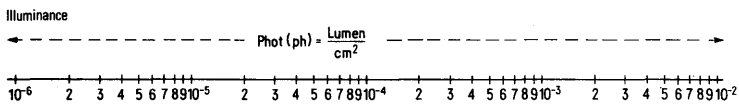
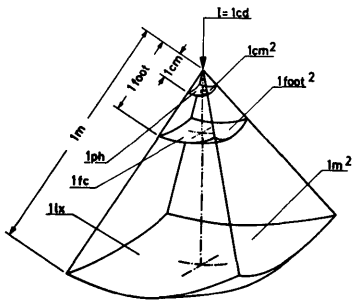

¹⁾ equivalent footcandle } footlambert (Luminous density) ≅ footcandle (Illuminance).
 apparent footcandle

Figure 5.1
Conversion of illuminance E_v into irradiance E_e
(Planck's black body)

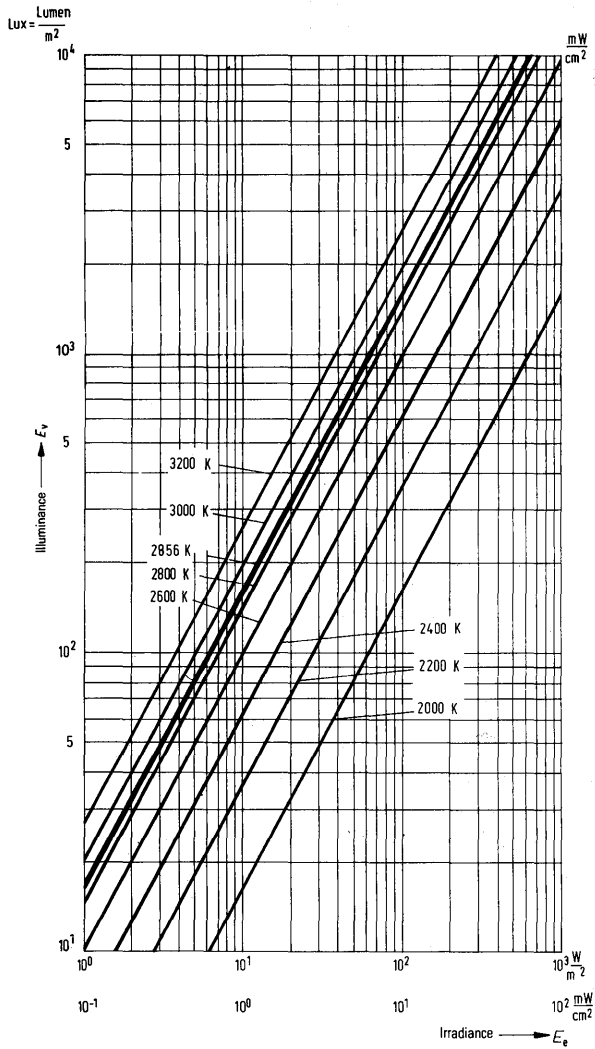
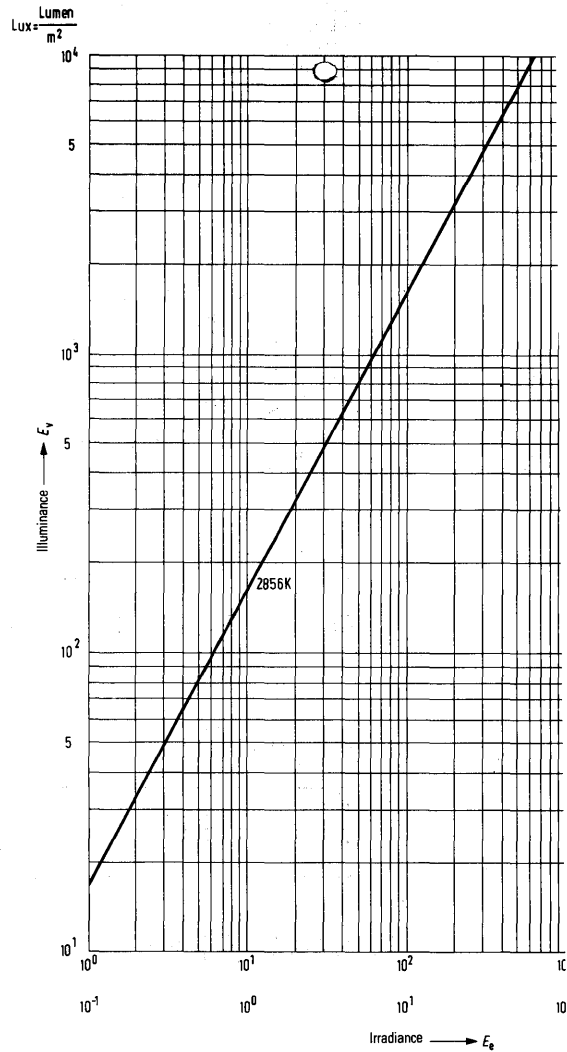
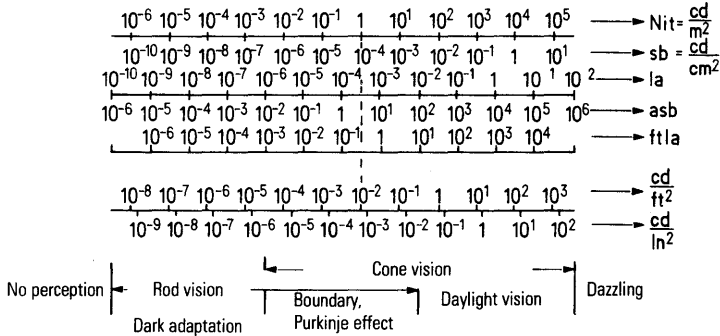

Figure 5.2
Conversion of illuminance E_v into irradiance E_e at 2856 K
(Planck's black body)



Luminous density (units and conversion factors)

Units	sb	cd/m ²	cd/ft ²	cd/in ²	asb	L	Lm	ftL
1 Stib = cd/cm ² = sb	= 1	10 ⁴	929	6.45	31400	3.14	3140	2920
1 cd/m ² = Nit = nt	= 10 ⁻⁴	1	9.29 × 10 ⁻²	6.45 × 10 ⁻⁴	3.14	3.14 × 10 ⁻⁴	0.314	0.292
1 cd/ft ²	= 1.076 × 10 ⁻³	10.76	1	6.94 × 10 ⁻³	33.8	3.38 × 10 ⁻³	3.38	3.14
1 cd/in ²	= 0.155	1550	144	1	4870	0.487	487	452
1 Apostilb = asb	= 3.18 × 10 ⁻⁵	0.318	2.96 × 10 ⁻²	2.05 × 10 ⁻⁴	1	10 ⁻⁴	0.1	9.29 × 10 ⁻²
1 Lambert = L or la	= 0.318	3183	296	2.05	10 ⁴	1	10 ³	929
1 mL or mla	= 3.18 × 10 ⁻⁴	3.18	0.296	2.05 × 10 ⁻³	10	10 ⁻³	1	0.929
1 footlambert	=							
1 equivalent footcandle	=							
1 apparent footcandle ftL or ftla	= 3.43 × 10 ⁻⁴	3.43	0.318	2.21 × 10 ⁻³	10.76	1.076 × 10 ⁻³	1.076	1



Electromagnetic radiation

Figure 5.3
Frequency and wave bands

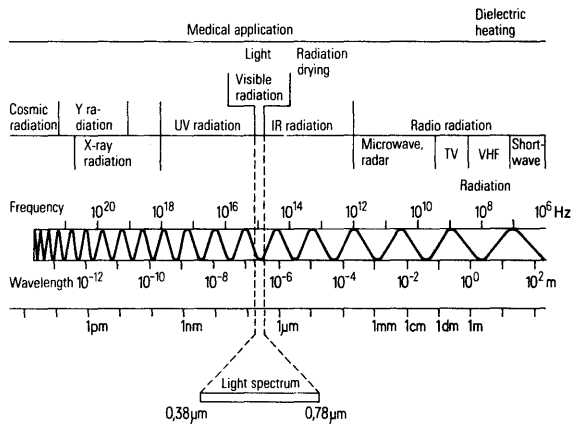

Figure 5.4
Relative sensitivity of different light-sensitive detectors

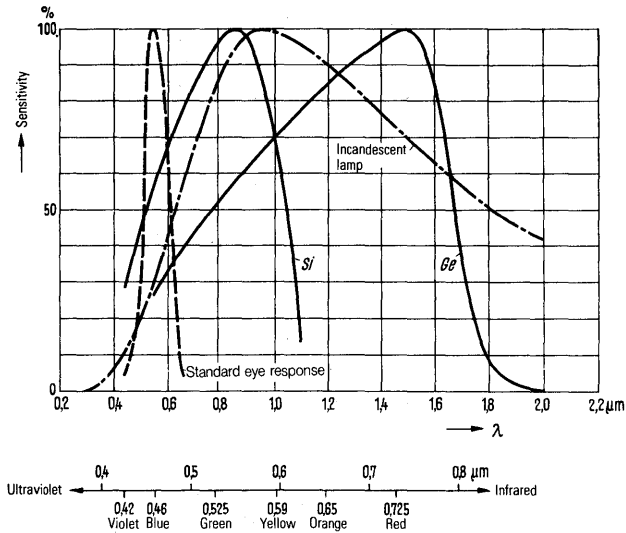

Figure 5.5
Nomogram for electromagnetic radiation

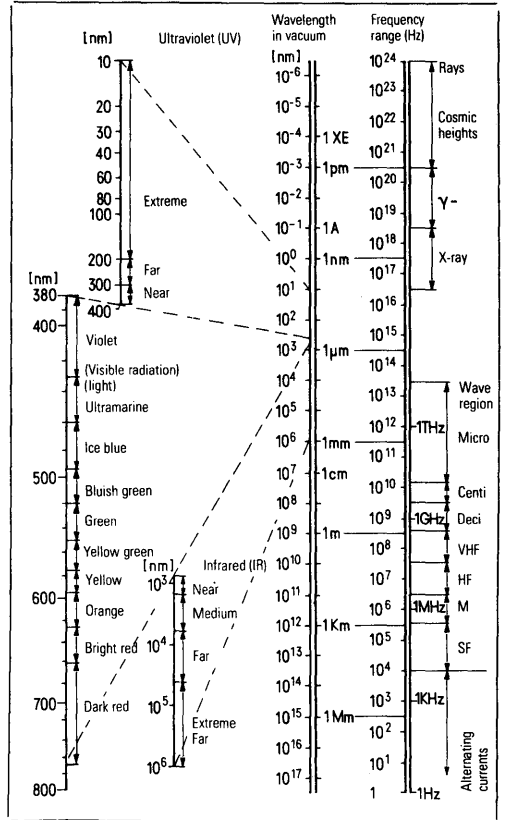
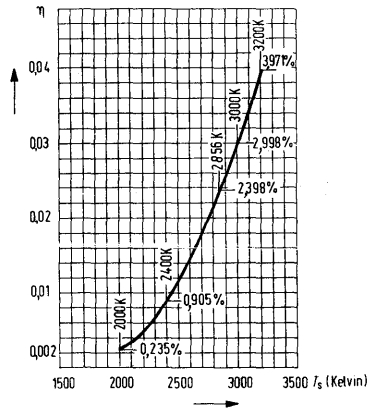
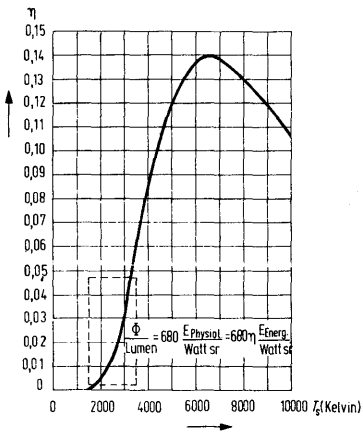

Figure 5.6
Visual efficiency η of the total radiation of a black body versus temperature



SIEMENS

Surface Mounting

Appnote 38

1. What is Surface Mounting?

In conventional board assembly technology the component leads are inserted into holes through the PC board and connected to the solder pads by wave soldering on the reverse side (through-hole assembly). In hybrid circuits (thick and thin film circuits) "chips", i.e. leadless components, are reflow soldered (see chapter 7.2) onto the ceramic or glass substrate in addition to the components already integrated on the substrate. Surface mounting evolved from these two techniques (fig. 1).

In through-hole technology the components are placed on one PCB side (component side) and soldered on the other (solder side) (fig. 1, top), whereas in surface mount technology the components can be assembled on both sides of the board (fig. 1, bottom). The components are attached to the PCB by solder paste or non-conductive glue and then soldered.

In the near future mixed assemblies, i.e. a combination of leaded and surface mounted components, will prevail, since not yet all component types are available as surface mount version.

Automatic assembly machines are a must for an expedient production; there are systems for simultaneous and for sequential assembly (see chapter 12).

The following explanations point out what actually new in surface mounting is:

- Up to now the connection of materials with large differences in the thermal coefficient of expansion, such as plastic boards and ceramic components, by rigid soldering has been regarded as a serious problem. Practice has shown, however, that this is feasible owing to the elasticity of board and solder; of course, component size and thermal stress are subject to certain restrictions (see chapter 4).
- Components for surface mounting have to withstand high thermal stress during the soldering procedure. Not all component types meet these requirements; therefore new components suitable for surface mounting are constantly developed (see chapter 4).

- In some cases the components are non-conductively glued to the PCB before soldering.
- As compared to through-hole technology there is a closer interrelation between the individual steps in design and production.
- Automatic assembly gains prior importance.

Figure 1 Through-hole assembly - Hybrid technology - Surface mounting

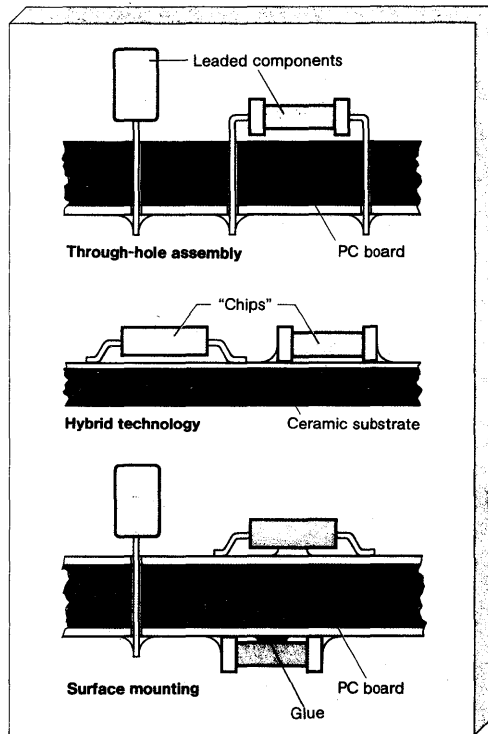

2. What are SMDs?

The abbreviation SMD* for **S**urface **M**ounted **D**evice is the most common designation for this new component. SMDs are designed with soldering pads or short leads and are much smaller than comparable leaded components. In contrast to conventional components, the leads of which must be inserted into holes, SMDs are directly attached to the surface of the PCB and then soldered. In figure 2 and the section below the various SMD types are summarized. Surface mountable components include "chips"*** with cubic dimensions, cylindrical SMDs, plastic packages with solder pins (SOT, SO, VSO package), chip carrier packages, miniature IC packages (Quad Flat Pack, Flat Pack), TAB components and special SMDs such as inductors, trimmers, quartz crystals, switches, plugs, relays etc.

* Besides, the terms SMC (**S**urface **M**ounted **C**omponent), SMT (**S**urface **M**ount **T**echnology), SMA (**S**urface **M**ount **A**ssembly) are used.

** The designation "chip" should only be used when confusion with semiconductor chip as used in semiconductor technology can be excluded.

SMD types:

(see also chapter 13 "Siemens SMD Product Spectrum")

Cubic components ("chips")

Preference types 0805, 1206, 1210, 1812, 2220, ...

Cylindrical components

MELF¹⁾, MINIMELF, MIKROMELF

TUBULAR (e.g. tubular capacitors)

SOD 80 (MELF-similar diodes)

SOT 23, 143, 89, 192

SO²⁾ 4...28 pins (SOIC)

VSO³⁾ 40 pins

CHIP CARRIER

Plastic case (PLCC⁴⁾)

Ceramic case (LCCC⁵⁾)

ICs with gull-wing leads

Flat Pack

Quad Flat Pack

MIKROPACK TAB⁶⁾

Special packages for:

Inductors, SAWs⁷⁾, trimmers, quartz crystals, switches, plugs, relays etc.

¹⁾ Metal Electrode Face Bonding

²⁾ Small Outline

³⁾ Very Small Outline

⁴⁾ Plastic Leaded Chip Carrier

⁵⁾ Leadless Ceramic Chip Carrier

⁶⁾ Tape Automated Bonding

⁷⁾ Surface Acoustic Wave Filter

Figure 2 SMD types

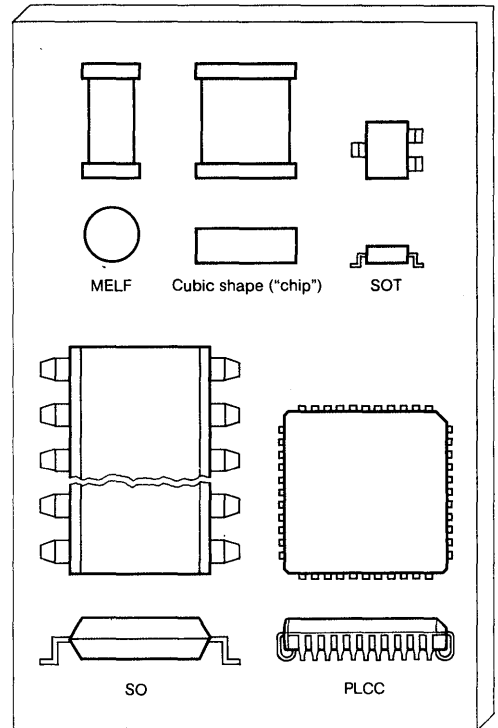

Most of these components are suitable for dip soldering; chip carriers, TAB (MIKROPACK) and some special versions require other soldering methods.

Resistors, ceramic capacitors and discrete semiconductors represent at 80% the largest part of the SMD spectrum. In the range of SMDs the cubic shape prevails over cylindrical versions, as the latter can only have two pins thus being exclusively suitable for resistors, capacitors and diodes.

If development of a special SMD package is not advisable for electric or economic reasons, the DIP package can be converted into a surface mountable version by bending the leads (see chapter 13.2, optocouplers in DIP 6 SMD package).

Package	Dimensions (mm)	Standard
0805	2.0 x 1.25	IEC
1206	3.2 x 1.6	IEC
1210	3.2 x 2.5	IEC
1812	4.5 x 3.2	IEC
2220	5.7 x 5.0	IEC
MELF	5.9 x 2.2 ϕ	
MINIMELF	3.6 x 1.4 ϕ	
MIKROMELF	2.0 x 1.27 ϕ	
SOD 80	3.5 x 1.6 ϕ	
SOT 23	3.0 x 1.3	DIN 23 A 3 JEDEC TO-236
SOT 143	3.0 x 1.3	DIN 23 A 3
SOT 89	4.5 x 1.5	JEDEC TO-243
SOT 192	4.5 x 4.0	
SO 4...28 ¹⁾		JEDEC MO-046...
VSO (SOT 158) ²⁾	spacing 1.27	
PLCC	spacing 0.76	JEDEC MO-04...
LCCC	spacing 1.27	JEDEC MO-04...

- ¹⁾ SO 6 3.9 x 4.0 or 3.9 x 6.2 (incl pins)
SO 8 5.2 x 4.0 or 5.2 x 6.2 (incl. pins)
SO 14 8.8 x 4.0 or 8.8 x 6.2 (incl. pins)
SO 20 L 12.8 x 7.6 or 12.8 x 10.7 (incl. pins)
²⁾ VSO 15.5 x 7.6 or 15.5 x 12.8 (incl. pins)

An important factor for automatic assembly is the components' adequate and uniform geometry. Some packages are already standardized (IEC) or are proposed for standardization (JEDEC Recommendation).

For more than ten years Siemens has offered its customers SMDs and thus has gained considerable experience in the field of SMD production through continual modernization and development. The spectrum of active and passive components available covers ICs, transistors, diodes, ceramic multilayer capacitors, NTC thermistors, as well as SIFERRIT miniature ferrites, and the product menu is growing larger almost daily.

3. Advantages of Surface Mounting

The three major benefits of surface mounting

- rationalization
- miniaturization
- reliability

are discussed in the following.

A consistent concept as regards components, board layout, assembly machines, processing and testing is essential for an efficient application of surface mount technology; in other words, the aim should be an optimized overall concept. The component price, for example, should not be seen isolated, but with regard to the total cost including placement, soldering and testing

which may already be considerably lower than with conventional board assembly technology.

In the following the advantages of surface mounting are analyzed as to component, PC board, automatic assembly, reliability and rework.

3.1 Components

- SMDs are much smaller than leaded components, thus enabling smaller board size, higher packing density, reduced storage space and finally smaller equipment to be obtained.
- Light weight makes them ideal for mobile appliances.
- No leads means high resistance to shock and vibration.
- Cutting and bending of leads are eliminated.
- Parasitic inductance and capacitance due to leads are substantially lowered making SMDs particularly suitable for RF applications.
- Automatic assembly machines ensure accurate placement.
- MIKROPACKs, PLCCs and similar packages permit a considerably higher number of pins.
- Closer capacitance tolerances can easily be obtained for capacitors with low capacitance values.
- The growing demand for SMDs results in lower production costs, so that further cost reductions can be anticipated. The surface mount version of ceramic multilayer capacitors, for example, is even today cheaper than the leaded version.

3.2 Printed Circuit Board

- Surface mount technology makes PC boards smaller. When using SMDs on both sides of the board, size can be reduced by more than 50 per cent. On the other hand, maintaining the PCB size implies reduced packing density and thus higher yields and higher reliability.
- In many cases the printed circuits can be shortened and reduced in number. Owing to the compact "lead-less" construction the electrical characteristics can easily be reproduced, thus cutting the cost for adjusting RF circuits.
- Surface mount technology does not require a special PCB material; standard materials such as phenolic resin laminated paper and glass-fiber laminated epoxy material are quite suitable, but of course, special materials, e.g. for RF circuits, can be used, too. For normal packing density the printed circuit precision should meet current requirements.
- The elimination of through-holes entails a further cost reduction. This is quite an important factor, as the cost for the drilling of holes can amount up to 10% of the total PCB cost.
- Mixed assembly with leaded components is possible. The reason for using this assembly variation was explained in the beginning.

3.3 Assembly

The average cost per component for automatic assembly can be considerably cut by surface mounting, because the smaller number of assembly machines¹⁾ entails less capital investment, maintenance, servicing and factory space.

- A major advantage of surface mounting are the high component placement rates attained by automatic placers. Fast machines can place several hundred thousand components on the PCBs per hour.
- Automatic placement systems for SMDs feature high placement reliability. Failure rates of less than or equal to 20 ppm (parts per million) can be obtained by machines capable of identity checking and defective recognition. This means that out of a million placed components only max. 20 are not at all or incorrectly assembled.
- In mixed assembly any ratio of SMDs and leaded components is possible, thus facilitating transition to the new technology.
- Some automatic placement systems can handle a wide range of different components. For details see chapter 12.3.

3.4 Reliability

The demands on quality and reliability of PCB assemblies increase steadily. It is a matter of fact, that in this respect SMDs have at least to meet the standard set by conventional through-hole technology.

As surface mount technology is a relatively new development, sufficient proven information on quality and reliability is not yet available. However, the following general statements can be made:

- The failure rate of SMDs does not exceed that of leaded components. Omission of leads means one point of contact less. Owing to their small size and light weight SMD assemblies feature a higher resistance to mechanical stress (vibration, shock) than the corresponding assemblies with leaded components.
- A quality approval for SMDs used in hybrid circuits can be usually applied to surface mounting, as well.
- High requirements are placed on the solderability of SMDs. The specifications for wetting, leaching and storage have to be observed (see chapter 7).
- In many cases the soldering methods are the same as with other mounting methods. The known advantages and disadvantages apply to surface mount technology as well. One should bear in mind, however, that the criteria for judging solder joints are different for wave soldering and reflow soldering (see chapter 7.2). For example, the filling of through-holes with solder is only possible with the wave soldering method, with reflow soldering the amount of solder is too small.
- If components have to be replaced because of incorrect assembly, reliability of the board – although correctly assembled then – is diminished. Hence, automatic placement systems with their high degree of placement reliability enhance board reliability.

3.5 Rework

Elimination of component preparation, high placement reliability provided by automated systems, and careful planning of each step of the design and production process considerably reduce expensive rework of PCB assemblies with SMDs.

¹⁾ At present three assembly machines are usually required for leaded components:
insertion machine for radial-leaded components,
insertion machine for axial-leaded components,
insertion machine for DIPs.

4. Restrictions and Special Features of Surface Mounting

Maximum packing density – one of the primary goals in surface mount technology – requires the use of miniature components, i.e. certain IC packages (e.g. VSO or MIKROPACK). This involves problems, not necessarily resulting from surface mount technology as such, but from miniaturization in general.

- The use of high-pin-count ICs may require new PCB design (fine etching and super-fine etching) and an increased number of layers (multilayer) because the space between the IC pins is too narrow for printed circuits.
- Due regard must be paid to heat dissipation. The high packing density may cause thermal problems. Special PCBs with good thermal conductivity can aid heat removal, if necessary.
- The use of ceramic components is restricted. Due to the different thermal expansion coefficient of ceramic and PCB material, ceramic SMDs with edges longer than 6 mm should not be used on phenolic resin laminated paper and epoxy glass fiber boards.
- Not all SMDs are suitable for dip or wave soldering. This has to be considered when designing the PC board.
- Some components are not yet available as SMD version. Not all SMDs available are standardized.
- High voltages naturally require certain minimum spacings.
- Visual inspection of solder joints becomes difficult if the leads are partially beneath the component body. Therefore, soldering methods should be optimized so that visual inspection will become unnecessary.
- Test methods have to be adjusted to SMD assemblies. Development of new adapters may be required.
- Repair of SMD assemblies may be more costly as compared with conventional PCB assemblies.

5. Market Forecast for SMD Applications

Figure 3 shows the increasing share of surface mount technology in the market. Internationally, the replacement of leaded components on PCB assemblies by SMDs is expected to reach 50% by 1990.

Figure 3 Trends in mounting techniques

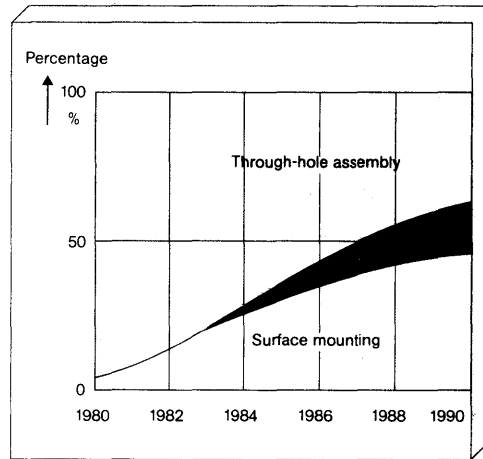

6. Fixing SMDs by Glue

New in surface mounting is the gluing procedure required for fixing the components when the PC board is to be turned upside down for soldering. The glue has to meet numerous requirements. It must provide reliable fixing of the components (also of heavy ones) on all kinds of PC boards. Furthermore, it should feature uniform viscosity to ensure easy handling; a pot life of at least several days is advisable. The glue should feature short curing time at low temperature. After curing the glue must not show chemical reactions in order not to impair board or components. On the one hand the adhesive is required to withstand high thermal stress, and on the other hand it must permit removal of SMDs from the assembled board in case of repair. For repairs the component body is heated, so that the adhesive becomes soft and allows the component to be removed without damaging the printed circuit below it. The glue has to be non-toxic, as odorless as possible, and free of solvents. Besides, it should feature good heat conductivity. Development of new adhesives is under way.

The component outline should be such that the adhesive can easily be applied, i.e. the distance between component body and board must be closely tolerated (fig. 4).

There are three methods of dispensing the glue

- by applicator
- by pin transfer
- by screen printing.

Not all adhesives are equally suitable for all methods.

The Siemens pick-and-place machine (see chapter 12.3) dispenses the glue by an applicator simultaneously with the placement process.

Figure 4 Form of the glue dot and component outline. Component and glue dot have to be shaped such that the component is reliably wetted while the contact area remains free of glue.

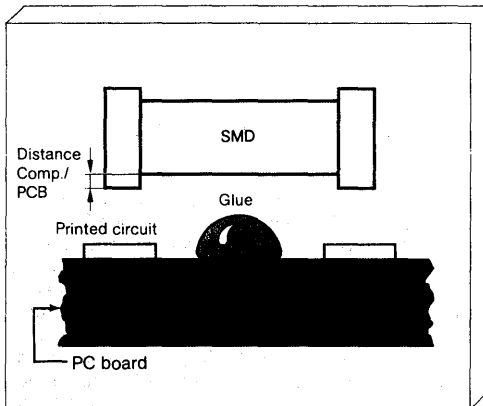

7. Soldering Techniques

An appropriate soldering method is particularly important for obtaining good electrical contact and inhibiting short circuits. The choice of the soldering procedure depends on the PCB design (single or double-clad, multilayer etc.), the components supplied, and the production facilities. While many SMDs are suitable for all soldering methods, the soldering technique for ICs, for example, has to be chosen very carefully. Besides manual soldering, which should only be used for repair purposes, there are several automated soldering methods such as bath soldering (wave and dip soldering) and reflow soldering.

With bath soldering the solder is applied during the soldering process itself, whereas with reflow soldering the solder is applied before. For this reason the preconditions for bath soldering, e.g. component orientation and configuration are quite different from those for reflow soldering. The reflow method is particularly advisable for soldering certain ICs (see chapter 9).

7.1 Wave soldering

Wave soldering is the most popular automated soldering process in the production of PCB assemblies. The solder bath temperature lies between 240 and 260°C and the dwell time is 1 to 3 seconds. Before soldering the flux is applied.

High packing density on the PCB side to be wave soldered involves the problem of solder bridges and shadows (not completely wetted leads and pads). Therefore, PCB layout, i.e. component configuration, should match the soldering method used.

Dual-wave soldering best meets requirements of surface mounting. The first turbulent wave sends up a jet of solder to ensure good wetting of all metalization areas, while the second more laminar wave removes the excess solder (solder accumulations and bridges).

7.2 Reflow soldering

In reflow soldering a specific amount of solder, e.g. in form of solder paste, is applied to the PC board. After attaching the SMDs the reflow process is performed by one of the following methods:

- vapor phase soldering
- hot gas soldering
- heat collet soldering
- infrared soldering.

The latest reflow technique is vapor phase soldering, where the entire PC board is uniformly heated until a defined temperature is reached; there is no possibility of overheating. The defined temperature (e.g. 215°C) in a saturated vapor zone is obtained by heating an inert (neutral) fluid to the boiling point. A vapor lock above this primary vapor zone prevents the expensive primary medium from escaping (fig. 5).

Figure 5 Principle of vapor phase soldering

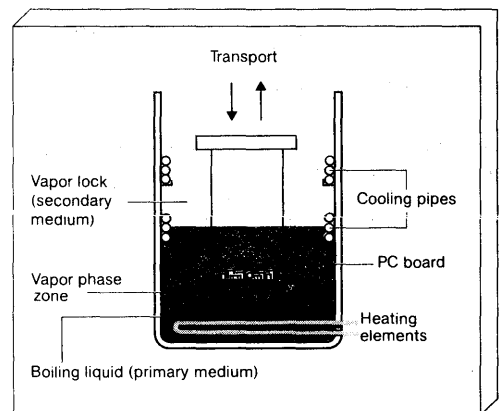

When the assembled PC board is immersed in the vapor zone the vapor condenses at the cold parts and transfers its heat to the workpiece. Adequate heating control ensures continuous vapor supply. Summing up, it can be said that vapor phase soldering is a very gentle method that excludes overheating. At present it is the best reflow soldering method, if components with different thermal capacity are densely positioned or if adequate heating cannot be provided otherwise.

Other methods are hot gas and infrared soldering in continuous-type furnace. As compared to vapor phase soldering these methods have the disadvantage of poor heat transfer and nonuniform heating effect on components with different thermal capacity.

For heat collet or pulse soldering a collet or a soldering iron is used to transfer the heat to the component leads. It is important to force the leads into reliable contact with the solder pads before and during the soldering process. This method is preferably used for MIKRO-PACK and Flat Pack packages.

7.3 Iron soldering

Manual soldering with temperature-controlled miniature iron should only be used in exceptional cases (repair, etc.), because this method is not only uneconomic, but can also damage components or PC board.

7.4 Fluxes, cleaning agents

Wave soldering requires no other fluxes than those used for conventional techniques (e.g. colliphony F-SW32 in accordance with DIN 8511).

Most of the solder pastes required for reflow soldering, however, contain aggressive fluxes the residues of which must be removed by a cleaning process.

7.5 Conductive adhesion

Conductive adhesion is not a soldering process, but shall be described here for the sake of completeness. It is not very often used since most conventional PC boards with a surface of tin or solder tin are not suitable for gluing. If components or PC board permit gluing, silver-filled mixed epoxy resin adhesives can be recommended. These can be spread by an applicator, screen printing, or by pin transfer. The times required for curing are between 1 min and 12 h depending on the temperature. The thermal stress imposed on the components is less than with soldering, but the adhesion process must be performed separately after soldering the other components.

8. Assembly Variations

Figure 6 shows the PCB assembly variations possible with SMDs: Assemblies exclusively with SMDs in the top row (fig. 6a and 6b), mixed assemblies, i.e. SMDs combined with leaded components in the middle (fig. 6c and 6d), and mixed assembly consisting of dip solderable components (on solder side) and non-dip-solderable components (on component side) in the last row (fig. 6e). The versions illustrated in figures 6b, d, e require double-clad PC boards.

Figure 6 Variations of PCB assemblies

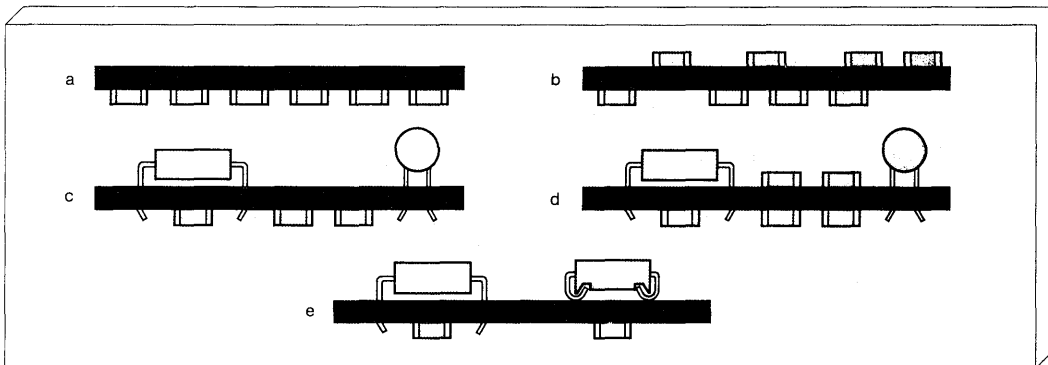

In mixed assemblies with SMDs and leaded components (fig. 6c and 7) the leaded components are usually placed first, then the board is turned over and the glue applied. Subsequently the SMDs are placed, the glue is cured and after a renewed turn over the board is wave soldered.

Figure 7 Mixed assembly of SMDs and leaded components (variant 1)

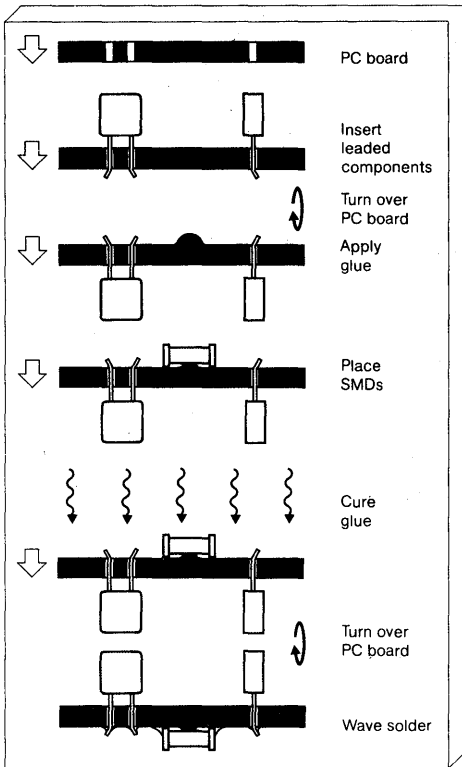

The second variant shown in figure 8 differs from the first in so far as the glue is applied by screen printing at first; the following production steps are executed as illustrated in figure 8. This procedure has the advantage that the glue can be applied by screen printing, however, it has to be taken into account that because of the already mounted SMDs vacant board space is required for the mounting tools of the insertion machines, which are needed for cutting and bending the leads of conventional components.

Figure 8 Mixed assembly of SMDs and leaded components (variant 2)

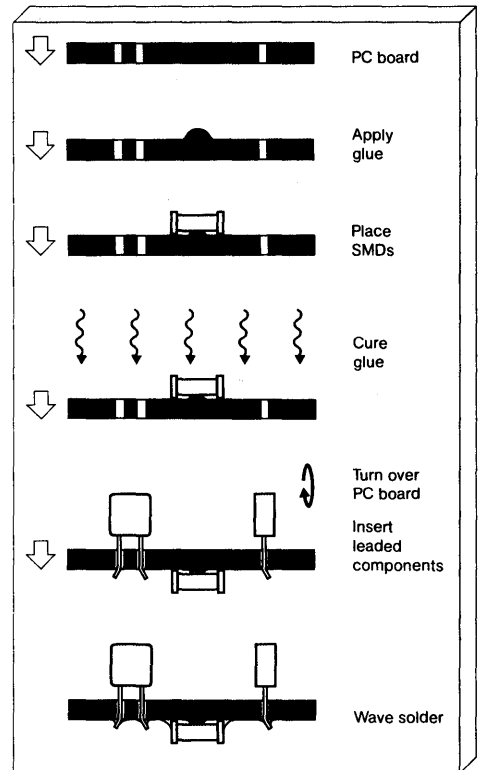

The procedure for double-sided SMD mounting is as follows:

- Screen printing of solder paste
- SMD placement
- Reflow soldering
- Insertion of leaded components
- PCB turn over
- Application of glue
- Placement of SMDs on the reverse side
- Curing of the glue
- PCB turn over
- Mounting of components requiring special handling
- Fluxing, wave soldering

Here both reflow and wave soldering are used. Assemblies including leaded components always require wave soldering.

The aim is a uniform mounting procedure with the exclusive use of SMDs. Figure 9 shows examples for totally surface mounted assemblies with reflow soldering (top) and wave soldering (bottom).

Figure 10 is a flow chart for the various assembly and soldering variants.

Figure 9 PC board exclusively with SMDs, reflow soldered or wave soldered

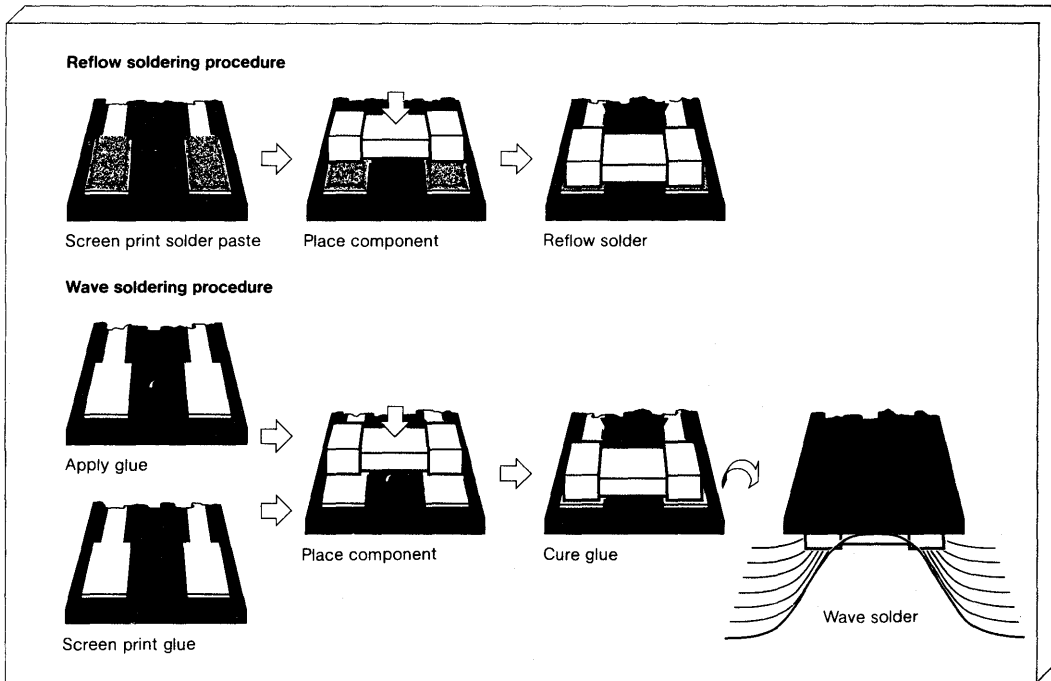
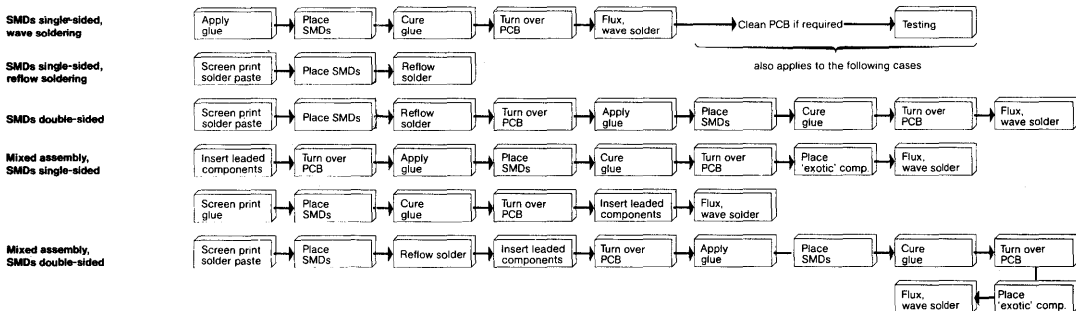

Figure 10 Possible assembly procedures for SMDs and leaded components



Solderability of the Small Outline Coupler Appnote 39

by Karsten Uhde
Jim Hopper

OBJECTIVE

Investigate the effect of various surface mount component assembly operations on the electrical and mechanical performance of the small outline coupler (SOC).

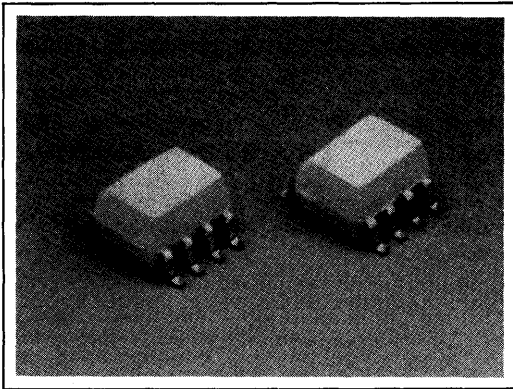

SUMMARY

The small outline coupler is an SOIC-8 package, modified in height to achieve adequate isolation between input and output. Because of the reduced package dimensions of the device and the rigorous soldering techniques that surface mount technology requires, the coupler was submitted for testing under wave solder, vapor phase, and IR reflow processes.

The SOC performed well in all the assembly and soldering tests. All three soldering processes can be safely used with no trade-off in electrical performance (data sheet compliance) or package integrity (hermeticity). For wave soldering, correct orientation of the devices is recommended to minimize solder bridging.

DESCRIPTION

A test lot of 240 SOC's were processed through a state-of-the-art surface mount assembly line (see *Table 3, Equipment*). The couplers were mounted in lots of ten on 5" by 5" test boards using the Dyna Pert MPS-118 pick and place machine. The assembled boards were prepared for soldering by curing and preheating. The soldering processes chosen were the three most common techniques; wave soldering, vapor phase, and IR reflow. The tests varied the durations, temperature profiles, and repetitions. After the first and last soldering steps, the boards passed through a cleaning operation (See 4, *Cleaning Conditions*).

All 240 couplers were tested for compliance to the IL212 specification after each soldering step. For each soldering technique, read and record data was taken on twenty devices (see *Table 2, Worst Case Examples*). To study the effect of solder heat on package integrity and long term reliability, two lots of unmounted SOC's were submerged in 260°C solder and then subjected to pressure pot and 85°C/85% RH tests.

1. DUAL WAVE SOLDERING

A. Process Description

The Dyna Pert MPS-118 was used for the automatic epoxy dispensing and the pick-and-placement of the SOC. After curing the epoxy for 3 min. at 110-120°C the boards passed through the Electrovert Century 3000 dual wave solder machine (*Figure 1, Wave Soldering Procedure*).

This equipment has 2 waves, 2" and 4" wide respectively and 4" apart. The first wave is turbulent to avoid shadowing on high density boards and to reach all exposed contacts with liquid solder. The second wave is homogeneous and removes excess solder, i.e., solder bridges.

After the first and the last pass through the solder equipment, the boards were cleaned to remove flux and other residue.

B. Process Conditions

NORMAL PROCESS

4 boards, 40 units

Preheating Temp/Time: 25°C - 120°C, linear/12 min.

Solder Temp/Time: 256°C/4 seconds (submerged)

Cleaning

Number of passes: 2

Result: 0/40 failures to IL212 spec. (See Table 2, Group 1 for read/record data)

NORMAL PROCESS, Repetitive

2 boards, 20 units

Same as normal process except:

Number of passes: 5

Result: 0/20 failures to IL212 spec.

Figure 3. Typical Vapor Phase Profile

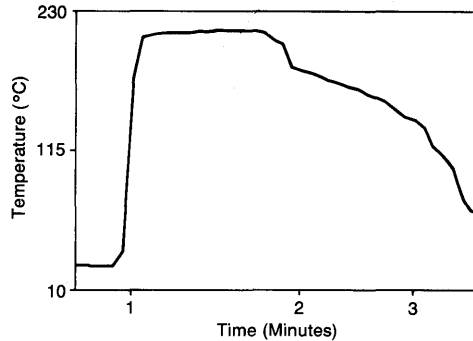

2. VAPOR PHASE SOLDERING

A. Process Description

After the solder paste screening of the boards, the couplers were placed on the PC boards. To harden the solder paste, the boards were heated to 110°C to 120°C for three minutes. This curing secures component positioning during handling. Curing is followed by preheating, vapor phase soldering (HTC IL-18), and cleaning after the first and last pass. (Figure 2).

B. Process Conditions

NORMAL PROCESS

8 boards, 80 units

Preheating Temp/Time: 25°C - 120°C, linear/12 min.

Primary Zone Temp/Time: 215°C/18 seconds (See Figure 3, Temperature Profile)

Cleaning

Number of passes: 2

Result: 0/80 failures to the IL-212 spec. (See Table 2, Group 2 for read/record data)

LONG FLOW PROCESS

2 boards, 20 units

Same as normal process except:

Primary Zone Temp/Time: 215°C/46 seconds

Number of passes: 2

Result: 0/20 failures to the IL-212 spec.

LONG FLOW PROCESS, Repetitive

2 boards, 20 units

Same as Long Flow process except:

Number of passes: 5

Result: 0/20 failures to the IL-212 spec.

Figure 1. Wave Soldering Procedure

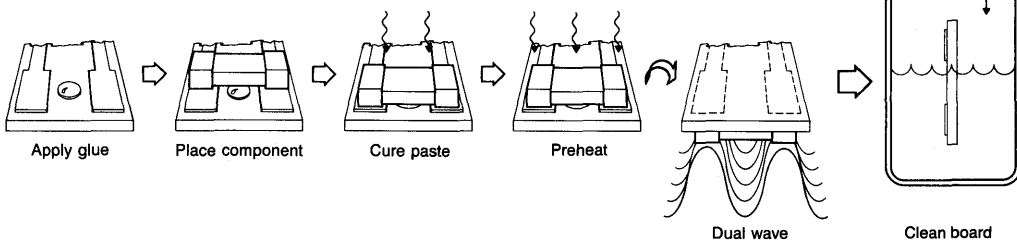
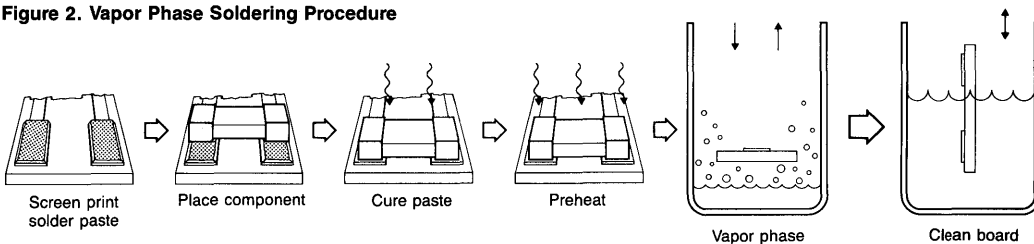

Figure 2. Vapor Phase Soldering Procedure



3. IR REFLOW SOLDERING

A. Process Description

Preparation and assembly were similar to the vapor phase process. The boards were passed through the SPT 770 for the reflow process and then cleaned (Figure 4, IR Reflow Soldering Procedure) using the Cougar 1000, and Dyna Pert pick and place machine except for the omission of the epoxy attachment operation.

B. Process Conditions

NORMAL PROCESS

2 boards, 20 units

Preheating Temp/Time: 100°C/30 seconds

Reflow Temp/Time:

Zone 1 150°C/1 minute

Zone 2 180°C/1.5 minutes

Zone 3 235°C/1.5 minutes (includes cool down)

(see Figure 5, Temperature Profile)

Cleaning

Number of passes: 2

Result: 0/20 failures to the IL212 spec. (See Table 2, Group 3 for read/record data)

LONG FLOW PROCESS

2 boards, 20 units

Preheating Temp/Time: 100°C/1 minute

Reflow Temp/Time:

Zone 1 150°C/2 minutes

Zone 2 180°C/3 minutes

Zone 3 235°C/3 minutes (includes cool down)

Number of passes: 2

Result: 0/20 failures to the IL212 spec.

LONG FLOW PROCESS, Repetitive

2 boards, 20 units

Same as Long Flow process, except:

Number of passes: 5

Result: 0/20 failures to IL212 spec.

Figure 4. IR Reflow Soldering Procedure

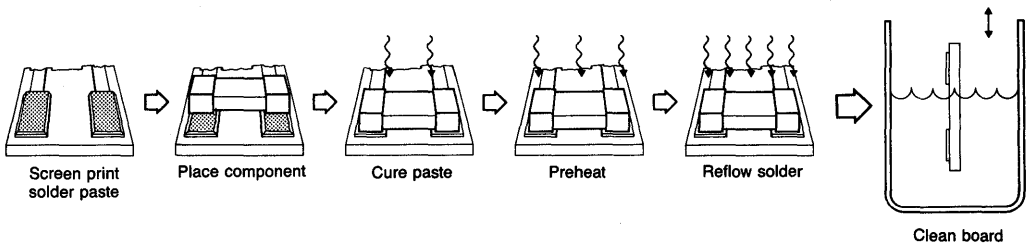
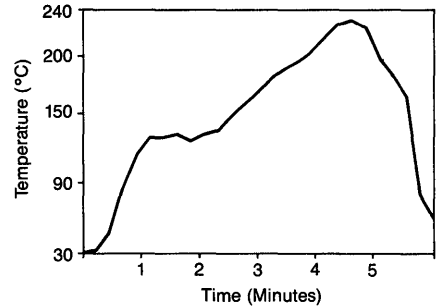

Figure 5. Typical IR Reflow Profile



4. CLEANING CONDITIONS

Solvent: Freon TMS

Solvent Temp: 40°C

Cleaning Zones:

1. Spray: 23 PSI top of PWB
16 PSI bottom of PWB
2. Emersion: 16 PSI top spray to create turbulence
3. Spray: 10 PSI top of PWB
8 PSI bottom of PWB

Dwell time: Approx. 1 minute in each Zone

Table 1. Reliability Test (after Solder Heat)

1A. Pressure Pot Test (121°C, 15 psig steam)

Sample Size	260°C 3 x 10 sec.	48h	96h	144h	192h	240h	288h	BViso	Overall
38	0/38	0/38	0/38	1/38*	0/37	0/37	0/37	0/37	1/38

*failed I_R (25 μ a at $V_R = 10$ V)

1B. Temperature/Humidity (85°C/85% RH)

Sample Size	260°C 3 x 10 sec.	168h	504h	1Kh	BViso	Overall
38	0/38	0/38	0/38	0/38	0/38	0/38

Note: Datasheet parameters were checked at each time point. BViso was only tested at the end of the test sequence.

5. PACKAGE INTEGRITY TEST

To simulate a worst case condition of heat exposure, the couplers were submerged in solder for 10 seconds, three times consecutively. Immediately thereafter, the parts were submitted to pressure pot test and high temperature/humidity to verify the package integrity as well as isolation breakdown voltage (see *Table 1, Reliability Tests after Solder Heat*). These tests could not be done mounted on a board. FR4 PC board material is not completely moisture resistant, therefore providing a leakage path.

No discoloring of the white outermold was observed. After 5 cycles of wave soldering the pc board started to discolor and flex.

The effect on CTR change was minimal.

The average change at 1 mA I_F was:

Dual Wave Soldering	+ 1.5%
Vapor Phase Soldering	+ .8%
IR Reflow Soldering	+ 1.8%

The visual inspection showed no cracks or damages and the reliability test results were excellent. After a pre-conditioning of 3 times 10 seconds in 260°C solder, only 1 out of 38 units failed 288h pressure pot (after 144h one I_R failure) and 0 failures out of 38 after 1000h 85°C/85% RH.

6. CONCLUSIONS

The small outline coupler, a modified SOIC-8 package, was easy to handle during assembly and processing. No electrical failures occurred as a result of the soldering processes. Visual inspection of the solder joints showed consistent results. Solder bridges tended to form in the wave soldering process due to the narrow lead spacing. This is a recognized phenomena for this process, although the increased component height may be another factor contributing a shadowing effect. This possible effect can be minimized by orienting the SOC with its length perpendicular to the solder wave (see *Figure 6*).

Figure 6. Orientation of Components on PC Board Before Wave Soldering

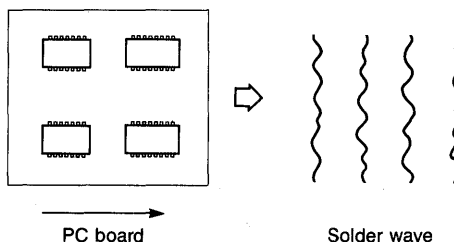

Table 2. Worst Case Examples of Read/Record Data

Group 1: Dual wave soldering

CTR (%) at VCE = 5 V									H _{FE} at VCE = 5V		
PRE	I _F = 1 mA POST	CHG	PRE	I _F = 5 mA POST	CHG	PRE	I _F = 10 mA POST	CHG	PRE	I _B = 1 μA POST	CHG
90	85	-6%	170	168	-1%	200	200	0	600	620	+3%
80	80	0	160	180	+12%	195	200	+3%	590	600	+2%
80	85	+6%	150	150	0	175	180	+3%	580	600	+3%
Average of 20 samples: PRE = 64, POST = 65, CHG = +1.5%											

Group 2: Vapor phase soldering

CTR (%) at VCE = 5 V									H _{FE} at VCE = 5V		
PRE	I _F = 1 mA POST	CHG	PRE	I _F = 5 mA POST	CHG	PRE	I _F = 10 mA POST	CHG	PRE	I _B = 1 μA POST	CHG
70	80	+14%	150	160	+7%	170	180	+6%	580	590	+2%
60	62	+3%	136	124	-8%	150	155	+3%	600	620	+3%
77	80	+4%	150	160	+6%	170	180	+6%	640	650	+2%
Average of 20 samples: PRE = 63, POST = 64, CHG = +1%											

Group 3: IR reflow soldering

CTR (%) at VCE = 5 V									H _{FE} at VCE = 5V		
PRE	I _F = 1 mA POST	CHG	PRE	I _F = 5 mA POST	CHG	PRE	I _F = 10 mA POST	CHG	PRE	I _B = 1 μA POST	CHG
62	65	+5%	140	130	-7%	155	160	+3%	560	570	+2%
53	57	+8%	120	116	-3%	140	145	+3%	530	550	+4%
74	84	+14%	150	160	+7%	170	180	+6%	550	560	+2%
Average of 20 samples: PRE = 60, POST = 61, CHG = +2%											

Table 3: List of Equipment

Procedure	Equipment Used
Solder Paste Screen	Cougar, 1000
Pick-and-Place	Dyna Pert, MPS-118
IR Reflow	SPT, 770
Vapor Phase	HTC, IL-18
Dual Wave	Electrovert, Century 3000
Solvent Clean	Detrex, PCBD - 18ER - A

Table 4: List of Materials

Procedure	Material
Mount Components	FR4 PC board, single side
Attach Wave Soldered Components to PWB	Locktite #360 epoxy
Wave Solder	Alpha Flux RMA SM34-18
Wave Solder	Federated Fry Metals bar solder (63Sn/37Pb)
Vapor Phase & IR Reflow	Alpha Solder Paste RMA 390 DH3 (62Sn/36PB)
Vapor Phase	Fluorinert 5312 (mfg. by 3M)
Cleaning	Freon TMS

Low Cost, Plastic Fiber Optic Systems Using Siemens Light-Link Emitters and Detectors Appnote 40

Part 1 – Light-Link Emitters & Detectors Features & Description

by Heinz Haas, Wilhelm Karsten, Franz Schellhorn

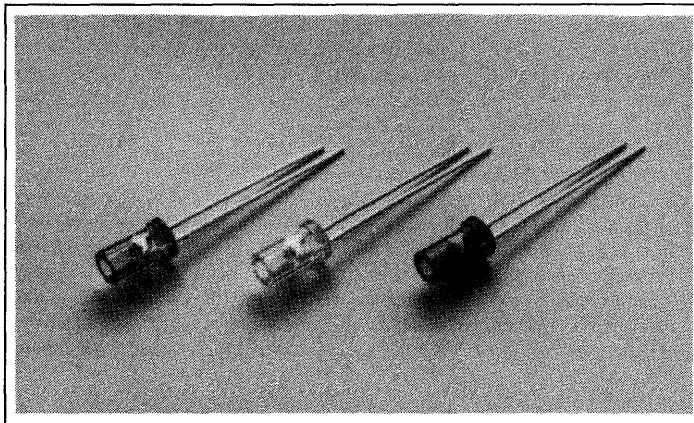

Signal transmission through optical fibers is a fully developed technology. Some million kilometers of transmission systems have already been installed. Making full use of the benefits of this technique in all conceivable applications is so far held back by extremely high cost of opto-electronic components and connectors. The new light-link components described here are ideal for applications with less stringent requirements, for example, where only low bit rates have to be transmitted or fairly short distances need to be covered. The devices are very inexpensive because they are derived from proven emitter diodes and detector components. Typical applications, apart

from signal transmission are in optical sensors, optocouplers, display elements and optical-fiber sensors. Siemens has introduced three emitter diodes, for radiation wavelengths of 560 nm (SFH 751), 660 nm (SFH 750, SFH 750V), and 950 nm (SFH450, SFH450V) and these can easily be connected via optical fibers. A high-sensitivity phototransistor (SFH 350, SFH 350V) and a PIN photodiode (SFH 250, SFH 250V) for high frequencies and pulse rates up to several Mbit/s are available as detectors.

Special emphasis on the device shape

The particular shape of the new light-link devices, which are similar to 5-mm

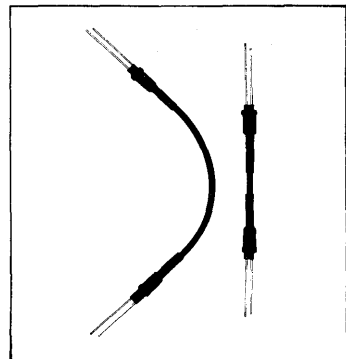

Fig. 1 Optocouplers built from light-link components optical fiber and connected with a shrink sleeve.

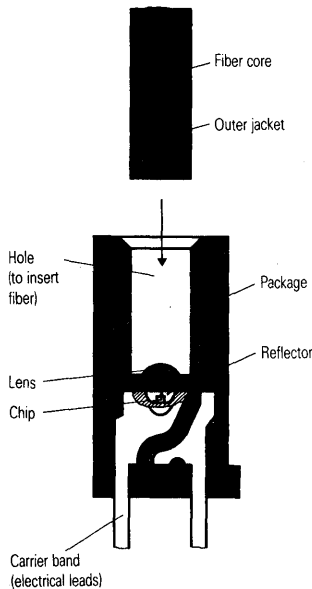

Fig. 2 Cross section of light-link emitter diode

diodes, is crucial to making transmission links simple to construct. A cylindrical opening is provided in the top of the component for inserting the plastic fiber (Fig. 2).

Minimum hole diameter is 2.2 mm to suit commercially available plastic fibers. The light-link core, 1 mm in diameter,

has an opaque outer jacket which need not be stripped off before insertion. The optical fiber is automatically located on the chip. Firm connection between the component and the optical fiber is made by a shrink sleeve which also provides protection against extraneous light (Fig. 1). Except the SFH 751 all parts are also available in our plastic connector version (SFH 250V, SFH 350V, SFH 450V, SFH 451V, SFH 750 V).

Lens prevents misalignment

The bottom of the insertion hole is lens-shaped so that most of the radiation emitted from the semiconductor chip is coupled into the optical fiber and then guided to the detector chip at the receiving end. This increases the coupled-in power by around 20%.

Another important function of this computer-designed lens is in compensating for production tolerances and assembly errors to concentrate maximum radiation at the fiber ends. Possible inaccuracies are: position of the semiconductor on the carrier, dimensional tolerances of the fiber and incorrect lens-fiber distance.

The effect of these tolerances when deviations are kept fairly small can be seen from Figs. 3 and 4.

So even with a lens-fiber distance of 1 mm as much as 60% of the maximum obtainable radiation is coupled in (Fig. 3).

Fig. 4 shows that the lateral misalignment is negligible with a 0.05-mm typical center inaccuracy of the plastic fiber. The lens incorporated in the package allows simple mechanical construction of a transmission system at low cost using light-link components.

Effects of the fiber on the transmitted power

Fiber ends

What proportion of radiant power is coupled into the fiber is not only determined by the emitter diode characteristics but depends a great deal on the finish of the optical fiber ends. Cutting the fiber to the desired length with a blade introduces attenuation up to a factor of 3. For short-distance applications (below 3 m) this loss may be acceptable because no special fiber treatment is required. With long transmission distances, however, it is a good idea to polish the fiber ends with a suitable finishing compound. All data sheet values refer to polished fiber ends.

Fiber bending

The total reflection at the boundary between the fiber core and the outer jacket, that is, at the transition from a high refractive index to a low one, is crucial to the light guidance in the fiber. Radiation striking the boundary at a glancing angle is reflected and remains in

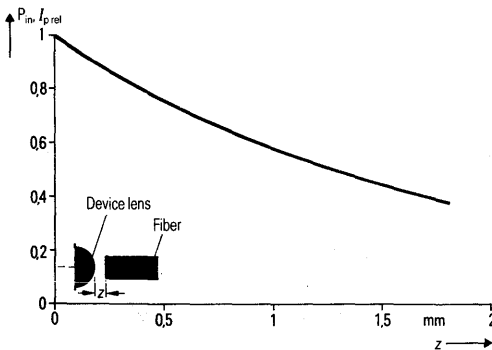

Fig. 3 Relative change of coupled-in power P_{in} and photocurrent I_p measured at the receiver with distance z between device lens and fiber

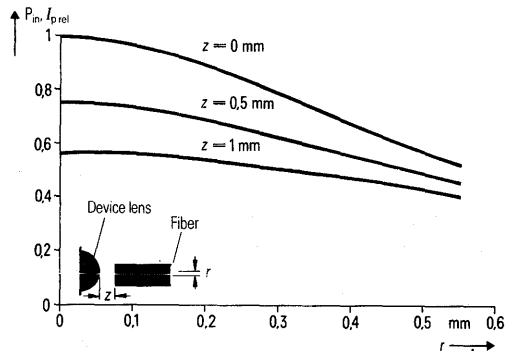

Fig. 4 Relative change of coupled-in power P_{in} and photocurrent I_p measured at the receiver with lateral misalignment r of fiber to device lens

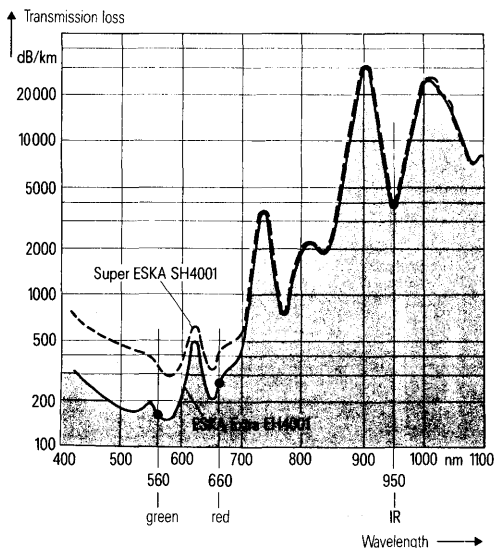

Fig. 5 Transmission losses of two Mitsubishi fibers with radiation wavelength

the fiber core. Bending the fiber, however, changes the angle of incidence at the bending point and allows a certain proportion of the radiation to disappear through the outer jacket.

To give an example: bending a plastic fiber to about 180° with a radius of 1 cm produces losses of 10 to 20%. Particularly with large cables and fixed connections it is important to maintain or, better, to choose as large a radius as possible.

Absorption losses in the fiber

Radiation losses discussed so far appear to be negligible as they are easily reduced by appropriate methods. Losses produced by absorption of radiation in the fiber material, however, cannot be influenced at all. Fig. 5 shows transmission losses of two Mitsubishi plastic fibers.

These plastic fibers do not stand up to some of the optical fiber cables widely discussed in the media.

Their advantages are low price and easy use in linking short distances. The red emitting diode SFH 750, SFH 750V in pulsed mode and the ESKA EXTRA EH 4001 fiber are capable of reliably covering transmission distances up to 100 m.

Quality safeguards long service life

Experience gained from producing millions of optical transmitters and detectors is now going into the manufacture of light-link components.

The SFH 450, SFH 450V infrared diode have an average service life of 10⁶ component hours at 10 mA forward current and 60°C ambient temperature. SFH 750, SFH 750V and SFH 751 achieve more than 10⁵ component hours (at 20 mA and 40 °C). Ageing effects are not to be expected with optical detectors.

The ruggedness of light-link components makes them ideal for applications where they are exposed to severe mechanical stresses. Stress tests on vibration (to DIN IEC, part 2 to 6, test Fc) and shock (to IEC 68-2-27, test Ea) were successfully passed.

Optocouplers with almost unlimited dielectric strength

Optocouplers are used to transmit signals between areas making no electrical connection or between areas at different potentials. In conventional optocouplers the transmitter and receiver are a very

short distance apart. Even the outer creepage distance along the plastic package is only a few millimeters. Thus the maximum voltage that can be handled by the devices, is relatively low. For higher dielectric strength requirements, couplers constructed from light-link components are to be preferred.

Using a 5-cm long fiber to connect emitter diode and detector allows an insulation voltage of 40 kV. Even when the dielectric strength is not the important point, the set up has a capacitance of only 0.01 pF between emitter and detector. A low coupling capacitance is necessary in transmitting high-frequency signals.

One application of such an optocoupler is described on the following pages.

Part 2 – Plastic Fiber, Light-Link Optocouplers are Faster

Application Example

by Günther Hirschmann

Derived from opto-electronic mass-produced components, light-link devices are special types which permit the simple construction of signal transmission paths using plastic fibers.

Optical signal transmission has the following advantages relative to conventional wire links:

- Handling of high frequencies because of short switching times and negligible capacitive coupling,
- maximum transmission distance is several yards,
- the low power transmitter allows operation in areas subject to explosion hazards because there is no risk of ignition,
- interference-free transmission even in the presence of strong, varying electromagnetic fields,
- no crosstalk because of negligible capacitive coupling between emitter and detector,
- unlimited isolation voltage ratings.

Every device has particular features

The three optical emitter diodes available are distinguished by emission colors and radiation wavelengths:

SFH 450 – infrared, 950 nm,
SFH 750 – red, 660 nm and
SFH 751 – green, 560 nm.

In addition, they have features which either recommend or exclude their use in particular applications. The SFH 450 IR-diode provides the highest efficiency in converting electrical power into radiation. It allows the strongest signals to be obtained in the detector circuit.

Attenuation in the plastic fiber at 950 nm is so high (Fig. 5), however, that this combination is only suitable for short-distance transmission.

Moreover, the switching times of about 1 μ s do not satisfy the more stringent frequency response requirements. With ten times shorter switching times [2] but reduced radiation power, the SFH 750 red diode is better suited to handling high-frequency pulse trains. The SFH 751 green diode is not suitable for signal transmission tasks. Its radiation power is

far below that of the red diode and its switching time is much longer. Attenuation in the plastic fiber is fairly small with the green diode. The human eye, however, is particularly sensitive at a wavelength of 560 nm. For these reasons, the SFH 751 diode is mainly employed as a single spot or to set up displays.

Detector devices can be distinguished in a similar way. The SFH 350 device benefits from on-chip power gain and so has a high sensitivity. With a given fiber output power, its signal is 250 times greater than that of the SFH 250 diode. Transistor switching times in the order of 15 μ s permit applications of only 10 kHz when the switching edges of pulse trains have to be detected with almost no delay. If there is no such requirement the phototransistor is capable of handling frequencies of 50 to 100 kHz.

The SFH 250 silicon PIN-diode is ideal when switching speed and frequency response requirements are more stringent. Its signal rise and fall times are around 10 ns. When the PIN-diode is used in conjunction with the SFH 750 diode, however, the latter is the frequency-determining component with rise times of about 120 ns and fall times of 50 ns.

Coupler circuits using light-link components

The mechanical construction of transmission paths is simple:

The plastic fiber is inserted in the cylindrical holes on top of the components and is firmly connected by a shrink sleeve. With long transmission distances, it is a good idea to polish the fiber ends to avoid attenuation losses. Fig. 1 gives examples of such optocoupler set-ups.

In the circuits described here the SFH 750 red emitting diode is used as the transmitter and the SFH 250 PIN-diode as the detector. The basic circuit is shown in Fig. 6. The resistor connected in series with the transmitter diode serves for current limiting.

When the diode is measured its forward current may reach values (independent

of switch-on time and duty factor) as listed in Fig. 7. In the following examples the diode's rms current is limited to about 27 mA.

The reverse diode is operated in the reverse condition. Its load resistor R_L across which the output signal is developed, not only influences the output amplitude \hat{u}_{out} but also the rate of change of the output pulses. High resistances result in higher signal voltages and longer rise and fall times. Characteristics

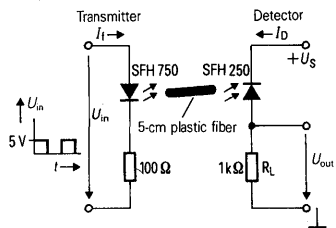

Fig. 6 Basic circuit to operate light-link optocouplers

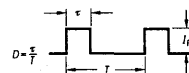
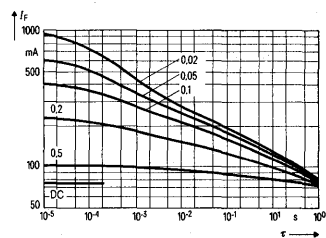

Fig. 7 Pulse handling capability of the SFH750 emitter diode

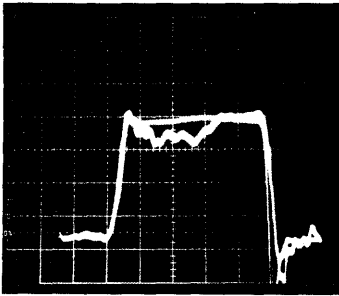

Fig. 8 Drive signal (5 V) and output voltage (70 mV) with 1-MHz frequency in the Fig. 6 circuit

of the input signal U_{in} and the output signal U_{out} for the Fig. 6 circuit with a 1-MHz switching frequency are shown in Fig. 8.

The current transfer ratio is a crucial factor with opto-electronic coupling distances.

This is the ratio of current through the detector to current through the emitting diode. In the described set-up of SFH 750, 5-cm long plastic fiber and SFH 250, the current transfer ratio is 0.13%. Under these conditions the detector signal has to be further amplified. Fig. 9 is a simple amplifier circuit suitable for frequencies up to 50 kHz.

The detected signal is amplified by a common-emitter stage. The unit is characterized by high current gain and low upper limit frequency. To phase match the input and output signals, a phase reversal stage is provided by transistor T2.

The anti-saturation diode D1 improves the switching characteristic. Rise and fall times of the output signals are about 200 ns. The output signal delay relative to the input signal is 0.7 μ s.

Fig. 10 is a circuit suitable for transmitting analog signals up to 200 kHz:

The TAE 1453 A op-amp has a pnp input differential stage and an open-collector output. The incoming signal is applied to the non-inverting op-amp input and is amplified by the ratio of R_2/R_1 . A high-speed CMOS logic driver converts the output signal to TTL level. Delay times with this circuit are only about 250 ns, while rise and fall times can be neglected. To handle higher frequencies (up to 1 MHz) the Fig. 11 circuit is the most

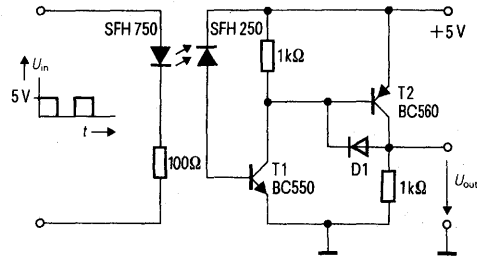

Fig. 9 Amplifier with common-emitter circuit suitable for analog signals up to 50 kHz

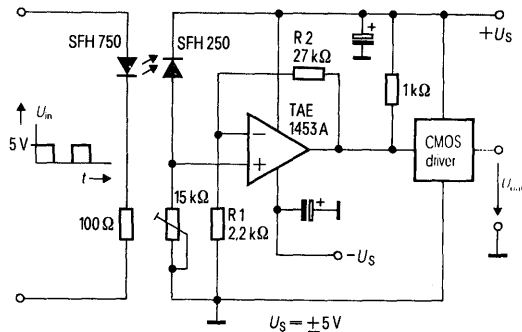

Fig. 10 Optocoupler circuit to transmit analog signals up to 200 kHz

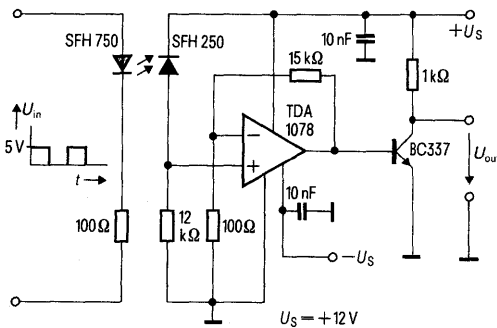
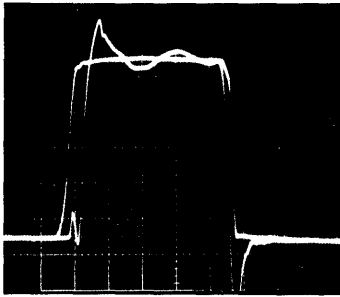
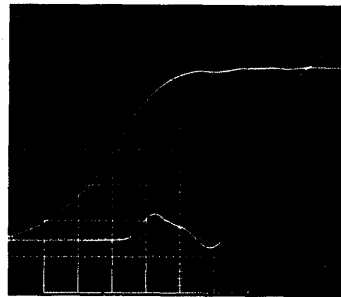

Fig. 11 Optocoupler circuit to transmit analog signals up to 1 MHz



$U = 1 \text{ V/Div}$
 $t = 100 \text{ ns/Div}$
 $f = 1 \text{ MHz}$

Fig. 12 Switching performance of the Fig. 11 circuit, input pulse (left) and output pulse (right)



$t = 10 \text{ ns/Div}$
 $f = 1 \text{ MHz}$
 35 ns delay time of the output signal
 25 ns rise time of the output signal

Fig. 13 Rising edges of input and output pulses in Fig. 11

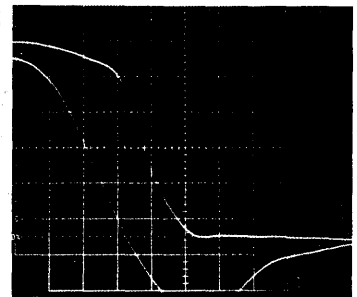

$t = 10 \text{ ns/Div}$
 $f = 1 \text{ MHz}$
 16 ns delay time of the output signal
 18 ns fall time of the output signal

Fig. 14 Falling edges of input and output pulses in Fig. 11

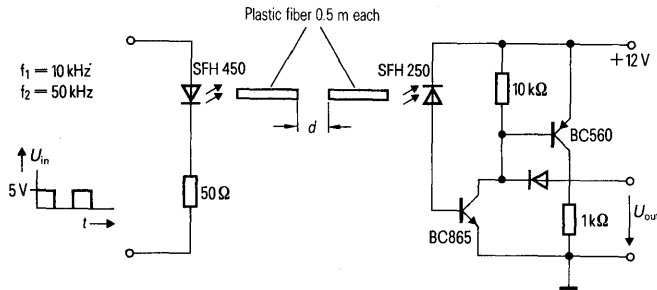

Fig. 15 Photo interrupter arrangement using light-link components

suitable. It uses the fast TDA 1078 op-amp. The device is operated as a non-inverting amplifier with a gain of about 150.

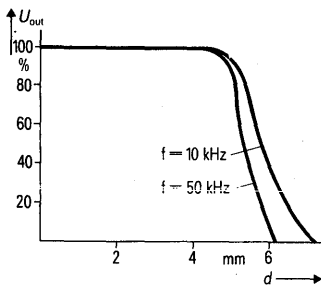

Fig. 16 Output signal of the photo interrupter circuit dependent on the distance of the end of the plastic fiber

Transistor T1 brings the output voltage U_{out} to 5 V. Fig. 12 shows the appropriate switching characteristic. Fig. 13 and 14 illustrate in more detail the rising and falling edges of the input pulses on the left, and the waveforms of the output pulses on the right. It is obvious that the amplifier circuit introduces short delays of 35 and 10 ns but does not further extend the remaining switching times.

Photo interrupter circuit

In Fig. 15 a photo interrupter arrangement is shown. The ends of the optical fiber are polished. As shown in Fig. 16 the distance from the optical fiber end must not exceed 5 mm to avoid an excessive voltage drop in signal voltage level. Thanks to the optical fiber the optical detection area can be remote from the

electronic circuit. The optical detector is ideal for use in atmospheres subject to explosion hazards.

Light-Link Components Control High-Frequency Switched-Mode Power Supplies

Appnote 41

by Reinhard Blöckl

Operating frequencies of 100 kHz are common practice in modern switched-mode power supplies. And the trend continues towards even higher frequencies. The reason for this is that they allow the development of power supplies of smaller size and improved dynamic control characteristics. The necessary feedback is done by Siemens light-link components which permit reliable control of SMPS with working frequencies in the MHz range.

Feedback of control information in switched-mode power supplies is mainly handled by integrated analog optocouplers (e.g. CNY 17 and SFH 600). The limited bandwidth of these couplers allows SMPS to be controlled at working frequencies below 100 kHz.

Use of the new light-link components, SFH 450 and SFH 750 (emitters) and SFH 250 (detector), greatly extends the range of optical signal transmission.

The circuits described here for analog signal transmission are characterized by

- suitability for SMPS with high and very high working frequencies,
- minimizing parasitic coupling capacitance between emitter and detector,
- no electromagnetic interference in the transmission line (plastic fiber).

Using the new light-link components in SMPS results in a higher efficiency and a reduction of screening. The savings achieved largely compensate for the extra costs of light-link components and mounting them relative to integrated optocouplers.

Low-cost opto-electronic coupling elements can be used in SMPS with higher working frequencies (above 100 kHz). This has so far been the domain of sophisticated transformer techniques.

Electrical isolation of the SMPS is provided by a power transformer with primary and secondary windings isolated from each other. Fig. 1 is a block diagram of such an arrangement.

With the control and monitoring circuit on the primary side of the SMPS, as shown in Fig. 1, the closed-loop voltage control therefore bridges the isolation between the primary and secondary sides.

To maintain electrical isolation, the control feedback path must include an isolated linear transmission device.

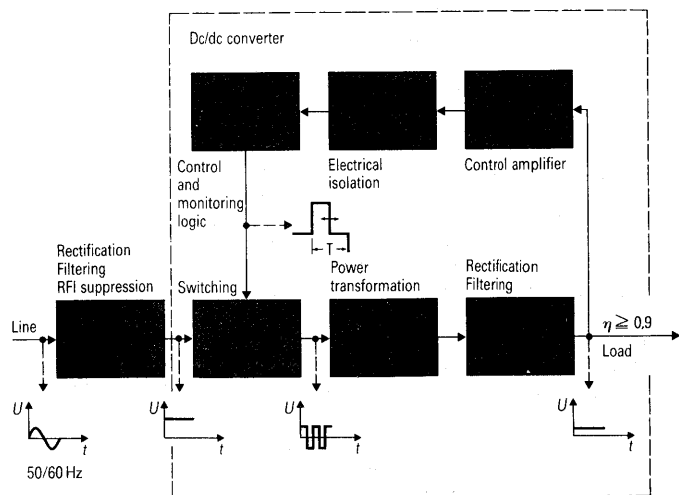

Fig. 1 Block diagram of a pulsewidth-modulation controlled switched-mode power supply

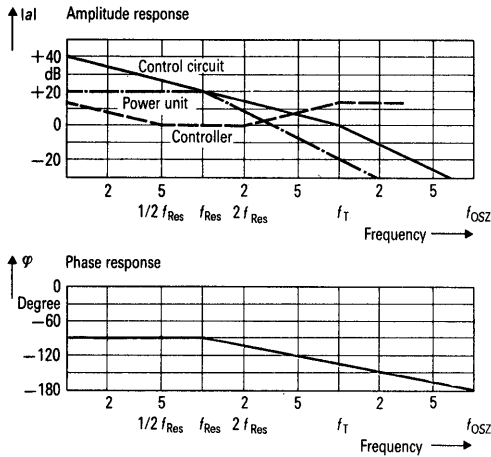

Fig. 2 Typical frequency characteristics in the control of switched-mode power supplies

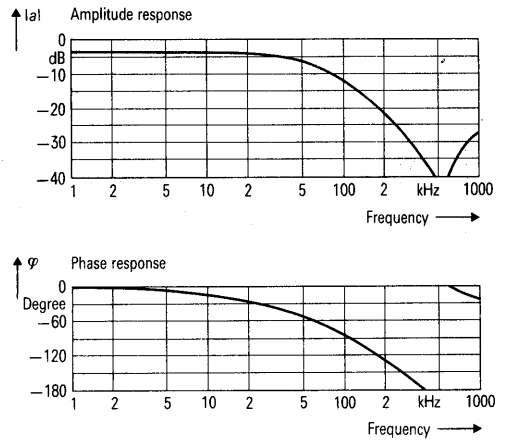

Fig. 3 Frequency characteristics of CNY 17-1 coupler

This device is governed by the same VDE regulations as the power transformer in terms of isolation voltage, air and creepage paths.

Two methods are currently employed in isolated signal transmission:

- transformer signal transmission,
- optical signal transmission.

Relative to the technically valuable but expensive transformer solution, optocouplers are less costly. But this method does have some engineering restrictions.

Design of SMPS control circuits

Forward-converter SMPS operating in the »voltage mode«, normally use a controller with PIDT1-characteristic (proportional – integral – derivative 1st order action) whereas SMPS in the »current mode« use controllers with a PIT1 characteristic. Frequency response is compensated to maintain the widest possible bandwidth with sufficient stability.

The SFH 600, CNY 17 available optocouplers have a limited achievable bandwidth.

The new broadband light-link components are linear transmission elements

which allow for a control bandwidth depending only on the chosen working frequency of the SMPS. Hence an improved SMPS dynamic control characteristic (the most important reason for increasing the working frequency) can be implemented in practice. Fig. 2 shows the Bode diagram of a »voltage mode« forward converter power unit (chain line).

The LC output filter has a transfer function with two poles at the resonance point. This implies a -180° phase shift at higher frequencies. The circuitry for frequency response compensation is designed so that the control amplifier has the desired PIDT1 type frequency response, as shown in Fig. 2 (broken lines). From this the frequency response (solid line) of the complete control circuit is obtained.

Time constant T_I has been chosen so that the associated corner frequency corresponds to the transition frequency f_T of the system

$$f_T = 1/(2 \cdot \pi \cdot T_I)$$

This serves for the bandwidth limiting necessary to suppress the switching frequency.

Sufficient attenuation is guaranteed by making the transition frequency one decade below the switching frequency.

A parameter of control stability is the phase shift of the separated control circuit at the transition frequency (gain at transit frequency is 0 dB). A maximum phase angle of -150° – this means a -30° phase margin – is still considered sufficiently stable.

So far we have neglected the optocoupler's frequency response. We started from the assumption that the control op-amp would not cause any significant phase shift of the given transition frequency.

A phase shift of -135° results from Fig. 2 for the transition frequency.

Consequently, the additional phase shift of the optocoupler at transition frequency may be a maximum of -15° to maintain a minimum phase margin of 30° .

As a rule of thumb, the working frequency of a switched-mode power supply should exceed the frequency at which the optocoupler produces a -15° phase shift by a factor of ten.

Although a higher switching frequency is possible, it will not improve the dynamic control characteristics as the transition

frequency cannot be raised appropriately for reasons of stability.

Properties of integrated optocouplers in linear operation

Obvious benefits of optocouplers are their compact size and low price.

Against these, however, are some drawbacks:

- low cut-off frequency,
- coupling capacitance between emitter and detector,
- air and creepage paths between external connections are likely to fall short of requirements after pc board mounting.

Frequency response of integrated optocouplers

When a high cut-off frequency is required, the optocoupler should be used in a low-impedance circuit. For example, the data sheet specifications for the SFH 600 optocoupler is 250 kHz with a load resistance of $R_L = 75 \Omega$.

The permissible component current limits the reduction of resistance values. To assess the possibilities of using optocouplers as part of a control circuit, the frequency response characteristic method (Bode diagram) is very useful.

Fig. 3 shows the measured frequency response characteristics of the CNY 17 standard optocoupler for a load resistance $R_L = 1 \text{ k}\Omega$.

The amplitude characteristic $|a|$ here has a logarithmic current transfer ratio.

$$|a| = 20 \cdot \log(I_C/I_F)$$

The phase response shows the phase angle between the light emitting diode current I_F and the detector transistor current I_C .

From the frequency response characteristic it can be seen that

- the phase angle of -15° lies at about 10 kHz,
- a zero occurs at about 550 kHz in the amplitude response.

From the first, it can be concluded that the integrated optocoupler is suitable for working at frequencies up to 100 kHz. The second observation points to the effect of the parasitic coupling capacitance. By superimposing both signal transfer paths, optoelectrical and capacitive, which produce phase displacements

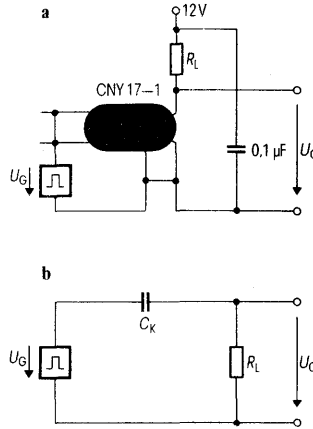

Fig. 4 Common-mode transmission through coupling capacitance C_K
a measuring circuit to determine the coupling capacitance
b equivalent circuit of common-mode transmission

with opposite signs, the output signal may be partially erased. This gives the observed non-uniformity of the frequency response.

Common-mode suppression with integrated optocoupler

The undesired transmission of common-mode signals through optocouplers is caused by the parasitic coupling capacitance C_K between the input and the output of the optocoupler.

Fig. 4 shows a measurement circuit to find the coupling capacitance and obtain the high-frequency equivalent circuit. As can be seen from the equivalent circuit the transmission of common-mode signals corresponds to an RC first-order high pass filter consisting of parasitic coupling capacitance C_K and the external load resistance R_L .

The common-mode signal transmission produces spiked interference waveforms in the output voltage U_C from the square-wave input voltage U_G .

The appropriate signal characteristics are shown in **Fig. 5**. The measured load resistance R_L was 10 $\text{k}\Omega$.

With the switched-mode power supply described common-mode transfer action is most disturbing as capacitively coupled in (e.g. transformer winding capacitance) common-mode signals of high amplitude are likely to occur at regular intervals because of the clock-pulse mode of operation.

Insufficient common-mode suppression may cause these interference waveforms to be transmitted through the optocoupler to the pulsewidth-modulation control circuit.

This often leads to incorrect operation of the PWM. Here an additional interference suppression in the form of a screen inside the power transformer is required.

Useful features of light-link components

Unlike integrated optocouplers, light-link components consist of separate emitter and detector units optically coupled through an optical fiber (for example plastic fiber) over any desired distance.

This technology brings some major benefits with it:

- The coupling capacitance is negligible because of the spacing between emitter and detector.
- the required air and creepage paths and isolation voltages are easily provided because of the spacing between emitter and detector,
- optical fiber links can neither emit nor receive electromagnetic interference in the radio frequency band,
- using a PIN photodiode as the detector provides very broad bandwidths.

A technical description of available emitter and detector devices and amplifier circuits is given in [1].

This article deals with applications in linear transmission, especially in the control feedback paths of SMPS. Suitable circuits are discussed.

To determine the limit values of the individual circuits, their frequency response characteristics were measured and plotted as Bode diagrams.

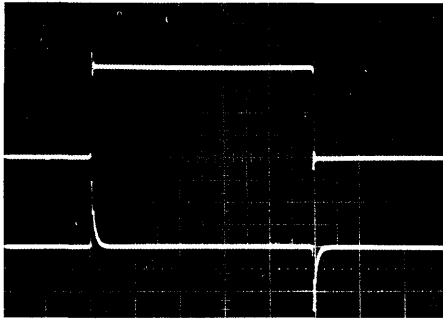

$U_G = 5 \text{ V/Div}$
 $U_C = 200 \text{ mV/Div}$
 $t = 2 \mu\text{s/Div}$

Fig. 5 Common-mode interference at the output of the Fig. 4 circuit with $R_L = 10 \text{ k}\Omega$

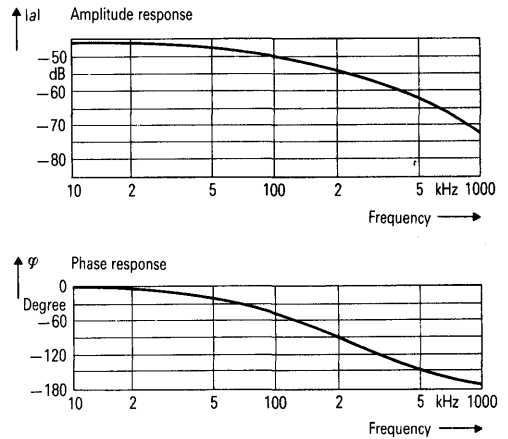

Fig. 7 Frequency characteristics of the Fig. 6 circuit

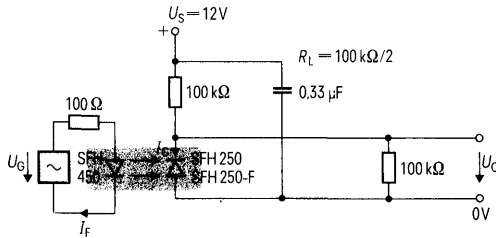

Fig. 6 Optical signal transmission circuit without amplifier

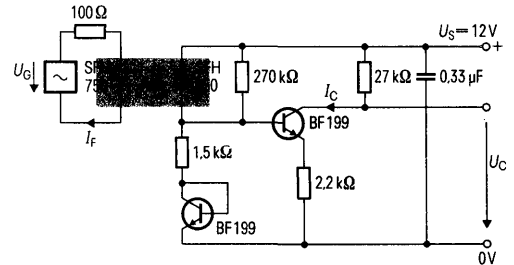

Fig. 8 Optical signal transmission circuit with single-stage amplifier

Circuits for linear optical signal transmission

Interface requirements

The design of optical signal transmission circuits is based on the following assumptions:

- for driving the photodiode (emitter) a current I_F between 0 and 50 mA is available,
 - a voltage U_C of about 5 V is provided at the detector circuit output,
 - with LED control current $I_F = 0 \text{ A}$, the output voltage is $U_C \geq 5 \text{ V}$,
 - the complete circuit is inverted – in other words – the output voltage U_C drops with rising control current I_F .
- These interface conditions are so chosen that the optoelectronic circuits can be

driven by standard amplifiers and there is compatibility with the TDA 47xx and TDA 49xx SMPS control IC series. The optical signal transmission circuit can be incorporated into the SMPS concept of Fig. 1.

Three optical transmission circuits are described which meet the increasing demands for transmissible frequencies.

Optical signal transmission circuits without amplifiers for frequencies up to 450 kHz

The circuit shown in Fig. 6 is built from just a few components. As the current transfer ratio I_C/I_F of the combination SFH 450 (IR emitter diode) and SFH 250 (photodiode) is sufficient, the output signal can be obtained at the load resistor

R_L without any additional amplification after the photodiode.

As the 1- μs switching time of the SFH 450 is rather long, a wide bandwidth cannot be achieved with this simple circuit.

The SFH 250-F infra-red light-transmitting filter detector diode can be used with the same results as protection against daylight in the Fig. 6 circuit. The associated Bode diagram is given in Fig. 7.

From this it can be seen that at about 45 kHz a phase shift of -15° occurs. With these parameters the circuit is suitable for switched-mode power supplies operating at frequencies up to 450 kHz. Technical data are summarized in the Table.

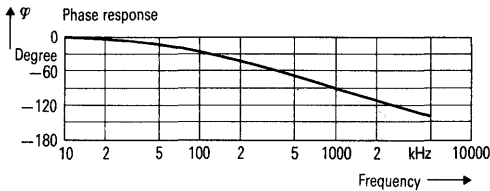
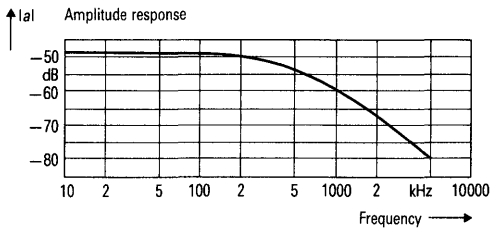

Fig. 9 Frequency characteristics of Fig. 8 circuit

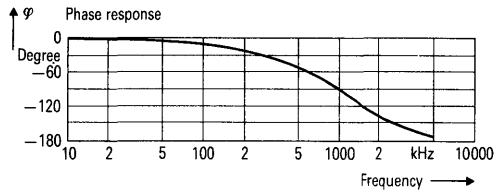
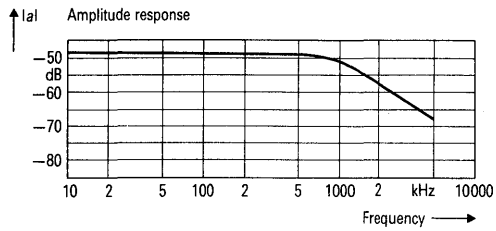

Fig. 11 Frequency characteristics of Fig. 10 circuit

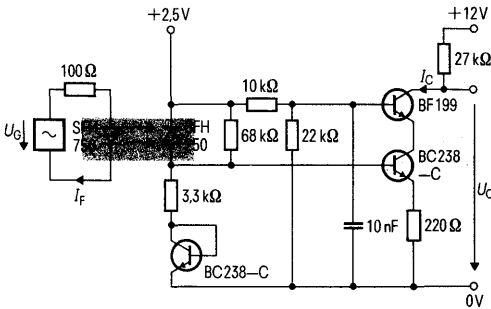
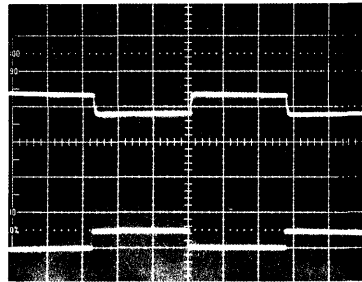

Fig. 10 Optical signal transmission circuit with amplifier in cascode arrangement



$U_C = 1 \text{ V/Div}$
 $I_F = 10 \text{ mA/Div}$
 $t = 10 \text{ } \mu\text{s/Div}$

Fig. 12 Output voltage U_C waveform with square-wave current I_F

Circuits with single-stage amplifier for frequencies up to 650 kHz

The limit frequency can be increased when the SFH 450 IR LED is replaced by the SFH 750 emitter diode operating in the red spectral range. Switching times are reduced by a factor of 10. The radiant power coupled into the optical fiber from this LED is, however, much smaller. An amplifier stage is required to produce the necessary output voltage. Fig. 8 is the block diagram.

The BF 199 transistor is used as common-emitter amplifier. The base-emitter

diode of another transistor provides temperature compensation.

To allow for the manufacturing tolerances of the transistor, it may become necessary to trim the 270-k Ω resistor. The Bode diagram of this arrangement is shown in Fig. 9.

The frequency at which the phase is shifted by -15° lies at 65 kHz. The transmission circuit is suitable for SMPS with working frequencies up to 10 times higher than this. The Table gives the technical data on this circuit.

Circuits using cascode amplifier for frequencies up to 1600 kHz

The cascode circuit is characterized by an excellent high-frequency performance. The Fig. 10 arrangement requires a stabilized 2.5-V source and 12-V supply voltage, which are already provided when TDA 47xx or TDA 49xx SMPS control ICs are used.

The cascode circuit uses one BC238-C and one BF 199 transistor.

The operating point of the BF 199 transistor is set by a voltage divider supplied from the 2.5-V source. The base-emitter

Description	Symbol	Circuit to			Unit
		Fig. 6	Fig. 8	Fig. 10	
Operating point ($U_S = 12$ V)	I_F	10	10	12	mA
	U_C	4.2	5.5	5	V
DC transmission performance	$\frac{\Delta U_C}{\Delta I_F}$	0.24	0.1	0.1	$\frac{V}{mA}$
3-dB limit frequency	f_{3dB}	100	250	700	kHz
Dependency of output voltage on U_S	$\frac{\Delta U_C}{\Delta U_S}$	0.5	-0.53	-	-
Dependency of output voltage on 2.5-V supply voltage	$\frac{\Delta U_C}{\Delta 2.5 V}$	-	-	9.5	-
Temperature coefficient of output voltage (in the range $0^\circ C \leq \vartheta \leq 60^\circ C$) $I_F = 15$ mA	$\frac{\Delta U_C}{\Delta \vartheta}$	9	2	~ 0	$\frac{mV}{K}$

Table Technical data on three transmission circuits using light-link components to control switched-mode power supplies with different working frequencies

diode of the third transistor provides temperature compensation. To allow for the transistor manufacturing tolerances, it may be necessary to trim the 68-k Ω resistor. The Bode diagram of this arrangement is shown in **Fig. 11**. The frequency at which the phase is shifted by -15° lies at 160 kHz. Consequently, the highest possible working frequency for a SMPS using this circuit is about 1.6 MHz.

Fig. 12 shows the behaviour of the circuit with time. The emitter diode is driven with a square-wave current I_F of 5-mA amplitude. The amplitude of the output signal U_C is 0.6 V. Technical data are given in the **Table**.

Conclusion

Switched-mode power supplies using light-link components in the control feedback path provide broadband control characteristics which depend on the chosen switching frequency. Stability and excellent dynamic control characteristics are obtained.

The small coupling capacitance between emitter and detector in the optical transmission path (large spacing) eliminates the need for a screen in the power transformer.

The possibility of obtaining higher working frequencies with simpler and thus lower-cost configurations of SMPS will be an impetus towards further increases of frequency in power supply design.

Motor Control with Electrical Isolation of Operator Module and Power Unit Using Light-Link Components

Appnote 42

by Manfred Stürzer

There are already numerous applications of motor speed control in household and leisure appliances using the TLE 3102 phase control IC. New areas for use are opened up by the method described in this article.

Benefits of this phase control circuit are standby operation, soft start and overheat protection.

A stepless speed control using the TLE 3102 IC was developed for 220-V universal motors. The operator unit which is supplied from low voltage is electrically isolated from the motor control circuitry to cater for situations where the operator unit must not be powered from line potential.

Control signals are transmitted optically by an optocoupler or a combination of light-link transmitter diode, phototransistor and plastic fiber of any desired length.

The potentiometer for speed adjustment and an LED used for status indication can be combined in a single unit which is connected to the control electronics by two leads.

Operation

The circuit (**Figure**) consists of the operator module, which works at low voltage, and the control unit. The latter utilizes the TLE 3102 phase control IC to trigger the triac (e. g. TXD 10K60). Design of external circuitry for the power

supply, sawtooth voltage, trigger pulse width, triac trigger current and synchronization, is identical to that of established systems.

A PTC thermistor is used for temperature monitoring as protection against overheating. The temperature-dependent divider voltage from R_K and R_1 is inverted by the op-amp of the TLE 3102 IC and amplified to become effective at the control input U_ψ from a defined temperature.

Hence the conduction angle and motor speed are reduced. The temperature protection circuit – at first glance a rather expensive one – allows the triac and PTC thermistor to be mounted onto the motor and connected straightforwardly to the drive circuit by only 4 wires. In normal operation, the maximum permissible conduction angle is defined by a voltage of 0.6 to 2 V at U_ψ to eliminate the risk of half-wave operation caused by phase shift between current and voltage. The maximum rating must be adapted to the motor type. For this purpose the full-scale control setting of the trimmer R_2 is made so that full-wave operation is guaranteed. The operator module and power unit are electrically isolated. The control information is transmitted in the form of a pulse-width modulated rectangular signal via an optocoupler to generate the control voltage U_{st} . Any effects of non-linearity, tolerances and ageing of the optocouplers are reliably excluded.

Light-link components are ideal for replacing optocoupler elements. The use of the SFH 450 light-link transmitter diode, the SFH 350 phototransistor and a plastic fiber permits not only electrical isolation but also separate low-voltage module and power unit and enables them to be interconnected via a plastic fiber. The permissible distance is determined by the coupled-in power of the transmitter diode and the plastic fiber attenuation. Capacitor C_1 serves mainly for filtering the rectangular signal to dc voltage.

In addition, it supports soft motor start from the standby mode. Here »standby« means zero rpm.

In the range 1.2 to 4 V an increase of control voltage U_{st} causes a drop in motor speed.

When line voltage is supplied, the operating voltage is built up gradually and is still below its maximum at the time of the trigger pulse.

Therefore the motor starts abruptly and is then slowed down to the desired speed. This is avoided and a soft start is permitted by inserting capacitor C_2 .

As long as the operating voltage is changing appreciably the capacitor's impedance is negligible and provides higher voltage at the control input U_{st} .

In the steady state, however, it no longer affects the control voltage, which then reaches the desired value.

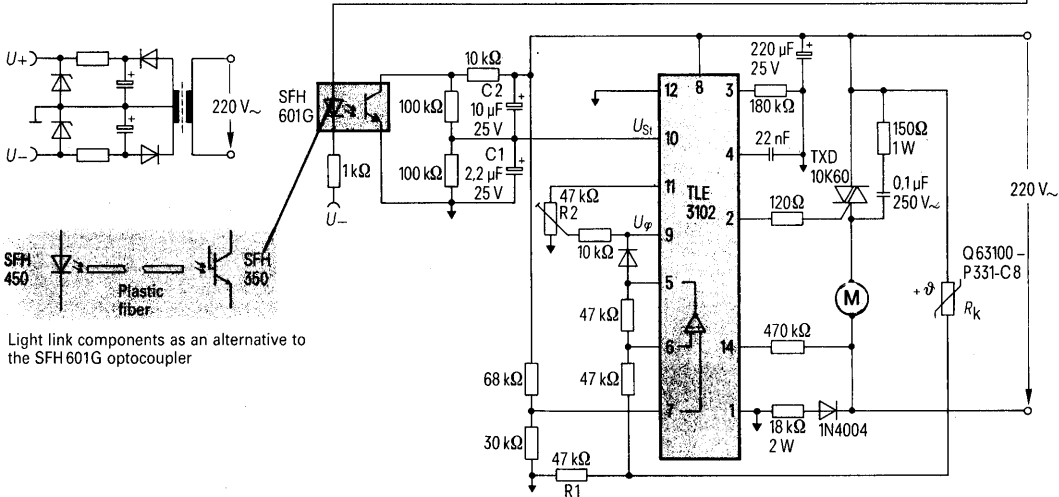
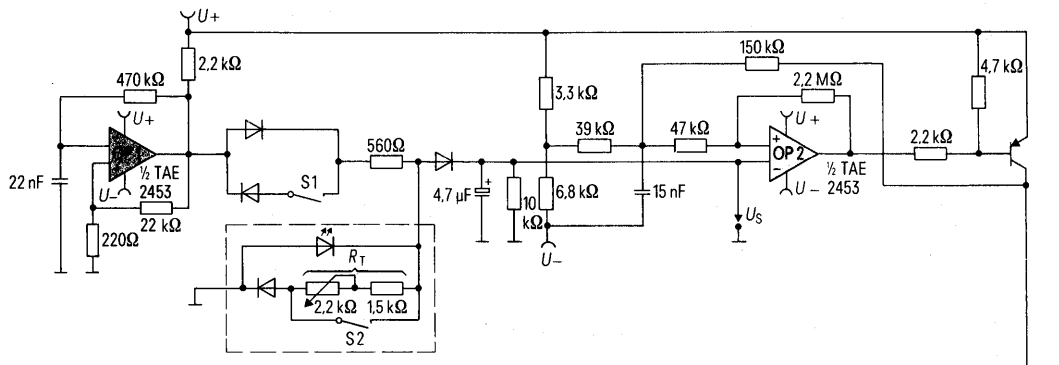

Circuit diagram of motor control with electrical isolation of operator module and power unit

A rectangular signal generator and a pulse width modulator are the main components of the low-voltage control. OP1 op-amp works as a multivibrator and supplies a bipolar square-wave voltage at a frequency of about 2.5 kHz. The positive half-wave should be considered first. The variable voltage, falling at R_T is smoothed before further processing.

From a defined range of the signal voltage the subsequent pulse duty converter [2] generates a rectangular signal in which the duty cycle is proportional to the voltage and drives the transmitter diode of the optocoupler via the pnp transistor. When the voltage drops below the lower threshold, for example, by

closing standby switch S2, the duty cycle is zero and the phototransistor is no longer conducting.

Voltage U_{st} at the control input of the phase control IC is above 4 V. The triac is not triggered and the motor is stationary.

For voltages exceeding the upper threshold the transmitter diode is permanently conducting. Hence U_{st} is at a minimum and the motor runs at a maximum speed determined by U_{φ} .

An additional indication not requiring extra wiring is provided by the negative half-wave of the square-wave generator. Whenever switch S1 is closed, an LED is activated and indicates the current status without affecting the signal voltage U_s .

Applications

One application of this motor control is in canister-type vacuum cleaners. Potentiometer, standby switch S2 and LED are easily housed in the cleaner handle.

Thanks to the electrical isolation of the low-voltage module and power unit, only two, fairly thin wires run through the hose to the canister without restricting the suction hose flexibility.

Adjustable speed, in other words, suction performance, soft start and standby operation are ideal for vacuum cleaner operation. The additional LED can be used to indicate dust bag fill level. The control method ensures proper cleaner operation even with a broken wire in the hose which would only reduce the convenience to the user. Finally, the temperature circuit gives protection against overheating of the motor and its housing.

FREDFET Power Half-Bridge: Short-Circuit Proof through Light-Link Components Appnote 43

by Walter Schumbrutzki

With higher clock frequencies in power switches inverse-capable MOS power transistors (FREDFET) are going to replace bipolar devices. In the low power range (≤ 2 kW) MOS half-bridges are already being designed which are far superior to those using bipolar transistors.

The most important requirements to be met by bridge circuits are: minimum forward and switching losses, duty factor of 0 to 100%, current limiting (if necessary, short-circuit and leakage protection), low control power, separate drive of individual transistors, electrical isolation of control and output circuits.

Driving of »high side« transistors is made somewhat difficult because of the switched source potential (floating). Apart from providing a solution to this problem, the circuit described in this article fulfils all the above requirements.

Transformer-coupled SIPMOS half-bridge (Fig. 1)

Pulse transmission of input signal using a ring core

Though transformer coupling permits fast switching times, the effects of

magnetic saturation generally confine the duty factor to about 50%. Magnetic saturation also limits the time a transformer can hold a MOSFET in the on-state. To overcome this problem the transformer in the circuit described is fed with a high-frequency pulse train (burst of 1 MHz) for the duration of the input pulse.

The FET is operated as long as the *burst* is present. Thus turn-on times are freely selectable. An auxiliary power supply on the secondary side is not necessary. Driving the half-bridge entails two opposed square-wave signals with some delay of the positive edge (around 500 ns) and a 2-MHz clock signal. These signals can be derived from a pulse-width modulation circuit. The 2-MHz clock can be obtained from the drive circuit via the ALE line of a microcomputer. The drive signal (active high) goes to a turn-off logic circuit which blocks the input signal when the current threshold is reached. Then, with active low on pins R and S of the data flipflop 4013, complementary 1-MHz bursts are delivered to the push-pull stage and the ring core transformer (R 10/N 30) is energized. Both windings are put on face to face to minimize their capacitance. The primary has 10 turns, the secondary 12.

As the carrier current flowing through the capacitance between primary and secondary circuits is rectified and may cause spurious turn-on of the FREDFET, special attention has to be given to the design of the transformer.

Common-mode rejection of more than 100 V/ μ s is achieved by simply using a thin coaxial cable for the secondary winding. One end of the outer shield (not both) has to be connected to the appropriate FREDFET source.

On the secondary side the burst is rectified via a diode bridge and a positive gate signal is produced which simultaneously switches on the load and the current measuring MOSFETs.

Fig. 2 shows the transmission of an input pulse of 1.5 μ s duration. When switched on the MOSFET gates are discharged via the BC 327/25 pnp transistor. Discharge time is determined by the time constant of the base resistance (1 k Ω) and smoothing capacitance (220 pF). The FREDFET is operated as long as the 1-MHz carrier is available, that is, when the control input (R, S) is low.

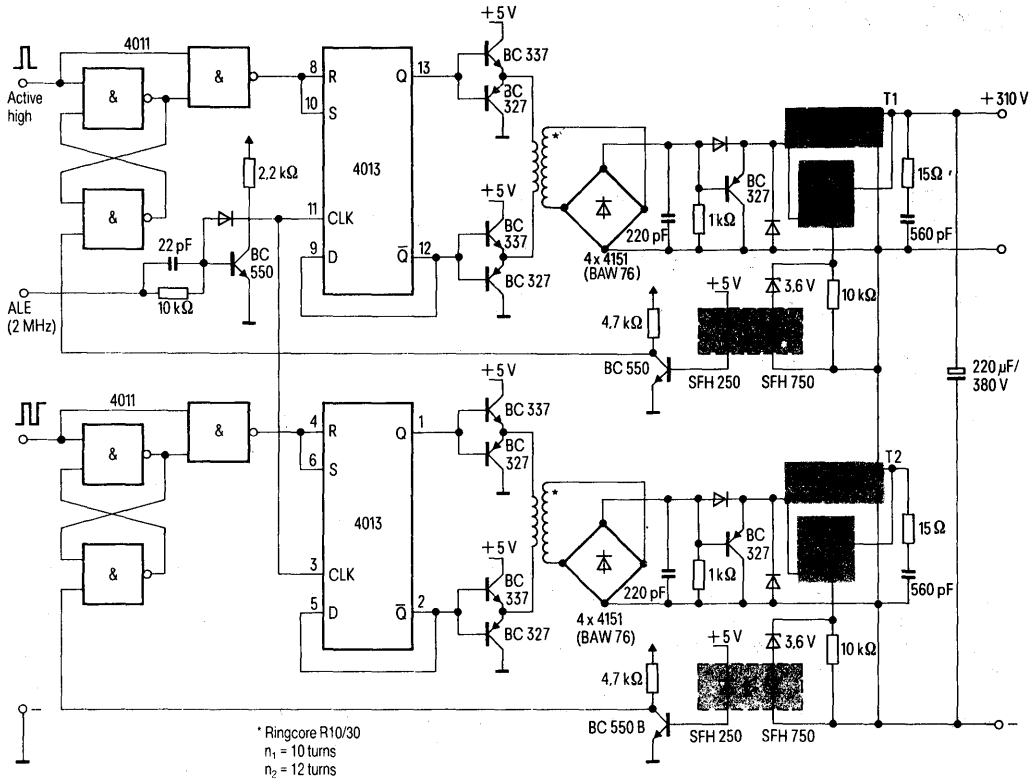

Fig. 1 Circuit diagram of SIPMOS half-bridge

Low-loss use of the signal for current measurement (Fig. 3)

Current measurement resistance in the load circuit means high additional losses. For current measurement the drain-source voltage of the load transistor in the on-state is taken out via a small-signal transistor (BSS 125). In the on-state it can be measured by the BSS 125 source resistance as the gates and drains of the two transistors are connected. This drain voltage is a direct measure for the flowing current ($U_{DS} = I_{DS} \cdot R_{DS(on)}$) and can be used to turn off the transistor via a threshold switch.

Transmission of current measurement signals via light-link components

The main problem in transmitting the turn-off pulse is the $\frac{du}{dt}$ sensitivity of

commercially available fast optocouplers. Their high coupling capacitance prevents the transmission of steep signal edges. For this reason, a diode coupler is used here as a transfer device. It is made

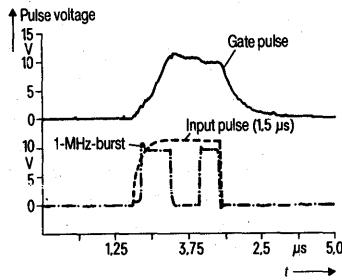

Fig. 2 Waveform in the driver stage

up from one special light-link transmitting diode and one receiving diode and a plastic fiber about 4-cm long. A shrink sleeve supports the junction between the diodes and the fiber and protects the

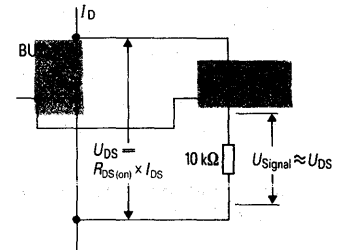

Fig. 3 Circuit (extract) for low-loss capture of the signal for current measurement

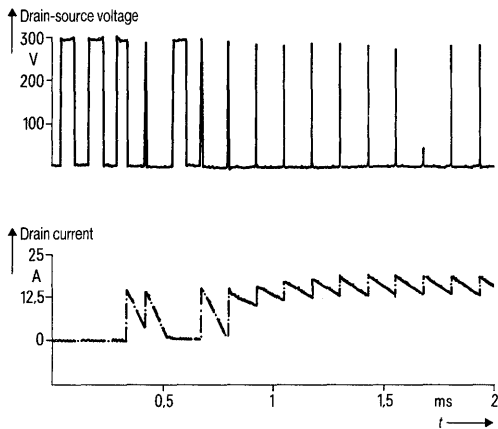

Fig. 4 Overcurrent behaviour of the Fig. 1 circuit with a load switched in abruptly via T2 (77 μ H, 186 m Ω)

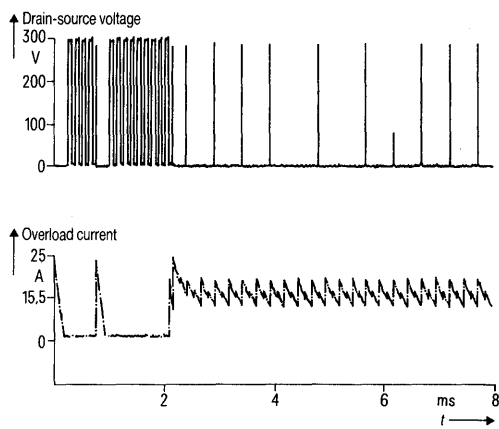

Fig. 6 Current and voltage waveforms in the FREDFET with overload

assembly against extraneous light (Fig. 5).

Coupling capacitance can be neglected in this case, which, in turn leads to excellent $\frac{du}{dt}$ immunity. Here the signal voltage is taken from the source circuit of the small signal transistor. The transmitting diode of the light-link device is connected in series with the Z-diode.

With a certain signal voltage (limit current drop) sufficient current flows through the transmitting diode to cause information to be sent through the plastic fiber to the detecting diode in the drive circuit. An amplifier transistor then actuates the flipflop which turns off the output stage.

The turn-off circuit is incorporated on the low-voltage side because any short-circuit would seriously load the transformer and the risk of coupling in capacitive interference currents in the turn-off circuit would occur.

The current transfer ratio of the diode coupler is very low with this system configuration.

Unambiguous pulse transmission requires a diode current of 50 to 60 mA. The on-resistance of the BSS 125 transistor is a crucial factor in this current, so that the Z-diode voltage should be fairly small for a trigger current of 10 A. The actual turn-off current (after 2 μ s) is about 18 A with a test overload of 77 μ H and 186 m Ω , see Fig. 4.

The circuit is so designed as to reset the flipflop immediately after the overload current has been turned off. If the overload is not eliminated, the remaining input control pulses will initiate another turn-off operation. This constant repetition results in load current limiting, as can be seen in Fig. 6.

Refer to Appnote 40 "Low Cost, Fiber Optic Systems Using Siemens Light-Link Emitters and Detectors."

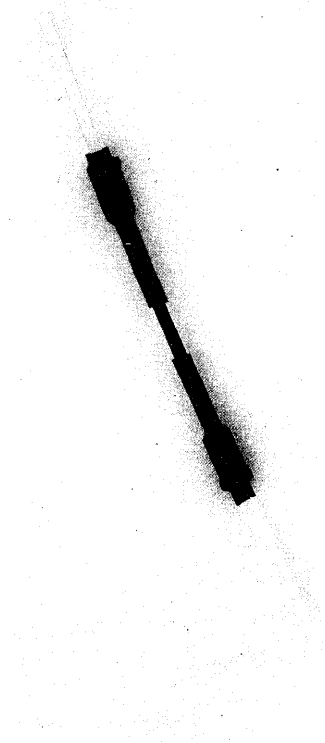

Fig. 5 Diode coupler built from light-link diodes and plastic fiber

SIEMENS

Designing with the Small AlphaNumeric Display Appnote 44

By Bob Krause and Dave Takagishi

Introduction

The Siemens Small AlphaNumeric (SAN) Display family is one of the most versatile and flexible LED readout systems available today. Its four 5x7 characters are dot addressable permitting alphanumeric, graphics, and special symbols to be easily programmed in four colors (red, high efficiency red, yellow, green). SANs are available in 0.15" or 0.20" character heights, which are efficiently assembled in row and column stackable plastic or ceramic DIP packages. These packages allow environmental operation from commercial to the most demanding industrial and military requirements. Table 1 lists the SAN model numbers and their principle characteristics.

The internal CMOS row drivers and memory reduce power consumption and support electronics. Blanking Control makes night vision to sunlight ambient intensity control easy.

This appnote covers the SAN family capabilities which include: display operation, intensity control, thermal and optical management, and an 8051 MPU interface.

Display Operation

As compared to Siemens Intelligent and Programmable Displays, SANs require dot decoded serial data rather than parallel ASCII to operate. Figure 1 block diagram shows that the display with its four 5x7 LED characters and two CMOS 14 bit serial-in, parallel-out (SIPO) shift registers. Each LED matrix is a 5x7 diode array organized with the anode of each column tied in common and the cathodes of each character tied in common. The seven row cathode commons of each character are connected to the constant current sinking outputs of the seven successive stages of the shift register. The like columns of the four characters are tied together and brought to a single column pin (i.e., column one of all four digits is connected to pin one, etc.). So that any diode of any character may be addressed by shifting data to the appropriate shift register location and supplying current to the appropriate column.

The SIPO shift register has constant current sinking outputs associated with each shift register stage. A FET current mirror supplies a reference signal to all of the 28 constant

Table 1. SAN Display Principal Characteristics

Part No.	Color	Character Height	Power Dissipation*	Temperature Range	Package Type
HDSP2000LP HDSP2001LP HDSP2002LP HDSP2003LP	Red Yellow HER Green	0.15 in.	0.40 W	-40°C to +85°C	Plastic
ISD/MSD2010 ISD/MSD2011 ISD/MSD2012 ISD/MSD2013	Red Yellow HER Green	0.15 in.	0.40 W	-55°C to +100°C	Ceramic
ISD/MSD2310 ISD/MSD2311 ISD/MSD2312 ISD/MSD2313	Red Yellow HER Green	0.20 in.	0.52 W	-55°C to +100°C	Ceramic
ISD/MSD2351 ISD/MSD2352 ISD/MSD2353	Yellow HER Green	0.20 in.	0.74 W	-55°C to +100°C	Ceramic

* 15 LEDs ON per character/4 characters per package.

Figure1. Block Diagram

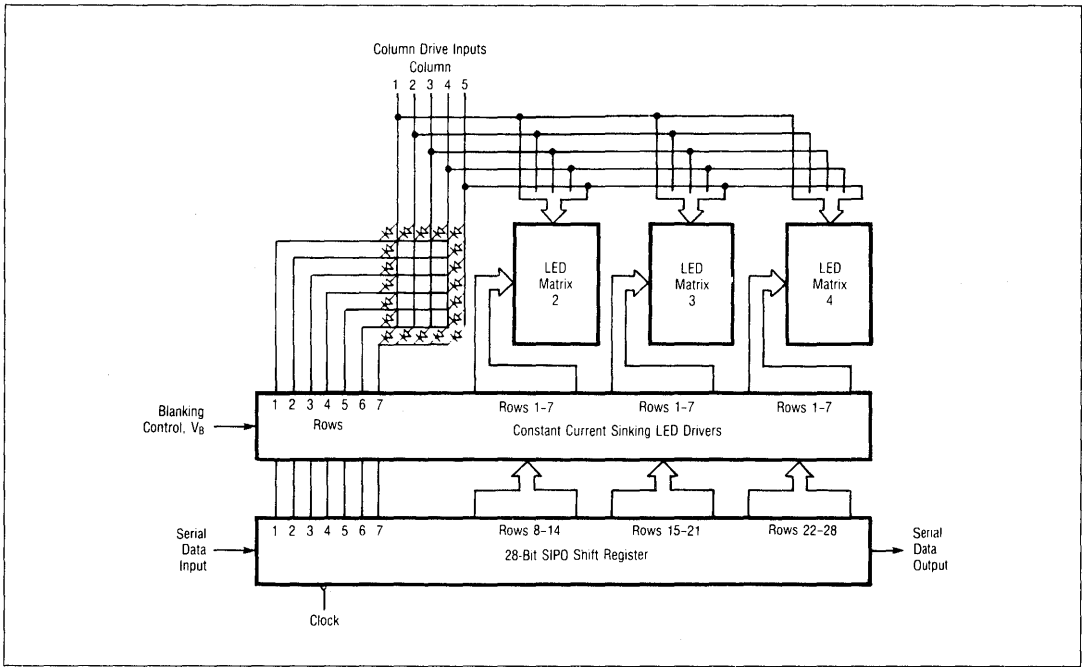

current shift register out (logic 1) and is ANDed with this reference source to turn on the output drivers. Data is loaded serially into the shift register when the clock goes from HIGH to LOW and the data is stable for a minimum hold time and will be latched on the LOW to HIGH signal of the clock.

The Data Output (pin 7) is a TTL buffer interface from the 28th bit of the shift register (i.e., the 7th row of character four in each package). The Data Output directly interconnects to the Data Input (pin 12) on a succeeding SAN display. The data, clock and Vb inputs are all buffered to allow direct interface to any TTL logic family.

Theory of Operation

Dot matrix alphanumeric display systems generally are organized logically so that any character can be generated either as a combination of five subsets of seven bits each or seven subsets of five bits each. This technique reduces from 35 to five or seven the number of outputs required from the character generator. To display a complete character, these subsets of data appear sequentially in the appropriate locations of the display matrix. Repeating this process a minimum of 100 times per second insures that

each of the appropriate matrix locations is re-energized, the eye will perceive a continuous image of the entire character. The apparent intensity of each of the display elements will be equal to the intensity of that element during the "ON" period multiplied by the ratio of the "ON" time to refresh period. This ratio is referred to as the display duty factor and the technique, "strobing."

Each character of SANs is made up of five subsets of seven bits. For a four character display, 28 bits representing the first subset of each of the four characters are loaded serially into the on-board SIPO shift register. The first column is energized for a period of time, T. This process is repeated for columns two through five. If the time required to load the 28 bits into the SIPO shift register is t, the duty factor is: $DF = t/5(t+T)$, and the term $5(t+T)$, the refresh period. For a satisfactory display, the refresh frequency should be $\geq 100\text{Hz}$, which means:

$$5(t+T) = 10\text{ms}$$

$$(t+T) = 2\text{ms}$$

Therefore, two milliseconds is the maximum time period which should be allowed for loading and displaying of each column.

Interfacing

A display system using the SAN display requires interfacing with a character generator and refresh memory electronics. The system in Figure 2 is a single four digit display, therefore the $1/N$ counter becomes a $1/4$ counter where N equals the number of characters in the string. The refresh memory stores the information to be displayed. Information can be coded in any one of several different standard data codes, such as ASCII or EBDIC; or a customized code and display font using a custom coded ROM. The only requirement being that the output data be generated as five subsets of seven bits each.

The character generator receives data from the refresh memory and outputs seven displaying data bits that correspond to the character and the column select data input. This data is converted to serial format in the parallel to serial shift register. In a typical system the right most character to be displayed is selected first, and the data corresponding to the ON and OFF display elements in the first column is clocked into the first seven shift register locations of the SAN.

In a similar manner, column one data for characters three, two and one is selected by the $1/N$ counter, decoded and shifted into the display shift register. After 28 clock counts, data for each character is located in the SAN shift register locations which are associated with the seven rows of the appropriate LED matrix. The $1/N$ counter overflows, triggering the display time counter enabling the output of the $1/5$ column select decoder, and disabling the clock input to the display. The information now in the shift registers will be displayed for a period, T . The divide by five counter which provides column select data for both the SAN and the character generator is incremented one count and column data is loaded and displayed in the same manner as column one.

This process is repeated for each of the five columns which comprise the five subsets of data necessary to display the desired characters. After the fifth count, the $1/5$ decoder automatically resets to one and the sequence is repeated. The only changes required to extend this interface to character strings of more than four digits are to increase the size of the refresh memory and to change the divide one by four counter to a module equal to the number of digits in the desired string.

Since data is loaded for all of the like columns in the display string and these columns are enabled simultaneously, only five columns are enabled simultaneously. Only five column transistors are required regardless of the number of characters in the string. The column switch transistors should be selected to handle approximately 110 mA per character in the display string. The collector voltage saturation voltage characteristics and column voltage supply should be chosen to provide a $2.6V \leq V_{col} < V_{cc}$. To save power supply costs and improve efficiency, this supply may be a full rectified unregulated DC voltage as long as the PEAK value doesn't exceed the V_{cc} and the minimum value doesn't drop below 2.6 volts. Since large current transients can occur if a column line is enabled during data shifting operations, the most satisfactory operations will be achieved if the columns current is switched off before clocking begins.

Interface Design

A logical "1" in the display shift register turns a corresponding LED "ON." Clocking occurs on the high to low transition of the clock input. A character generator which produces seven bit "column" data can be used. The internal shift register is 28 bits in length. The right hand digit is loaded first. Each column should be refreshed at a minimum rate of 100 Hz.

The following program uses a single chip microprocessor to control a SAN display (i.e., the 8051 microprocessor and a Sprague UCN5890A driver). See Figure 3.

The processing speed of a microprocessor is so high that the refresh rate of $1/5$ can't be comprehended, therefore this program repeats itself 255 times before continuing to another line of data (similar to the scanning technique of a television screen).

Figure 2. Block Diagram

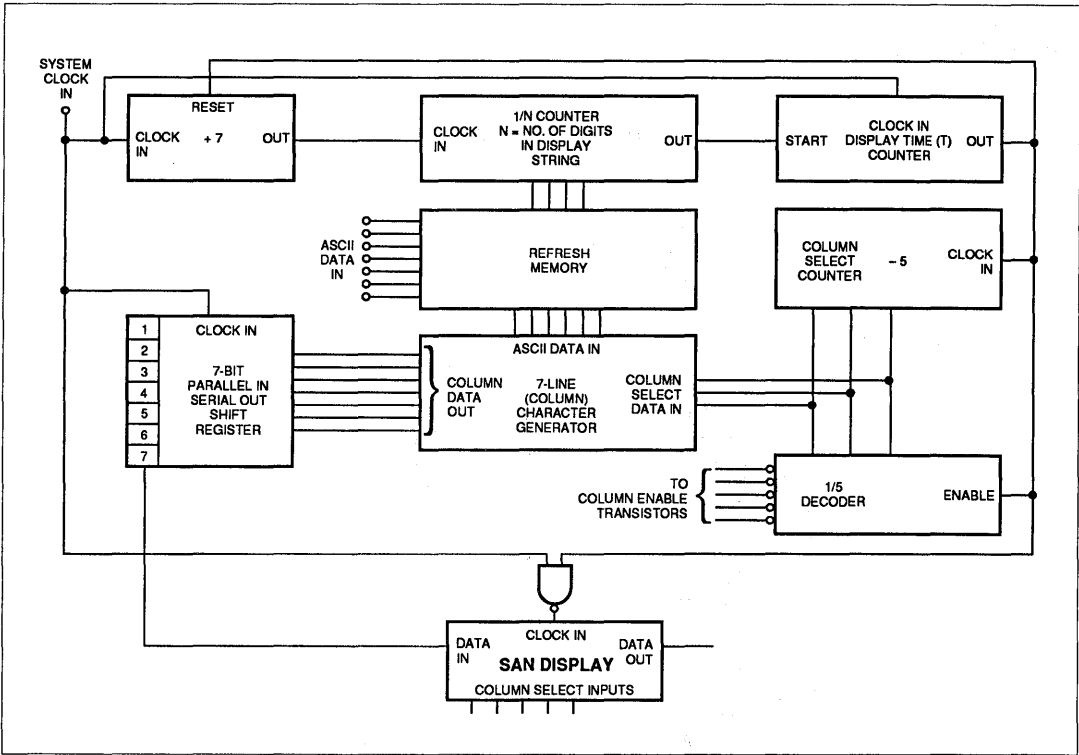
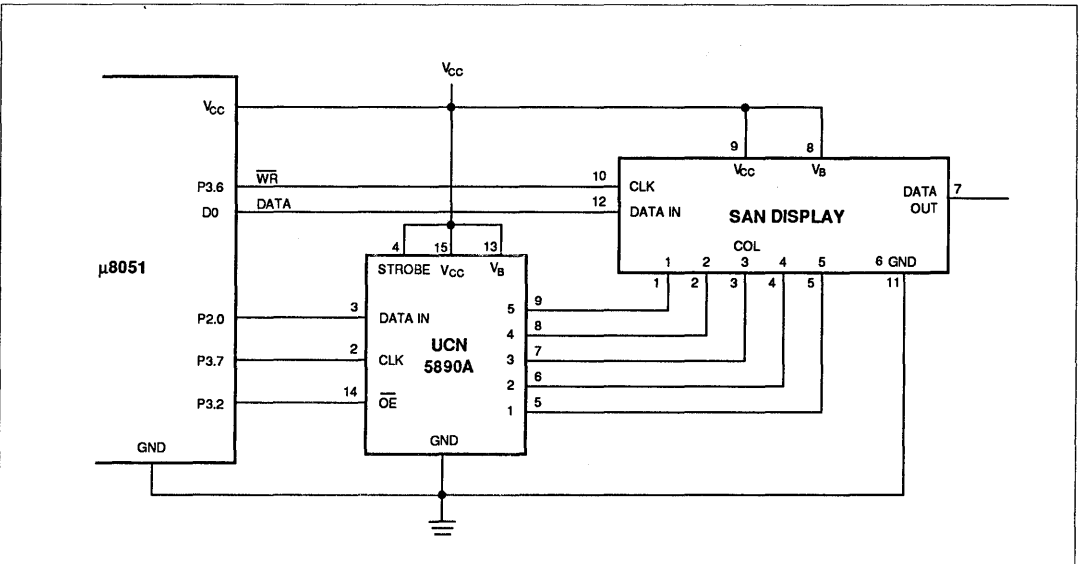

Figure 3. Schematic for SAN Display & UCN5890A



**Program to Drive One SAN Display with the 8051
and the UCN5890A as the Column Driver**

This program assumes that the data memory address is loaded into DPTR prior to entering this subroutine:

```

;R0 = # REPEATS
;R1 = DISPLAY ADDRESS
;R2 = WAIT
;R3 = # COL
;R4 = ROW COUNTER
;R5 = BIT/COL
;R6 = DIGIT COUNTER
;R7 = UNUSED

```

```

REG 30H EQU DPTRL ;DPTR MEM LOW REGISTER
REG 31H EQU DPTRH ;DPTR MEM HIGH REGISTER

HDSP: MOV R0, #0FFH ;# OF REPEAT CYCLES
BEGIN: MOV DPTRL, DPL ;SAVE DPTR LOW
MOV DPTRH, DPH ;SAVE DPTR HIGH
SETB P3.2 ;TURN OFF COLUMN
SETB P2.0 ;DATA 1st COLUMN
START: MOV R3, #5H ;# OF COL
CLR P3.7 ;COL CLK
SETB P3.7 ;COL CLK
MOV R4, #7H ;# ROWS
NXCOL: MOV R6, #4H ;4 DIGITS
NWBYT: MOV R5, #7H ;7 BIT/COL
CLR A
MOVC A, @A+DPTR ;GET DATA
INC DPTR ;INC DATA ADDRESS
NXBT: MOVX @R1, A ;OUTPUT D0 & CLK
RR A ;SHIFT TO NEXT BIT
DJNZ R5, NXBT ;DO 7 TIMES
DJNZ R6, NWBYT ;DO 4 CHARS
CLR P3.2 ;TURN ON COL
MOV R2, #77H ;WAIT TIME
DJNZ R2, $ ;WAIT
MOV R2, #77H
DJNZ R2, $ ;WAIT
SETB P3.2 ;TURN OFF COL
MOV P2, #00H ;SET COL DRVR DATA
DJNZ R3, START ;NEXT COL
MOV DPH, DPTRH ;RESTORE DPTR HIGH
MOV DPL, DPTRL ;RESTORE DPTR LOW
DJNZ R0, BEGIN ;REPEATS?
RET ;RETURN FOR ANOTHER LINE

```

Table 2. SAN Display Optical Characteristics

Part No.	LED PK I_V	Average LED I_V	Character* I_V	Peak I_F	Average I_F	η_V	Average Sterance I_V LED	
	μcd	μcd	mcd	mA	mA	$\mu\text{cd}/\text{mA}$	cd/m^2	ft candle
HDSP2000LP	200	40	0.60	12.0	2.4	17	717	67
HDSP2001LP	750	150	2.25	12.0	2.4	63	1923	179
HDSP2002LP	1430	286	4.30	12.0	2.4	119	3667	340
HDSP2003LP	1550	310	4.65	12.0	2.4	129	3974	369
ISD/MSD2010	200	40	0.60	12.0	2.4	17	717	67
ISD/MSD2011	750	150	2.25	12.0	2.4	63	1923	179
ISD/MSD2012	1430	286	4.30	12.0	2.4	119	3667	341
ISD/MSD2013	1550	310	4.65	12.0	2.4	129	3974	369
ISD/MSD2310	300	60	0.90	13.6	2.7	22	1075	100
ISD/MSD2311	1140	228	3.42	13.6	2.7	84	2923	271
ISD/MSD2312	1632	326	4.89	13.6	2.7	120	4179	388
ISD/MSD2313	2410	482	7.23	13.6	2.7	177	6179	573
ISD/MSD2351	3400	680	10.20	16.0	3.2	212	8718	810
ISD/MSD2352	2850	570	8.55	16.0	3.2	178	7308	679
ISD/MSD2353	3000	600	9.00	16.0	3.2	187	7692	714

* 15 LEDs ON per character, DF=20%.

Optical Considerations

Luminous Intensity Control

The luminous intensity of the Small Alphanumeric display can be easily adjusted from sunlight viewability through night vision requirements (ISD/MSD 235X only).

The light output of the SAN display depends on a number of variables. These include the absolute efficiency of the LED material, the average current through the LED, and the LED's junction temperature. The readability of the display's light output depends upon the luminous and chrominous contrast of the LED diode to the package and ambient lighting environment.

Table 2 lists the luminous intensity per LED for the SAN family. The average character brightness is based on 15 LEDs per character with a 20% duty factor. The time averaged LED current for the SAN is in the range of 2.4 – 3.2 mA/LED (DF = 20%). The Blanking Control (VB) can be used to change the duty factor ON time, resulting in a lower LED intensity. Figure 4 shows a 74LS122 timer whose pulse width can be manually adjusted for a 1000:1 intensity control.

Optical Filtering

Having a bright display does not guarantee readability in a given lighting ambient. The readability of the SAN depends on the contrast of the LED to the ambient light. The human eye measures contrast in both brightness (luminance) and color (chrominance) perception.

There are three contrast ratios that describe the optimum readability for the display. The first is ratio between the ON LED to an OFF LED and should be much greater than one. The second ratio deals with the ON LED to the color and brightness of the surrounding package and also is much greater than one. The third ratio is equal to OFF LED to the brightness and color of the surrounding package. This ratio should be equal to one, meaning no color or brightness difference between the OFF LED and the package.

Figure 4. Brightness Control Using a One Shot Multivibrator

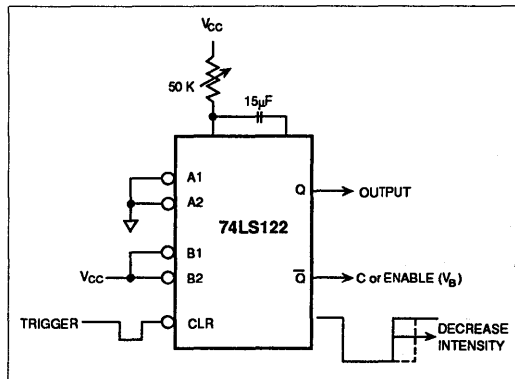

Using proper package design and optical filter selection insures high contrast ratios. In dim ambients high optical transmission long wave and bandpass filters are the best choice. However, in high light ambients low transmission neutral density (grey) filters give the best contrast ratios of the OFF LED and ON LED to the package background, improving the true readability of the display. For sunlight readability, the SAN's glass window permits the use of glass or plastic circularly polarized filters. These filters greatly minimize the incident light that falls on the surface of the OFF LEDs and the package background. Table 3 is a guide for filter selection.

Table 3. Contrast Enhancement Filters

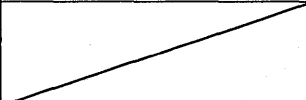
Display Color ⁽²⁾ Part No.	Ambient Light		
	Dim	Moderate	Bright
Red HDSP2000LP	Panelgraphic Dark Red 63 Panelgraphic Ruby Red 60 Chequers Red 118 Plexiglass 2423	Polaroid HNCP37 3M Light Control Film Panelgraphic Gray 10 Chequers Gray 105	
Yellow HDSP2001LP	Panelgraphic Yellow 27		
HER HDSP2002LP	Panelgraphic Ruby Red 60 Chequers Red 112		
Bright Green HDSP2003LP	Panelgraphic Green 48 Chequers Green 107		
			Polaroid HNCP10-Glass Marks Polarized MPC 30-25C Note 1 Polaroid HNCP10-Glass Marks Polarized MPC 20-15C Polaroid HNCP10-Glass Marks Polarized MPC 50-12C
Display Color Part No.	Filter Color	Marks Polarized Corp. Filter Series	Optical Characteristics of Filter
Red, HER MSD 2010, 2012, 2310, 2312, 2352	Red	MPC 20-15C	25% @ 635 nm
Yellow MSD 2011, 2311, 2351	Amber	MPC 30-25C	25% @ 583 nm
Green MSD 2013, 2313, 2353	Yellow/Green	MPC 50-22C	22% @ 568 nm
Multiple Colors High Ambient Light	Neutral Gray	MPC 80-10C	10% Neutral
Multiple Colors	Neutral Gray	MPC 80-37C	37% Neutral

Circular Polarizer

- Note:**
 1. Optically coated circular polarized filters, such as Polaroid HNCP10.
 2. For multiple colors use Marks Polarized Corporation filters, MPC 80-10C or MPC 80-37C.

Polaroid Corporation
 1 Upland Road, Bldg. #2
 Norwood, MA 02062
 ☎ (800) 225-2770

Marks Polarized Corporation
 25-B Jefryn Blvd. W.
 Deer Park, NY 11729
 ☎ (516) 242-1300
 FAX (516) 242-1347

Marks Polarized Corp. manufactures to MIL-I-45208 inspection system.

Figure 5. Normalized Luminous Intensity vs. Junction Temperature

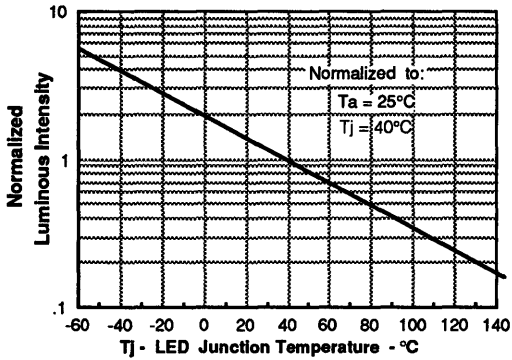

The light output of the LEDs is inversely related to the LED diodes junction temperature as shown in Figure 5. For optimum light output, keep thermal resistance of the socket of PC board as low as possible.

For example, when the HDSP200XLP is mounted in a 10°C/W socket and operated at Absolute Maximum Electrical conditions, the LED junction will rise 17°C above ambient. If $T_A = 40^\circ\text{C}$, then the LED's T_J will be 57°C. Under these conditions Figure 5 shows that the I_v will be 75% of its 25°C value.

Figure 6. Maximum LED Junction Temperature vs. Socket Thermal Resistance

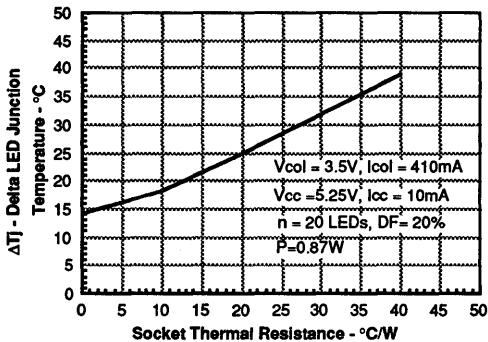

Thermal Consideration

Optimum reliability and optical performance will result when the junction temperature of the LEDs and CMOS ICs are kept as low as possible. The plastic HDSP200XLP should operate to a maximum ambient temperature of 85°C, while maintaining a maximum junction temperature of $\leq 100^\circ\text{C}$. The ceramic and glass SANs (ISD/MSD2XXX) may operate up to 100°C as long as the junction temperature of the IC is maintained at less than 125°C.

Table 4.

Model Number	V_f		
	Min.	Typ.	Max.
HDSP2000LP	1.6	1.7	2.0
HDSP2001/2/3LP	1.9	2.2	3.0

Figure 7. Thermal Model

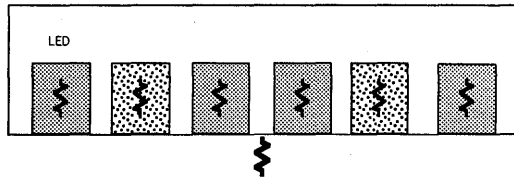

Thermal Modeling

For a thermal model of the display, see Figure 7 which shows junction self heating + the case temperature rise + ambient temperature = junction temperature of the semiconductor. Equation 1 shows this relationship.

Equation 1.

$$T_{J(LED)} = P_{LED} Z_{\theta JC} + P_{CASE} (R_{\theta JC} + R_{\theta CA}) + T_A$$
$$T_{J(LED)} = [(I_{COL}/28) V_{F(LED)} Z_{\theta JC}] + [(n/35) I_{COL} DF (5 V_{COL}) + V_{CC} I_{CC}] \cdot [R_{\theta JC} + R_{\theta CA}] + T_A$$

The junction rise within the LED equals the thermal impedance of an individual LED (37°C/W, DF = 20%, F = 200 Hz) times the forward voltage, $V_{F(LED)}$, and forward current, $I_{F(LED)}$, of 13–14.5 mA. This rise averages $T_{J(LED)} = 1^\circ\text{C}$. Table 4 shows the $V_{F(LED)}$ for respective displays.

The junction rise within the LED driver IC is the combination of the power dissipated by the IC quiescent current and the 28 row driver current sinks. The IC junction rise is given in Equation 2. A thermal resistance of 28°C/W results in a typical junction rise of 6°C.

Equation 2.

$$T_{J(IC)} = P_{COL} (R_{\theta JC} + R_{\theta CA}) + T_A$$
$$T_{J(IC)} = [5 (V_{COL} - V_{F(LED)}) \cdot (I_{COL}/2) \cdot (n/35) DF + V_{CC} \cdot I_{CC}] \cdot [R_{\theta JC} + R_{\theta CA}] + T_A$$

For easier calculations, the maximum allowable electrical operating condition is dependant on the the aggregate thermal resistance of the LED matrixes and the two driver ICs. The parallel combination of these two networks is 15°C/W. All of the thermal management calculations are based on this number. The maximum allowable power dissipation is given in Equation 3.

Equation 3.

$$P_{DISPLAY} = \frac{T_{J(MAX)} - T_A}{R_{\theta JC} + R_{\theta CA}}$$
$$P_{DISPLAY} = 5 V_{COL} I_{COL} (n/35) DF + V_{CC} I_{CC}$$

KEY TO EQUATION SYMBOLS

DF	Duty factor
I_{CC}	Quiescent IC current
I_{COL}	Column current
n	Number of LEDs on in a 5 x 7 array
P_{CASE}	Package power dissipation excluding LED under consideration
P_{COL}	Power dissipation of a column
$P_{DISPLAY}$	Power dissipation of the display
P_{LED}	Power dissipation of a LED
$R_{\theta CA}$	Thermal resistance case to ambient
$R_{\theta JC}$	Thermal resistance junction to case
T_A	Ambient temperature
$T_{J(IC)}$	Junction temperature of an IC
$T_{J(LED)}$	Junction temperature of a LED
$T_{J(MAX)}$	Maximum junction temperature
V_{CC}	IC voltage
V_{COL}	Column voltage
$V_{F(LED)}$	Forward voltage of LED
$Z_{\theta JC}$	Thermal impedance junction to case

How to Use Optocoupler Normalized Curves Appnote 45

by Bob Krause

An optocoupler provides insulation safety, electrical noise isolation, and signal transfer between its input and output. The insulation and noise rejection characteristics of the optocoupler are provided by the mechanical package design and insulating materials.

A phototransistor optocoupler provides signal transfer between an isolated input and output via an infrared LED and a silicon NPN phototransistor.

When current is forced through the LED diode, infrared light is generated that irradiates the photosensitive base-collector junction of the phototransistor. The base-collector junction converts the optical energy into a photocurrent which is amplified by the current gain (HFE) of the transistor.

The gain of the optocoupler is expressed as a Current Transfer Ratio (CTR), which is the ratio of the phototransistor collector current to the LED forward current. The current gain (HFE) of the transistor is dependent upon the voltage between its collector and emitter. Two separate CTRs are often needed to complete the interface design. The first CTR, the non-saturated or linear operation of the transistor, is the most common specification of a phototransistor optocoupler and has a V_{ce} of 10 volts. The second is the saturated or switching CTR of the coupler with a V_{ce} of 0.4 volts. Figure 1 and 2 illustrate the Normalized CTR_{CE} for the linear and switching operation of the phototransistor. Figure 1 shows the Normalized Non-Saturated CTR_{CE} operation of the coupler as a function of LED current and ambient temperature when the transistor is operated in the linear mode. Normalized $CTR_{CE(SAT)}$ is illustrated in Figure 2. The saturated gain is lower with LED drive greater than 10 mA.

Figure 1. Normalized CTR versus I_F and T_{amb}

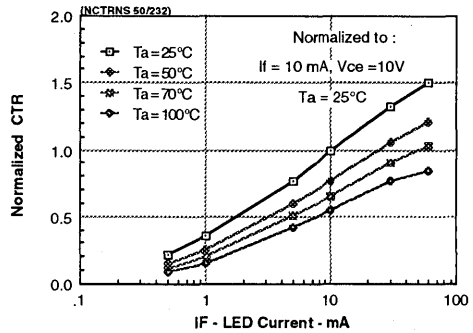
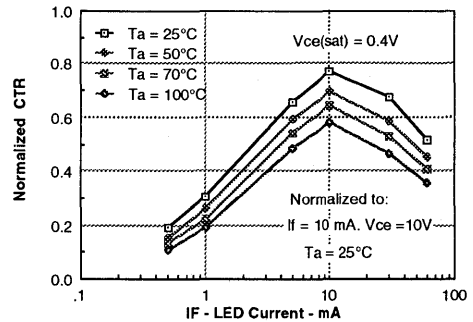

Figure 2. Normalized Saturated CTR



The following design example illustrates how normalized curves can be used to calculate the appropriate load resistors.

Problem 1.

Using an IL1 optocoupler in a common emitter amplifier (Figure 3) determine the worst case load resistor under the following operation conditions:

Figure 3. IL1 to 74HC04 Interface

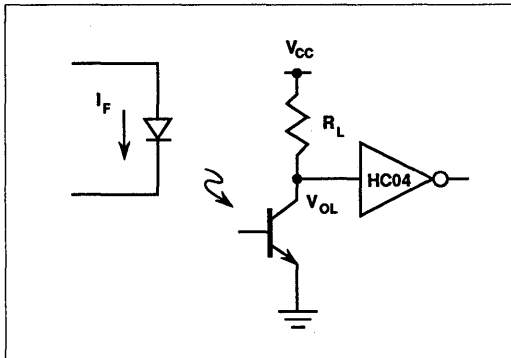

$T_{amb}=70^{\circ}\text{C}$, $I_F=2\text{ mA}$, $V_{OL}=0.4\text{ V}$, Logic load=74HC04

IL1 Characteristics:

$CTR_{CE(NON\ SAT)}=20\%$ Min. @ ($T_{amb}=25^{\circ}\text{C}$, $I_F=10\text{ mA}$, $V_{CE}=10\text{ V}$)

Solution

Step 1. Determine $CTR_{CE(SAT)}$ using the normalization factor ($NF_{CE(SAT)}$) found in Figure 2.

Figure 4. Normalized Saturated CTR

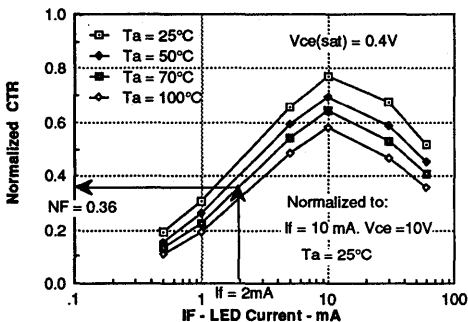

$$(1) \quad CTR_{CE(SAT)} = CTR_{CE(NON\ SAT)} \cdot NF_{CE(SAT)}$$

$$CTR_{CE(SAT)} = 20\% \cdot 0.36$$

$$CTR_{CE(SAT)} = 7.2\%$$

Step 2. Select the minimum load resistor using the following equation

$$(2) \quad R_{L(MIN)} = \frac{V_{CC} - V_{OL}}{\frac{CTR_{CE(SAT)} I_F}{100\%} - I_{IL}}$$

$$R_{L(MIN)} = \frac{5\text{ V} - 0.4\text{ V}}{\frac{7.2\% \cdot 2\text{ mA}}{100\%} - 50\mu\text{A}}$$

$$R_{L(MIN)} = 48.94\text{ K}\Omega, \text{ select } 51\text{ K}\Omega \pm 5\%$$

The switching speed of the optocoupler can be greatly improved through the use of a resistor between the base and emitter of the output transistor. This is shown in Figure 5. This resistor assists in discharging the charge stored in the base to emitter and collector to base junction capacitances. When such a speed-up technique is used the selection of the collector load resistor and the base-emitter resistor requires the determination of the photocurrent and the HFE of the optocoupler.

The photocurrent generated by the LED is described by the CTR_{CB} of the coupler. This relationship is shown in equations 3 and 4. Equation 5 shows that CTR_{CE} is the product of the CTR_{CB} and the HFE of the transistor is easily determined by evaluating equation 4, once the $CTR_{CE(SAT)}$ and CTR_{CB} are known. The Normalized CTR_{CB} is shown in Figure 6. Equations 5, 6, and 7 describe the solution for determining the R_{BE} that will permit reliable operation.

Figure 5. Optocoupler/Logic Interface with R_{BE} Resistor

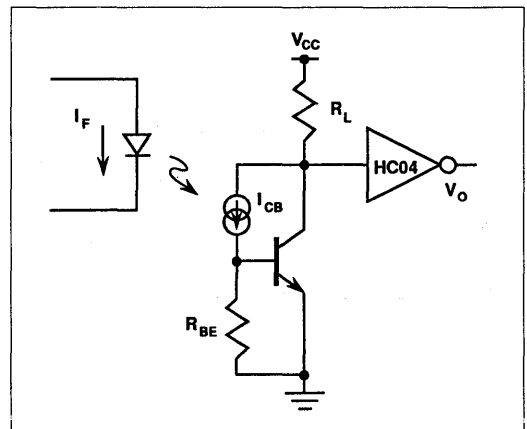
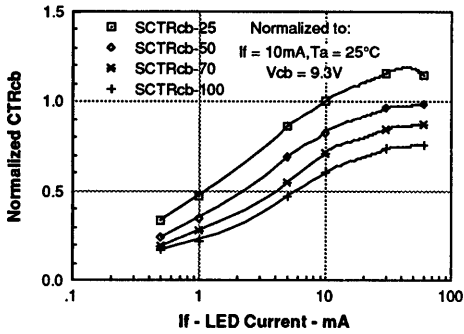

Figure 6. Normalized CTR_{CB} versus LED Current



$$(3) \quad CTR_{CB} = \frac{i_{CB}}{I_F} \times 100\%$$

$$(4) \quad I_{CB} = I_F \frac{CTR_{CB}}{100\%}$$

$$(5) \quad CTR_{CE(SAT)} = CTR_{CB} HFE_{(SAT)}$$

$$(6) \quad HFE_{(SAT)} = \frac{CTR_{CE(SAT)}}{CTR_{CB}}$$

$$(7) \quad R_{BE} = \frac{V_{be}}{I_{CB} - I_{BE}}$$

$$(8) \quad R_{BE} = \frac{V_{BE} HFE_{(SAT)} R_L}{I_{CB} HFE_{(SAT)} R_L - [V_{CC} - V_{CE(SAT)}]}$$

$$(9) \quad R_{BE} = \frac{V_{BE} \frac{CTR_{CE} NF_{CE(SAT)}}{CTR_{CB} NF_{CB}} R_L}{\frac{I_F CTR_{CE} NF_{CE(SAT)} R_L}{100\%} - [V_{CC} - V_{CE(SAT)}]}$$

Problem 2

Using an IL2 optocoupler in the circuit shown in Figure 6, determine the value of the collector load and base-emitter resistor, given the following operational conditions:

$$T_{amb} = 70^\circ\text{C}, I_F = 5 \text{ mA}, V_{OL} = 0.4 \text{ V}, \text{ Logic load} = 74\text{HC04}$$

IL2 Characteristics:

$$CTR_{CE} = 100\% @ T_{amb} = 25^\circ\text{C}, V_{CE} = 10 \text{ V}, I_F = 10 \text{ mA}$$

$$CTR_{CB} = 0.24\% @ T_{amb} = 25^\circ\text{C}, V_{CB} = 9.3 \text{ V}, I_F = 10 \text{ mA}$$

Solution

Step 1. Determine $CTR_{CE(SAT)}$ and CTR_{CB} .

From Figure 2 the $CTR_{CE(SAT)} = 55\%$, $[NF_{CE(SAT)} = 0.55]$

From Figure 6 the $CTR_{CB} = 0.132\%$, $[NF_{CB} = 0.55]$

Step 2. Determine R_L

From Equation 2 $R_L = 1.7 \text{ K}\Omega$

Select $R_L = 3.3 \text{ K}\Omega$

Step 3. Determine R_{BE} , using Equation 9

$$(10) \quad R_{BE} = \frac{0.65 \text{ V} \frac{100\% \cdot 0.55}{0.24\% \cdot 0.55} \cdot 3.3 \text{ K}\Omega}{\frac{5 \text{ mA} \cdot 100\% \cdot 0.55 \cdot 3.3 \text{ K}\Omega}{100\%} - [5 \text{ V} - 0.4 \text{ V}]}$$

$$R_{BE} = 199 \text{ K}\Omega, \text{ select } 220 \text{ K}\Omega$$

Using a $3.3 \text{ k}\Omega$ collector and a $220 \text{ K}\Omega$ base-emitter resistor greatly minimize the turn-off propagation delay time and pulse distortion. The following table illustrates the effect the R_{BE} has on the circuit performance.

	$I_F = 5 \text{ mA}, V_{CC} = 5 \text{ V}$	
	$R_L = 3.3 \text{ K}\Omega$ $R_{BE} = \infty \Omega$	$R_L = 3.3 \text{ K}\Omega$ $R_{BE} = 220 \text{ k}\Omega$
t_{delay}	1 μs	2 μs
t_{rise}	4 μs	5 μs
$t_{storage}$	17 μs	10 μs
t_{fall}	5 μs	12 μs
t_{PHL}	3.5 μs	7 μs
t_{PLH}	22 μs	12 μs
Pulse Distortion 50 μs pulse	37%	10%

Not only does this circuit offer less pulse distortion, but it also improves high temperature switching and lower static DC power dissipation and improved common mode transient rejection.

Sunlight Readability Contrast Measurements for the MSD2351 and MSD2353 Serial Input Small Alphanumeric Military Display Appnote 47

by Bob Krause

Introduction

Light emitting diode alphanumeric displays have had a long and successful relationship with military and avionic equipment. Applications with very high light ambients now are possible because of advances in the efficiency of LEDs. Polarized filters enhance the readability of LEDs by eliminating much of the ambient reflection from the LED die and the surrounding package.

Readability Criteria

An observer's ability to perceive the information from an alphanumeric display depends on two factors. These include font and size of the message in relationship to the viewing position and the optical contrast of the message to the surrounding environment.

Optical contrast is the comparison of the brightness or sterance (L) of the On/OffLED to the brightness of the surrounding environment. High readability results by optimizing the following contrast ratios. The first ratio, C_1 , involves the OnLED sterance, L_{LEDOn} , and the background sterance, L_B , is optimized when the OnLED is brighter than the surrounding area. Thus C_1 will be much greater than unity (1).

The next ratio, C_2 , involves the sterance ratio of the On, L_{LEDOn} , and Off, L_{LEDOff} LED. C_2 is optimized when the L_{LEDOn} is much greater than the L_{LEDOff} resulting in being much greater than unity (1).

Ratio Equations

1) C_1 —OnLED to Background

$$C_1 = \frac{L_{LEDOn} - L_B}{L_B}$$

2) C_2 —OnLED to OffLED

$$C_2 = \frac{L_{LEDOn} - L_{LEDOff}}{L_{LEDOff}}$$

3) C_3 —OffLED to Background

$$C_3 = \frac{|L_{LEDOff} - L_B|}{L_B}$$

The optimal ratio of C_3 , involving OffLED to the background, is achieved when the ratio is near zero. The OffLED should have minimal contrast with the background.

The equations for these three ratios are given below.

The U.S. military has established contrast ratios limits to satisfy sunlight readability criteria. These criteria are published in, "Night Vision Goggle Lighting Specification." The specifications are shown below:

$$C_1\text{—OnLED to Background} \geq 2.0 : 1 \text{ Minimum}$$

$$C_2\text{—OnLED to OffLED} \geq 2.0 : 1 \text{ Minimum}$$

$$C_3\text{—OffLED to Background} \leq 0.25 : 1 \text{ Maximum}$$

Optical Filtering

An LED, regardless of its brightness, has a difficult time competing with the sterance of the sun. An LED display's readability can be greatly improved by using contrast enhancement filters. The filter of choice is one that eliminates the interference of the sun with the background of the display. A number of filter vendors offer anti-reflection coated, circular polarized (AR/CP), optically tinted bandpass and neutral density filters which have proven very helpful in satisfying the sunlight readability contrast requirements.

The display front surface and the areas surrounding the LEDs have specular reflector characteristics. This reflective property allows optimum contrast when used with a circular polarized filter with anti-reflective coating. See Table 1 for Filter Selection Guide.

Table 1. Contrast Enhancement Filter Selection Guide

Display P/N or Condition	Display Color	Transmission	Filter Color	Filter Model No. Filter Manufacturer
MSD2010 MSD2012 MSD2352* MSD2310 MSD2312	Red/ Hi Eff. Red	25% @ 635nm	Red	MPC 20-15C Marks
MSD2011 MSD2351* MSD2311	Yellow	25% @ 585nm	Amber	MPC 30-25C Marks
MSD2013 MSD2353* MSD2313	Hi Eff. Green	22% @ 565nm	Yellow/Green	MPC 50-22C Marks
High Ambient Light	All Colors	10% Neutral	Neutral Gray	MPC 80-10C Marks
High Ambient Light	All Colors	37% Neutral	Neutral Gray	MPC 80-37C Marks
MSD2010 MSD2012 MSD2352* MSD2310 MSD2312	Red/ Hi Eff. Red	14%	Reddish Orange	HLF-608-5R Hoya
MSD2011 MSD2351* MSD2311	Yellow	14%	Yellowish Orange	HLF-608-3Y Hoya
MSD2013 MSD2353* MSD2313	Hi Eff. Green	14%	Yellow/Green	HLF-608-1G Hoya
High Ambient Light	All Colors	10% Neutral	Neutral Gray	HNCP10 Polaroid

* Sunlight viewable displays. All other part numbers represent *all* the standard Military Small Alphanumeric Displays.

Manufacturers

Marks Polarized Corporation
25B Jefryn Blvd. West
Deer Park, NY 11729-5715
(516) 242-1300

HOYA Optics, Inc.
3400 Edison Way
Fremont, CA 94538-6138
(415) 490-1880

Polaroid Corp.
Polarizer Division
1 Upland Road
Norwood, MA 02062
(617) 577-2000

CONTRAST MEASUREMENTS

The ability to read a display in direct sunlight used to be determined by using a series of standard observers and irradiating the display with one sun. Recent technical studies have established contrast criteria permitting laboratory measurements that verify sunlight readability.

A yellow MSD2351 and a high efficiency green MSD2353 Small Alphanumeric Display were evaluated for sunlight readability under a simulated sun with an incident of 4200fc. These two displays were tested with both pass-band and neutral density AR/CP filters. The measurement technique and results follow.

Contrast Measurement Setup

Contrast measurements require the use of a spot photometer, which measures the luminance of the surface within a specific spot size. A Photo Research Spectra Pritchard spot photometer Model 1980B with a Macro Spectra MS-80 Lens was calibrated and set to read out in foot Lamberts, fL. The display and filter were mounted on a micro adjustable X/Y/Z stage. This stage, the spot photometer, and a 500W Unimat LX80 light source were mounted on an optical bench. The light source was oriented 30° from the normal of the display. See Figure 1.

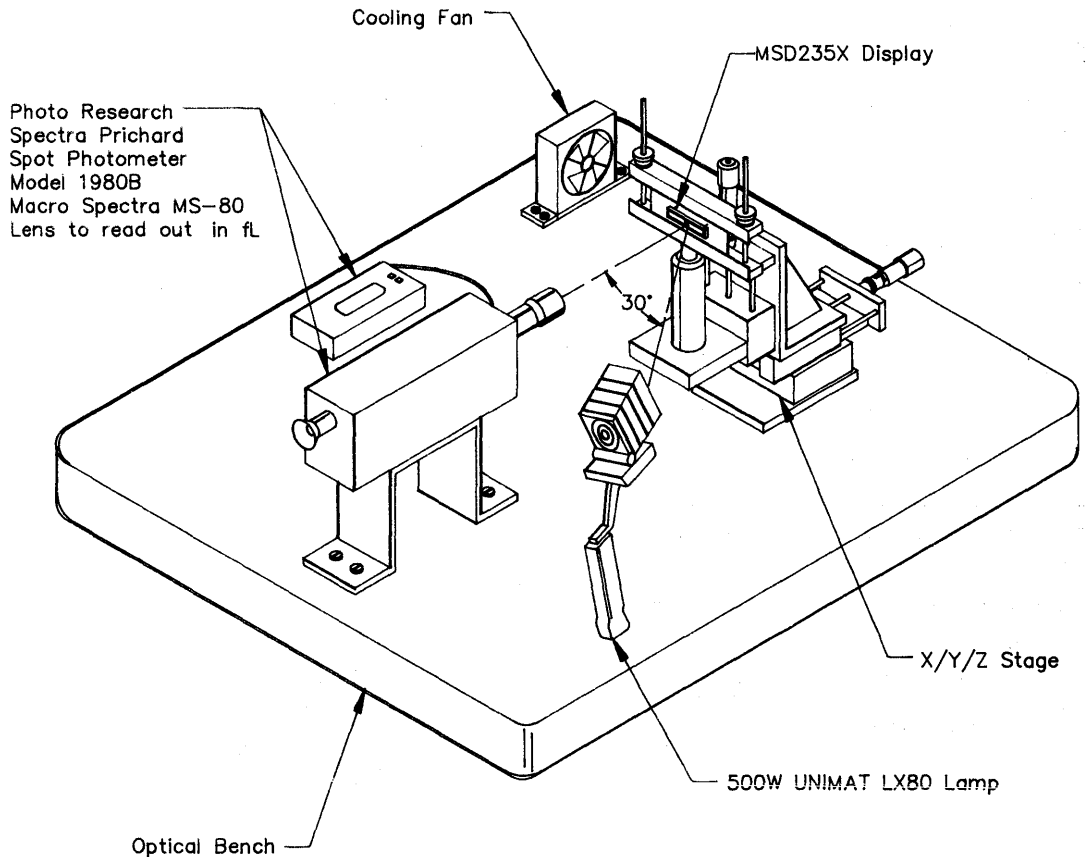

Figure 1. Sunlight Readability Contrast Measurement Setup

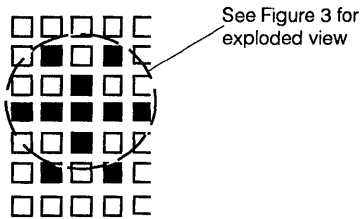

Figure 2. LEDs Selected for Measurement

The sterance measurements were made using the photometer with an angle setting of 2 minutes resulting in a spot size of .004 in. The incidence flux was determined by using a Kodak 6080 standard lambertian reflector painted slide.

The X/Y/Z stage supported the display, the AR/CP filter, and the display drive electronics. Figure 2 shows the asterisk (*) programmed on the display. Each LED had a duty factor of ON 17.6%. The center of the asterisk was used as the measurement LED. The stage was used to position the display at the four contrast measurements points as shown in Figure 3.

Contrast Calculations

The data derived from the spot photometer was used to calculate the three contrast ratios, C_1 , C_2 , C_3 . For best accuracy, L_B was the average of three spot locations. Figure 2 shows these as L_a , L_b , L_c . L_a is the substrate sterance between two LED die; L_b is the substrate sterance of the area between four LED die; and L_c is the sterance of a gold trace connecting the LEDs.

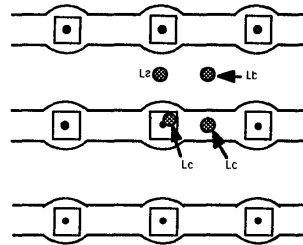

Figure 3. Points for Luminous Stearance Measurement

Measurements were made using a yellow MSD2351 and a Marks MPC80-10C neutral density gray filter. This display had a typical intensity of 2450 μ cd/LED with an average wavelength of 585nm.

Measurements were also made using a green MSD2353 with a Marks MPC50-22C yellow/green bandpass filter and a Marks MPC80-10C neutral density gray filter. This display had a typical intensity of 3470 μ cd/LED with an average wavelength of 572nm.

The data and results of the experiment are shown in Table 2.

Conclusion

From the data, the most readable combination is the green MSD2353 display and a green bandpass AR/CP filter, followed by the green display and the 10% transmissive neutral density gray AR/CP filter. In both cases these combinations exceeded the military limit by almost 2.5 times. The yellow display has optimum contrast with a neutral density AR/CP gray filter.

Table 2. Luminous Contrast @ 4200fC

Display Color Filter Model #	Status	Footlamberts							
		L_a	L_b	L_c	L_d	L_B	C_1	C_2	C_3
Green MPC50-22C	LED-On	12.00	10.20	27.10	101.60	16.43	5.18	7.06	0.08
	LED-Off	11.00	9.40	20.60	12.60	13.67			
Green MPC80-10C	LED-On	9.70	8.60	17.80	69.80	12.03	4.80	5.91	0.05
	LED-Off	8.80	8.60	11.40	10.10	9.60			
Green MPC50-22C	LED-On	12.60	11.30	37.30	111.00	15.30	6.25	6.71	0.12
	LED-Off	11.10	9.80	17.70	14.40	12.87			
Yellow MPC80-10C	LED-On	9.30	8.20	19.40	46.50	12.30	2.78	5.04	0.09
	LED-Off	7.80	7.20	10.30	7.70	8.43			
Yellow No Filter	LED-On	208.00	198.00	650.00	480.00	352.00	0.36	1.81	0.58
	LED-Off	198.00	171.00	853.00	171.00	407.33			

Optocouplers for Safe Electrical Isolation to VDE 0884 Appnote 48

by Gerhard Kaiser

Because of their high reliability and long life, optocouplers are used in applications requiring safe electrical isolation of two circuits, such as in switched-mode power supplies (SMPS). Optocouplers have to comply with the relevant VDE standards and/or international standards like IEC when used for protecting systems against electrical damage.

Currently the tendency is to incorporate international standards (e.g. IEC) into the German VDE regulations. On the other hand, the goal is to make a national VDE standard (such as one that has proved to increase safety) into an internationally recognized IEC standard. For example, a new VDE standard, VDE 0884, has just been introduced in Germany and also is being reviewed in various international standardization committees.

German VDE standards are divided into three main groups:

- Basic VDE standards, such as VDE 0110 which describes air and creepage path requirements in general
- VDE standards governing components, such as the recently expired VDE 0883 standard for optocouplers
- VDE standards governing systems and equipment, such as VDE 0805/0806 for office machines and EDP systems

Optocouplers used in a switched mode power supply of a computer have to satisfy the requirements of VDE 0883 and VDE 0805/0806.

Thickness of solid insulation between conducting parts, the *isolation test voltage* and the *air and creepage paths* are crucial in applications requiring reliable electrical isolation. Depending on the sensitivity of the application, different values are given in the VDE standards.

For example, an electrical control cabinet will probably be opened and operated infrequently and only by skilled staff. However, it's not unusual for a cup of coffee to be spilled accidentally over the keyboard of an electric typewriter. Thus the requirements to be met in the two cases are very different.

The latest findings in high-voltage technology have questioned two parameters *thickness of solid insulation* and *isolation test voltage*. Dielectric strength does increase with the thickness of the insulating material, but *only* when the insulating material is

homogeneous and free of impurities or air-pockets. A high-quality thin insulation can be better than a thick layer with impurities or air-bubbles. The trend is clearly towards reducing insulation thickness (about 0.3 to 0.5 mm) for more economical manufacturing and technologically advanced optocoupler functions

To test the breakdown strength, isolation test voltage normally lasts 60 seconds in qualification tests and up to one second in 100% inspection (depending on the particular VDE standard). However, no determination is made whether any partial discharge occurs in the insulation material during testing. This requires measurement equipment of extreme sensitivity and has been introduced on the market only recently.

Studies in high-voltage technology have shown that a single partial discharge will probably not be extinguished at low voltages and that permanent partial discharge may degrade and damage the insulating material. So that even under normal operating conditions partial discharge may occur when operating voltage is applied. A high-voltage breakdown is likely to occur after a certain time of operation.

The new standard for optocouplers, VDE 0884, used for safe electrical isolation addresses the two drawbacks mentioned earlier. Suitable dielectric strength is now determined by the presence of partial discharges at a defined test voltage. Partial discharges occur with impurities or air-bubbles in the insulating material or insufficient thickness of solid insulation.

The conventional breakdown test (isolation test voltage) may risk causing initial damage to the optocoupler which is not detectable. This test has been replaced in VDE 0884 by the partial discharge test which detects any partial discharge. The absence of partial discharge during the test reliably proves the isolation capability without any undesirable initial damage to the insulation material.

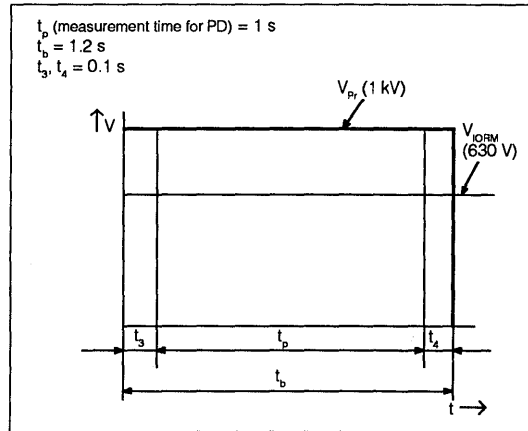
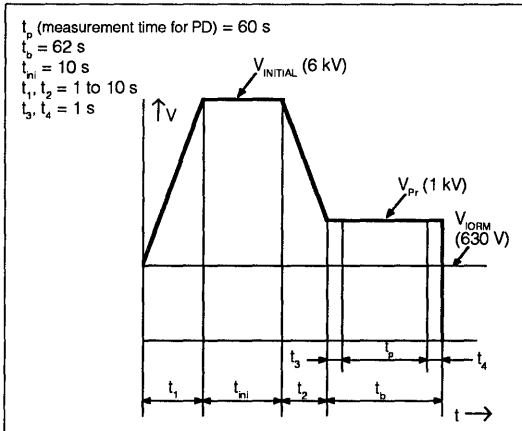

FIGURE 1. Measurement Method A of VDE 0884: A destructive test for the qualification of optocouplers and sample testing in manufacture. This time-test voltage diagram can be used with SFH601 and CNY17 couplers

FIGURE 2. Measurement Method B: A non-destructive test of every component (100% inspection)

Partial discharge measurement method per VDE 0884

Two measurement methods, as described in VDE 0884, have proved to be reliable and suitable for optocouplers.

- Measurement method A—a destructive test to qualify optocouplers and for sample testing in manufacture.
- Measurement method B—a non-destructive test of every component (100% inspection).

Figures 1 and 2 show two typical voltage time curves (AC voltage peak-to-peak values) for Siemens optocoupler testing per VDE 0884.

More VDE 0884 test criteria for safe electrical isolation by optocouplers

In addition to the partial discharge test, VDE 0884 has further requirements to improve optocoupler reliability. For example, data on reliability limits such as limit current, temperature, and/or power dissipation must be given for every approved and qualified component. Figure 3 shows the reliability limit values for SFH601 and CNY17 optocouplers

Limit values are generally higher than the maximum ratings. They indicate whether and if additional components are required in the circuit to ensure safe electrical isolation in case of failure in the surrounding circuitry.

In the qualification test (destructive test) the optocoupler is exposed to numerous tests in rough environments such as humidity cycles or temperature shocks. The optocouplers are then stressed to the limit values for 72 hours. Finally, they are tested partial discharge. Absence of partial discharge (PD) currently means a value below 5 picocoulombs.

Importance of VDE 0884 standard for the future

Optocouplers used in applications for safe electrical isolation are tested for freedom from partial discharge to give improved reliability and useful information on the long term stability of insulating materials. VDE 0884 is only a first

step in this direction. Partial discharge measurements probably will become applicable to transformers, capacitors, and other components. VDE 0883 is no longer the standard since December 1988. However, until the end of 1991 approvals to VDE 0883 will be accepted in the marketplace.

From 1992 optocouplers must have VDE 0884 approval. New designs of PC boards or systems using optocouplers which have to fulfil the requirements of safe electrical isolation, must use only optocouplers with VDE 0884 approval.

Siemens already offers the SFH601 and CNY17 optocouplers with VDE 0884 approval under option I. Other types, especially DIP-4 series, have been approved and soon will be available.

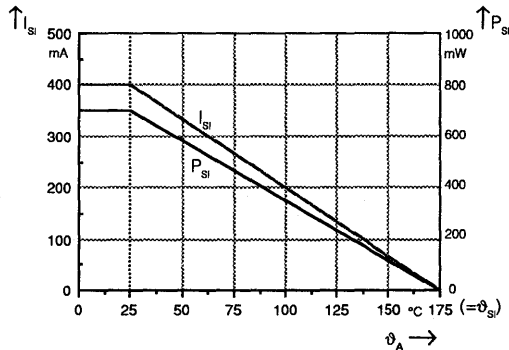

FIGURE 3. Dependency of reliability maximum ratings on ambient temperature for SFH601, CNY17. For every optocoupler type approved to VDE 0884, reliability limit values such as limit temperature, current and power dissipation must be given

About the author
Gerhard Kaiser, Dipl.-Ing. (FH)
Siemens AG Semiconductors,
Optoelectronics Marketing, Munich

SIEMENS

Interfacing the PD243X Alphanumeric Programmable Display™ with the SAB80515/SAB80535 Microcontroller To Produce a Bidirectional, Speed Regulated Moving Message Display by Using the SAB80515/SAB80535's Timer 2 & 8-Bit Converter

Appnote 49

by Ashutosh Ahluwalia

This application note introduces the user to one of the features of Timer 2 and A/D converter of the SAB 80515/535. Included in this application note is a description of both the software and hardware implementations of the SAS 80515/535 to use its Timer 2 and 8-bit A/D converter for the bidirectional, speed regulated moving message display. The program listing demonstrates how the Timer 2 and the 8-bit A/D converter of the SAB 80515/535 can be combined to generate time delays controlled by analog levels. The hardware circuitry shows an interface of the SAP 80515/535 with a simulated analog input, a 2 kbyte EPROM, and intelligent display chips of Siemens used in memory mapped I/O scheme.

The SAB 80515/535 microcontroller with on-chip A/D converter and a 16-bit Timer (Timer 2) with reload capability offers a solution which can be applied to a wide range of industrial applications. These applications vary from analog controlled digital delays to controlled frequency converters for pulse width modulation.

In the present application example, the above features of the SAB 80515/535 are used in conjunction to generate the software delays. The software delay results in varying the voltage level of the analog signal applied to the A/D converter of the SAB 80515/535.

A/D Converter

The SAB 80515/535 provides an 8-bit A/D converter with eight multiplexed analog input channels on-chip. In addition, the A/D converter has a sample and hold circuit and offers the feature of software programmable reference voltages. For the conversion, the method of successive approximation with a capacitor network is used.

Figure 1 shows a block diagram of the A/D converter. There are three user-accessible special function registers:

- ADCON (A/D converter control register)
- ADDAT (A/D converter data register)
- DAPR (D/A converter program register) for the programmable reference voltages.

Special function register ADCON is used to select one of the eight analog input channels to be converted, to specify a single or continuous conversion, and to check the status bit BSY which signals whether a conversion is in progress or not.

The special function register ADDAT holds the converted digital 8-bit data result. The data remains in ADDAT until it is overwritten by the next converted data. The new converted value will appear in ADDAT in the 15th machine cycle after a conversion has been started. ADDAT can be read and written to under software control. If the A/D converter of the SAB 80515/535 is not used, register ADDAT can be used as an additional general-purpose register.

The special function register DAPR is provided for programming the internal reference voltages IVAREF and IVAGND. In the present application DAPR holds a value of 00H. For this value of DAPR, IVAREF and IVAGND are the same as VAREF and VAGND respectively.

A/D Conversion

A conversion is started by writing to the special function register DAPR. A "Write-to-DAPR" will start a new conversion even if a conversion is currently in progress. The conversion begins with the next machine cycle. The busy flag BSY will be set in the same machine cycle as the "write-to-DAPR" operation occurs. If the value written to DAPR is 00H, meaning that no adjustment of the internal reference voltages is desired, the conversion needs 15 machine cycles to be completed. Thus, the conversion time is 15 μ s for 12 MHz oscillator frequency.

Figure 1. Block Diagram of A/D Converter

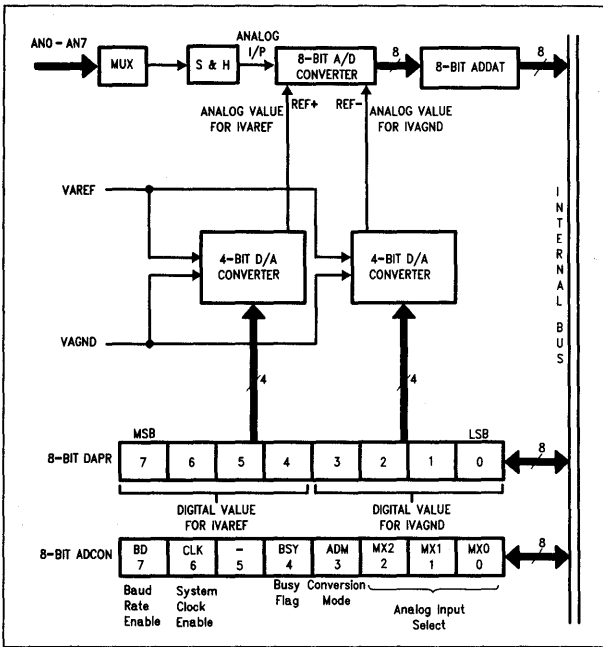

After a conversion has been started by writing into the special function register DAPR, the analog voltage at the selected input channel is sampled for 5 machine cycles (5 μ s at 12 MHz oscillator frequency), which will then be held at the sampled level for the rest of the conversion time. The external analog source must be strong enough to source the current in order to load the sample & hold capacitance, being 25 pF, within those 5 machine cycles.

Conversion of the sampled analog voltage takes place between the 6th and 15th machine cycle after sampling has been completed. In the 15th machine cycle the converted result is moved to ADDAT.

Figure 2. Functional Diagram of Timer 2 in Reload Mode

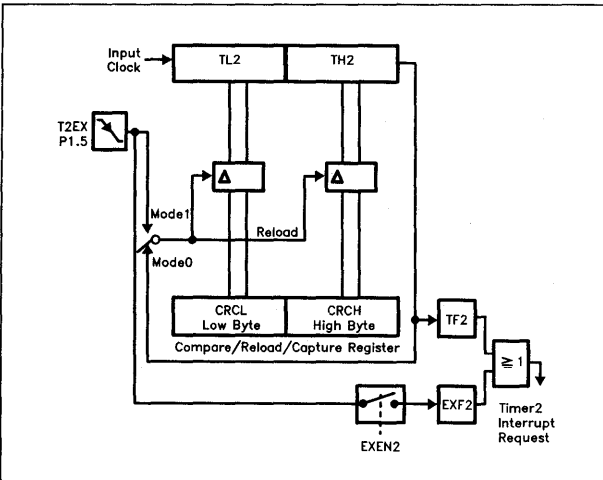

Timer 2

The SAB 80515 has three 16-bit Timer/Counters: Timer 0, Timer 1 and Timer 2. These Timers can be configured to operate either as timers or event counters. Timer 2 is the time base of the programmable Timer/Counter Register Array (PTRA) unit. In addition to the operational modes "Timer" or "counter", Timer 2, being the time base for the PTRA unit, provides the features of:

- 16-bit reload
- 16-bit compare
- 16-bit capture

The reload mode of Timer 2 is used in this application to generate software delays. For explanation of the other modes please refer to the users' manual.

Reload

The reload mode for Timer 2 is selected by bits T2R0 and T2R1 in special function register T2CON as illustrated in Table 1. In mode 0, when Timer 2 rolls over from all 1s to all 0s, it not only sets TF2 but also causes the Timer 2 registers to be loaded with the 16-bit value in the CRC (compare/reload/capture) register which is preset by software. The reload will happen in the same machine cycle in which TF2 is set, thus overwriting the count value 0000H.

Table 1. Timer 2 Reload Mode Selection

T2R1	T2R0	Mode
0	X	Reload Disabled
1	0	Mode 0: Auto-Reload upon Timer 2 Overflow (TF2)
1	1	Mode 1: Reload upon Falling Edge at Pin T2EX/P1.5

PD2435

The PD2435 is a CMOS 4-character 5 x 7 dot matrix alphanumeric programmable display with ROM to decode 128 ASCII alphanumeric characters and enough RAM to store the display's complete four digit ASCII message with software programmable attributes. The CMOS IC incorporates special interface control circuitry to allow the user to control the module as a fully supported microprocessor peripheral.

Microprocessor Interface

The interface to the microprocessor is through the address lines (A0-A2), the data bus (D0-D7), two chip select lines (CE0, CE1), and (RD) and (WR) lines. The CE0 should be held low and CE1 held high when executing a read or write to a specific PD243X device. The read and write lines are both active low. A valid write will enable the data as input lines.

Programming the PD2435

There are five registers within the PD2435. Four of the registers are used to hold the ASCII code of the four display characters. The fifth register is the Control Word, which is used to blink, blank, clear or dim the entire display to change the presentation (attributes) of individual characters.

Figure 3. PD2435 Block Diagram Showing the Major Blocks and Internal Registers

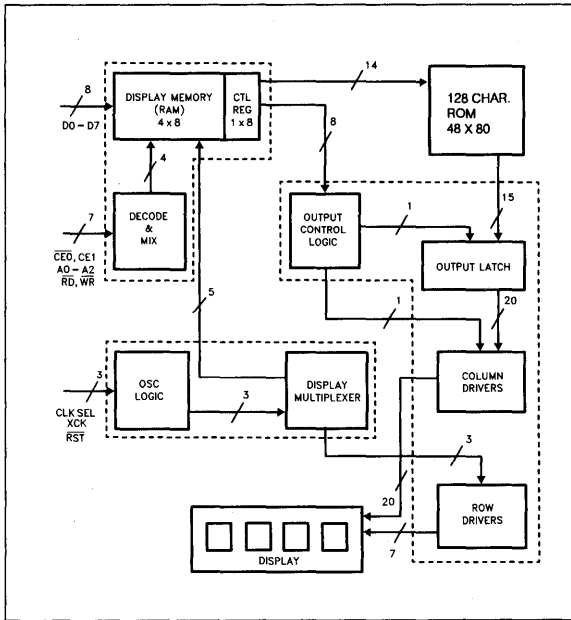

Application

The speed regulated moving message display is an example where a digitized value of the controlling analog signal is used to compute a reload value for the Timer 2. The Timer 2 is operated in mode 0 where this reload value becomes a starting point for the Timer to count up. On overflow the Timer automatically takes the restart value for counting from reload register CRC. While the Timer is counting up, a new reload value is computed using the present A/D value.

Hardware

The circuit used in this application has the advantage of requiring a minimum of components. The single chip microcomputer SAB 80535 operates in conjunction with four alphanumeric programmable display chips PD 2435 to form a 16-digit long display.

The ASCII-coded data is transferred from the SAB 80535 to the display ICs via the data port P0 and using the control signal WR (P3.6) of the SAB 80535. The address pins from the ports P0 and P2 of the SAB 80535 are used to address the EPROM as well as the display chips in a memory-mapped I/O scheme. The display chips are addressed as memory locations with the following addresses.

Display Chip	Control Register Address	Digits Address
1	1000H	1004H-1007H
2	2000H	2004H -2007H
3	4000H	4004H -4007H
4	8000H	8004H -8007H

A push button is interfaced to port P3.2 of the SAB 80535 to provide an external interrupt to the microcontroller.

Firmware Description

Besides controlling speed of the moving message, there is a provision to interrupt the moving message and roll it backwards to the beginning of the message. The microcontroller reads the code and the message to display from an EPROM 2716A interfaced to the ports P0 and P2 of the SAB 80535. A virtual image of the message is created in the internal RAM of the SAB 80535. Four display chips PD2435 are interfaced to the SAB 80535 in a memory-mapped scheme and can be addressed as external memory to the SAB 80535. The virtual image of the message in internal RAM of the SAB 80535 is used to manipulate data to be displayed on the display chips. The internal RAM used for the display can be viewed as an area divided into two portions:

1. For active display
2. As a data buffer

The active display area is the replica of the data being displayed on the display chips. In this case the 16-digit display would need 16 RAM locations which correspond to 16 digits currently being displayed. The data buffer contains the rest of the message which is not being displayed. The message is shifted character by character in the RAM area. When the message on the display moves from right to left, the RAM buffer acts in "First In First Out" mode, and when the message on the display moves from left to right, the data to the display from the microcontroller RAM buffer is supplied in the "Last In First Out" scheme.

Between display of every character there is a software delay which depends upon the level of the analog signal supplied to the ANO pin of the SAB 80535. The external interrupt 0 (at port P3.2) is used to interrupt the microcontroller to inform it that the message needs to be scrolled backwards. On getting this interrupt the software sets the flag bit 0 which remains set until the message is scrolled back to the beginning of the message.

List of Components

Name	Number
SAB 80535	1
271 6A	1
PD2435	4
12 MHz Crystal	1
74LS373	1
22 pF Capacitors	2
100 nF Capacitor	1
4.7 µf Capacitor	1
1 k Resistor	1
10 k Pot	1

Reference Material for ICs

1. SAB 80515/80535 User's Manual.
2. PD2435 Data-Sheet or Optoelectronic Data Book (1990).

Figure 4. Interface Circuit

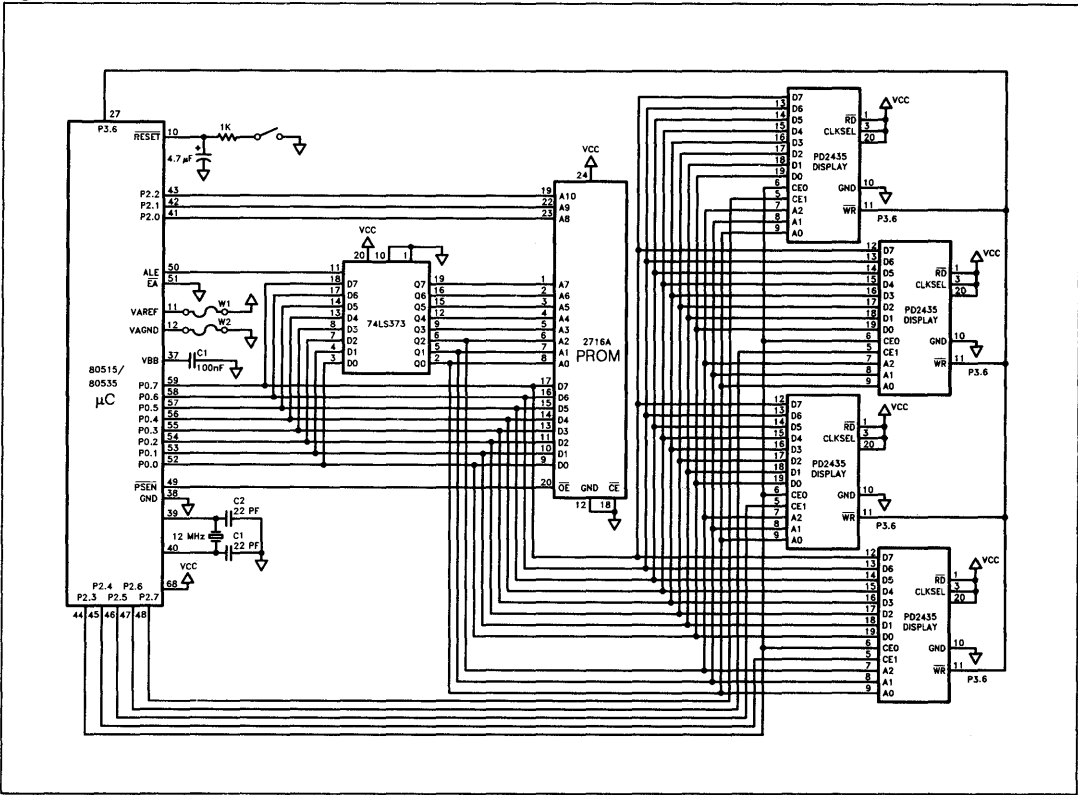
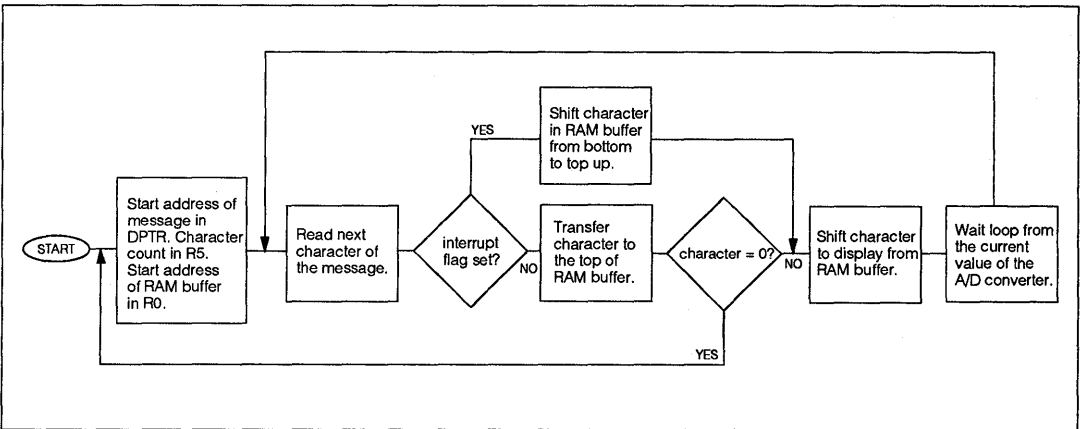

Figure 5. Program Flow Chart



Program Listing

```

UDISP      'PD 2435 DISPLAY PROGRAM'

          1      $TITLE ('PD 2435 DISPLAY PROGRAM')
          2      $MOD515
          3      $NOSYMBOLS
          4
.....     5      CSEG
          6      $DEBUG
          7
0000       8
          9      ORG      00H
         10
0000 02000C 11      LJMP     BEGIN      ;Jump on reset
         12
         13      ;
         14      ;-----
         15      ; This is the interrupt subroutine for INTO. This is used to set a flag
         16      ; which then indicates that the message needs to be rolled back.
         17      ;-----
         18
0003       19      ORG      03H
0003 C0E0   20
0005 D2D5   21      PUSH     ACC
0007 D0E0   22      SETB     F0          ;Set flag for external interrupt
0009 C289   23      POP      ACC
000B 32     24      CLR      IE0
         25      RETI
         26
         27      ;
         28      ; MAIN PROGRAM
         29      ;-----
         30
000C D282   31      BEGIN:  SETB     P3.2      ;Set bit for INTO
000E 758110 32      MOV      SP,#10H
0011 75D800 33      MOV      ADCON, #00H      ;Select analog channel 0
         34
0014 C2D5   35      OPTS:   CLR      F0          ;Clear flag 0
0016 7800   36      MOV      R3,#00H        ;Character pointer in the message
0018 79FF   37      MOV      R1,#0FFH      ;R1 used as a flag
001A 90F000 38      MOV      DPTR,#0F000H   ;Control register of all displays
001D 7403   39      MOV      A,#03H        ;Control word for display
001F F0     40      MOVX     @DPTR,A
0020 9000C2 41      MOV      DPTR,#(TEXT-1) ;Beginning of the text
0023 7820   42      MOV      R0,#20H      ;Internal RAM location
0025 7D65   43      MOV      R5,#101      ;A count for 101 characters
0027 7420   44      MOV      A,#20H      ;ASCII for space
0029 F6     45      BLANK:  MOV      @R0,A      ;Fill all locations with blank
002A 08     46      INC      R0
002B DDFC   47      DJNZ     R5, BLANK
         48
002D 12006C 49      SHIF:   CALL     NEXTC      ;Read the next character
0030 20D501 50      JB      F0, TEMP      ;Check if the interrupt was raised
0033 0B     51      INC      R3          ;If no interrupt
0034 7D65   52      TEMP:   MOV      R5,#101    ;Character count in message
0036 7820   53      MOV      R0,#20H      ;RAM location 20H
0038 20D506 54      JB      F0, REV0
003B C6     55      SHFT:   XCH      A,@R0      ;If no interrupt
003C 08     56      INC      R0          ;Add the character
003D DDFC   57      DJNZ     R5,SHFT      ;To the top of the RAM buffer
003F 0158   58      AJMP     CONT0

```

```

0041 7421      59      REVO:  MOV      A,#21H      ;If there is an interrupt
0043 2B        60      ADD      A,R3          ;Offset for the RAM buffer
0044 F8        61      MOV      R0,A         ;Pointer in the RAM buffer
0045 7600      62      MOV      @R0,#00H     ;Displayed so far
0047 7820      63      MOV      R0,#20H     ;Beginning of the RAM buffer
0049 E6        64      MOV      A,@R0       ;Read the character
004A C0E0      65      PUSH     ACC          ;Save it
004C 08        66      AGAIN: INC      R0        ;Next location in RAM buffer
004D E6        67      MOV      A,@R0       ;Read the next character
004E 18        68      DEC      R0          ;Back to first character
004F F6        69      MOV      @R0,A       ;Replace with second character
0050 08        70      INC      R0          ;Process repeats
0051 DDF9      71      DJNZ    R5, AGAIN    ;Moving character backwards
0053 08        72      INC      R0
0054 7600      73      MOV      @R0,#00H     ;End of character buffer
0056 D0E0      74      POP      ACC          ;Restore character
0058 7820      75      CONTO: MOV     R0,#20H     ;Beginning of character buffer
005A E9        76      MOV      A,R1         ;Check if end of character buffer
005B 6087      77      JZ       OPTS
005D 12071     78      CALL    OUTC
0060 C2AF      79      CLR      IEN0.7       ;Disable interrupt
0062 1200A4    80      CALL    WAITA         ;Before delay
0065 75A881    81      MOV      IEN0,#81H    ;Enable interrupt
0068 D288      82      SETB    IT0           ;INT0 control bit
006A 012D      83      AJMP    SHIF
84
85
86      ; -----
86      ; The routine moves a character of the message to ACC.
87      ; -----
88
006C A3        89      NEXTC: INC      DPTR
006D 7400      90      MOV      A,#0
006F 93        91      MOVC    A,@A+DPTR    ;Move the character to Acc.
0070 22        92      RET
93
94
95      ; -----
95      ; This routine displays and moves a character over the four digits of
96      ; the PD2435 and then repeats for the next display chip and so on.
97      ; -----
98
99
0071 C0E0      100     OUTC:  PUSH     ACC
0073 C082      101     PUSH     DPL
0075 C083      102     PUSH     DPH
0077 7A04      103     MOV      R2,#4        ;For four digits (0 to 3) in a chip
0079 901004    104     MOV      DPTR,#1004H  ;Digit 0 in first display chip
007C 120098    105     CALL    OUTC0
007F 902004    106     MOV      DPTR,#2004H  ;Digit 0 in second display chip
0082 120098    107     CALL    OUTC0
0085 904004    108     MOV      DPTR,#4004H  ;Digit 0 in third display chip
0088 120098    109     CALL    OUTC0
008B 908004    110     MOV      DPTR,#8004H  ;Digit 0 in fourth display chip
008E 120098    111     CALL    OUTC0
0091 D083      112     POP      DPH
0093 0082      113     POP      DPL
0095 D0E0      114     POP      ACC
0097 22        115     RET
116
117
118
119      ; -----
119      ; This is a nested subroutine. It moves a nonzero hex value (ASCII)
120      ; from left to right of the four digit display.
121      ; -----
122

```

```

0098 E6      123      OUTC0:  MOV      A,@R0
0099 6007    124              JZ        FIN
0098 F0      125              MOVX     @DPTR,A
009C 08      126              INC      R0
009D A3      127              INC      DPTR
009E DAF8    128              DJNZ    R2,OUTC0
00A0 7A04    129              MOV      R2,#4
00A2 F9      130      FIN:   MOV      R1,A
00A3 22      131              RET
132
133
134
135
136
137
138
139
00A4 7E03    140      WAITA:  MOV      R6,#03H
00A6 7D10    141      WAITB:  MOV      R5,#10H
00A8 75DA00  142      WAITC:  MOV      DAPR,#00H
00AB E5D9    143              MOV      A,ADDAT
00AD 75F0FF  144              MOV      B,#255          ;For computing reload value
00B0 A4      145              MUL     AB              ;Reload value is computed
00B1 F5CA    146              MOV      CRCL,A         ;Load the reload value low
00B3 85F0C8  147              MOV      CRCH,B         ;Load the reload value high
00B6 75C811  148              MOV      T2CON,#11H
00B9 10C602  149      WAITD:  JBC     TF2,WAITE
00BC 01B9    150              AJMP    WAITD
00BE DDE8    151      WAITE:  DJNZ    R5,WAITC
00C0 DEE4    152              DJNZ    R6,WAITB
00C2 22      153              RET
154
155
156
157
158
00C3 20202020 159      TEXT:  DB
00C7 20202020
00CB 20202020
00CF 20202020
00D3 5349454D 160      DB      'SIEMENS MICROCONTROLLER SAB 80515/535'
00D7 454E5320
00D8 4D494352
00DF 4F434F4E
00E3 54524F4C
00E7 4C455220
00EB 53414220
00EF 38303531
00F3 352F3533
00F7 35
00F8 20202020 161      DB      SAB 80515/535      ',0
00FC 20202020
0100 20202020
0104 53414220
0108 38303531
010C 352F3533
0110 35202020
0114 20202020
0118 20202020
011C 20202020
0120 00      162      END

```

```

; This subroutine generates the software delay. The delay is
; generated by the timer 2. The start count of the timer 2 is
; computed from the present value of the A/D converter.

```

```

; MESSAGE

```

ASSEMBLY COMPLETE, 0 ERRORS FOUND

Designing Linear Amplifiers Using the IL300 Optocoupler Appnote 50

by Bob Krause

Introduction

This application note presents isolation amplifier circuit designs useful in industrial, instrumentation, medical, and communications systems. It covers the IL300's coupling specifications, and circuit topologies for photovoltaic and photoconductive amplifier design. Specific designs include unipolar and bipolar responding amplifiers. Both single ended and differential amplifier configurations are discussed. Also included is a brief tutorial on the operation of photodetectors and their characteristics.

Galvanic isolation is desirable and often essential in many measurement systems. Applications requiring galvanic isolation include: industrial sensors, medical transducers, and mains powered switch mode power supplies. Operator safety and signal quality are insured with isolated interconnections. These isolated interconnections commonly use isolation amplifiers.

Industrial sensors include thermocouples, strain gauges, and pressure transducers. They provide monitoring signals to a process control system. Their low level DC and AC signal must be accurately measured in the presence of high common mode noise. The IL300's 130 dB common mode rejection (CMR), ± 50 ppm/ $^{\circ}$ C stability and $\pm 0.01\%$ linearity provide a quality link from the sensor to the controller input.

Safety is an important factor in instrumentation for medical patient monitoring. EEG, ECG, and similar systems demand high insulation safety for the patient under evaluation. The IL300's 7500 V Withstand Test Voltage (WTV) insulation, DC response, and high CMR are features which assure safety for the patient and accuracy of the transducer signals.

The aforementioned applications require isolated signal processing. Current designs rely on A to D or V to F converters to provide input/output insulation and noise isolation. Such designs use transformers or high speed optocouplers which often result in complicated and costly solutions. The IL300 eliminates the complexity of these isolated amplifier designs without sacrificing accuracy or stability.

The IL300's 200 KHz bandwidth and gain stability make it an excellent candidate for subscriber and data phone interfaces. Present OEM switch mode power supplies are approaching 1 Mhz switching frequencies. Such supplies need output monitoring feedback networks with wide bandwidth and flat phase response. The IL300 satisfies these needs with simple support circuits.

Operation of the IL300

The IL300 consists of a high efficiency AlGaAs LED emitter coupled to two independent PIN photodiodes. The servo (pins 3, 4) photodiode provides a feedback signal which controls the current to the LED emitter (pins 1, 2). This photodiode provides a photocurrent, IP1, that is directly proportional to the LED's incident flux. This servo operation linearizes the LED's output flux and eliminates the LED's time and temperature. The galvanic isolation between the input and the output is provided by a second PIN photodiode (pins 5, 6) located on the output side of the coupler. The output current, IP2, from this photodiode accurately tracks the photocurrent generated by the servo photodiode.

Figure 1 shows the package footprint and electrical schematic of the IL300. The following sections discuss the key operating characteristics of the IL300. The IL300 performance characteristics are specified with the photodiodes operating in the photoconductive mode.

Figure 1. IL300 Schematic

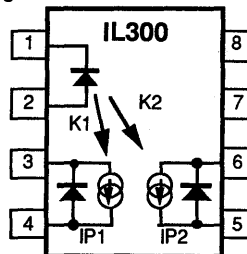

Servo Gain—K1

The typical servo photocurrent, IP1, as a function of LED current, is shown in Figure 2. This graph shows the typical nonservo LED-photodiode linearity is $\pm 1\%$ over an LED drive current range of 1 to 30 mA. This curve also shows that the nonservo photocurrent is affected by ambient temperature. The photocurrent typically decreases by -0.5% per $^{\circ}\text{C}$. The LED's nonlinearity and temperature characteristics are minimized when the IL300 is used as a servo linear amplifier.

Figure 2. Servo Photocurrent vs. LED current

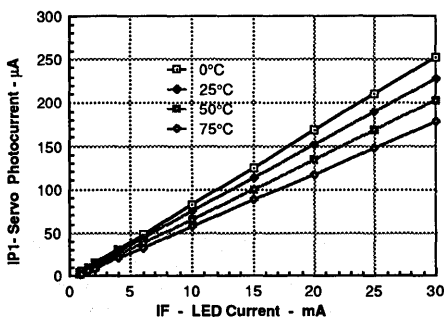

The servo gain is defined as the ratio of the servo photocurrent, IP1, to the LED drive current, IF. It is called K1, and is described in equation 1.

$$\text{Equation 1: } K1 = IP1 / IF$$

The IL300 is specified with an IF = 10mA, Ta = 25°C, and Vd = -15V. This condition generates a typical servo photocurrent of IP1 = 70 µA. This results in a typical K1 = 0.007. The relationship of K1 and LED drive current is shown in Figure 3.

The servo gain, K1, is guaranteed to be between 0.005 minimum to 0.011 maximum of an IF = 10 mA, TA = 25°C, and VD = -15V.

$$\text{Equation 2: } K1(IF, Ta) = K1(\text{data sheet limit}) \cdot NK1(IF, Ta)$$

The minimum servo photocurrent under specific use conditions can be determined by using the minimum value for K1 (0.005) and the normalization factor from Figure 4. The example is to determine IP1 (min) for the condition of K1 at Ta = 75°C, and IF = 6mA.

$$\text{Equation 3: } NK1(IF = 6\text{mA}, Ta = 75^{\circ}\text{C}) = 0.72$$

$$\text{Equation 4: } K1 \text{ MIN}(IF, Ta) = K1 \text{ MIN}(0.005) \cdot NK1(0.72)$$

$$\text{Equation 5: } K1 \text{ MIN}(IF, Ta) = 0.0036$$

Using $K1(IF, Ta) = 0.0036$ in Equation 1 the minimum IP1 can be determined.

$$\text{Equation 6: } IP1 \text{ MIN} = K1 \text{ MIN}(IF, Ta) \cdot IF$$

$$\text{Equation 7: } IP1 \text{ MIN} = 0.0036 \cdot 6\text{mA}$$

$$\text{Equation 8: } IP1 \text{ MIN}(IF = 6\text{mA}, Ta = 75^{\circ}\text{C}) = 21.6\mu\text{A}$$

The minimum value IP1 is useful for determining the maximum required LED current needed to servo the input stage of the isolation amplifier.

Figure 3. Servo Gain vs. LED Current

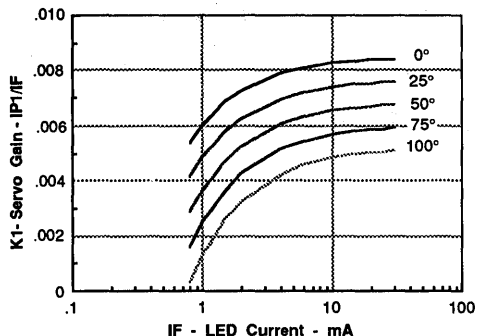

Figure 4. Normalized Servo Gain vs. LED Current

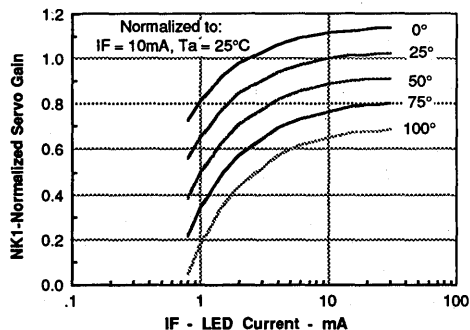

Figure 4 presents the Normalized servo gain, NK1(IF, Ta), as a function of LED current and temperature. It can be used to determine the minimum or maximum servo photocurrent, IP1, given LED current and ambient temperature. The actual servo gain can be determined from equation 2.

Output Forward Gain—K2

Figure 1 shows that the LED's optical flux is also received by a PIN photodiode located on the output side (pins 5, 6) of the coupler package. This detector is surrounded by an optically transparent high voltage insulation material. The coupler construction spaces the LED 0.4 mm from the output PIN photodiode. The package construction and the insulation material guarantee the coupler to have a Withstand Test Voltage of 7500V peak.

K2, the output (forward) gain is defined as the ratio of the output photodiode current, IP2, to the LED current, IF. K2 is shown in Equation 9.

Equation 9: $K2 = IP2 / IF$

The forward gain, K2, has the same characteristics of the servo gain, K1. The normalized current and temperature performance of each detector is identical. This results from using matched PIN photodiodes in the IL300's construction.

Transfer Gain – K3

The current gain, or CTR, of the standard phototransistor optocoupler is set by the LED efficiency, transistor gain, and optical coupling. Variation in ambient temperature alters the LED efficiency and phototransistor gain and result in CTR drift. Isolation amplifiers constructed with standard phototransistor optocouplers suffer from gain drift due to changing CTR.

Isolation amplifiers using the IL300 are not plagued with the drift problems associated with standard phototransistors. The following analysis will show how the servo operation of the IL300 eliminates the influence of LED efficiency on the amplifier gain.

The input-output gain of the IL300 is termed transfer gain, K3. Transfer gain is defined as the output (forward) gain, K2, divided by servo gain, K1, as shown in Equation 10.

Equation 10: $K3 = K2 / K1$

The first step in the analysis is to review the simple optical servo feedback amplifier shown in Figure 5.

The circuit consists of an operational amplifier, U1, a feedback resistor R1, and the input section of the IL300. The servo photodiode is operating in the photoconductive mode. The initial conditions are: $Va = Vb = 0$ V. Initially, a positive voltage is applied to the noninverting input (Va) of the opamp. At that time the output of the opamp will swing toward the positive Vcc rail, and forward bias the LED. As the LED current, IF, starts to flow, an optical flux will be generated. The optical flux will irradiate the servo photodiode causing it to generate a photocurrent, IP1. This photocurrent will flow through R1 and develop a positive voltage at the inverting input (Vb) of the operational amplifier. The amplifier output will start to swing toward the negative supply rail, -Vcc. When the magnitude of the Vb is equal to that of Va, the LED drive

current will cease to increase. This condition forces the circuit into a stable closed loop condition.

When Vin is modulated, Vb will track Vin. For this to happen the photocurrent through R1 must also track the change in Va. Recall that the photocurrent results from the change in LED current times the servo gain, K1. The following equations can be written to describe this activity.

Equation 11: $Va = Vb = Vin = 0$

Equation 12: $IP1 = IF \cdot K1$

Equation 13: $Vb = IP1 \cdot R1$

The relationship of LED drive to input voltage is shown by combining Equations 11, 12, and 13.

Equation 14: $Va = IP1 \cdot R1$

Equation 15: $Vin = IF \cdot K1 \cdot R1$

Equation 16: $IF = Vin / (K1 \cdot R1)$

Equation 16 shows that the LED current is related to the input voltage Vin. A changing Va causes a modulation in the LED flux. The LED flux will change to a level that generates the necessary servo photocurrent to stabilize the optical feedback loop. The LED flux will be a linear representation of the input voltage, Va. The servo photodiode's linearity controls the linearity of the isolation amplifier.

The next step in the analysis is to evaluate the output transresistance amplifier. The common inverting transresistance amplifier is shown in Figure 6. The output photodiode is operated in the photoconductive mode. The photocurrent, IP2, is derived from the same LED that irradiates the servo photodetector. The output signal, Vout, is proportional to the output photocurrent, IP2, times the transresistance, R2.

Equation 17: $Vout = - IP2 \cdot R2$

Equation 18: $IP2 = K2 \cdot IF$

Combining Equations 17 and 18 and solving for IF is shown in Equation 19.

Equation 19: $IF = - Vout / (K2 \cdot R2)$

Figure 5. Optical Servo Amplifier

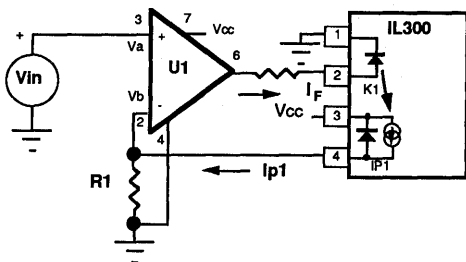
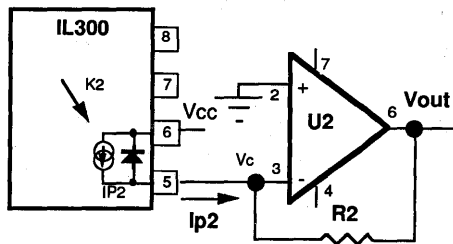

Figure 6. Output Transresistance Amplifier



The input-output gain of the isolation amplifier is determined by combining Equations 16 and 19.

Equation 16: $I_F = -V_{in}/(K1 \cdot R1)$

Equation 19: $I_F = -V_{out}/(K2 \cdot R2)$

Equation 20: $V_{in}/(K1 \cdot R1) = -V_{out}/(K2 \cdot R2)$

Equation 21 gives the solution for the input-output gain.

Equation 21: $V_{out}/V_{in} = -(K2 \cdot R2)/(K1 \cdot R1)$

Note that the LED current, I_F , is factored out of Equation 21. This is possible because the servo and output photodiode currents are generated by the same LED source. This equation can be simplified further by replacing the $K2/K1$ ratio with IL300's transfer gain, $K3$.

Equation 22: $V_{out}/V_{in} = -K3 \cdot (R2/R1)$

Figure 7 shows the composite isolation amplifier including the input servo amplifier and the output transresistance amplifier. This circuit offers the insulation of an optocoupler and the gain stability of a feedback amplifier.

The IL300 isolation amplifier gain stability and offset drift depends on the transfer gain characteristics. Figure 8 shows the consistency of the normalized $K3$ as a function of LED current and ambient temperature. The transfer gain drift as a function of temperature is $\pm 0.005\%/^{\circ}\text{C}$ over a 0°C to 75°C range.

Figure 8. Normalized Servo Transfer Gain

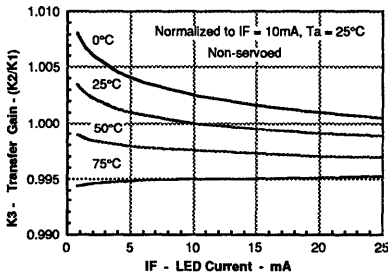
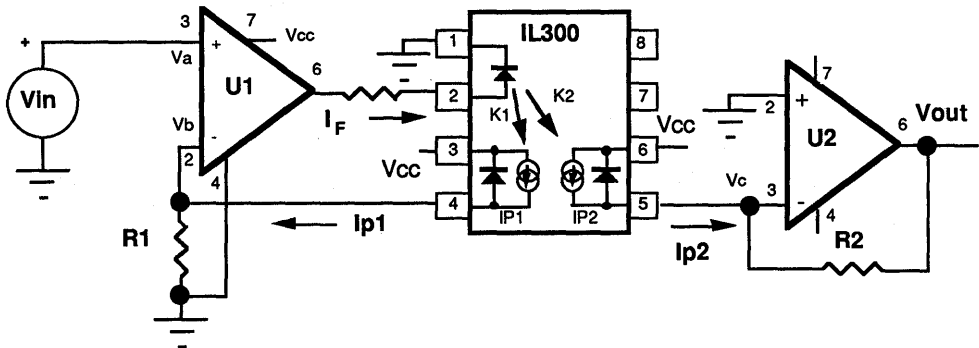

Figure 7. Composite Amplifier



An instrumentation engineer often seeks to design an isolation amplifier with unity gain: $V_{out} / V_{in} = 1.0$. The IL300's transfer gain is targeted for unity gain: $K3 = 1.0$. Package assembly variations result in a range of $K3$. Because of the importance of $K3$, Siemens offers the transfer gain sorted into $\pm 5\%$ bins. The bin designator is listed on the IL300 package. The $K3$ bin limits are shown in Table 1.

This table is useful when selecting the specific resistor values needed to set the isolation amplifier transfer gain.

Table 1: $K3$ Transfer Gain Bins

Bin	Typ.	Min.	Max.
A	0.59	0.56	0.623
B	0.66	0.623	0.693
C	0.73	0.693	0.769
D	0.81	0.769	0.855
E	0.93	0.855	0.95
F	1.0	0.95	1.056
G	1.11	1.056	1.175
H	1.24	1.175	1.304
I	1.37	1.304	1.449
J	1.53	1.449	1.61

Isolation Amplifier Design Techniques

The previous section discussed the operation of an isolation amplifier using the optical servo technique. The following section will describe the design philosophy used in developing isolation amplifiers optimized for input voltage range, linearity, and noise rejection.

The IL300 can be configured as either a photovoltaic or photoconductive isolation amplifier. The photovoltaic topology offers the best linearity, lowest noise, and drift performance. Isolation amplifiers using these circuit configurations meet or exceed 12 bit AD performance. Photoconductive photodiode operation provides the largest coupled frequency bandwidth. The photoconductive configuration has linearity and drift characteristics comparable to a 8-9 bit AD converter.

Photovoltaic Isolation Amplifier

When low offset drift and greater than 12 bit linearity is desired, photovoltaic amplifier designs should be considered. The schematic of a typical positive photovoltaic isolation amplifier is shown in Figure 9.

The transfer characteristics of this amplifier are shown in Figure 10.

The input stage consists of a servo amplifier, U1, which controls the LED drive current. The servo photodiode is operated with zero voltage bias. This is accomplished by connecting the photodiodes anode and cathode directly to U1's inverting and non-inverting inputs. The characteristics of the servo amplifier operation are presented in Figure 10a and 10b. The servo photocurrent is linearly proportional to the input voltage, $IP1 = VIN/R1$. Figure 10b shows the LED current is inversely proportional to the servo transfer gain, $IF = IP1/K1$. The servo photocurrent, resulting from the LED emission, keeps the voltage at the inverting input of U1 equal to zero. The output photocurrent, $IP2$, results from the incident flux supplied by the LED. Figure 10c shows that the magnitude of the output current is determined by the output transfer gain, $K2$. The output voltage, as shown in Figure 10d, is proportional to the output photocurrent $IP2$. The output voltage equals the product of the output photocurrent times the output amplifier's transresistance, $R2$.

The composite amplifier transfer gain (Vo/Vin) is the ratio of two products. The first is the output transfer gain, $K2 \cdot R2$.

Figure 10. Positive Unipolar Photovoltaic Amplifier Transfer Characteristics

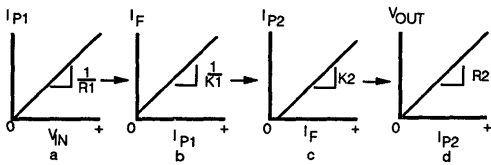
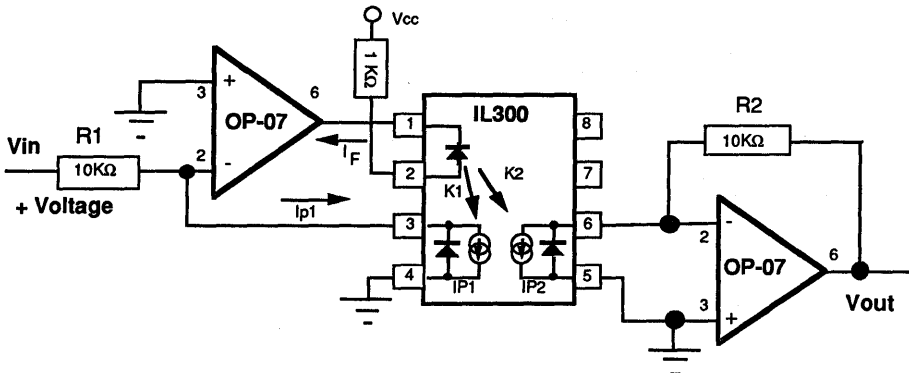

Figure 9. Positive Unipolar Photovoltaic Isolation Amplifier



The second is the servo transfer gain, $K1 \cdot R1$. The amplifier gain is the first divided by the second. See Equation 23.

$$\text{Equation 23: } \frac{V_o}{V_{in}} = \frac{K2 \cdot R2}{K1 \cdot R1}$$

Equation 23 shows that the composite amplifier transfer gain is independent of the LED forward current. The $K2/K1$ ratio reduces to IL300 transfer gain, $K3$. This relationship is included in Equation 24. This equation shows that the composite amplifier gain is equal to the product of the IL300 gain, $K3$, times the ratio of the output to input resistors.

$$\text{Equation 24: } \frac{V_o}{V_{in}} = \frac{K3 \cdot R2}{R1}$$

Designing this amplifier is a three step process. First, given the input signal span and U1's output current handling capability, the input resistor $R1$ can be determined by using the circuit found in Figure 9 and the following typical characteristics:

OP-07	$I_{out} = \pm 15\text{mA}$
IL300	$K1 = 0.007$
	$K2 = 0.007$
	$K3 = 1.0$
V_{in}	$0 \geq + 1.0\text{V}$

The second step is to determine servo photocurrent, $IP1$, resulting from the peak input signal swing. This current is the product of the LED drive current, IF , times the servo transfer gain, $K1$. For this example the $I_{out,max}$ is equal to the largest LED current signal swing, i.e., $IF = I_{out,max}$.

$$IP1 = K1 \cdot I_{out,max}$$

$$IP1 = 0.007 \cdot 15\text{mA}$$

$$IP1 = 105\ \mu\text{A}$$

The input resistor, R1, is set by the input voltage range and the peak servo photocurrent, IP1. Thus R1 is equal to:

$$R1 = Vin / IP1$$

$$R1 = 1.0 / 105 \mu A$$

$$R1 = 9.524 K\Omega$$

R1 is rounded to 10 KΩ.

The third step in this design is determining the value of the transresistance, R2, of the output amplifier. R2 is set by the composite voltage gain desired, and the IL300's transfer gain, K3. Given K3 = 1.0 and a required $V_{out}/V_{in} = G = 1.0$, the value of R2 can be determined.

$$R2 = (R1 \cdot G) / K3$$

$$R2 = (10 K\Omega \cdot 1.0) / 1.0$$

$$R2 = 10 K\Omega$$

When the amplifier in Figure 9 is constructed with OP-07 operational amplifiers it will have the characteristics shown in Figures 11 and 12.

Figure 11. Photovoltaic Amplifier Transfer Gain

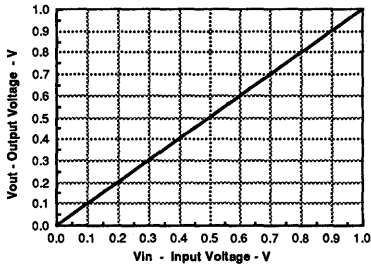

The frequency response is shown in Figure 12. This amplifier has a small signal bandwidth of 45 KHz.

Figure 12. Photovoltaic Amplifier Frequency Response

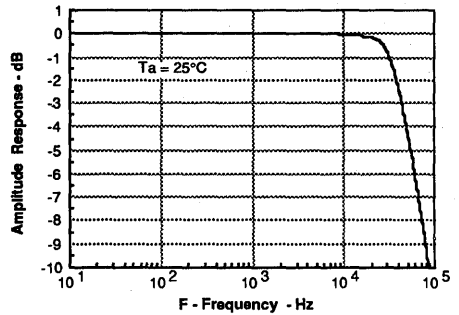

The amplifier in Figure 9 responds to positive polarity input signals. This circuit can be modified to respond to negative polarity signals. The modifications of the input amplifier include reversing the polarity of the servo photodiode at U1's input and connecting the LED so that it sinks current from U1's output. The noninverting isolation amplifier response is maintained by reversing the IL300's output photodiodes connection to the input of the transresistance amplifier. The modified circuit is shown in Figure 13.

The negative unipolar photovoltaic isolation amplifier transfer characteristics are shown in Figure 14. This amplifier, as shown in Figure 13, responds to signals in only one quadrant. If a positive signal is applied to the input of this amplifier, it will forward bias the photodiode, causing U1 to reverse bias the LED. No damage will occur, and the amplifier will be cut-off under this condition. This operation is verified by the transfer characteristics shown in Figure 14.

Figure 13. Negative Unipolar Photovoltaic Isolation Amplifier

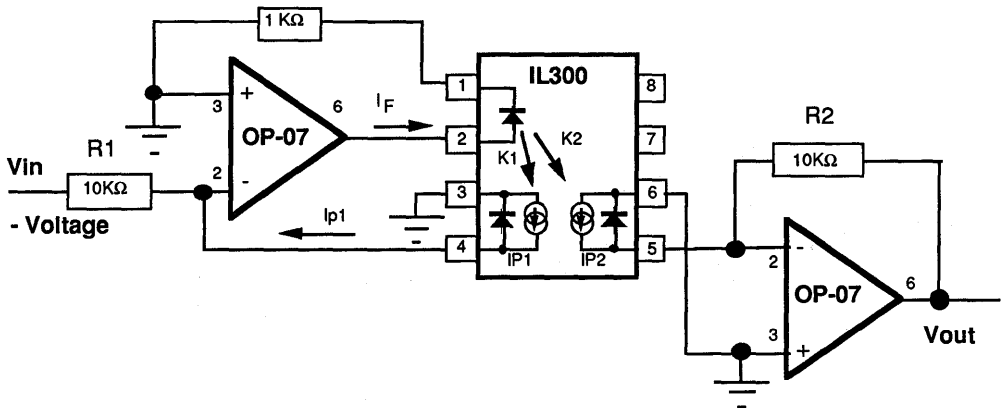
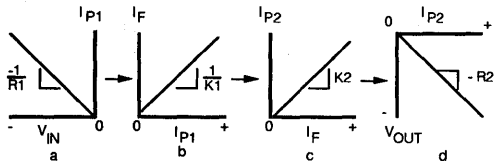

Figure 14. Negative Unipolar Photovoltaic Isolation Amplifier Transfer Characteristics



A bipolar responding photovoltaic amplifier can be constructed by combining a positive and negative unipolar amplifier into one circuit. This is shown in Figure 15. This amplifier uses two IL300s with each detector and LED connected in antiparallel. The IL300a responds to positive signals while the IL300b is active for the negative signals. The operation of the IL300s and the U1 and U2 is shown in the transfer characteristics given in Figure 16.

Figure 15. Bipolar Input Photovoltaic Isolation Amplifier

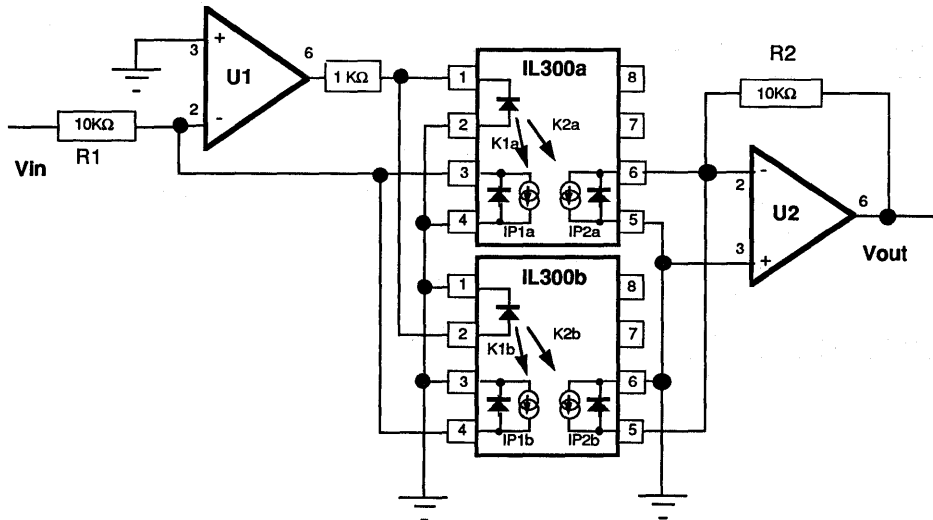
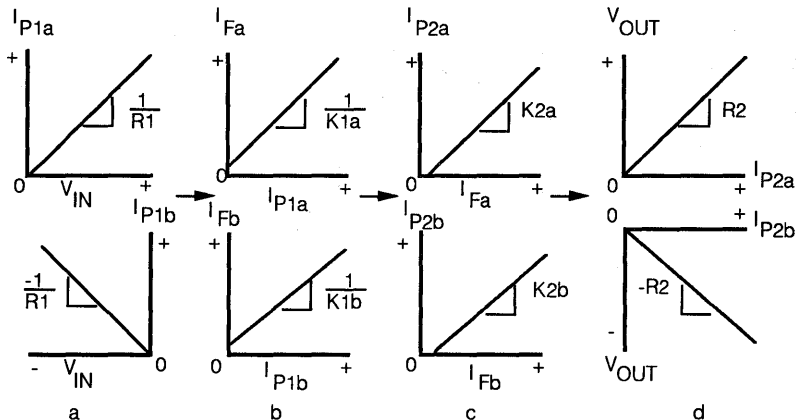

Figure 16. Bipolar Input Photovoltaic Isolation Amplifier Transfer Characteristics



The operational analysis of this amplifier is similar to the positive and negative unipolar isolation amplifier. This simple circuit provides a very low offset drift and exceedingly good linearity. The circuit's useful bandwidth is limited by cross-over distortion resulting from the photodiode stored charge. With a bipolar signal referenced to ground and using a 5% distortion limit, the typical bandwidth is under 1KHz. Using matched K3s, the composite amplifier gain for positive and negative voltage will be equal.

If it is not always practical to match K3s. Whenever the need to couple bipolar signals arises a prebiased photovoltaic isolation amplifier is a good solution. By prebiasing the input amplifier the LED and photodetector will operate from a selected quiescent operating point. The relationship between the servo photocurrent and the input voltage is shown in Figure 17.

Figure 17. Transfer Characteristic Prebiased Photovoltaic Bipolar Amplifier

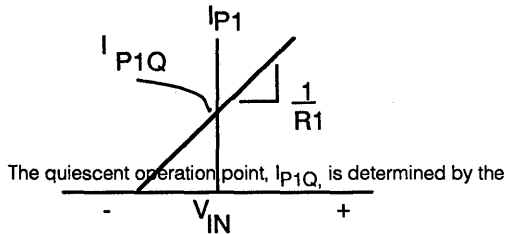

dynamic range of the input signal. This establishes maximum LED current requirements. The output current capability of the OP-07 is extended by including a buffer transistor between the output of U1 and the LED. The buffer transistor minimizes thermal drift by reducing the OP-07 internal power dissipation if it were to drive the LED directly. This is shown in Figure 18.

The bias is introduced into the inverting input of the servoamplifier, U1. The bias forces the LED to provide photocurrent, I_{P1} , to servo the input back to a zero volt equilibrium. The bias source can be as simple as a series resistor connected to V_{CC} . Best stability and minimum offset drift is achieved when a good quality current source is used. Figure 20 shows the amplifier found in Figure 18 including two modified Howland current sources. The first source prebiases the servo amplifier, and the second source is connected to U2's inverting input which matches the input prebias.

Figure 19. Prebiased Photovoltaic Isolation Amplifier Transfer Characteristics

The previous circuit offers a DC/AC coupled bipolar

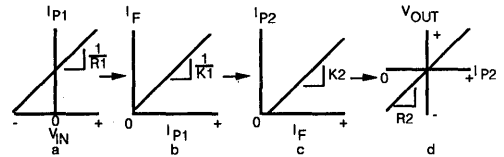

Figure 18. Prebiased Photovoltaic Isolation Amplifier

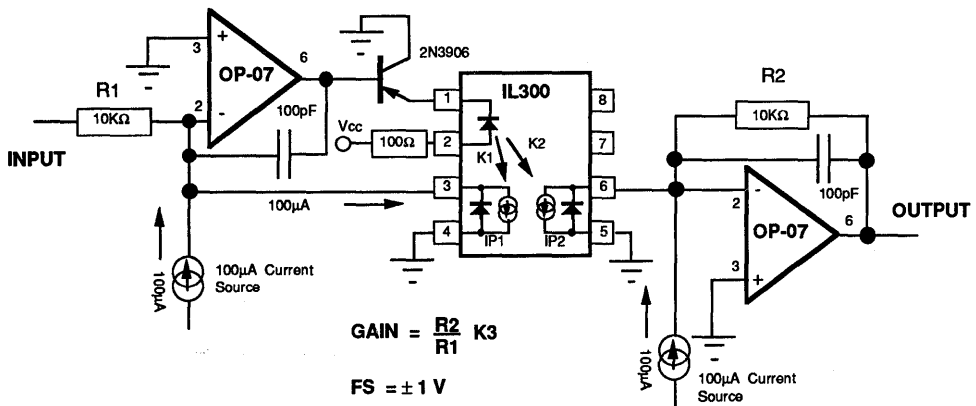

Figure 20. Prebiased Photovoltaic Isolation Amplifier

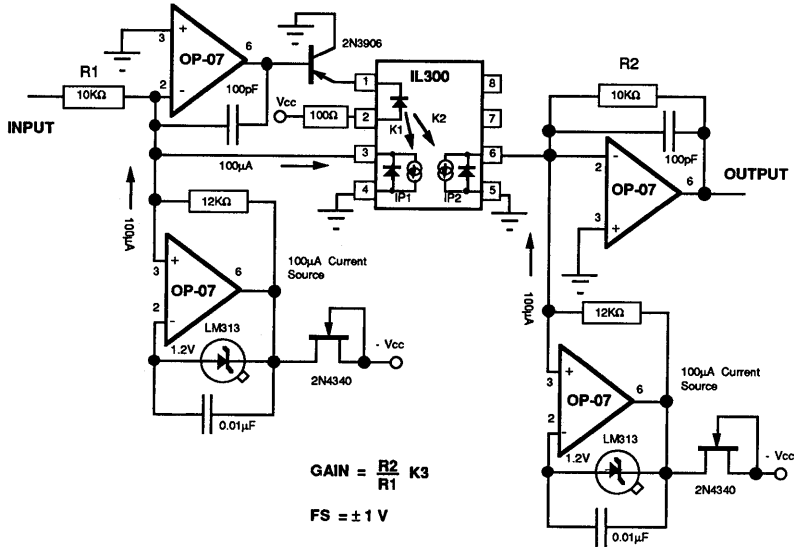
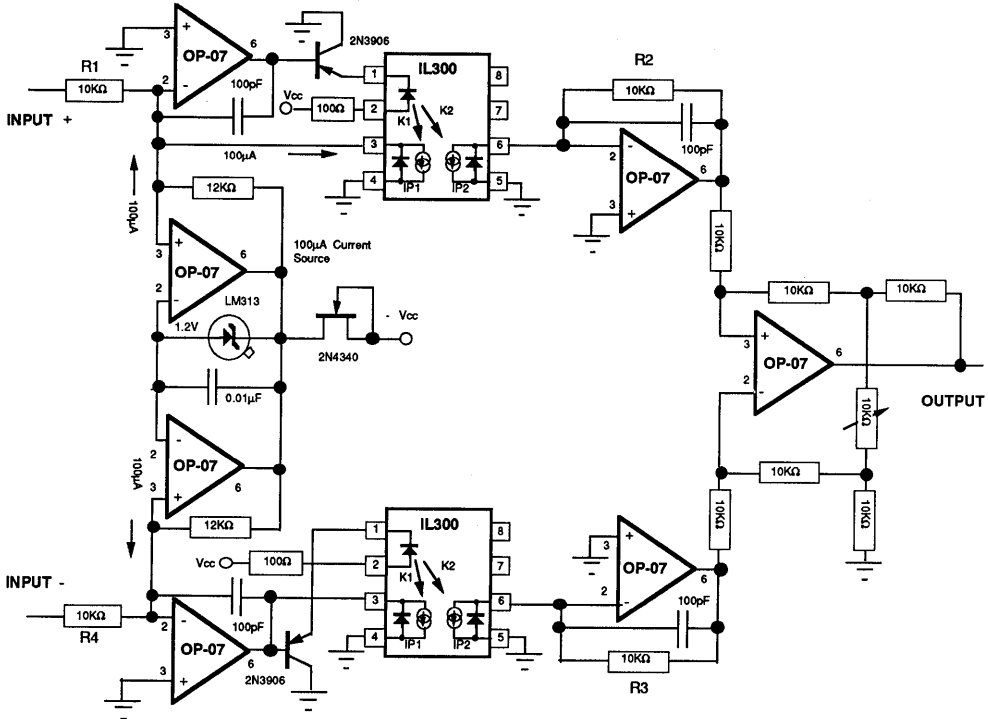

Figure 21. Differential Prebiased Photovoltaic Isolation Amplifier



isolation amplifier. The output will be zero volts for an input of zero volts. This circuit exhibits exceptional stability and linearity. This circuit has demonstrated compatibility with 12 bit A/D converter systems. The circuit's common mode rejection is determined by CMR of the IL300. When higher common mode rejection is desired one can consider the differential amplifier shown in Figure 21.

This amplifier is more complex than the circuit shown in Figure 20. The complexity adds a number of advantages. First the CMR of this isolation amplifier is the product of the IL300 and that of the summing differential amplifier found in the output section. Note also that the need for an offsetting bias source at the output is no longer needed. This is due to differential configuration of the two IL300 couplers. This amplifier is also compatible with instrumentation amplifier designs. It offers a bandwidth of 50KHz, and an extremely good CMR of 140dB at 10KHz.

Photoconductive Isolation Amplifier

The photoconductive isolation amplifier operates the photodiodes with a reverse bias. The operation of the input network is covered in the discussion of K3 and as such will not be repeated here. The photoconductive isolation amplifier is recommended when maximum signal bandwidth is desired.

Unipolar Isolation Amplifier

The circuit shown in Figure 22 is a unipolar photoconductive amplifier and responds to positive input signals. The gain of this amplifier follows the familiar form of $V_o/V_{in} = G = K3 \cdot (R2 / R1)$. R1 sets the input signal range in conjunction with the servo gain and the maximum output current, I_o , which U1 can source. Given this, $I_{o,max} = I_{F,max}$. R1 can be determined from Equation 28.

$$\text{Equation 28: } R1 = V_{in,max} / (K1 \cdot I_{o,max})$$

The output section of the amplifier is a voltage follower. The output voltage is equal to the voltage created by the output photocurrent times the photodiode load resistor, R2. This resistor is used to set the composite gain of the amplifier as shown in Equation 29.

$$\text{Equation 29: } R2 = (R1 \cdot G) / K3$$

This amplifier is conditionally stable for given values of R1. As R1 is increased beyond 10K Ω , it may become necessary to frequency compensate U1. This is done by placing a small capacitor from U1's output to its inverting input. This circuit uses 741 op-amps and will easily provide 100 KHz or greater bandwidth.

Figure 22. Unipolar Photoconductive Isolation Amplifier

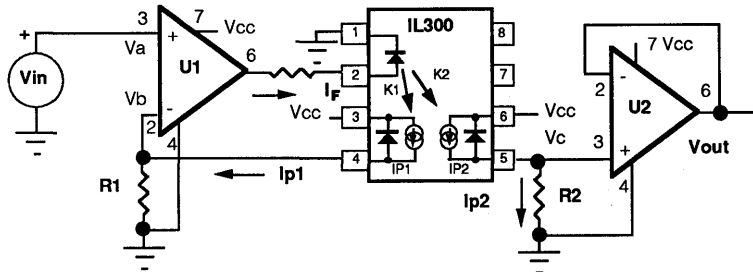
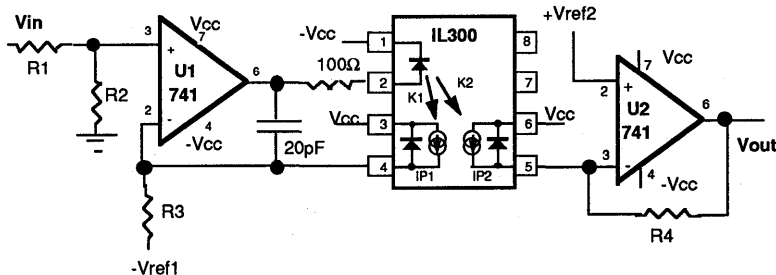

Figure 23. Bipolar Photoconductive Isolation Amplifier



Bipolar Isolation Amplifier

Many applications require the isolation amplifier to respond to bipolar signals. The generic inverting isolation amplifier shown in Figure 23 will satisfy this requirement. Bipolar signal operation is realized by prebiasing the servo loop. The prebias signal, V_{ref1} , is applied to the inverting input through $R3$. $U1$ forces sufficient LED current to generate a voltage across $R3$ which satisfies $U1$'s differential input requirements. The output amplifier, $U2$, is biased as a transresistance amplifier. The bias or offset, V_{ref2} , is provided to compensate for bias introduced in the servo amplifier.

Much like the unipolar amplifier, selecting $R3$ is the first step in the design. The specific resistor value is set by the input voltage range, reference voltage, and the maximum output current, I_o , of the op-amp. This resistor value also affects the bandwidth and stability of the servo amplifier.

The input network of $R1$ and $R2$ form a voltage divider. $U2$ is configured as an inverting amplifier. This bipolar photoconductive isolation amplifier has a transfer gain given in Equation 30.

$$\text{Equation 30: } \frac{V_{out}}{V_{in}} = - \frac{K3 \cdot R4 \cdot R2}{R3 (R1 + R2)}$$

Equation 31 shows the relationship of the V_{ref1} to V_{ref2} .

$$\text{Equation 31: } V_{ref2} = (V_{ref1} \cdot R4) / R3$$

Another bipolar photoconductive isolation amplifier is shown in Figure 24. It is designed to accept an input signal of ± 1 V and uses inexpensive signal diodes as reference sources. The input signal is attenuated by a 50% by a voltage divider formed with $R1$ and $R2$. The solution for $R3$ is given in Equation 30.

$$\text{Equation 30: } R3 = (0.5 \cdot V_{in_{max}} + V_{ref1}) / (I_F \cdot K1)$$

For this design $R3$ equals $30K\Omega$.

Figure 24. Bipolar Photoconductive Isolation Amplifier

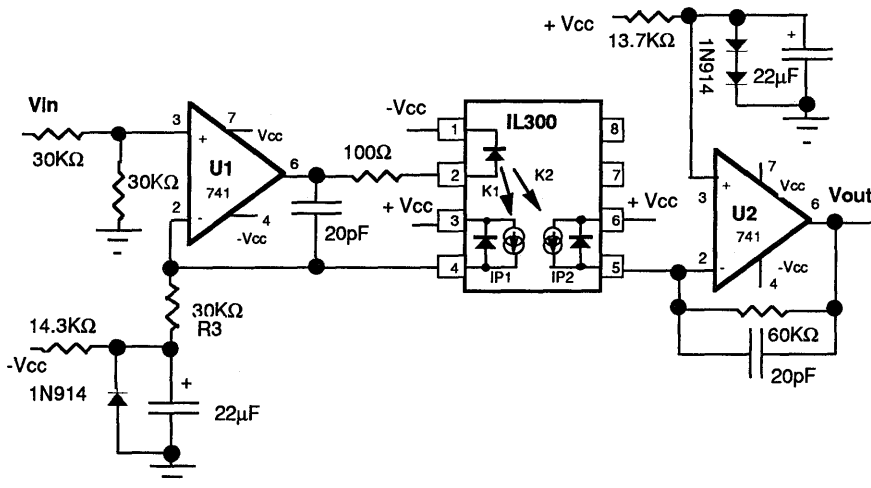

The output transresistance, is selected to satisfy the gain requirement of the composite isolation amplifier. With $K3 = 1$, and a goal of unity transfer gain, the value of $R4$ is determined by Equation 33.

$$\text{Equation 33: } R4 = (R3 \cdot G \cdot (R1 + R2)) / (K3 \cdot R2)$$

$$R4 = 60 K\Omega$$

From Equation 31, V_{ref2} is shown to be twice V_{ref1} . V_{ref2} is easily generated by using two 1N914 diodes in series.

This amplifier is simple and relatively stable. When better output voltage temperature stability is desired, consider the isolation amplifier configuration shown in Figure 25. This amplifier is very similar in circuit configuration except that the bias is provided by a high quality LM113 band gap reference source.

This circuit forms a unity gain non-inverting photoconductive isolation amplifier. Along with the LM113 references and low offset OP-07 amplifiers the circuit replaces the 741 opamps. A 2N2222 buffer transistor is used to increase the OP-07's LED drive capability. The gain stability is set by $K3$, and the output offset is set by the stability of OP-07s and the reference sources.

Figure 26 shows a novel circuit that minimizes much of the offset drift introduced by using two separate reference sources. This is accomplished by using an optically coupled tracking reference technique. The amplifier consists of two optically coupled signal paths. One IL300 couples the input to the output. The second IL300 couples a reference voltage generated on the output side to the input servo amplifier. This isolation amplifier uses dual opamps to minimize parts count. Figure 26 shows the output reference being supplied by a voltage divider connected to V_{cc} . The offset drift can be reduced by using a band gap reference source to replace the voltage divider.

Figure 25. High Stability Bipolar Photoconductive Isolation Amplifier

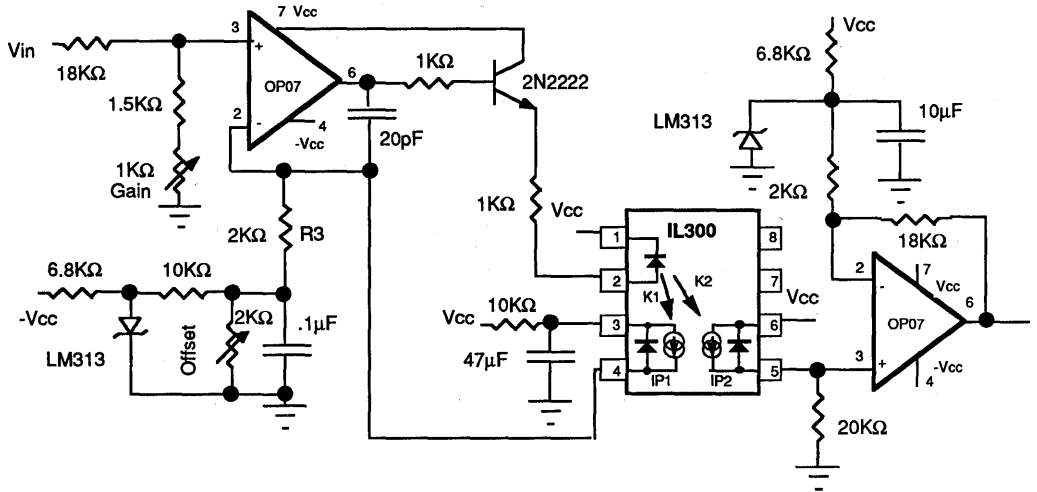
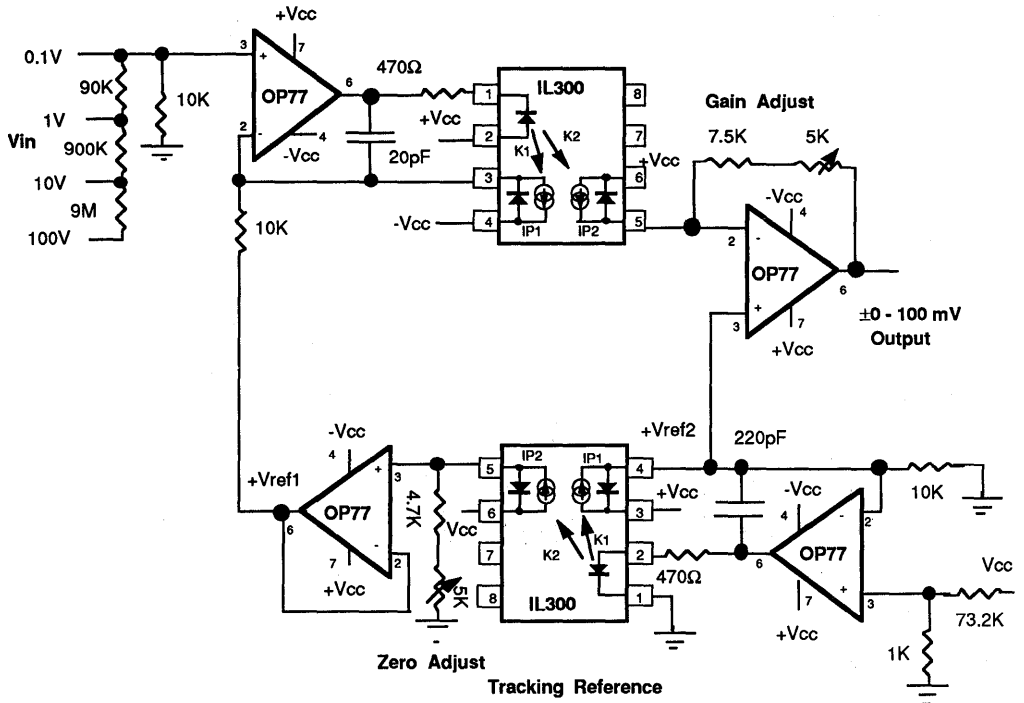

Figure 26. Bipolar Photoconductive Isolation Amplifier with Tracking Reference



Differential Photoconductive Isolation Amplifier

One of the principal reasons to use an isolation amplifier, is to reject electrical noise. The circuits presented thus far are of a single ended design. The common mode rejection, CMRR, of these circuits is set by the CMRR of the coupler and the bandwidth of the output amplifier. The typical common mode rejection for the IL300 is shown in Figure 27.

Figure 27. Common Mode Rejection

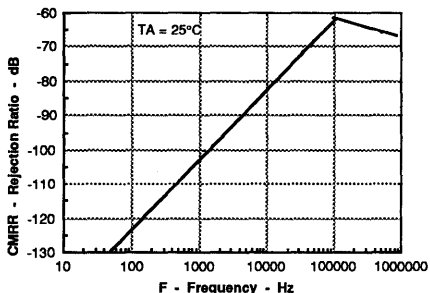

The CMRR of the isolation amplifier can be greatly enhanced by using the CMRR of the output stage to its fullest extent. This is accomplished by using a differential amplifier at the output that combines optically coupled differential signals. The circuit shown in Figure 28 illustrates the circuit.

Opamps U1 and U5 form a differential input network. U4 creates a 100 μA, I_S, current sink which is shared by each of the servo amplifiers. This bias current is divided evenly between these two servo amplifiers when the input voltage is equal to zero. This division of current creates a differential signal at the output photodiodes of U2 and U6. The transfer gain, V_{out}/V_{in}, for this amplifier is given in Equation 34.

Equation 34:

$$\frac{V_{out}}{V_{in}} = \frac{R4 \cdot R2 \cdot K3(U5) + R3 \cdot R1 \cdot K3(U2)}{2 \cdot R1 \cdot R2}$$

The offset independent of the operational amplifiers is given in Equation 35.

Equation 35:

$$V_{offset} = \frac{I_s \cdot [R1 \cdot R3 \cdot K3(U2) - R2 \cdot R4 \cdot K3(U5)]}{R1 + R2}$$

Equation 35 shows that the resistors, when selected to produce equal differential gain, will minimize the offset voltage, V_{offset}. Figure 29 illustrates the voltage transfer characteristics of the prototype amplifier. The data indicates the offset at the output is -500 μV when using 1 KΩ 1% resistors.

Figure 28. Differential Photoconductive Isolation Amplifier

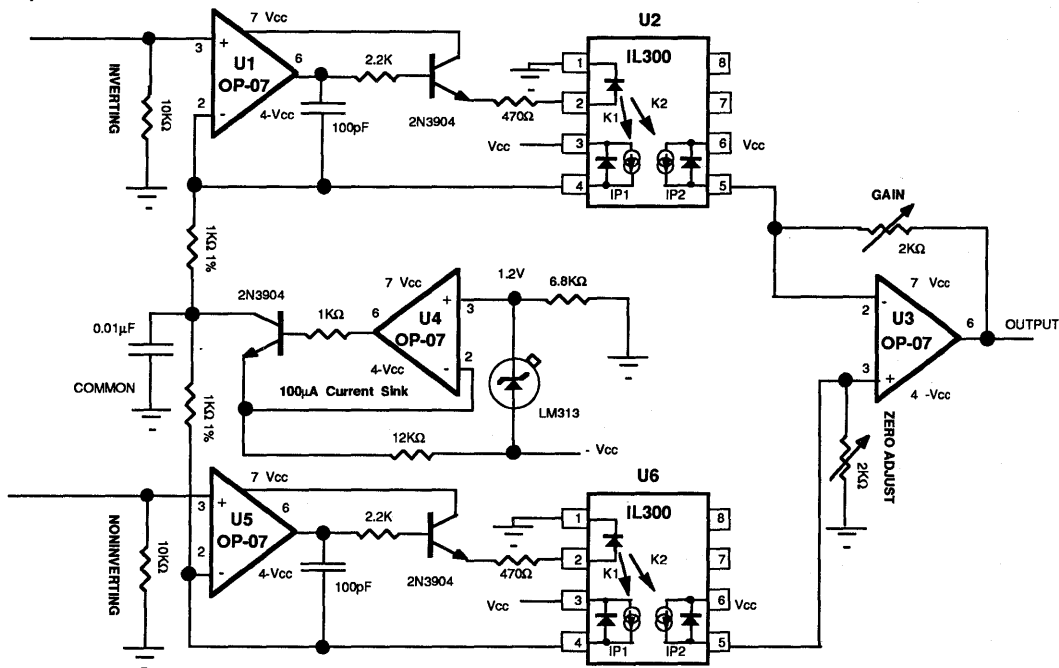
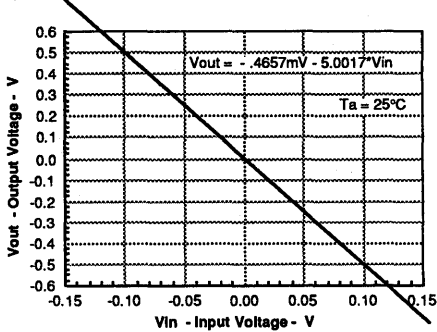

Figure 29. Differential Photoconductive Isolation Amplifier Transfer Characteristics



Discrete Isolation Amplifier

A unipolar photoconductive isolation amplifier can be constructed using two discrete transistors. Figure 30 shows such a circuit. The servo node, Va, sums the current from the photodiode and the input signal source. This control loop keeps Va constant. This amplifier was designed as a feedback control element for a DC power supply. The DC and AC transfer characteristics of this amplifier are shown in Figures 31 and 32.

Figure 31. Transistor Unipolar Photoconductive Isolation Amplifier Transfer Characteristics

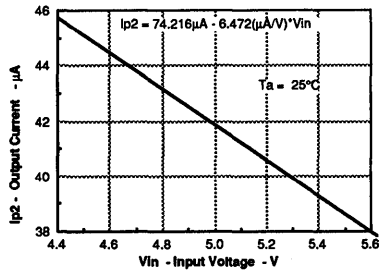

Figure 30. Unipolar Photoconductive Isolation Amplifier with Discrete Transistors

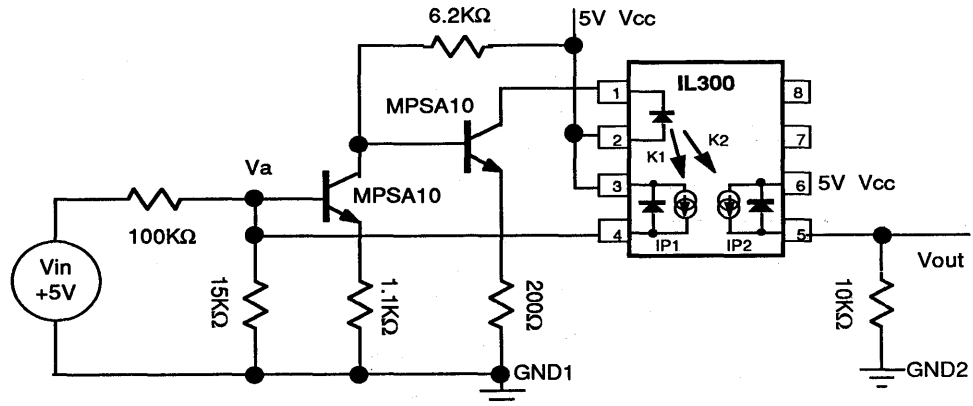
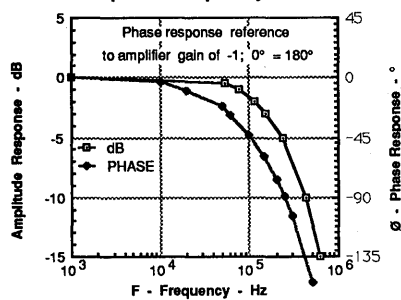

Figure 32. Transistor Unipolar Photoconductive Isolation Amplifier Frequency and Phase Response



CONCLUSION

The analog design engineer now has a new circuit element that will make the design of isolation amplifiers easier. The preceding circuits and analysis illustrate the variety of isolation amplifiers that can be designed. As a guide, when highest stability of gain and offset is needed, consider the photovoltaic amplifier. Widest bandwidth is achieved with the photoconductive amplifier. Lastly, the overall performance of the isolation amplifier is greatly influenced by the operational amplifier selected. Noise and drift are directly dependent on the servo amplifier.

The IL300 also can be used in the digital environment. The pulse response of the IL300 is constant over time and temperature. In digital designs where LED degradation and pulse distortion can cause system failure, the IL300 will eliminate this failure mode.

SUPPLEMENTAL INFORMATION

PHOTODETECTOR OPERATION TUTORIAL

Photodiode Operation and Characteristics

The photodiodes in the IL300 are PIN (P-material - Intrinsic material - N-material) diodes. These photodiodes convert the LED's incident optical flux into a photocurrent. The magnitude of the photocurrent is linearly proportional to the incident flux. The photocurrent is the product of the diode's responsivity, S_I , (A/W), the incident flux, E_e (W/mm²), and the detector area A_D , (mm²). This relationship is shown below:

$$\text{Equation 1a: } I_P = S_I \cdot E_e \cdot A_D$$

Photodiode I/V Characteristics

Reviewing the photodiode's current /voltage characteristics aids in understanding the operation of the photodiode, when connected to an external load. The I-V characteristics are shown in Figure 1a. The graph shows that the photodiode will generate photocurrent in either forward biased (photovoltaic), or reversed biased (photoconductive) mode.

In the forward biased mode the device functions as a photovoltaic, voltage generator. If the device is connected to a small resistance, corresponding to the vertical load line, the current output is linear with increases in incident flux. As R_L increases, operation becomes nonlinear until the open circuit (load line horizontal) condition is obtained. At this point the open circuit voltage is proportional to the logarithm of the incident flux.

In the reverse biased (photoconductive mode), the photodiode generates a current that is linearly proportional to the incident flux. Figure 1a illustrates this point with the equally spaced current lines resulting from linear increase of E_e . The photocurrent is converted to a voltage by the load resistor R_L . Figure 1a also shows that when the incident flux is zero ($E_e = 0$), a small leakage current, or dark current (I_D) will flow.

Figure 1a. Photodiode I/V Characteristics

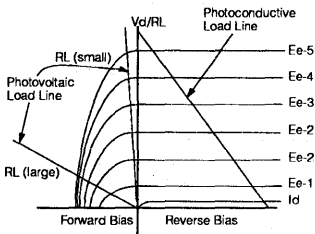

Photovoltaic Operation

Photodiodes, operated in the photovoltaic mode, generate a load voltage determined by the load resistor, R_L , and the photocurrent, I_P . The equivalent circuit for the photovoltaic operation is shown in Figure 2a. The photodiode includes a current source (I_P), a shunt diode (D), a shunt resistor (R_P), a series resistor (R_S), and a parallel capacitor (C_P). The intrinsic region of the PIN diode offers a high shunt resistance resulting in a low dark current, and reverse leakage current.

Figure 2a. Equivalent Circuit—Photovoltaic Mode

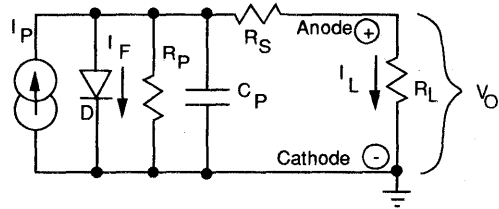

The output voltage, V_0 , can be determined through nodal analysis. The circuit contains two nodes. The first node, V_F , includes the photocurrent generator, I_P , the shunt diode, D, shunt resistor (R_P), and parallel capacitance, C_P . The second node, V_0 , includes the series resistor, R_S , and the load resistor, R_L . The diode, D, in the V_F node is responsible for the circuit's nonlinearity. The diode's current voltage relationship is given in Equation 2a.

$$\text{Equation 2a: } I_F = I_S \cdot [\text{EXP}(V_F / K) - 1]$$

This graphical solution of 2a for the IL300 is shown in Figure 3a.

Figure 3a. Photodiode Forward Voltage vs. Forward Current

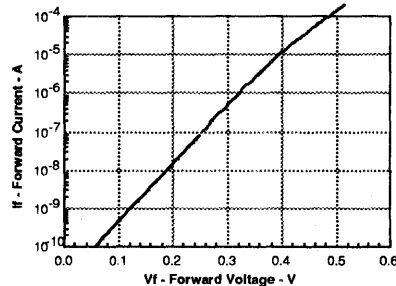

Inserting the diode Equation 2a, into the two nodal equations gives the following DC solution for the photovoltaic operation (Equation 3a):

$$\text{Equation 3a}$$

$$0 = I_P - I_S \cdot \{ \text{EXP}[V_0 \cdot (R_S + R_L) / K \cdot R_L] - 1 \} - V_0 \cdot [(R_S + R_L + R_P) / R_P \cdot R_L]$$

Typical IL300 values:

$$\begin{aligned} I_S &= 13.94 \cdot 10^{-12} \\ R_S &= 50 \Omega \\ R_P &= 15 \text{ G}\Omega \\ K &= 0.0288 \end{aligned}$$

By inspection, as R_L approaches zero ohms the diode voltage, V_F , also drops. This indicates a small diode current. All of the photocurrent will flow through the diode series resistor and the external load resistor. Equation 3a was solved with a computer program designed to deal with nonlinear transcendental equations. Figure 4a illustrates the solution.

Figure 4a. Photovoltaic Output vs. Load Resistance and Photocurrent

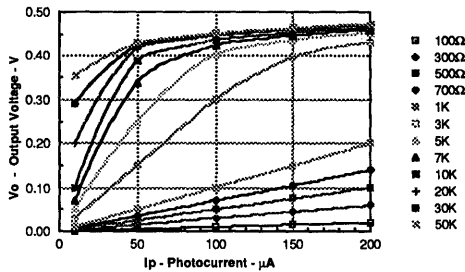

This curve shows a series of load lines, and the output voltage, V_o , caused by the photocurrent. Optimum linearity is obtained when the load is zero ohms. Reasonable linearity is obtained with load resistors up to 1000 ohms. For load resistances greater than 1000Ω, the output voltage will respond logarithmically to the photocurrent. This response is due to the nonlinear characteristics of the intrinsic diode, D. Photovoltaic operation with a zero ohm load resistor offers the best linearity and the lowest dark current, I_D . This operating mode also results in the lowest circuit noise. A zero load resistance can be created by connecting the photodiode between the inverting and non-inverting input of a transresistance operational amplifier, as shown in Figure 5A.

Figure 5a. Photovoltaic Amplifier Configuration

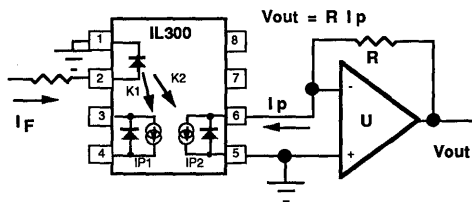

Photoconductive Operation Mode

Isolation amplifier circuit architectures often load the photodiode with resistance greater than zero ohms. With non-zero loads, the best linearity is obtained by using the photodiode in the photoconductive or reverse bias mode. Figure 6a shows the photodiode operating in the photoconductive mode. The output voltage, V_o , is the product of the photocurrent times the load resistor.

The reverse bias voltage causes a small leakage or dark current, I_D , to flow through the diode. The output photocurrent and the dark current, sum the load resistor. This shown in Equation 4a.

$$\text{Equation 4a: } V_L = R_L \cdot (I_p + I_D)$$

Figure 6a. Photoconductive Photodiode Model

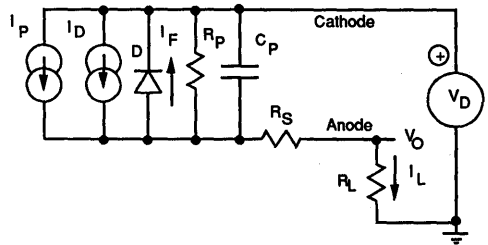

The dark current depends on the diode construction, reverse bias voltage and junction temperature. The dark current can double every 10°C. The IL300 uses matched PIN photodiodes that offer extremely small dark currents, typically a few picoamps. The dark current will usually track one another, and their effect will cancel each other when a servo amplifier architecture is used. The typical dark current as a function of temperature and reverse voltage is shown in Figure 7a.

The responsivity, S, of the photodiode is influenced by the potential of the reverse bias voltage. Figure 8a shows the responsivity percentage change versus bias voltage. This graph is normalized to the performance at a reverse bias of 15 volts. The responsivity is reduced by 4% when the bias is reduced to 5 volts.

Figure 7a. Dark Current vs. Reverse Bias

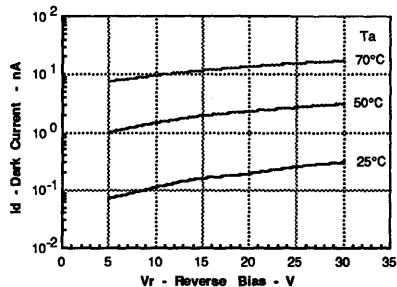
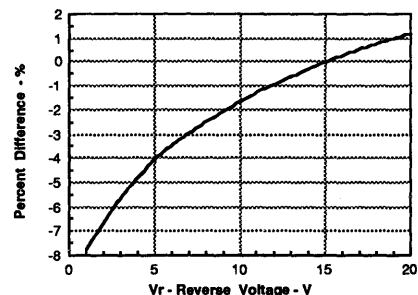

Figure 8a. Photoconductive Responsivity vs. Bias Voltage



The photodiode operated in the photoconductive mode is easily connected to an operational amplifier. Figure 9a shows the diode connected to a transresistance amplifier. The transfer function of this circuit is given in Equation 5a.

$$\text{Equation 5a: } V_{\text{out}} = R \cdot (I_p + I_d)$$

Bandwidth Considerations

PIN photodiodes can respond very quickly to changes in incident flux. The IL300 detectors respond in tens of nanoseconds. The slew rate of the output current is related to the diodes junction capacitance, C_j , and the load resistor, R . The product of these two elements set the photo-response time constant.

$$\text{Equation 6a: } t = R \cdot C_j$$

This time constant can be minimized by reducing the load resistor, R , or the photodiode capacitance. This capacitance is reduced by depleting the photodiode's intrinsic region, I , by applying a reverse bias. Figure 10a illustrates the effect of photodiode reverse bias on junction capacitance.

Figure 9a. Photoconductive Amplifier

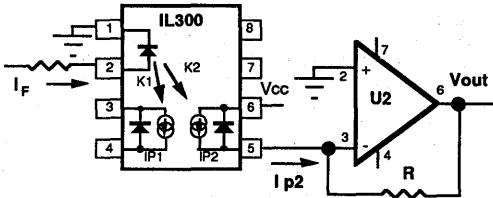
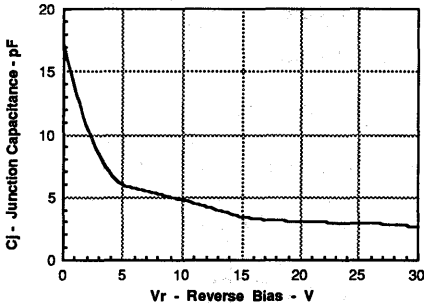
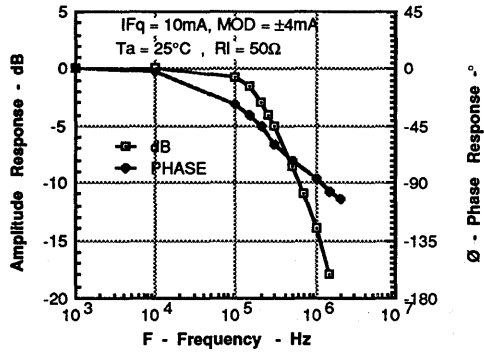

Figure 10a. Photodiode Junction Capacitance vs. Reverse Voltage



The zero biased photovoltaic amplifier offers a 50 KHz-60 KHz usable bandwidth. When the detector is reverse biased to -15 V, the typical isolation amplifier response increases to 100-150 KHz. The phase and frequency response for the IL300 is presented in figure 11a. When maximum system bandwidth is desired, the reverse biased photoconductive amplifier configuration should be considered.

Figure 11a. Phase and Frequency Response



Applications of Surface Mount LEDs Appnote 51

by Michael D. Clarkin, Brian Platter
Hewlett-Packard, Optoelectronics Division, San Jose, California
Frank Möllmer, Günther Waitl
Siemens AG, Semiconductor Group, Munich, Germany

SMT Replaces Through Hole Technology

The use of SMT-TOPLED™ varies greatly from the use of traditional through hole LEDs. Historically through hole LEDs have been incorporated directly into front panels using the leads as a stand off (Figure 1).

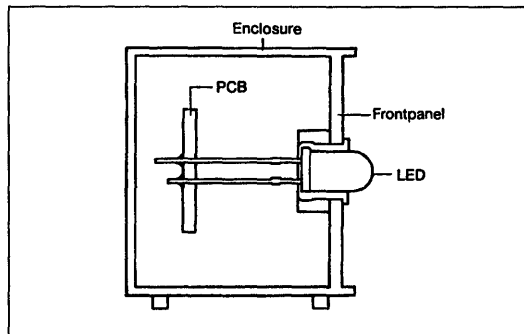

Figure 1. Typical through hole LED mounting.

Due to the automated nature of SMT assembly, and the size constraints of SMT component and assemblies, SMT-TOPLED™ applications are different from through hole applications. For SMT applications the LED is often 1.0 mm or more from the front panel (Figure 2). Employing light pipes can create the optimum display to the final viewer. Because of the size and radiation pattern of the Siemens/Hewlett-Packard SMT-TOPLED™ the final light emitting surfaces can be created in almost any shape. Lenses can also be combined with SMT-TOPLED™. Because of the uniform repeatable radiation pattern, the lens design can be matched to the exact customer requirements. Additional applications include backlighting of symbols and liquid crystal displays.

Applications

Of course the simplest way of using the new SMT-TOPLED™ is in a direct view application. Efficient optical design ensures that further optics are not required. Direct view applications include simple displays and moving message boards. Figures 3 and 4 show these examples.

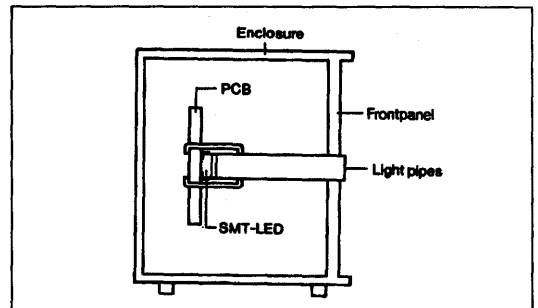

Figure 2. SMT TOPLED™ with light pipe to front panel

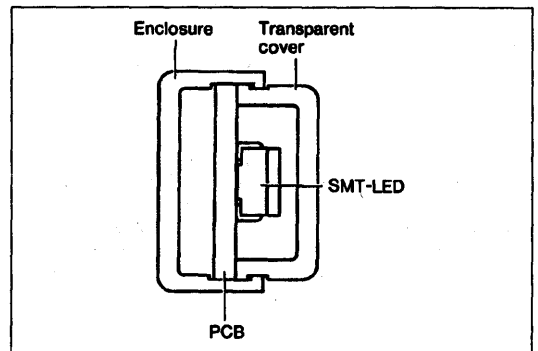

Figure 3. Direct view application of SMT-TOPLED™.

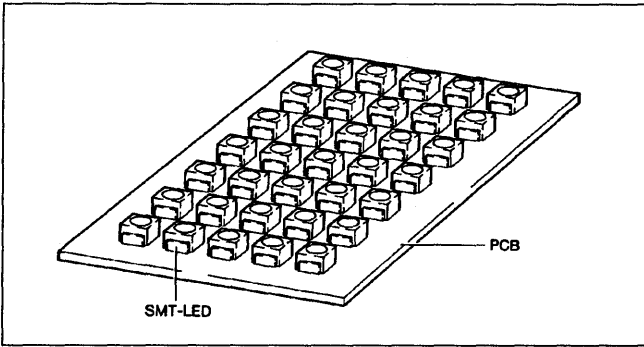

Figure 4. Moving message board with SMT-TOPLED™

In direct view applications, the following features are of particular advantage:

- Defined, rounded light emitting area
- Uniform illumination
- Large, uniform radiation pattern
- Due to the optical and package design, the performance of the package is very robust.
- Misplacement and tilting will not adversely affect the optical performance.

All these applications are addressed with the same SMT-TOPLED™ design. For the user this means simplified design and standardized assembly. This improved optical design freedom is an additional benefit of the new SMT-TOPLED™.

Light Pipes

A major application of the new SMT-TOPLED™ will be with light pipes. Figure 5 shows some possible designs.

By using light pipes, the distances between boards and front panels can be bridged and almost any luminous area or picture can be produced. The light emitted from a light pipe does not need to be directly above the SMT-TOPLED™. By making use of the critical angle of an optical system, (based on total internal reflection), or with mirrored reflectors, the light can be

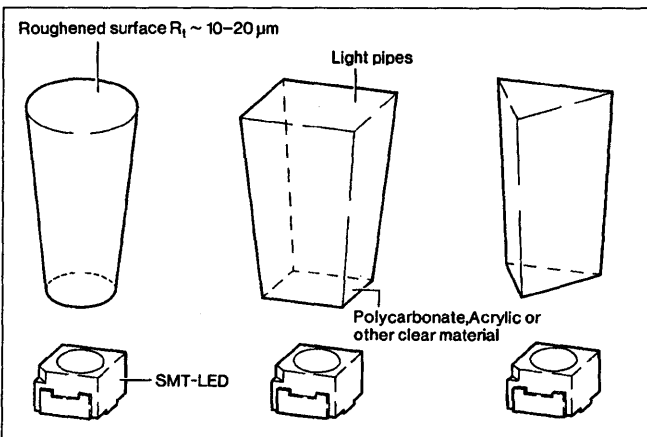

Figure 5. Light pipes used in conjunction with SMT-TOPLED™

deflected to any angle with only minimal losses. Figure 6 illustrates one example.

Multi Color Light Pipes

By coupling LEDs of different wavelengths (colors) into the same light pipe it is possible to have either multicolor capability, or new colors formed by the combination of the existing colors (Figure 7).

Bridging the distance between PC boards and front panels by an electrically non conducting light pipe automatically produces protection for electronics against ESD or for users against high voltage.

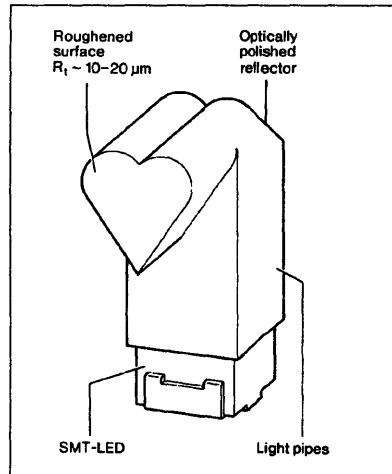

Figure 6. Right angle light pipe.

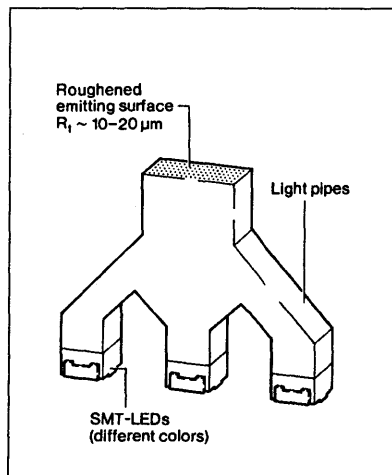

Figure 7. Light pipe used to form a multicolor indicator

Backlighting

Backlighting of legends and LCDs is a major application possibility for this new SMT-TOPLED™ design. There are three ways of getting the light from the LED to the backlighting area.

- Direct use of SMT-TOPLED™
- Incorporating reflectors
- Incorporating large area light pipes

Direct use is appropriate for low total height applications such as membrane keyboards. Because of the uniform, wide emission angle, surfaces with heights of 2 to 3 mm can be illuminated uniformly without any additional measures (Figure 8).

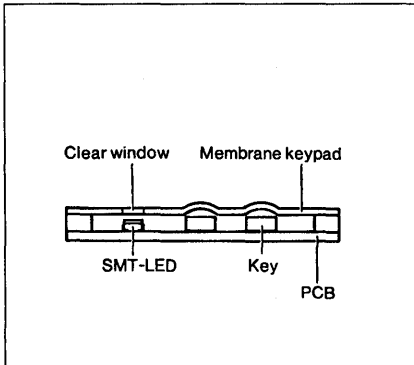

Figure 8. LED behind membrane keypad.

If more height is available or required and larger surfaces are to be illuminated, such as car dashboards, the SMT-TOPLED™ can be combined with external reflectors. In this way both single legends (Figure 9) and surfaces of any size can be backlit brightly and uniformly (Figure 10). A reflector/SMT-TOPLED™ combination is advantageous for backlighting positive and negative LCDs as sufficient brightness is produced with only a few LEDs.

If the assembly does not leave space for an external reflector, legends and LCDs can be backlit with flat light pipes. In this way it is possible to produce backlit units of only a few mm height. Figure 11 illustrates backlighting for a LCD display where the LCD is at a right angle to the LED board.

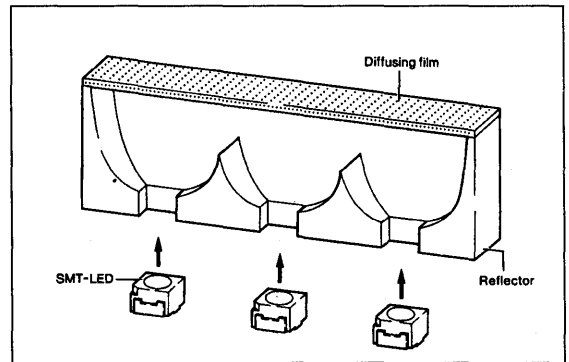

Figure 10. SMT-TOPLED™ illuminating a large area.

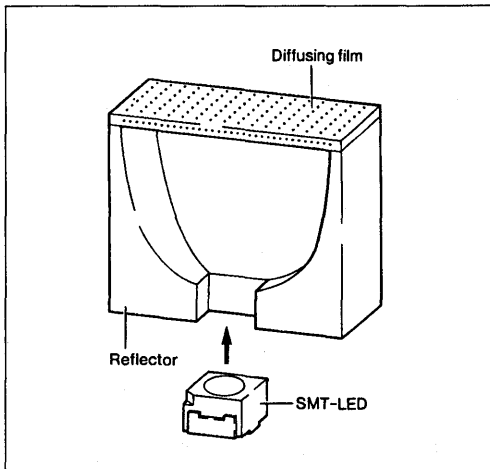

Figure 9. SMT-TOPLED™ illuminating a reflecting cavity.

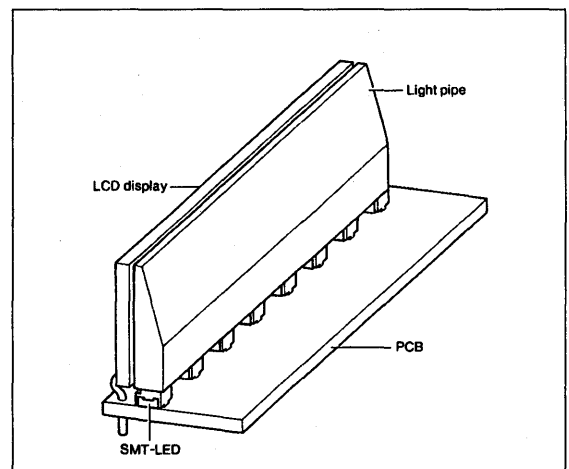

Figure 11. LEDs backlighting an LCD display with a right angle light pipe.

Figure 12 and 13 outline locations in which the LCD is parallel to the LEDs. In Figure 13 the light couples into the light pipe on both sides to increase brightness or illuminate a large area.

Lenses

The common through hole LED standards of 3 mm and 5 mm diameter emit light through a lens integrated into the package. Different radiation patterns are produced depending on the die and lens spacing and the shape of the lens. With straight forward design lenses can be produced to couple with the SMT-TOPLED™ to emit light at any required angle or pattern (Figure 14).

Using an external lens can change both the on axis intensity and the viewing angle. For example it is possible to change the typical light output from an Iv of 6 mcd and a viewing

angle to 120 degrees to an Iv of 1.8 mcd and a viewing angle of 60 degrees, or even to an Iv of 40 mcd with a viewing angle of 30 degrees (Figures 15 & 16).

Exercise proper care in the design of the light pipes for optimum coupling of the light emitted by the SMT-TOPLED™ to the final viewer. Tests have shown that with proper design and care more than 90% of the light can be transmitted by the light pipe. The design guidelines for light pipes are effectively covered by existing application notes, common literature associated with fiber optics as well as most texts covering optics. Both Hewlett-Packard and Siemens have advanced ray tracing programs and services.

HP and Siemens will give application support for design and manufacturing of boards incorporating SMT-TOPLED™. Clarification of the optical and electrical needs for each application are the first step in the support process.

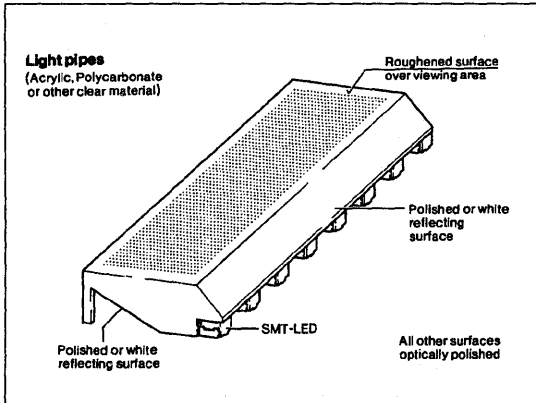

Figure 12. LCD backlighting configuration.

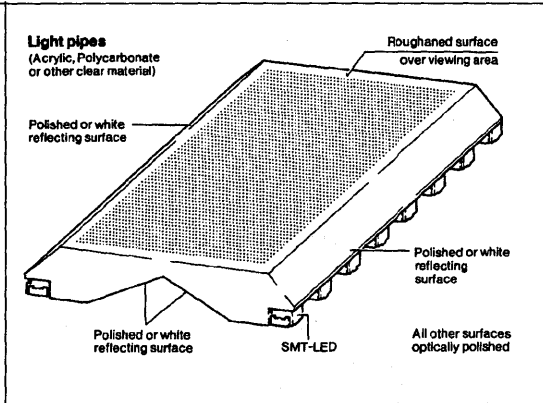

Figure 13. Improved brightness for LCD backlighting.

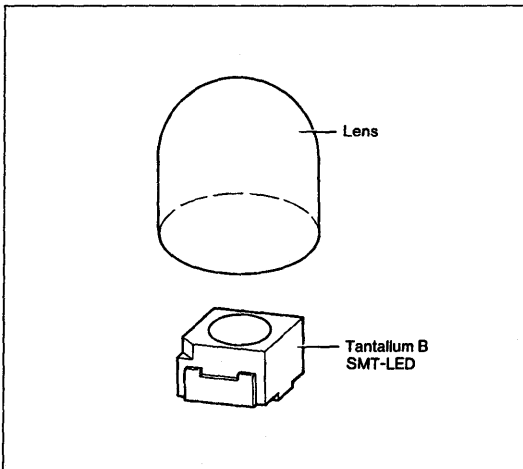

Figure 14. LED with lens.

Increase luminous intensity I_v



Bare LED: $I_v = 6 \text{ mcd}$
Viewing angle* = 120°

Material for light pipe: Polycarbonate or acrylic
(refractive index $n = 1.5$) with polished optical surfaces

* Included angle between half luminous intensity points.

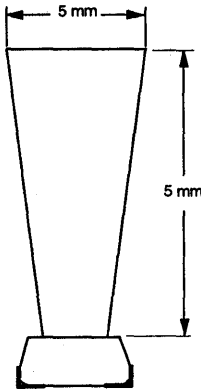

Light pipe 1:

Measured: $I_v = 18 \text{ mcd}$
Viewing angle* = 60°

Without Immersion

Calculated: $I_v = 21 \text{ mcd}$
Viewing angle* = 65°

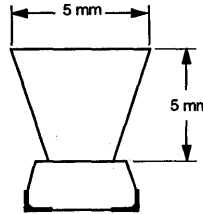

Light pipe 2:

Calculated: $I_v = 39 \text{ mcd}$
Viewing angle* = 30°

Figure 15. Different light pipe configurations.

Radiation pattern of SMT LED, with light pipes viewing angle
Computer simulation (Figure 19)

Near field radiation pattern (at the surface of the light pipe)

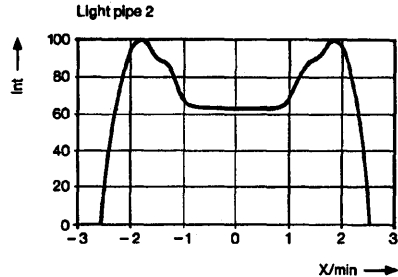
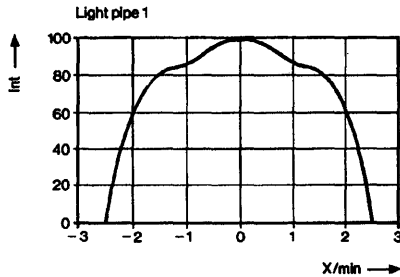

Far field radiation pattern (20 cm from the light pipe)

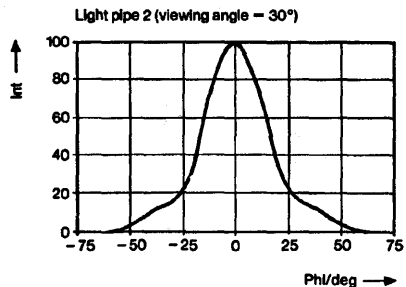
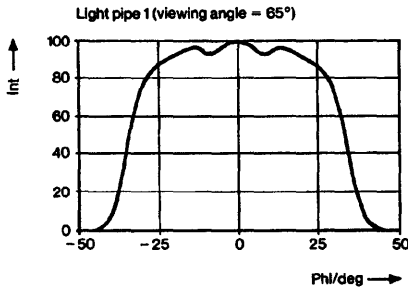

Figure 16. Computer simulation of radiation patterns of SMT-TOPLED™ with light pipes.

Designing with Surface Mount LEDs

The evolution from through hole technology to SMT demands surface mount optoelectronic components. HP and Siemens have addressed this need by creating a SMT standard for LEDs. The advantages to the user of using SMT-TOPLED™ are many:

- Lower PC board costs: reduced area, less drilling, fewer plated through holes
- Quality, time and cost improvement through automatic placement
- Components packaged in standard tape and reel
- Standard package allows for ease of landing pad design
- Low component height compared to through hole
- Uniformly placed components
- Uniform soldering techniques
- Improvement in reliability
- More flexibility during assembly
- Assembly processes compatible with active and passive components

SMT LED Design

Figure 17 shows a cross sectional view of the SMT-TOPLED™. High temperature thermoplastic is insert molded around a continuously stamped lead frame. Selection criteria for the plastic material included mechanical and thermal characteristics, and its high value of diffuse reflectance (90% efficient). Optical characteristics were achieved by reflector cavity geometry and the material features. The light output intensity is a factor of 2 greater than the SOT-23 LED with a more usable radiation pattern. A semiconductor die is placed in the prefabricated leadframe/molding assembly. An epoxy resin is used to improve the light output coupling, and seals the reflector cavity for environmental protection. The resin and the package materials were carefully matched to minimize mechanical and thermal stresses during soldering.

SMT Compatibility

Due to the specific and standardized assembly techniques that evolved in SMT, the following list of requirements are essential for a true SMT-TOPLED™.

Pick and Place

- Flat surfaces on LED package
- Tight package tolerances
- Standard dimensions for automation
- Standard tape and reel sizes
- Standard lead bends and finishes

Traditional through hole LEDs lack many if not all of these features. Careful engineering and cooperation with standards setting organizations assures that all of these requirements are met.

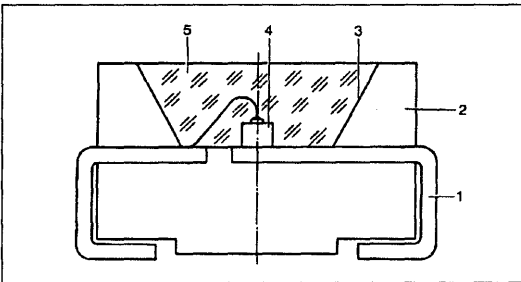

Figure 17. SMT-TOPLED™ cross section.

Soldering

- Infrared Reflow (IR)
- Vapor Phase Reflow (VP)
- Through the Wave Soldering
- (TTW) Solder finished leads for soldering processes
- Standard Landing Pads

Characterization of these processes insured an LED designed to withstand the specific mechanical, thermal, and chemical extremes of each.

Cleaning

- Ethyl Alcohol
- Isopropyl Alcohol
- Aqueous Cleaning solutions
- Solvent Cleaning solutions

Aqueous and organic solvents containing alcohol are suitable for cleaning soldered components to remove the remaining soldering flux. Due to environmental concerns and possible negative effects on the LED package do not use chlorinated hydrocarbons, fluorated hydrocarbons, and ketones.

Optics

- Rounded emitting area
- High on axis intensity
- Wide viewing angle
- Compatible with external optical systems
- Compatible with light pipes
- Suitable for backlighting: legends or LCDs

Siemens has produced LEDs in a SOT-23 package for a number of years. Similarly HP has produced gull wing and yoke lead LEDs for SMT. Experience with these designs formed the foundation for developing a new SMT-TOPLED™. A major objective was improvement of the optical performance with respect to intended SMT applications.

Reliability

Incoming inspection of SMT-TOPLED™ supplied in tape and reel format is difficult for the user. This means that high quality must be assured at incoming inspection in the low parts per million (PPM) defective range. To ensure this the quality departments of the user and the supplier must have effective communication to monitor quality levels and concerns. Working together it is possible to achieve incoming quality levels of better than 10 PPM.

HP and Siemens SMT-TOPLED™ Solution

Figure 18 shows the design of the new SMT-TOPLED™ in a form that matches the Tantalum B molded capacitor. This is from the IEC publication 286 part 3, and from EIA standard IS28. Refer to Table 1 of the last page of this appnote for optical characteristics .

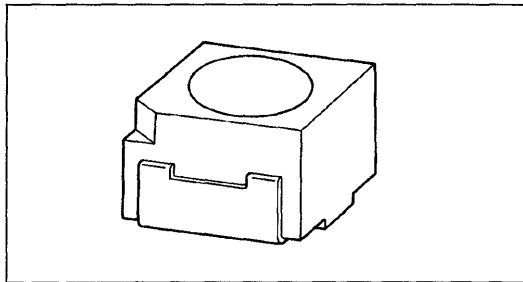

Figure 18. Package drawing of SMT-TOPLED™ .

Features

- EIA and IEC Standard Package
- Standard Lead Bend and Footprint
- Cathode Identification
- Flat top and sides for Pick and Place Compatibility
- High Temperature Thermoplastic Housing for SMT Soldering
- Nonimaging Optical Design for High Intensity Light Output

Close cooperation between Siemens and Hewlett-Packard's Optoelectronic Divisions carried out the development of the SMT-TOPLED™. These two worldwide leaders in optoelectronic components have agreed upon this package standard.

SMT-TOPLED™ Manufacturing

A stable, controlled manufacturing line helps to assure quality (Figure 19). The SMT-TOPLED™ manufacturing line incorporates the latest semiconductor assembly equipment in a "hands off" environment for process quality and repeatability. Decisions which affect quality are made based on statistical data and process capability data. The use of extensive automation eliminates the possibility of random uncontrolled failures in the process. From leadframe manufacturing to final bagging, the SMT-TOPLED™ is never handled by human hands.

Quality and Reliability

With SMT comes a heightened need for

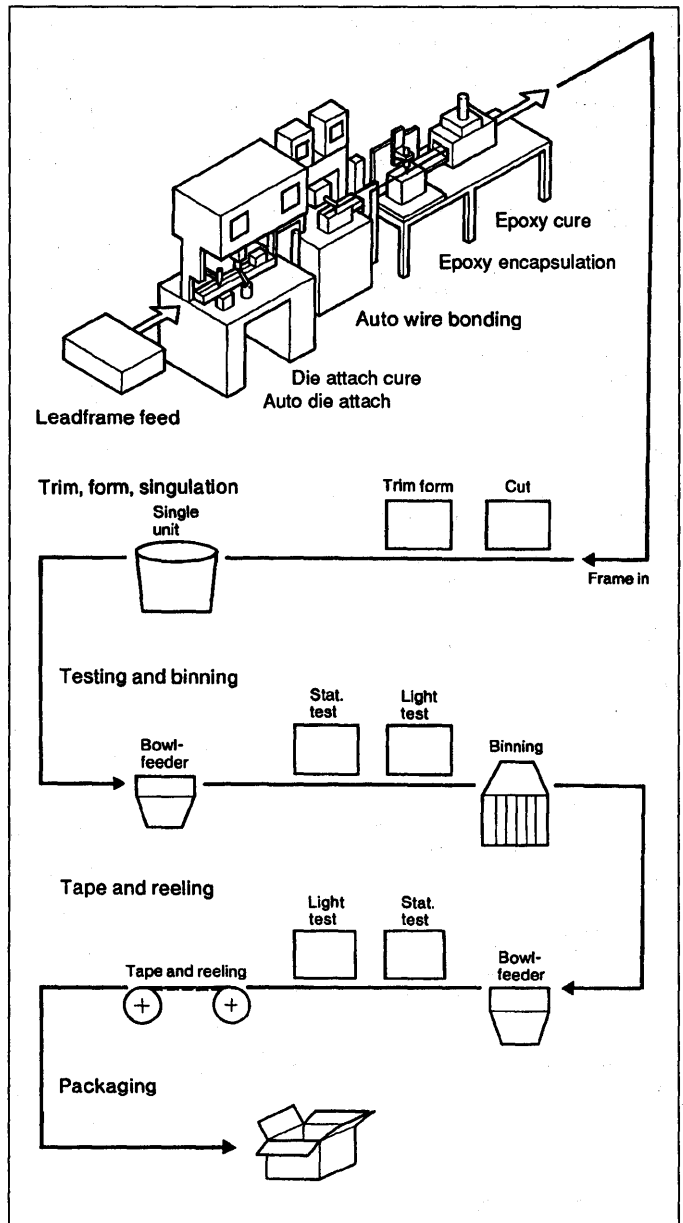

Figure 19. Manufacturing process flow.

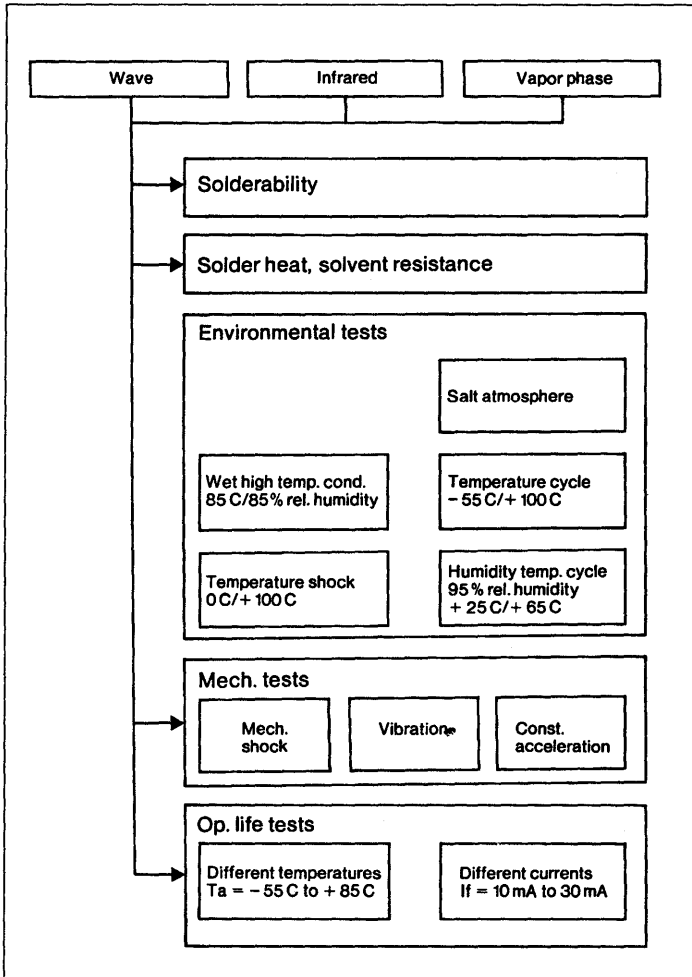

Figure 20. SMT-TOPLED™ qualification tests.

quality and reliability. Cost and complexity of boards demand high yields in SMT assembly. To meet these yields effectively, the components must exhibit outstanding initial quality and long term reliability. Performing stringent qualification testing by the component manufacturer ensures adherence to customers' strict requirements.

Reliability qualification of the SMT-TOPLED™ includes preconditioning of the LEDs before testing. This consists of screen printing adhesive to the test boards, pick and placing the LEDs, and soldering the board through the intended soldering process. On completing preconditioning, the boards' reliability testing may begin. Figure 20 illustrates the qualification tests done on the SMT-TOPLED™.

These tests simulate and accelerate actual user environments. Demanding qualification criteria used in testing assures LED users a guarantee for a product that will function after soldering and long into the future in the field.

SMT-TOPLED™ Performance

Table 1 highlights the important optical and electrical data for the new SMT design. Of special note is the combination of the high on axis intensity (I_v), and the large, uniform radiation pattern characterized by $2\theta_{1/2}$ (Figure 21). The uniformity and repeatability of the radiation pattern assure uniform viewing of multiple LEDs in both direct view or through secondary optics.

Conclusion

Through joint design efforts Hewlett-Packard and Siemens have assured true second sourcing of a high quality SMT-TOPLED™ that meets the manufacturability and illumination needs of the industry. Work is already under way on IR and detector implementations. It can be expected that further optoelectronic devices such as seven segment displays, light bars, multicolor emitters and sideways emitting LEDs will be standardized in this or a similar technology.

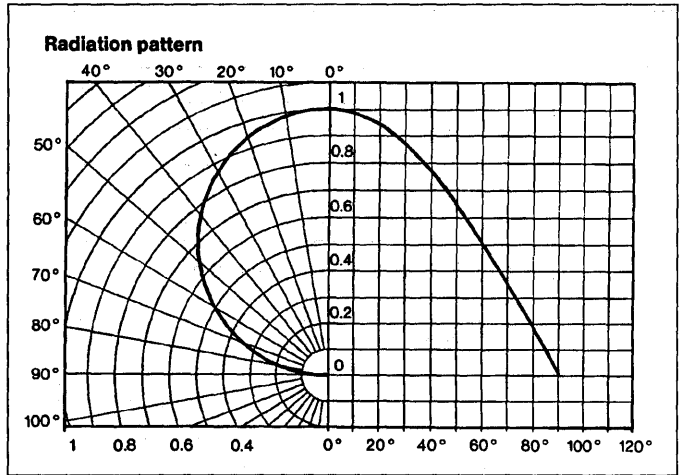

Figure 21. SMT-TOPLED™ radiation patterns.

Table 1: SMT LED Typical Data

Parameter	Symbol	AlGaAs	Red	Orange	Yellow	Green	Unit
Luminous Intensity (If = 10 mA)	I_v	14	6	5	5	8	mcd
Dominant Wavelength (If = 10 mA)	λ_{dom}	641	627	605	588	570	nm
Forward Voltage (If = 10 mA)	V_f	1.8	1.9	1.9	1.9	2.0	V
Viewing Angle $2\theta_{1/2}$	$2\theta_{1/2}$	120	120	120	120	120	Degrees
HP Part No.		HSMA T400	HSMS-T400	HSMD-T400	HSMY-T400	HSMG-T400	
Siemens Part No.		LH T674	LS T670	LO T670	LY T670	LG T670	

Visible and IR LEDs in SMT-TOPLED™ Package Tape and Reel Packaging Data Appnote 52

by

Applicable Part Numbers

Visible LEDs

LS T670-HO	High Efficiency Red
LY T670-HO	Yellow
LG T670-HO	Green
LO T670-HO	Orange

IR Emitters/Detectors

SFH320	Phototransistor
SFH320F	Phototransistor with daylight filter
SFH420	GaAs 950 nm IRED

For Automatic Placement

These parts come packaged on 18 cm diameter spools with 1500 pieces/spool. 33 cm spools (7500 pieces) are also available. The tape is compartmentalized and sealed with a foil cover.

Spool/Tape Characteristics

Maximum Storage Temperature	40° +5°
C/R-H = 95%/240 hrs.	
Tape Tear Resistance (max.)	≥10 N
(at right angle to direction of unreeling)	
Cover Foil Pull Force	0.2 to 1.0 N
(pull speed = 300 mm/min.)	

Polarity and Orientation

- Mounting surface (bottom) on bottom of tape compartment
- All devices are oriented in one direction

Reel Marking

All reels are marked with manufacturer's name, part number, date code, and order number.

Parameter	Symbol	Dimensions (mm)	Notes
Tape Width	W	8 ±0.3	
Carrier Tape Thickness	t	0.3 max.	
Sprocket Hole Pitch	P ₀	4 ±0.1	Cumulative pitch error, ±0.5 mm pitches
Sprocket Hole Diameter	D ₀	1.5 +0.1	
Sprocket Hole Distance	E	1.75 ±0.1	
Component Position	F P ₂	3.5 ±0.05 2 ±0.05	Center hole to center compartment
Component to Component Position	P ₃	4	
Compartment Dimensions	K OL R ₁ , R ₂ H ₀ A ₀ B ₀	3 max. 15° max. 0.5 max. 0.3 +0.1/-0.05	See individual component for exact dimensions Between inner side of the compartment bottom and the reference level for measuring A ₀ , B ₀ Tolerances chosen so that the components can change their orientation, but can easily be removed from the tape.
Hole in Compartment	D ₁	1 +0.2	Tolerance to the center or sprocket hole: ±0.1 mm
Fixing Tape Width	W ₁	5.5 typ.	Fixing tape not to cover sprocket holes, nor protrude beyond carrier tape so not to exceed max. tape width
Device Tilt in Compartment	d	0.1 max. 15° max.	
Bending Radius	R	25 min.	

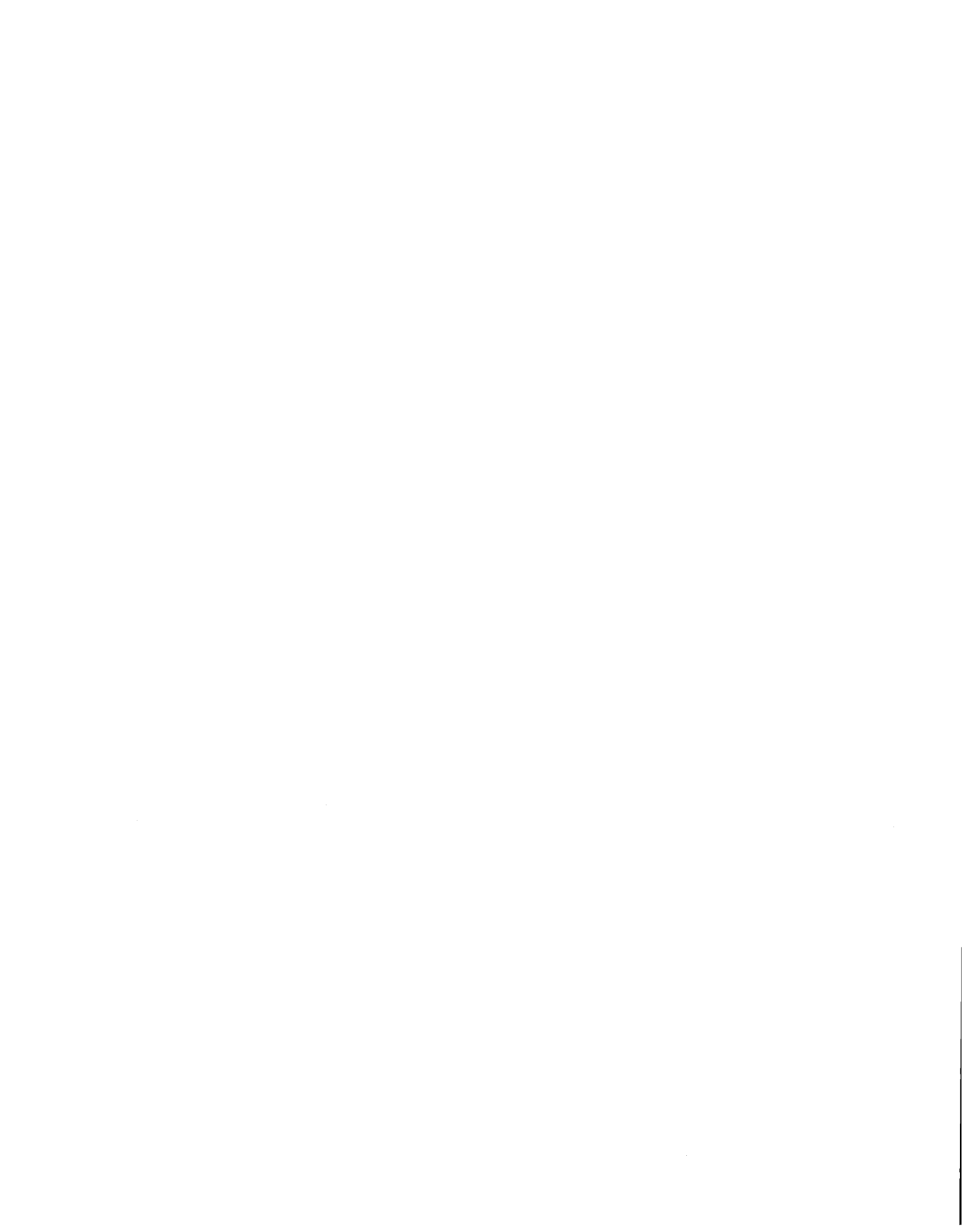

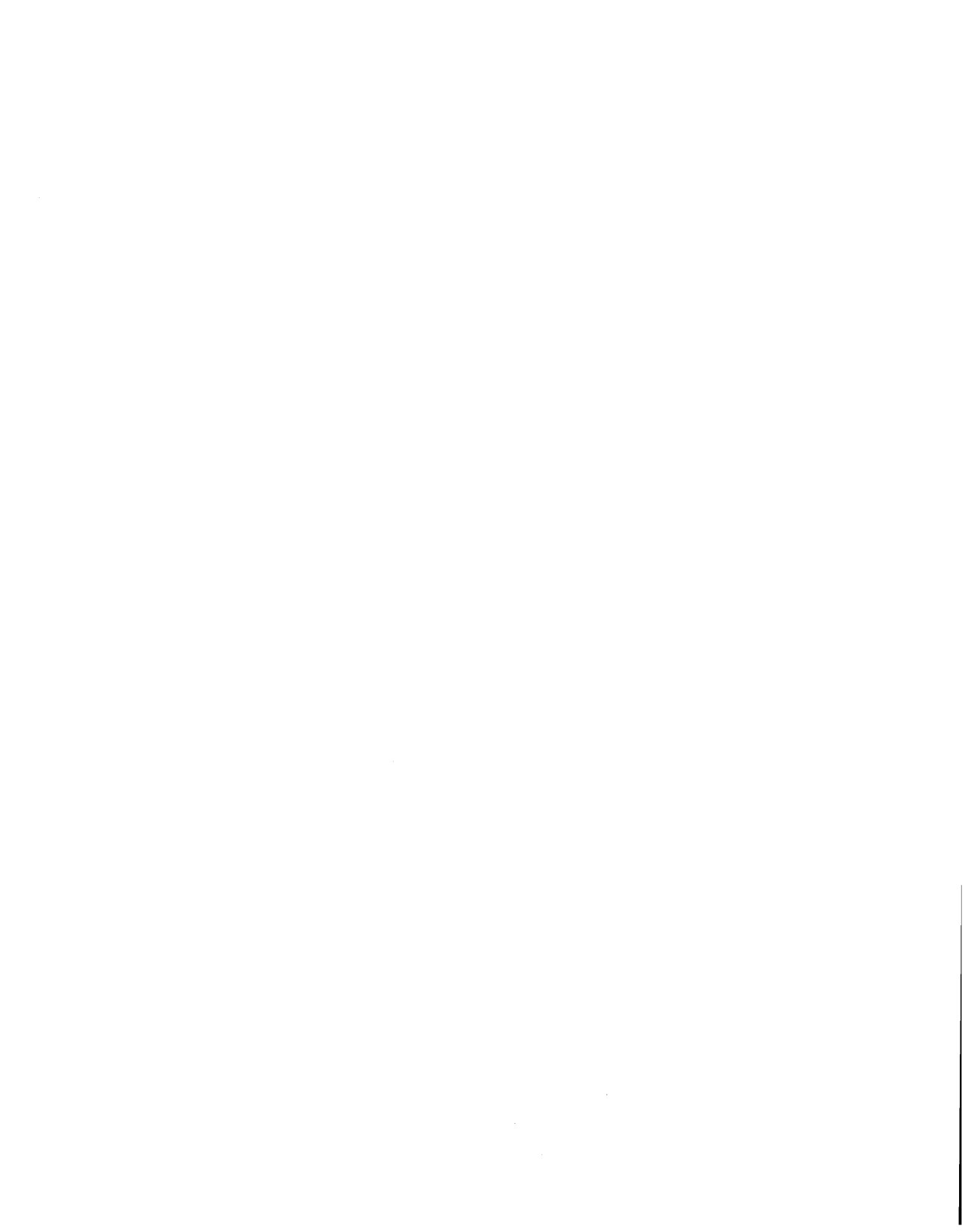







Siemens Optoelectronic Semiconductors

International Sales Offices

List is alphabetical by country name, not country symbol

A Austria

Siemens AG Österreich
Postfach 326
1031 Wien
Phone (01) 71711-5661
Telex 1372-10
Fax (01) 71711-5973

AUS Australia

Siemens Limited, Head Office
544 Church Street
Richmond (Melbourne), Vic. 3121
Phone (03) 4207111
Telex 30425
Fax (03) 4207275

B Belgium

Siemens S.A.
chaussée de Charleroi 116
1060 Bruxelles
Phone (02) 536-2111
Telex 21347
Fax (02) 536-2492

BR Brazil

ICOTRON SA
Indústria de Componentes
Eletrônicos
Avenida Mulinga, 3650-6º andar
05150 São Paulo-SP
Phone (011) 833-2211
Telex 11-81001
Fax (011) 831-4006

CDN Canada

Siemens Electric Ltd.
Electronic Components Division
1180 Courtney Park Drive
Mississauga, Ontario L5T 1P2
Phone (416) 564-1995
Telex (069) 68841
Fax (416) 670-6563

DK Denmark

Siemens A/S
Borupvang 3
2750 Ballerup
Phone 44 774477
Telex 1258222
Fax 44 774017

SF Finland

Siemens Oy
P.O.B. 60
02601 Espoo
Phone (0) 51051
Telex 124465
Fax (0) 51052398

F France

Siemens S.A.
39/47 Bd. Ornano
93527 Saint-Denis CEDEX 2
Phone (1) 49223100
Telex 234077
Fax (1) 49223970

D Germany

Siemens AG
Salzhofer 6-8
W-1000 Berlin 10
Phone (030) 3993-0
Telex 17308196 sieznvb
Fax (030) 3993-2490
Teletex 308196=sieznvb

Siemens AG
Lahnweg 10, Postfach 1115
W-4000 Düsseldorf 1
Phone (0211) 399-0
Teletex 21134401
Fax (0211) 399-1481

Siemens AG
Rödelheimer Landstraße 5-9
Postfach 111733
W-6000 Frankfurt 1
Phone (069) 797-0
Telex 4141650
Fax (069) 797-2582

Siemens AG
Lindenplatz 2, Postfach 105609
W-2000 Hamburg 1
Phone (040) 2889-0
Telex 215584-0
Fax (040) 2889-3096

Siemens AG Hannover
Hildesheimer Straße 7
Postfach 110551
W-3014 Laatzen
Phone (0511) 877-0
Telex 922333
Fax (0511) 877-2078

Siemens AG
Bereich Halbleiter
Schützenstraße 4-10,
Postfach 820
O-7010 Leipzig
Phone (0341) 210-2422/2423
Fax (0341) 210-2441

Siemens AG
Richard-Strauss-Straße 76
Postfach 202109
W-8000 München 80
Phone (089) 9221-0
Telex 529421-19
Fax (089) 9221-4692
Teletex 8985084

Siemens AG
Von-der-Tann-Straße 30
Postfach 4844
W-8500 Nürnberg 1
Phone (0911) 654-0
Telex 622251-0
Fax (0911) 654-6505

Siemens AG
Geschwister-Scholl-Straße 24
Postfach 106026
W-7000 Stuttgart 1
Phone (0711) 2076-0
Telex 723941-50
Fax (0711) 2076-2448

GR Greece

Siemens AE
Paradissou & Artemidous
P.O.B. 61011
15110 Amaroussio/Athen
Phone (01) 6864111
Telex 216292
Fax (01) 6864299

HK Hong Kong

Schmidt & Co. (H.K.) Ltd.
18/Fl., Great Eagle Centre
23 Harbour Road
Wanchai, Hong Kong
Phone 852/8330222
Telex 74766 schmc hx
Fax 8382652

IND India

Siemens Ltd.,
Head Office
134-A, Dr. Annie Besant Road, Worli
P.O.B. 6597
Bombay 400018
Phone (022) 4938786
Telex 1175142
Fax (022) 4940240

IRL Ireland

Siemens Ltd.
Electronic Components Division
8 Raglan Road
Ballsbridge
Dublin 4
Phone (01) 684727
Telex 93744
Fax (01) 684633

I Italy

Siemens SpA
Div. Componenti, Impianti per
la Grafica e il Segnalamento
Via dei Valtorta, 48
20127 Milano
Phone (02) 6676-1
Fax (02) 6676-4439

J Japan

Fuji Electronic Components Ltd.
Chin Yurakucho Building, 8F
12-1 Yurakucho 1-Chome,
Chiyoda-ku
Tokyo 100
Phone (03) 3201-2401
Telex 32182
Fax (03) 3201-6809

ROK Korea

Siemens, Limited
P.O.B. 3001
Seoul 100-391
Phone (02) 275-6111
Telex 23229
Fax (02) 2752170

NL Netherlands

Siemens Nederland N.V.
Postb. 16068
2500 BB Den Haag
Phone (070) 333-3333
Telex 31373
Fax (070) 3332790

N Norway

Siemens A/S
Østre Aker vei 90
Postboks 10, Veitvet
0518 Oslo 5
Phone (02) 633000
Telex 784 77
Fax (02) 633805

P Portugal

Siemens S.A.
Estrada Nacional 117, Km 2,6
Alfregade
2700 Amadora
Phone (01) 4170011
Telex 62955
Fax (01) 4172870

SGP Singapore

Siemens Components Pte. Ltd.
Promotion Office
166 Kallang Way
Singapore 1334
Phone 7417418
Fax 7426239, 7422803

ZA South Africa

Siemens Limited
Siemens House
P.O.B. 4583
Johannesburg 2000
Phone (011) 3151950
Telex 450091
Fax (011) 3151968

E Spain

Siemens S.A.
Departamento de Componentes
Orense, 2
Apartado 155
28020 Madrid
Phone (01) 5552500
Telex 44191
Fax (01) 5565408

S Sweden

Siemens Components
Österögatan 1
Box 46
S-164 93 Kista
Phone (08) 7033500
Telex 11672
Fax (08) 7033501

CH Switzerland

Siemens-Albis AG
Freilagerstraße 28
8047 Zürich
Phone (01) 495-3111
Telex 823781-23
Fax (01) 495-5050

RC Taiwan

TAI Engineering Co., Ltd.
6th Fl., Central Building
108 Chung Shan N. Rd, Sec. 2
P.O.B. 68-1882
Taipei 10449
Phone (02) 5234700
Telex 27860 taiengco
Fax (02) 5367070

TR Turkey

SIMKO Ticaret ve Sanayi AS
Mecidi Mebusan Cad. No. 125
PK 1001, 80007 Karaköy
80040 Findikli
Phone (01) 2510900
Telex 24233 sies tr
Fax (01) 2524134

GB United Kingdom

Siemens P.L.C.
Electronics Components Group
Oldbury
Bracknell
Berks
RG 12 HFZ
Phone (0344) 862222
Fax (0344) 850900

Siemens Components, Inc.
Optoelectronics Division

U.S. Sales Offices

Serving the Northern USA

Siemens Components, Inc.
3023 Tiffany Court
Carmel, IN 46032
Phone (317) 844-5592
Fax (317) 844-0558

Siemens Components, Inc.
238 Littleton Road
Westford, MA 01886
Phone (508) 692-0550
Fax (508) 692-2309

Siemens Components, Inc.
38701 West Seven Mile Road,
Suite 435
Livonia, MI 48152
Phone (313) 462-1195
Fax (313) 462-1694

Serving the Southern USA

Siemens Components, Inc.
6525 The Corners Parkway, Suite 206
Norcross, GA 30092
Phone (404) 449-3981
Fax (404) 449-4522

Siemens Components, Inc.
120 Wood Avenue South, Suite 606
Iselin, NJ 08830-2709
Phone (908) 603-0600
Fax (908) 603-0669

Siemens Components, Inc.
307 Fellowship Road, Suite 202
Mt. Laurel, NJ 08054
Phone (609) 273-6677
Fax (609) 273-8904

Siemens Components, Inc.
16479 Dallas Parkway, Suite 690
Dallas, TX 75248
Phone (214) 733-4511
Fax (214) 733-4862

Serving the Western USA

Southern California
Siemens Components, Inc.
625 The City Drive South,
Suite 320
Orange, CA 92668
Phone (714) 971-1274
Fax (714) 971-1294

Northern California
Siemens Components, Inc.
Integrated Circuits Division
2191 Laurelwood Road
Santa Clara, CA 95054-1514
Phone (408) 980-7968
Fax (408) 980-9246

Siemens Components, Inc.
1901 N. Roselle Road, Suite 565
Schaumburg, IL 60195
Phone (708) 884-7009
Fax (708) 884-7599

Regarding patents and rights of third parties: Liability is only assumed for components per se, not for applications, processes, and circuits implemented within components or assemblies.

Printed information describes the type of component and shall not be considered as assured characteristics.

Terms of delivery and rights to change design are reserved.

Due to technical requirements, components may contain dangerous substances. For more information, please contact Siemens Components, Optoelectronics Division.

For technology, delivery, and price information, please contact the nearest Siemens office or distributor, as shown on the preceding address list.

Published by Siemens Components, Inc., Optoelectronics Division, Marketing Communications, 19000 Homestead Road, Cupertino, CA 95014, (408) 257-7910.

©Siemens Optoelectronics 1993. All Rights Reserved.

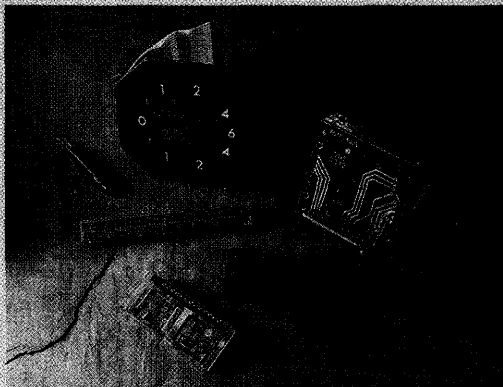

Custom Optoelectronic Products

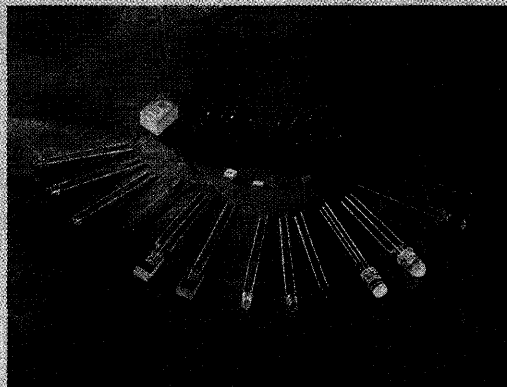

LED Lamps, Alphanumeric Displays

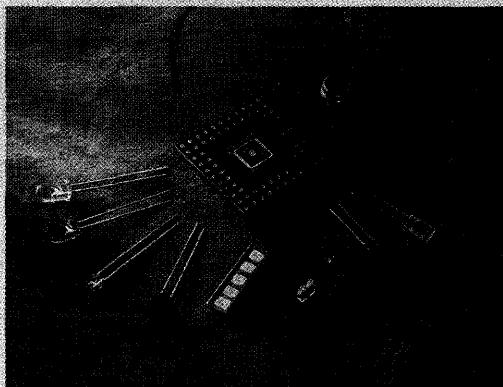

Infrared Emitters, Photodiodes, Phototransistors



Optocouplers

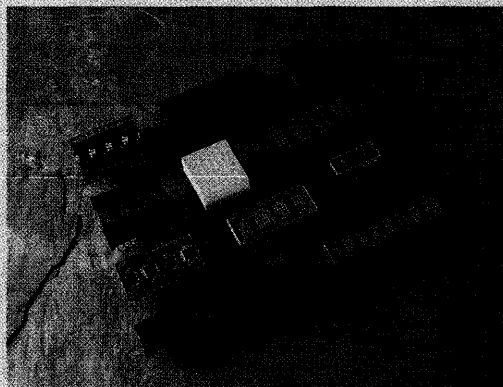

Intelligent Display® Devices, Programmable Displays,
Slimline Intelligent Displays, Small Alphanumeric
Displays, and HI-REL Displays

Issued by
Siemens Components, Inc., Optoelectronics Division
19000 Homestead Road, Cupertino, California 95014

Data Subject to Change
BANTA 1993 Printed in USA

Order Number R143-H6441-X-X-7900. Use only when ordering data back in Europe.

Printed on Recycled Paper