

COMPUTER DESIGN

THE MAGAZINE OF MODERN DIGITAL ELECTRONICS

JANUARY 1968



96133
7083
04

**This 16-bit, real-time computer
is so fast you can have one in 45 days.**



It's our SEL 810A, for high-speed data acquisition and control. All integrated circuits, 3 levels of priority interrupt, 4K memory, teletype, high-speed hardware multiply and divide, real-time I/O structure, and an outstanding software package. Over 50 in the field. Price: \$23,950. Systems Engineering Laboratories, 6901 West Sunrise Blvd., Fort Lauderdale, Florida 33310, Area Code 305 587-2900. Offices also in Washington, D.C.; Los Angeles, California; Boston, Massachusetts; San Francisco, California; Cleveland, Ohio; Houston, Texas; Huntsville, Alabama; and Orlando, Florida.

Systems Engineering Laboratories

where will you be in 1973?

Five years at Sanders will make you immeasurably more accomplished.

Here you will work on new things, designing and building systems to answer yet unsolved problems — significant problems that can change the way we live, perhaps the course of history. To carry out such an assignment you are going to have to find new answers.

Answers in turn raise further questions.

This is progress — cutting a path to what is meaningful through the choking flow of random data that all too often is a substitute for thought.

This is the opportunity at Sanders. Here your role can be personally and professionally rewarding.

WRITE to Mr. T.J. Auger today for career information. The address: Sanders Associates, Inc., Dept. 296 CD, 95 Canal Street, Nashua, New Hampshire 03060.

COMPUTER SYSTEM ENGINEERS ■ DIGITAL DESIGN ENGINEERS ■ PROJECT ENGINEERS ■ PRODUCT DESIGNERS ■ SYSTEM ANALYSTS ■ SYSTEM PROGRAMMERS ■ APPLICATION PROGRAMMERS

CREATING NEW DIRECTIONS IN ELECTRONICS



* T. M. SANDERS ASSOCIATES, INC. An Equal Opportunity Employer M/F

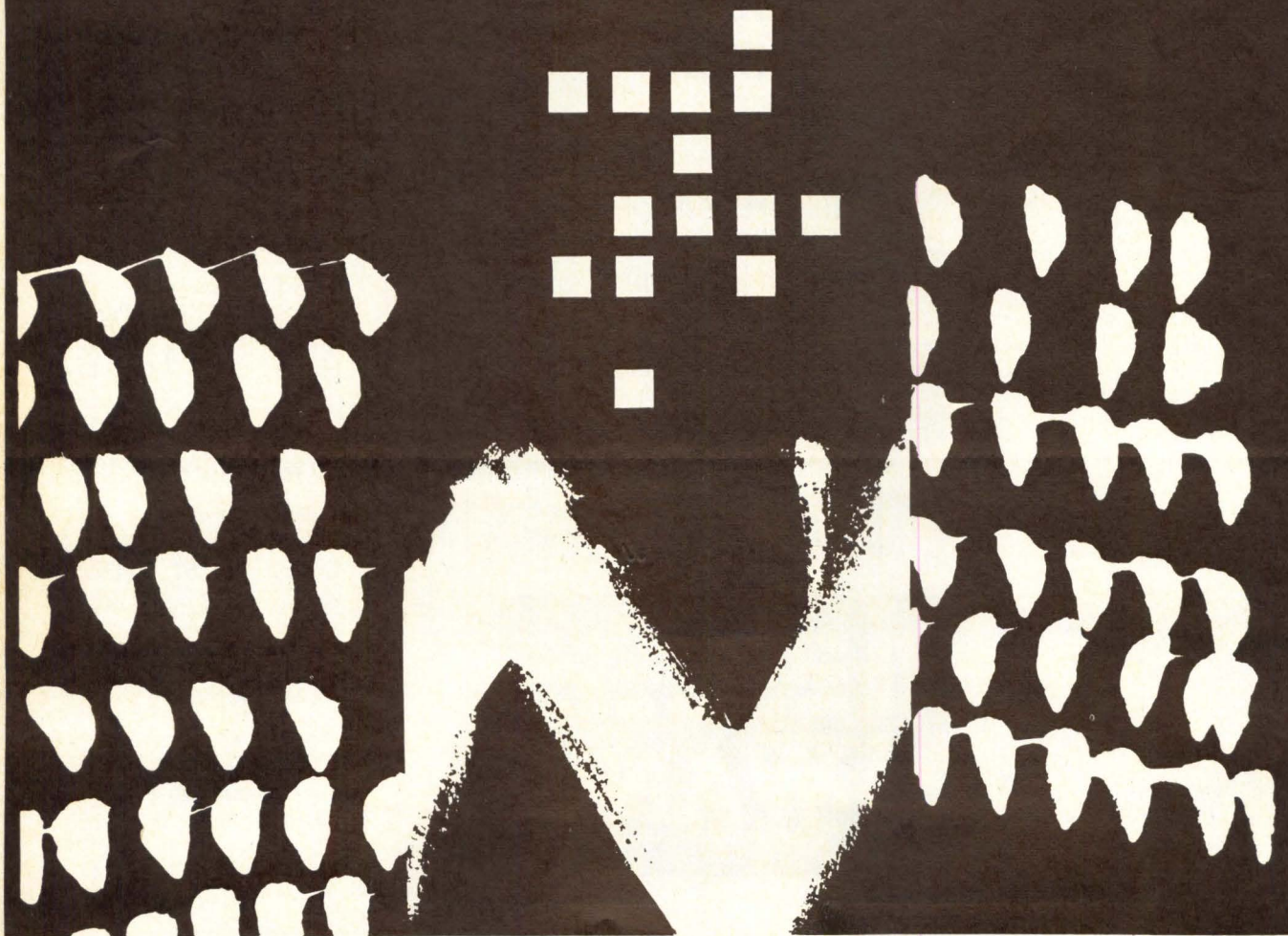

CIRCLE NO. 904 ON INQUIRY CARD

NUMBER **1**
IN NUMBERS



The world's most versatile PERSONAL CALCULATING SYSTEM

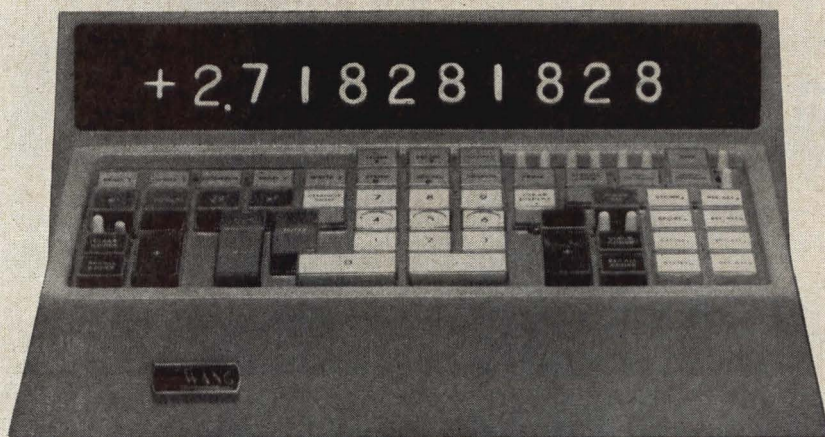

**thinks in logarithms...
answers in decimals**

THE MODEL 370 GIVES YOU MOST OF THE ADVANTAGES OF A BIG COMPUTER

- Expandable, random-access core memory
- Looping, branching, subroutines
- Extraordinary power and versatility — handles statistical computations, simultaneous equations, problems with logs and exponentials, etc.
- Time-sharing — fully compatible with standard 320 series for "in-field" expandability
- Extensive software library
- Modular design — buy only the functions you need; add more capabilities at any time.

WITH NONE OF THE DISADVANTAGES

- No major investment required — price in upper "calculator" range
- No waiting — always available at your fingertips
- No special language needed — programs in minutes in simple keyboard format
- No space problems — compact keyboard/control console takes little more room than a phone on your desk; small electronics unit takes no more room than a desk drawer and may be located up to 50' away.

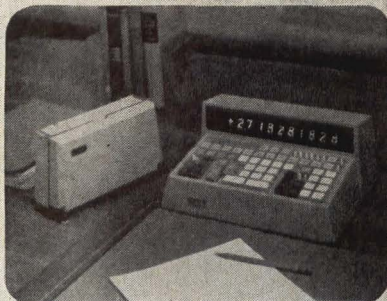

Let us tell you more about the
extraordinary WANG Model 370.
Write for complete data.

WANG
LABORATORIES, INC.



SALES OFFICES

BOSTON

Lindsay H. Caldwell
Professional Bldg.
Baker Ave.
W. Concord, Mass.
phone: (617) 369-6660

NEW YORK

Kaiser, McElwain, Dolbey
Advertising Sales, Inc.
60 E. 42nd St.
New York, N.Y.
phone: (212) YU 6-2654

CHICAGO

Robert Dunn
2 N. Riverside Place
Chicago, Ill. 60645
phone: (312) 372-6266

Donald C. White
616 Dalton Place
Northbrook, Ill. 60062
phone: (312) 272-6459

LOS ANGELES

David Barton
672 So. Lafayette Park Pl.
Los Angeles 57, California
phone: (213) 382-1121

SAN FRANCISCO

David Barton
672 So. Lafayette Park Pl.
Los Angeles 57, California
phone: (213) 382-1121

FT. LAUDERDALE

Dan Wiper
2801 E. Oakland Park Blvd.
Ft. Lauderdale, Fla. 33308
phone: (305) 563-1376

Publisher and Editor
ROBERT BROTHERSTON

Associate Publisher
ANTHONY SALTALAMACCHIA

Managing Editor
WILLIAM G. KEYWORTH

Editorial Advisers
RICHARD AHRONS
ELI ANFENGER
JAMES R. BRIGHT
GERHARD L. HOLLANDER
BERNARD M. GORDON
WALDRON S. MacDONALD
ROBERT S. SENATOR
HAROLD H. SEWARD

Contributing Editors
T. PAUL BOTHWELL
A. S. BUCHMAN
M. P. de REGT
RUDOLPH J. KADLEC
ROBERT P. FORAN
RICHARD B. LAWRENCE
WALTER A. LEVY
H. S. MILLER
MADELINE SULLIVAN

Washington Editor
HAROLD V. SEMLING, JR.

Art Director
JAMES FLORA

Production Manager
TERRY ARMENTI

Tech. Illus.
JOHN BROTHERSTON

Editorial Ass't.
PRISCILLA HANNON

Adv. Prod.
JOAN WASIUK

Circ. Mgr.
ALMA BROTHERSTON

Vice Pres.-Sales
LINDSAY H. CALDWELL

Editorial & Executive Offices
Prof. Bldg., Baker Ave.,
W. Concord, Mass. 01781
Tel. 369-6660

Computer Design is published monthly. Copyright 1968 by Computer Design Publishing Corporation. Accepted as controlled circulation publication at Post Office at Boston, Massachusetts. No material may be reprinted without permission. Postmaster: CHANGE OF ADDRESS — FORM 3579 to be sent to Computer Design, Circulation Dept., P. O. Box A, Winchester, Mass. 01890. Subscription rate to nonqualified subscribers is \$15.00 per year; \$1.50 per issue. Subscription rate to all foreign subscribers is \$25.00 per year; \$2.50 per copy.



Circulation
over 40,000

COMPUTER DESIGN

THE MAGAZINE OF MODERN DIGITAL ELECTRONICS

FEATURES

36 SOLID-STATE CIRCUITS CONFERENCE

Schedule and abstracts of papers of particular interest to Computer Design readers

38 A REVIEW OF DIGITAL DIFFERENTIAL ANALYZERS

A discussion of applications, advantages and disadvantages of digital differential analyzers, how they are designed, programmed and used and recent improvements that make them faster and more accurate.

44 THE DEVELOPMENT OF A LARGE INTEGRATED COMPLEMENTARY MOS MEMORY ARRAY

Work accomplished toward fabricating a 16-word by 18-digit complementary MOS, memory array, including decoder and word drivers on a single silicon chip is described.

56 SIMULATION OF A SMALL LOGIC SYSTEM WITH A FORTRAN PROGRAM

A design problem of a small logic system is used as an example to demonstrate application of a simulation program.

62 NEGATIVE RADIX ARITHMETIC PART 8: COMPLEMENTARY ARITHMETIC

In this last part of this series the author points out that the potential of negative radix arithmetic lies in using it to do things that are impractical using conventional arithmetic.

67 A NEW-DESIGN TRANSMISSION-LINE ADDER

Use of directional couplers adds another dimension to logical adder design. Carry propagations are now free of current delays, permitting fast add times without use of additional logical decisions for look-ahead capabilities.

DEPARTMENTS

- 14 CD READERS' FORUM: A COMPATIBLE LOGIC SYSTEM
- 22 CD COMMENTARY: IMPACT OF LSI ON COMPUTER MEMORIES
- 28 INDUSTRY NEWS
- 70 NEW PRODUCTS
- 82 NEW LITERATURE

Reader subscription cards opposite pg. 1
Reader inquiry cards opposite pg. 88

If Brand-Rex is already supplying wire and cable to Burroughs, Control Data, G. E., Honeywell, IBM, NCR, Univac and RCA...

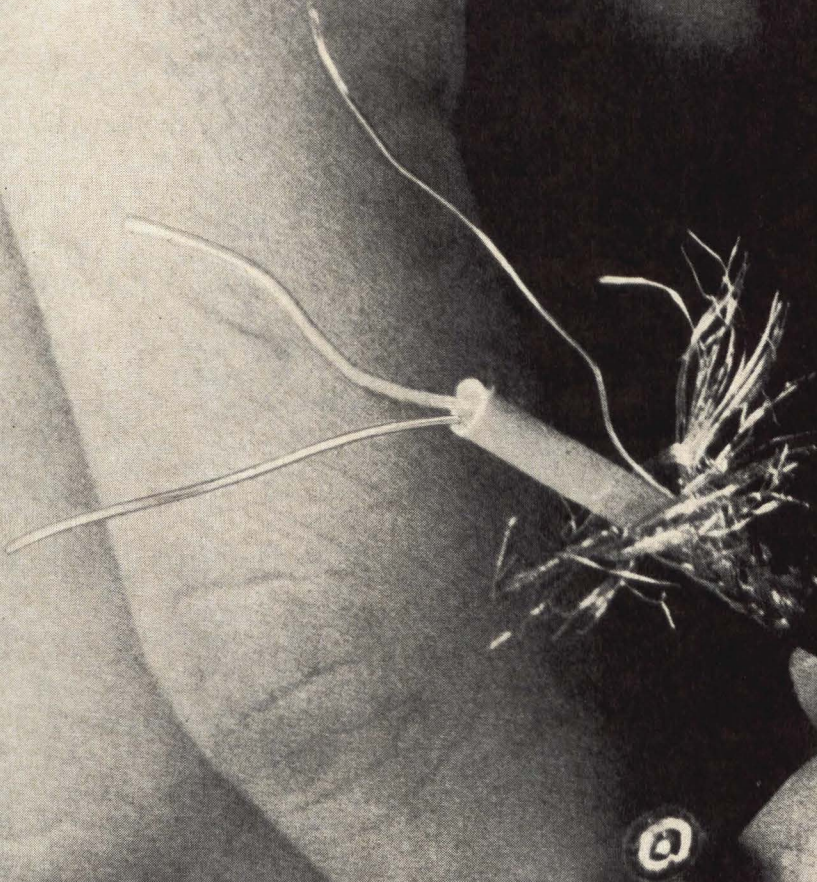

why are we so interested in making connections with you right now?

Brand-Rex can help make wire and cable procurement the easiest part of your next computer. Here's what we offer:

BROAD PRODUCT LINE Brand-Rex is the largest supplier of wire and cable to the computer industry. Our EDP line includes back-panel wires, hook-up wires, miniature air-spaced coaxial cables, power supply wires, patch cord wires, interconnecting and communication cables.

DESIGN CAPABILITY We're probably already making the wire and cable you

need. If not, we can quickly develop new constructions for new applications. The miniature 95 ohm coaxial cable illustrated here was specifically designed for one of the leading data processing systems. Brand-Rex designs cable to standard specifications or to your specific requirements. (Over 3,000 new designs last year alone.)

Any insulation. Any configuration.

U.L. APPROVAL We are well equipped to help you get U.L. approvals. Brand-Rex has more of them on computer wire and

cable than any other manufacturer.

ENGINEERING KNOW-HOW With more than 16 years' experience serving the computer field, you'll find our engineers eager and able to work with you — from drawing board to production line. Call Brand-Rex now — while your next design project is only a gleam in your eye.

AMERICAN  CORPORATION

BRAND-REX DIVISION

WILLIMANTIC, CONNECTICUT 06096

PHONE 203 423-7711

REX

What good is getting an answer in microseconds

if set-up takes weeks?

Computer set-up time is cut from weeks to less than an hour...with the new Hewlett-Packard 2115A. Here's a computer especially designed for fast, simple set-up whether for a scientific computation application or for hooking up a complete computer instrumentation system.

Take the hardware...just use standard plug-in cards, plug in the peripheral cable...and the interface is complete...a snap. The same story of simplicity is true for the software, using standard peripheral drivers. Your system's ready to go to work in *under an hour*.

The 2115A offers extensive software, including FORTRAN, ALGOL and BASIC compilers and a relocatable assembler. Other features you get with this powerful small computer include 16-bit word length, 2 μ sec cycle time, 4K or 8K memory; 8 channels of I/O in the main frame, 40 channels with an external extender. The standard plug-in interfaces are offered for all the usual peripherals...and general-purpose interfaces are available for your particular I/O devices.

Price, including Teleprinter, \$16,500.

Make your move now toward time-saving, work-saving computer set up. You can do it with a call to your local HP field engineer. Or get all the information by writing Hewlett-Packard, Palo Alto, California 94304; Europe: 54 Route des Acacias, Geneva.

HEWLETT  PACKARD
DIGITAL COMPUTERS

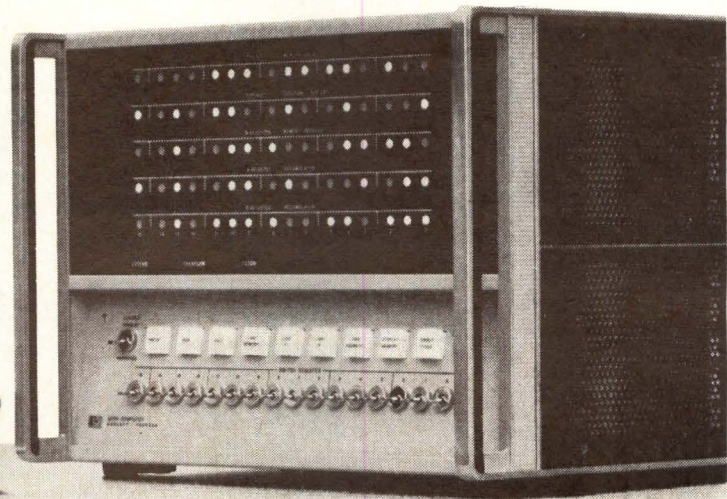

06717

CIRCLE NO. 5 ON INQUIRY CARD

← CIRCLE NO. 40 ON INQUIRY CARD

The great LSI race.

While the rest of the semiconductor industry tried to squeeze enough ICs on a chip to get into the MSI/LSI business, Fairchild turned systems inside out. We were looking for an intelligent alternative to component mentality. Our investigation led to a whole new set of design criteria for medium and large scale integration devices.

A computer isn't a computer.

It's a digital logic system. It has the same functional needs as any other digital system: control, memory, input/output and arithmetic. There's no logical reason to custom design a complex circuit for each system. That's why Fairchild MSIs and LSIs are designed to function as fundamental building blocks in any digital logic system. Even if it's a computer.

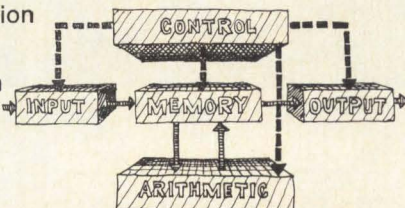

A little complexity goes a long way.

Anybody can package a potpourri of circuitry and call it MSI or LSI. But, that's not the problem. Why multiply components, when you should divide the system? Like we did. We found that sub-systems have a common tendency toward functional overlap. There are too many devices performing similar functions. More stumbling blocks than building blocks. Our remedy is a family of MSIs and LSIs with multiple applications. The Fairchild 9300 universal register, for example, can also function as a modulo counter, shift register, binary to BCD shift converter, up/down counter, serial to parallel (and parallel to serial) converter, and a half-dozen other devices.

Watch out for that first step.

There are all kinds of complex circuits. Some of them have a lot of headache potential. Especially if you want to interface them with next year's MSIs and LSIs. We decided to eliminate the problem before it got into your system. All Fairchild building blocks share the same compatible design characteristics.

We're also making the interface devices that tie them together. For example, our 9301 one-of-ten decoder can be used as an input/output between our universal register, dual full adder and memory cell.

(It could also get a job as an expandable digital demultiplexer, minterm generator or BCD decoder.)

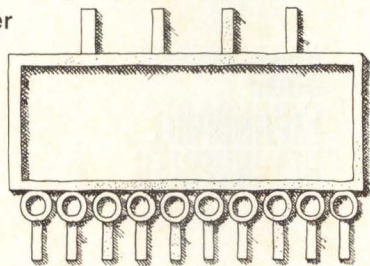

Hurry. Before the price goes down.

Gate for gate, today's complex circuits are about the same price as discrete ICs. But, by the time you're ready to order production quantities, the price should be a lot lower. At least ours will. The reason is simple: Fairchild devices are extremely versatile. There are fewer of them. But, they do more jobs. That means we'll be producing large quantities of each device. That also means low unit cost to you. And you'll have fewer devices to inventory. And fewer to assemble.

If you agree with our approach to medium and large scale integration, we'd like to tell you more about it. There are two ways you can get additional information. One is by mail. Simply write us on your company letterhead. You can also get more data by watching the trade press. Fairchild is introducing a new integrated circuit each week for 52 weeks. (We started on October 9, 1967)

Many of them will be MSI and LSI. If you'd like to see the last few we've introduced, turn the page.

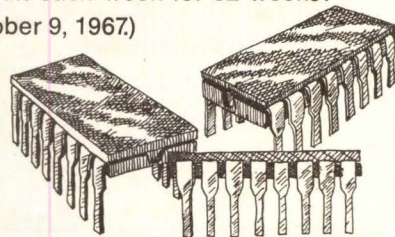

FAIRCHILD SEMICONDUCTOR

A Division of Fairchild Camera and Instrument Corporation
313 Fairchild Drive, Mountain View, California 94040
(415) 962-5011, TWX: 910-379-6435

RECAP:

9112 HIGH LEVEL HEX CONVERTER

Fairchild will introduce
a new integrated circuit
each week for 52 weeks.
This is number **6.**

The 9112 is part of our new family of high noise immunity integrated circuits. It is designed to convert CMOS logic levels to high logic levels. It is ideal for driving MOS devices. The 9112 consists of six high-level DTL gates. Each gate performs a single inversion operation. Worst case noise immunity is 5.5 volts. This high voltage device enables over the entire range of 12 to 20V to operate from 0°C to +70°C. It comes in an hermetic dual in-line package and is available in volume quantities. Fairchild distributors have it in stock now. Write for complete specs and applications information. Ask about our other new products, too.

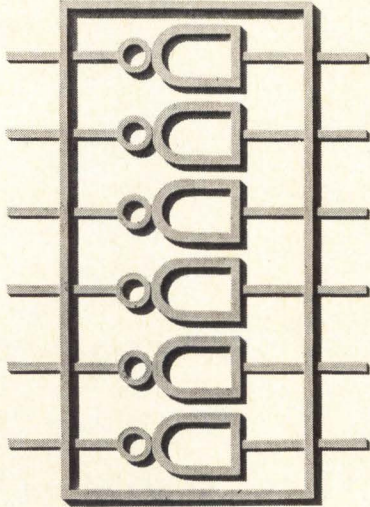

FAIRCHILD SEMICONDUCTOR / A Division of Fairchild Camera and Instrument Corporation
FAIRCHILD SEMICONDUCTOR 311 Fairchild Drive, Mountain View, California 94035 (415) 961-3001 • TWX: 910-574-6413

CIRCLE READER SERVICE NUMBER 106

9989 FOUR-BIT BINARY COUNTER

Fairchild will introduce
a new integrated circuit
each week for 52 weeks.
This is number **7.**

The 9989 is a low-cost, high rate, modulo 16 counter in a single package with great capability. It is compatible with the entire C₁₈ family and can operate directly into TTL, DTL, or TTL circuitry. Typical power dissipation is only 120mW. Its operating frequency is 15MHz. It's designed to operate in the 0°C to +70°C temperature range with nominal power supply voltage of 3.6 to 5.5 volts. The 9989 comes in a 14-pin hermetic DIP. Primary applications include counters, event meters and logic conversion functions. The four-bit binary counter is available in volume quantities. Fairchild distributors have it in stock now. Write for complete specs and applications information. Ask about our other new products, too.

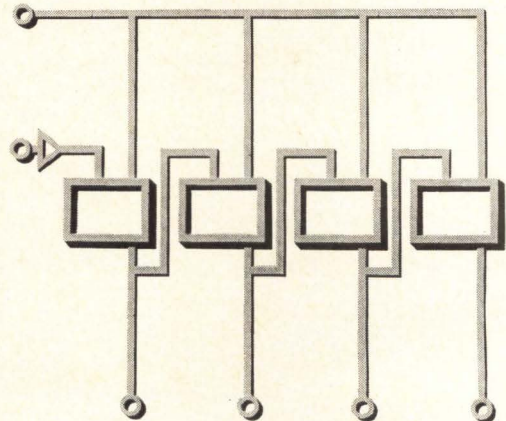

FAIRCHILD SEMICONDUCTOR / A Division of Fairchild Camera and Instrument Corporation
FAIRCHILD SEMICONDUCTOR 311 Fairchild Drive, Mountain View, California 94035 (415) 961-3001 • TWX: 910-574-6413

CIRCLE READER SERVICE NUMBER 107

μA719 HIGH FREQUENCY COMMUNICATIONS SYSTEM

Fairchild will introduce
a new integrated circuit
each week for 52 weeks.
This is number **8.**

The μA719 is a new linear integrated circuit for military and industrial communications systems. It can function as an FM detector, an AM or FM amplifier, a modulator or an audio amplifier. It contains two independent amplifiers designed for IF systems to 50MHz. It provides excellent stability (70dB noise gain), AGC capability and extreme reliability. And, it has three counters directly on the chip. The μA719 comes in a hermetic TO-99 package. It is available in quantity in both military and industrial temperature ranges (-50°C to +125°C and 0°C to +70°C). Your Fairchild distributor has it in stock now. Write for complete specs and applications information. Ask about our other new products, too.

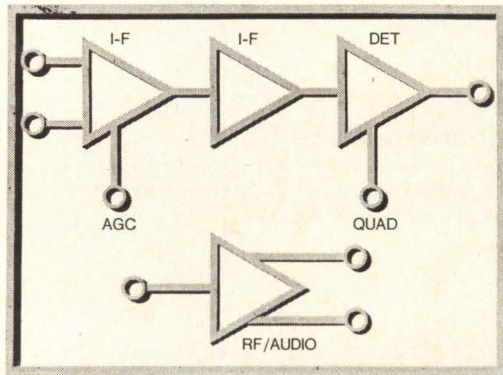

FAIRCHILD SEMICONDUCTOR / A Division of Fairchild Camera and Instrument Corporation
FAIRCHILD SEMICONDUCTOR 311 Fairchild Drive, Mountain View, California 94035 (415) 961-3001 • TWX: 910-574-6413

CIRCLE READER SERVICE NUMBER 108

9935 EXPANDABLE HEX INVERTER

Fairchild will introduce
a new integrated circuit
each week for 52 weeks.
This is number **9.**

The Fairchild 9935 is a fundamental element in the CMOS family. It can serve as the basis of virtually any digital logic circuit. It consists of six DTL gates without input diodes. Each gate performs a single inversion operation. The device can be expanded to an arbitrary number of gates. Therefore, it can be used in a great variety of functions. For example, it can serve as a counting circuit, a parallel multiplier, or as a flip-flop in adders, registers, counters, decoders, etc. It can be "wired or" connected to reduce overall system costs. The 9935 comes in both a 14-pin hermetic DIP and Fairchild's "Ceram"™. It's available in both military and industrial temperature ranges (-55°C to +125°C and 0°C to +70°C). Propagation delay is typically 20 nanoseconds. Typical power dissipation is 8 milliwatts per gate. The 9935 is available in volume quantities. Fairchild distributors have it in stock now. Write for complete specs and applications information. Ask about our other new products, too.

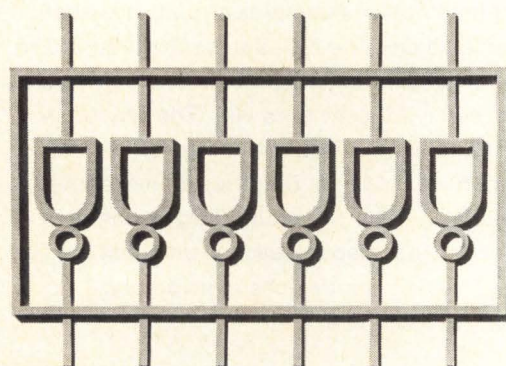

FAIRCHILD SEMICONDUCTOR / A Division of Fairchild Camera and Instrument Corporation
FAIRCHILD SEMICONDUCTOR 311 Fairchild Drive, Mountain View, California 94035 (415) 961-3001 • TWX: 910-574-6413

CIRCLE READER SERVICE NUMBER 109

Fairchild is introducing a new integrated circuit every week. The last two months look like this.

FAIRCHILD
SEMICONDUCTOR

3701 SIX-CHANNEL MULTIPLEX SWITCH

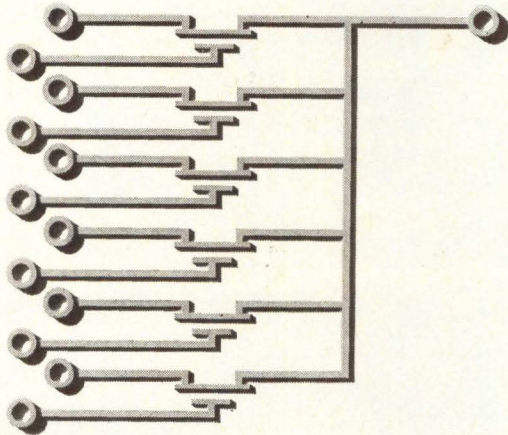

FAIRCHILD SEMICONDUCTOR • A Division of Fairchild Camera and Instrument Corporation
FAIRCHILD SEMICONDUCTOR 313 Fairchild Drive, Mountain View, California 94035 (415) 961-9111 • FAX: 919-274-8428
 CIRCLE READER SERVICE NUMBER 110

Fairchild will introduce a new integrated circuit each week for 52 weeks. This is number **10.**

The Fairchild 3701 is a P-channel enhanced mode MOS six-channel single output switch. It can be used in virtually any switching application. It's ideal for analog and digital data transmission, logic control in industrial systems, and sense line switching in core memory systems. The 3701 approximates a perfect switch. It has very low "on" resistance (300 Ohms), extremely high "off" resistance (2 x 10¹⁰ Ohms), and zero offset voltage. Output leakage current is typically as low as 1 nanampere. Input gate protection minimizes handling problems.

It can handle total inputs up to 2.5 watts. Accuracy and reliability are assured by Planar[®] technology. The 3701 comes in a 14-pin package. It will operate in a temperature range of -55°C to +85°C.

Volume quantities of this device are now available. Your Fairchild distributor has it in stock. Write for complete specs and applications information. Ask about our other new products, too.

*Planar is a patented Fairchild process.

9016 TTL HEX INVERTER

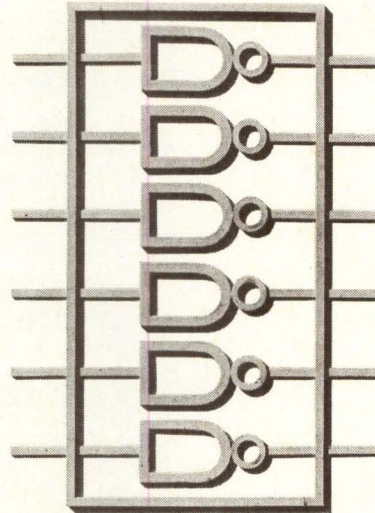

FAIRCHILD SEMICONDUCTOR • A Division of Fairchild Camera and Instrument Corporation
FAIRCHILD SEMICONDUCTOR 313 Fairchild Drive, Mountain View, California 94035 (415) 961-9111 • FAX: 919-274-8428
 CIRCLE READER SERVICE NUMBER 111

Fairchild will introduce a new integrated circuit each week for 52 weeks. This is number **11.**

The 9016 completes our 9000 series TTL family. It is a CMOS device designed primarily for high speed inverter applications. It consists of six inverting gates with input clamping diodes to prevent ringing. Active pull-up is provided in the output for high impedance drive. It can also be used as a line driver. Propagation delay is 11 nanoseconds maximum (standard for the entire TTL family). Power dissipation per gate is typically 10mW. The 9016 comes in a 14-lead hermetic DIP and in a package. It is available in both military and industrial temperature ranges (-55°C to +125°C and 0°C to +70°C). You can now order volume quantities of the 9016. Fairchild distributors have it in stock. Write for complete specs and applications information. Ask about our other new products, too.

9022 DUAL JK FLIP-FLOP

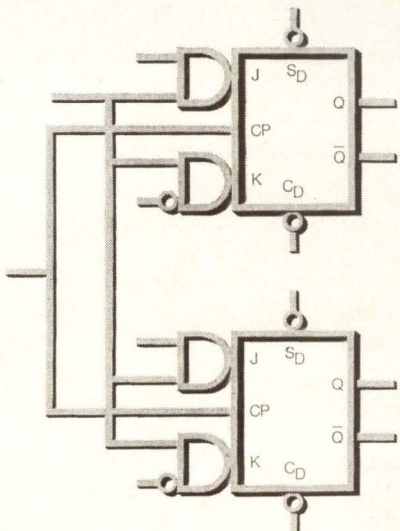

FAIRCHILD SEMICONDUCTOR • A Division of Fairchild Camera and Instrument Corporation
FAIRCHILD SEMICONDUCTOR 313 Fairchild Drive, Mountain View, California 94035 (415) 961-9111 • FAX: 919-274-8428
 CIRCLE READER SERVICE NUMBER 112

Fairchild will introduce a new integrated circuit each week for 52 weeks. This is number **12.**

The 9022 is a CMOS device in a 16-pin hermetic DIP. The TTL circuit consists of two JK flip-flops with common clock input, common JK input, and separate J and K inputs. The K input flip-flop performs as a dual flip-flop for the J and K inputs together. The common JK input eliminates the need for gating clock waveforms and can result in simplified logic designs and minimized clock skew problems. The 9022 is fast (30MHz) and flexible. It is a true CMOS device (master-slave dual flip-flop). As a comparison to our 9020 dual JK flip-flop, it provides additional logical flexibility because it has separate set-direct inputs in addition to clear-direct. Both types of inputs are truly asynchronous and overriding. A single clock buffer reduces clock fan-in and noise. The 9022 comes in both military and industrial temperature ranges (-55°C to +125°C and 0°C to +70°C). It is available in volume quantities. Your Fairchild distributor has it in stock. Write for complete specs and applications information. Ask about our other new products, too.

3102 MOS THREE- INPUT GATE

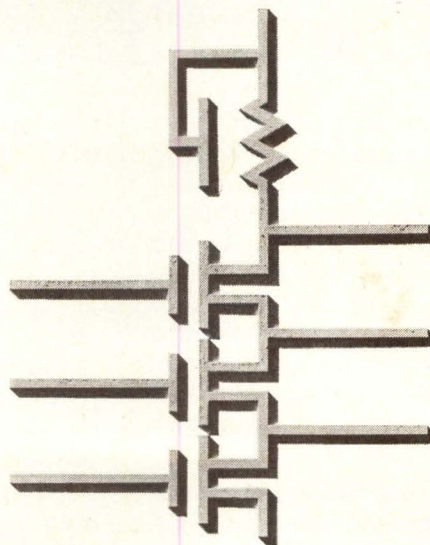

FAIRCHILD SEMICONDUCTOR • A Division of Fairchild Camera and Instrument Corporation
FAIRCHILD SEMICONDUCTOR 313 Fairchild Drive, Mountain View, California 94035 (415) 961-9111 • FAX: 919-274-8428
 CIRCLE READER SERVICE NUMBER 113

Starting October 9, 1987, Fairchild promises to introduce a new integrated circuit each week for 52 weeks. This is number **13.**

The 3102 is an extremely versatile three-input breadboard gate which can serve as the fundamental element in any MOS digital logic system. It can also function as an evaluation tool for determining the performance of Fairchild's line of MOS devices, or simply as a vehicle for gaining familiarity with MOS integrated circuitry. The 3102 comes in both 16-pin cans (one 3102 per can) and in 16-pin DIPs (two devices per package). The versatility of all source and drain leads for each transistor provides excellent logic versatility. Input protection reduces handling problems. Power consumption is typically as low as 8mW. Operating temperature ranges from -55°C to +85°C. Volume quantities of the 3102 are now available. Your Fairchild distributor has it on his shelf. Write us for complete specs and applications information. While you're at it, ask about our other new products, too.



Data Display Devices from Raytheon

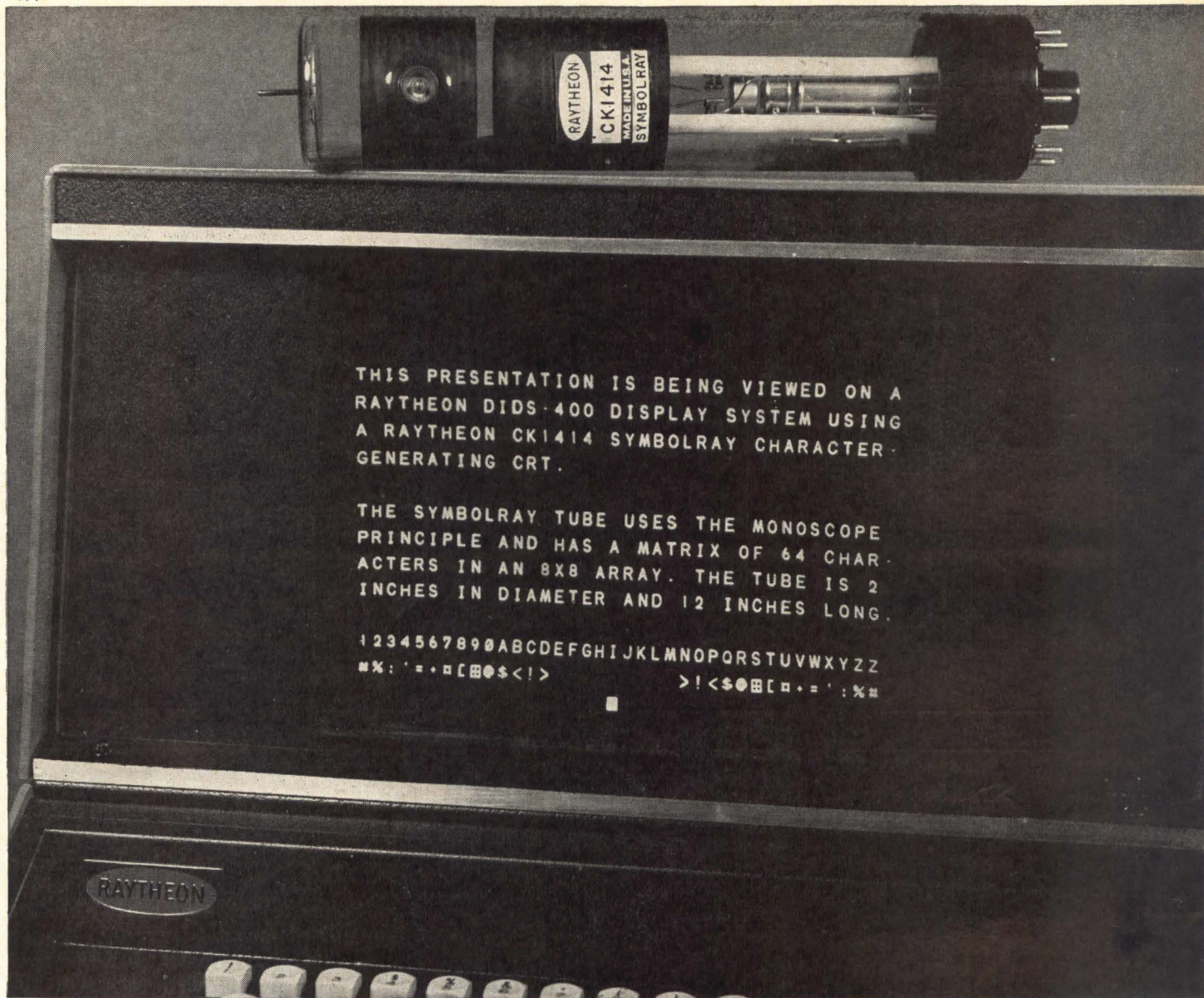

The presentation you see above was generated by a Symbolray* Cathode Ray Tube identical to the one lying on the console. A new type of monoscope, the Symbolray can generate alphanumeric characters from electrical signals for cathode-ray display or for hard copy print-out. The presentation here is shown on a Raytheon tube (CK1415) used in a Raytheon DIDS-400 display system.

An economical method of generating characters. Priced at less than \$100 in quantities of 1,000, the Symbolray provides a more economical method of generating

electronic displays than using large numbers of circuit cards.

The output of the Symbolray operating as a monoscope is obtained by electrically deflecting the electron beam to desired characters on the target and scanning them sequentially with small raster. The display cathode ray tube on which this output is viewed is scanned in synchronism. When the Symbolray method is used in conjunction with buffer-memory techniques, full messages can be displayed—as shown above. The Symbolray tube uses electrostatic deflection and

focus, and is available in designs with 64 and 96 character matrices.

Raytheon's wide range of Data-ray* CRTs cover the screen sizes from 7 to 24". Electrostatic, magnetic and combination deflection types are available for writing alphanumeric characters while raster scanning. Raytheon also offers combination deflection or "diddle plate" types and all standard phosphors. Or, Raytheon can meet your special CRT design requirements.

For more information—or a demonstration—call or write your Raytheon regional sales office.



Cathode-Ray Projection Tube. A new family of Projectoray* CRTs provide high quality projection of television or other displays. As compared with more conventional projection tubes, the Projectoray provides substantial improvement in life and brightness without sacrifice in picture quality.

These devices are available in designs which utilize refractive optics or Schmidt optics, with one special design using a Schmidt spherically-curved mirror built within the cathode-ray tube.

The high light output and long life—more than 500 operation hours—are due to novel design. The phosphor screens are deposited on thermally conductive materials capable of being cooled readily by air flow or liquid cooling techniques to inhibit screen burning. The final display will provide 15 foot-lamberts on a 3-foot by 4-foot lenticular screen, permitting operation of the projection system in a lighted room.

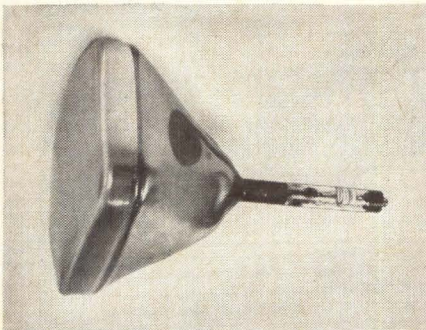

Dataray* Cathode Ray Tubes. Raytheon makes a wide range of industrial CRTs—including special types—in screen sizes from 7" to 24". Electrostatic, magnetic, and combination deflection types are available for writing alphanumeric characters while raster scanning. All standard phosphors are available and specific design requirements can be met. Combination deflection or "diddle plate" types include CK1395P (24" rectangular tube), CK1400P (21" rectangular), and CK1406P (17" rectangular).

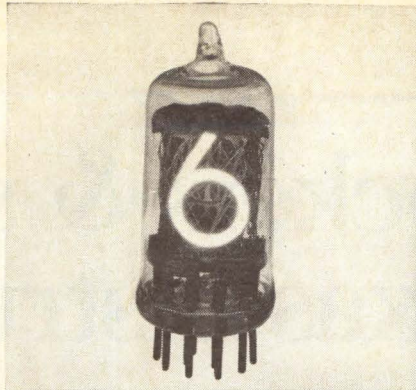

Datavue* Side-view Tubes. Type 8754 with numerals close to the front, permits wide-angle viewing. These side-view, in-line visual readout tubes display single numerals 0 through 9, preselected symbols, + and - signs, and decimal points. Their 5/8" high characters are easily read from a distance of 30 feet. Less than \$5 each in 500 lots, they can be supplied with lacquer coating to eliminate the need for expensive filters. Datavue types are interchangeable with NL840, 841, 842, 843, and 848 tubes.



Datavue* End-View Tubes. Raytheon makes round (CK8421) and rectangular (CK8422) Datavue indicator tubes on automated equipment capable of high production rates and top quality. The CK8422 rectangular tube is also available with decimal point, ± symbols, and in other special versions. Both round and rectangular types fit existing sockets and conform to EIA ratings. These ultra-long-life tubes are designed for 200,000 hours or more of dynamic operation.

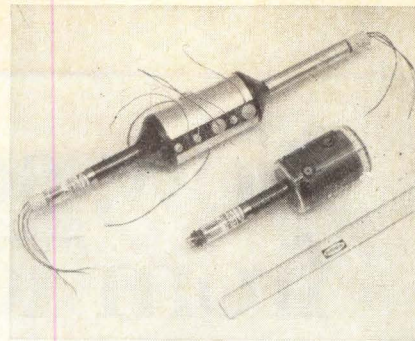

Recording Storage Tubes. The two new designs shown utilize miniaturized guns and necks to provide high deflection and focus sensitivity, resulting in savings in coil and power supply weight and size. They provide Kiloline resolution, long storage and fast erase capability. The single-gun version is Type CK1537 and the dual-gun version is Type CK1535.

Raytheon's complete line of electrical-output storage tubes feature high resolution and non-destructive reading. Information can be written and stored by sequential techniques or by random-access writing. Complete, gradual or selective erasure is possible.

Raytheon storage tubes are readily available for applications in radar scan conversion, slow-down video, signal processing, signal enhancement, time delay, and stop motion.



Send Reader Service Card for literature on the:

Symbolray CRT	50
Projectoray CRTs	51
Datavue Indicator Tubes	52
Recording Storage Tubes	53
Dataray CRTs	54

Or call your Raytheon regional sales office. Or write to *Raytheon Company, Components Division, Quincy, Mass. 02169.*

*Trademark of Raytheon Company



Industrial Components Operation—A single source for Circuit Modules/Control Knobs/Display Devices/Filters/Hybrid Thick-Film Circuits/Industrial Tubes/Optoelectronic Devices/Panel Hardware

CIRCLE NO. 6 ON INQUIRY CARD

Now, sockets & systems from Texas Instruments.

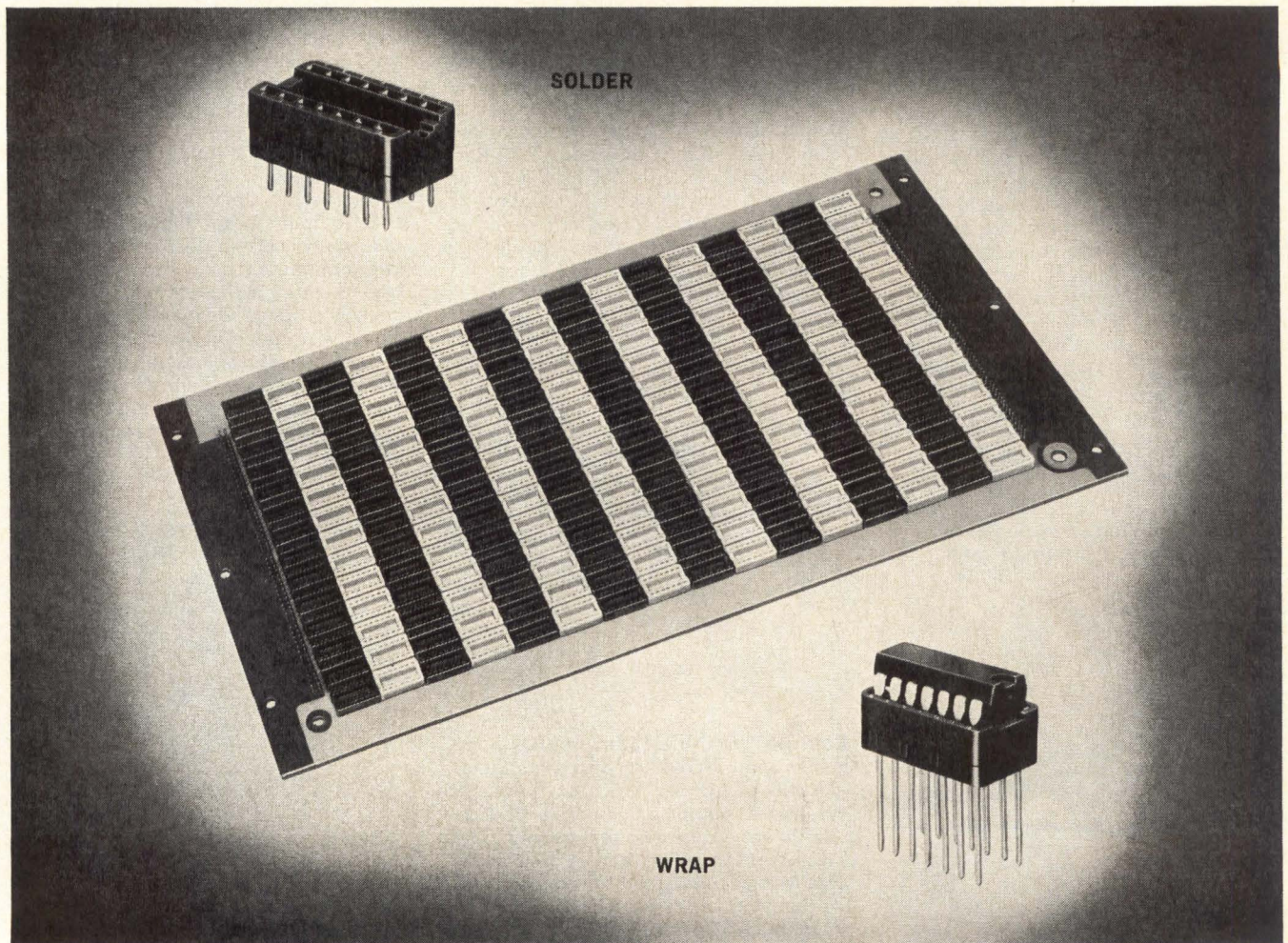

**LOW COST - HIGH RELIABILITY.
LOW PROFILE - HIGH DENSITY.
YOUR BEST BUY IS TI.**

TI MATERIALS DIVISION, ATTLEBORO, MASS. 02703.

TEXAS INSTRUMENTS

INCORPORATED

CIRCLE NO. 7 ON INQUIRY CARD



**Presenting the
Allied Control TU154
(the 'Cradle'® Relay with
Underwriters' Laboratories
Component Recognition)**

Now, all of the advantages of the well-known "Cradle" Relay—a time-proven design—plus the benefit of Underwriters' Laboratories Component Recognition. Available in 4PDT and 6PDT, the TU154 is intended for applications in industrial control and data processing systems, where long life, reliability and maximum economy are needed. Send for complete details and brochure today.

Allied Control Co., Inc. 2 East End Ave., New York, N.Y. 10021 • (212) 288-7403

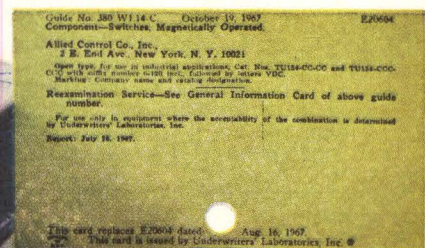

CIRCLE NO. 8 ON INQUIRY CARD

what do you think?



This department is devoted to a continuous interchange of ideas, comments, and opinions on significant problems facing the industry. What do you think about the impact of a computer-automated world and the engineer/scientist's role in it? What do you think about engineering unions — professional societies — industry conferences? Or any significant facet of your professional life. COMPUTER DESIGN will print your views here. Write to: CD Readers' Forum, Computer Design, Baker Ave., West Concord, Mass. 01781.

CD READERS' FORUM

COMPATIBLE LOGIC SYSTEM

by
R. E. Connally

Editor's Note: The following letter and accompanying article have proven to us that an industry-wide standard for logic symbols is still a vital issue.

Gentlemen:

I have been on your subscription list since February of this year and have been following your "Readers' Forum" sequence on Logic Symbol Standard with great interest. I was disappointed when I read your October issue in which you mention your long campaign for an industry-wide standard is no longer considered a vital issue.

With new textbooks being written every day and the great proliferation of integrated circuit logic modules into commercial and consumer products, a single, easily understood logic symbol standard is vitally needed, now! To this end I would like to submit the following letter to your "CD Readers' Forum" section.

Very truly yours,
R. E. Connally
Research Associate
Radiochemical Analysis
Battelle Northwest
Battelle Memorial Inst.
Richland, Wash.

The long-standing debate over a logic symbols standard need not be resolved by the acceptance of one standard and the rejection of the other. The two logic symbols standards now in use can be compatible with each other if we follow a few simple rules:

1. The distinctive shape symbols of the Military Standard 806B will be used.
2. The rules of USA Standard Y32.14 will be followed, with certain restrictions.
 - a. The 1-state will be high (H) (POSITIVE LOGIC).
 - b. The logic negation symbol will also indicate that a low (L) level is required to implement an input or that an output is low (L) when implemented.
3. When signal lines are labeled with English titles we must recognize that the English title is negated whenever we pass through the logic negation symbol, in entering or leaving a logic symbol. For example in Case I of Figure 1 we negate the literal after we have applied the AND connective. In Case II we take the negation of the literals A and B before we combine them with the OR connective.

With these restrictions on the Y32.14 Standard the resulting logic diagram can't be distinguished from a logic diagram based on the 806B Standard. Those who prefer 806B can continue to use their familiar symbols. Those

who prefer Y32.14 will recognize we have utilized the wide flexibility incorporated into this standard to implement the compatible logic system. Those who have no strong attachment to either standard should welcome a settlement to the logic standards dispute if a compatible logic system were to find industry-wide acceptance.

The suggested restrictions for Y32.14 are taken from the following USAS Y32.14 paragraphs:

Either the distinctive shape or the uniform shape symbols are allowed in paragraph 1.2.1. Paragraph 6.9.1 specifies a triangular symbol for an amplifier where the gain can be of any value and of either sign. A gain of -1 is included in this set, therefore our inverting amplifier symbol can be identical to the 806B triangle. Paragraph 4.4.4 allows us to omit the small, filled (high level indicating), right triangle if it is understood we are using "Positive Logic". From Appendix D we find the low level indicator may be replaced by its opposite kind and adjacent small circle (logic negation symbol). This results in the small circles indicating a low activating level and lines without small circles indicating a high activating level as in Standard 806B.

In order to obtain universal interpretation of Boolean statements taken from separate logic diagrams, it is preferred that we assign English titles as follows:

1. The assignment for gate outputs which are low when implemented should show the entire output expression as negated. And, conversely, we should not negate the entire expression for outputs which are high when implemented.
2. When the English title is a single letter the Boolean assignment is straight forward. The output of a gate, flip flop or single shot which is high upon implementation is assigned the English letter. The output which is low upon implementation is assigned the negated English letter.

As an example of preferred English titles, in Figure 1 we have shown a logic gate followed by an inverter. Let us examine this condition in more detail by use of Case I, Case II and their truth table. For Case I the output is low when implemented and for Case II the output is high when implemented. However, we see from the truth table that only one gate is implemented for any particular input combination, the other gate is not implemented. The output of the implemented gate will take on the level indicated by its output line (low for a small circle, high otherwise). The nonimplemented gate will have an output level opposite to that indicated by its output line. Thus, the two gates not only have opposite indicated output levels, but when one is implemented, the other is not implemented. The net result is identical electrical outputs with equal Boolean expressions. However the form of the English titled output is a function of the logician's original choice of logic symbol.

When drawing a logic diagram from a circuit diagram the logician must recognize that each gate can be represented by two equivalent logic symbols which follows from DeMorgan's Theorem as shown in Figure 2. We have found this transition to involve three steps in sequence as follows:

A FAIRCHILD #94G GATE, FOLLOWED BY AN ELECTRIC INVERTER

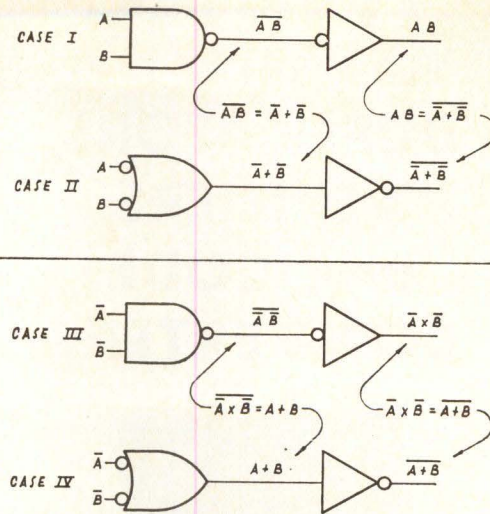

	A INPUT	B INPUT	GATE OUTPUT	INVERTED OUTPUT
CASE II IMPLEMENTED	L	L	H	L
	L	H	H	L
CASE I IMPLEMENTED	H	L	H	L
	H	H	L	H

TRUTH TABLE OF A #94G LOGIC GATE, CASE I & CASE II

Fig. 1. Examples of Boolean assignments.

EXAMPLES OF CONVERTING HARDWARE TO LOGIC SYMBOLS

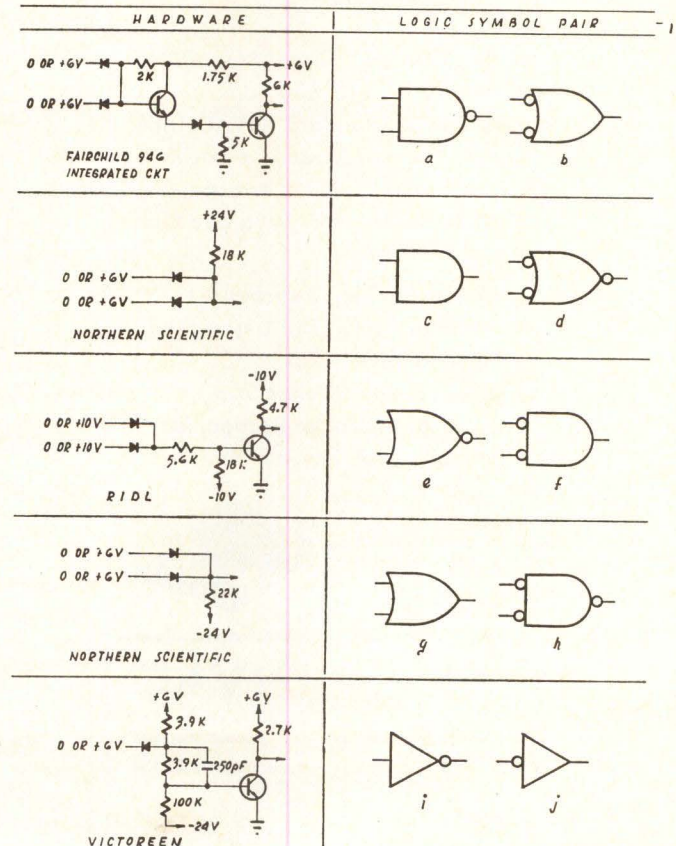
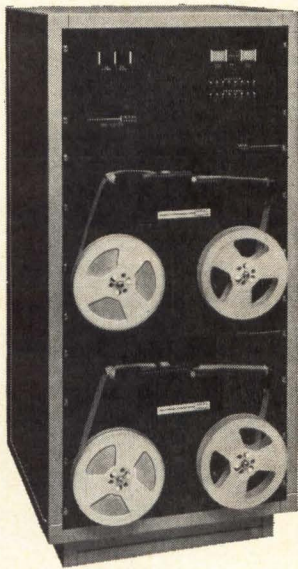

Fig. 2. Examples of converting hardware to logic symbols.

INVAC

PERFORATED TAPE DUPLICATORS, VERIFIERS, and CODE- CONVERTERS



INVAC Off-Line Tape Preparation Systems, Series S10-S50 combine the capabilities of standard INVAC Tape Punches, Readers, and associated electronic logic circuitry to duplicate, verify, or code convert using any tape material or code.

- ... Optional Editing Switches
- ... Optional Parity Error Detection
- ... Optional Blank Skip
- ... Optional Code Delete Skip
- ... Optional Character Recognition
- ... Optional Tape Rewind Panel.

HIGH SPEED KEYBOARD
enhances system versa-
tility. Makes new tape.
Edits existing tapes.



Write for data

•••••••• **INVAC**
CORPORATION

26 Fox Road, Waltham, Massachusetts 02154
Tel. (617) 899-2380

PHOTOELECTRIC KEYBOARDS • TAPE PUNCHES
READERS AND HANDLERS • I/O TYPEWRITERS
PRINTERS AND SYSTEMS

CIRCLE NO. 9 ON INQUIRY CARD

1. The logician must first decide whether he wants to consider the logic gate as performing an AND or an OR function. Once selected, the proper symbol is drawn.
2. The inputs are analyzed one at a time to determine the electric level which implements the logic function selected. If a low (L) input implements the function, the logic negation symbol is used to show that a low (L) electric level is required for implementation. If a high (H) input implements the function, no special symbol is required on the input line.
3. The output of the logic circuit is analyzed to determine the output electric level which results when the gate is implemented. The logic negation symbol is used to indicate a low (L) output when implemented. If the implemented output is high (H) no special symbol is required on the output line.

DEFINITIONS

DeMorgan's Theorem DeMorgan's Theorem changes the form and not the value of a Boolean expression and is implemented as follows:

1. Add parentheses around all product terms.
2. Negate the entire function.
3. Change all connectives (exchange all x for + and all + for x).
4. Negate each literal.

For example: $AB + CD = (AD) + (CD) =$

$$\overline{(\overline{A} + \overline{B}) (\overline{C} + \overline{D})}$$

Implement To implement is to satisfy the input conditions which are indicated by a particular distinctive shape logic symbol. A logic gate will have the indicated output level when implemented and the opposite level when not implemented.

Literal An alphabetic letter or combination of letters (sometimes an acronym or a mnemonic sequence) used to indicate a Boolean variable.

Logic Negation Symbol A small circle drawn at the point where a single line joins a logic symbol indicates a logic negation.

NAND Gate A logic gate with a low output only when all inputs are high. Symbol (a) of Figure 2.

NAND/NOR Gate Any AND or OR logic gate with a negated output. Symbols (a), (b), (e) and (f) of Figure 2.

Negation The negation of a binary variable x is the opposite of x, written either x' (x-prime) or \overline{x} (x-bar). x is also called not x.

NOR Gate A logic gate with a low output when at least one input is high. Symbol (e) of Figure 2.

Positive Logic If all signal line terminals in a logic diagram have the same pair of physical states, and if both are electric potentials or currents, and if the more positive is consistently selected as the 1-state, the diagram is said to have positive logic.

Truth Table A tabulation of all possible input level combinations and their resulting output level.

NEW FROM MICRO SWITCH

solid-state-encoded keyboard assemblies

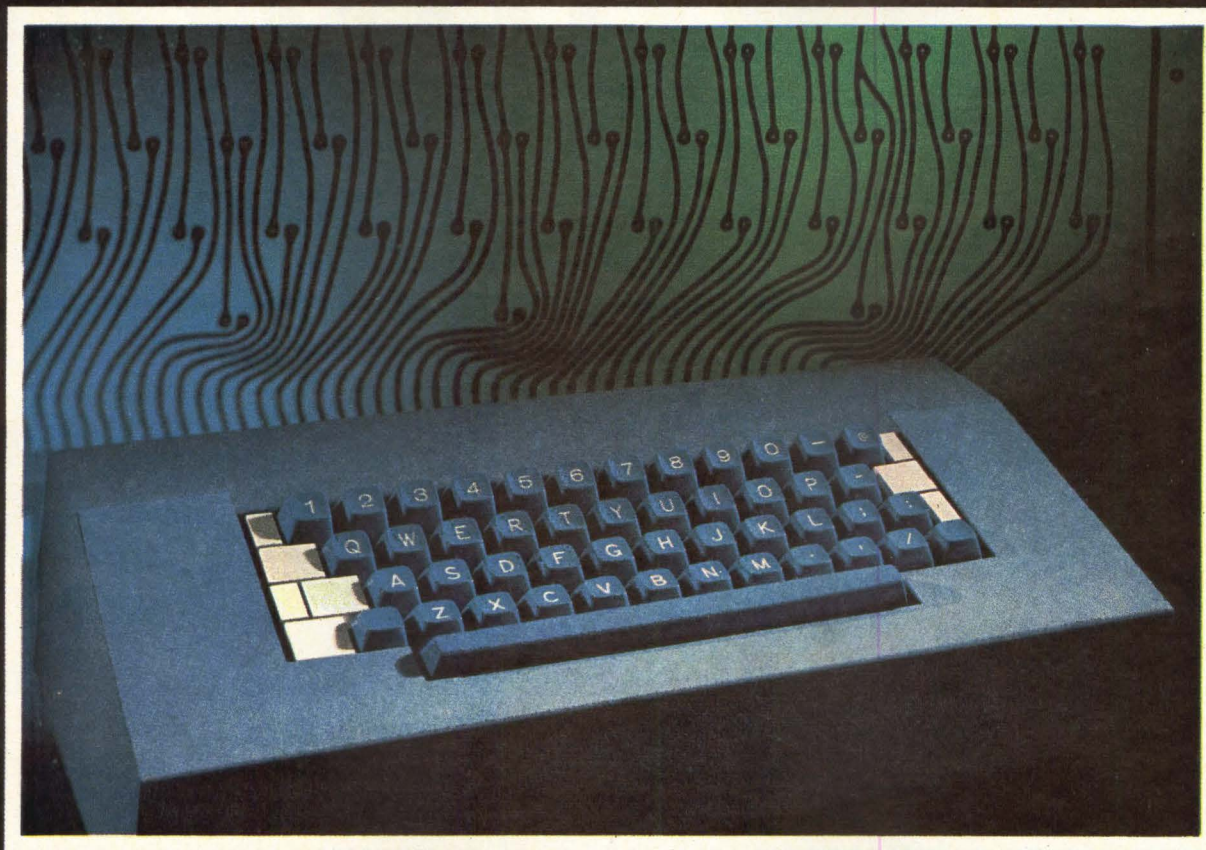

Complete keyboards—assembled, encoded, and ready to interface with your equipment.

These new keyboards feature reliability, flexibility and customized appearance that will give new sales appeal to your equipment. Exclusive new solid-state encoding and dry reed switch input assure your user the maximum in up time, and these features assure you the

minimum in maintenance.

You get a wide choice of custom-design opportunities to reduce your engineering and production costs. A unique new electronic interlock to increase operator speed and efficiency over existing approaches. An electronic strobe to delay the read cycle until the output is stabilized. Input flexibility to match your requirements.

MICRO SWITCH capabilities provide efficient factory assembly techniques to give you a customized keyboard at a price competitive with fixed format keyboards.

When you think of keyboards, think of MICRO SWITCH. Our Field Engineers can be a valuable asset to your design team. Call a Branch Office today. Or write for complete information.

MICRO SWITCH

FREEPORT, ILLINOIS 61032

A DIVISION OF HONEYWELL

mark sensing with no trouble-gap

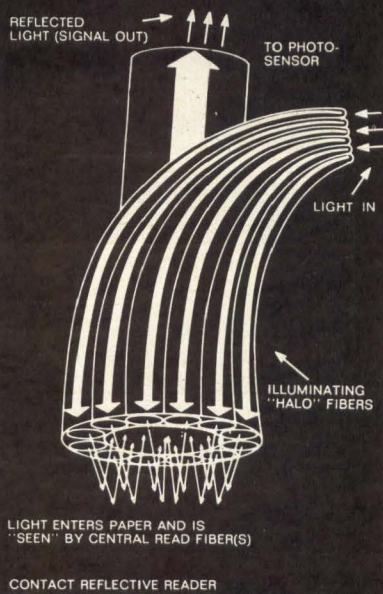

THE NEW BENDIX FIBER OPTIC CONTACT REFLECTIVE READER! Now you can achieve a new consistently reliable, extraordinarily high level of efficiency in your data processing mark-sensing, punch tape reading and magnetic tape monitoring. Efficiency in signal-to-noise ratio of 100:1. The answer: the unique, new fiber optic read head developed by Mosaic — it rides in contact with the paper!

The Mosaic fiber optic reflective reader components are based on a new discovery by Mosaic: that with certain fiber sizes and bundle configurations, very high signal-to-noise ratios can be achieved with the sensor head in contact with the paper. A special *fused flexible fiber bundle* was designed and fabricated to utilize the phenomenon: a central core of read fibers .008" in diameter, surrounded by a halo of thirteen .003" illuminating fibers. The result is the elimination of the trouble-gap in mark-sensing: the critical gap ordinary fiber optic readers need to angle light onto the work so it can reflect back into the pick-up fibers.

Gone with the gap is the troublesome collecting point for dirt carried by the paper: contaminants that cause rapid degeneration of signal-to-noise ratios and resultant sensor errors. Gone, too, are the clear epoxy or transparent plastic gap-fillers utilized with ordinary read heads — compromisers at best which do nothing to increase efficiency. Dramatic efficiency. Consistent, superior performance with signal-to-noise ratios of 100:1. Reliability never possible before. This is what you achieve with the new fiber optic contact reflective reader from Mosaic — the largest single source of fiber optic technology in the world. Contact Mosaic Fabrications Division, The Bendix Corporation, Galileo Park, Sturbridge, Massachusetts 01518. Telephone: 617/347-9191.

Write for complete descriptive literature, today!

Bendix Electronics

CIRCLE NO. 11 ON INQUIRY CARD

How do you grundle the buyer of memory stacks?

(Take a powder and control it all the way).

The man who buys memory stacks (or planes or just cores) knows that a myriad of tiny variables which affect performance can pass right through the tightest spec. It's nobody's fault, but still it leaves the buyer disgruntled.

How to grundle him? Well, this is what we do at Ferroxcube. We control the entire process from formulation of the powder for the cores to the planes or stacks that go out the door. To the naked eye

much of this looks like textbook QC procedure. But some of it goes deeper. It's the kind of control you associate with a veteran airline pilot whose experience amounts almost to intuition. As pioneers in ferrites and core memory components, we have people like that in control at every vital stage of manufacture.

This is one reason why Ferroxcube can design and build to exacting requirements (example: military stacks that exceed the en-

vironmental requirements of MIL-E-16400 and MIL-E-5400). And it's the main reason why every production unit performs like the prototype you approved.

If you specify cores, planes or stacks, talk with the people who pioneered ferrite technology. As a conversation piece, a sheaf of technical literature awaits you. Write for it today.

Ferroxcube 
Saugerties, New York

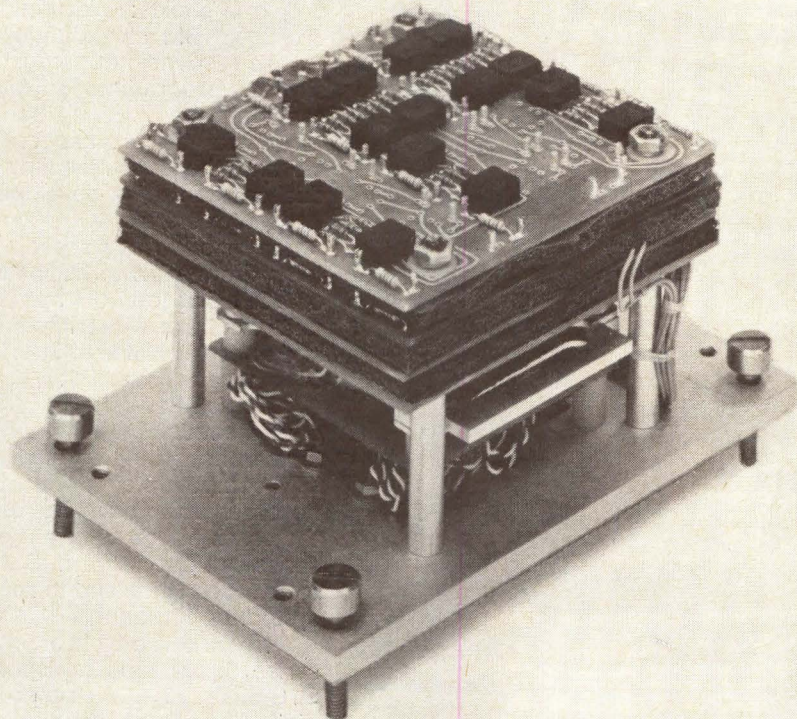

Albuquerque—Electronic Enterprises, (505) 256-1585; Baltimore—Eastern Components, (301) 322-1412; Dayton—(513) 253-3158; Encino, Cal.—(213) 788-2060; Englewood, Col.—(303) 771-2000; Houston—Noakes Engineering, (713) 529-6213; Irving, Texas—Noakes Engineering, (214) 255-0441; Lansing, Mich.—(517) 482-7140; Minneapolis—(612) 888-4681; Northlake, Ill.—(312) 261-7880; Orlando—(305) 841-6380; Philadelphia—Eastern Components, (215) 927-6262; Phoenix—(602) 265-1792; San Francisco—Wm. J. Purdy Agents, (415) 863-3300; Saugerties, N. Y.—(914) 246-2811; Union, N. J.—(201) 964-1844; Waltham, Mass.—(617) 899-3110; Toronto, Ontario—Philips Electron Devices, Ltd., (416) 425-5161.

CIRCLE NO. 12 ON INQUIRY CARD

IBM STARTED SOMETHING WITH ITS DUAL-CAPSTAN TAPE DRIVE. (MIDWESTERN FINISHED THE JOB.)

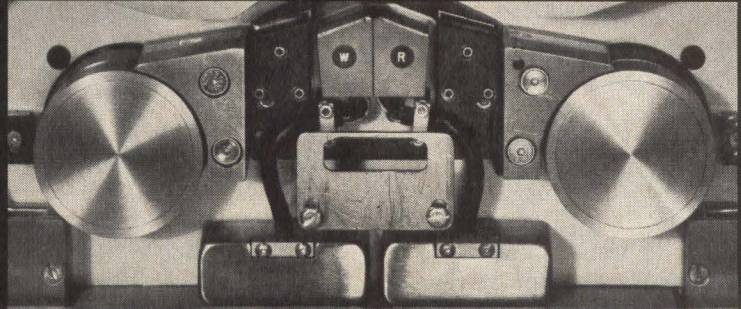

In the field of high performance digital tape transports for use with computer systems, there are really only four names to consider: IBM, Midwestern Instruments, Ampex and Potter. If it's an IBM system you're working with, there are only two logical choices: IBM and Midwestern. If data reliability to the order of 10^9 data bits is any criteria, there's only *one* choice: Midwestern's 4000 series transport.

Both IBM and Midwestern tape transport designs utilize a rapid-response, dual-capstan drive. This eliminates the necessity for programmed delays which are required by single-capstan drive systems. But not even IBM's original equipment can equal the trouble-free performance, the extended tape life and the data reliability of the patented, positive-pressure dual-capstan drive developed by Midwestern.

Midwestern's 4000 series transports cover the complete range of operating speeds required by various computer systems, from a low of 25 ips to a high of 150 ips, at bit densities of 200, 556 or 800 bpi (1600 bpi on special order). These units can be provided in either 7 track or 9 track configurations, and all are available to interface with either discrete component or integrated circuitry.

These Midwestern 4000 series transports and IBM original equipment units are the *only* field-proven IBM-compatible digital tape transports—the only units actually working on line with IBM computers at various customer installations. What's more, no other unit (*including* IBM) can guarantee data reliability in the order of one transient error per 10^9 data bits. If the 4000 series can out-perform IBM units on their own computing systems, doesn't it stand to reason they're the best choice for *your* system application?

If you'd like to hear more about our 'small wonder' 4000 series digital tape transports, just give us a call (collect) at 918-627-1111. We're programmed for fast analysis of any digital tape transport application, no matter how unique.



**MIDWESTERN
INSTRUMENTS** / **TELEX**

6422 E. 41st STREET • TULSA, OKLAHOMA 74135
PHONE (918) 627-1111 • TWX (918) 627-6030 • TELEX 049-589

MIDWESTERN INSTRUMENTS, INC.

A SUBSIDIARY OF THE TELEX CORPORATION

CIRCLE NO. 13 ON INQUIRY CARD

DATA COMMUNICATIONS

equipment for on-line,
real-time processing

two talented tape terminals

Input of taped data at high speeds into computers and other business machines is just one of the many applications of Teletype CX and DX paper tape readers. These units also are used as the sending terminals of high-speed tape-to-tape systems to transmit data collected by slower speed equipment. Data is sent vast distances accurately, automatically.

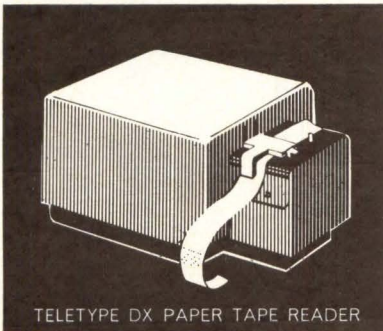

TELETYPE DX PAPER TAPE READER

OPERATING SPEEDS

The Teletype DX reader generates parallel-wire signals. Equipped with step-by-step feeding, the DX reader operates at any speed up to 240 characters per second (2400 words per minute) without modifications.

machines that make data move

Operating speed of the CX reader is 105 char/sec (1050 wpm). It generates parallel-wire signals that may be converted externally to sequential signals by Teletype electronic storage and conversion equipment.

Both readers are capable of sending 5, 6, 7, or 8-level coded data including the official United States of America Standard Code for Information Interchange (ASCII). They also may be equipped to control computers, buffer storage units, and other electronic register elements.

ASSURES LONGER LIFE

These Teletype readers utilize precision machined parts and rubber motor mounts to permit quieter operation and longer life. A TAUT TAPE mechanism can stop the readers

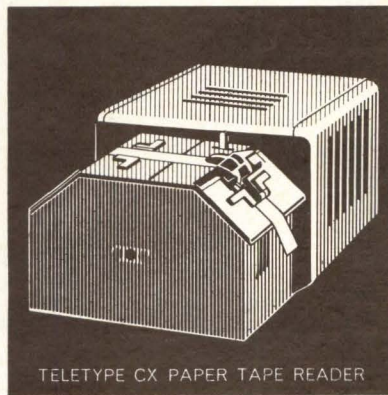

TELETYPE CX PAPER TAPE READER

until the tape is slackened. A TAPE OUT switch automatically can stop the readers at the end of tape.

The CX reader has a pulse generator that provides synchronization to accurately control timing of code intelligence to associated equipment.

Both readers are available as self-contained units or can be mounted in upright cabinets with driving electronics for use as sending terminals in tape-to-tape systems as well as for many other applications.

COMBINES WITH HIGH-SPEED PUNCHES

For high-speed data transmission and reception over vast distances, the CX and DX readers can be combined with a Teletype BRPE and DRPE paper tape punch. The BRPE punch operates at 105 char/sec (1050 wpm) and the DRPE up to 240 char/sec (2400 wpm).

For more about these *two talented tape terminals*, contact: Teletype Corporation, Dept. 71A, 5555 Touhy Avenue, Skokie, Illinois 60076.



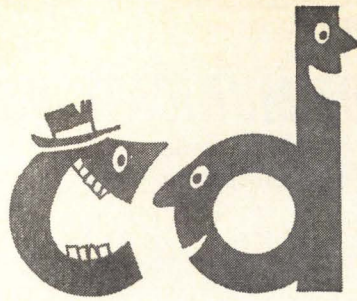

commentary

Comments and opinions on topics of current interest to digital design engineering personnel. A monthly column organized and prepared under the direction of **T. PAUL BOTHWELL, Contributing Editor.**

THE IMPACT OF L. S. I. ON COMPUTER MEMORIES

by

T. PAUL BOTHWELL
Vice President, Engineering
Computer Controls Division
Honeywell, Incorporated

Computational capability has developed at an astonishing rate during the brief life of the electronic digital computer. Figure 1 shows that since 1959, computing power per dollar of first cost for small scientific computers has not only been increasing, but accelerating. It constitutes a straight-line trend on a logarithmic scale — a 200-to-1 improvement during the past eight years. Computing power is the word length multiplied by the average number of instructions (weighted) executed per second in a machine having a 4,000-word mainframe with minimum paper tape I/O.

Can the performance per computer dollar go on increasing at this pace? Not indefinitely. History tells us that all products eventually level off. Has that time come for computers?

Two Important Power Factors

Much of the gain in computing power per dollar has come about through the evolution of the magnetic core memory. During the dozen years that core memory has dominated main memory design, both cost per bit and cycle time have been reduced by a factor of ten, which represents a gain in memory value of 100 during these years. Another factor in gain of computer power, of course, is the lowering cost and rising speed of semiconductors. This achievement, together with the ingenuity of the logic designers, has greatly increased value in the non-memory part of computers, and has contributed to the growth in memory value.

Memory costs will continue to reduce. Core memory will probably give way to the plated wire memory. But even when we consider the substantial cost and per-

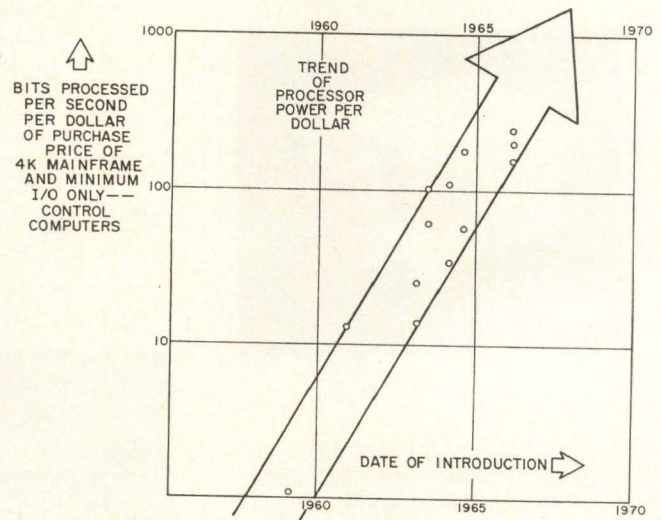

Fig. 1

formance improvements this will offer, it is hard to foresee another hundred-to-one reduction.

L.S.I. As A Factor

It seems, then, that the trend of the last few years may not continue beyond this decade unless something new enters the picture. And that "something" may be future developments in integrated-circuit technology — conveniently lumped into the term "L.S.I." As used here, the term applies to a chip containing more than 100 logic gates.

As I/C technology advances, circuits are growing more and more complex. We measure this complexity by the number of logic gates per chip (Fig. 2). A chip with up

DATA COMMUNICATIONS

equipment for on-line,
real-time processing

keeping track of the ins and outs

Teletype data communications equipment serves as the terminals in a variety of computer systems. Many systems designers specify Teletype terminal equipment because they have found the sets to be the most reliable, versatile, and economical available.

The examples below point up the many capabilities of Teletype equipment as used in a number of different computer systems.

AIDS SCIENTIFIC COMPUTATIONS

Primarily designed for control applications and scientific computations, a computer that uses monolithic integrated circuits can be operated alone, as a multiprocessor system, or as a satellite to a larger computer system. A Teletype Model 35 KSR (keyboard send-receive) set is the system's terminal. It uses an 8-level code compatible with the United States of America Standard Code for Information Interchange (ASCII).

AIDS BILLING AND INVOICING

An electronic billing and invoicing machine uses a Teletype Model 33 ASR (automatic send-receive) set to provide on-line communications involving a variety of accounting data. Continuous pin-feed invoice forms with multiple copies are used in the system. In addition, a punched by-product tape is prepared for further analysis by management.



The terminal device of a small integrated circuit computer is a Teletype Model 33 ASR (Automatic Send-Receive) set. The computer is a 16-bit parallel, binary machine with nanosecond speeds.

Users of a time shared computer system can contact the computer for service and inputs of all instructions, data, and plot programs through standard Teletype equipment. The computer processes the data and transmits via a Model 33 ASR set a complete plot program, including identification codes for that particular plotter and output signals for remote on-line plotting.

A compact 16-bit real-time computer provides high-speed data acquisition and control. The system multiplies and divides faster, has a faster throughput and costs less than many larger systems. It uses a Teletype Model 33 ASR set as its terminal.

AIDS TO YOUR SYSTEMS

These are only a few of the many Teletype equipment applications in both large and small computer systems. To learn how Teletype equipment can aid the systems you're designing, send for our brochure, "ALL ABOUT TELETYPE EQUIPMENT." Contact: Teletype Corporation, Dept. 71A, 5555 Touhy Avenue, Skokie, Illinois 60076.

machines that make data move

CIRCLE NO. 14 ON INQUIRY CARD



reduce system size 7:1 with MicroVersaLOGIC IC Modules

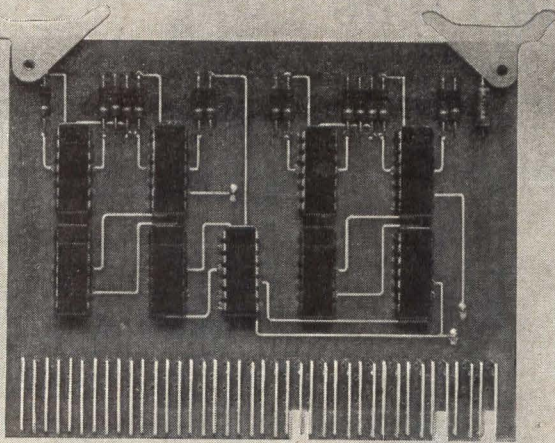

The complete MicroVersaLOGIC line gives you all the ready-made building blocks you need for anything from a register to an entire digital system—with a 7:1 size reduction because of MicroVersaLOGIC's high density IC packaging.

MicroVersaLOGIC also means increased reliability over discrete components, lower power requirements, greatly reduced costs. MicroVersaLOGIC features NAND, NOR logic with wired OR capacity at the collector, operates to 5v. logic levels, has excellent noise rejection of over 1v. There are over 20 basic module types, all meticulously designed and assembled to give you utmost reliability.

Our new MicroVersaLOGIC brochure will show you how easy and economical it is to design digital systems with MicroVersaLOGIC IC Modules. Write or call.



varian data machines
a varian subsidiary

Formerly Decision Control, Inc.
1590 Monrovia Ave., Newport Beach, Calif.
(714) 646-9371 TWX (910) 596-1358

to 10 gates is simply an integrated circuit; 20 or 30, functional array; close to 100, M.S.I. L.S.I. is still a few years away, but is certainly coming, and it is interesting to speculate its impact on memories.

By its nature, L.S.I. is applicable where large numbers of similar circuits are required, where interconnection between the circuits can be made all on the same wafer of silicon and where it offers the lowest unit circuit cost. Industry sources project costs as low as a penny per gate in five or ten years.

Now, remembering that two gates can make a flip-flop, and that a flip-flop is still one of the fastest and simplest memory elements ever devised, it is clear that L.S.I. will be used for the construction of memories.

Many different types of memories are used in computers today, however, and many more have been suggested for the computers of tomorrow. Which of these are likely to make effective use of L.S.I.?

Although many L.S.I. enthusiasts would disagree, I believe it will be a long time before L.S.I. can achieve the performance and economic advantages of magnetic main memories and mass memories. The development of batch fabricated magnetic devices, represented by flat film and plated wire, the extreme desirability of the non-volatile storage properties, and the high level of technological momentum in magnetics combine to provide

DEFINITIONS

	INTEGRATED CIRCUIT	FUNCTIONAL ARRAYS	MSI	LSI
NO. OF GATES	1-10	8-30	30-100	100
NO. OF COMPONENTS	5-50	50-300	150-1000	500
NO. OF PINS	14-30	14-50	14-50	30-100
INTERNALLY CONNECTED	NO	YES	YES	YES

Fig. 2

formidable obstacles to the integrated circuit as the primary memory device.

In contrast, however, application of L.S.I. to peripheral buffers and the more specialized memories is not only technically feasible today, but will offer increasing advantages during the next decade. Since cost per bit of a core memory rises steeply as the size is reduced, core memory will soon lose its cost advantage for small memories. Moreover, many of the more specialized memories, such as read-only and scratch-pad units, can make good use of the very high speed available from L.S.I. technology.

The advent of L.S.I. is going to stimulate the introduction of more specialized memories into computer systems. Specialized memories, such as scratch-pads, read-only memories and content addressable memories, have long been attractive to the computer designer, but

DATA COMMUNICATIONS

equipment for on-line,
real-time processing

...at the press of a button

Time. In today's data communications and processing systems it is measured in microseconds. And Teletype R&D engineers know it. For instance, look at the Push Button Data Generator they have developed to cope with the situation.

The PBDG is an automatic data preparation unit that simplifies and speeds the flow of fixed data. By preprogramming fixed data into the PBDG, you can automatically print up to 24 alphanumeric and other characters *by pressing a single button.*

AIDS COMPUTER OPERATION

The PBDG can be used wherever there is a need for automatic handling of repetitive data. For instance, in a time sharing system, the intricate instructions needed to activate the computer for a particular user can be programmed into the PBDG, and transmitted automatically to the computer merely by *pressing the appropriate button.*

In addition, the PBDG offers many important advantages to data communications and processing operations. Information is stored and reproduced in the same form every

time at the press of a button. Data is easily programmed or reprogrammed for automatic transmission of fixed data. This saves time, saves key strokes, and eliminates errors.

GENERATES 288 CHARACTERS

Operating on either a 5 or 8-level code, the basic Teletype PBDG unit consists of 12 pushbuttons capable

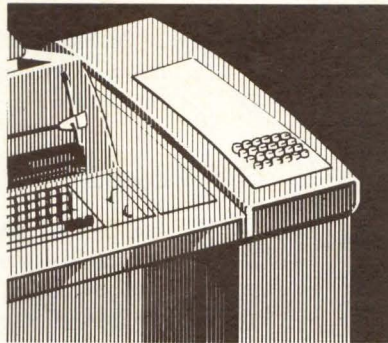

Cabinet at right of this Teletype Model 35 ASR set houses control panel and circuitry of Push Button Data Generator

of generating a total of 288 characters. The PBDG can be used as a self-contained unit or combined with other Teletype equipment to punch paper tape, print page copy, or transmit to a remote unit.

Programming is made and/or changed simply by movement of push-on type terminals. No technical skill is needed to make or change a program. The unit also may be programmed to stop on any predetermined character position. This permits insertion of variable information from a keyboard. After the variable data has been entered, automatic entry of fixed data is continued *at the press of a button.*

AVAILABLE IN SPECIAL CABINET

Where space permits, the PBDG control panel and its associated electronics can be housed in a Teletype printer console. When more than 24 pushbuttons are needed, special cabinets can be provided that contain as many as 96 buttons in units of 12.

For more information about transmitting your data *at the press of a button*, simply request our PBDG data sheet by contacting: Teletype Corporation, Dept. 71A, 5555 Touhy Avenue, Skokie, Illinois 60076.

machines that make data move



CIRCLE NO. 15 ON INQUIRY CARD

A NEW DIMENSION IN COMPUTER COMPATIBILITY

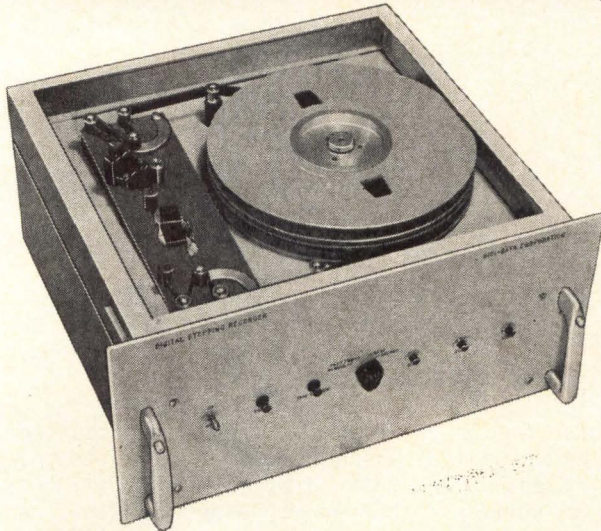

Magnetic tape unit complete with interface designed for peripheral use with your small computer.

Slew mode write or read at speeds of 1000 to 3000 char/sec Incremental writing to 500 char/sec. Choice of 200, 556 or 800 BPI, 7 track or 9 track. All computer compatibility features including IR GAP, LRCC, EOF. Low Cost.



Digital Stepping Recorders
Digital Data Handling Equipment

**DIGI-DATA
CORPORATION**

Main Office: 4315 Baltimore Ave.
Bladensburg, Md. 20710 • (301) 277-9378

CIRCLE NO. 18 ON INQUIRY CARD

MEMORY REQUIREMENTS

Memory Type	Price Range Cents/Bit
Mass Memories	0.5 to 0.01
Main Memories	5 to 10
Peripheral Buffers	10 to 25
Specialized Memories	10 to 100
Read Only Memories	
Control Memories	
Scratch Pads	
Content Addressable Memories	

Fig. 3

because of their excessive cost (Fig. 3) have been bypassed in favor of more main memory and software devices. Such memories can have dramatic effects on overall computer power and will have a significant effect in maintaining the power-per-dollar trend.

L.S.I., by virtue of the great reduction in the length of interconnections and the even smaller geometry of the transistor junctions, will permit faster logic switching in the computer, thus increasing the demand for more memory speed. The need, therefore, to relieve the main memory of as much mundane work as possible will be intensified. This, in turn, will increase the need for more specialized memories to take over suitable functions.

Conclusion

L.S.I. will have primary impact in changing our approach to memory and computer system organization, resulting in many more economic, specialized memory devices. These devices, in turn, will modify our views on the role and mode of use of the memory, software logic and system architecture.

Computer architecture has really changed very little in a decade — in fact, almost two decades. The early concept of a single main memory into and out of which all information is pumped as it is stored and processed has not changed appreciably. Ten years or more of design has been devoted primarily to optimizing that principle and re-optimizing it in the light of new components and new application knowledge.

L.S.I. will change many of the rules which have been axioms for system architects for ten years. The availability of economic, fast, specialized memories will gradually modify the basic single memory concept which has held sway so long; and this will lead us into a new era of computer power in the 1970's. We are a long way from the end of the road in computer power per dollar.

We have a complete line of photodevices — from a 50-cent epoxy transistor to a \$4,000 custom photo array. Light-emitting and light-sensing devices for everything from computers to electric organs. They can translate keyboard signals, read punched cards and tape, measure height and volume, perform character recognition, read motion picture sound track. You name it. Write for complete information and we'll throw in a glossary of the latest photometric and radiometric terms.

FAIRCHILD

FAIRCHILD SEMICONDUCTOR / A Division of Fairchild Camera and Instrument Corporation ■ 313 Fairchild Drive, Mountain View, California 94040, (415) 962-5011 ■ TWX: 910-379-6435 SEMICONDUCTOR

***What this country
needs is a good
50¢ phototransistor.***

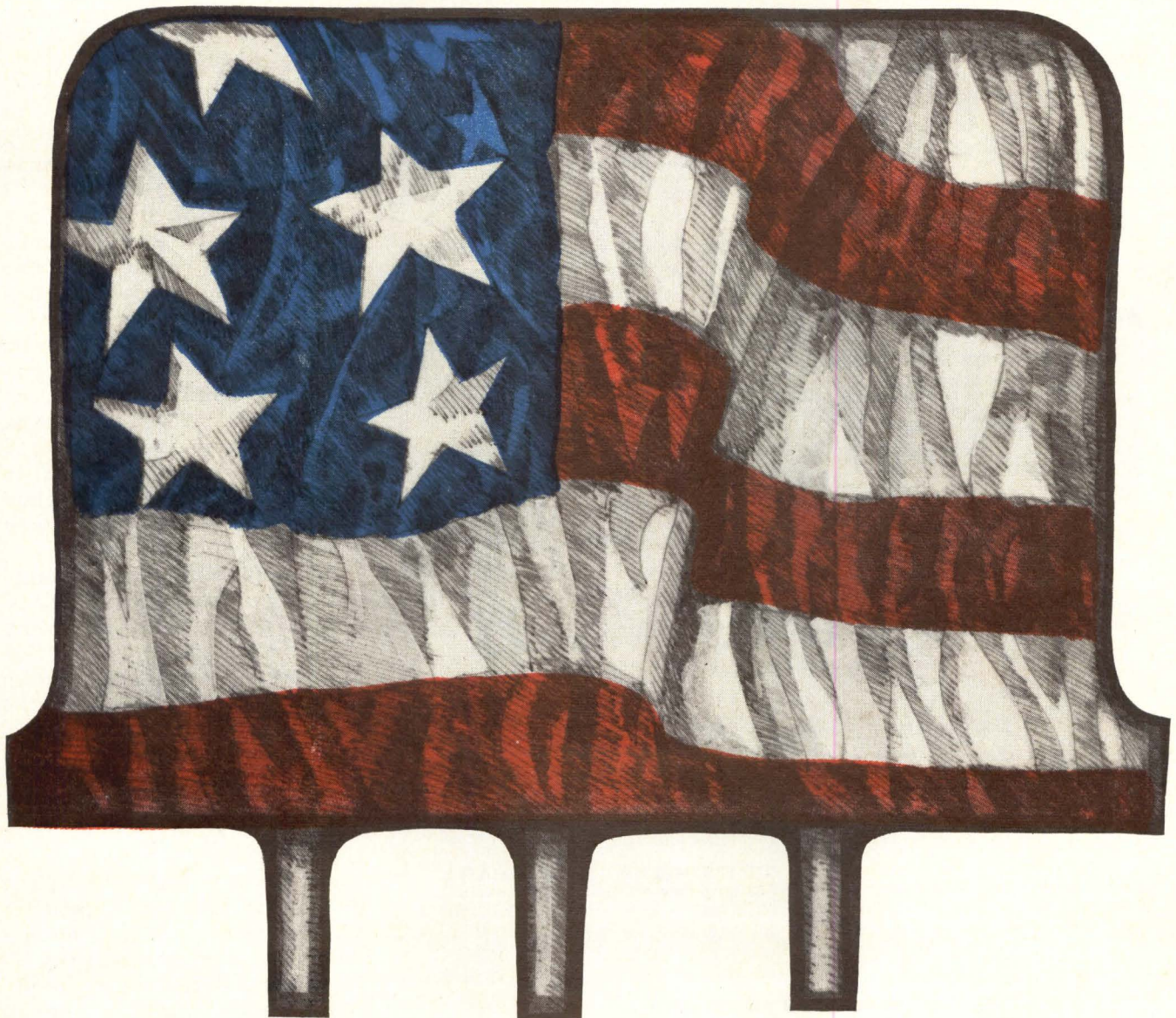

CIRCLE NO. 19 ON INQUIRY CARD



INDUSTRY NEWS

PHOTO-DIGITAL STORAGE SYSTEM—The Atomic Energy Commission recently completed installation of what is claimed to be the world's largest computer storage system at the University of California Lawrence Radiation Laboratory. More than one trillion bits of information—enough data to provide the average person with nearly 200 years of uninterrupted reading—can be stored by this photo-digi-

tal storage system which was built for the AEC by International Business Machines Corporation under a \$1 million contract. Any item in the system's file is directly accessible upon request and can be retrieved in seconds without scanning other items in the memory. Information is handled entirely automatically within the system.

When fully activated, the IBM Photo-Digital Storage

System will store and retrieve information for a network of interconnecting computer systems at the Livermore Laboratory. This network—said to be one of the most powerful time-sharing data processing facilities in operation—stores and analyzes data obtained from large-scale computations.

The photo-digital system stores information at very high densities by using a beam of electrons to record the data on 1.3- by 2.7-inch "chips"—pieces of high-resolution, photographic film. Nearly five million bits of information can be packed on a single film chip.

The chips are positioned in a vacuum chamber for recording, and the information is "written" during repeated sweeps of the beam across the chip surface. The beam, in effect, paints data as combinations of dark and clear spots corresponding to the zeros and ones of the binary language of the computer. Sensitive control devices in the recorder continually align and adjust the beam.

The photo-digital system houses its own film-processing "laboratory" which develops the film chips under automatic control. Chips are treated individually with chemicals, then washed and dried to prepare them for filing.

Recorded chips are transported and stored in protective plastic cells somewhat smaller than a cigarette package. A single cell holds 32 chips and could store enough information to process a complete payroll for a 30,000-man company.

Cells are blown through transport tubes connecting the processing stations to the storage area. This pneumatic transport network is designed for two-way travel at speeds reaching 25 feet per second.

In the storage area, cells

speed reader

Digitran[®] and Miniswitch[®], the industry's standard in thumbwheel switches. Rapid setting for rapid reading. With large, clear symbols for improved accuracy.

Digitran switches read great. Look great. And save you up to 50% in panel space. Digitran switches make your product look better, sell better. And modular design lets you use any number of digits. Digitran switches are easy to use,

and we make them easier to use: As the world's largest, most experienced thumbwheel switch manufacturer, we have more application experience than anyone else. We can save you hours of design time.

Send for our complete catalog. We'll speed it to you.

THE DIGITRAN COMPANY
 Subsidiary of Becton, Dickinson and Company [ED]
 855 S. Arroyo Pkwy./Pasadena, Cal. 91105
 Tel: (213) 449-3110/TWX 910-588-3794

CIRCLE NO. 20 ON INQUIRY CARD



A word to the do-it-yourself module builder:

Don't.

Buy our J Series modules instead.

The J Series is our new family of general purpose, all integrated circuit logic modules. Their performance almost matches that of our famous T Series modules, but they cost about 25% less. They're made to the same dimensions as the T Series, with the same 52 pin connectors, so they're physically interchangeable. We make them for our own seismic recorder systems, so they're rugged and reliable. Now, as of January, you can buy them (com-

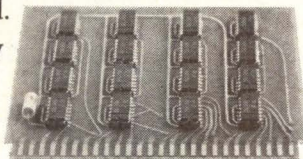

These will cost you less.

plete with mounting hardware, racks and power supplies, if you wish) in any of 25 different functions.

And save yourself the time and cost of making your own: designing, assembling, testing, new procedures, new equipment, new personnel, additional training, to say nothing of the added paper work.

If you're building systems, you must have better things to do than go into the module assembly business. Such as reading our J Series catalog.

It's free.

SDS

Scientific Data Systems,
Santa Monica, California

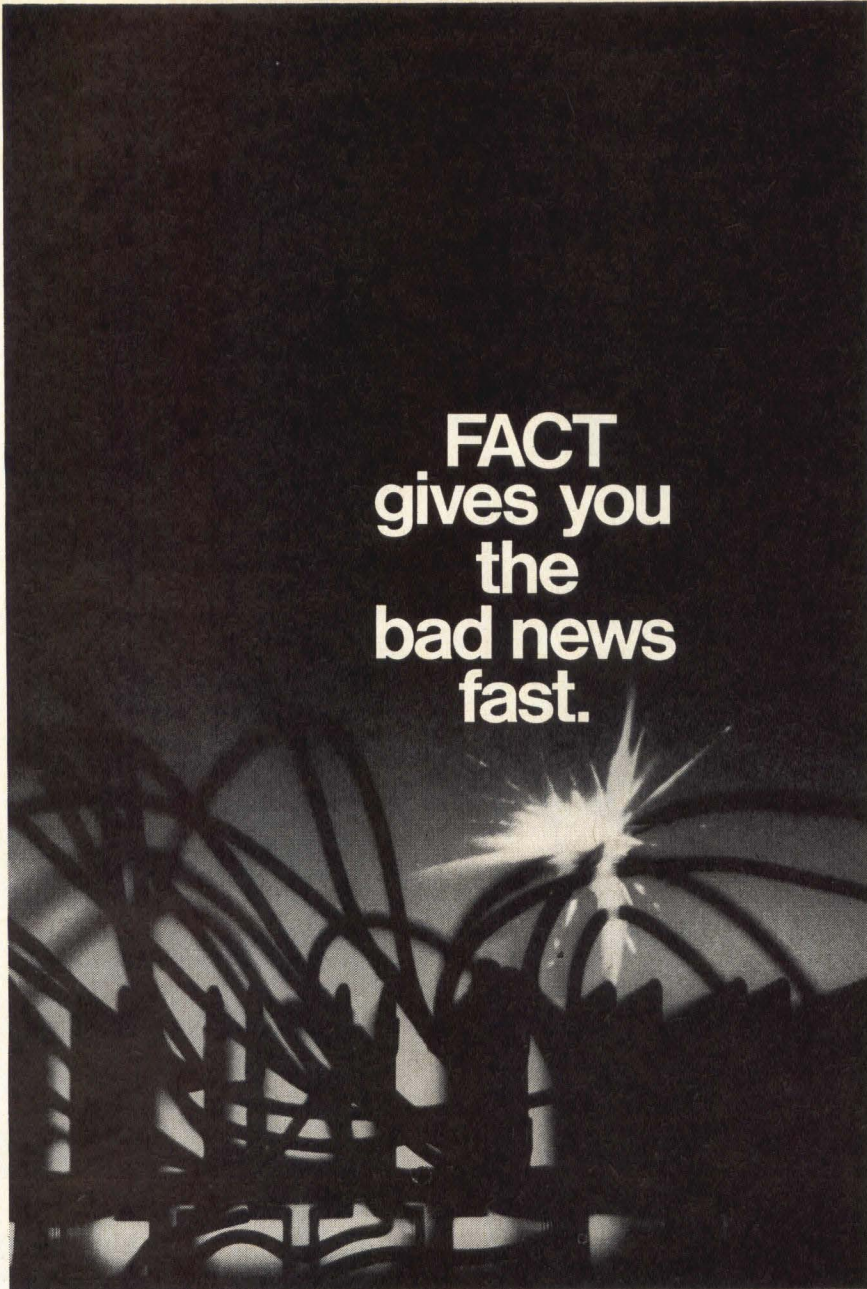

**FACT
gives you
the
bad news
fast.**

FACT stands for Flexible Automatic Circuit Tester. It doesn't pull any punches.

It's a completely automatic system for continuity and leakage testing. Fully programmable with card or tape input.

When a computer won't play, or there's a circuit discrepancy in any type of electrical harness or assembly — FACT pinpoints the failure exactly.

And reports the fault and precise location to the operator.

FACT'S fast. Testing is performed at an average rate of 3000/minute. FACT'S flexible. Adaptation to new

projects requires only new tapes or test decks, plus the appropriate adapter cables.

It's completely modular — designed for easy expansion and adaptable to a wide variety of test conditions.

FACT is now reporting wiring discrepancies for many commercial military and space programs. And producing significant cost/schedule savings.

Write Hughes for the good news. FACT Systems, P.O. Box 90929, Los Angeles, California 90009. FACT'S available off-the-shelf. In 90 days or less.



CIRCLE NO. 22 ON INQUIRY CARD

are placed in individual compartments of movable trays resembling a stack of egg crates. A computer keeps track of all records stored in the trays and initiates requests for the retrieval of information.

Individual cells are withdrawn from any location in the file and pneumatically delivered to a reader where the selected chip is read by a high-speed flying spot scanner. Data is automatically checked and corrected before it is transmitted to the computer.

The photo-digital system operates under the control of a stored-program processor similar to the control computers which regulate an automatic assembly line or traffic network. This control processor is part of the system and sets in motion the many discrete mechanical, electrical, and chemical processing steps that make up such activities as positioning the storage trays or developing the film chip.

Requests are translated into action by the processor in response to a program that speeds the flow of events by allowing many independent actions to occur at one time in a variety of combinations. The control program also acts as a tool for continuous, automatic diagnosis of the system's performance.

A second photo-digital system is scheduled for the Lawrence Radiation Laboratory facility located on the Berkeley campus of the University of California. Somewhat smaller in capacity, this system will store masses of data used to track and identify atomic particles.

Both systems were developed by IBM's development laboratories in San Jose, Calif.

* * *

The new VersaSTORE II core memory system can give you all the speed, capacity, and convenience you'll ever need.

It can also save you a few bucks.

1.6 μ sec asynchronous speed with 650 nsec access time.

Capacity up to 4096 36-bit words, up to 8192 18-bit words.

Occupies only 5 $\frac{1}{4}$ " rack space, weighs less than 35 lbs.

VersaSTORE II capacity is expandable via exclusive "Party Line" design.

Plug-in stack permits easy service.

Includes timing and control flags, test points, and optional self-test for easy system checkout.

All-silicon design and modular front-access construction.

Servoed current drive system compensates for ambient temperature changes, insures excellent margins under elevated temperatures.

VersaSTORE II is our improved version of the original VersaSTORE memory with more than two years' success in hundreds of systems.

We'd be happy to give you an unlimited amount of our own personal time, or even send you a copy of our complete new VersaSTORE II brochure. Just call or write.

Let us quote on a VersaSTORE II to meet your requirements. Our low price will surprise you.



varian data machines
a varian subsidiary

Formerly Decision Control, Inc.

1590 Monrovia Ave., Newport Beach, Calif.
TEL. (714) 646-9371 TWX (910) 596-1358

We need Senior Development Engineers and Programmers. Write to Mr. Bruce Ferris.

DELAY LINES

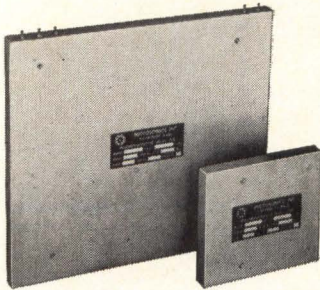

GENERAL

Delay .4 to 10,000 usec at frequencies from 10 to 400 mc. Wide bandwidth and low spurious response for excellent pulse reproduction and dynamic range.

COMPUTER STORAGE SYSTEMS

Ultrasonic delay lines using fused quartz or special glasses represent an ideal medium for high-speed Computer Storage, up to 20 mc rates.

Send for Microsonics' Brochure #5350.

DIGITAL DELAY LINES

Delay lines for storage of high-speed digital pulses with zero temperature coefficient of delay for Computer applications. Design Bulletin available on request.

MAGNETOSTRICTIVE DELAY LINES

Microsonics, Inc. has a broad delay line and systems experience with capability to deliver both off-the-shelf and custom-designed systems for any specific application.

Systems provide for the delay or storage of both analog and digital signals and are available to handle all modes of modulation (RZ, NRZ and Bipolar). Output signals are available in either clocked or unclocked signal.

Send for Microsonics' Brochure #M735.

VARIABLE AND TAPPED DELAY LINES

Featuring all usual advantages of superior fixed Delay Lines.

MICROSONICS INC.

A subsidiary of the
SANGAMO ELECTRIC CO.

60 Winter Street
Weymouth, Mass.

Area Code (617) 337-4200



DELAY LINES

QUARTZ CRYSTAL PRODUCTS

CIRCLE NO. 24 ON INQUIRY CARD

REPORT ON MEETING OF IFIP GENERAL ASSEMBLY IN MEXICO CITY. At the meeting of the General Assembly of the International Federation for Information Processing (IFIP) held recently in Mexico City two further countries were admitted to membership — Yugoslavia and Cuba. This brings the number of countries represented on IFIP to 28. Professor R. Tomovic is the delegate for Yugoslavia and Mr. Rual Alvarez Marcer for Cuba.

President-elect

Professor A. A. Dorodnicyn of the U.S.S.R. has been elected to succeed Dr. A. P. Speiser as President of IFIP following IFIP Congress 68. A second Vice-President—Mr. D. Chevion of Israel was elected and given responsibility for co-ordinating and supervising the activities of the IFIP special interest groups and IFIP Technical Committee 3 (TC3—Education). Professor L. Lukaszewicz of Poland will continue as Vice-President and be responsible for the activities of the other IFIP Technical Committees.

IFIP Congress 71

Yugoslavia will be the host country for IFIP Congress 71 which will be held in Ljubljana.

Administrative Data Processing Group

The bylaws of the Administrative Data Processing Group were approved by the General Assembly and the Group will become operative when at least five member countries have ratified the bylaws and appointed delegates to serve with the Group.

New IFIP technical committee formed

A new IFIP technical committee—TC 4—has been formed. Its area of interest will be medical data processing and Professor F. Gremy of France has been elected its first chairman.

Joint Conference

In association with other professional organizations, IFIP are to sponsor a number of joint conferences over the next two years. The first will be held in June 1968 at Novosibirsk in the U.S.S.R. and the subject will be "Optimal programming in process control and economics". In June 1968, an IFAC/IFIP conference on the state of the art in the application of control computers will be held in Toronto; and plans are being considered for an IFAC/IFIP conference in 1969 on programming languages for numerically-controlled machine tools. In September 1969 a conference on hybrid computing will be held in Munich, Germany in association with the A.I.C.A.

SEEING IS BELIEVING—Work pioneered by IBM and continued by IBM, United Aircraft, and General Motors has resulted in the production of holograms of objects that do not exist. Computers, after being programmed with information about what an object should look like, calculate the interference pattern that the object would produce. This pattern is recorded and transferred to a transparency. When the transparency is viewed in monochromatic light, a three-dimensional image of the "object" appears. So far the images have been of relatively simple objects like letters or geometrical figures, but the technique should have wide application. For example, designs of objects could be displayed and studied in three dimensions before being built. Computers also can be used to translate holograms of very large or very small objects into useful display sizes. Several possible uses of this technique have already become apparent to researchers. An acoustical hologram of a

The world's lowest cost Core Memory...right in the palm of your hand

We build some pretty sophisticated core memory systems—but not everybody needs them. A lot of you out there have asked for a compact, no-nonsense, inexpensive memory for such applications as data transmission buffering, data logging, formatting and CRT refresh. Thus challenged, we came up with (it wasn't easy) the FI-1—a 1024 x 1 core memory system at a cost that lets you abandon even delay lines

without a qualm.

Briefly, the FI-1 has a full cycle time of $2\mu\text{sec}$ and access time of 900 nsec. Power? Just $\pm 6\text{v}$. Utilizing ICs we have packed address decoding, ferrite core drivers, data I/O circuits and internal timing logic for half cycle operation into a handful-size package. And there's still room in it for an extra universal circuit card to add logic functions for specific applications.

Single quantity cost? Just \$650.

Designers, arise! You have nothing to lose but the limitations of other storage techniques. For complete data on the FI-1 Memory System, get on the horn (collect) or write for Bulletin MS-671.

Ferroxcube 
Systems Division, Englewood, Colorado

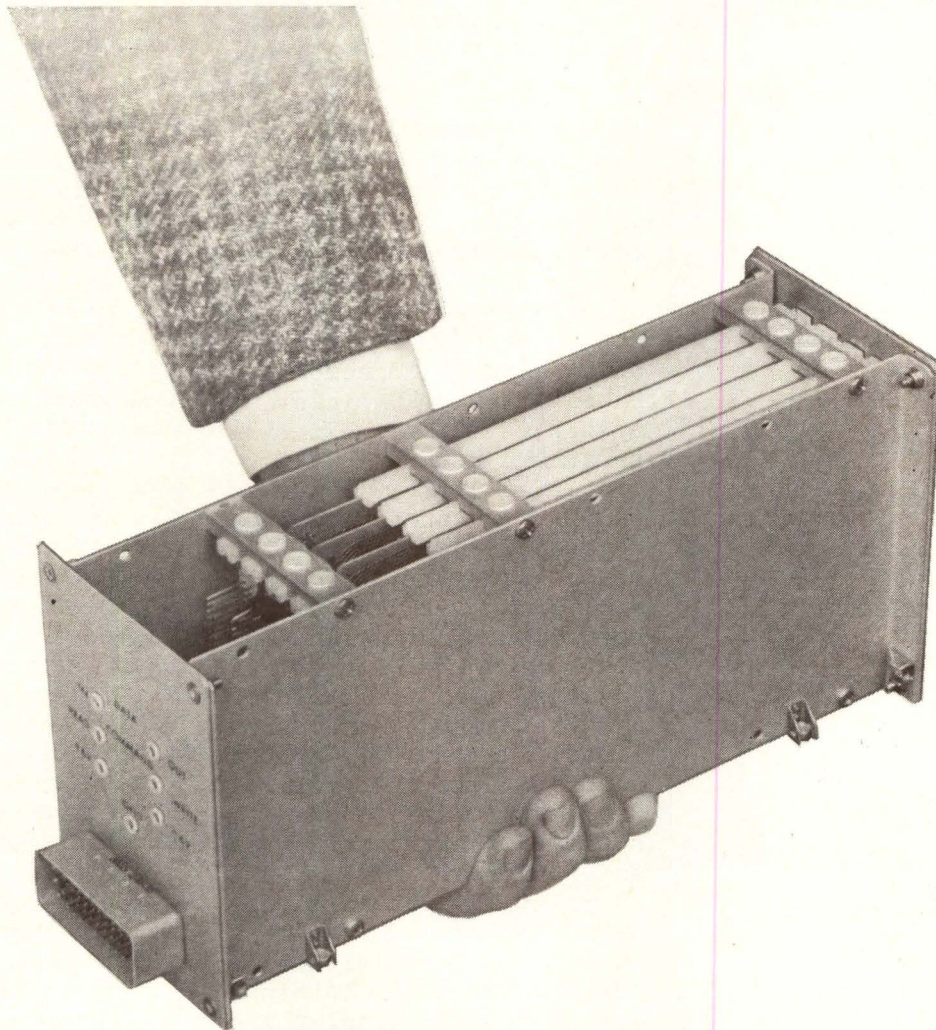

Albuquerque—Electronic Enterprises, (505) 256-1585; Baltimore—Eastern Components, (301) 322-1412; Dayton—(513) 253-3158; Encino, Cal.—(213) 788-2060; Englewood, Col.—(303) 771-2000; Houston—Noakes Engineering, (713) 529-6213; Irving, Texas—Noakes Engineering, (214) 255-0441; Lansing, Mich.—(517) 482-7140; Minneapolis—(612) 888-4681; Northlake, Ill.—(312) 261-7880; Orlando—(305) 841-6380; Philadelphia—Eastern Components, (215) 927-6262; Phoenix—(602) 265-1792; San Francisco—Wm. J. Purdy Agents, (415) 863-3300; Saugerties, N. Y.—(914) 246-2811; Union, N. J.—(201) 964-1844; Waltham, Mass.—(617) 899-3110; Toronto, Ontario—Philips Electron Devices, Ltd., (416) 425-5161.

CIRCLE NO. 25 ON INQUIRY CARD

Any day now you computer people will make an incredible discovery:



Nobody has made custom
power supplies longer than
Varo.

Or with a better
performance record.

Or to tougher mil specs.

Funny we haven't crossed
paths with you folks.

Funny?

It's incredible!

Let's discover each other.

Write Rex Carter, Varo,
Inc., Static Power Division,
1600 Dallas North Parkway,
Plano, Texas 75074.
TWX 9108605640
TELEX 73-2713



large object, like a submarine or part of the ocean floor, can be made with long wavelength sound energy. A computer calculates the interference pattern that would have been formed with short wavelength light energy and produces the transparency of this pattern. In the developed hologram, the object would be small enough to study in an ordinary room. It is also possible to reverse the process and to enlarge a hologram made of a microscopic object. In this case, the original hologram would be made with radiation having a very short wavelength. The computer would calculate the interference pattern for longer wavelength radiation, and the result would be an enlarged three dimensional image of the object.

AUTOMATIC TICKET AGENCIES— Computicket Corporation, a subsidiary of Computer Sciences Corp., has awarded a \$3.3 million contract for production of electronic terminals that will serve as neighborhood box offices in the company's computer-based instant ticketing system. The terminals will be manufactured by Wyle Laboratories, El Segundo, Calif., to specifications developed by Computicket engineers. The terminals will be installed in neighborhood markets, banks, and other retail and commercial outlets, and will be linked by private communication lines to a central computer complex. The units will be used to request seats to sports, theater, and other entertainment events, and to print the actual admission tickets for these events. Television-like screens at each terminal will instantly display the computer's response to requests. The development of the Computicket terminals is said to have a significance extending beyond the

ticketing business. The units are flexible enough in their design to satisfy the inquiry, response and high speed printing requirements of a number of other important applications; for example, travel and hotel reservations, inventory control and credit checking. The first terminals produced will be installed in the Southern California Computicket network, which will begin operation next spring. Similar networks will be established in New York and other metropolitan areas throughout the United States in 1968 and 1969. The ultimate plan is to form a nationwide Computicket network.

RCA TO BUILD \$11.7 MILLION COMPUTER PLANT—RCA has announced plans to build a 220,000 square-foot facility in Marlboro, Mass. for the engineering and production of computer peripheral equipment. Construction of the new plant, to be located on a 128-acre site on Interstate Highway 495, will begin in 1968, with the target date for initial occupancy scheduled for early 1969. A temporary 50,000-square-foot facility has been leased near Framingham, Mass., to recruit and train the personnel who will form the nucleus of the permanent operation four miles away. Engineering efforts will begin at the Framingham plant around January 1968. Initially, a limited number of different types of electronic data processing devices for RCA's Spectra 70 systems will be assembled at the Marlboro plant. At full operation, a broad range of computer peripheral devices will be designed and manufactured. According to James R. Bradburn, Vice President and General Manager of RCA Electronic Data Processing, the new plant will be built with an eye toward additional expansion in the early 1970's.

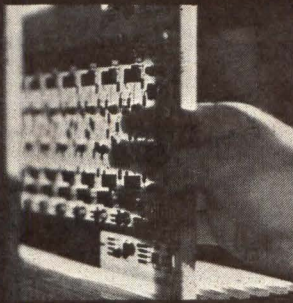

It's no longer \$30K and up to give your system big computer power.

The DATA 620/i comes in at less than one-half that amount. And it gives you more raw computer muscle than the \$30K machine.

It's because the DATA 620/i was designed from scratch for *systems* work, no double-duty design, no we-cover-the-waterfront philosophy. It's a pure, lean computer for systems.

Fully IC'd for reliability and small size, the DATA 620/i handles 16 and 18 bit words, operates at 1.8 μ sec speed, with more than 100 basic commands and a 4K to 32K word memory. It comes with Party Line I/O, complete software proven out by the DATA 620, and a full selection of peripherals and options.

We know of more than 300 systems that couldn't afford not to have the DATA 620/i, because that's how many we sold in the first six months. We'd be happy to show you what it can do for your system, or at least send you our illustrated brochure full of functional and operational information. Just call or write.

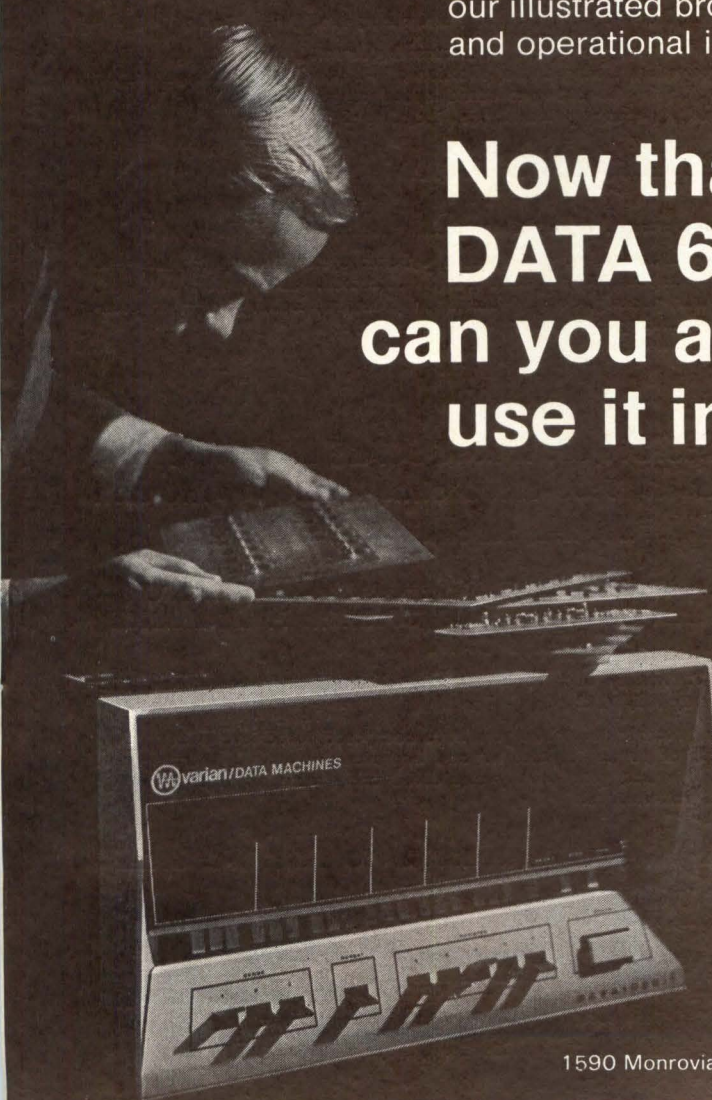

**Now that the
DATA 620/i computer is out
can you afford not to
use it in your system?**

We need Senior Development Engineers
and Programmers.
Write to Mr. Bruce Ferris.

varian data machines
a varian subsidiary
Formerly Decision Control, Inc.



1968 SOLID-STATE CIRCUITS CONFERENCE

University of Pennsylvania and Sheraton Hotel

Philadelphia, Pa., Feb. 14, 15, 16, 1968

TECHNICAL PROGRAM SUMMARY

Reflecting the extraordinary growth of solid-state technology, this year's International Solid-State Circuits Conference has scheduled more papers than ever before — 15 formal sessions comprising 78 invited and contributed papers authored by over 140 scientists, engineers and educators from here and abroad will be presented at the University of Pennsylvania.

In the evenings, informal discussions will again be held at the Sheraton Hotel. Twelve sessions, with over 80 participants, are on the agenda.

Those daytime sessions and evening informal discussions of prime interest to Computer Design readers are listed in the following schedule.

FORMAL OPENING —

Wed., 1:45-2:45 p.m., Irvine Auditorium

KEYNOTE ADDRESS: MAKING INTEGRATED ELECTRONICS TECHNOLOGY WORK

R. N. Noyce, Fairchild Semi-Conductor, Mountain View, Calif.

Applications of large-scale integration require solutions to technical, organizational, economic and logistic problems significantly more complex than those in applications of today's integrated circuits. The solution will require greater flexibility and communication between vendor and user.

SESSION III — INVITED: THE FUTURE OF INTEGRATED ELECTRONICS IN SYSTEMS — Wed., 2:50-5:30 p.m., Irvine Auditorium

Moderator: R. L. Petritz, Texas Instruments, Inc., Dallas, Texas

Progress in integrated electronics has had a widespread impact on the electronics industry prompting a critical appraisal of its productive application to real systems. In the keynote address, technology problems and their interface with customers were underscored. The following invited papers will report on allied problems. The first three will discuss the application of the technology to three major systems: computers, telecommunications and consumers. The concluding presentation will consider a new approach to integrated electronics through recent discoveries of bulk phenomena in semiconductors.

3.1: THE IMPACT OF LSI IN LARGE COMPUTER SYSTEMS

M. O. Paley, IBM Corp., Menlo Park, Calif.

LSI technology offers significant performance gain in large computers through higher-speed switching and higher circuit density. The challenge to the system designer is to balance this increased logic with high performance memory, input-output considerations and architectural innovations.

3.2: INTEGRATED ELECTRONICS IN TELECOMMUNICATIONS

G. C. Dacey, Bell Telephone Laboratories, Inc., Holmdel, N. J.

Integrated electronics offers a new approach to the design of telecommunications systems. This factor and related problems will be

discussed in this paper. The touch-tone dial system will be assessed as a system application.

3.4: SOLID-STATE BULK PHENOMENA AND THEIR APPLICATION TO INTEGRATED ELECTRONICS

R. S. Engelbrecht, Bell Telephone Laboratories, Murray Hill, N. J.

Bulk phenomena in semiconductors can be used to achieve oscillation, amplification, modulation, detection, logic decisions, pulsed-train generation and other functions. Methods for combining these phenomena in single structures for achieving integrated electronic functions will be discussed.

INFORMAL DISCUSSIONS

Wed., 8:00 p.m., Sheraton Hotel

1: HIGH SPEED DIGITAL INTEGRATED CIRCUITS (West Ballroom)

Moderator: D. Chung, Texas Instruments, Inc., Dallas, Texas

Two general topics will be discussed: current problems in the design, production, testing and application of 1-2 ns ICs, and next generation circuits in the sub-nanosecond speed range with emphasis in high density packaging techniques, including LSI.

4: WHERE MOS IS TODAY

(Pennsylvania East)

Moderator: H. C. Lin, Westinghouse Electric Corp., Elkridge, Md.

The advantages of static versus dynamic systems, complimentary and non-complimentary circuits will be discussed. Such factors as speed, power, packing, density fabrication problems, loading, interface problems, and specific-end use will be assessed.

Panel Members:

SESSION IV: LARGE-SCALE INTEGRATION, Thurs., 9:00-12:00 a.m., Irvine Auditorium

Chairman: R. A. Henle, IBM Corp., Hopewell Junction, N. Y.

4.1: TRANSISTOR-TRANSISTOR LOGIC WITH HIGH PACKING DENSITY AND OPTIMUM PERFORMANCE AT HIGH INVERSE GAIN

B. T. Murphy and V. J. Glinski, Bell Telephone Laboratories, Inc., Murray Hill, N. J.

Very narrow epitaxial layers have been used to achieve packing densities of 10^5 logic gates/in² and improved logic circuit performance. High inverse gain, usually considered undesirable, provides improved TTL performance.

4.2: A FLEXIBLE APPROACH TO EMITTER-COUPLED LOGIC ARRAYS

M. D'Agostino, RCA, Somerville, N. J.; A. Feller, RCA, Camden, N. J.

A CML array fabrication approach which originated in a systems-circuit study will be described. The design attempts to merge high-speed computer system requirements and solid-state fabrication capabilities, incorporating design automation techniques.

Chairman: R. A. Henle, IBM Corp., Hopewell Junction, N. Y.

4.3: LSI SUBSYSTEMS ASSEMBLED BY THE SILICON WAFER-CHIP TECHNIQUE

C. G. Thornton, Philco-Ford Corp., Blue Bell, Pa.

This paper will cover techniques for face-down bonding of individual LSI chips onto a high-density silicon interconnection substrate, projected to permit the design of several large multi-chip subsystems.

4.4: TOTAL DESIGN OF HIGH-SPEED COUNTERS: PROCESS TO SUB-SYSTEM

R. C. Foss and J. S. Brothers, The Plessey Co., Ltd., Northants, England

High-speed counting sub-systems in which process technology, circuit and logic design are optimized separately and together will be described. A current steering counter element achieves 10 MHz/mW at a 350-MHz counting rate.

4.5: AN APPROACH TO SMALL MACHINE DESIGN IN LARGE-SCALE INTEGRATION

C. S. Gurski, IBM Corp., Endicott, N. Y.; W. R. English and G. G. Langdon, Syracuse University, Syracuse, N. Y.

This paper will consider the large-scale integration part-number problem by consolidating the development of several small machines. A portion of the physical embodiment of this concept was constructed in large-scale integration.

INFORMAL DISCUSSIONS

Thurs., 8:00 p.m., Sheraton Hotel

7: LSI IMPLICATION IN COMPUTER ORGANIZATION (West Ballroom)

Moderator: L. M. Spandorfer, UNIVAC/Sperry Rand Corp., Blue Bell, Pa.

The problems in making hardware/software tradeoffs and introducing new system organizations for the purpose of accommodating LSI will be discussed.

10: WHICH MEMORY TECHNOLOGY FOR FUTURE SYSTEMS

(Pennsylvania East)

Moderator: J. H. Wuorinen, Bell Telephone Labs., Inc. Murray Hill, N. J.

The range of memory applications expected in future data-processing systems will be explored and the relative merits of ferrites, thin films, semiconductors and optics for this range of applications evaluated.

12: IMAGING MOSAIC SENSORS AND DISPLAYS (Hall of Flags)

Moderator: T. E. Bray, General Electric Co., Syracuse, N. Y.

A variety of mosaic sensor and display techniques will be discussed and compared. Probable applications, image surface-device characteristics, and problems encountered with interfacing circuitry will also be appraised.

SESSION X: MEMORY TECHNIQUES Thurs., 9:00-12:00 a.m., Irvine Auditorium

Chairman: A. W. Lo, Princeton, N. J.

10.1: COINCIDENT-SELECT MDS STORAGE ARRAY

J. H. Friedrich, Fairchild Semiconductor, Palo Alto, Calif.

This paper will discuss the development of a coincident-select 64-bit p-channel MOS monolithic storage array to achieve low cost and high performance in future random access memory.

10.2: A MONOLITHIC DECODE-DRIVE CIRCUIT FOR MAGNETIC MEMORIES

W. F. Jordan, Jr., Computer Control Div./Honeywell, Framingham, Mass.

Integrated circuits are now being used for low-cost, high-speed,

high-current switching in magnetic memories. Details of a new monolithic function and its application in a new address selection scheme will be described.

10.3: A 100-MHz, 1024-BIT, RECIRCULATING ULTRASONIC DELAY LINE STORE

G. L. Heiter, Bell Telephone Laboratories, Inc., Murray Hill, N. J.

By combining a short high-speed delay line with integrated recirculation circuitry, it is possible to obtain a small size, relatively fast-access digital store which holds the promise of great economy. A suitable configuration will be discussed.

10.4: HIGH-SPEED, INTERLACED DRO AND NDRO OPERATION OF A PLATED-WIRE MEMORY SYSTEM

T. R. Finch and S. Waaben, Bell Telephone Laboratories, Inc., Murray Hill, N. J.

Interlaced DRO and NDRO 150-ns read-write operation of an 80,000-bit plated-wire memory system will be described. Functional integration of read-write, select circuits, using beam-lead, sealed-junction technology will be reported.

10.5: AN 80-NS PLATED-WIRE STORE FOR A TIME COMPRESSION MULTIPLEX TRANSMISSION SYSTEM

J. D. Heightley and A. J. Perneski, Bell Telephone Laboratories, Inc., Murray Hill, N. J.

Sequential read and sequential write of a 720-word 9-bit per word plated-wire memory system at a 12-MHz rate will be described. Time compression multiplex system requirements and store performance will be discussed.

SESSION XV: HIGH-SPEED CIRCUIT TECHNIQUES

Fri., 1:30-4:30 p.m., Annenberg Auditorium

Chairman: R. B. Seeds, Fairchild Semiconductor, Palo Alto, Calif.

15.1: LOW TEMPERATURE OPERATION OF Ge PICOSECOND LOGIC CIRCUITS

E. S. Schlig, IBM Corp., Yorktown Heights, N. Y.

Low-temperature operation of emitter-coupled logic circuits offers potential advantages in power dissipation, noise immunity, and reliability. Experimental ps germanium integrated circuits exhibit significant improvements in delay with moderate cooling, in contrast to observed degradation in the performance of comparable silicon circuits.

15.2: A NEW TECHNIQUE TO CONTROL STORAGE TIMES IN INTEGRATED-CIRCUIT TRANSISTORS

F. Capocaccia, SGS-Fairchild, Agrate Brianza, Italy

This paper will cover a Limited Saturation Device technique found to improve the absolute value, spread and temperature dependence of storage times in integrated transistors, and compatible to existing integrated-circuit processing.

15.3: CONTROLLED SATURATION AS AN APPROACH TO HIGH-SPEED LOGIC

H. Mukai, Nippon Telegraph and Telephone Public Corp., Tokyo, Japan

A controlled saturation logic gate developed in a monolithic integrated circuit form has been found to offer exceptional performance and speed capability through saturation control coupled with operation of a push-pull output network.

15.4: TRANSISTOR-SCHOTTKY BARRIER-DIODE INTEGRATED-LOGIC CIRCUIT

Y. Tarui, Y. Hayashi, H. Teshima and T. Sekigawa, Government Electrotechnical Laboratory, Tokyo, Japan

A new high-speed, low-power logic circuit using Schottky barrier diodes to avoid saturation of bipolar transistors will be described. Both devices are compatibly realized in the form of monolithic integrated circuits.

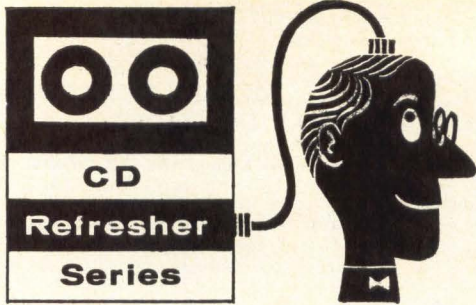

A Review of Digital Differential Analyzers

NORTON MARKIN
Senior Engineer
The Bendix Corporation
North Hollywood, California

Mr. Markin discusses the applications, advantages and disadvantages of the DDA, describes how it is designed, programmed and used, and indicates recent improvements that make the DDA faster and more accurate.

The DDA was developed about 20 years ago,² to provide a greater precision than could be obtained using analog computers. It is composed of a set of integrator units that perform an integration by summing incremental areas under the curve of the function to be integrated. The basic block diagram for such a unit is shown in Fig. 1: For the arbitrary function $Y = f(x)$ shown in Fig. 2, a rectangular area, Δz , is added to the integrator unit each time an iteration is performed; when all the Δz areas under the curve have been summed, an approximation to the integral Ydx is obtained. The value of this approximation approaches the value of the integral as Δx approaches zero; therefore, the accuracy of the integration process can be increased at the expense of increased computation time by decreasing the Δx increments.

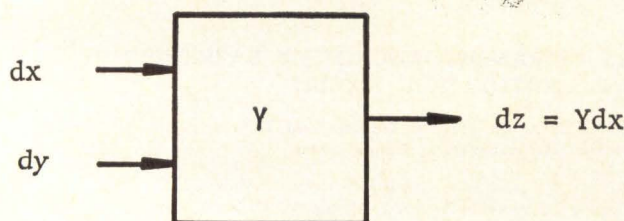

Fig. 1: Block diagram of integrator unit.

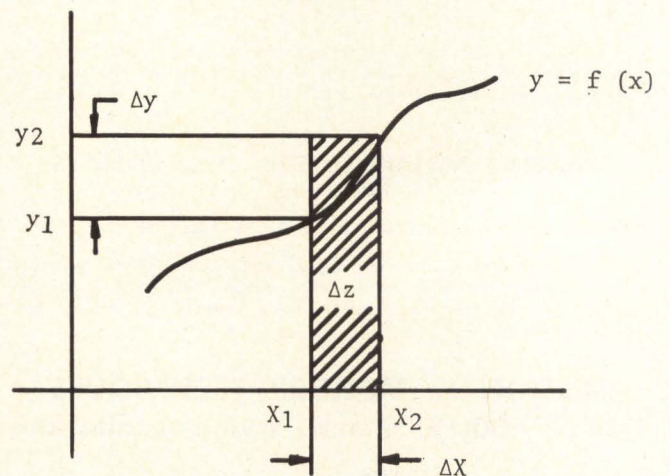

Fig. 2: Approximation of integral by rectangular summation.

The DDA can be used for solving any ordinary differential equation of any order or degree, linear or non-linear, or a simultaneous set of such equations.¹ It can also be used to solve integral equations, transcendental algebraic equations, and simultaneous sets of such equations. Complexity of the equations that can be solved by a DDA is limited only by the number of available integrator units.

In general, DDA's are much slower than electronic analog computers. For example, a serial DDA with an operating speed of 100 kc takes ten times as long to produce an answer with an accuracy equivalent to that of an electronic analog computer.² However, with today's inexpensive integrated circuitry and technological advances, parallel DDA's can be built that operate at speeds more closely approaching the speed of the analog computer. For example, MOS integrated DDA chips are commercially available from which a parallel 500 kc DDA can be built, and each integrator unit in this DDA is composed of only 2 MOS chips.^{3,4}

Advantages of the DDA over the analog computer include its greater precision (i.e., given enough time, the DDA can produce an accurate answer to more significant places than an analog computer), its ability to make logical decisions, its compactness, and its flexibility. Moreover, since the DDA handles information in digital form it is more readily adaptable for use as a part of a large computer system.

Since the DDA is specifically designed to solve differential equations, it is faster, simpler, and requires fewer programming steps than a general purpose digital computer, and is less expensive because it has no need for the elaborate control system or stored program required by the digital computer. Also, since the DDA output is of a differential form (i.e., the output indicates a change in a previous value rather than the new value itself), it is more adaptable for process control work (e.g., oil refining, power generation, machining, etc.) than the digital computer. Thus even with today's faster and cheaper general purpose computers there are still applications where the special purpose DDA cannot be easily replaced.

Programming

The method for setting up a differential equation on a DDA is similar to that used for an analog computer. The basic properties of the integrator unit shown in Fig. 1 are (1) the dy input is integrated in the unit to obtain a Y value; and (2) this value is multiplied by the dx input to give a resulting output of Ydx , which is called dz . The general procedure involved in setting up a problem for integrator units having such properties is as follows^{1,5}:

1. Isolate the highest derivative of each independent variable on the left side of the differential equation.
2. Multiply both sides of the equation by the differential of the independent variable.
3. Assume the highest derivative in the equation formed in Step 1 is known and stored in the first integrator unit. Then use the output from this unit as an input into other units to generate the lesser order derivatives. Finally, sum the appropriate lesser order terms given by the equation derived in Step 2 to form the required input to the first unit.

The equation $d^2y/dt^2 + a(dy/dt) + by = 0$ will be used to illustrate the above procedure. First the highest derivative of the equation is isolated:

$$d^2y/dt^2 = -a(dy/dt) - by \quad (\text{Eq. 1})$$

Next, the multiplication in Step 2 is carried out:

$$(d^2y/dt^2)(dt) = -a(dy/dt)(dt) - by(dt)$$

or,

$$d(dy/dt) = -a(dy/dt)(dt) - by(dt) \quad (\text{Eq. 2})$$

Finally, Step 3 results in the interconnections among

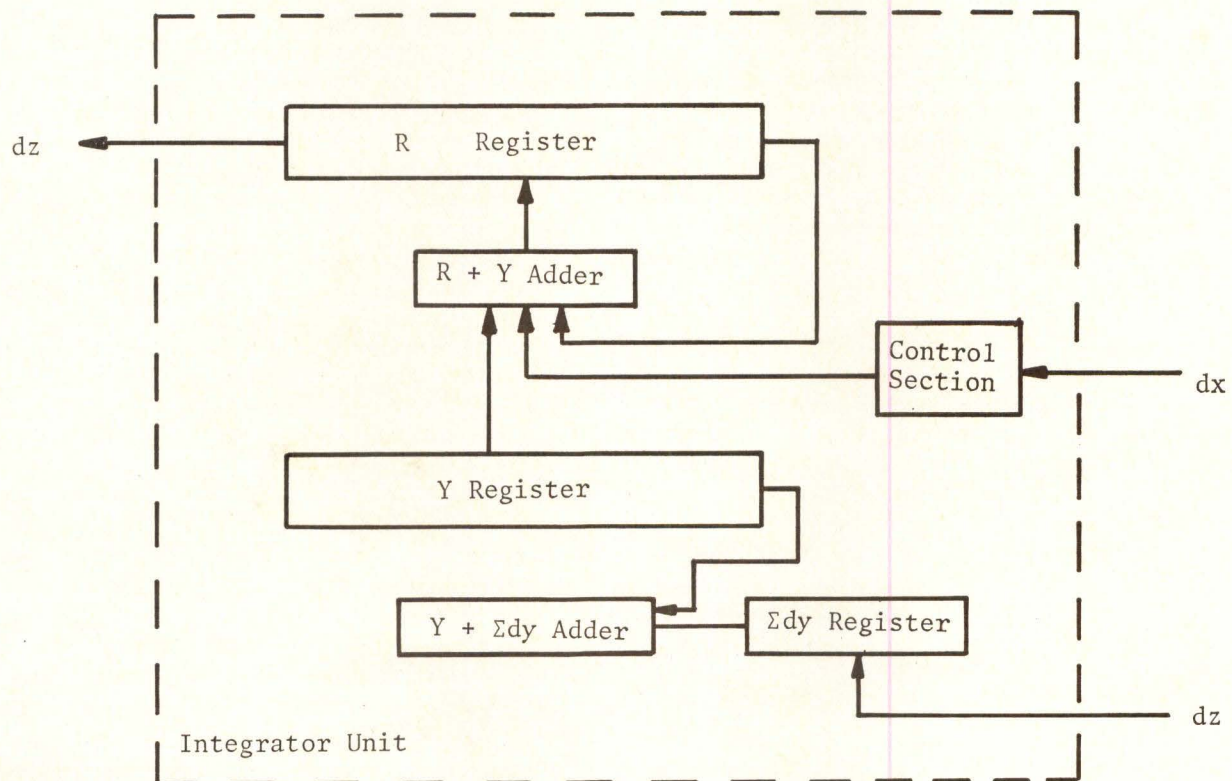

Fig. 3: Detailed diagram of integrator unit.

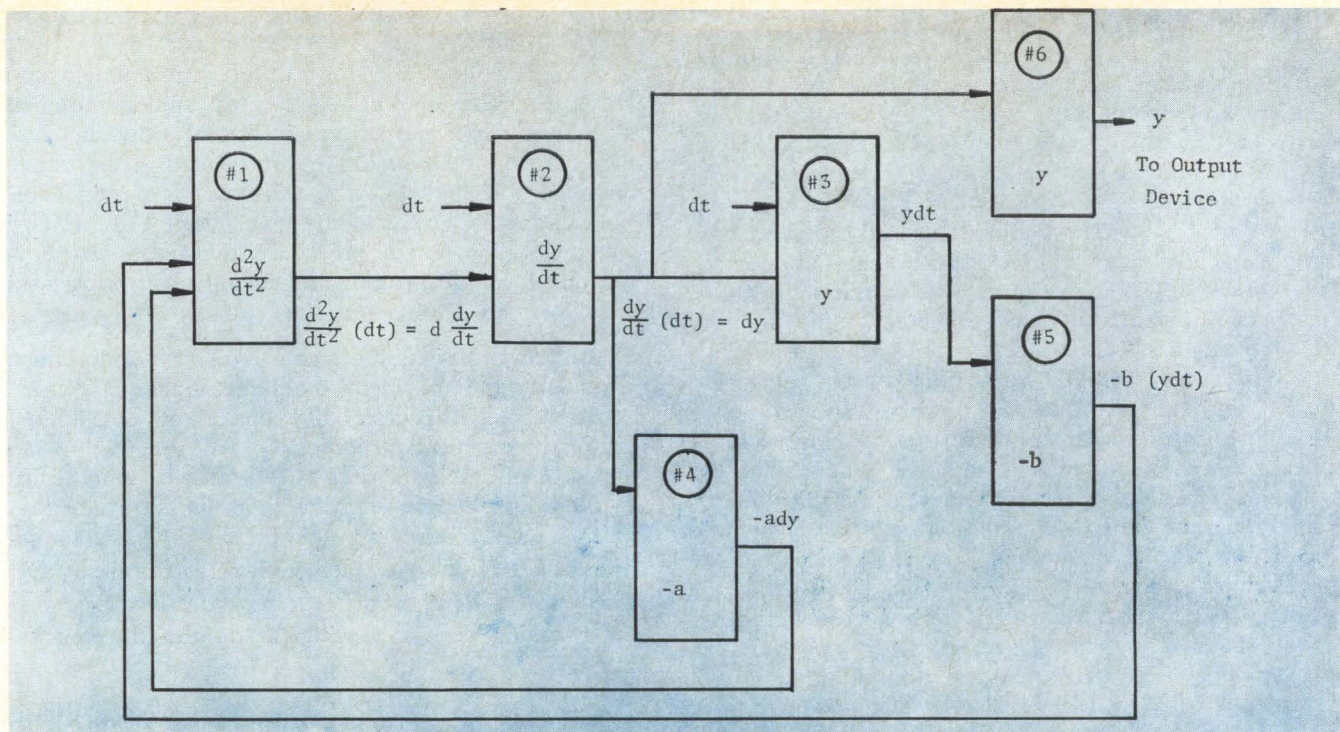

Fig. 4: Schematic representation for $(d^2y/dt^2) + a(dy/dt) + by = 0$

integrator units as shown in Fig. 4. To generate this diagram, it is first assumed that the derivative d^2y/dt^2 on the left side of equation 1 is available in integrator unit 1. Then integrator unit 1 integrates this value to form dy/dt , and integrator unit 2 integrates dy/dt to form dy . The dy output from unit 2 is put into the "dx" position (the multiplier position) of unit 4, which is used to multiply dy by a constant value, $-a$. This resulting product is used as one of the necessary inputs to unit 1 to satisfy Equation 2. There is no "dy" incremental input into unit 4 because unit 4 contains a constant value in the Y register. The ydt output of unit 3 is put into unit 5 to produce $-bydt$, and this output becomes the other required input to unit 1. With these two inputs going into unit 1, Equation 2 is satisfied and the iteration loop is completed. The dy output from unit 2 can be put into unit 6 where it is integrated to form the value for Y, the output.

After the interconnections shown in Fig. 4 are determined, initial values determined from the initial conditions given in the original problem are inserted into the integrator unit registers before the integration process begins. The quantities in the problem are scaled so that the capacity of the integrator unit registers will not be exceeded. Scaling consists of estimating the maximum value each variable is likely to attain during the course of the problem and then designating the number of significant digits for each integrator unit. If the estimate is too low, the register will overflow and the problem will have to be rescaled; if the estimate is too high, it will take longer than necessary to obtain a solution.¹

Basic Design

Figure 3 is a detailed block diagram of an integrator unit.⁵ For each iteration the dy inputs to the unit are added together and the sum updates the contents of the

Y register. At this same time, the Y value is multiplied by the incremental dx input and the resulting "rectangular area" is added to the areas already stored in the R register. Thus, for the curve in Fig. 2, the previous contents (y_1) of the Y register are modified by Δy , and during the next iteration time the updated value in the Y register (y_2) is multiplied by Δx to obtain the cross-hatched Δz area. Since the value of the dx increment is taken as unity, the multiplication process consists of simply adding the contents of Y to the contents of R.

If it were necessary to store the entire sum of all Ydx products in the R register, the R register would have to be larger than the Y register. This requirement is eliminated by having the capacity of the registers equal and summing the R register overflow (i.e., the dz output) in another integrator unit when it is necessary to actually obtain the value of the integral. For most cases it is not necessary to sum the value in an integrator unit because the dz outputs are mainly used to satisfy the input requirements to other integrator units.

When designing a particular DDA, the methods for mechanizing the basic components shown in Fig. 3 are based upon a consideration of cost, computation speed, accuracy, precision, and reliability. One of the more conventional methods of mechanization, which represents a compromise between cost and iteration speed, is shown in Fig. 5. In this method each integrator unit is represented by a segment on a magnetic drum. One recirculating track represents the Y registers for all integrator units; another track represents all R registers; a third track, called the L track, contains instruction information for all integrator units; a fourth track contains the dz information; and a fifth track (not shown) is the clock track. If the integrator unit information is recorded and processed serially, all units can share a common set of adder circuits, coincidence circuits, etc.

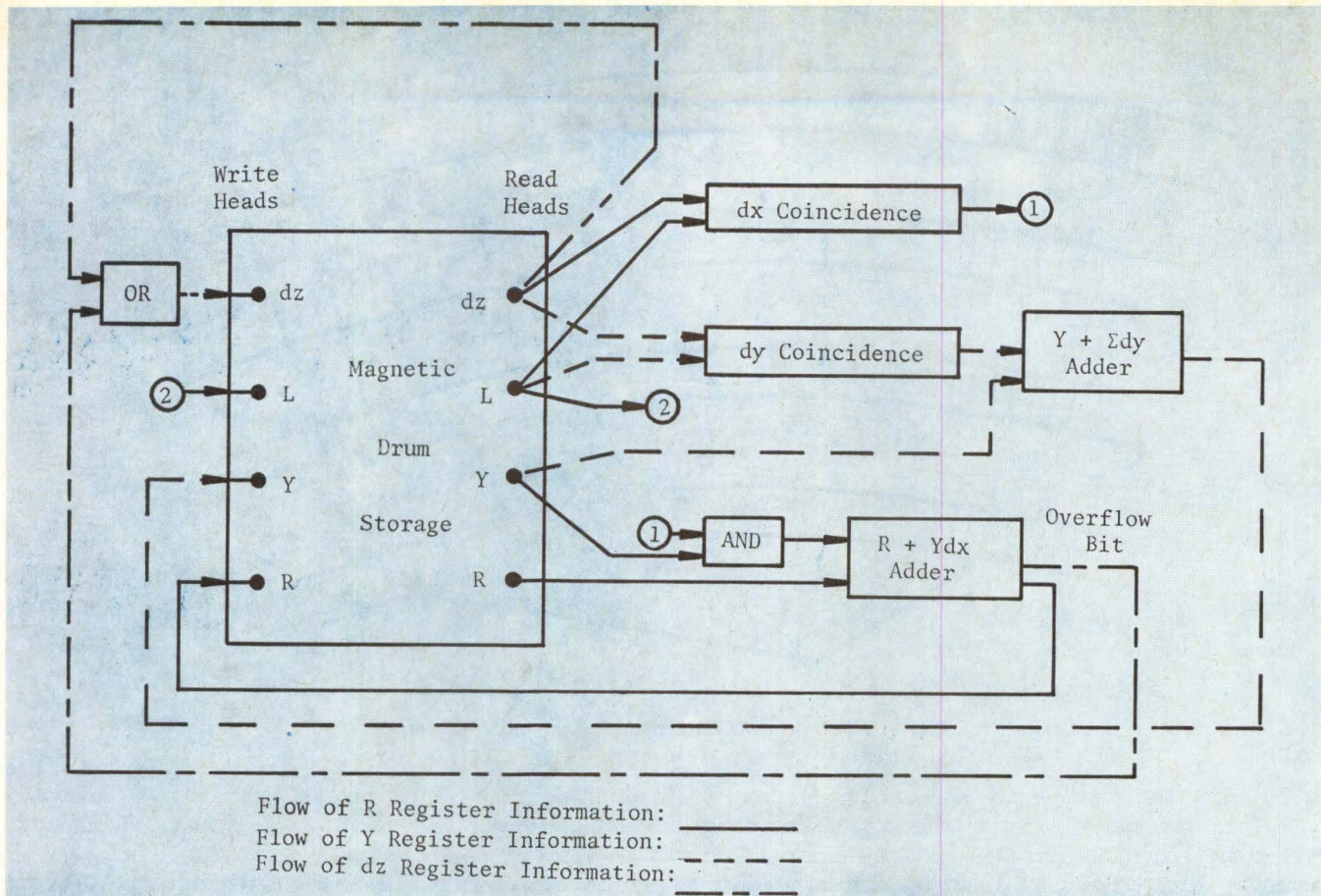

Fig. 5: Mechanization of serial DDA.

The interrelation between track segments is shown in Fig. 6. The dz output from each particular integrator unit is written into a specific position on the dz segment. Thus the overflow bit from the R register of unit 1 is always recorded in position 1 on the dz segment, the overflow from unit 2 is always recorded in position 2, etc.; and this dz segment is then repeated for all integrator units around the drum.

During one iteration period all dy inputs to the integrator unit being read are summed and added to the present contents of the Y register; and this result replaces the Y information that was just read. The dy inputs come from the outputs of other integrator units and can be found on the dz line during the iteration time. The L track information indicates which of these other integrator outputs are to be used as dy inputs. For example, if bits 3, 8, and 13 of the L track are true, then the dz outputs from integrator units 3, 8, and 13 will be summed together with the present Y register information to form the new Y register information.

At the same time that the Y register is being updated, the present Y register information is added to the contents of the R register, if the dx input is present, and this result replaces the contents of the R register. Once again the L track is used to indicate which integrator unit output is used as the dx input. Finally the overflow bit from the updated R register is recorded in the proper position of the dz segment, replacing the previously recorded bit.

The iteration process just described is shown in the diagram of Fig. 5. This process, which occurs each time

a track segment representing an integrator unit passes under the read head of the drum, can be summarized as follows: (1) the value of Y is updated, (2) a new Ydx area is added to the R register, and (3) the overflow bit from the updated R register is recorded on the dz segment.

Improvements On Basic Design

In the basic binary design described, there is no true representation for an output of "zero." An output of $+1$ indicates addition and a -1 indicates subtraction. Thus a "zero" dy input to an integrator unit is represented by alternate values of $+1$ and -1 ; and at any given time the round-off error (ϵ) is $\epsilon \leq |dz|$, where dz is the dy input that comes from another integrator unit.^{1,6} If this dz output error is fed back to its own integrator unit directly or through a short loop, the error term becomes additive and the computation process soon becomes worthless. This type of error can be eliminated by using a ternary number representation, with the outputs $+1$, 0 , and -1 , so that a "zero" value is actually represented. This increases hardware costs but reduces the error to $\epsilon \leq \frac{1}{2} |dz|$. If the same precision is maintained, the computation speed will be doubled when a ternary representation is used.

Another improvement of the basic DDA design involves approximating the integral by trapezoidal summation instead of by rectangular summation. In rectangular summation (shown in Fig. 2) each area is approximated by $y\Delta x$, while in trapezoidal summation (shown

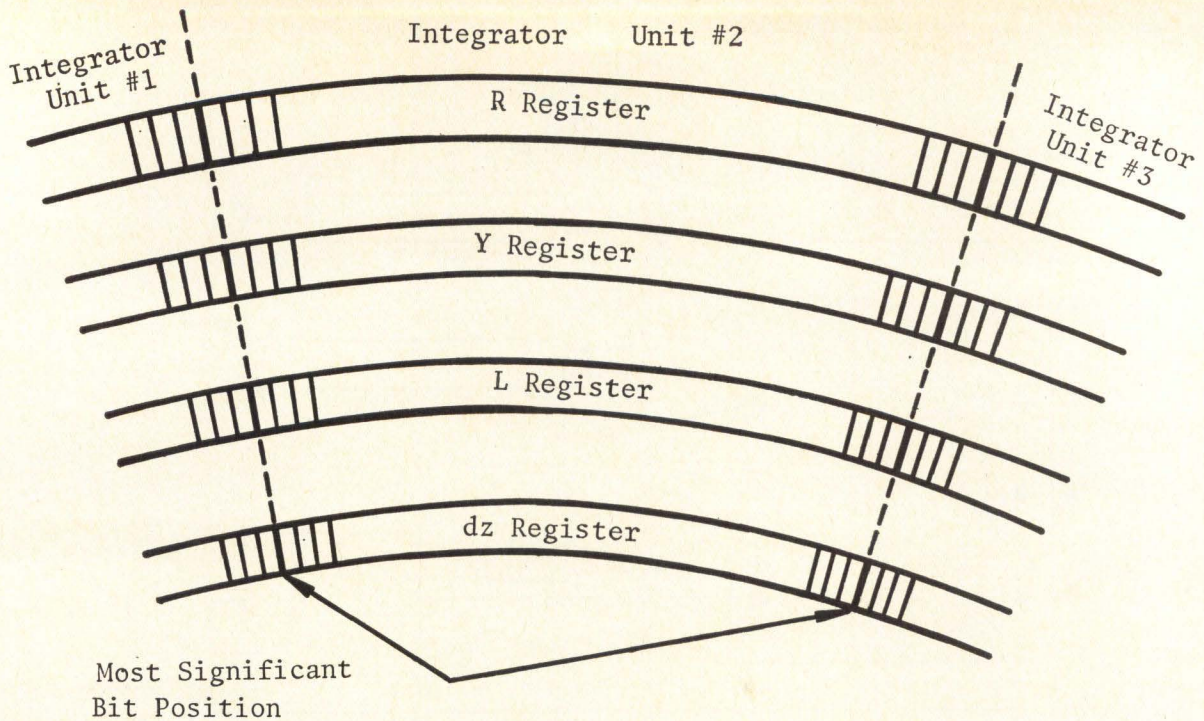

Fig. 6: Relationship between integrator unit registers.

in Fig. 7) the fundamental area of integration is $(y + \frac{1}{2} \Delta y) \Delta x$. The ratio of the trapezoidal error term to the rectangular error term is of the order of dx^2 ; therefore, when Δx is some small fraction, a considerable amount of error reduction can be attained by adding the extra hardware for trapezoidal integration.

For real-time problems where time is of the essence, computation time can be reduced by processing all integrator units in parallel — i.e., the arithmetic process is still done serially, but the integrator units are all processed at the same time. Thus, if 20 integrator units are processed in parallel instead of serially, the iteration speed is increased by a factor of 20. However, the cost is also increased considerably because this method requires 20 separate adders, 20 separate coincidence circuits, etc.

One such parallel DDA uses trapezoidal integration, a ternary number representation, and delay lines instead of a magnetic drum to store the integrator unit register

information.^{7,8} Three separate delay lines are used for each integrator unit: Two perform the same functions as were previously described; and the third register stores the initial value of Y entered into the DDA at the beginning of a problem; enabling repetition of the computation process without having to re-enter the initial conditions. Wired plugboard programming is used to connect the dz output from an integrator unit directly to specific dy and dx inputs. As a result, an L instruction line and a dz information line are no longer necessary.

In the design of this parallel DDA, separate adders are used for summing the dy inputs together. This means that all dy inputs must first be added separately. The result is then fed into the integrator unit where it is added to the contents of the Y register. Since most integrator units normally have only one dy input, the total amount of hardware can be reduced by using a group of adders that are common to all integrator units — i.e., fewer adders are necessary if they are shared among integrator units than if separate adders are used for each unit. Similarly the DDA also uses a group of multipliers common to all integrator units in order to reduce hardware.

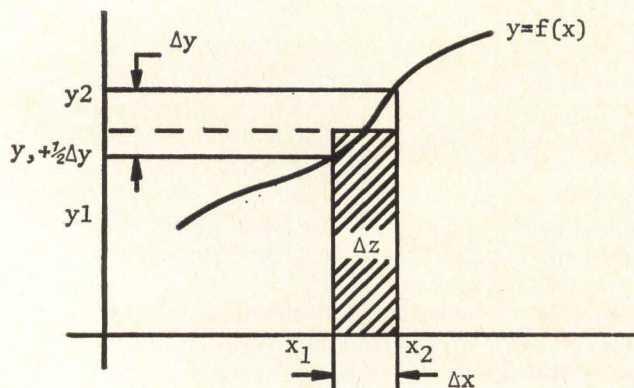
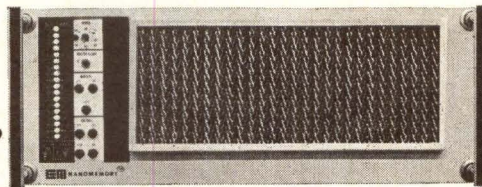

Fig. 7: Approximation of integral by trapezoidal summation.

REFERENCES

1. Forbes, George F., "Digital Differential Analyzers," 4th ed., Pacoima: George F. Forbes, 1957.
2. Johnson, Clarence L., "Analog Computer Techniques," New York: McGraw-Hill Book Co., Book Co., 1956. Chap. 13.
3. Callan, J. D., "MOS Integrated Digital Differential Analyzer," General Instrument Micologic Application Notes, Aug. 1966.
4. "General Instrument MOS Integrated Circuit specification sheet for the Digital Differential Adder Element" (MEM 5021), Aug. 1966.
5. Grabbe, E. E., Simon Ramo, D. E. Woolridge, ed., "Handbook of Automation Computation and Control," Vol. 2, New York: Wiley & Sons, 1959. Chap. 28.
6. Palevsky, Max. "The Design of the Bendix Digital Differential Analyzer," Proceedings of the IRE, Vol. 41 (Oct., 1935), p. 1352-1356.
7. Mitchell, J. S. Ruhman. "The TRICE — A High Speed Incremental Computer," 1958 IRE National Convention Record, Part 4 (March 1958), p. 206-216.
8. "Transistorized Realtime Incremental Computer Expandable," Packard-Bell Computer Corp., 1958.

**This new memory may not
do everything better.
But it does everything.
And it takes up
less space doing it.**



All together, the specs on our medium capacity memory systems are unsurpassed. Some systems may have slightly faster cycle times, but they don't offer speeds of 650 nanoseconds in a unit that's so small you'll be surprised to find a power supply and tester also included—just like the I.C. electronics and 2½ D magnetics. All are contained in only 2⅝ cubic feet (7"x19"x21.5").

Capacities range up to 295,000 bits per unit. Multiple module capability is available for larger capacity requirements.

Compact as it is, the design doesn't get in the way of maintenance. The systems are extremely easy to repair. Stacks, electronics and tester are on plug-in modules—all are accessible and slip in and out easily.

Information on both the Nanomemory 2650 (650 nsecs cycle time) and Nanomemory 2900 (900 nsecs) are in our compact (8½x11") brochure. Write for Litpak 200.

EM electronic memories

12621 Chadron Aveune, Hawthorne, California 90250
(213) 772-5201

The Development of a Large Integrated Complementary MOS Memory Array

by
S. KATZ and C. HANCHETT
Radio Corporation of America
Electronic Components and Devices
Somerville, N.J.

Complementary-symmetry MOS circuits are ideal for high-density memory arrays because of their economic use of silicon area, extremely low power dissipation and high-speed circuit operation which is tolerant of large variations in device parameters. The authors describe progress made in design and fabrication of a word-organized 288-bit complementary memory array on a high silicon chip.

Batch fabrication of both logic and memory systems is important in increasing the operating speed of computers while reducing their size and cost. There are indications that future high-speed scratch-pad and possibly main memories will be built entirely with large monolithic semiconductor arrays. The random-access

storage matrix, and the address decoders used to select a particular memory cell location, can be processed simultaneously on a common substrate. Most active memory cells currently in use employ flip-flops to store binary information; some logic gating is incorporated in the cells to ensure that information is written

into, or read out of, only the selected memory location. To decrease cycle time, the state of the cell is usually sensed in a nondestructive read-out mode (NDRO).

An active memory cell designed for large integrated arrays should meet the following requirements:¹

- It should consume a small amount of silicon area so that the cost per bit is minimized.
- Power dissipation should be low so that the cost of packaging and cooling is kept low.
- The memory cell should be capable of high-speed operation so that it can be used in a variety of applications.
- Memory-cell circuit operation should be tolerant of large variations in device parameters, so that circuit yield is high.
- Stored information should be capable of being sensed with a minimum of circuitry.

Extremely low quiescent-power dissipation is desirable in any volatile memory system, and especially in aerospace and portable battery-

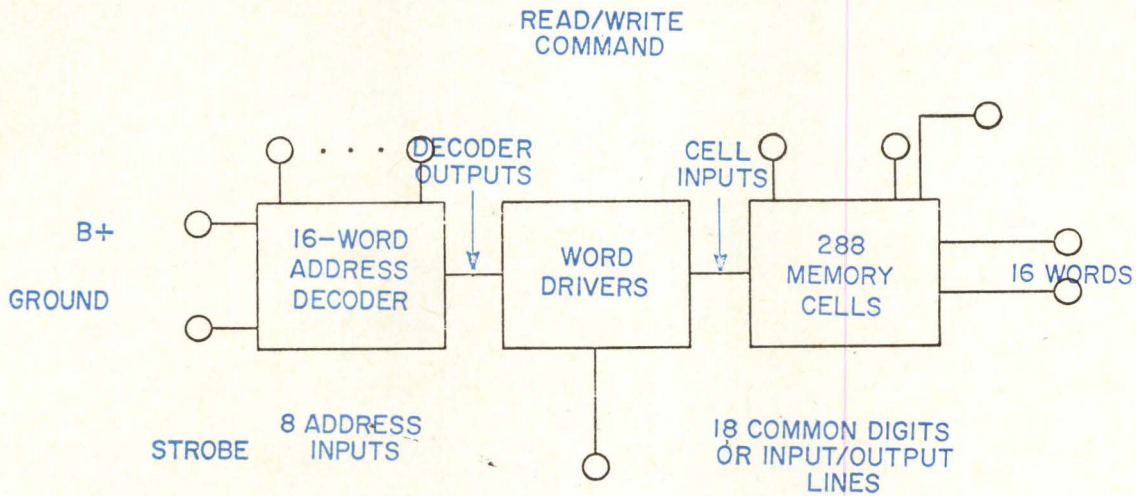

Fig. 1 — Block diagram of proposed 288-bit complementary MOS memory array.

operated equipment.

Thus far, only small monolithic bipolar memory arrays have been built; the size of the isolation regions required for bipolar devices, and the relatively high power dissipation characteristics of these devices appear to restrict the potential for large-capacity memories. Some work has been done in the fabrication of memory arrays composed almost entirely of p-channel MOS transistors.^{2,3} Although amenable to high-packing densities, the single-channel MOS cells operate at lower speeds and dissipate higher standby power than cells consisting of both p-channel and n-channel MOS devices.

Complementary-symmetry MOS digital circuits⁴ are ideal for high-packing-density memory arrays because of their economical use of silicon area, extremely low power dissipation, high-speed circuit operation, and tolerance to large variations in device parameters. A process has been established that permits fabrication of high-gain stable p-channel and n-channel MOS enhancement transistors on a common substrate.⁴ Circuits of this type require little silicon area because they are composed entirely of MOS devices that exhibit natural isolation between units and bilateral properties. In addition, complementary MOS digital circuits feature excellent noise

immunity and large fanout capability and require only one supply voltage. MOS cells requiring a minimum of circuitry to nondestructively detect their stored binary information have been designed.

This paper describes the work accomplished to date toward the fabrication of a 16-word by 18-digit complementary MOS memory array (module), including decoder and word drivers, on a single silicon chip. An experimental design of the memory cell and basic selection circuitry has been completed. Although the final array remains to be built, several integrated complementary MOS circuits which incorporate the functions of the final module have been successfully fabricated.

AN EXPERIMENTAL 288-BIT INTEGRATED MOS MEMORY ARRAY

A block diagram of the proposed 288-bit complementary MOS memory array, (16 words by 18 digits) is shown in Fig. 1. The memory is strobe activated, word organized, and nondestructively sensed. Word organization simplifies the memory cell, but at the same time makes decoding and word-drive circuitry more complex. However, because of the much greater number of cells, overall pellet size is minimized. The integrated

array consists of a 16-output address decoder, 16 word drivers (which also select either the read or write mode of operation), and 288 memory cells. Eight address inputs are required for a high-speed 16-word MOS address decoder when a quaternary tree configuration is used. A read/write command is necessary for activation of the word-drive circuitry. To minimize the external connections to the chip, data is written into, and read out of, common digit (input-output) lines. The memory operates with a single

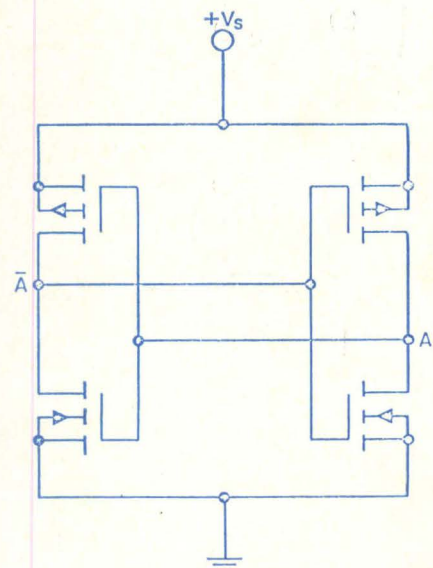

Fig. 2 — Complementary MOS flip-flop.

voltage supply. The 288-bit array, consisting of approximately 1800 devices, can be fabricated on a silicon chip 150-mils square for mounting in a 30-terminal package. Large memory systems can be constructed through the use of many of these arrays.

COMPLEMENTARY MOS MEMORY CELLS

Fig. 2 shows a flip-flop configuration common to all complementary MOS memory cells. The flip-flop, consisting of two cross-coupled inverter stages, dissipates negligible power when holding stored binary information. The circuit also exhibits excellent noise immunity because of the level of threshold voltage of the enhancement devices. Low power dissipation and excellent immunity are characteristic of complementary MOS logic.

A useful circuit configuration that simplifies and improves memory-cell performance is shown in Fig. 3(a).⁴ The circuit is called a single transmission gate. Current can flow in either direction in the gate because of the bilateral property of the MOS device, i.e., the functions of source and drain can be interchanged. If, with the p-channel device biased off,

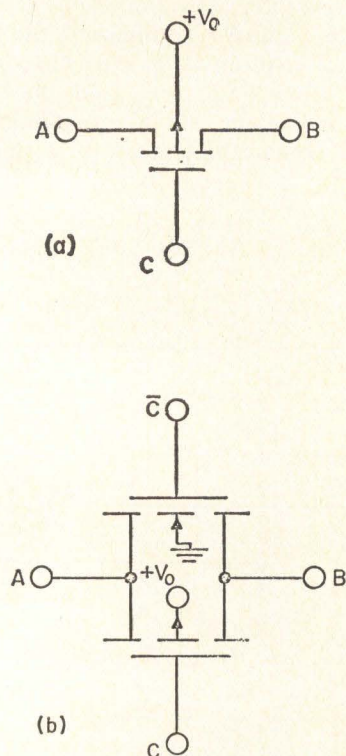

Fig. 3—MOS transmission gates:
(a) Single gate
(b) Complementary gate

terminal A of Fig. 3(a) is considered to be at a fixed potential and B is considered to be at a relatively high impedance, the voltage at B is independent of that at A. When the transistor is conducting, the voltage at B approaches that of A. Depending on the current direction, the transistor operates as either a drain-loaded or source-follower stage. The source-follower mode is characterized by slow-speed operation. Under this mode the circuit may cease conducting when the source-to-gate potential equals the threshold voltage. Both slow-speed and non-conducting tendencies can be greatly reduced or eliminated if the voltage swing at C is made larger than that at B and A or if the complementary transmission-gate of Fig. 3(b) is used. Although this gate requires an extra transistor and a gating signal, it operates on just two basic logic levels, ground and supply voltage, thus simplifying the memory system. One MOS transistor in the complementary transmission-gate always operates in the drain-loaded state.

Several circuit configurations have been investigated in the search for a reliable high-speed memory cell well suited to high-packing-density complementary MOS arrays. These circuit configurations are first described, and then compared below. The optimum cell should contain a minimum number of transistors and signal lines in a simple mask layout so that silicon area is conserved.

Description and Operation of Memory Cells

The circuit of Fig. 4 represents a feedback memory cell. The cell consists of 12 transistors; a word-write line, W; a word-read line, R; and a digit line, D.⁵ In the quiescent state, transistors Q_7 and Q_8 conduct, while Q_5 and Q_6 are biased off. Therefore, points C and A are shorted together while an open circuit exists between C and D. Transistors Q_1 , Q_2 , Q_3 and Q_4 form the flip-flop; transistors Q_5 and Q_6 , and Q_7 and Q_8 form two complementary transmission gates. The inversion for the word-write complement, \bar{W} , is obtained with transistors Q_9 and Q_{10} . The digit line cannot change the state of an unselected cell because transistors Q_5 and Q_6 remain nonconducting, i.e., $W = +V_s$ and

$W = 0$. Data is written into a selected cell by opening the feedback loop from C to A and connecting C to the digit line; then, $W = 0$ and $\bar{W} = +V_s$. The write signal returns to the supply voltage, $+V_s$, as soon as the digit information is securely transferred to C and A. This constitutes an extremely reliable write operation. Transistors Q_{11} and Q_{12} are included in the cell to allow nondestructive sensing of the state of the flip-flop by setting $D = R = 0$. Under these conditions the voltage at A determines whether a current is present in the low-impedance digit line. If $A = +V_s$ there is no current, if $A = 0$ there is a current. When $A = 0$ there is a surge of sense current at the start of the read command that is greater than the final steady-state sense current because the initial source-to-drain voltage of transistor Q_{12} equals the full supply. All twelve enhancement transistors are usually the same size.

The push-pull memory cell shown in Fig. 5 consists of twelve transistors; a word-write line, W; a word-read line, R; and two digit lines, D and \bar{D} . During the quiescent state, A and \bar{A} are disengaged from D and \bar{D} respectively; $W = +V_s$ and $\bar{W} = 0$. Transistors Q_1 , Q_2 , Q_3 , and Q_4 form the flip-flop, and transistors Q_5 and Q_6 , and Q_7 and Q_8 form two complementary transmission gates. The inverted-write signal is obtained through transistors Q_9 and Q_{10} . The D line and its complement \bar{D} (obtained internal to the chip) cannot alter an unselected cell state because neither transmission-gate is conducting. Both gates are activated during the write-in operation for a selected cell when $W = 0$ and $\bar{W} = +V_s$. As one side of the flip-flop is charging to $+V_s$, the opposite side is discharging to ground potential, i.e., the voltage at A is forced to that of D, and correspondingly, the voltage at \bar{A} is forced to that of \bar{D} . This push-pull drive scheme results in very high-speed operation, but at the expense of an additional digit line. The width of each of the four flip-flop transistors is less (the source-to-drain impedance is greater) than that of each of the transmission-gate drive transistors to ensure a change in cell state during the write-in operation. The difference in flip-flop and transmission-gate transistor

widths also increases the speed of the cell while lowering the quiescent power dissipation. The ratio of flip-flop to transmission-gate transistor size is 3:1. The sense arrangement for this circuit is the same as that of the memory cell shown in Fig. 4.

A simplified eight-transistor version of the basic complementary push-pull cell is depicted in Fig. 6. The circuit requires one word-write line, W ; a word-read line, R ; and two digit lines D and \bar{D} . The complementary transmission-gates and associated inverter used in Fig. 4 are replaced by single gates. The write signal need not be overdriven for high-speed operation because of the action of the push-pull digit drive.

By using the transmission-gates to sense the state of the flip-flop, transistors Q_7 and Q_8 and the associated read line can be eliminated with little sacrifice in reliability. The resulting cell, shown in Fig. 7, is composed of only six transistors; one word line, W ; and two digit lines, D_1 and D_2 . The input-output lines complement each other during the write operation, but are equal during read-out. The write operation is the same as that for the circuits of Figs. 5 and 6, i.e., $W = 0$ and $D_2 = \bar{D}_1$. Nondestructive sensing of the cell state requires that both transistors Q_5 and Q_6 be biased in the source-follower mode, i.e., $W = D_1 = D_2 = 0$. Current in only one digit line need be detected. If the voltage at A is $+V_s$ there will be a current in digit line D_1 ; if the voltage at A is zero there will be no current. Transistors Q_5 and Q_6 must not change the state of the flip-flop when they are in the source-follower mode and nondestructive-readout operation is desired. Therefore, transistors Q_1 , Q_2 , Q_3 and Q_4 are smaller in periphery than either Q_5 or Q_6 for reliable write-in operation, but not small enough to cause a destructive read-out. D_2 digit-line signals are obtained with some simple gating circuitry internal to the package.

Another six-transistor circuit that uses a transmission-gate to reliably write and read information into and out of a memory element appears in Fig. 8. The memory cell has two word lines, W_1 and W_2 , and one digit line, D . Transistors Q_1 , Q_2 , Q_3 , and Q_4 make up the binary-storing flip-flop, and transistors Q_5

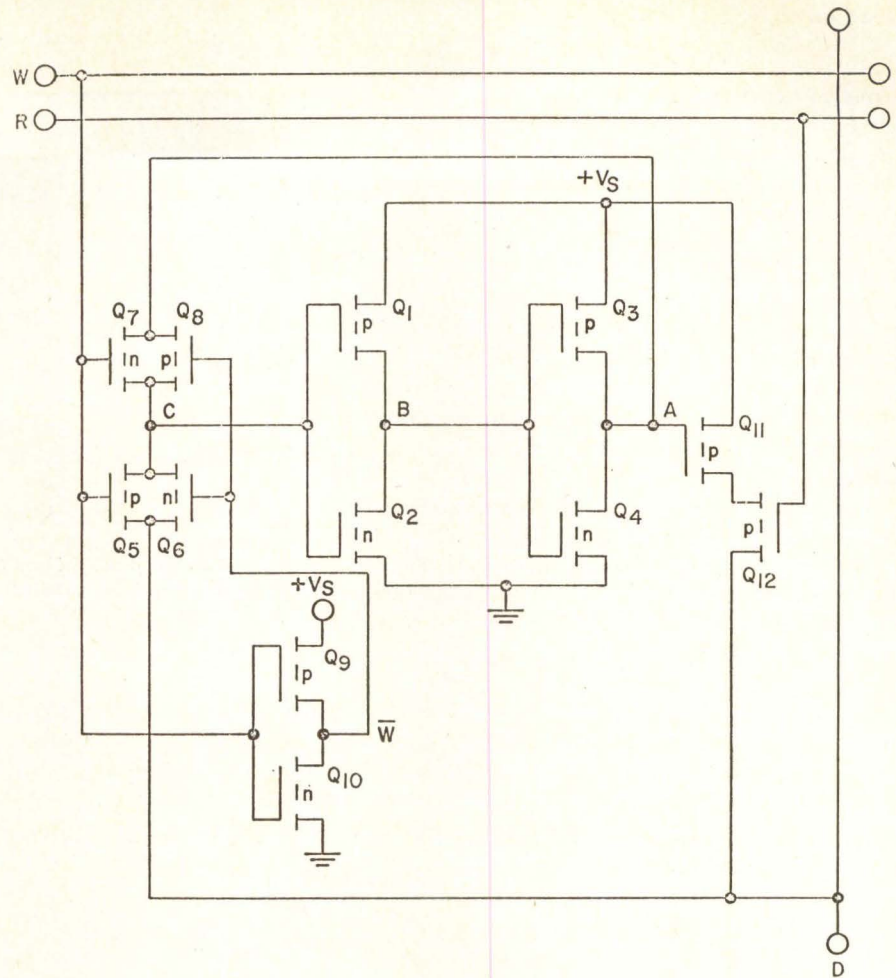

Fig. 4—Feedback memory cell. All n-channel substrates connected to ground; all p-channel substrates connected to $+V_s$.

and Q_6 form a complementary transmission-gate. Information is written into a memory cell by activating the transmission-gate, i.e., by making $W_1 = 0$ and $W_2 = +V_s$. This brings the voltage at A to that of the digit line. Transistors Q_3 and Q_4 are smaller in width than devices Q_5 and Q_6 so that a change in cell state will be ensured. Transistors Q_1 and Q_2 are made larger in width than either Q_3 or Q_4 ; this increases the speed of the write-in operation. The state of the flip-flop is sensed with signals $W_1 = W_2 = D = 0$. Under these conditions Q_5 is biased on and Q_6 is biased off. If there is zero potential at A , there is no sense current in the digit line. However, if $A = +V_s$ a current will be sensed because transistor Q_5 is operating as a source-follower. To avoid a change in cell state when nondestructive-readout operation is desired and Q_5 is in the source-follower mode, and to ensure reliable write-in operation, transistors Q_3 and Q_4 are made smaller in width than Q_5 but

not small enough to cause a destructive read-out. Because transistor Q_6 is nonconducting during the sense operation, there is no limitation on how large its size may be relative to Q_3 and Q_4 . When $A = +V_s$ in the cells of Figs. 7 and 8, there is a surge of sense current at the start of the read command. This occurs because the initial source-to-drain voltage of Q_5 equals the full supply voltage. The steady-state voltage at A during the read command is a function of the relative impedances of transistors Q_3 and Q_5 .

Comparison of Memory Cells

To select the complementary-MOS memory cell best suited for use in reliable high-speed high-packing-density arrays, a comparison was made of the five cells described above. To aid in the comparison each circuit was bread-boarded using semi-integrated transistors (separate p-channel and n-channel transistors, four to a package).

Readout Time

The basic bipolar-transistor digit-drive circuitry shown in Fig. 9 was used to measure the readout time of each memory cell, i.e., the delay from the leading edge of the read command to the sense-out voltage.⁶ The circuit of Fig. 9 operates as follows: To write a "1" into the cell, the data input signal is pulsed to the supply voltage; this places a forward bias on the n-p-n transistor. To write a "0" into, or sense the state of, the memory cell, the data line is set to ground potential. Even with a heavy capacitive load (C_L) on the digit line to simulate the effect of unselected cells, the low input impedance of the forward-biased p-n-p transistor results in a fast readout or sense time.

All five memory cells exhibit essentially the same readout time of 5 to 10 nanoseconds under a capacitive load of 100 picofarads with a 10-volt supply. The basic sense arrangement common to the circuits of Figs. 4 through 6 offers little or no increase in speed over the transmission-gate sense scheme incorporated in the six-transistor cells of Figs. 7 and 8. The somewhat lower steady-state sense current of the six-transistor cells resulting from the smaller width of transistor Q_3 is offset by the

light capacitive load on the digit line. The initial sense-current surge is equal for both six-transistor circuit configurations.

Write Time

The cell write times were obtained by measuring that minimum word-write pulse width, at 50 percent of signal swing, required for the cells to change state. It is not necessary

that the storage flip-flop be completely switched when the write signal is removed; however, the flip-flop output voltage, A in Figs. 4 through 8, should be at 80 percent of its final value at the time a read command is initiated at the same location. It may be necessary to sense the stored binary state 50 to 70 nanoseconds after the removal of the write signal. Actual measurements were made by alternately writing a "1" ($A = +V_s$) and a "0" ($A = 0$) into each cell using a 10-volt supply, and by monitoring the flip-flop output voltage with an extremely low-capacitance probe. Table I compares the number of devices, external signal lines, reliability, and average write times for each memory cell.

General Comparisons

Although the complementary push-pull cell of Fig. 5 demonstrates fast write-in operation, it incorporates a large number of MOS transistors and signal leads and offers only slight improvement in overall memory-array cycle time at a high cost in silicon area. The twelve-transistor feedback cell of Fig. 4 requires an area of approximately 170 square mils in integrated form. Both six-transistor memory cells exhibit sufficiently good reliability and essentially the same high-speed performance as the more complex circuits while requiring fewer transistors, fewer signal lines, and correspondingly less area.

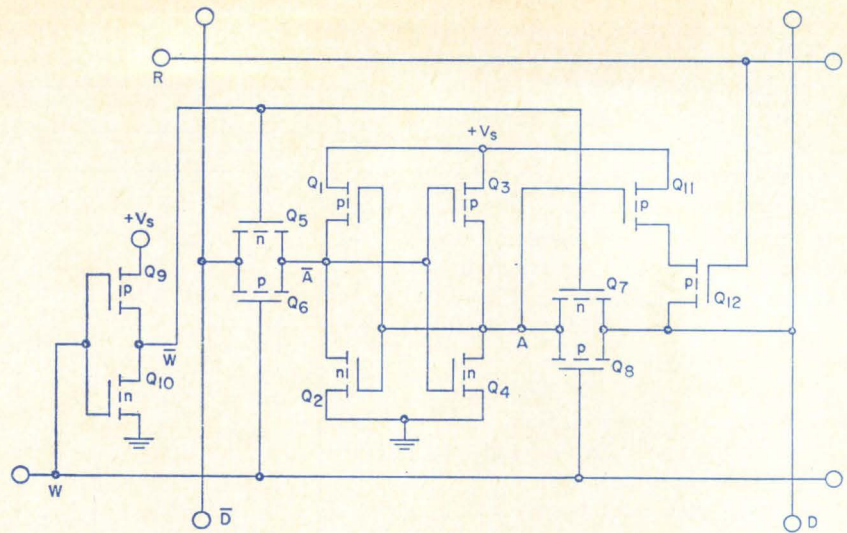

Fig. 5—Twelve-transistor push-pull memory cell. All n-channel substrates connected to ground; all p-channel substrates connected to $+V_s$.

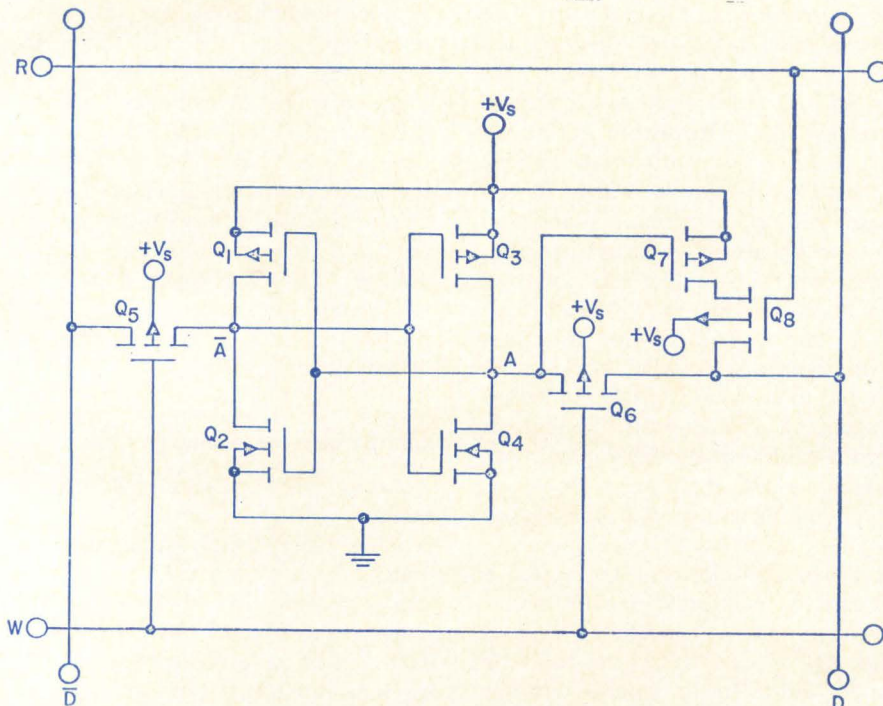

Fig. 6—Eight-transistor push-pull memory cell.

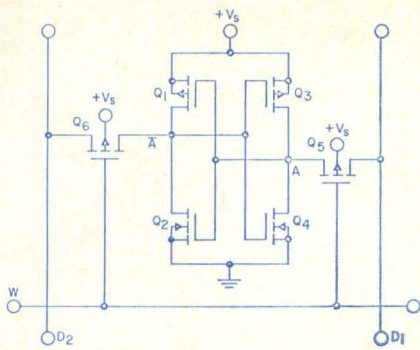

Fig. 7 — Six-transistor push-pull memory cell.

Results of Comparison

The six-transistor single-digit-drive cell of Fig. 8, which requires 60 square mils of silicon, has tentatively been designated best for high-packing density memory arrays. Because of its single-digit drive, the cell permits a simpler mask layout than that required for the circuit of Fig. 7. In addition, the write-in speed of the single-digit circuit can be increased without adverse effect on nondestructive readout operation by lowering the impedance of drive transistor Q_6 ; the push-pull cell of Fig. 7 does not offer this feature. Under the present state-of-the-art, the fabrication of 288-bit MOS memory cells on a single pellet is feasible provided that the cell design follows that of Fig. 8.

COMPLEMENTARY MOS DECODER-WORD DRIVERS

The 16-output quaternary-tree decoder shown in Fig. 10 may be used in the 288-bit array. The strobe-activated decoder includes 21 n-channel and 16 p-channel MOS enhancement devices and requires 8 input lines for 16 outputs. A given address signal is conducted by only one path consisting of two transistors. Because the strobe signal is at ground potential during the quiescent state, the p-channel devices are biased on, and all outputs are brought to the positive supply voltage $+V_s$. Upon command, the common n-channel strobe-controlled transistor activates the selected address path and switches the output to ground. The other fifteen unselected outputs remain at $+V_s$. When the strobe signal (which can be the decoded output of a large memory system) returns to ground, the selected output voltage reverts to the

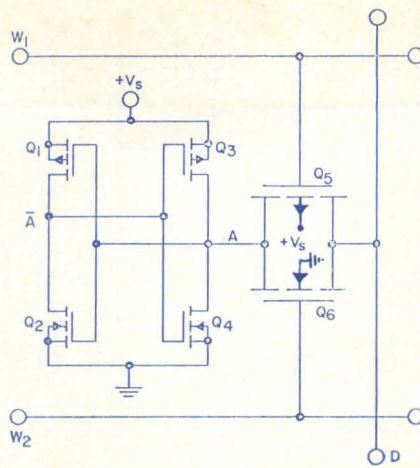

Fig. 8 — Six-transistor single-digit drive.

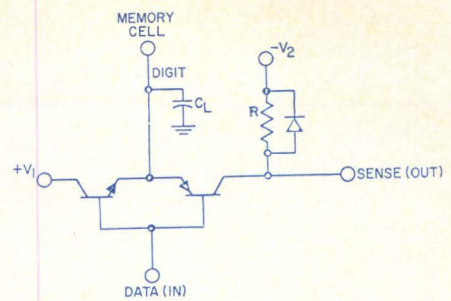

Fig. 9 — Bipolar-transistor digit-drive circuit for measuring memory-cell read-out time.

supply voltage. The maximum strobe-pulse width is limited by the time required for unselected lines to charge toward ground potential due to device leakage current.

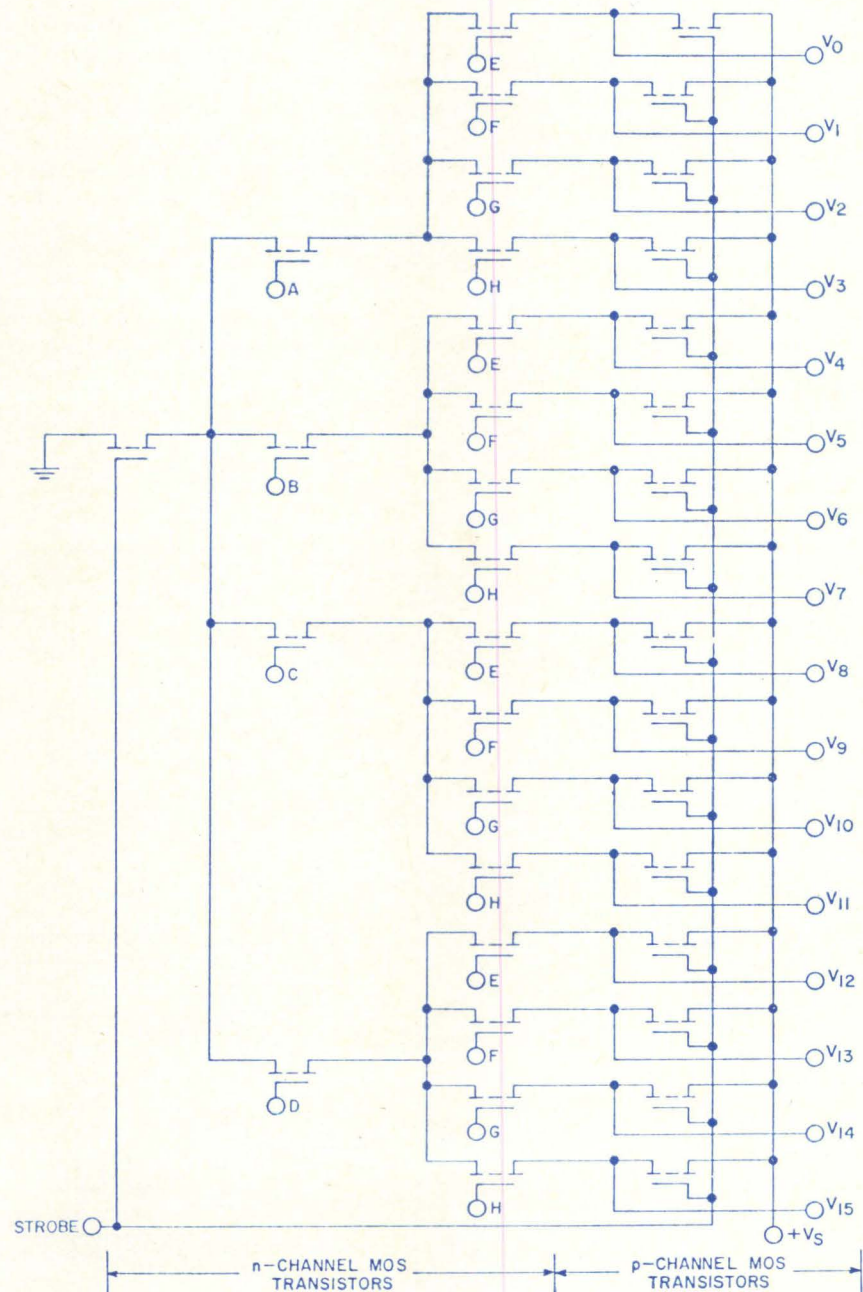

Fig. 10 — Complementary MOS 16-word quaternary-tree decoder. All n-channel substrates connected to ground; all p-channel substrates connected to $+V_s$.

The word-drive circuitry, which determines whether the cell is in the read or write mode of operation, is driven by the selected decoder output as shown in Fig. 11. Only one inverter per word line and one read/write command signal for each individual module is required for the memory cell of Fig. 8. Stored information is read out of a selected location with the read/write command at ground level, i.e., with $W_1 = W_2 = 0$. Data is written into the memory with the command signal at the supply voltage level, i.e., with $W_1 = 0$ and $W_2 = +V_s$. The time required by the decoder to perform its function constitutes a major portion of the module cycle time. Decoder time is defined as the time required to discharge the W_1 line capacitance through a three-level tree. The capacitance of the decoder is about equal to that of 18 MOS gates in parallel, i.e., one MOS gate per digit line.

As an alternate approach to the use of the quaternary decision tree just described, consideration is being given to the use of a tree similar to that of Fig. 10 except that the n-channel and p-channel devices are interchanged along with supply and ground lines, and an inverter is added to each output. Higher-speed operation may result because the total line capacitance is discharged through an inverter.

FABRICATION OF INTEGRATED COMPLEMENTARY MOS TRANSISTORS

The processing steps involved in the fabrication of integrated complementary-symmetry MOS transistors on a single chip are illustrated in Fig. 12.⁴ Steps 1 and 2 prepare the substrate for the p-channel devices. As shown, a p-type region is diffused into the n-type silicon substrate. The p-type region then becomes the substrate for the p-channel transistors.

Steps 3 through 6 provide the heavily doped p+ and n+ source and drain regions for the transistors. After these diffusions are completed, the diffusion-masking oxide is removed from the active region of the chip, the region occupied by the transistors. A new oxide is then grown in this area. This new oxide, the channel oxide, determines the characteristics of the transistors of

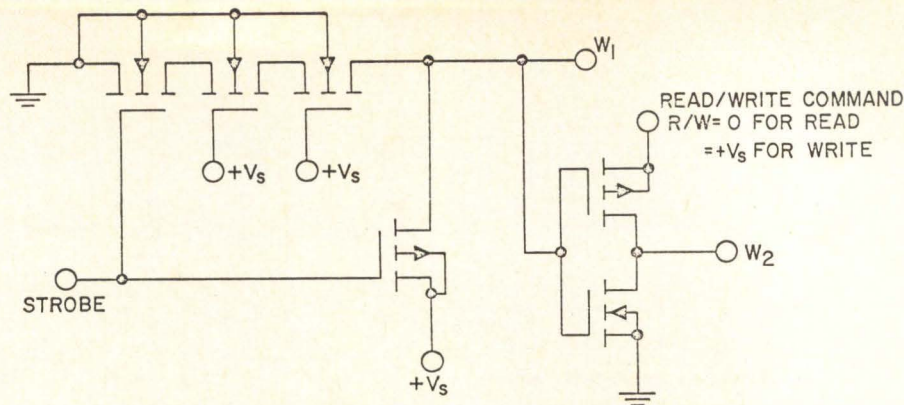

Fig. 11 — Decoder-word-driver-for selected line output.

which it is a part.

The final processing step consists of making contact openings over the source and drain diffusions, metalizing the wafer, and defining the metal pattern which consists of the gate electrode, the source and drain contacts, and interconnections. The wafer is then ready for electrical testing and dicing into individual circuit pellets.

The fabrication process used to construct integrated complementary-

symmetry MOS transistors has yielded high-gain stable enhancement type MOS devices with good source-to-drain breakdown voltages: about 40 volts for the p-channel transistors and about 25 volts for the n-channel transistors. All breakdown voltages are measured at zero gate-to-source bias. Typical threshold voltages are -2.5 volts for the p-channel transistors and $+1.5$ volts for the n-channel transistors. The stability of MOS devices fabricated

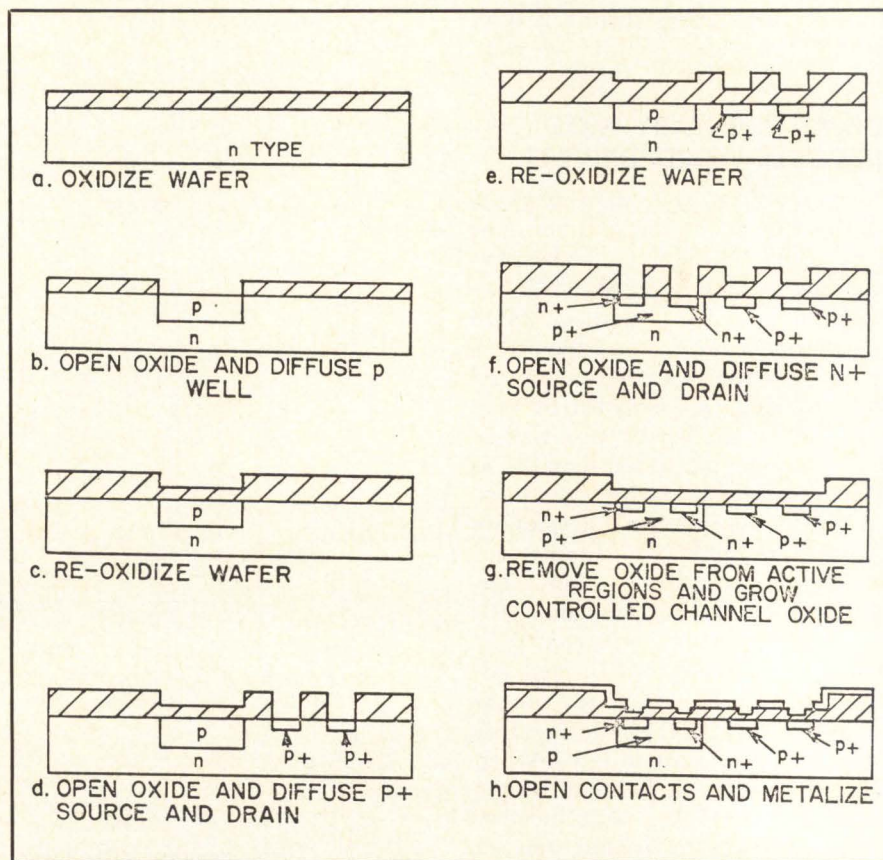

Fig. 12 — Complementary-symmetry MOS transistor processing steps.

by the complementary-symmetry process was evaluated under voltage-stress conditions at elevated temperatures. Typical transfer-characteristic shifts of less than 200 millivolts were exhibited after 1000 hours of operation under a gate bias of 10 volts and a temperature of 125°C.

RESULTS OF INTEGRATED MEMORY CIRCUIT FABRICATION

The layout design of the final 288-bit memory-array mask has been programmed for a future date. However, several integrated complementary-MOS circuits that functionally represent the ultimate module have been successfully designed and fabricated.

Single Memory Cells

The basic memory cells of Figs. 4 and 5, less the \bar{W} line inverter, have been processed on the same wafer for a direct comparison in integrated form. Both cells, consisting of 10 MOS transistors each, are fabricated on a 35- by 25-mil silicon chip and mounted one per 12-lead package. Except for transistors Q_1 , Q_2 , Q_3 , and Q_4 of Fig. 5 which have channel widths of 1.67 mils, all transistors fabricated have channels 5 mils wide; the channel length in all transistors is 0.2 mil. Some crossovers are performed external to the package. Photomicrographs of the single memory cells appear in Fig. 13.

The integrated push-pull cell of Fig. 13(a) has a typical write-in time of 10 nanoseconds, as compared to 20 nanoseconds for the feedback cell of Fig. 13(b). A switching waveform for the push-pull circuit appears in Fig. 14. The cell write time can be reduced by eliminating the external crossover wiring. The sense time for both cells is approximately 10 nanoseconds for a 100-picofarad digit-line load. The quiescent power dissipation in both circuits is typically 30 microwatts. Recent process improvements would contribute an even lower value of standby-power dissipation. All measurements were taken with a supply of 10 volts.

Binary Tree Decoder

An experimental 16-output complementary-MOS address decoder, equivalent to 16 five-input NAND

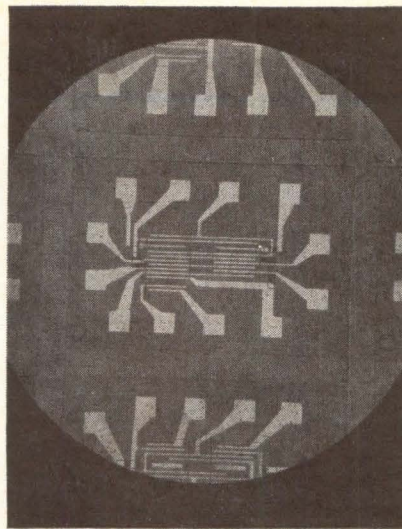

(a) Feedback cell of Fig. 4.



(b) Push-pull cell of Fig. 5.

Fig. 13 — Photomicrographs of memory cells:

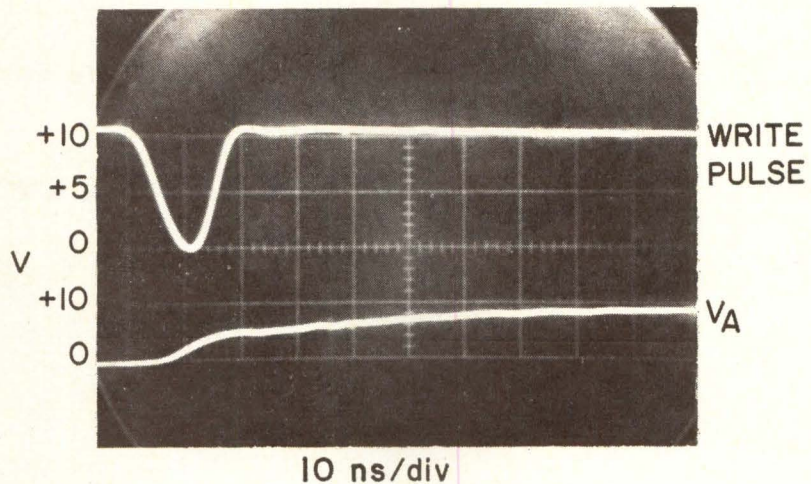

Fig. 14 — Switching waveform for the push-pull cell of Fig. 5.

gates, has been processed on a 120- by 70-mil silicon chip.⁷ The fabrication of the decoder demonstrates the feasibility of making large complementary MOS circuit arrays.

The circuit, which is shown in Fig. 15, is a strobe-activated binary decision tree that comprises 31 p-channel and 16 n-channel MOS enhancement devices, a four-bit binary input with corresponding address complements, and 16 outputs. The circuit is mounted in a 28-lead flat-pack. Because the decoder tree fans out toward the output, transistor channel widths can be changed without affecting the linear dimensions of the chip. Therefore, the channel width of the five series p-channel transistors varies from 20 mils to 7 mils. All n-channel units are 6-mils wide. The increase in device size improves the speed of operation of the decoder because the "on" path

resistance is reduced without increasing the overall silicon area. The total active gate width is quite large, exceeding 500 mils. Both p-channel and n-channel transistors have a 0.3-mil channel length. A photomicrograph of the pellet is shown in Fig. 16.

Measurements on samples of the integrated decoder show an output rise-time of 125 nanoseconds with a 10-volt supply and a 7-picofarad load. The rise time is reduced to 70 nanoseconds when the magnitude of the source-to-gate voltage is increased from 10 to 15 volts. Because there is only one n-channel transistor at each output, as compared to the series of five p-channel MOS units, the typical fall time is about 40 percent of the rise time. Standby power dissipation, measured on operational units, is about 10 microwatts with a supply voltage of

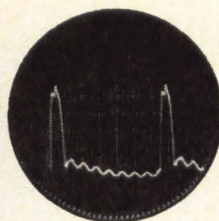
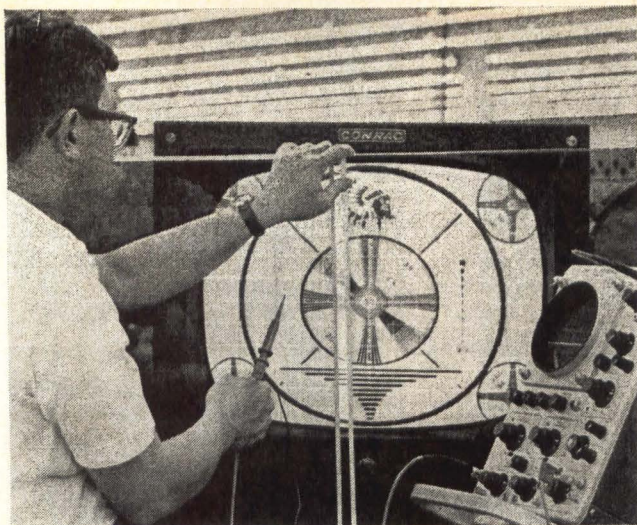

Scope in photo (left) shows effectiveness of Sierracote transparent RF shielding. Scope above shows RF penetrating uncoated glass.

Transparent Metal Shield Blocks Radiation

Sierracote, a vacuum-deposited thin-film layer of conductive metal, can be applied to varied shapes of monolithic or laminated glass or plastic to provide a transparent RF shield for radar displays, computer and tape read-outs, electronic counters, meter faces, oscilloscopes, fluorescent lights, etc. (Newest application: ultra-thin

membrane to shield lighted push buttons.) Distinct resistance ranges, sizes up to 42" x 72" are available. Send for RFI Technical Bulletin #515C.

Sierracin

THE SIERRACIN CORP.

12780 San Fernando Road, Sylmar, Calif. 91342
(213) 367-6184

CIRCLE NO. 29 ON INQUIRY CARD

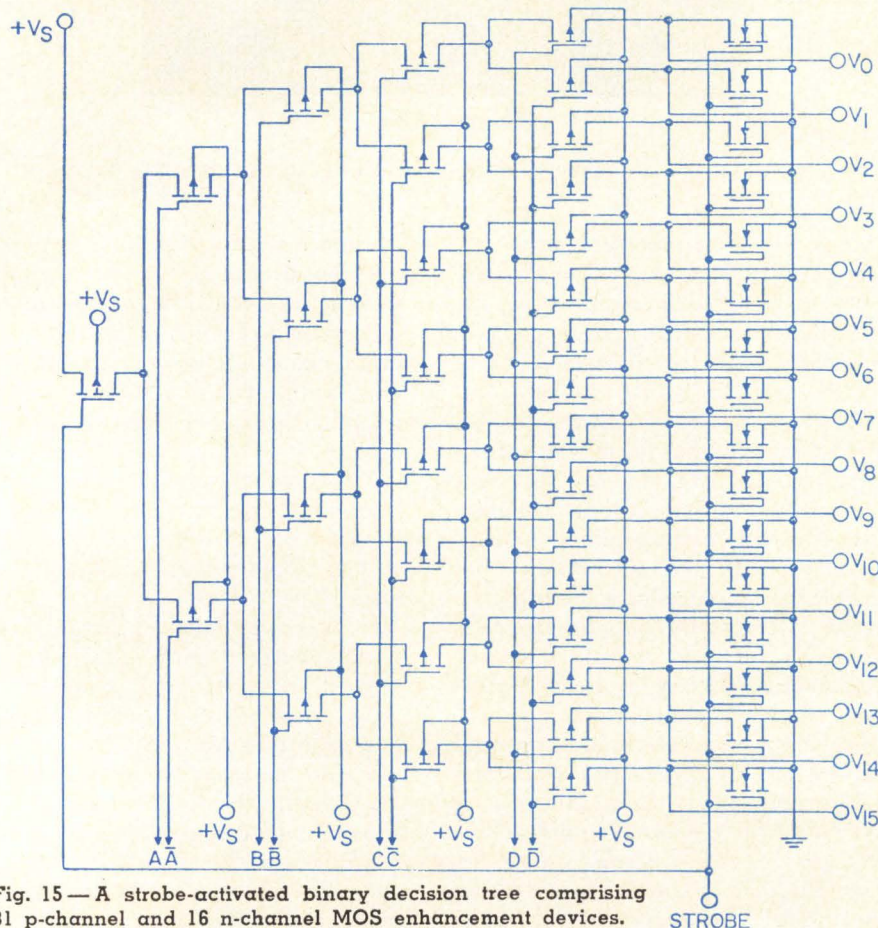

Fig. 15—A strobe-activated binary decision tree comprising 31 p-channel and 16 n-channel MOS enhancement devices.

10 volts. Recent process improvements would contribute a lower quiescent-power dissipation. Because of the presence of the five series transistors, the binary-tree decoder is slower than the quaternary-tree decoder.

Memory Cell Arrays

An experimental 4-word by 9-digit memory array made up entirely of circuits of the type shown in Fig. 4 has been designed and fabricated on a 135- by 75-mil silicon pellet. Both p-channel and n-channel devices included are 1 mil in width and 0.3 mil in length. Individual cells require approximately 170 square mils of silicon area. The complete memory-cell array consists of 432 MOS transistors and is mounted in a 28-lead flat-pack. A photomicrograph of the pellet, which contains no decoding or word-drive circuitry, appears in Fig. 17. Several 36-bit memory arrays with all bits operational have been fabricated. Typical write-in and read-out times of 30 nanoseconds have been measured. The quiescent power dissipation of the pellets fabricated is approximately one milliwatt with a supply of 10 volts.

An experimental 8-word by 9-digit memory array composed entirely of 6-transistor cells such as those shown in Fig. 8 is presently being designed on a 103- by 81-mil silicon chip. Optimum device geometries have been determined by means of a computer-aided worst-case analysis. The mask design requires no metalized crossovers. Each cell requires 60 square mils, sharply increasing the packing density over that of the 36-bit array.

The 288-bit memory module will be designed after full evaluation of the 36- and 72-bit memory cells.

CONCLUSIONS

Complementary-symmetry MOS circuits are ideal for high-packing-density memory arrays because of their economical use of silicon area, extremely low power dissipation, and high-speed circuit operation which is tolerant of large variations in device parameters. A process has been established whereby high-gain stable p-channel and n-channel MOS enhancement transistors are fabricated on a common substrate.

Progress has been made, in the design and fabrication of a word-organized 288-bit complementary MOS memory array on a single silicon chip. The array is composed of an experimental 16-output quaternary-tree decoder, 16 word drivers, and 288 memory cells. The tentative cell design consists of six MOS transistors and requires an area of 60 square mils, making it ideal for high packing density arrays. The memory module, incorporating approximately 1800 devices, can be fabricated on a 150- by 150-mil silicon chip.

Fig. 16—Photomicrograph of the pellet containing the circuit of Fig. 15.

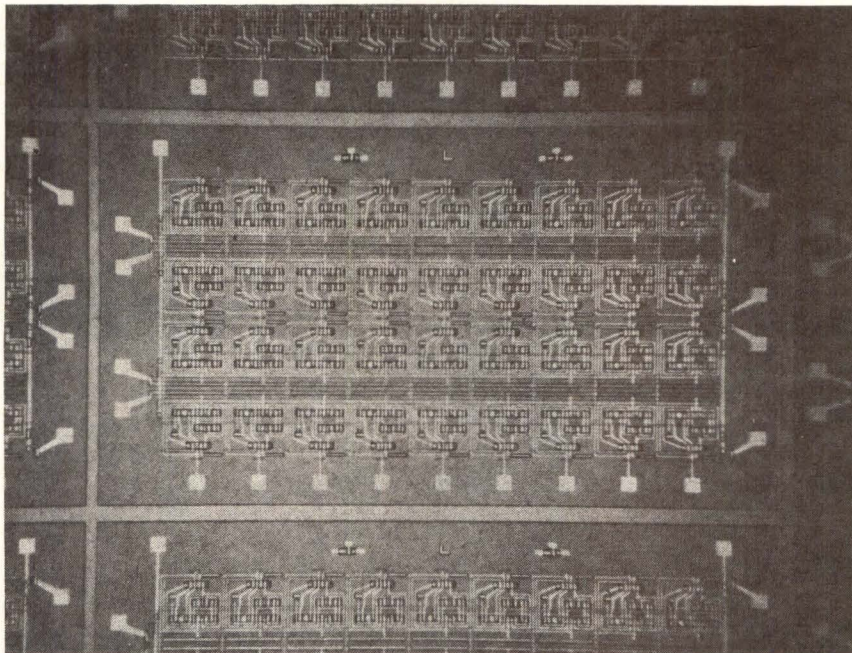
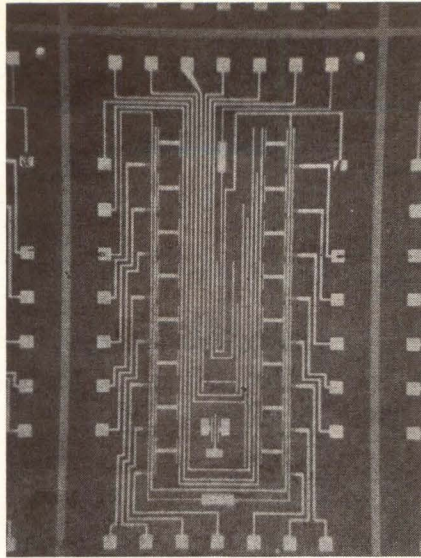

Fig. 17—Photomicrograph of a 36-bit memory-cell array.

Although the mask layout of the final array is programmed for the future, several integrated circuits that functionally represent the final module have been successfully fabricated. Two of these are individual memory cells which demonstrate the advantages of complementary-symmetry MOS circuitry. The feasibility of making large complementary MOS arrays has been proven with the successful processing of a 16-output address decoder on a 120- by 70-mil silicon chip. Several operational 36-bit memory-cell arrays of 12 transistors per cell have also been fabricated.

ACKNOWLEDGMENTS

The authors express their appreciation to the technical personnel at RCA whose ideas and efforts have contributed to the integrated complementary MOS program. Special thanks are extended to R. Feryszka and A. K. Yung for their contributions concerning the monolithic decoder, A. Pittius and D. Puntillo for fabrication of the memory cells, and J. A. Ford for his work in obtaining the experimental results.

The work described in this article is supported by Air Force contract AF33(615)-3491.

IN-LINE DISPLAYS

We also make panel displays, CRT displays, readouts, switches and indicators.

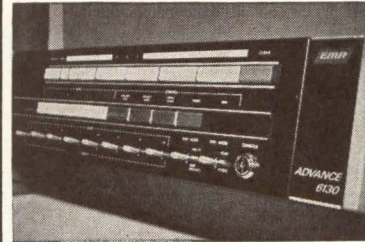

DATA-LINE DISPLAY BRINGS A TOTALLY NEW MEANING TO THE WORD VERSATILITY



Compatible with today's demand for human engineered, high density packaging. Intermix message display, neon or incandescent indicators, switch-indicators or switch functions in this new, in-line modular package on .700" centers in frame lengths up to four feet. Mechanically and electrically, DATA-LINE Display is as versatile as your needs. Price compares favorably with other multi-pole lighted push button switches.

For complete information, contact your local TEC-Rep, or write direct.



INFORMATION DISPLAY AND CONTROL DEVICES
TRANSISTOR ELECTRONICS CORPORATION

Box 6191
Minneapolis, Minnesota 55424
Phone (612) 941-1100

CIRCLE NO. 30 ON INQUIRY CARD

TABLE I
COMPARISONS OF MOS MEMORY CELLS

Memory Cell	No. of Devices	No. of Signal Lines*	Reliability	Write Time (nsec)
Feedback Cell (Fig. 4)	12	3	Excellent	18
12-transistor push-pull cell (Fig. 5)	12	4	Very Good	12
8-transistor push-pull cell (Fig. 6)	8	4	Very Good	20
6-transistor push-pull cell (Fig. 7)	6	3	Good	20
6-transistor single-digit drive cell (Fig. 8)	6	3	Good	20

*Two additional lines are needed for supply voltage and ground.

REFERENCES:

- (1) M. Canning, R. S. Dunn, and G. Jean-sonne, "Active Memory Cells for Discretion", Electronics, Feb. 1967.
- (2) S. R. Hofstein and F. P. Heiman, "The Insulated-Gate Field-Effect Transistor", Proc. IEEE, Sept. 1963.
- (3) J. D. Schmidt, "Integrated MOS Transistor Random Access Memory", Solid State Design, Jan. 1965.
- (4) R. W. Ahrons and P. D. Gardner, "Complementary MOS Integrated Circuits", Proc. of Integrated Circuits Seminar, Stevens Institute of Technology Feb. 1967.
- (5) J. R. Burns, J. J. Gibson, K. C. Hu, and R. A. Powlus, "Integrated Memory Using Complementary Field-Effect Transistors", ISSCC, Feb. 1966.
- (6) Circuit developed by J. R. Burns of RCA Laboratories.
- (7) R. Feryszka, S. Katz, and A. K. Yung, "Monolithic Complementary-Symmetry MOS Decoder", Digest of IEC, Toronto, Canada, Sept. 1967.

Chapter III. *The Word from GENISCO.*

THINK ABOUT THE AC TRANSIENT FREE SWITCH 1 FOR 2 FORMULA

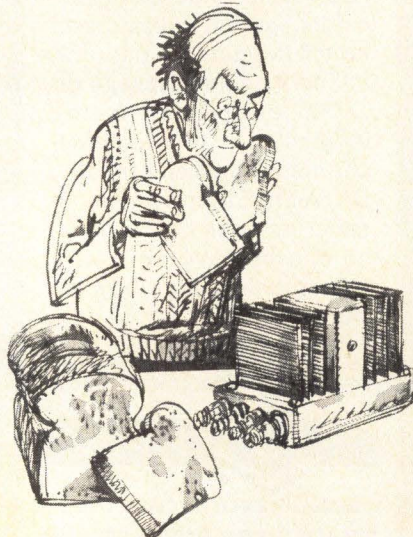

Think about—one high reliability* solid-state component, that replaces two components. The Genisco

Switch eliminates filters, and relays or contactors. It also eliminates noise hash caused by spurious transients. Turns AC currents on or off in any type of switching mode.

Just think! Size is reduced about 50% for simpler design, more convenient packaging; and it costs less, too. Works manually or remotely with either electrical or pneumatic triggering.

The Genisco AC Transient Free Switch meets or exceeds MIL-STD-826 and MIL-I-6181D, in 60 and 400 cycle versions, and is available in 5, 15, or 25 amp configurations.

Now stop thinking about it! Send for complete information.



*Tested without failure through 20 million cycles.

GENISCO TECHNOLOGY CORPORATION
COMPONENTS DIVISION
18435 SUSANA ROAD
COMPTON, CALIFORNIA 90221

CIRCLE NO. 31 ON INQUIRY CARD

A GRAPHIC TABLET DISPLAY CONSOLE FOR USE UNDER TIME-SHARING.

Discusses the problems of using highly interactive graphic consoles with a time-shared processor. Some solutions to these problems are given and are illustrated in the graphic tablet display (GTD) console used with the SDC Time-Sharing System (TSS). Report also describes the components of the GTD, its interface with the TSS, and its operation.

Order from Clearinghouse, U. S. Dept. of Commerce, Springfield, Va. 22151. Order No. AD-658 470.

AN ANALYTICAL COST COMPARISON OF COMPUTER OPERATING SYSTEMS.

Evaluates computer system performance on general system characteristics that include the computer and its operating system and users and their jobs.

Order from Clearinghouse, U. S. Dept. of Commerce, Springfield, Va. 22151. Order No. AD-661 983.

THE MAKING OF TEST, THESAURUS OF ENGINEERING AND SCIENTIFIC TERMS.

Final report of Project LEX describes the background and building of the Thesaurus of Engineering and Scientific Terms. Appendices include authorizing papers, agreements, reference material, participants, and joint EJC-DoD conventions for thesaurus building. Results show collection and development of a large data bank, and description of final product as well as computer support and interface to automatic typesetting equipment.

Order from Clearinghouse, U. S. Dept. of Commerce, Springfield, Va. 22151. Order No. AD-661 001.

PRESENT AND FUTURE STATE OF THE ART IN GUIDANCE COMPUTER MEMORIES.

Discusses non-destructive read-out vs. destructive read-out type memory techniques and technologies with particular reference to six types of advanced solid-state memory devices: magnetic cores, plated wire, planar-magnetic thin

Order from Clearinghouse, U. S. Dept. of Commerce, Springfield, Va. 22151. Order No. N67-40319.

TOWARD ECONOMICAL REMOTE COMPUTER ACCESS.

Considers the communications services available to a user remotely accessing a time-shared computer system in the light of the requirements of such usage. A plan is suggested which would share communication facilities among many users; each user would have access to the facility for brief periods of time.

Order from Clearinghouse, U. S. Dept. of Commerce, Springfield, Va. 22151. Order No. AD-657 783.

Unheard-of quiet.

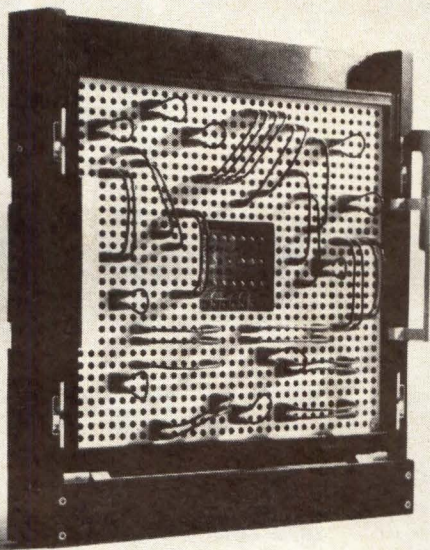

Low Capacitance Shielded Programming System. Crosstalk isolation: better than 132 -db at 1 KHz. Capacitance: 0.001 pf at 1.6 KHz. Interchangeable shielded front boards. Exclusive plating process insures perfect ground. Full egg crating: front and rear boards. AMP's exclusive double-wiping contacts. Use plug-in packaging, or any wiring method. Shhhh.

One of a broad line of SYSCOM Programming Devices available from AMP Incorporated... Worldwide.*

*Trademark of AMP Incorporated

AMP
INCORPORATED
Harrisburg, Pennsylvania

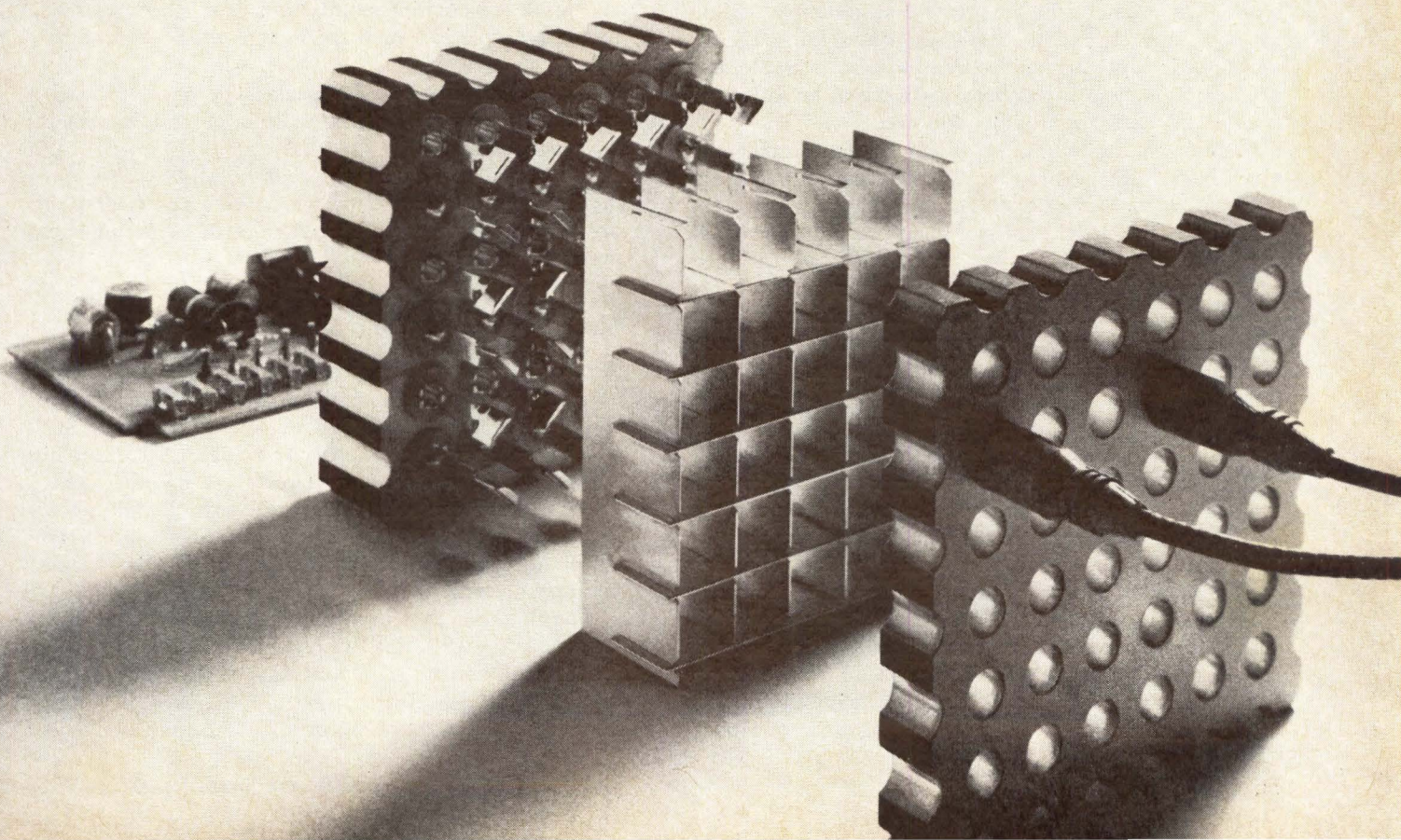

A design problem of a small logic system is used as an example to demonstrate the application of a simulation program. After the system requirements are established, a flow diagram for the timing and sequence control is developed. The simulation program can be considered the next step in the design phase. Written in the most basic Fortran, the program requires only a short time to write, debug and run.

SIMULATION OF A SMALL LOGIC SYSTEM

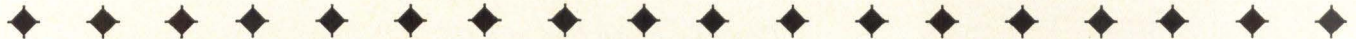

DONALD R. STANG
Southwest Center for Advanced Studies
Dallas, Texas

A logic designer faced with a small logic system or subsystem can easily write a simulation program himself. Much actual breadboard time may be saved with computer simulation, and flexibility in testing is gained without investment in elaborate test circuitry. Many types of input situations, both usual and unusual, may be applied to the system in order to test, evaluate, and analyze the system behavior. Discovery of errors at this stage in the design is a tremendous aid.

A brief description of a sample design problem is given below. The system requirements are outlined and a block diagram is drawn. A flow diagram is worked out which defines the modes of operation for the control. Next, the flow diagram is converted into a Fortran program, the terminology used in the program is defined and the input data is described. Finally, a sample print-out is shown to demonstrate the operation of the system in accordance with the system requirements.

Design Problem

A logarithmic electrometer amplifier provides the output signal for an ion mass spectrometer satellite experiment. The electrometer amplifier signal is characterized by base line or zero voltage and voltage peaks. The mass spectrometer is swept by an exponentially decreasing voltage having a one second period. Peak position within the 1 second sweep range determines the ion mass in amu (atomic mass units). The peak amplitudes range from 0 volts to +5 volts and are the logarithmic function of the ion density.

The problem is to design a circuit that will find the peak values in digital form. First, the analog signal is sampled and digitized at 1 KHz rate, by an analog-to-digital converter whose output is a 9 bit number that represents the analog signal. The circuitry operates on these digital numbers to determine the average peak value, and then supplies this value to the spacecraft telemetry (TM) for readout. There may be up to 10 peaks within the 1 second sweep, each made up of approximately 20 points. The TM readout is fast enough so that no peaks will be lost.

The criteria for peak detection are as follows:

1. Points that are increasing indicate that a peak may be coming up.
2. After 3 increasing points in a row, check to see if the last sample is 4 or more increments above the base line.
3. Start "looking" for the peak. The peak is found if adjacent points are within a limit of ± 3 increments from each other.
4. Accumulate 4 points that fall within the limit.
5. The peak has occurred when three points in a row are decreasing. Store the average of the 4 accumulated points for readout.

Block Diagram of Logic System

A block diagram of the peaks logic circuitry is shown in Fig. 1. The logic beyond the A-to-D converter consists of registers (A, B, S, S', O), a 3 bit shift-register (SR), a 2 bit counter (Accum. Ctr.), an adder, control bits (Look and Line), compare circuit (A:B), limit check ($\leq \pm 3$), and control. The registers A, B, and O are 9 bits; registers S and S' are 11 bits. The control provides the timing or program sequence for the "peaks" circuitry operation.

The flow diagram of Fig. 2 incorporates the criteria for peaks and provides the basis for the control design. The overall control sequence may be divided into four phases or modes of operation. These are (1) Search Mode; (2) Peak Look Mode; (3) Accumulate Mode;

WITH A FORTRAN PROGRAM



(4) Output Mode. The mode descriptions given below refer to Figs. 1 and 2.

• **Search Mode:** The point in register A is transferred into register B, and the new point from the A-to-D converter is transferred into register A. These two points are then compared. If the number in register A is larger than the number in register B ($A > B$), a "1" is shifted into the shift register; if the number in register A is smaller or equal to the number in register B ($A \leq B$), a "0" is shifted into the shift register. The adder in the circuit is used for subtraction by 1's complementing the lesser of A or B and then adding A and B. The end

around carry is not performed so that the result in the sum register S will be $A-B-1$ or $B-A-1$.

After three successive 1's are detected in the shift register, a check is made to see if the last point is 4 or more increments above the base line. Each "1" in the SR means that A was greater than B by at least 1. Three 1's mean that the last point must be at least 3 increments above the base line. Therefore, if any of the 3 subtractions $A-B-1 \geq 1$, the "line" bit will be set.

The control remains in the search mode till the three 1's and the base line 4 conditions are met. These conditions set the peak look bit which puts the control into the peak look mode.

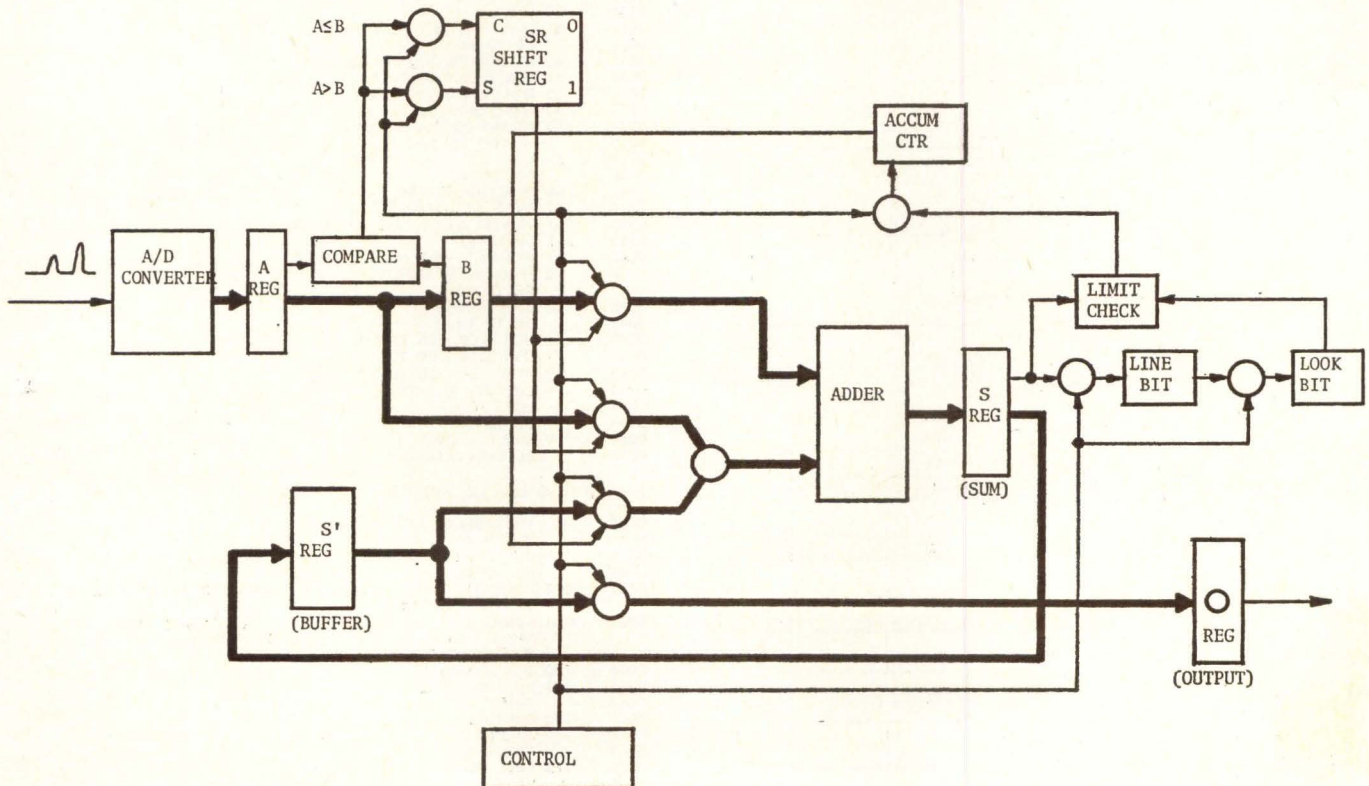

Fig. 1 — Block diagram of "peaks" circuitry.

• **Peak Look Mode:** When in the peak look mode, the control is looking for the condition where adjacent points are within a limit of ± 3 increments. If $A < B$, A is 1's complemented and added to B as described above. This result is $\bar{A} + B = B - A - 1$. If the $B < A$, B is 1's complemented and added to A to form $A - B - 1$. If either of these results falls within the limit, B is accumulated. B is automatically accumulated for the case $A = B$.

• **Accumulation Mode:** The first point that meets the limit criteria is accumulated. Four points are accumulated in the accumulation mode. If the peak of the curve is smooth, the 4 points will all meet the limit criteria successively; however, if a noise spike occurs after the first accumulation, the circuitry sees that the limit criteria is not met, the noise point is ignored, and the last point is **again** accumulated.

• **Output Mode:** After 4 points have been accumulated, the control circuitry looks for three consecutive 0's in the shift register. Three 0's mean that the peak has occurred and the input signal is decreasing toward the base line. The control returns to the search mode. The accumulated result divided by 4 (average peak value) is transferred to the output register for readout by the TM.

Simulation of Peaks Control by Computer

Operation of the control circuitry under different peak sizes and shapes tests that the peaks criteria is met. The program by operating on such a variety of inputs (peaks with different amplitudes, with noise etc.) is a great aid in uncovering errors that may exist in the design.

In general, the flow diagram for the control serves equally well for a Fortran simulation program. However, much more detail is required to obtain a program that

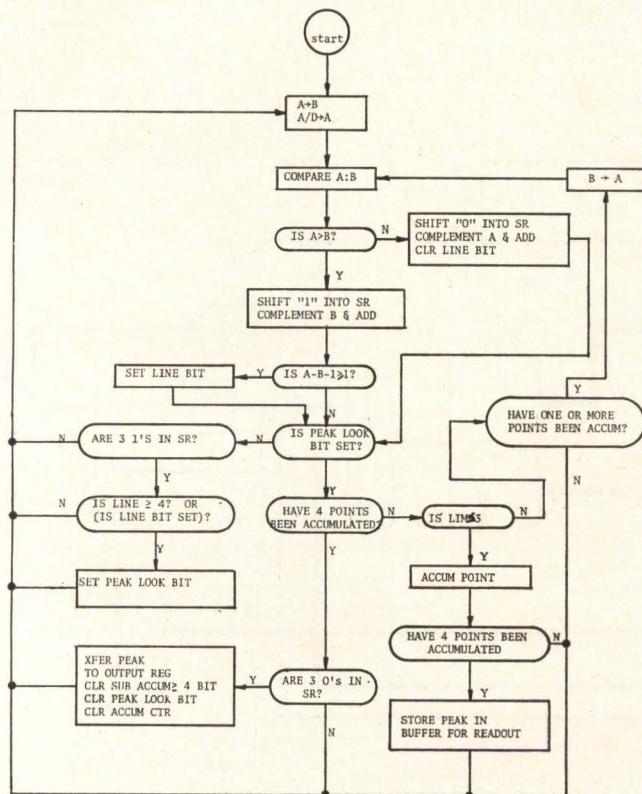

Fig. 2 — Flow diagram of "peaks" circuitry.

will run on the computer. This detailed flow diagram (Fig. 3) and the program as written (Table I) are shown below. The Fortran statement numbers appear in parentheses in the boxes of the flow diagram.

Definitions of the terminology used in the program are:

Input (I) = point I in the A/D converter output register

A (I) = point I in the A register

B (I) = point I in the B register

N(1), N(2), N(3) = 3 stages of the shift register

Accum = accumulation counter which keeps track of number accumulations that have been completed

TABLE I

FORTRAN SIMULATION PROGRAM

```

Fortran IV G Level 0, MOD 0      Main
0001      IMPLICIT INTEGER(A-Z)
0002      DIMENSION A(100),B(100),INPUT(100),SUM(100),N(3)
0003      J=1
0004      5 READ(1,1000)(INPUT(K),K=1,20)
0005      1000 FORMAT(20(1X,13))
0006      N(1)=0
0007      N(2)=0
0008      N(3)=0
0009      LOOK=0
0010      LINE=0
0011      OUTPUT=0
0012      BUFFER=0
0013      ACCUM=0
0014      WRITE(3,2001)
0015      I=1
0016      SUM(I-1)=0
0017      A(I)=INPUT(I)
0018      GO TO 11
0019      10 WRITE(3,2000)I,INPUT(I+1),A(I+1),B(I),N(1),N(2),N(3),LINE,LOOK,
1ACCUM,SUM(I),BUFFER,OUTPUT
IF(I.EQ.20)GO TO 100
0020      I=I+1
0021
0022      11 B(I)=A(I)
0023      A(I+1)=INPUT(I+1)
0024      N(3)=N(2)
0025      N(2)=N(1)
0026      12 IF(A(I+1).GT.B(I))GO TO 30
0027      20 N(1)=0
0028      LINE=0
0029      GO TO 40
0030      30 N(1)=1
0031      31 IF(A(I+1)-B(I)-1.GE.1)LINE=1
0032      GO TO 40
0033      40 IF(LOOK.EQ.1)GO TO 60
0034      41 IF(N(3).EQ.0)GO TO 10
0035      42 IF(N(2).EQ.0)GO TO 10
0036      43 IF(N(1).EQ.0)GO TO 10
0037      50 IF(LINE.EQ.1)GO TO 51
0038      GO TO 10
0039      51 LOOK=1
0040      GO TO 10
0041      60 IF(ACCUM.EQ.4)GO TO 70
0042      161 IF(A(I+1)-B(I).GT.0)GO TO 10
0043      261 IF(B(I)-A(I+1).LE.3)GO TO 80
0044      361 GO TO 62
0045      61 IF(A(I+1)-B(I).LE.3)GO TO 80
0046      62 IF(ACCUM.GT.0)GO TO 63
0047      GO TO 10
0048      63 A(I+1)=B(I)
0049      GO TO 12
0050      70 IF(N(3).EQ.1)GO TO 10
0051      71 IF(N(2).EQ.1)GO TO 10
0052      72 IF(N(1).EQ.1)GO TO 10
0053      OUTPUT=BUFFER
0054      LOOK=0
0055      GO TO 10
0056      80 SUM(I)=SUM(I-1)+B(I)
0057      ACCUM=ACCUM+1

Fortran IV G Level 0, MOD 0      Main
0058      IF(ACCUM.EQ.4)GO TO 90
0059      GO TO 10
0060      90 BUFFER=SUM(I)/4
0061      GO TO 10
0062      2000 FORMAT(' ',4X,13,4X,15,2(5X,15),4X,11,2(3X,11),6X,11,7X,11,
8X,11,81X,15,2(5X,15))
0063      2001 FORMAT(' ',6X,'1',4X,'INPUT(I+1)',2X,'A(I+1)',2X,'B(I)',3X,
'N(1)N(2)N(3)',3X,'LINE',4X,'LOOK',5X,'ACCUM',5X,'SUM(I)',4X,
'BUFFER',4X,'OUTPUT')
0064      100 IF(I.EQ.4)GO TO 110
0065      101 DO 102 I=1,20
0066      SUM(I)=0
0067      102 CONTINUE
0068      J=J+1
0069      GO TO 5
0070      110 CALL EXIT
0071      STOP
0072      END

```

TABLE II
PRINTOUT OF PEAKS SIMULATION

PEAK NUMBER 1

I	INPUT(I+1)	A(I+1)	B(I)	N(1)	N(2)	N(3)	LINE	LOOK	ACCUM	SUM(I)	BUFFER	OUTPUT
1	0	0	0	0	0	0	0	0	0	0	0	0
2	1	1	0	1	0	0	0	0	0	0	0	0
3	2	2	1	1	1	0	0	0	0	0	0	0
4	4	4	2	1	1	1	1	1	0	0	0	0
5	10	10	4	1	1	1	1	1	0	0	0	0
6	20	20	10	1	1	1	1	1	0	0	0	0
7	50	50	20	1	1	1	1	1	0	0	0	0
8	90	90	50	1	1	1	1	1	0	0	0	0
9	100	100	90	1	1	1	1	1	0	0	0	0
10	100	100	100	0	1	1	0	1	1	100	0	0
11	100	100	100	0	0	1	0	1	2	200	0	0
12	100	100	100	0	0	0	0	1	3	300	0	0
13	90	100	100	0	0	0	0	1	4	400	100	0
14	50	50	100	0	0	0	0	0	4	0	100	100
15	20	20	50	0	0	0	0	0	4	0	100	100
16	0	0	20	0	0	0	0	0	4	0	100	100
17	0	0	0	0	0	0	0	0	4	0	100	100
18	0	0	0	0	0	0	0	0	4	0	100	100
19	0	0	0	0	0	0	0	0	4	0	100	100
20	0	0	0	0	0	0	0	0	4	0	100	100

PEAK NUMBER 2

I	INPUT(I+1)	A(I+1)	B(I)	N(1)	N(2)	N(3)	LINE	LOOK	ACCUM	SUM(I)	BUFFER	OUTPUT
1	0	0	1	0	0	0	0	0	0	0	0	0
2	2	2	0	1	0	0	1	0	0	0	0	0
3	5	5	2	1	1	0	1	0	0	0	0	0
4	10	10	5	1	1	1	1	1	0	0	0	0
5	20	20	10	1	1	1	1	1	0	0	0	0
6	40	40	20	1	1	1	1	1	0	0	0	0
7	50	50	40	1	1	1	1	1	0	0	0	0
8	53	53	50	1	1	1	1	1	1	50	0	0
9	50	50	53	0	1	1	0	1	2	103	0	0
10	53	53	50	1	0	1	1	1	3	153	0	0
11	50	50	53	0	1	0	0	1	4	206	51	0
12	53	53	50	1	0	1	1	1	4	0	51	0
13	49	49	53	0	1	0	0	1	4	0	51	0
14	40	40	49	0	0	1	0	1	4	0	51	0
15	30	30	40	0	0	0	0	0	4	0	51	51
16	10	10	30	0	0	0	0	0	4	0	51	51
17	5	5	10	0	0	0	0	0	4	0	51	51
18	0	0	5	0	0	0	0	0	4	0	51	51
19	0	0	0	0	0	0	0	0	4	0	51	51
20	0	0	0	0	0	0	0	0	4	0	51	51

PEAK NUMBER 3

I	INPUT(I+1)	A(I+1)	B(I)	N(1)	N(2)	N(3)	LINE	LOOK	ACCUM	SUM(I)	BUFFER	OUTPUT
1	5	5	0	1	0	0	1	0	0	0	0	0
2	10	10	5	1	1	0	1	0	0	0	0	0
3	5	5	10	0	1	1	0	0	0	0	0	0
4	1	1	5	0	0	1	0	0	0	0	0	0
5	3	3	1	1	0	0	1	0	0	0	0	0
6	5	5	3	1	1	0	1	0	0	0	0	0
7	10	10	5	1	1	1	1	1	0	0	0	0
8	20	20	10	1	1	1	1	1	0	0	0	0
9	30	30	20	1	1	1	1	1	0	0	0	0
10	25	25	30	0	1	1	0	1	0	0	0	0
11	30	30	25	1	0	1	1	1	0	0	0	0
12	40	40	30	1	1	0	1	1	0	0	0	0
13	45	45	40	1	1	1	1	1	0	0	0	0
14	47	47	45	1	1	1	1	1	1	45	0	0
15	50	50	47	1	1	1	1	1	2	92	0	0
16	49	49	50	0	1	1	0	1	3	142	0	0
17	46	46	49	0	0	1	0	1	4	191	47	0
18	30	30	46	0	0	0	0	0	4	0	47	47
19	10	10	30	0	0	0	0	0	4	0	47	47
20	0	0	10	0	0	0	0	0	4	0	47	47

PEAK NUMBER 4

I	INPUT(I+1)	A(I+1)	B(I)	N(1)	N(2)	N(3)	LINE	LOOK	ACCUM	SUM(I)	BUFFER	OUTPUT
1	1	1	0	1	0	0	0	0	0	0	0	0
2	2	2	1	1	1	0	0	0	0	0	0	0
3	3	3	2	1	1	1	0	0	0	0	0	0
4	4	4	3	1	1	1	0	0	0	0	0	0
5	10	10	4	1	1	1	1	1	0	0	0	0
6	15	15	10	1	1	1	1	1	0	0	0	0
7	25	25	15	1	1	1	1	1	0	0	0	0
8	40	40	25	1	1	1	1	1	0	0	0	0
9	41	41	40	1	1	1	1	1	1	40	0	0
10	42	42	41	1	1	1	1	1	2	81	0	0
11	50	42	42	0	1	1	0	1	3	123	0	0
12	40	40	42	0	0	1	0	1	4	165	41	0
13	30	30	40	0	0	0	0	0	4	0	41	41
14	20	20	30	0	0	0	0	0	4	0	41	41
15	30	30	20	1	0	0	1	0	4	0	41	41
16	35	35	30	1	1	0	1	0	4	0	41	41
17	20	20	35	0	1	1	0	0	4	0	41	41
18	10	10	20	0	0	1	0	0	4	0	41	41
19	0	0	10	0	0	0	0	0	4	0	41	41
20	0	0	0	0	0	0	0	0	4	0	41	41

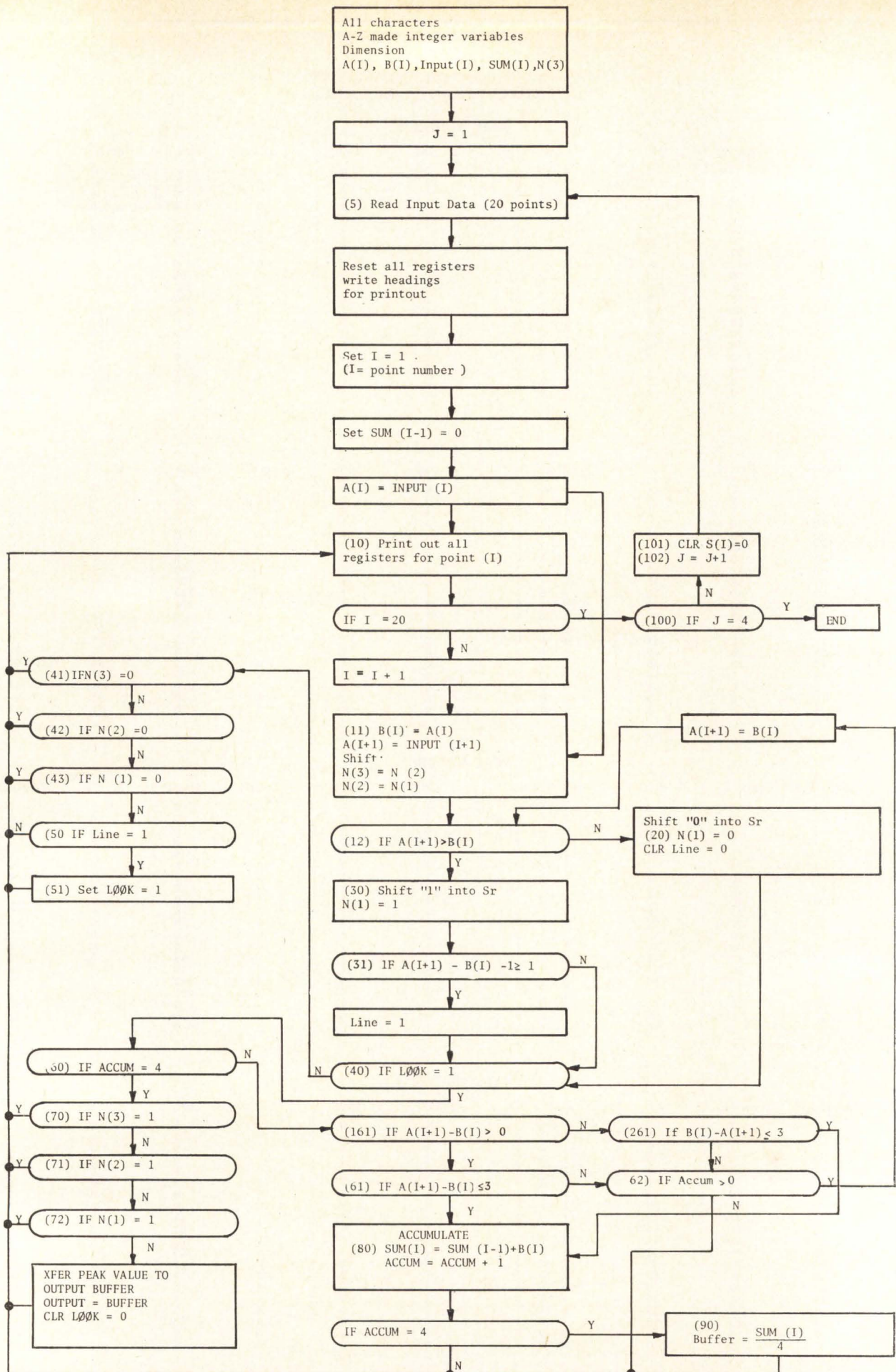
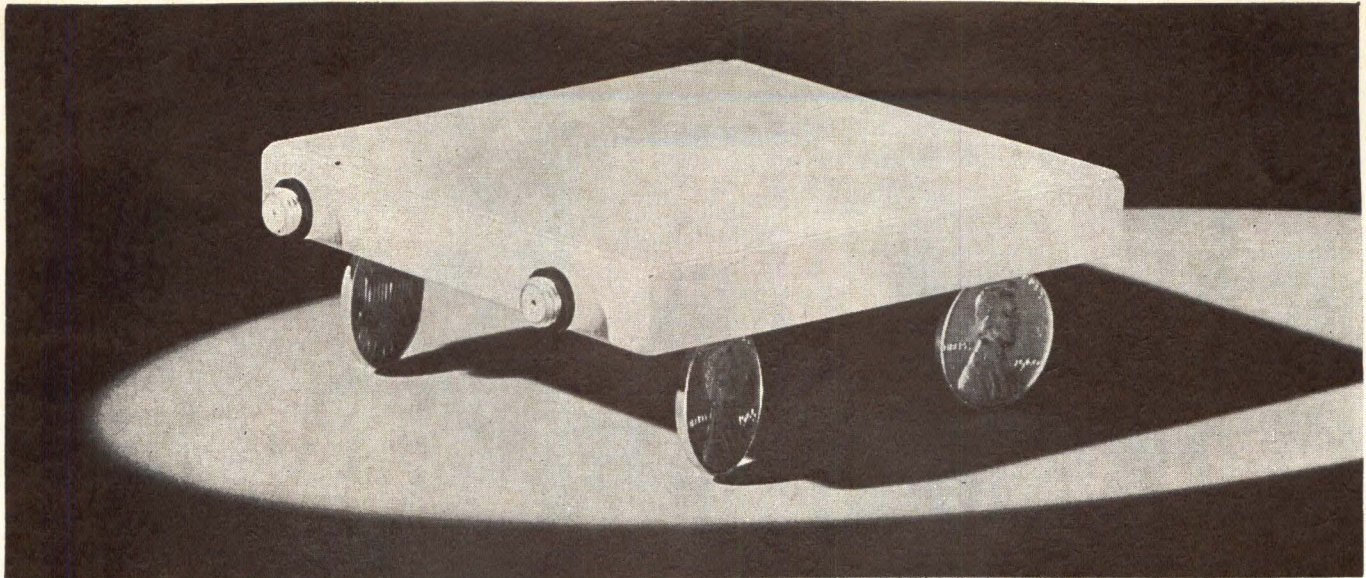

Fig. 3 — Flow diagram of "peaks" circuitry simulation.



GLASS MEMORY

Think Even Smaller

This is the compact causing all the excitement at the computer rallies. Reasons are high speeds (to 60 MHz), with high storage capacity (up to 4,000 bits). You wouldn't expect glass to make such a difference, would you? Also notice the simple styling. It's so functional we won't make a change in body style for years to come. And economical—less than \$200. Other models also available.

SEND FOR FREE LITERATURE

Blue Hills Avenue Bloomfield, Connecticut 06002

ANDERSEN LABORATORIES, INC.

CIRCLE NO. 33 ON INQUIRY CARD

Line = control flip-flop is set when the point is 4 or more increments above the base line

Look = control flip-flop is set in the peak look mode

Sum (I) = is the accumulated sum up to and including point I

Buffer = register where the average value to peak is stored

Output = output register for TM readout

Data input to the program consists of 20 points (called I, where $I = 1$ to 20) that make up the peak. The program first reads in 20 points as input data. All four modes of operation are executed as the program processes all of these 20 points. A printout is done after each point of all registers, and control bits. The modes of operation become apparent when the total printout is observed.

The program exits after 4 peaks are processed. This number of peaks can be changed to any number by substituting another instruction for Fortran statement 100.

Computer Printout

A sample printout is shown in Table II. The contents of each register appear for each of the 20 points ($I = 1$ to 20) across the row. The contents of the registers Input ($I + 1$), $A(I + 1)$, and $B(I)$ are decimal numbers for simulation purposes.

Four different shapes of peaks have been used as examples for this particular run. These types are likely to occur so must be handled successfully by the logic system.

A summary of the program printout of these peaks follows.

Peak number 1 has a smooth top at value 100 which is reached at point $I = 10$. The 4 values of 100 are accumulated, divided by 4 and transferred to the buffer. When three 0's are detected, the buffer value is set into the output register.

Peak number 2 oscillates between values 50 and 53 at the top. The first 4 points that fell within the limit ± 3 were accumulated, averaged, and stored for readout. The average of 51 appears in the output register.

Peak number 3 has some base line noise which is rejected because the 3 criteria is not met. Also, a negative spike occurs after the program is in the peak look mode. This point is also rejected. At point $I = 14$ the limit is found and the next 4 points are accumulated. The average value is 47.

Peak number 4 has a noise spike ($I = 11$) after the program is in the accumulation mode. This noise spike is rejected, and the value 42 is accumulated twice. The average peak value in this case is 41.

Conclusion

A simulation program such as described above is a very worthwhile step in the design phase of a small logic system in terms of time and money. Also, this phase can be very enjoyable because the designer can observe his system in operation long before it is built.

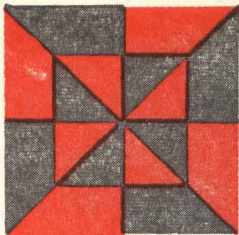

negative radix



arithmetic

M. P. de Regt

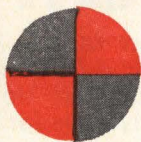

Part 8. COMPLEMENTARY ARITHMETIC

The negadecimal arithmetic presented thus far is characterized by being closely parallel to decimal, in that the same tables for addition, subtraction, and multiplication are used. In fact, the basic rule for the arithmetic is "same as decimal, except change sign of carry." In this article, new arithmetic operations will be introduced in which negative carry-outs do not occur, and the tables contain only positive digits. These operations in positive radix arithmetic are trivial because they involve only sign manipulation; in negative radix arithmetic, the tables are new, and the old addition, subtraction and multiplication tables do not apply. If we extend the possibilities by permitting use of negative digits, the operations comprise, with the negative radix notation, a rather distinctive, elegant and remarkable system of computation. The practical result is an incredible wealth of algorithms by which the normal arithmetic operations can be accomplished.

1. Complementation

The first of these operations is complementation, or changing the polarity of a number. This is a trivial operation in posiradix notation, in which it consists simply of changing the sign. In negaradix, however, it is not trivial; it is done by subtraction from zero. Note that this is somewhat related to complementation of a number in a system using the complement on R for negative numbers, except that in these cases, the subtraction is not from zero, but from R^n , where n is the number of digits including the sign position. Naturally, subtraction from zero is much cleaner; no separate convention such as a specified and known number of positions is required.

Since we have already discussed subtraction, in Part 3, it is necessary here only to focus on the case where the minuend is zero. The table is simple; it is the first

or zero minuend column of the negadecimal digit-difference table, Table 4, of Part 3. However, since a negative carry-out cannot occur, the "N" carry column may be deleted. Several examples follow.

Example 1:

$$\begin{array}{r} 00000 \\ -(21797) \\ \hline 180423 \end{array} \qquad \begin{array}{r} 000000 \\ -(180423) \\ \hline 021797 \end{array}$$

2. Co-addition

The name of this operation derives from the term "complementary addition," or the operation which combines two numbers to produce the additive inverse of their sum. The symbol "@" will be used to represent the operation, and the result will be called the "co-sum." Thus, the cosum R of A and B is defined as:

$$R = A @ B = -(A + B) = (-A) + (-B)$$

It should be noted that this operation does not replace addition, but is defined in terms of addition. In fact, the operation of addition will continue to be used as the basic operation for carrying, so that negative digits can still appear within the carry arithmetic. For the properties of the operation, the inverse and commutative laws apply; the associative law does not, and there is no identity element. These properties are all readily demonstrated by examples.

An interesting property of this operation is that the positions of the operation and equal symbols may be interchanged, and the positions of the operands may be interchanged without altering the truth of the equation. For example, in decimal:

$$\begin{aligned} 3 @ 5 &= -8 \\ 3 &= 5 @ (-8) \\ 5 &= 3 @ (-8) \\ (-8) &= 3 @ 5 \end{aligned}$$

The digit cosum table for decimal is trivial; for negadecimal, however, it is a completely new table, as shown in Table 1. Note that all carries are positive, and that

TABLE I
NEGADECIMAL DIGIT COSUM TABLE

Co-Addend Digit	Carry Digit			Co-Augend Digit									
	2	1	0	0	1	2	3	4	5	6	7	8	9
0	-	-		02	01	00	19	18	17	16	15	14	13
1	0	-		01	00	19	18	17	16	15	14	13	12
2	1	0		00	19	18	17	16	15	14	13	12	11
3	2	1		19	18	17	16	15	14	13	12	11	10
4	3	2		18	17	16	15	14	13	12	11	10	29
5	4	3		17	16	15	14	13	12	11	10	29	28
6	5	4		16	15	14	13	12	11	10	29	28	27
7	6	5		15	14	13	12	11	10	29	28	27	26
8	7	6		14	13	12	11	10	29	28	27	26	25
9	8	7		13	12	11	10	29	28	27	26	25	24
-	9	8		12	11	10	29	28	27	26	25	24	23
-	-	9		11	10	29	28	27	26	25	24	23	22

there are still three carry possibilities: 0, +1, and +2. In negabinary, there are only two carry possibilities, 0 and +1, so that the negative carry is eliminated, and only one carry signal line is required. Thus, a full negabinary co-adder circuit has a structure like that of a full

binary adder, and can be used as a module for combining operands in completely novel ways. For example, if an "@" sign represents such a module, the structure implied by the left hand side of each of the following equations will perform the arithmetic on the right.

$$\begin{aligned} (A @ B) @ 0 &= A + B && (2 \text{ modules}) \\ (A @ 0) @ B &= A - B && (2 \text{ modules}) \\ (A @ B) @ C &= A + B - C && (2 \text{ modules}) \\ (A @ B) @ (C @ D) &= A + B + C + D && (3 \text{ modules}) \end{aligned}$$

There is no limit to the number or arrangement of modules. Thus, circuits providing for combination of more than two operands can be provided. Since the operands may have either polarity, such structures are possible only using negaradix co-adder modules. Similar structures comprising positive radix co-adders for sign and magnitude notation are impossible; for complementary notation, they would require hopelessly complex overflow discrimination circuits, because each negative operand would have an R^n bias.

An example of co-addition follows:

Example 2.

$$\begin{array}{r} 86074 \\ 7642 \\ \hline 148504 \end{array} \qquad \begin{array}{r} + 73934 \\ - 6438 \\ \hline - 67496 \end{array}$$

3. Co-multiplication

Co-multiplication is defined as the operation which combines two numbers to produce the additive inverse of their product. The symbol "#" will be used to represent the operation, and the result will be called the co-product. Thus, the co-product, R, of A and B is $R = A \# B = -(A \times B) = (-A)(B) = (A)(-B)$. Co-multiplication may also be defined in terms of co-addition. Co-addition was defined for a pair of numbers, but the operation can be extended to apply to three or more numbers. Thus, $R = A_1 @ A_2 \dots @ A_n = -(A_1 + A_2 \dots + A_n)$.

$$\begin{aligned} \text{If all the } A_i \text{ are equal, then we have} \\ R &= A @ A @ \dots \text{ to } N \text{ terms} \\ &= -(A + A + \dots \text{ to } N \text{ terms}) \\ &= -(AN) \\ &= A \# N \end{aligned}$$

For co-multiplication, the associative and commutative laws hold, as does the distributive law over addition. The identity element is -1, so that $A \# (-1) = A$, and the inverse law (for $A \neq 0$) is $A \# (1/A) = -1$. The various laws can easily be demonstrated using decimal numbers.

The table of digit co-products for decimal is trivial, but for negadecimal it is a completely new table, having only two positive digits. It is presented in Table 2.

Examples of co-multiplication follow, as usual with negadecimal on the left, and decimal on the right.

Example 3 (+, -):

$$\begin{array}{r} 541 \\ 67 \\ \hline 4833 \\ 3373 \\ \hline 36573 \end{array} \qquad \begin{array}{r} + 461 \\ - 53 \\ \hline + 1383 \\ + 2305 \\ \hline + 24433 \end{array}$$

Your "special" peripheral may already be a standard product at Potter...

the peripheral specialist

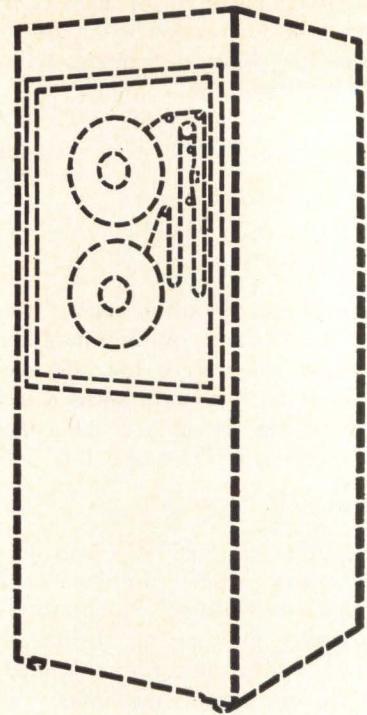

Example 4 (+, +):

$$\begin{array}{r}
 267 \\
 316 \\
 \hline
 1298 \\
 1953 \\
 1659 \\
 \hline
 164528
 \end{array}
 \qquad
 \begin{array}{r}
 +147 \\
 +296 \\
 \hline
 -882 \\
 -1323 \\
 -294 \\
 \hline
 -43512
 \end{array}$$

An interesting application of the co-multiplication operation is that the two square roots of opposite polarity may be co-multiplied to produce the square.

Example 5:

$$\begin{array}{r}
 194 \\
 26 \\
 \hline
 0096 \\
 0032 \\
 \hline
 00216
 \end{array}
 \qquad
 \begin{array}{r}
 -14 \\
 +14 \\
 \hline
 +196
 \end{array}$$

4. Multiplication Using Co-addition

In examples 3 and 4, it is quite obvious that if the additive inverse of the sum of the digit products had been taken, the result would have been the product of the operands instead of the co-product. In other words, we can also multiply two numbers by co-adding the digit co-products. This is a trivial distinction in normal decimal, but it is a different algorithm in negadecimal, as illustrated in the following example.

Example 6: Multiply by co-adding the digit co-products.

$$\begin{array}{r}
 7219 \\
 461 \\
 \hline
 14801 \\
 40806 \\
 33204 \\
 \hline
 18480959
 \end{array}
 \qquad
 \begin{array}{r}
 -6801 \\
 +341 \\
 \hline
 +6801 \\
 +27204 \\
 +20403 \\
 \hline
 -2319141
 \end{array}$$

TABLE 2
NEGADECIMAL DIGIT CO-PRODUCT TABLE

#	1	2	3	4	5	6	7	8	9
1	19	18	17	16	15	14	13	12	11
2	18	16	14	12	10	28	26	24	22
3	17	14	11	28	25	22	39	36	33
4	16	12	28	24	20	36	32	48	44
5	15	10	25	20	35	30	45	40	55
6	14	28	22	36	30	44	58	52	66
7	13	26	39	32	45	58	51	64	77
8	12	24	36	48	40	52	64	76	88
9	11	22	33	44	55	66	77	88	99

Although it is not possible in this short summary to go into details, it is clear that a host of possible algorithms can be defined for multiplication, co-multiplication, division, and co-division* by combining use of digit product or digit co-product tables with addition, subtraction, co-addition or co-subtraction*. This wealth of method provides an extremely large choice of design options for special purpose equipment.

*We have not defined co-division and co-subtraction, but the reader should have no difficulty in doing this for himself.

for instance

the industry's *lowest-cost* single-capstan tape-transport system with both 7 and 9 channel IBM compatible operation

The Potter SC-1030 doesn't *look* like a low-cost unit, nor does it *perform* like one. It incorporates many of the features of more expensive higher speed single-capstan units. These include low-inertia capstan drive and reliable photoelectric control of tape loop movement that completely eliminates need for mechanical adjustments. Up to 37.5 ips in all industry compatible formats, including 1600 bpi phase modulated recording. Write for full details on this or any of the products listed below.

The complete line of Potter peripherals includes magnetic tape transports, high speed printers, random access memories, paper tape readers and punches.

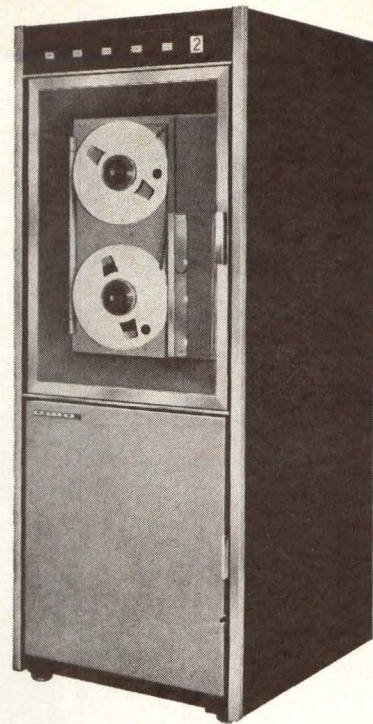

 **POTTER**
INSTRUMENT CO., INC.

151 Sunnyside Blvd. • Plainview, N.Y. 11803 • (516) 681-3200
TWX-510-221-1852 • Cable PICO
In Europe: Potter Instrument Co. Ltd., McGraw-Hill House,
Maidenhead, Berkshire, England • Maidenhead 20361

CIRCLE NO. 34 ON INQUIRY CARD

5. Complementary Representation

The notion of a number system having digits of negative value was discussed in Parts 1 and 2; in Part 2, the cobinary system was defined as one whose base is -2 and whose numerals are 0 and -1 . It was further explained in that article that overflow in multiplication was possible in negabinary, but not in cobinary. This fact is generally true for other radices, and the implications can be more readily understood for cobinary by considering "co-decimal" — the system whose base is -10 and whose numerals are 0 and -1 through -9 . Some idea as to the implications of the use of negative digits (represented by italics) in multiplication and division can be obtained by multiplying numbers of minimum and maximum magnitude for the quantity of digits, as we did in Part 4, p. 43 of the August 1967 issue. Note that the digits product table for codecimal looks like the digit co-product table for negadecimal except that it is all in italics, e.g., $\bar{8} \times \bar{7} = \bar{64}$.

$$\begin{aligned}\bar{1}90\bar{9} \times \bar{1}90\bar{9} &= \bar{9}899 \\ \bar{9}0\bar{9} \times \bar{1}90\bar{9} &= \bar{9}8899 \\ \bar{9}0\bar{9} \times \bar{9}0\bar{9} &= \bar{9}87899\end{aligned}$$

Without going into the details of the arithmetic, it is evident that, unlike degadecimal, the quantity of digits in the product is equal to the sum of the quantities of digits in the two factors, or it is two or four less. In other words, no overflow is possible, and for mechanical division, this may mean that a restore operation could be indicated by an overflow, just as in normal division. To

explore in detail the operation of the various algorithms would take much more space than we have available. In fact, if we consider all of the various combinations of using digit product or co-product; addition, subtraction, coaddition, or cosubtraction; and positive or negative digits, we have a total of $2 \times 4 \times 2$ or sixteen different ways to multiply and sixteen different ways to divide. These sixteen ways to divide do not include the methods using alternating diminishing operations and "special" systems which we discussed in Parts 6 and 7. It is clear that if we had investigated these different possibilities using binary number systems as examples, we should by this time be hopelessly confused in zeros and ones. As it is, we are in some position to draw a tentative conclusion as to which of these many possible systems might be most appropriate for a system of computation using a negative radix. It will be discussed next.

6. Through The Looking Glass

Although much more consideration is required, the arithmetic which appears to be simplest for mechanical operation from all points of view, including division, is one using:

- a negative radix,
- negative digits,
- co-adder modules for addition and subtraction,
- repeated subtraction of digit co-products for multiplication,

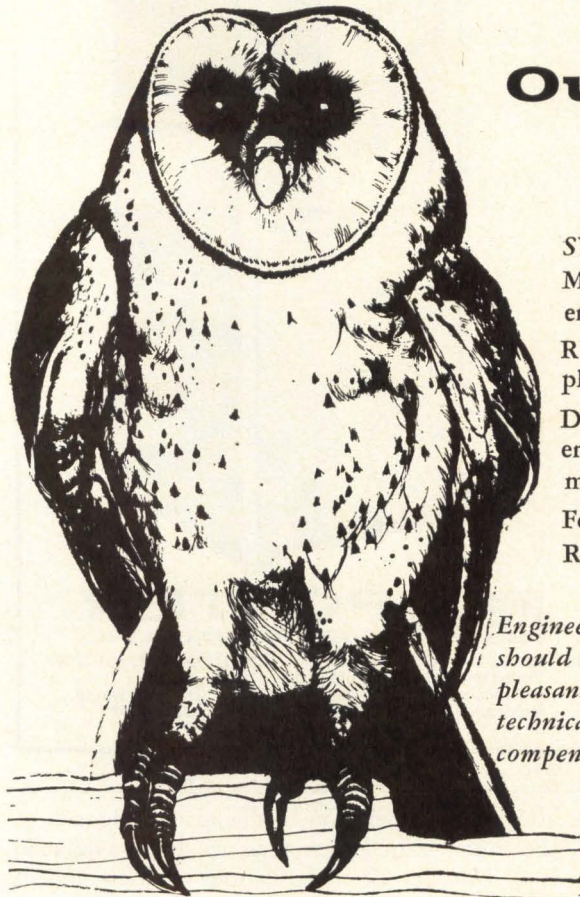

Outstanding Engineers —That's Who

SYSTEMS ENGINEERING MGR.: For creative system group. MSEE in Physics or Math plus extensive systems engineering with emphasis on signal processing for radar, communications and ECM.
RF/IF ENGINEER: To supervise engineers and technicians. BSEE plus experience in RF. Exposure to L Band and above desirable.
DIGITAL ENGINEERS: Design and Development. Supervision of engineers and technicians. BSEE plus experience in discrete and micro-circuits.

For these and other openings send resume or call collect, Richard W. Stanion, Personnel Manager, at (203) 242-0761.

Engineers making solid contribution in radar, laser, and computer areas should investigate Andersen offerings: Brand new, well-equipped facility in pleasant setting in Hartford outskirts . . . Acknowledged leadership through technical superiority . . . Highly qualified associates . . . and very noteworthy compensation and benefits. **An Equal Opportunity Employer**

CHECK READER SERVICE CARD
FOR MORE INFORMATION



1280 BLUE HILLS AVENUE • BLOOMFIELD, CONN. 06002

ANDERSEN LABORATORIES, INC.

CIRCLE NO. 900 ON INQUIRY CARD

- repeated addition of digit co-products for division,
- a non-restoring division algorithm using both polarity and overflow tests.

Because virtually everything in this list is the inverse of the normal, the title of the Rev. Mr. Dodgson's famous book has been borrowed for this section. And yet, compared with the negative radix arithmetic we have discussed, the arithmetic looks so much like normal arithmetic, that (given stage-level adder-subtractor circuitry) the arithmetic control logic of a conventional computer could almost be used for such relatively complex operations as multiplication and division — even perhaps for the so-called high-speed operations, such as carry-save multiplication. On the other hand, the control logic for addition and subtraction is just as simple as for any negative radix system.

One item of critical importance which should be mentioned, but which is more appropriately discussed under the topic of logic design, is the matter of polarity determination. The logic for this is extremely simple and

fast, and is amenable to modular design and incorporation with add/subtract modules. A signal for the polarity of a newly-computed number can be provided at the same instant as the signal for its most significant digit.

This series of articles is complete, but before leaving it, the reader should review that portion of Part 1 entitled "Arithmetic, Computers, and Integrated Circuits." It starts on page 60 of the May 1967 issue. As a final note to emphasize the significance of what is suggested there, we should say that the potential of digital computation using negative radix arithmetic does *not* lie in a small saving of circuit cost or operation time in a computer designed to look and act just like one of the current or future generations of computers. The potential of negative radix arithmetic lies in using it to do things which are impracticable or perhaps even impossible using conventional arithmetic. The challenge, then, is to explore such possibilities, to evolve their designs, and to develop their applications.

A New Design Transmission-Line Adder

Use of directional couplers adds another dimension to logical adder design in that the carry propagations are now free of circuit delays, thereby permitting fast add times without use of additional logical decisions for look-ahead capabilities.

M. H. Bolt, H. H. Nick

IBM Systems Development Division
Poughkeepsie, New York

In the logical design of an adder, we begin by considering the addition of two n -position registers. The following definitions and sum expressions are arrived at by Booleanizing the adder operation of two- and three-position sums, and will allow us to write a general expression for an n -position sum.

Let

- P_k = k^{th} bit of the P register
- Q_k = k^{th} bit of the Q register
- C_k = carry bit from the $k-1^{\text{st}}$ position during a sequential add operation between the P and Q registers
- S_k = result in the k^{th} position of adding the P and Q registers

Then

$$\begin{aligned} S_1 &= C_1 M_1 + \bar{C}_1 \bar{M}_1 \\ S_k &= C_k M_k + \bar{C}_k \bar{M}_k \\ S_n &= C_n M_n + \bar{C}_n \bar{M}_n \end{aligned} \quad (\text{Eq. 1})$$

where C_1 = input carry into the adder

$$\begin{aligned} \bar{C}_k &= \bar{C}_{k-1} \cdot (P_{k-1} + Q_{k-1}) + P_{k-1} \cdot \bar{Q}_{k-1} \\ \bar{M}_k &= P_k \cdot Q_k + \bar{P}_k \cdot \bar{Q}_k \\ \bar{M}_k &= P_k \cdot \bar{Q}_k + \bar{P}_k \cdot Q_k \end{aligned} \quad (\text{Eq. 2})$$

n = number of positions in the register, i.e., $1 \leq k \leq n$

Also, $C_{\text{out}} = P_n Q_n + C_n \bar{M}_n$ = output carry from the adder.

Before the k^{th} position can produce a correct sum, it must know the condition of the $k-1^{\text{st}}$ position or the $k-2^{\text{nd}}$ position, etc.; that is, if the bits in the $k-1^{\text{st}}$ position are:

$$\begin{bmatrix} P_{k-1} = 0 \\ Q_{k-1} = 0 \end{bmatrix} \quad \text{or} \quad \begin{bmatrix} P_{k-1} = 1 \\ Q_{k-1} = 1 \end{bmatrix}$$

then S_k may be computed.

If the bits in the $k-1^{\text{st}}$ position are:

$$\begin{bmatrix} P_{k-1} = 1 \\ Q_{k-1} = 0 \end{bmatrix} \quad \text{or} \quad \begin{bmatrix} P_{k-1} = 0 \\ Q_{k-1} = 1 \end{bmatrix}$$

then we must look into the $k-2^{\text{nd}}$ position.

The following definitions will help generalize the above property:

Let

$$\begin{aligned} \text{Gen}_k^T &= P_k \cdot Q_k \quad \text{for } 1 \leq k \leq n \\ \text{No Gen}_k^T &= \bar{P}_k \cdot \bar{Q}_k \quad \text{for } 1 \leq k \leq n \end{aligned}$$

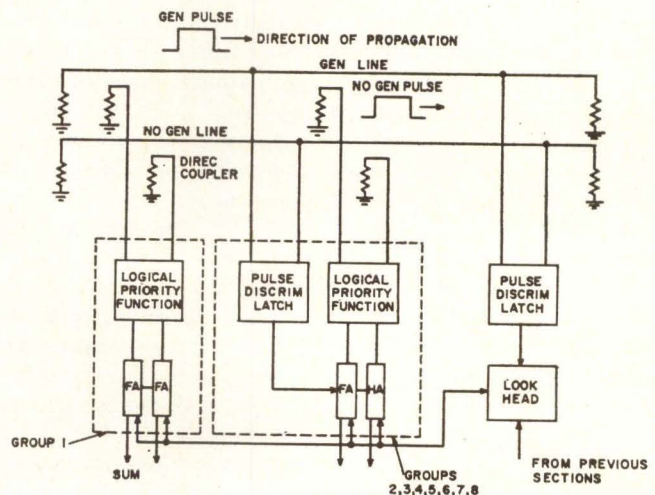

Fig. 1 — Main logic flow

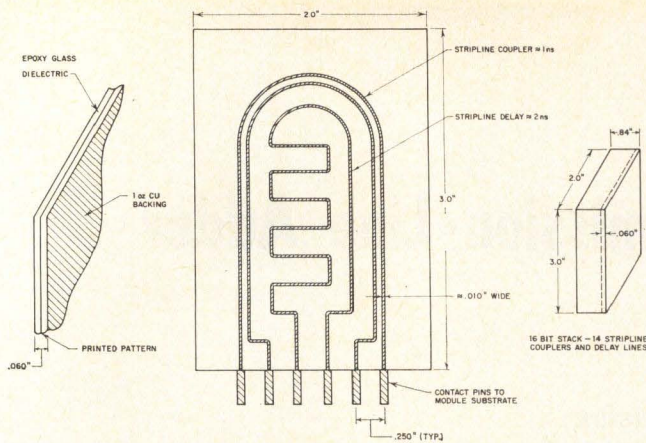

Fig. 2 — Directional coupler assembly

$Gen_k^R = Gen_l^T$ for $l < k$ such that if there exists a No Gen_p^T for $p < k$, then $p < l$.
 No $Gen_k^R = No Gen_l^T$ for $l < k$ such that if there exists a Gen_p^T for $p < k$, then $p < l$.

In order to compute S_k , it is only necessary to establish whether a Gen_k^R or a No Gen_k^R exists. This implies that the lowest-order position of the adder is position 1. The succeeding higher-order positions proceed in a conventional manner, i.e., 2 through n . The establishment of a Gen_k^R or a No Gen_k^R can be accomplished without logical interference if we provide capabilities for each position in the adder to transmit its information (being a Gen^T or No Gen^T) down one of two transmission lines toward the higher-order positions, and each position to sense the transmission lines in order to determine whether a Gen^T or No Gen^T was transmitted. With each position spaced along the transmission lines, and by reserving one line for Gen^T transmission, and the other for a No Gen^T transmission, a Gen_k^R is easily distinguished from a No Gen_k^R because the true signal will first arrive at position k .

General Adder Philosophy and Design

The adder is divided into four main sections; each section consists of 16 add positions and is further divided into eight groups of two positions each. Every two-position group may contain one full adder and one half adder, or two full adders. Two drivers and two transmission line couplers are associated with each group (see Fig. 1), except the eighth group, which does not drive its information onto the transmission lines since there are no further higher-order groups in the section. If the directional couplers are one-nanosecond long when driven by a step of voltage, they will emit a two-nanosecond pulse onto the transmission line traveling toward the higher-order groups in the section.

A logical priority function in each group allows priority to be established by the higher-order position. Should, for example, the higher-order position be required to emit a Gen^T and the lower-order member be required to emit a Gen^T or a No Gen^T , the lowest-order group will be inhibited from any transmission. In Fig. 1, a number of blocks labeled logical priority function, pulse discriminating latch, FA, HA, look-ahead, and their various input/output connections are shown, and the

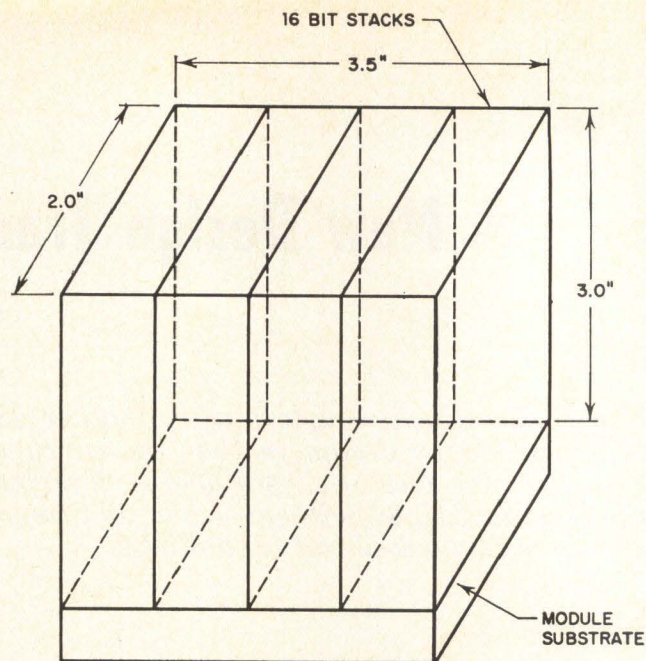

Fig. 3 — Complete adder

diagram also depicts a general section containing, as previously discussed, eight groups and 16 adder positions. The look-ahead circuits are of the standard type and are present at the output of each section of the adder.

A model of the adder was constructed with Gen and No Gen Transmission lines and with the couplers mounted on a series of small cards (2 x 3 x 0.06 inches). When packaged, the cards form one assembly consisting of 14 directional couplers (see Fig. 2). A length of strip line, used as a two-nanosecond delay line, and not part of the coupling mechanism, is packaged on the card for convenience. It is used in the latch circuits as a means of widening the Gen and No Gen pulses. Transmission line continuity is maintained via strip line connections between the small cards that are affixed to a larger card. Connections of circuit modules are made via the large card where the modules are also packaged. There are actually two 3 ft. 9 in. transmission lines packaged in sections on the 14 coupler cards whose assembled dimensions are 2 x 3 x 0.840 inches. The complete adder (Fig. 3) consists of a base card with modules affixed to one surface. Mounted on the other surface are the small pluggable cards containing the directional couplers and the delay lines. The dimensions of the 64-bit adder are 3 x 2 x 3.5 inches.

Summary

Unique features of the new design transmission-line adder are summarized as follows:

- Carry look-ahead within a section is accomplished by transmitting carries via directional couplers along a transmission line.
- Coupling length per group is a function of the pulse width required by the pulse discriminating latch.
- Group priority logic allows the couplers to be spread in a continuous string along the transmission line.
- Allowances for circuit skew may be made by adjusting the spacing between any two directional couplers.

Contemporary Electronics is one of the largest producers of computer pulse transformers in the U.S.

SO?

So, maybe you're missing a bet if you haven't checked Contemporary Electronics for *quality, service and price.*

Contemporary Electronics *specializes* in pulse transformers. It's not a sideline, but a principal part of our business. Well over 100,000 pulse transformers are produced each month in 75 different designs.

Advantages? Here are some.

Technical Capability. Contemporary Electronics engineering staff knows computers and can design any special product for any application.

High Quality. Most transformers have special high quality design features. All pulse transformers are 100% inspected as many as three times before shipment. QC system meets MIL-Q-9858, and has been approved for use on the Apollo program.

Fast Sample Service. Samples, small production lots and specials are normally shipped 24 to 72 hours after receipt of request.

Interested in what can be done in terms of performance, size, delivery, or MIL-specs? Get to us—we've got lots more to tell.

WRITE, OR CALL COLLECT AND WE'LL HAVE THE FULL STORY TO YOU WITHIN 48 HOURS

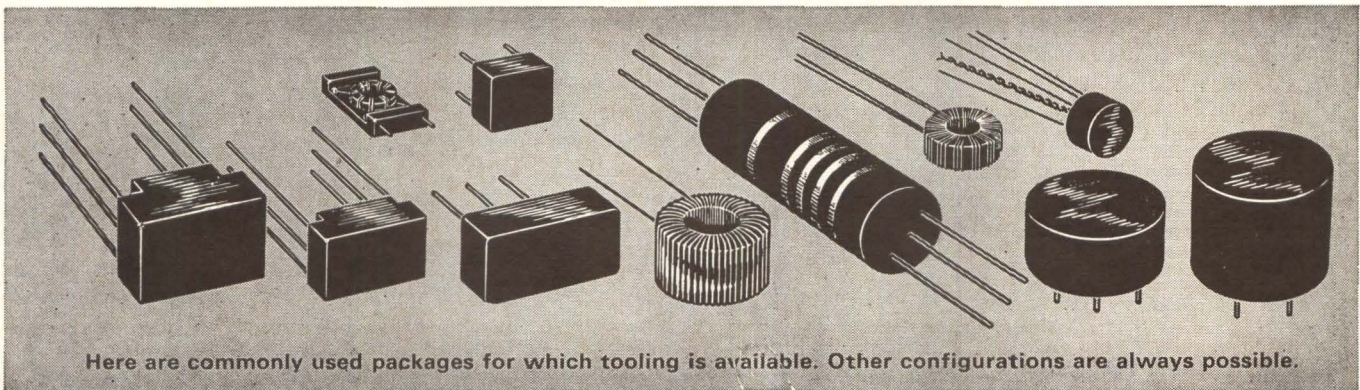

 **CONTEMPORARY
ELECTRONICS**

4838 West 35th Street, Minneapolis, Minnesota 55416

612/920-6444

EXTRA SERVICE TO THE DATA PROCESSING INDUSTRY

CIRCLE NO. 35 ON INQUIRY CARD



NEW PRODUCTS

KEYBOARD

A high quality keyboard switch recently developed is said to have the action and touch of a fine typewriter. Designed particularly for use in alphanumeric keyboards for the control of computers and other electronic equipment, the switch is characterized by high reliability and ease mounting and soldering. The design lends itself readily to flow soldering techniques. The switch is available as either mechanical or reed and with either one or two switching levels. The mechanical switch, KBSM-1, is a wipe-action design which insures minimum contact "bounce," less than 10 milliseconds. The reed unit, KBSR-1, is a single-level dry-reed type keyboard switch, similar in design to the mechanical switch except that contacts are hermetically sealed in glass and actuated by a moving permanent magnet. "Touch" of the reed type switch is identical to the mechanical type and offers the additional reliability and minimum "bounce" inherent in a reed switch. The KBSR-2 is a double level reed type switch similar in design to the KBSR-1 except for the second level. The mechanical switch pressure contacts are made of beryllium; the sliding contact employs stainless steel. The reed switch contacts are noble metal. Raytheon Co., Burlington, Mass.

Circle No. 228 on Inquiry Card

MAGNETIC DISK PACKS

Magnetic disk packs, after extensive research, development and testing, have been transferred from pilot plant to full production, according to the manufacturer. Each unit is designed, tested and guaranteed to function with IBM 1311, IBM 2311, and compatible equipment. The 10 coated surfaces in the disk pack each have 203 tracks of information. It is capable of storing up to 14.5 million bits with access time in the 75-85 millisecond range. The pack

rotates at either 1500 rpm or 2400 rpm. Maximum weight of the disk pack, complete with cover, is 10 pounds and dimensions are 4 inches in height by 14.6 inches in diameter. Units are shipped in sculptured and ribbed styrofoam containers. Additional protection is provided by a vented hub assembly and Lexam top and bottom covers. Caelus Memories, Inc., San Jose, California.

Circle No. 239 on Inquiry Card

DATA SYSTEMS

Miniature data systems for applications where digital displays and other Binary Coded Decimal (BCD) outputs are required include a 16-channel multiplexer, a sample-and-hold amplifier and a 13-bit BCD, 80-Khz analog-to-digital converter, all mounted on a compact connector block. Named "Miniverter," the new device is pre-wired, assembled, tested, and ready to use, it costs under \$1,900. The data system is one of several new instruments Raytheon is assembling from standard M Series analog and digital IC Modules at its Computer Operation in Santa Ana, California. The data systems can be purchased in various case sizes and with controls, digital power supplies, and displays. The complete M Series Logic System, including cases and accessories, is compatible with the Miniverter system. This allows expansion to an unlimited number of channels and inclusion of other logic and data processing functions. Raytheon Computer, Santa Ana, California.

Circle No. 241 on Inquiry Card

MOS ANALOG SWITCH

An MOS 6-channel analog switch featuring a low ON resistance is well-suited as a basic switching element for airborne or ground instrumentation, telemetry or other analog or digital data transmission applications. Designated the 3701, the

new device includes gate protection to minimize handling problems and by providing a lower r_{ON} , typically 300 ohms, to give higher current carrying capability and reduced signal division with the output load resistor. A sixth channel makes use of all package pins and to make it possible to reduce package count in large multiplex systems. The device is characterized by low input and output leakage current, typically 10 picoamperes and 100 picoamperes respectively, and may be operated over a temperature range of -55°C to $+85^{\circ}\text{C}$. Prices: \$40.00 each for quantities up to 25; \$32.00 each for quantities of 25-99; and \$26.80 each for 100-999. The device is available in a 14-lead flat package. Fairchild Semiconductor, Mountain View, Calif.

Circle No. 230 on Inquiry Card

DIGITAL DATA SIMULATOR

A fully programmable 900-bit digital data simulator which provides either parallel or serial outputs at clock rates to 10 Mhz is in production. The heart of the SRC Model 900-SP is a tiny plastic programming pin which makes it possible to program 900 bits on a colorful pin board just 7 inches by 13 inches. The programming pin is actually a linear octal switch. It comes in eight discrete lengths, each an octal increment (0 through 7). To program a binary 1-0-1, for example, a number 5 pin is simply inserted into the appropriate hole in the plug-board. (Octal five is the equivalent of the three binary bits 1-0-1). Not only have three binary bits been quickly and easily programmed, but a readable program is presented at the front panel since the heads of the pins are permanently embossed with the octal value. A front panel switch provides either serial or parallel operation. In the parallel mode, 9 bits per clock pulse are available at nine convenient front panel BNC connectors. In the serial mode, one bit of output data per clock pulse appears at the serial BNC connector. Ten front panel thumbwheel switches make it simple to vary word length, words per cycle, provide a floating synch pulse, and insert a 9 bit word of overriding data. Magnitude of the output data can be adjusted from one

to five volts using the front panel control, while a front panel polarity switch makes it possible to have either positive or negative output polarity with respect to chassis ground. A convenient front panel BNC connector is provided for the necessary external clock. Any pulse or sine wave generator capable of delivering from 1 to 5 volts over the 0 to 10 Mhz range of the simulator can be used to clock the output data. The versatility of programming in a small package makes the device useful in an unlimited number of applications. For example, the unit can be used to simulate telemetry data, teletype messages, paper tape devices, magnetic tape units, computer outputs, PCM messages, or any digital output for that matter. It can operate and control production test devices, teletype equipment, paper tape punches, disc or drum memories, digital to analog converters, programmable power supplies or frequency devices. The nine-bit parallel output of the SRC 900-SP plus its high clock rate makes it ideal for programming high-low limits in data systems. The data simulator is also useful in testing integrated circuit logic design, digital sub-systems, PCM transmission, Dataphone transmission, interface devices, core memory systems, and telemetry decommutators. The 900-SP is priced at \$3,227 with delivery 30-60 days. SRC Div., Moxon Electronics, Los Angeles, Calif.

Circle No. 231 on Inquiry Card

DIGITAL TEACHING COMPUTER

A digital computer trainer, DCT350, which is a small-scale replica of a computer central processor, has been designed specifically for teaching student engineers and technicians the principles of modern computing. Filling the "instructional gap" between logic trainers and the complete, operational computing facilities found now in many educational institutions, it performs the following serial binary operations: shifting — addition — accumulation — 1s and 2s complementation, subtraction using either form of complement, multiplication by successive addition, multiplication by add and shift, division by successive subtraction. The numbers are stored in 3 registers, each with a 10 bit capacity and with the contents of each stage indicated by a lamp. The

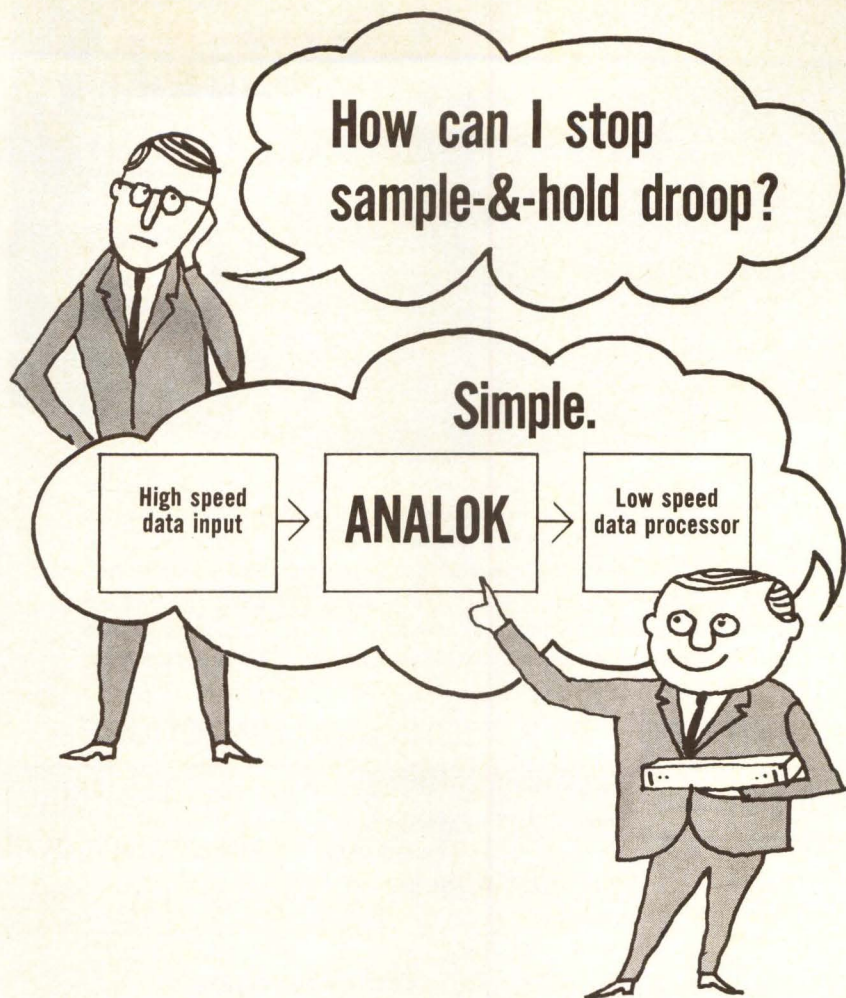

Forget about droop with ANALOK because it doesn't. What it *does* do is give you a simpler, less expensive system with greater flexibility.

Here's how. ANALOK is a multichannel unity gain track-and-hold amplifier with *zero* decay. It can retain stored values *in an analog state* indefinitely. This unique memory capability gives you greater flexibility because there's no time restriction between acquisition and use of sampled values. Check these applications:

- Use ANALOK as a high speed data buffer. Sample multiple functions simultaneously, or transient phenomena in a programmed sequence. Transfer the data to your low speed data processor as slowly or rapidly as you wish. No matter how much time you take, the stored values won't droop.
- Decommuration with one DAC and a multichannel ANALOK eliminates the need for periodic updating necessary when using conventional sample-and-hold channels. The result of using ANALOK is optimum use of your computer since it need only address each ANALOK channel when it has *new* information.
- Provide the information storage capability in your analog system with ANALOK. You may not have to go hybrid.

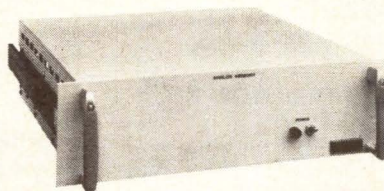

Get complete specifications. Write to ANALOK Sales, Dept. 234, Analog-Digital Systems Division, Control Data Corporation, 4455 Eastgate Mall, La Jolla, California 92037. Or phone 714/453-2500.

**CONTROL DATA
CORPORATION**

4455 Eastgate Mall, La Jolla, Calif.

CIRCLE NO. 36 ON INQUIRY CARD

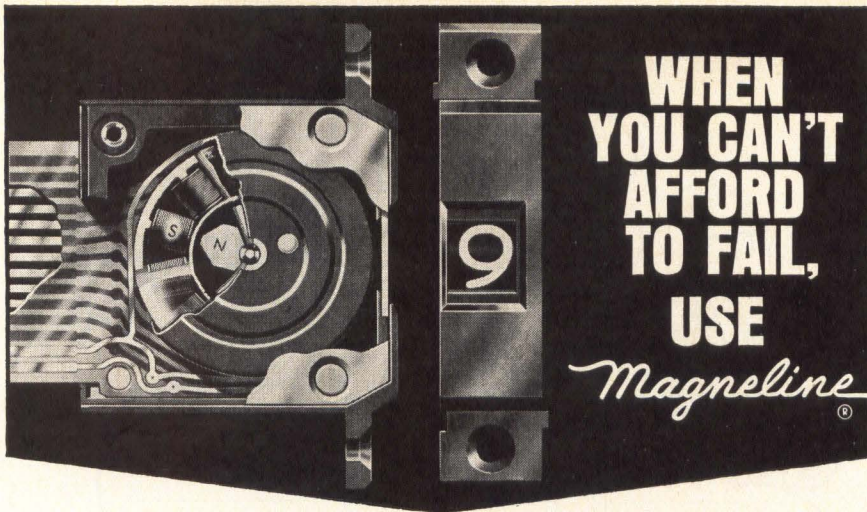

Magneline® digital indicators are used to display random information. They have high readability and extremely long life. Sharp black and white digits are positioned electromagnetically. The number drum rotates on a polished shaft in a jewel bearing. Coil assemblies are encapsulated in heat and shock resistant epoxy. Test units have been run through 35 million cycles without failure or measurable wear. Applications range from aircraft and spacecraft instrumentation to control systems for heavy industry.

WRITE FOR OUR TECHNICAL BROCHURE

PATWIN ELECTRONICS

Manufactured under one or more of the following
U.S. Patents: 2,943,313, 3,009,140, 3,118,138,
3,201,785, 3,260,871. Other patents pending.

A DIVISION OF PATWIN, INC. WATERBURY, CONNECTICUT • 06720

CIRCLE NO. 37 ON INQUIRY CARD

adder unit has a carry store, with indication of contents. There is a complement units, pulse counter, internal clock pulse generators and all the manually operated keys needed to store and clear the instructions. The registers and other units are interconnected as required for a particular operation by patch leads. The number of leads involved is so small that the mimic diagram does not become cluttered. Operations may be performed manually step by step or by use of "telephone dial." Alternatively they can be performed automatically at clock rates of 2Hz or 10kHz. A comprehensive manual of theory and details of a program of laboratory experiments accompanies the equipment. Interface elements allow the computer to be used in conjunction with Logikit — Feedback's logic trainer. This enables the overall facilities of the equipment to be extended or allows for detailed expansion of the individual computer circuits. Available on short delivery at \$2,105. Feedback, Inc., Mountaintside, N. J.

Circle No. 214 on Inquiry Card

TAB CARD READERS

A line of tab card readers for use with the Bell System 401 series "Data Phone" can be fed manually and will process any standard 80 column, 12 row card at a speed of 10 cards per minute. It is also available with an automatic hopper feed for semi-unattended service and includes a numerical or alphabetical keyboard for transmitting additional information other than what is on the cards. The reading speed is 15 columns per second. The unit is a direct replacement for other card readers now on the market that read only 20 columns per minute. Cost is approximately \$890 in small quantities. Vema Industries, Wyckoff, N. J.

Circle No. 215 on Inquiry Card

THERMISTOR KIT

Positive temperature coefficient thermistors for circuit compensation, time delay, current limiting and thermostatic sensing, are now available in a convenient designers' kit. The kit contains sixteen PTC devices, curves and application notes,

in a tabbed file folder-type package for convenient reference. Price — \$20.00. Order from: The Carborundum Company, Electronic Devices, Niagara Falls, New York 14302.

Circle No. 206 on Inquiry Card

DIGITALLY PROGRAMMABLE RF SIGNAL GENERATORS

Initially developed for automatic checkout of military avionic systems, these RF generators are useful for calibration, alignment, production test and maintenance for application in communications, radar and related areas. Rapid test rate and versatility of operating mode permit these generators to replace a multitude of individual equipment and to reduce hook-up time, human error and technician manpower requirements. Model RFS-301 covers 30 KHz to 50 MHz while Model RFS-302 spans the 40 MHz to 400 MHz range. Digitally programmable functions include frequency, output power level, and mode, i.e., CW, AM, FM, PM, PAM, sweep width, sweep rate and marker frequency. Design and performance of RF generators is state-of-the-art including: 10^{-8} frequency stability, 2% sweep linearity, 0.2% sweep marker accuracy and +23 dbm to -120 dbm dynamic range. Canoga Electronics Corporation, Canoga Division, Chatsworth, California.

Circle No. 208 on Inquiry Card

PRECISION X-Y CRT DISPLAY

Model PD900 Precision X-Y CRT Display is a high resolution 5-inch cathode ray tube display specifically designed to offer maximum performance in terms of resolution and speed at the lowest possible cost. It utilizes all solid-state circuitry and is intended for application in film and hard copy recording and film reading. It resolves more than 1700 elements/diameter and is capable of random access X-Y deflection from DC to a slewing speed of 7 microseconds for the full diameter. Small-signal bandwidth is greater than 1 megahertz. Other features include high stability, repeatability and linearity. Mating of the basic option package, OP900, to the Model PD900 display enables the inclusion of optional circuits such as video amplifiers, sawtooth generators and phosphor protection circuits. The

display utilizes a narrow deflection angle cathode ray tube to minimize deflection defocusing and pin cushion distortion. It is a 5-inch flat face magnetically deflected and electrostatically focused tube. Through the use of highly regulated power supplies, temperature stable components and temperature stabilized circuits, exceptional stability and reliability is achieved. The display includes deflection and blanking circuits, CRT and power supplies. Availability: 60-90 days; price: \$6,200.00. Beta Instrument Corp., Newton Upper Falls, Mass.

Circle No. 205 on Inquiry Card

20-MHz IC COUNTER-TIMER

General Radio has announced its first integrated-circuit instrument, a 20-MHz counter featuring eight digits, storage, and programmability of all major functions. The new Type 1191 counter measures frequency, frequency ratio, period, and time-interval. Time base is either a 10-MHz crystal oscillator operating at room temperature or, for extreme stability, a crystal oscillator in a proportional-control oven. Another optional extra is provision for BCD data output. Readout is eight digits of high-intensity neon tubes, with automatically positioned decimal point and units. The basic counter is priced at \$1340 in the U.S. With high-precision time base and data output, the price is \$1540. General Radio Co., W. Concord, Mass.

Circle No. 212 on Inquiry Card

MOLDED MEMORY PLANE

A new memory plane for coincident current applications in commercial, military and industrial computers is available from Indiana General Corporation. Named Cor-Gard, the plane includes supporting plates to prevent core mat sag, encapsulating compound over solder connections and a foam pad (optional) over the cores, resulting in high resistance to shock and vibration. For ease in stacking, the plane offers these advantages: All X, Y, sense, and inhibit wire terminations are inside the frame, eliminating the chance of damage during handling and soldering; planes fit flush, one against the other, providing structural rigidity; pins of an upper plane can contact pins of a lower plane allowing dip

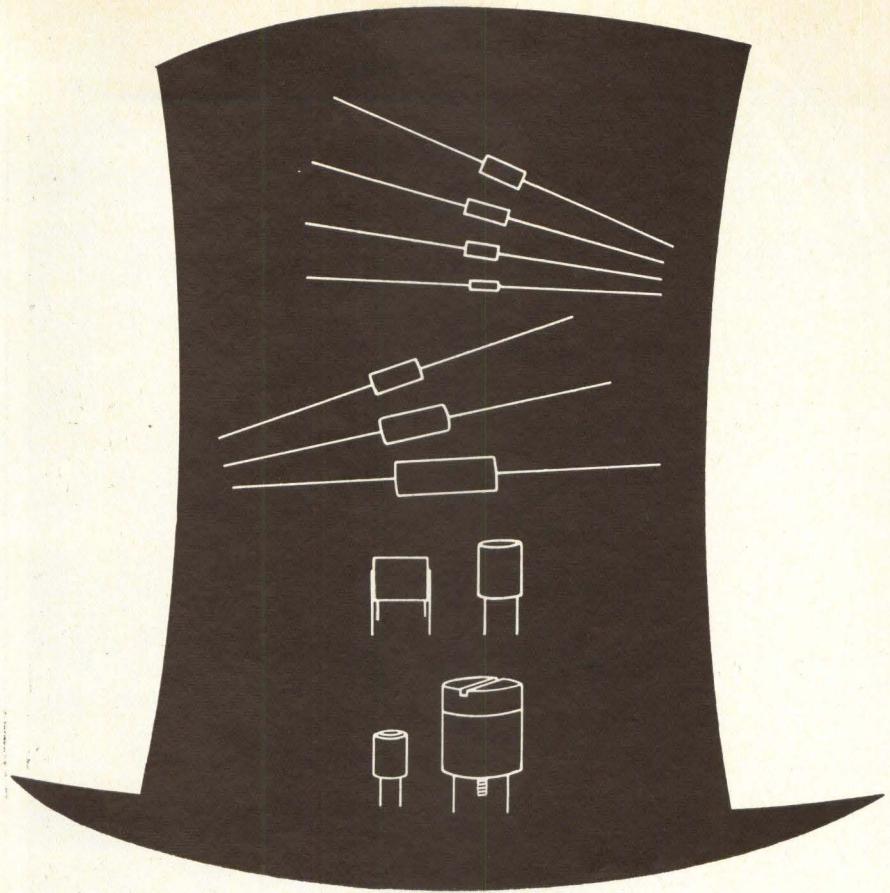

If you think Nytronics Inductors are tops...you ought to try our Ceramic Capacitors!

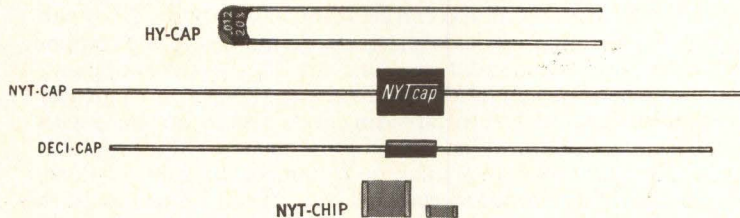

You'll find they're tops in quality and performance, too. Because they're the result of the very same unremitting research and development — and a standard line concept that links volume production with utmost precision. And you'll find the widest range of units with the greatest capacitance-to-unit size.

HY-CAP: .01 to 2.5 mfd.; $\pm 20\%$ tolerance; 100 WVDC; no derating to 125°C; and meets MIL-C-11015.

NYT-CAP: Molded epoxy package 0.1" diameter by 0.250" long.... 4.7 to 220 pf; and 0.350" by 0.250" by 0.1"..... 270 to 4700 pf; T/C does not exceed ± 40

ppm/°C (–55°C to +125°C); and 200 WVDC.

DECI-CAP: Epoxy molded envelope 0.100" diameter by 0.250" long.... 4.7 to 27,000 pf; and $\pm 10\%$ tolerance.

NYT-CHIP: 0.170" by 0.065" by 0.070" ... 4.7 to 220 pf; and 0.280" by 0.195" by 0.070".... 270 to 4700 pf; T/C does not exceed ± 40 ppm/°C (–55°C to +125°C); and 200 WVDC.

In addition to ceramic capacitors and inductors, we maintain inventories of high quality delay lines and resistors. Complete engineering data on all products will be sent on request.



NYTRONICS®

...for Precision Electronic Components

550 Springfield Ave., Berkeley Heights, N. J. 07922 ■ (201) 464-9300 ■ TWX: 710-984-7977

CIRCLE NO. 38 ON INQUIRY CARD

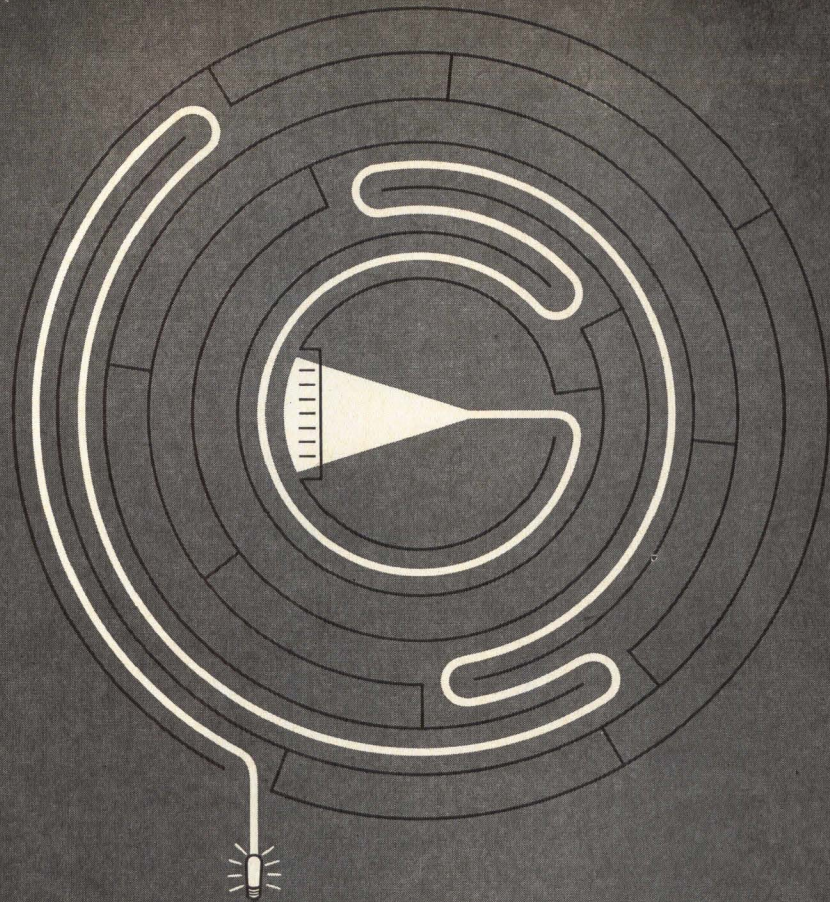

LIGHT WIRES® MAY SOLVE YOUR COMPLEX LIGHTING AND CONTROL PROBLEMS

Bausch & Lomb Fiber Optics Light Wires enable you to conduct light to any desired location as easily as you can string an electric wire. They can be threaded easily through intricate mechanical and electronic components of sophisticated instrumentation. For Data Processing equipment, they can increase accuracy in automatic read-out systems, give greater speed and reliability in punched card reading and verification. Used with a single light source, they can eliminate the problem of balancing individual lamps. They are relatively immune to temperature fluctuations, are unaffected by vibrations and mechanical wear. Their unique abilities may be the answer in your application. You can find out—for only \$25.

(NOT PLASTIC!)

ORDER A BAUSCH & LOMB LIGHT WIRES EXPERIMENTAL SET YOU GET:

One each 48 inch x $\frac{1}{16}$ inch, 24 inch x $\frac{3}{32}$ inch, 18 inch x $\frac{1}{8}$ inch covered with polyvinyl chloride sheathing and one each 12 inch x $\frac{3}{16}$ inch, 6 inch x $\frac{1}{4}$ inch covered with crush-resistant aluminum tubing.

List price of the complete set is regularly \$55.75—but you pay just \$25.00! When ordering, please use your company letterhead. Send request with check or money order to Bausch & Lomb, 29901 Bausch Street, Rochester, New York 14602.

NOTE: For applications requiring the transmittance of an image, Bausch & Lomb Coherent Light Wire bundles are available in any length up to 4 feet.



BAUSCH & LOMB 

In Canada, Bausch and Lomb Optical Co., Ltd., 16 Grosvenor St., Toronto.

soldering; a frame is replaceable (without disturbing any mat wires) by heating the pins and sliding a thin blade between them. Flexibility in design is made possible by accommodating a variety of winding configurations with up to 32 sense and inhibit terminals. The plane is available, off-the-shelf, with 30-mil Ferramic^R cores in the following matrices: 1 bit — 128 x 128; 2 bits — 64 x 128; 4 bits — 32 x 128; 8 bits — 16 x 128; 4 bits — 64 x 64; 8 bits — 32 x 64; and 16 bits — 32 x 32. The plane can also be strung with 20-mil cores. Although Cor-Gard is designed for coincident current applications, it can be modified for linear select memories on special request. The plane meets temperature requirements of MIL-E-5400 and MIL-E-16400. Electronics Div., Memory Products, Indiana General Corp., Keasbey, N. J.

Circle No. 213 on Inquiry Card

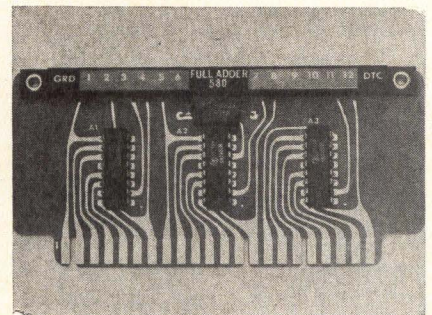

12-BIT ADDER

Twelve-bit adder, consisting of three four-bit circuits, performs a four-bit addition in 60 nsec, and a carry in 48 nsec. Test points are provided on all circuit outputs, and a unique color-coded test point strip clearly identifies each test point, without card removal. With power requirements of +5 volts, 78 mA, the unit features a decoupling capacitor for minimizing noise interference, and is compatible with the Blue Chip modules and all DTL and TTL logic circuits. Module size is 5.4" x 2.16" with gold-plated 44-pin connector. Data Technology Corp., Mountain View, Calif.

Circle No. 219 on Inquiry Card

TEST PANEL

A telegraph-data test panel for fixed installations has recently been announced, which combines units providing both generating and testing

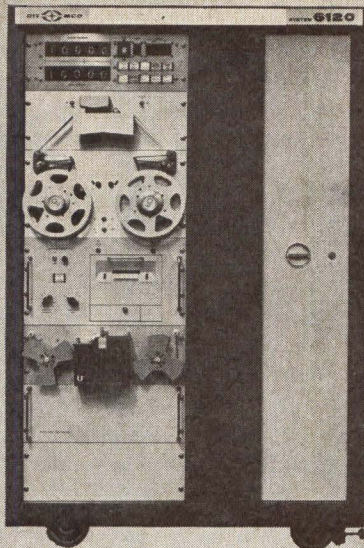

**FASTEST WIRING
SYSTEM ANALYZER
IN THE WEST AND
EAST AND NORTH
AND SOUTH.**

The DIT-MCO System 6120 walks tall in the world of wiring system analyzers. It's a tough, versatile and highly adaptable testing unit that's ready, willing and able to meet today's demand for speed, accuracy and flexibility. Works on the latest fully automatic taped program and printout concept.

**INSULATION TEST
CAPACITY:
2010 PER MINUTE!
CONTINUITY TEST
CAPACITY:
2963 PER MINUTE!**

The DIT-MCO System 6120 has been thoroughly lab and field tested.

Switching Console contains terminal selector and high speed 500-termination Reed relay switching modules that give you a total system capacity of up to 50,000 terminations. Save time, save manpower, save dollars — and — improve both the testing function and the tested product with the DIT-MCO System 6120.

Write for Detailed Specs and Full Information.



DIT-MCO INTERNATIONAL
A DIVISION OF XEBEC CORPORATION

5612 BRIGHTON TERRACE
KANSAS CITY, MISSOURI 64130
TELEPHONE (816) 363-6288
TELEX NUMBER 42-6149

IT'S NO WONDER APPROXIMATELY 90% OF ALL MAJOR MANUFACTURERS IN THE COMPUTER AND AEROSPACE INDUSTRIES ARE SATISFIED USERS OF DIT-MCO SYSTEMS.

CIRCLE NO. 39 ON INQUIRY CARD

facilities. The TMG-3 is a solid state portable test generator that simulates the language of any computer and that programs two characters continuously or one character at a time in 5, 6, 7, or 8-level codes. The new test panel, providing this broad test capability in a fixed installation, will enable communications and other test centers to find trouble quickly, easily, and economically. According to the manufacturer, it has been the habit of small or extremely busy installations to rely on portable test packages for routine testing. This new product, which will measure and test all data signals, also has jacks for testing MIL-188B interface, EIA interface, and conventional teletype loops, so will permit such installations to have an always-available, economical unit to do the same jobs. H. I. Clarkson Associates, Washington, D. C.

Circle No. 217 on Inquiry Card

PRINTED CIRCUIT CORREDS

Miniature printed circuit (MPC) correed, compatible with the high-density packaging demanded by the

computer industry, has a low silhouette (0.350" above the mounting surface), and is said to simplify equipment and system design. Terminals are located on multiples of 0.050" centers to match circuit board grids. Magnetically shielded coils permit close spacing of modules and improve the sensitivity. Each reed switch in an MPC Correed consists of two overlapping ferro-magnetic blades sealed in a glass capsule, and separated at the overlap by a small air gap. They are plated with rhodium over gold at the contact area. Automatic Electric Company, Northlake, Illinois.

Circle No. 210 on Inquiry Card

MAGNETIC TAPE

"Minireels" of magnetic computer tape, 200 feet on a 6-inch reel, are designed to fill a gap in tape packaging resulting from the growing use of remote auxiliary data processing units. In addition to facilitating mailings from such units, the small tapes also offer cost-savings where the relatively limited data do not require standard 2400-foot reels.

"Minireels" also make possible greater efficiencies where magnetic tape input equipment is used to replace punch card operations. Both Audev K-61 and Audev K-68 are offered in "Minireel" form. Audev K-68 is a newly-introduced magnetic computer tape that features specially balanced characteristics for extended reliability in modern digital computer systems. Audio Devices, Inc., New York, N. Y.

Circle No. 207 on Inquiry Card



BINARY TO BCD CONVERTER

A new Binary to BCD converter, which translates binary inputs into a 1-2-4-8 BCD output at a rate of one

micro-second per decimal digit, accepts unipolar binary inputs, or bipolar inputs in one's complement or two's complement code. Binary inputs of up to 20 bits with corresponding BCD outputs of up to 6 decades are available. Conversion capacity of units with less than 20 bits input can be expanded at any time by addition of plug-in cards. The all solid-state Model 3000 converter uses silicon transistors throughout and integrated circuits in the logic circuitry. It is packaged in a 5¼" high, 8½" wide, 12" deep box. Price \$375.00 up. AIC Instruments, Div. of AIC Corp., Houston, Texas.

Circle No. 218 on Inquiry Card

IC VOLTAGE REGULATOR

Designed to power integrated circuits in computers, control, automation, GSE, and other systems using digital logic, a new device is said to advance the state-of-the-art of voltage regulators to that of integrated circuits. Markedly improved performance is claimed because this I. C. voltage regulator 1) dissipates only 20% of the power consumed by conventional regulators; 2) distributes power to digital systems in the form of higher voltage and lower current; 3) delivers high current only at the point of installation; and 4) reduces system noise by reducing buss bar currents. Circuitry and operating characteristics conform with integrated circuit requirements. Size: 1-9/16 x 1¼ x ½ in. high. With an output power of 2.5 W., unit provides an output voltage of 4.5, 5.0, or 5.5 VDC from a nominal input voltage of 20V. Efficiency at full load: greater than 65%. Designed to operate in the 0° to 65°C. temperature range. Gar Enterprises, Pasadena, Calif.

Circle No. 216 on Inquiry Card

MAGNETIC CORE MEMORY

Model DC-31 Magnetic Core Memory is a compact 2D high-speed device featuring random access operation with full cycle time of less than 900 nanoseconds. Memory access time is less than 450 nanoseconds. Maximum capacity of the unit is 1024 x 12 in one bit per word increments. Prices for the new unit start at \$1210 and delivery can be made in 30 days. Datacraft Corp., Fort Lauderdale, Florida.

Circle No. 235 on Inquiry Card

LOGIC TRAINER

A digital logic trainer designed especially for the teaching of digital computer logic is said to use 60 separate basic computer circuits, identical to those employed in computers in industrial and commercial use today, to enable the student to construct computer logic circuits. Each of the 60 circuits is screened on the front panel and corresponds to the logic diagram in the student manual which accompanies the trainer. This versatile device may be used in the teaching of computer maintenance and logic systems breadboarding. A telephone dial and numerical display panel combine to serve as an input-output device which simulates entering and retrieving data from a computer. Designed for continual use, the unit uses solid-state components mounted on individual printed circuit boards. It also contains built-in short-circuit protection. A removable rear panel provides access to all components for instruction in computer maintenance and servicing. Digital Electronics, Inc., Plainview, L.I., N.Y.

Circle No. 243 on Inquiry Card.

HYPERBOLIC CONTACT

A hyperbolic contact for use in all electrical connectors and interconnection devices utilizes a design concept that is basically linear generatrices of a hyperbola achieved by stringing very fine wires inside a tube at some angle to the tube axis and securing these wires to the tube ends. The tube then receives an outer sleeve with the appropriate terminal (solder cup, pin, turret, wire wrap, etc.) and the socket is complete. The inserted pin is "hugged" in a grip of taut wires. Extremely low contact resistance, low insertion/extraction forces, over 100,000 mate/unmate life cycling, and no noise (discontinuity) at high shock or vibration levels are achieved by the hyperbolic wire design. High density, multiple pin connectors are capable of being mated and unmated by hand, thus permitting lighter and less expensive jacking or locking devices. This contact design is applicable to all common and many non-standard connector configurations including cylindricals, rack and panel, edgeboards, etc. Contacts will be initially available in size #'s 26, 20 and 16,

and later in all other commonly used sizes. The insertion/extraction forces and contact resistance parameters may be varied by changing the angle of inclination of the wires and/or the number of wires in the socket. Increase of angle within the range 6°-10° increases insertion/extraction forces and decreases contact resistance. Increasing the number of wires employed produces the same effect. Wire materials are normally phosphor bronze or beryllium copper. With variations depending on connector materials, accessories, finish, specifications, etc., price per mated contact pair will begin at 6¢ to 9¢. Industrial Electronic Hardware, New York, N.Y.

Circle No. 244 on Inquiry Card.

PROGRAM BOARD

A new program board engineered for machine-tool programming applications features 12 x 33 hole format and 12 x 3 spares for pin storage. It will permit pre-selection of spindle speeds and tool selection, and is supplied drilled for lights to indicate program step and active functions per step. The board is supplied with engraving for easy program set-up of machine tool functions and is supplied with a drilled cover panel for indicator lamp mounting. Sealectro Corporation, Mamaroneck, N.Y.

Circle No. 246 on Inquiry Card.

SNAP-IN INDICATOR

Snap-in neon glow indicators feature long operating life, low cost and are self-securing for dependable electrical connections. Simple, square lenses permit the indicators to be mounted exactly side-by-side for compact installations, and lend themselves to a wide variety of applications as panel indicator lights. Two models are available in different neon lamp intensities: a bright bulb intensity for a 5,000 hour operating life, and a medium intensity for a 25,000 hour life. Each is available in red, clear, amber, and opal for color coding various circuits, switches, parameters, etc. All assemblies are complete with lamp; incandescent models available 4 to 28 volts. Chicago Switch, Chicago, Ill.

Circle No. 247 on Inquiry Card.

COMPOSITING SYSTEM

A portable integrated digital compositing system employing disk pack and a core memory provides rapid access to limited amounts of data. Coupled with this is the random access disk pack capable of holding in excess of six million bits of data. The system concept replaces the tape loop as a mass storage medium. From an operator's viewpoint, the entire memory system can be thought of as a nearly instantaneous access, 6-million bit, all-electronic memory. The primary features of the compositing system are: continuing normalization during compositing operation; compliance with either SEG format A or B (it has an exponent resolution of 6db); stacked conventional recordings, fixed gain recording, and binary gain recordings (since it incorporates floating point addition it will accept the information with or without gain coding information); instant start capabilities because of its random access feature (no tape or other mechanical changes are necessary when changing sampling rate and length of recordings); reliability far exceeds tape loop systems because disk files are practically error free. Dresser Ind., Houston, Texas.

Circle No. 249 on Inquiry Card.

STEPPING MOTOR SYSTEM

A computer-controlled system incorporating both software and hardware is now available for use in stepping motor applications. The computer automatically selects the motor to be driven and programs its operation according to a prescribed stepping sequence. If the application requires that the computer control a number of stepping motors, they can be accommodated on a real-time basis, including positive regulation of their acceleration and deceleration characteristics. Feedback from transducers governing how far these motors are to be moved on the basis of readings from an analog-to-digital converter is also assimilated by the new system. Typical applications include numerical control machine problems, computer-controlled gain systems, circuit synthesizing networks, and stage lighting control systems. IRA Systems, Lexington, Mass.

Circle No. 250 on Inquiry Card.

**this man has
your printed
circuit problems
well in hand**

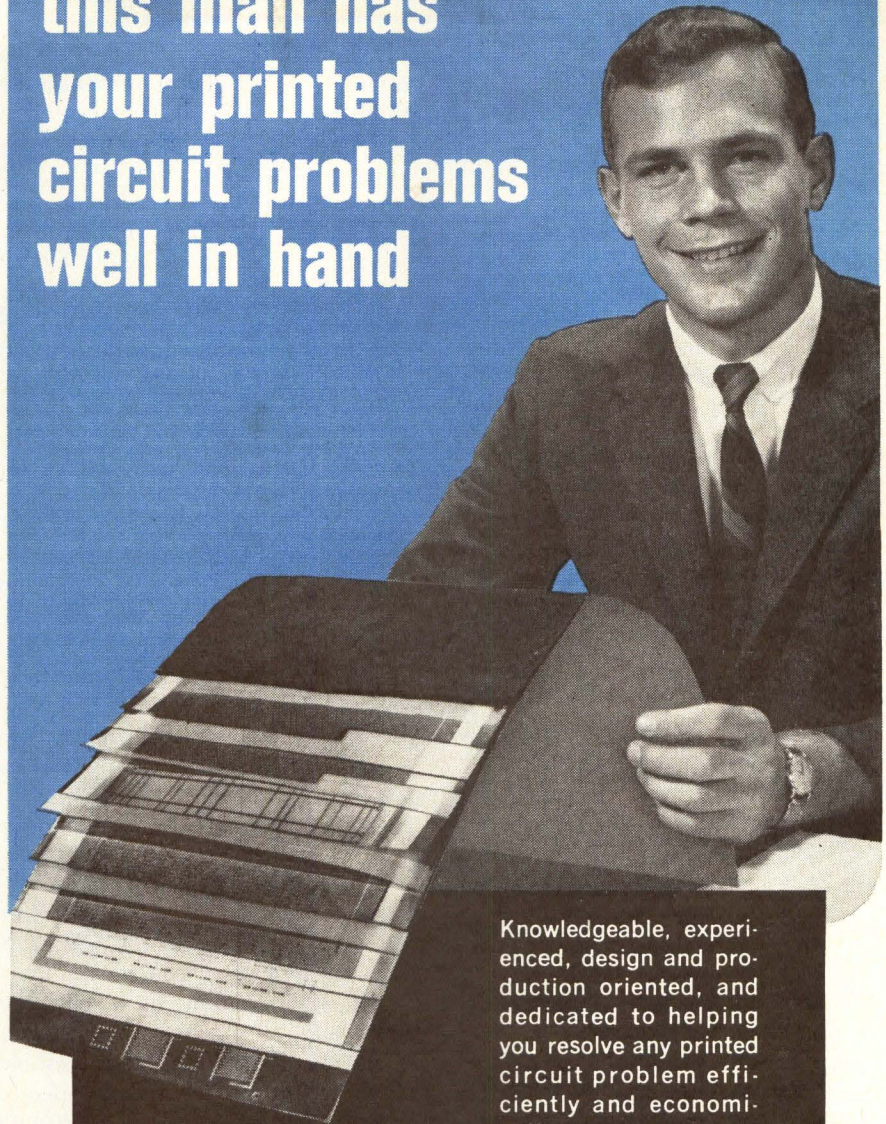

Knowledgeable, experienced, design and production oriented, and dedicated to helping you resolve any printed circuit problem efficiently and economically.

Methode is staffed, equipped, and experienced to provide you with a practically limitless printed circuit production capability from sub-miniature to king size, single to multi-layer boards with as many as 20 layers — with an established reputation for performance and reliability to meet the demands of any product, military or commercial.

If the space-age is pushing you into multi-layer integrated circuit designs, METHODE can show you how to keep the number of layers to a minimum. Your production costs will be reduced; reliability increased.

We are confident these capabilities can prove beneficial to you.

We invite your inquiry.



Printed Circuit Division

Methode Electronics, Inc.

General Offices:

7447 W. Wilson Ave., Chicago, Illinois 60656 • 312 867-9600

CIRCLE NO. 41 ON INQUIRY CARD

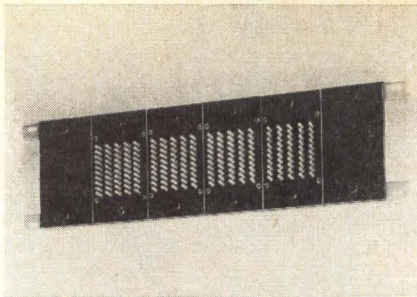

PROGRAM BOARD

A 10 x 20 captive pin programmer, featuring modular construction and bussed upper-individual lower contacts, mounts in a standard 19" cabinet rack. A maximum of six 10 x 5 individual modules can be grouped in the board to provide up to 10 x 30 of program selection. Features include spare "blank" panels and pins that "make" in the up position. Pins and contacts are available with either gold or silver plating for minimum contact resistance. The design employed permits rapid programming and program cancellation. Sealectro Corporation, Mamaroneck, New York.

Circle No. 211 on Inquiry Card

IC SENSE AMPLIFIERS

A new generation of integrated circuit sense amplifiers, called series 7520N, are designed for high-speed coincident-current computer memory systems. The ICs detect bipolar, differential-input signals from the memory, and provide a faster, more stable interface between memory and logic sections than previously available sense amplifiers, either in discrete or integrated form. Low-level pulses originating in the magnetic-core memory are detected and translated into logic levels compatible with standard TTL or DTL circuitry. The computer designer may choose from three basic circuit designs — two versions of dual preamplifiers driving common-output circuits, or two complete sense amplifiers in a single package. Two threshold levels for each of the three basic circuits provide additional design versatility. Series 7520N sense amplifiers offer substantial cost savings because of four factors. First, dual amplifiers in a single chip inherently cost less than two separate packages. Second, a selection from six different combinations of circuit

complexity and threshold sensitivity enables the designer to use and pay for only that level of performance actually needed. Third, a high degree of integration reduces the amount of peripheral circuitry required. And fourth, encapsulation in a 16-pin dual in-line plastic package reduces assembly cost. The SN7520N and SN7521N sense amplifiers include dual preamplifiers driving a common-output circuit consisting of two cascaded TTL NAND gates, each with external gate inputs. Complementary-output logic levels compatible with standard TTL, and two strobe inputs permit application flexibility. Differential input threshold voltage for the SN7520N ($V_{ref} = 15$ mV) ranges from 11 to 19 mV, while the SN7521 ranges from 8 to 22 mV. Threshold-voltage levels of the SN7522N and SN7524N are the same as the SN7520N, and the SN7523N and SN7525N correspond with the SN7521N. These input threshold levels are virtually drift-free over a wide range of power-supply voltage levels (15 to 40 V) and temperature ranges (0° to 70°C). This stability is the result of a "matched amplifier" design, based on matched resistor ratios rather than absolute values. The SN7524N and SN7525N units include two completely independent but simple sense channels in a single chip. A common reference voltage establishes the threshold level on both channels simultaneously. The outputs are TTL gates with high fan-out. Typical characteristics of the entire series are low propagation delay (25 nsec input-to-output and 15 nsec strobe-to-output), fast overload recovery time to both differential and common-mode signals (20 nsec with 2-volt input), and high d-c logic noise margin (1 V). Independent strobing of dual sense-input channels permits signal detection to take place when signal-to-noise ratio is at a maximum. Logical "1" output is 3.9 V and logical "0" is 0.25 V. Supply voltage is ± 5 V. The new sense amplifiers are available in production quantities. Prices at the 100-999 quantity level are \$13.20 for SN7520N, \$10.10 for SN7521N, \$12.65 for SN7522N, \$9.50 for SN7523N, \$11.90 for SN7524N, and \$8.90 for SN7525N. Texas Instruments, Dallas, Texas.

Circle No. 232 on Inquiry Card

D/A CONVERTER SYSTEM

An integrated circuit digital to analog converter system, designed for use as an output device for general purpose digital computers, Data Loggers, PCM Decommutter or systems outputting address and data in a parallel binary multiplex, accepts 8, 10, or 12 bit binary data at rates up to 100-kc. The system includes front panel mounted thumb-wheel switches which allow decommutation of any 16 selected words from the multiplex source. Analog output signals from the converter are plus or minus 10-volts with output currents to 100 milliamps. The device includes such options as bi-level channels, bi-polar operation, and sub-frame decommutation, thus providing many possible operational configurations for custom system applications. Discon Corp., Fort Lauderdale, Fla.

Circle No. 233 on Inquiry Card

TAPE READER

The Model 1282 paper tape reader is a low cost, asynchronous device adaptable to a wide variety of paper and mylar tape processing applications. The standard unit reads 8-level 1 inch tape; other models are available for 5, 6, and 7-level narrow tapes. Extremely compact and reliable, the reader offers positive interrogation of even those tapes that are well worn or that exceed EIA hole-to-hole tolerances. Paper or mylar tape is advanced and sensed at up to 30 characters per second, asynchronously. A push-button permits manual advance of tape. The extremely small size of the tape reader (4"L x 3 $\frac{3}{4}$ "H x 1 $\frac{1}{2}$ "W) permits it to be mounted on the same plane as the tape spools; no separate mounting plate or rear mounted driving motors are necessary. Shock mounting is available as an option. The pin sensing method ensures long tape life because the pins do not rub against the tape but are withdrawn when the tape is in motion. Even when sensing, each pin exerts only 20 to 30 grams of pressure against the tape. In current life tests, the reader has sensed and advanced standard parchment tape over 10,000 times without tape damage. No external drive mechanism is required. A single external advance

pulse (45V, 6.5 amp peak) is used to feed and interrogate tape. Driver units are available as separate assemblies. Internally timed, the tape reader is controlled solely by the inertia of its few moving parts, a characteristic which never varies. It requires a minimum of lubrication and field adjustment. Price is \$295 and is available from stock. Navigation Computer Corp., Norristown, Pa.

Circle No. 234 on Inquiry Card

LOW POWER DTL IC's

Low power DTL integrated circuits are available in a new ceramic-and-metal "dual in-line" package with "plug-in" capability. Called the "CD2200D Series," the low power DTL circuits are electrically identical with the RCA CD2200 Series, but utilize the ceramic-and-metal 14-lead "dual in-line" package employing the popular 100-mil lead spacing and 300-mil spacing between rows. This package provides "plug-in" capability and embodies several unique design features which contribute to its reliability, hermeticity, and ruggedness. The hermetically sealed ceramic units are designed for application in aerospace and airborne computers, portable military equipment, instrumentation and industrial control equipment and other applications where circuits with low device dissipation and high noise immunity are primary design requirements. Features of these low power DTL integrated circuits are: low device dissipation of 2.3 mW per gate or 7 mW per flip-flop; full military operating temperature range of -55°C to $+125^{\circ}\text{C}$; low impedance T²L type output; excellent noise immunity of 1200 mV typical at 25°C ; and typical flip-flop clock frequencies of 3 MHz for a fanout of 5. RCA Electronic Components and Devices, Harrison, N.J.

Circle No. 236 on Inquiry Card

DELAY MODULE

A 5 MS delay module employs a magnetostrictive delay line in the RZ mode and interfaces directly with DTL 930 micrologic and TTL. Designated model 213A/RZ-9, the new module is designed specifically for logic and information processing engineers who desire a digital delay

delttime[®] SONIC DELAY LINES

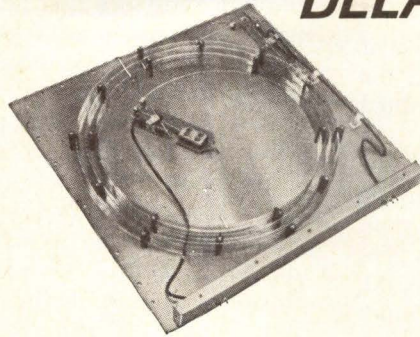

for
Digital,
Analog
or
Memory
Applications

Delttime, with over a decade of experience in the design and manufacture of precision sonic (magnetostrictive) delay lines, offers models to fill virtually every requirement. Delays from 10 to 10,000 microseconds, as well as complete input/output circuit modules, including units using the latest integrated circuit technology, are offered for RZ, NRZ or carrier applications. Torsional, longitudinal, tapped and adjustable delay lines with units designed for airborne and other high shock and vibration environments are also included in the standard line.

If your application requires a signal delay or extremely economical delay line memory element, contact us. Our application engineers are at your service . . . or write for our complete technical literature.



® SUB-SYSTEMS DIVISION

SEALECTRO
CORPORATION

MAMARONECK • NEW YORK 10543

PHONE: 914 698-5600 TWX: 710-566-1110

Sealectro Ltd., Portsmouth, Hants, England

CIRCLE NO. 42 ON INQUIRY CARD

module for direct interface with their integrated circuitry. Only input pulse data and a suitable power supply are required for operation. In addition, the module easily converts into a serially-recirculating memory through the addition of an external feed-back loop with appropriate gating and clocking. The device features a maximum delay of 5 MS with a 1 MHz prf. Power supply requirements are +10 volts DC, $\pm 10\%$, 56 ma; -10 volts DC, $\pm 10\%$, 20 ma and +5 volts DC, $\pm 10\%$ at 35 ma. Sealectro Corporation, Mamaroneck, New York.

Circle No. 237 on Inquiry Card

ON-LINE INPUT DEVICE

A versatile, low-cost, on-line computer input device that rapidly and accurately transmits alphanumeric and graphic information as a function of its X-Y page position is said to require less communication time and bandwidth than keyboard type computer terminal devices, reduce operator errors, and permit fast, economical information han-

dling in applications such as hospital and management information systems, reservation systems, planning, production and inventory control, and computer-aided teaching. Called Datacoder, it consists of a traveler and manually operated cursor linked to wipers on a pair of X-Y 8-bit Grey encoder boards. The introductory model of the unit is fully enclosed in an 18" x 20" x 3" cabinet, and has a 12½" x 10½" active working area. The Datacoder is used in conjunction with a teletypewriter in a remote, time-shared computer terminal. In operation, possible input data are typed out in list form (up to 63 lines of standard teletypewriter printing per sheet) by the computer, which maintains an image of the location of individual items on the list. After placing the list on the Datacoder, the operator selects an individual item with the cursor and presses the "Transmit" button. The X-Y coordinates of the selected item are sent to the computer, and the item is identified by comparison with its retained image on the list. In graphic-to-digital applications — such as transmitting

data from charts, graphs, etc. — the operator selects the graphic data to be digitized with the cursor. The encoder boards are strobed from an external source when the "Transmit" button is pressed. This provides a direct digital output of the X and Y coordinates of the cursor. Data can be transmitted from hard copy or from film and slide images projected through the Datacoder's translucent working surface. Accuracy is better than $\pm 0.5\%$; resolution is 1 part in 256. Small quantity price is \$995.00. Bolt, Beranek and Newman, Santa Ana, Calif.

Circle No. 221 on Inquiry Card

WIDEBAND DC AMPLIFIER

Gains up to 12,500 at very low noise levels are possible with a new wide-band dc data amplifier. Called Model 2820, it is a direct-coupled, active guard differential amplifier designed for research instrumentation and data acquisition. In addition to low noise the unit features outstanding rejection of RF interference, wide bandwidth, and a high level of common mode rejection. Full scale output is ± 10 volts and ± 100 mA. It provides differential isolation between the input signal source and output common. No common mode return path is required to achieve a common-mode rejection of 120 dB, dc to 60 Hz. If desired, the amplifier may also be used as a single-ended unit, inverting or non-inverting, in applications in which either the signal source or the load is isolated from ground. System noise contributed by the amplifier circuitry is exceptionally low. The noise referred to the input at a gain of 1,000 is less than 4 microvolts rms at full bandwidth and less than 1 microvolt, peak to peak, at a 10 Hz bandwidth. Gain controls include specific gain settings, plus a vernier that covers a range equal to $2\frac{1}{2}$ times the nominal gain setting. The result is a continuously variable gain from the lowest setting to $2\frac{1}{2}$ times the highest setting. Up to eight amplifiers fit in a standard 7-inch by 19-inch rack supplied by the manufacturer. Dana Laboratories, Inc., Irvine, Calif.

Circle No. 222 on Inquiry Card

MEDIUM CURRENT SILICON RECTIFIERS

A new series of medium-current silicon rectifiers is said to meet the moisture resistance specifications required by glass-to-metal seal types. Designated Series M, these rectifiers offer stable uniform electrical characteristics by using a passivated double-diffused junction technique. Using compact tubular construction, Series M rectifiers incorporate pure silver axial leads to facilitate point-to-point circuit soldering and to provide excellent thermal conductivity. Many stud-mounted types can be replaced by this design and reduced assembly costs are claimed. Standard and bulk avalanche types are available in voltage ratings from 50 to 1000 volts PIV and currents range from 1.5 to 3.0 amps. Edal Industries, Inc. East Haven, Conn.

Circle No. 227 on Inquiry Card

COMPUTER GRAPHICS SYSTEM

A high precision CRT display system, which has been signed for real-time and analytical off-line applications, includes a 16-inch cathode ray tube masked to a 10.24 by 10.24 inch image area, vector generator, intensity compensation logic, electromagnetic deflection network, maintenance controls and a digital control unit. Standard system options include a high-speed character generator, line texture control unit, light pen, function switches and a computer graphics processor. Systems Engineering Labs, Ft. Lauderdale, Fla.

Circle No. 226 on Inquiry Card

CHIP CAPACITOR

Introduction of a broad line of miniature chip capacitors, to be used in thick or thin film hybrid circuits for filtering, buffering, bypass, coupling, timing and tuning applications, has been recently announced. The K1200 bodies are available in a capacitance range of 120pf to 3.3 Mfd with voltage ratings of 50, 100 and 200 VDCW. Standard tolerance is $\pm 10\%$, with $\pm 5\%$ and $\pm 20\%$ available. Sixteen body configurations are scaled from .075" x .035" x .040" to .865" x .595" x .080". The monolithic chips have silver

electrodes as standard, with gold or palladium gold also available. The precious metal electrodes provide excellent bonding characteristics for mounting by soldering or welding. The chips are manufactured through an exclusive process which insures the stability of the electrical characteristics while optimizing high capacitance packing into small physical size units. Moisture resistant and contamination free, the chips meet all applicable paragraphs of MIL-C-11015 and MIL-C-39014. Prices range from \$.13 to \$1.86 in production quantities. Availability is 10 days. U. S. Capacitor Corp., Burbank, Calif.

Circle No. 225 on Inquiry Card

SIX FORM "A" REED RELAYS

Designed for low-level switching, multiplexing and many other switching applications, a new reed relay card provides six Form "A" normally open single-pole single-throw contact relays each controlled with a 3-input driver. The reed contact is closed when all three inputs to each driver are true and open when any one of the three inputs is false. Only one +5v power supply is required. Each IC driver is protected from reverse surge by diodes mounted on the card. The IRR-2293 sells for \$84.00. Delivery is stock to 4 weeks. Form "C" (make before break) single-pole double-throw contact relays are available as IRR-2294. Price is \$100.00. Electronic Engineering Co., Santa Ana, Calif.

Circle No. 224 on Inquiry Card

FIVE-INCH-ROUND CRT

A compact high-brightness CRT that features 70 degrees magnetic deflection and a 0.004-inch (4 mil) line width has been developed for use in precision airborne radar and other monitor display applications. The CRT's 5-inch-diameter, aluminum faceplate allows 90 percent light transmission. The electrostatically focused tube weighs only one pound, is less than 8 inches long, and has a 0.87-inch-diameter neck. It can be mounted in any position and is inherently rugged. Other important features of the unit include flying leads and low deflection power. Although normally supplied with phos-

phor P31, it is available with most standard JEDEC phosphors to suit various applications. Westinghouse Electronic Tube Division, Elmira, N. Y.

Circle No. 223 on Inquiry Card

DDC CONTROL OF BATCH PROCESSES

BATCH, a software system designed to simplify programming for direct digital control of batch sequence processes, is designed to run in a minimum of core memory. The new system can be easily learned and applied by process people who do not have a background in computer technology. Process engineers may write batch process control programs using 12 basic control statements such as CONT (Contact Output) and SETV (Set Value). BATCH can reduce the cost of a batch process computer system by reducing programming time by the vendor or user. The system has been used successfully to program batch processes in textile mills and chemical plants and has shown promise for use in the start-up and shutdown of continuous processes. BATCH consists of a language, a compiler and an operating system. The compiler converts the language into an operational sequence control program. The operating system executes the compiled statements and implements the actual sequence control. Foxboro Co., Foxboro, Mass.

Circle No. 242 on Inquiry Card.

VOLTAGE REGULATOR

A hybrid, cermet thick-film, adjustable d-c voltage regulator, Model 806 can be externally adjusted to provide any output from +3 to +9 volts with $\pm 0.1\%$ regulation for both line and load variations. It is short-circuit proof and has a current handling capability of 0.5 amps. Operating temperature range is from -55°C to $+125^{\circ}\text{C}$, and power dissipation is 5 watts at $+25^{\circ}\text{C}$ with heat sink. All units are fully sealed and environmentally tested to meet the most stringent aerospace and military specifications. The new solid-state regulator measures only 1" x 0.5" and is 0.170" high. Beckman Instruments, Fullerton, Calif.

Circle No. 245 on Inquiry Card.

Ferranti-Packard Paper Tape Readers sales & service-as close as your phone

Our representatives cover every state in the Union. They can help in selecting and servicing the proven Ferranti-Packard reader to meet your needs. For the name of our representative nearest you, check the listings below, or if you prefer, contact us direct. Write, wire, or better still, just phone.

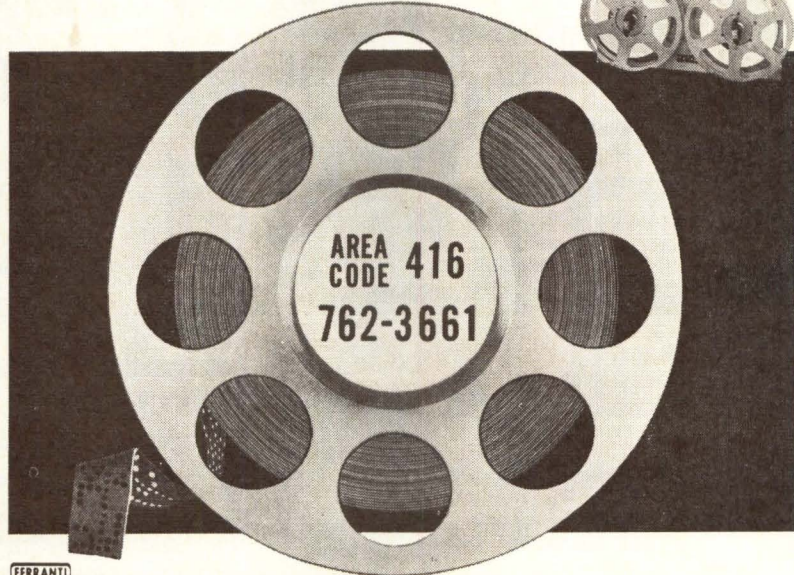
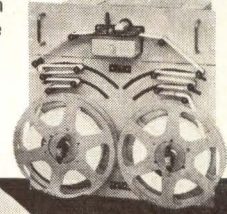

FERRANTI-PACKARD ELECTRIC LIMITED
ELECTRONICS DIVISION • TORONTO 15 • ONTARIO • CANADA
AREA CODE (416) 762-3661 TWX (610)491-1434

REGIONAL REPRESENTATIVES

NEW YORK / LONG ISLAND

Wild and Associates Inc.,
200 Michael Drive,
SYOSSET,
Long Island, N.Y., 11791
(516) 921-7100
TWX 510-221-2187

NORTHERN NEW JERSEY

Wild and Associates Inc.,
P.O. Box 300,
RAMSEY,
New Jersey, 07446
(201) 327-4244

MARYLAND / VIRGINIA WASHINGTON, D.C.

Wild and Associates Inc.,
1011 North Highland St.,
ARLINGTON,
Virginia, 22201
(202) 524-2274

PENNSYLVANIA / DELAWARE SOUTHERN NEW JERSEY

Wild and Associates Inc.,
80 Second Street Pike,
SOUTHAMPTON,
Pennsylvania, 18966
(215) 357-6645

UPPER NEW YORK STATE CONNECTICUT

Wild and Associates Inc.,
P.O. Box 266,
HASTINGS-ON-HUDSON,
New York, 10706
(914) 963-3803

VERMONT / RHODE ISLAND MAINE / MASSACHUSETTS NEW HAMPSHIRE

Wild and Associates Inc.,
570 Hillside Avenue,
NEEDHAM,
Massachusetts, 02914
(617) 444-2366

OHIO / W. PENNSYLVANIA MICHIGAN / WEST VIRGINIA

REP/CORP.,
2077 Embury Park Road,
DAYTON,
Ohio, 45414
(513) 278-5885

MISSOURI / OKLAHOMA / KANSAS ARKANSAS

Engineers International Co.,
P.O. Box 35601,
DALLAS,
Texas, 75235
(214) 352-2666

TEXAS

Engineers International Co.,
954 Corbindale,
HOUSTON,
Texas, 77024
(713) 465-9246

NEVADA / ARIZONA WASHINGTON / OREGON CALIFORNIA

Roland Olander & Company,
540 Hollywood Way,
BURBANK,
California, 91505
(213) 843-5200
TWX 910-498-2720

ILLINOIS / WISCONSIN

Scientific Sales Corporation,
7132 N. Harlem Avenue,
CHICAGO,
Illinois, 60631
(312) 775-7595

FLORIDA

Technical Associates Inc.,
2319 E. South Street,
ORLANDO,
Florida, 32803
(305) 424-5681

IOWA / MINNESOTA NORTH AND SOUTH DAKOTA NORTHERN WISCONSIN

Scientific Sales Corporation,
6121 Excelsior Boulevard,
MINNEAPOLIS,
Minnesota, 55416
(612) 929-6115
TWX 910-576-2404

INDIANA — KENTUCKY

Scientific Sales Corporation,
706 Sherwood Drive,
INDIANAPOLIS,
Indiana, 46240
(317) 545-9950

ALABAMA / MISSISSIPPI WESTERN TENNESSEE

Technical Associates Inc.,
P.O. Box 4088
HUNTSVILLE,
Alabama, 35802
(205) 881-8494

LOUISIANA FLORIDA PANHANDLE

Technical Associates Inc.,
P.O. Box 731,
SLIDELL,
Louisiana, 70458
(504) 288-7122

NORTH & SOUTH CAROLINA TENNESSEE / GEORGIA

Technical Associates Inc.,
P.O. Box 5583,
SPARTANBURG,
South Carolina, 29301
(803) 585-3864

CIRCLE NO. 43 ON INQUIRY CARD

6711A

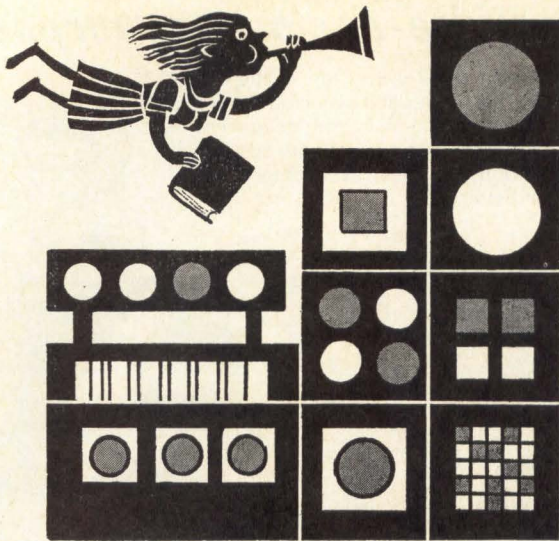

COMPUTER INDUSTRY ANNUAL 1967-68

**NOW AVAILABLE IN
HARD COVER EDITION**

The industry's first complete reference
guide and directory. 390 pages.

Over 33,000 copies already distributed.

FEATURING

COMPUTER PRIMER FOR MANAGEMENT

COMPUTER MANUFACTURERS' PROFILE . . . sales and earnings records, corporate highlights, stock price performance of 18 computer companies.

MARKET SURVEY . . . results of industrywide survey of annual sales volume of 400 types of computer-related products and services.

SURVEY OF TIME-SHARING FACILITIES

DIRECTORY OF PRODUCTS . . . contains over 400 types of computer-related products with corresponding manufacturers listed after each.

DIRECTORY OF SERVICES . . . contains nearly 200 service firms and 21 different types of computer-related services such as software development, equipment leasing, personnel recruitment, time-sharing etc.

MANUFACTURERS' INDEX . . . Alphabetical list of nearly 2000 suppliers of computer-related products and services. Includes corporate addresses, sales offices, national sales managers, number of employees and annual sales.

EQUIPMENT CHARACTERISTICS REVIEW . . . in-depth review

of all currently available computers, peripherals and major components. Includes 81 pages of Product Summary Charts to aid in equipment selection and competitive analyses. The following products are reviewed in detail:

- DIGITAL COMPUTERS
- ANALOG & HYBRID COMPUTERS
- DATA COMMUNICATIONS TERMINALS & PROCESSORS
- GRAPHIC DATA SYSTEMS & DEVICES
- EDP FORMS
- EXTERNAL STORAGE SYSTEMS
- INTERNAL MEMORY SYSTEMS
- DIGITAL MAGNETIC TAPE SYSTEMS
- COMPUTER PRINTERS
- PUNCHED CARD EQUIPMENT
- PUNCHED TAPE EQUIPMENT
- INPUT TYPEWRITERS & KEYBOARDS
- LOGIC CIRCUITS & MODULES

→
SEND
COUPON
NOW
→

PRICE:
\$18.50

including
quarterly
updating
supplements.
Make checks
payable
to:
**SIMON &
SCHUSTER,
INC.**

SEND ORDERS TO:
SIMON & SCHUSTER
1 WEST 39th ST., N.Y. 10018

Enclosed is my check for \$.....
for.....copy(ies) of the 1967-68
Computer Industry Annual.

Enter my order for.....copy(ies)
of the 1967-68 Computer Industry Annual.
Bill me \$18.50 per copy plus shipping and
handling charges.

PLEASE PRINT

NAME TITLE

COMPANY

STREET

CITYSTATEZIP

SIGNATURE

ORGANIZATIONAL CLASSIFICATION OF MY COMPANY OR DEPARTMENT (check one best descriptor)

- | | |
|---|---|
| <input type="checkbox"/> 1. Mfgs. of computers, data processing equipment, or related systems or components. | <input type="checkbox"/> 5. EDP consulting & service organizations (excluding those connected with mfg. co.). |
| <input type="checkbox"/> 2. Mfgs. of consumer or industrial products (other than computer-related equipment). | <input type="checkbox"/> 6. Business & commercial (finance, banking, insurance, real-estate, wholesale & retail trade, etc.). |
| <input type="checkbox"/> 3. Government installations (federal, state or city including military). | <input type="checkbox"/> 7. Utilities (transportation, communications, electric, gas, etc.). |
| <input type="checkbox"/> 4. Educational institutions (colleges, universities, schools, etc.). | <input type="checkbox"/> 8. Other |

DESK-TOP READER



Developed by Motorola Instrumentation and Control, a desk-top reader, called "MDR-1000", provides a simple means of entering into a data processing system, in computer language, data marked or punched on cards or marked on standard 8½" x 11" documents. Cards can be fed into the device singly or automatically in batches of up to 500 with an optional automatic hopper.

The reader offers systems designers a new, low-cost method of getting raw data, right from the source, without need for skilled data processing equipment operators. In addition, the unit is small enough (16¾" wide by 16¼" deep by 9¾" high) to fit almost anywhere.

The MDR-1000 produces a standard USASCII output that is compatible with standard telephone transmission interfaces for long-distance transmission or directly with standard data processing equipment, such as teletypewriters, tape recorders, or computers. Cards fed to the optical-read head can be either tab-punched or pencil-marked (mark-sense) or carry a combination of both types of data. Thus cards can be prepunched with certain basic or identifying data for later variable data marking by field personnel.

Also, the device will accept mark-sense data from the edge of page-size documents, in a 12-row band equivalent to a standard tab card. Input format for the reader is standard Hollerith coding arranged in either 80- or 40-column spacing. Data can be handled in either bit serial or bit parallel form. Bit serial data rates can be either 10 characters per sec (110 bits per sec) or 105 characters per sec (1050 bits per sec). Bit parallel data rate is 75 characters per sec (750 bits per sec). Parity can be either odd or even.

Besides USASCII, other codes, such as BCDIC, PTT6, and Binary are available on request. Document rates at 10 characters per sec are 5 sec per card for 40-column spacing and 10 sec per card for 80-column. At 105 characters per sec, document rates are 0.5 sec per card at 40-column spacing and 1 sec per card at 80-column spacing.

Communications facilities can be either a 150-Baud channel or voice-grade circuit. The telephone transmission is by Data-Phone Model 202C, 103A, or their equivalents. The electronic interface is dry contact, EIA standard RS-232B. Manual feed is standard, but automatic card feed with a hopper capacity of 500 cards is optionally available. Power requirement is 115 volts AC, 60 Hz. Motorola Instrumentation and Control, Inc., Phoenix, Ariz.

Circle No. 220 on Inquiry Card

ELECTRONICS ENGINEERING POSITIONS IN SOUTHERN CALIFORNIA

Lockheed Electronics Company is the fastest growing commercial computer memory systems company in the country today. Its engineers are involved in all phases of memory systems technology, from the smallest ferrite cores to the largest sophisticated systems. The company is staffed with an engineering team with many years of digital circuit logic and systems design experience.

Openings include:

**DIGITAL CIRCUIT DESIGN
LOGIC DESIGN
MEMORY SYSTEMS ENGINEERING
COMPUTER SYSTEMS DESIGN
APPLICATIONS ENGINEERING**

If you are an experienced electronics engineer interested in joining a growing company backed by the solidarity of a major corporation, write **Mr. A. J. Petit, 6201 E. Randolph Street, Los Angeles, California 90022.** Lockheed is an equal opportunity employer.

**LOCKHEED ELECTRONICS
COMPANY**

A Division of Lockheed Aircraft Corporation

CIRCLE NO. 901 ON INQUIRY CARD

FILM RESISTOR NETWORKS

Eight new standard tin-oxide film resistor networks that exhibit high volumetric efficiency and low noise characteristics are now available for applications where tight packaging of components is required. Number of resistors on a single network range from two to nine. Each network contains one more pin, or lead, than the number of resistors. Resistance values range from a minimum of 20 ohms to a maximum of 250K, depending on purchase tolerance. The eight resistor network types have purchase tolerances of 1, 2, or 5 percent. Also available on special order are networks with 0.5 and 10 and 20 percent tolerances. Tracking between resistors on a single network substrate is typically less than 50 PPM. Resistance values on a single substrate can be matched to 0.5 percent of nominal resistance. The 200 PPM TC of the networks is guaranteed over a range of -55°C to +165°C. A TC of 150 PPM is typical over this temperature range. Load life change is guaranteed to be less than 1.0 percent under tests specified in Mil-R-10509F, characteristic D. Resistance change under low temperature operation at -65°C is typically 0.1 percent and is guaranteed not to exceed ±0.25 percent. Resistance change due to moisture is guaranteed not to exceed 1.5 percent when the units are subjected to 90-98 percent relative humidity at 25°C to 65°C for 240 hours. Corning Glass Works, Electronic Products Division, Raleigh, N. C.

Circle No. 229 on Inquiry Card

DIGITAL PLOTTER

A built-in photoelectric punched-tape reader (with self-contained tape handler), integrated circuit electronics, and a versatile manual control panel are central highlights of the Model 501-1 Digital Plotter. The series, the manufacturer reports, retains all the features of previous first-of-kind lines of equipment which function to produce permanent 3-D removable hard-copy graphs/charts/records from a compact, self-contained desk-height cabinet. Typical uses and fields of application for this unit are cited to include stress and strain measurements, economic growth, urban renewal, traffic engineering, highway design, earth moving, statistical data, historical trends, antenna patterns, servo analysis, circuit analysis, seismic waves, magnetic and gravitational fields, natural resources, ocean currents, demonstration models. Also, design aids, wind patterns, barometric pressures, temperature, ocean floor, salinity, undersea tracking, nuclear measurements, heat flow, electro-magnetic fields, population maps, income distribution. And, teaching aids, race distribution, missile trajectories, aircraft tracking, submarine movements, relief maps, mathematical analyses, earth's strata, industrial design models, others.

The primary feature of the new built-in tape reader incorporated in Model 501-1 is a self-contained tape handler — handling up to 175 feet of paper tape or 500 feet of mylar tape, on easily removable 4-inch diameter tape reels. From this capacity, average size 3-D plots may be prepared with but a single tape loading. Quick rewinding is also a feature of the tape handler. The electronic control section uses DTL integrated circuit logic and all silicon semiconductors. Result is a high degree of noise immunity, plus 0° to 70°C operating temperature range for high reliability. Circuits are mounted on color-coded plug-in cards, with color-coded test points for ease of servicing and maintenance. The manual control panel features a convenient control layout. Here, a single control is provided for simultaneously resetting the X, Y, and Z axes of the plotter before starting a plot. Make-up of a plot is a series of vertical wires firmly fixed into lightweight, removable

plotting board, 12" x 18" x 1/2-inch. Visible from any angle, plot displays mathematical functions or empirical data involving any three variables. The new system operates to receive data in incremental form from eight level punched paper-tape. Data points may be placed anywhere on board within the resolution of positioning mechanism. Stepping motors, internal wire-spool supply, wire cutter mechanism all are within the console. Also included with Model 501-1 is a special Fortran program, PINPLOT, to prepare incremental punched-paper tape for operation of the plotter. This program features scaling, optimizing point density, ordering data. Special requirements may also be met, upon request. Spatial Data Systems, Goleta, Calif.

Circle No. 251 on Inquiry Card.

DATA PHONE INTERFACE

A Data Phone Interface has been designed to complete the connection between any digital data generating, recording, or handling device and the Bell System Data Phone Series, and other similar modems. The DPI-1 can be supplied as a rack mounted unit or in a convenient case which sits beneath the 202-C and supports it, the entire assembly being approximately 1 1/2 inches higher than the Data Phone alone without occupying any additional surface area. The device accepts parallel characters up to 10-bits in length and transmits them serially over the Data Phone link. It also receives serial characters from 5 to 10 bits in length, and presents them in parallel to the user. The unit can be supplied to match any common user signal levels, while its interface with the Data Phone conforms to the EIA RS-232 A specification. The DPI-1 generates its own bit rate clock for transmit and receive, while the user controls the character rate. The interface automatically detects, and resets, false starts due to line impulse noise in the receive mode. Infotech, Westbury, N.Y.

Circle No. 254 on Inquiry Card.

Woven Ribbon Cable

New flat ribbon cable's unique feature is that the bundling is a weaving process, using yarn of nylon, kapton, nomex, teflon, or others

as required. Special features of Fab-Ri-Cable, as it is called, are its light-weight, durability, flexibility, and ribbon thin-ness. It offers wide design and functional possibilities, in that any number of conductors from 4 to 100 may be used, of any tape manufactured today. Single or multiple fold and cut lines are possible. The number of "picks" (cross-weavings) may be varied for tighter bundling or better abrasion resistance. It is possible to route conductors from a single connector to a number of different locations throughout the electronic package. The cable may be tacked, accordion-folded, spiraled, or folded. Zipper-tubing Company, Los Angeles, Calif.

Circle No. 303 on Inquiry Card.

Hardware/Software Evaluator

An evaluation program that enables any 360 user to determine his hardware and software requirements for a communications system before installation encompasses DOS or OS communication's systems run with programs written in BTAM or QTAM macros. According to the manufacturer, the evaluator represents a major breakthrough in eliminating costly design errors in communications systems. The evaluator can pre-determine: 1. The minimum system configuration necessary to handle message loads. 2. The time it takes for messages to pass through the system. 3. The time available for non-communication programs in other partitions. 4. The optimum design for message processing programs. The evaluator can also be used as a design tool for further modification of existing communications systems. It can determine the effect of changes to an existing system before the changes are implemented, and can help 360 users who are planning to install a communications system as well as 360 users who already have a communications system operating but wish to effect certain changes. Perhaps the greatest potential for the program is with second generation users who are planning to go to the 360 and plan to incorporate a communications system. Descriptive literature is available. Worldwide Computer Services, Port Chester, N.Y.

Circle No. 322 on Inquiry Card.

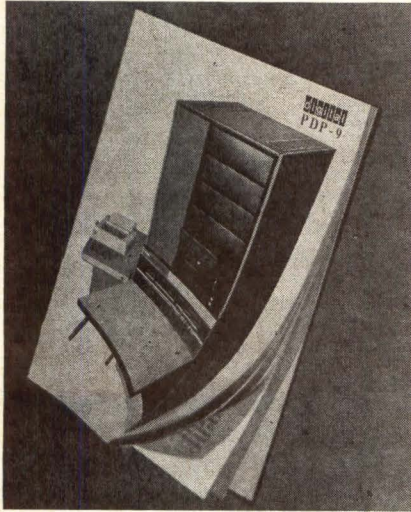

Computer Brochure

50-page illustrated brochure explains the PDP-9 computer system for complex problems in data acquisition, process or instrument control, computation or man/machine communication. The publication's first three pages cover questions and answers in applying the computer, which is priced at \$35,000 for the basic system. Processor and memory specifications, I/O facilities, instructions, software, options and detailed application information also are covered. More than a score of charts, graphs and pictures are included. Digital Equipment Corporation, Maynard, Massachusetts.

Circle No. 316 on Inquiry Card

I/C Capability

Described as being a first-of-its-kind Perpetual Integrated Circuits Condensed Catalog a new 50-page guide has been designed so that pages — or complete sections — can be replaced or added to accommodate updating material as new I/C devices are announced. Included in the catalog are eight different families of digital circuits, and five family groups of linear circuits (operational amplifiers, high-frequency amplifiers, power amplifiers, differential amplifiers, and sense amplifiers). The fam-

ilies are color-coded on multi-colored pastel stock for quick, easy location. Device functions and characteristics, plus logic diagrams are included for each family. The sections are assembled in "loose-leaf" fashion and bound with a metal slide fastener for updating ease. A "Comparison Chart" is included that allows the designer to quickly compare some of the major features of the different I/C logic families, weigh the advantages and limitations of each logic line, and select the most suitable circuit for his particular set of system requirements. An "Application Selector Guide" lists all circuit functions available, indicating which functions are provided by each logic family. In all, specifications are provided for 25 linear types and 376 digital types, each available in one or more package styles: flat pack (2 versions); metal can (6 versions), and the 14-pin dual in-line plastic package — for a total of more than 675 different devices to meet exact design specifications. Motorola Semiconductor Products Inc., Phoenix, Arizona.

Circle No. 317 on Inquiry Card

High-Speed Printer

A printer that operates at speeds of up to 120 characters per second (1,200 words per minute) is described in a new product flyer now available. Detailed is how the machine prints by electrostatic deflection of highly charged ink particles fired from jets. The jets trace characters in much the same way that a beam of electrons traces patterns on an oscilloscope tube. Up to 64 alphanumeric characters can be printed at a maximum of 80 a line. Potential data communications applications for the Inktronic include use as a monitor in high-speed tape-to-tape systems, computer interrogation when equipped with a keyboard and for computer print-out. Teletype Corporation, Skokie, Illinois.

Circle No. 315 on Inquiry Card

Power Modules

Catalog sheet 147A, which describes the recently introduced LC series of low-cost wide-range power modules. This new series of compact power supplies provides DC outputs over the range 4-32 vdc with current ratings from 750 milliamperes to 10 amperes. The bulletin offers electrical and physical data, descriptive information, application data and prices. Electronic Research Associates, Inc., Cedar Grove, New Jersey.

Circle No. 314 on Inquiry Card

Mercury-Wetted Contact Relays

Two new engineering manuals on mercury-wetted contact relays for wired assemblies and printed circuit board applications describe relays that incorporate low, constant-contact resistant characteristics, no contact bounce, maximum reliability over 22×10^9 operations and switching speeds as fast as 1 ms. New 32-page Manual 801 describes in detail electrical, environmental and physical characteristics of Mercury-wetted contact relays for wired assemblies. Basically, these are the various types of HGS (high-speed relays) and HG high load-carrying capacity relays. These models are available in round cans, with plug-in or solder terminals or AN connectors. The characteristics of Types HGSR, HGM, HGSM and HGPM relays for printed circuit board applications are included in 24-page Manual 802. Completely compatible with other pcb components, these relay modules provide a wide range of electrical characteristics. Circuit board assemblies, combining HG relays with other components on pcb boards, are also included in Manual 802. C. P. Clare & Co., Chicago, Ill.

Circle No. 311 on Inquiry Card

Ceramic Capacitors

General characteristics and complete ordering data by series for a com-

plete line of ceramic capacitors — type 1200 or NPO — are highlighted in a new 16-page brochure. Details provided in the illustrated brochure cover the following series of ceramic capacitors: G5, 50 volts, dipped or molded; B1, 100 volt, dipped or molded; RH, 200 volt, dipped or molded; WM, 100 volt, dipped or molded; CK, 200 volt and 100 VDC, both per MIL-C-11015; and CKR, in 100 VDC and 200 VDC configurations, per MIL-C-39014. Also featured is the SC series, type 1200 or NPO, of ceramic capacitor chips. Information given in the brochure extends comprehensively from sizes and configurations in each series to temperature ranges and coefficients, capacitances, tolerances, types of leads, and electrical parameters. Completing the brochure is a series of charts comparing typical temperature, voltage and frequency characteristics of the type 1200 and NPO ceramic capacitors. San Fernando Electric Manufacturing Co., San Fernando, Calif.

Circle No. 312 on Inquiry Card

High Speed Data Sets

Two 4-page technical bulletins on Modem 4400 data sets are available describing models that transmit digital data at rates of 2400 bps and 4800 bps and are capable of transmitting this high speed data over unconditioned voice frequency channels. The bulletins highlight the advantages of the narrow band approach to transmission, and also include a general technical description of each 4400 data set. Milgo Electronic Corp., Miami, Fla.

Circle No. 310 on Inquiry Card

Capacitors

Sixteen page brochure presents manufacturer's complete line of film and metallized capacitors. Of particular interest is the section devoted to Polycarbonate units. Also featured are high voltage, low current, solid state power supplies, hermetically sealed, for both military and industrial applications. Wesco Electrical Co., Inc., Greenfield, Mass.

Circle No. 309 on Inquiry Card

Miniature Switches

52-page catalog includes the latest prices for momentary contact push button switches, up to 12 position multi-deck rotary switches, test clips, binding posts, plastic cases and header boards, stand-off insulators, and printed circuit test jacks. Detail drawings, product photographs, electrical ratings, and materials give design engineers necessary specifying data. Grayhill, Inc., La Grange, Ill.

Circle No. 305 on Inquiry Card

Memory Systems

A full line catalog and standard price sheet listing over 500 different memory systems for off-the-shelf delivery has just been published. The 22-page 8 x 11 inch book is the first catalog ever published listing off-the-shelf memory systems and prices. It contains specifications on 513 standard systems with word and bit capacities from 128 x 8 to 4096 x 32 and a summary of the complete line of standard coincident-current magnetic-core memory systems, said to be the largest and most diversified line of standard memory systems in the industry. Operational theory, applications and packaging are discussed in detail and illustrated through the use of charts, graphs and block diagrams. Ferroxcube Corp., Englewood, Colo.

Circle No. 306 on Inquiry Card

Data Acquisition System

Major feature of an advanced, fully computer programmable data acquisition system for automatic checkout of missile components, subsystems and systems are described in a new applications bulletin. The illustrated bulletin highlights the computer-compatibility of the system which permits range, throughout rate, channel addressing mode and other functions to be totally controlled under computer program. Applications cited in the brochure include current use of the system at several remote test stations, with a digital computer, as part of a large checkout complex for a major missile manufacturer. Among major system capabilities listed in the bulletin are: up to 256 fully differential analog input channels, open-circuit detection on all channels, and auto ranging of two different ranges

($\pm 5V$ full scale and $\pm 40V$ full scale). Redcor Corp., Canoga Park, Calif.

Circle No. 307 on Inquiry Card

Printed Circuit Test Point Connectors

Designated Series 672 and TJ, 8-page catalog covers a variety of configurations and sizes from single contact to 63 contacts, all designed to accept an .080 test probe. Recessed and protected floating pin terminals are mounted at right angle to the test socket and dip solder to a printed circuit board. Various molding materials are available. Complete technical specifications, outline drawings and illustrations are also available. Continental Connector Corp., Woodside, N. Y.

Circle No. 308 on Inquiry Card

I/C Logic Modules

General-purpose digital logic modules that use dual-in-line diode-transistor-logic (DTL) circuits are described in a four-page brochure. Designated J Series, these modules operate at clock rates up to 5 MHz and supplement the high-performance T Series modules, which are the basic building blocks of Sigma computers. The J Series family is a complete set of components needed to build a digital system. The brochure describes J Series features, including use of DTL ICs and low price. The DTL ICs are easy to obtain, easy to replace, and are housed in hermetically sealed, ceramic 14-lead dual-in-line packages. Typical prices are \$2.50 per NAND gate and \$7.50 per clocked flop-flop. Available modules by model numbers, together with price and number of circuits per module, are listed. J Series accessories, services, and major specifications are also briefly described. Scientific Data Systems, Santa Monica, California.

Circle No. 302 on Inquiry Card

Drum Memory System

Drum memory and drum memory systems are described in a new 3-part modular brochure which contains a 12-page booklet on standard drum memories and an 8-page booklet on standard drum memory systems.

The new product booklets are completely revised versions of earlier editions. DB6711 (12-pg. booklet) covers drum reliability; mechanical, magnetic and electronic design factors; and standard logic modules used. It also provides dimensioned illustrations, specifications and operating parameters of five standard drum models with capacities from 2,624,000 to 64,307,200 bits. SB6711 (8-pg.) discusses standard VRC drum memory systems for use with small computers, such as the PDP-8 and 8/S. The booklet describes three different system configurations and provides basic I/O instructions and programming data. Vermont Research Corporation, North Springfield, Vermont.

Circle No. 319 on Inquiry Card

Zeners, Reference Diodes, Silicon Rectifiers

48-page catalog C-67/68 contains descriptions, ratings and specifications for Zener voltage regulator diodes, voltage reference diode and low-power silicon rectifiers and lists 66 different series of Zener regulator diodes ranging from 150 milliwatts to 50 watts in nine package designs. In addition, there are 11 different series of voltage reference diodes listed with nominal temperature coefficient ratings to five parts per million, as well as 34 different series of low power silicon rectifiers in current ranges from 0.4 amperes to 16 amperes and voltage ratings (maximum peak reverse) ranging from 50 volts to 100 volts. The catalog is completely indexed with numerical cross-reference lists and includes an "easy-to-locate" table of contents to facilitate device location. International Rectifier, El Segundo, California.

Circle No. 320 on Inquiry Card

Switch/Relay Catalog

A 24-page catalog describes high density switches and relays capable of switching from 4 to 144 circuits simultaneously in computers, automatic testers, and process controls. Relays, toggle switches and pushbutton switches are described. A new low profile 4-pole flat pack relay is also illustrated. Typical applications and unique advantages of each type

Ultra-miniature Neon or Incandescent

DATALITES[®]

Meet most space-saving, multiple readout requirements

Datalites offer a system of indication for computer, data processing and other readout applications.

Datalites are ultra-miniature in size... can be mounted in 3/8" clearance hole. Lampholders can be spaced in any center-to-center measuring from 1/2" up.

Flexibility is provided by a choice of Neon or Incandescent light sources... with a wide range of lens colors and/or legend presentations available.

Typical Datalites are shown. For the many possibilities open to you and your application—ask for our latest 12 page Datalite catalog.

Why not do it today!

SAMPLES ON REQUEST—AT ONCE—NO CHARGE

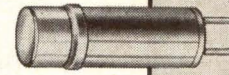

507-3918-1471-600

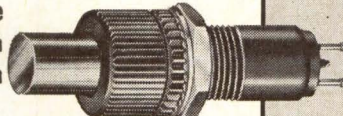

508-4538-504 Holder w/ 507-3836-1531-600 cartridge

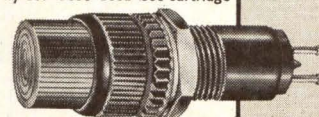

250-8738-3331-504

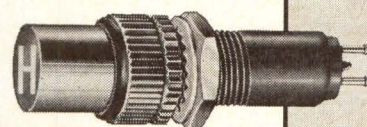

250-8745-1531-504

(Illus. approx. actual size)



Foremost Manufacturer of Indicator Lights

DIALIGHT CORPORATION

60 STEWART AVE., BROOKLYN, N.Y. 11237

AREA CODE 212 497-7600

CIRCLE NO. 44 ON INQUIRY CARD

are listed. Environmentally and hermetically sealed versions and latching types are also described and fully specified. Electronic Controls, Inc., Wilton, Connecticut.

Circle No. 301 on Inquiry Card

Micro Switch

Over a dozen switch applications to help solve industrial problems are described in the latest edition of "Uses Unlimited," an 8-page booklet now available featuring uses of CMC (Coordinated Manual Control) in controlling the action of blast furnaces in the steel industry. Another article points out how small precision switches help set bindery records by preventing paper jams... and insuring perfect page alignment. The direct programming of machine settings is shown to be easy with a KB matrix which eliminates numerical control tapes and punch cards. Other features describe various switching mechanisms used to control hydraulic pumps, launch missiles, economize on special communication systems, and gauge, sheer, and stack sheet metal with proximity

sensors. Micro Switch, Freeport, Illinois.

Circle No. 300 on Inquiry Card

Desk-Top Computer

An informative 18-page full color brochure provides complete and detailed information on the features and operations of the EAI 580, a desk-top computer providing advanced analog computing capabilities and all the essentials necessary for expansion into a hybrid system. The information is presented both in brief outline form and in detailed descriptions. Pictures of the overall system and its sub-systems are used liberally to provide a comprehensive understanding of the computer. The brochure covers the system's advanced analog and hybrid features, design and operation of the master control panel and analog readout panels, programming, the digital logic system, the individual computing components, system expansion and options, applications and company support. Electronic Associates, Inc., W. Long Branch, N. J.

Circle No. 318 on Inquiry Card

SOFTWARE ENGINEERS

THINK FOXBORO

**Where Programming Variety
Is a Way of Life**

Step into the big league of programming for process control in such industries as petro-chemical, power, food, textile, cement and steel . . . where every assignment is a challenge to your programming creativity.

You will be joining a company that rates the quality of its people among its most important assets. Your opportunities for individual growth are limited only by your ability and performance.

- BATCH CONTROL
- COMMAND AND CONTROL
- DIRECT DIGITAL CONTROL
- MULTI-LEVEL PROGRAMMING
- PRIORITY STRUCTURE
- REAL TIME
- SCIENTIFIC PROGRAMMING
- SUPERVISORY CONTROL
- TIME SHARING

*Are you ready for big league programming?
If so, forward your resume to:*

FOXBORO[®]
"Specialists in Process and
Energy Control"

An equal Opportunity Employer

J. G. WILLET
Central Recruiting Office
THE FOXBORO CO.
Dept. 12CD Neponset Ave.
Foxboro, Mass. 02035

CIRCLE NO. 902 ON INQUIRY CARD

ADVERTISERS' INDEX

ALLIED CONTROL CO., INC.	13
AMP, INC.	55
ANDERSON LABORATORIES, INC.	61, 66
BAUSCH & LOMB	74
BRAND-REX DIV.	4
BURROUGHS CORP.	Cover 3
COMPUTER INDUSTRY ANNUAL	82
CONTEMPORARY ELECTRONICS	69
CONTROL DATA CORP. Analog-Digital Systems Div.	71
DIALIGHT	87
DIGI-DATA CORP.	26
DIGITRAN	28
DIT-MCO INTERNATIONAL, INC.	75
ELECTRONIC MEMORIES	43
FAIRCHILD SEMICONDUCTOR	6, 7, 8, 9, 27
FERRANTI-PACKARD Electric Limited	81
FERROXCUBE CORP. OF AMERICA	19, 33
FOXBORO CO.	88
GENISCO TECHNOLOGY CORP. Components Div.	54
HEWLETT-PACKARD	5
HUGHES AIRCRAFT CO.	30
INVAC CORP.	16
LOCKHEED CORP.	83
METHODE ELECTRONICS, INC. Printed Circuit Div.	77
MICROSONICS	32
MICRO SWITCH	17
MIDWESTERN INSTRUMENTS	20
MOSAIC FABRICATIONS Div. The Bendix Corp.	18
NYTRONICS, INC.	73
PATWIN ELECTRONICS	72
POTTER INSTRUMENT CO.	64, 65
RAYTHEON CO. (Components Div.)	10, 11
SANDERS ASSOCIATES	1
SCIENTIFIC DATA SYSTEMS	29
SEAELECTRO CORP.	79
SIERRACIN CORP.	52
SYSTEM ENGINEERING LABORATORIES	Cover 2
TALLY	Cover 4
TELETYPE CORP.	21, 23, 25
TEXAS INSTRUMENTS Materials Div.	12
TRANSISTOR ELECTRONICS CORP.	53
VARIAN DATA MACHINES	24, 31, 35
VARO, INC.	34
WANG LABORATORIES, INC.	2

new

NIXIE® TUBE DRIVERS WITH INTEGRATED CIRCUITS MAKE "BUY" DECISIONS

- PRICED AS LOW AS \$26.00 INCLUDING THE NIXIE TUBE (100 QUANTITY) ■ SMALLEST, MOST CONVENIENT PACKAGES ■ COMPATIBLE WITH TTL, DTL, & RTL ■ DECODER/DRIVERS WITH OR WITHOUT MEMORY ■ COMPLETE ASSEMBLIES AVAILABLE OFF-THE-SHELF FROM BURROUGHS AND DISTRIBUTORS ■ 0.6" CHARACTER HEIGHT OR 0.3" CHARACTER HEIGHT NIXIE TUBES ■ MINIMAL NOISE PROBLEMS — DRIVERS ARE MOUNTED AS CLOSE TO TUBES AS POSSIBLE.

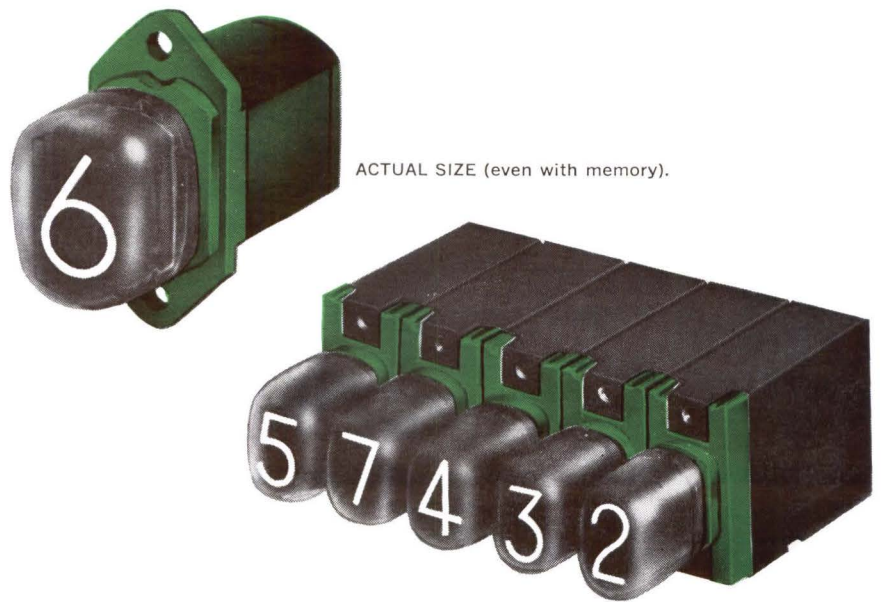

ACTUAL SIZE (even with memory).

ACTUAL SIZE miniature drivers.*

SPECIFICATIONS OF IC NIXIE TUBE DRIVERS

Part Number	Tube Type	Character Height	Max. Overall Length (with tube)	Max. Height	Max. Width	Has Memory	Input Code	Price 100 quantity (includes NIXIE tube)
BIP-8806	Standard B-5991	0.6"	2.506"	1.583"	0.750"	Yes	4 line 8-4-2-1 BCD	30.00
BIP-8804	Standard B-5991	0.6"	2.506"	1.583"	0.750"	No	4 line 8-4-2-1 BCD	26.00
BIP-9801	Miniature B-4998	0.3"	2.648"*	0.960"	0.480"	No	4 line 8-4-2-1 BCD	42.00

*Note new shorter overall length.

For additional information contact, Burroughs Corporation
P.O. Box 1226, Department D2, Plainfield, N.J.



Burroughs Corporation

easy to interface... easy to use



New Tally R-150A Tape Reader

Whether you're involved in system design or system usage, the new Tally R-150A Tape Reader will fill the bill. From the user point of view, the big, new feature is "top load" design for convenient, fast "straight line" tape loading. The "free" tape path and front panel control switches add up to a fast and simple rewind operation. Dependable starwheel sensing from the bottom of the tape allows high speed reading of chadless tape. Bidirectional and asynchronous, the R-150A operates at speeds up to 150 characters per second. Newly developed servo motors for reeling are featured. Reliability of the R-150A has been proven through extensive use in high traffic military communications networks. Write us on your letterhead and we'll send you interface specs on this outstanding new reader. Please address Tom Tracy, Tally Corporation, 1310 Mercer Street, Seattle, Washington 98109. Phone: (206) MA 4-0760. In Europe and the U.K., address Tally/APT, Ltd., 6a George Street, Croydon, Surrey, England. Phone: MUN 6838.

TALLY