

12512 1 1 0161786 50634V073  
PRINCETON UNIVERSITY  
R L FETTERHOOF  
COMP CTR RM 205  
PRINCETON N J 08540

structured  
programming  
& the chief  
programmer concept

also: mini strings... computing  
in cuba... the eurodata report...

# A three mini-peripheral for your computer.

## The Kennedy Model 330.

At last,

While the cost of computers has been plummeting in the last two years, peripheral add-on charges have been relatively constant. Now the Model 330 "carriage tape drive fills the gap. A dual system provides the throughput and data capacity of a "wide" carriage tape drive at half the price of a "narrow" one. And being a redundant system, you can immediately "fail over" to the second drive should the first fail. "Wide" carriage tape drives are in the form of "wide block" data, a type of information which is organized into blocks of "wide" data. The Model 330 provides a "wide" block of information and a "wide" block of information, and all the information is processed through a "wide" block of information. Separately, Model 330 and Model 330 are available together, they are not. Reason why Kennedy is known in the peripheral business. With a complete line of peripheral products.

**KENNEDY**

2000 W. Washington Blvd., Santa Ana, California 92701

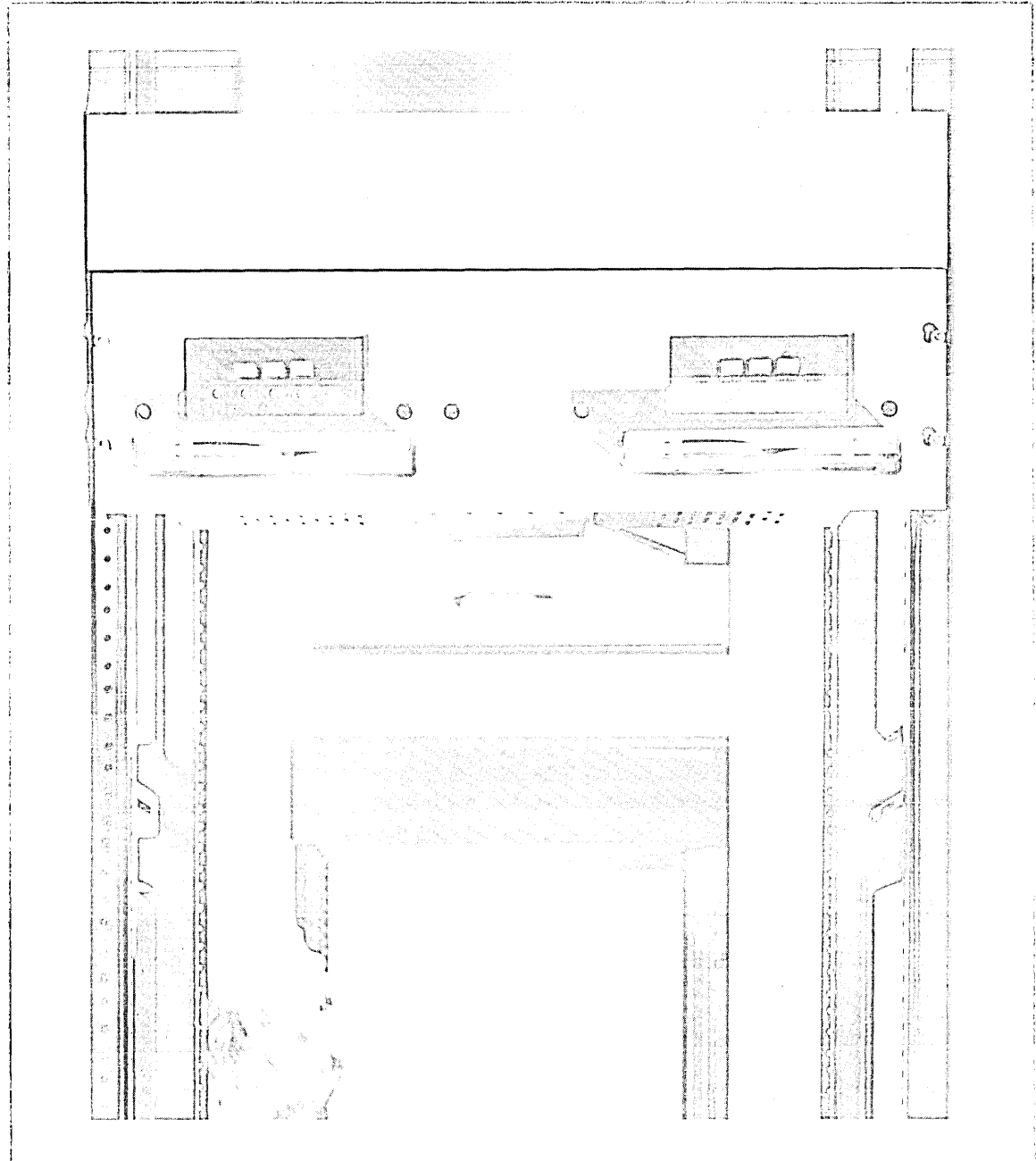

# LET'S MAKE A DEAL!



Why not deal with the printer manufacturer who really understands the tough, real-world performance demands of the remote terminal environment? Tally's years of experience in meeting the needs of data communications users are reflected in the no-nonsense simplicity and reliability of our Series 2000 line printer. Designed for the heavy printing loads of batch terminals and small business computers, it economically produces 6 beautiful copies at 200 lines per minute, day in and day out, without need for any more attention than an occasional cleaning. It has earned its reliability reputation as part of Tally's own Datascribe terminal. Let us prove it can do the same for you. Let's make a deal.

**TALLY**

Tally Corporation, 8301 S. 180th Street, Kent, Washington 98031 (206) 251-6770  
Data Terminals • Printers • Card Reader Terminals •  
Paper Tape Terminals

CIRCLE 4 ON READER CARD



# Minicomputer SOFTWARE

Here's an exciting new operating system with RPG that dramatically simplifies and speeds data processing applications

**CiMOS-22** is a disk-based operating system for the CIP/2200 minicomputers which consists of language processors, programming and debugging aids and services that simplify data processing applications. The capabilities of CiMOS-22 are packaged in a flexible system design so that each user can tailor the operating system to his individual needs. From either RPG or assembly language programs, the user can take advantage of the high-level data management facilities of CiMOS-22. These facilities include the ability to organize, catalog, store, retrieve and update data files. From a system console or assembler language program the user can create and delete disk-based files. On-line editing capability permits the user to build and maintain data files as well as source and object program libraries. There is much more to CiMOS-22 that you should know about. It's all detailed in our new brochure shown here . . . and it's yours free. Cincinnati Milacron, Process Controls Division, Lebanon, Ohio 45036.

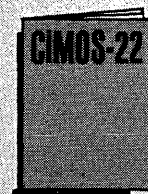

**FREE**

minicomputers



**CINCINNATI  
MILACRON**

Machine Tools  
Process Controls  
Chemicals  
Plastics  
Plastics Processing Machinery  
Abrasives

Cincinnati area (513) 494-5444 • Chicago area (312) 439-5726 • Los Angeles area (714) 847-2576 • Detroit area (313) 557-2700  
New York area (201) 687-4500 • Houston area (713) 622-4620 • San Francisco area (408) 735-0701 • Atlanta area (404) 634-6312

CIRCLE 22 ON READER CARD

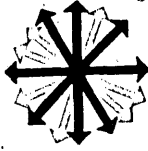

**DECEMBER, 1973**  
volume 19 number 12  
This issue 137,600 copies

## revolution in programming

According to guest editor McCracken, structured programming is a major intellectual invention that will revolutionize the way programs are produced. Our articles on this subject approach the issue in several ways. Before reading them, be sure to read the overview.

**50 Revolution in Programming: An Overview**  
DANIEL D. MC CRACKEN

**52 Structured Programming**  
JAMES R. DONALDSON

**55 Structured Programming: Top-down Approach**  
EDWARD F. MILLER, JR. and GEORGE E. LINDAMOOD

**58 Chief Programmer Teams**  
F. TERRY BAKER and HARLAN D. MILLS

**62 A Linguistic Contribution to GOTO-less Programming**  
R. LAWRENCE CLARK

## 69 The State of Computation in Cuba

RAMON C. BARQUIN. The year 1959 marked the coming to power of the revolutionary government; 1968 was the year of the computer revolution in Cuba.

## 76 Eurodata: Data Communications in Europe 1972-1985

RICHARD A. PETERS and KEPPEL M. SIMPSON. West Germany will pull ahead of U.K. in the data communications race by 1985.

## 87 Mini Strings with Many Uses

JOHN L. CHRISTOFFERSON. The simplicity of this data-structuring concept leads to greater reliability and programmer productivity, and reduced maintenance costs.

## 96 News in Perspective

ANTI-TRUST .....	96	COMMUNICATIONS ..	114
LAWSUITS .....	100	SERVICE BUREAUS ...	120
RETAILING .....	101	PROCUREMENT .....	120
PRIVACY .....	105	INTERNATIONAL ....	125
COMPANIES .....	110	BENCHMARKS .....	130

## 170 The Forum

JOHN J. CALLAHAN, JR. The shortage of qualified dp personnel is probably an artificial one—many qualified people are being bypassed.

## departments

<i>Calendar</i>	11
<i>Look Ahead</i>	17
<i>Letters to the Editor</i>	25
<i>News in Perspective</i>	96
<i>Hardware</i>	136
<i>Software &amp; Services</i>	150
<i>Literature</i>	157
<i>Books</i>	158
<i>People</i>	164
<i>Index to Advertisers</i>	168
<i>The Forum</i>	170

# "graf/pen<sup>TM</sup> is the most widely used graphic-to-digital converter in the world!"

"That's because it's the unrestricted digitizer!"

It's easy to understand how graf/pen, the sonic digitizer, became the standard device for converting graphic information — graphs, maps, physiological shapes and so on — into the language used in data processing, recording or transmission.

Consider graf/pen's flexibility.

It's a multi-media digitizer. Unlike other digitizers, the graf/pen uses sonic waves to generate position coordinates. Hence, the sensors which detect the position of the graf/pen point can be mounted adjacent to any flat display surface — a drawing board, a CRT screen, a blackboard, a projection screen. There are even 3-D versions which require no writing surface at all. Naturally, if you need a tablet, it is available with graf/pen.

Ideal for big jobs, too. graf/pen sensors come in lengths up to six feet. This means you can digitize oversize drawings, the profile of an automobile seat or even a human form.

You'll go "beyond" graphics. By placing a preprinted "menu" on your graf/pen tablet, you can also enter alphanumeric information or programming instructions by simply touching pen to a printed letter or message.

Great operational freedom. Only a single wire connects the pen to its control unit; there are no clumsy mechanical connections. You can select continuous digitizing, as when tracing a curve, or point digitizing to create one set of coordinates each time the pen touches the display surface. You can choose between a ball-point pen tip to generate "hard" copy as you digitize or an inkless stylus which leaves no trace.

Service is international. In the unlikely event your graf/pen should ever require service, it's available on-site internationally.

There are a lot more freedom-of-use advantages to the graf/pen. So, if your data handling system requires graphic-to-digital conversion, get all the facts on graf/pen — the unrestricted digitizer. Call our marketing vice president, Rolf Kates, at (203) 255-1526 or write:

**SAC SCIENCE  
ACCESSORIES  
CORPORATION**

65 Station Street  
Southport, Connecticut 06490

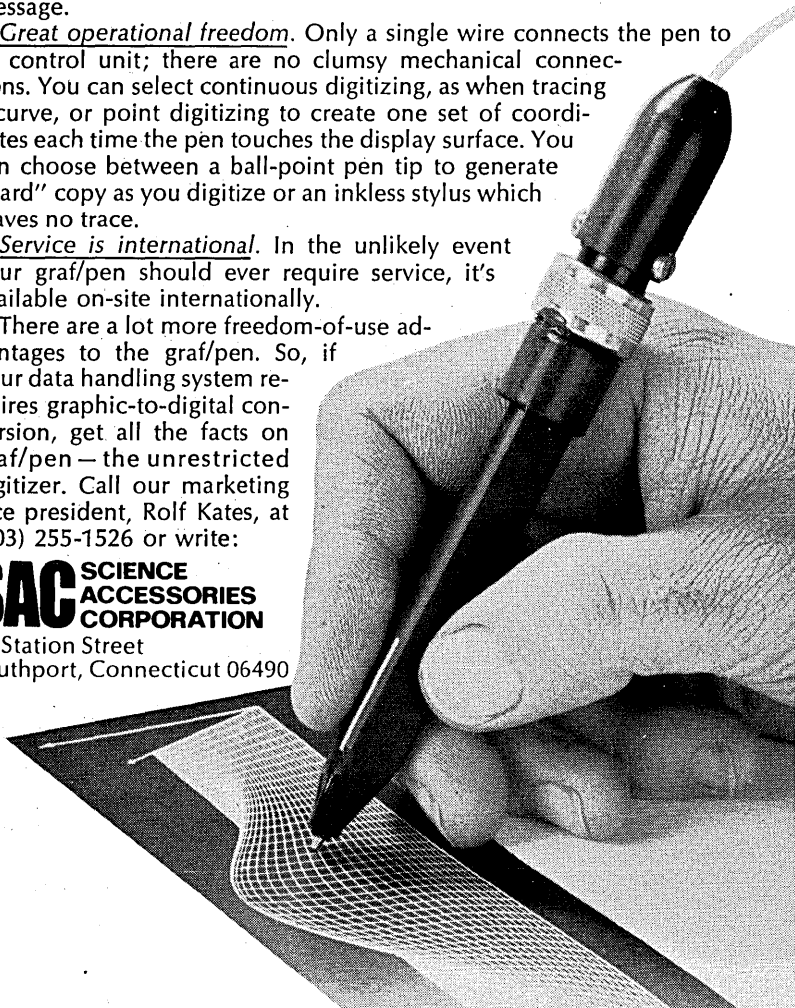

CIRCLE 77 ON READER CARD

## DATAMATION.

### EDITORIAL STAFF

<b>Editor</b>	Robert B. Forest
<b>Articles Editor</b>	John L. Kirkley
<b>International Editor</b>	Angeline Pantages
<b>Communications Editor</b>	Phil Hirsch
<b>Technology Editor</b>	Richard A. McLaughlin
<b>Industry Editor</b>	W. David Gardner
<b>Products Editor</b>	Michael William Cashman
<b>Copy Editor</b>	Merrill Press Cherlin
<b>Calendar Editor</b>	Carol A. Constantian
<b>Letters Editor</b>	Angela V. Smith
<b>News Editor</b>	Tom McCusker
<b>Bureau Managers</b>	
<b>San Francisco</b>	Edward K. Yasaki
<b>Los Angeles</b>	Edith D. Myers
<b>Washington, D.C.</b>	Phil Hirsch
<b>New York</b>	Angeline Pantages
<b>New England</b>	W. David Gardner
<b>Correspondents</b>	
<b>Minneapolis</b>	James K. Johnson
<b>Southwest</b>	Robert F. Alexander
<b>Europe</b>	Pearce Wright
<b>Australia</b>	Frederick A. Bland
<b>Editorial Advisor</b>	Robert L. Patrick
<b>Technical Advisor</b>	Lowell Amdahl
<b>Contributing Editors</b>	Paul Armer, Howard Bromberg, Philip H. Dorn, Louis B. Marienthal, Ray W. Sanders, Milton R. Wessel, F. G. Withington

### EDITORIAL OFFICES

**Headquarters:** 1801 S. La Cienega Blvd., Los Angeles, CA 90035. Phone (213) 559-5111. **Eastern:** 35 Mason St., Greenwich, CT 06830, (203) 661-5400. **Lakeside Office Park,** 599 North Avenue, Wakefield, Mass. 01880, (617) 246-2121, 9805 Singleton Dr., Bethesda, MD 20034, (301) 530-7271. **Southwestern:** 2711 Cedar Springs, Dallas, TX 75201, (214) 744-0161. **Western:** 2680 Bayshore Frontage Rd., Suite 401, Mountain View, CA 94043, (415) 965-8222. **Foreign:** 65, Hill Road, Chelmsford, Essex, England, 64/90 Blues Point Rd., McMahon's Point, NSW 2060, Australia.

### GRAPHIC DESIGN & PRODUCTION

**Art & Production Director** Cleve Marie Boutell  
**Production Manager** Marilee Pitman

### CIRCULATION

35 Mason Street, Greenwich, CT 06830  
**Circulation Director** Suzanne A. Ryan

**Marketing Research Director** Douglas De Carlo  
**Publisher** James M. Morris

Circulation audited  
by Business Publications  
Audit



Member  American Business Press, Inc.



**DATAMATION** is published monthly on or about the first day of every month by Technical Publishing Company, 1301 South Grove Ave., Barrington, Illinois 60010; Arthur L. Rice, Jr., Chairman of the Board; James B. Tafel, President; Gardner F. Landon, Executive Vice President. Executive, Circulation and Advertising offices, 35 Mason Street, Greenwich, CT 06830, (203) 661-5400. Editorial offices, 1801 S. La Cienega Blvd., Los Angeles, CA 90035. Published at Chicago, Ill. **DATAMATION** is circulated without charge by name and title to certain qualified individuals who are employed by companies involved with automatic information handling equipment. Available to others by subscription at the rate of \$18 annually in the U.S. and Canada. Reduced rate for qualified students. Foreign subscriptions are available for £12.50 or for the equivalent of \$30 U.S. in most West European currencies. Sole agent for all subscriptions outside the U.S.A. and Canada is J. B. Tratsart, Ltd., 154 A Greenford Road, Harrow, Middlesex HA13QT, England. No subscription agency is authorized by us to solicit or take orders for subscriptions. Controlled circulation paid at Columbus, OH and Form 3579 to be sent to Technical Publishing Company, P.O. Box 2000, Greenwich, CT 06830. Copyright 1973, Technical Publishing Company. Microfilm copies of **DATAMATION** may be obtained from University Microfilms, A Xerox Company, 300 No. Zeeb Road, Ann Arbor, Michigan 48106. Printed by Beslow Associates, Inc.

## ICC modems help your terminals do their thing... better.

Terminals give their best performance when they're free to deliver data — without concern for varying phone line conditions. Teamed up with your terminals, ICC modems handle most line problems so that your terminals can handle the data.



**4800 bps**  
Higher throughput is the objective of ICC's 4 different 4800 bps modems. We have models for dial-up or dedicated lines — all ICC dependable.

**2000 bps**  
ICC's two compatible 2000 bps modems operate reliably over dial-up or dedicated lines — even when line quality varies.



**7200 bps**  
Modem 4800/72 delivers 7200 bps data over C-1 lines, with 4800 bps dial backup. It offers features like multichannel operation, built-in test and automatic adaptive equalization.

**2400 bps**  
Dependable 2400 bps transmission is easy with ICC's 201B on-line compatible modems. The new LSI model has some really great features.



**9600 bps**  
Modem 5500/96 operates dependably over C-2 lines, and even offers 4800 bps dial backup, multi-channel operation, built-in test, and automatic adaptive equalization.

**3600 bps**  
Fast line turn-around, and a reverse low-speed channel are two of the ways Modem 3300/36 increases the efficiency of 3600 bps transmission.



**Multispeed**  
Economical high-speed transmission over short distances is what COM-LINK II does best. It operates over hard wire at switch-selectable data rates up to 19,200 bps. Modem 1100 can operate at even higher speeds ... up to 1 million bps!



### International Communications Corporation

7620 N.W. 36th Avenue, Miami, Florida 33147 Telephone 305 + 691-1220 305 + 836-4550

In Europe: RACAL-MILGO LIMITED Reading, Berks, England

Send for ICC's new Data Communication Catalog.

a milgo company member of IDCMA

© 1973

CIRCLE 38 ON READER CARD

The \$5,600  
computer you  
don't have to  
talk down to.

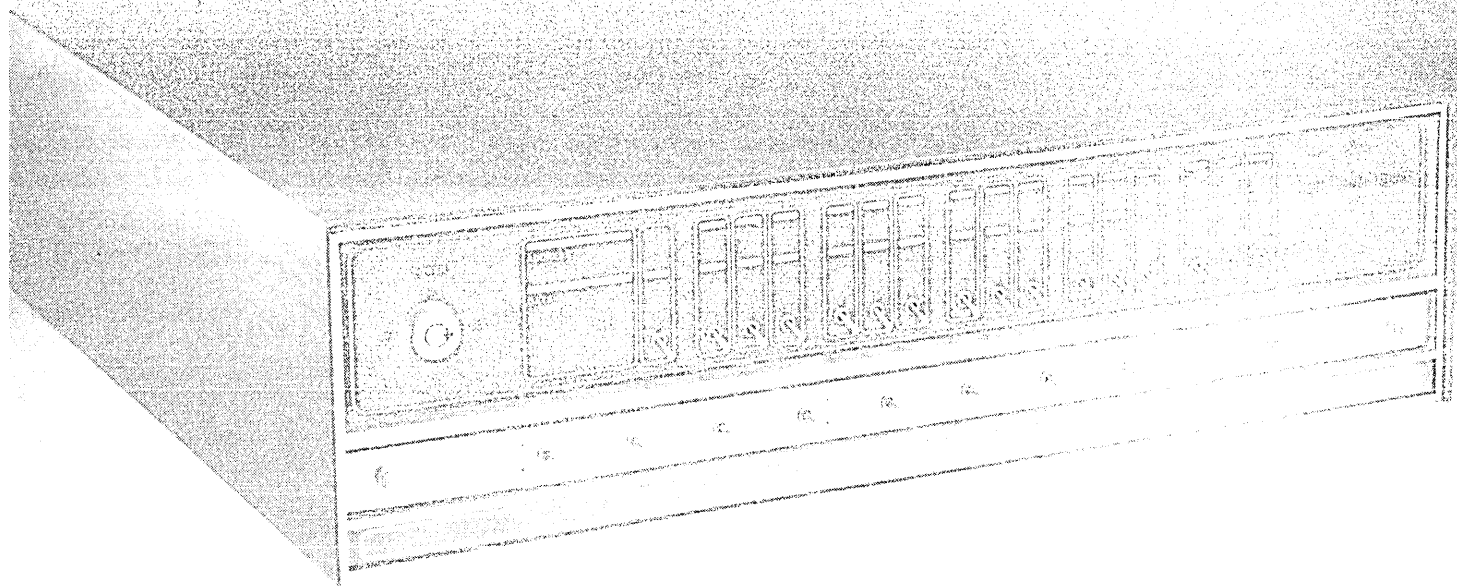



We've gotten into the habit of referring to any IBM<sup>®</sup> who's trying to bring you the best of this product.

Go buy your IBM<sup>®</sup> 16K now, and you'll have the new 16K memory boards (Yes, we'll have you up and running with less memory, we're serious.)

Also take a look at our new line of high speed multi-accumulator IBM<sup>®</sup> 16K 16K systems with programmed priority interrupt, direct address Memory Access, programmed scan rate, and a frame power supply and 16K boards of memory expansion, expandable to 64K. With 16K and 16K boards also available.

Then, you'll have a whole new world of computer hardware to choose from. It's the best of other computers but better, we think.

### Hold on! It's not over yet.

When you're done, you'll have to talk down to the computer to get it to do what you're going to be able to program in the first place.

So your programming will be able to spend more time on what the system is doing, less on how to say it.

Which means the whole job done faster. And you'll get your program done a lot faster.

Both of you will get a lot of time and money.

### It's not over yet.

Consider how your system costs go down when your program gets into the computer.

The system program is the one that doesn't fit?

And that's where the system discounts get figured in.

\*Five systems is the minimum order.

# The 16K Nova 2 Data General

Southboro, Massachusetts 01772 (617) 485-9100.

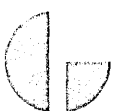

# NCR CENTURY COMPUTERS SAVE TIME...

## OR MONEY...

## OR BOTH!

For information on the NCR Century system that can save time and money for you, call your local NCR office. Or write NCR, Dayton, Ohio 45479.

**NCR**  
Terminals & Computers



**"Our quarterly reports used to take two full days. Now they're out in three hours. The difference? Our NCR Century."**

Bob Schrader, President  
Evanston Federal Savings & Loan  
Evanston, Illinois



**"With our NCR Century 101 we are moving toward a total school information system at a cost of only \$2.50 per student!"**

Calvin L. Owens, Director  
Audio Visual Education Department  
Cooperating School Districts of  
the St. Louis Suburban Area, Inc.



**"Benchmark tests proved the NCR Century could handle our inventory requirements faster and for less cost than other computer systems."**

James L. Meagher, President  
Stratton & Terstegge, Inc.  
Louisville, Kentucky



**"Despite inflation, our labor and food costs have actually dropped thanks to the reports we get from our NCR Century Computer."**

J. Michael Bodnar, Treasurer  
Shoney's South, Inc.  
Memphis, Tennessee



**"Our NCR Century 200 goes from 7000 random registrants to class rosters and student locators in just 4½ hours. That's really moving!"**

Terry L. Veters, Director, Computer Center  
St. Mary's University  
San Antonio, Texas



**"With the NCR Century computer, off-the-shelf software is economical and practical, and conversion is quick. Our return on investment began in less than a month."**

Harold Canada, Vice President  
Hafers', Inc., Salt Lake City, Utah



**"Keeping customers waiting means bad press for any savings and loan. It's a problem our NCR Century eliminated. Twice."**

Dick Pokorny, General Manager  
Financial Computer Services  
Cleveland, Ohio



**"We chose the NCR Century because the product for the price was better than anyone else had to offer."**

Dan Seyfarth, Data Processing Manager  
McHenry Hospital, McHenry, Illinois

# Tough Application?



## Crack it with a SLASH 4 Computer System.

Datacraft® SLASH 4 Computer Systems are built for those tough-to-crack, real-time, multi-programming applications. *The tougher the better.* Simulation. Process Control. Sophisticated Data Acquisition. Avionics Checkout. Nuclear Experiments. Or Research . . . Medical, Academic, Scientific, Oceanographic. Applications that *demand* a high-performance, medium-scale computer system. One with field-proven, big-machine software and a wide range of quality peripherals.

If your application is tough, crack it with the *real* medium-scale computer system. The throughput performer that's not overloaded . . . or overpriced. Datacraft's® SLASH 4 Computer System. It's a nutcracker.

Write today for complete specifications, price and delivery.

*Datacraft® Corporation*

1200 GATEWAY DRIVE, FORT LAUDERDALE, FLORIDA 33307, (305) 974-1700

# We Make Documation Card Handling Equipment As If Your Reputation Were on the Nameplate

If your job is to select or plan a computer system, then in a very real sense your name should be on Documation's card readers and punches. Analysis of computer system requirements takes a very special set of skills. A type of experience that can't be measured in months or years. Brains. Pride in judgment. And just a dash of old fashioned guts.

Because so much is at stake, we make

Documation card handling equipment as if your reputation were on the nameplate.

More than 100 of the best known and respected computer and minicomputer companies of the world now use Documation readers and punches. Many of these companies became our customers because you made your own independent evaluation and specified Documation. We think that says a lot about you, as well as us.



# Calendar

---

## DECEMBER

**Seminar on COM: Computer Output Microfilm, Dec. 12-13** (Washington, D.C.), **Jan. 24-25** (Los Angeles). This Advanced Management Research seminar, for computer professionals, financial specialists, and business executives, will deal with COM systems, applications, trends, software, operations, and systems design. Fee: \$250. Contact: AMR International, Inc., 1370 Avenue of the Americas, New York, NY 10019.

**Course on Data Center Operations Management, Dec. 17-19** (Chicago), **Jan. 23-25** (Atlanta), **March 18-20** (New York). Data center operations managers, supervisors, and key staff members will examine methods of achieving effective management control of data center operations in this American Management Assns. meeting. Fee: \$280, members; \$320, nonmembers; reduced rates for company teams. Contact: AMA, 135 W. 50 St., New York, NY 10020.

## JANUARY

**National Retail Merchants Assn.'s 63rd Annual Convention and Business Equipment Exposition, 6-9**, New York. This annual event for retail management includes sessions on aspects of marketing, financial control and profit improvement, productivity, sales volume increase, and expense reduction; and an exhibition with emphasis on point-of-sale equipment, security devices, credit processing systems, and store image builders. Fee: \$40, individual members; \$450, 12 or more members from a single company; \$75, individual nonmembers. Contact: Mary Ellen McGroary, NRMA, 100 West 31 St., New York, NY 10001.

**Seventh Hawaii International Conference on System Sciences, Jan. 8-10**, Honolulu. Hosted by the Univ. of Hawaii depts. of electrical engineering and information and computer sciences, this conference deals with research and applications of system sciences. Fee: \$40. Contact: HICSS-7, Dept. of Electrical Engineering, Univ. of Hawaii, 2540 Dole St., Honolulu, HI 96822.

**International Animation Film Festival and Conference, Jan. 9-12**, New York. In conjunction with this festival of animated films, a conference will be held on computer animation, designed to acquaint participants with new systems for using computers to create animated films. Contact: Fred Mintz, International Animation Film Festival, Suite 903, 331 Madison Ave., New York, NY 10017.

**Course on Basic Project Management—Planning, Scheduling, and Control, Jan. 21-24** (Lake Buena Vista, Fla.), **Feb. 4-7** (San Francisco), **Feb. 11-14** (New York), **March 4-7** (Dallas), **April 22-25** (Toronto). Designed for those from any field involved in the design and implementation of projects, this American Management Assns. course presents the fundamentals of successful project management. The course is also available for customized presentation at individual companies. Fee: \$465, members; \$535, nonmembers; reduced rates for company teams. Contact: AMA, 135 W. 50 St., New York, NY 10020.

**ADAPSO Systems/Programming Seminar, Jan. 23-24** (San Francisco), **April 3-4** (Atlanta), **July 10-11** (New York), **Oct. 2-3** (Chicago). The goal of this seminar is the exchange of information on the selection, development, control, and sale of general application programs for specific industries, and for contract programming for a variety of users and applications. Registration limited to 20 per session. Fee: \$80. Contact: ADAPSO, 551 Fifth Ave., New York, NY 10017.

**Fifth Annual Assn. for Educational Data Systems (AEDS) Conference, Jan. 25**, Orlando, Fla. This conference on systems in high schools, technical schools, junior colleges, and colleges will have as its theme: "The Development and Evaluation of Educational Programs in Computer Science and Data Processing." Fee: \$40; after Jan. 15, add \$4. Contact: Ralph E. Lee, AEDS Workshops, P.O. Box 951, Rolla, MO 65401.

**Winter Meeting of the Assn. for the Development of Computer-Based Instructional Systems (ADCIS), Jan. 29-Feb. 1**, Washington, D.C. ADCIS is an international organization, representing education, business, and industry, as well as military and government agencies. The purpose of this meeting is to share research findings, operational notes, and strategies in computer-aided instruction. Fee: \$15, members; \$20, nonmembers. Contact: G. Ronald Christopher, Computer Assisted Instruction, Ohio State Univ., 1080 Carmack Rd., Columbus, OH 43210, or Catherine E. Morgan, Montgomery County Public Schools, Einstein High School, Kensington, MD 20795.

## FEBRUARY

**ADAPSO Operations Seminar, Feb. 20-21** (New York), **May 22-23** (Chicago), **Aug. 21-22** (San Francisco), **Nov. 20-21** (Atlanta). This seminar's purpose is the exchange of ideas and information among managers whose basic responsibility is to keep customer service and satisfaction high and cost low. Registration limited to 20 per session. Fee: \$80. Contact: ADAPSO, 551 Fifth Ave., New York, NY 10017.

**Computer Science Conference, Feb. 12-14**, Detroit. With sponsors including ACM, IEEE Computer Society, ASEE Computers in Education Div., the National Science Foundation, and several universities and industrial organizations, this second annual conference consists primarily of short, current research reports. There will also be exhibits of books, research, and terminals. Fee: \$20. Contact: Seymour J. Wolfson, 643 Mackenzie Hall, Wayne State Univ., Detroit, MI 48202.

---

Conferences are generally listed only once. Please check recent issues of DATAMATION for additional meetings scheduled during these months.

---

INTERDATA  
ANNOUNCES  
THE INDUSTRY'S  
FIRST 32-BIT  
MINICOMPUTER  
FOR UNDER  
\$10,000.

# WITH UP TO A MILLION BYTES OF DIRECTLY ADDRESSABLE MEMORY.

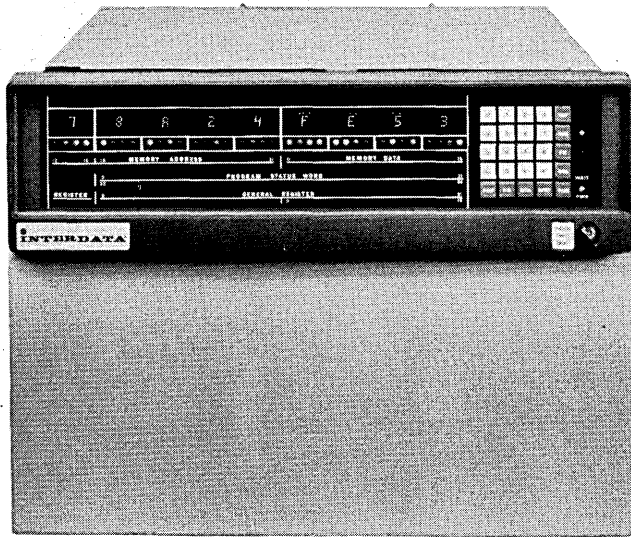

Minicomputer myths you can live without:

1. There's no such thing as a 32-bit minicomputer.
2. Minicomputers have an absolute 64K addressing limit.
3. The only way to even access more is to resort to some sort of hardware kluge with a hairy software scheme that'll cost you an arm and a leg.

All wrong.

Because now there's the Interdata 7/32 – a powerful new 32-bit minicomputer with main memory expandable up to a million bytes and direct addressing up to 16 million bytes.

Big it is. But hairy it isn't.

Because it's simple, straightforward and efficient. And it's the industry's first uncomplicated extended-memory software environment.

Backed up by a lot of hardware muscle like thirty two, 32-bit registers, 1024 I/O interrupts with automatic vectoring, 239 instructions. And a lot more. All of which would lead you to expect to pay a lot more money, right? Well, that's also a myth.

Performance	7/32	Nova 840	PDP-11/40
Word length	32	16	16
Memory speed (nanoseconds)	750	800	900
Maximum memory capacity (bytes)	1,048,576	262,144	262,144
Addressing range (bytes)			
Direct	1,048,576	512	65,536
Relative	±16,384	±256	±32,768
Indexed	1,048,576	65,536	65,536
Double indexed	1,048,576	No	No
General-purpose registers	32 32-bit	4 16-bit	8 16-bit
Index registers	30 32-bit	2 16-bit	8 16-bit
Vectored interrupt levels	Yes	No	Yes
Minimum interrupt overhead time (usec)	6.5	47.5	46.5

Price	7/32	Nova 840	PDP-11/40
32 KB processor	\$ 9,950	\$12,930	\$15,345
64 KB processor	14,450	19,330	26,925
128 KB processor	23,450	35,630	44,725
256 KB processor	41,450	61,230	80,825
1 Megabyte processor	171,650	Not available	Not available

Source: Data General Price List, 5/15/73. DEC PDP-11/40 Price List, 6/73. DEC OEM & Product Services Catalog, 1972. Auerbach Minicomputer Characteristic Digest, June, 1973. "How to use Nova Computers", 1973.

The software muscle is all there, too. A new FORTRAN V compiler. An optimizing assembler called CAL. And the first extended operating system that's both powerful and simple – OS/32. Plus all the other field-proven Interdata software – it's all compatible.

The new Interdata 7/32.

We put our muscle where their myth is.

## **INTERDATA®**

2 Crescent Place, Oceanport, New Jersey 07757 (201) 229-4040.  
 Boston – (617) 890-0557. Washington – (703) 525-4806. Philadelphia – (215) 436-5579.  
 Orlando – (305) 851-6962. Chicago – (312) 437-5120. Detroit – (313) 356-5515.  
 Dayton – (513) 434-4193. Kansas City – (913) 384-1606. Houston – (713) 783-3060.  
 Dallas – (214) 238-9656. Denver – (303) 758-0474. Los Angeles – (213) 640-0451.  
 Phoenix – (602) 968-2477. San Diego – (714) 565-0602. San Francisco – (415) 969-1180.  
 Seattle – (206) 455-0680. Toronto – (416) 677-8990. Tokyo – (270) 7711.  
 Sydney – 439-8400. London – Uxbridge 52441. Munich – 0811-8543887.

**INTERDATA  
ANNOUNCES  
THE INDUSTRY'S  
FIRST \$3200  
MINICOMPUTER  
TO CHALLENGE  
THE NOVA.**



# PDP-11 PERFORMANCE AT A NOVA 2 PRICE.

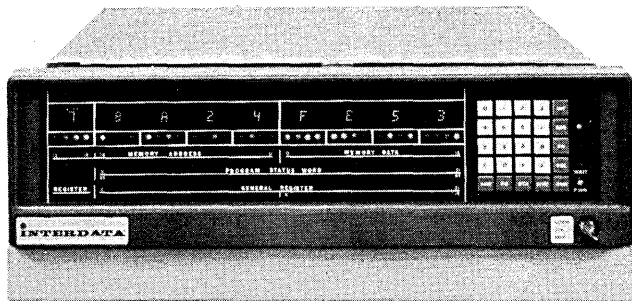

Minicomputer myths you can live without:

1. There is no such thing as a high-performance, low-cost minicomputer.
2. You have to choose between two extremes – pay a ton for a machine like the PDP-11 and save on software costs, or buy a cheapie like the Nova 2 and pay the price later.

All wrong.

Because now there's the Interdata 7/16 – an extremely flexible 16-bit OEM minicomputer that combines the best of both worlds.

It's easier to program than the PDP-11 because it has 16 hardware registers, up to 64K bytes of directly addressable main memory, 255 I/O interrupts with automatic vectoring to service routines and a comprehensive set of more than 100 instructions. That's a lot of muscle.

It's completely modular in design – plug-in options can be installed in the field to meet your specific application requirements.

Options like multiply/divide, programmers' console with hexadecimal display, power fail/auto restart, memory protect and a high-speed Arithmetic Logic Unit that includes floating point hardware. In fact, you can expand the low-cost 7/16 all the way up to the 32-bit Interdata 7/32.

Yet it costs as little as \$3200. Just like the machines that give you the barest minimum. And quantity discounts can reduce that low price by as much as 40%.

Performance	7/16	Nova 2/4	PDP-11/05
Data word length (bits)	4, 8, 16	16	1, 8, 16
Instruction word length (bits)	16, 32	16	16, 32, 48
General-purpose registers	16	4	8
Hardware index registers	15	2	8
Maximum memory available (K-bytes)	64	64	64
Directly addressable memory (K-bytes)	64	2	64
Automatic interrupt vectoring	Standard	Not available	Standard
Parity	Optional	Not available	Special order
Cycle time (usec.)	1.0 or 0.75	1.0 or 0.8	0.9
Available I/O slots	4	2	2

Price	7/16	Nova 2/4	PDP-11/05
8 KB processor	\$3,200	\$3,200	\$4,795
16 KB processor	3,700	3,700	6,495
32 KB processor	5,300	5,300	10,895
Multiply/Divide option	\$950	\$1,600	\$1,800
Floating Point option	\$4,900	\$4,000 plus \$1,000 for 2/10 configuration	Not available

Source: Data General Price List, Copyright 1973, and addendum dated 5/15/73. Nova 2/4 bulletin 012-000060, 1973. DEC OEM & Product Services Catalog, 1972. Auerbach Minicomputer Characteristic Digest, June, 1973. "How to use Nova Computers", 1973.

So you no longer have to make the painful choice between good performance and good price. Or between hardware economy and software efficiency. Now you have a minicomputer that gives you both.

The Interdata 7/16.

We put our muscle where their myth is.

## ● INTERDATA®

2 Crescent Place, Oceanport, New Jersey 07757 (201) 229-4040.  
 Boston – (617) 890-0557. Washington – (703) 525-4806. Philadelphia – (215) 436-5579.  
 Orlando – (305) 851-6962. Chicago – (312) 437-5120. Detroit – (313) 356-5515.  
 Dayton – (513) 434-4193. Kansas City – (913) 384-1606. Houston – (713) 783-3060.  
 Dallas – (214) 238-9656. Denver – (303) 758-0474. Los Angeles – (213) 640-0451.  
 Phoenix – (602) 968-2477. San Diego – (714) 565-0602. San Francisco – (415) 969-1180.  
 Seattle – (206) 455-0680. Toronto – (416) 677-8990. Tokyo – (270) 7711.  
 Sydney – 439-8400. London – Uxbridge 52441. Munich – 0811-8543887.

# Thinking of additional memory for your mini-computer?



## The best idea is Fabri-Tek's add-on core.

Fabri-Tek's add-on core memories are plug compatible and they're available in 8K word increments to any word size you desire.

So, whatever your needs . . . HP-2100, 2114A/B, DEC-PDP8E, PDP8 I, PDP8M, PDP11, DG NOVA 1200 and others, think first of Fabri-Tek for off-the-shelf delivery. Another Fabri-Tek plus: on-site and factory service by a highly trained professional staff.

For additional information, call or write:



**FABRI-TEK** INC.

5901 South County Road 18 • Minneapolis, Minnesota 55436 • (612) 935-8811

REGIONAL OFFICES: Boston (617) 969-5077 Chicago (312) 437-4116 New Jersey (201) 964-4770 Phoenix (602) 266-4448 Long Beach (213) 420-2493 Sunnyvale (408) 739-4780

*Leader in  
Memory Technology  
For over a Decade*

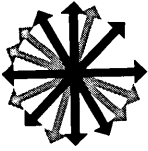

# Look Ahead

## FINALLY A MACHINE THAT READS HAND PRINT?

It may be quite some time before all kinds of hand-printed characters can be accurately read by a machine, but a West Los Angeles firm is working on such a system, and the British may buy it if it's successful.

Information International, Inc. has been given a feasibility contract and a test case by the U.K. government's Central Computer Agency. The agency has to decide by next June whether to buy the III device for a new project for the Dept. of Health and Social Services, or to go the keypunch route (one that would require hiring some 5,000 keypunch operators).

The test case consists of 2,000 forms filled out by 200 British civil servants, each in his own style of hand printing. The III Grafix 1 must be able to recognize all the different ways the 200 people shaped letters, numbers and punctuation marks with an error rate (substituting the wrong letter) of approximately 0.01%. Further, while most OCR systems read only 14 hand-printed symbols, the Grafix 1 must recognize 40. So far, the system has been able to convert some 30K characters to microfilm with a substitution rate of 0.2% and a 3% rate for correctible errors (rejects).

The company's Grafix 1 system, meanwhile, will be used by the U.S. Navy to convert some three million pages of technical manuals into an updated microfilm data base under a six-month project that will cost \$8 million. It will be III's first sale of the system announced two years ago.

## A PENNY A VOTE -- SOME DAY

Voting at home by phone at a penny per vote was cited by Dr. Harold Sackman of The Rand Corp. as a "hard dollars" advantage that could come with the advent of wired cities. Dr. Sackman was a panelist at a "Wired City" session at the American Society of Information Science's Info Expo '73.

Meanwhile, the nation's largest voting entity, Los Angeles County, isn't looking quite this far ahead but it is aiming at more automation in its voting with the award last month by the county's Board of Supervisors of a \$242,700 contract to Arthur Young & Co. It will do a one-year conceptual study of vote requirements and preliminary design of a total voting system which would encompass everything from on-line registration at remote sites through automation of data preparation for the vote tally, but stopping short of the vote count itself. The county has been using the Votomatic punch card system for vote counting since 1968 at an estimated cost of \$1 per ballot; not quite a penny a vote but on its way there.

## AN OK TO ADD VALUE

Packet Communications, Inc. thinks it will begin offering commercial service on its value-added network within 18 months. President Lee Talbert tells us the company needs \$15-20 million in additional capital, but only \$2 million within the next year. The company last month was given the go-ahead from the Federal Communications Commission to operate the nationwide commercial packet-switched network. The Waltham, Mass. company is one of four planning to offer "added value" to ordinary transmission lines by using special processors to organize data into packets that are transmitted at high speeds with error correction and code translation for different

# Look Ahead

computers.

In allowing PCI to proceed with its system, the FCC implied that it would soon approve a competing application by Telenet, a subsidiary of Bolt Beranek & Newman, the company that developed a similar system used by the Defense Department's Advanced Research Projects Agency (ARPA).

PCI's Talbert says some financial "commitments" already have been obtained. As now planned, its system will interconnect 18 major cities and span the nation.

## HIGH-DENSITY BREAK FOR PRIVATE LINE USERS

Specialized communications carriers are expected to object to AT&T's new "high-lo" private line tariff schedule which was filed last month with the Federal Communications Commission. A customer who now pays \$260.50 for a 100-mile voice grade channel would be charged \$205 if he is on a high-density route, and \$330 if he's on a low-density route. Despite the objections, FCC seems likely to approve the tariff but delay its implementation up to 90 days beyond the proposed effective date of next Jan. 14.

## WHAT MANUFACTURERS DON'T TALK ABOUT

From cars to pencil sharpeners, there are many devices on the market today that offer some good things their manufacturers don't talk about. Computers are no exception. Take the Burroughs 2500 (\$4,700 to \$18,000 monthly rental). Many 2500 users have learned they can make their machines operate like a B3500 (\$5,300 to \$27,000 monthly rental) with a simple switch of a single wire -- OK knowledge for a user but not for a sales prospect. One Burroughs salesman reddened when he took a prospect to visit a 2500 installation for a demonstration and had the user ask: "Shall I run it as a 2500 or a 3500?"

## REMOVABLE PACKS AREN'T OFTEN REMOVED

People with 3330 type removable disc pack drives tend to use them as fixed-media devices. Vendors asked to comment on a contention by Storage Technology Corp. that for every spindle in use today there are only one and one quarter packs (Nov., p. 159), agree with the statistic. Spokesmen for Caelus Memories and Memorex say the ratio could be slightly higher, but it's anyone's guess.

Phil Yaconelli of Memorex says the ratio might rise to two and a half packs per spindle after two years of installation and go up to four and a half after four years. The ratio is two or three times higher for 2314 type drives and for 2311's it's about six or seven packs per spindle. But for 3330 devices, the growth will be slower because there's so much more storage capacity.

## DOWN UNDER: MOONLIGHTERS THRIVE

On the surface, Australia's market for programmers is fantastic. Our correspondent cites recent statistics showing that of the \$9-10 million market for software projected for next year, \$3-4 million will go begging because of a shortage of programmers. One software house says that in Sydney moonlighting by programmers amounts to \$2 million a year.

But our correspondent cautions Americans that the salary range is \$11,000 to \$12,000 and that everything except meat costs more -- including housing, where inflation is wild.

The Australian Computer Society, meanwhile, has formed a special

(Continued on page 167)

**more than batch...  
more than timeshare...  
less than \$170,000\***

Hewlett-Packard's 3000.  
**The New  
Multiprogramming  
Multilingual Computer.**

Full system capability from multiple interactive terminals. For your new brochure call (408) 257-7000, Ext. 3000.

Or write



Sales and service from 172 offices in 65 countries.  
1501 Page Mill Road, Palo Alto, California 94304

22408 \*Domestic USA Price Only.

# Datapoint 1100 processor based systems

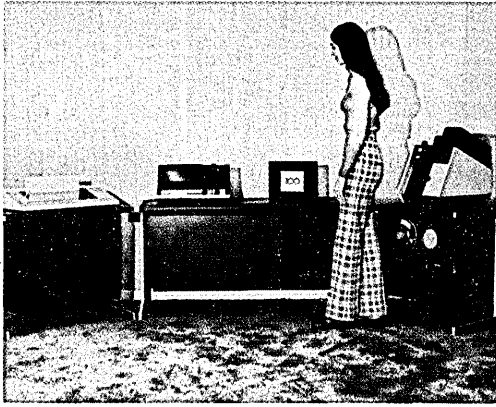

Remote Batch Terminal

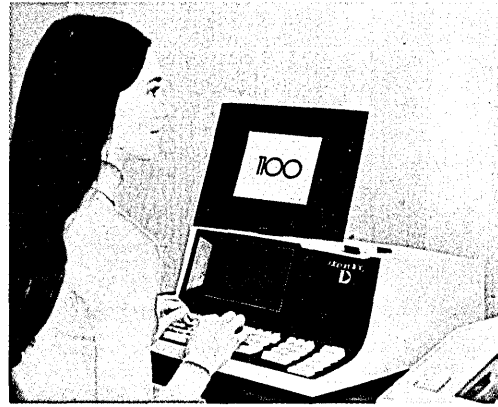

Intelligent Terminal

# Datapoint 2200<sup>®</sup> processor based systems



Remote Job Entry



Terminal Processor

# Datapoint 5500 processor based systems



Local Processor



Remote Processor

The pictures indicate a typical growth pattern of 1100-2200-5500 usage as a field office's work load increases. In the left-hand column, normal progression begins with the Datapoint 1100 for Remote Batch Terminal applications. In this mode, card readers, tape units, communication equipment, and printers are utilized as peripheral devices for efficient transmission of data between the remote location and host computer. In the second phase, the Remote Batch Terminal operation is upgraded to a 2200 to provide stand alone processing power to expedite Remote Job Entry applications. In addition to the expanded processing power of the 2200, disk capability and RPG II substantially enhance the effectiveness of the 2200 used in this way. In the third phase, a stand alone Datapoint 5500 is utilized as an independent Local Processor to meet all the dispersed processing requirements at the remote site without relying

on a central host facility.

In the right-hand column, the first picture shows the Datapoint 1100 used as a powerful Intelligent Terminal for data entry and limited processing tasks. In the next phase, field office needs have grown to an intelligent multi-station requirement and are satisfied by the Datapoint 2200 used as a Terminal Processor. In this mode, a single Datapoint 2200 can provide "intelligence" for up to eight keyboard/display stations with subsequent transmission of data between the host and remote sites. The final progression is to the Datapoint 5500 Remote Processor, used in field offices as local "computer utilities," still linked to the host processor system, but now providing substantial independent compute power of their own to an array of peripherals and terminals located in the field offices.

# Dispersed data processing the Datapoint way — as easy as 1100-2200-5500

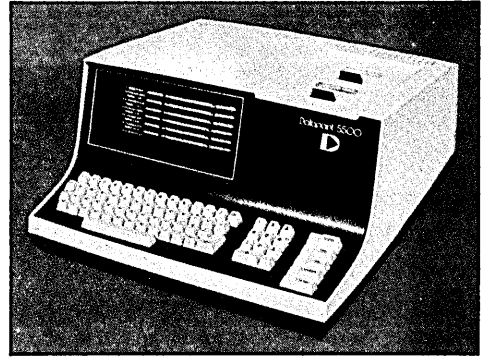
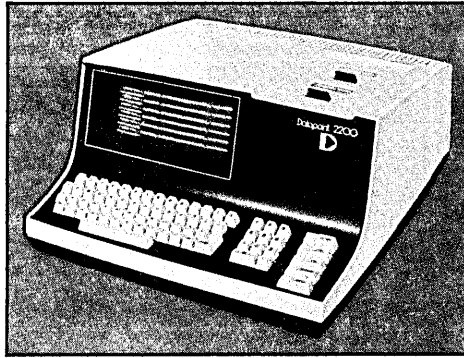
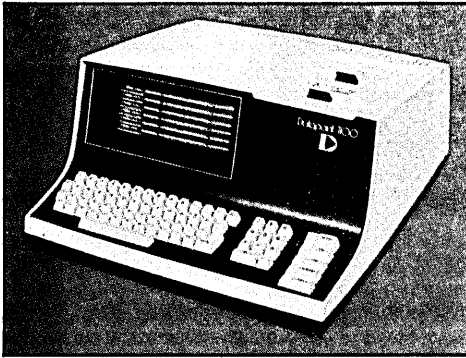

Dispersed data processing the Datapoint way is the productive, economic approach to providing your field offices with the on-site computer power needed to compete in today's business world, while yet being linked to a central computing operation. Datapoint's trio of upward-compatible dispersed processors—the 1100, 2200 and 5500—offer you a capability that can be readily and painlessly augmented as office work load increases, as your company's communications network becomes more sophisticated and your field office personnel more knowledgeable.

Let's look at these processors: the Datapoint 1100, available with 4K or 8K central memory, is the new Intelligent Terminal system from Datapoint Corporation that can bring your field offices into the on-line computer age immediately. Competitively priced, and with extensive capability for business processing tasks such as on-line (or off-line) data conversion and entry, it is a basic building block for creation of a multi-use dispersed data processing and data handling capability in your field offices. Once installed, the 1100 can do double duty for progressively more sophisticated data processing and data communications assignments including

remote batch applications through utilization of card reader, magnetic tape, and printer peripherals. In software, Datapoint provides a CTO5 operating system, Assembly Language, and the new DATAFORM language for sophisticated data entry and editing. Initial deliveries of the 1100, with a monthly lease price of \$138, will begin in January.

When your field office work load grows beyond the capability of the 1100, it is an easy, painless transition to a more powerful Datapoint processor, without the need for jarring systems redesign and expensive software revision. The secret is in the upward compatibility of the 1100 with the well-established Datapoint 2200 Terminal Processor and the new Datapoint 5500 Remote Processor. It is as simple as pulling the plug on the 1100, plugging in the 2200. No complex systems changeover, no costly software rewriting is entailed; the user obtains the needed increment in dispersed data processing power in his field offices without disruption. The 2200, a widely used and well-established system with up to 16K central memory and dual ECMA standard cassette drives, will do everything the 1100 will do, and also provide an expanded on-site computer power. In a multi-station mode, it can service up to eight low-cost terminals for data entry and related tasks.

The 2200 is a natural step towards the 64K Datapoint 5500 Processor (deliveries in third quarter, 1974), which will do everything the 2200 does and also constitutes an on-site "computer utility" in your field offices. This system will provide computer power for a large number of associated peripherals and for a variety of low-cost, non-programmable terminals while simultaneously furnishing a high

speed link to a central computer facility. These three Datapoint communications-oriented dispersed processors, progressively larger, faster and more powerful, open a new world of capability to the network-oriented user who sees the need for a growing satellite computing capability in his field offices, while still accessing a central computer facility for heavy duty processing and primary file storage.

Chalk up another innovative approach from Datapoint Corporation to the solution of business data processing problems. With the versatile Datapoint 1100, the proven Datapoint 2200 and the powerful Datapoint 5500; with their associated peripherals including line and serial printers, 7- and 9-channels magnetic tape units, a cartridge disk system, and synchronous and asynchronous communications adaptors; with full operating systems and extensive programming language capability including RPG II, BASIC, DATABUS and others under development, no other source can serve your dispersed data processing and field data handling needs so effectively, so economically. For further information on the growing Datapoint family of dispersed data processing systems, peripherals and software, contact the sales office nearest you or write or call Datapoint Corporation, San Antonio, Texas 78284, (512) 696-4520.

Datapoint

 The Datapoint logo symbol, which is a stylized 'D' shape composed of several parallel lines, creating a sense of depth or a 3D effect.

Home Office: 9725 Datapoint Drive/San Antonio, Texas 78284/(512) 696-4520 • Direct Sales Offices: Atlanta/(404) 458-6423 • Boston/(617) 478-2441 • Chicago/(312) 671-5310 • Cleveland/(216) 921-9200 • Dallas/(214) 630-1342 • Detroit/(313) 557-6092 • Greensboro/(919) 299-8401 • Houston/(713) 688-5791 • Los Angeles/(213) 645-5400 • Minneapolis/(612) 854-4054 • Newark/(201) 568-1225 • New York/(212) 759-4656 • Philadelphia/(215) 643-5767 • Phoenix/(602) 265-3909 • San Francisco/(415) 968-7020 • Seattle/(206) 747-2317 • Washington D.C./ (703) 525-6924



**THE LONGEST LINE,  
FASTEST SPEEDS,  
MOST INTELLIGENT,  
LEAST EXPENSIVE  
REMOTE BATCH  
TERMINALS AVAILABLE.**

Perhaps these superlatives don't impress you much. But, let's look at what they mean. First, you can select from several different systems to meet your precise current requirements without paying for more than you need. Yet, we can upgrade your system any time at your facility without costly down-time. If you are ready for a high speed system (up to 50.kbps) we can provide the most efficient terminal available plus a wide variety of peripherals for maximum through-put. Being intelligent, Singer-M&M terminals are compatible with all major main frames. Emulators are available for IBM System 360/370, UNIVAC 1108, Control Data Corporation 6000, Honeywell 6000/355 and others. When you consider price/performance, the chart below quickly shows that basic Singer—M&M Remote Batch Terminal Systems deliver more for the money than any other equipment now on the market.

BASIC SYSTEMS	520	580	565	560
<b>Card Reader</b>				
300 cpm	x	x	x	
600 cpm				x
<b>Line Printer</b>				
200 lpm	x			
400 lpm		x	x	
600 lpm				x
<b>Communications</b>				
2. to 4.8 kbps	x	x		
2. to 7.2 kbps			x	
9.6 to 50. kbps				x
<b>ASR 33</b>	Opt	Opt	Std	Std
<b>Multileaving</b>				
HASP Work Station	N/A	N/A	Std	Std
<b>Monthly Rental</b>				
Including Maintenance	\$675	\$940	\$1160	\$1645

Call today for a demonstration or send for complete literature. SINGER-M&M COMPUTER INDUSTRIES, INC., 2201 N. Glassell St., Orange, Calif. 92665 (714) 998-1551. Telex 65 5464

**SINGER**

M&M COMPUTER INDUSTRIES, INC.

CIRCLE 11 ON READER CARD



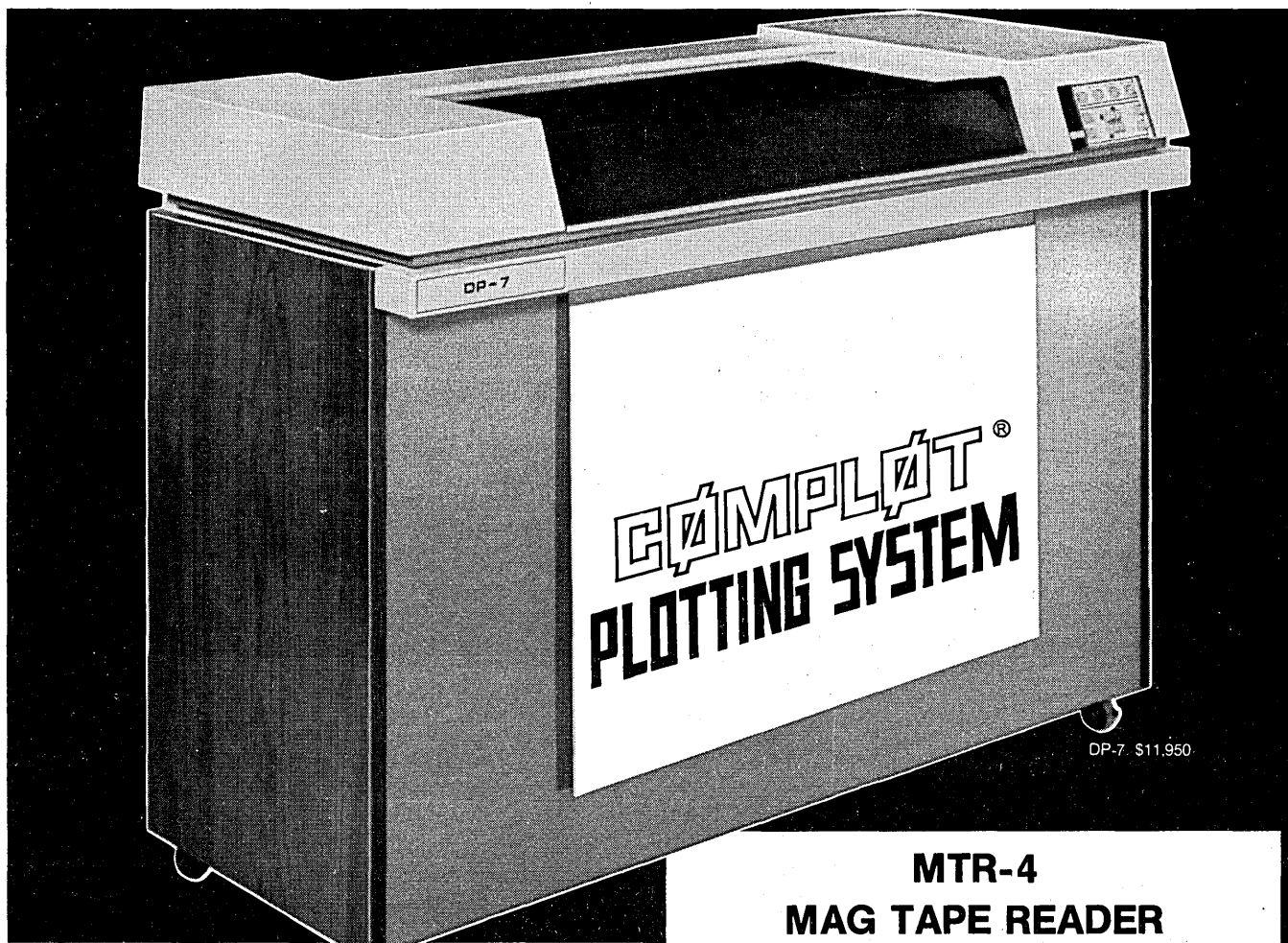

### DP-7 DIGITAL PLOTTER

**36.5" (92.7 cm) WIDE, 1800 STEPS PER SECOND**

- Three automatically selectable colored pens.
- 1800 increments per second continuous speeds at 0.002" (0.05 mm) step size.
- 36.5" (92.7 cm) wide — can do the job of many larger, more expensive flat beds.

A radically new BIG, WIDE and accurate COMPLØT® digital plotter from The Recorder Company, Houston Instrument. Incremental too. Works fast, costs little (in comparison to competition) and offers all the operational advantages you desire. Send for brochure today.

®Registered Trademark of Houston Instrument

**Would You Believe...**

**The DP-7, DP-1 and DP-3**

are now interfaced to the H-P 9830 Desk Calculator. Ask H-P for Model No. 11282A Interface. \$750

### MTR-4 MAG TAPE READER

- 7 or 9 TRACK 800 BPI
- Automatic block search—forward and reverse.
- Hardware vector generator—cuts computer time significantly.
- Buffered mag tape reader.

New from The Recorder Company, the model MTR-4, a fourth generation offline COMPLØT® magnetic tape reader with features found only in much higher priced competitive models. Send for details today.



**THE  
RECORDER  
COMPANY**

**houston  
instrument**

DIVISION OF BAUSCH & LOMB

4950 TERMINAL AVENUE, BELLAIRE, TEXAS 77401

•(713) 667-7403, TWX 910-881-5782

**European Office**

Rochesterlaan 6 8240 Gistel Belgium

Telephone 059-27445 Telex BAUSCH 19399



Photographed on location at Loch Duich, Scotland.

## “Black Watch” waits for the challenge to guard.

“Black Watch” tape has a special-textured back side which guards against cinching, shifting and scratching. You get this “Scotch” 700 tape from the people who developed the first computer tape in 1953. People who will go to any length to solve a customer’s problem. People who thrive on assisting. The Data Recording Products Division of 3M. A proud clan.



“Scotch” and “Black Watch” are registered trademarks of 3M Co.



## Call out the clan.

# Letters

## IBM ethics defended

It was with shock and disbelief that I read the anonymous article "Anti-trust—A New Perspective," (Oct., p. 183). I just cannot understand how DATA-MATION could publish an erroneous, unsubstantiated article without any verification, or why you elected to print it as "a reader's opinion" without identifying who held that opinion.

The men and women of IBM's Data Processing Division were maligned by this article and on their behalf, and my own, I am compelled to comment on it.

The apparent "factual base" for this article was a handful of months-old press clippings, detailing situations that allegedly occurred over a period of more than a year. Each of these situations was thoroughly investigated and, in most instances, no IBM employee was found to have acted unethically. In the few cases where there was a degree of impropriety on our part, appropriate disciplinary action was taken.

While it may be impossible for a company the size of ours to attain absolute ethical integrity, there is no group of employees anywhere that strives harder to reach this goal. IBM's long established reputation as an honorable and ethical corporation attests to their success.

RALPH A. PFEIFFER, JR.  
President, Data Processing Division  
IBM  
White Plains, New York

As Mr. Pfeiffer obviously realizes, the "Forum" is a place for readers' opinions, and opinions can hardly be counted as errors, except perhaps by those who hold contradictory opinions. To such people our Forum is open. In this case, we substantiated what needed to be substantiated; the name, position, and character of the author, and that he had valid reasons for wishing to remain anonymous. We believe his opinions are based on personal experience; that close detailing of this experience would have identified him to the detriment of his career; that the references to press clippings were only made to back up his conclusions.

It is our feeling that IBM on the whole behaves no less ethically than its competitors. But what makes any breach of ethics on the part of IBM more noteworthy than those of its competitors is that IBM has so much more weight, and can bring so much more pressure to bear.

The appearance of an anonymous article in the "Forum" column of your October issue is a disgrace. Unfortunately, I find in checking your recent past issues, this is not an isolated occurrence; e.g. "Management Tips from a Programmer" in June. If the

Forum is intended to promote the free discussion of issues in information processing, an aim of which I fully approve, then you must not encourage the irresponsible cowardice implied by an author's unwillingness to accept credit and blame for his views. It is a supreme act of intellectual dishonesty not to stand behind one's own ideas.

PETER SZOLOVITS  
California Institute of Technology  
Pasadena, California

We disagree. Ideas can be considered independent of their source; indeed that treatment helps to promote objective review.

It is easy for one sitting in what is evidently the safety of an institution predicated upon freedom of expression to call the author a coward. He feels, for what are probably more than casual reasons, that the publication of his name could place his career in jeopardy.

We try to be responsible editors, and would not assign anonymity to a piece without good reason.

## Getting a move on

With regard to your item concerning DPMA and AFIPS (Sept., p. 163) please be aware that DPMA has *not* cancelled its 1975 Conference—we only moved it from Los Angeles to Atlanta to avoid an unnecessary conflict with the NCC.  
DONN W. SANFORD  
Data Processing Management Assoc.  
Park Ridge, Illinois

## ABC dba "0368549"

The article by Merle Rocke on "The Need for Data Code Control," (Sept., p. 105) is, unfortunately, typical of a widespread tendency in computer systems design to make inhuman use of human beings and unmechanical use of machines.

Customers, salesmen, and executives all have a natural and desirable tendency to think of themselves and their

products in human terms—of names, addresses, descriptions and the like. It is both unnecessary and error-productive to expect them to think of the ABC Corp. as "0368549," just to make up an order or inquiry to the computer system.

The mechanical process of translating "natural" references to data base codes and vice versa is a process best left to the software, which, if properly designed, can do it faster and more accurately than people. The trivial expense of a few extra keystrokes and a data coding pass must be weighed against the often "hidden" cost of people (often highly paid people) looking up codes in listings, transcribing them, and the cost of mistakes.

The advantages of word recognition, syntax analysis and "natural" language processing are already so widely in use by programmers for themselves (COBOL, FORTRAN, and even BAL) that perhaps they lose sight of the fact that their own programs no longer need to ask users to "encode" their data either.

A case in point is a system used at the Census Bureau to update a file using control numbers with check digits. The program detected invalid control numbers and kicked them out on an error report. After a while we discovered that the clerical section, which received the error report, merely recalculated the check digit manually on the basis of the control number and resubmitted the transaction, thus clobbering the master file.

The error message was merely "INVALID CHECK DIGIT" and they had discovered that, sure enough, the check digit was always wrong! The point is that there was no way to tell, from the transaction itself, which record it was supposed to be for except by the control number, and if any digit of

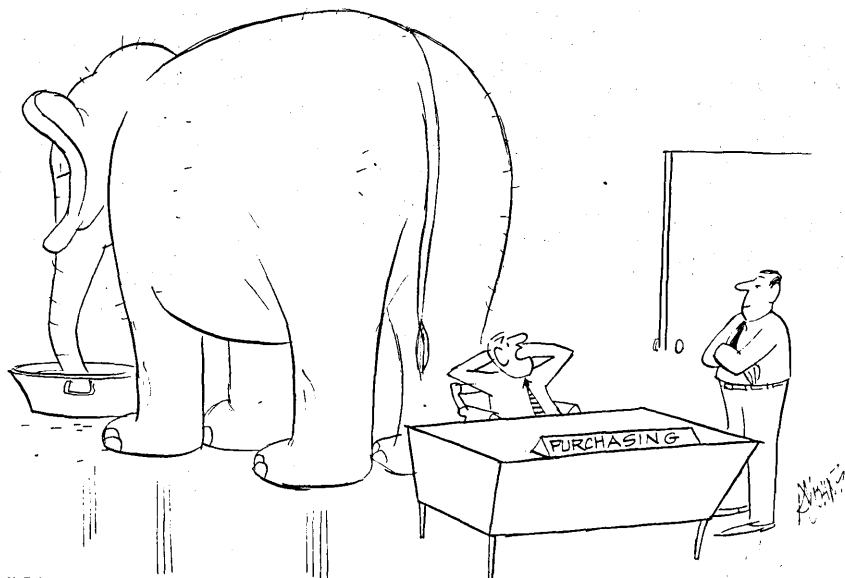

"Okay . . . but except for that, when have I ever made a bad mistake?"

# computers delivered gently

When you ship computer hardware, look for an experienced computer mover like Burnham Van Service, which helped pioneer the nationwide moving of electronics and other high value cargo. Burnham Van Service has air-ride vans with power tailgates and the most advanced tie-down systems, along with other specialized equipment for moving electronics. More important, Burnham has the know-how to load, move, and unload your computer hardware without damage, and the ability to spot your shipments at all times, day and night, from one end of the country to the other. Call the man from Burnham Van when you're ready to talk about computer shipments. Or write to us and we'll be glad to send you a copy of a new 32-page equipment manual that illustrates Burnham's specialized equipment for handling high-value cargo.

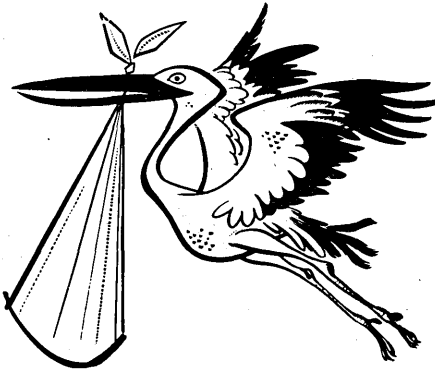

## BURNHAM VAN SERVICE, INC.

5000 Burnham Boulevard, Columbus, Georgia 31907 • Phone 404/563-1120  
Denver 303/433-8619 • Chicago 312/372-4323 • New York 212/679-4111 • Cheverly, Md. 301/322-1300

CIRCLE 93 ON READER CARD

# Noise sensitivity problems go away

*Topaz Ultra-Isolation Transformers eliminate power-line noise problems associated with sensitive equipment*

Box-shielding techniques achieve maximum coupling between windings while offering a very low impedance for common-mode noise to ground. Primary to secondary effective interwinding capacitances of:

- 0.005 picofarads
- 0.001 picofarads
- 0.0005 picofarads

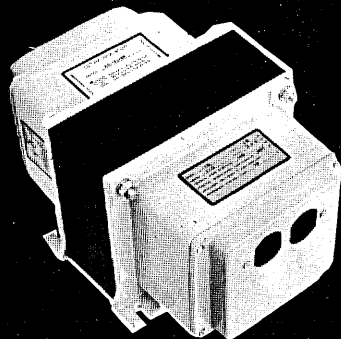

### SPECIFICATIONS:

**Common-Mode Noise Rejection:**  
to more than 145 dB.

**Transverse Noise Suppression:**  
greater than 125 dB at 1 kHz.

**Input/Output Voltages Available:**  
115, 230, 240 and 480 VAC  
at 50 or 60 Hz.

**Models Available:**  
125 VA to 20 kVA 1 phase;  
3 kVA to 60 kVA 3 phase.

**Priced from \$75.00**

# TOPAZ

ELECTRONICS

SOLUTIONS TO  
POWER PROBLEMS

3855 Ruffin Road, San Diego, CA 92123 Phone (714) 279-0831 TWX (910) 335-1526

CIRCLE 73 ON READER CARD

## letters

that was mispunched or miscopied, the check digit test would fail. But nothing could legitimately be done about it except to discard the transaction.

A name reference that fails because of misspelling, on the other hand, can usually be interpreted and corrected because of its high information content and redundancy. If "WASHINGTON" is misspelled as "XASHINGTON" any clerk can fix it, but if "01276394" is misspelled "01376394" there is virtually no hope of figuring out what it should have been, even if the system notices that the code is invalid.

GEORGE L. FARNSWORTH  
*Assistant Project Director  
Bureau of the Census  
Washington, D.C.*

Mr. Rocke replies: You seem basically concerned over the use of codes in place of uncoded (English words and phrases) data. Let's review five basic reasons for coding data which aid both machines and humans:

1. To translate from a difficult-to-use source language (words/phrases) to one which is more oriented toward the needs of data translation and analytical activities.

2. To decrease required data element size per unit of information.

3. To supplement the information available in the source language (i.e., to provide more than simple identification of the item).

4. To distinguish between alternative ideas or words which are not easily distinguished (are ambiguous) when described in text.

5. To enhance accuracy of data translation processes.

Note that people benefit every bit as much as computers from usage of codes. But the point remains that if we are to successfully interface with the computer, we must adjust to its requirements. We must recognize, accept and cope with its idiosyncrasies—but must minimize and control them in order to reduce inconvenience for its users.

### Apples and Oranges

I commend your attempt to shed additional light on the extremely complex issue of IBM and its influence on the edp industry ("Monopoly is Not a Game," Sept., p. 73).

I believe that your customer-oriented analysis is a sound approach to this issue. It goes to where the action is. However, one is compelled to take issue with "Table 1: Mainframe Manufacturers Ranked by Specific Attributes." Although you point out that "the results may show a hazy outline of the real world, not necessarily a clear image," comparisons may be oversimplified to the degree that a disservice is rendered to several mainframe manufacturers. Specifically, the number of responses received for IBM and the other mainframe manufacturers leaves

(Continued on page 161)

# DP DIALOG

Notes and observations from IBM which may prove of interest to data processing professionals.

*DP DIALOG appears regularly in these pages. As its name suggests, we hope DP DIALOG will be a two-way medium for DP professionals. We'd like to hear from you. Just write: Editor, DP DIALOG, IBM Data Processing Division, White Plains, N.Y. 10604.*

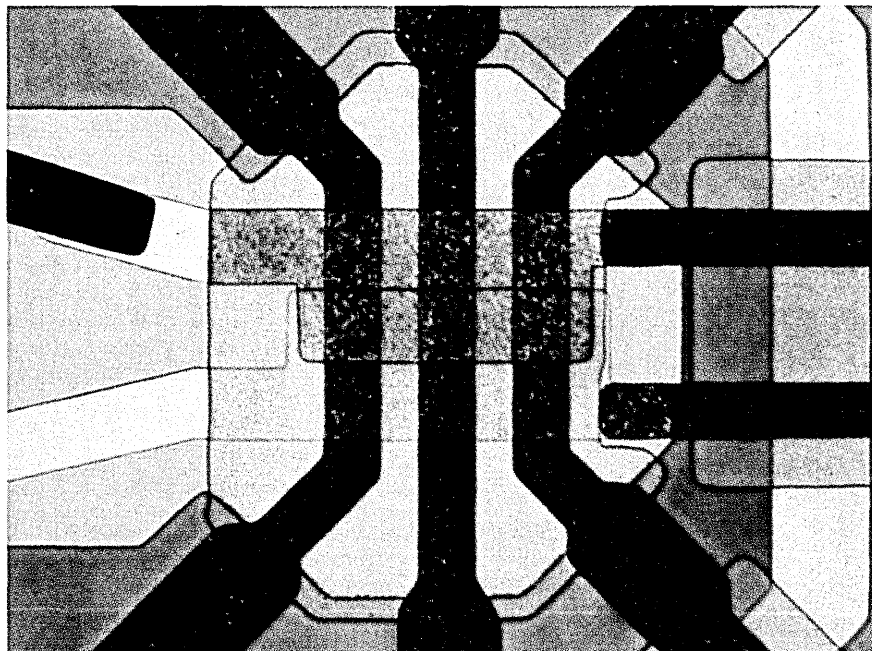

*The Josephson junction magnified many times its actual size.*

## Superconducting Computers May Run at Super Speeds

Computer technology in the last decade has advanced by quantum leaps. Microscopic transistors can speak the simple "yes-no" binary language of computers in less than a billionth of a second. Giant memories hold massive amounts of data which can be tapped to solve complex problems with astonishing speed and accuracy.

But as fast as modern computers can now operate, present speeds can

not cope with the heavy demands of missions in space and long-range weather forecasts.

However, it appears a major advance may be in the making. After many years of intensive research, IBM scientists at the Thomas J. Watson Research Center in Yorktown Heights, New York and at IBM's research center in Zurich have developed an electronic switch which can operate at a speed of

### Nobel Prize to Three Scientists

The Swedish Academy of Sciences in Stockholm awarded the 1973 Nobel Prize for Physics to three scientists for their pioneering work in the field of electron tunneling. They are Dr. Brian Josephson, British scientist, Dr. Leo Esaki of the IBM Thomas J. Watson Research Center and Dr. Ivar Giaever of the General Electric Company.

Dr. Esaki, who joined IBM in 1960, was the first to clearly demonstrate electron tunneling in semiconductor junctions and put it to use in the tunnel diode, a high-frequency electronic device. The later research of Giaever and Josephson on tunneling and superconductors revealed effects which, in addition to their scientific importance, have been combined by IBM scientists to build a new type of computer switching device which is reported to be the world's fastest.

about ten-trillionths of a second—more than 100 times faster than the fastest transistor now used in computers. Even more important is that the new switch requires only about one ten-thousandth of the power needed to run present-day transistors. It thus gives off only a very small amount of heat.

Dr. Wilhelm Anaker, of the Yorktown Research Center, explains: "Computer speed is limited by heat as much as by switching time because when transistors are placed closer to-

*(Continued on next page)*



Students at De Anza College in Santa Clara County, part of California's state-wide community college system and one of the many users of SRA textbooks.

## SRA's Textbook Systems Motivate Students

In the last two decades as the data processing industry has grown, so has the ever-present need for better education and materials in the computer sciences/data processing field. Toward this end IBM, through its subsidiary Science Research Associates, is publishing a wide range of data processing texts for the college market.

The SRA College Division in Palo Alto, California is a part of SRA in Chicago, an innovative publisher specializing in instructional materials and tests for the elementary and secondary markets. It became a subsidiary of IBM in 1965.

The college division, now in its fourth year, has available 70 titles with the main strength in the computer science/data processing area. Unlike other publishers, SRA turns out not just textbooks but entire educational systems, based on exhaustive research in the academic market to find out just what is needed in what areas. A wide array of supportive material accompanies many of the texts.

These innovative capabilities have been successfully combined not only with IBM's own data processing expertise but also with that of experts in the field. The combination has so far produced a string of successes. C. W. Gear's *Introduction to Computer Science*, which was published earlier this year, is already in use at over 125 colleges. It introduces the student to the computer problem-solving process, with emphasis on the basic principles with which the student can learn any

of the common computer languages.

The text comes with an instructor's guide, transparency masters and three language manuals on BASIC, FORTRAN and PL/I. SRA also has available individual textbooks on every major programming language.

Another successful text, *Information Processing* by Marilyn Bohl, came out in 1971 and is now in use at over 200 colleges. Her book gives a comprehensive view of the hardware and software components of modern data processing systems and the part each plays in the processing of information. It comes with an instructor's guide, a study guide for students and transparency masters.

On the more advanced level SRA offers several texts, including Mark Elson's *Concepts of Programming Languages*, Harold Stone's *Discrete Mathematical Structures and Their Applications* and *Simulation of Discrete Stochastic Systems* by Herbert Maisel and Guilano Gnugnoli.

Although SRA textbooks are sold on all levels, emphasis is on the introductory. Michael Crisp, publisher of SRA's new College Division, explains: "Our objective is to get high quality, readable texts in the hands of the student. We want to get him started in a better way, through superior editing and design, along with a wide range of teacher and student aids."

He concludes: "Our philosophy is to motivate these students by presenting material in exciting, meaningful ways with examples they can relate to and identify with." **IBM**

## Superconducting Computers

(Continued from preceding page)

gether to speed up the flow of signals between them, the risk of overheating is sharply increased."

The new switch is called a Josephson junction, after the British scientist, Brian Josephson. During his graduate studies at Cambridge in 1962, he predicted through mathematical calculations that electron pairs in a superconductive state could "tunnel" through an electrical insulator, if it is thin enough and placed between two superconductors. Superconductivity is the state in which there is no electrical resistance in certain materials when they are cooled to within a few degrees of absolute zero or minus 460°F.

Josephson also believed there would be no difference in voltage across the insulator between the superconductors if the flow of electrons were kept below a certain threshold. However, if the flow of electrons should exceed this threshold, then a small voltage would develop across the insulator. (An electric current in normal conductors never flows unless there is a voltage differential.) His calculations also determined that if a magnetic field were applied to the junction, a voltage drop would appear.

Josephson's thesis was later verified by other scientists. In 1965 the so-called Josephson effect came to the attention of Dr. Juri Matisoo at IBM's Yorktown Research Center. He was convinced the new phenomenon could be used in high speed switches and set to work to demonstrate it.

He knew that a small voltage drop could be produced across the Josephson junction by applying a weak magnetic field while a current was flowing through it. He also suspected that the voltage would develop rather quickly. It then could be used to steer a current from one superconducting branch into another and in turn represent the basic "yes-no" language of a computer. Since the voltage drop would be small, only a fraction of the energy needed to switch a transistor would be required.

As Dr. Anacker recalls: "At first our main problem was to fabricate an ultrathin, pinhole-free oxide layer about ten to twenty atomic layers thick. There were those who thought it couldn't be done. But after a while we were able to come up with a new method for preparation of these oxide layers which worked."

Although Dr. Anacker reports the Josephson junction is still in an early stage of development with many more improvements to be made, he says: "It is now a real possibility that the world's fastest switch may become a part of computers in the years to come." **IBM**

# New Computer System to Benefit Retailing

As costs in the retail business mount, store managers are taking a closer look at how they can improve operations. Many believe that a major need is the organization of store operations into a single smoothly-flowing system, both for individual stores and multiple units. Up until now efforts to automate operations have been limited to accounting procedures.

Recently, IBM expanded that focus with the introduction of the IBM 3650, a total operating system, designed to integrate the full range of store-wide merchandising and financial functions. It includes a point-of-sale terminal which helps the sales personnel to complete a sale swiftly and accurately. But it goes far beyond that. The new system can control the flow of merchandise from purchase order, through receiving goods, ticketing them with a retail price and the actual sale to inventory control and accounts receivable.

It can streamline such functions as credit authorization, sales audit, personnel training and scheduling. And it can provide management with an up-to-date overview of operations as a whole, vital to maximizing profit opportunities.

Although the IBM 3650 is a store-wide system, involving virtually all store activities, implementation can be carried out in phases, with different functions becoming operative over a period of time.

Components of the 3650 System include four systems devices used by store personnel. They are the 3653

Point-of-Sale Terminal, the 3657 Ticket Unit, the 3275 Model 3 Display Station and the 3284 Printer. These components are linked to a control unit, the 3651 Store Controller, which is on line to an IBM System/370 computer. Up to six remote stores can be linked to a controller by means of the 3659 Remote Communication Unit. **IBM**



## The Computer Helps Market Chiquita® Bananas

Every week 10 or 11 shiploads of bananas marketed by Chiquita Brands, Inc., a subsidiary of United Brands Company of Boston, arrive in U.S. ports from Albany to Seattle, most of them ordered before arrival. Buyers for the remainder must be found while the bananas are being unloaded and shipped from the ports. It is vital to match supply and demand on a day-by-day basis.

With the help of an IBM computer, Chiquita Brands now has ample data available so management can make marketing decisions quickly and efficiently, based on their knowledge of the continual variations in demand and the heavy volume of highly perishable merchandise. The System/370 Model 155 computer, operating with IMS, is in Boston where it is linked to terminals at

eight ports and six sales centers. When a ship arrives at a port, customers' trucks are loaded in accordance with orders previously entered in the system and transmitted to the ports. Any discrepancies in filling the orders are transmitted back to the computer. These records become the basis for invoices.

With the information this new system provides, management can make better pricing and distribution decisions. They also gain a better understanding of buying patterns for a given geographic market.

Bananas not sold at the ports can be routed to areas of greatest demand shown by nationwide data, rather than the limited information formerly available to local offices. The system makes it possible for Chiquita's customers to place orders farther in advance. At any time, they can get quick answers as to the status of their orders. The IBM system enables Chiquita Brands, Inc. to serve each customer in a more effective and efficient manner than ever before. **IBM**

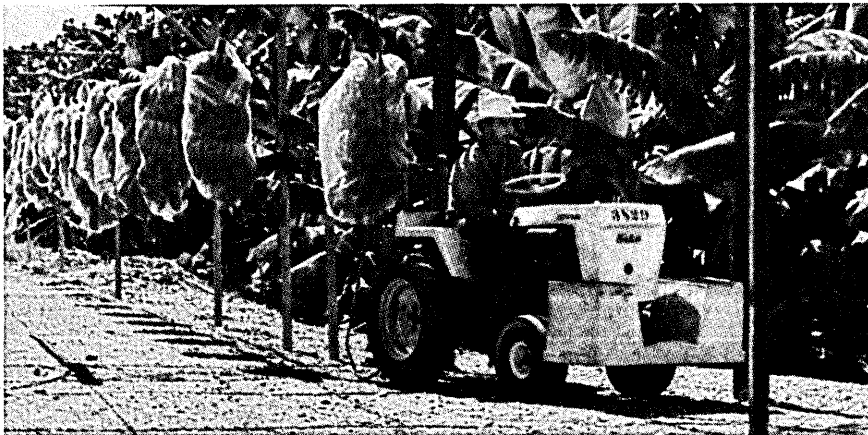

*Every week 10 or 11 shiploads of Chiquita Brand bananas arrive in U.S. ports.*

# Data Processing Training...

**in Watts** "This course was not only one of the most stimulating educational experiences I've had, but it also gave me the chance I really needed to get and keep an interesting job that paid well."

This was Jackie Glover's reaction to the computer programming course she took three years ago at the Los Angeles Urban League Data Processing Center. The center teaches data processing courses for no tuition to those who could not otherwise afford the training. The curriculum includes courses in computer programming, computer operating, keypunch operating and one just recently added in clerical skills. The center, which opened in 1968 near Watts, is sponsored jointly by IBM, the Bank of America and the Urban League. IBM provides the manager and instructors and the educational materials. The bank supplies the building and pays for its maintenance. The Urban League screens and tests the students and places them after they have completed the course.



*In Los Angeles, instructor Jackie Glover (second from right) reviews a program with students Diane Johnson, Ennis Davis and Willie Davis.*

Just before coming to the center, Jackie had worked as a hair color technician. Upon graduating from the center's intensive 13-week programming course, she was hired as a programmer at IBM's Systems Manufacturing Division in San Jose. Since then she has come full circle to return to the center as a programming instructor.

Jackie is one of over 700 students who so far have graduated from the Urban League Data Processing Center. Ernie Barrios, the center's manager, says over 97% have been hired by over 200 companies—most in the Los Angeles area but some out of state.

On a tour through the large stucco building, Barrios said: "These people are high school graduates and they're bright. They're disadvantaged only economically."

To qualify, students must be high school graduates and show an aptitude for the particular course they are interested in. Prospective programmers must also pass a logic exam. Barrios emphasizes: "Our students probably have a better chance of success, not only because of the intense instruction they get, but also because at least half their time at the center is spent in the computer room with actual on-site, hands-on computer experience."

**and Harlem** The success of the Urban League's data processing center in Watts prompted IBM to help open a similar center in New York City's Harlem just last year. This time IBM teamed up with the Sperry & Hutchinson Foundation and the Opportunities Industrialization Center of New York (OIC). Again, IBM provided the data processing equipment and materials along with the instructors and manager. Sperry & Hutchinson donated \$25,000 to help convert a Harlem factory into a data processing center.

Lauchland Henry, IBM's manager, reports: "We've graduated over 135 students with about 90% placement. Most are working at many corporations and banks in the New York area. Many of them have already made rapid progress."

Their success is no accident. Besides a rigorous screening process, the center demands high performance from the students. "We're pretty tough on them," says Lauchland Henry. "But we have to be, if they're going to learn what they have to in the three months or less they are here."

One of the instructors, Dorothy Fort, a former systems engineer for IBM, explains: "What we're trying to do is get the students used to 'working' while they're learning. We not only give them as much computer time as possible but also full knowledge of actual work situations. It's really a golden opportunity for them."

The students seem to concur. Jan Webster, who spent a year at college, could not afford further training. Anxious to

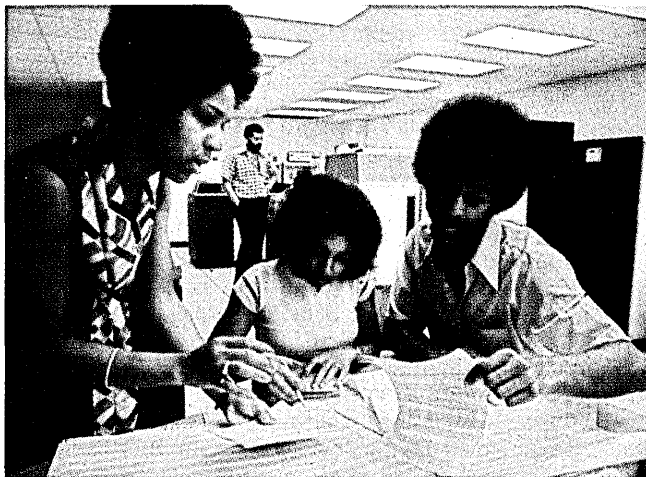

*In Harlem, Patricia Baker and Malcolm Baptiste discuss results of program with instructor Dorothy Fort (far left).*

go into data processing, she heard about OIC's data processing center and was able to qualify for the course in programming. Another student, Jamie Perez, had worked at a variety of odd jobs. After passing his high school equivalency exam, he took OIC's eight-week course in computer operations. Mike Macklin, who had been a baker at several large hotels in Manhattan, was lured into data processing by the prospect of high salaries, but could not afford the training. After completing the computer operator's course at OIC, he said: "This school offers the best opportunity in the city. They're not only helping us learn what we have to know to get good jobs but how to keep jobs when we get them."

# IBM®



# the centronics phenomenon!

## now a 120 cps keyboard/printer for under \$3000.

## why pay 50% more?

**The new 308.** It's a 120 char/sec, 80 column incremental keyboard/printer. Now a teleprinter with line printer speed. There's nothing like it anywhere for less than 50% more.

**Or, why get less?** Compare the 308 with a 30 char/sec teleprinter—you can get 4 times the speed for the same money with the 308. Or, compared to a 10 char/sec teleprinter, the 308 gives you 12 times the speed and cuts telephone line costs dramatically.

**Interfaces!** With the Centronics RS-232 send/receive interface, you can select from the full baud range of 110 to 9600 bps instead of the typical 110-300 range. Our current loop interface handles most teleprinter applications, too.

**Innovations!** Immediate viewing lets you see any characters you type instantly after you type them. A backspace key for editing (option). Horizontal tab set/clear (option). A lighted column indicator tells operator the next column print position.

**Multicopy.** The 308 prints an original and four copies in paper widths up to 9½ inches.

**The 308.** \$2690. Add the communications interface and still be under \$3000. OEM discounts available. A new era in price/performance. Purchase or lease. And service is nationwide. There's nothing like it. Anywhere.



### CENTRONICS

centronics data computer corp.

hudson, n.h. 03051

telephone (603) 883-0111

eastern region: (617) 646-7200

central region: (513) 294-0070 (ohio)

chicago office: (312) 398-4500

western region: (714) 979-6650 (calif.)

## dawn of a new era

CIRCLE 89 ON READER CARD

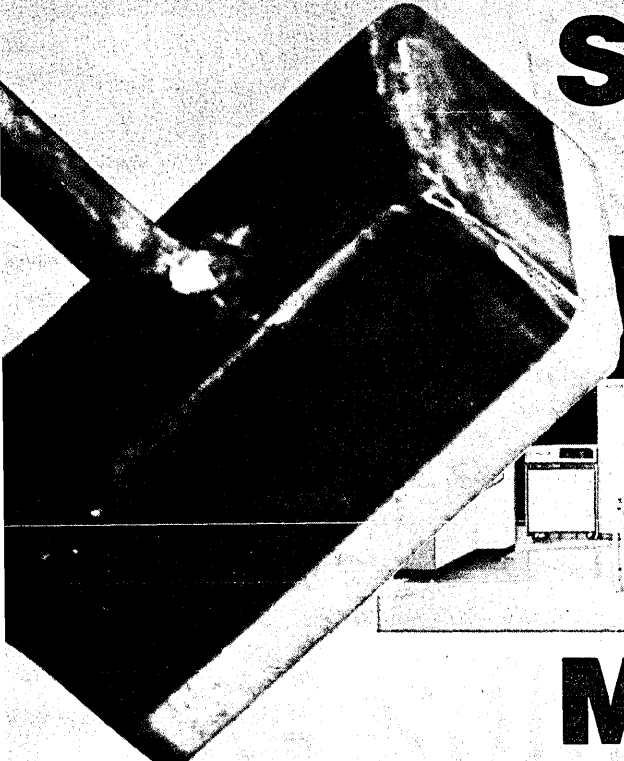

# **SYSTEMS 85/86**

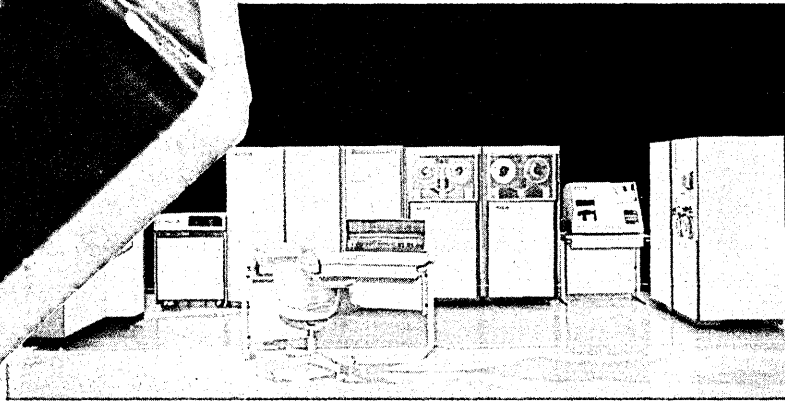

**More than  
just "Hot Iron."**

**... Cool Software.**

What makes SYSTEMS 86 the hottest 32-bit real-time computer?

Memory cycle time for one thing... 600 nanoseconds. Plus, a 1.8 microsecond interrupt response time. Then, there's the standard four-port memory structure. Throughput? Each port has a transfer rate of over six megabytes per second. Repertoire? Over 150 instructions, including bit manipulation and direct addressing to over 1/2-million bytes. That's HOT. Want economy instead of speed? There's the SYSTEMS 85 with all the goodies of the 86 except that it has an 850 nanosecond memory.

But, what good is hot iron without cool software?

With SYSTEMS 85 and 86, the right software is there... software that works at high speed and gets the maximum utilization of system hardware resources.

The Real-Time Monitor software package is a good example. RTM supports *true* multiprogramming... it can handle up to 255 foreground tasks concurrently while performing batch processing in the background. Full input and output spooling. Dynamic resource allocation. Code and data sharing through the reentrant library and global COMMON... save valuable memory space. Then, there's RTM's Text Editor that lets up to 16 users at remote terminals simultaneously create and maintain text files. An excellent time and data saver in developing large, complex application programs.

Take a look at SYSTEMS 85/86 Extended FORTRAN IV. It's the one that performs semi-global optimization of generated code... maximizes savings in memory space and minimizes execution time. So efficient it's often used for real-time and time-critical programs. Rich in repertoire... takes full advantage of the instruction set and recognizes eleven data types including bit for logical items and halfword for analog data. There's also full mixed mode, ENCODE/DECODE, BUFFER IN/OUT, Random Access I/O, in-line coding and more. SYSTEMS 85/86 FORTRAN IV... a powerful language for a powerful machine.

Process Control? SYSTEMS 85/86 Process Control Executive is a software structure that's both application adaptable and peripheral independent. Now, add MACS, SYSTEMS new universal interface which links the computer to most any scientific or industrial process. The result... a process control system unmatched in versatility and virtually obsolescence-free.

This is only part of the SYSTEMS 85/86 story... two computer systems that have teamed hot iron with cool software. Price? You'll be pleasantly surprised. About a third less than any nearly-comparable 32-bit real-time system. OEM discounts? Of course.

6901 W. SUNRISE BLVD., FT. LAUDERDALE, FLORIDA 33313, PHONE (305) 587-2900

# SYSTEMS

ENGINEERING LABORATORIES  
OFFICES IN PARIS AND FRANKFURT  
CIRCLE 94 ON READER CARD

# Lead the way

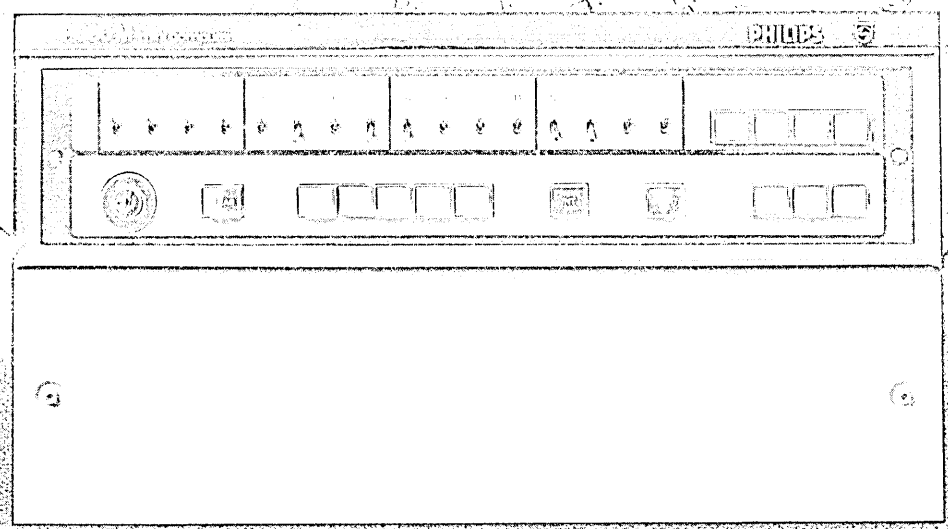
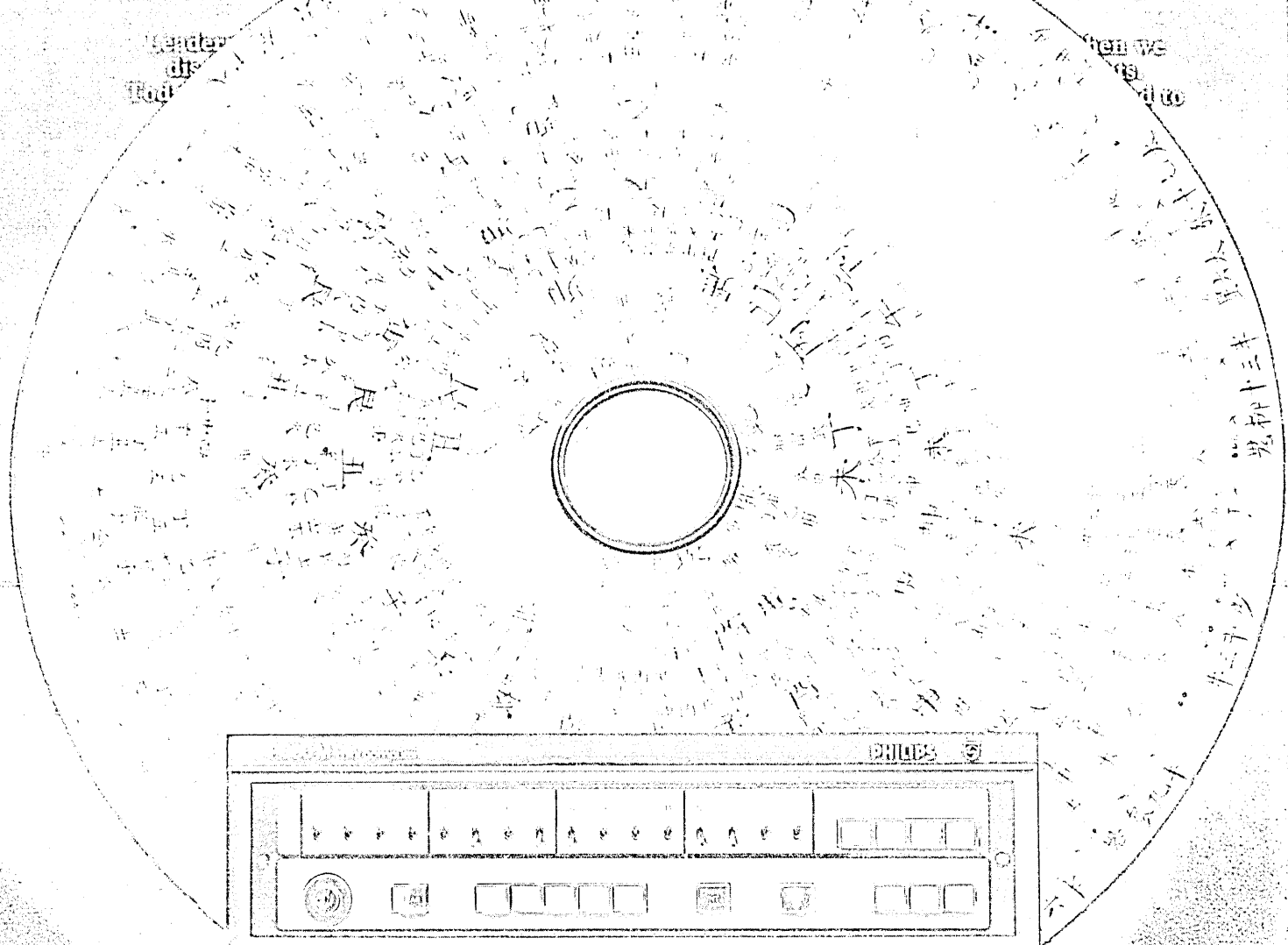

PHILIPS CD-ROM drives are available in a range of capacities from 230 MB to 1024 MB. The CD-ROM drive is a standard feature on many of our PCs. For more information, please contact your local Philips representative or call 1-800-4-A-Philips. Philips is a registered trademark of Philips North America Consumer Electronics Co. © 1992 Philips North America Consumer Electronics Co.

Philips respects your reputation.



# PHILIPS

# United gives you The box that you built.

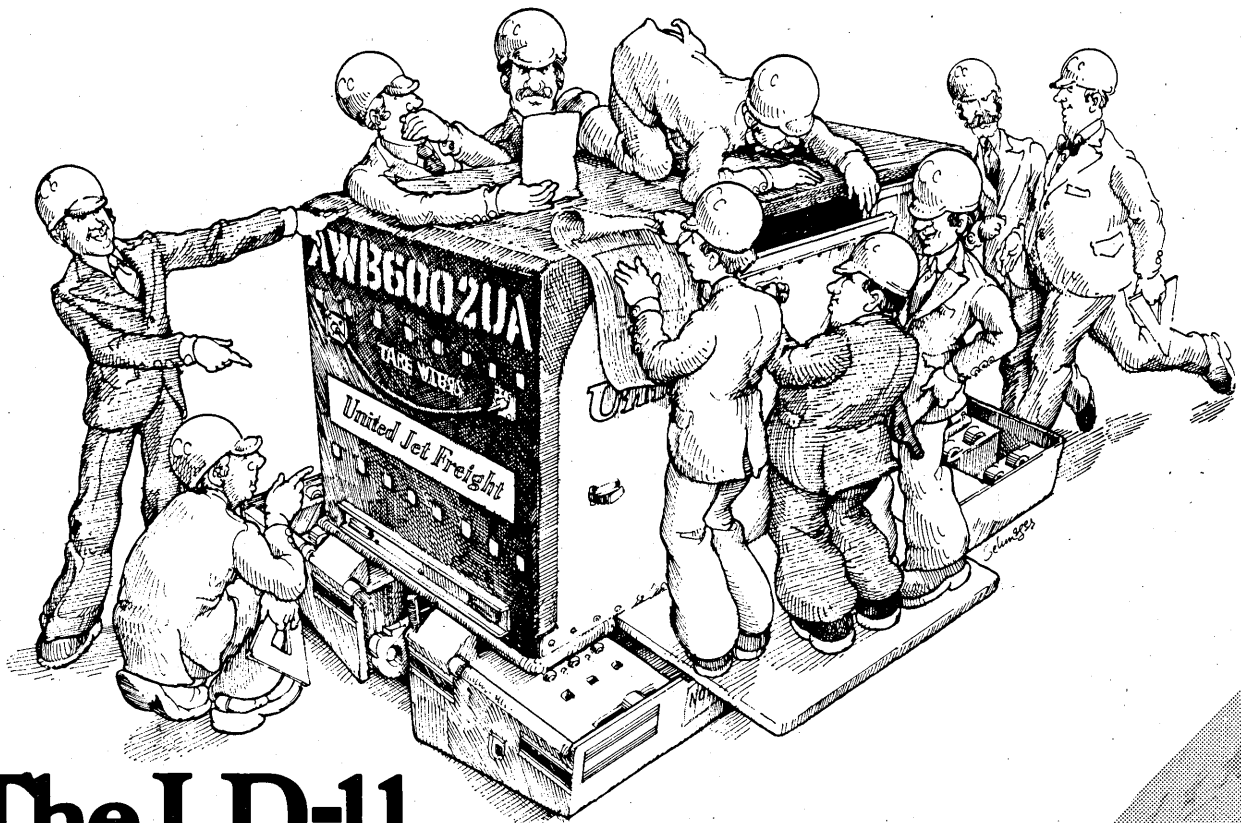

## The LD-11.

We knew our shippers wanted a container larger than the LD-3. So we asked a cross section of our best customers, who we knew would speak for all our shippers, specifically what you wanted in a larger container. You told us you wanted:

1. Straight sides
2. Structured fiberglass body (weatherproof)
3. Tie-down (United's "Soft Touch") capability
4. One-seal security
5. Bars for garment-on-hanger shipments
6. Off-airport dollies
7. Full-width door opening
8. Internal height of 61 inches
9. Pull-rings and Push-plates
10. 6,300-pound-plus net capacity
11. Most important to many shippers, a Time-of-Tender rate structure.

**You've got it.** It's United's LD-11. It fits in all our 747's and DC-10's. And our "Daylight Savings" time-of-tender rates are designed to make it fit your shipping budget.

**Typical "Daylight Savings" rate:** 6,300 lbs. in one LD-11 container from New York City to Los Angeles for \$482—only \$7.65 per 100 lbs.

The LD-11 in action. United's newest lower deck container, the ten-foot-long LD-11, can move over 6,300 pounds of weather-safe, pilfer-proof freight.

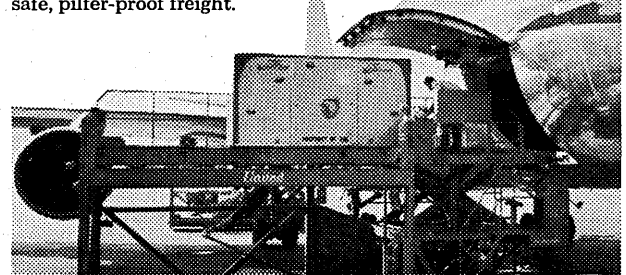

UNITED'S LD-11		
Dimensions	Internal	External
Length	120"	125"
Width	56"	60"
Height	61"	64"
<b>Capacity</b>		
Cubic Feet	242	277
Net Pounds	6,300 plus	
Minimum Chargeable Weight (Pounds) 1,800		

**United Air Lines**  
**Jet Freight** No. 1 in the  
U.S. sky

# PDP-11 is out to take over your plant.

PDP-11/45 and PDP-11/40.  
The real-time computer systems  
with all the raw power you could  
ever need.

All the speed. (Up to 3 mil-  
lion instructions per second on  
the PDP-11/45.)

All the capacity. (248K bytes  
main memory, 320 million bytes  
on disk.)

All the flexibility. Our power-  
ful RSX-11D operating system

handles a limitless number of  
tasks, with over 250 priority levels.

RSX-11D has everything  
you need to run your whole plant,  
get all the information you want  
out of it, and do whatever you  
want to do with what you've  
learned.

All for half the cost of plant  
systems that cannot do nearly as  
much.

And that's not the half of it.  
Even after you've put  
RSX-11D on your production

lines, there's enough power left  
over to do the other things that  
need doing. Production reports.  
Lab testing. Quality control.  
Inventory control. Management  
reports. Engineering calculations.  
Even plant security.

All at the same time. And yet  
each totally protected from the  
other by hardware.

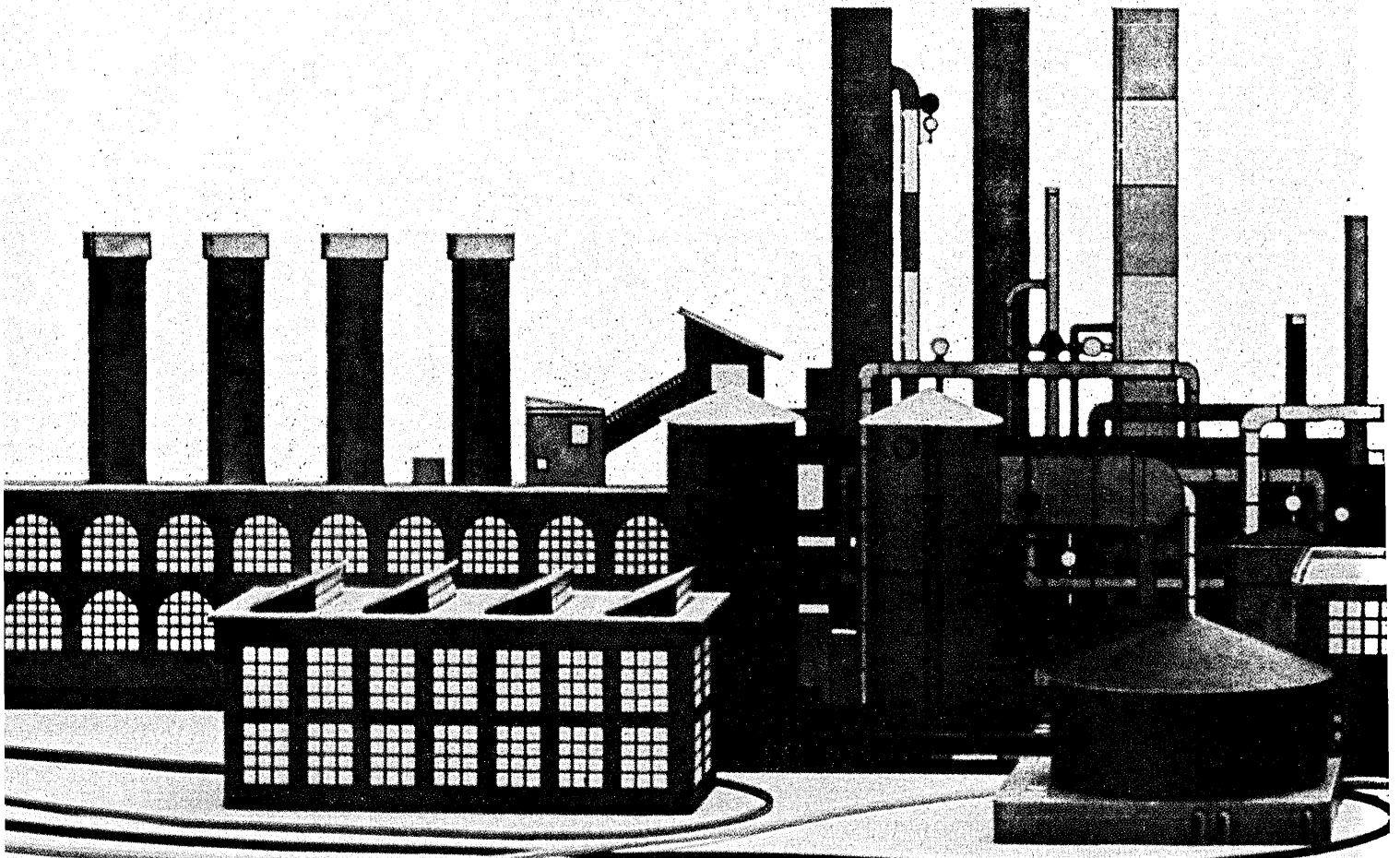

RSX-11D is a powerhouse of a real-time system. With dynamic memory and disk file allocation, multi-tasking foreground operation, spooled I/O, and on-line batch processing. But it's a powerhouse that adapts to your needs. With easy FORTRAN IV programming and ISA standard real-time calling conventions.

Last year, our newest PDP-11's took the medium scale computer world by storm. Three months after we introduced them, PDP-11/40 and PDP-11/45 were the hottest computers we'd ever made. And we've made a lot. Over 23,000.

Guess what's going to happen now that they're both available to plants like yours.

Send for the information.

Digital Equipment Corporation, Maynard, Mass. 01754. (617) 897-5111. European headquarters: 81 route de l'Aire, 1211 Geneva 26, Tel: 42 79 50. Digital Equipment of Canada Ltd., P.O. Box 11500, Ottawa, Ontario K2H 8K8. (613) 592-5111.

**digital**



# Reliability is burned into every Westinghouse 1600 video display terminal

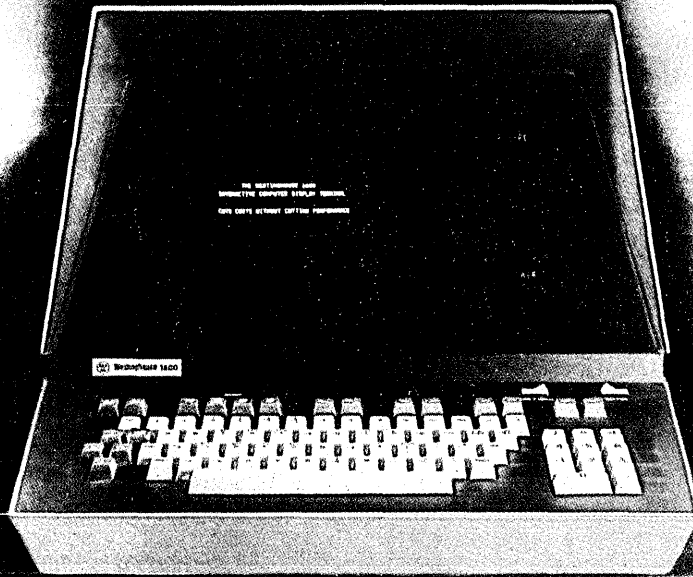

Before we deliver a Westinghouse terminal, its reliability has been confirmed by a rigorous, 7-day burn-in cycle. Each terminal is placed on continuous, operational test at 40°C (104°F) to screen out possible circuit defects and assure all systems meet their performance specifications.

The result is a terminal you can depend on. In fact, our MTBF is

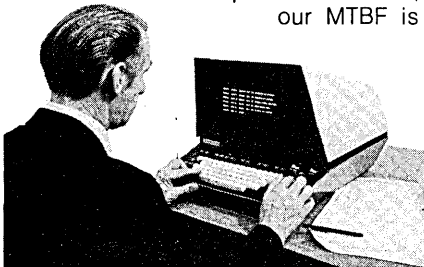

now over 4,500 hours. That spells reliability whether the application is a management information system, coordinated production control, batch entry system or engineering design and testing.

Besides reliability, the Westinghouse 1600 provides the user with exceptional flexibility thanks to an extensive range of features offered as standard in the base price. These include both synchronous and asynchronous operating modes, eleven switch-selectable data rates plus format mode and a full selection of edit functions. In addition, a low-cost option—station address for polling by computer—can yield significant cost reductions by line sharing.

You can be sure... if it's Westinghouse.

Want more information? Just call any of these representatives.

**WESTON MARKETING CORPORATION**  
2351 Shady Grove Road  
Rockville, MD 20850

Tel. Rockville, MD	301-948-8300
New York, NY	212-541-5340
Chicago, IL	312-827-7787

**ADVANCED TECHNIQUES**  
3848 E. Colorado Blvd.  
Pasadena, CA 91107  
Tel. 213-681-1093

Distributed in U.K. by:  
**The Exchange**  
Telegraph Company Limited  
London 01-739-2041 Telex 27595

Westinghouse Canada Limited,  
Box 510, Hamilton, Canada  
416-528-8811 Telex 021-655

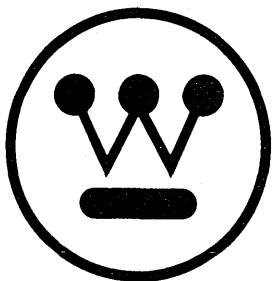

# Westinghouse helps make it happen



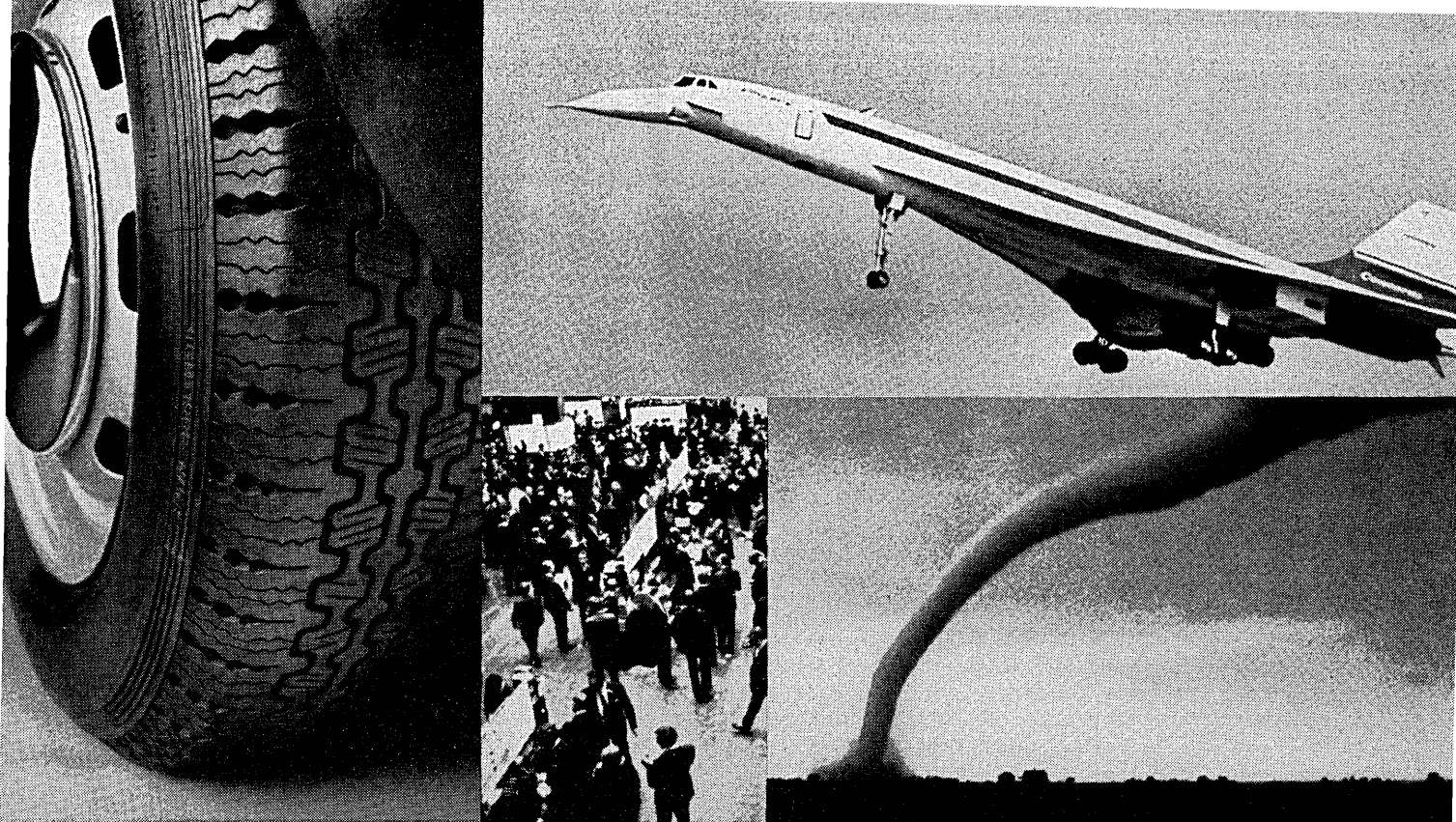

# The plot changes. The story stays the same.

On Monday morning, weather maps will be drawn on a CalComp system — those for the German weather service on a flatbed plotter — and those for the United Kingdom on a microfilm graphic system.

At the same time, a leading firm of London stock-brokers and many of their clients will begin their week with trend analysis graphs plotted on CalComp drum plotters.

During the week, Pirelli of Italy will use a CalComp plotter to design tire treads.

The Concorde supersonic jet will fly, thanks in part to engineering drawings produced by a CalComp plotter. And map makers all over the world can draw maps with a speed and precision man cannot approach.

The plots change.

Wherever in the world a new need for computer graphics arises, CalComp will assuredly have the hardware and the software to meet the need.

We set the standards for our industry. We service what we sell around the world.

The plot changes. But our reputation for innovation and our concern for excellence — those stay the same.

For information on plotters, call your local CalComp office, or contact California Computer Products, Inc., DM-12-73, 2411 West La Palma Avenue, Anaheim, California 92801. (714) 821-2011.

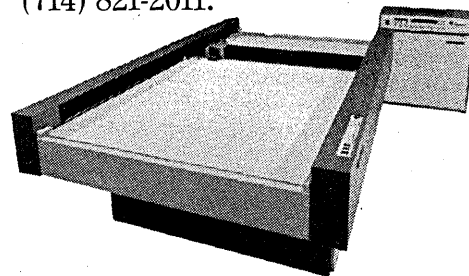

**CALCOMP**

# 370/ST

When we built our new add-on memory for IBM System/370 Model 145, we wanted to give you more reasons to buy ours than anyone else's. Here are eight of them.

## ONE.

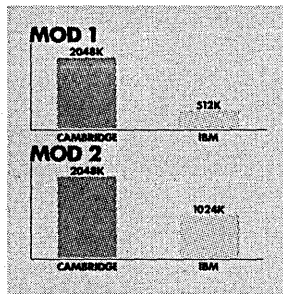

**DOUBLE (OR QUADRUPLER) YOUR IBM 370/145 MEMORY CAPACITY...**

Regardless of the Model 145 you now have, you can expand it to two megabytes. For most 145 users, that means unlimited growth of systems, applications, files, packages and processing flexibility. Memory restriction is a thing of the past. Your investment in mainframe hardware is preserved for years to come.

## TWO.

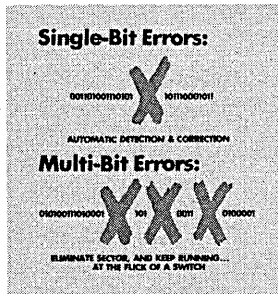

**GET THE MOST COMPLETE MEMORY PROTECTION EVER OFFERED...**

370/STOR 145 detects and corrects all single-bit errors, so efficiently they don't exist as far as you are concerned. And it provides immediate reconfiguration in the event of a multi-bit error. A flick of a switch isolates the error sector, and the rest of memory keeps running... and running... and running. It's like having no downtime problems to worry about.

## THREE.

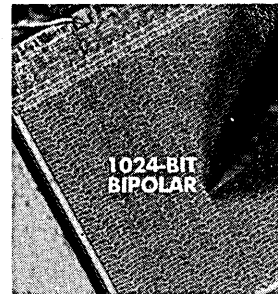

**USE THE FASTEST, SAFEST MEMORY TECHNOLOGY AVAILABLE TODAY...**

The 1024-bit bipolar chip. Both Cambridge and IBM use it for their 145 memories. It's extremely fast. It provides stable storage of data. It uses a single power level that eliminates many circuits, components, interconnect points and materials. The result: lower cost and great reliability for you.

## FOUR.

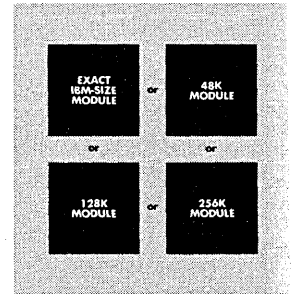

**AND GET THE MEMORY SIZE YOU WANT RIGHT NOW. NO WAITING.**

No one ever offered the choice of memory sizes available with 370/STOR 145. You can select exact IBM-size modules. Or 48K modules. Or 128K modules. Or 256K modules. And mix them any way you want. So you grow the way you want—in big steps or small. And you can start right now. We're already delivering.



CAMBRIDGE MEMORIES, INC., 696 Virginia Road, Concord, Mass. 01742 (617) 259-9880

# OR 145

## FIVE.

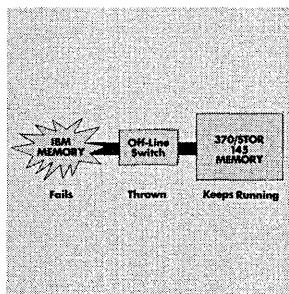

**THAT'S NOT ALL. THIS MEMORY KEEPS WORKING, EVEN WHEN IBM'S QUITS.**

It's like having a built-in back-up main memory. If your resident IBM memory fails, 370/STOR 145 will keep going. Just throw a little switch on our memory panel, and the failed IBM memory is disconnected while 370/STOR 145 continues to run full speed. Need we explain the virtues of that attribute?

## SIX.

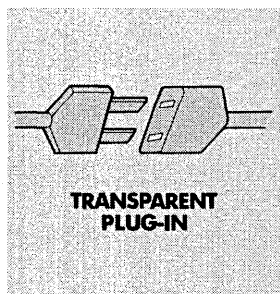

**AND YOU CAN INSTALL ONE MEGABYTE IN LESS THAN A SINGLE DAY...**

370/STOR 145 is a stand-alone unit. It connects to your CPU through plug-in connector cables. That makes it completely transparent. You can use all IBM hardware, software and maintenance without alteration. The interconnect is so direct that we'll get your first megabyte running in less than a day.

## SEVEN.

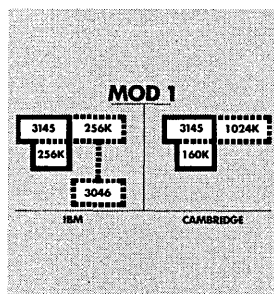

**IN FAR LESS FLOOR SPACE THAN IBM OR OTHER MEMORIES NEED...**

We are noted for our compact memories. They help us get orders, because computer sites have space problems, too. With 370/STOR 145, we get compact indeed: up to a megabyte in a single chassis, with power supply built-in. The result, if you have a 145 Mod 1, is more than twice the capacity in about half the space.

## EIGHT.

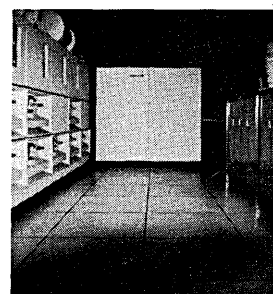

**AT A PRICE THAT YOU CAN'T BEAT... UNLESS ALL YOU SHOP IS PRICE.**

Cambridge sells value. That means the right performance at the right price. We've gone out of our way to build 370/STOR 145 as a memory product you can't beat in performance, regardless of the supplier. But we also know you want the right price—so we give it to you. Ask our local sales office to quote you our lease and purchase terms.

370/STOR 145. The newest product from Cambridge, a company that knows that its future depends upon the excellence of the products it builds for you.

## CAMBRIDGE.

A good place to put your information.

### 360/CORE

Up to two megabytes of main memory for Models 22, 30, 40, 50, 65 and 67 processors in the System/360 line.

### 370/STOR

Up to four megabytes of main memory for the Models 145, 155 and 165 in the System/370 computer family.

### EXPANDACORE-11

Memory expansion systems for all PDP-11 processors, featuring up to 30% speed increases. Two-way data save and interleaving.

### EXPANDACORE-620

Up to 65K of main storage for all 620/i, L, F-100 and L-100 minis. Self-contained and self-powered 5/4" plug-in systems.

### OTHER MEMORIES

Core, semiconductor and DOT data storage systems for OEM and End-user computer mainframe, controller, peripheral, terminal and auxiliary memory products.

# Introducing the Statos 31 Family of Printer/Plotters. Illustrating what Three Widths can do for your computer output.

Look at graphic output the Statos® way.

If you need a combination of line-printers, X-Y plotters or just plain old CRT's for your computer output, you need an electrostatic printer/plotter. Statos.

In the Statos 31 family, you have three output widths to choose from. 8½", 11", or 15". Whether you're turning out business forms and reports, program listings, spectrum analyses, weather or seismic maps, Statos has the optimum width. Roll or fan fold.

No matter what your output, Varian's Statos family will reproduce it. With high resolution, pinpoint accuracy. In just words (Chinese is just as clear as English). Or in pictures.

Or pictures simultaneously interspersed with words. Or words and numbers superimposed over plots, graphs, and charts. At speeds ranging from 1,000 to 2,000 lines per minute.

The Statos family will merge fixed and variable data. It

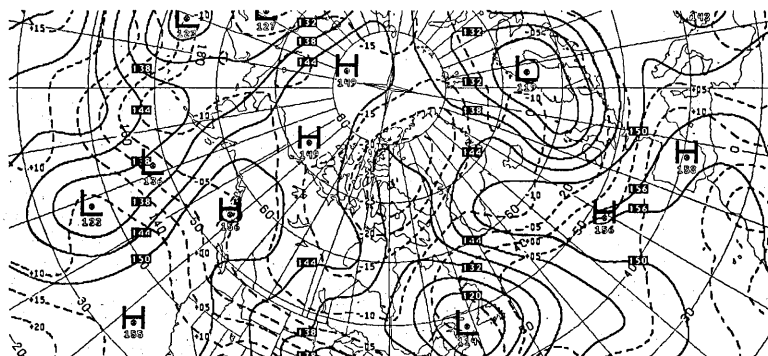
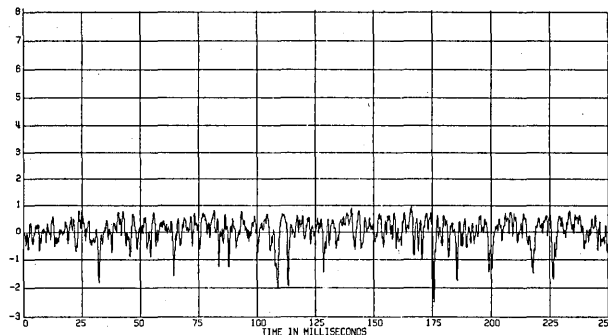
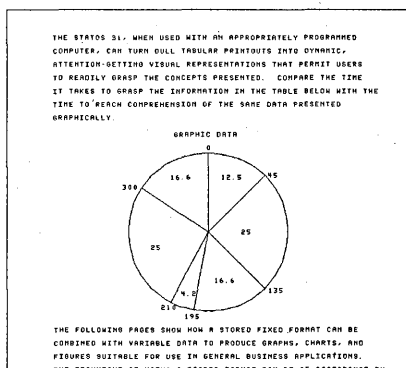

will superimpose real-time data over fixed information stored in the computer memory—getting rid of expensive preprinted paper.

Which puts line printers and pen plotters in a different ball park. Not to mention most other printer/plotters.

Separating Statos even further from the competition is its powerful interface capability and software packages. Its unique computer compatible bus architecture gives an easy and immediate plug-in and go capability to both small and larger computer systems. On-line or off-line, the Statos family gets along with everyone.

And you can have as many copies of read-out as you want.

If you'd like a further illustration of what electrostatics and the Statos family of printer/plotters can do for your computer output and your profit and loss statement, write or call Varian Data Machines, 611 Hansen Way, Palo Alto, Calif. 94303 (415) 493-4000.

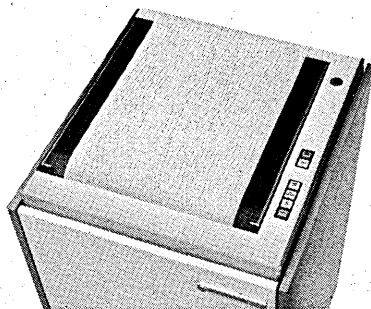

**varian data machines**



# RBT

In the good old days, it was RFD. Today, it's RBT . . . the INCOTERM® SPD® 900 Remote Batch Terminal Systems. They deliver.

And because of INCOTERM "push-button" compatibility, what you receive is a bundle of unsurpassed user options. You can mix and match . . . with batch . . . and interactive. Select 2780, 3780, and 2740, 360/20 and 2265, 1004 and Uniscope 100, 200 User Terminal and Series 710. You can interface with your CPU, with your service bureau . . . or with a combination of multiple CPU's or service bureaus.

You get card reading at 150 or 300 cpm and printing at 200 or 400 lpm. And if you want a lot of storage for programs, formats, or data, choose

the INCOTERM SPD Diskette. You get up to 500,000 bytes.

But the SPD 900 is far more than just a remote batch terminal. Use it for order entry, remote job entry, file inquiry, and a host of other applications. It all adds up to true multi-function capability.

There are many models available. One of them can deliver for you.



6 Strathmore Road • Natick, Massachusetts 01760 • (617) 655-6100

**INCOTERM Sales Offices:** Boston (617) 655-6100 • New York (212) 541-5780 • Washington, D.C. (703) 524-8610 • Atlanta (404) 289-4230 • Chicago (312) 593-2230 • Dallas (214) 634-2600 • Los Angeles (213) 640-0328 • San Francisco (415) 697-3643

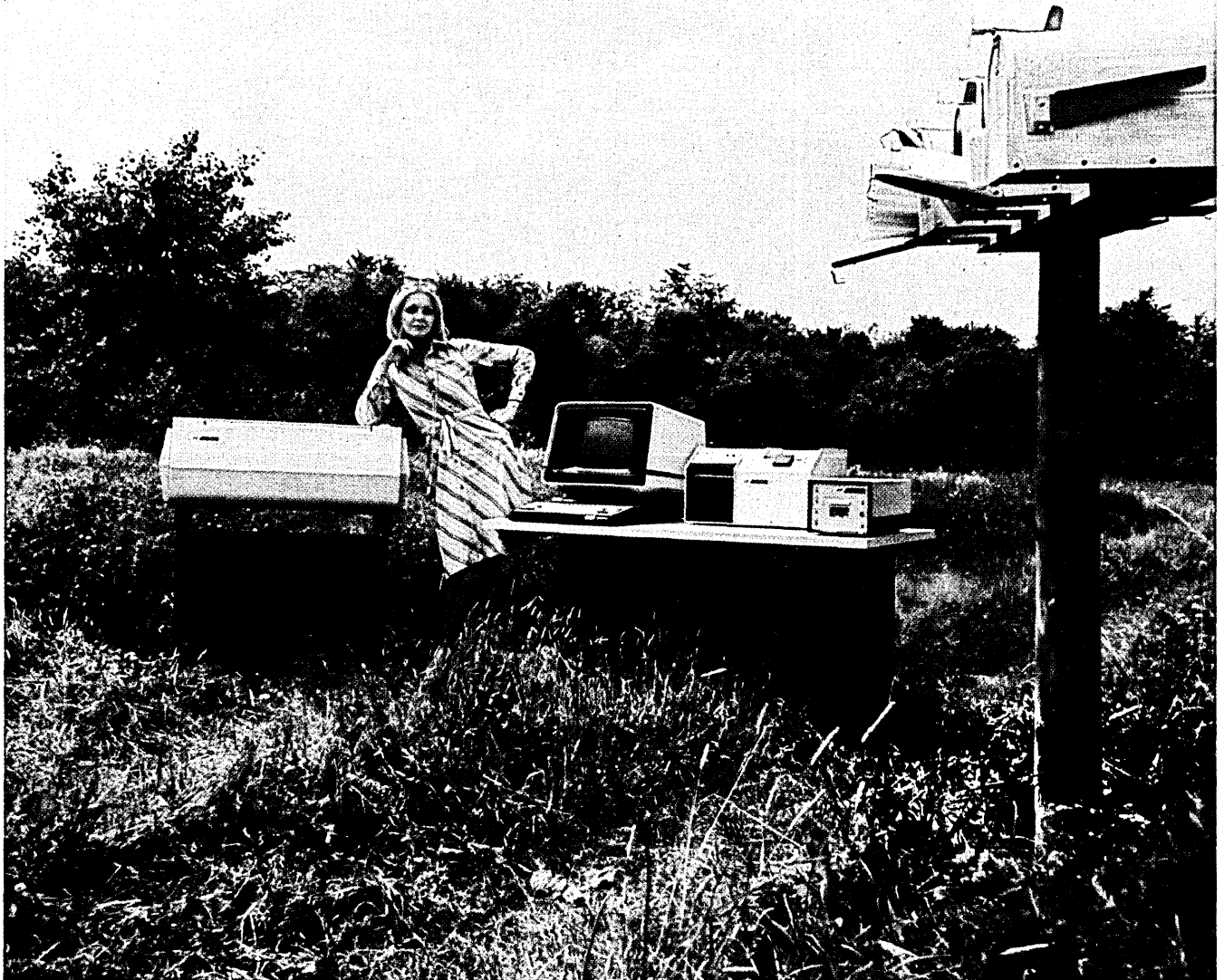

# Now there's the Singer 1500 intelligent terminal system.

## **Model 1511/1512 Tape Drives.**

Convert and edit mini-cartridges into half-inch computer-compatible magnetic tape for communications or direct processing. The 1511 records 556 bits per inch on 7-track tape; the 1512 records 800 bits per inch on 9-track tape. Both have 7" reels.

**Also available: Model 1513/1514 Tape Drives.** The 1513 records 800 bits per inch; the 1514 records 1600 bits per inch. Both are 9-track with 10½" reels.

## **Model 1525 Serial Printer.**

A quiet, highly reliable serial impact printer. Extremely versatile within its price range, it prints up to 30 characters per second on either single or multi-part continuous forms. Accepts continuous journal roll paper from 7" to 15" widths. And continuous pin feed paper of up to six-part copies from 8½" to 15½" widths. Features automatic paper alarms.

## **Model 1533 Dual Mini-Cartridge Tape Drive.**

Allows you to update multiple files, store information off-line, and sort and merge records right in the department where they originate. Up to three cartridge drives, each with two mechanically independent tape transports, can be serially interfaced with the 1501 Video Display Workstation at a distance of up to 1500 feet.

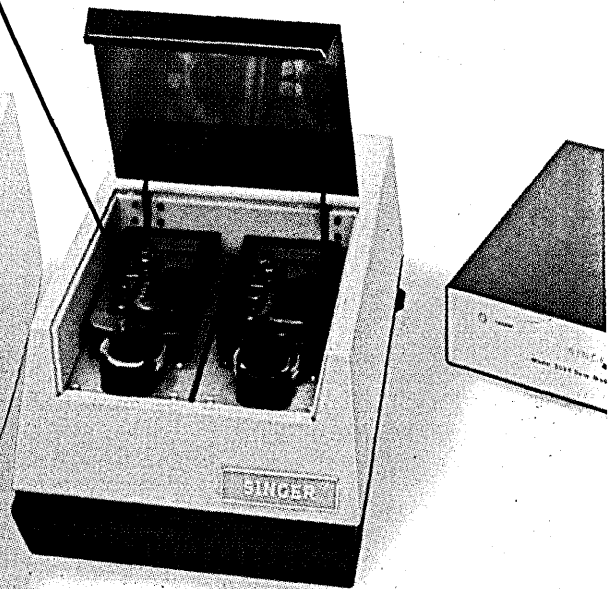
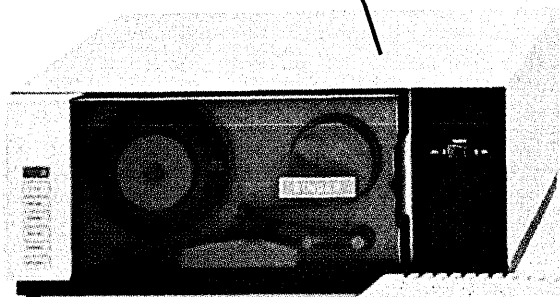

## **Model 1501 Video Display Workstation.**

For data entry, verification and validation, it combines an input keyboard, 256-character video display screen; automatic threading magnetic tape drive for a mini-cartridge that holds 122,400 characters; a solid state of 8K memory; and a 300 Nanosecond processor.

## **Synchronous Communications Adapter.**

Enables the 1500 system to communicate with computers using IBM binary synchronous communications standards.

# Now there's no better way to disperse computer power throughout your company.

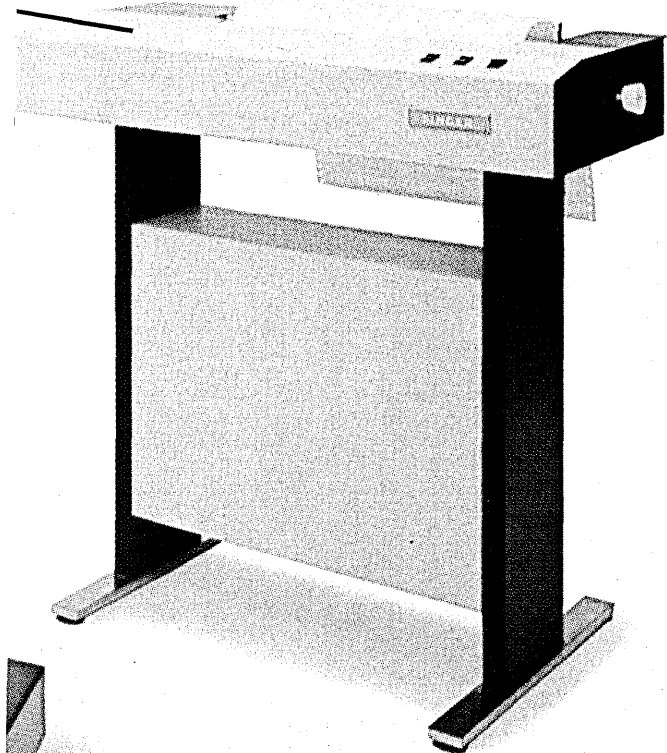

#### Model 2024 Data Modem.

Transmits and receives data at rates up to 2400 bps over dedicated or switched telephone lines in half-duplex mode. A low cost option, fully compatible with the Bell 201A or 201B modem.

Dispersed computer power. In theory, it sounds great.

In practice though, it's a different story. It seems like the only way to make all that new hardware and software interface with the equipment you've already got is to use a shoehorn. Or a magic wand.

That's why the new Singer\* 1500 intelligent terminal system is such a hot piece of news. Because it's designed to fit right into the operation you're running now. With an absolute minimum of fuss. And expense.

And look what you've got once it's in: Besides the basic job of recording data, the 1500 gives you capabilities for verification, production statistics, self-check numbers, field totals, contents searching, table look-ups, range checking and copying.

Since the 1500 has BSC communication, along with unattended terminal operations, HASP capabilities, polling and selection, automatic error checking and recovery, expanded features and growth operations, you've got the most flexible means of getting your data processed you could ask for. At transmission rates from 600 to 9600 BAUD. The system is completely compatible with System Ten\* computer by Singer, as well as the IBM 360/370.

Add to that the peripherals for printing and the extra tape drives for sort/merge capabilities and there you have it: one of the most complete systems available to meet today's needs. All backed by a world-wide service organization, with 145 service centers in the U.S. alone.

And that's only the beginning. From here, you can really spread out. And put the full power of your computer wherever you need it. Because you've got a system of completely programmable, go-anywhere desktop terminals. With a pre-processor in each unit.

And that brings the practice of dispersed computer power up to par with the theory. At last.

For complete information or a demonstration, call your nearest Singer Business Machines representative. Or write: Singer Business Machines, San Leandro, California 94577.

*We are an equal opportunity employer M/F.  
For employment information, write: Singer Business Machines, 2350 Washington Avenue, Dept. 508, San Leandro, California 94577.*

**Touch & Know  
Information Systems by  
SINGER**



\*A trademark of The Singer Company.

# Add Staran. Subtract processing time. Multiply effectiveness.

Thinking of adding more computer capability? Think about Goodyear's STARAN<sup>TM</sup> associative array processor.

STARAN provides an effective combination of fast associative array processing and conventional sequential processing—the most efficient approach to a variety of data processing problems.

As the charts show, the higher the number of items to be processed, the more advantageous STARAN array processing is for both arithmetic and matching operations. For applications involving a high degree of parallelism, or a highly dynamic data base, STARAN is unequalled. It can solve problems economically that are too expensive in money and time with sequential processing alone.

STARAN can achieve input-output rates of up to several billion bits per

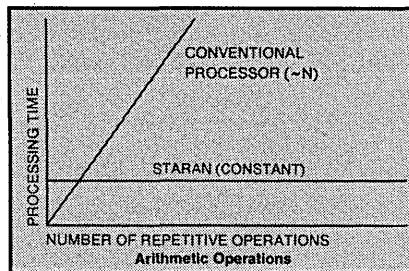
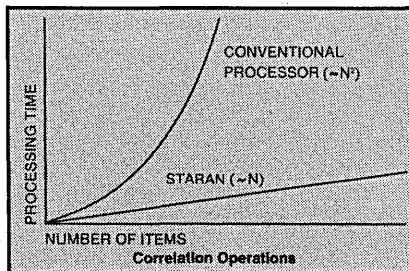

second. And execution rates of up to several hundred million operations per second.

Yet STARAN is relatively inexpensive. You can buy it with varying capacities of array and sequential capability to suit your needs. A minimum basic STARAN system can cost as little as \$250,000 and software cost can be reduced to one-third of conventional system software.

To determine if these savings can be achieved for you, let us work with you on your problem. Goodyear invites you to test STARAN at our Akron, Ohio facility.

For more information, or to plan a demonstration, write:  
STARAN Marketing, Department 920,  
Goodyear Aerospace Corporation,  
Akron, Ohio 44315, or call  
(216) 794-3631.

**GOODYEAR**  
AEROSPACE



# Meet the Hazeltine "Mod Squad"



Our "Mod Squad" is a highly qualified engineering staff dedicated to one purpose—taking a great CRT terminal and tailoring it to the special requirements of individual large quantity customers.

"Hazeltine 2000" terminals are operating throughout the world with modifications that range from a simple change in the color of the cabinet (just send us the paint chip that matches your system) to complex electronic

modifications such as custom interfaces, unique circuits, or special-purpose keyboards—and all delivered with the proven reliability of the standard "Hazeltine 2000" combined with the custom tailoring you require.

If your application demands a tailor-made fit, see what the Hazeltine "Mod Squad" can do for you.

Contact your Hazeltine representative for complete details.

## Hazeltine Corporation

Computer Peripheral Equipment Greenlawn, N.Y. 11740 (516) 549-8800 Telex 96-1435

EAST: NEW YORK (212) 586-1970 □ BOSTON (617) 261-5867 □ EDISON, N.J. (201) 828-5678 □ PHILADELPHIA (215) 676-4348  
 □ PITTSBURGH (412) 343-4449 □ WASHINGTON, D.C. (703) 979-5500 □ ROCHESTER (716) 852-6570

MIDWEST: CHICAGO (312) 986-1414 □ CLEVELAND (216) 734-5363 □ DETROIT (313) 355-3510

SOUTH: DALLAS (214) 233-7776 □ ATLANTA (404) 252-2045 □ GREENSBORO, N.C. (919) 855-0307 □ HOUSTON (713) 783-1760  
 □ ORLANDO (305) 423-1201

WEST: SAN MATEO (S.F.) (415) 574-4800 □ DENVER (303) 770-6330 □ LOS ANGELES (213) 553-1811 □ SEATTLE (206) 242-0505

IN CANADA: CAE ELECTRONICS, LTD. (514) 341-6780

FOR WORLDWIDE SALES INFORMATION CALL: (516) 549-8800



HAZELTINE AND THE PURSUIT OF EXCELLENCE

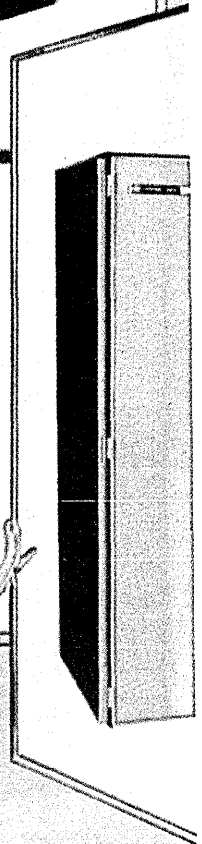
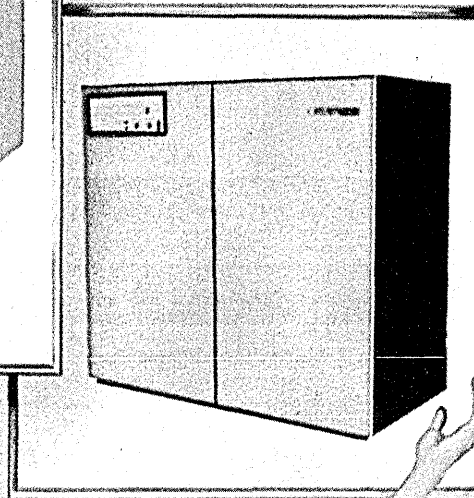
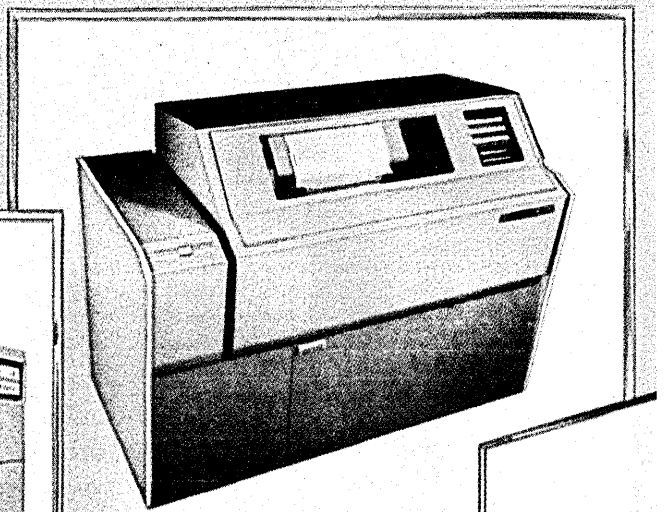
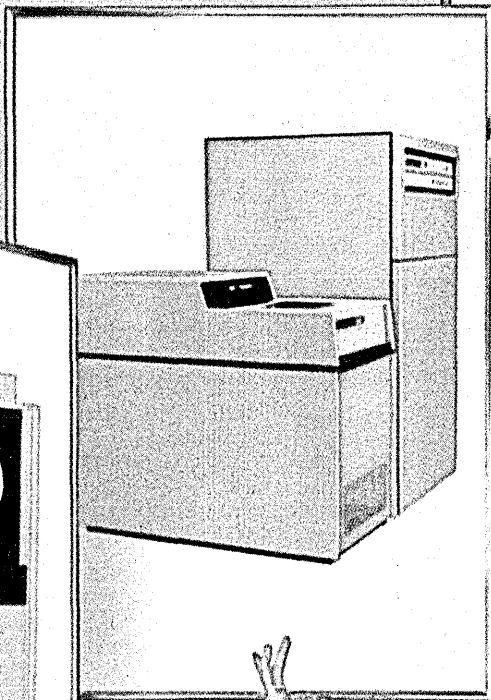
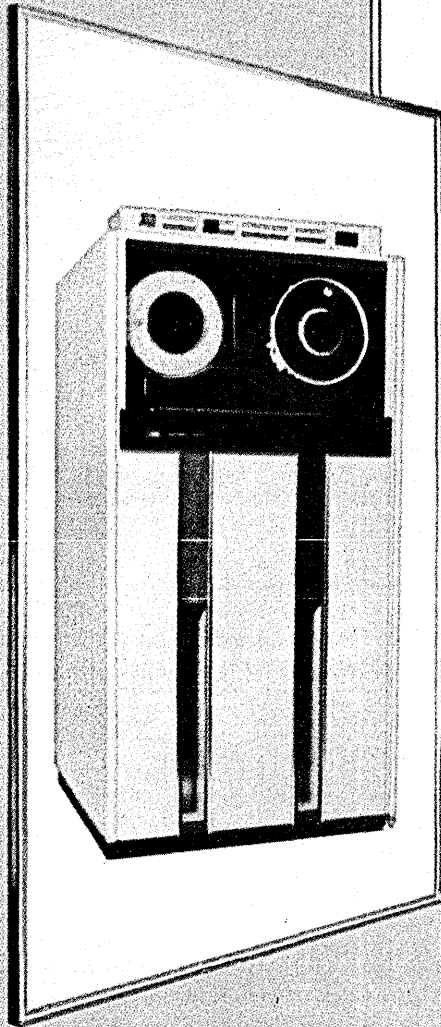

# consider all these peripheral advantages from Control Data

Control Data is the only major mainframe manufacturer offering an extensive array of peripheral products for IBM and other central processors...plus worldwide services.

## Replacement products often add up to much more than just that

CDC peripheral products usually enable computer users to upgrade system capabilities at lower cost.

## In service, your world is our world

We back what we sell with a worldwide maintenance service organization. You would expect to save money by going to your original computer system supplier for any engineering needed to make the most of new peripherals. Actually, chances are good you will do as well or better with Control Data. We will even help with financing, if desired, through our Commercial Credit Company.

Contact your local CDC sales office...or dial our Hot Line collect (612/853-3535)...or write Control Data, Dept. D-123, Box 1980, Airport Station, Minneapolis, Minnesota 55111.

**CONTROL DATA**  
**CORPORATION**

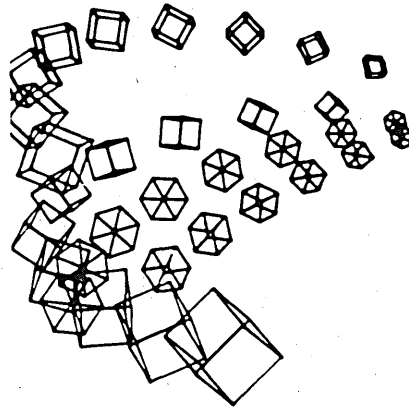

Before launching into the articles on structured programming, the reader is advised to read this overview. Ignore at your own risk

# revolution in

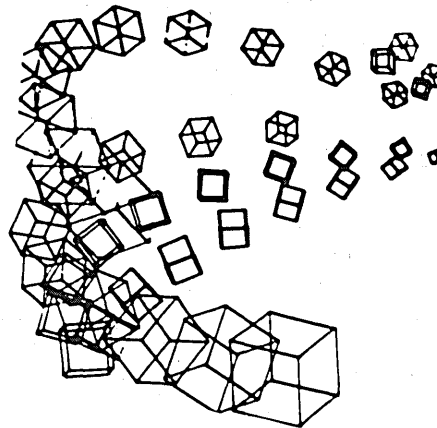

# an overview

by Daniel D. McCracken

Structured programming is a major intellectual invention, one that will come to be ranked with the subroutine concept or even the stored program concept.

What *is* structured programming? Extravagant claims have been heard for several years, but few people would venture a definition. In fact, it is not clear that there exists a simple definition as yet, but several threads seem to run through the discussions.

The theoretical framework is usually traced to a paper by Böhm and Jacopini. They showed that it is possible to write any program using only three structures:

1. Simple sequence; in the absence of instructions to the contrary, statements are executed in the order written.
2. IF-THEN-ELSE; combine with statement brackets (begin and end) so that groups of statements can be included in the THEN and ELSE clauses. In fact, the THEN and ELSE clauses may contain any of the three structures, recursively.
3. A loop control mechanism such as DO-WHILE or DO-UNTIL.

Using only these constructions, assuming that they are available in the language being used or can somehow be simulated, it is possible to write programs that can be read from top to

**Our Cover** and the designs on page 50 were developed from the computer film *Matrix I* by California film maker John Whitney. Mr. Whitney's work, which explores the capability of the graphic crt to produce thousands of incrementally different images, has been internationally acclaimed for several years. He is currently lecturing at UCLA and Art Center College of Design and completing a new film with a grant from the Judith S. Thomas Foundation.

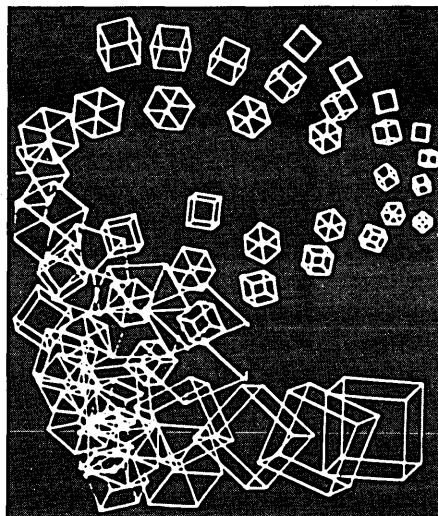

# programming

bottom without ever branching back to something earlier. The GOTO statement is not needed at all, although most people would admit that there are occasional situations where efficiency dictates its use. Programs are accordingly *much* easier to read and understand.

Sometimes the elimination or minimization of GOTO's is presented as the whole point of structured programming, but that is getting the matter backwards. The real situation is that when the three basic structures are used correctly, there simply isn't much occasion to consider using the GOTO.

Harlan Mills extended this result by adding the requirement that a program module have only one entry point and one exit point; with this restriction it becomes possible to prove whether a program is correct. Program proving isn't yet a practical matter for programs of realistic size, but the theory influences the daily practice of programming anyway.

A set of conventions, the details of which depend on the language being used, dictate how to indent program statements so as to make the structure more obvious to the reader of the program. A simple example from FORTRAN is to indent all the statements in the range of a DO by some consistent amount; DO's within DO's are further indented, and so forth.

It seems to be a matter of disbelief in some quarters that such a simple idea as consistent indentation could make

much difference, but the practical experience of lots of programmers is that it does. It may in fact make the program harder to write, but the reading is greatly simplified. And when a program has to be maintained it is the reading that is crucial. Following such a practice also makes it much easier for another programmer to check a program for correctness.

Large projects in the past have had reported coding rates in the range of two or three statements per man-day. Since it would be difficult to spend more than ten minutes writing three statements, it is clear that a lot of time was being wasted, presumably in debugging and recoding modules that didn't interface properly with other modules. Structured programming, together with the idea of top-down programming, greatly reduces this waste. The net effect is that although the initial coding is harder, overall programmer efficiency goes up dramatically.

It has been said that skilled programmers have pretty much been using structured programming for years, anyway. This isn't really true. The discipline imposed by using only the three basic program structures and following indentation rules rigidly, improves the performance of even the best programmers. Perhaps more important, it can greatly enhance the effectiveness of the rest of us, who are not geniuses and who sometimes program in rather sloppy ways if left to our own devices.

Historically, recognition of the idea of structured programming seems to date from a famous letter in the *Communications of the ACM* by Professor E. W. Dijkstra of the Netherlands. The title attached to the letter, published in March of 1968, was "GOTO Statement Considered Harmful." The letter attracted considerable attention and puzzlement at the time. I well remember asking people, "Do you understand what Dijkstra is talking about?" The representative answer was: "I'm sure it's important, but I don't really quite understand it." This perplexity was caused in part by the fact that some of the few published articles were rather difficult to obtain, and circulated in a sort of underground library.

So long as the matter seemed to be a theoretical issue that most people could not quite get a good grasp of, nothing much happened. Then came the IBM work for the *New York Times*, with reports of greatly increased programmer productivity and very greatly reduced coding error rates (one detected error per 10,000 lines of coding, or one per man-year)! Absolutely incredible, but these were the facts. The IBM project involved more than just structured programming, to be sure, notably the concept of F. T. Baker of the chief programmer team. But the participants assure me that structured programming was most definitely part of the reason for the amazing results.

What was for a few years an underground ivory tower—to mix meta-

## Revolution in Programming

phors a bit—has now come out in the open as a very important thing indeed. The practicality of the theory has been demonstrated in a fashion that simply cannot be ignored, and one hears of lots of demonstration projects underway, elsewhere within IBM and in many other organizations.

This is a development that could revolutionize programming in several ways. The most obvious benefits are increased productivity and reduced error rates. Programming is perhaps on the verge of becoming a science instead of a craft. The analogy has been made that the hardware people have known for years that any logic circuit can be made up from a few basic primitives, such as the "and" and "or" operations. Programming is now approaching something of the same maturity.

There will also be a strong effect on the use of procedure-oriented languages. Of those in wide use today, only ALGOL and PL/1 are anywhere close to suitable for easy use in structured programming. Applying these ideas even in FORTRAN will make for better FORTRAN programs, but it is clear that FORTRAN is not an ideal language for structured programming. And since ALGOL, sad to say, has not caught on in a big way in the U.S., that leaves PL/1. I predict that within the three-to-five-year future, there will be, at long last, a swing to PL/1, precisely because it is well-suited for structured programming.

This issue of DATAMATION is important! Read the articles closely, because they describe a movement that is going to change your future.

(It is also an idea of such importance that it would be a good idea to get the history straight. Readers are invited to use the "Letters" column to clarify the picture.) □



Mr. McCracken is a consultant specializing in writing texts on introductory computer programming, and is a former contributing editor to DATAMATION.

The fundamental message is "simplify your control paths"

# Structured Programming

by James R. Donaldson

Recent shifts in emphasis have occurred in the field of software development. The primary requirement to be met in software development has always been to perform the function specified for the software. But, where at one time secondary emphasis was placed only on software efficiency, that is, core and time required, today three other factors are recognized as requiring special emphasis. These factors are reliability, maintainability, and extensibility. The emphasis on these factors has increased because their economic importance has been recognized. Software maintenance and modification account for a substantial portion of total software expenditures and, as the volume of existing software grows, so does the expense of maintenance and modification. This trend can be counteracted by designing and implementing software in a way that minimizes errors and maximizes the ease with which errors are corrected and modifications are made; hence, reliability, maintainability, and extensibility. While much work is needed to determine how best to design and implement software with these characteristics, there are already some techniques known that contribute materially to these aims.

The development of these new techniques has been motivated by a desire to reduce the cost of developing and maintaining software. The technique discussed in this article does so by reducing a program's complexity and increasing its clarity. The high cost of programming today is due in large measure to the complexity of the programs. As a result of this complexity, the program development process is characterized by a large number of mistakes and a great deal of waste and rework. To the practicing programmer this may not seem like an accurate description; certainly it is a pessimistic one. But when you step back and look at the programming process from the proper perspective and compare it with

other scientific disciplines, you will find that the picture is bleak.

Program complexity causes problems not only during development but also during maintenance of a program. When a program must be modified to correct a bug or provide a new feature, the complexity of the program makes its operation hard to decipher—even if the person doing the maintenance developed the program originally. Furthermore, once the program is deciphered, inserting the change and insuring that it works correctly is made difficult by program complexity. The expense of program maintenance is becoming more and more important as the volume of programs in existence increases. Use of the technique described in this article can reduce the cost of maintenance dramatically—say, by 50%.

Improvement in program clarity also benefits program development and maintenance. Program clarity is its "understandability"; that is, the ease with which a person unfamiliar with the program (it may even be the original developer) reads code to determine what it does and how it operates. Improved program clarity will decrease

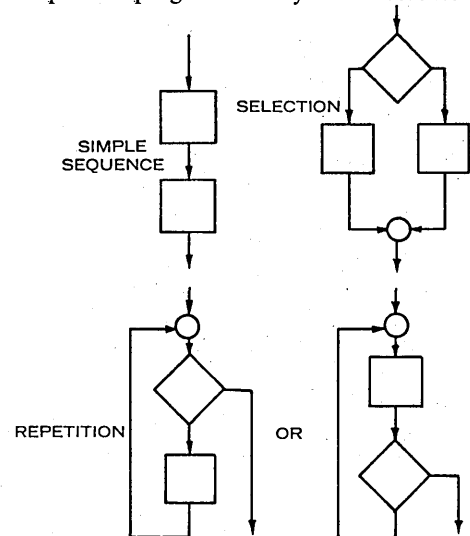

Fig. 1. Control structures.

the cost of program development and maintenance.

Reduced program complexity can be thought of as a process of removing things from the program: obscure structures, complicated control paths, redundant and obsolete code, meaningless notes, etc. Improving program clarity can be thought of as a process of adding things to the program: self-explanatory labels, good notes, code layout and indentation that has information content for the reader, more levels of modularity, etc.

A technique known as structured programming has been developed which offers improvements in both program complexity and program clarity. Structured programming is a manner of organizing and coding programs that makes the programs easily understood and modified. Easy modification in turn permits easy maintenance of the product and easy building of a new product using this product as a base. Much has been written about structured programming in the last couple of years and its definition varies from writer to writer. However, the fundamental message is "simplify your control paths."

Much of a program's complexity arises from the fact that the program contains many jumps to other parts of the program—jumps both forward and backward in the code. These jumps make it difficult to follow the logic of the program and difficult to be sure at any given point of the program what present conditions are (such as what the state of variables is, what other paths of the program have already been executed or are yet to be executed, etc.). Furthermore, as a program undergoes change during its development period, as it gets further

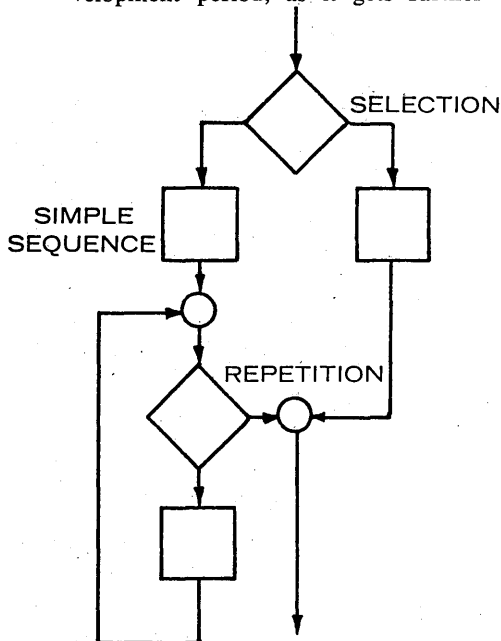

Fig. 2. Nesting of control structures.

debugged during its maintenance period, and as it gets modified in subsequent new projects, the complexity of the program grows alarmingly. New jumps are inserted, increasing the complexity. In some cases, new code is added because the programmer cannot find existing code that performs the desired function, or isn't sure how the existing code works, or is afraid to disturb the existing code for fear of undoing another desirable function, and the result, after many modifications, is a program that is nearly unintelligible. This is the software equivalent of being shop-worn; the time when it is better to throw the whole thing out and start over.

In a structured program, any program function can be performed using one of three control structures (see Fig. 1): 1. simple sequence, 2. selection, 3. repetition. Any kind of processing, any combination of decisions, any sort of logic, can be accommodated with one of these control structures or a combination of these structures. Each structure is characterized by a simple and single point of transfer of control into the structure, and a single point of transfer of control out of the structure. These structures can be combined to form a program that is very simple in the sense that control flows from top to bottom or from beginning to end. There is no back-track-

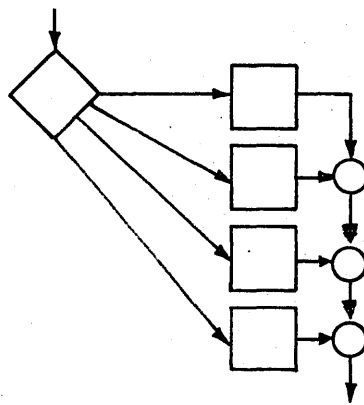

Fig. 3. From a two-valued to a multi-valued operation.

ing. The control structures can be nested, as shown in Fig. 2, but they retain their characteristic of single-entry/single-exit.<sup>1</sup>

The three control structures can be constructed in any programming language. Thus, structured programming can be practiced by anyone, although the difficulty of it varies with the language you are using. Some high-level languages have language features or constructs that correspond directly to these control structures. PL/I, for ex-

<sup>1</sup> A proof of the ability of these structures to accommodate any program requirement can be found in Böhm, C., and G. Jacopini, "Flow Diagrams, Turing Machines and Languages with Only Two Formation Rules," *Communications of the ACM*, May 1966, p. 366-371.

ample, has IF-THEN-ELSE and DO constructs which perform selection and repetition functions, respectively. COBOL has IF-THEN-ELSE, and a PERFORM construct that performs the repetition function. FORTRAN has a simple IF construct, and a DO construct. Most other high-level languages have equivalent or closely equivalent capabilities. Structured programming can be approximated in assembly language particularly if a powerful macro facility is available, but if assembly language is used many of the benefits sought with structured programming are lost, as discussed below. In a high-level language with suitable capabilities, structured programming produces code that is very clear and intelligible.

Use of the three classical control structures of structured programming in their pure form results in inefficiency in two situations. This inefficiency is avoided through the use of a variant of the selection structure and a slight relaxation of the single-exit rule. The first situation is that handled in conventional programming by computed-GOTO's or switches; the case where only one of a series of functions is to be performed depending on the value of a variable. This is really a generalization of the selection function (IF-THEN-ELSE) from a two-valued to a multi-valued operation as shown in Fig. 3. The second situation arises when the programmer wishes to terminate a repetition block abnormally, as in Fig. 4,

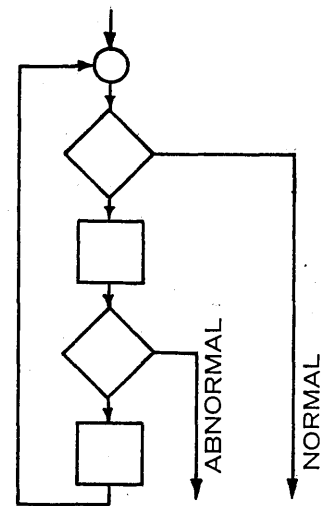

Fig. 4. An abnormal termination of a repetition block.

and the languages do not explicitly allow this. Although such an abnormal termination violates the single-entry/single-exit rule of structured programming, it may produce significant savings in space and time. If properly flagged, this practice maintains the spirit of structured programming.

In addition to the use of the restricted control structures, many other refinements and attributes have been

# Structured Programming

attached to structured programming. We shall now look at these.

Routine lengths should be limited to a manageable size. The size is usually expressed as a number of lines, say 50, or as a displayable unit such as one crt screenful or one printer page.

This size restriction helps limit programs to a comprehensible unit; one that can be "held in the mind." In addition, since the unit has a single entry and a single exit and no arbitrary jumps to other parts of the program, there is little need for page-turning or

Structured programming, combined with some traditional coding practices such as good annotation, descriptive labels, and judicious spacing in the source code, greatly clarifies source coding. This increased clarity, and the reduced complexity of structured programs are responsible for another advantage of a structured program: its correctness is more easily proven than that of an unstructured program. There are two senses in which this is true. First, since the flow of control is simpler in a structured program, the development and execution of test cases to adequately debug the program is simpler. Second, since the program

methodology has been developed that is better than the proving system used today by practicing programmers, that is, debugging on the hardware. The proof-of-correctness methods that have been developed are very cumbersome and require more work to prove the program than it takes to debug the program in the conventional way. It is likely that the representation of algorithms for computers will have to be simplified in order that analytical proving can become practical. Structured programming is one step toward that simplification.

Fig. 5 outlines the same function coded in an unstructured program and in a structured program. The dashed lines indicate various program statements. GOTO's (conditional and unconditional) and RETURN's are shown in order to indicate the flow of control, shown by the arrows in the diagram. The program on the left is not structured. Notice the complexity of the flow of control. Note too that this program has no backward goto's, which would further add to its complexity. This form of programming, the traditional form, is very bug-prone, difficult to understand (even for the program's author), and hard to modify.

The program on the right is fully structured. There are no GOTO's, although multiple RETURN's are used for efficiency as described earlier. Control flows uniformly from top to bottom. Each block of code is clearly shown by indentation. The only exception to the simple flow of control is that the program can exit at any one of five points. Necessary program functions are accomplished with various constructs such as IF and CASE (which performs a computed-GOTO function). The structured program is simpler to write, easier to read and understand, and easier to modify. Furthermore, it will usually have fewer bugs when written. □

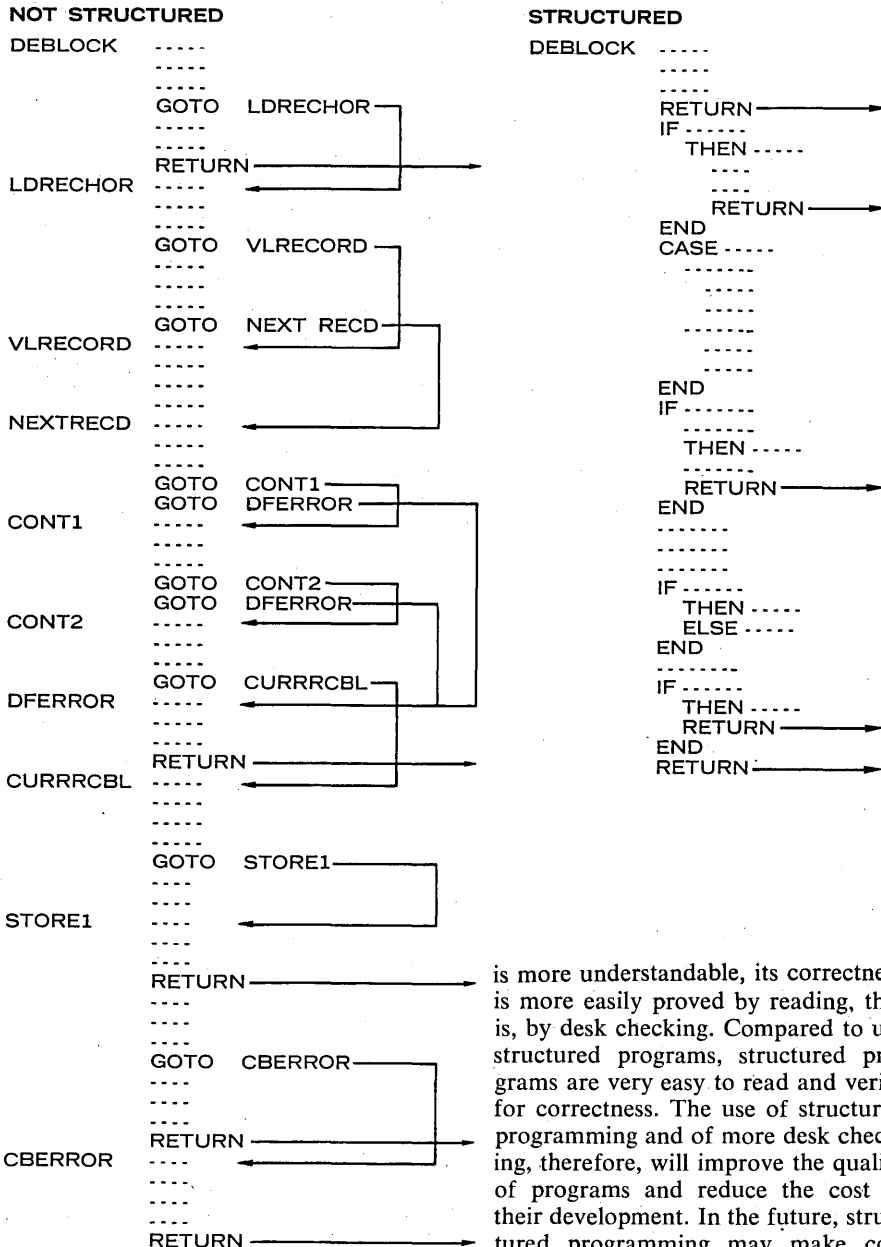

Fig. 5. Unstructured and structured programming example.

for holding several places in a listing to which you must constantly refer.

Careful indenting of coding to show nesting levels also gives increased clarity to the code.

is more understandable, its correctness is more easily proved by reading, that is, by desk checking. Compared to unstructured programs, structured programs are very easy to read and verify for correctness. The use of structured programming and of more desk checking, therefore, will improve the quality of programs and reduce the cost of their development. In the future, structured programming may make correctness-proving easier in another way.

There is a study of program proof-of-correctness in which the correctness of a program is proved analytically, similar to the proving of a mathematical theorem. However, this work has not yet produced any practical results. No

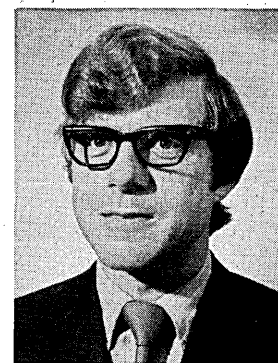

Mr. Donaldson is a senior consultant for software development at Control Data Corp. He is a member of the Assn. for Computing Machinery and of the Minnesota State Commission on Local Government. He has a BS from the Univ. of Minnesota.



Structured programming is a technique that reduces a program's complexity, increases its clarity, and results in easy maintenance

# Structured Programming: Top-down Approach

by Edward F. Miller, Jr.  
and George E. Lindamood

Structured programming, if the current level of interest and controversy within the computing community is any measure, is an idea whose time has come. You hear about it at conferences, there is increasing mention of the concept in the literature, and, very likely, there are numerous hallway discussion groups trying to unravel the difference between what is and isn't structured programming.

Some of the early successes reported to have been achieved with structured programming techniques include spectacular increases in programmer productivity and correspondingly spectacular decreases in overall software system error rates. One spokesman is reported to have announced that with structured programming "... we have observed programmer error rates on the order of one per programmer man-year, or one per 10,000 lines of code." This statement, when viewed against the current increasing concern for the unreliability of software—and what to do about it—suggests that something more than a simple technique is involved. If that kind of productivity and reliability is involved, further study of the techniques which produced it is certainly warranted.

In a very general way, structured programming is a reflection of the concern with form and the interrelationships which exist between the attributes of a "good" program and what the program is supposed to do. Thus, the intense interest in structured pro-

gramming may be a manifestation of a coming maturation of computing, which is intrinsically a human activity.

## What's it all about?

No one "invented" structured programming. A few people, however, have contributed to its development by providing enthusiasm for the idea. Certainly, E. W. Dijkstra can be considered the common-law father of some of the underlying concepts. The now-famous "GOTO letter," which warned that GOTO statements were potentially hazardous to the state of mind of programmers charged with debugging complex and intertwined codes, was the starting point for much of the current interest. Subsequently, Dijkstra's "Notes on Structured Programming" has been widely circulated in the underground press, and has converted many a soul to Dijkstra's version of "right thinking." Along the way, a slightly different thrust—one which dealt with the necessity for certain degrees of clarity of thought during the design (and possibly during the implementation) phases of software system design—surfaced in Dijkstra's description of the "THE" operating system. These two concepts will be discussed in detail later on.

A slightly different approach, which falls into the category of structured programming, was that described by F. T. Baker. That technique, called the "chief programmer team" approach to

system design and system implementation, was used with startling success in an IBM programming effort on behalf of the *New York Times*; IBM implemented a complex information retrieval system using only a handful of highly skilled programmers, all under the direction of a chief programmer, in a rather short time. More importantly, it is claimed that the resulting software system had virtually no errors and has run satisfactorily from the day it was implemented. The approach used combined good management with the use of special structured programming techniques.

Some basic notions about what constitutes structured programming have evolved from these sources. The main ideas seem to be:

1. The construction of programs without the use of GOTO statements (and, consequently, without the necessity for statement labels). This may require certain extensions to the more common procedure languages, as will be made clear below.
2. The use of strict rules for the top-down design and implementation of a system of programs, and the requirement that the components adhere to a hierarchical form as much as possible.
3. The generalization of the notion of "abstract resource," so that a hierarchically organized software system obeys some additional rules about the way it per-

## Top-down Approach

forms operations on the "objects" it manipulates.

At the current time it is not possible to say which of these is the basis of structured programming. Indeed, the concept may be an amalgam of these and other ideas, but each is rich enough to require some additional explanation.

### GOTO-less programming

In Dijkstra's GOTO letter, he argued that the blatant use of GOTO statements—unconditional transfers of control—resulted in unnecessarily complex flow patterns leading to difficult debugging efforts on the part of programmers. His suggestion was to avoid the GOTO statement as much as possible. The result would be program code which more accurately reflected the relationship between the static and the dynamic behavior of the program. The result of that would be a better correspondence between what the programmer uses (the source code listing) and what the program is supposed to do (the source code translated, linked, loaded, and executed).

The fundamental difficulty with the GOTO statement is that it distracts the reader of the program by forcing him to examine the program in an unnatural way. For example, consider the FORTRAN program fragment below:

```
Line 1: IF(A.GT.20) GOTO 2
Line 2: IF(A.GT.10) GOTO 1
Line 3: X = 5.0
Line 4: GOTO 3
Line 5: 1 X = 6.0
Line 6: GOTO 3
Line 7: 2 X = 4.0
Line 8: 3 CONTINUE
```

To understand what is going on in this program, the programmer would consider the conditional statements in the sequence presented. First, if "A.GT.20" is true, the program continues execution at Line 7. Next, if "A.GT.20" is false but "A.GT.10" is true, the program continues execution at Line 5. Only if both conditionals fail does the program perform Line 3, and then control passes to Line 8. To a FORTRAN-experienced eye this may not seem to be very difficult code structure, but if the eventual target, the label "3," were several pages away (and if the labels "1" and "2" were not so conveniently located) there would be a considerable amount of page flipping in order to discern the intended meaning of the program.

This problem would be eliminated, or at least greatly simplified, if the program were organized so that there was greater "locality." In a sense, achieving this kind of correspondence

between static placement of statements and dynamic flow depends on the vague concept of "program style." It is also clear that there would have to be some additional features in the FORTRAN language. (There is no intention here to generate another programming language; the widespread use of FORTRAN makes the question of an appropriate set of extensions to FORTRAN for support of structured programming an important one.) To illustrate how this program segment would look in GOTO-free form, we can rewrite it in IFTRAN as follows:

```
Line 1: IF(A.GT.20)
Line 2: X = 4.0
Line 3: ORIF(A.GT.10)
Line 4: X = 6.0
Line 5: ELSE
Line 6: X = 5.0
Line 7: END IF
```

In this example, the IF, ORIF, and ELSE statements behave very much like similar statements in such languages as ALGOL, PL/1 and JOVIAL. The resulting value of X, after the set of checks on the value of A, is evident by the organization of the statements. Because there are no GOTO statements there are no labels and there is a direct correspondence between the static form of the program and the dynamic flow during execution.

Many languages, including those just mentioned, have the facilities to support GOTO-free programming without modification. PL/1 and ALGOL have been used extensively as structured programming languages.

Besides the apparent advantages of logical "locality" with better IF statement forms than commonly available (in FORTRAN, at least) there is the related problem of dealing with iterations of one form or another. FORTRAN requires a label as the target of a DO statement and that is esthetically unsatisfying. The syntax of the DO WHILE iteration form ordinarily has been found sufficient.

The question arises naturally: can all programs be written without the use of statement labels? Yes, according to Böhm and Jacopini. The program structures which result from a label-free conditional statement and a DO WHILE statement are sufficient to express any algorithm. Not every program which currently has labels can be converted into a label-free program, however; Manna has shown that it may be necessary to introduce certain "flag" variables in order to eliminate GOTO's and labels completely.

Other enrichments of common programming languages are under consideration as additional means to bring the textual form of the source language the programmer reads into closer correlation with the dynamics during execution. Sullivan outlines a number of

such additions for PL/1, for example.

### Top-down design

Merely removing all of the GOTO statements will not "structure" the programs; in fact, even though GOTO-free programs are intrinsically easier to read and debug than their labelled counterparts, the form and style of the expression of the algorithms is not explicitly changed by avoidance of the GOTO. Structured programming is also concerned with ways of developing complicated program structures in an orderly manner.

This point is the major feature of the "chief programmer team" approach. This approach to software development (which is now being practiced by a small but growing minority of IBM programmers) involves the following additional ideas:

1. Design of the software system should proceed from the top to the bottom. This is called "top-down" design.
2. Implementation of the software system should also proceed in a top-down fashion, and program "stubs" (which simulate the presence of yet-to-be-implemented modules) should be used as early as possible.
3. Individual program modules should be as short as possible, preferably no longer than one page of machine output, to facilitate partitioning of logic into individual chunks which are easy to debug.
4. Overall control of the software development should be in the hands of a highly competent and experienced chief programmer, upon whose shoulders fall all questions of module-to-module interfacing and testing.

Thus, embedded within techniques which are purely management related are strict rules of hierarchical design. There are two major advantages of a strictly hierarchical form for a software system. First, adhering to the hierarchical constraints forces the organization of the software system along "natural" algorithmic boundaries; individual program modules tend to organize themselves so that each performs some specific function. The result is that each module is easier to debug and so the entire system is easier to debug.

During implementation, just after the design stage is complete, the hierarchical organization is filled out with program stubs which simulate the operation of the modules and provide the means to operate the entire system from the beginning of the implementation phase.

Second, performing the complete system design from the topmost levels

ensures that the software will adequately meet its design goals, and that any failures exhibited when implementation begins will become apparent as early as possible. This translates into a smaller number of implementation iterations; if the initial top-down design is good enough, the number of implementation iterations may be reduced to one. There would be no more multiple releases if a strictly hierarchical implementation scheme were followed.

The early results of this type of software design/implementation environment are heartening. The *New York Times* system was apparently completed in record time, with an unprecedented absence of major errors. Several other projects are yielding similar results.

The chief IBM proponent of hierarchical design and implementation is Harlan Mills, who has reported some initial experiences.

### Abstract resources

The ideas underlying hierarchical structuring of software systems are a partial outgrowth of the work of Dijkstra. In a landmark paper on Dijkstra's experience with the development of the "THE" multiprogramming system Dijkstra discussed his views on the use of abstract resources in the structure of software systems. In his opinion, each level of the hierarchy of software modules which comprise a system generates an abstract resource which is supported by the lower levels of the hierarchy, and which is available to the higher levels of the hierarchy. Thus, at one level the programming amounts to manipulation of the abstract resources supported by the next lower level of the hierarchy. The programs at that level manipulate abstractions—the abstractions of the resource, whatever it may be—and at the same time participate in generating a higher level of abstraction for the next layer of the hierarchy to manipulate.

An example may help to clarify these concepts. Suppose that a software package is to be built to retrieve information from a file. A file can be considered a collection of "vectors," and each vector may lie on some sector of a disc, for example. In turn, each

vector is composed of words, each word is composed of bytes, and each byte composed of bits. The hierarchy of resources needed in order to retrieve single bits from a file is the following:

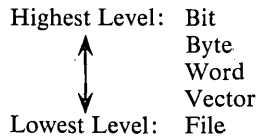

A set of programs would be written to manipulate files—in this case, to locate and extract particular vectors. The next level of programs would operate solely on vectors, extracting words from vectors retrieved by the file manipulating programs. In turn, the next level of abstraction would be represented by a set of programs which extract bytes from words; at the top would be the capability to extract bits from bytes.

In implementing the software system for this hierarchy of resources, Dijkstra advises that special care be taken to assure that each level is "complete," at least in the sense that it will always be true that the desired operations at one level are actually supportable by the abstract resource provided by the underlying level. He doesn't say just how to do this; there appears to be no mathematical theory which could apply to this problem, either.

It is important to note that this concept of abstraction bears only a slight resemblance to the concept of "modularity." A highly modular implementation is one in which specific functions are performed by specific modules (and nowhere else); on the other hand, a system which preserves a hierarchy of abstract resources would appear to require modularity as a minimum, and perhaps a great deal more "structure."

The relationship between Dijkstra's ideas and those of Mills is yet to be completely revealed. Mills' work on the theory of structured programming is more concerned with clarity of exposition and ease of debugging than with preservation of levels of abstraction. Dijkstra's work on the subject is ambivalent on issues of clarity. The discussion is likely to go on for some time.

We have seen that "structured pro-

gramming" is an aggregation of three main ideas: 1. the inherent properties of GOTO-free programming, 2. the application of management techniques to the process of top-down design and implementation of software systems, and 3. the idea of having levels within a hierarchy of software modules lie in specific relations with one another. Collectively, these techniques seem to produce surprisingly reliable systems with relative ease and seem to have inherent qualities of reliability not possible with other implementation techniques.

While structured programming represents a concern with the specific forms programs take, it also represents some first steps toward a deeper understanding of the intrinsic nature of programming, and of the factors which distinguish "good" from "not-so-good" programming. At this point, it appears that structured programming is a viable alternative worth early-on use in a variety of circumstances. □

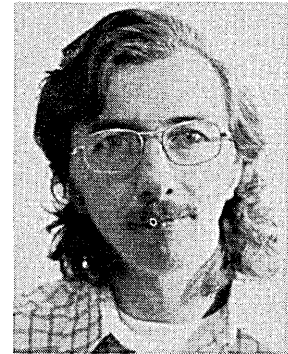

Dr. Miller is a member of the technical staff of General Research Corp., Santa Barbara, Calif., where he is also the leader of the Program Validation Research Project, which has been active in developing structured programming technology, new measures of computer performance, and a fully automated FORTRAN verification system. He has a PhD from the Univ. of Maryland, where he was an instructor for three years.

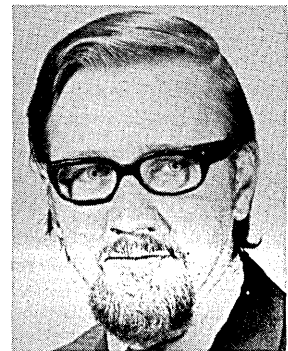

Mr. Lindamood is at the Institute for Computer Sciences and Technology, National Bureau of Standards. Prior to joining NBS, he taught computer science at the Univ. of Maryland. He has an MA in mathematics from the Univ. of Maryland.

### Bibliography

1. E. W. Dijkstra, "goto Statement Considered Harmful," *Communications of the ACM*, Vol. 11, No. 3, March 1968, pp. 147-148.
2. E. W. Dijkstra, "The Structure of the THE Multiprogramming System," *Communications of the ACM*, May 1968, pp. 341-356.
3. E. W. Dijkstra, "Notes on Structured Programming," T.H.E. Report No. ewd-248, 70-wsk-03, 2nd Edition, April 1970.
4. C. Böhm & G. Jacopini, "Flow Diagrams, Turing Machines and Languages with only Two Formation Rules," *Communications of the ACM*, May 1966, pp. 366-371.
5. Z. Manna & E. A. Ashcroft, "The Translation of goto Programs to WHILE Programs," Stanford Univ., Report CS-188, 1970.
6. E. F. Miller, Jr., "Extensions to FORTRAN and Structured Programming—An Experiment," General Research Corp., RM-1608, March 1972.
7. F. T. Baker, "Chief Programmer Team Management of Production Programming," *IBM Systems Journal*, Vol. 11, No. 1, 1972.
8. E. W. Dijkstra, "The Humble Programmer," *Communications of the ACM*, October 1972, pp. 859-866.
9. J. E. Sullivan, "Extending PL/I For Structured Programming," MITRE Corp., Report MTR-2353, March 1972.
10. H. Mills, "Mathematical Foundations for Structured Programming," IBM Corp., Federal Systems Div., Report No. rsc 71-5108, 1971.
11. H. Mills, "Top Down Programming in Large Systems," *Debugging Techniques in Large Systems*, R. Rustin, (Ed) Prentice-Hall, 1971.

This fundamental change in the managerial framework of production programming structures programming work into specialized jobs, defines relationships among specialists, and stresses discipline and teamwork

# Chief Programmer Teams

by F. Terry Baker and Harlan D. Mills

There is a myth these days that programming consists of a little strategic thinking at the top (program design), and a lot of coding at the bottom. But one small statistic is sufficient to explode that myth.

Including all overhead, five to ten debugged instructions are coded per man-day on a large production programming project. The coding time for these instructions cannot exceed more than a few minutes of an eight-hour day. What do programmers do with their remaining time? They debug.

Programmers usually spend more time debugging code than they do writing it. They are also apt to spend even more time reworking code (and then debugging that code) due to faulty logic or faulty communication with other programmers. In short, it is the thinking errors, more than the coding errors, which limit programming productivity.

The problem is as much one of organization as of technology. To address this, IBM has developed a programming organization called a chief programmer team.

A chief programmer team represents a new managerial approach to production programming. While the approach is made possible by recent technical advances in programming, it also incorporates a fundamental change in managerial framework which includes restructuring the work of programming into specialized jobs, defining re-

lationships among specialists, developing new tools to permit these specialists to interface effectively with a developing, visible project; and providing for training and career development of personnel within these specialties.

This approach contrasts sharply with that of conventional programming groups which frequently suffer from lack of functional separation, discipline, and teamwork. By moving the programming production process from private art to public practice, chief programmer team operations substantially improve the manageability, quality, and productivity of programming.

In addition to the organizational approach, chief programmer team operations are based on two major innovative disciplines. The first is provided by a development support library (DSL) in which all programs under development are maintained by a programming secretary in a visible, standardized form. The second discipline, introduced in a practical way by IBM, is structured programming (SP), which defines a top-down sequence for program unit creation and testing and a technical standard for the coding of each unit.\*

Chief programmer team operations provide increased productivity by sharply reducing the debugging and reworking required in a project. The initial coding requires the same amount

of time, but the design level thinking is transmitted deeper into the coding by technical and organizational means. SP displays program organization and interactions more effectively for the coding process. More competent, but fewer, people do the coding with carefully orchestrated teamwork. The result is increased productivity, and even more significant, improvements in the reliability and maintainability of the code produced.

This is accomplished by dividing the work of a programming project among special skills addressed to each type of work, rather than simply parceling out a project among programmer generalists, with all the attendant problems of communication and integration. Recognizing that program design capability is a scarce commodity, the work is organized around a senior architect/programmer. This key programmer operates in a disciplined team environment rather than as an individual. There are checks and balances in the restructuring to ensure the integrity of the team effort.

The nucleus of a chief programmer team consists of a chief programmer, a backup programmer, and a programming secretary. This nucleus is standardized to provide management continuity, not only for programming expertise but also for project recording and documentation. Requirements for additional personnel are defined by the chief programmer; a typical team will

\*See articles by Donaldson, and Miller and Lindamood in this issue.

involve three to five programmers, a secretary, and other specialists. In addition, a project officer may be part of a team to help the chief programmer with administrative, financial, legal, and personnel matters, thus allowing him to concentrate on technical management.

The chief programmer team allows for professional growth and technical excellence in programming. Since delegated clerical procedures are used to maintain programming system development in a structured form, more time and energy can be allocated to developing key technical skills and building the deliverable system. This creative environment provides good training for other programmers associated with a team and prepares them for future team leadership.

### Team member responsibilities

The chief programmer is a technical manager to whom all team members report directly, but whose principal job is to design and code programs. The chief programmer codes central, critical segments of a programming system and specifies programs for other team members to complete using SP techniques. The programs done by others are reviewed and incorporated

into the developing system under the immediate supervision of the chief programmer.

The chief programmer is a professional programming manager who maintains organization discipline and bears project responsibility. His managerial duties are simplified by the structure and the continuous project interaction of the team.

Project management exposure is reduced by the use of a backup programmer, so that a second person is totally familiar with the developing project and its rationale. The backup programmer, a peer of the chief programmer in program design and development, is involved in every aspect of the work and participates in making all important decisions. He can assume the leadership role at any time, if required.

He also participates in the system design and in the coding of the key parts of the system under the direction of the chief programmer. In addition, the backup programmer serves as a research assistant for the chief programmer in programming strategy and tactics, allowing the chief programmer to concentrate on the central problems of system development. Finally, he can provide test planning for the system

independent of the chief programmer.

The job of programming secretary is standard in every chief programmer team, and is independent of the subject matter of the project. A programming secretary maintains the records of a project in the development support library in both an internal (machine-readable) and an external (human-readable) form.

The external project records of a chief programmer team are maintained in a set of filed listings that define the current status and previous history of the project. Current status is maintained in loose-leaf notebooks, each headed by a directory and followed by an alphabetized list of member modules. When members and directories are updated and replaced in the status notebooks, the replaced copies are logged in chronological journals. All results of test runs are also maintained in journals.

The main function of a programming secretary is to maintain this current status of program and test data so that programmers can work more effectively and with fewer errors. A by-product of this function is a significant saving in clerical work on the part of the programmers.

In addition to maintaining the DSL, a programming secretary performs secretarial duties in maintaining all other project records. The workload balances well for one secretary on a team. In the middle of a project, DSL maintenance predominates; at the beginning and end, design and documentation create a great deal of paperwork.

It is significant in chief programmer team operations that the programming secretary is a full-fledged, professional team member, not simply a pooled assistant to the programmers on the team.

The reintroduction of senior people such as the chief and backup programmers into detailed program coding recognizes a new set of circumstances in comprehensive modern operating systems. The job control language (JCL), data management and utility facilities, and high-level source languages are so complex that there is both a need and an opportunity for using senior personnel at the detailed coding level.

The need is to make the best possible use of a very extensive and complicated set of facilities. The functions of such systems are impressive, but they are called into play by language forms that require much study, experience, and sustained mental effort to use effectively.

The opportunity also exists for a good deal of work reduction and simplification in the application being written, both in original programming and later in maintenance. For example, the

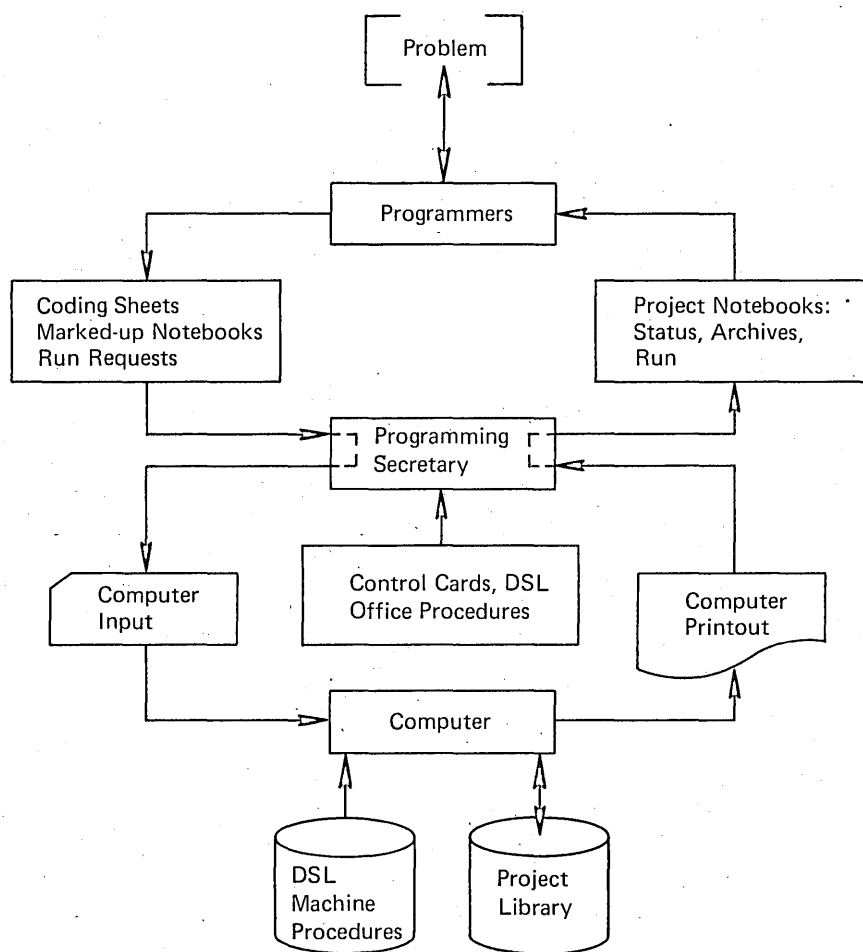

Fig. 1. Development support library.

## Chief Programmer Teams

intelligent use of a high-level data management capability may eliminate the need to develop a private file processing system. Finding such an intelligent use is not an easy job, but it can bring about substantial reduction in code required and easier system maintenance.

### Development support library

The DSL is a system of office and machine procedures that permits the isolation and delegation of secretarial, clerical, keypunching, and machine operations in programming systems development. The office procedures create input for the machine procedures from programmer-generated material, and file output in project notebooks and archives of the external library. The machine procedures maintain and process library data on a disc file in the internal library, including procedures for performing all runs from initial source code entry through final system testing.

Programmers create or alter the project status by writing programs or data on coding sheets, by marking corrections in the status notebooks, and by requesting runs. The programming secretary is responsible for the preparation and execution of all runs and the filing of output. Fig. 1 illustrates the relationship between the people, the DSL, and the procedures. Because of this functional breakup of work, each programmer can work on more coding in parallel than is normally expected.

The DSL represents a concept in which people work on a common product rather than on separate, isolated products. Chief programmer team members communicate through this visible product. While the programming secretary is responsible for maintaining the notebooks and archives of the DSL, the chief programmer is responsible for its contents. This structure of responsibility permits a new level of management standardization in project record keeping.

The DSL permits a chief programmer to exercise a wider span of detailed control over the programming, resulting in fewer programmers doing the same job. This reduces communication requirements and allows still more control in the programming. With structured programming, this span of detailed control over code can be greatly expanded beyond present practice; the DSL plays a crucial role in this expansion.

As noted, the chief programmer team concept is primarily an organizational method of increasing programmer productivity. Several compo-

nents of the method have been tried before. While the chief programmer team bears a superficial similarity to a close-knit programming team working under a lead programmer, two innovations distinguish it from such situations. First is the functional organization and disciplined approach used in the DSL operations. Second is the introduction of structured programming, which results in a new order of quality, productivity and understandability.

In chief programmer team operations, the traditional ad hoc mystique of a developing program is reduced. The visibility of the DSL motivates each team member to think more accurately and consistently about his specific job.

IBM has introduced a set of standards which enables structured programming techniques to be applied to production programming. These standards permit the chief programmer to read, understand, and validate all program data developed by other programmers on the team; this motivates better programming. The other programmers, in turn, read and understand programs written by the chief programmer that define the program stubs with which they must interface. While this organization results in the benefits of "egoless programming," as described by Weinberg, it goes further

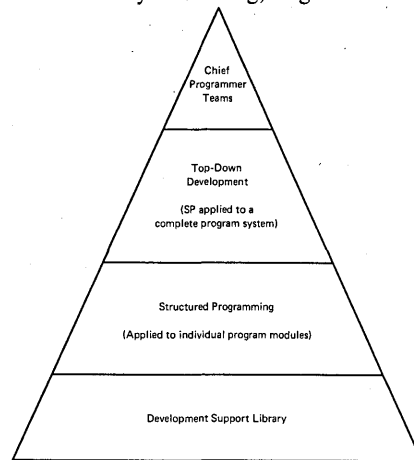

Fig. 2. Techniques and their relationship.

in ensuring that at least two programmers fully understand every line of the developing program.

The separation of skills forces a high degree of public practice. For example, the programming secretary is responsible for picking up all computer output, good or bad, and filing it in the notebooks and archives of the DSL where they become part of the public record. By contrast, in traditional programming operations, the bad runs go into the wastebasket, often destroying information of latent value, and certainly destroying information about errors of carelessness or ignorance. The identification of all computer runs and program data as public assets, not private

property, is a key principle in chief programmer team operations.

### Group of teams

About 100,000 lines of source code appears to be a practical maximum for a single team. Larger systems will require the extension of the organization to a group of teams.

In an approach now being tried, overall system design and development of key control code are being carried out by a single team of skilled programmer/analyst/managers under overall chief and backup programmers. When the core system is operational, some members of the original team will become chief programmers of subordinate teams developing major functional subsystems. The nucleus of the original team will complete the control coding and then become the technical monitor of the developing functional coding. That team will control all specification and design changes, and integrate the subsystems into the overall system as they evolve in a top-down fashion. As the system nears completion, programmers on the lower level teams may proceed to other assignments. Because of the original team's detailed familiarity with the entire system and the use of the tools described above, it will supervise testing and turnover of the system.

Although the techniques have been described above in the context of a chief programmer team, they need not all be applied to realize substantial benefits. Fig. 2 illustrates the relationship of the individual ideas described.

DSL's are the foundation for the entire method. They provide visibility of the developing programs and the basis for a more functional breakup of the programming process. Structured programming at the individual module level may be applied at any point in the development of a system, even during its operation as modules are rewritten to add new functions. SP requires a DSL to provide effective support for the hierarchical organization and inclusion of code as a module evolves.

When a complete new program system is begun, SP can be applied in a more extensive form ("top-down development") to the development sequence of the entire system. It, too, requires a DSL and presupposes SP at the module level.

A chief programmer team is designed to make the most effective use of the three programming techniques. If one applies the techniques rigorously to development of a moderately sized system, it is hard to avoid creating an organization similar if not identical to that of a team.

To institute the techniques in an existing organization, it is most practical to develop and install a DSL and to

begin applying SP to new modules being written. As SP experience is gained and the support tools become familiar, an entire new program system can be developed. At this time, a chief programmer team nucleus can be established using two experienced programmers and a programming secretary familiar with SP. As the system evolves, additional programmers can be added to complete its development.

The information bank of the *New York Times* was produced under contract by a chief programmer team which specified and designed the system and developed over 83,000 lines of original high-level language source code. The task took 22 months. By today's productivity standards for systems of comparable complexity, such a task would require several times the 11 man-years of effort actually used by the team.

The information bank was developed using SP so that no integration period was required between the completion of detailed coding and delivery for acceptance testing. In other words, the integration work was completed parallel with, rather than after, unit coding. As a result of the high-precision coding techniques, the acceptance testing and subsequent system operation have been nearly error-free. For example, the file processing system (delivered one week after unit coding was completed) passed a week of acceptance tests without error, and ran 20 months until the first error was detected. In the first 13 months of operation of the on-line retrieval system, only one program error was detected that resulted in system failure. The chief and backup programmers produced code that had one detected error per man-year of effort.

### Future implications

The *New York Times*' information bank project was a forerunner of many other internal and customer projects. These results show the possibility of a new level of manageability in programming projects through a combination of technical and organization standards. The results also show a significant decrease in error incidence and a corresponding increase in productivity, all with greater job satisfac-

tion and less trauma in project completion.

There is a third property resulting from chief programmer team operations—harder to measure than manageability and quality, but even more important; the integrity and comprehensibility of the product for maintenance and growth. This occurs because an entirely new technical standard for design quality is enforced in structured programming systems.

At a more specific personal level, achievable targets for applications programming (as opposed to system programming—i.e., for system control programs) are 10,000 lines of source code and one error per man-year. This target includes system and program design, documentation and testing time as well as actual coding time. These targets were achieved by the principal programmers on the chief programmer team performing on the information bank project.

While *The Times* project was still under way, it became apparent that the techniques and organization were effective. Within the IBM Federal Systems Division, programmers and programming managers were trained in structured programming. Similar courses have been given in other IBM divisions, and management techniques have been developed for SP projects.

A number of projects have since begun using SP techniques, and chief programmer teams are active in many of them. Several have already been successfully completed. One of the largest was the mission simulation system used in preparation and training for Skylab operations. The software for this totalled about 400,000 lines of source code produced over a two-year period using SP techniques. Productivity was again significantly higher than that previously experienced in comparable efforts.

More remarkably, the software was delivered on the original schedule in spite of 1,200 formal changes in the requirements, coupled with cuts in manpower and computer budgets. One of the striking facts about this development was that the rate at which computer time was used remained nearly constant from the 9th to the 24th month, a consequence of the continuous integration performed as part

of the top-down development process. There was no overtime peak at the end of the project. Similar results are being achieved in other projects at IBM, both for products and for internal systems.

"... As long as there were no machines, programming was no problem at all; when we had a few weak computers, programming became a mild problem; now that we have gigantic computers, programming has become an equally gigantic problem." E. W. Dijkstra, in the 1972 Turing Award Lecture, has articulated the problem. The problem is as much one of organization as of technology, and the chief programmer team is primarily an organizational solution.

Further application and extension of the concepts could move the programming process a long way toward a true professional discipline with a recognized, standard methodology. □



Mr. Baker, manager of the Newspaper System Development Group Development dept. in the IBM/FSD Federal Systems Center's Advanced Technology dept., was manager of the Application Studies group responsible for implementation of the *New York Times* information bank system. He has an MS from Harvard Univ.

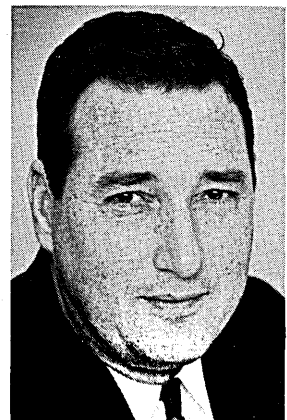

Dr. Mills, recently named an IBM Fellow for his work in the concepts of chief programmer teams and structured programming within IBM and the programming profession, is a member of the IBM Corporate Technical Committee. He has a PhD from Iowa State Univ.

### Bibliography

1. C. Bohm and G. Jacopini, "Flow Diagrams, Turing Machines and Languages with Only Two Formation Rules," *Communications of the ACM*, May 1966, pp. 366-371.
2. E. W. Dijkstra, "Notes on Structured Programming," *THE* (Technische Hogeschool Eindhoven), Netherlands, Second Edition, 1970.
3. H. D. Mills, *Mathematical Foundations for Structured Programming*, International Business Machines Corp., Gaithersburg, Md., FSC 72-6012, February 1972.
4. H. D. Mills, "Top-Down Programming in Large Systems," *Courant Computer Sciences Symposium 1*, New York Univ., June 1971, Randall Rustin (Ed.), Prentice-Hall, 1971, pp. 41-55.
5. G. M. Weinberg, *The Psychology of Computer Programming*, New York, Van Nostrand Reinhold, 1971, p. 72.
6. F. T. Baker, "Chief Programmer Team Management of Production Programming," *IBM Systems Journal*, Vol. 11, No. 1, 1972.
7. F. T. Baker, "System Quality Through Structured Programming," 1972 Fall Joint Computer Conference.
8. R. C. McHenry, *Management Concepts for Top Down Structured Programming*, International Business Machines Corp., Gaithersburg, Md., FSC 73-0001, February 1973.
9. E. W. Dijkstra, "The Programmer" (1972 ACM Turing Award Lecture), *Communications of the ACM*, October 1972, p. 859.

We don't know where to GOTO  
 if we don't know where we've COME FROM.  
 This linguistic innovation lives up to all expectations

# A Linguistic Contribution to GOTO-less Programming

by R. Lawrence Clark\*

Nearly six years after publication of Dijkstra's now-famous letter,<sup>1</sup> the subject of GOTO-less programming still stirs considerable controversy. Dijkstra and his supporters claim that the GOTO statement leads to difficulty in debugging, modifying, understanding and proving programs. GOTO advocates argue that this statement, used correctly, need not lead to problems, and that it provides a natural, straightforward solution to common programming procedures.

Numerous solutions have been advanced in an attempt to resolve this debate. Nevertheless, despite the efforts of some of the foremost computer scientists, the battle continues to rage.

The author has developed a new language construct on which, he believes, both the pro- and the anti-GOTO factions can agree. This construct is called the COME FROM statement. Although usage of the COME FROM statement is independent of the linguistic environment, its use will be illustrated within the FORTRAN language.

## Unconditional COME FROM statement

General Form
COME FROM xxxxx
Where: xxxxx is the number of an executable statement in the same program unit.

\*The author is indebted to G. F. Groner and N. A. Palley for a valuable discussion which took place in New Haven, Conn.

<sup>1</sup>E. W. Dijkstra, "GOTO Statement Considered Harmful," Letter to the Editor, *Communications of the ACM*, March 1968, pp. 147-148.

This statement causes control to be transferred to the next statement (the statement immediately following the COME FROM upon completion of the designated statement.

Example:

```
10 J = 1
11 COME FROM 20
12 WRITE (6,40) J
   STOP
13 COME FROM 10
20 J = J+2
40 FORMAT (I4)
```

Explanation:

In this example, J is set to 1 by statement 10. Statement 13 then causes control to be passed to statement 20, which sets J to 3. Statement 11 then causes control to be passed to statement 12, which writes the current value of J. The STOP statement then terminates the program.

## Conditional COME FROM statement

General Form
IF (cond) COME FROM xxxxx
Where: cond is any logical expression.
xxxxx is the number of an executable statement in the same program unit.

This statement causes control to be transferred to the next statement whenever the condition cond is true and the designated statement has just been completed.

Example:  
 I = 1

```
IF (I .LT. 10) COME FROM 50
I = I+1
50 WRITE (6,60) I
   STOP
60 FORMAT (I4)
```

Explanation:

The COME FROM takes effect only while I is less than 10. Thus when I is equal to 10, the program continues past statement 50 and terminates. This is equivalent to the now-obsolete formulations:

```
I = 1
30 I = I+1
   WRITE (6,60) I
   IF (I .LT. 10) GO TO 30
   STOP
60 FORMAT (I4)
```

or

```
DO 50 I = 2, 10
50 WRITE (6,60) I
   STOP
60 FORMAT (I4)
```

Note how much clearer is the intent of the code containing the COME FROM construct.

## Computed COME FROM statement

General Form
COME FROM (x1, x2, x3, . . . , xn), i
Where: Each x is the number of an executable statement in the same program unit.
i is an integer variable.

This statement causes control to be transferred to the next statement whenever any of the following conditions holds:

- statement x1 has just been exe-



- statement x2 has just been executed and i is equal to 2
- statement x3 has just been executed and i is equal to 3

- statement xn has just been executed and i is equal to n

If, when statement xj is executed, i has any value other than j, this statement has no effect.

Example:

```
DO 200 INDEX=1,10
10 X = 1.
20 X = X*2.
30 X = X*3.
40 X = X*4.
50 X = X*5.
60 X = X*6.
70 X = X*7.
80 X = X*8.
90 X = X*9.
100 X = X*10.
    COME FROM (10,20,30,40,
    50,60,70,80,90,100),INDEX
    WRITE (6,500) INDEX,X
200 CONTINUE
    STOP
500 FORMAT (14,2X,F12.0)
```

Explanation:

This program illustrates the power of the computed COME FROM by providing a compact algorithm for computing factorials. On the first iteration (INDEX=1), as soon as statement 10 has been executed, control passes to the WRITE statement. As a more general case, consider the fifth iteration: X is set to 1, and then multiplied by 2., 3., 4. and 5. before control passes to the WRITE statement.

### Assign and assigned COME FROM statements

#### General Form

```
ASSIGN xxxxx TO m
```

```
·
·
·
```

```
COME FROM m, (x1, x2, x3, ..., xn)
```

Where: xxxxx is the number of an executable statement. It must be one of the numbers

x1, x2, x3, ..., xn.

Each x is the number of an executable statement in the same program unit.

m is an integer variable which is assigned one of the statement numbers

x1, x2, x3, ..., xn.

The assigned COME FROM causes control to be transferred to the next statement upon completion of the statement whose number is currently assigned to m. This provides a convenient means of passing control to a common point from a variety of points in the program unit. The actual point from which control is to be passed can be selected under program control.

Example:

```
DO 60 I=6,32
20 X = I*6+14
    IF (X-20.) 10, 30, 50
10 ASSIGN 40 TO JUMP
30 Y = 2*X**2.-17.4
    COME FROM JUMP, (40,20,30)
    ASSIGN 30 TO JUMP
    X = X*Y-X**2
40 ASSIGN 40 TO JUMP
    IF (Y-X) 20, 60, 50
50 ASSIGN 20 TO JUMP
60 CONTINUE
```

Explanation:

This example is self-explanatory.

The author feels that the COME FROM will prove an invaluable contribution to the field of computer science. It is confidently predicted that this solution will be implemented in all future programming languages, and will be retrofitted into existing languages. Although it is clear that the COME FROM statement fulfills most of the requirements of the advocates of GOTO-less programming, it remains for the practitioners of automatic programming to evaluate just how much this construct contributes to the development of automatic proofs of program correctness. Having at last put to rest the GOTO controversy, we now may enter the era of the COME FROM conundrum. □



Mr. Clark is a programmer/analyst in the computation center of the Rand Corp. He has been active in the development of user-oriented, interactive computer systems, especially graphics systems. He has a BS in mathematics from Pennsylvania State Univ.

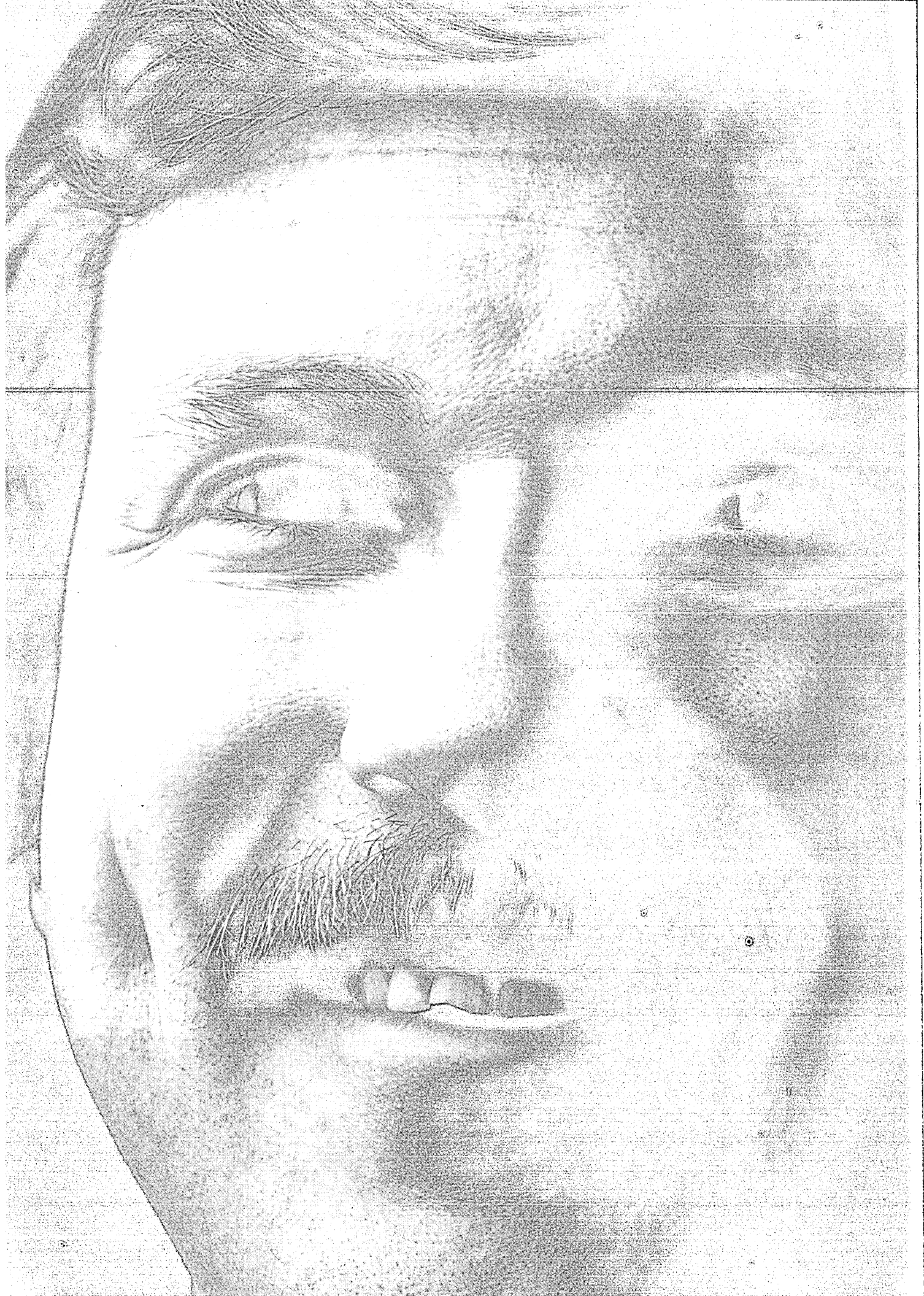

# Answering the question "Why is the printing?"

## Why is the printing?

Command 5100: The lowest terminal, the printing, is for  
printing, not for the terminal. The printing, not for the  
terminal, is for the printing. The printing, not for the  
terminal, is for the printing. The printing, not for the  
terminal, is for the printing.

Printing is a process of printing. Printing is a process of  
printing. Printing is a process of printing.

Printing is a process of printing.

Printing is a process of printing.

Printing is a process of printing. Printing is a process of printing.

Printing is a process of printing.

Printing is a process of printing. Printing is a process of printing.  
Printing is a process of printing. Printing is a process of printing.  
Printing is a process of printing. Printing is a process of printing.  
Printing is a process of printing. Printing is a process of printing.  
Printing is a process of printing. Printing is a process of printing.  
Printing is a process of printing. Printing is a process of printing.  
Printing is a process of printing. Printing is a process of printing.  
Printing is a process of printing. Printing is a process of printing.

Printing is a process of printing. Printing is a process of printing.  
Printing is a process of printing. Printing is a process of printing.

Printing is a process of printing. Printing is a process of printing.  
Printing is a process of printing. Printing is a process of printing.  
Printing is a process of printing. Printing is a process of printing.  
Printing is a process of printing. Printing is a process of printing.  
Printing is a process of printing. Printing is a process of printing.  
Printing is a process of printing. Printing is a process of printing.  
Printing is a process of printing. Printing is a process of printing.  
Printing is a process of printing. Printing is a process of printing.

Printing is a process of printing.

Printing is a process of printing. Printing is a process of printing.

ADDIS Applied Digital Data Systems, 1100 Madison Blvd.,  
Hempstead, New York, 11552-5400

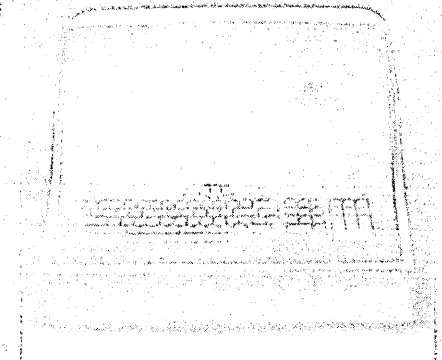

ADDIS Applied Digital Data Systems, 1100 Madison Blvd.,  
Hempstead, New York, 11552-5400

ADDIS Applied Digital Data Systems, 1100 Madison Blvd.,  
Hempstead, New York, 11552-5400

# THREE MORE IRRESISTIBLE REASONS NOT TO KEEP YOUR IBM 1130.

We've already covered three reasons you ought to replace your IBM 1130 with our 18/30 DMS.

You get a lot more throughput. You don't have the hassle of rewriting your software. And it doesn't cost any more money.

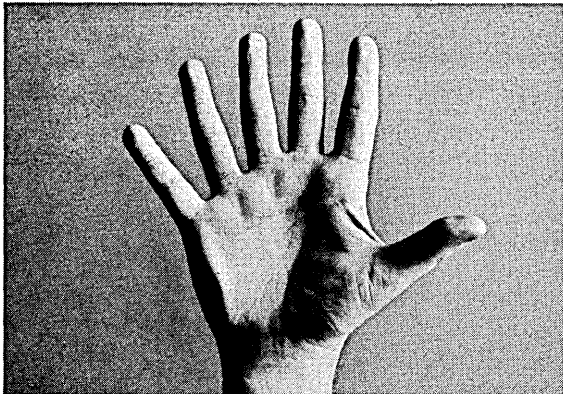

Now we give you three more reasons. Three new real time software telecommunications systems that run on the 18/30 DMS. And they're still DM2 compatible.

You can buy the basic 18/30 DMS now and upgrade when you want to. You don't pay for real time until you're ready to use real time.

If your needs are simple, our Real Time Communications Monitor System, with front end communications multiplexer, will do the job.

In case you need more power, we have two Real Time Data Processing

Systems, one with time sharing capability (Dartmouth Basic). Both systems have General Automation's SPC-16 as a front end processor; it's the most powerful minicomputer available. Both have a powerful file management package and accessibility from as many as 32 remote terminals.

No matter which system you start out with, you get capability for greatly expanded core memory and floating point hardware.

It all boils down to this. If you want more throughput ability, our 18/30 DMS can save you money. If what you're looking for is multi-programming and real time, we can save you a fortune.

And headaches too.

For all the details, write General Automation, 1055 South East Street, Anaheim, California 92805. Or call us at (714) 778-4800.

European headquarters:  
Centre Silic, Cidex L242, 94533 Rungis,  
Paris, France. Phone 686-7431.

## GENERAL AUTOMATION 18/30 DMS

# Acco is the only manufacturer to offer retractable hooks on all 14-7/8" x 11" data binders at no extra cost.

Versatile, high-impact plastic Accodata hooks. Slide out easily for hanging. Push-in flush for everyday use. Permanently attached to all our 14<sup>7</sup>/<sub>8</sub>" x 11" (9007) P1P, P4P and P6P Accodata Binders. No extras to buy. No hooks to get lost. Our famous Accodata Binders come in 20 pt. genuine pressboard in 7 colors. 23 pt. Accohide\* in 4 colors and heavy-duty 90 pt. Accohide\* in

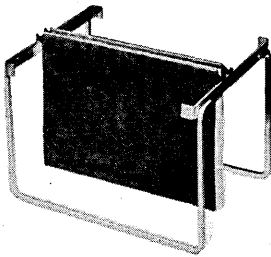

2 colors — practically indestructible. New, all metal binding mechanisms provide greater compression. Steel Dataflex™ posts. Top and bottom loading for easy access. Holds up to 8" burst or unburst printout. Write for our 4/color catalog or see Accodata Binders (with the *no extra cost* data hooks) at your office products dealer. Seeing's believing.

\*A chemical resin.

*Innovators . . . by design*

**ACCO**

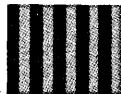

**ACCO INTERNATIONAL INC.**

5150 N. Northwest Highway/Chicago, Illinois 60630

New York, Los Angeles, Boston/Canada/England/Holland/Mexico/Venezuela/El Salvador/Jamaica/Japan

**Now you see 'em**

**...now you don't.**

# Some tape drives have some of these features. Our new 2700 series has all of them at the lowest cost to you... That's Bright!

Until now, if you were configuring a system using digital tape drives, you had to compromise—but no more!

Bright's new 2700 series features quiet, industry-compatible, high-performance vacuum column or tension arm drives ranging up to 75 ips, and a line of formatters, NRZI, PE, or both.

These easy loading drives have 80% common parts, low-cost and high reliability. We made them applications-oriented to meet your exact needs (and your user's exact needs) without compromise. That's Bright!

1. Low cost vacuum or tension-arm with common spares, training, and servicing.
2. Industry-compatible transports and formatters.
3. Wide range of speeds.
4. Formatters: PE, NRZI, or PE/NRZI.
5. True one-hand loading and operation.
6. Reliability backed by a 13-month warranty.
7. Easy serviceability—access to everything from the front.
8. Electronic write deskew (channel by channel) with three lead level thresholds.
9. Overwrite (edit).
10. Precise IBM guide spacing.

11. Daisy-chain capability built in with transport configuration line.
12. Strobe disc.
13. 200 ips rewind.
14. Easy update NRZI to phase or dual PE/NRZI.
15. Vacuum transports feature linear vacuum sensors, vacuum tape cleaner.
16. Quiet, 3" wide vacuum columns (Bright 2740).

Send for our free brochure or call our regional representative for more information.

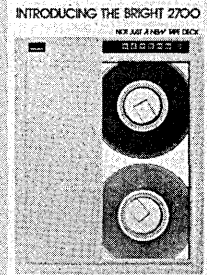

BRIGHT 2730 TENSION ARM, TO 45 IPS.

**Bright**  
INDUSTRIES INC

683 West Maude Avenue  
Sunnyvale, California 94086  
Telephone (408) 735-9868

Name .....

Title .....

Company .....

Address .....

City .....

State ..... Zip .....

Phone .....

BRIGHT 2750 VACUUM COLUMN,  
TO 75 IPS.

BRIGHT 2740 VACUUM COLUMN,  
TO 45 IPS.

Regional representatives: Fullerton, CA—(714) 879-3911; Cleveland, OH—(216) 228-0624; Orlando, FL—(305) 644-5500; Elmsford, NY—(914) 592-8658; Buffalo, NY—(716) 839-5020; Ottawa, Canada—(613) 234-4797.

The goal is to control  
the national economy through computers

# The State of Computation in Cuba

by Ramon C. Barquin

Computer technology has, in little over two short decades, left its imprint upon mankind. The achievements made possible by computation would undoubtedly highlight any list of postwar scientific events of major importance. Yet it hasn't been in the field of science alone that the computer has made an impact. Its capacity for information processing and data manipulation has truly revolutionized large areas of industry, commerce, banking, public utilities, services, etc. The effects of this revolution have largely contributed to the economic development process that has also characterized the more advanced nations in these last few decades. At the same time, the diversity of applications, the diminishing costs, and the ease of handling have allowed the computer to enter most of the less developed countries by now. Latin America, a developing region par excellence, saw its first computers over 15 years ago, although the existence of computation as an identifiable phenomenon does not go back beyond 1964-65. Cuba, specifically, received its first digital computer in 1959 in the form of an IBM Rmac 305.

From that beginning, although there had been prior use of punched card unit record equipment throughout the island, Cuba went through many ups and downs in its computer industry. Some of these were a consequence of the external pressures and economic vicissitudes that the country as a whole went through during the first years of the revolution. As of 1968, however, the country took a new look at the possible benefits of computation. The revolutionary leadership having been won over, Cuba embarked on a most ambitious plan to develop itself in the field of computers and their use. This plan is still under way, and it is still early to assess its results. Nonetheless, it is quite clear that in a matter of a few short years Cuba went from a point of almost zero computation, to one of rather extensive use of computers, at least within the economic planning spheres, and has become the only country in Latin America to be actively manufacturing computers of its own design. (Brazil manufactured the IBM 1401 some years back, and is now planning to build IBM 370/135s.

However, this is really an IBM project in which most of the machines were actually exported. The development of the "Patinho Feo" machine at the Universidade do São Paulo is more in line, but it has not yet reached a definitive stage.)

The purpose of this work is basically to present the state of computer arts in Cuba today. For this the background of computation in the island will first be described, with an exposition of the history of data processing in Cuba prior to the revolution, and up through the first few years of the revolutionary regime. Following this, a presentation of the situation in Cuba today is made, emphasizing the educational program, the national policy aspects, and the decision to manufacture minicomputers. A very brief analysis of future development is also included, but is quite sketchy due to the lack of first-hand information with which to work.

As are many other areas, the Cuban experiment with computers, especially the manufacturing phase, is being observed with extreme interest by most Latin American countries. If Cuba can prove that its minicomputers are technologically competitive and economically sound, then it will probably become a model for a number of nations with similar needs. If it cannot—and the critical test will be whether it can solve the majority of its computational needs over an extended period, and at a lower cost than that of importing the computers—it will at least have determined the advisability for a developing country to manufacture its own computers.

Lastly, it should be noted that for an adequate treatment of the subject, first-hand research is necessary. The author has had to rely on the scant written material that exists, and interviews with a few computer-related persons who have visited Cuba, or worked there within the last few years.<sup>1</sup>

In 1927 the United Railways of Havana (Ferrocarriles Unidos) brought

the first adp equipment to Cuba. This was in the form of IBM punched card machines which were to be used in administrative applications for the railroad company. The success of this innovation soon made the Consolidated Railways of Cuba (Ferrocarriles Consolidados) also adopt the use of IBM machines, and in 1928, shortly after their installation, the IBM Company appointed its first representative to Cuba in the person of John A. Griffin, who would later on become the head of IBM's main office for Northern Latin America. By 1931 a number of other enterprises, including the City of Havana, were using the punched card machines, and the 1930 census had been processed using adp equipment. In fact, business for IBM was sufficiently good for the establishment of a permanent branch office in Havana in 1933. This office, a branch of the IBM Co. of Delaware, had Chester Lecher as its first manager, and was also responsible for Puerto Rico, Panama Canal Zone, Nicaragua, Jamaica, Haiti, Costa Rica, and the Dominican Republic. Chester was replaced by R. B. Guijarro in 1935, and later on by Marcial Digat in 1940. Digat remained as IBM country manager in Cuba until the confiscation of IBM by the Castro government in 1961.

Not all adp equipment that entered the island prior to the revolution was IBM manufactured; there were some Sperry Rand and NCR machines also, but in almost negligible numbers. The history of dp in Cuba during this phase is basically the history of IBM in Cuba. There were numerous unit record installations throughout the country. Most of them were within the private sector of the economy. The public sector had not advanced very much in the use of dp equipment. The majority of the machines were concentrated in Havana, although the diffusion of demand was great enough to warrant the establishment of a new IBM office in Santiago de Cuba by 1954. Towards the latter years of this phase, and thus the situation just prior to the revolution, the types of equipment to be found in the island were typically key-punches and verifiers, sorters, collators, reproducers, interpreters, and accounting machines. These last were

<sup>1</sup> Most of the information presented here comes from the following: J. Connolly, *A Chronology of Computing in Europe, Africa, Asia and Latin America*, IBM World Trade Corp., N.Y., 1968; O. Carnota Lauzán, *The Use of Computers in the Economic and Social Field in a Developing Country: Cuba*, Conference on the Role of Computers in Economic and Social Research in Latin America, Cuernavaca, Mexico, October 25-29, 1971; and interviews with former employees of IBM de Cuba.

## Computation In Cuba

probably of the IBM 402, 403, and 407 types. The first IBM 632 machine to be installed in Latin America was the one at Incera y Hnos. of Havana. There were also some calculators of the IBM 602 variety.

By 1959 there was a rather progressive IBM organization in Cuba that had managed to establish a firm base for commercial dp in the country, placing it in a privileged position technologically, with respect to most of the other Latin American countries. In effect, by this time both the country and the local IBM organization were ready to bring the first digital computer into Cuba. This was to be a Ramac 305, to be installed at IBM's office in the La Rampa building in Havana, and later to be passed on to the Cuban government after some final commercial agreements had been reached. By the time all of the devices had been received in Cuba, and an attempt to install them had been made, the years 1960 and early 1961 had come around. With them came many of the major confrontations of the early revolution; the migration of most of the IBM technicians, and a general lack of interest on the part of the government to devote a great deal of its resources to the endeavor. The Ramac 305 apparently did become operational in 1961, but that was about all that could be said. It does not seem probable that any useful work was ever obtained from it. At least this was the case up to the time of the confiscation of IBM's equipment in Cuba. (Apparently the computer was actually installed by an IBM customer engineer who was promised that he could leave the country if he got it working. This he did, but once the computer needed maintenance for the first time, there was probably no one to provide it.)

Some comments have been made concerning the actual arrival at the docks in Havana of some computers which were returned to the U.S. by IBM before they were allowed to be delivered to the customers in Cuba during the 1959-60 period. This whole issue is not very clear, and Carnota mentions some punched card machines that were re-embarked. However, it is also possible that an IBM 1401 which had been ordered by the Cuban Telephone Co. and scheduled for arrival about that time could have been re-shipped due to the rapidly deteriorating political situation in the country. In any case, it is clear that prior to the revolution there was no digital computer in operation inside of Cuba, and that the first two years saw only the

arrival of the Ramac 305 which was never really usable.

Data processing had reached a point of maturity in the country, however, and most of the major commercial schools in the nation were establishing curricula. Thus one could see key-punching, basic machine operations, wiring, and mechanized accounting being taught on unit record equipment at Colegio Baldor, Academia Pitman, Havana Business School, and the Universidad Masónica, among others.

The confiscation of IBM was an interesting process, since there were no major industrial facilities (except a card plant) to actually take over. In 1960 the IBM manager, Marcial Digat, was called back to New York in view of the Castro government's initial confiscations of U.S. companies. Shortly afterwards, Nicanor Infiesta was named to represent IBM interests in Cuba, and in 1961 the representation fell on IBM's general accountant, Manuel Rodríguez. Further on during that year the government decided to confiscate IBM, thus acquiring the stock of unit record punched card machines installed in the country up until that time. It also placed them in the position of having to obtain spare parts to maintain the machines without recourse to the IBM Co. directly. This they managed to do indirectly for some time, through rather ingenious methods. The major blow to the country as

good educational base for computation and to implement sound programs apparently came from Mexico in the 1960-61 period, and later on from the East bloc countries, especially Czechoslovakia.<sup>2</sup> None of these attempts seem to have been very successful, probably because their priority was not sufficiently high within the overall scope of the central leadership. In addition, a scarcity of trained personnel, or of personnel with the necessary background, must have been in evidence. Up to and including 1967, Cuba was only able to acquire one computer, an Elliot 803 which was bought from Great Britain without peripherals. Carnota seems to suggest that they could not get peripherals with the machine for political reasons.

The year 1968 seems to mark the dividing line between the old and the new in Cuban dp or computation. If 1959 marked the coming to power of the revolution, 1968 was the year of the revolution in computation.

### A need for computers

In 1968, apparently through the agencies of French advisors, the top leadership was convinced of the need for using computers for the solution of many of the major problems confronting the Cuban economy, primarily in order to plan properly. As a result of this decision a number of events took place in rapid succession. First, two

Computer CID-201-A	
Number	Location
2	CID
1	Central Azucarera Camilo Cienfuegos
3	Ministerio del Azucar
1	CEIS
1	Escuela de Matematicas
1	Instituto Cubano del Petroleo
1	Industria Textil Ariguanabo
1	Industria Nacional Deporte y Recreacion
1	Ferrocarriles
1	Central Azucarera Ecuador
1	Construimport
1	Maguimport
1	MINAZ
1	Grupo Nacional de Genetica
1	Instituto de Economia
1	Mineria

Source: Report of Prof. Jose Duran, from Universidad de Concepcion, Chile, on his visit to Universidad de La Habana, Cuba, 1972.

Table 1

a whole, as far as dp and subsequently computation were concerned, was the emigration of many technicians, operators, programmers, analysts and managers. Almost all of IBM's Cuban staff left the land and went on to provide the IBM Latin American organization with a large number of country managers for Central and South America, and to strengthen the technical staffs of these countries. Cuba's loss was their gain, and still today one finds IBM's offices in these countries dotted with Cuban technicians who left after the revolution.

Some early attempts to establish a

SEA 4000 second generation computers were ordered from CII (Compagnie Internationale pour l'Informatique), and the Dirección de Cálculo Electrónico (Central Directorate for Electronic Calculation) was created under the Central Planning Board (JUCEPLAN). Next, in 1969, the Centro de Investigación Digital (CID) was founded at Universidad de La Habana to study the problem of manufacturing mini-computers in Cuba. And in that same

<sup>2</sup> Personal communication to the author by Ing. Sergio Beltrán, who was then director of the Centro de Cómputos at the Universidad Nacional Autónoma de México; and from Mr. Al Sitrnad, systems analyst for the Czechoslovak govt., later a research associate at MIT.



year the Plan Cálculo Nacional, modelé on the French Plan Cálcul, was established. Lastly, the preparation of study programs for the rapid training of personnel at the different levels was begun.

All of this feverish activity, which took place because of the sudden importance attributed to computation by the revolutionary leadership, gave the island a major set of goals to achieve. These can be divided into four major categories: education, applications, manufacturing, and planning.

Insofar as the need existed to train new personnel for the computer industry, a number of plans were formed to satisfy this need. At first the French and other foreign instructors were used for the first set of courses at the University of Havana, and subsequently Cuban personnel took over the teaching. There was a great addition of computer-related courses within the formal engineering curricula at the universities, as well as in those for mathematicians, physicists, economists, and public accountants. A degree program in systems engineering and a graduate program at the MS level were begun in 1972. The Universidad de La Habana and the Universidad Central de Las Villas also offer the degree of Licenciado en Ciencias de Computación under the Mathematics curriculum. Lastly, the Technical Institutes in Economy turn out the mass of computer

tige issues. The most important is massive sports archives and statistics. Cuba's chances of winning a medal at an international event can be assessed in this manner, and the decision made whether or not to send a representative.

#### Creation of a mini

Probably the most important aspect of Cuba's post-1968 computation programs has been its decision to manufacture minicomputers. Upon the creation of the CID with five engineers and a mathematician, the job was assigned them of studying the feasibility of manufacturing computers in Cuba. The main justification found for this was the huge payoff to be obtained by the optimization of rail traffic during the sugar harvest. Just this application, with the gigantic 10 million ton prospective harvest of 1970 in mind, drove the full staff at the center to complete the first computer in April 1970. After slight modifications the final version, called the CID-201-A, became operational. This machine, which may be classified as a minicomputer, is a 4K, 12-bit word, 1.5-usec cycle machine. The CID-201-A is programmed using the LEN I assembler, or the LEAL compiler. LEAL is a high-level language similar to Digital Equipment's FOCAL. (The PDP-8 is a 4K minicomputer quite similar to the CID-201-A. Prof. Carlos Domingo, of Universidad Central de Caracas, Vene-

word and 8K memory. Work was under way on a CID-201-B, whose specifications are not yet known.

Programming the CID machines seems to be fairly straightforward with the use of the two languages and the program library. Lenguaje Ensamblador I (LEN I) is an assembler language that permits the use of mnemonics to substitute for the actual machine code. Lenguaje Algorítmico (LEAL) is a compiler which permits the writing of code in a higher level fashion. It is similar to DEC's FOCAL, which is used on the PDP-8. LEAL was developed at CID by Victor M. Llopis and collaborators.

The program library includes most of the I/O subroutines and the systems utilities as well as some of the mathematical ones. The list as presented in the specifications manual is:

1. Paper tape read
2. Paper tape punch
3. Paper tape verification
4. Decimal format keyboard input
5. Decimal format keyboard verification
6. Floating point addition
7. Floating point subtraction
8. Floating point multiplication
9. Floating point division
10. Transcendental functions
11. Monitor and trace programs
12. Core dump routines

Software development is really the main work ahead of the CID group at present. The hardware works, apparently, so now it must be put to good use, and here is where software is central. One aid to this effort seems to be a mutual deal whereby three CID machines were given to Chilean universities in exchange for software development.

At present, the CID seems to have built around 40 computers. Of these, approximately 20 are listed in Table 1 with their respective installation sites. Table 2 provides the characteristics of both the CID-201-A and the CID-202.

The planning function seems to be extremely important in Cuba today, at least in theory. Designing a computer system for planning is thus also quite important. The Cuban government has undertaken the implementation of a national computing system (Sistema Nacional de Computación) which is to be the fundamental instrument for controlling the Cuban economy. The grandiose master plan envisions a national switching and data processing center as the main depository, with a telecommunications network and decentralized systems providing the whole country with access to the data. Although this system is still far from implementation, the first steps have been very deliberately taken to bring it

Characteristics of the CID-201-A and the CID-202

Specification	CID-201-A	CID-202
Memory type	magnetic core	magnetic core
Memory capacity	4,096 words	8,192 words
Cycle time	1.5 usec.	1.5 usec.
Word length	12 bits	16 bits
Instruction set	59 inst.	200 inst.
Additions per second	25,000	50,000
Peripherals:		
Teletype	yes	yes
Paper tape read	yes	yes
Paper tape punch	yes	yes
Cassette recorder	yes	yes
Auxiliary storage capacity	240K words	240K words
Multiprogramming	no	yes
LEN I (Assembler language)	yes	yes
LEAL (Algorithmic language)	yes	yes
Development date	April 1970	July 1971

Source: "Computadora CID 201-A," Centro de Investigacion Digital, Universidad de La Habana, Cuba, 1972, and "Computadora CID 202," Centro de Investigacion Digital, Universidad de La Habana, Cuba, 1972.

Table 2

programmers that are needed, while the Technical Institutes in Electronics produce the hardware maintenance technicians.

As far as applications go, the government seems to have undertaken the automation of a national cattle control system, a population and housing census, a sugar crop control system, etc. There have been major limitations as to the implementation of these systems due to the lack of hardware, but they should be working fairly well in theory by now. There are other applications which demonstrate the Cuban government's preoccupation with pres-

zuela, who spent a year as UNESCO advisor on computation in Cuba, suggests the possibility of Cuba's having borrowed from this original design through Digital's very fine set of manuals.) The computer is a bit limited in its peripheral equipment, however, having a poor assortment of I/O devices. At present there is only a teletype-printed output at 7 cps. Paper tape input and output is also standard, as is magnetic tape cassette with 35 word/second read-write speed.

In July of 1971 the CID-202 was developed, with basically the same characteristics, except for a 16-bit

## Computation In Cuba

about. The equipment to be used has been ordered from CII, and is probably in the process of being installed in Cuba now. Carnota lists it in some detail being composed primarily of IRIS series machines: 2 IRIS 50's and 9 IRIS 10's. The IRIS computers are third generation equipment, and have data communications facilities. They will be working on 1200- and 2400-baud voice grade lines.

### The final objective

Cuba seems to have developed a very definite strategy, at a national level, with respect to computation. This strategy covers both application goals and allocation of computer resources. It has as its final objective the establishment of a national computation system which will control the national economy. This system will span the island through the use of data communications facilities and several intercommunicating IRIS series computers. The allocation of computer resources seems to follow a two-part path. First, importation of some medium to large third generation machines with which to implement the NCS. Secondly, but simultaneously, the design and manufacture of small digital computers to satisfy the problems which characterize typical large enterprise operations such as sugar mills, large factories, large farms, etc.

The NCS idea is not new, and socialist regimes, because of their central planning and control, usually identify with the scheme quite strongly. There are many pitfalls that could conceivably hamper the actual operation and effectiveness of such a system. One of the most evident problems is the reliability and timeliness of the information collected. This is the base of any information system, and great care must be taken to ensure that the data gathered meets both requirements. Another possible difficulty in the implementation of such a system is the complexity problem. The software for the NCS will have to be written quite for that specific purpose. The magnitude of the project being considered bears the characteristics of a major systems development undertaking. If the experience of almost everyone who has developed a major system holds, there will be a tendency to grossly underestimate the magnitude of the problem. This is even more likely to occur in Cuba because of the lack of experience in software development and major systems projects. The intent of the project is definitely worth a good try, and Cuba seems determined to give one.

The establishment of a national computation system with a universal data base encompassing all sorts and types of economic information could have terrifying effects on individual privacy. Yet, because of the very nature of the present Cuban regime, individual privacy has very low priority, and the centralized authoritarian regime which has characterized the revolution would probably prize some additional elements of control.

By deciding to manufacture its own computers, Cuba departed from the accepted practice among most developing countries of importing its dp equipment. Usually economies of scale, the cost of R&D, and the impossibility of competing with the major manufacturers have made this appear to be a sound policy. Cuba was impeded, for political reasons, from purchasing adequate computing equipment in the U.S., and what it could get from the East bloc was not satisfactory technologically speaking. The French seemed eager and capable of satisfying certain requirements concerning hardware by late 1967. But with the creation of the CID, and some additional advice received from the start, Cuba decided to build its own computers at the lower end of the scale. They would import what they needed for immediate operations, along with some of the large machines which they could not conceivably justify constructing. The CID would develop minicomputers with which to solve the basic problems of medium to large scale Cuban firms. Was the decision correct? Should it be followed in other developing countries? It is still too early to reach a conclusion on either inquiry. Certainly the fact that Cuba was not able to freely acquire U.S. computers places it in a unique position which from the start casts doubt on the further applicability of the model. At the same time, it becomes clear that it could probably be justified in the Cuban case due to this special circumstance. But in order to reach a better conclusion on the questions asked, certain facts should be collected. The costs of building the CID machines—how are they broken down? How much is allocated to materials? Where does Cuba obtain the components? Does she manufacture them also? What were the real R&D costs? What other projects could have been accomplished by the same people at the same cost? What is the life cycle of the CID-201-A? Of the CID-202? How long before it becomes obsolete? What is the cost of software development vs. use of a system with ready-to-use software? These and many other questions need answers before a final evaluation can be made concerning the Cuban experiment. There is no doubt, how-

ever, that it is being closely watched and will probably be emulated before long. This is another point which should be recognized when analyzing Cuba's decision to build computers. By undertaking this project, Cuba highlights her technological prowess, thereby gaining considerable prestige, especially among the developing countries, which is central to the conduct of its foreign policy.

Lastly, in order to place Cuba comparatively within the context of Latin America, it is necessary to say that it has a CIDP ranking of 12th, and belongs in Group C of the corresponding categorization of the Latin American nations.<sup>3</sup> Other members of this group include Chile, Colombia, Uruguay, Peru, Panama, and Costa Rica. Cuba, with a CIDP of 31.63, is towards the lower end. Because of the peculiar conditions governing the island's development within the computer industry, the CIDP concept does not seem to be specifically applicable. Nonetheless, it gives an idea of the general position. It also corresponds approximately to the basic level as defined by the United Nations ad hoc Committee on Computer Technology.<sup>4</sup> In addition, Cuba has 4.85 computers per million inhabitants, which is below the median for the region and compares with Chile's 5.88 and Colombia's 4.07. It also has 17.59 computers per billion dollars of GNP. This is again below the region's median, but above Chile's 12.54 and Colombia's 16.73. □



Mr. Barquin is presently on a leave of absence from IBM to complete his PhD at MIT. He has previously been an instructor and a systems engineer at IBM in San Juan, and has BS and MS degrees from the Univ. of Puerto Rico. He was born in Cuba, and came to the U.S. in 1960.

<sup>3</sup> The Computer Industry Development Potential (CIDP) index is a measure of the short term potential of a country for developing a computer industry. It is computed through the weighing of 11 variables of economic, educational and technological character. See R. C. Barquin, *Development of the Computer Industry in the Latin American Nations: Strategies and Policy*, Electrical Engineer's Thesis, MIT, Cambridge, Mass., 1972.

<sup>4</sup> *The Application of Computer Technology for Development*, United Nations publication, NYC, 1971.

# Can a DIVA Disc System really maximize my mini and save me a cool million?

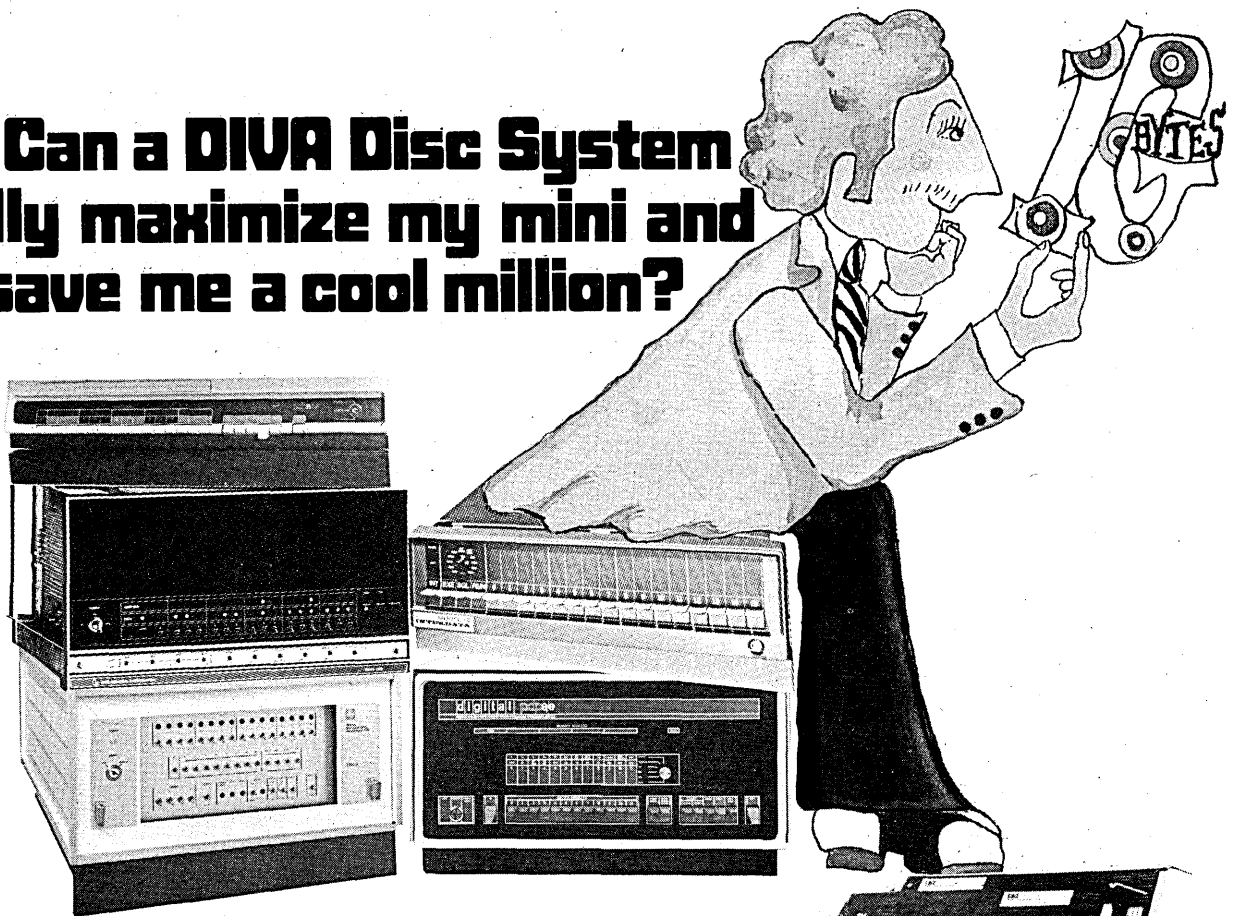

It sure can. Say you own or use one or more of the mini-computers George is sitting on. You can select, according to your particular needs, any one of eight standard mini-maximizer disc systems. George happens to be contemplating a mass memory system with a capacity of approximately 1 gigabyte.

**That's a lot of data storage capacity.**

But you might be thinking smaller: 7.5 million bytes, or somewhere in between. We can make you both happy. DIVA makes a disc system that will let you or George segment and store your number-crunching, time-consuming calculations and make short shrift of them. These systems are high-performance units: 624K bytes/sec transfer, 32-msec avg access, 11 sec stop that cut running costs to a few bucks/hr.

**That's maximizing your mini.**

Now, about the cool million. You don't need a mini for this calculation. DIVA's top-of-the-line disc system with 8 spindles tags out at \$111,900. Add the cost of your mini. Subtract the total from \$1 to \$4 million: the cost of a comparable maxi.

**That's saving a cool million, or more.**

Obviously, there's more to mini-maximizing than is written here. Options like IBM compatible formatting, an exclusive DIVA feature, and psuedo-sectoring for efficient disc use. Features like overlap seek and removable packs. The rest is in our free brochure. Send for your copy. Read the specs on all the systems. Talk with George Roessler about costs or any unanswered questions on software, training, application, etc. Then maximize your mini. She's got a lot of potential. DIVA, Inc./607 Industrial Way West/Eatontown, N. J. 07724/ Phone: 201-544-9000/TWX 710-722-6645.

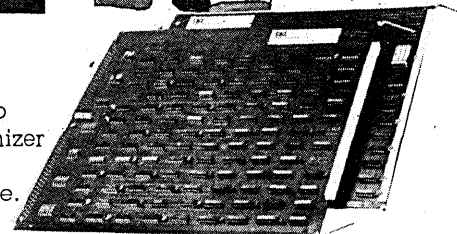

Mini maximizer systems

# IF THE IBM 3270 HAD INTELLIGENCE, IT WOULD BE A SYCOR 250.



And it would cost you less, too.

Because, while our new Sycor 250 does everything IBM's 3270 does and more, its monthly lease cost is lower.

And thanks to its intelligence, that's only the beginning of your savings.

Take data entry. Our 250's high I.Q. insures every piece of data your operator enters is absolutely clean. So less time is spent on the line.

Which means you can install more terminals per line and probably end up needing fewer lines and ports.

Give your Sycor representative a call. He'll be happy to point out other money-saving ways the 250's intelligence can be tailored to your operation.

While you're at it, ask him about the 250's impressive optional equipment. Like the badge reader, the light pen and the whole family of versatile printers in speeds of 40, 80 or 165 cps.

He knows it takes a smart DP manager to pick an intelligent terminal.



## SYCOR

**Corporate Offices:** Ann Arbor, Michigan 48104 (313) 971-0900. **District Sales Offices:** Atlanta (404) 457-1166 • Boston (617) 890-7290 • Chicago (312) 986-1833 • Cleveland (216) 831-8625 • Dallas (214) 521-6710 • Detroit (313) 355-5770 • Hartford (203) 529-1100 • Houston (713) 688-5224 • Indianapolis (317) 784-6779 • Los Angeles (213) 640-0120 • New York (212) 371-9050 • Philadelphia (609) 665-1170 • Pittsburgh (412) 922-3350 • San Francisco (415) 349-6626 • St. Louis (314) 878-0090 • Washington (703) 525-7300. **Canada:** Sycor International Ltd., Toronto (416) 429-0883. **Service Centers in 80 cities.**

# FOR \$26,123 A MONTH, IBM WILL RENT YOU THIS:

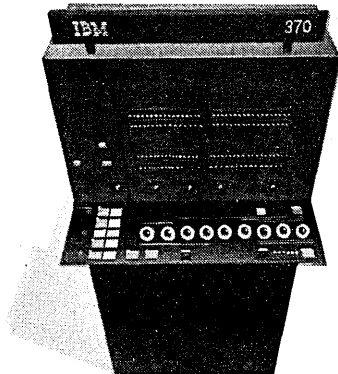

# FOR \$25,022 A MONTH, ITEL WILL LEASE YOU THIS:

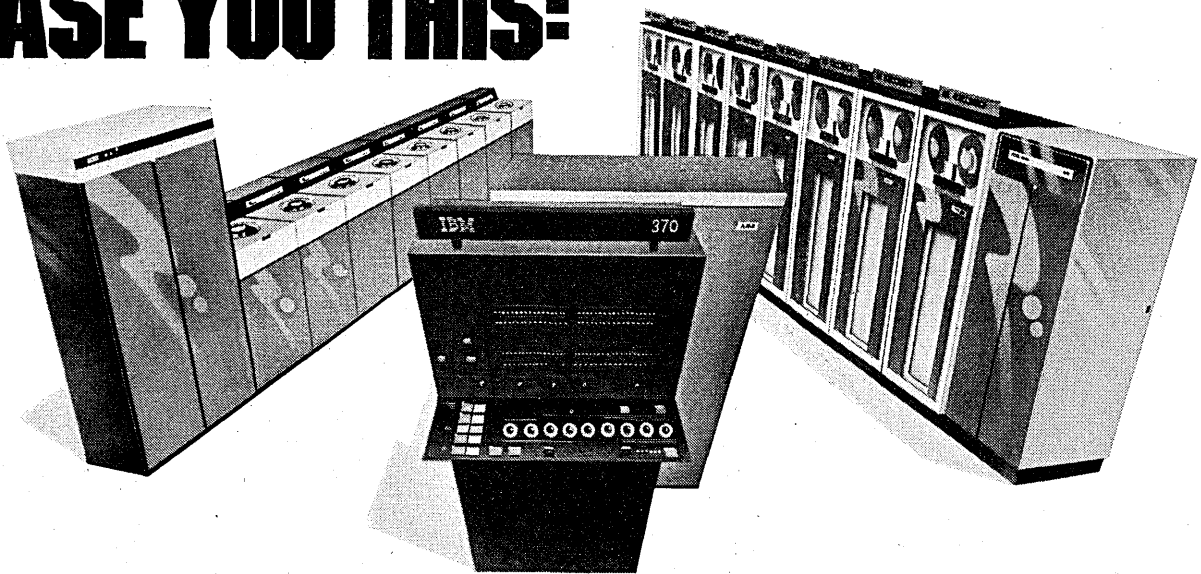

The big difference between IBM and ITEL shows up on your financial statement.

As an example, for \$26,123 a month, IBM rents you a System/370 Central Processing Unit alone, but for \$25,022, ITEL will give you the 370 CPU plus one megabyte of Monolithic Memory, 8 ITEL disk drives plus controller, as well as 8 ITEL tape drives and one controller.

A full computer system for less than the IBM cost of the CPU alone.

Rented from IBM, the same complete system would cost you \$51,405 per month, more than

double the ITEL cost.

And that's only one example. We'll lease any kind of computer package (360 or 370) on 3- to 8-year terms at proportional savings. Which explains why we have \$300 million of IBM computer equip-

ment on lease right now.

When you're making a data processing move, you'll save big by calling the Data Products Group at ITEL—the financial alternative to IBM.

**ITEL CORPORATION** One Embarcadero Center, San Francisco, Calif. 94111 (415) 989-4220

I'm interested. Please send me more detailed information.

Name _____	Title _____
Company _____	Phone _____
Address _____	
City _____	State _____ Zip _____

D-12

Results of a comprehensive study forecasting growth, needs, and applications of data communications in seventeen Western European countries through 1985

# Eurodata: Data Communications In Europe 1972-1985

by Richard A. Peters  
and Keppel M. Simpson

Telecommunications and postal services in Europe are generally controlled and/or administered by the national government. The responsible department is usually a "Ministry of Posts and Telecommunications." The operating entity which actually provides services is loosely known as the PTT (originally postal, telephone, telegraph), which may be a separate public corporation, part of the government, or one or more private companies.

These PTT's usually have a monopoly in providing telecommunication services. Those of Western Europe recognise the significance of the exploding technology and economic importance of data communications and acted as a consortium to seek basic information about data communications to meet their facility and service planning needs over the next 15 years. The Eurodata market study was their first major step. Eurodata is a means of creating a body of knowledge, and a consistent structure for assembling and subsequently updating facts relevant to the design of data communications facilities throughout Europe.

Data communications began in

Europe in the 1960s with pilot operations by a few large organisations in manufacturing, the airlines, and banking. The period up to 1970 saw a dramatic expansion in the number and variety of data transmission applications, with inventories of modems increasing at over 100% per annum in many countries. These developments coincided with predictions of vast growth potential for data traffic in the U.S. and increasingly strong pressures from multinational organisations for pan-European private network facilities for data. Several observers commented on the economic importance

of data communications in three main areas:

1. As a means of promoting economic growth and increased efficiency in European commerce and industry, in the context of the developing European economic communities and the continuing trends toward larger industrial units and multinational operations.
2. As a means of implementing government policies of decentralised administration, together with a uniformly high standard of public service throughout a country.
3. As a factor in the future of the dp and telecommunications manufacturing industries, particularly in relation to the viability of independent European producers.

The relatively unpenetrated state of data transmission service demand in Europe is illustrated by the fact that the gross domestic product of the Eurodata countries will grow only 1.8 times over the forecast period while traffic volumes increase over 12 times and the terminal population will increase over 10 times. By 1985 the equivalent of about 70 billion words will be transmitted daily by PTT customers. The

Country	1972	1985
Belgium	2.0	27.7
Denmark	1.1	14.9
Finland	11.0	135.0
France	14.6	220.0
Germany	0.1	2.5
Greece	—	0.2
Iceland	—	0.1
Ireland	0.3	0.3
Italy	6.2	60.4
Luxembourg	0.1	0.7
Netherlands	3.0	41.9
Norway	0.6	10.3
Portugal	0.0	4.0
Spain	0.3	29.0
Sweden	0.7	30.6
Switzerland	0.3	26.2
United Kingdom	26.3	193.1
Total	79.3	814.5

Table 1. Terminal populations in thousands

population of terminals operating over PTT lines will increase 10 times, from 80,000 units in 1972 to over 800,000 in 1985, so that by 1985 there will be over 2.2 terminals per thousand European inhabitants. In addition, by 1985 there will be some 600,000 terminals operating over in-house communications facilities to make a grand total of 1.4 million terminals in Europe in 1985. This grand total is approximately three times the 1972 inventory in the U.S.

### Economic trends

Data traffic forecasts are made against the background of a Western Europe which in 1985 will have a gross domestic product (GDP) of over \$1.5 trillion, a population of about 375 million, and a GDP per capita of about \$4,000. These figures compare to 1972 U.S. figures of about \$1.2 trillion, 210 million people, and \$5,500 respectively. (All figures are in terms of 1972 dollars.)

As a group, the Eurodata countries will be enjoying a level of income 60% higher in 1985 than in 1972. The main impact of growth on future European international economic structure will be the emergence of the Mediterranean countries in terms of absolute and per capita product. The projected growth rates make relatively minor differences in the ranking of countries by real GDP per capita. The projections of future growth to 1985 within the Eurodata countries provide for an overall annual growth rate of about 4.5% (see Fig. 1).

### International traffic

France, Germany, and U.K. will continue to be the main centres for international data traffic up to 1985, with links to North America accounting

for a significant proportion of the total. The demand for international data links will result in a five-fold increase in traffic between countries up to 1985. Most of this growth will stem from international banking and air transport applications, together with the activities of multinational manufacturing and information service organisations. While traffic between the European countries will continue to be the most important single factor in international data flows, the most rapid growth will be between Europe, North America, and the rest of the world.

### Terminal and traffic forecasts

The factors which cause some countries to experience high growth in the early years are related to the quality and price of telephone and data communications services, as perceived by the users; the marketing emphasis given to data communications by the local telecommunication authority; and the economic strength and structure of the potential customer groups.

Table 1 shows forecasts of PPT-connected terminals for the 17 Eurodata countries for the years 1972 and 1985. Germany, U.K., France, and Italy will account for 75% of the terminals installed in 1985. In-house terminals are excluded.

### Data traffic growth

#### Belgium

Data traffic volumes in Belgium will grow over 22% per year over the next 13 years. The rate of growth in the 1972-1976 period will exceed 40% per year due to demands in manufacturing, banking, government and dp services. Important factors encouraging the growth of data communications include Belgium's key position in international business and government.

#### Denmark

There will be a long-term trend towards increased use of remote computing service bureaus and a significant increase in demand for data transmission services from manufacturing industries. Banks and the edp service organisations together account for two-thirds of the traffic and over 30% of the terminals in 1985.

#### Finland

The main features of data transmission usage in Finland over the forecast period are the dominance of service bureaus, the importance of large organisations which will install sophisticated systems, and cooperative schemes (e.g. the Scandinavian savings banks which are active in Finland).

#### France

France will retain its position as the third largest user of data transmission in Europe, with a volume of traffic in 1985 nearly double the total 1972 traffic for all the Eurodata countries. The high economic growth rate, together with major government support for the dp and telecommunications industries and close cooperation with the leading users, will enable the PTT to undertake projects to improve its already wide range of data transmission services.

There will be continued experimental work with the CADUCEE analogue circuits switched network before installing HERMES, probably during the 1980s. HERMES is intended to use state-of-the-art technologies for circuit and packet switched data, as well as for telex and other digital traffic. A cpu load-sharing network, CYCLADES, is also scheduled for experimental evaluation and is due to be handling "live" applications by 1975.

By 1985 the dp services sector will account for more than six times the total French traffic for 1972, and will represent 45% of the total traffic as against some 14% in 1972. It will account for more than four times the volume of traffic of the next largest sector (discrete manufacturing).

#### Germany

West Germany will become the largest user of data communications in Europe by 1985. The population of terminals connected to PTT lines is expected to rise from about 14,600 in 1972 to over 220,000 by 1985. A major factor contributing to this expansion will be the implementation of large multiple-access networks servicing particular sectors of the economy. Other important factors affecting the growth of data communications in W. Germany are: the development of an

Gross Domestic Product at Factor Cost 1985

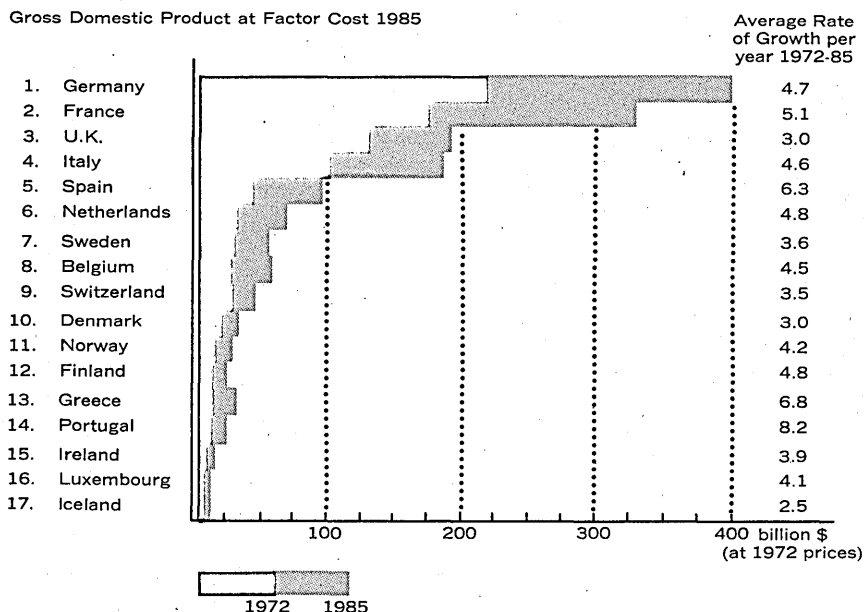

Fig. 1. The Eurodata countries.

integrated public data communications network by the Bundespost; high economic growth (the GDP is forecast to almost double between 1972 and 1985) including the service industries, where banks, travel organisations and dp services will be major users; the government's second programme for developing the dp industry, which is injecting more than DM 3,000 million into training and applications development.

Germany has very great experience with digital networks because of its high penetration of telex and the relatively high speed (200 bps) public telegraph network. The EDS (Electronic Data Switched) system developed by Siemens is presently being installed to replace and upgrade the existing telex network and to carry data traffic up to 4800 bps. Ultimately the EDS system is expected to be a fully integrated public switched network to carry all telecommunications traffic in digital form.

## Greece

Greece will increase its use of data transmission dramatically by 1985 in comparison to almost negligible usage today. By 1985, there will be about 2,500 terminals installed mostly in government and dp services. It is clear that in a country with so little traffic in 1972, new users and service bureau customers will have significant impact on the types of services needed.

All the PTT's in Europe provide a range of services for data transmission. These generally fall into the three main groups:

### Telegraph Type Services

- Telex generally gives a maximum speed of 50 bps, but France has allowed 200 bit machines to be used on their Telex network.
- Public Telegraph or Specialised Telegraph Systems such as the Datex network in Germany which allows speeds of up to 200 bps.
- Leased Telegraph Circuits generally offer 110 or 200 bps, although in Sweden the maximum transmission speed is 75 bps.

### Telephone Facilities

- Public Switched Telephone Networks have generally allowed transmission speeds of up to 1200 bps. There are occasionally some restrictions to 600 bps caused by older lines still in service or heavily loaded cables. U.K. and Italy are now offering 2400 bps on the switched telephone network.
- Leased Telephone Circuits generally provide a maximum speed of 4.8 Kbps, and in some cases, up to 9.6 Kbps is possible.

### Wide Band Facilities

- The most commonly available is the 48 KHz which offers speeds of about 50 Kbps, but 72 KHz, 240 KHz and even up to the MHz range are available. They are not immediately available however, because of long planning and lengthy installation periods. In addition, they are expensive.

PTT Services presently available and planned.

## Iceland

Iceland's unique geographic situation in relation to environmental measurements, North Atlantic sea and air routes, and trans-oceanic communications networks are likely to be the main factors in determining the circuit requirements for data between Iceland and other countries. Dp services offer the most promising growth opportunity for remote computing in Iceland.

## Ireland

Data transmission in Ireland is at a very early stage of development. The economy of Ireland is underdeveloped but if government economic plans are fulfilled the country could become a relatively large user of data transmission. Primary impetus to growth could come by drawing on edp resources in the U.K. and other European Economic Community (EEC) countries. The dp services sector will give great impetus to growth and will account for 75% of 1985 volumes. Other important user sectors in 1985 will be banking and financial, government and manufacturing.

## Italy

Italy has significant potential for growth in the use of data transmission based on the size of its economy and its industrial patterns. Both the terminal population and the traffic volumes in 1972 account for less than 10% of the European total, whereas Italy's GDP accounts for approximately 13% of the total.

A considerable acceleration in the demand for data communication services is forecast for the period up to 1985. Process manufacturing in Italy on a world level is at the forefront in its use of data communication technology. The dp services sector is the largest user of data communications in Italy, and accounts for over 22% of total traffic today, and will account for almost 50% of total traffic in 1985.

The emphasis will be on improve-

ties as quickly as possible.

## Luxembourg

Important factors which will affect the growth of data transmission relate primarily to EEC activities, multinationals, the steel industry, local utilities and to a certain extent, banking. The EEC computer centre is in Luxembourg and enlargement of the EEC will lead to greater use of data communications on an international scale.

## Netherlands

The Netherlands is surpassed only by France, Germany and U.K. in terms of 1972 data traffic volume. Data traffic will increase at an annual rate of 20% keeping the Netherlands in the top five in 1985. Over 42,000 terminals will be installed by 1985 compared with about 3,200 in 1972. Growth prospects for banking and dp services are good.

International traffic as a percentage of total traffic is about three times the European average. This trend will hold throughout the forecast period as multinational organisations continue to establish switching centers in the Netherlands.

## Norway

The period 1972-1985 will bring a major expansion in the requirements for data communications services in Norway. For every user of Televerket's data transmission services in 1972, there will be 18 users in 1985.

By 1985 the number of terminals using Televerket lines in Norway is forecast to be nearly 11,000. Of these, nearly 6,400 will be installed in the banking and dp services sectors. In 1972, dp services account for the largest proportion (64%) of total Norwegian traffic and by 1985 this percentage will increase to 67%.

## Portugal

The expansion of the economy is the major factor encouraging use of data communications. In particular, the manufacturing and dp sectors will grow rapidly and will between them account for over 50% of all terminals using PPT lines by 1985. The penetration of data communications in Portuguese organisations is in its early phases. Rapid growth is expected for data traffic from 1972 to 1985, especially in the period up to 1976 when the growth rate in traffic volumes will be 40% per annum.

## Spain

The period 1972-1985 will see a major expansion in the use of data communications in Spain. For every user of CTNE's data transmission services in 1972, there will be 12 users



# COM can boost your throughput.

---

That's what Kodak computer output microfilm is all about.

---

The idea of bypassing impact printers to go directly to microfilm via COM is bound to appeal. It's an electronic path versus a mechanical one. That means speed with reliability.

Kodak KOM microfilmers do this job at 20 or more times the speed of impact printers. So you have more time to get more jobs done on the mainframe.

Besides speed, consider what else comes with a KOM microfilmer. First, Kodak specialists will help you design, develop, and implement your COM system. Second, Kodak software helps you get each job done faster and in the format you need. Third, Kodak equipment service that will help keep your COM unit up and running.

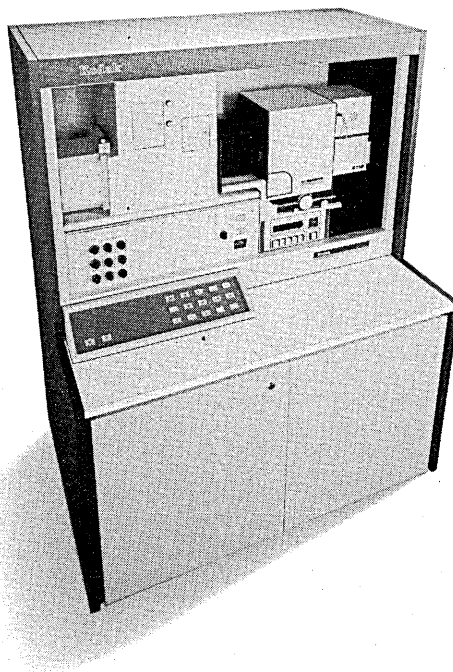

---

Take the important first step.

---

Write us for our new booklet, "The New Generation of Computer Output". Eastman Kodak Company, Business Systems Markets Division, Dept. DP634, Rochester, New York 14650.

**Kodak: for better use of information.**



## Eurodata

in 1985. Over 46% of the terminals in 1985 will be used within the dp services sector, by far the largest user of data communications services in Spain by 1985. The banking and financial sector will be the second largest user, with education and research also accounting for a considerable amount of traffic.

CTNE has developed a special data communications network which is presently operating. The banking community has shown great interest in its possibilities and the network is expected to contribute significantly to the overall growth of data transmission.

### Sweden

In 1985, Sweden will rank sixth in terminal installations in Europe and will have 20% more terminals than U.K. in 1972. Approximately 30,000 terminals are forecast to be contributing directly to PTT traffic in 1985. Dp services is forecast to be the largest sector in 1985 contributing some 57% total traffic volume. Discrete manufacturing, banking, and government are the next most important sectors in terms of traffic volume.

### Switzerland

In 1972 Switzerland ranks sixth among the Eurodata countries in terms of total data traffic volume. The sustained growth rate of data traffic in Switzerland will be about 20% per year which is slightly below the European average, but near term growth rates of 38% per year far exceed the average.

In the medium term, banking, retail/wholesale, and the process manufacturing sectors will develop rapidly; banks implementing on-line systems for all activities, process manufacturing putting emphasis on production planning and control, and retail/wholesale with point-of-sale data collection. From 1975 on, discrete manufacturing and insurance will be the likely major growth industries. Government applications will also be important through the forecast period for scientific and engineering applications.

### United Kingdom

The United Kingdom is the largest user of data transmission in Europe in 1972, accounting for over 30% of total data traffic volumes. This relatively high usage of data transmission services stems from advanced applications in the banking and airline sectors, and high volume usage in manufacturing and in dp service organisations. By 1985, U.K. will have three times the traffic of the whole of Europe in 1972.

The demand for data communica-

tion services will be far from saturated in 1985 with traffic growth rates seven times higher than the overall economic growth rate of the country. The demand for data transmission services will be stimulated by economic growth in the major user sectors of banking and manufacturing and through concentration and rationalisation in emerging user sectors like retailing. The Post Office offers a wide range of data transmission services and is contemplating a special network for data transmission to be operational in 1977.

The EPSS (Experimental Packet Switched System) is being installed at present and this will probably be the forerunner of a comprehensive dedicated data network. The digital data system (DDS) involving high speed links and up to 20 data switching exchanges is at present targeted for 1977.

### The main applications

Three significant trends in relation to applications development in Europe relevant to all industries:

1. Many large organisations are integrating applications to the point where it will become difficult to differentiate between traffic flows for individual application areas.
2. Systems will be developed involving networks that cross industry sector boundaries, especially with regard to payments, and travel and accommodation.
3. Major companies are now considering total communications systems that handle voice, message and data traffic in an integrated bit-stream; in such circumstances it will become virtually impossible to distinguish one sort of traffic from another.

There will be a significant shift in the makeup of computer terminal inventories in terms of data signalling rate characteristics. This shift will come as a result of increased use of buffering, the requirement for higher printing speeds for manual input terminals, greater local intelligence of terminals, and the tendency to a higher batch content of the work performed by terminals.

By 1985 there will be some 13,000 organisations in Western Europe with their own computer operating in conjunction with terminals over PTT lines. In addition there will be tens of thousands of data processing services customers with over 230,000 terminals linked to bureau and other service company computers.

The two most significant user groups in creating the demand for data transmission services over the forecast period are those organisations that are now already using their own data communications terminals and computers,

and the data processing services sector. These two groups alone will account for over 85% of 1985 traffic volumes. Worthy of note, however, is the point that the 15% of the 1985 traffic volume exceeds the 1972 volumes.

This relationship creates certain challenges and opportunities for the PTT's. The 1972 users and the dp service organisations constitute a sophisticated user group. By 1985 they will have assumed greater cohesion through the establishment and perpetuation of "user clubs" and industry lobbies. These groups will certainly be a positive force in encouraging the use of data transmission, but there is also the possibility that they could be in a position to influence network requirements in favour of larger organisations. In any event PTT policies must take account of them in future planning. □

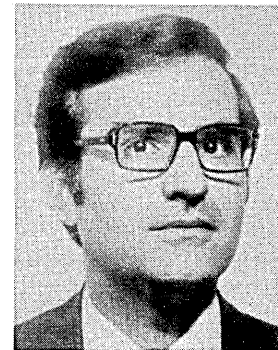

Mr. Peters is responsible for Quantum Science Corp.'s operations in Europe and the Middle East, and played a key role in the Eurodata project central team in data traffic forecasting and country market analysis. He was previously director of Quantum Science's computer technology div. in the U.S. and before that was with the Grumman Corp. He has master's degrees from Columbia Univ. and Polytechnic Institute of Brooklyn.

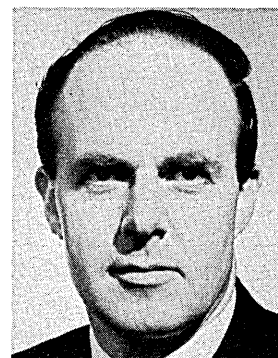

Mr. Simpson was project director of Eurodata and had overall responsibility for the organization and control of the study. He previously established the PA Technology and Science Centre in Cambridge, England. He has a B. Engineering degree from Liverpool Univ.

# We're the guys who dared you to compare the specs.

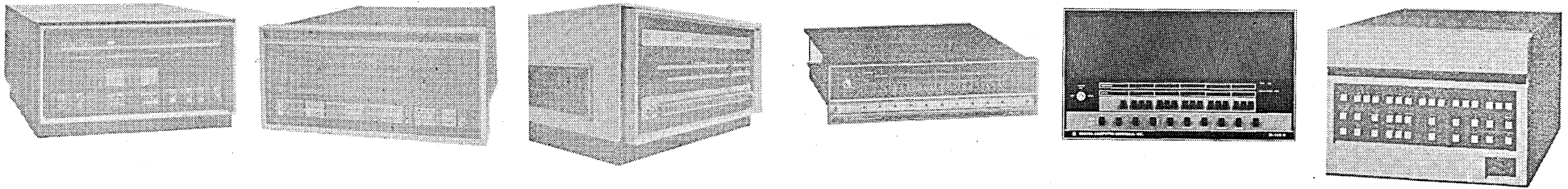

Our D-116 is the best minicomputer available . . . and 85% of you agreed with us.

- We've delivered more than 2,000 minicomputers.
- We brought you the first 8K memory on a single board.
- We brought you the first 16K memory on a single board.
- We brought you the first 8-channel asynchronous line unit on a single board.

We've done what other computer manufacturers say they're going to do. And we continue to do it.

For more information,  
please call or write:  
Digital Computer Controls, Inc.  
12 Industrial Road  
Fairfield, New Jersey 07006  
(201) 227-4861



**DIGITAL  
COMPUTER  
CONTROLS INC**

# Big data

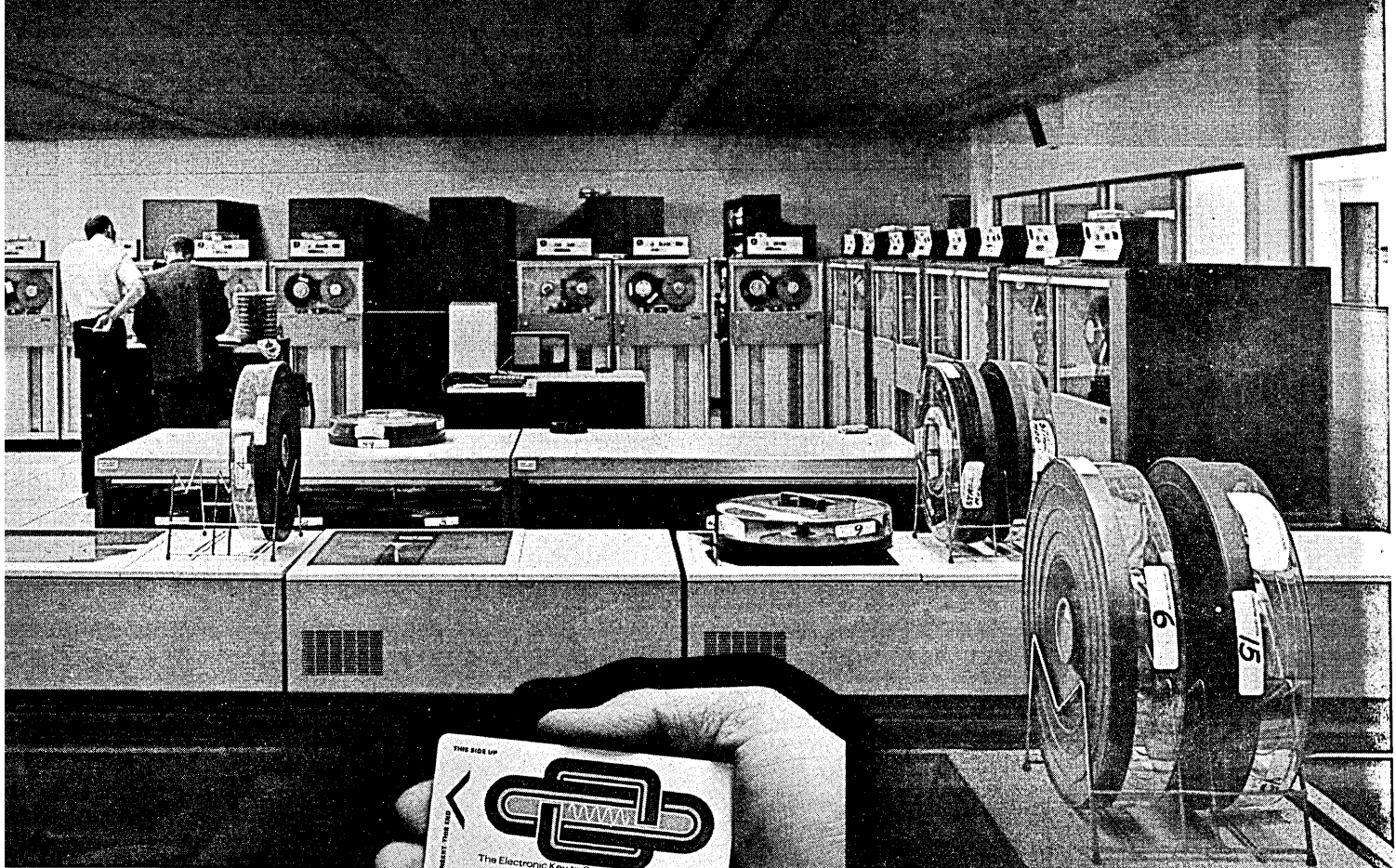

## needs

## protection

Nothing is more important, or more vulnerable, than your computers.

The data center world is buying the extraordinary Ruscard® electronic access control systems almost faster than we can produce and install them.

Why? Security means access control. Who goes where, and when.

If you can confine traffic only to those authorized individuals who require access to the computers... with an automatic printout of every access, by individual—point of access—and time of access... and if you can do all this economically... you have, in effect, a 24-hour guard on every door.

A 24-hour guard costs \$35,000 a year. That's why you don't have one on every critical door today.

**Now you can.**

Rusco's access control systems give you all that, and much, much more. These are the electronic access control systems that are revolutionizing the entire world of security.

For full information, circle the reply card number, write or phone: Rusco Electronic Systems, Box 2848D, Pasadena, California 91105; phone toll free (800) 423-4194, or call collect in California: (213) 682-3691. Ask for Mr. Martin.

# Rusco ELECTRONIC SYSTEMS

A RUSCO INDUSTRIES COMPANY

CIRCLE 43 ON READER CARD



# The new Wang System 2200. What you see is what you get. You get a lot for under \$7,000\*.

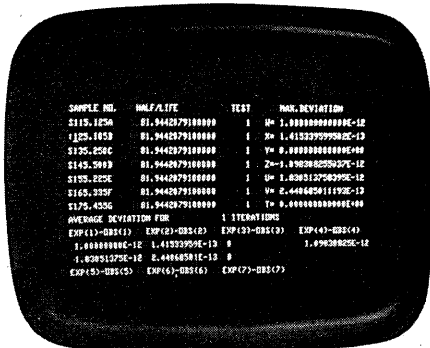

**Big 16 Lines (of 64 Characters) CRT Display:** It's hard to crowd this tube. You'll get ample space for monitoring programs, and results. Remaining storage is automatically displayed as the last line on every program. It tells you where you've been, where you are and how far you can go. You can go a long way on the Wang System 2200.

**BASIC Programming With Hard Wired R/O Memory:** You get 4K (field expandable to 32K) of fully accessible memory. And BASIC programming; the easiest to work with language yet developed.

**Programming Doesn't Byte Off Much Storage:** In the Wang 2200, program statements are a single keystroke and single byte. Example: The statement PRINT USING takes only one byte of memory; not ten! This almost doubles capacity compared to the usual system. Plug in the new Wang 2200 and you're in business. If your data handling has been constantly delayed or reshuffled by crowded, expensive time-sharing ... here's a cost/efficient alternative.

If you are thinking of time-sharing to meet growing needs: here's a way to beat high terminal cost and programing time. If you run a smaller engineering or technical/scientific group: the Wang 2200 may be all the computing power you will ever need.

**Drives Wide Range of Peripherals:** Our new 2200 gives you more ways to solve problems. We have 15 (more soon) peripheral devices like flat bed plotters, additional mag tape cassette drives, a typewriter that makes graphs, a 4.9 mega-byte high speed disc, matrix ROMs and more.

**A Low Cost Alternative To Time-Sharing:** Since the 2200 can tackle big problems many users are installing them to replace more expensive time-sharing terminals. And, they are eliminating the waiting, scheduling and priority problems of time-sharing. They're getting more done at lower cost.

**Faster Problem Solving:** "Basic" programming on the 2200 is almost literal. You get to the heart of problems and examine alternatives faster. And, the Wang *special function* feature gives you 32 additional keys that allow you to "tailor" the system to facts, figures and constants that are particular to your business or your company ... or your department.

**For under \$7,000, Try To Match The Wang 2200 For Price/Performance and Flexibility.** Even if you call the 2200 a small system, you've got to admit it's a big idea.

\*U.S. List Price: 4K CPU & CRT with mag tape drive and choice of data entry keyboards.

**For More Information**  
 Please send me full details on the Wang System 2200.  
 Please have your representative call me at (phone): \_\_\_\_\_

Name \_\_\_\_\_  
 Title \_\_\_\_\_  
 Company \_\_\_\_\_  
 Street \_\_\_\_\_  
 City \_\_\_\_\_  
 State \_\_\_\_\_ Zip \_\_\_\_\_  
 D12



**Laboratories, Inc.**  
 836 North St., Tewksbury, Ma. 01876  
 Telephone (617) 851-4111



# Your First Mate

## TECHTRAN offers the best MATE for your CRT or data terminal.

Our **BUFFERED CASSETTE RECORDERS** are:

**FIRST IN INSTALLATIONS.** Users are saving countless dollars in computer time and connect charges.

**FIRST IN APPLICATIONS.** You name the usage and our MATE will be there. Add-on cassette to Data Entry Terminals, Collection Systems and MTST applications.

**FIRST IN FEATURES.** Remote control, Bi-Directional Search, Data Edit, 110-2400 Speeds, Code Transparent (Binary) Mode, ASCII or Baudot Coding, Standard Interfaces.

**FIRST IN COMPATABILITY.** They're plug compatible add-on to virtually all data terminals.

**FIRST IN COST SAVINGS.** Our mates provide ease of operator entry and faster transmission speeds which provide cost savings in any system.

Only Techtran offers you **TOTAL PERFORMANCE** mates which are operationally and plug compatible to most data terminals and communication systems. Most users are applying our mates. Shouldn't you?

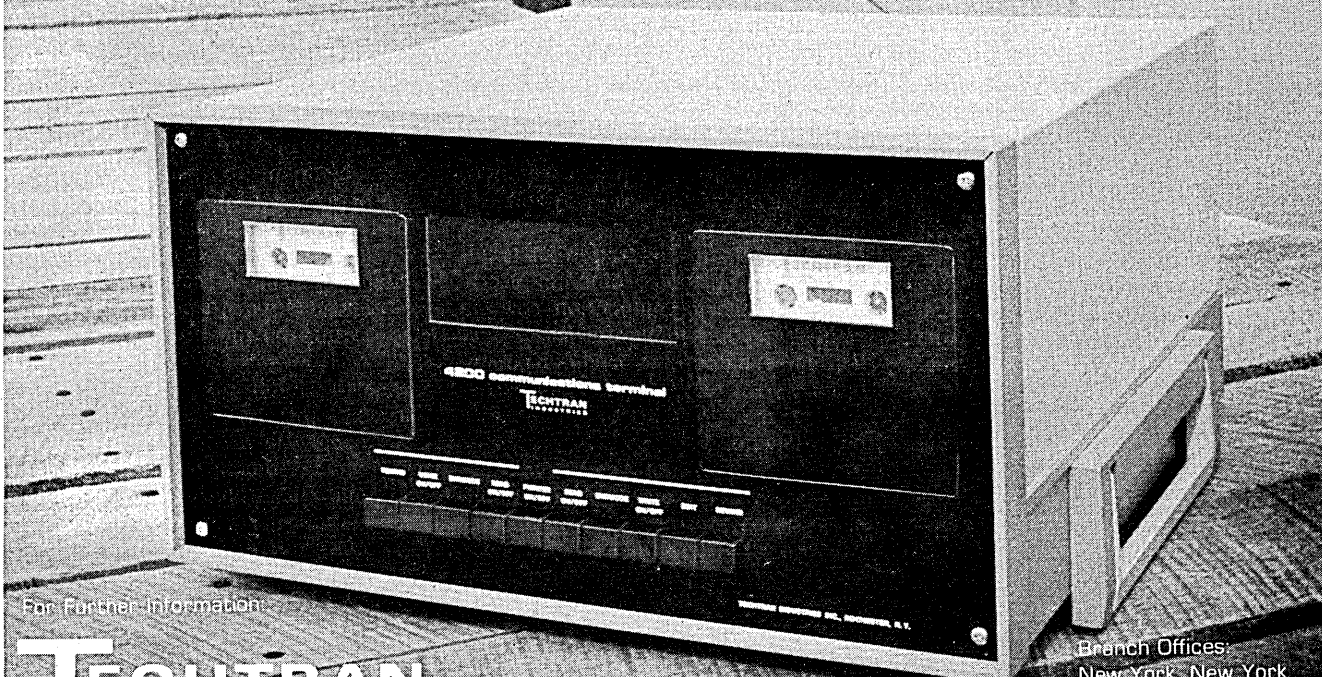

For Further Information:

# TECHTRAN

INDUSTRIES

TECHTRAN INDUSTRIES INC., 580 Jefferson Road,  
Rochester, New York 14623 ☐ Telephone: (716) 271-7953

Branch Offices:  
New York, New York  
914-963-1284  
Chicago, Illinois  
312-671-3220  
Overseas Offices

# EXTEND YOUR COMPUTING CAPABILITY.

## USE A TELETERM.

(And get a 50' extension cord, free!)

There's nothing like a portable time-sharing terminal to let you go where the data is. The only trouble is that sometimes where you have to go is the last place you want to take a piece of computer hardware.

But if your hardware is the CDI 1030 TELETERM, you can forget about problems. It weighs only 22 lbs, and fits under an airline seat. It's also rugged, dependable, and moves data three times faster than TTY... plus it's so quiet you'll hardly know it's there.

The CDI 1030 TELETERM can be on-the-air to your computer in seconds. All you do is plug a telephone receiver into the audio coupler and connect the TELETERM to an ordinary electrical outlet. But just in case you wind up in Ketchikan, Biloxi, or Fond-du-Lac, we've thrown in a fifty-foot extension cord. So no matter what a nice terminal like this is doing in a place like that, it will work. And you can, too.

Get a CDI TELETERM, the go-anywhere portable from Computer Devices, Inc. For a limited time, you can get a 50' heavy-duty extension cord, absolutely free. Just ask for one when you order

your terminal. Use the handy coupon... and get connected to your own TELETERM. Remember, anywhere you can go, a TELETERM can go, too!

I want to order a CDI 1030 TELETERM with a free extension cord. Please contact me immediately.

I want more information on CDI's family of TELETERMS. Please send me literature.

Name \_\_\_\_\_ Title \_\_\_\_\_

Company \_\_\_\_\_

Address \_\_\_\_\_ City \_\_\_\_\_

State \_\_\_\_\_ Zip \_\_\_\_\_

Phone \_\_\_\_\_

Computer System \_\_\_\_\_

a  
**TECHVEN**  
corporate  
partner



9 Ray Ave., Burlington, Mass. 01803  
Tel. (617) 273-1550

# Only NCR Paper has it...



Business forms on NCR Paper are now easier to read, thanks to our new deep blue system. Easier for people. Easier for normally "blue blind" office copiers. Easier years from now because the image has much more resistance to fade. Only NCR Paper has the deep blue system. What else would you expect from the leader? NCR Paper Sales, Appleton Papers, Box 348, Appleton, Wisconsin 54911.

**NCR** Paper®

**NCR** APPLETON PAPERS DIVISION  
GENERAL OFFICES: APPLETON, WISCONSIN 54911



The use of a simple data-structuring technique can eliminate problems with software

# Mini Strings With Many Uses

by John L. Christofferson

This article describes a simple and effective data-structuring concept which can be especially useful in the design and development of application programs for minicomputers. Although not limited to minis, the applicability of the concept here is singled out for several reasons. Applications software generated for minis is frequently programmed in a rudimentary fashion. Such programs are often in assembly language, developed from scratch, and do not use any manufacturer-supplied operating system. Software support tools, such as debug and edit facilities, are often inadequate. Such constraints have curious and often costly by-products. They can lead to the development of sister software packages which do not share what could otherwise be common subroutines and techniques. This is particularly true in areas related to peripheral devices, data-structuring, and message-handling. These dissimilarities also contribute to increased specialization among members of an organization's programming staff.

The use of a simple data-structuring technique, as offered here, can help to avoid these and other costly problems. Although the concept is rich with potential and extremely simple (and fun) to implement, it is seldom found in mini-software packages. This concept can be quite valuable to those experi-

encing problems with software which a. requires a virtual rewrite when minor modifications are involved, b. accepts only the most skeletal (and vaguely meaningful) operator keyboard entry codes and entry procedures, c. contains a multitude of internal software "flags" which are marvelously juggled in some fortunate coincidence of design-independent forgiveness, or d. contains a stylistic implementation of one of the basic data-handling techniques which renders it unrecognizable and unmanageable.

Among the many cures for such common design ills, the concept of data-structuring is outstanding. This article deals, by way of example, with a specific data-structure design. However, the reader could create variations which may better lend themselves to particular needs. Comments regarding the distinct cost advantages of this

concept are included in the summary.

There are two complementary parts to the design and use of the data-structure concept. First, one must design the actual structure itself, and then a set of subroutines must be generated to operate upon this structure.

In describing the structure itself, consider the illustration in Fig. 1, referred to as a "string," which is composed of a header section containing essential information for managing the structure, and a body where information is to be kept. The header contains a pointer to the first cell of the string (F), another pointer to the last cell (L), and input (I) and output (O), pointers which are used for data insertion and data removal, respectively.

There are several characteristics of this elementary string design which should be emphasized:

1. The symbolic name given to a

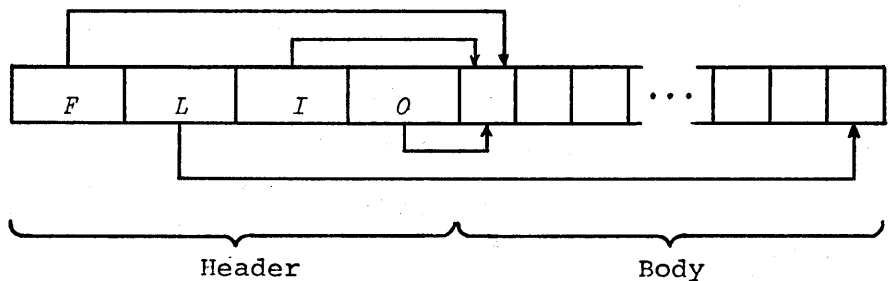

Fig. 1. Elementary string, initial state.

# Mini Strings

string is associated with the first word of the header portion.

2. The input pointer (I) always points to the next cell available for insertion of data into the string.
3. The output pointer (O) always points to the next cell available for removal of data from the string.
4. The initial, empty state of the string is indicated in Fig. 1. In general, the string is considered empty whenever the output pointer (O) catches up to and becomes equal to the input pointer (I).
5. Similarly, the string is considered full whenever the input pointer (I) catches up to and becomes equal to the output pointer (O).
6. A convention must be established for removing the ambiguity between the empty and full conditions; the equal valued nature of the input and output pointers does not indicate which one caught up with the other. One simple method might be to use the sign bit of the pointer to the first cell of the string (F). Another method might be to incorporate a counter into the header which would indicate how many cells are occupied at any time. In terms of the impact on the execution speed of the string-handling subroutines, the first method, or a method equally simple, is preferred.
7. The header words are assumed to be contiguous memory locations, as are those locations consumed by the body of the string. However, the header and body need not be contiguous to each other in their implementation.
8. The pointers contained in the header are considered here to be byte addresses, a convenient unit for operating on teletype and punched tape input and output data. Further, this does not restrict their use with full word data, whereas word pointers would make byte operations cumbersome and inefficient.

This elementary string design is offered primarily to indicate the essential elements required. A more interesting and useful string design is shown in Fig. 2 in its initial state. There is a pair each of input and output pointers in this case. This small change provides for some interesting additional capabilities. The characteristics of this double-pointer string are much the same as

those of the single pointer type, except that:

1. The "active" input pointer ( $I_a$ ) always points to the next cell available for placing data into the string.
2. The "static" input pointer ( $I_s$ ) remains unchanged while data is placed into the string, and is simply maintained as the start position of the data currently being input.
3. The "active" output pointer ( $O_a$ ) always points to the next cell available for removal of data from the string.
4. The "static" output pointer ( $O_s$ ) remains unchanged during data removal operations, and is simply maintained as the start position of the current output from the string.
5. The initial, empty state of the double-pointer string is illustrated in Fig. 2; in general, the string is considered empty whenever the active output pointer ( $O_a$ ) catches up and becomes equal to the static input pointer ( $I_s$ ). Likewise, the string is full when the active input pointer

in the string which is available for removal and processing. (The "\*" indicates the end of message resulting, say, from the input of the carriage-return and line-feed characters on a teletype.) The available output is partially removed (only four characters) at this moment.

In case of operator typing errors, it is easy to build in a backspacing feature (perhaps like the backarrow character used in BASIC) by backing the active input pointer once per backarrow character. Also, the static input pointer represents the boundary of this current input, should multiple or even excessive backspacing be attempted. Simple erasure of the complete current input line is possible by merely resetting the active input pointer to the same position as the static input pointer. This erasure has no effect on the previous input message(s).

If the operator attempts to enter a lengthy input message, the input will be accepted only up to the cell pointed to by the static output pointer, thus protecting partially-removed information from being written upon. Hence, the shaded area is protected from excessive input by its static pointer. Thus,

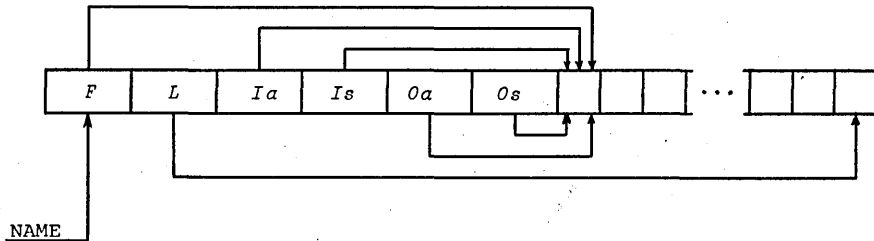

Fig. 2. Double-pointer string, initial state.

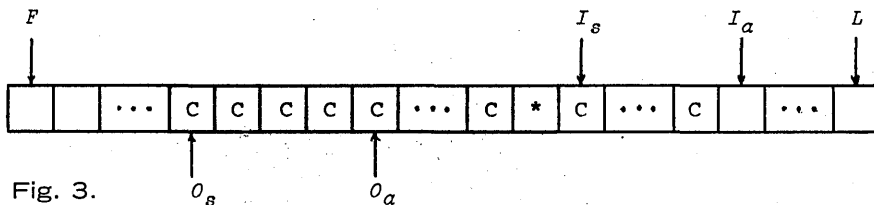

Fig. 3.

becomes equal to the static output pointer.

6. A convention is needed for removing the ambiguity of the empty and full states; the suggestions made earlier in this regard are applicable here.

This double-pointer feature provides a convenient mechanism for handling several important situations, which are described in Fig. 3. This illustration shows only the body of the string and the assigned values of the input and output pointers at some arbitrary moment. Assume that the string is used as an input buffer for collecting character data entered at a keyboard. The input pointers show the current line of input to be in-process, with  $I_a$  pointing to the next available cell to be used. The shaded area shows the data contained

simultaneous input and output operations on a string of this design are possible since neither operation interferes with the other.

Another feature of this design is the inherent capability of multiple removal of the same data from the string. If, for example, the input lines are matched character-by-character against the contents of another string (containing legal input commands, existing file-names, etc.), any unsuccessful match would result in the resetting of the active output pointer back to the beginning of the data for yet another removal operation. This is easily accomplished by resetting the active output pointer to the cell pointed to by its static counterpart. In cases where multiple removal operations are likely, this design ensures that input to the string

will not destroy any information currently being removed.

As stated earlier, data removal operations cannot be carried out on partially completed input to the string, since this input data may, in fact, be erased or modified via the backspacing feature before it is completed. Thus, the only information available for removal is that in the shaded area.

Finally, the mechanics of double pointers can readily be adapted to managing simultaneous input and output operations and peripheral devices. This observation is discussed in detail further on.

#### String-handling subroutines

Thus far, the design of the strings has not itself imposed any particular method of use. For example, they can be used as linear strings, operating in a strictly left-to-right manner, or as circular strings where the input and output pointers wrap around from the end back to the beginning again. Further, they can be used as queues (first-in, first-out) or as stacks (last-in, first-out). Their use is only limited to the types of string-handling subroutines created by the programmer. In this article, they will operate as circular queues. The specifications for some string-handling subroutines are given below. Note that they are generally small, fast-executing subroutines; due to their frequency of use, efficiency in their operation may be essential. All of these routines require a string name as an argument associated with their use.

#### INIT

This subroutine clears the argument string's full indicator, and resets all input and output pointers to the first cell address of the body of the string.

#### PUT

This subroutine places the byte contained in a specified register into the argument string cell indicated by the active input pointer,  $I_a$ . This pointer is advanced one cell, and any required addressing wraparound is performed. If the string has become full, its full indicator is set and an indication of this is made in the return to the calling program.

#### GET

If the argument string is non-empty, the next available byte indicated by the active output pointer is removed for return to the calling program. The active output pointer is advanced one cell, with any necessary wraparound performed. This program resets the full indicator.

If the argument string is empty, at the time of the call to GET, an indication to this effect is made to the caller (for example, returns with -1).

#### RESETI

This program resets the active input

datum inc



now number one in  
magnetic tape control



SERIES 5091

Available off the shelf  
for these computers

PDP8E  
PDP8M  
PDP8I  
PDP8L  
PDP 11  
PDP 12  
NOVA 800  
NOVA 1200

IBM 1130  
Micro Systems 810  
HP 2100  
HP 2114  
HP 2115  
HP 2116  
CAI 816  
Varian 620i

Varian 620L  
Honeywell 416  
Honeywell 316  
Honeywell 516  
XDS CF 16  
XDS CE 16  
Univac 1616  
Pacer 100

DATUM 5091 Series Magnetic Tape Systems, Controllers and Formatters outsell any others (more than 2000 systems installed to date). One reason is our fast delivery. We fill orders from units stocked for the above computers so you can be in operation without delay. Units plug together and into the computer for uncomplicated installation.

Series 5091 consists of Formatter and Computer Adapter, with complete controls, chassis and power supply. Series 5091 Input/Output System consists of a Controller, and as many as four magnetic tape recorders.

Select NRZ or Phase-Encoded formats; control 7- and/or 9-track tape units; compatible with computer software while handling multiple-speed, multiple-density tapes.

It's your choice: complete System, Controller or Formatter

Write for specifications  
and prices

Peripheral Equipment Division

Datum inc

1363 State College Boulevard, Anaheim, California 92806 ■ 714/533-6333

CIRCLE 64 ON READER CARD

## Mini Strings

pointer to the cell specified by the static input pointer. If the two pointers are initially different, the full indicator is also reset.

### SETI

The static input pointer is set to the value of the active input pointer.

### RESETO

Resets the active output pointer to the value of the static output pointer.

### SETO

This program sets the static output pointer to the value of the active output pointer. The full indicator is reset.

### BACKI

Backspaces the active input pointer of the argument string one cell, performing any necessary address wraparound. This program allows such backspacing only until the active input pointer becomes equal to its static input pointer boundary. If backspacing occurs, the full indicator is reset.

### BACKO

Backspaces the active output pointer one cell, performing any required wraparound. Does not allow the active output pointer to back up beyond the boundary maintained by its static counterpart.

There are additional subroutines which the reader may want to create, depending upon the string uses desired. However, many other string functions can be built around uses of these primitive string operations. For example, in moving data from one string to another, as might be needed in an editing program, the MOVE subroutine might simply involve the use of the GET and PUT primitives, and as such be considered of a different class (that is, non-primitive). Proper selection of the primitives and their specifications is stressed since strings are to be accessed only by way of these subroutines. Primitives used in both background and interrupt servicing functions will obviously require immunity from those interrupts related to their use.

### Usefulness of the data structuring concept

There is an enormous amount of software, particularly for minicomputers, which can benefit from this concept: assemblers, editors, interpreters, media conversion software (punched tape to disc, etc.), and even a good deal of real-time software. In the case of real-time, one must consider the likelihood of becoming compute-bound and its effects upon the real-time elements of the system. However,

one should keep in mind the actual computing time of typical non-structured real-time software. It certainly can be rather time-consuming, due to weaknesses of design, and only be *observed* to work well.

Another useful application of structures, quite possibly strings, is in creating an interpreted operator language associated with the use of some peripheral equipment (such as heavy equipment, instruments, circuit testers, etc.). Language commands might include some version of a DO-loop, perhaps, for easily specifying a repetitious set of operations. One might also consider the ease of permitting macros using such structures. The form could be that whenever input characters are found to match a certain acceptable input command, the action taken in response to this successful match is to temporarily switch to a secondary string, using it for the input data. Certainly this concept can be extended through recursive techniques (employing a string stack).

One might make the additional discovery (briefly mentioned earlier) that the double-pointer string and the primitives, as specified, contain the elements needed for managing simultaneous, asynchronous input and output devices themselves, as distinct from the management of the data related to them. Consider a "management" string as shown in Fig. 4. This is, for this example, a string whose body is only four bytes in size.

The objective is to maintain simultaneous double-buffering of input records (perhaps on punched tape) with

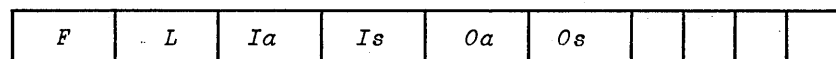

MGMT Fig. 4. Management string.

the processing and output of this information to another device. The management string plays a central role. The processing program determines which input buffer to use next by removing two control bytes placed into the management string by the input program.

Byte #1 =	0	Buffer #1 to be processed next.
	= 1	Buffer #2 to be processed next.
Byte #2 =	-1	Input error.
	= 0	Normal input record.
	= +1	This is the final record.

A detailed time sequence of the operation is described in Fig. 5. The operation begins with the processing program attempting to determine which

buffer to use. This is done (the first step in Fig. 5) by attempting to remove a control byte from the management string. Since the string is empty, there are no input buffers available. Therefore, no processing occurs, and the input device is turned on (if it is not already on). In step (c), the first input record is completely buffered and is a normal record. The string is marked to reflect this. Then, in step (d), the processing program succeeds in its attempt to locate an available input buffer and begins processing the data. Meanwhile, input operations continue on the other input buffer. Fig. 5 shows a case where the input gets ahead of the processing program, and the input device is turned off. The processing and input programs do not restart the input device in those cases where the previous record was in error or was the final record. Note in this example that the protection provided by the static pointers is essential.

This particular string design has been successfully used in several cases. One project involved the maintenance of a loadable software library stored on a cassette. Two punched tape input buffer strings collect data during the cassette file creation process. The simultaneous I/O operations are managed by an intermediate management string. Two other strings contain sets of character data followed by two single precision integer values as shown in Fig. 6. One is the string containing the acceptable keyboard commands, and the integer values are the addresses of routines to be invoked given a successful match. The other is a directory

string containing filenames, with each filename followed by two integer values related to its cassette tape position. Each cassette contains its own directory to allow convenient switching from one cassette to another. Finally, there is one string containing a considerably long list of input commands whose left-to-right sequence of execution performs a useful function. This is an example of the macro capability mentioned earlier. This permits the operator (who is not considered a typist) to enter a single command which results in the execution of many internally-stored input commands. Further, as an operator convenience, backspacing and erasure of the keyboard input occurs in response to the backarrow and asterisk characters respectively. The typed-in commands are free-form,

**When a Pertec stops,  
he starts.**



**Almost anywhere  
on earth.**

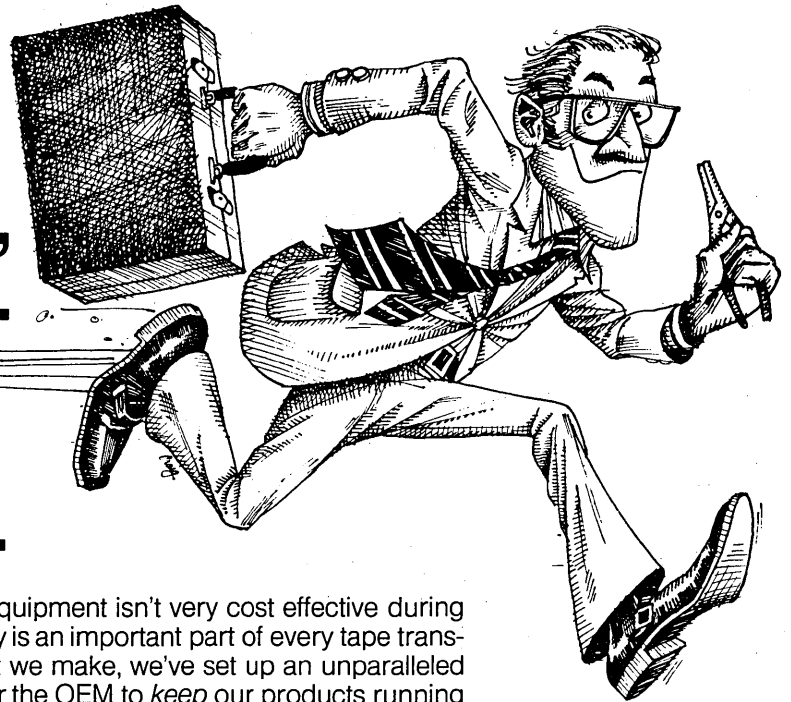

A piece of cost-effective equipment isn't very cost effective during down-time. And since economy is an important part of every tape transport, disk drive and printer that we make, we've set up an unparalleled international service network for the OEM to *keep* our products running economically.

Strategically located Repair Services Depots perform repairs and refurbishments on your warranty and non-warranty units.

Our Technical Support Group provides technical backup directly to you.

Our Spares Administration supplies your inventory needs, plans distribution of emergency spares, stocks regional offices and provides customer logistics support. (You can reach us for emergency spares 24 hours a day, 7 days a week, simply by calling [213] 882-6980.)

And you get assistance in the design and development of your system. Factory training for your service people. And backup by a sales, service and support network spanning major U.S. cities and many foreign countries.

All because Pertec is serious about keeping down-time down. Contact us and we'll prove it.

For more information about Pertec's tape transports, disk drives, printers and service, call us collect in the area nearest you: Boston (617) 890-6230; Chicago (312) 696-2460; Los Angeles (213) 996-1333; London (Reading) 582-115. Or write us at 9600 Irondale Avenue, Chatsworth, California 91311.



The best values in  
computer peripherals  
come from

**PERTEC**

Already the world's  
largest independent  
manufacturer  
of tape transports.



# Computer headache.

You can't afford to run a computer working with real-time data on raw power. Line transients, blackouts from natural disasters and brownouts can cause shut-down, severe damage, and even loss of the memory.

But dependable, precise power from a Garrett Uninterruptible Power System (UPS) can protect your computer operation and other vital electrical or electronic systems.

Garrett specializes in power systems designed and engineered to protect your computer operations. Our UPS protect the incredibly sensitive operations of America's Air

Route Traffic Control Centers — where even a momentary outage could mean disaster.

The ARTCC specifications were the most severe ever

established for this type of system, including a reliability requirement of better than 200,000 hours continuous operation. That's double the industry standard, and good reason for you to look to Garrett UPS.

Protect your vital systems with Garrett Uninterruptible Power Systems.

## Garrett Uninterruptible Power Systems. Positive protection from brownouts, blackouts and line transients.

For more information, write to Garrett, specialists in power technology. The Garrett Corporation, AiResearch Manufacturing Company of California 2525 West 190th Street, Torrance, California 90509

Name \_\_\_\_\_

Position \_\_\_\_\_ Firm \_\_\_\_\_

Street \_\_\_\_\_ City \_\_\_\_\_

State \_\_\_\_\_ Zip \_\_\_\_\_



**The Garrett Corporation**

One of the Signal Companies 



**The more you ask about data communications,  
the more the answer is minicomputers.**

**And the more you ask about minicomputers,  
the more the answer is Digital.**

There's a revolution going on in data communications. And Digital's leading the way.

Digital's putting minis to work in data concentration, front end processing, message switching, remote

systems for RJE and local processing, and in network applications around the world.

Today that revolution moves forward. With Digital's leading PDP-11 family of minicomputers, the highly

sophisticated DEC system-10 time sharing system, and a full range of tools, including peripherals, interfaces and software.

If you have questions on where the revolution's going next, now's



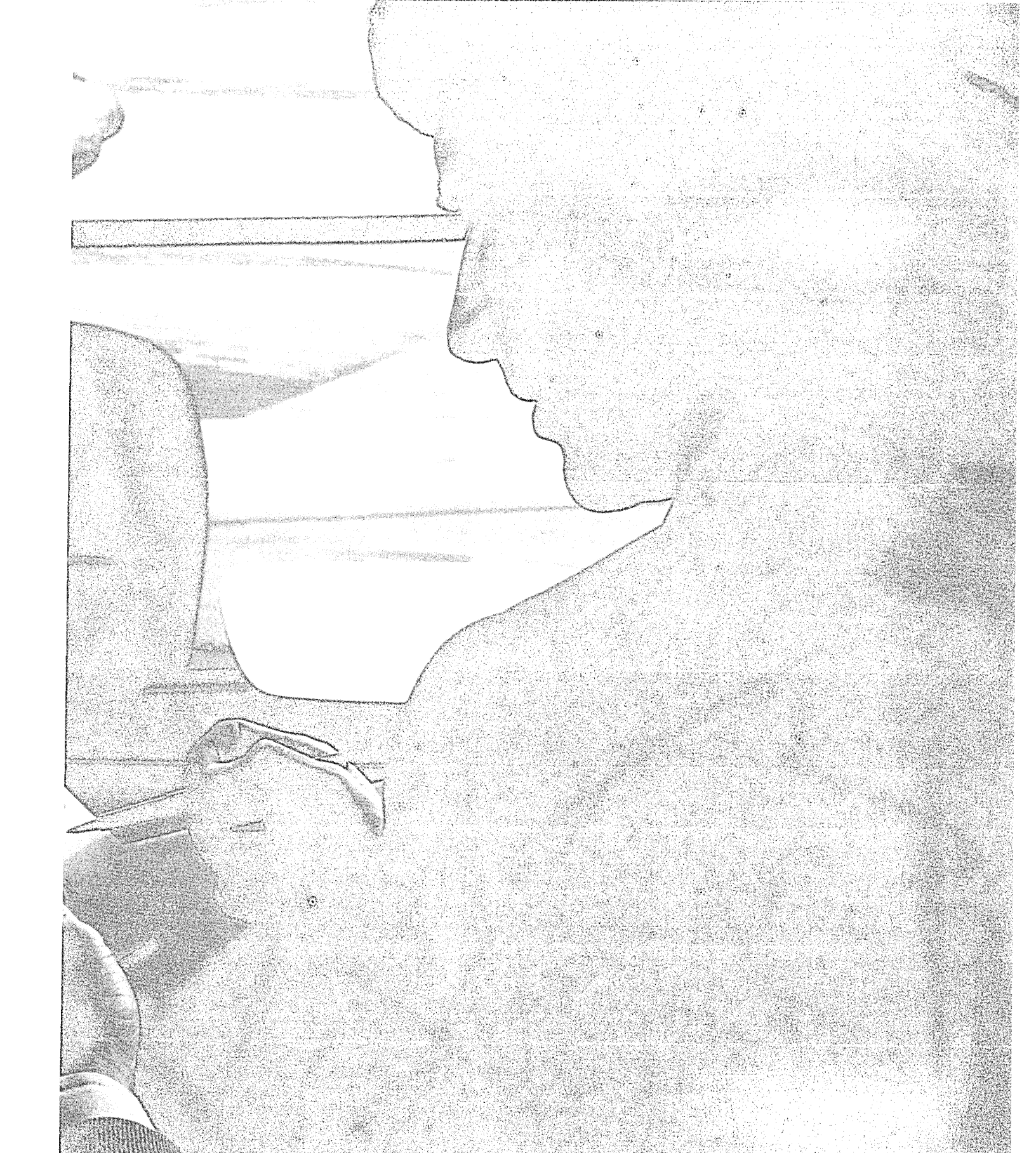

the time to get the answers. Ask Digital's DECcomm group. The specialists who made the world's leader in minicomputers the world's best source of new thinking in data communications.

Call or write the DECcomm Group, Digital Equipment Corporation, Maynard, Mass. 01754 (617) 897-5111, European headquarters: 81 route de l'Aire, 1211 Geneva 26. Tel: 42 79 50. Digital Equipment of

Canada Ltd., P.O. Box 11500, Ottawa, Ontario K2H8K8. (613) 592-5111.

digital

CIRCLE 60 ON READER CARD



# News in Perspective

Judge Christensen's watered-down injunctive relief in the Telex-IBM case suggests a deal between the two antagonists may be in the offing. To Europeans, the change of heart on the release of IBM specifications is a big blow. But to IBM's retiring Thomas J. Watson, the company has always operated within the law and "within the dictates of fair play and good taste." (See this and the following three pages) ...

An 80-year-old inventor, Vernon M. Bugg, recalls his days as a senior research engineer with IBM back in the '30s and '40s (page 100). Mr. Bugg says Thomas Watson, Sr., was "a great salesman, but not much of an engineer." Now he's asking \$120 million from IBM and the telephone company over the alleged quashing of his invention of a device similar to the teletype machine ...

The Spice has gone from point-of-sale. Pitney-Bowes-Alpex, the generally-acknowledged number three in that market, pulled out last month, writing off \$37 million, page 101 ...

Meanwhile, AT&T enters the POS market with two new terminals for credit card verification, page 104 ...

Privacy proponents solidly oppose a sweeping Presidential order to allow the Agriculture Dept. to look at the income tax returns of farmers, page 105 ...

Rapidly-expanding Storage Technology Corp. makes or markets tape drives, disc drives, and add-on memories. Is the next step a cpu? page 110 ...

MCI goes to court to force AT&T to supply local loops for its transmission systems, page 114 ...

## Anti-Trust

### Judge Christensen's New Ruling: A Landmark is Now a Stepping Stone

It now makes eminent business sense for those once bitter judicial foes—Telex and IBM—to make a final peace in an out-of-court settlement. If they don't, the Tenth Circuit Court in Denver can be counted upon to speed along appeal proceedings of Telex's anti-trust case against IBM.

In his amended judgment in the case, Judge A. Sherman Christensen, either advertently or inadvertently, helped set the stage for final settlement.

How? For one thing, by ruling that only Telex can enforce injunctions against IBM. While that measure improves Telex's hand in its ongoing legal poker game with IBM, it also neatly eliminates other manufacturers and computer users from breaking into the game.

Anti-trust lawyers felt that Judge Christensen had, in his original decision, made a specific effort to allow the public and the remainder of the industry to share in the ramifications of his decision. In that initial decision, the judge had stated: "the court further finds that defendant (IBM) threatens to, and will unless restrained ... continue its unlawful conduct to the irreparable injury of plaintiffs (Telex) and of the industry and the public generally ..."

The judge watered down his injunctions against IBM in the case and cut Telex's award \$93 million, from \$352 million to \$259 million, but the stipulation that only Telex could enforce the injunctions was the most important new development in his amended decision.

It now appears that the remainder of the battered IBM plug compatible industry will have to institute its own full court proceedings to seek relief from the IBM practices that Judge Christensen found to be "predatory" and "monopolistic" rather than simply reaping the benefits from the Telex decision with little legal action on the part of the PCM's.

One sharp observer of the computer industry noted that Telex can just set up a clearing house operation for other plug compatible companies to complain about IBM practices. It would be a simple and practical thing for IBM to eliminate such machinery by settling with Telex.

#### The issue is cash

For its part, Telex has been deserted by waves of its technical-research and sales people and, many believe, it makes more sense for the Tulsa-based company to accept a wad of cash from IBM rather than to attempt to gear up heavily in the PCM industry again. The fact that Telex went along with the watered down injunctions was an indi-

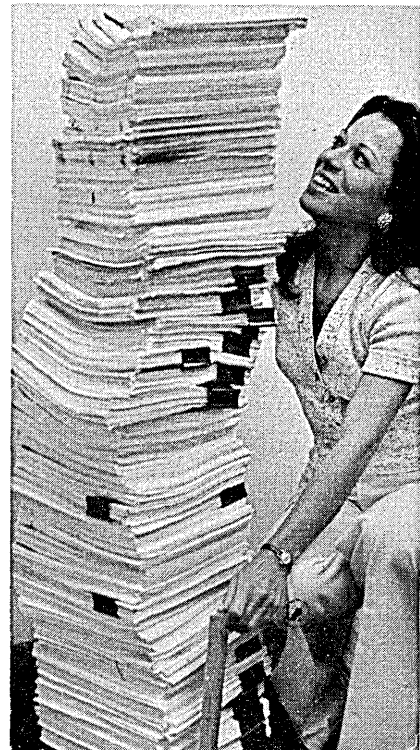

STACK OF DOCUMENTS produced during Telex-IBM trial stand nearly ceiling high in offices of Computer Industry Association which distributes them.

cation to many that Telex was more interested in an early cash settlement than in attempting to compete with IBM in the future.

Specifically regarding the injunctions, the judge states: "They and any changes, modifications or amendments thereto should be enforced, construed or considered only upon motion duly made by the Telex Corp., Telex Computer Products, Inc., or International Business Machines Corp. ..."

However, Judge Christensen held to his basic premise that IBM had broken the anti-trust laws of the land and the \$259 million he awarded to Telex was nevertheless a sizable sum for Telex,

if not for IBM. Moreover, the fact remains that mighty IBM—heretofore considered invincible in court—has lost its first big anti-trust case. In a related counterclaim case, the judge did not budge; he ordered Telex to give IBM \$21.9 million for industrial spying against that company. Each firm said it would appeal the case it lost.

Ironically, the amended decision does little if anything to restore competition to the IBM plug compatible industry that the judge found that IBM had illegally monopolized. Thus, rather than crystallizing the issues in the case, the amended decision makes the Telex decision look more like a stepping stone to further litigation than a landmark, as it had originally appeared.

### Who really lost?

IBM clearly gained in the amended decision, but Telex didn't really lose—the peripheral company won too much money to be termed a loser. The real loser was the plug-to-plug industry and, to some extent, users who are unlikely to be seeing as large an assortment of peripheral products from a dwindling number of peripheral manufacturers.

One optimistic voice in favor of the peripherals firms was that of A. G. W. Biddle, executive director of the Computer Industry Assn., a group of companies competing with IBM. "I'm disappointed in the amended decision," said Biddle. "But the decision as a whole says to me that the PCM industry is alive and well. I expect more suits to be filed against IBM."

IBM should have little trouble living with the revised injunctions—indeed, many think the computer colossus' dominance of the industry is such that it would have had little difficulty getting around the original, tougher injunctions. However, one injunction could nag IBM and could represent something of a wild card in the contest between IBM and what remains of the PCM industry. That injunction is a sweeping one and states simply: "IBM should be enjoined from adopting, implementing or carrying out predatory pricing, leasing or other acts, practices or strategies with intent to obtain or maintain an illegal monopoly in a relevant submarket thereof, in violation of Section 2 of the Sherman Act."

IBM has been contesting that injunction fiercely but were it to hold up, competing firms would most likely attempt to invoke it or its spirit if they felt IBM singled them out for questionable competitive action.

As for the other injunctions, IBM is required to disclose peripheral interfacing specifications only when the product in question is shipped, rather

than when it is announced or manufactured as was stipulated in the original injunction.

Also, IBM must price 370 memory products not marketed as single products and can't enforce penalty payment clauses on some long-term leases. Another complicated injunction covered the pricing of some computer accessories that are also offered in the mainframe assembly.

As for the entire case, IBM stuck to its guns and to its self-avowed innocence. IBM chairman Frank T. Cary said, "although the court has reduced the damages by \$93 million and significantly modified the injunctive relief granted Telex, we continue to believe the basic ruling against IBM is erroneous both in its theory of anti-trust law and its interpretation of IBM marketing practices."

The IBM-Telex litigation may have the Justice Dept.'s five-year-old case already produced positive results in against IBM. Judge David Edelstein of the U. S. District Court in New York, set an Oct. 7, 1974 trial date for the case. The fact that Judge Christensen and Telex and IBM attorneys pulled the Telex case together and tried it in a period of some 20 months stood out

in bold relief against the sluggish pace of the government case.

"There will be no delays permitted, except for very unusual circumstances," Judge Edelstein vowed.

### IBM controls the pace

Whether the Justice Dept.'s puny staff will ever be capable of putting together much of a case against the IBM legal armada remains to be seen. Thus far, IBM, although it is officially the defendant in the case, has controlled the pace and much of the direction of the case while the beleaguered Justice Dept. attorneys have had difficulty keeping up. Furthermore, IBM has stated that it intends to examine documents and take depositions at nearly 100 government agencies in connection with the case, and this is expected to consume a great amount of time.

In another important development in the government case, top executives of four of the five remaining seven dwarfs in the edp mainframe business broke their silence on the case, met with the assistant Atty. General for anti-trust, and urged that two trials be conducted in the case. The executives of Sperry Rand, Honeywell, Control

## "The Record Must Stand on its Own"

If IBM's competitors are to be successful, "the responsibility must lie with their managements, not ours," says Thomas J. Watson, Jr., who retires next month from IBM.

Mr. Watson gave up the chairmanship of the company in June of



THOMAS J. WATSON, JR.

'71 after an illness the previous fall, but remained as chairman of IBM's executive committee. His statement was in a letter to DATA-MATION last month in which Watson commented on a report in the magazine's November issue (p. 134) that he was leaving IBM "under a cloud." Following is the text of the letter:

"The November DATAMATION article by W. David Gardner about the IBM-Telex case says that I was responsible for "anti-PCM strategies" which will leave IBM "under a cloud" when I retire in January. This is of great concern to me because I have spent more than 36 years of my life with this company. However, I have concluded that it is impossible to state clearly in this letter the aims and content of those 36 years and that the record must stand on its own.

"Our efforts since the founding of our company in 1914 have always been the same. In summary, they are to conduct our business in an ethical and lawful manner, to always be competitive, but competitive not only well within the letter and the spirit of the law, but also within the dictates of fair play and good taste. After carefully observing these rules, it appears to me that the primary responsibility of any chief executive officer is to try to make the enterprise grow for the benefit of its customers, its stockholders, and its employees. This we have tried to do at IBM.

"The responsibility to make our competitors successful must lie with their managements, not ours." □

# news in perspective

Data, and NCR called for one trial on the monopoly issue and a later trial on that of relief. They also asked for an order that would provide interim early relief to IBM's competitors.

Conspicuous by its absence at the meeting was Burroughs Corp. whose top management is understood to oppose the government's institution of the anti-trust case against IBM.

—W. David Gardner

## IBM-Telex Decision: Step to Regulation

The IBM-Telex decision may be the first step toward world-wide regulation of the computer industry, according to one expert who recently completed a study of the long-term effects of the decision.

The decision establishes legal precedent for the contention that computer manufacturers' control over their customers and competitors must be regulated, according to the study by Frederic G. Withington of the Cambridge-based management and technical consulting firm of Arthur D. Little.

"However," he added, "the problems experienced by Judge Christensen and the Justice Dept. indicate the inappropriateness of expecting the judiciary to formulate or administer the necessary regulation." Although he was personally unenthusiastic about the creation of yet another bureaucracy, Withington concluded that the creation of a "supranational regulatory body" was the most likely means of providing the necessary regulation.

Data processing, he said, is an industry characterized by rapid technological evolution. Innovations tend to render judicial injunctive provisions, such as the ones issued against IBM, obsolete. It is also an industry characterized by a diminishing number of mainframe manufacturers operating in a world market.

Citing recent amalgamations among American, Japanese, and European manufacturers, Withington said that if present trends continue unchecked by national governments, there will be only four or five international mainframe vendors within five to ten years. "None will owe allegiance to any single nation, nor will any national regulatory body have a significant degree of control."

### Federal commission

Withington predicted that Congress will act within three or four years to create a "Federal Data Processing

Commission" styled after the Federal Communications Commission. The commission would regulate manufacturers' freedom to manipulate prices, products, standards, and policy insofar as such manipulation would unfairly damage their customers' interest. Such a commission, however, would be faced with an industry dominated by a handful of multinational companies. This situation would demand either close cooperation among the regulatory agencies of nations, or an international agency of unprecedented authority.

The United Nations is studying the problem of regulating multinational corporations as the need for international cooperation becomes more and more apparent in such areas as communications, air transportation, and fishing rights, as well as dp.

"It seems that if the regulation Judge Christensen has found necessary is to be made workable, the United Nations effort or something like it is going to have to succeed," said Withington.

—Lynn Miller

## Interface Reversal A Blow to Europe

European computer manufacturers will be disappointed that Judge A. Sherman Christensen has reversed his injunction requiring early disclosure by IBM of interface specifications. It was "the one thing most important to us," said Maurice Allegre, head of the French government's influential Délégation à L'Informatique.

Allegre, interviewed three weeks before the Judge announced his change of heart last month, said it was that part of the IBM-Telex decision that could most significantly impact the European computer industry. By implication, the early detailed disclosures which the decision at first decreed would not only help peripheral and terminal manufacturers, but also the Unidata partnership and its future "IBM-compatible" line.

"One of the major weapons used by IBM," Allegre said, "is disclosing specifications as late as possible and giving as little information as possible." He recalled at the Paris computer exhibition, SICOB, that IBM had its Winchester disc file "tied up with a chain and locked." He smiled, "I don't say I would have approved if anyone had stolen it, but it was an interesting fact."

Noting that anti-trust law is not strong in Europe, Allegre said "we are very much interested in how U.S. anti-

trust law is starting to apply deeply in the computer field. We are in the beginning of a new era."

Overall, the Telex decision (see Nov., p. 134), as it applies to plug-compatible peripheral manufacturers, has minor interest for the various governments because almost all of those firms are American.

Conceding that indigenous PCM's could have given Europe's national computer industries significant penetration of IBM installations, Allegre explained the roadblocks that prevented such developments. First was "the question of technology. For a plug-compatible policy, one must be closer (to IBM) than 6,000 kilometers . . . The changes go very fast and one must be able to make them in time to continue to be competitive."

### Not so common

Allegre also noted that the markets of individual European countries are too small to profitably support such firms; he pointed out that "although there is a Common Market, it is still difficult for, say, a French company to sell in the German market."

Asked if faltering PCM companies in the U.S., like Memorex, might now be candidates for purchase by a European company, Allegre said this has been considered but the likes of Memorex are "too large, too heavy to support from Europe," and Memorex was not willing to sell off portions of its operation. Too, "we have not enough people." But, "if such a case occurs in three or four years, it may be possible. I don't say nothing will be done in the future with Memorex or some other peripheral company."

Allegre, once quoted as rebuffing Honeywell-Bull's offer to be part of the Unidata computer partnership, contends that H-B did not make a formal proposal. But its participation is not now acceptable for the same philosophical reasons that CII, Siemens, and Philips formed a partnership rather than merging or selling out their computer interests. Honeywell-Bull is a subsidiary of an international company with a worldwide policy, the U.S. firm, Honeywell, Inc. Honeywell wants to be the boss, he said, as was true when Honeywell took over Bull-GE and raised the question of possible cooperation with CII. "I understand their position," but, he explained, this is not "true cooperation."

Right now Europe is not unified, so industrialists do not accept being absorbed; nor is this preferable from a government point of view today, he said. ". . . Maybe in 50 or 100 years when Europe is unified as the U.S. is."

But cooperation is necessary to achieve economies of scale to battle

# Now you can have key-to-disk and RJE going in one system. Concurrently.

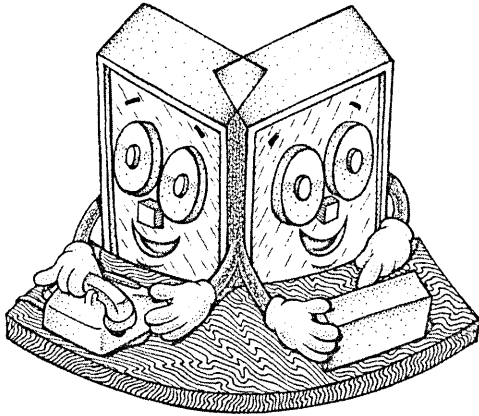

System 2400 invites you to forget scheduling hassles.

You can have an RJE terminal available full time. You can access about any major mainframe you wish, and do it at speeds as fast as your communication lines can move the bytes.

At the same time, your operators can key data to disk uninterrupted. From up to 24 stations. With all the efficiencies of tutorial key display and edit-as-you-go intelligence, of course.

Consider it two systems for the rental of one, because that's what System 2400 delivers.

Consider, too, the other System 2400 options for your RJE site. On- or offline printing, editing, media conversion, your own programming. They're all available today or as you need them with a minimum of added hardware and a growing library of software.

System 2400 goes together your way, so you master today's needs and are more than ready for tomorrow's.

Call us, and we'll put it all in terms of your requirements. That's how MDS has grown to have a user list second only to IBM. Phone your local MDS representative or call headquarters at (315) 792-2424. Mohawk Data Sciences Corp., Utica, N.Y. 13503.

CIRCLE 33 ON READER CARD

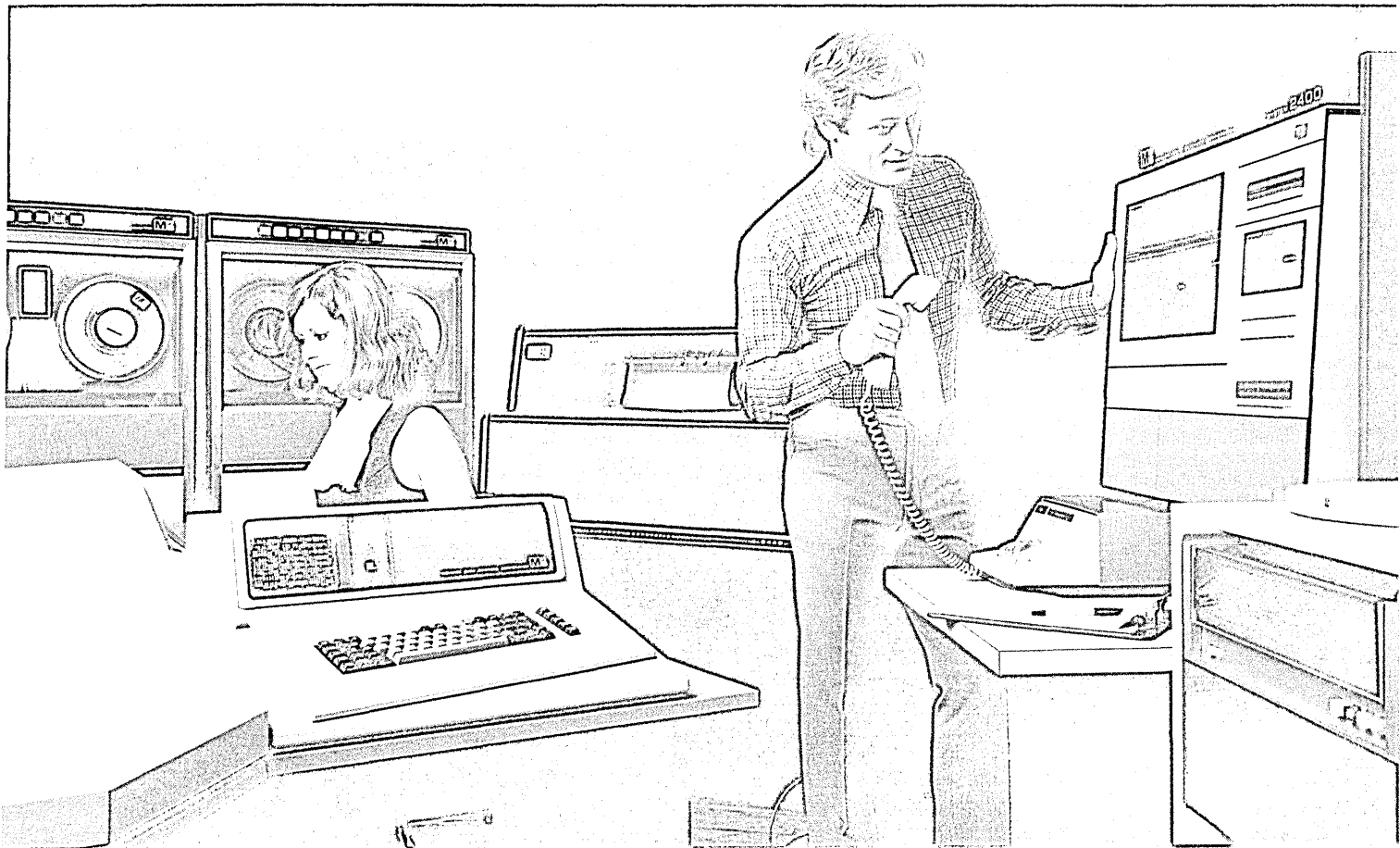

**System 2400.**  
It earns its place  
between you and your mainframe.

**Mohawk Data Sciences**

**MDS**

the competition from IBM, "so we have to invent something else besides absorption—the truly multinational cooperation." This means "several centers of decision in different companies in different countries, none of which is dominant." This is more difficult to manage, he admitted, but it is the "only way to go, they have no choice."

Allegre does not preclude merger or a larger association including non-European companies someday. But, "each in its own time."

—Angeline Pantages

## Lawsuits

### The Inventions and Trials of Mr. Bugg

"Mr. Watson was a great salesman, but not much of an engineer. He'd purchased rights to an automatic coon-skinning machine, a radio-controlled player piano, a machine that weighed feathers one at a time, and a weight-losing attachment for motorists—a big metal ball that rode on the driver's stomach as he sat at the wheel. My teletype machine really looked good against this competition, so he offered me a job."

Vernon M. Bugg, who's now 80, was explaining how he came to be hired as IBM's senior research engineer back in 1932. Bugg recently filed a \$120 million treble damage suit against IBM and AT&T, charging that the two companies conspired to defraud him of the rights to his teletype. If his story is true, IBM is guilty not only of conspiracy but of literal, naked theft.

Bugg says he has documentation to support all of his charges. He presented a copy of a letter from the elder Watson, dated Sept. 6, 1940, which acknowledges that the company is holding "models of your last two printer units." Bill Rodgers, author of a widely-praised history of IBM called *Think*, has seen the rest of the documentation and is helping Bugg prosecute his case.

The improved teletype machine is one of 52 inventions Bugg says he has developed. The first ballpoint pen, the first automatic voting machine, the first stock quotation display board, and the first automatic railroad crossing gate are among the others. The ballpoint pen was subsequently sold to Milton Reynolds, "who made a fortune out of it," Bugg says ruefully.

His stock quotation board, fed from a Western Union ticker tape, was set up in an abandoned warehouse in the

Manhattan financial district in 1922, and Bugg charged brokers \$2.50 a head to look at it. "Everything was fine until Old Man Green, the secretary of the New York Stock Exchange, came in one day and saw what I was doing. He insisted my operation was illegal because I wasn't a member of the stock exchange. The next day, Western Union took away the ticker and I was out of business." But Bugg says the building is still there, and on one wall is a commemorative plaque announcing that he established New York City's first curb exchange on the site. In the '30s, the display board patent was sold to the Teleregister Co. which became a major supplier of this equipment.

#### Dial a file

Bugg also invented an automated filing cabinet that could deliver any of 140,000 stored documents less than a minute after the user selected what he wanted by operating a dial. This is one of several devices and systems in common use today which Bugg claims to have developed several years ago. Another is a system for monitoring bed-ridden hospital patients from a remote location. A modification of this device dispensed cashier's checks to bank customers through a remote terminal connected by leased telephone lines to the bank's main office. The customer began the transaction by inserting a specially coded card into a slot at the terminal. Bugg's "Teletalk" machine seems to be a forerunner of the myriad foreign attachments now being marketed to telephone company customers. His device was a small, keyboard-equipped printer. When attached to a standard telephone, it could send data—entered through the keyboard—to any similarly-equipped phone. The device could also receive incoming messages and either print them out immediately or store them.

Early in the 1950s, Bugg says he invested half a million dollars of his own money in a system for transmitting voice messages underwater, between submarines up to 140 miles apart. The Navy was interested for awhile, but ultimately decided not to buy the system, so Bugg decided to look for other customers by placing ads in *The New York Times* and *Washington Post*.

#### Soviets liked it

"One prospective buyer told me over the phone to meet him at a certain office inside a building at 120 Broadway. When I got there, the office was

locked and there was no name on the door, but a fellow standing a few feet away came over and, after identifying himself as the person who had called me, said we would have to go to another location to discuss my invention. We got into a cab and ended up at the Soviet embassy."

Bugg implies that he was able to escape from the clutches of the Soviets only because a party of government officials, headed by the late Adlai Stevenson, then our ambassador to the UN, happened to be entering the embassy at the same time.

Later, says Bugg, he was lured to Europe by a "Mr. DeSmidt," another prospective buyer of the underwater communication system, who said he was English. After meeting with representatives of the mysterious DeSmidt in Paris, Nice, and Monaco, but never seeing the man himself, Bugg says he became suspicious and consulted a lawyer, who sent him to the U.S. consul general in Southampton, England. This official, allegedly acting on direct orders from the State Dept., confiscated all of Bugg's plans and sent him back to the U.S. on the *Queen Mary*.

Bugg recounts these adventures in a quiet, unexcited voice. Retired, and living in Churchville, Md., Bugg is

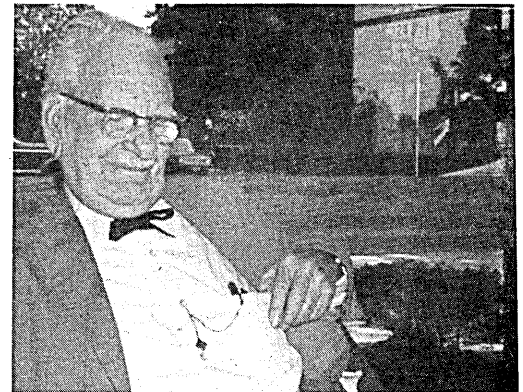

VERNON M. BUGG: He wants \$120 million from IBM and AT&T.

white-haired, heavily-jowled, and benign looking—the stereotype of everybody's grandfather. It's hard to visualize him enmeshed in international intrigue. But he has evidence to support his story, including letters from Retired Adm. Arleigh Burke, who was Chief of Naval Operations at the time Bugg was developing the underwater communications system.

Bugg became interested in underwater communications after leaving IBM for the second and final time, in 1940. One of the many mysteries surrounding his teletype suit is why he didn't begin it then, instead of waiting more than 30 years. Asked why, Bugg says, "despite everything that had happened, I didn't want to do Mr. Watson any harm. Besides, I was pretty well

off in 1940 and until a few years ago, pretty busy with other projects."

Considering "everything that had happened," this forbearance seems truly remarkable.

In 1934, two years after going to work at IBM's Endicott, N.Y., lab, Bugg demonstrated his teletype machine to the Erie Railroad in competition with the AT&T device, which they had bought from its inventor, Otto Kleinschmidt, for \$38 million. Bugg says that immediately after the demonstration, the railroad wanted to place an order for 106 of his machines. But AT&T, which was buying \$6 million worth of tabulating equipment per year from IBM at that time, "persuaded" Watson and his board of directors not to accept the order—by threatening to take the tabulating business to Remington Rand.

### To the "morgue"

Bugg remained with IBM "until about 1937." Watson, he says, was friendly with the board chairman of the Weston Electrical Instrument Co. and thought an arrangement might be worked out with them to manufacture the Bugg teletype machine. But this project was eventually abandoned and Bugg, despairing of ever getting IBM's support for his invention, decided to quit. Word of his decision apparently leaked out ahead of time, however, and the company confiscated his prototype machines, locking them in a "machine morgue" at the Endicott lab.

Shortly after leaving Endicott, Bugg, at T. J. Watson's specific request, came back to work for IBM at 590 Madison Avenue. His new title was "Special Assistant to the President," and he was given a large office on the 16th floor, a few doors from Watson's own quarters. Bugg said recently that he accepted this second job because he was offered a big increase in salary and also because he had hopes of recapturing his teletype machines.

The job lasted about two years, until Watson learned that Bugg had rented a shop at 28th and Lexington, a few blocks from IBM World Headquarters, and had started building two new prototypes of his teletypewriter. "I was visited by Mr. W. R. Wilson, chief of the IBM patent group," recalls Bugg. Wilson told him that IBM could not allow any of its employees to develop teletype machines; the company had an agreement to that effect with AT&T. So the shop would have to be closed. Watson, who was then in Europe, had called Wilson by transatlantic telephone and told him to reimburse Bugg for what he'd spent on the two new prototypes.

Last year, Bugg prepared a detailed, 29-page account of his troubles with

IBM, and had it printed at his own expense. After describing the confrontation with Wilson, he says that the company's ultimatum "proved to me how strong this agreement must be between these two conglomerates." IBM had agreed not only to keep a competing teletype off the market, "but to tie up my teletype machine so I could not do anything with it . . . This made me mad, and I now, again, decided to resign my job. I saw that for all I have done to help the company at its foundation, they expected me to endure this kind of trick. I felt nothing as I left my six-foot desk and signed a receipt for six months' separation pay . . . I walked out and said goodbye to the whole shebang."

Bugg seems particularly incensed about the way IBM "cooked up" a scheme to negate the patent rights to his invention. It's a rather complicated story, but essentially he accuses the company of sending the patent office an application requesting abandonment of his original claims. Bugg says IBM forged his signature to the application and hoodwinked his assistant, J. D. Johnson, into signing the form as co-inventor. "I could hardly suspect this of the great man I thought Mr. Watson was," Bugg says in the written account of his career at IBM.

Several times in this account, he mentions the many honors and titles bestowed on T. J. Watson, Sr. While admitting that it would be "childish" to assume that Watson received them because of merit or accomplishment, Bugg seems to have trouble convincing himself, for immediately afterward, he says, "I am that old-time inventor who has taken quite a beating through the directives and indirectives of this honored big man . . . I happened to be proud of . . . working with Mr. Watson to make the IBM company what he dreamed it would be. Somehow, he seemed to have picked me out among the others at the laboratory . . . I did not have a single medal or button, but my background and experience in engineering put me out in front . . ."

It seems almost impossible for Bugg to win his suit, considering who he's suing and the many years that have passed since he was allegedly deprived of rights to his invention. But Bugg's attorney, Benny Kass, is a member of a prestigious Washington law firm. One apparent impediment, the statute of limitations, doesn't apply in this case, contends Kass, because the teletype machine has been in continuous use since the period covered by Bugg's suit. And although many of his associates at IBM have died, enough are still around, Bugg says, "to supply all the witnesses we need."

—Phil Hirsch

## Retailing

### Spice Leaves POS Market

Even its customers didn't know until they read it in the newspapers last month that Pitney Bowes-Alpex, generally acknowledged to be number three in the booming, competitive retail point-of-sale market, was pulling out of that market.

"We looked at their annual report and things like that," said Stephen Bluestein, executive vp of The Sam Solomon Co., Charleston, S.C., which has a 150-terminal Pitney Bowes-Alpex Spice system in its four catalog showroom stores. "We knew they were



**Pitney Bowes**  
Retail Systems

You are cordially invited to  
cocktails & hors d'oeuvres  
at our hospitality suite

Los Angeles Hilton  
State Suite, Room 1601  
6:00 to 7:30 p.m.  
October 7, 8, 9 and 10

Jack Lee  
Vice President, Retail Systems

October 1973

## Pitney Bowes, Alpex Venture To Quit Field

Check-Out Systems Concern  
Had Losses of \$28 Million  
Since It Was Begun in '70

*By a WALL STREET JOURNAL Staff Reporter*  
DANBURY, Conn.—The swelling and highly competitive market for electronic check-out systems for retail stores, known for its high mortality rate, killed off one of its biggest manufacturers as Pitney Bowes-Alpex Inc. an-

November 1973

losing money but NCR lost money on research and development too and we didn't think it meant anything."

Pitney Bowes-Alpex said it had run up losses of \$28 million on revenue of \$29.4 million since it was formed in 1970. Pitney Bowes, which owns 64% of the venture, said it will write off

# Bon



Jaffe



# appétit

Large, Hippo-like computers are gluttons for data. But even wallowing in rivers of watered down data isn't the answer. Your computer needs a gourmet diet of high quality data — great mouthfuls at a time.

Inforex Data Entry Systems give you both quantity *and* quality.

For example, concurrent data entry and verification improves throughput. Full record display simplifies error detection and correction. System-generated messages assist operators. Processor logic and checks make sure only the choicest data gets to your computer.

Plus a full range of data entry functions: Virtual Program Control, Keystroke Counting, Automatic Batch Transfer, Keystation Command Mode...and more. In addition, only Inforex Systems let you do file searching and update in place on both disc and tape.

You can get more than just data entry, too. Line and Serial Printing, fully formatted, On- and Off-Line Communications for local or remote locations, and advanced 1600 BPI Phase Encoded tape output for high performance tape transports.

No wonder Inforex has more key-to-disc systems installed than anyone else in the world.

Oui.

Choose system 1301, 1302, 1303 or In-Line Data Entry for the price/performance/backup mix that best meets your needs.

Inforex. The high performance feed company for your computers. Offices in major cities throughout the United States, Canada and Europe. Distributors world wide. Talk to us. Inforex, Inc., 21 North Avenue, Burlington, Mass. 01803.

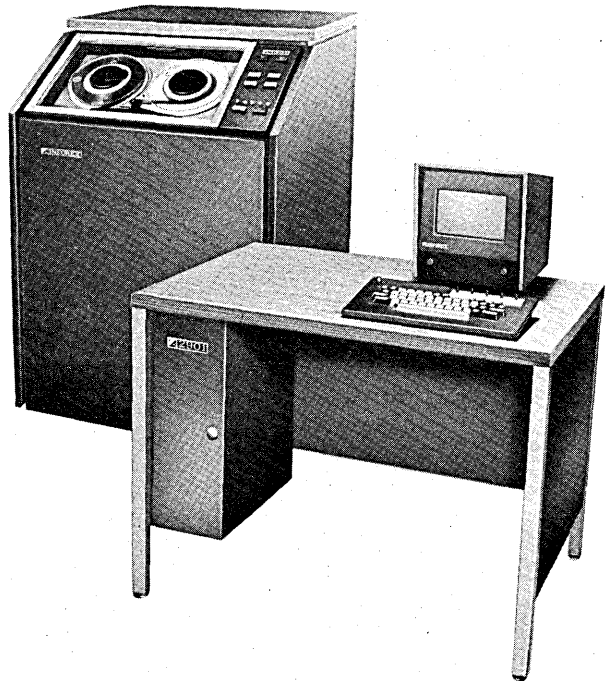

 **INFOREX**

# Buy by the button

Add cassette storage to your communications terminal.

**BASIC PRICE \$1765.**

Over 20 options including single or dual transports are available at a modest incremental cost.

Buy just the amount of flexibility and power you need for your particular application. The Sykes Series 3000 EIA Cassette System was explicitly designed for use in data communications systems.

## 1. Paper Tape Replacement



Basic Sykes 3000/EIA System to create and store data, provides 8 switch functions and 8 remote commands.

## 2. Data Preparation



Add dual drive, high-transmission rates, full editing and remote operation for reference or updating.

## 3. Computer Peripheral

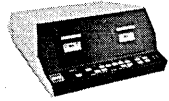

Add binary write mode, certify data, and expanded coding capability.

## 4. Time Sharing



Add variable baud rates, expanded coding capability, monitor and auto disconnect.

## 5. Information Storage and Retrieval System



Add high speed search, rack mount, custom baud rates and fully unattended operation.

Call or write for a Sykes applications specialist to help you buy by the button in tailoring a Sykes Series 3000 system to your needs. For distributors in Europe, Japan and Australia, contact:

# SYKES

SYKES DATATRONICS INC. ®  
375 ORCHARD STREET  
ROCHESTER, NEW YORK 14606  
(716) 458-8000 TELEX 97-8326  
CIRCLE 70 ON READER CARD

## news in perspective

\$37 million as of Sept. 30. Alpex Computer Corp., which formed the operation with Pitney Bowes as a 50-50 joint venture, said it may sue Pitney Bowes which assumed control of the operation last July when Alpex was unable to contribute a pledged percent of profit.

James A. Carter, PBA president, said the decision to quit was prompted by recent developments, competitive conditions, and long-term prospects for the business that pointed to continued losses and the need for considerable additional investment before profit could be realized.

### IBM's entry a factor?

It's been guessed that IBM's entry into the point-of-sale market, with a department store system last August and a supermarket system in October, was a big contributor to the PBA decision. Surviving competitors weren't talking much after the withdrawal announcement but those who would didn't feel the IBM entry was a big factor. "They were in trouble long before that (the IBM entry)," said one, "and they had to face the fact that the costs to upgrade their systems to scanning would be enormous. Processors would have to be replaced."

The surprise of the PBA customers must have been shared by employees, 850 of whom were released immediately after the announcement.

As recently as one month prior to the announcement, Pitney Bowes-Alpex was an active part of the National Retail Merchants Assn.'s national information system conference in Los Angeles. The firm was marketing hard in its hospitality suite and in the halls, and it participated in the conference with a "Retailing Workshop." There was little evidence of a company about to go out of business.

Among the competition the degree of surprise varied. Numbers one and two in the POS market, Singer and NCR, weren't commenting. Pat Byrne, vp of marketing for Unitote Div. of General Instrument Corp., the pioneer in the field and probably number four in terms of installations, wouldn't comment on impact or reasons but said "the totality of it surprised me." Tom Anthony, marketing director of National Semiconductor, a relative newcomer to the field with its Datachecker system for supermarkets, said he wasn't surprised a bit. Bill Bowers, president of MSI Data Corp., Costa Mesa, Calif., which markets a system called Astros for supermarkets, said he was surprised and "regretful that they didn't make it. I hope it doesn't put a damper on the whole POS industry."

### Be prepared

It hasn't put a damper on Solomon Co.'s Bluestein's enthusiasm for POS. Although the PBA announcement surprised him, it didn't upset him. "The retail business is a fast-moving business. You have to be prepared for surprises." The Solomon Co. is adding four new stores this year and although Bluestein said he was completely satisfied with his PBA Spice system, "we had been considering other systems all along." He said Pitney Bowes has assured him he can count on them for service and parts and he feels assured.

"And why shouldn't they (PBA customers)," said a competitor. "Pitney Bowes is big and solid and this could represent a nice source of maintenance income for them."

Bluestein has no intention of replacing his Spice terminals even though he will have to go to a different source for expansion.

In mid-October, still announcing new orders, Pitney Bowes-Alpex was claiming it had delivered more than 7,000 Spice (discount store) and Super Spice (supermarket) registers to more than 325 stores in the U.S. and Canada. Time will tell if these stores, like Mr. Bluestein's, want to keep the Spice in their lives.

—Edith Myers

## AT&T Field-Tests POS Terminals

AT&T is field-testing two new telephones capable of reading magnetically-encoded credit cards automatically. The new terminals, which also provide standard telephone service, are intended for merchants whose transaction volumes don't justify specialized devices or the use of leased lines. Any credit card complying with existing national standards, including those distributed by oil companies, airlines, and banks, can be read by Bell's "Transaction Telephone."

If the new devices are added to AT&T's commercial product line, they're almost certainly going to provoke an outcry from point-of-sale (POS) equipment makers who, understandably, won't relish competing with the world's biggest and richest corporation. The manufacturers are likely to argue that the Transaction Telephone, despite its name, is not primarily a communications device, and therefore violates the FCC's Computer/Communications Decision which requires the Bell System to provide only communications services.

The field test, which began Nov. 1,

is scheduled to end Jan. 31. It's being conducted by BancSystems Assn., Cleveland, a Master Charge processing center. Robert LaHair, president of the company, said AT&T officials are "talking about" ultimately marketing a family of Transaction Telephones that would range from simple to sophisticated devices, and would include, at the top of the line, a unit capable of competing with the leased line terminals now being marketed by several POS equipment makers. Bell officials are also thinking about additional applications, beyond those included in the current test—for example, installation of the Transaction Telephone in supermarkets to verify customer checks on-line before they're cashed. LaHair indicated that a final decision regarding commercial production, marketing, and pricing of the new equipment will not be made until the test is completed.

In Cleveland and Akron, 30 Transaction Telephones are installed in 15 stores; they retail lumber, jewelry, apparel, and books, among other items. A third terminal, known as AMCAT 1, and manufactured by Addressograph-Multigraph, is being tested in four other stores. Unlike the Bell devices, the A-M unit uses a leased line.

The essential difference between the two Bell terminals is that the "deluxe"

model has more logic than the "basic" unit, and has a memory.

A store clerk inserts a customer's credit card into the deluxe version and it reads the first digit of his magnetically-encoded account number. This information enables the terminal to automatically access the telephone number of the local credit card authorization center, stored in memory. The call is dialed automatically and all other information, except for the transaction amount, is read off the magnetic stripe on the back of the customer's card. The transaction amount is punched in via the touchtone keyboard. Enough memory capacity is built into the terminal to hold six telephone numbers.

With the basic terminal, two magnetically-stripped cards must be used: one has the authorization center's telephone number and the merchant's ID encoded on it, and the second identifies the customer.

In both cases, the store clerk gets an audio response from the authorization center, approving or disapproving the transaction.

Meanwhile, Howard Deimel, AT&T's banking industry coordinator, said last month that the company is exploring the need for a switched private line network, enabling merchants, using a standard terminal like the Transaction

Telephone, to access any of several credit card authorization centers. He indicated that opinions have been solicited from prospective users, but emphasized that the whole project is in a "very preliminary stage of development."

—P.H.

## Privacy

### Tax Records: First The Farmers; Then?

On Jan. 17, 1973, President Nixon signed Executive Order 11697, permitting the Dept. of Agriculture to inspect the income tax returns of the nation's three million farmers. Regulations were issued that same day by the Treasury Dept., authorizing Agriculture officials to obtain "the names, addresses, taxpayer identification numbers, or any other data on such returns."

The order and the regulation generated quite a storm in Congress, plus hearings by a House Government Operations subcommittee (Oct., p. 133). (The chairman of the subcommittee, William Moorhead of Pennsylvania, last year discovered the feds are developing a system for turning on every radio and tv set in the nation, to warn people of impending disasters. Moor-

# WANTED!

## General agency for diskettes for Scandinavia

We are one of the biggest service-bureaus in Sweden and are first with the installation of IBM system 3740.

Our organization is well-known to computerusers in Scandinavia and more than a 100 customers are weakly served by our registrationcenter.

For further information please contact:

**malmö datacenter ab**  
S. Tullgatan 3 S-21140 Malmö, Sweden  
Phone 040/78465 or 78470

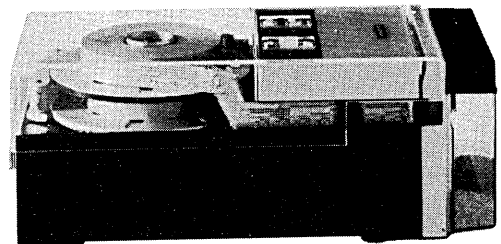

### OUR PUNCH FEATURES OUTNUMBER YOUR PROBLEMS

- 75 cps
- 5-8 track standard, 6 track TTS optional
- Automatic tape monitoring system
- Back spacing for accuracy control
- Includes control and drive electronics
- Modular construction
- Powered, wired and space provided for extra PC board
- Built in tape supply and take-up spools
- No routine lubrication necessary
- Very quiet—54 db.
- Lightweight
- Low power consumption
- Immediate delivery from stock

Facit-Addo Inc.  
501 Winsor Drive  
Secaucus, N.J.

Gentlemen:

I am interested in receiving detailed data on your Tape Punch

Name  Title

Phone

Company

Address

City  State  Zip

DATAM-12



**SILENT 700**  
electronic data terminals

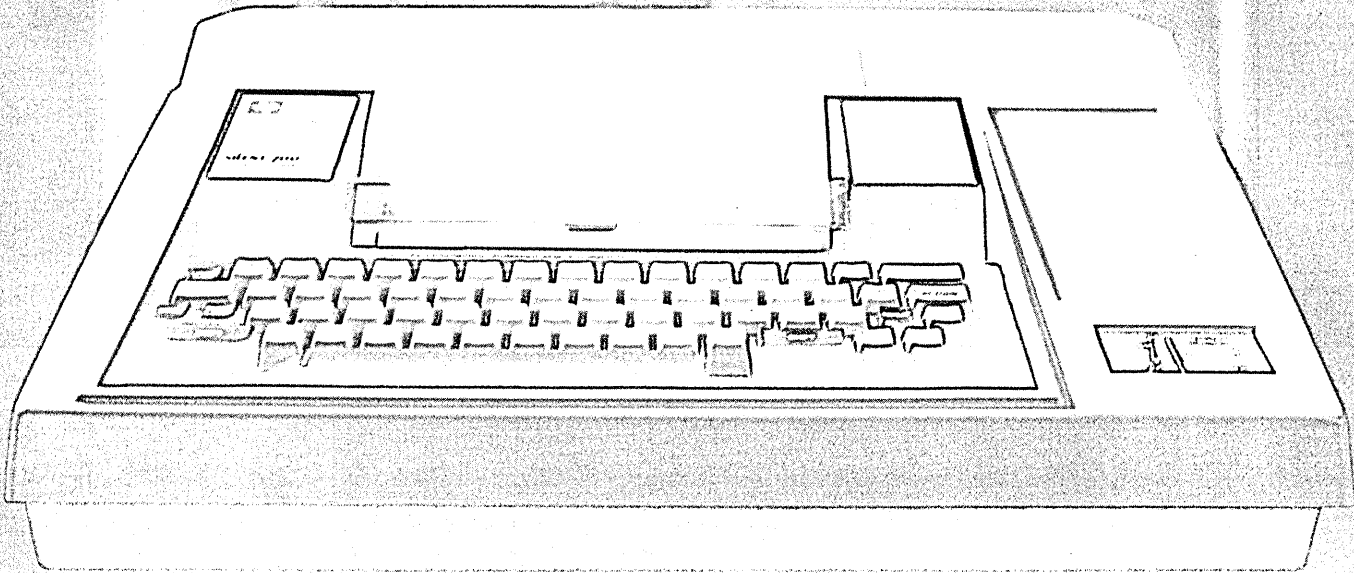

## Now. A quiet, reliable, 30 characters-per-second I/O data terminal. Only \$1500

*Silent 700*\* KSR data terminals cost-effectively enhance communications, process control, lab instrumentation and data processing systems.

They reduce the cost of downtime and repairs. A *Silent 700* KSR terminal will typically operate a year with only one or two service calls. They are backed by a nationwide force of TI service engineers and the field experience of thousands of *Silent 700* terminals operating worldwide.

They reduce costs with speeds up to three times that of conventional terminals.

\*Trademark of Texas Instruments Incorporated

And they feature quiet, non-impact electronic printing.

*Silent 700* KSR terminals are

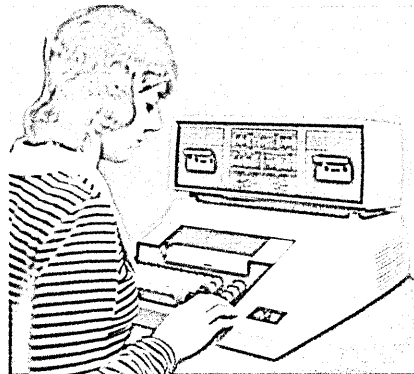

"*Silent 700*" ASR terminal. \$2750.00

available with a variety of options to meet your system requirements.

And—as your system requirements grow—KSR terminals are convertible to ASR models simply by adding the cassette module and its controller.

KSR lease rates are \$75 per month for a 12-month lease, and only \$55 per month for a 48-month lease... both include maintenance.

For information, contact the nearest office listed below or Texas Instruments Incorporated, P. O. Box 1444, Houston, Texas 77001. Or call (713) 494-5115, ext. 2124.



Arlington, Va. (703) 525-1444 • Atlanta, Georgia (404) 458-7791 • Chicago, Illinois (312) 671-0300 • Cleveland, Ohio (216) 464-1192 • Dallas, Texas (214) 238-5318 • Dayton, Ohio (513) 294-0774 • Denver, Colorado (303) 758-5536 • Detroit, Michigan (313) 353-0830 • Hamden, Conn. (203) 281-0074 • Houston, Texas (713) 777-1301 ext. 261 • Los Angeles, Calif. (213) 860-1379, (714) 547-9221 • Minneapolis, Minn. (612) 835-5711 • Newark, N.J. (201) 574-9800 • Orlando, Florida (305) 644-3535 • Philadelphia, Penn. (215) 643-6450 • San Francisco, Calif. (408) 732-1840 • Waltham, Mass. (617) 890-7400 • Elizabeth, S. Australia 552066 • Bedford, England 58701 • Paris, France 6450707 • Frankfurt, Germany 726441 • Bad Godesberg, Germany 65534 • St. Laurent, Quebec, Canada (514) 332-3552 • Toronto, Ontario, Canada (416) 889-7373

**TEXAS INSTRUMENTS**  
INCORPORATED

CIRCLE 39 ON READER CARD

# news in perspective

head called it "a Nixon Administration plan for a potential government-operated propaganda and spy system.")

Recently, the Moorhead subcommittee disclosed what it thinks of letting the Agriculture Dept. look at farmers' income tax returns. Appended to the report are "additional views" of one member, Rep. Bill Alexander of Arkansas, who suggests that the Presidential order was part of a bizarre plot by "certain White House aides . . . to use the Internal Revenue Service as a political weapon against the Administration's 'enemies'."

Agriculture officials who testified at the hearings said they wanted to improve the accuracy and reduce the costs of the department's crop and livestock estimates. These estimates are based on questionnaires mailed to a sample of all farmers. The basic problem, explained the witnesses, is that the present sample isn't representative enough; the best way to develop a better one would be to look at income tax returns, since this file, unlike commercially-available mailing lists, encompasses virtually all farmers and shows the size and type of each operation. The witnesses acknowledged, however, that Executive Order 11697 gave them more authority than they had requested.

## Only the first

A Justice Dept. witness added that the Agriculture Dept.'s authorization was designed to be the first in a series. Successors would allow other federal agencies to extract personal financial information from income tax returns of other groups of citizens.

The original Presidential order, 11697, was replaced last March by another, 11709, apparently in an attempt to mollify Congress. But according to Rep. Jerry Litton of Missouri, the new language still enabled the Agriculture Dept. to obtain virtually any information on a farmer's income tax return. Executive Order 11709 is still in effect, although it hasn't been implemented yet because of "procedural questions" that remain to be resolved between Agriculture and IRS officials. The IRS, which wasn't eager to disclose the information in the first place, apparently is hoping that Congressional pressure will lead to some other arrangement.

The House subcommittee suggested such an alternative in its recent report: IRS should provide "only names, addresses, and taxpayer identification numbers" to the Agriculture Dept. "No personal financial data on farmers' income tax returns should be pro-

vided unless an individual citizen gives his voluntary, informed consent in writing." The subcommittee also recommends that Section 6103 of the Internal Revenue Code be amended to make tax returns "explicitly confidential." As presently written, Section 6103 says tax returns are public records except as otherwise limited.

## "Politicize" the IRS?

In his supplementary statement, Congressman Alexander says: "The (Senate) testimony of John Wesley

Dean III, former White House counsel, showed clearly there was a determined and active effort to politicize the Internal Revenue Service, and much consternation over the resistance of top officials in the IRS to be a party to any such effort. My concern was heightened when it was revealed that J. Gordon Liddy and John Caulfield were employed by the Department of the Treasury . . . The Dean documents included a reference to a way in which the IRS could 'target' individuals by requesting an IRS audit 'of a group of individuals having the same occupation.' To me, this struck a responsive chord. Executive Orders 11697 and

## We Got Your Message... We've Gone International!



Evergreen Computer and Financial, Inc. is now meeting the mushrooming international demand for previously owned EDP equipment.

Evergreen is expanding its operations to wherever you are . . . United Kingdom, Europe or the Far East countries. We began buying and selling EDP equipment in the U.S. four years ago. Our sales tripled in the past year. Now we're aiming to equal that growth outside the U.S.

Our coordination between marketing and purchasing makes our company unique in the "buy-sell-lease" industry. And our financing capabilities are unparalleled. Contact us; we'd like to tell you more.

We handle all EDP equipment, including IBM, Control Data, Univac and Honeywell. These systems are available now, or will be available in the near future:

3019-00	UNIVAC 9400 CPU	5856	Program Mode	
	F1092-00 First Selector	6960	1st Selector Channel	
	Channel	7520	Storage Protection	
	F1092-01 Second Selector	7915	1051 Attachment	
	Channel	1051	N1 Control Unit	54165
		1051	8 Printer-KeyBoard	62902
7010-97	Storage 65K	360/65	J IBM CPU	60075
711-05	Card Reader and Controller		756K Fab Core	
604-99	Card Punch and Controller		7070/7074 Compat.	
768-00	Printer and Controller		7920 1052 Adapter - 1st	
5017-99	Uniservo 12 Control	1052	7 Printer-KeyBoard	50908
0861-00	Uniservo 12 Master Tape Unit	2860	2 Selector Channel	60098
	1600 BPI (includes logic for up to 3 slave units)		1850 Channel to Channel	
0861-01	(3) Uniservo 12 Slave Tape Units		Adaptor	
	9 Track 1600 BPI	2870	1 Multiplexor Channel	
	F0826-00 9 Track NRZ1			
	Capability			
	F0935-00 Dual Density			
5024-02	Disk File Controller	360/40	G IBM CPU	21353
8414-92	Disk Drive		3237 Decimal Arithmetic	
8414-85	Disk Drive		4427 Floating Point	
			6980 Selector Channel 1st	
			7520 Storage Protection	
			7920 1052 Adaptor	
		1052	7 Printer-KeyBoard	
360/30	F IBM 64K CPU			
	3237 Decimal Arithmetic			
	4456 Basic 1401 Compat.			
	4463 1402/03 Attach.			
	4465 Compat. Console Inq.			
	4468 Compat. Magnetic Tape			
		CDC	3300 96K Core	
			Disk & Tape System	



Evergreen Computer and Financial, Inc.

Suite 120 / 9100 Bloomington Freeway West  
Bloomington, Minn. 55431  
(612) 884-9751 TWX 29-0569 Evergreen BLTN

11709 are aimed at 'a group of individuals having the same occupation'—namely, farmers.

"...The subcommittee... was unable to establish any confirmed link between the White House political enemies operation and the new executive orders. At the same time, there

is no conclusive evidence as to the nonexistence of a connection, direct or remote. But there is at least ample proof of an attitude or state of mind in the White House, of an obsession by high officials with domestic security and the extreme measures concocted to deal with the alleged prob-

### Californians Refining Privacy Bill

California legislators this month are refining a bill known as the Computer Crime Prevention Act of 1973 for reintroduction into the Assembly when the new legislative session opens in January.

The refining follows a series of hearings held throughout the state by the Assembly Committee on Efficiency and Cost Control to which the bill, AB 2656, was referred following its first introduction by Assemblyman William Bagley last August.

Among the expected refinements are a further statement of the mechanics of administering the bill, better definition of some terminology, and a specific costing out of administration of the bill should it become law. These were the concerns of many who testified at the hearings. Bagley has said his bill is designed "to protect individuals' rights against computer wrongs." Testimony from some groups indicates they feel the bill would be doing them a legislative wrong. Essentially, AB 2656 would impose fines or imprisonment as well as civil penalties on operators of computer systems for unauthorized invasion of privacy, improper dissemination of personal information, or failure to file a public declaration of the existence and nature of a personal data record.

#### Avoid trouble, don't sell

This last requirement seemed the most bothersome to Leonard Blyer of the state's Dept. of Motor Vehicles who testified his department opposed the bill on the basis of the administration burden it would place on his department rather than on any philosophical grounds. He said making a declaration of the existence of the 42 million records in the department's files would cost \$6 million in postage alone. Noting that some government agencies would be exempt from the bill as written, Assemblyman Mike Cullen, chairman of the Committee on Efficiency and Cost Control, ques-

tioned the social desirability of the DMV's sale of vehicle registration information and the department's need for the half million dollars it gains a year from such sale. "If you'd stop retailing information to third parties," he said, "we could exempt you from the Bagley bill."

Kent Gould of the state's Dept. of Finance said he supports the bill "in concept" but questioned an earlier deletion of a requirement that data system operators "Obtain prior informed consent of the individual to whom the data pertain before making computer use of personal data."

"I would hope an individual would be informed as to what he is authorizing, what they are doing with the information on him," said Gould.

Louis Keller of the Assn. of California Life Insurance Companies was one of those who opposed the bill on grounds it would be unfair to his group, particularly as it would affect California companies which are tied in with national services—especially the Medical Information Bureau (see Dec., p. 148) which stores information on medical conditions "deemed relevant to underwriters, strictly flagging information. There are no dossiers." A spokesman for the Associated Credit Bureaus said that group already is adequately regulated by the Fair Credit Reporting Act.

Among the terms that were questioned were personal data and access. These undoubtedly will receive additional definition in the refined bill. Access, it was noted at one hearing, excludes normal house-keeping, but this was not stated in the bill in its original form. And costs, which weren't spelled out at all in the original AB 2656, are expected to be in the form the legislature gets in January. Whatever its contents, the bill is expected to get prompt attention from the new legislature because of widespread attention from the popular press. □

# For the or private



# switched telephone network lines, depend on Bell System Dataphone<sup>®</sup> 4800 service.



Which 4800 b.p.s. data set is better for you?

The Bell System's Dataphone 4800 service is designed to transmit data at 4800 b.p.s.—economically. It is now available for data customers who use the switched telephone network, as well as for those with private-line facilities.

Dataphone 4800 service features automatic adaptive equalization. Turnaround times of 50 milliseconds for private lines and 50 or 150 milliseconds for the switched network, as you choose. And low monthly charges.

Provisions for local and remote loop-back testing are built right into the 4800 data sets. Signal lights indicate the status of the sets at all times.

And solid-state technology from Bell Laboratories fits all these features into a compact housing 16 by 11 by 4½ inches.

In addition to our local maintenance forces, the Bell System's Data Technical Support Team stands behind all our Dataphone service. The Team's collective expertise analyzes and corrects malfunctions quickly, and so minimizes your cost of downtime.

At AT&T and your Bell Company, we know good data service at moderate cost is vital to your business. Whether you use the switched network or private lines.

**We hear you.**



lem . . . President Nixon's Executive Order 11697 . . . and a slightly modified Executive Order 11709 . . . present the frightening prospect that the Administration is attempting to begin the process of making personal income information of whole classes of people available to various departments and agencies without regard to the private nature of the information, or protecting individuals from possible abuses."

—P.H.

## Ervin Tries Again on Arrest Data Issue

Sen. Sam Ervin has again failed to persuade Congress that it should obey a court decision banning the dissemination of arrest records to non-law enforcement agencies.

The decision, in a case titled *Menard vs. Mitchell*, was issued in 1971 by a federal district court in Washington, D.C. In 1972, Sen. Alan Bible of Nevada introduced an amendment to the Justice Dept.'s FY '73 appropriation bill, permitting continued dissemination of FBI arrest records to non-law enforcement agencies despite the court's conclusion in *Menard vs. Mitchell*. Ervin persuaded Bible to accept a limitation allowing dissemination only if the record indicated the defendant had pleaded guilty, or had been convicted of the crime he was arrested for; in other words, arrest records of those who hadn't been found guilty couldn't be distributed outside the law enforcement community.

Somehow, in the House-Senate conference on the Justice Dept. appropriations bill, this latter change was dropped and the word "hereafter" was inserted. The result was to authorize continued dissemination of *all* Justice Dept. arrest records indefinitely. This at least was what the Administration argued when it introduced the FY '74 Justice Dept. appropriation bill last January, and Sen. Ervin announced his intention of getting the language changed. The Senate went along with Ervin, but in the conference committee meeting on the FY '74 appropriation, the House "adamantly refused to admit it had made a mistake," as Ervin put it last month in a Senate Floor speech.

The conference version of the appropriation bill must still be approved by the Senate (as well as the House), but observers doubt the measure will be rejected. Ervin suggested that it would be easy to get a court to reverse the conference committee's reversal of

the 1971 court decision. "The petitioner could succeed by simply presenting the judge with a copy of the *Menard* order," he said. Meanwhile, Ervin has introduced a bill that would bar the Justice Dept. from disseminating arrest-only records until the end of the current session.

Support for his position came last month from the National Advisory Commission on Criminal Justice Standards and Goals, a group of outside experts set up some time ago to review the nation's whole law enforcement machinery. It is funded by the Law Enforcement Assistance Administration (LEAA). The commission said that "easy availability of criminal justice information files for credit checks, pre-employment investigations, and other non criminal-justice activities is highly prejudicial to the operation of a . . . system designed only for law enforcement agencies." It advocated allowing subjects of criminal history records to review and correct the information. Also, arrest information on an individual who is not convicted should be returned to him. The commission added that each state should establish machinery to consider, and hopefully implement, these recommendations.

—P.H.

## Companies

### Storage Technology: Will a cpu be Next?

Lawyers continue to debate the guilt or innocence of IBM in the anti-trust suit brought by Telex Corp. While the debate lingers on, as it surely will, one question keeps popping up. If IBM is guilty of having violated the nation's anti-trust laws for the way it treated the peripherals manufacturers, how much more successful would Storage Technology Corp. be with a more beneficent competitor?

Like Telex, stc was formed expressly to compete with IBM in the marketing of tape drives; unlike Telex, it has racked up an enviable record of steady and phenomenal growth despite IBM's marketing shenanigans. In the slightly more than four years since its founding, the Louisville, Colo., company has become a profitable venture, with annual revenues approaching \$50 million. It has installed more than 6,000 drives at more than 225 accounts, was able to demonstrate to a prospect its own 6250-bpi drive on the same day that IBM announced this capability, and now has come up with an improved version of the IBM double-density 3330 disc drive, which stc

unashamedly calls Super Disk (see Nov., p. 159). At this rate, one wonders who will be first with a storage device that combines both disc and tape technologies.

In a more serious vein, others have conjectured that stc might develop its own mainframe, much like Telex had once considered doing. But stc president Jesse I. Aweida says they have no plans for a standalone computer in the next two or three years, certainly nothing comparable to a 145, 155, or 165. "Now when you come into a smaller area, a small computer for certain applications, I see no reason why we can't do something, because the talent and expertise are there." He continues: "The complexity of the control unit is equivalent to a mod 30, for example. So you're talking about a good size computer we could do with that talent . . . But we see that market as one of application, rather than head-on competition with the IBM product line."

### Do jobs off-line

Thus Storage Technology foresees data base oriented systems, say, "where we tie in the peripherals we have with more intelligence in the control unit, and do some jobs off-line without any of the cpu."

The 42-year-old Aweida, who fled from Palestine to Jordan in 1948 during the fighting between Arabs and Jews, and who later came to the U.S. to attend college, got his degree in mechanical engineering at Swarthmore College. On the tall side, he has a slim build that makes him look taller than he really is. An avid skier, he's known to arrive home from a business trip late at night and immediately leave for a weekend of skiing in the nearby Rockies. Jesse spends a lot of time on the road, and perhaps because of this he makes it a point to take his wife and four children on some of his trips. A company sales meeting in Hawaii earlier this year provided such an opportunity. Final arrangements to acquire a marketing company in France, Promodata S.A., did the same last month, allowing Jesse to take his family for their first prolonged vacation together.

Following his graduation from Swarthmore in '56, Aweida joined IBM, continuing his education at night and acquiring his MS from Syracuse Univ. He was senior engineer and head of the Advanced Tape Drive Dept. with program responsibility for the IBM 2420 line when he left to form stc in August of 1969. He took with him Zoltan Herger, highly respected for his technical knowledge, who was managing the 2420 mod 7 program, to become vp-engineering at stc. Two other



# This month Burroughs delivers its 10,000th TC 700

With 10,000 units installed and thousands more on order, Burroughs TC 700 Teller Terminal Systems is, by a wide margin, the world industry's most successful answer to its on-line processing requirements.

This TC 700 is just one element of Burroughs on-line financial service capability... a full service capability encompassing teller terminal systems, unattended teller systems, inquiry and display systems, data sets, central computer systems and on-line program products.

Call your nearest Burroughs office for complete information. Or, write to Mr. John Braden at Burroughs World Headquarters, Detroit, 48232.

Full range financial systems from the full service company

Burroughs

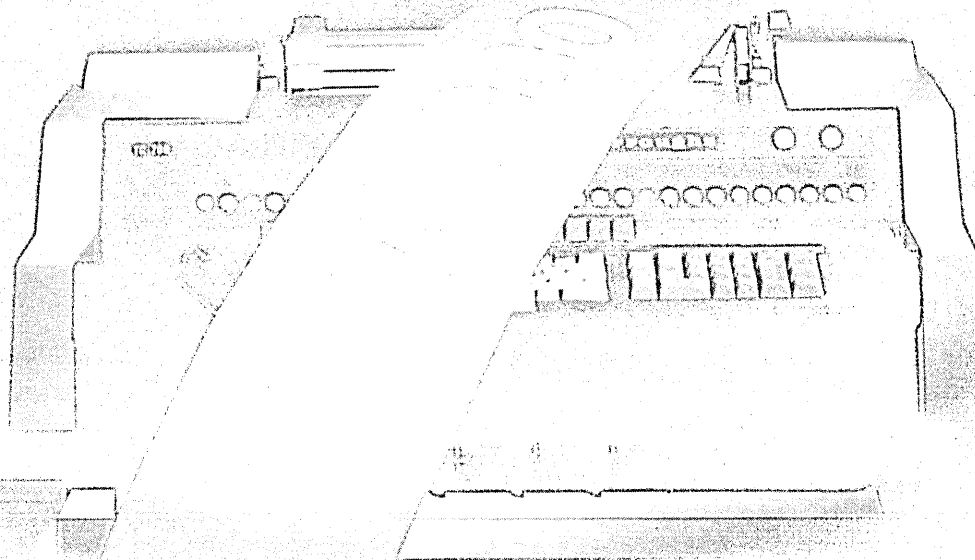

Our new low-profile  
Our new low price

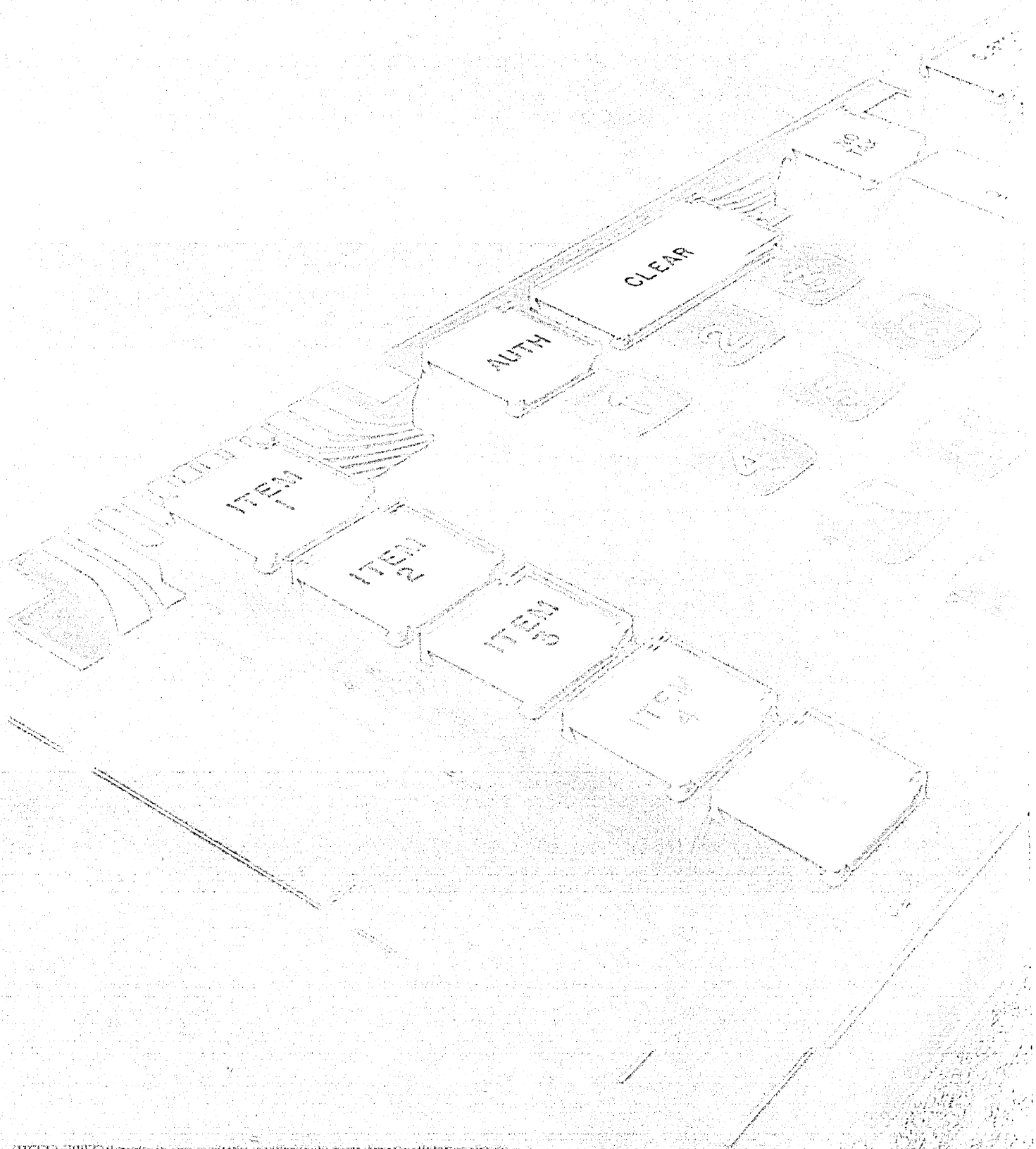

# keyboard is solid-state. is mechanical.

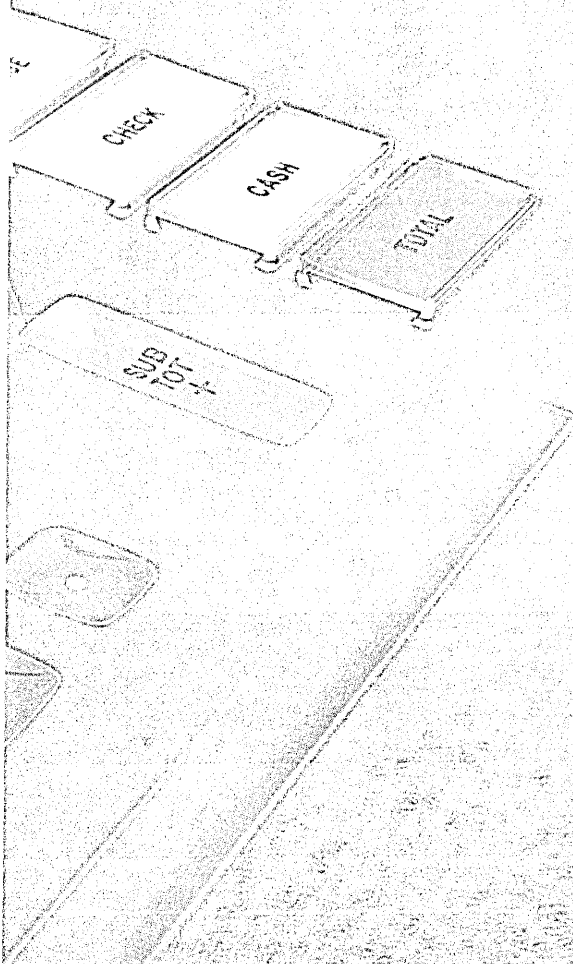

We've expanded your keyboard options dramatically with our new SD low-profile keyboard.

It makes MICRO SWITCH solid-state prices (based on 1975 delivery) competitive with less reliable mechanical-contact keyboards.

So price is no barrier. No matter what your need. Be it word processing, point-of-sale or other data entry applications.

We've coupled our unique Hall effect switch with an advanced "flip-chip" ceramic mounting technique to further increase the reliability of our solid-state keyboards.

And our new low-profile design is ideal for modern compact terminal needs.

Picture a MICRO SWITCH keyboard in your system design. We're ready to talk prototypes now, with production in late 1974. Contact a MICRO SWITCH Branch Office for complete information.

It's the change you've really been looking for.

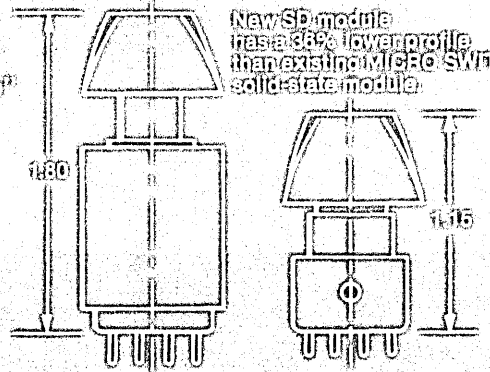

**MICRO SWITCH**

THE FORT WORTH, TEXAS OFFICE  
 AT 5705 HUNTER DRIVE  
 FORT WORTH, TEXAS 76116  
 TELEPHONE 817-341-1111  
 TELEFAX 817-341-1112

co-founders were Tom Kavanagh and Juan Rodriguez, both of whom formerly held managerial positions with IBM in Boulder and are now technical managers at STC.

Within about a month, they were joined by Jim MacGuire who is one of only two corporate officers on the board; the other is Aweida. MacGuire, formerly associated with Univac, IBM, and MAI, was a vp of field operations for Telex's Computer Products Div. before joining STC. At that time, the new company was quartered in an insurance office in Boulder, whence they moved to become co-tenants of a Sears catalog sales office in Boulder's main shopping center. MacGuire, who has a quick and congenial smile, recalls that they had about 50 employees crowded into that facility before they moved the executive offices to a vacant house. That was the situation when they broke ground for the present plant in nearby Louisville.

In its first 20 months, STC spent some \$9.5 million, which averages out to \$475,000 a month; only at the end of that period were they starting to produce some revenue. The first tape drive didn't get its public showing until May 1970, the first delivery taking place the following September. But operating revenues didn't start coming in until January '71. Still, in October '71, the company had delivered its 600th drive. By the end of the year, employment had risen to almost 600 and total revenues came to \$3.6 million. The following year, employment had gone over the thousand mark and revenues exceeded \$26 million, producing for the first time a net profit of \$3.7 million. In the first nine months of this year, employment neared the 1,200 mark, gross revenues were more than \$38 million, and the net income was \$4.3 million.

### Close to 6,600 tapes?

The performance exceeded even the bullish projections of analysts at the brokerage firm of Smith, Barney & Co. In a report dated May 1972, they estimated total revenues of \$21 and \$33 million for '72 and '73. By the end of this year, they thought, STC will have installed some 6,600 tape drives, a figure STC will not comment on but which is believed to be close.

"The annual rental value of equipment we have on lease was \$18.3 million at the end of July '73," says Aweida. "It's building up very nicely. Our plan is to sell half the machines we ship, and retain (for rental income) the other half. If you look at the total to date, we own more than half... we've sold less than half."

Since these deliveries are to end users who seldom buy their hardware, it's required that the equipment be sold at reduced prices to third-party lessors. As long as Aweida is able to find lessors who are willing to undertake such arrangements at reasonable rates, the company is in good shape.

Of course, the marketing strategy that made it all possible was that initial sales were to only large customers, those with 50 or more drives, where enough transports could be installed to make it worthwhile for STC to set up a service office or assign an FE fulltime.



JIM MACGUIRE: STC won't become "The Peripheral Company."

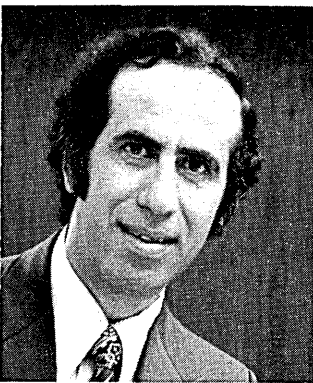

JESSE I. AWEIDA: Sell half, lease half, and then go skiing.

There must be several FE's at the Social Security Administration, STC's largest customer with some 460 drives, but a number of others have more than 200, including Ford Motors and EDS. But now the company can afford to go after the smaller user. Says MacGuire: "If there's a user who needs, say, four drives, and he's a block away from a 155 or 165 user, we'll go after that business as hard as for a large user... Starting this year, once we got those larger installations, we were able to diversify to the smaller accounts."

According to Aweida, the new Super Disks will be marketed initially to existing accounts, but can also be part

of a package with appeal to others. "So I believe it will allow us to get into new accounts."

### A matter of price

Interviews with several users indicate that the service provided by STC is a prime appeal. One user mentioned a call at 2:30 a.m. that brought an FE in 45 minutes. But it's still the bucks saved that make it possible for outfits like STC to get their drives into an IBM installation. And part of that savings comes from enhanced performance features, such as the 250-ips speed that STC was first to come out with, along with a 400 KB transfer rate. In the controller, too, are microprogrammed diagnostics that make preventive maintenance possible without the user having to turn the whole system over to the FE.

"Our users tell us to be very judicious about expanding the product line," says MacGuire. "They say we should be careful about trying to become a peripheral company handling everything available. To a certain extent I agree." Similar sentiments come from an eastern user who says, "They're in trouble when they think they can do everything well." And, he continues, when they start spending money on things like company planes and plush offices.

To date, STC probably has been too busy trying to find space for both the growing office staff and for its production activities to be concerned with plushness. And we'll give odds the company will buy a ski resort before it acquires an executive jet.

—Edward K. Yasaki

## Communications

### MCI's Quest for Bell Lines Ends up In Court

MCI filed suit in Philadelphia, asking a federal district court judge to issue a writ of mandamus—literally a court command—forcing Bell to fill MCI's orders for local loop connections. Without these facilities neither MCI nor any of the other specialized carriers can operate very effectively.

The suit was the latest development in a long, bitter battle between the two companies. Earlier, MCI won a major victory when the FCC, in a 6-0 decision, told AT&T to provide the loops (Nov., p. 153). Bell, while protesting the decision, promised to comply. But soon afterward, the company said that it couldn't provide certain kinds of interconnection facilities ordered by MCI—those involving foreign exchange and CCSA (customer-controlled switching

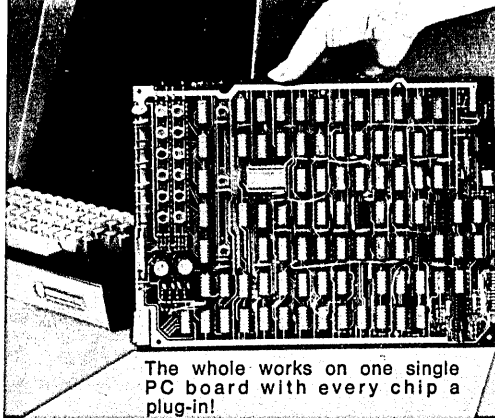

The whole works on one single PC board with every chip a plug-in!

LOWEST COST  
 LOWEST COST  
 LOWEST COST  
 HIGHEST UPTIME  
 HIGHEST UPTIME

Large, double-size characters available for super-readability!

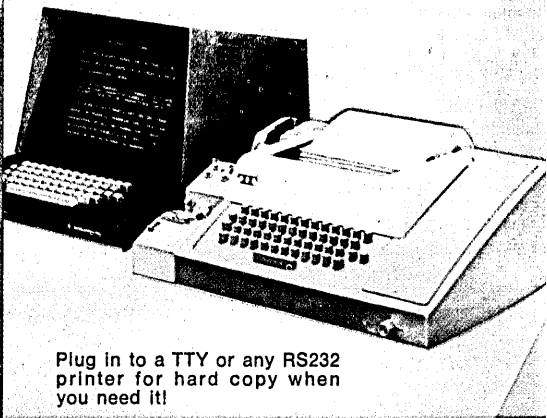

Plug in to a TTY or any RS232 printer for hard copy when you need it!

## OUR CRT HAS LESS GUTS ...AND FEWER BELLYACHES

Teleray users call it the **Uptime Terminal** because it rarely gets sick. If it ever does, the cure is simple. We replace *one single plug-in board* that contains **ALL** logic, character generation, drives, interface, the works. Just about anything that can go wrong is on that board and is plug-in replaceable, *right down to every chip*. Teleray is so quickly and easily repaired, you can do it yourself with our easy-to-understand service manual — or we'll do it for you. MSI circuitry and top-grade components have drastically

cut down the number of Teleray parts that can go wrong, and that brings down your cost, too. Our price is competitive, but we're different on the inside . . . we're "healthier."

### FEATURES

- RS232-C, TTL, 20 ma current loop signal connections
- ASCII coding; 98 characters generated, 64 displayed
- Data rates to 2400 baud
- Displays of 960, 1728 or 1920 characters
- Full or half duplex, switch selectable
- Local or remote modes, switch selectable

- Non-contacting solid-state keyboard (read-only if you want)
- Direct TTY replacement without interface or software changes

### OPTIONS

- Switchable baud rates
- Switchable line formats
- Numeric keypad adapter
- RS232 output to any printer
- 50/60 Hz, 115/230 VAC power
- Remote keyboard
- Slave up to 5 video repeaters

Call collect (612) 941-3300 and ask for Teleray! It's a "gutless wonder"! (We have a warranty that's different, too!)

# TELERAY 3300



**RESEARCH INC**  
 BOX 24064 MINNEAPOLIS, MINNESOTA USA 55422

CIRCLE 35 ON READER CARD

# SUPERMIN

**Our new RDS-500 minicomputer... a real hero  
for half the cost of a mere mortal.**

Any minicomputer will cost you.  
Including our new Supermin.

But Supermin—our RDS-500—  
takes just about the smallest bite  
in the business: about half of our  
major competitor's.

And our mini marvel gives you  
maxi features that include:  
System characteristics you'd  
expect to find only on big  
machines. Multi-port memory  
system for greater I/O bandwidth  
... high speed floating-point  
arithmetic... 8 general purpose  
CPU registers... 100 nanosecond  
CPU clock time  
Powerful software like Real-  
Time FORTRAN, COBOL,  
Multiprogramming, RPG, RJE

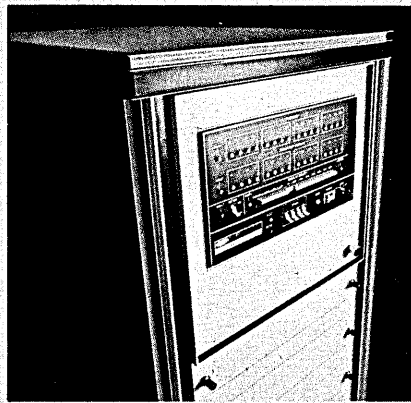

The NEST—*real-time* process I/O  
interface between our RDS-500  
Supermin and your plant auto-  
mation digital and analog  
controls  
An international service organ-  
ization of 2500 members  
Lease and rental plans to fit  
your budget.

The dramatic RDS-500 Super-  
min details are available right  
now. Just duck into the nearest  
telephone booth, or send us a  
post card. (And as you do,  
remember: 25 years ago, we  
thrilled the world with our  
Hurricane Computer. Today we  
celebrate a quarter of a century  
in computers with... Supermin!)

Raytheon Data Systems,  
1415 Boston-Providence Turn-  
pike, Norwood, Mass. 02062.  
(617) 762-6700. TWX: 710-336-  
0646. Telex: 92-4408. Att: Bill  
Karavatos. Raytheon mini-  
computer, programmable  
terminal, and microwave radio  
systems. They make it easier for  
your data to work harder.

## RAYTHEON DATA SYSTEMS

RAYTHEON

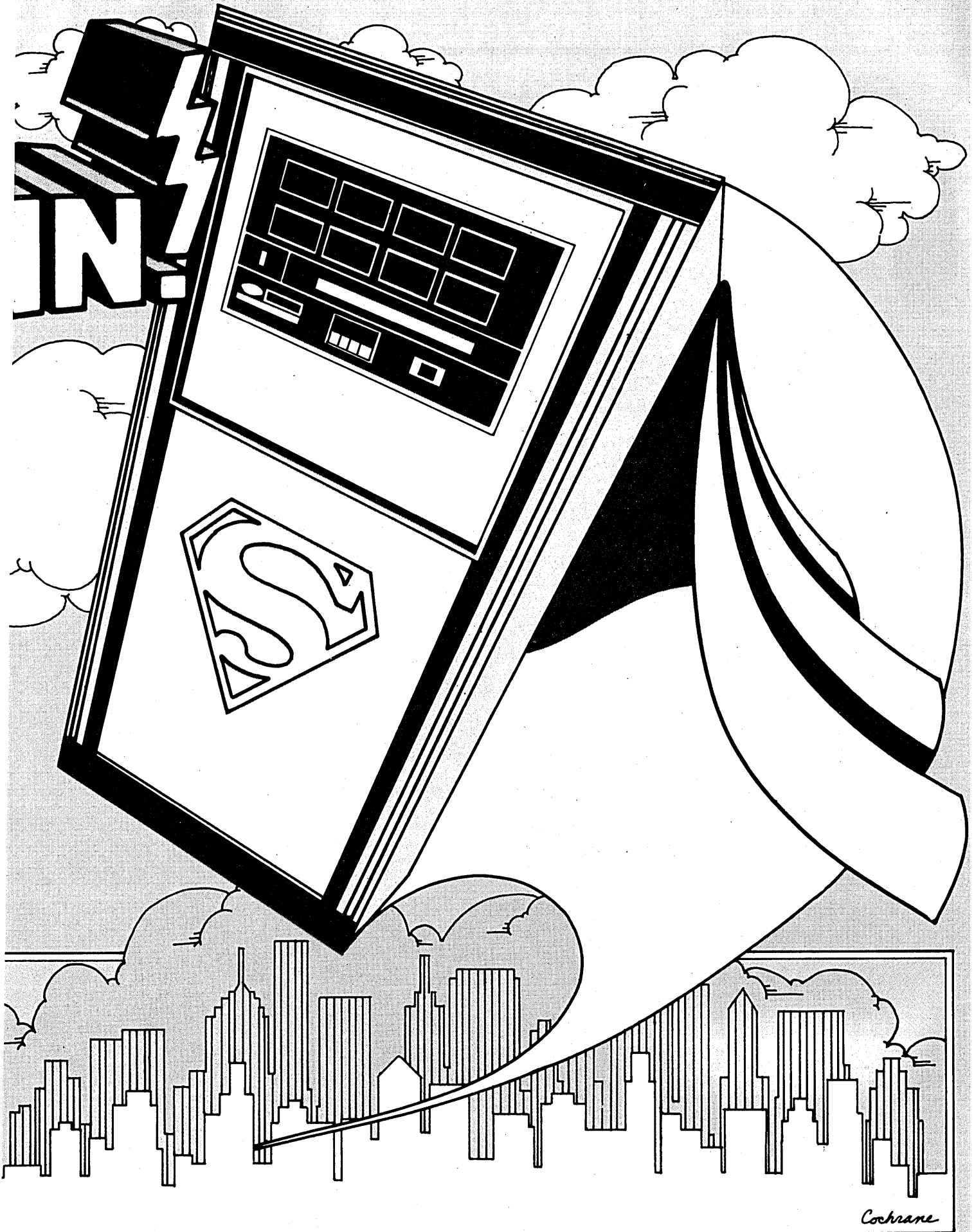

CIRCLE 71 ON READER CARD

arrangement) facilities. According to Bell, "Such requests indicate that MCI, far from providing 'specialized' services of its own . . . in competition with the established carriers, simply seeks to operate . . . as a connecting carrier in providing joint through service with the Bell companies." AT&T contended that under section 201(a) of the Communications Act, joint through service can be provided only after an FCC hearing.

Bell took this position in the face of a statement by the commission's common carrier bureau specifically authorizing MCI to obtain local loops for use with CCSA foreign exchange facilities. It was at this point that MCI filed suit.

AT&T's reluctance to provide MCI with local loops, combined with some other recent actions—such as President John DeButts' request for a moratorium on FCC approval of specialized carrier applications—has suggested to a number of observers that the company's position on interconnection has become unreasonable. Bernard Strassburg, chief of the common carrier bureau, clearly implied this in a recent speech to the National Assn. of Manufacturers when he said, "The Bell System, in lockstep with certain regulatory commissioners and their national regulatory organization—NARUC—has now called for a halt to interconnection and hopes for the ultimate reversal of this national policy."

## Five year dispute

All of which may turn out to be good for the interconnect camp—the specialized carriers and suppliers of foreign attachments—because Bell's position is crystallizing an issue that has been argued back and forth at the FCC ever since the Carterfone Decision in 1968. And if AT&T's position is proven unreasonable, as appears likely, it will almost certainly encourage the Justice Dept. to jump in, assuming the FCC can't persuade Ma Bell to take a different tack.

Besides the MCI suit, four others involving the interconnection question are now pending against AT&T. The most significant one pits Macom, an automatic dialer distributor, against the telephone company. The key issue here is the technical need, and hence the legality, of requiring every foreign attachment to be connected to the dial-up network through an interface obtainable only from Bell. A federal district court judge in San Francisco, after ruling that AT&T can be sued under the anti-trust laws—the company had insisted otherwise—remanded the case to the FCC. The judge told the

commission it would have to reach a decision within seven months after Macom files a formal complaint, stating the issues. Bill Borghesani, Macom's attorney, said last month that he expects the complaint to be filed within 30 days.

Hearings on the telephone interconnect hassle will be held at the end of next month by Sen. Philip Hart's anti-trust subcommittee, according to Jerry Hellerman, a member of the subcommittee staff. The interconnection problems of MCI and other specialized carriers may also be covered, but primary attention will be directed at the difficulties which independent modem makers and others are having in attaching their equipment to the telephone system.

Meanwhile, the Justice Dept., which reportedly has looked at data already unearthed by the Hart subcommittee on the foreign attachment problem, was talking to the North American Telephone Assn. (NATA) last month about technical support the association could provide if the department decides to get more deeply involved. In a recent interview, Barry Grossman, chief of the anti-trust division's evaluation section, indicated that no federal anti-trust action against AT&T is likely for some time; Justice Dept. officials apparently believe the issues require further clarification, or alternatively, that they need better evidence that Bell is violating the anti-trust laws.

## Direct Connect Plan for California

A case for direct connection of foreign devices to telephone lines may be made in California early next year when hearings are held on a proposed General Order, issued by the state's Public Utilities Commission, which would allow direct connection to intrastate networks of equipment certified by a designated registered electrical engineer.

The proposed order does not specify who appoints this engineer, only that he shall be one "who shall have no interest, pecuniary or otherwise, in any manufacturer, vendor or utility that is a party to certification proceedings which interest may tend to influence an independent evaluation of the customer-provided equipment."

His duties under the order would be to "examine the design specifications, operating characteristics, and interaction of the customer-provided equipment with the telecommunica-

tions network. This examination shall include an evaluation of the production and quality control methods used in the manufacture of the . . . equipment to determine if said methods are adequate and shall include the direction, supervision and performance of tests necessary to ensure compliance with standards set forth in these rules."

And these standards are comprehensive, covering maintenance and disconnection, power supplies and wiring methods, hazardous voltages and currents, surge voltage protection, signal and noise power, nonlinearity distortion, longitudinal balance, dial pulsing characteristics, tone address signalling, impedance, and environmental conditions.

Complaints seeking special permission for interconnection have become commonplace, says the PUC order. It specifically lists 14 which it says either have been, or are presently anticipated to be, "handled on an individual basis through a lengthy, costly and non-standard hearing approach." The order, says the commission, was designed to avoid just that.

"Interested parties," and the order lists 83, were given 60 days from the Oct. 24 issuance date to file comments, and an additional 40 days to comment on first comments which will be circulated. Then, says Paul Popenoe of the PUC, "we will determine what the issues are and hearings probably will be scheduled."

In the meantime, the commission, in a separate order issued Oct. 30, asked "interested parties" to submit proposals for interim measures "to relieve economic hardships" alleged by parties to contested matters now pending before the commission. One of these parties, Phonetele, Inc., whose case is pending before the California Supreme Court rather than the commission, and which is scheduled to be heard this month, declined to propose an interim measure on grounds it would be inappropriate because of the pending court hearing.

Direct Connect disciples who complain that state regulatory bodies present a bigger hurdle than the FCC, have long excepted California and this latest action by the PUC would seem to justify this exception. Two other states, North Carolina and Nebraska, had been moving in an opposite direction—toward banning foreign attachments—until the FCC stepped in stating the ban would be illegal under current tariffs.

The FCC also has initiated an inquiry aimed at delineating the boundary between state and federal jurisdiction over interconnection.

—E.M.

(Continued on page 120)



# Diablo II: The Game of the Year

Diablo II is a game that has taken the gaming world by storm. It's a game that's easy to pick up and play, but it's also a game that's full of depth and challenge. The game is set in a dark, gothic world where you're the last of a dying breed. You're a warrior, a mage, or a barbarian, and you're the only one standing between the forces of evil and the world of Sanctuary. The game is a masterpiece of game design, with a story that's as compelling as the action. It's a game that's full of secrets and hidden treasures, and it's a game that's always changing. Diablo II is a game that's worth every penny.

Diablo II is a game that's full of secrets and hidden treasures. It's a game that's always changing, and it's a game that's worth every penny. The game is a masterpiece of game design, with a story that's as compelling as the action. It's a game that's full of secrets and hidden treasures, and it's a game that's always changing. Diablo II is a game that's worth every penny.



Circle 19 on Reader Card

CIRCLE 19 ON READER CARD

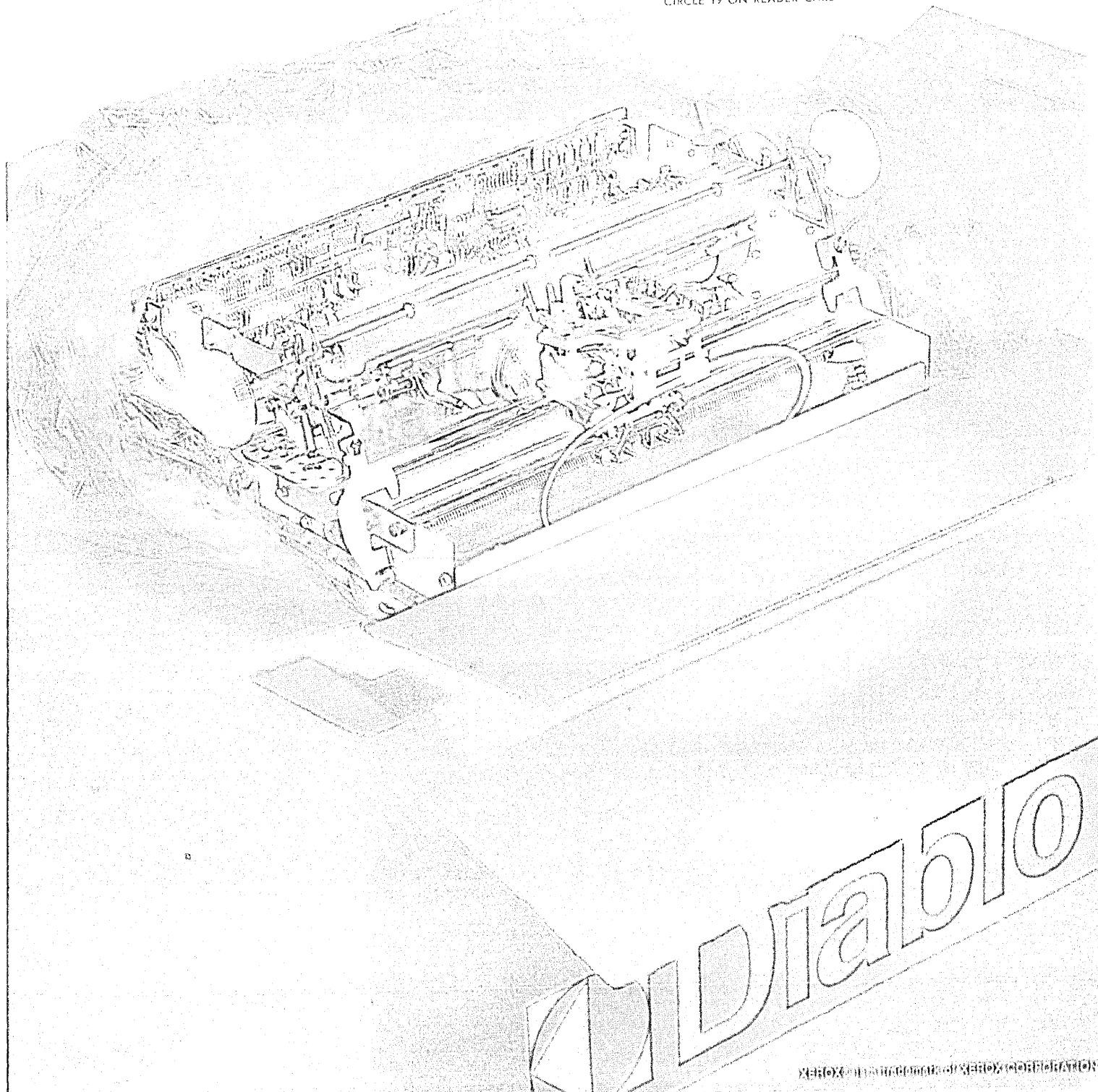

# Diablo II

## Service Bureaus

### ADAPSO Sues The Feds

The Assn. of Data Processing Service Organizations is renewing its fight against encroachment by federally-regulated organizations on commercial dp services.

It has filed a lawsuit together with one of its members; United Data Processing, Inc., Cincinnati, against the Federal Home Loan Bank Board (FHLBB). The suit charges that the board is allowing the Federal Home Loan Bank in Cincinnati to sell commercial dp services to savings and loan institutions without statutory authorization.

The association of 287 dp service companies also decided at its annual meeting in Chicago in October to investigate the influence of commercial banks in the dp services business. Some members complained that banks offer huge discounts for dp services as incentives for customers' deposit accounts.

At a meeting exploring the question, Garrett R. Walroth, general manager of Swift Computer Services, Harvey, Ill., said he lost a bid for the dp service business of a 3,500-account credit union at Wisconsin Steel Corp. to Beverly Bank of Chicago. Swift bid \$1,100 a month for the business against the bank's \$275.

Robert W. Olsen, president of Computer Services Corp., Southfield, Mich., was elected president of the association, succeeding Thomas J. O'Rourke, president of Tymshare, Inc. Gordon Taubenheim, Citizens Financial Corp., Painesville, Ohio, was elected president of the association's Data Center Section; Larry Welke, International Computer Programs, Indianapolis, was elected president of the ADAPSO/Software Industry Assn.; and Steve Beach, The Service Bureau Corp., was elected president of the Computer Timesharing Services Section.

The association's counsel Herb Marks said of the suit against the FHLBB: "What we're objecting to, basically, is that the federal government is competing with private enterprise. FHLBB is an institution of limited jurisdiction. Therefore, if it doesn't have specific authority to carry on an activity, it can't do it."

Marks added that federal home loan banks in Des Moines, Pittsburgh, and New York City also are offering commercial dp services, so if ADAPSO wins, the victory presumably will have a

broad effect. The case has been set for hearing before a Cincinnati federal district court late this month.

An FHLBB spokesman believes his agency is "fully empowered to authorize federal home loan banks to provide the challenged services. The board intends to vigorously defend against the complaint."

## Procurement

### Brooks Balks at Brand-Name RFP's

Non-IBM mainframers seem to be in a much better position to compete for several hundred million dollars in big systems contracts that will be put out for bid in the next several months; IBM's position seems to be weakened. Much of it is due to action of the influential Rep. Jack Brooks of Texas, the leading dp expert in Congress who criticized the use of "brand-name RFP's" (requests for proposal) that require bidders to offer a specified manufacturer's dp system.

Meanwhile, the General Services Administration (GSA) was preparing to impose tighter controls over federal dp users who renew contracts on already-leased dp equipment without seeking competitive bids. The new controls also will affect purchase of such systems on a sole source basis. The Computer Lessors Association (CLA) recently complained about both practices, and the General Accounting Office (GAO), in a report not yet released, was equally critical.

Brooks is the author of legislation passed in 1965 to centralize in the GSA the purchases of edp equipment for government agencies. His latest foray into federal procurement practices was precipitated by an RFP converting the lease of an IBM 370/168 for the Dept. of Agriculture's Washington, D.C., dp center. The request for bids from leasing agencies required the vendors to offer that equipment and no other.

Several agencies are known to be planning similar procurements, including the Veterans Administration, Labor Dept., Social Security Administration, National Library of Medicine, and the Air Force. In most cases, big follow-on buys are scheduled.

For example, the Veterans Administration, after operating a pilot 370 for several months, reportedly plans to request separate bids on nine more systems. At Agriculture, a follow-on procurement of as many as nine systems is planned 18-30 months after the 370/168 is installed at its Washington

dp center. Up to four of the systems will be taken by GSA, reportedly to perform some federal service bureau work now being farmed out to CSC's Infonet system. All of the computers to be acquired by GSA and the Agriculture Dept. as a result of the follow-on procurement will access a common telecommunications network.

Rep. Brooks got involved early last October after bids on the 370/168 had been received and after certain non-IBMs, CDC in particular, visited him. They charged that IBM would gain an insurmountable advantage in competing for the big follow-on buy if a 370/168 was specified for the first stage. Shortly afterward, Brooks "requested" GSA not to award the 370/168 lease contract until he had a chance to investigate further.

## No advantage

Both GSA and the Agriculture Dept. then sent the congressman long letters contending that the proposed contract wasn't really a sole source procurement, and wouldn't give IBM an extra advantage in bidding the follow-on. System conversion costs would not be considered in evaluating the latter bids, they pointed out, and besides, some of the centers to be re-equipped as a result of the big buy are currently using non-IBM gear. Also, all new programs written at all centers are to be coded in higher-level languages.

The two agencies said that the RFP for the 370/168 specified a 72-month system life, especially so that third-party lessors would be encouraged to bid. They insisted that the only reason for specifying IBM was to avoid a double reprogramming job. Since the center now has IBM gear, acquiring another make for the interim system would require present software to be rewritten. And this exercise would then have to be repeated if the interim was replaced, after the follow-on buy, with still another make.

Early last month, Brooks told GSA officials they could go ahead with the 370/168 lease contract award, but he warned that the "far-reaching questions of sole source procurement and the possibility of creating a dominant position for one computer manufacturer" are of "major concern." When a using agency selects the type of computer to be acquired, "opening the bidding to third party leasing companies does not make the procurement fully competitive," he added.

GSA apparently has gotten the message. The agency has "deferred" the VA's proposal for leasing a 370 and, according to a knowledgeable source, will "bear down harder" on future proposals of the same kind. He insisted

Strid from technology and experience proven in our world-famous Series 30 and 40 drives, our new Series 20 fixed disk drives are being shipped now! Their inherent reliability, compactness, cool, quiet operation and low cost make them ideal for mini computer and intelligent terminal systems. Yet, you get

powerful performance features: 24 million bit capacity, 100 tracks per inch, 2200 bits per inch. Power consumption is less than 1/50 watts. Only DC power is used, which means Series 20 drives can operate anywhere in the world without modification. For more information on the new Series 20 fixed disk

drives, call or write Diablo Systems, Incorporated, 24500 Industrial Boulevard, Hayward, California 94545, (415) 786-8910.

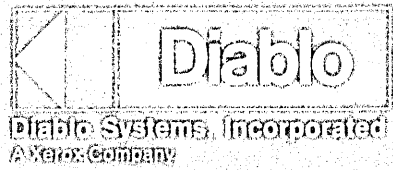

## NOW, DIABLO POWER AND PERFORMANCE IN A FIXED DISK DRIVE.

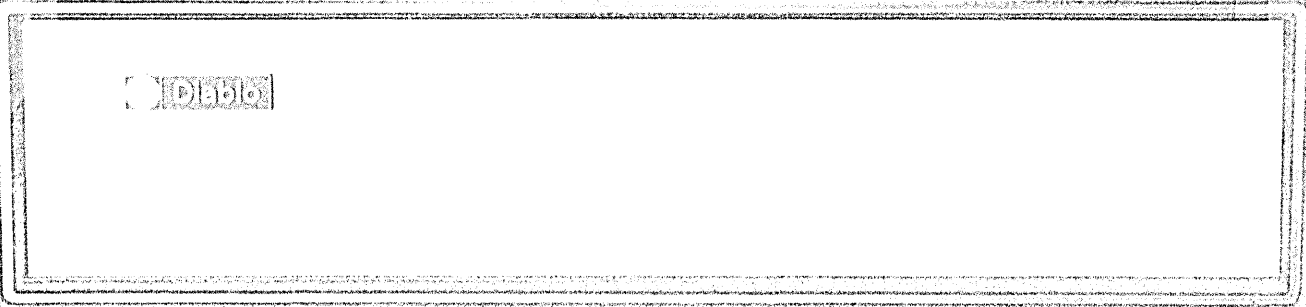
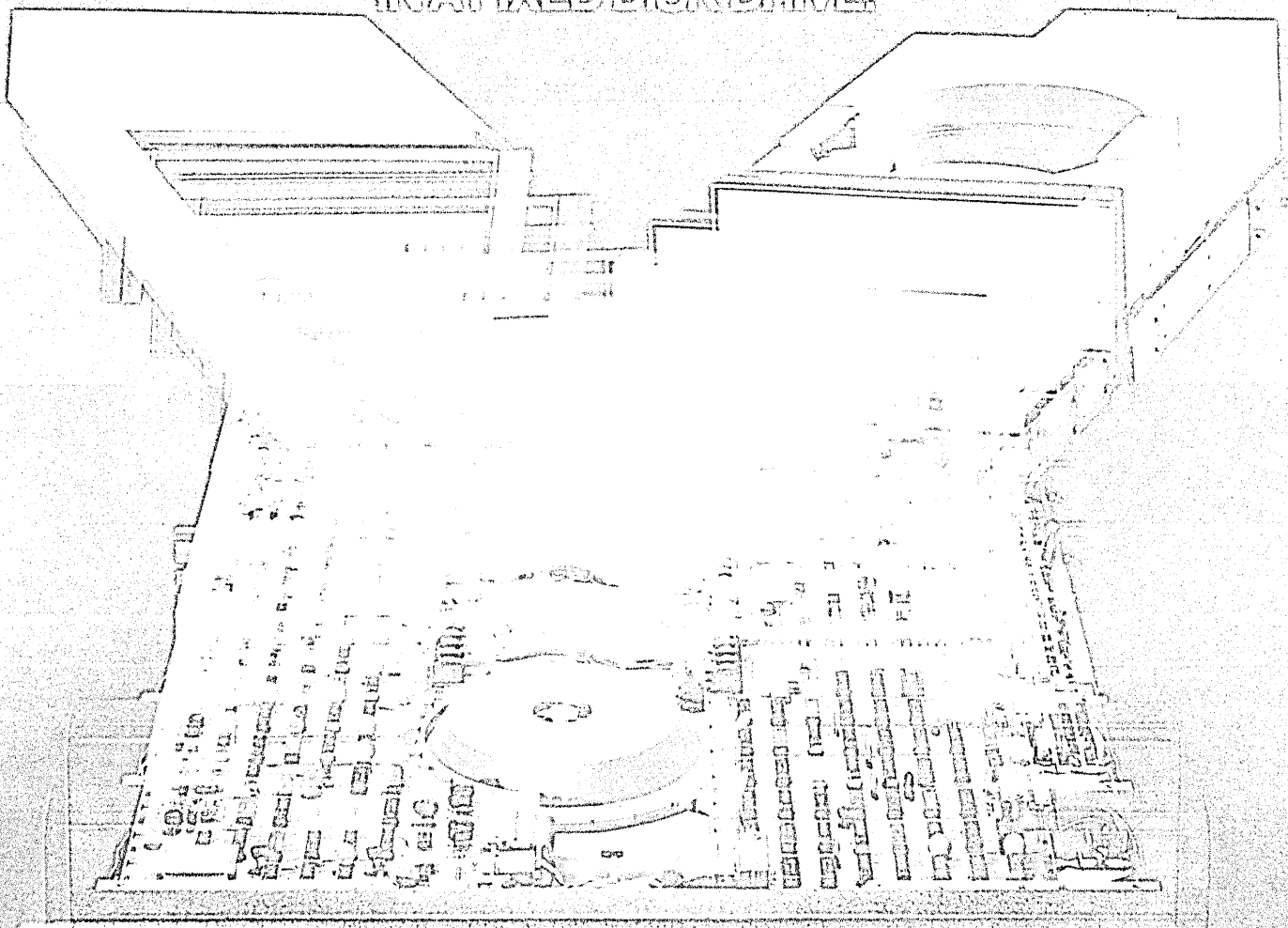

DIABLO SYSTEMS, INCORPORATED

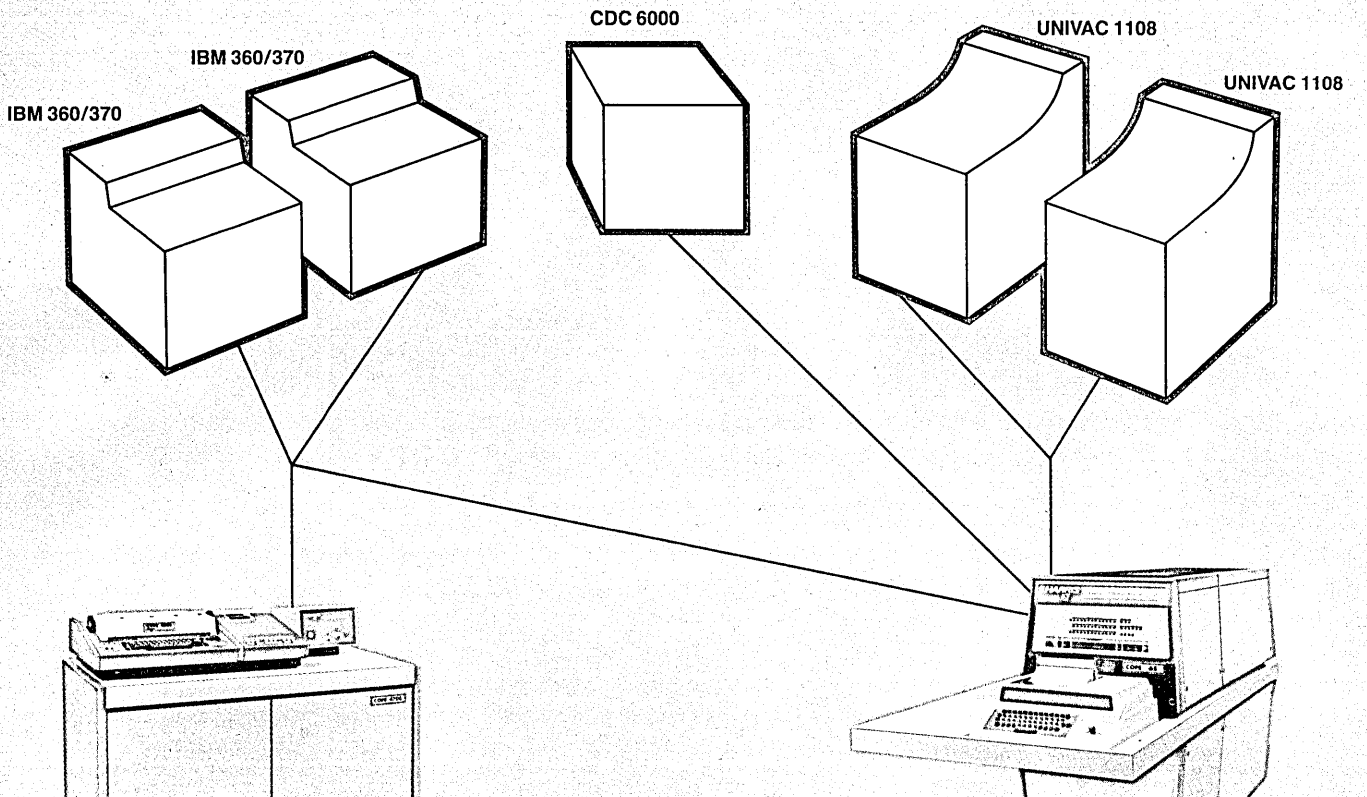

**TRANSMISSION CONTROL UNITS**

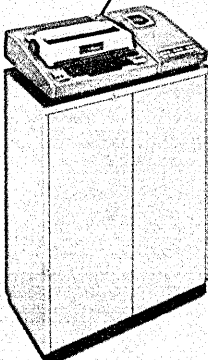
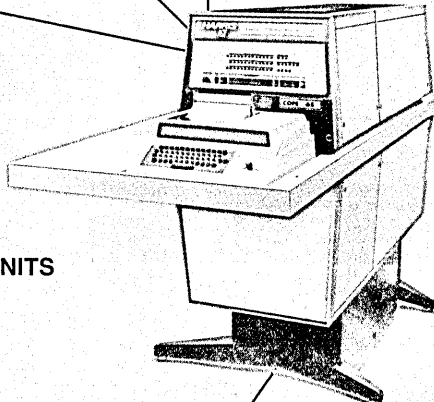
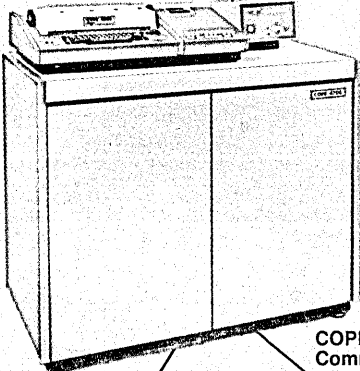

**CONVERSATIONAL TERMINALS**

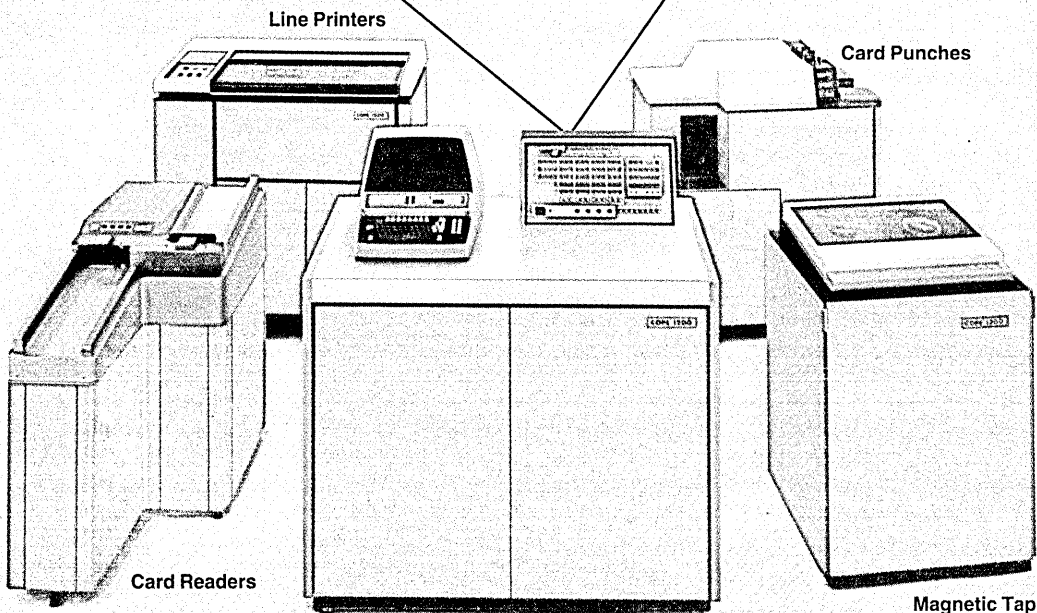

**REMOTE BATCH TERMINAL SYSTEM**

# A better communications system.

# COPE<sup>®</sup>

No matter what mainframe you're using, you can build a better data communications system with COPE terminals, controllers and peripherals.

Start at your CPU and add a COPE Communications Controller. Choose a COPE 4705 to front-end your 360/370. It's an enhanced alternate for the IBM 3705 at lower cost. Or specify our COPE 65 for full-duplex operation at up to 50 Kbps to your Univac 1108, CDC 6000 or IBM 360/370. Both controllers allow you to realize the utmost in efficiency from your big computer.

Next, for your remote location, there's just one choice in remote batch terminals — the COPE 1200. Latest in a broad line of COPEs, the 1200 provides an extremely high rate of throughput using ordinary voice-grade telephone or Telpak lines. COPE 1200 provides your most cost-effective, reliable access to your big computer.

Then you need to surround your COPE terminal with the peripherals that will do the best job for your application. COPE has card readers from 150 to 1200 cpm. Line printers from 50 to 1500 lpm. Card punches up to 200 cpm. Mag tape — 7 or 9 track — 200, 556, 800 or 1600 bpi.

You can choose half- or full-duplex communications modems operating on voice-grade telephone circuits from 2 Kbps to 50 Kbps. And from multiple communications interfaces: ordinary voice-grade lines, co-axial cable or Telpak lines.

Plus, COPE offers both Teletype and CRT consoles for operator I/O control and a line of industry-compatible conversational keyboard terminals.

When you put it all together, you'll find COPE provides the most flexible, modular, cost-effective data communications system in the industry. And backs it up with complete software services and full maintenance by an expert Field Engineering Department with offices conveniently located throughout the U.S. and in Canada.

To find out more about our total systems capability, call your nearest Harris Communication Systems, Inc., office or contact the home office listed below.

TO: Harris Communication Systems, Inc.  
11262 Indian Trail/P. O. Box 44076  
Dallas, Texas 75234 (214) 241-0551

D12

Please send more information on COPE Communication Systems.

I'm especially interested in your:

- |  |   |
|--|---|
| <input type="checkbox"/> COPE 4705 Communications Controller | <input type="checkbox"/> COPE 1200 Series RBTs                        |
| <input type="checkbox"/> COPE 65 Communications Controller   | <input type="checkbox"/> COPE 1000 Series portable keyboard terminals |
|  | <input type="checkbox"/> Please Have a Salesman Contact Me            |

Name \_\_\_\_\_

Company \_\_\_\_\_

Telephone \_\_\_\_\_

Street \_\_\_\_\_

City \_\_\_\_\_

State \_\_\_\_\_

Zip \_\_\_\_\_

**HARRIS**  

**COMMUNICATION SYSTEMS, INC.**

a subsidiary of Harris-Intertype Corporation  
11262 Indian Trail/P.O. Box 44076/Dallas, Texas 75234 (214) 241-0551

Canada: 1400 Don Mills Road/Don Mills, Ontario (416) 449-8571

CIRCLE 67 ON READER CARD

# We deliver 370/145 memory

MULTIMEMORY is our new line of high speed, semiconductor, monolithic compatible memory systems. But actually, only the name is new. We've been delivering semiconductor monolithic memory modules for over five years. In fact, many of our basic storage modules are already in the field, operating in 370/145 installations. Now we're making them available in a totally integrated, plug compatible system.

EMM has more *experience* with semiconductor, core, and disk

memory technology than any other independent memory company. Our *technology* goes right down to basics. EMM is the only independent memory company actually manufacturing both semiconductor and core memory. We make our own monolithic integrated circuits and cores. Build our own stacks and basic storage modules. Add the electronics for the total memory system. Control every critical manufacturing step to make sure we meet delivery schedules with reliable products.

We have the *stability* of a major NYSE company committed to the memory market.

But the main reasons for our success are *satisfied customers*. Satisfied with performance. Satisfied with terms. Satisfied with service.

If you want to know more about the MULTIMEMORY 7370/145 compatible memory, call us at (213) 644-9881 or our nearest field office. We'll send you a full color descriptive brochure.

**EMM** COMPUTER PRODUCTS

A Division of Electronic Memories & Magnetics Corporation  
12621 Chadron Avenue, Hawthorne, Ca 90250



## news in perspective

that GSA for some time has required "full justification" before allowing a user to issue bid requests that specify a particular make of equipment.

### And the winner is . . .

Shortly after Brooks assented to the Agriculture Dept.'s acquisition of a leased 370/168, GSA awarded the contract to Intel. One industry source suggests that "it was intended all along to award the lease to a non-IBM." Apparently, the agency can't avoid criticism no matter what it does.

GSA's upcoming controls over the re-leasing or lease-to-purchase conversion of already-installed dp equipment will impose "maximum order limitations" (MOL's) on such systems. The effect will be to deprive federal dp users of the virtually total authority they have had over these transactions. Under the new setup, proposed lease renewals or conversions-to-purchase will have to be approved beforehand by GSA's dp directorate, the Automatic Data and Telecommunications Service, if they involve more than one cpu, more than 10 peripherals of the same make and model, or expenditures of more than \$400K.

The new order was inspired partly by a complaint last August from the lessors assn., but even more by the GAO.

The lessors' group said that many federal agencies were renewing leases on already-installed equipment, or purchasing such equipment, without seeking competitive bids. CLA argued that this practice violates "the intent and spirit" of federal procurement regulations.

The GAO report is still in draft form, and may never be released because of Defense Dept. opposition. It points out that 66% of all federal dp acquisitions in 1972—\$443 million out of \$671 million—"represent equipment purchased or leased under (Federal Supply) Schedule contracts, for which there was no price competition."

—P.H.

### International

## Chile: End of a Cybernetic Era

Computers can be used to give greater freedom of choice, rather than limit it. London professor Stafford Beer is convinced that the system he designed for Salvadore Allende's government in Chile was of this "liberating" type. His collection of models for companies, industries, industry sectors, and

the national economy was developed over an 18-month period on a very low budget.

When Allende's government came to an end in September, the cybernetic system also screeched to a halt, and Beer returned to England to reflect on the lessons of the experiment.

"The press had the wrong emphasis," Beer maintains. "Because of the publicity given to the single operations room in Santiago, people have seen this thing as immense centralization of power, Big Brother stuff. But what we were really trying to do was decentralize, to devolve power out to worker groups in the companies."

When Allende decided to bring management science into Chile, he had a structural problem, on top of all his political problems. The country is 3,000 miles long; most of the managers who had been kicked out had taken their management information with them. So the workers who took over, or the "interventores" sent in by the government to run the companies, rarely knew what orders they had to fill or what work was in process or who owed what to whom. The country's business was organized with about 20 companies in a typical industry or "sector," such as wood or fishing, with 20 sectors in a branch or "Rama." Four Ramas—heavy, light, consumer, and materials—make up the national organization.

### Sixty percent on the system

Beer's concept was to put a telex into every firm and transmit less than a dozen indicators (expressed universally as numbers between zero and one) to do daily updating of the company models and feed into the aggregated models for the industry, Rama, and national planning. It took 18 months to create the nested, recursive models and to build a prototype control room in Santiago; then Beer spent another six months training and bringing new companies into the system. When Allende's government finally fell, Beer says he had about 60% of the economy on the system.

"Don't be misled by the single computer," he says firmly. "It ought to have been a minicomputer, with others in other control rooms in every factory. We were planning a factory to mass-produce such rooms. They would have no paper, just seven chairs, with big screens and back projectors that could show animated models that workers could understand, appropriate to the people in the chairs. You can't have a creative situation with more

## There's an EMM office near you.

### SAN FRANCISCO

BURLINGAME 1818 Gilbreth Road  
CALIFORNIA Suite 214  
94010 (415) 692-4250

### LOS ANGELES

LOS ANGELES 10960 Wilshire Blvd.  
CALIFORNIA Suite 320  
90024 (213) 477-3911

### CHICAGO

DES PLAINES 1400 East Touhy Avenue  
ILLINOIS (312) 297-3110  
60018

### BOSTON

WELLESLEY #4 Wellesley Office Park  
MASSACHUSETTS 40 William Street  
02181 (617) 237-4800

### DETROIT

SOUTHFIELD 21411 Civic Center Drive  
MICHIGAN (313) 352-1040  
48075

### ST. LOUIS

CLAYTON 130 South Bemiston  
MISSOURI Suite 101  
63102 (314) 863-0015

### NEW YORK

SADDLE BROOK 299 Market Street  
NEW JERSEY (201) 845-0450  
07662

### CLEVELAND

CLEVELAND 6500 Pearl Road  
OHIO (216) 884-1980  
44130

### PHILADELPHIA

ABINGTON 947 Old York Road  
PENNSYLVANIA (215) 887-4940  
19001

### PITTSBURGH

PITTSBURGH 395 Seven Parkway Center  
PENNSYLVANIA (412) 921-1221  
15220

### DALLAS

DALLAS 2655 Villa Creek  
TEXAS Suite 280  
75234 (214) 243-2374

### HOUSTON

HOUSTON 1200 South Post Oak  
TEXAS Suite 104  
77027 (713) 626-3592

### WASHINGTON, D. C.

ANNANDALE 7617 Little River Turnpike  
VIRGINIA (703) 941-2100  
22003

### BRUSSELS

BRUSSELS Rue Du Luxembourg #19  
BELGIUM First Floor  
1040 (02) 12-30-80  
TWX: 846-22462

### LONDON

FELTHAM 92 The Centre  
MIDDLESEX 01-751 1213/6  
ENGLAND TWX: 935187  
TW 13 4BH

### PARIS

PARIS 17<sup>eme</sup> 92, Rue Joffroy  
FRANCE 227-5619  
TWX: 21 311

**EMM** COMPUTER PRODUCTS

Ask about how the system is implemented and how it is configured.  
Ask about the hardware and software.

Ask about  
the nuts and bolts  
and how many bytes...  
before you decide on  
the Curmin's KeyScan<sup>™</sup>  
Data Entry System.





Ask about key/disk. Up to 32 Cummins CRT Terminals are monitored by the powerful 96k byte 4400 Processor. Whether in large or small clusters, the CRT terminals and 4400 Processor afford the most accurate and reliable means of processing non-scannable data.

Ask about the powerful editing and validating features such as batch balancing, table look-ups, range checks, re-formatting, linked program levels, extended record processing, and batch summary records.

Ask about price. And discover that Cummins key/disk terminals provide more processing power per dollar than any other key entry system.

Ask about scanning for high volume data entry. And about re-entering rejects with a single key stroke of each unrecognized character. Ask about printers and communications and learn about the 4400 KeyScan Multimedia Data Entry System.

Ask around. And while you're at it ask about Cummins, a company with over 45 branch sales and service offices located across the country. Send for the 4400 KeyScan System brochure. Write: 836 Waukegan Rd., Glenview, IL 60025. Or ask the operator to dial 312/724-8000 and make an appointment to visit our demonstration facilities.

Ask about the KeyScan Data Entry System. Then ask about other systems and you decide which is best.

 **CUMMINS**  
CUMMINS-ALLISON CORP.

# 4400

**KeyScan Multimedia Data Entry System**

than seven people. The people in the control room were able to call up information—current information—and act on it. At the same time, the design of filters for the information prevented overreaction.”

Discussing the cyclical nature of economics, Beer points out that there is usually an information lag, so policy-makers are responding to out-of-date indicators, and often make a system resonate by doing exactly the wrong thing at exactly the wrong time. The bigger the system, the more lag is likely, and the more wrong actions are likely to make things worse. When you can get information to flow sufficiently fast that the relaxation time of the system is appropriate to the duration and magnitude of any disturbance or cycle, then, as Beer says, “Whatever goes on at any level is appropriate to that level. Total freedom to every level of a hierarchy is anarchy. If, on the other hand, everyone does as he is told, you lose all freedom. The notion of autonomy is important here. My inspiration for cybernetics comes from neurophysiology. In the human system, subsystems like respiration are not

“decentralized” or “centralized” but “autonomous.” Autonomy gives you variety; it implies being in control or out-of-control, not me-controlling-you. Allende wanted his Marxist state this way. He was a physician; he *knew* about physical autonomy.”

### What was going on

Beer developed for Allende a system based on certain methods of description that could apply to all systems, with all numbers expressed between zero and one. For each element in the system they could develop very simple models, like flow-charts, in which the lines representing the flows were proportional to the size of the flow. “This gave worker/managers a very clear perception of what was really going on.”

The system was built on Beer’s premise that “it is better to dissolve problems than solve them.” However, the distribution subsystem within Chile, and the pressures from the world system upon the Chilean subsystem, he maintains, brought the whole thing to an untimely end. (Just before he left Santiago, dollars were bring 16 times

the official exchange rate on the black market.) When he discussed the system in London last month, a colleague asked what would have happened if a different government had taken over when the entire system was up and running, with control rooms in every factory. “We spent night after night discussing this point,” Beer replied. “We came to the conclusion that despotic governments already have enough instruments, so the addition of this one is irrelevant. They can shoot people, or take them to concentration camps in the middle of the night. They would be more likely to sabotage this system than use it. It’s eminently sab-otagable. It has too many access points. There’s no sense in carrying it on unless you value autonomy and openness. A participative system like Allende’s tends to be more muddled than an autocratic system, so it has a greater need for mechanisms like this. The thing is to make the processes of government visible. This system did that.”

He uses the past tense now. The control room is locked, and Beer no longer commutes from London to Santiago. He is still convinced the concepts for open management can someday be put to use.

—Nancy Foy  
(Continued on page 130)

## Correct your data transmission errors!

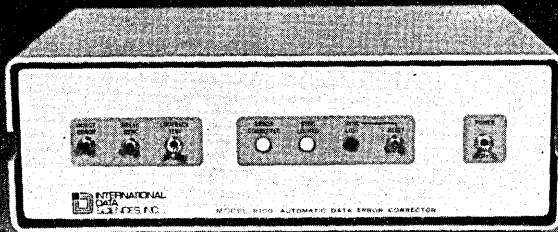

### New Accucom 9100 and 9200 AUTOMATIC DATA ERROR CORRECTORS

- Corrects errors in TDM and Point-to-Point Systems.
- Finds and corrects up to 99.999% of all data errors.
- Operates at speeds up to 9600 bits/second.
- Corrects errors due to noise, line drop out, loss of modern sync—simultaneously in both directions.
- Compatible with all full duplex, synchronous modems, data concentrators and time division multiplexers.



INTERNATIONAL  
DATA  
SCIENCES, INC.  
ADVANCED TECHNIQUES IN DATA COMMUNICATIONS  
100 Nashua St., Providence, R.I. 02904.  
Phone (401) 274-5100/TWX 710-381-0285.

CIRCLE 98 ON READER CARD

Now... lease your Teletype equipment from  
the data communications experts...

# RCA

*It's a better deal!*

- Save time, money, trouble with RCA Single Source Reliability.
- Teletype Models 28, 32, 33 and 35 equipment available for prompt installation.
- Low monthly rates include nationwide maintenance service — based in over 130 cities.
- System planning assistance and accessory equipment also available — data sets, telephone couplers, solid state selectors and multiplexing equipment.
- For use in computer time sharing, dial-up, private line, and management information systems.

For full details and rates call or write:

RCA Service Company  
A Division of RCA,  
Technical Products Service  
Bldg. 204-2  
Camden, N.J. 08101  
Phone: (609) 779-4129

# RCA

CIRCLE 76 ON READER CARD

**DATAMATION**

# Think of what just one company can do to stop pollution. We have.

**WHAT  
INDUSTRY  
IS DOING  
TO STOP  
POLLUTION**



Keep America Beautiful, Inc.  
99 Park Avenue  
New York, New York 10016

Please send me a free copy of  
"What industry is doing to stop pollution."

Name \_\_\_\_\_

Street \_\_\_\_\_

City \_\_\_\_\_

State \_\_\_\_\_ Zip \_\_\_\_\_

Twenty years ago some farsighted businessmen had an idea. To establish an organization to combat littering. They called it Keep America Beautiful, Inc.

Since then, KAB, Inc. has led a national movement to stop not just littering. But pollution as well. A movement that involves

almost 70 million Americans.

To show you what companies like yours are doing to fight pollution, we've put together this folder, "What industry is doing to stop pollution."

It's a special way to celebrate our first twenty years.

**People start pollution. People can stop it.**



A Public Service of  
This Magazine &  
The Advertising Council

**Keep America Beautiful**  
99 Park Avenue, New York, New York 10016



## Japan Balances Mainframe Strength

From the beginning it was established that foreign mainframe manufacturers (mostly Americans) shall be allowed to dominate the market in Japan for large-scale computers, while the Japanese kept for themselves the markets for small and medium-scale systems.

This alignment resulted from priorities the Japanese themselves set many years ago when they chose to acquire the know-how and develop the industry with small and medium-scale computers, leaving the big stuff for later years. Apparently they figure they've dawdled long enough.

Latest figures show that for the first time the Japanese have installed more large-scale computers than have the foreigners, the scoreboard reading 666 to 664. But at the same time, the figures show that for the first time there are more foreign-made "very small systems" installed than there are domestic brands. Included in this category—for the sake of convenience, we'll call them minis—are general purpose computers selling for less than \$28,000.

As recently as Fiscal Year 1969, which closed at the end of March

1970, only 62 foreign-made minis had been installed, compared with 443 made by the Japanese. This stemmed more from lack of interest on the part of U.S. mini makers than from any superior technology or marketing savvy possessed by the Japanese.

It was not until the year ending March '72 that the number of foreign minis shipped outnumbered those of Japanese origin, although the total number installed was still in favor of the Japanese.

Now, as of March '73, Japanese computers outnumber those of foreign origin in all size classes except the mini. The totals are 10,531 of the domestic variety and 6,724 foreign, for an installed base of 17,255.

These figures were released recently by the Japanese Ministry of International Trade and Industry, which controls and tracks imports; and by the Japan Electronic Computer Co., leasing firm for the six major mainframe manufacturers. They also show, however, that domestic manufacturers account for less than half the value of installed large-scale systems (41.4%), for 70.7% of medium-scale systems, 71% of small systems, and 51.4% of the minis. Of the total market, they have the upper hand by a slim 53.5%.

A presidential candidate might consider that to be a strong mandate, but the Japanese express no glee at the slim plurality.

For the record it should perhaps be explained that a large-scale system is one that's priced at some \$649K or more, a medium-scale at \$111K or above, and a small system at more than \$28K. Additionally, although IBM manufactures in Japan, their machines are counted as foreign hardware.

—E.K.Y.

## Benchmarks

**Fabri-Tek Acquires Data Recall:** In a two-way transaction, Fabri-Tek, Inc., Minneapolis, agreed to acquire Data Recall Corp., Los Angeles, from Computer Investors Group, Inc., while a CIG subsidiary, CIG Computer Products, Inc., Stamford, Conn., said it had purchased Fabri-Tek's entire installed base of IBM-compatible memories. CIG and Fabri-Tek also said they've signed an exclusive marketing agreement under which CIG will purchase, market, lease, and service Fabri-Tek and Data Recall end user memories in the U.S., Canada, and Western Europe. Price tag on the combined transaction was approximately \$10 million.

**Time-Sharing Merger:** Financially troubled Allen-Babcock Computing, Inc. appears to have found a parent in International Timesharing Corp., Minneapolis, which last month said it was negotiating to purchase the Los Angeles firm's customer list, computer programs, and operating software. Allen-Babcock has filed a \$35 million suit in Los Angeles Superior Court against Tymshare, Inc., an earlier merger negotiations partner, complaining about the nature of the termination of negotiations. The Los Angeles company talked to other prospective parents between Tymshare and ITS. ITS said it plans to establish Allen Babcock as a separate division, operating on the West Coast.

**Commodity Exchanges—Computerization Or . . .:** The idea of computerization of trading activities at the nation's commodity exchanges drew mixed response from commodities brokers and exchange officials testifying at hearings conducted by the House Agriculture Committee. Some said computerization wasn't necessary. Others opposed mandatory legislation. The committee is continuing to investigate the need for additional government supervision of commodity exchange activities, and legislation may be enacted during this Congress calling for computerization and/or other measures. □

## WHICH IS FASTER, MORE RELIABLE, AND EASIER TO USE FOR PROGRAM PREPARATION?

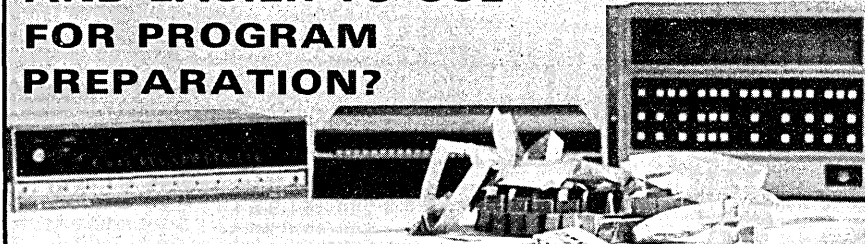

**LINC TAPE**  
and it comes

**with a Complete Operating System**

Computer Operations has plug-compatible, mass-memory for NOVA, DEC PDP-11, HP-2100, and many other mini-computers. The LINC Tape Operating System provides complete support for assemblers, loaders, text editors, BASIC, FORTRAN and file utilities.

LINC Tape is 28 times faster than paper tape and 15 times faster than cassettes. And it has proven error-free performance and reliability.

- Low Price and quick delivery
- Complete plug-to-plug compatibility
- Block addressable disc format
- 8400 bytes/sec transfer rate
- 100,000 passes without error guaranteed
- 204,800 or 335,872 data bytes per reel in blocks of 512
- Utility software drivers — complete operating system for most popular minis
- Expandable to 16 drives
- Optional compatibility with DEC tape®

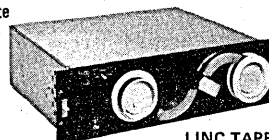

LINC TAPE  
TRANSPORT

For your own satisfaction, see LINC Tape demonstrated before you decide on any mass-memory system.

**Computer Operations, Inc.**

10774 TUCKER ST. BELTSVILLE, MD.  
20705 301-937-5377

CIT  
*Alcatel*

GROUPE CGE

LEADER...

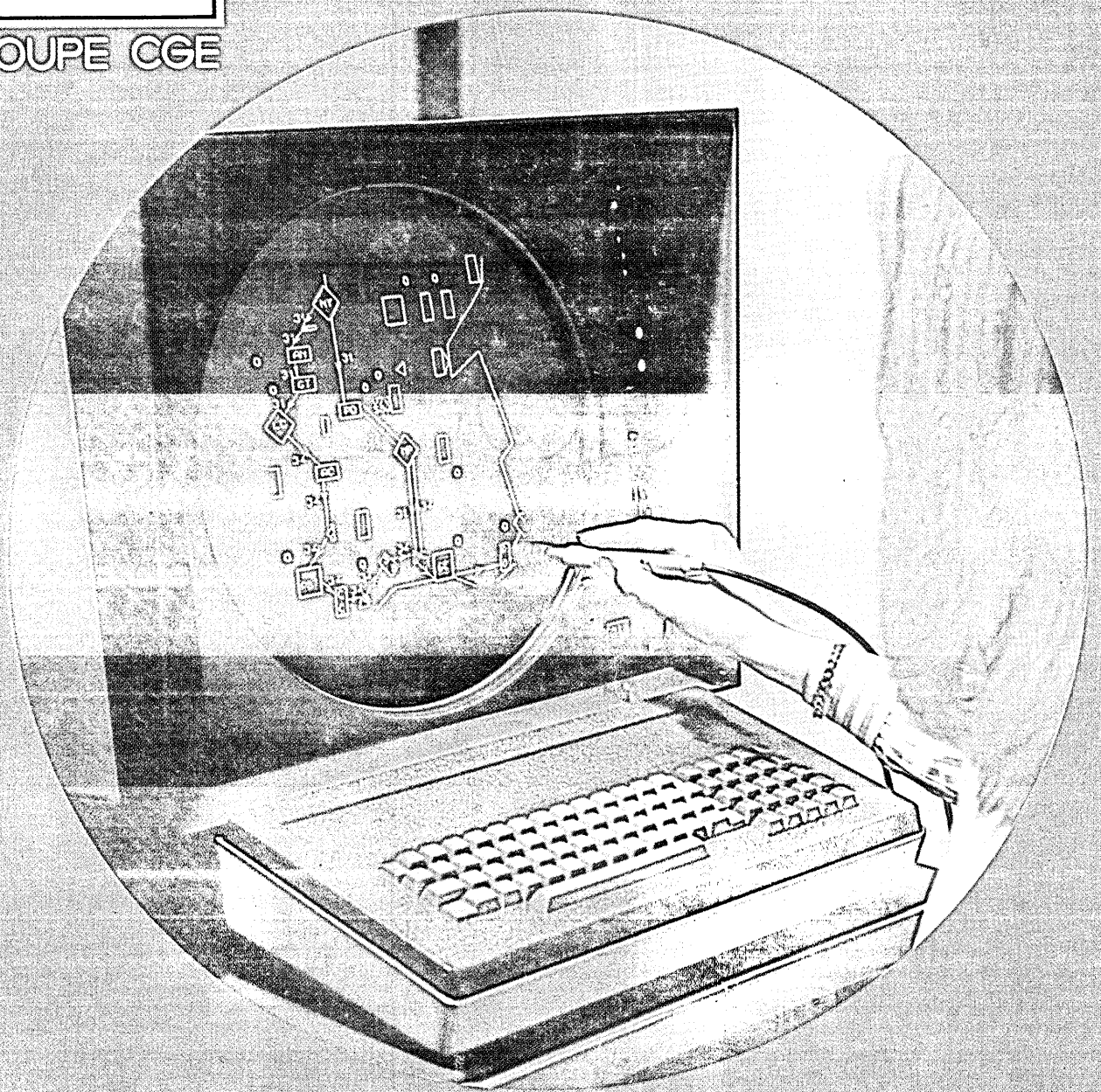

- de la visualisation graphique couleur
- of colour graphical display
- für die grafische farbvisualisierung
- de la visualización gráfica en colores
- della visualizzazione grafica a colori
- В ОБЛАСТИ ЦВЕТНОЙ  
ГРАФИЧЕСКОЙ ВИЗУАЛИЗАЦИИ"
- 是彩色图表显示的前导者。

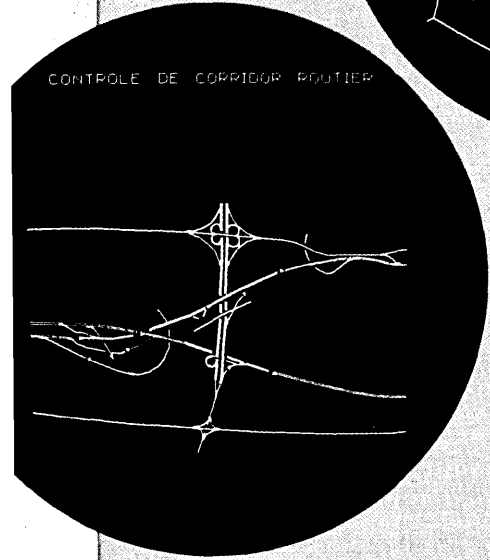
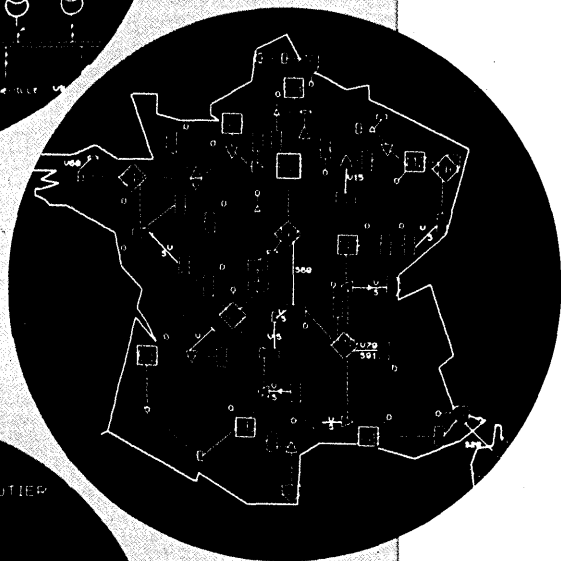
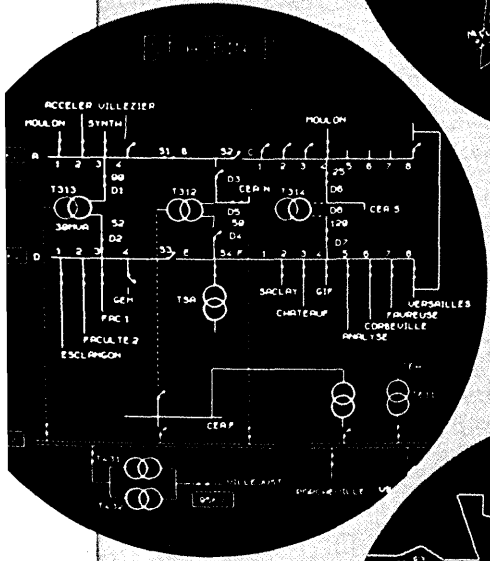
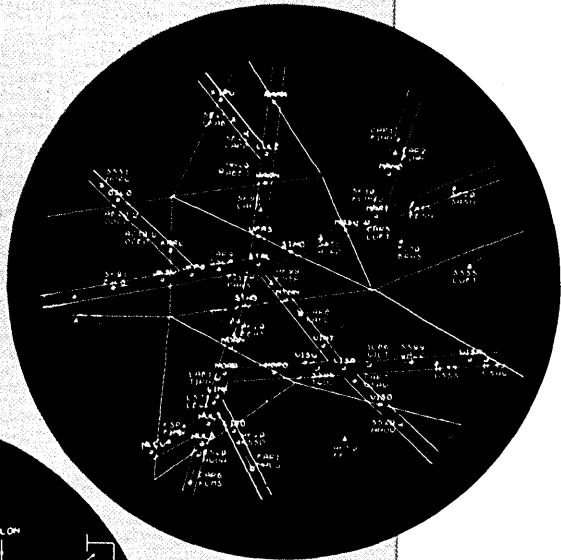

un software  
développé  
une équipe  
expérimentée  
un groupe  
puissant

garantissent  
le succès  
de vos  
applications

advanced  
software

experienced  
team

powerful  
industrial group

ensure  
successful  
applications

COMPAGNIE  
INDUSTRIELLE DES  
TÉLÉCOMMUNICATIONS  
CIT-ALCATEL

DIVISION DES  
APPLICATIONS  
ÉLECTRONIQUES

Centre de Villarceaux-Nozay  
91310 Monthéry (France)  
Tél. (1) 920.88-90  
Télex 26 860



GRUPE CGE

# How 89 Different Banks, with 7,200 Branches, Carry on Exchange.

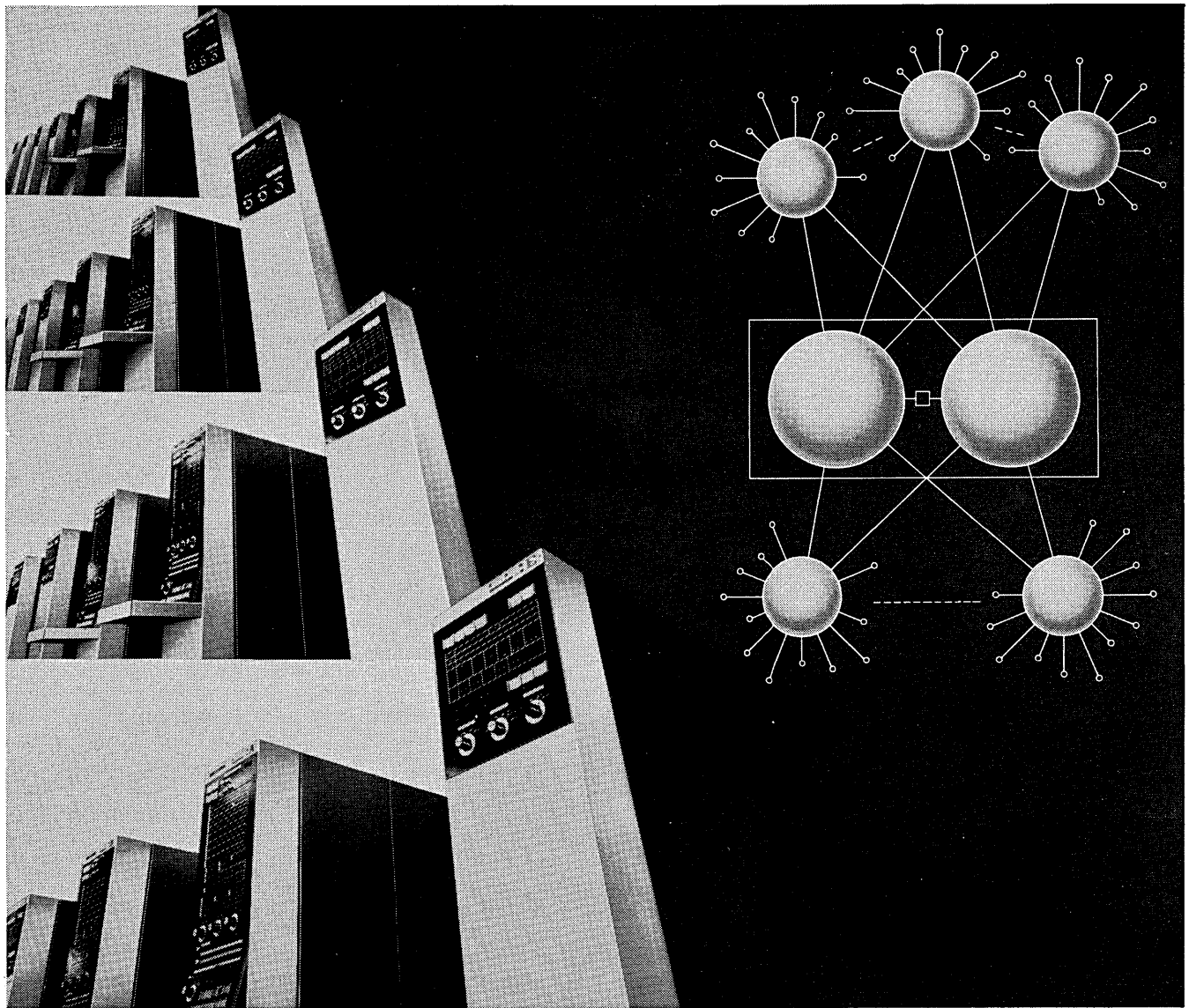

Most people don't know it, but April 9, 1973 marks a very important day in the history of banking. On that day, in Japan, the first truly nationwide, inter-bank computer "message switching system" went into operation.

**FACOM** To help "rationalize" the handling of exchange transaction between 89 different banks and their 7,200 branches, FACOM computer played a major role

in the creation of this gigantic data communication system for banking.

At the heart of the system are six Central Processing Units. By means of a "divided installation" system and a load sharing system, these processing units are connected with two or more terminals installed in individual banks by way of special computers.

This is just one contribution our FACOM computers, with more than dozen models ranging from large to small, have made to banking. If the task involves highly sophisticated data processing techniques in every field from business calculation to scientific computation, then you can rely on FACOM from Fujitsu — a pioneer and developer in electronics and communications the world over.

**FUJITSU LIMITED**  
*Communications and Electronics*  
Marunouchi, Tokyo, Japan

**MAIN PRODUCTS** □ Telephone Exchange Equipment □ Carrier Transmission Equipment □ Radio Communication Equipment □ Space Electronics Systems □ Electronic Computers & Peripheral Equipment (FACOM) □ Telegraph & Data Communication Equipment □ Remote Control & Telemetering Equipment □ Electronic Components

# The Prime Computer

**A totally new way to buy, use and upgrade computer systems.**

The Plan introduces the first two-year guaranteed trade-in schedule. This program fully protects your computer investment when it's time to expand. Grow as much and as fast as you wish. The Plan will back you up all the way.

The Plan protects your budget by eliminating arbitrary system packaging. You only buy what you need. With 3 discount schedules, you need pay as little as possible.

The Plan also protects your software investment. Only Prime offers upward *and* downward system compatibility. Without modification.

The Plan offers a whole new maintenance procedure, too. Built-in integrity checks can isolate a fault to a circuit board and maintenance is as simple as replacing the board.

There's even a program called Air Spare. It's fast delivery of a backup board and low-cost repair of the defective one.

Everything we offer at Prime, hardware, software and support, works together as a logical system, be it large or small. You can put together a powerful, reliable, easy-to-use computer system at a better total system price than ever before possible. The Plan shows you how.

Read on.

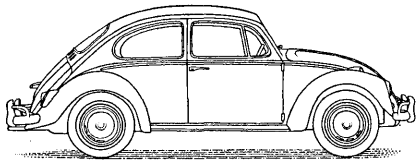

**Plan on a guaranteed trade-in**

You can start your system with any Prime Computer. If, for any reason it isn't the best one to handle expanding applications, trade it in. Trade all of it or



parts of it. Trade whatever is standing between you and better performance.

For instance, to upgrade from a Prime 200 to a 300 processor, simply trade in the original processor board. You can then plug in a fully equipped\* Prime 300 for \$5000 (less a 50% trade-in credit for certain optional features on the

original processor).

You can also elect to keep the original processor as a spare. The cost is only \$1000. Keep your original power supply, memory and chassis, too. Or selectively upgrade any of them under similar trade-in arrangements.

Of course, all the software written on the original system

\*Standard features include: virtual memory, restricted execution mode, memory protection, byte parity, extended direct addressing, integer multiply/divide, direct memory access system, automatic program loaders and microverification.



# User Plan.

will run on the new one without modification. Only Prime makes this possible. Only the Prime Plan guarantees it.

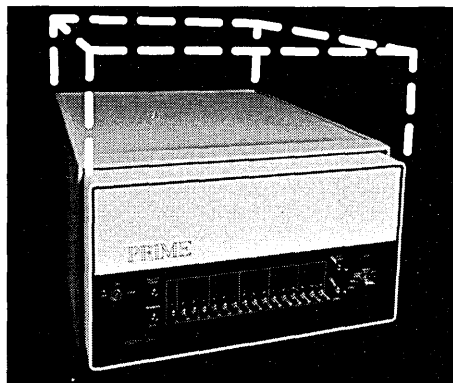

## Plan on unheard of compatibility

*On any Prime processor, you can write real-time and time independent programs in any language, under the control of any development system with its associated support packages. What's more, you can execute them on any Prime processor under the control of any operating system without modification (time, peripheral and memory size dependency aside).*

Choose Any Processor*	Choose Any Development System	Choose From Support Packages
100 200 300	DOS DOS (VM) (Virtual Memory) Stand-Alone	File System Library Utilities IOCS
Choose Any Language	Choose Any Operating System*	
Macro Assembler FORTRAN BASIC	DOS DOS (VM) RTOS RTOS (VM) Stand-Alone	

\*Software utilizing unique Prime 300 hardware features may require modification to execute on the Prime 100 or 200. Software dependent on unique RTOS features does not run under control of DOS or DOS (VM).

## Plan it right, right off

The right combination of computer resources are all here and they're yours to select.

Pick a processor. Enhance it with options if you wish. Select memory size and speed. Add peripherals and controller.

		PROCESSOR					
		100		200		300	
Memory	First Increment	4K	8K	4K	8K	8K	8K
	Cycle Time	1 $\mu$ sec	1 $\mu$ sec	750 nsec	750 nsec	750 nsec	600 nsec
	Parity	no	no	yes	yes	yes	yes
Chassis	5 Slot	x	x	x	x	x	x
	10 Slot	x	x	x	x	x	x
	17 Slot	x	x	x	x	x	x
Features	Battery Backup		x		x		x
	Automatic Prog. Load		x		x		x
	Direct Mem. Access		x		x		x
	Integer MUL/DIV		x		x		x
	Extended Direct Addressing				x		x
	Microverification				x		x
	Single Precision Floating Point Arith.				x		x
	Double Precision Floating Point Arith.				x		x
	Writeable Control Store						x
	Virtual Memory						x

Then package the electronics in the right size chassis and you're done. We'll provide the right power supply to handle whatever you put together.

There are no arbitrary restrictions. No surprises, either. With the chart above you could start planning now.

## Plan on running full time

Prime service is every bit as sound as its technology. It's just as inventive, too. For instance, you can pick a full service contract or choose to use our services only when required. In either case we maintain a nationwide network of service and customer service representatives. They're ready to help.

We even have a way to hold maintenance costs to an absolute minimum. We call our idea Air Spare. For \$200 we'll loan you a spare (processor, memory or controller). We'll then repair the faulty unit while you keep on running. And better than running, the whole replacement is handled by air express.

Read more about it in the Plan.

## One more thing to plan on

The Prime Computer User Plan is a unique and remarkably logical document. You've just been treated to a sampling here. For the first time you'll know everything to expect in a computer system. Read the Plan. Send for it today.

To: Prime Computer Inc.  
23 Strathmore Rd.  
Natick, Ma. 01760

- Send the Plan  
 Send Planner  
(He'll call for an appointment.)

\_\_\_\_\_  
Name

\_\_\_\_\_  
Title

\_\_\_\_\_  
Company

\_\_\_\_\_  
Address

\_\_\_\_\_  
City State Zip

# PRIME

# Hardware

## Off-line

If there were a category in The Guinness Book of Records for the world's largest shift register, Intel Corp. would probably be in first place. The Mt. View, Calif., firm recently delivered a nine-channel, fully buffered 4.8 megabit store to an unnamed government agency to replace a large drum memory. The register is organized 480K words by 10 bits and has an adjustable clock rate range of 10 KHz to 3 MHz.

RCA and General Electric, two firms that don't get much mention anymore when discussing computers, continue to work on various computer technologies to better serve man. RCA has come up with a chemical compound capable of boosting the data transfer rates of bubble memories 100 fold. The compound, bismuth thulium garnet, is used in a design that features low-power light-emitting diodes to read the bubble memory.

At GE, two scientists whose hobby is skin diving have developed a computer no larger than a pocket compass that tells them where to make decompression stops while surfacing from deep dives. GE is negotiating licensing the technology to anyone interested in marketing the computer commercially. Incidentally, GE has recently sold its GEPAC line of process computers to Honeywell, a segment of its business held out of the original 1970 merger agreement, perhaps in hopes it would remain profitable. Thus, GE retains only the very successful worldwide time-sharing network as its contribution to commercial data processing.

One of the more powerful and better selling microprocessors has had its price substantially reduced, which can only be good news to applications designers looking for 16-bit computing capability. National Semiconductor's IMP-16C is down from \$1,380 to \$950 each, or \$480 each for an order of 200. The 16C has 256 words of dynamic memory and provision for 512 words of read-only memory (PROM or ROM) all contained on an 8½ x 11-inch pc board.

## Medium-scale Computer

The Univac 90/60 system looks so much like an IBM 370 model in appearance that it would probably take a pretty sharp dp director to spot the difference were it substituted for one on the operations room floor—which Sperry hopes will happen. The byte-oriented, disc-based system looks a lot like a 370 inside, too, and the pricing and performance of the first member in Univac's Series 90 make it clear that the 370 model 135 is the target of the 90/60—a natural enough attraction for users of the old RCA Series 70 equipment.

To attract IBM users, the 90/60 has been equipped with DOS emulation, and it's said that the pure hardware speed of the new system will emulate the 135 faster than it can run in its native mode. Just announced is the capability



for running the emulation under OS-7 as a slave job while converting programs from 360/370 source code into 90/60 language. About the only point where the software notably differs on the two machines is in communications. There, the method is totally Univac, but we're told that it will present no big surprises to DOS users. The OS-7 monitor is described as a hybrid of the features found in IBM's OS/MFT executives. Though disc-based, the system runs up to 14 levels of multiprogramming in variable memory regions, and includes automatic scheduling, spooling, and telecommunications support for up to 30 communication lines.

Memory on the system is semiconductor, starting with 128K bytes and expanding in 32, 64, and 128K byte increments up to a maximum of 512K. Storage is accessed in four-byte gulps in 350 nsec, with a storage cycle time of 600 nsec. There are 16 general-purpose registers, 16 more reserved for the system, four for floating-point arithmetic, and one for program relocation functions. An eight-position multiplexor channel rated at 175 KB is standard, as is one 1.1 Megabyte/second selector channel with seven device positions. A second selector channel is optional.

A typical system is thought to be one with 196K of memory, floating-point arithmetic capability, video operator console, two selector channels, a 1000-cpm reader, 1400-lpm printer, six 120KC tape drives, a 300-cpm punch, and 232 megabytes of disc storage on four spindles. This system rents for \$14,716/month on a five-year lease; \$17,742 on a one-year contract. Bumping the memory capacity to 256K adds only \$700 to the monthly rental and \$124 to the maintenance. There are no overtime charges on equipment, and the software is bundled. The 90/60 systems will go to the field next month. UNIVAC, Blue Bell, Pa.

FOR DATA CIRCLE 226 ON READER CARD

## Key-to-cassette Terminal

The A-100A Datacumulator appears to be one of the smartest, lowest-cost source data entry devices introduced in a long time. The compact unit can be used in a number of different ways, including as a verifying keypunch; as an intelligent terminal capable of performing such operations as check digit and range checking; or as a polled terminal at rates up to 1200 baud. The key to these various capabilities is the little Intel 8008 microprocessor, with 2-4K of memory, that is loaded up with programs from the cassette unit.

A full keyboard, supplied in either keypunch or typewriter style, is standard (a strictly numeric keyboard is also available), and above the keyboard is a 32-character 5x7 dot-matrix crt display that accesses a 96-character buffer. Interfaces are available for the Datapoint Corp. intelligent terminal products, Digital Equipment's PDP-8, and the Eldorado Electrodata minicomputer system. The base price of the unit is \$2,000, with a 4K microprocessor model priced at approximately \$3,300. Deliveries are underway. KEY-WRITE CORP., Seattle, Wash.

FOR DATA CIRCLE 227 ON READER CARD

## Datapoint Peripheral

Two peripherals that are high on the list of the industry's "most interesting peripherals" have been combined into a powerful subsystem for the Datapoint minicomputer/intelligent terminal. The model 975 contains two 130KB floppy discs, and the highly regarded Diablo printer which has the ability to print 30 cps faster than most other 30-cps printers by virtue of its ability to print both directions, decreasing slewing time to near zero. Attached to the Datapoint, the 975 will

(Continued on page 140)

# product spotlight

## Channel Extender

The company that recently participated in the design and implementation of Canada's all-digital data transmission network has a little Christmas present for 360 and 370 installations that already have a network or are thinking about constructing one. The Multitron M4000 attaches directly to the multiplexor channel of the host computer and controls each remote device—regardless of its location or distance away from the cpu—as if it were in the same room. Network designers are not limited to using IBM peripherals, either, since device instruction conversion tables are loaded into the M4000 that can make nearly any manufacturer's peripheral look like the IBM counterpart.

There are a number of advantages in designing a network using a device like the M4000. First, it obviates the use of telecommunications software, such as TCAM and its friends, for all but those types of applications that absolutely must have it. Second, any error along the network automatically invokes the channel error recovery procedures instead of additional software overhead. Third, it would seem that cpu use would be improved because slack couldn't build up between what the

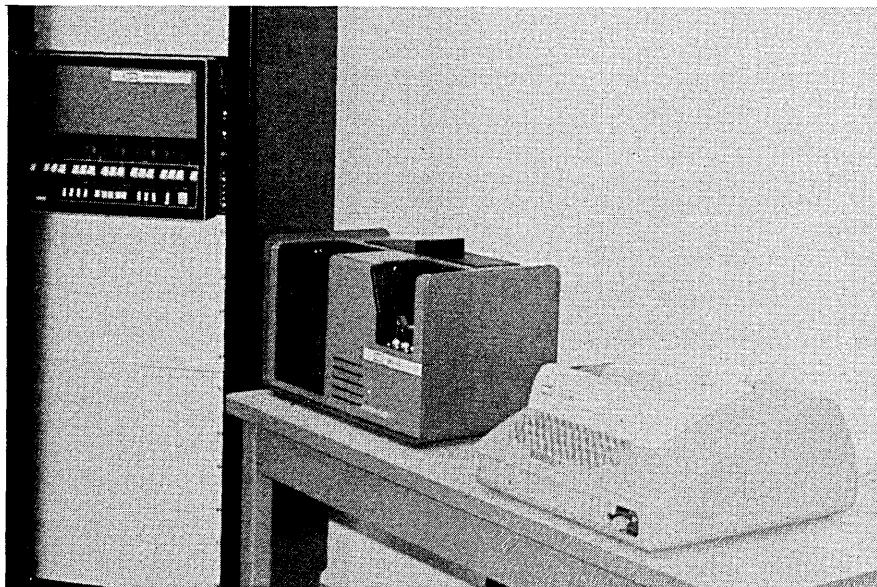

cpu was ready to accept or transmit, and what such devices as 3705's are willing to receive or send.

The concept isn't really a new one; Paradyne's PIX modem pioneered it for relatively slow speed devices about two years ago. But the M4000 can support data rates up to 134.4 kilobaud, and

can be subdivided into a number of half- or full duplex channels.

There are a number of configurations in which the M4000 can be used. One would be for controlling up to seven remote job entry locations. Almost any kind of device can be appended to the RJE location—plotters, paper and/or magnetic tape gear, and even factory data collection systems, which the host cpu thinks is a local reader/punch or a line printer. A second application would be for using the M4000 for support of a number of polled crt clusters in a multiprocessing environment. Here, a user at some distant 3271 terminal location can automatically access cics on one system and IMS on another. If site centralization is planned, the M4000 could permit you to move a 360/30 back to the main computer center. The peripherals would remain at the remote location attached to the M4000. The devices could alternately communicate with either the 360/30 or the 370 during the switch.

The hardware consists of the 4010 channel extension unit, and the 4050 remote device interface unit, priced at \$30,500 and \$22,500, respectively. To each of these is added an ASR 33 tty console which can be used in a number of ways, including for voice coordination of activities through an acoustic coupler interface, or as a remote 360 or 370 console so that remote personnel will know what is happening at

central site. Depending on specific interfaces desired, typical configuration prices will be under \$100K, and can also be leased. M4000 systems are available for 90 day delivery. COMPUTER TRANSMISSION CORP., El Segundo, Calif.

FOR DATA CIRCLE 225 ON READER CARD

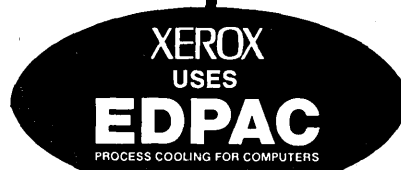
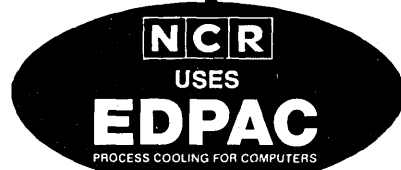
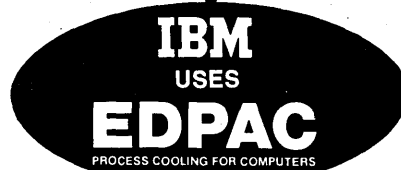
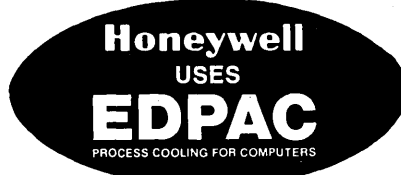
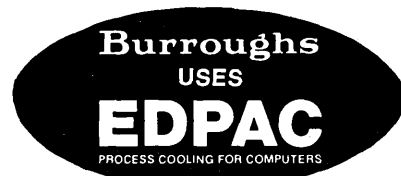

These leading manufacturers all use EDPAC<sup>®</sup> PROCESS COOLING SYSTEMS for their own computer facilities. Don't you think you ought to find out why? Fill out the coupon for our new guidebook, "Process Cooling for the Data Center Environment." It's FREE.

**AC MANUFACTURING COMPANY**  
 Old Cuthbert & Deer Roads  
 Cherry Hill, New Jersey 08034 (609) 428-9800

NAME \_\_\_\_\_ TITLE \_\_\_\_\_

COMPANY \_\_\_\_\_

ADDRESS \_\_\_\_\_

CITY/STATE \_\_\_\_\_ ZIP \_\_\_\_\_

TELEPHONE \_\_\_\_\_ EXT. \_\_\_\_\_

We are planning a new/expansion, of our computer facilities.

Send me copy of your new guidebook.

CIRCLE 90 ON READER CARD

# Our microelectronic business has grown in two directions.

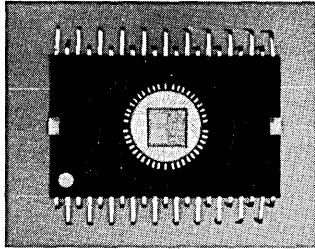

## So now we have two divisions:

### Microelectronic Device Division

If you need help in designing or building microelectronic circuits for your product, read here. We've formed a separate division with separate engineering staff to serve you.

Our product line now includes a family of powerful one-chip calculator and slide rule circuits, a multi-circuit four-bit microprocessor system with software for microprogramming by equipment manufacturers and telephone frequency tone generation circuits—all at more-functions-per-dollar prices.

Future developments: an 8-bit microprocessor; SOS-LSI logic and memory circuits with bipolar speeds at MOS prices; magnetic bubble domain devices for mass data storage; CCD devices for batch storage, scratchpad memories and video systems.

Want to hear more? Write C. V. Kovac, Vice President and General Manager, Microelectronic Device Division, P.O. Box 3669, Anaheim, California 92803.

### Microelectronic Product Division

Interested in "private label" or custom calculators, or other microelectronic products?

Read here. We've formed a separate division with its own engineering and manufacturing departments to design and produce a broadening line of microelectronic products and subassemblies.

Right now, our biggest market is in calculators for mass merchandisers—hand held, desk top, display, and printing machines . . . all low cost.

Other new products? Microelectronic wrist watches with digital liquid crystal displays. Digital anti-skid systems for hydraulic brakes of automobiles. Subsystems for business and telecommunications terminals, including: our MOS/LSI 4800 b/s modem, the only one working in field equipment to our knowledge, and our embossed credit card reader for P-O-S systems.

Want to hear more? Write H. L. Edge, Vice President and General Manager, Microelectronic Product Division, 3430 Miraloma Avenue, Anaheim, California 92803.



**Rockwell International**

...where science gets down to business

# Venus and Mercury Calling...

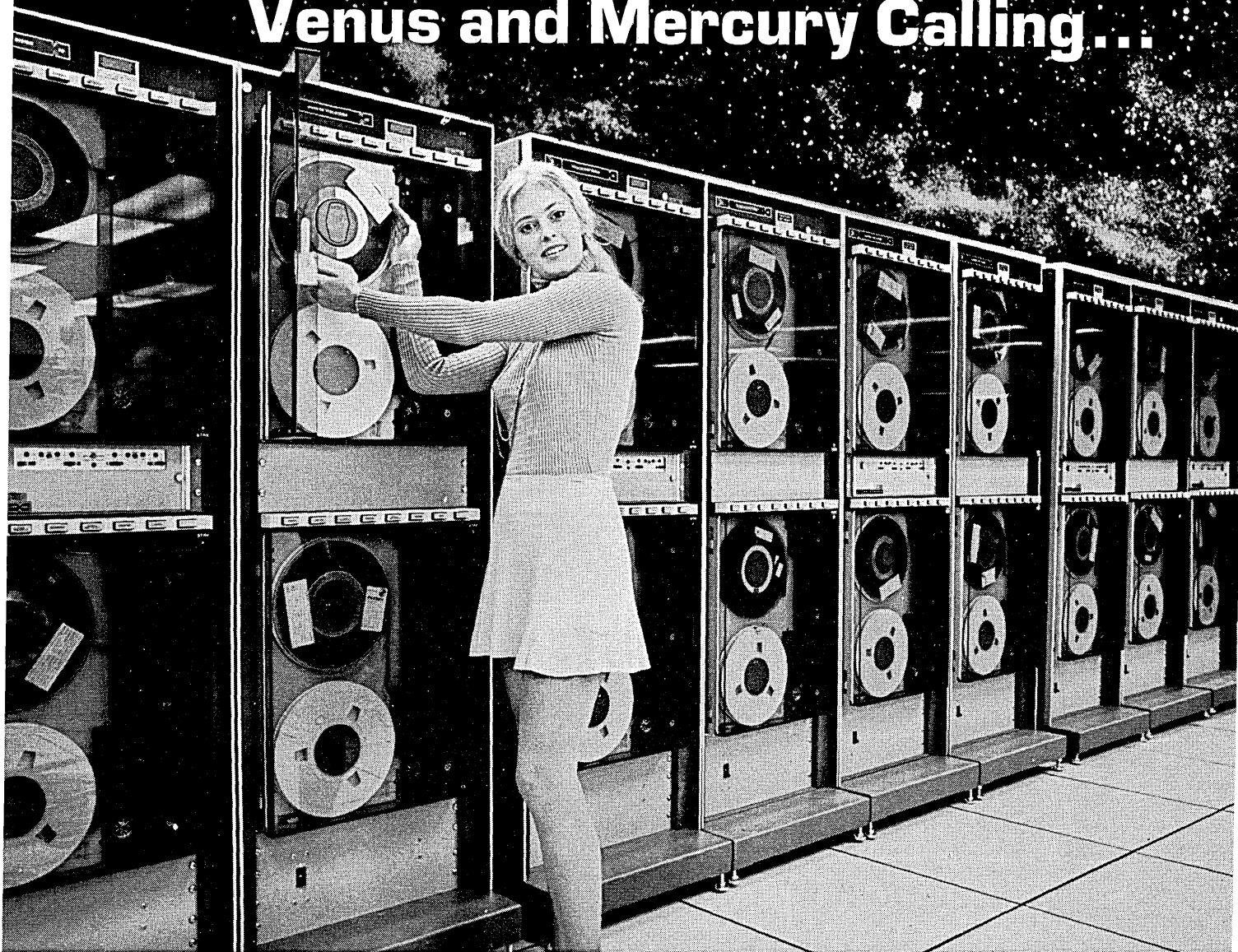

...and **WANGCO** Tape drives  
get the message...every bit!

When NASA's Mariner 10 flies past Venus and Mercury early next year, telemetry and video signals will be recorded at Jet Propulsion Laboratory on 48 WANGCO Mod 1100 Tape Drives. The reliability of these standard production line WANGCO tape systems gives JPL assurance that they will get these vital messages from deep space. When the data arrives from Mariner 10, it will be recorded in 7 and 9 track modes, and used to generate master data records . . . more than 8000 tapes in all.

The Mod 1100 protects these irreplaceable tapes with the gentle handling provided by vacuum column buffers, at a tape speed of 75 ips. Mod 1100's are available with transfer rates as high as 120,000 bytes-per-second, with data densities of 800 cpi NRZI, and 1600 cpi phase encoded, individually or in switch-selectable dual-density combination.

Low cost, reliability, maintainability and operator convenience . . . that's *our* message. For more information call the WANGCO office nearest you, or write for our latest literature package. WANGCO Incorporated, 5404 Jandy Place, Los Angeles, Calif. 90066. (213) 390-8081.

# WANGCO

SETTING THE PACE IN PERIPHERALS

New York, N.Y. 519/294-0893 • Boston, Mass. 617/444-9264 • Washington, D.C. 801/937-2215  
Huntsville, Ala. 205/881-7836 • Chicago, Ill. 312/336-1555 • Houston, Tex. 713/785-0581  
Dallas, Tex. 214/620-1551 • Denver, Colo. 303/355-3521 • Phoenix, Ariz. 602/956-5300 • San  
Francisco, Calif. 408/732-6210 • Seattle, Wash. 206/632-0710

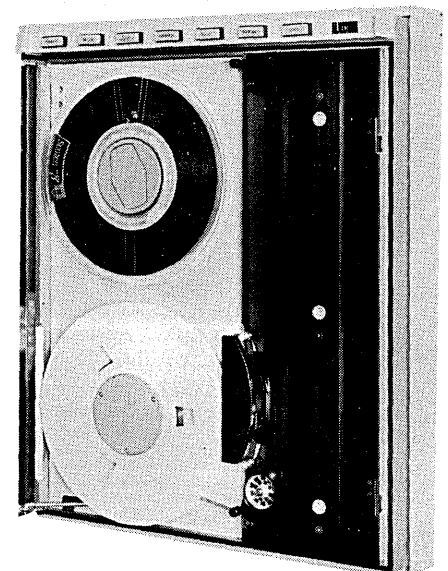

# hardware

typically be commanded to print out crt screen images, of which the two floppy discs can hold 120. Track-to-track access time on the removable media floppies is 6 msec, with a data transfer rate of 3,076 cps.

The 975 hardware sells for \$8,950 and is available for 60-day delivery. The builders can also furnish a comprehensive library of application software packages for the Datapoint with imbedded 975 peripheral commands.

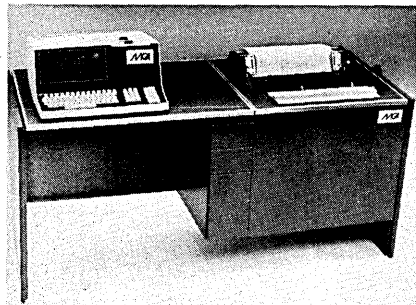

The packages include a combination order entry/invoicing/accounts receivable/inventory package; a separate inventory package; a medical package using RVS codes; a law office package; a property management and escrow package; and a payroll, general ledger,

and generalized sort program. The software is separately priced and runs from \$700 to \$5,000. The 975 peripheral can also be supplied with the Datapoint minicomputer for the same price it would cost at the factory, claims the systems house. MGA COMPUTER CORP., Beverly Hills, Calif.

FOR DATA CIRCLE 228 ON READER CARD

## Minicomputers

Varian has introduced two minicomputers that fit on either side of its V-73 system in terms of price and performance. The V-72 and V-74 are basically packaged systems; a number of features that are usually options are included, with a price break given the customer as a result.

The V-72 is expandable from 8-32K of 660-nsec core and features a bootstrap loader, multiply/divide, real-time clock, memory protect, and power fail/restart. Optional features include separate cabinet memory expansion and mapping for up to 256K 16-bit words, priority memory access, parity check, and a writable control store. An 8K version is priced at \$10,500; 16K is \$14,000.

Varian has a tradition of offering faster memory speeds than most of its competitors; its 620/f was one of the first minis to crack the 1 usec barrier.

The V-74 carries on this pattern by offering a choice of either 660-nsec core and/or 330-nsec MOS semiconductor storage. The memory mapping for up to 256K 16-bit words, dual-port memory access, priority memory access, and a writable control store are standard features on the V-74; memory parity checking is optional. This system is a direct competitor for Digital Equipment's PDP-11/45 and /50 models, but seems to have advantages—such as the ability to load FORTRAN-supporting firmware into the 512 x 64-bit writable control store. Prices for 32K systems start at \$40K. VARIAN DATA MACHINES, Irvine, Calif.

FOR DATA CIRCLE 232 ON READER CARD

## 370/145 Add-on Memory

If you are one of the 370/145 users who has implemented new applications made possible by IBM's virtual memory announcement and have come to find that you need more real memory to support them than you originally figured on, then perhaps the 745 MOS semiconductor memory for 145 models 1 and 2 is what you need. The memory is priced at an even \$100K per each 256K byte increment, or \$2,700/month on a full-payout lease. The 745 features storage protection, useful to users involved in shared data

## “Ask not what you can do for your Modem, but what your Modem can do for you!”

We believe a MODEM should set in a corner and quietly do its job 24 hours a day, day in and day out. Not only should you be able to forget it, but it should pay for itself and then make money for you. Here are a few of our “forgettable” Modems.

(From the Inaugural Address of  
ASTROCOM CORPORATION, 1968)

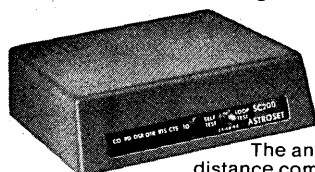

**Astroset  
SC200  
Series**

The answer to short distance communications between computer and sophisticated business machines. 1800 to 9600 bps. Switch selectable options.

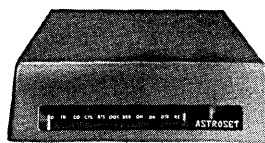

**Astrosets  
120 & 130  
Series**

Extremely reliable asynchronous Modems. 120 is compatible with W.E. 202 data sets to 1800 bps. 130 is compatible with W.E. 101 & 103 data sets to 300 bps.

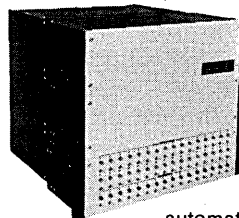

**Astroset  
800  
Series**

High-speed automatic computer port allocation unit, automatically connects up to 128 incoming calls with up to 64 computer ports. Incoming calls automatically queued until computer port available.

**Astroset  
300 Series**

Synchronous Modems for use with DDD network and leased lines. The 320 and 324 Astrosets are compatible with W.E. 201A and 201B data sets, respectively.

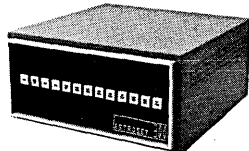

**Astroset  
400 Series**

Synchronous Modem designed to operate over twisted pair lines and interface-compatible with Bell 301/303 Data Sets. 10K to 100K bps. available.

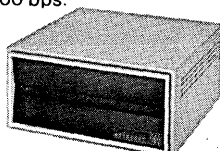

**ASTROCOM  
CORPORATION**

15012 Minnetonka Industrial Road  
Minnetonka, Minnesota 55343  
Phone (612) 933-2208

Our “forgettable” Modems have up to 35,000 hr. MTBF, IC failure rate—40 million actual hours. If you have to “remember” an Astroset for any reason, we have a *four-hour* maintenance service in over 50 cities. Call Tom Frahm collect for info on how Astrocom can save your dollars.

CIRCLE 91 ON READER CARD

# hardware

base applications; a diagnostic isolation capability that enables customer engineers to locate faults and identify individual array cards without requiring the use of the cpu; and an error correc-

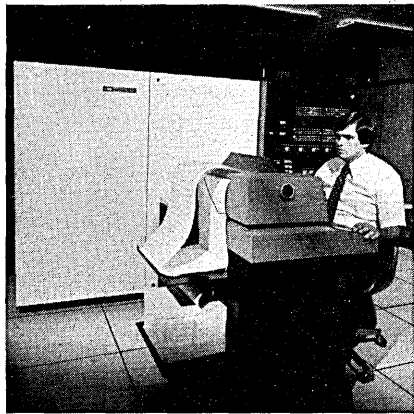

tion/detection capability that can correct any single-bit errors and detect very unusual double-bit errors. The first 745 has gone to the field with subsequent units scheduled for 90-day ARO delivery. MEMORY TECHNOLOGY INC., Sudbury, Mass.

FOR DATA CIRCLE 233 ON READER CARD

## COM Recorders

A new magnetic tube that produces higher-quality images at intensity levels up to 12 times brighter than this manufacturer's previous products is the heart of its latest series of COM products, the 4500. Also featured is a camera and lens combination that precisely focuses images reduced 24, 42, or 48 times with equal facility. The recorders display data pages with up to 160 characters per line and up to 80 lines per page, and will record images in horizontal or vertical sequence on 105mm microfiche and in cine or comic mode on 16mm film. Processing 64-line-by-132-character page sizes, the 4500 series is basically rated at 14,000 lpm, with an option available for boosting this performance by 50%. The 4500 models all use the OCR B font.

There are three models. The model 120 is for on-line use with 360 and 370 computers and is priced at \$90K. The model 110 comprises a 9-track tape drive for processing 556, 800, and 1,600 bpi density tapes off-line, and is priced in the region of \$110K. The top model in the new series is the 150, capable of complete data formatting and microfiche management from print tapes produced by almost any computer, thanks to a 16K minicomputer tucked in its innards. This model goes for \$125K. First models go to the field this month. STROMBERG DATA-GRAPHIX INC., San Diego, Calif.

FOR DATA CIRCLE 234 ON READER CARD

## Calculator

Here is a good idea: the series 4000 calculator line uses compact magnetic cards for loading programs into it and for storing the completed programs for future use. The new fall line features 14-digit operation and a high-speed matrix printer that prints up to five lines (110 characters) per second for hard copy requirements. The program library consists of hundreds of routines in the fields of general finance, banking, statistics, mathematics, numerical analysis, mechanical engineering and machine design, structural engineering, and civil engineering.

The basic model, the 4500, sells for \$995 and does not have the card reader. The 4600 adds the reader, 128 programming steps, and six user registers

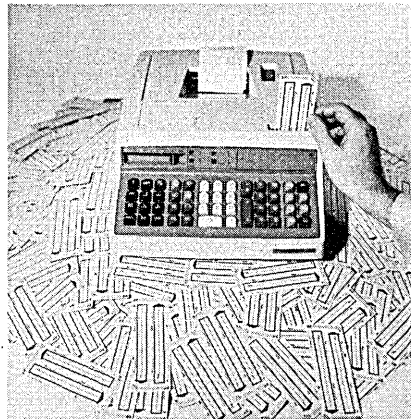

and is \$1,295. The 4700 has 512 program step capacity and 54 registers for \$1,595, and the top-of-the-line 4800 comes equipped with 102 registers and 1,000 programmable step capability for \$1,995. VICTOR COMPTOMETER CORP., Chicago, Ill.

FOR DATA CIRCLE 231 ON READER CARD

## New Minicomputer Packages

Digital Equipment has come up with packaging refinements for some of its more popular products, including the PDP-11/05, PDP-11/40, and even the venerable 12-bit PDP-8.

The PDP-11/05E is now available in a 10½-inch rack-mountable chassis that can accommodate from 8-28K words of memory. Using the same central processor as before, the expanded version contains a serial line interface, a programmer's console, a line frequency clock, a power fail/restart capability, prewired connector slots for extra memory, a communication interface, and a more powerful power supply unit for supporting additional peripherals. It's priced at \$6,495.

The PDP-11/35 is a special version of the PDP-11/40 which differs from the 40 in that it incorporates Digital's new high-density memory which allows expansion from 8-128K. Two rack sizes are available: a 10½-inch high rack that holds up to 32K of

Want  
to take  
the  
crisis  
out of your  
payroll  
deadline  
???

Finally, there's a way to eliminate slow and costly keying in this critical area. We've developed a unique new system for time sheet record keeping that speeds your time sheet processing.

The new low-cost OpScan 17 source document reader is the key to the system. Let us show you how.

Another computer input problem solved the OpScan way.

**Optical Scanning Corporation**  
Newtown, Pa. 18940  
(215) 968-4611

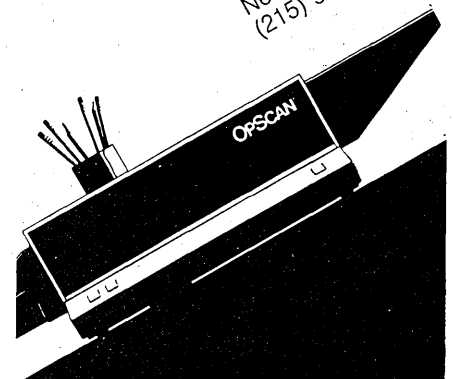

CIRCLE 85 ON READER CARD

# Why sell only software when you could be selling a complete turnkey system?

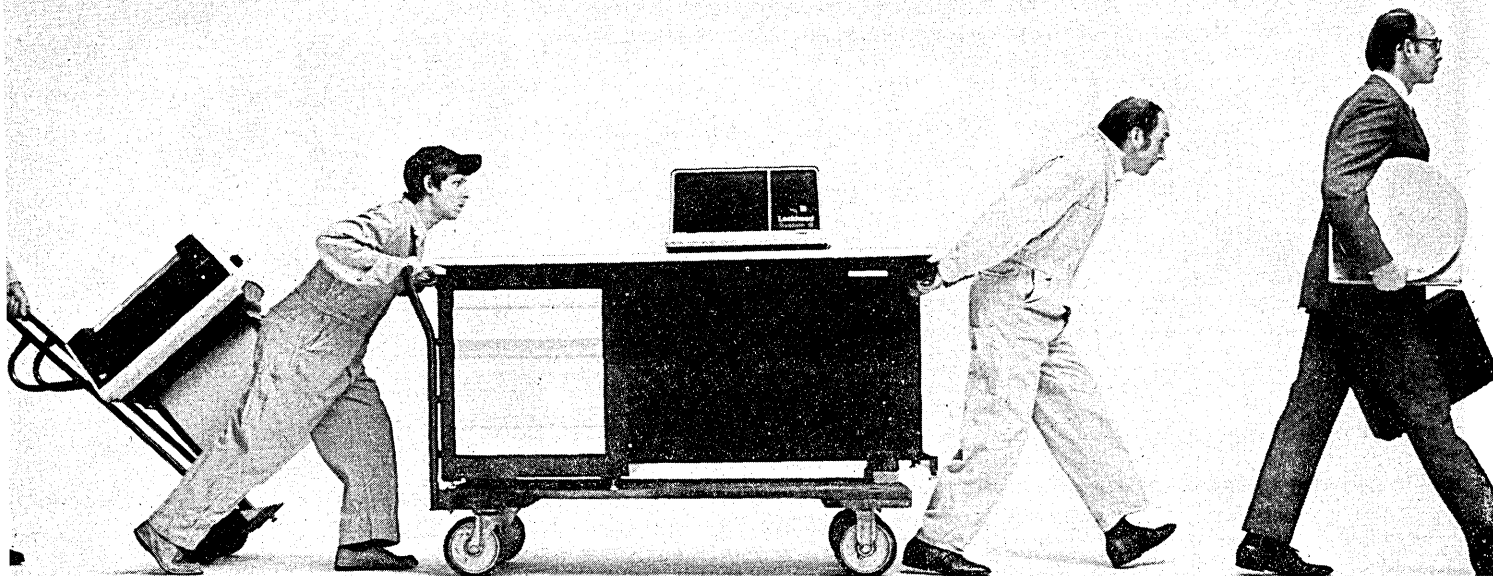

## The Lockheed System III

If that question intrigues you, maybe it's because you've already begun to think about expanding your business beyond software. If it doesn't, maybe you should. In either case, Lockheed has the answer to how you might go about doing it. It's called the Lockheed System III.

Why the Lockheed System III? Because it offers you a unique opportunity to supply the total needs of your customers by combining your own application software with an inexpensive, flexible, minicomputer system. A computer built by Lockheed Electronics and backed by dependable, nationwide service.

How unique? Let System III speak for itself:

It has an RPG II compiler in operation with proven reliability. Others make this claim, we deliver.

You can use existing RPG II source level programs and tie in easily with new technology peripherals.

In addition to the RPG II compiler, we offer

DOS, sort/merge, assembler and utilities.

The basic configuration includes 16K bytes of memory, CRT/keyboard, 100 CPS printer and 5 million byte disk. Furthermore, System III is easily expandable without a lot of hidden cost.



And what's probably most important to you and your customers: the cost of a typical System III can be substantially less than the cost of competing systems.

One more thing.

Lockheed delivers in a hurry. So you don't have to miss a sale just because somebody missed a delivery date.

If selling turnkey systems makes good business sense to you, call us now (213) 722-6810 collect. Or write 6201 East Randolph Street, Los Angeles, California 90040.

## Lockheed Electronics

Data Products Division

Boston 861-1880 • New York metro (215) 542-7740 • Philadelphia 542-7740 • Washington (703) 525-3600 • Atlanta 266-0730  
Detroit 557-5037 • Chicago 833-4600 • Dallas 231-6163 • Houston 682-2617 • San Francisco (408) 257-3357

CIRCLE 46 ON READER CARD



# hardware

memory, and a 21-inch box that can accommodate all 128K. Prices start at \$9,495 for an 8K model, and \$20,495 for 32K.

The PDP-8M can be equipped with a combination of programmable read-only memory (PROM) and dynamic memory. It is available with either 1 or 2K of memory, with the 1K model having 256 12-bit RAM words. The 8M, which is compatible with Digital's other OMNIBUS offerings, retains the same architectural layout as the original PDP-8. It's priced at \$1,760 for the 1K model and \$2,240 for the 2K version in quantities of 100. Deliveries have begun. DIGITAL EQUIPMENT CORP., Maynard, Mass.

FOR DATA CIRCLE 237 ON READER CARD

## Optical Mark Reader

The W2300 is a standalone, high capacity optical mark reading system basically consisting of an optical sheet scanner and its associated computer, control console, and tape drive. Optional equipment such as a card scanner, video display console, printer, additional tape drives, disc storage, and expanded mainframe memory can be added to this. The W2300 operates at 18,000 documents/hour, equivalent to 36,000 pages per hour since the system is capable of reading both sides of 8½ x 11-inch input documents.

The scanner detects four levels or intensities of pencil marks—high, medium, low, or none—giving it the ability to distinguish between smudges, er-

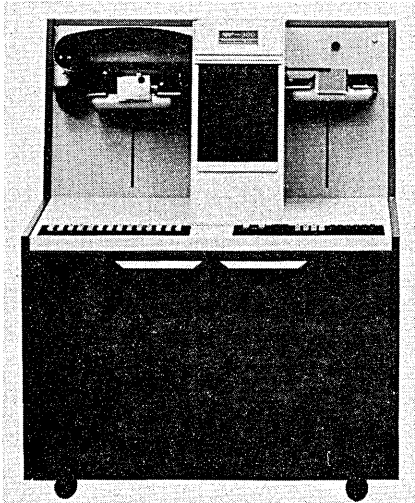

asures, and intended marks. A 16-bit Hewlett-Packard minicomputer is the system controller and can be expanded from 8-32K. Inside, it runs the SCROL software package, said to be easy for non-programmers to use. A typical system as described above rents for approximately \$2,900/month on a one-year lease, including nationwide main-

tenance. It currently takes six months to get a system. WESTINGHOUSE LEARNING CORP., Iowa City, Iowa.

FOR DATA CIRCLE 239 ON READER CARD

## Data Entry Terminal

The model 10-9 is a 10-digit numeric data input device that would seem to have a number of natural applications in the fields of inventory control, banking, credit verification, and point-of-sale. The terminal has a 48-character

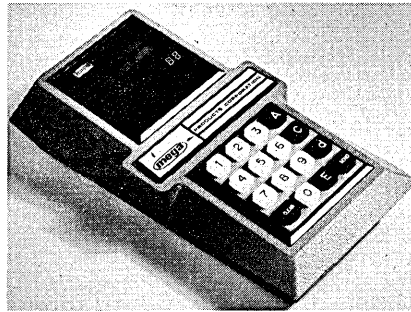

buffer for holding numerals and a limited number of special characters. Up to nine legends are illuminated by host computer programs, and up to four of the "TILT" panels can be lighted simultaneously. The transmission speeds offered are 150, 300, 600, and 1200 baud. The product is really oriented toward the oem market, but several custom interfaces have been developed for it, including one for the Burroughs 5000, IBM 360, and Univac 1100 series. In quantities of 100-500, prices for the 10-9 drop to less than \$300 each. MEGA PRODUCTS CORP., Berwyn, Pa.

FOR DATA CIRCLE 235 ON READER CARD

## Graphics Terminal

The GT-44 graphics system fits between table-top terminals and large-scale systems, both in price and capabilities. It was developed when it was found that many buyers of Digital's GT-40 graphics terminal were adding supporting peripherals to enhance its capability. The 44 comprises a 16K PDP-11/40 minicomputer, a special-purpose processor, a 17-inch crt monitor and light pen, two disc packs (total of 5 million 16-bit words of capacity), and the DEC-writer terminal. Software consists of BASIC-GT, a graphics variant of the BASIC language that runs under RT-11, a real-time, single-user operating system.

The hardwired display processor is the most interesting part of the package. Once initiated by user software, it uses its own instruction set and path to main memory to process images as short or long vectors, absolute points, etc. A vector generator capable of corner-to-corner draws in 250 usec, with 10-bit (1K x 1K) resolution, is included. The GT-44 is priced at \$34,500

What  
does  
it cost  
to  
process  
an  
order  
???

Plenty! But now there's a way to cut those costs sharply. We've developed a unique new system for order processing that eliminates keying and streamlines the whole operation. The new low-cost OpScan 17 source document reader is the key to the system. Let us show you how. Another computer input problem solved the OpScan way.

**Optical Scanning Corporation**  
Newtown, Pa. 18940  
(215) 968-4611

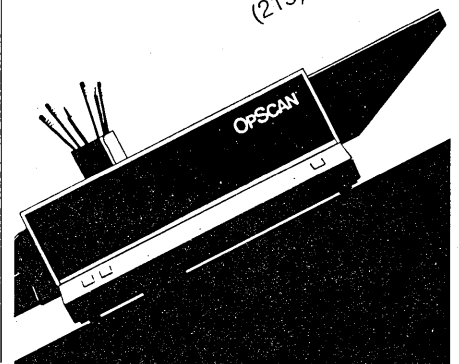

CIRCLE 86 ON READER CARD

# If Singer's family of Modems doesn't have what you need, it's probably not available at all.

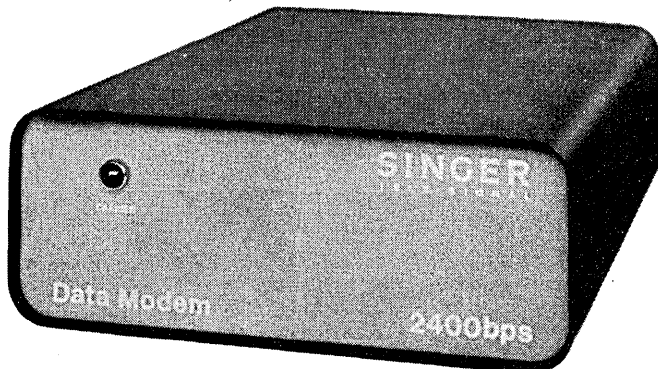

Singer TELE-SIGNAL now offers a line of modems broad and varied enough to ensure you'll find the perfect one no matter what your requirements. Also, every model features the utmost in reliability — MTBF's of 16,000 hrs. are common.

Look at the many ways we can ease your modem miseries:

**Speeds.** From 75 BPS in steps to 2400 BPS. And we're working now on even higher speeds (4800/9600 BPS).

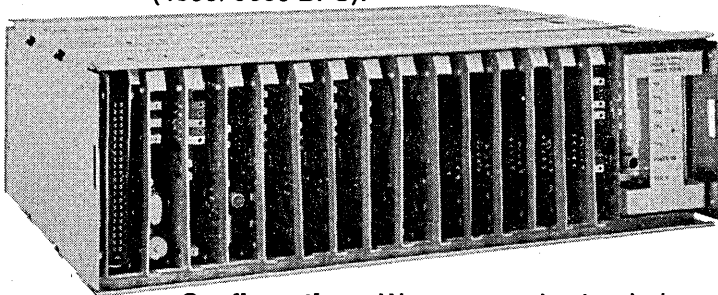

**Configurations.** We can supply stand-alone, card, rack or shelf models, in any of the speeds listed above.

**Options and Features.** Our modems can be either dedicated, dial-up or auto-answer type.

**Modem Tester.** Part of our reliability story is of course the way we build our modems. But

the Singer Model TE950 Communication Error Rate Analyzer contributes a lot too. It's a big help in trouble-shooting and maintenance—with rates from 75 to 9600 baud, and bit or block error rates.

The reliability of our products has been proven by thousands of units in service at places like American Airlines, RCA Global, Pan Am, American Express, and U.S. military services.

And modems are just one aspect of the broad tele-communications capabilities of Singer

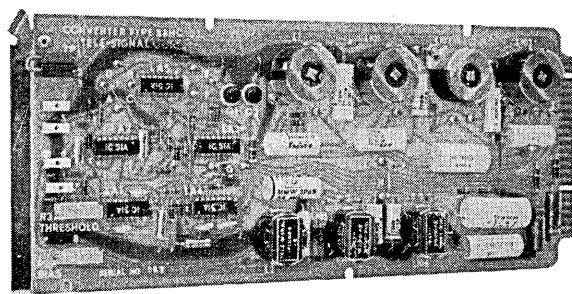
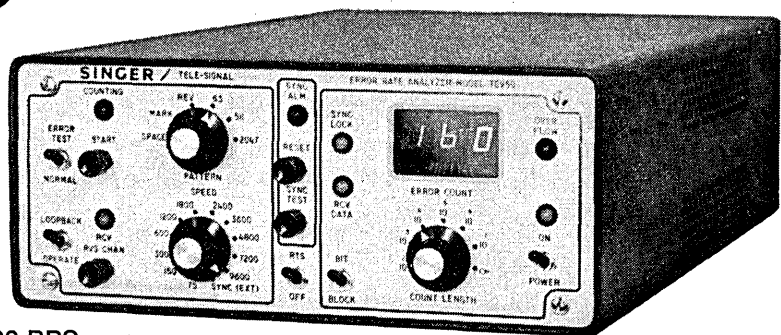

TELE-SIGNAL. We have the works, from individual components to highly complex computer-based systems. All backed by our reputation for reliability and service.

For further information, write: The Singer Company, Kearfott Division, TELE-SIGNAL Operation, 250 Crossways Park Drive, Woodbury, N.Y. 11797. Or phone: (516) 921-9400.

## SINGER

AEROSPACE & MARINE SYSTEMS

Computer users:

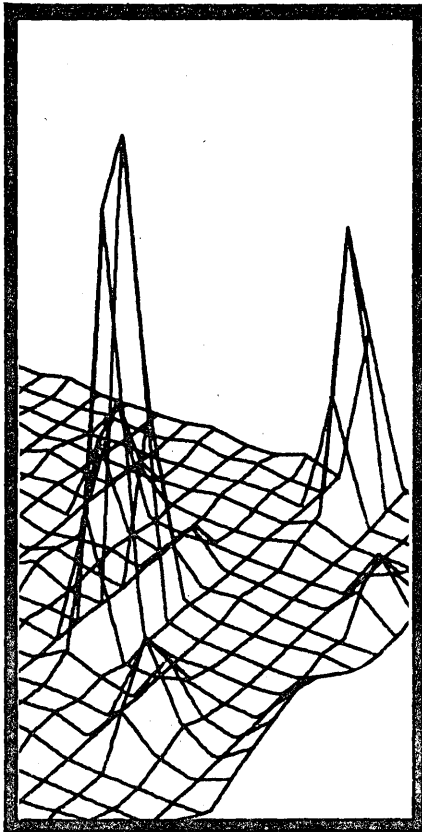

**Is your computer boring you with numbers? Teach it to draw pictures instead.**

Why not get your facts in easy-to-read pictures—charts, graphs, plots that anybody can understand.

TSP Plotting Systems are the fastest on the market—a minimum of 3 times faster than anyone else. At \$3300, we're the lowest available. We've got both On Line, from 10 to 30 CPS, and Off Line Systems. And because we were the first in the field, we've got a long history of trouble-free installations.

Sound too good to be true? We can prove every word of it right in your office, lab or plant. Just call or write today for a demonstration.

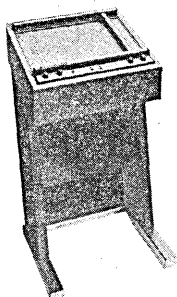

*Spend a little time with us—you'll spend a lot less time with your computer.*

**T S P** CORP.

TIME SHARE PERIPHERALS CORPORATION  
Route 6, Bethel, CT 06801 (203) 743-7624

CIRCLE 72 ON READER CARD  
December, 1973

hardware



as described; initial units have been delivered. DIGITAL EQUIPMENT CORP., Maynard, Mass.

FOR DATA CIRCLE 236 ON READER CARD

### School District System

The W2000 is a minicomputer-based system that is oriented toward school districts, educational cooperatives, and small colleges by virtue of its hardware and software complement. The mini is a Hewlett-Packard 2100, expandable from 4-32K of 980-nsec memory—enough to support a 32-terminal BASIC time-sharing network. Peripherals include a choice of line printer speeds ranging from 300-1,200 lpm, tape drives, tty console, drum and disc stores, card reader, and optical mark reader.

The administrative software packages would seem to include just about every commonly required program, ranging from payroll/personnel to inventory programs, a bus scheduling job, and even teacher retirement programs. Instructional software includes computer-assisted instruction (CAI) programs, problem-solving, gaming and simulation, and others. System software includes FORTRAN, COBOL,

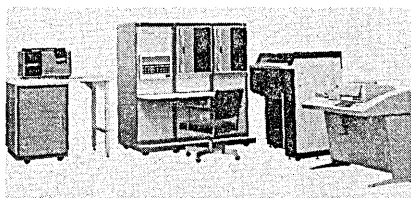

PL/1, ALGOL, extended BASIC, and BASIC language processors; an operating system; a generalized report package; and various statistical packages. An 8K system, 700-lpm 132-position printer, 400-cpm reader, and choice of crt or ASR 33 console rents for approximately \$2K/month on a one-year lease, including maintenance. Deliveries may take as long as six months. WESTINGHOUSE LEARNING CORP., Iowa City, Iowa.

FOR DATA CIRCLE 230 ON READER CARD

(Continued on page 148)

**Have you ever tried to key-punch**

**a sales call report ???**

Deciphering those scribbles and scrawls is a headache for your keypunch operators. And that costs money! We've developed a unique new system for sales reporting and control that eliminates keying and makes your total sales effort more efficient and productive. The new low-cost OpScan 17 source document reader is the key to the system. Let us show you how. Another computer input problem solved the OpScan way.

**Optical Scanning Corporation**  
Newtown, Pa. 18940  
(215) 968-4611

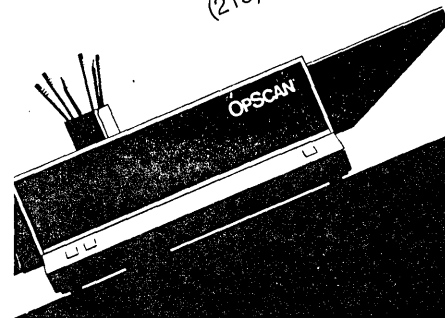

CIRCLE 87 ON READER CARD

**Tab makes -**

**one desk for  
CRT displays,**

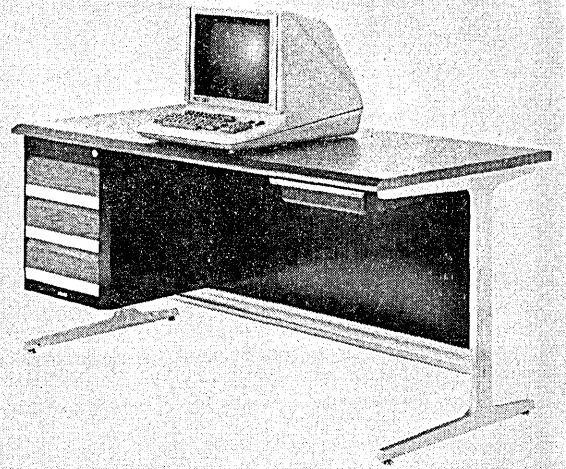

**one for  
typewriters,**

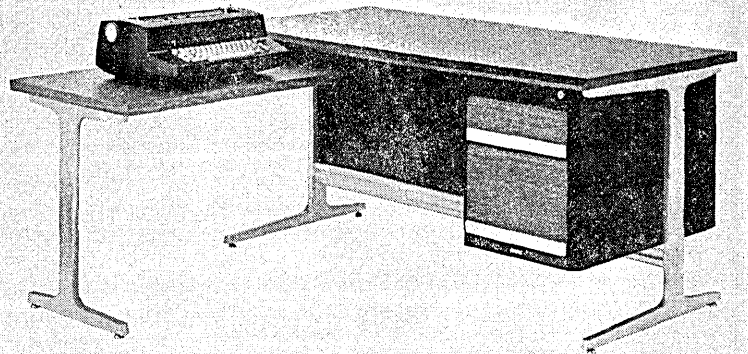

**one for  
programmers,**

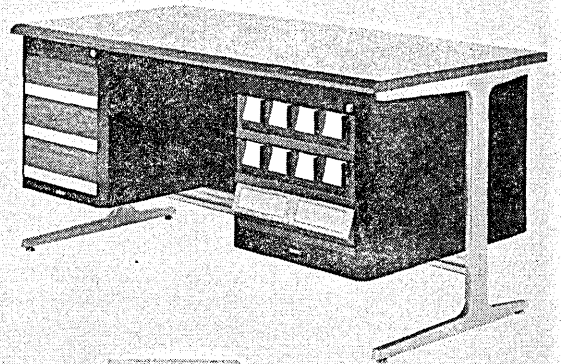

**one for  
microfilm readers,**

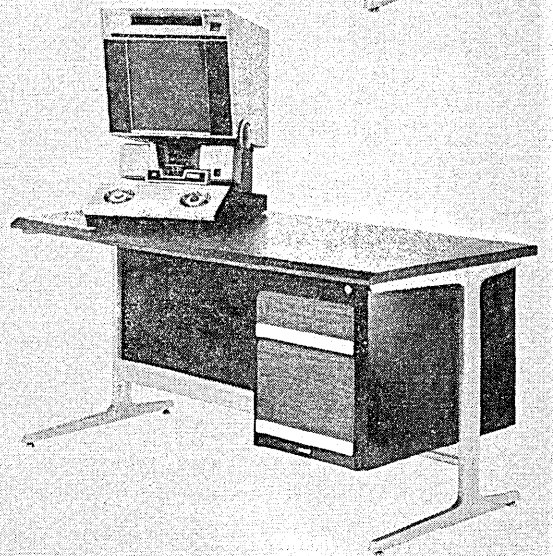

# and one for just plain work.



## This one.

The function of Tab Data Display Desks can be adapted to whatever work you need to get done. Component options let you make the desk a programmer's work station; another change makes it ideal as a CRT desk; still other pedestals and desk returns can transform it into a secretarial desk; or, used without components, the desk is an ideal conference or work table. You select from 2 and 3 drawer pedestals, 6 and 12 drawer card files, desk return, modesty panels, 27"

and 30" heights and 31 1/2", 45" and 62" lengths to create the exact desk you need to accommodate virtually any function. Tab display desks come in black and simulated walnut or contrasting shades of grey, with pedestals in any color you need to suit your office decor.

For complete information contact your local Tab representative, or write Tab Products Company, 2690 Hanover Street, Palo Alto, California 94304.

Tab Data Display Desk  
"Make of it what you will"

**TAB**  
PRODUCTS CO

CIRCLE 49 ON READER CARD

**Summagraphics**  
DATA TABLET  
is now the  
**Summagraph**  
DATA TABLET

**Summagraphics** CORP.  
is now  
**Summagraphics**  
CORPORATION

**Summagraphics**  
**Summagraphics**  
**Summagraphics**  
**Summagraphics**  
**Summagraphics**



only the name is new . . .

The same staff, the same engineering and performance standards—the same phone to bring you the same field reps to demonstrate the same product with the same unique combination of outstanding simplicity, versatility, stability, linearity, repeatability, accuracy and resolution that have made us a leading supplier of Data Tablets—**Summagraph** Data Tablets, that is!

Write for specs, or phone for a demo.

**Summagraphics**  
An affiliate of  
American Research & Development Corp. (ARD)

398 KINGS HIGHWAY, FAIRFIELD, CONN. 06430, 203-384-1344

## hardware

**Audio Response Terminal**  
The model 411 is a portable, buffered audio response terminal complete with an acoustic coupler and numeric keyboard, all packaged in an attache case. Information is entered through a 10-key touch-tone numeric pad and stored in a 256-character buffer for later transmission. Light-emitting diode dis-

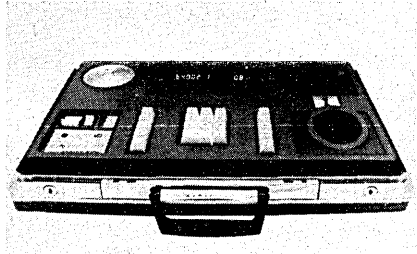

plays are used to verify data input, with transmission at 10 cps through the coupler. There are 10 additional function keys to move the memory address forward or backward for checking or changing input data. The 411 (the universal telephone information number) runs from an AC wall socket or from batteries, and is priced at \$795. COMPUTONE SYSTEMS, INC., Atlanta, Ga.

FOR DATA CIRCLE 240 ON READER CARD

**Printer/Plotter Terminal**  
The DTC-300 terminal was announced some months ago with hardware capable of being used for plotting, but without plotting software. Since then, this company has been selected as Data Terminals & Communications' marketing agent for the 30-cps impact printing terminal, and the software has been completed.

CalComp-like commands are used to direct the graphics of generation, but, unlike CalComp plotters, the terminal uses the 132-column width of the paper as the x-axis direction. Resolution is a 60th of an inch horizontally and a 48th vertically, and text may be interspersed with plotting. An imbedded Diablo HyType print mechanism and three Intel processor chips make it all possible.

The unit runs at 10, 15, or 30 cps, performs its own ASCII/EBCDIC conversions, and sells for \$3,950. Pin-registered forms feed runs an extra \$75, and Sykes cassette drives are offered from about \$2,000. Interfaces for IBM and Burroughs software have been developed, and GSI will "work with" customers with other systems in converting the FORTRAN-based plot routines. GEN COM SYSTEMS, INC., Los Angeles, Calif.

FOR DATA CIRCLE 238 ON READER CARD

← CIRCLE 79 ON READER CARD

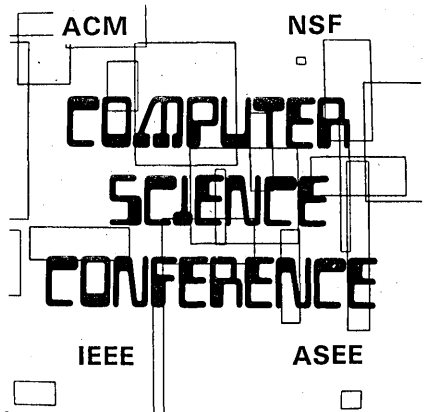

February 12-14, 1974  
Detroit Hilton  
Detroit, Michigan

- RESEARCH REPORTS
- INVITED PAPERS
- EMPLOYMENT REGISTER
- BOOK EXHIBIT
- DISPLAYS

An innovative COMPUTER SCIENCE CONFERENCE . . . devoted to short current research reports. Invited speakers will include Juris Hartmanis, Thomas Cheatham, Hubert Dreyfus, Frederick Brooks, John Opel, and John Pasta.

An employment register is planned to bring together employers and prospective employees to aid in the employment process. Last year's register was the first in the field and was a great success.

A book exhibit, terminal and computer research displays, a luncheon for computer science department chairmen, and joint meetings of the Association for Computing Machinery Special Interest Group on Computer Science Education and the American Society for Engineering Education, Computers in Education Division will also be held at the Detroit Hilton.

The Conference is sponsored jointly by the ACM and a number of universities and industrial organizations in cooperation with the Computer Society of IEEE and ASEE, with partial support from the National Science Foundation. Registration fee: \$20; students, \$5.

For further information:  
**Seymour J. Wolfson**  
Computer Science Section  
Wayne State University  
Detroit, Michigan 48202

CIRCLE 88 ON READER CARD



# Butterflies are free from Victor Temporaries

(If they don't provide complete satisfaction.)



We think that each of our Victor Temporaries is as bright as a butterfly. That's why we can make this exclusive offer.

Call in a Victor Temporary next time your workload runs heavy. If you're not completely satisfied with her performance, the billing for her first eight hours will be cancelled without further obligation on your part.

Each Victor Temporary is given job-related evaluations. This means she's matched with your specific needs.

So for all your temporary help needs—even EDP conversion help—you simply cannot do better than call your local Victor Temporaries office. It's your assurance of excellence from coast-to-coast.

After all, Victor Temporaries is the largest network of company-owned temporary help offices in the business and part of Victor Comptometer Corporation, a \$200 million business equipment and systems company.

If you're a volume user of temporary services, we can tailor a program to your requirements—at special volume discounts.

Just complete and mail the coupon. Our local representative will fly out to tell you the complete Victor Temporaries story. And as a special thanks for the time you invested learning about us, we'll bring you an attractive free butterfly pin.

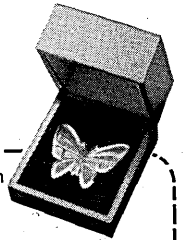

Victor Comptometer Corporation  
3900 North Rockwell Street  
Chicago, Illinois 60618

- Yes, I'd like a free butterfly pin and a flying visit from your representative.
- Please send me the address and phone number of my nearest Victor Temporaries office.
- I am interested in your program for volume use. Send contract information.

Name \_\_\_\_\_

Company \_\_\_\_\_

Address \_\_\_\_\_

City \_\_\_\_\_

State \_\_\_\_\_

Zip \_\_\_\_\_



**VICTOR  
TEMPORARIES**

*Bright as a Butterfly*

D-123

An equal opportunity employer.  
December, 1973

CIRCLE 56 ON READER CARD

# Software & Services

## Updates

The Air Force is developing a "data base in the sky" known as SEEK BUS. It is a single channel communications technique that provides up to several thousand users with the ability to send, receive, or share information anywhere in a combat theater. Information is broadcast into the air, with access to it provided by specialized terminal equipment. The advantage of this technique is that it's hard to destroy a data base that doesn't physically exist. Another is that perhaps some of the silvery discs that have been used as part of the Universal File Organization (UFO) project can be released back to the manufacturer.

A service called "In-Touch" is being tried out by Telephone Computing Service, Inc., a subsidiary of the Seattle First National Bank. For \$6.50 per month, TCS customers receive six primary services: check-less bill payment, family budgeting, income tax records, personal calendar, household records, and a slip-on template card that transforms a Touch-Tone telephone into a calculator keyboard, with computations performed at the remote computer. Acceptance of the voice-response system is said to be highly enthusiastic.

Pacific Southwest Airlines (PSA) has just brought a new on-line reservations system on the air complete with 140 three-inch crt terminals, and supporting software supplied by Bunker Ramo. The most striking thing about the system is that only four months were required to design, program, and deliver the system to the world's largest intrastate (Calif.) airline.

With the rediscovery of virtual memory recently, many software firms are not saying how much coding is in their application programs. Standard Data Corp. was willing to tell us how much memory the SYMBUG COBOL debugger required--and then we fouled up the explanation (Oct., p. 169). The 80K byte figure was the size of all the coding in the program were it resident in real memory.

## VM/370 Enhancements

Release 2 for IBM's OS/VS2 operating system provided users with a quantum jump in capabilities and capacities, and much the same can be said for Release 2 of VM/370, the monitor that uses virtual storage and other techniques to create and control multiple virtual environments in one 370 computer. Each of these virtual environments can provide the same functions as the real system while managing the various operating systems, including OS/VS1, OS/VS2, and DOS/VS.

There are four major enhancements: support of 3704 and 3705 communications controllers, support of local 3270 intelligent display terminals, a conversational monitor system (CMS) batch facility that provides increased batch mode throughput, and some changes in the virtual memory management mechanism to speed up the paging functions. (These last changes have been accomplished by implementing some of the privileged operation codes into 370 model 135, 145, and 158 microcode stores instead of executing them in regular memory. This is said to noticeably decrease system supervisor state time when doing shadow page table maintenance and interrupt handling.) VM/370 Release 2 will be available in March at no charge. IBM CORP., White Plains, N.Y.  
FOR DATA CIRCLE 213 ON READER CARD

## DOS Spooling

The INTERCEPT spooling package was developed by an IBM DOS/360 user who wasn't entirely happy with some of the features of IBM's POWER (and some competitors), particularly the core storage requirements and the necessity of dedicating an entire 2311 disc pack for its operation.

All output commands for a single 1403 or 1443 are captured and reissued at printer speed by INTERCEPT from a foreground partition (6K bytes for 2311; 8K for 2314 or 2319), with no intermediate storage requirement. If the commands cannot be immediately executed, they are stored on only two disc surfaces. If the disc storage space fills up (50 2311 cylinders store 197 pages; 995 pages on a 2314), the spooler seizes the system and prints until sufficient space is again available for normal operation. The program is priced at \$1,500 including supervisor assembly modification card deck, object code, implementation directions, and user documentation. KEYWRITE CORP., Seattle, Wash.

FOR DATA CIRCLE 214 ON READER CARD

## On-line Order Entry

One of IBM's many System/3 customers has developed an on-line order entry system that appears to have had broad enough customer interest for IBM to arrange to distribute the program for a relatively nominal charge. The submonitor can be used in either a standalone system, or as part of a distributive data base network using 3270 intelligent terminals for I/O.

Order entry, billing, credit checking, shipping, and inquiry functions are among the list of things that the program is said to be good at. The same basic applications are provided in the standalone system with the requirement that users complete development of the inventory control, accounts receivables, and sales analysis applications locally instead of centrally.

The program is available this month for a charge of \$375/month, waived after 12 months. A 32K system, printer, binary synchronous communications capability, and numerous other special IBM features (which are actually quite common) are required to support the submonitor. IBM CORP., White Plains, N.Y.

FOR DATA CIRCLE 216 ON READER CARD

## Time Series Data Management

Some examples of applications that typically maintain historical records in time series format include inventory records, product sales histories, monthly expenses, population figures, daily stock prices, etc. The Time Series Access Method (TSAM) is a service supported by a three-cpu configuration of large-scale Digital Equipment Corp. PDP-10 processors for manipulating and reporting such data. Access to the service can be from a crt of any speed or from a hardcopy device, with any

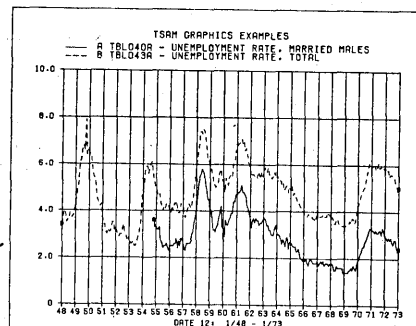

necessary code conversion accomplished transparently by the host cpu.

Once data has been entered, it can be processed by calling on a number of modules, from CypherStat, for per-



# Mark IV: *the mark of performance.*

**Theirs:** High Performance  
**Hardware**

**Ours:** *High Performance*  
*Software*

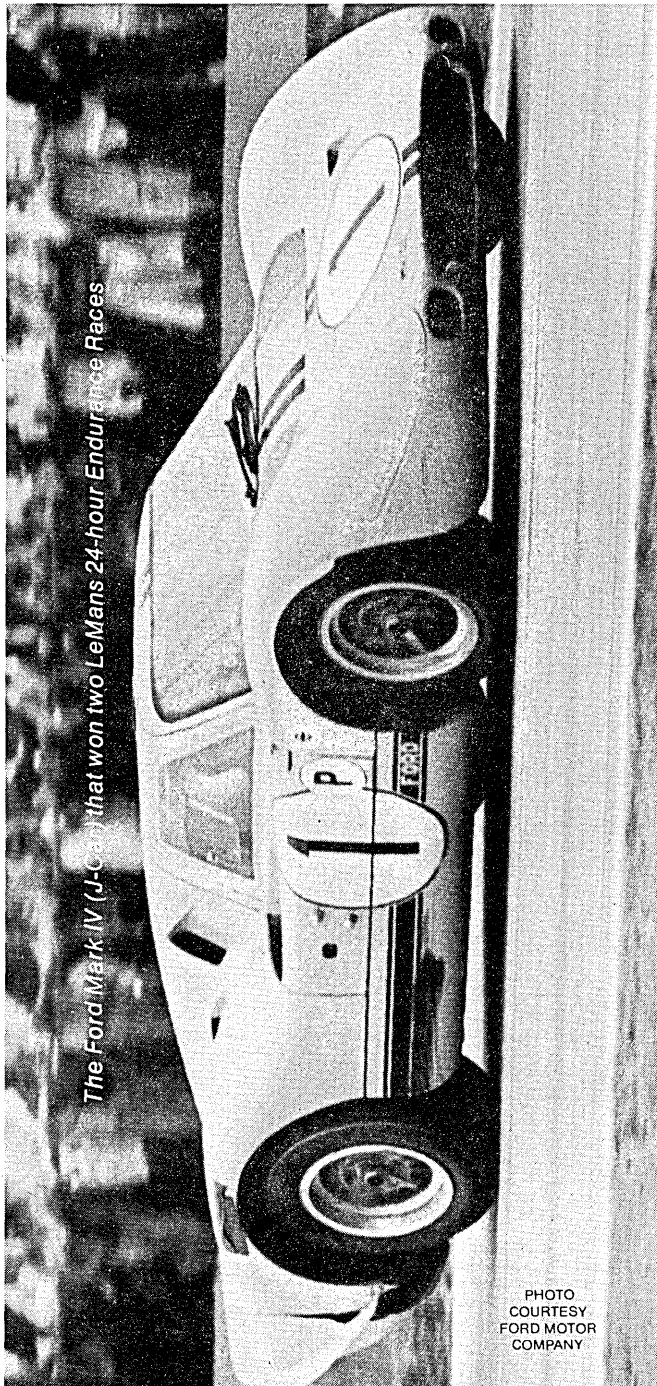

The Ford Mark IV (J-Car) that won two LeMans 24-hour Endurance Races

PHOTO  
COURTESY  
FORD MOTOR  
COMPANY

Over six years of user experience have been incorporated into our newest models. On-Line versions are available for in-house use or on nationwide time sharing networks.



*Automatic  
General Purpose  
Computer Software  
for all  
Data Processing*

With more than 700 satisfied users, our MARK IV File Management Systems have undergone over 1600 improvements since introduction. Our newest models fulfill the most sophisticated data processing requirements for IBM 360 / 370, Univac Series 70, 9400 / 9700 and Siemens 4004 computer users.

If you want Mark IV automotive performance, see your Ford dealer.

If you want MARK IV performance in computing, call us.

*North America—*  
MARK IV Systems Co.  
21050 Vanowen Street  
Canoga Park, California 91304  
Telephone (213) 887-9121

- Chicago (312) 648-0280
- Dallas (214) 233-6861
- New York (201) 488-2700
- Washington, D. C. (301) 770-5951
- Toronto, Canada (early 1974)

*Worldwide—*

- Geneva • London • Paris • Copenhagen
- Dusseldorf • Mannheim • Rome • Tokyo

informatics inc  
MARK IV Systems Company

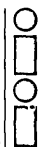

## software & services

forming statistical analysis, to Cypher-Tab for reporting and data analysis. The service is oriented toward management personnel who want self-documenting control of time-related records. Plots can be generated at the vendor site and forwarded to the user, if desired. Connect time for the service is \$10/hour; from there the billing algorithm gets very complex depending on cpu, memory, and file space used. CYPHERNETICS CORP., Ann Arbor, Mich.

FOR DATA CIRCLE 215 ON READER CARD

### DOS Device Assignment

The problems of device contention between partitions and conflicting I/O assignments due to fixed device addressing in IBM DOS installations are said to be eliminated by using DYNAC. In effect, the package makes all JCL partition and device independent by creating a device pool. When a tape drive is required by a program, DYNAC scans the regular DOS available device table, locates a unit with no outstanding assignments, and notifies the operator by

generating a mount message, similar to the way it is done in OS/360 shops. The change is a relatively simple one (no system software changes are necessitated) with only about two bytes of storage per device added to the system requirements.

DYNAC is priced at \$1,250. A com-

panion program, JCL CONVERTER, punches out new JCL with symbolic assignments (including back-references and UNASSIGN cards) to ease the conversion to the new monitor. It's priced at \$250. DATACHRON CORP., New York, N.Y.

FOR DATA CIRCLE 212 ON READER CARD

## software spotlight

### Interpretive Dumps

The System Interrupt Supervisor (SIS) module should decrease debugging time for programmers working with IBM's OS/MVT and OS/VS2 operating systems because it supplies a much easier to read dump of the problem program's memory contents. SIS gains control at ABEND time and, by means of parameters passed to it by JCL entries, prints only the types of information the user requests. The information that can be supplied by SIS include the completion code, program status word, the setting of the general-purpose registers, displacements from both the entry and loading memory points to the instruction that caused the ABEND, attributes of all load modules, data control blocks for all opened files, the last buf-

fer read or written for each opened file, and any desired portion of the aborted program's object code—for example, the first 400 bytes of working storage.

When operating under the IMS data base management system, the DL/I portion of SIS formats the IMS buffer pool statistics and the number and type of all DL/I calls, generates a list of all program control blocks (including the last eight calls made to them and the status codes for each call), and lists the parameters passed with the last call.

One of the by-products of SIS is the potential for reducing the length of dumps from upwards of 100 pages to perhaps the 15 pages actually needed. The OS/MVT and VS/2 versions are priced at \$2K, with an additional \$2K required for the IMS DL/I features. Prices include object code, documentation, and training. DATA BASE MANAGEMENT, INC., Vernon, Conn.

FOR DATA CIRCLE 210 ON READER CARD

# MMS General Ledger Protects Your Professional Reputation

Don't take chances on just *any* corporate financial reporting system. Look into the world's number one seller—the MMS General Ledger.

The MMS General Ledger is ready to go anytime you are—whether you use DOS, O/S, IMS or TOTAL. It's a proven software package, already hard at work for more than 80 leading corporations of all sizes.

Data processing professionals who have installed the MMS General Ledger are heroes to their users (and bosses).

Get the MMS General Ledger . . . and live up to *your* reputation.



### SOFTWARE INTERNATIONAL CORPORATION

A Subsidiary of MMS, Inc.  
2 Elm Square, Andover, Mass. 01810  
(617) 475-5040

New York (212) 972-9540

Chicago (312) 729-7410

Atlanta (404) 255-0039

Los Angeles (213) 437-3301

# SWITCH...DON'T FIGHT!!

ANHEUSER-BUSCH, BABCOCK-WILCOX, NORTHROP CORPORATION,  
HARTFORD INSURANCE GROUP, UNITED CALIFORNIA BANK,  
COMBUSTION ENGINEERING, NORTHWESTERN MUTUAL LIFE  
INSURANCE COMPANY, SHELL OIL OF JAPAN....

SWITCHED TO:

## ASI-ST, *The Advanced Approach to Data Management*

Why did these leading companies drop such packages as: MARK IV, GIS, CULPRIT, GRS, Data Analyzer, RSVP, Qwick Qwery and others??

**Because ASI-ST provides:**

- The most complete user-language interface to IMS and TOTAL
- The only Conversational Language supported in multiple teleprocessing environments . . .
  - TSO
  - IMS DB/DC
  - CICS
- The easiest-to-use system for programmers and non-programmers.
- Unparalleled execution efficiency
- Full Virtual (VS, VS1, VS2), OS and DOS support.
- The widest range of file/data base functions

These are just a few of the *many* reasons why ASI-ST represents the state-of-the-art data management system available to IBM 360/370 users.

To learn more, call or write today:

Director of Marketing

Applications Software, Incorporated

21515 Hawthorne Boulevard

Torrance, California 90503

(213) 542-4381, Telex 653-563. . . . other offices in Boston and Tokyo



**The Software Manufacturer**

# software & services

## In-house Computer Course

A computer course is available in video tape form that is oriented toward individuals in a relatively large installation who must act as liaison between user departments and the dp department. The course begins by covering basic concepts of data processing, the historical development of the computer, and the functions it performs. Instruction continues with sessions in computer programming: the components of a program, the writing of a simple program in machine language, the advantages of using a symbolic language, and the writing of a simple FORTRAN program. The course does not get into concepts such as structured or modular programming, as these are considered unnecessary for the type of job being performed by the course attendees. The course concludes by covering the evolution of input and output devices, and the meaning and importance of multi-programming, time-sharing, and simulation to data processing.

The course exists in the form of eight three-quarter-inch video tapes, each of which runs for approximately 30 minutes, and was designed by some instructors affiliated with the State

Univ. of New York. The course can be rented for \$400/month or purchased outright for \$2,400. Annual the two-year membership plans are offered which qualify subscribers for discounts on other dp training courses. DATA PROCESSING EDUCATION NETWORK, New York, N.Y.

FOR DATA CIRCLE 217 ON READER CARD

## OS/360 Partition Balancing

The Dynamic Dispatch System (DDS) is added to the IBM OS/MFT and MVT operating systems (even if running HASP as long as it doesn't have the dynamic dispatch feature) in an attempt to increase cpu use. It does this by monitoring priority assignments and assigning I/O-bound jobs relatively higher priorities than those of compute-bound jobs. The user has the ability to override DDS's thinking on priorities and permanently override DDS in specific partitions, if desired. According to the developers, actual usage has shown very little degradation in cpu-bound applications, with marked improvement in the throughput of batch data manipulation runs. Less than 8K of memory are required by DDS, which is priced at \$6K and can be rented for \$300/month on a one-year contract. GTE INFORMATION SYSTEMS, Stamford, Conn.

FOR DATA CIRCLE 211 ON READER CARD

## 1401 Conversion

There aren't many excuses left for installations to cling to 1401 programs considering that combination software/services like UPGRADE II are available. The conversion to ANS COBOL from either Autocoder or Symbolic Programming System (SPS) object decks is accomplished in three steps: manual conversion of non-translatable code, an automatic translation into ANS COBOL, and a post-translation verification performed both by software and trained personnel. All data and procedure names generated by the translator may be replaced with names of the customer's choosing. Standard output consists of a COBOL source deck; a 1401 assembly listing showing pre-translation changes; an SPS format list of the disassembled 1401 program; a count of the instructions by type; and a list showing input, output, and work files with their assigned names. Optional output includes a machine-generated flow chart, a cross-reference list, and a disassembled source deck. Both 1401 disc and tape code is handled.

UPGRADE II software and instruction manuals are sold outright for \$8K, or conversion is performed on a service basis by IM personnel for negotiated prices. A 100% translation guarantee is available. INFORMATION MANAGEMENT, San Francisco, Calif.

FOR DATA CIRCLE 218 ON READER CARD

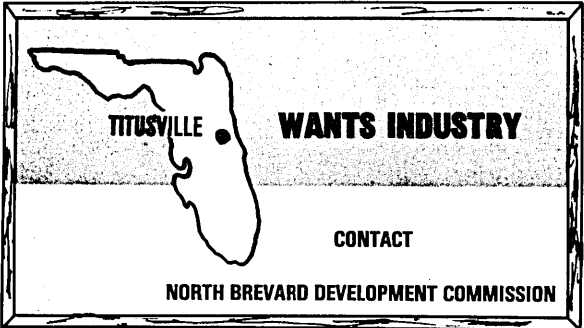

**TITUSVILLE WANTS INDUSTRY**

**CONTACT**

**NORTH BREVARD DEVELOPMENT COMMISSION**

Have you received the survey entitled "Florida Profit Potentials in Electronics"?

IF NOT, WRITE TO  
**George H. Grodhaus, C.I.D.,**  
Executive Director

**THE NORTH BREVARD  
DEVELOPMENT COMMISSION**

**P.O. Box 1960, Titusville, Florida 32780**  
**Phone 305/269-3221**

CIRCLE 102 ON READER CARD

**QUALIFIED ASSISTANCE TO USERS OF**

# **IBM\* CICS**

**IS NOW AVAILABLE —**

- FEASIBILITY STUDIES AND SURVEYS
- INSTALLATION AND MAINTENANCE
- ENHANCEMENTS AND EXTENSIONS
- NON-STANDARD TERMINAL SUPPORT
- APPLICATIONS SYSTEMS
- SYSTEM UPGRADE AND CONVERSION

OS VERSION 1 DOS ENTRY  
OS VERSION 2 DOS STANDARD

FROM LIMITED COUNSELING THROUGH FULL "TURNKEY" RESPONSIBILITY — IN BOTH "SYSTEMS" AND "APPLICATIONS" AREAS

IBM IS A REGISTERED TRADEMARK OF INTERNATIONAL BUSINESS MACHINES, INC.

PHONE OR WRITE FOR ADDITIONAL INFORMATION NOW  
CONTACT: VICE PRESIDENT, MONITOR SYSTEMS DIVISION

 **ON-LINE SOFTWARE INCORPORATED**

411 Hackensack Ave  
Hackensack, N.J. 07601  
PHONE (201) 489-0400

CIRCLE 82 ON READER CARD

# FLEXIBILITY brought RCA and the Postal Service together

The Western Region Postal Service required terminals to perform a **broad range of functions** unique to postal operations — like commodity sales, bulk mail transactions, and overall accounting operations. Terminals **custom configured** with postal oriented keyboards and displays, and printers and card readers... a system **compatible** with existing procedures ...and **growth capability** to accommodate future postal requirements in a flexible and economical manner.

## The results ...

Terminals with ROM-programmable flexibility to meet a variety of user needs.

Built-in keyboard, CRT display, receipt printer, and card reader.

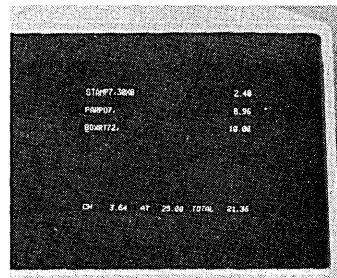
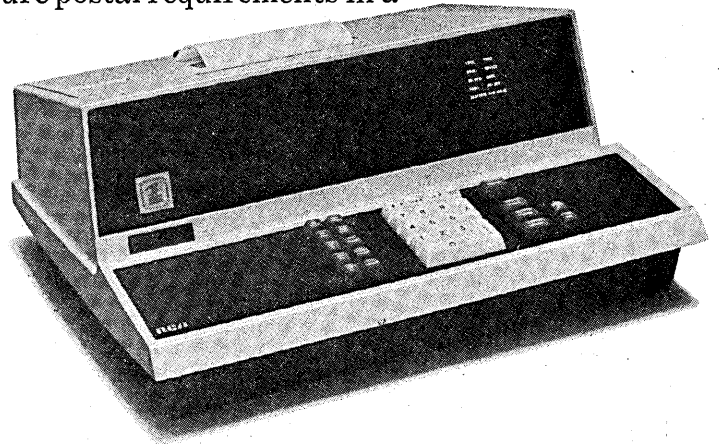

Custom tailored keyboards and specially formatted displays.

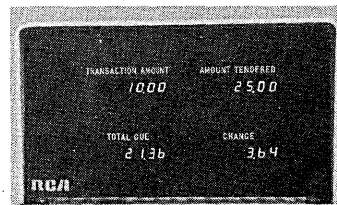

Ability to interconnect cash drawers, cassettes, scales, meters, and displays for the postal window customer.

Flexibility comes with all our terminals. That's why the name **FLEXITERM<sup>TM</sup>**, and that makes togetherness with you both possible and beneficial.

For more on RCA's **FLEXITERM** terminal systems, call our Marketing Manager, George Turner at (213) 894-8111 or write him at this address. He's flexible too. RCA Custom Terminal Systems, 8500 Balboa Blvd., Van Nuys, California 91409.

# RCA

# INTRODUCING THE INTELLIGENT WAY TO DO LARGE SCALE REMOTE JOB ENTRY.



It's our intelligent Sycor 340. You see, we've given it the same large scale remote job entry capability as IBM's 2780. Including a high-speed card reader, 300 lpm printer, 2780 compatible bi-sync . . . the whole package.

But that's where the similarity between the two ends. Our Sycor 340 not only costs less, but runs circles around the old 2780 when it comes to intelligence and versatility.

Standard on the Sycor 340 is its capability for error-free data entry. It's also programmable—so you can edit, validate and perform range checks and other operations only an intelligent terminal can. Since it already features a CRT and keyboard console, you don't have to pay for them as extras.

And how's this for versatility: you can use the 340 to talk to your time-sharing computer using our asynchronous communications package.

Or if you need bulk storage, you can get an optional IBM-compatible magnetic tape drive.

What's more, for those locations where you don't need a 300 lpm printer, we have 50 lpm and 80 cps models for you to choose from.

To find out more about this versatility, economy and 2780 compatibility in large scale remote job entry, call your Sycor representative today.

It's the intelligent thing to do.

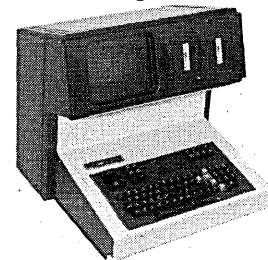

## SYCOR

**SI**  
SYCOR INC

**Corporate Offices:** Ann Arbor, Michigan 48104 (313) 971-0900. **District Sales Offices:** Atlanta (404) 457-1166 • Boston (617) 890-7290 • Chicago (312) 986-1833 • Cleveland (216) 831-8625 • Dallas (214) 521-6710 • Detroit (313) 355-5770 • Hartford (203) 529-1100 • Houston (713) 688-5224 • Indianapolis (317) 784-6779 • Los Angeles (213) 640-0120 • New York (212) 371-9050 • Philadelphia (609) 665-1170 • Pittsburgh (412) 922-3350 • San Francisco (415) 349-6626 • St. Louis (314) 878-0090 • Washington (703) 525-7300. **Canada:** Sycor International Ltd., Toronto (416) 429-0883. **Service Centers in 80 cities.**

# Literature

## Designing Business Forms

*How to Design Business Forms* is a 64-page, step-by-step guide to planning and laying out forms for hand entry, typewriter, accounting machine, and computer printer. Divided into three sections (General Principles, Forms Design Instructions, and Forms Design Aids), this booklet with many diagrams should be of particular use to systems people, forms salesmen, and forms users. The cost is \$7, with discounts for bulk orders. INTERNATIONAL BUSINESS FORMS INDUSTRIES, Printing Industries of America, Graphic Communications Center, 1730 North Lynn St., Arlington, VA 22209.

## U.K. Communications

A comprehensive, 500-page report costing \$395 details data communications services in the United Kingdom. For the user or potential user of data transmission services in the U.K., this manual serves as a reference for rate schedules, service availability, characteristics of service, appropriate application formats, and names of key personnel in the British Post Office. For the manufacturer of telecommunications equipment, the manual gives technical interface specifications, "type approval" requirements, policies regarding customer-owned equipment, and an examination of the BPO's upcoming Digital Data Network. Background information, including a table of contents and excerpts, is available free of charge. CENTER FOR COMMUNICATIONS MANAGEMENT, INC., Ramsey, N.J.

FOR COPY CIRCLE 202 ON READER CARD

## Supermarket Point-of-Sale

Two brochures describe two NCR supermarket checkout systems; one, 22 pages, the NCR 250 Electronic Retail Food Store System, and the other, 26 pages, the NCR 255 with an in-store controller and memory. The NCR 255, the newer system, consists of up to 16 NCR 255 retail terminals operating under the control of an NCR 726 controller, and can provide price lookup as well as sales recording and media control. NCR CO., Dayton, Ohio.

FOR COPY CIRCLE 203 ON READER CARD

## Data Entry Market

A descriptive letter and a detailed table of contents give information on a \$445 355-page report (#156) analyzing the computer data entry market. The report forecasts sales and average unit prices through 1982 for 30 products in the following categories: keypunch

and buffered keypunch, keyboard to storage, alphanumeric display terminals, optical readers, keyboard readers, magnetic readers, industrial data collection, electronic point-of-sale, pushbutton telephone, and portable data recorder. The report also contains results of a survey of 500 dp managers in the major data entry user industries. FROST AND SULLIVAN, INC., New York, N.Y.

FOR COPY CIRCLE 201 ON READER CARD

## Writing by Phone

Two brochures (one glossy, full-color and one black & white foldout) describe the Talos Telenote System, which has a variety of applications. Comprised of transmitters, transceivers, and receivers, the system extends the telephone to include graphic ex-

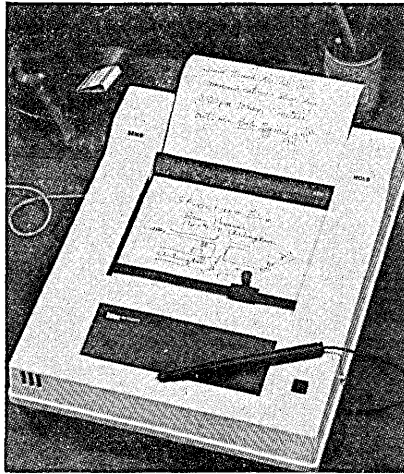

pression. In a normal telephone conversation, the sender can transmit drawings by using a send pen with a standard ballpoint tip; the receiver gets a duplication of the written message as well as the voice reproduction. The system can also be hardwired. TALOS SYSTEMS, INC., Scottsdale, Ariz.

FOR COPY CIRCLE 200 ON READER CARD

## Simulation

The fourth edition of *A Quick Look at SIMSCRIPT II.5* describes in 38 pages this simulation language, with three complete simulation models written in it: a queuing problem, an inventory control problem, and a job shop problem. SIMSCRIPT II.5, organized in five levels and designed to operate in an interactive as well as batch processing environment, has had applications in such fields as urban growth, hydroelectric planning, transportation systems, election redistricting, cancer and tuberculosis study, hospital planning, communications, and multicomputer

networks. CONSOLIDATED ANALYSIS CENTERS, INC., Los Angeles, Calif.

FOR COPY CIRCLE 204 ON READER CARD

## Software Tool

This 39-page manual describes AUTOFLOW II, "a totally new concept in structured applications development." AUTOFLOW II can be used both as a management tool to help create and sustain an organized program development environment and as a programming tool to help develop and maintain reliable applications. APPLIED DATA RESEARCH, INC., Princeton, N.J.

FOR COPY CIRCLE 205 ON READER CARD

## A Look at Japan

Published by the Office of Naval Research, this 12-page report assesses the state-of-the-art of computer science in Japan. The writer uses information gathered in two trips to Japan (the latter, in fall 1972, included participation in the First U.S.A./Japan Computer Conference) and in conversations with various computer scientists in the U.S. The cost is \$2.75 for paper copy, \$1.45 for microfiche. Order AD-764 853/8. NATIONAL TECHNICAL INFORMATION SERVICE, U.S. Dept. of Commerce, 5285 Port Royal Rd., Springfield, VA 22151.

## Statistical Tool

This 27-page manual documents ACCUFOR, a time-sharing forecasting and analytic tool. Designed for use by line management as well as by the technical specialist, ACCUFOR produces detailed reports of a company's past history and forecasts of future periods, using modified regression analysis techniques. These reports are available in either tabular or plotted format. Requiring a minimal amount of training, ACCUFOR has had such varied users as airlines, utilities, food processors, and retail grocery operations. STS, INC., St. Louis, Mo.

FOR COPY CIRCLE 206 ON READER CARD

## Minicomputer Review

This loose-leaf, pocket-size guide reviews over 120 minicomputers individually. With new equipment updates every four months, the guide contains about 200 pages of technical information on minicomputers and their manufacturers. A one-year subscription costs \$38; until Dec. 31, there is an introductory price of \$28.50. GML CORP., 594 Marrett Rd., Lexington, MA 02173. □

# find out if digital is your kind of place

*At Digital it's the way we're put together that makes us move.*

An unstructured environment, the give and take between people, an attitude that encourages technical excellence and the freedom to achieve it.

*We've got a good thing going.*

*Write us. Digital is your kind of place*

## PRODUCT SUPPORT ENGINEERS

Two musts: 3-5 years of maintenance experience on digital central processors and peripheral equipment and a desire to travel. You will be responsible for product line support on a regional or U.S. basis. You may also assist in engineering analysis and suitability of product design and final acceptance criteria of particular products.

## FIELD SERVICE ENGINEERS

For DEC/Systems 10 In-House Group

This is an outstanding opportunity to be part of Digital's internal team, working directly on Digital's internal computers and in direct communication with the people who design and build the equipment. No traveling, just the beauty of working in the heart of challenging large computer maintenance, installation, development and evaluation activities. If you have 2-3 years large computer system hardware expertise with a strong working knowledge of processors, memories and peripherals, ie. IBM 360/370, Spectra 70, CDC 6600/7600, or any comparable machine, investigate what we have to offer in training, opportunity and benefits.

## HARDWARE INSTRUCTORS

We need dynamic and innovative individuals as instructors teaching computer hardware systems. The courses are taught in our newly completed educational services center at our corporate headquarters in Maynard, Massachusetts. Applicants should have an interest in using "state-of-the-art" teaching techniques, ie. IPI, AV, PSI, etc. Field service experience and digital computer repair and at least 1 year teaching experience preferred.

*Please direct your resume in strictest confidence to Clay Brown, Digital Equipment Corporation, 110E Main Street, Maynard Mass. 01754*

**digital**  
digital equipment corporation

The above positions are open for application to men and women regardless of race, national origin, age, religion or creed.

# Books

### Computer-Aided Design

J. Vlietstra and R. F. Wielinga, ed.  
American Elsevier Publishing Co., Inc.,  
52 Vanderbilt Ave., New York,  
N.Y., 1973  
462 pp. \$23.50

Based on the IFIP Working Conference on Principles of Computer-Aided Design (held in October 1972 in the Netherlands), the charm of this book is in the dialogues that follow the presentation of each of the 18 papers. The casual, often humorous exchange of information by the panel of international experts goes far beyond the scope of the papers—which cover the definition and analysis of computer-aided design, its software philosophy, language, techniques, economics, hardware configuration options, and applications.

### Design of On-Line Computer Systems

by Edward Yourdon  
Prentice-Hall, Inc., 1972  
608 pp. \$16.

This book presents a lucid, practical approach to systems design, strengthened by a chapter devoted to the conception and demise of GE's MEDINET hospital information system. The details of MEDINET's failure provide the basis for many of author Yourdon's design principles—and much of the book's humor. ("By June of 1967, the weather in Boston had improved to the point where the Phoenix engineers could be convinced to pack their golf clubs and come to Boston to fix the hardware.")

After a general introduction and review of the subject, Yourdon discusses design calculations and guidelines, statistics and performance measurements, analyses and comparisons of applications programs, files and data bases, operating systems, and concepts and aids for testing and debugging.

We are often asked to recommend books for professional libraries or university courses. *The Design of On-Line Computer Systems*, carefully researched and written, presents interesting, accurate historical and technical information, and is a first-draft choice.

### Auerbach on Small Business Computers

by Auerbach Editorial Staff, ed.  
Auerbach Publishers, Inc., 121 N.  
Broad St., Philadelphia, Pa., 1973  
183 pp. \$19.95

A primer, the contents include guidelines and evaluation criteria for determining the applicability of a computer to specialized business environments. The text discusses small stored-program computers renting for under \$3K/month that are used to perform standard commercial dp functions.



Chapters detail when and how to buy, and include a point-scoring system for rating the various machines on the market in terms of the needs of the prospective user.

Appendices give manufacturers' profiles, and offer a selection checklist, an explanation of semiconductor technology, and a glossary of basic dp terms.

The book's information is directed at the small businessman who has little



or no knowledge of or experience with computers; the explanations are presented with a modicum of technical detail and emphasize the cost-effective considerations of computerization at the small-business level.

#### Peripheral Devices

by Ivan Flores  
Prentice-Hall, Inc., 1973  
499 pp. \$22.95

The author acknowledges in the preface that the proofreader "got eyestrain, headaches and distemper from proofreading the final page proofs." Well she might. Whatever merits this basic text on peripherals may prove to have, the author's method of definition-by-typeface (small capitals for hardware, outline type for software, and even more), plus italics thrown in for the usual emphases, creates a confusing format reminiscent of *Cosmopolitan*.

December, 1973

Designed as a textbook, chapters cover I/O hardware—line printers, punchcard devices, mag tape units and controls, direct access storage, disc drives, drums, consoles—their functions, and necessary software. Each chapter is followed by a series of questions and exercises, and an appendix is added specifically to explain the structure of the 360.

#### European Technology (The Politics of Collaboration)

by Roger Williams  
Halsted Press, A Div. of John Wiley & Sons, Inc., 605 Third Ave., New York, N.Y., 1973  
214 pp. \$13

Roger Williams' credentials include a happy combination of physics and political science, and his book reflects this dual education. Concentrating primarily on the fields of aerospace, computers, and nuclear science, Williams analyzes the possibilities for cooperation and collaboration within Europe, and chronicles the political and administrative problems that have thwarted these possibilities in the past. The book, despite its awkward style, should be valuable for a historical understanding of the effects of politics on the advancement of European technologies. However, a reader hoping to evaluate conclusions or proposed solutions may be somewhat disappointed in the author's rather timid premises, offered in an attempt at objectivity.

#### Sparse Matrices and Their Applications

Donald J. Rose and Ralph A. Willoughby, ed.  
Plenum Publishing Corp., 227 W. 17th St., New York, N.Y., 1972  
215 pp. \$17.50

Fifteen papers presented at the IBM Research symposium on sparse matrix analysis and applications in September of 1971 examine computational circuit design, linear programming, partial differential equations, and combinatorics and graph theory. The conference was also sponsored by the Office of Naval Research and the National Science Foundation. According to the editors, an important feature of this symposium and its proceedings is the cross-fertilization achieved among a broad spectrum of application areas and among combinatorialists, numerical analysts, and computer scientists. The book contains an extensive bibliography dating from 1947 to articles to be published this year. The price seems a bit steep, but, then, some of the algorithms are pretty heavy. Also, the title page says the book was published in the "United of America," and it probably costs a lot to ship it from there.

—Wendy Reid Crisp



## with the Princeton 801 Graphic Computer Terminal

Plug it in to any computer or mini... adjacent or remote. For the brightest, sharpest, most versatile information visualization by any self-contained graphic CRT terminal. Derived from our unique Lithocon® silicon-silicon oxide image storage tube as the heart of the matter.

- Selective erase by computer, precise to single characters and vectors.
- Flicker-free, 50 ft. lamberts bright display on 10 x 10 inch raster; standard 1,029-line resolution.
- High density displays without refresh flicker.
- 32 linear-level gray scale on 1,024 x 1,024 matrix.
- Self-refreshing display from stored image—data independent.
- Zoom... up to 16X... and a joystick to zero-in.
- Built-in character and vector generators.

#### The Princeton 801 Puts It All Together

For everyday work. For extraordinary information needs. A full ASCII keyboard. Three character sizes. Short, long, visible and invisible vectors. Or points. TV stills or action. With the interfaces, control logic and software that make the 801 so easy and compatible to use. All for \$7,950 with RS232C interface.

See what it can do for you. Phone or write:



**PRINCETON  
ELECTRONIC  
PRODUCTS, INC.**

Box 101, North Brunswick, N.J. 08902  
Telephone: (201) 297-4448

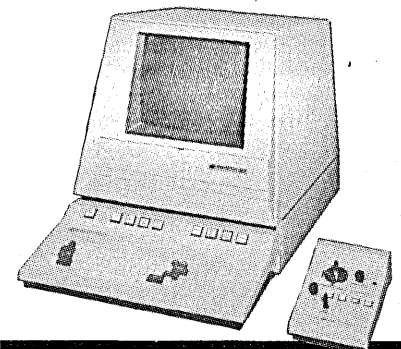

CIRCLE 80 ON READER CARD

# Monarch has the bar code that works, and a choice of "tools" to create and capture data accurately, efficiently, economically.

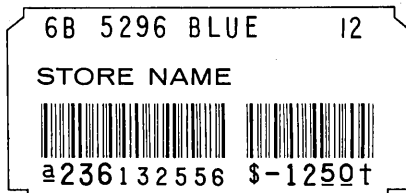

## The bar code that fits you.

Whatever your size, Monarch has the bar code and complete systems you need for fast, accurate information control. The CODABAR™ code is flexible and reliable; compatible with your present operation. Complementing the code is a choice of systems to create and capture it economically; plus a wide range of equipment for attaching encoded tags to merchandise. The CODABAR code and related Monarch bar code products are currently in use with Pitney Bowes-Alpex SPICE®/PEPPER™ Systems.

An automated input system is vital to your future. Monarch has one that fits you. For more information on the CODABAR code and related products . . . how and why they can serve you best . . . write to Vice President for Marketing, Dept. 288, Monarch Marking Systems, P.O. Box 608, Dayton, Ohio 45401.

## Monarch Marking Systems



© 1973 Monarch Marking Systems, Inc. All Rights Reserved

## 3 ways to create it.

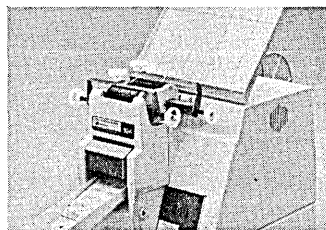

**Model 104 Dial Printer** is a low-cost, easy-to-operate in-store printer. Accurate . . . you can see what you dial. It prints what you see . . . both eye readable and machine readable. Has a nominal speed of 174 impressions per minute on all sizes of tags and labels.

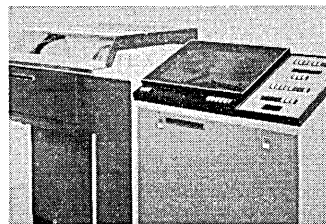

**Monarch 2000 CODABAR Encoding System** is a high-speed computer-controlled line printer with programmable logic and expandable memory. Ideal for high-volume distribution center printing of bar-coded tags and labels.

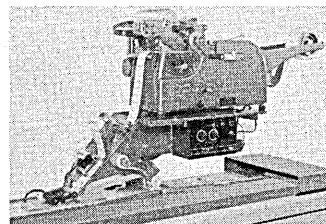

**Model 2023 Rotary Imprinter** is a fast, simple and reliable rotary mat printer. Enables vendors to print data on conventional merchandise tag and label supplies right on their packaging lines.

## 2 ways to capture it.

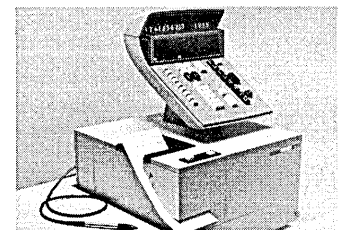

**Model 2243 Bar Code Scanner** is connected to the Pitney Bowes-Alpex SPICE® terminal to read the CODABAR code at point of sale. Data is checked seven times in the logic to assure accuracy before being released to the interface and transmitted to the terminal.

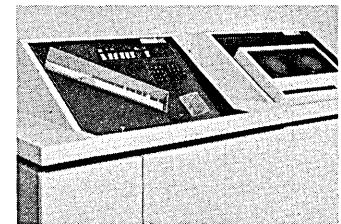

**Model 2310 Batch Reading System** is a high-speed data collection center. Reads 400 encoded tags per minute, feeds automatically, requires no tag orientation, records data on computer-compatible magnetic tape.

**Get Monarch into your system . . . to get the most out of it.**

# letters

Continued from page 26

a basket of attribute-ratio rankings consisting of mixed apples and oranges. This is because the difference between sizes of IBM samples and all other mainframe manufacturers' samples tends to distort the true relationship among these rankings.

For instance, IBM's share of total responses received ranges from 43% for product performance per dollar to 58% for support. This gives a very wide range in variation of the percentage of "best" and "most complete" votes which can be statistically inferred from each sample. The next table shows ranges for product performance per dollar, using a 95% probability.

For instance, of the 137 responses received for IBM, 46% rated IBM as providing the best product performance per dollar. At 95% probability, the range of variation about the 46% was 16.6%, or 8.3% in either direction. However, the same type of inference isn't nearly as explicit in the case of RCA, for which only 14 responses were received. The smaller samples give a much greater range of variation—56.2%.

Obviously, this sort of difference in the range of the two estimates prohib-

its a conclusive comparison of the actual customer attitudes toward these mainframe manufacturers. It is very important that the possibility of such error in your conclusions be recognized.

R. G. GRONEMEIER  
*The National Cash Register Co.*  
Dayton, Ohio

Mr. McLaughlin replies: Thank you for your careful appraisal, but we have to throw a monkey wrench into your analytical engine. The sample size for RCA users is larger than the 14 votes it received for "best" and "worst" product performance per dollar. Similarly, the sample size for IBM users is larger than the number of votes it received for these rankings. We only tabulated those 14 users who felt RCA was either best or worst; many other RCA users may have voted IBM best or worst, or even voted for NCR if they had used NCR equipment. It is likely that most RCA users didn't feel RCA was either best or worst, but somewhere in between.

The attribute-ratio rankings, admittedly, will more accurately show the relationships between the non-IBM vendors.

### Aggressive advertising

I was intrigued by the emphasis in your October issue—a tiger on p. 100, a gorilla on p. 102, followed up by confirmation, "It's a Jungle!" on p. 131. The epilogue included panthers on p. 139, jungle fever on p. 149, and a

jungle god on p. 185. Perhaps the camels and eskimo on the back cover are a preview of November?

MARK R. GARDNER  
*Electronics Engineer*  
Illinois State Water Survey  
Urbana, Illinois

### Questionable criterion

Dr. Philippakis' recent article on "Programming Language Usage" (Oct., p. 109) while interesting, missed the point. His questionnaire "measured" the effort put into programming in several languages, and then he drew conclusions about the use of the various languages.

May I point out that, for example, one might spend 99% of one's time doing COBOL coding and never get much done, while the other 1% programming effort using another language might produce code that is used time and time again for years and years.

From the same basic data, I might just as justifiably have concluded that programming in APL takes less effort than does programming in COBOL.

MYRON A. CALHOUN  
*Kansas State Univ.*  
Manhattan, Kansas

Dr. Philippakis replies: I used the terms "to use a programming language" to refer to writing programs in that lan-

## Why make a project out of a special project?

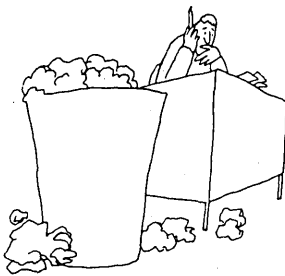

Special projects have a way of fouling up an entire operation. They waste too much time, tie up too many people.

Instead, why not call Manpower. We'll get those special projects completed quickly, reliably and professionally. No matter what you're up against. Just give us a call.

### MANPOWER®

TEMPORARY SERVICES

### DATAPOWER® SERVICES

We'll give you all the help you need.

Keypunch Operators. Tab Operators. Computer Operators. Edit Clerks. Systems Analysts. Coding Clerks. Computer Programmers.

## PROGRAMMER ANALYSTS

Control Data's AUTOCON industries subsidiary has excellent career applications programming opportunities available for software personnel with 1-5 years experience on the;

### Data General NOVA 1200 System Control Data 1700 System

Work will involve designing and implementing software on supervisory control systems for use by the electric utility or water and waste-water treatment industries.

Additional qualifications which are desirable include Fortran or Assembly language experience, knowledge of electric utility or real time process control applications, and BSEE or equivalent technical or related experience.

For further information, call: (collect) or send your resume to:

R. L. Berger

Autocon Industries Subsidiary

### CONTROL DATA CORPORATION

2300 Berkshire Lane No.

Minneapolis, Minn. 55441

(612) 545-2851 Ext. 4809

**CONTROL DATA**  
CORPORATION

To investigate other opportunities nationwide, send your resume to:  
Control Data Corporation,  
Box 888,  
Minneapolis, Minn. 55440

An Equal Opportunity Employer, M/F

CIRCLE 111 ON READER CARD

December, 1973

CIRCLE 114 ON READER CARD

161

# letters

guage. Mr. Calhoun's opinion that "use" means to run programs already written seems both unconventional and unwarranted from the context of my article.

On reading Dr. Philippakis' article I take distinct exception to the measurement criterion presented. Ranking languages by the estimated percentages of effort that go into their usage inherently discriminates against the more efficient languages; APL, for example. Consider the effort necessary to have written your average three-line APL program in BAL.

Another example, from our shop, is an RPG we have, called QUEST. QUEST is used for detailed single-questionnaire analysis. The QUEST interpreter is written in FORTRAN. Comparing the effort required to originate and maintain our QUEST programs and their FORTRAN host against writing the same programs in, say, COBOL, would be honestly unbelievable . . . in fact, for us, COBOL would be economically unconscionable.

The only reasonable measure of relative language usage I can see offhand is the comparison of the percentage of an installation's throughput that is processed by program modules written in

a given language.

L. F. WYGANT  
*Senior Programmer/Analyst  
Pelam Inc.  
Schiller Park, Illinois*

Dr. Philippakis replies: The ranking presented in my article was devoid of any reference to measures of goodness. Therefore, there seems no justification for Mr. Wygant's attempt to transform a ranking based on programming effort into a ranking of efficiency.

Efficiency describes the ratio of input to output. Mr. Wygant's suggestion to compare installation throughput to program modules written in a language would be one possible way to measure efficiency, but certainly it would not be a way to measure usage which I defined as ". . . man-hours of programming in each language per one hundred man-hours of programming."

### Superficial breakdown

Glenford Myers' article "Characteristics of Composite Design" (Sept., p. 100) is a welcome addition to the literature on program development. I agree wholeheartedly with his concept of module independence as the key to successful program design. However, it is not clear that the specific techniques he suggests provide more than a superficial approach toward achieving this objective.

The decomposition of a program into modules solely along functional

lines seems fundamentally incompatible with the goal of eliminating global variables. Many systems—subroutine packages and operating systems are only two examples—require data to be shared by separate functions or by separate invocations of a single function where it would either be unreasonable or undesirable for the calling module to supply all required input data explicitly via parameters. System integrity or problem complexity often dictate that the calling module not even have access to the required information.

Difficulties also arise in self-contained systems during the debugging or maintenance stages of program development where, either through an oversight or a change in requirements, a fairly low-level routine needs access to a data item not currently available to it. The result is either to implement a quick fix in the form of a global variable or to change a number of routines in order to pass the required data item down through the program hierarchy to where it is needed. The latter approach can be rather a complex solution to a seemingly simple problem.

A more direct method of dealing with the problem of global variables is to organize programs not simply along functional lines but rather in terms of *data reference*. That is to say, all code which references a particular set of

## REAL TIME/SCIENTIFIC PROGRAMMERS SYSTEMS ENGINEERS

POSITIONS AVAILABLE IN ANAHEIM, CALIF.

- Define requirements for Airborne Computer Programs
- Conduct Systems Requirements Analysis
- Perform trade-off studies
- Define experimental test and verification requirements
- Analyze and evaluate test results for:
  - Command and control
  - Performance analysis
  - Simulation/Automated testing

Send resume to: Government Products Divisions  
3370 Miraloma Ave., Anaheim, Calif. 92803  
Attn: R. P. Nickens, D/051 BA39



**Electronics Group  
Rockwell International**

An Equal Opportunity Employer

## UNIVERSITY OF OTAGO

Dunedin—New Zealand

### Senior Lecturer or Lecturer in Computer Systems

Applications are invited for the position of Lecturer or Senior Lecturer in Computer Systems in the Faculty of Commerce. The position involves developing and teaching courses in the analysis and design of information processing systems.

Practical experience is desirable, both in the technical design aspects and in the management of systems projects. Opportunities exist for consulting work.

Salary scales: Lecturer:

\$NZ 6,335—\$NZ 8,103 per annum.

Senior Lecturer:

\$NZ 8,249—\$NZ 10,606 per annum  
with a bar at \$NZ 9,723 per annum.

(Note: \$NZ 100 = approx. £60 sterling; \$US 147; \$A 100).

Salary scales are subject to both triennial review and regular cost-of-living adjustments.

Further particulars are available from the Secretary-General, Appointments Department, Association of Commonwealth Universities, 36 Gordon Square, London W.C.1, or from the undersigned.

Applications, quoting Ref: A 73/54, close in London and New Zealand on 30th November, 1973. LATE APPLICATIONS WILL BE ACCEPTED.

J. W. Hayward,  
Registrar.

# New Computer Salary Data- and proven career advancement techniques- yours free.

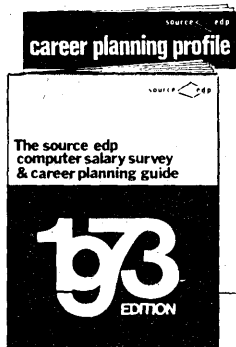

The seventh annual Source EDP Computer Salary Survey and Career Planning Guide and the all new Career Planning Profile are now available. These important reports allow you to rank your current salary with those of your peers, pinpoint the strengths and weaknesses of your experience to date and apply proven advancement techniques to your career plan.

All of this vital information has been compiled by Source EDP, the largest and most ethical nationwide recruiting firm devoted solely to computer professionals. To speed delivery of your free copies call, write or visit your nearest Source EDP office or circle the reader inquiry card.



**ATLANTA**—W. G. Barnett  
11 Corporate Sq. 30329, (404) 634-5127

**CHICAGO**—T. D. Walsh  
100 S. Wacker Dr. 60605, (312) 782-0857, 903 Commerce Dr., Oak Brook, Ill. 60521, (312) 323-8980 and 550 Frontage Rd., Northfield, Ill. 60093, (312) 446-8395

**DALLAS**—P. E. Dittmer  
7701 Stemmons Fwy. 75247, (214) 638-4080

**DETROIT**—R. T. Stevens  
24500 Northwestern Hwy., Southfield, Mich. 48075, (313) 352-6520

**HOUSTON**—S. A. Love  
4635 Southwest Fwy. 77027, (713) 626-8705

**KANSAS CITY**—Ray R. Moor, Jr.  
20 W. 9th St. 64105, (816) 474-3593

**LOS ANGELES**—W. B. Emigh  
3550 Wilshire Blvd. 90010, (213) 386-5500, 2081 Business Center Drive, Irvine, Ca. 92664, (714) 833-1730

**MINNEAPOLIS**—F. N. Anderson  
801 Nicolet Mall 55402, (612) 332-8735

**NEW YORK**—J. R. Masi  
600 Third Ave. 10016, (212) 682-1160

**PALO ALTO**—G. F. Best  
525 University Ave. 94301, (415) 328-7155

**PHILADELPHIA**—G. P. Ramming  
1700 Market St. 19103, (215) 665-1717

**ST. LOUIS**—R. H. Trumbull  
130 S. Bemiston Ave., Clayton, Mo. 63105, (314) 862-3800

**SAN FRANCISCO**—R. M. Clark  
111 Pine St. 94111, (415) 434-2410

**UNION, N.J.**—D. A. Mickel  
2400 Morris Ave. 07083, (201) 687-8700

Client companies assume our charges.

CIRCLE 104 ON READER CARD  
December, 1973

data items is contained in a single module. Global variables are nonexistent in this context.

Consider, for example, a compiler function which performs a lexical scan of input statement to provide the next component of the statement each time it is called. Suppose that facilities for skipping the entire statement in case of a syntax error or backing up to try an alternate parse are also included in the compiler. Each of these functions requires access to some pointer indicating the current position within the statement. Treating this pointer as a parameter to be passed back and forth among various routines within the system is both clumsy and unreliable. A more straightforward approach is to treat each of these three functions as a separate entry point in a single module dealing with the scanning process. The internal structure of the module would be a small group of routines clustered around a common data structure—containing the scanning pointer—which is local to the module. Note that this organization conflicts with Mr. Myers' criteria for program decomposition on two counts—the module performs more than one function and it keeps track of its own history. Yet it greatly strengthens the independence of the system components by isolating all of the scanning functions and machinery in a single module. And its multiple functions make it no less a candidate for a general-purpose program library.

Although we differ on the appropriate approach to program decomposition, Mr. Myers and I are in agreement that the particular techniques used can have a significant effect on software reliability, extensibility, and cost. This is an idea which is often lost sight of in the mad scramble to "get the job done."

JAY A. SULLIVAN  
*Agoura, California*

Mr. Myers replies: I agree that my three-page article is (by necessity) superficial; for a more thorough treatment, readers can request a copy of technical report TROO.2406 from their local IBM office or obtain additional material from me (D92/706, P. O. Box 390, Poughkeepsie, NY 12603).

Functional decomposition (functional strength) is not incompatible with the elimination of global variables. When a program or system is decomposed in a "top-down" fashion, the required data is always available to the calling module. Hence, passing all data explicitly via parameters is not unreasonable.

Mr. Sullivan describes a module with "communicational strength," a module with sufficient degree of strength. However, such a module does not have optimal strength because it normally performs multiple functions, with the danger of the coding of these functions becoming intertwined. □

# NCR

ACCOUNTING COMPUTER  
DIVISION

## ENGINEERS

Join the dynamic computer industry now with NCR in Wichita ... developing new products in a new facility. Earn an important place as fast as your abilities will permit.

And, spend off-work hours enjoying the good life ... fishing, hunting, boating, golfing or just relaxing at nearby recreational areas.

### PRODUCT ENGINEERS — ACCOUNTING MACHINE PERIPHERALS AND MINICOMPUTERS

Hands-on experience with mini-computers and complex peripherals (card readers, paper tape equipment, line printers, disc, mag tape, etc.) to provide engineering support for existing products and design / development of future miniperipherals and minicomputers. BSEE/MSEE with two or more years experience in logic design, electromechanical system analysis, and/or computer-based systems. Programming experience helpful but not required.

### CIRCUIT DESIGN/ ANALYSIS ENGINEERS

Requires experience in "worst case" design/analysis of digital and analog circuits incorporating the latest techniques in solid state, microelectronics and electro-mechanical circuits.

### ELECTRICAL COMPONENTS ENGINEERS

Requires experience in the evaluation of purchased active and passive components. Will be responsible for generation of specifications for semi-conductors, LED/PT and logic devices including MSI. BSEE required.

### PROJECT ENGINEER — ADVANCED MEMORY

Lead effort in the advanced development of semiconductor memories. Responsible for evaluation and determination of future MOS memory subsystems.

### PROJECT ENGINEER — ADVANCED SOFTWARE DEVELOPMENT

Responsible for evaluation of proposed mini-computer systems with respect to software impact and evaluation and determination of the general purpose software for NCR's future minicomputer systems.

Send complete resume, including salary history and requirements to:  
Industrial Relations Dept.,  
P. O. Box 1297,  
Wichita, Kansas 67201.

An Equal Opportunity Employer

CIRCLE 109 ON READER CARD

**WE'RE LOOKING  
FOR EDP  
PROFESSIONALS**



**ON WITH AN EYE  
ON THE FUTURE**

If you want a truly professional career opportunity and not just another job—now is the time to talk to us about your future.

You'll be working in one of the industry's largest and most progressive computer centers—with a dynamic combination of engineering, management science, business and realtime applications. Openings are immediately available for:

**PROGRAMMERS/ANALYSTS**

All levels with FORTRAN and COBOL languages.

**SYSTEMS ENGINEERS**

With experience in structure analysis, fluid mechanics or thermodynamics.

If you want to join a company where you can measure your progress in terms of accomplishments—and realize a high degree of professional satisfaction reflected in a highly attractive salary, exceptional benefits, rapid advancement opportunities and pleasant living conditions in the beautiful, historic surroundings of the Southeast (relocation expenses paid)—Newport News Shipbuilding is where your tomorrow is—NOW.

For consideration, send your resume with salary history to G. O. Vaughn.

**Newport News Shipbuilding**

A Tenneco Company Newport News, Virginia



An Equal Opportunity Employer

# People

## A Survivor of the Perils

He called them the "perils of Pauline" when he was going through them—"them" being the troubles encountered by Intranet Computing Corp. as it went into and out of Chapter XI, and "he" being James W. Halverson, 45, its new president and chief executive officer. The Van Nuys, Calif., firm is now solidly on the come-back trail—in a somewhat different direction than it had when founded



James W. Halverson

in 1968. Halverson was one of the founders of what was once primarily a time-sharing firm, and was the moving force in putting the company back on its feet as a producer of medical instrumentation and of proprietary mass storage and communications systems for computers.

And now Halverson wants to marry the two capabilities and provide complete hardware and software systems for medical centers, in hospitals, or elsewhere.

Currently, their biggest customer for the computer side of the business is California Computer Products which uses Intranet controllers in its tape and disc drive systems for Univac users. But Halverson said Intranet's new 8020 controller (for 80% hardwired and 20% programmable) can be programmed for many things and "we're looking at several places to go. We think our next shot will be in hanging on tapes and discs in a Honeywell environment."

Intranet is up to 95 people now, having slipped from a peak of 130 down to 5 in the dark days of Chapter XI. Halverson refuses to take total credit for the revitalization of the company. He likes to share it with Sam Volpintest, an investor who helped with money raising, and Dick Dooley, an Intranet vp who helped him operate the skeletal firm. Halverson rode a motorcycle to work in the bad times to save money, but his big love is horses. He owns four saddle horses and half a race horse.

The biggest lesson he learned from Chapter XI? "To have an alternate way to go in every situation."

## Hired to Buy, He Had to Sell

"At times I felt we were running two companies," says Gary A. Stoltz, former vp and secretary of Data 100 Corp. of Minneapolis. "One was doing fantastically well in the marketplace; the other was on the verge of collapsing in red ink."

The company has installed more than 2,000 batch terminals in less than five years, but until this year has posted huge losses because most of the equipment was on lease. Stoltz left Control Data Corp. five years ago to direct Data 100's acquisition program, but immediately found himself in a frantic search for credibility in the money market. Instead of looking at balance sheets of acquisition candidates as he had done at CDC, Stoltz commuted to New York with president Ed Orenstein to speak to analysts and bankers. Instead of acquisition reports, he wrote financial briefs explaining the company's potential despite its more than \$14 million in losses over four years. The former computer salesman and M.B.A. (from Northwestern) found himself wearing the company's public relations hat.



Gary A. Stoltz

But since Data 100 finally moved into the black in the last quarter of 1972, its financial outlook has become as bright as the market outlook (see October, p. 154). But Stoltz, now free to pursue acquisitions (the company this year acquired a minicomputer company, a printed circuits firm, and was bidding this fall to acquire ailing Computer Communications, Inc., of Los Angeles) has decided that financing struggling businesses is too exciting to give up. "I've just turned 40 and need either a mistress or a challenge," he jokingly told friends Oct. 15, when he announced his resignation to open a financial consulting and investment firm in Minneapolis. In selecting the latter path, Stoltz, who is a graduate of Case Institute of Technology, also remains a consultant to Data 100 in which he holds a sizable financial interest.

A surprise announcement early last month was that of the resignation of EUGENE E. PRINCE as vp and general manager of Ampex Corp.'s Computer Products Div. He was succeeded by CHARLES V. ANDERSON, most recently vp, corporate manufacturing, for Ampex in Redwood City, and formerly vp and general manager, Europe, Africa and Middle East, for Ampex International . . . WILLIAM J. SCHMITT was elected president and chief operating officer of Tickertron, Inc. . . . FREDERIC B. PALMER, of The Singer Co., was named chairman of the International EDP Audit Committee of The Institute of Internal Auditors, Inc. . . . DR. JOHN W. TUKEY of Bell Laboratories, credited with coining the term "bit," received a 1973 National Medal of Science from the federal government.

## Salesman to the Soviets

"The Soviets don't buy products the way we do, but they do buy," says Jim Blow, who goes to Moscow next month to head up a new Commerce Dept. trade promotion program.

His office, a block from the U.S. embassy, will offer extensive support to U.S. exporters. "We'll develop sales leads, locate prospective customers and sales agents for any U.S. company that requests our help," Blow explains. "And when the company sends a representative to Moscow, we'll help set up his business meetings."



Jim Blow

Regarding Soviet buying proclivities, he observed them first hand at an auto service equipment show sponsored by the Commerce Dept. in Moscow last summer. "Almost nothing was sold during the show itself," Blow recalls. "The day after it closed, the exhibitors were pretty discouraged as they began packing up. But then the buyers arrived, and by the end of that day orders had been written for virtually every item displayed."

Blow has been director of the trade promotion division, Bureau of East-West Trade. He came to the Commerce Dept. three years ago from the Ford Motor Co., where he was a district sales manager for the truck division. At Commerce, Blow was assigned initially to Latin American trade promotion activities. He gravitated to Moscow "partly through luck."

First, there was a dinner he arranged in Mexico City for some high-level Commerce Dept. officials. He did such a good job, that last year, when a Soviet trade delegation was invited to visit the U.S., Blow was appointed liaison officer for the group. The main result of the visit was the signing of a far-reaching agreement covering expanded technical cooperation and trade. Soon afterward, Commerce decided to open an office in Moscow. □

## Even Webster's Knows About QUEST

**QUEST** (kwĕst). v. 1. To make a search; to go on a quest.

**QUEST SYSTEMS, INC.** n. 1. A corporation founded in 1968. 2. The largest professional recruitment firm in the U.S. functioning solely in the computer sciences; its client companies pay all employment fees, interviewing and relocation expenses. Quest is known for its deep personal commitment to relate to each candidate as an individual with individual goals. 3. Its professional staff averages over 6 years of experience in EDP recruiting (additionally, staff members have direct hands-on experience in programming, systems, hardware sales, etc.) 4. Quest is presently searching for degreed programmers and analysts (commercial, scientific, systems software) for over 3,500 client companies in the U.S. *Quest has openings in over 700 U.S. towns and cities.* 5. Methodology — see Questsystem.

**QUESTSYSTEM** (kwĕst sis'tĕm). n. 1. Discussing with a man what he would like to be doing in light of what he has been doing. 2. Analyzing the realities of his objectives as they relate to the current job marketplace. 3. Contacting client companies and other Quest staff personnel to identify positions of possible interest. 4. Introducing the job candidate to his prospective employers by providing complete details to each about the other, ensuring the efficacious use of everyone's time. 5. Arranging interviews. 6. If employment offers are extended, Quest assists in evaluating the responsibilities, compensation and opportunities (and relates those to the initially stated objectives). The Questsystem has been working for thousands of professionals at no expense, whatsoever. Ask your friends of their past dealings with Quest. Then, put the Questsystem to work for you. For additional information on this subject, please inquire directly to Quest Systems, Inc. (All inquiries/resumes received will be responded to immediately and in confidence).

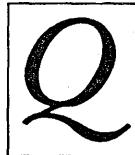

**QUEST SYSTEMS INC.**

6400 Goldsboro Road  
Washington, D. C. 20034 (301) 229-4200  
Baltimore Office: 265-1177

## FREE EMPLOYMENT SERVICE FOR PROGRAMMERS AND ANALYSTS

Serving Northeast, Southeast and Midwest U.S.

RSVP will provide free employment counselling and develop and selectively distribute your resume.



Our openings include scientific and commercial applications, telecommunications, control systems, software development and systems programming utilizing most languages, computers and operating systems. We also serve engineering and marketing personnel in the computer field.

Call or send resume or rough notes of objectives, salary, location restrictions, education and experience (including computers, models, operating systems and languages) to any one of our offices. Or check the reader service card for a free sample resume and typical job descriptions. We will answer all correspondence from U.S. citizens and permanent residents and will guarantee our best efforts in a professional and ethical manner to all qualified applicants. Our client companies pay all of our fees.

- RSVP SERVICES, Dept. M., Suite 700, One Cherry Hill Mall, Cherry Hill, New Jersey 08034 (609) 667-4488
- RSVP SERVICES, Dept. M., Suite 104, Towle Bldg., 1777 Walton Road, Blue Bell, Penn., 19422 (215) 643-5550
- RSVP SERVICES, Dept. M., 1651 Old Meadow Road, McLean, Va. 22101 (703) 790-5166

## RSVP SERVICES

Employment Agency for Computer Professionals

It's everything you've ever wanted in a peripheral for your mini. With a price/performance ratio superior to every other electrostatic printer/plotter on the market.

In fact, the Gould 5000 gives you 1200 lines per minute—or 600 more than Brand V. And at a lower price.

That means you get high speed for improved mini throughput efficiency. Low cost for economic justification. And, of course, high reliability backed by Gould's reputation for quality.

But you also get a lot more. Resolution of 100 dots per inch. Full alphanumeric and graphic capabilities. 132 characters per line. A 64 ASCII character set. Fan fold and roll paper. 8 bit wide data path.

Optional features? The Gould 5000 is loaded. 96 ASCII character set, upper and lower case. 128 ASCII character set custom designed to your requirements. On-line mini-computer and off-line magnetic tape interfaces.

What's more, Gould software is the most efficient and flexible available anywhere.

It lets your mini print and plot considerably faster than competitive units.

We say that the new Gould 5000 is the best buy on the market, with the best features of any mini-computer printer/plotter. And our Pete Highberg or Bill Koepf can prove it to you. Get in touch with them now at Dept.

D12, Gould Inc., Data Systems Division, 20 Ossipee Road, Newton Upper Falls, Mass. 02164.

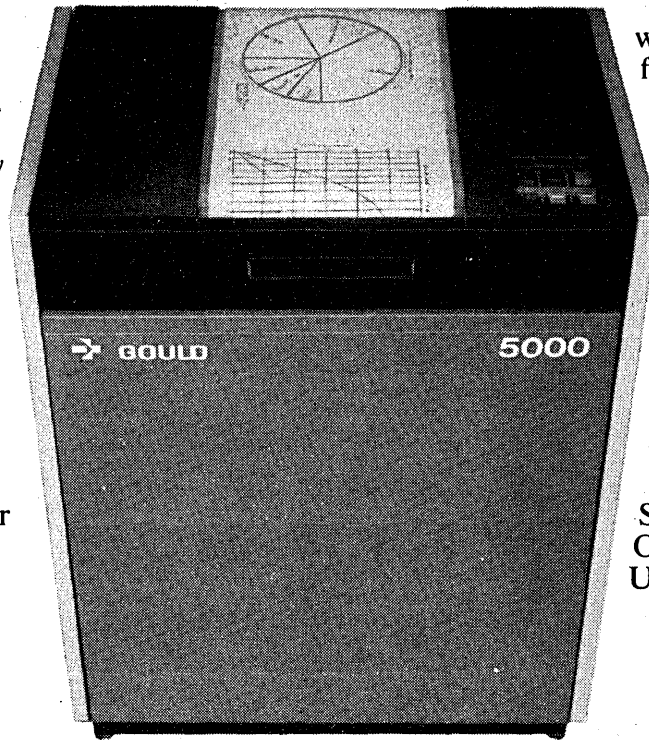

# The new Gould 5000. Twice as fast as any printer/plotter ever designed for mini-computers.



# Look Ahead

(Continued from page 18)

interest group to investigate forming a union for computer people.

## A QUESTION OF QUARANTINE?

A communicable disease felled five small computer systems at United Computer Corp., Carson, Calif. based software house, and one system at a customer's location. At least that's what United president John Wright thought when the systems went down in rapid succession. The ailment was diagnosed. On the first system to go, a disc got scored and ruined the head. Not suspecting the disc, United technicians put it on a second system with the same result. Now the disc was suspect so a new disc was tried on no. 2 system and was scored by the damaged head. But this disc was still considered OK and was tried on a third system in part of a chain reaction that victimized six computers and a half-dozen discs. Wright wouldn't name the brand of computer afflicted by the malady. He believes it could happen to any kind of system.

## A LOT OF KICKS

Of the multitude of computer-based gifts surfacing this Christmas season, Robert W. Kross' \$2,500 bar may be the most intriguing. It's the sole product of his 19-man company, Leisure Products Co., Dallas, which turns out 50-70 a month. He claims 100 were sold as of last Thanksgiving through prestigious department stores. Users give their party guests punched cards from which they select one of 47 cocktails from 12 containers of different mixes and liquors, dispensed through the minicomputer system Kross designed. One unconventional drink -- added "just for kicks" by the former aerospace engineer -- is the Brown cocktail: 2/3 vermouth, 2/3 gin and 2/3 rum. It should provide a lot of kicks.

## RUMORS AND RAW RANDOM DATA

Developers of the widely used Mark IV file management system (700 systems installed) are about to introduce CL\*IV, a similar system for COBOL programmers. Three have been installed so far by Informatics, Los Angeles software house...Univac, still delaying its long-rumored oem deal for Pertec's key-to-disc data entry systems, now is reported ready to announce a new keypunch system. Called the 1801, it would compete with IBM's 129...The American Society for Information Science automated the tricky job of conference time scheduling at its Info 73 last fall in Los Angeles. People attending keyed in their special interests at a terminal near the registration desk and out came a list of the sessions that matched these interests... AFIPS is trying to figure out how to get a National Computer Week established in conjunction with next May's National Computer Conference in Chicago...ADAPSO's Computer Time-Sharing Section (CTSS) is now the Remote Processing Services Section (RPSS). The end of an ambiguous designation?...Bernard Strassburg, chief of the FCC's Common Carrier Bureau for the past 10 years, will retire at the end of the year and may become an FCC commissioner. Asher Ende, the Bureau's deputy chief, is a likely successor...One computernik was surprised to find a European airline asking for his U.S. social security number on a property claim report. The airline never did explain just how it might help locate his luggage...The Federal Information Processing Standards Coordinating and Advisory Committee filed the notice of its Oct. 30 meeting on Oct. 29 for publication in the Federal Register which reached those invited to attend...two days after the meeting.

# Advertisers' Index

## Have you heard about NCR's new organization?

We've changed! And in that change there could be opportunity for greater professional involvement for you!

We've changed many of our products from mechanical free-standing equipment to complete electronic systems for business, industry, and diverse government functions. Among other things, they include

- Accounting Computer Systems
- Data Entry Systems
- Data Processors
- Electronic Communication Systems
- Financial Systems
- Postal Systems
- Retail Systems

And we've changed our location! NCR Engineering was once basically in Dayton, Ohio. Now it is California, Ohio, New York, Florida, Kansas and Delaware—wherever the product itself is made!

Now we must staff to meet our goals. Developing the many current products (as well as those yet to come) for complete systems requires professionals with advanced understanding of applied electronics and innovative minds in people who think fresh and new. Business systems is the fastest growing segment of the electronic industry, and our invitation to you is come, grow with us!

If you have experience in digital logic and circuit design for business systems, or if you are software-oriented and knowledgeable with the firmware and hardware that goes into computerized systems, terminals, or mini-computers, contact us now!

Let us know your product interest, your geographic preference and your professional credentials. One of our many divisions will be happy to explore employment with you.



**NCR Worldwide Headquarters**  
Corporate Executive & Professional  
Placement  
Dayton, Ohio 45479

An Equal Opportunity Employer M/F

AC Manufacturing Company	137
ACCO International Inc.	67
American Telephone and Telegraph Company	108, 109
†Ampex	132-Y
Applications Software, Incorporated	153
Applied Digital Data Systems, Inc.	64, 65
†ASEA	132-M
Astrocom Corporation	140
BASF Systems	Cover 3
Bright Industries Inc.	68
Burnham Van Service, Inc.	26
Burroughs	111
Cadillac Associates, Inc.	172
California Computer Products, Inc.	39
Cambridge Memories, Inc.	40, 41
Centronics Data Computer Corp.	31
†CII	132-N, 132-O
Cincinnati Milacron, Process Controls Division	2
CIT Alcatel	131, 132
Computer Devices Inc.	85
Computer Operations, Inc.	130
Control Data Corporation	48, 49, 161
Cummins-Allison Corp.	126, 127
Data General	6, 7
Datcraft Corporation	9
Datapoint Corporation	20, 21
Datum, Peripheral Equipment Division	89
Diablo Systems, Incorporated, A Xerox Company	119, 121
Digital Computer Controls, Inc.	81
Digital Equipment Corporation	36, 37, 94, 95, 158
†Digital Equipment Corporation International	132-R, 132-S
DIVA, Inc.	73
Documation Incorporated	10
Eastman Kodak Company, Business Systems Markets Division	79
Electronic Memories & Magnetics	124, 125
Evergreen Computer and Financial, Inc.	107
Fabri-Tek Inc.	16
†Facit-Addo	132-Z, 132-AA
Facit-Addo, Inc.	105
Fujitsu Limited	133
The Garrett Corporation	93
General Automation	66
†Geveke Elektronica en Automatie bv	132-X

Goodyear Aerospace Corporation	46, 172
Gould Inc., Data Systems Division	166
Robert Half Personnel Agencies	169
Harris Communication Systems, Inc.	122, 123
Hazeltine Corporation	47
Hewlett-Packard	19
Houston Instrument, Division of Bausch & Lomb	23
IBM	27, 28, 29, 30
Incoterm Corporation	43
Inforex, Inc.	102, 103
Informatics Inc.	151
Interdata	12, 13, 14, 15
International Communications Corporation	5
International Data Sciences, Inc.	128
Itel Corporation	75
C. Itoh & Co. (America) Inc.	170
†ITT Business Systems	132-V, 132-W
Kennedy Co.	Cover 2
Krantz Computer	132-P
Lockheed Electronics, Data Products Division	142
Malmo Datacenter AB	105
Manpower Temporary Services	161
†Memorex Precision Products Ltd.	132-G, 132-H, 132-I, 132-J
Micro Switch, A Division of Honeywell	112, 113
M&M Computer Industries, Inc.	22
Mohawk Data Sciences Corp.	99
Monarch Marking Systems	160
NCR	168
NCR, Accounting Computer Division	163
NCR Paper	86
NCR Terminals & Computers	8
Newport News Shipbuilding	164
The North Brevard Development Commission	154
On-Line Software, Incorporated	154
Optical Scanning Corporation	141, 143, 145
University of Otago	162
Pertec Corporation/Peripheral Equipment Division	91
Philips Data Systems	34
†Philips Telecommunicatie Industrie B.V.	132-U

Prime Computer Inc. . . . . 134, 135  
 Princeton Electronic Products . . . . 159

Quest Systems Inc. . . . . 165

†Racal-Milgo Limited . . . . . 5  
 Raytheon Data Systems . . . . . 116, 117  
 RCA Custom Terminal  
 Systems . . . . . 155

RCA Service Company,  
 A Division of RCA,  
 Technical Products Service . . . . 128

†Regnecentralen . . . . . 132-CC  
 Research Inc. . . . . 115

Rockwell International, Government  
 Products Divisions . . . . . 162

Rockwell International,  
 Microelectronic Product  
 Division . . . . . 138

RSVP Services . . . . . 165

†R2E . . . . . 132-DD, 132-EE

Rusco Electronic Systems, A  
 Rusco Industries Company . . . . . 82

Science Accessories Corporation . . . . 4

Singer Business Machines . . . . . 44, 45

The Singer Company, Kearfott  
 Division, Tele-Signal Operation . 144

Software International  
 Corporation . . . . . 152

†Software Sciences . . . . . 132-T

Source EDP . . . . . 163

Summagraphics Corporation . . . . . 148

Sycor Inc. . . . . 74, 156

Sykes Datatronics Inc. . . . . 104

Systems Engineering  
 Laboratories . . . . . 32, 33

Tab Products Co. . . . . 146, 147

Tally Corporation . . . . . 1

Techtran Industries . . . . . 84

†Telecommunications  
 Radioelectriques &  
 Telephoniques . . . . . 132-FF

Teletype Corporation . . . . . Cover 4

†Tesdata Systems Corporation . 132-BB

Texas Instruments Incorporated,  
 Digital Systems Division . . . . . 106

3M Company, Data Recording

Products Division . . . . . 24

Time Share Peripherals

Corporation . . . . . 145

Topaz Electronics . . . . . 26

United Air Lines . . . . . 35

Varian Data Machines . . . . . 42

Victor Comptometer Corporation . 149

Wang Laboratories, Inc. . . . . 83

Wangco Incorporated . . . . . 139

Wayne State University,

Computer Science Section . . . . . 148

Westinghouse Canada Limited . . . . 38

†European Insert Advertisers

# Technical Publishing Company

Arthur L. Rice, Jr., Chairman of the Board  
 James B. Tafel, President  
 Gardner F. Landon, Exec. Vice President  
 Calverd F. Jacobson, Financial Vice President  
 Edwin C. Prouty, Jr., Secretary and Director  
 of Data Processing

## Advertising Offices

Sales Manager and Vice President  
 John Brennan: Greenwich, Ct. 06830  
 35 Mason St. (203) 661-5400  
 Cable: DATAMATION,  
 Greenwich, Connecticut

Eastern District Managers  
 A. Treat Walker,  
 Warren A. Tibbetts: Greenwich, Ct. 06830  
 35 Mason St. (203) 661-5400

New England District Manager & Vice President  
 Warren A. Tibbetts: Manchester, N.H. 03104  
 112 W. Haven Rd.  
 (603) 625-9498

Midwest District Manager  
 John M. Gleason: Chicago, Ill. 60606  
 205 W. Wacker Drive  
 (312) 346-1026

Western Manager and Senior Vice President  
 Hamilton S. Styron: Los Angeles, Calif. 90035  
 1801 S. La Cienega Blvd.  
 (213) 559-5111

District Manager  
 Alan Bolté, Jr.: Los Angeles, Calif. 90035  
 1801 S. La Cienega Blvd.  
 (213) 559-5111

Western District Manager  
 James E. Filiatrault: Mountain View, CA 94043  
 2680 Bayshore Frontage Rd.  
 Suite 101  
 (415) 965-8222

U.K., Scandinavia, Benelux  
 Wallace K. Ponder, European Director  
 31 Lyncroft Avenue  
 Pinner, Middx. HA5 1JU  
 England  
 Tel: (01) 868 9289  
 Cables: PACOM, Pinner

France, Switzerland, Italy  
 Gerard Lasfargues  
 48 rue Vital  
 75016 Paris  
 France  
 Tel: 288 90 22

Germany  
 Bohn International KG  
 6000 Frankfurt/Main 1  
 Hansaallee 7  
 Germany  
 Tel: 0611/55 80 77

## Other Technical Magazines

Plant Engineering      Pollution Engineering  
 Power Engineering      Purchasing World  
 Research/Development

**Beat the Big One...  
 Heart Attack  
 Give Heart Fund**



## Use Robert Half

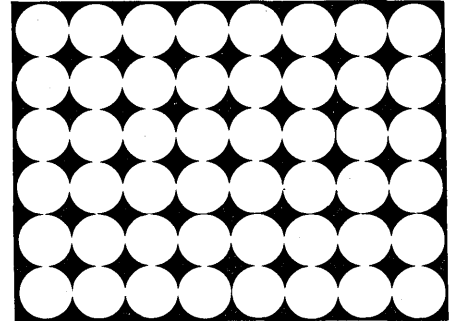

## for a change



Searching for a competent Financial or Data Processing talent?

Looking for a better position?

ROBERT HALF offers personalized, intensive coverage . . . locally, regionally, nationally or internationally.

ROBERT HALF IS GOOD FOR A CHANGE.

World's Largest Financial & EDP Personnel Specialists

Alexandria, Va. 5001 Seminary Road . . . . .	(703) 931-3600
Allentown, Hotel Traylor Building . . . . .	(215) 439-1506
Atlanta, 3379 Peachtree Road N.E. . . . .	(404) 233-2416
Baltimore, The Quadrangle-Cross Keys . . . . .	(301) 323-7770
Boston, 140 Federal St. . . . .	(617) 423-6440
Charlotte, 4801 E. Independence Blvd. . . . .	(704) 535-3370
Chicago, 333 N. Michigan Ave. . . . .	(312) 782-6930
Cincinnati, 606 Terrace Hilton . . . . .	(513) 621-7711
Cleveland, 1367 E. 6th St. . . . .	(216) 621-0670
Dallas, 2001 Bryan Tower . . . . .	(214) 742-9171
Denver, 1612 Court Place . . . . .	(303) 244-2925
Detroit, 670 Honeywell Center, Southfield . . . . .	(313) 354-1535
Hartford, 111 Pearl St. . . . .	(203) 278-7170
Houston, 1200 Centra Nat'l. Bank Bldg. . . . .	(713) 228-0056
Indianapolis, 9 North Illinois St. . . . .	(317) 636-5441
Kansas City, Mo., 127 West 10th St. . . . .	(816) 474-4583
Lancaster, Pa. 8 North Queen St. . . . .	(717) 299-5621
Long Island, 420 Jericho Turnpike, Jericho . . . . .	(516) 822-8080
Los Angeles, 3600 Wilshire Blvd. . . . .	(213) 386-6805
Louisville, 680 South 4th St. . . . .	(502) 589-6657
Memphis, 12 S. Main St. . . . .	(901) 523-8950
Miami, 1190 N.E. 163 St., North Miami Beach . . . . .	(305) 947-0684
Milwaukee, 777 East Wisconsin Ave. . . . .	(414) 271-9380
Minneapolis, 80 South 8th St. . . . .	(612) 336-8636
Newark, 1180 Raymond Blvd. . . . .	(201) 623-3661
New York, 330 Madison Ave. . . . .	(212) 986-1300
Omaha, 7101 Mercy Road . . . . .	(402) 397-8107
Orange, Ca., 500 South Main St. . . . .	(714) 835-4103
Philadelphia, 2 Penn Center Plaza . . . . .	(215) 568-4580
Phoenix, 1517 Del Webb TowneHouse . . . . .	(602) 279-1688
Pittsburgh, Gateway Towers . . . . .	(412) 471-5946
Portland, Or., 610 S.W. Alder St. . . . .	(503) 222-9778
Providence, 400 Turks Head Bldg. . . . .	(401) 274-8700
St. Louis, 7733 Forsyth Blvd., Clayton . . . . .	(314) 727-1535
San Francisco, 111 Pine St. . . . .	(415) 434-1900
San Jose, 675 North First St. . . . .	(408) 293-9040
Seattle, 1215 Fourth Ave. . . . .	(206) 624-9000
Stamford, 111 Prospect Ct. . . . .	(203) 325-4158
Tampa, 1311 N. Westshore Blvd. . . . .	(813) 876-4191
Washington, D.C., 7316 Wisconsin Ave. N.W. . . . .	(301) 652-1960
Wilmington, 4102 West St. . . . .	(302) 652-3244

London E C 2, England, 17 Finsbury Square . . . . . 01-638-4394  
 Toronto, Canada, 15 Toronto St. . . . . (416) 868-1314



CIRCLE 113 ON READER CARD

Another fine OEM product from C. Itoh.

Model AN-101F

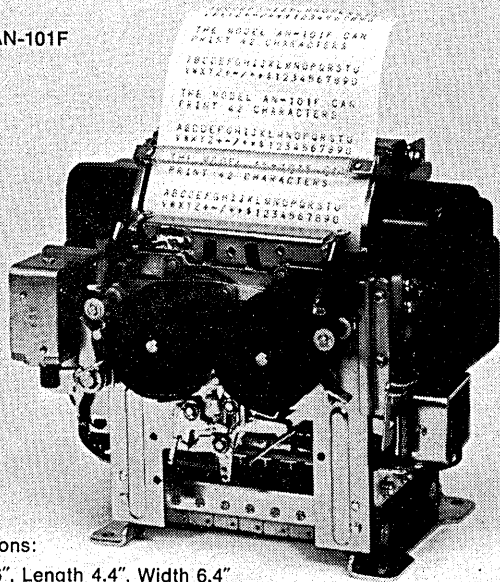

Dimensions:  
Height 6", Length 4.4", Width 6.4"

## Alpha-Numeric Printing Mechanism.

Designed for the computer peripheral market, this model AN-101F has a capability of printing all 26 alphabetic characters and 10 numeric characters. It can handle up to 21 columns with 42 characters per column, including six special symbols, at a speed of up to 1.2 lines per second.

The Model AN-101F provides a permanent printed record of management information, hospital information, order processing, production scheduling and warehouse inventory. Other features include two-color printing, low electrical power consumption and compact design.

There are 10 additional models available to serve various applications, each ready for immediate delivery at a most attractive C. Itoh price.

Send in the coupon for more information.

### C. Itoh & Co. (America) Inc.

270 Park Avenue, New York, N.Y. 10017 • (212) 953-5452/5447

West Coast office: 555 S. Flower Street, Los Angeles, Calif. 90071  
(213) 687-0610

New Jersey office: (201) 347-7997 Ohio office: (513) 492-1159

Canadian office: Suite 4181, Commerce Court West Bldg.  
Commerce Court Postal Station, Toronto, Ontario • (416) 868-0011

Attention: Industrial Electronics Div. D-12  
C. Itoh & Co. (America) Inc.  
270 Park Avenue, New York, N.Y. 10017

Please send me more information on your Alpha-Numeric Printing Mechanism.

Name \_\_\_\_\_ Title \_\_\_\_\_

Company \_\_\_\_\_ Telephone No. \_\_\_\_\_

Street \_\_\_\_\_

City \_\_\_\_\_ State \_\_\_\_\_ Zip \_\_\_\_\_

Specific Application \_\_\_\_\_

CIRCLE 99 ON READER CARD

This forum is offered for readers who want to express their opinion on any aspect of information processing. Your contributions are invited.

# The Forum

## Who is Qualified?

In spite of the economic crunch that has been a pressure factor in the dp field over the last two years, there still persists the cry of a shortage of well-qualified personnel in both dp and systems. A number of recent articles in both trade journals and newspapers have reported this same occurrence. According to such voices there does indeed exist a shortage of well-qualified applicants. So many people have bemoaned the difficulty of finding the right applicants to fill the jobs they want to fill. And it appears there will be no let-up of such shortages for many years to come, possibly through the 1970's. Yes, there are many applicants available in the job market these days, but so few of them are well-qualified, it is often necessary to interview hundreds to find just the right man.

It may be that your company has had this problem. Perhaps you are one of those trying to find well-qualified applicants, and are having a difficult time. But why are there so few qualified applicants? Do they lack intelligence, or the right kind of background, experience, education, habits, or what? It might be some combination of these factors, or maybe even all of them in some cases.

There is another possibility which is rarely mentioned and seldom given any serious consideration. Possibly the hiring criteria contain serious flaws based on false assumptions axiomatically concluded to be true. Such existing fallacies would eliminate qualified applicants who are in the market and who could do a good job, if this could only be recognized by those making the hiring decisions. How many such applicants are daily being passed over because of existing fallacies is difficult to say without research, but it is at least inferential that when a firm screens 200 applicants for its systems and dp openings, and can find none qualified, there is more amiss than that none of those applicants measure up.

One factor which is abused is the job specification level. A position has to have, for example, an MBA degree holder. Does such a position definitely require the management science techniques which an MBA would know? Does the position require such knowledge only occasionally . . . or maybe it is better to play safe than to have any doubts? If not often needed, is it not just as satisfactory to bring in a consultant when that management science knowledge is needed? And besides management science techniques, what part of the MBA is required beyond what a BA degree would offer?

Yet, insisting upon the MBA excludes any who do not

"qualify." And far too often the MBA really is not needed for success in the job, but it makes management feel safe, guaranteed that a successfully performing person has been hired. It is rare that a job requires the full expertise and knowledge of the person hired. This results in the too widespread phenomenon of overqualification for the job, which in turn leads to job dissatisfaction and high turnover. So deeply set is this habit that firms are themselves helping to create a personnel shortage.

A second factor which limits the selection of candidates is the false assumption that any professional man who is in the job market is automatically suspect. Here the dominating illusion is that such applicants must be deadwood or incompetent, because were this not so, such persons would indeed be working. After all, everyone knows that firms are always looking for well-qualified people and will make room for them when found.

What are the reasons for such fallacies? People get fired because someone in upper management demands a change, or because cost reductions dictate terminations which often reflect little insight into individual performance. Sometimes people could not get along with their bosses the way the bosses would have liked, or there was a political shakeup in which the wrong team was supported. With rare exceptions, firms just do not make room for well-qualified applicants when in the midst of an economic retrenchment or sharp cost-cutting effort.

Yet, in candidate selection the word is dictated by management that they are only interested in hiring those who are currently working, because they are the ones who are competent. How many non-working, but qualified applicants are shut out because of such axiomatic assumptions! What this attitude says is that you are qualified to work if you are working. This fallacy pervades hiring qualifications, even in dp and systems jobs. How often have you followed this false assumption?

A third factor built upon the basis of negative assumption is that the person who has had beyond a reasonable number of jobs (perhaps four) in a given period of years is unqualified by the fact of the number of jobs. A qualified person does not change jobs often, because such a person easily finds his niche, and the company with which he is happy, and can find fulfillment of his goals. It is only the person who is unstable, or deadwood, or undecided who changes positions. It used to be found mainly in the defense industry that job instability was a way of life.

More recently, though, there has been an increase of non-defense firms that have practiced job elimination as economic pressures have intensified, and that have operated on a project hiring basis in the hope that by the time one project had been implemented, new ones would have arisen to maintain the systems and dp workforce. If not, such persons find that they have worked themselves out of a job. Non-defense industry management assumes a job stability exists within their operations which, more often than not, just does not exist. The kind of stability which is assumed in non-defense industry exists where systems and dp departments have been staffed on the thin side, so there is a workload of more than double what the staff can turn out and no question of what is to be done next. But without checking into specific situations of individual applicants to determine the facts about numerous job changes, management again closes the door automatically upon many applicants who are qualified.

A fourth factor is one which should have been buried long ago, but, again, it lives on from failure of management to check and challenge false premises. This factor, that an applicant is too old upon reaching the magic age of 40, has in theory been outlawed by legislation. In practice it is widely followed. It is expressed by the hiring of younger men over the more mature. Given the choice between a man under 40 and one over 40, the hiring criteria are stacked in favor of the younger man. There have been so many contradictions to this bias, it should be laid to rest. The more mature persons usually have a better sense of their goals and a more realistic concept of the business world, with far less itchiness to be looking for greener pastures elsewhere. A striking example of this bias is the hiring of recent MBA grads, with little or no work-world experience, at salaries equalling or exceeding those of mature workers with years of experience behind them. In one case, an administrative vp was interviewing a systems man for a position in his organization only to find that this young man, with 7 years of systems dp background, was earning almost as much as the vp himself.

A fifth instance of negativism, again based upon false assumptions, is the sacred cow, "you can only do what you have done." Systems job specs set forth years of experience of certain kinds, depending upon the type of job to be assigned. The manufacturing systems man is relegated to that specialty; so is the inventory systems man, the personnel systems man, etc. Often a specific number of years of

## ARE YOU ONE OF THE "MOST NEEDED" PEOPLE IN EDP?

You are if your experience and salary are in the following areas:

PROGRAMMERS .....	\$10,500-\$14,500
PROGRAMMER/ANALYSTS .....	\$12,000-\$16,000
SYSTEMS ANALYSTS .....	\$14,000-\$18,000
SYSTEMS (SOFTWARE) PROGRAMMERS .....	\$13,500-\$20,000

These are some of the positions which Cadillac has open—coast to coast. Cadillac, the largest placement firm in the nation, can help you find a better position in EDP from Maine to California and in every industry, from banking through manufacturing and distribution to retailing.

Let us know your experience and objectives and we will evaluate your marketability. Our service is absolutely free of charge to you. Client companies pay all fees and expenses. So write today!

### FREE JOB OPPORTUNITIES BULLETIN

Our bulletin, published quarterly, listing available opportunities in the Systems & Data Processing field is available free of charge and will be mailed to your home upon request.

For your free bulletin, without any obligation, circle reader service card #115. Please USE HOME ADDRESS ONLY!



E. W. Moore  
Executive Vice President

### CADILLAC ASSOCIATES, INC.

32 W. Randolph St., Chicago, Ill. 60601  
(312) 346-9400

"Where More Executives Find Their Positions Than  
Anywhere Else in the World"

CIRCLE 115 ON READER CARD

## ENGINEERS PROGRAMMERS

OPENINGS FOR ENGINEERS WITH  
EXPERIENCE IN:

MATH MODELING FOR ROTARY AND  
FIXED WING SIMULATION  
SIMULATION SYSTEMS ENGINEERS WITH  
REAL TIME PROGRAMMING EXPERIENCE  
IN SYSTEMS SOFTWARE

we are a leader in simulation training devices,  
join GOODYEAR, and GO.

PLEASE WRITE:

Mr. J. G. Evans, Coordinator  
Technical and Scientific Personnel

### GOODYEAR AEROSPACE CORPORATION

Akron, Ohio 44315

CIRCLE 112 ON READER CARD

## the forum

experience with specific equipment and software is called for. If a person has two years of experience, he is not qualified for jobs specified as needing 4-6 years; a job set for 6-8 years would not be satisfied by 3 years of experience, etc. For jobs at a supervisory level, one must have supervisory experience on the job. This means a corps of systems and dp specialists has to be built, one for each type of systems project to be undertaken. An alternative to that would be to train a specialist in each job in the principles of systems and dp.

Each set of experience qualifications raises the same questions as to why the job needs X years of experience. What would happen if someone with less than that amount of experience had to get the job done? With such stress placed upon experience and what a person's specialty is, little if any recognition is made of systems principles, techniques, and methodology that do exist. These can be applied by persons with intelligence to many different functions, even those new to the person.

This insistence upon in-depth specialized experience negates the desideratum that systems people should be (or become) systems generalists. The recent *Profile of a Systems Man*\* makes this clear: "Systems discipline is excellent because it encourages the generalist's approach to integrated problem-solving as opposed to the specialist's 'axe to grind' approach . . . The executive of the future will be trained in the systems approach to the management process. He will be skilled in how to use the current technology available. He will be more interested in achieving a practical balance between the various disciplines than he will be [in] creating his own empire of specialism. He will seek . . . a quality balance between the social and economic systems in his organization."

How are such goals to be achieved when the emphasis in hiring is placed upon the systems specialists to the near exclusion of those who are systems generalists? It is far more difficult to train the man who is an expert in a given function to grasp the broader perspective than it is to train the generalist to learn what is needed in a new function. At the rate of current job qualification specs it will be at least 10 years before a change is effected, and we move in the direction of developing, using, and hiring systems generalists.

It should be evident that hiring practices and qualification standards for positions in systems and dp have been infected with a number of fallacies which limit the selection of applicants who really are qualified to perform successfully, if they could be recognized and seriously considered to fill such positions. This creates an artificial shortage of qualified personnel by bypassing the many who are in the job market and who are fully capable of contributing successfully. This unfortunate situation is not going to change until managers begin to challenge, examine, and correct these false assumptions in their hiring practices. If this is not done, systems personnel will continue to be in short supply, because many of those qualified will continue to be shut out automatically. The talents, experience, and maturity of these applicants will continue to be wasted. Even correcting the current false assumptions will not solve the problem of short supply entirely, but it would help to lessen it. It remains to be seen if systems managers will ever take the steps needed to effect the changes required.

—John J. Callahan, Jr.

Mr. Callahan is an independent consultant in systems and management, and is a professional member of the Assn. of Systems Management.

\*Monograph of the Assn. of Systems Management, 24587 Bagley Rd., Cleveland, Ohio, 1972, p. 1-2.

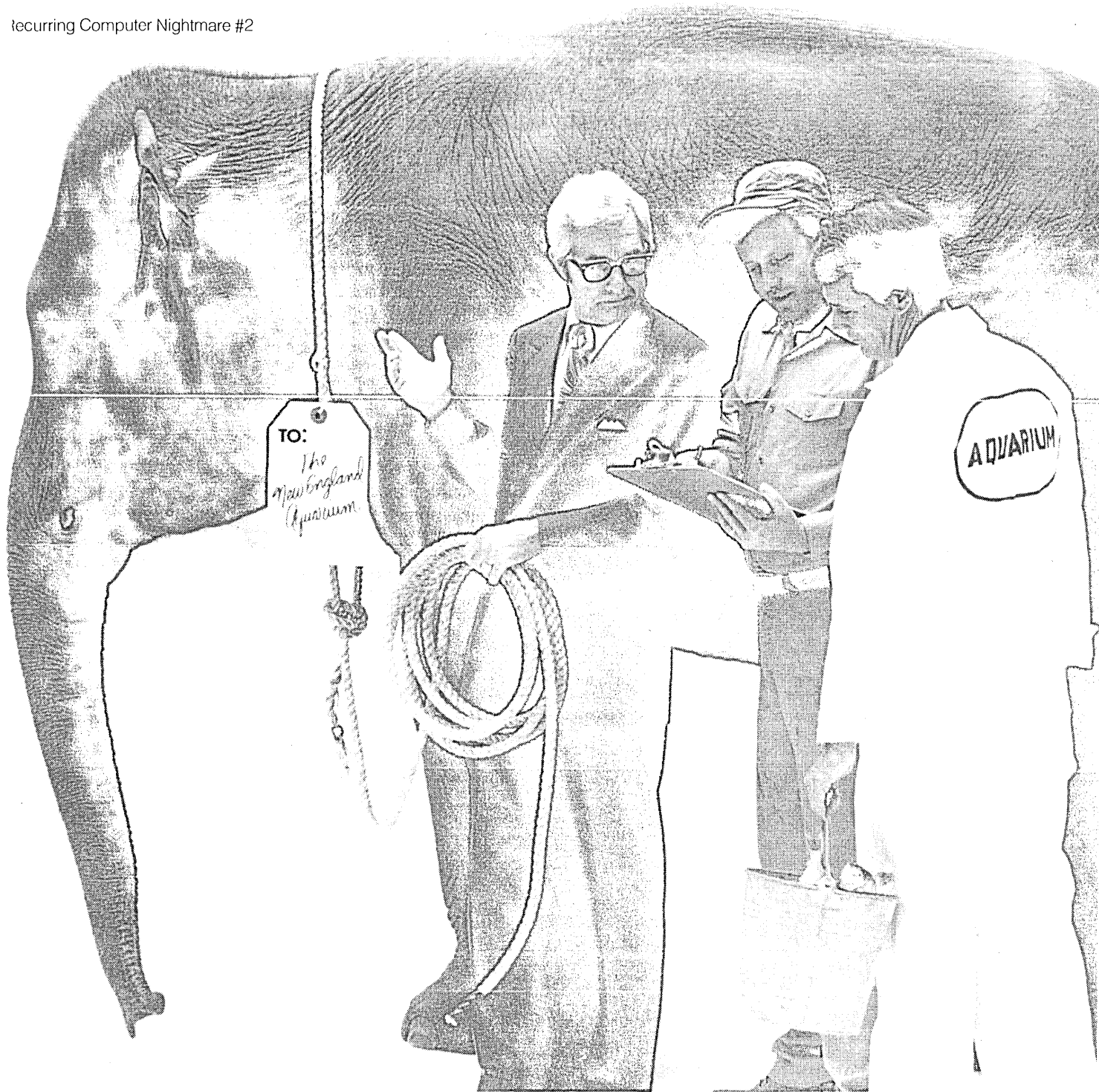

## The day the baby whale arrived at the Aquarium.

Maybe it was the office party the night before, or some transient crud on your tape head. The fact is, it doesn't take much to produce a jumbo error.

What it does take is a whale of a lot of care to keep your possibility of EDP error down to a manageable minimum. And the easiest place to start is in your selection of computer tape. How? By specifying BASF.

At BASF, we put a great deal more effort into producing tape to our standards, rather than industry standards. Take a small detail like tape width. Industry standards say a tolerance of  $\pm .002$ " is okay. Our standard is pegged at  $\pm .001$ ". A small detail maybe. But to us it's the difference between a whale and an elephant.

One thing more. Our tapes don't cost any more than the competition's. You're already paying for BASF quality. . . you might as well have it. Write today for the complete story of how BASF computer tapes stack up against the competition. Remember, nobody makes a better tape than the people who invented it. BASF Systems, Crosby Drive, Bedford, Mass. 01730.



**When it's BASF...you know it's not the tape that goofed.**

**This member  
of our family  
is still the  
thriftiest ASR  
terminal  
around.**

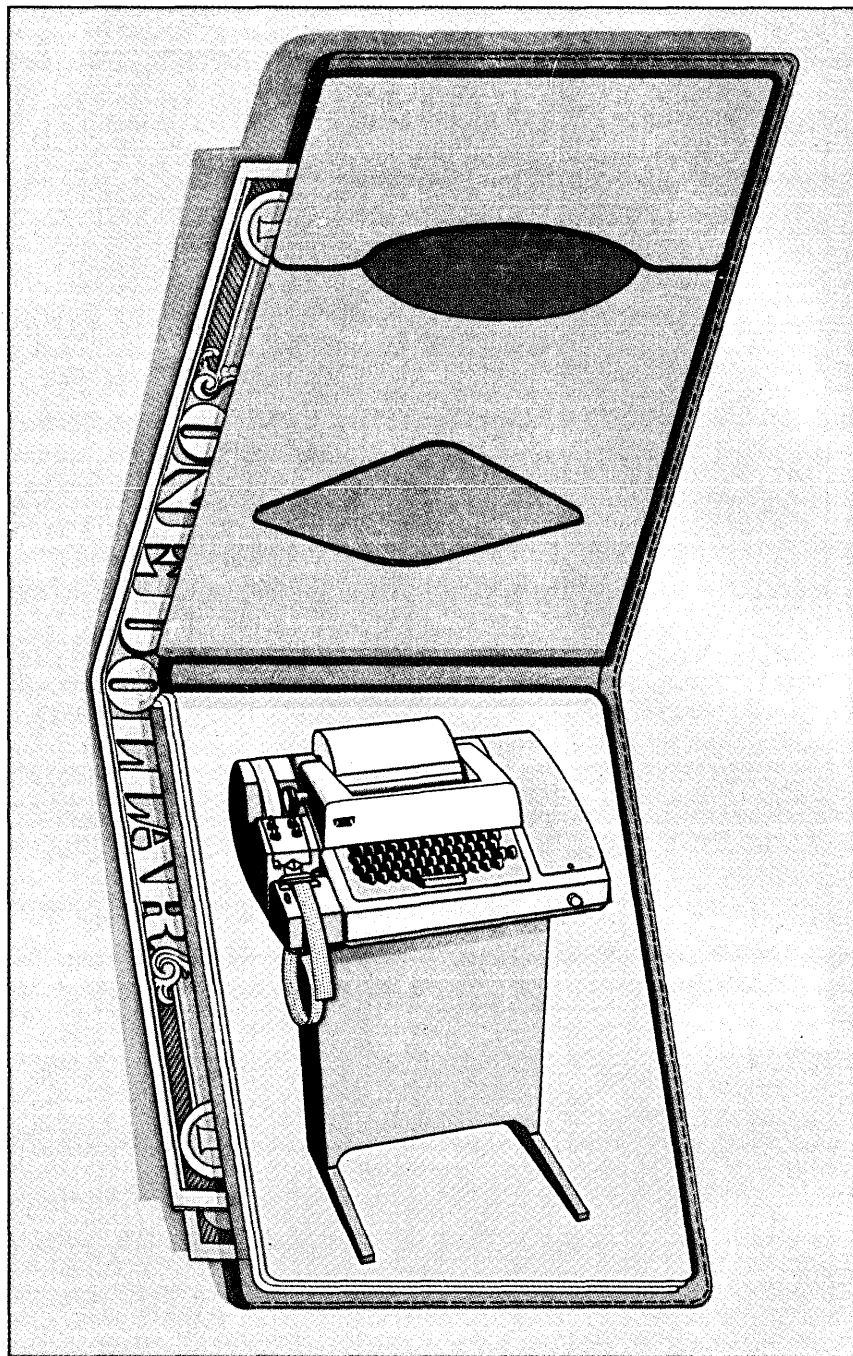

Teletype is a trademark registered in the United States Patent Office.

Dollar for dollar, the Teletype® model 33 is the least expensive, most reliable data terminal in its class. Because once you see how well it performs, you won't believe its price.

That's one reason why the model 33 is the most popular terminal in the industry. But it's hardly the only reason.

The model 33 is designed and built for extremely reliable operation at 100 wpm. And since

it operates on the eight-level ASCII code, it speaks the language most computers understand. Both mini-computers and maxi-computers. Which makes compatibility another reason behind its popularity.

Then there are some reasons you can't see. But they're there just the same. Like complete technical sales and service back-up to help you with installation and maintenance.

Available in three basic configurations, the model 33 is a lot of machine. At a very small price.

It takes more than manufacturing facilities to build the machines Teletype Corporation offers. It also takes commitment. From people who think service is as important as sales. In terminals for message communications and computers.

That's why we invented a new name for who we are and what we make. The computercations people.



**The computercations people.**

For more information about any Teletype product, write or call: **TERMINAL CENTRAL**, Teletype Corporation, Dept. 81P, 5555 Touhy Avenue, Skokie, Illinois 60076. Phone 312/982-2500.

CIRCLE 3 ON READER CARD