

# EDN<sup>®</sup>

Part 2 of EDN's  
Decade 90 Series

Design crystal oscillators  
with wide tuning range

Monolithic filters for  
data-acquisition systems

Update on CASE

ELECTRONIC TECHNOLOGY FOR ENGINEERS AND ENGINEERING MANAGERS



Viab! VGA-emulator  
chip sets reach  
design marketplace



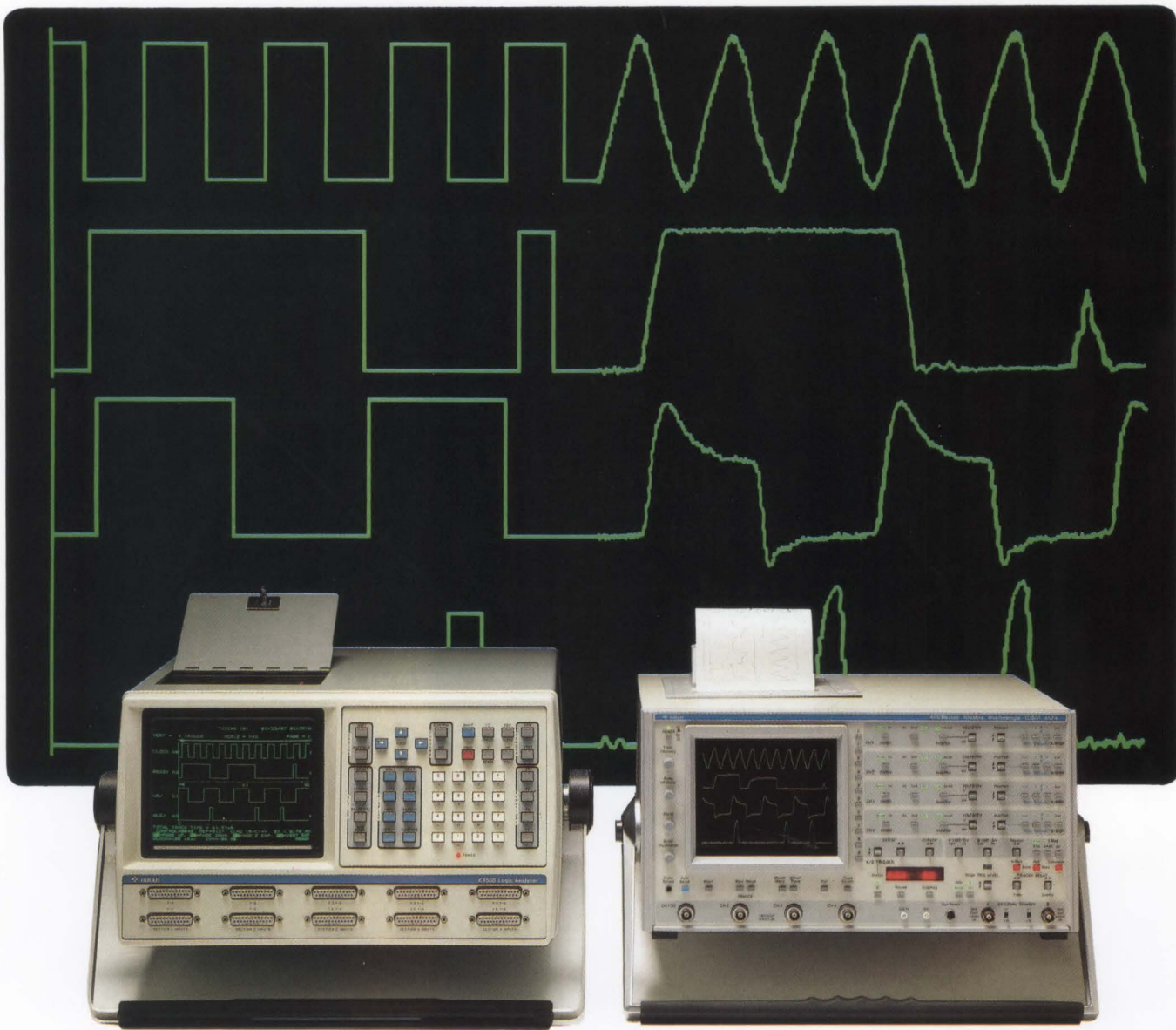

# The best of both worlds.

## The K450B Logic Analyzer and the 4074 Digital Storage Oscilloscope from Gould...

State-of-the-art test instruments for designers of today's superfast digital and data communications systems.

### Powerful measurement capabilities...

The K450B Logic Analyzer, with up to 80 channels at 100 MHz or 40 channels at 200 MHz and glitch capture across all channels, provides top performance. AND the 4074 DSO—the only 4 channel instrument with 400 MSample/Sec 8 bit converters on every channel—is the most sophisticated oscilloscope available for the high speed pulse measurements

required by electronics designers and test engineers. TOGETHER—they work as an integrated system without any of the compromises of hybrid systems; APART—two high performance instruments available for separate test applications.

### ease of use...

We provide that on both the K450B and the 4074 with our AUTO SETUP facility.

### and fail-safe performance!

Gould Electronics created the timing analyzer market in 1978 with the introduction of the first logic analyzer; and we were pioneers in DSO technology. Today we supply leading computer and telecommunications equipment makers with

logic analyzers and DSOs for digital design verification, hardware and software integration, component and subsystem test, hardware debug and digital remote diagnostics.

Wherever high performance test and analysis is required in digital electronics design, Gould is at the leading edge with a price/performance record second to none.

For further details, contact:  
Gould, Inc.  
Test & Measurement  
19050 Pruneridge Avenue  
Cupertino, CA 95014  
**1-800-GOULD 10**



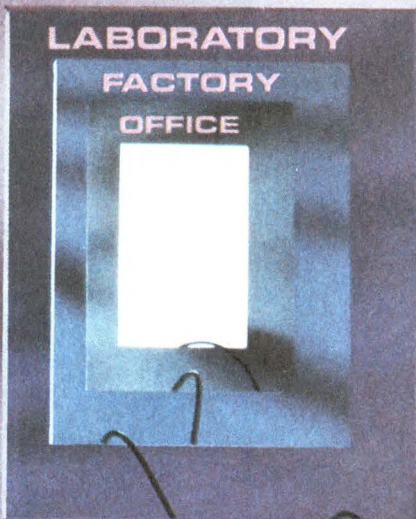

## New Simple To Use Network Expands Power of STD Systems

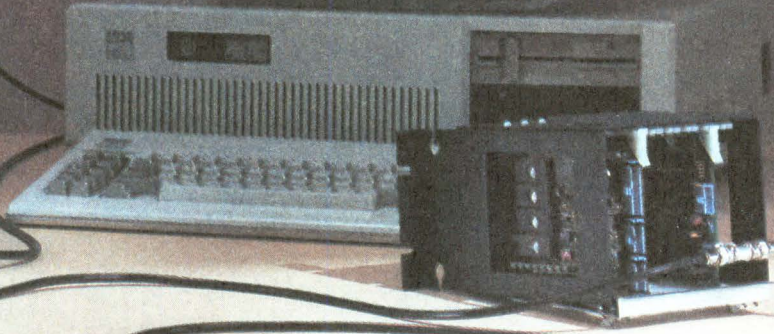

### Turnkey industrial networking for STD Bus and personal computers

Z-NET is a complete, simple to use network for industrial applications. Z-NET extends the capabilities of Ziatech's PC DOS-based STD Bus systems by allowing them to share information and resources with other STD systems and IBM-compatible personal computers.

### ARCNET hardware protocol, ViaNet software

Ziatech's STD and PC network controllers are based on the well-established ARCNET protocol, and are supported by ViaNet, a software package from Western Digital that makes using the network as easy as making simple DOS calls.

### Remote control for embedded systems

Z-NET was designed to meet the specific network needs of industrial STD Bus computers, which are typically unattended or embedded in equipment. Z-NET makes an ideal sub-network in a large factory or a total solution for smaller applications.

Ziatech's exclusive Virtual Network Console (VNC) lets a network manager control a remote node from his local STD or PC console. VNC capabilities let operators remotely reboot a node and remotely execute or download programs, eliminating the need for PROM installation or replacement.

### A single network source

Z-NET is a complete network solution for industrial STD and personal computers, available now from an established source. The necessary hardware, software, cables, documentation, and applications support are all available from Ziatech, a leading manufacturer of STD Bus and IEEE 488 products.

### Free industrial networking guide

For a complete technical brochure and configuration guide to a complete STD and PC network, call Ziatech today, (805) 541-0488



3433 Roberto Court  
San Luis Obispo, CA 93401 USA  
ITT Telex 4992316  
FAX (805) 541-5088  
Telephone (805) 541-0488

ARCNET is a registered trademark of Datapoint Corporation.  
ViaNet is a registered trademark of Western Digital Corporation.  
PC DOS and IBM are registered trademarks of International Business Machines, Incorporated.



# PUNCH UP YOUR FLASH A/D PERFORMANCE.

## FREEZE VIDEO SIGNALS WITH A SAMPLE & HOLD AMP LIKE THIS.

Introducing the VA730 High-Speed Sample & Hold Amplifier . . . the only monolithic IC of its kind that operates in the 50MHz range.

The only one that's available in surface-mount packaging, and in both commercial and military grades.

And the only one that's designed specifically to operate with 8-bit flash converters.

Best of all, not only is it less costly than expensive hybrids, it's priced well below competing Japanese monolithics.

The VA730 has an A/D converter reference power supply, a sample & hold function, and an ECL clock output section operating to a frequency of 50MHz.

It's available in a 14-pin cerdip package, in a 20-pin ceramic leadless chip carrier (LCC), and in die form.

The VA730 Sample & Hold Amp is just part of VTC's broad line of Linear Signal Processing (LSP) ICs, which includes *Op Amps* to 500MHz gain bandwidth . . . precision, high-speed, and fast settling, plus dual and quad . . . with no sacrifice in performance.

*A/D Converters* to 12 bits, 1 $\mu$ sec conversion.

*Flash Converters* to 8 bits, 250MHz.

*DACs* to 12 bits, 100nsec settling time.

A family of ECL and TTL *High-Speed Comparators* to 1.5GHz.

*Video Amps and Unity Gain Amps* to 2000V/ $\mu$ sec, 300MHz.

And *Operational Transconductance Amplifiers* to 50V/ $\mu$ sec, 75MHz.

Quite simply, if your analog application requires high performance, you should be specifying VTC's LSP ICs!

Most of these standard parts are also available as cells in our 6GHz Linear/Digital Bipolar Standard Cell Library, the VL3000.

They all feature  $\pm 5V$  operation, which means they help simplify your system power requirements, and reduce power consumption.

For samples and data sheets on the VA730, or any of our LSP products, call toll-free or write us today: VTC Incorporated, 2401 East 86th Street, Bloomington, MN 55420. (In Minnesota: 612/851-5200.)

**CALL 1-800-VTC-VLSI**

NEED TO MINIMIZE DISTORTION WHEN DIGITIZING VIDEO SIGNALS: USE SAMPLE/HOLD AS COMPANION TO FLASH CONVERTER.

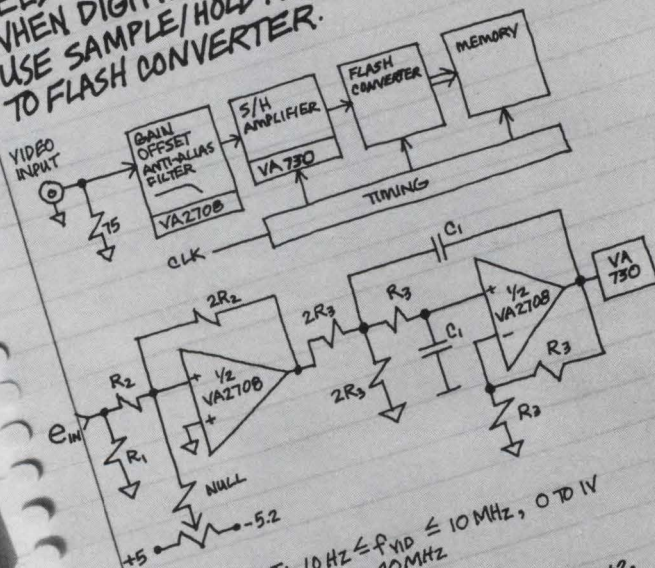

VIDEO INPUT:  $10 \text{ Hz} \leq f_{\text{VID}} \leq 10 \text{ MHz}$ , 0 TO 1V  
 CLOCK RATE:  $f_{\text{CLK}} = 40 \text{ MHz}$   
 SH GAIN = 0 TO -2V  
 DESIGN APPROACH: USE DUAL VA270B FOR GAIN = +2,  
 OFFSET AND ANTI-ALIAS FILTERING.  
 USE SALEN-KEY TYPE 2ND ORDER FILTER, Q=1.



**VTC Incorporated**  
 Performance, Pure & Simple.™



3490 CALL Set 178

"FLESCOPAL"

3500 FOR I=1 TO 10

3510 OUTPUT 109;

"F"&Freq&"I"

3520 READ Freq

## Writing a GPIB program shouldn't take an eternity.



You shouldn't have to hammer out hundreds of lines of BASIC, or look up all those instrument commands. All you should have to do is tell the computer what kind of test you want to run, what instruments to use, and what to do with the data.

Then it should do the rest. After all, it is a computer. Starting now, that's how it'll

be, if you have our new WaveTest® software.

Just point to the program elements you need, assemble them either as a flowchart or a string of icons. WaveTest writes all the program code, including the GPIB commands for more than fifty different makes and models of instruments.

You'll be able to take months off of test development. Best of all, you'll be putting your time into the design of the program—and

not into tedious code writing. WaveTest runs on your PC-compatible computer and it uses Microsoft® Windows and a mouse, making it very user-friendly.

To write another program without WaveTest would be a basic error. For immediate information, call our Applications Department at (619) 279-2200.

Wavetek San Diego, Inc.,  
P.O. Box 85265, San Diego, CA  
92138. TWX 910-335-2007.

Circle 1 for Literature

Circle 40 for Demonstration



# WHO YA GONNA CALL TO ICE 68020 BUGS? ATRON BUGBUSTERS!

We recently received a competitive analysis written by a billion-dollar competitor of ours. In it, they rank in-circuit emulation companies in order of importance. We were number one.

## SO WHO'S ATRON?

Today, Atron is the number-one supplier of hardware-assisted software debuggers for 8088/80286/80386-based PCs. Nine of the top ten software packages were written by Atron customers. Everybody from AST to Borland to Oracle to Zenith. Now, we can make the same claim in the 68020 marketplace.

Everybody from Apple (MAC IIs) to Wellfleet (datacom) will attest to the superiority of Atron's 68020 debugging technology. One Atron customer even said, "We sent our non-Atron ICE unit out several months ago for repairs; nobody around here seems to know or care if it's back yet. The Atron unit is the tool of choice."

## 25-MHZ, REAL-TIME, EMULATION: SOONER OR LATER, YOU KNOW YOU'LL NEED IT.

Why invest in a slower emulator (especially one that costs more)? Some bugs only occur in real time, and you know your next design will be 25 mhz. Before Atron's state-of-the-art design, there was no such thing as a 25-mhz emulator. There still isn't another one anywhere near our price.

## PROBE CAN TRACE IT THROUGH THE PIPELINE, SO YOU WON'T LOSE YOUR MIND.

The 68020 has an on-board pre-fetch pipeline. Without Atron's 68020 PROBE, your best software engineer will spend a lot of time figuring out which instructions actually execute, and then, which bus cycles go with those instructions. The 68020 PROBE eliminates all these

tedious mental translations and displays what the processor really did. The technology, called pipeline dequeuing, is only available from Atron. Because the Atron bugbusters are the only ones anywhere who've figured out how to do it. And it took us 100,000 lines of code. Consider it our contribution to your sanity. (It was a dirty job, but somebody had to do it.)

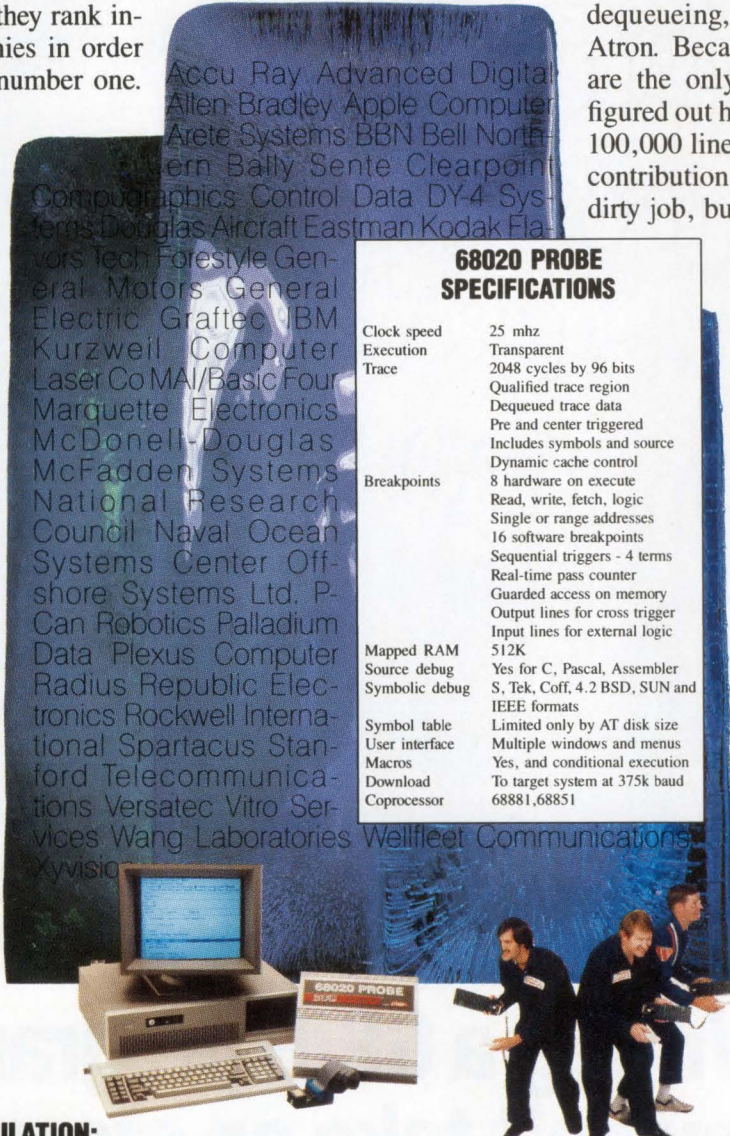

### 68020 PROBE SPECIFICATIONS

Clock speed	25 mhz
Execution	Transparent
Trace	2048 cycles by 96 bits Qualified trace region Dequeued trace data Pre and center triggered Includes symbols and source Dynamic cache control
Breakpoints	8 hardware on execute Read, write, fetch, logic Single or range addresses 16 software breakpoints Sequential triggers - 4 terms Real-time pass counter Guarded access on memory Output lines for cross trigger Input lines for external logic
Mapped RAM	512K
Source debug	Yes for C, Pascal, Assembler
Symbolic debug	S, Tek, Coff, 4.2 BSD, SUN and IEEE formats
Symbol table	Limited only by AT disk size
User interface	Multiple windows and menus
Macros	Yes, and conditional execution
Download	To target system at 375k baud
Coprocessor	68881, 68851

## LET THE SOURCE BE WITH YOU.

Why spend all day doing mental translations between your C source code and the machine code in your target? These tedious operations are eliminated with Atron's source-level debugging capabilities.

Since PROBE uses a PC AT as its instrumentation chassis, you can get compiled code to its target via Ethernet, VAXNet, SUNNet, SCSI or RS-232. And whether you are compiling on a PC, a workstation or a VAX, Atron supports more object-module formats than anybody else (see specification box).

## YOU'LL BE A BELIEVER AFTER A SHORT DEMONSTRATION.

So who ya gonna call? Bugbusters! Today. At 408/741-5900. Or send in the attached coupon.

My business card or company letterhead is attached:

- I've got to see this for myself. Please have a representative call me to schedule a demonstration.
- Please send me your 36-page 68020 PROBE user's guide, with its command summary and examples of use.



### BUGBUSTERS

A division of Northwest Instrument Systems, Inc.

Saratoga Office Center • 12950 Saratoga Avenue  
Saratoga, CA 95070 • Call 408/253-5933 today.

EDN031788



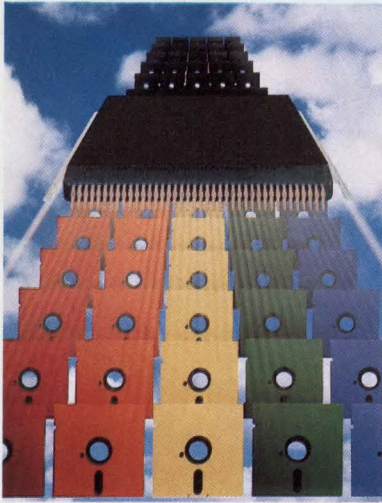

*On the cover: VGA chip sets bring color graphics within designers' reach. See pg 118. (Photo courtesy Video Seven Inc)*

## DESIGN FEATURES

### Special Report: VGA chip sets

118

While debating degrees of compatibility with IBM's Video Graphics Array standard, manufacturers of VGA-like chips are attempting to woo designers by offering exotic features and backward compatibility with other IBM display products.—*J D Mosley, Regional Editor*

### Decade 90: The future of system design—Part 2

130

The next decade's billion-transistor ICs will rapidly make manual system-design methods obsolete. If engineers are to tackle larger, more complex electronic designs, they will need automated design tools. Today's CAE tools help engineers develop system components. Tomorrow's tools will help designers develop entire systems.—*Steven H Leibson, Regional Editor*

### Design method yields low-noise, wide-range crystal oscillators

141

A characterization technique allows you to design frequency-determining networks for tunable crystal oscillators.—*Tim L Hillstrom, Hewlett-Packard Co*

### System architecture dominates design of no-wait-state cache

155

To extract maximum efficiency from today's 32-bit CPUs, you must provide them with zero-wait-state access to program and data memory.—*James K Flynn and Narciso Mera, AT&T Microelectronics*

### Token-bus-controller interface must resolve family disparities

167

A system designed for a token bus network can benefit from a token bus controller such as the MC68824. The amount of glue logic required to interface the host to the controller will differ, however.—*Paul Polansky, Motorola Inc*

### Evaluate model types before simulating logic circuits

187

By modeling your logic-circuit design in software before, or in place of, building a hardware prototype, you can save yourself a great deal of time and money. Before you can make this determination, however, you must know more about the four basic types of simulation models.—*Kent Moffat and Don Carter, Mentor Graphics Corp*

*Continued on page 7*



V BPA ABP



EDN® (ISSN 0012-7515) is published 38 times a year (biweekly with 1 additional issue a month) by Cahners Publishing Company, A Division of Reed Publishing USA, 275 Washington Street, Newton, MA 02158-1630. Terrence M McDermott, President; Frank Sibley, Electronics/Computer Group Vice President; Jerry D Neth, Vice President/Publishing Operations; J J Walsh, Financial Vice President/Magazine Division; Thomas J Dellamaria, Vice President/Production and Manufacturing. Circulation records are maintained at Cahners Publishing Company, 44 Cook Street, Denver, CO 80206-5191. Telephone: (303) 388-4511. Second-class postage paid at Denver, CO 80206-5191 and additional mailing offices. POSTMASTER: Send address corrections to EDN® at the Denver address. EDN® copyright 1988 by Reed Publishing USA; Saul Goldweitz, Chairman; Ronald G Segel, President and Chief Executive Officer; Robert L Krakoff, Executive Vice President; William M Platt, Senior Vice President. Annual subscription rates for nonqualified people: USA, \$95/year; Canada/Mexico, \$110/year; Europe air mail, \$135/year; all other nations, \$135/year for surface mail and \$200/year for air mail. Except for special issues where price changes are indicated, single copies of regular issues are available for \$6, \$8, and \$10 (USA, Canada/Mexico, and foreign). Please address all subscription mail to Eric Schmierer, 44 Cook Street, Denver, CO 80206-5191.





PHILIPS

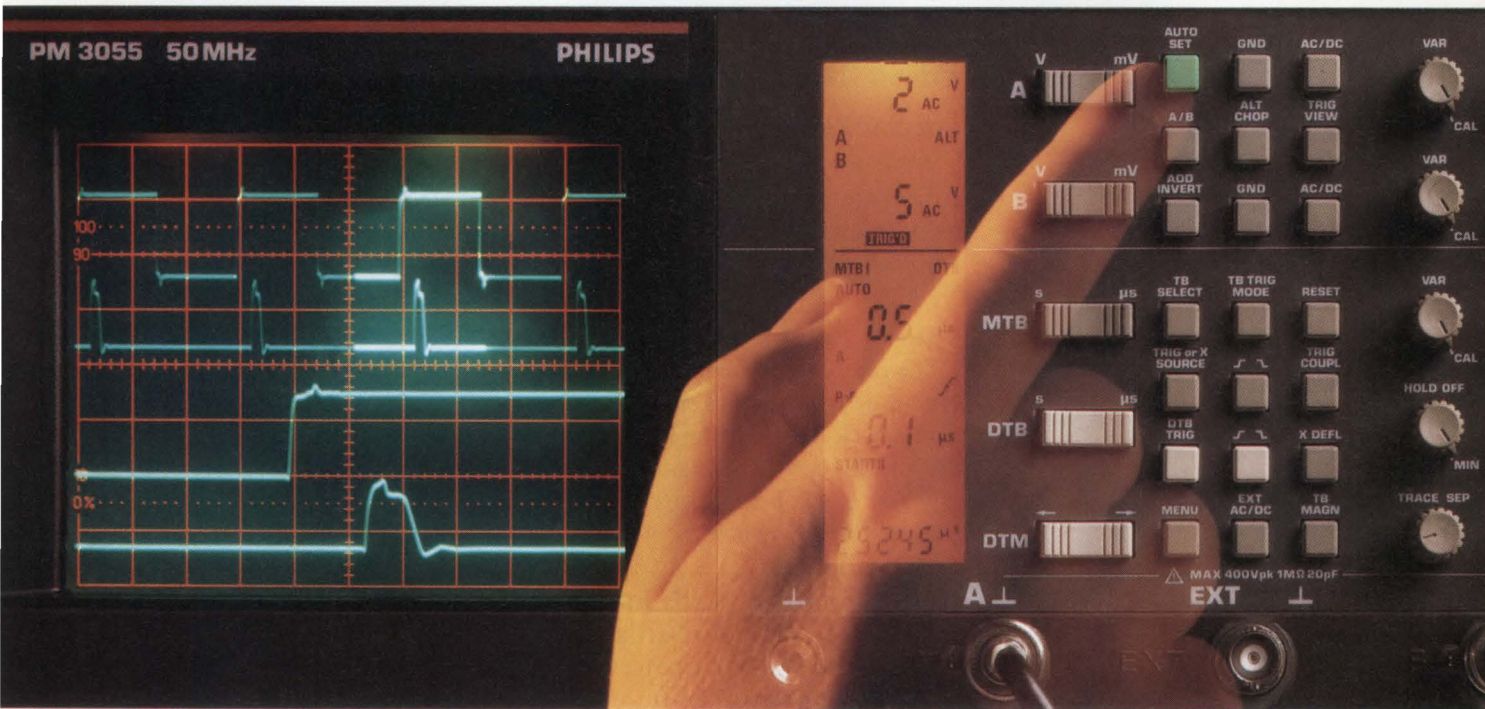

# The smart scope for people who hate to wait

**The Philips microcomputer-controlled PM 3050 Series. The only 50 MHz scopes in the world smart enough to find and display the signal—automatically.**

## SMART PERFORMANCE

- *Autoset finds the signal at the touch of a button.* Philips' intelligent beamfinder automatically selects amplitude, timebase and triggering for error-free instant display of any input signal on any channel.
- *16kV CRT for optimum viewing.* When it comes to brilliance, clarity and spot quality, nothing in its class shines brighter.
- *LCD Panel for confident, at-a-glance operation.* A valuable information center, it instantly displays all instrument settings and parameter values. With no mistakes.

- *Auto-Triggering "thinks for you".* This built-in intelligence provides fast, accurate, properly-triggered signals up to 100 MHz.

- *IEEE Compatibility.* The PM 3050 Series is the only family of 50 MHz scopes with an add-on IEEE-488 interface option for fast computer hook-up.

- *Choice of Models.* Single timebase or delayed sweep versions are available.

## SMART SUPPORT

Philips PM 3050 Series also comes with a 3-year warranty and all the technical and service assistance you need. From Fluke—the people who believe that extraordinary technology deserves extraordinary support.

## SMART BUY

For about what you'd pay for the next-best scope you get innovative engineering that's

more productive and easier to use. You get plug-in modularity and IC microelectronics for reliability you've never seen in this class before. Plus, for a limited time, you get a no-risk, no-questions-asked, 30-day money-back guarantee. So why wait any longer?

## TEST THE DIFFERENCE

So call Fluke today at **800-44-FLUKE ext. 77**. And find out how smart your next oscilloscope buy can be.

John Fluke Mfg. Co., Inc., P.O. Box C9090, M/S 250C, Everett, WA. 98206  
U.S.: 206-356-5400 CANADA: 416-890-7600  
OTHER COUNTRIES 206-356-5500

© Copyright 1987 John Fluke Mfg. Co., Inc.  
All rights reserved. Ad No. 1075-P305X



PM 3050/55 • 50 MHz • OSCILLOSCOPES







Board- and device-level testability products are available to proponents of design for testability (pg 57).

EDN magazine now offers Express Request, a convenient way to retrieve product information by phone. See the Reader Service Card in the front for details on how to use this free service.

**Express Request** 

## TECHNOLOGY UPDATE

**Pioneering engineers begin to adopt board-level automatic test generation**

57



You can recognize a pioneer by the arrow in his back: Despite that adage's implied warning, some designers of board-level products are beginning to adopt design methodologies compatible with testability techniques like automatic test-pattern generation (ATPG).

—Dan Strassberg, Associate Editor

**Customer training and reverse engineering promise to escalate the acceptance of CASE**

73

CASE (computer-aided software engineering) is only now reaching the stage of maturity that CAE tools were at several years ago, but it won't be long before CASE catches up to CAE.—Chris Terry, Associate Editor

**Digitally programmable 1-chip filters yield lower-cost data-acquisition systems**

83

Monolithic filters that combine programmability with the proven advantages of switched-capacitor technology promise to let engineers develop less-expensive, more versatile data-acquisition systems.—Tarlton Fleming, Associate Editor

## PRODUCT UPDATE

100-MHz digital scope/logic analyzer combo	99
Single-output current-mode power supply	102
Matrix-switching system	105
Analog-signal multiplexer	106

## DESIGN IDEAS

Watchdog circuit makes $\mu$ P fault tolerant	197
Precision circuit measures shunt resistance	198
Converter output swings 5V using 5V supply	200
Multidrop circuit cuts cable cost	202
Spy terminal monitors RS-232C traffic	205

Continued on page 9

Cahners Publishing Company, A Division of Reed Publishing USA  Specialized Business Magazines for Building & Construction  Manufacturing  Foodservice & Lodging  Electronics & Computers  Interior Design  Printing  Publishing  Industrial Research & Technology  Health Care  and Entertainment. Specialized Consumer Magazines:  American Baby  and Modern Bride.



# TekCASE™: HOW TO BREAK A PROJECT INTO PIECES. AND PUT IT TOGETHER AGAIN. RIGHT.

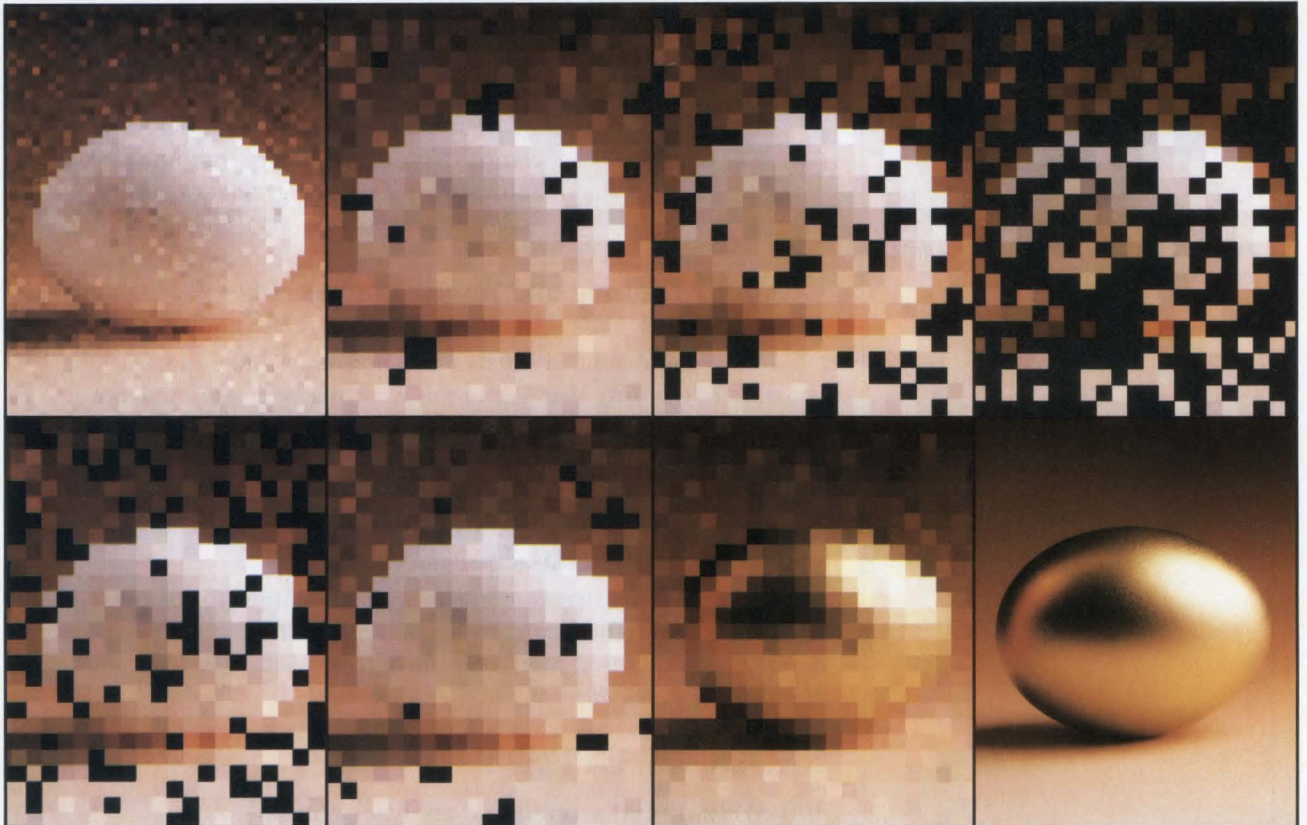

**You know how to maintain control and ensure quality of a complex systems project: first you divide it into parts and work on them concurrently, then you put it back together again.** You also know how seldom a project survives this kind of reassembly intact — frequently, the final result barely resembles the original intent. Tektronix, a developer of complex systems for many years, now introduces a solution to the problem. This solution is TekCASE: a complete set of software engineering tools and services to guide you through the specification, design, and documentation of even the largest and most complex systems projects. Tektronix supports the entire software development life cycle.

**Finally, a flexible and extensible tool set that gives you forward and reverse traceability and verification.** Thanks to Analyst/RT and Designer, only TekCASE provides auto-

matic transformation from specification to design and automatic conversion from code back to design. With the addition of Auditor, providing support for software developers complying with DOD-STD 2167, only TekCASE gives you uninterrupted visibility of your project from start to finish. And TekCASE runs on any VAX® configuration.

**TekCASE is more than just a software tool set — it's a strategic partnership.** From project concept to code and beyond, TekCASE provides support, service, and frequent product updates. So, whether your project is in parts, back together, or somewhere in between, TekCASE is there to help you make sure the pieces fit. For more information, contact your local Tektronix representative or call 1-800-TEK-WIDE, extension 682. Tektronix, Inc., Computer-Aided Software Engineering Division, P.O. Box 14752, Portland, Oregon 97214.

**Tektronix®**  
COMMITTED TO EXCELLENCE

™ TekCASE is a trademark of Tektronix, Inc.  
® VAX is a registered trademark of Digital Equipment Corp.  
Copyright © 1987 by Tektronix, Inc. All rights reserved. MIA454.



**VP/Publisher**  
F Warren Dickson

**VP/Associate Publisher/Editorial Director**  
Roy Forsberg

**Editor**  
Jonathan Titus

**Managing Editor**  
John S Haystead

**Assistant Managing Editor**  
Joan Morrow

**Special Projects**  
Gary Legg

**Home Office Editorial Staff**  
275 Washington St, Newton, MA 02158  
(617) 964-3030

Tom Ormond, *Senior Editor*  
Deborah Asbrand, *Associate Editor*  
Joanne Clay, *Associate Editor*  
Tarlton Fleming, *Associate Editor*  
John A Gallant, *Associate Editor*  
Clare Mansfield, *Associate Editor*  
Dave Pryce, *Associate Editor*  
Cynthia B Rettig, *Associate Editor*  
Charles Small, *Associate Editor*  
Dan Strassberg, *Associate Editor*  
Chris Terry, *Associate Editor*  
Jim Wiegand, *Associate Editor*  
Ron Gilbert, *Staff Editor*  
Valerie Lauzon, *Staff Editor*  
Helen McElwee, *Staff Editor*  
Steven Paul, *Senior Production Editor*

**Editorial Field Offices**

Margery S Conner, *Regional Editor*  
Los Osos, CA: (805) 528-0833  
Doug Conner, *Regional Editor*  
Los Osos, CA: (805) 528-0865

Bob Cushman, *Special Features Editor*  
Port Washington, NY: (516) 944-6524

Steven H Leibson, *Regional Editor*  
Boulder, CO: (303) 494-2233

J D Mosley, *Regional Editor*  
Arlington, TX: (817) 465-4961

Richard A Quinnell, *Regional Editor*  
San Jose, CA: (408) 296-0868

David Shear, *Regional Editor*  
San Jose, CA: (408) 997-5452

Maury Wright, *Regional Editor*  
San Diego, CA: (619) 748-6785

Peter Harold, *European Editor*  
0603-630782  
(St Francis House, Queens Rd,  
Norwich, Norfolk NR1 3PN, UK)

**Contributing Editors**  
Robert Pease, Bob Peterson,  
Don Powers, Bill Travis

**Editorial Services**  
Kathy Leonard, *Office Manager*  
Loretta Curcio, Nancy Weiland,  
Sharon Gildea

**Art Staff**  
Kathleen Ruhl, *Art Director*  
Ken Racicot, *Assistant Art Director*  
Chin-Soo Chung, *Graphic Designer*  
Cathy Filipski, *Graphic Designer*

**Production/Manufacturing Staff**  
William Tomaselli, *Production Supervisor*  
Donna Pono, *Production Manager*  
Andrew A Jantz, *Production Assistant*  
Linda Lepordo, *Production Assistant*  
Diane Malone, *Composition*

**Graphics Director**  
Norman Graf

**VP/Production/Manufacturing**  
Wayne Hulitzky

**Director of Production/Manufacturing**  
John R Sanders

**Director of Research**  
Deborah Virtue

**Marketing Communications**  
Janice Molinari, *Manager*  
Jennifer Ware, *Communications Manager*  
Corie Rand, *Promotion Coordinator*  
Anne Foley, *Promotion Assistant*

## EDITORIAL

47

A magazine like EDN cannot survive for long without a following of loyal, involved readers.

## NEW PRODUCTS

Computers & Peripherals . . . . .	209
Integrated Circuits . . . . .	225
Components & Power Supplies . . . . .	234
CAE & Software Development Tools . . . . .	242
Test & Measurement Instruments . . . . .	250

## PROFESSIONAL ISSUES

267

Ability—not disability—makes the engineer. *Deborah Asbrand, Associate Editor*

## LOOKING AHEAD

283

Smart power invades IC/discrete-device market . . . Changes forecast for electronic car sensors.

## DEPARTMENTS

News Breaks . . . . .	23
News Breaks International . . . . .	26
Signals & Noise . . . . .	34
Calendar . . . . .	38
Readers' Choice . . . . .	110
Leadtime Index . . . . .	114
Literature . . . . .	265
Business/Corporate Staff . . . . .	266
Career Opportunities . . . . .	274
Advertisers Index . . . . .	282



# High-resolution conversion

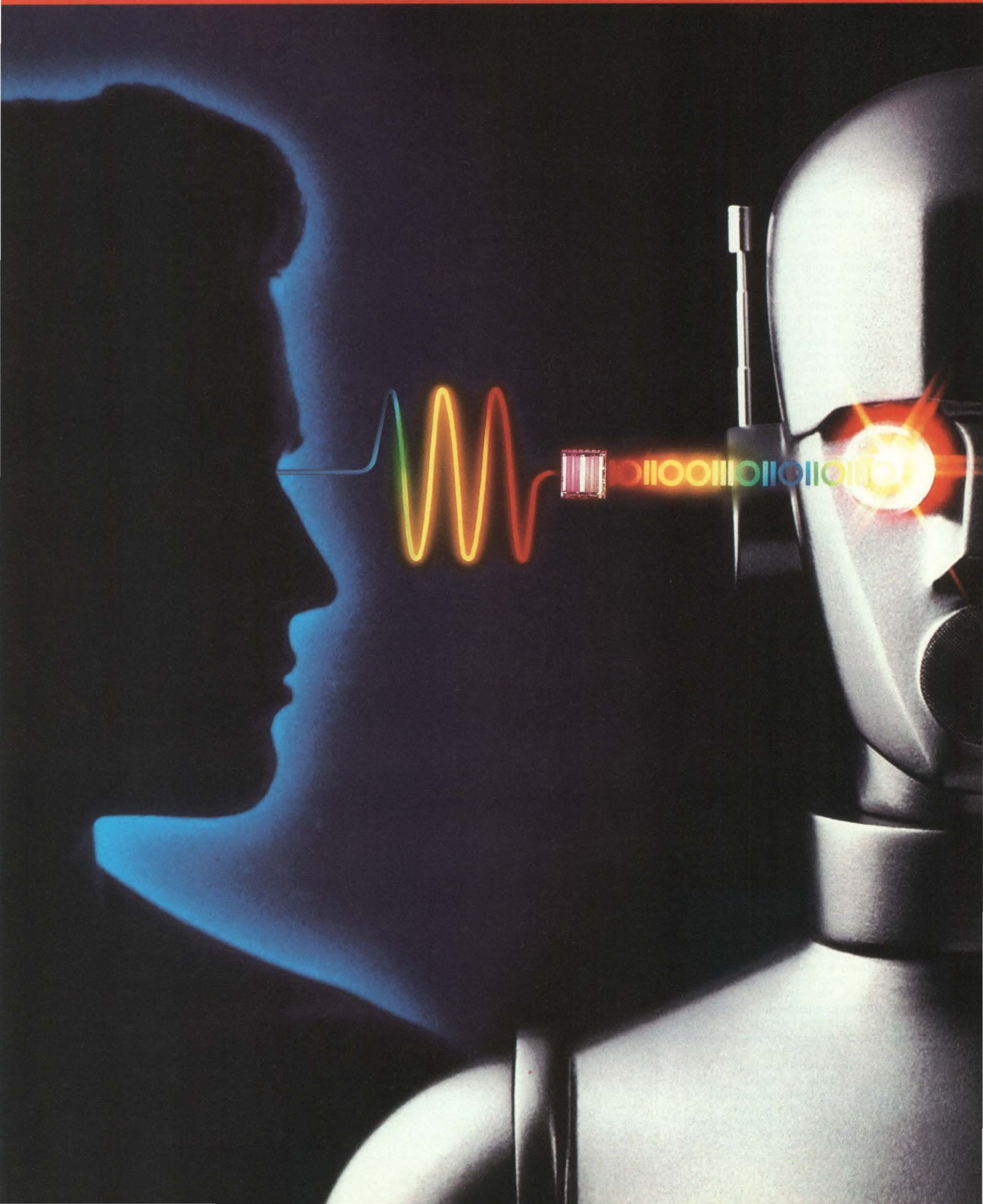



# in the blink of an eye.

Get video speed, low power consumption, high resolution and superior price/performance with our new CMOS data converters.



4-bit



8-bit

We've expanded our line to include more CMOS flash ADC's, a charge balancing ADC, an SPI ADC and a DAC. All featuring single 5V supply operation.

We also offer a new high-speed op amp especially well-suited to driving ADC's or video cables.

### 4, 6 and 8-bit CMOS flash ADC's.

Choose from 4, 6 and 8-bit ADC's. All operate at video speeds, with clocking speed and input bandwidth specified at 5V. What makes these flash ADC's special is silicon-on-sapphire construction, resulting in low cost, high speed, very low input capacitance, low power consumption and inherent latch-up resistance.

### 10-bit CMOS charge balancing ADC.

This 10-bit successive approximation ADC captures fast moving signals, providing excellent resolution.

It features a built-in fast track and hold, with conversion rates of 150 KHz and an input bandwidth of 1.5 MHz. Even at the maximum rate, power consumption is less than 20 mW.

### 10-bit CMOS serial ADC.

The CDP68HC68A2 is selectable for either 8- or 10-bit resolution and has an 8-channel multiplexer allowing up to 8 channels of inputs. The device can be used directly with our CDP68HC05C4, C8 or D2 microprocessors or other similar SPI (Serial Peripheral Interface) buses.

### 8-bit CMOS R-2R video-speed DAC's.

These CMOS/SOS digital-to-analog converters operate

from a single 5V supply at video speeds and can produce "rail-to-rail" output swings. Typical update rate is 50 MHz. Settling is fast (20 ns typical) to 1/2 LSB. "Glitch" energy is minimized by segmenting and bar graph decoding of upper 3 bits.

### High-speed op amp.

Specially designed for use with data converters, the CA3450 op amp has excellent speed and transmission line driving capabilities.

For 10-bit accuracy, it settles to within 1/2 LSB in 40 ns with a 2V input signal. And it can drive up to four 50 ohm transmission lines.

ADC's	Res. Bits	Conv. Rate Hz	Power Diss. (mW)	Pkg. Leads	1K Price
CA3304E	4	20M	30	16	2.95
CA3304AE	4	25M	35	16	4.50
CA3306CE	6	10M	65	18	5.50
CA3306E/3306AE	6	15M	70	18	6.25/11.25
CA3318E/3318CE	8	15M	150	24	38.50/24.00
CA3310E/3310AE	10	150K	15	24	6.00/8.00
CDP68HC68A2E	10	10K	15	16	3.75
DAC's					
CA3338E/3338AE	8	50M	100	16	6.00/8.40
OP AMP	UGBW Hz	Slew Rate (X10)	I <sub>out</sub> mA	Pkg Leads	1K Price
CA3450E	200M	300V/ $\mu$ Sec	$\pm 75$	16	2.70

### Data in a flash.

For data sheets of these new products, call toll-free 800-443-7364, extension 19. Or contact your local GE Solid State sales office or distributor.

In Europe, call: Brussels, (02) 246-21-11; Paris, (1) 39-46-57-99; London, (276) 68-59-11; Milano, (2) 82-291; Munich, (089) 63813-0; Stockholm (08) 793-9500.



GE Solid State

GE/RCA/Intersil Semiconductors

Three great brands. One leading-edge company.





**MOTOROLA**

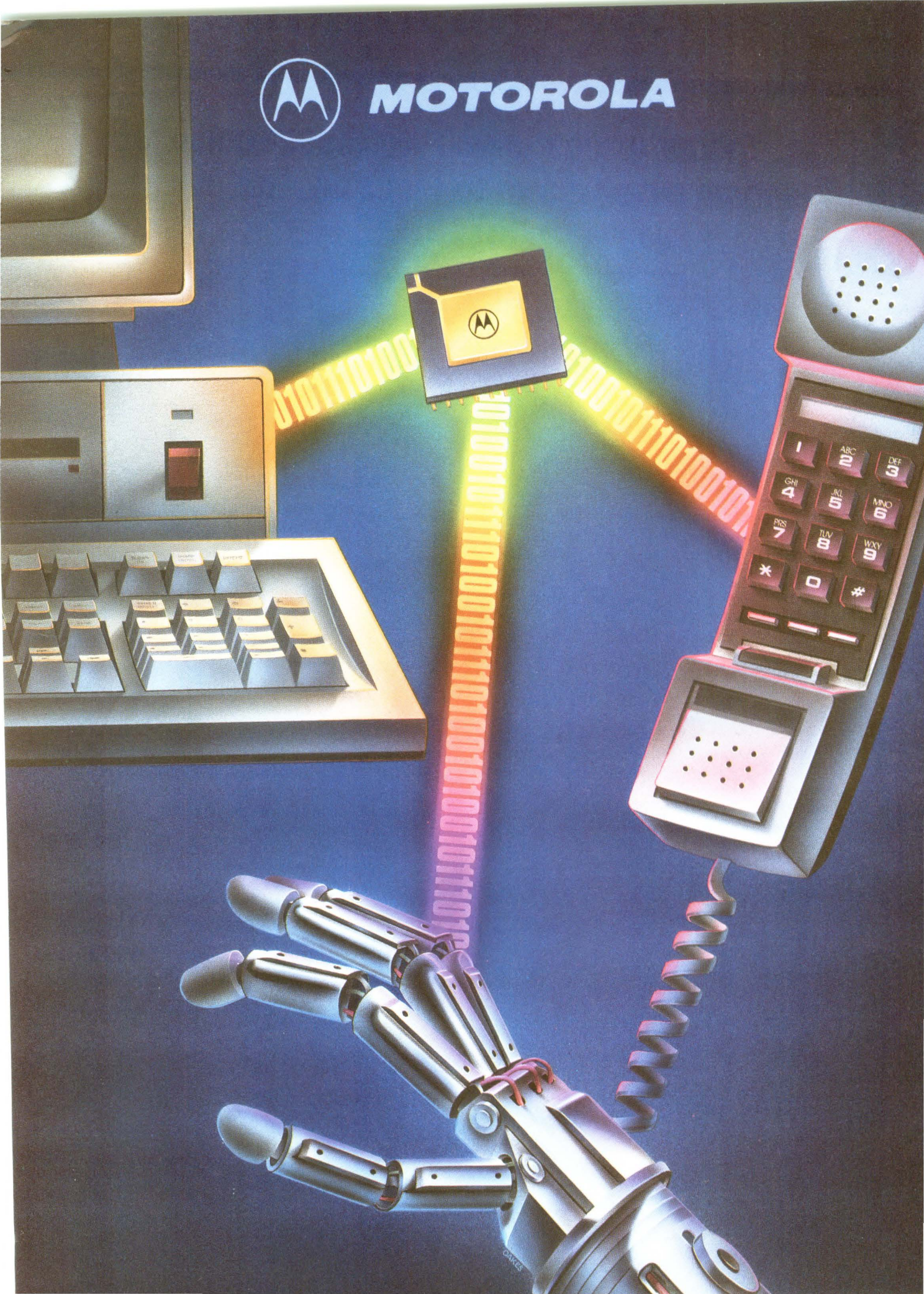



# Silicon talks.

The most popular communication protocols are available in silicon to simplify your designs.

With protocol controllers from Motorola, designing data communications is easier and their markets are more universal than ever before. Standard protocols are built into silicon so there's no need to burden your host. Built with Motorola's proven HCMOS technology, they offer the reliability you've come to expect and the advanced designs you demand.

## Communicate now with our family of protocol controllers.

Our MC68000 Family offers three different protocol controllers to handle all your data communication needs; whether it's across the building or around the world there's a Motorola device that will make your job easier. With our '68000 Family you can choose the protocol and system designs that get you on line quickly and economically.

### X.25 Protocol Controller 1984 CCITT X.25 LAPB.

The MC68605 Protocol Controller (XPC) implements the 1984 CCITT Recommendation X.25 Link Access Procedure Balanced (LAPB) for U.S. and European T1 applications. By generating link-level commands and responses, the XPC relieves the host processor of communication link managerial tasks. It's also fully DDN and Telenet certifiable.

Our XPC features an optional transparent mode which allows the implementation of other HDLC-based protocols, with user generation of all frames. The XPC handles full-duplex synchronous serial data rates up to a maximum 10 Megabits Per Second (Mbps) for high-speed computer links.

### Multi-link LAPD Controller CCITT Q.920/Q.921 LAPD.

The MC68606 Multi-link LAPD (MLAPD) Protocol Controller fully implements CCITT Recommendation Q.920/Q.921 Link Layer Access Procedure (LAPD) protocol for ISDN networks. The MLAPD is designed to handle both signalling and data links in high-performance ISDN primary rate applications.

This VLSI device provides a cost-effective solution to ISDN link-level processing with simultaneous support for up to 8K logical links. The MC68606 is an intelligent communications protocol

controller compatible with AT&T specifications for ISDN devices and features low power consumption and high performance, with an aggregate data rate in excess of 2.048 Mbps.



### Token Bus Controller IEEE 802.4 MAC.

The MC68824 Token Bus Controller (TBC) is the only single-chip solution to implement the IEEE 802.4 Media Access Control (MAC), specified by Manufacturing Automation Protocol (MAP). The TBC implements four levels of message priority and the Request With Response (RWR) frame type to meet the real-time needs of factory floor communications and MAP 3.0.

The TBC conforms to the IEEE 802.4G standard MAC to Physical layer serial interface to support broadband, carrier-band, and fiber optic networks. The TBC's low power consumption coupled with its extended temperature range versions make it ideally suited for factory automation applications.

### Token Bus Frame Analyzer Software speeds development of token bus networks.

The MC68KT BFA Token Bus Frame Analyzer Software (TBFA) is a real-time software tool that speeds development of token bus networks. The TBFA keeps track of statistics while monitoring network performance. By using the simple menu-driven interface, the user can define triggers to selectively store and display frames, creating a powerful tool for network analysis.

The TBFA is a set of four EPROMs which runs on a VMEbus MVME372 Token Bus Controller board and requires a modem, a VT100 terminal, and a power source. The cost-effective TBFA sells for about one-tenth the cost of existing token bus protocol analyzers.

### One-on-one design-in help.

Get an engineer-to-engineer update on designing-in Motorola's M68000 Family of protocol controllers.

**1-800-521-6274**

Call toll-free any weekday, 8:00 a.m. to 4:30 p.m., M.S.T. If the call can't cover your needs, we'll have a local applications engineer contact you.

We're  
on your  
design-in  
team.



**MOTOROLA**

To: Motorola Semiconductor Products, Inc.  
P.O. Box 20912, Phoenix, AZ 85036

Please send me information on the following:

MC68606 Multi-link LAPD Protocol Controller  MC68824 Token Bus Controller  
 MC68KT BFA Token Bus Frame Analyzer  MC68605 Protocol Controller (X.25)

Name \_\_\_\_\_ 335END031788

Title \_\_\_\_\_

Company \_\_\_\_\_

Address \_\_\_\_\_

City \_\_\_\_\_ State \_\_\_\_\_ Zip \_\_\_\_\_

Call me (\_\_\_\_\_) \_\_\_\_\_





# It's your choice.

## PRODUCT DEVELOPMENT SCHEDULE

PAGE 2

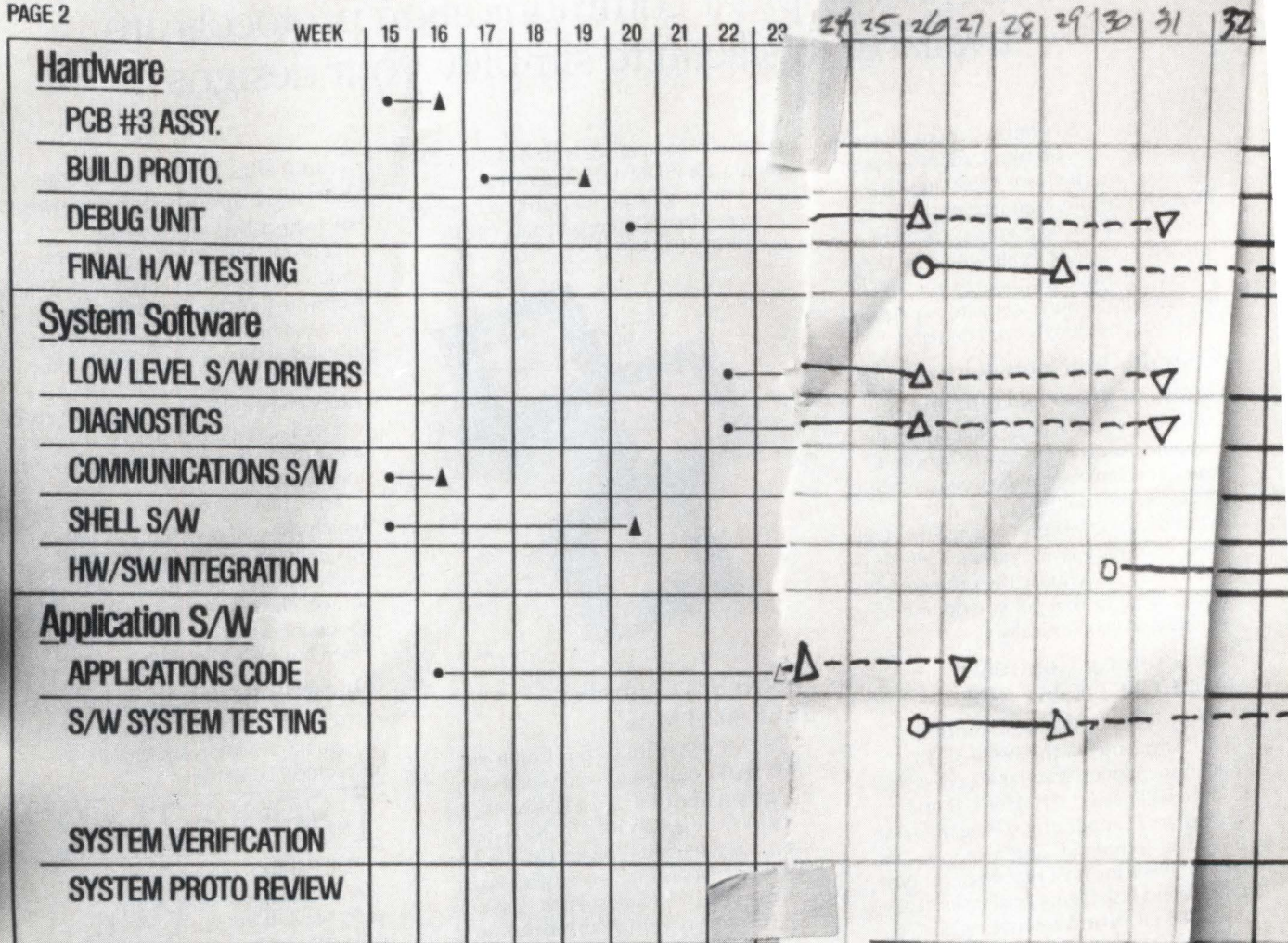

Let's face it. Slipped development schedules and budget overruns can mean lost opportunities. Yet many traps that seriously delay a development schedule are quite complex, especially when they are compounded by problems that arise in cross development work.

Like not knowing whether the errors you are getting from your prototype processor are real. Or losing bugs in the cracks between your development system and the prototype.

Fortunately, the answer to these complex problems is simpler than you might think. Because now Applied Microsystems offers what we call performance packages: complete, fully integrated development solutions, designed to meet your development requirements and to detect even subtle problems quickly.

### Performance Packages that Live Up to Their Name.

Each package includes a powerful in-circuit emulator, the only tool that can

successfully bridge the gap between host computer and prototype. With features like complex triggering, reliable memory, built-in target diagnostics, I/O simulation, and special interrupt handling.

And to complement the power of our emulators, we provide software tools that work with a variety of platforms and languages.

Whichever package you choose, you're getting the highest performance.



# Invest now or pay later.

are designed for any language producing complete Intel OMF information.

A PC-based, in-circuit source level debugger and simulator are closely cou-

remote control and simulation of I/O; plus user-definable windows for viewing registers, stacks and variables

## High-speed Symbolic Debugging for Intel, Motorola and Zilog Microprocessors

Our VALIDATE/ES DRIVER package includes easy-to-use (menu-driven and remote control) software that smoothly links the host functions to the ES 1800 emulator. This allows the upload and download of programs, symbol tables and command files.

```

15: for (count = 1; count <= 100; count++)
16: {
17:     beep k; /* Beep at user. */
18:     outscopef k; /* Display -> SOFTSCOPE 2.0 */
19:     outlangf k; /* Display -> C-86 example */
20:     outcount/count; /* Display -> Count=xx */
21:     do_dataf k; /* Data reference demo. */
22:     delayf k; /* Slow display down. */
23: }
24: }
*reg
AX=0000 SP=0006 CS=30D0 IP=0000
BX=0000 BP=0000 DS=30B7 FL=0000 - 0D 00 10 70 50 Z0 A0 P0 C0
CX=0000 SI=0000 SS=3057
DX=0000 DI=0000 ES=0000
*asm 12
12: main()
2FD3:0000 56 PUSH SI
2FD3:0001 57 PUSH DI
2FD3:0002 55 PUSH BP
2FD3:0003 8BEC MOV BPSP
    
```

pled with our ES 1800 emulator. You can use commands to examine variables on the fly, check contents of registers, and determine current position in code. And real-time trace is displayed as source level statements, machine instructions or bus cycles.

The packages also include a logic state analyzer probe, and provide up to 2 Megabytes of overlay memory plus full protect mode support for the 80286.

## Source Level Debugging for Motorola Microprocessors

The window-oriented VALIDATE/XEL package combines our XEI source-level debugger, a simulator and the MCC68K compiler with our ES 1800

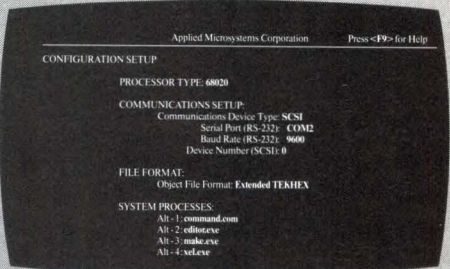

Also included are a logic state analyzer probe; the SCSI option for increasing download speeds by up to 30 times; plus up to 2 Megabytes of overlay memory.

To find out more about 8, 16 or 32-bit development solutions that save money in the long run, write Applied Microsystems Corp., P.O. Box 97002, Redmond, WA 98073-9702. Or call 1-800-426-3925 (In Washington, call 206-882-2000).

In Europe, contact Applied Microsystems Corporation Ltd., Chiltern Court, High Street, Wendover, Aylesbury, Bucks, HP22 6EP, United Kingdom. Call 44-(0)-296-625462.

```

DATA: count 0 ptr N tape 004724E72 taps(count) 0000
TRACE: 0.000012 TURNINGSTART

CODE:
13 for (i = 0; ptr = tape; i < TAPE_SIZE; i++)
14 *ptr++ = 0; /* Clean the tape */
15 state = 1; /* Starting state */
16 count = 0; /* Initial count */
17
18 ptr = &tape[TAPE_SIZE/2]; /* Start in the middle */
19 do {
20 switch (state) {
21 case 1:
22 if (*ptr == 'T')
    
```

emulator. The package also includes a logic state analyzer probe and our well-known SCSI interface option, that significantly decreases download time.

In addition to up to 2 Megabytes of overlay memory, you get target control from your source code; powerful "C" language macros for code patching,

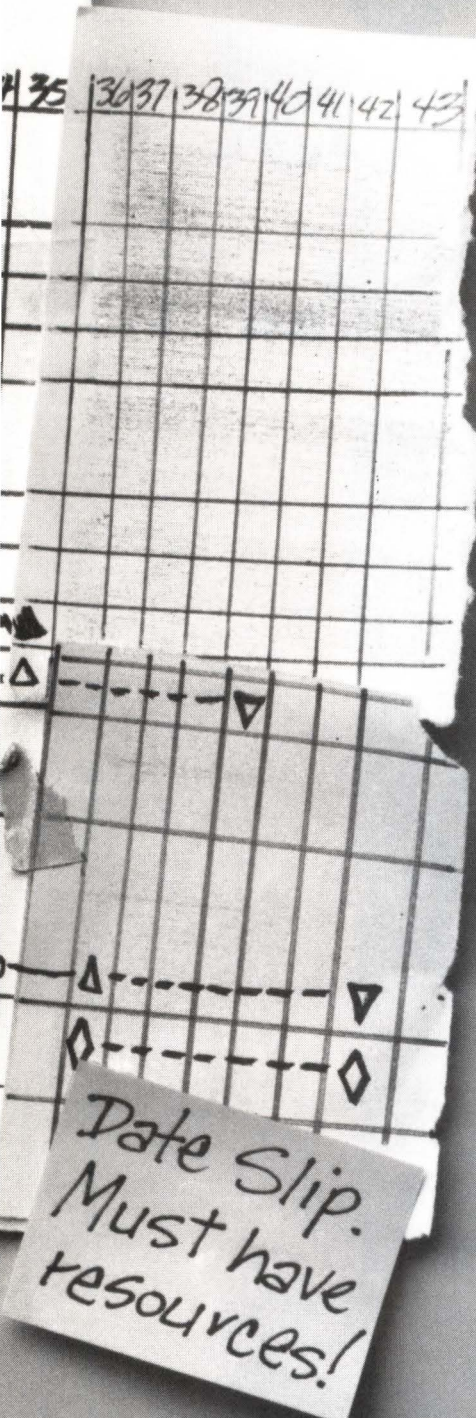

development tools available.

## Source Level Debugging for Intel Microprocessors

Our VALIDATE/Soft-Scope and VALIDATE/Soft-Scope 286 packages



# Introducing the world's most powerful desk.

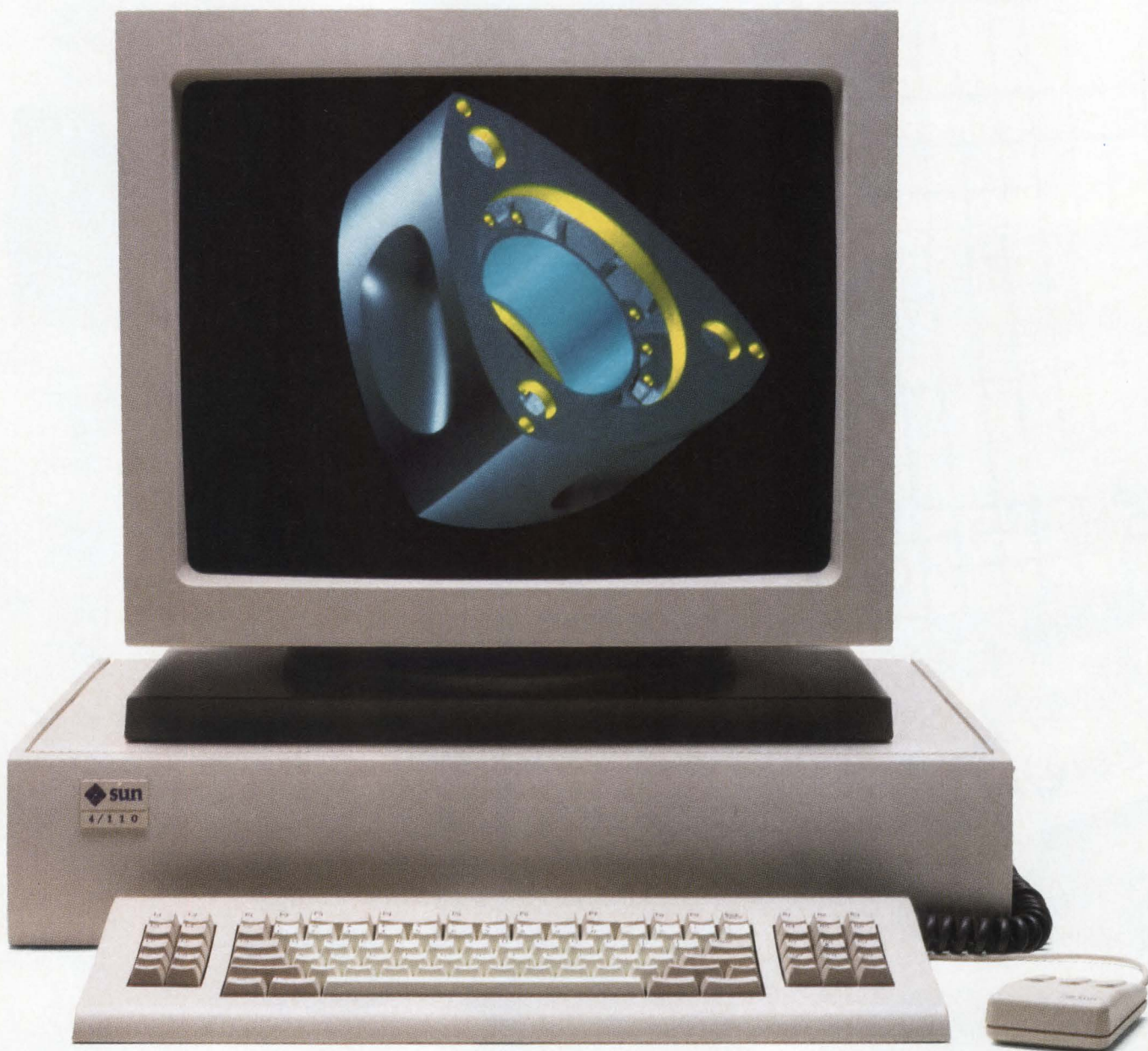

Copyright © 1988 Sun Microsystems, Inc. SPARC, OSN, X11/NeWS, Sun-4, SunOS, and The Network Is The Computer are trademarks and Sun Microsystems, and the Sun Logo are registered trademarks of Sun Microsystems, Inc. X Window System is a product of the Massachusetts Institute of Technology. Other brand or product names are trademarks or registered trademarks of their respective holders.



## SUN-4/110. THE FIRST SUPERCOMPUTING DESKTOP WORKSTATION.

This is the newest member of our extensive SPARC™ (for Scalable Processor ARChitecture) family of binary-compatible supercomputing workstations.

Sun-4/110 is a full 32-bit RISC machine that runs at a blistering 7 VAX® MIPS and .8 double precision Linpack MFLOPS.

It also has an ultra-smart, ultra-fast memory management unit that keeps memory active so it — and you — can run at processor speeds.

Its graphics performance is just as thrilling. There's an optional 3-D graphics accelerator you can plug right in, plus a dedicated, pipelined, frame buffer bus that moves solid and wire frame models so fast, you'll think you're at the movies.

You can crunch numbers with the same dispatch thanks to an optional floating-point accelerator.

And you can expand main memory to a very hefty 32 Mbytes.

Which reminds us, the Sun-4/110's main memory has a unique caching scheme. It dynamically allocates up to 32 Kbytes of its static column random access memory to cache. So it's there when you need it. Yet, since it's really just a part of main memory, it doesn't cost you extra.

You see, the object here wasn't just to build a small, fast workstation.

It was to build a balanced workstation that

delivers true supercomputing performance from every corner of its being.

That just happens to sit on a desk.

And costs far less than a comparable machine.

So there is no comparable machine.

*When is a desktop workstation not a paperweight? When it has this much software support.*

AI Environment	Imaging
Analysis/Design	Layout Verification
Animation	Logic/Fault Simulation
Auto Test Generation	Machining
Bio Engineering	Math & Stat
Computational Chemistry	MCAD
Design/Drafting	Molecular Modeling
Doc. Config. Mgmt.	Numerical Control
Earth Resources	Schematic Capture
ECAD	Seismic Processing
Electronic Publishing	Silicon Compilation
Engineering Graphics	Simulation/Test
Expert Systems	Software Development Environment
FEA	Solids Modeling
Financial	Structural Analysis
Fluid Dynamics	Styling & Appearance Modeling
Graphics	

## SIT DOWN IN FRONT OF EVERY COMPUTER IN THE COMPANY.

The great power of Sun-4/110 allows you to now perform compute intensive applications on your own, right at your desk.

But its openness also allows you to run, transparently, any other computer in the company on your own, right at your desk. Thanks to Sun's Open Systems Network (OSN™). The most comprehensive open system offering in the industry.

In addition, Sun-4/110 is designed to run the Sun Operating System (SunOS™), a converged version of UNIX System V and UNIX 4.3/4.2BSD, that has, for the first time, a standard window system (X11/NeWS™), and a standard network file system.

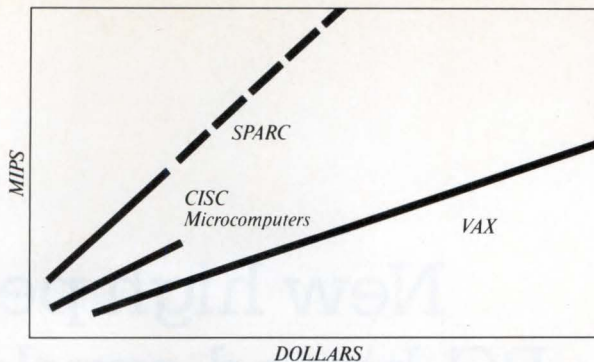

*Sun-4's Scalable Processor ARChitecture (SPARC) sends computing in a whole new direction.*

Not only is the Sun Operating System compatible with the huge base of existing UNIX applications, it also will conform to the new application binary interface (ABI) standard which will allow you to run any and all SPARC-based applications, straight off-the-shelf.

And because ours is an open, non-proprietary Operating System — specifically designed for high performance computing, by the way — you can be sure there are going to be a lot of its applications around.

Not to mention lots of machines from lots of vendors to run them.

## THIS IS WHERE YOU'LL WANT TO BE FROM NOW ON.

Every member of our SPARC-based Sun-4™ family, the Sun-4/110 included, incorporates another high performance standard.

The SPARC chip. An open, non-proprietary 32-bit RISC-based microprocessor.

SPARC chips are being built under license by some of the world's premier semiconductor houses. So they'll be competitively priced.

But unlike every microprocessor that's gone before, SPARC's scalability provides an uninterrupted growth path.

In fact, SPARC has so much headroom, in five years, it'll allow us to deliver a system that runs 100 MIPS.

For the price of a workstation. SPARC's extendability even includes other Sun workstations. And allows us to upgrade Sun-3/110 and 3/140 systems to Sun-4/110s with a simple board swap.

For more information about the new Sun-4/110 and the SPARC standard, call us at 800-821-4643, or 800-821-4642 in California. Or write Sun Microsystems, Inc., 2550 Garcia Ave., Mountain View, CA 94043.

And make the world's most powerful desk your own.



The Network *Is* The Computer™



# New high performance PC-based emulators from HP.



Introducing the HP 64700 Series emulators. Low-cost, entry-level, PC-based emulators with features you won't find with any others in the price range—or even higher. The HP 64700s deliver unmatched capability, ease-of-use, measurement power, flexibility, and reliability... plus HP support.

While the HP 64700s are tailored to meet the needs of individual engineers and small design teams, they'll

perform equally well for large teams working on complex projects.

The rapidly expanding family of HP 64700 emulators provide real-time, transparent emulation at full processor speeds with no wait states. The PC user interface gives a new meaning to the term "friendly" with features like multiple windows, single-letter keystroke command entry, access to symbols for powerful debugging

capability, timing diagrams, and on, and on, and on. The experienced user as well as the beginner will appreciate how easy these emulators are to work with.

In addition to the features shown above, there are lots of others that put the HP 64700s in a class by themselves. To name a few: function with IBM-PC, HP Vectra and compatibles, RS-422 high-speed serial



we never stop asking

“What if...”

# You could spend a lot more and get a lot less.



Multiwindow viewing allows up to eight displays on-screen simultaneously.

“Sky-hook” handles plus flexible 2- to 3-foot cables and low-profile probes allow easy access into target systems.

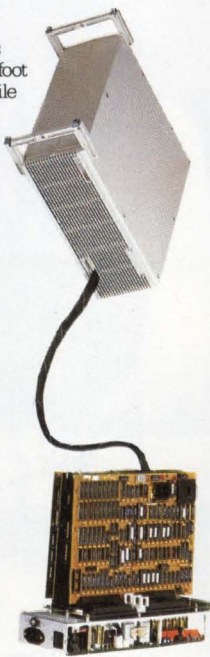

Powerful emulation bus analyzer with 8-level sequencing and optional 16-channel, 25 MHz state & 100 MHz timing analyzer available.

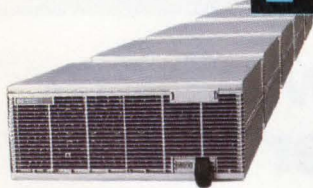
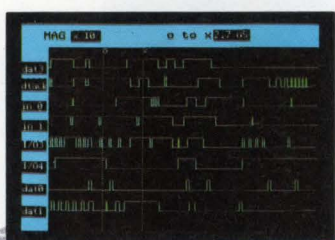

Up to 32 emulators can be interconnected, synchronously started, cross armed, cross triggered, and halted.

Entry level HP 64700 emulators are hardware and software compatible with the HP 64000-UX environment.

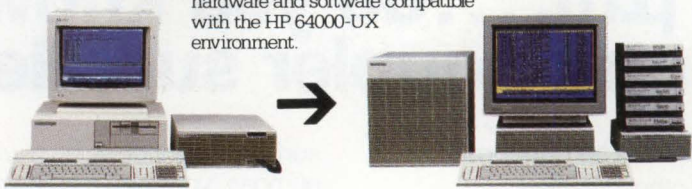

interface for superior download and upload speed, code coverage analysis for efficient software testing and design, host-independent portability, and compatibility with popular absolute file formats such as Tektronix and Intel hexadecimal and Motorola S record.

Once you get your hands on an HP 64700 emulator, you'll agree that this is the new standard in the field. Especially at a starting price of \$8,900.

### Free demo disc.

For a free demo disc that gives you the “hands-on” feel for HP 64700 Series capabilities, call HP at 1-800-752-0900 ext. 215N, or mail the attached business reply card.



©1988 Hewlett-Packard Co. DS15830/EDN

CIRCLE NO 13



# SIEMENS



## It's 6:00 p.m.... do you know where your optocoupler supplier is?

### With Siemens you wouldn't be concerned.

Because unlike several other suppliers...

- We're not moving our manufacturing plant
- We're not farming your jobs out to subcontractors
- We're not merging
- We're not up for sale

Siemens means confidence and security as a stable, world-respected components supplier. And, as a coupler user, you can depend on the Siemens commitment to design, manufacture, and distribute high quality optocouplers—now and for the long term.

Count on Siemens for price competitive industry-standard couplers, duals and quads, SOIC-8

surface mount devices, a wide range of special purpose types and a broad offering of UL and VDE approvals.

Find out why more companies are opting for Siemens... the optocoupler supplier that will be there in the morning.

### For more information, call 408-257-7910.

Or write to Siemens Components, Inc., Optoelectronics Division, 19000 Homestead Road, Cupertino, CA 95014.

Distributors: Advent Electronics, Inc., Almo Electronics, Hall-Mark, Insight Electronics, Marshall, Quality Components, Western Microtechnology.

© 1987 Siemens Components, Inc.

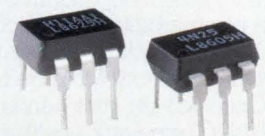

**Siemens...your partner for the future.**

CGI/2000-409 WLM 570



# NEWS BREAKS

EDITED BY JOANNE CLAY

## **BUS-DRIVING, BiCMOS ASIC FEATURES 72-mA OUTPUTS**

The LDD10000 family of gate arrays from LSI Logic (Milpitas, CA, (408) 433-8000) lets you create an ASIC that directly drives  $\mu$ P and peripheral I/O buses. Members of the family share a 3-region architecture consisting of I/O modules, internal BiCMOS blocks, and a compacted CMOS core array. The six products that comprise the family contain an estimated 8000 to 45,000 usable CMOS and BiCMOS gates and 144 to 256 I/O pads. You can configure each I/O buffer as an input (with CMOS, TTL, or Schmitt-trigger input characteristics) or an output (with 6-, 12- or 24-mA drive). In addition, you can gang as many as three I/O buffers to create a 72-mA driver. The I/O modules include test circuitry that supports boundary-scan testing. Nonrecurring engineering (NRE) charges for the LDD10000 family range from \$100,000 to \$250,000, depending on design complexity and factory support. Part costs range from \$50 to \$500, depending on part complexity and packaging.—Steven H Leibson

## **ARRAY-PROCESSOR BOARDS ADD COMPUTATIONAL POWER TO PCs**

The DSP32-PC family of floating-point array processors from Communications Automation & Control (Bethlehem, PA, (215) 865-9706) are based on AT&T's DSP32 floating-point DSP chip. The products include an 8M-flop processor on an IBM PC half card and a full-size, 25M-flop processor card that's compatible with the IBM PC/AT. Designers who develop computation-intensive applications such as signal processing, graphics, CAE/CAD/CAM, image processing, and scientific applications can employ the processors to run their software on a personal computer. The company also offers software-development tools, including assemblers, user-friendly window-based emulators, C compilers, libraries, and demonstration programs. The IBM PC version of the DSP32-PC is available now; it costs \$695 in single quantities. The IBM PC/AT version will cost \$1500 and will be available for delivery by the beginning of the fourth quarter of 1988.—Maury Wright

## **FLOATING-POINT PROCESSOR OFFERS 32-WORD REGISTER FILE**

The WTL 3364 floating-point processor from Weitek Corp (Sunnyvale, CA, (408) 738-8400) can execute 20M flops. Integrated on one chip is a 64-bit floating-point multiplier, a 64-bit floating-point ALU, a divide/square-root unit, and a 32-word $\times$ 64-bit register file with six ports. This chip conforms fully to the IEEE standard for binary floating-point operations. The on-chip register file minimizes bus traffic and allows you to use the multiplier and ALU simultaneously with independent operands. In addition, the divide/square-root unit can operate in parallel with the multiplier and ALU. The 3364 has three 32-bit I/O ports configured as one input port, one output port, and one bidirectional port. You can also use these ports as one 64-bit bidirectional port. The WTL 3164 is functionally identical to the 3364, except that the 3164 has only one 32-bit bidirectional I/O port and comes in a 144-pin PGA (pin-grid array) package. The WTL is mounted in a 168-pin PGA. Samples of both chips are available now; volume deliveries will begin in July. The WTL 3364 costs \$909 (10); the WTL 3164 sells for \$829 (10).—Doug Conner

## **UTILITY CONVERTS MS-DOS CODE TO EXECUTABLE 68020 CODE**

You can employ the binary-to-binary code-conversion facility provided by XDOS to convert IBM PC-compatible programs for direct execution on Unix-based systems. Hunter Systems (Mountain View, CA, (415) 965-2400) offers XDOS, a Unix utility program, for 68020-based systems. The software includes a binary compiler that performs the code conversion and an environment emulator that emulates the MS-DOS



# NEWS BREAKS

---

environment. The end user can simultaneously execute multiple converted IBM PC-compatible programs in Unix windows. The program maps the MS-DOS file environment into Unix, so MS-DOS programs can read and write Unix files. The package also includes a Unix utility that reads MS-DOS files. Programs converted with XDOS are not affected by the MS-DOS limit on 32M-byte disk volumes, and therefore can use the full Unix disk capacity. The software is available now for 68020-based systems. OEMs can license the software on a royalty basis. Suggested end-user pricing ranges from \$425 to \$2000, depending on the number of users a system supports. You can also expect the company to offer XDOS for systems with non-68020 processors, such as Unix systems based on RISCs (reduced-instruction-set computers).—Maury Wright

## **FLOATING-POINT PROCESSORS SUPPORT IBM-370 FORMAT**

The WTL 2364 multiplier and WTL 2365 ALU from Weitek Corp (Sunnyvale, CA, (408) 738-8400) provide an exact implementation of the IBM-370 Basic Floating-Point Facility standard, the vendor claims. The 2-chip set is capable of performing 32M flops for single-precision operations and 16M flops for double-precision operations. The vendor claims these chips are the only double-precision IBM-format VLSI floating-point processors available. Both chips are available in 144-pin PGA packages. Samples are available now; volume deliveries will begin in June. A 60-nsec chip set is priced at \$825 (1000); a 75-nsec chip set costs \$700 (1000).—Doug Conner

## **IEEE-488 MACINTOSH INTERFACE TRANSFERS 800k BYTES/SEC**

Providing transparent data translation for as many as 14 IEEE-488 instruments and peripherals, the MacSCSI 488 interface from IOtech Inc (Cleveland, OH, (216) 439-4091) plugs into the SCSI (Small Computer Systems Interface) port of your Apple Macintosh+, Macintosh SE, or Macintosh II computer. It facilitates data transfers from as many as 14 devices to the Macintosh+ and Macintosh SE at 600k bytes/sec, and to the Macintosh II at 800k bytes/sec. The modem-size MacSCSI 488 owes its speed advantage to the fact that it uses no interpreted languages during the data-transfer process. The MacSCSI 488 will not interfere with the operation of any hard-disk drives you may connect to your SCSI port.

You can use either high-level, Hewlett-Packard-style commands or low-level bus-transaction commands when writing IEEE-488 programs for the MacSCSI 488. The \$795 unit comes with software device drivers that let you program it in many popular languages, such as Microsoft Basic 3.0, Turbo Pascal, Lightspeed C, VIP, and Hypercard. You also get a memory-resident desk-accessory program that lets you acquire and save data from an IEEE-488 instrument while running any application program on your host computer.—J D Mosley

## **TOKEN-BUS CONTROLLER SPECS 16-MHz DATA-TRANSFER RATE**

Besides boosting the speed of its Enhanced TBC token-bus controller, Motorola (Austin, TX, (512) 440-2140) has cut the price by 43% and packaged the controller in a plastic leaded chip carrier (PLCC). The Enhanced TBC provides a maximum communication speed of 16 MHz. Further, it performs IEEE 802.2 Logical Link Control Type 3 acknowledged connectionless services, which increase the controller's performance and decrease the volume of the program code you have to write. The controller can operate at serial data rates as low as 10 kHz. You can use the Enhanced TBC for local PBX backplane connections, or you can use it to avoid protocol conversion in field buses, providing a simple and inexpensive MAP interface. Available in 10-, 12.5-, and 16-MHz versions, the Enhanced TBC starts at \$43.30 (100).—J D Mosley



# TRW LSI now offers you genuine TDC1048 performance in low-cost plastic!

**\$19 ea. – 1,000 PC. QTY**  
**\$15 ea. – 10,000 PC. QTY**

You can obtain the TDC1048N6C at your nearest Hamilton/Avnet, Arrow or Hall-Mark distributor. For full data sheet or technical assistance, call or write our Literature Service Department at:

TRW LSI Products  
P.O. Box 2472  
La Jolla, CA 92038  
619.457.1000

In Europe, phone:  
TRW LSI Products  
Munich, 089.7103.124;  
Paris, 1.69.82.92.41;  
Surrey (U.K.), 0483.302364

In the Orient, phone:  
Hong Kong, 3.880629;  
Tokyo, 03.234.8891; Taipei, 751.2062;  
Seoul, 2.553.0901

The TRW logo consists of the letters 'TRW' in a bold, italicized, sans-serif font. The letters are red with a white outline, giving it a three-dimensional appearance.

TRW LSI Products

CIRCLE NO 16

25



# NEWS BREAKS: INTERNATIONAL

---

## **NETWORK SUITS REAL-TIME CONTROL AND DATA ACQUISITION**

The Efiway industrial-control network from Efisystème (Montluel, France, TLX 340821) allows you to control as many as 8064 distributed I/O lines from a Multibus I computer or an IBM PC/AT. The token-ring network, which employs an optical-fiber cable operating at a bit rate of 3.5M bps, can accommodate as many as 63 computers or I/O stations. Communication between a computer and the network takes place via dual-port RAM on the computer's network-interface card. The network's automatic-packet-transmission facility transfers the contents of this dual-port RAM to remote I/O locations or into the dual-port RAM of other network computers. It also transfers the input status of remote I/O channels back into the computer's dual-port RAM. These transfers occur automatically, without any software support from the control computer. As a result, the entire system appears to the computer to be a memory-mapped system rather than a network. The company estimates the cost of a 5-station network with one intelligent station at around Fr fr 150,000.—Peter Harold

## **PROGRAMMABLE AUDIO PREAMP ELIMINATES GAIN-SWITCHING NOISE**

By employing multiple-input, switchable op amps, the TEA6300 audio-frequency preamplifier provides electronic volume, bass, treble, and balance controls; an input-source selector; and a quad fader, none of which generate audible noise when you adjust them. Available from Philips' Components Div (Eindhoven, The Netherlands, TLX 51573) for approximately gld 8.50 (10,000), the device is suitable for use in a variety of consumer hi-fi audio equipment. The preamplifier has an overall gain of 20 dB, and it typically introduces 0.05% total harmonic distortion. It has an input sensitivity of 50 mV for full output voltage, a signal-to-noise ratio of 80 dB, and a channel separation of 70 dB typ.

The device's pinout allows you to introduce additional signal-conditioning circuitry between the input source selector and the preamplifier's input. An I<sup>2</sup>C-bus interface allows you to program the preamplifier's control settings from a microcontroller. The TEA6300 is supplied in a 28-pin DIP or a surface-mount minipack.—Peter Harold

## **ANGLO-AMERICAN ACCORD PUTS VRTX32 AND UNIX ONTO VME BUS**

Plessey Microsystems Ltd (Towcester, UK, TLX 31628; in the US, Pearl River, NY, (914) 735-4661) and Ready Systems (Palo Alto, CA, (415) 326-2950) have cooperated to produce Vxcel, a software package that supports Ready Systems' VRTX32 real-time operating system on Plessey's 32-bit VME Bus CPU cards. The package not only allows you to use Unix V.3 as a program-development environment, but also lets you integrate Unix and ROM-resident VRTX32 executives in a target system.

Links between the two operating systems allow you to request Unix services from programs running under the VRTX32 executive. The links also let you request real-time services provided under VRTX32 from an application program running in the Unix environment. With Vxcel, you can also use Plessey CPU cards as target systems for software generated by Ready Systems' Cardtools computer-aided software-engineering (CASE) packages, or as targets for Ada programs that use ARTX as their run-time operating system. The companies haven't yet decided on licensing arrangements for Vxcel, but they expect to have the first release of the product ready in the second quarter of 1988.—Peter Harold



The New 4180 Plug-In

# SPEED TRIALS.

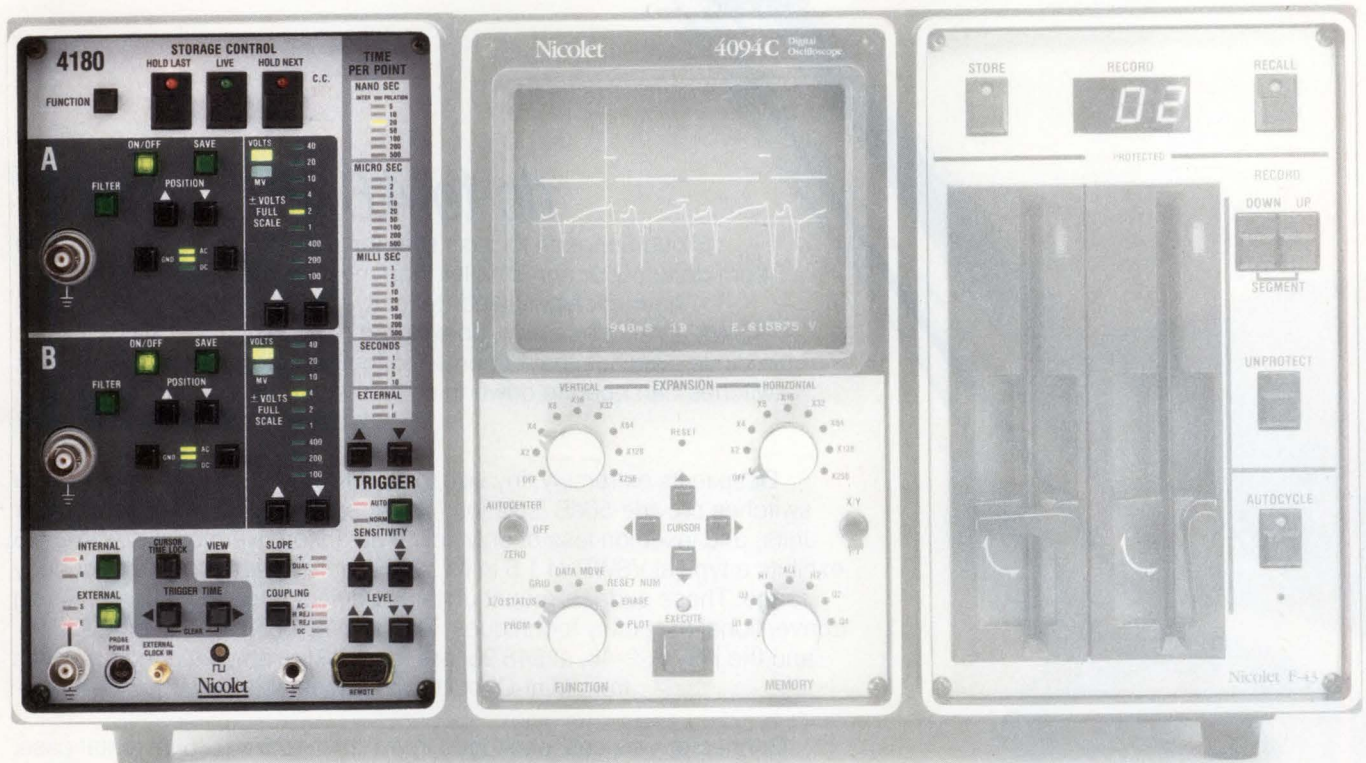

- **Multi-channel: two or four channel configurations.**
- **Unmatched single-shot capabilities.**
- **High speed, 200 MHz digitizing.**
- **100 MHz analog input bandwidth.**
- **Real-time math functions.**
- **For your Free Speed Trial call: 800-356-3090 or 608-273-5008**

## Nicolet Digital Oscilloscopes

**Speed.** Using the latest designs in ADC technology, your input signal can be digitized at speeds up to 200 MHz (5ns per data point) and saved for analysis. The wide band input amplifiers allow signals up to the 100 MHz Nyquist limit to be input without distortion. Sophisticated trigger setup displays allow you to accurately set the level, sensitivity, and slope to make one-shot transients easy to catch; eliminating the usual hit or miss guesswork. For multi-channel applications two 4180's can operate together in one mainframe producing a four channel scope with no degradation in speed or performance.

**Real-Time Math.** In addition to the extensive post-processing capabilities in the mainframe, the 4180 has several useful routines which present computed results as live, real-time displays: *FFT*, *MAX/MIN*, *A+B*, *A-B*, *A×B*, *A/B*, and *AVERAGING*.



Nicolet Test Instruments Division  
P.O. Box 4288  
5225-2 Verona Road  
Madison, WI 53711-0288

# Nicolet

INSTRUMENTS OF DISCOVERY



# tiny SPDT switches

## absorptive... reflective

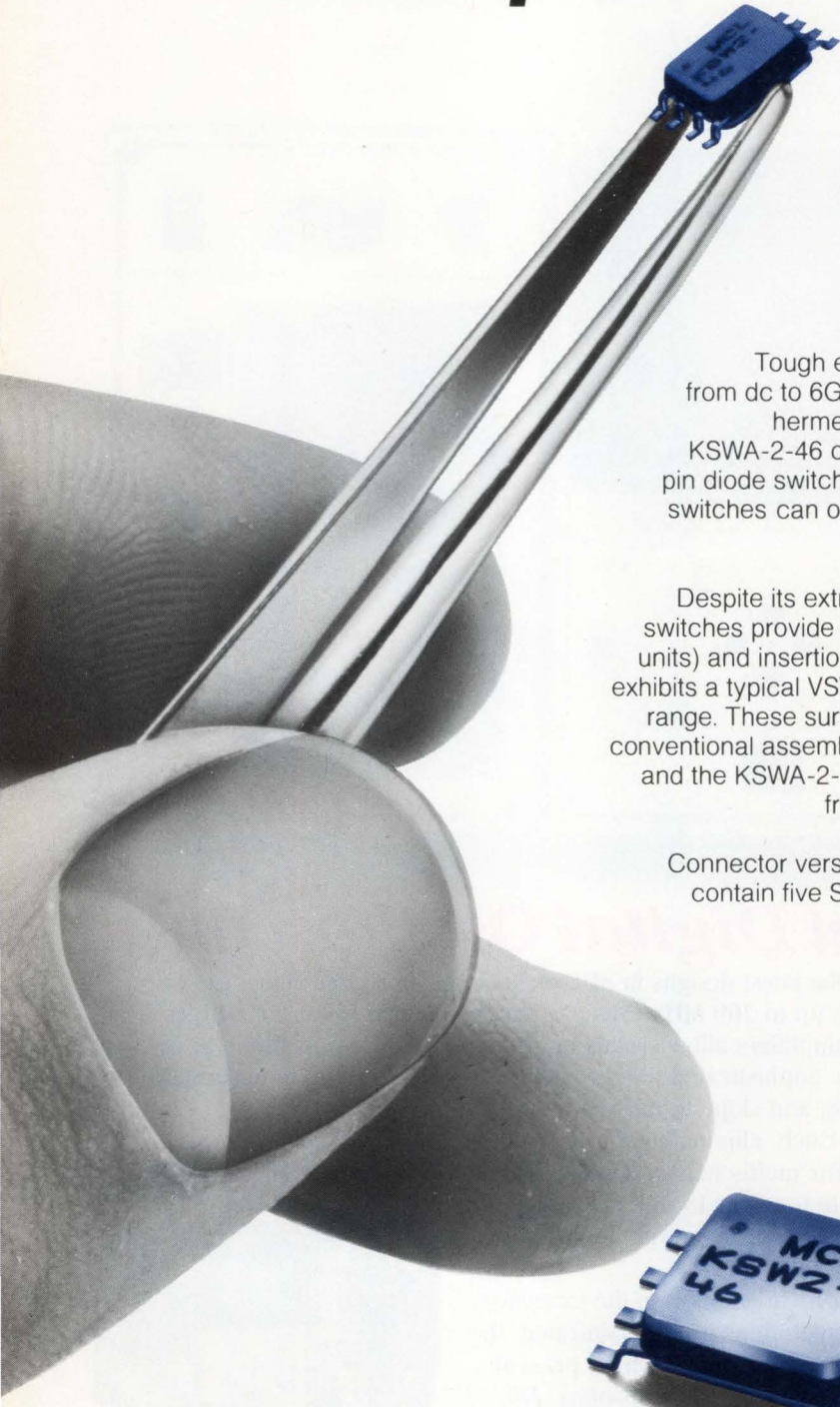

dc to 4.6GHz from \$32<sup>95</sup><sub>(1-24)</sub>

Tough enough to pass stringent MIL-STD-202 tests, useable from dc to 6GHz and smaller than most RF switches, Mini-Circuits' hermetically-sealed (reflective) KSW-2-46 and (absorptive) KSWA-2-46 offer a new, unexplored horizon of applications. Unlike pin diode switches that become ineffective below 1MHz, these GaAs switches can operate down to dc with control voltage as low as -5V, at a blinding 2ns switching speed.

Despite its extremely tiny size, only 0.185 by 0.185 by 0.06 in., these switches provide 50dB isolation (considerably higher than many larger units) and insertion loss of only 1dB. The absorptive model KSWA-2-46 exhibits a typical VSWR of 1.5 in its "OFF" state over the entire frequency range. These surface-mount units can be soldered to pc boards using conventional assembly techniques. The KSW-2-46, priced at only \$32.95, and the KSWA-2-46, at \$48.95, are the latest examples of components from Mini-Circuits with unbeatable price/performance.

Connector versions, packaged in a 1.25 x 1.25 x 0.75 in. metal case, contain five SMA connectors, including one at each control port to maintain 3n sec switching speed.

**Switch fast... to Mini-Circuits' GaAs switches.**

### SPECIFICATIONS

PIN MODEL	KSW-2-46		KSWA-2-46	
CONNECTOR MODEL	ZFSW-2-46		ZFSWA-2-46	
FREQ. RANGE	dc-4.6 GHz		dc-4.6 GHz	
INSERT. LOSS (db)	typ	max	typ	max
dc-200MHz	0.9	1.1	0.8	1.1
200-1000MHz	1.0	1.3	0.9	1.3
1-4.6GHz	1.3	1.7	1.5	2.6
ISOLATION (dB)	typ	min	typ	min
dc-200MHz	60	50	60	50
200-1000MHz	45	40	50	40
1-4.6GHz	30	23	30	25
VSWR (typ)	ON	1.3:1	1.3	
	OFF	—	1.4	
SW. SPEED (nsec)				
rise or fall time		2(typ)		3(typ)
MAX RF INPUT (bBm)				
up to 500MHz		+17		+17
above 500MHz		+27		+27
CONTROL VOLT.		-5V on, OV off		-5V on, OV off
OPER./STOR TEMP.		-55° to +125°C		-55° to +125°C
PRICE (1-24)		<b>\$32.95</b>		<b>\$48.95</b>
		<b>\$72.95</b>		<b>\$88.95</b>

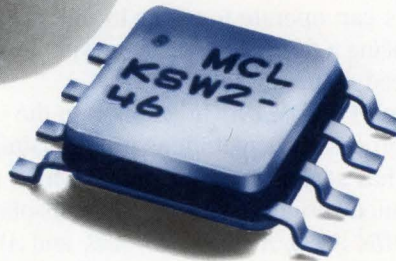

finding new ways...  
setting higher standards

## Mini-Circuits

A Division of Scientific Components Corporation  
P.O. Box 350166, Brooklyn, New York 11235-0003 (718) 934-4500  
Fax (718) 332-4661 Domestic and International Telexes: 6852844 or 620156

CIRCLE NO 18

C117REV.C

EDN March 17, 1988



# RF transformers

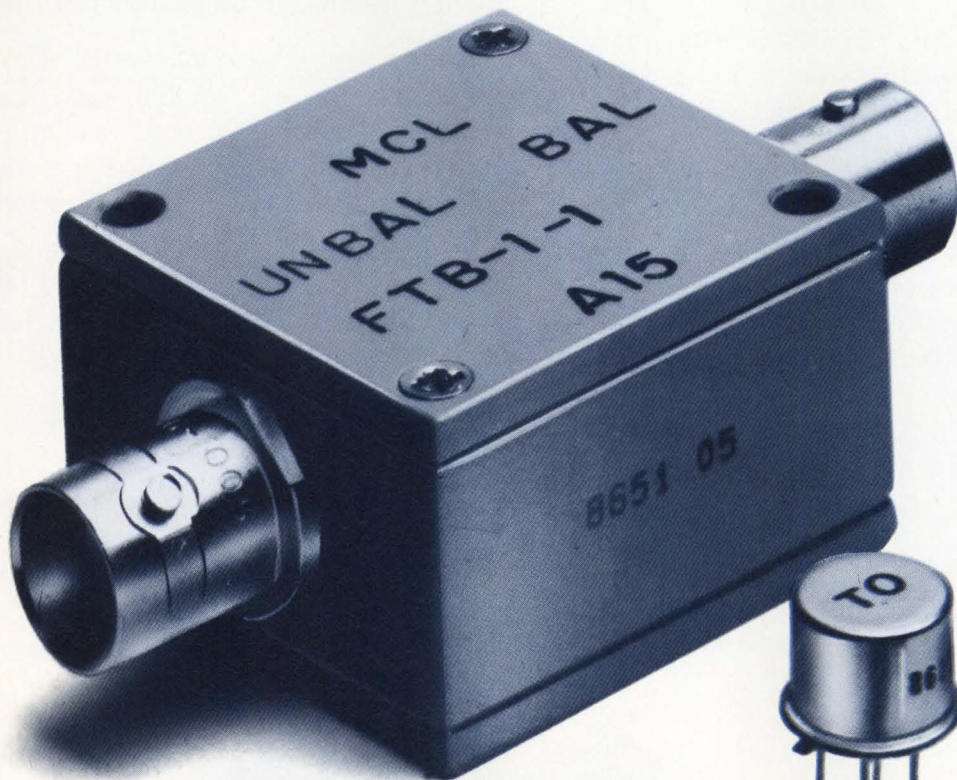

3 KHz-800 MHz  
over 50 off-the-shelf models  
from \$2<sup>95</sup>

Choose impedance ratios from 1:1 up to 36:1, connector or pin versions (plastic or metal case built to meet MIL-T-21038 and MIL-T-55631 requirements\*). Fast risetime and low droop for pulse applications; up to 1000M ohms (insulation resistance) and up to 1000V (dielectric withstanding voltage). Available for immediate delivery with one-year guarantee.

Call or write for 64-page catalog or see our catalog in EBG, EEM, Gold Book or Microwaves Directory.

\*units are not QPL listed

finding new ways...  
setting higher standards

 **Mini-Circuits**

A Division of Scientific Components Corporation  
P.O. Box 350166, Brooklyn, New York 11235-0003 (718) 934-4500  
Domestic and International Telexes: 6852844 or 620156

C71 Rev. A



# Hitachi's Wide Selection of CMOS Microprocessors Gives You Freedom of Choice

*Visit the grasslands of Africa, and you'll be amazed by the sheer variety of life. Each animal has evolved with specific traits, especially suited to its needs... its environment.*

Take a look at the CMOS Microprocessors and Microcontrollers from Hitachi. Here's an incredible variety of devices, each created to meet your specific design needs.

*Hitachi makes more devices in CMOS than anybody else.* Our product lines include CMOS microprocessors and microcontrollers, as well as peripherals, gate arrays, and a broad range of memories. They're available in various industry-

standard architectures, in a choice of speeds, temperature ranges, and packaging variations.

Now you can get CMOS benefits in many of your old favorites. Plus, we've come up with some new devices destined to become your new favorites.

*Hitachi has the CMOS solution for all your designs.* Our high-speed CMOS devices are perfect for portable instrumentation, telecommunications, high-reliability industrial control, automotive applications, and systems used in harsh environments.

These devices are available in production quantities today. Many are second-sourced. Now you can build high-performance systems that are more reliable, smaller, and less expensive.

# Abundant Variety

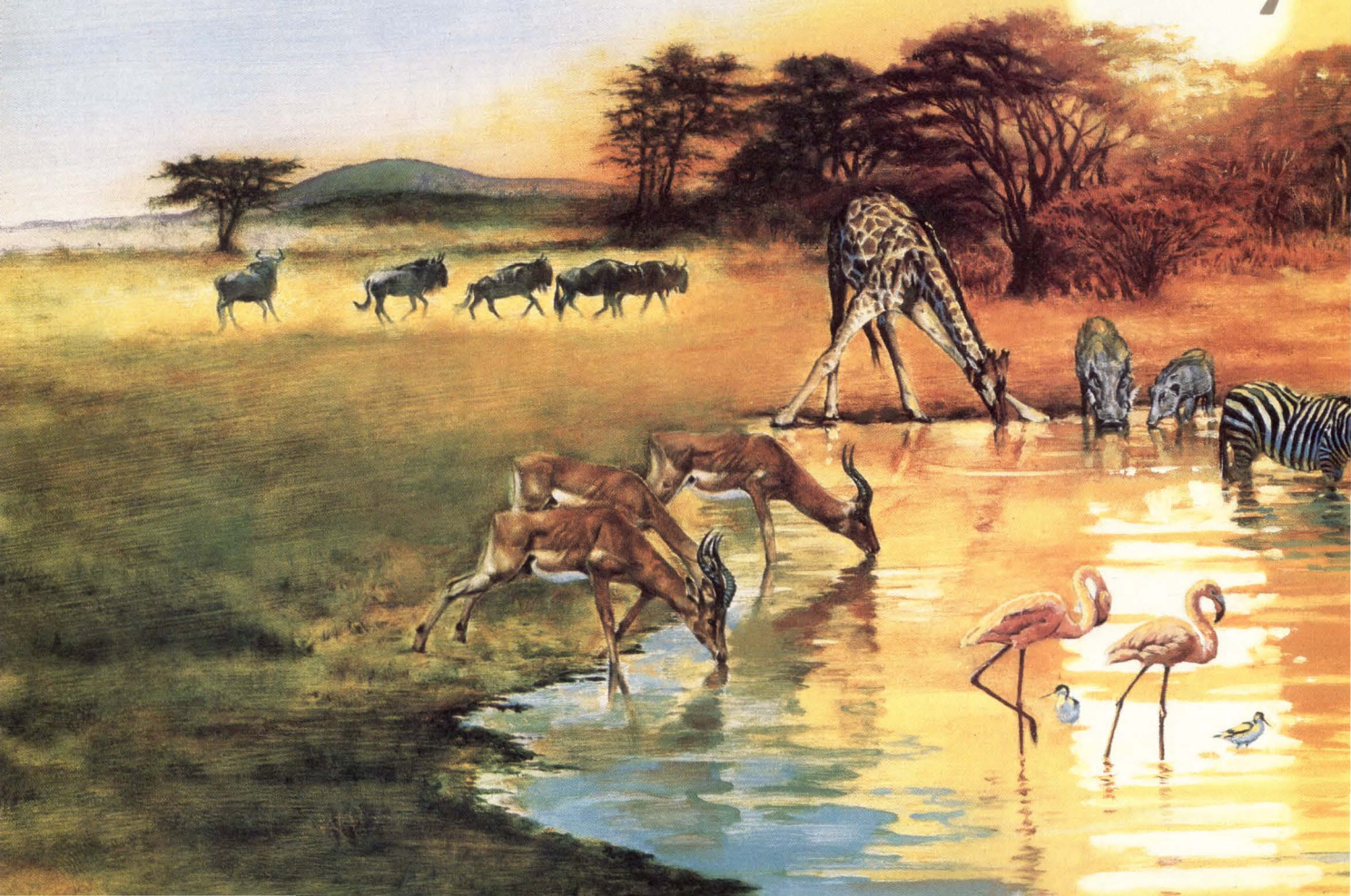



Our CMOS products include:

- HMCS400 Series 4-Bit Microcontrollers
- HD6301/6305 8-Bit Microcontrollers
- HD64180 Family of 8-Bit High-Integration Microprocessors
- HD6303/6309 Microprocessors
- HD68HC000 16-Bit Microprocessors
- 8/16-Bit Microprocessor Peripherals

*Fantastic devices are only part of Hitachi's total CMOS solution.* Hitachi's CMOS products also deliver unsurpassed quality and reliability. We have comprehensive hardware and software development support running on popular systems such as IBM-PC.\* The conclusion: You have a complete solution with Hitachi.

***Fast Action:*** To obtain product literature immediately, CALL TOLL FREE, 1-800-842-9000, Ext. 6809. Ask for literature number R16.

\*IBM-PC is a registered trademark of International Business Machines Corporation.

**Hitachi America, Ltd.**  
Semiconductor and IC Division  
2210 O'Toole Avenue, San Jose, CA 95131  
Telephone 1-408/435-8300

 **HITACHI®**  
*We make things possible*





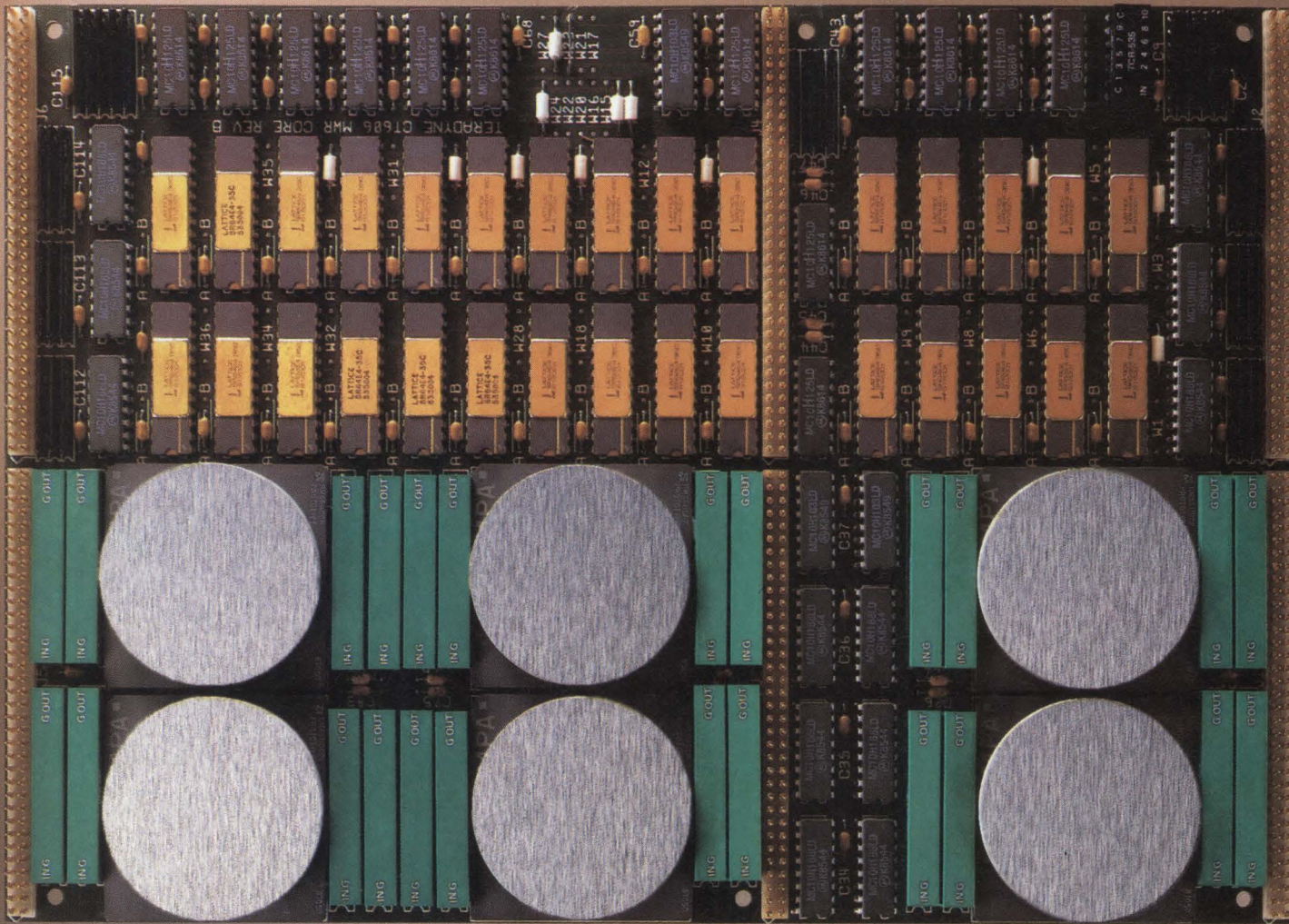

# If you're testing complex boards

You're facing one of test engineering's toughest challenges. VLSI boards like this one. But with a Teradyne L200 board tester on your side, complex test problems can be conquered quickly.



The L293 VLSI Module Test System.

## Stay in front of VLSI/VHSIC advances.

Start with the most advanced hardware for analog and digital testing. An L200 fires functional test patterns at 40 MHz rates. At up to 1152 test channels. Top speed is 80 MHz. That's 4 to 8 times faster than any competitor can deliver.

And the L200 hits test signal timing precisely. With up to 32 timing sets for drive phases and test windows. Its 250 ps programming resolution with zero dead time puts signal edges right where you want them.

## Divide and conquer.

VLSI/VHSIC boards demand large, complex test programs. But the L200's distributed computer architecture simplifies matters.

Testing is controlled by a VAX computer. It sends tasks to specialized processors for rapid deployment of analog, digital, and memory tests.



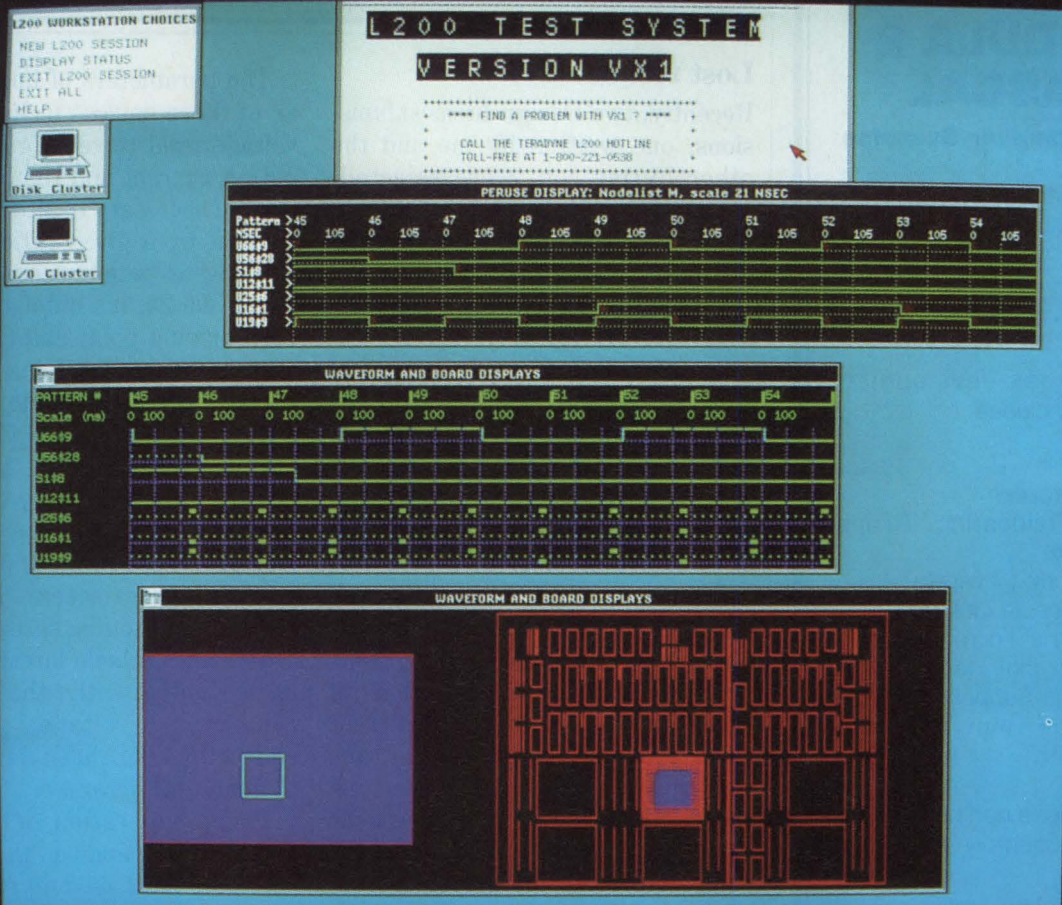

# here's a simple plan of attack.

Programmers will appreciate clustered VAX workstations. Graphics, like waveforms and shmoo plots, make heavy debug and analysis light work. **Simulation and other tactics.**

High-powered software tools tailor L200 test development to modern design techniques and test strategies. Precisely the caliber of tools you need to get tests up and running fast.

Test Channels	Maximum Pattern Rate	Channel Skew
L297	1152	80 MHz ±1.5 ns
L293	576	80 MHz ±1.5 ns
L280vx	1152	10 MHz ±10 ns
L210vx	576	10 MHz ±10 ns

L200 VLSI board test systems are the performance leaders.

Take our LASAR simulator. It works closely with the L200 for both cluster and board-level testing. LASAR accurately predicts VLSI circuit responses and reports test program fault coverage.

Significantly, LASAR simulates L200 charac-

teristics. So test programs automatically include when to test board responses. And what response is expected. The result is uncompromising go/no go tests as well as precise guided probe or fault dictionary diagnosis.

### A powerful ally.

L200's have proven themselves under fire at hundreds of advanced manufacturing sites worldwide. So if you're about to take on a new VLSI/VHSIC project, find out how to launch a winning test strategy. Call Daryl Layzer at (617) 482-2700, Ext. 2808 without delay.



VAX is a trademark of Digital Equipment Corp.



# C MODULA 2 PASCAL

## Cross-Compiler Systems

- High performance, field-proven software development systems producing extremely compact, fast-executing, ROMable output code.
- Each cross-development package includes:
  - C, Modula 2, or Pascal Cross-Compiler
  - Macro Relocating Cross-Assembler
  - Object Code Librarian
  - Object Module Linker
  - Hexadecimal Format Loader [S-Records, Intel Hex, TEK Hex]
  - Standalone Support Library [EPROMable, with full floating point support]
- All languages can be intermixed with assembly language

### • Targets supported:

**6301/03**  
**6801/03**  
**6809**  
**68HC11**  
**68000/08/10/12**  
**68020/881/851**  
**32000/32/81/82**

### • Available for following hosts:

VAX: VMS/UNIX/ULTRIX  
 PDP-11: UNIX/TNIX/VENIX  
 68000: UNIX System V  
 PC,XT,AT: MS-DOS  
 PowerNode: UTX/32

UNIX: TM of AT&T Bell Labs.  
 VAX, VMS, PDP-11, ULTRIX:  
 TM of Dig. Equip. Corp.  
 TNIX: TM of Tektronix Inc.  
 VENIX: TM of VenturCom  
 PowerNode, UTX/32: TM of Gould Inc.

**INTROL CORPORATION**  
**647 W. Virginia Street**  
**Milwaukee, WI 53204**  
**(414) 276-2937**  
**FAX: (414) 276-7026**

# SIGNALS & NOISE

## Lost technology?

Recently, two Design Ideas submissions, one written by me and the other by my son, were rejected, showing your reviewers' lack of understanding of the concepts illustrated.

I'd like to solicit your readers' comments on this subject.

In my view, the parameter of transconductance ( $g_m$ ) characterizes active devices better—whether bipolar transistor, FET, or vacuum tube—than the much more commonly used parameters of current gain or voltage gain ( $\beta$  or  $\mu$ ).

Bipolar and FET devices, as well as electron tubes, are transconductance-controlled devices. Their transconductances are functions of  $(q/kT)$  and the device output current ( $I_o$ ). The reason that standard tube testers and transconductance-type testers give essentially equivalent results is that both respond in the same manner to the deviation from ideal  $g_m$  ( $I_o q/kT$ ). This deviation increases with  $I_o$ , thanks to the increasing cathode (interface) impedance.

At low currents and with minimal leakage, the transconductances of both FETs and electron tubes are  $(q/kT)$  times the output currents for the devices. Because edge-current effects increasingly shield the control of channel current as  $I_o$  increases, the effective transconductance decreases.

The parameters of importance to all of these devices include the bias voltage used to set a given level of output current and the bias-voltage change necessary to alter the output current by a given ratio (like 2:1). As long as beta exceeds a nominal value like 20, it's unimportant. But both driving point and transfer admittances are functions of the respective currents and define the admittances in terms of  $(q/kT)$  and an efficiency parameter. All of these devices have inherently exponential nonlinearities, and the discrepancies are consequences of inherent parasitic parameters like base, emitter, and source spreading resistances and cathode interface impedance. Consequently, the use of current or voltage gain in characterizing these devices leads to analytical errors.

Proper operation of solid-state amplifiers depends on the control of voltage gain. Freedom from oscillation and achievement of minimum-phase characteristics, so vital in color TV and Doppler measuring systems, for example, can only be achieved with amplifiers whose voltage gain is stabilized. And transconductance defines voltage gain.

IEEE publications accept only analytical studies. Publications like EDN can fill the gap between pure theory and applications. EDN needs to encourage articles and Design Ideas that fulfill this goal.

I ask your readers to send in their opinions on this subject.

*Keats Pullen*  
*Kingsville, MD*

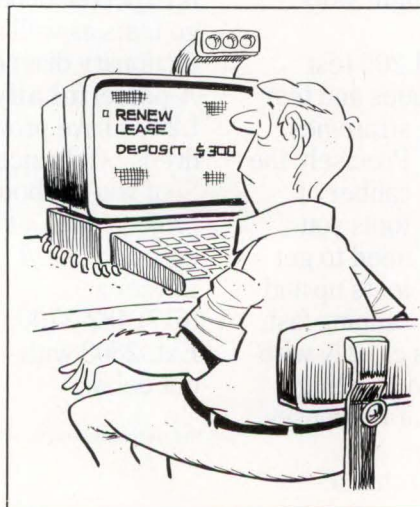

## WRITE IN

Send your letters to the Signals and Noise Editor, 275 Washington St, Newton MA 02158. We welcome all comments, pro or con. All letters must be signed, but we will withhold your name upon request. We reserve the right to edit letters for space and clarity.



# The next step in TELEMETRY SYSTEMS

## System 500

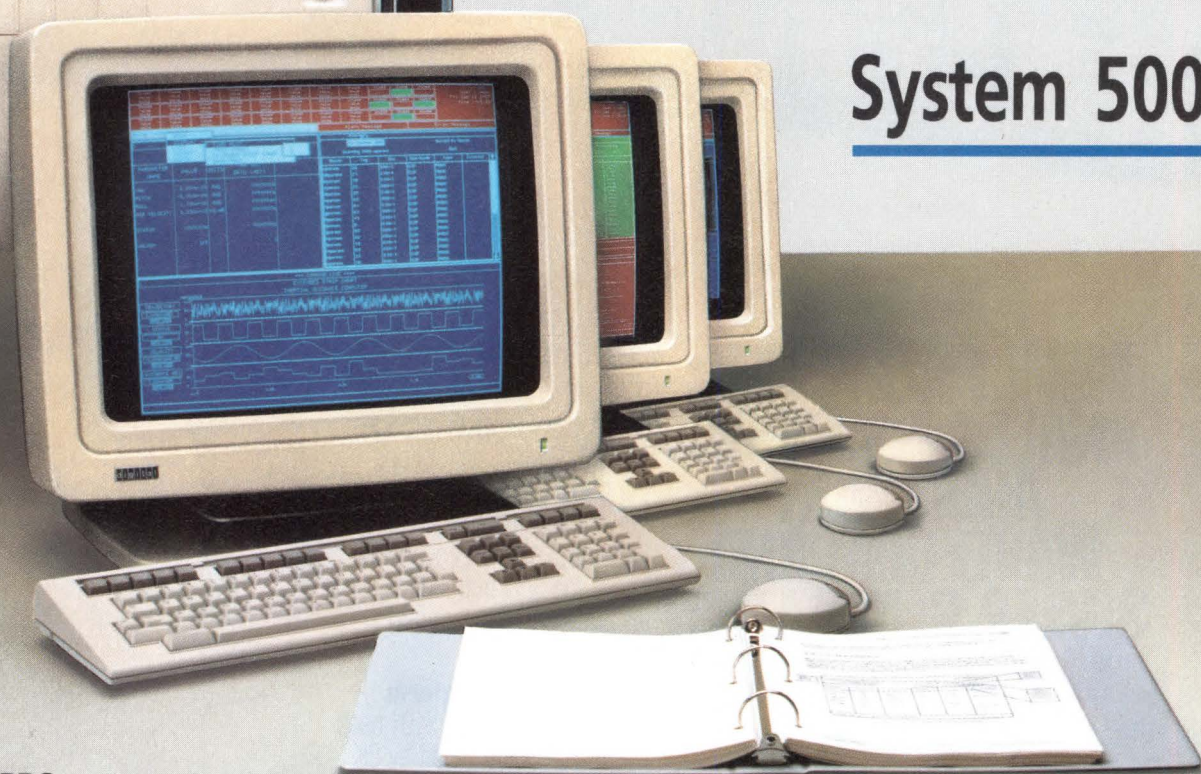

### LORAL SETS NEW STANDARDS FOR POWER, SPEED, AND PERFORMANCE

Your next step in telemetry systems is the System 500 from Loral Instrumentation. Behind our easy-to-use interface is more capability to merge diverse data streams and process and display data in real-time, making this the new standard in telemetry systems.

The System 500's distributed open architecture disperses real time processing and high-speed Gigabyte storage *within* the system, eliminating host computer bottlenecks. Multiple color graphics workstations simultaneously monitor data on-the-fly.

Advanced color graphics, pop-up windows, pull-down menus, and mice make it easy to set up and view data acquisition from multiple data streams and sources, including

- PCM (up to 20 Mb/s)
- PAM
- MIL-STD-1553
- ARINC 429
- Analog and Digital

#### More real-time processing power.

Each processor provides up to 730K measurements per second using a single 20-MFLOPS numerics processor. A single System 500 can handle a *minimum* of 4M measurements per second, for greater real-time processing.

Escape laborious microcode

development with your choice of algorithm development languages: C, Fortran, and direct algebraic entry, and a large algorithm library that includes data compression, EUC, FFT, and PSD.

#### A system designed for you and your future.

Buy only the capability you need today, and rely on our library of acquisition, storage, and distribution modules

when your needs change. The System 500 is the new standard for

- power
- speed
- performance
- ease of use
- flexibility

Call us at 1-800-351-8483, ext. 500 (1-619-560-5888, ext. 500) to see why Loral's System 500 is your next telemetry system. We're located at 8401 Aero Drive, San Diego, California 92123-1720.

# LORAL

Instrumentation



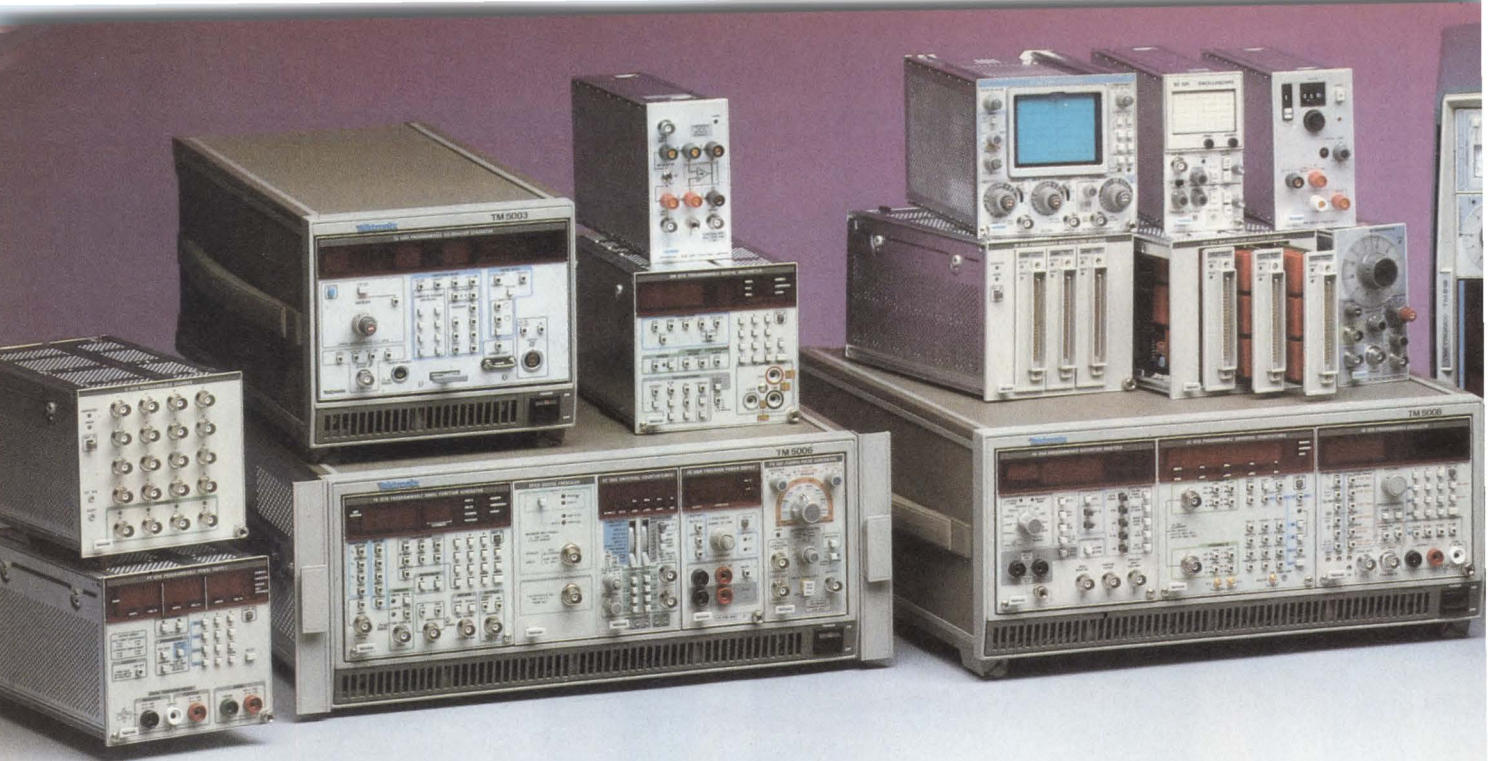

# NEW FROM TEK: ANALOG FUNCTION, ARBITRARY WAVEFORM AND SWEEP GENERATION IN ONE COMPACT PACKAGE.

**The Tek AFG 5101 Programmable Arbitrary/Function Generator is the latest addition to Tek's TM 5000 family of proven, programmable, modular test instruments.**

**An analog function generator,** the AFG 5101 can generate standard sine, square and triangle waveforms, plus dc level, with frequencies from .012 Hz to 12 MHz and amplitudes of 10 mV to 9.99V peak-to-peak, into 50 ohms. Waveforms can be continuous, triggered, gated or burst, from a

full range of triggering modes.

With synthesizer option, the AFG 5101 achieves frequency accuracies to .005% (120 Hz to 12 MHz) over and above the .2% frequency accuracies in the standard instrument.

**An arbitrary waveform generator,** the AFG 5101 uses two independent 12-bit by 8K waveform memories to build any imaginable signal from an array of 8,192 horizontal addresses and 4,096 vertical addresses. Enter the waveforms manually from the front panel, from computer data —or select one of the unit's predefined, 1,000-point waveforms.

**A sweep generator,** the AFG 5101 includes linear,





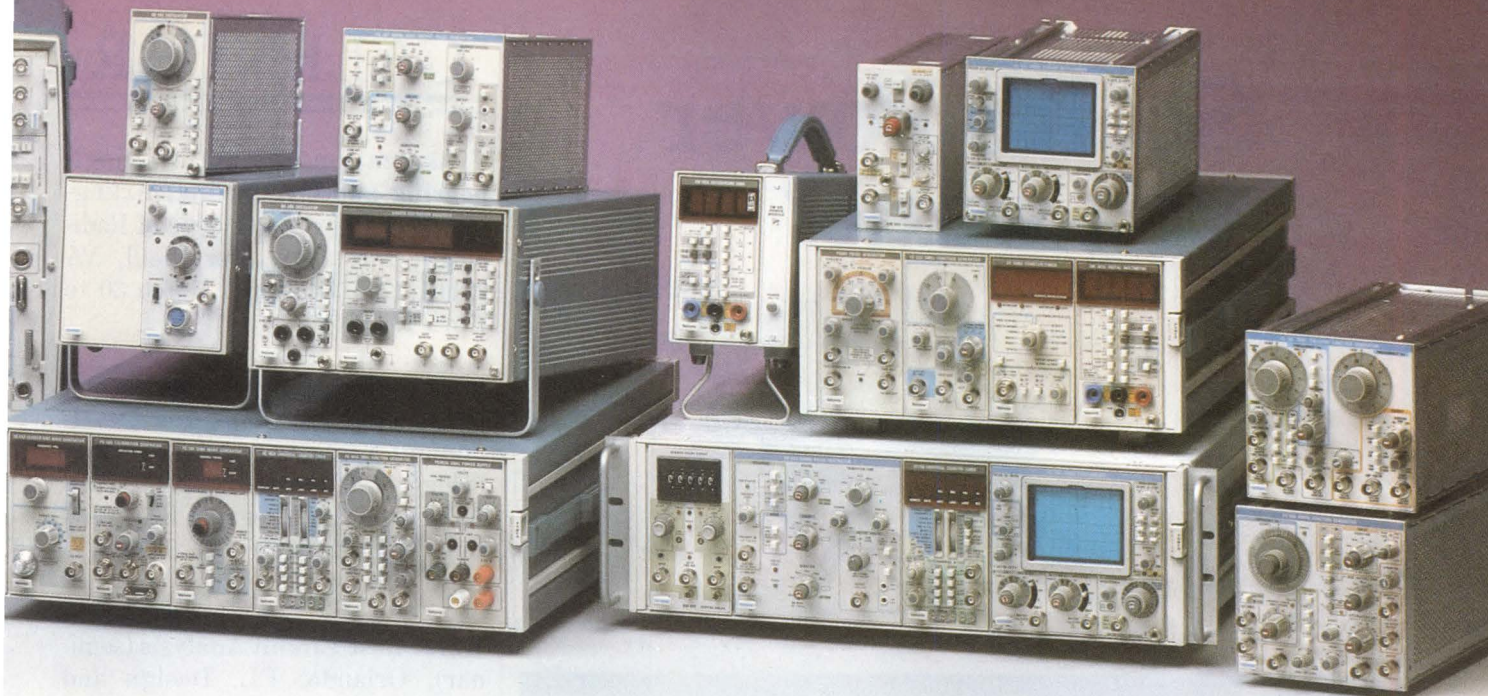

logarithmic and arbitrary sweeps, with any sweep usable in continuous, triggered, gated or burst mode. Users can receive instant frequency readout of breakpoints, notches, or response anomalies.

**The applications are wide open.** Use the AFG 5101 to drive sensors, timers, and other R&D equipment. To simulate metal stress or vibration characteristics. To teach waveform theory to students. And much more.

Easy waveform editing capabilities... non-volatile storage of up to 99 front panel settings and two 8K point waveforms... binary block GPIB transfer... two waveform memories plus third, execution memory—these and other features make the AFG 5101 a simple, powerful and uniquely flexible tool.

**AVAILABLE IN THREE CONFIGURATIONS.**

The first triple-duty test instrument of its kind, it is available in monolithic (AFG 5501), as a plug-in (AFG 5101), or in our Programmable Arbitrary Stimulus/Measurement package (EBS 5002).

**Take 10% off with our package offer.** Order the AFG 5101 in our Programmable Arbitrary Stimulus/Measurement package and take 10% off catalog prices.

**For the full story on these and other Tek modular instruments, call 1-800-426-2200.** Or contact your nearby Tektronix field office.

*(Center photo) The AFG 5101 can be ordered in either monolithic version, top right, or as a plug-in for the TM 5000 series mainframes, top left. Or, combine it with the DM 5010 4.5 Digit Multimeter and DC 5009 135 MHz Digital Counter within a TM 5006 mainframe (EBS 5002), as shown at bottom, and take 10% off the normal catalog price.*

**Tektronix**  
COMMITTED TO EXCELLENCE



# So, it's Power you want?

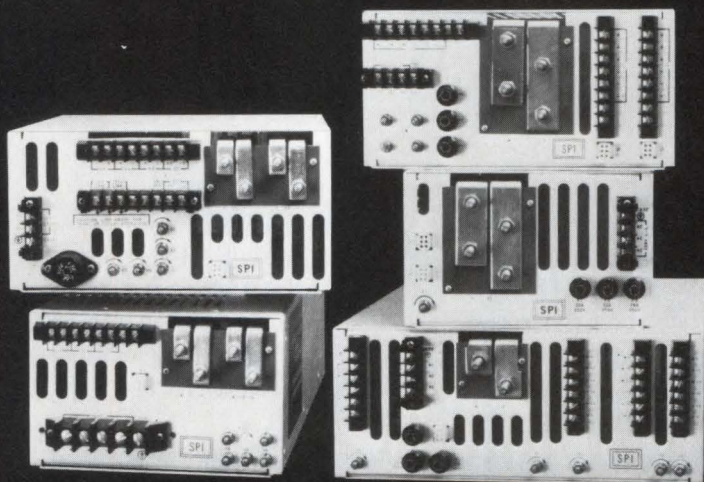
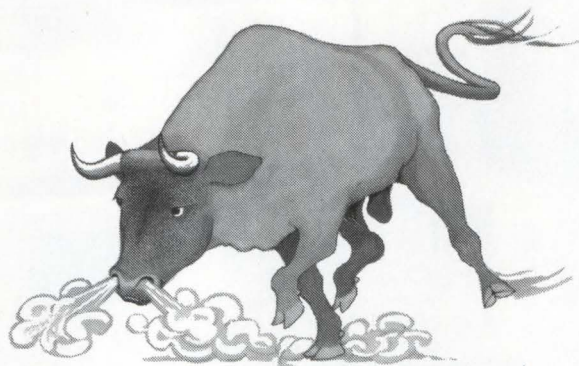

- Up to 800 Amps • Up to five outputs
- 115 VAC • 230 VAC • Single phase • Three phase
- All safety approvals • Equal current sharing

## SWITCHING POWER INC

3601 VETERANS HIGHWAY, RONKONKOMA, NEW YORK 11779  
TEL. (516) 981-7231 FAX (516) 981-7266



Call or write for our free Catalog—  
130 to 4000 watts.

## CALENDAR

**Visualization Science in Engineering and Computing**, Arlington, VA. American College of Radiology, Box 2348, Merrifield, VA 22116. (703) 648-8961. March 30 to April 1.

**Digital Signal Microprocessor and Microcomputer Chips and Development Systems** (seminar), Cambridge, MA. Amnon Alphas, DSP Associates, 18 Peregrine Rd, Newton, MA 02159. (617) 964-3817. April 4 to 6.

**Worst-Case Circuit Analysis** (seminar), Orlando, FL. Design and Evaluation, 1000 White Horse Rd, Suite 304, Voorhees, NJ 08043. (609) 770-0800. April 4 to 6.

**Microcircuit Interconnections and Assembly Methods** (seminar), Fullerton, CA. California State University, Office of Extended Education, Fullerton, CA 92634. (714) 773-3080. April 7.

**Electrostatic Discharge (ESD): Concern or Over-Concern?** (seminar), Fullerton, CA. California State University, Office of Extended Education, Fullerton, CA 92634. (714) 773-3080. April 12.

**Hybrid Microcircuit Technology** (seminar), Fullerton, CA. California State University, Office of Extended Education, Fullerton, CA 92634. (714) 773-3080. April 18.

**American Power Conference**, Chicago, IL. Robert Porter, Illinois Institute of Technology, Chicago, IL 60618. (312) 567-3202. April 18 to 20.

**Worst-Case Circuit Analysis** (seminar), San Diego, CA. Design and Evaluation, 1000 White Horse Rd, Suite 304, Voorhees, NJ 08043. (609) 770-0800. April 18 to 20.

**4th International Integrated Services Digital Networks Exposition**, St Louis, MO. Information Gate-



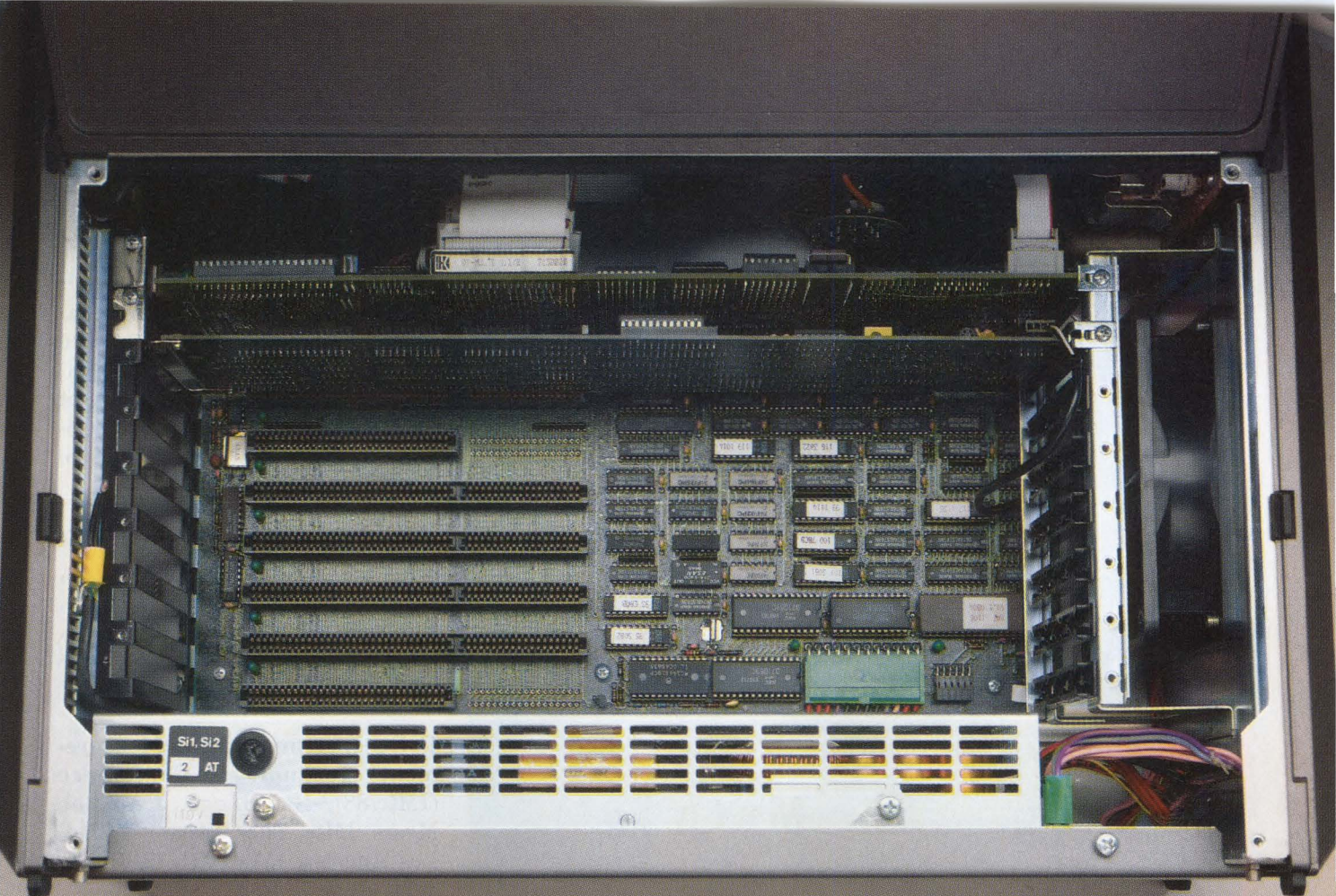

# We Suggest You Approach Your Logic Analyzer Decision Backwards.

Up front, the PLA 286 gives you more of what you need to solve even the toughest timing problems. Much deeper memory, for example, than you'll find anywhere else: Up to 4K per channel for state analysis; up to 8K for timing. And from 48 up to 112 channels. So you get a much bigger window into problem areas.

But what you see when you look behind the machine may impress you even more. Because in addition to being a powerful logic analyzer, it's also a powerful 10-MHz, 0-wait-state, AT-compatible computer.

There they are. Count 'em.

Six standard slots, waiting to turn the PLA 286 into any-



thing else you want it to be. Now, or later. Pattern generator. Oscilloscope. SCSI tester. Frequency counter. Ethernet node. Whatever.

So when you look at it backwards, the PLA 286 is a very forward-thinking machine, indeed. Fold up the keyboard, grab the handle, and it moves from heavy-duty, complex R&D lab applications, to complete, multi-function field analysis. All the power,

depth, range, and flexibility you need for the most demanding software and hardware analysis, in one, neat box.

The PLA 286 is one decision you can back into, and feel great about. Give us a call. (800) 227-8834.

**KONTRON  
ELECTRONICS**

United States KONTRON ELECTRONICS INC., 630 Clyde Avenue, Mountain View, CA 94039-7230, Toll free number 800-227-8834  
Europe KONTRON MESSTECHNIK, GmbH, Oskar-von-Miller-Str.1, 8057 ECHING/W. Germany, Phone: 49 (08165) 77-0



# "MATHCAD IS THE BEST THING TO HAPPEN TO THE ENGINEER SINCE THE POCKET PROTECTOR."

— PC Magazine

For problems involving engineering calculations or scientific analysis, the answer is MathCAD.®

MathCAD is the only PC-based software package specifically designed to give technical professionals the freedom to follow their own scientific intuition. You decide how to solve the problem — MathCAD does the "grunt work."

- Ends tedious programming and debugging.
- Displays instant answers as you change variables.
- Generates quick plots to help you view results.

MathCAD includes such built-in features as:

- Matrix operations
- Simultaneous equation solver
- Real and complex numbers
- Dynamic error flagging
- Automatic unit conversions
- Greek character set
- Fast Fourier Transform and much more

To find out what MathCAD can do for you, call us today for a **free demo disk: 1-800-MathCAD** (in MA, 617-577-1017). Or write to MathSoft, Inc., One Kendall Square, Cambridge, Massachusetts 02139.

Requires IBM® PC or compatible.  
512KB RAM, graphics card.

**Math Soft**  
Σ + √ - = × ∫ ÷ δ  
Software Tools for Calculating Minds

CIRCLE NO 28

## LCD readability taken to new heights!

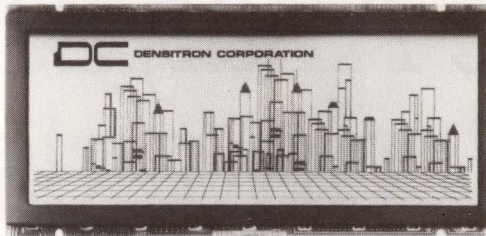

- Fluorescent backlighting and Supertwist technology combine to create the brightest and most dynamic graphic liquid crystal display available today.
- Long life 20,000-hr. fluorescent tube emits a bright, even light.
- Supertwist LCD produces a high contrast display with a wide viewing angle.
- Available in 3 sizes: 400x640, 200x640 and 128x256.
- Available in positive or negative images with white, yellow or blue background.
- Thin package with CMOS drivers.
- Controller cards available.

**DC**  
**DENITRON**  
**CORPORATION**

**2540 West 237th Street**  
**Torrance, CA 90505**  
**(213) 530-3530**  
**FAX: G2/G3: 213-534-8419**  
**TELEX II: 910-349-6200**  
**Europe/UK: (0959) 76600**

CIRCLE NO 29

## CALENDAR

keepers, 214 Harvard Ave, Boston, MA 02134. (800) 323-1088; in MA, (617) 232-3111. April 18 to 21.

**Instrument Society of America/IEEE Columbus Conference and Exhibit**, Columbus, OH. Sol Black, AT&T Network Systems, Dept 11CB123430, 6200 E Broad St, Columbus, OH 43213. (614) 860-5605. April 19 to 20.

**Fiber Optic Communication Systems** (short course), Washington, DC. Integrated Computer Systems, Box 3614, Culver City, CA 90231. (800) 421-8166; in CA, (213) 417-8888. April 19 to 22.

**IEEE Instrumentation/Measurement Technology Conference** (IMtc/88), San Diego, CA. Bob Myers, IMtc, 1700 Westwood Blvd, Los Angeles, CA 90024. (213) 475-4571. April 19 to 22.

**Modern Electronic Packaging** (seminar), Raleigh, NC. Technology Seminars, Box 487, Lutherville, MD 21093. (301) 269-4102. April 20 to 22.

**Modern Microwave Techniques** (short course), Los Angeles, CA. UCLA Extension, 10995 Le Conte Ave, Los Angeles, CA 90024. (213) 825-3344. April 25 to 28.

**Systems Engineering for Engineers and Managers**, Los Angeles, CA. N B Reilly & Associates, 4220 S Harbor Blvd, Suite 305, Oxnard, CA 93030. (805) 985-7413. April 26 to 28.

**Uninterruptible Power Systems: Design, Selection, and Specification** (short course), Milwaukee, WI. Center for Continuing Engineering Education, University of Wisconsin-Milwaukee, 929 N 6th St, Milwaukee, WI 53203. (414) 227-3120. April 28 to 29.



# WATCH WHAT YOU'RE DOING.



## Introducing UniLab 8620 analyzer-emulator with InSight.

■ There's nothing like InSight™. A feature of the new 8620 that lets you actually **watch** your program go through its paces. So you can debug faster. And speed up microprocessor development. For demanding applications like the automotive controller shown.

■ An exciting industry first, InSight blends analyzer/emulator techniques to give you continuous, real time monitoring of key processor functions. See changing register contents, I/O lines, ports, user-defined memory windows. With your own labels. And all at once. Interactively. Without stopping your program.



■ InSight is made possible by the 8620's advanced bus state analyzer, its 2730-bus-cycle trace buffer, and a new high-speed parallel interface that eliminates RS-232 bottlenecks.

■ The fast interface also speeds data throughput. From your hard drive, you can load a 64K program into emulation memory in five seconds.

■ On top of that, you get a new, crystal-controlled 1 μsec clock for super precise event timing.

■ Computer integrated instruments from Orion prove debugging needn't be costly or tedious. For more than 150 processors. Like all our analyzer-emulators, the 8620 debugs by symptom. Via advanced truth table triggering. Always included is enough breakpointing and single stepping (now faster than ever) to assure optimum efficiency. We even provide a stimulus generator and built-in EPROM programmer to help finish the job.

■ Get serious about price/performance. Save big on design, test, and support costs. UniLab 8620 analyzer-emulator.

■ Look into it.

Toll free: 800/245-8500. In CA: 415/361-8883.

**ORION**  
INSTRUMENTS

Computer Integrated Instrumentation  
702 Marshall Street, Redwood City, CA 94063  
Telex: 530942

\*InSight is a trademark of Orion Instruments, Inc.



**“We don’t plan  
to let VME  
rest on its  
laurels.”**

**Shlomo Pri-Tal** Manager, VME System  
Architecture and Technology

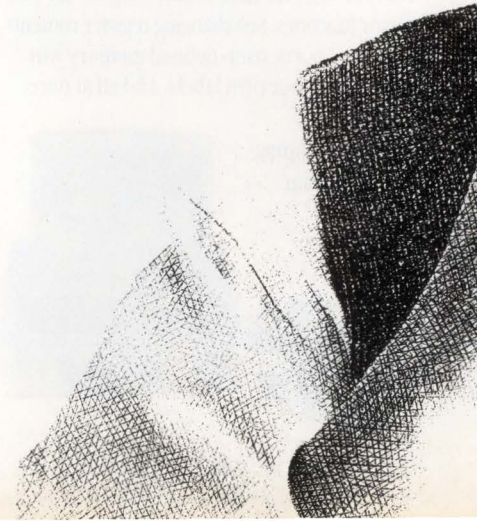



People think Motorola invented VME. Actually, a lot of companies had a hand in developing it. That's one of its main strengths: it's an *open architecture*, with no patents or copyrights to worry about.

#### **Building open systems, to open markets.**

In the long run, open systems benefit everyone. That's why we've always fought so hard for VME standardization through VITA, IEEE and IEC. Because standards create a very competitive market, where the OEM has literally thousands of VME choices—from Motorola and elsewhere.

#### **Chipping away at interface standards.**

These same standards have enabled Motorola to push bus hardware to higher levels of integration. Take our two new bus

interface products, for example—the VME and VSB chips. They eliminate a major source of potential design errors for OEMs. So they can focus on *applications*, rather than bus interface problems.

#### **Plugging in mainframe performance.**

To maximize OEM product life cycles, you need a way to keep on plugging in new technologies, without obsoleting your current products. That's exactly what our 68000 family—within a VME architecture—does for you. Right now we have 020-based boards that are more powerful than the mainframes of 10 years ago. And 030 products that put the power of *today's* minicomputers on a desktop.

#### **Pushing hard for software standards.**

Through our VMEexec project, Motorola continues to take the initiative in standardization. We want to make sure VME software modules from different vendors work together in a common environment. That includes UNIX<sup>®</sup>, real-time executives, device drivers, network services, and so on. Eventually you'll be able to plug, say, any real-time kernel you like into a VME board—without affecting your software investment.

#### **Putting it all together.**

To be successful in today's more complex VME environment, a company has to take a systems approach to everything it does. That means putting together all the elements—chips, boards, software, complete systems—from a single reliable source. Motorola has more advanced technology, more high quality products, more software resources, more technical support and more VME experience. And frankly, I don't know of anyone who's investing more in the future of VME than Motorola. That's what being the leader means.



**MOTOROLA**

**Microcomputer Division**

*Approaching our technology from  
your point of view.*

**CIRCLE NO 31**

For reprints of this series,  
call 1-800-556-1234, Ext. 230;  
in California, 1-800-441-2345, Ext. 230.  
Or write: Motorola Microcomputer Division,  
2900 South Diablo Way, Tempe, AZ 85282.  
UNIX is a registered trademark of AT&T.



# NCR keeps standards

Finally,  
a cure for SCSI  
overheadaches.

NCR's 53C90 is the only chip that can give you fast, fast, fast relief from overheadaches... and that includes the newest "A" and "6250" versions from the competition.

Using combination commands, dedicated sequential logic and dual-ranked registers for command pipelining, the 53C90 is magnitudes faster on and off the bus. Plus NCR implements complex bus sequencing in hardware, not time-wasting software.

Here's our benchmarks. But run your own and you'll see the other guys cause overheadaches, we cure them.



How our data  
transfer rates  
rate.

You either got great numbers. Or you don't. We got 'em. NCR 53C90 delivers the SCSI bus maximum of 5.0 MBytes/sec synchronous at 25 MHz for the full length of the bus. That's at least 1MByte/sec better than most competitive chips can do, without migraine-sized overheadaches. Asynchronous? NCR's rate of 3.0MBytes/sec—for the full bus—is twice as fast as 99.9% of all others SCSI chips.

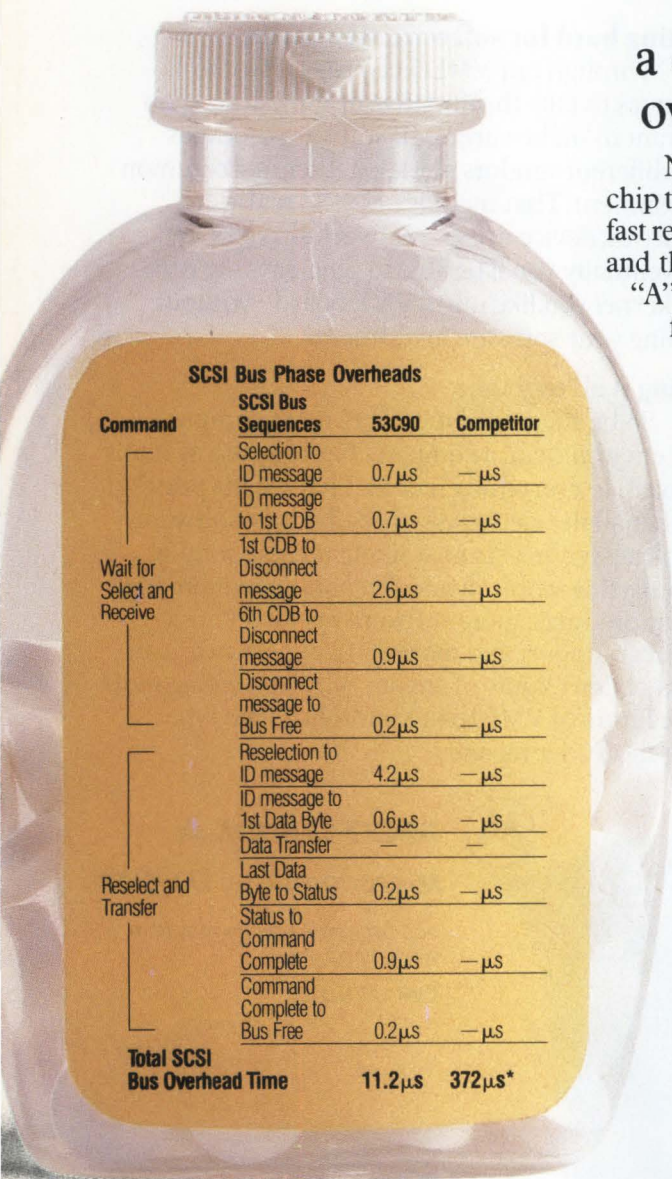

## SCSI Bus Phase Overheads

Command	SCSI Bus Sequences	53C90	Competitor
Wait for Select and Receive	Selection to ID message	0.7 $\mu$ s	— $\mu$ s
	ID message to 1st CDB	0.7 $\mu$ s	— $\mu$ s
	1st CDB to Disconnect message	2.6 $\mu$ s	— $\mu$ s
	6th CDB to Disconnect message	0.9 $\mu$ s	— $\mu$ s
	Disconnect message to Bus Free	0.2 $\mu$ s	— $\mu$ s
	Reselection to ID message	4.2 $\mu$ s	— $\mu$ s
Reselect and Transfer	ID message to 1st Data Byte	0.6 $\mu$ s	— $\mu$ s
	Data Transfer	—	—
	Last Data Byte to Status	0.2 $\mu$ s	— $\mu$ s
	Status to Command Complete	0.9 $\mu$ s	— $\mu$ s
	Command Complete to Bus Free	0.2 $\mu$ s	— $\mu$ s
	<b>Total SCSI Bus Overhead Time</b>		<b>11.2<math>\mu</math>s</b>

\*Electronics Magazine August 20, 1987 Pg. 65



# raising the for SCSI.

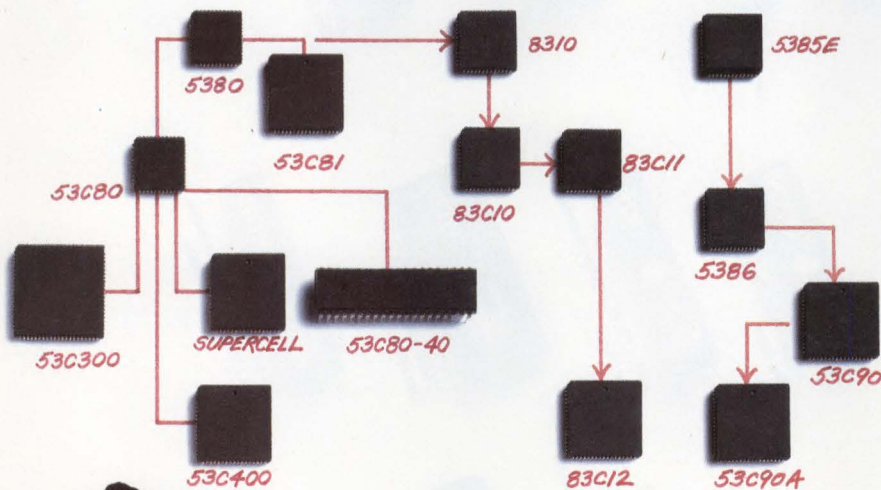

## A big well-connected family.

Other suppliers can't show you much of a family tree compared to NCR. That's because NCR goes back to the "Mayflower" of SCSI controllers with the 5385 in 1982. The most recent offshoot of that original line is the high-performance 53C90A. Consistent with

good family planning the software for the 53C90 is similar to our 5385 and 5386, so you can quickly convert to the 53C90. A single chip host bus adapter (53C400), integrated buffer controller (53C300) and an ASIC supercell fill out our product offering. And you can bet we'll be there when you need SCSI II.

**How to get zap-resistance, latch-up protection and the blessings of the FCC.**

For example, the NCR 5380 and 53C90 families give you ESD protection up to 10,000 volts on the SCSI bus. NCR also provides controlled fall times to reduce the undershoot that could cause other CMOS chips to latch-up. Controlled assertion rates also reduce generated RFI, an important factor in winning FCC approval for the final product.

NCR Microelectronics Division

## It's time to raise your standards.

In SCSI, it's not so much if you implement the standard, but how. Because our chips have an edge over other chips from other manufacturers, they can help give you and your product an edge in the market. We've shipped more than 3-million 5385's and 5380's and production quantities of the 53C90. If you don't want to just settle for the standard, call NCR today.

For documentation call our hot line 1-800-334-5454. Or write to, NCR Microelectronics, SCSI Products, 1635 Aeroplaza Drive, Colorado Springs, CO 80916.

For technical assistance, call 800-525-2252, Telex 452457.

CIRCLE NO 32



# No other PROM or PLD vendor can make this statement:

“



**C17C225**  
512x8 Registered PROM  
25ns Set-up 12ns t<sub>co</sub> 90mA



**C17C235**  
1024x8 Registered PROM  
30ns Set-up 15ns t<sub>co</sub> 90mA



**C17C245**  
2048x8 Registered PROM. Reprogrammable.  
25ns Set-up 12ns t<sub>co</sub> 90mA



**C17C255**  
2048x8 Registered PROM. Reprogrammable.  
18ns Set-up 12ns t<sub>co</sub> 120mA



**C17C268**  
8192x8 Registered PROM. Reprogrammable.  
40ns Set-up 20ns t<sub>co</sub> 100mA



**C17C289**  
8192x8 Registered PROM. Reprogrammable.  
40ns Set-up 20ns t<sub>co</sub> 100mA



**C17C281**  
1024x8 PROM  
30ns 100mA



**C17C282**  
1024x8 PROM  
30ns 100mA



**C17C291**  
2048x8 PROM. Reprogrammable.  
35ns 60mA



**C17C291A**  
2048x8 PROM. Reprogrammable.  
25ns 120mA



**C17C292**  
2048x8 PROM  
35ns 60mA



**C17C293A**  
2048x8 PROM. Reprogrammable. Power down.  
25ns 120mA 20mA Standby



**C17C261**  
8192x8 PROM. Reprogrammable. Power down.  
35ns 100mA 30mA Standby



**C17C263**  
8192x8 PROM. Reprogrammable.  
35ns 100mA



**C17C264**  
8192x8 PROM. Reprogrammable.  
35ns 100mA



**C17C251**  
16384x8 PROM. Reprogrammable. Power down.  
45ns 100mA 30mA Standby



**C17C254**  
16384x8 PROM. Reprogrammable.  
45ns 100mA



**PALC1618**  
Quarter-Power PAL20  
25ns 45mA. Reprogrammable.



**PALC16R8**  
Quarter-Power PAL20  
20ns 45mA. Reprogrammable.



**PALC16R8**  
Quarter-Power PAL20  
25ns 45mA. Reprogrammable.



**PALC16R4**  
Quarter-Power PAL20  
25ns 45mA. Reprogrammable.



**PLDC20G10**  
Quarter-Power Generic PLD. Reprogrammable.  
25ns 55mA



**PALC2V10**  
Quarter-Power Macro-Cell Configured PLD.  
25ns 33MHz 55mA. Reprogrammable.

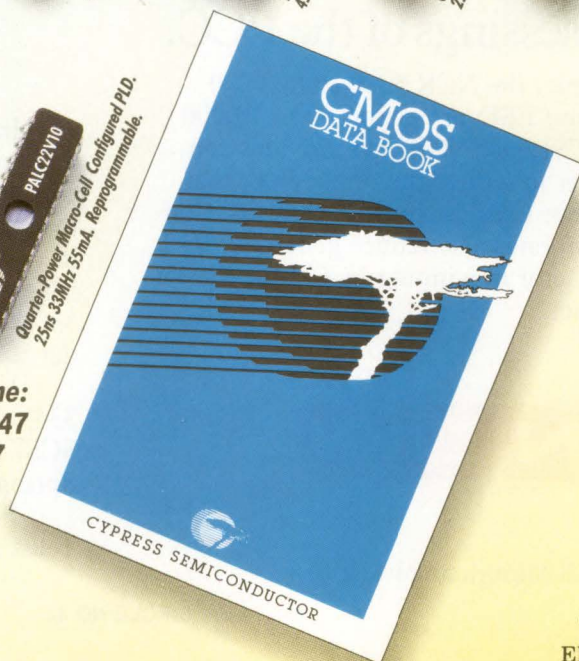

”

**Data Book Hotline:**  
1-800-952-6300 ask for Dept. C 47  
1-800-423-4440 (In CA), ask for Dept. C 47  
(32) 2-672-2220 (In Europe)  
(416) 475-3922 (In Canada)



# EDITORIAL

## Thanks for the help



Some people think EDN is supported completely by advertising sales. That's about half true. The other half of our support comes from loyal readers like you who continue to select EDN as your favorite professional publication. But, besides supporting EDN by picking it up and reading it, readers provide almost 40% of what we publish and greatly influence the remaining 60%.

We continually rely on readers to provide our applications articles, which contain useful technical information that helps you do your job better. You can count on four or five of those articles in each issue. I'm sorry to say, though, that many people think writing for EDN is a formidable task. It's true that we're selective in what we publish, but we've made the writing task a bit less daunting. You can get a copy of our revised booklet *Writing for EDN* by calling (617) 558-4216 and giving us your name and mailing address, or you can circle number 800 on the Information Retrieval Service card bound in this issue.

Readers make other useful contributions, too. For example, in each issue, several readers share their helpful hints, suggestions, programs, and circuits in our *Design Ideas* section. We encourage you to send us a submission; you'll find a Design Entry Blank published in almost every issue near the *Design Ideas* section. You can also call Associate Editor Tarlton Fleming at (617) 558-4743 to discuss your idea.

Engineers—and readers—don't live by designing alone. So, we also encourage you to call Deborah Asbrand at (617) 558-4324 when you have an idea for nontechnical editorial coverage of the engineering profession or to discuss important workplace issues. Debbie runs our popular *Professional Issues* section, and she says that readers have contributed many interesting article ideas. From time to time we run contributed Professional Issues columns, too. Joanne Clay runs our Signals and Noise, or letters-to-the-editor, section, in which you can express opinions about articles, industry trends, Irwin Feerst, the IEEE, and other subjects. We appreciate your letters and we read every one.

You also make other contributions that don't show up directly in print. Nonetheless, those efforts influence what we publish. Many of you take the time to let us know what you think of our articles—whether staff written or contributed. To get involved, take a look at the end of each article we run and you'll find our Article Interest Quotient "bingo" numbers. As we receive cards, we get regular reports about how many of you rated each article of high, medium, or low interest. Those numbers determine which contributed article wins the "Best of the Issue" award, a framed certificate that acknowledges an author's fine work. Those scores also tell us what you like and dislike so we can be sure to consider your needs for future articles.

Many readers also take a few minutes to write down comments on the bottom portion of their Information Retrieval Service cards. To us, those cards are a valuable source of information. In fact, they're so important that we route them to everyone on the editorial staff. We read them all.

Unfortunately, some people think that all magazine editors are inaccessible. After all, how many of us have even thought of calling a *Newsweek* or *Time* magazine editor to tell them what we think about one of their articles? At EDN, we're accessible. You can reach any of us by calling our main office at (617) 964-3030. You can reach me directly at (617) 558-4573.

You can reach our nine regional editors directly, too. You'll find their phone numbers listed in the masthead in the front of each issue. You can also contact our regional editors via their MCI mailboxes. We have an MCI mailbox for EDN, too—EDNBOS or 286-2057.

In sum, you're an important part of why we do what we do. We enjoy writing for you and we enjoy hearing from you. So, the next time you have an idea for an article, want to talk about what we should cover, or want to talk with an editor about something he or she wrote, give us a call or drop us a note.

**Jon Titus**  
Editor



# Expand your

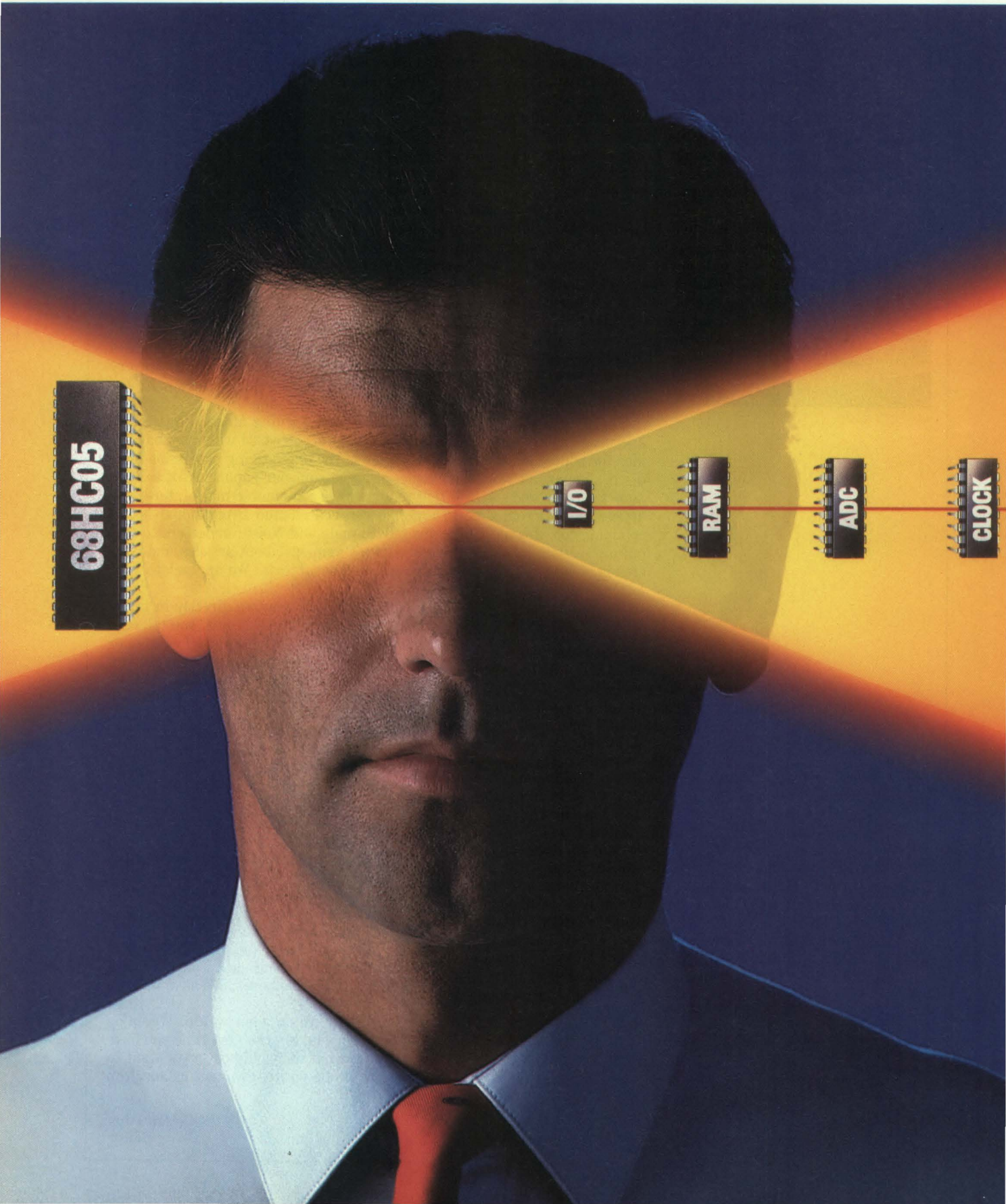



# design vision.

## Enhance your design at any stage with RCA CMOS 6805 micros and SPI peripherals.

Your challenge is to increase system performance and capability while reducing board size.

Not an easy job. But certainly easier when you use our 6805 and 68HC05 micros and serial peripheral interface devices.

### Extend your micro's power.

Many microcomputers rely on parallel I/O ports to communicate with peripheral devices. An inefficient method at best.

That all changes with the serial peripheral interface incorporated into our 68HC05 microcomputers.

This three-wire (plus device select) synchronous, full-duplex, serial communication system contains separate lines for input and output data, serial clock and device select. You don't have to sacrifice I/O ports to communicate off-chip: our 68HC05 micros can communicate with our own serial peripherals, the serial peripherals of other manufacturers, and even with other microcomputers via only three port lines.

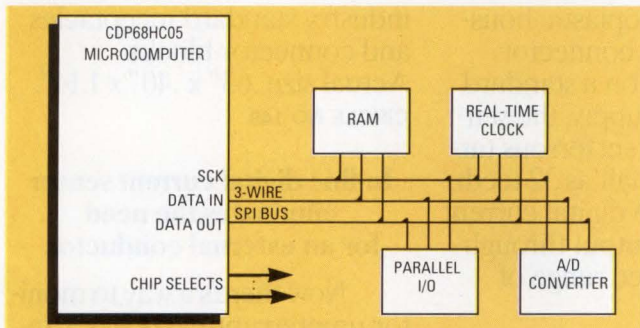

### True design versatility.

The real beauty of the SPI is that it eliminates limitations imposed by microcomputers.

For example, you can easily extend the amount of I/O or memory with SPI RAMs, I/O chips or shift registers. And the modular SPI bus gives you the ability to expand without losing lots of PC-board space. Reduced package sizes and minimized interconnect wiring lead to reduced board size.

And since you don't need complex software to

operate the bus, you save ROM space.

Right now, we can offer you a versatile family of peripheral devices, including 128-byte and 256-byte static RAMs, a real-time clock with RAM, an 8-bit programmable I/O port, and a 10-bit 8-channel A/D converter. And more parts are coming soon, including a digital pulse-width modulator and a serial bus interface chip for networking microcomputers. These serial peripherals are also compatible with other microcomputer types.

### Powerful family of micros.

We can provide 6805 microprocessors for external memory address, but the heart of our SPI system is the 6805 Series high-speed CMOS microcomputers:

#### 68HC05 Microcomputers

Features	68HC05C4	68HC05C8	68HC05D2	68HC05D2A
Pins	40	40	40	28
On-Chip RAM (bytes)	176	176	96	96
On-Chip User ROM (bytes)	4160	7744	2176	2176
Bidirectional I/O Lines	24	24	28	16
Unidirectional I/O Lines	7 inputs	7 inputs	3 inputs	3 inputs
Timer size (bits)	16	16	16	16
Prescaler size (bits)	*	*	*	*
External timer oscillator	no	no	yes	yes
Serial peripheral interface	yes	yes	yes	no
Serial communications interface	yes	yes	no	no

\*prescaler fixed as ÷4

### Easy to prototype, too.

If you need another reason to choose our 6805 family, here it is: they're so easy to prototype with our Piggyback! We have the 68EM05C4 and 68EM05D2 Emulators, custom 40-pin packages that contain the C4/C8 or D2 micros with a Piggyback EPROM socket.

When installed with a 27C64 EPROM, these devices together become functionally identical to a CDP68HC05C4, CDP68HC05C8 or CDP68HC05D2.

Two final points: we'll give you fast turnaround, and a wide variety of packages.

For more information, call toll-free 800-443-7364, extension 22. Or contact your local GE Solid State sales office or distributor.

In Europe, call: Brussels, (02) 246-21-11; Paris, (1) 39-46-57-99; London, (276) 68-59-11; Milano, (2) 82-291; Munich, (089) 63813-0; Stockholm, (08) 793-9500.



GE Solid State

GE/RCA/Intersil Semiconductors  
Three great brands. One leading-edge company.



# How to improve your designs by the process of elimination.

Here are five new ways to enhance your product's performance, or reduce costs, either by eliminating non-essential component features or by eliminating manufacturing steps with ready-made subassemblies.

## **Long-life miniature pushbuttons provide wide-angle viewing, \$1 each.**

Our special, low-cost square and rectangular MML pushbuttons feature simple momentary action, and come in a choice of five button colors. They're ideal for applications that require high performance, but not UL listing or audible feedback.

Square buttons are available in LED

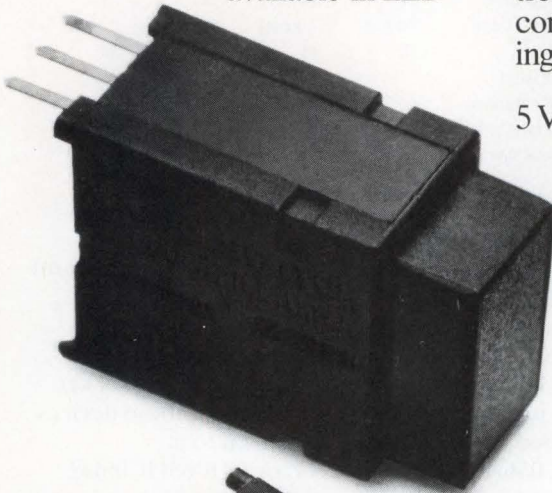

Low-Cost  
MML Miniature  
Pushbuttons



or incandescent lighted versions with one-piece molded lens caps for good visibility from any angle. All versions are covered by an 18-month warranty, and come at a defect rate of less than 50 per million. Actual sizes, .39" x .39" square, .39" x .59" rectangular. All are .67" deep. **CIRCLE NO 147**

## **High-resolution gear tooth sensor has built-in magnets and resistors to simplify design and installation.**

The completely self-contained SR7P gear tooth sensor reduces manufacturing steps by providing a magnetoresistive sensing element, biasing magnet, signal-conditioning electronics and pull-up resistor in a compact thermoplastic housing with plug-in connector.

Operating on a standard 5 VDC power supply, the sensor can detect ferrous targets as small as 32 teeth/inch, with digital current sinking output throughout a speed range of

0-12 kHz. Actual size, .345" x 1.25" x 1.775". **CIRCLE NO 148**

## **Simple cantilever spring switch saves money where precision snap-action isn't needed.**

Our V10 Series basic switch uses a cantilever spring system that's ideal for simple on/off applications, or where its spring rate, travel or force specifications are more compatible with your requirements. The V10 comes in general purpose and UL/CSA versions, with a wide choice of plunger or integral lever actuators, and capacities from 1 to 25 amps at 277 VAC.

All V10s feature combination quick-connect/solder terminals that are compatible with industry standard receptacles and connector blocks.

Actual size .63" x .40" x 1.14". **CIRCLE NO 149**

## **In-line digital current sensor eliminates the need for an external conductor.**

Now there's a way to monitor uninterrupted power supplies without sacrificing precious board space. Our miniature CS series-connect current sensor



SR7P High-Resolution  
Gear Tooth Sensor



V10 Non-Snap  
Basic Switch



can be mounted directly to a PC board. It uses a Hall effect chip to respond accurately within  $\pm 10\%$  of a setpoint between 1.3 and 15 amps. Digital output is compatible with electronic control devices. Actual size, .58" x .50" x .67".

CIRCLE NO 150

**Ergonomic pushbutton subassemblies increase design freedom, reduce manufacturing steps.**

Our new SLP Series push-button panels are complete operator interface units ready to install in your product. They are available in standard or custom layouts and packages to meet your specifications, with plug-in connectors to save wiring time. Actuator travel is .050", providing positive tactile feedback.

Design options are almost limitless. You can choose from solid state LEDs, built-in interface electronics, and tamper-resistant buttons with custom colors, textures, shapes and legends. Individual or multi-station lighting is available with or without button actuation to

SLP  
Pushbutton  
Panel



help guide a user through a sequence of operating steps.

CIRCLE NO 151

**Let us help improve your next design.**

If none of these innovations will improve your designs, or reduce costs, talk to us anyway. With your input and our experience, we'll come up with one that will.

For more information, just call The Sensor Consultants at 815-235-6600. Or write MICRO SWITCH, Freeport, IL 61032.

Together, we can find the answers.

**MICRO SWITCH**  
a Honeywell Division

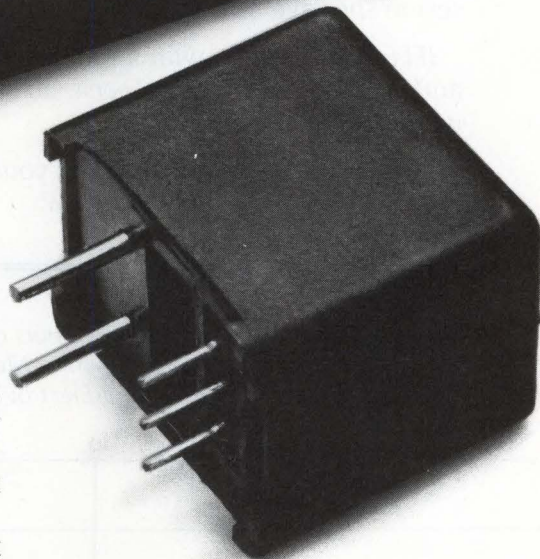

CS Series-Connect  
Digital Current Sensor



# AMERICAN IEEE MEMBERS

---

---

It is time that IEEE represented the American working engineer, rather than the gang of professors and corporate executives who have been the cause of our economic decline. Contrary to their beliefs, *THERE IS NO SHORTAGE OF ENGINEERS*. There is, however, a severe shortage of jobs.

IEEE has come up with a new scheme to perpetuate themselves. We ask you to nominate and vote ONLY for Irwin Feerst, an American-born (veteran of World War II) and trained working engineer.

Please gather the signatures of your colleagues who belong to the IEEE. Return the petitions to the address shown below.

---

---

We, the undersigned voting members of the Institute of Electrical and Electronics Engineers, Inc. (IEEE) nominate Irwin Feerst, a Senior Member (mailing address: P.O. Box 19, Massapequa Park, NY 11762) for the office of President-Elect of IEEE for the period from 1/1/89 until 12/31/89.

Name (print)	Name (sign)	Member Number (if known)	Date

If elected, I shall serve.

**RETURN PETITIONS TO:**  
Committee of Concerned EEs  
P.O. Box 19  
Massapequa Park, NY 11762



***MULTIBUS II  
TAKES YOU  
BACK TO  
THE BASICS***



# ...AND INTO THE FUTURE

## MULTIBUS II OPENS UP ADVANCED APPLICATIONS IN WAYS NO OTHER BUS CAN.

When the architects of Multibus II set out to create an advanced bus, they set their sights far beyond just another souped-up traditional bus.

They went back to the basics and created a truly advanced bus.

A bus capable of supporting vast new levels of microcomputer performance. To make possible low cost microcomputer systems that outperform minis, and rival mainframes.

An inherently more reliable bus, suitable for applications that process huge volumes of data at unprecedented speeds.

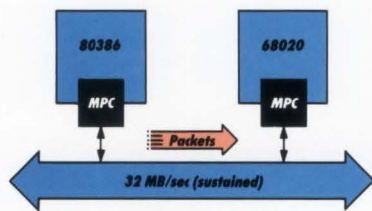

### BASIC #2: HARDWARE-ASSISTED MESSAGE PASSING.

This advanced technique gives Multibus II a true sustained bandwidth of 32 megabytes per second. Standardized in a single silicon chip, message passing simplifies system design, and makes it possible to mix totally different microprocessor architectures and operating systems in the same application.

A more maintainable bus, to reduce the cost and complexity of configuration, trouble-shooting and repair.

A bus solid enough to gain the support of a broad base of hardware and software vendors, and ensure that all products would work

together efficiently and dependably.

It would be the ideal advanced bus — the perfect higher performance alternative to Multibus I,

VME and other traditional architectures.

## MULTIBUS II IS CHANGING THE WORLD!

The advanced bus of the future is here today, to the delight of designers needing to transcend the limitations of today's other bus alternatives.



### BASIC #3: AUTO CONFIGURATION.

Like a chameleon, Multibus II boards automatically configure themselves when system power is turned on, eliminating DIP switch hassles during configuration and maintenance.

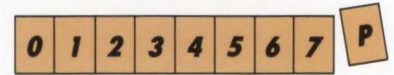

### BASIC #1: PARITY.

Multibus II's parity error detection provides the basic protection needed by advanced applications that process large volumes of data at high speeds.

For example, NCR and Prime based their newest Tower™ and EXL™ systems on Multibus II. Both provide several times the power of a VAX™ 11/780 minicomputer,

TRADITIONAL VS. ADVANCED

		CHARACTERISTICS	TRADITIONAL
			MULTIBUS I
BASIC FEATURES	TIMING (Synchronous or Asynch)		ASYNCH
	PIN USAGE (MPX) Multiplexed (NON) Non-Multiplexed		NON
	ARBITRATION (CENT)ralized (DIST)ributed		CENT.
	INTERRUPTS (DED)icated (VIR)tual		DED.
	GLOBAL MEMORY Communications		YES
	PARITY		NO
ADVANCED FEATURES	AUTO-CONFIGURATION (Geographic Addresses)		NO
	MESSAGE PASSING (Hardware)		NO
	BUS I/F SILICON		NO
OTHER FEATURES	ADDRESS WIDTH (Bits)		20,24
	DATA WIDTH		8,16
	BOARD AREA (sq. in.)		84
	CONNECTOR TYPE		EDGE
	MAX. 5V POWER (Per slot)		24A

\*Implemented outside IEEE 1014 using several proprietary schemes.

at a fraction of the price.

A major U.S. department store chain has put into operation a revolutionary home shopping network, based on Multibus II.

In Europe, Multibus II was chosen by a leading automation company as its



# URE.

architecture  
for the  
future for  
advanced  
factory  
automation  
applications.

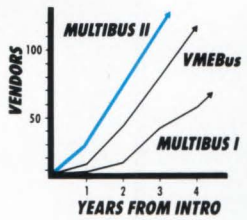

**MULTIBUS II:**  
The world's fastest growing open system architecture!

And two leading aerospace companies are using Multibus II to build the world's most advanced

## ADVANCED ARCHITECTURES

AL BUSES	ADVANCED BUSES	
	VME	MULTIBUS II
ASYNCH	SYNCH	SYNCH
NON	MPX	MPX
CENT.	DIST.	DIST.
DED.	VIR.	VIR.
YES	YES	YES
NO	YES	YES
NO	YES	YES
NO*	YES	YES
AVAIL. '88	YES	YES
24,32	32	32
8,16,24,32	8,16,24,32	8,16,24,32
59.8	80	73.4
DIN	DIN	ZIF
6A	15A	Not Published

aircraft flight simulators.

Throughout the world, these and scores of other companies have introduced

### BASIC #4: MULTI-VENDOR COMPATIBILITY.

A host of unique features ensure that Multibus II boards will work together efficiently and dependably. The IEEE 1296 specification is complete and concise. And, the Multibus II Message Passing Coprocessor (MPC), now universally available, ensures compatibility even between boards using different processor architectures and operating system software.

or are now developing Multibus II applications that set new standards of performance, price and reliability.

## BUILD YOUR OWN MULTIBUS II LIBRARY.

The broad base of Multibus II hardware, software, accessories and systems is growing almost daily. Yet it's easy for you to keep up to date.

Just circle the reader service number, and each of the companies on the back of this ad will send you in-depth technical data on their complete Multibus II product lines. Plus timely updates and new product announcements.

And, to keep your Multibus II library organized, the Multibus Manufacturers Group will send you this convenient indexed bookshelf binder. Absolutely free!

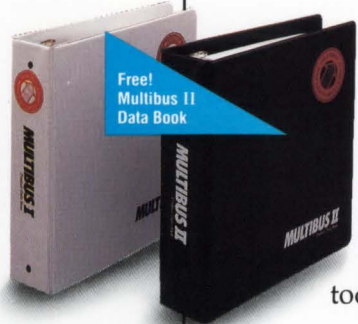

**CIRCLE NO. 99**

today.



### MULTIBUS MANUFACTURERS GROUP

P.O. Box 6208 Aloha, OR 97007 (503) 629-8497

Multibus® is a trademark of Intel Corp.  
EXL™ is a trademark of Prime Computer Inc.  
Tower™ is a trademark of NCR Corp.  
VAX™ is a trademark of Digital Equipment Corp.

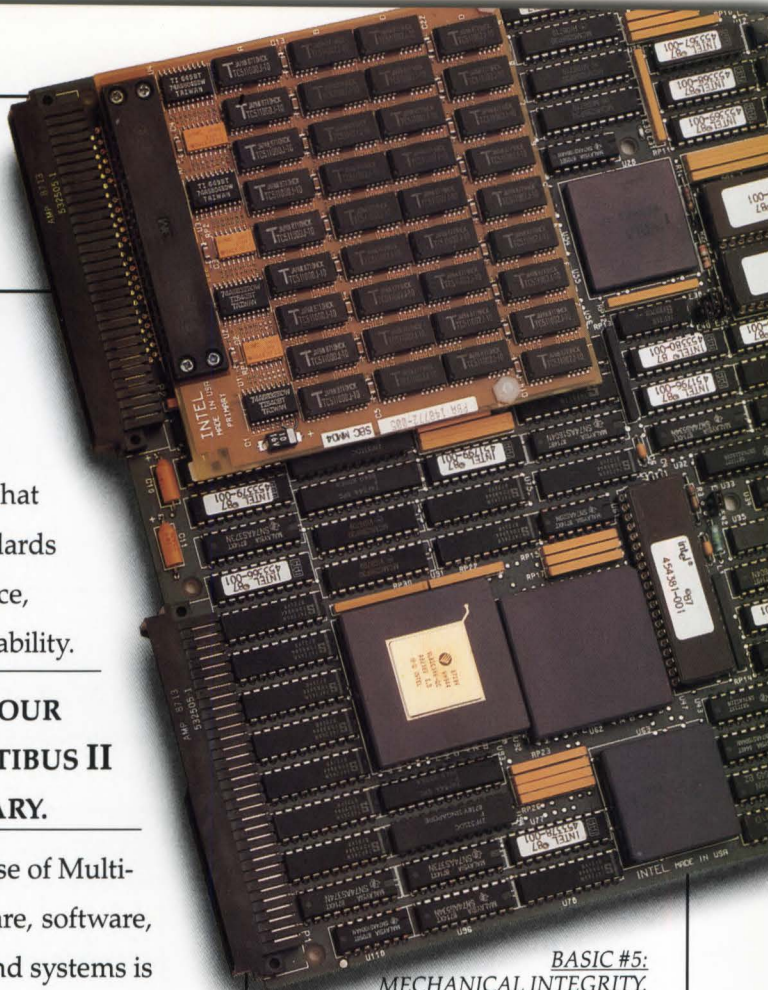

**BASIC #5: MECHANICAL INTEGRITY.**  
Naturally, Multibus II uses DIN connectors, for the most reliable mechanical connections. But, it also incorporates built-in front panels for EMI shielding. And, its standard Eurocard form factor provides enough board space (a full 80 sq. in.) to accommodate complex designs.

So don't delay. Get the whole story on Multibus II and discover the new levels of performance and reliability

that are possible with a truly advanced bus. Multibus II. The bus of your future is here















# WE'RE HERE FOR YOU!

The companies listed below would like you to know that Multibus II is now in full swing. These industry leaders offer a complete selection of Multibus II boards, software, systems and accessories—everything you need to develop advanced, high performance applications today.

plus future new product announcements, just return the reader service card. Or, for faster response, call the MMG or one of the participating companies listed below.

For your free Multibus II Data Book

Discover what the world's most advanced OEM microcomputer bus can do for *your* next generation applications.

	CPU's	Digital I/O	Analog I/O	Special I/O	Periph Cont	Comm/Net	Graphics	Memory	Software	Packaging	Systems	
 <p>P.O. Box 1037 Attleboro, MA 02703 Contact: Dept. X2403 (617) 222-2202 FAX (617) 226-5257</p>												 <p>Intel Corporation 3065 Bowers Avenue Santa Clara, CA 95051 (800) 548-4725</p>
 <p>1602 Newton Drive Champaign, IL 61821 Contact: André Felix (800) 482-0315 FAX (217) 359-6904</p>												 <p>2925 Merrell Road Dallas, TX 75229 Contact: Sales Admin. (214) 350-9000 FAX (214) 350-1433</p>
 <p>2955 Xenium Lane Plymouth, MN 55441 Contact: Don Peterson (612) 559-2034 FAX (612) 559-8799</p>												 <p>785 Lucerne Drive Sunnyvale, CA 94086 Contact: Bill Burton Telephone (408) 720-9300 FAX (408) 773-9475</p>
 <p>25401 Cabot Road, Suite 206 Laguna Hills, CA 92653 Contact: Robert McAuley (714) 768-3332 FAX (714) 951-8902</p>												 <p>10 Mupac Drive Brockton, MA 02401 Contact: Steve Cobb (617) 588-6110 FAX (617) 588-0498</p>
 <p>60 Garden Court, Box DRI Monterey, CA 93942 Contact: Customer Service (800) 443-4200 Telex 910-360-5001</p>												 <p>3445 Fletcher Avenue El Monte, CA 91731 Contact: Mike Burton (800) 227-0557 FAX (818) 444-3953</p>
 <p>6790 Flanders Drive San Diego, CA 92121 Contact: Frank Hom (800) 854-7086 In CA: (800)772-7086</p>												 <p>6465 Nancy Ridge Drive San Diego, CA 92121 Contact: Trevor Constable (619) 453-8970</p>

The Multibus Manufacturers Group, or MMG, is dedicated to the proposition that everyone benefits from strong, open standards. Membership is open to hardware and software manufacturers, application integrators, end users and even students.

To learn more about what the MMG can do for you, contact Dan Fink, MMG executive director.

Use this convenient product reference guide to quickly locate the companies that offer the types of Multibus II products you need.

**CIRCLE NO. 99**

**MULTIBUS MANUFACTURERS GROUP**

P.O. Box 6208, Alhambra, CA 91807 (510) 620-8487





# TECHNOLOGY UPDATE

## Pioneering engineers begin to adopt board-level automatic test generation



Dan Strassberg,  
*Associate Editor*

You can recognize a pioneer by the arrow in his back: Despite that adage's implied warning, some designers of board-level products are beginning to adopt design methodologies compatible with testability techniques like automatic test-pattern generation (ATPG).

These pioneers might well acquire a few surface wounds. But proponents of design for testability, or DFT (see **box**, "Overcoming the initial problem"), maintain that companies that delay or avoid confronting testability at the design stage risk much more serious—and possibly even fatal—injury.

In its most elemental form, DFT yields designs that are partitioned by function, that can be easily initialized and controlled, and whose behavior can be observed. Some people, however, use the term DFT to imply considerably more.

For example, DFT approaches include such highly formalized design techniques as LSSD (level-sensitive scan design), one of several scan-design methodologies. With the exception of boundary scan, which is a technique for isolating functional blocks and observing them at their I/O terminals, scan design enables you during test to reconnect sequential logic (which most ATPG programs can't handle) to form combinatorial networks (which ATPG programs can handle).

### DFT will change attitudes

Test vectors, also called test patterns, are the combinations of 1s and 0s that a tester applies and looks for when it tests a logic net. Although adherence to DFT ap-



*This board test system, Hewlett-Packard's 3065ST, performs digital in-circuit and analog-functional tests. An automatic program generator for it runs on the vendor's workstations.*

proaches in their simplest form doesn't guarantee success in generating vectors automatically, it improves the chances of success and can significantly reduce test-development time, even with manual vector generation. To achieve its goals, DFT imposes new disciplines on designers and requires them to reorient their priorities. DFT advocates insist that new attitudes are mandatory—they insist that tried-and-true approaches (for example, a design engineer's treating test as someone else's problem) simply won't work in today's market.

Many factors influence the pace at which companies are adopting DFT and ATPG, particularly for board-level designs. Although ATPG and DFT have not yet taken device design by storm, these techniques

have so far affected the design of ASICs and PLDs much more than they have that of board-level products (**Ref 1**).

Despite offering solutions to very real and pressing problems, vendors of ATPG software and other test-development aids recognize that if they want to grow they must deal with several legitimate concerns. They must also educate their potential customers and thus dispel a long list of misconceptions. Here are some of the issues they are addressing:

- Greater complexity of boards than of ICs
- The perception that ASIC design is risky enough to justify unusual approaches, but board-level design is not
- Difficulty in measuring costs





**MOVE UP  
TO A  
NEW LINE**

**FROM  
HOUSTON  
INSTRUMENT**

Prepare to be impressed. Meet the new line of high-performance plotters from Houston Instrument.™ HI's sleek new DMP-60 series is designed to impress even the most demanding CAD professional.

Discover unprecedented flexibility—blended with ultra-fine resolution, speed, and software compatibility. Benefit from HI's rigorous standards for quality, reliability, and service. All at prices starting from \$4,695.\*

Watch the DMP-60 series double as a scanner with HI's unique SCAN-CAD™ option. Quickly produce multicolored drawings when you use the Multi-Pen adaptor. Plot several originals—without tying up your PC when you add HI's buffer expansion board.

Select media as small as 8½"×11" or as large as 36"×48". Load either DM/PL™ or HP-GL 758X-compatible software. Then watch as your plotter quickly produces a drawing polished to a precise resolution of 5 ten-thousandths of an inch. Smile when you see smoothly formed circles, curves, and lettering.

Explore HI's host of support

programs including an overnight plotter-replacement service. And then relax, knowing that HI's new plotters rest on 27 years of engineering excellence.

Move up. To a fine, new line. From Houston Instrument. Begin by calling 1-800-444-3425 or 512-835-0900 or writing Houston Instrument, 8500 Cameron Road, Austin, TX 78753.

*\*U.S. suggested retail price.*

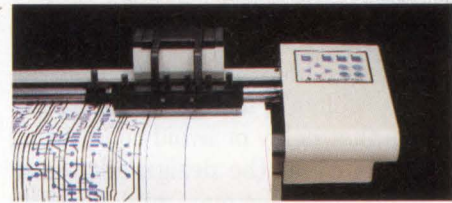
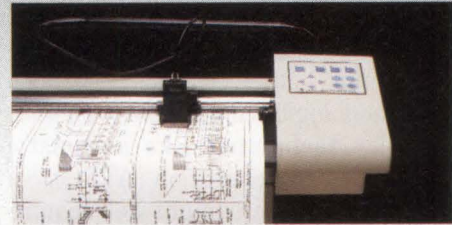

**HOUSTON  
INSTRUMENT**

A DIVISION OF **AMETEK**

*Houston Instrument, SCAN-CAD, and DM/PL are trademarks of AMETEK, Inc.*





# TECHNOLOGY UPDATE

of current test and test-development practices

- Use of traditional methods, because some companies don't understand the shortcomings of current methods and so they feel comfortable with them
- Cost of learning how to apply new techniques
- Cost of computing resources required to run ATPG software
- Fear of requiring more pc-board real estate
- Fear of higher component cost
- Fear of lower reliability
- Slow adoption of logic simulation
- Incompatibilities of simulator/ATPG-database formats
- Incompatibility between automatically generated vectors and tester capabilities
- Difficulty in obtaining scannable components.

## Big boards challenge ATPG

Although ASICs and PLDs are complex, with gate counts in the neighborhood of 10,000, they tend to be significantly less so than the typical logic board designed with CAE tools. Such boards—especially if they house complex chips—can easily contain more than 100,000 gate equivalents. The diversity and com-

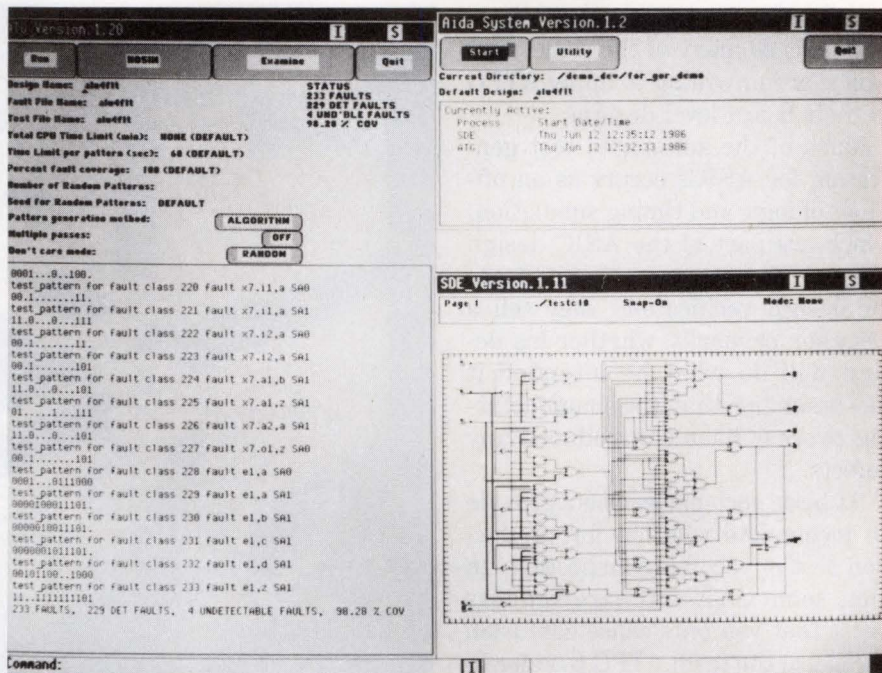

Multiple windows on a workstation screen allow you to view your schematic as well as the descriptions of vectors generated by Aida Corp's ATPG.

plexity of board-level designs taxes many of today's ATPG programs beyond their limits. But if you design in partitionable functional blocks, you can frequently use ATPG on networks that at first glance seem to exceed the capabilities of the software.

Board-level test-development procedures evolved at most equipment-manufacturing companies before board complexity approached today's levels. Many of these compa-

nies have little idea of the cost of developing or performing board-level tests, and their managements have not yet recognized the inadequacy of the classical approaches they are using. Naturally, if they are unaware of the shortcomings of existing practices, managers can see no reason to make changes.

But unlike printed circuits, ASICs are a new technology—one which engineers and managers realized warranted a complete set of new tools. These tools now exist, and ironically, are ready to be applied to the older, pc-design technology, if only engineers and managers realize the techniques' potential.

## ATPG minimizes ASIC risk

When you develop ASICs, you spend a lot of money up front, and you wait a long time to see real devices. If prototypes don't work, you can't probe their internal nodes and you can't make repairs. Because of these risks, many companies perceive that IC development warrants extraordinary measures and are willing to try using ATPG on their custom chips. With printed boards,

## Overcoming the initial problem

The electronics industry has its share of confusing acronyms and abbreviations, but few seem quite so unfortunate as DFT—used throughout this article, and throughout the industry, to mean design for testability. Practically everyone who refers to design for testability as DFT uses those same initials to denote digital functional test and sometimes dynamic (as opposed to static) functional test, a subset of digital functional test. To an even larger group of EEs, DFT means discrete Fourier transform. It's quite likely that someone reading this article is planning to employ DFT to test a high-speed signal-processing board that performs DFTs, and because of the board's complexity, he plans to make DFT a guiding principle in his project. Of course, his pc (printed-circuit) vendor probably uses PCs (personal computers) for both PC (process control) and PC (production control). Now, is that perfectly clear?



# TECHNOLOGY UPDATE

the situation is—or appears to be—different, so many of the same companies are unwilling to apply ATPG to their board-level designs.

Much of the automated test generation for ASICs occurs as an offshoot of logic and timing simulation, which are part of the ASIC design phase. The patterns generated are for design verification; they tell a designer primarily whether his design will do what he intended it to—assuming that the manufacturing process hasn't introduced any defects.

At best, such pattern sets provide an incomplete solution for production test or incoming inspection. In fact, some CAE-software vendors insist that you only cause confusion if you use the term ATPG to refer to development of test patterns for design verification. They say that you should use ATPG only to describe the generation of vectors for determining whether manufacturing has introduced defects. (Sometimes such vectors also locate the defects.)

If you use design-verification test patterns in production board test, you can miss faults introduced during board-loading and soldering, and you can waste time checking device properties that you should have checked before you loaded the devices onto the board. But although design-verification patterns are usually inadequate for production test, the converse isn't true. You don't develop production test vectors to find functionality problems in boards without manufacturing-induced faults, but vectors developed for production test frequently reveal problems that design verification should have uncovered.

Another factor inhibiting adoption of ATPG is the slow pace of acceptance of logic simulation itself. If you wanted to use ATPG to generate a board's test vectors, you would almost certainly design the board using simulation; otherwise you would have to create the equivalent of the simulation database from

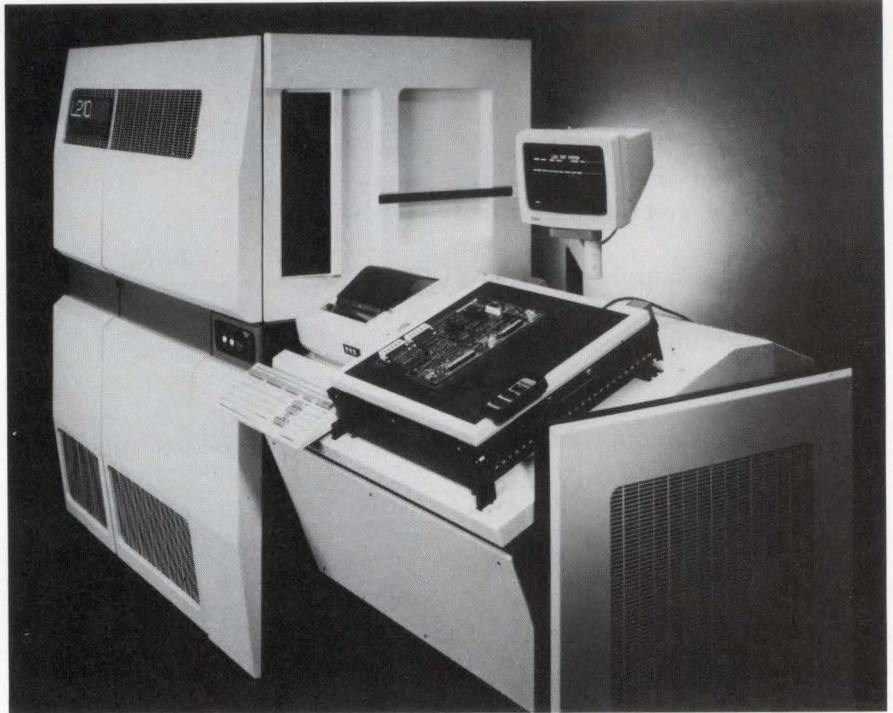

*Exemplifying large ATE systems capable of performing both in-circuit and functional testing, Teradyne's L210 combinational board test system employs high-speed pin electronics to help it diagnose timing faults.*

scratch. So far, even for complex boards, use of logic simulation remains in its infancy.

The cost of most ATPG software is not insignificant (Table 1). But some potential customers worry about having to commit great sums for computer resources (CPUs, data-storage hardware, and workstations) to run ATPG programs. For companies using simulation, however, the resources may cost nothing—at least at first. Usually, there's no need to augment a computer system until you are utilizing it fully. On the other hand, if you didn't originally factor ATPG into your plans but are now using it, you may have to acquire additional computer equipment sooner than you had expected to. To the relief of engineers concerned with controlling the cost of individual projects, most companies recognize that such equipment is used on many projects and is part of the cost of being in business; rarely do they assign the charges to a single development program.

Fear of the unknown as well as

engineers' innate conservatism affects their willingness to make changes. In the case of DFT, managements fear that the time designers spend in learning how to apply the new techniques will add to project costs and slow down product-development schedules. Something to keep in mind is that an organization normally needs to climb the DFT learning curve only once—not once per project. After engineers have learned the techniques, the organization reaps additional benefits with each new project.

Designers fear that testable designs will require more printed-circuit real estate and have higher parts cost and possibly lower reliability than equivalent "untestable" designs. Of these concerns, the one about reliability is easiest to disprove: With appropriate components, the added complexity of a scannable design (measured by gate count) is usually less than 10%. A cost attributable to the added complexity is an estimated 10% decrease in MTBF (mean time between failure); but a benefit is an



# 9 OUT OF 10 OF AMERICA'S TOP MANUFACTURERS USE STD-BUS

It's not obvious because the STD BUS is usually hidden away, controlling your tollways, the temperature of your office, the quality of your manufacturing, and even the animation in the local fun park.

STD BUS anonymously helps build personal computers, bottle soft drinks, and even brings you the evening news. Why? Because the STD BUS provides the best all-around solution to process control, manufacturing automation, data acquisition and instrumentation.

STD BUS provides the widest range of 8- and 16-bit processors and operating systems, plus the largest selection of industrial I/O cards available from any bus. The small-form-factor boards are rugged, reliable, and provide you with a building block

approach that ensures cost-effective systems design and maximum flexibility.

We're here, you just can't see us.

Find out if you have a hidden application for the STD BUS, call us today.

## STD MG

STD BUS  
Manufacturers Group  
(312) 255-3003

STD Bus Manufacturer's Group

Analog Devices, Inc. ....	(617) 461-3359	Octagon Systems Corporation .....	(303) 426-8540
Computer Dynamics Sales .....	(803) 877-8700	Pro-Log Corporation ...	(800) 538-9570
Contemporary Control Systems, Inc. ....	(312) 963-7070	Proteus Industries Inc. ...	(415) 962-8237
Enlode Incorporated ...	(800) 874-7729	R.L.C. Enterprises .....	(805) 466-9717
GW Three Incorporated .....	(703) 451-2043	Robotrol Corp. ....	(408) 778-0400
Matrix Corp. ....	(919) 833-2000	Technology 80 Inc. ....	(612) 542-9545
Micro-Aide, Inc. ....	(818) 915-5502	VersaLogic Corp. ....	(800) 824-3163
Mizar Inc. ....	(214) 466-2664	WinSystems, Inc. ....	(817) 274-7553
		ZYZ Electronics Inc. ....	(317) 335-2128
		Ziatech Corporation ...	(805) 541-0488
		National Instruments ...	(512) 250-9119



# TECHNOLOGY UPDATE

estimated order-of-magnitude reduction in MTTR (mean time to repair).

MTTR is usually a small fraction (less than about 1%) of MTBF. Suppose an untestable product has an

MTBF of 1000 hours and an MTTR of 10 hours: Its availability is  $100(1000-10)/1000$ , or 99%. If the

**TABLE 1—REPRESENTATIVE BOARD- AND DEVICE-LEVEL TESTABILITY PRODUCTS**

VENDOR	PRODUCT	DESCRIPTION	PREREQUISITES	US BASE PRICE
AIDA CORP	AIDA ATPG	GENERATES PATTERNS WITH 100% COVERAGE OF DETECTABLE FAULTS IN SCANNABLE DESIGNS. USES PATH-SENSITIZING AND RANDOM-VECTOR GENERATION. DETECTS "STUCK-AT" FAULTS. SUPPORTS BIDIRECTIONAL I/O AND 3-STATE BUSES AS WELL AS WIRED-OR AND WIRED-AND GATES.	APOLLO OR SUN WORKSTATION AND AIDA FAULT SIMULATOR	\$45,000 (AIDA FAULT SIMULATOR: \$15,000)
ANVIL SOFTWARE	ANVIL ATG SOFTWARE	GENERATES FUNCTIONAL TESTS FOR PROGRAMMABLE LOGIC DEVICES WITHOUT USING PRELOAD. SUPPORTS >50 DEVICE TYPES. LINKS TO COMPONENT AND IN-CIRCUIT TESTERS.	IBM PC OR COMPATIBLE WITH 640K-BYTE RAM AND HARD DISK	\$4950
GATEWAY DESIGN AUTOMATION CORP	TESTSCAN	ATPG FOR DIGITAL CIRCUITS EMPLOYING SCAN-DESIGN. PROVIDES 100% TEST-VECTOR COVERAGE, DESIGN-RULE AUDIT, AND FAULT SIMULATION. SUPPORTS SCAN-PATH, LSSD, RANDOM-ACCESS SCAN, AND SCAN-SET TECHNIQUES.	IBM, APOLLO, SUN, OR VAX/VMS	\$75,000
	BITGRADE	FAULT SIMULATOR AND RANDOM-VECTOR GENERATOR FOR CIRCUITS WITH BUILT-IN SELF-TEST (BIST) ABILITY. INCLUDES HARDWARE-DESCRIPTION LANGUAGE.	IBM, APOLLO, SUN, OR VAX/VMS	\$25,000
GENRAD INC	GENESIS	TEST PROGRAMMING ENVIRONMENT FOR GR 275X SERIES OF HIGH-PERFORMANCE BOARD-TEST SYSTEMS. GENERATES MULTISTRATEGY (IN-CIRCUIT/FUNCTIONAL) TEST PLANS. RUNS IN TESTER OR OFF-LINE IN WORKSTATION.	SUN WORKSTATIONS WITH SUN UNIX	INCLUDED IN PRICE OF TEST SYSTEM; NOT AVAILABLE SEPARATELY
	ATG-32	TEST-GENERATION SOFTWARE FOR GR 227X FAMILY OF MID-RANGE COMBINATIONAL TESTERS. RUNS OFF-LINE. DOWNLOADS PATTERNS VIA ETHERNET/GRNET NETWORK.	ANY DEC VAX SYSTEM OR GENRAD 3200V	\$30,000
HEWLETT-PACKARD CO	HP 74241A	AUTOMATICALLY GENERATES READY-TO-RUN IN-CIRCUIT ASIC- AND FUNCTIONAL CIRCUIT-TEST PROGRAMS THAT ARE FULLY COMPATIBLE WITH HP-3065 SERIES TESTERS.	HP ELECTRONIC DESIGN SYSTEM; HP 3065-SERIES TESTER.	\$3980
HHB SYSTEMS INC	THESEUS	ANALYSIS TOOL THAT PINPOINTS AREAS NEEDING IMPROVED TESTABILITY. ASSURES THAT VECTORS PROVIDE GOOD FAULT COVERAGE. HANDLES DESIGNS USING SEQUENTIAL DEVICES, FEEDBACK LOOPS, AND RECONVERGENT FANOUT.	DEC VAX/VMS OR SUN/UNIX, WITH 8M BYTES RAM AND 300M-BYTE HARD DISK.	\$100,000
LOGICAL SOLUTIONS TECHNOLOGY INC	TESTABILITY CHIP SET	TESTABLE FUNCTIONAL CIRCUITS (SHIFT REGISTERS, LATCHES, DECODERS, ETC) THAT PROVIDE PERFORMANCE PLUS A TESTABILITY-BUS PORT. COMMERCIAL AND MIL, LEADED AND SURFACE-MOUNTING VERSIONS.	NONE	\$6 TO \$50 (100)
NCR CORP	VITEST	FACILITATES DEVELOPMENT OF HIGH-SPEED TEST PROGRAMS TO RUN ON TRILLIUM AND SCHLUMBERGER SENTRY DEVICE TESTERS. CHECKS PATTERN TIMING AND BUS CONTENTION. USES BEST- AND WORST-CASE SIMULATIONS TO ANALYZE PATTERNS. IDENTIFIES POSSIBLE FUNCTION ERRORS.	CADNETIX, DAISY, MENTOR GRAPHICS, OR VALID WORKSTATIONS, OR DEC VAX MAINFRAMES	INCLUDED AS PART OF VENDOR'S VISYS ASIC-VERIFICATION PACKAGE. VISYS: \$7950
SILICON COMPILER SYSTEMS INC	AUTOMATIC TEST GENERATION (ATG)	SET OF SOFTWARE TOOLS THAT EVALUATES TESTABILITY OF BLOCKS, MODULES, AND CHIPS; GENERATES COMPRESSED TEST VECTORS; AND DETERMINES GATE-LEVEL TEST COVERAGE OF THE VECTORS.	GENESIL DESIGN SYSTEM + APOLLO DN3000, DN4000, DN570T; SUN 3; OR DEC VAX 8650 OR $\mu$ VAX2.	\$39,500 PER USER
TERADYNE INC	CIRCUIT BREAKER	ACHIEVES > 95% COVERAGE OF LOGIC AND FUSE FAULTS; CREATES GRADED DYNAMIC TESTS FOR SLOW-PATH FAULTS ON COMBINATIONAL AND HIGHLY SEQUENTIAL PLDs. FOR HIGH-VOLUME INCOMING INSPECTION AND IN-CIRCUIT BOARD TEST.	LASAR VERSION 6 SIMULATION SYSTEM RUNNING ON ANY VAX/VMS SYSTEM.	\$6250 FOR VAX-STATION 2000, \$70,000 FOR VAX 8800
TEST SYSTEMS STRATEGIES INC	TEST DEVELOPMENT SERIES (TDS)	TEAMS UP ASIC-DESIGN AND SIMULATION TOOLS TO PRODUCE SETS OF FUNCTIONAL VECTORS FOR SPECIFIC ATE FORMATS. SUPPORTS >30 TESTER TYPES FROM EIGHT VENDORS AND 14 SIMULATION ENVIRONMENTS.	APOLLO/AEGIS, SUN/UNIX, OR DEC VAX/VMS	\$28,000 (DEPENDS ON SIMULATOR AND TESTER)



# Only one controller fits here.

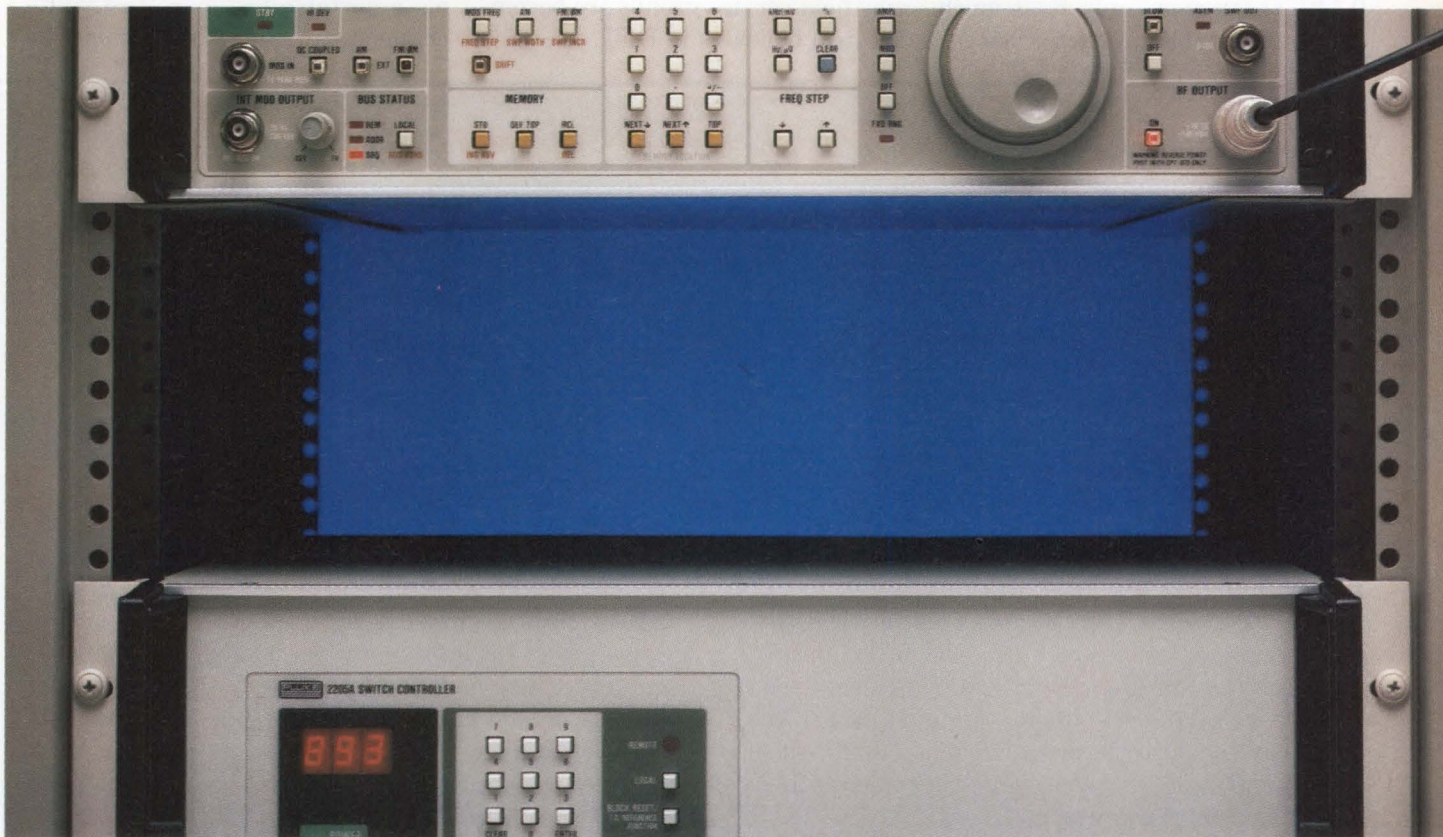

## The 1722A is designed for fast system integration, right down to the size.

When you're configuring an ATE station, no computer makes integration as fast and easy as Fluke's 1722A Instrument Controller. Designed for a standard 19-inch rack, the 1722A doesn't have to be adapted to your system. It slides into your rack in seconds.

We've built a powerful microcomputer, disk drive, CRT with graphics, and IEEE interfacing into one compact package. It's everything you need to automate your test station.

Speed integration with Fluke's software. Choose from 5 different programming



languages, including Extended BASIC, FORTRAN, C, and ATLAS for fast development. IEEE-488 commands are built in, not added on, so each command does more. Application packages like our new Touchscreen Toolbox simplify the process even more.

Once programmed, the touch-sensitive display replaces the keyboard for system control. The operator is prompted one step at a time and responds by simply touching the screen.

When you size up your options, you'll choose the only powerful controller that can slide right into your rack.

Contact your local Fluke Sales Engineer or call **1-800-426-0361** for more information.

**FLUKE**®



# TECHNOLOGY UPDATE

equivalent testable product has an MTBF of 900 hours and an MTTR of one hour, its availability is 99.89%. The testable product is unavailable 0.11% of the time, only 1/3 as much as the untestable product. Chances

are the customer is *really* concerned more about being able to use the product than he is about its failure rate. Quicker repair is a key reason why field-service groups are becoming firm believers in DFT.

DFT can reduce MTTR if, for example, in a large system containing dozens of boards, you can isolate faults to the board level by connecting a portable tester to "testability connectors" accessible from the

## Board test strategies: The bus is waiting

When you use ATE to test a loaded pc board, the testing can fall into two major categories or into combinations of the two. The categories are in-circuit and functional. Until about five years ago, board-test systems were characterized by which of these two types of testing they performed. Now, so-called combinational systems are commonplace. The word "combinational" really has nothing to do with combinational logic, although a combinational tester clearly can test combinational logic. As used by the ATE manufacturers, the word refers to the systems' *combination* of functional and in-circuit test capabilities.

With in-circuit testing, you basically test the components *after* they have been loaded onto the board to prove that the assembly process hasn't damaged them. In-circuit testing is popular because, compared with functional testing, test programs are easy to write, and they inherently isolate defective components.

A tester can perform in-circuit tests on a component even though the outputs of other components are connected to some of its pins. The tester accomplishes this feat by "back driving" the pins of the other devices. Suppose you are testing a gate whose input is driven low by the output of a flip-flop. If for a very brief interval, you force enough current into the node, you can make the output of the flip-flop go high, without, you hope, causing permanent damage.

### In-circuit test has problems

But in-circuit testing has problems, too. One problem is that military agencies are unwilling to accept the idea that back driving doesn't introduce latent defects that cause components to fail prematurely, long after a board leaves the factory. A second problem relates to the effect of capacitive loading imposed by the tester on the circuit nodes of the board under test. A third problem results from the physical means used to access the component under test; the customary probing method uses bed-of-nails fixtures.

The trend toward surface-mount technology, with its high circuit densities, multiplies problems

with bed-of-nails fixturing. When component leads are on 0.1-in. centers, the spring-loaded pogo pins used in bed-of-nails fixtures can be relatively durable. But pogo pins for the 0.50-in. centers, which are common with surface mounting, are much less durable, and when you surface-mount components on both sides of a board, you need still more complex and finicky clam-shell fixtures. Furthermore, pressing on the leads of surface-mount components (which don't pass through holes in a pc board) can cause bad solder joints to test good. Consequently, when laying out surface-mount boards that will be tested on in-circuit testers, printed-circuit designers now usually use probe points separate from the component leads and place them on 0.1-in. centers. Adding such probe points decreases component density to achieve testability.

### In-circuit and SMT mix poorly

It isn't hard to see that if every surface-mounted component requires probe points on 0.1-in. centers, the density advantage of surface mounting quickly evaporates. The fight to retain high densities is one factor that has helped to bring about a resurgence of interest in functional testing. Functional testing actually attempts to make a board perform as it would in its target system. In true functional testing, you access the board only through its I/O connections, although you can add I/O connections to improve observability or controllability.

As mentioned earlier, it is much harder to write functional test programs than in-circuit programs, and functional programs don't inherently isolate faults. ATPG programs address both of these functional-testing problems. They can check a design for compliance with testability rules (for example, absence of asynchronous circuits, ability to break feedback loops by use of gates included for testability, and ability to substitute external clocks for internal ones that you can disable while testing). ATPG programs also perform "fault grading."

Like so many other terms in the digital-test



# TECHNOLOGY UPDATE

front of the boards—the same connectors used to access the boards during production test (see **box**, “Board test strategies: The bus is waiting”). You should be able to control the boards and observe their

function at these connectors, and so run functional tests of all the boards without unplugging them.

A more advanced (but much more costly) approach builds each board's control and observation points onto

a connector that mates with the system backplane. The system itself contains the equivalent of the portable tester. With such capabilities, the system can diagnose its own faults; an operator's only function is

lexicon, fault-grading seems to be a misnomer; a better term would be pattern grading. Fault grading introduces simulated faults into a circuit model. The objective is to determine which faults a test pattern can find. Not only does fault grading let you evaluate the usefulness of particular patterns, it helps you to isolate faults by indicating which patterns detect them. Even though nodes stuck at 1 and stuck at 0 aren't the only possible faults (for example, nodes can be shorted together by a solder bridge), many years of experience have shown that you can get the information you need if you limit the simulated conditions to “stuck-at” faults.

## Cluster testing holds answers

A promising approach to board test is called cluster-functional testing. It literally represents a divide-and-conquer strategy. The time required to write a functional test program appears to increase geometrically with the complexity of the circuit. By dividing a board into clusters—small blocks of logic that perform identifiable functions that you can isolate and test functionally—you reduce the test-development time significantly and improve the odds that ATPG will work. Moreover, compared with in-circuit testing, you dramatically reduce the number of probe points you need.

But cluster functional testing still usually presupposes that you probe the board with a bed-of-nails fixture. Testers without such fixtures can be more compact and less expensive than those based on the bed-of-nails approach. Here's where the IEEE testability bus enters the picture. The proposed standard (currently called P1149) is one of several that aim to simplify control and observation of logic—from the device level to the system level. In a board-level design that complied with the testability-bus standard, you would, if possible, place all control and observation nodes on connectors; but if a board lacks room for connectors, the standard allows node access via probe points.

An IEEE committee has been working on

P1149 for several years and is ready to submit a formal proposal for acceptance. Despite sweeping goals, the committee feels the proposed standard is workable. It defines a set of testability inputs and outputs that should appear on every complying device, board, and system. As the complexity of the item increases, the number of testability inputs and outputs can increase. Implementation of the standard on an IC usually requires some dedicated pins.

At the board level, the standard recommends using dedicated pins on existing connectors, but if backplane pins are limited, you can substitute special test connectors. If space along the front of a board is at a premium, the test connectors can be accessible only if you place the board on an extender, and if there is no room for test connectors at all, you can use probe points. Using backplane pins provides the greatest potential advantage; test connectors accessible without extending boards are next best, and so on.

## Bye bye, bed of nails?

By eliminating bed-of-nails fixturing in most cases, the testability bus appears to make it possible to use lower-cost ATE systems than those used for cluster functional testing. However, you can implement cluster-functional test's divide-and-conquer strategy *and* conform to the testability bus standard at the same time.

An intangible advantage of a testability-bus standard is that it can convert an arm-waving exercise into something quantifiable. In the absence of a standard, determining the difficulty of testing a proposed design can be an exercise in circumlocution. With a standard in place, you can replace hours of fruitless, time-consuming discussions with a simple statement of whether a product does or does not comply with the standard, and if it complies, what level of the standard it meets.



# TECHNOLOGY UPDATE

to perform the actual board replacement.

At the nuts-and-bolts level, a seemingly trivial problem—incompatibility among some logic-simulator database formats and the input requirements of some ATPG programs—has placed roadblocks in the way of automatic test-vector generation. The quick solution is database-translation programs. With a little more effort, vendors can modify the simulators and ATPG programs to cure the incompatibilities. For example, they can make their software support relatively new industry standards such as EDIF (Electronic Design Interchange Format).

Another form of incompatibility can also cause problems: ATE systems can't always run the test vectors generated by ATPG software. Some vendors are addressing this problem with software that compares generated vectors against a target tester's resources and flags incompatibilities. You can also use such software to modify the vectors until they are compatible with the tester.

Other vendors are adamant that you shouldn't start designing a product until you fully understand the resources of the ATE system that you will use to test it. At least in US companies, it is very unusual for designers to let tester capabilities constrain their designs, although the idea of doing so is totally consistent with DFT. However, it is quite clear that you will wind up with a usable vector set a lot sooner if you consider the tester's capabilities *before* freezing your hardware design rather than waiting until afterward.

## Scannable components needed

A real problem with acceptance of ATPG for board-level designs relates to component availability: To effectively implement the scannable designs required for compatibility with ATPG programs, you need scannable devices. Otherwise, you

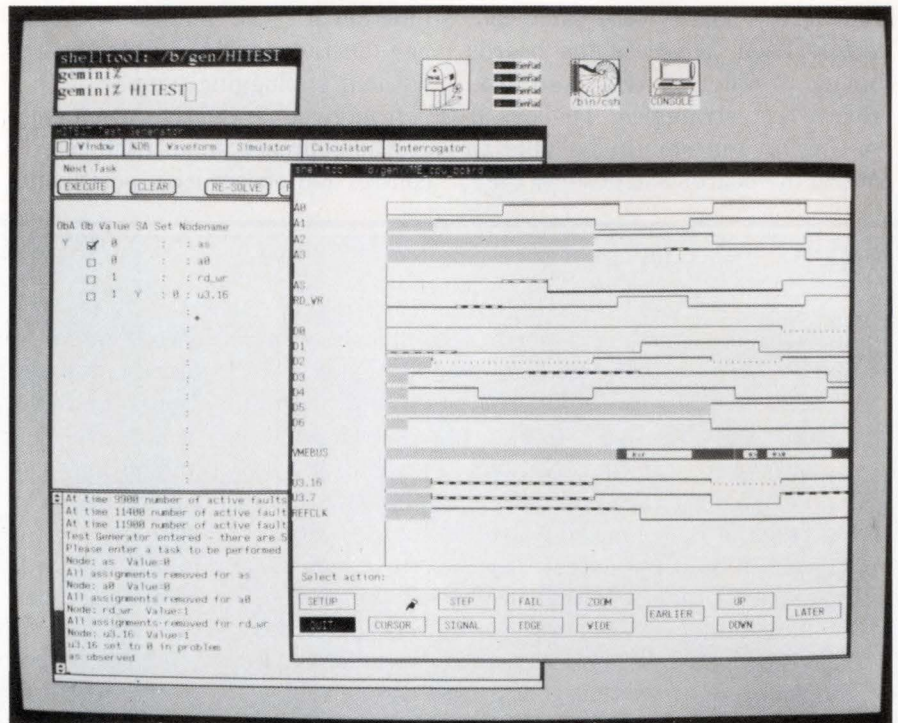

*You can view waveforms beside program statements while using the Hitest program generator on Genrad's Genesis test-development environment for the company's 275x tester family.*

must create their equivalent from unwieldy numbers of SSI devices. Many ASICs now incorporate circuits that implement at least a boundary-scan approach. Scannable equivalents of the most-used MSI devices and  $\mu$ Ps still aren't widely available. (One vendor is represented in **Table 1**.)

Advocates of DFT categorize several of the above concerns as results of a one-sided view of the product-development process. A good example is the fear of lengthened product-development cycles. Today, the test-development phase of a complex-board project often consumes as much time and money as the traditional design phase. DFT advocates insist that once designers are familiar with the new discipline, the cost and duration of the design portion of a project that uses DFT will probably not exceed what you experience using traditional approaches, but the cost and duration of test development can *decrease* by 90% or more. Even if adopting DFT does increase the cost and duration of the design phase by 20%, a 90% de-

crease in test-development time and cost will cut the overall project cost and duration by 35%. In fact, ATPG vendors cite reduced time to market as the selling point that strikes a responsive chord with more potential customers than any other.

Surprisingly, aside from defense-electronics manufacturers required to comply with MIL testability standards, the few US companies that have adopted DFT for board- and system-level designs have done so in response to pressure not from manufacturing but from strong field-service profit centers. These companies have found that to service their products profitably, they must diagnose and repair board faults at depots located close to their customers. Such depots don't process the volumes of boards that would justify purchases of million-dollar testers. Repair depots need low-cost testers that they can quickly reconfigure to troubleshoot and test boards of many types. Unless the boards are designed for test, low-cost testers won't do the job.

In the Pacific rim, the situation is



# SMT STANDARDS.



4SW-6127R3

## SPRAGUE TANTALUMS SET SURFACE MOUNT STANDARDS.

Sprague Type 195D and 293D solid tantalum chips meet the brand new EIA size and packaging standards for surface mount capacitors. These miniature components fill your surface mount needs with economy, reliability and high performance. Conformal-coated Type 195D TANTAMOUNT<sup>®</sup> capacitors meet EIA specifications for Extended Capacitance Range devices. These units feature gold or solder plated terminals and the highest capacitance in the smallest packages available in the industry. Rugged, fully molded Type 293D TANTAMOUNT<sup>®</sup> capacitors conform to EIA specifications Standard Capacitance Range

devices. These "machine-friendly" tantalum chips are compatible with all automatic placement equipment. Both types are supplied taped and reeled per EIA 481A. Standard ratings: 0.10 to 100 $\mu$ F, 4 to 50 WVDC. For "Quick Guide To Tantalum Chip Capacitors", ASP-642, write to Marketing Communications, Sprague Electric Company, P.O. Box 9102, Mansfield, MA 02048-9102. For applications assistance, call our Customer Service Center at Concord, NH at 603/224-1961.



CIRCLE NO 39



# IEEE-Z

Our Personal488™ IEEE (GPIB) interfaces for PC/AT/386 & PS/2s are packed with these easy-to-use features:

- DOS device driver loads at power-on
- Hewlett-Packard style commands
- Automatic error indication
- BASIC ON SRQ GOSUB capability
- DMA transfers over 300K bytes/s
- Up to four IEEE boards/computer
- NEC-7210 compatible software
- Serial/Parallel/IEEE port redirection
- DMA and interrupt channel sharing
- Compatible with popular languages, (no extras to buy), including BASICA, GWBASIC, Quick BASIC, Compiled BASIC, Turbo BASIC, True BASIC, TBASIC, Turbo Pascal, Microsoft Pascal, Turbo C, Microsoft C, Aztec C, Lotus 1-2-3/Symphony/Measure, ASYST, DADISP, Test Windows, AutoCAD, and many more.

- 30 day money-back guarantee
- 2 year warranty
- Call or send for your FREE Technical Guide

**Lotech**

**(216) 439-4091**

Telex 6502820864  
Fax (216) 439-4093

25971 Cannon Road • Cleveland, Ohio 44146

London (0734) 86-12-87 • Paris (1) 34810178 • Zurich (01) 821 9444  
Milan 02-4120360 • Linköping 013 11 01 40 • Amsterdam 01830-35333  
Vienna (0222)253626 • Munich and other European, North African, and Middle East countries not listed (089) 710020.

## TECHNOLOGY UPDATE

### For more information . . .

For more information on the testability products listed in **Table 1**, circle the appropriate numbers on the Information Retrieval Service card, contact the following manufacturers directly, or use EDN's Express Request service.

**Aida Corp**  
5155 Old Ironsides Dr  
Santa Clara, CA 95054  
(408) 980-5200  
Circle No 701

**Anvil Software**  
Box 901  
Arlington, MA 02174  
(617) 641-3861  
Circle No 702

**Gateway Design  
Automation Corp**  
6 Lyberty Way  
Westford, MA 01886  
(617) 692-9400  
Circle No 703

**Genrad Inc**  
300 Baker Ave  
Concord, MA 01742  
(617) 369-4400  
Circle No 704

**Hewlett-Packard Co**  
1820 Embarcadero Rd  
Palo Alto, CA 94303  
Phone local office  
Circle No 705

**HHB Systems Inc**  
100 Wyckoff Ave  
Mahwah, NJ 07403  
(201) 848-8000  
Circle No 706

**Logical Solutions Technology Inc**  
310 W Hamilton Ave, Suite 101  
Campbell, CA 95008  
(408) 374-3650  
TLX 172867  
Circle No 707

**NCR Corp**  
2001 Danfield Ct  
Ft Collins, CO 80525  
(303) 226-9500  
Circle No 708

**Silicon Compiler Systems Inc**  
2045 Hamilton Ave  
San Jose, CA 95125  
(408) 371-2900  
Circle No 709

**Teradyne Inc**  
321 Harrison Ave  
Boston, MA 02118  
(617) 482-2700  
Circle No 710

**Test Systems Strategies Inc**  
8205 SW Creekside Pl  
Beaverton, OR 97005  
(503) 643-9281  
TLX 992633  
Circle No 711

different. Possibly because of their emphasis on serving geographically far-flung export markets, major Japanese equipment manufacturers, unable to purchase what they consider to be suitable ATPG software, have developed it in house. They are also moving aggressively to design their board-level products so that ATPG software can generate the necessary vector sets.

In the US, the prevalent view is that Asian companies lag behind their American counterparts in software-development expertise. ATPG software is complex; the Japanese companies' ability to develop it in house may indicate that Japanese software development is more advanced than Americans suspect. The Asian companies' decision to focus on ATPG appears to indicate a greater commitment to testability in Japan than in the US, and it provides strong evidence that Japanese hardware designers think of test as *their* problem, not as somebody else's.

If you think about the earlier discussion of the effect of using DFT on a product's availability for use, and if you realize that Asian companies are leading the world in adopting

DFT, you come up with yet another reason why American manufacturers should heed the advice of companies urging use of DFT. The push for quality in the US within the past year or two has probably equalized the MTBF of electronic products of similar complexity made in the US and Asia. However, if the use of DFT gives the Asian products a clear edge in availability, US companies will again be uncompetitive.

**EDN**

### References

1. Small, Charles H, "Automatic test generators for PLDs clean up your logic designs," *EDN*, September 17, 1987, pg 59.

2. Parker, Kenneth P, *Integrating Design and Test: Using CAE Tools for CAE Programming*, IEEE Computer Society Press, Washington, DC, 1987.

3. Turino, Jon, and H Frank Binnendyk, *Design to Test*, Logical Solutions Technology Inc, Campbell, CA, 1985.

Article Interest Quotient  
(Circle One)

High 518 Medium 519 Low 520



# Who leads the ranks in military ICs? The General does.

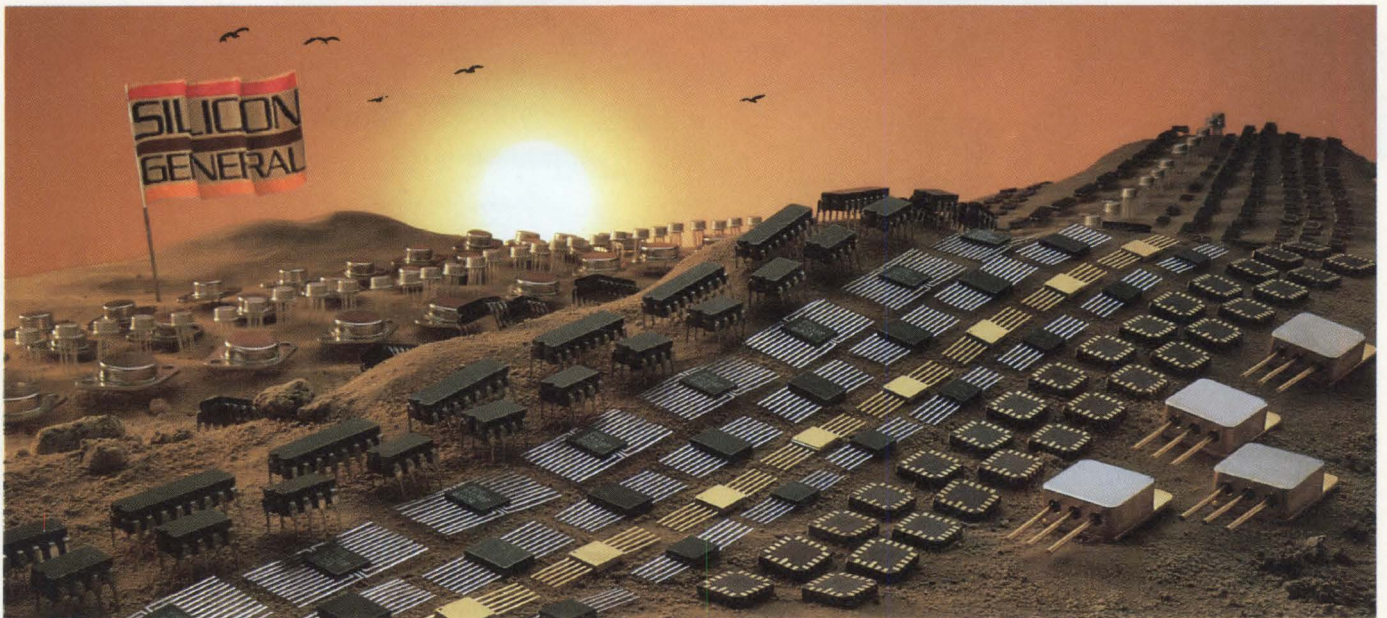

The General has mobilized the greatest army of Hi Reliability ICs ever. There are troops of leadless chip carriers, flat packs, power packages, cerdips, side brazed, standard metal cans, and our newest recruit, the hermetic TO-220. It's an army of pulse width modulators, supervisory circuits, power supply ICs, regulators, FET drivers, memory drivers, diode arrays, and transistor arrays.

The introduction of the Hermetic TO-220 is another example of the General's commitment to the demanding requirements of the military marketplace.

Other examples include:

- Radiation hardened devices
- Military hybrids
- Flat packs/LCCs
- New JAN quals
- Aggressive deliveries.

You'll like the General's allies too:

• Mil-M-38510 • Mil-S-19500 • Mil Std 883 Class B, Class S • Mil/DESC Drawing • SCD.

Call Silicon General for our new short form catalog and an updated JAN QPL listing (including 7800, 7900 series regulators in process). Please address Silicon General, 11861 Western Ave., Garden Grove, CA 92641. Phone (714) 898-8121, TWX (910) 596-1804, FAX (714) 893-2570.

**SILICON**  
**GENERAL**



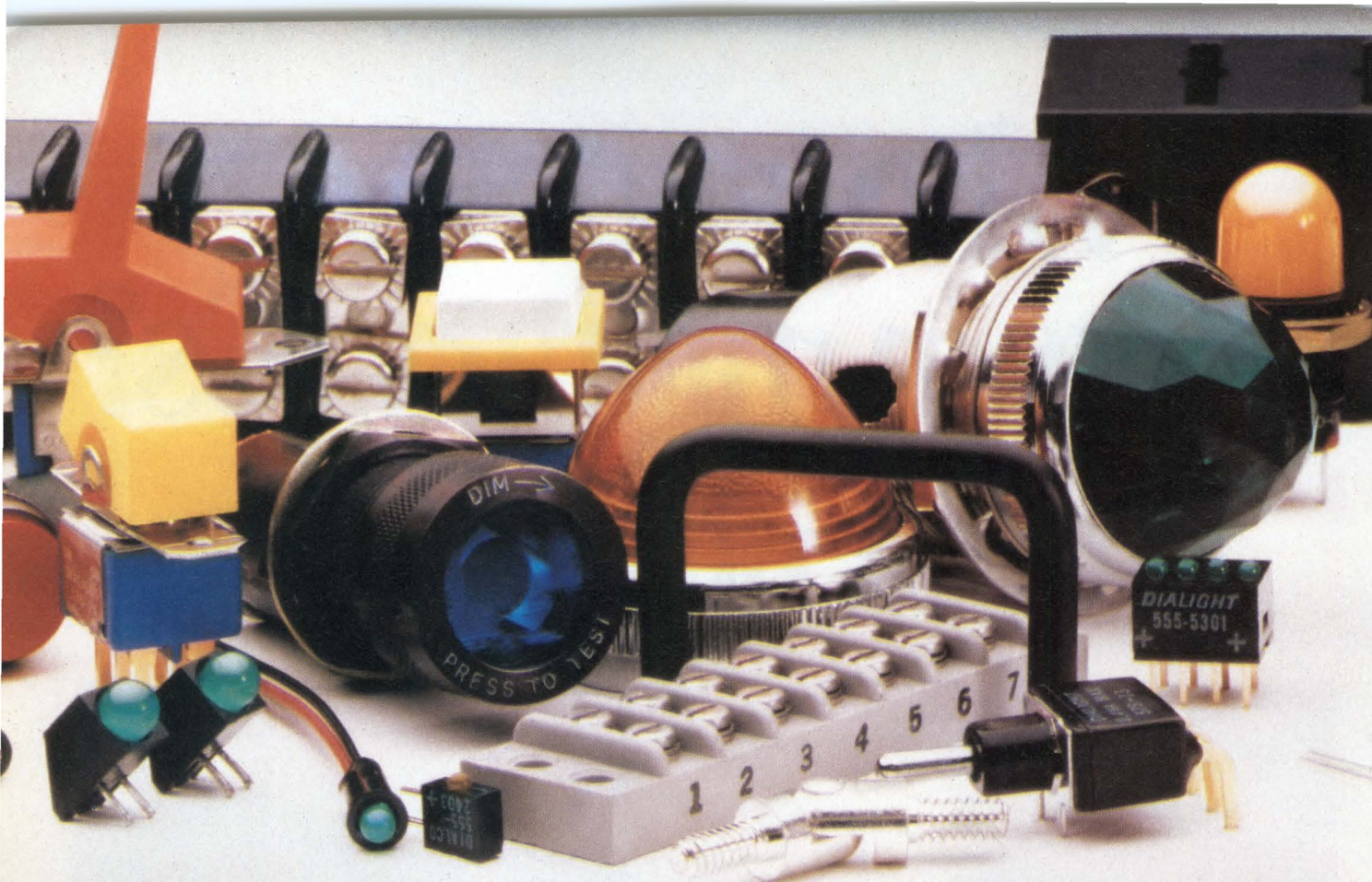

# Engineering is the only

It's widely held that if you've seen one LED, you've seen them all. The same goes for things like terminal blocks and switches. A myth at times perpetuated by the very companies that make and market these products. With one notable exception.

Dialight Company.

## **Passive components, actively engineered.**

We believe that passive components are no less important than integrated circuits. An attitude that's reflected in the way we go about our work.

Our design team is constantly assessing the manufacturing techniques of OEMs in every important technology. Anticipating ways to make our products easier and more economical to design-in and install (our invention, the Circuit Board Indicator is a good example).

They'll spend months developing a new compound for our sealed switches. Or devising a reliable way of testing each and every one of our Circuit Board Indicators and LEDs. They'll lose sleep over milliohms of contact resistance, or a fraction of an inch clearance on our switch terminals.

It's an attitude that's ultimately reflected in the products we sell.

## **Dialight Circuit Board Indicators**

A product concept we pioneered over fifteen years ago to facilitate fast, reliable circuit board installation of LEDs, the Dialight Circuit Board Indicator is designed to insert and wave solder in up to one fourth the time at up to one fourth the cost of non-packaged LEDs.

All 100% tested and available in hundreds of standard and custom designs including the latest super-bright gallium aluminum arsenide units.

## **Dialight Indicator Lights**

No one makes more indicator lights for more applications than Dialight. Over a million designs accrued through fifty years of innovation. Incandescent, neon and LED units available in commercial and even the latest military configurations to meet MIL-L-85762A night vision requirements.

## **Dialight Switches**

More than 100,000 designs that include illuminated pushbuttons, rockers, toggles and levers in a wide range of terminations, contact





# commodity we sell.

ratings and mounting styles. All 100% tested. All customized to meet any application need.

Even sealed switches specifically engineered for board-mounted solvent washing with sealed O-rings to prevent seepage.

## **Kulka Terminal Blocks**

Molded from special aggregates that in some models, withstand temperatures in excess of 155°C. Making Kulka the only manufacturer to meet B, F and HT requirements of MIL-T-55164C.

Standard features include solid brass, nickel-plated screws, molded-in contacts and special plates that prevent overtightening and breakage. All readily engineered into any conceivable custom or special order.

## **HHSmith Hardware**

Spacers, stand-offs, handles, knobs and other components all available in an extremely wide

variety of sizes, configurations, and materials, as well as thread and finish specifications to meet any and every requirement. From the most basic and cost-sensitive to the most demanding Mil-spec applications.

Dialight, Kulka and HHSmith products that speak of rigorous quality control, exhaustive testing and the Company philosophy of design and engineering: the word passive may be used to describe our components, but never the way we build them.

Find out more about Dialight LEDs, Circuit Board Indicators, Indicator Lights, Switches, Kulka Terminal Blocks and HHSmith Components. Call us at 201-223-9400, or write Dialight Company, 1913 Atlantic Ave., Manasquan, NJ 08736, and ask for a free catalog today.

**DIALIGHT COMPANY** A Division of  
North American Philips

**DIALIGHT · KULKA · HHSMITH**

Engineering is the only commodity we sell.



# 100,000 12-BIT A/D CONVERSIONS—FREE

Get  $3\mu\text{s}$ , 12-bit accuracy  
for the price of a  $5\mu\text{s}$  AD7572 converter.

The new 12-bit CMOS MAX162 from Maxim delivers a 40% increase in A/D conversion rate for the same price as the industry standard AD7572. That's over 100,000 more conversions per second—absolutely free.

The MAX162 packs on-chip a buried zener reference, three-state output drivers, high-speed microprocessor interface circuitry, internal or external clock options and maintains a low power drain of only 135mW. It operates from +5V and -15V or -12V supplies. And is pin for pin compatible with the AD7572.

If you have a design that uses the slower AD7572, you can upgrade to the MAX162 at no extra cost. If you're in the throes of a new design, you can rest assured that the MAX162 is the ticket for today's faster DSP applications.

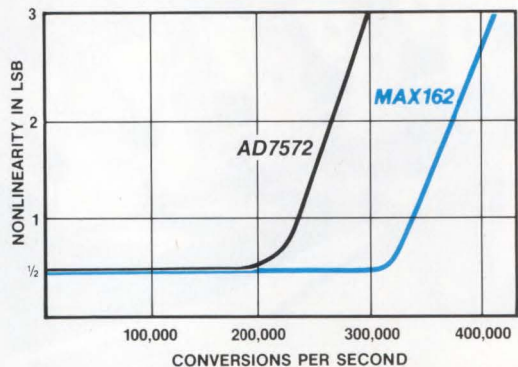

## Or get a low noise AD7572 from Maxim.

If your design is committed to the AD7572, consider this—Maxim's AD7572s (and MAX162s) deliver a 3X reduction in noise over the original manufacturer. And every standard part we put into a DIP is burned-in at 150°C for 24 hours—at no extra charge. This results in an incredibly low failure rate of 6.8 failures per billion hours of operation.

## In a smaller footprint than PLCC.

Only Maxim offers you both the MAX162 and AD7572 in the smallest surface-mounted package available—the SOIC. Our SOIC packages are subjected to rigorous lot qualifications, pressure pot, solder immersion and life tests. And thanks to advanced packaging materials developed specifically for surface-mount, over 99% of our SOICs survive these tests to become the most reliable surface-mount parts you can buy.\* Anywhere.

So what will it be? A  $3\mu\text{s}$  MAX162 or a  $5\mu\text{s}$  AD7572? The price is the same. The choice is yours. And soon, that choice will include a military version screened to MIL-STD-883B Rev. C requirements.

Call your Maxim representative or distributor today for data sheets and samples. Or write Maxim Integrated Products, 120 San Gabriel Dr., Sunnyvale, CA 94086, (408) 737-7600. And tell them you'd like 100,000 12-bit A/D conversions—free.

\* Maxim Reliability Report RR-IC 1987.

# MAXIM

**Distributed by Anthem/Lionex, Bell/Graham, Hall-Mark, and Pioneer. Authorized Maxim Representatives:** Alabama, (205) 830-4030; Arizona, (602) 860-2702; California, (408) 727-8753, (619) 278-8021; (714) 739-8891; Colorado, (303) 841-4888; Connecticut, (203) 754-2823; Florida, (305) 365-3283; Georgia, (404) 992-7240; Idaho, (503) 620-1931; Illinois, (312) 956-8240; Indiana, (317) 849-4260; Iowa, (319) 377-8275; Kansas, (316) 838-0884, (913) 339-6333; Maryland, (301) 799-7490; Massachusetts, (617) 449-7400; Michigan, (313) 968-3230; Minnesota, (612) 944-8545; Missouri, (314) 291-4777; Montana, (503) 620-1931; Nevada, (408) 727-8753; New Jersey, (609) 933-2600, (201) 428-0600; New Mexico, (505) 884-2256; New York, (516) 752-1630, (315) 437-8343; North Carolina, (919) 846-6888; Ohio, (216) 659-9224, (513) 278-0714, (614) 895-1447; Oklahoma, (214) 386-4888; Oregon, (503) 620-1931; E. Pennsylvania, (614) 895-1447; W. Pennsylvania, (609) 933-2600; South Carolina, (704) 365-0547; Tennessee, (404) 992-7240; Texas, (214) 386-4888, (512) 451-2757, (713) 778-0392; Utah, (801) 266-9939; Virginia, (301) 621-1313; Washington, (206) 453-8881; Wisconsin, (414) 476-2790; Canada, (416) 238-0366, (604) 439-1373, (613) 726-9562, (514) 337-7540.

Maxim is a registered trademark of Maxim Integrated Products. ©1987 Maxim Integrated Products.



## Customer training and reverse engineering promise to escalate the acceptance of CASE

Chris Terry, *Associate Editor*

**C**ASE (computer-aided software engineering) is only now reaching the stage of maturity that CAE tools were at several years ago, but it won't be long before CASE catches up to CAE. As computer hardware falls in price and increases in graphics power, any software engineer who has a PC/AT can make use of CASE tools. More to the point, many CASE vendors have switched the focus of their customer-training courses from promoting specific methodologies to teaching management what they realistically can—and can't—expect from the tools. And finally, new tools have made reverse engineering possible: Reconstructing design diagrams from the source code of existing programs makes program maintenance and enhancement much easier.

### CASE isn't a cure-all

Tools for the analysis of software requirements and for the design of software modules have been around since the mid-70s. IBM's HIPO (hierarchical input-process-output) diagrams, Edward Yourdon and Tom DeMarco's data-flow diagrams, Jean Warnier and Kenneth Orr's stepwise-decomposition diagrams, Nassi and Shneiderman's decision diagrams, and others have all proven useful. More recently, Chen and Merise entity-relationship diagrams have facilitated database design.

Although none of these CASE

originators ever claimed that their techniques were a panacea for all design problems, CASE has suffered from this misconception. Some of the more vociferous apologists for CASE espoused one or another technique so vehemently and so exclusively that skeptics perceived that adopting a particular CASE methodology for a large project was almost as total a commitment as embracing a new religion. This attitude, and the resistance it engendered, has done much to slow the acceptance of CASE tools.

Moreover, until the advent of inexpensive workstations with good graphics, the cost of using such tools was high. A relatively simple change in functional requirements could require the manual updating of many pen-and-ink diagrams. For this reason, too, conservative analysts and management resisted the introduction of such tools, dismissing them as "arc-and-bubble games."

It was also common knowledge that CASE tools were useful only for new software systems. Nobody in his right mind would ever undertake the labor of constructing design diagrams from the source code of programs that had been running satisfactorily for months or years, but which needed some updating.

CASE-tool vendors readily admit that no one methodology is ideal for

all types of software systems, and they are trying to provide a practical education for their customers. Peter Craig, president of Promod Inc, emphasizes that there is still a shortage of software developers trained in the techniques needed for the successful development of large systems. His company's 1-day, in-house seminars focus a customer's attention on the need for new tools, and stimulate serious consideration of which tools and techniques will best meet the needs of the customer's current and future projects.

Craig finds that management is most receptive in companies that are developing embedded systems, and whose engineers have already found that CAE tools have far outstripped the original expectations of their value. Such companies appreciate the potential of CASE tools far more readily than companies that are concerned principally with man-

**P**eter Craig of Promod finds the best reception at companies where engineers have already found that CAE tools have far outstripped the original expectations of their value.

agement information systems.

John Romano, a product manager at Hewlett-Packard, has also found that customer training is most effective when it avoids a particular methodology initially, and instead concentrates on what management



# End the connector compromise...

1. SIMPLE PUSH BUTTON RELEASE

2. OPTIONS FOR 3, 7, 9 AND 12 POSITIONS

3. NO SHOCK PLASTIC HOUSING

...in patient  
monitoring  
equipment



Only Hypertronics ends the compromise in quick-disconnect plugs and receptacles...by combining patient-proof design, economical plastic housings and the reliability of military approved contacts in a line of electrical connectors.

Our injection-molded polycarbonate and polysulfone housings completely shroud current-carrying elements to avoid both reliability and repair problems, as well as user hazards. Yet a simple push-button release allows quick disconnects by untrained personnel.

The economically priced D Series connectors are available in 3, 7, 9 and 12 position modules. Each incorporates the Hypertac® low insertion force contact for unique operational and cost efficiency.

Now you can have it all...in long-life, user-

friendly circular connectors for medical, personal computer and other equipment. End the connector compromise by calling 1-800-225-9228, toll free.

**HYPERTAC®:**  
Inserting pin into hyperboloid sleeve.

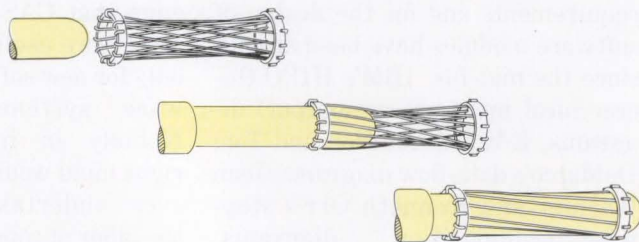

**HYPERTRONICS CORPORATION**

*"New Horizons in Connectors"*

16 Brent Drive, Hudson, MA 01749 (617) 568-0451 Telex 951152 FAX 617-568-0680

CIRCLE NO 48

EDN March 17, 1988



# TECHNOLOGY UPDATE

can and cannot expect from the introduction and use of CASE tools. Romano believes that CASE is still in an early stage of its development, and that all projects that use CASE tools are basically pilot projects. According to him, it's important not to lock users into one particular methodology but rather to discover what they are trying to do, which current tools will best help them to do it, and how best to make data models accessible to all phases of the development process.

Romano also points out that this type of customer training relieves some kinds of pressure from developers, because it convinces management that the use of appropriate CASE tools will yield better quality in the end product. CASE probably won't shorten the total development time, but developers will be able to make better, more effective use of their time.

A less obvious benefit, which can form an important part of a company's return on investment, is that the higher quality of a first deliverable item means less time and energy spent later on maintenance: There'll be fewer defects to correct, and enhancements will be easier to incorporate.

Dave West, president of Visual Software Inc, feels that the key to CASE's wide acceptance is making the tools adaptable to different needs. It's particularly important to extend the tools to cover all phases of development from requirements analysis through coding to maintenance.

Along the same lines, Eyal Levy of Ready Systems Inc expresses the view that CASE will undergo "onionization." The tools available today are just the core of the onion—acceptable, but needing many additional layers to be completely satisfactory. Levy doesn't believe that there will be any total, generalized solution for all problems; rather,

new tools and techniques will evolve to provide complete solutions for specific environments such as embedded systems, real-time systems, and databases. Because the needs of each environment are so different, engineers will need a different toolset for each and communication capability between toolsets.

He, too, has found that customer management is confused (and skeptical) about the value of CASE, which is why Ready Systems (which specializes in real-time systems) chose to classify its toolset as CARD (computer-aided real-time design) instead of CASE.

## Integration is the challenge

One of the major concerns of CASE-tool users and vendors alike is the need to make CASE-generated design data available during as many phases of a software project as possible. Ideally, this data should also be available in a form that CAE tools and CASE tools from other vendors can also use.

The vendors have achieved the first goal. Requirements-analysis tools generate detailed specifications of data items and processes.

These specifications reside in the data dictionary and are the raw material on which the completeness and consistency checks in all phases are based.

In multiuser workstation systems, the specifications are automatically available to all members of the design team. In a system running on IBM PCs (or compatibles), the obvious course is to link the PCs in a network and let the data dictionary reside on the network file server; in this way, all team members can use and update

the data dictionary and drawing files with no delay or conflicts.

Hewlett-Packard's Romano says that the biggest challenge involves linking CASE tools and other development tools. Links currently exist between HP/Teamwork and the company's AX-LS cross compilers, and Romano says that HP's long-term goal is to provide links between HP/Teamwork and all of the company's cross-development tools.

One new tool that uses data generated by HP/Teamwork tools is the AX-BA branch analyzer, which exercises part or all of the C code that the design team generates. You can generate test cases and run AX-BA at any stage of the design; AX-BA then reports all branches that are executed, as well as sections of code that are not executed during the run.

Software-testing considerations affect all phases of your design, and you should certainly take them into account during the requirements-analysis phase. If you start thinking about testing early enough, you can use information residing in the data dictionary as the basis for constructing test cases. At present you may

**J**ohn Romano of Hewlett-Packard believes that CASE is still in an early stage of its development, and that all projects that use CASE are basically pilot projects.

have to export this data to other tools (such as H-P's AX-BA) that actually perform the tests, but vendors are looking to develop and integrate tools that will automatically access the data dictionary, extract the information necessary for generating test data, and then run the tests.



# TECHNOLOGY UPDATE

**C**ASE tools, to be fully effective, must facilitate three kinds of communication. All members of a design team must be able to communicate among themselves; tools from the same vendor must be capable of exchanging information; and tools from different vendors must be able to communicate.

A multiuser host or a network of workstations running an integrated set of CASE tools provides the primary communication between team members, who then all have access to the same database. The CASE tools check the work for consistency and completeness according to the same set of rules.

HP's Romano points out that when you're designing a real-time or embedded system, another level of communication is also essential: making sure that the hardware engineers are fully integrated with the design team right from the start of the requirements-analysis phase.

Failure to arrive at a joint hardware/software approach to a design can bring about a situation in which the hardware operates correctly, but requires undesirable or time-consuming software operations, or in which real-time software considerations require modifications to hardware that's already in the manufacturing stage. Such conflicts can be expensive to resolve, and need never arise if the two groups are in continuous communication.

The value of communication between all of a vendor's CASE tools hardly needs any further emphasis. CASE's use of a common data dictionary containing specifications of all data items and processes is what makes possible not only consistency and completeness checking through all of the design stages, but also some of the reverse-engineering techniques that are starting to allow CASE to maintain existing software.

The need for communication between tools from different vendors arises when portions of a very large system are distributed between several subcontractors. (MIL-spec projects are a good example.) Each subcontractor may use a different vendor's CASE tools, but at some point in the project their results have to be combined.

The CAE industry faced this same obstacle several years ago. Several formats existed for interchanges between some specific CAE products, but a growing need for a wider interchange of data resulted in the development of a standard interchange format, EDIF (Electronic Data Interchange Format).

In 1987, Cadre Technologies Inc, one of the leading CASE-tool vendors, proposed extensions to the EDIF format that would permit the exchange of data between CASE tools from different vendors (Ref 1). These extensions would place particular emphasis on allowing both interactive and batch data exchange, as well as incremental updates to a database. They would also permit data interchanges between CASE and CAE tools.

A number of vendors are supporting the use of these extensions to EDIF, or are at least serving on a committee whose aims are to refine Cadre's original proposals into a generally acceptable standard. The vendors hope that a widely accepted standard will allow data interchange not only among CASE tools and between CASE tools and CAE tools, but also between CASE tools and a wide range of other existing cross-development and documentation tools.

Software-documentation standards such as DoD-STD-2167 have already had an impact on the growth and features of CASE tools. One of the requirements of this standard is that there must be a clear audit trail from the system-requirements specifications to all software modules. The need for this audit trail has stimulated the development of tools that can provide such cross-checking.

## Tools are improving

You won't find many automatic code generators yet, and many people still regard those that do exist (such as EPOS-R from SPS Inc) with a certain degree of suspicion. But you will find a number of tools that partially automate, or at least facilitate, the generation and updating of documentation.

Tekcase from Tektronix, for example, includes an Auditor tool that correlates the software modules and their functions with the design requirements and then reports discrepancies and incomplete items. This tool provides a complete audit trail (vital for compliance with DoD-

**E**yal Levy of Ready Systems has found that customer management is confused about the value of CASE—the company calls its toolset CARD (computer-aided real-time design) instead of CASE.

STD-2167) from requirements analysis to software deliverable items.

Even more important, there are now tools (such as Re-Source in the Promod toolset, and Designer in the Tekcase toolset) that will scan the source code of an existing program or system that is written in Ada, Pascal, or C, and will automatically construct module-design and data-



# NOW YOU CAN DRIVE OUR SUBCOMPACTS.

Seagate's family of 3½" hard disc drives.



As computers grow smaller, the demand for high-quality drives grows larger. But if you're looking for 3½" drives for your small computer systems, you don't have a lot to choose from.

Except at Seagate.

We offer six 3½" drives with 21, 32 and 48 MB formatted capacities. You also have a choice of interfaces: SCSI or ST412 with RLL or MFM encoding. All with 28 msec access time.

Our 3½" drives use Seagate's field-proven, proprietary stepper motors to achieve fast access times normally found only with more expensive voice coil actuators.

Seagate's 3½" drives are not only fast —they're power savers, using as little as 8 watts. And for added data integrity, the drives feature autopark with a balanced positioner.

All of Seagate's 3½" drives are built with the precision and quality that have made us the world's leading independent manufacturer of 5¼" full-height and half-height hard disc drives.

Only Seagate has the worldwide, high-volume manufacturing efficiency to meet the growing demand for 3½" drives.

When you're ready to go for a little drive, give us a call. 800-468-DISC.



 **Seagate**

The first name in disc drives.



# TECHNOLOGY UPDATE

flow diagrams in the notation of your choice. These tools extend the usefulness of CASE to an installed base of software that was previously inaccessible to CASE tools. Clearly, such tools are invaluable when the need arises to update and enhance existing programs, particularly if the designers of these programs have left the company.

Another standard that may provide even more impetus for the use of CASE is MIL-STD-1840A, which requires that by the year 1990 all documentation on projects submitted to the DoD be in machine-readable form. The increasing complexity of such documentation, which may amount to several thousand pages for large projects, makes it vital to have a means of making changes to one document and the ensuing changes to the many other documents that may be affected. Further, it's essential that there be a means of obtaining the latest version of each drawing and specification that the CASE tools generate.

Context Corp offers a documentation management system that can

help you fulfill the requirements of MIL-STD-1840A. The system provides distributed processing on a heterogeneous network of all types of computers from mainframes to workstations. Two important features reduce the problem of keeping track of changes.

The "inclusion by reference" feature allows you to keep just one copy of each reusable text module or drawing on the network server. Thus, for example, if you're going to use a drawing in five different documents, you access it at print time, by means of its name. The copy that you access is always up to date. This feature eliminates the need to maintain a separate copy for each document (with all the inherent problems of updating five copies).

The other feature is a link, either to Cadre's Teamwork or to Teledyne-Brown's Tags suite of CASE tools, that allows you to display or print drawings and specifications generated by those CASE tools. Effectively, if you need a CASE drawing or text for your document, the link requests the CASE

tool to supply it in printable form as if it were standard output. Therefore, the link does not need any filter (such as conversion to or from EDIF). Context plans to work with other CASE-tool vendors in the near future to create additional links.

**EDN**

## Reference

1. Hecht, Alan, and Matt Harris, *A CASE standard interchange format: proposed extension to EDIF 2.0.0*, Cadre Technologies Inc, Providence, RI, 1987.

Article Interest Quotient  
(Circle One)

High 509 Medium 510 Low 511

## For more information . . .

For more information on the CASE tools described in this article, contact the following manufacturers directly, circle the appropriate numbers on the Information Retrieval Service card, or use EDN's Express Request service.

**Cadre Technologies Inc**  
222 Richmond St  
Providence, RI 02903  
(401) 351-5950  
Circle No 715

**Context Corp**  
8285 SW Nimbus Ave  
Beaverton, OR 97005  
(503) 646-2600  
Circle No 716

**Hewlett-Packard**  
3000 Hanover St  
Palo Alto, CA 94304  
Phone local office  
Circle No 717

**Promod Inc**  
22981 Alcalde Dr  
Laguna Hills, CA 92653  
(714) 855-3046  
Circle No 718

**Ready Systems**  
Box 61029  
Palo Alto, CA 94306  
(415) 326-2950  
Circle No 719

**SPS Software Products & Services Inc**  
14 E 38th St, 14th Fl  
New York, NY 10016  
(212) 686-3790  
Circle No 720

**Tektronix Inc**  
CASE Div  
Box 14752  
Portland, OR 97214  
Phone local office  
Circle No 721

**Teledyne Brown Engineering**  
300 Sparkman Dr  
Cummings Research Park  
Huntsville, AL 35807  
(205) 532-1482  
Circle No 722

**Visual Software Inc**  
3945 Freedom Circle, Suite 540  
Santa Clara, CA 95054  
(408) 988-7575  
Circle No 723



# The low-pass filter for real signals

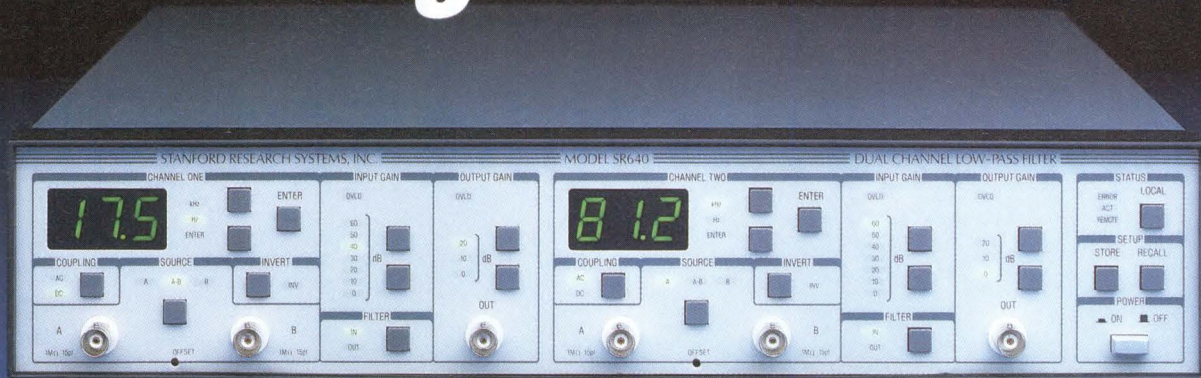

**The SR640 dual channel, programmable, low-pass filter. 115 dB/octave rolloff. \$2990.**

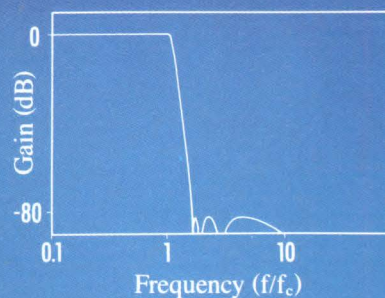

The SR640 offers a unique combination of filter specifications, preamplifier performance, and programmability at a price far less than other instruments. Featuring two fully independent 8-pole, 6-zero elliptic filters with less than 0.1 dB p-p passband ripple and 115 dB/octave rolloff, the SR640 is the ideal filter for general purpose signal processing as well as anti-aliasing for digital signal processing systems.

The GPIB and RS232 interfaces allow complete control of all instrument settings via computer control. The micro-processor components are optically isolated from the filter sections to provide optimum noise performance.

Whether your needs are for laboratory benchtop filters or signal conditioning filters in data acquisition systems, the SR640 is the natural choice.

## **SR640**

**\$2990**

- 1 Hz to 100 kHz cutoff frequency
- 3 digit frequency resolution
- 0.1 dB passband ripple
- 115 dB/octave rolloff
- 80 dB stopband attenuation
- 10 nV/ $\sqrt{\text{Hz}}$  input noise
- 60 dB prefilter gain
- 20 dB postfilter gain
- GPIB, RS232 interfaces standard

## Stanford Research Systems

1290 D Reamwood Avenue  
Sunnyvale, CA 94089  
TEL (408) 744-9040  
FAX 4087449049  
TLX 706891 SRS UD



# How To Keep All Your Horsepower From Running Around In Circles.



**T**o really understand your performance problem, just turn traditional thinking around.

You see, your CPU is really more like a peripheral—it's usually your storage subsystem that sets the pace.

When you look at the problem that way, it's a horse of a different color. The solution, of course, isn't a CPU upgrade. It's better management of the data.

At System Industries, that's an

idea we've championed all along. And the same one behind our new CLUSTOR™ family of shared data storage systems.

CLUSTOR allows you to integrate MicroVAXs and other small VAX CPUs, with or without DEC's bigger, high ticket iron. And it takes over most of the I/O functions that normally bog down those CPUs.

CLUSTOR is built around a true multitasking controller, capable of





overlapped seeks and simultaneous data transfers. Between up to 8 CPUs and 16 high performance mass storage devices.

As for what it costs, let's put it this way. When was the last time you saved six figures getting more performance? Up to 90% more, in I/O intensive environments.

And you can saddle it with complex multi-host configurations with no drop in performance.

CLUSTOR is just one example of how our systems can improve the performance of yours. We have a whole company full of people dedicated to doing nothing but that.

Including the largest, best-equipped, best-trained service and support organization this side of Route 128.

Give us a ring at **800-333-2220**.

We'll have all your horses pulling together in no time.



**SYSTEM  
INDUSTRIES**

CIRCLE NO 51



# Finally . . . PRECISION IN SURFACE MOUNT DEVICES

Yes, finally! Precision in a small package.

PMI's precision bipolar analog and CMOS converter product line is now offered in SMD. Write for our SMD brochure which lists the availability of 65 devices in various surface mount packages.

PMI's precision SMDs are available in commercial and industrial temperature ranges. The surface mount offerings include SO, SOL, LCC, and PLCC versions.

To get your SMD brochure, circle the reader service number or call . . . 1-800-843-1515.

You'll also receive a free copy of our new 1988 Data Book!

Precision Monolithics Inc.

A Bourns Company  
Santa Clara, California, USA  
408-727-9222

ORANGE COUNTY: (714) 637-9602. LOS ANGELES: (818) 886-6881. MILPITAS: (408) 942-8060.  
DALLAS: (214) 341-1742. CHICAGO: (312) 250-0808. ATLANTA: (404) 263-7995.  
PHILADELPHIA: (215) 675-7600. BOSTON: (617) 794-0026



*The precision solution.*

CIRCLE NO 52



## Digitally programmable 1-chip filters yield lower-cost data-acquisition systems

Tarlton Fleming,  
Associate Editor

Monolithic filters that combine programmability with the proven advantages of switched-capacitor (SC) technology promise to let engineers develop less-expensive, more versatile data-acquisition systems. By allowing a host processor to control the center frequency ( $f_0$ ) and quality factor ( $Q$ ) of an antialias filter, for instance, these devices enable the system to better accommodate a variety of signals within one channel.

Digital programming also enhances the value of SC state-variable (or universal) filters. These filters can produce any of the five basic frequency responses (lowpass, highpass, bandpass, band reject, or all-pass), and you can achieve higher values of odd- or even-order response by cascading the filter chips. The state-variable filters are useful for prototyping and for low-quantity requirements. Some of the recent programmable versions let you place the filter's frequency response,  $f_0$ , and  $Q$  under software control.

Although digital control is a new feature for monolithic-IC filters, companies such as Frequency Devices (Haverhill, MA) have offered digitally programmable conventional (RC) active filters for some time. These products come in 2×4-in. encapsulated modules that cost \$150 to \$300 each. Monolithic, programmable SC filters, on the other hand, present not only a different array of technical choices, but also smaller size and a lower price (\$25 typ). Manufacturers anticipate that these advantages will inspire an increased use of SC filters in programmable applications.

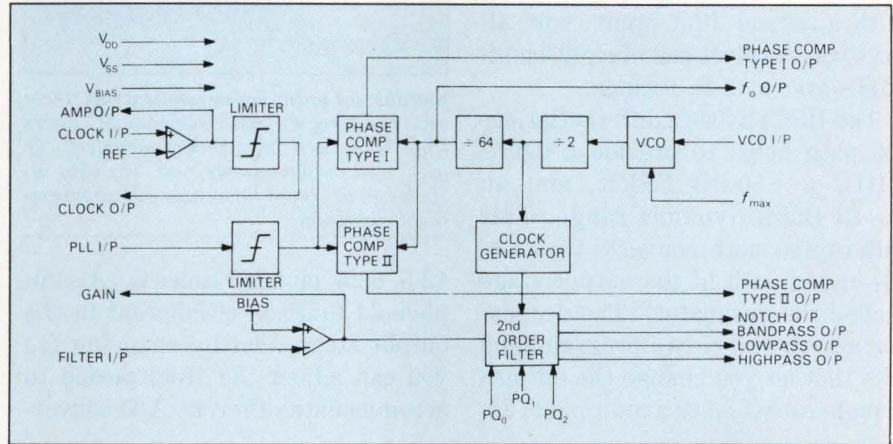

*Based on a phase-locked loop, this state-variable, switched-capacitor filter from Mx-Com produces a corner (or center) frequency ( $f_0$ ) that's equal to the PLL reference frequency that you apply to the chip.*

Standard-product filters pose a dilemma for an IC manufacturer's product planners: They must decide whether to offer a universal filter that will be of interest to many customers but only in small quantities, or whether to propose a more efficient design that targets a dedicated application. The second strategy can result in large initial orders, but it entails the risk that a commodity-IC manufacturer may take notice, duplicate the product, and capture much of the business. Competition from ASICs also complicates the planner's job. Manufacturers agree that filters residing on ASICs account for more than half of the new filter applications (aside from the large quantities of committed-purpose filters used in the military and the telecomm industry).

The category of nonuniversal, standard-product SC filters has few members. Exar offers several non-programmable devices: The eight XR-1001/1008 Series fourth-order lowpass filters cost \$1.30 to \$1.55 (100), and the seventh-order, elliptic, lowpass XR-1016 filter costs \$5.97 (100).

Honeywell's HSCF24040 is one of the few digitally programmable filters in this category. The monolithic HSCF24040 responds to the widespread need for bandlimiting (antialiasing) protection that precedes the A/D converter in an instrument or a data-acquisition system. The chip's SC section is a seventh-order, Chebyshev, lowpass ladder configuration that emulates a series-inductor/shunt-capacitor, LC-filter network. A 3-bit input code selects one of seven fixed ratios of clock to center frequency ( $f_{CLK}/f_0$ ). Further, you can vary  $f_{CLK}$  as required to obtain any  $f_0$  in the 78-Hz to 20-kHz range.

### Filters create alias frequencies

Because the SC filter itself can create alias frequencies as a result of the switched capacitors' sampling action (see box, "An overview of switched-capacitor filters"), designers often bandlimit the SC filter by preceding it with a conventional RC active filter. For convenience, Honeywell has included such a 3-pole, continuous-time, lowpass RC filter in the HSCF24040 chip. Internal



# TECHNOLOGY UPDATE

switches can connect the RC filter either to the SC-filter input, where it provides the antialias function, or to the SC-filter output, where it removes the SC filter's quantization noise. What's more, the RC-filter's  $f_0$  is also programmable—the chip's thin-film resistor network, along with a second 3-bit input code, allows you to select one of eight bandedges over a 12 to 1 range.

The HSCF24040's differential signal path helps to provide a 0.05% THD, a -50-dB PSRR, and an 85-dB (min) dynamic range. This differential path converts to a single-ended path in the output stage (called the decimator). The decimator also provides two programming bits that let you change the output-sample rate ( $f_{S/H}$ ) to a multiple of 25,

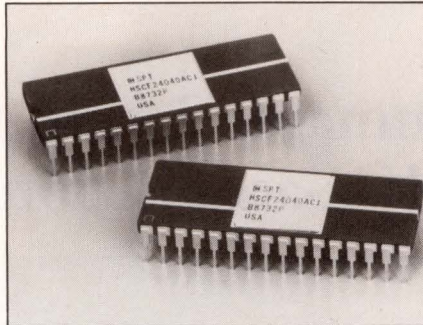

*Suitable for antialiasing applications, these seventh-order, lowpass-Chebyshev SC filters from Honeywell offer programmable  $f_0$ , dc gain, and output sample rate. The chip includes an RC input filter, also with programmable bandedge.*

12.5, 6.25, or 4.167 times  $f_0$ . (A sample/hold function is inherent in the output stage, and by changing  $f_{S/H}$  you can adjust the Hold period to accommodate different A/D-conver-

sion times.) Finally, the last two programming bits let you set the HSCF24040's overall gain to a value of 1, 2, 4, or 8. The device costs \$26.90 (100), comes in a 32-pin DIP, operates on  $\pm 5V$ , and dissipates about 150 mW.

One other programmable, non-universal SC filter is the ML202CP telephone-line equalizer from Micro Linear. This CMOS chip compensates for the frequency response of a telephone line by adjusting the signal spectrum's height (gain peak at 3250 Hz), its bandwidth, and the slope of its lower bandedge. You program these parameters by loading the chip's serial-data input with a 14-bit word that contains 4 bits each for the height, slope, and bandwidth. The device contains a clock

## An overview of switched-capacitor filters

If you need a frequency-agile, easily adjusted filter, or if ease of manufacture, simplicity, and freedom from calibration are paramount in your filter design, you should consider using a switched-capacitor (SC) type. For such applications, the SC filter's advantages may outweigh the noise, charge-injection, and alias-frequency effects that are inherent in the SC technology.

SC techniques were developed in the 1930s, but the first practical SC filters didn't appear until the 1960s, after the advent of the integrated circuit. AMI (now Gould Inc, Santa Clara, CA) introduced dual-tone multifrequency (DTMF) filters late in that decade, followed by EG&G Reticon and others; National Semiconductor's dual universal filter (the MF10) became an industry-standard component. Those early products suffered performance limitations related to the evolution of CMOS analog switches and op amps: They had low bandwidth; high levels of noise and clock feedthrough; tight power-supply tolerance; and excessive input-offset voltage, which was caused by charge injection from the switches. Today's SC filters offer much-improved specs, however, thanks to the ongoing refinements in circuit design and process technology.

Unlike digital filters, which operate on bit-parallel, digitally encoded data, SC filters and their conventional RC-filter counterparts operate on continuous analog-voltage waveforms. SC and RC

filters employ similar feedback networks around op amps, except that the SC circuit substitutes switched capacitors for the RC circuit's resistors. The SC filter's major disadvantage is the switching action that introduces discrete-time sampling in an otherwise continuous signal-processing circuit. Like an A/D converter, the SC filter produces phantom (alias) frequencies when operating on signals that exceed  $\frac{1}{2}$  the sampling (switching) frequency.

When alias frequencies are a problem, you must add a continuous-time bandlimiting filter at the SC filter's input. That is, you must provide an RC filter as antialiasing protection for the SC filter, which often is being used as antialiasing protection for something else! Adding the RC filter is justified, though, by the SC filter's advantages: The SC filter has few external components and an easily variable center frequency ( $f_0$ ), and its precise operation is stable both over temperature and from unit to unit. A high switching rate ( $f_{CLK}$ ) within the SC filter will ease the RC filter's job and generally minimize your concerns about aliasing.

SC filters usually fix the internal  $f_{CLK}/f_0$  ratio at 50 or 100; you then change  $f_0$  by varying  $f_{CLK}$ . In these applications, the RC antialiasing filter (if one is present) must maintain its  $f_0$  at a respectful distance from the SC filter's  $f_0$ . This requirement has led to an emerging need for RC lowpass fil-



# TECHNOLOGY UPDATE

generator; a 2-pole antialiasing filter; a highpass SC filter for 60-Hz rejection; height, slope, and bandwidth SC filters; and a 2-pole RC smoothing filter at the output. It costs \$8.95 (100), consumes 6 mW from  $\pm 5V$  supplies, and comes in a 16-pin DIP.

## A filter for all seasons

The universal filter's versatility has made it attractive to many filter manufacturers. Among the SC-filter offerings that are not digitally programmable, Linear Technology Corp's dual-filter LTC1060CN and triple-filter LTC1061CN are notable for their low levels of output noise: That parameter remains well under 100  $\mu V$  rms in many configurations, exclusive of clock feedthrough. The

LTC1060CN costs \$3.90 (100); the LTC1061CN sells for \$8.25 (100). (LTC also plans to introduce a monolithic quad filter later this year that features noise levels approximately half those of the LTC1061.) Micro Linear's dual universal ML2111CCS, which costs \$7.15 (100), has the distinction of the highest available  $f_0$  (150 kHz, with Q as high as 20).

Among universal SC filters with digitally programmed functions, the MX406P from Mx-Com provides a 3-bit input for setting eight values of Q between 0.54 and 8.0. The usual parallel outputs (lowpass, highpass, bandpass, and notch) are available, and you can set  $f_0$  between 100 Hz and 5 kHz. The CMOS chip includes a phase-locked loop (PLL), which

generates the internal clock signal at a frequency that is 64 times  $f_0$ ; you supply the PLL with a reference frequency equal to the desired  $f_0$ . This part costs \$5.63 (100), comes in a 22-pin DIP, operates on 5V, and consumes about 15 mW.

EG&G Reticon's RU5620A provides higher-resolution programming of Q and  $f_0$ . One 5-bit word lets you vary the  $f_{CLK}/f_0$  ratio from 50 to 200 in 32 logarithmic increments; you can set  $f_{CLK}$  as high as 1.25 MHz. A second 5-bit word sets Q to one of 32 values between 0.57 and 85.0, again in logarithmic increments. The NMOS chip costs \$4.70 (100), comes in an 18-pin DIP, operates with bipolar supplies in the  $\pm 5$  to  $\pm 10V$  range, and consumes 200 mW max (quiescent) at  $\pm 10V$ .

ters with digitally programmable corner frequencies.

The SC filter's output (a staircase of quasi-dc voltage levels) resembles that of a D/A converter. You can remove this quantization noise, if necessary, by adding another simple RC filter such as a passive RC network. But if the SC filter drives an A/D converter, the staircase output represents a sample/hold function that's potentially useful as an interface to an A/D converter. You must synchronize the converter with the filter, and the Hold interval must exceed the conversion time. Honeywell's HSCF24040 filter, for example, lets you change this Hold time by altering the output sample rate independently of  $f_{CLK}$ .

## What's a biquad?

The majority of SC-filter products comprise one or more second-order sections whose transfer function,  $H(s)$ , has the form

$$H(s) = \frac{As^2 + Bs + C}{s^2 + \frac{s\omega_0}{Q} + \omega_0^2},$$

where  $s$  is the complex-frequency variable and  $\omega_0 = 2\pi f_0$ . In the general case shown in the equation, the numerator and the denominator are quadratic (second-order) expressions, and there are two of them, so the function is labeled "biquadratic" or "biquad" for short.

Many circuit topologies yield (realize) the biquad transfer function, but the state-variable realization lets you set selected numerator coefficients to zero. The resulting "universal" circuit can give you a lowpass filter ( $A=B=0$ ), a highpass filter ( $B=C=0$ ), a bandpass filter ( $A=C=0$ ), or a band-reject filter ( $B=0$ ). Using all three coefficients gives you the allpass (phase-shift) filter. (Note that some engineers refer to the universal state-variable filter as a biquad, but others reserve the term "biquad" for a particular second-order bandpass filter that maintains constant bandwidth as you vary  $f_0$ .)

Finally, four attributes define any filter: the type (lowpass or highpass, for example), the  $f_0$  (which is called "center frequency" in bandpass and notch filters, and "corner frequency" in lowpass and highpass filters), the passband gain, and the Q. As the "quality factor" for second-order functions, Q serves as a figure of merit for the filters corresponding to those functions. For bandpass and notch filters, Q measures the sharpness of the response:  $Q = f_0 / (f_H - f_L)$ , where  $f_H$  and  $f_L$  are the filter's upper and lower -3-dB frequencies. For lowpass and highpass filters, Q describes the degree of amplitude peaking in the vicinity of  $f_0$ . By bringing one or more of these four attributes under software control, digitally programmable SC filters are expanding the capabilities of electronic systems.



# TECHNOLOGY UPDATE

You can achieve even higher resolution and more comprehensive programming of SC-filter functions by choosing a programmable device such as those from Crystal Semiconductor or Maxim Integrated Products. First, Maxim's MAX260/261/262 series of dual, second-order, universal filters gives you separate control of  $f_0$  and  $Q$  for each of the two independent sections. An internal memory stores the configuration data: Two 2-bit codes set each filter section in one of four modes, two 7-bit codes set each  $Q$  to one of 128 values (0.500 to 64.0 or 0.707 to 90.5, depending on the mode), and two 6-bit codes set each  $f_{CLK}/f_0$  ratio to one of 32 values. (You can obtain any intermediate ratio, of course, by varying  $f_{CLK}$ .)

Model MAX260BCNG has the highest range of  $f_{CLK}/f_0$  values, giving it the lowest  $f_0$  (7.5 kHz max) and the best spec for input-offset voltage (250 mV max). This device also includes autozero circuitry that improves the low-frequency performance while providing a sample/hold function at the chip's notch/highpass/allpass outputs. Its price is \$7 (100). Models MAX261 and -262, on the other hand, each contain an uncommitted amplifier

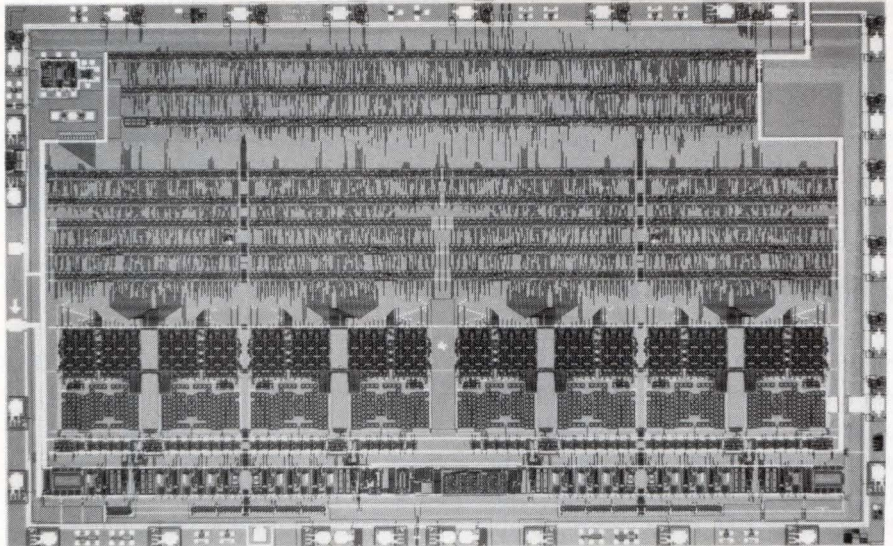

Containing four universal filter sections, this SC filter from Crystal Semiconductor offers digitally programmable  $f_0$ , filter order, and operating mode. The CMOS chip also includes a user-configurable input op amp and another uncommitted op amp.

that you can use for input anti-aliasing or output smoothing. Model MAX261BCNG has a maximum  $f_0$  of 30 kHz (with a  $Q$  of 8) and costs \$8.50 (100). Model MAX262BCNG achieves a maximum  $f_0$  of 75 kHz (with a  $Q$  of 8) by employing a lower range of  $f_{CLK}/f_0$  ratios; it costs \$11 (100).

All three models operate on 5V or  $\pm 5V$  supplies and come in 24-pin DIPs. Because the pinout allows only two data pins and a 4-bit ad-

dress, you must program the chip by writing a 16-word sequence of 2-bit words. Maxim offers four filter-design programs to simplify this task; the programs are free to customers who purchase any of the three filter models. When you use the programs, you first express the desired filter response in frequency-domain terms ( $f_0$ ,  $Q$ , passband ripple, and stopband attenuation). The programs calculate the necessary poles, zeros,  $Q$ s, and filter stages,

## For more information . . .

For more information on the digitally programmable, monolithic filters discussed in this article, contact the following manufacturers directly, circle the appropriate numbers on the Information Retrieval Service card, or use EDN's Express Request service.

**Crystal Semiconductor Corp**  
Box 17847  
Austin, TX 78760  
(512) 445-7222  
TWX 910-874-1352  
Circle No 725

**EG&G Reticon**  
345 Potrero Ave  
Sunnyvale, CA 94086  
(408) 738-4266  
TWX 910-339-9343  
Circle No 726

**Exar Corp**  
750 Palomar Ave  
Sunnyvale, CA 94086  
(408) 732-7970  
TWX 910-339-9233  
Circle No 727

**Honeywell Inc**  
Signal Processing Technologies  
150 E Cheyenne Mountain Blvd  
Colorado Springs, CO 80906  
(303) 577-1000  
TLX 452433  
Circle No 728

**Linear Technology Corp**  
1630 McCarthy Blvd  
Milpitas, CA 95035  
(408) 432-1900  
TLX 4993977  
Circle No 729

**Maxim Integrated Products**  
510 N Pastoria Ave  
Sunnyvale, CA 94086  
(408) 737-7600  
TWX 910-350-4114  
Circle No 730

**Micro Linear Corp**  
2092 Concourse Dr  
San Jose, CA 95131  
(408) 433-5200  
TLX 275906  
Circle No 731

**Mx-Com Inc**  
4800 Bethania Station Rd  
Winston-Salem, NC 27105  
(919) 744-5050  
TWX 510-101-2852  
Circle No 732

**National Semiconductor Corp**  
Box 58090  
Santa Clara, CA 95052  
(408) 721-5000  
TWX 910-339-9240  
Circle No 733



# Saratoga FIFOs.

**Our new FIFOs are the world's fastest. Available now in 10, 15, 25, 40 and 50 MHz.**

Slow interprocessor communication headaches. You thought you'd tried every buffering remedy in the book to get rid of them.

But here's one you haven't: *raw FIFO speed*. Using Saratoga's new family of BiCMOS FIFOs—the world's first 50-MHz first-in, first-out memories.

Organized as 64 words by 4 and by 5 bits wide, these RAM-based

devices deliver performance unmatched in the industry—at 10, 15, 25, 40 and 50 MHz.

Even so, they consume no more power than CMOS FIFOs, while offering high output drive that's TTL compatible. And they can be cascaded to expand in word width and depth. Plus they're available in both commercial and military temperature ranges, in industry-standard pin-outs.

This new generation of FIFOs

will soon include 64 by 9 and larger density 512, 1K and 2K by 9 devices. Joining Saratoga's existing lines of high-performance TTL and ECL static RAMs—also among the fastest now available. And all made possible by our proprietary BiCMOS technology—SABIC™—which combines the best of both the bipolar and CMOS worlds.

So if system timing headaches have got you down, take one of our new FIFO buffers. And call us in

the morning: (408) 864-0500. Or write: Saratoga Semiconductor, 10500 Ridgeview Court, Cupertino, CA 95014.

#### Saratoga FIFO Memories

Clock Frequency	50 MHz (40 MHz military)
Data Access Time	15 nsec
Data Set-up and Hold Time	3 nsec
Bubble-through Time	25 nsec (max)
Power Consumption	385 mW
Output Drive	16 mA

## Introducing

# The First 50-MHz FIFOs.

## In BiCMOS.



The Technology Leader in BiCMOS

CIRCLE NO 53





# Now in-house prototyping is truly affordable.

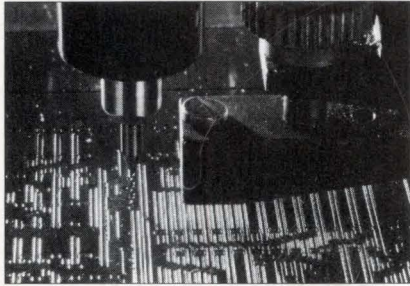

## Mills and drills circuits in minutes.

There's no reason to waste time and money sending out for prototype circuit boards any longer. With the new BoardMaker, you can make your own prototypes in your own lab directly from your PCB CAD—as fast as you need them.

## No delays or rush charges.

BoardMaker engraves single and double-sided boards, forming conductor lines as small as 5 mil. (There is a throughplate option too.)

A 2" x 3" board with medium density, for example, takes about 15 minutes. So you can save a week or more *at every level* of design development. You also save the money spent on outside sources, along with costly charges for rush service that can't compare with BoardMaker speed.

## No chemicals.

BoardMaker is totally *mechanical*. There are no chemicals, no fumes, and no toxicity problems.

## At \$5,000, pays for itself fast.

BoardMaker is revolutionary because it costs *one-sixth* the price of first generation prototype machines—and literally pays for itself after about a dozen boards. For more information, call (415) 883-1717 or use the reader card.



20A Pamaron Way  
Novato, CA 94948

CIRCLE NO 54

# TECHNOLOGY UPDATE

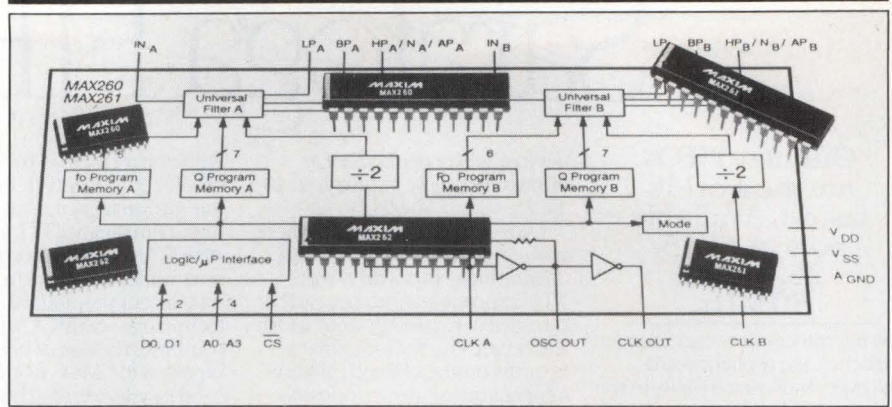

Dual universal SC filters from Maxim's MAX260 Series let you program the filter's  $f_0$  and  $Q$ , as well as its operating mode.

and compute the required digital input codes. You can load these codes into the chip via the parallel port of a personal computer, using a short Basic program listed in the filter's data sheet.

## Four biquads in a single chip

Crystal Semiconductor's monolithic, CMOS CS7008 is a more elaborate filter that contains four universal "biquad" SC sections. Available in a 28-pin DIP, the device has six data lines and six address lines, which give you access to a 6-bit x 64-word memory for storing the configuration data. An 11-bit word configures the biquads in a cascade of 1, 2, 3, or 4 sections, and a 3-bit clock-divide code sets  $f_0$ . For each biquad, a 2-bit word sets the filter mode. The remaining memory stores 11-bit words that define each of 24 programmable capacitors (six in each section).

The CS7008 lets you define any second-, fourth-, sixth-, or eighth-order response, including lowpass, highpass, bandpass, allpass, notch, lowpass notch, and highpass notch. Corner frequencies ( $f_0$ ) can range from 1 Hz to 25 kHz typ (the manufacturer hasn't yet determined the max  $f_0$ ). The chip includes an op amp that's connected to the input for use as a gain amplifier or RC anti-aliasing filter, and another uncommitted op amp for general use. The company also makes the CS7004, which is pin compatible with the 7008, but contains two biquad sections instead of four.

Before either chip can function, you must load it with valid data. Crystal's CDS7000 development system computes this data for you; the system includes an in-circuit emulator that provides immediate feedback on the proposed filter's performance. The CDS7000 consists of menu-driven software, the emulator-electronics module, and cables. You must provide an IBM PC or compatible computer with an 8087 math coprocessor, a Hercules monochrome graphics card (or a compatible card), 256k bytes of memory, and PC-DOS or MS-DOS version 2.1 or higher. The CS7008-P filter costs \$30 (100); Crystal expects this price to drop by a third within nine months. The CDS7000 development system costs \$3595. **EDN**

Article Interest Quotient  
(Circle One)

High 512 Medium 513 Low 514



No matter  
how you  
look at our  
new line of 3½-inch  
hard disk drives,

Quantum  
delivers.



*“Half my job is taking risks...”*

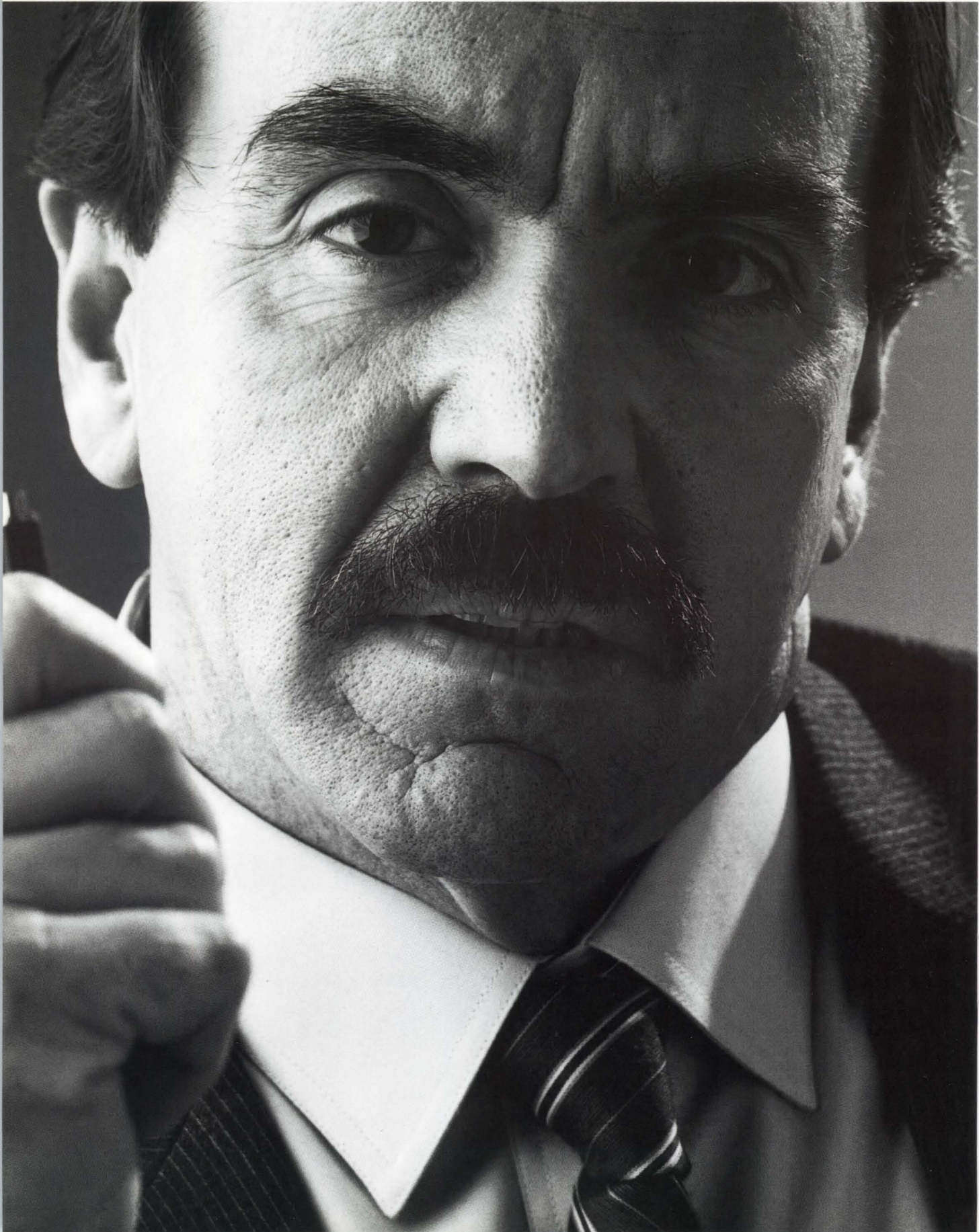



# *the other half is managing them. We simply can't afford second-best."*

WHAT YOU SHOULD KNOW ABOUT THE NEW PRODRIVE™ SERIES OF 3½-INCH HARD DISK DRIVES FROM QUANTUM.

In a fast-paced, competitive marketplace, your suppliers can make you... or break you.

That's why it's important to go with a leader. One with a broad product line to meet your systems needs today. And one with the resources and technology to grow as your needs grow tomorrow.

That's why you should know about Quantum.

Our new ProDrive Series of 3½-inch hard disk drives is *available now* in 42 and 84 megabyte formatted capacities with SCSI interface. And later this year, we'll be shipping capacities up to 168 megabytes, in SCSI, ESDI, and AT-Bus. Ten new drives in all.

Which means our ProDrive Series offers you the broadest range of capacities in the broadest range of interfaces in the industry.

All with access times of 19 milliseconds or less. All with our proprietary DisCache™ data buffer that can increase system throughput by as much as 50%, making our fast drives even faster. And all with a 50,000-hour MTBF.

No one offers you higher performance with higher reliability.

And no one has more experience in the 3½-inch form factor. We pioneered the 3½-inch hard disk add-in card for PCs, and created Plus Development Corporation to develop and market it. Since 1986, Plus™ has shipped over 300,000 3½-inch Hardcard™ products worldwide.

The Quantum ProDrive Series builds on that same Hardcard technology, and is manufactured in the same high-volume, world-class facility.

Leading technology. Leading performance. Leading reliability. From a leading company.

That's what you expect today.

That's what you want tomorrow.

That's what Quantum delivers.

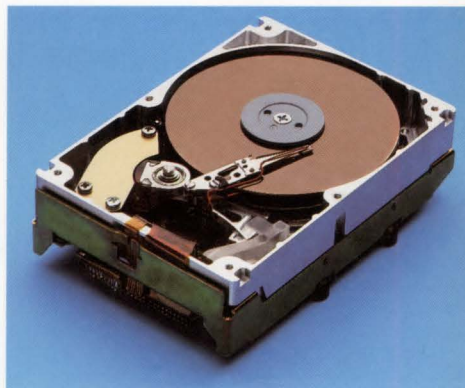

#### INTRODUCING THE PRODRIVE SERIES

- 3½-inch form factor
- 42, 84, 103, 120, 145, 168 MBs formatted
- SCSI, ESDI, AT-Bus
- 19 ms or faster average access time
- 64 KB buffer with exclusive DisCache™
- 50,000-hour MTBF
- 42, 84 MB SCSI evaluation units AVAILABLE NOW
- 42, 84 MB AT-Bus units available early summer '88

**Quantum**



*"I shop the specs*

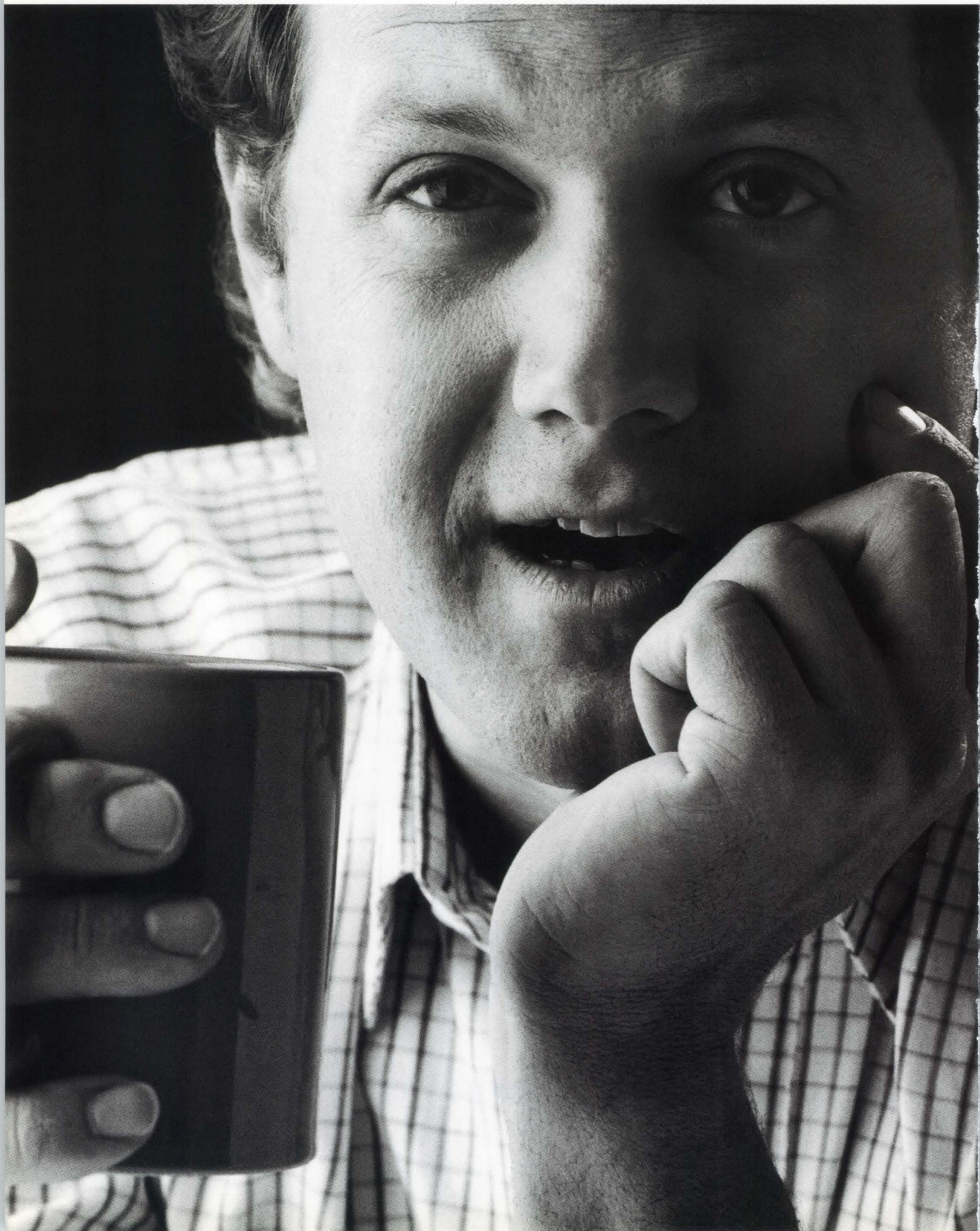



# *because it's my job. But I buy the product because it's my career."*

WHAT YOU SHOULD KNOW ABOUT THE NEW PRODRIVE™ SERIES OF 3½-INCH HARD DISK DRIVES FROM QUANTUM.

The numbers are the easy part. Either a product has them or it doesn't.

But you can't build a system out of specs.

You also need dedicated product-support people who will sit down and help you solve some tough engineering problems and put those specs to work.

Quantum is ready to deliver both.

Our new ProDrive Series of 3½-inch hard disk drives offers you the broadest range of capacities in the broadest range of interfaces in the industry. 42 and 84 megabyte formatted with embedded SCSI interface right now. And later this year, up to 168 megabytes, in SCSI, ESDI, and AT-Bus. Ten new drives in all.

All with access times of 19 ms or less.

With synchronous data transfers to the SCSI bus of 4 megabytes per second, and asynchronous data transfers of 2 megabytes per second.

With an MTBF of 50,000 hours.

And with DisCache™, Quantum's unique 64 kilobyte data-buffering scheme that can make our 19-ms drive perform like a 12-ms drive—or even faster, depending on your application.

But Quantum also offers you the people who can help you put those numbers to work in your own system. A dedicated team of engineering professionals who understand the particular needs of the systems designer—and can help meet those needs quickly, efficiently, cost-effectively.

The new ProDrive Series. The specs you want. The support you need.

That's what Quantum delivers.



#### INTRODUCING THE PRODRIVE SERIES

- 3½-inch form factor
- 42, 84, 103, 120, 145, 168 MBs formatted
- SCSI, ESDI, AT-Bus
- 19 ms or faster average access time
- 64 KB buffer with exclusive DisCache™
- 50,000-hour MTBF
- 42, 84 MB SCSI evaluation units  
AVAILABLE NOW
- 42, 84 MB AT-Bus units available early summer '88

**Quantum**



*“I purchase 1,571 products*

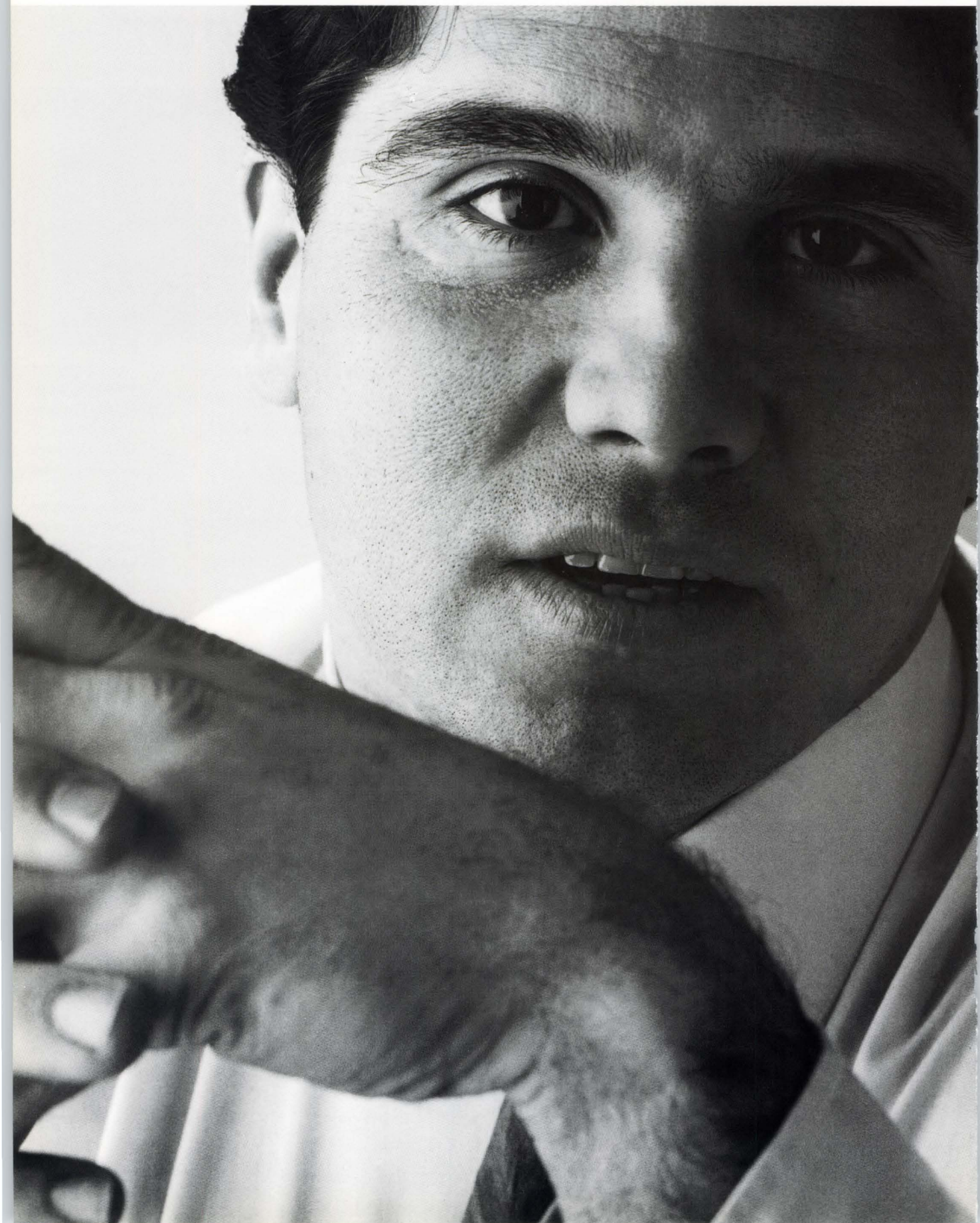



# *for my company. Don't tell me just about price, tell me about cost."*

WHAT YOU SHOULD KNOW ABOUT THE NEW PRODRIVE™ SERIES OF 3½-INCH HARD DISK DRIVES FROM QUANTUM.

Successful system designs begin as an idea in someone's mind. But they end up as a purchase request on your desk.

The challenge, of course, is to balance the demands of engineering for product performance with the demands of management for financial restraint.

Quantum can help you do that.

Our new ProDrive Series of 3½-inch hard disk drives is *available now* in 42 and 84 megabyte formatted capacities with embedded SCSI interface. And later this year, in capacities up to 168 megabytes, in SCSI, ESDI, and AT-Bus. Ten new drives in all.

The broadest range of capacities in the broadest range of interfaces in the industry.

All with unequalled price/performance ratios.

And all backed by a high-volume, world-class manufacturing capability that has already delivered over 300,000 3½-inch hard disk drives to the retail market.

Which means you can meet a wide range of systems demands today—and a wide range of systems upgrades tomorrow.

And because Quantum has a customer acceptance rate of over 99% for all our products, you can reduce costly pretesting, reduce inventories, and reduce product backlogs.

So your engineers get the high performance they want.

Your managers get the low cost of ownership they want.

And you get the wide range of products you want.

All from one company.

That's what Quantum delivers.

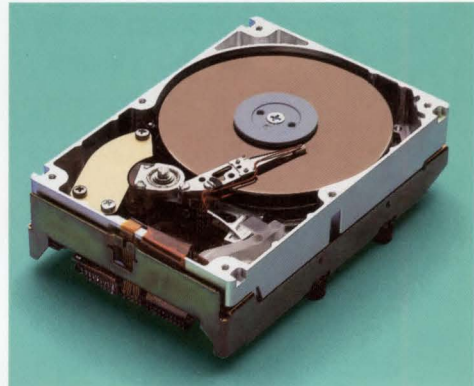

## INTRODUCING THE PRODRIVE SERIES

- 3½-inch form factor
- 42, 84, 103, 120, 145, 168 MBs formatted
- SCSI, ESDI, AT-Bus
- 19 ms or faster average access time
- 64 KB buffer with exclusive DisCache™
- 50,000-hour MTBF
- 42, 84 MB SCSI evaluation units
- AVAILABLE NOW
- 42, 84 MB AT-Bus units available early summer '88

**Quantum**



## Introducing the ProDrive™ Series

## High-performance 3½-inch hard disk drives

	Pro40	Pro80	Pro100	Pro120	Pro145	Pro170
Capacity (Formatted)	42 MB	84 MB	103 MB	120 MB	145 MB	168 MB
Interfaces	SCSI, AT-Bus	SCSI, AT-Bus	ESDI	SCSI, AT-Bus	ESDI	SCSI, AT-Bus
Access Time (Typical)	19 ms	19 ms	<19 ms	<19 ms	<19 ms	<19 ms
DisCache™	64 KB*	64 KB*		64 KB*		64 KB*
Effective Seek Time with DisCache™	12 ms**	12 ms**		12 ms**		12 ms**
MTBF (POH)	50,000	50,000	50,000	50,000	50,000	50,000

\*16 KB in AT-Bus versions

\*\*As with any caching scheme, actual performance depends on the application.

### QUANTUM SALES OFFICES

#### DOMESTIC OPERATIONS:

Quantum Corporation  
1804 McCarthy Blvd.  
Milpitas, CA 95035  
(408) 432-1100  
TWX 910-338-2203  
Fax (408) 943-0689

#### WESTERN REGIONAL OFFICE:

4633 Old Ironsides Drive  
Suite 270  
Santa Clara, CA 95054  
(408) 980-8555

#### SOUTHWEST SALES:

2659 Townsgate Road  
Suite 101  
Westlake Village, CA 91361  
(805) 495-7955

#### EASTERN REGIONAL OFFICE:

18 Pelham Road  
Salem, NH 03079  
(603) 893-2672

#### SOUTHEAST SALES:

2710 Jefferson Street  
Austell, GA 30001  
(404) 944-7442

#### EUROPEAN OPERATIONS:

Quantum GmbH  
Hahnstrasse 70  
D-6000 Frankfurt/M.71  
West Germany  
(49) 069-666-6167  
Telex 417166  
Fax (49) 69-666-1043

Quantum Peripheral Products Ltd.  
Runnymede Malt House  
Runnymede Road  
Egham, Surrey, TW20 9BO England  
(011) 44-784-34377  
Telex 919778  
Fax (44) 784-31923

# Quantum

Specifications subject to  
change without notice.

ProDrive and DisCache are  
trademarks of Quantum Corporation.

Plus and Hardcard are trademarks of  
Plus Development Corporation.

Copyright 1988 Quantum Corp. U.S.A.



# Power and Precision. Piezoelectric Actuators from Tokin.

A job worth doing, is worth doing with excellence and impeccability. That means not compromising standards. Especially where multilayer piezoelectric actuators are concerned. And that brings us to Tokin. Because when you get the inside story on Tokin actuators, you won't settle for less.

The difference comes from Tokin's exclusive *non-adhesive sintering, HIP (hot isostatic press)* and *insulation* processes. Combined, they deliver an incomparable boost in mechanical strength.

Tokin offers two types of piezoelectric actuators. Powerful, supersensitive stack-type actuators for printers and piezoelectric relays. And bimorph types for low-voltage (60V), large displacement applications.

Don't compromise. And don't procrastinate. Call us now.

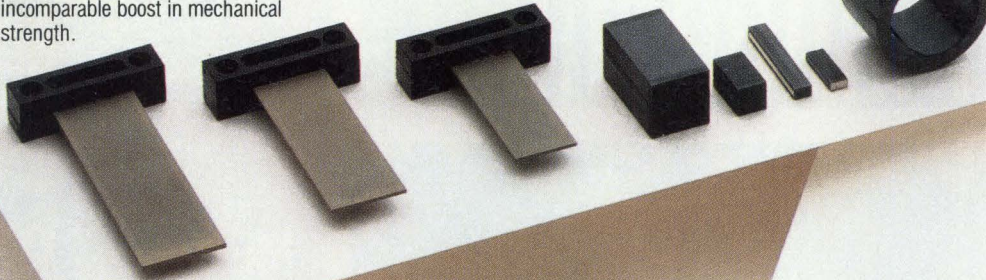

## Shapes and Dimensions

### Stack type NLA-10 × 10 × 18

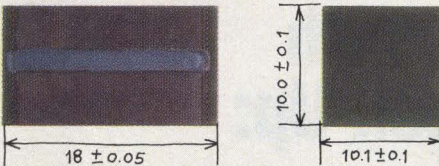

### Bimorph type NLB-40 × 12 × 1

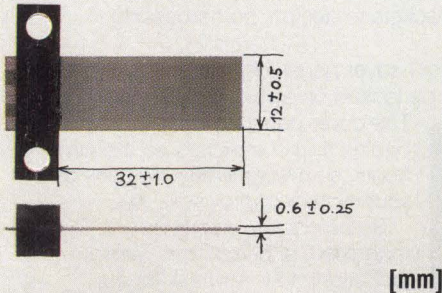

[mm]

## Voltage vs. Displacement

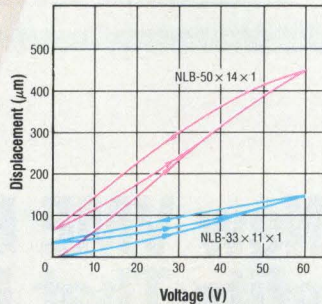

## Force generation vs. Displacement (measured at 60V DC)

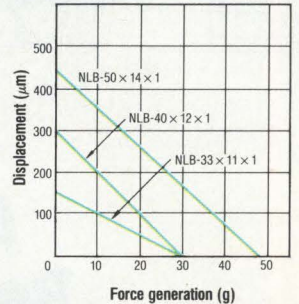

## Voltage vs. Displacement

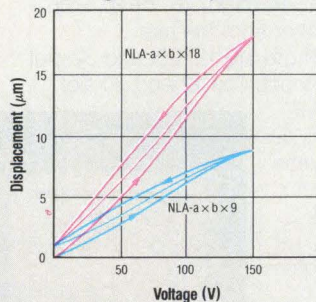

Displacement reduction ratio is 5% or less at 85°C.

## Force generation vs. Displacement (measured at 100V DC)

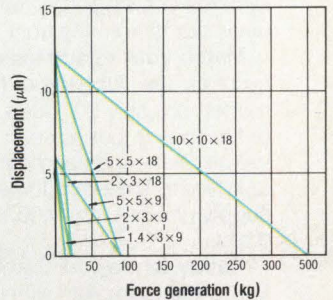

## Performance

	Dielectric displacement	Force generation
Stack type	( $\mu\text{m}/100\text{V}$ ) $\pm 10\%$	( $\text{kg}/100\text{V}$ ) $\pm 20\%$
NLA-1.4 × 3 × 9	6.5	14.0
NLA-2 × 3 × 9	6.5	21.0
NLA-2 × 3 × 18	15.0	21.0
NLA-5 × 5 × 9	6.5	87.0
NLA-5 × 5 × 18	15.0	87.0
NLA-10 × 10 × 18	15.0	350.0
Bimorph types	( $\mu\text{m}/60\text{V}$ ) $\pm 20\%$	( $\text{g}/60\text{V}$ ) $\pm 20\%$
NLB-33 × 11 × 1	150	30
NLB-40 × 12 × 1	300	30
NLB-50 × 14 × 1	450	48

# Tokin

**Tokin Corporation**

**Head Office**  
Hazama Bldg., 5-8, Ni-chome, Kita-Aoyama,  
Minato-ku, Tokyo 107, Japan  
Tel: Tokyo (03) 402-6166 Fax: Tokyo (03) 497-9756  
Telex: 02422695 TOKIN J

**Tokin America Inc.**

155 Nicholson Lane, San Jose, California 95134, U.S.A.  
Tel: 408-432-8020 Fax: 408-434-0375

**Chicago Branch**  
Presidents Plaza 1, Suite 200N, 8600 W. Bryn Mawr,  
Chicago, IL 60631  
Tel: 312-380-0030 Fax: 312-693-8334

**München Liaison Office**

Elisabethstraße 21, 8000 München 40, Bundesrepublik Deutschland  
Tel: (089) 271 75 22 Fax: (089) 271 75 67 Telex: 5 24 537 tokin d

You can reach our agents by phone: London 01-837 2701; Paris 1-45 34 75 35; Milan (0331) 678.058; Munich (089) 5164-0; Seoul (02) 777-5767; Taipei (02) 7311425; Hong Kong 3-315769; Singapore 747-8668

CIRCLE NO 55



# Gemini.

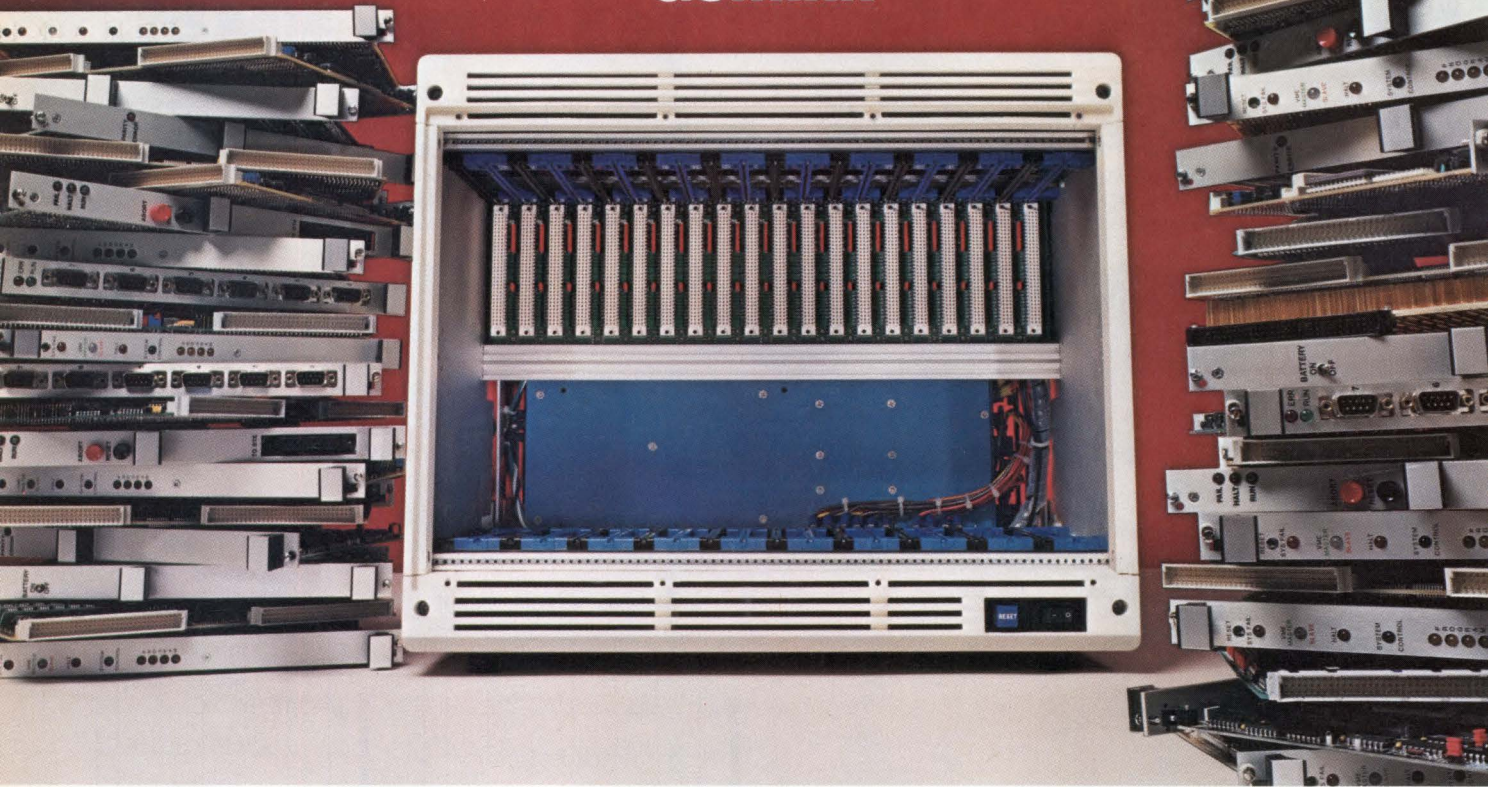

## A New VME Enclosure with Benefits That Really Stack Up:

**40 Slot Capacity.** Big systems in less space. In its maximum configuration, Gemini has two 20-slot VME card cages and two power supplies—two complete 20-slot VME systems in a single package only 14" high, 26" deep. One takes cards from the front, the other from the rear.

**Match your needs exactly.** There are 12, 20, and 32-slot systems, too. Tabletop or rack mount. The 12 and 20 slot models are only 20" deep for VME or Multibus II, but you can get triple height (9U) cages and card depths to 400mm. There are three power supply choices from 400 to 800 Watts.

**Ready to play.** All Geminis come fully wired, complete with high-performance VME or Multibus II J1

backplanes. Just add your cards.

**Disk drive modularity.** The 12 and 32-slot models have slide-in peripheral mounting assemblies that hold up to four half-height drives. No brackets to design, no harnessing to make.

**RFI tight.** There's a front cover panel that holds RFI in (and out) so your system will be looked on approvingly by the FCC.

The cover panel covers all those cables and connectors on the card fronts, so everyone else will look on your system approvingly, too.

So before you stack this magazine, phone for our Gemini facts right now. And ask for our complete catalog of VME, Multibus and Multibus II system packaging.

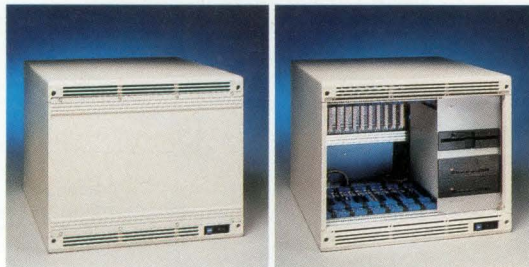

**We'll FAX you the facts.**

REQUESTED INFORMATION  
PLEASE RETURN IMMEDIATELY

TO: \_\_\_\_\_  
COMPANY: \_\_\_\_\_  
FAX: \_\_\_\_\_

**FAXSHEET**

GEMINI SERIES  
VME SYSTEM  
ENCLOSURE

INDICATIONS

POWER SUPPLY

GENERAL INFORMATION

Want the latest data in a hurry?  
Nothing is faster than Electronic  
Solutions' new "FAX the FACTS" pro-  
gram. If you have a FAX machine, just  
call our "800" number, give us your  
FAX number and type of FAX  
machine, and the information you  
need from us. We'll FAX it to you  
immediately.



**Electronic  
Solutions**  
UNIT OF ZERO CORPORATION

6790 Flanders Drive, San Diego, CA 92121 • (619) 452-9333 Telex II(TWX): 910-335-1169

**Call Toll Free: (800)854-7086 In Calif: (800)772-7086**

CIRCLE NO 56



## Instrument combines 100-MHz digital scope with 48-channel logic analyzer

The Omnilab 9240 combines a full-function 100-MHz digital storage oscilloscope (DSO) with a 48-channel logic analyzer. The unit is housed in a 15×5.4×11.5-in. enclosure with its own power supplies, and it requires a PC/AT or compatible computer for display and control.

The fact that the instrument executes the functions of both a DSO and a logic analyzer doesn't detract from its performance. Consider the DSO function, for example. The Omnilab 9240 can digitize one channel at 204M samples/sec and two channels at 102M samples/sec. For repetitive waveforms, the DSO has an equivalent-time-sampling rate of 680M samples/sec on both channels. **Table 1** gives some of the key specifications for both the DSO and the logical-analyzer functions.

When you acquire waveforms with the instrument, you can use its signal-averaging mode to reduce noise, or you can choose point-accumulate, envelope, or normal mode. After acquiring a waveform, you can scroll through the entire waveform record or zoom in on a specific area. The standard 4k-sample record memory holds enough data to fill 12 screens. Besides obtaining the standard waveform displays, you can select cursors for digital readouts of voltage or time. You can also choose other digital readouts—such as frequency, rise time, and peak-to-peak voltage—for continuous display. The display is updated 15 times/sec.

When it's used as a logic analyzer, the Omnilab 9240 can sample asynchronously at rates as high as 204M samples/sec. Unlike most logic analyzers, the Omnilab 9240 has equivalent time sampling, a DSO feature that gives you the equivalent of a 680M-sample/sec rate on 48 channels for repetitive events. This fea-

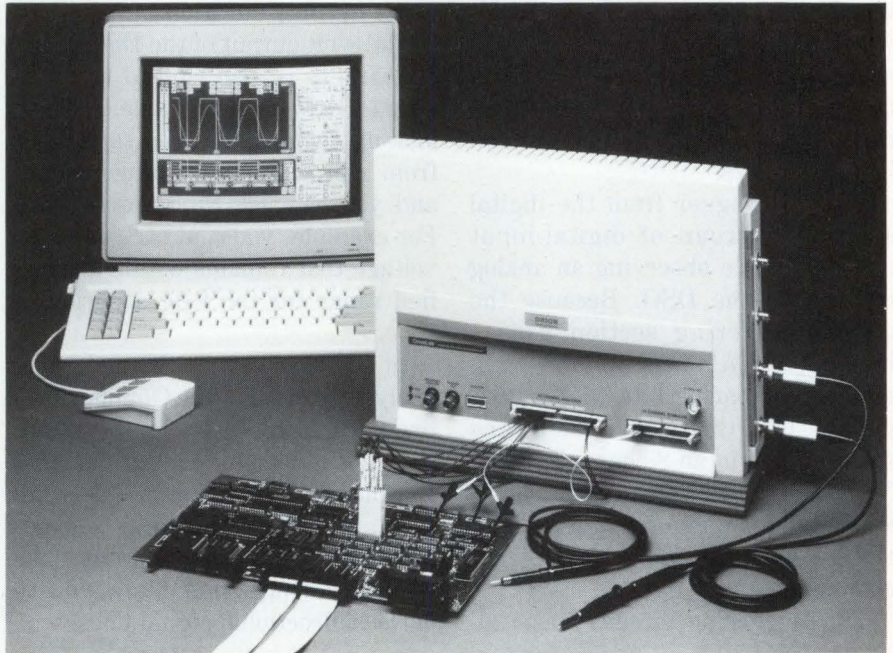

*Performing both digital and analog sampling at 204M samples/sec, the Omnilab 9240 lets you run DSO and logic-analysis functions simultaneously. You use a host PC/AT or compatible computer for control, display, and data storage.*

ture gives you 1.5-nsec timing resolution for repetitive events. For synchronous clocking applications, you can sample at as much as 34M samples/sec on all 48 channels. The vendor offers disassemblers for more than 100 different microprocessors.

The instrument also lets you use the DSO and logic-analysis functions simultaneously. At 34M samples/sec, you can use two DSO channels and 32 logic-analyzer channels. For repetitive signals, you can use two DSO channels and 32 logic-analyzer channels, all with equivalent

**TABLE 1—OMNILAB 9240 SPECIFICATIONS**

DIGITAL-STORAGE-OSCILLOSCOPE FUNCTION	
BANDWIDTH	100 MHz
MAX SAMPLE RATE	204M SAMPLES/SEC
RECORD LENGTH	4k SAMPLES (64k SAMPLES OPTIONAL)
VERTICAL RESOLUTION	8 BITS
VERTICAL SCALING	5 mV/DIV TO 10V/DIV
LOGIC-ANALYZER FUNCTION	
ASYNCHRONOUS OPERATION	48 CHANNELS AT 34M SAMPLES/SEC
	16 CHANNELS AT 102M SAMPLES/SEC
	8 CHANNELS AT 204M SAMPLES/SEC
SYNCHRONOUS OPERATION	48 CHANNELS AT 34M SAMPLES/SEC
SETUP TIME	1 nSEC
HOLD TIME	4 nSEC
GLITCH DETECTION	5 nSEC



# PRODUCT UPDATE

time sampling at 680M samples/sec. The logic-analyzer and DSO displays are time correlated.

The instrument's triggering functions include the standard analog slope and level triggering for signals within the DSO's 100-MHz bandwidth. Because the Omnilab 9240 is also a logic analyzer, its DSO function can share many trigger functions that are usually found only on logic analyzers.

You can trigger from the digital state of a group of digital-input channels while observing an analog input with the DSO. Because the digital-triggering section uses a high-speed RAM look-up table rather than comparing bits with a trigger register, the trigger can be any set of values in an 8-channel group. You can logically combine multiple 8-channel groups for trigger conditions requiring more than eight channels.

The triggering circuitry also al-

lows you to specify as many as four sequential events combined with event counters that can count as many as 1 million events before triggering. The instrument can also use clock-driven counters to qualify an event by time duration.

The 8-bit output of the DSO's A/D converters is also routed to high-speed RAM look-up tables. These look-up tables allow you to trigger from a programmed voltage range, and you can use timing qualifiers. For example, you could trigger on a voltage that remains within a specified range for too long a period of time.

In addition to its DSO and logic-analysis functions, the Omnilab 9240 provides 24 digital-stimulus channels with a 4k-bit (or an optional 16k-bit) pattern memory. The stimulus generator, which has a maximum clock rate of 34 MHz, has 3-state outputs that allow you to drive bidirectional signal lines.

The stimulus generator also has an analog-output channel: An 8-bit DAC provides analog stimulus generation over a full-scale amplitude range of 8 mV to 8V. The instrument's standard function-generator outputs include sine, triangle, and square waves, but you can also generate your own waveform or play back waveforms captured by the DSO. The stimulus generator can run simultaneously with the logic analyzer and DSO. The Omnilab 9240 costs \$8900.—**Doug Conner**

*Orion Instruments Inc, 702 Marshall St, Redwood City, CA 94063. Phone (415) 361-8883. TLX 530942.*

**Circle No 699**

**OYSTER 64**  
Graphics LCD for diagrams, special characters, etc., with 16 char. x 4 lines in text mode; redefinable keyboard; 75-9600 baud; range of interfaces.

**PC COMPACT**  
Hand-held replacement for an IBM PC, XT, AT, PS/2 and compatible keyboards. 32 keys on standard keyboard.

**OYSTER 84B**  
20 char. x 4 line LCD, battery-powered, 8K memory, control character display, 75-19200 baud, range of interfaces.

**OYSTER RT80**  
20 char. x 4 line LCD, battery-powered, programmable in C or BASIC, up to 1Mb RAM, redefinable keyboard, 75-19200 baud.

## HAND-HELD TERMINALS A FEW PEARLS FROM THE OYSTER RANGE

Are you wasting time and money developing and manufacturing a hand-held terminal? Why, when Oyster's extensive range has a unit with the specification and field-proven reliability you need?

The range starts with simple ASCII keyboards and goes right on up to sophisticated programmable, battery-powered terminals. The units on the left are just a few examples of what we can offer.

For OEMs we have a special engineering service, enabling us to customise any of our standard units to specific requirements.

If you can't see exactly what you want, then give us a call.

- Applications include:
- PRINTING
  - AEROSPACE
  - TELECOMMUNICATIONS
  - PROCESS CONTROL
  - ATE

1640 Fifth Street,  
Santa Monica, CA 90401  
Tel: (213) 395-4774.  
Telex: 65-2337.  
Facsimile: (213) 393-6040  
301 Daniel Webster Highway,  
Merrimack, NH 03054  
Tel: (603) 429-2566





Z I L O G



# The highest performance and highest integration, ever. Together on a single 16-bit chip.

The Z280™ gives you a more powerful CPU and higher performance peripherals than you've ever seen on a 16-bit chip. Think of it as a complete microsystem on a chip.

## Unmatched performance...

Start with the most powerful 16-bit engine available, add on-board Cache, MMU and Burst Mode memory support — and you'll begin to understand the Z280's power and potential.

## ...powerful on-board peripherals...

Imagine the savings in cost and board size when you have peripherals like 4 DMA channels that'll give you transfers at 6.6 Mbytes/sec, and a full-duplex UART.

... and the glue to tie it all together.

With a DRAM Controller to support up to 1 MBit DRAMs and

Programmable Wait State Logic — on board — you're really looking at significant glue reduction.

## Z280: Truly a microsystem.

The Z280 gives you a lot more performance. In a lot less board space. All off the shelf and backed by Zilog's proven quality and reliability. Plus, it's binary code-compatible with the Z80® and priced to rival 8-bit chips. And all the development support tools you need are available from industry leaders. Contact your local Zilog sales office or your authorized distributor today. Seeing is believing. Zilog, Inc., 210 Hacienda Ave., Campbell, CA 95008 (408) 370-8000.

	Z280™	80186	68070
<b>Package</b>	68-pin PLCC/CMOS	68-pin LCC/NMOS	84-pin PLCC/CHMOS
<b>Typical Power</b>	375 mW	2 W	800 mW (est)
<b>Speed</b>	10-25 MHz	8-12.5 MHz	10 MHz
<b>Memory Support</b>	16 Mb Physical Paged	1 Mb Physical Segmented	16 Mb Physical 8 or 128 Segments
<b>16-bit Registers</b>	12 General	8 General	15 Dedicated
<b>Instruction Pre-fetch</b>	256-Byte Assoc. Cache; Burst Mode	6-Byte Queue	None
<b>Multiprocessor Support</b>	Local or Global	Local only	Local only
<b>Wait Logic</b>	Programmable	Programmable	Hardwire
<b>DMA</b>	4 Channels, 6.6 Mb/s @ 10 MHz	2 Channels 2 Mb/s @ 8 MHz	2 Channels, 3.2 Mb/s @ 10 MHz
<b>Counter/Timers</b>	3 16-bit	3 16-bit	2 16-bit
<b>Serial I/O</b>	1 Full-Duplex UART	None	1 Full-Duplex UART
<b>DRAM Controller</b>	10-bit Refresh	None	None
<b>Price (100)</b>	\$33	\$43	\$50

## The choice is clear.

## Right product. Right price. Right away.

**ZILOG SALES OFFICES:** CA (408) 370-8120, (714) 432-9971, (818) 707-2160, CO (303) 494-2905, FL (813) 585-2533, GA (404) 923-8500, IL (312) 885-8080, MA (617) 273-4222, MN (612) 831-7611, NJ (201) 288-3737, (609) 778-8070, OH (216) 447-1480, TX (214) 231-9090, **CANADA** Toronto (416) 673-0634, **ENGLAND** Maidenhead (44) (628) 781227, **W. GERMANY** Munich (49) (89) 612-6046, **JAPAN** Tokyo (81) (3) 587-0528, **HONG KONG** Kowloon (852) (3) 723-8979, **R. O. C.:** Taiwan (886) (2) 731-2420, **U.S. AND CANADA DISTRIBUTORS:** Anthem Electric, Bell Indus., Graham Elec., Hall-Mark Elec., JAN Devices Inc., Lionex Corp., Schweber Elec., Western Microtech., **CANADA** Future Elec., SEMAD.

**Zilog**  
an affiliate of  
**EXON** Corporation



## Single-output current-mode power supply packs 3000W in a 5×8×13½-in. package

Series 9R power supplies comprise 2, 3, 5, 12, 15, 24, 28, 36, and 48V devices. Each of the current-mode switchers outputs 3000W and fits in a 5×8×13½-in. package—only 4 in. longer than the industry-standard 1500W package.

The 3000W rating derives from the four inverters that operate in parallel within each device. The inverters share equally in the production of output current because they are synchronized and employ current-mode control; the current-mode design also lets you connect multiple power supplies in parallel.

The multiple inverters furnish a degree of fault tolerance to a system in which you use a Series 9R supply. Should one of the device's four inverters fail, the supply will continue to operate at a reduced power level; for example, if only three of a 5V, 600A supply's inverters are operating, it can nonetheless produce 500A.

Consequently, you can specify a 3000W supply in a system that only requires 2500W and thereby ensure that the system will continue to operate even if an inverter fails. If one does, the power supply outputs a TTL signal indicating the condition. The system operator can then replace the power supply at his or her convenience.

Series 9R supplies meet domestic and international safety standards. They operate from a 120 or 208V ac 3-phase source, or from a 230V ac single-phase source. You can power them with a 200 to 365V dc source.

The supplies typically operate at 75% efficiency when running from a 230V ac source. When operating in the 0 to 50°C range, they supply

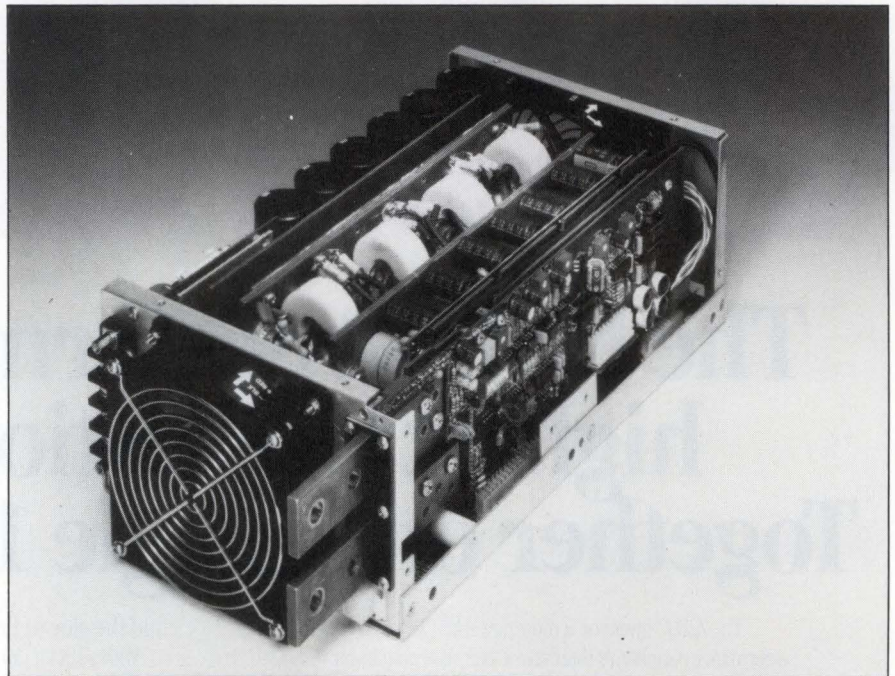

*The four inverters employed in each Series 9R supply make it fault tolerant and permit it to continue operating even if one of the inverters fails.*

100% of their rated load, although the 2V device can only supply 1400W because of output-bus-bar and rectifier-diode current-carrying limitations.

Current-limiting circuitry in the supplies regulates their maximum peak current to 120% of their rated current, and the devices recover automatically upon removal of the short-circuit or overload condition. In the event of overvoltage, the supplies' inverters shut down at factory-set trip points. For further overvoltage protection, you can specify an SCR-crowbar feature as an option.

The devices have terminals for remote sensing, and you can remotely control the supplies' output to within ±10% of nominal. The supplies also produce signals indi-

cating valid output or input-power failure.

Other key specs include the greater of 5 mV or 0.1% for line regulation, and the greater of 10 mV or 0.2% for load regulation; dynamic response of 4% max output deviation as a result of a 25% step load change; output recovery within 1% of nominal in 200 μsec; and thermal regulation of ±0.02%/°C.

The vendor is shipping samples of the Series 9R supplies. \$1800.

—Maury Wright

Bonar Powertec, 20550 Nordhoff St, Chatsworth, CA 91311. Phone (818) 882-0004. TWX 910-494-2092.

Circle No 700





# MOTOROLA

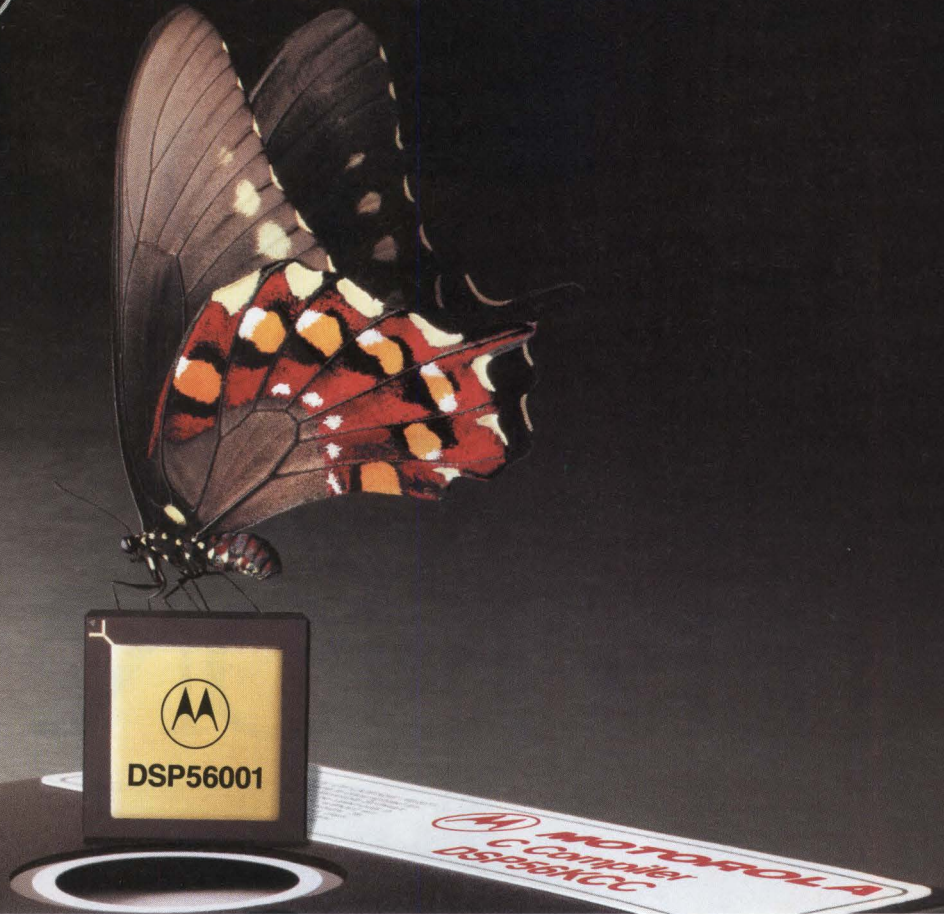

## New wings for DSP.

### Motorola announces availability of the first real C language compiler for DSP applications.

A new dawn has arrived for DSP programmers. Using the new C language compiler from Motorola you can now write DSP code using a high level language. The DSP56KCC C-compiler is a full Kernighan and Ritchie C implementation supporting development of the high performance DSP56000 family applications.

This easy-to-use program features compiler assembly language with full in-line code capability and a C-language preprocessor to support MACRO expansion, file inclusion, and conditional compilation. Using it, programmers can perform the entire compilation process in a single step. It also facilitates incremental compilation so that your time-critical DSP codes can be optimized.

The DSP56KCC is available for use on the IBM PC for MS DOS and PC-DOS, Sun 3 for UNIX BSD 4.2, VAX for VMS Version 4.2, VAX for UNIX BSD 4.2, and for the Macintosh II.

#### One-on-one Design-in help.

Get an engineer-to-engineer update on using the Motorola DSP56KCC C-cross compiler.

## 1-800-521-6274

Call toll-free any weekday, 8:00 a.m. to 4:30 p.m., M.S.T. If the call can't answer

all your questions we'll have a local applications engineer contact you.

For printed data on the DSP56KCC, complete and return the coupon below.

**We're on your design-in team.**



# MOTOROLA

	To: Motorola Semiconductor Products, Inc. P.O. Box 20912, Phoenix, AZ 85036	
	<b>Please send me more information on Motorola's DSP56KCC C-cross compiler.</b>	
	Name _____	352EDN031788
	Title _____	
	Company _____	
	Address _____	
	City _____ State _____ Zip _____	
	Call me (_____) _____	



# HOW TO END THE OPTICAL ILLUSION.

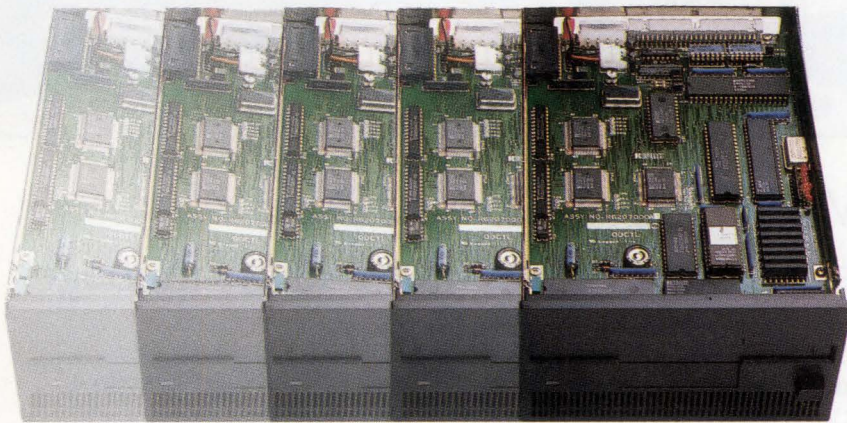

People have been talking about optical drives for years. But have you ever actually seen one work?

Well, now you can.

Because while others were talking about optical drives and solutions, Maxtor was developing them. And now we're shipping our 800MB 5¼-inch optical WORM drive in volume.

It's the first in our family of optical drives. And it's perfect for high-volume back-up, image or archival storage.

It's offered with a full complement of integration software and hardware, including media, cable and host adapter. Or it's available as a fully-configured plug-and-play mass storage subsystem.

Either way, it's fully compatible with most popular computers.

So don't wait to make optical drives a reality for your system.

Contact the Maxtor distributor or sales office listed below for complete technical and ordering information.

Because seeing is believing.

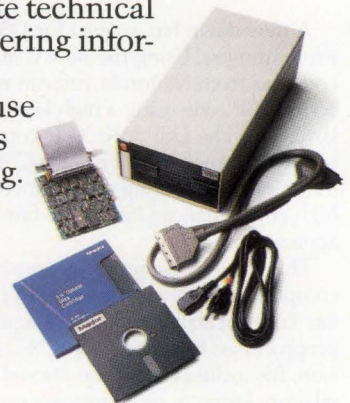

## Maxtor

Sales offices: Atlanta (404) 455-4226, Austin (512) 345-2742, Boston (617) 872-8556, New Jersey (201) 747-7337, Orange County (714) 472-2344, San Jose (408) 435-7884, Woking, England (44)/4862-29814, Tokyo, Japan 81-3-431-8940.

Distributed by Anthem Electronics, (714) 768-4444, (408) 295-4200, (617) 657-5170, Future Electronics, (514) 694-7710, Pioneer Standard Electronics, Inc., (216) 587-3600, (301) 921-0660, Quality Components, Inc., (214) 733-4300, Storex Corporation, (617) 769-3400, Storage Dimensions, Inc., (408) 395-2688.

© 1987 Maxtor Corporation

CIRCLE NO 60



# WHERE TO END THE OPTICAL ILLUSION.

# PRODUCT UPDATE

## Matrix-switching system connects 2880 cross points

Engineers who work with a lot of relays may be interested in the Model 707 matrix-switching system for electronic-device and -circuit testing. Housed in a 6-slot mainframe that plugs into any IEEE-488 automatic-test equipment (ATE) system, the 707 can connect as many as 2880 cross points on a breadboard prototype of an IC or on a pc board. It also provides a light-pen user interface, which simplifies test development.

You can connect as many as five of the 707 mainframes, each of which can switch configurations of as many as eight 72-pin paths. The cards available for the slots in each mainframe include a general-purpose matrix for microvolt to 200V signal levels, a coaxial matrix for low-noise shielded interconnections, a semiconductor matrix card that automates both current-voltage (IV) and capacitance-voltage (CV) tests through two high-isolation current paths, and a universal adapter card for prototyping or troubleshooting.

Because the unit controls all those switches through one master device, you can set up as many as 200 matrices per second while monopolizing only one IEEE-488 address. The unit's nonvolatile matrix memo-

ry retains as many as 100 of those matrix settings for fast-triggered relay sequences or rapid recall. The 707 also provides a simplified wire-connection feature that lets you use standard coaxial cable instead of custom assemblies. In addition, you don't have to hard-wire the plug-in cards together, because the 707's analog backplane automatically carries the signals from one card to another.

The 707 has a front-panel LED matrix display that represents the cross points on the circuit under test. It also has a continuous switch-status display, so you can determine the status of a relay by glancing at the panel. The light-pen user interface lets you change the state of a relay simply by touching the front panel with the pen. This method reduces both the setup time and the potential for errors.

The Model 707 costs \$3500. The light-pen interface sells for \$250, and prices for the plug-in cards range from \$800 for the universal adapter card to \$4900 for the semiconductor matrix card.

—J D Mosley

Keithley Instruments Inc, 28775 Aurora Rd, Cleveland, OH 44139. Phone (216) 248-0400.

Circle No 698

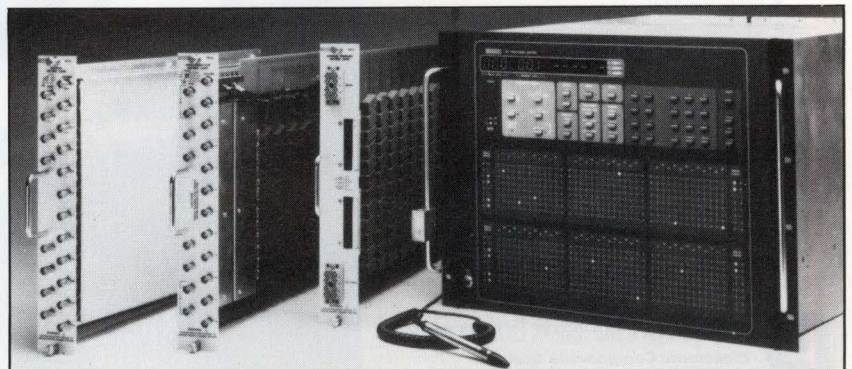

Besides providing a light-pen user interface that simplifies testing, the Model 707's front-panel LED matrix display lets you note the status of as many as 2880 cross points at a glance.

<b>ALABAMA</b> (205) 837-9300 (P) (205) 830-1881 (Q)	<b>MISSOURI</b> (314) 432-4350 (P)
<b>ARIZONA</b> (602) 966-6600 (A)	<b>NEW JERSEY</b> (201) 575-3510 (P) (201) 227-7960 (A)
<b>CALIFORNIA</b> (818) 700-1000 (A) (714) 768-4444 (A) (916) 922-6800 (A) (619) 453-9005 (A) (408) 295-4200 (A)	<b>NEW YORK</b> (516) 921-8700 (P) (516) 273-1660 (A) (607) 722-9300 (P) (716) 381-7070 (P)
<b>COLORADO</b> (303) 790-4500 (A)	<b>N. CAROLINA</b> (704) 527-8188 (P) (919) 876-7767 (Q) (919) 544-5400 (P)
<b>CONNECTICUT</b> (203) 853-1515 (P) (203) 237-2282 (A)	<b>OHIO</b> (216) 587-3600 (P) (513) 236-9900 (P)
<b>FLORIDA</b> (305) 834-9090 (P) (305) 428-8877 (P)	<b>OKLAHOMA</b> (918) 664-8812 (Q)
<b>GEORGIA</b> (404) 448-1711 (P) (404) 449-9508 (Q)	<b>OREGON</b> (503) 643-1114 (A)
<b>ILLINOIS</b> (312) 437-9680 (P) (312) 640-6066 (A)	<b>PENNSYLVANIA</b> (412) 782-2300 (P) (215) 674-4000 (P) (215) 443-5150 (A)
<b>INDIANA</b> (317) 849-7300 (P)	<b>TEXAS</b> (512) 835-4000 (P) (214) 386-7300 (P) (713) 988-5555 (P) (214) 733-4300 (Q) (512) 835-0220 (Q) (713) 240-2255 (Q)
<b>KANSAS</b> (913) 492-0500 (P)	<b>UTAH</b> (801) 973-8555 (A)
<b>MARYLAND</b> (301) 921-0660 (P) (301) 995-6640 (A)	<b>WASHINGTON</b> (206) 881-0850 (A)
<b>MASSACHUSETTS</b> (617) 861-9200 (P) (617) 657-5170 (A) (617) 769-3400 (S)	<b>CANADA</b> (403) 235-5325 (F) (403) 438-2858 (F) (514) 694-7710 (F) (613) 820-8313 (F) (416) 638-4771 (F) (604) 294-1166 (F) (204) 339-0554 (F)
<b>MICHIGAN</b> (313) 525-1800 (P) (616) 698-1800 (P)	
<b>MINNESOTA</b> (612) 944-3355 (P) (612) 944-3045 (A)	

(A) = Anthem Electronics  
(P) = Pioneer  
(Q) = Quality Components  
(S) = Storex  
(F) = Future Electronics, Inc.

# Maxtor

CIRCLE NO 59



**WHEN PRECISION  
AND PERFORMANCE  
ARE CRITICAL,  
CHECK  
DELEVAN/DELCAP**

**For Custom-Engineered Surface Mountable Coils and Inductors:**

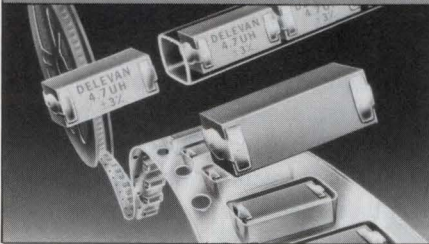

- 1%, 3% Tolerance for Unshielded Matched Parts, 0.022 $\mu$ H to 150,000 $\mu$ H
- 5% Shielded, from 0.1 $\mu$ H to 10,000 $\mu$ H

**For Multilayer Ceramic Chip Capacitors:**

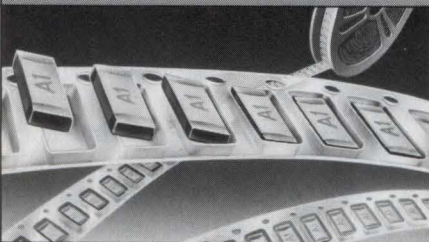

- Exceed RS 198 & MIL C-55681
- Class I COG (NPO) from 1.0 pFd to .027 $\mu$ Fd
- Class II X7R - 100 pFd to .68 $\mu$ Fd
- Leach resistant terminations

**For the ultimate in engineering capability:**

- Matched parts on reel or magazine
- Tight tolerance
- Laser marking
- Custom values or dimensions
- Environmental lab qualification
- Specialized burn-in
- SPC program
- Hi-reliability performance

**For fast answers to your really tough application problems call (716) 652-3600; Telex 91-293; Fax (716) 652-4814**



**AMERICAN PRECISION INDUSTRIES**  
**Electronic Components Group**  
270 Quaker Road,  
East Aurora, NY 14052-0449

MADE IN AMERICA BY AMERICAN CRAFTSMEN  
TO AMERICAN STANDARDS OF EXCELLENCE

**CIRCLE NO 86**

## PRODUCT UPDATE

### Analog-signal multiplexer plugs into Macintosh II

The Amux-64 card provides analog-signal-multiplexing capability for the vendor's NB-MIO-16 multifunction data-acquisition card for the Apple Macintosh II. The multiplexer card resides in a card cage and connects via a cable to the data-acquisition card, which resides in the Macintosh II.

The multiplexer card provides 16 separate 4:1 analog-multiplexer circuits and can multiplex as many as 64 single-ended or 32 differential inputs. The NB-MIO-16 card provides 16 analog-input channels, a 12-bit A/D converter capable of rates as fast as 100k samples/sec, two multiplying 12-bit D/A converters, eight digital I/O lines, and three independent 16-bit counter/timers. You can daisy-chain as many as four Amux-64 cards, thus allowing the NB-MIO-16 to measure as many as

256 single-ended analog inputs simultaneously.

Each Amux-64 card has two 50-pin, male DIN connectors for connecting ribbon cables. One cable connects directly to the I/O connector of the NB-MIO-16 card, which plugs into the chassis of the host computer. You can use the other connector to daisy-chain multiple Amux-64 cards. The Amux-64 sells for \$695. Prices for the NB-MIO-16 vary from \$1195 to \$1495, depending on the A/D-converter speed.

—**J D Mosley**

*National Instruments, 12109 Technology Blvd, Austin, TX 78727. Phone (800) 531-4742; in TX, (800) 433-3488. TLX 756737.*

**Circle No 697**

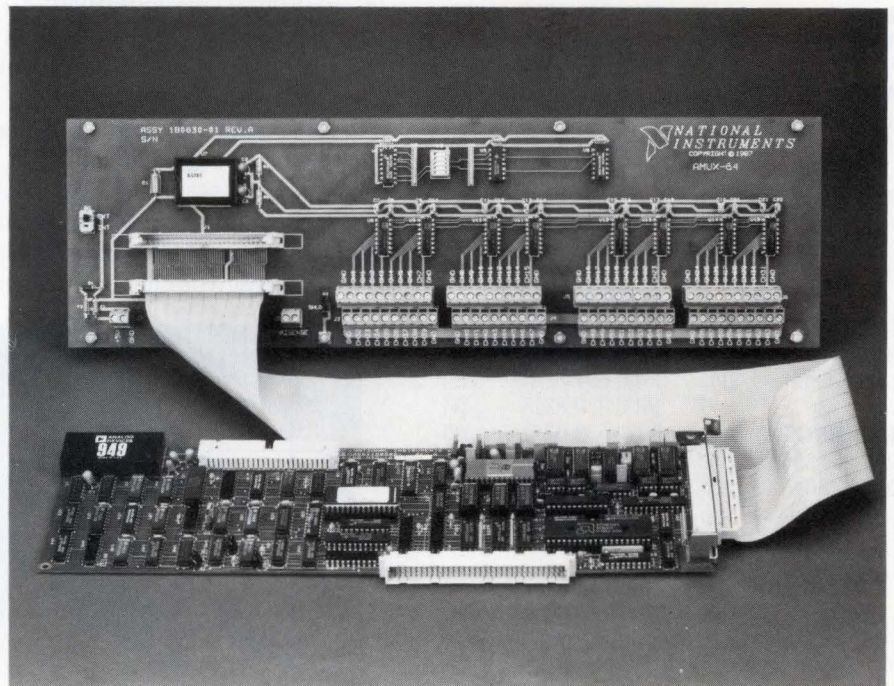

**Daisy-chaining as many as four Amux-64 analog-signal-multiplexer cards to the NB-MIO-16 data-acquisition card lets your Macintosh II measure as many as 256 single-ended analog signals simultaneously.**



**FEATURES**

**12-Bit Resolution and Accuracy**

**Fast Conversion Time**

AD7672XX03 - 3 $\mu$ s

AD7672XX05 - 5 $\mu$ s

AD7672XX10 - 10 $\mu$ s

**Unipolar or Bipolar Input Ranges**

**Low Power: 110mW**

**Fast Bus Access Times: 90ns**

**Small, 0.3", 24-Pin Package**

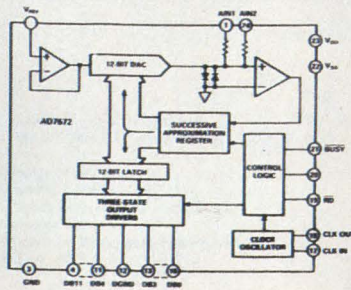

AD7672 Functional Block Diagram

**PRODUCT DESCRIPTION**

The AD7672 is a high-speed 12-bit ADC, fabricated in an advanced, mixed technology, Linear-Compatible CMOS (LC<sup>2</sup>MOS) process, which combines precision bipolar components with low-power, high-speed CMOS logic. The AD7672 uses an accurate high-speed DAC and comparator in an otherwise conventional successive-approximation loop to achieve conversion times as low as 3 $\mu$ s while dissipating only 110mW of power.

To allow maximum flexibility, the AD7672 is designed for use with an external reference voltage. This allows the user to choose a reference whose performance suits the application, or to drive many AD7672s from a single system reference, since the reference input of the AD7672 is buffered and draws little current. For digital signal processing applications, where absolute accuracy and temperature coefficients may be unimportant a low-cost reference can be used. For maximum precision, the AD7672 can be used with a high-accuracy reference such as the AD588.

The on-chip clock-circuit may be used with a crystal for accurate definition of conversion time. Alternatively the clock input may be driven from an external source such as a microprocessor clock.

**PRODUCT HIGHLIGHTS**

1. Fast, 3 $\mu$ s, 5 $\mu$ s and 10 $\mu$ s conversion speeds make the AD7672 ideal for a wide range of applications in telecommunications, sonar and radar signal processing or any high-speed data acquisition system.
2. LC<sup>2</sup>MOS circuitry gives high precision with low power drain (110mW typ)
3. Choice of 0 to +5V, 0 to +10V or  $\pm$ 5V input ranges, accomplished by pin-strapping.
4. Fast, simple, digital interface has a bus access time of 90ns allowing easy connection to most microprocessors.
5. Available in space-saving 24-pin, 0.3" DIP or surface mount package.

**AT 5 $\mu$ S, WE SET  
THE 12-BIT A/D RECORD. THIS PAGE  
TELLS HOW WE BROKE IT.**



When we introduced our AD7572, it set the monolithic 12-bit A/D conversion speed record at 5 $\mu$ s.

Now, our AD7672 establishes a new record with an even

faster conversion time of only 3 $\mu$ s.

This blazing speed is reached with only 110mW of power dissipation because the AD7672, like the AD7572, is manufactured on an advanced merged bipolar/CMOS process.

The 90ns bus access time of the AD7672 affords easy interfacing with most microprocessors, while the +5V and -12V nominal power supply voltages allow its use in PC and modem designs. All this is available in a narrow 0.3" DIP or a surface mount package.

The AD7672 also features unipolar or bipolar analog inputs that are selected by pin-strapping. This lets you avoid external circuitry for input range changing.

The 3 $\mu$ s version of the AD7672 is available for as little as \$63.75; the 5 $\mu$ s version, from \$37.40; and the 10 $\mu$ s model, from \$28.05 (1000s).

For more information on how the AD7672 can speed up your designs, call Applications Engineering at (617) 935-5565, Ext. 2628 or 2629. Or write to Analog Devices, P.O. Box 9106, Norwood, MA 02062-9106.



# Your next destination:





# The ACL Computer Age.

## The future belongs to computers and peripherals built with RCA Advanced CMOS Logic (ACL).

The pressure is on to make your systems smaller, faster, cheaper.

Some of your competitors are doing just that by incorporating ACL into their new designs. If you want to stay on the fast track, you can't afford not to consider ACL for your new designs.

### The computer of the future.

Imagine a computer with power dissipation so low you could eliminate all cooling systems. Or design a sealed system to prevent dust problems.

And get dramatically improved reliability, thanks to the far lower heat generated. As well as far smaller system size.

You'd also be able to use it in a far wider operating temperature range (-55°C to +125°C). Even in high-noise environments.

### FAST\* speed, CMOS benefits.

Advanced CMOS Logic gives you high speed (less than 3ns propagation delay with our AC00 NAND gate) and 24 mA output drive current.

But unlike FAST, it gives you a whole new world of design opportunity for computers, peripherals, telecommunications and other speed-intensive applications.

ACL dissipates less than 1/8 Watt while switching, compared to 1/2 Watt for a FAST IC (octal transceiver operating at 5 MHz). And quiescent power savings are even more dramatic: ACL idles at a small fraction of the power of a FAST IC.

\*FAST is a trademark of Fairchild Semiconductor Corp.

In Europe, call: Brussels, (02) 246-21-11; Paris, (1) 39-46-57-99; London, (276) 68-59-11; Milano, (2) 82-291; Munich, (089) 63813-0; Stockholm (08) 793-9500.



**GE Solid State**

**GE/RCA/Intersil Semiconductors**

Three great brands. One leading-edge company.

In addition, ACL offers balanced propagation delay, superior input characteristics, improved output source current, low ground bounce and a wider operating supply voltage range.

### Latch-up and ESD protection, too.

Latch-up concern is virtually eliminated, because ACL uses a thin epitaxial layer which effectively shorts the parasitic PNP transistor responsible for SCR latch-up.

And a dual diode input/output circuit provides ESD protection in excess of 2KV.

### A broad and growing product line.

Our line already includes over 100 of the most popular types (SSI, MSI and LSI). More are coming soon. And many are available in High-Rel versions.

### All this at FAST prices.

Our ACL line is priced comparably to FAST. So you get better performance at no extra cost. Why wait, when your competition is very likely designing its first generation of ACL products right now?

Get into the passing lane, with RCA ACL from the CMOS leader: GE Solid State. Free test evaluation kits are available for qualified users. Kits must be requested on your company letterhead. Write: GE Solid State, Box 2900, Somerville, NJ 08876.

For more information, call toll-free 800-443-7364, extension 24. Or contact your local GE Solid State sales office or distributor.



# READERS' CHOICE

Of all the new products covered in EDN's **January 7, 1988**, issue, the ones reprinted here generated the most reader requests for additional information. If you missed them the first time, find out what makes them special: Just circle the appropriate numbers on the Information Retrieval Service card, or refer to the indicated pages in our **January 7, 1988**, issue, or use EDN's Express Request service.

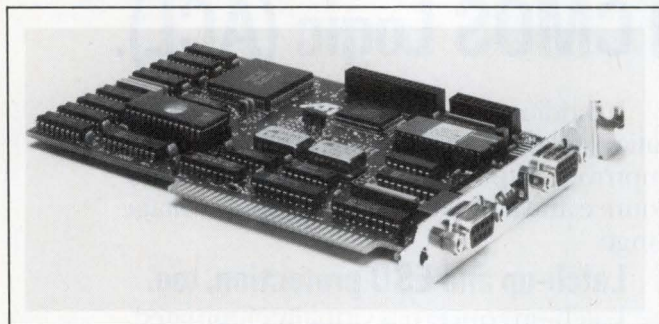

## ◀ GRAPHICS CARD

The VIP video graphics adapter (VGA) card works with the IBM PC, PC/XT, PC/AT, PS/2 Model 30, Compaq Portable PC, and compatibles. It can display all 17 VGA modes on analog monitors (pg 228).

**ATI Technologies Inc.**

**Circle No 604**

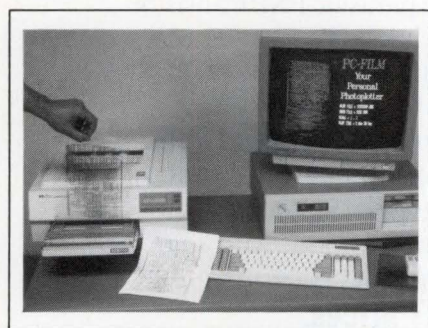

## ▲ PHOTO-PLOT SYSTEM

The PC-Film photo-plotting package provides a rasterizer card that plugs into your IBM PC or compatible and software that interfaces the system to a 300-dot/in. laser printer (pg 255).

**CAD Solutions Inc.**

**Circle No 605**

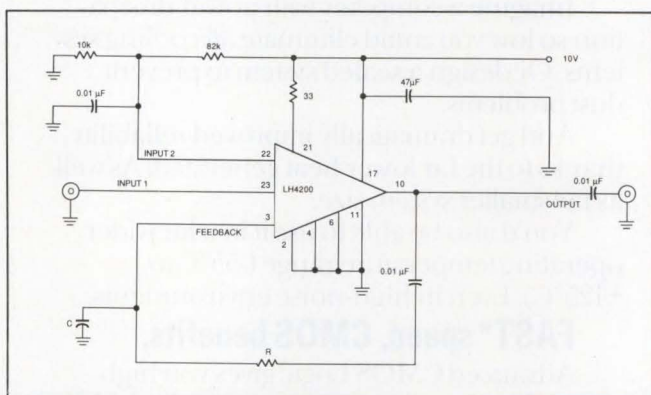

## ▲ HYBRID AMPLIFIER

The LH4200 is a general-purpose 500-kHz to 1-GHz amplifier that includes internal decoupling capacitors to simplify its use (pg 103).

**National Semiconductor Corp.**

**Circle No 602**



## ▲ MEMBRANE KEYPADS

The Series 4000 membrane keypads are available in 4x4 and 3x4 arrays with embossed, detented, or flat nontactile keys (pg 215).

**C&K Components Inc.**

**Circle No 603**

## CALCULATORS

The HP-27S calculator offers both scientific and financial functions to aid the engineering manager who must do engineering design as well as figure out budgets. The HP-28S, an upgrade of the HP-28C, has 32k bytes of user RAM and an augmented user interface (pg 106).

**Hewlett-Packard Co.**

**Circle No 601**



This year, you'll  
hear a lot of claims  
that "systems"  
design automation  
has arrived.

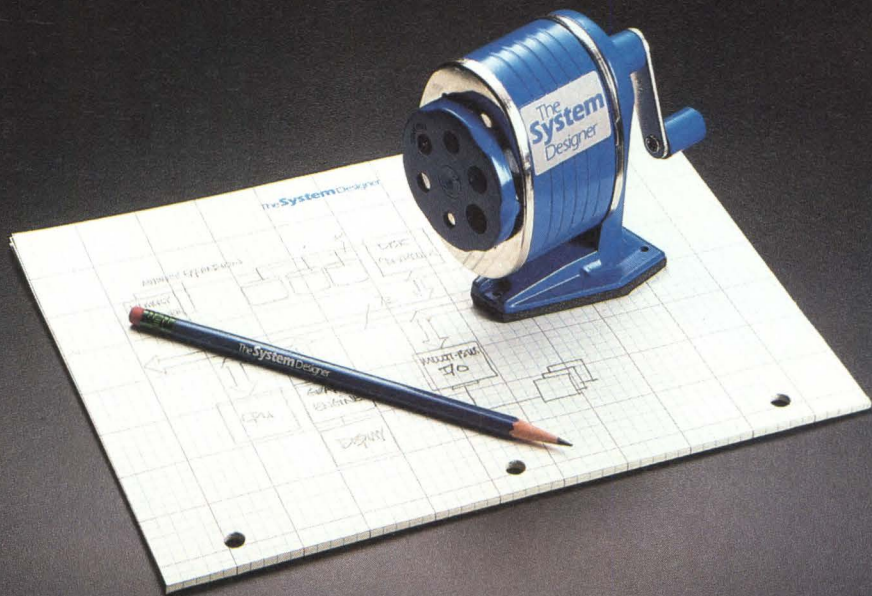



# At Mentor Graphics, we And so do our customers.

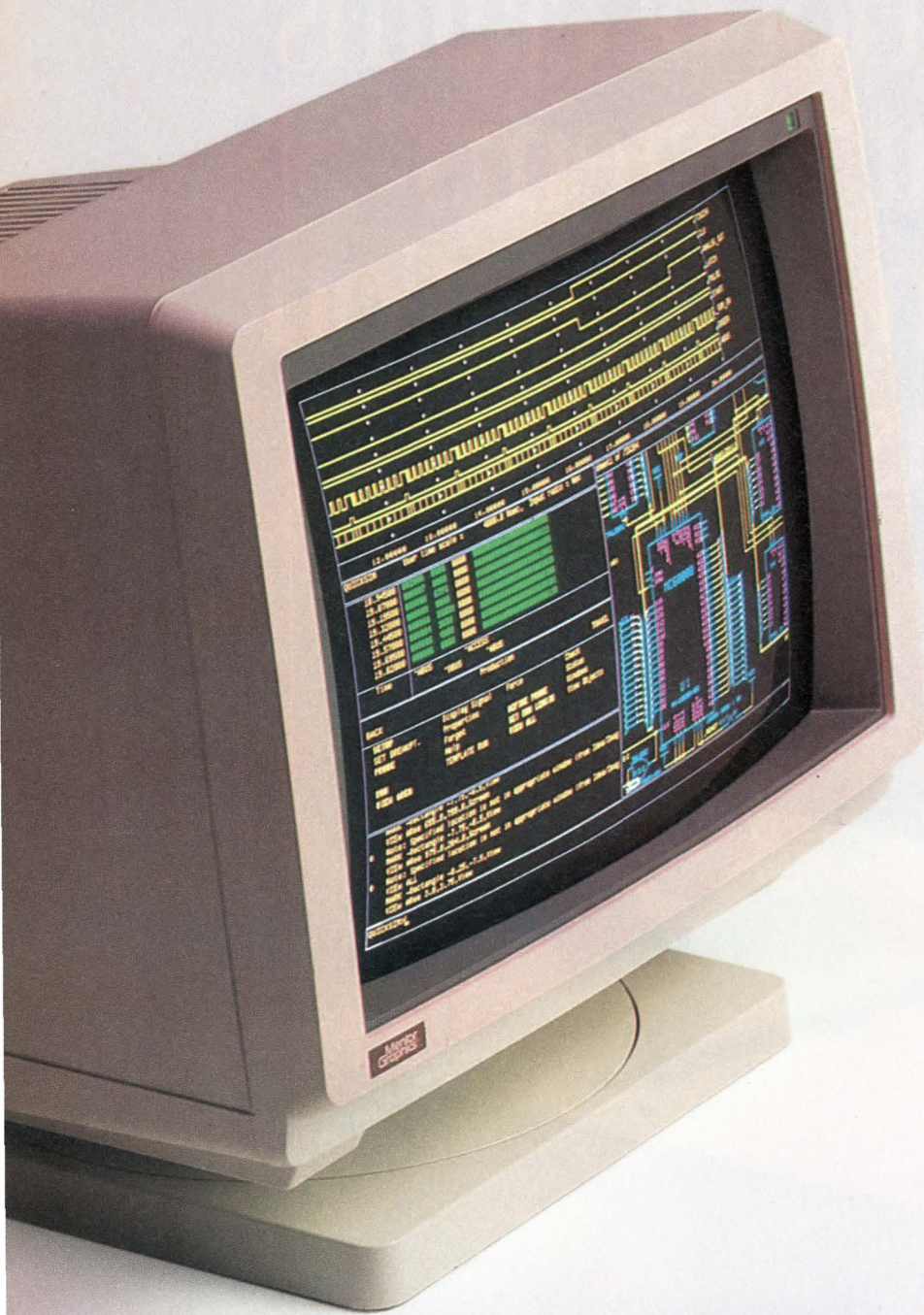

## Skeptical about "systems" electronic design automation?

You should be. Because in many cases, it's a triumph of form over content. Look behind the facade of so-called "systems" design automation tools, and you'll find little substance, if any.

Buy into this kind of systems design methodology and you're participating in a very costly experiment. With highly uncertain results.



# know better.

## They preach. We practice.

There's only one practical yardstick for evaluating a systems design solution. And that's how many successful products it has produced.

Apply this measure and the field narrows dramatically. Essentially, down to a single vendor.

Mentor Graphics.

For over five years, our customers have been turning out sophisticated board products with our EDA tool set. Repeatedly. Like Sequent Computer Systems which in 1987 designed and simulated a 32-bit processor board with over 175 chips, including three ASICs, on Mentor Graphics workstations. From design start to diagnostic firmware verification and fabrication prototype in just seven months.

## Test their claims.

Many "systems" design automation vendors have a tendency to bypass the obvious and dwell on the esoteric. And for good reason. Most have gaping holes in their product offering. Some interesting (and essential) questions that you should ask vendors:

Does your tool set have a common database and user interface? Does it extend from design definition through to PCB layout and output to manufacturing?

Do you have more ASIC libraries supported on your workstation than any other EDA vendor? Can you include ASICs in board simulations?

*This 32-bit processor board was designed and simulated on Mentor Graphics workstations by Sequent for its multi-processor Symmetry computer system. It contains over 175 IC components including 80386 processors, a 14,000-gate standard cell and two 10,000-gate arrays. By simulating at the board level, Sequent was able to bypass breadboarding and proceed directly to fabrication prototype.*

Are your tools capable of managing over 1000-page product documentation projects from start to finish?

Have you integrated mechanical packaging and analysis into the electronic design and layout process?

Anything less than a perfect score is a total loss. And a perfect score does not mean just a check in every box. Each item must be backed with the production-proven performance only Mentor Graphics can provide.

## Experience makes the difference.

When we speak about systems design automation, we speak from experience. We have the largest customer base in the electronic design automation industry. And with good reason. Some 70% are repeat customers who are gaining genuine value from our products and expanding their competitive advantage.

Our long-term partnership with these customers allows us to contin-

ually refine our tools in a very pragmatic and innovative manner. With Mentor Graphics, you get productivity instead of speculation.

## To be continued.

So much for the present. We're already developing new systems EDA tools that will extend to every dimension of electronic product development. From high-level systems descriptions to CASE. It's what our customers expect. It's what we'll deliver.

It's all part of a vision unique to Mentor Graphics, the leader in electronic design automation. Let us show you where this vision can take you.

Call us toll-free for an overview brochure and the number of your nearest sales office.

Phone 1-800-547-7390  
(in Oregon call 284-7357).

**Mentor  
Graphics®**

*Your ideas. Our Experience.*

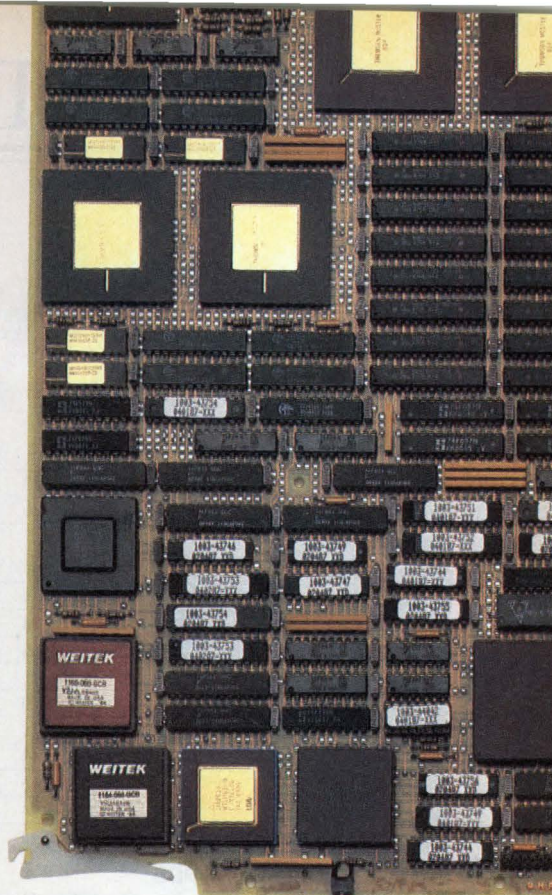



# LEADTIME INDEX

Percentage of respondents

ITEM	Percentage of respondents							Average (weeks)	Last month's average (weeks)
	Off the shelf	1-5 weeks	6-10 weeks	11-20 weeks	21-30 weeks	Over 30 weeks	Average (weeks)		
<b>TRANSFORMERS</b>									
Toroidal	7	36	36	21	0	0	7.3	5.7	
Pot-Core	0	33	47	20	0	0	7.8	8.2	
Laminate (power)	0	40	30	30	0	0	8.3	7.8	
<b>CONNECTORS</b>									
Military panel	0	0	63	37	0	0	10.8	12.2	
Flat/Cable	10	55	20	15	0	0	5.6	5.3	
Multi-pin circular	7	14	43	36	0	0	9.4	8.0	
PC (2-piece)	8	23	54	15	0	0	7.4	8.0	
RF/Coaxial	17	44	28	11	0	0	5.3	8.1	
Socket	17	52	22	9	0	0	4.7	6.0	
Terminal blocks	14	50	23	13	0	0	5.4	5.4	
Edge card	5	52	33	10	0	0	5.7	6.3	
D-Subminiature	9	57	26	8	0	0	5.1	6.6	
Rack & panel	7	43	36	14	0	0	6.4	8.6	
Power	0	72	14	14	0	0	5.5	11.2	
<b>PRINTED CIRCUIT BOARDS</b>									
Single-sided	0	68	21	11	0	0	5.4	4.7	
Double-sided	0	56	37	7	0	0	5.8	6.0	
Multi-layer	0	29	58	13	0	0	7.5	7.4	
Prototype	4	79	8	9	0	0	4.3	3.4	
<b>RESISTORS</b>									
Carbon film	26	45	23	6	0	0	4.2	3.0	
Carbon composition	35	34	24	7	0	0	4.0	4.3	
Metal film	20	45	32	3	0	0	4.4	4.3	
Metal oxide	12	59	13	6	0	0	4.6	5.2	
Wirewound	4	31	31	34	0	0	8.8	7.2	
Potentiometers	7	44	41	4	4	0	6.1	5.2	
Networks	10	40	35	15	0	0	6.3	6.6	
<b>FUSES</b>									
	30	40	20	10	0	0	4.4	1.8	
<b>SWITCHES</b>									
Pushbutton	17	48	13	22	0	0	5.8	3.9	
Rotary	4	50	33	13	0	0	6.1	5.5	
Rocker	15	50	20	15	0	0	5.4	5.5	
Thumbwheel	6	44	19	31	0	0	7.7	5.7	
Snap action	0	56	28	16	0	0	6.5	5.3	
Momentary	5	58	16	21	0	0	6.3	5.0	
Dual in-line	0	50	36	14	0	0	6.6	7.8	
<b>WIRE AND CABLE</b>									
Coaxial	17	63	12	8	0	0	4.2	2.8	
Flat ribbon	11	48	30	11	0	0	5.5	3.8	
Multiconductor	14	52	29	5	0	0	4.6	3.5	
Hookup	43	32	21	4	0	0	3.2	2.9	
Wire wrap	38	25	31	6	0	0	4.2	2.2	
Power cords	13	54	12	21	0	0	5.9	10.8	
<b>POWER SUPPLIES</b>									
Switcher	4	44	26	26	0	0	7.4	7.2	
Linear	0	41	35	24	0	0	7.7	6.6	
<b>CIRCUIT BREAKERS</b>									
	6	35	29	30	0	0	8.0	8.3	
<b>HEAT SINKS</b>									
	15	50	23	12	0	0	5.1	4.7	
<b>RELAYS</b>									
General purpose	19	43	14	24	0	0	6.1	4.3	
PC board	20	30	20	30	0	0	7.2	5.7	

ITEM	Percentage of respondents							Average (weeks)	Last month's average (weeks)
	Off the shelf	1-5 weeks	6-10 weeks	11-20 weeks	21-30 weeks	Over 30 weeks	Average (weeks)		
<b>RELAYS</b>									
Dry reed	0	46	15	39	0	0	8.6	7.5	
Mercury	0	43	14	43	0	0	9.1	4.4	
Solid state	0	36	29	35	0	0	8.9	6.5	
<b>DISCRETE SEMICONDUCTORS</b>									
Diode	37	15	27	12	6	3	7.0	3.8	
Zener	32	25	18	14	7	4	7.3	4.7	
Thyristor	12	29	24	29	6	0	8.8	7.2	
Small signal transistor	24	19	33	19	5	0	7.4	4.3	
MOSFET	12	29	18	29	6	6	10.2	7.0	
Power, bipolar	6	47	13	20	7	7	9.3	6.4	
<b>INTEGRATED CIRCUITS, DIGITAL</b>									
Advanced CMOS	10	19	33	33	5	0	9.6	6.8	
CMOS	11	36	36	14	3	0	7.1	6.4	
TTL	29	17	38	12	4	0	6.5	5.8	
LS	24	36	24	12	4	0	5.9	5.2	
<b>INTEGRATED CIRCUITS, LINEAR</b>									
Communication/Circuit	15	23	31	23	8	0	8.7	6.7	
OP amplifier	25	33	21	17	4	0	6.3	7.1	
Voltage regulator	15	40	20	20	5	0	7.2	6.6	
<b>MEMORY CIRCUITS</b>									
RAM 16k	15	25	25	20	15	0	9.7	7.8	
RAM 64k	13	35	22	17	13	0	8.8	7.7	
RAM 256k	12	18	35	23	12	0	10.0	9.5	
RAM 1M-bit	8	17	17	42	16	0	12.5	11.8	
ROM/PROM	7	27	20	33	13	0	11.0	8.2	
EPROM 64k	5	38	19	29	9	0	9.5	7.8	
EPROM 256k	9	30	26	26	9	0	9.3	8.4	
EPROM 1M-bit	7	13	33	34	13	0	11.6	9.4	
EEPROM 16k	6	24	29	29	12	0	10.6	8.3	
EEPROM 64k	11	17	33	22	17	0	10.9	8.3	
<b>DISPLAYS</b>									
Panel meters	8	50	17	25	0	0	6.7	6.0	
Fluorescent	11	45	11	22	11	0	8.5	11.1	
Incandescent	22	45	0	33	0	0	6.5	8.8	
LED	15	30	25	25	5	0	8.1	5.6	
Liquid crystal	0	29	29	35	7	0	10.5	11.3	
<b>MICROPROCESSOR ICs</b>									
8-bit	22	17	39	17	5	0	7.6	6.5	
16-bit	11	17	39	28	5	0	9.3	6.7	
32-bit	7	26	47	20	0	0	7.6	7.1	
<b>FUNCTION PACKAGES</b>									
Amplifier	20	30	30	20	0	0	6.4	6.4	
Converter, analog to digital	13	20	40	20	7	0	8.6	8.2	
Converter, digital to analog	17	17	33	25	8	0	9.2	8.0	
<b>LINE FILTERS</b>									
	0	45	22	22	11	0	9.4	6.8	
<b>CAPACITORS</b>									
Ceramic monolithic	22	37	22	19	0	0	5.8	5.5	
Ceramic disc	22	44	19	15	0	0	5.1	5.6	
Film	32	41	9	18	0	0	4.8	6.0	
Aluminum electrolytic	30	41	18	7	4	0	4.8	6.4	
Tantalum	28	31	21	17	3	0	6.2	5.9	
<b>INDUCTORS</b>									
	0	40	30	20	10	0	9.3	7.7	

Source: Electronics Purchasing magazine's survey of buyers



# Get it out of your system.

## Mentor Graphics presents a one-day technical seminar on applying electronic design automation to board and systems development.

With the advent of 32-bit processors, ASICs with VLSI densities, and surface mount PCB technology, board design is reaching an unprecedented level of complexity. This one-day seminar will show you how Electronic Design Automation (EDA) can help you handle this mounting complexity — without disrupting your current methodologies.

### Who should attend.

Engineering managers, design engineers, project leaders, and any other technical professionals who are concerned with developing engineering strategies for board design and layout.

### What you'll learn.

You'll learn how EDA can help you produce better designs and substantially accelerate board design and analysis through advanced design definition and simulation tools. And how other engineering departments have already tackled complex designs while also cutting months off their design cycles with EDA.

The seminar will cover a wide range of topics and include the actual experiences of board and systems designers who have successfully adopted EDA to a broad array of projects. Among other issues, it will examine:

- New approaches to absorbing the steady increase in design complexity.
- Logic verification of board designs with ASICs and PLDs.
- Techniques for addressing timing problems.
- Handling SMT packaging problems efficiently.

- Firmware debugging with software-based breadboards.
- Controlling placement and routing early in the design process.
- Handing off a more testable product to test engineering.
- Comparisons of traditional prototype tools with electronic design automation tools.

You'll also hear a variety of leading systems designers discuss real-world design techniques that maximize the value of EDA tools. Extensive audio/visual aids will be employed and you'll also be provided with a designer's casebook to capture many of the examples provided throughout the day.

### How to register.

Call the seminar coordinator at the phone numbers in the cities listed below. But hurry, because space is limited. There is a \$65 charge, which includes all materials and lunch. PLEASE NOTE: Checks or money orders postmarked after April 8 will be returned.

### Where and When.

<b>April 19:</b> Chicago	Call 312-490-0230
San Jose	Call 408-436-5494
<b>April 22:</b> Minneapolis	Call 612-541-0776
Los Angeles	Call 213-640-9525
<b>April 26:</b> Paramus NJ	Call 201-845-0550
Orange County	Call 714-770-1573
<b>April 28:</b> Boston	Call 617-891-3341
<b>April 29:</b> Dallas	Call 214-233-9897

**Mentor  
Graphics®**

*Your ideas. Our Experience.*



## SINGLE LEAF .156 CONNECTORS

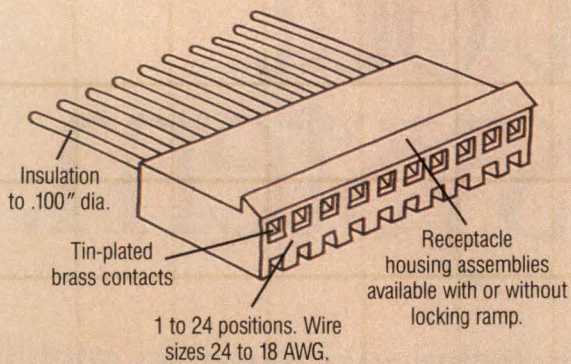

Crimp-termination, wire-to-board and board-to-board connectors mate with pin half or MTA-156 Series post headers. Housings molded from flame-retardant material to meet UL 1410 Standard for Television and Video Products. Contacts rated 6.5 amps, 250 VAC.

## BOARD TO BOARD RECEPTACLES

Right angle or vertical receptacle housing assemblies. Hook or robotic mounting styles. 3 to 15 positions.

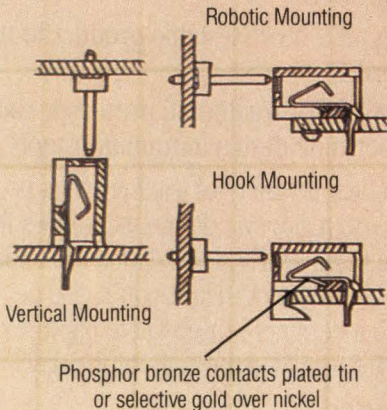

## MTA-100 MASS TERMINATION ASSEMBLIES

Closed end or feed-thru housings

Contact accepts solid, stranded, or fused stranded wires

# Meet our

They've gone everywhere. And gotten into everything.

And proven themselves in literally millions of applications.

Our MTA assemblies have been problem solvers since we introduced them. They reflect a business attitude we have—that the best way to win a customer is to help. With big con-

cerns like availability. Or simple concerns like having a question, and wanting an answer.

### **Test our reflexes.**

Our real job is to be the kind of company you want to do business with.

So we take availability seriously, and make AMP products available the way *you* need them. From worldwide manufacturing and stocking to our nationwide network of AMP Autho-

rized Distributors, we offer the source that suits you.

You sometimes need parts in a rush. We've done something about that, too. We've taken our popular industry standard products—including MTA connectors—and stocked up, nationwide.

### **Your Immediate Shipment Catalog is ready.**

For thousands of products from switches to sockets, terminals to coax, and more, our Industry Standard Products Catalog is almost as good



## MTA-156 MASS TERMINATION ASSEMBLIES

Connectors for .045" round or square posts on .156" centers. 2 to 24 positions, 24-18 AWG. Standard contacts rated 5 amps, high-current contacts rated 8 amps at 105°C.

Housing body color indicates wire size

Tin-plated or gold-plated copper alloy contacts

Tin-plated or gold-plated contacts

Cable-to-board, cable-to-cable versions

Available in component form or in finished cable assemblies

Same selection of header styles as MTA-100 Series

## HEADERS

Straight or right angle headers with or without polarization and with or without friction lock.

## RECEPTACLE CONTACTS

Slotted beam insulation displacement offers four-point wire contact

# multi-millionaires.

as a warehouse around the corner.

And you can get your copy just by calling our Information Center and asking for it.

### **One number to call.**

We've consolidated our information systems into a single toll-free number, with hours to cover the business day, coast to coast.

Call us. We can supply product literature. Answer technical questions about any of our catalog products. Guide you to the closest AMP Authorized Distributor.

Any question we can't answer, any problem we can't solve on the spot, will get priority attention. It doesn't matter if your concern is a big one or a little one. Your business matters to us.

**For the name and location of your nearest AMP Authorized Distributor, call the toll-free number.**

We want to be your supplier.

**AMP** Interconnecting ideas

**1-800-522-6752**



Special Report

# VGA chip sets



*Vendors of graphics chips are helping you achieve the impressive color-graphics capabilities of IBM's VGA without sacrificing compatibility with existing software. (Photo courtesy Paradise Systems Inc)*



---

While debating degrees of compatibility with IBM's Video Graphics Array standard, manufacturers of VGA-like chips are attempting to woo designers by offering exotic features and backward compatibility with other IBM display products. Fortunately, the shipping delays and vaporware that had plagued this market have abated.

---

J D Mosley, *Regional Editor*

IBM's PS/2 Series computers and their Video Graphics Array (VGA) graphics controllers are less than one year old, and already the market is thick with competing versions of the controller that IBM tried to make unclonable. Therefore, designers and programmers who have finally begun to make full use of the colors and resolution provided by IBM's earlier Enhanced Graphics Adapter (EGA) standard must now deal with the VGA. However, debate rages over the pace of the evolution from EGA to VGA.

Although most of IBM's PS/2 computers come with VGA hardware, conversion of IBM PCs and compatible computers to the VGA standard requires users to purchase both a VGA board and an analog monitor, because VGA won't work with the ubiquitous digital monitors that dominate the current PC market. Further, IC manufacturers disagree about the level of VGA compatibility that will be necessary to let an expansion board run VGA software that doesn't yet exist. And some industry observers doubt that the VGA standard offers enough of a performance improvement over EGA to justify the expense of conversion.

#### **Yet another new standard**

When IBM introduced the PS/2 line, the company forced yet another new video standard into the PC market. The mother boards of the PS/2 Series Models 50, 60, and 80 come equipped with a VGA circuit that surpasses the performance of IBM's EGA. Conversely,

users of PC-compatible computers must select and purchase graphics boards for their machines and then plug them into expansion slots in the computers' chassis. Besides EGA, PC users can choose from a number of graphics standards, including the Hercules (Berkeley, CA) monochrome graphics controller and IBM's Monochrome Display Adapter (MDA), Color Graphics Adapter (CGA), Professional Graphics Adapter (PGA), and Multicolor Graphics Array (MCGA).

EGA boards provide a selection of 16 simultaneous colors from a palette of 64, with a resolution of 640×350 pixels, on a digital monitor. VGA requires an analog monitor and lets you select 16 colors from a palette of 256, with 640×480-pixel resolution. At a lower resolution of 320×200 pixels, VGA can simultaneously display 256 colors from a palette of 262,144. The analog monitor permits infinitesimal shading gradations, thereby providing spectral variations that digital monitors can't achieve. However, the EGA standard is now more than two years old, and an EGA board's price is about half that of a VGA board's. Moreover, an analog monitor, such as the NEC (Mountain View, CA) Multisync, could add more than \$700 to the cost of VGA conversion.

Because companies that purchase the PS/2 line of computers automatically get VGA, they probably will eventually want to standardize their PCs on the VGA specification to prevent software incompatibility problems from surfacing. And the chip manufacturers that have entered the VGA market contend that such com-



---

*Because IBM built its VGA controller into the PS/2 mother board, VGA BIOS is part of the system BIOS—not a separate, easily deciphered entity.*

---

*Electing not to get into the chip business, STB Systems is one graphics-board manufacturer that preferred to use a commercial VGA controller instead of trying to design and debug a semicustom VGA IC.*

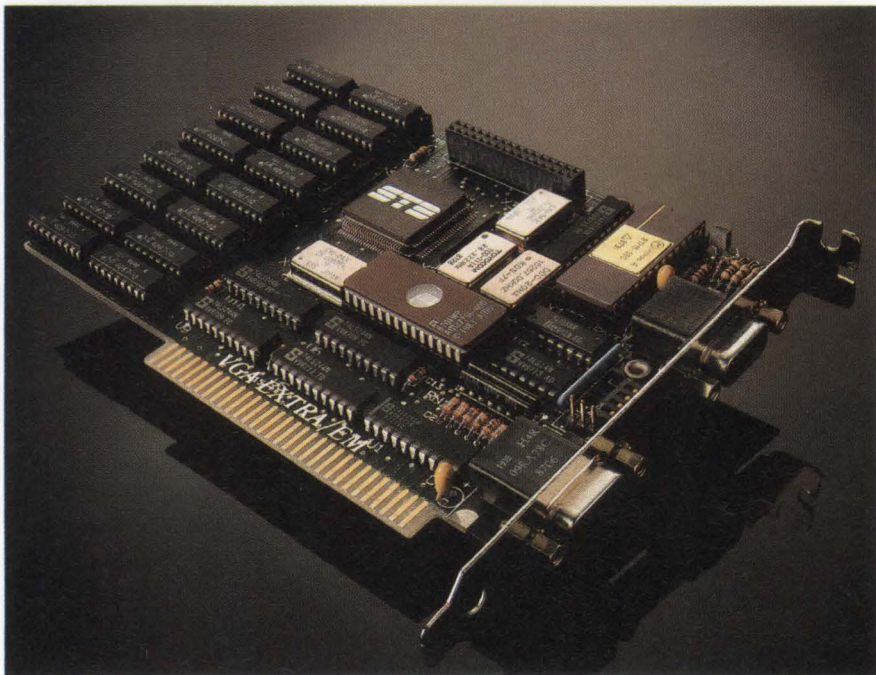

panies will create a viable market for plug-in VGA boards.

#### **Availability is a problem**

Video Seven, one of the first chip manufacturers to ship ICs that attempt to emulate the VGA, uses two 84-pin packages to house its rendition of IBM's controller. The chip set provides hardware- and software-compatible emulation and has all the control and data registers defined for the VGA, EGA, CGA, MDA, and Hercules graphics controllers. The chip set automatically switches among these graphics standards when it detects software conditions that are unique to each. You can also lock the hardware into a single standard or program the chips to generate a nonmaskable interrupt if a program tries to access hardware features that are unavailable in a particular mode. A new video-RAM version of the chip set costs \$50 (10,000).

Because the VGA is a graphics controller and not a processor, display processing occurs in the host computer's CPU. To minimize the wait-state-induced delays that can arise as the CPU's workload increases when accessing video memory, the Video Seven chip set lets you allocate all memory cycles that aren't being used to refresh the display or video memory to process CPU memory requests. And to reduce the software overhead created by mouse-oriented programs such as Microsoft's (Remond, WA) Windows, the chip set in-

cludes a hardware-controlled 32×32-pixel graphics cursor.

The chip set's 33-MHz max dot-clock rate provides display resolution as great as 800×600 pixels. A fast dot-clock spec translates into greater display resolution, because the faster the chip can shift pixel data out of the frame buffer, the more time the CPU has for writing graphics data to the frame buffer. The chip set also includes a scratchpad RAM, a BIOS ROM-disable function, a restorable-state function, flicker-free CGA text scrolling, and eight text fonts.

Video Seven also sells its \$499 Vega VGA expansion card, which uses the company's chip set to provide VGA compatibility for your PC or compatible computer. The board comes with high-resolution 800×600-pixel drivers for Microsoft's Windows, Autodesk's (Sausalito, CA) AutoCAD, and Lotus's (Cambridge, MA) 1-2-3 graphics. However, you can only display at this resolution if you have a variable-frequency monitor. IBM-compatible analog monitors limit you to a maximum resolution of 640×480. However, the Vega VGA has both analog- and digital-monitor connectors, so you can postpone the decision to upgrade your monitor. The board interfaces with its VGA chip set and the system bus via video RAM instead of dynamic RAM, thereby producing zero-wait-state operation at speeds four times faster than IBM's EGA.

Video Seven's chip set isn't 100% hardware-compati-



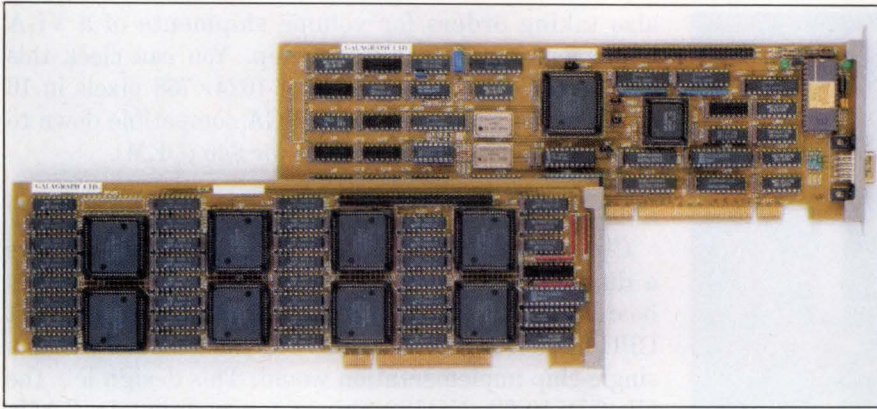

*If you want to boost the display specs of a PS/2 computer, you can plug in Galapagos's Galaxy Mercury/2 board set to gain zoom windows and resolution as great as 1024x768 for your CAD applications.*

ble with IBM's VGA because of register conflicts between the EGA and VGA standards. To have both on the same chip set, Video Seven elected to provide complete EGA register compatibility and VGA compatibility at the software level. The engineers at Video Seven determined that 100% EGA compatibility would be a major factor influencing VGA-chip consumers until a broad range of software written to the VGA standard appears on the market. In addition, some of IBM's VGA registers remain undocumented, presenting a degree of uncertainty when attempting hardware compatibility with IBM's VGA chip.

In contrast, Paradise Systems chose to design its PVGA1 chip with full VGA hardware compatibility and EGA BIOS-level software compatibility. Citing the danger of system crashes as the primary concern, company officials note that register-dependent programs written to the VGA standard are already commercially available. Furthermore, it isn't unusual for software developers to write programs that bypass the host's software-interface BIOS and directly access the graphics hardware to accelerate program execution.

The PVGA1, which is 81% smaller than IBM's VGA video controller, provides 17 graphics modes and eight alphanumeric modes with resolutions ranging from 320x200 to 1024x768 pixels. This 1.5- $\mu$ m, 12,000-gate CMOS LSI device comes in either a 100-pin plastic pin-grid array (PGA) or a plastic flat package. Five proprietary graphics modes that Paradise defined for this chip provide resolution greater than the IBM VGA controller allows. Because of the PVGA1's 40-MHz max video clock rate, one mode lets you select from 256 simultaneous colors in a palette of 262,144 colors at a resolution of 640x480 pixels. A monochrome graphics mode permits you to boost resolution to 1024x768 pixels. The chip provides flicker-free operation in all video modes.

The PVGA1's bus interface functions with either an 8- or 16-bit-wide data bus, which makes the chip as much as three times faster than IBM's VGA chip with its 8-bit data bus. The chip also contains six lock-protected I/O registers that you can use to enhance certain video, memory, and address functions contained in IBM's VGA standard. Further, the company claims that a VGA expansion board for a PC or compatible computer would require only 21 components for designers using the PVGA1, instead of 32 components if the IBM VGA were used. A PS/2 mother board based on the Paradise chip would require only 16 components. The \$60 (100) PVGA1 comes with a proprietary BIOS.

Paradise has designed two boards based on the PVGA1: The VGA Professional Card and the VGA Plus Card. When compared to the \$595 IBM PS/2 Display Adapter, Paradise's \$399 VGA Plus Card adds Hercules monochrome compatibility and 132-column support to the IBM card's standard features. The \$599 VGA Professional Card includes a 16-bit bus, monochrome graphics resolution reaching 1024x768 pixels, and color graphics featuring 800x600-pixel resolution. The company expects to provide high-resolution drivers for a number of software packages, including Microsoft Windows, Digital Research (Monterey, CA) GEM, and Ashton-Tate (Torrance, CA) Framework, Lotus 1-2-3 and Symphony, AutoCAD, and Xerox (Rochester, NY) Ventura Publisher.

The VGA Professional Card should be available in May; the VGA Plus card should be available now, although driver design delays have postponed quantity shipments of the boards. Customers such as Compaq Computer Corp, however, have acknowledged receipt of volume shipments of the Paradise PVGA1 video controller. In fact, Compaq is now shipping its own \$599 VGA controller board for use in its Deskpro and Portable 386 and 286 computers.



---

*It isn't unusual for software developers to write programs that bypass the host's software-interface BIOS and directly access the graphics hardware.*

---



*The VGA standard supports analog monitors; the VGA-compatible chip set from Cirrus Logic lets you display as many as 256 colors with more subtle shading than is possible using the EGA graphics standard and a digital monitor.*

In a maneuver to boost specs for NSI Logic's Enhanced Video Controller (EVC) 415 chip, the company offers three enhancement ICs, one of which is dubbed a "resolution multiplier," which allegedly can double display resolution—that is, the 640×480 mode would appear as 1280×960 pixels. A color-expander chip provides 256 simultaneous colors at resolutions of 640×480 or 800×600 pixels, and a bus-enhancer chip lets 32-bit host computers directly access the EVC 415's 32-bit video bus. Without the bus enhancer, your system interfaces with the EVC 415 via a 16-bit-wide data path.

NSI Logic has graced the chip with such techniques as packed pixel mapping in the video memory array to accelerate screen drawing. Another such technique is the board's 1:1 interleave scheme, called Proprietary Virtual Access Arbitration, which lets the CPU access the chip's video memory on demand. Company officials expect to begin shipping these ICs in volume this month. Pricing begins at less than \$20 (OEM).

### **Volume shipments begin**

Chips and Technologies is now accepting orders for volume shipments of the company's 2-chip set, which includes the \$30.50 (1000) 82C441 VGA chip and the \$10 (1000) 82A442 bus-interface chip. They provide a maximum dot-clock rate of 38 MHz for 800×600-pixel resolution in 16 colors. Tseng International Laboratories is

also taking orders for volume shipments of a VGA implementation—its ET3000 chip. You can clock this chip to 65 MHz for a display of 1024×768 pixels in 16 colors out of a palette of 256. VGA compatible down to the register level, this IC sells for \$45 (OEM).

### **Package eases design effort**

Cirrus Logic, another VGA chip manufacturer, offers a dual-chip set that includes glue logic to simplify board-level design and a sequencer that allows the host CPU more frequent access to the video memory than a single-chip implementation would. This design lets the CL-GD510/CL-GD520 chip set use dynamic RAMs rather than expensive video RAMs to drive high-resolution displays. In addition, the chips include a hardware reconfiguration capability that provides register-level compatibility with both the EGA and VGA standards. When the software indicates EGA or VGA mode, the chips actually enable and disable reserved registers to provide full compatibility.

The hardware provides both a graphics and a text cursor to reduce software overhead and speed application processing by the host. You also get a hardware-driven split screen that provides simultaneous and independent scrolling of two separate text screens. The set also includes an on-chip scratchpad RAM for storage of BIOS and driver software. Backwards compatible with earlier PC-based graphics standards, and supporting both digital and analog monitors, the CL-GD510/CL-GD520 set also includes a host register read-back capability that eliminates any need for shadow registers and permits graphics-controller state saving for

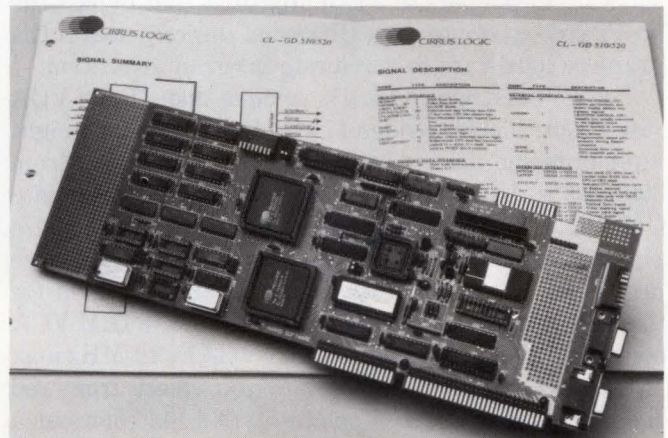

*To cut your development time, you can start your prototype design with this VGA board from Cirrus Logic. It provides room for additional circuitry and gives you access to extra switches, jumpers, and crystal options.*



multitasking applications.

By using two chips instead of one, Cirrus Logic eliminated complex I/O multiplexing to simplify your board design effort. The company also sells a \$450 fully functional VGA graphics development board that has extra switches, jumpers, and crystal options as well as space for additional prototyping to help you develop your own custom VGA board. The CL-GD510/CL-GD520 chip set comes in an 84-pin PLCC package and costs \$45 (1000).

### Boards sport proprietary ICs

Many graphics-board manufacturers have developed their own ASICs instead of relying on the IC houses for commercial chip sets. ATI Technologies, for example, features a proprietary graphics array chip on its VGA

Improved Performance (VIP) board. The VIP plugs into IBM PC, PC/XT, and PC/AT or compatible, computers, including portable models and the IBM PS/2 Series Model 30. ATI used CMOS VLSI SMDs to reduce the VIP's chip count and power consumption. The board's 256k bytes of video RAM eliminate any need for supplemental memory modules. The VIP is compatible with both digital and analog monitors, and if you use an analog display with this board, you can display 16 colors at a resolution of 640x480 pixels. This \$449 board comes with a 2-year warranty, including parts and labor. The board features software drivers for AutoCAD, GEM, Lotus 1-2-3, Aldus Corp's (Seattle, WA) Pagemaker, Ventura Publisher, and Microsoft Windows.

Another board-level offering is Sigma Designs' \$579

## COMPARATIVE FEATURES OF REPRESENTATIVE VGA CHIP SETS

MANUFACTURER	PART	DOWNWARD COMPATIBILITY	VGA REGISTER-LEVEL COMPATIBILITY	MAXIMUM DOT-CLOCK RATE (MHz)	ADDITIONAL MODES	AVAILABILITY	PRICE
ATI TECHNOLOGIES	PROPRIETARY	EGA, CGA, MDA, HGC	NO	32	800x560, 132 COLUMNS	NOW (ON \$449 VIP BOARD)	N/A (PROPRIETARY)
CHIPS & TECHNOLOGIES	82C441/82A442	EGA, CGA, MDA, HGC	YES	38	800x600	NOW	\$30.50 & \$10 (1000)
CIRRUS LOGIC	CL-GD510/ CL-GD520	EGA, CGA, MDA, HGC	YES	32.5	1056x200, 1056x350, 960x350, 880x480, 800x500, 800x600	NOW	\$45 (1000)
GALAGRAPH LTD	PROPRIETARY	MDA, MCGA, HGC	NO	N/A	800x600, 1280x960	NOW (ON \$2495 GALAXY MERCURY/2 BOARD)	N/A (PROPRIETARY)
IBM	VGA CONTROLLER	EGA, CGA, MDA, MGCA, HGC	YES	28.5	N/A	NOW (ON \$595 PS/2 DISPLAY ADAPTER)	N/A (PROPRIETARY)
NSI LOGIC	EVC 415	EGA, HGC	YES	40	752x410, 800x600, 960x720, 1280x960	NOW	<\$20 (OEM)
PARADISE SYSTEMS	PVGA1	EGA, CGA, MDA, MCGA, HGC	YES	40	800x600, 960x780, 1024x768, 1056x344, 1056x770, 1188x350	NOW	\$60 (100)
SIGMA DESIGNS	PROPRIETARY	EGA, CGA, MDA, MCGA, HGC	YES	65	800x600, (1024x768 & 8514/A OPTIONAL)	NOW (ON \$579 VGA/X BOARD)	N/A (PROPRIETARY)
TSENG LABORATORIES	ET3000	EGA, CGA, MDA, HGC	YES	65	1024x768, 960x720, 800x600, 160 COLUMNS	NOW	\$45 (OEM)
VIDEO SEVEN	VGA CHIP SET	EGA, CGA, MDA, HGC	NO	33	800x600	NOW	\$50 (OEM)

**LEGEND:** HGC=HERCULES MONOCHROME GRAPHICS CONTROLLER  
MDA=IBM MONOCHROME DISPLAY ADAPTER  
CGA=IBM COLOR GRAPHICS ADAPTER  
MCGA=IBM MULTICOLOR GRAPHICS ARRAY



*Many graphics-board manufacturers have developed their own ASICs instead of relying on the IC houses for commercial chip sets.*

VGA/X board. Teamed with an X-Plus upgrade option that lets you display 16 colors at a resolution of 1024×768 pixels, the enhanced board with its proprietary VGA chip will also provide software compatibility with IBM's 8514/A display adapter, which boasts 256-simultaneous-color display at a resolution of 1024×768 pixels. IBM's 8514/A board sells for \$1290, and its 16-in., interlaced, analog monitor costs an additional \$1550. The X-Plus upgrade will cost less than \$200; OEM quantities should be available by the end of this month. The VGA/X board and a \$399 version, called the VGA/H, provide register-level compatibility with IBM's VGA, as well as downward compatibility with the older PC-graphics standards. The VGA/X features software drivers for AutoCAD, GEM, Lotus 1-2-3, Ventura Publisher, and Microsoft Windows.

#### Leave Si to the chip designers

STB Systems sells a board, called the VGA Extra/EM, that sports a Tseng Laboratories chip that emu-

lates VGA at the register level. VGA enhancements found on this board—which the manufacturer is currently shipping in volume—include a 1024×768-pixel mode with 16 simultaneous colors; 256 simultaneous colors in resolutions of either 960×720, 800×600, or 640×480 pixels; and a 160-column×55-line text mode that is particularly useful for spreadsheet production and terminal emulation. You can order this board with 256k bytes of video RAM for \$495 or with 512k bytes for \$595. The VGA Extra/EM also has an interlaced video mode for use with IBM's 8514/A display monitor.

Similar specs are offered by Genoa Systems for its SuperVGA HiRes board—another board that uses the Tseng Laboratories controller chip. The SuperVGA lets you display 256 colors at 800×600-pixel resolution. An optional 1024×768-pixel mode offers 16 simultaneous colors. The \$695 board provides 512k bytes of video RAM. A \$495 version, called the SuperVGA, presents 16-color, 800×600- and 640×480-pixel modes; a 256-color, 320×200-pixel mode; and compatibility with the

## Manufacturers of VGA ICs and boards

For more information on VGA ICs and boards such as those described in this article, contact the following manufacturers directly, circle the appropriate numbers on the Information Retrieval Service card, or use EDN's Express Request service.

**ATI Technologies Inc**  
3761 Victoria Park Ave  
Scarborough, Ontario  
Canada, M1W 3S2  
(416) 756-0711  
TLX 069666  
Circle No 650

**Chips and Technologies Inc**  
3050 Zanker Rd  
San Jose, CA 95134  
(408) 434-0600  
Circle No 651

**Cirrus Logic Inc**  
1463 Centre Pointe Dr  
Milpitas, CA 95035  
(408) 945-8300  
Circle No 652

**Compaq Computer Corp**  
20555 FM 149  
Box 692000  
Houston, TX 77269  
(713) 370-0670  
Circle No 653

**GalaGraph Ltd**  
Box 32127  
Tel Aviv 61321 Israel  
(972-3) 751-4425  
TLX 361539  
Circle No 654

**GalaGraph Ltd**  
c/o Electrograph Sales Inc  
1568 Ocean Ave  
Bohemia, NY 11716  
(516) 563-1320  
Circle No 655

**Genoa Systems Corp**  
73 E Trimble Rd  
San Jose, CA 95131  
(408) 432-9090  
Circle No 656

**IBM**  
Old Orchard Rd  
Armonk, NY 10504  
Phone local office  
Circle No 657

**NSI Logic Inc**  
257-B Cedar Hill Rd  
Marlboro, MA 01752  
(617) 460-0717  
Circle No 658

**Paradise Systems Inc**  
99 S Hill Dr  
Brisbane, CA 94005  
(415) 468-7300  
Circle No 659

**Quadram**  
1 Quad Way  
Norcross, GA 30093  
(404) 923-6666  
TWX 810-766-4915  
Circle No 660

**Sigma Designs Inc**  
46501 Landing Parkway  
Fremont, CA 94538  
(415) 770-0100  
FAX 415-770-0110  
Circle No 661

**STB Systems Inc**  
1651 N Glendale  
Suite 210  
Richardson, TX 75081  
(214) 234-8750  
Circle No 662

**Tseng International Laboratories**  
10 Pheasant Run  
Newtown, PA 18940  
(215) 968-0502  
Circle No 663

**Video Seven Inc**  
46335 Landing Parkway  
Fremont, CA 94538  
(415) 656-7800  
Circle No 664



# Display technology is often the last thing you specify.



## And the first thing your customer sees.

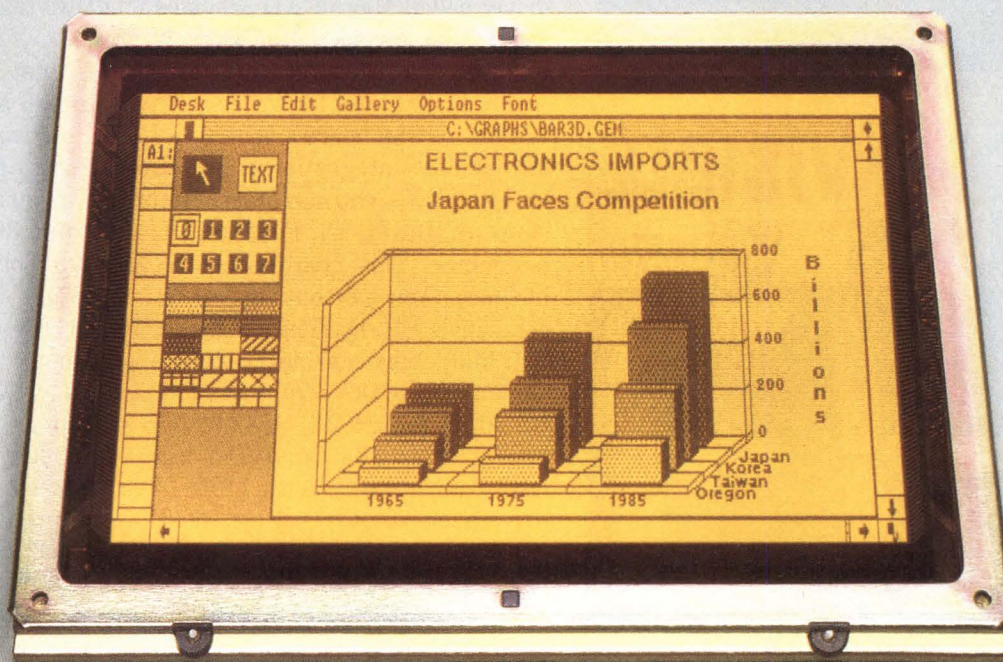

LCD display and Planar EL display photographed under identical ambient lighting conditions.

From a customer's viewpoint, there's only one real window into your product.

The display.

If it's inferior, your product is judged inferior. No matter how good it really is.

For flat panel displays, there's a simple, yet elegant solution. Planar's electroluminescent (EL) display. Why is EL the preferred display technology? Better viewing angle. Better brightness. Better contrast.

It adds up to superior performance.

So contact us today. Choose the flat panel display that surpasses all others from every one's point of view.

For a brochure, please phone either 503-690-1100 or 503-690-1102, or write to

**PLANAR SYSTEMS, INC.**

1400 N.W. Compton Drive  
Beaverton, Oregon 97006.

**PLANAR**



## Low Cost EL Lamps. Fast.

Reliable, quality EL lamps. Any size. Any shape. With the fastest turnaround in the industry.

BKL's new soft touch EL lamps are made with KARD-O-LITE™, a revolutionary material that is quickly and easily die-cut to any configuration.

BKL's patented automated manufacturing process produces extremely thin (.012" to .018"), superior quality EL lamps at a drastically reduced cost. Ideal for LCDs, membrane switches, flat panel displays, emergency and safety lighting.

Call Dean Smith at (215) 277-2910.

# BKL

Bonar KARD-O-LITE™ Inc.

421 Feheley Drive, King of Prussia, PA 19406  
(215) 277-2910

CIRCLE NO 65

## DAYLIGHT VISIBLE DISPLAYS

UP TO  
1,000 FEET

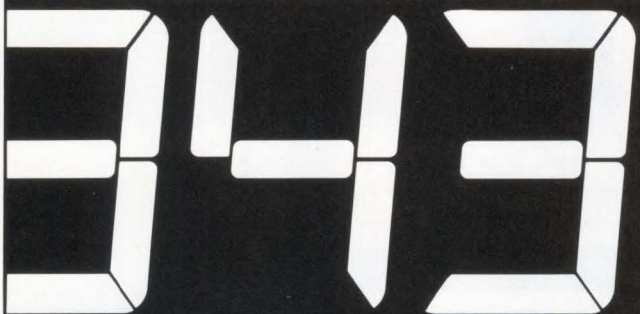

Display sizes: 1½", 4", 6", 9", 12", 18" & 24"

### ENERGY SAVING:

- Electromagnetic, bi-stable operation
- No bulbs to replace
- Maintenance-free
- Indication remains with power loss
- Power used only to change display
- Use indoors or outdoors
- 40°C to 75°C

### IDEAL FOR:

- Instrumentation
- Industrial controls
- Timing Devices
- Toll Displays
- Metering Displays
- Production Line Displays

Call or write for full information

THE **STAVER** CO., INC.

P.O. Box H, Bay Shore, NY 11706  
516-666-8000  
TLX: 6711657  
FAX: 516-666-8039

**SIGNALEX**®  
HIGH VISIBILITY  
DISPLAYS

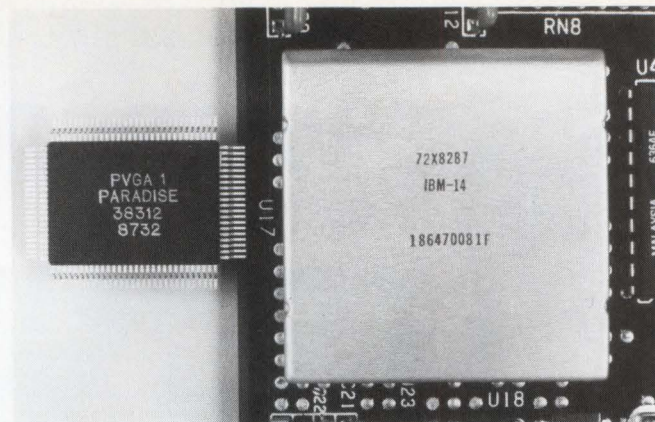

*Packing more features into a package that's 81% smaller than IBM's VGA video controller, Paradise Systems' PVGA1 VGA chip lets you display 16 simultaneous colors at a resolution of 800×600 pixels. The chip also offers a 1024×768-pixel monochrome graphics resolution and increases processing performance because of its 16-bit architecture.*

standard 17 IBM VGA modes.

In case you already have a PS/2 Model 50, 60, or 80 and you long for higher resolution, you'll be relieved to know that you can order a graphics controller that will upgrade your PS/2's resolution to 1024×768 pixels. The Galaxy Mercury/2 board from GalaGraph Ltd also lets you select an 800×600-pixel mode. A special AutoCAD driver called MagniCAD provides windows that let you zoom in on any section of your design.

The board includes software drivers not only for AutoCAD but also for Ventura Publisher and Microsoft Windows. The board's Galaxy HI-PTK software package includes integration utilities and a library of graphics primitives and language bindings for various versions of Basic, C, Fortran, Pascal, and 8086/8088 assembler. This board provides 1M byte of display memory. You can buy this board for \$2495 from the company's US distributor, Electrograph Sales Inc.

If budgetary considerations are your major problem, consider the \$395 QuadVGA board from Quadram. Based on the 82C441/82A442 chip set from Chips and Technologies, the QuadVGA board provides register-level compatibility with IBM's VGA and comes with drivers for AutoCAD, Microsoft Windows, GEM, Lotus 1-2-3 and Symphony, and Ventura Publisher. The board has ports for both analog and digital monitors. **EDN**

## References

1. Conner, Margery S, "IC supports PS/2 graphics modes and 800×600-pixel, 16-color resolution," *EDN*, September 17, 1987, pg 105.
2. Hays, Dean and Bill Knapp, "Developing a VGA chip set with redefinable IC technology," *VLSI Systems Design*, November 1987, pg 68.
3. Williams, Tom, "VGA chips offer design opportunities and latest IBM compatibility," *Computer Design*, November 15, 1987, pg 50.

Article Interest Quotient (Circle One)  
High 470 Medium 471 Low 472



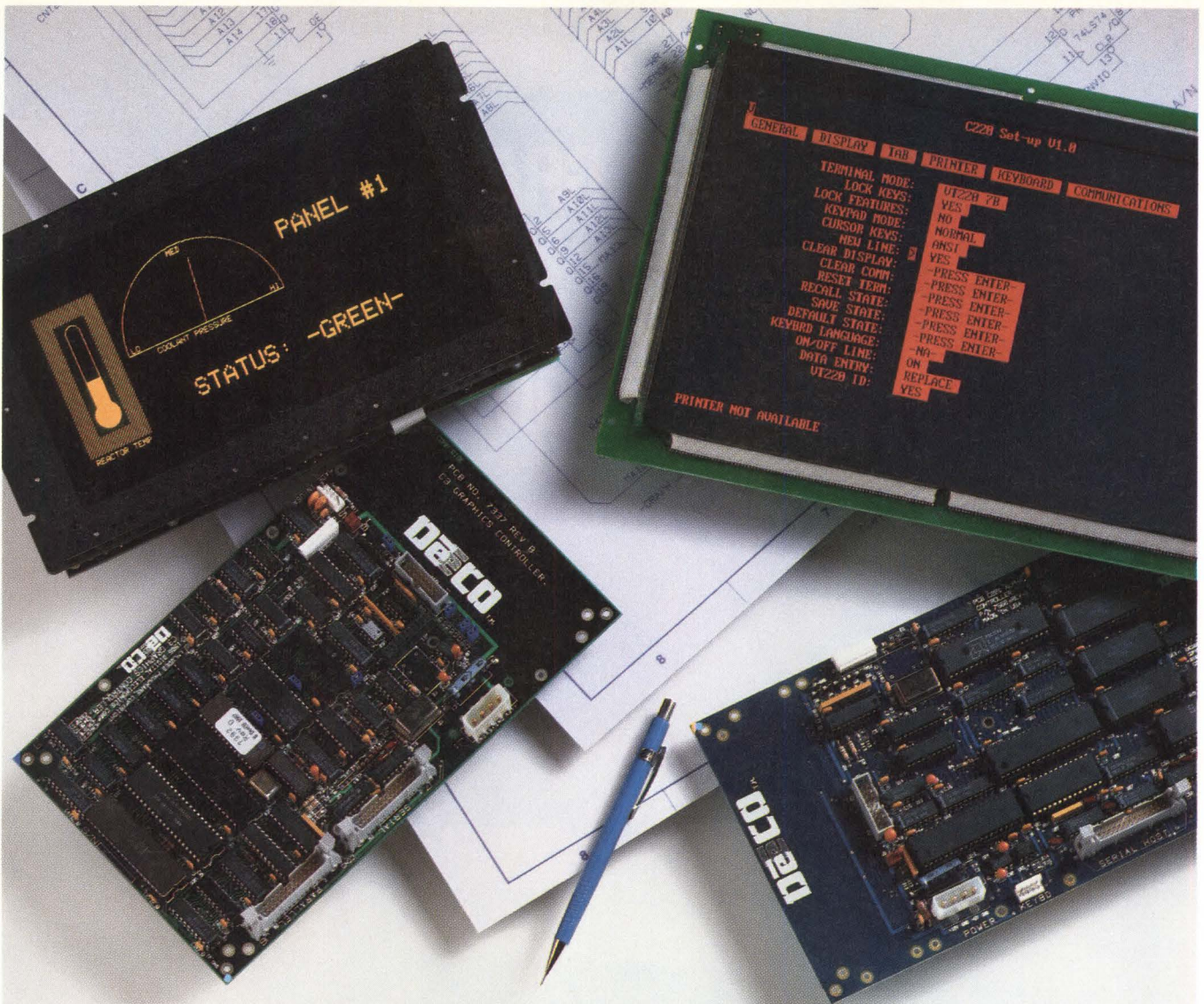

## DEECO MODULES AND CONTROLLERS. SINGLE-BOARD SOLUTIONS FOR MULTIPLE TECHNOLOGIES.

When it comes to finding a single solution to your multiple flat-panel display needs, the choice is Deeco modules or controllers. Deeco controllers easily interface to either electroluminescent or plasma displays, eliminating the need for time-consuming modifications and speeding product design.

### Drawing Graphics and VT100 Emulation Controller.

The C3 controller makes your software development easier. Over 200 simple ASCII handler commands enable powerful capabilities for advanced flat-panel graphics and VT terminal text applications.

The system draws lines, arcs, circles, inside and outside paint and several styles of fill patterns, plus 16 levels of character zoom and displays text on any 45-degree angle. Internal frame storage saves frequently-used screens, which frees up valuable host time.

If your application is in harsh environments and requires operator interaction, Deeco's SealTouch options provide a complete system solution.

### VT220 Emulation and Character Graphics Controller.

The C220 controller emulates VT220 terminal operation, supporting 80 columns and 25 lines of text. Plus you can choose from multiple character sets for ASCII, multinational, graphics and Hebrew.

The system software designer will appreciate features such as, "window" and non-destructive "overlay" primitives.

Multiple I/O ports for host, keyboard and printer interfaces provide expanded design flexibility and convenience.

To find out more about Deeco display solutions, call or write today. Because when it comes to modules and controllers for multiple technologies, we have one solid solution.



Digital Electronics Corporation, 31047 Genstar Road, Hayward, CA 94544-7831 (415) 471-4700  
Deeco is a registered trademark of Digital Electronics Corporation. VT220, VT100 are trademarks of Digital Equipment Corporation.



**TEK UNIX-BASED WORKSTATIONS**

**OUR NEW GRAPHICS  
WORKSTATIONS RUN CIRCLES,  
CYLINDERS AND SOLIDS  
AROUND THE COMPETITION.**





**Led by dual 32-bit engines dividing computing and graphics processing tasks, Tek's new 4300 Series Workstations set the pace in graphics-intensive productivity.**

Now you can count on Tek's 68020-based graphics processor, parallel pipelined architecture, and five custom gate arrays to put your graphics throughput on the fastest track.

Match these workstations against the rest of the field: with

speeds like 450,000 2D vectors, 340,000 3D vectors, and 20,000 Gouraud shaded polygons per second—plus Tek's high resolution displays, superior user interface and unsurpassed quality—the 4300 Series outdistances them all.

The 4300 Series protects your software investment, too, because it's compatible with more than 300,000 PLOT 10<sup>®</sup> packages already written for Tek terminals.

Finally, 14 different stand-alone workstation and high-performance terminal products let you shape and reshape each configuration to fit your evolving needs.

For more information on the graphics workstations that run circles, cylinders and solids around the competition, contact your local Tektronix representative.

**Or call 1-800-225-5434.**  
In Oregon, 1-235-7202.

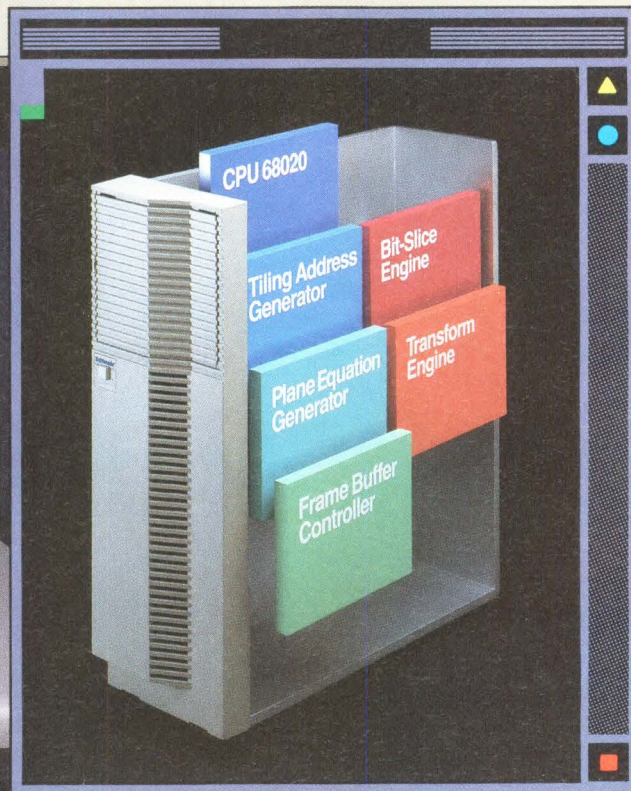

Copyright ©1987, Tektronix, Inc.  
All rights reserved. AHT-105  
Graphics courtesy of DELTACAM  
Systems Ltd., and  
PLOT 10<sup>®</sup> TEKTRONIX

**Tektronix**<sup>®</sup>  
COMMITTED TO EXCELLENCE

CIRCLE NO 68



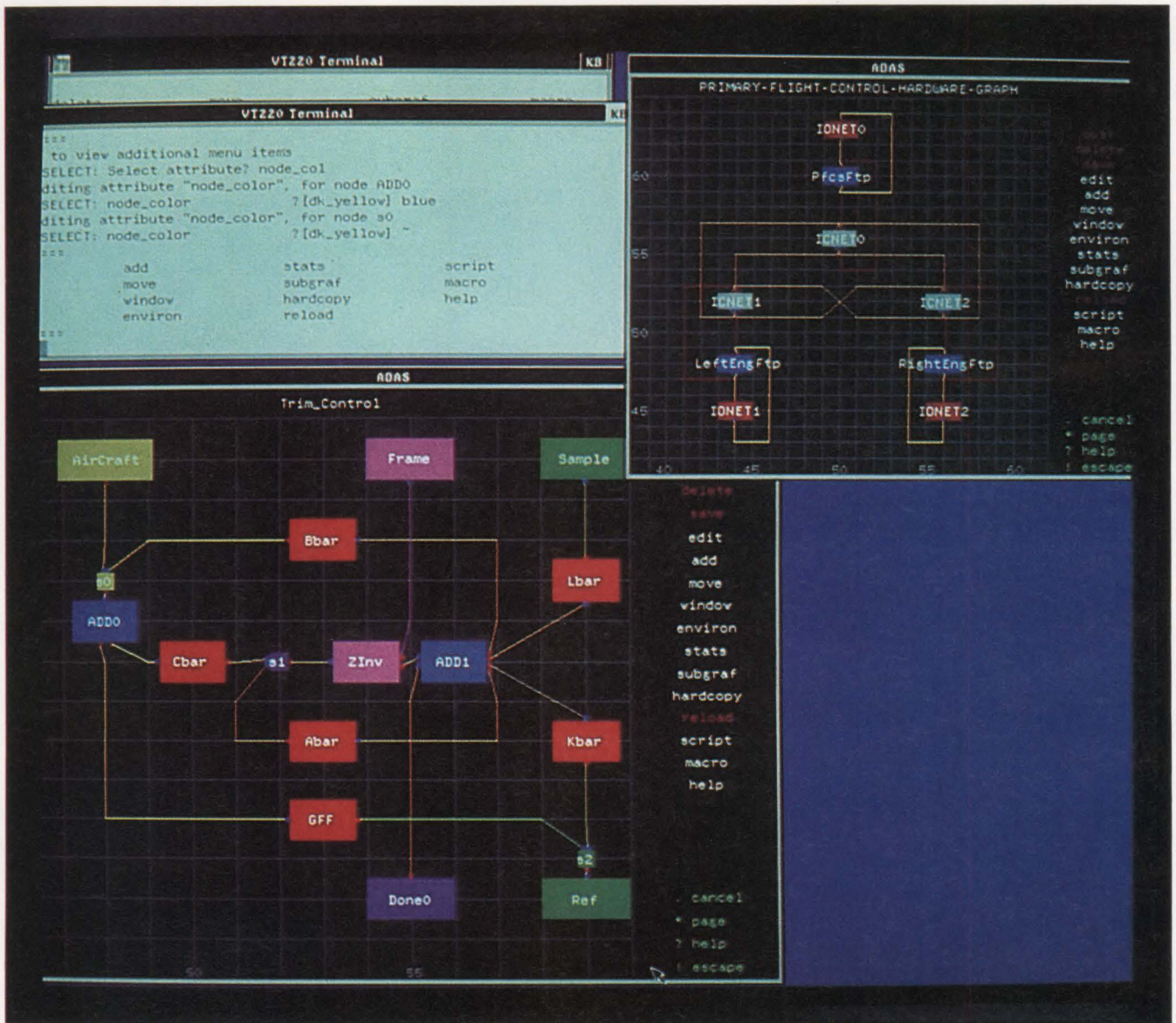

*System-level CAE tools allow you to explore alternative system architectures by simulating system performance with behavioral models of system components. This approach lets you ignore implementation details while dealing with architectural considerations at a very abstract level. (Photo courtesy Research Triangle Institute)*



# Developing CAE tools target top-down design of complex systems

---

*The next decade's billion-transistor ICs will rapidly make manual system-design methods obsolete. If engineers are to tackle larger, more complex electronic designs, they will need automated design tools. Today's CAE tools help engineers develop system components. Tomorrow's tools will help designers develop entire systems.*

---

Steven H Leibson, *Regional Editor*

The growing complexity of standard and custom ICs is making the task of designing electronic systems ever more arduous. Many vendors now offer CAE tools that help engineers manage such complexity, but today each tool handles, at best, only part of the job. These CAE products help you design ASICs or pc boards, or aid in the coding of software, for example, but no one product can yet help you do the total system design from top to bottom. Furthermore, today's automated IC-design tools can't transform inexperienced engineers into chip designers, and merely using a pc-board design system doesn't ensure that you'll come up with a good board design.

Over the next decade, however, CAE-tool vendors will start distilling design expertise into their tools so

that inexperienced engineers can design noncritical parts of systems, and seasoned engineers can vastly improve their productivity. At the same time, system-level CAE tools will give designers better control over the definition and attainment of project goals.

## Today's CAE tools work

Although most engineers still don't use CAE tools for any kind of design, a few designers are already using today's tools to create very complex systems. For example, Sequent Computer Systems (Portland, OR) used CAE tools from Mentor Graphics (Beaverton, OR) to develop two backplanes, three ASICs, and three pc boards for its Symmetry Series multiprocessor computers. The Symmetry computers are compatible with Sequent's earlier Balance Series.

Each Symmetry CPU board incorporates two processor subsections based on Intel (Santa Clara, CA) 80386  $\mu$ Ps. Sequent developed three ASICs for the Symmetry processor board: a 5000-gate cache-memory controller based on a gate array, a 10,000-gate bus-interface controller also based on a gate array, and a 14,000-gate data-path bus controller built with standard-cell technology. The company also used a 6000-gate serial-link-controller IC that it had designed for its earlier Balance Series computers. The company's engineers used Mentor Graphics tools to design all four of these ASICs.

Paul Gifford, manager of central systems engineering at Sequent, says the Mentor Graphics ASIC-design



## PART TWO DECADE



The future of  
system design

*Today's CAE tools are helping engineers design and simulate complex systems. Engineers at Apollo Computer Inc used Mentor Graphics tools to develop the CPU board for the Apollo's DN4000 Series workstations.*



tools are "pretty robust" for developing chips at the 9000-gate level and are quite capable of developing ASICs having as many as 20,000 gates. Beyond that number of gates, he says, "the tools start to let go."

According to Gifford, Sequent also used Mentor Graphics tools to design the dual-processor boards for the Symmetry Series. Engineers performed simulations on about half of the processor board's circuitry, which is the equivalent of about 70,000 gates. A typical design iteration, including simulation, evaluation, and design editing, required about 24 hours.

### Expanding the backplane

Sequent's engineers used MSpice analog simulation on the Mentor systems to help develop the Symmetry's backplane. They used bus-driver and -receiver models from the IC vendors and simulated several termination schemes to optimize the backplane's design. As a result, Symmetry's backplane has 26 slots. If the engineers hadn't been able to use analog simulation to verify the feasibility of the bigger backplane, says Walt Mayberry, Sequent's director of engineering, time-to-market pressures would have forced the company to use a more conservative 16-slot backplane, which would have limited the capacity of the machine.

Another computer manufacturer, Apollo Computer (Chelmsford, MA), also employed Mentor Graphics tools to design the processor board of one of its latest products, the DN4000 workstation. The DN4000's CPU

board incorporates Motorola's (Phoenix, AZ) 68020  $\mu$ P, 68881 floating-point coprocessor, and 68851 memory-management unit (MMU), plus other LSI components and 40 programmable-logic devices (PLDs).

### Assorted device models

Apollo engineers used an assortment of device models to simulate the CPU board. They used hardware models for the 68020 and 68881, behavioral models for some of the other VLSI parts on the board, gate models for glue logic, and downloaded programs for PLDs and PROMs. Using this wide assortment of models, the designers were able to make design changes and perform simulations on the revised design in about 30 minutes.

Ted Elkind, a section manager in charge of Apollo's CAE logic-design tools group, estimates that the company saved one to two months of the 6-month prototyping cycle by using these CAE tools. Engineers brought the system debugger up on the CPU board in one day—for an earlier project, that task required about a week—and they had the operating system running on the new system in three weeks, instead of the usual three months.

### Some shortcuts cost time

Apollo could have saved even more time by making better use of the simulation tools, Elkind notes. For example, because of time and resource constraints,



Apollo didn't create hardware models of the 68851 MMU and the cache-tag comparator. Instead, the engineers wrote a simple, "pass-through" model of the MMU and a behavioral model of the cache-tag comparator.

When debugging the newly fabricated CPU board, the engineers spent a disproportionate amount of time finding and fixing design flaws centered around the MMU, and they discovered that the cache-tag comparator didn't operate according to its specifications. The comparator vendor had to redesign the part to meet the specifications and, fortunately, the revised part was ready in time for Apollo's first production run. Gifford says that better modeling of these two parts would have revealed these problems earlier in the design cycle and would have further reduced the time required to debug the new system.

Because of their experiences, both Sequent and Apollo strongly advocate the use of CAE development tools. Both companies intend to make even more use of simulation in future projects to further reduce debugging efforts and overall development time. However, the 24-hour design cycle required for the Sequent design shows that workstations can have a tough time coping with complex system design. In fact, most engineers would even consider the 30-minute time that Apollo achieved to be far too long.

### Expert design assistance

These two examples illustrate the way that today's CAE tools can help engineers who have design expertise to create new designs more quickly. The CAE tools of the 1990s will go a step further: Just as general-purpose software, such as a spreadsheet, allows casual computer users to perform complex computational tasks without programming, the next decade's CAE tools will allow system-design engineers to create ICs without becoming IC designers.

Dr Prabhu Goel, president of Gateway Design Automation Corp (a Westford, MA, CAE-tool vendor) believes a dichotomy will emerge in IC-design CAE tools. He believes that some tools will mask the details of IC design so that inexperienced chip designers can easily create noncritical portions of a chip. The critical portions of a chip—the ones that directly affect the IC's performance—will still be created by expert IC designers, who will use tools that allow for fine sculpturing of silicon, Goel says.

Artificial intelligence is already providing one way for

engineers with some experience to become better IC designers. For example, NCR's (Fort Collins, CO) Design Advisor, an expert-system tool, can review IC designs and suggest improvements. The design rules built into the software were gathered from NCR's own IC engineering staff. The Design Advisor checks for several different types of design problems and can offer a wide range of advice concerning speed, testability, manufacturability, and silicon-area usage (Fig 1). To build the Design Advisor, NCR used the Proteus expert system developed by the MCC (Microelectronics and Computer Technology Corp) Artificial Intelligence Laboratory in Austin, TX.

But engineers use CAE software for more than just IC design. Some CAE tools aid in the development of pc boards or PLD programs. Unfortunately, the databases for these design tools are generally incompatible, creating an electronic Tower of Babel. One solution companies employ to overcome this mass of incompatible data is translation. For example, Aida Corp (Santa Clara, CA) offers software that performs file-format conversion, which allows Aida's system-design tools to accept design information from Mentor, Viewlogic, Tegas, and Hilo systems.

### A standard language will allow for interchange

Translation is not the solution to the basic problem of incompatibility: If each CAE-tool vendor were to write translators for selected data-file formats, the industry would end up with an incomplete solution at a horrendous cost in development time. Instead of using translation, CAE-product vendors will employ standard interchange languages such as EDIF—the Electronic Design Interchange Format—to help eliminate database-format incompatibilities in the 1990s. EDIF allows CAE systems to exchange engineering information, and it encompasses several types of engineering documents or "views," including mask layouts, documents, behavioral descriptions of circuits, schematics, and net lists.

Some companies plan to take EDIF beyond hardware design. Cadre Technologies Inc (Providence, RI) has proposed a set of extensions to EDIF version 2.0.0 to accommodate software developed with CASE (computer-aided software engineering) tools. The EDIF Technical Committee, sponsored by the Electronic Industries Association (EIA) is currently considering that proposal.

EDIF allows CAE systems to exchange only low-level design information. Hardware definition languages



# PART TWO DECADE



The future of  
system design

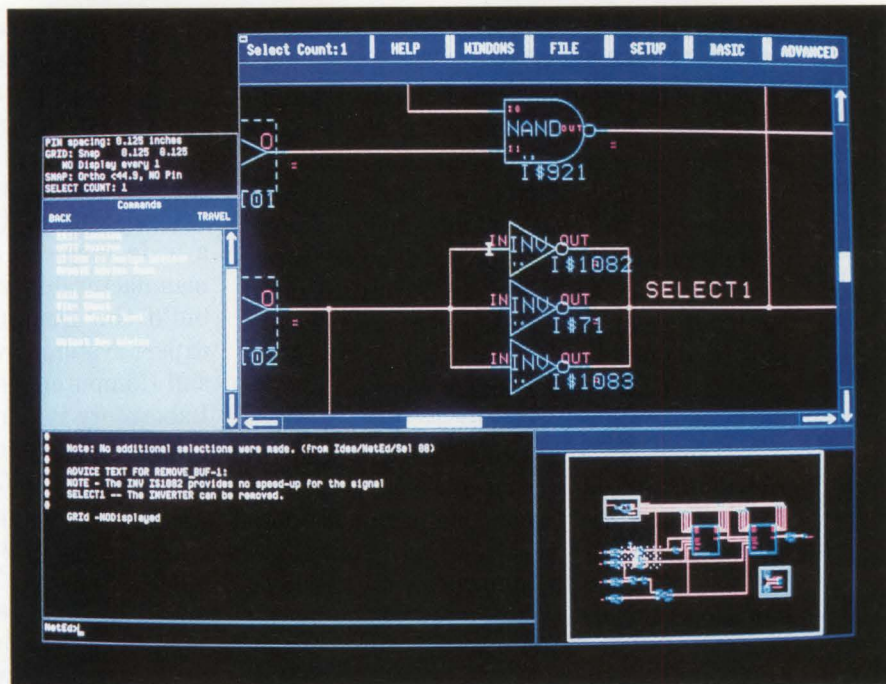

(a)

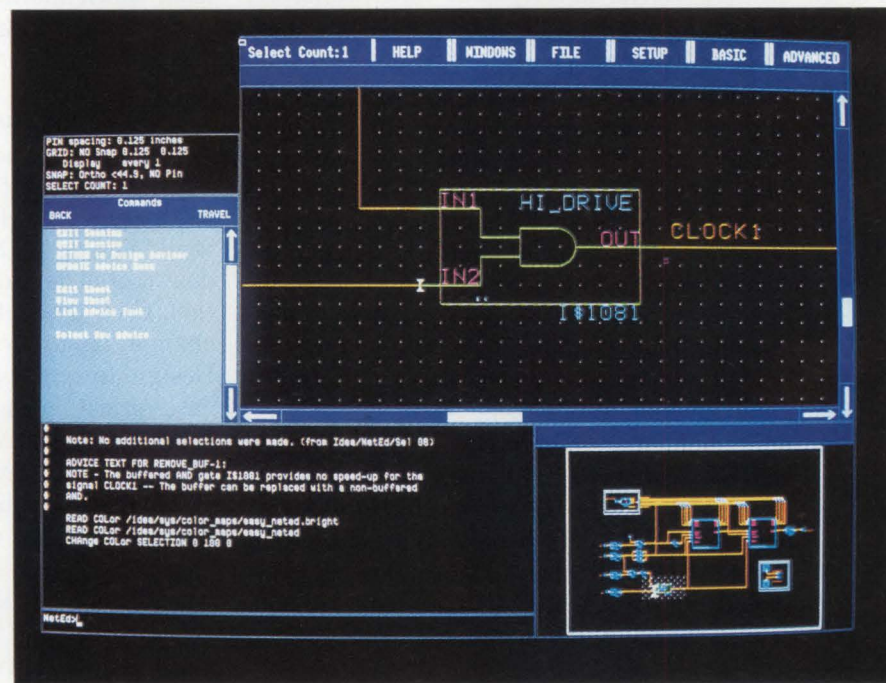

(b)

**Fig 1—Based on artificial intelligence, NCR's Design Advisor CAE tool provides expert design assistance for IC development. The program uses several criteria to evaluate IC designs, and it also gives advice. Here, for example, it recommended that the designer eliminate one of three parallel inverters (a) and suggested the use of an unbuffered instead of a buffered gate (b). Design Advisor made both suggestions because the designer selected components that don't speed circuit operation yet use more silicon than necessary.**

(HDLs), however, promise to allow designers to manage and exchange information at several levels of abstraction, from the system level down. Engineers will need system-level CAE tools such as HDLs to help them design systems around billion-transistor ICs. Sys-

tem development of that complexity demands a structured approach such as that supplied by HDLs.

A few HDLs already exist; they include Gateway's Verilog-XL, Aida's ADL, VHDL (the VHSIC hardware definition language developed for the Department of



Defense's VHSIC (very-high-speed IC) program), and ISP' from Endot (Cleveland, OH). Verilog-XL and ISP' incorporate a syntax resembling the C software programming language. VHDL uses an Ada-like syntax.

According to Dr Thomas A Zimmerman, director of VHSIC programs at TRW's Electronics and Technology Div, VHDL's current lack of a good simulator is a major shortcoming of the language. Dr Zimmerman feels that HDLs will be extremely important for communicating the specifications and requirements of systems and system components. In fact, he says, in much the same way that Ada has become the software language of choice for military systems, VHDL may become mandatory for systems commissioned by the Department of Defense.

Intermetrics Inc (Cambridge, MA) developed the existing VHDL tool set under a VHSIC contract. In December 1987, a revised version of VHDL became IEEE standard 1076. Intermetrics plans to introduce software during 1988 that supports this IEEE standard; the software will include an analyzer that's somewhat like an HDL compiler, as well as a reverse analyzer, and both interactive and batch simulators. Intermetrics also plans to support other CAE vendors who wish to develop VHDL tools—the company will share its front-end software technology with them.

### **HDLs support many levels**

HDLs allow you to describe circuits at the gate, functional, and behavioral levels. For top-down designs, you can use an abstract, behavioral description that avoids the clutter of implementation details and enables you to focus on how the circuit performs. Later, you can design the detailed circuit by using the HDL's lower-level syntax.

Because HDLs give you the ability to describe a system component behaviorally, you can simulate a complex system before designing the circuitry. For example, Gateway's Verilog-XL includes a mixed-mode simulator that accepts behavioral, functional, and gate-level models simultaneously. According to Dr Goel, hardware designers working for some of Gateway's clients have become software gurus while learning to define systems by using Verilog.

One of the benefits of HDL-based hardware design, says Goel, is that it permits the easier partitioning of large designs into blocks that one person can handle. Goel also believes that HDLs help move much of the design process to the conceptual level, freeing engi-

neers from design details that frequently bog them down.

Other CAE experts, however, do not believe that today's hardware engineers will quickly abandon the design techniques they use today. Schematic circuit representations are firmly embedded in most engineers' work habits, and system-design tools that support those familiar ways are also appearing. Further, several CAE-tool vendors allow you to mix schematic and HDL representations. You should expect to use each design technique where it fits best. As usual, most engineers will adopt the available tools in ways that suit them, not the tool designers.

### **Graphic system design**

An example of a system-level, graphic design tool is the ADAS (architecture design and assessment system) CAE tool set developed by the Research Triangle Institute (RTI, Research Triangle Park, NC). ADAS allows you to develop schematic representations of system data-flow and hardware configurations. Petri net simulators and analyzers then verify your design and simulate your system's performance. By using various definitions to map the execution of abstract operations onto system hardware resources, you can experiment with different levels of parallelism to find the optimum combination of hardware and software.

Honeywell (Minneapolis, MN) used ADAS to optimize the design of a video-image processor that will be used on NASA's space station. Honeywell simulated systems employing different network topologies (1-, 2-, and 3-bus systems, hypercube, and both unidirectional and bidirectional braided rings), different numbers of processors (four, eight, and 16), different processor speeds (2, 5, and 10 MIPS), and different bandwidths for interprocessor communications (2M, 5M, and 10M bytes/sec).

Honeywell used ADAS to simulate systems built with these various attributes. The company then decided that the optimum system configuration would have sixteen 10-MIPS processors that communicated over a dual bus at 5M bytes/sec. Clearly, system-level design tools such as ADAS allow you to make informed architectural decisions for very complex systems.

### **Getting chips from system tools**

ADAS is strictly a system-level design tool, however. It produces descriptions of system components, but it doesn't help you design those components. You must



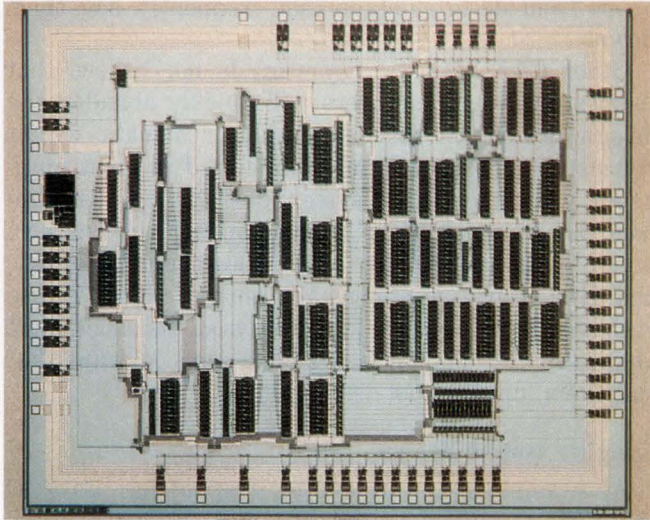
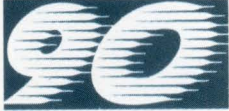

**Fig 2—To develop the architecture for this edge-detection image-processor IC, engineers at the Research Triangle Institute (RTI) used ADAS, RTI's system-level CAE tool. To create the IC, they then transferred the architectural design to Silicon Compiler Systems' Genesil silicon compiler. In the future, standard hardware definition languages such as VHDL will make the conversion process automatic.**

use other CAE tools for the individual component designs. For example, RTI recently created a system definition of an optical processor that employs the Sobel algorithm for edge detection. After using ADAS to create, simulate, and verify a system architecture, the RTI engineers transferred the architecture to Silicon Compiler Systems Corp's (San Jose, CA) Genesil compiler and implemented the various functional blocks in the optical processor (registers, multiplexers, adders, etc) with elements from the Genesil library. They then used Genesil to simulate the compiled version of the image processor as part of the verification process.

In an additional verification step, the engineers created a VHDL description of the edge-detection chip and verified the design with a VHDL simulator. Of course, the working chip provided the ultimate verification of the design (Fig 2). In the future, tools such as ADAS and Genesil will exchange design information directly, using automatically generated VHDL files. Both RTI and Silicon Compiler Systems are currently working on VHDL interfaces for their CAE tools.

### Bearing the cost

Although CAE tools such as those mentioned here clearly boost engineering productivity, it's not clear how many companies will bear the cost of these tools.

Most CAE tools run on workstations that cost at least \$10,000. Add to this several thousand dollars—or tens of thousands of dollars—for the software, and you arrive at a total outlay that represents a substantial investment per design engineer.

Companies that believe that a shortened development cycle and optimized designs justify such a large outlay are already adopting these tools. If you're waiting for the tools to get a bit better before you adopt them, consider that at any point in time, CAE tools will always seem inadequate for the task of designing leading-edge systems. However, engineers routinely push their tools beyond commonly accepted limits to design state-of-the-art systems, and semiconductor technology shows no signs of slowing down to wait for the CAE tools to catch up.

From the Sequent and Apollo success stories, you can see that engineers at some firms have taken the sometimes difficult measures necessary to master today's design tools, and are already making plans to use tomorrow's offerings. Companies that cannot or will not invest in CAE tools may find themselves less able to tackle the large projects that will become more common in the next decade. Such companies will find themselves at a competitive disadvantage in the 1990s. **EDN**

### References

1. Conner, Margery, "ASIC simulation," *EDN*, February 4, 1988, pg 118.
2. Hines, Dr John, "Where VHDL fits within the CAD environment," *Printed Circuit Design*, December 1987, pg 8.
3. Marx, Esther, Hart Switzer, and Mike Waters, "EDIF format brings uniformity to CAE/CAD data," *EDN*, January 22, 1987, pg 153.
4. Marx, Esther, Hart Switzer, and Mike Waters, "Use EDIF to create test vectors and verify your logic," *EDN*, February 19, 1987, pg 185.
5. Marx, Esther, Hart Switzer, and Mike Waters, "EDIF readers/writers handle data transfer between CAE systems," *EDN*, March 4, 1987, pg 171.
6. Mosley, J D, "Artificial-intelligence techniques boost utility of CAE/CAD tools," *EDN*, February 19, 1987, pg 83.
7. "Video Image Processor for Space Station Applications," *ADAS News*, October, 1987, pg 1.
8. Waters, Mike, Esther Marx, and Hart Switzer, "Use an interchange format to port component libraries," *EDN*, February 5, 1987, pg 175.

Article Interest Quotient (Circle One)  
High 494 Medium 495 Low 496



# Enter The New Age of Electronic CAD

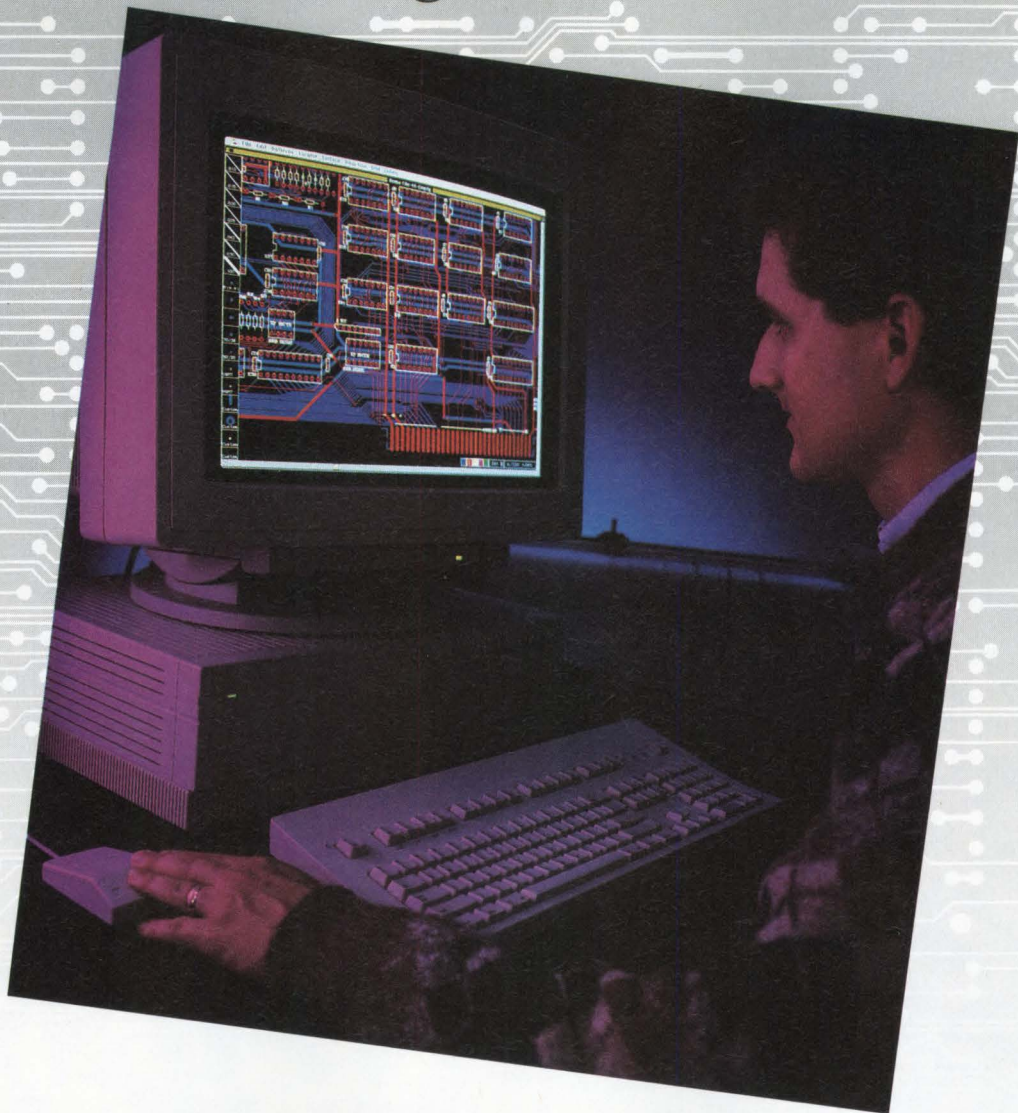

The wait is over for a powerful, easy to use electronic design workstation.

With the new Douglas CAD/CAM Professional System, you can now experience computer-aided design without going over budget and without sitting through months of tedious training. Running on the Apple Macintosh Plus, SE and II, the Professional System from Douglas Electronics excels in price/performance, short learning curves and ease of use.

As the newest addition to the Douglas CAD/CAM line of printed circuit board design and manufacturing systems, the Professional System is a fully integrated engineering tool that will take you from the schematic drawing to the final routed board. The software features full color, unlimited multi-

layers and .001" control which makes surface mount technology (SMT) and other difficult tasks a snap. Professional Layout includes a parts placement facility. Schematic includes fully interactive digital simulation and net list generation. A flexible, multi-pass router completes the design cycle with a 16 layer routing capability.

The new age of electronic CAD has come with the high resolution and speed of a Macintosh engineering workstation. You'll be designing your first circuit board just minutes after the Professional System software has been loaded into your computer. In addition, the Macintosh's graphics capa-

bilities allow for powerful features such as the ability to transfer Professional System drawings into final engineering documentation.

Computer-aided design wasn't meant to be time consuming and complicated. If your present CAD system has got the best of you, it may be time you enter the new age of electronic CAD with the powerful, easy to use Douglas CAD/CAM Professional System.

Take your first step by ordering a full-feature Demo. All three programs are included for just \$25.

Call or write for more information and to place your order.

CIRCLE NO 69

**Douglas**  
Electronics

718 Marina Blvd.  
San Leandro, CA 94577  
(415) 483-8770





# Our ASIC Program targets all your design needs.

**In gate arrays, standard cells  
or Compiled Cell Custom, you'll  
always score with S-MOS.**

**Complete design tools.**

S-MOS SYSTEMS supports a large and growing number of workstations, including Daisy, Mentor, Calma and PC-based systems using FutureNet, Orcad and Viewlogic. Our proprietary LADS simulator is one of the fastest in the world,

and our engineering support will keep you ahead of the competition.

**Advanced manufacturing.**

Our manufacturing affiliate, Seiko Epson, is one of the world's most advanced CMOS IC manufacturers, with 18 years of CMOS experience.

At our highly automated Class 10 facility in Japan, Seiko Epson can produce 40,000 4" wafers, 20,000 5" wafers and 20,000 6" wafers. Each month.

That's a total equivalent of about 23 million units a month.

**High quality and total reliability.**

With a product reject rate of less than .0001%, S-MOS and Seiko Epson deliver the ASICs you can depend on.

For a fully integrated ASIC program, call us. (408) 922-0200.

**S-MOS SYSTEMS  
2460 North First Street  
San Jose, CA 95131-1002**



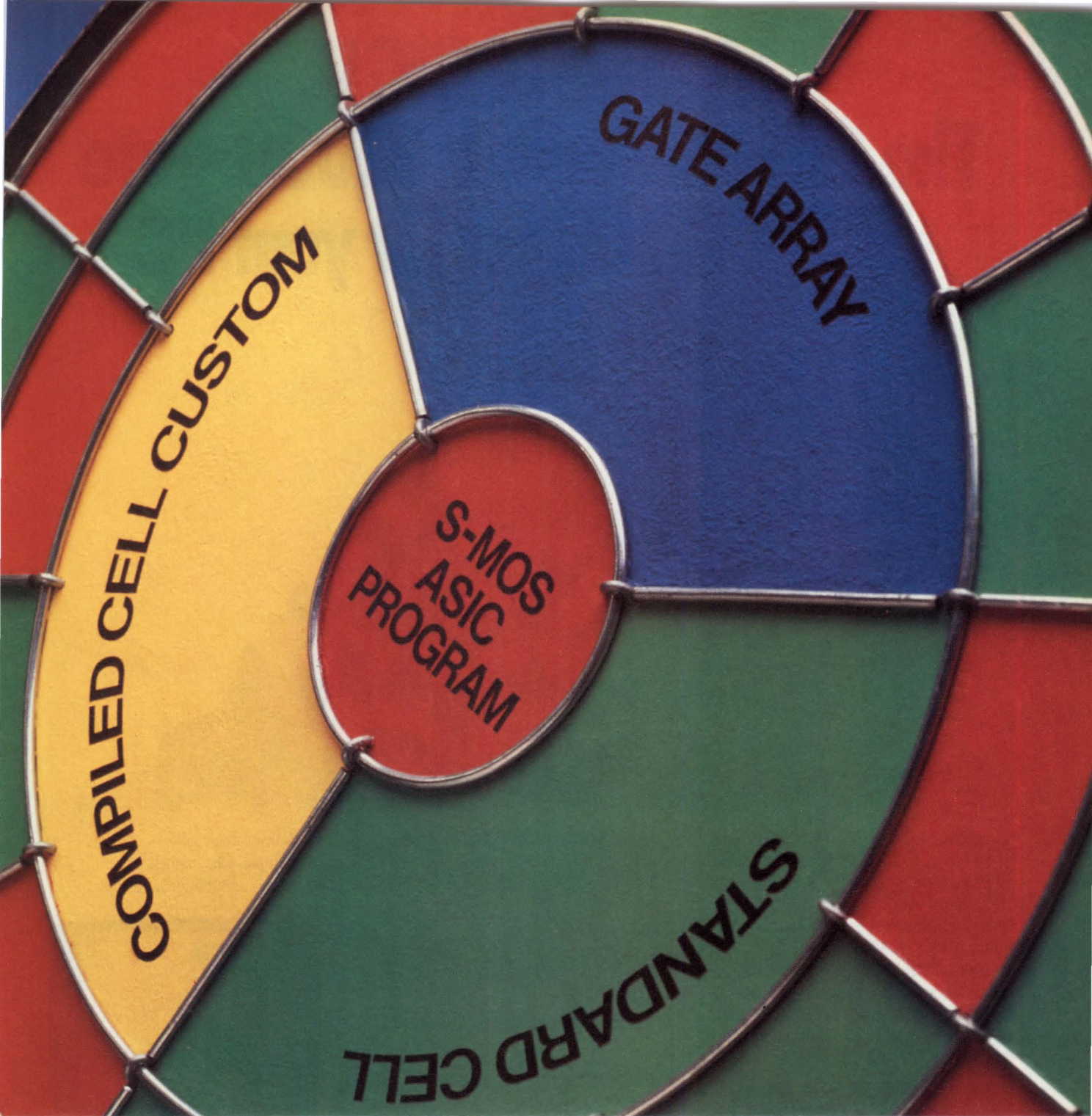

CMOS Gate Arrays	CMOS Standard Cells	Compiled Cell Custom
Complexities to 16K gates • SLA8000 (500ps)* 1.2 $\mu$ drawn, 0.95 $\mu$ Leff • SLA7000 (640ps)* 1.5 $\mu$ drawn, 1.2 $\mu$ Leff • SLA6000 (1.3ns)* 2.0 $\mu$ drawn, 1.7 $\mu$ Leff • SLA5000 (2.2ns)* 3.0 $\mu$ drawn, 2.3 $\mu$ Leff	Complexities to 16K gates • SSC1000 (720ps)* 1.8 $\mu$ drawn, 1.5 $\mu$ Leff • Fully migratable from S-MOS gate arrays • RAM and ROM blocks available	<i>The Alternative to Full Custom</i> • 1.5 $\mu$ CMOS Process • Can utilize dissimilar cell geometries • 3-button approach to custom design • Currently over 300 fully characterized cells • Fast 14-week implementation time • Timing-driven TANCELL* Place-and-Route Software

\*Typical propagation delay of 2-input NAND gate driving 1 internal load including 100 $\mu$  interconnect.

\*TANCELL is a registered trademark of Tangent Systems.

**S-MOS**  
**SYSTEMS**  
*A Seiko Epson Venture*



# MICRO-LOGIC II.™

## The CAE tool with a 10,000-gate digital simulator for your PC.

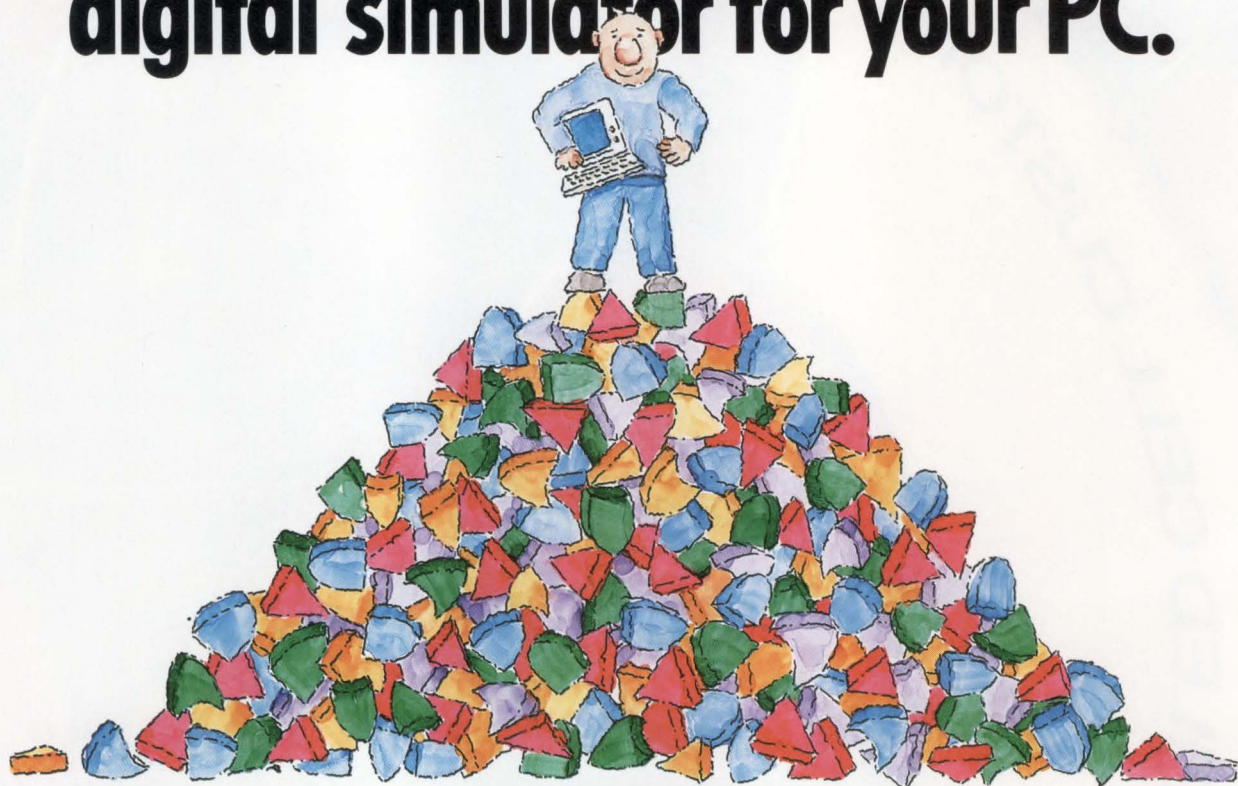

Spectrum Software's MICRO-LOGIC II® puts you on top of the most complex logic design problems. With a powerful total capacity of 10,000 gates, MICRO-LOGIC II helps engineers tackle tough design and simulation problems right at their PCs.

MICRO-LOGIC II, which is based on our original MICRO-LOGIC software, is a field-proven, second-generation program. It has a high-speed event-driven simulator which is significantly faster than the earlier version.

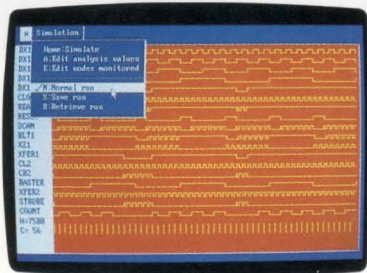

Timing Simulator

The program provides you with a top-notch interactive drawing and analysis environment. You can create logic diagrams of up to 64 pages with ease. The software features a sophisticated schematic editor with pan and zoom capabilities.



Shape Editor

A 200-type library of standard parts is at your fingertips. And for a new high in flexibility, a built-in shape editor lets you create unique or custom shapes.

MICRO-LOGIC II is available for the IBM® PC. It is CGA, EGA, and Hercules® compatible and costs only \$895 complete. An evaluation version is available for \$100. Call or write today for our free brochure and demo disk. We'd like to put you in touch with a top digital solution.

- Total capacity of 10,000 gates
- Integrated schematic editor
- Fast assembly language routines
- Standard parts library of 200 types
- Event-driven timing simulator

- Built-in shape editor
- Multiple delay models
- Printer and plotter hard copy

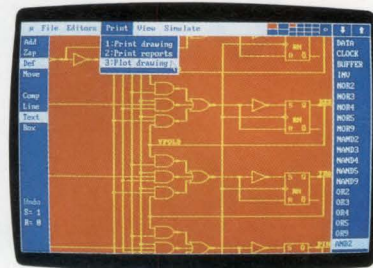

Schematic Editor

**Spectrum**

1021 S. Wolfe Road, Dept. E  
Sunnyvale, CA 94087  
(408) 738-4387

MICRO-LOGIC II is a registered trademark of Spectrum Software.  
Hercules is a registered trademark of Hercules Computer Technology  
IBM is a registered trademark of International Business Machines, Inc.



# Design method yields low-noise, wide-range crystal oscillators

---

*A characterization technique allows you to design frequency-determining networks for tunable crystal oscillators. The method yields oscillators that provide a wide tuning range and exhibit low-noise performance. The design methodology accurately quantifies all effects relevant to oscillator performance.*

---

Tim L Hillstrom, *Hewlett-Packard Co*

Traditionally, designing crystal oscillators that have wide tuning range and acceptable noise performance requires time-consuming trial-and-error methods. However, you can use a straightforward design procedure to achieve a tuning range of hundreds of ppm without compromising noise performance. By characterizing the tuning range of the frequency-determining network of a crystal oscillator, you can accurately quantify all the effects that determine oscillator performance and fully include them in your design.

This design technique extends the traditional approach that uses a crystal's equivalent-circuit model—a model that fails to adequately characterize the crystal in difficult designs. The equivalent-circuit approach simply does not accommodate such relevant effects as

off-resonance lossiness, crystal-model element variation with frequency, and spurious modes. Traditionally, these effects are lumped into a vague term called "crystal pullability."

The material given here will concentrate on feedback-type oscillators using crystals configured in the series-resonant mode (**Fig 1a**). Note, however, that the design techniques presented here are applicable to other topologies as well. In this block diagram,  $H(f)$  is a low-Q bandpass filter that selects the desired harmonic.  $G_2$  is a buffer that provides a low-impedance termination for the frequency-determining network, and  $G_1$  is a nonlinear gain block that provides the variable gain or amplitude limiting necessary for stable oscillation. The gain of  $G_1$  decreases monotonically as a function of signal level. When the circuit turns on (and signal levels are low),  $G_1$  varies to provide an open-loop gain greater than three to ensure that the circuit oscillates. Once the circuit is oscillating and signal levels attain a steady-state condition,  $G_1$ 's gain is approximately unity.

The frequency-determining network contains the crystal and associated tuning elements. This circuit block is a 1-port network ideally described as  $Z_T(f)$ . For optimum performance, you must minimize undesirable admittances, such as those attributable to stray capacitance and varactor-isolating resistors. The dotted ground connection (which carries negligible current) from the frequency-determining network is an example of a low-admittance stray network path.

In order for the circuit to oscillate, open-loop phase



*The equivalent-circuit approach to designing crystal oscillators simply does not accommodate a number of relevant effects.*

shift must equal  $0^\circ$ . Because the circuit in **Fig 1** contains two frequency-dependent blocks, a number of harmonic-selecting filter and frequency-determining-network phase combinations will provide an overall loop phase shift of  $0^\circ$ . For two reasons (maximum loop gain and minimum phase noise), it's best to have  $0^\circ$  phase shift in each network. The design method shown here uses  $0^\circ$  phase shift as a condition.

Now it's time to concentrate on the crystal loop—the closed path around  $R_{t1}$ , the frequency-determining network, and  $R_{t2}$ . The crystal loop partially determines the oscillator's phase noise and totally determines the frequency tuning. The frequency-determining aspect of the loop is true because everything outside the crystal loop is independent of frequency over the narrow frequency range of interest. In the model,  $G_1$ 's input impedance is infinite, and  $G_2$ 's output impedance equals zero. If  $I_{STRAY}$  is negligible, you can consider the frequency-determining network to be a 1-port imped-

ance  $Z_f(f)$ . Therefore, the relevant equations for oscillation and noise become

$$I_m [Z_f(f)] = 0 \tag{1}$$

$$Q_L(f) = \frac{f_0}{2(R_{t1} + R_{t2} + \text{Re}[Z_f(f)])} \cdot \frac{d\text{Im}[Z_f(f)]}{df}, \tag{2}$$

where  $Q_L(f)$  is the Q of the frequency-determining network. This parameter is also known as the "loaded Q" of the crystal. The dominant parameter under designer control,  $Q_L(f)$ , determines the oscillator's noise level. According to Leason's equation, the single-sided phase noise equals

$$L(f_m) = \frac{FkT}{2P_o} \left[ 1 + \left( \frac{f_0}{f_m 2Q_L} \right)^2 \right] \left[ 1 + \frac{f_1}{f_m} \right] \tag{3}$$

$$\cong \frac{FkT}{2P_o} \left[ \frac{f_0}{f_m 2Q_L} \right]^2 \text{ for } f_1 < f_m < \frac{f_0}{2Q_L}$$

$$\cong \frac{FkT}{2P_o} \left[ \frac{f_0}{2Q_L} \right]^2 \left[ \frac{f_1}{f_m^3} \right] \text{ for } f_m < f_1 < \frac{f_0}{2Q_L}$$

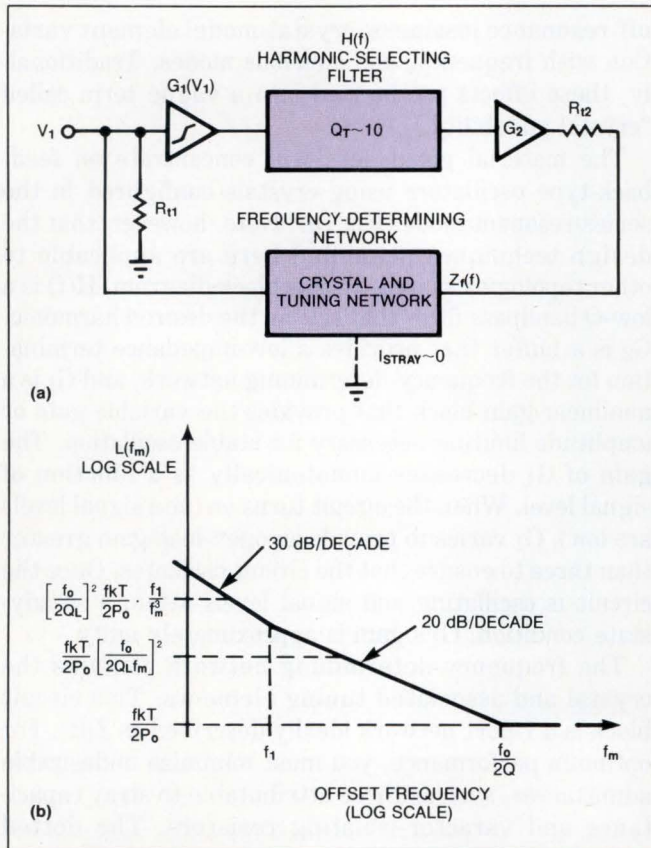

**Fig 1—Because this circuit includes two frequency-dependent blocks, a number of harmonic-selecting filter and frequency-determining-network phase combinations will provide an overall loop phase shift of  $0^\circ$ —a necessary condition for oscillation.**

where

$f_0$ =oscillation frequency

$f_m \approx f - f_0$ =offset frequency

$f_1 = [1/f]$  noise corner ( $< f_0/2Q_L$ )=resonator half bandwidth

$kT$ =thermal noise floor= $-174$  dBm/Hz

$F$ =noise figure of the circuit

$P_o$ =output power

$Q_L$ =loaded Q

**Fig 1b** illustrates this phase-noise characteristic. It's worth noting that the crystal itself can contribute noise that exceeds that predicted by Leason's equation. This noise is generally attributable to contaminants in the crystal. Proper crystal-manufacturing techniques (in a clean room) and cold- or resistive-weld sealing techniques minimize the problem.

Inspection of **Eq 2** and **Eq 3** suggests that for minimum phase noise over the entire tuning range,  $Z_f(f)$  must have an imaginary part having a large slope and a real part that remains small. Ideally, oscillator loop gain remains constant over the tuning range. This condition ensures oscillator start-up and minimal AM noise over the tuning range. You can realize constant loop gain by selecting  $Z_f(f)$  such that it has a small and fairly constant real part over the tuning range. A constant  $Q_L$  is also desirable because it provides consis-



tent noise performance over the tuning range and also simplifies the design of the tuning network. For constant loop gain and optimal noise performance over the tuning range, therefore, you'll need a  $Z_f(f)$  that has a large slope, an imaginary part that's fairly linear, and a real part that's small and fairly constant.

You must observe one final requirement for stable oscillation—the imaginary part of  $Z_f(f)$  must equal zero at only one frequency over the entire frequency range in which sufficient loop gain exists for oscillation. To meet this requirement, you'll need a crystal that has a monotonic reactance-vs-frequency characteristic.

### Frequency-determining network

To attack the design problem, first consider an ideal ( $C_0=0$ ) crystal connected in series with a variable tuning capacitor (Fig 2). As Fig 2 illustrates, this network meets all the requirements stated above. The variable tuning capacitance  $C_S$  shifts the crystal reactance down by a variable amount that's essentially independent of frequency over a small fractional frequency range. Oscillation occurs at the point where the shifted reactance curve crosses zero. A straightforward analysis yields the equation

$$\frac{\Delta f}{f_0} = \frac{C_m}{2C_{smin}} \left[ 1 - \frac{1}{C_R} \right], \quad (4)$$

where  $\Delta f$  is the tuning range and  $C_R$  is the tuning-capacitance ratio ( $C_{smax}/C_{smin}$ ).

Clearly, a series tuning capacitor can only shift the oscillation frequency to a value above the series-resonant frequency of the crystal. Therefore, most VCXOs (voltage-controlled crystal oscillators) using this configuration are tuneable to a frequency above the series-resonant frequency of their crystals. You can lower the tuning frequency by adding an inductor in series with the tuning capacitor. Although adding inductance helps avoid the spurious modes that typically occur at frequencies above the crystal's series-resonant frequency, the addition introduces susceptibility to magnetic-pick-up problems.

Now consider a network (Fig 3) in which the ideal crystal's  $C_0$  is greater than 0 pF. Clearly, this circuit fails to meet two of the previously cited requirements—the real part of  $Z_X$  is not constantly low, and the imaginary part is not linear. You can remove the effects of  $C_0$  by adding an appropriate inductor  $L_0$  to form a parallel-resonant circuit. Unfortunately, you cannot select  $L_0$ 's value based on measured or specified values

of  $C_0$ , because the crystal model is not adequate for difficult applications.

The best design approach is to measure  $\text{Re}[Z_X(f)]$  and  $\text{Im}[Z_X(f)]$  over the entire tuning range. You then mathematically (or physically) add enough parallel inductance to satisfy the design requirements. Although in theory it's possible to precisely meet the crystal's requirements, the crystal could deviate substantially from any modeled performance in practice. However, the approach does allow you to quickly evaluate crystal prototypes in environments that mirror the actual application. This advantage can be a real time saver.

To get down to specifics, let's design an 80-MHz

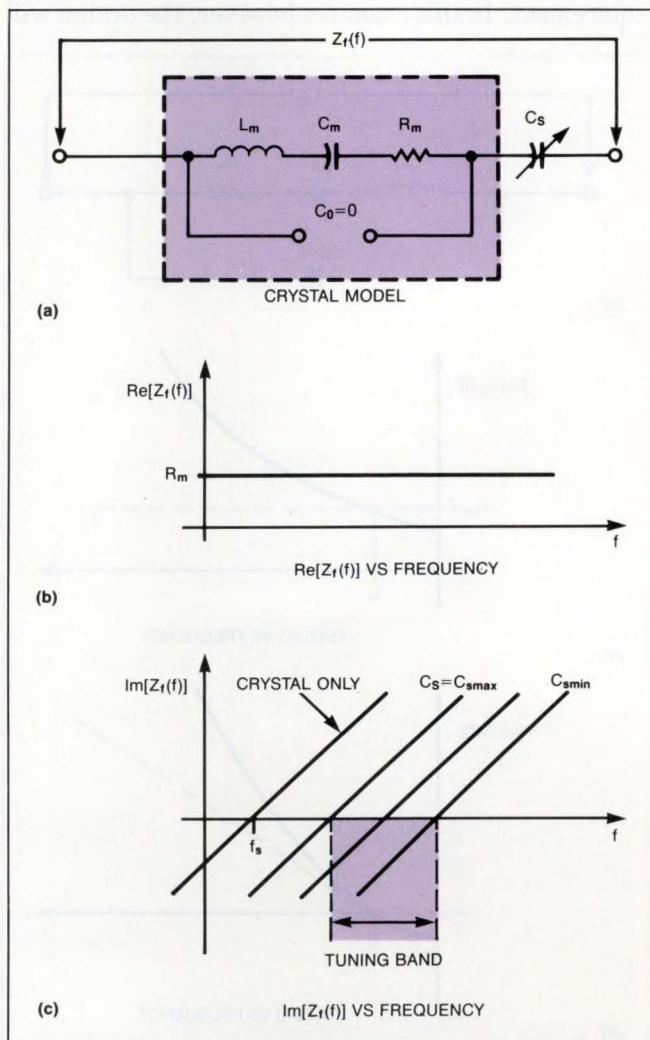

Fig 2—Because a series tuning capacitor can only raise the oscillation frequency above the series-resonant frequency of the crystal, oscillators using this configuration are tuneable to frequencies above their crystal's series-resonant frequency.



*Proper crystal-manufacturing techniques and cold- or resistive-weld sealing techniques can minimize intrinsic crystal noise problems.*

VCXO for use in a phase-locked loop that must accommodate a  $\pm 15$ -ppm absolute error in its reference frequency. Typically, low-cost crystals specify a  $\pm 5$ -ppm absolute frequency error, a  $\pm 15$ -ppm aging error over 10 years, and a  $\pm 10$ -ppm variation as a function of temperature (over an industrial operating range). To accommodate all these error sources, the oscillator must have a  $\pm 45$ -ppm tuning-range capability—that is,  $\Delta f = 90$  ppm. This is considered a very wide tuning range for a low-noise, 80-MHz VCXO.

In some cases, you could use two devices to develop the required overall tuning capacitance—a mechanical trimmer capacitor for crystal-frequency error and aging, and a varactor to satisfy the remaining tuning requirement. In this example, however, the design will

use a varactor for the entire 90-ppm tuning range. Eq 4 shows that a wide tuning range requires a large varactor capacitance ratio ( $C_R$ ), a small  $C_{smin}$ , and an appropriately large crystal motional capacitance  $C_M$ . Increasing  $C_M$  may decrease the unloaded-crystal  $Q$ , so you must make some tradeoffs to realize the optimum combination.

To obtain a large varactor  $C_R$ , you must use a hyper-abrupt diode. For a hyper-abrupt VHF varactor like the BB105,  $C_R \approx 5.5$  and  $C_{smin} = 2.2$  pF. From Eq 4, therefore,  $C_M$  must be at least 0.5 fF to ensure  $\Delta = 90$  ppm. The mean frequency (80 MHz by design in this case) over the tuning range is

$$\bar{f} = f_0 \left[ 1 + \frac{C_m}{4C_{smin}} \left( 1 + \frac{1}{C_r} \right) \right]. \quad (5)$$

From Eq 5, the crystal's series-resonant frequency comes out to 79.99462 MHz, or 67 ppm below 80 MHz. The crystal must have no spurious modes or aberrant characteristics over the tuning range—between 22 and 112 ppm above the series resonant frequency.

This design is based on the properties of an ideal crystal. In a real-world situation, you'll have to measure a real crystal to determine the tuning-band measurements of the frequency-determining network. You then use this data to select the correct varactor and a crystal with the proper frequency.

To add detail to the theory, Fig 4 illustrates a 2-transistor feedback oscillator that effectively implements the block diagram of Fig 1.  $L_1$ ,  $C_1$ , and  $C_2$  combine to set the desired crystal harmonic frequency.  $D_1$ , which is isolated from the crystal, provides amplitude limiting.  $D_1$ 's impedance decreases with signal level. This impedance drop reduces  $Q_1$ 's voltage gain and thereby implements the  $G_1$  variable-gain block of Fig 1. The network comprising the crystal,  $L_2$ , and  $D_2$  determines the oscillator's frequency.  $Q_2$  isolates the tank from the crystal and provides a low-impedance termination for the crystal's closed loop, composed of  $R_{t1}$ , the crystal,  $D_2$ , and  $R_{t2}$ .  $Q_1$  supplies the voltage gain necessary for oscillation and also provides a low-impedance termination for the crystal loop.

To start, you must adjust the oscillator's frequency-determining network to run at  $0^\circ$  phase. To do this, you can substitute an ac-coupled resistor whose value is equal to the typical value of  $\text{Re}[Z_f(f)]$  over the tuning range. You then select  $C_1$  and/or  $C_2$  to establish the oscillator's desired operating frequency—80 MHz in this case. You then replace the resistor by the frequen-

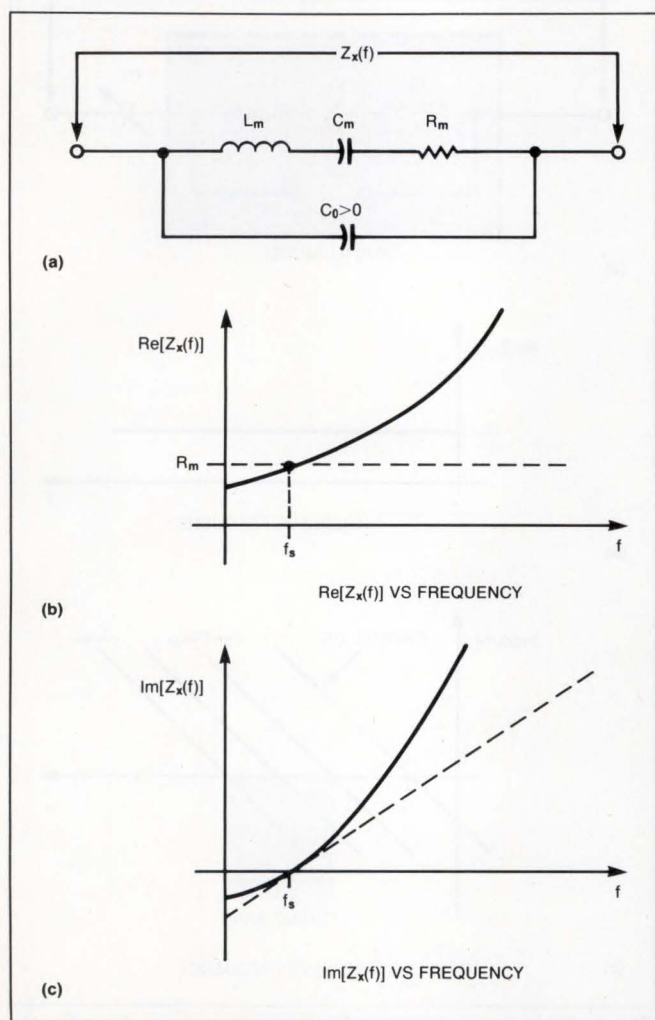

**Fig 3—Tuning range is limited** (and oscillator noise is inconsistent) when the ideal crystal's  $C_0$  is greater than 0 pF, because the real part of  $Z_X$  is not constantly low and the imaginary part is not linear.



# SILVAR-LISCO Performance Redefined.

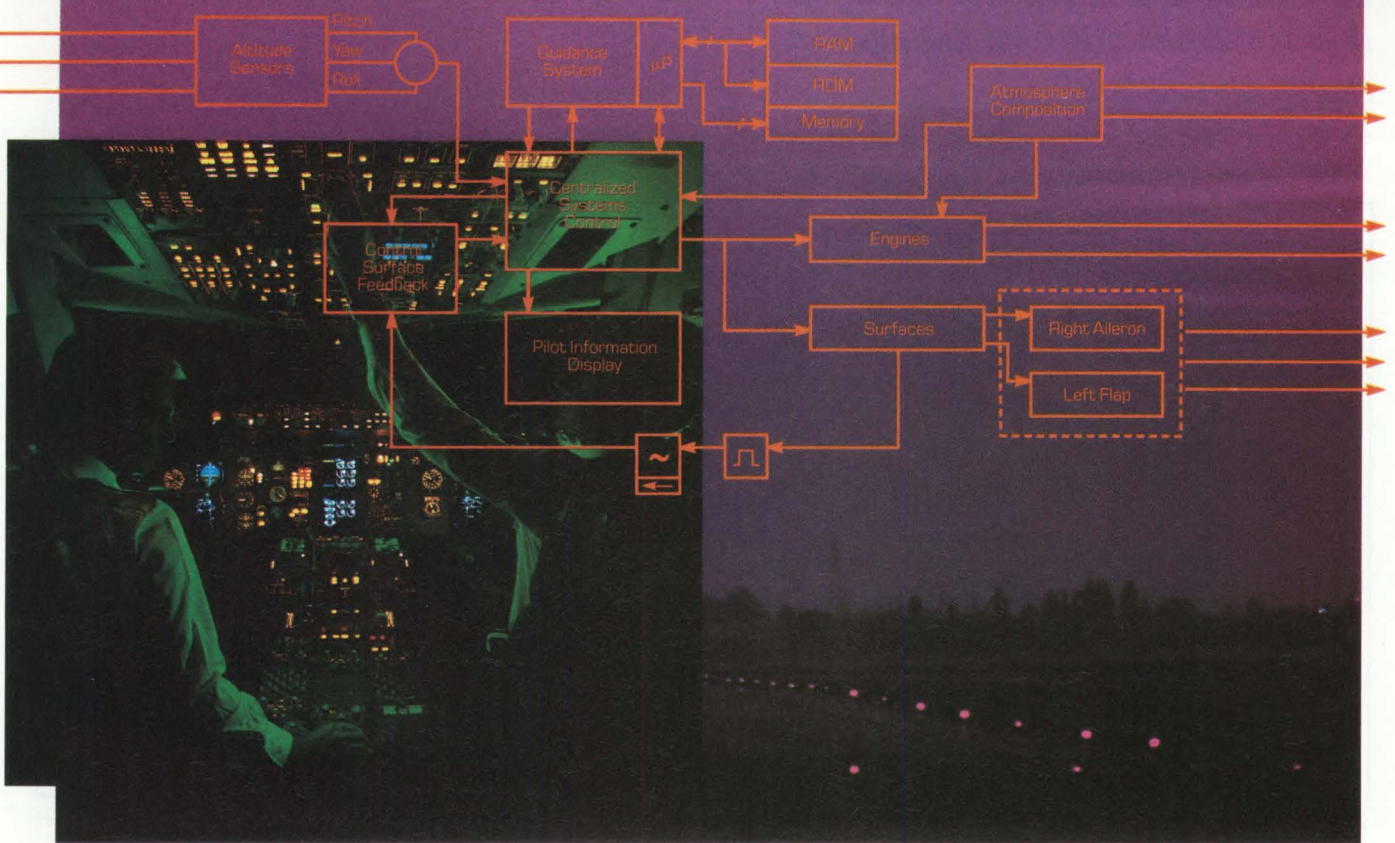

## For complex designs, HELIX™ is the "what if" simulator!

When designing large systems, printed circuit boards or VLSI/VHSIC chips, simulation becomes an invaluable aid. Logic, switch level and circuit simulators are excellent tools for validating design implementations. Silvar-Lisco's Helix Behavioral Simulator takes you one giant step further. In addition to design validation, system architects now can optimize the design itself through analysis of various implementation alternatives.

With Helix you can define and test your system concepts first. If the concept works, you move down to the register level. Then the gate level. Multi-level throughout. If it doesn't work, you can rethink the concept and probe Helix with additional design alternatives. In the end, you will get the best design. The first time.

Helix is a vital component of Silvar-Lisco's Architectural Design Series. Incorporating

design capture, simulation and design libraries, the Architectural Design Series gives you the competitive edge.

**Be a design winner! Contact Silvar-Lisco today!**

### SILVAR-LISCO OFFICES

*Corporate Headquarters*  
1080 Marsh Rd.  
Menlo Park, CA 94025  
TEL: (415) 324-0700  
WATS: 1 (800) 624-9978  
TWX: 910-373-2056  
FAX: (415) 327-0142.

*European Headquarters*  
Leuven, Belgium  
TEL: 32-16-200016  
TWX: 221218  
FAX: 32-16-236076

*Far East*  
Nihon Silvar-Lisco  
Tokyo, Japan  
TEL: 81-3-449-5831  
FAX: 81-3-449-4040



Architectural Design Series

# SILVAR-LISCO

CAE Software products for electronic design.

CIRCLE NO 74



*It's hard to precisely meet theoretical crystal requirements because the crystal may deviate substantially from any modeled performance in practice.*

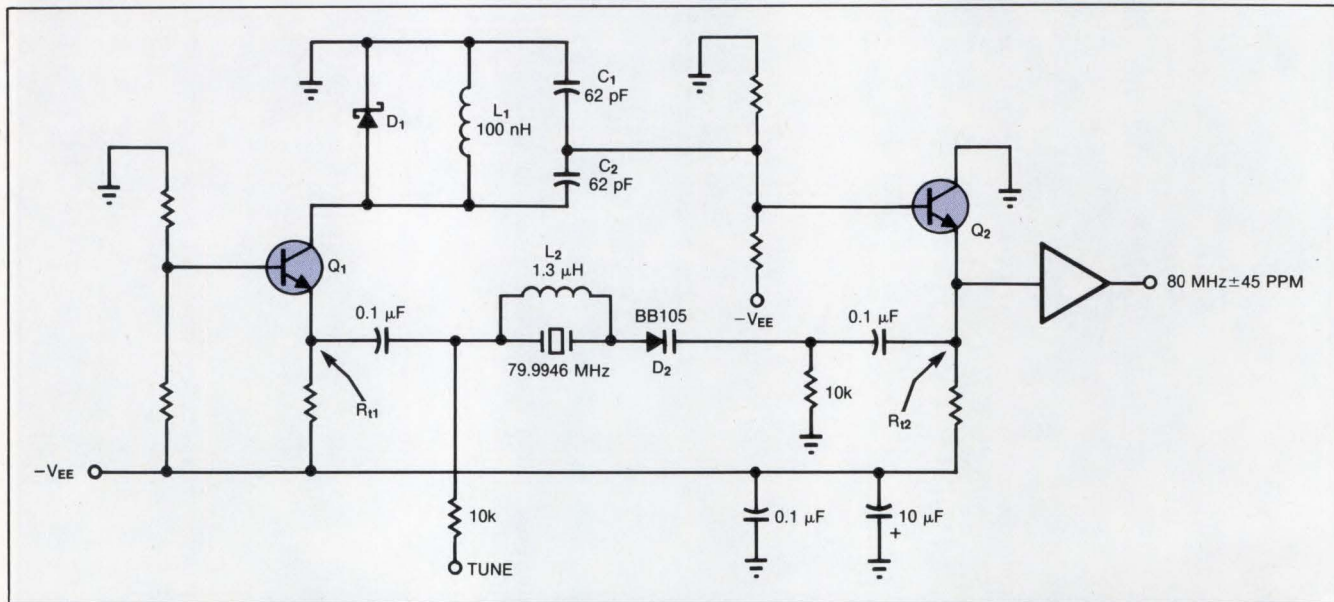

**Fig 4**— $C_1$ ,  $C_2$ , and  $L_1$  combine to set the desired crystal harmonic frequency in this 2-transistor feedback oscillator. The network comprising the crystal,  $L_2$ , and  $D_2$  determines the oscillator frequency.

cy-determining network to complete the design.

When you physically add the frequency-determining network, you should minimize stray admittances. You can do this by removing the ground plane from beneath the frequency-determining network and using large impedance values for the varactor's bias resistors. Note that some nodal impedances in the frequency-determining network are very high—900Ω in this case. To maintain this high impedance at high frequencies, pay strict attention to the physical layout. At this point, the oscillator's tuning range should be very close to the design goal. In addition, noise performance will be fairly constant over the tuning range.

Several mechanisms will act to limit your attempts to achieve greater and greater oscillator tuning ranges. Spurious operating modes are inevitable as you attempt to tune further away from the crystal's series-resonant frequency. Other crystal characteristics can also cause problems.

Crystal reactance, for example, may become non-monotonic with frequency and thus cause unstable tuning. Maintaining high impedance at high frequencies is another problem area. The crystal's high-impedance node has a design impedance of

$$Z(f) \cong R_{t1} + R_m + j \frac{f - f_0}{\pi f_0^2 C_m}$$

Stray capacitance and the varactor-bias ports will

eventually limit your attempts to increase the design impedance. In addition, the accuracy of measurements of the frequency-determining network decreases as you attempt to develop very high impedance levels. For example, if you use an HP3577A vector network analyzer and an HP35677A s-parameter test set, the measurements will have adequate accuracy for impedances between 0.5 and 1000Ω.

**EDN**

### Author's biography

*Tim Hillstrom is a design engineer at the Hewlett-Packard Lake Stevens Instrument Div (Everett, WA), where he is responsible for designing RF circuits for frequency-domain instruments. A 5-year employee at HP, Tim holds a BSEE degree from the University of Portland and an MSEE from the University of Washington. In his spare time, Tim enjoys music; he plays the piano and the guitar. He also enjoys playing basketball and is a tennis fanatic.*

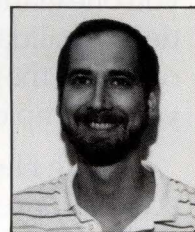

Article Interest Quotient (Circle One)  
High 497 Medium 498 Low 499



**FEATURES**

- Ultrahigh Speed: Current Settling to 1LSB in 35ns
- 12-Bit Integral and Differential Linearity Guaranteed Over Temperature
- 10.24mA Full-Scale Output Suitable for Video Applications
- High Stability Buried Zener Reference on Chip
- 0.3" "Skinny DIP" Packaging
- Variable Threshold Allows TTL and CMOS Interface

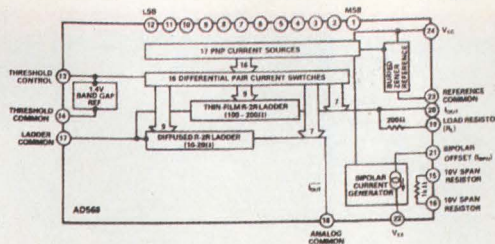

AD568 Functional Block Diagram

**PRODUCT DESCRIPTION**

The AD568 is an ultrahigh-speed, 12-bit digital-to-analog converter (DAC) settling to 0.025% in 35ns. The monolithic device is fabricated using Analog Devices' Complementary Bipolar (CB) Process. This is a proprietary process featuring high-speed NPN and PNP devices on the same chip without the use of dielectric isolation or multichip hybrid techniques. The high speed of the AD568 is maintained by keeping impedance levels low enough to minimize the effects of parasitic circuit capacitances.

Laser wafer trimming insures full 12-bit linearity. All grades of the AD568 are guaranteed monotonic over their full operating temperature range. The low linearity error allows the AD568 to be used in high-speed applications requiring real 12-bit performance. There is no longer any compromise between speed and accuracy in those applications that require both.

The DAC consists of 16 current sources configured to deliver a 10.24mA full-scale current output or a 1.024V FS unbuffered voltage output. Multiple matched current sources and thin-film ladder techniques are combined to produce bit weighting. Additionally, a 10.24V FS buffered output may be generated using an onboard 1kΩ span resistor with an external op amp. Bipolar ranges are accomplished by pin strapping.

**PRODUCT HIGHLIGHTS**

1. The ultrafast settling time of the AD568 allows leading edge performance in waveform generation, graphics display and high-speed A/D conversion applications.
2. Full 12-bit accuracy is provided in a monolithic converter.
3. Pin strapping provides a variety of voltage and current output ranges for application versatility. Tight control of the absolute output current reduces trim requirements in externally scaled applications.
4. Matched on-chip resistors can be used for precision scaling in high-speed A/D conversion circuits.
5. The digital inputs are compatible with TTL and +5V CMOS logic families.
6. Skinny DIP (0.3") packaging minimizes board space requirements and eases layout considerations.

**THE SPEED RECORD FOR  
REAL 12-BIT DAC PERFORMANCE  
IS SET ON THIS PAGE.**



If your high-speed DAC applications are often plagued by a loss of accuracy, we'd like to direct you to our AD568. With a settling time of only 35ns to  $\pm 0.025\%$ , no other monolithic DAC is faster. And it combines this speed with unmatched  $\pm 1/4$  LSB integral nonlinearity, as well as guaranteed monotonicity over the entire operating temperature range, for real 12-bit performance.

This unique combination of speed and accuracy allows you to delve into new application areas like high-speed/high-resolution A/D converters, vector graphic displays, and direct digital frequency synthesizers.

For design versatility, the AD568 offers a variety of user-programmable voltage and current outputs. And all

this comes in a skinny 0.3" CERDIP package, which conserves board space and allows for auto-insertion.

The AD568 delivers an unmatched level of performance with prices starting at only \$35 in 100s. Now you could spend almost twice that for other high-speed monolithics, and still not get the same level of accuracy as the AD568. And while some hybrids might come close in performance to the AD568, they also cost twice as much.

To find out how the AD568 can help set speed records for your designs, call Applications Engineering at (617) 935-5565, Ext. 2628 or 2629.

Or write to Analog Devices, P.O. Box 9106, Norwood, MA 02062-9106.



Analog Devices, Inc., One Technology Way, P.O. Box 9106, Norwood, MA 02062-9106; Headquarters: (617) 329-4700; California: (714) 641-9391, (619) 268-4621, (408) 559-2037; Colorado: (303) 590-9952; Maryland: (301) 992-1994; Ohio: (614) 764-8795; Pennsylvania: (215) 643-7790; Texas: (214) 231-5094; Washington: (206) 251-9550; Austria: (222) 885504; Belgium: (3) 237 1672; Denmark: (2) 845800; France: (1) 4687-34-11; Holland: (1620) 81500; Israel: (052) 28995; Italy: (2) 6883831, (2) 6883832, (2) 6883833; Japan: (3) 263-6826; Sweden: (8) 282740; Switzerland: (22) 31 57 60; United Kingdom: (932) 232222; West Germany: (89) 570050



# Suppress those





# nasty little surges.

## With Surgector™ and GE-MOV® surge suppressors.

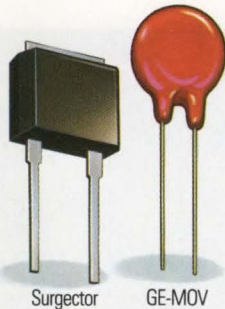

Now, whether you're designing small consumer products, industrial controls, high-rel military and aerospace systems, or anything in between, we have a surge protection solution for you. Because if one of our GE-MOV varistors isn't exactly right for the job, then one of our Surgectors probably will be.

### Leader in Varistors.

We have the broadest line of varistors in the industry, with a range from 5V to 3500V, including the highest-energy MOV's in the industry (up to 70,000 peak amps and 10,000 joules).

They're widely used for incoming ac line protection in power supplies, clamping circuits and low voltage supply protection.

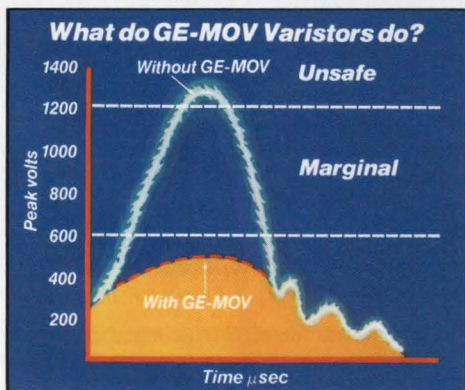

They're available in a variety of packages, including axial leaded, radial leaded, leadless surface mount, high-energy modules and connector-pin configurations. And they're all available for fast delivery.

### Inventor of Surgector devices.

Surgector devices respond rapidly and handle a lot of energy. So they're ideal for protecting

sensitive or expensive components from lightning strikes, load changes, switching transients, commutation spikes, electro-static discharge and line crosses.

### How they work.

Surgector devices combine a zener diode and an SCR into one reliable, cost-effective device.

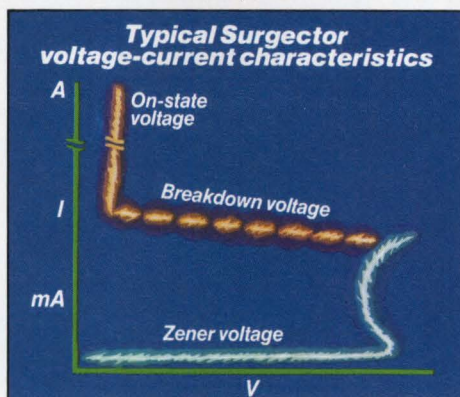

At low voltages, the Surgector is "off," representing high forward impedance (only 50nA leakage current). The instant clamping voltage is exceeded, the Surgector turns "on" and the zener immediately starts conducting. Within nano-seconds, the SCR turns on to handle heavy currents. Destructive surges are shunted to ground.

Once the surge passes, the device makes a fast transition back to the "off" state. You can choose from two-terminal, three-terminal or bi-directional devices.

### We'll help you decide.

To determine which of these powerful technologies is best for you, plug into our applications hotline and let our experts help you decide.

For more information, call toll-free 800-443-7364, extension 21. Or contact your local GE Solid State sales office or distributor.

In Europe, call: Brussels, (02) 246-21-11; Paris, (1) 39-46-57-99; London, (276) 68-59-11; Milano, (2) 82-291; Munich, (089) 63813-0; Stockholm (08) 793-9500.



GE Solid State

GE/RCA/Intersil Semiconductors

Three great brands. One leading-edge company.



# ONE LABEL, 50 HITS. WHAT A RECORD.

Chances are, you didn't even know we were in the SRAM business. We admit we've been a little quiet on the subject. But we've changed our tune and now we're offering them in record numbers.

In fact, Fujitsu now offers more than any other SRAM supplier. More densities. More organizations. More quality.

You can choose from over 50 part numbers. The standards and





the latest hits. With new releases on the way. In densities from 2K to 256K. Organizations of x1, x4, x8 — even x9. And a selection of packaging that includes DIP, flat packs, SOP, LCC, ZIP and SOJ. All in volume. All pin-for-pin compatible with every major supplier.

Here's something else of note. Our SRAMs have an important feature that no one else can duplicate. We call it "technology that works."

It's the quality and reliability that comes from conservative design standards, state-of-the-art production methods and rigorous testing. Not to mention 25 years of experience. The result is music to the ears of Incoming Inspection. And no sour notes in the products you ship.

So if you're looking for selection, availability and quality in SRAMs, we've got your number. Now all

you have to do is punch ours. Call (408) 727-1700 and ask for Standard Products Marketing. Or write Fujitsu Microelectronics, Inc., 3320 Scott Blvd., Santa Clara, CA 95054.

You'll get what you need in record time.



**FUJITSU**  
MICROELECTRONICS, INC.

Technology that works.  
CIRCLE NO 76



© 1986 Fujitsu Microelectronics, Inc.



# The Latest Advance In Servos And Support.

*Toshiba MK-250  
5.25" Winchester.  
382 MB, 18 ms seek,  
15Mb/sec transfer,  
30,000 MTBF.*

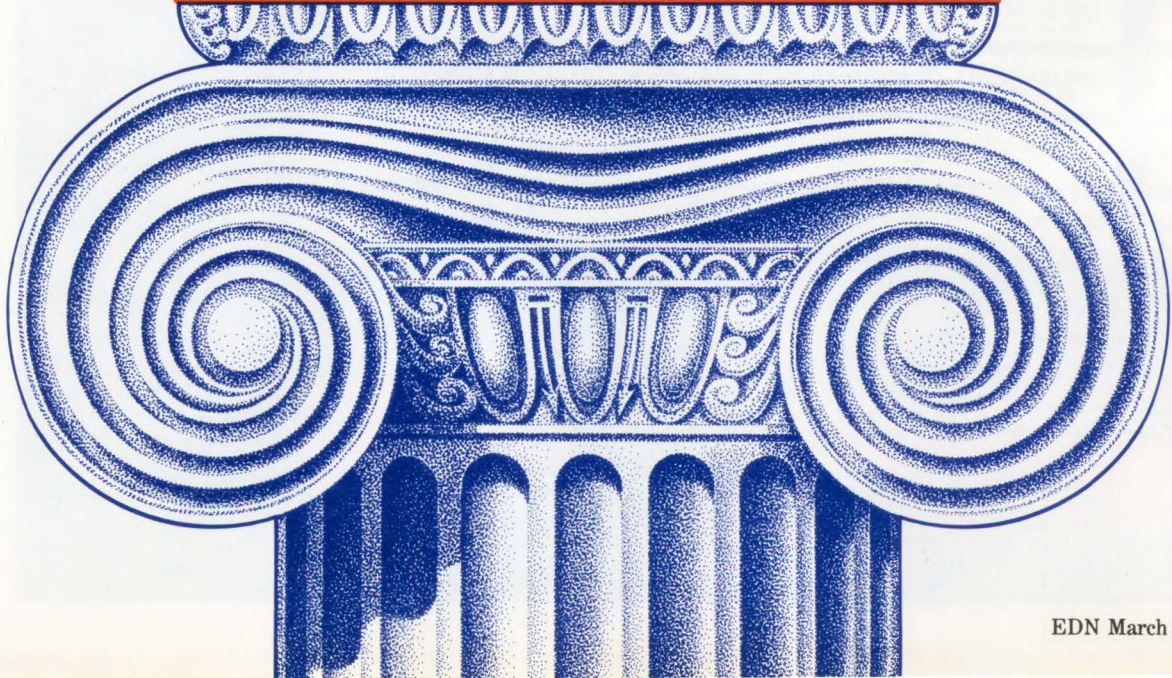





The new Toshiba MK-250 may look like your average 5.25" Winchester drive, but looks can be deceiving. Because you can't really see the 15Mb/sec transfer rate or 18 ms access time that make it the perfect drive for UNIX™ and graphics applications.

Nor can you see what makes it one of the most advanced Winchester drives ever produced. And that's our new Hybrid-Servo. An innovation that allows us to provide the 382 MB capacity you need but with fewer platters and heads in the drive. Which, in turn, gives you other benefits. Like the fast transfer rate. Higher reliability. And more tolerance across the range of operating environments.

But one of the best things about our new servo is the support it gives our position as a leader in disk drive technology. Because the Hybrid-Servo concept is a fundamental requirement in pushing 5.25" Winchester capacities toward the gigabyte level. All of which means Toshiba is well on the way to where the rest of the industry will be going.

Of course, supporting your efforts to get ahead is really the driving force behind our advancements. It's the reason for our multi-million dollar R&D program. Extensive engineering and integration assistance. Dependable Just-In-Time delivery, and more. Because if you're not successful, we can't be either.

To find out more about what Toshiba servos and support can do for you, call us at 714-583-3150.

And who knows? The next major advance could be yours.

In Touch with Tomorrow  
**TOSHIBA**  
TOSHIBA AMERICA, INC.

Disk Products Division, 9740 Irvine Boulevard, Irvine, CA 92718

©1987 Toshiba America, Inc. UNIX is a trademark of AT&T Bell Laboratories.



# World's fastest FCT™

FAMILY COMPARISONS				
MAXIMUM SPEED OVER COMMERCIAL TEMPERATURE/SUPPLY RANGE				
	FAST	FACT	IDT	Part Numbers
Registers	10.0ns	N/A	6.0-7.2ns	273A, 299A, 374A, 377A, 533AA, 574A
Latches	8.0-10.0ns	N/A	5.2ns	373A, 533A, 573A
Buffers	6.5-8.0ns	13.5ns	4.3-4.8ns	240A, 244A
Transceivers	7.0-9.0ns	N/A	4.6-5.0ns	245A, 640A, 645A

	29800A	29C800	IDT	Part Numbers
Registers	10.5ns	12.0ns	7.5ns	821B, 822B, 823B, 824B, 825B, 826B
Latches	9.0ns	11.0ns	6.5ns	841B, 842B, 843B, 844B, 845B, 846B
Buffers	6.0ns	8.0ns	5.0ns	827B, 828B
Transceivers	6.0ns	8.0ns	5.0ns	861B, 862B, 863B, 864B

## CMOS power—TTL levels

### Increase the speed of your system and cut power with JEDEC standard pinouts and TTL levels.

Last year IDT introduced a large family of CMOS logic devices that were pin/performance compatible with FAST and with 29800 parts. Now we have something new: speed grades that are 50% faster than FAST and 60% faster than the 29800 series. At 1/5th to 1/3rd the TTL dynamic power consumption.

#### FCT compared to FAST.

Our FCT "A" speed grade is 50% faster than the 54/74F FAST series, yet provides the same input and output specs—plus dramatically lower CMOS power levels over the full temperature and voltage supply extremes.

**FCT compared to FACT.** All FCT CMOS is TTL compatible on inputs and outputs, while the FACT series only contains a few TTL compatible parts. FCT "A" is three times faster than FACT, provides better output drive, lower dynamic power and more parts in production. TTL compatible FACT is nowhere near as fast as FAST.



**FCT compared to 29800, 29800A and 29C800.** FCT800B is a complete CMOS family equivalent to—but about 60% faster than—the 29800 bipolar series. Compared to the 29800A series, FCT is 30% faster and provides both CMOS and TTL compatible inputs and outputs at low CMOS power levels. Compared to the 29C800 series, our FCT is 60% faster and provides twice the output drive.

**Packaging.** All of our packaging and pinouts support the existing JEDEC standards.

FCT devices come in plastic and hermetic 16- and 20-pin DIPs, plastic and hermetic 24-pin DIPs, plastic 16- and 20-pin SOICs, 28-pin PLCCs and hermetic 28-pin LCCs.

Military versions are available tested to MIL-STD-883C, Class B, Methods 5004 and 5005.

**Interfacing.** FCT devices are specified to directly drive CMOS SRAMs without pullup resistors.

- Inputs.** 5µA max. input current levels are substantially lower than bipolar.
- Outputs.** Com'1 I<sub>OL</sub> is 48 to 64mA. Com'1 I<sub>OH</sub> is -15mA.
- ESD Protected.** Withstands over 2000V static discharge.

### May we be of assistance?

Contact your local IDT representative, call today (408) 492-8550, or fill in the bingo for a copy of an *Application Note* explaining how to use the world's fastest logic.

You will also receive our *Product Selector Guide* on cost effective, high-performance CEMOS™ MICROSLICE™ (bit-slice products), **Subsystems, DSP Circuits, ultra-fast Logic** and one of the fastest, broadest lines of CMOS **Static RAMs** in the world.

CEMOS and MICROSLICE are trademarks of Integrated Device Technology, Inc.  
FAST is a trademark of Fairchild Semiconductor Company

When cost effective performance counts



**Integrated  
Device Technology**

3236 Scott Blvd.  
Santa Clara, CA 95054-3090  
(408) 492-8550  
FAX: 408 727-3468



# System architecture dominates design of no-wait-state cache

---

*To extract maximum efficiency from today's 32-bit CPUs, you must provide them with zero-wait-state access to program and data memory. With  $\mu$ P clock speeds approaching 30 MHz, however, designing a cost-effective zero-wait-state memory is more difficult than ever.*

---

James K Flynn and Narciso Mera,  
*AT&T Microelectronics*

Dynamic RAMs can no longer support zero-wait-state accesses, and main memories built entirely from static RAMs are too expensive for today's low- to medium-performance computer systems. However, one way to achieve cost-effective, zero-wait-state performance is to combine a small, high-speed, static-RAM cache memory with a main memory based on a slower, less expensive dynamic RAM.

When considering such a memory architecture, however, you must evaluate several design options. In addition to choosing between a virtual and a physical cache, you must match your cache design to a CPU and memory-management unit (MMU). You must also consider the system-level impact of your operating system and application programs.

One of the first decisions you must make is between a

combined MMU/CPU or separate unit approach. Your choice impacts not only your cache timing and expense, but your memory-management efficiency. In high-performance multiuser applications, designers generally opt for a separate CPU and MMU. That's because the separate MMU is able to store more virtual-address translation descriptors as well as support multiple users—both of which are essential for efficiently executing multiuser operating systems.

Having chosen a separate MMU and CPU, you must choose between a virtual and physical cache. A virtual cache stores virtual addresses and is located physically and logically between the  $\mu$ P and MMU. A physical cache stores the physical addresses it gets from the MMU's output.

To illustrate some of the tradeoffs, consider a virtual and physical cache implementation, both of which use Motorola's 68020 microprocessor and 68881 paged memory-management unit (PMMU).

**Fig 1a** shows a 68020 design with a virtual-address cache. The design assumes a 30-MHz clock frequency (approximately 30 nsec per clock cycle). Because the 68020 has a normal bus-read cycle of three clock periods, the memory system must supply valid data within 90 nsec for zero-wait-state read operations. **Fig 1b** shows the timing for a normal zero-wait-state bus cycle. The address is valid in the first clock period; the CPU reads data in the third period.

Because the virtual address from the CPU isn't valid until the end of the first clock cycle, to achieve a zero-wait-state access bus cycle, you must design the



*You must match your cache design to a CPU and memory-management unit. Also consider the system-level impact of your operating system and application programs.*

virtual cache so that it responds with valid data within 60 nsec (for cache hits). Assuming that the cache-control logic requires 30 nsec to make a hit/miss determination, the cache memory must have an access time of 30 nsec or less. You can design such a cache with fast CMOS static RAM at a cost of about \$200 for a 64k-byte cache—roughly \$150 for 30-nsec CMOS static RAM and \$50 for the control logic.

### Too slow for physical cache

Although it's feasible to implement a zero-wait-state virtual cache at 30 MHz using fast CMOS static RAM, such RAM is not fast enough for a physical cache using the same ICs (Fig 2a). The virtual-to-physical address-translation time, added by the MMU, delays the availability of a valid address until the end of the second clock period (Fig 2b shows the read-cycle timing for a physical cache). Consequently, to support a zero-wait-state access, the cache must respond in less than 30 nsec.

When you consider the delay that's inherent in the cache-control logic, only ECL static RAM can support

zero-wait-state accesses at 30 MHz. A CMOS cache, in this application, sustains one or more wait states (inactive clock cycles) for each read operation.

### Virtual vs physical cache

Although a virtual cache allows you to achieve zero-wait-state accesses with slower, less expensive memory, it also presents several design and performance obstacles—particularly in multiuser, multitasking, and multimaster applications. First, for some operating systems, you must design your system to handle cases where more than one virtual address maps into the same physical address (alias addressing). AT&T's Unix is one operating system that allows alias addressing; Berkley's System V Unix is one that does not.

Alias addressing is not a problem if the size of the virtual cache equals the page size used in the memory architecture. That's because only one cache entry can map to any given physical address. However, when the cache size exceeds the page size, two sections of code, or tasks, can access the same data using different

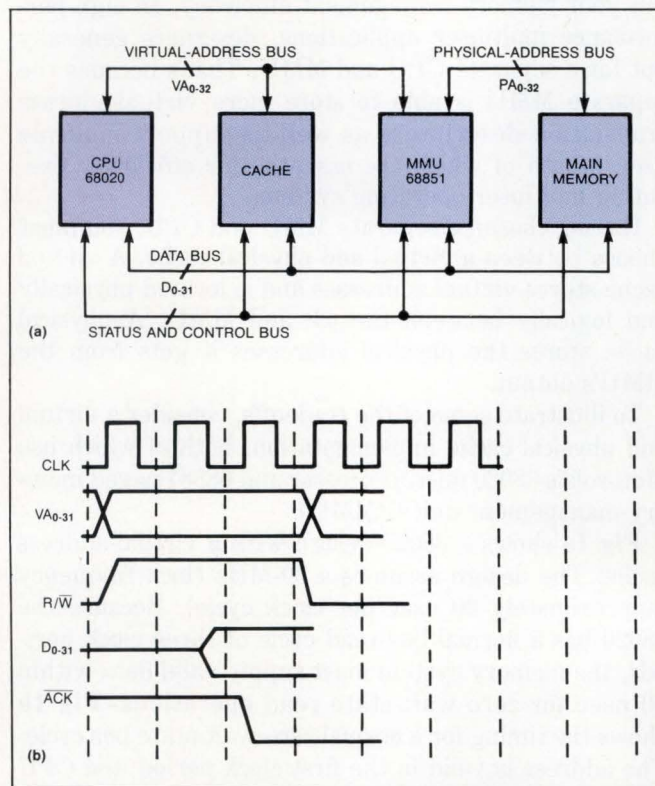

**Fig 1**—Because the 68020 has a normal bus-read cycle of three clock periods, the memory system must supply valid data within 90 nsec for zero-wait-state read operations (a); (b) shows the timing for a normal zero-wait-state bus cycle.

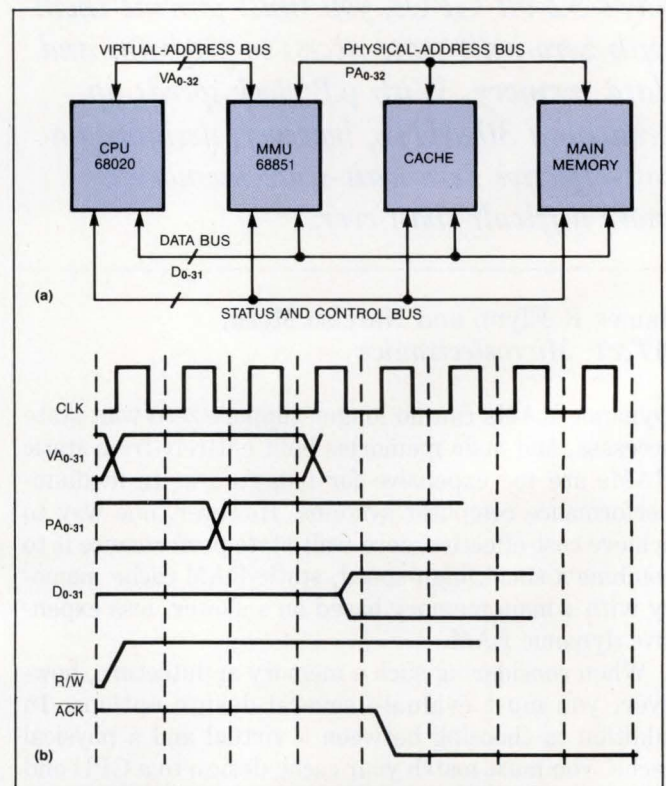

**Fig 2**—CMOS static RAM is not fast enough for a physical cache using the same ICs as in Fig 1a. The virtual-to-physical address-translation time, added by the MMU, delays the availability of a valid address until the end of the second clock period (b).



## Getting down to cache basics

A cache is a small array of high-speed semiconductor memory that designers typically use to economically reduce the effective time needed to access a larger, slower bank of memory (semiconductor or magnetic). The cache strategy relies on the locality of instructions and data. Operating systems and applications programs tend to spend large portions of time executing programs and accessing data in small sections of memory. As a result, a small cache can often sustain a high hit rate. As long as the hit rate is high, the effective memory access time for the entire memory mirrors that of the cache.

For a 16M-byte semiconductor address space, a 4k-byte cache is often sufficient to ensure a high hit rate. A 300M-byte disk, on the other hand, might merit a semiconductor cache of 1M byte or more.

### A typical design

Fig A depicts a typical cache design. The cache consists of two sections of memory. The section on the right stores the cached data organized as eight entries of 8 bytes each. The section on the left contains a tag field for each 8-byte data entry. Address bits  $A_{3-10}$  select the tag as well as the 8-byte data entry. Bits  $A_{0-2}$  can select a byte within

each entry, usually within a 32-bit word. The tag field stores the upper address bits for the 8-byte entry associated with each tag. This scheme allows any memory page or portion of a page to map into the cache.

In a system that uses a  $\mu P$  with 32 address bits, for example, the tag stores bits  $A_{11-31}$  for each entry. The tag also includes other bit fields that signify status information, such as whether the entry is valid.

On a memory access, the cache-control logic compares the upper address bits presented on the  $\mu P$  address bus with the address stored in the cache tag. The tag entry corresponds to the entry selected by address bits  $A_{3-10}$ . A hit occurs when the  $\mu P$  address is the same as the tag address and the other tag fields indicate that the data are valid.

### Other organizations possible

In this example, the cache is organized as 256 8-byte entries. However, you're free to use a variety of other configurations, as long as the cache is at least as large as the page size used in your memory system. If the higher-order address bit needed to distinguish between pages is of a higher order than the bit needed to distinguish between cache entries, then two addresses from the same page would map into the same cache address. Such a design limits cache effectiveness.

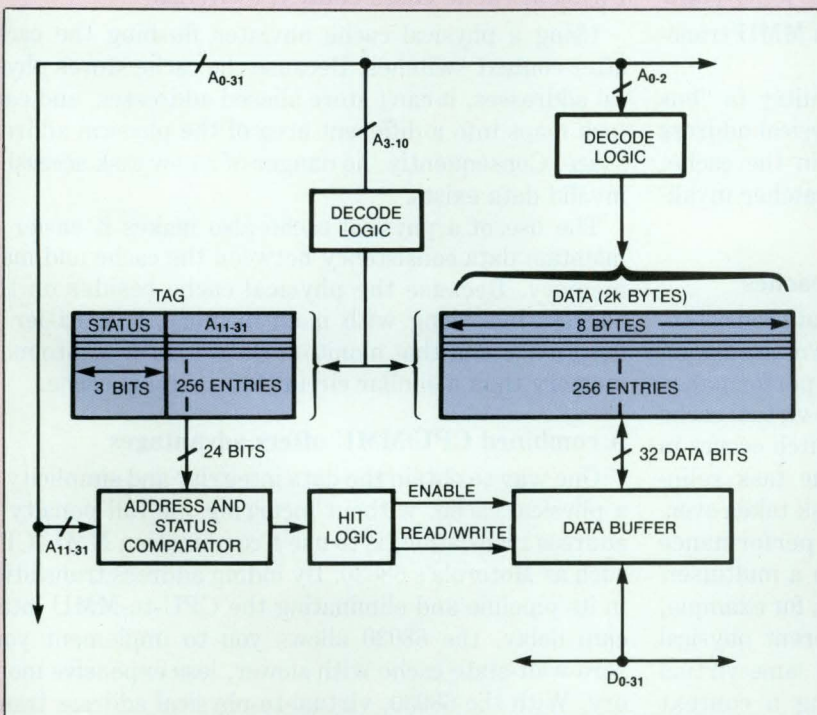

Fig A—This cache design consists of two sections of memory: The section on the right stores the cached data organized as eight entries of 8 bytes each, and the section on the left contains a tag field for each 8-byte data entry.



---

*In high-performance multiuser applications, designers generally opt for a separate CPU and MMU.*

---

virtual addresses mapped to the same physical location in the cache. One section can then read or write cache data without detecting changes made at the aliased address by the other section.

In a functionally similar case, a multiprocessor or multimaster design that uses a virtual cache must also be able to ensure data integrity when a second  $\mu$ P, or master, makes memory changes. For example, if your system uses a disk controller that performs DMA operations in physical memory, the system must be able to detect DMA transfers, because they may change the physical-memory contents that are also currently stored in the virtual cache. In such a situation, to ensure consistency between the cache and main memory, the system must invalidate cache entries that correspond to altered physical-address locations.

#### **Maintaining data integrity**

You can solve the integrity problem two ways. First, you can design the system so that the MMU handles all physical memory accesses. In this solution, even during a disk DMA operation, the  $\mu$ P's virtual-address bus carries virtual-address data automatically. The disadvantage is that it degrades performance. Each DMA operation incurs the additional delay of an MMU translation.

An alternative strategy is to add circuitry (a "bus watcher") to the cache to monitor the physical address bus for changes to data also contained in the cache. Upon detecting such a change, the bus watcher invalidates the appropriate cache entries.

#### **Performance considerations in virtual caches**

In addition to the problem of ensuring data consistency, using a virtual cache in a multiuser/multitasking system will present other design and performance challenges. First, you'll have to design the virtual cache to handle context switches. A context switch occurs in multiuser/multitasking systems when one task relinquishes control of the  $\mu$ P, and another task takes over.

Virtual caches may degrade system performance when accommodating context switches in a multiuser/multitasking system. In Unix applications, for example, though each task gets mapped to a different physical address space, several tasks may use the same virtual address space. Consequently, following a context switch, the cache may contain data that's not valid for the new tasks's virtual address space.

To prevent the new task from accessing invalid data, you must ensure that the task-specific portions of the

cache are flushed when the operating system swaps that task out. You must also modify the operating system so that it issues a flush command after each context switch.

The problem with flushing and refilling the cache is degraded performance. The cache must be refilled one entry at a time, and main memory accesses typically require three to four wait states each. One way to reduce the overhead associated with flushing and refilling the cache is to design the system so that it leaves the operating-system kernel in the cache during context switches.

Naturally, the effect that context switches have on performance depends on your particular application. For example, consider a typical CAE-workstation application. Such a system may use Unix but primarily execute only one task at a time. Therefore, context switches don't occur often, and overhead associated with flushing and refilling the cache is negligible. In a business application, on the other hand, each user is given a small time slice and context switches occur more frequently. In this case, performance may suffer.

#### **Physical cache eases context switches**

Using a physical cache obviates flushing the cache after context switches. Because the cache stores physical addresses, it can't store aliased addresses, and each task maps into a different area of the physical address space. Consequently, no danger of a new task accessing invalid data exists.

The use of a physical cache also makes it easier to maintain data consistency between the cache and main memory. Because the physical cache resides on the address bus along with main memory, it is easier to design a circuit that monitors DMA transfers into main memory than a similar circuit for a virtual cache.

#### **A combined CPU/MMU offers advantages**

One way to obtain the data integrity and simplicity of a physical cache, without incurring the full penalty of address translation, is to use a combination MMU/CPU such as Motorola's 68030. By hiding address translation in its pipeline and eliminating the CPU-to-MMU interchip delay, the 68030 allows you to implement your zero-wait-state cache with slower, less expensive memory. With the 68030, virtual-to-physical address translation occurs within the  $\mu$ P, and a physical address appears on its external address bus.

While the CPU is executing one instruction, it fetches and loads the code required for the next one into



its pipeline. Since the accesses required to fill the pipeline initially incur the full translation delay, one or more wait states result. However, once the pipeline is full, subsequent accesses can proceed with no wait states. The  $\mu$ P performs them concurrently with the execution of the current instruction, thereby hiding the translation delay.

The system experiences address-translation overhead only when the pipeline is empty, or following a branch—after which the  $\mu$ P must flush and refill its pipeline. The on-chip MMU also improves performance by eliminating the interchip delay between the MMU and CPU. This savings can eliminate a wait state for physical cache and main memory accesses, allowing you to use slower memory for a given performance level.

The penalty for using a combined MMU/CPU is reduced MMU capability. Because of IC-layout limitations, combined MMU/CPU's often compromise translation-buffer size. The translation buffer contains the descriptors that the MMU uses to translate virtual addresses to physical addresses. Where an external MMU can typically store descriptors for as many as 64 pages, combined CPU/MMU's such as the 68030 are typically limited to 22 descriptors.

Because the 68030 stores fewer descriptors, the probability of misses is higher. When the translation buffer

does not contain the descriptor required for a given translation (a translation buffer miss), the MMU has to fetch the descriptor from main memory. A translation-buffer miss typically results in a system delay of 20 wait states.

Again, your application determines the importance of the translation buffer's size. Large multiuser applications, with several tasks executing simultaneously, require the translation buffer to map more pages of memory. In single-user PC applications, however, a small translation buffer probably won't have a significant impact on system performance.

Another popular CPU that includes a memory-management unit is Intel's 80386. Like the 68030, the 80386 hides address translation in its pipeline. The 80386's advantage is that, as long as the pipeline is full, a valid physical address is available at the end of the clock period preceding the start of a bus cycle. Consequently, the memory system has two full clock periods to provide valid data (Fig 3 shows the read cycle timing). The 80386 allows you to use slower and less expensive cache memory than you can with the 68030.

Another way to eliminate the overhead of address translation without settling for a virtual cache is to employ the WE 32201 combination MMU/data cache. This IC eliminates the interchip delay between the MMU and the cache and also reduces address-translation overhead by performing translation in parallel with data-cache lookup.

In addition to providing high-speed, zero-wait-state accesses and data consistency, this combination MMU/data cache also offers smaller system size and lower cost. A cache implemented with discrete logic, programmable logic, and memory chips requires 3 in<sup>2</sup> of pc-board space for just its cache controller.

In addition to providing a 64-entry MMU, the WE 32201 has a 4k-byte, 2-way set-associative physical data cache that supports zero-wait-state accesses at speeds as high as 30 MHz. Fig 4 shows a block diagram of the MMU/cache chip.

The WE 32201 uses two techniques to hide address translation and open the cache's access-time window. Rather than hiding address-translation time in the CPU, as combined CPU/MMU's do, the 32201 MMU/cache overlaps address translation with data-cache lookup. While the MMU portion of the chip translates address bits  $A_{11-31}$ , the cache controller uses address bits  $A_{0-10}$  to access one of two 2k-byte sets in the 4k-byte cache. The device can use the low-order bits for cache access while the upper bits are being translated, be-

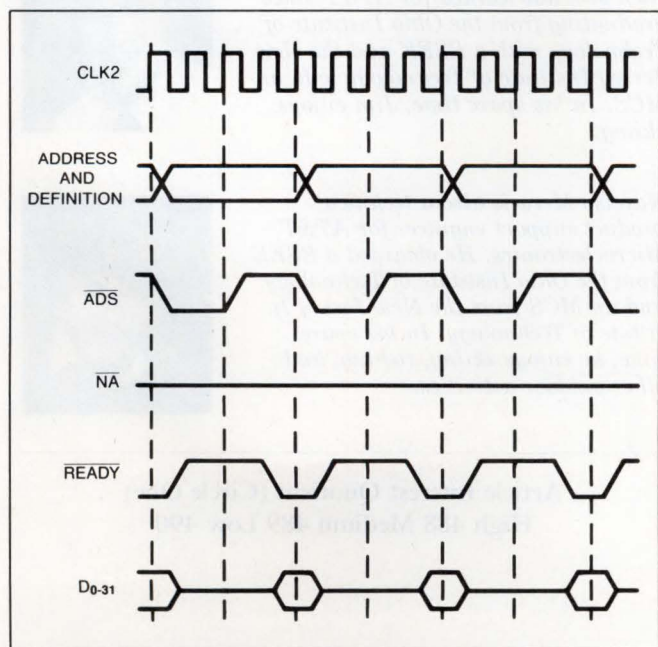
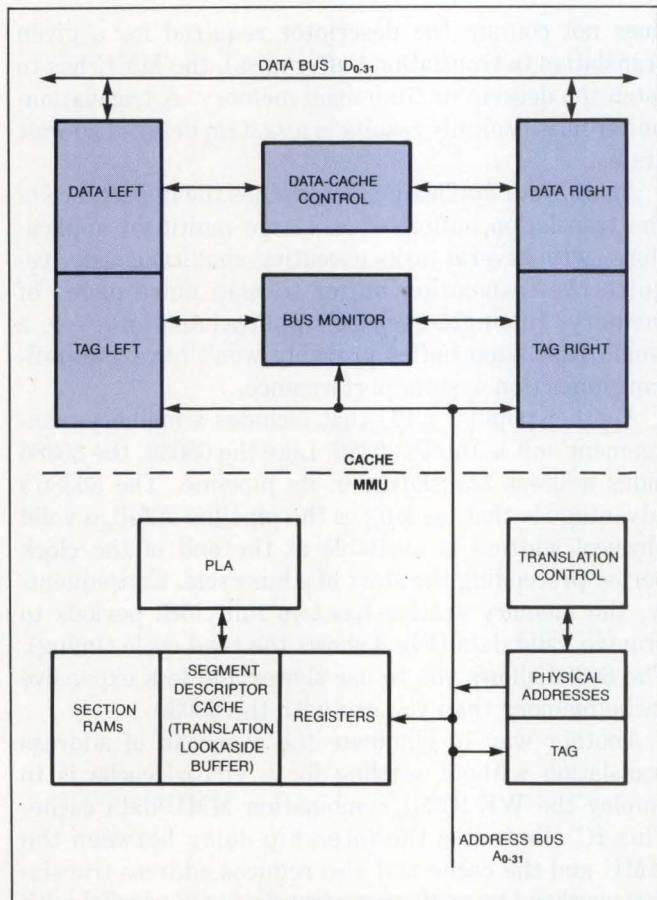

Fig 3—As long as the 80386's pipeline is full, a valid physical address is available at the end of the clock period preceding the start of a bus cycle.



*While a virtual cache allows you to achieve zero-wait-state accesses with slower, less expensive memory, it also presents design and performance obstacles.*



**Fig 4**—In addition to providing a 64-entry MMU, the WE 32201 provides a 4k-byte, 2-way set-associative physical data cache that supports zero-wait-state accesses at speeds up to 30 MHz.

cause the lower address bits are simply an offset into the 2k-byte set and don't get modified during address translation.

Following address translation, the cache logic simply compares the physical address ( $A_{11-31}$ ) with the address stored in the tag/data entry and selected by  $A_{0-10}$ . For hits, the cache presents valid data in the third clock period of the bus-read cycle (zero-wait-state access).

### Built-in bus watcher

To ensure data consistency between the cache and main memory when the system has multiple processors and multiple masters, the WE 32201 combines a bus watcher to automatically monitor the physical address bus with a write-through feature. When a bus master, such as a DMA controller, accesses physical addresses in main memory, the cache automatically invalidates cache locations corresponding to them. For cache hits, the cache-control circuitry also updates the cache entry

and sets its valid and most recently used flags.

During CPU write operations, the system writes data through to main memory, whether a cache hit occurs or not. To maintain zero-wait-state 3-cycle operations in the event of a write-through, you must add buffer logic that completes the write to main memory. Your buffer logic latches the data, sends an acknowledge signal to the CPU, and continues the write operation to main memory. For write operations that do not generate a cache hit (misses), the CPU writes data only to main memory.

An alternative to write-through is the write-back design. In write-back schemes, the cache controller writes data only into the cache—and not main memory—on hits. This scheme simplifies normal write cycles for cache hits. However, following a context switch, or when a cache entry is replaced with data from a different address, the system must transfer the cache data to main memory before flushing the cache or replacing the entry.

**EDN**

### Authors' biographies

*James K Flynn is a technical-product support engineer for microprocessors at AT&T Microelectronics (Holmdel, NJ). Jim has worked for AT&T since graduating from the Ohio Institute of Technology with a BSEE and the New Jersey Institute of Technology with an MCS. In his spare time, Jim enjoys skiing.*

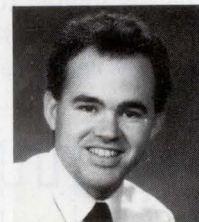

*Narciso Mera is also a technical-product support engineer for AT&T Microelectronics. He obtained a BSEE from the Ohio Institute of Technology and an MCS from the New Jersey Institute of Technology. In his spare time, he enjoys skiing, fishing, and other outdoor activities.*

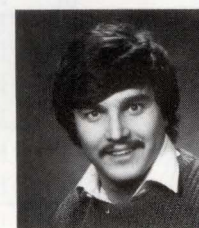

Article Interest Quotient (Circle One)  
High 488 Medium 489 Low 490



# The hot single shot.

The HP 54111D digitizing oscilloscope has your numbers: 1 gigasample/s\*  
250 MHz single-shot and  
500 MHz repetitive bandwidth.

The HP 54111D brings you the blazing speed and complex waveform triggering you need to capture those elusive glitches that cause headaches.

The HP 54111D is loaded with features you can appreciate: simultaneous two-channel capture; 8K memory per channel; up to eight bits of vertical resolution; waveform math which now includes A vs B, A x B, and integrate; and the advantages of HP digitizing technology including automatic answers, one-button hard copy output, auto-scale, digital storage, and HP-IB programmability (waveform capture and transfer now three to six times

faster in ATE applications).

Plus the exceptional reliability you've come to expect from HP scopes, and extended warranty coverage as well.

**Call HP today!**  
1-800-752-0900, ext. 215S.

We'll send all the details including Application Note *Sub-nanosecond Single-shot Digitizing Using The 54111D*, HP 54111D Data Sheet, and our brochure *Feeling Comfortable with Digitizing Oscilloscopes*. Or contact your local HP sales office listed in the white pages and ask for your HP rep.



HP-IB: Not just IEEE-488, but the hardware, documentation and support that delivers the shortest path to a measurement system.

© 1988 Hewlett-Packard Co. E115801/EDN(A)

\*See our Application Note on 2 gigasample/s performance.

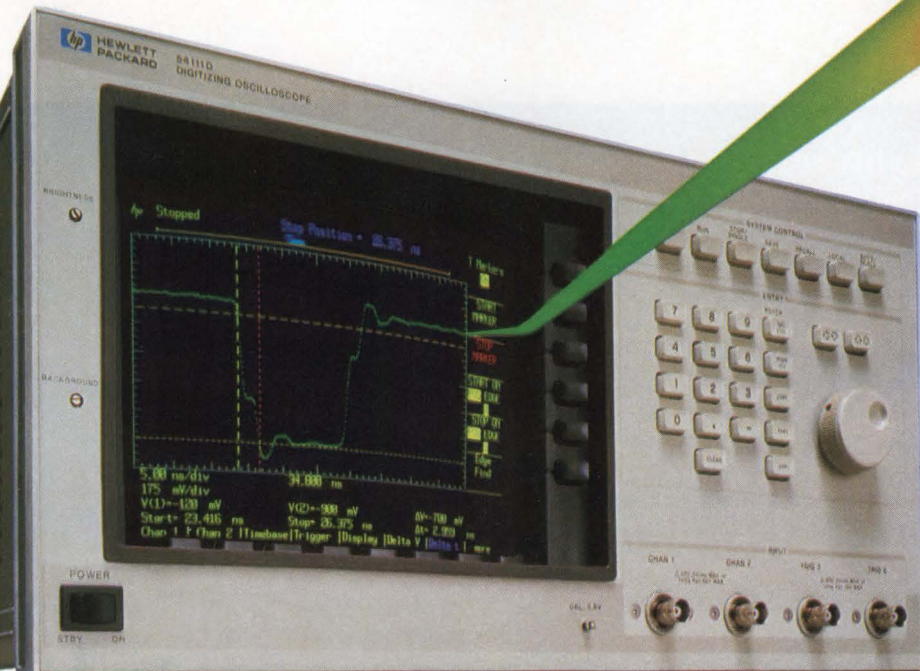

 **HEWLETT  
PACKARD**

CIRCLE NO 80

we never stop asking

“What if...”





# Microprocessor Support Made Simple



**N**ow, ZAX simplifies microprocessor design, integration and testing with their advanced line of ERX- and ICD-series emulators. You simply tell us the processor that drives your design and we tailor a development system especially for your environment, including full software support.

Our ERX-series emulators provide over 80 debugging commands, with 256,000 hardware breakpoints, real-time performance analysis, high-level language debug and trace analysis of program execution while you emulate in real-time. And they interface directly to your personal computer (AT-class) to provide you with a complete host development station and emulation manager. This consolidated approach utilizes industry-standard equipment and eliminates the use of a proprietary dedicated chassis.

ZAX established the benchmark for standalone emulation tools when they introduced their versatile line of ICD-series emulators. Completely flexible, ICD-series emulators can be interfaced to either a simple terminal or host computer (from pc to mainframe) depending on your requirements. This makes them ideal for both in-house development and on-site testing.





**ZAX**  
Zax Corporation



Simplify support for your microprocessor development projects with the help of ZAX! Call today to arrange a product demonstration or write for complete details about our product line. Call us TOLL FREE at 800-421-0982 (in California phone 800-233-9817) or write to ZAX CORPORATION, 2572 White Road, Irvine, CA 92714.

In Europe, call United Kingdom: 0628 476 741,  
West Germany: 02162-3798-0, France: (03)  
956-8142, Italy: (02) 688-2141.

CIRCLE NO 81



# Aeroflex announces the new math for MIL-STD-1553 design engineers.

## In which three goes into one just once.

1.

Low power dual redundant transceivers

2.

Dual decoder, encoder and protocol processor for Remote Terminal, Bus Controller and Bus Monitor

3.

Dual port RAM with 8K words of memory and full memory management

You are looking at the most powerful, flexible and unique MIL-STD-1553B interface currently available. Bar none.

Now, in one 2 x 3.1" package, this new ARX 2427 Universal Bus Interface Unit (UBIU) combines all the functions it takes three competitive hybrids to perform. Fact is, of all hybrids today, only the ARX 2427 reduces interface and hardware time to absolute zero.

The powerful ARX 2427 contains a dual port RAM that's double-sided and double-buffered to eliminate contention problems and wait states. Data can be mapped into RAM blocks by subaddress or alternately stacked. Memory is accessed for read and write using address lines and a select line, treated as subsystem memory. The host system is therefore freed from critical



timed response to Bus traffic and communication overhead is kept to a bare minimum. The unit also includes extensive error checking, which eliminates handling bad data. Fault monitoring plus many other features make the ARX 2427 clearly the most useful of 1553 interfaces.

So forget complex interconnect schemes. Forget special glue logic circuitry design

for subsystem compatibility. Forget using up valuable PC board real estate. The ARX 2427 is the UBIU to remember when you want to solve your 1553 problems—once—and for all.

For additional information call toll-free: 1-800-THE-1553 or TWX 510-224-6417. Or write Aeroflex Laboratories Inc., Microelectronics Division, 35 South Service Road, Plainview, NY 11803.



# Token-bus-controller interface must resolve family disparities

---

*A system designed for a token bus network can benefit from a token bus controller such as the MC68824. The amount of glue logic required to interface the host to the controller will differ, however, depending on whether you're using an Intel or Motorola  $\mu$ P.*

---

Paul Polansky, *Motorola Inc*

The MC68824 token bus controller (TBC) permits you to implement the media access-control sublayer of a token bus network based on IEEE Standard 802.4, which is part of a collection of standards for the Manufacturing Automation Protocol (MAP). The TBC uses an on-chip FIFO memory to queue data transmission on the network so it can share the local bus with a host  $\mu$ P (Ref 1). Because the TBC and the host mainly communicate through shared memory, the interface between the TBC and the CPU will vary, depending on your microprocessor—either an Intel 80186 or a Motorola MC68000, in this case. (For more information on the differences between the two types of  $\mu$ Ps, see **box**, "Family differences can affect communications".)

The MC68824 basically adheres to Motorola's conventions, and thus designing an interface to an MC68000

$\mu$ P is straightforward (Fig 1). An address decoder creates a chip select ( $\overline{CS}$ ) line by decoding the memory-mapped address lines for the TBC and conditioning them with the address-strobe ( $\overline{AS}$ ) line. Most of the other signal lines connect directly to the TBC.

The data-transfer-acknowledge ( $\overline{DTACK}$ ) line from the TBC ties directly to the system  $\overline{DTACK}$  through a 3-state buffer that is in a high-impedance state when the TBC isn't selected. The bus-arbitration lines tie directly to the TBC. When the system has other bus masters, all of the  $\overline{BR}$  lines are tied together and pulled up externally. Similarly, all of the  $\overline{BGACK}$  lines are tied together. When other bus masters are present, the  $\overline{BG}$  lines may be routed through a daisy-chained network or through a specific priority-encoded network. The address and data lines from the MC68000 also tie directly to their counterparts on the TBC. If the  $\overline{BGACK}$  line is in an inactive high state, the peripheral drives it to an active low state to take control of the bus.

The TBC generates an interrupt to the CPU by routing its interrupt-request ( $\overline{IRQ}$ ) line to the appropriate input of a 74148 priority encoder. The encoded interrupt request appears on the interrupt control lines ( $\overline{IPL}_{0-2}$ ). The interface circuitry then sends an interrupt-acknowledge ( $\overline{IACK}$ ) signal back to the TBC by decoding the interrupt level being serviced on the address lines  $A_{1-3}$  and gating this priority level with both the processor status lines ( $\overline{FC}_{0-2}$ ) and the  $\overline{AS}$  line. An interrupt acknowledge occurs when the  $\overline{FC}_{0-2}$  lines are all at logical ones.



The TBC and the host communicate mainly through shared memory, so you must account for architectural differences.

Building an MC68824 interface for the 80186  $\mu$ P requires more attention to the architectural differences between the two families. Fig 2 depicts a block diagram of a relatively easy interface to construct. The design

utilizes a CLK input to the TBC that is asynchronous with respect to the host processor clock. The TBC must have a clock rate equal to or greater than the 80186 to satisfy the bus-timing requirements. In this design, the

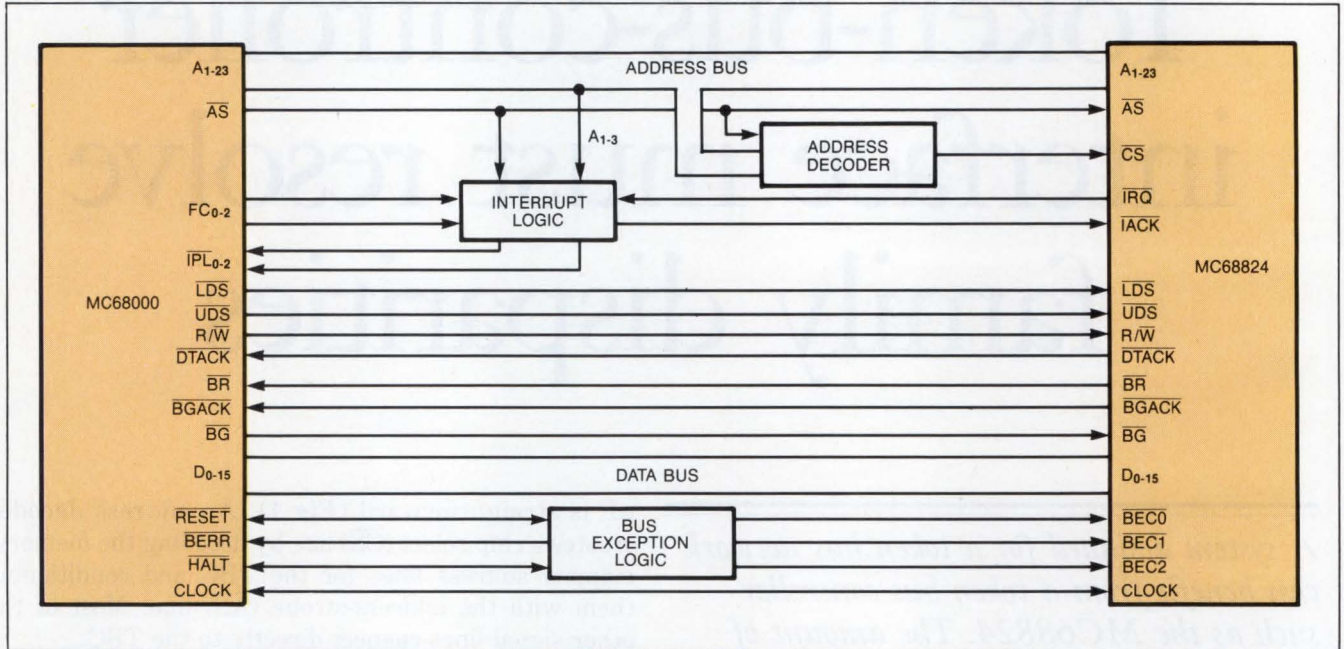

Fig 1—An interface for the MC68824 TBC to the MC68000 CPU requires minimal glue logic.

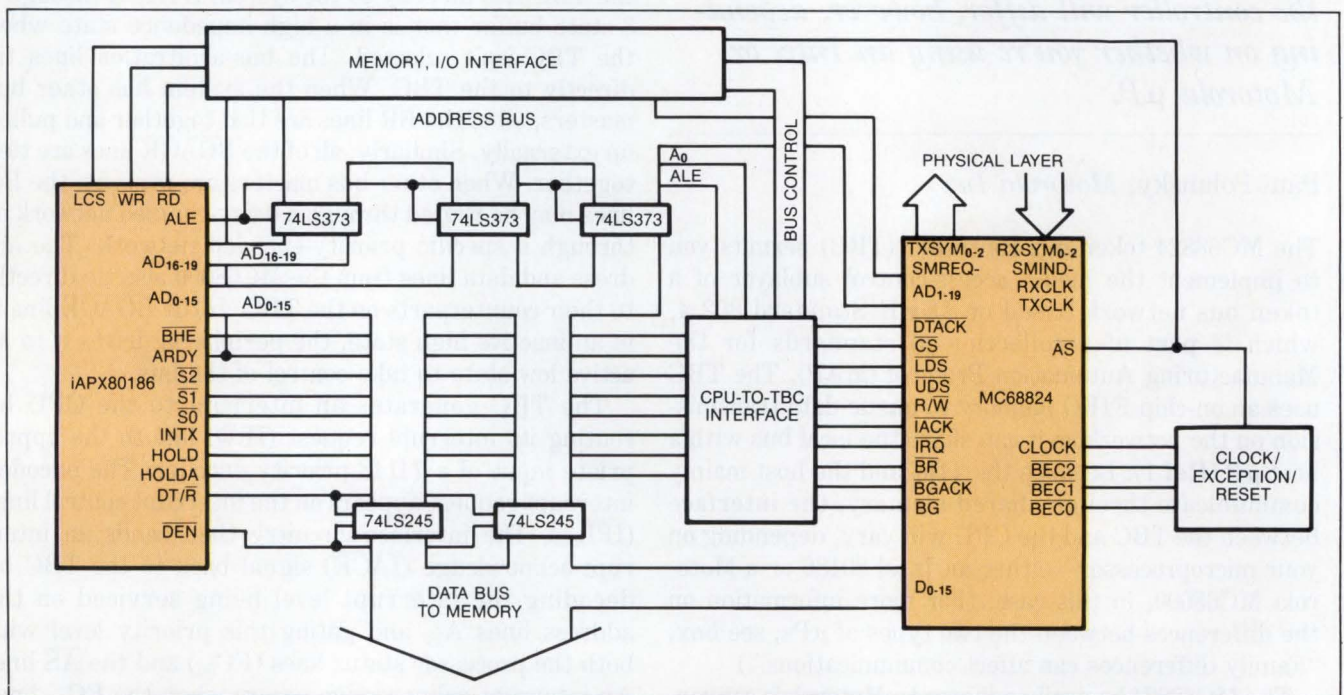

Fig 2—An interface for the MC68824 TBC to the 80186 CPU must demultiplex the addresses from the data.



clock rate is 12.5 MHz for the TBC and 10.0 MHz for the 80186. Incidentally, this interface is virtually the same for an 8086 CPU.

Because the 80186 multiplexes the address and data onto the same I/O lines, the interface requires 3-state latches to form the physical address bus, and isolation transceivers to form the physical data bus (Fig 3). The hold-acknowledge output command (HLDA) from the 80186 places the address latches (74LS373s) in a 3-state condition when the TBC has control. Similarly, the data-enable ( $\overline{\text{DEN}}$ ) command from the CPU isolates the 74245 transceivers while the TBC has control.

### Logic eases communications

Fig 4 shows the circuitry necessary for the 80186 to write to such registers in the TBC as the command register (CR), the interrupt-vector (IV) register, and two 16-bit sections of the 32-bit data register (DR). The circuitry also allows reading of the semaphore register (SR), execution of bus arbitration, and servicing of an interrupt.

A 1-of-8 decoder (74138) decodes the three status lines ( $\overline{\text{S}}_{0-2}$ ) to generate the  $\overline{\text{R/W}}$  signal to the TBC. The

$\overline{\text{RD}}$  and  $\overline{\text{WR}}$  signals from the CPU are not used to develop  $\overline{\text{R/W}}$ , because the  $\overline{\text{R/W}}$  signal must be valid before the upper and lower data strobes ( $\overline{\text{UDS}}$  and  $\overline{\text{LDS}}$ ) are asserted in the Motorola architecture. Using the  $\overline{\text{RD}}$  and  $\overline{\text{WR}}$  signals would require delaying the  $\overline{\text{UDS}}$  and  $\overline{\text{LDS}}$  commands an extra clock period to meet the 20-nsec setup-time requirement of the TBC. The Intel  $\mu\text{P}$ 's architecture provides the information early enough on the status lines to avoid this problem. The design is suitable for either memory or I/O mapping; however, memory mapping allows software to be written in a machine-independent language, such as C.

This design also supports autovectored interrupts in the fully nested mode of the 80186. When acknowledging an interrupt, the 80186 executes two consecutive  $\overline{\text{INTA}}$  cycles; the CPU reads the interrupt vector on the second cycle. During this time, the TBC can provide one of two possible interrupt vectors to the host. The TBC reserves one vector for a severe bus error or address error interrupt. A severe interrupt indicates that a bus or address error has occurred twice consecutively without the host taking appropriate action. All of the other interrupts use the second reserved vector. In

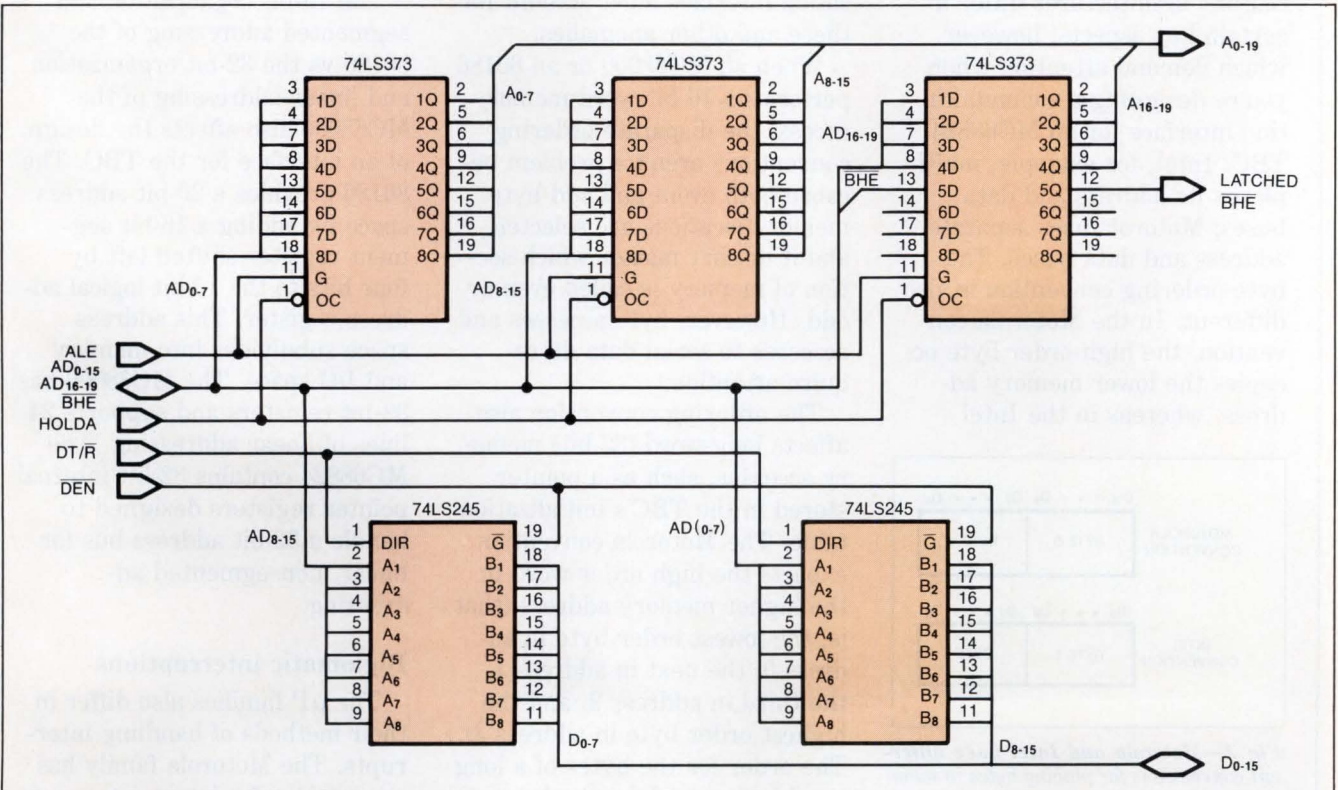

Fig 3—Three-state latches and 3-state transceivers create the physical address and data buses.



---

*The interface requires 3-state latches to form the physical address bus, and isolation transceivers to form the physical data bus.*

---

addition, a bus or address error can be detected by examining the BAERR bit in the TBC's interrupt status word 0.

The TBC interface develops Motorola's  $\overline{UDS}$  command from Intel's  $\overline{BHE}$  command, and it develops Motorola's  $\overline{LDS}$  command from Intel's  $A_0$  command. The  $\overline{UDS}$  and the  $\overline{LDS}$  signals represent transfers on the upper and lower eight bits of the data bus, respectively. The 74374, labeled Latch<sub>1</sub> in Fig 4, latches the  $\overline{R/W}$ ,  $\overline{UDS}$ ,  $\overline{LDS}$ ,  $A_1$ , and  $A_2$  signals on the falling edge of the address latch enable (ALE) command. The latched outputs of the  $\overline{R/W}$ ,  $A_1$ , and  $A_2$  lines connect directly to the TBC to meet the setup-time requirements. Then, the falling edge of the clock line from the CPU gates the remainder of the signals to the TBC.

When the ALE line is high, the outputs of Latch<sub>1</sub> are

in a 3-state condition, permitting the  $\overline{UDS}$  and the  $\overline{LDS}$  lines to be inactive for at least one clock period before enabling Latch<sub>1</sub>'s outputs, which satisfies a timing requirement of the TBC. The other latch, labeled Latch<sub>2</sub> in Fig 4, latches the inactive state of the  $\overline{UDS}$  and  $\overline{LDS}$  lines until the next clock edge makes these lines active. It is this timing restraint that forces the clock rate of the TBC to be equal to or greater than the CPU's clock rate.

### Don't forget bus arbitration

The bus-arbitration scheme roughly corresponds to the one used in the MC68000 design, but it is not a perfect analogy. The HOLD command, which is analogous to the  $\overline{BR}$  command, must remain active the entire time that an alternate bus master controls the bus. The

---

## Family differences can affect communications

Two popular 16-bit  $\mu P$  families are Motorola's MC68000 and Intel's 8086/80186. The processors' architectures differ in certain key aspects, however, which demand attention when you're designing a communication interface for an MC68824 TBC. Intel, for example, multiplexes its address and data buses; Motorola uses separate address and data buses. The byte-ordering convention is also different. In the Motorola convention, the high-order byte occupies the lower memory address, whereas in the Intel

architecture, the high-order byte appears in the higher memory address (Fig A). The communication interface must account for these and other anomalies.

When an MC68000 or an 80186 performs a 16-bit-word memory access, the disparate ordering conventions aren't a problem because both even- and odd-byte memory locations are selected, and it doesn't matter which section of memory is called even or odd. However, byte accesses and accesses to serial data do require attention.

The ordering convention also affects long-word (32-bit) memory accesses, such as a pointer stored in the TBC's initialization table. The Motorola convention expects the high order word in the higher memory address (that is, the lowest order byte in address 0, the next in address 1, the third in address 2, and the highest order byte in address 3). The order for the bytes of a long word is reversed for the Intel

convention. Your interface design must account for these differences.

The 16-bit organization and segmented addressing of the 80186 vs the 32-bit organization and linear addressing of the MC68000 also affects the design of an interface for the TBC. The 80186 provides a 20-bit address space by adding a 16-bit segment register shifted left by four bits to the 16-bit logical address register. This address space subdivides into memory and I/O space. The MC68000 has 32-bit registers and supports 24 lines of linear addressing. The MC68824 contains 32-bit internal pointer registers designed to handle a 32-bit address bus for linear, nonsegmented addressing.

### Diplomatic interruptions

The  $\mu P$  families also differ in their methods of handling interrupts. The Motorola family has two options for interrupts: regu-

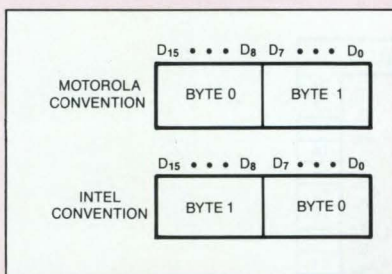

**Fig A—Motorola and Intel have different conventions for placing bytes in memory locations.**



$\overline{BR}$  line from the TBC becomes inactive shortly after the TBC takes control of the bus. Therefore, the  $\overline{BR}$  line and the  $\overline{BGACK}$  line from the TBC connect to a NAND gate with an output latch to form the HOLD command. Also the 80186 requires the HOLD command to be inactive for at least one clock period plus 25 nsec before the next falling clock edge occurs for internal synchronization. This requirement corresponds to an inactive HOLD time between 125 and 225 nsec when the 80186 runs at 10 MHz.

The halt-generator enable mode of the TBC places another constraint on the interface design for the HOLD command. This mode limits a DMA burst to eight consecutive cycles when the SET MODE 3 command enables the HLEN bit in the command register. At the end of the burst, the TBC relinquishes the bus.

If more cycles are needed, the TBC reasserts the  $\overline{BR}$  line in at least one and one-half clock periods plus 20 nsec. Therefore, the HOLD command to the CPU must remain active until the HOLDA line becomes inactive.

The generation of the  $\overline{BG}$  signal to the TBC also requires some attention. While the TBC is in the halt-generator mode, it must relinquish the bus after eight consecutive DMA cycles, and therefore one DMA burst may not fill up or empty the TBC's FIFO buffer. Under these circumstances, if the CPU gives it permission, the TBC will want to re-establish control of the bus.

The TBC timing requires that the  $\overline{BG}$  line is valid only until the  $\overline{BR}$  line becomes inactive. However, if the TBC reasserts the  $\overline{BR}$  line before the CPU invalidates the  $\overline{BG}$  line, the TBC will recognize that  $\overline{BG}$  is valid and

lar (vectored) and autovectored. The regular interrupts are encoded as priority levels on lines  $IPL_{0-2}$ ; level 7 ( $IPL_{0-2}=000$ ) is nonmaskable. The MC68000 enters an interrupt acknowledge cycle by setting the  $FC_{0-2}$  lines to 111. The interrupting source places its vector on data lines  $D_0$  through  $D_7$  and terminates the cycle with  $\overline{DTACK}$ . In the autovectored mode, the interrupting source asserts  $\overline{VPA}$  during an interrupt cycle instead of  $\overline{DTACK}$ . This assertion causes the CPU to fetch a priority-based vector.

The Intel family handles vectored and autovectored interrupts in one of several modes. The 80186 offers a mode compatible with the iRMX86 operating system as well as a master mode. In the master mode, different configurations of the interrupt lines permit the use of either four request lines or two request and two acknowledge lines.

In the vectored mode, the CPU runs two consecutive interrupt acknowledge cycles. During the first cycle, the  $\mu P$  informs the system that it is acknowledging an interrupt. During the second cycle, the interrupting source places its vector type on the lower half of the data bus. The CPU uses the vector type to access a vector table. When the 80186 is in a fully nested mode, the CPU responds to autovectored interrupts.

#### Impartial arbitration is best

Both families have bus-arbitration schemes that allow an alternate source to request control of the bus. In the Intel scheme, the requesting device asserts a HOLD signal and then waits for the host to assert a HOLDA signal before taking control of the bus. The alternate bus master must assert the HOLD command for the entire time it owns the bus. When there are multiple bus masters, the scheme re-

quires an external arbiter.

In the Motorola scheme, the requesting device asserts the  $\overline{BR}$  line and waits for the host to assert the  $\overline{BG}$  command. The requesting agent then samples the state of the  $\overline{BGACK}$  and  $\overline{AS}$  signals to ensure that no other device is using the bus. When both lines are inactive, the agent asserts  $\overline{BGACK}$ , deactivates  $\overline{BR}$ , and starts running its own bus cycles. The bus master asserts  $\overline{BGACK}$  for the entire time that it controls the bus.

The highest level of exception handling in the Intel architecture is the nonmaskable interrupt. The hardware uses this interrupt to initiate processing of an exceptional condition on a high-priority basis at the end of the current bus cycle. In the Motorola architecture, a bus exception terminates the current bus cycle with or without the  $\overline{DTACK}$  signal.







The design must also account for differences in the byte-ordering conventions of the two families. Byte ordering is critical in a serial system where you must maintain the sequence of successive bytes. The host  $\mu P$  can run a byte-swapping routine in software, but this routine requires valuable CPU time. The MC68824 has an optional feature, however, whereby this task is performed automatically. The user accesses this feature in software by setting the SWAP bit in the SET MODE 3 command to the TBC. This capability only applies to data buffers, though, because the byte order isn't important for other shared memory locations for the TBC.

You must partition the shared memory space of the TBC interface to accommodate each peripheral. The upper address bits ( $A_{17}$ ,  $A_{18}$ ,  $A_{19}$ ) select the boundaries in the memory space for the DUART, TBC, ROM, and RAM. A 1-of-8 decoder (74LS138) develops the respective enable commands, which are labeled  $\overline{DUARTEN}$ ,

$\overline{TBCEN}$ ,  $\overline{ROMEN}$ , and  $\overline{RAMEN}$  (Fig 6).

Except for  $\overline{TBCEN}$ , the design also uses these commands to create an active high asynchronous ready (ARDY) signal with no wait states for the RAM and with one wait state for the EPROM in order to terminate bus cycles. Fig 8 shows the sequential circuitry necessary to perform a logical NAND operation on the  $\overline{RAMEN}$ ,  $\overline{ROMEN}$ ,  $\overline{DUARTEN}$ , and  $\overline{DTACK}$  line to develop the ARDY signal. The  $\overline{DTACK}$  line is an input line to the CPU when the TBC is the bus master, and it is an output line to the TBC when the host is the master. The 74365 3-state latch avoids any contention for the  $\overline{DTACK}$  signal.

Fig 9 depicts the bus exception and reset circuitry for the TBC. The  $\overline{RESET}$  line drives a 74LS148 priority encoder to command a reset condition on the  $\overline{BEC}$  line to the TBC (all zeros). The  $\overline{BERR}$  line drives the same priority encoder to signal the TBC on the  $\overline{BEC}$  lines that a bus error has occurred. The  $\overline{BERR}$  line acts as a

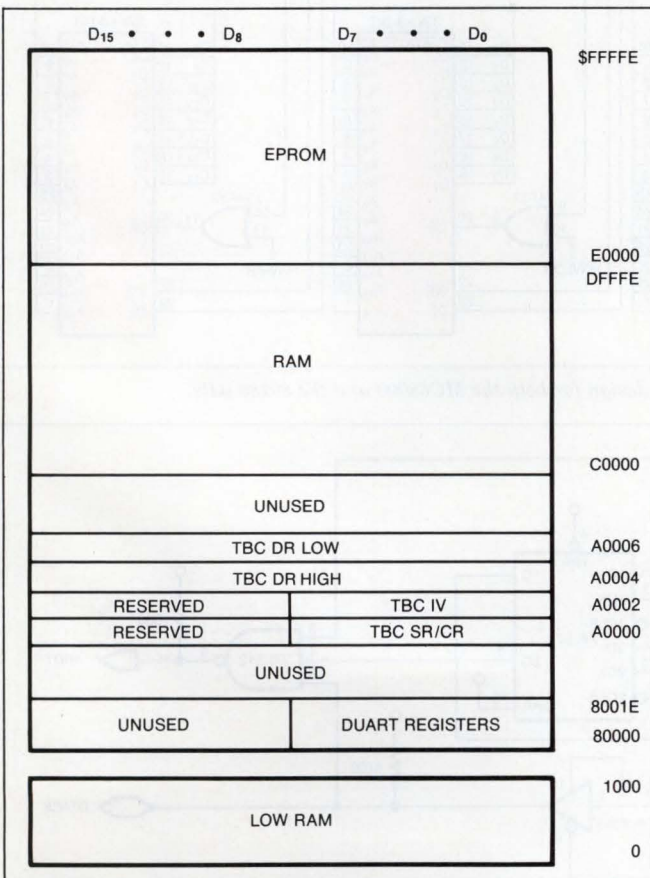

Fig 5—The memory map places the interrupt vector table and stack in low RAM. The map places the DUART registers after the gap followed by the TBC, RAM, and EPROM.

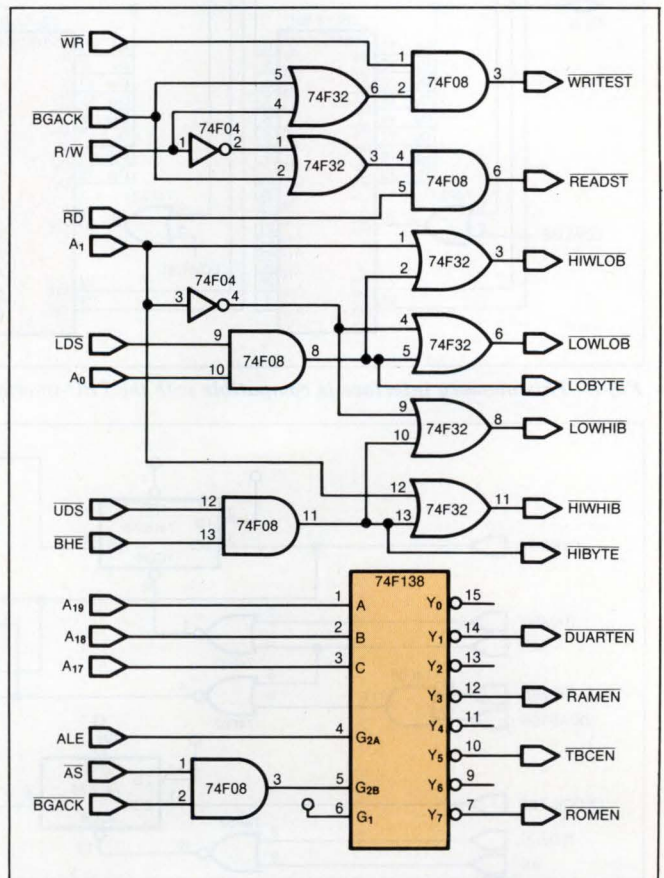

Fig 6—The memory controller for developing the signals necessary to access memory uses simple logic gates and a 74F138 1-of-8 decoder.



If you write the application software in C, you must pay attention to pointers stored in memory.

timeout signal when the TBC tries to access a device other than the static RAM.

If you write the application software in C, you must

pay attention to pointers stored in memory because the 80186 has a segmented architecture and a 16-bit internal organization, whereas the MC68000 has a linear,

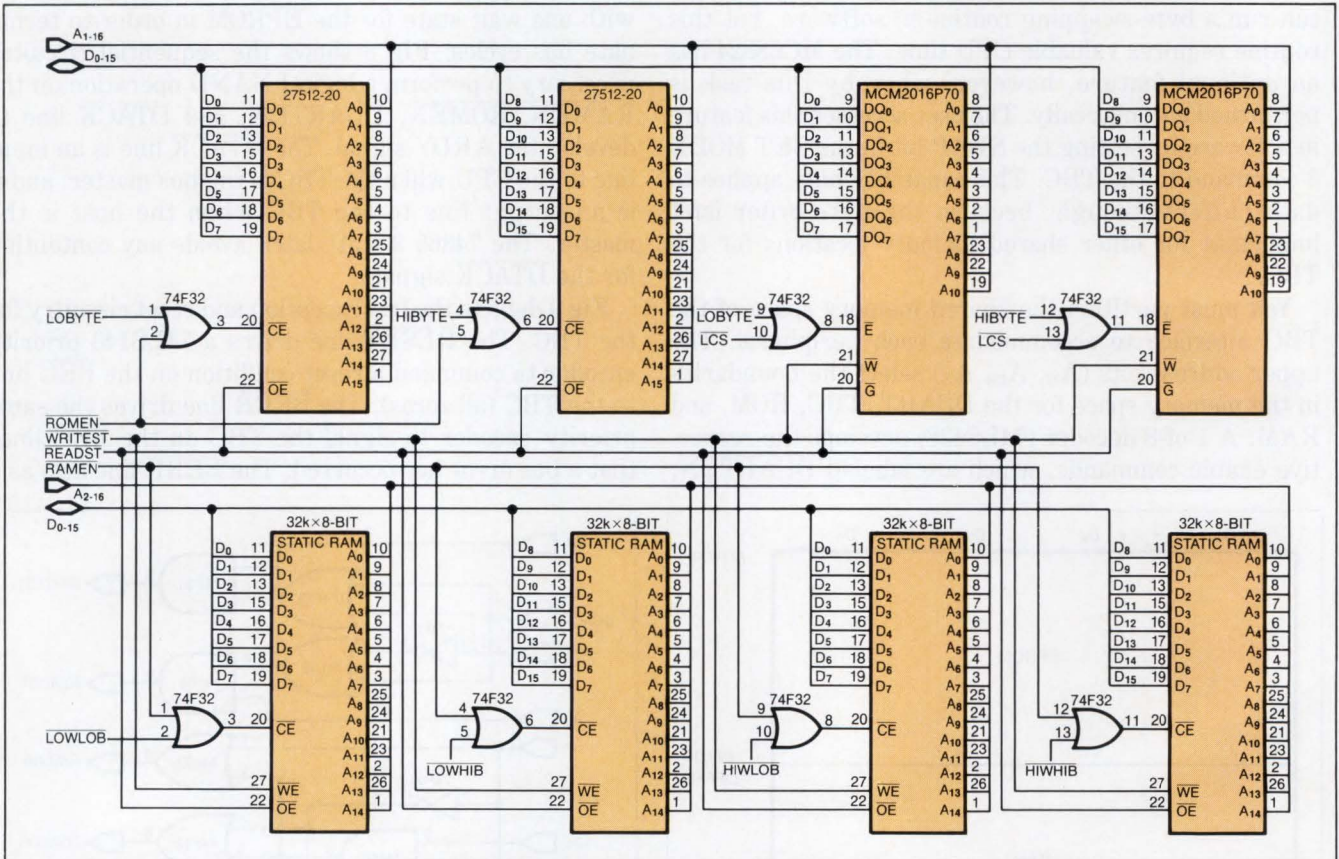

Fig 7—This memory interface is compatible with the TBC-interface design for both the MC68000 and the 80186 μPs.

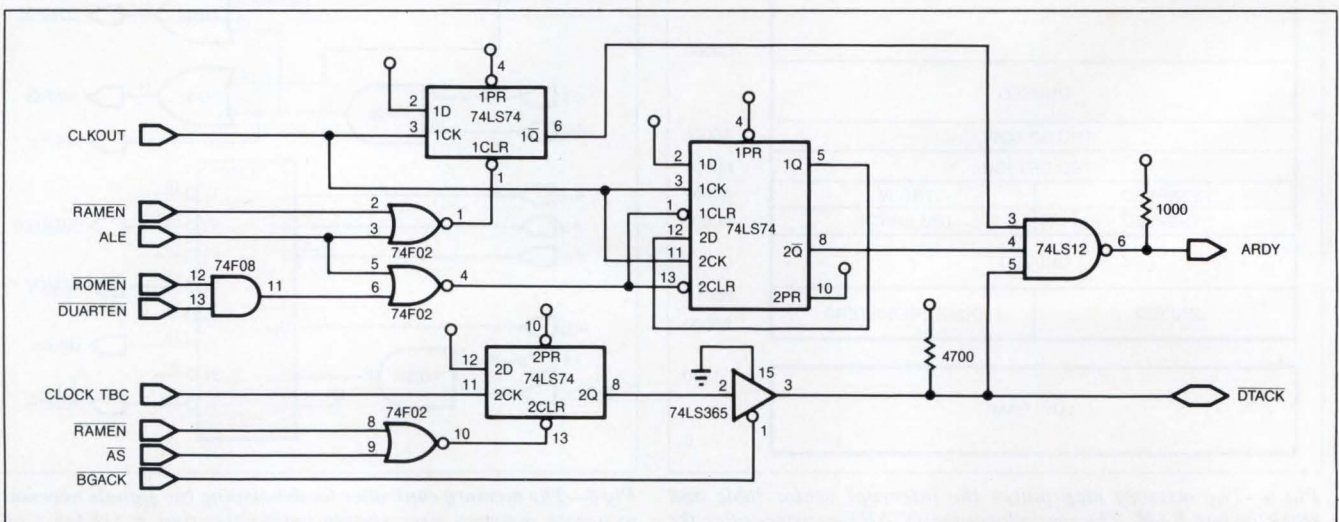

Fig 8—This schematic illustrates the sequential and level logic required to create the ARDY and DTACK lines.



# DSP Development Cut through the clutter.



INMOS and IMS are trademarks of the INMOS Group of Companies.

You've seen the advantages offered by the A100 Digital Signal Processor. The single-chip DSP solution that features 32 multiply-accumulators, executes up to 320 MOPs, and easily attaches to microprocessors.

Now INMOS speeds A100 system development with the new D704, the complete DSP Development System. The D704 overcomes the clutter normally encountered in developing DSP systems such as hand-crafted assemblers, interleaved busses and power-hungry glue. And since it is tailored for the A100, your end product is first to market and second-to-none in performance.

The D704 combines a comprehensive set of software tools, PC plug-in card and extensive documentation, providing a powerful yet easy-to-use DSP environment. You can experiment with the technology, simulate DSP algorithms in software and run them in real time on the A100's provided on the board.

The A100 is quickly becoming the number one choice in everything from avionics to ultrasonics. And with MIL-STD 883C devices available soon, it will be a natural for military DSP programs of all types. With the D704 Development System, creating DSP solutions has never been easier.

So if you'd like to cut through the clutter, start by clipping the coupon.

## THE A100 DSP FAMILY

<b>IMS A100</b>	Single-Chip 32-Stage Cascadable Transversal Filter—16-Bit Data, 16-Bit Coefficients, 320 MOPs
<b>IMS B009</b>	PC Plug-In Card Including Four A100's
<b>IMS D704</b>	IMS B009 + Interactive Software Simulator/ DSP Development Suite



I'd like to cut through the clutter. Please send me full details of the IMS D704 DSP development system.

Name \_\_\_\_\_ Title \_\_\_\_\_

Company \_\_\_\_\_

Address \_\_\_\_\_

Telephone \_\_\_\_\_

**EDN031788**

INMOS Corporation, PO Box 16000, Colorado Springs, Colorado 80935.  
Tel (303) 630-4000.

INMOS Limited, PO Box 424, Bristol BS99 7DD. Tel (0454) 616616.



*The TBC should be given a high priority on the local bus because of the real-time nature of the token bus medium.*

32-bit internal organization. A pointer for the 80186 is stored in memory as an offset in the first word, followed by a segment in the second word. In the MC68000 and TBC structure, a pointer is stored as a 32-bit linear address with the high address word stored in the first memory location, and the low address word stored in the second memory location.

The application software must reconcile these differences. Software written for the 80186 must initialize a TBC pointer by converting the segmented address to a linear 32-bit address. This requires a routine—call it `int_to_mot()`—which takes a 2-word pointer in Intel format and converts it to Motorola format. Similarly, a routine called `mot_to_int()`, converts a 32-bit linear address from the TBC to a segment and an offset.

Because the TBC has a larger addressing range than

the 80186, you can locate the TBC's 128-byte private area of RAM beyond the addressing range of the 80186, but within the range of the TBC. This isolates the private area from the  $\mu$ P and any intrusive software, and it also ensures proper IEEE-802.4 operation.

The interrupt handler for the TBC is defined as a C function, which is addressed at the location for the INT0 autovector (30 hex). At boot-up, the software copies the handler from the EPROM into RAM and substitutes the IRET instruction for the RET instruction, which the C compiler places at the end of the function. The internal 80186 registers map into the memory space, which allows the user to write high-level code to process interrupts like the end-of-interrupt (EOI) instruction. The EOI instruction is necessary to clear the in-service bit for the particular

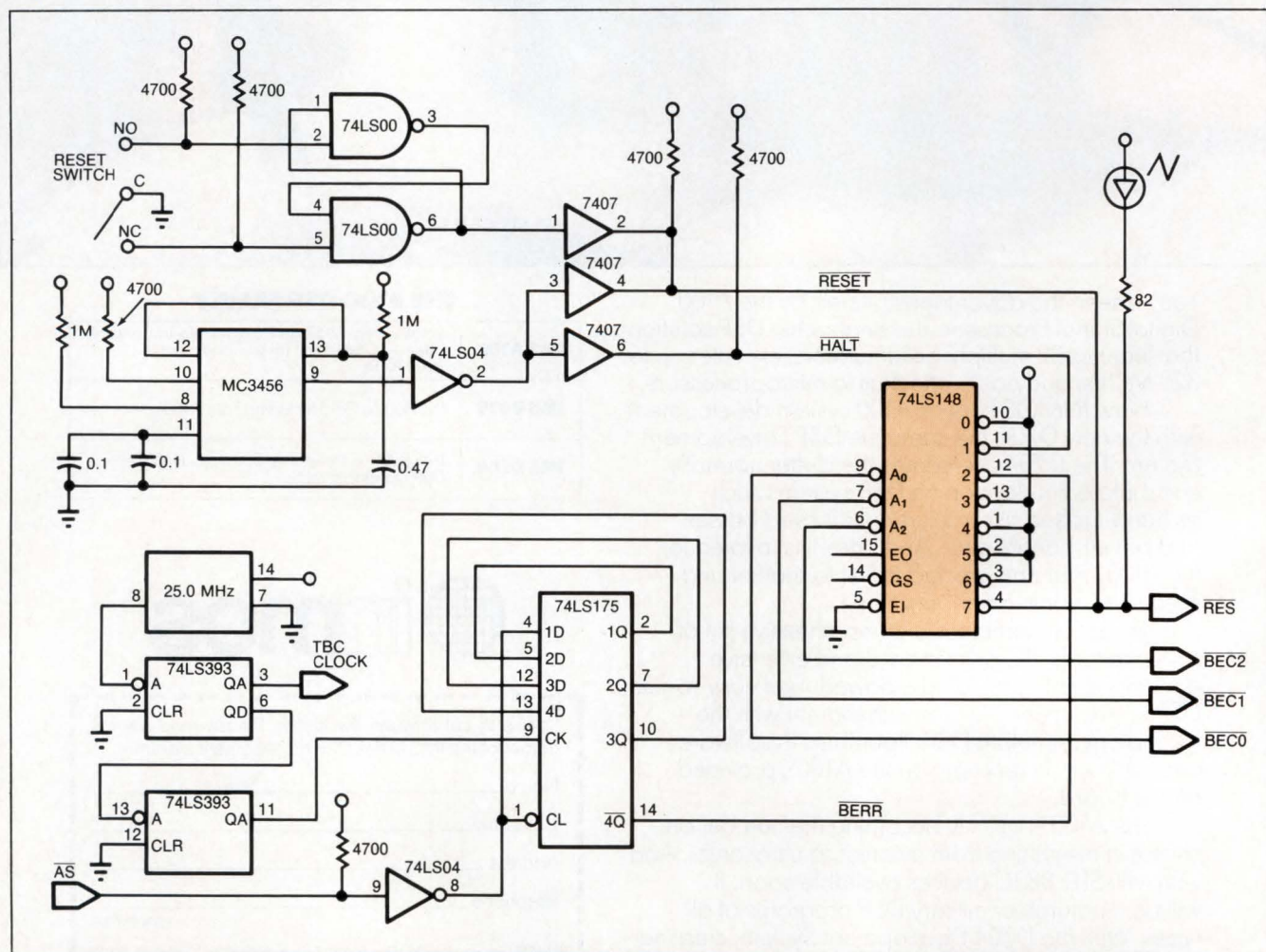

**Fig 9—A 74LS148 priority encoder translates the  $\overline{RESET}$ ,  $\overline{HALT}$ , and  $\overline{BERR}$  signals to bus exception conditions on the  $\overline{BEC}_{0-2}$  lines to the TBC.**



# THE MASTER SERIES™ VME by MATRIX

*The power of  
the Future is Here ...*

*The MS-CPU Series with  
1 Megabyte dual ported RAM  
and 68881 Math Co-processor  
meets today's and tomorrow's  
performance requirements.*

The new MS-CPU100 Series reduces board count by integrating key features such as no-wait-state dynamic RAM, ROM/EPROM sockets, two communication ports and a clock/calendar. A system controller supporting multi-processing with a mail box interface rounds out the features of this highly integrated VMEbus processor board. And interface is EASY... the MS-CPU100 and MS-CPU110 are almost entirely configurable under software control!

*Let Matrix provide your future  
VMEbus solutions with our high  
quality Master Series VMEbus  
products.*

#### MS-CPU100/110 Features

- 1Meg/512K Dual Ported, No-Wait-State DRAM
- 12.5 MHz 68000/68010 with Optional 68881 Math Accelerator
- (2) RS-232 Serial Ports; Optional RS422/485 Multidrop Support
- (2) 28-Pin ROM/EPROM Sockets, 8K Battery-Backed Static Ram
- Full VMEbus System Controller, Supports Multi-Processing
- Time of Day Clock/Calendar, Watchdog Timer and General Purpose 16-bit Timer

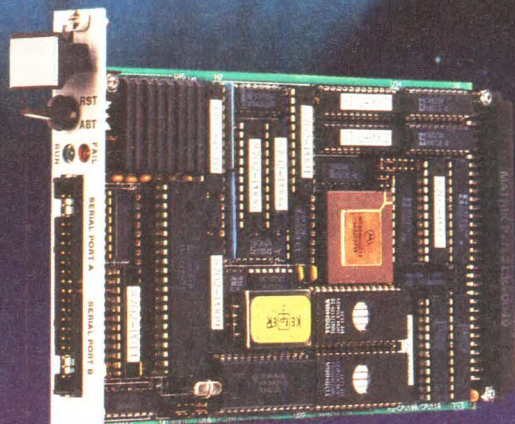

*6U Format  
for use in  
double-height  
systems*

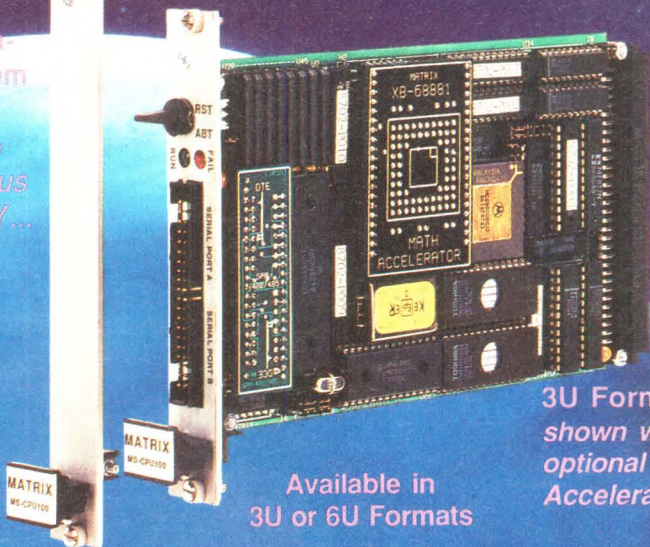

*3U Format  
shown with  
optional Math  
Accelerator*

*Available in  
3U or 6U Formats*



**MATRIX CORPORATION**

1203 New Hope Road • Raleigh, NC 27610 • Phone (919) 833-2000 • FAX (919) 833-2550

CIRCLE NO 84



**If you could design your own workstation, what features would you choose?**

- 386-Based Platform
- MS-DOS and UNIX Compatibility
- EGA, CGA Bus-Level Emulation
- X-Windows Standard
- Multi-User, Multi-Tasking
- 1280x1024 Color Graphics
- Graphics

at 20 Megapixels per Second  Support for Graphics and Network Standards  Entire System Under \$15,000

At Interfirm Graphics Systems, we've combined *all* of these performance features into our dynamic new XSYS Engineering Workstation. More features than you ever imagined. Lower cost than you ever dreamed. Call today for details.

**800-338-4513**

**INTERFIRM**  
GRAPHIC SYSTEMS



CIRCLE NO 87

**Noise problems? Soundmat PBM™ is the greatest thing since sliced bread.**



Soundcoat's exclusive SOUNDMAT PBM is made with a sheet of thin flexible limp mass sandwiched between two layers of foam to provide absorption, transmission loss and isolation. It has excellent resistance to oxidation, UV light and weathering. And our flexible plastic barrier meets UL-94V-0. For outdoor applications, aircraft, vehicles, business machines and EDP, generators, compressors and health care equipment.

SOUNDMAT PBM from Soundcoat. A great way to stop noise. No matter how you slice it.

The noise stops here.

**SOUNDCOAT®**

One Burt Drive, Deer Park, NY 11729 516-242-2200  
3002 Croddy Way, Santa Ana, CA 92704 714-979-9202

Send for your free noise control bulletin no. 719, today

CIRCLE NO 88

interrupt being serviced. The handler monitors both of the TBC's interrupt status words and responds to any bits that are set.

When designing a token bus interface, you should have overall system performance objectives in mind, which requires a thorough calculation of the expected network data rate in bytes/sec and the number of stations on the network, as well as system parameters like memory cycle time and arbitration latency. A good TBC interface should not occupy much more than 15% of the overall system bandwidth. If the interface design significantly exceeds this value, you should increase the system resources available to the TBC or host. These include such factors as faster clock speeds and faster memory chips. In addition, the TBC should be given a high priority on the local bus because of the real-time nature of the token bus medium. The system should only allocate dynamic-RAM refreshes at a higher priority than the TBC.

**EDN**

## Reference

1. Ivan Erickson, "Token-ring bus controller simplifies network design," *EDN*, April 30, 1987, pg 159.

## Author's biography

*Paul Polansky is an applications engineer at Motorola's High End Micro-processor Div in Austin, Texas. He holds BSEE and MBA degrees from the University of Texas in Austin. Paul is a member of the American Finance Association and enjoys racquetball, weightlifting, backpacking, and movies in his spare time.*



Article Interest Quotient (Circle One)

High 485 Medium 486 Low 487



DRAMs,  
SRAMs,  
EEPROMs,  
CMOS Logic,  
Flash Converters,  
SOT-23s,  
Linear,  
MOSFETs:

Samsung sets the pace.



# Samsung. Setting the pace.

**S**amsung is a leading semiconductor company with worldwide resources. In process, design and manufacturing, we're setting the pace for the industry.

To date, Samsung has invested more than \$600 million in the development of new products. By 1989, this will have grown to one billion dollars. Such commitment will place Samsung among the top ten producers in the world by the beginning of the next decade.

Samsung is a leader in the manufacture of products utilizing state-of-the-art CMOS processes. Our 6-inch wafer fabrication lines in Korea are some of the most advanced in existence, as is our Class I wafer fab facility in San Jose, the heart

of Silicon Valley. Not only are we able to produce such leading edge products as DRAMs, SRAMs, CMOS Programmable Logic and Advanced CMOS Logic, but we produce them in high volume at low cost.

Samsung maintains advanced R&D facilities in Kiheung and Bucheon, Korea and in San Jose, California. At each of these facilities we have not only created our own advanced designs for current products, but we are at work now on our 4-megabit DRAM and our 1-megabit SRAM designs.

As you read on, one thing will be clear: Samsung is committed to designing, developing and delivering sophisticated products.

Products that set the pace.



*Samsung's sophisticated manufacturing facility at Bucheon employs internally-developed Advanced CMOS and Bipolar processes.*



*Samsung's high-volume manufacturing facility at Kiheung has one of the world's most advanced 6-inch wafer fabrication lines.*

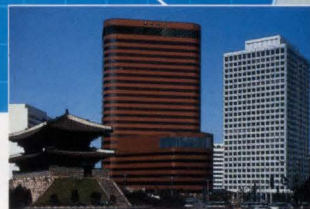

*Samsung's World Headquarters in Seoul is the center of a global organization comprised of 26 companies which operate worldwide.*



*Samsung's U.S. Headquarters in San Jose includes Engineering, Marketing, Sales and Administration and also boasts state-of-the-art R&D and Class 1 manufacturing wafer fabrication.*



# Samsung's new 1Mb DRAMs set today's fast memory pace.



*In the 1Mb DRAM, Samsung's pacesetting CMOS technology provides superior immunity to electrostatic discharge, lower soft error rates and high immunity to latchup.*



The KM41C100X and KM44C25X series of one-megabit DRAMs in CMOS technology are our latest high-density memory offerings. Fabricated using Samsung's internally developed CMOS technology, they feature line widths as fine as  $1\mu\text{m}$ .

This leading technology enables us to offer a device with very low power consumption and high-speed access times. Our pace setting

*Samsung technology has evolved from 2.5 micron to sub-micron in just four years.*

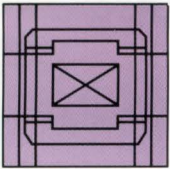

**1984-64K**  
117 $\mu\text{m}^2$  cell size  
2.5 $\mu\text{m}$  geometry



**1985-256K**  
62.5 $\mu\text{m}^2$  cell size  
1.6 $\mu\text{m}$  geometry



**1987-1Mb**  
27 $\mu\text{m}^2$  cell size  
1.0 $\mu\text{m}$  geometry



**1988-4Mb**  
10.25 $\mu\text{m}^2$  cell size  
0.8 $\mu\text{m}$  geometry

DRAMs are designed for computing applications from mainframes and minis to high performance graphics stations and work stations, as well as for instruments and telecommunications products.

Our 1Mb DRAMs are manufactured in production volumes at our 6-inch wafer fabrication facility, considered to be one of the most advanced of its kind, using very high-resolution step-pers and state-of-the-art etching and implantation equipment. Samsung is adding

DRAM wafer capacity with a new 6-inch facility which will be equipped to manufacture our 4Mb DRAM.

Samsung 1Mb DRAMs are available in a wide variety of options and organizations. We offer a choice

of 256K x 4 or 1M x 1 organizations with features like Fast Page, Nibble and Static Column modes. With the addition of the 1Mb to the 64K and 256K, Samsung's dynamic RAMs cover the entire range of densities and organizations.

All are available in plastic DIP, ZIP, and SOJ or PLCC industry standard packages.

Our packaging technology is not limited to components. Samsung SIP and SIMM memory modules for

the 256K and 1Mb DRAMs offer a cost effective method of utilizing surface mount technology to increase board density.

Fill out the coupon on the back page of this insert for data sheets and a reliability report.

Part Type	Organ.	Features	Speeds	Packages	Avail.
KM41C1000	1M x 1	Fast Page mode	100,120	DIP, ZIP, SOJ	Now
KM41C1001	1M x 1	Nibble mode	100,120	DIP, ZIP, SOJ	2Q 88*
KM41C1002	1M x 1	Static Column mode	100,120	DIP, ZIP, SOJ	2Q 88*
KM44C256	256K x 4	Fast Page mode	100,120	DIP, ZIP, SOJ	2Q 88
KM44C258	256K x 4	Static Column mode	100,120	DIP, ZIP, SOJ	2Q 88
KM41256	256K x 1	Page mode	120,150	DIP, ZIP, PLCC	Now
KM41257	256 x 1	Nibble mode	120,150	DIP, ZIP, PLCC	Now
KM41464	64K x 4	Page mode	120,150	DIP, ZIP, PLCC	Now
KM4164	64K x 1	Page mode	120,150	DIP	Now
KMM48/9256	256K x 8/9	Page or Nibble modes	120,150	SIP module	Now
KMM58/9256	256K x 8/9	Page or Nibble modes	120,150	SIMM module	Now
KMM48/91000	1M x 8/9	Fast Page mode	100,120	SIP module	2Q 88
KMM58/91000	1M x 8/9	Fast Page mode	100,120	SIMM module	2Q 88

\*Samples available now.

*Samsung's 6-inch wafer fabrication facility in Kihung is one of the most advanced in the world, boasting a Class 10 level clean room. Samsung is now expanding its 6-inch capacity.*



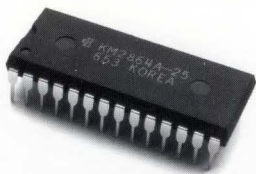

Advanced Samsung 16K and 64K EEPROMs are now available in production quantities.

# Samsung EEPROMs also outpace industry standards.

Samsung's 64K and 16K EEPROMs meet or surpass all industry standards for performance, reliability and quality. They have standard endurance ratings of 10,000 erase/write cycles and data retention

rated with our pacesetting floating gate CMOS processing. It features low power dissipation of 100 $\mu$ A standby and access times of 150ns, 200ns and 250ns. These advanced 8K x 8 EEPROMs also feature a 32-byte page mode to slash write times to 150 microseconds per byte and a 5-millisecond write cycle. This allows the entire 64K memory to be written in only 1.3 seconds.

Part Type	Organization	Speed	Features	Technology	Pinout	Availability
KM2816AP	2K x 8	250,300,350	10ms (max) write time	NMOS	24 pin	Now
KM2817AP	2K x 8	250,300,350	Ready/Busy, 10ms (max) write time	NMOS	28 pin	Now
KM2864AP	8K x 8	250,300,350	Data Polling, 10ms (max) write time	NMOS	28 pin	Now
KM2865AP	8K x 8	250,300,350	Data Polling, Ready/Busy, 10ms (max) write time	NMOS	28 pin	Now
KM2864AHP	8K x 8	250,300,350	Data Polling, 2ms (max) write time	NMOS	28 pin	Now
KM2865AHP	8K x 8	250,300,350	Data Polling, Ready/Busy, 2ms (max) write time	NMOS	28 pin	Now
KM28C64P	8K x 8	150,200,250	Data Polling, 32-byte Page Mode, Low Power, 5ms (max) write time	CMOS	28 pin	May '88*
KM28C65P	8K x 8	150,200,250	Data Polling, 32-byte Page Mode, Low Power, 5ms (max) write time	CMOS	28 pin	May '88*

\*Samples available now.

ratings of 10 years.

And our "H" version 64Ks offer a quick 2 millisecond per byte write time, reducing

write time by a factor of 5.

Our new 64K KM28C64 series (available 2nd quarter 1988) is fabri-

cated with our pacesetting floating gate CMOS processing. It features low power dissipation of 100 $\mu$ A standby and access times of 150ns, 200ns and 250ns. These advanced 8K x 8 EEPROMs also feature a 32-byte page mode to slash write times to 150 microseconds per byte and a 5-millisecond write cycle. This allows the entire 64K memory to be written in only 1.3 seconds.

Samsung's EEPROMs excel in such rugged applications as communications, instrumentation, robotics and industrial control. All our EEPROMs meet JEDEC pinout standards. Fill out the coupon on the back page of this insert for samples, a data sheet, and reliability report.

Circle No. 168



Samsung's 256K (32K x 8) KM62256 SRAMs are available with access times of 100ns, 120ns and 150ns, all in low-power versions with standby current of only 4 $\mu$ A (typical).

# The fast pace continues with Samsung low power SRAMs.

The pace of Samsung's technology development in static RAMs is as strong as it is for all our memory products. With the introduction of the KM62256 (32K x 8) SRAM Family, we now offer a wide low power CMOS SRAM line, including our KM6264A industry standard 64K SRAMs.

ideal for process control, medical instruments, and hand held devices.

Samsung is ramping up production of both the 256K and 64K

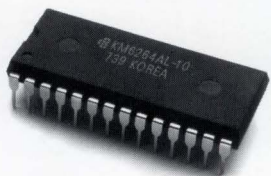

Samsung SRAMs are fabricated using 1.2  $\mu$ m CMOS technology. In 1988, we are ramping up 256K and 64K SRAM production.

The KM62256 256K SRAM is fabricated using our internally developed 1.2  $\mu$ m CMOS technology which meets both high speed and low power requirements. We offer 80ns 64K SRAMs and 100ns 256K SRAMs in high volume. They're

CMOS SRAMs. Our complete line is available now in industry standard packages and pinouts.

Fill out the coupon on the back page of this insert for a data sheet and reliability report.

Part Type	KM62256L	KM6264AL
Organization	32K x 8	8K x 8
Speeds	100, 120, 150ns	80, 100, 120ns
Package	28 DIP	28 DIP
Max Current (standby)	100 $\mu$ A	100 $\mu$ A
Availability	Now	Now

Circle No. 169



# Samsung Advanced AHCT CMOS Logic Family keeps pace with the fastest 16- and 32-bit microprocessors.

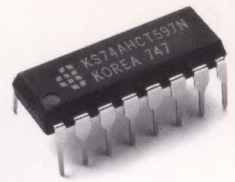

*Samsung's Advanced CMOS Logic is available in both DIP and SOIC packages.*

Available now in production quantities, our Advanced AHCT CMOS Logic Family meets the demands of your 16- and 32-bit designs for high speed, high drive and low power.

Samsung has 111 of the most popular standard logic functions available off the shelf now, with samples free for the asking. By mid-year, we will add

another 50 part types to the list. This means you can design our part

into your product and move into production now with no waiting.

For power reduction in your existing designs, AHCT offers pin-

for-pin, part-for-part replacement for ALS and FAST.<sup>™</sup> It fits right in and reduces power tenfold. Yet our AHCT doesn't have a premium price. It costs the same as ALS.

Fill out the coupon on the back page of this insert for free samples and a data book.

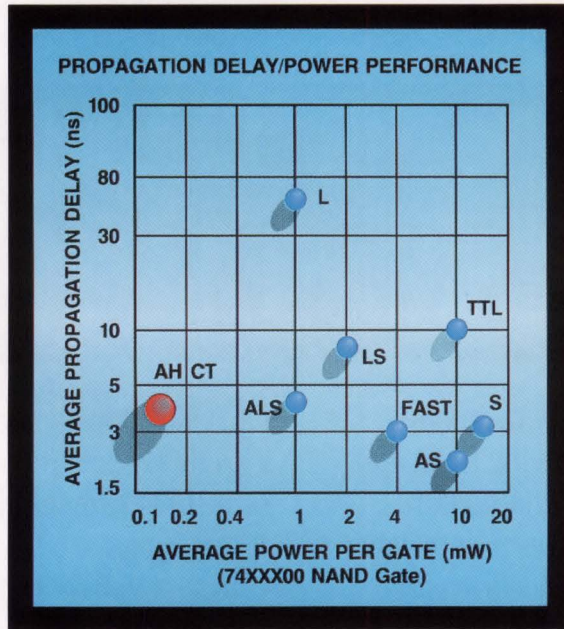

Circle No. 170

## KS74AHCT PARTS LIST

Gates and Inverters		Flip-Flops		Transceivers/Registered Transceivers			Multiplexers	
00	20	73	399	242*	643	652*	151	253
01	21	74	534	243*	645	658*	153	257
02	22	76	564	245	646	659*	157	258
03	27	78	574	640	648	664*	158	352
04	30	107	670		651*	665*	251	353
05	32	109	794*	<b>Counters</b>			<b>Shift Registers</b>	
08	51	112	821*	160	190	590*	164	299
09	58	173	822*	161	191	591*	165	595
10	86	174	823*	162	192	592*	166	596
11	132	175	824*	163	193	593*	194	597
12	133	273	825*	168	390*		195	
14	266	374	826*	169	393		<b>Arithmetic Circuits</b>	
		377		<b>Decoders/Encoders</b>			181*	522*
<b>Buffers &amp; Line Drivers</b>		<b>Latches</b>		42	148*	238	182*	679
125	367	75*	793*	138	154	239	183	680
126	368	77*	841*	139	155		280	682
210	465*		842*	<b>Multivibrators</b>			518*	684*
240	466*	259	843*	121*	123*	423*	519	686*
241	467*	373	844*				520*	688
244	468*	533	845*	<b>Logic Level Converters</b>			521	689*
365	540	563	846*	4049	4050*			
366	541	573						

\*Part types available in 2Q '88. All other part types available now.



# Samsung's KSV3110 combo A/D-D/A and KSV3208 A/D set the pace in flash converters.

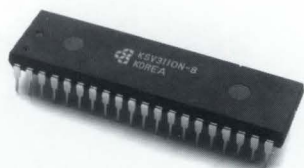

KSV3110 Combo A/D-D/A Flash Converter



KSV3208 A/D Flash Converter

The pacesetting technology of our single-chip KSV3110 A/D-D/A data converter provides independent 8-bit A/D converter functions and 10-bit R-2R D/A converter functions over an operating range of DC to 20MHz.

With the ease of design you get with the KSV3110's two chips in one, you'll save both money and real estate, leaving room and resources to add other features. And having fewer parts cuts down power drain and boosts system reliability.

The KSV3110 gives TTL-compatible input/output, 1% absolute non-linearity and selectable peak level input or keyed clamping.

The impressive linear characteristics of the KSV3110 are shared by our new KSV3208 A/D flash converter. It provides the same features for applications that don't require D/A conversion.

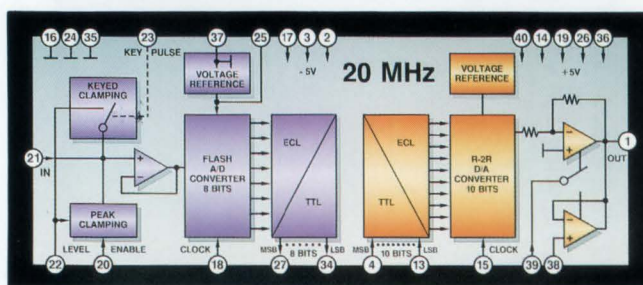

Samsung also offers the support chips to ease the integration of the KSV3110

into video applications. For example:

- KA2606 Sync Separate IC
- KA2153 Chrominance Signal Processor for NTSC systems
- KA2154 Video Chroma Deflection System for NTSC and PAL systems

Fill out the coupon on the back page of this insert for samples and a Flash Converter IC Data Book.

Circle No. 171

Part Type	Resolution		Linearity		Conversion Speed	Industry Part
	A/D	D/A	A/D	D/A		
KSV3110N-10	8 bits	10 bits	$\pm \frac{1}{2}$ LSB	$\pm \frac{1}{2}$ LSB	20 MSPS	
KSV3110N-9	8 bits	10 bits	$\pm \frac{1}{2}$ LSB	$\pm 1$ LSB	20 MSPS	
KSV3110N-8	8 bits	10 bits	$\pm \frac{1}{2}$ LSB	$\pm 2$ LSB	20 MSPS	
KSV3110N-7	8 bits	10 bits	$\pm \frac{1}{2}$ LSB	$\pm 4$ LSB	20 MSPS	
KSV3100AN-8	8 bits	10 bits	$\pm \frac{1}{2}$ LSB	$\pm 2$ LSB	20 MSPS	UVC3101
KSV3100AN-7	8 bits	10 bits	$\pm \frac{1}{2}$ LSB	$\pm 4$ LSB	20 MSPS	UVC3101
KSV3208N	8 bits		$\pm \frac{1}{2}$ LSB		20 MSPS	
KAD0820ACN	8 bits		$\pm \frac{1}{2}$ LSB		1.5 $\mu$ sec	ADC0820BCN
KAD0820BCN	8 bits		$\pm 1$ LSB		1.5 $\mu$ sec	ADC0820CCN
KAD0808IN	8 bits		$\pm \frac{1}{2}$ LSB		100 $\mu$ sec	ADC0808CCN
KAD0809IN	8 bits		$\pm 1$ LSB		100 $\mu$ sec	ADC0809CCN
KDA0800CN		8 bits		$\pm \frac{1}{2}$ LSB	*100 nsec	DAC0800LCN
KDA0801CN		8 bits		$\pm 1$ LSB	*100 nsec	DAC0801LCN
KDA0802CN		8 bits		$\pm \frac{1}{4}$ LSB	*100 nsec	DAC0802LCN
KDA0806CN		8 bits		$\pm 2$ LSB	*150 nsec	DAC0806LCN
KDA0807CN		8 bits		$\pm 1$ LSB	*150 nsec	DAC0807LCN
KDA0808CN		8 bits		$\pm \frac{1}{2}$ LSB	*150 nsec	DAC0808LCN
KS7126CN	3½ digit		$\pm \frac{1}{2}$ LSB		333 msec	TSC7126
KS25C02	CMOS 8-bit successive approx. register					DM2502
KS25C03	CMOS 8-bit successive approx. register					DM2503
KS25C04	CMOS 12-bit successive approx. register					DM2504

\*Settling Time



# Samsung's SOT-23s set the pace for surface mount technology.



Samsung has 100 types of SOT-23 available now.

Samsung has introduced 100 types of SOT-23s with an AOQL of 100 ppm or better—all with competitive pricing. They're ideal for both hybrid and surface mount applications. The entire line is in full production and available from stock. Samsung can deliver SOT-23s in the quantities you need when you need them.

## SOT-23 PART TYPES

MMBR5179	MMBT5087	MMBTA55
MMBT2222A	MMBT5088	MMBTA56
MMBT2484	MMBT5401	MMBTA63
MMBT2907A	MMBT5550	MMBTA64
MMBT3904	MMBT6428	MMBTA70
MMBT3906	MMBTA05	MMBTA92
MMBT4123	MMBTA06	MMBTA93
MMBT4124	MMBTA13	MMBTH10
MMBT4125	MMBTA14	MMBTH17
MMBT4126	MMBTA20	MMBTH24
MMBT4401	MMBTA42	BCX70G
MMBT4403	MMBTA43	BCX71G

66 other types also available

Samsung now has available a new family of digital transistors, the KSR1000 Series (NPN) and KSR2000 Series (PNP), with 40 part types in each family. They're especially useful for applications where logic circuits are being interfaced with electromechanical systems.

We also offer an extensive line of industry standard TO-92, TO-126, and TO-220 transistors, plus TIP-Series power transistors, small signal transistors, high speed high voltage switching power transistors, Darlington power transistors and 1500V TO-3P transistors.

Fill out the coupon on the back page of this insert for samples and a copy of our new Transistor Data Book.

Circle No. 172

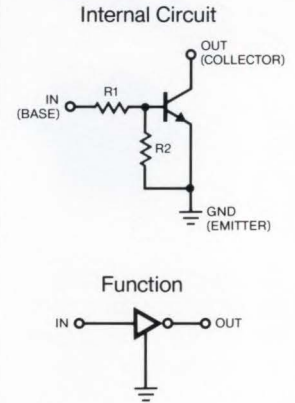

Samsung's new KSR1000 and KSR2000 Series digital transistors are especially useful for applications where logic circuits are being interfaced with electromechanical systems.

## Samsung sets a fast pace in delivering linear ICs.

The quality of Samsung linear ICs has gained them solid market acceptance. We now have over 250 industry-standard ICs available for immediate delivery. And Samsung has invested substantially to ensure that you get the latest technology, with high reliability in high volume at very low cost.

Fill out the coupon on the back page of this insert for samples and a data book.

Circle No. 173

### Voltage Regulators

KA336Z-5 (LM336-5)  
KA431CZ\* (TL431)  
KA431CN (TL431)  
LM723CN  
LM317T  
MC78TXXCT  
MC78XXCT  
MC78XXACT  
MC78LXXACZ  
MC78MXXCT  
MC79LXXACZ  
MC79MXXCT  
MC79XXCT  
μA78S40CN  
KA385Z-1.2 (LM385-1.2)

### OP AMPS

KA301AN\* (LM301A)  
LM741CN\*  
MC1458CN\*  
MC4558CN\*  
LM358N\*  
LM358AN\*  
LM348N\*  
LM324N\*  
LM324AN\*  
MC3403N\*  
KS271 (TLC271)  
KS272 (TLC272)  
KS273 (TLC273)

### Telecommunications ICs

KA2410N—Tone ringer  
KA2411N—Tone ringer  
KA2418N—Tone ringer with bridge diode  
KA2412FN—Speech network  
KA2413N—DTMF  
KS5808N—DTMF  
KS5805AN/BN—Pulse dialer  
KS5819N—Pulse/DTMF (22 DIP)  
KS5820N—Pulse/DTMF (18 DIP)  
KT3040—CODEC filter  
KT5116—CODEC  
LM567N\*—Tone decoder  
LM567LN—Tone decoder Micropower

### Timers

KS555N\* (CMOS)  
KS555HN\* (CMOS)  
KS556N\* (CMOS)  
NE555CN\*  
NE556CN\*  
NE558CN

### Comparators

KA319N  
KA710CN  
LM311N\*  
LM393N/AN\*  
LM339N/AN\*  
KS374N (TLC374)  
KA361N (LM361)

### RS-232 Interface

MC1488N\*—Driver  
MC1489N/AN\*—Receiver

\*Also available in surface-mount package (SOIC).



# Samsung's MOSFETs have had fast-paced market acceptance.

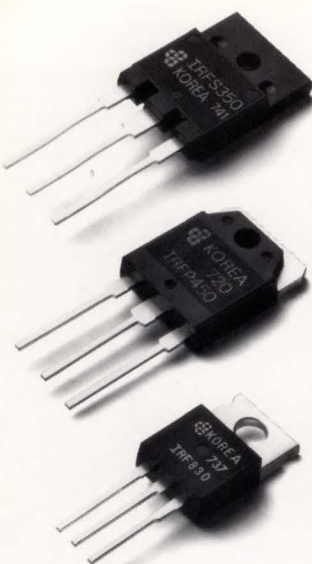

Samsung's high-quality, industry-standard MOSFETs directly replace IR and Motorola® and are competitively priced.

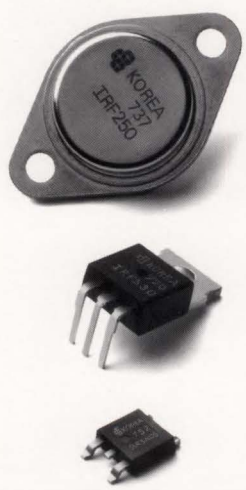

Samsung's industry-standard power MOSFETs have rapidly gained market acceptance. Independent testing has demonstrated their excellent quality and superior ruggedness (2J at 500V). Each is screened to MIL-STD-750 specifications.

Our MOSFETs directly replace IR and Motorola®. They're available in a variety of packages, including lead-formed TO-220s, state-of-the-art TO-247 FULL PACK and DPAK.

And Samsung is an established supplier with over 400 part types, in both N and P channel, one of the broadest lines on the market. Our MOSFETs range from 60V to 700V. Plus, we're especially deep in the 500V to 700V range. All with competitive pricing.

Fill out the coupon on the back page of this insert for samples, a data book, and a ruggedness application note.

Circle No. 174

<b>TO-247 Full Pack</b> <b>N-Channel Types</b> IRFS130 IRFS443 IRFS133 IRFS450 IRFS140 IRFS453 IRFS143 SSS4N70 IRFS150 SSS6N70 IRFS153 SSS10N70 IRFS230 SSS4N60 IRFS233 SSS6N60 IRFS240 SSS8N60 IRFS243 SSS15N60 IRFS250 SSS6N55 IRFS253 SSS8N55 IRFS330 SSS15N55 IRFS333 SSS20N50 IRFS350 SSS20N45 IRFS353 SSS25N40 IRFS430 SSS25N35 IRFS433 SSS40N20 IRFS440 SSS40N15  <b>TO-3P Package</b> <b>N-Channel Types</b> IRFP120 IRFP423 IRFP121 IRFP430 IRFP122 IRFP431 IRFP123 IRFP432 IRFP130 IRFP433 IRFP131 IRFP440 IRFP132 IRFP441 IRFP133 IRFP442 IRFP140 IRFP443 IRFP141 IRFP450 IRFP142 IRFP451 IRFP143 IRFP452 IRFP150 IRFP453 IRFP151 SSM3N70 IRFP152 SSM4N70 IRFP153 SSM6N70 IRFP220 SSM10N70 IRFP221 SSM4N60 IRFP222 SSM6N60 IRFP223 SSM8N60 IRFP230 SSM15N60 IRFP231 SSM4N55 IRFP232 SSM6N55 IRFP233 SSM8N55 IRFP240 SSM15N55 IRFP241 SSM4N50 IRFP242 SSM20N50 IRFP243 SSM4N45 IRFP250 SSM25N45 IRFP251 SSM5N40 IRFP252 SSM25N40 IRFP253 SSM5N35 IRFP320 SSM25N35 IRFP321 SSM7N20 IRFP322 SSM8N20 IRFP323 SSM40N20 IRFP330 SSM7N18 IRFP331 SSM8N18 IRFP332 SSM7N15 IRFP333 SSM8N15 IRFP340 SSM40N15 IRFP341 SSM7N12 IRFP342 SSM8N12 IRFP343 SSM12N10 IRFP350 SSM10N10 IRFP351 SSM12N08 IRFP352 SSM10N08 IRFP353 SSM12N06 IRFP420 SSM10N06 IRFP421 SSM12N05 IRFP422 SSM10N05  <b>TO-3 Package</b> <b>P-Channel Types</b> IRFP9120 IRFP9132 IRFP9121 IRFP9133 IRFP9122 IRFP9140 IRFP9123 IRFP9141 IRFP9130 IRFP9142 IRFP9131 IRFP9143 IRFP9132 IRFP9232 IRFP9133 IRFP9233 IRFP9140 IRFP9240 IRFP9141 IRFP9241 IRFP9142 IRFP9242 IRFP9143 IRFP9243  <b>TO-220 Package</b> <b>N-Channel Types</b> IRF510 IRF741 IRF511 IRF742 IRF512 IRF743 IRF513 IRF820 IRF520 IRF821 IRF521 IRF822 IRF522 IRF823 IRF523 IRF830 IRF530 IRF831 IRF531 IRF832 IRF532 IRF833 IRF533 IRF840 IRF540 IRF841 IRF541 IRF842 IRF542 IRF843 IRF543 IRF844 IRF544 IRF845 IRF550 IRF846 IRF551 IRF847 IRF552 IRF848 IRF553 IRF849 IRF554 IRF850 IRF555 IRF851 IRF556 IRF852 IRF557 IRF853 IRF558 IRF854 IRF559 IRF855 IRF560 IRF856 IRF561 IRF857 IRF562 IRF858 IRF563 IRF859 IRF564 IRF860 IRF565 IRF861 IRF566 IRF862 IRF567 IRF863 IRF568 IRF864 IRF569 IRF865 IRF570 IRF866 IRF571 IRF867 IRF572 IRF868 IRF573 IRF869 IRF574 IRF870 IRF575 IRF871 IRF576 IRF872 IRF577 IRF873 IRF578 IRF874 IRF579 IRF875 IRF580 IRF876 IRF581 IRF877 IRF582 IRF878 IRF583 IRF879 IRF584 IRF880 IRF585 IRF881 IRF586 IRF882 IRF587 IRF883 IRF588 IRF884 IRF589 IRF885 IRF590 IRF886 IRF591 IRF887 IRF592 IRF888 IRF593 IRF889 IRF594 IRF890 IRF595 IRF891 IRF596 IRF892 IRF597 IRF893 IRF598 IRF894 IRF599 IRF895 IRF600 IRF896 IRF601 IRF897 IRF602 IRF898 IRF603 IRF899 IRF604 IRF900 IRF605 IRF901 IRF606 IRF902 IRF607 IRF903 IRF608 IRF904 IRF609 IRF905 IRF610 IRF906 IRF611 IRF907 IRF612 IRF908 IRF613 IRF909 IRF614 IRF910 IRF615 IRF911 IRF616 IRF912 IRF617 IRF913 IRF618 IRF914 IRF619 IRF915 IRF620 IRF916 IRF621 IRF917 IRF622 IRF918 IRF623 IRF919 IRF624 IRF920 IRF625 IRF921 IRF626 IRF922 IRF627 IRF923 IRF628 IRF924 IRF629 IRF925 IRF630 IRF926 IRF631 IRF927 IRF632 IRF928 IRF633 IRF929 IRF634 IRF930 IRF635 IRF931 IRF636 IRF932 IRF637 IRF933 IRF638 IRF934 IRF639 IRF935 IRF640 IRF936 IRF641 IRF937 IRF642 IRF938 IRF643 IRF939 IRF644 IRF940 IRF645 IRF941 IRF646 IRF942 IRF647 IRF943 IRF648 IRF944 IRF649 IRF945 IRF650 IRF946 IRF651 IRF947 IRF652 IRF948 IRF653 IRF949 IRF654 IRF950 IRF655 IRF951 IRF656 IRF952 IRF657 IRF953 IRF658 IRF954 IRF659 IRF955 IRF660 IRF956 IRF661 IRF957 IRF662 IRF958 IRF663 IRF959 IRF664 IRF960 IRF665 IRF961 IRF666 IRF962 IRF667 IRF963 IRF668 IRF964 IRF669 IRF965 IRF670 IRF966 IRF671 IRF967 IRF672 IRF968 IRF673 IRF969 IRF674 IRF970 IRF675 IRF971 IRF676 IRF972 IRF677 IRF973 IRF678 IRF974 IRF679 IRF975 IRF680 IRF976 IRF681 IRF977 IRF682 IRF978 IRF683 IRF979 IRF684 IRF980 IRF685 IRF981 IRF686 IRF982 IRF687 IRF983 IRF688 IRF984 IRF689 IRF985 IRF690 IRF986 IRF691 IRF987 IRF692 IRF988 IRF693 IRF989 IRF694 IRF990 IRF695 IRF991 IRF696 IRF992 IRF697 IRF993 IRF698 IRF994 IRF699 IRF995 IRF700 IRF996 IRF701 IRF997 IRF702 IRF998 IRF703 IRF999 IRF704 IRF1000 IRF705 IRF1001 IRF706 IRF1002 IRF707 IRF1003 IRF708 IRF1004 IRF709 IRF1005 IRF710 IRF1006 IRF711 IRF1007 IRF712 IRF1008 IRF713 IRF1009 IRF714 IRF1010 IRF715 IRF1011 IRF716 IRF1012 IRF717 IRF1013 IRF718 IRF1014 IRF719 IRF1015 IRF720 IRF1016 IRF721 IRF1017 IRF722 IRF1018 IRF723 IRF1019 IRF724 IRF1020 IRF725 IRF1021 IRF726 IRF1022 IRF727 IRF1023 IRF728 IRF1024 IRF729 IRF1025 IRF730 IRF1026 IRF731 IRF1027 IRF732 IRF1028 IRF733 IRF1029 IRF734 IRF1030 IRF735 IRF1031 IRF736 IRF1032 IRF737 IRF1033 IRF738 IRF1034 IRF739 IRF1035 IRF740 IRF1036 IRF741 IRF1037 IRF742 IRF1038 IRF743 IRF1039 IRF744 IRF1040 IRF745 IRF1041 IRF746 IRF1042 IRF747 IRF1043 IRF748 IRF1044 IRF749 IRF1045 IRF750 IRF1046 IRF751 IRF1047 IRF752 IRF1048 IRF753 IRF1049 IRF754 IRF1050 IRF755 IRF1051 IRF756 IRF1052 IRF757 IRF1053 IRF758 IRF1054 IRF759 IRF1055 IRF760 IRF1056 IRF761 IRF1057 IRF762 IRF1058 IRF763 IRF1059 IRF764 IRF1060 IRF765 IRF1061 IRF766 IRF1062 IRF767 IRF1063 IRF768 IRF1064 IRF769 IRF1065 IRF770 IRF1066 IRF771 IRF1067 IRF772 IRF1068 IRF773 IRF1069 IRF774 IRF1070 IRF775 IRF1071 IRF776 IRF1072 IRF777 IRF1073 IRF778 IRF1074 IRF779 IRF1075 IRF780 IRF1076 IRF781 IRF1077 IRF782 IRF1078 IRF783 IRF1079 IRF784 IRF1080 IRF785 IRF1081 IRF786 IRF1082 IRF787 IRF1083 IRF788 IRF1084 IRF789 IRF1085 IRF790 IRF1086 IRF791 IRF1087 IRF792 IRF1088 IRF793 IRF1089 IRF794 IRF1090 IRF795 IRF1091 IRF796 IRF1092 IRF797 IRF1093 IRF798 IRF1094 IRF799 IRF1095 IRF800 IRF1096 IRF801 IRF1097 IRF802 IRF1098 IRF803 IRF1099 IRF804 IRF1100 IRF805 IRF1101 IRF806 IRF1102 IRF807 IRF1103 IRF808 IRF1104 IRF809 IRF1105 IRF810 IRF1106 IRF811 IRF1107 IRF812 IRF1108 IRF813 IRF1109 IRF814 IRF1110 IRF815 IRF1111 IRF816 IRF1112 IRF817 IRF1113 IRF818 IRF1114 IRF819 IRF1115 IRF820 IRF1116 IRF821 IRF1117 IRF822 IRF1118 IRF823 IRF1119 IRF824 IRF1120 IRF825 IRF1121 IRF826 IRF1122 IRF827 IRF1123 IRF828 IRF1124 IRF829 IRF1125 IRF830 IRF1126 IRF831 IRF1127 IRF832 IRF1128 IRF833 IRF1129 IRF834 IRF1130 IRF835 IRF1131 IRF836 IRF1132 IRF837 IRF1133 IRF838 IRF1134 IRF839 IRF1135 IRF840 IRF1136 IRF841 IRF1137 IRF842 IRF1138 IRF843 IRF1139 IRF844 IRF1140 IRF845 IRF1141 IRF846 IRF1142 IRF847 IRF1143 IRF848 IRF1144 IRF849 IRF1145 IRF850 IRF1146 IRF851 IRF1147 IRF852 IRF1148 IRF853 IRF1149 IRF854 IRF1150 IRF855 IRF1151 IRF856 IRF1152 IRF857 IRF1153 IRF858 IRF1154 IRF859 IRF1155 IRF860 IRF1156 IRF861 IRF1157 IRF862 IRF1158 IRF863 IRF1159 IRF864 IRF1160 IRF865 IRF1161 IRF866 IRF1162 IRF867 IRF1163 IRF868 IRF1164 IRF869 IRF1165 IRF870 IRF1166 IRF871 IRF1167 IRF872 IRF1168 IRF873 IRF1169 IRF874 IRF1170 IRF875 IRF1171 IRF876 IRF1172 IRF877 IRF1173 IRF878 IRF1174 IRF879 IRF1175 IRF880 IRF1176 IRF881 IRF1177 IRF882 IRF1178 IRF883 IRF1179 IRF884 IRF1180 IRF885 IRF1181 IRF886 IRF1182 IRF887 IRF1183 IRF888 IRF1184 IRF889 IRF1185 IRF890 IRF1186 IRF891 IRF1187 IRF892 IRF1188 IRF893 IRF1189 IRF894 IRF1190 IRF895 IRF1191 IRF896 IRF1192 IRF897 IRF1193 IRF898 IRF1194 IRF899 IRF1195 IRF900 IRF1196 IRF901 IRF1197 IRF902 IRF1198 IRF903 IRF1199 IRF904 IRF1200 IRF905 IRF1201 IRF906 IRF1202 IRF907 IRF1203 IRF908 IRF1204 IRF909 IRF1205 IRF910 IRF1206 IRF911 IRF1207 IRF912 IRF1208 IRF913 IRF1209 IRF914 IRF1210 IRF915 IRF1211 IRF916 IRF1212 IRF917 IRF1213 IRF918 IRF1214 IRF919 IRF1215 IRF920 IRF1216 IRF921 IRF1217 IRF922 IRF1218 IRF923 IRF1219 IRF924 IRF1220 IRF925 IRF1221 IRF926 IRF1222 IRF927 IRF1223 IRF928 IRF1224 IRF929 IRF1225 IRF930 IRF1226 IRF931 IRF1227 IRF932 IRF1228 IRF933 IRF1229 IRF934 IRF1230 IRF935 IRF1231 IRF936 IRF1232 IRF937 IRF1233 IRF938 IRF1234 IRF939 IRF1235 IRF940 IRF1236 IRF941 IRF1237 IRF942 IRF1238 IRF943 IRF1239 IRF944 IRF1240 IRF945 IRF1241 IRF946 IRF1242 IRF947 IRF1243 IRF948 IRF1244 IRF949 IRF1245 IRF950 IRF1246 IRF951 IRF1247 IRF952 IRF1248 IRF953 IRF1249 IRF954 IRF1250 IRF955 IRF1251 IRF956 IRF1252 IRF957 IRF1253 IRF958 IRF1254 IRF959 IRF1255 IRF960 IRF1256 IRF961 IRF1257 IRF962 IRF1258 IRF963 IRF1259 IRF964 IRF1260 IRF965 IRF1261 IRF966 IRF1262 IRF967 IRF1263 IRF968 IRF1264 IRF969 IRF1265 IRF970 IRF1266 IRF971 IRF1267 IRF972 IRF1268 IRF973 IRF1269 IRF974 IRF1270 IRF975 IRF1271 IRF976 IRF1272 IRF977 IRF1273 IRF978 IRF1274 IRF979 IRF1275 IRF980 IRF1276 IRF981 IRF1277 IRF982 IRF1278 IRF983 IRF1279 IRF984 IRF1280 IRF985 IRF1281 IRF986 IRF1282 IRF987 IRF1283 IRF988 IRF1284 IRF989 IRF1285 IRF990 IRF1286 IRF991 IRF1287 IRF992 IRF1288 IRF993 IRF1289 IRF994 IRF1290 IRF995 IRF1291 IRF996 IRF1292 IRF997 IRF1293 IRF998 IRF1294 IRF999 IRF1295 IRF1000 IRF1296 IRF1001 IRF1297 IRF1002 IRF1298 IRF1003 IRF1299 IRF1004 IRF1300 IRF1005 IRF1301 IRF1006 IRF1302 IRF1007 IRF1303 IRF1008 IRF1304 IRF1009 IRF1305 IRF1010 IRF1306 IRF1011 IRF1307 IRF1012 IRF1308 IRF1013 IRF1309 IRF1014 IRF1310 IRF1015 IRF1311 IRF1016 IRF1312 IRF1017 IRF1313 IRF1018 IRF1314 IRF1019 IRF1315 IRF1020 IRF1316 IRF1021 IRF1317 IRF1022 IRF1318 IRF1023 IRF1319 IRF1024 IRF1320 IRF1025 IRF1321 IRF1026 IRF1322 IRF1027 IRF1323 IRF1028 IRF1324 IRF1029 IRF1325 IRF1030 IRF1326 IRF1031 IRF1327 IRF1032 IRF1328 IRF1033 IRF1329 IRF1034 IRF1330 IRF1035 IRF1331 IRF1036 IRF1332 IRF1037 IRF1333 IRF1038 IRF1334 IRF1039 IRF1335 IRF1040 IRF1336 IRF1041 IRF1337 IRF1042 IRF1338 IRF1043 IRF1339 IRF1044 IRF1340 IRF1045 IRF1341 IRF1046 IRF1342 IRF1047 IRF1343 IRF1048 IRF1344 IRF1049 IRF1345 IRF1050 IRF1346 IRF1051 IRF1347 IRF1052 IRF1348 IRF1053 IRF1349 IRF1054 IRF1350 IRF1055 IRF1351 IRF1056 IRF1352 IRF1057 IRF1353 IRF1058 IRF1354 IRF1059 IRF1355 IRF1060 IRF1356 IRF1061 IRF1357 IRF1062 IRF1358 IRF1063 IRF1359 IRF1064 IRF1360 IRF1065 IRF1361 IRF1066 IRF1362 IRF1067 IRF1363 IRF1068 IRF1364 IRF1069 IRF1365 IRF1070 IRF1366 IRF1071 IRF1367 IRF1072 IRF1368 IRF1073 IRF1369 IRF1074 IRF1370 IRF1075 IRF1371 IRF1076 IRF1372 IRF1077 IRF1373 IRF1078 IRF1374 IRF1079 IRF1375 IRF1080 IRF1376 IRF1081 IRF1377 IRF1082 IRF1378 IRF1083 IRF1379 IRF1084 IRF1380 IRF1085 IRF1381 IRF1086 IRF1382 IRF1087 IRF1383 IRF1088 IRF1384 IRF1089 IRF1385 IRF1090 IRF1386 IRF1091 IRF1387 IRF1092 IRF1388 IRF1093 IRF1389 IRF1094 IRF1390 IRF1095 IRF1391 IRF1096 IRF1392 IRF1097 IRF1393 IRF1098 IRF1394 IRF1099 IRF1395 IRF1100 IRF1396 IRF1101 IRF1397 IRF1102 IRF1398 IRF1103 IRF1399 IRF1104 IRF1400 IRF1105 IRF1401 IRF1106 IRF1402 IRF1107 IRF1403 IRF1108 IRF1404 IRF1109 IRF1405 IRF1110 IRF1406 IRF1111 IRF1407 IRF1112 IRF1408 IRF1113 IRF1409 IRF1114 IRF1410 IRF1115 IRF1411 IRF1116 IRF1412 IRF1117 IRF1413 IRF1118 IRF1414 IRF1119 IRF1415 IRF1120 IRF1416 IRF1121 IRF1417 IRF1122 IRF1418 IRF1123 IRF1419 IRF1124 IRF1420 IRF1125 IRF1421 IRF1126 IRF1422 IRF1127 IRF1423 IRF1128 IRF1424 IRF1129 IRF1425 IRF1130 IRF1426 IRF1131 IRF1427 IRF1132 IRF1428 IRF1133 IRF1429 IRF1134 IRF1430 IRF1135 IRF1431 IRF1136 IRF1432 IRF1137 IRF1433 IRF1138 IRF1434 IRF1139 IRF1435 IRF1140 IRF1436 IRF1141 IRF1437 IRF1142 IRF1438 IRF1143 IRF1439 IRF1144 IRF1440 IRF1145 IRF1441 IRF1146 IRF1442 IRF1147 IRF1443 IRF1148 IRF1444 IRF1149 IRF1445 IRF1150 IRF1446 IRF1151 IRF1447 IRF1152 IRF1448 IRF1153 IRF1449 IRF1154 IRF1450 IRF1155 IRF1451 IRF1156 IRF1452 IRF1157 IRF1453 IRF1158 IRF1454 IRF1159 IRF1455 IRF1160 IRF1456 IRF1161 IRF1457 IRF1162 IRF1458 IRF1163 IRF1459 IRF1164 IRF1460 IRF1165 IRF1461 IRF1166 IRF1462 IRF1167 IRF1463 IRF1168 IRF1464 IRF1169 IRF1465 IRF1170 IRF1466 IRF1171 IRF1467 IRF1172 IRF1468 IRF1173 IRF1469 IRF1174 IRF1470 IRF1175 IRF1471 IRF1176 IRF1472 IRF1177 IRF1473 IRF1178 IRF1474 IRF1179 IRF1475 IRF1180 IRF1476 IRF1181 IRF1477 IRF1182 IRF1478 IRF1183 IRF1479 IRF1184 IRF1480 IRF1185 IRF1481 IRF1186 IRF1482 IRF1187 IRF1483 IRF1188 IRF1484 IRF1189 IRF1485 IRF1190 IRF1486 IRF1191 IRF1487 IRF1192 IRF1488 IRF1193 IRF1489 IRF1194 IRF1490 IRF1195 IRF1491 IRF1196 IRF1492 IRF1197 IRF1493 IRF1198 IRF1494 IRF1199 IRF1495 IRF1200 IRF1496 IRF1201 IRF1497 IRF1202 IRF1498 IRF1203 IRF1499 IRF1204 IRF1500 IRF1205 IRF1501 IRF1206 IRF1502 IRF1207 IRF1503 IRF1208 IRF1504 IRF1209 IRF1505 IRF1210 IRF1506 IRF1211 IRF1507 IRF1212 IRF1508 IRF1213 IRF1509 IRF1214 IRF1510 IRF1215 IRF1511 IRF1216 IRF1512 IRF1217 IRF1513 IRF1218 IRF1514 IRF1219 IRF1515 IRF122
--



# Evaluate model types before simulating logic circuits

---

*By modeling your logic-circuit design in software before, or in place of, building a hardware prototype, you can save yourself a great deal of time and money. Before you can make this determination, however, you must know more about the four basic types of simulation models.*

---

Kent Moffat and Don Carter,  
*Mentor Graphics Corp*

It is well known that you can avoid the expense of fabricating a flawed circuit or system by first "building" and testing a model of the device. However, there are several very different types of models you can choose from, and you'll find that some designs call for the use of multiple model types. Before you start developing a simulation strategy, you should carefully consider each type of model. The model or models you select will determine your simulation's speed, accuracy, and the number of reports that it produces. By choosing carefully, you can meet all of your requirements.

Models are principally classed according to whether they are software or hardware based (**Fig 1**). You'll find

advantages and disadvantages to both of these approaches. For example, you can construct a software simulation model in the same amount of time—or less—than it takes to construct a complete prototype circuit or system (see **box**, "Software breadboard reduces required investment"). And, once you have such a model, you can debug and correct it quickly. Because it takes more time to physically test and rewire a hardware prototype, the design-verification costs for software models are often lower.

On the other hand, hardware models use a real IC, and thus they provide all of the good—and the faulty—functions of a chip. A software model is only as accurate as the tests written to verify its operation; it is almost impossible for a software model to simulate both the good and faulty functions of a device. For example, a software model probably won't contain a response for each illegal input-signal combination that you can possibly apply to a  $\mu$ P chip. Likewise, it's unlikely that a chip's undocumented features and bugs are available in a software model, unless the model's programmer had access to the chip maker's proprietary information. You can see that you must thoroughly understand and carefully weigh your simulation requirements against the relative benefits and drawbacks of the two disciplines.

Software models are further categorized according to the complexity level of the devices they effectively



---

*All but the simplest logic circuits can benefit from simulation techniques.*

---

simulate. Gate-level models, for example, are software models that simulate primitive logic devices such as individual AND, NAND, and OR gates by exactly describing each gate's internal logic. These models are useful in describing individual gates that aren't part of a large chip (Fig 2).

On the down side, gate-level models require a good deal of time to develop. Also, because the simulation software must evaluate each gate's response to every simulation event, simulation run-times are lengthy as well. Even a gate-level simulation of the devices on one pc board, such as a VME Bus CPU board, consumes more computer time than is practical. Gate-level accelerators can help speed this type of simulation, but they are expensive and inflexible.

Likewise, because gate-level models must duplicate each gate in a chip's internal circuitry, they are a poor choice for simulating complex ICs. For instance, you can use a manufacturer's spec sheet to find the overall input-to-output signal delay for an IC, but the data sheet won't provide the delay for each of the IC's internal gates. So, if you simply estimate the gate-delay times and then simulate a complex device, timing errors will accumulate and produce erroneous results. Keep in mind, too, that you can't obtain gate-level designs for many proprietary chips. Therefore, gate-level models are appropriate only for small-scale integration (SSI) and medium-scale integration (MSI) ICs.

The next level of software model is the functional model. A functional model uses a simplified device description that accurately describes a device's I/O and timing properties, but it doesn't have to describe each gate within a chip. These types of models also require

less computer memory—for design storage and recording of simulation details—than gate-level models.

Functional models require a software language that reveals a device's structure. Designers typically construct these models by connecting simulation primitives such as gates, registers, and other common logic functions:

```
SUM ≤ X xor Y xor CIN after 5 ns;  
C ≤ (Y and CIN) or (X and CIN) or (X and Y);  
COUT ≤ C after 6 ns
```

For functional modeling, you can also express a device's function in a Boolean language. For example, Mentor Graphics' functional-modeling language lets you create a schematic that is made up of primitives that model a device's operation. You combine this schematic with a text file that describes the device's input-to-output, or pin-to-pin, timing relationships.

Functional-model libraries include most MSI and some LSI ICs. But, if you can't find a needed functional model in a library, you can create it yourself. For instance, you can model an address latch by describing the device's logic and by entering the data sheet's timing information.

Although functional models work well for MSI chips, you can't use them to describe VLSI (very large scale integrated) components. Functional models simply interconnect logical elements, and it's inefficient—and often impossible—to use them to describe a VLSI device. Therefore, to model all VLSI and most LSI devices, you must use a behavioral-modeling language. Such languages use a series of instructions and equa-

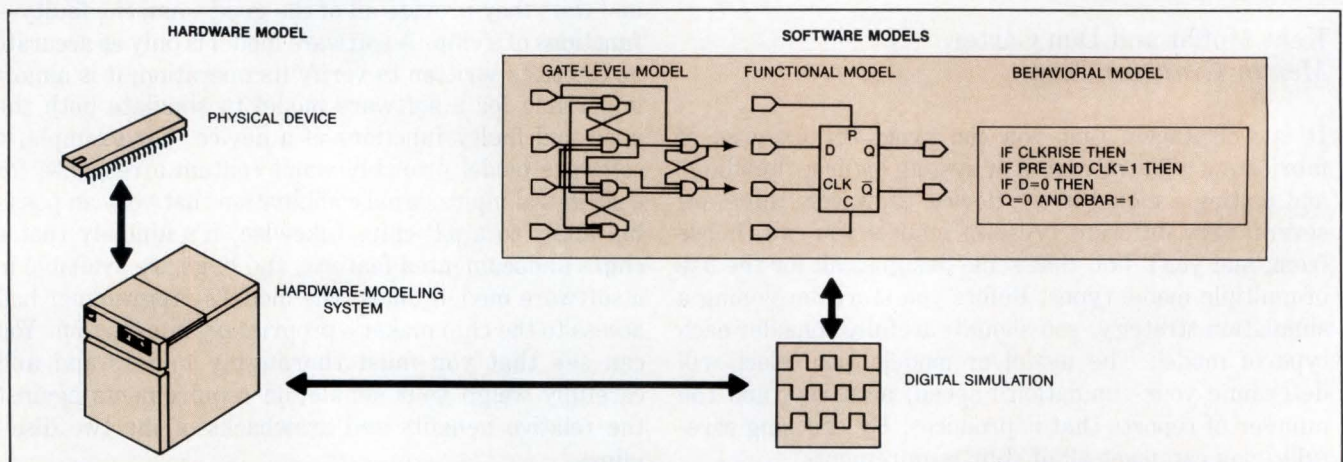

**Fig 1—Simulating a complex digital circuit** may require all four types of models: gate-level, functional, behavioral, and hardware. Specific choices depend on the complexity of your design.



tions to describe a device's timing and logic.

In contrast to functional languages, behavioral languages do not describe a device's structure in terms of existing simulation models or primitives. Instead, they use languages similar to C and Pascal. In fact, several CAE systems use an extended form of C or Pascal as their behavioral-modeling language:

```

while (TX < TY)
  loop
    TX := TX + 1;
    TSUM := TSUM * TX;
  end loop;

```

In general, behavioral languages are more flexible and can describe more complex devices than functional languages. ASICs are typical of devices that you would model with a behavioral-modeling language. Because each ASIC is unique, ASIC models aren't available in a standard-device library.

The VHSIC Description Language (VHDL), an emerging IEEE standard, includes both functional- and behavioral-modeling constructs. You can therefore use each modeling method to its best advantage. Both of the previously shown functional- and behavioral-program examples conform to this IEEE specification.

Microprocessors and other standard VLSI devices also benefit from behavioral models. A  $\mu$ P gate-level simulation takes months to develop, consumes large amounts of memory, and delivers inaccurate results due to timing errors. Moreover, behavioral models let you simulate VLSI devices that aren't yet available.

Behavioral-modeling languages also give you better control of your simulations. You can augment a behavioral model by adding to the software several design and debugging aids to produce error messages, perform timing checks, and issue instructions to device handlers. And, you can trade detailed reporting for speed, programming your model to simulate only the modes that your design uses and to leave out report-generating steps.

### Use ready-made models

For all their flexibility, behavioral models do have a disadvantage; it takes a great deal of time to write them—often several months. However, you can purchase models of many standard VLSI components from vendors such as Mentor Graphics or from model vendors such as Logic Automation (Beaverton, OR) and Quadtree (Bridgewater, NJ). For complex components such as floating-point arithmetic-logic units, a commercial behavioral model is a good choice.

Behavioral-model vendors offer two types of models. The first of these is the full-functional model, which simulates the complete instruction sets and timing characteristics of complex chips such as  $\mu$ Ps. These models simulate the execution of a  $\mu$ P's individual op codes. The second model is the bus-functional model, which simulates only bus operations and bus-timing cycles. If you're using a simulation to test a  $\mu$ P's microcode, you can't use a bus-functional model because it doesn't contain the information that characterizes each of the  $\mu$ P's op codes.

A processor-control-language (PCL) file controls bus-functional models. These PCL files are relatively easy

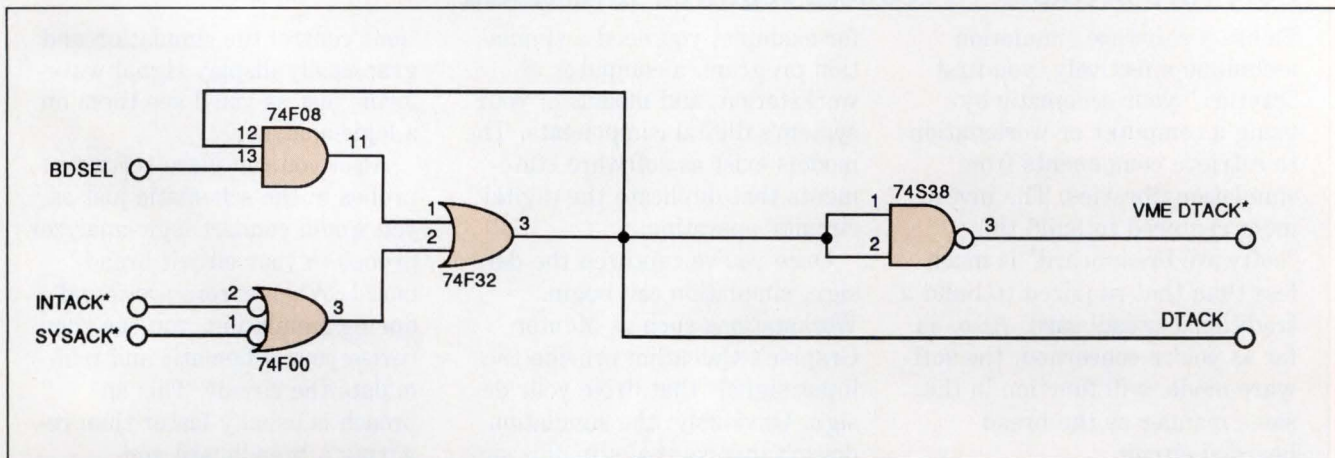

**Fig 2—You can use gate-level simulation** when individual logic circuits don't fit within the architecture of larger devices. Control circuits that require SSI chips are candidates for gate-level simulations.



---

*Gate-level simulation works well for SSI components, but it requires extra preprocessing time.*

---

to develop. For example, a PCL file that simulates a 68020  $\mu$ P's write-memory and read-memory cycles requires only five statements:

```
processor MC68020
begin
  write 5,16#620,4,16#FFFF
  read 5,16#624,4,16#AAAA
end
```

Although a detailed description of the program lines is beyond this article's scope, it should be evident that it's possible to simulate a complex operation in software.

Commercial behavioral models provide features that help you evaluate your system and improve your design. Models can not only identify timing errors for you, but can also help explain them. You can also write behavioral models to tell you of errors such as those that involve the misuse of a  $\mu$ P's internal registers. These error-handling techniques can dramatically improve your debugging efficiency. Commercial models sometimes offer a choice of clock frequencies and timing delays for the devices they simulate.

#### **Hardware models are most accurate**

The fourth type of device model—the hardware model—is the most accurate. Although software and hardware models basically operate in the same way, hardware models are incapable of making interpretation

errors because they derive responses directly from a real device and not from a group of simulation instructions. Furthermore, software models must acquire timing information from a look-up file. Hardware models, in contrast, can obtain timing information from an attached timing analyzer that measures delays directly from device responses. By using a timing analyzer, you can avoid developing a timing shell for your IC.

Hardware models run quickly, so you can use them to simulate several ASICs. Thus, by plugging a prototype of a bus-controller gate-array IC into a hardware-modeling system, you can simulate your VME Bus CPU board much faster than would be possible with a gate-level model. And, in addition to running your simulation faster, hardware modeling also lets you evaluate the ASIC prototype chip.

#### **Hardware models do have limits**

Hardware-modeling systems also have their drawbacks, however. You can't use a hardware-modeling system unless its speed, memory capacity, and available pin count are adequate for your application. As an example, Mentor Graphic's Hardware Modeling Library operates at 16 MHz, controls a maximum of 256 pins on each device, and stores as many as 256,000 stimulus vectors for each pin. A model built completely of software commands doesn't have such limitations. Because software models don't physically exist as wires and circuits, you can program them to run at almost any speed. You simply tell the software model how fast you

---

### **Software breadboard reduces required investment**

To use a software simulation technique effectively, you first "capture" your schematic by using a computer or workstation to retrieve components from simulation libraries. The investment required to build this "software breadboard" is much less than that required to build a traditional breadboard. Also, as far as you're concerned, the software model will function in the same manner as the breadboarded circuit.

To simulate a digital system,

for example, you need a simulation program, a computer or workstation, and models of your system's digital components. The models exist as software statements that duplicate the digital circuits' operation.

Once you've captured the design, simulation can begin. Workstations such as Mentor Graphic's QuickSim provide the input signals that drive your design. Obviously, the simulation doesn't involve real stimulus signals. Instead, software opera-

tions control the simulation and graphically display signal waveforms just as you'd see them on a logic analyzer.

Also, you can place software probes in the schematic just as you would connect logic-analyzer probes to your circuit breadboard. When errors are found during simulation, you can then revise your schematic and resimulate the circuit. This approach is usually faster than rewiring a breadboard and retesting your circuit.





## *“CASE Technology: CAE Solutions Planned Right from the Start”*

CASE Technology's new Vanguard CAE Design System supports a full range of industry standard hardware platforms — DEC VAX (VMS), Sun (UNIX) and PC (DOS) — and a comprehensive set of electronic design applications for PCB and ASIC design. Applications include schematic capture, digital logic simulation, circuit simulation and PCB design capabilities.

Since initial product introductions four years ago, CASE Technology has been setting trends in the computer-aided engineering

industry. CASE was the first to introduce:

- a PC-based CAE solution in June 1983
- an integrated PC to VAX solution in November 1985
- a PC as an intelligent graphics terminal for CAE in February 1986
- a complete Sun Workstation-based CAE solution in October 1986

In 1986, CASE also announced major marketing agreements with Digital Equipment Corporation and Sun Microsystems for the joint promotion of the Vanguard CAE Design System on the VAXstation and Sun-3 series of high performance engineering workstations.

Over the last three years, CASE Technology has experienced explosive growth to the rate of 80 percent per year and has remained profitable every quarter since the first product shipped. Today, CASE has over 3000 installations of the Vanguard CAE Design System worldwide, in companies

such as Hughes Aircraft, Honeywell, and Rockwell International.

Why has CASE Technology been so successful? It's simple. We listen to our customers very carefully. Corporate and engineering managers want *solutions* that work. CASE provides electronic design solutions through a well-conceived, long term plan for product migration, an open database philosophy, and data and operating system independence.

Before you make a decision on CAE, take the time to see what CASE has to offer.

CASE Technology, Inc., 2141 Landings Drive,  
Mountain View, California 94043  
Phone (415) 962-1440; Telex 506513;  
FAX (415) 962-1466.

**CASE  
TECHNOLOGY**



---

## *Hardware models let you obtain simulation data directly from ASICs and other complex ICs.*

---

want the simulated signals to operate when you run the simulation on your CAE workstation.

Also, hardware-modeling systems require a sizable investment in equipment. Depending on a hardware-modeling system's operating speed, its ability to handle multiple users, and the number of models in its library, it can cost \$40,000 to \$90,000. Thus, the choice between a hardware-modeling system and commercial behavioral models depends on the number of devices that you're modeling and the number of simulations that you'll be performing. The more models you need, the more cost effective hardware modeling becomes. Also, one hardware-modeling system can typically serve a network of users.

### **There are other considerations, too**

After you determine which types of models you'll need, the availability of accurate models must be your next concern. If you don't have a working version of your ASIC or other IC, for example, you can't use a hardware model to simulate it. Model availability is even more of a problem for software models than for hardware models. Commercial behavioral models of many VLSI components just aren't available. Even among the available models, most are bus-functional, not full-functional, models.

You can create a hardware model and testing information for a typical VLSI component in about a month, and with a bit of experience, you can reduce this time to two to three weeks. In contrast, you need between six

months and a year to write a behavioral model for the same device. Before you select a model, make sure it is available and that it provides all the functions you need.

Don't forget to also consider the time available on your computer system for modeling programs. Especially for short simulation runs, preprocessing time can play a major role in determining a simulation's length (see **box**, "Allow time for preprocessing"). Keep in mind that hardware models require less preprocessing time than any type of software model.

### **Multiple simulations and system-level modeling**

For some advanced applications, you can improve the quality of your analysis by swapping different types of models and then repeating a simulation. During each simulation, you adjust and improve your models for increased accuracy and performance, until you are satisfied with the results.

Architectural-level simulations of entire systems can also benefit from model swapping. You start your simulation at the architectural level by writing behavioral models of large system blocks. Once you verify the proper operation of the blocks, you replace each block with the interconnected components that each contains.

For a system that runs microcode, you can begin analyzing your system by emulating a representative set of the microcode instructions. Then you can simulate the system's execution of complete instruction words. Your behavioral models record timing results and collect functional statistics as the simulations run.

---

## **Allow time for preprocessing**

When you evaluate a model's performance, you must consider the simulation's actual run-time as well as its preprocessing time. Both of these factors contribute to the total simulation time. During preprocessing, the simulation software converts your schematic diagram into a simulation file. In creating this file, the preprocessor replaces gate or functional models with primitive library definitions and replaces behavioral models with instructions, logical expressions, and

equations. Complex devices require longer preprocessing times than simple ones.

Basically, functional models require less preprocessing time than gate-level models because functional models contain only a few library definitions. Therefore, even though hardware accelerators can speed gate-level logic simulations, this increase in speed is often offset by the additional time needed to preprocess gate-level simulations.

Behavioral models can also be

preprocessed in less time than gate-level models because behavioral models have few interconnections. Preprocessing a behavioral model consists primarily of compiling the model's source code into an executable format that runs efficiently. In contrast, hardware models don't have coded definitions at all—the simulator applies stimulus vectors directly to the device. As a result, hardware models have the shortest preprocessing times.



# LEADER

A TYPICAL "PORTABLE" SCOPE

THE TRULY PORTABLE  
LBO-315

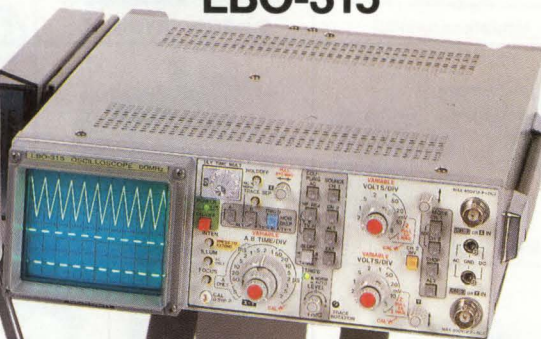
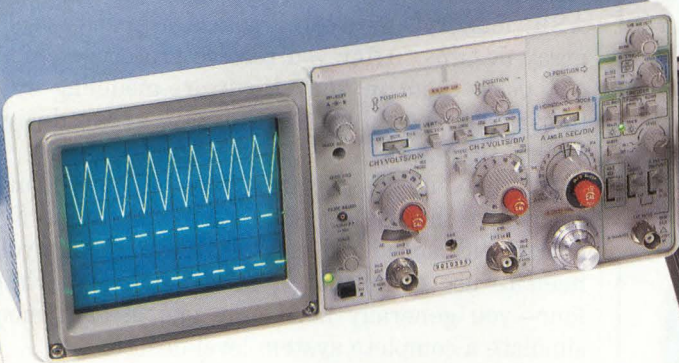

If both of these scopes are portable,  
then this is a lapdog.

What's the difference between a portable scope and the *truly* portable LBO-315? A lot of weight, among other things. At just 10 lbs and 10.5 x 3 x 13" with battery, the full-function LBO-315 can easily go everywhere a technician goes.

#### Don't waste money.

When a tech must return to the shop or a car, for the heavy scope left behind, time costs money. LBO-315, the scope techs love to carry, saves time and *delivers more profit*. It's that simple.

#### No so-called "portable" even comes close.

Compact 60-MHz LBO-315 packs all the performance of a bench scope. Operates from



supplied 12-Vdc battery, external 10 to 20 Vdc source or 85 to 264 Vac, without switching. Has bright 3.5", 12-kV, PDA CRT; alternate trigger, time base, and sweep; 2-channel and X-Y operation; variable holdoff, and more. *All this from a unit small enough to fit into an attache case!* Leader has "truly portable" 20 to 60-MHz oscilloscopes for ac/dc or ac operation. Each is backed by our 2-year warranty and factory service on both coasts.

Call toll-free

**1 800 645-5104**

In NY State

**516 231-6900**

Ask for our full-line Catalog, an evaluation unit, and the address of your nearest Leader Distributor.

Circle 2 for Demonstration

Circle 41 for Literature

Leader Instruments Corporation  
380 Oser Avenue, Hauppauge, New York 11788  
Regional Offices:  
Chicago, Dallas, Los Angeles, Boston, Atlanta  
In Canada call Omnitronix Ltd. 416 828-6221

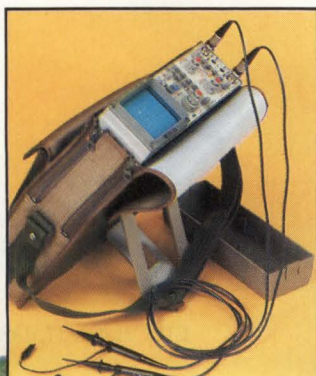

The truly portable LBO-315 comes with complete accessories, as shown at left.

**LEADER**  
FOR PROFESSIONALS WHO KNOW  
THE DIFFERENCE



**V SERIES  
SWITCHING POWER SUPPLIES**  
Engineered and Manufactured  
by Perfectionists!

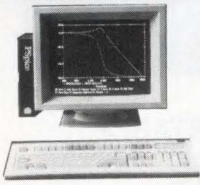

Simulations by SPICE

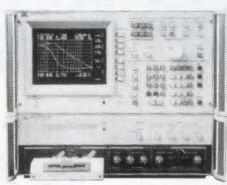

Stability by HP/VENABLE

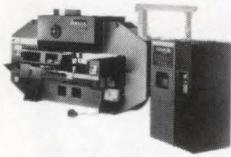

Sheet Metal by AMADA



Auto Insert by UNIVERSAL

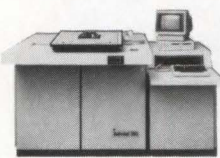

Testing by ZEHNTel

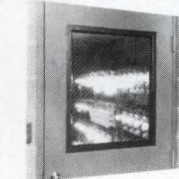

Burn In by CENTIGRADE

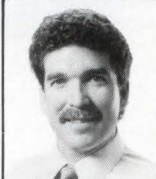

Service by PHILLIPS

Call Toll Free 1-800-523-2332



P.O. BOX 1369 ■ WISSAHICKON AVENUE, NORTH WALES, PA 19454  
PHONE 215/699-9261 TWX 510/661-8061

CIRCLE NO 90

# SURGE PROTECTION FOR AC AND DATA LINES

## FREE CATALOG

8 pages. The problems, the causes, the MCG solution.

Features data line protectors for RS232, 422, 423, 4-20 ma loops, coaxial, twin axial, single or twisted pairs.

AC power line protectors range from plug-in to heavy duty facility protectors—

120 VAC to 480 VAC, 10A to 5000A, 1 phase, 3 phase, delta, wye, etc. Applications,

specs, prices. Circle the number below or call.

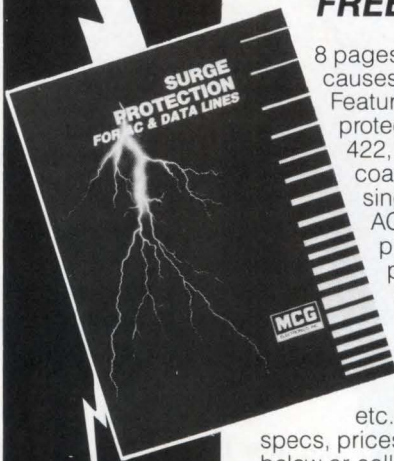

**MCG Electronics, Inc.**  
12 Burt Dr., Deer Park, NY 11729  
(516) 586-5125

Then, when your system runs complete algorithms efficiently at the architectural level, you can use your ASIC foundry's gate-level models to specify real gate-array designs. After you receive prototype chips, you can place them in your hardware-modeling system's library and possibly use the gate-array designs in several projects.

By choosing the optimal type of model for each component in a system simulation, you can verify your design with speed and accuracy. Even though you may need to use different types of models—perhaps all four—you generally need only one of each model to simulate a complete system-level design. **EDN**

### Authors' biographies

*Kent Moffat is a technical marketing engineer at Mentor Graphics (Beaverton, OR). His job responsibilities include managing the company's parts-library products, developing modeling programs, and defining software requirements. Kent has a BSEE from Stanford University as well as a BA in physics from Willamette University.*

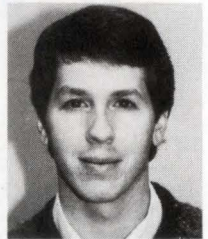

*Don Carter has worked for Mentor Graphics for six years, and he is now a marketing manager in the company's Major Accounts Div. While at Stanford University as a research associate, Don assisted in the initial development of a microelectronic artificial-hearing implant for the deaf.*



Article Interest Quotient (Circle One)  
High 491 Medium 492 Low 493



# Wield the Power...

Reach legendary heights of performance with the new NS32532-based family of Heurikon VME processors.

The next time you do battle with your application, wield the power of the HK32/V532. Command the performance of existing development tools and software. And stand confidently on a strong foundation of support.

Key HK32/V532 features include:

- up to 30 MHz NS32532 CPU
- 4 or 16 MB of on-board DRAM
- up to 1 MB EPROM ■ optional NS32381 floating point coprocessor
- 4-channel, 32-bit DMA ■ SCSI interface
- 2 RS-232 serial ports ■ 128 bytes non-volatile RAM
- optional time-of-day clock ■ mailbox interrupt support
- full interface to VMEbus
- UNIX™, VRTX® and 680X0 cross compiler support.

For more information and a free poster, call 1-800-356-9602 ext. # 500.

Or to correspond by telefacsimile, call 608-251-1076.

HK32/V is a trademark of Heurikon Corporation. UNIX is a trademark of AT&T Bell Laboratories, Inc. VRTX is a registered trademark of Ready Systems, Inc. Original illustration by Frank Frazetta. © 1988 Heurikon Corporation.

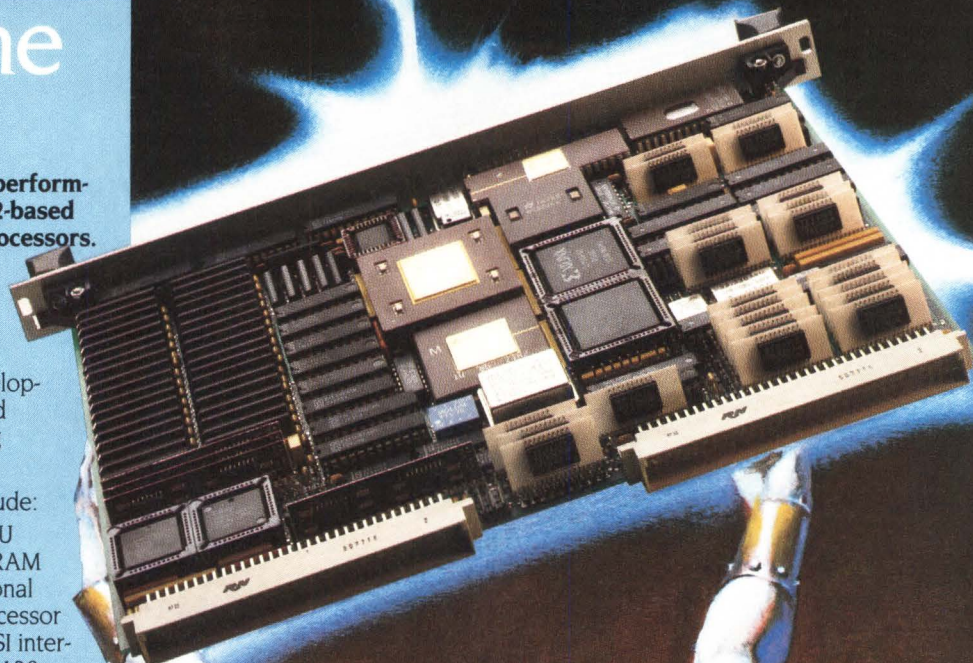

The New HK32/V™ Family  
of Heurikon Microprocessors

# HEURIKON

CORP

3201 Latham Dr., Madison, WI 53713

CIRCLE NO 92

*Frazetta* © 88



# GOODBYE WORKSTATION

# HELLO PADS-PCB

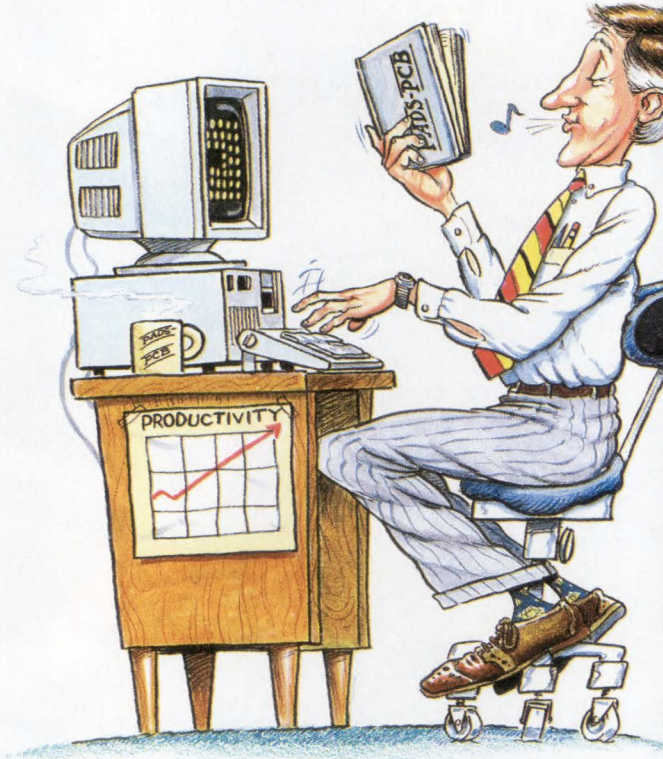

## It's time to say goodbye

to expensive engineering workstation based CAD systems. Why should management tie up \$100,000.00 or more in a workstation when the same (and often better) performance is obtained with PADS-PCB, a PC based CAD system?

PADS-PCB is a high performance printed circuit board design software that offers a degree of functionality a designer could expect only from an expensive engineering workstation.

Powerful auto/interactive features are a part of what makes PADS-PCB the best selling CAD system on the market:

- 1 mil database-32"x32" board size-30 layers
- Large circuit capabilities: In excess of 400 equivalent 14 pin IC's
- Automatic and interactive component placement aids
- Automatic and interactive track routing
- Automatic design rule checking
- Superior Surface Mounted Device capability
- One, two, and three track capability between IC Pins
- Superb analog design capability
- Inputs from Futurenet, Orcad, Schema, PADS-CAE and others

- 100% routing with PADS-SuperRouter, the only rip-up and reroute router on a personal computer

CAD Software asks you to try its Evaluation Package, priced at only \$50.00, so you can see for yourself how PADS-PCB puts an end to those

workstation blues. Call our Sales Hotline today at **(800) 255-7814**; in Massachusetts **(617) 486-9521**.

119 Russell Street  
P.O. Box 1142  
Littleton, MA 01460



CIRCLE NO 93

**CAD**  
Software, Inc.



# DESIGN IDEAS

EDITED BY TARLTON FLEMING

## Watchdog circuit makes $\mu$ P fault tolerant

Mario Milberg  
CNEA, Buenos Aires, Argentina

The Fig 1 circuit provides a watchdog function for the 68705R3  $\mu$ P. The system generates a temporary reset in response to single faults but resets the  $\mu$ P permanently when two consecutive faults occur. You can apply this technique to other processors, and you can make the system tolerate  $N-1$  consecutive faults by replacing the flip-flop IC<sub>3A</sub> with a modulo- $N$  counter.

At power up,  $R_3$  and  $C_3$  ensure that the flip-flop IC<sub>3B</sub> is set ( $\overline{Q}_{D2}$  low), which holds the  $\mu$ P in reset mode by driving its  $\overline{R}$  input low. You must momentarily depress  $S_1$  to initiate program execution.

During normal operation, the  $\mu$ P's PA7 output generates 7- $\mu$ sec pulses at 6-msec intervals. By continually

triggering the one-shot IC<sub>2A</sub>, these pulses maintain the flip-flops IC<sub>3A</sub> and IC<sub>3B</sub> in the cleared state. A processor malfunction will interrupt the pulses, causing the circuit to generate a brief reset (see waveform H in Fig 1) whose duration depends on  $R_2$  and  $C_2$ . The  $\mu$ P immediately regains control.

The appearance of a second fault triggers the alarm and causes the  $\mu$ P reset to remain low; you must then press  $S_1$  to restore control to the processor. If a second fault does not occur, the watchdog pulses clear the flip-flop IC<sub>3A</sub> so that again two consecutive faults must occur to stop the  $\mu$ P.

EDN

To Vote For This Design, Circle No 749

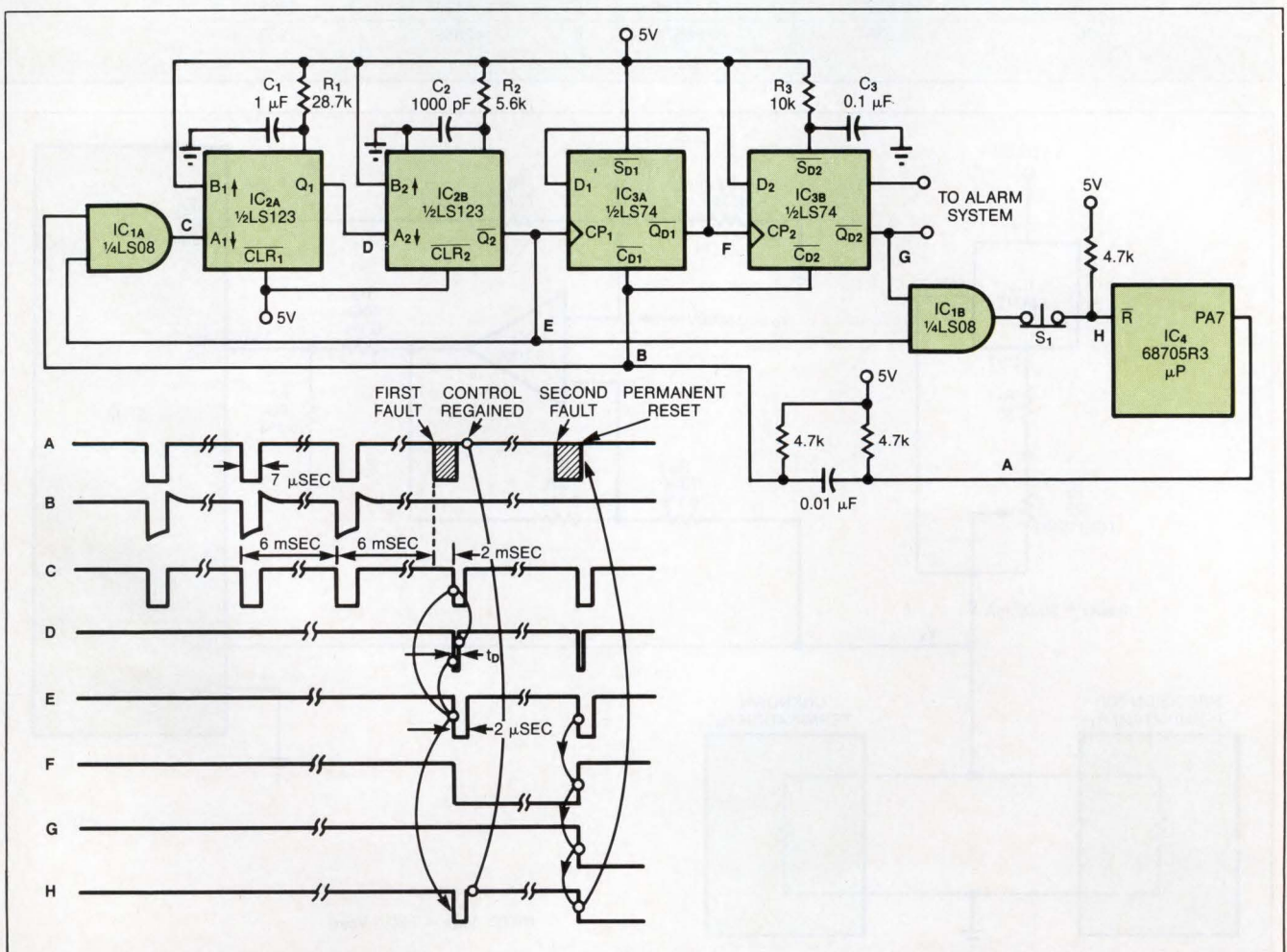

Fig 1—This watchdog circuit briefly resets the  $\mu$ P following a single fault; two consecutive faults reset and halt the  $\mu$ P until you restore operation by pressing  $S_1$ , a normally closed push button.



## Precision circuit measures shunt resistance

Eric Blomberg  
Cogent Design Inc, Brookline, MA

The Fig 1 circuit allows you to measure unknown resistance values by connecting them in parallel with a known resistance  $R_T$  (in this case, a precision 50 $\Omega$  termination). The circuit is useful, for instance, in trimming resistive RF components that are terminated by a 50 $\Omega$  precision load.

The DVM (a digital panel meter, for example) measures the voltage  $V_X$  produced by forcing a constant 20 mA through the parallel combination of  $R_T$  and  $R_X$ .  $V_X$  is a nonlinear function of  $R_X$ , but the DVM's ratiometric property lets you linearize the measurement (Table 1) by feeding forward a portion of  $V_X$  to the DVM's reference input. (The DVM's ratiometric response is the inverse of the the resistors' proportional current sharing.) A minor modification on the panel meter gives

TABLE 1—REPRESENTATIVE  $R_X$  MEASUREMENTS

$R_X$ ( $\Omega$ )	$R_X/R_T$	$V_X$ (V)	$V_{REF}$ (V)	DVM (COUNT)
80	30.769	0.61538	0.076924	7999
60	27.273	0.54546	0.090908	6000
50	25.000	0.50000	0.100000	5000
40	22.222	0.44444	0.111111	3999
20	14.286	0.28571	0.142858	1999

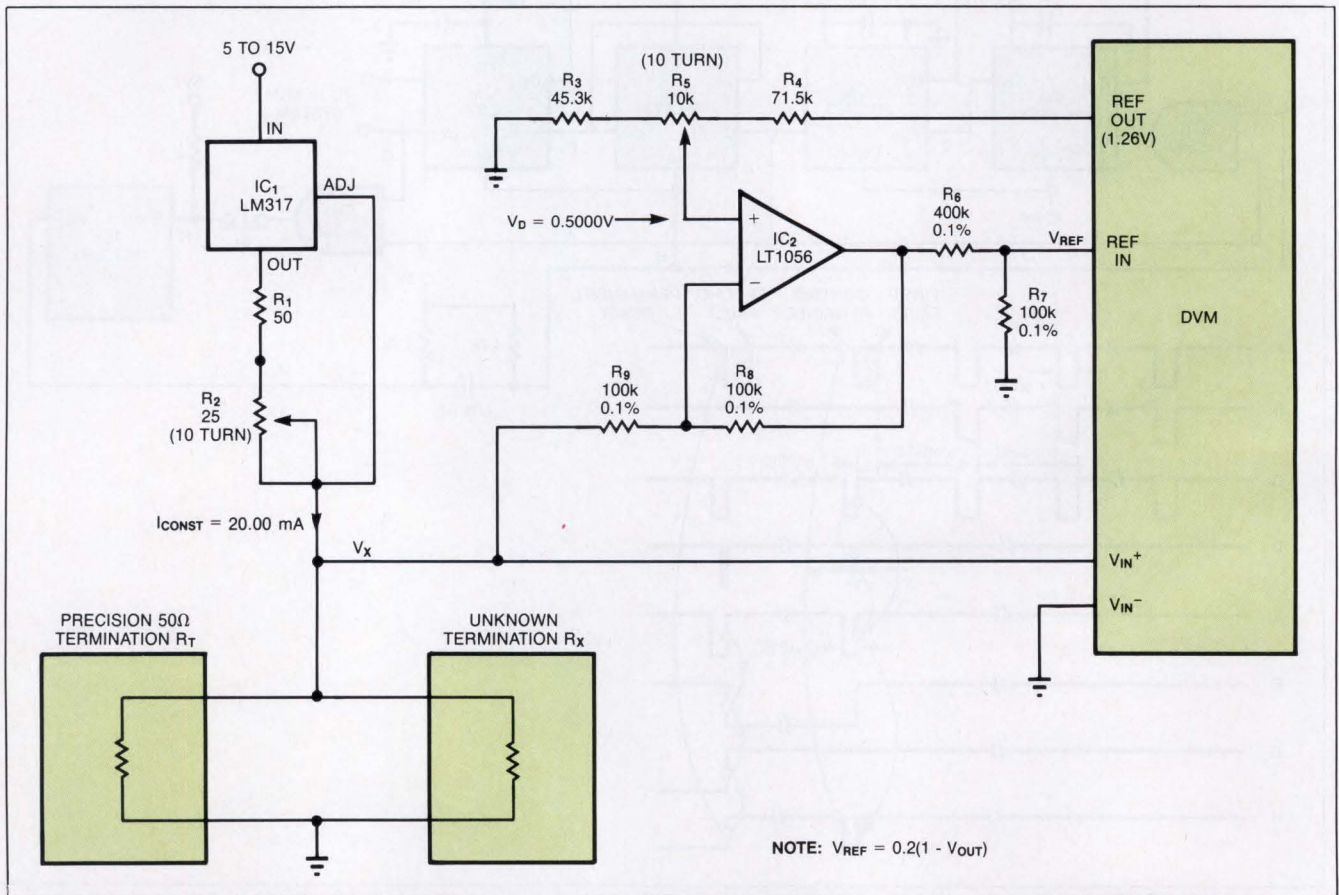

Fig 1—This circuit uses a known resistance value to produce a linear measurement of the unknown value  $R_X$ .



# SURFACE MOUNT MIXERS



**\$2.49**  
(1,000 qty)

The opportunity for automated, low-cost assembly is a key benefit of surface-mount technology, but is often wiped out by the high price of surface-mount components. Now, Mini-Circuits offers a new series of mixers to meet the pricing demands of SMT ... only \$2.49 in 1,000 quantity (\$3.75 ea. in quantity of 10) ... at a cost even lower than most conventionally-packaged mixers.

The SCM-1 spans 1 to 500MHz with only 6.0dB conversion loss, 45dB LO-RF isolation, and 40dB LO-IF isolation. Housed in a rugged, non-hermetic 0.4 by 0.8 by 0.3 in. high (maximum dimensions) plastic/ceramic package. Spacing between connections is 0.2 in. The mixer is offered with leads (SCM-1L) or without leads (SCM-1NL) to meet a wide range of pc board mounting configurations.

Each SCM-1 is built to meet severe environmental stresses including mechanical shock/vibration as well as temperature shock. The operating and temperature storage range is -55°C to +100°C. Each SCM-1, designed and built to meet today's demanding reliability requirements, carries Mini-Circuits' exclusive 0.1% AQL guarantee of no rejects on every order shipped (up to 1,000 pieces).

When you think SMT for low-cost production, think of Mini-Circuits' low-cost SCM mixers.

SPECIFICATIONS (typical)	SCM-1L (with leads)	SCM-1NL (no leads)
FREQ. RANGE (MHz)		
LO, RF	1-500	
IF	DC-500	
CONVERSION LOSS (dB)		
Mid-Band (10-250MHz)	6.3	
Total Range (1-500)	7.5	
ISOLATION (dB)	(L-R)	(L-I)
Low-Band (1-10MHz)	60	45
Mid-Band (10-250MHz)	45	40
High-Band (250-500MHz)	40	35
PRICE	\$2.49 (1,000 qty)	\$3.75 (10-49)

Units are shipped in anti-static plastic "tubes" or "sticks" for automatic insertion.

finding new ways ...  
setting higher standards

**Mini-Circuits**

A Division of Scientific Components Corporation  
P.O. Box 350166, Brooklyn, New York 11235-0003 (718) 934-4500  
Fax (718) 332-4661 Domestic and International Telexes: 6852844 or 620156



# DESIGN IDEAS

you access to its reference input.

Design equations are

$$V_X = I_{\text{CONST}} \left( \frac{R_T R_X}{R_T + R_X} \right)$$

(where  $I_{\text{CONST}}$  equals 20 mA),

$$V_{\text{REF}} = \frac{2V_D - V_X}{5}$$

(where  $V_D$  is a constant voltage derived from the DVM's reference voltage), and

$$\text{DVM READING} = 0.1 \left( \frac{V_X}{V_{\text{REF}}} \right).$$

The values shown provide reliable  $\pm 0.1\%$  measurements. To achieve greater precision, you must account for the stability of  $I_{\text{CONST}}$ , the op amp's input-offset voltage, and the resistor values' tolerances. Note also that the shunting effect of  $R_9$  causes a worst-case error of 0.015% in measuring  $R_X = 20\Omega$ . **EDN**

To Vote For This Design, Circle No 747

## Converter output swings 5V using 5V supply

Mike Jachowski

Precision Monolithics Inc, Santa Clara, CA

The **Fig 1** circuit offers a 0 to nearly 5V output swing while operating on a single 5V supply. The 8-bit, CMOS D/A converter ( $IC_1$ ) behaves like a digital potentiometer by operating in the voltage mode rather than the more conventional current mode. That is, the  $V_{\text{REF}}$  terminal (pin 15) produces a digitally controlled output voltage when you apply a 1.25V reference voltage to pin 1. The op amp, transistor, and associated components constitute a gain-of-4 amplifier that can swing  $V_{\text{OUT}}$  to within one  $V_{\text{CE(SAT)}}$  of the 5V rail. Potentiometer  $R_6$  adjusts the amplifier's gain.

As you increment the D/A converter's input code from 00H<sub>HEX</sub> to FFH<sub>HEX</sub>, the pin-15 output increases from 0 to 1.25V. Resistor  $R_2$  loads the op amp and draws an output current that also flows in  $R_1$  (along with the op amp's 20- $\mu$ A quiescent current). When the op-amp output reaches 0.5V, the  $R_2$  current is 50  $\mu$ A. The resulting 70  $\mu$ A in  $R_1$  produces a 0.7V drop that begins to turn on  $Q_1$ , allowing the transistor to supply current to the load. In turn,  $V_{\text{OUT}}$  rises to satisfy the requirements of the op amp's feedback loop.

Because the circuit's output drive is the collector of a pnp transistor,  $V_{\text{OUT}}$  can range as high as 4.97V (with a 5.00V supply and a load of 0.1 to 1.0 mA).  $V_{\text{OUT}}$  can exceed 4.92V while delivering 10 mA of load current. The circuit, however, consumes less than 120  $\mu$ A of quiescent supply current when  $V_{\text{OUT}} = 0V$ . Quiescent current rises with  $V_{\text{OUT}}$  because increasing current flows into the base of  $Q_1$ ; through  $R_2$ ,  $R_3$ ,  $R_4$ ,  $R_5$ , and  $R_6$ ;

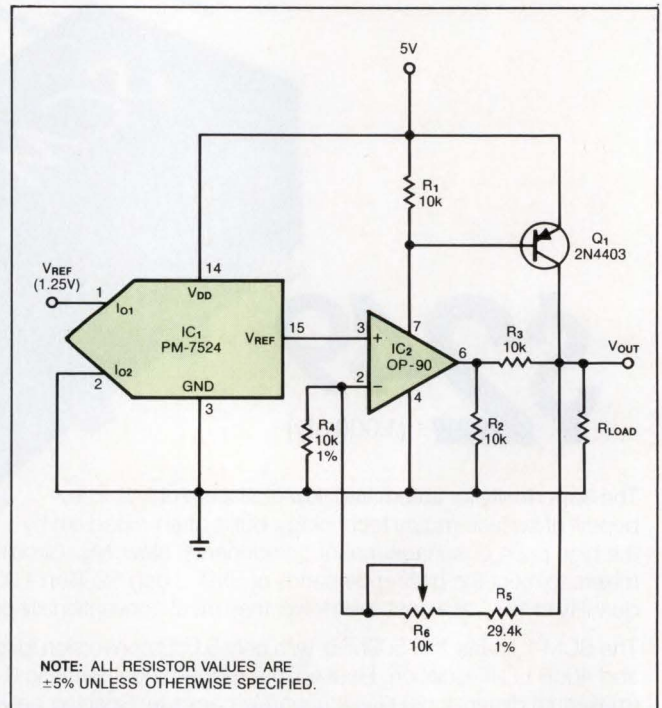

**Fig 1**—This combination of 8-bit CMOS D/A converter, low-power op amp, and pnp transistor operates on 5V and produces a digitally controlled 0 to 5V output.

and into  $IC_1$ 's pin 1. When the output is delivering 10 mA at 5V, for example, the circuit's quiescent supply current is about 650  $\mu$ A. **EDN**

To Vote For This Design, Circle No 746





## THE SOUND OF A SEIKO THERMAL PRINTER.

If you need a printer that's very, very quiet, here's something to shout about. The DPU-411 from Seiko Instruments. It's so quiet, you'll forget it's there. So you can work while it does.

And thanks to its small size and rechargeable battery back-up, it's completely portable. In fact, at a featherweight 2.2 pounds, you can take it wherever you need a small, ultra-quiet printer.

With both RS232C and Centronics 8-bit parallel interfaces standard, the DPU-411 will fit easily into your system. And you can print either a standard 40 column or condensed 80 column line.

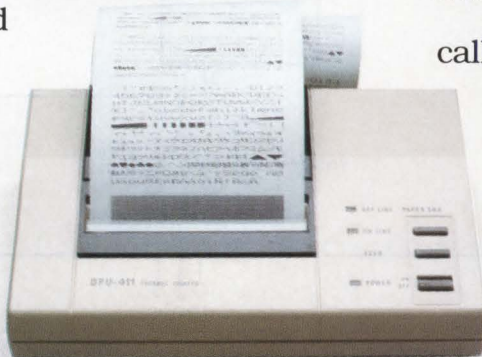

Of course, like all Seiko printers, it's manufactured for a long life.

What's more, the only maintenance you'll ever need to perform is putting in new paper. Which means it won't create any noise from people yelling about messy ribbons or upkeep.

It won't cause any noise when you get the bill, either. Because the DPU-411 is very competitively priced.

To help keep your office quiet, call Seiko today at (213) 517-7770. And ask about the thermal printer that's quiet, portable and affordable.

**SEIKO I**   
Seiko Instruments USA

2990 West Lomita Blvd., Torrance, CA 90505  
(213) 517-7770 • FAX: (213) 517-7792

CIRCLE NO 95



## Multidrop circuit cuts cable cost

R Jayapal  
 Bharat Heavy Electricals Ltd,  
 Tiruchirapalli, India

The multidrop arrangement in **Fig 1** enables a CPU system to monitor as many as 255 points of contact closure, valve status (open or closed), and other 1-bit

data sources. The system minimizes cabling by using a single 3-conductor cable to interconnect the central unit with all field locations.

On command, the system clears all field counters by asserting a momentary high on the PA1 line; it then scans the addresses in ascending order by simply generating a square wave on the clock line. Each field

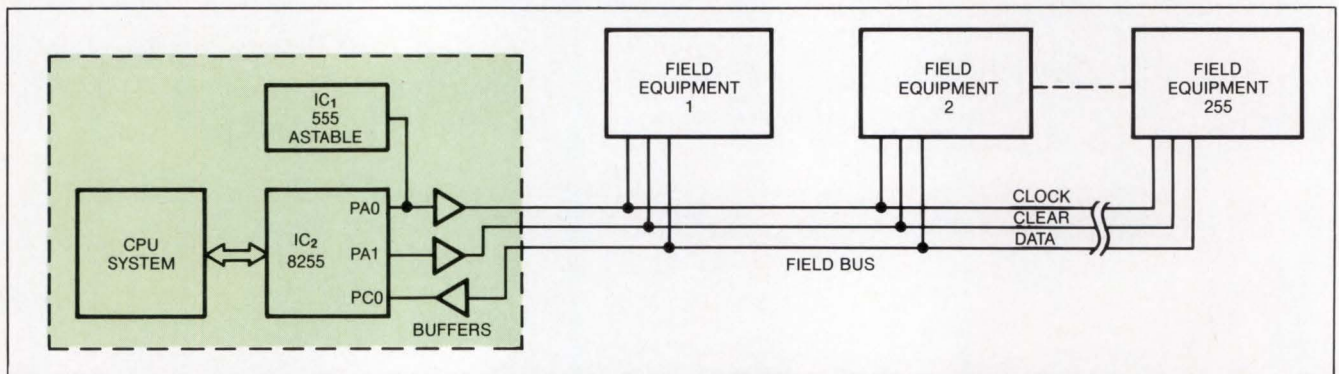

**Fig 1**—A single 3-conductor cable enables this  $\mu P$  system to scan and record as many as 255 single-bit data points.

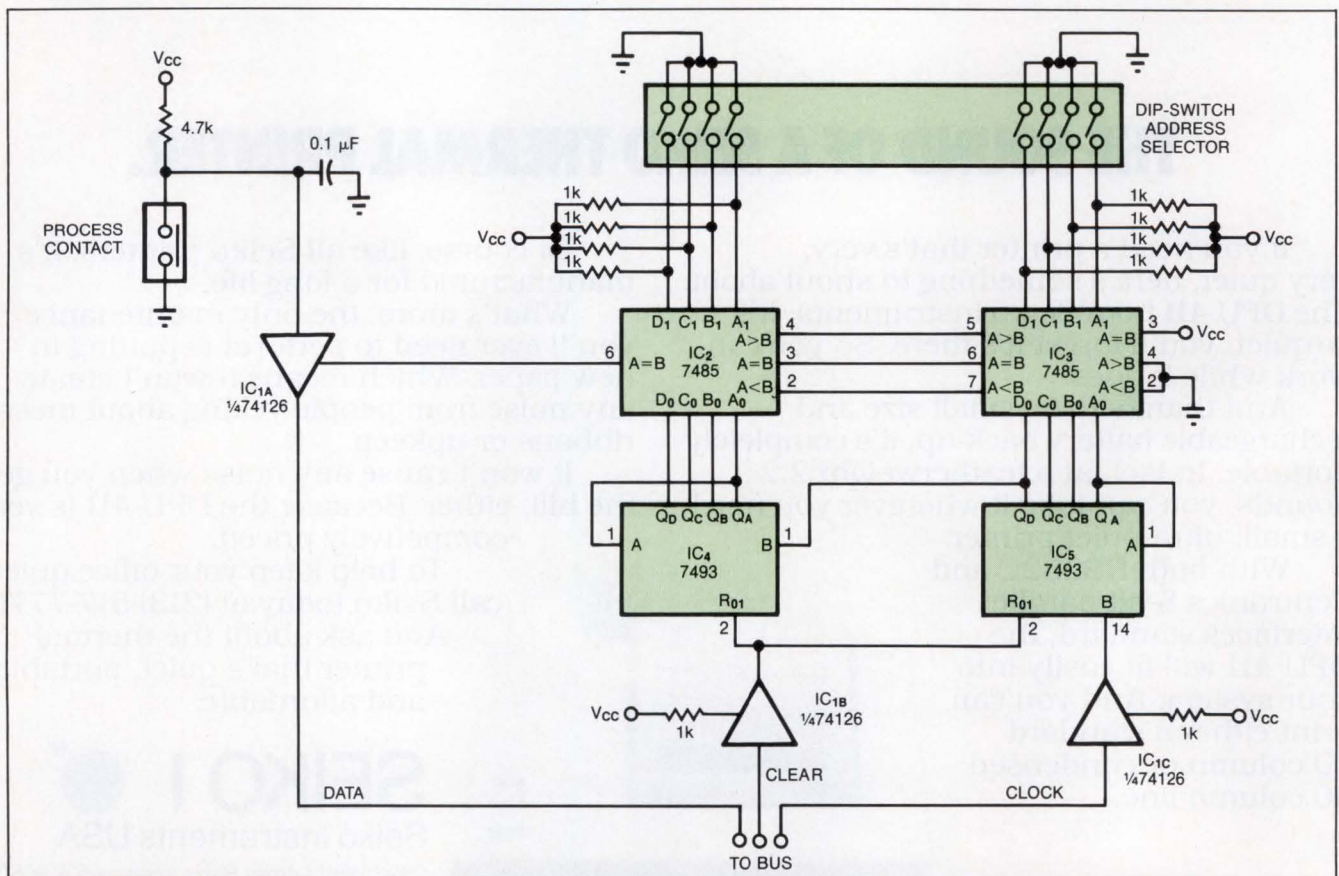

**Fig 2**—At a typical field location, you set the desired address using the DIP switches. The comparators  $IC_2$  and  $IC_3$  then activate the data line only when the counters  $IC_4$  and  $IC_5$  reach that address.



## Inductor Selection for LT1070 Switching Regulators

Jim Williams

A common problem area in switching regulator design is the inductor, and the most common difficulty is saturation. An inductor is saturated when it cannot hold any more magnetic flux. As an inductor arrives at saturation it begins to look more resistive and less inductive. Under these conditions current flow is limited only by the inductor's DC copper resistance and the source capacity. This is why saturation often results in destructive failures.

While saturation is a prime concern, cost, heating, size, availability and desired performance are also significant. Electromagnetic theory, although applicable to these issues, can be confusing, particularly to the non-specialist.

Practically speaking, an empirical approach is often a good way to approach inductor selection. It permits real time analysis under actual circuit operating conditions using the ultimate simulator—a breadboard. If desired, inductor design theory can be used to augment or confirm experimental results.

Figure 1 shows a typical flyback regulator utilizing the LT1070 switching regulator. A simple approach may be employed to determine the appropriate inductor. A very useful tool is the #845 inductor kit\* shown in Figure 2. This kit provides a broad range of inductors for evaluation in test circuits such as Figure 1.

\*Available from Pulse Engineering, Inc., P.O. Box 12235, San Diego, CA 92112, 619-268-2400

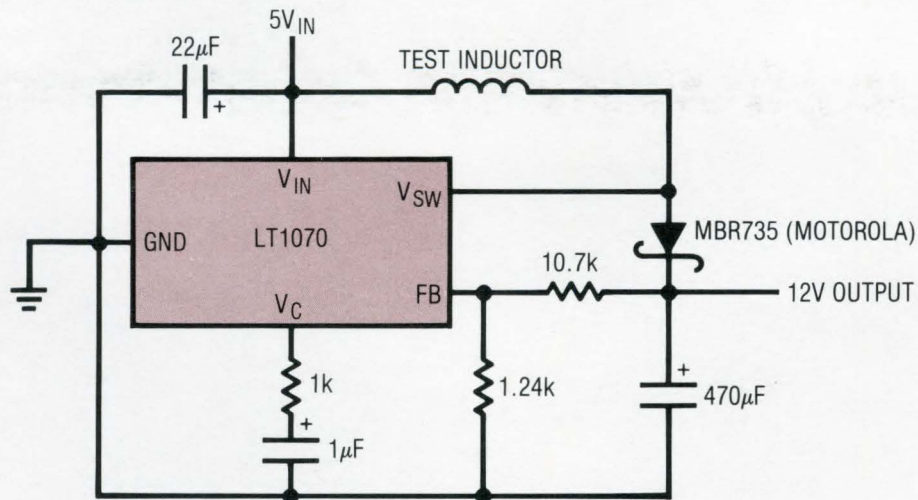

Figure 1. Basic LT1070 Flyback Regulator Test Circuit



Figure 3 was taken with a  $450\mu\text{H}$  value, high core capacity inductor installed. Circuit operating conditions such as input voltage and loading are set at levels appropriate to the intended application. Trace A is the LT1070's  $V_{\text{SWITCH}}$  pin voltage while trace B shows its current. When  $V_{\text{SWITCH}}$  pin voltage is low, inductor current flows. The high inductance means current rises relatively slowly, resulting in the shallow slope observed. Behavior is linear, indicating no saturation problems. In Figure 4, a lower value unit with equivalent core characteristics is tried. Current rise is steeper, but saturation is not encountered. Figure 5's selected inductance is still lower, although core characteristics are similar. Here, the current ramp is quite pronounced, but well controlled. Figure 6 brings some informative surprises. This high value unit, wound on a low capacity core, starts out well but heads rapidly into saturation, and is clearly unsuitable.

The described procedure narrows the inductor choice within a range of devices. Several were seen to produce acceptable electrical results, and the "best" unit can be further selected on the basis of cost, size, heating and other parameters. A standard device in the kit may suffice, or a derived version can be supplied by the manufacturer.

Using the standard products in the kit minimizes specification uncertainties, accelerating the dialogue between user and inductor vendor.

### References

- AN-25 "Switching Regulators for Poets", Jim Williams, Linear Technology Corporation
- AN-19 "LT1070 Design Manual", Carl Nelson, Linear Technology Corporation

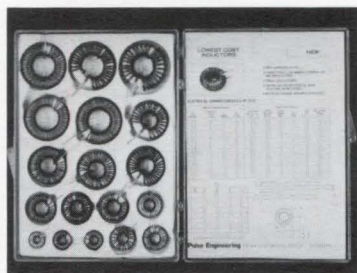

Figure 2. Model 845 Inductor Selection Kit from Pulse Engineering, Inc. (includes 18 fully specified devices)

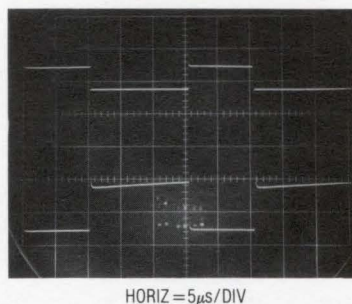

Figure 3. Waveforms for  $450\mu\text{H}$ , High Core Capacity Unit

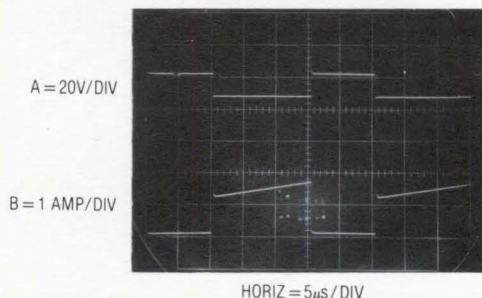

Figure 4. Waveforms for  $170\mu\text{H}$ , High Capacity Core Unit

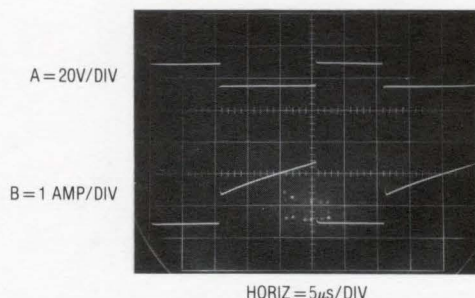

Figure 5. Waveforms for  $55\mu\text{H}$ , High Capacity Core Unit

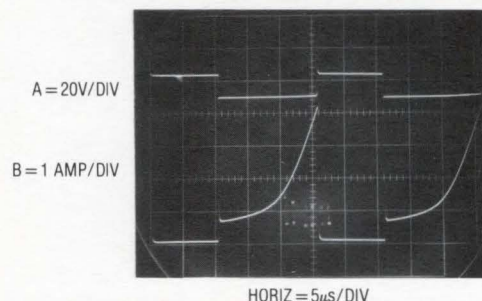

Figure 6. Waveforms for  $500\mu\text{H}$ , Low Capacity Core Inductor (note saturation effects)

For Switching Regulator literature call 800-637-5545. For help with an application call (408) 432-1900, Ext. 361.



## Spy terminal monitors RS-232C traffic

Sebastiao Santiago Barretto  
Scopus Tecnologia S A, Sao Paulo, Brazil

Fig 1 shows a simplification of the Design Idea "Line tap aids software debugging" (*EDN*, July 9, 1987, pg 268). Using just two diodes and one resistor, this circuit allows a spy terminal to monitor RS-232C communications between two computers. The circuit also allows you to enter messages on the spy terminal's display via its keyboard.

Current flowing from the spy terminal's output (pin 3) through  $R_1$  maintains the spy-terminal input (pin 2) in a Mark condition ( $-V$ ) except when data passes between the target and host computers. Then, current flowing through one of the diodes pulls the spy-terminal

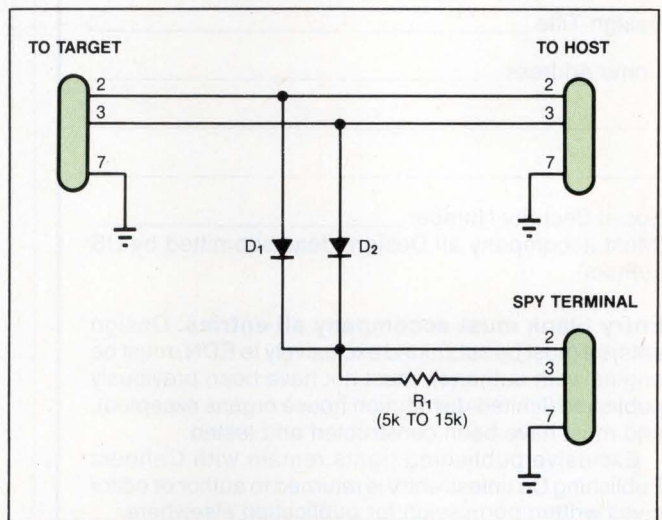

Fig 1—This simple circuit allows the spy terminal to monitor RS-232C traffic between the target and host computers.

input to the Space condition ( $+V$ ). You can use any diode whose reverse-breakdown voltage exceeds 25V.

**EDN**

To Vote For This Design, Circle No 748

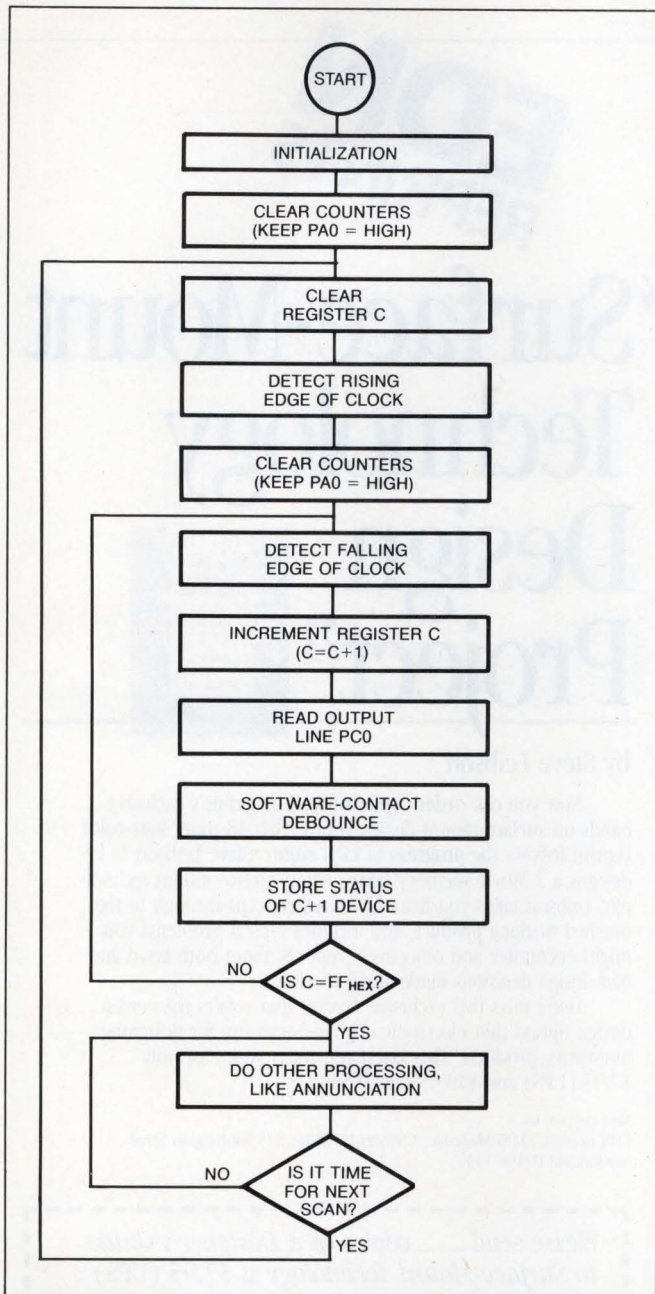

Fig 3—Software for the system shown in Fig 1 follows this flow-chart.

location (Fig 2) includes an 8-bit counter, digital comparator, and DIP switch that enables the location to respond when its counter reaches the address value stored in its DIP switches. The location then responds by asserting its 1-bit data value on the data line; all other data outputs remain in the high-impedance state. The system reads and stores each data point before generating the next address and increments a CPU register to keep track of the address currently active. Fig 3 is a flow chart for the system's software. **EDN**

To Vote For This Design, Circle No 750



# DESIGN IDEAS

## Design Entry Blank

**\$75 Cash Award** for all entries selected by editors. An additional **\$100 Cash Award** for the winning design of each issue, determined by vote of readers. Additional **\$1500 Cash Award** for annual Grand Prize Design, selected among biweekly winners by vote of editors.

To: Design Ideas Editor, EDN Magazine  
Cahners Publishing Co  
275 Washington St, Newton, MA 02158

I hereby submit my Design Ideas entry.

Name \_\_\_\_\_

Title \_\_\_\_\_ Phone \_\_\_\_\_

Company \_\_\_\_\_

Division (if any) \_\_\_\_\_

Street \_\_\_\_\_

City \_\_\_\_\_ State \_\_\_\_\_ Zip \_\_\_\_\_

Design Title \_\_\_\_\_

Home Address \_\_\_\_\_

Social Security Number \_\_\_\_\_

(Must accompany all Design Ideas submitted by US authors)

**Entry blank must accompany all entries.** Design entered must be submitted exclusively to EDN, must be original with author(s), must not have been previously published (limited-distribution house organs excepted), and must have been constructed and tested.

Exclusive publishing rights remain with Cahners Publishing Co unless entry is returned to author or editor gives written permission for publication elsewhere.

In submitting my entry, I agree to abide by the rules of the Design Ideas Program.

Signed \_\_\_\_\_

Date \_\_\_\_\_

**Your vote determines** this issue's winner. All designs published win \$75 cash. All issue winners receive an additional \$100 and become eligible for the annual \$1500 Grand Prize. **Vote now**, by circling the appropriate number on the reader inquiry card.

### ISSUE WINNER

The winning Design Idea for the December 10, 1987, issue is entitled "Amp provides 100V common-mode range," submitted by Mark Stitt of Burr-Brown Corp (Tucson, AZ).

# EDN REPRINTS

## "Surface-Mount Technology Design Project"



by Steve Leibson

Now you can order copies of EDN magazine's exclusive hands-on surface-mount design series. This 48-page, four-color reprint follows the progress of EDN editor Steve Leibson as he designs a 2 Mbyte memory board using surface-mount technology. Leibson takes you from his initial concept through to the finished working product, and includes typical problems you might encounter and objectively reports about both good and bad design decisions made along the way.

Don't miss this exclusive reprint that covers the newest design option that electronic engineers can use for designing innovative products. This latest reprint is yours for only \$7.95 (UPS) and \$10.95 (non-USA).

Mail coupon to:  
EDN Reprints, EDN Magazine, Cahners Building, 275 Washington Street,  
Newton, MA 02158-1630

Please send \_\_\_\_\_ copies of *A Designer's Guide to Surface-Mount Technology* at \$7.95 (UPS) or \$10.95 (non-USA)\*

*Please print clearly. This is your mailing label.*

Name \_\_\_\_\_

Title \_\_\_\_\_

Company \_\_\_\_\_

Address \_\_\_\_\_

City \_\_\_\_\_ State \_\_\_\_\_ Zip \_\_\_\_\_

\*Check or money order made out to EDN REPRINTS must accompany each order. No COD. Mass. residents add 5% sales tax.

EDN031788



# Embedded Power

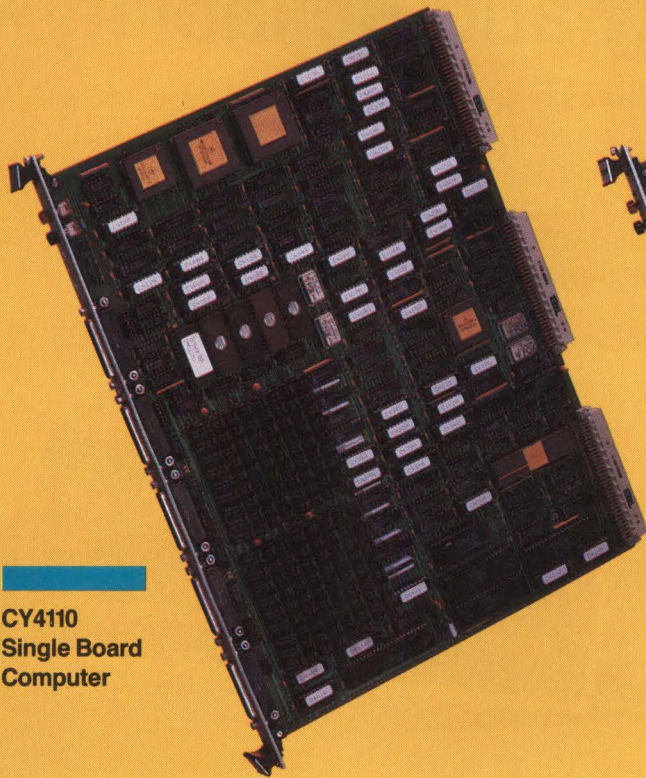

**CY4110**  
Single Board  
Computer

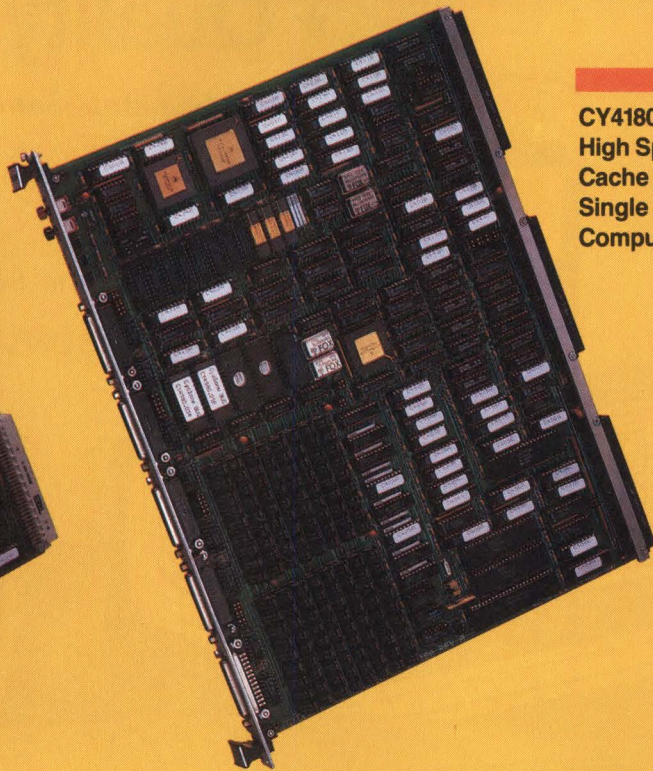

**CY4180**  
High Speed  
Cache Memory  
Single Board  
Computer

## Cyclone Microsystems' VME Single Board Computers can accelerate your system development with a growing family of highly integrated embedded computers.

Our VME Single Board Computers feature a 68020 with co-processors supported by extensive memory, disk controllers, DMA, serial and parallel I/O.

The CY4110 and CY4180 Single Board Computers offer system designers the benefits of a highly integrated system coupled with the advanced performance of extensive local resources.

Resources like a zero wait state cache, up to 16 Mbytes of dual ported DRAM, VSB Interface, and SCSI.

PDOS is a trademark of Eyring  
OS-9 is a trademark of Microware

EDN March 17, 1988

Product development is enhanced by our support of the PDOS™ and OS-9™ Real Time Operating Systems.

Accelerate your next system design with a powerful Single Board Computer packed with functionality. Call us at (203) 786-5536. And discover what our embedded power can do for your next system.

**CYCLONE**  
**MICROSYSTEMS**

25 Science Park, New Haven, CT 06511  
(203) 786-5536 FAX (203) 786-5023  
TELEX 643998

CIRCLE NO 96

Features	CY4110	CY4180
MC68020 CPU	Up to 20 Mhz	Up to 25 Mhz
MC68851 Paged Memory Mgt.	Optional	
MC68881 Floating Point	Optional	Optional
16K Cache Memory		Zero Wait State
DRAM	2,4,8 or 16 Mbytes	2,4,8 or 16 Mbytes
ROM/SRAM	256K	256K
DMA Controller	Two Channel	Two Channel
SCSI	1.5 Mybtes/sec	1.5 Mybtes/sec
Floppy Disk Controller	Yes	
RS-232-C	4 Ports	4 Ports
Parallel	1 Port	1 Port
VME Master/Slave	A32, D32	A32, D32
VSB Interface		Master
Counter timer	24 bit	24 bit
Interrupts	18 Sources	18 Sources
Form Factor	9U x 280mm	9U x 280mm

207



# Simpson® Professional Series

## ★ Quality and Reliability ★

The **Professional Series** of test instruments are characterized by the uncompromising quality and exceptional reliability that are synonymous with Simpson. The commitment to satisfy the needs of the professional began over 50 years ago with the world famous Simpson 260® and continues with the introduction of the **Professional Series**.

**CLASSIC SIMPSON → THE PROFESSIONAL SERIES**

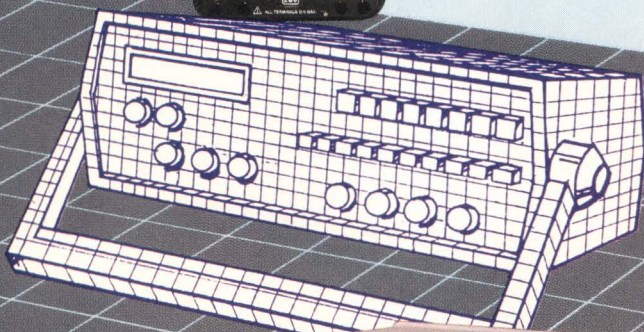

### SWEEP/FUNCTION GENERATORS

5 MHz . . . . . Model 421  
5 MHz with 6-Digit Display . Model 422

#### Features

- .05 Hz to 5 MHz in 7 ranges
- Linear and Log Sweeps
- Sine, Square and Triangle Waveforms
- Selectable Start/Stop Sweep Frequencies
- Internal/External Reading Frequency Counter — Model 422

### UNIVERSAL FREQUENCY COUNTERS

200 MHz Model 712  
520 MHz Model 713

#### Features

- Period
- Frequency Ratio
- Time Interval
- 0.56" 8-Digit Orange LED Display
- Adjustable Triggering
- Totalize

Model 712 . . . . . \$525.00  
Model 713 . . . . . \$675.00  
Model 421 . . . . . \$535.00  
Model 422 . . . . . \$650.00

For information on:  
712/713 circle **3**

421/422 circle **42**



**SIMPSON ELECTRIC COMPANY**  
853 Dundee Avenue, Elgin, Illinois 60120-3090  
(312) 697-2260 • Telex 72-2416 • FAX (312) 697-2272

**A CHIPPEWA NATION TRIBAL ENTERPRISE**



# NEW PRODUCTS

## COMPUTERS & PERIPHERALS

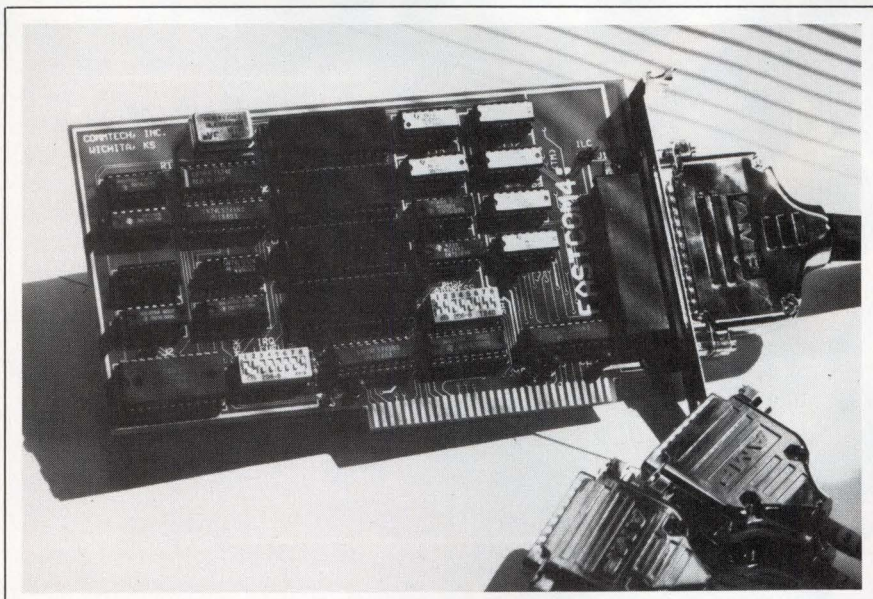

### RS-232C ADAPTER

- Uses the 82050 and the 82510 UARTs
- Provides four serial ports for multiple operating systems

The Fastcom4 communications board for the IBM PC, PC/XT, and PC/AT and compatible computers provides four RS-232C serial ports. The board runs with MS-DOS, Microsoft Xenix, SCO Xenix, and Crosstalk Mk.4. A standard configuration uses Intel's 82050 UART, which is compatible with the 16450

UART but requires less than half the power. The board is optionally available with Intel's 82510 UART, which features two baud-rate generators, a baud-rate range from 50 to 288k baud, and control-character recognition for generating a maskable interrupt. The board comes with cables, RFI shielding, and hardware and software manuals. \$375. 82510 UART, \$25.

**Commtech Inc.**, 8622 Mt Vernon Ct, Wichita, KS 67207. Phone (316) 651-0077.

Circle No 351

### TRANSPUTER BOARD

- VME Bus board utilizes either a T800 or T414 Transputer
- Supports Occam, C, Pascal, and Fortran 77 programs

The BBK-V2 is a VME Bus processing board. It's equipped with a 20-MHz T800 or T414 Transputer and a 1M- or 2M-byte dual-port RAM that you can access with other VME Bus processors or DMA devices. The onboard Transputer's access to the VME Bus supports A32 and A24 addressing with D32, D16, and D8 Hdata widths. The four Transputer links connect to four

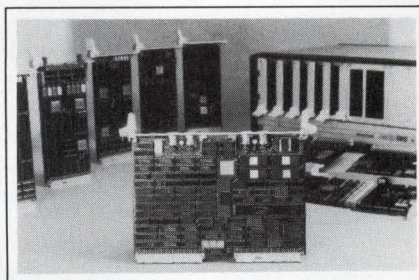

communications channels that transmit data at 20M bps. A 1M-byte onboard EPROM also makes the board a stand-alone unit. The double Eurocard board delivers 10 MIPS and 1.5M flops performance figures. The OS-9 and Unix operating systems allow you to use the

board as a Transputer development system. The hardware supports the parallel programming language Occam and compilers for C, Pascal, and Fortran 77. DM 8900.

**Parsytec GmbH**, C&C Marketing, Box 280, Batavia, IL 60510. Phone (312) 879-7003. TLX 4974811.

Circle No 352

### GRAPHICS ADAPTER

- Uses the TMS 34010 as a processor
- Provides video capture as well as display

The NuVista video graphics card for the Macintosh II combines high-resolution video capture and display with a 32-bit, TMS 34010 graphics processor. The board provides capture and display resolutions of 1024×768 pixels; 640×480 pixels; 756×486 pixels; and 738×576 pixels. It features four 8-bit video channels for real-time capture and display. Its 4M bytes of dual-ported video RAM and its video cross-point chip accommodate several memory organizations: 1024×1024 pixels×32 bits, 2048×1024 pixels×16 bits, and 2048×2048 pixels×8 bits. The board produces 16.7 million colors for its RGB outputs. 4M-byte version, \$5995; 2M-byte version, \$4250.

**Truevision Inc.**, 7351 Shadeland Station, Suite 100, Indianapolis, IN 46256. Phone (317) 841-0332. FAX 317-576-7700.

Circle No 353

### MOTION CONTROLLER

- Controls as many as six axes in a master/slave configuration
- Master board has two PWM motor drivers that handle 3A pk

DRiMotion is a motion controller that can handle as many as six independent axes in a master/slave configuration. A stand-alone master



Conservative thermal design – massive heatsinks and substantial component derating keep temperatures low and reliability high

Full-load operation to 50°C without fan cooling

Output "On" LED indicator for simplified system fault-finding

Input line transient and electrostatic discharge protection

Shindengen designed and manufactured power semi-conductors and control hybrids

High value, 250V rated storage bus caps provide extended input voltage operation and 25 ms hold-up at 100 VAC input

115/230 VAC operation user selectable

Soft-start circuitry limits inrush current with series resistor and SCR to permit multiple on/off cycles without cooldown

Built-in EMI filter meets FCC and VDE Level B requirements down to 10 KHz keeping total system costs down

# Compare.. Our Switcher Designs

Pick a Shindengen switching power supply from 15 to 2,250 watts, single or multiple output, open-frame or enclosed. Compare our designs, component-by-component, with those of our competition: thermal management, derating factors, worst-case temperatures. Compare MTBF and field reliability data. Shindengen has a design philosophy and a combination of features that stand up to the closest scrutiny.

Call us today for literature or an evaluation sample to make your own comparison. You won't be disappointed.

*Shindengen—for 40 years a world leader in power conversion.*

**Shindengen**  **America, Inc.**

2649 Townsgate Road • Suite 200 • Westlake Village, California 91361  
(805) 373-1130 • FAX (805) 373-3710 • 1(800) 634-3654 (except California)



board, the MP2, has a 68HC11 microcontroller and two HCTL 1000 motor-controller ICs. The board also contains two PWM motor drivers that can drive 3A max of peak start current; an 8-channel, 8-bit A/D converter; four programmable 8-bit, I/O ports; 16k bytes of EPROM; 32k bytes of static RAM with battery backup; a real-time clock; a UART for communications with a host or modem to 9600 baud; an RS-232C port for communicating with an IBM PC, PC/XT, PC/AT, or compatible computer located as far as 2000m away; and two ports for master/slave communications at a transfer rate of 1M bps. A slave board, the SP1, has one digital motor controller with a PWM driver, an 8-bit  $\mu$ C, 8k bytes of nonvolatile memory, and an 8-channel, 8-bit A/D converter. MP2, \$749; SP1, \$399.

Dallas Robotics Corp, 1500 E Beltline Rd, Suite 100, Carrollton, TX 75006. Phone (214) 446-2643.

Circle No 354

CPU bus, a dedicated I/O processor controls all the board's I/O functions, such as its 1024x768-pixel graphics, audio, and clock/calendar functions, and its SCSI, Ethernet, X.25, keyboard, and mouse interfaces. The boards' VME Bus interface provides AM6/A32/A24 and D32/D16/D8 VME Bus operation in either master or slave modes. The

VME Bus interface also includes interrupt-support and system-controller functions. You can order the board as an OEM product with I/O software drivers and a debug monitor, or as a system integration package with a Unix System V license and the Open-Top windowing system. The board is Sun NFS compatible, which permits you to share a

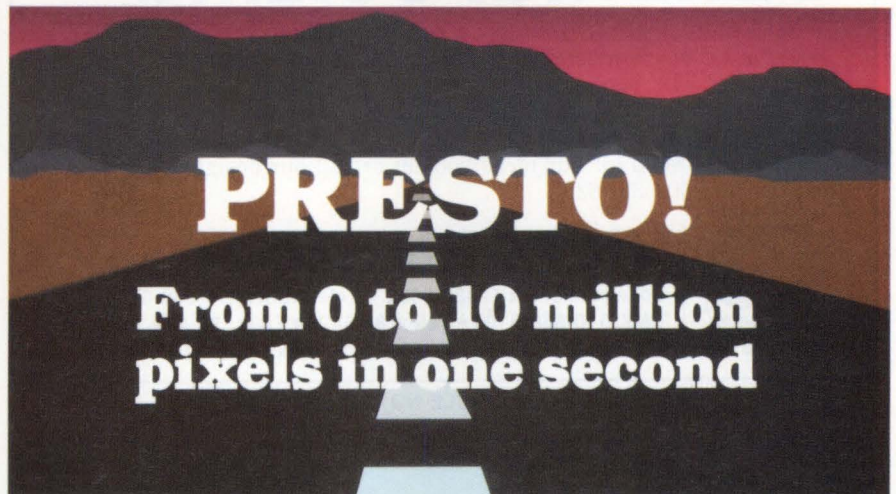

## Finally a TI™-34010 graphics controller card in sync with your 286/386-based application

Vectrix matches your high-speed microprocessor with high-speed graphics. The PRESTO! graphics controller card utilizes a proprietary Digital Differential Analyzer (DDA), the TI-34010 graphics controller, 512K to 4.5 MBytes of on-board DRAM, and a unique organization of high-speed video shifter RAMs. The result — line drawing speeds in excess of 10 million pixels per second.

### 5 YEARS OF GRAPHICS EXPERIENCE

Sophisticated technology like this doesn't just happen. Vectrix has been a leader in the complicated and competitive field of graphics for over five years. During that time, we have assembled an experienced, innovative engineering staff ready to focus their expertise on your system needs.

### OEM-ORIENTED DEVELOPMENT TOOLS

Because they understand your requirements, our engineers provide a variety of tools to simplify applications development. Onboard high-level graphics commands are accessible directly or through standard programming language libraries provided on disk. Our PRESTO! TI-34010 Toolkit simplifies development of customized firmware. An optional RAM card is available for either data storage or additional code.

PRESTO!'s optional Line Drawing Engine accelerates the speed of the TI-34010. Bitblts, raster ops and enhanced DMA transfer capabilities further enhance PRESTO!'s speed.

Thus PRESTO! is ready to provide the graphics for your next system. And Vectrix stands ready to serve you with state-of-the-art technology, proven product reliability, and an engineering staff capable of translating your system needs into product functionality.

### SPECIFICATIONS

Resolution — 1280 x 1024 or 1024 x 768  
Available in the following configurations:  
16 colors  
256 colors from a palette of 4096  
256 colors from a palette of 16.8 million  
Speed — 10,000,000 pixels per second  
Average Block Move: 25 million bits/second  
Horizontal line or fill: 50 million bits/second  
DMA speed: matches host bus speed

Interface — 16-bit PC family

Video — 60 Hz non-interlaced

### SOFTWARE DEVELOPMENT TOOLS

Industry-standard PGL Command Set  
Compatibility

PRESTO! TI-34010 Developer Toolkit

PRESTO! PGL Developer Toolkit

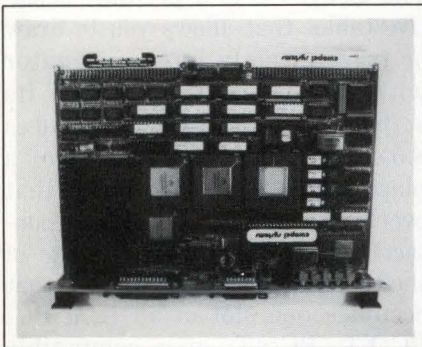

## BOARD COMPUTER

- Provides a 32-bit Unix workstation on a single VME Bus card
- Offloads I/O operations to an onboard I/O processor

The Venus VME Bus-compatible single-board computer has a 68020  $\mu$ P, 68881 math coprocessor, 68851 paged-memory-management unit, and 4M bytes (16M bytes optional) of RAM. Both the  $\mu$ P and the VME Bus have access to the dual-ported RAM. You can run the Unix System V operating system on the board. To prevent bottlenecks on the main

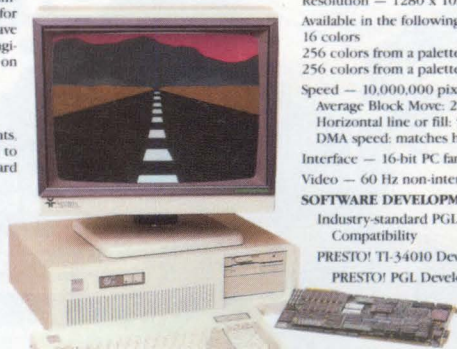

TI is a registered trademark of Texas Instruments, Dallas, Texas

**Vectrix**  
THE COMPUTER GRAPHICS COMPANY

Vectrix Corporation, 2606 Branchwood Drive, Greensboro, NC 27408 (919) 288-0520

CIRCLE NO 100



the unlimited design benefits of miniature metal tubing.

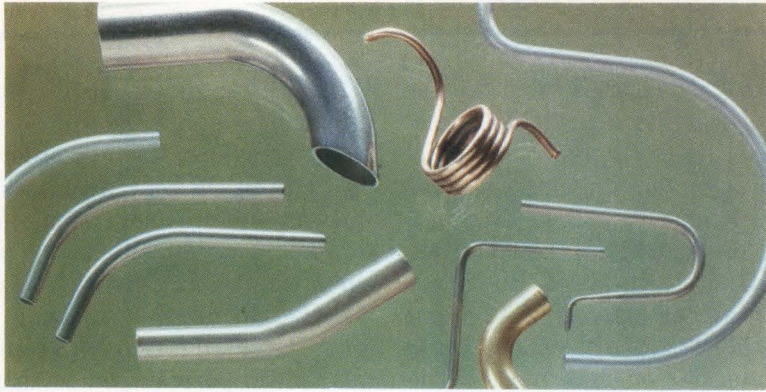

## design benefits number 329 and 330 **BENDING/COILING**

Need more space in your package? More surface area? Looking for mechanical or thermal expansion/contraction properties? The bent or coiled tube can give this to you within your exacting specification. And we can put holes, notches and other problem solving operations into those same tubes. Send for our ideas booklet or call our design experts at 1-800/321-6285.



### **UNIFORM TUBES, INC.**

Collegetown, PA 19426-0992 • Telephone: 215/539-0700  
TWX: 510-660-6107 • Telex: 84-6428 • FAX: 215/489-1150  
In Europe: UTI U.K. 983-404049 • Telex: 869441 UTIUK G

CIRCLE NO 101

## COMPUTERS & PERIPHERALS

virtual file system over a Sun NFS Ethernet LAN. Systems integration package, £4000.

**Europel Systems**, 5 Vo-Tec Centre, Hambridge Lane, Newbury, Berkshire RG14 5TN, UK. Phone (0635) 31074. TLX 848507.

Circle No 355



### **DRAWING TABLET**

- *Pressure-sensitive tablet lets you draw into a computer*
- *Plastic material overlays grid of 1024x1024 contacts*

The Easy1 PC is a pressure-sensitive tablet that allows you to draw or trace directly into a computer with an ordinary pencil or pen. Its active surface area measures 8.5x12.875 in. and is made of a plastic compound material that overlays a grid of 1024x1024 contact points. The device consists of the tablet and an interface card that occupies one slot of an IBM PC, PC/XT, PC/AT, or a compatible computer, and it sends X and Y coordinate pairs to the computer at rates as high as 200 pairs/sec. The software drivers emulate Summagraphics 961 and Bit Pad 1 standards that allow you to use the tablet with software packages such as PC Paintbrush and Dr Halo in either IBM CGA, EGA, or compatible modes. The package also includes PC Windows and Gem drivers. \$539.

**Inforite Corp**, 1670 S Amphlett Blvd, Suite 201, San Mateo, CA 94402. Phone (415) 571-8766.

Circle No 356

**CONNOR-WINFIELD  
OSCILLATORS:**



## FASTEST TIMES ON THE CIRCUIT.

Performance. That's what you expect from a high-speed oscillator, and that's what you get from Connor-Winfield's HCMOS and ECL series.

#### **Take a look at these specs:**

**Model:** HCl5R5  
**Fixed Frequencies Available:** 1KHz to 50MHz  
**Supply Current:** 25mA Max.

**Model:** ECLA, B  
**Fixed Frequencies Available:** 8MHz to 200 MHz  
**Output:** Squarewave 10K ECL or 100K ECL Compatible  
**Supply Voltage:** -5.2 Vdc or -4.5 Vdc

Fire one up today. We have plenty of models available for a test drive.



**CONNOR-WINFIELD CORPORATION**  
West Chicago, IL 60185 USA  
Phone 1-312-231-5270  
TLX 270244  
Cable: CONWIN WCGO



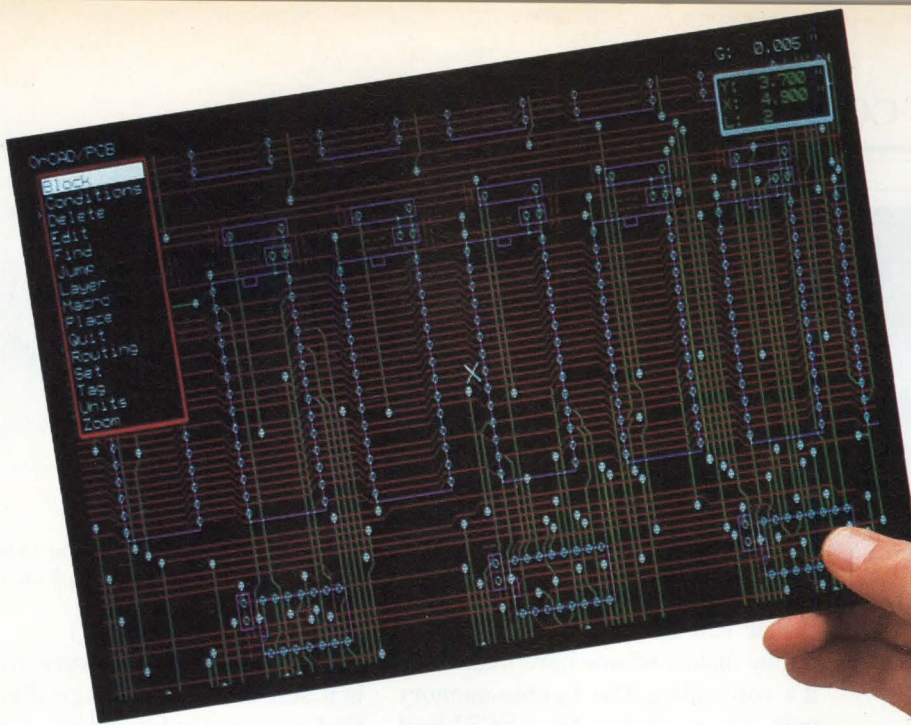

## PCB LAYOUT ON YOUR PC. FOR ONLY \$1495. OrCAD PCB COMES TO LIFE.

**W**ith nearly 10,000 systems already in use, electrical engineers like the no-nonsense capability of OrCAD/SDT schematic capture. Well, now there's even more to like. Introducing OrCAD/PCB. A fast, easy-to-use PCB layout package that runs on your PC. And costs only \$1,495.

### A NO-NONSENSE DESIGN TOOL FOR NO-WAIT DESIGNERS.

OrCAD/PCB pumps up your productivity. Pop-up menus appear in a flash. Macros speed repetitive operations.

Bit-mapped graphics make redraws, zooms and pans instantaneous. And, since you know SDT, you have no new commands to learn; PCB's interface is exactly the same.

### POWER AND FLEXIBILITY MINUS CLUTTER.

OrCAD/PCB produces structured, elegant PCB layouts. It auto-routes boards up to 32"x32" with up to 6,000 track segments and 16 layers, taking into account manually routed connections. And, it adapts to your design with features like:



Find your OrCAD region number on this map; then locate your sales and support representative on the list below.

- Selectable track and via widths from 0.001" to 0.255"
- Square, rectangular, round, elliptical, and SMD pads.
- Grid bases of 100, 50, 25, 10 and 5 mils. Or, go off grid to 1 mil.

- Support for digital and analog components and surface-mount devices.
- Ratsnest and force vector placement.
- Definition of board edge, forbidden zones, and copper zones.

### GIVE OUR DEMO DISK A SPIN.

If you need affordable, no-nonsense PCB layout, call for a free OrCAD/PCB demo disk. Not an OrCAD user? Call for the SDT demo disk while you're at it (OrCAD/SDT costs only \$495). Then, watch your PCB layouts take shape.

#### OrCAD sales and support representatives.

- |  |  |  |   |
|--|--|--|---|
| 1. WA, OR, MT, ID, AK<br>Seltech, Inc.<br>206-746-7970               | 5. ND, SD, MN, W. WI<br>Comstrand, Inc.<br>612-788-9234              | 11. FL<br>High Tech Support<br>813-920-7564                        | 16. BC, AB, SK, MB<br>Interworld Electronics &<br>Computer Industries, Ltd.<br>604-984-4171 |
| 2. N. CA, Reno NV<br>Elcor Associates, Inc.<br>408-980-8868          | 6. NE, KS, IA, MO<br>Walker Engineering, Inc.<br>913-888-0089        | 12. DE, VA, MC, DC<br>MGM Visuals<br>703-352-3919                  | 17. ON, PQ<br>Electralert, Ltd.<br>416-475-6730   |
| 3. S. CA<br>Advanced Digital Group<br>714-897-0319                   | 7. TX, OK, AR, LA<br>Abcor, Inc.<br>713-486-9251                     | 13. MS, AL, GA<br>Electro-Cadd<br>404-446-7523                     |   |
| 4. Las Vegas NV, UT, AZ, NM, CO<br>Tusar Corporation<br>602-998-3688 | 8. MI, E. WI, IL<br>Cad Design Systems, Inc.<br>312-882-0114         | 14. E. PA, NJ, NY<br>Beta Lambda, Inc.<br>201-446-1100             |   |
|  | 9. IN, OH, KY, WV, W. PA<br>Frank J. Campisano, Inc.<br>513-574-7111 | 15. CT, RI, MA, VT, NH, ME<br>DGA Associates, Inc.<br>617-935-3001 |   |
|  | 10. TN, NC, SC<br>Tingen Technical Sales<br>919-878-4440             |  |   |

OR8801

**OrCAD**<sup>™</sup>  
Systems Corporation

1049 S.W. Baseline St., Suite 500  
Hillsboro, OR 97123 USA  
503-640-5007





**BUBBLE MEMORY**

- Bubble memory unit runs with STD DOS industrial computers
- Removable data cartridge stores 720k bytes of data

The ZT 8854 is a bubble-memory unit for industrial computer systems running STD DOS. It consists of an electronic drive with a removable cartridge, a disk controller,

and an STD DOS software driver. The drive is a functional replacement for 3½-in. half-height drives, and you can plug it directly into an STD Bus card cage. The removable data cartridge stores 720k bytes of data and has an MTBF of 40 years. A design feature of the unit prevents loss of the seed bubble in the chip. An error-detection and error-correction capability, as well as a power-fail circuit increase the unit's reliability. The multiunit disk controller can also interface with two floppy disks and one hard disk while it's controlling the bubble-memory unit. The controller has a SCSI host adapter and provides DMA and interrupt functions. The DOS device driver makes the drive appear as a 720k-byte floppy-disk drive to the STD DOS system. \$1800.

**Ziatech Corp.**, 3433 Roberto Ct, San Luis Obispo, CA 93401. Phone (805) 541-0488.

Circle No 357



**IMAGE DIGITIZER**

- Accepts composite video inputs
- Digitizes the image and stores it in 300k bytes of RAM

The NI-100 Video Capture System is a self-contained image digitizer that operates independent of a host computer. It accepts standard composite video from video cameras and VCRs. The unit uses a flash converter to digitize the image and stores the data in 300k bytes of onboard memory. The host computer accepts the data over an RS-232C or a parallel communications link. The unit grabs real-time frames (1/30



# The First

When you're looking for input on raster plotters, take a look at some major CalComp output. Twenty-four different versions from the fastest growing raster family in the world. (With more family members arriving soon.)

Every raster plotter incorporates more industry firsts, more choices. From simple, colorful business graphics to the complexity of super-dense integrated circuit design, mapping, etc.

The 5800 and 5700, our color and black-and-white electrostatic plotters, deliver speed, superior resolution, multiple configurations and A to E size plots.

For CAD graphics, PlotMaster™ produces quick-check "A" size presentation-quality color. Or plug ColorMaster® into your PC and through CalCompatibility, you can run the most popular business presentation graphics software.

ColorMaster is a registered trademark of CalComp. © 1987 CALCOMP



## COMPUTERS & PERIPHERALS

sec) with 640×480-pixel resolution and 256-level gray scale. Connectors for the RS-170/NTSC input, a monitor output, and computer communications are located on the back panel of a 9×7×1½-in. desktop case. A microcontroller-based design lets you produce custom functions such as data-compression algorithms. \$598 (OEM qty).

**Lodge Electronics**, 1972 Larkin Ave, Elgin, IL 60123. Phone (312) 695-6622.

Circle No 358

### LAPTOP COMPUTER

- Runs on 110V, 220V, a 12V car lighter or a battery pack
- LCD backlit screen has 720×350-pixel resolution

The LP-286 laptop computer is compatible with the IBM PC/AT. It features an 80C286  $\mu$ P that runs at 6 or 12 MHz with an 80287 coprocessor option. A supertwist backlit LCD screen that is Hercules monochrome compatible provides a resolution of 750×350 pixels. Its 1M byte of RAM memory is expandable to 4M bytes. The unit comes with a 1.44M-byte 3½-in. floppy-disk drive; it has a 20M-byte hard-disk drive with a 65-msec access time. Power for the unit comes from four optional sources: 110V ac, 220V ac, a 12V car lighter, or a battery pack. Two serial ports and one parallel port are also available. A numeric



keypad complements the full-sized keyboard. The unit measures 13.6×15×4.2 in. and weighs 15.4 lbs; the battery-pack option increases the weight to 18 lbs. \$2495.

**Dauphin**, 1125 E St Charles Rd, Lombard, IL 60148. Phone (312) 627-4004. TLX 297246.

Circle No 359

### I/O CARDS

- Communicate via a Bitbus network
- Suitable for use in harsh industrial environments

Communicating with a host computer via a Bitbus serial interface, Axiom Bitbus I/O cards allow you to implement distributed I/O applications for industrial automation. The single Eurocard-size cards are available for digital I/O applications, A/D conversion, and D/A conversion. Each card has an onboard 8044/8051

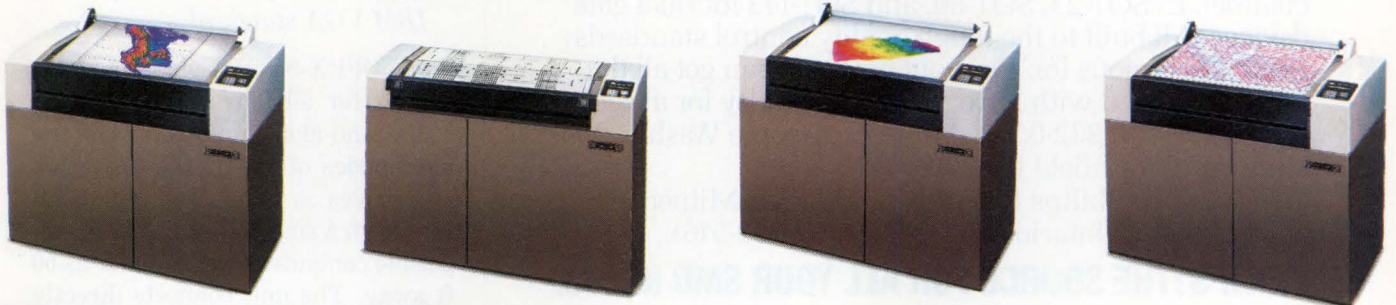

# Family.

The first family? You bet. First in high-resolution 400 DPI color. First in pin-point accuracy with electronic registration. First in embedded controllers to save space. First with convenient ROM pack firmware. First with flexibility of over 2,000 line and area fill colors. And too many more firsts to talk about here.

There's also a national 800 helpline, 425 trained service persons, 46 service centers nationwide, 32 international field offices, and on-site service. And a single supply source.

Don't be the last to learn about the first family. Call 1-800-CALCOMP or write CALCOMP, P.O. Box 3250, Anaheim, CA 92803. In Canada, call (416) 635-9010.

We draw on  
your imagination.™

 **CalComp**

A Lockheed Company



Series microcontroller. You can connect as many as 250 of the interface cards to a single Bitbus network. The DIO 4805 digital interface card provides 48 digital I/O channels that you can select as inputs or outputs in 8-channel groups. The DAD 1612 optically isolated analog-input card has 16 single-ended or 8 differential analog-input channels, and digitizes

each channel to 12-bit resolution. Its A/D conversion time is 25  $\mu$ sec/channel max. The DDA 0812 optically isolated analog-output card provides eight 12-bit-resolution analog outputs that you can jumper-select to operate as analog inputs. Voltage-output or voltage-input ranges are 0 to 10V or -10 to +10V. You can select four of the channels to oper-

ate as 0 to 20-mA or 4 to 20-mA current outputs. DIO 4805, DM 1400; DAD 1612, DM 3600; DDA 0812, DM 3500.

**Delcon Oy**, Lakkisepantie 11, 00621 Helsinki, Finland. Phone (0) 7571744. TLX 123989.

**Circle No 360**

# PHILIPS FETS WON'T GIVE YOU FITS.

For the surface-mounted FETS that fit your application, go right to the source: Philips/Amperex. You'll find J FETS, MOS FETS and D MOS FETS in both P and N channel. In SOT-23, SOT-89, and SOT-143 for dual gate devices. All built to the tough quality control standards Philips is famous for. Find out how you can get all the FETS you need with fewer FITS. Call today for a free brochure: (401) 232-0500. Amperex, George Washington Highway, Smithfield RI 02917

In Canada: Philips Electronics Ltd., 601 Milner Ave. Scarborough, Ontario M1B 1M8, (416) 292-5161.

**PHILIPS: THE SOURCE FOR ALL YOUR SMD NEEDS.**

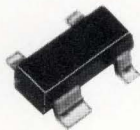

**Amperex**<sup>®</sup>  
A NORTH AMERICAN PHILIPS COMPANY

**SMD**  
TECHNOLOGY

CIRCLE NO 105

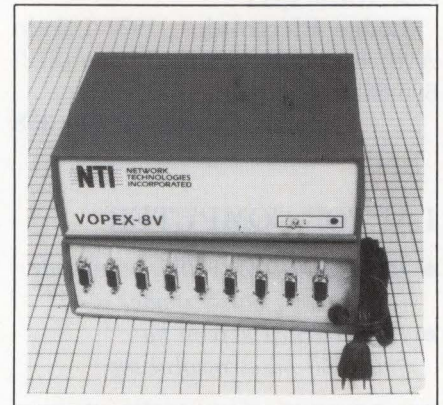

## PORT EXPANDER

- Drives as many as eight monitors from an IBM PS/2
- Supports all four modes of the IBM VGA standard

The VOPEX-8V is a video port expander for all four PS/2 monitors. The stand-alone unit supports the four modes of IBM VGA operation and drives as many as eight monitors from a single IBM PS/2 or compatible computer located as far as 50 ft away. The unit connects directly to the PS/2's video port via a 4-ft NTI-type cable. It reads the monitor ID code on output port 1 and feeds it to the PS/2 for proper VGA operation. This allows the unit to operate with monochrome and 13- and 14-in. color monitors, as well as with the 16-in. 1024x768-pixel monitor. The unit handles scan rates of 31.5 and 35.5 kHz. Cables with a 15-pin, high-density D connector are available in lengths of 25, 35, and 50 ft. The unit requires 1120V ac and comes in an 8x2.5x6.2-in. chassis. \$899.

**Network Technologies Inc.**, 19145 Elizabeth St, Aurora, OH 44202. Phone (216) 543-1646.

**Circle No 361**



# New dual 16-bit DAC saves space, time, and money.

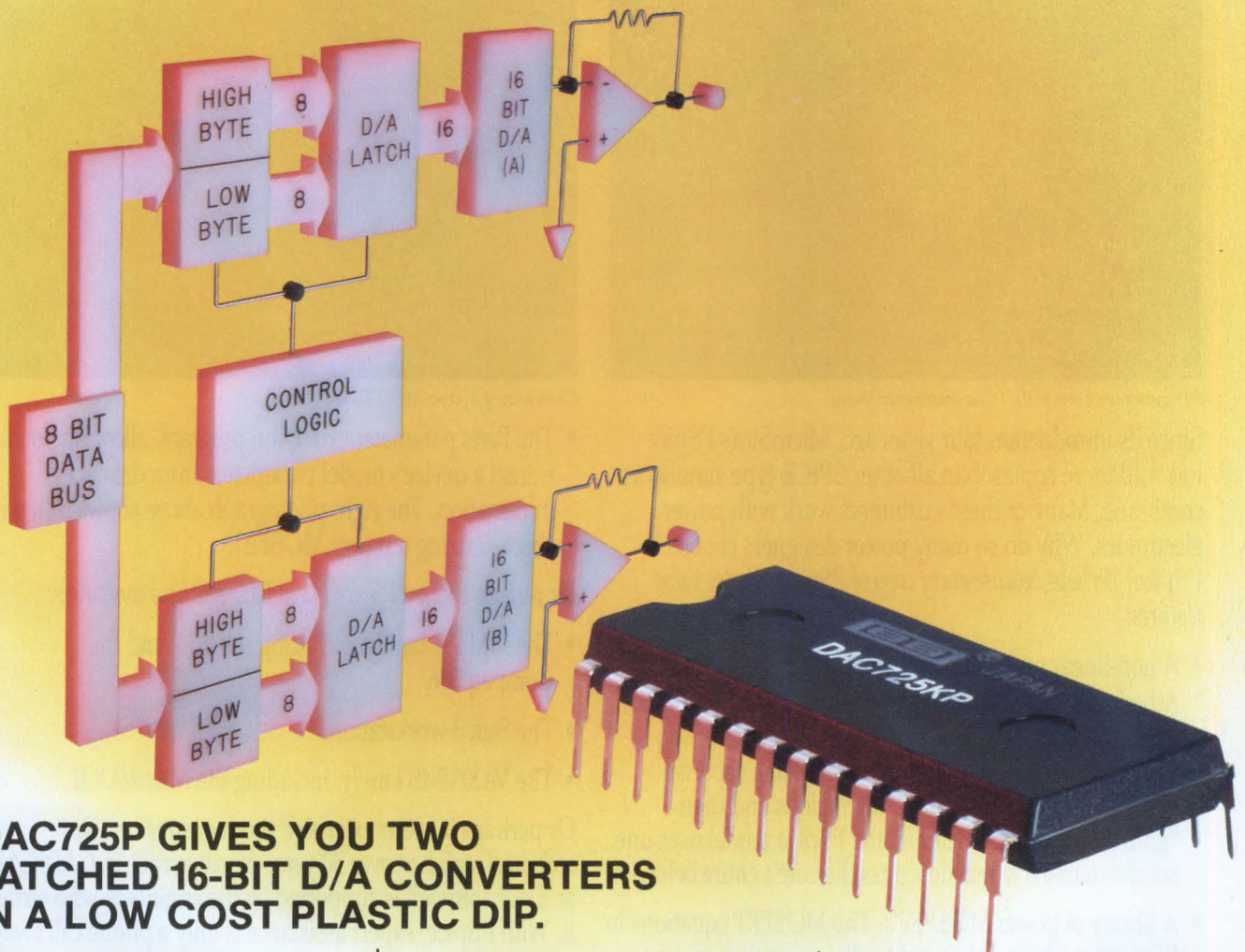

## DAC725P GIVES YOU TWO LATCHED 16-BIT D/A CONVERTERS IN A LOW COST PLASTIC DIP.

The new DAC725P dual 16-bit D/A converter conserves valuable board space and requires no external parts to interface directly to 8-bit buses. High performance, compact size, and low cost make DAC725P ideal for ATE, robotics, precision process control, waveform synthesis, and other multiple-DAC applications.

### Easy to Use

DAC725P simplifies design tasks. Data is loaded in two 8-bit bytes. Separate lines for CHIP SELECT, LATCH CONTROL, and CLEAR

\*U.S. unit prices, in 100s.

provide maximum design flexibility. A single CLEAR pin may be used to reset the DAC's outputs to zero during system initialization.

### Unique Features

- each channel complete with double-buffered input port, precision buried-zener reference, DAC, and low noise  $V_{OUT}$  op amp;
- 14-bit monotonicity over 0/+70°C;
- high speed serial or parallel data input;
- $\pm 0.003\%$  linearity error;
- $\pm 5, \pm 10V$  output ranges;

- 4 $\mu$ s settling time ( $\pm 0.003\%$  FSR)
- low cost plastic 28-pin DIP;
- from \$34.90\*

Ask your Burr-Brown sales engineer for full details, or contact Applications Engineering, 602/746-1111. Burr-Brown Corporation, PO Box 11400, Tucson, AZ 85734.

**BURR-BROWN®**  
**BB**



# PSPice

## Simulation

### With Enhancements for Power Electronics

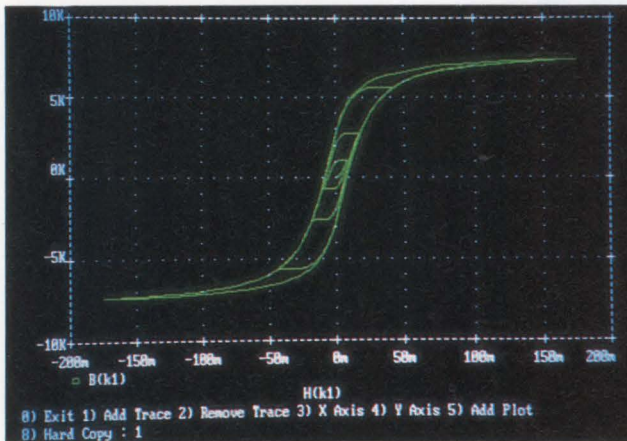

B-H curve from a core in the PSPice transformer library

Since its introduction four years ago, MicroSim's PSPice has sold more copies than all other SPICE-type simulators combined. Many of these customers work with power electronics. Why do so many power designers choose PSPice? Perhaps because every copy of PSPice includes these features:

- A non-linear magnetics model based on the Jiles-Atherton ferromagnetic equations. It models saturation, hysteresis, eddy current losses, and air gap effects. Instead of approximating the core by using separate equations for different operating regions and then "gluing" the results together, the PSPice model uses one set of equations which describes the core's entire behavior.
- A library of power MOSFET's. The MOSFET equations in PSPice have been enhanced to allow more convenient and accurate modeling of power devices.
- Ideal switches. Logarithmic interpolation for the ON/OFF transition avoids numerical problems.

Or perhaps because of these options available for PSPice:

- Monte Carlo analysis to calculate the effect of parameter tolerances on circuit performance.
- The Probe "software oscilloscope", allowing interactive viewing of simulation results. The left photograph above is a Probe display.

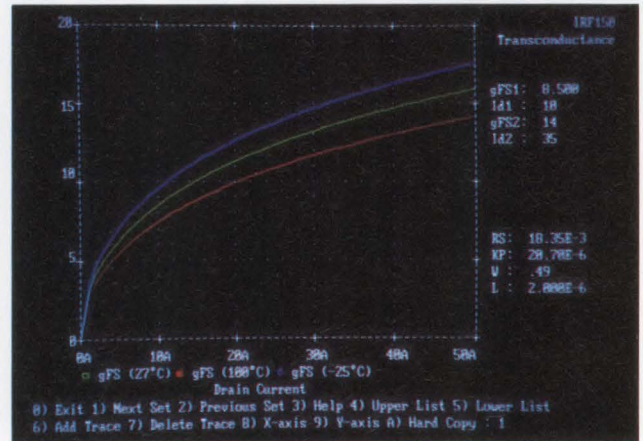

Characterizing a power MOSFET using Parts

- The Parts parameter extraction program, allowing you to extract a device's model parameters from data sheet information. The right photograph above shows a step in characterizing a power MOSFET.

Or perhaps because PSPice is available on these computers:

- The IBM PC family, including the PS/2 and the Compaq 386.
- The Sun 3 workstation.
- The VAX/VMS family, including the MicroVAX II.

Or perhaps it is our extensive product support. Our technical staff has over 50 years of experience in CAD/CAE and our software is supported by the engineers who write it. With PSPice, expert assistance is only a phone call away.

Please call or write today for a free evaluation version of PSPice. Find out for yourself why PSPice is the standard for analog circuit simulation.



**MicroSim Corporation**

23175 La Cadena Drive • Laguna Hills, CA 92653  
(714) 770-3022 • (800) 826-8603 • Telex: 265154 SPICE UR

PSPice is a registered trademark of MicroSim Corporation



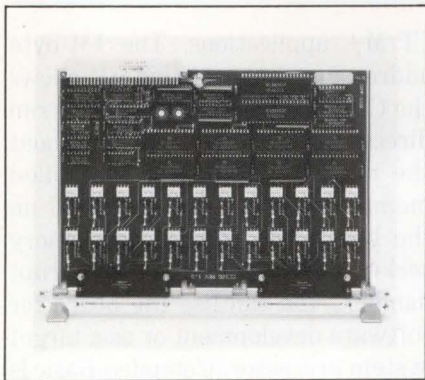

**TIMER/COUNTER CARD**

- 24 timer/counters with optically isolated clock inputs
- Has comprehensive VME Bus interrupt capabilities

Suitable for use in harsh electrical environments, the CC-106 double-Eurocard VME Bus timer/counter card provides you with 24 independent timer counters, each with an optically isolated clock input. Under software control, you can use the timer/counters to measure frequen-

cies or count events. The maximum input clock rate is 250 kHz. You can generate VME Bus interrupts when individual timer/counters overflow and select a software-programmable interrupt level, interrupt vector, and interrupt mask for each group of three timer/counters. The optically isolated clock inputs are protected against inadvertent overvoltage and reverse-input polarity conditions. The board operates as a VME Bus slave module, occupying 256 memory locations in the 64k-byte VME Bus short-address space. \$1425.

**Compcontrol bv**, Stratumsedijk 31, 5600 AD Eindhoven, The Netherlands. Phone (040) 124955. TLX 51603.

Circle No 362

**Compcontrol Inc**, 15,466 Los Gatos Blvd, Suite 109-365, Los Gatos, CA 95032. Phone (408) 356-3817. TWX 510-601-2895.

Circle No 363

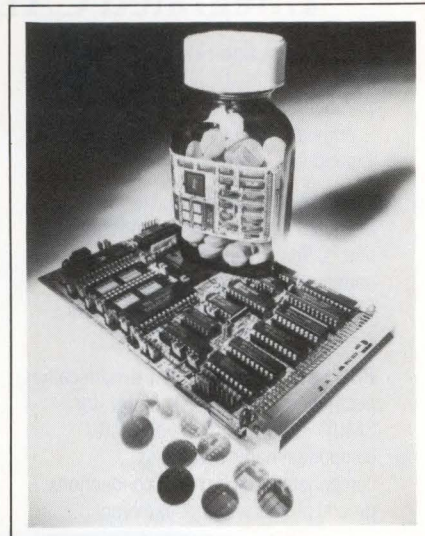

**CPU CARD**

- Runs a 64180  $\mu$ P and addresses STE Bus memory
- Suits software development or target-system use

Featuring a 6-MHz 64180 CMOS  $\mu$ P, the SC180 STE Bus CPU card suits systems that run banked

# “Erector Set”

We'll put this versatile TRU-GLIDE® Series 375QD steel chassis slide together for you but then we offer a wide choice of adjustable mounting brackets and insertable bar nuts to make it easy for you to finish your chassis installation in any standard 19" cabinet. Thin design, low profile, as well as smooth ball-bearing action and quick disconnect features are pleasant alternatives to the cumbersome slip-stick friction slides now in use. Get complete information on this versatile 75-lb. capacity slide series for your own cabinet... and they're off the shelf!

**Jonathan Manufacturing Corporation** • 1101 So. Acacia Ave., Fullerton, CA 92634 • (714) 526-4651 • TWX: 910-592-1241

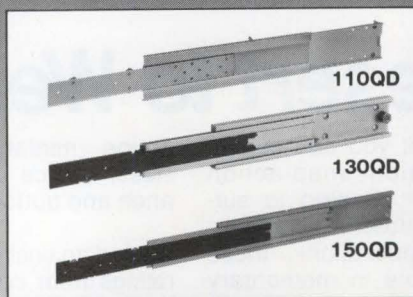

Jonathan's extensive line of aluminum slides are industry standards in military and aerospace application - with load ratings to 800 lbs.





# DOING PART OF THE JOB IS NOT ENOUGH

## Integrated CADdy Does It All!

**Schematic capture:** Dynamic symbol call-up... automatic naming/numbering... rubberbanded connections... edge-of-sheet and bus symbols... expandable library.

**Component data base:** Defines/manages data flow between schematic and PC Board. Automatic features—file naming, multi-sheet management, BOM, netlist, back-annotation, layer management, project archiving.

**PCB Layout:** Components dynamically positioned with rotate or mirror (for SMD)... auto-ratsnest... pin/gate/component name swapping... component dragging with connections... ground planes with fill/hatching...

user-defined pads, vias, trace width, automatic artwork generator... output to major pen plotters and Gerber... optional Excellon.

**CADdy Autorouter:** Options—Standard or High-performance.

**Full-featured Drafting:** Mechanical auto-dimensioning with tolerancing, construction aids, calculators... and more.

Polished **Technical Documentation**

For additional information call:  
CADdy CORPORATION, 3 Crossroads of  
Commerce, Rolling Meadows, IL 60008  
Toll-free: 1-800-CADDY11 (In Illinois:  
1-312-394-7755)

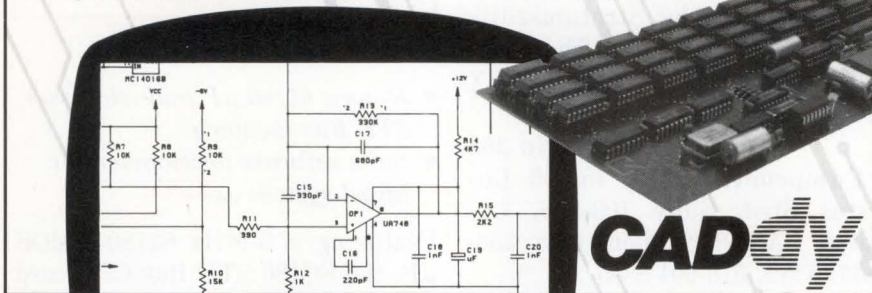

CIRCLE NO 110

## OTTO® Sealed Switches

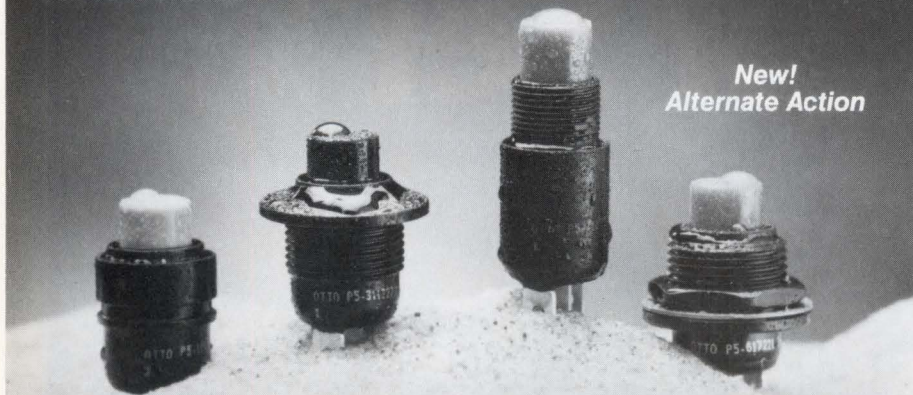

# Dry Desert to Wet World

Survival! That's what you can expect from OTTO precision snap-action pushbutton switches. Sealed to survive the rigors of industrial, commercial and military applications, these switches are available in momentary and alternate (push-on, push-off)

action, miniature and subminiature sizes, choice of front panel appearance and button colors.

Sealed against dirt and water. Electrical ratings from computer level to 10 Amperes. Contact resistance < .025 ohms.

**OTTO®**  
CONTROLS Division, OTTO ENGINEERING, INC.

2 East Main Street • Carpentersville, Illinois 60110 • Phone: 312/428-7171 • FAX 312/428-1956 • TELEX: 72-2426

## COMPUTERS & PERIPHERALS

CP/M+ applications. The 1M-byte addressing range of this  $\mu$ P allows the CP/M+ operating system to run directly, at optimum speed, without the need for hardware-controlled memory banks. Also provided on the board are four 28-pin memory sockets and a prioritized interrupt handler. You can use the board for software development or as a target system processor. Compiled Basic is available for use with the board. £245.

**Arcom Control Systems Ltd,**  
Unit 8, Clifton Rd, Cambridge CB1  
4WH, UK. Phone (0223) 411200.  
TLX 94016424.

Circle No 364

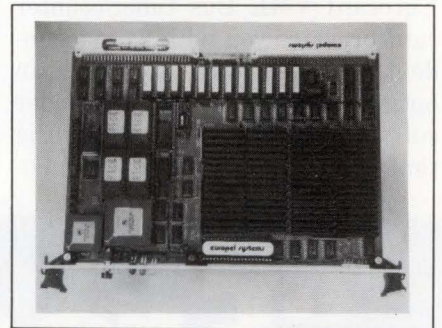

## GRAPHICS CARD

- Achieves screen resolutions as high as 2048x2048 pixels
- Can control as many as eight independent screens

The Opal-2 graphics card for VME Bus systems can output video information at a pixel rate as high as 300 MHz, allowing you to produce interlaced or noninterlaced displays with resolutions as high as 2048x2048 pixels. Alternately, you can use the board's speed to simultaneously control as many as eight independent screens. On color or monochrome screens, you can control the number of bits/pixel at 32 bits/pixel max. When you're using the card to control multiple screens, you can operate different screens at different pixel depths; each screen has its own hardware cursor. The board is controlled by a 16-, 20-, or 25-MHz 68020  $\mu$ P and a 68881 math coproc-



# Simply does what others should.

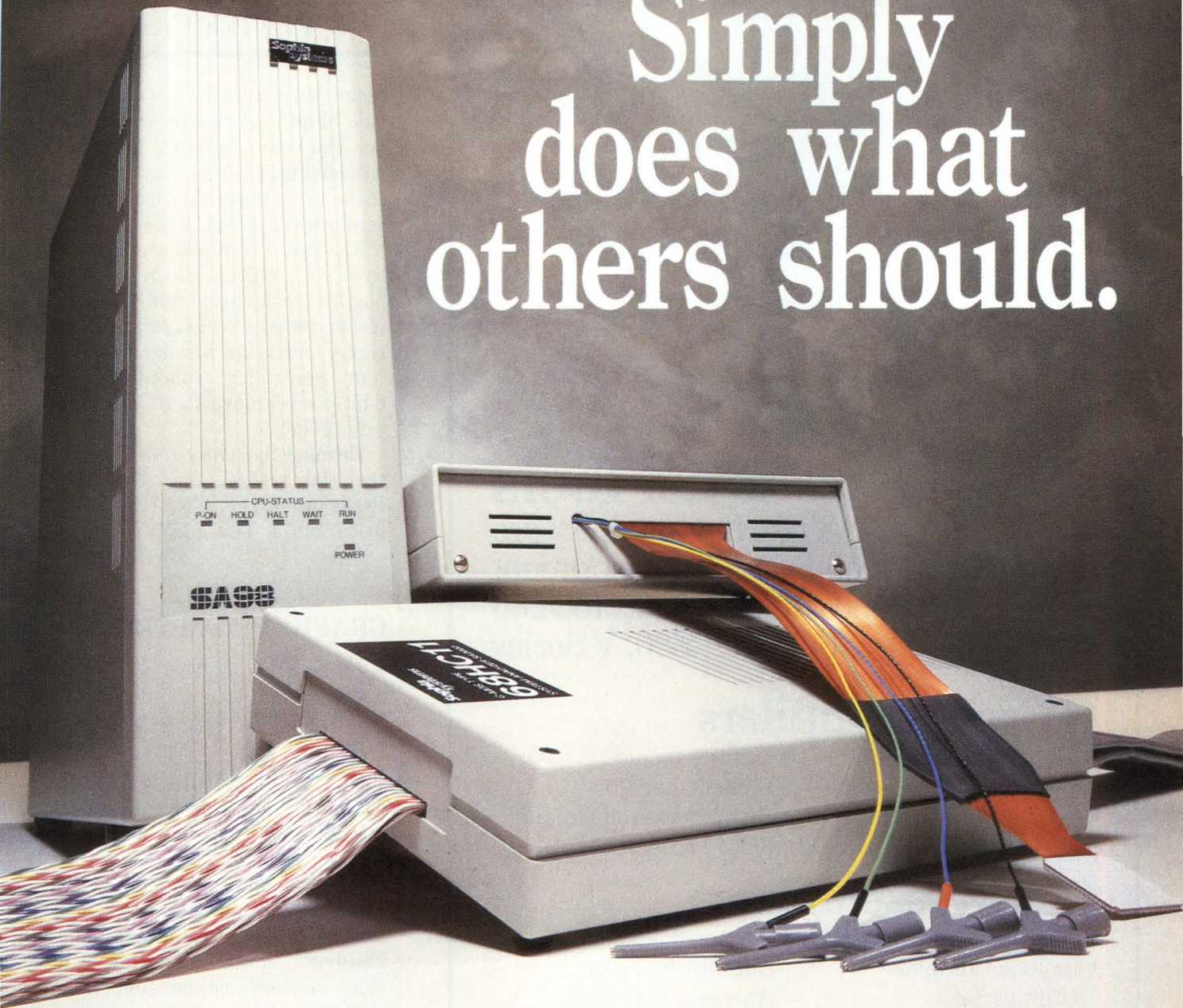

## **An MDS/ICE system designed for power, growth, and ease of operation.**

Ten years of universal development system experience shows in the SA98's exceptional performance. Performance you've got to see to believe. It moves from 8- to 32-bit microprocessors with ease.

### **Direct interface**

Saves hours of development time with its direct bus interface between the SA98 and IBM PC/AT or XT. Plus allows you full access to all IBM compatible software and hardware available.

### **Powerful Command Structure**

The SA98 has the most powerful, detailed, and easy to use command structure at hand. You'll need fewer commands to isolate and solve your debug problems. You can even use two SA98's in tandem to emulate two microprocessors simultaneously.

### **Productivity Booster**

The SA98 is designed to make you more productive. Get your hands on an SA98 and see the difference. See how fast you can zero-in on problems with full symbolic debugging. Compatibility with industry standard symbol table formats. And you can pick from a large list of assemblers and compilers.

### **See for Yourself**

Get your hands on our SA98 and see how simply, and efficiently it gets the job done. It simply out performs the others.

### **Call Toll-Free Today**

1-800-824-9294 (U.S.)  
1-800-824-6706 (CA)

# **Sophia systems.**

**Dedicated to MDS/ICE Support**

U.S. & European Headquarters: Sophia Computer Systems, Inc., 3337 Kifer Road, Santa Clara, CA 95051 (408) 733-1571  
Corporate Headquarters: Sophia Systems Co., Ltd., NS Bldg. 8F, 2-4-1 Nishishinjuku, Shinjuku-ku, Tokyo 160 03-348-7000  
©1988 Sophia Computer Systems, Inc. Sophia Systems is a registered trademark of Sophia Computer Systems, Inc.  
ICE is a registered trademark of Intel Corporation. MDS is a registered trademark of Mohawk Data Science Corporation.  
IBM PC/AT and XT are registered trademarks of International Business Machines Corporation.





## InterTools™

### Time Saving Software

#### For Embedded System Development

68000/010/020, 8086/186/286  
68HC11, Z80, V Series

### C Cross Compilers

- Global Optimization Features
- Produce Re-entrant, ROM-able Code
- Utilities include Linkers, Locators, Formatters, and Unique ROM Processor

### Cross Assemblers

- Full Macro Capabilities
- Include Complete Utilities Set
- Support Relocatable, Combinable, and Absolute Segments

### XDB Cross Debuggers

- Debug at C or Assembly Source Code Level
- User-Friendly Interface and Command Set
- Powerful Assertion, Breakpoint Commands
- Direct Command Interface to Emulator

**InterTools** are available for VAX, SUN, Apollo, HP, IBM PC, and other engineering computers.

**Demo Disks available.**

**Intermetrics, Inc.**  
**Software Products Division**  
**733 Concord Avenue**  
**Cambridge, MA 02138**  
**(617) 661-0072**  
**Toll-Free: 1-800-356-3594**



## COMPUTERS & PERIPHERALS

essor. Hardware accelerators provide block- and area-fill operations, and the board supports hardware windowing, panning, and zooming of the video image. You can directly access the dynamic RAM from the VME Bus. The board also has 64k bytes of CMOS static RAM. The board's master/slave VME Bus interface includes a bus arbiter, interrupter, interrupt handler, and system controller functions. An 8-bit-pixel card with a 40-MHz pixel rate, £4750.

**Europel Systems**, 5 Vo-Tec Centre, Hambridge Lane, Newbury, Berkshire RG14 5TN, UK. Phone (0635) 31074. TLX 848507.

**Circle No 365**

### GRAPHICS ADAPTER

- Features VGA compatibility and 256 colors
- Provides 800×600-pixel resolution

The SuperVGA HiRes VGA-compatible graphics-adaptor board for the IBM PS/2 computer can simultaneously display 256 colors at 800×600-pixel resolution. You can obtain it with an optional 16-color 1024×768-pixel resolution mode. The board contains 512k bytes of video memory and can support an IBM 8514 monitor. It is compatible with the IBM BIOS VGA and automatic CGA or compatibles. It comes with connectors for analog and TTL/multifrequency monitoring. You can employ one of 10 text modes for spreadsheet and desktop-publishing applications. The unit is also compatible with the Hercules and IBM VGA, EGA, MCGA, CGA, and MDA standards. \$695.

**Genoa Systems Corp**, 73 E Trimble Rd, San Jose, CA 95131. Phone (408) 432-9090. TLX 172319.

**Circle No 366**





# Simplify your system with V25

The most powerful single-chip  
16-bit CMOS microcomputer

Less is more. It's an engineering axiom. And the elegant proof is NEC's single-chip microcomputer: the 16-bit CMOS V25.

Features? The V25 has more than we can list. Check these for a preview.

- High integration: two full-duplex UARTs, 2-channel DMA, programmable interrupt controller, 2-channel serial and 24 parallel I/O ports, comparator, three 16-bit timers, time base counter, etc.
- High speed: 16/32-bit temporary register/shifter, 16-bit loop counter, program counter and prefetch pointer, plus dual 16-bit data bus for simultaneous fetching of two operands.
- Enhanced interrupt handling: 8 programmable priority levels, hardware context switching for 8 register banks, 8-channel macro service controller.
- 256-byte RAM, 16K-byte ROM on-chip; ROM-less version available.
- Two stand-by modes: halt and stop.
- Package: 84-pin PLCC.

For further information, please contact:

USA Tel: 1-800-632-3531. In California: Tel: 1-800-632-3532. TWX: 910-379-6985. W. Germany Tel: 0211-650302. Telex: 8589960.  
The Netherlands Tel: 040-445-845. Telex: 51923. Sweden Tel: 08-732-8200. Telex: 13839. France Tel: 1-3946-9617. Telex: 699499.  
Italy Tel: 02-6709108. Telex: 315355. UK Tel: 0908-691133. Telex: 826791. Hong Kong Tel: 3-755-9008. Telex: 54561. Taiwan Tel:  
02-522-4192. Telex: 22372. Singapore Tel: 4819881. Telex: 39726. Australia Tel: 03-267-6355. Telex: 38343.

**NEC**



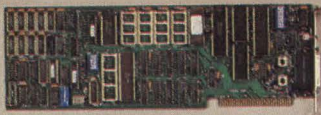

Y88, B88 and R188 PC Bus CPUs

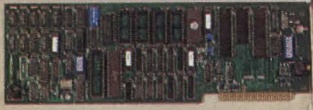

F286 PC-AT Bus 8/10 MHz CPU



IQ188 Parallel Processor

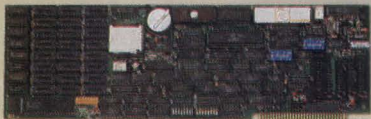

12-Slot PC-AT Bus Card Cage

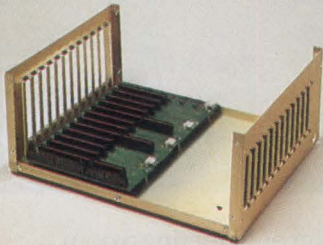

6 and 9-Slot PC Bus Chassis



9-Slot PC Chassis with Two Disk Drive Slots

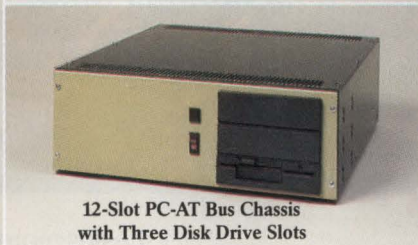

12-Slot PC-AT Bus Chassis with Three Disk Drive Slots

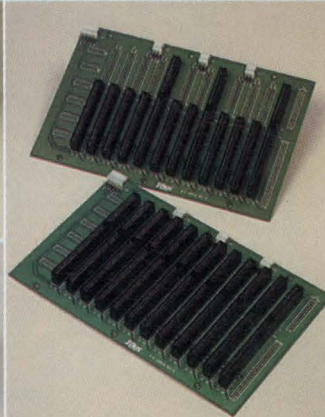

PC-AT Bus Backplanes

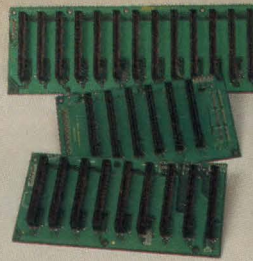

PC Bus Backplanes

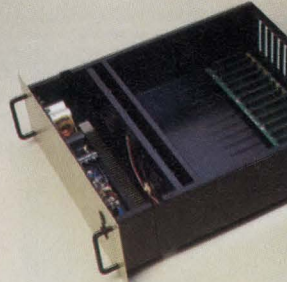

15-Slot PC Bus Chassis

6-Slot PC Bus Chassis with Two 3 1/2" Disk Drives



# The Board Level PC Bus by I-Bus. We Speak Systems.

If you're looking for an ordinary PC clone for your system, there are plenty out there. But only I-Bus builds PC and PC-AT Bus hardware that's designed specifically for dedicated OEM system applications.

Ours are board-level: the CPU is on a card, just like PC expansion cards. The mother board is just a passive backplane with the connectors interconnected. That's best for serviceability and ease of upgrading.

If you don't need a keyboard you don't have to use one. Or a display, either. Or even a disk. The I-Bus enhanced BIOS lets you control your PC system from a terminal, another computer, or just by itself—there's up to 256K of EPROM on board for just about any application.

You don't even have to produce ROMable code to run an I-Bus processor from its ROMs. Ask us about PROMDISK, that lets any PC applications program run from ROM.

I-Bus has 4 CPU cards, plus chassis, card cages, and all the rest you need for a board-level PC Bus or PC-AT Bus system. All you add are your favorite PC expansion cards for your application.

Call us today to get your development unit. Call TOLL FREE:

**(800) 382-4229**  
in Calif. call (619) 569-0646

If you're into systems, I-Bus speaks your language.

# I-BUS

The Full Service PC Bus Company



# NEW PRODUCTS

## INTEGRATED CIRCUITS

### MOTOR-CONTROL ICs

- Custom 3-chip set
- For brushless dc, ac-induction, and stepper motors

Three custom ICs are available for designing proprietary motion-control systems. The MC3A is a 16-bit internal, 8-bit external, data-bus  $\mu$ P. It has 8k bytes of mask-programmed ROM that holds the servo algorithms and an abbreviated command set for minimum-performance systems. Working with the MC3A is the Motion-LSI chip, which has four channels of A/B quadrature encoder decoding. Internal registers permit software selection of various encoder operating modes. Six digital outputs from the Motion-LSI chip provide PWM signals for the control of 2-, 3-, or 4-phase brushless dc, ac-induction, or stepper motors. The SMCC chip is a 27256 EPROM with a 12k-byte program that extends



the command set beyond that contained in the MC3A  $\mu$ P. The 27256 chip comes with the first trial chip set. Thereafter, you must make your own duplications. MC3A  $\mu$ P

and Motion-LSI chip, \$210 (100).

**Delta Tau Data Systems**, 21119 Osborne St, Canoga Park, CA 91304. Phone (818) 998-2095.

Circle No 370

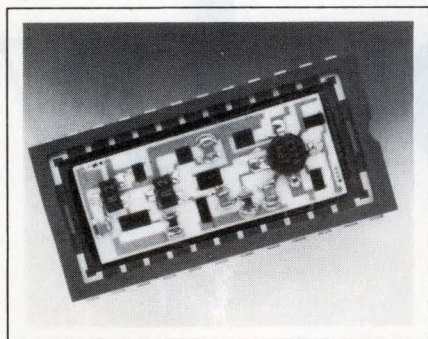

### HYBRID RF AMPLIFIER

- Features a GaAs FET front end
- 14-dB power gain at 500 MHz

The LH4200 hybrid IC is a 3-stage amplifier that includes a GaAs FET for the front end, and bipolar devices for the second and third stages. This combination results in low noise at high frequencies and high power-output capability. The device's decoupling capacitors eliminate parasitic oscillations without requiring series inductors. The de-

vice has a guaranteed power gain of 14 dB at 500 MHz and a noise figure of 3 dB in a 50 $\Omega$  system. By applying -2V to the input of the FET's second gate, you can obtain as much as 60 dB of gain reduction at 100 MHz, thus making the device useful for a variety of applications that require automatic-gain control. The LH4200 is packaged in a 24-pin ceramic DIP. \$54 (100).

**National Semiconductor Corp.**, Box 58090, Santa Clara, CA 95052. Phone (408) 749-7421. TLX 346353.

Circle No 371

### 1-MHz 12-BIT ADC

- Low-power monolithic CMOS construction
- Guaranteed linearity and harmonic distortion

According to the vendor, the CSZ5412 is the first monolithic

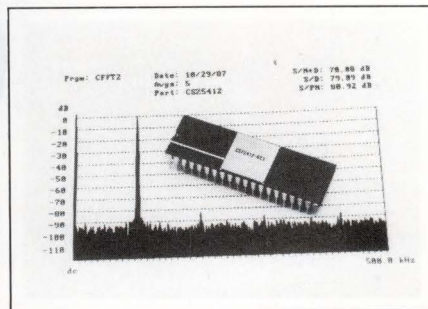

12-bit ADC to offer 1-MHz throughput. The device's 2-step conversion technique uses complex subcircuit blocks to achieve high resolution and accuracy. Its self-calibration circuitry constantly adjusts linearity to keep the final specification within  $\pm 1/2$  LSB. The dynamic range is 72 dB, and the total harmonic distortion is 0.02% max. Its typical power consumption is 700 mW. The device includes a T/H amplifier, a  $\mu$ P interface, 3-state output buffers, and an overrange output, which you can use to signal completion of the self-



calibration cycle. You can use the ADC in oscilloscopes, radar, and thermal-imaging systems. It comes in a 40-pin ceramic DIP. From \$115 to \$187 (100).

**Crystal Semiconductor Corp.**, Box 17847, Austin, TX 78760. Phone (512) 445-7222. TWX 910-874-1352.

Circle No 372

**CHIP SET**

- Floating-point multiplier
- Floating-point ALU

The IDT721264, a multiplier, and the IDT721265, an ALU (arithmetic logic unit), comprise a floating-point chip set that performs 32-bit operations at 33.4M flops and 64-bit operations at 25M flops. The units are pin compatible with the Weitek 1264 and 1265, but feature 30-nsec clock speeds. In addition to providing standard ALU functions, the devices include an instruction that

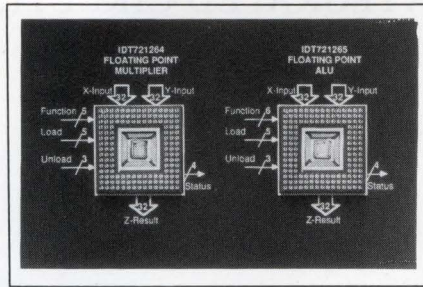

supports the Newton-Raphson algorithm, which simplifies floating-point division operations. The devices conform to IEEE STD 754 version 10.0 and provide an input-to output-register delay of 120 nsec. They operate from a single 5V supply and employ a 3-bus architecture that features two 32-bit input ports and one 32-bit output port. In a 144-pin PGA package, \$406 each (100).

**Integrated Device Technology**, Box 58015, Santa Clara, CA 95052. Phone (408) 727-6116. TWX 910-338-2070.

Circle No 373

**EMBEDDED CONTROLLER**

- 8-bit controller offers 16-bit performance
- Provides a stepping-stone from 8- to 16-bit microcontrollers

Suitable for real-time 8-bit control applications, the 8098 is an 8-bit external bus version of the 16-bit 8096. Its on-chip features include a 10-bit A/D converter, 32 I/O lines, a 16-bit CPU, 8k bytes of program memory, and 232 bytes of general-purpose registers. The device, which offers the same 16-bit CPU and onboard peripherals as its 8096 counterpart, provides a low-cost alternative for achieving 16-bit performance in real-time-event and motor-control systems. In a 48-pin PLCC, \$4.75 (OEM qty).

**Intel Corp.**, Literature Dept W-407, 3065 Bowers Ave, Santa Clara, CA 95051. Phone (800) 548-4725.

Circle No 374

# Color by

Watch Apple's new Macintosh II do for color computing what the original Macintosh did for black & white. Our RAMDAC enables Macintosh II to display some of the finest quality graphics available in a personal computer.



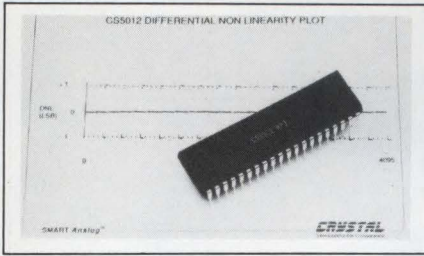

**12-BIT ADC**

- Features 7- $\mu$ sec conversion time
- Self-calibrates

The CS5012-7 features 12-bit accuracy to within  $\pm 0.5$  LSB max, converts in 7  $\mu$ sec, and has a 100-kHz throughput. The device's on-chip sample-and-hold amplifier eliminates the need for external components to convert ac signals. The converter incorporates 3-state output buffers and a  $\mu$ P interface. An on-chip microcontroller adjusts the device's linearity, resulting in  $\pm 0.25$  LSB typ nonlinearity, with no missing codes. The converter features 100-psec aperture jitter. You can

obtain the device in a plastic or ceramic DIP. \$43.70 (100).

**Crystal Semiconductor Corp**, Box 17847, 2028 E Saint Elmo Rd, Austin, TX 78760. Phone (512) 445-7222. TLX 910-874-1352.

Circle No 375

**CROSSBAR SWITCH**

- Transfers data from multiple sources to multiple destinations
- Features 64 I/O pins

The S618840 crossbar switch eases computer interconnections by providing high-speed switching between input and output ports. Functionally compatible with the 74AS8840, the device features 64 I/O pins arranged in 16 switchable nibbles of 4 bits each. The switch will transmit a single input nibble to any combination of 15 output nibbles or, when operating off registered data, to 16 nibbles, including itself.

The device's broad routing capabilities facilitate high data rates. It performs port-to-port switching in 25 nsec. The device features dynamic programmability; you may configure the switch to couple a processor to memory, to another processor, or to I/O ports. \$59 (100).

**Gould Inc**, Semiconductor Div, 3800 Homestead Rd, Santa Clara, CA 95051. Phone (408) 246-0330.

Circle No 376

**STATIC RAMS**

- Comply with MIL-STD-883C
- Have data inputs and outputs that feature TTL compatibility

The EDI81256C, EDI8464C, and EDI8832C are 256k $\times$ 1-, 64k $\times$ 4-, and 32k $\times$ 8-bit static RAMs, respectively. Available with speeds ranging from 35 to 55 nsec, the units feature battery-powered backup data-retention capability of 2V/50

# Brooktree®



**Macintosh II.** 640x480 resolution, displays 256 colors simultaneously from a 16.8 million color palette.

**Bt453.** Triple 8-bit 40 MHz RAMDAC with 256 color lookup table. Monolithic CMOS.

Brooktree Corporation, 9950 Barnes Canyon Road, San Diego, California 92121. 1-800-VIDEO IC or 1-800-422-9040, in California.



Apple® and Macintosh™ II are trademarks of Apple Computer Corporation.





# “We bet our entire company’s future on our partnership with Hitachi.”

—Jim Balkcom  
President and Chief Executive Officer  
Humminbird® Depth Sounders  
Techsonic Industries, Inc.

“As the second largest manufacturer of depth-sounding equipment, we were determined to become the leader. We knew it would take a breakthrough in meeting the fisherman’s needs.

“In strategic partnership with Hitachi, we developed the LCD technology that redefined the depth-sounder market and ultimately quadrupled its size. Our share went from 20 to over 50%. The new technology was a big risk for us. We laid the whole future of our company in Hitachi’s hands, and it paid off.”

**“Whether between two people, or two companies, trust is what makes partnerships work.”**

“We’ve shared technologies, design concepts, marketing plans and other critically confidential information across both sides

of the table. That’s partnership. Trust makes it work... and continue to grow.”

**“Hitachi defines quality the same way we do—meeting customers’ needs.”**

“Hitachi gives Techsonic the technological edge, and more. We’ve learned it’s a waste of time to do incoming testing on Hitachi LCDs. And when we sold over three times our forecast, they were flexible enough to come through for us. Whatever support we need, we get.

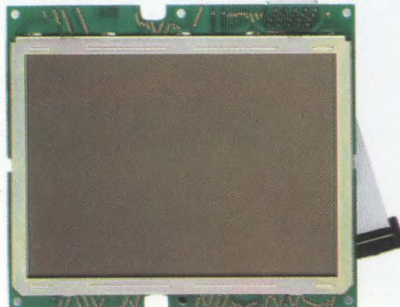

And the best part is, we never have to ask for it.”

**“Hitachi makes it clear that their most important product is our product.”**

“We needed to team up with an LCD supplier who had the expertise, the capabilities, and the desire to work with us to develop the right solutions. Partnering with Hitachi made Humminbird No. 1, and we’re sure it’s going to keep us there.”

To learn about how partnering with Hitachi can benefit your company, call Tom Klopcic or David Ross at (312) 843-1144. Or write to Hitachi America, Ltd., Electron Tube Division, 300 N. Martingale Road, Suite 600, Schaumburg, IL 60173.



Hitachi America, Ltd.  
Electron Tube Division



$\mu$ A. The 256k $\times$ 1- and 64k $\times$ 4-bit units offer 35-, 45-, and 55-nsec access-time options. The 32k $\times$ 8-bit unit offers 45- and 55-nsec access times. Each member of the 256k-bit static RAM family operates from a 5V supply. The data inputs and outputs feature TTL compatibility. From \$223 to \$453 (100).

**Electronic Designs Inc**, 42 South St, Hopkinton, MA 01748. Phone (617) 435-2341. TLX 948004.

Circle No 377

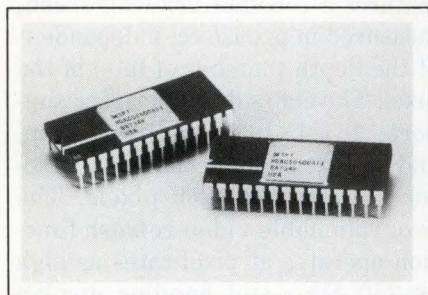

### 14-BIT DAC

- Voltage output of 0 to  $\pm 3V$
- 500-nsec settling time

Fabricated in bipolar-enhanced CMOS (BEMOS), the HDAC50600 DAC maintains 14-bit linearity over its entire operating range. Its output voltage range is 0 to 3V or 0 to  $\pm 3V$ , and on-chip resistors allow you to scale the output voltage to either 5 or 10V full-scale ranges. Both integral and differential non-linearity are  $\pm \frac{1}{2}$  LSB, and the gain is within  $\pm 4$  LSBs for the A grade device. The settling time is 500 nsec, and power dissipation is 30 mW. The HDAC50600 is faster than comparable current-output DACs and is  $\mu$ P compatible. Its 100-nsec max write pulse allows it to interface with the fastest  $\mu$ Ps without any wait states. It's available in either the industrial or military temperature range in A or B linearity grades. From \$21.85 (100).

**Honeywell Inc**, Signal Processing Technologies, 1150 E Cheyenne Mountain Blvd, Colorado Springs, CO 80906. Phone (303) 577-1000.

Circle No 378

### WIDEBAND OP AMPS

- Feature 12-MHz compensated bandwidth
- Provide 100-MHz uncompensated bandwidth

The SP-2600 family of op amps offers excellent dc characteristics and bandwidths as high as 100 MHz. The 2600, 2602, and 2605 feature

internal compensation and each provide a 12-MHz gain-bandwidth product, a 500-M $\Omega$  input impedance, and an open-loop voltage gain of 150,000. The 2620, 2622, and 2625 are uncompensated and each offer a 100-MHz gain-bandwidth product, a 500-M $\Omega$  input impedance, and a 1-nA input-bias current. You can use the devices in video amplifiers,

## A Breakthrough in Higher Performance.

### CMOS/DMOS

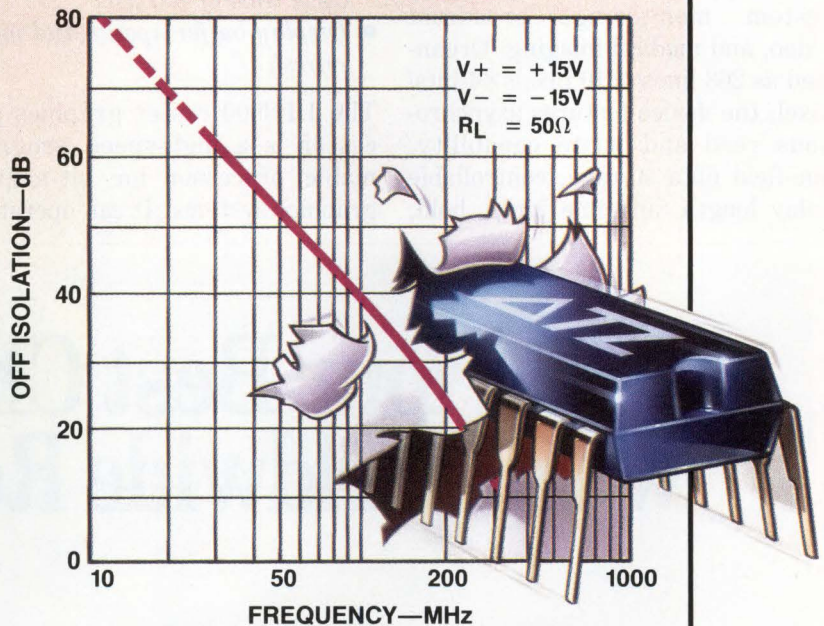

**Topaz** combines the best of CMOS and DMOS: high off-isolation at frequencies up to 250 MHz with low insertion loss, achieved only through DMOS, and the low-power control circuitry of CMOS.

Our CMOS/DMOS ICs are available in 1x, 2x and 4x SPST analog switches, 2x SPDT with latches, and 4-to-1 multiplexers, all available in standard DIPs and S.O. packages.

Data sheets are available on Topaz CMOS/DMOS products as well as our full line of DMOS FETs, high-frequency analog switches and digitally controlled attenuators. Break through the performance barrier with Topaz products.



**TOPAZ**  
SEMICONDUCTOR

Topaz Semiconductor, 1971 N. Capitol Avenue, San Jose, CA 95132-3799  
 TEL (408) 942-9100 TWX 910-338-0025 FAX (408) 942-1174



high-speed comparators, low-distortion oscillators, buffers for D/A converters, and high-speed S/H amplifiers. All versions come in metal cans, ceramic DIPs, or die form. From \$3.01 (100).

**Sipex Corp**, DataLinear Div, 491 Fairview Way, Milpitas, CA 95035. Phone (408) 945-9080.

**Circle No 379**

## NTSC FIELD BUFFER

- Provides 263 lines×910 pixels
- Features asynchronous read and write capability

You can use the  $\mu$ PD42270C field buffer IC in digital TV applications and in applications such as teletext system monitoring, broadcast video, and medical imaging. Organized as 263 lines×910 pixels×4-bits/pixel, the device features asynchronous read and write capability, one-field data storage, controllable delay length, and line jump, hold,

and reset functions. The IC has a 60-nsec cycle time and a 40-nsec access time. The device allows users to view data in teletext and video-response systems and to implement high-end video telephones. It comes in a 28-pin, 400-mil plastic DIP. The vendor can provide samples now and will begin shipping production quantities in May. \$30 (OEM qty).

**NEC Electronics Inc**, Box 7241, Mountain View, CA 94039. Phone (415) 960-6000. TWX 910-379-6985.

**Circle No 380**

## GRAPHICS PROCESSOR

- 20-MHz CMOS chip features a cycle time of 100 nsec
- Display-buffer update and video refresh

The DP8500 raster graphics processor is a high-speed programmable processor for bit-mapped graphics systems. It can operate to

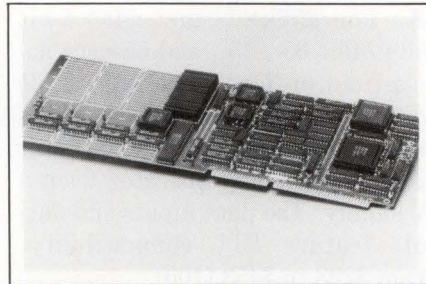

20 MHz and has a cycle time of 100 nsec on back-to-back vector and block operations, thereby boosting the speed of graphics operations. It supports a system architecture that features a constant drawing speed, measured in pixels/sec, independent of the depth (number of bits) of the pixel. The chip's drawing space supports 16384×16384 pixels/bit map, and its text support handles character sizes to 256×256 pixels. The programmable video-refresh function operates at pixel rates as high as 250 MHz and handles display formats to 65536 pixels×4096 scan lines. The DP8500 comes in a 68-pin

**FUJI NOVEL**

# Your Best Choice with Worldwide Reputation.



## PRODUCTS LIST

- Lithium batteries
- Silver oxide button cells
- Alkaline button cells
- Alkaline batteries
- Zinc chloride batteries
- Zinc carbon batteries
- NI-CD rechargeable batteries etc.

**FDK**  
Fuji Electrochemical Co., Ltd.  
Tokyo, Japan

**FDK AMERICA, INC.**  
17326 Edwards Road, A-130, Cerritos, California  
90701, U.S.A.  
Phone 213-404-1770 Telex 18-1998 (FEC CALIF LA)  
Fax. 213-404-2850



# THE BEST PRO SHOPS ALWAYS HAVE WHAT YOU NEED.



And when it comes to delivering the R6502 family of products from Rockwell, Marshall scores a hole-in-one.

Marshall continues to offer a complete line of high-performance R6502 microcontrollers, microprocessors, and peripheral devices for 8 bit processing applications, including their development systems. Just like we've been doing for over 30 years. We offer broad-line inventory, competitive prices, and delivery schedules that won't leave you in the rough.

So call Marshall today for the R6500 line from Rockwell, in NMOS and CMOS versions. We'll follow through for you.

## Marshall

### ROCKWELL'S R6502 FROM MARSHALL. WE'LL ALWAYS FOLLOW THROUGH.

(*Authorized Locations)	San Diego (619) 578-9600*	GA Atlanta (404) 923-5750*	MI Michigan (313) 525-5850*	Rochester (716) 235-7620*	El Paso (915) 593-0706*
AL Huntsville (205) 881-9235*	San Francisco (408) 942-4600*	IL Chicago (312) 490-0155*	MN Minneapolis (612) 559-2211*	OH Cleveland (216) 248-1788*	Houston (713) 895-9200*
AZ Phoenix (602) 496-0290*	CO Denver (303) 451-8383*	IN Indianapolis (317) 297-0483*	NC Raleigh (919) 878-9882*	Dayton (513) 236-8088*	San Antonio (512) 734-5100*
Tucson (602) 790-5687	CT Connecticut (203) 265-3822*	KS Kansas City (913) 492-3121*	NJ N. New Jersey (201) 882-0320*	OR Portland (503) 644-5050*	UT Salt Lake City (801) 485-1551*
CA Irvine (714) 859-5050*	FL Ft. Lauderdale (305) 977-4880*	Wichita (316) 264-6333*	Philadelphia (609) 234-9100*	PA Pittsburgh (412) 963-0441*	WA Seattle (206) 747-9100*
Los Angeles (818) 407-4100*	Orlando (305) 841-1878*	MA Boston (617) 658-0810*	NY Binghamton (607) 798-1611*	TX Austin (512) 837-1991*	WI Wisconsin (414) 797-8400*
Sacramento (916) 635-9700*	Tampa (813) 576-1399*	MD Maryland (301) 840-9450*	Long Island (516) 273-2424*	Dallas (214) 770-0616*	



PLCC. Production quantities will be available in the third quarter of 1988 for \$95 (10,000). The DP850EB evaluation board is available now and costs \$1495.

**National Semiconductor Corp.**, Box 58090, Santa Clara, CA 95052. Phone (408) 721-5404. TWX 910-339-9240.

Circle No 381

## SMART POWER SWITCH

- Switches 500-mA load currents
- Detects thermal overloads, and short- and open-circuit loads

The TDE1799 smart power switch can drive resistive, inductive, or capacitive loads at currents as high as 500 mA. Complementary to the TDE1798, the device is a low-side

driver suitable for operation between the negative supply rail and a load connected to the positive supply rail. The IC's output short-circuit protection extends to 32V, and its thermal overload-protection circuitry incorporates a reset control input. Output short circuits, thermal overloads, and open-circuit load conditions activate the switch's alarm. The switch has a differential control input that allows you to use the device with various logic families. Its operating input voltage ranges from 1 to 45V; the input is protected against negative voltages as great as -25V. You can employ switches in parallel to increase the load current. In an 8-pin plastic mini-DIP, \$2.90 (1000).

**SGS-Thomson Microelectronics**, Via C Olivetti 2, 20041 Agrate Brianza, Italy. Phone (039) 65551. TLX 330131.

Circle No 382

**SGS-Thomson Microelectronics**, 1000 E Bell Rd, Phoenix, AZ 85022. Phone (602) 867-6100. TLX 249976.

Circle No 383

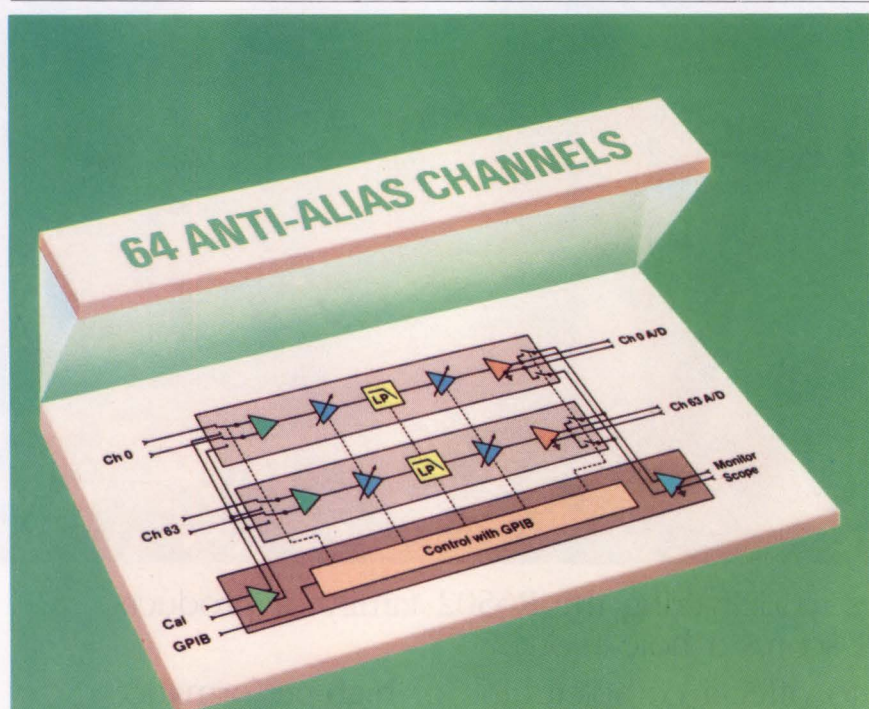

**64 anti-alias filter channels.**  
**80 dB/octave.**  
**0.1Hz to 10.23 kHz.**  
**1° phase match.**  
**Pre and post gain.**  
**Differential input.**  
**Calibration input.**  
**Output monitor.**  
**All in 7" mainframe.**

## Only With System Friendly

Just one of hundreds of programmable hardware building block configurations possible with our operating system. Just one of hundreds of exclusive possibilities that make Precision 6000 truly System Friendly now and easy to update in the future. Call (607) 277-3550 for brochure. Or write.



**PRECISION FILTERS, INC.**

240 Cherry Street, Ithaca, New York 14850

CIRCLE NO 121

## DSP CHIP

- Multiplies two 16+16-bit complex numbers
- Can conjugate its inputs to ease complex correlation

The PDSP16116 complex multiplier can multiply two 16+16-bit complex words to produce a 32+32-bit complex result every 100 nsec. You can use the device in conjunction with two of the vendor's PDSP1601 ALUs and two of its PDSP16316 complex accumulators to produce a block floating-point butterfly processor for evaluating FFTs. By combining the device with a single PDSP16316, you can create a 10-MHz 16×16-bit complex multiplier/accumulator. The device contains four 16×16-array multipliers, two 32-bit adder/subtractors, and control logic that provides fully auto-



## INTEGRATED CIRCUITS

matic block floating-point operation. It also includes trap logic to prevent  $-1 \times -1$  products from leading to erroneous results. You can cause the IC to conjugate either input and thereby ease the implementation of complex correlators. A single pipeline delay allows you to use the device with recursive algorithms. You can obtain the IC in either a military or industrial temperature range version. For the industrial temperature range, £331.43 (100).

**Plessey Semiconductors Ltd**, Cheney Manor, Swindon, Wiltshire SN2 2QW, UK. Phone (0793) 36251. TLX 449637.

Circle No 384

**Plessey Semiconductors**, 9 Parker, Irvine, CA 92718. Phone (714) 472-0303.

Circle No 385

Housed in a 28-pin DIP, the device operates over a  $-20$  to  $+75^\circ\text{C}$  temperature range. The ADC-B304E sampling board is a complete A/D conversion board containing a buffer amplifier, gain adjustment, and filtering and timing circuitry. It's packaged on a standard Eurocard and operates over a  $0$  to  $70^\circ\text{C}$  temperature range. The board has a

20-MHz sampling rate. Applications include high-speed data acquisition, voice signal analysis, video signal processing, and radar imaging. ADC-304 \$45; ADC-B304E \$350.

**GE Datel**, 11 Cabot Blvd, Mansfield, MA 02048. Phone (617) 339-9341. TWX 710-346-1953.

Circle No 386

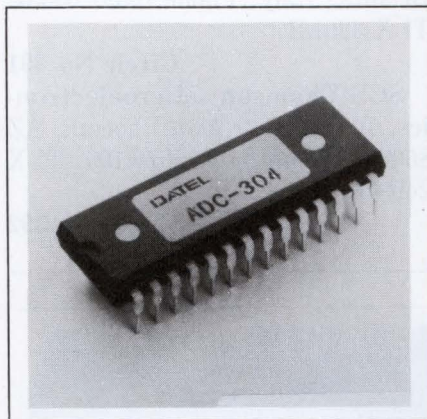

### ADC/SAMPLING BOARD

- $\frac{1}{2}$ -LSB nonlinearity
- 20-MHz conversion rate

The ADC-304 A/D flash converter and the ADC-B304E A/D sampling board are both TTL compatible and provide an 8-MHz analog-input bandwidth. Using a single 5V supply, the ADC-304 provides an input range of 3 to 5V. A 0 to  $-2\text{V}$  input range is available, using a  $\pm 5\text{V}$  supply. The ADC-304 features user-selectable output coding in binary, complementary binary, or complementary two's complement via the LINV and MINV pins. The data-acquisition applications include radar, sonar, and video imaging.

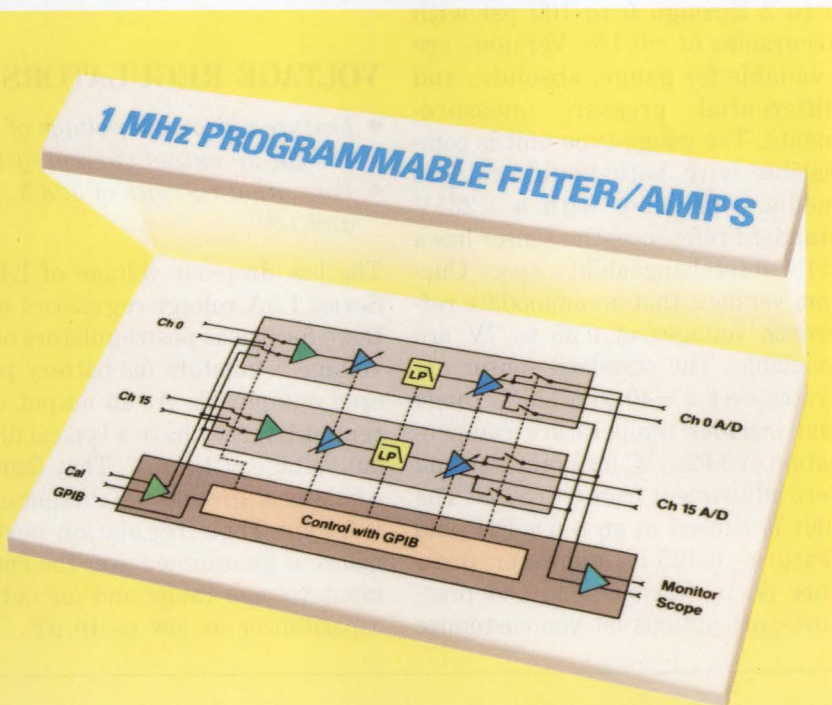

### Only With System Friendly

Just one of hundreds of programmable hardware building block configurations possible with our operating system. Just one of hundreds of exclusive possibilities that make Precision 6000 truly System Friendly now and easy to update in the future. Call (607) 277-3550 for brochure. Or write.

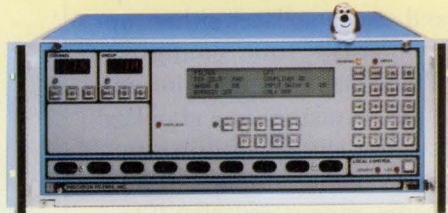

- Up to 16 channels.**
- 100 Hz to 1 MHz.**
- HP, LP, TD.**
- 80 dB/octave.**
- 1° phase match.**
- Pre and post gain.**
- Differential input.**
- Calibration input.**
- Output monitor.**
- All in 7" mainframe.**



**PRECISION FILTERS, INC.**

240 Cherry Street, Ithaca, New York 14850

CIRCLE NO 121



# NEW PRODUCTS

## COMPONENTS & POWER SUPPLIES

### PRESSURE SENSOR

- Features  $\pm 0.1\%$  accuracy
- In gauge, absolute, and differential pressures

The Model 1220 piezoresistive sensor measures full-scale pressures of 0 to 2 through 0 to 100 psi with accuracies of  $\pm 0.1\%$ . Versions are available for gauge, absolute, and differential pressure measurements. The gauge-type unit is compatible with both liquid and gas media. Operating with a 1.235V standard reference, the sensor has a  $\pm 1\%$  interchangeability spec. Custom versions that accommodate reference voltages of 0.35 to 7V are available. The standard sensor operates over a  $-40$  to  $+125^\circ\text{C}$  range and includes temperature compensation of  $0.02\%/^\circ\text{C}$  for both span and zero adjustment from 0 to  $50^\circ\text{C}$ . The unit is housed in an 8-pin DIP and features 0.125-in.-diameter pressure ports. Various lead and pressure-port options let you customize

the sensor for specific applications. From \$10 (OEM qty). Delivery, stock to six weeks ARO.

**IC Sensors Inc**, 1701 McCarthy Blvd, Milpitas, CA 95035. Phone (408) 432-1800.

Circle No 390

### VOLTAGE REGULATORS

- Feature a drop-out voltage of 450 mV for an output current of 1A
- For output voltages of 5, 8.5, 10, and 12V

The low drop-out voltage of L4940 Series 1.5A voltage regulators suits them for use as postregulators or as voltage regulators for battery-powered equipment. At an output current of 1A, they have a typical drop-out voltage of 450 mV. They feature a quiescent ground-pin current of 35 mA typ! Their regulation performance is guaranteed over the entire input voltage range and for output capacitances as low as  $10\ \mu\text{F}$ . The

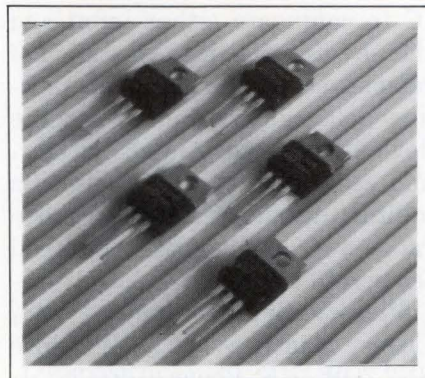

series comprises four regulators, with output voltages of 5, 8.5, 10, and 12V, respectively. The regulators come in TO-220 plastic packages. \$1.20 (1000).

**SGS-Thomson Microelectronics**, Via C Olivetti 2, 20041 Agrate Brianza, Italy. Phone (039) 65551. TLX 330131.

Circle No 391

**SGS-Thomson Microelectronics**, 1000 E Bell Ave, Phoenix, AZ 85022. Phone (602) 867-6100. TLX 249976.

Circle No 392

### PRESSURE SENSOR

- Available in four differential pressure ranges
- Mounts on pc boards

Packaged in plastic lead frames, the NPS Series pressure sensor features two pressure ports that are compatible with  $\frac{1}{16}$ -in. plastic tubing. The sensor mounts on a pc board and accommodates either top- or bottom-entry tube configurations. The sensor employs ion-implanted piezoresistors in a standard Wheatstone-bridge configuration. They are available in four differential pressure ranges covering 0 to 5 through 0 to 100 psi. The output signal is 100 mV at 1.5 mA. Combined pressure nonlinearity, hysteresis, and repeatability is 0.1% of full-scale output. The sensor package provides three times overpres-

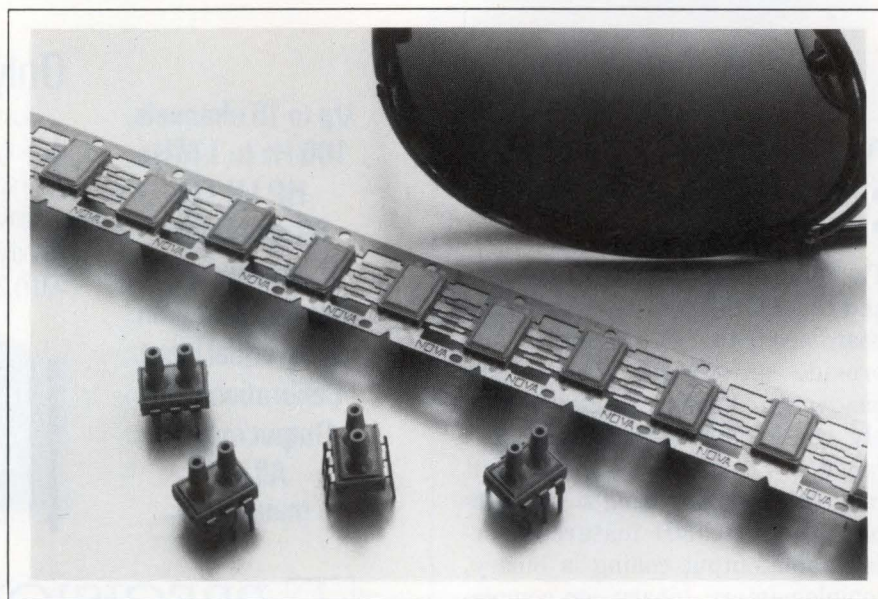

sure protection at 100 psi without degrading performance. \$10 (100). Evaluation-quantity delivery, two to eight weeks ARO.

**NovaSensor**, 1055 Mission Ct, Fremont, CA 94539. Phone (415) 490-9100. TLX 990010.

Circle No 393



# Switching Times

 **TELEDYNE RELAYS**  
Innovations In Switching Technology

© 1988 Teledyne Relays

## MAGLATCH NOW CMOS COMPATIBLE

### Maglatch Low Power and Indestructible Memory Ideal For Aircraft and Space

Teledyne Relays has introduced a new CMOS compatible Centigrad<sup>®</sup> version of its popular TO-5 Maglatch relay. This I22C relay is set with a short pulse of coil voltage and retains its state until it is reset, even if the system power fails or is shut off. Since no holding power is required, the I22C is also ideal where power is at a premium. A power FET driver in each input enables direct relay interfacing with CMOS and most other logic families. In addition, its small footprint is well-suited to the newest high-density printed circuit boards. For RF switching applications, the in-

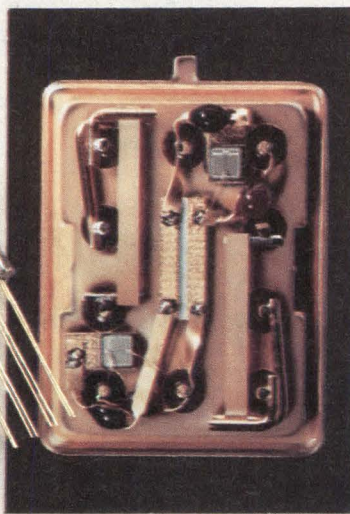

herently low intercontact capacitance of the I22C provides high isolation and low insertion loss up through 1GHz. The I22C is built to meet the requirements of established reliability mil specs MIL-R-28776 and can be screened to P level. Teledyne's non-latching CMOS compatible relays introduced earlier are already QPL approved to MIL-R-28776/7 and /8.

### Teledyne Supplies Hi-Rel Space Programs

Teledyne's dedication to reliability has made its TO-5 relay the choice of virtually every space program in the Free World. Expanded NASA and Military use of Teledyne's TO-5 for space applications

reliability is vertical integration. All piece parts are produced, and critical manufacturing processes are controlled in-house. Teledyne's dedicated "Blue Traveler" hi-rel production line provides

### 2 Amp TO-5 Relay In Squib Firing Application

The new 2 amp version of Teledyne's proven TO-5 relay is finding new uses, including squib firing applications. The 212 Series TO-5 relay combines the small package—only .390 inches high—and the time-tested Teledyne reliability which are required for squib firing and other military applications. The 212 Series TO-5 relay is also ideal for controlling small motor loads, lamp loads, and capacitive loads, where current surge at turn-on and turn-off run as high as 2 amps. An innovative proprietary contact system, called TELESIMUM<sup>™</sup>, makes the higher power level possible and also gives the 212 Series a resistive load rating up to 2 amperes for 100,000 operations.

utilizing 2-micron small particle cleaning prior to hermetic sealing. All hi-rel TO-5s must pass rigorous functional and environmental screening tests to assure "spaceworthiness." An asynchronous miss test

### Teledyne Solid State Introduces New ATE Relay

New C66 Solid State Relay was developed for use in automotive diagnostic test equipment, but other applications are emerging. When this device is turned off it has an extraordinarily low leakage (50 nanoamps). The hermetically sealed units are only 0.458" square and 0.190" high and have current ratings of from  $\pm 0.3$  amp at  $\pm 380$  volts to  $\pm 1$  amp at  $\pm 200$  volts. They are available from Teledyne Solid State now.

### For More Information

Teledyne Relays, 12525 Daphne Ave., Hawthorne, California 90250 • (213) 777-0077/European Headquarters: W. Germany: Abraham Lincoln Strasse 38-42, 6200 Wiesbaden/ Belgium: 181 Chaussee de la Hulpe, 1170 Brussels/ U.K.: The Harlequin Centre, Southall Lane, Southall, Middlesex, UB2 5NH/ Japan: Taikoh No. 3 Building, 2-10-7 Shibuya, Shibuya-Ku, Tokyo 150/ France: 85-87 Rue Anatole-France, 92300 Levallois-Perret.



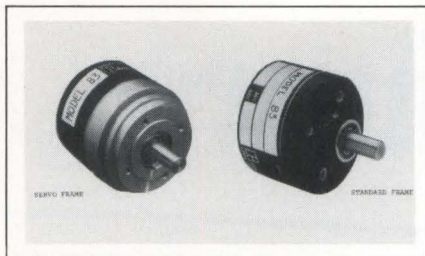

## ENCODER

- Provides quadrature outputs with marker pulse
- Housing meets 94V-0 UL requirements

The Model 83 incremental shaft encoder features quadrature outputs with an index marker pulse and offers resolutions ranging to 1400 pulses per revolution. The outputs are TTL and CMOS compatible. For a light source, the unit uses a single LED that has a useful-life spec of 100,000 hours min. The housing meets 94V-0 UL flammability requirements, and the shielded termination cable is UL/CSA approved.

The encoder is available in either round or servo-mount type housings. Its operating range specs at 0 to 70°C. \$79 (100). Delivery, six weeks ARO.

**Litton Encoder**, 20745 Nordhoff St, Chatsworth, CA 91311. Phone (818) 341-6161.

Circle No 394

## POWER MODULES

- Meet UL544 requirements for medical equipment
- Feature split-bobbin transformers for high resolution

The MED300 and MED500 series of ac/dc encapsulated power modules meet the UL544 requirements for medical equipment. They incorporate split-bobbin-wound transformers that provide 2500V ac isolation and leakage current of 10  $\mu$ A. All the units feature overload, overtemperature, and short-circuit protec-



tion. You can obtain single-, dual-, and triple-output versions in various combinations—5, 12, 15, 24V. The modules' output power ranges from 1 to 15W. The vendor supplies the modules in pc-board and chassis-mountable configurations. Both series are UL recognized and CSA certified. 12V/400 mA model, \$72.80 (100).

**Computer Products Inc**, 2900 Gateway Dr, Pompano Beach, FL 33069. Phone (305) 974-5500. TWX 510-956-3098.

Circle No 395

## You Don't Need a Thousand Words When You Have a Picture Like This!

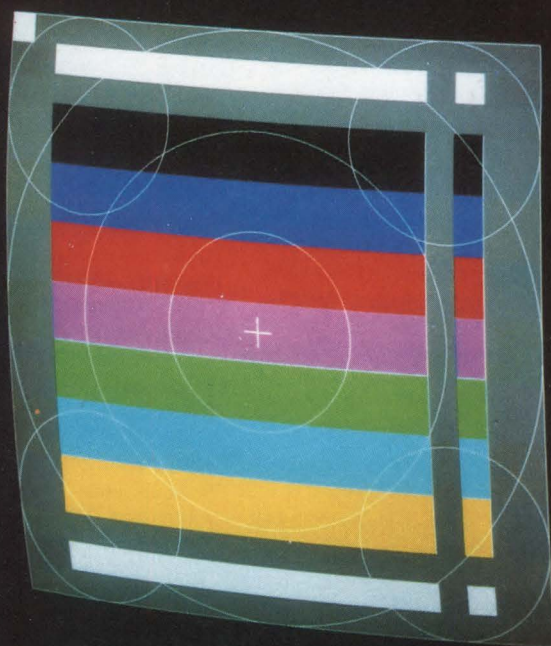

Unretouched photograph  
\*3.5 NS max. rise & fall time measured at CRT cathode.

The image quality demonstrated here is required by your customers... and will be appreciated! They expect THE BEST from original equipment manufacturers. You can provide it! While other video monitor vendors claim, "about 100 + MHz" video bandwidth,\* **Video Monitors, Inc.** provides it! While other vendors claim, "full gray-scale color capability," **VMI** delivers it!

And if your customers or you need semi-custom or custom designs, **VMI** can provide this service. These are just a few of the reasons why **Video Monitors, Inc.** should be your supplier of very high resolution monitors.

**Video Monitors Inc**

3933 North White Avenue  
Eau Claire, Wisconsin 54703  
(715) 834-7785

A Subsidiary of DOTRONIX, INC.



Large Image Area

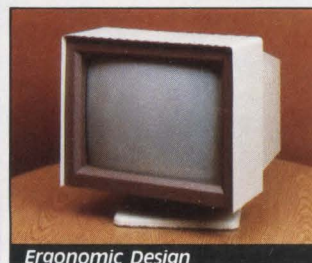

Ergonomic Design



State-of-the-Art Technology



## KEYPAD

- Features a total environmental seal
- EMI shielding is standard

When mounted to a panel, Series 84 4×4-position keypads are completely sealed to the environment. A military-grade silicone rubber boot seals the contact system and also serves as the mounting seal. The snap-dome contact system provides tactile feedback for the operator. The contact side of the dome is gold plated to ensure low contact resistance for 3×10<sup>6</sup> operations per position. EMI shielding is a standard keypad feature. The buttons are located on 0.75-in. centers and are removable and interchangeable. The standard button color is white and legends employ a black epoxy ink that bonds with the button's plastic surface. Special legends and button colors are available. \$25.85 (100). Delivery, six to eight weeks ARO for production qty.

**Grayhill Inc.**, Box 10373, La-Grange, IL 60525. Phone (312) 354-1040.

Circle No 396



## VF DISPLAY

- Requires only 5V for operation
- Comes in a compact package

At 7.85×2.5×1.1 in., the 2-line×40-character 3601-86-080 vacuum fluorescent display is smaller than many 1-line×40-character displays. Its 5×7 dot-matrix characters have a height of 0.18 in. Its onboard  $\mu$ P controller handles all scan, refresh, and data I/O tasks, making it easy for you to interface the display to an 8-bit ASCII parallel data bus. The display module operates on a 5V supply. It displays 96 upper- and lower-case letters, as well as num-

bers and symbols. Its standard display color is blue-green but the vendor offers a wide variety of color filters. \$111 (100). Delivery, four to six weeks ARO.

**IEE Inc.**, Industrial Products Div, 7740 Lemona Ave, Van Nuys, CA 91409. Phone (818) 787-0311. TLX 4720556.

Circle No 397

## DISPLAY

- Viewable in ambient light
- Features a 20:1 contrast ratio

The EL8358HR is a 640×400-pixel IBM EGA-compatible electro-luminescent display. Well-suited to MS-DOS applications, the display is viewable in all ambient light and provides a 5×8-in., high-resolution,



**Dotronix Engineers work closely with you to design products that meet your exacting requirements.**

Monochrome Displays from 3" to 25"  
Color Displays from 10" to 19"  
Fixed- and Multi-Frequency

### Applications include:

Desktop Publishing	Bank/Brokerage Terminals
CAD/CAM/CAE and Graphics	Airline Flight Information
Medical Imaging/Diagnostics	Government/Military
Industrial Process Control	
Test and Measurement Instruments	
Closed Circuit TV Security Systems	

Includes the full product line of Video Monitors, Incorporated, a subsidiary of Dotronix, Inc.

## DOTRONIX, INC.

160 First Street S.E. New Brighton, Minnesota 55112-7894

(612) 633-1742 TWX: 9105633541  
FAX: (612) 633-7025

Facilities in Minnesota, Wisconsin and Taiwan

CIRCLE NO 125



yellow, active-matrix area. The display has a 20:1 contrast ratio. Its viewing angle specs at 160°, and its power consumption equals 5 to 10W. The display's EGA compatibility makes it suitable for industrial markets that use MS-DOS utility or graphics software packages. \$675 (OEM qty).

**Planar Systems Inc.**, 1400 NW Compton Dr, Beaverton, OR 97006. Phone (503) 690-1100.

**Circle No 398**

### FLAT CABLE

- High impedance/low capacitance and full shielding
- Complies with FCC regulations for EMI/ESD protection

In addition to providing high impedance and low capacitance, the 3751 PVC flat cable offers full shielding. It's designed for applications involving certain DEC Q Bus- and Unibus-

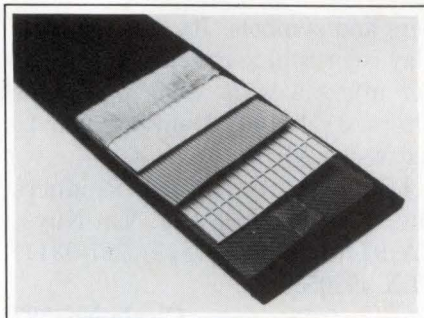

compatible peripherals. The cable also helps you comply with FCC regulations for EMI/ESD protection; it features a full 360° wrap of extended copper shield. Dielectric PVC material, located above and below the cable inside the shield, maintains precise shield-cable spacing, thus providing the high-impedance and low-capacitance values. The cable is available with 26, 40, and 50 28 AWG conductors on a 0.05-in. center pitch. The impedance measures 90Ω with connectors in ground-signal-ground configuration and 115Ω in the signal-to-

ground shield configuration. The capacitance specs at 17.4 pF/ft. \$3.20/ft (1000 ft) for 40-conductor cable.

**3M**, Box 2963, Austin, TX 78769. Phone (512) 834-1800.

**Circle No 399**

### SWITCHES

- Feature 1 million-actuation lifetime
- Meet military requirements

You can use water-clear Touch-View screens as transparent switches or control elements for direct placement over CRTs, alphanumeric readouts, or backlit displays. The conductive switch elements are made by depositing indium tin oxide onto a stabilized polyester base. You can place the switches in any location along the X-Y axis of the screen at 0.5-in. center-to-center spacings. The vendor can also configure the

## The only thing faster costs millions more.

**T**he ST-100 32-bit array processor gives your host the power of a supercomputer. So you can get 100 megaflops of computing capability from your current mainframe or superminicomputer. And get Cray 1 speed for less than \$300,000.

Not surprisingly, this kind of price-performance relationship makes the ST-100 an ideal companion for even the fastest host.

Just ask any of the engineers and scientists in industry and government using the ST-100 for high-speed time-critical applications in image processing, signal processing, medical diagnostics, modeling and simulation.

And our other products, including the compact 50 megaflops ST-50, also provide powerful and economical processing alternatives.

If you need the power of a supercomputer but don't have a super budget, call us today at (800) 782-7005. **Or call from your modem 1-800-444-8080 (300-1200 baud, 8 bit, no parity 1 stop bit) and enter the access code STAR 1 when prompted.**

And get super speed and reliability at a super price.



**STAR TECHNOLOGIES, INC.**

515 Shaw Road, Sterling, Virginia 22170





# Thanks Datron Instruments ...

*... we needed this!*

## A Multifunction Calibrator for DMM's, *In one feature-packed single unit!*

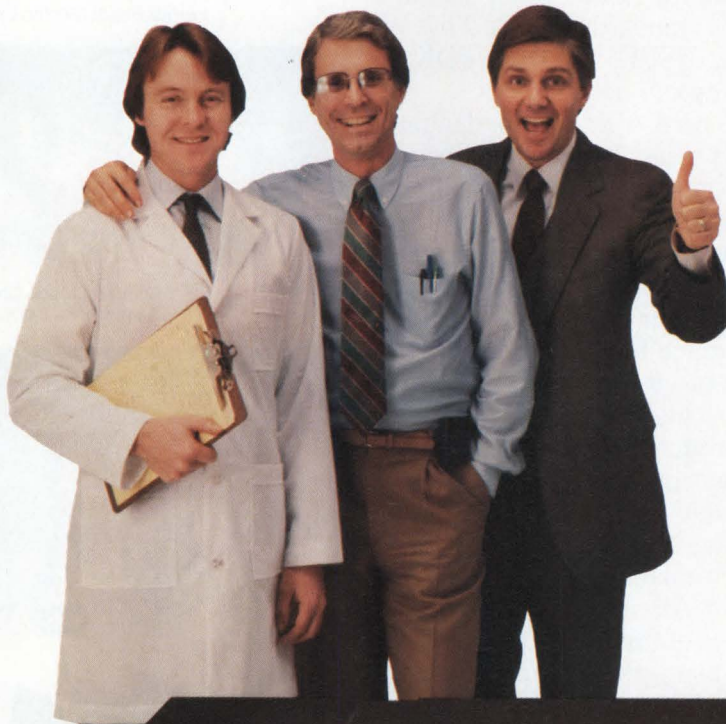

- DC VOLTAGE (10nV to 1100V) 16ppm
- AC VOLTAGE (100nV to 1100V) 220ppm
- FREQUENCY (10Hz to 1MHz) 100ppm
- RESISTANCE (10  $\Omega$  to 100 M $\Omega$ ) 20ppm
- DC CURRENT (0.1nA to 2A) 110ppm
- AC CURRENT (0.1nA to 2A) 450ppm
- RESOLUTION 6 $\frac{1}{2}$ -7 $\frac{1}{2}$  Digits
- AUTOCAL "Covers-on Calibration"
- IEEE-488 COMPATIBLE

What's More ... It's Here!

Model **4700**



**Also here!**

The 4707 Standard and  
versatile 4705 models.

**datron**  
INSTRUMENTS

A WAVETEK COMPANY

Wavetek Corporation 9191 Towne Centre Drive, Suite 450, San Diego, California 92122 (619) 450-9971

Datron Instruments Ltd. Hurricane Way, Norwich Airport, Norwich NR6 6JB England (0603) 404824 Telex 975173

CIRCLE NO 127



# How to Beat EMI/RFI Once and For All!

With high performance TDK EMI/RFI components



EMI/RFI Suppression Filters

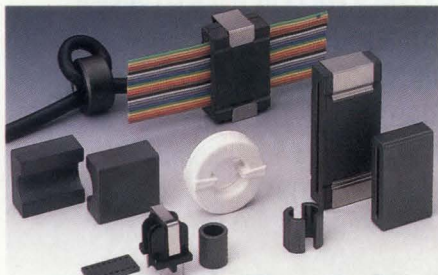

EMI/RFI Suppression Ferrites



UL Recognized (CSA, VDE, SEV, SEMKO, BS) Ceramic Capacitors

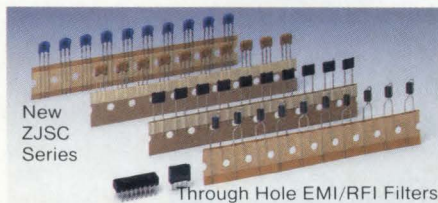

New ZJSC Series

Through Hole EMI/RFI Filters

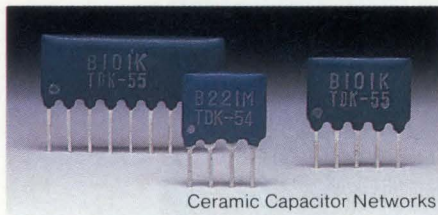

Ceramic Capacitor Networks

With recent advances in digitization and integration, electronic circuits require a higher degree of reliability than ever before. Advanced circuits and devices now have to overcome expanding EMI environments and the tighter international EMI/RFI standards enforced by the FCC, CISPR, and DIN. TDK technology can help.

Our expertise in ferrite and other materials technology has produced an outstanding line of noise-beating components, all manufactured according to integrated production processes. We offer every kind of EMI/RFI filter imaginable—from power source filters to through hole filters—to combat noise from the low to high frequency range.

Our products include ferrite cores, amorphous magnetic materials, ceramic capacitors, varistors, radio wave absorbent materials, and electromagnetic shielding materials. All carry the TDK guarantee of reliability, and are suitable for a variety of applications, including advanced computers, automobile electronics, and OA and FA equipment.

And with TDK, you get more than noise-combatant components. You also get our full support services, whether it's a matter of constructing an electromagnetic wave anechoic chamber, or devising the right measurements.

**CEL** is at your service. CEL, TDK's Component Engineering Laboratory in Torrance, CA, can assist you by custom designing and test manufacturing TDK EMI/RFI Components to meet your specific requirements. Call (213) 530-9397.

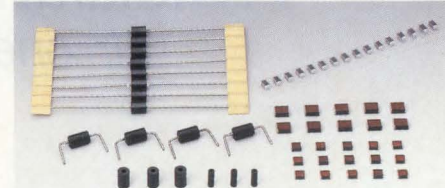

Ferrite Beads/Ferrite Chip Beads

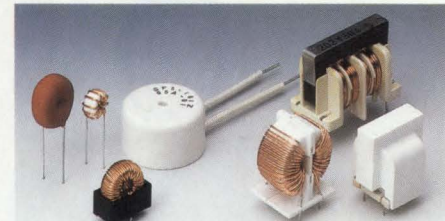

Common Mode Choke Coils / Line Choke Coils (SF Type)



Varistors



Microwave Absorbers



Radio Wave Absorbents

TDK Electromagnetic Compatibility Technology — At Your Service!



TDK CORPORATION OF AMERICA HEAD OFFICE 1600 Feehanville Drive, Mount Prospect, IL 60056, U.S.A. Phone: (312) 803-6100 CHICAGO REGIONAL OFFICE Phone: (312) 803-6100 INDIANAPOLIS REGIONAL OFFICE Phone: (317) 872-0370 NEW YORK REGIONAL OFFICE Phone: (516) 625-0100 LOS ANGELES REGIONAL OFFICE Phone: (213) 539-6631 DETROIT DISTRICT OFFICE Phone: (313) 353-9393 NEW JERSEY DISTRICT OFFICE Phone: (201) 736-0023 HUNTSVILLE DISTRICT OFFICE Phone: (205) 539-4551 GREENSBORO DISTRICT OFFICE Phone: (919) 292-0012 DALLAS DISTRICT OFFICE Phone: (214) 506-9800 SAN FRANCISCO DISTRICT OFFICE Phone: (408) 437-9585 TDK CORPORATION, TOKYO, JAPAN.



switches into a linear control element with almost infinite resolution. Applying pressure to different positions of the linear screens produces different resistance values. You can order Touch-View screens with combinations of fixed-position switches and linear-control devices. The vendor has tested the screens over 1 million actuations and can supply screens that meet various military specifications for ground or airborne applications. \$55 to \$500. Delivery, 10 to 12 weeks ARO.

**CAM Graphics Co Inc**, 15 Ranick Dr West, Amityville, NY 11701. Phone (516) 842-3400.

Circle No 400

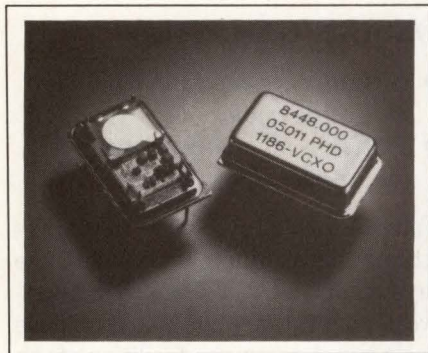

### CRYSTAL OSCILLATORS

- Crystal controlled for high stability
- Voltage controlled frequency variation of  $\pm 160$  ppm

Suitable for use in the PCM signal-recovery PLLs of telephone exchange or LAN equipment, the 9922 Series voltage-controlled quartz-crystal oscillators feature a pullability of  $\pm 160$  ppm, and a stability of more than  $\pm 20$  ppm over their entire operating temperature range. The long-term frequency drift is typically less than one part in  $10^5$  over a period of 10 years. Standard versions are available with center frequencies of 8.192, 8.448, 11.456, and 14.912 MHz. The company can also provide custom versions for your own frequency requirements. The oscillator's linear-frequency variation over a finite control-voltage range also makes

the oscillators suitable for other applications—for example, color-level locking in video/broadcast cameras. Although they operate from a single 5V supply, the oscillators accept bipolar control voltages. Their output is LSTTL-compatible and they consume approximately 30 mW of power. They are housed in 4.9-mm-high, hermetically sealed packages

that have leadouts on the same lead spacing as a 14-pin DIP. They operate over a  $-5$  to  $+60^\circ\text{C}$  temperature range. Approximately Gld 80 in small quantities.

**Philips**, Components Div, Box 523, 5600 AM Eindhoven, The Netherlands. Phone (040) 757189. TLX 51573.

Circle No 401

# TUSONIX

If you're looking for a reliable source  
for EMI Filters and Custom Filter Assemblies . . .

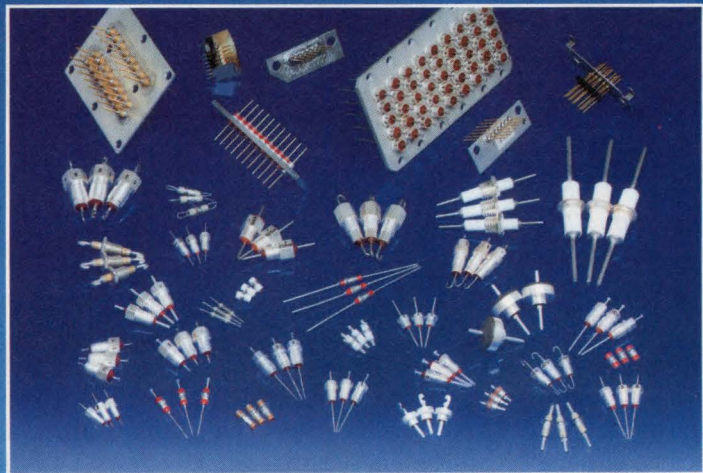

**Tusonix, as a QPL source,  
is proud of its JIT performance**

Miniature EMI/RFI ceramic filters and filter capacitors attenuate most frequency ranges in a wide variety of QPL approved styles. Most are available from stock in production quantities, ready for immediate shipment.

When it comes to custom packaging EMI/RFI feed-thru filters and/or filter capacitors, Tusonix offers a complete in-house custom assembly capability. Every assembly is 100% tested in Tusonix' quality assurance laboratories. The result is a reliable, economic assembly that satisfies your unique needs.

So let Tusonix supply your filter requirements in discrete filters and assemblies. Write for literature TODAY . . . or please call us at:

Phone: 602-744-0400

## TUSONIX

P.O. Box 37144, Tucson, AZ 85740-7144  
Phone: 602-744-0400 Telex: (RCA) 299-640  
FAX: 602-744-6155



# NEW PRODUCTS

## CAE & SOFTWARE DEVELOPMENT TOOLS

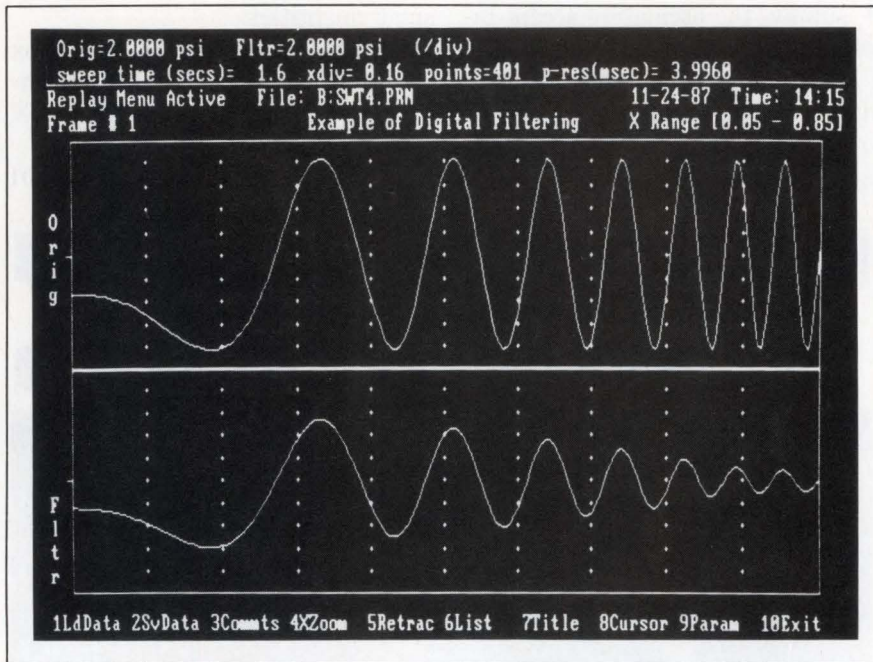

### DIGITAL FILTERING

- Provides digital filtering on an IBM PC or compatibles
- Works with acquisition and analysis software

Snap-Filter provides four types of filter: lowpass, highpass, bandpass, and band-reject. You can specify all four types as either FIR (finite impulse response) filters, which preserve the time relationship of different signal components; or as IIR (infinite impulse response) filters, which emulate analog filters such as Butterworth and Chebyshev. Simple, 1-letter commands specify the

type of filter you want, and you add parameters to specify FIR or IIR and the cutoff frequency (or frequencies). The package works in conjunction with the vendor's Snapshot Storage Scope data-acquisition software and Snap-Calc monitoring and analysis program. All three programs run on the IBM PC and compatibles and work with a wide variety of D/A and A/D converter boards. Combined software package, \$1185; Snap-Filter only, \$395.

**HEM Data Corp**, 17025 Crescent Dr, Southfield, MI 48076. Phone (313) 559-5607.

Circle No 405

### CAE FOR GATE ARRAYS

- Low-cost schematic capture for programmable gate arrays
- Component library includes more than 3700 parts

The LCA-MDS151 is a low-cost schematic-capture package that runs on the IBM PC/AT, PS/2, and compatibles. It features an enhanced version of the SDT-III schematic editor from OrCAD (Hills-

boro, OR), and Xact, the vendor's design editor for programmable gate arrays. The library consists of OrCAD's library of 3700 parts in addition to the vendor's own programmable-gate-array macro library of TTL and standard logic-family equivalents. You enter your schematics with the aid of the editor, using the library of gates and macros; a software translator converts the schematics into specifica-

tions for working programmable gate arrays. Pop-up menus and English-like commands make the system easier to use. The system provides five levels of zoom and automatic pan, 16 user-configurable colors, and more than 100 keyboard macros. LCA-MDS151, \$4950; LCA-MDS152, schematic-capture editor without Xact, \$1850.

**Advanced Micro Devices Inc**, Box 3453, Sunnyvale, CA 94088. Phone (408) 732-2400.

Circle No 406

### DESIGN UTILITIES

- Include rule-checking and format conversion
- Statistics on component usage and copper area

Tango-Tools is a set of utility programs that can help you during the layout, design verification, and artwork generation of pc boards. These tools supplement the facilities of the vendor's schematic capture, pc-board layout, and autorouter programs. A design-rule checker checks your pc-board file for violations of your electrical and clearance rules; a net-list editor helps you create and edit net lists. A Tango-to-DXF converter converts Tango pc-board files to industry-standard DXF (data-exchange format) files. You can then use the DXF files with a wide variety of CAD programs from other vendors. A pc-board file scanner displays the number of power- and ground-plane connections, the number of components, and the area of copper per layer. A menu-driven, layer-swap utility lets you swap layers within a pc board or remove entire layers. The tools run on an IBM PC, PC/XT, PC/AT, PS/2, or compatible computer that has at least 256k bytes of RAM; two disk drives; and monochrome, Hercules, or IBM CGA or EGA, (or com-



# SIMPLY THE BEST DEFENSIVE LINE IN THE GAME.

When it comes to depth, diversity, and a proven winning record, no other line of circuit breakers can compare with ours. The Airpax team is your source for fast response and reliable performance in your choice of more styles, configurations and ratings to meet your specific needs.

We've been tackling the toughest applications for more than thirty years. Chalking up milestone victories such as twenty years of uninterrupted MIL-C-39019 approval in Type AP electromagnetic circuit breakers. Blitzing international markets

with the VDE-approved and rail-mount magnetic circuit breakers. Continually striving through innovation to keep you, the Airpax customer, at the forefront of circuit breaker technology.

Draft the best defensive players into your design. Contact Airpax Corporation, Cambridge Division, Woods Road, Cambridge, MD 21613. (301) 228-4600. Telex: 6849138, Fax: (301) 228-8910. A North American Philips Company.

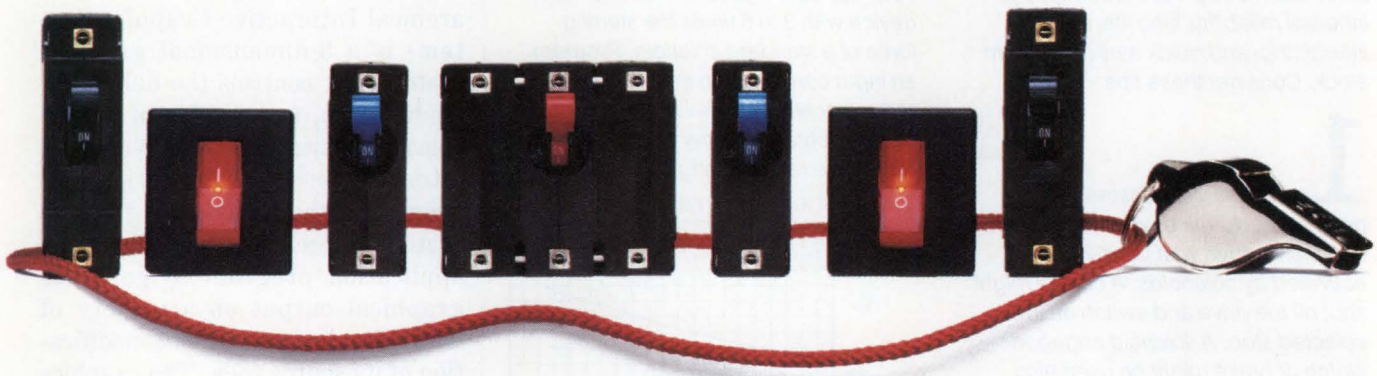

# AIRPAX®

CAMBRIDGE DIVISION



# Repeat positioning design tips



Ledex solenoids simplify positioning.

Solenoids can help you position repeatably and accurately. The advantages in automatic control and automation equipment are simplicity, inherent reliability, long life, ease of interfacing, and quick availability from stock. Consider these tips:

**1 Positive stops.** Instead of a position feedback drive, consider a less expensive drive with positive stops activated by solenoids. A control might shut off the drive and switch on the selected stop. A solenoid engaged clutch or brake might be used also.

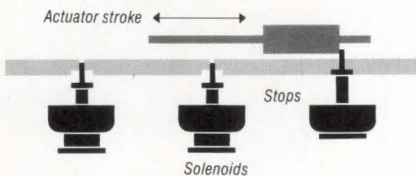

Push or pull solenoids can be selected for repeatable positioning.

**2 Safe-arm mechanisms.** Safe positioning sometimes requires sure but simple lockout of potentially dangerous positions until desired. Ledex solenoids and switches used in radiation hardened safe-arm and arm-fire devices make weapons safe to handle, store, and carry until the appropriate time. We'll design one for you, or share some hints if you're safe-arming.



Solenoid device in the safe-arm positively positions missile on safe or arm status.

**3 Fail-safe.** A solenoid with a return spring makes an ideal fail-safe device. In the event of power failure, the spring mechanically returns the plunger. Useful in fire doors, for example.

**4 Microprocessor solenoid positioning.** If you're already using a microprocessor, a Soft Shift™ solenoid will give you accurate positioning at low cost. You obtain smooth actuation in a device with 3 to 5 times the starting force of a standard solenoid. Program an input current ramp to vary speed, reduce or eliminate noise. Five stock models, charted below at continuous duty, have return spring.

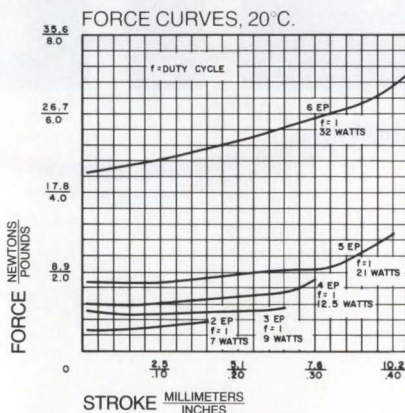

## Want to know more?

Request catalogs.

Ledex Inc.  
A Subsidiary of Lucas Industries  
P.O. Box 427  
Vandalia, Ohio 45377-0427 U.S.A.  
Phone: 513-898-3621



patible) graphics boards. Until May 1, 1988, \$195; thereafter, \$295.

Accel Technologies Inc, 7358 Trade St, San Diego, CA 92121. Phone (619) 695-2000.

Circle No 407

## PHIGS FOR VAX/VMS

- Provides device-independent graphics
- Allows hidden-surface removal, shading, and depth-cuing

VAX PHIGS (Programmer's Hierarchical Interactive Graphics System) is a 3-dimensional graphics system that controls the definition, modification, and display of hierarchical graphics data. It provides the interface between application programs and the underlying graphics system in a manner that allows the application program to generate graphical output on a variety of hardware devices without modification of its source code. The graphics system is based on the ANSI draft PHIGS standard, dpANS X3.144-198X, but it contains extensions that permit hidden-surface removal, shading, and depth cuing. It provides Fortran and C bindings, as well as a language-independent binding. \$3500.

Digital Equipment Corp, Maynard, MA 01754. Phone local office.

Circle No 408

## MONTE CARLO ANALYSIS

- Provides results in terms of probabilities
- Lets you set accuracy limits for each variable

Monte Carlo Plus runs on the IBM PC and compatible computers and performs risk and sensitivity analyses of data contained in a Lotus 1-2-3 spreadsheet. The program prompts you to supply high- and low-accuracy limits for key variables, and then estimates the statistical probability that a particular result computed by the spreadsheet will exceed or fall short of the pre-



dicted value. You can also use the program to determine the effect of independent variables on a dependent result; the program identifies the variables that have the least and the greatest effect on the result. The program provides both risk and sensitivity results in the form of tables and graphs. \$89.

**Suntex National Corp**, Box 772868, Houston, TX 77215. Phone (713) 783-9059.

Circle No 410

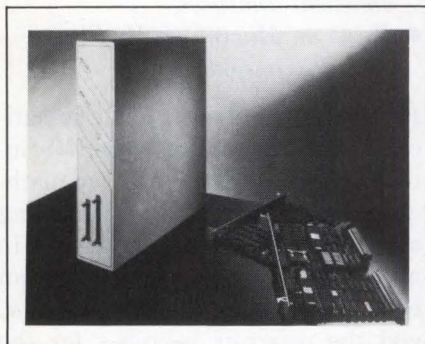

## IN-CIRCUIT EMULATOR

- Supports a range of popular 8-bit  $\mu$ Ps
- Includes paged-memory-system emulation

The Mime-600 in-circuit emulator supports numerous 8-bit  $\mu$ Ps, including the 6801, 6803, 6805, 6809, 68HC05, 68HC11, 6301, 6309, 64180, Z80, Z180, 8085, and NSC800  $\mu$ Ps. You can configure the trace memory to capture as many as 8000 48-bit words or 4000 96-bit words, and you can set as many as 256 hardware breakpoints. The emulator can address as much as 16M bytes of memory, and it supports paged-memory systems by emulating page breaks and by performing page housekeeping functions. When debugging a target system, you can monitor target processor registers and various other system parameters during program execution. The emulator operates with any host computer or PC. You can obtain terminal-emulation and program-development software that runs on a PC for use with the emulator.

From \$10,000.

**Pentica Systems Ltd**, Oakland Park, Wokingham, Berkshire RG11 2FE, UK. Phone (0734) 792101. TLX 848210.

Circle No 411

**Pentica Systems Inc**, 1 Kendall Square, Suite 2200, Cambridge, MA 02139. Phone (617) 494-1253.

Circle No 412

## FILTER DESIGNER

- Lets you design FIR and IIR digital filters
- Uses 64-bit floating-point arithmetic in calculations

Filter Design and Analysis System (FDAS) version 1.2 lets you design lowpass and highpass IIR (infinite impulse response) filters with as

# Programmable Anti-Alias Filters for Critical A/D Prefiltering

**848P8E Series are Elliptic lowpass filters providing extremely sharp roll-off for A/D prefiltering.**

### Features:

- 8 pole, 6 zero elliptic lowpass filters
- Digitally programmable corner frequency
- Shape factor of 1.77 at 80db
- 8 bit (256:1) tuning ratio
- Internally latched control lines to store frequency selection data
- Ideal for single or multi-channel applications
- Plug in, ready to use, fully finished filter modules
- Five frequency ranges to 51.2kHz

### Other Filter Products Available:

- Linear phase • Programmable
- Fixed frequency • Instrumentation
- Custom designs

For more information about how Frequency Devices can meet your most critical filtering requirements, call our applications engineers at **(617) 374-0761**.

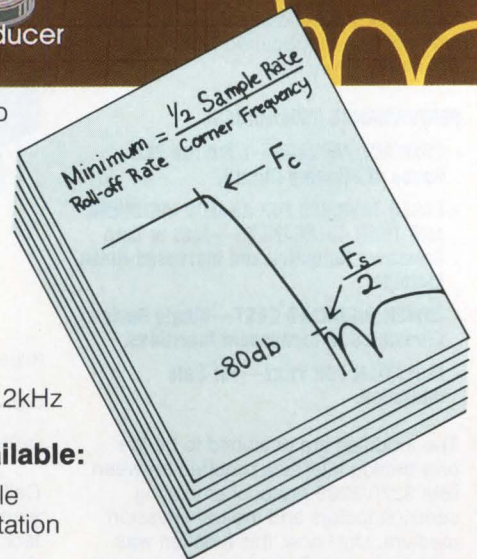
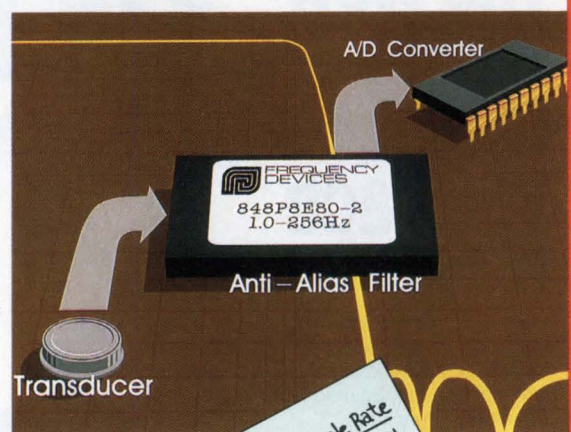

**FREQUENCY DEVICES**

25 Locust Street  
Haverhill, MA 01830  
(617) 374-0761



many as 40 poles, bandpass and bandstop IIR filters with as many as 80 poles, FIR (finite impulse response) windows with as many as 1024 poles, and Parks-McClellan FIR filters with as many as 256 poles. The transformation methods comprise bilinear and impulse-invariant transformations. The program uses 64-bit floating-point

arithmetic for all calculations; you can vary the coefficient quantization from 8 to 32 bits to suit the word lengths of various digital-signal-processor ICs. Menu-driven screens and extensive error checking make the program easy to use. To run the program, you need an IBM PC/XT, PC/AT, PS/2, or a compatible machine having at least 640k bytes of

RAM and 800k bytes of available hard-disk storage. The vendor recommends that you use MS-DOS version 3.1, but the program will run under version 2.0 or later. \$495.

**Momentum Data Systems Inc.**, 1666 Newport Blvd, Suite 115, Costa Mesa, CA 92627. Phone (714) 548-3257.

Circle No 413

**ANOTHER FIRST FROM PULSE**

**The New 3270 Line Interface For "Type A" Coax**

Pulse's module design reduces to a single component all transmission and receive signal conditioning, line coupling circuitry and the required isolation transformer functions.

**PERFORMANCE ADVANTAGES:**

- **COMPACT PACKAGE**—1/3rd the PCB Space of Discrete Circuit.
- **LASER TRIMMED FOR ANALOG MATCHING AND TIGHT TOLERANCES**—Aids in Zero Crossover Detection and Increased Noise Margins.
- **LOWER INSTALLED COST**—Single Device Eliminates 12 Component Insertions.
- **ISOLATION 700 Vrms**—For Safe Operation.

The modules are designed to be the only analog interface required between IBM 3270/3299 protocol emulating semiconductors and the transmission medium. Until now, this function was achieved using Pulse transformers and various additional components.

Our experience with millions of 3270 isolation transformers is combined with many years of thick film technology to provide a new generation of Specific Application Modules—SAM™



**Comparison Table**

	Manufacturer P/N	Pulse P/N
National Semiconductor	BCP8344V	PE-857623
Chips and Technologies	82C570	PE-857621
Standard Microsystems	COM 9004/9064	PE-857621

Call our applications engineers or your nearest sales office for samples, technical support, data sheets or design/applications assistance.



P.O. Box 12235 San Diego CA 92112  
(619) 268-2400

**MATH TOOL**

- Lets you perform complex mathematical analyses
- Runs on Macintosh II, Plus, and SE computers

Eureka: The Solver is a mathematical tool that lets you use your Macintosh to solve a wide variety of mathematical problems, including simultaneous linear equations in multiple variables. You enter an equation in the text-editor window, and the program searches for the variables and finds a solution. You can then verify the solution, plot it, or send a report to the printer or to a disk file. The program can use the Macintosh II's 60881 math coprocessor and color capabilities. \$195.

**Borland International Inc.**, 4585 Scotts Valley Dr, Scotts Valley, CA 95066. Phone (408) 438-8400. TLX 172373.

Circle No 414

**MATH LIBRARY**

- Mathematical and statistical Fortran routines
- Available in object form or transportable source code

The Scientific Desk Library is a set of mathematical and statistical callable subroutines written in Fortran. They are available either in source-code or in an object-code format compiled for any one of a wide variety of computers, including IBM System/370; DEC VAX; IBM PC, PC/XT, PC/AT, PS/2, and RT PC families; Sun workstations; and Apple Macintosh. The routines in-



# WHY STD BUS ?

- V40 PROCESSOR  
RUNS AT 7.4 MHz
- 8088 CODE COMPATIBLE
- ALL CMOS
- 64K BATTERY-BACKED  
RAM
- 128K EPROM
- TWO RS-232/RS-485  
LINES
- THREE 8-BIT PARALLEL  
PORTS
- BATTERY-BACKED  
CLOCK-CALENDAR
- SBX CONNECTOR
- 8-BIT, 8-CHANNEL  
A/D CONVERTER
- DEBUG FIRMWARE  
LINKS TO PC

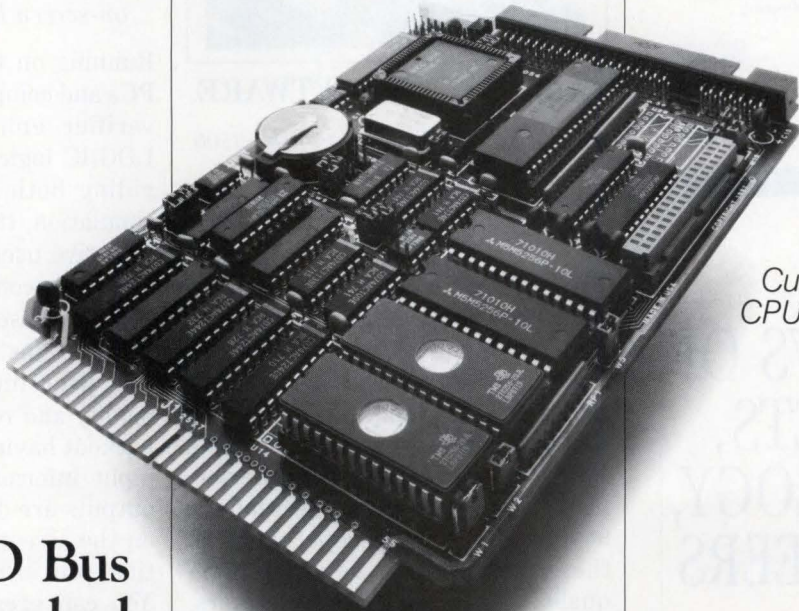

*Cubit's Model 8400  
CPU Board - \$490*

STD Bus  
is packed  
with power,  
simple to use  
and costs less  
than VME  
or Multibus<sup>®</sup>.

Please call or write for our  
full catalog.

**CuBIT** DIVISION  
OF  
PROTEUS  
INDUSTRIES

190 South Whisman Road  
Mountain View, CA 94041-1577  
Telephone: (415) 962-8237

Multibus<sup>®</sup> is a registered trademark of Intel Corp.



# EDN NEWS



## HOT NEWS OF PRODUCTS, TECHNOLOGY, AND CAREERS

**EDN NEWS**

## CAE & SOFTWARE DEVELOPMENT TOOLS

clude arithmetic; elementary and special functions of mathematical physics; linear algebra; optimization; nonlinear equations; differential equations; integral transforms; statistics and probability; and error analysis. The annual license fee of \$1500 includes maintenance, consultation, and the automatic forwarding of augmented versions.

**C Abaci Inc**, 208 St Mary's St, Raleigh, NC 27605. Phone (919) 832-4847.

Circle No 415



### CALIBRATION SOFTWARE

- Checks specifications of the 9400 digital oscilloscope
- Reference parameters traceable to NBS standards

The CS01 calibration software package runs on an IBM PC or a compatible computer equipped with a math coprocessor and an IEEE-488 interface from National Instruments. The program performs an extensive series of tests that verify the performance specifications of the vendor's 9400 digital oscilloscope; some of these tests require the use of high-quality external signal generators. The software allows you to test individual specifications with computer assistance or to perform an automated calibration check. If you use signal sources traceable to a standard, the calibration will be traceable to the same standard. The package includes a computer-aided adjustment procedure that guides a trained technician through the steps that are needed to correct the settings of the 9400 so that the performance of the instrument meets all

the specifications. \$1200. Delivery, eight weeks ARO.

**LeCroy Corp**, 700 Chestnut Ridge Rd, Chestnut Ridge, NY 10977. Phone (914) 578-6084. TWX 710-577-2832.

Circle No 416

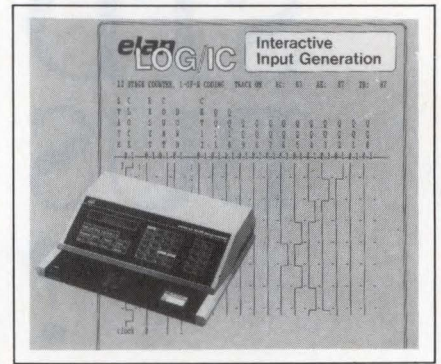

### LOGIC SIMULATOR

- High-level-language constructs
- Displays simulation results as on-screen logic waveforms

Running on the DEC VAX or IBM PCs and compatibles, this functional verifier enhances the company's LOG/IC logic design compiler. Providing both logic verification and simulation, the package features interactive user input and high-level-language constructs—for example, If-Then-Else, Do-While, and For-End-For instructions. The interactive user interface allows you to modify and resimulate logic circuits without having to create new binary input information. The inputs and outputs are displayed as waveforms on the screen in a format similar to that provided by a logic analyzer. You can breakpoint inputs or outputs and trace as many as 1024 simulated states. £730 for IBM PCs and compatibles; £2200 for the DEC VAX.

**Elan Digital Systems Ltd**, 16-20 Kelvin Way, Crawley, West Sussex RH10 2TS, UK. Phone (0293) 510448. TLX 877314.

Circle No 417

**Elan Digital Systems**, 2162B N Main St, Walnut Creek, CA 94596. Phone (415) 932-0882.

Circle No 418



# When quality counts, count on Allen-Bradley

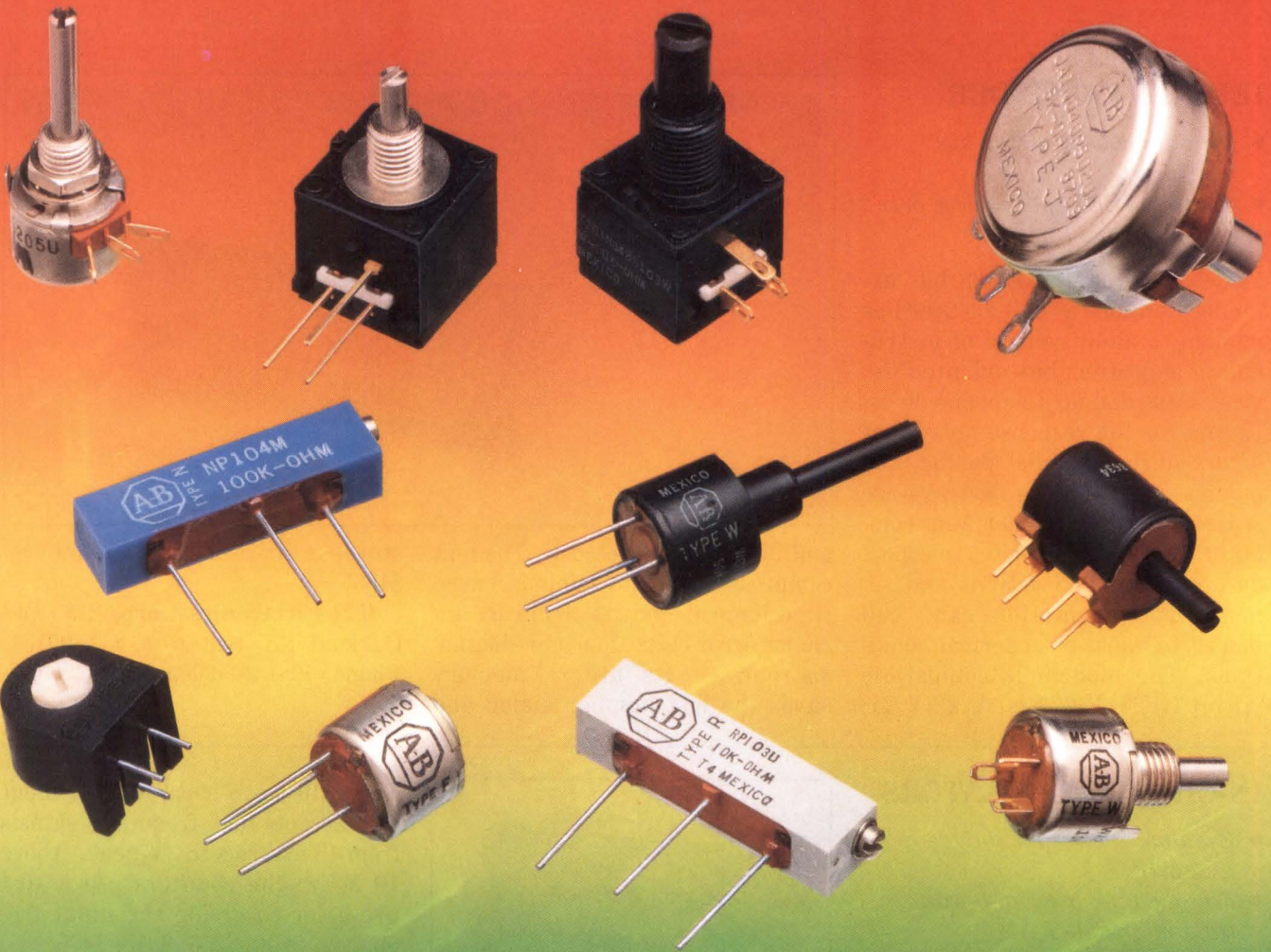

## We cover the spectrum in custom and standard panel and trimming pots

Allen-Bradley has been making rugged Variable Resistors since the 1930's. Our quality was good then. It's *excellent* now. While we have one of the broadest lines of standard panel and trimming potentiometers in the industry... Allen-Bradley's strength is in our ability to *customize* pots to suit your particular applications with special tapers, shafts and much more. We can accommodate your needs with a reliable unit at a reasonable cost.

Our hot-molded, heavy-duty Type J Panel pot continues to be the standard in the industry for tough applications and high power capabilities. Single, dual and triple sections are available in a wide resistance range (to 5 Megohm). It's simply the best in the business.

Our Type W compact hot-molded pots are available in a metal or all plastic housing. We customize these reliable pots to suit you and your application needs. W pots provide high performance panel control with lug or PC terminals and a wide resistance range (to 5 Megohm).

Allen-Bradley covers the spectrum... in variety, styles and products with only one standard of quality... *superior*.

For more information, call:

**1-800-592-4888** or **1-800-292-4888** (in Texas)

Or write for Publication ROPP

**Allen-Bradley**

**1414 Allen-Bradley Dr.**

**El Paso, TX 79936-6414**



**ALLEN-BRADLEY**  
A ROCKWELL INTERNATIONAL COMPANY



# NEW PRODUCTS

## TEST & MEASUREMENT INSTRUMENTS

### IEEE-488 EXTENDER

- Includes 300/1200/2400 bps modem
- Controls IEEE-488 devices over dial-up phone lines

Model 4888, an IEEE-488 bus extender, contains a 300/1200/2400-bps modem to allow control of instruments and other bus-oriented devices over dial-up telephone lines. Except for the response delay that occurs during parallel polling, the bus operates as if the devices were adjacent to the controller; your computer can call remote sites to collect data or command actions and remote instrumentation can "call home" to warn of abnormal conditions. The modem is compatible with CCITT V.22 bis, V.22/V.21,



and Bell 212/103 protocols. The unit compresses data to minimize message length, and its firmware includes error-correction and -diagnosis routines. Its integral memory saves the last number dialed and

stores a directory of 32 numbers. \$1895.

**ICS Electronics Corp**, 2185 Old Oakland Rd, San Jose, CA 95131. Phone (408) 432-9009. TLX 286895.

Circle No 420

### IN-CIRCUIT EMULATORS

- Emulate 80286 and 80C186 at 12.5 MHz
- Feature 128k bytes of 0-wait-state mappable RAM

The Ice-286 and -186 in-circuit emulators support the vendor's 80286 and 80C186 (a CHMOS version of the 80186)  $\mu$ Ps at clock rates as high as 12.5 MHz with zero wait states. The emulators are hosted by an IBM PC/AT or compatible computer; their trace buffers can capture 2048 data frames, including both execution and data-bus activity. The zero-wait-state emulation memory for each unit totals 128k bytes. You can map the I/O addresses anywhere within the emulation memory, in 4k-byte increments. The vendor furnishes a symbolic debugger with the units; you can debug code developed in PL/M, Pascal, Fortran, and C. Ice-186, \$9995; Ice-286, \$12,495.

**Intel Corp**, Box 58065, Santa Clara, CA 95052. Phone (408) 987-8080.

Circle No 421



### FREQUENCY COUNTERS

- Cover 10 Hz to 100 MHz and 10 Hz to 1 GHz
- Provide 8-digit LED display

Sporting reference ovens that hold timebase temperature coefficients to  $\pm 10^{-6}$  from 0 to 40°C and offering timebase aging of  $\pm 3 \times 10^{-7}$ /month, the 9800 and 9810 frequency counters cover 10 Hz to 100 MHz and 10 Hz to 1 GHz, respectively. Eight 7-segment LED digits display the readings. All inputs to the counters occur via front-panel connectors. A 1-M $\Omega$  input provides sensitivity of 25 mV rms at 5 MHz and below, and of 50 mV rms from 5 to 100 MHz.

The 9810 has a separate 50 $\Omega$  input that accepts high-frequency signals from 15 mV rms to 3V peak. Above 10 MHz, the counters use a 10:1 prescaler to divide the input frequency. 9800, \$255; 9810, \$475.

**Mercer Electronics**, 859 Dundee Ave, Elgin, IL 60120. Phone (312) 697-2260. TLX 722416.

Circle No 422

### SURGE TESTER

- Supplies high-energy surges and makes surge measurements
- Includes 80386-based computer

The System 2/XX is a family of high-speed, high-power surge testers for testing semiconductor surge protectors and protector arrays (for example, protected connectors). The vendor can also configure the products for testing power semiconductor devices such as rectifiers, transistors, power FETs, and SCRs. The systems can generate high-power surges, such as 8 $\times$ 20  $\mu$ sec impulses at 500A peak or



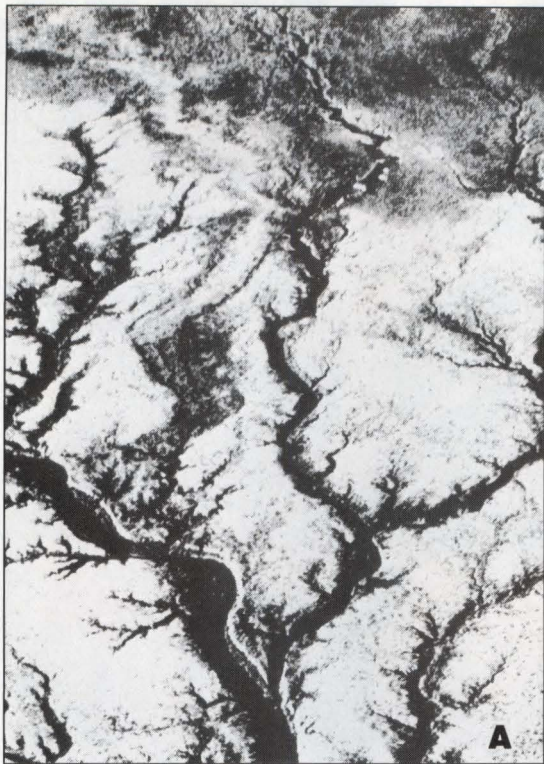

## Delta or Aorta? Which is Which?

No problem here because both of these images were processed on Raytheon's new TDU-850 Thermal Display Unit.

The TDU-850 is the only thermal recorder to display true grey levels (not mere halftone representations) at such high speeds and resolutions. Utilizing 203 dots per inch, the unit offers 64 grey levels and can provide 256 grey levels through the use of super pixels. The TDU-850 is your assurance of high quality images. Standard units about \$5,000. (Slightly higher overseas). RS-170 video and IEEE-488 computer interfaces are available.



When you must know what you're looking at, look for equipment that knows what to look for. For details call or write **Marketing Manager, Recorder Products, Raytheon Company, Submarine Signal Division, 1847 West Main Road, Portsmouth, RI 02871-1087. Phone: (401) 847-8000.**

---

# Raytheon

**A.** Satellite view of river delta. **B.** Arterial angiogram.

Note: These began as continuous tone images which were processed in black and grey by a TDU-850. The TDU-850 images, however, had to be converted to conventional halftones in order to be shown in this magazine. Thus the high quality of the original TDU-850 images have been obscured. For true results ask to see a demonstration.



# MOVING AIR IS EASY

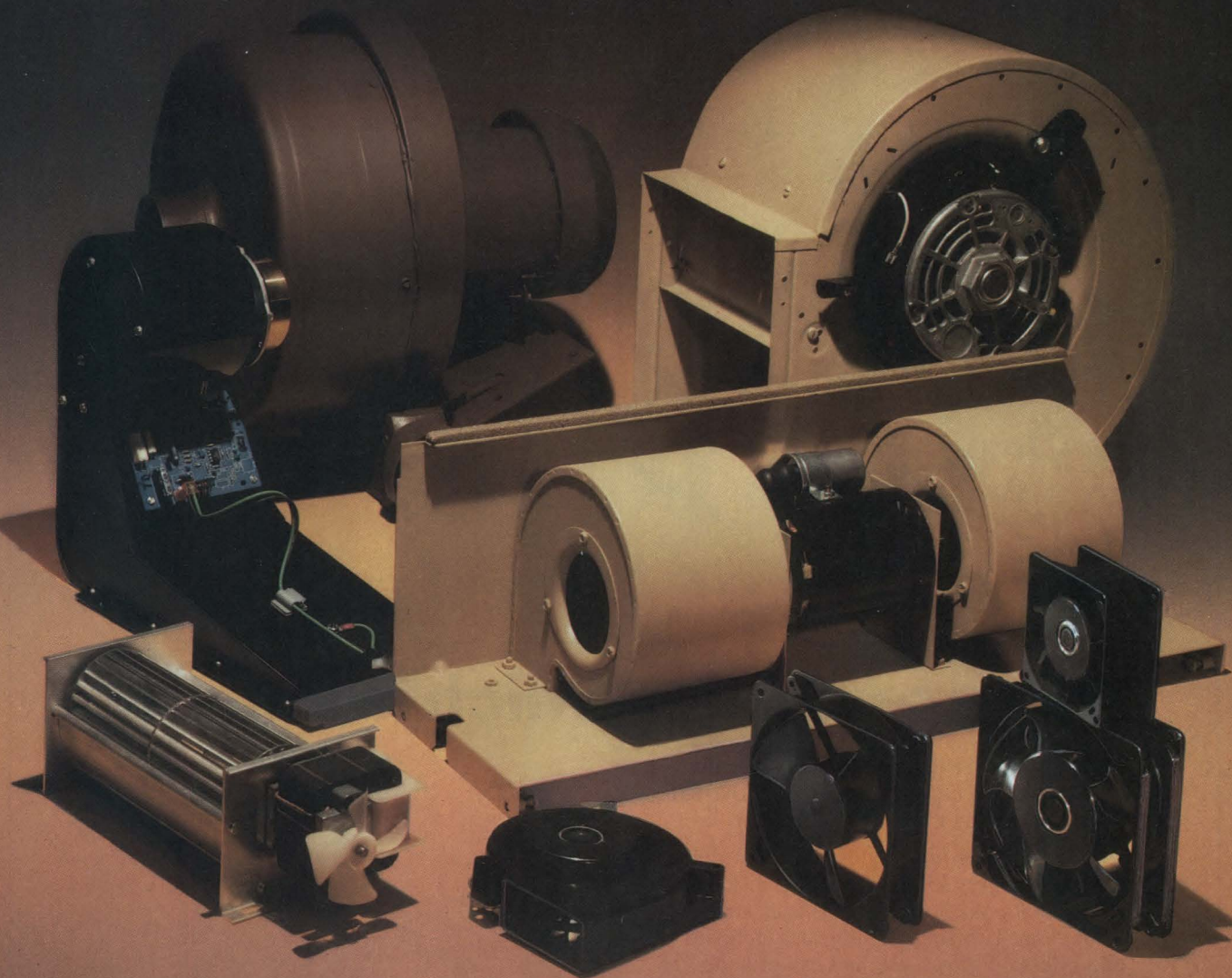

## CONTROLLING IT TAKES AN EXPERT

With the TORIN line of blowers, FASCO specializes in creating solutions to air-moving problems. Over 50 years of experience has established our reputation for leadership in custom blower design. Applications include cooling for electronic, business machine, aerospace and military products.

Our design expertise covers single, dual and multi-stage centrifugal blowers, transverse-flow blowers, mixed-flow blowers, cabinet blowers, tube and vane-axial fans. We provide country-wide factory sales coverage, in-house availability of electric motors and cost-effective production capabilities.

Call on us when your air-moving requirements exceed the ordinary. Our product line is limited only by your imagination.



**FASCO INDUSTRIES, INC.**  
MOTOR DIVISION HEADQUARTERS  
500 Chesterfield Center  
Suite 200  
St. Louis, MO 63017  
(314) 532-3505/Telex: 44-7455  
Telecopy: (314) 532-9306







# Who manages the power in GAI's MATE 390 Hybrid Automatic Test Systems?

## KEPCO POWER MANAGERS™

For many years, Giordano Associates, Inc. has manufactured commercial factory functional test equipment in support of major military and commercial test equipment. Their new line of Air Force MATE compatible equipment, designated the MATE 390 Test System, was created as part of their continuing effort to be completely responsive to the needs and requirements of ATLAS 716 based systems. It integrates commercially available programmable test instruments into a modular functioning test system that will deter obsolescence.

From the beginning, Kepco Power Managers programmed by Kepco Digital Interfaces have supplied the controlled power in GAI systems. And, says GAI's Automation Division president, Al Esser, "Kepco's proven track record in the Air Force's MATE System arena, and its past record in GAI Test Systems, make Kepco programmable power supplies the natural choice for use in GAI's new line."

In the MATE 390 System shown here, four Kepco Series ATE Power Managers are controlled by a Kepco MATE Verified\* TLD 488-16 Interactive Programmer.

The Kepco Power Managers are linear power supplies that have been designed specifically for programming applications. They stabilize voltage to 0.001% and current to 0.005%, respond to programming step inputs in microseconds, and will deliver maximum rated voltage *and* current simultaneously.

The Kepco TLD 488-16 commands, *and reacts to responses from*, up to 16 Kepco Power Managers at once through a single GPIB address. It communicates with GAI's computer in the Control Interface Intermediate Language (CIIL), over their IEEE-488 bus. The responses it receives from the power supplies under its control tell it whether they have obeyed its commands, and if not, why not. When combined with Kepco Power Managers, the TLD 488-16 gives GAI the most precise, the most flexible control of power available today.

Can we manage the power in your systems?

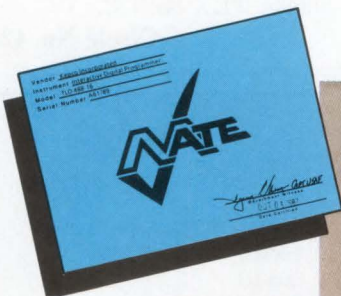

\*On October 1, 1987 Kepco's TLD officially achieved "MATE-verified" status. The certificate shown was issued by the MATE program office, Kelly AFB, Texas.

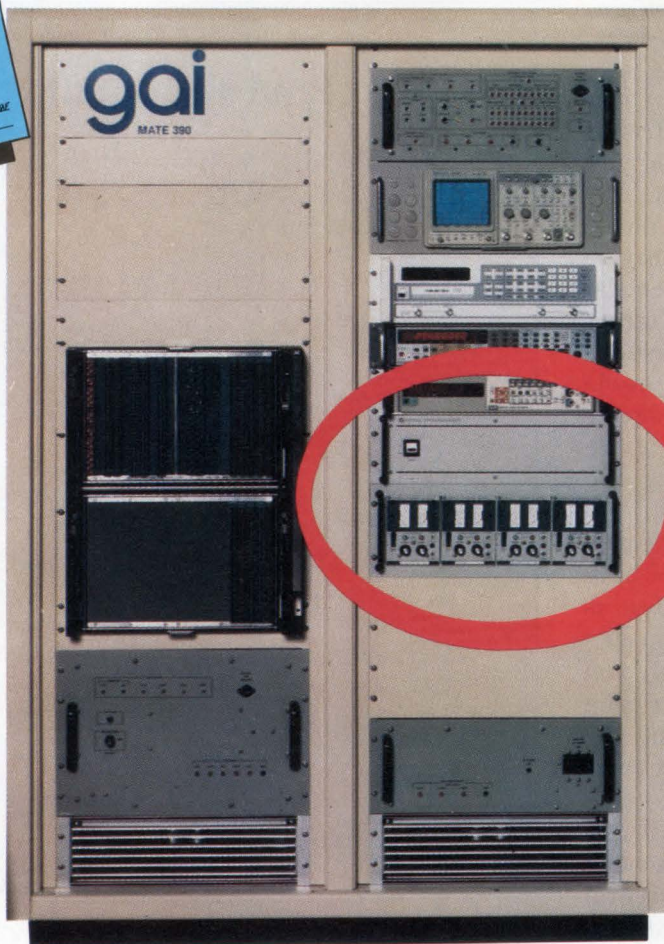

Call or write:  
Dept. KSF-12,  
KEPCO, INC.,  
131-38 Sanford Avenue,  
Flushing, NY 11352 USA  
(718) 461-7000  
TWX #710-582-2631  
FAX (718) 767-1102.





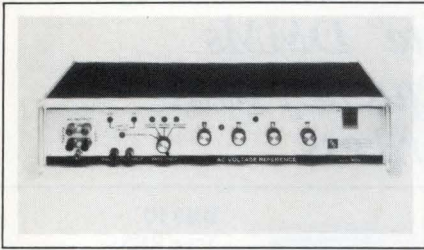

**AC CALIBRATOR**

- Covers 50 to 400 Hz
- Output rms voltage is within 0.06% of setting

The 4032 calibrator provides an ac voltage of as much as 10V rms that is accurate to within 0.06% of setting; its harmonic distortion doesn't exceed 0.03%. The unit's output frequency ranges from 50 to 400 Hz. The instrument generates 50, 60, and 400 Hz internally and provides terminals to which you can connect an oscillator that produces other frequencies. The rack-mount unit is 3.5 in. high and weighs 8 lbs. \$945.

**Electronic Development Corp.**, 11 Hamlin St, Boston, MA 02127. Phone (617) 268-9696.

Circle No 426

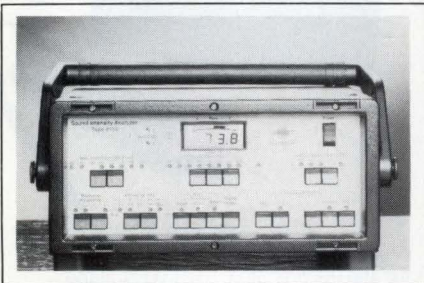

**SOUND METER**

- Performs in situ measurements even in high ambient noise
- Discriminates between different sound sources

The Model 4433 sound-intensity analyzer's 2-microphone pressure-gradient technique lets you take measurements in situ that you would normally have to take in an anechoic room. The technique allows the instrument to locate and discriminate between different sound sources to provide you with a complete acoustic picture, even in environments

with high ambient-noise levels. The instrument has sound-intensity, particle-velocity, and sound-pressure measurement modes. It also performs automatic sequential-octave analysis, A-weighted and linear analysis, and linear or exponential averaging. The instrument features autoranging and provides an indication of noise impulses that exceed the selected range. It is battery powered. You can obtain software that permits you to postprocess measurements on a Hewlett-Packard personal computer or on an IBM PC or compatible computer. With a Model 3520 sound probe, \$11,950.

**Bruel & Kjaer**, Hovedgade, 2850 Naerum, Denmark. Phone (2) 800500. TLX 37316.

Circle No 427

**Bruel & Kjaer Instruments Inc.**, 185 Forest St, Marlborough, MA 01752. Phone (617) 481-7000. TWX 710-347-1187.

Circle No 428

**EPROM EMULATOR**

- Emulates 2716 through 27256
- Features battery-backed RAM

The ROMX-2 emulates EPROMs in the 2716 through 27256 series. It contains 64k bytes of battery-backed RAM; you can also order it with 256k bytes as an option. Unlike EPROM data, which you can't easily change, data in the emulated EPROM is easy to change. As with EPROMs, you can remove power from the target system without losing data and without damaging the emulator. The unit accepts data as ASCII characters through its RS-232C port or in Intel hex format at rates of 1200 to 19,200 bps. You can use multiple emulators with a target system that has a 16- or 32-bit-wide ROM memory. \$399.

**Gtek Inc**, Drawer 1346, Bay St Louis, MS 39520. Phone (601) 467-8048. TLX 315814.

Circle No 429

**QUICK—Memorize this list:**

175.69	18.905	1.7868	171.67	143.98
1.6523	153.47	15.097	132.69	185.36
17.546	185.98	16.264	1.3789	1.6243
154.52	19.090	15.778	197.35	16.230
188.58	129.34	174.58	19.875	1.9465
1.3876	101.09	16.790	1.9721	1.6759
1.7566	18.236	1.7805	198.67	189.20
187.43	17.647	152.78	189.36	17.654
18.347	16.154	1.5737	18.745	195.86
17.961	1.8497	15.876	191.60	17.949
16.975	186.67	175.87	15.134	145.87
1.8264	13.478	16.783	16.598	157.83
15.783	1.1654	136.56	11.387	1.6781
15.786	118.75	158.70	114.36	17.169
11.080	1.1342	178.67	10.287	1.6085
1.2136	1.8514	10.562	1.2905	191.70

The 175 Autoranging DMM can—up to a hundred readings, and it determines minimum and maximum values. Five functions and a lot more—for \$449. IEEE-488 and battery options, too. QUICK—Call the Keithley Product Information Center: (216) 248-0400.

**The Model 175  
Autoranging  
DMM**



CIRCLE NO 139



# More Functions. Smaller Budget.

## Beckman Industrial Circuitmate™ DMMs put hFE, Logic, Capacitance, Frequency and True RMS In Your Hand. For Less.

**Get more, for less. It's a simple definition of value.** For DMMs, value means finding the combination of capabilities that meets your needs at the right price. Without losing sight of accuracy and reliability. If you want more functions at a low price, Beckman Industrial's Circuitmate™ Digital Multimeters are the best value around.

From the pocket-sized DM20L to the DM850, with true RMS capability and accuracy to 0.05% ± 1 digit, Circuitmate DMMs give you the functions you need.

For instance, the DM20L puts both a Logic Probe, a transistor gain function (hFE), and a full range of DMM functions in the palm of your hand. For only \$79.95.

Then there's the DM25L. Where else does \$99.95 buy you a Logic Probe, capacitance measurement, transistor gain function (hFE), and 24 DMM ranges including resistance to 2000 megohms? Nowhere else.

When high accuracy counts, there's the DM800 with a 4 1/2 digit display. The DM800

### DM20L Pocket-Size w/Logic \$79.95\*

TTL Logic Probe: 20MHz  
Hi/lo/off indications  
Detects 25nS pulse widths

hFE (NPN or PNP):  
1 range (1000)

DMM: Input Impedance—  
10 Megohms  
DCA/ACA-5 ranges  
(200µA to 2A)

Ohms-8 ranges (200 ohms  
to 2000 Megohms)

Continuity beeper



also gives you frequency counting. A full-function DMM, and more, doesn't have to cost over \$195.00. If it's a Circuitmate DM800.

Or, for a few dollars more, get true RMS (AC coupled) to let you accurately measure non-sinusoidal AC waveforms, and all the capability of the DM800, in the DM850.

Of course, there's a whole range of Circuitmate DMMs and service test instruments, including the DM78 autoranger that

### DM850 True RMS

4 1/2 digits. DCV accuracy is .05% + 3 digits

True RMS

Frequency counter to 200KHz

Data Hold display capability

Continuity beeper

Built-in bail

Anti-skid pads

Price: DM850 (True RMS) . . . \$219.95\*  
DM800 (Average) . . . \$195.00\*



fits in a shirt pocket, yet gives you a full size 3 1/2 digit, 3/8" readout. Not to mention a complete line of accessories like test leads, current clamps, even probes that can extend your DMMs range and sensitivity. All designed to work flawlessly with your Beckman Industrial Circuitmate DMM.

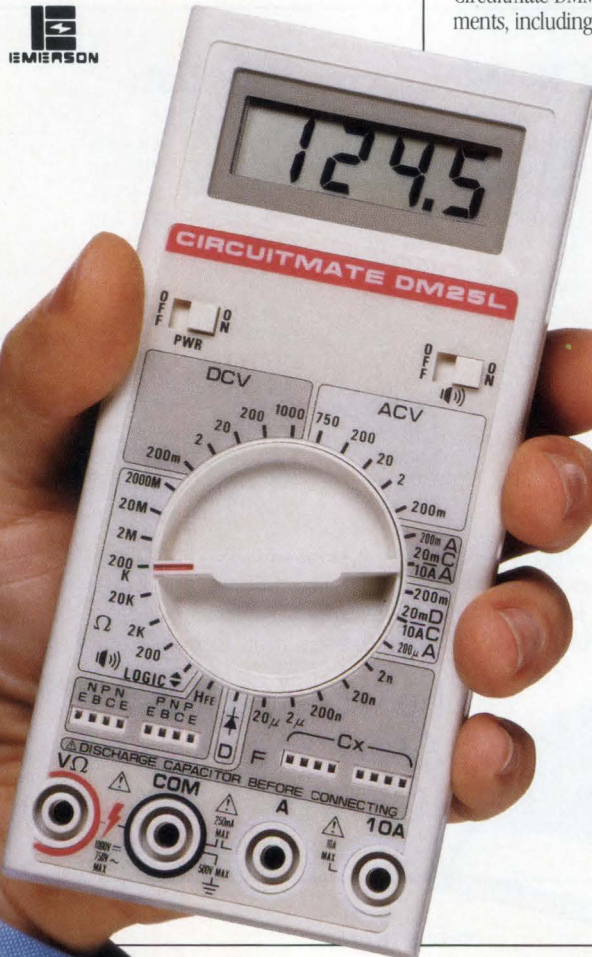

### DM25L Capacitance, Logic, hFE \$99.95\*

TTL Logic Probe: 20MHz  
Hi/lo/off indications  
Detects 25nS pulse widths

Capacitance: 5 ranges  
(2nF to 20µF)

hFE (NPN or PNP):  
1 range (1000)

Continuity beeper

Built-in bail

Anti-skid pads



See your Beckman Industrial distributor and discover more DMM performance. For less.

\*Suggested list price (\$US) with battery, test leads and manual.

In Service Instruments, We're The One.

**Beckman Industrial™**

Beckman Industrial Corporation, Instrumentation Products Division  
A Subsidiary of Emerson Electric Company  
3883 Ruffin Road, San Diego, CA 92123-1898  
(619) 495-3200 • FAX: (619) 268-0172 • TLX: 249031

© 1987 Beckman Industrial Corporation





## 30-MHz CALIBRATOR

- Levels are programmable from -70 to 20 dBm
- Meets spec 150 msec after a level change

The 2520 RF calibrator produces an NBS-traceable 30-MHz output at levels from -70 dBm to 20 dBm with 0.1 dB resolution. At 0 dBm, the maximum error is  $\pm 0.055$  dB. The instrument, which is programmable from its front panel and from an IEEE-488 interface, meets all requirements of MIL STD-28800C, type II, class 5. Its front-panel alphanumeric display with cursor controls provides status and output-level indications. The unit's output meets its accuracy specifications within 150 msec after you command it to change. The output impedance is  $50\Omega$  with VSWR of  $<1.05$ . The vendor ships the unit with a  $75\Omega$  adapter. When you use the adapter, the output automatically adjusts to correct for impedance mismatch. \$2250. Delivery, 12 weeks ARO.

**Boonton Electronics Corp**, 791 Rte 10, Randolph, NJ 07869. Phone (201) 584-1077.

Circle No 430

## DIGITAL MULTIMETER

- Provides  $3\frac{1}{2}$ - to  $6\frac{1}{2}$ -digit resolution
- Features a 2V-range, mid-band, ac-voltage accuracy of 0.06%

The 7150-plus is an enhanced version of the company's 7150 digital multimeter. It features a revised ac converter that provides its  $5\frac{1}{2}$ -digit ac-voltage measurement function with a 2V-range, 40-Hz to 10-kHz,

90-day accuracy of  $\pm 0.06\%$  of reading 15 digits. The 2V-range, 90-day accuracy of its  $6\frac{1}{2}$ -digit dc-voltage measurement function is  $\pm 0.005\%$  of reading 4 digits, and its  $6\frac{1}{2}$ -digit resistance function has a 20-k $\Omega$ -range, 90-day accuracy of  $\pm 0.015\%$  of reading 4 digits. The ac-voltage accuracy is specified to a frequency of 1 MHz, and the instrument achieves 1  $\mu$ V-ac voltage resolution on its 0.2V range. You can also measure temperatures with a 0.01°C or 0.01°F sensitivity. The instrument uses digital filtering to achieve greater stability and faster settling times than are obtainable using analog input filters. You can reduce the scale length to a low level of  $3\frac{1}{2}$  digits, if required. Other features of the instrument include front-panel push-button calibration and an external trigger input. An IEEE-488 interface is standard. The 7150-plus meets DEF-STD-66/31, issue 1, category 3; and MIL-T-28800, type 3,



class 5, style E requirements. \$1295.

**Schlumberger Technologies**, Instrument Div, Victoria Rd, Farnborough, Hampshire GU14 7PW, UK. Phone (0252) 544433. TLX 858245.

Circle No 431

**Schlumberger Instruments**, 20 N Ave, Burlington, MA 01803. Phone (617) 229-4825.

Circle No 432

## Go easy on your cal lab:

All of your Model 175 and 197 DMMs can be calibrated automatically—without the need to access internal test points. Even if they're not equipped with the IEEE-488 interface option. All it takes is the Model 1755 Calibration Interface (below). You'll be saving your calibration lab manager his most critical asset—time.

Get day-in, day-out high performance and reduce instrument maintenance. Call the Keithley Product Information

Center: (216) 248-0400.



## Keithley Digital Multimeters

**KEITHLEY**

CIRCLE NO 140



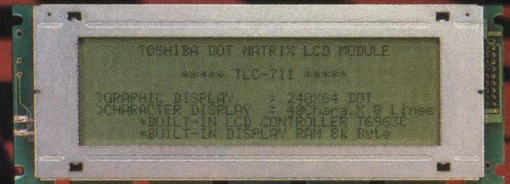
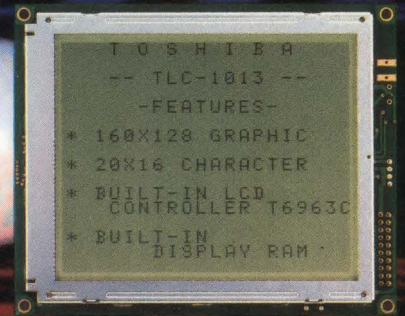

# A Wide Lineup Builds Quality and Reliability

From small to large sizes, from character to graphic displays, Toshiba has a wide lineup of LCDs with high quality and superior readability. The employment of H-TN offers you easier reading. And built-in controllers enable easy operation. There's even a module that accepts an EL backlight. So when you look for an LCD — look for Toshiba.

## Character Display Type with Built-in Controller

High character height and easy-to-read display. Easy-to-use design thanks to high contrast TN.

Model name	Number of characters	Outline dimensions (mm)
TLC-671	16 × 1	80.0 × 36.0 × 12.0
TLC-241	16 × 1	80.0 × 36.0 × 12.0
TLC-491	16 × 2	80.0 × 36.0 × 12.0
TLC-731	16 × 4	87.0 × 60.0 × 12.0
TLC-501	20 × 2	116.0 × 37.0 × 12.5
TLC-721	20 × 4	98.0 × 60.0 × 12.0
TLC-691	24 × 1	126.0 × 36.0 × 12.0
TLC-771	24 × 2	118.0 × 36.0 × 12.0
TLC-601	40 × 1	182.0 × 33.5 × 13.0
TLC-591	40 × 2	182.0 × 33.5 × 13.0
TLC-1001	40 × 4	221.0 × 76.0 × 12.5

## Graphic Display Type with Built-in Controller

Clear display thanks to high contrast TN. Easy-to-use C/G, RAM and ROM built-in types.

Model name	Number of dots	Outline dimensions (mm)	Controller
TLC-1021	120 × 64	85.0 × 70.0 × 20.0	T6963C
TLC-682	160 × 64	125.0 × 50.0 × 18.0	T6963C
TLC-711A	240 × 64	180.0 × 65.0 × 12.0	T6963C
TLC-1013	160 × 128	129.0 × 104.5 × 14.0	T6963C
TLC-1091	240 × 128	241.0 × 125.3 × 12.0	T6963C
TLC-1101	160 × 32	140.0 × 40.0 × 12.0	T6963C

\*We provide many options.  
\*We can meet the need for customized products.

## Graphic Display Type

Clear display through employment of high contrast TN. Capable of displaying large-size letters and special letters.

Model name	Number of dots	Outline dimensions (mm)	Controller
TLC-612	640 × 32	320.0 × 48.0 × 14.0	(T6963C)
TLC-761	640 × 64	320.0 × 47.0 × 14.0	(T6963C)
TLC-341AK	128 × 128	93.2 × 86.6 × 12.0	(T6963C)
TLC-531A	128 × 128	132.2 × 111.0 × 13.0	(T7755)
TLC-972	480 × 128	274.0 × 114.4 × 20.0	(T7755)

( ): Recommended controller ICs.

In Touch with Tomorrow  
**TOSHIBA**

Toshiba America, Inc., Chicago Office: 1101A Lake Cook Rd., Deerfield, IL 60015 Tel: 312-945-1500 Northwestern Area Office: 2021 The Alameda, Suite 220, San Jose, CA 95126 Tel: 408-244-4070 Eastern Area Office: 67 South Bedford Street, Suite 200W, Burlington, MA 01803 Tel: 617-272-4352, 5548



# EDN PRODUCT MART

This advertising is for new and current products.

Please circle Reader Service number  
for additional information from manufacturers.

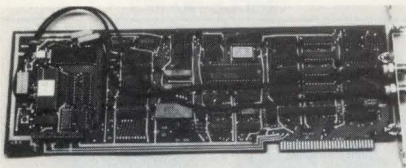

### PC BASED DIGITAL SIGNAL PROCESSING AND DATA ACQUISITION

- TMS320C10 based Model 10 - 25 Mhz
- TMS320C25 based Model 25 - 40 Mhz
- Optional 12 Bit, 110 Khz A/D and D/A
- Development Software, including Debugger
- Applications Software: FFTs, Spectral Analysis Program
- Optional Continuous, No Gap sampling to/from disk at high rates
- Prices start at \$650.

#### DALANCO SPRY

2900 Connecticut Ave NW Suite 241  
Washington, DC 20008  
(202) 232-7999

CIRCLE NO 325



"The Best 8051 Emulator"

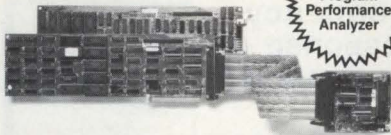

## 8051

PC based emulators for the 8051 family

(8051, 8751, 8052, 8752, 8031, 8032, 8344, 80C452, 80C152, 80535, 80C451)

- PC plug in boards
- Command driven User Interface with static windows
- 16 MHz real time emulation
- 128K emulation memory
- 48 bit wide, 16K deep trace buffer with loop counter
- Program performance analyzer
- Powerful Macros with IF-ELSE, REPEAT-WHILE structures
- Single step in PLM-51 and C-51
- Symbolic debugging with in-line assembler and disassembler
- No external boxes
- Execution time counter
- Trace can be viewed during emulation!

PRICES: 32K Emulator for 8031 \$1790, 4K Trace \$1495  
CALL OR WRITE FOR FREE DEMO DISK!  
Ask about our demo VIDEO!

#### NOHAU CORPORATION

51 E. Campbell Ave. #107E, Campbell, CA 95008 (408) 866-1820

CIRCLE NO 326

## PAL®/EPLD PROGRAMMER

From  
\$689.00



Stand Alone/RS-232 Programs and Verifies  
20/24 pin PLDs from MMI, TI, National  
Cypress, Lattice, AMD, Altera  
PAL is a registered trademark of MMI.

From A Name You Can Trust

### LOGICAL DEVICES INC.

1201 N.W. 65th Place  
Ft. Lauderdale, FL 33309

1-800-331-7766 (305) 974-0967  
Telex 383142 Fax (305) 974-8531

CIRCLE NO 329

## EMUL51-PC IN EUROPE

SWEDEN, NORWAY, FINLAND

Nohau Elektronik AB tel. 040 92 24 25

GERMANY

iSystem GmbH tel. 08131 1687

FRANCE

Emulations s.a.r.l. tel. 01 69 412 801

DENMARK

Tage Olsen A/S tel. 02 65 81 11

SWITZERLAND

thau Computer AG tel. 01 740 41 05

PORTUGAL

Fatronica lda tel. 01 83 56 70

We are currently seeking representatives in:

Great Britain, Italy, Spain, Holland,  
Belgium and Austria

CIRCLE NO 327

### ELIMINATE DECOUPLING CAPACITORS

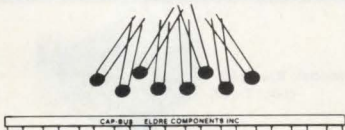

#### CAP-BUS® CAPACITOR/BUS BAR

Eliminate the decoupling capacitors and the power and ground traces from your PCB for more reliability. CAP-BUS® has a distributed capacitance of .05 micro-farads per lin. in., at 50 VDC with low inductance and low impedance. The capacitor and the bus bar have been joined together for CAP-BUS®; a more efficient capacitive decoupled power distribution system, increasing IC density on a two sided board.

ELDRE COMPONENTS, INC. 1500 Jefferson Rd.  
Rochester, NY 14623  
(716) 427-7280

CIRCLE NO 328

## Worried About EMI/RFI? USE ELECTRODAG® SHIELDING COATINGS

- Air or Force Dry Formulations.
- UL Recognized for Good Adhesion.
- Line Proven, Easy Application.
- Stable Low Electrical Resistance.
- Choice of Copper, Nickel or Low Cost Silver Conductive Fillers.
- Prototype Service Available.



1600 Washington Ave., Port Huron, MI 48060

TOLL FREE 1-800-255-1908

CIRCLE NO 330

To advertise in Product Mart, call Joanne Dorian, 212/463-6415



# E & H Field Probes

**\$495**



**EDN "Readers Choice" (6/25/87)**

Makes finding E & H Field emissions easy!

Use with any o-scope or spectrum analyzer. Set includes three H and two E field probes, extension handle, case, documentation, two year warranty. Pre-amp with battery charger, optional. Call, write to order or for brochure.

1-800-253-3761  
PO Box 1546 Austin, TX 78767



**CIRCLE NO 331**

## WAVEFORM SYNTHESIZER

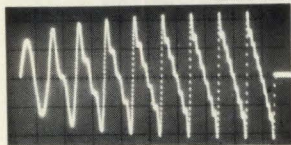
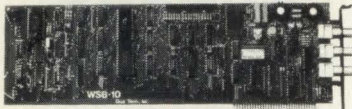

- For IBM-PC/XT/AT and compatibles
- Generates user-definable signal
- Up to 2000 points per envelope



**\$795.00**

478 E. Exchange St. Akron OH 44304  
(216) 434-3154 TLX: 5101012726  
1-800-553-1170

**CIRCLE NO 334**

## IBM PC/XT/AT ENGINEERING SOFTWARE FOR THE ELECTRONIC PACKAGING INDUSTRY

**HEAT85:** Thermal Analysis of Electronic Equipment.  
• A complete computerized solution to Thermal Analysis studies of Electronic Components, Assemblies, PCBs and Enclosures. Provides a fast and practical method of analysis.

**NATFRE:** Vibration Analysis of PCBs.

- Calculates Natural Frequency, max deflection and max design goal deflection of PCBs subjected to sine or random vib.

**COLDPLT:** Compact Heat Exchanger Design.

- Determines thermal design parameters of coldplate designs typically utilized for cooling high density electronics.

**WT:** Weight Analysis of Electronic Equipment.

- Weight analysis without performing tedious manual calculations. Output generates a detail weight analysis report.

**EMP ENGINEERING**

(516) 361-8921

P.O. BOX 1000, NESCONSET, N.Y. 11767

**CIRCLE NO 337**

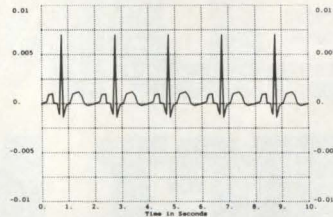

### LOW COST ANALOG CIRCUIT ANALYSIS

Introducing a **NEW RELEASE** of **EC-Ace**, a subset of the powerful **ECA-2** analog circuit simulator. **EC-Ace 2.31** includes all of the basics, with increased graphics, expanded documentation, and a new low price.

- AC, DC, Transient
- Temperature
- Interactive or batch
- Twice as fast as SPICE
- Over 100 nodes
- 525 pg. ECA-2 manual
- Sine, Pulse, PWL, SFFM, and Exponential generators
- User friendly
- Fully supported
- Money back guarantee

**EC-Ace 2.31 \$145**

**ECA-2 2.31 IBM PC/XT/AT/PS-2 \$675**

An upgrade from **EC-Ace** to **ECA-2** is available.

Call 313-663-8810 For **FREE DEMO** disk



**Tatum Labs, Inc**

1478 Mark Twain Court, Ann Arbor, MI 48103

**CIRCLE NO 332**

Increase the frequency response of your present chart recorder to **5 kHz...**

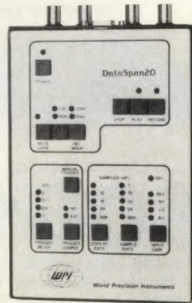

...for less than **\$1000!**

## DataSpan20™

STATIC DIGITAL RECORDER



**World Precision Instruments, Inc.**  
375 Quinpiac Avenue

New Haven, CT 06513 • (203) 203-469-8281

**CIRCLE NO 335**

## SBX MODULES

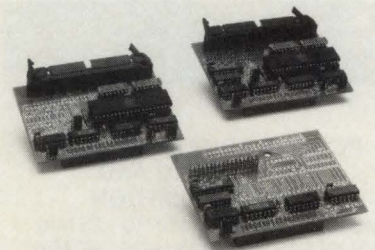

We've upgraded our SBSxSCSI module to support Block-Mode Pseudo-DMA transfers. That means CPUs without DMA can increase transfer speeds by not polling for READY on every byte. We've also added an optional Centronics-compatible printer port (SBSxSCSI/CEN). If you only need the printer port, save money with our low-cost SBSxSCSI module. We also offer a Floppy-Disk Controller module (SBSxFDC) that handles 3 1/2", 5 1/4", and 8" drives with SD, DD and HD formats.

Call or write for more information.

**Single Board Solutions, Inc.**  
20045 Stevens Creek Blvd.  
Cupertino, CA 95014  
(408) 253-0250

**CIRCLE NO 336**

## TIGER POWER

40-350W range of switching power supplies

Model: **BM-2150**  
(Mini Tiger)



Lead Year's main SPSs products are:

- PS/2 models
- 286/386-type PC/AT models
- Mini Tiger' super compacts
- Cubic Baby AT models
- PC/XT models
- 386 tower models
- AT models
- OEM are welcome

**RU** E 97155 U.S.A.  
**SP** LR 65589 CANADA  
**WPI** R60200 W.G.  
**S** SEMKO SWEDEN  
**PC** FMC8HM U.S.A.  
**FTZ** FTZ W.G.

Visit us at **CeBIT'88 (Hall 6, Booth #G64)** or contact us today for more information on how **Lead Year's Tiger Power** make your electronics great!

**Lead Year Enterprise Co., Ltd.**  
3F, No. 481, Chung Hsiao E., Rd., Sec. 6,  
Taipei, Taiwan, R.O.C.  
**TIGER POWER** P.O. BOX 53-352 Taipei Tel: 886-2-7857858  
Tx: 12862 LEADYEAR Fax: 886-2-7857852  
PC/XT, PC/AT, Baby AT and PS/2 are trademarks of the International Business Machines Corp.

**CIRCLE NO 339**



## Highly reliable piezoelectric ceramics for sensor applications.

Piezo Kinetics manufactures all types of lead zirconate titanates and lead metaniobate for sensor applications. Different ceramic composites are offered to satisfy properties inherent to various applications. Special electrode patterns, precision machining, lead attachments and feedback tabs are available upon request.

Find out how you can increase design flexibility, reliability and quality. For additional information write for catalog or call today. Piezo-Kinetics Inc., Pine & Mill Streets, P.O. Box 756, Bellefonte, PA 16823, (814) 355-1594.



**CIRCLE NO 338**

To advertise in Product Mart, call Joanne Dorian, 212/463-6415



**FREE**  
CATALOG  
AND APPLICATIONS GUIDE

**AFFORDABLE  
ENGINEERING  
SOFTWARE**

PC/MSDOS — Macintosh — CP/M

<b>ACNAP — \$125.00</b> AC Network Analysis, Component Libraries, Macros, AUTO Execute	<b>LCFIL — \$95.00</b> LC Filter Design/Analysis/Synthesis
<b>DCNAP — \$95.00</b> DC Network Analysis, Component Libraries, Macros, AUTO Execute	<b>LSP — \$95.00</b> Logic Circuit Design/Simulation
<b>SPP — \$125.00</b> Signal Processing Program Macros, AUTO Execute, Windowing	<b>RIGHTWRITER — \$95.00</b> Report Proofreader Program, Applies 3000 Rules of English
<b>PLOTPRO — \$72.95</b> Scientific Graph Printing	<b>PDP — \$95.00</b> Scientific Plotting Program for Pen Plotters
<b>PCPLOT3 — \$95.00</b> High Resolution Engineering Graphics Package	<b>TEKCALC — \$95.00</b> Programmable Scientific Calculator, Statistics/Curve-fitting
<b>LOCIPRO — \$95.00</b> Root Locus Stability Analysis, Multiple, Nested Loops	<b>COMCALC — \$72.95</b> Communications Budget Calculator and Spreadsheet Program
<b>ACTFIL — \$95.00</b> Active Filter Design, Analysis, Synthesis	<b>XFER — \$95.00</b> Transfer Function Analysis and Circuit Synthesis
<b>MICRO-3 — \$125.00</b> Design & Analyze Microstrip Circuits, Filters, Hybrids, Couplers, Transformers	<b>SPANNER — \$95.00</b> Integrated Word Processor, HP11C Calculator, and Scientific Graphics

**BV Engineering**

Professional Software (714) 781-0252

2023 Chicago Ave., Suite B-13, Riverside, CA 92507 U.S.A., TELE-3089864

**CIRCLE NO 340**

**SMART CARD EXTENDER  
EASY ON \$165<sup>00</sup> — PC/XT  
\$195<sup>00</sup> — AT**

A smart card extender for PC/XT/AT and compatibles

- Allows card insertion and extraction without power on/off cycles
- Saves time by eliminating DOS re-boots
- Reduces wear and tear on hard disk drives
- Extends host interface for hardware and software development and test
- A single switch controls the connection of all signals to and from the computer bus
- Patent pending

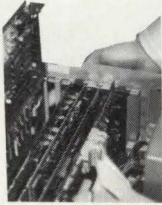

**30 DAY NO RISK EVALUATION**

APPLIED DATA SYSTEMS  
9811 Mallard Dr. Suite 203  
Laurel, MD 20708

For more information call **800-541-2003**

**CIRCLE NO 343**

**NO ENGINEER SHOULD BE WITHOUT ONE**

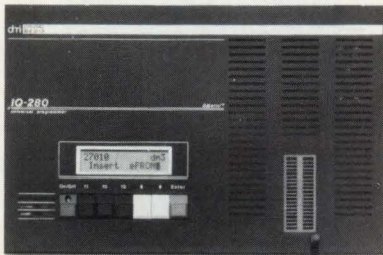

America's most advanced Personal Programmer

The Digital Media IQ-280 can program 40 PIN devices.

The most advanced firmware controlled pin driver system available means you never have to worry about buying another expensive module or PAK again. The IQ Personal Programmer line offers the power and features comparable to many of the \$5,000 programmers, but at a fraction of the costs.

Support for CMOS, NMOS, ECL, Bipolar, PROMs, EPROMs, ePROMs, PLDs, ePLDs, IFLs, FPLDs, up to 40 pin DIP packages.

Altera, AMD, Atmel, Cypress, Excel, Fairchild, Fujitsu, GI, Hitachi, Hughes, Intel, Lattice, Mitsubishi, Motorola, National, NEC, MMI, Samsung, Seeq, Sierra, Signetics, SMOS, TI, Toshiba, Waterscale and more. ALMOST 1000 DEVICES!

Whatever your need is, Digital Media can help you solve it. And you won't believe how little it costs.

Call (714) 751-1373 to receive a complete product specification package immediately.

**CIRCLE NO 346**

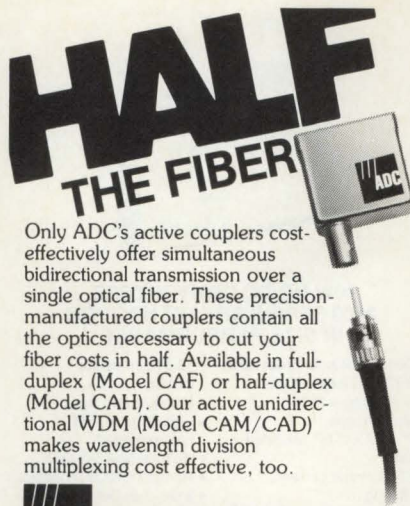

Only ADC's active couplers cost-effectively offer simultaneous bidirectional transmission over a single optical fiber. These precision-manufactured couplers contain all the optics necessary to cut your fiber costs in half. Available in full-duplex (Model CAF) or half-duplex (Model CAH). Our active unidirectional WDM (Model CAM/CAD) makes wavelength division multiplexing cost effective, too.

**ADC Telecommunications**

4900 West 78th Street, Minneapolis, MN 55435  
(612) 893-3010

**CIRCLE NO 341**

CapFast CF1000  
\$395

**World-Class  
Schematic  
Design Package**

for your PC/AT & PS/2  
with EGA.



- Open data bases & ASCII file formats.
- 100% data base compatibility with CapFast Sun Workstation tools.
- Schematic editor features unlimited hierarchical levels, flexible property editing, on-line electrical rules checking, & a split-screen capability.
- Complete package, with general purpose symbol editor, extensive parts library, net-listers, plotting program, documentation, & more.



Phase Three Logic, Inc.

P. O. Box 985, 5510 N. E. Elam Young Pkwy.  
Hillsboro, OR 97123 FAX 503-648-1547 (503) 640-2422

**CIRCLE NO 344**

**Servo Design  
SIMPLIFIED  
with PC-Based Kit**

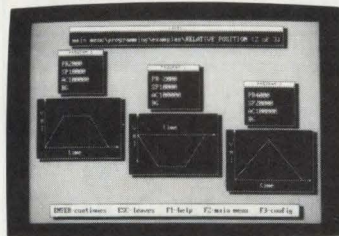

**KIT CONTAINS:**

- Plug-in Motion Controller
  - Servo Motor
  - Encoder
  - Design Software for PC
  - Power Driver & Supply
  - Cables
- ONLY \$1145**

**Galil Motion Control**  
1054 Elwell Court, Palo Alto, CA 94303  
**(415) 964-6494**

**CIRCLE NO 347**

**ALL  
THE INFO.**

How to cut your fiber optic costs in half.

Learn how you can cut your fiber costs with ADC's full-duplex bidirectional CAF coupler. This free application note shows the cost savings you can achieve by installing ADC couplers in place of conventional dual-fiber systems. No cost or obligation.

**ADC Telecommunications**

4900 West 78th Street, Minneapolis, MN 55435  
(612) 893-3010

**CIRCLE NO 342**

**NEW! R2 Virtual Graphic System**

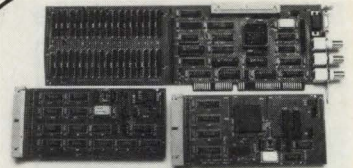

- TMS34010 GSP, XT/AT bus compatible.
- 32 MB total memory space; 512 KB DRAM and 1 MB VRAM on board.
- Open structure GSP bus; allows multiple bus masters.
- Flexible resolution and pixel depth. Window, clipping, or smooth hardware PAN across entire image space.
- Modular video adapters meet various display requirements.
- Optional hardware state machine protects software from piracy.

R2 \$1,995 V2 \$695  
V1 \$ 295 V4 \$395

**Maple Tech./RobotGraphics**

1120 Stewart Ct. #B, Sunnyvale, CA 94086  
(408) 732-0834 FAX: (408) 746-0894

**CIRCLE NO 345**

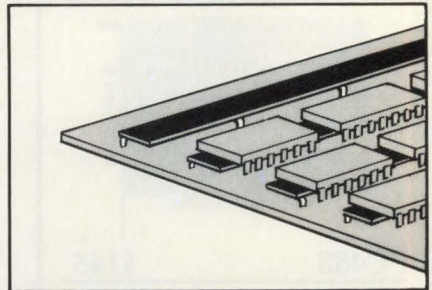

**SAVE SPACE WITH  
Q/PAC® COMPONENTS**

- Provide built-in capacitance
- Eliminate decoupling capacitance
- Gain 4-layer board quietness with 2-layer economy
- Vertical or horizontal mounting

Send for Rogers Q/PAC® Application Bulletin.

**Rogers Corp.**, 2400 S. Roosevelt St.  
Tempe, AZ 85282 602/967-0624

**CIRCLE NO 348**

To advertise in Product Mart, call Joanne Dorian, 212/463-6415



## 8051 SIMULATOR

Superb full function debugger simulator works just like the real thing! All 8051 interrupt modes are supported including a unique serial input buffer. 64K External Memory, 64K Code memory, and 256 Data Memory available. All SFRs are displayed in expanded bit by bit mode. Full disassembler and dynamic trace mode provided, many other unique features! Only \$150.00

## CROSS ASSEMBLERS

We support the 8080/8085, Z80, 8048, 8051, and 8096 families. Our prices are still the lowest in the field. Just \$75.00 each, or \$250.00 for the package of all five!!

SEND TODAY FOR MORE INFO

LEAR COM COMPANY

2440 Kipling St. Suite 206  
Lakewood, CO 80215  
(303) 232-2226

CIRCLE NO 349



## 20W DC/DC CONVERTERS, 2100 SERIES BREAKTHROUGH IN SIZE/PERFORMANCE

- Dense power for great value
- 9-72VDC input range
- -25°C to +71°C ambient oper.
- 2" x 2" x .375" shielded case
- Short circuit current limiting
- 100% Burn-in @ FL
- 13.3W/in<sup>3</sup> power density
- Single/dual output
- -55°C to +85°C opt. extended
- No heat sink required
- Remote ON/OFF Control
- \$129 (1-9) Del. 3-4 wks. ARO

CONVERSION DEVICES, INC.  
101 Tosca Dr., Stoughton, MA 02072  
Tel: (617) 341-3266, TLX: 920014

CIRCLE NO 350



## Schematic and PCB Software

Create and revise SCHEMATICS and PCBs quickly and simply with **HiWire-Plus**® and your IBM PC. Use symbols from HiWire-Plus's extensive library, modify them, or create your own quickly and painlessly. Netlist, bill-of-materials, and design-checking utilities are included. **HiWire-Plus** is \$895 and comes with a thirty-day money-back guarantee.

Wintek Corp.

1801 South St., Lafayette, IN 47904  
(800) 742-6809 or (317) 742-8428

CIRCLE NO 751

## SCHEMA II Schematic Capture

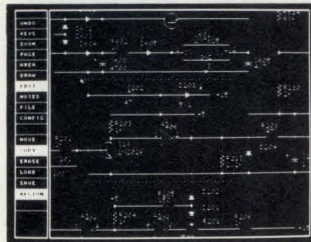

### FREE Demo Disk: 1-800-553-9119

SCHEMA's success is the talk of the CAE industry and thousands of satisfied SCHEMA owners know why. Incredible speed, ease of use, and power have made SCHEMA a best-selling schematic capture program for engineering professionals the world over.

Now, SCHEMA II is available.

SCHEMA II sells for \$495 and supports most common IBM PC/XT/AT configurations. Please call today for a free SCHEMA II demo disk.



**OMATION**

In Texas Call (214) 231-5167

CIRCLE NO 752

*When it comes to value,  
no one comes close.*

## DC/DESIGN™

The Truly Affordable, Feature-Packed PCB Design Package

**\$975**

Created for IBMPCs and compatibles, DC/DESIGN is a high-end CAE/CAD design tool that's priced for value and prepared to perform! Features include schematic capture, parts placement, full menu prompting option, interactive autorouting, surface mount technology support, user friendly reference manual, and comprehensive reference manual.

Our professional one-mil. diagonal autorouter is also available. 30-day money-back guarantee. Call today to order or for more information. Demo disk and data sheets available.

**DESIGN  
COMPUTATION**

Route 33 Sherman Square, Farmingdale, NJ 07727  
(201) 938-6661

CIRCLE NO 753

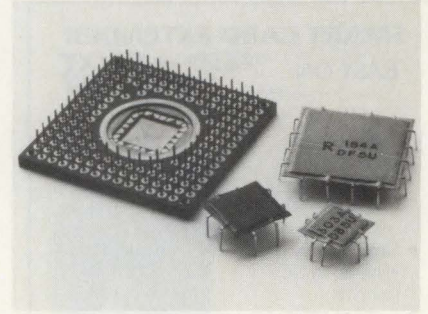

## STOP NOISE IN PGA, LCC PACKAGES

PGA MICRO/Q decoupling capacitors provide low-inductance, high-frequency noise decoupling for PGA, LCC packages on complex board layouts. Fit under PGA or LCC sockets use no extra board space. Choose from many pinout configurations. **Rogers Corp.**, 2400 S. Roosevelt St., Tempe, AZ 85282. 602/967-0624.

CIRCLE NO 754

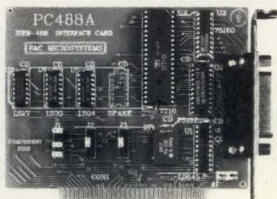

**PC488**

**\$145**

LOW COST PC/XT/AT INTERFACE FOR IEEE-488 (GPIB/HPIB)

- INCLUDES INSTALLABLE DOS DEVICE DRIVERS
- 1 OF 6 INTERRUPT LEVELS
- 1 OF 2 DMA CHANNELS
- UP TO 4 BOARDS PER COMPUTER
- CONTROLLER / TALKER / LISTENER
- CUSTOM SOFTWARE SUPPORT AVAILABLE
- COMPATIBLE WITH MOST IEEE488 SOFTWARE PACKAGES FOR THE IBM PC
- QUANTITY DISCOUNTS

VISA MC AMEX

Call today for datasheet!!

**B&C MICROSYSTEMS**

355 West Olive Ave., Sunnyvale, CA 94086  
PH: (408)730-5511 FAX: (408)730-5521 TELEX: 984185

CIRCLE NO 755

## NO WAITING FOR COMPLETE, LOW PRICED, CHIP COMPONENT KITS

CC-1 Capacitor Kit contains 365 pieces, 5 ea. of every 10% value from 1pf to 33µf. CR-1 Resistor Kit contains 1540 pieces; 10 ea. of every 5% value from 100 to 10 megΩ. Sizes are 0805 and 1206. Each kit is ONLY \$49.95 and available for Immediate One Day Delivery!

Order by toll-free phone, FAX, or mail. We accept VISA, MC, AMEX, COD orders, or company PO's with approved credit. Call for free detailed brochure.



**COMMUNICATIONS SPECIALISTS, INC.**  
429 West Taff Avenue • Orange, CA 92665-4296  
Local (714) 998-3021 • FAX (714) 974-3420

Entire U.S.A. 1-800-854-0547

CIRCLE NO 756

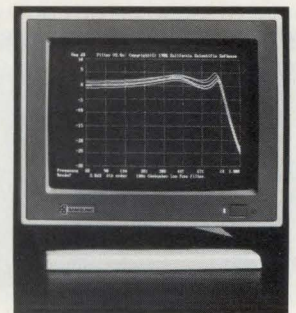

## FREE DEMO DISK

Filter designs, plots, and selects component values for active, passive L-C, and digital filters up to order 30. Full support for Allpass, Elliptic, Bessel, Butterworth, Chebyshev, and Inverse Chebyshev filters. Can design lowpass, highpass, bandpass, and bandstop filters. Filter will transform any filter function into the Z-domain for digital IIR filters. Screen editor allows modification of the transfer function for custom filters. Filter does Monte Carlo analysis, Bode and Transient Analysis plots. Fully menu driven, Filter is \$900 for the IBM PC.

**California Scientific Software**

1159 North Catalina Ave., Pasadena, CA 91104  
(818) 798-1201

CIRCLE NO 757

To advertise in Product Mart, call Joanne Dorian, 212/463-6415



Digital Control  
Intro \$200  
Digital Filter  
Tutor \$450  
Kalman Filter  
Tutor \$925

Practical hands-on training courses that run on the IBM PC. Ideal alternative to text books, seminars, and university courses. FREE demo disk available.

**Engineering Tutorial Software**  
22338 Lull Street  
Canoga Park, CA 91304  
(818) 716-0816

CIRCLE NO 758

## ZIPPY SWITCHES

NO: E91274

\*FULL DETAILS AND SAMPLES  
ON REQUEST  
\*OEM ARE WELCOME

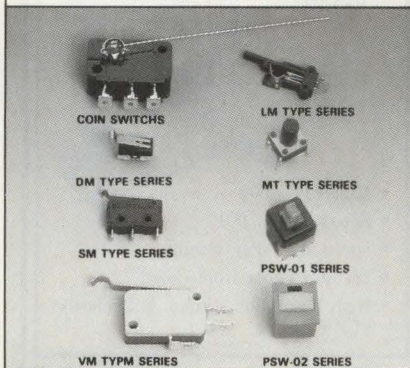

**ZIPPY SHIN JIUH CORP.**  
P.O. Box 10184 SHIN TIEN TAIPEI HSIEN, TAIWAN, R.O.C.  
TEL: (02) 9188512-5 TLX: 33418 ZIPPY FAX: 886-2-9155765

CIRCLE NO 759

## (E) PROM/(E) PLD MULTIPROGRAMMER™ OFFERS 18/12 PROTECTION PLAN

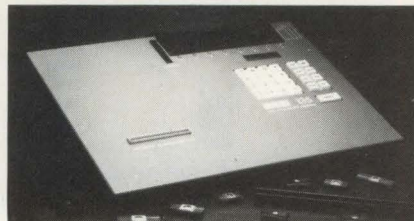

BYTEK's new 135 is a SET EPROM Programmer, a GANG EPROM Duplicator, & a UNIVERSAL Device Programmer. Complete stand alone operation via 25 keys, or PC hookup with RS232. With standard 256Kx8 RAM, the 135 supports more devices than any other production programmer, including 32 pin EPROMs. Can be easily expanded to support 40 pin EPROMs, 40 pin Micros, Bipolar PROMs & Logic Array Devices. 18 MONTH WARRANTY & 12 Month FREE Device Updates.  
Model 135-E just \$995.00

Call today: 1-800-523-1565  
In Florida: (305) 994-3520

**BYTEK Corporation**  
1021 S. Rogers Cir., Boca Raton, FL 33487  
FAX: (305) 994-3615 TELEX: 4998369 BYTEK

CIRCLE NO 760

## 72 DIGITAL I/O FOR PS/2

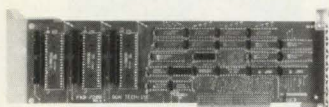

MODELS 50, 60, 80

- Parallel Expansion
- 72 I/O Lines
- Address Selectable

1-800-553-1170



478 E. Exchange St., Akron, OH 44304  
TEL: (216) 434-3154 FAX: (216) 434-1409  
TLX: 5101012726

CIRCLE NO 761



### 6800-Family Development Software

Combine our software and your editor for a powerful development system. Our C-Compilers feature a complete implementation (excluding bit fields) of the language as described by Kernigh & Ritchie and yields 30-70% shorter code than other compilers. Our Motorola-compatible Assemblers feature macros and conditional assembly. Linker and Terminal Emulator are included. **Wintek Corporation**, 1801 South St., Lafayette, IN 47904. (800) 742-6809 or (317) 742-8428.

CIRCLE NO 762

WRITE OR CALL FOR SAMPLE  
Low Cost Tempilabel® Temperature Monitor.

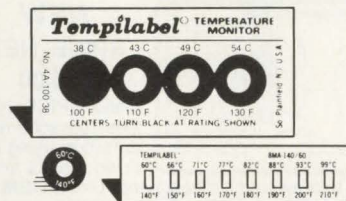

## How to put a low cost temperature gauge on everything.

Label's center spot turns black when surface to which it is affixed reaches specified temperature. Single- or multi-spot labels with pre-determined increment of ratings: 100°F (33°C) to 600°F (316°C). 1% accuracy guaranteed. 1 thru 8 ratings on each monitor with various increments. Self-adhesive, removable.

**TEMPIL DIVISION, Big Three Industries, Inc.**  
2901 Hamilton Blvd., South Plainfield, NJ 07080  
Phone: (201) 757-8300 Telex: 138662

CIRCLE NO 763

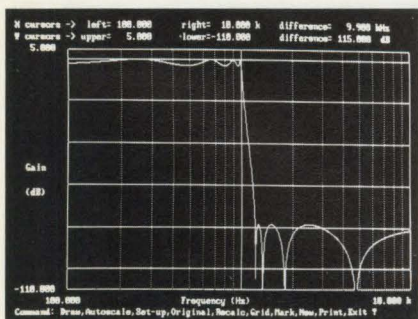

### NEW! ADVANCED ACTIVE FILTER DESIGN SOFTWARE

Version 3.0 designs Lowpass, Highpass, Bandpass, Bandstop and ALLPASS filters with Butterworth, Chebyshev, elliptic and Bessel response ■ NOW calculates values for National MF-10, Reticon, MFB, VCVS, biquad and state variable filter circuits ■ Interactive graphics for group or phase delay, gain, phase, impulse and step response of the complete filter or individual section ■ Combine filters for system design/analysis ■ Modify circuits to observe effects (\$525) ■ for IBM PC, XT, AT, PS/2

SPICE FILE CONVERSION OPTION AVAILABLE

**RLM Research**  
P.O. Box 3630  
Boulder, CO 80307-3630 (303) 499-7566

CIRCLE NO 764

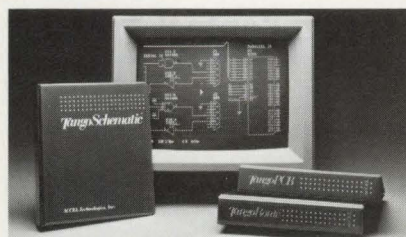

## Great Designs Start With Tango-Schematic.™ Just \$495.

Designs quickly come to life with Tango-Schematic's easy-to-use drawing editor and extensive component libraries. Features four line types, four text sizes, repeat and block functions, unique built-in word processor. Includes DRC, BOM, Wire List, Net List outputs and crisp plots, prints, or laserprints. The perfect front end to our popular Tango-PCB and Tango-Route board design systems.

For IBM PC/XT/AT/PS2. Just \$495. Full-function Demo Package: \$10. Order toll-free 800 433-7801. VISA/MC. Thirty-day money back guarantee.

ACCEL Technologies, 7358 Trade St., San Diego, CA 92121  
Outside N., S. America contact HST Technology (Australia)  
Phone: 61-02-34-8499 FAX: 61-02-23-8771

CIRCLE NO 766



## Glide Through PCB Design.

**TangoPCB™** Create the toughest board designs with powerful layout software that's a snap to use. Function-rich Tango-PCB supports eight layers, 1 mil grid, OrCAD™ or Schema™ netlist input, print/plot/photoplot output, and more.

**TangoRoute™** Get impressive completion rates and remarkable speed with Tango-Route, a four layer, eleven pass autorouter. **Just \$495 each.**

For IBM PC/XT/AT/PS2. Compare features and you'll buy Tango. Or try full-function Demo Package, just \$10. Order toll-free: 800 433-7801. VISA/MC. Thirty-day money back guarantee.

ACCEL Technologies, 7358 Trade St., San Diego, CA 92121

CIRCLE NO 766

To advertise in Product Mart, call Joanne Dorian, 212/463-6415



**EPROM PROGRAMMER  
\$349**



THE EP-1'S A GREAT VALUE & HERE'S WHY:

- READS, PROGRAMS, COPIES OVER 300 EPROMS AND EEPROMS FROM 29 MANUFACTURERS INCLUDING 2716-27513, 2804-28256, 27011
- READS & WRITES INTEL, MOTOROLA, STRAIGHT HEX AND BINARY
- OPTIONAL HEADS PROGRAM INTEL 874X, 8751, 87C51, 8755
- MENU-DRIVEN CHIP SELECTION BY MFG & P/N; NO MODULES
- FAST, SLOW, QUICK PULSE PROGRAMMING ALGORITHMS
- SPLITS FILES BY BASE ADDRESS AND ODD/EVEN (16&32 BIT)
- ALL INTELLIGENCE IN UNIT; 280 MICROPROCESSOR BASED
- 5, 12.5, 21, 25 VOLT PROGRAMMING FOR CMOS AND A-SUFFIX PARTS
- FREE PC-DOS SOFTWARE
- GOLD TEXT/TOOL ZIF SOCKET
- SAME DAY SHIPMENT
- ONE YEAR WARRANTY
- MONEY-BACK GUARANTEE
- RS232 TO ANY COMPUTER
- 8 BAUD RATES TO 38,400
- GENERATES, CHECKS CHECKSUMS
- TWO FREE FIRMWARE UPDATES
- UV ERASERS FROM \$34.95

CALL TODAY FOR MORE INFORMATION

**BP** MICROSYSTEMS

800/225-2102 713/461-9430 TELEX 1561477  
10681 HADDINGTON #190 HOUSTON, TX 77043

CIRCLE NO 776

**"D" SIZE PLOTTER**

\$2295<sup>00</sup>  
RETAIL

\$1695<sup>00</sup>  
INTRODUCTORY  
OFFER

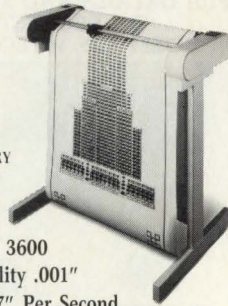

- Model PC 3600
- Repeatability .001"
- Speed at 7" Per Second
- Vacuum Paper Hold Down
- High Resolution Circles: Suitable for PCB Artwork

(415) 490-8380 **ZERICON**  
STEVENSON BUSINESS PARK  
BOX 1669 • FREMONT, CA 94538

CIRCLE NO 777



**AUTOROUTER  
NOW AVAILABLE  
FOR ADDITIONAL \$995<sup>00</sup>**

**EE DESIGNER™**  
CAE/CAD Integrated Software Package  
for IBM PC, XT or AT **\$995**

At only \$995, no electrical engineer can afford to be without this end-to-end circuit design, simulation and PCB layout tool. You can pay up to 15 times more and still not get all the features offered by EE Designer—Schematic Capture...Circuit Simulation...PCB Layout. 30 day money back guarantee. Full purchase price refunded if not completely satisfied.

Call 1-800-553-1177 today to order your package. Bank cards welcome.

**VISIONICS**  
343 Gibraltar Drive  
Sunnyvale, CA 94089

CIRCLE NO 778

**Analog Circuit Simulation**

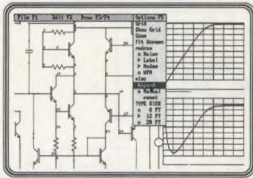

**NEW  
SPICE\_NET  
\$295.00**

Make SPICE input files from schematic drawings using pull down menus and a mouse to draw and connect parts. Use an IBM PC with any UC Berkeley compatible SPICE program.

**Simulation Programs**

for

**IBM  
PC's  
from  
intusoft**

■ **IS\_SPICE, \$95.00.** Performs AC, DC and Transient analysis.

■ **PRE\_SPICE \$200.00:** Adds Monte Carlo Analysis, Sweeps, Optimization, libraries and algebraic parameter evaluation.

■ **Intu\_Scope \$250:** A graphics post processor works like a digital oscilloscope. Easy to use with all the waveform operations you will ever need.

(213) 833-0710

P.O. Box 6607  
San Pedro, CA  
90734-6607

CIRCLE NO 779

**IBM COMPATIBLE RS232 EASI-DISK  
3 1/2-5 1/2" FLOPPY DATA STORAGE &  
TRANSFER SYSTEM**



Information Transfer to/from Non IBM Compatible Systems to/from IBM & Compatibles: (Over RS-232 or 488 Interface).

- Reads & Writes MS DOS Disks
- RS-232/488 I/O
- Rugged Portable Package/battery option
- ASCII or Full Binary Operation
- Baud Rate 110 to 38.4K Baud
- Automatic Data Verification
- Price \$895 in Singles—OEM Qtys. Less.

28 other systems with storage from 100K to 35 megabytes.  
**ADPI ANALOG & DIGITAL PERIPHERALS, INC.**  
815 Diana Drive Troy, Ohio 45373  
513/339-2241 TWX 810/450-2685

CIRCLE NO 780

**PROGRAMMERS  
FOR IBM PC/XT/AT**

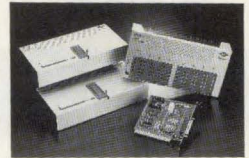

- Select Device with vender name & type number directly
  - Enable user to set up Program Pulse Width, Vpp, Vcc, Over-program Pulse Width & Iteration Counts
  - Capable of set & 8/16/32-bits wide-word programming.
  - Built in Intellex Hex, Tektronix Hex, Motorola S, Hexadecimal, JEDEC transmission formats
  - Suspend to DOS for operation of DOS utilities.
- |   |       |
|---|-------|
| XP6000 Adapter & cable installs in PC for connecting program mer externally | \$ 55 |
| XP6001 1-socket 1M-bits EPROMs programmer                                   | \$160 |
| XP6002 8-socket 1M-bits EPROMs programmer                                   | \$375 |
| XP6003 1-socket MCS-48 micros programmer                                    | \$215 |
| XP6004 1-socket MCS-51 micros programmer                                    | \$270 |

**2 YEARS WARRANTY + 30 DAYS MONEY BACK WARRANTY**

**Xender Corporation**  
2824, KENNEDY BLVD., JERSEY CITY, NJ 07306  
TEL: 201-659-2258 Tlx: 912 240 4444 CHAMPION

CIRCLE NO 781

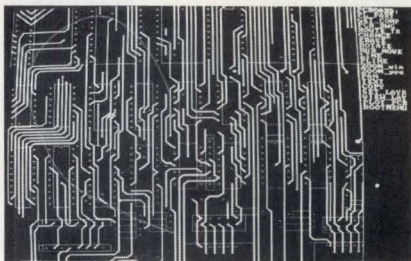

**AUTOROUTER USES  
ARTIFICIAL INTELLIGENCE TECHNIQUES**

AutoPCB 3.2 is a professional quality, PC-based PCB design system. No co-processor board is required. It features schematic capture, interactive part placement and route editing, and includes AutoROUTE, a powerful autorouter that uses artificial intelligence techniques to identify optimal routing patterns, such as the S turn and C patterns shown above, as part of the routing process. All layers of multilayer boards are routed simultaneously (up to 24). Post processors for photoplotters and drill tapes are available. A large, 4500 component part library lets you start designing boards immediately. A 30-day, full refund guarantee is provided.

**PRO. LIB, Inc.**  
624 E. Evelyn Ave., Sunnyvale, CA 94086  
Tel. (408) 732-1832, FAX 408-732-4932

CIRCLE NO 782

**Spring Contact Probes**

With more than 10 years' experience in manufacturing spring contact probes, we have over 100 different kinds of contact probes specialized for testing bare PCBs. We also offer probes for testing in-circuit PCBs. For full details, why not contact us today!



**C.C.P. Contact Probes  
Enterprise Co., Ltd.**

5F, No.19, Lane 155, Choung Ching Rd.,  
Panchiao, 22074, Taipei Hsien, Taiwan, R.O.C.  
Tel: (02)961-2525 Fax: 886-2-9548018  
Telex: 32517 CCPROB

CIRCLE NO 783



**UNIVERSAL E(EP)ROM  
PROGRAMMER \$495 (Kits from \$165)**

- No personality modules; Menu driven device selection.
- Built-in Eraser/Timer option (\$50); Conductive foam pad.
- Direct technical support; Full 1 year warranty.
- Stand alone duplication & verify (27XX parts).
- Quick pulse algorithm (27256 under 60 sec).
- 27xx to 1 Mbit; 25xx; 68xx; CMOS; EEPROMS.
- 8741,-2,-4,-8,-8H,-9,-9H,-51,-C51,-52,-55, 9761 & more.
- IBM-PC, Apple, CPM or Unix driver; Autobaud RS232.
- Offset/split Hex, Binary, Intel & Motorola 8,16,32 bit.
- Manual with complete schematics.

VISA MC AMEX Call today for datasheets !!

**B&C MICROSYSTEMS**

355 WEST OLIVE AVE. SUNNYVALE, CA 94086  
PH: (408) 730-5511 FAX: (408) 730-5521 TELEX: 984185

CIRCLE NO 784

To advertise in Product Mart, call Joanne Dorian, 212/463-6415



## Measurement terms in four languages

The 202-pg *Vocabulary of Terms*, which is published by The International Measurement Confederation (IMEKO), is a dictionary of measurement and instrumentation words and phrases in English, German, Russian, and French. Aimed at engineers, managers, and scientists working in the mainstream of engineering, the IMEKO vocabulary focuses on the terms used in research, development, design, production, marketing, and servicing, where terminology problems frequently arise. It addresses the needs of professionals in the fields of electrical, electronics, mechanical, civil, and aerospace engineering; instrumentation and control; production technology; and physics. The volume costs \$28.50, including shipping and handling.

**Stein Engineering Services Inc.**, 5602 E Monte Rose, Phoenix, AZ 85018.

**INQUIRE DIRECT**

## Brochure summarizes emulator's capabilities

This 4-pg brochure describes how the vendor's in-circuit emulator provides development-system support for 68000 CPUs. It focuses on the Ice-Engine/68K stand-alone product that you can use with PCs, host computers, or dumb terminals. The publication provides system configurations and block diagrams in schematic form, as well as a summary of commands.

**Ziltek Corp.**, 1651 E Edinger Ave, Santa Ana, CA 92705.

**Circle No 435**

## 8-channel recorder described

This 8-pg booklet describes the Model MT-8800 8-channel direct-writing recorder. It presents chart samples of a variety of real-time modes, including eight 20-mm channels and full-scale overlapping

waveforms. It also contains charts that demonstrate data captured by a trigger or by an on-demand snapshot. Finally, the publication reports on the vendor's family of signal conditioners and provides a complete list of specifications for the recorder.

**Astro-Med Inc.**, Astro-Med Industrial Park, West Warwick, RI 02893.

**Circle No 436**

## The human side of programming

In the 20-pg booklet *Experts' Views on the Human Interface Traits of Successful Commercial Software*, programmers discuss the importance of interaction with users during program development, as well as the need to provide accessible software. Rather than developing an impersonal flow chart, they emphasize that programmers should consider users' personalities, demands, and work styles. The document includes interviews with each programmer in question and answer format. Finally, the reference section gives brief descriptions of books, publications, and organizations devoted to the human side of software development.

**Solution Systems**, 541 Main St, South Weymouth, MA 02190.

**Circle No 437**

## Volume 4 added to WCA handbook series

Volume 4, the latest addition to the worst-case circuit analysis (WCA) handbook, covers worst-case testing of electronic circuits and systems. Each chapter in the book deals with different circuit technology—that is, analog, digital, and power-conversion circuits; and RF and microwave devices and circuits. Test descriptions include detailed block diagrams of test setups, theory of operation, step-by-step test procedures, examples of typical test results, and a discussion of those areas

where you must take special care to ensure the accuracy and repeatability of test data. The material is organized by circuit type and test parameter. 4-volume set, \$680. You may also purchase a volume separately.

**Design and Evaluation Inc.**, 1000 White Horse Rd, Suite 304, Voorhees, NJ 08043.

**INQUIRE DIRECT**

## Journal for Macintosh users

*The CAD/CAM Journal for the Macintosh Professional* surveys Macintosh advancements in computer-aided design and computer-aided manufacturing. The publication covers the expanding field of CAD/CAM/CAE applications and features stories about evaluations of 2D and 3D drafting and design software, communications and CAD, hardware evaluations, and the most recent CAD/CAM/CAE products. \$20 (six issues).

**The CAD/CAM Journal**, 16 Beaver St, New York, NY 10004.

**INQUIRE DIRECT**

## Listing of IEEE and data-acquisition devices

The 1988 catalog *IEEE-488 Control, Data Acquisition and Analysis for Your Computer* contains information about all of the vendor's IEEE-488 products, as well as software and supporting hardware products for data acquisition, data reduction, data analysis, and data presentation. It lists recently introduced hardware devices, such as the MC-GPIB interface for the PS/2 and three MicroGPIB products. An integrated software system, LabWindows, completes the roster of latest products.

**National Instruments**, 12109 Technology Blvd, Austin, TX 78727.

**Circle No 438**



## EDN's CHARTER

EDN is written for professionals in the electronics industry who design, or manage the design of, products ranging from circuits to systems.

EDN provides accurate, detailed, and useful information about new technologies, products, and design techniques.

EDN covers new and developing technologies to inform its readers of practical design matters that will be of concern to them at once or in the near future.

EDN covers new products

- that are immediately or imminently available for purchase
- that have technical data specified in enough detail to permit practical application
- for which accurate price information is available.

EDN provides specific "how to" design information that our readers can use immediately. From time to time, EDN's technical editors undertake special "hands-on" projects that demonstrate our commitment to readers' needs for useful information.

EDN is written by engineers for engineers.

# EDN

275 Washington St  
Newton, MA 02158  
(617) 964-3030

**F Warren Dickson**  
Vice President/Publisher  
Newton, MA 02158  
(617) 964-3030  
Telex 940573  
Diann Siegel, Assistant

**Peter D Coley**  
VP/Associate Publisher/  
Advertising Sales Director  
Newton, MA 02158  
(617) 964-3030  
Ora Dunbar, Assistant/Sales Coordinator

**NEW ENGLAND**  
John Bartlett, Regional Manager  
Chris Platt, Regional Manager  
199 Wells Ave  
Newton, MA 02159  
(617) 964-3730

**STAMFORD 06904**  
George Isbell, Regional Manager  
8 Stamford Forum, Box 10277  
(203) 328-2580

**NEW YORK, NY 10011**  
Daniel J Rowland, Regional Manager  
249 West 17th St  
New York, NY 10011  
(212)463-6419

**PHILADELPHIA AREA**  
Steve Farkas, Regional Manager  
487 Devon Park Dr  
Suite 206  
Wayne, PA 19087  
(215) 293-1212

**CHICAGO AREA**  
Clayton Ryder, Regional Manager  
Randolph D King, Regional Manager  
Cahners Plaza  
1350 E Touhy Ave, Box 5080  
Des Plaines, IL 60017  
(312) 635-8800

**DENVER 80206**  
John Huff, Regional Manager  
44 Cook St  
(303) 388-4511

**DALLAS 75243**  
Don Ward, Regional Manager  
9330 LBJ Freeway  
Suite 1060  
(214) 644-3683

**SAN JOSE 95128**  
Walt Patstone, Regional Manager  
Bill Klank, Regional Manager  
Philip J Branon, Regional Manager  
James W Graham, Regional Manager  
3031 Tisch Way, Suite 100  
(408) 243-8838

**LOS ANGELES 90064**  
Charles J Stillman, Jr  
Regional Manager  
12233 W Olympic Blvd  
(213) 826-5818

**ORANGE COUNTY/  
SAN DIEGO 92715**  
Jim McErean, Regional Manager  
18818 Teller Ave, Suite 170  
Irvine, CA  
(714) 851-9422

**PORTLAND, OREGON 97221**  
Pat Dakin, Regional Manager  
Walt Patstone, Regional Manager  
1750 SW Skyline Blvd, Box 6  
(503) 297-3382

**UNITED KINGDOM/BENELUX**  
Jan Dawson, Regional Manager  
27 Paul St  
London EC2A 4JU UK  
44 01-628 7030  
Telex: 914911; FAX: 01-628 5984

**SCANDINAVIA**  
Stuart Smith  
27 Paul St  
London EC2A 4JU UK  
01-628 7030  
Telex: 914911; FAX: 01-628 5984

**FRANCE/ITALY/SPAIN**  
Alasdair Melville  
27 Paul St  
London EC2A 4JU UK  
01-628 7030  
Telex: 914911; FAX: 01-628 5984

**WEST GERMANY/SWITZERLAND/AUSTRIA**  
Wolfgang Richter  
Sudring 53  
7240 Horb/Neckar  
West Germany  
49-7451-7828; TX: 765450

**ISRAEL**  
Igal Eilan  
Eilan Marketing Group  
13 Haifa St, Box 33439  
Tel-Aviv, Israel  
Tel: 972-3-268020  
TX: 341667

**EASTERN BLOC**  
Uwe Kretzschmar  
27 Paul St  
London EC2A 4JU UK  
01-628 7030  
Telex: 914911; FAX: 01-628 5984

**FAR EAST**  
Ed Schrader, General Manager  
18818 Teller Ave, Suite 170  
Irvine, CA 92715  
(714) 851-9422; Telex: 183653

**TOKYO 160**  
Kaoru Hara  
Dynaco International Inc  
Suite 1003, Sun-Palace Shinjuku  
8-12-1 Nishishinjuku, Shinjuku-ku  
Tokyo 160, Japan  
Tel: (03) 366-8301  
Telex: J2322609 DYNACO

**TAIWAN**  
Acteam International  
Marketing Corp  
6F, No 43, Lane 13  
Kwang Fu South Rd  
Mailing Box 18-91  
Taipei, Taiwan ROC  
760-6209 or 760-6210  
Telex: 29809  
FAX: (02) 7604784

**KOREA**  
BK International  
Won Chang Bldg, 3rd Floor 26-3  
Yoido-dong, Youngdungpo-ku  
Seoul 150, Korea  
Tel: 785-6665  
Fax: 784-1915  
Telex: K32487 BIZKOR

**PRODUCT MART**  
Joanne Dorian, Manager  
249 West 17th St  
New York, NY 10011  
(212) 463-6415

**CAREER OPPORTUNITIES/  
CAREER NEWS**  
Roberta Renard  
National Sales Manager  
103 Eisenhower Parkway  
Roseland, NJ 07068  
(201) 228-8602

Janet O Penn  
Eastern Sales Manager  
103 Eisenhower Parkway  
Roseland, NJ 07068  
(201) 228-8610

Western Sales Manager  
18818 Teller Ave  
Suite 170  
Irvine, CA 92715  
(714) 851-9422

Maria Cubas  
Production Assistant  
(201) 228-8608

Susan M Campanella, Advertising/Contracts Supervisor  
Nan Coulter, Advertising/Contracts Coordinator  
(617) 964-3030

**William Platt, Sr, Vice President, Reed Publishing USA  
Cahners Magazine Division**  
Terry McDermott, President, Cahners Publishing Co  
Frank Sibley, Group Vice President, Electronics/Computers  
Tom Dellamaria, VP/Production & Manufacturing

**Circulation**  
Denver, CO: (303) 388-4511  
Sherri Gronli, Group Manager  
Eric Schmierer, Manager

Reprints of EDN articles are available on a custom printing basis at reasonable prices in quantities of 500 or more. For an exact quote, contact Joanne R Westphal, Cahners Reprint Service, Cahners Plaza, 1350 E Touhy Ave, Box 5080, Des Plaines, IL 60018. Phone (312) 635-8800.



Deborah Asbrand, *Associate Editor*

# Ability—not disability— makes the engineer

Meet an engineer-to-be, a practicing engineer, and a retired engineer who explain why other people's attitudes are sometimes their greatest obstacle.

**R**alph Arnold is on his way to becoming an engineer's engineer. A lifetime devotee of electronics, Arnold was already a veteran of many Heathkit projects when he entered high school in 1963. He studied electronics through an RCA correspondence class, and, as a junior and senior, attended extracurricular sessions for students who excelled in science and technology. His senior project was the design and assembly of a computer that used discrete-transistor logic—a goal that was impossible for a high-school senior, but one that he pursued anyway.

After high school, Arnold enrolled in the electrical-engineering program at the Case Institute of Technology (now Case Western Reserve University) in Cleveland, OH. A successful engineering career seemed imminent.

But after one semester at Case Institute, Arnold left school and enlisted in the US Army. He flew more than 500 hours as a helicopter pilot in Vietnam. In 1970, while he was

**“I was getting tired of waiting for someone to find a cure for spinal-cord injury. I figured if they wouldn't do it, I'd try.”**

flying as copilot on a mission that took him 1½ hours west of Da Lat, his aircraft crashed. He suffered a broken back, and his legs remained paralyzed from the knees down. The

injury derailed his educational and career plans.

Now, at age 38, Arnold has returned to college to earn the degree he began studying for 20 years ago. A junior at the University of Akron, OH, he expects to complete his BSEE in two years and then pursue a master's degree in biomedical engineering. Having started a consulting practice four years ago that specializes in electronics aids for people with spinal-cord injuries, Arnold sees room for much improvement in the available technology. He hopes someday to close that gap. “People don't make electronic wheelchairs for the handicapped designed to MIL specs,” he says. “People think that when they design for the handicapped, they can design at a minimal level. But the opposite is true, because if you don't operate a wheelchair deftly, you hit a lot of walls.”

After completing his rehabilitation in the Veterans Administration Hospital at Wade Park (Cleveland, OH), Arnold spent several years trying out different jobs. He studied photography and opened a business as a children's photographer. Working with a friend, he produced jazz concerts and acquired public-relations expertise.

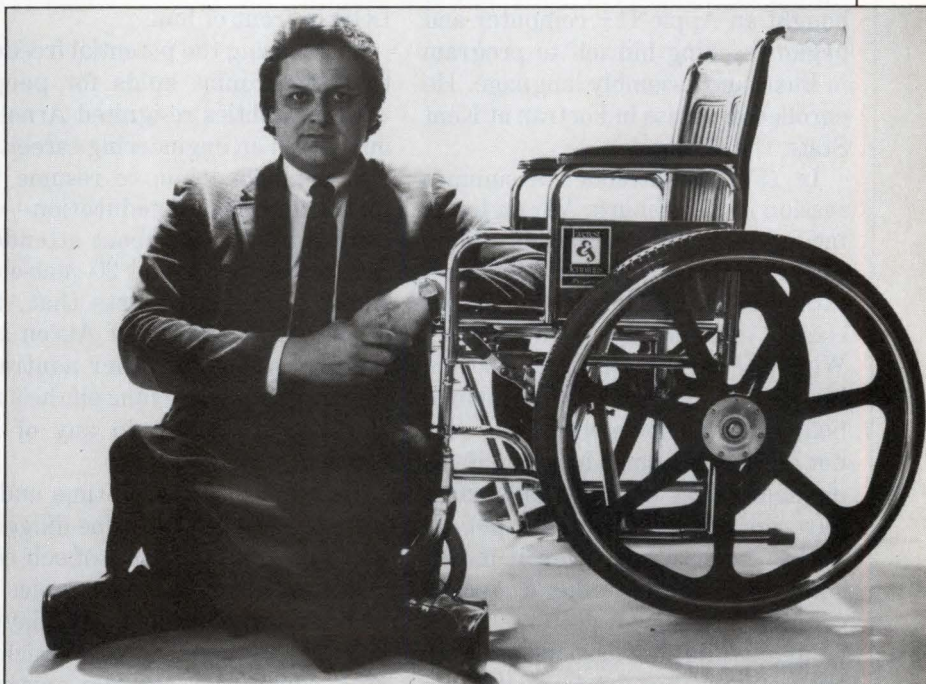

*Ralph Arnold, consultant, Memories Unlimited Inc*



He also continued to pilot helicopters. After nine months of negotiations with the Veterans Administration, Arnold managed to convince the Administration to pay for his training as a civilian helicopter pilot through its vocational-rehabilitation program. Throughout the protracted procedure, Arnold contemplated why he was so driven to fly again. "It was what I was most familiar with, and what I was best at before the injury," he says of flying. "Yet sometimes I wondered if I really wanted to fly, or if it was a matter of getting back onto the horse that threw me off."

In 1972, he climbed back into the cockpit of a helicopter, and 250 flight hours later, he received certification as a civilian, commercial, and instructor pilot. He also earned a license to pilot a single-engine airplane.

Throughout all of his ventures, Arnold continued to tinker with hardware. "I put together all sorts of odd little circuits," he says. "By the mid 1970s, I could strip down most things and repair them. But I wasn't sure why they had been designed in a certain way." In 1978, he bought an Apple II+ computer and began teaching himself to program in Basic and assembly language. He enrolled in a class in Fortran at Kent State University.

In 1979, he attended a summer session in Blacksburg, VA, on interfacing to the 8080 Series chips. Though Arnold was primarily interested in the 6502 line, he found the class enormously informative. What's more important, it boosted his self-confidence. "When somebody first sits down with a chip, it's not like a fuse, which blows up if you do something wrong. This class gave me the confidence to put together some chips, even if it was something simple like a decade counter."

Meanwhile, his association with the Veterans Administration

evolved into a consulting role. The hospital's vocational-rehabilitation program had purchased three Apple IIe computers, and Arnold drove to the VA hospital in Cleveland once a month to teach programming to residents. He'd also maintain the equipment, loading the hard disk, installing public-domain software, and hooking up peripherals.

In 1984, Arnold established Memories Unlimited, a consulting practice that specializes in troubleshooting electronic devices used by people with limited mobility and communications skills. Among his clients is a 36-year-old stroke victim with whom Arnold began working in 1986. "He lived as a vegetable in the VA hospital until they discovered he was coherent," Arnold says. "Then it was a matter of interfacing him to the world." With Arnold's guidance, the man, who's paralyzed from the nose down, wears a light stick attached to eyeglass frames and uses the device to communicate on a computer, operate a modem, and write letters. Using slight head movements, he beams the light for a specified period of time at a photocell that illuminates a letter on the LCD in front of him.

Discovering the potential freedom that electronics holds for people with disabilities re-ignited Arnold's interest in an engineering career. It also persuaded him to resume his formal engineering education—despite some qualms about attending classes full of 19- and 20-year-olds. Arnold happily reports that, because the University of Akron is a popular choice for other nontraditional students like himself, he's not the oldest student in any of his classes.

He applies to his full-time undergraduate studies the same diligence he's shown in a lifetime of self-education. "I look at electronics as being the tool that will someday let me hook patients up to a machine with which they can run anything

they want," says Arnold. "I was getting tired of waiting for someone to find a cure for spinal-cord injury. I figured if they wouldn't do it, I'd try."

**B**ob Barnes' electrical-engineering education began at the age of three, when he stuck his finger into a light socket. "I started asking questions then," he remembers. "Every answer led to another question, and I've never stopped asking questions since."

The answers to Barnes' questions propelled him along the way to an engineering career. In high school, he was a frequent Radio Shack customer and a fan of the chain's 151-projects kits. He later studied electrical engineering at Louisiana Tech University, and after graduation in 1979 he delayed his full-time job search by several months to pursue the art of television repair. "A television contains an example of nearly every kind of circuit there is in electronics. And that can't be said of any other device. The most sophisticated computer in the world contains hundreds of thousands of repetitions of the same circuits."

**"Blind people are  
85% unemployed or  
underemployed. The  
computer is the  
ticket in for them."**

For the past eight years, Barnes, 31, has worked for General Dynamics in Fort Worth, TX. Now an engineering specialist, he programs automatic test equipment (ATE) in the department of manufacturing-test-equipment engineering. After several years of programming, he's now training newcomers to his department in the techniques used to test avionics equipment both on the production line and in the field.



Barnes has been blind since birth, and he says his presence in the engineering laboratory sometimes surprises first-time visitors. "When people come into the lab with a technical question and they're referred to me, they don't realize I'm blind until they reach my desk. That surprises people, and they don't know how to go ahead and ask their question. They usually have a drawing that illustrates some of their problems and now they have to describe it." Yet Barnes understands their hesitation. "It's a cautiousness around situations they're unfamiliar with."

Among the engineers with whom he works, however, Barnes says such initial awkwardness quickly evaporates. "A lot of people view blindness as a barrier to be avoided. But the people I work with view it as a challenge to be overcome so that they can use the abilities a person has." The only special equipment Barnes uses is the computer system that he works with daily. It

employs a braille keyboard and a terminal that displays one line of 20 braille characters. A nearby printer produces Barnes' program listings in braille.

Indeed, Barnes sees computer training as a great asset to people in all levels of the workforce who have limited sight or no sight. "Blind people are 85% unemployed or underemployed. The computer is the ticket in for them. There are many noncomputerized offices where able-bodied people are somewhat afraid of computers. They can afford that fear because they are getting by. Blind people can't afford to be afraid."

Even with job applicants that have the appropriate skills, however, it's often difficult to convince people in the workplace to look beyond physical limitations. Corporate recruiters, for example, can become preoccupied with what a person can't do. Often they ask interviewees how they will handle the physical aspects of getting around in the

office and the paperwork associated with a position. Such questions are legitimate, Barnes points out, but difficult to answer at an interview, when the job candidate knows little about the physical characteristics of the building or the acceptability of asking others for assistance with paperwork.

More important, the applicant has undoubtedly tackled such logistical problems before and will be able to do so again. Barnes says that he had a ready answer for recruiters who asked him the inevitable questions. "I made it quite clear that these are the kinds of problems I've solved all of my life." Good salesmanship became an important part of his pitch. "Even if employers believe you, they consider themselves going out on a limb. They have to be sure."

Barnes serves as chairman of the board of the Center for Computer Assistance to the Disabled in the Dallas-Fort Worth area. Local residents and businesses provide the financial support and equipment

© Jay Elledge/Farrington

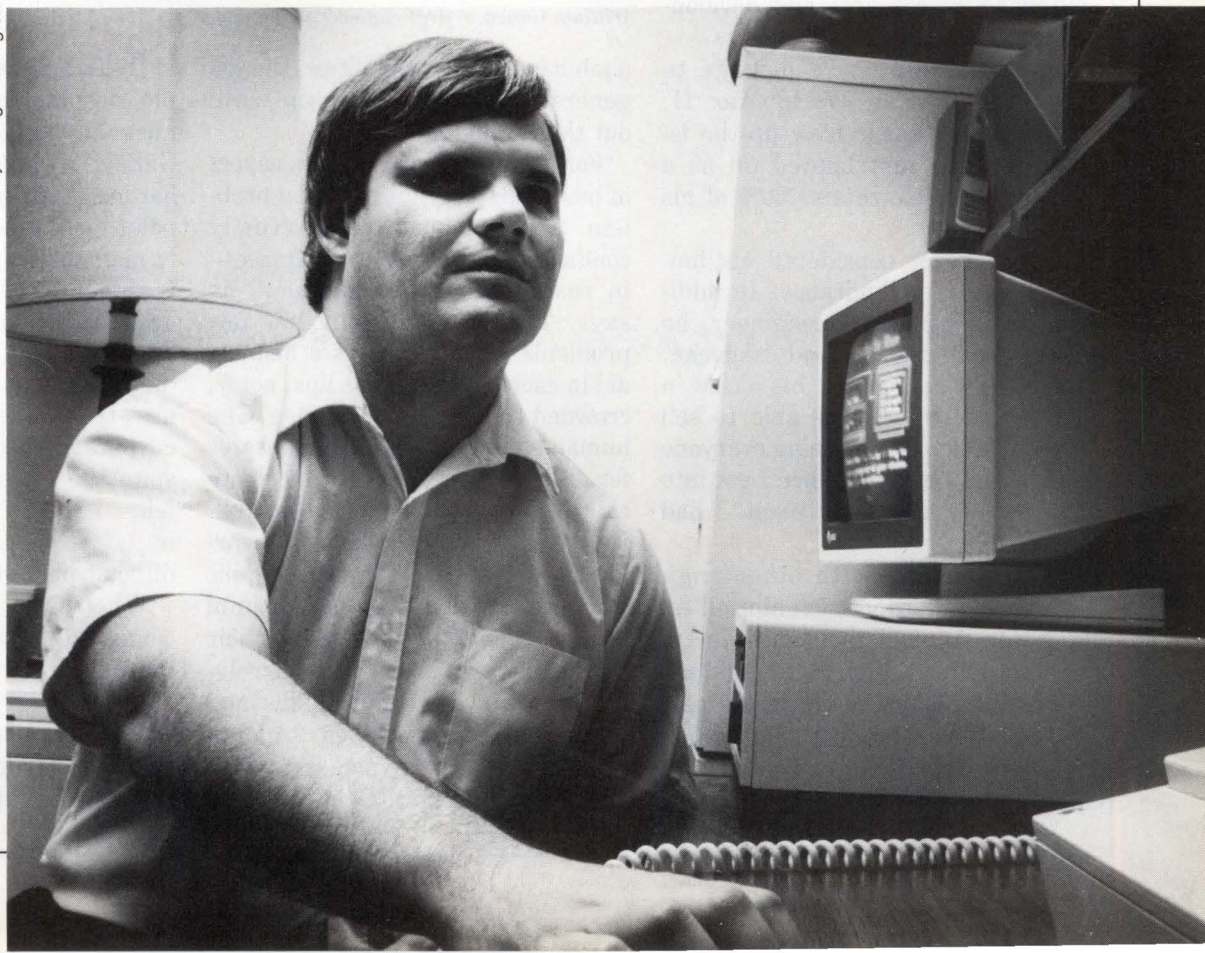

**Bob Barnes**, engineering specialist, General Dynamics



that Barnes and others use to teach computer skills to area residents who are blind. Barnes hopes the training will be the catalyst the center's clients need to start down the road to success.

**W**illiam Ganey recently retired after a 36-year engineering career. He began his career in 1951, designing command, control, and communication electronics for the Nautilus atomic submarine. After working on simulation and training for aircraft radar operators, he eventually participated in the Titan, Minuteman, and Peacekeeper missile projects. He also worked on a project that examined the feasibility of supporting a moon-based military and scientific station.

For the last 27 years, Ganey worked for GTE's Strategic Systems Div in Westborough, MA. In October 1987, he retired as engineering manager in the company's independent research and development laboratory.

He sustained nerve damage to both ears during World War II, when the Japanese blew up the island he had just landed on as a paratrooper. He retains 30% of his hearing.

Ganey never considered his limited hearing a hindrance: In addition to being a good engineer, he considers himself a good salesman. He simply sharpened his skills in self-promotion. "I was able to sell myself, which is something everyone has to do," he says. "Once I got into the engineering department, I had no trouble."

When talking with other engineers, he would position himself directly in front of them in order to facilitate lip-reading. But he did encounter difficulty in corporate personnel departments. "Personnel tends to look down on people with disabilities. If two people vying for

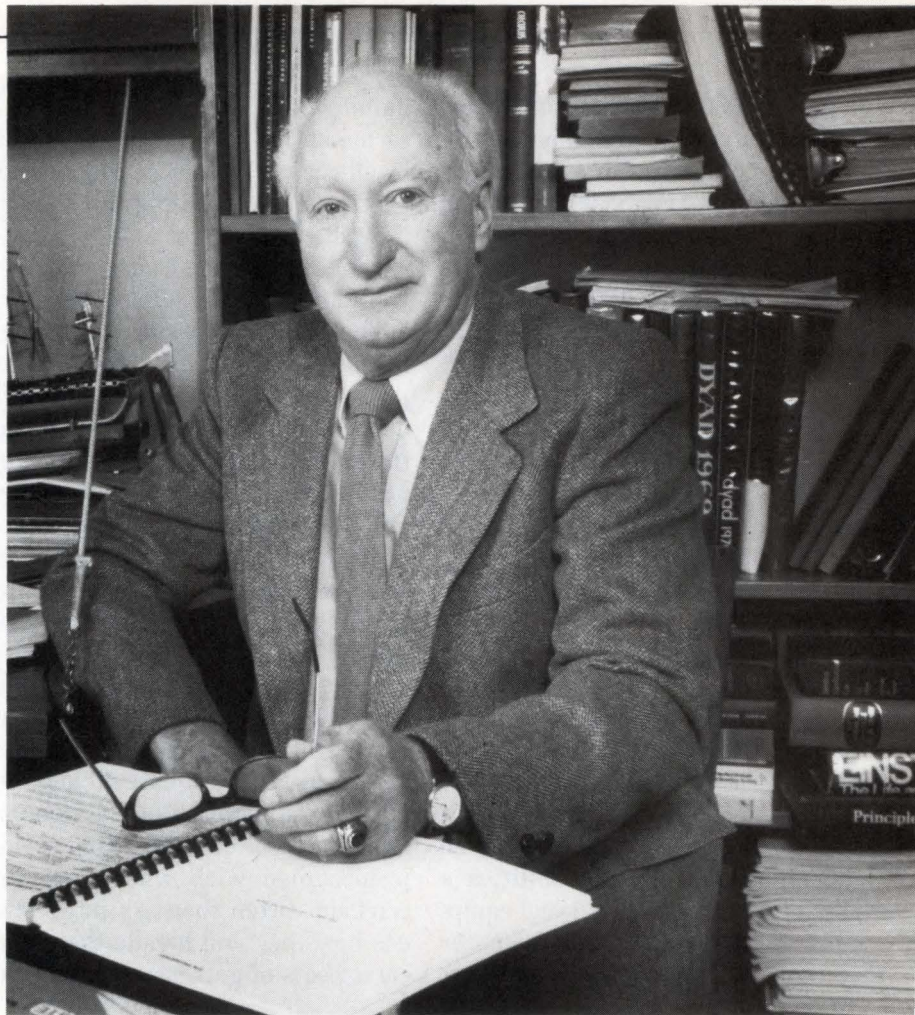

*William Ganey, retired engineering manager*

a job have equal capabilities, the job generally goes to the person without the disability."

For Ganey, the after-hours aspect of business sometimes posed a problem. "Lots of business is actually conducted outside the workplace—in restaurants, for example," he says. Though he usually has few problems when he wears a hearing aid in each ear and reads lips, noisy, crowded rooms are a challenge. The human ear adjusts and compensates for each environment, but mechanical hearing aids don't have that ability. When a person wearing a hearing aid enters a clamorous room, his ears are bombarded by loud, painful sounds. Many people turn off their hearing aids in such situations, relying on their lip-reading skills and sometimes feeling isolated. "A lot of people fake it. They nod and try to stay part of things," Ganey says.

"With a hearing loss, lots of people become introverts, and they miss an awful lot of life," says Ganey, who is 64. Ganey worked hard to avoid such seclusion. At one point in his career, he simultaneously managed engineering projects in Massachusetts, California, and Colorado. He spent 50% of his time traveling, and he made an effort to dine in restaurants with his business-trip colleagues and to attend corporate and social functions despite the discomfort he sometimes felt. "I couldn't avoid [the socializing]," he says. "It was the most difficult part of my job."

When GTE won a \$500 million contract to develop the MX missile, the company threw an elaborate celebration party. The din created by 2000 guests made for a difficult evening not only for Ganey, but also for other attendees. His boss later



pulled him aside and asked him if he'd had trouble hearing at the party. When Ganey answered yes, his boss commented that he, too, had had trouble hearing. The experience, his supervisor said, gave him a better understanding of Ganey's difficulties in public places.

**"I want to use the benefit of my experience to help someone who's just starting out."**

Ganey found his hearing impairment a small obstacle compared with the hurdles faced by individuals who need—and usually don't receive—more support from the workplace. For example, another engineer Ganey worked with had limited use of his legs and walked with the assistance of crutches. The two men frequently traveled together and Ganey often had to watch his colleague struggle with long flights of steps in facilities that had no elevators. "Industry doesn't do anything for handicapped people unless they're forced to by the government," he laments. "They put in ramps and special parking spots, but that's about as far as they go."

Since his retirement last fall, Ganey's decided to devote more of his time to providing guidance for young people with disabilities. He's a member of the Project on Science, Technology, and Disability within the American Association for the Advancement of Science, and he's listed in the Project's *Resource Directory of Scientists and Engineers with Disabilities*. Says Ganey: "I want to use the benefit of my experience to help someone who's just starting out."

**EDN**

Article Interest Quotient  
(Circle One)

High 515 Medium 516 Low 517

# Looking for a job doesn't have to be one.

EDN's Career Opportunities  
section keeps you informed  
of current job openings  
from coast-to-coast

**TURN TO  
PAGE 274**





See  
the  
all new

**1988**

**EDN CARAVAN**  
Eastern Show Tour

VTC, INCORPORATED  
BOURNS, INCORPORATED  
BURR-BROWN CORPORATION  
CAROL CABLE COMPANY, INC.  
MEREL COMPANY, INCORPORATED  
LOGIC DYNAMICS, INCORPORATED  
VLSI TECHNOLOGY, INCORPORATED

**CHECK THE ITINERARY FOR THE DATE WE VISIT YOU!**





# 1988 EASTERN EDN CARAVAN TRAVELING ELECTRONIC SHOW

## March 21 to April 22 (Northeastern Edition)

DATE	TIME	SITE	DATE	TIME	SITE
3/21 Monday	9:00-11:00 AM	GENERAL ELECTRIC COMPANY Chestnut St., Philadelphia, PA	4/6 Wednesday	1:30-4:00 PM	HAMILTON STANDARD Hamilton Road, Windsor Locks, CT
3/21 Monday	12:30-2:30 PM	UNISYS CORPORATION 70 E. Swedesford Rd., Paoli, PA	4/7 Thursday	10:00-12:30 AM-PM	ALCATEL TRANSCOM, INCORPORATED 1170 E. Main Rd., Portsmouth, RI
3/21 Monday	3:00-4:30 PM	UNISYS CORPORATION 2476 Swedesford Rd., Paoli, PA	4/7 Thursday	1:30-4:00 PM	RAYTHEON COMPANY, SSD 1847 W. Main Rd., Portsmouth, RI
3/22 Tuesday	9:00-11:00 AM	UNISYS CORPORATION Township Line & Union Meeting, Blue Bell, PA	4/8 Friday	8:30-10:30 AM	SIPPICAN CORPORATION 7 Barnabus Rd., Marion, MA
3/22 Tuesday	11:30-1:00 AM-PM	KULICKE & SOFFA INDUSTRIES, INC. 2101 Blair Mill Road, Willow Grove, PA	4/8 Friday	12:30-2:00 PM	CODEX CORPORATION 20 Cabot Blvd., Mansfield, MA
3/22 Tuesday	2:00-4:00 PM	LEEDS & NORTHRUP Sumneytown Pike, North Wales, PA	4/8 Friday	2:30-4:00 PM	FOXBORO COMPANY 33 Commercial Ave., Foxboro, MA
3/23 Wednesday	8:30-11:00 AM	RCA CORPORATION Delaware & Market St., Camden, NJ	4/11 Monday	8:30-11:00 AM	RAYTHEON COMPANY 528 Boston Post Rd., Sudbury, MA
3/23 Wednesday	11:30-1:30 AM-PM	RCA CORPORATION Marne Hwy., Moorestown, NJ	4/11 Monday	11:30-1:30 AM-PM	RAYTHEON COMPANY 430 Boston Post Rd., Wayland, MA
3/23 Wednesday	3:00-4:30 PM	DAVID SARNOFF RESEARCH CENTER 201 Washington Road, Princeton, NJ	4/11 Monday	2:30-4:30 PM	MITRE CORPORATION Burlington Rd., Bedford, MA
3/24 Thursday	8:30-11:00 AM	LOCKHEED ELECTRONICS U.S. Hwy. 22, Plainfield, NJ	4/12 Tuesday	8:30-10:00 AM	COMPUGRAPHIC CORPORATION 200 Ballardvale St., Wilmington, MA
3/24 Thursday	12:30-2:30 PM	ITT DEFENSE COMMUNICATIONS 492 River Road, Nutley, NJ	4/12 Tuesday	10:30-12:30 AM-PM	GENERAL ELECTRIC COMPANY Bedford St., Burlington, MA
3/24 Thursday	3:00-4:30 PM	ITT AVIONICS 390 Washington Ave., Nutley, NJ	4/12 Tuesday	1:30-3:30 PM	HONEYWELL INCORPORATED 300 Concord Pike, Billerica, MA
3/25 Friday	8:30-11:00 AM	AT&T BELL LABS 600 Mountain Ave., Murray Hill, NJ	4/13 Wednesday	8:00-10:45 AM	RAYTHEON COMPANY Hartwell Road, Bedford, MA
3/25 Friday	12:30-2:00 PM	AT&T BELL LABS 260 Cherry Hill Rd., Parispppany, NJ	4/13 Wednesday	11:30-12:30 AM-PM	APOLLO COMPUTER Elizabeth Dr., Chelmsford, MA
3/25 Friday	2:30-4:00 PM	AT&T BELL LABS Whippany Road, Whippany, NJ	4/13 Wednesday	1:30-4:00 PM	AT&T TECHNOLOGIES, INCORPORATED 1600 Osgood St., N. Andover, MA
3/28 Monday	8:30-11:00 AM	SINGER CO., KEARFOTT DIVISION 150 Totowa Rd., Wayne, NJ	4/14 Thursday	8:30-10:30 AM	DIGITAL EQUIPMENT CORPORATION Continental Blvd., Merrimack, NH
3/28 Monday	11:30-1:30 AM-PM	SINGER CO., KEARFOTT DIVISION 1150 McBride Ave., Little Falls, NJ	4/14 Thursday	11:00-12:30 AM-PM	KOLLSMAN INSTRUMENT 220 Daniel Webster Hwy., Merrimack, NH
3/28 Monday	2:30-4:30 PM	ALLIED BENDIX CORPORATION Route 46, Teterboro, NJ	4/14 Thursday	2:00-4:00 PM	WANG LABORATORIES, INCORPORATED One Industrial Ave., Lowell, MA
3/29 Tuesday	8:30-10:30 AM	EATON CORPORATION, AIL 45 Oser Ave., Hauppauge, NY	4/15 Friday	8:30-10:00 AM	DIGITAL EQUIPMENT CORPORATION 295 Foster St., Littleton, MA
3/29 Tuesday	11:00-1:00 AM-PM	EATON CORPORATION, AIL Walt Whitman Rd., Melville, NY	4/15 Friday	11:00-1:00 AM-PM	DIGITAL EQUIPMENT CORPORATION 146 Main St., Maynard, MA
3/29 Tuesday	2:00-4:00 PM	FAIRCHILD WESTON CORPORATION 300 Robbins Lane, Syosset, NY	4/15 Friday	2:00-4:00 PM	DIGITAL EQUIPMENT CORPORATION 200 Forest St., Marlboro, MA
3/30 Wednesday	8:30-11:00 AM	HAZELTINE CORPORATION Cuba Hill Road, Greenlawn, NY	4/18 Monday	9:00-11:30 AM	DATA GENERAL CORPORATION 4400 Computer Dr., Westborough, MA
3/30 Wednesday	11:30-1:00 PM	NORDEN SYSTEMS 75 Maxess Rd., Melville, NY	4/18 Monday	1:00-4:00 PM	DIGITAL EQUIPMENT CORPORATION 333 South St., Shrewsbury, MA
3/30 Wednesday	2:00-4:00 PM	GRUMMAN CORPORATION Maxess Rd., Melville, NY	4/19 Tuesday	8:00-10:30 AM	IBM CORPORATION Neighborhood Rd., Kingston, NY
3/31 Thursday	8:00-10:00 AM	GRUMMAN CORPORATION Stewart Ave., Bethpage, NY	4/19 Tuesday	11:30-1:00 AM-PM	IBM CORPORATION South Rd., Poughkeepsie, NY
3/31 Thursday	10:45-12:30 AM-PM	UNISYS CORPORATION Marcus Ave., Great Neck, NY	4/19 Tuesday	2:00-4:00 PM	IBM CORPORATION E. Fishkill Rd., Hopewell Jct., NY
3/31 Thursday	2:00-3:30 PM	LORAL ELECTRONIC SYSTEMS Ridge Hill, Yonkers, NY	4/20 Wednesday	9:00-12:00 AM-PM	IBM CORPORATION Bodle Hill Rd., Owego, NY
4/4 Monday	8:30-11:00 AM	NORDEN SYSTEMS Norden Place, Norwalk, CT	4/20 Wednesday	1:30-4:00 PM	IBM CORPORATION Glendale Dr., Endicott, NY
4/4 Monday	11:30-1:00 AM-PM	PERKIN-ELMER CORPORATION 761 Main Ave., Norwalk, CT	4/21 Thursday	8:30-10:30 AM	GENERAL ELECTRIC COMPANY Broad St., Utica, NY
4/4 Monday	1:30-4:00 PM	PITNEY BOWES, INCORPORATED 380 Main Ave., Norwalk, CT	4/21 Thursday	11:00-12:00 AM-PM	GENERAL ELECTRIC COMPANY French Rd., Utica, NY
4/5 Tuesday	8:30-10:30 AM	SIKORSKI AIRCRAFT COMPANY 6900 Main St., Stratford, CT	4/21 Thursday	2:00-4:00 PM	GENERAL ELECTRIC COMPANY Farrell Rd., Syracuse, NY
4/5 Tuesday	11:15-12:30 AM-PM	PHILIPS MEDICAL SYSTEMS 710 Bridgeport Ave., Shelton, CT	4/22 Friday	8:00-10:00 AM	XEROX CORPORATION 800 Phillips Rd., Webster, NY
4/5 Tuesday	2:00-4:00 PM	GENERAL DATA COMM INDUSTRIES Straights Tpk.-Rt. 63, Middlebury, CT	4/22 Friday	10:30-1:00 AM-PM	EASTMAN KODAK COMPANY 901 Elmgrove Rd., Rochester, NY
4/6 Wednesday	9:00-11:30 AM	HAMILTON STANDARD 1690 New Britain Ave., Farmington, CT	4/22 Friday	2:00-4:00 PM	HARRIS RF COMMUNICATIONS 1680 University Ave., Rochester, NY



# New Horizons In Computer Graphics

Lundy, a recognized innovator in computer graphics, is expanding to meet the growing demand for fast, high resolution displays. As we look ahead to our next generation of products, the opportunities to participate are wide open, including the following positions:

## SOFTWARE SYSTEMS MANAGER

Responsible for managing the software and systems design of all workstation products. You will also provide technical and administrative management services with regard to both hardware and software engineers. Requires knowledge of 'C', FORTRAN, UNIX, GKS, PHIGS, and Graphics with a minimum of 7 years relevant experience.

## SOFTWARE ENGINEER—CAD/CAM

You'll become part of a group responsible for the development of drivers and software interfaces for industry standards on both raster and vector refresh graphics systems. Knowledge of UNIX, VMS, FORTRAN 77, 'C', opsystem driver design, Assembly language, PHIGS, and GKS, plus graphics experience are desired. In addition, we're looking for approximately 5 years relevant experience.

## HARDWARE ENGINEER—RASTER

A key contributor to the group responsible for the development of new graphics products is needed. Knowledge of bipolar, CMOS technology, graphics, some bit slice firmware, and familiarity with graphics algorithms are required. You should also possess approximately 5 years relevant experience to make the level of contribution desired.

## RELIABILITY/MAINTAINABILITY ENGINEER

Responsible for all aspects of reliability and maintainability programs including proposals, administration, field failure analysis and customer interface as required. Requires 2-5 years experience in reliability and maintainability programs, analysis and calculations such as MTBF. Good verbal and written communication skills.

**We prefer a B.S.E.E., B.S.C.S., B.S.M.E or equivalent for all the above positions.**

In addition to excellent compensation and benefits, Lundy's location is a distinct advantage. We are near a number of pleasant suburban communities, as well as beautiful beaches and recreation areas. There is a good choice of colleges and universities, and New York City is easily accessible via train and major highways.

Take the first step toward broadening your professional horizons by sending your resume, indicating position of interest, in confidence to: **Ms. Susan DeThomas, Dept. EDN317, Lundy Electronics & Systems, Inc., 1 Robert Lane, Glen Head, NY 11545, (516) 671-9000.** Lundy is an equal opportunity employer m/f/h/v



# LUNDY

**"Designing The Future... Today"**

# CAREER OPPORTUNITIES

## 1988 Editorial Calendar and Planning Guide

Issue Date	Recruitment Deadline	Editorial Emphasis	EDN News
Apr. 14	Mar. 23	Communication Technology Special Issue, Communication Systems	Closing: Mar. 31 Mailing: Apr. 21
Apr. 28	Apr. 7	Software, Industrial Computers, Interface ICs	
May 12	Apr. 21	Analog Technology Special Issue, Analog Converters	Closing: Apr. 28 Mailing: May 19
May 26	May 5	CAE, Software, Sensors/Transducers	
June 9	May 19	CAE, Analog ICs, Test & Measurement	Closing: May 29 Mailing: June 16
June 23	June 2	Data Communications, DSP, Components	
July 7	June 14	Product Showcase—Vol. I, Power Sources, Software	Closing: June 23 Mailing: July 14
July 21	June 30	Product Showcase—Vol. II, CAE, Test & Measurement	
Aug. 4	July 14	Sensors & Transducers, Analog ICs, Graphics	Closing: July 21 Mailing: Aug. 11
Aug. 18	July 28	Military Electronics Special Issue, Displays, Military ICs	
Sept. 1	Aug. 11	Instruments, Op Amps, Computers & Peripherals	
Sept. 15	Aug. 25	Data Acquisition, Data Communications, Digital ICs	Closing: Sept. 1 Mailing: Sept. 22
Sept. 29	Sept. 8	DSP, Graphics, Optoelectronics	
Oct. 13	Sept. 22	Test & Measurement Special Issue, Instruments, Computers & Peripherals	Closing: Sept. 29 Mailing: Oct. 20
Oct. 27	Oct. 6	CAE, Computers & Peripherals, Integrated Circuits, Wescon '88 Show Preview	
Nov. 10	Oct. 20	Programmable Logic Devices, Integrated Circuits, Test & Measurements, Wescon '88 Show Issue	Closing: Oct. 27 Mailing: Nov. 17
Nov. 24	Nov. 3	Microprocessor Technology Directory Graphics, CAE	
Dec. 8	Nov. 16	Product Showcase—Vol. I, Power Sources, Software	Closing: Nov. 21 Mailing: Dec. 15
Dec. 22	Dec. 1	Product Showcase—Vol. II, Computers & Peripherals, Test & Measurement	

Call today for information:

East Coast: Janet O. Penn (201) 228-8610

West Coast: (714) 851-9422

National: Roberta Renard (201) 228-8602



# E N G I N E E R S

Home in on an extraordinary career at GE Government Electronic Systems Division. If you are an engineer with the ability to create sophisticated Sonar systems, there is tremendous future within range.

Our Undersea Systems Department is a recognized leader in ASW technology for Surface Ship and submarine based systems. We continue to expand our technology and program base through our reputation for delivering quality products and well funded IR&D programs.

As ASW technology continues to grow, you owe it to yourself to grow with the leader.

## **Systems Engineers**

*opportunities currently exist in:*

- Large Scale Combat Systems Analysis; Design & Development
- Acoustics & Signal Processing
- Algorithm development
- Sensor systems design & development
- Control systems engineering
- Reliability/Maintainability/ Human Factors

## **Hardware Engineers**

*help design the future by working in:*

- Advanced architecture and design
- CMOS gate array development
- Power supply design
- Analog or digital circuit design (board and component level)
- Transmitter design
- Electronics Packaging/Cabinet Design

## **Software Engineers**

*opportunity to advance if you're experienced with:*

- Real time software development
- Architecture and design of embedded programmable processors (68000 or similar processor)
- Top down structured design in ADA or Fortran (UYK-43 desirable)
- Software Quality Assurance in accordance with MIL-S-52779
- Configuration Management in accordance with MIL-S-483

## **Test and Evaluation Engineers**

*with experience in:*

- Detailed test plan development
- Facilities layout
- Top level test documentation
- Subcontract management
- EMI/EMC Engineering

Additional positions are available. For prompt response forward your resume to: GE-Government Electronic Systems Division, Code EDN, Box 4840, CSP-4-48, Syracuse, NY 13221



*GE Government  
Electronic Systems*

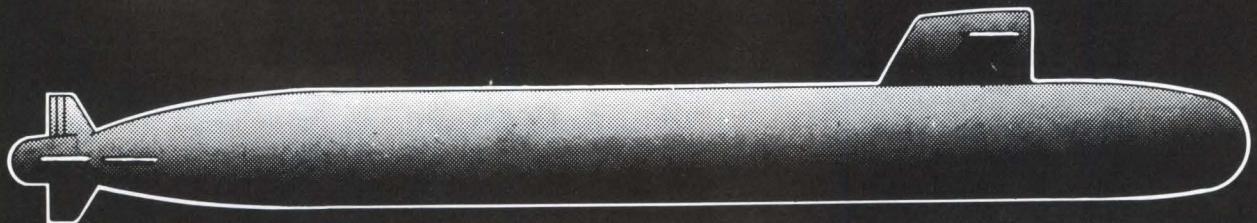

# **DON'T LET A GREAT OPPORTUNITY SLIP BY**

*U.S. Citizenship Required—minorities, females, handicapped and Vietnam Era Veterans encouraged to apply. No agencies please.*



# Everyone wants engineers who can walk on water.

**If you're an engineer who rises above the crowd, Compaq will send you soaring.**

Compaq people are innovative and independent. At the same time, they participate as part of a team. This "can do" environment has helped us design the most sophisticated personal computers for business use.

## **Surface Mount Technology Engineers:**

Challenge your surface mount technology experience in design, manufacturing, quality, reliability, and sustaining engineering. You'll have a hand in the process with your BS degree in engineering and two years' experience in a high-volume manufacturing environment.

## **Sustaining Engineers:**

Qualify with a BSEE or BSME plus three years' experience in the following areas: digital and analog component evaluation and failure analysis; electromechanical failure analysis and problem resolution specifying electrical and mechanical component requirements (resistors and capacitors through VLSI and ASICs); SMT components; component supplier interfacing on specifications and quality improvement; disk drives. Experience in INTEL 80286/80386 Assembly language programming is preferred.

## **Product Quality Assurance Engineers:**

Help us maintain the highest user satisfaction ratings through quality assurance management. From statistical process control, to formulating quality assurance procedures, to establishing workmanship standards, the challenge is yours. To qualify, you'll need a

BSEE degree and two years' experience with disk drives, keyboards, power supplies, or printed circuit boards, and failure analysis at the component level.

## **Diagnostic Test Engineers:**

Manage hardware and software diagnostic testing with state-of-the-art automatic test equipment. Your BSEE or MSEE degree should be complemented with at least two years' related experience in designated ATE test fixtures/bed of nails fixtures with a background in power supply testing and transmission line theory as related to fixturing.

Familiarity with Teradyne L200 and Genrad test equipment, "C" and Assembly programming languages, using industry standard architecture and MS-DOS in an 80286/80386/8086 environment is essential.

## **Component Test Engineers:**

You'll ensure quality control through engineering analysis, device characterization, and failure verification of digital and linear devices such as: custom ASICs,

complex microprocessors and peripheral; advanced CMOS logic, static and dynamic memories, and other precision components.

You should have a BSEE and three years' experience in either ATE component test equipment, analog testing, printed circuit boards, component/incircuit boards, or vendor quality inspection and supplier selection.

## **Vendor Quality Engineers:**

Coordinate device qualifications with vendors and purchasing. You'll lead the way conducting tests and evaluating design and redesign peripheral problems to maintain the highest user satisfaction ratings through quality control. You must have at least two years' experience with peripheral and project management, plus a BSIE or BSEE degree.

## **Cost Reduction Engineers:**

Provide innovative solutions to cost reduction problems by creating designs to meet the requirements of established goals. You should have a BS in EE, EET,

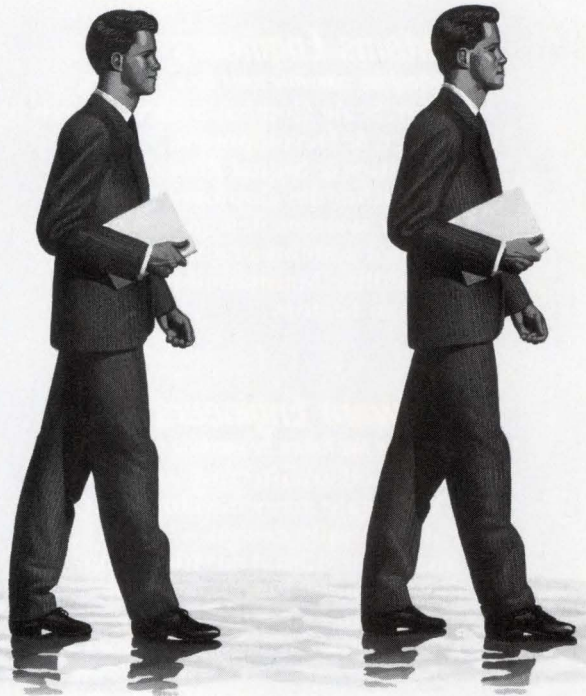



# We expect a little more.

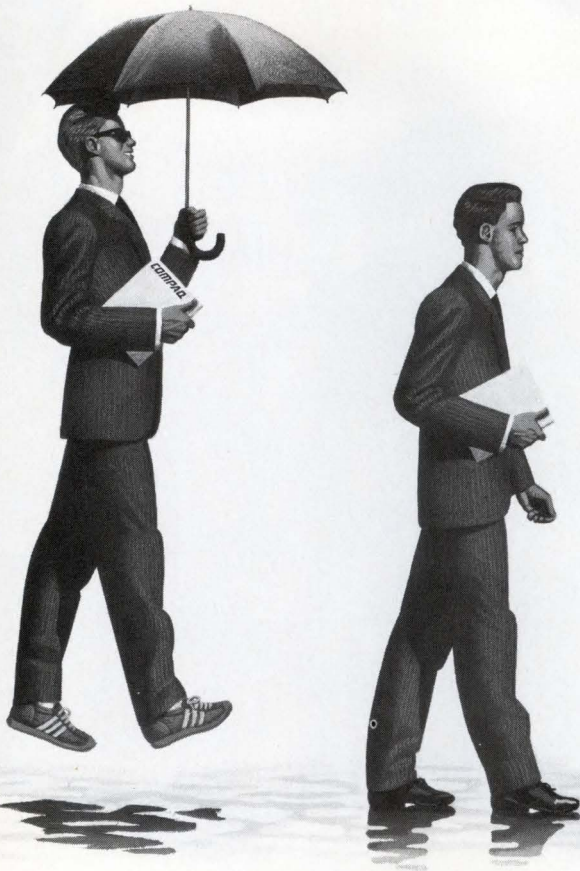

or other related engineering field, with two years' experience in digital systems design. In addition, you should have excellent communication skills and the ability to move multiple projects toward completion.

## **Packaging Engineers:**

Provide direct packaging engineering support for manufacturing operations, as well as product development support through improved packaging designs. Your BS in ME, Packaging Engineering, or equivalent, plus three years' related experience qualifies you for this challenging position. Excellent interpersonal skills are required to develop strong working relationships with outside vendors, contractors and consultants, as well as with multiple internal organizations.

## **Microprocessor Logic and ASIC Design Engineers:**

Challenge your expertise in high-speed logic design and/or microprocessor system design using flow charts and timing diagrams for digital design and detailed design analysis.

Your experience should include vendor libraries, test vector generation, simulation checkout, and TTL emulators for gate/array standard cell design. Familiarity with CAE systems used in logic design, test vector generation, simulation checkout, and documentation is also necessary. You must have five years' related experience plus a BSEE or equivalent degree; an MSEE degree is preferred.

## **Systems Software Engineers:**

Evaluate, design, and develop firmware, operating systems, device drivers, and utility software for PC systems. You'll need a BSCS, BSEE or equivalent degree with four years' related experience in PC software development, 8086/286/386 Assembly/"C" language programming in MS-DOS, OS/2, and/or UNIX/XENIX operating systems.

## **Systems Architects:**

Design new products by investigating and evaluating system compatibility and performance of design alternatives and new technologies. You'll develop hardware

compatibility tests and performance analysis tools.

Qualify with a BSEE, MSEE preferred, and three years' hardware background with a knowledge of microprocessor-based systems software. In addition, experience with CPUs/memory/bus architecture, numeric co-processors, file subsystems, network/communications, graphic subsystems, and state machines is required.

## **Graphics Display Manager:**

Coordinate and manage the definition, development and procurement of display subsystems. You'll provide compatible systems and develop high resolution products for engineering workstations, desktop publishing, and related applications.

You must have a BSEE or BS in Physics; an M.S. is preferred. Eight years' experience in electronics design engineering and management, including five years in design of computer equipment is necessary, as well as the ability to manage technical professionals in an engineering development environment.

## **Can you walk on water?**

Maybe you won't know until you try. Compaq offers competitive salaries, comprehensive benefits and an unequalled work environment. We have a variety of openings for select professionals within the company. If you're interested in one of the above positions—or any other—submit your resume and salary requirements to:

**Please specify the position for which you wish to be considered.**

Compaq Computer Corporation, Dept. EDN31788-RM, P.O. Box 692000, Houston, Texas 77269-2000. Compaq is an affirmative action employer, m/f/h/v.

**COMPAQ**



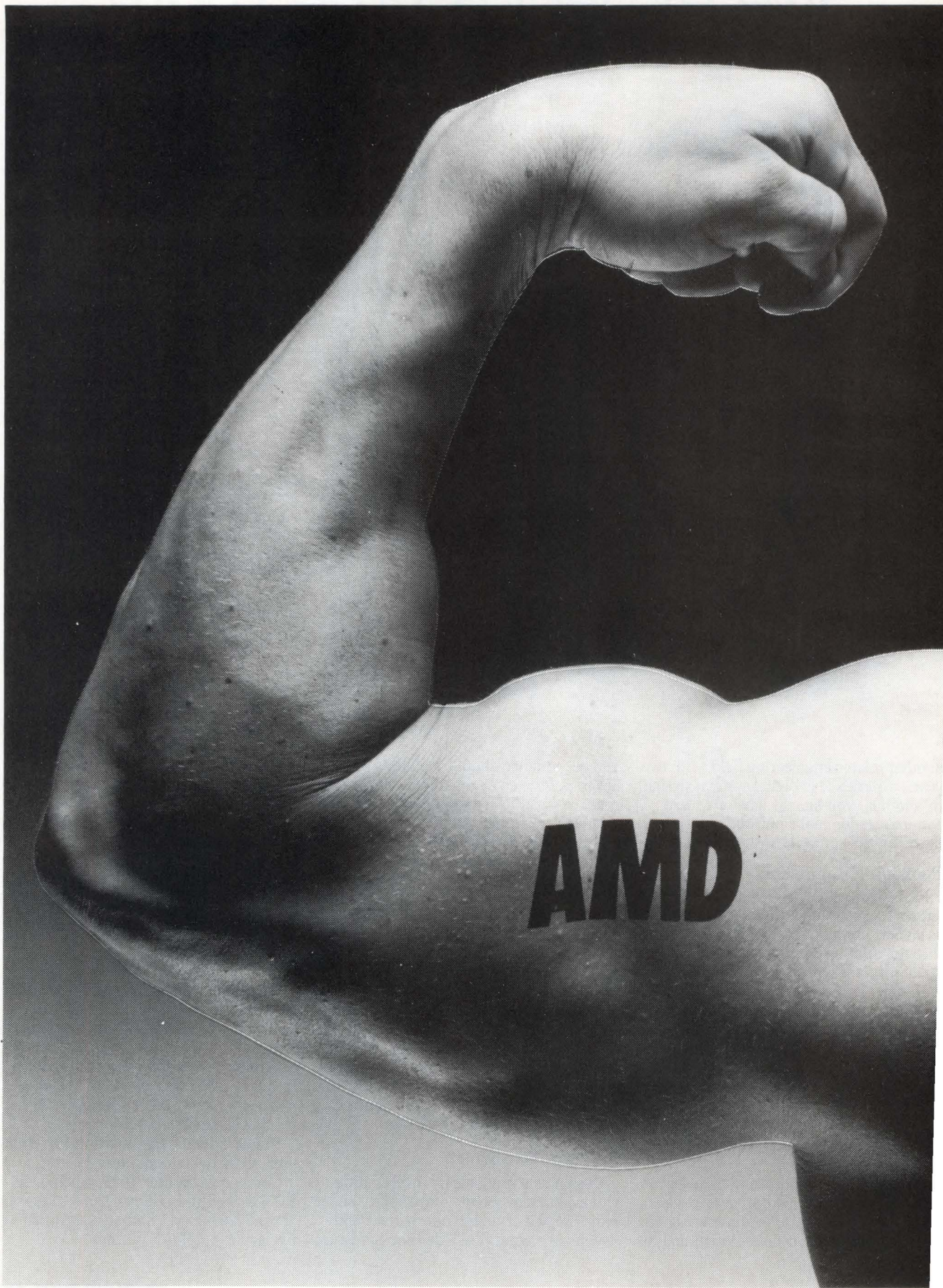



# MUSCLE.

In today's international semiconductor market, entrepreneurial spirit, marketing flair, and even engineering genius aren't always enough to achieve success.

## You need financial muscle.

And with sales figures that put us in the billion-dollar-company category, plus an R&D budget that represents a full 20 percent of sales — twice the industry standard — we've got it.

## Real RISC Clout

The same kind of long-term vision that has made AMD the largest exclusive manufacturer of integrated circuits in the world has also made it possible for us to develop a RISC program that's setting the standard for the next generation of 32-bit CMOS microprocessors. The Am29000 is already the most powerful monolithic microprocessor ever, capable of sustained performance of 17 MIPS, with a peak of 25 MIPS.

## Total systems solutions

The Am29000 promises — as do the products already in the second generation of development that will follow it — to open the door to new systems possibilities far beyond the performance of today's architectures. And when combined in the total RISC system, AMD's market-proven computer networking, telecommunications, high performance memory, and programmable logic device IC products

will also offer engineers the chance to work on solutions that until now seemed years away.

At this very moment, a full range of ground-floor opportunities are available in both our California and Texas facilities. If you're a Systems or IC Engineer, consider working with us in one of the following areas:

- Design
- Product
- Test
- CAD
- Software QA
- Applications
- Quality/Reliability
- Failure Analysis
- UNIX Software
- Technical Publications

For information about Texas opportunities, call Richard Holtry at (512) 462-5470, or send your resume to him at Advanced Micro Devices, MS-525, 5204 East Ben White Blvd., Austin, Texas 78741.

For information about California opportunities, call Mike Gore at (408) 749-5555, or send your resume to him at Advanced Micro Devices, MS-57, 901 Thompson Place, P.O. Box 3453, Sunnyvale, CA 94088. An equal opportunity employer.





## DATA COMMUNICATIONS ENGINEERS

We're Computrol, a division of MODCOMP, an AEG Company, and a recognized leader at the forefront of the datacommunications industry. Those who join us enjoy concept-through-completion responsibilities, openness and participation in all decision making processes and a stimulating environment that encourages and rewards creativity. Our on-going success and expansion has created the following career opportunities:

### SOFTWARE MANAGERS/ENGINEERS

Requires extensive experience in:

- "C", Assembly language (PDP 11, VAX, 68020, 80186)
- Operating Systems (UNIX, VAX/VMS, RSX11M, RMX86).

### HARDWARE DESIGN ENGINEERS

Requires extensive experience in:

- Digital Logic Circuit Design, ASICS, MOS, CMOS, ECL, TTL, PLD's
- Motorola Micros (68000/20), Intel Micros

### COMMUNICATIONS ENGINEERS

Requires extensive experience in:

- Datacommunications protocols, LAN, ISO/OSI standards
- Hardware & software systems

### RSX11M SOFTWARE PROJECT LEADER

State of the art project on the PDP 11 running RSX11M. Requires extensive experience in:

- RSX11M drivers, Internals, Memory Management, Q-Bus
- Real time high performance systems, microprocessors, UNIX, "C", VAX

### SYSTEMS ENGINEERS

Requires extensive experience in:

- Hardware & software systems, system integration
- Microprocessors, minicomputers, DEC computer systems

### SENIOR ENGINEERING AIDES

Requires an Associate's Degree (or equivalent) and 4 years extensive experience in:

- Prototype troubleshooting & fabrication, CAE Tools, PLD's
- Motorola micros (68000/20) Intel Micros, IBM PC

### RF/FIBER OPTIC ENGINEERS

### TEST/QA ENGINEERS

All Engineering positions above require BSEE/CS (MSEE/CS for managers) and at least 4 years experience and working knowledge of ISO/OSI standards and interfaces.

We offer a salary fully commensurate with your experience and an outstanding benefits package. To apply, please send your resume and salary history to: **K.L. Hunziker, Personnel Manager, COMPUTROL, 15 Ethan Allen Highway, Ridgefield, CT 06877-6297**

# COMPUTROL

Division of MODCOMP An AEG Company

Equal Opportunity Employer M/F/H/V

## Maintainability Software & Systems Engineers

LTV Missiles & Electronics Group, Sierra Research Division, a leader in avionics and electronics, has immediate opportunities for:

**Senior Engineer, Maintainability** — 10 years in maintainability a must. Will calculate MTBM, MTBR, MTR, MDT, MMH/OH; proposal input; M demo and M test plans. Also coordinates with design engineering, human factors, system safety.

**Senior Software Engineer, Command & Control Systems** — 5+ years developing real-time applications under DoD-STD-2167, Ada, SA/SD design methodology, LANs, integration/test.

**Senior Software Engineer, Knowledge Engineering** — 5+ years designing/implementing rule-based decision aids for military, mission planning, expert systems/Al.

**Senior Systems Engineer, Command & Control Systems** — 7+ years in requirements analysis, system specification, tactical digital data links, integration/test.

**Software Engineer, Control Systems** — 3+ years with real-time applications software under DoD-STD-1679A and 2167, integration/test.

All positions require BS; tactical systems experience a plus. For details, send resume in confidence to: **LTV Missiles and Electronics Group, Sierra Research Division, Attn: Joan Boyle, P.O. Box 222, Buffalo, NY 14225-0222. EOE.**



Missiles and Electronics Group  
Sierra Research Division

THE EDN MAGAZINE/EDN NEWS

## Recruitment Package

The most cost-effective way to reach the most professionals!

EDN reaches more than 137,000 engineers and engineering managers, the largest circulation in the electronics field. EDN News reaches EDN's U.S. circulation of more than 121,500. And, when you place equivalent space in both the *Career Opportunities* section of EDN, and the *Career News* section of EDN News in the same month, you'll get a 1/3 discount off the EDN News rate!

EDN MAGAZINE/EDN NEWS  
Where Advertising Works.





# HAVING THE BEST TECHNOLOGY IS ONLY HALF THE BATTLE.

The Trojan Horse was a very progressive technological idea for its day—but what was it without those ingenious and determined soldiers inside? Nothing but an oversized wooden horse on wheels.

At Litton Data Systems we understand that it's the people behind technologies that make them work. And the people inside a company who make things happen.

Over twenty-five years of excellence in the design and manufacture of vital military C<sup>3</sup> systems mark our commitment to an entrepreneurial atmosphere that encourages our professionals to do what's necessary to conquer today's technologies.

If you're interested in joining a company with a classically simple strategy for success, consider one of the following positions:

## PRODUCT ASSURANCE & SUPPORT

### Sr. Software Quality Engineer

This position requires a minimum 10 years' experience in software development, software configuration management and software audit. Familiarity with DOD-STD 1679 is essential.

### Programmers/Instructors

Qualified individuals must have at least 2 years' experience in one or more of the following:

- L 3050 or AN/GYK-12 computers
- TACPOL
- MOL (ASSEMBLER)
- NICS-TARE Systems
- CHRISTIAN ROVSING CR-80 computer

Teaching experience or 3 years' in telecommunications programming along with system programming experience are preferred.

### Sr. Quality Engineer (Advanced Planning)

We are seeking a Sr. Quality Engineer with a minimum of 5 years recent experience in a military electronics industry to perform primary interface with program office, subcontracts and engineering. Will obtain, and analyze quality and inspection requirements for TAOC/MCE and ships programs subcontracts and set up inspection plans and hiring schedules to support subcontract build and delivery schedules. Extensive travel is required.

### Supplier Quality

Will be responsible for subcontractor evaluation controls to MIL-Q-9858 and MIL-STD-1535A. Requires a CQE with a BS in Engineering and 3-5 years' experience in Supplier Q.E. and Production Q.E. of government electronics equipment, i.e. circuit board assemblies, power supplies.



## PRODUCT DESIGN ENGINEERING

### Electronic Design Standards Specialist

You will use your extensive engineering background to expand the electronic design standards and technology function in accordance with DoD Directive 4245.7M (Transition to Production) and NAVSO P6071 (Best Practices). The successful candidate will possess a minimum 15 years' technical hands-on experience. Requires a BSEE (advanced degree desirable) and a working knowledge of digital and analog design, component technology and specifications, testability requirements and management techniques.

### Automatic Test Equipment

Will work on division A.T.E. in Software development for unit level testers. Microprocessor Hardware design experience and familiarity with CMS2 programming language desirable. Requires 3-5 years' experience, BSCS/BSEE and the ability to follow a project through design, development and integration.

## SYSTEMS ENGINEERING

Due to a recently received major DoD multi-year production contract for mobile, modular C<sup>3</sup>I Air Defense Systems for Air Force and Marine Corps, we need strong systems engineers with a BSEE (Master's preferred) and 10 or more years experience to develop international applications of these systems for tactical air operations. In addition, concepts for product improvement are

needed for existing system configurations. Immediate openings exist for motivated, experienced systems engineers to lead the Engineering design process by performing requirements analyses, functional syntheses and hardware/software trade studies in the following areas:

- Tactical Air Operations
- Direct Air Support
- Command Operations Centers
- Forward Area Air Defense
- Artillery Fire Support
- Sensor Fusion
- Data Link Integration

## SOFTWARE/FIRMWARE ENGINEERING

• Requires a Sr. Software Engineer with experience on large military command and control systems. A background in CMS2 language and experience with communication data links such as TADIL-A, TADIL-B, TADIL-J, LINK-1 and ATDL-1 are highly desirable.

• Requires 5-10 years' experience in Assembly language programming for military systems and a minimum 5 years' experience in digital signal processing applications.

• Will be responsible for programming state-of-the-art digital and voice communication systems. Requires experience in the programming of the ZILOG Z80, INTEL 8748 and TI TMS32020 microprocessors, 3-5 years' experience in the development of communication firmware and a solid understanding of hardware design is necessary.

*Above positions require a BS in Computer Science or Engineering.*

• Will be responsible for contributing to the design and modeling of new algorithms. Requires an MS/PhD in Computer Science or Engineering and a minimum of 15 years' experience applying signal processing theory in the development of tracking systems.

• Will implement firmware for high speed digital data bus and impeded computer peripherals. Requires a BS in Computer Science, EE or Math and 3-5 years' experience in Assembly language, programming techniques and use of the UNIX\* Operating Systems.

### Sr. Level Programmers

• Will generate PDL from detailed design documents, coding of programs in CMS2 and Assembly language and unit testing of the programs. Requires 3-8 years' software experience.

**Send your resume to: Employment, Dept. 655, 8008 Woodley Ave., Van Nuys, CA 91409-7601.**

# Litton

# Data Systems

Principals Only/Equal Opportunity Employer

\*UNIX is a registered trademark of AT&T.



# ADVERTISERS INDEX

ACCEL Technologies Inc	263	Intermetrics Inc	222	The Soundcoat Co	178
Acheson Colloids Co	259	International Rectifier	C3	Spectrum Software	140
ADC Telecommunications	261	Introl Corp	34	Sprague Electric Co	67
ADPI	264	Intusoft	264	Stanford Research Systems Inc	79
Aeroflex Laboratories	166	I/O Tech	68	Star Technologies	238
Airpax Corp/Cambridge Div	243	Ji-Haw Industrial Co Ltd**	219	The Staver Co Inc	126
Allen-Bradley Co	249	John Fluke Manufacturing Co Inc*	6, 63	STD Mfg Group	61
AMP Inc	116, 117	Jonathan Mfg Co*	219	Sun Microsystems	16-17
Ampere Electronic Corp*	216	Keithley Instruments	253, 255, 257	Switching Power Inc	38
Analog Devices Inc	107, 147	Kepeco Inc	254	System Industries	80-81
Applied Data Systems	261	Kontron Electronics Inc	39	Tatum Labs	260
Applied Microsystems Corp	14-15	Ko Sheng Enterprises Co Ltd**	6	TDK Corp	240
Atron Div of TL Industries	4	Leader Instruments Corp	193	TEAC Corp**	139
B&C Microsystems	262, 264	Leadyear Enterprise Co Ltd	260	Tektronix Inc	8, 36-37, 128-129
Beckman Industrial Corp*	256	Learcom Co	262	Teledyne Relays	235
BKL Industries	126	Ledex Inc	244	Tempil Div	263
BP Microsystems	264	Linear Technology Inc	203-204	Teradyne Inc	32-33
Brooktree	226-227	Logical Devices Inc	259	Token Corp	97
Burr-Brown Corp	217	Loral Instrumentation	35	Topaz Semiconductor	229
BV Engineering	261	Maple Tech/Robot Graphics	261	Toshiba Corp	152-153, 258
CAD Software Inc	196	Marshall Industries	231	TRW/LSI Products	25
CADdy Corp	220	MathSoft Inc	40	Tusonix Inc	241
Calcomp	214-215	Matrix Corp	177	Uniform Tubes Inc	212
California Scientific Software	262	Maxim Integrated Products	72	Vectrix	211
Capital Equipment Corp	260	Maxtor	104-105	Video Monitors Inc	236
Case Technology	191	MCG Electronics	194	Vishay**	138
CCP Contact Probes Enterprise	264	Mentor Graphics Corp	111-115	Visionics Corp	264
CDI Corp—West	262	Micro Switch	50-51	VTC Inc	2
Committee of Concerned EE's	52	Mini-Circuits Laboratories	28, 29, 199, 284	Wavetek San Diego Inc	3
Communications Specialists Inc	262	Motorola Microcomputer Div	42-43	Wintek Corp	262, 263
Connor-Winfield Corp	212	Motorola Semiconductor Products Inc	12-13, 103	World Precision Instruments	260
Cubit/Proteus Industries Inc	247	Multibus Manufacturers Group	53-56	Xender Corp	264
Cyclone Microsystems Inc	207	NCR Microelectronics Div	44-45	Zax Corp	164-165
Cypress Semiconductor	46	NEC Corp	223	Zericon	264
Dalanco	259	Nicolet Test Instruments Div	27	Ziatech Corp	1
Data I/O Corp	C4	Nohau Corp	259	Zilog Inc	101
Datron Instruments/A Wavetek Co	239	Omation Inc	262	Zippy Shin Jih Corp	263
Delevan Div, API	106	OrCAD Systems Corp	213		
Deltron Inc	194	Orion Instruments	41	<b>Recruitment Advertising</b>	<b>274-281</b>
Densitron Corp	40	Otto Controls	220	AMD	
Design Computation Inc	262	Oyster Terminals	100	Compaq Computers	
Dialight Components	70-71	Phase Three Logic	261	Computrol	
Digital Electronics Corp	127	Phihong Enterprise Co Ltd**	22	GE Government Electronics	
Digital Media Inc	261	Philips Elcoma Div**	150-151	Litton Data Systems	
Dotronix	237	Philips Test & Measuring Instruments Inc**	63	LTV Aerospace	
Douglas Electronics	137	Piezo Kinetics	260	Lundy	
EDN Caravan	272-273	Planar Systems	125		
Eldre Components Inc	259	Precision Filters Inc	232, 233	*Advertiser in US edition	
Electro-Mechanics	260	Precision Monolithics Inc	32	**Advertiser in International edition	
Electronic Solutions	98	Prism Electronics Ltd**	230		
EMP Engineering	260	Pro-Lib Inc	264		
Engineering Tutorial Software	263	Pulse Engineering	246		
Fasco Industries Inc	252	Qua Tech Inc	260, 263		
Frequency Devices	245	Quantum Corp	89-96		
Fuji Electrochemical Co*	230	Raytheon	251		
Fujitsu Limited**	30	RLM Research	263		
Fujitsu Microelectronics Inc*	150-151	Rogers Corp	261, 262		
Galil Motion	261	Samsung Semiconductor	179-186		
GE/RCA		Saratoga Semiconductor	37		
Intersil Semiconductors	10-11, 48-49, 108-109, 148-149	Seagate Technology	77		
Gould Inc Test & Measurement Group	C2	Seiko Instruments			
Heurikon	195	USA/Thermal Printer	201		
Hewlett-Packard Co	18-20, 161-163	Shindengen America	210		
Hitachi America Ltd*	30-31	Siemens Corp**	31		
Hitachi Denshi America	228	Siemens Optoelectronics*	22		
Houston Instrument	58	Silicon General	52		
Hypertronics	74	Silvar-Lisco	145		
I-Bus Systems Inc	224	Simpson Electric Co	208		
Inmos Corp*	175	Single Board Solutions	260		
Instant Board Circuits Corp	88	S-MOS Systems*	138-139		
Integrated Device Technology	154	Sophia Computer Systems Inc	221		
Interfirm Graphic Systems	178				

This index is provided as an additional service. The publisher does not assume any liability for errors or omissions.



# LOOKING AHEAD

EDITED BY CYNTHIA B RETTIG

## Smart power invades IC/discrete-device market

The practice of combining logic with power-control functions to produce smart power devices will "revolutionize" electronic-component design within the next few years. According to Electronic Trend Publications (Saratoga, CA), the worldwide market for smart power devices of more than 2W should attain a value of \$1.1 billion by 1992, largely as a result of automotive, consumer, office-automation, and commercial- and military-aircraft applications. Indeed, by 1995, such devices will claim 33% of the total IC and discrete-product market, accounting for \$2.4 billion in sales.

Traditional power supplies can occupy as much as one-third of equipment space. Thus, replacing numerous discrete components with fewer chips—or, in some cases, with a single, monolithic chip—lowers both component count and system costs. Smart power devices also improve system reliability.

For example, smart-power ICs can improve individual features, overall performance, and reliability in the motion control of stepper and brushless dc motors. Other major areas of application include programmable voltage regulators and ignition controllers.

Manufacturers are currently employing various processes in the fabrication of smart-power ICs. The application of VLSI technologies, especially MOS, to power-control devices constitutes a major trend. However, some IC vendors are employing bipolar and MOS technologies to make multichip or hybrid designs that are geared toward improving specific device applications and performance. Furthermore, custom ICs should continue to play a significant role in the smart-power market through the mid-1990s.

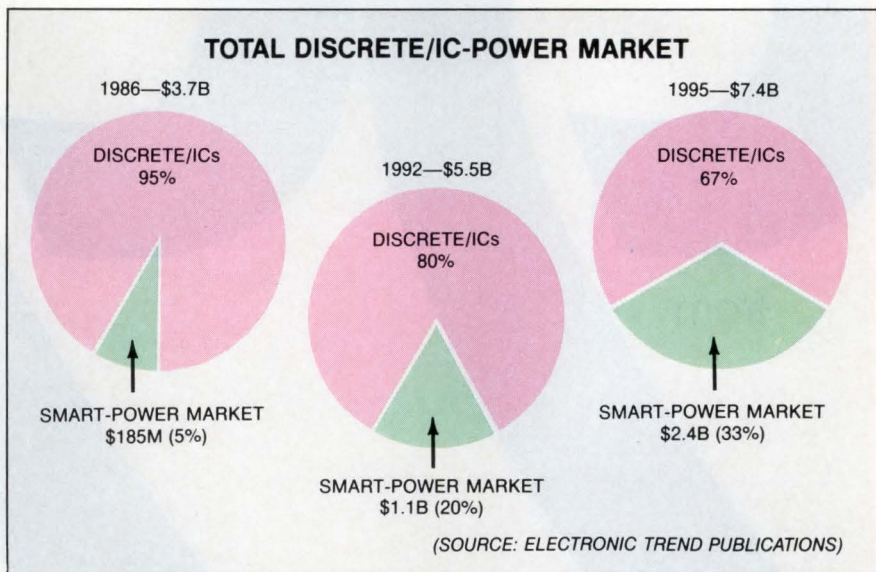

ETP predicts that a variety of high-voltage monolithic ICs will streamline design problems by rendering obsolete those hybrid circuits that require large numbers of components. These monolithic ICs will incorporate various technologies including bipolar, DMOS, and CMOS, or combinations thereof. When higher voltage is required,

hybrid and multichip solutions will fill the bill.

Because the successful combination of logic and power functions obviously remains central to the future of smart power devices, some companies are forming strategic alliances in an attempt to get dependable products to the market as quickly as possible.

## Changes forecast for electronic car sensors

The 1988 market for electronic, electromechanical, and electrical automotive sensors will have a value of nearly \$2.7 billion. By 1992, the market's value will increase to \$3.8 billion, representing an annual growth rate of 9.2%, according to a recent study conducted by Venture Development Corp of Natick, MA. However, it remains to be seen whether consumers will be willing to pay the added costs resulting from the inclusion of sensors in automobiles.

Automotive sensors detect physical parameters and convert them into measurable signals that various types of controllers can then use to make adjustments. These parameters include pressure, temperature,

speed, position, oxygen content, vibration, motion, and acceleration. In US-built passenger cars, temperature, position, pressure, oxygen content, and speed currently comprise the bulk of applications. However, there will be increasing demand for applications involving such parameters as torque, motion, vibration, proximity, instrumentation, and other vehicle-control mechanisms.

Traditionally, automotive sensors have employed electrical/electromechanical technology. Now, however, auto manufacturers are beginning to install sensors that use ICs capable of performing simple logic functions. Moreover, truly smart electronic sensors—that is, sensors that employ  $\mu$ P technology—should become available in the early 1990s.



# 99¢

from

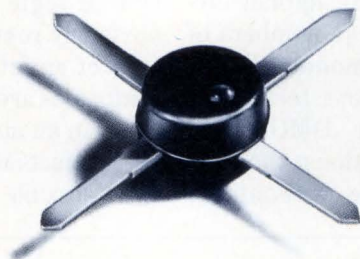

## dc to 2000 MHz amplifier series

### SPECIFICATIONS

MODEL	FREQ. MHz	GAIN, dB			Min. MHz (note)	• MAX. PWR. dBm	NF dB	PRICE \$	
		100 MHz	1000 MHz	2000 MHz				Ea.	Qty.
MAR-1	DC-1000	18.5	15.5	—	13.0	0	5.0	0.99	(100)
MAR-2	DC-2000	13	12.5	11	8.5	+3	6.5	1.50	(25)
MAR-3	DC-2000	13	12.5	10.5	8.0	+8□	6.0	1.70	(25)
MAR-4	DC-1000	8.2	8.0	—	7.0	+11	7.0	1.90	(25)
MAR-6	DC-2000	20	16	11	9	0	2.8	1.29	(25)
MAR-7	DC-2000	13.5	12.5	10.5	8.5	+3	5.0	1.90	(25)
MAR-8	DC-1000	33	23	—	19	+10	3.5	2.20	(25)

NOTE: Minimum gain at highest frequency point and over full temperature range.

- 1dB Gain Compression
- +4dBm 1 to 2 GHz

**designers amplifier kit, DAK-2**  
5 of each model, total 35 amplifiers  
only **\$59.95**

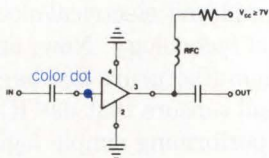

Unbelievable, until now... tiny monolithic wide-band amplifiers for as low as 99 cents. These rugged 0.085 in. diam., plastic-packaged units are 50ohm\* input/output impedance, unconditionally stable regardless of load\*, and easily cascadable. Models in the MAR-series offer up to 33 dB gain, 0 to +11dBm output, noise figure as low as 2.8dB, and up to DC-2000MHz bandwidth.

\*MAR-8, Input/Output Impedance is not 50ohms, see data sheet. Stable for source/load impedance VSWR less than 3:1

Also, for your design convenience, Mini-Circuits offers chip coupling capacitors at 12 cents each.†

Size (mils)	Tolerance	Temperature Characteristic	Value
80 x 50	5%	NPO	10, 22, 47, 68, 100, 470, 680, 100 pf
80 x 50	10%	X7R	2200, 4700, 6800, 10,000 pf
120 x 60	10%	X7R	.022, .047, .068, .1µf

† Minimum Order 50 per Value

finding new ways...  
setting higher standards

## Mini-Circuits

A Division of Scientific Components Corporation  
P.O. Box 350166, Brooklyn, New York 11235-0003 (718) 934-4500  
Fax (718) 332-4661 Domestic and International Telexes: 6852844 or 620156



# NOW

**TO-3  
Power  
in a  
Plastic  
Package**

## **TO-3P HEXFET®**

Now power supply OEMs can design out TO-3s and TO-3P bipolars and design in large-die TO-3P HEXFET power MOSFETs that offer the economy of TO-220s and the power handling capability of TO-3s.

Consider this. TO-3P HEXFETs meet or exceed TO-3 specs. Thermal resistance is lower than equivalent die sizes in TO-3s. Leads, too, conform to UL and VDE spacing.

TO-3P HEXFETs also offer an isolated mounting hole to simplify installation, cut hardware costs and assembly time.

Best of all, you can expect the same high quality and reliability all HEXFET power MOSFETs guarantee.

Over thirty TO-3P HEXFET part numbers are ready now to upgrade your design.

Voltage ratings range up to 500V, and current up to 41A depending on  $R_{ds(on)}$  and die size. For complete data, call (213) 607-8842. Today.

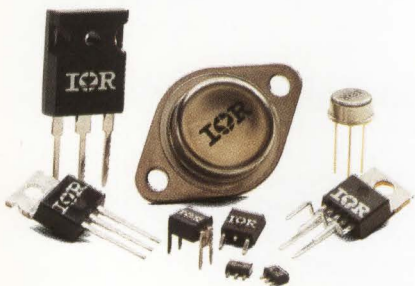
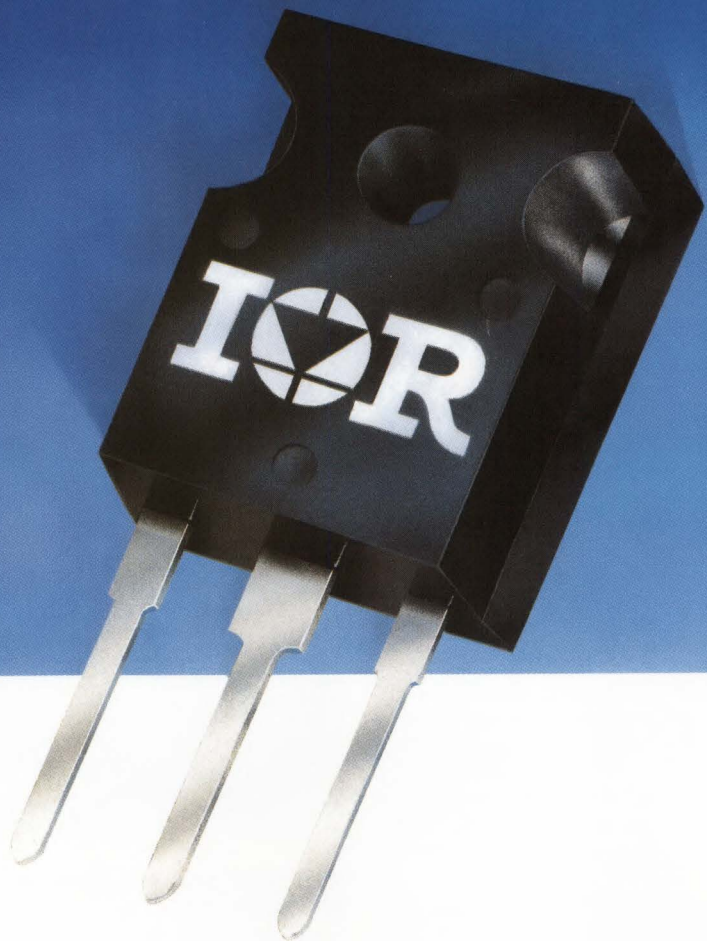

**Most HEXFETs now in stock  
for immediate delivery!**

**Number 1 in  
power MOSFETs**

**International  
IOR Rectifier**

WORLD HEADQUARTERS: 233 KANSAS ST., EL SEGUNDO, CA 90245. U.S.A. (213) 772-2000. TWX 910-348-6291, TELEX 472-0403  
EUROPEAN HEADQUARTERS: HURST GREEN, OXTED, SURREY RH8 9BB. ENGLAND TELEPHONE (088 33) 3215/4231. TELEX 95219

**Power MOSFETs • CMOS Power Ics • Commercial/Custom Power Packages • Schottkys  
Rectifiers • Thyristors (SCRs) • Diode Bridges • Molded Circuits • Assemblies**

CIRCLE NO 145





# THE UNISITE 40 PROGRAMMER: BECAUSE STATE-OF-THE-ART IS A STATE OF CHANGE.

## PROGRAMMING TECHNOLOGY THAT SUPPORTS ADVANCED DESIGNS— TODAY AND TOMORROW.

The UniSite™ 40's universal programming technology is the fastest and easiest way to keep up with new devices and packages. Its software-configured pin driver system provides a single site for programming any DIP device up to 40 pins, including PLDs, PROMs, IFLs, FPLAs, EPROMs, EEPROMs and microcontrollers. The same site accommodates the most popular surface-mount packages—PLCCs, LCCs and SOICs.

And now the UniSite 40 is also a gang/set programmer. With the new SetSite™ module, you can program and test as many as eight devices, up to 40 pins each, simultaneously.

## INSTANT ACCESS TO NEW DEVICES.

The UniSite 40's universal pin driver



electronics stores device-specific instructions on a 3 1/2" micro diskette. To update your UniSite 40 with the latest device releases, simply load a new master diskette.

**FAST, EASY PROGRAMMING.** Menu-oriented operation with step-by-step prompts makes programming simple.

Or bypass the menus and zoom directly to specific operations by selecting key commands. Help messages are available whenever you need assistance.

To speed parts selection, the UniSite 40 provides a built-in list of devices. And you can save your most frequently-used programming parameters for instant recall.

## DESIGN FREEDOM FOR TOMORROW.

When leading-edge designers use the latest devices in their designs, they need the programming freedom only the UniSite 40 provides. Call Data I/O® today and ask about the UniSite 40. Because state-of-the-art never stops changing.

**1-800-247-5700**

**Dept. 612**

# DATA I/O

Data I/O Corporation 10525 Willows Road N.E., P.O. Box 97046, Redmond, WA 98073-9746, U.S.A. (206) 881-6444/Telex 15-2167  
Data I/O Canada 6725 Airport Road, Suite 302, Mississauga, Ontario L4V 1V2 (416) 678-0761/Telex 06968133  
Data I/O Europe World Trade Center, Strawinskylaan 633, 1077 XX Amsterdam, The Netherlands +31(0)20-622866/Telex 16616 DATIO NL  
Data I/O Japan Sumitomosemei Higashishinbashi Bldg., 8F, 2-1-7, Higashi-Shinbashi, Minato-Ku, Tokyo 105, Japan  
(03)432-6991/Telex 2522685 DATAIO J

©1988 Data I/O Corporation

CIRCLE NO 146